

Keysight Wireless Test Set

This help file provides documentation for the following products:
E6640A EXM Wireless Test Set

V9063B Analog
Demod
Measurement
Application User's
and Programmer's
Guide

Notices

© Keysight Technologies, Inc.
2014

No part of this manual may be reproduced in any form or by any means (including electronic storage and retrieval or translation into a foreign language) without prior agreement and written consent from Keysight Technologies, Inc. as governed by United States and international copyright laws.

Manual Part Number
V9063-90001

Edition

September 2014
Printed in USA
Keysight Technologies, Inc.
5301 Stevens Creek Blvd.
Santa Clara, CA 95052 USA

Warranty

The material contained in this document is provided “as is,” and is subject to being changed, without notice, in future editions. Further, to the maximum extent permitted by applicable law, Keysight disclaims all warranties, either express or implied, with regard to this manual and any information contained herein, including but not limited to the implied warranties of merchantability and fitness for a particular purpose. Keysight shall not be liable for errors or for incidental or consequential damages in connection with the furnishing, use, or performance of this document or of any

information contained herein. Should Keysight and the user have a separate written agreement with warranty terms covering the material in this document that conflict with these terms, the warranty terms in the separate agreement shall control.

Technology Licenses

The hardware and/or software described in this document are furnished under a license and may be used or copied only in accordance with the terms of such license.

Restricted Rights

Legend

If software is for use in the performance of a U.S. Government prime contract or subcontract, Software is delivered and licensed as “Commercial computer software” as defined in DFAR 252.227-7014 (June 1995), or as a “commercial item” as defined in FAR 2.101(a) or as “Restricted computer software” as defined in FAR 52.227-19 (June 1987) or any equivalent agency regulation or contract clause. Use, duplication or disclosure of Software is subject to Keysight Technologies’ standard commercial license terms, and non-DOD Departments and Agencies of the U.S. Government will receive no greater than Restricted Rights as defined in FAR 52.227-19(c)(1-2) (June 1987). U.S. Government users will receive no greater than Limited Rights as defined in FAR 52.227-

14 (June 1987) or DFAR 252.227-7015 (b)(2) (November 1995), as applicable in any technical data.

Safety Notices

CAUTION

A CAUTION notice denotes a hazard. It calls attention to an operating procedure, practice, or the like that, if not correctly performed or adhered to, could result in damage to the product or loss of important data. Do not proceed beyond a CAUTION notice until the indicated conditions are fully understood and met.

WARNING

A WARNING notice denotes a hazard. It calls attention to an operating procedure, practice, or the like that, if not correctly performed or adhered to, could result in personal injury or death. Do not proceed beyond a WARNING notice until the indicated conditions are fully understood and met.

Table of Contents

V9063B Analog Demod Measurement Application User's and Programmer's Guide	i
Table of Contents	iii
1 About the Test Set	43
Installing Application Software	44
Viewing a License Key	44
Obtaining and Installing a License Key	44
Updating Measurement Application Software	44
EXM Options and Accessories	46
Front-Panel Features	47
Display Annotations	48
Rear-Panel Features	49
Window Control Keys	50
Virtual Front Panel	50
Windows Control Menu	50
Multi-Window	51
Zoom	51
Next Window	51
Mouse and Keyboard Control	53
Right-Click	53
PC Keyboard	55
Instrument Security & Memory Volatility	58
2 About the Analog Demod Measurement Application	59
3 Programming the Test Set	61
What Programming Information is Available?	62
List of SCPI Commands	63
STATus Subsystem	80
Detailed Description	80
What Are Status Registers	80
What Are Status Register SCPI Commands	81
How to Use the Status Registers	82
Using a Status Register	83
Using the Service Request (SRQ) Method	84
Generating a Service Request	84
Status Register System	85
The Status Byte Register	86
Standard Event Status Register	88
Operation and Questionable Status Registers	90
Operation Status Register	90
Questionable Status Register	90
STATus Subsystem Command Descriptions	91

Operation Register	91
Operation Condition Query	91
Operation Enable	92
Operation Event Query	92
Operation Negative Transition	92
Operation Positive Transition	93
Preset the Status Byte	93
Questionable Register	94
Questionable Condition	94
Questionable Enable	94
Questionable Event Query	95
Questionable Negative Transition	95
Questionable Positive Transition	95
Questionable Calibration Register	96
Questionable Calibration Condition	96
Questionable Calibration Enable	96
Questionable Calibration Event Query	97
Questionable Calibration Negative Transition	97
Questionable Calibration Positive Transition	98
Questionable Calibration Skipped Register	98
Questionable Calibration Skipped Condition	98
Questionable Calibration Skipped Enable	99
Questionable Calibration Skipped Event Query	99
Questionable Calibration Skipped Negative Transition	100
Questionable Calibration Skipped Positive Transition	100
Questionable Calibration Extended Failure Register	100
Questionable Calibration Extended Failure Condition	101
Questionable Calibration Extended Failure Enable	101
Questionable Calibration Extended Failure Event Query	101
Questionable Calibration Extended Failure Negative Transition	102
Questionable Calibration Extended Failure Positive Transition	102
Questionable Calibration Extended Needed Register	103
Questionable Calibration Extended Needed Condition	103
Questionable Calibration Extended Needed Enable	103
Questionable Calibration Extended Needed Event Query	104
Questionable Calibration Extended Needed Negative Transition	104
Questionable Calibration Extended Needed Positive Transition	105
Questionable Frequency Register	105
Questionable Frequency Condition	105
Questionable Frequency Enable	106
Questionable Frequency Event Query	106
Questionable Frequency Negative Transition	106
Questionable Frequency Positive Transition	107

Questionable Integrity Register	107
Questionable Integrity Condition	107
Questionable Integrity Enable	108
Questionable Integrity Event Query	108
Questionable Integrity Negative Transition	109
Questionable Integrity Positive Transition	109
Questionable Integrity Signal Register	109
Questionable Integrity Signal Condition	110
Questionable Integrity Signal Enable	110
Questionable Integrity Signal Event Query	111
Questionable Integrity Signal Negative Transition	111
Questionable Integrity Signal Positive Transition	111
Questionable Integrity Uncalibrated Register	112
Questionable Integrity Uncalibrated Condition	112
Questionable Integrity Uncalibrated Enable	112
Questionable Integrity Uncalibrated Event Query	113
Questionable Integrity Uncalibrated Negative Transition	113
Questionable Integrity Uncalibrated Positive Transition	114
Questionable Power Register	114
Questionable Power Condition	114
Questionable Power Enable	115
Questionable Power Event Query	115
Questionable Power Negative Transition	116
Questionable Power Positive Transition	116
Questionable Temperature Register	116
Questionable Temperature Condition	117
Questionable Temperature Enable	117
Questionable Temperature Event Query	117
Questionable Temperature Negative Transition	118
Questionable Temperature Positive Transition	118
Common Commands	120
All (Daily use)	120
Clear Status	122
Standard Event Status Enable	123
Standard Event Status Register Query	123
Identification Query	124
Operation Complete	124
Query Instrument Options	125
Recall Instrument State	125
*RST (Remote Command Only)	126
Save Instrument State	126
Service Request Enable	127
Status Byte Query	127

Trigger	127
Self Test Query	128
Wait-to-Continue	128
4 Input/Output Functions	129
Input/Output	130
Input/Output variables - Preset behavior	131
RF Input	132
Input Z Correction	132
RF Input Port	133
RF Input	134
RFIO1	134
RFIO2	134
External Gain	135
Ext Preamp	135
More Information	136
MS	137
BTS	138
Restore Input/Output Defaults	139
Freq Ref In	139
Sense	141
Internal	141
External	141
Ext Ref Freq	142
RF Output & Test Set Config	143
RF Output	143
RF Output	143
RFIO1	144
RFIO2	144
HalfDuplex Config	144
RF Input	144
RF Output	145
Output Config	145
Trig Out	145
Polarity	146
Off	146
Sweeping (HSWP)	147
Measuring	147
Main Trigger	147
Gate Trigger	147
Gate	148
Odd/Even Trace Point	148
Trig Out	148
Off	149

Source Marker 1	149
Source Marker 2	149
Source Marker 3	149
Source Marker 4	150
Analog Out	150
More Information	150
Auto	151
Off	151
LISN Control	152
V-network (Remote Command Only)	152
Phase (Remote Command Only)	152
150 kHz Highpass (Remote Command Only)	153
Protective Earth (Remote Command Only)	153
5 Mode Functions	155
Mode	156
More Information	157
Sequence Analyzer	158
IQ Analyzer (Basic)	158
W-CDMA with HSPA+	159
GSM/EDGE/EDGE Evo	159
Analog Demod	159
Bluetooth	160
TD-SCDMA with HSPA/8PSK	160
cdma2000	160
1xEV-DO	160
WLAN	161
LTE-Advanced FDD	161
LTE-Advanced TDD	162
802.16 OFDMA (WiMAX/WiBro)	162
Application Mode Number Selection (Remote Command Only)	162
Application Mode Catalog Query (Remote Command Only)	163
Application Identification (Remote Commands Only)	164
Current Application Model	164
Current Application Revision	164
Current Application Options	165
Application Identification Catalog (Remote Commands Only)	165
Application Catalog Number of Entries	165
Application Catalog Model Numbers	166
Application Catalog Revision	166
Application Catalog Options	166
Detailed List of Modes	167
1xEV-DO	167
802.16 OFDMA (WiMAX/WiBro)	167

89601 VSA	167
Analog Demod	168
Bluetooth	169
cdma2000	169
GSM/EDGE/EDGE Evo	169
IQ Analyzer (Basic)	169
LTE	170
LTE TDD	170
LTE-Advanced FDD	170
LTE-Advanced TDD	171
Sequence Analyzer	171
TD-SCDMA with HSPA/8PSK	172
W-CDMA with HSPA+	172
WLAN	172
Global Settings	173
Global Center Freq	173
Restore Defaults	174
6 System Functions	175
File	176
File Explorer	176
Print	177
Maximize/Restore Down	177
Maximize	177
Restore Down	177
Page Setup	177
Print	178
Restore Down	179
Minimize	179
Exit	180
Print	181
System	182
Show	182
Errors	182
Previous Page	183
Next Page	184
History	184
Verbose SCPI On/Off	184
Refresh	185
Clear Error Queue	185
Status	185
Input Overload Enable (Remote Command Only)	185
Power Up (Remote Command Only)	186
System	186

Show System contents (Remote Command Only)	187
Computer System description (Remote Command Only)	187
Hardware	188
System Remote Commands (Remote Commands Only)	188
System Powerdown (Remote Command Only)	189
List installed Options (Remote Command Only)	189
Lock the Front-panel keys (Remote Command Only)	189
List SCPI Commands (Remote Command Only)	190
SCPI Version Query (Remote Command Only)	190
Date (Remote Command Only)	190
Time (Remote Command Only)	191
Module Name (Remote Command Only)	191
Module Index (Remote Command Only)	192
Module Mnemonic (Remote Command Only)	192
Module List (Remote Command Only)	192
Module Enable (Remote Command Only)	193
Module Default (Remote Command Only)	194
Module Model Number (Remote Command Only)	194
Module Model Serial Number (Remote Command Only)	195
Power On	195
Mode and Input/Output Defaults	196
User Preset	196
Last State	196
Power On Application	197
Configure Applications	198
Preloading Applications	198
Access to Configure Applications utility	199
Virtual memory usage	199
Select All	199
Deselect All	200
Move Up	200
Move Down	200
Select/Deselect	200
Save Changes and Exit	200
Exit Without Saving	201
Restore Power On Defaults	201
Configure Applications - Instrument boot-up	202
Configure Applications - Windows desktop	202
Configure Applications - Remote Commands	202
Configuration list (Remote Command Only)	203
Configuration Memory Available (Remote Command Only)	203
Configuration Memory Total (Remote Command Only)	203
Configuration Memory Used (Remote Command Only)	203

Configuration Application Memory (Remote Command Only)	204
Alignments	204
Align Now	204
All (Daily use)	204
All but RF	207
RF (Weekly use)	208
Source (Weekly use)	210
IF Alignment (Weekly use) (Remote Command Only)	211
Show Alignment Statistics	212
Restore Align Defaults	215
Execute Expired Alignments (Remote Command Only)	216
I/O Config	217
SCPI LAN	217
SCPI Telnet	217
SCPI Socket	217
SICL Server	218
HiSLIP Server	219
SCPI Socket Control Port (Remote Command Only)	219
System IDN Response	220
Factory	220
User	220
Restore Defaults	221
Restore Input/Output Defaults	222
Restore Power On Defaults	222
Restore Align Defaults	223
Restore Misc Defaults	223
Restore Mode Defaults (All Modes)	225
All	225
Control Panel...	226
Licensing...	227
Security	229
USB	229
Read-Write	230
Read only	230
Diagnostics	230
Show Hardware Statistics	230
SCPI for Show Hardware Statistics (Remote Commands Only)	231
Self test	232
All Self Test	232
FEC Self Test	232
Show Result	232
Internet Explorer...	234
7 Trigger Functions	237

Trigger	238
Trigger Source Presets	239
RF Trigger Source	242
I/Q Trigger Source	243
More Information	244
Free Run	245
Video (IF Envelope)	246
Trigger Level	246
Trig Slope	247
Trig Delay	248
External 1	249
Trigger Level	250
Trig Slope	250
Trig Delay	251
Zero Span Delay Comp On/Off	252
External 2	252
Trigger Level	253
Trig Slope	253
Trig Delay	254
Zero Span Delay Comp On/Off	254
RF Burst	255
Absolute Trigger Level	256
Relative Trigger Level	257
Trigger Slope	258
Trig Delay	258
Periodic Timer (Frame Trigger)	259
Period	260
Offset	261
Offset Adjust (Remote Command Only)	262
Reset Offset Display	263
Sync Source	263
Off	264
External 1	264
External 2	266
RF Burst	267
Trig Delay	269
Auto/Holdoff	270
Auto Trig	270
Trig Holdoff	271
8 AM Demod Measurement	273
AMPTD Y Scale	277
Ref Value (AM)	277
Attenuation	278

Table of Contents

Scale / Div (AM)	278
Scale / Div (FM)	279
Scale / Div (PM)	280
Scale / Div (FM Stereo)	280
μW Path Control	281
Range	281
Adjust Range For Min Clip	282
Pre-Adjust for Min Clip	282
Peak to Average	283
Mixer Level Offset	283
Scale / Div (AM)	284
Ref Position	284
Auto Couple	286
BW	287
RF Res BW	287
Channel BW	288
AF Res BW	289
Cont (Continuous Measurement/Sweep)	290
File	292
FREQ Channel	293
Center Frequency	293
CF Step	294
AF Start Freq	294
AF Stop Freq	295
Input/Output	296
Marker	297
Select Marker	297
Normal	297
Delta	298
Fixed	298
Marker X	298
Marker Y	299
Off	299
Properties	300
Select Marker	300
Relative To	300
AM/FM/ΦM Marker Trace	300
RF Spectrum	301
Demod	302
Demod Average	302
Demod Max	302
Demod Min	302
AF Spectrum	303

Trace Auto Init	303
Lines	303
All Markers Off	304
Marker Function	305
Marker To	306
Mkr->CF	306
Meas	307
Remote Measurement Functions	307
Measurement Group of Commands	308
Current Measurement Query (Remote Command Only)	310
Limit Test Current Results (Remote Command Only)	310
Data Query (Remote Command Only)	310
Calculate/Compress Trace Data Query (Remote Command Only)	311
Calculate Peaks of Trace Data (Remote Command Only)	316
Hardware-Accelerated Fast Power Measurement (Remote Command Only)	317
Reset Fast Power Measurement (Remote Command Only)	317
Define Fast Power Measurement (Remote Command Only)	318
Define Fast Power Measurement Query (Remote Command Only)	327
Configure Fast Power Measurement (Remote Command Only)	328
Initiate Fast Power Measurement (Remote Command Only)	329
Fetch Fast Power Measurement (Remote Command Only)	329
Execute Fast Power Measurement (Remote Command Only)	329
Binary Read Fast Power Measurement (Remote Command Only)	330
Diagnostic Binary Read Fast Power Measurement (Remote Command Only)	330
Format Data: Numeric Data (Remote Command Only)	331
Format Data: Byte Order (Remote Command Only)	332
Meas Setup	333
Overview	333
Set Parameters	333
Auto Rules for Phase Noise Optimization:	333
Optimizing Measurement Speed	333
Channel Bandwidth	334
RF Spectrum Span	334
RF Spectrum RBW / AF Spectrum RBW	334
AF Waveform Sweep Time	334
Filters and Annotation	334
Average/Hold Num	334
Average/Hold On/Off Functionality	335
Modulation Rate Periodic	336
Filters	336
High Pass Filter (Post Demod)	336
Off	337
20 Hz	338

Table of Contents

50 Hz	338
300 Hz	338
Lowpass Filter (Post Demod)	338
Off	339
300 Hz	340
3 kHz	340
15 kHz	340
30 kHz	340
80 kHz	341
300 kHz	341
Band Pass Filter (Post Demod)	341
Off	342
CCITT	343
Demod to Speaker	343
Auto BW & Scale	344
Meas Preset	344
Mode	345
Mode Preset	346
How-To Preset	347
Restore Mode Defaults	348
Preset Type (Remote Command Only)	348
Global Settings	349
Global Center Freq	349
Restore Defaults	350
Peak Search	351
Next Peak	351
Pk-Pk Search	351
Min Search	352
Print	353
Quick Save	354
State	355
More Information	356
From File...	357
Edit Register Names	359
Register 1 thru Register 16	359
Register 1 thru Register 16	360
Restart	361
More Information	361
Save	363
State	363
To File . . .	364
Edit Register Names	366
More Information	366

Register 1 thru Register 16	367
Register 1 thru Register 16	367
Mass Storage Catalog (Remote Command Only)	368
Mass Storage Change Directory (Remote Command Only)	369
Mass Storage Copy (Remote Command Only)	369
Mass Storage Device Copy (Remote Command Only)	369
Mass Storage Delete (Remote Command Only)	370
Mass Storage Data (Remote Command Only)	370
Mass Storage Make Directory (Remote Command Only)	370
Mass Storage Move (Remote Command Only)	370
Mass Storage Remove Directory (Remote Command Only)	371
Sequences	371
Source Sequence	372
Save As . . .	372
Data	372
AM/FM/ Φ M Trace	373
Measurement Results	375
Meas Results File Contents	375
Marker Table	376
Peak Table	378
Spectrogram	381
Save As . . .	385
Screen Image	386
Themes	387
3D Color	388
3D Monochrome	388
Flat Color	388
Flat Monochrome	389
Save As...	389
Single (Single Measurement/Sweep)	390
More Information	390
Source	391
RF Output	391
Amplitude	391
RF Power	392
RF Power Range	393
Set Reference Power	393
Power Ref	393
Amptd Offset	394
Modulation	395
Frequency	395
Frequency	396
Channel	396

GSM/EDGE Channel Number Ranges	397
W-CDMA Channel Number Ranges	398
CDMA 2000 / 1xEVDO Channel Number Ranges	399
LTE FDD Channel Number Ranges	401
LTE TDD Channel Number Ranges	403
TDSCDMA Channel Number Ranges	403
Radio Setup	404
Radio Standard	405
Radio Band Link	423
Set Reference Frequency	423
Freq Reference	424
Freq Offset	425
Modulation Setup	426
ARB	426
ARB	426
Select Waveform	427
ARB Setup	432
Trigger Type	434
Trigger Source	438
Trigger Initiate	439
Waveform Sequences	439
Waveform Utilities	450
Marker Utilities	460
Header Utilities	465
Bus Trigger Command (Remote Command Only)	467
AM	467
AM	467
AM Depth	467
AM Rate	468
FM	468
FM	468
FM Deviation	468
FM Rate	469
PM	469
PM	469
PM Deviation	470
PM Rate	470
List Sequencer	470
Sequencer	471
Initiate Sequence	471
List Sequencer Setup	472
Number of Steps	472
Current Step	472

Insert Step Before	473
Delete Step	473
Clear List	473
Step Trigger	473
Transition Time	475
Radio Setup	476
Channel	493
Frequency	494
Power	494
Waveform	495
Step Duration	502
Output Trigger	504
Step Configuration (Remote Command Only)	504
Clear List (Remote Command Only)	512
Trigger Type	513
BeginningOfStep	513
DataMarker	513
Manual Trigger Now	514
Remote Software Trigger (Remote command Only)	515
Query List Sequence Initiation Armed Status (Remote Command Only)	515
Source Preset	515
SPAN X Scale	516
Span	516
Sweep/Control	517
Demod Wfm Sweep Time	517
Demod Time	517
System	519
Trace/Detector	520
Trigger	521
Free Run	521
Video	521
Trigger Level	521
Trig Slope	521
Trig Delay	521
External 1	521
Trigger Level	521
Trig Slope	521
Trig Delay	521
Zero Span Delay Comp	521
External 2	521
Trigger Level	521
Trig Slope	521
Trig Delay	522

Zero Span Delay Comp	522
RF Burst	522
Absolute Trigger	522
Relative Trigger	522
Trig Slope	522
Trig Delay	522
Periodic Timer	522
Period	522
Offset	522
Offset Adjust (Remote Command Only)	522
Reset Offset Display	522
Sync Source	522
Off	522
External 1	523
External 2	523
RF Burst	523
Trig Delay	523
Auto/Holdoff	523
Auto Trig	523
Trig Holdoff	523
User Preset	524
User Preset	524
User Preset All Modes	525
Save User Preset	526
View/Display (AM/FM/ Φ M)	527
Display	527
Annotation	527
Meas Bar On/Off	528
Screen	529
Active Function Values On/Off	529
Title	530
Change Title	530
Clear Title	531
Graticule	532
System Display Settings	532
Annotation Local Settings	532
Themes	533
Quad View	534
RF Spectrum Window	535
Demod Waveform Window	535
AF Spectrum Window	536
Metrics Window	536
RF Spectrum & Metrics View	536

Demod Waveform & Metrics View	537
AF Spectrum & Metrics View	538
Metrics Settings	539
Normal	540
Peak+ Only	540
Pk-Pk/2 Only	540
RMS Only	540
RMS Ratio	540
Modulation Rate	541
SINAD, THD, Distortion	542
Distortion & THD Unit	542
9 FM Demod Measurement	543
AMPTD Y Scale	547
Ref Value (FM)	547
Range	548
Adjust Range For Min Clip	548
Pre-Adjust for Min Clip	549
Peak to Average	549
Mixer Level Offset	550
Scale / Div (FM)	550
Ref Position	551
Auto Couple	553
BW	554
RF Res BW	554
Channel BW	555
AF Res BW	556
File	557
FREQ Channel	558
Center Frequency	558
CF Step	559
AF Start Freq	559
AF Stop Freq	560
Input/Output	561
Marker	562
Select Marker	562
Normal	562
Delta	563
Fixed	563
Marker X	563
Marker Y	564
Off	564
Properties	565
Select Marker	565

Relative To	565
AM/FM/ Φ M Marker Trace	565
RF Spectrum	566
Demod	567
Demod Average	567
Demod Max	567
Demod Min	567
AF Spectrum	568
Trace Auto Init	568
Lines	568
All Markers Off	569
Marker Function	570
Marker To	571
Mkr->CF	571
Meas	572
Remote Measurement Functions	572
Measurement Group of Commands	573
Current Measurement Query (Remote Command Only)	575
Limit Test Current Results (Remote Command Only)	575
Data Query (Remote Command Only)	575
Calculate/Compress Trace Data Query (Remote Command Only)	576
Calculate Peaks of Trace Data (Remote Command Only)	581
Hardware-Accelerated Fast Power Measurement (Remote Command Only)	582
Reset Fast Power Measurement (Remote Command Only)	582
Define Fast Power Measurement (Remote Command Only)	583
Define Fast Power Measurement Query (Remote Command Only)	592
Configure Fast Power Measurement (Remote Command Only)	593
Initiate Fast Power Measurement (Remote Command Only)	594
Fetch Fast Power Measurement (Remote Command Only)	594
Execute Fast Power Measurement (Remote Command Only)	594
Binary Read Fast Power Measurement (Remote Command Only)	595
Diagnostic Binary Read Fast Power Measurement (Remote Command Only)	595
Format Data: Numeric Data (Remote Command Only)	596
Format Data: Byte Order (Remote Command Only)	597
Meas Setup	598
Overview	598
Set Parameters	598
Auto Rules for Phase Noise Optimization:	598
Optimizing Measurement Speed	598
Channel Bandwidth	599
RF Spectrum Span	599
RF Spectrum RBW / AF Spectrum RBW	599
AF Waveform Sweep Time	599

Filters and Annotation	599
Average/Hold Num	599
Average/Hold On/Off Functionality	600
Modulation Rate Periodic	601
Filters	601
High Pass Filter (Post Demod)	601
Off	602
20 Hz	603
50 Hz	603
300 Hz	603
Lowpass Filter (Post Demod)	603
Off	604
300 Hz	605
3 kHz	605
15 kHz	605
30 kHz	605
80 kHz	606
300 kHz	606
Band Pass Filter (Post Demod)	606
Off	607
CCITT	608
De-emphasis (FM and FM Stereo Demod measurement only)	608
Off	609
25 μ s	609
50 μ s	609
75 μ s	610
750 μ s	610
Demod to Speaker	610
Auto BW & Scale	610
Meas Preset	611
Mode	612
Mode Preset	613
How-To Preset	614
Restore Mode Defaults	615
Preset Type (Remote Command Only)	615
Global Settings	616
Global Center Freq	616
Restore Defaults	617
Peak Search	618
Next Peak	618
Pk-Pk Search	618
Min Search	619
Print	620

Quick Save	621
State	622
More Information	623
From File...	624
Edit Register Names	626
Register 1 thru Register 16	626
Register 1 thru Register 16	627
Restart	628
More Information	628
Save	630
State	630
To File . . .	631
Edit Register Names	633
More Information	633
Register 1 thru Register 16	634
Register 1 thru Register 16	634
Mass Storage Catalog (Remote Command Only)	635
Mass Storage Change Directory (Remote Command Only)	636
Mass Storage Copy (Remote Command Only)	636
Mass Storage Device Copy (Remote Command Only)	636
Mass Storage Delete (Remote Command Only)	637
Mass Storage Data (Remote Command Only)	637
Mass Storage Make Directory (Remote Command Only)	637
Mass Storage Move (Remote Command Only)	637
Mass Storage Remove Directory (Remote Command Only)	638
Sequences	638
Source Sequence	639
Save As . . .	639
Data	639
AM/FM/ Φ M Trace	640
Measurement Results	642
Meas Results File Contents	642
Marker Table	643
Peak Table	645
Spectrogram	648
Save As . . .	652
Screen Image	653
Themes	654
3D Color	655
3D Monochrome	655
Flat Color	655
Flat Monochrome	656
Save As...	656

Single (Single Measurement/Sweep)	657
More Information	657
Source	658
RF Output	658
Amplitude	658
RF Power	659
RF Power Range	660
Set Reference Power	660
Power Ref	660
Amptd Offset	661
Modulation	662
Frequency	662
Frequency	663
Channel	663
GSM/EDGE Channel Number Ranges	664
W-CDMA Channel Number Ranges	665
CDMA 2000 / 1xEVDO Channel Number Ranges	666
LTE FDD Channel Number Ranges	668
LTE TDD Channel Number Ranges	670
TDSCDMA Channel Number Ranges	670
Radio Setup	671
Radio Standard	672
Radio Band Link	690
Set Reference Frequency	690
Freq Reference	691
Freq Offset	692
Modulation Setup	693
ARB	693
ARB	693
Select Waveform	694
ARB Setup	699
Trigger Type	701
Trigger Source	705
Trigger Initiate	706
Waveform Sequences	706
Waveform Utilities	717
Marker Utilities	727
Header Utilities	732
Bus Trigger Command (Remote Command Only)	734
AM	734
AM	734
AM Depth	734
AM Rate	735

Table of Contents

FM	735
FM	735
FM Deviation	735
FM Rate	736
PM	736
PM	736
PM Deviation	737
PM Rate	737
List Sequencer	737
Sequencer	738
Initiate Sequence	738
List Sequencer Setup	739
Number of Steps	739
Current Step	739
Insert Step Before	740
Delete Step	740
Clear List	740
Step Trigger	740
Transition Time	742
Radio Setup	743
Channel	760
Frequency	761
Power	761
Waveform	762
Step Duration	769
Output Trigger	771
Step Configuration (Remote Command Only)	771
Clear List (Remote Command Only)	779
Trigger Type	780
BeginningOfStep	780
DataMarker	780
Manual Trigger Now	781
Remote Software Trigger (Remote command Only)	782
Query List Sequence Initiation Armed Status (Remote Command Only)	782
Source Preset	782
SPAN X Scale	783
Span	783
Sweep/Control	784
Demod Wfm Sweep Time	784
Demod Time	784
System	786
Trace/Detector	787
Trigger	788

Free Run	788
Video	788
Trigger Level	788
Trig Slope	788
Trig Delay	788
External 1	788
Trigger Level	788
Trig Slope	788
Trig Delay	788
Zero Span Delay Comp	788
External 2	788
Trigger Level	788
Trig Slope	788
Trig Delay	789
Zero Span Delay Comp	789
RF Burst	789
Absolute Trigger	789
Relative Trigger	789
Trig Slope	789
Trig Delay	789
Periodic Timer	789
Period	789
Offset	789
Offset Adjust (Remote Command Only)	789
Reset Offset Display	789
Sync Source	789
Off	789
External 1	790
External 2	790
RF Burst	790
Trig Delay	790
Auto/Holdoff	790
Auto Trig	790
Trig Holdoff	790
User Preset	791
User Preset	791
User Preset All Modes	792
Save User Preset	793
View/Display (AM/FM/ Φ M)	794
Display	794
Annotation	794
Meas Bar On/Off	795
Screen	796

Active Function Values On/Off	796
Title	797
Change Title	797
Clear Title	798
Graticule	799
System Display Settings	799
Annotation Local Settings	799
Themes	800
Quad View	801
RF Spectrum Window	802
Demod Waveform Window	802
AF Spectrum Window	803
Metrics Window	803
RF Spectrum & Metrics View	803
Demod Waveform & Metrics View	804
AF Spectrum & Metrics View	805
Metrics Settings	806
Normal	807
Peak+ Only	807
Pk-Pk/2 Only	807
RMS Only	807
RMS Ratio	807
Modulation Rate	808
SINAD, THD, Distortion	809
Distortion & THD Unit	809
10 ΦM Demod Measurement	811
AMPTD Y Scale	815
Ref Value (PM)	815
Range	816
Adjust Range For Min Clip	816
Pre-Adjust for Min Clip	817
Peak to Average	817
Mixer Level Offset	818
Scale / Div (PM)	818
Ref Position	819
Auto Couple	821
BW	822
RF Res BW	822
Channel BW	823
AF Res BW	824
Cont (Continuous Measurement/Sweep)	825
File	827
FREQ Channel	828

Center Frequency	828
CF Step	829
AF Start Freq	829
AF Stop Freq	830
Input/Output	831
Marker	832
Select Marker	832
Normal	832
Delta	833
Fixed	833
Marker X	833
Marker Y	834
Off	834
Properties	835
Select Marker	835
Relative To	835
AM/FM/ Φ M Marker Trace	835
RF Spectrum	836
Demod	837
Demod Average	837
Demod Max	837
Demod Min	837
AF Spectrum	838
Trace Auto Init	838
Lines	838
All Markers Off	839
Marker Function	840
Marker To	841
Mkr->CF	841
Meas	842
Remote Measurement Functions	842
Measurement Group of Commands	843
Current Measurement Query (Remote Command Only)	845
Limit Test Current Results (Remote Command Only)	845
Data Query (Remote Command Only)	845
Calculate/Compress Trace Data Query (Remote Command Only)	846
Calculate Peaks of Trace Data (Remote Command Only)	851
Hardware-Accelerated Fast Power Measurement (Remote Command Only)	852
Reset Fast Power Measurement (Remote Command Only)	852
Define Fast Power Measurement (Remote Command Only)	853
Define Fast Power Measurement Query (Remote Command Only)	862
Configure Fast Power Measurement (Remote Command Only)	863
Initiate Fast Power Measurement (Remote Command Only)	864

Fetch Fast Power Measurement (Remote Command Only)	864
Execute Fast Power Measurement (Remote Command Only)	864
Binary Read Fast Power Measurement (Remote Command Only)	865
Diagnostic Binary Read Fast Power Measurement (Remote Command Only)	865
Format Data: Numeric Data (Remote Command Only)	866
Format Data: Byte Order (Remote Command Only)	867
Meas Setup	868
Overview	868
Set Parameters	868
Auto Rules for Phase Noise Optimization:	868
Optimizing Measurement Speed	868
Channel Bandwidth	869
RF Spectrum Span	869
RF Spectrum RBW / AF Spectrum RBW	869
AF Waveform Sweep Time	869
Filters and Annotation	869
Average/Hold Num	869
Average/Hold On/Off Functionality	870
Modulation Rate Periodic	871
Filters	871
High Pass Filter (Post Demod)	871
Off	872
20 Hz	873
50 Hz	873
300 Hz	873
Lowpass Filter (Post Demod)	873
Off	874
300 Hz	875
3 kHz	875
15 kHz	875
30 kHz	875
80 kHz	876
300 kHz	876
Band Pass Filter (Post Demod)	876
Off	877
CCITT	878
Demod to Speaker	878
Auto BW & Scale	879
Meas Preset	879
Mode	880
Mode Preset	881
How-To Preset	882
Restore Mode Defaults	883

Preset Type (Remote Command Only)	883
Global Settings	884
Global Center Freq	884
Restore Defaults	885
Peak Search	886
Next Peak	886
Pk-Pk Search	886
Min Search	887
Print	888
Quick Save	889
State	890
More Information	891
From File...	892
Edit Register Names	894
Register 1 thru Register 16	894
Register 1 thru Register 16	895
Restart	896
More Information	896
Save	898
State	898
To File . . .	899
Edit Register Names	901
More Information	901
Register 1 thru Register 16	902
Register 1 thru Register 16	902
Mass Storage Catalog (Remote Command Only)	903
Mass Storage Change Directory (Remote Command Only)	904
Mass Storage Copy (Remote Command Only)	904
Mass Storage Device Copy (Remote Command Only)	904
Mass Storage Delete (Remote Command Only)	905
Mass Storage Data (Remote Command Only)	905
Mass Storage Make Directory (Remote Command Only)	905
Mass Storage Move (Remote Command Only)	905
Mass Storage Remove Directory (Remote Command Only)	906
Sequences	906
Source Sequence	907
Save As . . .	907
Data	907
AM/FM/ Φ M Trace	908
Measurement Results	910
Meas Results File Contents	910
Marker Table	911
Peak Table	913

Spectrogram	916
Save As . . .	920
Screen Image	921
Themes	922
3D Color	923
3D Monochrome	923
Flat Color	923
Flat Monochrome	924
Save As...	924
Single (Single Measurement/Sweep)	925
More Information	925
Source	926
RF Output	926
Amplitude	926
RF Power	927
RF Power Range	928
Set Reference Power	928
Power Ref	928
Amptd Offset	929
Modulation	930
Frequency	930
Frequency	931
Channel	931
GSM/EDGE Channel Number Ranges	932
W-CDMA Channel Number Ranges	933
CDMA 2000 / 1xEVDO Channel Number Ranges	934
LTE FDD Channel Number Ranges	936
LTE TDD Channel Number Ranges	938
TDSCDMA Channel Number Ranges	938
Radio Setup	939
Radio Standard	940
Radio Band Link	958
Set Reference Frequency	958
Freq Reference	959
Freq Offset	960
Modulation Setup	961
ARB	961
ARB	961
Select Waveform	962
ARB Setup	967
Trigger Type	969
Trigger Source	973
Trigger Initiate	974

Waveform Sequences	974
Waveform Utilities	985
Marker Utilities	995
Header Utilities	1000
Bus Trigger Command (Remote Command Only)	1002
AM	1002
AM	1002
AM Depth	1002
AM Rate	1003
FM	1003
FM	1003
FM Deviation	1003
FM Rate	1004
PM	1004
PM	1004
PM Deviation	1005
PM Rate	1005
List Sequencer	1005
Sequencer	1006
Initiate Sequence	1006
List Sequencer Setup	1007
Number of Steps	1007
Current Step	1007
Insert Step Before	1008
Delete Step	1008
Clear List	1008
Step Trigger	1008
Transition Time	1010
Radio Setup	1011
Channel	1028
Frequency	1029
Power	1029
Waveform	1030
Step Duration	1037
Output Trigger	1039
Step Configuration (Remote Command Only)	1039
Clear List (Remote Command Only)	1047
Trigger Type	1048
BeginningOfStep	1048
DataMarker	1048
Manual Trigger Now	1049
Remote Software Trigger (Remote command Only)	1050
Query List Sequence Initiation Armed Status (Remote Command Only)	1050

Table of Contents

Source Preset	1050
SPAN X Scale	1051
Span	1051
Sweep/Control	1052
Demod Wfm Sweep Time	1052
Demod Time	1052
System	1054
Trace/Detector	1055
Trigger	1056
Free Run	1056
Video	1056
Trigger Level	1056
Trig Slope	1056
Trig Delay	1056
External 1	1056
Trigger Level	1056
Trig Slope	1056
Trig Delay	1056
Zero Span Delay Comp	1056
External 2	1056
Trigger Level	1056
Trig Slope	1056
Trig Delay	1057
Zero Span Delay Comp	1057
RF Burst	1057
Absolute Trigger	1057
Relative Trigger	1057
Trig Slope	1057
Trig Delay	1057
Periodic Timer	1057
Period	1057
Offset	1057
Offset Adjust (Remote Command Only)	1057
Reset Offset Display	1057
Sync Source	1057
Off	1057
External 1	1058
External 2	1058
RF Burst	1058
Trig Delay	1058
Auto/Holdoff	1058
Auto Trig	1058
Trig Holdoff	1058

User Preset	1059
User Preset	1059
User Preset All Modes	1060
Save User Preset	1061
View/Display (AM/FM/ Φ M)	1062
Display	1062
Annotation	1062
Meas Bar On/Off	1063
Screen	1064
Active Function Values On/Off	1064
Title	1065
Change Title	1065
Clear Title	1066
Graticule	1067
System Display Settings	1067
Annotation Local Settings	1067
Themes	1068
Quad View	1069
RF Spectrum Window	1070
Demod Waveform Window	1070
AF Spectrum Window	1071
Metrics Window	1071
RF Spectrum & Metrics View	1071
Demod Waveform & Metrics View	1072
AF Spectrum & Metrics View	1073
Metrics Settings	1074
Normal	1075
Peak+ Only	1075
Pk-Pk/2 Only	1075
RMS Only	1075
RMS Ratio	1075
Modulation Rate	1076
SINAD, THD, Distortion	1077
Distortion & THD Unit	1077
11 FM Stereo Measurement	1079
AMPTD Y Scale	1087
Ref Value (FM Stereo)	1087
Scale / Div (FM Stereo)	1088
Ref Position	1088
Auto Couple	1090
BW	1091
RF Res BW	1091
Channel BW	1092

Table of Contents

AF Res BW	1093
Cont (Continuous Measurement/Sweep)	1094
File	1096
FREQ Channel	1097
Center Frequency	1097
CF Step	1098
AF Start Freq	1098
AF Stop Freq	1099
Input/Output	1100
Marker	1101
Select Marker	1101
Normal	1101
Delta	1102
Fixed	1102
Marker X	1102
Marker Y	1103
Off	1103
Properties	1104
Select Marker	1104
Relative To	1104
FM Stereo Marker Trace	1104
FM Stereo Marker Trace	1106
FM Stereo Marker Trace	1108
FM Stereo Marker Trace	1110
FM Stereo Marker Trace	1112
FM Stereo Marker Trace	1115
Trace Auto Init	1117
Lines	1117
All Markers Off	1118
Marker Function	1119
Marker To	1120
Mkr->CF	1120
Meas	1121
Remote Measurement Functions	1121
Measurement Group of Commands	1122
Current Measurement Query (Remote Command Only)	1124
Limit Test Current Results (Remote Command Only)	1124
Data Query (Remote Command Only)	1124
Calculate/Compress Trace Data Query (Remote Command Only)	1125
Calculate Peaks of Trace Data (Remote Command Only)	1130
Hardware-Accelerated Fast Power Measurement (Remote Command Only)	1131
Reset Fast Power Measurement (Remote Command Only)	1131
Define Fast Power Measurement (Remote Command Only)	1132

Define Fast Power Measurement Query (Remote Command Only)	1141
Configure Fast Power Measurement (Remote Command Only)	1142
Initiate Fast Power Measurement (Remote Command Only)	1143
Fetch Fast Power Measurement (Remote Command Only)	1143
Execute Fast Power Measurement (Remote Command Only)	1143
Binary Read Fast Power Measurement (Remote Command Only)	1144
Diagnostic Binary Read Fast Power Measurement (Remote Command Only)	1144
Format Data: Numeric Data (Remote Command Only)	1145
Format Data: Byte Order (Remote Command Only)	1146
Meas Setup	1147
Overview	1147
Set Parameters	1147
Auto Rules for Phase Noise Optimization:	1147
Optimizing Measurement Speed	1147
Channel Bandwidth	1148
RF Spectrum Span	1148
RF Spectrum RBW / AF Spectrum RBW	1148
AF Waveform Sweep Time	1148
Filters and Annotation	1148
Average/Hold Num	1148
Average/Hold On/Off Functionality	1149
Modulation Rate Periodic	1150
Filters	1150
High Pass Filter (Post Demod)	1150
Off	1151
20 Hz	1152
50 Hz	1152
300 Hz	1152
Lowpass Filter (Post Demod)	1152
Off	1153
300 Hz	1154
3 kHz	1154
15 kHz	1154
30 kHz	1154
80 kHz	1155
300 kHz	1155
Band Pass Filter (Post Demod)	1155
Off	1156
CCITT	1157
De-emphasis (FM and FM Stereo Demod measurement only)	1157
Off	1158
25 μ s	1158
50 μ s	1158

Table of Contents

75 μ s	1159
750 μ s	1159
Demod to Speaker	1159
Advanced	1159
BLER Block Count	1160
Ref Deviation	1160
SINAD MPX BW	1160
SINAD Mono BW	1161
Meas Preset	1161
Mode	1162
Mode Preset	1163
How-To Preset	1164
Restore Mode Defaults	1165
Preset Type (Remote Command Only)	1165
Global Settings	1166
Global Center Freq	1166
Restore Defaults	1167
Peak Search	1168
Next Peak	1168
Pk-Pk Search	1168
Min Search	1169
Print	1170
Quick Save	1171
State	1172
More Information	1173
From File...	1174
Edit Register Names	1176
Register 1 thru Register 16	1176
Register 1 thru Register 16	1177
Restart	1178
More Information	1178
Save	1180
State	1180
To File . . .	1181
Edit Register Names	1183
More Information	1183
Register 1 thru Register 16	1184
Register 1 thru Register 16	1184
Mass Storage Catalog (Remote Command Only)	1185
Mass Storage Change Directory (Remote Command Only)	1186
Mass Storage Copy (Remote Command Only)	1186
Mass Storage Device Copy (Remote Command Only)	1186
Mass Storage Delete (Remote Command Only)	1187

Mass Storage Data (Remote Command Only)	1187
Mass Storage Make Directory (Remote Command Only)	1187
Mass Storage Move (Remote Command Only)	1187
Mass Storage Remove Directory (Remote Command Only)	1188
Sequences	1188
Source Sequence	1189
Save As . . .	1189
Data	1189
FM Stereo Trace	1190
FM Stereo Trace	1192
FM Stereo Trace	1196
FM Stereo Trace	1199
FM Stereo Trace	1203
FM Stereo Trace	1206
Measurement Results	1210
Meas Results File Contents	1211
Marker Table	1211
Peak Table	1214
Spectrogram	1216
Save As . . .	1221
Screen Image	1222
Themes	1223
3D Color	1223
3D Monochrome	1224
Flat Color	1224
Flat Monochrome	1224
Save As...	1224
Single (Single Measurement/Sweep)	1226
More Information	1226
Source	1227
RF Output	1227
Amplitude	1227
RF Power	1228
RF Power Range	1229
Set Reference Power	1229
Power Ref	1229
Amptd Offset	1230
Modulation	1231
Frequency	1231
Frequency	1232
Channel	1232
GSM/EDGE Channel Number Ranges	1233
W-CDMA Channel Number Ranges	1234

CDMA 2000 / 1xEVDO Channel Number Ranges	1235
LTE FDD Channel Number Ranges	1237
LTE TDD Channel Number Ranges	1239
TDSCDMA Channel Number Ranges	1239
Radio Setup	1240
Radio Standard	1241
Radio Band Link	1259
Set Reference Frequency	1259
Freq Reference	1260
Freq Offset	1261
Modulation Setup	1262
ARB	1262
ARB	1262
Select Waveform	1263
ARB Setup	1268
Trigger Type	1270
Trigger Source	1274
Trigger Initiate	1275
Waveform Sequences	1275
Waveform Utilities	1286
Marker Utilities	1296
Header Utilities	1301
Bus Trigger Command (Remote Command Only)	1303
AM	1303
AM	1303
AM Depth	1303
AM Rate	1304
FM	1304
FM	1304
FM Deviation	1304
FM Rate	1305
PM	1305
PM	1305
PM Deviation	1306
PM Rate	1306
List Sequencer	1306
Sequencer	1307
Initiate Sequence	1307
List Sequencer Setup	1308
Number of Steps	1308
Current Step	1308
Insert Step Before	1309
Delete Step	1309

Clear List	1309
Step Trigger	1309
Transition Time	1311
Radio Setup	1312
Channel	1329
Frequency	1330
Power	1330
Waveform	1331
Step Duration	1338
Output Trigger	1340
Step Configuration (Remote Command Only)	1340
Clear List (Remote Command Only)	1348
Trigger Type	1349
BeginningOfStep	1349
DataMarker	1349
Manual Trigger Now	1350
Remote Software Trigger (Remote command Only)	1351
Query List Sequence Initiation Armed Status (Remote Command Only)	1351
Source Preset	1351
SPAN X Scale	1352
Span	1352
Sweep/Control	1353
Demod Wfm Sweep Time	1353
Demod Time	1353
System	1355
Trace/Detector	1356
Trigger	1357
Free Run	1357
Video	1357
Trigger Level	1357
Trig Slope	1357
Trig Delay	1357
External 1	1357
Trigger Level	1357
Trig Slope	1357
Trig Delay	1357
Zero Span Delay Comp	1357
External 2	1357
Trigger Level	1357
Trig Slope	1357
Trig Delay	1358
Zero Span Delay Comp	1358
RF Burst	1358

Table of Contents

Absolute Trigger	1358
Relative Trigger	1358
Trig Slope	1358
Trig Delay	1358
Periodic Timer	1358
Period	1358
Offset	1358
Offset Adjust (Remote Command Only)	1358
Reset Offset Display	1358
Sync Source	1358
Off	1358
External 1	1359
External 2	1359
RF Burst	1359
Trig Delay	1359
Auto/Holdoff	1359
Auto Trig	1359
Trig Holdoff	1359
User Preset	1360
User Preset	1360
User Preset All Modes	1361
Save User Preset	1362
View/Display (FM Stereo)	1363
Display	1363
Annotation	1363
Meas Bar On/Off	1364
Screen	1365
Active Function Values On/Off	1365
Title	1366
Change Title	1366
Clear Title	1367
Graticule	1368
System Display Settings	1368
Annotation Local Settings	1368
Themes	1369
MPX View	1370
RF Spectrum Window	1371
Demod Waveform Window	1371
Spectrum Window	1372
Metrics Window	1372
Mono (L+R) View	1372
Stereo (L-R) View	1373
Left View	1374

Right View	1375
RDS/RBDS View	1376
Result Metrics Summary View	1377
Distortion & THD Unit	1378
Metrics Settings	1378
Normal	1379
Peak+ Only	1379
Pk-Pk/2 Only	1379
RMS Only	1380
RMS Ratio	1380
Modulation Rate	1381
SINAD, THD, Distortion	1381
12 Metrics	12-1
Metrics	12-2

1 About the Test Set

The X-Series E6640A EXM Wireless Test Set is a one-box tester consisting of instruments loaded into a M9018A PXI mainframe with a front impact cover. The mainframe has a common PC controller (located on the far left) and M9300A PXI Frequency Reference (located in the center of the rack). The test set has one to four Keysight M9430A TRX (transmit/receive) instruments installed.

Each TRX includes a signal analyzer and a signal source, both of which interface with the front panel of the test set through an input/output matrix, and is run by its own instance of the XSA firmware application (a fully loaded test set shows four independent XSA windows on its monitor display).

The E6640A can be configured to test cellular products with a standard 40 MHz of analysis bandwidth. It could also be configured to test Wireless products with 80 or 160 MHz of analysis bandwidth. If your requirement is to test both, the TRX instruments can be configured to test both products.

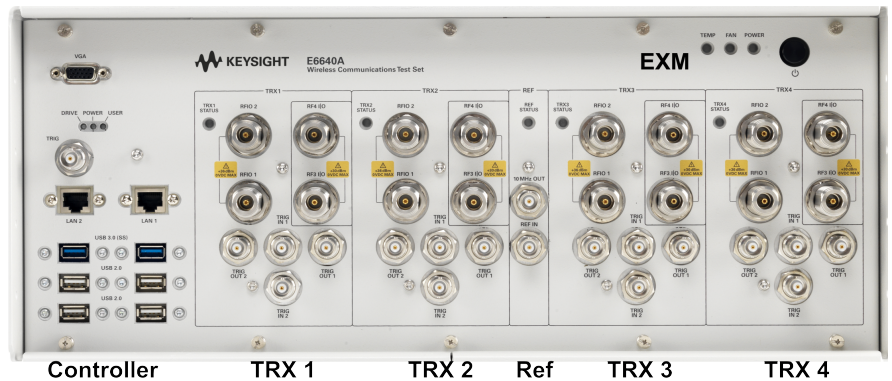

Installing Application Software

If you want to install a measurement application after your initial hardware purchase, you need only to license it. All of the available applications are loaded in your test set at the time of purchase.

Thus, when you purchase a new application, you will receive an entitlement certificate that you can use to obtain a license key for that application. To activate the new measurement application, enter the license key that you obtain into the test set.

For the latest information on Keysight X-series measurement applications and upgrade kits, visit the following internet URL.

<http://www.keysight.com/find/e6640a>

Viewing a License Key

Measurement applications that you purchased with your instrument have been installed and activated at the factory before shipment. The instrument requires a unique License Key for every measurement application purchased. The license key is a hexadecimal string that is specific to your measurement application, instrument model number and serial number. It enables you to install, or reactivate, that particular application.

Press **System, Show, System** to display the measurement applications that are currently licensed in your analyzer.

Go to the following location to view the license keys for the installed measurement applications:

C:\Program Files\Agilent\Licensing

You may want to keep a copy of your license key in a secure location. To do this, you can print out a copy of the display showing the license numbers. If you should lose your license key, call your nearest Keysight Technologies service or sales office for assistance.

Obtaining and Installing a License Key

If you purchase an additional application that requires installation, you will receive an "Entitlement Certificate", which may be redeemed for a license key for one instrument. To obtain your license key, follow the instructions that accompany the certificate.

Installing a license key for the selected application can be done automatically using a USB memory device. To do this, you copy the license file to the USB memory device, at the root level. Follow the instructions that come with your software installation kit.

Installing a license key can also be done manually using the built-in license management application, which may be found via the instrument front panel keys at **System, Licensing. . .**, or on-disk at:

C:\Programming Files\Agilent\Licensing

You can also use these procedures to reinstall a license key that has been accidentally deleted, or lost due to a memory failure.

Updating Measurement Application Software

All the software applications were loaded at the time of original instrument manufacture. It is a good idea to regularly update your software with the latest available version. This helps to ensure that you receive

any improvements and expanded functionality.

Because the software was loaded at the initial purchase, further additional measurement applications may now be available. If the application you are interested in licensing is not available, you will need to do a software update. (To display a list of installed applications, press **System, Show, System.**)

Check the appropriate page of the Keysight web site for the latest available software versions, according to the name of your instrument, as follows:

http://www.keysight.com/find/E6640A_software

You can load the updated software package into the analyzer either from a USB drive or directly from the internet. An automatic loading program is included with the files.

EXM Options and Accessories

You can view an online list of available Options and Accessories for your instrument as follows:

1. Browse to one of the following URLs, according to the product name of your analyzer:
www.keysight.com/find/e6640a
2. The home page for your instrument appears (in some cases, you may see an initial splash screen containing a button named View the Webpage, which you should click to display the home page).
3. Locate the **Options & Accessories** tab, as highlighted in the example below, which shows the home page for the E6640A.

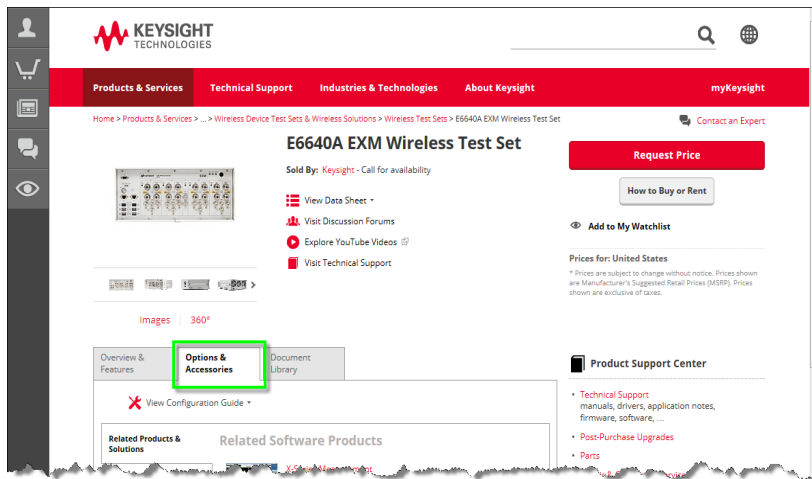

4. Click the **Options & Accessories** tab, to display a list of available options and accessories for your instrument.

Front-Panel Features

The instrument Front-panel features are fully detailed in the section "Front-Panel Features" (under the chapter "Front and Rear Panel Features") of the document:

Latest available on line document: [E6640A Getting Started Guide](#)

Embedded PDF installed with the latest firmware revision:

If you are viewing this information as a Help file in the instrument, then you can click on the link above to open the PDF document.

Display Annotations

Display Annotations are fully detailed under the chapter "Front and Rear Panel Features" of the document:

Latest available on line document: [E6640A Getting Started Guide](#)

Embedded PDF installed with the latest firmware revision:

If you are viewing this information as a Help file in the instrument, then you can click on the links above to open the PDF document.

Rear-Panel Features

The instrument's Rear-panel features are fully detailed in the section "Rear-Panel Features" (under the chapter "Front and Rear Panel Features") of the document:

Latest available on line document: [E6640A Getting Started Guide](#)

Embedded PDF installed with the latest firmware revision:

If you are viewing this information as a Help file in the instrument, then you can click on the link above to open the PDF document.

Window Control Keys

The instrument provides three virtual-front-panel keys or four menu items for controlling windows.

Virtual Front Panel

The virtual-front-panel keys are Multi Window, Zoom, and Next Window. These are all “immediate action” keys.



Windows Control Menu

The menu items are Zoom, Split Screen, Next [Window], and Full screen. These are all “immediate action” menu selections. Zoom and Full Screen are toggle functions.

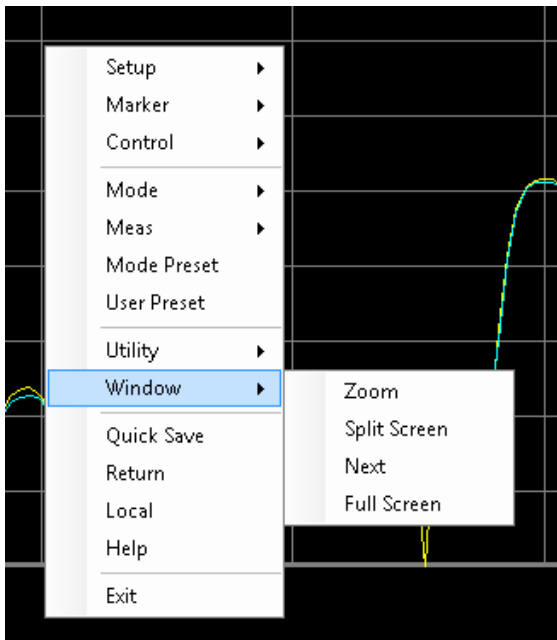

Multi-Window



The Multi Window front-panel key will toggle you back and forth between the Normal View and the last Multi Window View (Zone Span, Trace Zoom or Spectrogram) that you were in, when using the Swept SA measurement of the Spectrum Analyzer Mode. It remembers which View you were in through a Preset. This “previous view” is set to Zone Span on a Restore Mode Defaults.

Key Path	Front-panel key
Initial S/W Revision	Prior to A.02.00

Zoom

Zoom is a toggle function. Pressing this key once increases the size of the selected window. Pressing the key again returns the window to the original size.

When Zoom is on for a window, that window will get the entire primary display area. The zoomed window, since it is the selected window, is outlined in green.

Zoom is local to each Measurement. Each Measurement remembers its Zoom state. The Zoom state of each Measurement is part of the Mode’s state.

NOTE

Data acquisition and processing for the other windows continues while a window is zoomed, as does all SCPI communication with the other windows.

Remote Command	:DISPlay:WINDow:FORMat:ZOOM
Remote Command	:DISPlay:WINDow:FORMat:TILE
Example	:DISP:WIND:FORM:ZOOM sets zoomed :DISP:WIND:FORM:TILE sets un-zoomed
Preset	TILE
Initial S/W Revision	Prior to A.02.00

Next Window

Selects the next window of the current view. When the Next Window key is pressed, the next window in the order of precedence becomes selected. If the selected window was zoomed, the next window will also be zoomed.

The window numbers are as follows. Note that these numbers also determine the order of precedence (that is, Next Window goes from 1 to 2, then 2 to 3, etc.):



Four window display

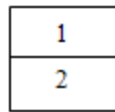

Two window display

RTSA measurements:

Only two windows are available in the Spectrogram view under the Spectrum measurement and up to three windows are available in the Power vs. Time measurement, depending on the view set up.

Remote Command	:DISPlay:WINDow[:SElect] <number> :DISPlay:WINDow[:SElect]?
Example	:DISP:WIND 1
Preset	1
Min	1
Max	If <number> is greater than the number of windows, limit to <number of windows>
Initial S/W Revision	Prior to A.02.00

One and only one window is always selected. The selected window has the focus; this means that all window-specific key presses apply only to that window. You can tell which window is selected by the thick green border around it. If a window is not selected, its boundary is gray.

If a window in a multi-window display is zoomed it is still outlined in green. If there is only one window, the green outline is not used. This allows the user to distinguish between a zoomed window and a display with only one window.

The selected window is local to each Measurement. Each Measurement remembers which window is selected. The selected window for each Measurement is remembered in Mode state.

NOTE When this key is pressed in Help Mode, it toggles focus between the table of contents window and the topic pane window.

Mouse and Keyboard Control

If you do not have access to the instrument front-panel, there are several ways that a mouse and PC Keyboard can give you access to functions normally accessed using the front-panel keys.

For instrument lacking a physical front panel display, you can watch the instrument display via external monitor or remote desktop connection

Right-Click

If you plug in a mouse and right-click on the analyzer screen, a menu will appear as below:

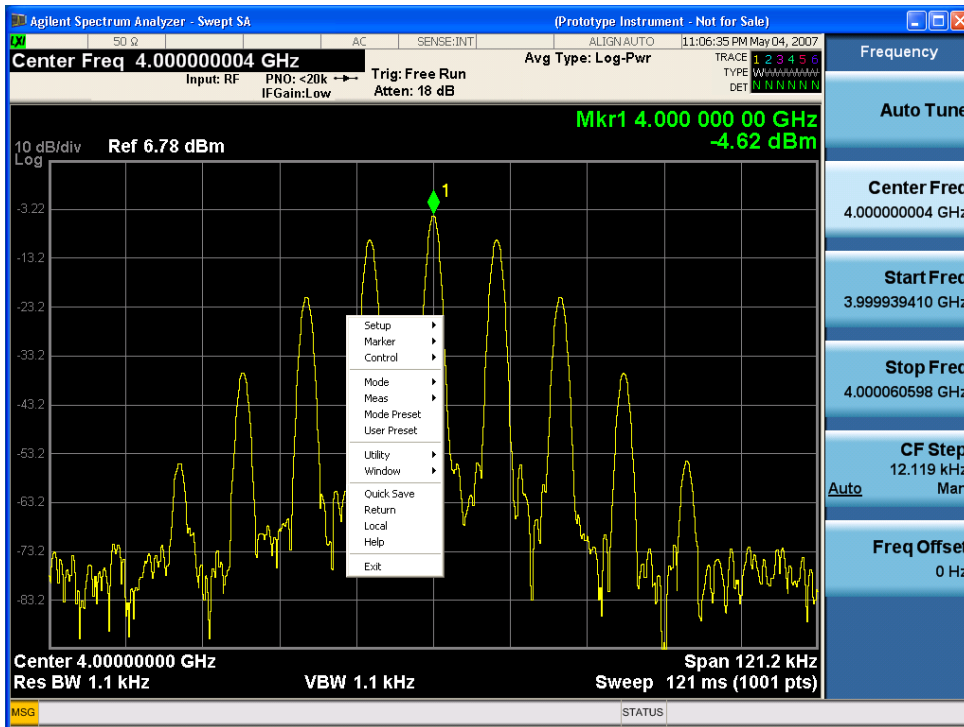

Placing the mouse on one of the rows marked with a right arrow symbol will cause that row to expand, as for example below where the mouse is hovered over the “Utility” row:

1 About the Test Set
 Mouse and Keyboard Control

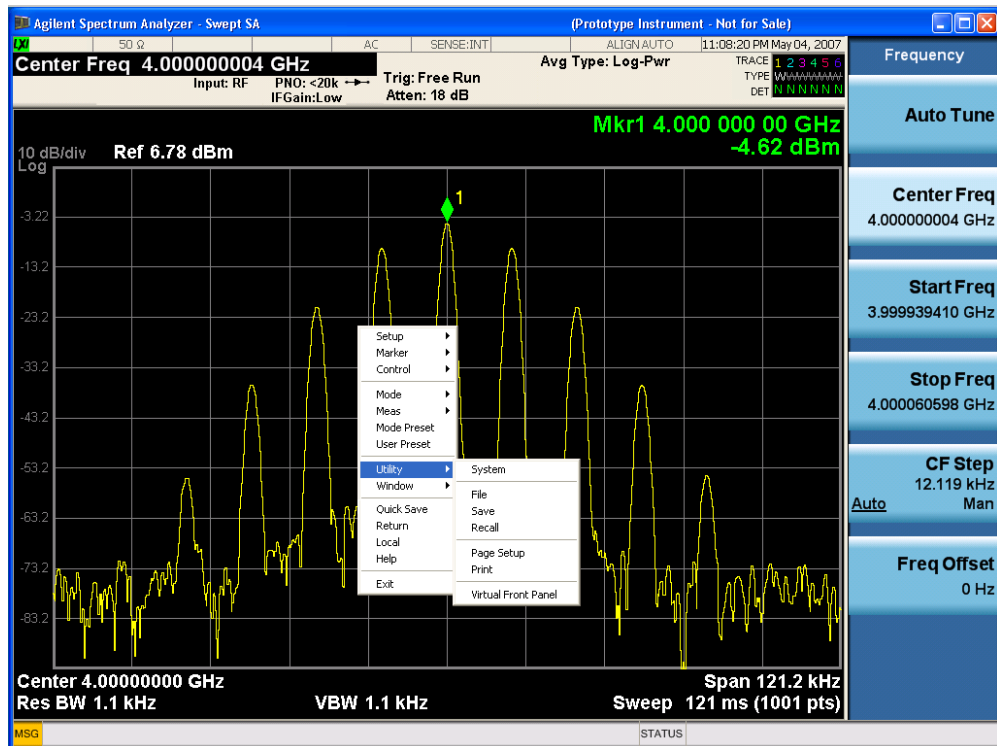

This method can be used to access any of the front-panel keys by using a mouse; as for example if you are accessing the instrument through Remote Desktop.

The array of keys thus available is shown below:

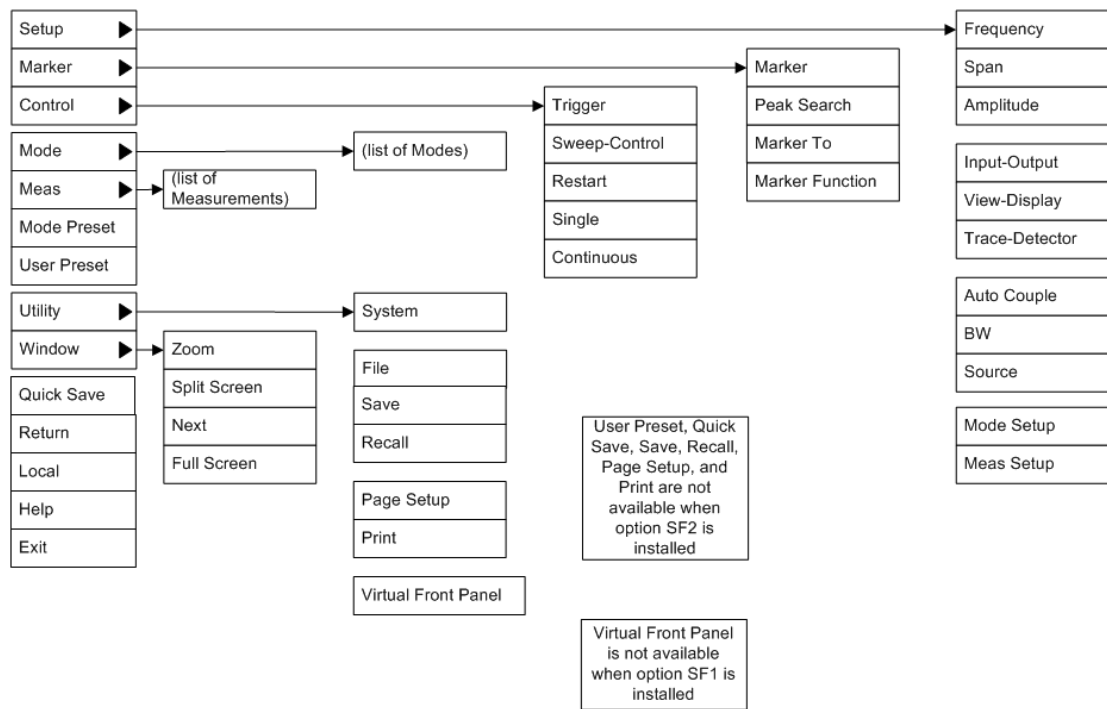

PC Keyboard

If you have a PC keyboard plugged in (or via Remote Desktop), certain key codes on the PC keyboard map to front-panel keys on the GPSA front panel. These key codes are shown below:

Front-panel key	Key code
Frequency	CTRL+SHIFT+F
Span	CTRL+SHIFT+S
Amplitude	CTRL+SHIFT+A
Input/Output	CTRL+SHIFT+O
View/Display	CTRL+SHIFT+V
Trace/Detector	CTRL+ALT+T
Auto Couple	CTRL+SHIFT+C
Bandwidth	CTRL+ALT+B
Source	CTRL+ALT-U
Marker	CTRL+ALT+K
Peak Search	CTRL+ALT+P
Marker To	CTRL+ALT+N
Marker Function	CTRL+ALT+F
System	CTRL+SHIFT+Y
Quick Save	CTRL+Q
Save	CTRL+S
Recall	CTRL+R
Mode Preset	CTRL+M
User Preset	CTRL+U
Print	CTRL+P
File	CTRL+SHIFT+L
Mode	CTRL+SHIFT+M
Measure	CTRL+ALT+M
Mode Setup	CTRL+SHIFT+E
Meas Setup	CTRL+ALT+E
Trigger	CTRL+SHIFT+T
Sweep/Control	CTRL+SHIFT+W
Restart	CTRL+ALT+R
Single	CTRL+ALT+S
Cont	CTRL+ALT+C
Zoom	CTRL+SHIFT+Z
Next Window	CTRL+SHIFT+N
Split Screen	CTRL+L

1 About the Test Set
Mouse and Keyboard Control

Front-panel key	Key code
Full Screen	CTRL+SHIFT+B
Return	CTRL+SHIFT+R
Mute	Mute
Inc Audio	Volume Up
Dec Audio	Volume Down
Help	F1
Control	CTRL
Alt	ALT
Enter	Return
Cancel	Esc
Del	Delete
Backspace	Backspace
Select	Space
Up Arrow	Up
Down Arrow	Down
Left Arrow	Left
Right Arrow	Right
Menu key 1	CTRL+SHIFT+F1
Menu key 2	CTRL+SHIFT+F2
Menu key 3	CTRL+SHIFT+F3
Menu key 4	CTRL+SHIFT+F4
Menu key 5	CTRL+SHIFT+F5
Menu key 6	CTRL+SHIFT+F6
Menu key 7	CTRL+SHIFT+F7
Backspace	BACKSPACE
Enter	ENTER
Tab	Tab
1	1
2	2
3	3
4	4
5	5
6	6
7	7
8	8
9	9
0	0

This is a pictorial view of the table:

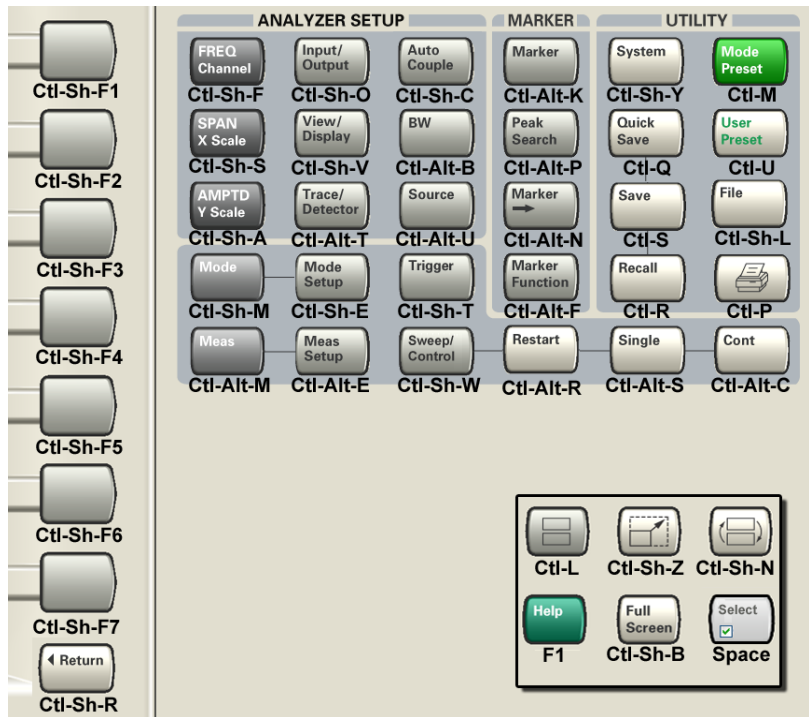

Instrument Security & Memory Volatility

If you are using the instrument in a secure environment, you may need details of how to clear or sanitize its memory, in compliance with published security standards of the United States Department of Defense, or other similar authorities.

For X-Series test sets, this information is contained in the document "Security Features and Document of Volatility". This document is not included in the instrument on-disk library, but it may be downloaded from the Keysight web site.

To obtain a copy of the document, click on or browse to the following URL:

<http://www.keysight.com/find/security>

To locate and download the document, select Model Number, for example "E6607A", then click "Submit". Then, follow the on-screen instructions to download the file.

2 About the Analog Demod Measurement Application

The analog demodulation measurements provide the capability of demodulating Amplitude, Frequency, Phase, or Stereo modulated signals (AM, FM, PM). These measurements provide functionality that can be generally categorized as follows:

- Demodulating a modulated carrier and playing the modulating signal over a speaker (sometimes referred to as tune and listen)
- Displaying demodulated signals in both time and frequency domain
- Displaying modulation metrics

Each measurement has four basic windows in which to display demodulated data. The primary view displays all four of these windows. In all views, the display is split into signal display windows and a numeric results (metrics) window. The metrics window displays carrier and modulation metrics.

These views are designed such that you can identify analog modulated carriers, determine whether the carrier is a commercial or other broadcast station, and analyze the modulating signal.

3 Programming the Test Set

This section provides introductory information about the programming documentation included with your product.

["What Programming Information is Available?" on page 62](#)

["STATus Subsystem " on page 80](#)

["Common Commands" on page 120](#)

What Programming Information is Available?

The X-Series Documentation can be accessed through the Additional Documentation page in the instrument Help system. It can also be found online at: <http://www.keysight.com/find/exm>.

The following resources are available to help you create programs for automating your X-Series measurements:

Resource	Description
X-Series Programmer's Guide	<p>Provides general SCPI programming information on the following topics:</p> <ul style="list-style-type: none">• Programming the X-Series Applications• Programming fundamentals• Programming examples <p>Note that SCPI command descriptions for measurement applications are not in this book, but are in the User's and Programmer's Reference.</p>
User's and Programmer's Reference manuals	<p>Describes all front-panel keys and softkeys, including SCPI commands for a measurement application. Note that:</p> <ul style="list-style-type: none">• Each measurement application has its own User's and Programmer's Reference.• The content in this manual is duplicated in the analyzer's Help (the Help that you see for a key is identical to what you see in this manual).
Embedded Help in your instrument	<p>Describes all front-panel keys and softkeys, including SCPI commands, for a measurement application. Note that the content that you see in Help when you press a key is identical to what you see in the User's and Programmer's Reference.</p>
X-Series Getting Started Guide	<p>Provides valuable sections related to programming including:</p> <ul style="list-style-type: none">• Licensing New Measurement Application Software - After Initial Purchase• Configuring instrument LAN Hostname, IP Address, and Gateway Address• Using the Windows XP Remote Desktop to connect to the instrument remotely• Using the Embedded Web Server Telnet connection to communicate SCPI <p>This printed document is shipped with the instrument.</p>
Keysight Application Notes	<p>Printable PDF versions of pertinent application notes.</p>
Keysight VISA User's Guide	<p>Describes the Keysight Virtual Instrument Software Architecture (VISA) library and shows how to use it to develop I/O applications and instrument drivers on Windows PCs.</p>

List of SCPI Commands

```

*CAL?
*CLS
*ESE <integer>
*ESE?
*ESR?
*IDN?
*OPC
*OPC?
*OPT?
*RCL <register#>
*RST
*SAV <register#>
*SRE <integer>
*SRE?
*STB?
*TRG
*TST?
*WAI
CALCulate:AM|FM|PM|FMSTereo:MARKer:AOff
CALCulate:AM|FM|PM|FMSTereo:MARKer[1]|2|...|12:LINEs[:STATE] OFF | ON | 0
| 1
CALCulate:AM|FM|PM|FMSTereo:MARKer[1]|2|...|12:LINEs[:STATE]?
CALCulate:AM|FM|PM|FMSTereo:MARKer[1]|2|...|12:MAXimum
CALCulate:AM|FM|PM|FMSTereo:MARKer[1]|2|...|12:MAXimum:NEXT
CALCulate:AM|FM|PM|FMSTereo:MARKer[1]|2|...|12:MINimum
CALCulate:AM|FM|PM|FMSTereo:MARKer[1]|2|...|12:MODE POSition | DELTa |
FIXed | OFF
CALCulate:AM|FM|PM|FMSTereo:MARKer[1]|2|...|12:MODE?
CALCulate:AM|FM|PM|FMSTereo:MARKer[1]|2|...|12:PTPeak
CALCulate:AM|FM|PM|FMSTereo:MARKer[1]|2|...|12:REFerence <int>
CALCulate:AM|FM|PM|FMSTereo:MARKer[1]|2|...|12:REFerence?
CALCulate:AM|FM|PM|FMSTereo:MARKer[1]|2|...|12[:SET]:CENTer
CALCulate:AM|FM|PM|FMSTereo:MARKer[1]|2|...|12:TRACe:AUTO OFF | ON | 0 | 1
CALCulate:AM|FM|PM|FMSTereo:MARKer[1]|2|...|12:TRACe:AUTO?
CALCulate:AM|FM|PM|FMSTereo:MARKer[1]|2|...|12:X <time> | <freq>
CALCulate:AM|FM|PM|FMSTereo:MARKer[1]|2|...|12:X?
CALCulate:AM|FM|PM|FMSTereo:MARKer[1]|2|...|12:Y <real>
CALCulate:AM|FM|PM|FMSTereo:MARKer[1]|2|...|12:Y?
CALCulate:AM|FM|PM:MARKer[1]|2|...|12:TRACe RFSpectrum | AFSpectrum |
DEMod | DAVerage | DMAXimum | DMINimum | RFENvelope | DRAW
CALCulate:AM|FM|PM:MARKer[1]|2|...|12:TRACe?
CALCulate:CLIMits:FAIL?
CALCulate:DATA<n>:COMPRESS? BLOCk | CFIT | MAXimum | MINimum | MEAN |
DMEan | RMS | RMSCubed | SAMPLe | SDEViation | PPHase[, <soffset>[,
<length>[, <roffset>[, <rlimit>]]]]
CALCulate:DATA[n]?
CALCulate:DATA[1]|2|...|6:PEAKs? <threshold>, <excursion>[, AMPLitude |
FREQuency | TIME]
CALCulate:DATA[1]|2|...|6:PEAKs? <threshold>, <excursion>[, AMPLitude |
FREQuency | TIME[, ALL | GTDLine | LTDLine]]

```

3 Programming the Test Set

List of SCPI Commands

```
CALCulate:FMSTereo:MARKer[1]|2|...|12:TRACe RFSpectrum | AFSpectrum |
DEMod | DAVerage | DMAXimum | DMINimum | MDEMod | MDAverage | MMAXimum |
MMINimum | MSpectrum | SDEMod | SDAverage | SMAXimum | SMINimum |
SSpectrum | LDEMod | LDAverage | LMAXimum | LMINimum | LSpectrum | RDEMod
| RDAverage | RMAXimum | RMINimum | RSpectrum
CALCulate:FMSTereo:MARKer[1]|2|...|12:TRACe?
CALCulate:FMSTereo:MONO[:BANDwidth] <freq>
CALCulate:FMSTereo:MONO[:BANDwidth]?
CALCulate:FMSTereo:MPX[:BANDwidth] <freq>
CALCulate:FMSTereo:MPX[:BANDwidth]?
CALCulate:FPOWER:POWER[1,2,...,999]?
CALCulate:FPOWER:POWER[1,2,...,999]:CONFigure
CALCulate:FPOWER:POWER[1,2,...,999]:DEFine "configurationstring"
CALCulate:FPOWER:POWER[1,2,...,999]:DEFine?
CALCulate:FPOWER:POWER[1,2,...,999]:FETCh?
CALCulate:FPOWER:POWER[1,2,...,999]:INITiate
CALCulate:FPOWER:POWER[1,2,...,999]:READ2?
CALCulate:FPOWER:POWER[1,2,...,999]:READ?
CALCulate:FPOWER:POWER[1,2,...,999]:READ1?
CALCulate:FPOWER:POWER[1,2,...,999]:RESet
CALibration[:ALL]
CALibration[:ALL]?
CALibration[:ALL]:NPENding
CALibration:EXPIred?
CALibration:IF
CALibration:IF?
CALibration:IF:NPENding
CALibration:INTernal:SOURce[:ALL]
CALibration:INTernal:SOURce[:ALL]?
CALibration:INTernal:SOURce[:ALL]:NPENding
CALibration:NRF
CALibration:NRF?
CALibration:NRF:NPENding
CALibration:RF
CALibration:RF?
CALibration:RF:NPENding
CALibration:TEMPerature:CURRent?
CALibration:TEMPerature:LALL?
CALibration:TEMPerature:LIF?
CALibration:TEMPerature:LRF?
CALibration:TEMPerature:SOURce:LALL?
CALibration:TIME:LALL?
CALibration:TIME:LIF?
CALibration:TIME:LRF?
CALibration:TIME:SOURce:LALL?
CONF FSC
CONFigure?
CONFigure?
CONFigure?
CONFigure?
CONFigure:AM
CONFigure:AM:NDEFault
```



```

CONFigure:FM
CONFigure:FM:NDEFault
CONFigure:FMSTereo
CONFigure:FMSTereo:NDEFault
CONFigure:PM
CONFigure:PM:NDEFault
DISPlay:<measurement>:ANNOtation:TITLe:DATA <string>
DISPlay:<measurement>:ANNOtation:TITLe:DATA?
DISPlay:ACTivefunc[:STATE] ON | OFF | 1 | 0
DISPlay:ACTivefunc[:STATE]?
DISPlay:AM|FM|PM:VIEW:DISToRtion:UNIT DB | PCT
DISPlay:AM|FM|PM:VIEW:DISToRtion:UNIT?
DISPlay:AM|FM|PM:VIEW:METRics:MMAGnitude ALL | PPK | PNPk | RMS | RMSRatio
DISPlay:AM|FM|PM:VIEW:METRics:MMAGnitude?
DISPlay:AM|FM|PM:VIEW[:SElect] QUAD | RFSpectrum | DEMod | AFSpectrum |
ARTime
DISPlay:AM|FM|PM:VIEW[:SElect]?
DISPlay:AM|PM|FMSTereo:WINDow[1]|2|3:TRACe:Y[:SCALe]:RPOStion TOP |
CENTer | BOTTOm
DISPlay:AM|PM|FMSTereo:WINDow[1]|2|3:TRACe:Y[:SCALe]:RPOStion?
DISPlay:AM:WINDow[1]|2|3:TRACe:Y[:SCALe]:PDIVision <real>
DISPlay:AM:WINDow[1]|2|3:TRACe:Y[:SCALe]:PDIVision?
DISPlay:AM:WINDow[1]|2|3:TRACe:Y[:SCALe]:RLEVel <real>
DISPlay:AM:WINDow[1]|2|3:TRACe:Y[:SCALe]:RLEVel?
DISPlay:ANNOtation:MBAR[:STATE] OFF | ON | 0 | 1
DISPlay:ANNOtation:MBAR[:STATE]?
DISPlay:ANNOtation:SCREen[:STATE] OFF | ON | 0 | 1
DISPlay:ANNOtation:SCREen[:STATE]?
DISPlay:FMSTereo:VIEW:DISToRtion:UNIT DB | PCT
DISPlay:FMSTereo:VIEW:DISToRtion:UNIT?
DISPlay:FMSTereo:VIEW:METRics:DISToRtion [:STATE]?
DISPlay:FMSTereo:VIEW:METRics:DISToRtion[:STATE] ON | OFF | 1 | 0
DISPlay:FMSTereo:VIEW:METRics:MRATE[:STATE] ON | OFF | 1 | 0
DISPlay:FMSTereo:VIEW:METRics:MRATE[:STATE]?
DISPlay:FMSTereo:VIEW[:SElect] MPX | MONO | STEReo | LEFT | RIGHT | RDS |
NRESults
DISPlay:FMSTereo:VIEW[:SElect]?
DISPlay:FMSTereo:WINDow[1]|2|3:TRACe:Y[:SCALe]:PDIVision <real>
DISPlay:FMSTereo:WINDow[1]|2|3:TRACe:Y[:SCALe]:PDIVision?
DISPlay:FMSTereo:WINDow[1]|2|3:TRACe:Y[:SCALe]:RLEVel <real>
DISPlay:FMSTereo:WINDow[1]|2|3:TRACe:Y[:SCALe]:RLEVel?
DISPlay:FM:WINDow[1]|2|...|5:TRACe:Y[:SCALe]:PDIVision <real>
DISPlay:FM:WINDow[1]|2|...|5:TRACe:Y[:SCALe]:PDIVision?
DISPlay:FM:WINDow[1]|2|...|5:TRACe:Y[:SCALe]:RLEVel <real>
DISPlay:FM:WINDow[1]|2|...|5:TRACe:Y[:SCALe]:RLEVel?
DISPlay:FM:WINDow[1]|2|...|5:TRACe:Y[:SCALe]:RPOStion TOP | CENTer |
BOTTOm
DISPlay:FM:WINDow[1]|2|...|5:TRACe:Y[:SCALe]:RPOStion?
DISPlay:PM:WINDow[1]|2|3:TRACe:Y[:SCALe]:PDIVision <real>
DISPlay:PM:WINDow[1]|2|3:TRACe:Y[:SCALe]:PDIVision?
DISPlay:PM:WINDow[1]|2|3:TRACe:Y[:SCALe]:RLEVel <real>
DISPlay:PM:WINDow[1]|2|3:TRACe:Y[:SCALe]:RLEVel?

```

3 Programming the Test Set

List of SCPI Commands

```
DISPlay:WINDow[1]:ANNotation[:ALL] OFF | ON | 0 | 1
DISPlay:WINDow[1]:ANNotation[:ALL]?
DISPlay:WINDow:FORMat:TILE
DISPlay:WINDow:FORMat:ZOOM
DISPlay:WINDow[:SElect] <number>
DISPlay:WINDow[:SElect]?
DISPlay:WINDow[1]:TRACe:GRATICule:GRID[:STATE] OFF | ON | 0 | 1
DISPlay:WINDow[1]:TRACe:GRATICule:GRID[:STATE]?
FEED:RF:PORT:OUTP RFIO1
FETCh:AM[n]?
FETCh:FM[n]?
FETCh:FMSTereo[n]?
FETCh:PM[n]?
FORMat:BORDER NORMAL | SWAPped
FORMat:BORDER?
FORMat[:TRACe][:DATA] ASCii | INTeger, 32 | REAL, 32 | REAL, 64
FORMat[:TRACe][:DATA]?
GLOBal:DEFault
GLOBal:FREQuency:CENTer[:STATE] 1 | 0 | ON | OFF
GLOBal:FREQuency:CENTer[:STATE]?
HCOpy:ABORT
HCOpy[:IMMediate]
INITiate:AM
INITiate:CONTinuous OFF | ON | 0 | 1
INITiate:CONTinuous?
INITiate:FM
INITiate:FMSTereo
INITiate[:IMMediate]
INITiate:PM
INITiate:REStArt
INPut<1|2>:TYPE INPUT1 | INPUT2
INPut<1|2>:TYPE?
INPut[1]|2:LISN:FILTer:HPAS[:STATE] ON | OFF
INPut[1]|2:LISN:FILTer:HPAS[:STATE]?
INPut[1]|2:LISN:PEARth GROunded | FLOating
INPut[1]|2:LISN:PEARth?
INPut[1]|2:LISN:PHASe L1 | L2 | L3 | N
INPut[1]|2:LISN:PHASe?
INPut[1]|2:LISN[:TYPE] FOURphase | ESH2Z5 | ENV216 | OFF
INPut[1]|2:LISN[:TYPE]?
INPut:MIXer EXTernal | INTernal
INPut:MIXer?
INST:NSEL 102
INST:NSEL 105
INSTrument:CATalog?
INSTrument:COUple:DEFault
INSTrument:COUple:FREQuency:CENTer ALL | NONE
INSTrument:COUple:FREQuency:CENTer?
INSTrument:DEFault
INSTrument:NSElect <integer>
INSTrument:NSElect?
INSTrument[:SElect] SA | RTSA | SEQAN | EMI | BASIC | WCDMA | EDGE GSM |
WIMAX OFDMA | VSA | PNOISE | NFIGure | ADEMODO | BTOoth | TDSCDMA | CDMA2K |
```

```

CDMA1XEV | LTE | LTETDD | LTEAFDD | LTEATDD | MSR | DVB | DTMB | DCATV |
ISDBT | CMMB | WLAN | CWLAN | CWIMAXOFDM | WIMAXFIXED | IDEN | RLC |
SCPILC | VSA89601
INSTrument[:SElect] RECeiver
INSTrument[:SElect] GSM
INSTrument[:SElect] SANalyzer
INSTrument[:SElect] 'SA' | 'PNOISE' | 'EDGE' | 'GSM' | 'BASIC'
INSTrument[:SElect]?
INST:SEL SCPILC
INST:SEL LTETDD
INST:SEL EMI
INST:SEL LTE
MEASure:AM[n]?
MEASure:FM[n]?
MEASure:FMSTereo[n]?
MEASure:PM[n]?
MMEMemory:CATalog? [<directory_name>]
MMEMemory:CDIRectory [<directory_name>]
MMEMemory:CDIRectory?
MMEMemory:COpy <string>, <string>[, <string>, <string>]
MMEMemory:COpy:DEvice <source_string>, <dest_string>
MMEMemory:DATA <file_name>, <data>
MMEMemory:DATA? <file_name>
MMEMemory:DELeTe <file_name>[, <directory_name>]
MMEMemory:HEADer:ID? "<filename>"
MMEMemory:LOAD:STATE <filename>
MMEMemory:LOAD:STATE 1, <filename>
MMEMemory:MDIRectory <directory_name>
MMEMemory:MOVE <string>, <string>[, <string>, <string>]
MMEMemory:RDIRectory <directory_name>
MMEMemory:REGister:STATE:LABel <regnumber>, "label"
MMEMemory:REGister:STATE:LABel? <regnumber>
MMEMemory:STORE:RESults:MTABLE|PTABLE|SPECTrogram <filename>
MMEMemory:STORE:SCReen <filename>
MMEMemory:STORE:SCReen:THEME TDColor | TDMonochrome | FColor | FMONochrome
MMEMemory:STORE:SCReen:THEME?
MMEMemory:STORE:STATE 1, <filename>
MMEMemory:STORE:STATE <filename>
MME:STOR:SEQuences:| SLIST | ALIST | SAAList | SStep"MySequence.txt"
OUTPut:ANALog OFF | SVIDeo | LOGVideo | LINVideo | DAUDIO
OUTPut:ANALog?
OUTPut:ANALog:AUTO OFF | ON | 0 | 1
OUTPut:ANALog:AUTO?
OUTPut[:EXtErnal][:STATE] ON | OFF | 1 | 0
OUTPut[:EXtErnal][:STATE]?
OUTPut:MODulation[:STATE] ON | OFF | 1 | 0
OUTPut:MODulation[:STATE]?
READ:AM[n]?
READ:FM[n]?
READ:FMSTereo[n]?
READ:PM[n]?
[:SENSE]:<measurement>:TRIGger:SOURce
[:SENSE]:<measurement>:TRIGger:SOURce IF

```

3 Programming the Test Set

List of SCPI Commands

```
[ :SENSe ]:ACPR:TRIGger:SOURce
[ :SENSe ]:AM|FM|PM}|FMSTereo:AFSPectrum:BANDwidth <freq>
[ :SENSe ]:AM|FM|PM:BANDwidth[:RESolution]:AUTO OFF | ON | 0 | 1
[ :SENSe ]:AM|FM|PM:BANDwidth[:RESolution]:AUTO?
[ :SENSe ]:AM|FM|PM:BPFilter OFF | CCITT | AWEighting | CWEighting |
CMESsage | CCIR1k | CCIR2k | CUNWeighting
[ :SENSe ]:AM|FM|PM:BPFilter?
[ :SENSe ]:AM|FM|PM:DEMod:TIME:AUTO OFF | ON | 0 | 1
[ :SENSe ]:AM|FM|PM:DEMod:TIME:AUTO?
[ :SENSe ]:AM|FM|PM|FMSTereo:AFSPectrum:BANDwidth?
[ :SENSe ]:AM|FM|PM|FMSTereo:AFSPectrum:BANDwidth:AUTO OFF | ON | 0 | 1
[ :SENSe ]:AM|FM|PM|FMSTereo:AFSPectrum:BANDwidth:AUTO?
[ :SENSe ]:AM|FM|PM|FMSTereo:AFSPectrum:FREQuency:START <freq>
[ :SENSe ]:AM|FM|PM|FMSTereo:AFSPectrum:FREQuency:START?
[ :SENSe ]:AM|FM|PM|FMSTereo:AFSPectrum:FREQuency:STOP <freq>
[ :SENSe ]:AM|FM|PM|FMSTereo:AFSPectrum:FREQuency:STOP?
[ :SENSe ]:AM|FM|PM|FMSTereo:AVERage:COUNT <integer>
[ :SENSe ]:AM|FM|PM|FMSTereo:AVERage:COUNT?
[ :SENSe ]:AM|FM|PM|FMSTereo:AVERage[:STATE] ON | OFF | 1 | 0
[ :SENSe ]:AM|FM|PM|FMSTereo:AVERage[:STATE]?
[ :SENSe ]:AM|FM|PM|FMSTereo:BANDwidth:CHANnel <freq>
[ :SENSe ]:AM|FM|PM|FMSTereo:BANDwidth:CHANnel?
[ :SENSe ]:AM|FM|PM|FMSTereo:BANDwidth[:RESolution] <freq>
[ :SENSe ]:AM|FM|PM|FMSTereo:BANDwidth[:RESolution]?
[ :SENSe ]:AM|FM|PM|FMSTereo:DEMod:TIME <time>
[ :SENSe ]:AM|FM|PM|FMSTereo:DEMod:TIME?
[ :SENSe ]:AM|FM|PM|FMSTereo:DWSweep:TIME <time>
[ :SENSe ]:AM|FM|PM|FMSTereo:DWSweep:TIME?
[ :SENSe ]:AM|FM|PM|FMSTereo:FREQuency:SPAN <freq>
[ :SENSe ]:AM|FM|PM|FMSTereo:FREQuency:SPAN?
[ :SENSe ]:AM|FM|PM|FMSTereo:PERIodic[:STATE] ON | OFF | 1 | 0
[ :SENSe ]:AM|FM|PM|FMSTereo:PERIodic[:STATE]?
[ :SENSe ]:AM|FM|PM:HPFilter OFF | HPF20 | HPF50 | HPF300 | HPF400
[ :SENSe ]:AM|FM|PM:HPFilter?
[ :SENSe ]:AM|FM|PM:LPFfilter OFF | LPF300 | LPF3K | LPF15K | LPF30K | LPF80K
| LPF300K | LPF100K | MANual
[ :SENSe ]:AM|FM|PM:LPFfilter?
[ :SENSe ]:AUToscale
[ :SENSe ]:CORRection:BTS[:RF]:GAIN <rel_ampl>
[ :SENSe ]:CORRection:BTS[:RF]:GAIN?
[ :SENSe ]:CORRection:BTS[:RF]:LOSS <rel_ampl>
[ :SENSe ]:CORRection:BTS[:RF]:LOSS?
[ :SENSe ]:CORRection:IMPedance[:INPut][:MAGNitude] 50 | 75
[ :SENSe ]:CORRection:IMPedance[:INPut][:MAGNitude]?
[ :SENSe ]:CORRection:MS[:RF]:GAIN <rel_ampl>
[ :SENSe ]:CORRection:MS[:RF]:GAIN?
[ :SENSe ]:CORRection:MS[:RF]:LOSS <rel_ampl>
[ :SENSe ]:CORRection:MS[:RF]:LOSS?
[ :SENSe ]:CORRection:OFFSet[:MAGNitude]
[ :SENSe ]:CORRection:SA[:RF]:GAIN <rel_ampl>
[ :SENSe ]:CORRection:SA[:RF]:GAIN?
[ :SENSe ]:FEED IQ | IONLy | QONLy
[ :SENSe ]:FEED RF | AIQ | EMIXer
```

```

[:SENSe]:FEED AREFERENCE
[:SENSe]:FEED?
[:SENSe]:FEED?
[:SENSe]:FEED:RF:PORT[:INPut] RFIN | RFIN2 | RFIO1 | RFIO2 | RFIO3 | RFIO4
[:SENSe]:FEED:RF:PORT[:INPut]?
[:SENSe]:FEED:RF:PORT:OUTPut RFOut | RFIO1 | RFIO2 | GPSout | GNSSout |
RFIO3 | RFIO4
[:SENSe]:FEED:RF:PORT:OUTPut?
[:SENSe]:FM|FMSTereo:DEEMphasis OFF | US25 | US50 | US75 | US750
[:SENSe]:FM|FMSTereo:DEEMphasis?
[:SENSe]:FMSTereo:BLER:COUNT <real>
[:SENSe]:FMSTereo:BLER:COUNT?
[:SENSe]:FMSTereo:BPFILTER OFF | CCITT | AWAUDIO
[:SENSe]:FMSTereo:BPFILTER?
[:SENSe]:FMSTereo:HPFILTER OFF | HPF20 | HPF50 | HPF300
[:SENSe]:FMSTereo:HPFILTER?
[:SENSe]:FMSTereo:LPFILTER OFF | LPF300 | LPF3K | LPF15K | LPF30K | LPF80K
| LPF300K
[:SENSe]:FMSTereo:LPFILTER?
[:SENSe]:FMSTereo:RDEVIATION <freq>
[:SENSe]:FMSTereo:RDEVIATION?
[:SENSe]:FREQUENCY:CENTER <freq>
[:SENSe]:FREQUENCY:CENTER?
[:SENSe]:FREQUENCY:CENTER:STEP:AUTO OFF | ON | 0 | 1
[:SENSe]:FREQUENCY:CENTER:STEP:AUTO?
[:SENSe]:FREQUENCY:CENTER:STEP[:INCRement] <freq>
[:SENSe]:FREQUENCY:CENTER:STEP[:INCRement]?
[:SENSe]:HDUPlex:PORT:INPut RFIO3 | RFIO4
[:SENSe]:HDUPlex:PORT:OUTPut RFIO3 | RFIO4
[:SENSe]:POWER[:RF]:RANGE <real>
[:SENSe]:POWER[:RF]:RANGE?
[:SENSe]:POWER[:RF]:RANGE:MIXer:OFFSet <real>
[:SENSe]:POWER[:RF]:RANGE:MIXer:OFFSet?
[:SENSe]:POWER[:RF]:RANGE:OPTimize IMMEDIATE
[:SENSe]:POWER[:RF]:RANGE:OPTimize:ATTenuation OFF | ON | ELECTRICAL |
COMBINED
[:SENSe]:POWER[:RF]:RANGE:OPTimize:ATTenuation?
[:SENSe]:POWER[:RF]:RANGE:PARatio <real>
[:SENSe]:POWER[:RF]:RANGE:PARatio?
[:SENSe]:ROSCillator:EXTErnal:FREQUENCY <freq>
[:SENSe]:ROSCillator:EXTErnal:FREQUENCY?
[:SENSe]:ROSCillator:SOURce INTernal | EXTErnal
[:SENSe]:ROSCillator:SOURce?
[:SENSe]:ROSCillator:SOURce:TYPE INTernal | EXTErnal | SENSE | PULSE
[:SENSe]:ROSCillator:SOURce:TYPE?
[:SENSe]:SPEaker[:STATE] ON | OFF | 1 | 0
[:SENSe]:SPEaker[:STATE]?
SOURCE:AM[:DEPTh][:LINEar]
SOURCE:AM[:DEPTh][:LINEar]?
SOURCE:AM:INTernal:FREQUENCY
SOURCE:AM:INTernal:FREQUENCY?
SOURCE:AM:STATE

```

3 Programming the Test Set

List of SCPI Commands

```
SOURce:AM:STATe?
SOURce:FM[:DEVIation]
SOURce:FM[:DEVIation]?
SOURce:FM:INTernal:FREQuency
SOURce:FM:INTernal:FREQuency?
SOURce:FM:STATe
SOURce:FM:STATe?
SOURce:FREQuency:CHANnels:BAND NONE | PGSM | EGSM | RGSM | DCS1800 |
PCS1900 | TGSM810 | GSM450 | GSM480 | GSM700 | GSM850 | BANDI | BANDII |
BANDIII | BANDIV | BANDV | BANDVI | BANDVII | BANDVIII | BANDIX | BANDX |
BANDXI | BANDXII | BANDXIII | BANDXIV | BANDXIX | USCELL | USPCS | JAPAN |
KOREAN | NMT | IMT2K | UPPER | SECOND | PAMR400 | PAMR800 | IMTEXT |
PCS1DOT9G | AWS | US2DOT5G | PUBLIC | LOWER | BAND1 | BAND2 | BAND3 |
BAND4 | BAND5 | BAND6 | BAND7 | BAND8 | BAND10 | BAND11 | BAND12 | BAND13
| BAND14 | BAND17 | BAND18 | BAND19 | BAND20 | BAND21 | BAND24 | BAND25 |
BAND26 | BAND27 | BAND28 | BAND31 | BAND33 | BAND34 | BAND35 | BAND36 |
BAND37 | BAND38 | BAND39 | BAND40 | BAND41 | BAND42 | BAND43 | BAND44 |
BANDA | BANDB | BANDC | BANDD | BANDE | BANDF
SOURce:FREQuency:CHANnels:BAND?
SOURce:FREQuency:CHANnels:NUMBER <int>
SOURce:FREQuency:CHANnels:NUMBER?
SOURce:FREQuency[:CW] <freq>
SOURce:FREQuency[:CW]?
SOURce:FREQuency:OFFSet <freq>
SOURce:FREQuency:OFFSet?
SOURce:FREQuency:REFerence <freq>
SOURce:FREQuency:REFerence?
SOURce:FREQuency:REFerence:SET
SOURce:FREQuency:REFerence:STATe OFF | ON | 0 | 1
SOURce:FREQuency:REFerence:STATe?
SOURce:LIST:INITiation:ARMed?
SOURce:LIST:NUMBER:STEPS <integer>
SOURce:LIST:NUMBER:STEPS?
SOURce:LIST:SETup:AMPLitude <ampl>, <ampl>, <ampl>, ...
SOURce:LIST:SETup:AMPLitude?
SOURce:LIST:SETup:CLEar
SOURce:LIST:SETup:CNFFrequency <double>, <double>, <double>, ...
SOURce:LIST:SETup:CNFFrequency?
SOURce:LIST:SETup:DURATION:TYPE <enum>, <enum>, <enum>, ...
SOURce:LIST:SETup:DURATION:TYPE?
SOURce:LIST:SETup:INPut:TRIGger <enum>, <enum>, <enum>, ...
SOURce:LIST:SETup:INPut:TRIGger?
SOURce:LIST:SETup:OUTPut:TRIGger ?
SOURce:LIST:SETup:OUTPut:TRIGger <bool>, <bool>, <bool>, ...
SOURce:LIST:SETup:RADio:BAND <enum>, <enum>, <enum>, ...
SOURce:LIST:SETup:RADio:BAND?
SOURce:LIST:SETup:RADio:BAND:LINK <enum>, <enum>, <enum>, ...
SOURce:LIST:SETup:RADio:BAND:LINK?
SOURce:LIST:SETup:TOCount <time/int>, <time/int>, <time/int>, ...
SOURce:LIST:SETup:TOCount?
SOURce:LIST:SETup:TRANSition:TIME <time>, <time>, <time>, ...
SOURce:LIST:SETup:TRANSition:TIME?
```

```

SOURCE:LIST:SETup:WAVEform <string>, <string>, <string>, ...
SOURCE:LIST:SETup:WAVEform?
SOURCE:LIST[:STATE] ON | OFF | 1 | 0
SOURCE:LIST[:STATE]?
SOURCE:LIST:STEP[1]|2|...|4..1000:SETup IMMEDIATE | INTERNAL | KEY | BUS |
EXTERNAL2, <time>, NONE | PGSM | EGSM | RGSM | DCS1800 | PCS1900 | TGSM810
| GSM450 | GSM480 | GSM700 | GSM850 | BANDI | BANDII | BANDIII | BANDIV |
BANDV | BANDVI | BANDVII | BANDVIII | BANDIX | BANDX | BANDXI | BANDXII |
BANDXIII | BANDXIV | BANDXIX | USCELL | USPCS | JAPAN | KOREAN | NMT |
IMT2K | UPPER | SECOND | PAMR400 | PAMR800 | IMTEXT | PCS1DOT9G | AWS |
US2DOT5G | PUBLIC | LOWER | NONE | BAND1 | BAND2 | BAND3 | BAND4 | BAND5 |
BAND6 | BAND7 | BAND8 | BAND10 | BAND11 | BAND12 | BAND13 | BAND14 |
BAND17 | BAND18 | BAND19 | BAND20 | BAND21 | BAND24 | BAND25 | BAND26 |
BAND33 | BAND34 | BAND35 | BAND36 | BAND37 | BAND38 | BAND39 | BAND40 |
BAND41 | BAND42 | BAND43 | BANDA | BANDB | BANDC | BANDD | BANDE | BANDE,
DOWN | UP, <freq>, <ampl>, <string>, TIME | COUNT | CONTinuous, <time>, ON
| OFF | 1 | 0, [<int>],
SOURCE:LIST:STEP[1]|2|...|4..1000:SETup?
SOURCE:LIST:STEP[1]|2|3...1000:SETup:AMPLitude <double>
SOURCE:LIST:STEP[1]|2|3...1000:SETup:AMPLitude?
SOURCE:LIST:STEP[1]|2|3...1000:SETup:CNFRequency <double>
SOURCE:LIST:STEP[1]|2|3...1000:SETup:CNFRequency <double>
SOURCE:LIST:STEP[1]|2|3...1000:SETup:CNFRequency?
SOURCE:LIST:STEP[1]|2|3...1000:SETup:CNFRequency?
SOURCE:LIST:STEP[1]|2|3...1000:SETup:DURation:TCOUNT <double>
SOURCE:LIST:STEP[1]|2|3...1000:SETup:DURation:TCOUNT?
SOURCE:LIST:STEP[1]|2|3...1000:SETup:DURation:TYPE TIME | COUNT |
CONTinuous | CABort
SOURCE:LIST:STEP[1]|2|3...1000:SETup:DURation:TYPE?
SOURCE:LIST:STEP[1]|2|3...1000:SETup:INPut:TRIGger IMMEDIATE | INTERNAL |
EXTERNAL2 | KEY | BUS | EXTERNAL4
SOURCE:LIST:STEP[1]|2|3...1000:SETup:INPut:TRIGger?
SOURCE:LIST:STEP[1]|2|3...1000:SETup:OUTPut:TRIGger ON | OFF | 1 | 0
SOURCE:LIST:STEP[1]|2|3...1000:SETup:OUTPut:TRIGger
SOURCE:LIST:STEP[1]|2|3...1000:SETup:RADio:BAND NONE | PGSM | EGSM | RGSM
| DCS1800 | PCS1900 | TGSM810 | GSM450 | GSM480 | GSM700 | GSM850 | BANDI
| BANDII | BANDIII | BANDIV | BANDV | BANDVI | BANDVII | BANDVIII | BANDIX
| BANDX | BANDXI | BANDXII | BANDXIII | BANDXIV | BANDXIX | USCELL | USPCS
| JAPAN | KOREAN | NMT | IMT2K | UPPER | SECOND | PAMR400 | PAMR800 |
IMTEXT | PCS1DOT9G | AWS | US2DOT5G | PUBLIC | LOWER | NONE | BAND1 |
BAND2 | BAND3 | BAND4 | BAND5 | BAND6 | BAND7 | BAND8 | BAND10 | BAND11 |
BAND12 | BAND13 | BAND14 | BAND17 | BAND18 | BAND19 | BAND20 | BAND21 |
BAND24 | BAND25 | BAND26 | BAND27 | BAND28 | BAND31 | BAND33 | BAND34 |
BAND35 | BAND36 | BAND37 | BAND38 | BAND39 | BAND40 | BAND41 | BAND42 |
BAND43 | BAND44 | BANDA | BANDB | BANDC | BANDD | BANDE | BANDE
SOURCE:LIST:STEP[1]|2|3...1000:SETup:RADio:BAND?
SOURCE:LIST:STEP[1]|2|3...1000:SETup:RADio:BAND:LINK DOWN | UP
SOURCE:LIST:STEP[1]|2|3...1000:SETup:RADio:BAND:LINK?
SOURCE:LIST:STEP[1]|2|3...1000:SETup:TRANSition:TIME <time>
SOURCE:LIST:STEP[1]|2|3...1000:SETup:TRANSition:TIME?
SOURCE:LIST:STEP[1]|2|3...1000:SETup:WAVEform <string>

```

3 Programming the Test Set

List of SCPI Commands

```
SOURce:LIST:STEP[1]|2|3...1000:SETup:WAVEform?
SOURce:LIST:TRIGger[:IMMediate]
SOURce:LIST:TRIGger:INITiate[:IMMediate]
SOURce:LIST:TRIGgerout:TYPE BEGinningofstep | DATamarker
SOURce:PM[:DEVIation]
SOURce:PM[:DEVIation]?
SOURce:PM:INTernal:FREQuency
SOURce:PM:INTernal:FREQuency?
SOURce:PM:STATe
SOURce:PM:STATe?
SOURce:POWER[:LEVel][:IMMediate][:AMPLitude] <ampl>
SOURce:POWER[:LEVel][:IMMediate][:AMPLitude]?
SOURce:POWER[:LEVel][:IMMediate]:OFFSet <rel_ampl>
SOURce:POWER[:LEVel][:IMMediate]:OFFSet?
SOURce:POWER:REFerence <ampl>
SOURce:POWER:REFerence?
SOURce:POWER:REFerence:STATe OFF | ON | 0 | 1
SOURce:POWER:REFerence:STATe?
SOURce:PRESet
SOURce:RADio:ARB:BASEband:FREQuency:OFFSet <freq>
SOURce:RADio:ARB:BASEband:FREQuency:OFFSet?
SOURce:RADio:ARB:CATalog?
SOURce:RADio:ARB:DEFault:DIRectory <string>
SOURce:RADio:ARB:DEFault:DIRectory?
SOURce:RADio:ARB:DELeTe <string>
SOURce:RADio:ARB:DELeTe:ALL
SOURce:RADio:ARB:FCATalog?
SOURce:RADio:ARB:HEADer:CLEar
SOURce:RADio:ARB:HEADer:SAVE
SOURce:RADio:ARB:LOAD <string>
SOURce:RADio:ARB:LOAD:ALL <string>
SOURce:RADio:ARB:MDESTination:ALCHold NONE | M1 | M2 | M3 | M4
SOURce:RADio:ARB:MDESTination:ALCHold?
SOURce:RADio:ARB:MDESTination:PULSE NONE | M1 | M2 | M3 | M4
SOURce:RADio:ARB:MDESTination:PULSE?
SOURce:RADio:ARB:MPLicensed:NAME:LOCKed?
SOURce:RADio:ARB:MPLicensed:UID:LOCKed?
SOURce:RADio:ARB:MPOLarity:MARKer4 POSitive | NEGative
SOURce:RADio:ARB:MPOLarity:MARKer1 POSitive | NEGative
SOURce:RADio:ARB:MPOLarity:MARKer3 POSitive | NEGative
SOURce:RADio:ARB:MPOLarity:MARKer2 POSitive | NEGative
SOURce:RADio:ARB:MPOLarity:MARKer3?
SOURce:RADio:ARB:MPOLarity:MARKer2?
SOURce:RADio:ARB:MPOLarity:MARKer4?
SOURce:RADio:ARB:MPOLarity:MARKer1?
SOURce:RADio:ARB:RETRigger ON | OFF | IMMediate
SOURce:RADio:ARB:RETRigger?
SOURce:RADio:ARB:RSCaling <real>
SOURce:RADio:ARB:RSCaling?
SOURce:RADio:ARB:SCLock:RATE <freq>
SOURce:RADio:ARB:SCLock:RATE?
SOURce:RADio:ARB:SEQuence[:MWAVEform] <filename>, <waveform1>, <reps>,
NONE | M1 | M2 | M3 | M4 | M1M2 | M1M3 | M1M4 | M2M3 | M2M4 | M3M4 |
```



```

M1M2M3 | M1M2M4 | M1M3M4 | M2M3M4 | M1M2M3M4 | ALL, {<waveform2>, <reps>,
NONE | M1 | M2 | M3 | M4 | M1M2 | M1M3 | M1M4 | M2M3 | M2M4 | M3M4 |
M1M2M3 | M1M2M4 | M1M3M4 | M2M3M4 | M1M2M3M4 | ALL, }...
SOURCE:RADio:ARB:SEQUence[:MWAVEform]? <filename>
SOURCE:RADio:ARB[:STATE] ON | OFF | 1 | 0
SOURCE:RADio:ARB[:STATE]?
SOURCE:RADio:ARB:TRIGger:INITiate
SOURCE:RADio:ARB:TRIGger[:SOURCE] KEY | BUS | EXTErnal2
SOURCE:RADio:ARB:TRIGger[:SOURCE]?
SOURCE:RADio:ARB:TRIGger:TYPE CONTInuous | SINGle | SADVanceGATE
SOURCE:RADio:ARB:TRIGger:TYPE?
SOURCE:RADio:ARB:TRIGger:TYPE:CONTInuous[:TYPE] FREE | TRIGger | RESet
SOURCE:RADio:ARB:TRIGger:TYPE:CONTInuous[:TYPE]?
SOURCE:RADio:ARB:TRIGger:TYPE:SADVance[:TYPE] SINGle | CONTInuous
SOURCE:RADio:ARB:TRIGger:TYPE:SADVance[:TYPE]?
SOURCE:RADio:ARB:WAVEform <string>
SOURCE:RADio:ARB:WAVEform?
SOURCE:RADio:BAND:LINK DOWN | UP
SOURCE:RADio:BAND:LINK?
SOURCE:RADio:DEVIce BTS | MS
SOURCE:RADio:DEVIce?
STATus:OPERation:CONDition?
STATus:OPERation:ENABle <integer>
STATus:OPERation:ENABle?
STATus:OPERation[:EVENT]?
STATus:OPERation:NTRansition <integer>
STATus:OPERation:NTRansition?
STATus:OPERation:PTRansition <integer>
STATus:OPERation:PTRansition?
STATus:PRESet
STATus:QUESTionable:CALibration:CONDition?
STATus:QUESTionable:CALibration:ENABle <integer>
STATus:QUESTionable:CALibration:ENABle?
STATus:QUESTionable:CALibration[:EVENT]?
STATus:QUESTionable:CALibration:EXTended:FAILure:CONDition?
STATus:QUESTionable:CALibration:EXTended:FAILure:ENABle <integer>
STATus:QUESTionable:CALibration:EXTended:FAILure:ENABle?
STATus:QUESTionable:CALibration:EXTended:FAILure[:EVENT]?
STATus:QUESTionable:CALibration:EXTended:FAILure:NTRansition <integer>
STATus:QUESTionable:CALibration:EXTended:FAILure:NTRansition?
STATus:QUESTionable:CALibration:EXTended:FAILure:PTRansition <integer>
STATus:QUESTionable:CALibration:EXTended:FAILure:PTRansition?
STATus:QUESTionable:CALibration:EXTended:NEEDED:CONDition?
STATus:QUESTionable:CALibration:EXTended:NEEDED:ENABle <integer>
STATus:QUESTionable:CALibration:EXTended:NEEDED:ENABle?
STATus:QUESTionable:CALibration:EXTended:NEEDED[:EVENT]?
STATus:QUESTionable:CALibration:EXTended:NEEDED:NTRansition <integer>
STATus:QUESTionable:CALibration:EXTended:NEEDED:NTRansition?
STATus:QUESTionable:CALibration:EXTended:NEEDED:PTRansition <integer>
STATus:QUESTionable:CALibration:EXTended:NEEDED:PTRansition?
STATus:QUESTionable:CALibration:NTRansition <integer>
STATus:QUESTionable:CALibration:NTRansition?
STATus:QUESTionable:CALibration:PTRansition <integer>

```

3 Programming the Test Set List of SCPI Commands

```
STATUS:QUESTIONABLE:CALIBRATION:PTRANSITION?
STATUS:QUESTIONABLE:CALIBRATION:SKIPPED:CONDITION?
STATUS:QUESTIONABLE:CALIBRATION:SKIPPED:ENABLE <integer>
STATUS:QUESTIONABLE:CALIBRATION:SKIPPED:ENABLE?
STATUS:QUESTIONABLE:CALIBRATION:SKIPPED[:EVENT]?
STATUS:QUESTIONABLE:CALIBRATION:SKIPPED:NTRANSITION <integer>
STATUS:QUESTIONABLE:CALIBRATION:SKIPPED:NTRANSITION?
STATUS:QUESTIONABLE:CALIBRATION:SKIPPED:PTRANSITION <integer>
STATUS:QUESTIONABLE:CALIBRATION:SKIPPED:PTRANSITION?
STATUS:QUESTIONABLE:CONDITION?
STATUS:QUESTIONABLE:ENABLE <integer>
STATUS:QUESTIONABLE:ENABLE?
STATUS:QUESTIONABLE[:EVENT]?
STATUS:QUESTIONABLE:FREQUENCY:CONDITION?
STATUS:QUESTIONABLE:FREQUENCY:ENABLE <integer>
STATUS:QUESTIONABLE:FREQUENCY:ENABLE?
STATUS:QUESTIONABLE:FREQUENCY[:EVENT]?
STATUS:QUESTIONABLE:FREQUENCY:NTRANSITION <integer>
STATUS:QUESTIONABLE:FREQUENCY:NTRANSITION?
STATUS:QUESTIONABLE:FREQUENCY:PTRANSITION <integer>
STATUS:QUESTIONABLE:FREQUENCY:PTRANSITION?
STATUS:QUESTIONABLE:INTEGRITY:CONDITION?
STATUS:QUESTIONABLE:INTEGRITY:ENABLE <integer>
STATUS:QUESTIONABLE:INTEGRITY:ENABLE?
STATUS:QUESTIONABLE:INTEGRITY[:EVENT]?
STATUS:QUESTIONABLE:INTEGRITY:NTRANSITION <integer>
STATUS:QUESTIONABLE:INTEGRITY:NTRANSITION?
STATUS:QUESTIONABLE:INTEGRITY:PTRANSITION <integer>
STATUS:QUESTIONABLE:INTEGRITY:PTRANSITION?
STATUS:QUESTIONABLE:INTEGRITY:SIGNAL:CONDITION?
STATUS:QUESTIONABLE:INTEGRITY:SIGNAL:ENABLE <integer>
STATUS:QUESTIONABLE:INTEGRITY:SIGNAL:ENABLE?
STATUS:QUESTIONABLE:INTEGRITY:SIGNAL[:EVENT]?
STATUS:QUESTIONABLE:INTEGRITY:SIGNAL:NTRANSITION <integer>
STATUS:QUESTIONABLE:INTEGRITY:SIGNAL:NTRANSITION?
STATUS:QUESTIONABLE:INTEGRITY:SIGNAL:PTRANSITION <integer>
STATUS:QUESTIONABLE:INTEGRITY:SIGNAL:PTRANSITION?
STATUS:QUESTIONABLE:INTEGRITY:UNCALIBRATED:CONDITION?
STATUS:QUESTIONABLE:INTEGRITY:UNCALIBRATED:ENABLE
STATUS:QUESTIONABLE:INTEGRITY:UNCALIBRATED:ENABLE?
STATUS:QUESTIONABLE:INTEGRITY:UNCALIBRATED[:EVENT]?
STATUS:QUESTIONABLE:INTEGRITY:UNCALIBRATED:NTRANSITION <integer>
STATUS:QUESTIONABLE:INTEGRITY:UNCALIBRATED:NTRANSITION?
STATUS:QUESTIONABLE:INTEGRITY:UNCALIBRATED:PTRANSITION <integer>
STATUS:QUESTIONABLE:INTEGRITY:UNCALIBRATED:PTRANSITION?
STATUS:QUESTIONABLE:NTRANSITION <integer>
STATUS:QUESTIONABLE:NTRANSITION?
STATUS:QUESTIONABLE:POWER:CONDITION?
STATUS:QUESTIONABLE:POWER:ENABLE <integer>
STATUS:QUESTIONABLE:POWER:ENABLE?
STATUS:QUESTIONABLE:POWER[:EVENT]?
STATUS:QUESTIONABLE:POWER:NTRANSITION <integer>
STATUS:QUESTIONABLE:POWER:NTRANSITION?
```

```

STATus:QUEStionable:POWer:PTRansition <integer>
STATus:QUEStionable:POWer:PTRansition?
STATus:QUEStionable:PTRansition <integer>
STATus:QUEStionable:PTRansition?
STATus:QUEStionable:TEMPerature:CONDition?
STATus:QUEStionable:TEMPerature:ENABle <integer>
STATus:QUEStionable:TEMPerature:ENABle?
STATus:QUEStionable:TEMPerature[:EVENT]?
STATus:QUEStionable:TEMPerature:NTRansition <integer>
STATus:QUEStionable:TEMPerature:NTRansition?
STATus:QUEStionable:TEMPerature:PTRansition <integer>
STATus:QUEStionable:TEMPerature:PTRansition?
SYSTem:APPLication:CATalog[:NAME]?
SYSTem:APPLication:CATalog[:NAME]:COUNT?
SYSTem:APPLication:CATalog:OPTion? <model>
SYSTem:APPLication:CATalog:REVision? <model>
SYSTem:APPLication[:CURRent][:NAME]?
SYSTem:APPLication[:CURRent]:OPTion?
SYSTem:APPLication[:CURRent]:REVision?
SYSTem:COMMunicate:LAN:SCPI:HISLip:ENABle OFF | ON | 0 | 1
SYSTem:COMMunicate:LAN:SCPI:HISLip:ENABle?
SYSTem:COMMunicate:LAN:SCPI:SICL:ENABle OFF | ON | 0 | 1
SYSTem:COMMunicate:LAN:SCPI:SICL:ENABle?
SYSTem:COMMunicate:LAN:SCPI:SOCKet:CONTRol?
SYSTem:COMMunicate:LAN:SCPI:SOCKet:ENABle OFF | ON | 0 | 1
SYSTem:COMMunicate:LAN:SCPI:SOCKet:ENABle?
SYSTem:COMMunicate:LAN:SCPI:TELNet:ENABle OFF | ON | 0 | 1
SYSTem:COMMunicate:LAN:SCPI:TELNet:ENABle?
SYSTem:CONFigure[:SYSTem]?
SYSTem:CSYSTem?
SYSTem:DATE "<year>, <month>, <day>"
SYSTem:DATE?
SYSTem:DEFault [ALL] | ALIGn | INPut | MISC | MODes | PON
SYSTem:ERRor[:NEXT]?
SYSTem:ERRor:OVERload[:STATe] 0 | 1 | OFF | ON
SYSTem:ERRor:PUP?
SYSTem:ERRor:VERBose OFF | ON | 0 | 1
SYSTem:ERRor:VERBose?
SYSTem:HELP:HEADers?
SYSTem:HID?
SYSTem:IDN <string>
SYSTem:IDN?
SYSTem:KLOCK OFF | ON | 0 | 1
SYSTem:KLOCK?
SYSTem:LICense[:FPACK]:WAVEform:ADD <string>
SYSTem:LICense[:FPACK]:WAVEform:CLEar <int>
SYSTem:LICense[:FPACK]:WAVEform:FREE?
SYSTem:LICense[:FPACK]:WAVEform:LOCK <int>
SYSTem:LICense[:FPACK]:WAVEform:NAME? <int>
SYSTem:LICense[:FPACK]:WAVEform:REPLace <int>, <string>
SYSTem:LICense[:FPACK]:WAVEform:STATus? <int>
SYSTem:LICense[:FPACK]:WAVEform:UID? <int>
SYSTem:LICense[:FPACK]:WAVEform:USED?

```

3 Programming the Test Set

List of SCPI Commands

```
SYSTem:LKEY <"OptionInfo">, <"LicenseInfo">
SYSTem:LKEY? <"OptionInfo">
SYSTem:LKEY:DELeTe <"OptionInfo">, <"LicenseInfo">
SYSTem:LKEY:LIST?
SYSTem:LKEY:WAVEform:ADD <string>
SYSTem:LKEY:WAVEform:CLEAr <int>
SYSTem:LKEY:WAVEform:FREE?
SYSTem:LKEY:WAVEform:LOCK <int>
SYSTem:LKEY:WAVEform:NAME? <int>
SYSTem:LKEY:WAVEform:REPLace <int>, <string>
SYSTem:LKEY:WAVEform:STATUs? <int>
SYSTem:LKEY:WAVEform:UID? <int>
SYSTem:LKEY:WAVEform:USED?
SYSTem:MODule:DEFault "<mnemonic>"
SYSTem:MODule:DEFault?
SYSTem:MODule:ENABle "<mnemonic>", 0 | 1
SYSTem:MODule:ENABle? "<mnemonic>"
SYSTem:MODule:INDEx?
SYSTem:MODule:LIST?
SYSTem:MODule:MNEMonic?
SYSTem:MODule:MODEl?
SYSTem:MODule:NAME?
SYSTem:MODule:SERial?
SYSTem:OPTions?
SYSTem:PDOWn [NORMal | FORCe]
SYSTem:PON:APPLication:LLISt <stringofINSTRument:SElectnames>
SYSTem:PON:APPLication:LLISt?
SYSTem:PON:APPLication:VMEMory[:AVAIlable]?
SYSTem:PON:APPLication:VMEMory:TOTAL?
SYSTem:PON:APPLication:VMEMory:USED?
SYSTem:PON:APPLication:VMEMory:USED:NAME? <INSTRument:SElectname>
SYSTem:PON:MODE SA | BASIC | ADEMOD | NFIGURE | PNOISE | CDMA2K | TDSCDMA
| VSA | VSA89601 | WCDMA | WIMAXOFDMA
SYSTem:PON:MODE?
SYSTem:PON:TIME?
SYSTem:PON:TYPE PRESet
SYSTem:PON:TYPE MODE | USER | LAST
SYSTem:PON:TYPE?
SYSTem:PRESet
SYSTem:PRESet:TYPE FACTory | MODE | USER
SYSTem:PRESet:TYPE?
SYSTem:PRESet:USER
SYSTem:PRESet:USER:ALL
SYSTem:PRESet:USER:SAVE
SYSTem:PRINt:THEME TDColor | TDMonochrome | FCOLor | FMONochrome
SYSTem:PRINt:THEMe?
SYSTem:PUP:PROCEss
SYSTem:SECurity:USB:WPRotect[:ENABle] ON | OFF | 0 | 1
SYSTem:SECurity:USB:WPRotect[:ENABle]?
SYSTem:SHOW OFF | ERRor | SYSTem | HARDware | LXI | HWSTATistics |
ALIGNment | SOFTware | CAPplication
SYSTem:SHOW?
SYSTem:TEST:WCTS:[ALL]
```

```

SYSTEM:TEST:WCTS:FEC
SYSTEM:TEST:WCTS:FEC:RESult?
SYSTEM:TEST:WCTS:SHOW:RESult FEC
SYSTEM:TIME "<hour>, <minute>, <second>"
SYSTEM:TIME?
SYSTEM:VERSion?
TRIGger:<measurement>[:SEquence]:IQ:SOURce EXTernal1 | EXTernal2 |
IMMediate | IQMag | IDEMod | QDEMod | IINPut | QINPut | AIQMag
TRIGger:<measurement>[:SEquence]:IQ:SOURce?
TRIGger:<measurement>[:SEquence]:RF:SOURce EXTernal1 | EXTernal2 |
IMMediate | LINE | FRAME | RFBurst | VIDEo | IF | ALARm | LAN | TV
TRIGger:<measurement>[:SEquence]:RF:SOURce?
TRIGger:<measurement>[:SEquence]:SOURce EXTernal1 | EXTernal2 | IMMediate
| LINE | FRAME | RFBurst | VIDEo | IF | ALARm | LAN | IQMag | IDEMod |
QDEMod | IINPut | QINPut | AIQMag | TV
TRIGger:<measurement>[:SEquence]:SOURce?
TRIGger[:SEquence]:ATRigger <time>
TRIGger[:SEquence]:ATRigger?
TRIGger[:SEquence]:ATRigger:STATE OFF | ON | 0 | 1
TRIGger[:SEquence]:ATRigger:STATE?
TRIGger[:SEquence]:DELay <time>
TRIGger[:SEquence]:DELay?
TRIGger[:SEquence]:DELay:STATE OFF | ON | 0 | 1
TRIGger[:SEquence]:DELay:STATE?
TRIGger[:SEquence]:EXTernal1:DELay <time>
TRIGger[:SEquence]:EXTernal2:DELay <time>
TRIGger[:SEquence]:EXTernal:DELay
TRIGger[:SEquence]:EXTernal1:DELay?
TRIGger[:SEquence]:EXTernal2:DELay?
TRIGger[:SEquence]:EXTernal1:DELay:COMPensation OFF | ON | 0 | 1
TRIGger[:SEquence]:EXTernal2:DELay:COMPensation OFF | ON | 0 | 1
TRIGger[:SEquence]:EXTernal1:DELay:COMPensation?
TRIGger[:SEquence]:EXTernal2:DELay:COMPensation?
TRIGger[:SEquence]:EXTernal1:DELay:STATE OFF | ON | 0 | 1
TRIGger[:SEquence]:EXTernal2:DELay:STATE OFF | ON | 0 | 1
TRIGger[:SEquence]:EXTernal2:DELay:STATE?
TRIGger[:SEquence]:EXTernal1:DELay:STATE?
TRIGger[:SEquence]:EXTernal2:LEVel
TRIGger[:SEquence]:EXTernal1:LEVel <level>
TRIGger[:SEquence]:EXTernal:LEVel
TRIGger[:SEquence]:EXTernal1:LEVel?
TRIGger[:SEquence]:EXTernal2:LEVel?
TRIGger[:SEquence]:EXTernal1:SLOPe POSitive | NEGative
TRIGger[:SEquence]:EXTernal:SLOPe
TRIGger[:SEquence]:EXTernal2:SLOPe POSitive | NEGative
TRIGger[:SEquence]:EXTernal2:SLOPe?
TRIGger[:SEquence]:EXTernal1:SLOPe?
TRIGger[:SEquence]:FRAME:ADJust <time>
TRIGger[:SEquence]:FRAME:DELay <time>
TRIGger[:SEquence]:FRAME:DELay?
TRIGger[:SEquence]:FRAME:DELay:STATE OFF | ON | 0 | 1
TRIGger[:SEquence]:FRAME:DELay:STATE?

```

3 Programming the Test Set

List of SCPI Commands

```
TRIGger[:SEquence]:FRAMe:EXTeRnAl1:LEVel
TRIGger[:SEquence]:FRAMe:EXTeRnAl2:LEVel
TRIGger[:SEquence]:FRAMe:EXTeRnAl1:SLOPe
TRIGger[:SEquence]:FRAMe:EXTeRnAl2:SLOPe
TRIGger[:SEquence]:FRAMe:OFFSet <time>
TRIGger[:SEquence]:FRAMe:OFFSet?
TRIGger[:SEquence]:FRAMe:OFFSet:DISPlay:RESet
TRIGger[:SEquence]:FRAMe:PERiod <time>
TRIGger[:SEquence]:FRAMe:PERiod?
TRIGger[:SEquence]:FRAMe:RFBurst:LEVel:ABSolute
TRIGger[:SEquence]:FRAMe:RFBurst:SLOPe
TRIGger[:SEquence]:FRAMe:SYNC EXTeRnAl1 | EXTeRnAl2 | RFBurst | OFF
TRIGger[:SEquence]:FRAMe:SYNC EXTeRnAl
TRIGger[:SEquence]:FRAMe:SYNC?
TRIGger[:SEquence]:HOLDoFF <time>
TRIGger[:SEquence]:HOLDoFF?
TRIGger[:SEquence]:HOLDoFF:STATe OFF | ON | 0 | 1
TRIGger[:SEquence]:HOLDoFF:STATe?
TRIGger[:SEquence]:IF:LEVel
TRIGger[:SEquence]:IF:LEVel?
TRIGger[:SEquence]:IF:SLOPe NEGAtive | POSitive
TRIGger[:SEquence]:IF:SLOPe?
TRIGger[:SEquence]:OFFSet <time>
TRIGger[:SEquence]:OFFSet?
TRIGger[:SEquence]:OFFSet:STATe OFF | ON | 0 | 1
TRIGger[:SEquence]:OFFSet:STATe?
TRIGger[:SEquence]:RFBurst:DElay <time>
TRIGger[:SEquence]:RFBurst:DElay?
TRIGger[:SEquence]:RFBurst:DElay:STATe OFF | ON | 0 | 1
TRIGger[:SEquence]:RFBurst:DElay:STATe?
TRIGger[:SEquence]:RFBurst:LEVel
TRIGger[:SEquence]:RFBurst:LEVel:ABSolute <ampl>
TRIGger[:SEquence]:RFBurst:LEVel:ABSolute?
TRIGger[:SEquence]:RFBurst:LEVel:RELative <rel_ampl>
TRIGger[:SEquence]:RFBurst:LEVel:RELative?
TRIGger[:SEquence]:RFBurst:LEVel:TYPE ABSolute | RELative
TRIGger[:SEquence]:RFBurst:LEVel:TYPE?
TRIGger[:SEquence]:RFBurst:SLOPe POSitive | NEGAtive
TRIGger[:SEquence]:RFBurst:SLOPe?
TRIGger[:SEquence]:SLOPe POSitive | NEGAtive
TRIGger[:SEquence]:SLOPe?
TRIGger[:SEquence]:SOURCe EXTeRnAl
TRIGger[:SEquence]:VIDeo:DElay <time>
TRIGger[:SEquence]:VIDeo:DElay?
TRIGger[:SEquence]:VIDeo:DElay:STATe OFF | ON | 0 | 1
TRIGger[:SEquence]:VIDeo:DElay:STATe?
TRIGger[:SEquence]:VIDeo:LEVel <ampl>
TRIGger[:SEquence]:VIDeo:LEVel?
TRIGger[:SEquence]:VIDeo:SLOPe POSitive | NEGAtive
TRIGger[:SEquence]:VIDeo:SLOPe?
TRIGger|TRIGger1|TRIGger2[:SEquence]:OUTPut HSWP | MEASuring | MAIN | GATE
| GTRigger | OEVEN | SPOINT | SSweep | SSETtled | S1Marker | S2Marker |
S3Marker | S4Marker | OFF
```

```
TRIGger|TRIGger1|TRIGger2[:SEQuence]:OUTPut?  
TRIGger|TRIGger1|TRIGger2[:SEQuence]:OUTPut:POLarity POSitive | NEGative  
TRIGger|TRIGger1|TRIGger2[:SEQuence]:OUTPut:POLarity?
```

STATus Subsystem

The following diagram shows the entire Status Register Subsystem implementation of the X Series instruments.

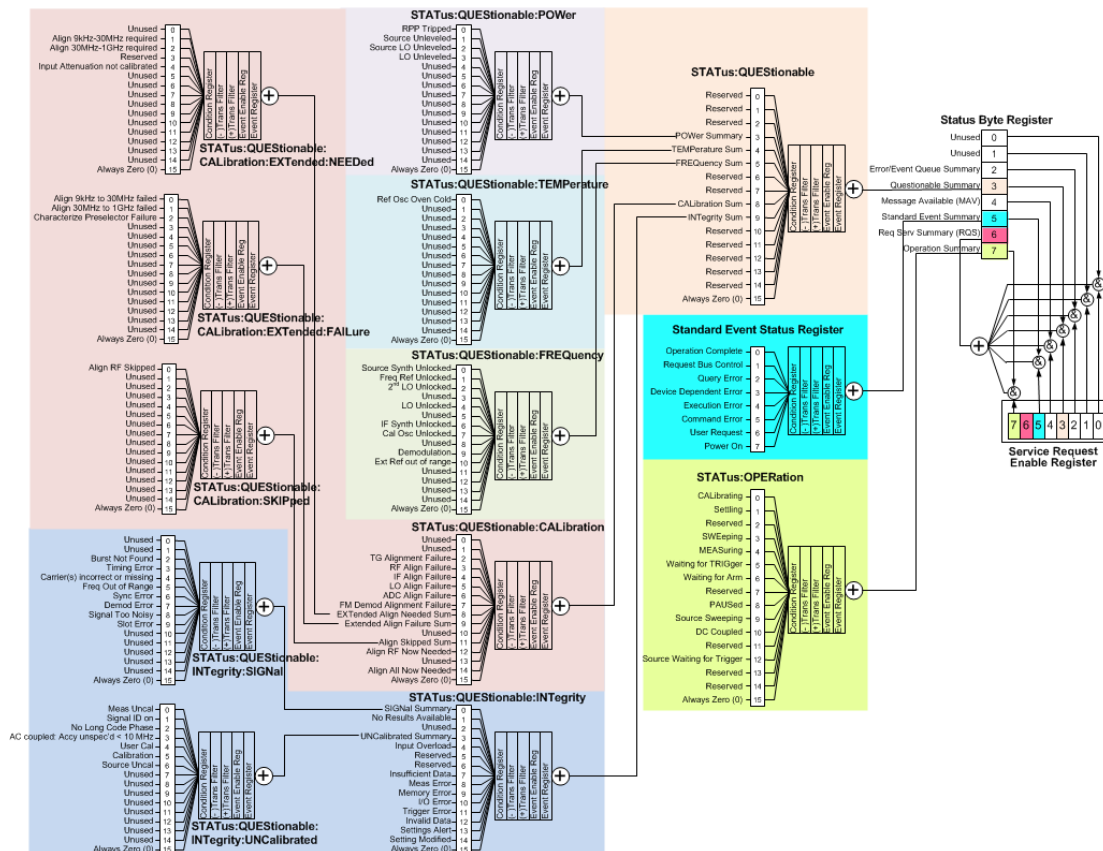

Detailed Description

The STATus subsystem remote commands set and query the status hardware registers. This system of registers monitors various events and conditions in the instrument. Software written to control the instrument may need to monitor some of these events and conditions.

NOTE

All status register commands are sequential. Most commands can be started immediately and will overlap with any existing commands that are already running. This is not true of status commands. All the commands in the spectrum analyzer are assumed to be overlapped unless a command description specifically says that it is sequential.

What Are Status Registers

The status system contains multiple registers that are arranged in a hierarchical order. The lower-level status registers propagate their data to the higher-level registers in the data structures by means of summary bits. The status byte register is at the top of the hierarchy and contains general status information for the instrument's events and conditions. All other individual registers are used to determine the specific events or conditions. For a diagram of the registers and their interconnections, see above.

The operation and questionable status registers are sets of registers that monitor the overall instrument condition. They are accessed with the STATus:OPERation and STATus:QUEStionable commands in the STATus command subsystem. Each register set is made up of five registers:

- Condition Register—It reports the real-time state of the signals monitored by this register set. There is no latching or buffering for a condition register.
- Positive Transition Register—This filter register controls which signals will set a bit in the event register when the signal makes a low to high transition (when the condition bit changes from 0 to 1).
- Negative Transition Register—This filter register controls which signals will set a bit in the event register when the signal makes a high to low transition (when the condition bit changes from 1 to 0).
- Event Register—It latches any signal state changes, in the way specified by the filter registers. Bits in the event register are never cleared by signal state changes. Event registers are cleared when read. They are also cleared by *CLS and by presetting the instrument.
- Event Enable Register—It controls which of the bits, being set in the event register, will be summarized as a single output for the register set. Summary bits are then used by the next higher register.

The STATus:QUEStionable registers report abnormal operating conditions. The status register hierarchy is:

1. The summary outputs from the six STATus:QUEStionable:<keyword> detail registers are inputs to the STATus:QUEStionable register.
2. The summary output from the STATus:QUEStionable register is an input to the Status Byte Register. See the overall system in Figure at the beginning of this section.

The STATus:OPERation register set has no summarized inputs. The inputs to the STATus:OPERation:CONDition register indicate the real time state of the instrument. The STATus:OPERation:EVENT register summary output is an input to the Status Byte Register.

What Are Status Register SCPI Commands

Most monitoring of the instrument conditions is done at the highest level using the IEEE common commands indicated below. Complete command descriptions are available in the IEEE commands section at the beginning of the language reference. Individual status registers can be set and queried using the commands in the STATus subsystem of the language reference.

- *CLS (clear status) clears the status byte by emptying the error queue and clearing all the event registers.
- *ESE, *ESE? (event status enable) sets and queries the bits in the enable register part of the standard event status register.
- *ESR? (event status register) queries and clears the event register part of the standard event status register.
- *OPC, *OPC? (operation complete) sets the standard event status register to monitor the completion of all commands. The query stops any new commands from being processed until the current processing is complete, then returns a '1'.
- *PSC, *PSC? (power-on state clear) sets the power-on state so that it clears the service request enable register and the event status enable register at power on.
- *SRE, *SRE? (service request enable) sets and queries the value of the service request enable register.

- *STB? (status byte) queries the value of the status byte register without erasing its contents.

How to Use the Status Registers

A program often needs to be able to detect and manage error conditions or changes in instrument status. There are two methods you can use to programmatically access the information in status registers:

- The polling method
- The service request (SRQ) method

In the polling method, the instrument has a passive role. It only tells the controller that conditions have changed when the controller asks the right question. In the SRQ method, the instrument takes a more active role. It tells the controller when there has been a condition change without the controller asking. Either method allows you to monitor one or more conditions.

The polling method works well if you do not need to know about changes the moment they occur. The SRQ method should be used if you must know immediately when a condition changes. To detect a change using the polling method, the program must repeatedly read the registers.

Use the SRQ method when:

- you need time-critical notification of changes
- you are monitoring more than one device which supports SRQs
- you need to have the controller do something else while waiting
- you can't afford the performance penalty inherent to polling

Use polling when:

- your programming language/development environment does not support SRQ interrupts
- you want to write a simple, single-purpose program and don't want the added complexity of setting up an SRQ handler
- To monitor a condition:
 - a. Determine which register contains the bit that reports the condition.
 - b. Send the unique SCPI query that reads that register.
 - c. Examine the bit to see if the condition has changed.

You can monitor conditions in different ways.

- Check the current instrument hardware and firmware status.

Do this by querying the condition registers which continuously monitor status. These registers represent the current state of the instrument. Bits in a condition register are updated in real time. When the condition monitored by a particular bit becomes true, the bit is set to 1. When the condition becomes false, the bit is reset to 0.

- Monitor a particular condition (bit).

You can enable a particular bit(s), using the event enable register. The instrument will then monitor that particular condition(s). If the bit becomes true (0 to 1 transition) in the event register, it will stay set until the

event register is cleared. Querying the event register allows you to detect that this condition occurred even if the condition no longer exists. The event register can only be cleared by querying it or sending the *CLS command.

- Monitor a particular type of change in a condition (bit).
 - The transition registers are preset to register if the condition goes from 0 to 1 (false to true, or a positive transition).
 - This can be changed so the selected condition is detected if the bit goes from 1 to 0 (true to false, or a negative transition).
 - It can also be set for both types of transitions occurring.
 - Or it can be set for neither transition. If both transition registers are set to 0 for a particular bit position, that bit will not be set in the event register for either type of change.

Using a Status Register

Each bit in a register is represented by a numerical value based on its location. See figure below. This number is sent with the command to enable a particular bit. If you want to enable more than one bit, you would send the sum of all the bits that you want to monitor.

Figure: Status Register Bit Values

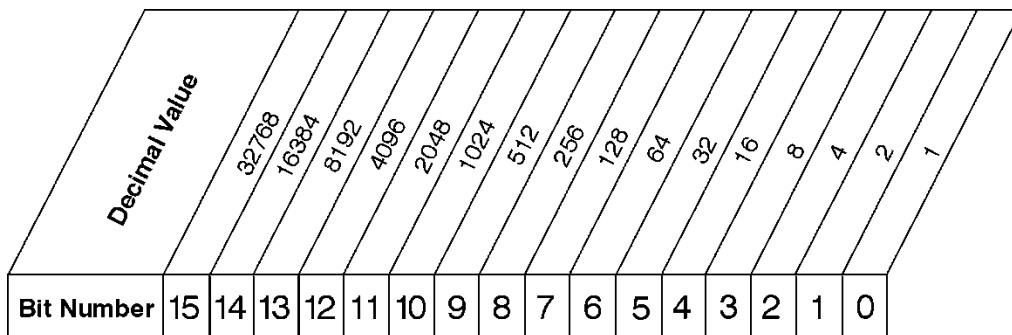

STATus:OPERation:ENABLE < num >
STATus:OPERation:ENABLE?

Standard Operation Event Enable Register

ck730a

Bit 15 is not used to report status.

Example 1:

1. To enable bit 0 and bit 6 of standard event status register, you would send the command *ESE 65 because $1 + 64 = 65$.
2. The results of a query are evaluated in a similar way. If the *STB? command returns a decimal value of 140, ($140 = 128 + 8 + 4$) then bit 7 is true, bit 3 is true and bit 2 is true.

Example 2:

1. Suppose you want to know if an Auto-trigger Timeout occurs, but you only cared about that specific condition. So you would want to know what was happening with bit 10 in the Status Questionable Integrity register, and not about any other bits.

2. It's usually a good idea to start by clearing all the status registers with *CLS.
3. Sending the STAT:QUES:INT:ENAB 1024 command lets you monitor only bit 10 events, instead of the default monitoring all the bits in the register. The register default is for positive transition events (0 to 1 transition). That is, when an auto-trigger timeout occurs. If instead, you wanted to know when the Auto-trigger timeout condition is cleared, then you would set the STAT:QUES:INT:PTR 0 and the STAT:QUES:INT:NTR 32767.
4. So now the only output from the Status Questionable Integrity register will come from a bit 10 positive transition. That output goes to the Integrity Sum bit 9 of the Status Questionable register.
5. You can do a similar thing with this register to only look at bit 9 using, STAT:QUES:ENAB 512.
6. The Status Questionable register output goes to the "Status Questionable Summary" bit 3 of the Status Byte Register. The output from this register can be enabled using the *SRE 8 command.
7. Finally, you would use the serial polling functionality available for the particular bus/software that you are using to monitor the Status Byte Register. (You could also use *STB? to poll the Status Byte Register.)

Using the Service Request (SRQ) Method

Your language, bus, and programming environment must be able to support SRQ interrupts. (For example, BASIC used with VXI-11.3 (GPIB over LAN). When you monitor a condition with the SRQ method, you must:

1. Determine which bit monitors the condition.
2. Determine how that bit reports to the request service (RQS) bit of the status byte.
3. Send SCPI commands to enable the bit that monitors the condition and to enable the summary bits that report the condition to the RQS bit.
4. Enable the controller to respond to service requests.

When the condition changes, the instrument sets its RQS bit. The controller is informed of the change as soon as it occurs. As a result, the time the controller would otherwise have used to monitor the condition can be used to perform other tasks. Your program determines how the controller responds to the SRQ.

Generating a Service Request

To use the SRQ method, you must understand how service requests are generated. Bit 6 of the status byte register is the request service (RQS) bit. The *SRE command is used to configure the RQS bit to report changes in instrument status. When such a change occurs, the RQS bit is set. It is cleared when the status byte register is queried using *SRE? (with a serial poll.) It can be queried without erasing the contents with *STB?.

When a register set causes a summary bit in the status byte to change from 0 to 1, the instrument can initiate the service request (SRQ) process. However, the process is only initiated if both of the following conditions are true:

- The corresponding bit of the service request enable register is also set to 1.
- The instrument does not have a service request pending. (A service request is considered to be pending between the time the instrument's SRQ process is initiated and the time the controller reads the status byte register.)

The SRQ process sets the SRQ true. It also sets the status byte's request service (RQS) bit to 1. Both actions are necessary to inform the controller that the instrument requires service. Setting the SRQ line only informs the controller that some device on the bus requires service. Setting the RQS bit allows the controller to determine which instrument requires service.

If your program enables the controller to detect and respond to service requests, it should instruct the controller to perform a serial poll when the SRQ is set true. Each device on the bus returns the contents of its status byte register in response to this poll. The device who's RQS bit is set to 1 is the device that requested service.

When you read the instrument's status byte register with a serial poll, the RQS bit is reset to 0. Other bits in the register are not affected.

If the status register is configured to SRQ on end-of-measurement and the measurement is in continuous mode, then restarting a measurement (INIT command) can cause the measuring bit to pulse low. This causes an SRQ when you have not actually reached the "end-of-measurement" condition. To avoid this:

1. Set INITiate:CONTinuous off.
2. Set/enable the status registers.
3. Restart the measurement (send INIT).

Status Register System

The hardware status registers are combined to form the instrument status system. Specific status bits are assigned to monitor various aspects of the instrument operation and status. See the diagram of the status system above for information about the bit assignments and status register interconnections.

The Status Byte Register

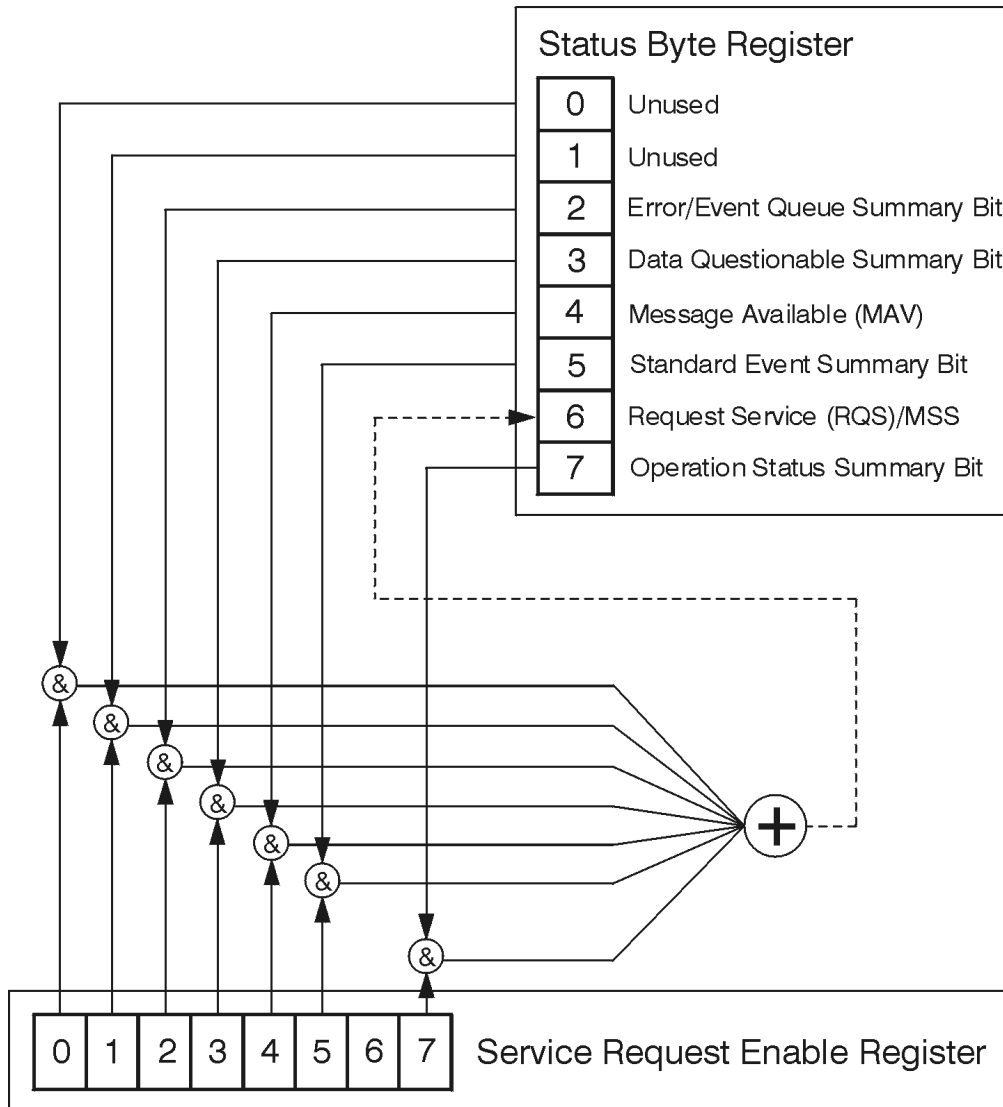

ck776a

The RQS bit is read and reset by a serial poll. The same bit position (MSS) is read, non-destructively by the *STB? command. If you serial poll bit 6 it is read as RQS, but if you send *STB it reads bit 6 as MSS. For more information refer to IEEE 488.2 standards, section 11.

Description	Standard Operation Status Summary Bit	Request Service (RQS) Summary Bit	Standard Event Status Summary Bit	Message Available (MAV)	Data Questionable Status Summary Bit	Error/Event Queue Summary Bit	Unused	Unused	
Bit Number	7	6	5	4	3	2	1	0	

*STB?

Status Byte Register

ck725a

Bit	Description
0, 1	These bits are always set to 0.
2	A 1 in this bit position indicates that the SCPI error queue is not empty which means that it contains at least one error message.
3	A 1 in this bit position indicates that the data questionable summary bit has been set. The data questionable event register can then be read to determine the specific condition that caused this bit to be set.
4	A 1 in this bit position indicates that the instrument has data ready in the output queue. There are no lower status groups that provide input to this bit.
5	A 1 in this bit position indicates that the standard event summary bit has been set. The standard event status register can then be read to determine the specific event that caused this bit to be set.
6	A 1 in this bit position indicates that the instrument has at least one reason to report a status change. This bit is also called the master summary status bit (MSS).
7	A 1 in this bit position indicates that the standard operation summary bit has been set. The standard operation event register can then be read to determine the specific condition that caused this bit to be set.

To query the status byte register, send the command *STB?. The response will be the decimal sum of the bits which are set to 1. For example, if bit number 7 and bit number 3 are set to 1, the decimal sum of the 2 bits is 128 plus 8. So the decimal value 136 is returned. The *STB command does not clear the status register.

In addition to the status byte register, the status byte group also contains the service request enable register. This register lets you choose which bits in the status byte register will trigger a service request.

Send the *SRE <integer> command where <integer> is the sum of the decimal values of the bits you want to enable plus the decimal value of bit 6. For example, assume that you want to enable bit 7 so that whenever the standard operation status register summary bit is set to 1 it will trigger a service request. Send the command *SRE 192 (because 192 = 128 + 64). You must always add 64 (the numeric value of RQS

bit 6) to your numeric sum when you enable any bits for a service request. The command *SRE? returns the decimal value of the sum of the bits previously enabled with the *SRE <integer> command.

The service request enable register presets to zeros (0).

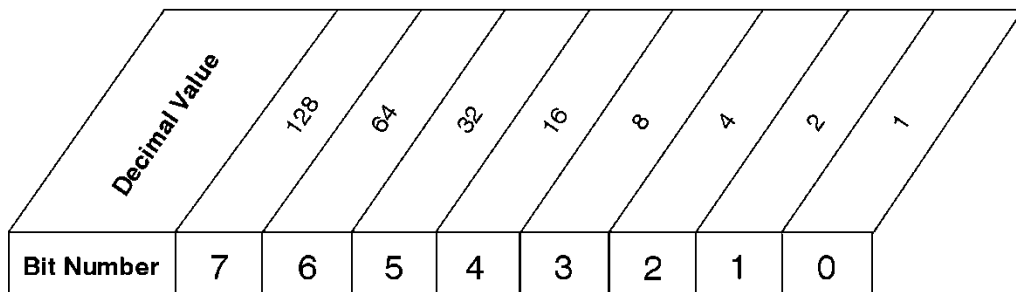

*SRE <num>
 *SRE?

Service Request Enable Register

ck726a

Standard Event Status Register

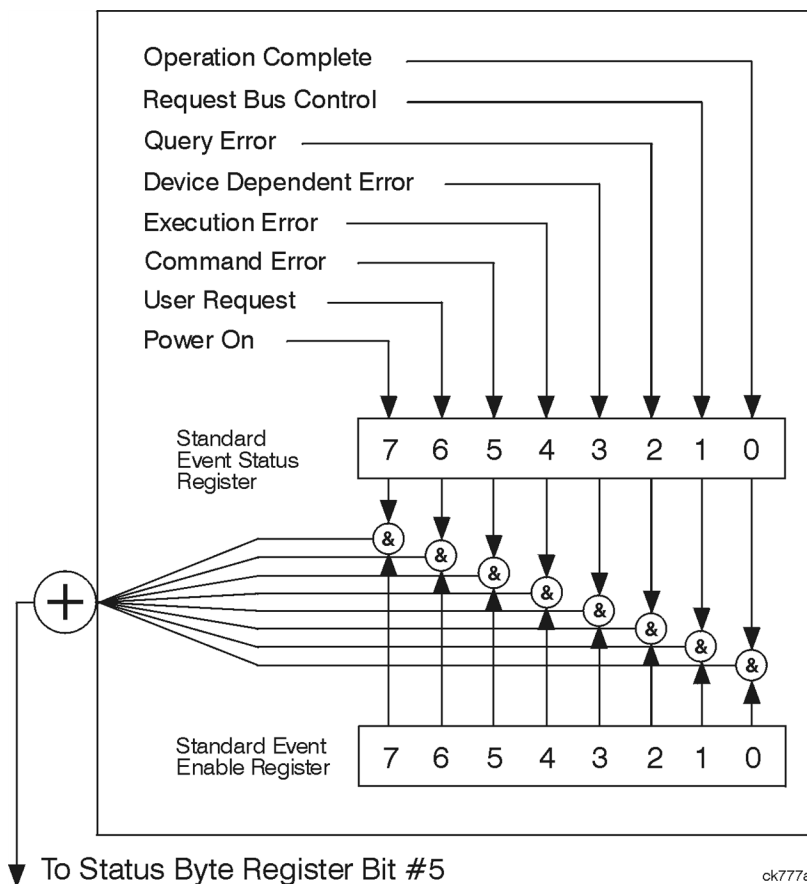

ck777a

The standard event status register contains the following bits:

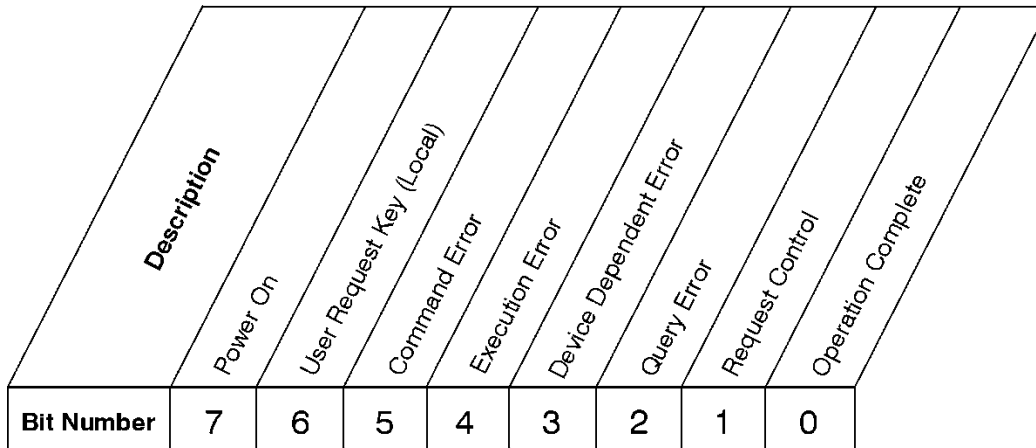

*ESR?

Standard Event Status Register

ck727a

Bit	Description
0	A 1 in this bit position indicates that all pending operations were completed following execution of the *OPC command.
1	This bit is for GPIB handshaking to request control. Currently it is set to 0 because there are no implementations where the spectrum analyzer controls another instrument.
2	A 1 in this bit position indicates that a query error has occurred. Query errors have SCPI error numbers from -499 to -400.
3	A 1 in this bit position indicates that a device dependent error has occurred. Device dependent errors have SCPI error numbers from -399 to -300 and 1 to 32767.
4	A 1 in this bit position indicates that an execution error has occurred. Execution errors have SCPI error numbers from -299 to -200.
5	A 1 in this bit position indicates that a command error has occurred. Command errors have SCPI error numbers from -199 to -100.
6	A 1 in this bit position indicates that the LOCAL key has been pressed. This is true even if the instrument is in local lockout mode.
7	A 1 in this bit position indicates that the instrument has been turned off and then on.

The standard event status register is used to determine the specific event that set bit 5 in the status byte register. To query the standard event status register, send the command *ESR?. The response will be the decimal sum of the bits which are enabled (set to 1). For example, if bit number 7 and bit number 3 are enabled, the decimal sum of the 2 bits is 128 plus 8. So the decimal value 136 is returned.

In addition to the standard event status register, the standard event status group also contains a standard event status enable register. This register lets you choose which bits in the standard event status register will set the summary bit (bit 5 of the status byte register) to 1. Send the *ESE <integer> command where <integer> is the sum of the decimal values of the bits you want to enable. For example, to enable bit 7 and bit 6 so that whenever either of those bits is set to 1, the standard event status summary bit of the status

byte register will be set to 1, send the command *ESE 192 (128 + 64). The command *ESE? returns the decimal value of the sum of the bits previously enabled with the *ESE <integer> command.

The standard event status enable register presets to zeros (0).

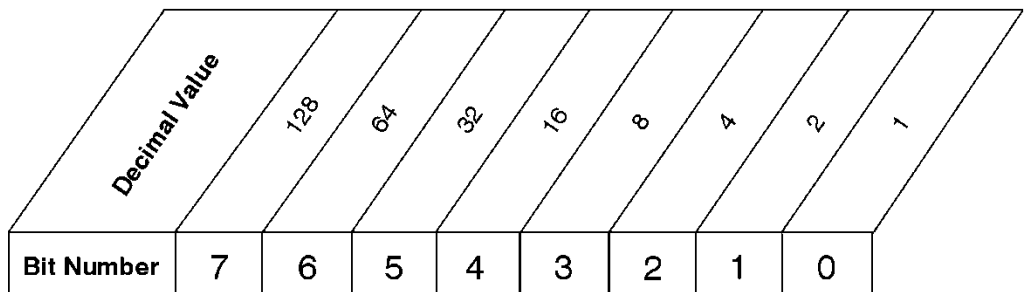

*ESE <num>
 *ESE?

Standard Event Status Enable Register

ck728a

Operation and Questionable Status Registers

The operation and questionable status registers are registers that monitor the overall instrument condition. They are accessed with the STATus:OPERation and STATus:QUEStionable commands in the STATus command subsystem. See the figure at the beginning of this chapter.

Operation Status Register

The operation status register monitors the current instrument measurement state. It checks to see if the instrument is calibrating, sweeping, or waiting for a trigger. For more information see the *OPC? command located in the IEEE Common Commands section.

Bit	Condition	Operation
0	Calibrating	The instrument is busy executing its Align Now process
3	Sweeping	The instrument is busy taking a sweep.
4	Measuring	The instrument is busy making a measurement. Measurements often require multiple sweeps. They are initiated by keys under the MEASURE key or with the MEASure group of commands. The bit is valid for most X-Series Modes.
5	Waiting for trigger	The instrument is waiting for the trigger conditions to be met, then it will trigger a sweep or measurement.

Questionable Status Register

The questionable status register monitors the instrument's condition to see if anything questionable has happened to it. It is looking for anything that might cause an error or a bad measurement like a hardware problem, an out of calibration situation, or a unusual signal. All the bits are summary bits from lower-level event registers.

Bit	Condition	Operation
-----	-----------	-----------

3	Power summary	The instrument hardware has detected a power unlevelled condition.
4	Temperature summary	The instrument is still warming up.
5	Frequency summary	The instrument hardware has detected an unlocked condition or a problem with the external frequency reference.
8	Calibration summary	The instrument has detected a hardware problem while doing the automatic internal alignment process.
9	Integrity summary	The instrument has detected a questionable measurement condition such as: bad timing, bad signal/data, timeout problem, signal overload, or "meas uncal".

STATus Subsystem Command Descriptions

The STATus subsystem controls the SCPI-defined instrument status reporting structures. Each status register has a set of five commands used for querying or masking that particular register.

Numeric values for bit patterns can be entered using decimal or hexadecimal representations. (i.e. 0 to 32767 is equivalent to #H0 to #H7FFF. It is also equal to all ones, 111111111111111) See the SCPI Basics information about using bit patterns for variable parameters.

Operation Register

"Operation Condition Query" on page 91

"Operation Enable" on page 92

"Operation Event Query" on page 92

"Operation Negative Transition" on page 92

"Operation Positive Transition" on page 93

Operation Condition Query

This query returns the decimal value of the sum of the bits in the Status Operation Condition register.

NOTE The data in this register is continuously updated and reflects the current conditions.

Mode	All
Remote Command	:STATus:OPERation:CONDition?
Example	STAT:OPER:COND?
Preset	0
Status Bits/OPC dependencies	Sequential command
Initial S/W Revision	Prior to A.02.00

Operation Enable

This command determines which bits in the Operation Event register, will set the Operation Status Summary bit (bit 7) in the Status Byte Register. The variable <integer> is the sum of the decimal values of the bits you want to enable.

NOTE

The preset condition is to have all bits in this enable register set to 0. To have any Operation Events reported to the Status Byte Register, one or more bits need to be set to 1.

Mode	All
Remote Command	:STATus:OPERation:ENABle <integer> :STATus:OPERation:ENABle?
Example	STAT:OPER:ENAB 1 Sets the register so that Align Now operation will be reported to the Status Byte Register.
Preset	0
Min	0
Max	32767
Status Bits/OPC dependencies	Sequential command
Initial S/W Revision	Prior to A.02.00

Operation Event Query

This query returns the decimal value of the sum of the bits in the Operation Event register.

NOTE

The register requires that the associated PTR or NTR filters be set before a condition register bit can set a bit in the event register. The data in this register is latched until it is queried. Once queried, the register is cleared.

Mode	All
Remote Command	:STATus:OPERation[:EVENT]?
Example	STAT:OPER?
Preset	0
Status Bits/OPC dependencies	Sequential command
Initial S/W Revision	Prior to A.02.00

Operation Negative Transition

This command determines which bits in the Operation Condition register will set the corresponding bit in the Operation Event register when the condition register bit has a negative transition (1 to 0). The variable <integer> is the sum of the decimal values of the bits that you want to enable.

Mode	All
Remote Command	:STATus:OPERation:NTRansition <integer> :STATus:OPERation:NTRansition?
Example	STAT:OPER:NTR 1 Align Now operation complete will be reported to the Status Byte Register.
Preset	0
Min	0
Max	32767
Status Bits/OPC dependencies	Sequential command
Initial S/W Revision	Prior to A.02.00

Operation Positive Transition

This command determines which bits in the Operation Condition register will set the corresponding bit in the Operation Event register when the condition register bit has a positive transition (0 to 1). The variable <integer> is the sum of the decimal values of the bits that you want to enable.

Mode	All
Remote Command	:STATus:OPERation:PTRansition <integer> :STATus:OPERation:PTRansition?
Example	STAT:OPER:PTR 1 Align Now operation beginning will be reported to the Status Byte Register.
Preset	32767
Min	0
Max	32767
Status Bits/OPC dependencies	Sequential command
Initial S/W Revision	Prior to A.02.00

Preset the Status Byte

Sets bits in most of the enable and transition registers to their default state. It presets all the Transition Filters, Enable Registers, and the Error/Event Queue Enable. It has no effect on Event Registers, Error/Event QUEUE, IEEE 488.2 ESE, and SRE Registers as described in IEEE Standard 488.2–1992, IEEE Standard Codes, Formats, Protocols, and Common Commands for Use with ANSI/IEEE Std 488.1–1987. New York, NY, 1992.

Remote Command	:STATus:PRESet
Example	STAT:PREs
Initial S/W Revision	Prior to A.02.00

Questionable Register

"Questionable Condition " on page 94

"Questionable Enable " on page 94

"Questionable Event Query " on page 95

"Questionable Negative Transition " on page 95

"Questionable Positive Transition" on page 95

Questionable Condition

This query returns the decimal value of the sum of the bits in the Questionable Condition register.

NOTE The data in this register is continuously updated and reflects the current conditions.

Mode	All
Remote Command	:STATus:QUEStionable:CONDition?
Example	STAT:QUES:COND?
Preset	0
Status Bits/OPC dependencies	Sequential command
Initial S/W Revision	Prior to A.02.00

Questionable Enable

This command determines which bits in the Questionable Event register will set the Questionable Status Summary bit (bit3) in the Status Byte Register. The variable <integer> is the sum of the decimal values of the bits you want to enable.

NOTE The preset condition is all bits in this enable register set to 0. To have any Questionable Events reported to the Status Byte Register, one or more bits need to be set to 1. The Status Byte Event Register should be queried after each measurement to check the Questionable Status Summary (bit 3). If it is equal to 1, a condition during the test may have made the test results invalid. If it is equal to 0, this indicates that no hardware problem or measurement problem was detected by the analyzer.

Mode	All
Remote Command	:STATus:QUEStionable:ENABle <integer> :STATus:QUEStionable:ENABle?
Example	STAT:OPER:PTR 1 Align Now operation beginning will be reported to the Status Byte Register.
Preset	0
Min	0
Max	32767
Status Bits/OPC dependencies	Sequential command
Initial S/W Revision	Prior to A.02.00

Questionable Event Query

This query returns the decimal value of the sum of the bits in the Questionable Event register.

NOTE

The register requires that the associated PTR or NTR filters be set before a condition register bit can set a bit in the event register. The data in this register is latched until it is queried. Once queried, the register is cleared.

Mode	All
Remote Command	:STATus:QUESTionable[:EVENT]?
Example	STAT:QUES?
Preset	0
Status Bits/OPC dependencies	Sequential command
Initial S/W Revision	Prior to A.02.00

Questionable Negative Transition

This command determines which bits in the Questionable Condition register will set the corresponding bit in the Questionable Event register when the condition register bit has a negative transition (1 to 0). The variable <integer> is the sum of the decimal values of the bits that you want to enable.

Mode	All
Remote Command	:STATus:QUESTionable:NTRansition <integer> :STATus:QUESTionable:NTRansition?
Example	STAT:QUES:NTR 16 Temperature summary 'questionable cleared' will be reported to the Status Byte Register.
Preset	0
Min	0
Max	32767
Status Bits/OPC dependencies	Sequential command
Initial S/W Revision	Prior to A.02.00

Questionable Positive Transition

This command determines which bits in the Questionable Condition register will set the corresponding bit in the Questionable Event register when the condition register bit has a positive transition (0 to 1). The variable <integer> is the sum of the decimal values of the bits that you want to enable.

Mode	All
------	-----

Remote Command	:STATus:QUEStionable:PTRansition <integer> :STATus:QUEStionable:PTRansition?
Example	STAT:QUES:PTR 16 Temperature summary 'questionable asserted' will be reported to the Status Byte Register.
Preset	32767
Min	0
Max	32767
Status Bits/OPC dependencies	Sequential command
Initial S/W Revision	Prior to A.02.00

Questionable Calibration Register

"Questionable Calibration Condition " on page 96

"Questionable Calibration Enable " on page 96

"Questionable Calibration Event Query " on page 97

"Questionable Calibration Negative Transition " on page 97

"Questionable Calibration Positive Transition " on page 98

Questionable Calibration Condition

This query returns the decimal value of the sum of the bits in the Questionable Calibration Condition register.

NOTE

The data in this register is continuously updated and reflects the current conditions.

Mode	All
Remote Command	:STATus:QUEStionable:CALibration:CONDition?
Example	STAT:QUES:CAL:COND?
Preset	0
Status Bits/OPC dependencies	Sequential command
Initial S/W Revision	Prior to A.02.00

Questionable Calibration Enable

This command determines which bits in the Questionable Calibration Condition Register will set bits in the Questionable Calibration Event register, which also sets the Calibration Summary bit (bit 8) in the Questionable Register. The variable <integer> is the sum of the decimal values of the bits you want to enable.

Mode	All
Remote Command	:STATus:QUESTionable:CALibration:ENABle <integer> :STATus:QUESTionable:CALibration:ENABle?
Example	STAT:QUES:CAL:ENAB 16384 Can be used to query if an alignment is needed, if you have turned off the automatic alignment process.
Min	0
Max	32767
Status Bits/OPC dependencies	Sequential command
Initial S/W Revision	Prior to A.02.00

Questionable Calibration Event Query

This query returns the decimal value of the sum of the bits in the Questionable Calibration Event register.

NOTE

The register requires that the associated PTR or NTR filters be set before a condition register bit can set a bit in the event register. The data in this register is latched until it is queried. Once queried, the register is cleared.

Mode	All
Remote Command	:STATus:QUESTionable:CALibration[:EVENT]?
Example	STAT:QUES:CAL?
Preset	0
Status Bits/OPC dependencies	Sequential command
Initial S/W Revision	Prior to A.02.00

Questionable Calibration Negative Transition

This command determines which bits in the Questionable Calibration Condition register will set the corresponding bit in the Questionable Calibration Event register when the condition register bit has a negative transition (1 to 0). The variable <integer> is the sum of the decimal values of the bits that you want to enable.

Mode	All
Remote Command	:STATus:QUESTionable:CALibration:NTRansition <integer> :STATus:QUESTionable:CALibration:NTRansition?
Example	STAT:QUES:CAL:NTR 16384 Alignment is not required.
Preset	0
Min	0

Max	32767
Status Bits/OPC dependencies	Sequential command
Initial S/W Revision	Prior to A.02.00

Questionable Calibration Positive Transition

This command determines which bits in the Questionable Calibration Condition register will set the corresponding bit in the Questionable Calibration Event register when the condition register bit has a positive transition (0 to 1). The variable <integer> is the sum of the decimal values of the bits that you want to enable.

Mode	All
Remote Command	:STATus:QUESTionable:CALibration:PTRansition <integer> :STATus:QUESTionable:CALibration:PTRansition?
Example	STAT:QUES:CAL:PTR 16384 Alignment is required.
Preset	32767
Min	0
Max	32767
Status Bits/OPC dependencies	Sequential command
Initial S/W Revision	Prior to A.02.00

Questionable Calibration Skipped Register

"Questionable Calibration Skipped Condition " on page 98

"Questionable Calibration Skipped Enable " on page 99

"Questionable Calibration Skipped Event Query " on page 99

"Questionable Calibration Skipped Negative Transition " on page 100

"Questionable Calibration Skipped Positive Transition " on page 100

Questionable Calibration Skipped Condition

This query returns the decimal value of the sum of the bits in the Questionable Calibration Skipped Condition register.

NOTE The data in this register is continuously updated and reflects the current conditions.

Mode	All
Remote Command	:STATus:QUESTionable:CALibration:SKIpped:CONDition?

Example	STAT:QUES:CAL:SKIP:COND?
Preset	0
Status Bits/OPC dependencies	Sequential command
Initial S/W Revision	Prior to A.02.00

Questionable Calibration Skipped Enable

This command determines which bits in the Questionable Calibration Skipped Condition Register will set bits in the Questionable Calibration Skipped Event register, which also sets bit 11 of the Questionable Calibration Register. The variable <integer> is the sum of the decimal values of the bits you want to enable.

Mode	All
Remote Command	:STATus:QUESTionable:CALibration:SKIPped:ENABle <integer> :STATus:QUESTionable:CALibration:SKIPped:ENABle?
Example	STAT:QUES:CAL:SKIP:ENAB 1 Can be used to query if an EMI alignment skipped condition is detected
Preset	32767
Min	0
Max	32767
Status Bits/OPC dependencies	Sequential command
Initial S/W Revision	Prior to A.02.00

Questionable Calibration Skipped Event Query

This query returns the decimal value of the sum of the bits in the Questionable Calibration Event register.

NOTE

The register requires that the associated PTR or NTR filters be set before a condition register bit can set a bit in the event register. The data in this register is latched until it is queried. Once queried, the register is cleared.

Mode	All
Remote Command	:STATus:QUESTionable:CALibration:SKIPped[:EVENT]?
Example	STAT:QUES:CAL:SKIP?
Preset	0
Status Bits/OPC dependencies	Sequential command
Initial S/W Revision	Prior to A.02.00

Questionable Calibration Skipped Negative Transition

This command determines which bits in the Questionable Calibration Skipped Condition register will set the corresponding bit in the Questionable Calibration Skipped Event register when the condition register bit has a negative transition (1 to 0). The variable <integer> is the sum of the decimal values of the bits that you want to enable.

Mode	All
Remote Command	:STATus:QUEStionable:CALibration:SKIpped:NTRansition <integer> :STATus:QUEStionable:CALibration:SKIpped:NTRansition?
Example	STAT:QUES:CAL:SKIP:NTR 1 Align RF skipped is not required.
Preset	0
Min	0
Max	32767
Status Bits/OPC dependencies	Sequential command
Initial S/W Revision	Prior to A.02.00

Questionable Calibration Skipped Positive Transition

This command determines which bits in the Questionable Calibration Skipped Condition register will set the corresponding bit in the Questionable Calibration Skipped Event register when the condition register bit has a positive transition (0 to 1). The variable <integer> is the sum of the decimal values of the bits that you want to enable.

Mode	All
Remote Command	:STATus:QUEStionable:CALibration:SKIpped:PTRansition <integer> :STATus:QUEStionable:CALibration:SKIpped:PTRansition?
Example	STAT:QUES:CAL:SKIP:PTR 1 Align RF skipped is required.
Preset	32767
Min	0
Max	32767
Status Bits/OPC dependencies	Sequential command
Initial S/W Revision	Prior to A.02.00

Questionable Calibration Extended Failure Register

"Questionable Calibration Extended Failure Condition " on page 101

"Questionable Calibration Extended Failure Enable " on page 101

"Questionable Calibration Extended Failure Event Query " on page 101

"Questionable Calibration Extended Failure Negative Transition " on page 102

"Questionable Calibration Extended Failure Positive Transition " on page 102

Questionable Calibration Extended Failure Condition

This query returns the decimal value of the sum of the bits in the Questionable Calibration Extended Failure Condition register.

NOTE The data in this register is continuously updated and reflects the current conditions.

Mode	All
Remote Command	:STATus:QUEStionable:CALibration:EXTended:FAILure:CONDition?
Example	STAT:QUES:CAL:EXT:FAIL:COND?
Preset	0
Status Bits/OPC dependencies	Sequential command
Initial S/W Revision	Prior to A.02.00

Questionable Calibration Extended Failure Enable

This command determines which bits in the Questionable Calibration Extended Failure Condition Register will set bits in the Questionable Calibration Extended Failure Event register, which also sets bit 9 of the Questionable Calibration Register. The variable <integer> is the sum of the decimal values of the bits you want to enable.

Mode	All
Remote Command	:STATus:QUEStionable:CALibration:EXTended:FAILure:ENABle <integer> :STATus:QUEStionable:CALibration:EXTended:FAILure:ENABle?
Example	STAT:QUES:CAL:EXT:FAIL:ENAB 1 Can be used to query if an EMI conducted alignment is needed.
Preset	32767
Min	0
Max	32767
Status Bits/OPC dependencies	Sequential command
Initial S/W Revision	Prior to A.02.00

Questionable Calibration Extended Failure Event Query

This query returns the decimal value of the sum of the bits in the Questionable Calibration Extended Failure Event register.

NOTE The register requires that the associated PTR or NTR filters be set before a condition register bit can set a bit in the event register. The data in this register is latched until it is queried. Once queried, the register is cleared.

Mode	All
Remote Command	:STATus:QUESTionable:CALibration:EXTended:FAILure[:EVENT]?
Example	STAT:QUES:CAL:EXT:FAIL?
Preset	0
Status Bits/OPC dependencies	Sequential command
Initial S/W Revision	Prior to A.02.00

Questionable Calibration Extended Failure Negative Transition

This command determines which bits in the Questionable Calibration Extended Failure Condition register will set the corresponding bit in the Questionable Calibration Extended Failure Event register when the condition register bit has a negative transition (1 to 0). The variable <integer> is the sum of the decimal values of the bits that you want to enable.

Mode	All
Remote Command	:STATus:QUESTionable:CALibration:EXTended:FAILure:NTRansition <integer> :STATus:QUESTionable:CALibration:EXTended:FAILure:NTRansition?
Example	STAT:QUES:CAL:EXT:FAIL:NTR 1 EMI conducted align failure is not required.
Preset	0
Min	0
Max	32767
Status Bits/OPC dependencies	Sequential command
Initial S/W Revision	Prior to A.02.00

Questionable Calibration Extended Failure Positive Transition

This command determines which bits in the Questionable Calibration Extended Failure Condition register will set the corresponding bit in the Questionable Calibration Extended Failure Event register when the condition register bit has a positive transition (0 to 1). The variable <integer> is the sum of the decimal values of the bits that you want to enable.

Mode	All
Remote Command	:STATus:QUESTionable:CALibration:EXTended:FAILure:PTRansition <integer> :STATus:QUESTionable:CALibration:EXTended:FAILure:PTRansition?
Example	STAT:QUES:CAL:EXT:FAIL:PTR 1 EMI conducted align failure is required.
Preset	32767
Min	0
Max	32767

Status Bits/OPC dependencies	Sequential command
Initial S/W Revision	Prior to A.02.00

Questionable Calibration Extended Needed Register

"Questionable Calibration Extended Needed Condition " on page 103

"Questionable Calibration Extended Needed Enable " on page 103

"Questionable Calibration Extended Needed Event Query " on page 104

"Questionable Calibration Extended Needed Negative Transition " on page 104

"Questionable Calibration Extended Needed Positive Transition " on page 105

Questionable Calibration Extended Needed Condition

This query returns the decimal value of the sum of the bits in the Questionable Calibration Extended Needed Condition register.

NOTE

The data in this register is continuously updated and reflects the current conditions.

Mode	All
Remote Command	:STATus:QUESTionable:CALibration:EXTended:NEEDED:CONDition?
Example	STAT:QUES:CAL:EXT:NEED:COND?
Preset	0
Status Bits/OPC dependencies	Sequential command
Initial S/W Revision	Prior to A.02.00

Questionable Calibration Extended Needed Enable

This command determines which bits in the Questionable Calibration Extended Needed Condition Register will set bits in the Questionable Calibration Extended Needed Event register, which also sets bit 14 of the Questionable Calibration Register. The variable <integer> is the sum of the decimal values of the bits you want to enable.

Mode	All
Remote Command	:STATus:QUESTionable:CALibration:EXTended:NEEDED:ENABle <integer> :STATus:QUESTionable:CALibration:EXTended:NEEDED:ENABle?
Example	STAT:QUES:CAL:EXT:NEED:ENAB 2 Can be used to query if an EMI conducted alignment is needed.
Preset	32767
Min	0

Max	32767
Status Bits/OPC dependencies	Sequential command
Initial S/W Revision	Prior to A.02.00

Questionable Calibration Extended Needed Event Query

This query returns the decimal value of the sum of the bits in the Questionable Calibration Extended Needed Event register.

NOTE

The register requires that the associated PTR or NTR filters be set before a condition register bit can set a bit in the event register. The data in this register is latched until it is queried. Once queried, the register is cleared.

Mode	All
Remote Command	:STATus:QUESTionable:CALibration:EXTended:NEEDed[:EVENT]?
Example	STAT:QUES:CAL:EXT:NEED?
Preset	0
Status Bits/OPC dependencies	Sequential command
Initial S/W Revision	Prior to A.02.00

Questionable Calibration Extended Needed Negative Transition

This command determines which bits in the Questionable Calibration Extended Needed Condition register will set the corresponding bit in the Questionable Calibration Extended Needed Event register when the condition register bit has a negative transition (1 to 0). The variable <integer> is the sum of the decimal values of the bits that you want to enable.

Mode	All
Remote Command	:STATus:QUESTionable:CALibration:EXTended:NEEDed:NTRansition <integer> :STATus:QUESTionable:CALibration:EXTended:NEEDed:NTRansition?
Example	STAT:QUES:CAL:EXT:NEED:NTR 2 Align EMI conducted is not required.
Preset	0
Min	0
Max	32767
Status Bits/OPC dependencies	Sequential command
Initial S/W Revision	Prior to A.02.00

Questionable Calibration Extended Needed Positive Transition

This command determines which bits in the Questionable Calibration Extended Needed Condition register will set the corresponding bit in the Questionable Calibration Extended Needed Event register when the condition register bit has a positive transition (0 to 1). The variable <integer> is the sum of the decimal values of the bits that you want to enable.

Mode	All
Remote Command	:STATus:QUEStionable:CALibration:EXTended:NEEDED:PTRansition <integer> :STATus:QUEStionable:CALibration:EXTended:NEEDED:PTRansition?
Example	STAT:QUES:CAL:EXT:NEED:PTR 2 Align EMI conducted is required.
Preset	32767
Min	0
Max	32767
Status Bits/OPC dependencies	Sequential command
Initial S/W Revision	Prior to A.02.00

Questionable Frequency Register

"Questionable Frequency Condition " on page 105

"Questionable Frequency Enable " on page 106

"Questionable Frequency Event Query " on page 106

"Questionable Frequency Negative Transition " on page 106

"Questionable Frequency Positive Transition " on page 107

Questionable Frequency Condition

This query returns the decimal value of the sum of the bits in the Questionable Frequency Condition register.

NOTE

The data in this register is continuously updated and reflects the current conditions.

Mode	All
Remote Command	:STATus:QUEStionable:FREQuency:CONDition?
Example	STAT:QUES:FREQ:COND?
Preset	0
Status Bits/OPC dependencies	Sequential command
Initial S/W Revision	Prior to A.02.00

Questionable Frequency Enable

This command determines which bits in the Questionable Frequency Condition Register will set bits in the Questionable Frequency Event register, which also sets the Frequency Summary bit (bit 5) in the Questionable Register. The variable <integer> is the sum of the decimal values of the bits you want to enable.

Mode	All
Remote Command	:STATus:QUEStionable:FREQuency:ENABle <integer> :STATus:QUEStionable:FREQuency:ENABle?
Example	STAT:QUES:FREQ:ENAB 2 Frequency Reference Unlocked will be reported to the Frequency Summary of the Status Questionable register.
Preset	32767
Min	0
Max	32767
Status Bits/OPC dependencies	Sequential command
Initial S/W Revision	Prior to A.02.00

Questionable Frequency Event Query

This query returns the decimal value of the sum of the bits in the Questionable Frequency Event register.

NOTE

The register requires that the associated PTR or NTR filters be set before a condition register bit can set a bit in the event register. The data in this register is latched until it is queried. Once queried, the register is cleared.

Mode	All
Remote Command	:STATus:QUEStionable:FREQuency[:EVENT]?
Example	STAT:QUES:FREQ?
Preset	0
Status Bits/OPC dependencies	Sequential command
Initial S/W Revision	Prior to A.02.00

Questionable Frequency Negative Transition

This command determines which bits in the Questionable Frequency Condition register will set the corresponding bit in the Questionable Frequency Event register when the condition register bit has a negative transition (1 to 0). The variable <integer> is the sum of the decimal values of the bits that you want to enable.

Mode	All
------	-----

Remote Command	:STATus:QUEStionable:FREQuency:NTRansition <integer> :STATus:QUEStionable:FREQuency:NTRansition?
Example	STAT:QUES:FREQ:NTR 2 Frequency Reference 'regained lock' will be reported to the Frequency Summary of the Status Questionable register.
Preset	0
Min	0
Max	32767
Status Bits/OPC dependencies	Sequential command
Initial S/W Revision	Prior to A.02.00

Questionable Frequency Positive Transition

This command determines which bits in the Questionable Frequency Condition register will set the corresponding bit in the Questionable Frequency Event register when the condition register bit has a positive transition (0 to 1). The variable <integer> is the sum of the decimal values of the bits that you want to enable.

Mode	All
Remote Command	:STATus:QUEStionable:FREQuency:PTRansition <integer> :STATus:QUEStionable:FREQuency:PTRansition?
Example	STAT:QUES:FREQ:PTR 2 Frequency Reference 'became unlocked' will be reported to the Frequency Summary of the Status Questionable register.
Preset	32767
Min	0
Max	32767
Status Bits/OPC dependencies	Sequential command
Initial S/W Revision	Prior to A.02.00

Questionable Integrity Register

"Questionable Integrity Condition " on page 107

"Questionable Integrity Enable " on page 108

"Questionable Integrity Event Query " on page 108

"Questionable Integrity Negative Transition " on page 109

"Questionable Integrity Positive Transition " on page 109

Questionable Integrity Condition

This query returns the decimal value of the sum of the bits in the Questionable Integrity Condition register.

NOTE The data in this register is continuously updated and reflects the current conditions.

Mode	All
Remote Command	:STATus:QUESTionable:INTEgrity:CONDition?
Example	STAT:QUES:INT:COND?
Preset	0
Status Bits/OPC dependencies	Sequential command
Initial S/W Revision	Prior to A.02.00

Questionable Integrity Enable

This command determines which bits in the Questionable Integrity Condition Register will set bits in the Questionable Integrity Event register, which also sets the Integrity Summary bit (bit 9) in the Questionable Register. The variable <integer> is the sum of the decimal values of the bits you want to enable.

Mode	All
Remote Command	:STATus:QUESTionable:INTEgrity:ENABle <integer> :STATus:QUESTionable:INTEgrity:ENABle?
Example	STAT:QUES:INT:ENAB 8 Measurement Uncalibrated Summary will be reported to the Integrity Summary of the Status Questionable register.
Preset	32767
Min	0
Max	32767
Status Bits/OPC dependencies	Sequential command
Initial S/W Revision	Prior to A.02.00

Questionable Integrity Event Query

This query returns the decimal value of the sum of the bits in the Questionable Integrity Event register.

NOTE The register requires that the associated PTR or NTR filters be set before a condition register bit can set a bit in the event register. The data in this register is latched until it is queried. Once queried, the register is cleared.

Mode	All
Remote Command	:STATus:QUESTionable:INTEgrity[:EVENT]?
Example	STAT:QUES:INT?
Preset	0
Status Bits/OPC dependencies	Sequential command
Initial S/W Revision	Prior to A.02.00

Questionable Integrity Negative Transition

This command determines which bits in the Questionable Integrity Condition register will set the corresponding bit in the Questionable Integrity Event register when the condition register bit has a negative transition (1 to 0)

The variable <integer> is the sum of the decimal values of the bits that you want to enable.

Mode	All
Remote Command	:STATus:QUEStionable:INTEgrity:NTRansition <integer> :STATus:QUEStionable:INTEgrity:NTRansition?
Example	STAT:QUES:INT:NTR 8 Measurement 'regained calibration' Summary will be reported to the Integrity Summary of the Status Questionable register.
Preset	0
Min	0
Max	32767
Status Bits/OPC dependencies	Sequential command
Initial S/W Revision	Prior to A.02.00

Questionable Integrity Positive Transition

This command determines which bits in the Questionable Integrity Condition register will set the corresponding bit in the Questionable Integrity Event register when the condition register bit has a positive transition (0 to 1). The variable <integer> is the sum of the decimal values of the bits that you want to enable.

Mode	All
Remote Command	:STATus:QUEStionable:INTEgrity:PTRansition <integer> :STATus:QUEStionable:INTEgrity:PTRansition?
Example	STAT:QUES:INT:PTR 8 Measurement 'became uncalibrated' Summary will be reported to the Integrity Summary of the Status Questionable register.
Preset	32767
Min	0
Max	32767
Status Bits/OPC dependencies	Sequential command
Initial S/W Revision	Prior to A.02.00

Questionable Integrity Signal Register

"Questionable Integrity Signal Condition" on page 110

"Questionable Integrity Signal Enable" on page 110

"Questionable Integrity Signal Event Query" on page 111

"Questionable Integrity Signal Negative Transition" on page 111

"Questionable Integrity Signal Positive Transition" on page 111

Questionable Integrity Signal Condition

This query returns the decimal value of the sum of the bits in the Questionable Integrity Signal Condition register.

NOTE

The data in this register is continuously updated and reflects the current conditions.

Mode	All
Remote Command	:STATus:QUESTionable:INTEgrity:SIGNal:CONDition?
Example	STAT:QUES:INT:SIGN:COND?
Preset	0
Status Bits/OPC dependencies	Sequential command
Initial S/W Revision	Prior to A.02.00

Questionable Integrity Signal Enable

This command determines which bits in the Questionable Integrity Signal Condition Register will set bits in the Questionable Integrity Signal Event register, which also sets the Integrity Summary bit (bit 9) in the Questionable Register. The variable <integer> is the sum of the decimal values of the bits you want to enable.

Mode	All
Remote Command	:STATus:QUESTionable:INTEgrity:SIGNal:ENABle <integer> :STATus:QUESTionable:INTEgrity:SIGNal:ENABle?
Example	STAT:QUES:INT:SIGN:ENAB 4 Burst Not Found will be reported to the Integrity Summary of the Status Questionable register.
Preset	32767
Min	0
Max	32767
Status Bits/OPC dependencies	Sequential command
Initial S/W Revision	Prior to A.02.00

Questionable Integrity Signal Event Query

This query returns the decimal value of the sum of the bits in the Questionable Integrity Signal Event register.

NOTE

The register requires that the associated PTR or NTR filters be set before a condition register bit can set a bit in the event register. The data in this register is latched until it is queried. Once queried, the register is cleared.

Mode	All
Remote Command	:STATus:QUESTionable:INTEgrity:SIGNal[:EVENT]?
Example	STAT:QUES:INT:SIGN?
Preset	0
Status Bits/OPC dependencies	Sequential command
Initial S/W Revision	Prior to A.02.00

Questionable Integrity Signal Negative Transition

This command determines which bits in the Questionable Integrity Signal Condition register will set the corresponding bit in the Questionable Integrity Signal Event register when the condition register bit has a negative transition (1 to 0). The variable <integer> is the sum of the decimal values of the bits that you want to enable.

Mode	All
Remote Command	:STATus:QUESTionable:INTEgrity:SIGNal:NTRansition <integer> :STATus:QUESTionable:INTEgrity:SIGNal:NTRansition?
Example	STAT:QUES:INT:SIGN:NTR 4 Burst found will be reported to the Integrity Summary of the Status Questionable register.
Preset	0
Min	0
Max	32767
Status Bits/OPC dependencies	Sequential command
Initial S/W Revision	Prior to A.02.00

Questionable Integrity Signal Positive Transition

This command determines which bits in the Questionable Integrity Signal Condition register will set the corresponding bit in the Questionable Integrity Signal Event register when the condition register bit has a positive transition (0 to 1). The variable <integer> is the sum of the decimal values of the bits that you want to enable.

Mode	All
Remote Command	:STATus:QUESTionable:INTEgrity:SIGNal:PTRansition <integer> :STATus:QUESTionable:INTEgrity:SIGNal:PTRansition?
Example	STAT:QUES:INT:SIGN:PTR 4 Burst not found will be reported to the Integrity Summary of the Status Questionable register.
Preset	32767
Min	0
Max	32767
Status Bits/OPC dependencies	Sequential command
Initial S/W Revision	Prior to A.02.00

Questionable Integrity Uncalibrated Register

"Questionable Integrity Uncalibrated Condition " on page 112

"Questionable Integrity Uncalibrated Enable " on page 112

"Questionable Integrity Uncalibrated Event Query " on page 113

"Questionable Integrity Uncalibrated Negative Transition " on page 113

"Questionable Integrity Uncalibrated Positive Transition " on page 114

Questionable Integrity Uncalibrated Condition

This query returns the decimal value of the sum of the bits in the Questionable Integrity Uncalibrated Condition register.

NOTE

The data in this register is continuously updated and reflects the current conditions.

Mode	All
Remote Command	:STATus:QUESTionable:INTEgrity:UNCalibrated:CONDition?
Example	STAT:QUES:INT:UNC:COND?
Preset	0
Status Bits/OPC dependencies	Sequential command
Initial S/W Revision	Prior to A.02.00

Questionable Integrity Uncalibrated Enable

This command determines which bits in the Questionable Integrity Uncalibrated Condition Register will set bits in the Questionable Integrity Uncalibrated Event register, which also sets the Data Uncalibrated Summary bit (bit 3) in the Questionable Integrity Register. The variable <integer> is the sum of the decimal values of the bits you want to enable.

Mode	All
Remote Command	:STATus:QUEStionable:INTEgrity:UNCalibrated:ENABle :STATus:QUEStionable:INTEgrity:UNCalibrated:ENABle?
Example	STAT:QUES:INT:UNC:ENAB 1 Oversweep (Meas Uncal) will be reported to the Integrity Summary of the Status Questionable register.
Preset	32767
Min	0
Max	32767
Status Bits/OPC dependencies	Sequential command
Initial S/W Revision	Prior to A.02.00

Questionable Integrity Uncalibrated Event Query

This query returns the decimal value of the sum of the bits in the Questionable Integrity Uncalibrated Event register.

NOTE

The register requires that the associated PTR or NTR filters be set before a condition register bit can set a bit in the event register. The data in this register is latched until it is queried. Once queried, the register is cleared.

Mode	All
Remote Command	:STATus:QUEStionable:INTEgrity:UNCalibrated[:EVENT]?
Example	STAT:QUES:INT:UNC?
Preset	0
Status Bits/OPC dependencies	Sequential command
Initial S/W Revision	Prior to A.02.00

Questionable Integrity Uncalibrated Negative Transition

This command determines which bits in the Questionable Integrity Uncalibrated Condition register will set the corresponding bit in the Questionable Integrity Uncalibrated Event register when the condition register bit has a negative transition (1 to 0). The variable <integer> is the sum of the decimal values of the bits that you want to enable.

Mode	All
Remote Command	:STATus:QUEStionable:INTEgrity:UNCalibrated:NTRansition <integer> :STATus:QUEStionable:INTEgrity:UNCalibrated:NTRansition?
Example	STAT:QUES:INT:UNC:NTR 1 Oversweep cleared will be reported to the Integrity Summary of the Status Questionable register.

Preset	0
Min	0
Max	32767
Status Bits/OPC dependencies	Sequential command
Initial S/W Revision	Prior to A.02.00

Questionable Integrity Uncalibrated Positive Transition

This command determines which bits in the Questionable Integrity Uncalibrated Condition register will set the corresponding bit in the Questionable Integrity Uncalibrated Event register when the condition register bit has a positive transition (0 to 1). The variable <integer> is the sum of the decimal values of the bits that you want to enable.

Mode	All
Remote Command	:STATus:QUEStionable:INTEgrity:UNCalibrated:PTRansition <integer> :STATus:QUEStionable:INTEgrity:UNCalibrated:PTRansition?
Example	STAT:QUES:INT:UNC:PTR 1 Oversweep (Meas Uncal) occurred will be reported to the Integrity Summary of the Status Questionable register.
Preset	32767
Min	0
Max	32767
Status Bits/OPC dependencies	Sequential command
Initial S/W Revision	Prior to A.02.00

Questionable Power Register

"Questionable Power Condition " on page 114

"Questionable Power Enable " on page 115

"Questionable Power Event Query " on page 115

"Questionable Power Negative Transition " on page 116

"Questionable Power Positive Transition " on page 116

Questionable Power Condition

This query returns the decimal value of the sum of the bits in the Questionable Power Condition register.

NOTE

The data in this register is continuously updated and reflects the current conditions.

Mode	All
Remote Command	:STATus:QUESTionable:POWer:CONDition?
Example	STAT:QUES:POW:COND?
Preset	0
Status Bits/OPC dependencies	Sequential command
Initial S/W Revision	Prior to A.02.00

Questionable Power Enable

This command determines which bits in the Questionable Power Condition Register will set bits in the Questionable Power Event register, which also sets the Power Summary bit (bit 3) in the Questionable Register. The variable <integer> is the sum of the decimal values of the bits you want to enable.

Mode	All
Remote Command	:STATus:QUESTionable:POWer:ENABle <integer> :STATus:QUESTionable:POWer:ENABle?
Example	STAT:QUES:POW:ENAB 32 50 MHz Input Pwr too High for Cal will be reported to the Power Summary of the Status Questionable register.
Preset	32767
Min	0
Max	32767
Status Bits/OPC dependencies	Sequential command
Initial S/W Revision	Prior to A.02.00

Questionable Power Event Query

This query returns the decimal value of the sum of the bits in the Questionable Power Event register.

NOTE

The register requires that the associated PTR or NTR filters be set before a condition register bit can set a bit in the event register. The data in this register is latched until it is queried. Once queried, the register is cleared.

Mode	All
Remote Command	:STATus:QUESTionable:POWer[:EVENT]?
Example	STAT:QUES:POW?
Preset	0
Status Bits/OPC dependencies	Sequential command
Initial S/W Revision	Prior to A.02.00

Questionable Power Negative Transition

This command determines which bits in the Questionable Power Condition register will set the corresponding bit in the Questionable Power Event register when the condition register bit has a negative transition (1 to 0). The variable <integer> is the sum of the decimal values of the bits that you want to enable.

Mode	All
Remote Command	:STATus:QUESTionable:POWer:NTRansition <integer> :STATus:QUESTionable:POWer:NTRansition?
Example	STAT:QUES:POW:NTR 32 50 MHz Input Power became OK for Cal will be reported to the Power Summary of the Status Questionable register.
Preset	0
Min	0
Max	32767
Status Bits/OPC dependencies	Sequential command
Initial S/W Revision	Prior to A.02.00

Questionable Power Positive Transition

This command determines which bits in the Questionable Power Condition register will set the corresponding bit in the Questionable Power Event register when the condition register bit has a positive transition (0 to 1). The variable <integer> is the sum of the decimal values of the bits that you want to enable.

Mode	All
Remote Command	:STATus:QUESTionable:POWer:PTRansition <integer> :STATus:QUESTionable:POWer:PTRansition?>
Example	STAT:QUES:POW:PTR 32 50 MHz Input Power became too high for Cal will be reported to the Power Summary of the Status Questionable register.
Preset	32767
Min	0
Max	32767
Status Bits/OPC dependencies	Sequential command
Initial S/W Revision	Prior to A.02.00

Questionable Temperature Register

"Questionable Temperature Condition" on page 117

"Questionable Temperature Enable" on page 117

"Questionable Temperature Event Query" on page 117

"Questionable Temperature Negative Transition" on page 118

"Questionable Temperature Positive Transition" on page 118

Questionable Temperature Condition

This query returns the decimal value of the sum of the bits in the Questionable Temperature Condition register.

NOTE

The data in this register is continuously updated and reflects the current conditions.

Mode	All
Remote Command	:STATus:QUESTionable:TEMPerature:CONDition?
Example	STAT:QUES:TEMP:COND?
Preset	0
Status Bits/OPC dependencies	Sequential command
Initial S/W Revision	Prior to A.02.00

Questionable Temperature Enable

This command determines which bits in the Questionable Temperature Condition Register will set bits in the Questionable Temperature Event register, which also sets the Temperature Summary bit (bit 4) in the Questionable Register. The variable <integer> is the sum of the decimal values of the bits you want to enable.

Mode	All
Remote Command	:STATus:QUESTionable:TEMPerature:ENABle <integer> :STATus:QUESTionable:TEMPerature:ENABle?
Example	STAT:QUES:TEMP:ENAB 1 Reference Oscillator Oven Cold will be reported to the Temperature Summary of the Status Questionable register.
Preset	32767
Min	0
Max	32767
Status Bits/OPC dependencies	Sequential command
Initial S/W Revision	Prior to A.02.00

Questionable Temperature Event Query

This query returns the decimal value of the sum of the bits in the Questionable Temperature Event register.

NOTE

The register requires that the associated PTR or NTR filters be set before a condition register bit can set a bit in the event register. The data in this register is latched until it is queried. Once queried, the register is cleared

Mode	All
Remote Command	:STATus:QUESTionable:TEMPerature[:EVENT]?
Example	STAT:QUES:TEMP?
Preset	0
Status Bits/OPC dependencies	Sequential command
Initial S/W Revision	Prior to A.02.00

Questionable Temperature Negative Transition

This command determines which bits in the Questionable Temperature Condition register will set the corresponding bit in the Questionable Temperature Event register when the condition register bit has a negative transition (1 to 0). The variable <integer> is the sum of the decimal values of the bits that you want to enable.

Mode	All
Remote Command	:STATus:QUESTionable:TEMPerature:NTRansition <integer> :STATus:QUESTionable:TEMPerature:NTRansition?
Example	STAT:QUES:TEMP:NTR 1 Reference Oscillator Oven not cold will be reported to the Temperature Summary of the Status Questionable register.
Preset	0
Min	0
Max	32767
Status Bits/OPC dependencies	Sequential command
Initial S/W Revision	Prior to A.02.00

Questionable Temperature Positive Transition

This command determines which bits in the Questionable Temperature Condition register will set the corresponding bit in the Questionable Temperature Event register when the condition register bit has a positive transition (0 to 1). The variable <integer> is the sum of the decimal values of the bits that you want to enable.

Mode	All
Remote Command	:STATus:QUESTionable:TEMPerature:PTRansition <integer> :STATus:QUESTionable:TEMPerature:PTRansition?
Example	STAT:QUES:TEMP:PTR 1 Reference Oscillator Oven became cold will be reported to the

	Temperature Summary of the Status Questionable register.
Preset	32767
Min	0
Max	32767
Status Bits/OPC dependencies	Sequential command
Initial S/W Revision	Prior to A.02.00

Common Commands

- "All (Daily use)" on page 204
- "Clear Status " on page 122
- "Standard Event Status Enable " on page 123
- "Standard Event Status Register Query " on page 123
- "Identification Query " on page 124
- "Operation Complete " on page 124
- "Query Instrument Options " on page 125
- "Recall Instrument State " on page 125
- "*RST (Remote Command Only)" on page 126
- "Save Instrument State " on page 126
- "Service Request Enable " on page 127
- "Status Byte Query " on page 127
- "Trigger " on page 127
- "Self Test Query " on page 128
- "Wait-to-Continue " on page 128

All (Daily use)

Immediately executes an alignment of all subsystems which includes both the source and the analyzer in the TRX module. The "All" alignment is sufficient to maintain specified performance, provided that (1) the TRX's internal temperature has not drifted more than +/-5 degree C since the previous alignment, and (2) no more than 8 hours have elapsed since the previous "All" alignment., and (3) no more than 1 week has elapsed since these three alignments have all been run: IF, RF, and Source, and (4) a 45 minute warm-up period between power-up of the TRX and invoking the "All" alignment. The instrument stops any measurement currently underway, performs the alignment, then restarts the measurement from the beginning (similar to pressing the Restart key).

If an interfering user signal is present at the RF Input, the alignment is performed on all subsystems except the RF. After completion, the Error Condition message "Align skipped: 50 MHz interference" or "Align skipped: 4.8 GHz interference" is generated. In addition the Error Condition message "Align Now, RF required" is generated, and bits 11 and 12 are set in the Status Questionable Calibration register.

The query form of the remote commands (:CALibration[:ALL]? or *CAL?) invokes the alignment of all subsystems and returns a success or failure value. An interfering user signal is not grounds for failure; if the alignment was able to succeed on all portions but unable to align the RF because of an interfering signal, the resultant will be the success value.

Successful completion of Align Now, All will clear the "Align Now, All required" Error Condition, and clear bit 14 in the Status Questionable Calibration register. It will also begin the elapsed time counter for Last Align Now, All Time, and capture the Last Align Now, All Temperature.

If the Align RF subsystem succeeded in aligning (no interfering signal present), the elapsed time counter begins for Last Align Now, RF Time, and the temperature is captured for the Last Align Now, RF Temperature. In addition the Error Conditions “Align skipped: 50 MHz interference” and “Align skipped: 4.8 GHz interference” are cleared, the Error Condition “Align Now, RF required” is cleared, and bits 11 and 12 are cleared in the Status Questionable Calibration register

Align Now, All can be interrupted by pressing the Cancel (ESC) front-panel key or remotely with Device Clear followed by the :ABORT SCPI command. When this occurs the Error Condition message “Align Now, All required” is generated, and bit 14 is set in the Status Questionable Condition register. This is because new alignment data may be employed for an individual subsystem, but not a cohesive set of data for all subsystems.

In many cases, you might find it more convenient to change alignments to Normal, instead of executing Align Now, All. When the Auto Align process transitions to Normal, the analyzer will immediately start to update only the alignments that have expired, thus efficiently restoring the alignment process.

NOTE

In EXM, Source ARB play will be turned off and the source states will not be restored after Align Now, All.

Key Path	System, Alignments, Align Now
Mode	All
Remote Command	:CALibration[:ALL] :CALibration[:ALL]?
Example	:CAL
Notes	:CALibration[:ALL]? returns 0 if successful :CALibration[:ALL]? returns 1 if failed :CALibration[:ALL]? is the same as *CAL? While Align Now, All is performing the alignment, bit 0 in the Status Operation register is set. Completion, or termination, will clear bit 0 in the Status Operation register. This command is sequential; it must complete before further SCPI commands are processed. Interrupting the alignment from remote is accomplished by invoking Device Clear followed by the :ABORT command. Successful completion will clear bit 14 in the Status Questionable Calibration register. An interfering user signal is not grounds for failure of Align Now, All. However, bits 11 and 12 are set in the Status Questionable Calibration register to indicate Align Now, RF is required. An interfering user supplied signal will result in the instrument requiring an Align Now, RF with the interfering signal removed.
Couplings	Initializes the time for the Last Align Now, All Time. Records the temperature for the Last Align Now, All Temperature. If Align RF component succeeded, initializes the time for the Last Align Now, RF Time. If Align RF component succeeded, records the temperature for the Last Align Now, RF Temperature.
Status Bits/OPC dependencies	Bits 11, 12, or 14 may be set in the Status Questionable Calibration register.
Initial S/W Revision	Prior to A.02.00

Mode	All
Remote Command	*CAL?
Example	*CAL?
Notes	*CAL? returns 0 if successful *CAL? returns 1 if failed :CALibration[:ALL]? is the same as *CAL? See additional remarks described with :CALibration[:ALL]? Everything about :CALibration[:ALL]? is synonymous with *CAL? including all conditions, status register bits, and couplings
Initial S/W Revision	Prior to A.02.00

Mode	All
Remote Command	:CALibration[:ALL]:NPENding
Example	CAL:NPEN
Notes	:CALibration[:ALL]:NPENding is the same as :CALibration[:ALL] including all conditions, status register bits, except this scpi command does not BLOCK the scpi session, so the user should use status register bits to query if the calibration is successfully completed or not. Typical usage is: 1) :CALibration:ALL:NPENding (Start a calibration) 2) :STATus:OPERation:CONDition? (Check if the calibration is completed or not, If bit 0 is set, then the system is doing calibration, the user should repeat this scpi query until the bit is cleared) 3):STATus:QUEStionable:CALibration:CONDition? (Check if there are any errors/failures in previous calibration procedure
Initial S/W Revision	X.14.20

Clear Status

Clears the status byte register. It does this by emptying the error queue and clearing all bits in all of the event registers. The status byte register summarizes the states of the other registers. It is also responsible for generating service requests.

Key Path	No equivalent key. Related key System, Show Errors, Clear Error Queue
Remote Command	*CLS
Example	*CLS Clears the error queue and the Status Byte Register.
Notes	For related commands, see the SYSTem:ERRor[:NEXT]? command. See also the STATus:PRESet command and all commands in the STATus subsystem.
Status Bits/OPC dependencies	Resets all bits in all event registers to 0, which resets all the status byte register bits to 0 also.
Backwards Compatibility Notes	In general the status bits used in the X-Series status system will be backwards compatible with ESA and PSA. However, note that all conditions will generate events that go into the event log, and some

	will also generate status bits.
Initial S/W Revision	Prior to A.02.00

Standard Event Status Enable

Selects the desired bits from the standard event status enable register. This register monitors I/O errors and synchronization conditions such as operation complete, request control, query error, device dependent error, status execution error, command error, and power on. The selected bits are OR'd to become a summary bit (bit 5) in the byte register which can be queried.

The query returns the state of the standard event status enable register.

Key Path	No equivalent key. Related key System, Show Errors, Clear Error Queue
Remote Command	*ESE <integer> *ESE?
Example	*ESE 36 Enables the Standard Event Status Register to monitor query and command errors (bits 2 and 5). *ESE? Returns a 36 indicating that the query and command status bits are enabled.
Notes	For related commands, see the STATus subsystem and SYSTem:ERRor[:NEXT]? commands.
Preset	255
State Saved	Not saved in state.
Min	0
Max	255
Status Bits/OPC dependencies	Event Enable Register of the Standard Event Status Register.
Initial S/W Revision	Prior to A.02.00

Standard Event Status Register Query

Queries and clears the standard event status event register. (This is a destructive read.) The value returned is a hexadecimal number that reflects the current state (0/1) of all the bits in the register.

Remote Command	*ESR?
Example	*ESR? Returns a 1 if there is either a query or command error, otherwise it returns a zero.
Notes	For related commands, see the STATus subsystem commands.
Preset	0
Min	0
Max	255
Status Bits/OPC dependencies	Standard Event Status Register (bits 0 - 7).
Initial S/W Revision	Prior to A.02.00

Identification Query

Returns a string of instrument identification information. The string will contain the model number, serial number, and firmware revision.

The response is organized into four fields separated by commas. The field definitions are as follows:

- Manufacturer
- Model
- Serial number
- Firmware version

Key Path	No equivalent key. See related key System, Show System.
Remote Command	*IDN?
Example	*IDN? Returns instrument identification information, such as: Keysight Technologies, E6640A, US01020004, E.14.50
Initial S/W Revision	Prior to A.02.00
Modified at S/W Revision	x.14.50

Operation Complete

The *OPC command sets bit 0 in the standard event status register (SER) to “1” when pending operations have finished, that is when all overlapped commands are complete. It does not hold off subsequent operations. You can determine when the overlapped commands have completed either by polling the OPC bit in SER, or by setting up the status system such that a service request (SRQ) is asserted when the OPC bit is set.

The *OPC? query returns a “1” after all the current overlapped commands are complete. So it holds off subsequent commands until the “1” is returned, then the program continues. This query can be used to synchronize events of other instruments on the external bus.

Remote Command	*OPC *OPC?
Example	INIT:CONT 0 Selects single sweeping. INIT:IMM Initiates a sweep. *OPC? Holds off any further commands until the sweep is complete.
Status Bits/OPC dependencies	Not global to all remote ports or front panel. *OPC only considers operation that was initiated on the same port as the *OPC command was issued from. *OPC is an overlapped command, but *OPC? is sequential.
Backwards Compatibility Notes	1. The ESA/PSA/VSA products do not meet all the requirements for the *OPC command specified by IEEE 488.2. This is corrected for X-Series. This will sometimes cause behavior that is not backward compatible, but it will work as customers expect.

2. Commands such as, *OPC/*OPC?/*WAI/*RST used to be global. They considered front panel operation in conjunction with the GPIB functionality. Now they are evaluated on a per channel basis. That is, the various rear panel remote ports and the front panel i/o are all considered separately. Only the functionality initiated on the port where the *OPC was sent, is considered for its operation.

3. *OPC used to hold off until the operation bits were cleared. Now it holds off until all overlapping commands are completed. Also, earlier instruments did not wait for completion of all processes, only the ones identified here (in the STATus:OPERation register):

Calibrating: monitored by PSA, ESA, VSA (E4406A)

Sweeping: monitored by PSA, ESA, VSA (E4406A)

Waiting for Trigger: monitored by PSA, ESA, VSA (E4406A)

Measuring: monitored by PSA and ESA (but not in all Modes).

Paused: monitored by VSA (E4406A).

Printing: monitored by VSA (E4406A).

Mass memory busy: monitored by VSA (E4406A).

Initial S/W Revision	Prior to A.02.00
----------------------	------------------

Query Instrument Options

Returns a string of all the installed instrument options. It is a comma separated list with quotes, such as: "503,P03,PFR".

To be IEEE compliant, this command should return an arbitrary ascii variable that would not begin and end with quotes. But the quotes are needed to be backward compatible with previous SA products and software. So, the actual implementation will use arbitrary ascii. But quotes will be sent as the first and last ascii characters that are sent with the comma-separated option list.

Remote Command	*OPT?
-----------------------	-------

Initial S/W Revision	Prior to A.02.00
----------------------	------------------

Recall Instrument State

This command recalls the instrument state from the specified instrument memory register.

- If the state being loaded has a newer firmware revision than the revision of the instrument, no state is recalled and an error is reported
- If the state being loaded has an equal firmware revision than the revision of the instrument, the state will be loaded.
- If the state being loaded has an older firmware revision than the revision of the instrument, the instrument will only load the parts of the state that apply to the older revision.

Remote Command	*RCL <register #>
-----------------------	-------------------

Example	*RCL 7 Recalls the instrument state that is currently stored in register 7.
----------------	---

Notes	Registers 0 through 6 are accessible from the front panel in menu keys for Recall Registers.
Min	0
Max	127
Status Bits/OPC dependencies	The command is sequential.
Initial S/W Revision	Prior to A.02.00

*RST (Remote Command Only)

*RST is equivalent to :SYST:PRES::INIT:CONT OFF, which is a Mode Preset in the Single measurement state. This remote command is preferred over Mode Preset remote command - :SYST:PRES, as optimal remote programming occurs with the instrument in the single measurement state.

Remote Command	*RST
Example	*RST
Notes	Sequential Clears all pending OPC bits and the Status Byte is set to 0.
Couplings	A *RST will cause the currently running measurement to be aborted and cause the default measurement to be active. *RST gets the mode to a consistent state with all of the default couplings set.
Backwards Compatibility Notes	In legacy analyzers *RST did not set the analyzer to Single, but in the X-Series it does, for compliance with the IEEE 488.2 specification. In the X-Series, *RST does not do a *CLS (clear the status bits and the error queue). In legacy analyzers, *RST used to do the equivalent of SYSTem:PRESet, *CLS and INITiate:CONTinuous OFF. But to be 488.2 compliant, *RST in the X-Series does not do a *CLS.
Initial S/W Revision	Prior to A.02.00

Save Instrument State

This command saves the current instrument state and mode to the specified instrument memory register.

Remote Command	*SAV <register #>
Example	*SAV 9 Saves the instrument state in register 9.
Notes	Registers 0 through 6 are accessible from the front panel in menu keys for Save Registers.
Min	0
Max	127
Status Bits/OPC dependencies	The command is sequential.
Initial S/W Revision	Prior to A.02.00

Service Request Enable

This command enables the desired bits of the service request enable register.

The query returns the value of the register, indicating which bits are currently enabled.

Remote Command	*SRE <integer> *SRE?
Example	*SRE 22 Enables bits 1, 2, and 4 in the service request enable register.
Notes	For related commands, see the STATus subsystem and SYSTem:ERRor[:NEXT]? commands.
Preset	0
Min	0
Max	255
Status Bits/OPC dependencies	Service Request Enable Register (all bits, 0 - 7).
Initial S/W Revision	Prior to A.02.00

Status Byte Query

Returns the value of the status byte register without erasing its contents.

Remote Command	*STB?
Example	*STB? Returns a decimal value for the bits in the status byte register. For example, if a 16 is returned, it indicates that bit 5 is set and one of the conditions monitored in the standard event status register is set.
Notes	See related command *CLS.
Status Bits/OPC dependencies	Status Byte Register (all bits, 0 - 7).
Initial S/W Revision	Prior to A.02.00

Trigger

This command triggers the instrument. Use the :TRIGger[:SEquence]:SOURce command to select the trigger source.

Key Path	No equivalent key. See related keys Single and Restart.
Remote Command	*TRG
Example	*TRG Triggers the instrument to take a sweep or start a measurement, depending on the current instrument settings.
Notes	See related command :INITiate:IMMEDIATE.
Initial S/W Revision	Prior to A.02.00

Self Test Query

This query performs the internal self-test routines and returns a number indicating the success of the testing. A zero is returned if the test is successful, 1 if it fails.

Remote Command	*TST?
Example	*TST? Runs the self-test routines and returns 0=passed, 1=some part failed.
Initial S/W Revision	Prior to A.02.00

Wait-to-Continue

This command causes the instrument to wait until all overlapped commands are completed before executing any additional commands. There is no query form for the command.

Remote Command	*WAI
Example	INIT:CONT OFF; INIT;*WAI Sets the instrument to single sweep. Starts a sweep and waits for its completion.
Status Bits/OPC dependencies	Not global to all remote ports or front panel. *OPC only considers operation that was initiated on the same port as the *OPC command was issued from.
Initial S/W Revision	Prior to A.02.00

4 Input/Output Functions

Input/Output

The Input/Output features are common across multiple Modes and Measurements. These common features are described in this section. See the Measurement description for information on features that are unique.

The Input/Output key accesses the keys that control the Input/Output parameters of the instrument. In general, these are functions associated with external connections to the analyzer, either to the inputs or the outputs. Since these connections tend to be fairly stable within a given setup, in general, the input/output settings do not change when you Preset the analyzer.

Other functions related to the input/output connections, but which tend to change on a measurement by measurement basis, can be found under the Trigger and AMPTD Y Scale keys. In addition, some of the digital I/O bus configurations can be found under the System key.

NOTE

The functions in the Input/Output menu are "global" (common) to all Modes (applications). But individual Input/Output functions only appear in a Mode if they apply to that Mode. Functions that apply to a Mode but not to all measurements in the Mode may be grayed-out in some measurements.

["Input/Output variables - Preset behavior" on page 131](#)

The Input Port selection is the first menu under the Input/Output key:

Key Path	Front-panel key
Remote Command	<code>[:SENSe] :FEED RF AIQ EMIXer</code> <code>[:SENSe] :FEED?</code>
Example	<code>:FEED RF</code> <code>:FEED?</code>
Couplings	The <code>[:SENSe] :FEED RF</code> command turns the calibrator OFF
Preset	This setting is unaffected by a Preset or power cycle. It survives a Mode Preset and mode changes. It is set to RF on a "Restore Input/Output Defaults" or "Restore System Defaults->All"
State Saved	Saved in instrument state
Backwards Compatibility SCPI	<code>[:SENSe] :FEED AREFERENCE</code> In the PSA the calibrator was one of the inputs and selected using the AREF parameter to the same <code>:FEED</code> command that switched the inputs. In the X-Series it is controlled in a separate menu and overrides the input selection. For code compatibility the <code>[:SENSe] :FEED AREFERENCE</code> command is provided, and is aliased to <code>[:SENSe] :FEED :AREF REF50</code> , which causes the input to be switched to the 50 MHz calibrator. The <code>[:SENSe] :FEED RF</code> command switches the input back to the RF port and turns the calibrator OFF, thus providing full compatibility with the PSA calibrator function. Note that after sending this, the query <code>[:SENSe] :FEED?</code> will NOT return "AREF" but instead the currently selected input.
Backwards Compatibility SCPI	<code>[:SENSe] :FEED IQ IONLy QONLy</code> <code>[:SENSe] :FEED?</code> The parameters <code>IQ IONLy QONLy</code> are supported for backwards compatibility with the E44406A. <code>[:SENSe] :FEED IQ</code> aliases to <code>[:SENSe] :FEED :IQ :TYPE IQ</code> <code>[:SENSe] :FEED IONLy</code> aliases to <code>[:SENSe] :FEED :IQ :TYPE IONLy</code>

	<p>[;SENSe]:FEED QONLY aliases to [;SENSe]:FEED:IQ:TYPE QONLY</p> <p>The query [;SENSe]:FEED? will always returns AIQ whatever the type of legacy parameters IQ IONLY QONLY has been used.</p>
Backwards Compatibility Notes	<p>Most of the settings in the X-Series Input/Output system, including External Gain, Amplitude Corrections settings and data, etc., are shared by all modes and are not changed by a mode switch. Furthermore, most variables in the Input/Output system key are not affected by Mode Preset. Both of these behaviors represent a departure from legacy behavior.</p> <p>In the X-Series. Input/Output settings are reset by using the "Restore Input/Output Defaults" function. They can also be reset to their default values through the System->Restore System Defaults-> In/Out Config key or through the System ->Restore System Defaults -> All key (and corresponding SCPI).</p> <p>While this matches most use cases better, it does create some code compatibility issues. For example, Amplitude Corrections are no longer turned off by a Mode Preset, but instead by using the "Restore Input/Output Defaults" key/SCPI.</p> <p>Although Input/Output settings are not part of each Mode's State, they are saved in the Save State files, so that all of the instrument settings can be recalled with Recall State, as in legacy instruments.</p>
Initial S/W Revision	Prior to A.02.00
Remote Command	<p>:INPut:MIXer EXTernal INTernal</p> <p>:INPut:MIXer?</p>
Example	<p>INP:MIX INT</p> <p>INP:MIX?</p>
Notes	<p>In legacy analyzers you choose between the Internal mixer or an External Mixer. In the X-Series, the External Mixer is one of the choices for the Input and is selected using the FEED command (:SENSe:FEED EXTMIxer).</p> <p>For compatibility, the INPut:MIXer EXTernal INTernal legacy command is mapped as follows:</p> <ol style="list-style-type: none"> 1. When INPut:MIXer EXTernal is received, SENSe:FEED EMIXer is executed. 2. When INPut:MIXer INTernal is received, SENSe:FEED RF is executed. 3. When INPut:MIXer? is received, the response will be INT if any input other than the external mixer is selected and EXT if the external mixer is selected
Preset	INT
Backwards Compatibility Notes	<p>PSA supports the following SCPI Command :</p> <p>:INPut:MIXer:TYPE PRESelected UNPReselect</p> <p>:INPut:MIXer:TYPE?</p> <p>PXA does not support the :INPut:MIXer:TYPE command.</p>
Initial S/W Revision	A.08.01

Input/Output variables - Preset behavior

Virtually all the input/output settings are NOT a part of mode preset. They can be set to their default value

by one of the three ways:

- by using the Restore Input/Output Defaults key on the first page of the input/output menu,
- by using the System->Restore System Defaults->Input/Output Settings or,
- by using the System -> Restore System Defaults->All. Also, they survive a Preset and a Power cycle.

A very few of the Input/Output settings do respond to a Mode Preset; for example, if the Calibrator is on it turns off on a Preset, and if DC coupling is in effect it switches to AC on a Preset. These exceptions are made in the interest of reliability and usability, which overrides the need for absolute consistency. Exceptions are noted in the SCPI table for the excepted functions.

RF Input

Selects the front-panel RF input port to be the analyzer signal input. If RF is already selected, pressing this key accesses the RF input setup functions.

Key Path	Input/Output
Example	[:SENSe]:FEED RF
Couplings	The act of connecting the U7227A USB Preamplifier to one of the analyzer's USB ports will cause the Input to automatically switch to the RF Input. If the RF Calibrator is on, it is turned off. Subsequently disconnecting the USB Preamp from USB does not change the Input selection nor restore the previous selection.
Readback	The RF input port, RF coupling, and current input impedance settings appear on this key as: "XX, YY, ZZ" where XX is RF, RF2, RFIO1, RFIO2, depending on what input is selected (only appears on analyzers with multiple RF inputs) YY is AC or DC ZZ is 50Ω or 75Ω
Initial S/W Revision	Prior to A.02.00
Modified at S/W Revision	A.14.00

Input Z Correction

Sets the input impedance for unit conversions. This affects the results when the y-axis unit is voltage or current units (dBmV, dBμV, dBμA, V, A), but not when it is power units (dBm, W). The impedance you select is for computational purposes only, since the actual impedance is set by internal hardware to 50 ohms. Setting the computational input impedance to 75 ohms is useful when using a 75 ohm to 50 ohm adapter to measure a 75 ohm device on an analyzer with a 50 ohm input impedance.

There are a variety of ways to make 50 to 75 ohm transitions, such as impedance transformers or minimum loss pads. The choice of the solution that is best for your measurement situation requires balancing the amount of loss that you can tolerate with the amount of measurement frequency range that you need. If you are using one of these pads/adaptors with the Input Z Corr function, you might also want to use the Ext Gain key. This function is used to set a correction value to compensate for the gain (loss) through your pad. This correction factor is applied to the displayed measurement values.

Key Path	Input/Output, RF Input
Remote Command	<code>[:SENSe] :CORRection:IMPedance [:INPut] [:MAGNitude] 50 75</code> <code>[:SENSe] :CORRection:IMPedance [:INPut] [:MAGNitude] ?</code>
Example	CORR:IMP 75 sets the input impedance correction to 75 ohms. CORR:IMP?
Preset	This is unaffected by a Preset but is set to 50 ohms on a "Restore Input/Output Defaults" or "Restore System Defaults->All" Some instruments/options may have 75 ohms available.
State Saved	Saved in instrument state
Readback	50 Ω or 75 Ω . Current setting reads back to the RF key.
Initial S/W Revision	Prior to A.02.00

RF Input Port

Specifies the RF input port used. The RF Input Port key only appears on units with multiple inputs, and lets you switch between the two inputs.

Switching from the RF input port to one of the RFIO ports, on units that have them, changes the receiver performance of the instrument.

Key Path	Input/Output, RF Input
Remote Command	<code>[:SENSe] :FEED:RF:PORT [:INPut] RFIN RFIN2 RFIO1 RFIO2 RFIO3 RFIO4</code> <code>[:SENSe] :FEED:RF:PORT [:INPut] ?</code>
Example	:FEED:RF:PORT RFIN
Dependencies	This key only appears in models that support multiple inputs. If the SCPI command is sent with unsupported parameters in any other model, an error is generated, -221.1900, "Settings conflict;option not installed" When any input is selected in a measurement that does not support it, the "No result; Meas invalid with this input" error condition occurs, and the measurement returns invalid data when queried.
Preset	This is unaffected by Mode Preset but is set to RF on a "Restore Input/Output Defaults" or "Restore System Defaults -> All"
State Saved	Saved in instrument state
Readback	The current RF Input Port selected is read back to this key
Backwards Compatibility SCPI	<code>INPut<1 2>:TYPE INPUT1 INPUT2</code> <code>INPut<1 2>:TYPE?</code> Included for R&S ESU compatibility. In the MXE, the INPUT1 parameter is aliased to RFIN and the INPUT2 parameter is aliased to RFIN2
Initial S/W Revision	A.05.01
Modified at S/W Revision	A.14.00

RF Input

Specifies using the main RF port for the current measurement

Key Path	Input/Output, RF Input, RF Input Port
Example	:FEED:RF:PORT RFIN
Notes	On E6640A with hardware M9430A, if RF Input is selected as RF Input Port, you need to choose the settings in the Half Duplex Config menu to determine which port (RFIO3 or RFIO4) will be used. On E6640A with hardware M9431A, this setting is not supported. If the SCPI command is sent with this setting, an error is generated, -221, "Settings conflict;option not installed"
ReadBack	RF Input
Initial S/W Revision	A.05.01
Modified at S/W Revision	A.14.00

RFIO1

Specifies using the RFIO 1 port for the current measurement

Key Path	Input/Output, RF Input, RF Input Port
Example	:FEED:RF:PORT RFIO1
Dependencies	RFIO1 is not available inE6607C. If Multiport Adapter is ON, Select RF Input to RFIO1, an error message is generated: "-221, Settings conflict; RFIO1 or RFIO2 Port unavailable when Multiport Adapter is ON".
ReadBack	RFIO 1
Initial S/W Revision	A.05.01

RFIO2

Specifies using the RFIO 2 port for the current measurement

Key Path	Input/Output, RF Input, RF Input Port
Example	:FEED:RF:PORT RFIO2
Dependencies	RFIO2 is not available inE6607C. If Multiport Adapter is ON, Select RF Input to RFIO2, an error message is generated: "-221, Settings conflict; RFIO1 or RFIO2 Port unavailable when Multiport Adapter is ON".
ReadBack	RFIO 2
Initial S/W Revision	A.05.01

External Gain

Compensates for gain or loss in the measurement system outside the spectrum analyzer. The External Gain is subtracted from the amplitude readout (or the loss is added to the amplitude readout). So, the displayed signal level represents the signal level at the output of the device-under-test, which can be the input of an external device that provides gain or loss.

Entering an External Gain value does not affect the Reference Level, therefore the trace position on screen changes, as do all of the values represented by the trace data. Thus, the values of exported trace data, queried trace data, marker amplitudes, trace data used in calculations such as N dB points, trace math, peak threshold, etc., are all affected by External Gain. Changing the External Gain, even on a trace that is not updating, will immediately change all of the above, without new data needing to be taken.

NOTE

Changing the External Gain causes the analyzer to immediately stop the current sweep and prepare to begin a new sweep. The data will not change until the trace data updates because the offset is applied to the data as it is taken. If a trace is exported with a nonzero External Gain, the exported data will contain the trace data with the offset applied.

In the Spectrum Analyzer mode, a Preamp is the common external device providing gain or loss. In a measurement application mode like GSM or W-CDMA, the gain or loss could be from a BTS (Base Transceiver Station) or an MS (Mobile Station). So in the Spectrum Analyzer mode MS and BTS would be grayed out and the only choice would be Ext Preamp. Similarly in some of the digital communications applications, Ext Preamp will be grayed out and you would have a choice of MS or BTS.

Key Path	Input/Output
Couplings	The Ext Preamp, MS, and BS keys may be grayed out depending on which measurement is currently selected. If any of the grayed out keys are pressed, or the equivalent SCPI command is sent, an advisory message is generated.
Readback	1-of-N selection [variable]
Initial S/W Revision	Prior to A.02.00

Ext Preamp

This function is similar to the reference level offset function. Both affect the displayed signal level. Ref Lvl Offset is a mathematical offset only, no analyzer configuration is affected. Ext Preamp gain is used when determining the auto-coupled value of the Attenuator. The External Gain value and the Maximum Mixer Level settings are both part of the automatic setting equation for the RF attenuation setting. (10 dB of Attenuation is added for every 10 dB of External Gain.)

Note that the Ref Lvl Offset and Maximum Mixer Level are described in the Amplitude section. They are reset by the instrument Preset. The External Preamp Gain is reset by the "Restore Input/Output Defaults" or "Restore System Defaults->All functions. . The External Gain is subtracted from the amplitude readout so that the displayed signal level represents the signal level at the output of the device-under-test, which is the input of the external device that is providing gain or loss.

["More Information" on page 136](#)

Key Path	Input/Output, External Gain
----------	-----------------------------

Remote Command	<code>[:SENSe] :CORRection:SA[:RF]:GAIN <rel_ampl></code> <code>[:SENSe] :CORRection:SA[:RF]:GAIN?</code>
Example	CORR:SA:GAIN 10 sets the Ext Gain value to 10 dB CORR:SA:GAIN -10 sets the Ext Gain value to -10 dB (that is, an attenuation of 10 dB)
Notes	Does not auto return.
Dependencies	The reference level limits are determined in part by the External Gain/Atten, Max Mixer Level, and RF Atten. This key is grayed out in Modes that do not support External Gain
Preset	This is unaffected by Preset but is set to 0 dB on a "Restore Input/Output Defaults" or "Restore System Defaults->All"
State Saved	Saved in instrument state
Min	-120 dB
Max	120 dB
Readback	Preamp Gain, <Ext Gain value> dB
Backwards Compatibility SCPI	<code>[:SENSe] :CORRection:OFFSet[:MAGNitude]</code> The legacy "Ext Preamp Gain" key is now called "Ext Gain" and the sub-menu has choices of Ext Preamp MS BTS for backwards compatibility.
Initial S/W Revision	Prior to A.02.00
Modified at S/W Revision	A.14.00

More Information

The U7227A USB Preamplifier is an accessory for the X-Series Signal Analyzer that provides gain externally, and whose gain settings are automatically loaded into the analyzer over USB whenever it is connected to one of the analyzer's USB ports.

While the USB Preamplifier is plugged into one of the analyzer's USB ports, the analyzer will consider it to be in the signal path of the RF Input and will apply the calibration data from the USB Preamp to measurements taken at the RF Input (on 2 input boxes, it will be considered to be in the signal path of RF Input 1; it is not supported for RF Input 2).

The USB Preamplifier contains its own cal data. This includes a noise trace suitable for use with NFE, for those models which support NFE. The act of connecting the Preamp to USB will cause the cal data to be downloaded from the preamp. When this happens an informational message is provided saying "Cal data loaded from USB Preamp". The analyzer will then automatically apply the calibration factors loaded from the Preamp in any measurement that supports the USB Preamp.

The External Preamp Gain setting may still be used, even though it is not required for the USB Preamp (since the USB Preamp supplies its own gain data to the analyzer which is applied automatically). Connecting the USB Preamp does not change the External Preamp Gain setting, however unless you have another gain or attenuation element in the signal path, the appropriate setting for External Preamp Gain is 0 dB.

Overload detection and reporting will apply when the USB preamplifier is connected to USB. The USB Preamplifier has its own overload detector which reports overloads to the instrument over USB. This generates an error condition, "Input Overload;USB Preamp."

If, while the USB Preamp is connected to USB, a measurement is selected that does not support the USB preamplifier, the "No result; Meas invalid with Preamp" error condition is generated.

MS

Sets an external gain/attenuation value for MS (Mobile Station) tests.

Key Path	Input/Output, External Gain
Remote Command	<code>[:SENSe]:CORRection:MS[:RF]:GAIN <rel_ampl></code> <code>[:SENSe]:CORRection:MS[:RF]:GAIN?</code>
Example	CORR:MS:GAIN 10 sets the Ext Gain value to 10 dB CORR:MS:GAIN -10 sets the Ext Gain value to -10 dB (that is, a loss of 10 dB.)
Notes	Does not auto return.
Dependencies	The reference level limits are determined in part by the External Gain, Max Mixer Level, RF Atten This key is grayed out in modes that do not support MS.
Preset	This is unaffected by a Preset but is set to 0 dB on a "Restore Input/Output Defaults" or "Restore System Defaults->All"
State Saved	Saved in instrument state.
Min	-100 dB
Max	100 dB
Readback	MS, <Ext Gain value> dB
Initial S/W Revision	Prior to A.02.00

Remote Command	<code>[:SENSe]:CORRection:MS[:RF]:LOSS <rel_ampl></code> <code>[:SENSe]:CORRection:MS[:RF]:LOSS?</code>
Example	CORR:MS:LOSS 10 sets the Ext Gain value to -10 dB, and subsequently querying :LOSS will give 10 dB CORR:MS:LOSS -10 sets the Ext Gain value to 10 dB, and subsequently querying :LOSS will give -10 dB
Notes	A positive value of <rel_ampl> in the above command means a loss and a negative value indicates a gain. Anytime :LOSS is set it sets :GAIN to the negative value of the parameter sent. Anytime :LOSS is queried it gives the negative of :GAIN
Preset	This is unaffected by a Preset but is set to 0 dB on a "Restore Input/Output Defaults" or "Restore System Defaults->All"
Min	100 dB
Max	-100 dB
Initial S/W Revision	Prior to A.02.00

BTS

Sets an external attenuation value for BTS (Base Transceiver Station) tests.

Key Path	Input/Output, External Gain
Remote Command	<code>[:SENSe]:CORRection:BTS[:RF]:GAIN <rel_ampl></code> <code>[:SENSe]:CORRection:BTS[:RF]:GAIN?</code>
Example	CORR:BTS:GAIN 10 sets the Ext Gain value to 10 dB CORR:BTS:GAIN -10 sets the Ext Gain value to -10 dB (that is, a loss of 10 dB.)
Notes	Does not auto return.
Dependencies	The reference level limits are determined in part by the External Gain, Max Mixer Level, RF Atten This key is grayed out in modes that do not support BTS.
Preset	This is unaffected by a Preset but is set to 0 dB on a "Restore Input/Output Defaults" or "Restore System Defaults->All"
State Saved	Saved in instrument state.
Min	-100 dB
Max	100 dB
Readback	BTS, <Ext Gain value> dB
Initial S/W Revision	Prior to A.02.00

Remote Command	<code>[:SENSe]:CORRection:BTS[:RF]:LOSS <rel_ampl></code> <code>[:SENSe]:CORRection:BTS[:RF]:LOSS?</code>
Example	CORR:BTS:LOSS 10 sets the Ext Gain value to -10 dB, and subsequently querying :LOSS will give 10 dB CORR:BTS:LOSS -10 sets the Ext Gain value to 10 dB, and subsequently querying :LOSS will give -10 dB
Notes	A positive value of <rel_ampl> in the above command means a loss and a negative value indicates a gain. Anytime :LOSS is set it sets :GAIN to the negative value of the parameter sent. Anytime :LOSS is queried it gives the negative of :GAIN
Preset	This is unaffected by a Preset but is set to 0 dB on a "Restore Input/Output Defaults" or "Restore System Defaults->All"
Min	100 dB
Max	-100 dB
Initial S/W Revision	Prior to A.02.00

Restore Input/Output Defaults

This selection causes the group of settings and data associated with the Input/Output key to be a reset to their default values. In addition, when a Source is installed, licensed and selected, Restore Input/Output defaults will initiate a Source Preset.

This level of Restore System Defaults does not affect any other system settings or mode settings and does not cause a mode switch. All the features described in this section are reset using this key, including Input Corrections and Data (described in the Corrections section).

Key Path	Input/Output
Example	:SYST:DEF INP presets all the Input/Output variables to their factory default values.
Notes	Refer to the Utility Functions for information about Restore System Defaults and the complete description of the :SYSTem:DEFault INPut: command.
Initial S/W Revision	Prior to A.02.00

Freq Ref In

Specifies the frequency reference as being the internal reference at the rear panel input labeled EXT REF IN, a 1 pulse per second signal at the EXT REF IN input,, external reference or sensing the presence of a signal at the EXT REF IN input.

When the frequency reference is set to internal, the internal 10 MHz reference is used even if an external reference is connected.

When the frequency reference is set to external, the instrument will use the external reference. However, if there is no external signal present, or it is not within the proper amplitude range, a condition error message is generated. When the external signal becomes valid, the error is cleared.

When the frequency reference is set to Pulse, the instrument expects a 1 pulse per second signal at the EXT REF IN input. The instrument uses this signal to adjust the frequency of the internal reference.

If Sense is selected, the instrument checks whether a signal is present at the external reference connector. If it senses a signal within 5 ppm of the External Ref Freq (as set on the External Ref Freq softkey), it will automatically switch to the external reference. If it senses a 1 pulse per second signal, it enters Pulse mode, wherein the signal is used to adjust the internal reference. When no signal is present, it automatically switches to the internal reference. No message is generated as the reference switches between pulse, external and internal. The monitoring of the external reference occurs approximately on 1 millisecond intervals, and never occurs in the middle of a measurement acquisition, only at the end of the measurement (end of the request).

If for any reason the instrument's frequency reference is not able to obtain lock, Status bit 1 in the Questionable Frequency register will be true and a condition error message is generated. When lock is regained, Status bit 1 in the Questionable Frequency register will be cleared and the condition error will be cleared.

If an external frequency reference is being used, you must enter the frequency of the external reference if it is not exactly 10 MHz. The External Ref Freq key is provided for this purpose.

NOTE:

A common frequency reference module serves all instrument instances, but only one instance of the software application can change the reference input type (INT or EXT or SENSE). The software application allowed to change the reference input is called the controlling instance; by default, the left most instrument instance is the controlling instance. This can be changed in the config file "E66XXModules.config" located under the folder E:\Agilent\Instrument. For the non-controlling instance (s) the reference input types (in SCPI commands, and in the Virtual Front Panel menus) are blanked and unavailable for use.

Key Path	Input/Output
Remote Command	<code>[:SENSe] :ROSCillator :SOURce :TYPE INTernal EXTernal SENSe PULSe</code> <code>[:SENSe] :ROSCillator :SOURce :TYPE?</code>
Dependencies	The PULSe parameter, and support of the 1 pps signal at the EXT REF IN input, are not available in firmware prior to A.13.00. They are also not available in some model numbers. If not available, the Pulse key will be blank, and sending the PULSe parameter via SCPI will generate an error:
Preset	This is unaffected by a Preset but is set to SENSe on a "Restore Input/Output Defaults" or "Restore System Defaults->All".
State Saved	Saved in instrument state.
Status Bits/OPC dependencies	STATus:QUEStionable:FREQuency bit 1 set if unlocked. Note: The status bit is not set for non-controlling instances. To determine if the frequency reference is unlocked, the controlling instance must be queried.
Backwards Compatibility Notes	Freq Ref In was not saved in state in the legacy instruments. It is a part of state in the X-Series.
Initial S/W Revision	Prior to A.02.00
Modified at S/W Revision	A.14.00

Remote Command	<code>[:SENSe] :ROSCillator :SOURce?</code>
Notes	The query <code>[SENSe]:ROSCillator:SOURce?</code> returns the current switch setting. This means: <ol style="list-style-type: none"> 1. If it was set to SENSe but there is no external reference nor 1 pps signal so the instrument is actually using the internal reference, then this query returns INTernal and not SENSe. 2. If it was set to SENSe and there is an external reference present, the query returns EXTernal and not SENSe. 3. If it was set to SENSe and there is a 1 pps signal present, the query returns PULSe and not SENSe. 4. If it was set to EXTernal, then the query returns "EXTernal" 5. If it was set to INTernal, then the query returns "INTernal". 6. If it was set to PULSe, then the query returns "PULSe" Note: The SCPI query always returns "INTernal" for non-controlling instances.
Preset	SENSe
Backwards Compatibility Notes	The query <code>[:SENSe] :ROSCillator :SOURce?</code> was a query-only command in ESA which always returned whichever reference the instrument was using. The instrument automatically switched to the ext ref if it was present. In PSA (which had no sensing) the command <code>[:SENSe] :ROSCillator :SOURce</code> set the reference (INT or EXT), so again its query returned the actual routing. Thus the query form of this command is 100% backwards compatible with both instruments.
Initial S/W Revision	Prior to A.02.00

Remote Command	<code>[:SENSe]:ROSCillator:SOURce INTernal EXTernal</code>
Notes	For PSA compatibility the command form is provided and is directly mapped to <code>[:SENSe]:ROSCillator:SOURce:TYPE</code> Note: The SCPI command does nothing for non-controlling instances.
Initial S/W Revision	Prior to A.02.00

Sense

If Sense is selected, the instrument checks whether a signal is present at the external reference connector. If it senses a signal within 5 ppm of the External Ref Freq (as set on the External Ref Freq softkey), it will use this signal as an External Reference. If it senses a 1 pulse per second signal, it will use this signal to adjust the internal reference by adjusting the User setting of the Timebase DAC. When no signal is present, it automatically switches to the internal reference.

Key Path	Input/Output, Freq Ref In
Example	<code>:ROSC:SOUR:TYPE SENS</code>
Couplings	If set to SENSE and the analyzer senses a 1 pulse per second signal, it sets the System, Alignments, Timebase DAC setting to "User". This setting survives Preset and Power Cycle but is set to "Calibrated" on a System, Restore Defaults, Align or a System, Restore Defaults, All
Readback	Sense
Initial S/W Revision	Prior to A.02.00
Modified at S/W Revision	A.14.00

Internal

The internal reference is used. A 1 pps signal at the EXT REF IN port, or a signal there between 1 and 50 MHz, will cause a warning triangle to appear in the settings panel next to the word "INTERNAL", but will otherwise be ignored.

Key Path	Input/Output, Freq Ref In
Example	<code>:ROSC:SOUR:TYPE INT</code>
Readback	Internal
Initial S/W Revision	Prior to A.02.00
Modified at S/W Revision	A.14.00

External

The external reference is used.

Key Path	Input/Output, Freq Ref In
Example	:ROSC:SOUR:TYPE EXT
Readback	External
Initial S/W Revision	Prior to A.02.00

Ext Ref Freq

This key tells the analyzer the frequency of the external reference. When the external reference is in use (either because the reference has been switched to External or because the Reference has been switched to Sense and there is a valid external reference present) this information is used by the analyzer to determine the internal settings needed to lock to that particular external reference signal.

For the instrument to stay locked, the value entered must be within 5 ppm of the actual external reference frequency. So it is important to get it close, or you risk an unlock condition.

Note that this value only affects the instrument's ability to lock. It does not affect any calculations or measurement results. See "Freq Offset" in the Frequency section for information on how to offset frequency values.

Key Path	Input/Output, Freq Ref In
Remote Command	[:SENSe] :ROSCillator:EXTernal:FREQuency <freq> [:SENSe] :ROSCillator:EXTernal:FREQuency?
Example	ROSC:EXT:FREQ 20 MHz sets the external reference frequency to 20 MHz, but does not select the external reference. ROSC:SOUR:TYPE EXT selects the external reference.
Dependencies	Still available with Internal or Pulse selected, to allow setup for when External is in use. However, the setting has no effect if the Internal Reference is in use (Freq Ref In set to Internal, Pulse, or SENSE:INT or SENSE:PULSE).
Preset	This is unaffected by a Preset but is set to 10 MHz on a "Restore Input/Output Defaults" or "Restore System Defaults->All"
Min	1 MHz
Max	50 MHz
Default Unit	Hz
Initial S/W Revision	Prior to A.02.00
Modified at S/W Revision	A.14.00

RF Output & Test Set Config

The RF Output & Test Set Config key allows you to set the RF Output Port and multipoint adapter unit which is connected to the instrument by USB for download of calibration data and additional control.

This menu also allows you to set Trigger Config which is used to set the input/output type of the 4 Bi-directional Trigger ports.

Key Path	Input/Output
Preset	All settings under this key are returned to their default state when Restore Input/Output Defaults is pressed.
State Saved	Saved in State
Initial S/W Revision	A.09.49

RF Output

Specifies the RF Output Port used.

Switching from the RF Output port to one of the RFIO ports changes the transmitter performance of the instrument.

Key Path	Input/Output, RF Output & Test Set Config
Remote Command	[:SENSe] :FEED:RF:PORT:OUTPut RFOut RFIO1 RFIO2 GPSout GNSSout RFIO3 RFIO4 [:SENSe] :FEED:RF:PORT:OUTPut?
Example	:FEED:RF:PORT:OUTP RFIO1
Preset	This is unaffected by Mode Preset but is set to RFOut on a "Restore Input/Output Defaults" or "Restore System Defaults -> All"
State Saved	Saved in State
Readback	The current RF Output Port selected is read back to this key
Initial S/W Revision	A.05.01
Modified at S/W Revision	A.14.00

RF Output

The RF port that will be used for the current output.

Key Path	Input/Output, RF Output & Test Set Config, RF Output
Example	:FEED:RF:PORT:OUTP RFO
Notes	On E6640A with hardware M9430A, if RF Output is selected as RF Output Port, you need to choose the settings in the Half Duplex Config menu to determine which port (RFIO3 or RFIO4) will be used. On E6640A with hardware M9431A, this setting is not supported. If the SCPI command is sent with this setting, an error is generated, -221, "Settings conflict;option not installed"

ReadBack	RF Output
Initial S/W Revision	A.05.01
Modified at S/W Revision	A.14.00

RFIO1

The RF port that will be used for the current output

Key Path	Input/Output, RF Output & Test Set Config, RF Output
Example	:FEED:RF:PORT:OUTP RFIO1
Dependencies	Not available in E6607C.
ReadBack	RFIO1
Initial S/W Revision	A.05.01

RFIO2

The RF port that will be used for the current output

Key Path	Input/Output, RF Output & Test Set Config, RF Output
Example	:FEED:RF:PORT:OUTP RFIO2
Dependencies	Not available in E6607C.
ReadBack	RFIO2
Initial S/W Revision	A.05.01

HalfDuplex Config

The HalfDuplex Config key allows you to set "RF Input" of RF Input Port menu and "RF Output" of RF Output Port menu, which will correspond to RFIO3 and RFIO4.

Key Path	Input/Output, RF Output & Test Set Config
Dependencies	This menu is available on E6640A with hardware M9430A. It's not available on E6640A with hardware M9431A.
State Saved	Saved in State
Initial S/W Revision	A.14.00

RF Input

Specify the RF Input port from RFIO3 and RFIO4.

Key Path	Input/Output, RF Output & Test Set Config, HalfDuplex Config
Remote Command	[:SENSe] :HDUPlex:PORT:INPut RFIO3 RFIO4
Example	:HDUPlex:PORT:INPut RFIO3 :HDUPlex:PORT:INPut?
Dependencies	If RFIO3 is selected as “RF Output”, then “RF Input” will be set to RFIO4 automatically. And if RFIO4 is selected as “RF Output”, “RF Input” will be set to RFIO3 automatically.
Preset	RFIO3
State Saved	Saved in State
Initial S/W Revision	A.14.00

RF Output

Specify the RF Output port from RFIO3 and RFIO4.

Key Path	Input/Output, RF Output & Test Set Config, HalfDuplex Config
Remote Command	[:SENSe] :HDUPlex:PORT:OUTPut RFIO3 RFIO4
Example	:HDUPlex:PORT:OUTPut RFIO3 :HDUPlex:PORT:OUTPut?
Dependencies	If RFIO3 is selected as “RF Input”, then “RF Output” will be set to RFIO4 automatically. And if RFIO4 is selected as “RF Input”, “RF Output” will be set to RFIO3 automatically.
Preset	RFIO4
State Saved	Saved in State
Initial S/W Revision	A.14.00

Output Config

Accesses keys that configure various output settings, like the frequency reference output, trigger output and analog output.

Key Path	Input/Output
Backwards Compatibility Notes	In ESA there was not a user interface to enable the Video Output (Analog Output), Trigger Output, or Gate Output. In the X-Series each of these physical connectors requires configuration, thus the user interface has been added for X-Series, along with the potential for an output you think is always on to be switched off.
Initial S/W Revision	Prior to A.02.00

Trig Out

Select the type of output signal that will be output from the Trig 1 Out, or Trig 2 Out connectors.

Key Path	Input/Output, Output Config
Remote Command	:TRIGger TRIGger1 TRIGger2[:SEquence]:OUTPut HSWP MEASuring MAIN GATE GTRigger OEVEN SPOint SSweep SSETtled S1Marker S2Marker S3Marker S4Marker OFF :TRIGger TRIGger1 TRIGger2[:SEquence]:OUTPut?
Example	TRIG:OUTP HSWP TRIG2:OUTP GATE
Dependencies	The second Trigger output (Trig 2 Out) does not appear in all models; in models that do not support it, the Trig 2 Out key is blanked, and sending the SCPI command for this output generates an error, "Hardware missing; Not available for this model number" In models that do not support the Trigger 2 output, this error is returned if trying to set Trig 2 Out and a query of Trig 2 Out returns OFF.
Preset	Trigger 1: Sweeping (HSWP) Trigger 2: Gate This is unaffected by a Preset but is preset to the above values on a "Restore Input/Output Defaults" or "Restore System Defaults->All"
State Saved	Saved in instrument state
Initial S/W Revision	Prior to A.02.00

Polarity

Sets the output to the Trig 1 Out, or Trig 2 Out, connector to trigger on either the positive or negative polarity.

Key Path	Input/Output, Output Config, Trig 1/2 Output
Remote Command	:TRIGger TRIGger1 TRIGger2[:SEquence]:OUTPut:POLarity POSitive NEGative :TRIGger TRIGger1 TRIGger2[:SEquence]:OUTPut:POLarity?
Example	TRIG1:OUTP:POL POS
Preset	This is unaffected by a Preset but is set to POSitive on a "Restore Input/Output Defaults" or "Restore System Defaults->All"
State Saved	Saved in instrument state
Initial S/W Revision	Prior to A.02.00

Off

Selects no signal to be output to the Trig 1 Out, or Trig 2 Out, connector.

Key Path	Input/Output, Output Config, Trig 1/2 Output
Example	TRIG1:OUTP OFF

Readback	Off
Initial S/W Revision	Prior to A.02.00

Sweeping (HSWP)

Selects the Sweeping Trigger signal to be output to the Trig 1 Out, or Trig 2 Out, connector when a measurement is made. This signal has historically been known as "HSWP" (High = Sweeping), and is 5 V TTL level with 50 ohm output impedance.

Key Path	Input/Output, Output Config, Trig 1/2 Output
Example	TRIG1:OUTP HSWP
Readback	Sweeping
Initial S/W Revision	Prior to A.02.00

Measuring

Selects the Measuring trigger signal to be output to the Trig 1 Out, or Trig 2 Out, connector. This signal is true while the Measuring status bit is true.

Key Path	Input/Output, Output Config, Trig 1/2 Output
Example	TRIG1:OUTP MEAS
Readback	Measuring
Initial S/W Revision	Prior to A.02.00

Main Trigger

Selects the current instrument trigger signal to be output to the Trig 1 Out, or Trig 2 Out, connector.

Key Path	Input/Output, Output Config, Trig 1/2 Output
Example	TRIG1:OUTP MAIN
Readback	Main Trigger
Initial S/W Revision	Prior to A.02.00

Gate Trigger

Selects the gate trigger signal to be output to the Trig 1 Out, or Trig 2 Out, connector. This is the source of the gate timing, not the actual gate signal.

Key Path	Input/Output, Output Config, Trig 1/2 Output
----------	--

Example	TRIG1:OUTP GTR
Readback	Gate Trigger
Initial S/W Revision	Prior to A.02.00

Gate

Selects the gate signal to be output to the Trig 1 Out, or Trig 2 Out, connector. The gate signal has been delayed and its length determined by delay and length settings. When the polarity is positive, a high on the Trig 1 Out, or Trig 2 Out, represents the time the gate is configured to pass the signal.

Key Path	Input/Output, Output Config, Trig 1/2 Output
Example	TRIG1:OUTP GATE
Readback	Gate
Initial S/W Revision	Prior to A.02.00

Odd/Even Trace Point

Selects either the odd or even trace points as the signal to be output to the Trig 1 Out, or Trig 2 Out, connector when performing swept spectrum analysis. When the polarity is positive, this output goes high during the time the analyzer is sweeping past the first point (Point 0) and every other following trace point. The opposite is true if the polarity is negative.

Key Path	Input/Output, Output Config, Trig 1/2 Output
Example	TRIG1:OUTP OEV
Readback	Odd/Even
Initial S/W Revision	Prior to A.02.00

Trig Out

Select the type of output signal that will be output from the Trig 1 Out, or Trig 2 Out connectors.

Key Path	Input/Output, Output Config
Remote Command	:TRIGger TRIGger1 TRIGger2[:SEquence]:OUTPut HSWP MEASuring MAIN GATE GTRigger OEVen SPoint SSweep SSETtled S1Marker S2Marker S3Marker S4Marker OFF :TRIGger TRIGger1 TRIGger2[:SEquence]:OUTPut?
Example	TRIG:OUTP HSWP TRIG2:OUTP GATE
Dependencies	The second Trigger output (Trig 2 Out) does not appear in all models; in models that do not support it, the Trig 2 Out key is blanked, and sending the SCPI command for this output generates an error, "Hardware missing; Not available for this model number" In models that do not support the Trigger

2 output, this error is returned if trying to set Trig 2 Out and a query of Trig 2 Out returns OFF.

Preset	Trigger 1: Sweeping (HSWP) Trigger 2: Gate This is unaffected by a Preset but is preset to the above values on a "Restore Input/Output Defaults" or "Restore System Defaults->All"
State Saved	Saved in instrument state
Initial S/W Revision	Prior to A.02.00

Off

Selects no signal to be output to the Trig 1 Out, or Trig 2 Out, connector.

Key Path	Input/Output, Output Config, Trig 1/2 Output
Example	TRIG1:OUTP OFF
Readback	Off
Initial S/W Revision	Prior to A.02.00

Source Marker 1

Trigger output at marker 1 in current playing Waveform file.

Key Path	Input/Output, Output Config, Trig 1/2 Output
Example	:TRIG1:OUTP S1M
ReadBack	Marker 1
Initial S/W Revision	A.05.01

Source Marker 2

Trigger output at marker 2 in current playing Waveform file.

Key Path	Input/Output, Output Config, Trig 1/2 Output
Example	:TRIG1:OUTP S2M
ReadBack	Marker 2
Initial S/W Revision	A.05.01

Source Marker 3

Trigger output at marker 3 in current playing Waveform file.

Key Path	Input/Output, Output Config, Trig 1/2 Output
Example	:TRIG1:OUTP S3M
ReadBack	Marker 3
Initial S/W Revision	A.05.01

Source Marker 4

Trigger output at marker 4 in current playing Waveform file.

Key Path	Input/Output, Output Config, Trig 1/2 Output
Example	:TRIG1:OUTP S4M
ReadBack	Marker 4
Initial S/W Revision	A.05.01

Analog Out

This menu lets you control which signal is fed to the “Analog Out” connector on the analyzer rear panel.

See ["More Information" on page 150](#)

Key Path	Input/Output, Output Config
Remote Command	:OUTPut:ANALog OFF SVIDeo LOGVIdIo LINVIdIo DAUDIo :OUTPut:ANALog?
Example	OUTP:ANAL SVIDeo ! causes the analog output type to be Screen Video
Preset	This is unaffected by Preset but is set to DAUDIo on a "Restore Input/Output Defaults" or "Restore System Defaults->All
Preset	OFF
State Saved	Saved in Input/Output State
Readback line	1-of-N selection [variable]
Backwards Compatibility Notes	Prior to A.04.00, OFF was the default functionality except when in the Analog Demod application or with Tune and Listen, in which case it was DAUDIo, and there was no selection menu. So for backwards compatibility with earlier X-Series firmware versions, Auto (:OUTP:ANAL:AUTO ON) will duplicate the prior behavior. The DNWB and SANalyzer parameters, which were legal in PSA but perform no function in the X-Series, are accepted without error.
Initial S/W Revision	A.04.00

More Information

The table below gives the range for each output.

Analog Out	Nominal Range exc. (10% overrange)	Scale Factor	Notes
Off	0 V		
Screen Video	0 – 1 V open circuit	10%/division	8566 compatible
Log Video	0 – 1 V terminated	1/(192.66 dB/V)	dB referenced to mixer level, 1V out for –10 dBm at the mixer.
Linear Video	0 – 1 V terminated	100%/V	Linear referenced to Ref Level, 1 V out for RF envelope at the Ref Level.
Demod Audio	(varies with analyzer setting)		

Auto

Selects the Auto state for the Analog Output menu. In this state, the Analog Output will automatically be set to the most sensible setting for the current mode or measurement.

If you make a selection manually from the Analog Out menu, this selection will remain in force until you change it (or re-select Auto), even if you go to a mode or measurement for which the selected output does not apply.

Key Path	Input/Output, Output Config, Analog Out
Remote Command	OUTPut:ANALog:AUTO OFF ON 0 1 OUTPut:ANALog:AUTO?
Example	OUTP:ANAL:AUTO ON
Preset	ON
State Saved	Saved in Input/Output State
Initial S/W Revision	A.04.00

Off

Turns off the analog output.

Key Path	Input/Output, Output Config, Analog Out
Example	OUTP:ANAL OFF ! causes the analog output to be off
Readback Text	Off
Initial S/W Revision	A.04.00

LISN Control

Enables you to access LISN related functions. LISN control is only available with option LSN indicating that the LISN IO board is installed. This is a remote query command only.

V-network (Remote Command Only)

Enables you to select the V-network that is controlled via the AUX IO port.

Remote Command	INPut [1] 2:LISN[:TYPE] FOURphase ESH2Z5 ENV216 OFF INPut [1] 2:LISN[:TYPE] ?
Example	:INP:LISN FOUR
Notes	FOURPhase and ESH2-Z5 R&S ESH2-Z5 (four phases and protective earth are controllable) ENV216 R&S ENV216 (two phases and highpass are controllable) OFF Remote control deactivated This query will return :- FOUR when ESH2-Z5 is selected.
Preset	Set to off on a "Restore Input/Output Defaults"
State Saved	Saved in instrument state
Initial S/W Revision	A.14.50

Phase (Remote Command Only)

This command enables you to select the phase of the V-network that is used, which is controlled via the AUX IO port. The permissible selection depends on the selected V-network.

Remote Command	INPut [1] 2:LISN:PHASe L1 L2 L3 N INPut [1] 2:LISN:PHASe ?
Example	:INP:LISN:PHAS L1
Couplings	L2, L3 keys are grayed out when ENV216 is selected. If the grayed out key is pressed, an advisory message is generated. If the equivalent SCPI command is sent, this same message is generated as part of a "-224, Illegal parameter value; must apply ESH2Z5 to make this phase available" warning.
Preset	Set to N on a "Restore Input/Output Defaults"
State Saved	Saved in instrument state
Range	Phase N Phase L1 Phase L2 Phase L3 Only one phase can be selected.
Initial S/W Revision	A.14.50

150 kHz Highpass (Remote Command Only)

Controls highpass setting on the V-network.

Remote Command	INPut [1] 2:LISN:FiLTeR:HPAS[:STATe] ON OFF INPut [1] 2:LISN:FiLTeR:HPAS[:STATe] ?
Example	:INP:LISN:FILT:HPAS ON
Dependencies	Only available for ENV216 V-network . This key is grayed out when a V-network that is not ENV216 is selected. If the grayed out key is pressed, an advisory message is generated. If the equivalent SCPI command is sent, this same message is generated as part of a “-221, Settings conflicts; LISN function not available” warning.
Preset	Set to off on a "Restore Input/Output Defaults"
State Saved	Saved in instrument state
Range	ON OFF
Initial S/W Revision	A.14.50

Protective Earth (Remote Command Only)

Enables you to set the Protective Earth setting that is controlled via the AUX IO port.

Remote Command	INPut [1] 2:LISN:PEARth GROunded FLOating INPut [1] 2:LISN:PEARth ?
Example	:INP:LISN:PEAR GRO
Dependencies	Only available for ESH2Z5. This key is grayed out when a v-network other than ESH2Z5 is selected. If the grayed out key is pressed, an advisory message is generated. If the equivalent SCPI command is sent, this same message is generated as part of a “-221, Settings conflict; LISN function not available” warning.
Preset	Set to GRO on a "Restore Input/Output Defaults"
State Saved	Saved in instrument state
Range	GRO FLO
Initial S/W Revision	A.14.50

5 Mode Functions

Mode

The Mode key allows you to select the available measurement applications or “Modes”. Modes are a collection of measurement capabilities packaged together to provide an instrument personality that is specific to your measurement needs. Each application software product is ordered separately by Model Number and must be licensed to be available. Once an instrument mode is selected, only the commands that are valid for that mode can be executed.

NOTE

Key operation can be different between modes. The information displayed in Help is about the current mode.

To access Help for a different Mode you must first exit Help (by pressing the Cancel (Esc) key). Then select the desired mode and re-access Help.

For more information on Modes, preloading Modes, and memory requirements for Modes, see ["More Information" on page 157](#)

Key Path	Front-panel key
Remote Command	:INSTrument[:SElect] SA RTSA SEQAN EMI BASIC WCDMA EDGE GSM WIMAX OFDMA VSA PNOISE NFIGure ADEMOD BTooth TDSCDMA CDMA2K CDMA1XEV LTE LTE TDD LTE AFDD LTE ATDD MSR DVB DTMB DCATV ISDBT CM MB WLAN CWLAN CWIMAX OFDM WIMAX FIXED IDEN RLC SCPI LC VSA89601 :INSTrument[:SElect]?
Example	:INST SA
Notes	The available parameters are dependent upon installed and licensed applications resident in the instrument. Parameters given here are an example, specific parameters are in the individual Application. A list of the valid mode choices is returned with the INST:CAT? Query.
Preset	This is unaffected by a Preset but is set on a “Restore System Defaults->All” to: SEQAN
State Saved	Saved in instrument state
Backwards Compatibility SCPI	:INSTrument[:SElect] GSM provided for backwards compatibility. Mapped to EDGE GSM.
Backwards Compatibility SCPI	:INSTrument[:SElect] SANalyzer provided for ESU compatibility. When this command is received, the analyzer aliases it to the following: INST:SEL SCPI LC This results in the analyzer being placed in SCPI Language Compatibility Mode, in order to emulate the ESU Spectrum Analyzer Mode.
Backwards Compatibility SCPI	:INSTrument[:SElect] RECeiver provided for ESU compatibility. When this command is received, the analyzer aliases it to the following: :INST:SEL EMI

	:CONF FSC
	This results in the analyzer being placed in the EMI Receiver Mode, running the Frequency Scan measurement, in order to emulate the ESU Receiver Mode.
Initial S/W Revision	Prior to A.02.00
Modified at S/W Revision	A.13.00

Example	:INST 'SA'
Notes	The query is not a quoted string. It is an enumeration as indicated in the Instrument Select table above. The command must be sequential: i.e. continued parsing of commands cannot proceed until the instrument select is complete and the resultant SCPI trees are available.
Backwards Compatibility SCPI	:INSTrument[:SElect] 'SA' 'PNOISE' 'EDGE' 'GSM' 'BASIC'
Initial S/W Revision	Prior to A.02.00

More Information

The Mode name appears on the banner after the word “Keysight” followed by the Measurement Title. For example, for the IQ Analyzer mode with the Complex Spectrum measurement running:

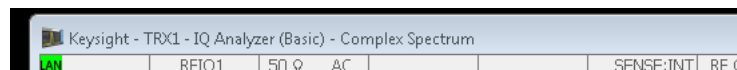

It is possible to specify the order in which the Modes appear in the Mode menu, using the Configure Applications utility (System, Power On, Configure Applications). It is also possible, using the same utility, to specify a subset of the available applications to load into memory at startup time, which can significantly decrease the startup time of the analyzer. During runtime, if an application that is not loaded into memory is selected (by either pressing that applications Mode key or sending that applications :INST:SEL command over SCPI), there will be a pause while the Application is loaded. During this pause a message box that says “Loading application, please wait...” is displayed.

Each application (Mode) that runs in the X-Series signal analyzers consumes virtual memory. The various applications consume varying amounts of virtual memory, and as more applications run, the memory consumption increases. Once an application is run, some of its memory remains allocated even when it is not running, and is not released until the analyzer program (xSA.exe) is shut down.

Keysight characterizes each Mode and assigns a memory usage quantity based on a conservative estimate. There is a limited amount of virtual memory available to applications (note that this is virtual memory and is independent of how much physical RAM is in the instrument). The instrument keeps track of how much memory is being used by all loaded applications – which includes those that preloaded at startup, and all of those that have been run since startup.

When you request a Mode that is not currently loaded, the instrument looks up the memory estimate for that Mode, and adds it to the residual total for all currently loaded Modes. If there is not enough virtual memory to load the Mode, a dialog box and menu will appear that gives you four options:

1. Close and restart the analyzer program without changing your configured preloads. This may free up enough memory to load the requested Mode, depending on your configured preloads
2. Clear out all preloads and close and restart the analyzer program with only the requested application preloaded, and with that application running. This choice is guaranteed to allow you to run the requested application; but you will lose your previously configured preloads. In addition, there may be little or no room for other applications, depending on the size of the requested application.
3. Bring up the Configure Applications utility in order to reconfigure the preloaded apps to make room for the applications you want to run (this will then require restarting the analyzer program with your new configuration). This is the recommended choice because it gives you full flexibility to select exactly what you want.
4. Exit the dialog box without doing anything, which means you will be unable to load the application you requested.

In each case except 4, this will cause the analyzer software to close, and you will lose all unsaved traces and results.

If you attempt to load a mode via SCPI that will exceed memory capacity, the Mode does not load and an error message is returned:

```
-225,"Out of memory;Insufficient resources to load Mode (mode name)"
```

where “mode name” is the SCPI parameter for the Mode in question, for example, SA for Spectrum Analyzer Mode.

Sequence Analyzer

Selects the Sequence Analyzer mode for sequenced measurements. Depending on licensed applications there may be a number of different measurements available in this mode. These measurements are all done on IQ captured data and can be set up to calculated on any part of the capture.

If you are using the Help feature, this mode must be currently active to access its detailed information. If it is not active, exit the Help feature (Esc key), select the mode, and re-access Help.

Key Path	Mode
Example	INST:SEL SEQAN INST:NSEL 400
Initial S/W Revision	A.05.01

IQ Analyzer (Basic)

The IQ Analyzer Mode makes general purpose frequency domain and time domain measurements. These measurements often use alternate hardware signal paths when compared with a similar measurement in the Signal Analysis Mode using the Swept SA measurement. These frequency domain and time domain measurements can be used to output I/Q data results when measuring complex modulated digital signals.

If you are using the Help feature, this mode must be currently active to access its detailed information. If it is not active, exit the Help feature (Esc key), select the mode, and re-access Help.

Key Path	Mode
Example	INST:SEL BASIC INST:NSEL 8
Initial S/W Revision	Prior to A.02.00

W-CDMA with HSPA+

Selects the W-CDMA with HSPA+ mode for general purpose measurements of signals following this standard. There are several measurements available in this mode.

If you are using the Help feature, this mode must be currently active to access its detailed information. If it is not active, exit the Help feature (Esc key), select the mode, and re-access Help.

Key Path	Mode
Example	INST:SEL WCDMA INST:NSEL 9
Initial S/W Revision	Prior to A.02.00

GSM/EDGE/EDGE Evo

Selects the GSM with EDGE mode for general purpose measurements of signals following this standard. There are several measurements available in this mode.

If you are using the Help feature, this mode must be currently active to access its detailed information. If it is not active, exit the Help feature (Esc key), select the mode, and re-access Help.

Key Path	Mode
Example	INST:SEL EDGE GSM INST:NSEL 13
Initial S/W Revision	Prior to A.02.00
Modified at S/W Revision	A.02.00

Analog Demod

Selects the Analog Demod mode for making measurements of AM, FM and phase modulated signals.

If you are using the Help feature, this mode must be currently active to access its detailed information. If it is not active, exit the Help feature (Esc key), select the mode, and re-access Help.

Key Path	Mode
Example	INST:SEL ADEMOM INST:NSEL 234
Initial S/W Revision	Prior to A.02.00

Bluetooth

Selects the Bluetooth mode for Bluetooth specific measurements. There are several measurements available in this mode.

If you are using the Help feature, this mode must be currently active to access its detailed information. If it is not active, exit the Help feature (Esc key), select the mode, and re-access Help.

Key Path	Mode
Example	INST:SEL BT INST:NSEL 228
Initial S/W Revision	A.06.01

TD-SCDMA with HSPA/8PSK

Selects the TD-SCDMA mode for general purpose measurements of signals following this standard. There are several measurements available in this mode.

If you are using the Help feature, this mode must be currently active to access its detailed information. If it is not active, exit the Help feature (Esc key), select the mode, and re-access Help.

Key Path	Mode
Example	INST:SEL TDSCDMA INST:NSEL 211
Initial S/W Revision	Prior to A.02.00

cdma2000

Selects the cdma2000 mode for general purpose measurements of signals following this standard. There are several measurements available in this mode.

If you are using the Help feature, this mode must be currently active to access its detailed information. If it is not active, exit the Help feature (Esc key), select the mode, and re-access Help.

Key Path	Mode
Example	INST:SEL CDMA2K INST:NSEL 10
Initial S/W Revision	Prior to A.02.00

1xEV-DO

Selects the 1xEV-DO mode for general purpose measurements of signals following this standard. There are several measurements available in this mode.

If you are using the Help feature, this mode must be currently active to access its detailed information. If it is not active, exit the Help feature (Esc key), select the mode, and re-access Help.

Key Path	Mode
Example	INST:SEL CDMA1XEV INST:NSEL 15
Initial S/W Revision	Prior to A.02.00

WLAN

Selects the WLAN mode for general purpose measurements of signals following this standard. There are several measurements available in this mode.

If you are using the Help feature, this mode must be currently active to access its detailed information. If it is not active, exit the Help feature (Esc key), select the mode, and re-access Help.

Key Path	Mode
Example	INST:SEL WLAN INST:NSEL 217
Initial S/W Revision	A.09.491

LTE-Advanced FDD

As LTE-Advanced FDD and LTE modes are converged into one single application, the single softkey under Mode menu is designed to select the covered mode. The display mode of the LTE and LTE-Advanced FDD are distinguished by the licenses.

If you are using the Help feature, this mode must be currently active to access its detailed information. If it is not active, exit the Help feature (Esc key), select the mode, and re-access Help.

Key Path	Mode
Example	INST:SEL LTEAFDD INST:NSEL 107
Notes	When the N9080A/80B-1FP exists, the display mode name is LTE. When the N9080A/80B-1FP and N9080B-2FP all exist, the display mode name is LTE FDD & LTE-A FDD.
Backwards Compatibility SCPI	INST:SEL LTE INST:NSEL 102
Initial S/W Revision	A.14.00
Modified at S/W Revision	A.14.50

LTE-Advanced TDD

As LTE-Advanced TDD and LTE TDD modes are converged into one single application, the single softkey under Mode menu is designed to select the covered mode. The display mode of the LTE TDD and LTE-Advanced TDD are distinguished by the licenses.

If you are using the Help feature, this mode must be currently active to access its detailed information. If it is not active, exit the Help feature (Esc key), select the mode, and re-access Help.

Key Path	Mode
Example	INST:SEL LTEATDD INST:NSEL 108
Notes	When the N9082A/82B-1FP exists, the display mode name is LTE TDD. When the N9082A/82B-1FP and N9082B-2FP all exist, the display mode name is LTE TDD & LTE-A TDD.
Backwards Compatibility SCPI	INST:SEL LTETDD INST:NSEL 105
Initial S/W Revision	A.14.00
Modified at S/W Revision	A.14.50

802.16 OFDMA (WiMAX/WiBro)

Selects the OFDMA mode for general purpose measurements of WiMAX signals. There are several measurements available in this mode.

If you are using the Help feature, this mode must be currently active to access its detailed information. If it is not active, exit the Help feature (Esc key), select the mode, and re-access Help.

Key Path	Mode
Example	INST:SEL WIMAXOFDMA INST:NSEL 75
Initial S/W Revision	Prior to A.02.00

Application Mode Number Selection (Remote Command Only)

Select the measurement mode by its mode number. The actual available choices depend upon which applications are installed in your instrument. The modes appear in this table in the same order they appear in the Mode menu (if the order is not changed by the Configure Applications utility found in the System, Power On menu). See "[Detailed List of Modes](#)" on page 167 for Mode details.

The Mode Number is the parameter for use with the :INSTrument:NSElect command. The Mode Parameter is the parameter for use with the :INSTrument[:SElect] command.

Mode	Mode Number	Mode Parameter
------	-------------	----------------

Sequence Analyzer	400	SEQAN
I/Q Analyzer (Basic)	8	BASIC
WCDMA with HSPA+	9	WCDMA
GSM/EDGE/EDGE Evo	13	EDGE GSM
Analog Demod	234	ADEMOD
Bluetooth	228	BTtooth
TD-SCDMA with HSPA/8PSK	211	TDSCDMA
cdma2000	10	CDMA2K
1xEV-DO	15	CDMA1XEV
LTE	102	LTE
LTE TDD	105	LTETDD
LTE-Advanced FDD	107	LTEAFDD
LTE-Advanced TDD	108	LTEATDD
WLAN	217	WLAN
802.16 OFDM (Fixed WiMAX)	104	WIMAXFIXED

Remote Command	:INSTRument:NSElect <integer> :INSTRument:NSElect?
Example	:INST:NSEL 1
Notes	SA mode is 1 The command must be sequential: i.e. continued parsing of commands cannot proceed until the instrument select is complete and the resultant SCPI trees are available.
Preset	Not affected by Preset. Set to default mode (1 for SA mode) following Restore System Defaults.
State Saved	Saved in instrument state
Initial S/W Revision	Prior to A.02.00

Application Mode Catalog Query (Remote Command Only)

Returns a string containing a comma separated list of names of all the installed and licensed measurement modes (applications). These names can only be used with the :INSTRument[:SElect] command.

Remote Command	:INSTRument:CATalog?
Example	:INST:CAT?
Notes	Query returns a quoted string of the installed and licensed modes separated with a comma. Example: "SA,PNOISE,WCDMA"

Backwards Compatibility Notes	VSA (E4406A) :INSTrument:CATalog? returned a list of installed INSTrument:SELEct items as a comma separated list of string values: "BASIC", "GSM", "EDGEgSM", "CDMA", "NADC", "PDC", "WCDMA", "CDMA2K", "CDMA1XEV", "IDEN", "WIDEN", "WLAN", "SERVICE" X-Series uses the ESA/PSA compatible query of a string contain comma separated values: "SA,PNOISE,NFIGURE,BASIC,CDMA,CDMA2K,WCDMA,CDMA1XEV,EDGEgSM,GSM,NADC,PDC,TDSCDMA,DMODULATION,WLAN"
Initial S/W Revision	Prior to A.02.00

Application Identification (Remote Commands Only)

Each entry in the Mode Menu will have a Model Number and associated information: Version, and Options. This information is displayed in the Show System screen. The corresponding SCPI remote commands are defined here.

["Current Application Model " on page 164](#)

["Current Application Revision" on page 164](#)

["Current Application Options" on page 165](#)

Current Application Model

Returns a string that is the Model Number of the currently selected application (mode).

Remote Command	:SYSTem:APPLication[:CURRent] [:NAME] ?
Example	:SYST:APPL?
Notes	Query returns a quoted string that is the Model Number of the currently selected application (Mode). Example: "N9060A" String length is 6 characters.
Preset	Not affected by Preset
State Saved	Not saved in state, the value will be the selected application when a Save is done.
Initial S/W Revision	Prior to A.02.00

Current Application Revision

Returns a string that is the Revision of the currently selected application (mode).

Remote Command	:SYSTem:APPLication[:CURRent] :REVision?
Example	:SYST:APPL:REV?
Notes	Query returns a quoted string that is the Revision of the currently selected application (Mode). Example:

	"1.0.0.0" String length is a maximum of 23 characters. (each numeral can be an integer + 3 decimal points)
Preset	Not affected by a Preset
State Saved	Not saved in state, the value will be the selected application when a Save is done.
Initial S/W Revision	Prior to A.02.00

Current Application Options

Returns a string that is the Options list of the currently selected application (Mode).

Remote Command	:SYSTem:APPLication[:CURRent]:OPTion?
Example	:SYST:APPL:OPT?
Notes	Query returns a quoted string that is the Option list of the currently selected application (Mode). The format is the name as the *OPT? or SYSTem:OPTion command: a comma separated list of option identifiers. Example: "1FP,2FP" String length is a maximum of 255 characters.
Preset	Not affected by a Preset
State Saved	Not saved in state per se, the value will be the selected application when a Save is invoked.
Initial S/W Revision	Prior to A.02.00

Application Identification Catalog (Remote Commands Only)

A catalog of the installed and licensed applications (Modes) can be queried for their identification.

["Application Catalog Number of Entries" on page 165](#)

["Application Catalog Model Numbers" on page 166](#)

["Application Catalog Revision" on page 166](#)

["Application Catalog Options" on page 166](#)

Application Catalog Number of Entries

Returns the number of installed and licensed applications (Modes).

Remote Command	:SYSTem:APPLication:CATalog[:NAME]:COUNT?
Example	:SYST:APPL:CAT:COUN?
Preset	Not affected by Preset
State Saved	Not saved in instrument state.
Initial S/W Revision	Prior to A.02.00

Application Catalog Model Numbers

Returns a list of Model Numbers for the installed and licensed applications (Modes).

Remote Command	:SYSTem:APPLication:CATalog[:NAME]?
Example	:SYST:APPL:CAT?
Notes	Returned value is a quoted string of a comma separated list of Model Numbers. Example, if SAMS and Phase Noise are installed and licensed: "N9060A,N9068A" String length is COUNT * 7 - 1. (7 = Model Number length + 1 for comma. -1 = no comma for the 1st entry.)
Preset	Not affected by a Preset
State Saved	Not saved in instrument state.
Initial S/W Revision	Prior to A.02.00

Application Catalog Revision

Returns the Revision of the provided Model Number.

Remote Command	:SYSTem:APPLication:CATalog:REvision? <model>
Example	:SYST:APPL:CAT:REV? 'N9060A'
Notes	Returned value is a quoted string of revision for the provided Model Number. The revision will be a null-string ("") if the provided Model Number is not installed and licensed. Example, if SAMS is installed and licensed: "1.0.0.0"
Preset	Not affected by a Preset.
State Saved	Not saved in instrument state.
Initial S/W Revision	Prior to A.02.00

Application Catalog Options

Returns a list of Options for the provided Model Number

Remote Command	:SYSTem:APPLication:CATalog:OPTion? <model>
Example	:SYST:APPL:CAT:OPT? 'N9060A'
Notes	Returned value is a quoted string of a comma separated list of Options, in the same format as *OPT? or :SYSTem:OPTion?. If the provided Model Number is not installed and licensed a null-string ("") will be returned. Example, if SAMS is installed and licensed: "2FP" String length is a maximum of 255 characters.
Preset	Not affected by a Preset

State Saved	Not saved in instrument state.
Initial S/W Revision	Prior to A.02.00

Detailed List of Modes

This section contains an alphabetical list of Modes available in the X-Series, along with a brief description of each Mode.

Note that with the exception of the 89601 VSA, only licensed applications appear in the Mode menu. The 89601 will always appear, because it's licensing is handled differently.

1xEV-DO

Selects the 1xEV-DO mode for general purpose measurements of signals following this standard. There are several measurements available in this mode.

If you are using the Help feature, this mode must be currently active to access its detailed information. If it is not active, exit the Help feature (Esc key), select the mode, and re-access Help.

Key Path	Mode
Example	INST:SEL CDMA1XEV INST:NSEL 15
Initial S/W Revision	Prior to A.02.00

802.16 OFDMA (WiMAX/WiBro)

Selects the OFDMA mode for general purpose measurements of WiMAX signals. There are several measurements available in this mode.

If you are using the Help feature, this mode must be currently active to access its detailed information. If it is not active, exit the Help feature (Esc key), select the mode, and re-access Help.

Key Path	Mode
Example	INST:SEL WIMAXOFDMA INST:NSEL 75
Initial S/W Revision	Prior to A.02.00

89601 VSA

Selecting the 89601 VSA mode will start the 89600 VSA software. The 89600 VSA software is powerful, PC-based software, offering the industry's most sophisticated general purpose and standards specific signal evaluation and troubleshooting tools for R&D engineers. Even for proprietary and non-standard signals in SATCOM or MILCOM applications, you can make signal quality measurements with customized IQ constellation. Reach deeper into signals, gather more data on signal problems, and gain greater insight.

- Over 35 general-purpose analog and digital demodulators ranging from 2FSK to 4096QAM
- Flexible and custom IQ and OFDM signal analysis for single carrier
- Standards specific modulation analysis including:
 - Cellular: GSM/EDGE, cdma2000, W-CDMA, TD-SCDMA, LTE(FDD/TDD),
 - LTE-Advanced and more
 - Wireless networking: 802.11a/b/g, 802.11n, 802.ac, 802.16 WiMAX (fixed/mobile), WiSUN (MR-FSK PHY)
 - RFID
 - Digital satellite video and other satellite signals, radar, LMDS
 - Up to 400K bin FFT, for the highest resolution spectrum analysis
 - A full suite of time domain analysis tools, including signal capture and playback, time gating, and CCDF measurements
 - 20 simultaneous trace displays and the industry's most complete set of marker functions
 - Easy-to-use Microsoft ® Windows ® graphical user interface

For more information see the Agilent 89600 Series VSA web site at www.agilent.com/find/89600vsa

To learn more about how to use the 89600 VSA running in the X-Series, after the 89600 VSA software is running, open the 89600 VSA Help and open the "About Agilent X-Series Signal Analyzer with 89600 VSA Software" help topic.

Key Path	Mode
Example	INST:SEL VSA89601 INST:NSEL 101
Initial S/W Revision	Prior to A.02.00

Analog Demod

Selects the Analog Demod mode for making measurements of AM, FM and phase modulated signals.

If you are using the Help feature, this mode must be currently active to access its detailed information. If it is not active, exit the Help feature (Esc key), select the mode, and re-access Help.

Key Path	Mode
Example	INST:SEL ADEMOM INST:NSEL 234
Initial S/W Revision	Prior to A.02.00

Bluetooth

Selects the Bluetooth mode for Bluetooth specific measurements. There are several measurements available in this mode.

If you are using the Help feature, this mode must be currently active to access its detailed information. If it is not active, exit the Help feature (Esc key), select the mode, and re-access Help.

Key Path	Mode
Example	INST:SEL BT INST:NSEL 228
Initial S/W Revision	A.06.01

cdma2000

Selects the cdma2000 mode for general purpose measurements of signals following this standard. There are several measurements available in this mode.

If you are using the Help feature, this mode must be currently active to access its detailed information. If it is not active, exit the Help feature (Esc key), select the mode, and re-access Help.

Key Path	Mode
Example	INST:SEL CDMA2K INST:NSEL 10
Initial S/W Revision	Prior to A.02.00

GSM/EDGE/EDGE Evo

Selects the GSM with EDGE mode for general purpose measurements of signals following this standard. There are several measurements available in this mode.

If you are using the Help feature, this mode must be currently active to access its detailed information. If it is not active, exit the Help feature (Esc key), select the mode, and re-access Help.

Key Path	Mode
Example	INST:SEL EDGE GSM INST:NSEL 13
Initial S/W Revision	Prior to A.02.00
Modified at S/W Revision	A.02.00

IQ Analyzer (Basic)

The IQ Analyzer Mode makes general purpose frequency domain and time domain measurements. These measurements often use alternate hardware signal paths when compared with a similar measurement in

the Signal Analysis Mode using the Swept SA measurement. These frequency domain and time domain measurements can be used to output I/Q data results when measuring complex modulated digital signals.

If you are using the Help feature, this mode must be currently active to access its detailed information. If it is not active, exit the Help feature (Esc key), select the mode, and re-access Help.

Key Path	Mode
Example	INST:SEL BASIC INST:NSEL 8
Initial S/W Revision	Prior to A.02.00

LTE

Selects the LTE mode for general purpose measurements of signals following the LTE FDD standard. There are several measurements available in this mode.

If you are using the Help feature, this mode must be currently active to access its detailed information. If it is not active, exit the Help feature (Esc key), select the mode, and re-access Help.

Key Path	Mode
Example	INST:SEL LTE INST:NSEL 102
Initial S/W Revision	Prior to A.02.00

LTE TDD

Selects the LTE TDD mode for general purpose measurements of signals following the LTE TDD standard. There are several measurements available in this mode.

If you are using the Help feature, this mode must be currently active to access its detailed information. If it is not active, exit the Help feature (Esc key), select the mode, and re-access Help.

Key Path	Mode
Example	INST:SEL LTETDD INST:NSEL 105
Initial S/W Revision	A.03.00

LTE-Advanced FDD

As LTE-Advanced FDD and LTE modes are converged into one single application, the single softkey under Mode menu is designed to select the converged mode. The display mode of the LTE and LTE-Advanced FDD are distinguished by the licenses.

If you are using the Help feature, this mode must be currently active to access its detailed information. If it is not active, exit the Help feature (Esc key), select the mode, and re-access Help.

Key Path	Mode
Example	INST:SEL LTEAFDD INST:NSEL 107
Notes	When the N9080A/80B-1FP exists, the display mode name is LTE. When the N9080A/80B-1FP and N9080B-2FP all exist, the display mode name is LTE FDD & LTE-A FDD.
Backwards Compatibility SCPI	INST:SEL LTE INST:NSEL 102
Initial S/W Revision	A.14.00
Modified at S/W Revision	A.14.50

LTE-Advanced TDD

As LTE-Advanced TDD and LTE TDD modes are converged into one single application, the single softkey under Mode menu is designed to select the converged mode. The display mode of the LTE TDD and LTE-Advanced TDD are distinguished by the licenses.

If you are using the Help feature, this mode must be currently active to access its detailed information. If it is not active, exit the Help feature (Esc key), select the mode, and re-access Help.

Key Path	Mode
Example	INST:SEL LTEATDD INST:NSEL 108
Notes	When the N9082A/82B-1FP exists, the display mode name is LTE TDD. When the N9082A/82B-1FP and N9082B-2FP all exist, the display mode name is LTE TDD & LTE-A TDD.
Backwards Compatibility SCPI	INST:SEL LTETDD INST:NSEL 105
Initial S/W Revision	A.14.00
Modified at S/W Revision	A.14.50

Sequence Analyzer

Selects the Sequence Analyzer mode for sequenced measurements. Depending on licensed applications there may be a number of different measurements available in this mode. These measurements are all done on IQ captured data and can be set up to calculated on any part of the capture.

If you are using the Help feature, this mode must be currently active to access its detailed information. If it is not active, exit the Help feature (Esc key), select the mode, and re-access Help.

Key Path	Mode
Example	INST:SEL SEQAN

	INST:NSEL 400
Initial S/W Revision	A.05.01

TD-SCDMA with HSPA/8PSK

Selects the TD-SCDMA mode for general purpose measurements of signals following this standard. There are several measurements available in this mode.

If you are using the Help feature, this mode must be currently active to access its detailed information. If it is not active, exit the Help feature (Esc key), select the mode, and re-access Help.

Key Path	Mode
Example	INST:SEL TDSCDMA INST:NSEL 211
Initial S/W Revision	Prior to A.02.00

W-CDMA with HSPA+

Selects the W-CDMA with HSPA+ mode for general purpose measurements of signals following this standard. There are several measurements available in this mode.

If you are using the Help feature, this mode must be currently active to access its detailed information. If it is not active, exit the Help feature (Esc key), select the mode, and re-access Help.

Key Path	Mode
Example	INST:SEL WCDMA INST:NSEL 9
Initial S/W Revision	Prior to A.02.00

WLAN

Selects the WLAN mode for general purpose measurements of signals following this standard. There are several measurements available in this mode.

If you are using the Help feature, this mode must be currently active to access its detailed information. If it is not active, exit the Help feature (Esc key), select the mode, and re-access Help.

Key Path	Mode
Example	INST:SEL WLAN INST:NSEL 217
Initial S/W Revision	A.09.491

Global Settings

Opens a menu that allows you to switch certain Meas Global parameters to a Mode Global state. These switches apply to all Modes that support global settings. No matter what Mode you are in when you set the “Global Center Frequency” switch to on, it applies to all Modes that support Global Settings.

Key Path	Mode Setup
Initial S/W Revision	Prior to A.02.00

Global Center Freq

The software maintains a Mode Global value called “Global Center Freq”.

When the Global Center Freq key is switched to On in any mode, the current mode’s center frequency is copied into the Global Center Frequency, and from then on all modes that support global settings use the Global Center Frequency. So you can switch between any of these modes and the Center Freq will remain unchanged.

Adjusting the Center Freq of any mode which supports Global Settings, while Global Center Freq is On, will modify the Global Center Frequency.

When Global Center Freq is turned Off, the Center Freq of the current mode is unchanged, but now the Center Freq of each mode is once again independent.

When Mode Preset is pressed while Global Center Freq is On, the Global Center Freq is preset to the preset Center Freq of the current mode.

This function is reset to Off when the Restore Defaults key is pressed in the Global Settings menu, or when System, Restore Defaults, All Modes is pressed.

Key Path	Mode Setup, Global Settings
Scope	Mode Global
Remote Command	:INSTrument:COUPle:FREQuency:CENTer ALL NONE :INSTrument:COUPle:FREQuency:CENTer?
Example	INST:COUP:FREQ:CENT ALL INST:COUP:FREQ:CENT?
Preset	Set to Off on Global Settings, Restore Defaults and System, Restore Defaults, All Modes
Range	On Off
Initial S/W Revision	Prior to A.02.00

Remote Command	:GLOBal:FREQuency:CENTer[:STATe] 1 0 ON OFF :GLOBal:FREQuency:CENTer[:STATe]?
Preset	Off
Initial S/W Revision	Prior to A.02.00

Restore Defaults

This key resets all of the functions in the Global Settings menu to Off. This also occurs when System, Restore Defaults, All Modes is pressed.

Key Path	Mode Setup, Global Settings
Remote Command	:INSTrument:COUPle:DEFault
Example	INST:COUP:DEF
Backwards Compatibility SCPI	:GLOBal:DEFault
Initial S/W Revision	Prior to A.02.00

6 System Functions

File

Opens a menu that enables you to access various standard and custom Windows functions. Press any other front-panel key to exit

Key Path	Front-panel key
Initial S/W Revision	Prior to A.02.00

File Explorer

Opens the standard Windows File Explorer. The File Explorer opens in the My Documents directory for the current user.

The File Explorer is a separate Windows application, so to return to the analyzer once you are in the File Explorer, you may either:

Exit the File Explorer by clicking on the red X in the upper right corner, with a mouse

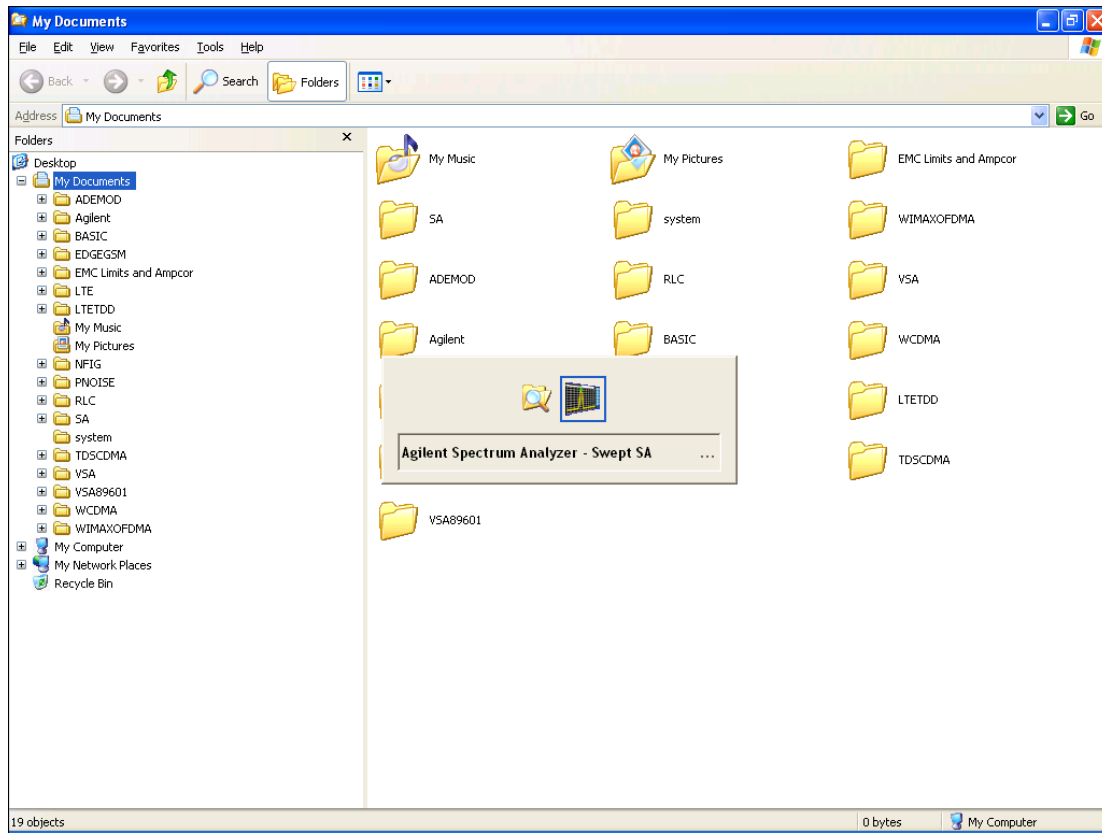

Or use Alt-Tab: press and hold the Alt key and press and release the Tab key until the Analyzer logo is showing in the window in the center of the screen, as shown above, then release the Alt key.

The ability to access File Explorer is not available if Option SF1 is installed.

Key Path	File
Initial S/W Revision	Prior to A.02.00

Print

The Print key opens a Print dialog for configured printing (for example, to the printer of your choice). Refer to your Microsoft Windows Operating System manual for more information.

Maximize/Restore Down

These keys allow the Instrument Application to be maximized and then restored to its prior state. Only one of the two keys is visible at a time. When not already maximized the Maximize Application key is visible, and when maximized, the Restore Down Application key is visible and replaces the Maximize Application key.

Maximize

This key allows you to Maximize the Instrument Application, which causes the analyzer display to fill the screen. Once the application is maximized, this key is replaced by the Restore Down key.

Key Path	File
Mode	All
Notes	No equivalent remote command for this key.
State Saved	No
Initial S/W Revision	A.05.01

Restore Down

This key allows you to Restore Down the Instrument Application and reverses the action taken by Maximize. This key is only visible when the application has been maximized, and after the Restore Down action has been completed this key is replaced by the Maximize key.

Key Path	File
Mode	All
Notes	No equivalent remote command for this key.
State Saved	No
Initial S/W Revision	A.05.01

Page Setup

The Page Setup key brings up a Windows Page Setup dialog that allows you to control aspects of the pages sent to the printer when the PRINT hardkey is pressed.

Key Path	File
Initial S/W Revision	Prior to A.02.00

Paper size, the printer paper source, the page orientation and the margins are all settable. Just like any standard Windows dialog, you may navigate the dialog using the front-panel keys, or a mouse. There are no SCPI commands for controlling these parameters.

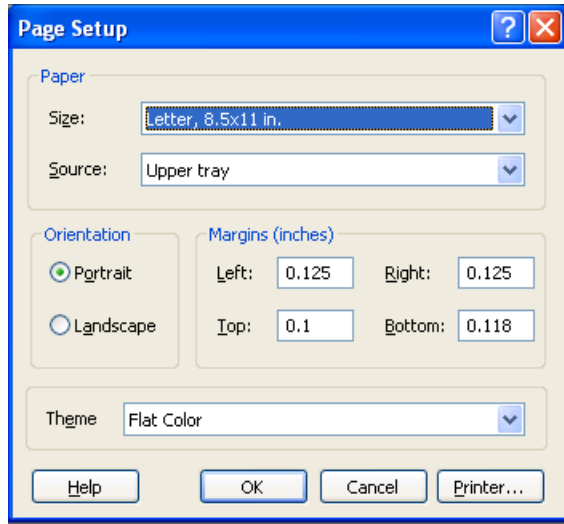

Also contained in this dialog is a drop-down control that lets you select the Theme to use when printing. For more on Themes, see information under View/Display, Display, System Display Settings, Theme. The Theme control has a corresponding SCPI command.

Parameter Name	Print Themes
Parameter Type	Enum
Mode	All
Remote Command	:SYSTem:PRINt:THEMe TDCOLOR TDMonochrome FCOLOR FMONochrome :SYSTem:PRINt:THEMe?
Example	:SYST:PRIN:THEM FCOL
Setup	:SYSTem:DEFault MISC
Preset	FCOL; not part of Preset, but is reset by Restore Misc Defaults or Restore System Defaults All and survives subsequent running of the modes.
State Saved	No
Initial S/W Revision	Prior to A.02.00

Print

This front-panel key is equivalent to performing a File, Print, OK. It immediately performs the currently configured Print to the Default printer.

The :HCOPY command is equivalent to pressing the PRINT key. The HCOPY:ABORT command can be used to abort a print which is already in progress. Sending HCOPY:ABORT will cause the analyzer to stop sending data to the printer, although the printer may continue or even complete the print, depending on how much data was sent to the printer before the user sent the ABORT command.

Key Path	Front-panel key
Remote Command	:HCOPY[:IMMEDIATE]
Initial S/W Revision	Prior to A.02.00

Key Path	SCPI command only
Remote Command	:HCOPY:ABORT
Initial S/W Revision	Prior to A.02.00

Restore Down

This key allows you to Restore Down the Instrument Application and reverses the action taken by Maximize. This key is only visible when the application has been maximized, and after the Restore Down action has been completed this key is replaced by the Maximize key.

Key Path	File
Mode	All
Notes	No equivalent remote command for this key.
State Saved	No
Initial S/W Revision	A.05.01

Minimize

The Minimize key causes the analyzer display to disappear down into the task bar, allowing you to see the

Windows Desktop. You can use Alt-Tab (press and hold the Alt  key and press and release the Tab key) to restore the analyzer display.

Key Path	File
Mode	All
Notes	No equivalent remote command for this key.
State Saved	No
Initial S/W Revision	A.05.01

Exit

This key, when pressed, will exit the Instrument Application. A dialog box is used to confirm that you intended to exit the application:

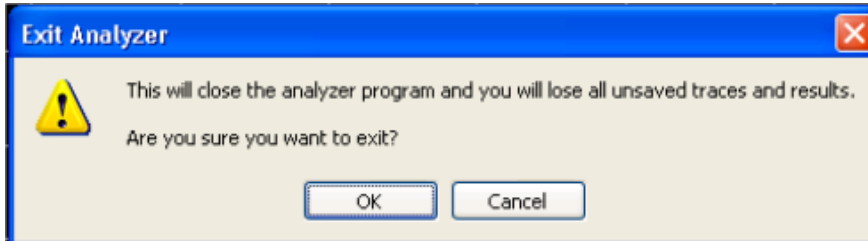

Key Path	File
Mode	All
Notes	The Instrument Application will close. No further SCPI commands can be sent. Use with caution!
Initial S/W Revision	Prior to A.02.00

Print

This front-panel key is equivalent to performing a File, Print, OK. It immediately performs the currently configured Print to the Default printer.

The :HCOPY command is equivalent to pressing the PRINT key. The HCOPY:ABORT command can be used to abort a print which is already in progress. Sending HCOPY:ABORT will cause the analyzer to stop sending data to the printer, although the printer may continue or even complete the print, depending on how much data was sent to the printer before the user sent the ABORT command.

Key Path	Front-panel key
Remote Command	:HCOPY[:IMMEDIATE]
Initial S/W Revision	Prior to A.02.00

Key Path	SCPI command only
Remote Command	:HCOPY:ABORT
Initial S/W Revision	Prior to A.02.00

System

Opens a menu of keys that access various configuration menus and dialogs.

Key Path	Front-panel key
Notes	No remote command for this key specifically.
Initial S/W Revision	Prior to A.02.00

Show

Accesses a menu of choices that enable you to select the information window you want to view.

Key Path	System
Mode	All
Remote Command	:SYSTem:SHOW OFF ERRor SYSTem HARDware LXI HWSTatistics ALIGNment SOFTware CAPplication :SYSTem:SHOW?
Example	:SYST:SHOW SYST
Notes	This command displays (or exits) the various System information screens.
Preset	OFF
State Saved	No
Range	OFF ERRor SYSTem HARDware LXI HWSTatistics ALIGNment SOFTware CAPplication
Initial S/W Revision	Prior to A.02.00

Errors

There are two modes for the Errors selection, History and Status.

The list of errors displayed in the Errors screen does not automatically refresh. You must press the Refresh key or leave the screen and return to it to refresh it.

History brings up a screen displaying the event log in chronological order, with the newest event at the top. The history queue can hold up to 100 messages (if a message has a repeat count greater than 1 it only counts once against this number of 100). Note that this count bears no relation to the size of the SCPI queue. If the queue extends onto a second page, a scroll bar appears to allow scrolling with a mouse. Time is displayed to the second.

Status brings up a screen summarizing the status conditions currently in effect. Note that the time is displayed to the second.

The fields on the Errors display are:

Type (unlabeled) - Displays the icon identifying the event or condition as an error or warning.

ID - Displays the error number.

Message - Displays the message text.

Repeat (RPT) - This field shows the number of consecutive instances of the event, uninterrupted by other events. If an event occurs 5 times with no other intervening event, the value of repeat will be 5.

If the value of Repeat is 1 the field does not display. If the value of Repeat is >1, the time and date shown are those of the most recent occurrence. If the value of repeat reaches 999,999 it stops there.

Time - Shows the most recent time (including the date) at which the event occurred.

Key Path	System, Show
Mode	All
Remote Command	:SYSTem:ERRor[:NEXT]?
Example	:SYST:ERR?
Notes	The return string has the format: “<Error Number>,<Error>” Where <Error Number> and <Error> are those shown on the Show Errors screen
Backwards Compatibility Notes	In some legacy analyzers, the Repeat field shows the number of times the message has repeated since the last time the error queue was cleared. In the X-Series, the Repeat field shows the number of times the error has repeated since the last intervening error. So the count may very well be different than in the past even for identical signal conditions Unlike previous analyzers, in the X-Series all errors are reported through the Message or Status lines and are logged to the event queue. They never appear as text in the graticule area (as they sometimes do in previous analyzers) and they are never displayed in the settings panel at the top of the screen (as they sometimes do, by changing color, in previous analyzers). As a consequence of the above, the user can only see one status condition (the most recently generated) without looking at the queue. In the past, at least in the Spectrum Analyzer, multiple status conditions might display on the right side of the graticule. In general, there is no backwards compatibility specified or guaranteed between the error numbers in the X-Series and those of earlier products. Error, event, and status processing code in customers' software will probably need to be rewritten to work with X-Series. In the legacy analyzers, some conditions report as errors and others simply turn on status bits. Conditions that report as errors often report over and over as long as the condition exists. In the X-series, all conditions report as start and stop events. Consequently, software that repeatedly queries for a condition error until it stops reporting will have to be rewritten for the X-series.
Initial S/W Revision	Prior to A.02.00

Previous Page

See ["Next Page" on page 184.](#)

Key Path	System, Show, Errors
Initial S/W Revision	Prior to A.02.00

Next Page

Next Page and Previous Page menu keys move you between pages of the log, if it fills more than one page. These keys are grayed out in some cases:

- If on the last page of the log, the Next Page key is grayed-out
- If on the first page of the log, the Previous Page key is grayed-out.
- If there is only one page, both keys are grayed out.

Key Path	System, Show, Errors
Initial S/W Revision	Prior to A.02.00

History

The History and Status keys select the Errors view. The Status key has a second line that shows a number in [square brackets]. This is the number of currently open status items.

Key Path	System, Show, Errors
Initial S/W Revision	Prior to A.02.00

Verbose SCPI On/Off

When you turn Verbose SCPI on, additional information is returned when you send the :SYSTem:ERRor? query. The additional information consists of the characters that stimulated the error. This can aid you in debugging your test programs by indicating where in the parsing of a SCPI command the instrument encountered an invalid command or query.

Specifically, with Verbose SCPI on, the SYSTem:ERRor? query is expanded to show the SCPI data received, with the indicator <Err> at the point in the stream that the error occurred.

Verbose SCPI has no effect on the Show Errors screen or front panel Message Line; it only changes the response to the :SYST:ERR? query.

See the example below, where the invalid command "SENS:BOGUS" is sent:

Normal response to :SYST:ERR (using the Telnet window):

```
SCPI> SENS:BOGUS
```

```
SCPI> SYST:ERR?
```

```
-113,"Undefined header"
```

Now after turning on Verbose SCPI:

```
SCPI> SYST:BOGUS
```

```
SCPI> SYST:ERR?
```

```
-113,"Undefined header;SYST:BOGUS<Err>"
```

Key Path	System, Show, Errors
Mode	All
Remote Command	:SYSTem:ERRor:VERBose OFF ON 0 1 :SYSTem:ERRor:VERBose?
Example	:SYST:ERR:VERB ON
Preset	This is unaffected by Preset but is set to OFF on a "Restore System Defaults->Misc"
State Saved	No
Range	On Off
Initial S/W Revision	Prior to A.02.00

Refresh

When pressed, refreshes the Show Errors display.

Key Path	System, Show, Errors
Initial S/W Revision	Prior to A.02.00

Clear Error Queue

This clears all errors in all error queues.

Note the following:

- Clear Error Queue does not affect the current status conditions.
- Mode Preset does not clear the error queue.
- Restore System Defaults will clear all error queues.
- *CLS only clears the queue if it is sent remotely and *RST does not affect any error queue.
- Switching modes does not affect any error queues.

Key Path	System, Show, Errors
Initial S/W Revision	Prior to A.02.00

Status

See "[History](#)" on page 184.

Input Overload Enable (Remote Command Only)

Input Overload errors are reported using the Input Overload status bit (bit 12 in the Measurement Integrity status register). Input Overloads (for example, ADC Overload errors) can come and go with great frequency, generating many error events (for example, for signals just on the verge of overload), and so are

not put into the SCPI error queue by default. Normally the status bit is the only way for detecting these errors remotely.

It is possible to enable Input Overload reporting to the SCPI queue, by issuing the :SYSTem:ERRor:OVERload ON command. To return to the default state, issue the :SYSTem:ERRor:OVERload OFF command. In either case, Input Overloads always set the status bit.

NOTE

For versions of firmware before A.10.01, the Input Overload was only a Warning and so was never available in the SCPI queue, although it did set the status bit. For A.10.01 and later, the Input Overload is an error and can be enabled to the SCPI queue using this command.

Key Path	SCPI only
Remote Command	:SYSTem:ERRor:OVERload[:STATe] 0 1 OFF ON
Example	:SYST:ERR:OVER 1 Enable overload errors
Preset	Set to OFF by Restore Misc Defaults (no Overload errors go to SCPI)
State Saved	Saved in instrument state.
Initial S/W Revision	A.10.01

Power Up (Remote Command Only)

This serves to show the errors encountered during the application boot-up, such as: mismatch FW-FPGA, missing Calibration data, missing hardware and construction errors.

Remote Command	:SYSTem:ERRor:PUP?
Notes	If no error occurs, the return value will be: "No Power Up Errors." Return Value: <list of error strings>. <List of error strings> is an <IEEE488 Block> format. Return Value Example: "Power up errors, see details in Windows Event Log" "Unmatched FPGA Version(s), See details in Windows Event Log"
Initial S/W Revision	E.14.30

System

The System screen is formatted into three groupings: product descriptive information, options tied to the hardware, and software products:

```

<Product Name> <Product Description>
Product Number: N9020A
Serial Number: US46220924
Firmware Revision: A.01.01
Computer Name: <hostname>
Host ID: N9020A,US44220924

N9020A-503      Frequency Range to 3.6 GHz
N9020A-PFR     Precision Frequency Reference
N9020A-P03     Preamp 3.6 GHz

N9060A-2FP     Spectrum Analysis Measurement Suite  1.0.0.0
N9073A-1FP     WCDMA                               1.0.0.0
N9073A-2FP     WCDMA with HSDPA                     1.0.0.0

```

The Previous Page is grayed-out if the first page of information is presently displayed. The Next Page menu key is grayed-out if the last page of information is presently displayed.

Key Path	System, Show
Mode	All
Example	SYST:SHOW SYST
Backwards Compatibility Notes	The hardware statistics that are displayed in the PSA Show System screen have been moved to a dedicated Show Hardware Statistics screen in the Service Menu.
Initial S/W Revision	Prior to A.02.00

Show System contents (Remote Command Only)

A remote command is available to obtain the contents of the Show System screen (the entire contents, not just the currently displayed page).

Remote Command	:SYSTem:CONFigure[:SYSTem]?
Example	:SYST:CONF?
Notes	The output is an IEEE Block format of the Show System contents. Each line is separated with a new-line character.
Initial S/W Revision	Prior to A.02.00

Computer System description (Remote Command Only)

A remote command is available to obtain the Computer System description. The Computer System is the operating system and patch level as reported by operating system.

Remote Command	:SYSTem:CSYSem?
Example	:SYST:CSYS?
Notes	The return value is the Computer System name and service pack level.
Initial S/W Revision	Prior to A.12.00

Hardware

The show hardware screen is used to view details of the installed hardware. This information can be used to determine versions of hardware assemblies and field programmable devices, in the advent of future upgrades or potential repair needs.

The screen is formatted into two groupings: product descriptive information and hardware information. The hardware information is listed in a table format:

Hardware Information									
Agilent EXM Wireless Test Set									
Product Number: E6640A									
Serial Number: US12341234									
Instrument S/W Revision: E.14.00_R0133									
Revision Date: 1/23/2014 10:33:35 AM									
Assembly Name	Part #	Serial #	Matl Rev	Rev	OF Rev	Hw Id	Cal Date	Cal Interval	Misc
Reference	M9300A	MY53000146				0165			
Reference Carrier	M9300A	W1312-63281-23-1306-00076		01	1.2.1	0166			
Reference Plugin	M9300A	W1312-63386-30-1306-00038		01	1.3.0	0167			
Wideband Digitizer	M943063005	111111111111	001	0	0	138			
Downconverter	M943063006	111111111111	001	0	A	139			
RFIO	M943063009	111111111111	001	0	A	140			
Power Supply	M943063002	111111111111	001	0	A	141			
M9430 TRX	1234567890	SN12344321	0	0	0	142	2013.10.02	2 years	
Baseband Generator	M943063007	111111111111	002	0	0	136			
ModulatorSrcOutput	M943063008	111111111111	001	0	A	137			

The Previous Page is grayed-out if the first page of information is presently displayed. The Next Page menu key is grayed-out if the last page is information is presently displayed.

Key Path	System, Show
Mode	All
Example	SYST:SHOW HARD
Initial S/W Revision	Prior to A.02.00

System Remote Commands (Remote Commands Only)

The commands in this section have no front-panel key equivalent.

"System Powerdown (Remote Command Only)" on page 189

"List installed Options (Remote Command Only)" on page 189

"Lock the Front-panel keys (Remote Command Only)" on page 189

"List SCPI Commands (Remote Command Only)" on page 190

"SCPI Version Query (Remote Command Only)" on page 190

"Date (Remote Command Only)" on page 190

"Time (Remote Command Only)" on page 191

Initial S/W Revision	Prior to A.02.00
----------------------	------------------

System Powerdown (Remote Command Only)

Remote Command	SYSTem:PDOWn [NORMal FORCe]
Notes	Shuts down the instrument in the normal way (NORMal) or forced way (FORCe). In case there is another application with modified data pending for saving, the application prompt the user. The system waits until the user responds in the normal mode. It will go off after 20 seconds of wait in the force mode and all data will be lost.

List installed Options (Remote Command Only)

Lists the installed options that pertain to the instrument (signal analyzer). .

Mode	All
Remote Command	:SYSTem:OPTions?
Example	:SYST:OPT?
Notes	The return string is a comma separated list of the installed options. For example: "503,P03,PFR" :SYSTem:OPTions? and *OPT? are the same.
State Saved	No
Initial S/W Revision	Prior to A.02.00

Lock the Front-panel keys (Remote Command Only)

Disables the instrument keyboard to prevent local input when the instrument is controlled remotely. Annunciation showing a "K" for 'Klock" (keyboard lock) alerts the local user that the keyboard is locked. Klock is similar to the GPIB Local Lockout function; namely that no front-panel keys are active with the exception of the Power Standby key. (The instrument is allowed to be turned-off if Klock is ON.) The Klock command is used in remote control situations where Local Lockout cannot be used.

Although primary intent of Klock is to lock-out the front panel, it will lock-out externally connected keyboards through USB. Klock has no effect on externally connected pointing devices (mice).

The front panel 'Local' key (Cancel/Esc) has no effect if Klock is ON.

Mode	All
Remote Command	:SYSTem:KLOCK OFF ON 0 1 :SYSTem:KLOCK?
Example	:SYST:KLOC ON
Notes	Keyboard lock remains in effect until turned-off or the instrument is power-cycled
Preset	Initialized to OFF at startup, unaffected by Preset
State Saved	No
Initial S/W Revision	Prior to A.02.00

List SCPI Commands (Remote Command Only)

Outputs a list of the valid SCPI commands for the currently selected Mode.

Remote Command	:SYSTem:HELP:HEADers?
Example	:SYST:HELP:HEAD?
Notes	The output is an IEEE Block format with each command separated with the New-Line character (hex 0x0A)
Initial S/W Revision	Prior to A.02.00

SCPI Version Query (Remote Command Only)

Returns the SCPI version number with which the instrument complies. The SCPI industry standard changes regularly. This command indicates the version used when the instrument SCPI commands were defined.

Remote Command	:SYSTem:VERSion?
Example	:SYST:VERS?
Initial S/W Revision	Prior to A.02.00

Date (Remote Command Only)

The recommended access to the Date, Time, and Time zone of the instrument is through the Windows native control (Control Panel or accessing the Task Bar). You may also access this information remotely, as shown in this command and Time (below).

Sets or queries the date in the instrument.

Mode	All
Remote Command	:SYSTem:DATE "<year>,<month>,<day>" :SYSTem:DATE?

Example	:SYST:DATE "2006,05,26"
Notes	<p><year> is the four digit representation of year. (for example, 2006)</p> <p><month> is the two digit representation of year. (for example. 01 to 12)</p> <p><day> is the two digit representation of day. (for example, 01 to 28, 29, 30, or 31) depending on the month and year</p> <p>Unless the current account has Power User or Administrator privileges, an error will be generated by this command and no action will be taken.</p>
Initial S/W Revision	Prior to A.02.00

Time (Remote Command Only)

Sets or queries the time in the instrument.

Mode	All
Remote Command	:SYSTem:TIME "<hour>,<minute>,<second>" :SYSTem:TIME?
Example	:SYST:TIME "13,05,26"
Notes	<p><hour> is the two digit representation of the hour in 24 hour format</p> <p><minute> is the two digit representation of minute</p> <p><second> is the two digit representation of second</p> <p>Unless the current account has Power User or Administrator privileges, an error will be generated by this command and no action will be taken.</p>
Initial S/W Revision	Prior to A.02.00

Module Name (Remote Command Only)

Query only. This will return the name of the instance as displayed on the xSA main window.

Mode	All
Remote Command	:SYSTem:MODule:NAME?
Example	:SYST:MOD:NAME?
Notes	<p>If the first instance displays on the xSA main window, the return string is "TRX1". If the second instance displays on the main window, the return string is "TRX2". If the third instance displays on the main window, the return string is "TRX3". If the fourth instance displays on the main window, the return string is "TRX4".</p>
Preset	Not affected by Preset, reset to "Left" with Restore System Defaults Misc.
State Saved	No
Initial S/W Revision	A.13.80

Module Index (Remote Command Only)

Query only. This will return the index of this xSA instance. This index is used as the device number in a VISA address (“hslip#”).

Mode	All
Remote Command	:SYSTem:MODule:INDeX?
Example	:SYST:MOD:IND?
Notes	It returns 0 if this instance’s device number in a VISA address is 0. It returns 1 if this instance’s device number in a VISA address is 1. It returns 2 if this instance’s device number in a VISA address is 2. It returns 3 if this instance’s device number in a VISA address is 3.
Preset	Not affected by Preset, reset to 0 with Restore System Defaults Misc.
State Saved	No
Initial S/W Revision	A.13.80

Module Mnemonic (Remote Command Only)

Query only. This will return the mnemonic of the instance as used in the command line “/Process:<mnemonic>” argument.

Mode	All
Remote Command	:SYSTem:MODule:MNEMonic?
Example	:SYST:MOD:MNEM?
Notes	This will return the mnemonic of the instance as used in the command line “/Process:<mnemonic>” argument.
Preset	Not affected by Preset and Restore System Defaults Misc.
State Saved	No
Initial S/W Revision	A.13.80

Module List (Remote Command Only)

Query only. This will return the list of defined mnemonics that can be used in the command line “/Process:<mnemonic>” argument with corresponding configuration information. The comma separated return values are: mnemonic, display name, Enabled/Disabled, VISA device id (instr# or hslip#), telnet port, socket port, Physics port, Physics configuration tag.

Mode	All
Remote Command	:SYSTem:MODule:LIST?
Example	:SYST:MOD:LIST?
Notes	Example:

it returns:

```
TRX1,TRX1,Enabled,0,5023,5025,3574,E6640AModules.config#TRX1
TRX2,TRX2,Disabled,1,5123,5125,3575,E6640AModules.config#TRX2
TRX3,TRX3,Disabled,2,5223,5225,3576,E6640AModules.config#TRX3
TRX4,TRX4,Disabled,3,5323,5325,3577,E6640AModules.config#TRX4
```

Preset	Not affected by Preset, reset to 0 with Restore System Defaults Misc.
State Saved	No
Initial S/W Revision	A.13.80

Module Enable (Remote Command Only)

Query and command. The query SYST:MOD:ENAB? "<mnemonic>" returns "0" for disabled, "1" for enabled. The command SYST:MOD:ENAB "<mnemonic>" 0|1 will disable/enable the configuration.

Notes: Enabling a configuration that does not have a HW will result in run-time errors when trying to start that configuration. Trying to disable the default configuration will result in the error: -221, "Setting conflict:Cannot disable default process configuration '<mnemonic>'".

Example:

```
}
```

```
SCPI>>syst:mod:enab? "TRX1"
```

```
<<1
```

```
SCPI>>syst:mod:enab? "TRX2"
```

```
<<0
```

```
SCPI>>syst:err?
```

```
<<+0,"No error"
```

```
SCPI>>syst:mod:enab "TRX1",0
```

```
SCPI>>syst:err?
```

```
<<-221,"Settings conflict;Cannot disable default process configuration 'TRX1'"
```

Mode	All
Remote Command	:SYSTem:MODule:ENABle? "<mnemonic>" :SYSTem:MODule:ENABle "<mnemonic>","0 1"

Example

```
:SYST:MOD:ENAB? "TRX1"  
:SYST:MOD:ENAB "TRX4",0
```

Preset	Not affected by Preset and Restore System Defaults Misc.
State Saved	No
Initial S/W Revision	A.13.80

Module Default (Remote Command Only)

Query and command. The query SYST:MOD:DEF? returns the mnemonic of the default configuration. The command SYST:MOD:DEF "mnemonic" will set that configuration as the default. If the configuration was disabled, the module default command on it will enable this configuration.

Example:

```
SCPI>>syst:mod:def?
<<"TRX1"
SCPI>>syst:mod:enab "TRX2",0
SCPI>>syst:mod:enab? "TRX2"
<<0
SCPI>>syst:mod:def "TRX2"
SCPI>>syst:mod:enab? "TRX2"
<<1
SCPI>>syst:mod:def?
<<"TRX2"
```

Mode	All
Remote Command	:SYSTem:MODule:DEFault? :SYSTem:MODule:DEFault "<mnemonic>"
Example	:SYST:MOD:DEF? :SYST:MOD:DEF "TRX1"
Preset	Not affected by Preset, reset to "Left" with Restore System Defaults Misc.
State Saved	No
Initial S/W Revision	A.13.80

Module Model Number (Remote Command Only)

Query only. The query ":SYST:MODule:MODEl?" will return model number of the current module.

Mode	All
-------------	-----

Remote Command	:SYSTem:MODUle:MODEl?
Example	:SYSTem:MODUle:MODEl?
Notes	This query will return model number. e.g. "M9430A"
Preset	Not affected by Preset,
State Saved	No
Initial S/W Revision	E.14.14

Module Model Serial Number (Remote Command Only)

Query only. The query ":SYST: MODUle:SERial?" will return model serial number of the current module.

Mode	All
Remote Command	:SYSTem:MODUle:SERial?
Example	:SYSTem:MODUle:SERial?
Notes	This query will return model serial number like "SN12344321"
Preset	Not affected by Preset
State Saved	No
Initial S/W Revision	E.14.14

Power On

Enables you to select how the instrument should power on. The options are: Mode and Input/Output Defaults, User Preset and Last State.

NOTE

In products that run multiple instances of the X-Series Application, the same Power On type is shared between all the instances.

Key Path	System
Mode	All
Remote Command	:SYSTem:PON:TYPE MODE USER LAST :SYSTem:PON:TYPE?
Example	:SYST:PON:TYPE MODE
Preset	This is unaffected by a Preset but is set to Mode on a "Restore System Defaults->All"
State Saved	No
Backwards Compatibility SCPI	:SYSTem:PON:TYPE PRESet the "PRESet" parameter is supported for backward compatibility only and behaves the same as MODE.
Backwards Compatibility Notes	The Preset Type key in legacy analyzers has been removed, and the Power On toggle key has been replaced by this 1-of-N key in the System menu.
Initial S/W Revision	Prior to A.02.00

Mode and Input/Output Defaults

When the analyzer is powered on in Mode and Input/Output Defaults, it performs a Restore Mode Defaults to all modes in the instrument and also performs a Restore Input/Output Defaults.

Persistent parameters (such as Amplitude Correction tables or Limit tables) are not affected at power on, even though they are normally cleared by Restore Input/Output Defaults and/or Restore Mode Defaults.

Key Path	System, Power On
Mode	All
Example	SYST:PON:TYPE MODE
Readback Text	Defaults
Initial S/W Revision	Prior to A.02.00

User Preset

Sets Power On to User Preset. When the analyzer is powered on in User Preset, it will User Preset each mode and switch to the power-on mode. Power On User Preset will not affect any settings beyond what a normal User Preset affects.

NOTE

In products that run multiple instances of the X-Series Application, the same User Preset is shared between all the instances.

An instrument could never power up for the first time in User Preset.

Key Path	System, Power On
Mode	All
Example	SYST:PON:TYPE USER
Readback Text	User Preset
Backwards Compatibility Notes	Power On User Preset will cause the instrument to power up in the power-on mode, not the last mode the instrument was in prior to shut down. Also, Power On User Preset will User Preset all modes. This does not exactly match legacy behavior.
Initial S/W Revision	Prior to A.02.00

Last State

Sets Power On to **Last**. When the analyzer is powered on, it will put all modes in the last state they were in prior to when the analyzer was put into Power Standby and it will wake up in the mode it was last in prior to powering off the instrument. The saving of the active mode prior to shutdown happens behind the scenes when a controlled shutdown is requested by using the front panel power Standby key or by using the remote command SYSTem:PDOWn. The non-active modes are saved as they are deactivated and recalled by Power On Last State.

NOTE

In products that run multiple instances of the X-Series Application, each instance has a unique Last State. An instrument can never power up for the first time in Last.

If line power to the analyzer is interrupted, for example by pulling the line cord plug or by switching off power to a test rack, Power On Last State may not work properly. For proper operation, Power On Last State depends on you shutting down the instrument using the Standby key or the SYSTem:PDOWn SCPI command. This will ensure the last state of each mode is saved and can be recalled during a power up.

Key Path	System, Power On
Mode	All
Example	SYST:PON:TYPE LAST
Notes	Power on Last State only works if you have done a controlled shutdown prior to powering on in Last. If a controlled shutdown is not done when in Power On Last State, the instrument will power up in the last active mode, but it may not power up in the active mode's last state. If an invalid mode state is detected, a Mode Preset will occur. To control the shutdown under remote control use the :SYSTem:PDOWn command.
Readback Text	Last State
Backwards Compatibility Notes	It is no longer possible to power-up the analyzer in the last mode the analyzer was running with that mode in the preset state. (ESA/PSA SYST:PRESET:TYPE MODE with SYST:PON:PRESET) You can power-on the analyzer in the last mode the instrument was running in its last state (SYST:PON:TYPE LAST), or you can specify the mode to power-up in its preset state (SYST:PON:MODE <mode>).
Initial S/W Revision	Prior to A.02.00

Power On Application

Accesses a menu that lists the available Modes and lets you select which Mode is to be the power-on application.

This application is used for Power On Type “Mode and Input/Output Defaults” and Restore System Defaults All.

NOTE

In products that run multiple instances of the X-Series Application, the same Power On Application is shared between all the instances.

Key Path	System, Power On
Mode	All
Remote Command	:SYSTem:PON:MODE SA BASIC ADEMOD NFIGURE PNOISE CDMA2K TDSCDMA VSA VSA89601 WCDMA WIMAXOFDMA :SYSTem:PON:MODE?
Example	SYST:PON:MODE SA
Notes	The list of possible modes (and remote parameters) to choose from is dependent on which modes are installed in the instrument.
Preset	This is unaffected by a Preset but is set on a “Restore System Defaults->All” to: SEQAN

State Saved	No
Initial S/W Revision	Prior to A.02.00

Configure Applications

The Configure Applications utility can be used to:

- select applications for preload
- determine how many applications can fit in memory at one time
- specify the order of the Modes in the Mode menu.

This utility consists of a window with instructions, a set of “Select Application” checkboxes, a “fuel bar” style memory gauge, and keys that help you set up your configuration.

NOTE

In products that run multiple instances of the X-Series Application, the same Configure Applications Utility is shared between all the instances.

For more information, see the following topics:

["Preloading Applications" on page 198](#)

["Access to Configure Applications utility" on page 199](#)

["Virtual memory usage" on page 199](#)

Key Path	System, Power On
Example	:SYST:SHOW CAPP Displays the Config Applications screen
Initial S/W Revision	A.02.00

Preloading Applications

During runtime, if a Mode that is not preloaded is selected using the Mode menu or sending SCPI commands, there will be a pause while the Application is loaded. During this pause a message that says “Loading application, please wait ...” is displayed. Once loaded, the application stays loaded, so the next time you select it during a session, there is no delay.

Preloading enables you to “preload” at startup, to eliminate the runtime delay. Preloading an application will cause it to be loaded into the analyzer’s memory when the analyzer program starts up. If you do this, the delay will increase the time it takes to start up the analyzer program, but this may be preferable to having to wait the first time you select an application. Note that, once an application is loaded into memory, it cannot be unloaded without exiting and restarting the analyzer program.

Note that there are more applications available for the X-Series than can fit into Windows Virtual Memory. By allowing you to choose which licensed applications to load at startup, the Configure Applications utility allows you to make optimal use of your memory.

Access to Configure Applications utility

A version of the utility runs the first time you power up the analyzer after purchasing it from Keysight. The utility automatically configures preloads so that as many licensed applications as possible are preloaded while keeping the total estimated virtual memory usage below the limit. This auto-configuration only takes place at the very first run, and after analyzer software upgrades.

You may, at any time, manually call up the Configure Applications utility by pressing System, Power On, Configure Applications, to find a configuration that works best for you, and then restart the analyzer program.

The utility may also be called if, during operation of the analyzer, you attempt to load more applications than can fit in memory at once.

Virtual memory usage

There are more applications available for the X-Series than can fit into memory at any one time, so the Configure Applications utility includes a memory tracker that serves two purposes:

1. It will not let you preload more applications than will fit into memory at once.
2. You can determine how many of your favorite applications can reside in memory at one time.

The utility provides a graphical representation of the amount of memory (note that the memory in question here is Virtual memory and is a limitation imposed by the operating system, not by the amount of physical memory you have in your analyzer). You select applications to preload by checking the boxes on the left. Checked applications preload at startup. The colored fuel bar indicates the total memory required when all the checked applications are loaded (either preloaded or selected during runtime).

Here is what the fuel bar colors mean:

RED: the applications you have selected cannot all fit into the analyzer's memory. You must deselect applications until the fuel bar turns yellow.

YELLOW: the applications you have selected can all fit into the analyzer's memory, but there is less than 10% of the memory left, probably not enough to load any other applications, either via preload or by selecting a Mode while the analyzer is running..

GREEN: The indicator is green when <90% of the memory limit is consumed. This means the applications you have selected can all fit into the analyzer's memory with room to spare. You will likely be able to load one or more other applications without running out of memory.

Select All

Marks all applications in the selection list. This allows you to enable all applications licensed on the instrument for pre-loading, or is a convenience for selecting all applications in one operation and then letting you deselect individual applications.

Key Path	System, Power On, Configure Applications
Initial S/W Revision	A.02.00

Deselect All

Clears the marks from all applications in the selection list, except the Power On application. The Power On application cannot be eliminated from the pre-load list.

Key Path	System, Power On, Configure Applications
Initial S/W Revision	A.02.00

Move Up

The application list is the order that applications appear in the Mode Menu. This key enables you to shift the selected application up in the list, thus moving the selected application earlier in the Mode Menu.

Key Path	System, Power On, Configure Applications
Initial S/W Revision	A.02.00

Move Down

The application list is the order that applications appear in the Mode Menu. This key enables you to shift the selected application down in the list, thus moving the selected application later in the Mode Menu.

Key Path	System, Power On, Configure Applications
Initial S/W Revision	A.02.00

Select/Deselect

Toggles the currently highlighted application in the list.

Key Path	System, Power On, Configure Applications
Initial S/W Revision	A.02.00

Save Changes and Exit

Applies the configuration of the applications list. The marked applications will be pre-loaded in memory the next time the instrument application is started, and the order of the applications in the list will be the order of the applications in the Mode Menu.

After saving your changes, the analyzer asks you if you would like it to restart so that your changes can take effect (see dialog box, below). If you choose not to restart, the changes will not take effect until the next time you shut down and restart the analyzer.

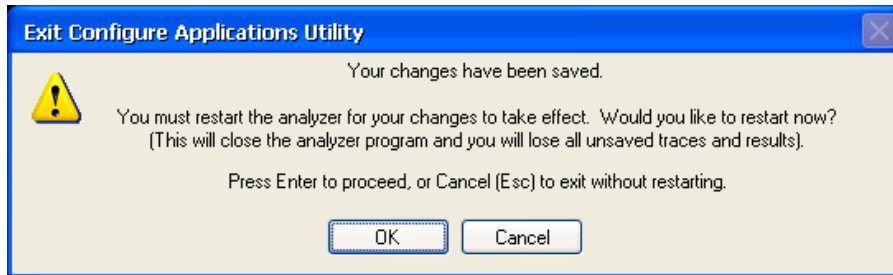

Key Path	System, Power On, Configure Applications
Remote Command	:SYSTem:PUP:PROcEss
Example	:SYST:PUP:PROC This is the SCPI command for restarting the analyzer. You must Wait after this command for the instrument application to restart
Notes	The softkey will be grayed-out when the virtual memory of the selected applications exceeds 100% of the limit.
Notes	You cannot use *WAI or *OPC? to synchronize operation after a restart. This command stops and restarts the instrument application, thus the SCPI operation is terminated and restarted. A remote program must use fixed wait time to resume sending commands to the instrument. The wait time will be dependent upon which applications are pre-loaded.
Initial S/W Revision	A.02.00
Modified at S/W Revision	A.04.00

Exit Without Saving

Pressing this key will exit the Configure Applications utility without saving your changes.

Key Path	System, Power On, Configure Applications
Initial S/W Revision	A.02.00
Modified at S/W Revision	A.04.00

Restore Power On Defaults

This selection causes the Power On Type and Power On Application settings to be a reset to their default values. This level of Restore System Defaults does not affect any other system settings, mode settings and does not cause a mode switch. The Power On key, under the Restore System Defaults menu, causes the same action.

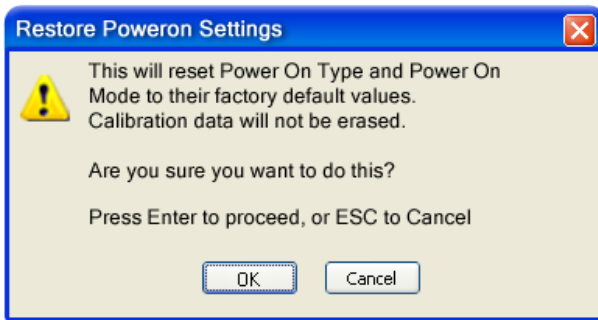

If you press any key other than OK or Enter, it is construed as a Cancel, because the only path that will actually cause the reset to be executed is through OK or Enter.

Key Path	System, Power On
Example	:SYST:DEF PON
Initial S/W Revision	Prior to A.02.00

Configure Applications - Instrument boot-up

At start-up of the analyzer program a dialog box similar to the one under the System, Power On, Configure Applications key will be displayed allowing you to choose which licensed applications are to be loaded. This dialog will only be displayed if the memory required to pre-load all of the licensed applications exceeds the Virtual Memory available.

Configure Applications - Windows desktop

The Configure Applications Utility may be run from the Windows Desktop. The utility is launched by double-



clicking the icon on the desktop, which brings-up a dialog box similar to the one under the System, Power On, Configure Applications key, allowing you to choose which licensed applications are to be loaded when the analyzer program starts up. This dialog box has mouse buttons on it that do the job the softkeys normally do in the System, Power On, Configure Applications menu.

NOTE

In products that run multiple instances of the X-Series Application, the same Configure Applications Utility launched from the Windows Desktop will apply to all the instances.

Configure Applications - Remote Commands

The following topics provide details on using remote commands to configure the list of applications you want to load into the instrument memory or query the Virtual Memory utilization for your applications.

- "Configuration list (Remote Command Only)" on page 203
- "Configuration Memory Available (Remote Command Only)" on page 203
- "Configuration Memory Total (Remote Command Only)" on page 203
- "Configuration Memory Used (Remote Command Only)" on page 203

- "Configuration Application Memory (Remote Command Only)" on page 204

Configuration list (Remote Command Only)

This remote command is used to set or query the list of applications to be loaded in-memory.

Remote Command	:SYSTem:PON:APPLication:LLISt <string of INSTRument:SElect names> :SYSTem:PON:APPLication:LLISt?
Example	:SYST:PON:APPL:LLIS "SA,BASIC,WCDMA"
Notes	<string of INSTRument:SElect names> are from the enums of the :INSTRument:SElect command. The order of the <INSTRument:SElect names> is the order that the applications are loaded into memory, and the order that they appear in the Mode Menu. Error message -225 "Out of Memory" is reported when more applications are listed than can reside in Virtual Memory. When this occurs, the existing applications load list is unchanged.
Preset	Not affected by Preset
State Saved	Not saved in instrument state
Initial S/W Revision	A.02.00

Configuration Memory Available (Remote Command Only)

This remote command is used to query the amount of Virtual Memory remaining.

Remote Command	:SYSTem:PON:APPLication:VMEMory[:AVAIlable]?
Example	:SYST:PON:APPL:VMEM?
Preset	Not affected by Preset
Initial S/W Revision	A.02.00

Configuration Memory Total (Remote Command Only)

This remote command is used to query the limit of Virtual Memory allowed for applications.

Remote Command	:SYSTem:PON:APPLication:VMEMory:TOTal?
Example	:SYST:PON:APPL:VMEM:TOT?
Preset	Not affected by Preset
Initial S/W Revision	A.02.00

Configuration Memory Used (Remote Command Only)

This remote command is a query of the amount of Virtual Memory used by all measurement applications.

Remote Command	:SYSTem:PON:APPLication:VMEMory:USED?
Example	:SYST:PON:APPL:VMEM:USED?

Preset	Not affected by Preset
Initial S/W Revision	A.02.00

Configuration Application Memory (Remote Command Only)

This remote command is used to query the amount of Virtual Memory a particular application consumes.

Remote Command	:SYSTem:PON:APPLication:VMEMory:USED:NAME? <INSTrument:SElect name>
Example	:SYST:PON:APPL:VMEM:USED:NAME? CDMA2K
Notes	<INSTrument:SElect name> is from the enums of the :INSTrument:SElect command Value returned will be 0 (zero) if the name provided is invalid.
Preset	Not affected by Preset
Initial S/W Revision	Prior to A.02.00

Alignments

The Alignments Menu controls and displays the automatic alignment of the instrument, and provides the ability to restore the default alignment values.

The current setting of the alignment system is displayed in the system Settings Panel along the top of the display, including a warning icon for conditions that may cause specifications to be impacted.



Key Path	System
Initial S/W Revision	Prior to A.02.00

Align Now

Accesses alignment processes that are immediate action operations. They perform complete operations and run until they are complete.

Key Path	System, Alignments
Initial S/W Revision	Prior to A.02.00

All (Daily use)

Immediately executes an alignment of all subsystems which includes both the source and the analyzer in the TRX module. The “All” alignment is sufficient to maintain specified performance, provided that (1) the TRX’s internal temperature has not drifted more than +/-5 degree C since the previous alignment, and (2) no more than 8 hours have elapsed since the previous “All” alignment., and (3) no more than 1 week has elapsed since these three alignments have all been run: IF, RF, and Source, and (4) a 45 minute warm-up

period between power-up of the TRX and invoking the “All” alignment. The instrument stops any measurement currently underway, performs the alignment, then restarts the measurement from the beginning (similar to pressing the Restart key).

If an interfering user signal is present at the RF Input, the alignment is performed on all subsystems except the RF. After completion, the Error Condition message “Align skipped: 50 MHz interference” or “Align skipped: 4.8 GHz interference” is generated. In addition the Error Condition message “Align Now, RF required” is generated, and bits 11 and 12 are set in the Status Questionable Calibration register.

The query form of the remote commands (:CALibration[:ALL]? or *CAL?) invokes the alignment of all subsystems and returns a success or failure value. An interfering user signal is not grounds for failure; if the alignment was able to succeed on all portions but unable to align the RF because of an interfering signal, the resultant will be the success value.

Successful completion of Align Now, All will clear the “Align Now, All required” Error Condition, and clear bit 14 in the Status Questionable Calibration register. It will also begin the elapsed time counter for Last Align Now, All Time, and capture the Last Align Now, All Temperature.

If the Align RF subsystem succeeded in aligning (no interfering signal present), the elapsed time counter begins for Last Align Now, RF Time, and the temperature is captured for the Last Align Now, RF Temperature. In addition the Error Conditions “Align skipped: 50 MHz interference” and “Align skipped: 4.8 GHz interference” are cleared, the Error Condition “Align Now, RF required” is cleared, and bits 11 and 12 are cleared in the Status Questionable Calibration register.

Align Now, All can be interrupted by pressing the Cancel (ESC) front-panel key or remotely with Device Clear followed by the :ABORt SCPI command. When this occurs the Error Condition message “Align Now, All required” is generated, and bit 14 is set in the Status Questionable Condition register. This is because new alignment data may be employed for an individual subsystem, but not a cohesive set of data for all subsystems.

In many cases, you might find it more convenient to change alignments to Normal, instead of executing Align Now, All. When the Auto Align process transitions to Normal, the analyzer will immediately start to update only the alignments that have expired, thus efficiently restoring the alignment process.

NOTE

In EXM, Source ARB play will be turned off and the source states will not be restored after Align Now, All.

Key Path	System, Alignments, Align Now
Mode	All
Remote Command	:CALibration[:ALL] :CALibration[:ALL]?
Example	:CAL
Notes	:CALibration[:ALL]? returns 0 if successful :CALibration[:ALL]? returns 1 if failed :CALibration[:ALL]? is the same as *CAL? While Align Now, All is performing the alignment, bit 0 in the Status Operation register is set. Completion, or termination, will clear bit 0 in the Status Operation register. This command is sequential; it must complete before further SCPI commands are processed. Interrupting the alignment from remote is accomplished by invoking Device Clear followed by the :ABORt command.

	<p>Successful completion will clear bit 14 in the Status Questionable Calibration register.</p> <p>An interfering user signal is not grounds for failure of Align Now, All. However, bits 11 and 12 are set in the Status Questionable Calibration register to indicate Align Now, RF is required.</p> <p>An interfering user supplied signal will result in the instrument requiring an Align Now, RF with the interfering signal removed.</p>
Couplings	<p>Initializes the time for the Last Align Now, All Time.</p> <p>Records the temperature for the Last Align Now, All Temperature.</p> <p>If Align RF component succeeded, initializes the time for the Last Align Now, RF Time.</p> <p>If Align RF component succeeded, records the temperature for the Last Align Now, RF Temperature.</p>
Status Bits/OPC dependencies	Bits 11, 12, or 14 may be set in the Status Questionable Calibration register.
Initial S/W Revision	Prior to A.02.00

Mode	All
Remote Command	*CAL?
Example	*CAL?
Notes	<p>*CAL? returns 0 if successful</p> <p>*CAL? returns 1 if failed</p> <p>:CALibration[:ALL]? is the same as *CAL?</p> <p>See additional remarks described with :CALibration[:ALL]?</p> <p>Everything about :CALibration[:ALL]? is synonymous with *CAL? including all conditions, status register bits, and couplings</p>
Initial S/W Revision	Prior to A.02.00

Mode	All
Remote Command	:CALibration[:ALL]:NPENding
Example	CAL:NPEN
Notes	<p>:CALibration[:ALL]:NPENding is the same as :CALibration[:ALL] including all conditions, status register bits, except this scpi command does not BLOCK the scpi session, so the user should use status register bits to query if the calibration is successfully completed or not.</p> <p>Typical usage is:</p> <ol style="list-style-type: none"> 1) :CALibration:ALL:NPENding (Start a calibration) 2) :STATus:OPERation:CONDition? (Check if the calibration is completed or not, If bit 0 is set, then the system is doing calibration, the user should repeat this scpi query until the bit is cleared) 3) :STATus:QUEStionable:CALibration:CONDition? (Check if there are any errors/failures in previous calibration procedure)
Initial S/W Revision	X.14.20

All but RF

Immediately executes an alignment of all subsystems except the RF subsystem which includes both the source and the analyzer in the TRX module. The instrument will stop any measurement currently underway, perform the alignment, and then restart the measurement from the beginning (similar to pressing the Restart key). This can be used to align portions of the instrument that are not impacted by an interfering user input signal.

This operation might be chosen instead of All if you do not want the device under test to experience a large change in input impedance, such as a temporary open circuit at the analyzer input.

The query form of the remote commands (:CALibration:NRF?) will invoke the alignment and return a success or failure value.

Successful completion of Align Now, All but RF will clear the “Align Now, All required” Error Condition, and clear bit 14 in the Status Questionable Calibration register. If “Align Now, All required” was in effect prior to executing the All but RF, the Error Condition message “Align Now, RF required” is generated and bit 12 in the Status Questionable Calibration register is set. It will also begin the elapsed time counter for Last Align Now, All Time, and capture the Last Align Now, All Temperature.

Align Now, All but RF can be interrupted by pressing the Cancel (ESC) front-panel key or remotely with Device Clear followed by the :ABORt SCPI command. When this occurs the Error Condition message “Align Now, All required” is generated, and bit 14 is set in the Status Questionable Condition register. This is because new alignment data may be used for an individual subsystem, but not a full new set of data for all subsystems.

NOTE

In EXM, Source ARB play will be turned off and the source states will not be restored after Align Now, All but RF.

Key Path	System, Alignments, Align Now
Mode	All
Remote Command	:CALibration:NRF :CALibration:NRF?
Example	:CAL:NRF
Notes	:CALibration:NRF? returns 0 if successful :CALibration:NRF? returns 1 if failed While Align Now, All but RF is performing the alignment, bit 0 in the Status Operation register is set. Completion, or termination, will clear bit 0 in the Status Operation register. This command is sequential; it must complete before further SCPI commands are processed. Interrupting the alignment from remote is accomplished by invoking Device Clear followed by the :ABORt command. Successful completion will clear bit 14 in the Status Questionable Calibration register and set bit 12 if invoked with “Align Now, All required”.
Couplings	Initializes the time for the Last Align Now, All Time. Records the temperature for the Last Align Now, All Temperature.
Status Bits/OPC dependencies	Bits 12 or 14 may be set in the Status Questionable Calibration register.
Initial S/W Revision	Prior to A.02.00

Mode	All
Remote Command	:CALibration:NRF:NPENding
Example	CAL:NRF:NPEN
Notes	:CALibration:NRF:NPENding is the same as :CALibration:NRF including all conditions, status register bits, except that this scpi command does not BLOCK the scpi session, so the user should use status register bits to query if the calibration is successfully completed or not. Typical usage is: 1):CALibration:NRF:NPENding (start theAll but RF calibration) 2):STATus:OPERation:CONDition? (If bit 0 is set, then the system is doing calibration, the user should do re-query until this bit is cleared) 3):STATus:QUEStionable:CALibration:CONDition? (to check if there are any errors/failures in previous calibration procedure)
Initial S/W Revision	X.14.20

RF (Weekly use)

Immediately executes an alignment of the RF subsystem which includes both the source and the analyzer in the TRX module . The instrument stops any measurement currently underway, performs the alignment, then restarts the measurement from the beginning (similar to pressing the Restart key).

This alignment corrects slow-rate drift which does not impair specifications for time periods shorter than one week. Thus, it is required to perform this alignment on a weekly basis to maintain specifications. This alignment typically takes >2 minutes to complete.

This operation might be desirable if the alignments had been set to not include RF alignments, or if previous RF alignments could not complete because of interference which has since been removed.

If an interfering user signal is present at the RF Input, the alignment will terminate and generate the Error Condition message “Align skipped: 50 MHz interference” or “Align skipped: 4.8 GHz interference”, and Error Condition “Align Now, RF required”. In addition, bits 11 and 12 will be set in the Status Questionable Calibration register.

The query form of the remote commands (:CALibration:RF?) will invoke the alignment of the RF subsystem and return a success or failure value. An interfering user signal is grounds for failure.

Successful completion of Align Now, RF will begin the elapsed time counter for Last Align Now, RF Time, and capture the Last Align Now, RF Temperature.

Align Now, RF can be interrupted by pressing the Cancel (ESC) front-panel key or remotely with Device Clear followed by the :ABORt SCPI command. When this occurs, the Error Condition message “Align Now, RF required” is generated, and bit 12 is set in the Status Questionable Condition register. None of the new alignment data is used.

NOTE

In EXM, Source ARB play will be turned off and the source states will not be restored after Align Now, All but RF.

Key Path	System, Alignments, Align Now
Mode	All
Remote Command	:CALibration:RF :CALibration:RF?
Example	:CAL:RF
Notes	<p>:CALibration:RF? returns 0 if successful</p> <p>:CALibration:RF? returns 1 if failed (including interfering user signal)</p> <p>While Align Now, RF is performing the alignment, bit 0 in the Status Operation register is set. Completion, or termination, will clear bit 0 in the Status Operation register.</p> <p>This command is sequential; it must complete before further SCPI commands are processed. Interrupting the alignment from remote is accomplished by invoking Device Clear followed by the :ABORt command.</p> <p>Successful completion clears the Error Conditions “Align skipped: 50 MHz interference” and “Align skipped: 4800 MHz interference” and the Error Conditions “Align RF failed” and “Align Now, RF required”, and clears bits 3, 11, and 12 in the Status Questionable Calibration register.</p> <p>A failure encountered during alignment will generate the Error Condition message “Align RF failed” and set bit 3 in the Status Questionable Calibration register.</p> <p>An interfering user signal will result in bits 11 and 12 to be set in the Status Questionable Calibration register to indicate Align Now, RF is required.</p> <p>An interfering user supplied signal will result in the instrument requiring an Align Now, RF with the interfering signal removed.</p>
Couplings	<p>Initializes the time for the Last Align Now, RF Time.</p> <p>Records the temperature for the Last Align Now, RF Temperature.</p>
Status Bits/OPC dependencies	Bits 11, 12, or 14 may be set in the Status Questionable Calibration register.
Initial S/W Revision	Prior to A.02.00
Mode	All
Remote Command	:CALibration:RF:NPENding
Example	CAL:RF:NPEN
Notes	<p>:CALibration:RF:NPENding is the same as :CALibration:RF including all conditions, status register bits, except that this scpi command does not BLOCK the scpi session, so the user should use status register bits to query if the calibration is successfully completed or not.</p> <p>Typical usage is:</p> <ol style="list-style-type: none"> 1):CALibration:RF:NPENding (Start a RF calibration) 2):STATus:OPERation:CONDition? (If bit 0 is set, then the system is doing calibration, the user should do re-query until this bit is cleared) 3):STATus:QUESTionable:CALibration:CONDition? (to check if there are any errors/failures in previous calibration procedure)
Initial S/W Revision	X.14.20

Source (Weekly use)

Accesses source alignment processes that are immediate action operations. They perform complete operations and run until they are complete.

Immediately executes an IQ alignment, and power level alignment. The instrument stops any sequence of the source, performs the alignment, then restarts the sequence from the beginning.

This alignment corrects slow-rate drift which does not impair specifications for time periods shorter than one week. Thus, it is required to perform this alignment on a weekly basis to maintain specifications. This alignment typically takes >2 minutes to complete.

There is no alert available for the source alignment. The operators have the responsibility to check temperature shift since last Align Now, Source to determine if the source alignment needs to be executed.

Key Path	System, Alignments, Align Now
Mode	All
Remote Command	:CALibration:INTernal:SOURce[:ALL] :CALibration:INTernal:SOURce[:ALL]?
Example	:CAL:INT:SOUR
Notes	:CAL:SOUR? Initiates an Alignment and returns 0 if successful :CAL:SOUR? Initiates an Alignment and returns 1 if failed
Couplings	Initializes the time for the Last Align Source Now, All Time. Records the temperature for the Last Align Source Now, All Temperature.
Initial S/W Revision	A.05.00

Mode	All
Remote Command	:CALibration:INTernal:SOURce[:ALL]:NPENding
Example	CAL:INT:SOUR:NPEN
Notes	:CALibration:INTernal:SOURce[:ALL]:NPENding is the same as :CALibration:INTernal:SOURce[:ALL] including all conditions, status register bits, except that this scpi command does not BLOCK the scpi session, so the user should use status register bits to query if the calibration is successfully completed or not. Typical usage is: 1):CALibration:INTernal:SOURce:NPENding (start an internal source calibration) 2):STATus:OPERation:CONDition? (Check if the calibration is completed or not, If bit 0 is set, then the system is doing calibration, the user should repeat this scpi query until the bit is cleared) 3):STATus:QUEStionable:CALibration:EXTended:FAILure:CONDition? (Check if bit 14 is set or not. If this bit is set, that means there are some errors in previous internal source calibration)
Initial S/W Revision	X.14.20

IF Alignment (Weekly use) (Remote Command Only)

Immediately executes an alignment of the IF subsystem which includes both the source and the analyzer in the TRX module. The instrument stops any measurement currently underway, perform the alignment, and then restart the measurement from the beginning (similar to pressing the Restart key). This alignment corrects slow-rate which the drift does not impair specifications for time periods shorter than one week. Thus, it is required to perform this alignment on a weekly basis to maintain specifications. This alignment typically takes >4 minutes to complete.

A failure of IF will set the Error Condition “Align IF failed” and set bit 4 in the Status Questionable Calibration register. A failure will not employ new IF alignment data.

Successful completion of IF will clear the Error Condition “Align IF failed” and clear bit 6 in the Status Questionable Calibration register.

Align IF can be interrupted by pressing the Cancel (ESC) front-panel key or from remote with Device Clear followed by the :ABORt SCPI command. When this occurs, no new IF alignment data will be employed.

The query form of the remote commands (:CALibration:IF?) will invoke the alignment of the IF subsystem and return a success or failure value.

Note: In EXM, Source ARB play will be turned off and the source states will not be restored after IF Alignment.

Mode	All
Remote Command	:CALibration:IF :CALibration:IF?
Example	:CAL:IF
Notes	:CALibration:IF? returns 0 if successful :CALibration:IF? returns 1 if failed While Align Now, IF is performing the alignment, bit 0 in the Status Operation register is set. Completion, or termination, will clear bit 0 in the Status Operation register. This command is sequential; it must complete before further SCPI commands are processed. Interrupting the alignment from remote is accomplished by invoking Device Clear followed by the :ABORt command. Successful completion will clear bit 14 in the Status Questionable Calibration register.
Preset	Not affected by Preset and Restore System Defaults Misc.
State Saved	No
Initial S/W Revision	E.14.00

Mode	All
Remote Command	:CALibration:IF:NPENding
Example	CAL:IF:NPEN
Notes	:CALibration:IF:NPENding is the same as :CALibration:IF including all conditions, status register bits, except that this scpi command does not BLOCK the scpi session, so the user should use status register bits to query if the calibration is successfully

completed or not.

Typical usage is:

- 1) :CALibration:IF:NPENDING (Start a IF calibration)
- 2) :STATus:OPERation:CONDition? (Check if the calibration is completed or not, If bit 0 is set, then the system is doing calibration, the user should repeat this scpi query until the bit is cleared)
- 3):STATus:QUEStionable:CALibration:CONDition? (Check if bit 4 is set or not. If this bit is set, that means there are some errors in previous internal source calibration)

Initial S/W Revision X.14.20

Show Alignment Statistics

Shows alignment information you can use to ensure that the instrument is operating in a specific manner. The Show Alignment Statistics screen is where you can view time and temperature information.

Values which are displayed are only updated when the Show Alignment Statistics screen is invoked, they are not updated while the Show Alignment Statistics screen is being displayed. The remote commands that access this information obtain current values.

An example of the Show Alignment Statistics screen would be similar to:

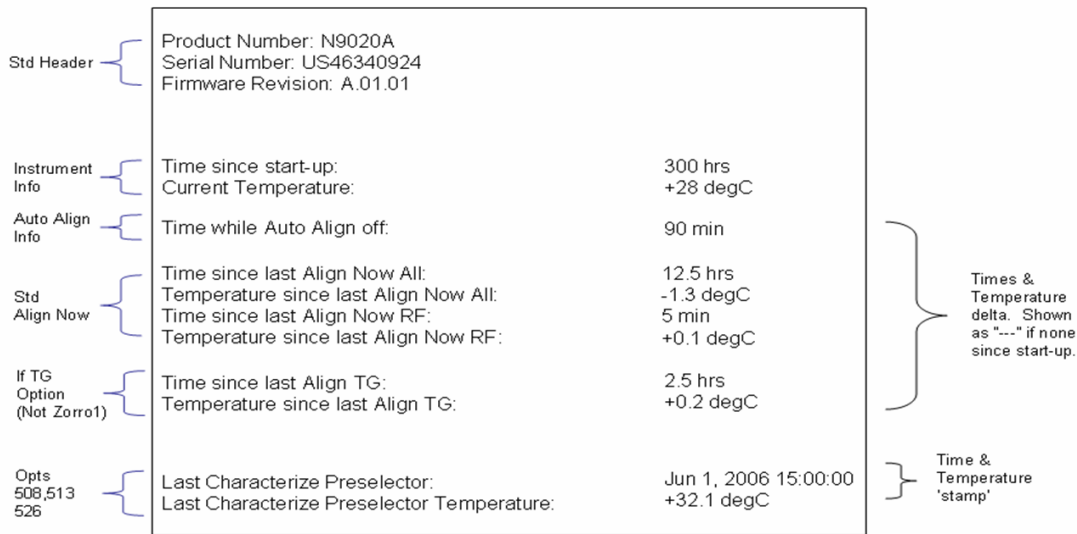

A successful Align Now, RF will set the Last Align RF temperature to the current temperature, and reset the Last Align RF time. A successful Align Now, All or Align Now, All but RF will set the Last Align Now All temperature to the current temperature, and reset the Last Align Now All time. A successful Align Now, All will also reset the Last Align RF items if the RF portion of the Align Now succeeded.

Key Path	System, Alignments
Mode	All
Notes	The values displayed on the screen are only updated upon entry to the screen and not updated while

	the screen is being displayed.
Initial S/W Revision	Prior to A.02.00

Key Path	Visual annotation in the Show Alignment Statistics screen
Mode	All
Remote Command	:SYSTem:PON:TIME?
Example	:SYST:PON:TIME?
Notes	Value is the time since the most recent start-up in seconds.
State Saved	No
Initial S/W Revision	Prior to A.02.00

Key Path	Visual annotation in the Show Alignment Statistics screen
Mode	All
Remote Command	:CALibration:TEMPerature:CURRent?
Example	:CAL:TEMP:CURR?
Notes	Value is in degrees Centigrade. Value is invalid if using default alignment data (Align Now, All required)
State Saved	No
Initial S/W Revision	Prior to A.02.00

Key Path	Visual annotation in the Show Alignment Statistics screen
Mode	All
Remote Command	:CALibration:TIME:LALL?
Example	:CAL:TIME:LALL?
Notes	Value is the elapsed time, in seconds, since the last successful Align Now, All or Align Now, All but RF was executed.
State Saved	No
Initial S/W Revision	Prior to A.02.00

Key Path	Visual annotation in the Show Alignment Statistics screen
Mode	All
Remote Command	:CALibration:TEMPerature:LALL?
Example	:CAL:TEMP:LALL?
Notes	Value is in degrees Centigrade at which the last successful Align Now, All or Align Now, All but RF

	was executed.
State Saved	No
Initial S/W Revision	Prior to A.02.00

Key Path	Visual annotation in the Show Alignment Statistics screen
Mode	All
Remote Command	:CALibration:TIME:LRF?
Example	:CAL:TIME:LRF?
Notes	Value is the elapsed time, in seconds, since the last successful Align Now, RF was executed, either individually or as a component of Align Now, All.
State Saved	No
Initial S/W Revision	Prior to A.02.00

Key Path	Visual annotation in the Show Alignment Statistics screen
Mode	All
Remote Command	:CALibration:TEMPerature:LRF?
Example	:CAL:TEMP:LRF?
Notes	Value is in degrees Centigrade at which the last successful Align Now, RF was executed, either individually or as a component of Align Now, All.
State Saved	No
Initial S/W Revision	Prior to A.02.00

Key Path	SCPI Only
Mode	All
Remote Command	:CALibration:TIME:LIF?
Example	:CAL:TIME:LIF?
Notes	Value is the elapsed time, in seconds, since the last successful Align IF was executed.
State Saved	No
Initial S/W Revision	A.14.50

Key Path	SCPI Only
Mode	All
Remote Command	:CALibration:TEMPerature:LIF?

Example	:CAL:TEMP:LIF?
Notes	Value is in degrees Centigrade at which the last successful Align IF was executed.
State Saved	No
Initial S/W Revision	A.14.50

Key Path	Visual annotation in the Show Alignment Statistics screen
Mode	All
Remote Command	:CALibration:TIME:SOURce:LALL?
Example	:CAL:TIME:SOUR:LALL?
Notes	Value is the date and time of the last successful Align Now, Source was performed on the instrument.
State Saved	No
Initial S/W Revision	A.05.00

Key Path	Visual annotation in the Show Alignment Statistics screen
Mode	All
Remote Command	:CALibration:TEMPerature:SOURce: LALL?
Example	:CAL:TEMP:SOUR:LALL?
Notes	Value is in degrees Centigrade at which the last successful Align Now, Source was performed on the instrument.
State Saved	No
Initial S/W Revision	A.05.00

Restore Align Defaults

Initializes the alignment user interface settings, not alignment data, to the factory default values. Align Now, All must be executed if the value of the Timebase DAC results in a change.

For front panel operation, you are prompted to confirm action before setting the alignment parameters to factory defaults:

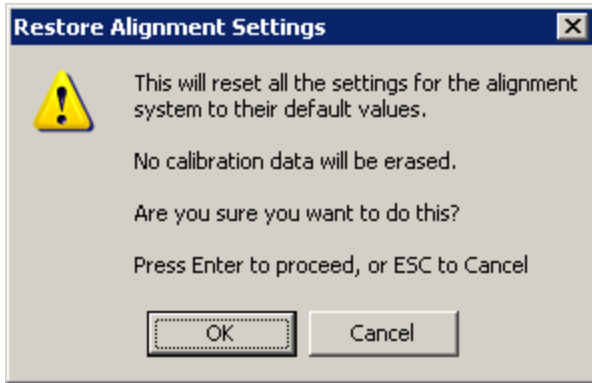

The parameters affected are:

Parameter	Setting
Timebase DAC	Calibrated
Timebase DAC setting	Calibrated value
Auto Align State	Normal (if the instrument is not operating with default alignment data, Off otherwise)
Auto Align All but RF	Off
Auto Align Alert	Time & Temperature

Key Path	System, Alignments
Mode	All
Example	:SYST:DEF ALIG
Notes	Alignment processing that results as the transition to Auto Alignment Normal will be executed sequentially; thus *OPC? or *WAI will wait until the alignment processing is complete.
Initial S/W Revision	Prior to A.02.00

Execute Expired Alignments (Remote Command Only)

Alignments can be expired in the situation where Auto Align is in the state of Partial or Off. This feature runs the alignments that have expired. This is different than performing an Align All, Now operation. Align All, Now performs an alignment of all subsystems regardless of whether they are needed or not, with Execute Expired Alignments, only the individual subsystems that have become due are aligned.

Mode	All
Remote Command	:CALibration:EXPIred?
Example	:CAL:EXP?
Notes	:CALibration:EXPIred? returns 0 if successful :CALibration:EXPIred? returns 1 if failed
Initial S/W Revision	Prior to A.02.00

I/O Config

Activates a menu for identifying and changing the I/O configuration for remote control.

Key Path	System
Initial S/W Revision	Prior to A.02.00

SCPI LAN

Activates a menu for identifying and changing the SCPI over a LAN configuration. There are a number of different ways to send SCPI remote commands to the instrument over LAN. It can be a problem to have multiple users simultaneously accessing the instrument over the LAN. These keys limit that somewhat by disabling the telnet, socket, and/or SICL capability.

NOTE

Telnet port 5023, socket port 5025, SICL server 0 and HiSLIP server 0 will be assigned to first instance; Telnet port 5123, socket port 5125, SICL server 1 and HiSLIP server 1 will be assigned to second instance; Telnet port 5223, socket port 5225, SICL server 2 and HiSLIP server 2 will be assigned to third instance; Telnet port 5323, socket port 5325, SICL server 3 and HiSLIP server 3 will be assigned to the fourth instance.

Key Path	System, I/O Config
Initial S/W Revision	Prior to A.02.00

SCPI Telnet

Turns the SCPI LAN telnet capability On or Off allowing you to limit SCPI access over LAN through telnet.

Key Path	System, I/O Config, SCPI LAN
Mode	All
Remote Command	:SYSTem:COMMunicate:LAN:SCPI:TELNet:ENABle OFF ON 0 1 :SYSTem:COMMunicate:LAN:SCPI:TELNet:ENABle?
Example	:SYST:COMM:LAN:SCPI:TELN:ENAB OFF
Preset	This is unaffected by Preset but is set to ON with a "Restore System Defaults->Misc"
State Saved	No
Range	On Off
Initial S/W Revision	Prior to A.02.00

SCPI Socket

Turns the capability of establishing Socket LAN sessions On or Off. This allows you to limit SCPI access over LAN through socket sessions.

Key Path	System, I/O Config, SCPI LAN
Mode	All
Remote Command	:SYSTem:COMMunicate:LAN:SCPI:SOCKet:ENABle OFF ON 0 1 :SYSTem:COMMunicate:LAN:SCPI:SOCKet:ENABle?
Example	:SYST:COMM:LAN:SCPI:SOCK:ENAB OFF
Preset	This is unaffected by a Preset but is set to ON with a "Restore System Defaults->Misc"
State Saved	No
Range	On Off
Initial S/W Revision	Prior to A.02.00

SICL Server

Turns the SICL server capability On or Off, enabling you to limit SCPI access over LAN through the SICL server. (SICL IEEE 488.2 protocol.)

Parameter	Description	Setting
Maximum Connections	The maximum number of connections that can be accessed simultaneously	5
Instrument Name	The name (same as the remote SICL address) of your analyzer	inst0
Instrument Logical Unit	The unique integer assigned to your analyzer when using SICL LAN	8
Emulated GPIB Name	The name (same as the remote SICL address) of the device used when communicating with your analyzer	gpi7
Emulated GPIB Logical Unit	The unique integer assigned to your device when it is being controlled using SICL LAN	8
Emulated GPIB Address	The emulated GPIB address assigned to your transmitter tester when it is a SICL server (the same as your GPIB address)	18

Key Path	System, I/O Config, SCPI LAN
Mode	All
Remote Command	:SYSTem:COMMunicate:LAN:SCPI:SICL:ENABle OFF ON 0 1 :SYSTem:COMMunicate:LAN:SCPI:SICL:ENABle?
Example	:SYST:COMM:LAN:SCPI:SICL:ENAB OFF
Preset	This is unaffected by Preset, but is set to ON with a "Restore System Defaults->Misc"
State Saved	No
Range	On Off
Initial S/W Revision	Prior to A.02.00

HiSLIP Server

Turns the HiSLIP server capability On or Off, enabling you to limit SCPI access over LAN through the HiSLIP server.

HiSLIP stands for High Speed LAN Instrument Protocol and is part of the IVI–6.1 specification.

Here is an example of a VISA connection string used to connect to the HiSLIP Server on an X-Series Spectrum Analyzer:

```
TCPIP0::a-n9030a-93016::hislip0::INSTR
```

In the example above, hislip0 is the HiSLIP device name that VISA users must include in their HiSLIP VISA Address strings. Your HiSLIP device name may be different depending on your VISA settings.

Key Path	System, I/O Config, SCPI LAN
Mode	All
Remote Command	:SYSTem:COMMunicate:LAN:SCPI:HISLip:ENABle OFF ON 0 1 :SYSTem:COMMunicate:LAN:SCPI:HISLip:ENABle?
Example	:SYST:COMM:LAN:SCPI:HISL:ENAB OFF
Preset	This is unaffected by Preset, but is set to ON with a “Restore System Defaults-> Misc”
State Saved	No
Range	On Off
Initial S/W Revision	A.11.00

SCPI Socket Control Port (Remote Command Only)

Returns the TCP/IP port number of the control socket associated with the SCPI socket session. This query enables you to obtain the unique port number to open when a device clear is to be sent to the instrument. Every time a connection is made to the SCPI socket, the instrument creates a peer control socket. The port number for this socket is random. The user must use this command to obtain the port number of the control socket. To force a device clear on this socket, open the port and send the string “DCL ” to the instrument.

If this SCPI command is sent to a non SCPI Socket interface, then 0 is returned.

Mode	All
Remote Command	:SYSTem:COMMunicate:LAN:SCPI:SOCKet:CONTRol?
Example	:SYST:COMM:LAN:SCPI:SOCK:CONT?
Preset	This is unaffected by Preset or “Restore System Defaults-> Misc”.
State Saved	No
Range	0 to 65534
Min	0
Max	65534
Initial S/W Revision	Prior to A.02.00

System IDN Response

This key allows you to specify a response to the *IDN? query, or to return the analyzer to the Factory response if you have changed it.

To choose the factory-set response, press the Factory key.

To specify your own response, press the User key, and enter your desired response.

If your test software is expecting the response to indicate Agilent Technologies as the Manufacturer, you can conveniently configure the response by pressing the Agilent key.

Key Path	System, I/O Config
Mode	All
Remote Command	
Notes	<ul style="list-style-type: none"> • This affects the response given in all Modes of the Analyzer, unless the current Mode has also specified a custom response, in which case the current Mode's custom IDN response takes precedence over the System's, but only while that Mode is the current Mode.. • It survives shutdown and restart of the software and therefore survives a power cycle
Preset	This is unaffected by Preset but is set to Factory on a "Restore System Defaults->Misc"
State Saved	No
Initial S/W Revision	A.06.00
Modified at S/W Revision	x.14.50

Factory

This key selects the factory setting, for example:

"Agilent Technologies,E6640,MY00012345, E.14.50"

where the fields are manufacturer, model number, serial number, firmware revision.

Note: In products that run multiple instances of the X-Series Application, all instances use the same factory System IDN response.

Key Path	System, I/O Config, IDN Response
Example	:SYST:IDN:CONF FACT
Initial S/W Revision	A.06.0

User

This key allows you to specify your own response to the *IDN? query. You may enter your desired response with the Alpha Editor or a plugin PC keyboard.

When you press this key, the active function becomes the current User string with the cursor at the end. This makes it easy to edit the existing string.

If you enter a null string (for example, by clearing the User String while editing and then pressing Done) the analyzer automatically reverts to the Factory setting.

Note: In products that run multiple instances of the X-Series Application, all instances use the same User System IDN response.

Key Path	System, I/O Config, IDN Response
Example	:SYST:IDN:CONF USER
Initial S/W Revision	A.06.00

SYSTEM:IDN Response setting (Remote command)

This SCPI command is used to set or clear the User SYSTEM:IDN response.

Remote Command	:SYSTem:IDN <string> :SYSTem:IDN?
Notes	<ul style="list-style-type: none"> The format of the <string> must be four fields each separated by a comma, example: :SYST:IDN "XYZ Corp,Model 12,012345,A.01.01" The four fields are <manufacturer>, <model number>, <serial number>, <firmware revision>. Thus, the text within a field cannot contain a comma. This affects the response given in all Modes of the Analyzer, unless the current Mode has also specified a custom response, in which case the current Mode's custom IDN response takes precedence over the System's, but only while that Mode is the current Mode.. It survives shutdown and restart of the software and therefore survives a power cycle Null string as parameter restores the Factory setting, example: :SYST:IDN ""
Preset	This is unaffected by Preset but is set to the original factory setting on a "Restore System Defaults->Misc"
Initial S/W Revision	A.06.00

Restore Defaults

Provides incremental initialization of the system setting groups along with supporting a comprehensive reset of the entire instrument back to a factory default state. The menu selections are the groups of system settings and when one is selected, that particular group of system settings is reset back to their default values.

NOTE

In products that run multiple instances of the X-Series Application, all instances have the same factory default states for Restore Defaults.

Key Path	System
Mode	All
Remote Command	:SYSTem:DEFault [ALL] ALIGn INPut MISC MODes PON

Example	SYST:DEF
State Saved	No
Initial S/W Revision	Prior to A.02.00

Restore Input/Output Defaults

Causes the group of settings and data associated with Input/Output front-panel key to be a reset to their default values. This level of Restore System Defaults does not affect any other system settings, mode settings and does not cause a mode switch. .

Confirmation is required to restore the Input/Output setting. The confirmation dialog is:

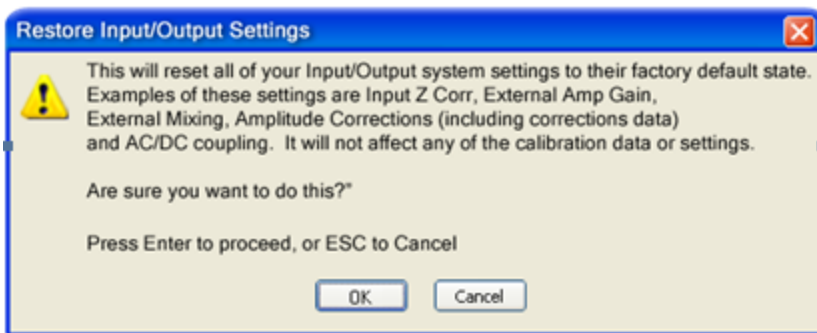

Key Path	System, Restore System Defaults
Example	:SYST:DEF INP
Initial S/W Revision	Prior to A.02.00

Restore Power On Defaults

This selection causes the Power On settings to be a reset to their default value. This level of Restore System Defaults does not affect any other system settings, mode settings and does not cause a mode switch. The Power On settings and their default values are Power On Type reset to Mode and Input/Output Defaults and Power On Application reset to whatever the factory set as its default value.

Confirmation is required to restore the factory default values. The confirmation dialog is:

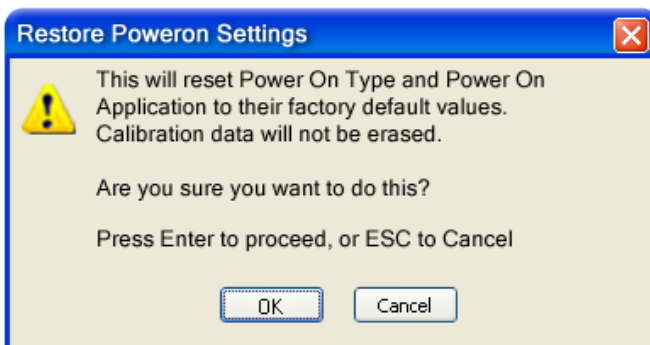

Key Path	System, Restore System Defaults
Example	:SYST:DEF PON
Initial S/W Revision	Prior to A.02.00

Restore Align Defaults

This selection causes the Alignment system settings to be a reset to their default values. This does not affect any Alignment data stored in the system. This level of Restore System Defaults does not affect any other system settings, mode settings and does not cause a mode switch.

After performing this function, it may impact the auto-alignment time of the instrument until a new alignment baseline has been established.

Confirmation is required to restore the factory default values. The confirmation dialog is:

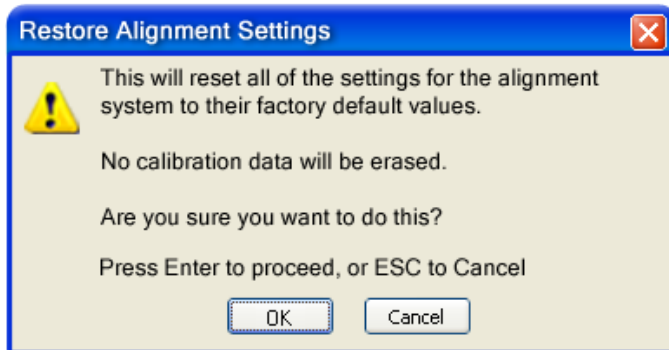

Key Path	System, Restore System Defaults
Example	:SYST:DEF ALIG
Initial S/W Revision	Prior to A.02.00

Restore Misc Defaults

This selection causes miscellaneous system settings to be reset to their default values. With this reset, you lose the GPIB address and it is reset to 18, so this should be used with caution. This level of Restore System Defaults does not affect any other system settings, mode settings and does not cause a mode switch. This miscellaneous group contains the rest of the settings that have not been part of the other Restore System Defaults groups. The following table is a complete list of settings associated with this group:

Miscellaneous Setting	Default Value
Verbose SCPI	Off
The SYST:PRES:TYPE	MODE
Auto File Name Number	000

Miscellaneous Setting	Default Value
Save Type	State
State Save To	Register 1
Screen Save To	SCREEN000.png
DISP:ENABle	ON
Full Screen	Off
SCPI Telnet	ON
SCPI Socket	ON
SICL Server	ON
Softkey Language	English
System Annotation	ON
Display Theme	TDColor
System IDN Response	Factory result of *IDN?
System IDN Response selection	Factory

Confirmation is required to restore the factory default values. The confirmation dialog is:

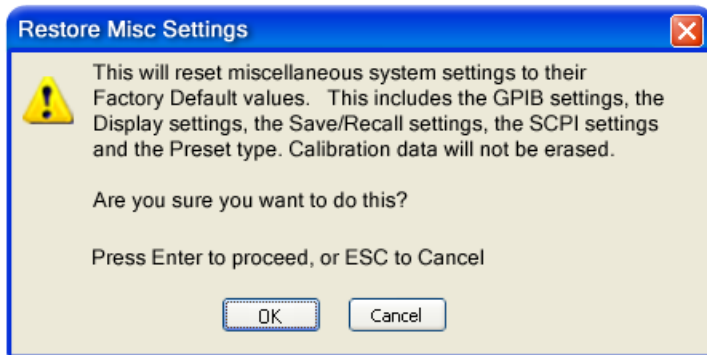

Key Path	System, Restore System Defaults
Example	:SYST:DEF MISC
Initial S/W Revision	Prior to A.02.00
Modified at S/W Revision	x.14.50

Restore Mode Defaults (All Modes)

This selection resets all of the modes in the instrument back to their default state just as a Restore Mode Defaults does and it switches the instrument to the power-on mode and causes the default measurement for the power-on mode to be active. This level of Restore System Defaults does not affect any system settings, but it does affect the state of all modes and does cause a mode switch unless the instrument was already in the power-on mode.

Confirmation is required to restore the factory default values. The confirmation dialog is:

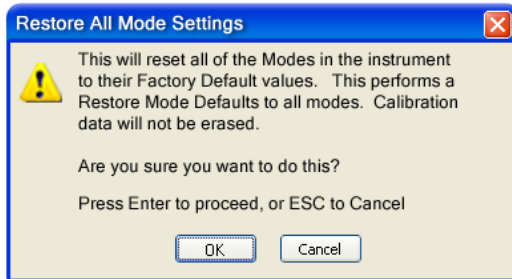

Key Path	System, Restore System Defaults
Example	:SYST:DEF MOD
Couplings	An All Mode will cause the currently running measurement to be aborted, mode switch to the power-on mode and activate the default measurement for the power-on mode.. It gets the mode to a consistent state with all of the default couplings set.
Initial S/W Revision	Prior to A.02.00

All

This performs a comprehensive reset of ALL analyzer settings to their factory default values. It resets all of the system setting groups, causes a Restore Mode Defaults for all modes in the instrument, and switches back to the power-on mode. It does not affect the User Preset file or any user saved files.

Confirmation is required to restore the factory default values. The confirmation dialog is:

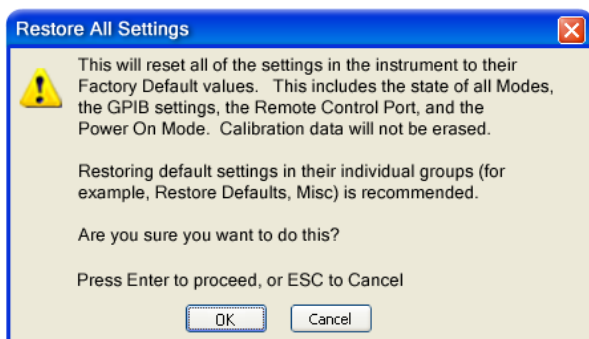

NOTE

If you are using an Keysight USB External Mixer, then you will need to perform a Refresh USB Mixer Connection after Restoring All Defaults.

Key Path	System, Restore System Defaults
Example	:SYST:DEF ALL
Notes	If using Keysight USB External Mixer, perform a Refresh USB Mixer Connection (SCPI command :MIX:BAND USB) following a Restore All Defaults.
Couplings	An All will cause the currently running measurement to be aborted and get all modes to a consistent state, so it is unnecessary to couple any settings.
Initial S/W Revision	Prior to A.02.00
Modified at S/W Revision	A.14.00

Control Panel...

Opens the Windows Control Panel. The Control Panel is used to configure certain elements of Windows that are not configured through the hardkey/softkey System menus.

NOTE This feature is not available if option SF1 is installed.

The Control Panel is a separate Windows application, so to return to the analyzer once you are in the Control Panel, you may either:

Exit the Control Panel by clicking on the red X in the upper right hand corner, with a mouse

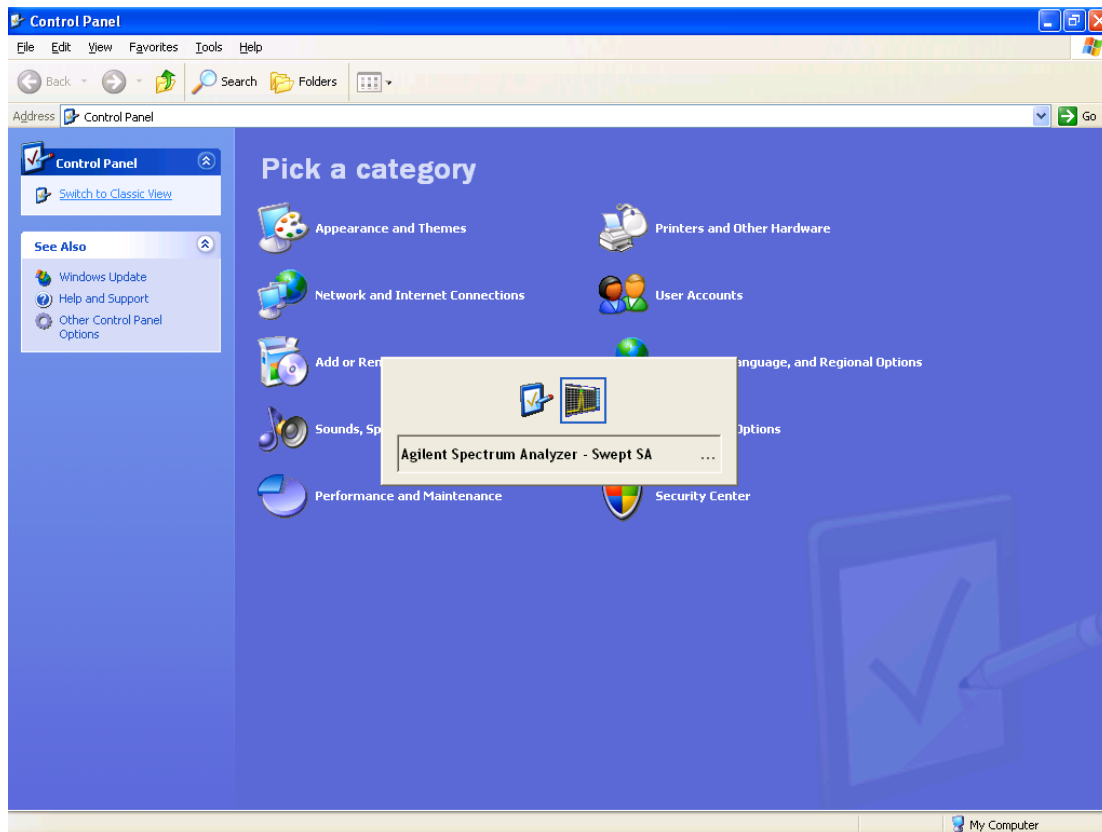



Or use Alt-Tab: press and hold the Alt key and press and release the Tab key until the Analyzer logo is showing in the window in the center of the screen, as above, then release the Alt key.

Key Path	System
Notes	No remote command for this key.
Initial S/W Revision	Prior to A.02.00

Licensing...

Opens the license explorer.

NOTE This feature is not available if option SF1 is installed.

For Help on this key, select Help in the menu bar at the top of the license explorer window.

Key Path	System
Notes	No equivalent remote command for this key.
Backwards Compatibility Notes	In ESA the SCPI command for displaying the Show Licenses screen is: :SYSTem:CONFigure:LKEY:STATe OFF ON 0 1 :SYSTem:CONFigure:LKEY:STATe? There are no equivalent SCPI commands in the X-Series for displaying the License Explorer.
Initial S/W Revision	Prior to A.02.00

Remote Command	:SYSTem:LKEY <"OptionInfo">, <"LicenseInfo">
-----------------------	--

Example	SYST:LKEY "N9073A-1FP", "027253AD27F83CDA5673A9BA5F427FDA5E4F25AEB1017638211AC9F60D9C639FE539735909C551DE0A91"
----------------	---

Notes	The <"OptionInfo"> contains the feature and the version. You must specify the feature but can omit the version. If you omit the version, the system regards it as the latest one, since the system knows which version is supported for each feature. The <"LicenseInfo"> contains the signature, the expiration date, and serial number for transport if transportable. You must specify the signature, but you can omit the other information. If you omit the expiration date, the system regards it as permanent. If you omit the serial number, the system regards it as non-transportable. As a result, this supports reverse compatibility.
-------	---

Initial S/W Revision	Prior to A.02.00
----------------------	------------------

Remote Command	:SYSTem:LKEY:DELeTe <"OptionInfo">, <"LicenseInfo">
-----------------------	---

Example	SYST:LKEY:DEL 'N9073A-1FP', "027253AD27F83CDA5673A9BA5F427FDA5E4F25AEB1017638211AC9F60D9C639FE539735909C551DE0A91"
Notes	The <"OptionInfo"> contains the feature and the version. You must specify the feature but can omit the version. If you omit the version, the system regards it as the latest one, if more than one version is installed. The <"LicenseInfo"> contains the signature, the expiration date, and whether or not be transportable. You must specify the signature, but you can omit the other information. If you omit the expiration date, the system regards it as permanent. If you omit the transportability, the system regards it as non-transportable. As a result, this supports reverse compatibility.
Initial S/W Revision	Prior to A.02.00

Remote Command	:SYSTem:LKEY:LIST?
Notes	<p>Return Value: An <arbitrary block data> of all the installed instrument licenses. The format of each license is as follows. <Feature>,<Version>,<Signature>,<Expiration Date>,<Serial Number for Transport></p> <p>Return Value Example: #3136 N9073A-1FP,1.000,B043920A51CA N9060A-2FP,1.000,4D1D1164BE64 N9020A-508,1.000,389BC042F920 N9073A-1F1,1.000,5D71E9BA814C,13-aug-2005</p> <p><arbitrary block data> is: #NMMM<data></p> <p>Where: N is the number of digits that describes the number of MMM characters. For example if the data was 55 bytes, N would be 2. MMM would be the ASCII representation of the number of bytes. In the previous example, N would be 55. <data> ASCII contents of the data</p>
Initial S/W Revision	Prior to A.02.00

Remote Command	:SYSTem:LKEY? <"OptionInfo">
Example	SYST:LKEY? "N9073A-1FP"
Notes	The <"OptionInfo"> contains the feature and the version. You must specify the feature but can omit the version. If you omit the version, the system regards it as the latest one. Return Value: <"LicenseInfo"> if the license is valid, null otherwise.

	<"LicenseInfo"> contains the signature, the expiration date, and serial number if transportable. Return Value Example: "B043920A51CA"
Initial S/W Revision	Prior to A.02.00

Remote Command	:SYSTem:HID?
Notes	Return value is the host ID as a string
Initial S/W Revision	Prior to A.02.00

Security

Accesses capabilities for operating the instrument in a security controlled environment.

Key Path	System
Initial S/W Revision	A.04.00

USB

The Windows operating system can be configured to disable write access to the USB ports for users who are in a secure environment where transferring data from the instrument is prohibited. This user interface is a convenient way for the customer to disable write access to USB.

Key Path	System, Security
Mode	All
Scope	Mode Global
Remote Command	:SYSTem:SECurity:USB:WPRotect[:ENABLE] ON OFF 0 1 :SYSTem:SECurity:USB:WPRotect[:ENABLE]?
Example	:SYST:SEC:USB:WPR ON Will set USB ports to Read-only
Notes	When the USB ports are in Read-only mode then no data can be stored to USB, including the internal USB memory used for a back-up location for the calibration data.
Dependencies	This key is grayed-out unless the current user has administrator privileges.
Preset	This is unaffected by Preset or any Restore System Defaults. An Agilent Recovery will set the USB to write protect OFF
State Saved	No
Range	Read-Write Read only
Initial S/W Revision	A.04.00

Read-Write

Selection for allowing full read-write access to the USB ports.

Key Path	System, Security, USB	
Example	:SYST:SEC:USB:WPR OFF	Will set USB ports to Read-Write
Initial S/W Revision	A.04.00	

Read only

Selection for disabling write access to the USB ports.

Key Path	System, Security, USB	
Example	:SYST:SEC:USB:WPR ON	Will set USB ports to Read only
Initial S/W Revision	A.04.00	

Diagnostics

The Diagnostics key in the System menu gives you access to basic diagnostic capabilities of the instrument.

Key Path	System
Initial S/W Revision	Prior to A.02.00

Show Hardware Statistics

Provides a display of various hardware statistics. The statistics include the following:

- High and Low temperature extremes
- Elapsed time that the instrument has been powered-on (odometer)

The display should appear listing the statistics, product number, serial number, and firmware revision.

Hardware Statistical Information	
Agilent MXA Signal Analyzer	
Product Number: N9020A	
Serial Number: US00061145	
Instrument S/W Revision: A.12.00	
Revision Date: 7/11/2012 12:11:10 PM	
Component Name	Value
MechAtten #1 Count Total	457304
Calibrator Switch Cycles	105953
AC/DC Switch Cycles	114240
2 dB #1 Mechanical Atten Cycles	112655
2 dB #2 Mechanical Atten Cycles	124456
MechAtten #2 Count Total	472265
6 dB Mechanical Atten Cycles	115302
10 dB Mechanical Atten Cycles	93602
20 dB Mechanical Atten Cycles	144781
30 dB Mechanical Atten Cycles	118580
Low Noise Path Switch	45668
Preselector Bypass Cycles	31133
High temperature operating extreme	45.75
Low temperature operating extreme	-23.9375
Elapsed Time (On-Time)(hours)	134164

In some CXA models this field is called "Fixed Aten"

Some CXA models omit these fields

Only shown if LNP installed

Only shown if MPB installed

The CXA models in which the AC/DC Switch field is called Fixed Aten and that omit the mechanical attenuation fields are the N9000A-503/507 models.

Modular HWs only have time and temperature information in Show Hardware Statistics.

The data will be updated only when the Show Hardware Statistics menu key is pressed, it will not be updated while the screen is displayed.

The tabular data should be directly printable.

Key Path	System, Diagnostics
Mode	All
Notes	The values displayed on the screen are only updated upon entry to the screen and not updated while the screen is being displayed.
Initial S/W Revision	Prior to A.02.00

SCPI for Show Hardware Statistics (Remote Commands Only)

Each of the hardware statistic items can be queried via SCPI.

- Error! Reference source not found.
- Error! Reference source not found.
- Error! Reference source not found.

Self test

This key gives you access to diagnostic capabilities for self tests of the instrument.

Key Path	System, Diagnostics
Initial S/W Revision	Prior to A.10.00

All Self Test

This key invokes all the self tests defined in the Diagnostics Self Test section.

Key Path	System, Diagnostics, Self Test
Remote Command	SYSTem:TEST:WCTS:[ALL]
Example	SYST:TEST:WCTS:[ALL]
Initial S/W Revision	A.12.50

FEC Self Test

This key invokes the EXT E6607C front end control self test. When operation is complete, the generated test summary information is appended to log file E:\Agilent\Instrument\FECTestLog.txt. This test summary file can be retrieved from the instrument using the MMEM set of SCPI command, once you have the fully qualified the path and file name.

If the self test fails, the following error message will be generated:

“-330, Self-test failed, see log file E:\Agilent\Instrument\FECTestLog.txt”

If the self test passes, an advisory message “FEC self-test completed successfully” is generated.

Key Path	System, Diagnostics, Self Test
Remote Command	SYSTem:TEST:WCTS:FEC
Example	SYST:TEST:WCTS:FEC
Notes	Access log with command : MMEM:DATA? "E:\ Agilent\Instrument\FECTestLog.txt"
Initial S/W Revision	A.12.50

Show Result

This key gives you access to show results of the following self tests:

- Source self-test results
- E6607C embedded MPA or E6640A/E6650A RFIO self-test results
- E6607C FEC self-test results

Key Path	System, Diagnostics, Self Test
Initial S/W Revision	A.12.50

FEC Self Test Results

Provides a display of last FEC test results, the display should appear listing model number, serial number and test time at the top of display, and then list test date/time, test name, measured value, valid range and pass/fail of each FEC test item, the tabular data should be directly printable.

Key Path	System, Diagnostics, Self Test, Show Results
Remote Command	SYSTem:TEST:WCTS:SHOW:RESult FEC
Example	SYST:TEST:WCTS:SHOW:RES FEC
Initial S/W Revision	A.12.50

The example of FEC self test result display is as follows:

FEC Self Test Results					
Produce Number: E6607C					
Serial Number: MY51380437					
Instrument S/W: 11/16/2012 2:51:19 PM					
FpgaVersionTest					
Date	Time(GMT)	Name	MeasValue	ValidRange	Result
11/23/2012	16:13:56	Analog_FPGA	16.000	>= 16.000	Pass
11/23/2012	16:13:56	Digital_FPGA	50.000	>= 46.000	Pass
11/23/2012	16:13:56	CRFS_FPGA	38.000	>= 38.000	Pass
PowerSupplyTest					
Date	Time(GMT)	Name	MeasValue	ValidRange	Result
11/23/2012	16:13:56	ABUS_+32CHK	31.904	30.900 - 32.900	Pass
11/23/2012	16:13:56	ABUS_+12CHK	12.296	10.800 - 13.200	Pass
11/23/2012	16:13:56	+10VA	9.935	9.600 - 10.200	Pass
11/23/2012	16:13:56	+5VA	4.995	4.900 - 5.100	Pass
11/23/2012	16:13:56	+3.3VA	3.299	3.200 - 3.400	Pass
11/23/2012	16:13:56	-3.3VA	-3.311	-3.400 - - 3.200	Pass
11/23/2012	16:13:56	ACOM	0.00	-0.200 -	Pass

					0.200	
11/23/2012	16:13:56	-5VA	-5.036	-5.100 - - 4.900	Pass	
11/23/2012	16:13:56	-6.1VA	-5.880	-6.200 - - 5.700	Pass	
11/23/2012	16:13:56	-10VA	-10.116	-10.200 - - 9.800	Pass	
11/23/2012	16:13:56	ABUS_-2.5V_REF	-2.508	-2.520 - - 2.470	Pass	
11/23/2012	16:13:56	ABUS_+2.5V_REF	2.508	2.480 - 2.520	Pass	
11/23/2012	16:13:56	ABUS_-10VPALC	-10.047	-10.200 - - 9.800	Pass	
11/23/2012	16:13:57	ABUS_DET_MOD_FLT	18.000	7.800 - 100.000	Pass	

Show FEC Self Test Results contents (Remote Command Only)

A remote command is available to obtain the contents of the Show FEC Self Test Results screen (the entire contents, not just the currently displayed page).

Remote Command	SYSTem:TEST:WCTS:FEC:RESult?
Example	SYST:TEST:WCTS:FEC:RES?
Notes	The output is an IEEE Block format of the Show FEC Self Test Results contents. Each line is separated with a new-line character.
Initial S/W Revision	A.12.50

	Keysight Converged	PSA
IP Address	SYSTem:COMMunicate:LAN:ADDRess <string> SYSTem:COMMunicate:LAN:ADDRess?	:SYSTem:COMMunicate:LAN[;SELF]:IP <string> :SYSTem:COMMunicate:LAN[;SELF]:IP?
Gateway	SYSTem:COMMunicate:LAN:DGATeway <string> SYSTem:COMMunicate:LAN:DGATeway?	:SYSTem:COMMunicate:LAN[;SELF]:GATEway <string> :SYSTem:COMMunicate:LAN[;SELF]:GATEway?
Subnet Mask	SYSTem:COMMunicate:LAN:SMASK <string> SYSTem:COMMunicate:LAN:SMASK?	:SYSTem:COMMunicate:LAN[;SELF]:SUBNetmask <string> :SYSTem:COMMunicate:LAN[;SELF]:SUBNetmask?

Internet Explorer...

This key launches Microsoft Internet Explorer. A mouse and external keyboard are highly desired for using Internet Explorer. When Internet Explorer is running, close Internet Explorer to return focus to the Instrument Application (or use Alt-Tab).

Key Path	System
Mode	All
Notes	No equivalent remote command for this key.
Initial S/W Revision	A.05.01

7 Trigger Functions

Trigger

Accesses a menu of keys to control the selection of the trigger source and the setup of each of the trigger sources. The analyzer is designed to allow triggering from a number of different sources, for example, Free Run, Video, External, RF Burst, and so forth.

The TRIG:SOURCe command (below) will specify the trigger source for the currently selected input (RF or I/Q). If you change inputs, the new input remembers the trigger source it was last programmed to for the current measurement, and uses that trigger source. You can directly set the trigger source for each input using the TRIGger:RF:SOURce and TRIGger:IQ:SOURce commands (later in this section). When in External Mixing, the analyzer uses the RF trigger source.

Note the inclusion of the <measurement> parameter in the command below. Because each measurement remembers its own Trigger Source, the command must be qualified with the measurement name. Note that for the Swept SA measurement this is not the case; for backwards compatibility, no <measurement> parameter is used when setting the Trigger Source for the Swept SA measurement.

See ["Trigger Source Presets" on page 239](#)

See ["RF Trigger Source" on page 242](#)

See ["I/Q Trigger Source" on page 243](#)

See ["More Information" on page 244](#)

Key Path	Front-panel key
Remote Command	<pre>:TRIGger:<measurement>[:SEquence]:SOURce EXTernal1 EXTernal2 IMMediate LINE FRAMe RFBurst VIDeo IF ALARm LAN IQMag IDEMod QDEMod IINPut QINPut AIQMag TV :TRIGger:<measurement>[:SEquence]:SOURce?</pre> <p>where <measurement> is the measurement for which you wish to set the Source (blank for the Swept SA measurement)</p>
Example	<pre>TRIG:ACP:SOUR EXT1</pre> <p>Selects the external 1 trigger input for the ACP measurement and the selected input</p> <pre>TRIG:SOUR VID</pre> <p>Selects video triggering for the Swept SA (SANalyzer) measurement in the Spectrum Analyzer mode. For SAN, do not use the <measurement> keyword. Only send this form in the Spectrum Analyzer mode or you will get an Undefined Header error</p>
Notes	<p>Not all measurements have all the trigger sources available to them. Check the trigger source documentation for your specific measurement to see what sources are available.</p> <p>Not all trigger sources are available for each input. See the "RF Trigger Source" on page 242 and "I/Q Trigger Source" on page 243 commands for detailed information on which trigger sources are available for each input.</p> <p>Other trigger-related commands are found in the INITiate and ABORt SCPI command subsystems.</p> <p>*OPC should be used after requesting data. This will hold off any subsequent changes to the selected trigger source, until after the sweep is completed and the data is returned.</p> <p>Available ranges and presets can vary from mode to mode.</p>
Dependencies	<p>In some models, there is no second External input. In these models, the External 2 key is blanked and</p>

	the EXternal2 parameter will generate a "Hardware missing; Not available for this model number" message.
Preset	See table below
Status Bits/OPC dependencies	The Status Operation Register bit 5 "Waiting for Trigger" is set at the same time as the Sweeping or Measuring bit is set. It is cleared when the trigger actually occurs (that is, after the trigger event occurs and all the applicable trigger criteria have been met). A corresponding pop-up message ("Waiting for trigger") is generated if no trigger signal appears after approximately 2 sec. This message goes away when a trigger signal appears.
Backwards Compatibility SCPI	:TRIGger[:SEquence]:SOURce EXTernal For backward compatibility, the parameter EXTernal is mapped to EXTernal1
Backwards Compatibility SCPI	[:SENSe]:<measurement>:TRIGger:SOURce This backwards compatibility alias command is provided for ESA/PSA compatibility This backwards compatibility command does not apply to the Swept SA measurement, for that just use :TRIGger:SOURce This backwards compatibility command does not apply to the monitor spectrum, log plot and spot frequency measurements
Backwards Compatibility SCPI	[:SENSe]:<measurement>:TRIGger:SOURce IF In earlier instruments, the parameter IF was used by apps for the video trigger, so using the IF parameter selects VIDeo triggering. Sending IF in the command causes VID to be returned to a query.
Backwards Compatibility SCPI	[:SENSe]:ACPr:TRIGger:SOURce This backwards Compatibility SCPI command is provided to support the same functionality as [:SENSe]:ACPr:TRIGger:SOURce (PSA W-CDMA, PSA cdma2000 and PSA 1xEVDO) due to the fact that the ACPr node conflicts with the ACPower node.
Initial S/W Revision	Prior to A.02.00
Modified at S/W Revision	A.03.00

Trigger Source Presets

Here are the Trigger Source Presets for the various measurements:

Meas	Mode	Preset for RF	Preset for IQ	Notes
Swept SA	SA	IMM	IQ not supported	
CHP	SA, WCDMA, C2K, WIMAX OFDMA, 1xEVDO, DVB-T/H, DTMB, LTE, LTETDD, CMMB, ISDB-T, Digital Cable TV, MSR	IMM	IQ not supported	
OBW	SA, WCDMA, C2K, WIMAX OFDMA,	1xEVDO: EXT1 others: IMM	IQ not supported	For 1xEVDO mode, the trigger source is coupled with the gate state, as well as the gate

	TD-SCDMA, 1xEVDO, LTE, LTETDD, CMMB, ISDB-T, MSR			source. When the trigger source changes to RFBurst, External1 or External2, the gate state is set to on, and the gate source is set identically with the trigger source. When the trigger source changes to IMMEDIATE, VIDEO, LINE, FRAME or IF, the gate state is set to off.
CCDF	SA, WCDMA, C2K, WIMAX OFDMA, TD-SCDMA, 1xEV-DO, DVB-T/H, DTMB, LTE, LTETDD, CMMB, ISDB-T, Digital Cable TV, MSR	WIMAX OFDMA: RFBurst LTETDD: BTS: External 1 MS: Periodic Timer TD-SCDMA and 1xEV-DO: BTS: External 1 MS: RFBurst SA, WCDMA, C2K, LTE, CMMB, ISDB-T, DVB-T/H, DTMB, Digital Cable TV, MSR: IMMEDIATE	TD-SCDMA and 1xEV-DO: BTS: External 1 MS: IQMag LTETDD: BTS: External 1 MS: Periodic Timer Others: IMM	For TD-SCDMA: Trigger source is coupled with radio device. When radio device changes to BTS, trigger source will be changed to EXTERNAL1. When radio device changes to MS, trigger source will be set as RFBurst for RF or IQ Mag for BBIQ. When TriggerSource is RFBurst or IQ Mag, Measure Interval is grayed out.
ACP	SA, WCDMA, C2K, WIMAX OFDMA, TD-SCDMA, 1xEVDO, DVB-T/H, DTMB, LTE, LTETDD, CMMB, ISDB-T, Digital Cable TV, MSR	IMM	IQ not supported	
Tx Power	SA, GSM, TD-SCDMA	SA, GSM: RFBurst TD-SCDMA: EXTERNAL	IMM	TD-SCDMA doesn't support the Line and Periodic Timer parameters. When the mode is TD-SCDMA, if the Radio Device is switched to BTS, the value will be changed to External 1 and if the Radio device is switched to MS, the value will be changed to RFBurst
SPUR	SA, WCDMA, C2K, WIMAX OFDMA, TD-SCDMA, 1xEV-DO, DVB-T/H, LTE, LTETDD, MSR	IMM	IQ not supported	
SEM	SA, WCDMA, C2K, WIMAX OFDMA, TD-SCDMA, 1xEVDO, DVB-	1xEVDO(BTS): EXTERNAL1 All others: IMMEDIATE	IQ not supported	

	T/H, DTMB, LTE, LTETDD, CMMB, ISDB-T, Digital Cable TV, MSR			
CDP	WCDMA	IMM	IMM	
RHO	WCDMA	IMM	IMM	
PCON	WCDMA	IMM	IMM	
QPSK	WCDMA, C2K, 1xEVDO	All except CDMA1xEVDO: IMMediate CDMA1xEVDO: EXT1	IMM	
MON	All except SA and BASIC	IMM	IQ not supported	
WAV		LTETDD: BTS: External 1 MS: Periodic Timer GSM/EDGE: RFBurst All others: IMMediate	LTETDD: BTS: External 1 MS: Periodic Timer GSM/EDGE: IQMag All others: IMMMediate	
PVT	WIMAXOFDMA	RFB	IMM	
EVM	WIMAXOFDMA, DVB-T/H, DTMB, LTE, LTETDD, CMMB, ISDB-T, Digital Cable TV	All but CMMB: IMM CMMB: Periodic Timer	All but CMMB: IMM CMMB: External 1	LTE, LTETDD supports Free Run, Video and External 1 only.
SPEC	BASIC	IMM	IMM	
LOG Plot	PN	IMM	IQ not supported	
Spot Freq	PN	IMM	IQ not supported	
GMSK PVT	EDGE/GSM	RFB	IMM	
GMSK PFER	EDGE/GSM	RFB	IQMag	
GMSK ORFS	EDGE/GSM	RF Burst	IQ not supported	
EDGE PVT	EDGE/GSM	RFB	IMM	

EDGE EVM	EDGE/GSM	RFB	IQMag
EDGE ORFS	EDGE/GSM	Periodic Timer	IQ not supported
Combined WCDMA	WCDMA	IMM	IQ not supported
Combined GSM	EDGE/GSM	RFB	IQ not supported
List Power Step	WCDMA, EDGE/GSM	IMM	IQ not supported
Transmit On/Off Power	LTETDD	LTETDD: BTS: External 1 MS: Periodic Timer	LTETDD: BTS: External 1 MS: Periodic Timer
Transmit Analysis	BLUETOOTH	RFB	IQ not supported
Adjacent Channel Power	BLUETOOTH	IMM	IQ not supported
LE In-band Emissions	BLUETOOTH	IMM	IQ not supported
EDR In-band Spurious Emissions	BLUETOOTH	Periodic Timer	IQ not supported
Conformance EVM	LTE, LTETDD, MSR	IMM	IMM

RF Trigger Source

The RF Trigger Source command selects the trigger to be used for the specified measurement when RF is the selected input. The RF trigger source can be queried and changed even while another input is selected, but it is inactive until RF becomes the selected input.

Note the inclusion of the <measurement> parameter in the command below. Because each measurement remembers its own Trigger Source, the command must be qualified with the measurement name. Note that for the Swept SA measurement this is not the case; for backwards compatibility, no <measurement> parameter is used when setting the Trigger Source for the Swept SA measurement.

Remote Command	:TRIGger:<measurement>[:SEquence]:RF:SOURce EXTernal1 EXTernal2 IMMEDIATE LINE FRAME RFBurst VIDEO IF ALARm LAN TV :TRIGger:<measurement>[:SEquence]:RF:SOURce?
-----------------------	--

Example	TRIG:ACP:RF:SOUR EXT1 Selects the external 1 trigger input for the ACP measurement and the RF input
----------------	--

	<p>TRIG:RF:SOUR VID</p> <p>Selects video triggering for the SANalyzer measurement and the RF input. For SAN, do not use the <measurement> keyword.</p>
Notes	<p>Not all measurements have all the trigger sources available to them. Check the trigger source documentation for your specific measurement to see what sources are available.</p> <p>Not all trigger sources are available for each input. For the RF Trigger Source, the following trigger sources are available:</p> <ul style="list-style-type: none"> –IMMediate - free run triggering –VIDeo - triggers on the video signal level –LINE - triggers on the power line signal –EXTernal1 (or EXTernal) - triggers on an externally connected trigger source marked “Trigger 1 In” on the rear panel –EXTernal2 - triggers on an externally connected trigger source marked “Trigger 2 In” on the front panel. In some models, there is no second External input. In these models, the External 2 key is blanked and the EXTernal2 parameter will generate a “Hardware missing; Not available for this model number” message –RFBurst - triggers on the bursted frame –FRAMe - triggers on the periodic timer –IF (video) - same as video, for backwards compatibility only <p>*OPC should be used after requesting data. This will hold off any subsequent changes to the selected trigger source, until after the sweep is completed and the data is returned.</p> <p>Available ranges, and presets can vary from mode to mode.</p>
Status Bits/OPC dependencies	<p>The Status Operation Register bit 5 "Waiting for Trigger" is set at the same time as the Sweeping or Measuring bit is set. It is cleared when the trigger actually occurs (that is, after the trigger event occurs and all the applicable trigger criteria have been met). A corresponding pop-up message ("Waiting for trigger") is generated if no trigger signal appears after approximately 2 sec. This message goes away when a trigger signal appears.</p>
Initial S/W Revision	Prior to A.02.00

I/Q Trigger Source

This command selects the trigger to be used for the specified measurement when I/Q (which requires option BBA) is the selected input. The I/Q trigger source can be queried and changed even while another input is selected, but it is inactive until I/Q becomes the selected input.

Remote Command	<pre>:TRIGger:<measurement>[:SEquence]:IQ:SOURce EXTernal1 EXTernal2 IMMediate IQMag IDEMod QDEMod IINPut QINPut AIQMag :TRIGger:<measurement>[:SEquence]:IQ:SOURce?</pre>
Example	<p>TRIG:WAVeform:SOUR IQM</p> <p>Selects I/Q magnitude triggering for the IQ Waveform measurement and the I/Q input</p>
Notes	<p>Not all measurements have all the trigger sources available to them. Check the trigger source documentation for your specific measurement to see what sources are available.</p> <p>Not all trigger sources are available for each input. For the I/Q Trigger Source, the following trigger sources are available:</p>

	<ul style="list-style-type: none"> –IMMediate - free run triggering –EXternal1 (or EXternal) - triggers on an externally connected trigger source on the rear panel –EXternal2 - triggers on an externally connected trigger source on the front panel –IQMag - triggers on the magnitude of the I/Q signal –IDEMod - triggers on the I/Q signal's demodulated I voltage –QDEMod - triggers on the I/Q signal's demodulated Q voltage –IINPut - triggers on the I channel's ADC voltage –QINPut - triggers on the Q channel's ADC voltage –AIQMag - triggers on the magnitude of the auxiliary receiver channel I/Q signal <p>*OPC should be used after requesting data. This will hold off any subsequent changes to the selected trigger source, until after the sweep is completed and the data is returned.</p> <p>Available ranges, and from mode to mode presets can vary</p>
Status Bits/OPC dependencies	The Status Operation Register bit 5 "Waiting for Trigger" is set at the same time as the Sweeping or Measuring bit is set. It is cleared when the trigger actually occurs (that is, after the trigger event occurs and all the applicable trigger criteria have been met). A corresponding pop-up message ("Waiting for trigger") is generated if no trigger signal appears after approximately 2 sec. This message goes away when a trigger signal appears.
Initial S/W Revision	Prior to A.02.00

More Information

The trigger menus let you select the trigger source and trigger settings for a sweep or measurement. In triggered operation (basically, any trigger source other than Free Run), the analyzer will begin a sweep or measurement only with the selected trigger conditions are met, generally when your trigger source signal meets the specified trigger level and polarity requirements. (In FFT measurements, the trigger controls when the data acquisition begins for FFT conversion.)

For each of the trigger sources, you may define a set of operational parameters or settings which will be applied when that source is selected as the current trigger source. Examples of these settings are Trigger Level, Trigger Delay, and Trigger Slope. You may apply different settings for each source; so, for example, you could have a Trigger Level of 1v for External 1 trigger and –10 dBm for Video trigger.

Once you have established the settings for a given trigger source, they generally will remain unchanged for that trigger source as you go from measurement to measurement within a Mode (although the settings do change as you go from Mode to Mode). Furthermore, the trigger settings within a Mode are the same for the **Trigger** menu, the **Gate Source** menu, and the **Sync Source** menu that is part of the **Periodic Timer Trigger Setup** menu. That is, if **Ext1** trigger level is set to 1v in the **Trigger** menu, it will appear as 1v in both the **Gate Source** and the **Sync Source** menus. For these reasons the trigger settings commands are not qualified with the measurement name, the way the trigger source commands are.

The settings setup menu can be accessed by pressing the key for the current trigger source a second time. For example, one press of Video selects the Video trigger as the source. The Video key becomes highlighted and the hollow arrow on the key turns black. Now a second press of the key takes you into the Video Trigger Setup menu.

Trigger Setup Parameters:

The following examples show trigger setup parameters using an external trigger source.

Example 1 illustrates the trigger conditions with negative slope and no trigger occurs during trigger Holdoff time.

Example 2 illustrates the trigger conditions with positive slope, trigger delay, and auto trigger time.

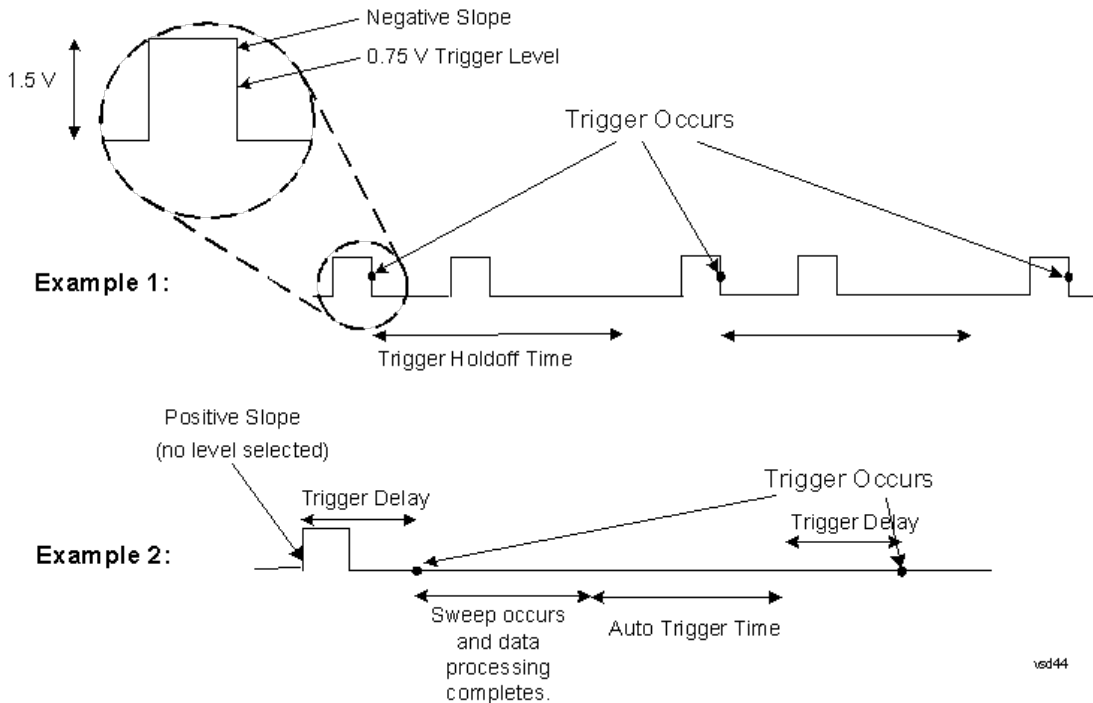

Free Run

Pressing this key, when it is not selected, selects free-run triggering. Free run triggering occurs immediately after the sweep/measurement is initiated.

Key Path	Trigger
Example	TRIG:SOUR IMM Swept SA measurement TRIG:<meas>:SOUR IMM Measurements other than Swept SA
State Saved	Saved in instrument state
Status Bits/OPC dependencies	The Status Operation Register bit 5 "Waiting for Trigger" is set at the same time as the Sweeping or Measuring bit is set. It is cleared when the trigger actually occurs (that is, after the trigger event occurs and all the applicable trigger criteria have been met). A corresponding pop-up message ("Waiting for trigger") is generated if no trigger signal appears after approximately 2 sec. This message goes away when a trigger signal appears.
Initial S/W Revision	Prior to A.02.00

Video (IF Envelope)

Pressing this key, when it is not selected, selects the video signal as the trigger. The Video trigger condition is met when the video signal (the filtered and detected version of the input signal, including both RBW and VBW filtering) crosses the video trigger level.

NOTE When the detector selected for all active traces is the average detector, the video signal for triggering does not include any VBW filtering.

The video trigger level is shown as a labeled line on the display. The line is displayed as long as video is the selected trigger source.

Pressing this key, when it is already selected, accesses the video trigger setup functions.

Key Path	Trigger
Example	TRIG:SOUR VID Swept SA measurement TRIG:<meas>:SOUR VID Measurements other than Swept SA
Notes	Log Plot and Spot Frequency measurements do not support Video Trigger
Dependencies	Video trigger is allowed in average detector mode.
State Saved	Saved in instrument state
Status Bits/OPC dependencies	The Status Operation Register bit 5 "Waiting for Trigger" is set at the same time as the Sweeping or Measuring bit is set. It is cleared when the trigger actually occurs (that is, after the trigger event occurs and all the applicable trigger criteria have been met). A corresponding pop-up message ("Waiting for trigger") is generated if no trigger signal appears after approximately 2 sec. This message goes away when a trigger signal appears.
Backwards Compatibility Notes	In the past, the Average detector was not available when Video triggering was on, and consequently, functions that set the detector to average (such as Marker Noise or Band/Intvl Power) were not available when the video trigger was on. Similarly, Video triggering was not available when the detector was Average. In the X-Series, these restrictions are removed.
Initial S/W Revision	Prior to A.02.00

Trigger Level

Sets a level for the video signal trigger. When the video signal crosses this level, with the chosen slope, the trigger occurs. This level is displayed with a horizontal line only if **Video** is the selected trigger source.

Key Path	Trigger, Video
Remote Command	:TRIGger[:SEquence]:VIDeo:LEVel <ampl> :TRIGger[:SEquence]:VIDeo:LEVel?
Example	TRIG:VID:LEV -40 dBm
Notes	When sweep type = FFT, the video trigger uses the amplitude envelope in a bandwidth wider than the FFT width as a trigger source. This might often be useful, but does not have the same relationship between the displayed trace and the trigger level as in swept triggering. Amplitude Corrections are not taken into account by the Video Trig Level. For example, if you have

given yourself effective gain with an amplitude correction factor, the Video Trigger will not fire until you have dropped the trigger line that far below the displayed signal level, rather than simply dropping it down to the displayed signal level.

Note that other corrections, specifically External Gain and Ref Level Offset, modify the actual trace data as it is taken and therefore ARE taken into account by Trig Level.

Couplings	This same level is used for the Video trigger source in the Trigger menu and for the Video selection in the Gate Source menu.
Preset	Set the Video Trigger Level -25 dBm on Preset. When the Video Trigger Level becomes the active function, if the value is off screen, set it to either the top or bottom of screen, depending on which direction off screen it was.
State Saved	Saved in instrument state
Min	-170 dBm
Max	+30 dBm
Default Unit	Depends on the current selected Y axis unit
Backwards Compatibility SCPI	:TRIGger[:SEquence]:IF:LEVel :TRIGger[:SEquence]:IF:LEVel?
Backwards Compatibility Notes	This alias is provided for backward compatibility with VSA/PSA comms apps.
Initial S/W Revision	Prior to A.02.00

Trig Slope

Controls the trigger polarity. It is set positive to trigger on a rising edge and negative to trigger on a falling edge.

Key Path	Trigger, Video
Remote Command	:TRIGger[:SEquence]:VIDeo:SLOPe POSitive NEGative :TRIGger[:SEquence]:VIDeo:SLOPe?
Example	TRIG:VID:SLOP NEG
Preset	POSitive
State Saved	Saved in instrument state
Backwards Compatibility SCPI	:TRIGger[:SEquence]:IF:SLOPe NEGative POSitive :TRIGger[:SEquence]:IF:SLOPe? For backward compatibility with VSA/PSA comms apps
Backwards Compatibility Notes	The legacy :TRIGger[:SEquence]:SLOPe command affects the slopes for the VID, LINE, EXT1, EXT2, and RFB triggers.
Initial S/W Revision	Prior to A.02.00

Remote Command	:TRIGger[:SEquence]:SLOPe POSitive NEGative :TRIGger[:SEquence]:SLOPe?
Example	TRIG:SLOP NEG
Preset	POSitive
State Saved	Saved in instrument state
Backwards Compatibility Notes	In ESA/PSA, the Trigger Slope was global to all triggers. In the X-Series, the slope can be set individually for each Trigger Source. For backward compatibility, the global SLOPe command updates all instances of trigger slope (VID, LINE, EXT1, EXT2, TV, RFB). The query returns the trigger slope setting of the currently selected trigger source.
Initial S/W Revision	Prior to A.02.00

Trig Delay

Controls a time delay during that the analyzer will wait to begin a sweep after meeting the trigger criteria. You can use negative delay to pre-trigger the instrument in the time domain or FFT, but not in swept spans.

Key Path	Trigger, Video
Remote Command	:TRIGger[:SEquence]:VIDeo:DELaY <time> :TRIGger[:SEquence]:VIDeo:DELaY? :TRIGger[:SEquence]:VIDeo:DELaY:STATe OFF ON 0 1 :TRIGger[:SEquence]:VIDeo:DELaY:STATe?
Example	TRIG:VID:DEL:STAT ON TRIG:VID:DEL 100 ms
Notes	Video trigger delay may be set to negative values, in time domain, FFT and even swept. It makes intuitive sense in time domain and works well in FFT mode where the bandwidth of the filter before the video trigger is about 1.25 span. In swept spans, negative settings of Trig Delay are treated as a zero setting within the internal hardware and the advisory message "Neg. Trig Delay unavailable in Swept Mode, zero delay used." is generated when such a delay is set.
Preset	Off, 1 us
State Saved	Saved in instrument state
Min	-150 ms
Max	+500 ms
Default Unit	s
Backwards Compatibility Notes	! For backward compatibility with VSA/PSA comms apps :TRIGger[:SEquence]:IF:DELaY :TRIGger[:SEquence]:DELaY The legacy :TRIGger[:SEquence]:DELaY command affects the delay for the VID, LINE, EXT1, EXT2, and RFB triggers.
Initial S/W Revision	Prior to A.02.00

Remote Command	:TRIGger[:SEquence]:DELay <time> :TRIGger[:SEquence]:DELay? :TRIGger[:SEquence]:DELay:STATE OFF ON 0 1 :TRIGger[:SEquence]:DELay:STATE?
Example	TRIG:DEL 1 ms
Preset	1 us
State Saved	Saved in instrument state
Backwards Compatibility Notes	In ESA/PSA, the Trigger Delay was global to all triggers. In the X-Series, the delay can be set individually for each Trigger Source. For backward compatibility, the global DELay command updates all instances of trigger slope (VID, LINE, EXT1, EXT2) except TV and RFBurst. The query returns the trigger delay setting of the currently selected trigger source.
Initial S/W Revision	Prior to A.02.00

Remote Command	:TRIGger[:SEquence]:OFFSet <time> :TRIGger[:SEquence]:OFFSet? :TRIGger[:SEquence]:OFFSet:STATE OFF ON 0 1 :TRIGger[:SEquence]:OFFSet:STATE?
Example	TRIG:OFFS ON TRIG:OFFS -100 ms
Notes	These are ESA commands for trigger offset that allowed you to use a positive or negative delay when in zero span and in a Res BW \geq 1 kHz. For ESA compatibility, X-series analyzers keep track of this offset and adds it to the Trigger Delay for VIDEo, LINE, EXTernal1 or EXTernal2 whenever the value is sent to the hardware, if in Zero Span and RBW \geq 1 kHz.
Preset	Off, 0 s
State Saved	Saved in instrument state
Min	-11 s
Max	+11 s
Initial S/W Revision	Prior to A.02.00

External 1

Pressing this key, when it is not selected, selects an external input signal as the trigger. A new sweep/measurement will start when the external trigger condition is met using the external 1 input connector on the rear panel.

Pressing this key, when it is already selected, accesses the external 1 trigger setup menu.

Key Path	Trigger
Example	TRIG:SOUR EXT1 Swept SA measurement TRIG:<meas>:SOUR EXT1 Measurements other than Swept SA

Dependencies	Grayed out if in use by Point Trigger in the Source Setup menu. Forced to Free Run if already selected and Point Trigger is set to External 1.
State Saved	Saved in instrument state
Status Bits/OPC dependencies	The Status Operation Register bit 5 "Waiting for Trigger" is set at the same time as the Sweeping or Measuring bit is set. It is cleared when the trigger actually occurs (that is, after the trigger event occurs and all the applicable trigger criteria have been met). A corresponding pop-up message ("Waiting for trigger") is generated if no trigger signal appears after approximately 2 sec. This message goes away when a trigger signal appears.
Initial S/W Revision	Prior to A.02.00

Trigger Level

Sets the value where the external 1 trigger input will trigger a new sweep/measurement.

Key Path	Trigger, External 1
Remote Command	:TRIGger[:SEquence]:EXTernal1:LEVel <level> :TRIGger[:SEquence]:EXTernal1:LEVel?
Example	TRIG:EXT1:LEV 0.4 V
Couplings	This same level is used for the Ext1 trigger source in the Trigger menu, for the Ext1 selection in the Periodic Timer sync source (in the Trigger menu and in the Gate Source menu), and also for the Ext1 selection in the Gate Source menu.
Preset	1.2 V
State Saved	Saved in instrument state
Min	-5 V
Max	5 V
Default Unit	V
Backwards Compatibility SCPI	:TRIGger[:SEquence]:EXTernal:LEVel For backward compatibility, the parameter EXTernal is mapped to EXTernal1
Backwards Compatibility SCPI	:TRIGger[:SEquence]:FRAMe:EXTernal1:LEVel
Initial S/W Revision	Prior to A.02.00

Trig Slope

Controls the trigger polarity. It is set positive to trigger on a rising edge and negative to trigger on a falling edge.

Key Path	Trigger, External 1
Remote Command	:TRIGger[:SEquence]:EXTernal1:SLOPe POSitive NEGative

	:TRIGger[:SEquence]:EXTernal1:SLOPe?
Example	TRIG:EXT1:SLOP NEG
Couplings	This same slope is used in the Ext1 selection for the trigger source in the Trigger menu and for the period timer sync source (in the Trigger menu and in the Gate Source menu).
Preset	POSitive
State Saved	Saved in instrument state
Backwards Compatibility SCPI	:TRIGger[:SEquence]:EXTernal:SLOPe For backward compatibility, the parameter EXTernal is mapped to EXTernal1
Backwards Compatibility SCPI	:TRIGger[:SEquence]:FRAMe:EXTernal1:SLOPe
Backwards Compatibility Notes	The legacy :TRIGger[:SEquence]:SLOPe command affects the slopes for the VID, LINE, EXT1, EXT2, and RFB triggers.
Initial S/W Revision	Prior to A.02.00

Trig Delay

Controls a time delay during which the analyzer will wait to begin a sweep after meeting the trigger criteria. You can use negative delay to pre-trigger the instrument in time domain or FFT, but not in swept spans.

Key Path	Trigger, External 1
Remote Command	:TRIGger[:SEquence]:EXTernal1:DELAy <time> :TRIGger[:SEquence]:EXTernal1:DELAy? :TRIGger[:SEquence]:EXTernal1:DELAy:STATe OFF ON 0 1 :TRIGger[:SEquence]:EXTernal1:DELAy:STATe?
Example	TRIG:EXT1:DEL:STAT ON TRIG:EXT1:DEL 100 ms
Notes	Video trigger delay may be set to negative values, in time domain, FFT and even swept. It makes intuitive sense in time domain and works well in FFT mode where the bandwidth of the filter before the video trigger is about 1.25 span. In swept spans, negative settings of Trig Delay are treated as a zero setting within the internal hardware and the advisory message "Neg. Trig Delay unavailable in Swept Mode, zero delay used." is generated when such a delay is set.
Preset	Off, 1.000 us
State Saved	Saved in instrument state
Min	-150 ms
Max	+500 ms
Default Unit	s
Backwards Compatibility SCPI	:TRIGger[:SEquence]:EXTernal:DELAy For backward compatibility, the parameter EXTernal is mapped to EXTernal1
Backwards Compatibility	The legacy :TRIGger[:SEquence]:DELAy command affects the delay for the VID, LINE, EXT1, EXT2,

Notes	and RFB triggers. The legacy :TRIGger[:SEQuence]:OFFSet command is supported for the VIDEO, LINE, EXT1, and EXT2 triggers.
Initial S/W Revision	Prior to A.02.00

Zero Span Delay Comp On/Off

In zero span, there is a natural delay in the signal path, which comes from the RBW filter. This is usually desirable, as it allows you to trigger on events and also see those events, because the signal is delayed from the trigger event. However, in some cases it is desirable to eliminate this delay, so that trigger events line up exactly with the zero time point in zero span. You can use the Zero Span Delay Comp On/Off feature to enable or disable zero span delay compensation.

Key Path	Trigger, External 1
Remote Command	:TRIGger[:SEQuence]:EXTernal1:DELY:COMPensation OFF ON 0 1 :TRIGger[:SEQuence]:EXTernal1:DELY:COMPensation?
Example	TRIG:EXT1:DEL:COMP ON
Dependencies	No effect except in zero-span, but not locked out in nonzero spans. Blanked in modes that do not support zero-span measurements. If the SCPI command is sent when the key is blanked, an error is returned: -221, "Settings conflict; Feature not supported for this measurement" In analyzers shipping N9060A, this feature requires N9060A-7FP.
Preset	OFF
State Saved	Saved in instrument state
Initial S/W Revision	A.11.00

External 2

Pressing this key, when it is not selected, selects an external input signal as the trigger. A new sweep/measurement will start when the external trigger condition is met using the external 2 input connector. The external trigger 2 input connector is on the rear panel.

Pressing this key, when it is already selected, accesses the external 2 trigger setup menu.

Key Path	Trigger
Example	TRIG:SOUR EXT2 Swept SA measurement TRIG:<meas>:SOUR EXT2 Measurements other than Swept SA
Dependencies	In some models, there is no second External input. In these models, the External 2 key is blanked and the EXTernal2 parameter will generate a "Hardware missing; Not available for this model number" message. Grayed out if in use by Point Trigger in the Source Setup menu. Forced to Free Run if already selected and Point Trigger is set to External 2.

State Saved	Saved in instrument state
Status Bits/OPC dependencies	The Status Operation Register bit 5 "Waiting for Trigger" is set at the same time as the Sweeping or Measuring bit is set. It is cleared when the trigger actually occurs (that is, after the trigger event occurs and all the applicable trigger criteria have been met). A corresponding pop-up message ("Waiting for trigger") is generated if no trigger signal appears after approximately 2 sec. This message goes away when a trigger signal appears.
Initial S/W Revision	Prior to A.02.00
Modified at S/W Revision	A.03.00

Trigger Level

Sets the value where the external 2 trigger input will trigger a new sweep/measurement.

Key Path	Trigger, External 2
Remote Command	:TRIGger[:SEquence]:EXTernal2:LEVel :TRIGger[:SEquence]:EXTernal2:LEVel?
Example	TRIG:EXT2:LEV 1.1 V
Couplings	This same level is used for the Ext2 trigger source in the Trigger menu, for the Ext2 selection in the Periodic Timer sync source (in the Trigger menu and in the Gate Source menu), and also for the Ext2 selection in the Gate Source menu.
Preset	1.2 V
State Saved	Saved in instrument state
Min	-5 V
Max	5 V
Default Unit	V
Backwards Compatibility SCPI	:TRIGger[:SEquence]:FRAMe:EXTernal2:LEVel
Initial S/W Revision	Prior to A.02.00

Trig Slope

Controls the trigger polarity. It is set positive to trigger on a rising edge and negative to trigger on a falling edge.

Key Path	Trigger, External 2
Remote Command	:TRIGger[:SEquence]:EXTernal2:SLOPe POSitive NEGative :TRIGger[:SEquence]:EXTernal2:SLOPe?
Example	TRIG:EXT2:SLOP NEG
Couplings	This same slope is used in the Ext2 selection for the trigger source in the Trigger menu and for the period timer sync source (in the Trigger menu and in the Gate Source menu).

Preset	POSitive
State Saved	Saved in instrument state
Backwards Compatibility SCPI	:TRIGger[:SEQuence]:FRAMe:EXTernal2:SLOPe
Backwards Compatibility Notes	The legacy :TRIGger[:SEQuence]:SLOPe command affects the slopes for the VID, LINE, EXT1, EXT2, and RFB triggers.
Initial S/W Revision	Prior to A.02.00

Trig Delay

Controls a time delay during which the analyzer will wait to begin a sweep after meeting the trigger criteria. You can use negative delay to pre-trigger the instrument in time domain or FFT, but not in swept spans.

Key Path	Trigger, External 2
Remote Command	:TRIGger[:SEQuence]:EXTernal2:DELay <time> :TRIGger[:SEQuence]:EXTernal2:DELay? :TRIGger[:SEQuence]:EXTernal2:DELay:STATe OFF ON 0 1 :TRIGger[:SEQuence]:EXTernal2:DELay:STATe?
Example	TRIG:EXT2:DEL:STAT ON TRIG:EXT2:DEL 100 ms
Notes	Video trigger delay may be set to negative values, in time domain, FFT and even swept. It makes intuitive sense in time domain and works well in FFT mode where the bandwidth of the filter before the video trigger is about 1.25 span. In swept spans, negative settings of Trig Delay are treated as a zero setting within the internal hardware and the advisory message "Neg. Trig Delay unavailable in Swept Mode, zero delay used." is generated when such a delay is set.
Preset	Off, 1.000 us
State Saved	Saved in instrument state
Min	-150 ms
Max	500 ms
Default Unit	s
Backwards Compatibility Notes	The legacy :TRIGger[:SEQuence]:DELay command affects the delay for the VID, LINE, EXT1, EXT2, and RFB triggers. The legacy :TRIGger[:SEQuence]:OFFSet command is supported for the VIDEo, LINE, EXT1, and EXT2 triggers.
Initial S/W Revision	Prior to A.02.00

Zero Span Delay Comp On/Off

In zero span, there is a natural delay in the signal path, which comes from the RBW filter. This is usually desirable, as it allows you to trigger on events and also see those events, because the signal is delayed

from the trigger event. However, in some cases it is desirable to eliminate this delay, so that trigger events line up exactly with the zero time point in zero span. You can use the Zero Span Delay Comp On/Off feature to enable or disable zero span delay compensation.

Key Path	Trigger, External 2
Remote Command	:TRIGger[:SEquence]:EXTernal2:DElay:COMPensation OFF ON 0 1 :TRIGger[:SEquence]:EXTernal2:DElay:COMPensation?
Example	TRIG:EXT2:DEL:COMP ON
Dependencies	No effect except in zero-span, but not locked out in nonzero spans. Blanked in modes that do not support zero-span measurements. If the SCPI command is sent when the key is blanked, an error is returned: -221, "Settings conflict; Feature not supported for this measurement" In analyzers shipping N9060A, this feature requires N9060A-7FP.
Preset	OFF
State Saved	Saved in instrument state
Initial S/W Revision	A.11.00

RF Burst

Pressing this key, when it is not selected, selects the RF Burst as the trigger. A new sweep/measurement will start when an RF burst envelope signal is identified from the signal at the RF Input connector. Pressing this key, when it is already selected, accesses the RF Burst trigger setup menu.

In some models, a variety of burst trigger circuitry is available, resulting in various available burst trigger bandwidths. The analyzer automatically chooses the appropriate trigger path based on the hardware configuration and other settings of the analyzer.

Key Path	Trigger
Example	TRIG:SOUR RFB Swept SA measurement TRIG:<meas>:SOUR RFB Measurements other than Swept SA
State Saved	Saved in instrument state
Status Bits/OPC dependencies	The Status Operation Register bit 5 "Waiting for Trigger" is set at the same time as the Sweeping or Measuring bit is set. It is cleared when the trigger actually occurs (that is, after the trigger event occurs and all the applicable trigger criteria have been met). A corresponding pop-up message ("Waiting for trigger") is generated if no trigger signal appears after approximately 2 sec. This message goes away when a trigger signal appears.
Backwards Compatibility Notes	The legacy command: :TRIGger[:SEquence]:RFBurst:FSElectivity[:STATe] OFF ON 0 1 is not supported in the X-Series, as the hardware to do Frequency Selective burst triggers does not exist in X-Series.
Initial S/W Revision	Prior to A.02.00
Modified at S/W Revision	A.04.00

Absolute Trigger Level

Sets the absolute trigger level for the RF burst envelope.

When using the External Mixing path, the Absolute Trigger Level is uncalibrated because the factory default was set to accommodate the expected IF levels for the RF path.

Key Path	Trigger, RF Burst
Scope	Meas Global
Remote Command	:TRIGger[:SEquence]:RFBurst:LEVel:ABSolute <ampl> :TRIGger[:SEquence]:RFBurst:LEVel:ABSolute?
Example	TRIG:RFB:LEV:ABS 10 dBm sets the trigger level of the RF burst envelope signal to the absolute level of 10 dBm
Notes	Sending this command does not switch the setting from relative to absolute; to switch it you need to send the :TRIGger[:SEquence]:RFBurst:LEVel:TYPE command, below. Amplitude Corrections are not taken into account by the Absolute Trigger Level. For example, if you have given yourself effective gain with an amplitude correction factor, the Absolute Trigger will not fire until you have set the trigger level that far below the displayed signal level, rather than simply to the displayed signal level. This is only true for Amplitude Corrections, not External Gain or Ref Level Offset functions. If mode is Bluetooth, the default value is -50 dBm.
Couplings	This same level is used for the RF Burst trigger source in the Trigger menu, for the RF Burst selection in the Periodic Timer sync source (in the Trigger menu and in the Gate Source menu), and also for the RF Burst selection in the Gate Source menu
Preset	-20 dBm
State Saved	Saved in instrument state
Min	-200 dBm
Max	100 dBm
Default Unit	depends on the current selected Y-Axis unit
Backwards Compatibility SCPI	:TRIGger[:SEquence]:FRAME:RFBurst:LEVel:ABSolute
Initial S/W Revision	Prior to A.02.00
Modified at S/W Revision	A.04.00

Key Path	Trigger, RF Burst
Remote Command	:TRIGger[:SEquence]:RFBurst:LEVel:TYPE ABSolute RELative :TRIGger[:SEquence]:RFBurst:LEVel:TYPE?
Example	TRIG:RFB:LEV:TYPE REL sets the trigger level type of the RF burst trigger to Relative.
Preset	ABSolute
State Saved	Saved in instrument state
Initial S/W Revision	Prior to A.02.00
Modified at S/W Revision	A.04.00

Relative Trigger Level

Sets the relative trigger level for the RF burst envelope.

In some models, the relative burst trigger function is implemented in hardware. In other models, without the advanced triggering hardware required, the relative burst trigger function is implemented in software in some measurements, and is unavailable in other measurements.

When implemented in software, the relative RF Burst trigger function is implemented as follows:

1. The measurement starts with the absolute RF Burst trigger setting. If it cannot get a trigger with that level, auto trigger fires and the acquisition starts anyway. After the acquisition, the measurement searches for the peak in the acquired waveform and saves it.
2. Now, in the next cycle of the measurement, the measurement determines a new absolute RF Burst level based on the peak value from the first measurement and the Relative RF Burst Trigger Level (always 0 or negative dB) set by the user. The following formula is used:
3. absolute RF Burst level = peak level of the previous acquisition + relative RF Burst level
4. If the new absolute RF Burst level differs from the previous by more than 0.5 dB, the new level is sent to the hardware; otherwise it is not updated (to avoid slowing down the acquisition)

Steps 2 and 3 repeat for subsequent measurements.

Key Path	Trigger, RF Burst
Scope	Meas Global
Remote Command	:TRIGger[:SEquence]:RFBurst:LEVel:RELative <rel_ampl> :TRIGger[:SEquence]:RFBurst:LEVel:RELative?
Example	TRIG:RFB:LEV:REL -10 dB sets the trigger level of the RF burst envelope signal to the relative level of -10 dB
Notes	Sending this command does not switch the setting from absolute to relative; to switch it you need to send the :TRIGger[:SEquence]:RFBurst:LEVel:TYPE command, above. The relative trigger level is not available in some measurements. In those measurements the RELative parameter, and the :TRIGger[:SEquence]:RFBurst:LEVel:TYPE command (above), will generate an error if sent.
Dependencies	This key is grayed out and Absolute Trigger Level selected if the required hardware is not present in your analyzer and the current measurement does not support Relative triggering.
Preset	-6 dB GSM: -25 dB
State Saved	Saved in instrument state
Min	-45 dB
Max	0 dB
Default Unit	dB or dBc
Backwards Compatibility SCPI	:TRIGger[:SEquence]:RFBurst:LEVel This legacy command is aliased to :TRIGger[:SEquence]:RFBurst:LEVel:RELative because the PSA

	had ONLY relative burst triggering
Initial S/W Revision	Prior to A.02.00
Modified at S/W Revision	A.04.00

Trigger Slope

It is set positive to trigger on a rising edge and negative to trigger on a falling edge.

Key Path	Trigger, RF Burst
Remote Command	:TRIGger[:SEquence]:RFBurst:SLOPe POSitive NEGative :TRIGger[:SEquence]:RFBurst:SLOPe?
Example	TRIG:RFB:SLOP NEG
Couplings	This same slope is used in the RF Burst selection for the trigger source in the Trigger menu and for the period timer sync source (in the Trigger menu and in the Gate Source menu).
Preset	POSitive
State Saved	Saved in instrument state
Backwards Compatibility SCPI	:TRIGger[:SEquence]:FRAME:RFBurst:SLOPe
Backwards Compatibility Notes	The legacy :TRIGger[:SEquence]:SLOPe command affects the slopes for the VID, LINE, EXT1, EXT2, and RFB triggers.
Initial S/W Revision	Prior to A.02.00

Trig Delay

Controls a time delay during which the analyzer will wait to begin a sweep after meeting the trigger criteria. You can use negative delay to pre-trigger the instrument in time domain or FFT, but not in swept spans.

Key Path	Trigger, RF Burst
Remote Command	:TRIGger[:SEquence]:RFBurst:DELAy <time> :TRIGger[:SEquence]:RFBurst:DELAy? :TRIGger[:SEquence]:RFBurst:DELAy:STATe OFF ON 0 1 :TRIGger[:SEquence]:RFBurst:DELAy:STATe?
Example	TRIG:RFB:DEL:STAT ON TRIG:RFB:DEL 100 ms
Notes	Video trigger delay may be set to negative values, in time domain, FFT and even swept. It makes intuitive sense in time domain and works well in FFT mode where the bandwidth of the filter before the video trigger is about 1.25 span. In swept spans, negative settings of Trig Delay are treated as a zero setting within the internal hardware and the advisory message "Neg. Trig Delay unavailable in Swept Mode, zero delay used." is generated when such a delay is set.

Preset	Off, 1.000 us
State Saved	Saved in instrument state
Min	-150 ms
Max	500 ms
Default Unit	s
Backwards Compatibility Notes	The legacy :TRIGger[:SEQuence]:DELay command affects the delay for the VID, LINE, EXT1, EXT2, and RFB triggers.
Initial S/W Revision	Prior to A.02.00

Periodic Timer (Frame Trigger)

Pressing this key, when it is not selected, selects the internal periodic timer signal as the trigger. Triggering occurrences are set by the **Period** parameter, which is modified by the **Sync Source** and **Offset**. Pressing this key, when it is already selected, accesses the periodic timer trigger setup functions.

If you do not have a sync source selected (it is Off), then the internal timer will not be synchronized with any external timing events.

Key Path	Trigger
Example	TRIG:SOUR FRAM Swept SA measurement TRIG:<meas>:SOUR FRAM Measurements other than Swept SA
State Saved	Saved in instrument state
Readback	[Sync: <value of Sync Source>], for example, [Sync: External 1]
Status Bits/OPC dependencies	The Status Operation Register bit 5 "Waiting for Trigger" is set at the same time as the Sweeping or Measuring bit is set. It is cleared when the trigger actually occurs (that is, after the trigger event occurs and all the applicable trigger criteria have been met). A corresponding pop-up message ("Waiting for trigger") is generated if no trigger signal appears after approximately 2 sec. This message goes away when a trigger signal appears.
Initial S/W Revision	Prior to A.02.00

Periodic Timer Triggering:

This feature selects the internal periodic timer signal as the trigger. Trigger occurrences are set by the **Periodic Timer** parameter, which is modified by the **Sync Source** and **Offset**.

The figure below shows the action of the periodic timer trigger. Before reviewing the figure, we'll explain some uses for the periodic trigger.

A common application is measuring periodic burst RF signals for which a trigger signal is not easily available. For example, we might be measuring a TDMA radio which bursts every 20 ms. Let's assume that the 20 ms period is very consistent. Let's also assume that we do not have an external trigger source available that is synchronized with the period, and that the signal-to-noise ratio of the signal is not high enough to provide a clean RF burst trigger at all of the analysis frequencies. For example, we might want to

measure spurious transmissions at an offset from the carrier that is larger than the bandwidth of the RF burst trigger. In this application, we can set the Periodic Timer to a 20.00 ms period and adjust the offset from that timer to position our trigger just where we want it. If we find that the 20.00 ms is not exactly right, we can adjust the period slightly to minimize the drift between the period timer and the signal to be measured.

A second way to use this feature would be to use **Sync Source** temporarily, instead of **Offset**. In this case, we might tune to the signal in a narrow span and use the RF Burst trigger to synchronize the periodic timer. Then we would turn the sync source off so that it would not miss-trigger. Miss-triggering can occur when we are tuned so far away from the RF burst trigger that it is no longer reliable.

A third example would be to synchronize to a signal that has a reference time element of much longer period than the period of interest. In some CDMA applications, it is useful to look at signals with a short periodicity, by synchronizing that periodicity to the "even-second clock" edge that happens every two seconds. Thus, we could connect the even-second clock trigger to Ext1 and use then Ext1 as the sync source for the periodic timer.

The figure below illustrates this third example. The top trace represents the even-second clock. It causes the periodic timer to synchronize with the leading edge shown. The analyzer trigger occurs at a time delayed by the accumulated offset from the period trigger event. The periodic timer continues to run, and triggers continue to occur, with a periodicity determined by the analyzer time base. The timer output (labeled "late event") will drift away from its ideal time due to imperfect matching between the time base of the signal being measured and the time base of the analyzer, and also because of imperfect setting of the period parameter. But the synchronization is restored on the next even-second clock event. ("Accumulated offset" is described in the in the **Offset** function section.)

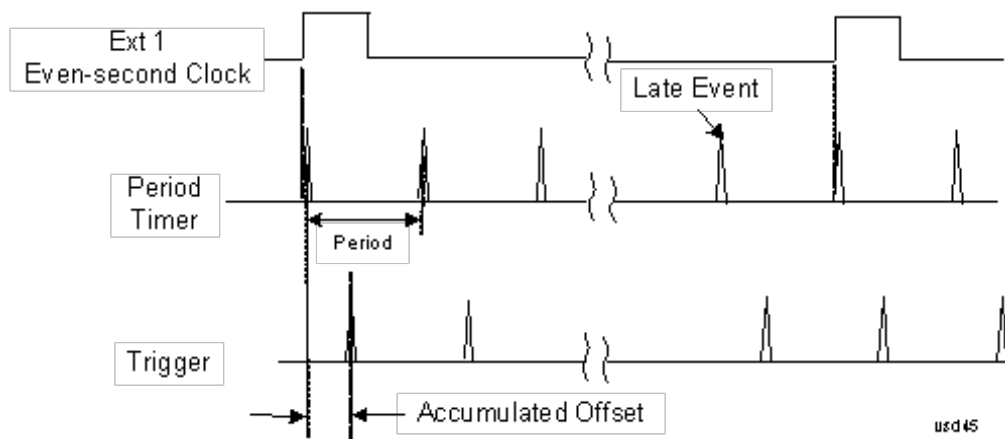

Period

Sets the period of the internal periodic timer clock. For digital communications signals, this is usually set to the frame period of your current input signal. In the case that sync source is not set to OFF, and the external sync source rate is changed for some reason, the periodic timer is synchronized at the every external synchronization pulse by resetting the internal state of the timer circuit.

Key Path	Trigger, Periodic Timer
Remote Command	:TRIGger[:SEquence]:FRAME:PERiod <time> :TRIGger[:SEquence]:FRAME:PERiod?

Example	TRIG:FRAM:PER 100 ms
Dependencies	The invalid data indicator turns on when the period is changed, until the next sweep/measurement completes.
Couplings	The same period is used in the Gate Source selection of the period timer.
Preset	20 ms GSM: 4.615383
State Saved	Saved in instrument state
Min	100.000 ns
Max	559.0000 ms
Default Unit	S
Initial S/W Revision	Prior to A.02.00

Offset

Adjusts the accumulated offset between the periodic timer events and the trigger event. Adjusting the accumulated offset is different than setting an offset, and requires explanation.

The periodic timer is usually not synchronized with any external events, so the timing of its output events has no absolute meaning. Since the timing relative to external events (RF signals) is important, you need to be able to adjust (offset) it. However, you have no direct way to see when the periodic timer events occur. All that you can see is the trigger timing. When you want to adjust the trigger timing, you will be changing the internal offset between the periodic timer events and the trigger event. Because the absolute value of that internal offset is unknown, we will just call that the accumulated offset. Whenever the Offset parameter is changed, you are changing that accumulated offset. You can reset the displayed offset using Reset Offset Display. Changing the display does not change the value of the accumulated offset, and you can still make additional changes to accumulated offset.

To avoid ambiguity, we define that an increase in the "offset" parameter, either from the knob or the SCPI adjust command, serves to delay the timing of the trigger event.

Key Path	Trigger, Periodic Timer
Remote Command	:TRIGger[:SEquence]:FRAMe:OFFSet <time> :TRIGger[:SEquence]:FRAMe:OFFSet?
Example	TRIG:FRAM:OFFS 1.2 ms
Notes	<p>The front panel interface (for example, the knob), and this command, adjust the accumulated offset, which is shown on the active function display. However, the actual amount sent to the hardware each time the offset is updated is the delta value, that is, the current accumulated offset value minus the previous accumulated offset value. Note that the accumulated offset value is essentially arbitrary; it represents the accumulated offset from the last time the offset was zeroed (with the Reset Offset Display key).</p> <p>Note that this command does not change the period of the trigger waveform. Note also that Offset is used only when the sync source is set to OFF, otherwise delay is used, see section "Trig Delay" on page 269.</p> <p>An increase in the "offset" parameter, either from the knob or the SCPI adjust command, serves to</p>

	delay the timing of the trigger event.
Notes	When the SCPI command is sent the value shown on the key (and the Active Function, if this happens to be the active function) is updated with the new value. However, the actual amount sent to the hardware is the delta value, that is, the current accumulated offset value minus the previous accumulated offset value. The SCPI query simply returns the value currently showing on the key.
Dependencies	The invalid data indicator turns on when the offset is changed, until the next sweep/measurement completes.
Couplings	The same offset is used in the Gate Source selection of the period timer.
Preset	0 s
State Saved	Saved in instrument state
Min	-10.000 s
Max	10.000 s
Default Unit	S
Initial S/W Revision	Prior to A.02.00

Offset Adjust (Remote Command Only)

This remote command does not work at all like the related front panel keys. This command lets you advance the phase of the frame trigger by the amount you specify.

It does not change the period of the trigger waveform. If the command is sent multiple times, it advances the phase of the frame trigger an additional amount each time it is sent. Negative numbers are permitted.

Remote Command	:TRIGger[:SEquence]:FRAMe:ADJust <time>
Example	TRIG:FRAM:ADJ 1.2 ms
Notes	Note also that Offset is used only when the sync source is set to OFF, otherwise delay is used, see section "Trig Delay" on page 269 An increase in the "offset" parameter, either from the knob or the SCPI adjust command, serves to delay the timing of the trigger event.
Notes	The front panel interface (for example, the knob) and the :TRIG:FRAM:OFFS command adjust the accumulated offset, which is shown on the active function display. However, the actual amount sent to the hardware is the delta value, that is, the current offset value minus the previous offset value. When the SCPI command is sent the value shown on the key (and the Active Function, if this happens to be the active function) is updated by increasing it (or decreasing it if the value sent is negative) by the amount specified in the SCPI command. This is a "command only" SCPI command, with no query.
Dependencies	The invalid data indicator turns on when the offset is changed, until the next sweep/measurement completes.
Couplings	The same offset is used in the Gate Source selection of the period timer.
Preset	0 s
State Saved	Saved in instrument state

Min	-10.000 s
Max	10.000 s
Default Unit	S
Initial S/W Revision	Prior to A.02.00

Reset Offset Display

Resets the value of the periodic trigger offset display setting to 0.0 seconds. The current displayed trigger location may include an offset value defined with the Offset key. Pressing this key redefines the currently displayed trigger location as the new trigger point that is 0.0 s offset. The Offset key can then be used to add offset relative to this new timing.

Key Path	Trigger, Periodic Timer
Remote Command	:TRIGger[:SEquence]:FRAMe:OFFSet:DISPlay:RESet
Example	TRIG:FRAM:OFFS:DISP:RES
Initial S/W Revision	Prior to A.02.00

Sync Source

Selects a signal source for you to synchronize your periodic timer trigger to, otherwise you are triggering at some arbitrary location in the frame. Synchronization reduces the precision requirements on the setting of the period.

For convenience you may adjust the level and slope of the selected sync source in a conditional branch setup menu accessed from the Sync Source menu. Note that these settings match those in the **Trigger** and **Gate Source** menus; that is, each trigger source has only one value of level and slope, regardless of which menu it is accessed from.

Key Path	Trigger, Periodic Timer
Remote Command	:TRIGger[:SEquence]:FRAMe:SYNC EXTernal1 EXTernal2 RFBurst OFF :TRIGger[:SEquence]:FRAMe:SYNC?
Example	TRIG:FRAM:SYNC EXT2
Dependencies	In some models, there is no second External input. In these models, the External 2 key is blanked and the EXTernal2 parameter will generate a "Hardware missing; Not available for this model number" message.
Preset	Off GSM/EDGE, MSR,LTE,LTETDD: RFBurst
State Saved	Saved in instrument state
Readback	The current setting is read back to this key and it is also Readback to the previous Periodic Timer trigger key.

Backwards Compatibility SCPI	:TRIGger[:SEquence]:FRAMe:SYNC EXTernal
Initial S/W Revision	Prior to A.02.00
Modified at S/W Revision	A.03.00, A.14.00

Off

Turns off the sync source for your periodic trigger. With the sync source off, the timing will drift unless the signal source frequency is locked to the analyzer frequency reference.

Key Path	Trigger, Periodic Timer, Sync Source
Example	TRIG:FRAM:SYNC OFF
Readback	Off
Initial S/W Revision	Prior to A.02.00

External 1

Pressing this key, when it is not selected, selects an external input signal as the trigger. A new sweep/measurement will start when the external trigger condition is met using the external 1 input connector on the rear panel.

Pressing this key, when it is already selected, accesses the external 1 trigger setup menu.

Key Path	Trigger
Example	TRIG:SOUR EXT1 Swept SA measurement TRIG:<meas>:SOUR EXT1 Measurements other than Swept SA
Dependencies	Grayed out if in use by Point Trigger in the Source Setup menu. Forced to Free Run if already selected and Point Trigger is set to External 1.
State Saved	Saved in instrument state
Status Bits/OPC dependencies	The Status Operation Register bit 5 "Waiting for Trigger" is set at the same time as the Sweeping or Measuring bit is set. It is cleared when the trigger actually occurs (that is, after the trigger event occurs and all the applicable trigger criteria have been met). A corresponding pop-up message ("Waiting for trigger") is generated if no trigger signal appears after approximately 2 sec. This message goes away when a trigger signal appears.
Initial S/W Revision	Prior to A.02.00

Trigger Level

Sets the value where the external 1 trigger input will trigger a new sweep/measurement.

Key Path	Trigger, External 1
Remote Command	:TRIGger[:SEquence]:EXTernal1:LEVel <level> :TRIGger[:SEquence]:EXTernal1:LEVel?
Example	TRIG:EXT1:LEV 0.4 V
Couplings	This same level is used for the Ext1 trigger source in the Trigger menu, for the Ext1 selection in the Periodic Timer sync source (in the Trigger menu and in the Gate Source menu), and also for the Ext1 selection in the Gate Source menu.
Preset	1.2 V
State Saved	Saved in instrument state
Min	-5 V
Max	5 V
Default Unit	V
Backwards Compatibility SCPI	:TRIGger[:SEquence]:EXTernal:LEVel For backward compatibility, the parameter EXTernal is mapped to EXTernal1
Backwards Compatibility SCPI	:TRIGger[:SEquence]:FRAME:EXTernal1:LEVel
Initial S/W Revision	Prior to A.02.00

Trig Slope

Controls the trigger polarity. It is set positive to trigger on a rising edge and negative to trigger on a falling edge.

Key Path	Trigger, External 1
Remote Command	:TRIGger[:SEquence]:EXTernal1:SLOPe POSitive NEGative :TRIGger[:SEquence]:EXTernal1:SLOPe?
Example	TRIG:EXT1:SLOP NEG
Couplings	This same slope is used in the Ext1 selection for the trigger source in the Trigger menu and for the period timer sync source (in the Trigger menu and in the Gate Source menu).
Preset	POSitive
State Saved	Saved in instrument state
Backwards Compatibility SCPI	:TRIGger[:SEquence]:EXTernal:SLOPe For backward compatibility, the parameter EXTernal is mapped to EXTernal1
Backwards Compatibility SCPI	:TRIGger[:SEquence]:FRAME:EXTernal1:SLOPe
Backwards Compatibility Notes	The legacy :TRIGger[:SEquence]:SLOPe command affects the slopes for the VID, LINE, EXT1, EXT2, and RFB triggers.
Initial S/W Revision	Prior to A.02.00

External 2

Pressing this key, when it is not selected, selects an external input signal as the trigger. A new sweep/measurement will start when the external trigger condition is met using the external 2 input connector. The external trigger 2 input connector is on the rear panel.

Pressing this key, when it is already selected, accesses the external 2 trigger setup menu.

Key Path	Trigger
Example	TRIG:SOUR EXT2 Swept SA measurement TRIG:<meas>:SOUR EXT2 Measurements other than Swept SA
Dependencies	In some models, there is no second External input. In these models, the External 2 key is blanked and the EXTernal2 parameter will generate a "Hardware missing; Not available for this model number" message. Grayed out if in use by Point Trigger in the Source Setup menu. Forced to Free Run if already selected and Point Trigger is set to External 2.
State Saved	Saved in instrument state
Status Bits/OPC dependencies	The Status Operation Register bit 5 "Waiting for Trigger" is set at the same time as the Sweeping or Measuring bit is set. It is cleared when the trigger actually occurs (that is, after the trigger event occurs and all the applicable trigger criteria have been met). A corresponding pop-up message ("Waiting for trigger") is generated if no trigger signal appears after approximately 2 sec. This message goes away when a trigger signal appears.
Initial S/W Revision	Prior to A.02.00
Modified at S/W Revision	A.03.00

Trigger Level

Sets the value where the external 2 trigger input will trigger a new sweep/measurement.

Key Path	Trigger, External 2
Remote Command	:TRIGger[:SEquence]:EXTernal2:LEVel :TRIGger[:SEquence]:EXTernal2:LEVel?
Example	TRIG:EXT2:LEV 1.1 V
Couplings	This same level is used for the Ext2 trigger source in the Trigger menu, for the Ext2 selection in the Periodic Timer sync source (in the Trigger menu and in the Gate Source menu), and also for the Ext2 selection in the Gate Source menu.
Preset	1.2 V
State Saved	Saved in instrument state
Min	-5 V
Max	5 V
Default Unit	V
Backwards Compatibility SCPI	:TRIGger[:SEquence]:FRAMe:EXTernal2:LEVel
Initial S/W Revision	Prior to A.02.00

Trig Slope

Controls the trigger polarity. It is set positive to trigger on a rising edge and negative to trigger on a falling edge.

Key Path	Trigger, External 2
Remote Command	:TRIGger[:SEquence]:EXTernal2:SLOPe POSitive NEGative :TRIGger[:SEquence]:EXTernal2:SLOPe?
Example	TRIG:EXT2:SLOP NEG
Couplings	This same slope is used in the Ext2 selection for the trigger source in the Trigger menu and for the period timer sync source (in the Trigger menu and in the Gate Source menu).
Preset	POSitive
State Saved	Saved in instrument state
Backwards Compatibility SCPI	:TRIGger[:SEquence]:FRAMe:EXTernal2:SLOPe
Backwards Compatibility Notes	The legacy :TRIGger[:SEquence]:SLOPe command affects the slopes for the VID, LINE, EXT1, EXT2, and RFB triggers.
Initial S/W Revision	Prior to A.02.00

RF Burst

Pressing this key, when it is not selected, selects the RF Burst as the trigger. A new sweep/measurement will start when an RF burst envelope signal is identified from the signal at the RF Input connector. Pressing this key, when it is already selected, accesses the RF Burst trigger setup menu.

In some models, a variety of burst trigger circuitry is available, resulting in various available burst trigger bandwidths. The analyzer automatically chooses the appropriate trigger path based on the hardware configuration and other settings of the analyzer.

Key Path	Trigger
Example	TRIG:SOUR RFB Swept SA measurement TRIG:<meas>:SOUR RFB Measurements other than Swept SA
State Saved	Saved in instrument state
Status Bits/OPC dependencies	The Status Operation Register bit 5 "Waiting for Trigger" is set at the same time as the Sweeping or Measuring bit is set. It is cleared when the trigger actually occurs (that is, after the trigger event occurs and all the applicable trigger criteria have been met). A corresponding pop-up message ("Waiting for trigger") is generated if no trigger signal appears after approximately 2 sec. This message goes away when a trigger signal appears.
Backwards Compatibility Notes	The legacy command: :TRIGger[:SEquence]:RFBurst:FSElectivity[:STATe] OFF ON 0 1 is not supported in the X-Series, as the hardware to do Frequency Selective burst triggers does not exist in X-Series.

Initial S/W Revision	Prior to A.02.00
Modified at S/W Revision	A.04.00

Absolute Trigger Level

Sets the absolute trigger level for the RF burst envelope.

When using the External Mixing path, the Absolute Trigger Level is uncalibrated because the factory default was set to accommodate the expected IF levels for the RF path.

Key Path	Trigger, RF Burst
Scope	Meas Global
Remote Command	:TRIGger[:SEquence]:RFBurst:LEVel:ABSolute <ampl> :TRIGger[:SEquence]:RFBurst:LEVel:ABSolute?
Example	TRIG:RFB:LEV:ABS 10 dBm sets the trigger level of the RF burst envelope signal to the absolute level of 10 dBm
Notes	Sending this command does not switch the setting from relative to absolute; to switch it you need to send the :TRIGger[:SEquence]:RFBurst:LEVel:TYPE command, below. Amplitude Corrections are not taken into account by the Absolute Trigger Level. For example, if you have given yourself effective gain with an amplitude correction factor, the Absolute Trigger will not fire until you have set the trigger level that far below the displayed signal level, rather than simply to the displayed signal level. This is only true for Amplitude Corrections, not External Gain or Ref Level Offset functions. If mode is Bluetooth, the default value is -50 dBm.
Couplings	This same level is used for the RF Burst trigger source in the Trigger menu, for the RF Burst selection in the Periodic Timer sync source (in the Trigger menu and in the Gate Source menu), and also for the RF Burst selection in the Gate Source menu
Preset	-20 dBm
State Saved	Saved in instrument state
Min	-200 dBm
Max	100 dBm
Default Unit	depends on the current selected Y-Axis unit
Backwards Compatibility SCPI	:TRIGger[:SEquence]:FRAME:RFBurst:LEVel:ABSolute
Initial S/W Revision	Prior to A.02.00
Modified at S/W Revision	A.04.00

Key Path	Trigger, RF Burst
Remote Command	:TRIGger[:SEquence]:RFBurst:LEVel:TYPE ABSolute RELative :TRIGger[:SEquence]:RFBurst:LEVel:TYPE?

Example	TRIG:RFB:LEV:TYPE REL sets the trigger level type of the RF burst trigger to Relative.
Preset	ABSolute
State Saved	Saved in instrument state
Initial S/W Revision	Prior to A.02.00
Modified at S/W Revision	A.04.00

Trigger Slope

It is set positive to trigger on a rising edge and negative to trigger on a falling edge.

Key Path	Trigger, RF Burst
Remote Command	:TRIGger[:SEQuence]:RFBurst:SLOPe POSitive NEGative :TRIGger[:SEQuence]:RFBurst:SLOPe?
Example	TRIG:RFB:SLOP NEG
Couplings	This same slope is used in the RF Burst selection for the trigger source in the Trigger menu and for the period timer sync source (in the Trigger menu and in the Gate Source menu).
Preset	POSitive
State Saved	Saved in instrument state
Backwards Compatibility SCPI	:TRIGger[:SEQuence]:FRAMe:RFBurst:SLOPe
Backwards Compatibility Notes	The legacy :TRIGger[:SEQuence]:SLOPe command affects the slopes for the VID, LINE, EXT1, EXT2, and RFB triggers.
Initial S/W Revision	Prior to A.02.00

Trig Delay

This setting delays the measurement timing relative to the Periodic Timer.

Key Path	Trigger, Periodic Timer
Remote Command	:TRIGger[:SEQuence]:FRAMe:DELAy <time> :TRIGger[:SEQuence]:FRAMe:DELAy? :TRIGger[:SEQuence]:FRAMe:DELAy:STATe OFF ON 0 1 :TRIGger[:SEQuence]:FRAMe:DELAy:STATe?
Notes	Note that delay is used when the sync source is not set to OFF. If the sync source is set to OFF, offset is used.
Preset	Off, 1.000 us
State Saved	Saved in instrument state
Min	-150 ms

Max	+500 ms
Default Unit	s
Initial S/W Revision	Prior to A.02.00

Auto/Holdoff

Opens up a menu that lets you adjust Auto Trigger and Trigger Holdoff parameters

Key Path	Trigger
Readback line	<p>Displays a summary of the Auto Trig and Holdoff settings, in square brackets</p> <p>First line: Auto Off or Auto On</p> <p>Second Line: "Hldf" followed by:</p> <ul style="list-style-type: none"> • If Holdoff is Off, readback Off • If Holdoff On and Type = Normal, readback value • If Holdoff On and Type = Above, readback value followed by AL • If Holdoff On and Type = Below, readback value followed by BL • If Holdoff Type selection is not supported by the current measurement, Holdoff Type is always Normal
Initial S/W Revision	A.02.00

Auto Trig

Sets the time that the analyzer will wait for the trigger conditions to be met. If they are not met after that much time, then the analyzer is triggered anyway.

Key Path	Trigger, Auto/Holdoff
Remote Command	<pre>:TRIGger[:SEquence]:ATRigger <time> :TRIGger[:SEquence]:ATRigger? :TRIGger[:SEquence]:ATRigger:STATe OFF ON 0 1 :TRIGger[:SEquence]:ATRigger:STATe?</pre>
Example	<pre>TRIG:ATR:STAT ON TRIG:ATR 100 ms</pre>
Notes	The "time that the analyzer will wait" starts when the analyzer is ready for a trigger, which may be hundreds of ms after the data acquisition for a sweep is done. The "time" ends when the trigger condition is satisfied, not when the delay ends.
Preset	Off, 100 ms
State Saved	Saved in instrument state
Min	1 ms
Max	100 s
Default Unit	s
Initial S/W Revision	Prior to A.02.00

Trig Holdoff

Sets the holdoff time between triggers. When the trigger condition is satisfied, the trigger occurs, the delay begins, and the holdoff time begins. New trigger conditions will be ignored until the holdoff time expires. For a free-running trigger, the holdoff value is the minimum time between triggers.

Key Path	Trigger, Auto/Holdoff
Remote Command	:TRIGger[:SEquence]:HOLDoff <time> :TRIGger[:SEquence]:HOLDoff? :TRIGger[:SEquence]:HOLDoff:STATe OFF ON 0 1 :TRIGger[:SEquence]:HOLDoff:STATe?
Example	TRIG:HOLD:STAT ON TRIG:HOLD 100 ms
Dependencies	Unavailable if the selected Input is BBIQ. If this is the case, the key is grayed out if it is pressed the informational message "Feature not supported for this Input" is displayed. If the SCPI command is sent, the error "Settings conflict; Feature not supported for this Input" is generated.
Preset	Off, 100 ms
State Saved	Saved in instrument state
Min	0 s
Max	0.5 s
Default Unit	s
Initial S/W Revision	Prior to A.02.00

8 AM Demod Measurement

For the AM Demod measurement, the analyzer will return the metrics results, such as AM depth, modulation rate, SINAD, total harmonic distortion and carrier power. The analyzer can display trace data of the RF spectrum, the AF spectrum, or the demod waveform.

If the Demod Min trace, Demod Max trace or Demod Average trace is queried using a Meas, Read or Fetch command when the Average/Hold feature is turned off, the resulting data will be default values.

For more measurement related commands, see the SENSE subsystem, and the ["Remote Measurement Functions" on page 1121](#).

This topic contains the following sections:

["Measurement Commands for AM Demod" on page 274](#)

["Remote Command Results for AM Demod" on page 275](#)

Measurement Commands for AM Demod

Parameter Name	AM Meas/Read/Fetch Query Results
SCPI Command	:MEASure READ FETCh:AM[1] 0 2 3 4 5 6?
SCPI Example	MEAS:AM? FETCH:AM0? READ:AM5?
Setup	[COMPARE OFF]
Post Setup	[COMPARE ON]

Remote Command Results for AM Demod

Command	n	Return Value
:INITiate:AM	n/a	n/a
:CONFigure?	n/a	name of current measurement: "AM"
:CONFigure:AM	n/a	n/a (selects AM measurement in Meas Preset state)
:CONFigure:AM:NDEFault	n/a	n/a (selects AM measurement without affecting settings)
:FETCh:AM[n]? :MEASure:AM[n]? :READ:AM[n]?	0	This query returns the RF Spectrum trace data as a list of x,y pairs. The x-axis values are in units of Hz. The y-value units depend on the current view.
	not specified or n=1	Returns the following comma-separated results. All modulation depth numbers are in units of percent. <ol style="list-style-type: none"> 1. The RF Spectrum window's center frequency 2. Carrier Power 3. 0 4. Modulation Rate 5. SINAD value 6. Distortion/Total Vrms (% - not ratio - or dB) 7. Total Harmonic Distortion (% - not ratio - or dB) 8. Modulation Depth (Peak+) 9. Modulation Depth (Peak-) 10. Modulation Depth (Pk-Pk)/2 11. Modulation Depth (RMS) 12. Modulation Depth (Peak+) Max Hold 13. Modulation Depth (Peak-) Max Hold 14. Modulation Depth (Pk-Pk)/2 Max Hold 15. Modulation Depth (RMS) Max Hold 16. SNR
	2	This query returns the Demod Min Trace data as a list of x,y pairs. The x-axis values are in units of seconds. The y-value units depend on the current view If Aver/Hold is off, all values are 10,000..
	3	This query returns the Demod Max Trace data as a list of x,y pairs. The x-axis values are in units of seconds. The y-value units depend on the current view If Aver/Hold is off, all y-values are -100.
	4	This query returns the Demod Trace data as a list of x,y pairs. The x-axis values are in units of seconds. The y-value units depend on the current view
	5	This query returns the Demod Average Trace data as a list of x,y pairs. The x-axis values are in units of seconds. The y-value units depend on the current view

Command	n	Return Value
		If Aver/Hold is off, all y-values are -100.
	6	This query returns the AF Spectrum Trace data as a list of x,y pairs. The x-axis values are in units of Hz. The y-value units depend on the current view
	7	Returns the following comma-separated results: 1. Mod Depth (RMS) 2. Mod Depth (RMS) Ratio 3. Ratio Reference
	8	Returns the Demod Waveform Trace data (without interpolation), as a series of floating trace point values, in %. The number of samples and the sample interval can be queried when n=10.
	9	Reserved.
	10	Returns the following scalar results: 1. Sample Interval is a floating point number representing the time between samples when using the trace queries (n=8). 2. Number of samples is the number of data points in the Demod Waveform Trace (without interpolation). This number is useful when performing a query on the signal (when n=8).
	11	Returns unprocessed I/Q trace data, as a series of trace point values, in volts. The I values are listed first in each pair, using the 0 through even-indexed values. The Q values are the odd-indexed values. The number of samples and the sample interval can be queried when n=12.
	12	Returns the following scalar results: 1. Sample Interval is a floating point number representing the time between samples when using the trace queries (n=11). 2. Number of samples is the number of data points in the captured signal. This number is useful when performing a query on the signal (when n=11).
Key Path	Meas	
Initial S/W Revision	Prior to A.02.00	

AMPTD Y Scale

Accesses a menu that enables you to set the reference level, attenuation, scale per division, reference position, and internal pre-amplifier parameters for your measurement.

Key Path	Front-panel key
Initial S/W Revision	Prior to A.02.00

Ref Value (AM)

The reference value specifies the amplitude of a signal displayed on the reference graticule line. The reference line is at the top, center, or bottom of the graticule, depending on the value of the Ref Position function.

Changing the reference value does not restart a measurement, but changes all displayed traces and markers to the new value. If a change to the reference value changes an auto-coupled attenuation value, the measurement restarts.

The Ref Value key applies only to the window with the focus. If the focus is on the Metrics window, the Ref Value key is unavailable.

Key Path	AMPTD Y Scale
Remote Command	:DISPlay:AM:WINDow[1] 2 3:TRACe:Y[:SCALe]:RLEVel <real> :DISPlay:AM:WINDow[1] 2 3:TRACe:Y[:SCALe]:RLEVel?
Example	DISP:AM:WIND:TRAC:Y:RLEV 20 dBm Sets the reference value in window 1 to 20 dBm.
Remote Command Notes	Regardless of the View, the windows are numbered as follows: 1. RF Spectrum 1. Demod Waveform 2. AF Spectrum 3. Metrics
Couplings	The value is constrained within the MAX and MIN values, but is otherwise generally not adjusted. In window 3, this value depends on Scale Type. If Scale Type is Log, the value will be expressed in decibel units. For example, x % will be expressed as y dBam, where $y = 20 * \log(x)$.
Preset	Demod Waveform 0% AF Spectrum Scale Type is "Lin": 100 % Scale Type is "Log": 40 dBam
State Saved	Saved in instrument state
Min	RF Spectrum -170 dBm - Ext Gain Demod Waveform -100% AF Spectrum Scale Type is "Lin": 1 m%

Scale Type is "Log": -60 dBam	
Max	Demod Waveform 100% AF Spectrum Scale Type is "Lin": 10 k% Scale Type is "Log": 80 dBam
Default Unit	depends on the current view
Initial S/W Revision	Prior to A.02.00
Modified at S/W Revision	A.14.00

Attenuation

Accesses a menu of functions that enable you to change the attenuation settings. This key has read-back text that describes the total attenuator value.

See AMPTD Y Scale, Attenuation@3003 for more information.

Key Path	AMPTD/Y Scale
Initial S/W Revision	A.14.00

Scale / Div (AM)

Sets the units per vertical graticule division on the display.

The Scale/Div key applies only to the window with the focus. If the focus is on the Metrics window, the Scale/Div key is unavailable.

Key Path	AMPTD Y Scale
Remote Command	:DISPlay:AM:WINDow[1] 2 3:TRACe:Y[:SCALe]:PDIVision <real> :DISPlay:AM:WINDow[1] 2 3:TRACe:Y[:SCALe]:PDIVision?
Example	DISP:AM:WIND:TRAC:Y:PDIV 5 DB
Remote Command Notes	Regardless of the View, the windows are numbered as follows: 1. RF Spectrum 1. Demod Waveform 2. AF Spectrum 3. Metrics
Preset	RF Spectrum 10 dB Demod Waveform 20 % AF Spectrum 10 dB
State Saved	Saved in State
Min	RF Spectrum 0.1 dB Demod Waveform 1%

	AF Spectrum 0.1 dB
Max	RF Spectrum 20 dB Demod Waveform 1 kHz AF Spectrum 20 dB
Initial S/W Revision	Prior to A.02.00
Modified at S/W Revision	A.14.00

Scale / Div (FM)

Sets the units per vertical graticule division on the display.

The Scale/Div key applies only to the window with the focus. If the focus is on the Metrics window, the Scale/Div key is unavailable.

Key Path	AMPTD Y Scale
Remote Command	:DISPlay:FM:WINDow[1] 2 ... 5:TRACe:Y[:SCALe]:PDIVision <real> :DISPlay:FM:WINDow[1] 2 ... 5:TRACe:Y[:SCALe]:PDIVision?
Example	DISP:FM:WIND:TRAC:Y:PDIV 5 DB
Remote Command Notes	Regardless of the View, the windows are numbered as follows: 1. RF Spectrum 2. Demod Waveform 3. AF Spectrum 4. RF Envelope (Attack/Release Time view) 5. FM Demod Waveform (Attack/Release Time view) 6. Metrics
Preset	RF Spectrum 10 dB Demod Waveform 15 kHz AF Spectrum 10 dB RF Envelope 10 dB FM Demod Waveform 15 kHz
State Saved	Saved in State
Min	RF Spectrum 0.1 dB Demod Waveform 1 Hz AF Spectrum 0.1 dB RF Envelope 0.1 dB FM Demod Waveform 1 Hz
Max	RF Spectrum 20 dB Demod Waveform 1 GHz AF Spectrum 20 dB RF Envelope 20 dB

	FM Demod Waveform 1 GHz
Initial S/W Revision	Prior to A.02.00
Modified at S/W Revision	A.14.00

Scale / Div (PM)

Sets the units per vertical graticule division on the display.

The Scale/Div key applies only to the window with the focus. If the focus is on the Metrics window, the Scale/Div key is unavailable.

Key Path	AMPTD Y Scale
Remote Command	:DISPlay:PM:WINDow[1] 2 3:TRACe:Y[:SCALe]:PDIVision <real> :DISPlay:PM:WINDow[1] 2 3:TRACe:Y[:SCALe]:PDIVision?
Example	DISP:PM:WIND:TRAC:Y:PDIV 5 DB
Remote Command Notes	Regardless of the View, the windows are numbered as follows: 1. RF Spectrum 2. Demod Waveform 3. AF Spectrum 4. Metrics
Preset	RF Spectrum 1 0 dB Demod Waveform Y Axis Unit is "rad": 1 rad Y Axis Unit is "deg": 57.296 deg AF Spectrum 10 dB
State Saved	Saved in State
Min	RF Spectrum 0.1 dB Demod Waveform Y Axis Unit is "rad": 1 rad Y Axis Unit is "deg": 0.573 deg AF Spectrum 0.1 dB
Max	RF Spectrum 20 dB Demod Waveform Y Axis Unit is "rad": 1 krad Y Axis Unit is "deg": 57295.780 deg AF Spectrum 20 dB
Initial S/W Revision	Prior to A.02.00
Modified at S/W Revision	A.14.00

Scale / Div (FM Stereo)

Sets the units per vertical graticule division on the display.

The Scale/Div key applies only to the window with the focus. If the focus is on the Metrics window, the Scale/Div key is unavailable.

Key Path	AMPTD Y Scale
Remote Command	:DISPlay:FMSTereo:WINDow[1] 2 3:TRACe:Y[:SCALe]:PDIVision <real> :DISPlay:FMSTereo:WINDow[1] 2 3:TRACe:Y[:SCALe]:PDIVision?
Example	DISP:FMST:WIND:TRAC:Y:PDIV 5 DB
Remote Command Notes	Regardless of the View, the windows are numbered as follows: 1. RF Spectrum 2. Demod Waveform 3. AF Spectrum 4. Metrics
Preset	RF Spectrum 10 dB Demod Waveform 15 kHz AF Spectrum 10 dB
State Saved	Saved in State
Min	RF Spectrum 0.1 dB Demod Waveform 1 Hz AF Spectrum 0.1 dB
Max	RF Spectrum 20 dB Demod Waveform 1 GHz AF Spectrum 20 dB
Initial S/W Revision	Prior to A.02.00
Modified at S/W Revision	A.14.00

μW Path Control

The μW Path Control function in the Analog Demod mode is similar to the marker system found in the SA mode, but excluding the Low Noise Path Enable feature. This function includes Standard Path and μW Preselector Bypass (Option MPB) controls in the High Band path circuits.

See μ Path Control@4027 under AMPTD Y Scale for more information.

Key Path	AMPTD/Y Scale
Initial S/W Revision	A.14.00

Range

Represents the amplitude of the largest sinusoidal signal that could be present within the IF without being clipped by the ADC. For signals with high peak-to-average ratios, the range may need to exceed the rms signal power by a fair amount to avoid clipping.

Key Path	Range
Mode	BASIC
Remote Command	<code>[:SENSe] :POWer [:RF] :RANGe <real></code> <code>[:SENSe] :POWer [:RF] :RANGe?</code>
Example	<code>:POW:RANG 10.0</code> <code>:POW:RANG?</code>
Notes	The MIN and MAX values are affected by the External Gain parameters, and by the Center Frequency. (The hardware compensates for frequency response and alters the Range setting.)
Preset	0
State Saved	Saved in instrument state.
Min	-100
Max	100
Initial S/W Revision	A.12.50

Adjust Range For Min Clip

Sets the combination of attenuation and gain based on the current measured signal level so that clipping will be at a minimum.

This is an "immediate action" function, that is, it executes once, when the key is pressed.

This key is grayed out in measurements that do not support this functionality.

Key Path	AMPTD Y Scale, Attenuation
Remote Command	<code>[:SENSe] :POWer [:RF] :RANGe:OPTimize IMMEDIATE</code>
Initial S/W Revision	Prior to A.02.00
Modified at S/W Revision	A.03.00

Pre-Adjust for Min Clip

If this function is on, it does the adjustment described under Adjust Range For Min Clip each time a measurement restarts. Therefore, in Continuous measurement mode, it only executes before the first measurement.

Key Path	AMPTD Y Scale, Attenuation
Remote Command	<code>[:SENSe] :POWer [:RF] :RANGe:OPTimize:ATTenuation OFF ON ELEctrical COMBined</code> <code>[:SENSe] :POWer [:RF] :RANGe:OPTimize:ATTenuation?</code>
Notes	This parameter is shared with old XA platform which uses AutoAtten. To keep the backward compatibility, ELEctrical and COMBined still can be used. Then, upon receiving ELEctrical and COMBined, these enums will be interpreted as aliases of ON.

	Then, when queried, ON will be returned.
Preset	OFF for Swept SA measurement; ON for all other measurements that support Pre-Adjust for Min Clip
State Saved	Saved in instrument state
Initial S/W Revision	Prior to A.02.00
Modified at S/W Revision	A.03.00

Peak to Average

The Peak to Average Ratio is used with the Range setting to optimize the level control in the instrument. The value is the ratio, in dB, of the peak power to the average power of the signal to be measured. A ratio of 0 should be used for sinusoidal signals; for 802.11g OFDM signals use 9 dB.

All Applications (Modes) will show the current value of Peak to Average ratio on the softkey. However, some applications will not permit changing the value. In these situations the softkey will be grayed-out.

Key Path	AMPTD Y Scale, Range
Remote Command	<code>[:SENSe]:POWer[:RF]:RANGe:PARatio <real></code> <code>[:SENSe]:POWer[:RF]:RANGe:PARatio?</code>
Example	POW:RANG:PAR 12 dB
Notes	In some Applications (Modes) this parameter will be read-only; meaning the value will appear on the softkey and query via SCPI, but not changeable. In such applications the softkey will be grayed-out. Attempting to change the value via SCPI will be ignored and no error message will be generated.
Preset	10 dB
State Saved	Saved in instrument state
Min	0 dB
Max	20 dB
Initial S/W Revision	A.13.00

Mixer Level Offset

Mixer level offset is an advanced setting to adjust target Range at the input mixer which in turn affects the signal level in the instrument's IF. This setting can be used when additional optimization is needed after setting Peak to Average ratio. Positive values of offset optimize noise performance over distortion, negative values optimize distortion performance over noise.

Key Path	AMPTD Y Scale, Range
Remote Command	<code>[:SENSe]:POWer[:RF]:RANGe:MIXer:OFFSet <real></code> <code>[:SENSe]:POWer[:RF]:RANGe:MIXer:OFFSet?</code>
Example	POW:RANG:MIX:OFFS -5 dB
Preset	0 dB

State Saved	Saved in instrument state
Min	-35 dB
Max	30 dB
Initial S/W Revision	A.13.00

Scale / Div (AM)

Sets the units per vertical graticule division on the display.

The Scale/Div key applies only to the window with the focus. If the focus is on the Metrics window, the Scale/Div key is unavailable.

Key Path	AMPTD Y Scale
Remote Command	:DISPlay:AM:WINDow[1] 2 3:TRACe:Y[:SCALe]:PDIVision <real> :DISPlay:AM:WINDow[1] 2 3:TRACe:Y[:SCALe]:PDIVision?
Example	DISP:AM:WIND:TRAC:Y:PDIV 5 DB
Remote Command Notes	Regardless of the View, the windows are numbered as follows: 1. RF Spectrum 1. Demod Waveform 2. AF Spectrum 3. Metrics
Preset	RF Spectrum 10 dB Demod Waveform 20 % AF Spectrum 10 dB
State Saved	Saved in State
Min	RF Spectrum 0.1 dB Demod Waveform 1% AF Spectrum 0.1 dB
Max	RF Spectrum 20 dB Demod Waveform 1 kHz AF Spectrum 20 dB
Initial S/W Revision	Prior to A.02.00
Modified at S/W Revision	A.14.00

Ref Position

Positions the reference value at the top, center, or bottom of the Y Scale display. Changing the reference position does not change the reference value.

The Ref Position key applies only to the window with the focus. If the focus is on the Metrics window, the Ref Position key is unavailable.

Key Path	AMPTD Y Scale
Remote Command	<p>AM/PM/FM Stereo:</p> <pre>:DISPlay:AM PM FMSTereo:WINDow[1] 2 3:TRACe:Y[:SCALe]:RPOSition TOP CENTer BOTTom :DISPlay:AM PM FMSTereo:WINDow[1] 2 3:TRACe:Y[:SCALe]:RPOSition?</pre> <p>FM:</p> <pre>:DISPlay:FM:WINDow[1] 2 ... 5:TRACe:Y[:SCALe]:RPOSition TOP CENTer BOTTom :DISPlay:FM:WINDow[1] 2 ... 5:TRACe:Y[:SCALe]:RPOSition?</pre>
Example	DISP:AM:WIND:TRAC:Y:RPOS BOTT
Remote Command Notes	<p>AM/PM/FM Stereo:</p> <p>Regardless of the View, the windows are numbered as follows:</p> <ol style="list-style-type: none"> 1. RF Spectrum 2. Demod Waveform 3. AF Spectrum 4. Metrics <p>FM:</p> <p>Regardless of the View, the windows are numbered as follows:</p> <ol style="list-style-type: none"> 1. RF Spectrum 2. Demod Waveform 3. AF Spectrum 4. RF Envelope (Attack/Release Time view) 5. FM Demod Waveform (Attack/Release Time view) 6. Metrics
Preset	<p>RF Spectrum window: Top</p> <p>Demod Waveform window: Center</p> <p>AF Spectrum window: Top</p>
State Saved	Saved in instrument state
Initial S/W Revision	Prior to A.02.00
Modified at S/W Revision	A.14.00

Auto Couple

The Auto Couple feature provides a quick and convenient way to automatically couple multiple instrument settings. This helps ensure accurate measurements and optimum dynamic range. When the Auto Couple feature is activated, either from the front panel or remotely, all parameters of the current measurement which have an Auto/Manual mode are set to Auto mode and all measurement settings dependent on (or coupled to) the Auto/Man parameters are automatically adjusted for optimal performance.

For Analog Demod, these parameters are:

- RF Res BW
- AF Res BW
- CF Step

Key Path	Front-panel key
Initial S/W Revision	Prior to A.02.00

BW

Opens a menu of keys that enable you to control the bandwidth functions of the application.

Key Path	Front-panel key
Initial S/W Revision	Prior to A.02.00

RF Res BW

Activates the RF Res BW function, which enables you to manually set the resolution bandwidth used in the RF Spectrum window.

Normally, the RF Res BW (Auto) key selects automatic coupling of the resolution bandwidth. To decouple the resolution bandwidth, press the RF Res BW key until Man is underlined, or enter a different value for the resolution bandwidth.

When the resolution bandwidth is manually selected, it may be returned to the coupled state by pressing the RF Res BW key until Auto is underlined. This may also be done by pressing the Auto Couple key or by performing a preset.

Only the Gaussian filter type is used.

Key Path	BW
Remote Command	<pre>[:SENSe] :AM FM PM FMSTereo:BANDwidth[:RESolution] <freq> [:SENSe] :AM FM PM FMSTereo:BANDwidth[:RESolution]? [:SENSe] :AM FM PM:BANDwidth[:RESolution]:AUTO OFF ON 0 1 [:SENSe] :AM FM PM:BANDwidth[:RESolution]:AUTO?</pre>
Example	<pre>AM:BAND 1 KHZ AM:BAND? AM:BAND:AUTO ON AM:BAND:AUTO?</pre>
Notes	Only certain discrete resolution bandwidths are available. For numeric entries, all RBW Types choose the nearest (arithmetically, on a linear scale, rounding up) available RBW to the value entered.
Couplings	<p>AM/FM/PM: In Auto, the 3 dB RBW of the desired filter is the closest possible choice to that given by Span divided by 106 (the Span: 3 dB RBW parameter), except that the range for auto-coupling is restricted to not exceed 3 MHz.</p> <p>FMST: In Auto, RBW is coupled to Span in the following ways: $RBW = Span / 500$ (Span > 500 kHz) $RBW = 1 \text{ kHz}$ (100kHz <= Span <= 500 kHz) $RBW = Span / 100$ (Span < 100 kHz)</p>
Preset	<p>AM/FM/PM: Preset is Auto, which results in a 680 Hz value since the preset span is 75 kHz and the Span/RBW ratio is 106</p> <p>FMST: Preset is Auto, which results in a 1 kHz value since the preset span is 500 kHz</p>
State Saved	Saved in Instrument state

Min	1 Hz
Max	8 MHz
Default Unit	Hz
Initial S/W Revision	Prior to A.02.00
Modified at S/W Revision	A.10.00

Channel BW

The Channel BW variable is used to determine the bandwidth used for the demodulation. The flat top filter type must be used for demodulation.

This parameter also controls the RBW hardware setting for the demodulation fed to the speaker.

Key Path	BW
Remote Command	[:SENSe] :AM FM PM FMSTereo:BANDwidth:CHANnel <freq> [:SENSe] :AM FM PM FMSTereo:BANDwidth:CHANnel?
Example	AM:BAND:CHAN 200 kHz
Notes	If the Channel BW is greater than 8 MHz, gives a warning message "Settings Alert; Analog Output Undefined".
Dependencies	The maximum value will be the maximum IF BW available in the instrument. For example, if the instrument has the options B25, B40, and B1X installed, the maximum available IF BW of the instrument is 140 MHz. Thus, the maximum Channel BW is not limited to 25 MHz but is 140 MHz.
Preset	= AM/FM/PM = 25 kHz = FMST = 400 kHz
State Saved	Saved in instrument state
Min	390 Hz
Max	When Option N9063A-AFP is installed, it depends on hardware: No Option = 10 MHz Option B25 = 25 MHz Option B40 = 40 MHz Option B85 = 85.0 MHz Option B1A = 125.0 MHz Option B1X = 140 MHz Option B1Y = 160 MHz
Default Unit	Hz
Initial S/W Revision	Prior to A.02.00
Modified at S/W Revision	A.10.00

AF Res BW

In the AF Spectrum window, the AF Res BW key is used to set the Resolution bandwidth of the FFT of the demodulated waveform.

The data acquisition uses the Channel BW value for hardware control during data acquisition, just as it does in the Demod Waveform window.

AF Res BW (Auto) selects automatic coupling of the AF Res BW to the AF Span (defined as AF Stop Freq – AF Start Freq) using the same factor of 106 used by the RF Res BW. To decouple the resolution bandwidth, press the AF Res BW key until Man is underlined, or enter a different value for the AF resolution bandwidth.

When the AF resolution bandwidth is manually selected, it may be returned to the coupled state by pressing the AF Res BW key until Auto is underlined. This may also be done by pressing the Auto Couple key or by performing a Preset.

Only the Gaussian filter type is used.

Key Path	BW
Remote Command	<pre>[:SENSe] :AM FM PM FMSTereo:AFSPectrum:BANDwidth <freq> [:SENSe] :AM FM PM FMSTereo:AFSPectrum:BANDwidth? [:SENSe] :AM FM PM FMSTereo:AFSPectrum:BANDwidth:AUTO OFF ON 0 1 [:SENSe] :AM FM PM FMSTereo:AFSPectrum:BANDwidth:AUTO?</pre>
Example	<pre>AM:AFSP:BAND 1 KHZ AM:AFSP:BAND?</pre>
Notes	Only certain discrete resolution bandwidths are available. For numeric entries, all RBW Types choose the nearest (arithmetically, on a linear scale, rounding up) available RBW to the value entered.
Notes	For numeric entries, all RBW Types choose the nearest (arithmetically, on a linear scale, rounding up) available RBW to the value entered.
Remote Command Notes	The setting and querying of values depends on the current bandwidth type.
Couplings	In Auto, the 3 dB RBW of the desired filter is the closest possible choice to that given by Span divided by 106 (the Span: 3 dB RBW parameter), except that the range for auto-coupling is restricted to not exceed 3 MHz.
Preset	Preset is Auto, which results in a 180 Hz value since the preset span is 20 kHz and the Span/RBW ratio is 106
State Saved	Saved in Instrument State
Min	1 Hz
Max	8 MHz
Default Unit	Hz
Initial S/W Revision	Prior to A.02.00
Modified at S/W Revision	A.10.00

Cont (Continuous Measurement/Sweep)

Sets the analyzer for Continuous measurement operation. The single/continuous state is Meas Global so the setting will affect all measurements. If you are Paused, pressing Cont does a Resume.

Key Path	Front-panel key
Remote Command	:INITiate:CONTinuous OFF ON 0 1 :INITiate:CONTinuous?
Example	:INIT:CONT 0 puts analyzer in Single measurement operation. :INIT:CONT 1 puts analyzer in Continuous measurement operation
Preset	ON (Note that SYST:PRESet sets INIT:CONT to ON but *RST sets INIT:CONT to OFF)
State Saved	Saved in instrument state
Backwards Compatibility Notes	For Spectrum Analysis mode in ESA and PSA, there is no Cont hardkey, instead there is a Sweep Single/Cont key. In these analyzers, switching the Sweep Single/Cont key from Single to Cont restarts averages (displayed average count reset to 1), but does not restart Max Hold and Min Hold. The X-Series has Single and Cont keys in place of the SweepSingleCont key. In the X-Series, if in single measurement, the Cont key (and INIT:CONT ON) switches to continuous measurement, but never restarts a measurement and never resets a sweep.
Initial S/W Revision	Prior to A.02.00

In Swept SA Measurement (Spectrum Analysis Mode):

The analyzer takes repetitive sweeps, averages, measurements, etc., when in Continuous mode. When the average count reaches the Average/Hold Number the count stops incrementing, but the analyzer keeps sweeping. See the Trace/Detector section for the averaging formula used both before and after the Average/Hold Number is reached. The trigger condition must be met prior to each sweep. The type of trace processing for multiple sweeps, is set under the Trace/Detector key, with choices of Trace Average, Max Hold, or Min Hold.

In Other Measurements/Modes:

With Avg/Hold Num (in the Meas Setup menu) set to Off or set to On with a value of 1, a sweep is taken after the trigger condition is met; and the analyzer continues to take new sweeps after the current sweep has completed and the trigger condition is again met. However, with Avg/Hold Num set to On with a value >1, multiple sweeps (data acquisitions) are taken for the measurement. The trigger condition must be met prior to each sweep. The sweep is not stopped when the average count k equals the number N set for Avg/Hold Num is reached, but the number k stops incrementing. A measurement average usually applies to all traces, marker results, and numeric results. But sometimes it only applies to the numeric results.

If the analyzer is in Single measurement, pressing the Cont key does not change k and does not cause the sweep to be reset; the only action is to put the analyzer into Continuous measurement operation.

If it is already in continuous sweep:

the INIT:CONT 1 command has no effect

the INIT:CONT 0 command will place the analyzer in Single Sweep but will have no effect on the current sequence until $k = N$, at which point the current sequence will stop and the instrument will go to the idle state.

8 AM Demod Measurement
File

File

See "File" on page 176

FREQ Channel

Accesses a menu of keys that enable you to control the Frequency parameters of the instrument.

Key Path	Front-panel key
Initial S/W Revision	Prior to A.02.00

Center Frequency

Sets the frequency that corresponds to the horizontal center of the RF Spectrum window. While adjusting the Center Frequency the Span is held constant, this means that both the start frequency and the stop frequency will change.

The Center Frequency is retained as you go from measurement to measurement.

Key Path	FREQ Channel
Remote Command	<code>[:SENSe] :FREQuency:CENTer <freq></code> <code>[:SENSe] :FREQuency:CENTer?</code>
Example	FREQ:CENT 50MHz FREQ:CENT UP changes the center frequency to 150 MHz if you use FREQ:CENT:STEP 100MHz sets the center frequency step size to 100 MHz FREQ:CENT?
Dependencies	The Center Frequency can be limited by Start or Stop Freq limits, In addition, the Center Frequency can be limited if the Span is so large that Start or Stop hit their limit.
Couplings	When operating in “swept span”, any value of the Center Frequency or Span that is within the frequency range of the analyzer is allowed when the value is being set through the front panel numeric key pad or the SCPI command. The other parameter is forced to a different value if needed, to keep the Start and the Stop Frequencies within the analyzer frequency range
Preset	1.000 GHz
State Saved	Saved in instrument state
Min	Depends on instrument minimum frequency and the 10 Hz minimum span. If the knob or step keys are being used, it depends on the value of the other three interdependent parameters.
Max	Depends on the instrument’s maximum frequency and the 10 Hz minimum span. If the knob or step keys are being used, it depends on the value of the other three interdependent parameters.
Default Unit	Hz
Status Bits/OPC dependencies	Non-overlapped
Initial S/W Revision	Prior to A.02.00

CF Step

Changes the step size for the center frequency function. Once a step size has been selected and the center frequency function is active, the step keys (and the UP|DOWN parameters for the Center Frequency from remote commands) change the center frequency by the step-size value. The step size function is useful for finding harmonics and sidebands beyond the current frequency span of the analyzer.

Key Path	FREQ Channel
Remote Command	[:SENSe]:FREQuency:CENTer:STEP[:INCRement] <freq> [:SENSe]:FREQuency:CENTer:STEP[:INCRement]? [:SENSe]:FREQuency:CENTer:STEP:AUTO OFF ON 0 1 [:SENSe]:FREQuency:CENTer:STEP:AUTO?
Example	FREQ:CENT:STEP:AUTO ON FREQ:CENT:STEP 500MHz FREQ:CENT UP increases the current center frequency value by 500 MHz FREQ:CENT:STEP? FREQ:CENT:STEP:AUTO?
Remote Command Notes	Preset and Max values are dependent on Hardware Options (503, 508, 513, 526)
Dependencies	Span, RBW, Center frequency
Couplings	When auto-coupled in a non-zero span, the center frequency step size is set to 10% of the span. When auto-coupled in zero span, the center frequency step size is set to the equivalent -3 dB RBW value.
Preset	Auto
State Saved	Saved in State
Min	- (the maximum frequency of the instrument). For example, a 27 GHz max frequency instrument has a CF step range of +/- 27 GHz.
Max	The maximum frequency of the instrument. For example, 27 GHz max freq instrument has a CF step range of +/- 27 GHz.
Default Unit	Hz
Status Bits/OPC dependencies	Non-overlapped
Initial S/W Revision	Prior to A.02.00

AF Start Freq

Sets the frequency at the left side of the graticule in the AF Spectrum window. While adjusting the AF start frequency the AF stop frequency is held constant.

The AF Start Frequency is retained as you go from measurement to measurement.

Key Path	FREQ Channel
Remote Command	[:SENSe]:AM FM PM FMSTereo:AFSPectrum:FREQuency:START <freq> [:SENSe]:AM FM PM FMSTereo:AFSPectrum:FREQuency:START?

Example	AM:AFSP:FREQ:STAR 0 Hz
Dependencies	You cannot set the Start frequency > the Stop frequency. You cannot set the Start frequency = Stop frequency. You cannot set the Start Frequency to a value that would create a span of less than 10 Hz. If you try to do any of these, Stop Frequency will change to maintain a minimum value of 10 Hz for the difference between Start and Stop.
Preset	0 Hz
State Saved	Saved in instrument state
Min	0 Hz
Max	99.999990 MHz
Default Unit	Hz
Status Bits/OPC dependencies	Non-overlapped
Initial S/W Revision	Prior to A.02.00
Modified at S/W Revision	A.10.00

AF Stop Freq

Sets the frequency at the right side of the graticule in the AF Spectrum window. While adjusting the AF Stop Frequency the AF Start Frequency is held constant.

Key Path	FREQ Channel
Remote Command	[:SENSe] :AM FM PM FMSTereo:AFSPectrum:FREQuency:STOP <freq> [:SENSe] :AM FM PM FMSTereo:AFSPectrum:FREQuency:STOP?
Example	AM:AFSP:FREQ:STOP 20 kHz
Dependencies	You cannot set the Stop frequency < the Start frequency. You cannot set the Start frequency = Stop frequency. You cannot set the Stop Frequency to a value that would create a span of less than 10 Hz. If you try to do any of these, the Start Frequency will change to maintain a minimum value of 10 Hz for the difference between Start and Stop.
Preset	20 kHz
State Saved	Saved in instrument state
Min	10 Hz
Max	100 MHz
Default Unit	Hz
Status Bits/OPC dependencies	Non-overlapped
Initial S/W Revision	Prior to A.02.00
Modified at S/W Revision	A.10.00

Input/Output

See "[Input/Output](#)" on page 130

Marker

Accesses the Marker menu. A marker can be placed on a trace to allow the value of the trace at the marker point to be determined precisely. The functions in this menu include a 1-of-N selection of the control mode Normal, Delta, Fixed, or Off for the selected marker.

If the selected marker is Off, pressing the Marker key sets it to the selected window. If the metrics window is selected, the marker will appear in the first visible window (RF Spectrum if Quad View is selected).

The units of Delta Marker are window dependent. In the Spectrum windows they are dB, in the Demod Waveform window they are the same as the Y-Axis Unit. In this window, the delta marker is a linear difference rather than a ratio. For example, in FM, in the Demod Waveform window, the units of delta marker are Hz.

Control Mode

Key Path	Front-panel key
Remote Command	:CALCulate:AM FM PM FMSTereo:MARKer[1] 2 ... 12:MODE POSition DELTa FIXed OFF :CALCulate:AM FM PM FMSTereo:MARKer[1] 2 ... 12:MODE?
Example	CALC:AM:MARK:MODE POS turns on marker 1 in Normal mode
Remote Command Notes	This command (not the query) causes the specified marker to become selected.
Preset	OFF (all markers)
Initial S/W Revision	Prior to A.02.00
Modified at S/W Revision	A.10.00

Select Marker

Displays a menu with 12 markers available for selection for the current measurement.

Key Path	Marker
Notes	The selected marker is remembered even when not in the Marker menu and is used if a Search is initiated.
Preset	Marker 1
State Saved	The number of the selected marker is saved in instrument state.
Initial S/W Revision	Prior to A.02.00

Normal

Sets the control mode for the selected marker to Normal and turns on the active function for setting its value. If the selected marker was off, it is placed at the center of the screen on the trace specified by the marker's Trace attribute.

A Normal mode (POSition type) marker can be moved to any point on the X Axis by specifying its X Axis value. Its absolute Y Axis value is then the value of the trace point at that X Axis value.

Key Path	Marker
Example	: CALC: MARK: MODE POS sets Marker 1 to Normal.
Remote Command Notes	See the description under the " Marker " on page 1101 key.
Couplings	The marker addressed by this command becomes the selected marker on the front panel.
State Saved	The marker control mode (Normal, Delta, Fixed, Off) and X Axis value are saved in instrument state.
Initial S/W Revision	Prior to A.02.00

Delta

Sets the control mode for the selected marker to Delta and turns on the active function for setting its delta value. If the selected marker is off, the marker is placed at the center of the screen on the trace specified by the marker's Trace attribute.

In Delta mode the marker result shows the relative result between the selected (Delta) marker and its reference marker. A delta marker can be moved to any point on the X Axis by specifying its X Axis offset from a reference marker. Its absolute Y Axis value is then the value of the trace point at that X Axis value.

Key Path	Marker
Example	:CALC:MARK:MODE DELT sets marker 1 to Delta.
Remote Command Notes	See the description under the " Marker " on page 1101 key.
Couplings	Coupled to fix absolute X when turned On.
State Saved	The marker control mode (Normal, Delta, Fixed, Off) and X Axis value are saved in instrument state.
Initial S/W Revision	Prior to A.02.00

Fixed

Sets the control mode for the selected marker to Fixed. A fixed marker is fixed in the sense that it stays where you place it. It can be directly moved in both X and Y. It can be moved with a Peak Search. It can also be indirectly moved by re-zeroing the delta if it is a relative marker. If it is moved, it again becomes fixed at the X Axis point it moved to and it has a Y-axis result that it took on when it moved there. If a Normal or Delta marker is changed to Fixed it becomes fixed at the X Axis point it was at, and with the Y-axis result it had when it was set to Fixed.

Key Path	Marker
Initial S/W Revision	Prior to A.02.00

Marker X

Sets and queries a marker's X value.

Key Path	Marker, Fixed
----------	---------------

Remote Command	:CALCulate:AM FM PM FMSTereo:MARKer[1] 2 ... 12:X <time> <freq> :CALCulate:AM FM PM FMSTereo:MARKer[1] 2 ... 12:X?
Remote Command Notes	The query is returned in the fundamental units for the current marker X Axis scale. This command (not the query) causes the specified marker to become selected.
Preset	After a preset, all Markers are turned off, so a Marker X Axis Value query will return not a number (9.91 e37). When a Marker is on, the default value of the Marker X value is the center of the appropriate window.
Min	-9.9E+37
Max	9.9E+37
Initial S/W Revision	Prior to A.02.00
Modified at S/W Revision	A.10.00

Marker Y

Sets and queries a marker's Y axis value.

Key Path	Marker, Fixed
Remote Command	:CALCulate:AM FM PM FMSTereo:MARKer[1] 2 ... 12:Y <real> :CALCulate:AM FM PM FMSTereo:MARKer[1] 2 ... 12:Y?
Remote Command Notes	The query is returned in the fundamental units for the current marker Y Axis scale. This command (not the query) causes the specified marker to become selected.
Preset	Defaults to the measurement result at the default X value, or not a number (9.91 e37) if off or if off screen is Fixed.
Min	-9.9E+37
Max	9.9E+37
Initial S/W Revision	Prior to A.02.00
Modified at S/W Revision	A.10.00

Off

Turns off the selected marker. Turning the marker off does not affect which marker is selected.

Key Path	Marker
Example	: CALC: MARK: MODE OFF sets Marker 1 to Off.
Remote Command Notes	See the description under the " Marker " on page 1101 key.
State Saved	The marker control mode (Normal, Delta, Fixed, Off) is saved in instrument state.
Initial S/W Revision	Prior to A.02.00

Properties

Accesses a menu used to assign properties to the selected marker.

Key Path	Marker
Initial S/W Revision	Prior to A.02.00

Select Marker

Displays a menu with 12 markers available for selection for the current measurement.

Key Path	Marker, Properties
Notes	The selected marker is remembered even when not in the Marker menu and is used if a Search is initiated.
Preset	Marker 1
State Saved	The number of the selected marker is saved in instrument state.
Initial S/W Revision	Prior to A.02.00

Relative To

Selects the reference marker for a marker in Delta mode.

If a delta marker has a reference marker in a different window, the delta marker's mode changes to POS (for example, it becomes a normal marker).

Key Path	Marker, Properties
Remote Command	:CALCulate:AM FM PM FMSTereo:MARKer[1] 2 ... 12:REFerence <int> :CALCulate:AM FM PM FMSTereo:MARKer[1] 2 ... 12:REFerence?
Example	CALC:AM:MARK1:REF 2 Sets marker 1's reference marker to 2 and turns marker 1 on as a delta marker.
Remote Command Notes	This command (not the query) causes the specified marker to become selected.
Preset	By default, marker X is relative to marker X + 1 except for marker 12, which is relative to marker 1.
Min	1
Max	12
Initial S/W Revision	Prior to A.02.00
Modified at S/W Revision	A.10.00

AM/FM/ΦM Marker Trace

Selects the trace on which to place the marker. A marker is associated with one and only one trace. This trace is used to determine the placement, result, and X Axis Scale of the marker. All markers have an

associated trace, even Fixed markers. It is from that trace that they determine their attributes and behaviors, and it is to that trace that they go when they become Normal or Delta markers.

In the AM/ Φ M measurements, there are five named traces, and in the FM measurement, there are seven named traces. The RF Spectrum trace is the trace in the RF Spectrum window, and the AF Spectrum trace is the trace in the AF Spectrum window. There are four traces in the Demod Waveform window: Demod, Demod Avg, Demod Max, and Demod Min. The RF Envelope trace and the Demod Raw trace are from Attack/Release Time view which is only available in the FM measurement. The RF Envelope trace is in the RF Envelope window and the Demod Raw trace is in the FM Demod Waveform window. When Auto Init is on, the marker's trace attribute is re-determined automatically by the analyzer whenever the marker turns on (Normal, Delta, or Fixed) from an off state. The marker goes to the trace in the window that has the focus, or onto the RF spectrum window if the Metrics window has the focus. If in the Demod Waveform window, it goes to the Demod trace.

This command associates the marker with the specified trace. Setting the Marker Trace directly (whether the marker is on or off) will turn off Auto Init.

If the marker is not off, it moves the marker from the trace it was on to the new trace. If the new trace is in the same window, the marker goes to the same data point on the new trace. If the marker changes windows, it retains its relative horizontal positions in the new window. If it is a fixed marker, it will retain both relative horizontal and vertical position.

If the marker is off it stays off, but is now associated with the specified trace.

The query returns the name of the trace on which the marker is currently placed.

Key Path	Marker, Properties
Remote Command	:CALCulate:AM FM PM:MARKer[1] 2 ... 12:TRACe RFSpectrum AFSPpectrum DEMod DAVerage DMAXimum DMINimum RFENvelope DRAW :CALCulate:AM FM PM:MARKer[1] 2 ... 12:TRACe?
Example	:CALC:AM:MARK1:TRAC DEM places marker 1 on the Demod trace
Couplings	This is not affected by Auto Coupling. Sending the remote command causes the addressed marker to become selected. If ever a delta marker has a reference marker in a different window, the delta marker's mode changes to POS (for example, it becomes a normal marker). When Marker Trace Auto Init State is on, the marker trace will automatically be set whenever the marker is turned on.
Preset	RF Spectrum on a Preset or All Markers Off
State Saved	The Marker Trace for each marker is saved in instrument state.
Readback line	[Trace name, Auto Init] or [Trace Name, Manual]
Initial S/W Revision	Prior to A.02.00

RF Spectrum

Selects the input RF signal in the RF Spectrum window as the trace on which you want to place your marker. This trace is used to determine the placement, result, and X Axis Scale of the marker.

Key Path	Marker, Properties, Marker Trace
Example	:CALC:AM:MARK1:TRAC RFSP
Initial S/W Revision	Prior to A.02.00

Demod

Selects the current demodulated signal in the Demod Waveform window, shown in yellow, as the trace on which you want to place your marker. This trace is used to determine the placement, result, and X Axis Scale of the marker.

Key Path	Marker, Properties, Marker Trace
Example	:CALC:AM:MARK1:TRAC DEM
Initial S/W Revision	Prior to A.02.00

Demod Average

Selects the averaged demodulation signal in the Demod Waveform window, shown in green, as the trace on which you want to place your marker. This trace is used to determine the placement, result, and X Axis Scale of the marker.

Key Path	Marker, Properties, Marker Trace
Example	:CALC:AM:MARK1:TRAC DAV
Initial S/W Revision	Prior to A.02.00

Demod Max

Selects the Demod Max trace in the Demod Waveform window, shown in cyan, as the trace on which you want to place your marker. This trace shows the maximum hold value for each data point since the last restart.

Key Path	Marker, Properties, Marker Trace
Example	:CALC:AM:MARK1:TRAC DMAX
Initial S/W Revision	Prior to A.02.00

Demod Min

Selects the Demod Min trace in the Demod Waveform window, shown in magenta, as the trace on which you want to place your marker. This trace shows the minimum hold value for each data point since the last restart.

Key Path	Marker, Properties, Marker Trace
Example	:CALC:AM:MARK1:TRAC DMIN
Initial S/W Revision	Prior to A.02.00

AF Spectrum

Selects the demodulated signal in the AF Spectrum window as the trace on which you want to place your marker.

Key Path	Marker, Properties, Marker Trace
Example	:CALC:AM:MARK1:TRAC AFSP
Initial S/W Revision	Prior to A.02.00

Trace Auto Init

Selects whether the marker trace is automatically reset to the selected window when the marker is turned on or not.

Key Path	Marker, Properties, Trace
Remote Command	:CALCulate:AM FM PM FMSTereo:MARKer[1] 2 ... 12:TRACe:AUTO OFF ON 0 1 :CALCulate:AM FM PM FMSTereo:MARKer[1] 2 ... 12:TRACe:AUTO?
Example	:CALC:AM:MARK1:TRAC:AUTO 0 turns off auto-initialization of marker trace.
Preset	On
State Saved	Saved in instrument state.
Readback line	Trace name
Initial S/W Revision	Prior to A.02.00
Modified at S/W Revision	A.10.00

Lines

When on, displays a vertical line of graticule height and a horizontal line of graticule width, intersecting at the indicator point of the marker (that is, the center of the X or the bottom tip of the diamond). The lines are blue in color.

If the marker is off screen, the lines should be extended from the marker so that they go through the screen area if possible. This is really useful for off screen Fixed markers as it lets you see their amplitude even though they are off the X Axis.

Key Path	Marker, Properties
Remote Command	:CALCulate:AM FM PM FMSTereo:MARKer[1] 2 ... 12:LINes[:STATE] OFF ON

	0 1
	:CALCulate:AM FM PM FMSTereo:MARKer [1] 2 ... 12:LINEs [:STATE] ?
Example	CALC:AM:MARK2:LIN ON turns Lines on for marker 2.
Couplings	Sending the remote command causes the addressed marker to become selected.
Preset	OFF
State Saved	Saved in instrument state
Initial S/W Revision	Prior to A.02.00
Modified at S/W Revision	A.10.00

All Markers Off

Turns off all markers.

Key Path	Marker
Remote Command	:CALCulate:AM FM PM FMSTereo:MARKer:AOFF
Example	CALC:AM:MARK:AOFF turns off all markers for the AM measurement
Couplings	Sets the selected marker to 1.
Initial S/W Revision	Prior to A.02.00
Modified at S/W Revision	A.10.00

Marker Function

There are no menus or marker functions under this key in the Analog Demod mode.

Key Path	Front-panel key
Initial S/W Revision	Prior to A.02.00

Marker To

Accesses a menu that contains only the marker center frequency key.

Key Path	Front-panel key
Initial S/W Revision	Prior to A.02.00

Mkr->CF

Sets the center frequency of the RF Spectrum window to the frequency of the selected marker. The marker stays at this frequency, so it moves to the center of the display.

In delta marker mode, this function sets the center frequency to the x-axis value of the delta marker.

Key Path	Marker ->
Remote Command	:CALCulate:AM FM PM FMSTereo:MARKer[1] 2 ... 12[:SET]:CENTer
Example	CALC:AM:MARK2:CENT sets the CF of the analyzer to the value of marker 2.
Remote Command Notes	Sending this command selects the sub-op coded marker. If the currently selected marker is not on when this key is pressed, it will be turned on at the center of the RF Spectrum trace as a normal type marker.
Dependencies	This function is unavailable (key is grayed out) unless the selected marker's trace is off, or on the RF Spectrum trace.
Couplings	All the usual couplings associated with setting Center Frequency apply (see " Center Frequency " on page 1097).
Initial S/W Revision	Prior to A.02.00
Modified at S/W Revision	A.10.00

Meas

The information in this section is common to all measurements. For key and remote command information for a specific measurement, refer to the section that describes the measurement of interest.

Measurements available under the Meas key are specific to the current Mode.

When viewing Help for measurements, note the following:

NOTE

Operation for some keys differs between measurements. The information displayed in Help pertains to the current measurement. To see how a key operates in a different measurement, exit Help (press the Cancel Esc key), select the measurement, then reenter Help (press the Help key) and press that key.

Key Path	Front-panel key
Initial S/W Revision	Prior to A.02.00

Remote Measurement Functions

This section contains the following topics:

"Measurement Group of Commands" on page 1122

"Current Measurement Query (Remote Command Only)" on page 1124

"Limit Test Current Results (Remote Command Only)" on page 1124

"Data Query (Remote Command Only)" on page 1124

"Calculate/Compress Trace Data Query (Remote Command Only)" on page 1125

"Calculate Peaks of Trace Data (Remote Command Only)" on page 1130

"Hardware-Accelerated Fast Power Measurement (Remote Command Only)" on page 1131

"Format Data: Numeric Data (Remote Command Only)" on page 1145

"Format Data: Byte Order (Remote Command Only)" on page 1146

Initial S/W Revision	Prior to A.02.00
----------------------	------------------

Measurement Group of Commands

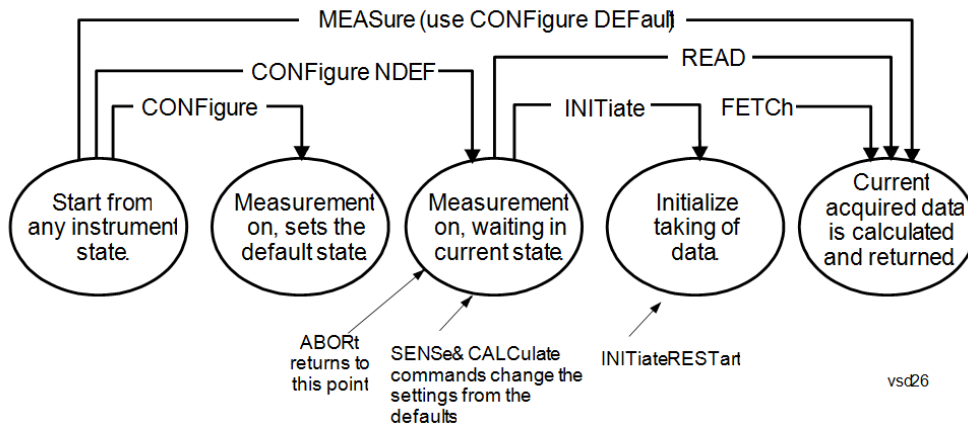

Measure Commands:

:MEASure:<measurement>[n]?

This is a fast single-command way to make a measurement using the factory default instrument settings. These are the settings and units that conform to the Mode Setup settings (e.g. radio standard) that you have currently selected.

- Stops the current measurement (if any) and sets up the instrument for the specified measurement using the factory defaults
- Initiates the data acquisition for the measurement
- Blocks other SCPI communication, waiting until the measurement is complete before returning results.
- If the function does averaging, it is turned on and the number of averages is set to 10.
- After the data is valid it returns the scalar results, or the trace data, for the specified measurement. The type of data returned may be defined by an [n] value that is sent with the command.
- The scalar measurement results will be returned if the optional [n] value is not included, or is set to 1. If the [n] value is set to a value other than 1, the selected trace data results will be returned. See each command for details of what types of scalar results or trace data results are available.
- ASCII is the default format for the data output. (Older versions of Spectrum Analysis and Phase Noise mode measurements only use ASCII.) The binary data formats should be used for handling large blocks of data since they are smaller and faster than the ASCII format. Refer to the FORMat:DATA command for more information.

If you need to change some of the measurement parameters from the factory default settings you can set up the measurement with the CONFigure command. Use the commands in the SENSe:<measurement> and CALCulate:<measurement> subsystems to change the settings. Then you can use the READ? command to initiate the measurement and query the results.

If you need to repeatedly make a given measurement with settings other than the factory defaults, you can use the commands in the SENSe:<measurement> and CALCulate:<measurement> subsystems to set up the measurement. Then use the READ? command to initiate the measurement and query results.

Measurement settings persist if you initiate a different measurement and then return to a previous one. Use READ:<measurement>? if you want to use those persistent settings. If you want to go back to the default settings, use MEASure:<measurement>?.

Configure Commands:

:CONFigure:<measurement>

This command stops the current measurement (if any) and sets up the instrument for the specified measurement using

the factory default instrument settings. It does not initiate the taking of measurement data unless INIT:CONTInuous is ON. If you change any measurement settings after using the CONFigure command, the READ command can be used to initiate a measurement without changing the settings back to their defaults.

In the Swept SA measurement in Spectrum Analyzer mode the CONFigure command also turns the averaging function on and sets the number of averages to 10 for all measurements.

:CONFigure: <measurement>: NDEFault stops the current measurement and changes to the specified measurement. It does not change the settings to the defaults. It does not initiate the taking of measurement data unless INIT:CONTInuous is ON.

The CONFigure? query returns the current measurement name.

The CONFigure:CATalog? query returns a quoted string of all licensed measurement names in the current mode. For example, "SAN, CHP, OBW, ACP, PST, TXP, SPUR, SEM, LIST".

Fetch Commands:

:FETCh:<measurement>[n]?

This command puts selected data from the most recent measurement into the output buffer. Use FETCh if you have already made a good measurement and you want to return several types of data (different [n] values, for example, both scalars and trace data) from a single measurement. FETCh saves you the time of re-making the measurement. You can only FETCh results from the measurement that is currently active, it will not change to a different measurement. An error message is reported if a measurement other than the current one is specified.

If you need to get new measurement data, use the READ command, which is equivalent to an INITiate followed by a FETCh.

The scalar measurement results will be returned if the optional [n] value is not included, or is set to 1. If the [n] value is set to a value other than 1, the selected trace data results will be returned. See each command for details of what types of scalar results or trace data results are available. The binary data formats should be used for handling large blocks of data since they are smaller and transfer faster than the ASCII format. (FORMat:DATA)

FETCh may be used to return results other than those specified with the original READ or MEASure command that you sent.

INITiate Commands:

:INITiate:<measurement>

This command is not available for measurements in all the instrument modes:

- Initiates a trigger cycle for the specified measurement, but does not output any data. You must then use the FETCh<meas> command to return data. If a measurement other than the current one is specified, the instrument will switch to that measurement and then initiate it.
- For example, suppose you have previously initiated the ACP measurement, but now you are running the channel power measurement. If you send INIT:ACP? it will change from channel power to ACP and will initiate an ACP measurement.
- Does not change any of the measurement settings. For example, if you have previously started the ACP measurement and you send INIT:ACP? it will initiate a new ACP measurement using the same instrument settings as the last time ACP was run.
- If your selected measurement is currently active (in the idle state) it triggers the measurement, assuming the trigger conditions are met. Then it completes one trigger cycle. Depending upon the measurement and the number of averages, there may be multiple data acquisitions, with multiple trigger events, for one full trigger cycle. It also holds off additional commands on GPIB until the acquisition is complete.

READ Commands:

:READ:<measurement>[n]?

- Does not preset the measurement to the factory default settings. For example, if you have previously initiated the ACP
-

measurement and you send READ:ACP? it will initiate a new measurement using the same instrument settings.

- Initiates the measurement and puts valid data into the output buffer. If a measurement other than the current one is specified, the instrument will switch to that measurement before it initiates the measurement and returns results.
 - For example, suppose you have previously initiated the ACP measurement, but now you are running the channel power measurement. Then you send READ:ACP? It will change from channel power back to ACP and, using the previous ACP settings, will initiate the measurement and return results.
 - Blocks other SCPI communication, waiting until the measurement is complete before returning the results
 - If the optional [n] value is not included, or is set to 1, the scalar measurement results will be returned. If the [n] value is set to a value other than 1, the selected trace data results will be returned. See each command for details of what types of scalar results or trace data results are available. The binary data formats should be used when handling large blocks of data since they are smaller and faster than the ASCII format. (FORMat:DATA)
-

Initial S/W Revision	Prior to A.02.00
----------------------	------------------

Current Measurement Query (Remote Command Only)

This command returns the name of the measurement that is currently running.

Remote Command	:CONFigure?
-----------------------	-------------

Example	CONF?
----------------	-------

Initial S/W Revision	Prior to A.02.00
----------------------	------------------

Limit Test Current Results (Remote Command Only)

Queries the status of the current measurement limit testing. It returns a 0 if the measured results pass when compared with the current limits. It returns a 1 if the measured results fail any limit tests.

Remote Command	:CALCulate:CLIMits:FAIL?
-----------------------	--------------------------

Example	CALC:CLIM:FAIL? queries the current measurement to see if it fails the defined limits. Returns a 0 or 1: 0 it passes, 1 it fails.
----------------	--

Initial S/W Revision	Prior to A.02.00
----------------------	------------------

Data Query (Remote Command Only)

Returns the designated measurement data for the currently selected measurement and subopcode.

n = any valid subopcode for the current measurement. See the measurement command results table for your current measurement, for information about what data is returned for the subopcodes.

This command uses the data setting specified by the FORMat:BORDER and FORMat:DATA commands and can return real or ASCII data. (See the format command descriptions under Input/Output in the Analyzer Setup section.)

Remote Command	:CALCulate:DATA[n]?
Notes	The return trace depends on the measurement. In CALCulate:<meas>:DATA[n], n is any valid subopcode for the current measurement. It returns the same data as the FETCH:<measurement>? query where <measurement> is the current measurement.
Initial S/W Revision	Prior to A.02.00

Calculate/Compress Trace Data Query (Remote Command Only)

Returns compressed data for the currently selected measurement and sub-opcode [n].

n = any valid sub-opcode for that measurement. See the MEASure:<measurement>? command description of your specific measurement for information on the data that can be returned.

The data is returned in the current Y Axis Unit of the analyzer. The command is used with a sub-opcode <n> (default=1) to specify the trace. With trace queries, it is best if the analyzer is not sweeping during the query. Therefore, it is generally advisable to be in Single Sweep, or Update=Off.

This command is used to compress or decimate a long trace to extract and return only the desired data. A typical example would be to acquire N frames of GSM data and return the mean power of the first burst in each frame. The command can also be used to identify the best curve fit for the data.

Remote Command	:CALCulate:DATA<n>:COMPRESS? BLOCK CFIT MAXimum MINimum MEAN DMEan RMS RMSCubed SAMPLE SDEVIation PPHase [,<soffset> [,<length>[,<roffset>[,<rlimit>]]]]
Example	To query the mean power of a set of GSM bursts: Supply a signal that is a set of GSM bursts. Select the IQ Waveform measurement (in IQ Analyzer Mode). Set the sweep time to acquire at least one burst. Set the triggers such that acquisition happens at a known position relative to a burst. Then query the mean burst levels using, CALC:DATA2:COMP? MEAN, 24e-6, 526e-6 (These parameter values correspond to GSM signals, where 526e-6 is the length of the burst in the slot and you just want 1 burst.)
Notes	The command supports 5 parameters. Note that the last 4 (<soffset>, <length>, <roffset>, <rlimit>) are optional. But these optional parameters must be entered in the specified order. For example, if you want to specify <length>, then you must also specify <soffset>. See details below for a definition of each of these parameters. This command uses the data in the format specified by FORMat:DATA, returning either binary or ASCII data.
Initial S/W Revision	Prior to A.02.00

- BLOCK or block data - returns all the data points from the region of the trace data that you specify. For example, it could be used to return the data points of an input signal over several timeslots, excluding the portions of the trace data that you do not want. (This is x,y pairs for trace data and I,Q pairs for complex data.)

- CFIT or curve fit - applies curve fitting routines to the data. <soffset> and <length> are required to define the data that you want. <roffset> is an optional parameter for the desired order of the curve equation. The query will return the following values: the x-offset (in seconds) and the curve coefficients ((order + 1) values).

MIN, MAX, MEAN, DME, RMS, RMSC, SAMP, SDEV and PPH return one data value for each specified region (or <length>) of trace data, for as many regions as possible until you run out of trace data (using <roffset> to specify regions). Or they return the number of regions you specify (using <rlimit>) ignoring any data beyond that.

- MINimum - returns the minimum data point (y value) for the specified region(s) of trace data. For I/Q trace data, the minimum magnitude of the I/Q pairs is returned.
- MAXimum - returns the maximum data point (y value) for the specified region(s) of trace data. For I/Q trace data, the maximum magnitude of the I/Q pairs is returned.
- MEAN - returns a single value that is the arithmetic mean of the data point values (in dB/ dBm) for the specified region(s) of trace data. For I/Q trace data, the mean of the magnitudes of the I/Q pairs is returned. See the following equations.

NOTE If the original trace data is in dB, this function returns the arithmetic mean of those log values, not log of the mean power which is a more useful value. The mean of the log is the better measurement technique when measuring CW signals in the presence of noise. The mean of the power, expressed in dB, is useful in power measurements such as Channel Power. To achieve the mean of the power, use the RMS option.

Equation 1

Mean Value of Data Points for Specified Region(s)

$$MEAN = \frac{1}{n} \sum_{X_i \in \text{region}(s)} X_i$$

where X_i is a data point value, and n is the number of data points in the specified region(s).

Equation 2

Mean Value of I/Q Data Pairs for Specified Region(s)

$$MEAN = \frac{1}{n} \sum_{X_i \in \text{region}(s)} |X_i|$$

where $|X_i|$ is the magnitude of an I/Q pair, and n is the number of I/Q pairs in the specified region(s).

- DMEan - returns a single value that is the mean power (in dB/ dBm) of the data point values for the specified region(s) of trace data. See the following equation:

Equation 3

DMEan Value of Data Points for Specified Region(s)

$$\text{DME} = 10 \times \log_{10} \left(\frac{1}{n} \sum_{X_i \in \text{region}(s)} 10^{\frac{X_i}{10}} \right)$$

- RMS - returns a single value that is the average power on a root-mean-squared voltage scale (arithmetic rms) of the data point values for the specified region(s) of trace data. See the following equation.

NOTE

For I/Q trace data, the rms of the magnitudes of the I/Q pairs is returned. See the following equation. This function is very useful for I/Q trace data. However, if the original trace data is in dB, this function returns the rms of the log values which is not usually needed.

Equation 4

RMS Value of Data Points for Specified Region(s)

$$\text{RMS} = \sqrt{\frac{1}{n} \sum_{X_i \in \text{region}(s)} X_i^2}$$

where X_i is a data point value, and n is the number of data points in the specified region(s).

Equation 5

RMS Value of I/Q Data Pairs for Specified Region(s)

$$\text{RMS} = \sqrt{\frac{1}{n} \sum_{X_i \in \text{region}(s)} X_i X_i^*}$$

where X_i is the complex value representation of an I/Q pair, X_i^* its conjugate complex number, and n is the number of I/Q pairs in the specified region(s).

Once you have the rms value for a region of trace data (linear or I/Q), you may want to calculate the mean power. You must convert this rms value (peak volts) to power in dBm:

$$10 \times \log[10 \times (\text{rms value})^2]$$

- SAMPLe - returns the first data value (x,y pair) for the specified region(s) of trace data. For I/Q trace data, the first I/Q pair is returned.
- SDEViation - returns a single value that is the arithmetic standard deviation for the data point values for the specified region(s) of trace data. See the following equation.
- For I/Q trace data, the standard deviation of the magnitudes of the I/Q pairs is returned. See the following equation.

Equation 6

Standard Deviation of Data Point Values for Specified Region(s)

$$\text{SDEV} = \sqrt{\frac{1}{n} \sum_{X_i \in \text{region}(s)} (X_i - \bar{X})^2}$$

where X_i is a data point value, \bar{X} is the arithmetic mean of the data point values for the specified region (s), and n is the number of data points in the specified region(s).

$$\text{SDEV} = \sqrt{\frac{1}{n} \sum_{X_i \in \text{region}(s)} (|X_i| - \bar{X})^2}$$

where $|X_i|$ is the magnitude of an I/Q pair, \bar{X} is the mean of the magnitudes for the specified region(s), and n is the number of data points in the specified region(s).

- PPHase - returns the x,y pairs of both rms power (dBm) and arithmetic mean phase (radian) for every specified region and frequency offset (Hz). The number of pairs is defined by the specified number of regions. This parameter can be used for I/Q vector ($n=0$) in Waveform (time domain) measurement and all parameters are specified by data point in PPHase.

The rms power of the specified region may be expressed as:

$$\text{Power} = 10 \times \log [10 \times (\text{RMS I/Q value})] + 10.$$

The RMS I/Q value (peak volts) is:

$$\sqrt{\frac{1}{n} \sum_{X_i \in \text{region}} X_i X_i^*}$$

where X_i is the complex value representation of an I/Q pair, X_i^* its conjugate complex number, and n is the number of I/Q pairs in the specified region.

The arithmetic mean phase of the specified region may be expressed as:

$$\frac{1}{n} \sum_{Y_i \in \text{region}} Y_i$$

where Y_i is the unwrapped phase of I/Q pair with applying frequency correction and n is the number of I/Q pairs in the specified region.

The frequency correction is made by the frequency offset calculated by the arithmetic mean of every specified region's frequency offset. Each frequency offset is calculated by the least square method against the unwrapped phase of I/Q pair.

Sample Trace Data - Constant Envelope

(See below for explanation of variables.)

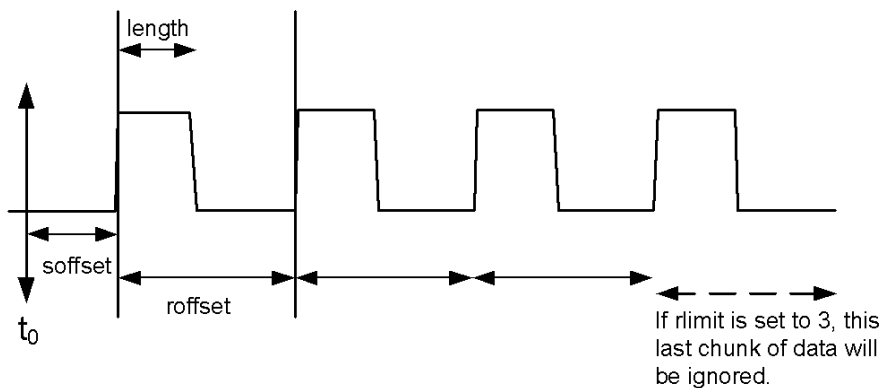

Sample Trace Data - Not Constant Envelope

(See below for explanation of variables.)

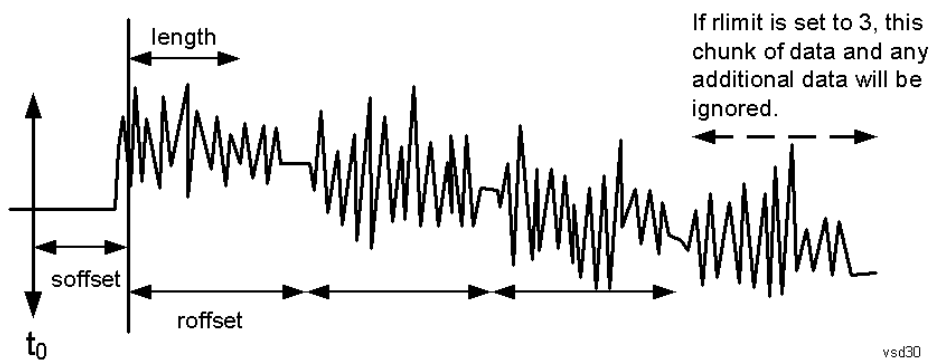

<soffset> - start offset is an optional real number. (It is in seconds for time-domain traces, and is a dimensionless index 0 to Npoints - 1, for frequency-domain traces). It specifies the amount of data at the beginning of the trace that will be ignored before the decimation process starts. It is the time or frequency change from the start of the trace to the point where you want to start using the data. The default value is zero.

<length> - is an optional real number. (It is in seconds for time-domain traces, and is a dimensionless index 0 to Npoints - 1, for frequency-domain traces). It defines how much data will be compressed into one value. This parameter has a default value equal to the current trace length.

<roffset> - repeat offset is an optional real number. (It is in seconds for time-domain traces, and is a dimensionless index 0 to Npoints - 1, for frequency-domain traces). It defines the beginning of the next field of trace elements to be compressed. This is relative to the beginning of the previous field. This parameter has a default value equal to the <length> variable. Note that this parameter is used for a completely different purpose when curve fitting (see CFIT above).

<rlimit> - repeat limit is an optional integer. It specifies the number of data items that you want returned. It will ignore any additional items beyond that number. You can use the Start offset and the Repeat limit to pick out exactly what part of the data you want to use. The default value is all the data.

Calculate Peaks of Trace Data (Remote Command Only)

Returns a list of all the peaks for the currently selected measurement and sub-opcode [n]. The peaks must meet the requirements of the peak threshold and excursion values.

n = any valid sub-opcode for the current measurement. See the MEASure:<measurement> command description of your specific measurement for information on the data that can be returned.

The command can only be used with specific sub-opcodes with measurement results that are trace data. Both real and complex traces can be searched, but complex traces are converted to magnitude in dBm. In many measurements the sub-opcode n=0, is the raw trace data which cannot be searched for peaks. And Sub-opcode n=1, is often calculated results values which also cannot be searched for peaks.

This command uses the data setting specified by the FORMat:BORDER and FORMat:DATA commands and can return real or ASCII data. If the format is set to INT,32, it returns REAL,32 data.

The command has four types of parameters:

- Threshold (in dBm)
- Excursion (in dB)
- Sorting order (amplitude, frequency, time)
- Optional in some measurements: Display line use (all, > display line, < display line)

Remote Command	<p>For Swept SA measurement:</p> <pre>:CALCulate:DATA[1] 2 ... 6:PEAKs? <threshold>,<excursion>[,AMPLitude FREQuency TIME[,ALL GTDLLine LTDLine]]</pre> <p>For most other measurements:</p> <pre>:CALCulate:DATA[1] 2 ... 6:PEAKs? <threshold>,<excursion>[,AMPLitude FREQuency TIME]</pre>
-----------------------	---

Example	<p>Example for Swept SA measurement in Spectrum Analyzer Mode:</p> <p>CALC:DATA4:PEAK? -40, 10, FREQ, GTDL This will identify the peaks of trace 4 that are above -40 dBm, with excursions of at least 10 dB. The peaks are returned in order of increasing frequency, starting with the lowest frequency. Only the peaks that are above the display line are returned.</p> <p>Query Results 1:</p> <p>With FORMat:DATA REAL, 32 selected, it returns a list of floating-point numbers. The first value in the list is the number of peak points that are in the following list. A peak point consists of two values: a peak amplitude followed by its corresponding frequency (or time).</p> <p>If no peaks are found the peak list will consist of only the number of peaks, (0).</p>
----------------	---

Notes	<p><n> - is the trace that will be used</p> <p><threshold> - is the level below which trace data peaks are ignored. Note that the threshold value is required and is always used as a peak criterion. To effectively disable the threshold criterion for this command, provide a substantially low threshold value such as -200 dBm. Also note that the threshold value used in this command is independent of and has no effect on the threshold value stored under the Peak Criteria menu.</p> <p><excursion> - is the minimum amplitude variation (rise and fall) required for a signal to be identified as peak. Note that the excursion value is required and is always used as a peak criterion. To effectively disable the excursion criterion for this command, provide the minimum value of 0.0 dB. Also note that the excursion value used in this command is independent of and has no effect on the</p>
--------------	---

excursion value stored under the Peak Criteria menu.

Values must be provided for threshold and excursion. The sorting and display line parameters are optional (defaults are AMPLitude and ALL).

Note that there is always a Y-axis value for the display line, regardless of whether the display line state is on or off. It is the current Y-axis value of the display line which is used by this command to determine whether a peak should be reported. Sorting order:

AMPLitude - lists the peaks in order of descending amplitude, with the highest peak first (default if optional parameter not sent)

FREQUENCY - lists the peaks in order of occurrence, left to right across the x-axis.

TIME - lists the peaks in order of occurrence, left to right across the x-axis.

Peaks vs. Display Line:

ALL - lists all of the peaks found (default if optional parameter not sent).

GTDLine (greater than display line) - lists all of the peaks found above the display line.

LTDLine (less than display line) - lists all of the peaks found below the display line.

Initial S/W Revision	Prior to A.02.00
----------------------	------------------

Hardware-Accelerated Fast Power Measurement (Remote Command Only)

The Fast Power option (FP2) enables very fast channel power measurements for instruments with the prerequisite hardware (DP2 and/or B40). It accomplishes this by performing real-time overlapped FFTs at the hardware layer, using software for basic post-processing before returning the result to the user. The upshot of this approach is improved throughput for user applications that require many sequential power measurements.

The analysis bandwidth of FP2 is limited by the licenses in the instrument, but its maximum overall analysis bandwidth per acquisition is 40 MHz.

FP2 is remote-only, which means the instrument does not switch to any particular mode or measurement. FP2 commands can be sent while another application is in use on the front panel.

Each Fast Power measurement can be predefined using an array index, and up to 1,000 measurements can be stored. In the following documentation, instances of [1,2,...,999] can be substituted with a particular measurement index, e.g. CALC:FPOW:POW1?, CALC:FPOW:POW2?, CALC:FPOW:POW134?. In this way, power measurements can be defined one time in a batch, and then executed multiple times without having to redefine them, similar to “list mode” on other measurements.

In addition to basic channel power measurements, there are a number of other measurement “functions” for each channel, including peak power, peak frequency, and power spectral density. See the Function parameter for more information.

Reset Fast Power Measurement (Remote Command Only)

Resets the measurement configuration to the defaults.

Mode	All
Remote Command	:CALCulate:FPOWer:POWer[1,2,...,999]:RESet
Example	:CALC:FPOW:POW1:RES

Notes	Option FP2 is required.
Initial S/W Revision	A.14.00

Define Fast Power Measurement (Remote Command Only)

Fast Power acquisitions are configured using the DEFine command. This command accepts a comma-delimited string of configuration parameters and their appropriate values, which are all specified in the subsection below.

Mode	All
Remote Command	:CALCulate:FPOWER:POWer[1,2,...,999]:DEFine "configuration string"
Example	:CALC:FPOW:POW1:DEF "CenterFrequency=2e9, AcquisitionTime=0.005"
Notes	See below for a list of measurement variables that can be defined in the configuration string.
Initial S/W Revision	A.14.00

Acquisition Time

Example	CALC:FPOW:POW1:DEF "AcquisitionTime=0.002"
Notes	The acquisition time parameter sets the time in which the entire spectrum is measured. An increase in the acquisition time yields an improvement in measurement repeatability.
Preset	0.001 s
Range	0 s to 1 s
Default Unit	Time (s)
Initial S/W Revision	A.14.00

Center Frequency

Example	CALC:FPOW:POW1:DEF "CenterFrequency=2e9"
Notes	The center frequency parameter sets the frequency in which the measurement is centered around. The OffsetFrequency parameter is calculated relative to the center frequency.
Preset	1 GHz
Range	0 Hz to maximum instrument frequency
Default Unit	Frequency (Hz)
Initial S/W Revision	A.14.00

DC Coupled

Example	CALC:FPOW:POW1:DEF "DCCoupled=True"
Notes	The DC coupled parameter allows the user to specify whether the DC blocking capacitor is utilized. Set parameter to true when measuring frequencies below 10 MHz.
Preset	False
Range	True (DC Coupled) or False (AC Coupled)
Default Unit	Boolean
Initial S/W Revision	A.14.00

DetectorType

Example	CALC:FPOW:POW1:DEF "DetectorType=Peak"
Notes	Option FP2 is required. The detector type parameter allows the user to choose whether a RMS average or peak value is used during the measurement.
Preset	RmsAverage
Range	RmsAverage, Peak
Initial S/W Revision	A.14.00

Do Noise Correction

Example	CALC:FPOW:POW1:DEF "DoNoiseCorrection=True"
Notes	When noise correction is enabled, the linear noise power contributed by the analyzer is subtracted from all measurements. This effectively lowers the noise floor of the analyzer. When noise correction is enabled, the first measurement for a given set of input parameters will take extra time. This is because the analyzer takes an extra acquisition with the RF input disconnected from the analyzer's front end to measure the noise of just the analyzer. The measured noise floor is stored in a cache so the noise acquisition will occur only once for the same state settings. In other words, if noise correction was turned on and the analyzer made an acquisition at frequency A, then frequency B, and back again to frequency A, the hidden initial noise floor acquisition would only occur for the first acquisition at frequency A and the cached noise floor would be used the second time frequency A was measured.
Preset	False
Range	True (enable noise correction) or False (disable noise correction)
Default Unit	Boolean
Initial S/W Revision	A.14.00

Do Spur Suppression

Example	CALC:FPOW:POW1:DEF "DoSpurSuppression=True"
Notes	<p>When measuring very low level signals, or when large out-of-band inputs are input into the analyzer, sometimes unwanted spurs and residuals can appear in the measured spectrum. Spur suppression is a method to help minimize the levels of these internally generated spurs and residuals.</p> <p>When spur suppression is enabled, the analyzer will automatically take two acquisitions using two different internal analog LO frequencies. The FFT spectrums from both acquisitions are combined by taking the minimum power between both traces on a per FFT bin basis. External signals will have the same amplitude for both traces and therefore will return the expected amplitudes. However, low level spurs and residuals generated internally to the analyzer tend to move to different FFT bins depending on the internal analog LO frequency used, and therefore tend to be suppressed using this spur suppression method.</p> <p>Because two acquisitions, rather than a single acquisition, are made when spur suppression is enabled, the measurement time will always be slower when spur suppression is enabled.</p>
Preset	False
Range	True (enable spur suppression) or False (disable spur suppression)
Default Unit	Boolean
Initial S/W Revision	A.14.00

Electronic Attenuator Bypass

Example	CALC:FPOW:POW1:DEF "ElecAttBypass =False"
Notes	The electronic attenuation bypass parameter allows the user to either utilize or bypass the electronic attenuator. The electronic attenuator is only available for frequencies up to 3.6 GHz. Set parameter to true when using frequencies above 3.6 GHz and set the parameter to false when using the preamp.
Preset	True
Range	True (bypass electronic attenuator) or False (use electronic attenuator)
Default Unit	Boolean
Initial S/W Revision	A.14.00

Electronic Attenuation

Example	CALC:FPOW:POW1:DEF "ElecAttenuation=10"
Notes	<p>Option EA3 is required.</p> <p>The electronic attenuation value parameter sets the amount of electrical attenuation from 0 to 24 dB (1 dB steps).</p> <p>Set "ElecAttBypass=False" to make sure the electronic attenuator path is enabled.</p>
Preset	0 dB
Range	0 – 24 dB (1 dB steps)

Default Unit	dB
Initial S/W Revision	A.14.00

IF Gain

Example	CALC:FPOW:POW1:DEF "IFGain=10"
Notes	The IF gain parameter allows the user to specify the gain at the IF stage anywhere from -6 to 16 dB (1 dB steps). This is an advanced feature, and for most cases this should remain at its default value of 0 dB.
Preset	0 dB
Range	-6 - 16 dB (1 dB steps)
Default Unit	dB
Initial S/W Revision	A.14.00

IF Type

Example	CALC:FPOW:POW1:DEF "IFType=B25M"
Notes	The IF type parameter allows the user to select between different IF paths. For example, if the signal is less than 25 MHz wide, then the user can select the B25M path to take advantage of additional filtering on this analog IF path.
Preset	B40M
Range	B10M, B25M, B40M
Initial S/W Revision	A.14.00

Include Power Spectrum

Example	CALC:FPOW:POW1:DEF "IncludePowerSpectrum=True"
Notes	The power spectrum parameter allows the user to read data on the entire spectrum for diagnostic purposes. It is not recommended for production use. See CALC:FPOW:POW[n]:READ2? for details on the binary format of the response.
Preset	False
Range	True (return both channel power and full power spectrum) or False (returns only channel power)
Default Unit	Boolean
Initial S/W Revision	A.14.00

Mechanical Attenuation

Example	CALC:FPOW:POW1:DEF "MechAttenuation=10"
Notes	The mechanical attenuation value parameter sets the amount of mechanical attenuation anywhere from 0 to 70 dB (2 dB steps).
Preset	0 dB
Range	0 – 70 dB (2 dB steps)
Default Unit	dB
Initial S/W Revision	A.14.00

Preamp Mode

Example	CALC:FPOW:POW1:DEF "PreAmpMode=Low"
Notes	The license for the appropriate preamp is required. The preamp mode parameter specifies whether the preamps are being utilized. Low allows any preamps up to 3.6 GHz, and Full allows all licensed preamps. Set "ElecAttBypass=True" in order to utilize any preamps.
Preset	Off
Range	Off, Low, Full
Initial S/W Revision	A.14.00

Resolution Bandwidth Mode

Example	CALC:FPOW:POW1:DEF "PreAmpMode=Low"
Notes	The resolution bandwidth mode parameter allows the user to choose whether the RBW filter is automatically or manually set. The BestSpeed value minimizes measurement time, while the Narrowest value minimizes RBW size (minimum of two FFT bins per RBW). To manually specify an RBW, set this parameter to Explicit, and set the ResolutionBW parameter to the desired value.
Preset	BestSpeed
Range	BestSpeed, Narrowest, Explicit
Initial S/W Revision	A.14.00

Resolution Bandwidth

Example	CALC:FPOW:POW1:DEF "ResolutionBW=25e3"
Notes	The resolution bandwidth parameter sets the 3-dB bandwidth of the RBW filter. The ResolutionBWMode parameter must be set to Explicit in order to manually set the RBW.

Preset	0 Hz
Default Unit	Hz
Initial S/W Revision	A.14.00

Trigger Delay

Example	CALC:FPOW:POW1:DEF "TriggerDelay=0.025"
Notes	The trigger delay parameter sets the time after an external trigger is detected until the measurement is performed.
Preset	0 s
Range	0 – 1 s
Default Unit	Seconds
Initial S/W Revision	A.14.00

Trigger Level

Example	CALC:FPOW:POW1:DEF "TriggerLevel=2"
Notes	The trigger level parameter sets the voltage value at which an external trigger is detected.
Preset	1.2 V
Range	-5 to 5 V
Default Unit	Volts
Initial S/W Revision	A.14.00

Trigger Slope

Example	CALC:FPOW:POW1:DEF "TriggerSlope=Negative"
Notes	The trigger slope parameter indicates the direction of the edge trigger voltage for detection.
Preset	Positive
Range	Positive, Negative
Initial S/W Revision	A.14.00

Trigger Source

Example	CALC:FPOW:POW1:DEF "TriggerSource=Ext1"
Notes	The trigger source parameter allows the user to choose between measurement's triggering freely or controlled by an external input. Ext1 and Ext2 correspond to Trigger 1 In and Trigger 2 In, respectively.
Preset	Free
Range	Free, Ext1, Ext2
Initial S/W Revision	A.14.00

Trigger Timeout

Example	CALC:FPOW:POW1:DEF "TriggerTimeout=0.1"
Notes	The trigger timeout parameter sets the time in which the analyzer will wait for a trigger before automatically performing the measurement.
Preset	1 s
Range	0 - 1 s
Default Unit	Seconds
Initial S/W Revision	A.14.00

Signal Input

Example	CALC:FPOW:POW1:DEF "SignalInput=Fp50MHzCW"
Notes	The signal input parameter allows the user to select between using the main RF input or the internal analyzer reference CW signal of 50 MHz.
Preset	FpMainRf
Range	FpMainRf, Fp50MHzCW
Initial S/W Revision	A.14.00

Use Preselector

Example	CALC:FPOW:POW1:DEF "UsePreSelector=True"
Notes	The preselector parameter allows the user to either utilize or bypass the front end tunable filter at frequencies above 3.6 GHz. For frequencies below 3.6 GHz, the preselector is automatically bypassed, so you do not need to set this parameter to False in those cases.
Preset	False
Range	True (use preselector above 3.6 GHz), or False (preselector bypassed)

Default Unit	Boolean
Initial S/W Revision	A.14.00

Channel Bandwidth Array

Example	CALC:FPOW:POW1:DEF "Bandwidth=[3.84e6, 5e6, 3.84e6]"
Notes	The bandwidth parameter array defines the bandwidth of each channel that will be measured. All array parameters should have the same number of elements. Alternatively, if all the elements are the same value, a single number with no square brackets can be used to define the parameter.
Preset	[1 e6]
Range	0 to 40 MHz
Default Unit	Hz
Initial S/W Revision	A.14.00

Channel Filter Type Array

Example	CALC:FPOW:POW1:DEF "FilterType=[RRC, IBW, RRC]"
Notes	The filter type parameter allows the user to choose between an integration bandwidth (IBW) filter or a root-raised-cosine (RRC) filter. The integration bandwidth filter weighs all frequencies within the bandwidth equally. The root-raised-cosine filter has an associated shape parameter, defined by the FilterAlpha parameter. All array parameters should have the same number of elements. Alternatively, if all the elements are the same value, a single value with no square brackets can be used to define the parameter.
Preset	[IBW]
Range	IBW, RRC
Initial S/W Revision	A.14.00

Channel Filter Alpha Array

Example	CALC:FPOW:POW1:DEF "FilterAlpha=[0.5, 0.0, 0.5]"
Notes	The filter alpha parameter allows the user to adjust the alpha value associated with the root-raised-cosine (RRC) filter type. Set FilterType to RRC in order to utilize this parameter. All array parameters should have the same number of elements. Alternatively, if all the elements are the same value, a single number with no square brackets can be used to define the parameter.
Preset	[0.22]
Range	0.0 – 1.0
Initial S/W Revision	A.14.00

Channel Measurement Function Array

Example	CALC:FPOW:POW1:DEF "Function=[BandPower, PeakPower, BandPower]"
Notes	<p>This parameter array defines what measurement is being made for each individually-specified channel:</p> <p>BandPower: Total power within the specified bandwidth of the channel (dBm)</p> <p>BandDensity: Total power density within the specified bandwidth of the channel (dBm/Hz)</p> <p>PeakPower: The peak power value within the specified bandwidth of the channel (dBm)</p> <p>PeakFrequency: The frequency which corresponds to the peak power value within the specified bandwidth of the channel. This frequency is relative to the center frequency (Hz)</p> <p>XdBBandwidth: The half power (-3.01 dB) bandwidth of the highest amplitude signal that resides within the channel (Hz), dB is configurable using XdBBandwidth parameter</p> <p>OccupiedBandwidth: The bandwidth at which 99% of the total power resides within the channel (Hz), percentage configurable using OccupiedBandwidthPercent parameter</p> <p>All array parameters should have the same number of elements. Alternatively, if all the elements are the same value, a single value with no square brackets can be used to define the parameter.</p>
Preset	[BandPower]
Range	BandPower, BandDensity, PeakPower, PeakFrequency, XdBBandwidth, OccupiedBandwidth
Initial S/W Revision	A.14.00

Channel Offset Frequency Array

Example	CALC:FPOW:POW1:DEF "OffsetFrequency=[-5e6, 0, 5e6]"
Notes	<p>The offset frequency parameter array defines the difference between the center frequency to the center frequency of each channel.</p> <p>All array parameters should have the same number of elements.</p>
Preset	[0]
Range	0 to 20 MHz
Default Unit	Hz
Initial S/W Revision	A.14.00

Channel Occupied Bandwidth Percent Array

Example	CALC:FPOW:POW1:DEF "OccupiedBandwidthPercent =[0.95, 0.95, 0.95]"
Notes	<p>This parameter only applies for channels whose Function is set to OccupiedBandwidth. The occupied bandwidth percent parameter specifies the percent of total power in these channels. The valid range for this parameter is 0.0 to 1.0, where 1.0 represents 100%. The default for this parameter is 0.99, which will return the bandwidth that contains 99% of the total channel power.</p>

Preset	[0.99]
Range	0 – 1.0
Initial S/W Revision	A.14.00

Channel x-dB Bandwidth Array

Example	CALC:FPOW:POW1:DEF " XdBBandwidth =[-6.02, -3.01, -1.0]"
Notes	This parameter only applies for channels whose Function is set to XdBBandwidth. The X dB bandwidth parameter is used to specify the power relative to the peak channel power over which the bandwidth is calculated. The parameter value must be a negative number.
Preset	[-3.01]
Range	-200 to 0 dB
Default Unit	dB
Initial S/W Revision	A.14.00

Define Fast Power Measurement Query (Remote Command Only)

The DEFine? command is used to retrieve a list of all defined parameters in an ASCII string format

M o d e	All
R e m o t e	:CALCulate:FPOWER:POWER[1,2,...,999]:DEFine?
C o m m a n d	
E x a m	:CALC:FPOW:POW1:DEF?

p
l
e

N This command query is used to retrieve a list of all defined parameters in an ASCII format.
o The following is an example of the returned results:
t "DCCoupled=False,ElecAttBypass=True,ElecAttenuation=0,IFGain=0,MechAttenuation=0,PreAmpMode=Off,PreSelectorOffset
e =0,UsePreSelector=False,ExternalReferenceFrequency=10000000,FrequencyReferenceSource=AutoExternalFrequencyRefer
s ence,IFType=B40M,LOMode=SLW,SignalInput=FpMainRf,AcquisitionTime=0.001,CenterFrequency=1000000000,Resolution
 BW=0,ResolutionBWMode=BestSpeed,DetectorType=RmsAverage,Bandwidth=[1000000],OffsetFrequency=[0],Function=
 [BandPower],FilterType=[IBW],FilterAlpha=[0.22],OccupiedBandwidthPercent=[0.99],XdBBandwidth=[-
 3.01],DoNoiseCorrection=False,DoSpurSuppression=False,MeasurementMethod=HardwareFFT,IncludePowerSpectrum=False,
 e,TriggerDelay=0,TriggerLevel=1.2,TriggerSlope=Positive,TriggerSource=Free,TriggerTimeout=1 "

I A.14.00
n
i
t
i
a
l

S
/
W

R
e
v
i
s
i
o
n

Configure Fast Power Measurement (Remote Command Only)

The configure command begins hardware setup and returns immediately, with no acquisition made. This can be used in parallel with other hardware operations to effectively hide the hardware setup time.

Mode	All
Remote Command	:CALCulate:FPOWer:POWer[1,2,...,999]:CONFigure
Example	:CALC:FPOW:POW1:CONF
Notes	Option FP2 is required.
Initial S/W Revision	A.14.00

Initiate Fast Power Measurement (Remote Command Only)

The INITiate command begins an acquisition and returns immediately. The results of the measurement can be retrieved using FETCh.

Mode	All
Remote Command	:CALCulate:FPOWER:POWER[1,2,...,999]:INITiate
Example	:CALC:FPOW:POW1:INIT
Notes	Option FP2 is required.
Initial S/W Revision	A.14.00

Fetch Fast Power Measurement (Remote Command Only)

The FETCh command query is used to retrieve the results of an acquisition initiated by the INIT command. The returned results are in ASCII string format. The string begins and ends with quotation marks.

Mode	All
Remote Command	:CALCulate:FPOWER:POWER[1,2,...,999]:FETCh?
Example	:CALC:FPOW:POW1:FETC?
Notes	Option FP2 is required. Returns m comma-separated ASCII values, where m corresponds to the number of bandwidths defined. 1. Declared function return in the 1st specified channel 2. Declared function return in the 2nd specified channel ... m. Declared function return in the last specified channel The INIT and FETC? command sequence performs the same functionality of a single CALC:FPOW:POW[n]? query. Units of the returned values are dependent on the Function parameter for each channel.
Initial S/W Revision	A.14.00

Execute Fast Power Measurement (Remote Command Only)

This command query is used as shorthand for an INIT command immediately followed by a FETC? command. The returned results are in ASCII string format. The string begins and ends with quotation marks.

Mode	All
Remote Command	:CALCulate:FPOWER:POWER[1,2,...,999]?
Example	:CALC:FPOW:POW1?
Notes	Option FP2 is required. See notes for Fast Power Fetch for return format.
Initial S/W Revision	A.14.00

Binary Read Fast Power Measurement (Remote Command Only)

This command query is used as shorthand for an INIT command immediately followed by a FETC? command. The returned results are in a binary format.

Mode	All
Remote Command	:CALCulate:FPOWER:POWER[1,2,...,999]:READ? :CALCulate:FPOWER:POWER[1,2,...,999]:READ1?
Example	:CALC:FPOW:POW1:READ? :CALC:FPOW:POW1:READ1?
Notes	Option FP2 is required. Returns m 4 byte floating point binary values (Little-Endian), where m corresponds to the number of bandwidths defined.
Initial S/W Revision	A.14.00

Diagnostic Binary Read Fast Power Measurement (Remote Command Only)

This command query is used as shorthand for an INIT command immediately followed by a FETC? command. The returned results are in a binary format. This command is used primarily for diagnostic purposes to test for ADC overloads and to visibly inspect the spectrum.

Mode	All
Remote Command	:CALCulate:FPOWER:POWER[1,2,...,999]:READ2?
Example	:CALC:FPOW:POW1:READ2?
Notes	Option FP2 is required. Note: Spectrum data is only returned if the IncludePowerSpectrum parameter is set to True. If IncludePowerSpectrum is False, the number of spectrum points will be zero (0). Units of the returned values are dependent on the Function parameter per channel (e.g. dBm for BandPower, Hz for PeakFrequency). Returns binary data (Little-Endian) that contains information on m amount of channels, along with ADC over range and full spectrum data. The following is the binary format of the response. Bandwidth Return Value 1. Number of channels specified, m [4 byte int] 2. Declared function result for the 1st specified channel [4 byte float] 3. Declared function result for the 2nd specified channel [4 byte float] ... (m + 1). Declared function result for the last (mth) specified channel [4 byte float] ADC Over Range 1. ADC over-range occurred (1: true, 0: false) [2 byte short]

	<p>Spectrum Data</p> <ol style="list-style-type: none"> 1. Number of points in the spectrum data, k [4 byte int] 2. Start frequency of spectrum data (Hz) [8 byte double] 3. Step frequency of spectrum data (Hz) [8 byte double] 4. FFT bin at 1st point (dBm) [4 byte float] 5. FFT bin at 2nd point (dBm) [4 byte float] <p>...</p> <p>(k + 3). FFT bin at last (kth) point (dBm) [4 byte float]</p>
Initial S/W Revision	A.14.00

Format Data: Numeric Data (Remote Command Only)

This command specifies the format of the trace data input and output. It specifies the formats used for trace data during data transfer across any remote port. It affects only the data format for setting and querying trace data for the :TRACe[:DATA], TRACe[:DATA]?, :CALCulate:DATA[n]? and FETCh:SANalyzer[n]? commands and queries.

Remote Command	:FORMat[:TRACe][:DATA] ASCii INTeger,32 REAL,32 REAL,64 :FORMat[:TRACe][:DATA]?
Notes	<p>The query response is:</p> <p>ASCii: ASC,8 REAL,32: REAL,32 REAL,64: REAL,64 INTeger,32: INT,32</p> <p>When the numeric data format is REAL or ASCii, data is output in the current Y Axis unit. When the data format is INTeger, data is output in units of m dBm (.001 dBm).</p> <p>The INT,32 format returns binary 32-bit integer values in internal units (m dBm), in a definite length block.</p>
Dependencies	<p>Sending a data format spec with an invalid number (for example, INT,48) generates no error. The analyzer simply uses the default (8 for ASCii, 32 for INTeger, 32 for REAL).</p> <p>Sending data to the analyzer which does not conform to the current FORMat specified, results in an error. Sending ASCII data when a definite block is expected generates message -161 "Invalid Block Data" and sending a definite block when ASCII data is expected generates message -121 "Invalid Character in Number".</p>
Preset	ASCii
Backwards Compatibility Notes	Note that the INT,32 format is only applicable to the command, TRACe:DATA. This preserves backwards compatibility for the Swept SA measurement. For all other commands/queries which honor FORMat:DATA, if INT,32 is sent the analyzer will behave as though it were set to REAL,32.
Initial S/W Revision	Prior to A.02.00

The specs for each output type follow:

AScii - Amplitude values are in ASCII, in the current Y Axis Unit, one ASCII character per digit, values separated by commas, each value in the form:

SX.YYYYYEsZZ

Where:

S = sign (+ or -)

X = one digit to left of decimal point

Y = 5 digits to right of decimal point

E = E, exponent header

s = sign of exponent (+ or -)

ZZ = two digit exponent

REAL,32 - Binary 32-bit real values in the current Y Axis Unit, in a definite length block.

REAL,64 - Binary 64-bit real values in the current Y Axis Unit, in a definite length block.

Format Data: Byte Order (Remote Command Only)

This command selects the binary data byte order for data transfer and other queries. It controls whether binary data is transferred in normal or swapped mode. This command affects only the byte order for setting and querying trace data for the :TRACe[:DATA], TRACe[:DATA]? , :CALCulate:DATA[n]? and FETCh:SANalyzer[n]? commands and queries.

By definition any command that says it uses FORMat:DATA uses any format supported by FORMat:DATA.

The NORMal order is a byte sequence that begins with the most significant byte (MSB) first, and ends with the least significant byte (LSB) last in the sequence: 1|2|3|4. SWAPped order is when the byte sequence begins with the LSB first, and ends with the MSB last in the sequence: 4|3|2|1.

Remote Command	:FORMat:BORDER NORMAL SWAPped :FORMat:BORDER?
Preset	NORMal
Initial S/W Revision	Prior to A.02.00

Meas Setup

Accesses a menu of keys that enable you to control specific parameters for the current measurement.

["Overview" on page 333](#)

["Set Parameters " on page 333](#)

Key Path	Front-panel key
Initial S/W Revision	Prior to A.02.00

Overview

This section describes the measurement setup features of the Analog Demod measurements.

Set Parameters

The following parameters are set as indicated and are not settable by the user, therefore they do not appear in any menus:

FFT IF Gain	Low (0 dB)
ADC Dither	On
Avg Mode	Exponential
Phase Noise Optimization	Auto

Auto Rules for Phase Noise Optimization:

Use "Optimize for $f < 20$ kHz" when the Channel BW < 120 kHz, otherwise use "Optimize for $f > 30$ kHz".

["Optimizing Measurement Speed" on page 333](#)

["Channel Bandwidth" on page 334](#)

["RF Spectrum Span " on page 334](#)

["RF Spectrum RBW / AF Spectrum RBW" on page 334](#)

["AF Waveform Sweep Time" on page 334](#)

["Filters and Annotation" on page 334](#)

Optimizing Measurement Speed

The speed of the analog demodulation measurements is driven largely by how much data must be acquired to satisfy the selected configuration.

Each measurement cycle generates all of the metrics and traces from a single acquisition, so there are several different settings which can affect the overall speed. Note that even though you may not be

viewing a particular result on the display, the result is available and its configuration and constraints are used to determine the acquisition settings.

Channel Bandwidth

This setting determines the sampling rate used by the measurement, higher bandwidths will result in larger data sets being acquired and processed. This should be set to the lowest value possible which allows your signal to be fully captured.

RF Spectrum Span

This setting is used in a similar way as the Channel Bandwidth in that it determines the sampling rate. As with channel bandwidth, it should be set as narrow as possible to capture the signal of interest.

RF Spectrum RBW / AF Spectrum RBW

These settings dictate a minimum acquisition time for the measurement. The Auto setting is recommended for optimal performance while maintaining measurement integrity. Narrower resolution bandwidths (RBWs) require longer acquisitions to achieve the resolution improvements.

AF Waveform Sweep Time

This setting sets another minimum acquisition time for the measurement. In many uses, the AF Spectrum RBW will dominate the determination of the data acquisition duration, but if the AF waveform view is not needed keeping its sweep time low will ensure that it does not negatively impact the throughput.

Filters and Annotation

You may choose to filter by frequency – choosing an optional low-pass filter and an optional high-pass filter – or may filter using a standard published band-pass filter (CCITT). Turning on a band-pass filter will automatically turn off the high-pass and low-pass filters; similarly, the band-pass filter will automatically turn off if you request either a high-pass or a low-pass filter.

Average/Hold Num

When turned on, the RF Spectrum and AF spectrum traces are averaged, and the Demod window shows an Average trace, a Max Hold trace, and a Min Hold trace in addition to the current trace. All metrics are averaged, and the metrics show an “Average” column and a “Max Hold” column.

The average feature for the Analog Demod measurement differs from other measurements in that the average type is fixed depending on the window as shown in the following table:

Window	Average Type
RF Spectrum	Pwr Average
Demod Waveform	Arithmetic Average
AF Spectrum	Log Average

For more details, see ["Average/Hold On/Off Functionality" on page 335](#).

Key Path	Meas Setup
----------	------------

Remote Command	[:SENSe]:AM FM PM FMSTereo:AVERage:COUNT <integer> [:SENSe]:AM FM PM FMSTereo:AVERage:COUNT? [:SENSe]:AM FM PM FMSTereo:AVERage[:STATe] ON OFF 1 0 [:SENSe]:AM FM PM FMSTereo:AVERage[:STATe]?
Example	AM:AVER:COUN 10
Preset	10 ON
State Saved	Saved in instrument state
Min	1
Max	9999
Initial S/W Revision	Prior to A.02.00
Modified at S/W Revision	A.10.00

Average/Hold On/Off Functionality

Average, Minhold, and Maxhold are coupled.

When Average/Hold is on:

- The RF Spectrum and AF Spectrum traces are averaged.
- The Demod Waveform window will display a current trace, an Average trace, a Max Hold trace, and a Min Hold trace.
- The Metrics window will display an “Average” column and a “Max Hold” column.
- Metrics will display to four significant digits.
- The Meas Bar will display the Average/Hold number (along with how many of those sweeps have been captured).
- Demod Min trace, Demod Max trace, and Demod Avg trace are maintained.
- The Max Hold column shows the maximum value the un-averaged metric has attained since the last Restart.

When Average/Max Hold is off:

- The RF Spectrum and AF Spectrum traces are not averaged.
- The Demod Waveform window will display only the demod trace.
- The Metrics window will display only a “Current” column.
- Metrics will display to two significant digits.
- The Meas Bar will not display the Average/Hold number.
- Max Hold metrics over SCPI will return SCPI not a number.

- Demod Min trace, Demod Max trace and Demod Avg trace will return default values in a Meas?, Read?, and Fetch? and when exported to a .csv file
- Max Hold column is blank.

Modulation Rate Periodic

The algorithms used by the instrument for demodulation have an improved speed/accuracy tradeoff when the modulation is both periodic (such as a sinusoidal test signal) and assumed to be periodic by the analysis system. Thus, “Yes” is best for periodic signals. When the modulation is aperiodic, such as voice or music or even multiple nonharmonically related tones, “No” gives better results.

Key Path	Meas Setup
Remote Command	<code>[:SENSe] :AM FM PM FMSTereo:PERIodic[:STATe] ON OFF 1 0</code> <code>[:SENSe] :AM FM PM FMSTereo:PERIodic[:STATe] ?</code>
Example	FM:PERI OFF
Preset	ON
State Saved	Saved in instrument state
Initial S/W Revision	A.12.00

Filters

Pressing this key displays the Filters menu, allowing you to control the post demodulation and de-emphasis filters.

If any filters are turned on and the filters cannot be applied, the error “161 Setting Modified; Filters not applied” will appear.

Key Path	Meas Setup
Initial S/W Revision	Prior to A.02.00

High Pass Filter (Post Demod)

This parameter allows you to adjust the post demodulation high pass filters. This filter allows you to remove unwanted low-frequency components from the modulated signal..

Key Path	Meas Setup, Filters
Remote Command	AM FM PM: <code>[:SENSe] :AM FM PM:HPFilter OFF HPF20 HPF50 HPF300 HPF400</code> <code>[:SENSe] :AM FM PM:HPFilter ?</code>
	FM Stereo: <code>[:SENSe] :FMSTereo:HPFilter OFF HPF20 HPF50 HPF300</code> <code>[:SENSe] :FMSTereo:HPFilter ?</code>

Example	FM:HPF HPF20
Remote Command Notes	<p>AM FM PM: Off = No filtering HPF20 = Use 20 Hz high pass filter HPF50 = Use 50 Hz high pass filter HPF300 = Use 300 Hz high pass filter HPF400 = Use 400 Hz high pass filter</p> <p>FM Stereo: Off = No filtering HPF20 = Use 20 Hz high pass filter HPF50 = Use 50 Hz high pass filter HPF300 = Use 300 Hz high pass filter</p>
Dependencies	The HPF400 is available only when Option N9063A-AFP is installed in AM/FM/PM.
Couplings	<p>AM/FM/PM: Turning on any high-pass filter will turn off bandpass filters. If a band-pass filter is turned off, the following advisory message is displayed: “Band-pass filter set to OFF”. If the band-pass filter was already off, no advisory message is displayed.</p> <p>FM Stereo: None</p>
Preset	Off (AM/FM/FM Stereo, HPF20 (PM))
State Saved	Saved in instrument state
Readback line	1-of-N selection
Initial S/W Revision	Prior to A.02.00
Modified at S/W Revision	A.14.00

Off

This selection turns the post demodulation high pass filter off.

Key Path	Meas Setup, HPF
Example	AM:HPF OFF
Notes	Annotation line (DC Coupled) appears in the Meas Bar, except if in the AM measurement.
Readback	Off
Initial S/W Revision	Prior to A.02.00

20 Hz

Sets the post demodulation high pass filter to 20 Hz. It is a 2-pole Butterworth filter, its 3 dB cutoff frequency is 20 Hz.

Key Path	Meas Setup, HPF
Example	AM:HPF HPF20
Readback	20 Hz
Initial S/W Revision	Prior to A.02.00

50 Hz

Sets the post demodulation high pass filter to 50 Hz. It is a 2-pole Butterworth filter, its 3 dB cutoff frequency is 50 Hz.

Key Path	Meas Setup, HPF
Example	AM:HPF HPF50
Readback	50 Hz
Initial S/W Revision	Prior to A.02.00

300 Hz

Sets the post demodulation high pass filter to 300 Hz. It is a 2-pole Butterworth filter, its 3 dB cutoff frequency is 300 Hz.

Key Path	Meas Setup, HPF
Example	AM:HPF HPF300
Readback	300 Hz
Initial S/W Revision	Prior to A.02.00

Lowpass Filter (Post Demod)

This parameter allows you to adjust the post demodulation low pass filter. The filter is useful in removing unwanted high frequency components of the modulating signal.

Key Path	Meas Setup, Filters
Remote Command	AM FM PM: [:SENSe]:AM FM PM:LPFilter OFF LPF300 LPF3K LPF15K LPF30K LPF80K LPF300K LPF100K MANual [:SENSe]:AM FM PM:LPFilter? FM Stereo: [:SENSe]:FMSTereo:LPFilter OFF LPF300 LPF3K LPF15K LPF30K LPF80K LPF300K

	[:SENSe] :FMSTereo:LPFilter?
Example	FM:LPF LPF3K
Remote Command Notes	<p>AM FM PM:</p> <p>Off = No filtering</p> <p>LPF300 = Use 300 Hz low pass filter</p> <p>LPF3K = Use 3 kHz low pass filter</p> <p>LPF15K = Use 15 kHz low pass filter</p> <p>LPF30K = Use 30 kHz low pass filter</p> <p>LPF80K = Use 80 kHz low pass filter</p> <p>LPF300K = Use 300 kHz low pass filter</p> <p>LPF100K = Use >20 kHz low pass filter</p> <p>MANual=Use user-defined low pass filter</p> <p>FM Stereo:</p> <p>Off = No filtering</p> <p>LPF300 = Use 300 Hz low pass filter</p> <p>LPF3K = Use 3 kHz low pass filter</p> <p>LPF15K = Use 15 kHz low pass filter</p> <p>LPF30K = Use 30 kHz low pass filter</p> <p>LPF80K = Use 80 kHz low pass filter</p> <p>LPF300K = Use 300 kHz low pass filter</p>
Dependencies	<p>LPF key is unavailable (grayed out) when the band pass filter is not OFF.</p> <p>The following filters are available only when Option N9063A-AFP is installed in AM/FM/PM: LPF100K and MANual.</p>
Couplings	<p>AM/FM/PM:</p> <p>Turning on any low-pass filter will turn off band-pass filters.</p> <p>If a band-pass filter is turned off, the following advisory message is displayed: "Band-pass filter set to OFF".</p> <p>If the band-pass filter was already off, no advisory message is displayed.</p> <p>FM Stereo:</p> <p>None</p>
Preset	Off
State Saved	Saved in instrument state
Readback line	1-of-N selection
Initial S/W Revision	Prior to A.02.00
Modified at S/W Revision	A.14.00

Off

Turns the post demodulation low pass filter off.

Key Path	Meas Setup, Post Demod LPF
Example	AM:LPF OFF
Readback	Off
Initial S/W Revision	Prior to A.02.00

300 Hz

Sets the post demodulation low pass filter to 300 Hz. It is a 5-pole Butterworth filter, its 3 dB cutoff frequency is 300 Hz.

Key Path	Meas Setup, HPF/LPF
Example	AM:HPBP LPF300
Readback	300 Hz
Initial S/W Revision	Prior to A.02.00

3 kHz

Selects the 3 kHz post demodulation low pass filter. It is a 5-pole Butterworth filter, its 3 dB cutoff frequency is 3 kHz.

Key Path	Meas Setup, Post Demod LPF
Example	AM:LPF LPF3K
Readback	3 kHz
Initial S/W Revision	Prior to A.02.00

15 kHz

Selects the 15 kHz post demodulation low pass filter. It is a 5-pole Butterworth filter, its 3 dB cutoff frequency is 15 kHz.

Key Path	Meas Setup, Post Demod LPF
Example	AM:LPF LPF15K
Readback	15 kHz
Initial S/W Revision	Prior to A.02.00

30 kHz

Selects the 30 kHz post demodulation low pass filter. It is a 3-pole Butterworth filter, its 3 dB cutoff frequency is 30 kHz.

Key Path	Meas Setup, Post Demod LPF
Example	AM:LPF LPF30K
Readback	30 kHz
Initial S/W Revision	Prior to A.02.00

80 kHz

Selects the 80 kHz post demodulation low pass filter. It is a 3-pole Butterworth filter, its 3 dB cutoff frequency is 80 kHz.

Key Path	Meas Setup, Post Demod LPF
Example	AM:LPF LPF80K
Readback	80 kHz
Initial S/W Revision	Prior to A.02.00

300 kHz

Selects the 300 kHz post demodulation low pass filter. It is a 3-pole Butterworth filter, its 3 dB cutoff frequency is 300 kHz.

Key Path	Meas Setup, Post Demod LPF
Example	AM:LPF LPF300K
Readback	300 kHz
Initial S/W Revision	Prior to A.02.00

Band Pass Filter (Post Demod)

This parameter enables you to choose the post demodulation band pass filters, allowing you to apply industry-defined filters.

Key Path	Meas Setup, Filters
Remote Command	<p>AM FM PM:</p> <pre>[:SENSe]:AM FM PM:BPFilter OFF CCITT AWEighting CWEighting CMESsage CCIR1k CCIR2k CUNWeighting</pre> <p>[:SENSe]:AM FM PM:BPFilter?</p> <p>FM Stereo:</p> <pre>[:SENSe]:FMSTereo:BPFilter OFF CCITT AWAudio</pre> <p>[:SENSe]:FMSTereo:BPFilter?</p>

Example	FM:BPF CCITT
Remote Command Notes	<p>AM FM PM: Off = No filtering CCITT = Use CCITT filter AWEighting = Use A-Weighted Audio filter CWEighting = Use C-Weighted audio filter CMESsage = Use C-Message audio filter CCIR1k = Use CCIR-1k Weighted audio filter CCIR2k = Use CCIR-2k Weighted audio filter CUNWeighting = Use CCIR Un-weighted audio filter</p> <p>FM Stereo: Off = No filtering CCITT = Use CCITT filter AWAudio = Use A-Weighted Audio filter</p>
Dependencies	The following filters are available only when Option N9063A-AFP is installed in AM/FM/PM: AWEighting, CWEighting, CMESsage, CCIR1k, CCIR2k and CUNWeighting.
Couplings	<p>AM/FM/PM: Turning on any bandpass filter will turn off high-pass and low-pass filters. If a high-pass filter is turned off, the following advisory message is displayed: “High-pass filter set to OFF”. If a low-pass filter is turned off, the following advisory message is displayed: “Low-pass filter set to OFF”. If both are turned off, the following advisory message is displayed: “High-pass and Low-pass filters set to OFF”. If both high-pass and low-pass filters were already off, no advisory message is displayed.</p> <p>FM Stereo: None</p>
Preset	Off
State Saved	Saved in instrument state
Readback	1-of-N
Initial S/W Revision	Prior to A.02.00
Modified at S/W Revision	A.14.00

Off

Turns the post demodulation band-pass filter off.

Key Path	Meas Setup, BPF
Example	AM:BPF OFF
Readback	Off
Initial S/W Revision	Prior to A.02.00

CCITT

Sets the post demodulation band-pass filter to CCITT.

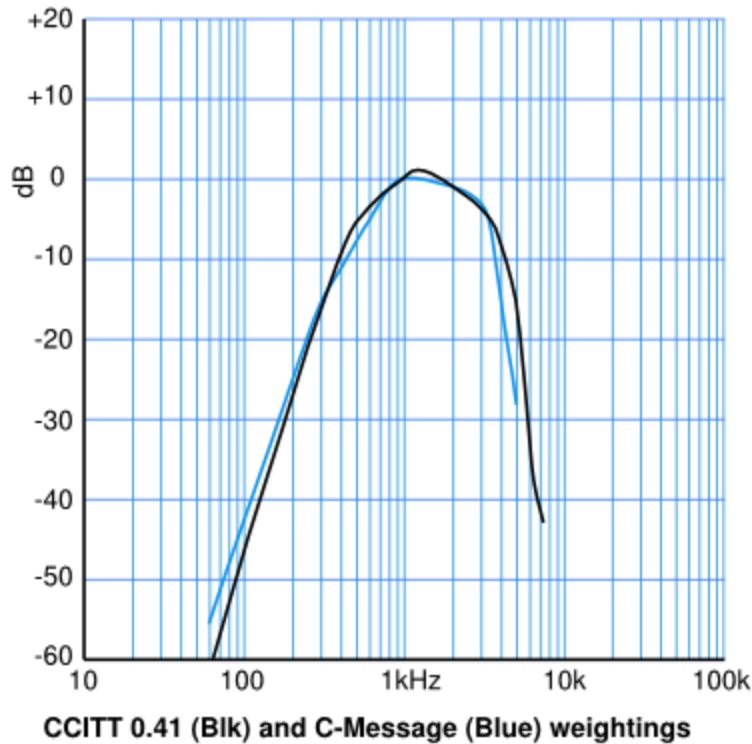

Key Path	Meas Setup, BPF
Example	AM:BPF CCITT
Readback	CCITT
Initial S/W Revision	Prior to A.02.00

Demod to Speaker

Controls whether a demodulated audio signal is connected to the speaker or not. This allows the demodulated audio to be turned off without completely disabling (muting) the instrument speaker. When the Analog Demod application is running, the demodulated signal can be heard from the speaker as long as the “Demod to Speaker” function is set to On.

NOTE The Windows controls for speaker volume and mute must also be properly set.

This function is shared among all measurements in the mode, but not across other modes.

Key Path	Meas Setup
----------	------------

Remote Command	<code>[:SENSe] :SPEaker [:STATe] ON OFF 1 0</code> <code>[:SENSe] :SPEaker [:STATe] ?</code>
Example	SPE OFF Disconnects demodulated audio from speaker circuit.
Preset	On
State Saved	Saved in instrument state
Initial S/W Revision	Prior to A.02.00

Auto BW & Scale

Automatically sets many measurement parameters by pressing one button, based upon the current signal under test. The feature requires that the center frequency be set to the signal of interest, and works best on stable periodic signals. The measurement is preset at the beginning of the Auto BW & Scale operation, with the exception that the user's Center Frequency and audio Filters are maintained.

The signal is analyzed using an Occupied Bandwidth measurement to automatically set the RF Spectrum Span and Channel Bandwidth to good values. And then it sets the combination of mechanical and electronic attenuation based on the current measured signal level so that clipping will be at a minimum. Once these two steps are done, the software examines the demodulated signal and appropriately sets the Sweep Time and Demod Waveform Scale/Div.

There are no configurable parameters for Auto BW & Scale. The function is pre-configured to work with most real-world use cases.

Key Path	Meas Setup
Remote Command	<code>[:SENSe] :AUToscale</code>
Example	AUT
Initial S/W Revision	Prior to A.02.00

Meas Preset

Returns the variables in the current measurement to their preset values.

Key Path	Meas Setup
Initial S/W Revision	Prior to A.02.00

Mode

See "Mode" on page 156

Mode Preset

Returns the active mode to a known state.

Mode Preset does the following for the currently active mode:

- Aborts the currently running measurement.
- Brings up the default menu for the mode, with no active function.
- Sets measurement Global settings to their preset values for the active mode only.
- Activates the default measurement.
- Brings up the default menu for the mode.
- Clears the input and output buffers.
- Sets Status Byte to 0.

Mode Preset does not:

- Cause a mode switch
- Affect mode persistent settings
- Affect system settings
- See "[How-To Preset](#)" on page 347 for more information.

Key Path	Front-panel key
Remote Command	:SYSTem:PRESet
Example	:SYST:PRES
Notes	*RST is preferred over :SYST:PRES for remote operation. *RST does a Mode Preset, as done by the :SYST:PRES command, and it sets the measurement mode to Single measurement rather than Continuous for optimal remote control throughput. Clears all pending OPC bits. The Status Byte is set to 0.
Couplings	A Mode Preset aborts the currently running measurement, activates the default measurement, and gets the mode to a consistent state with all of the default couplings set.
Backwards Compatibility Notes	In the X-Series, the legacy "Factory Preset" has been replaced with Mode Preset, which only presets the currently active mode, not the entire instrument. In the X-Series, the way to preset the entire instrument is by using System, Restore System Defaults All, which behaves essentially the same way as restore System Defaults does on ESA and PSA. There is also no "Preset Type" as there is on the PSA. There is a green Mode Preset front-panel key that does a Mode Preset and a white-with-green-letters User Preset front-panel key that does a User Preset. The old PRESet:TYPE command is ignored (without generating an error), and SYST:PRES without a parameter does a Mode Preset, which should cover most backward code compatibility issues. The settings and correction data under the Input/Output front-panel key (examples: Input Z Corr, Ext Amp Gain, etc.) are no longer part of any Mode, so they will not be preset by a Mode Preset. They are preset using Restore Input/Output Defaults, Restore System Defaults All. Note that because User Preset does a Recall State, and all of these settings are saved in State, they ARE recalled when using

	User Preset.
Initial S/W Revision	Prior to A.02.00

How-To Preset

The table below shows all possible presets, their corresponding SCPI commands and front-panel access (key paths). Instrument settings depend on the current measurement context. Some settings are local to the current measurement, some are global (common) across all the measurements in the current mode, and some are global to all the available modes. In a similar way, restoring the settings to their preset state can be done within the different contexts.

Auto Couple - is a measurement local key. It sets all Auto/Man parameter couplings in the measurement to Auto. Any Auto/Man selection that is local to other measurements in the mode will not be affected.

Meas Preset - is a measurement local key. Meas Preset resets all the variables local to the current measurement except the persistent ones.

Mode Preset - resets all the current mode's measurement local and measurement global variables except the persistent ones.

Restore Mode Defaults - resets ALL the Mode variables (and all the Meas global and Meas local variables), including the persistent ones.

Type Of Preset	SCPI Command	Front Panel Access
Auto Couple	:COUPlE ALL	Auto Couple front-panel key
Meas Preset	:CONFIgure:<Measurement>	Meas Setup Menu
Mode Preset	:SYSTem:PRESet	Mode Preset (green key)
Restore Mode Defaults	:INSTrument:DEFault	Mode Setup Menu
Restore All Mode Defaults	:SYSTem:DEFault MODEs	System Menu; Restore System Default Menu
*RST	*RST	not possible (Mode Preset with Single)
Restore Input/Output Defaults	:SYSTem:DEFault INPut	System Menu; Restore System Default Menu
Restore Power On Defaults	:SYSTem:DEFault PON	System Menu; Restore System Default Menu
Restore Alignment Defaults	:SYSTem:DEFault ALIGn	System Menu; Restore System Default Menu
Restore Miscellaneous Defaults	:SYSTem:DEFault MISC	System Menu; Restore System Default Menu
Restore All System Defaults	:SYSTem:DEFault [ALL] :SYSTem:PRESet:PERSistent	System Menu; Restore System Default Menu
User Preset	:SYSTem:PRESet:USER	User Preset Menu
User Preset All Modes	:SYSTem:PRESet:USER:ALL	User Preset Menu

Power On Mode Preset	:SYSTem:PON:TYPE MODE	System Menu
Power On User Preset	:SYSTem:PON:TYPE USER	System Menu
Power On Last State	:SYSTem:PON:TYPE LAST	System Menu

Restore Mode Defaults

Resets the state for the currently active mode by resetting the mode persistent settings to their factory default values, clearing mode data and by performing a Mode Preset. This function will never cause a mode switch. This function performs a full preset for the currently active mode; whereas, Mode Preset performs a partial preset. Restore Mode Defaults does not affect any system settings. System settings are reset by the Restore System Defaults function. This function does reset mode data; as well as settings.

Key Path	Mode Setup
Remote Command	:INSTrument:DEfault
Example	:INST:DEF
Notes	Clears all pending OPC bits. The Status Byte is set to 0. A message comes up saying: "If you are sure, press key again".
Couplings	A Restore Mode Defaults will cause the currently running measurement to be aborted and causes the default measurement to be active. It gets the mode to a consistent state with all of the default couplings set.
Initial S/W Revision	Prior to A.02.00

Preset Type (Remote Command Only)

As stated in the Backward Compatibility section, to be compatible with ESA/PSA the PRESet:TYPE command will be implemented as a no-op.

Mode	All
Remote Command	:SYSTem:PRESet:TYPE FACTory MODE USER :SYSTem:PRESet:TYPE?
Example	:SYST:PRESet:TYPE FACT
Notes	This command is supported for backward compatibility only. It is a no-op which does not change the behavior of any preset operation.
Preset	This is unaffected by Preset but is set to Mode on a "Restore System Defaults->All"
State Saved	No
Initial S/W Revision	Prior to A.02.00

Global Settings

Opens a menu that allows you to switch certain Meas Global parameters to a Mode Global state. These switches apply to all Modes that support global settings. No matter what Mode you are in when you set the “Global Center Frequency” switch to on, it applies to all Modes that support Global Settings.

Key Path	Mode Setup
Initial S/W Revision	Prior to A.02.00

Global Center Freq

The software maintains a Mode Global value called “Global Center Freq”.

When the Global Center Freq key is switched to On in any mode, the current mode’s center frequency is copied into the Global Center Frequency, and from then on all modes that support global settings use the Global Center Frequency. So you can switch between any of these modes and the Center Freq will remain unchanged.

Adjusting the Center Freq of any mode which supports Global Settings, while Global Center Freq is On, will modify the Global Center Frequency.

When Global Center Freq is turned Off, the Center Freq of the current mode is unchanged, but now the Center Freq of each mode is once again independent.

When Mode Preset is pressed while Global Center Freq is On, the Global Center Freq is preset to the preset Center Freq of the current mode.

This function is reset to Off when the Restore Defaults key is pressed in the Global Settings menu, or when System, Restore Defaults, All Modes is pressed.

Key Path	Mode Setup, Global Settings
Scope	Mode Global
Remote Command	:INSTrument:COUPle:FREQuency:CENTer ALL NONE :INSTrument:COUPle:FREQuency:CENTer?
Example	INST:COUP:FREQ:CENT ALL INST:COUP:FREQ:CENT?
Preset	Set to Off on Global Settings, Restore Defaults and System, Restore Defaults, All Modes
Range	On Off
Initial S/W Revision	Prior to A.02.00

Remote Command	:GLOBal:FREQuency:CENTer[:STATe] 1 0 ON OFF :GLOBal:FREQuency:CENTer[:STATe]?
Preset	Off
Initial S/W Revision	Prior to A.02.00

Restore Defaults

This key resets all of the functions in the Global Settings menu to Off. This also occurs when System, Restore Defaults, All Modes is pressed.

Key Path	Mode Setup, Global Settings
Remote Command	:INSTrument:COUPle:DEFault
Example	INST:COUP:DEF
Backwards Compatibility SCPI	:GLOBal:DEFault
Initial S/W Revision	Prior to A.02.00

Peak Search

Displays the Peak Search menu and places the selected marker on the trace point with the maximum y-axis value for that marker's trace.

Key Path	Front-panel key
Remote Command	:CALCulate:AM FM PM FMSTereo:MARKer[1] 2 ... 12:MAXimum
Example	CALC:AM:MARK2:MAX
Initial S/W Revision	Prior to A.02.00
Modified at S/W Revision	A.10.00

Next Peak

Moves the selected marker to the peak that has the next highest amplitude less than the current marker value. If there is no valid peak lower than the current marker position, an error is generated and the marker is not moved.

If the selected marker was off, then it is turned on as a normal marker and a peak search is performed. In Analog Demod, the Peak Threshold and Peak Excursion functions are both OFF. If there is no valid peak, an error is generated and the marker is not moved. If the selected marker was off, then it is turned on as a normal marker and a peak search is performed.

Key Path	Peak Search
Remote Command	:CALCulate:AM FM PM FMSTereo:MARKer[1] 2 ... 12:MAXimum:NEXT
Example	CALC:AM:MARK2:MAX:NEXT Selects marker 2 and moves it to the peak that is closest in amplitude to the current peak, but the next lower value.
Remote Command Notes	Sending this command selects the specified marker
State Saved	Not part of instrument saved state
Initial S/W Revision	Prior to A.02.00
Modified at S/W Revision	A.10.00

Pk-Pk Search

Finds and displays the amplitude and frequency (or time, if on a time domain trace) differences between the highest and lowest y-axis value. It places the selected marker on the minimum value on its selected trace and it places that marker's reference marker on the peak of its selected trace. This function turns on the reference marker and sets its mode to Fixed if it is not already on. (These markers may be on two different traces.)

When peak-to-peak search is successful, a message is displayed on the message line.

If the selected marker is off, a delta type marker is turned on and the peak-to-peak search is done. If the selected marker is on, but it is not a delta marker, then it is changed to delta, which turns on the reference marker if needed. It then performs the peak-to-peak function.

Key Path	Peak Search
Remote Command	:CALCulate:AM FM PM FMSTereo:MARKer [1] 2 ... 12:PTPeak
Example	CALC:AM:MARK:PTP CALC:AM:MARK:Y? Queries the delta amplitude value for marker 1.
Notes	Turns on the Marker Δ active function.
Remote Command Notes	Sending this command selects the specified marker.
Couplings	Selected marker becomes a delta marker if not already in delta mode..
State Saved	Not part of instrument saved state
Initial S/W Revision	Prior to A.02.00
Modified at S/W Revision	A.10.00

Min Search

Moves the selected marker to the minimum y-axis value on the current trace. If the selected marker is off, it is turned on before the minimum search is performed.

Key Path	Peak Search
Remote Command	:CALCulate:AM FM PM FMSTereo:MARKer [1] 2 ... 12:MINimum
Example	CALC:AM:MARK:MIN selects marker 1 and moves it to the minimum amplitude value.
Remote Command Notes	Sending this command selects the specified marker.
State Saved	Not part of instrument saved state
Initial S/W Revision	Prior to A.02.00
Modified at S/W Revision	A.10.00

Print

See "Print" on page 181

Quick Save

The Quick Save front-panel key repeats the most recent save that was performed from the Save menu, with the following exceptions:

- Register saves are not remembered as Saves for the purpose of the Quick Save function
- If the current measurement does not support the last non-register save that was performed, an informational message is generated, “File type not supported for this measurement”

Quick Save repeats the last type of qualified save (that is, a save qualified by the above criteria) in the last save directory by creating a unique filename using the Auto File Naming algorithm described below.

If Quick Save is pressed after startup and before any qualified Save has been performed, the Quick Save function performs a Screen Image save using the current settings for Screen Image saves (current theme, current directory), which then becomes the “last save” for the purpose of subsequent Quick Saves.

The Auto File Naming feature automatically generates a file name for use when saving a file. The filename consists of a prefix and suffix separated by a dot, as is standard for the Windows® file system. A default prefix exists for each of the available file types:

Type	Default Prefix	Menu
State	State_	(Save/Recall)
Trace + State	State_	(Save/Recall)
Screen	Screen_	(Save/Recall)
Amplitude Corrections	Ampcor_	(Import/Export)
Traces	Trace_	(Import/Export)
Limit Lines	LLine_	(Import/Export)
Measurement Result	MeasR_	(Import/Export)
Capture Buffer	CapBuf_	(Import/Export)

A four digit number is appended to the prefix to create a unique file name. The numbering sequence starts at 0000 within each Mode for each file type and updates incrementally to 9999, then wraps to 0000 again. It remembers where it was through a Mode Preset and when leaving and returning to the Mode. It is reset by Restore Misc Defaults and Restore System Defaults and subsequent running of the instrument application. So, for example, the first auto file name generated for State files is State_0000.state. The next is State_0001, and so forth.

One of the key features of Auto File Name is that we guarantee that the Auto File Name will never conflict with an existing file. The algorithm looks for the next available number. If it gets to 9999, then it looks for holes. If it find no holes, that is no more numbers are available, it gives an error.

For example, if when we get to State_0010.state there is already a State_0010.state file in the current directory, it advances the counter to State_0011.state to ensure that no conflict will exist (and then it verifies that State_0011.state also does not exist in the current directory and advances again if it does, and so forth).

If you enter a file name for a given file type, then the prefix becomes the filename you entered instead of the default prefix, followed by an underscore. The last four letters (the suffix) are the 4-digit number.

For example, if you save a measurement results file as “fred.csv”, then the next auto file name chosen for a measurement results save will be fred_0000.csv.

NOTE Although 0000 is used in the example above, the number that is used is actually the current number in the Meas Results sequence, that is, the number that would have been used if you had not entered your own file name.

NOTE If the filename you entered ends with _dddd, where d=any number, making it look just like an auto file name, then the next auto file name picks up where you left off with the suffix being dddd + 1.

Key Path	Front-panel key
Notes	No remote command for this key specifically.
Initial S/W Revision	Prior to A.02.00

State

The Recall State menu lets you choose a register or file from which to recall the state.

The content of a state file includes all of the settings and data required to return the analyzer as closely as possible to the Mode it was in, with the exact settings that were in place, when the save occurred. The Mode settings in each state file include the settings that are affected by Mode Preset, as well as the additional settings affected by Restore Mode Defaults; all of the Mode’s settings. In addition, all of the settings of the Input/Output system are included, even though they are outside of the Mode’s state, because they are needed to restore the complete setup. Persistent System settings (for example, GPIB address) are not affected by either a Mode Preset or Restore Mode Defaults, nor are they included in a saved State file.

Since each state file is only for one Mode, the settings for other Modes are unaffected when it is loaded. Recall State will cause a mode switch if the state being recalled is not from the current active mode.

After the recall completes, the message "File <filename> recalled" or “Recalled State Register <register number>” is displayed.

For rapid recalls, the State menu lists 16 registers that you can choose from to recall. Pressing a Register key initiates the recall. You can also select a file from which to recall.

The default path for all State Files is:

My Documents\<<mode name>\state

where <mode name> is the parameter used to select the mode with the INST:SEL command (for example, SA for the Spectrum Analyzer).

See "[More Information](#)" on page 356.

Key Path	Recall
----------	--------

Mode	All
Remote Command	:MMEMory:LOAD:STATe <filename>
Example	:MMEM:LOAD:STAT "myState.state" This recalls the file myState.state on the default path
Example	MMEM:LOAD:STAT "MyStateFile.state" This loads the state file data (on the default file directory path) into the instrument state.
Notes	<p>When you pick a file to recall, the analyzer first verifies that the file is recallable in the current instrument by checking the software version and model number of the instrument. If everything matches, a full recall proceeds by aborting the currently running measurement, clearing any pending operations, and then loading the State from the saved state file. You can open state files from any mode, so recalling a State file switches to the mode that was active when the save occurred. After switching to the mode of the saved state file, mode settings and data (if any for the mode) are loaded with values from the saved file. The saved measurement of the mode becomes the newly active measurement and the data relevant to the measurement (if there is any) is recalled.</p> <ul style="list-style-type: none"> • If there is a mismatch between file version or model number or instrument version or model number, the recall function tries to recall as much as possible and returns a warning message. It may limit settings that differ based on model number, licensing or version number. <p>After recalling the state, the Recall State function does the following:</p> <ul style="list-style-type: none"> • Makes the saved measurement for the mode the active measurement. • Clears the input and output buffers. • Status Byte is set to 0. • Executes a *CLS <p>If the file specified is empty an error is generated. If the specified file does not exist, another error is generated. If there is a mismatch between the file and the proper file type, an error is generated. If there is a mismatch between file version or model number or instrument version or model number, a warning is displayed. Then it returns to the State menu and File Open dialog goes away.</p> <p>After the Recall, the analyzer exits the Recall menu and returns to the previous menu.</p>
Backwards Compatibility SCPI	:MMEMory:LOAD:STATe 1,<filename> For backwards compatibility, the above syntax is supported. The "1" is simply ignored.
Initial S/W Revision	Prior to A.02.00

More Information

In measurements that support saving Traces, for example, Swept SA, the Trace data is saved along with the State in the State file. When recalling the State, the Trace data is recalled as well. Traces are recalled exactly as they were stored, including the writing mode and update and display modes. If a Trace was updating and visible when the State was saved, it will come back updating and visible, and its data will be rewritten right away. When you use State to save and recall traces, any trace whose data must be preserved should be placed in View or Blank mode before saving.

The following table describes the Trace Save and Recall possibilities:

You want to recall state and one trace's data, leaving other traces	Save Trace+State from 1 trace. Make sure that no other traces are	On Recall, specify the trace you want to load the one trace's data
---	--	--

unaffected.	updating (they should all be in View or Blank mode) when the save is performed.	into. This trace will load in View. All other traces' data will be unaffected, although their trace mode will be as it was when the state save was performed.
You want to recall all traces	Save Trace+State from ALL traces.	On Recall, all traces will come back in View (or Blank if they were in Blank or Background when saved)
You want all traces to load exactly as they were when saved.	Save State	On recall, all traces' mode and data will be exactly as they were when saved. Any traces that were updating will have their data immediately overwritten.

From File...

When you press “From File”, the analyzer brings up a Windows dialog and a menu entitled “File Open.” This menu allows you to navigate to the various fields in the Windows dialog without using a keyboard or mouse. The Tab and Arrow keys can also be used for dialog navigation.

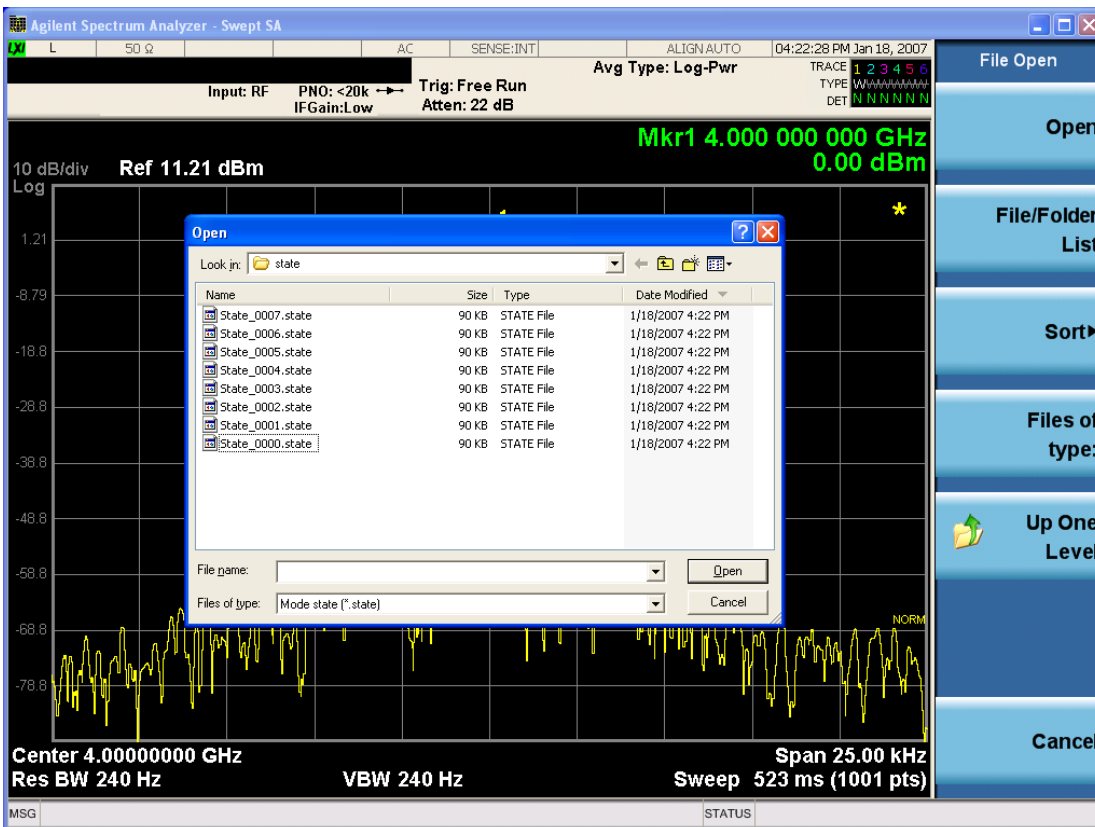

Listed below are the functions of the various fields in the dialog, and the corresponding softkeys:

Open

Performs the recall of the specified file. While the recall is being performed, the floppy icon appears briefly in the Meas bar.

File/Folder List

Enables you to navigate to the center of the dialog that contains the list of files and folders. Once here you can get information about the file and use the tab keys to navigate to the other fields in the dialog, such as Look In.

Look In

The Look In field shows the path from which the file will be recalled and allows you to change the path using the up and down arrow keys to navigate to other paths; the Enter key to open a directory; and the Backspace key to go back one directory. The **Look In field** first uses the last path from the Save As dialog **Save In:** path for that same file type. There is no softkey for directly navigating to the Look In field, but you can use the left tab to get here from the File/Folder List.

User specified paths are remembered when you leave and return to a Mode and are reset back to the default using Restore Mode Defaults.

Sort

Accesses a menu that enables you to sort the files within the File Open dialog. Only one sorting type can be selected at a time and the sorting happens immediately. The sorting types are By Date, By Name, By extension, and By Size.

Files of Type

This field shows the file suffix for the type of file you have selected to recall. For example, if you navigated here while recalling State, "Mode state (*.state)" is in the field. If you navigated here while recalling Trace, ""Mode state (*.trace)" is in the field. If you navigated here while importing a trace data file, "Trace Data (*.csv)" is in the field. For some file types, there is more than one choice in the dropdown menu, which you can select by using the up and down arrow keys and Enter.

Up One Level

This key corresponds to the icon of a folder with the up arrow that is in the tool bar of the dialog. When pressed, it causes the file and folder list to navigate up one level in the directory structure. The Backspace key does the same thing.

Cancel

This key corresponds to the Cancel selection in the dialog. It causes the current **Open** request to be cancelled. The ESC key does the same thing.

Key Path	Recall, State
Notes	Brings up the Open dialog for recalling a State Save Type
Initial S/W Revision	Prior to A.02.00

Edit Register Names

You may enter a custom name on any of the Register keys, to help you remember what you are using that state to save. To do this, press the Edit Register Names key, choose the register whose name you wish to edit, and then enter the desired label using the Alpha Editor or an external PC keyboard.

The maximum number of characters that can be added is 30. In most cases, 30 characters will fit on two lines of the key.

For more information and the SCPI command, see Edit Register Names under the Save, State function.

Key Path	Recall, State
Mode	All
Dependencies	N9060A-7FP or N9060B-2FP license required to edit the register names. When the feature is not licensed, sending the SCPI command generates an error, -221, "Settings conflict;Option not available"
Initial S/W Revision	A.11.00

Register 1 thru Register 16

Selecting any one of these register keys causes the State of the mode from the specified Register to be recalled. Each of the register keys annotates whether it is empty or at what date and time it was last modified. In addition, you can use the Edit Register Names key under Save, State to enter custom names for each register.

NOTE

In products that run multiple instances of the X-Series Application, recalling the same register name on each instance is a way to share setups between the instances.

Registers are shared by all modes, so recalling from any one of the registers will cause a mode switch to the mode that was active when the save to the Register occurred.

Although these 16 registers are the only registers available from the front panel, there are 128 state registers available in the instrument. Registers 17-128 are only available from the SCPI interface, using the *RCL command.

After the recall completes, the message "Register <register number> recalled" appears in the message bar. If you are in the Spectrum Analyzer Mode, and you are recalling a register that was saved in the Spectrum Analyzer Mode, then after the recall, you will still be in the Recall Register menu. If the Recall causes you to switch modes, then after the Recall, you will be in the Frequency menu.

If a requested register is empty an error is generated.

Key Path	Recall, State
Example	*RCL 1
Range	1-16 from front panel, 1-128 from SCPI
Readback	Date and time with seconds resolution are displayed on the key OR A custom name of up to 30 characters entered using the Save, State,Edit Register Names key

	OR “(empty)” if no prior save operation has been performed to this register.
Initial S/W Revision	Prior to A.02.00
Modified at S/W Revision	Prior to A.11.00

Register 1 thru Register 16

Selecting any one of these register keys causes the State of the mode from the specified Register to be recalled. Each of the register keys annotates whether it is empty or at what date and time it was last modified. In addition, you can use the Edit Register Names key under Save, State to enter custom names for each register.

NOTE

In products that run multiple instances of the X-Series Application, recalling the same register name on each instance is a way to share setups between the instances.

Registers are shared by all modes, so recalling from any one of the registers will cause a mode switch to the mode that was active when the save to the Register occurred.

Although these 16 registers are the only registers available from the front panel, there are 128 state registers available in the instrument. Registers 17–128 are only available from the SCPI interface, using the *RCL command.

After the recall completes, the message "Register <register number> recalled" appears in the message bar. If you are in the Spectrum Analyzer Mode, and you are recalling a register that was saved in the Spectrum Analyzer Mode, then after the recall, you will still be in the Recall Register menu. If the Recall causes you to switch modes, then after the Recall, you will be in the Frequency menu.

If a requested register is empty an error is generated.

Key Path	Recall, State
Example	*RCL 1
Range	1–16 from front panel, 1–128 from SCPI
Readback	Date and time with seconds resolution are displayed on the key OR A custom name of up to 30 characters entered using the Save, State, Edit Register Names key OR “(empty)” if no prior save operation has been performed to this register.
Initial S/W Revision	Prior to A.02.00
Modified at S/W Revision	Prior to A.11.00

Restart

The Restart function restarts the current sweep, or measurement, or set of averaged/held sweeps or measurements. If you are Paused, pressing Restart does a Resume.

The Restart function is accessed in several ways:

- Pressing the Restart key
- Sending the remote command INIT:IMMEDIATE
- Sending the remote command INIT:RESTART

See "[More Information](#)" on page 361

Key Path	Front-panel key
Remote Command	:INITiate[:IMMEDIATE] :INITiate:RESTART
Example	:INIT:IMM :INIT:REST
Notes	:INITiate:RESTART and :INITiate:IMMEDIATE perform exactly the same function.
Couplings	Resets average/hold count k. For the first sweep overwrites all active (update=on) traces with new current data. For application modes, it resets other parameters as required by the measurement.
Status Bits/OPC dependencies	This is an Overlapped command. The STATUS:OPERation register bits 0 through 8 are cleared. The STATUS:QUESTIONable register bit 9 (INTEgrity sum) is cleared. The SWEEPING bit is set. The MEASURING bit is set.
Backwards Compatibility Notes	For Spectrum Analysis mode in ESA and PSA, the Restart hardkey and the INITiate:RESTART command restart trace averages (displayed average count reset to 1) for a trace in Clear Write, but did not restart Max Hold and Min Hold. In the X-Series, the Restart hardkey and the INITiate:RESTART command restart not only Trace Average, but MaxHold and MinHold traces as well. For wireless comms modes in ESA and PSA, the Restart hardkey and the INITiate:RESTART command restart every measurement, which includes all traces and numeric results. There is no change to this operation.
Initial S/W Revision	Prior to A.02.00

More Information

The **Restart** function first aborts the current sweep/measurement as quickly as possible. It then resets the sweep and trigger systems, sets up the measurement and initiates a new data measurement sequence with a new data acquisition (sweep) taken once the trigger condition is met.

If the analyzer is in the process of aligning when **Restart** is executed, the alignment finishes before the restart function is performed.

Even when set for Single operation, multiple sweeps may be taken when Restart is pressed (for example, when averaging/holding is on). Thus when we say that **Restart** "restarts a measurement," we may mean:

- It restarts the current sweep
- It restarts the current measurement
- It restarts the current set of sweeps if any trace is in Trace Average, Max Hold or Min Hold
- It restarts the current set of measurements if Averaging, or Max Hold, or Min Hold is on for the measurement
- depending on the current settings.

With **Average/Hold Number** (in **Meas Setup** menu) set to 1, or Averaging off, or no trace in Trace Average or Hold, a single sweep is equivalent to a single measurement. A single sweep is taken after the trigger condition is met; and the analyzer stops sweeping once that sweep has completed. However, with **Average/Hold Number** >1 and at least one trace set to **Trace Average, Max Hold, or Min Hold (SA Measurement)** or **Averaging on (most other measurements)**, multiple sweeps/data acquisitions are taken for a single measurement. The trigger condition must be met prior to each sweep. The sweep is stopped when the average count k equals the number N set for **Average/Hold Number**. A measurement average usually applies to all traces, marker results, and numeric results; but sometimes it only applies to the numeric results.

Once the full set of sweeps has been taken, the analyzer will go to idle state. To take one more sweep without resetting the average count, increment the average count by 1, by pressing the step up key while **Average/Hold Number** is the active function, or sending the remote command CALC:AVER:TCON UP.

Save

The Save menu lets you choose what you want to save and where you want to save it. Among the types of files you can save are **States**, **Traces**, and **Screen Images**. In addition, an Export (Data) option lets you save a number of data types as CSV files for easy import into Excel and other spreadsheet programs.

Key Path	Front-panel key
Mode	All
Notes	No remote command for this key specifically, but the :MMEM:STORe command is available for specific file types. An example is :MMEM:STOR:STATe <filename>.
Initial S/W Revision	Prior to A.02.00

State

The Save State menu lets you choose a register or file for saving the state.

NOTE

In products that run multiple instances of the X-Series Application, all instances share the same register and file location where you want to save the state.

The content of a state file includes all of the settings and data required to return the analyzer as closely as possible to the Mode it was in, with the exact settings which were in place, when the save occurred. The Mode settings in each state file include the settings that are affected by Mode Preset, as well as the additional settings affected by Restore Mode Defaults; all of the Mode's settings. In addition, all of the settings of the Input/Output system are included, even though they are outside of the Mode's state, because they are needed to restore the complete setup. Persistent System settings (for example, Verbose SCPI) are not affected by either Mode Preset or Restore Mode Defaults, nor are they included in a saved State file.

After the save completes, the message "File <filename> saved" or "State Register <register number> saved" is displayed.

For rapid saving, the State menu lists 16 registers to save to. Pressing a Register key initiates the save. You can also select a file to save to.

The default path for all State Files is:

My Documents\<<mode name>\state

where <mode name> is the parameter used to select the mode with the INST:SEL command (for example, SA for the Spectrum Analyzer).

Key Path	Save
Mode	All
Remote Command	:MMEMory:STORe:STATe <filename>
Example	MMEM:STOR:STATe "MyStateFile.state" This stores the current instrument state data in the file MyStateFile.state in the default directory.
Notes	Both single and double quotes are supported for any filename parameter over remote.

After saving to a register, that register's menu key is updated with the date the time, unless a custom label has been entered for that key.

After saving to a register, you remain in the Save State menu, so that you can see the Register key update. After saving to a file, the analyzer automatically returns to the previous menu and any Save As dialog goes away.

Backwards :MMEMory:STORE:STATe 1,<filename>

Compatibility SCPI For backwards compatibility, the above syntax is supported. The "1" is simply ignored. The command is sequential.

Initial S/W Revision Prior to A.02.00

To File . . .

When you press “To File”, the analyzer brings up a Windows dialog and a menu entitled “Save As.” This menu allows you to navigate to the various fields in the Windows dialog without using a keyboard or mouse. The Tab and Arrow keys can also be used for dialog navigation.

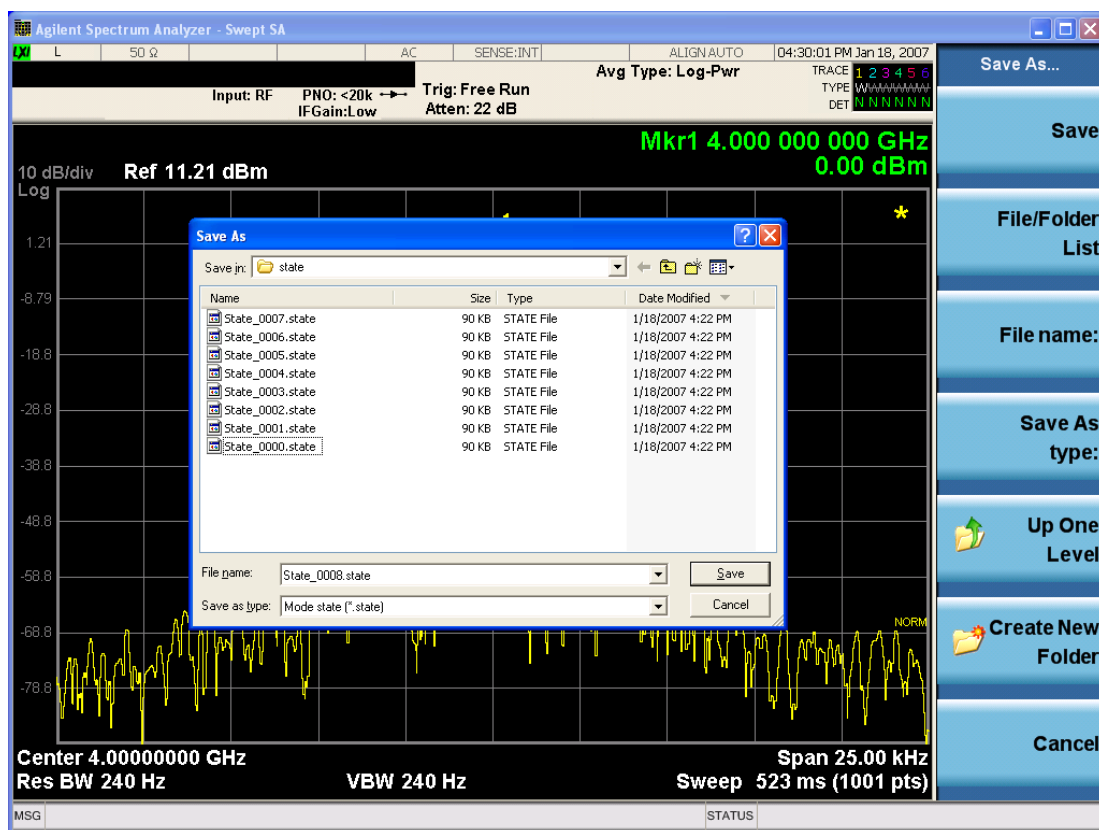

The Listed below

are the functions of the various fields in the dialog, and the corresponding softkeys:

Save

Performs the save to the specified file of the selected type. If the file already exists, a dialog will appear that allows you to replace the existing file by selecting OK, or you can Cancel the request. If you select OK,

the file will be overwritten. Using the C: drive is strongly discouraged, since it runs the risk of being overwritten during an instrument software upgrade.

While the save is being performed, the floppy icon appears briefly in the Meas bar.

File/Folder List

Enables you to navigate to the center of the dialog that contains the list of files and folders. Once here you can get information about the file and use the tab keys to navigate to the other fields in the dialog, such as Save In.

Save In

The Save In field shows the path to which the file will be saved and allows you to change the path using the up and down arrow keys to navigate to other paths; the Enter key to open a directory; and the Backspace key to go back one directory. The **Save In field** defaults to the default path for this type of file and remembers the last path you used to save this type of file. There is no softkey for directly navigating to the Save In field but you can use left tab to get here from the File/Folder List.

User specified paths are remembered when you leave and return to a Mode and are reset back to the default using Restore Mode Defaults.

File Name

The File Name field is initially loaded with an automatically generated filename specific to the appropriate Save Type. The automatically generated filename is guaranteed not to conflict with any filename currently in the directory. You may replace or modify this filename using the File Name key. See the ["Quick Save " on page 1171](#) documentation for more on the automatic file naming algorithm.

When you press the File Name key the analyzer displays the Alpha Editor. Use the knob to choose the letter to add and the front-panel Enter key to add the letter to the file name. The BK character moves you back and the FW character moves you forward in the filename. The Select key on the front panel generates a space character. When you are done entering the filename press the Done softkey. This returns back to the **File Open** dialog and menu, but does not cause the save to occur.

Save As Type

This field shows the file suffix for the type of file you have selected to save. For example, if you navigated here while saving State, "Mode state (*.state)" is in the field. If you navigated here from saving Trace, ""Mode state (*.trace)" is in the field. If you navigated here while exporting a trace data file, "Trace Data (*.csv)" is in the field. For some file types, there is more than one choice in the dropdown, which you can select by using the up and down arrow keys and Enter.

Up One Level

This key corresponds to the icon of a folder with the up arrow that is in the tool bar of the dialog. When pressed, it causes the file and folder list to navigate up one level in the directory structure. The Backspace key does the same thing.

Create New Folder

This key corresponds to the icon of a folder with the "*" that is in the tool bar of the dialog. When pressed, a new folder is created in the current directory with the name **New Folder** and you can enter a new folder name using the Alpha Editor.

Cancel

This key corresponds to the Cancel selection in the dialog. It causes the current **Save As** request to be cancelled. The ESC key does the same thing.

Key Path	Save, State
Mode	All
Notes	Brings up Save As dialog for saving a State Save Type
Initial S/W Revision	Prior to A.02.00

Edit Register Names

You may enter a custom name on any of the Register keys, to help you remember what you are using that state to save. To do this, press the Edit Register Names key, choose the register whose name you wish to edit, and then enter the desired label using the Alpha Editor or an external PC keyboard.

The maximum number of characters that can be added is 30. In most cases, 30 characters will fit on two lines of the key.

See ["More Information" on page 366](#)

Key Path	Save, State
Mode	All
Remote Command	:MMEMory:REGister:STATe:LABel <reg number>,"label" :MMEMory:REGister:STATe:LABel? <reg number>
Example	:MMEM:REG:STAT:LAB 1,"my label"
Notes	<reg number> is an integer from 1 to 16. If the SCPI specifies an invalid register number an error message is generated, -222,"Data out of range;Invalid register label number" "label" is a string from 0 to 30 characters in length. If a label exceeds 30 characters, an error message is generated, -150,"String data error;Label clipped to 30 characters" "label" of length 0 erases the custom label and restores the default (time and date) label. E.g.: :MMEM:REG:STAT:LAB 1,""
Dependencies	N9060A-7FP or N9060B-2FP license required to edit the register names. When the feature is not licensed, sending this command generates an error, -221,"Settings conflict;Option not available"
Preset	The names are unaffected by Preset or power cycle but are set to the default label (time and date) on a "Restore System Defaults->Misc"
Initial S/W Revision	A.11.00

More Information

When you edit one of the register names, the time and date field will be replaced by the custom name.

If you delete all the characters in the custom name, it restores the default (time and date).

The register names are stored within the state files, but they are not part of the instrument state; that is, once you have edited a register name, loading a new state will not change that register name. Another

consequence of this is that the names will be persistent through a power cycle. Also, if a named state file is transferred to another analyzer, it will bring its custom name along with it.

If you try to edit the name of an empty register, the analyzer will first save the state to have a file to put the name in. If you load a named state file into an analyzer with older firmware it will ignore the metadata.

The *SAV and *RCL commands will not be affected by the custom register names, nor will the MMEM commands.

Register 1 thru Register 16

Selecting any one of these register menu keys causes the State of the currently active mode to be saved to the specified Register. The registers are provided for rapid saving and recalling, since you do not need to specify a filename or navigate to a file. Each of the register menu keys annotates whether it is empty or at what date and time it was last modified. In addition, you can use the Edit Register Names key to enter custom names for each register.

NOTE

In products that run multiple instances of the X-Series Application, save with different register name if you do not want to overwrite the register of another running instance.

Although these 16 registers are the only registers available from the front panel, there are 128 state registers available in the instrument. Registers 17–128 are only available from the SCPI interface, using the *SAV command.

There is one set of 128 state registers in the instrument, not one set for each Mode. When a state is saved, the Mode it was saved from is saved with it; then when it is recalled, the instrument switches to that Mode.

After the save completes, the corresponding register menu key annotation is updated with the date and time and the message "Register <register number> saved" is displayed.

Key Path	Save, State
Mode	All
Example	*SAV 1
Range	1–16 from front panel, 1–128 from SCPI
Readback	Date and time with seconds resolution are displayed on the key OR A custom name of up to 30 characters entered using the Edit Register Names key OR “(empty)” if no prior save operation has been performed to this register.
Initial S/W Revision	Prior to A.02.00
Modified at S/W Revision	A.11.00

Register 1 thru Register 16

Selecting any one of these register menu keys causes the State of the currently active mode to be saved to the specified Register. The registers are provided for rapid saving and recalling, since you do not need to specify a filename or navigate to a file. Each of the register menu keys annotates whether it is empty or at

what date and time it was last modified. In addition, you can use the Edit Register Names key to enter custom names for each register.

NOTE In products that run multiple instances of the X-Series Application, save with different register name if you do not want to overwrite the register of another running instance.

Although these 16 registers are the only registers available from the front panel, there are 128 state registers available in the instrument. Registers 17–128 are only available from the SCPI interface, using the *SAV command.

There is one set of 128 state registers in the instrument, not one set for each Mode. When a state is saved, the Mode it was saved from is saved with it; then when it is recalled, the instrument switches to that Mode.

After the save completes, the corresponding register menu key annotation is updated with the date and time and the message "Register <register number> saved" is displayed.

Key Path	Save, State
Mode	All
Example	*SAV 1
Range	1–16 from front panel, 1–128 from SCPI
Readback	Date and time with seconds resolution are displayed on the key OR A custom name of up to 30 characters entered using the Edit Register Names key OR “(empty)” if no prior save operation has been performed to this register.
Initial S/W Revision	Prior to A.02.00
Modified at S/W Revision	A.11.00

Mass Storage Catalog (Remote Command Only)

Key path	SCPI Only
Remote Command	:MMEMory:CATalog? [<directory_name>]
Notes	The string must be a valid logical path. Queries disk usage information (drive capacity, free space available) and obtains a list of files and directories in a specified directory in the following format: <numeric_value>,<numeric_value>,{<file_entry>} It returns two numeric parameters and as many strings as there are files and directories. The first parameter indicates the total amount of storage currently used in bytes. The second parameter indicates the total amount of storage available, also in bytes. The <file_entry> is a string. Each <file_entry> indicates the name, type, and size of one file in the directory list: <file_name>,<file_type>,<file_size> As the windows file system has an extension that indicates file type, <file_type> is always empty. <file_size> provides the size of the file in bytes. For directories, <file_entry> is surrounded by square brackets and both <file_type> and <file_size> are empty
Initial S/W Revision	Prior to A.02.00

Mass Storage Change Directory (Remote Command Only)

Key path	SCPI Only
Remote Command	:MMEMory:CDIRectory [<directory_name>] :MMEMory:CDIRectory?
Notes	The string must be a valid logical path. Changes the default directory for a mass memory file system. The <directory_name> parameter is a string. If no parameter is specified, the directory is set to the *RST value. At *RST, this value is set to the default user data storage area, that is defined as System.Environment.SpecialFolder.Personal. Query returns full path of the default directory.
Initial S/W Revision	Prior to A.02.00

Mass Storage Copy (Remote Command Only)

Key path	SCPI Only
Remote Command	:MMEMory:COPY <string>,<string>[,<string>,<string>]
Notes	The string must be a valid logical path. Copies an existing file to a new file or an existing directory to a new directory. Two forms of parameters are allowed. The first form has two parameters. In this form, the first parameter specifies the source, and the second parameter specifies the destination. The second form has four parameters. In this form, the first and third parameters specify the source. The second and fourth parameters specify the directories. The first pair of parameters specifies the source. The second pair specifies the destination. An error is generated if the source doesn't exist or the destination file already exists. This command will generate an "access denied" error if the destination is a restricted folder (e.g., C:\Windows) and the current user does not have Power User or Administrator privileges.

Mass Storage Device Copy (Remote Command Only)

This command transfers data to/from a file and a peripheral device.

Key path	SCPI Only
Remote Command	:MMEMory:COPY:DEvice <source_string>,<dest_string>
Notes	The strings must be a valid logical path or a valid device keyword. If the dest_string is a device keyword, the data is copied from the source file to the device. If the source_string is a device keyword, the data is copied to the source file from the device. Valid device keywords are: SNS (smart noise source) An error is generated if the file or device is not found.

Mass Storage Delete (Remote Command Only)

Key path	SCPI Only
Remote Command	:MMEMory:DELeTe <file_name>[,<directory_name>]
Notes	The string must be a valid logical path. Removes a file from the specified directory. The <file_name> parameter specifies the file name to be removed. This command will generate an “access denied” error if the file is in a restricted folder (e.g., C:\Windows) and the current user does not have Power User or Administrator privileges.
Initial S/W Revision	Prior to A.02.00

Mass Storage Data (Remote Command Only)

Creates a file containing the specified data OR queries the data from an existing file.

Key path	SCPI Only
Remote Command	:MMEMory:DATA <file_name>, <data> :MMEMory:DATA? <file_name>
Notes	The string must be a valid logical path. The command form is MMEMory:DATA <file_name>,<data>. It loads <data> into the file <file_name>. <data> is in 488.2 block format. <file_name> is string data. The query form is MMEMory:DATA? <file_name> with the response being the associated <data> in block format.
Initial S/W Revision	Prior to A.02.00

Mass Storage Make Directory (Remote Command Only)

Key path	SCPI Only
Remote Command	:MMEMory:MDIRectory <directory_name>
Notes	The string must be a valid logical path. Creates a new directory. The <directory_name> parameter specifies the name to be created. This command will generate an “access denied” error if the new directory would be in a restricted folder (e.g., C:\Windows) and the current user does not have Power User or Administrator privileges.
Initial S/W Revision	Prior to A.02.00

Mass Storage Move (Remote Command Only)

Key path	SCPI Only
Remote Command	:MMEMory:MOVE <string>,<string>[,<string>,<string>]
Notes	The string must be a valid logical path. Moves an existing file to a new file or an existing directory to a new directory.

Two forms of parameters are allowed. The first form has two parameters. In this form, the first parameter specifies the source, and the second parameter specifies the destination.

The second form has four parameters. In this form, the first and third parameters specify the source. The second and fourth parameters specify the directories. The first pair of parameters specifies the source. The second pair specifies the destination. An error is generated if the source doesn't exist or the destination file already exists.

This command will generate an "access denied" error if the destination is a restricted folder (e.g., C:\Windows) and the current user does not have Power User or Administrator privileges.

Initial S/W Revision Prior to A.02.00

Mass Storage Remove Directory (Remote Command Only)

Key path	SCPI Only
Remote Command	:MMEMory:RDIRectory <directory_name>
Notes	<p>The string must be a valid logical path.</p> <p>Removes a directory. The <directory_name> parameter specifies the directory name to be removed. All files and directories under the specified directory shall also be removed.</p> <p>This command will generate an "access denied" error if the folder is a restricted folder (e.g., C:\Windows) or is in a restricted folder and the current user does not have Power User or Administrator privileges.</p>
Initial S/W Revision	Prior to A.02.00

Sequences

These keys allow you to save a Tab separated or CSV file of the setup parameters required to build a Sequence.

In order to save you must select the Save As button and choose a destination folder.

Key Path	Save, Sequences
Mode	All
Remote Command	:MMEM:STOR:SEquences: SLIST ALIST SAAList SSTep "MySequence.txt"
Example	:MMEM:STOR:SEQ:SLIST "MySequence.txt"
Notes	<p>Available file types are:</p> <ul style="list-style-type: none"> -CSV (Comma delimited) (*.csv) -Text (Tab delimited) (*.txt)
Initial S/W Revision	A.05.00

Source Sequence

The list of parameters, that configure steps, that makes up a sequence for the Source.

The Source sequence is a sequence of flexible configurable steps that can be set anywhere in the instruments frequency range.

Key Path	Save, Sequences
Example	:MMEM:STOR:SEQ:SLIS "MySequence.txt"
Dependencies	Only available in XOBT
Initial S/W Revision	A.05.00

Save As . . .

This menu lets you select the location where you can save the Sequence. This menu is a standard Windows® dialog with Save As menu keys. The "File Name" field in the Save As dialog is initially loaded with an automatically generated filename specific to the appropriate Save Type. The automatically generated filename is guaranteed not to conflict with any filename currently in the directory. You may replace or modify this filename using the File Name softkey. See the Quick Save key documentation for more on the automatic file naming algorithm.

The default path for all Sequence Files is:

My Documents\Sequences

Key Path	Save, Sequences
Mode	All
Notes	Brings up Save As dialog for saving a Sequence Save Type
Initial S/W Revision	A.05.00

Data

The Analog Demod Mode Export Data options include Traces and Measurement Results.

Key Path	Save, Data
Remote Command Notes	No SCPI command directly controls the Data Type that this key controls. The Data Type is included as part of the MMEM:STOR commands.
Preset	Trace; is not affected by a Preset, but is reset during Restore Mode Defaults and survives Power cycles.
State Saved	Saved in instrument state.
Readback line	1-of-N selection
Initial S/W Revision	Prior to A.02.00

AM/FM/ΦM Trace

Selects Trace as the data type to be exported with this save request. This key brings up the Trace menu that enables you to select one of the following traces:

- RF Spectrum (RFSpectrum)
- Demod (DEMod)
- Demod Avg (DAverage)
- Demod Max (DMaximum)
- Demod Min (DMINimum)
- AF Spectrum (AFSpectrum)
- RF Envelope (RFENvelope) --- only available in FM measurement
- Demod Raw (DRAW) --- only available in FM measurement

Once you select a trace, the menu returns back to the Data menu and the name of the selected trace is annotated on the Trace key. Now that you have selected exactly what needs to be saved, to trigger a save of the selected trace, you must select the Save As key in the Data menu.

If the Demod Min trace, Demod Max trace, or Demod Avg trace is exported when the Average/Hold Num feature is turned off, the resulting data will be default values.

The trace data file is a .csv file containing the data for one trace, suitable for import into spreadsheet software. There is a header block, followed by metadata that includes the parameters necessary to recreate the measurement, followed by a DATA block that contains the x,y data for the specified trace. Each line in the metadata includes the parameter, followed by a comma, followed by the parameter value. The metadata includes the following information:

Parameter	
Measurement †	AM FM PM
Trace	AM PM: AF Spectrum RF Spectrum Demod Demod Ave Demod Min Demod Max FM: AF Spectrum RF Spectrum Demod Demod Ave Demod Min Demod Max RF Envelope Demod Raw
X Axis Unit	Hz S
Y Axis Unit	dBm % Hz Rad
Center Frequency †	[units of Hz]
Channel BW †	[units of Hz]
Average State †	Off On
Average Count	#
HPF/BPF †	Off HPF20 HPF50 HPF300 HPF400 CCITT AWEighting

	CWEighting CMESsage CCIR1k CCIR2k CUNWeighting
LPF †	Off LPF300 LPF3K LPF10K LPF15K LPF30K LPF80K LPF300K LPF100K M500K
Attenuation †	[units of dB]
RF Coupling †	AC DC
Ref Level	[units of Y Axis Unit]
RF Span †	[units of Hz]
RF Res Bandwidth †	[units of Hz]
Sweep Time †	[units of S]
AF Start Freq	[units of Hz]
AF Stop Freq †	[units of Hz]
AF Res Bandwidth †	[units of Hz]
Trigger Source †	Off Ext1 Ext2
Trigger Level †	[units of V]
Trigger Slope †	Positive Negative
Trigger Delay †	[units of S]
PreAmp State †	Off On
PreAmp Band †	Low High
Input Z Correction †	50 75
RF Calibrator	Off 50 MHz 4.8 GHz Comb
External Gain	[units of dB]
Auto Carrier Frequency †	Off On
Auto Carrier Phase †	Off On

† Changing this parameter requires a measurement restart.

Note that all metadata is stored for each trace. After the metadata, the keyword DATA occurs on its own line, followed by the data (one X, Y pair per line).

Key Path	Save, Data
Notes	The first key press selects traces out of the 1-of-N file type options. The second key press brings up the Traces menu so you can select which trace you want to export.
Preset	RF Spectrum; is not affected by a Preset, but is reset during Restore Mode Defaults and survives Power cycles.
State Saved	Saved in instrument state.

Readback	Selected Trace table
Readback line	RF Spectrum, Demod, Demod Avg, Demod Max, Demod Min, AF Spectrum, RF Envelope, Demod Raw
Initial S/W Revision	Prior to A.02.00

Measurement Results

Pressing this key selects Meas Results as the data type to be exported. Pressing the key a second time brings up the Meas Results menu, which allows you to select which **Meas Result** to save. In the Swept SA measurement, there are three types of Measurement Results files: Peak Table, Marker Table and Spectrogram.

See "[Meas Results File Contents](#)" on page 375.

See "[Marker Table](#)" on page 376.

See "[Peak Table](#)" on page 378.

See Spectrogram

Remote Command	<code>:MMEMory:STORe:RESults:MTABle PTABle SPEctrogram <filename></code>
Example	<p><code>:MMEM:STOR:RES:MTAB "myResults.csv"</code> Saves the results from the current marker table to the file myResults.csv in the current path.</p> <p><code>:MMEM:STOR:RES:PTAB "myResults.csv"</code> Saves the results from the current peak table to the file myResults.csv in the current path.</p> <p><code>:MMEM:STOR:RES:SPEC "myResults.csv"</code> Saves the results from the current Spectrogram display to the file myResults.csv in the current path.</p> <p>The default path is My Documents\SA\data\SAN\results</p>
Notes	<p>If the save is initiated via SCPI, and the file already exists, the file will be overwritten. Using the C: drive is strongly discouraged, since it runs the risk of being overwritten during an instrument software upgrade.</p> <p>Both single and double quotes are supported for any filename parameter over SCPI.</p>
Dependencies	<p>If a save of Marker Table results is requested and the Marker Table is not on, no file is saved and a message is generated</p> <p>If a save of Peak Table results is requested and the Peak Table is not on, no file is saved and a message is generated</p> <p>If a save of Spectrogram results is requested and the Spectrogram is not on, no file is saved and a message is generated.</p> <p>The Spectrogram choice only appears if option EDP is licensed.</p>
Preset	Not part of Preset, but is reset to Peak Table by Restore Mode Defaults. Survives a shutdown.
Initial S/W Revision	Prior to A.02.00

Meas Results File Contents

All files are .csv files. The following section details the data in each file type.

Marker Table

This section discusses the Marker Table Meas Results file format.

Imagine that, at the point where a Marker Table Meas Result is requested, the following screen is showing:

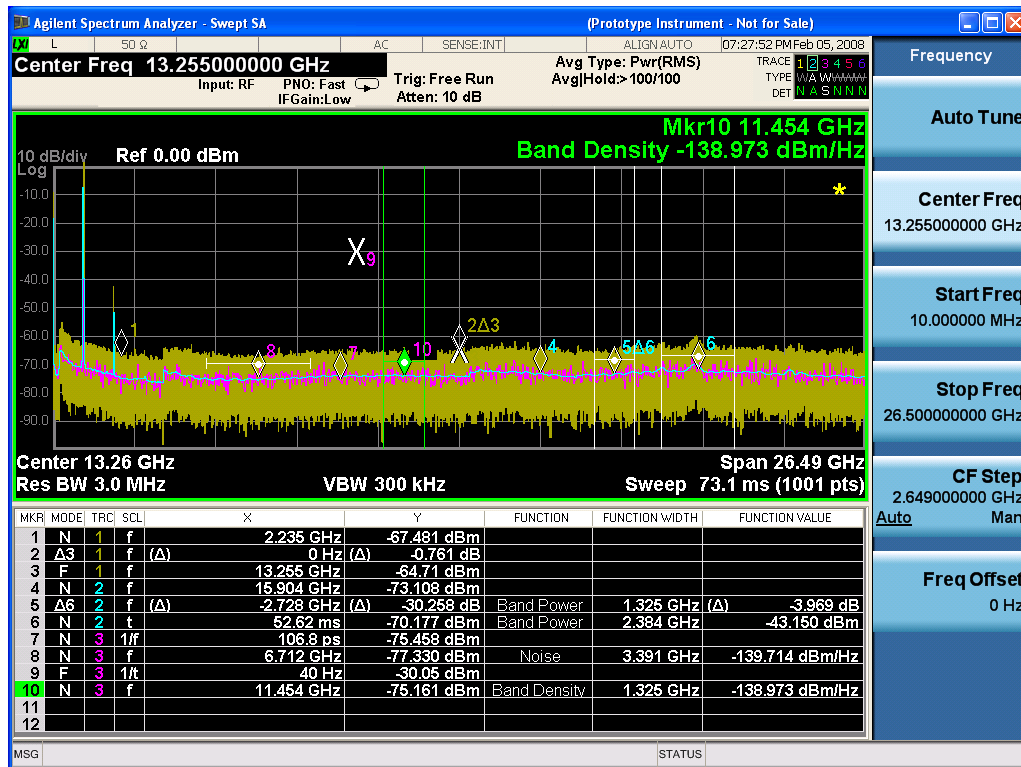

Then the Meas Results file, when opened, would show the following data:

MeasurementR	
result	
Swept SA	
A.01.40_R0017	N9020A
526 B25 PFR	1
P26 EA3	
Result Type	Marker Table
Ref Level	0
Number of Points	1001
Sweep Time	0.0662666 67
Start Frequency	10000000
Stop Frequency	26500000 000

Average Count	0
Average Type	LogPower (Video)
RBW	3000000
RBW Filter	Gaussian
RBW Filter BW	3dB
VBW	3000000
Sweep Type	Swept
X Axis Scale	Lin
PreAmp State	Off
PreAmp Band	Low
Trigger Source	Free
Trigger Level	1.2
Trigger Slope	Positive
Trigger Delay	1.00E-06
Phase Noise Optimization	Fast
Swept If Gain	Low
FFT If Gain	Autorange
RF Coupling	AC
FFT Width	411900
Ext Ref	10000000
Input	RF
RF Calibrator	Off
Attenuation	10
Ref Level Offset	0
External Gain	0
X Axis Units	Hz
Y Axis Units	dBm

DATA									
MKR	MODE	TRC	SCL	X	Y	FUNCTI ON	FUNCTIO N WIDTH	FUNCTI ON VALUE	FUNCTI ON UNIT
1	Normal	1	Freque ncy	2.2350E+ 09	- 67.4 81	Off	0.0000E+ 00	0	None
2	Delta3	1	Freque ncy	0.0000E+ 00	- 0.76 1	Off	0.0000E+ 00	0	None

3	Fixed	1	Frequency	1.3255E+10	-64.71	Off	0.0000E+00	0	None
4	Normal	2	Frequency	1.5904E+10	-73.108	Off	0.0000E+00	0	None
5	Delta7	2	Frequency	-2.7280E+09	-30.258	Band Power	1.3250E+06	-3.969	dB
6	Normal	2	Time	5.2620E-02	-70.177	Band Power	2.3840E+06	-43.15	dBm
7	Normal	3	Period	1.0680E-10	-75.458	Off	0.0000E+00	0	None
8	Normal	3	Frequency	6.7120E+09	-77.33	Noise	3.3910E+06	-139.714	dBm/Hz
9	Fixed	3	Inverse Time	4.0000E+01	-30.05	Off	0.0000E+00	0	None
10	Normal	3	Frequency	1.1454E+10	-75.161	Band Density	1.3250E+06	-138.973	dBm/Hz
11	Off	1	Frequency	0.0000E+00	0	Off	0.0000E+00	0	None
12	Off	1	Frequency	0.0000E+00	0	Off	0.0000E+00	0	None

The numbers appear in the file exactly as they appear onscreen. If it says 11.454 GHz onscreen, then in the file it is 11.454E+09.

The metadata header is very similar to the metadata used in the trace data .csv files. See Trace File Contents. The only new information concerns the 1-of-N fields in the marker table itself.

Peak Table

This section discusses the Peak Table Meas Results file format.

Imagine that, at the point where a Marker Table Meas Result is requested, the following screen is showing:

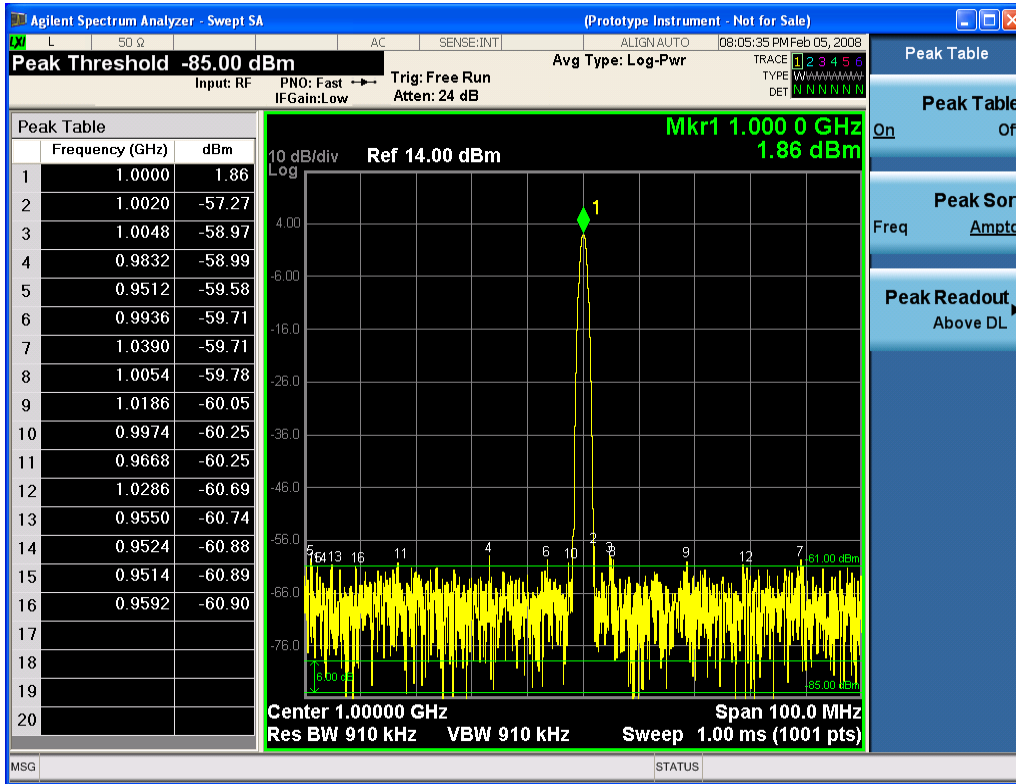

Then the Meas Results file, when opened, would show the header data (the same as for the Marker Table except that the Result Type is Peak Table) ending with a few fields of specific interest to Peak Table users:

- Peak Threshold
- Peak Threshold State (On|Off)
- Peak Excursion
- Peak Excursion State (On|Off)
- Display Line
- Peak Readout (All|AboveDL|BelowDL)
- Peak Sort (Freq|Amptd)

These fields are then followed by the data for the Peak Table itself.

Note that the label for the Frequency column changes to Time in 0 span.

Here is what the table for the above display looks like:

MeasurementResult	
Swept SA	
A.01.40_R0017	N9020A
526 B25 PFR P26 EA3	1

Result Type	Peak Table
Ref Level	0
Number of Points	1001
Sweep Time	0.066266667
Start Frequency	10000000
Stop Frequency	26500000000
Average Count	0
Average Type	LogPower(Video)
RBW	3000000
RBW Filter	Gaussian
RBW Filter BW	3dB
VBW	3000000
Sweep Type	Swept
X Axis Scale	Lin
PreAmp State	Off
PreAmp Band	Low
Trigger Source	Free
Trigger Level	1.2
Trigger Slope	Positive
Trigger Delay	1.00E-06
Phase Noise Optimization	Fast
Swept If Gain	Low
FFT If Gain	Autorange
RF Coupling	AC
FFT Width	411900
Ext Ref	10000000
Input	RF
RF Calibrator	Off
Attenuation	10
Ref Level Offset	0
External Gain	0
X Axis Units	Hz
Y Axis Units	dBm
Peak Threshold	-85
Peak Threshold State	On
Peak Excursion	6
Peak Excursion State	On

Display Line	-61	
Peak Readout	AboveDL	
Peak Sort	Amptd	
DATA		
Peak	Frequency	Amplitude
1	1.0000E+06	1.86
2	1.0020E+06	-57.27
3	1.0048E+06	-58.97
4	9.8320E+05	-58.99
5	9.5120E+05	-59.58
6	9.9360E+05	-59.71
7	1.0390E+06	-59.71
8	1.0054E+06	-59.78
9	1.1086E+06	-60.05
10	9.9740E+05	-60.25
11	9.6680E+05	-60.25
12	1.0286E+06	-60.69
13	9.5500E+05	-60.74
14	9.5240E+05	-60.88
15	9.5140E+05	-60.89
16	9.5920E+05	-60.90
17		
18		
19		
20		

Spectrogram

This section discusses the Spectrogram Results file format. The Spectrogram choice only appears if option EDP is licensed.

The Spectrogram results are the same as a Trace data export, except that instead of having just one trace's data, all 300 traces appear one after the other.

Each trace has its own data mark; the data for Spectrogram Trace 0 follows the row marked DATA, the data for Spectrogram Trace 1 follows the row marked DATA1, for Spectrogram Trace 2 follows the row marked DATA2, and so on.

Each DATA row has a timestamp in the second column (as of firmware revision A.11.01). So, for example, if Trace 0 had a relative start time of 1729.523 sec, then the first DATA row would look like this:

DATA,1729.523

And if Trace 13 had a relative start time of 100.45 sec, then the fourteenth data row would look like:

DATA13,100.453

To find the absolute time for the relative timestamps of each trace, the last row before the first DATA row gives the absolute start time of the Spectrogram, in the form YYYYMMDDHHMMSS

So, for example, if the absolute start time is 13:23:45:678 on January 30, 2012, this row would look like:

Start Time,20120130132345678

NOTE:

NOTE The resolution of the absolute time stored is 1 ms, which matches up with the fact that the fastest sweep time is also 1 ms. However, there is no specification for the absolute accuracy of the clock in the analyzer, nor is there any facility provided to allow the user to set this time to any particular degree of accuracy.

Traces that have not yet been filled in the Spectrogram display are empty; there is no DATA header for them. The file ends after the last non-empty trace.

Imagine that, at the point where a Spectrogram Meas Result is requested, the following screen is showing:



For the purpose of this example, we have set the Average/Hold Number to 10, thus we have only traces 0 thru 10. The Spectrogram was started at 02:28:08:700 pm on April 25, 2012 (that is, 700 ms after 2:28:08 pm), although the screen dump itself shows a different time, as it was taken ten minutes after the Spectrogram data. Trace 0 is showing a start time of 5.30 seconds, meaning 5.3 seconds after the Spectrogram started (trace 10 has a start time of 0, as it was the first trace taken but has now rolled up into the tenth trace slot).

The Meas Results file, when opened, shows the header data and ten traces of trace data. Below is an extract from the result file for the above display. Note the start time of 20120425142808700 showing in the last row before the first DATA row, and the relative time of 5.299231048 showing in the first DATA row:

Result Type	Spectrogram
MeasResult	
Swept SA	
A.11.00.01	N9020A
503 508 513 526 ALL ALV B1C B1X B25 B2X B40 BAB BBA CR3 CRP DP2 DRD EA3 EDP EMC EP1 ERC ESC ESP EXM FSA HBA K03 LFE MPB P03 P08 P13 P26 PFR RTL RTS S40 SB1 SEC SM1 UK6 YAS YAV	1
Segment	0
Number of Points	1001
Sweep Time	0.523333333
Start Frequency	5999984415
Stop Frequency	6000009415
Average Count	0
Average Type	LogPower(Video)
RBW	240
RBW Filter	Gaussian
RBW Filter BW	3dB
VBW	240
Sweep Type	Swept
X Axis Scale	Lin
PreAmp State	Off
PreAmp Band	Low
Trigger Source	Free
Trigger Level	1.2
Trigger Slope	Positive
Trigger Delay	0
Phase Noise Optimization	Wide
Swept If Gain	Low

Result Type	Spectrogram
FFT If Gain	Autorange
RF Coupling	AC
FFT Width	411900
Ext Ref	10000000
Input	RF
RF Calibrator	Off
Attenuation	14
Ref Level Offset	0
External Gain	0
Trace Type	Clearwrite
Detector	Normal
Trace Math	Off
Trace Math Oper1	Trace5
Trace Math Oper2	Trace6
Trace Math Offset	0
Trace Name	Trace1
X Axis Units	Hz
Y Axis Units	dBm
Start Time	20120425142808700
DATA	5.299231048
5999984415	-76.34749519
5999984440	-77.28097006
5999984465	-75.32317869
5999984490	-73.64417681
5999984515	-72.67154604

o
o
o

6000009315	-77.94423277
6000009340	-79.51829697
6000009365	-78.46108961
6000009390	-78.46108957
6000009415	-76.59570596
DATA2	4.708697055

5999984415	-80.98197882
5999984440	-80.98197879
5999984465	-75.83142132
5999984490	-74.02712079
5999984515	-73.57213005

0
0
0

6000009315	-75.9183103
6000009340	-79.53787488
6000009365	-78.82602191
6000009390	-78.82602188
6000009415	-76.37486709
DATA10	0
5999984415	-75.56751112
5999984440	-75.76485645
5999984465	-76.67718717
5999984490	-78.79238489
5999984515	-83.72680212

0
0
0

6000009315	-71.3942461
6000009340	-72.28308332
6000009365	-73.92684489
6000009390	-75.45548832
6000009415	-75.17904815

Save As . . .

When you press “Save As”, the analyzer brings up a Windows dialog and a menu entitled “**Save As.**” This menu allows you to navigate to the various fields in the Windows dialog without using a keyboard or mouse. The Tab and Arrow keys can also be used for dialog navigation.

See "[To File ...](#)" on page 1181 in Save, State for a full description of this dialog and menu.

The default path for saving files is:

For all of the Trace Data Files:

My Documents\`<mode name>`\data\traces

For all of the Limit Data Files:

My Documents\`<mode name>`\data\limits

For all of the Measurement Results Data Files:

My Documents\`<mode name>`\data\`<measurement name>`\results

For all of the Capture Buffer Data Files:

My Documents\`<mode name>`\data\captureBuffer

Key Path	Save, Data
Mode	All
Notes	The key location is mode-dependent and will vary. Brings up the Save As dialog for saving a <code><mode specific></code> Save Type. The save is performed immediately and does not wait until the measurement is complete.
Initial S/W Revision	Prior to A.02.00

Screen Image

Pressing Screen Image accesses a menu of functions that enable you to specify a format and location for the saved screen image. It brings up a menu that allows you to specify the color scheme of the Screen Image (Themes) or navigate to the Save As dialog to perform the actual save.

Screen Image files contain an exact representation of the analyzer display. They cannot be loaded back onto the analyzer, but they can be loaded into your PC for use in many popular applications.

The image to be saved is actually captured when the Save front panel key is pressed, and kept in temporary storage to be used if you ask for a Screen Image save. When the Screen Image key is pressed, a "thumbnail" of the captured image is displayed, as shown below:

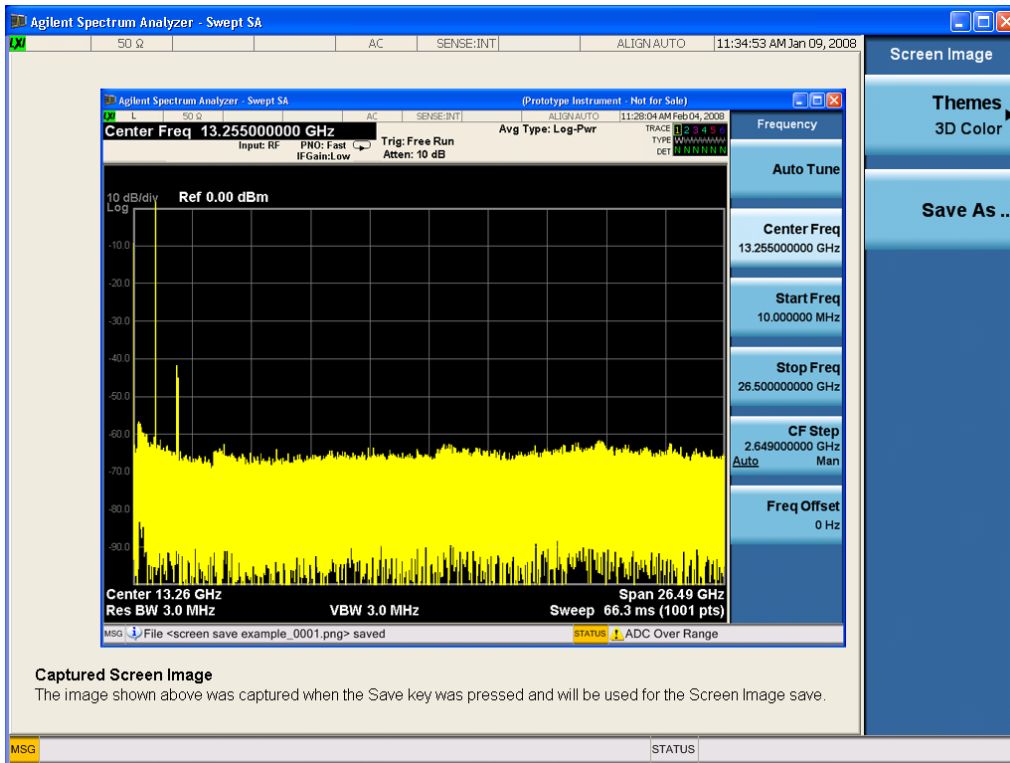

When you continue on into the Save As menu and complete the Screen Image save, the image depicted in the thumbnail is the one that gets saved, showing the menus that were on the screen before going into the Save menus. The save is performed immediately and does not wait until the measurement is complete.

After you have completed the save, the Quick Save front-panel key lets you quickly repeat the last save performed, using an auto-named file, with the current screen data.

NOTE

For versions previous to A.01.55, if you initiate a screen image save by navigating through the Save menus, the image that is saved will contain the Save menu softkeys, not the menus and the active function that were on the screen when you first pressed the Save front panel key.

Key Path	Save
Mode	All
Remote Command	:MMEMory:STORe:SCREen <filename>
Example	:MMEM:STOR:SCR "myScreen.png" This stores the current screen image in the file MyScreenFile.png in the default directory.
Initial S/W Revision	Prior to A.02.00

Themes

Accesses a menu of functions that enable you to choose the theme to be used when saving the screen image.

The **Themes** option is the same as the **Themes** option under the **Display** and **Page Setup** dialogs. It allows you to choose between themes to be used when saving the screen image.

Key Path	Save, Screen Image
Remote Command	:MMEMory:STORe:SCReem:THEMe TDColor TDMonochrome FCOLor FMONochrome :MMEMory:STORe:SCReem:THEMe?
Example	:MMEM:STOR:SCR:THEM TDM
Preset	3D Color; Is not part of Preset, but is reset by Restore Misc Defaults or Restore System Defaults All and survives subsequent running of the modes.
Readback	3D Color 3D Mono Flat Color Flat Mono
Backwards Compatibility Notes	In ESA and PSA we offer the choice of "Reverse Bitmap" or "Reverse Metafile" when saving screen images. This is much like the "Flat Color" theme available in X-Series. Also, if you selected Reverse Bitmap AND a black & white screen image, that would be much like "Flat Monochrome". In other words, each of the X-Series themes has a similar screen image type in ESA/PSA. But they are not identical.
Initial S/W Revision	Prior to A.02.00

3D Color

Selects a standard color theme with each object filled, shaded and colored as designed.

Key Path	Save, Screen Image, Themes
Example	MMEM:STOR:SCR:THEM TDC
Readback	3D Color
Initial S/W Revision	Prior to A.02.00

3D Monochrome

Selects a format that is like 3D color but shades of gray are used instead of colors.

Key Path	Save, Screen Image, Themes
Example	MMEM:STOR:SCR:THEM TDM
Readback	3D Mono
Initial S/W Revision	Prior to A.02.00

Flat Color

Selects a format that is best when the screen is to be printed on an ink printer.

Key Path	Save, Screen Image, Themes
-----------------	----------------------------

Example	MMEM:STOR:SCR:THEM FCOL
Readback	Flat Color
Initial S/W Revision	Prior to A.02.00

Flat Monochrome

Selects a format that is like Flat Color. But only black is used (no colors, not even gray), and no fill.

Key Path	Save, Screen Image, Themes
Example	MMEM:STOR:SCR:THEM FMON
Readback	Flat Mono
Initial S/W Revision	Prior to A.02.00

Save As...

When you press "Save As", the analyzer brings up a Windows dialog and a menu entitled "**Save As.**" This menu allows you to navigate to the various fields in the Windows dialog without using a keyboard or mouse. The Tab and Arrow keys can also be used for dialog navigation.

See "[To File ...](#)" on page 1181 in Save, State for a full description of this dialog and menu.

The default path for Screen Images is

My Documents\`<mode name>`\screen.

where `<mode name>` is the parameter used to select the mode with the INST:SEL command (for example, SA for the Spectrum Analyzer).

Key Path	Save, Screen Image
Notes	Brings up Save As dialog for saving a Screen Image Save Type
Initial S/W Revision	Prior to A.02.00

Single (Single Measurement/Sweep)

Sets the analyzer for Single measurement operation. The single/continuous state is Meas Global, so the setting will affect all the measurements. If you are Paused, pressing Single does a Resume.

See ["More Information" on page 390](#)

Key Path	Front-panel key
Example	:INIT:CONT OFF
Notes	See Cont key description.
Backwards Compatibility Notes	<p>For Spectrum Analysis mode in ESA and PSA, the Single hardkey and the INITiate:IMM switched from continuous measurement to single measurement and restarted sweeps and averages (displayed average count reset to 1), but did not restart Max Hold and Min Hold. In the X-Series, the Single hardkey and the INITiate:IMM command initiate a sweep/ measurement/ average sequence/hold sequence including MaxHold and MinHold.</p> <p>For Spectrum Analysis mode in ESA and PSA, the Single hardkey restarted the sweep regardless of whether or not you were in an active sweep or sweep sequence. In the X-Series, Restart does this but Single only restarts the sweep or sweep sequence if you are in the idle state.</p> <p>INIT[:IMM] in ESA & PSA Spectrum Analysis Mode does an implied ABORT. In some other PSA Modes, INIT[:IMM] is ignored if not in the idle state. . The X-Series follows the ESA/PSA SA Mode model, which may cause some Modes to have compatibility problems.</p>
Initial S/W Revision	Prior to A.02.00

More Information

See ["Restart" on page 1178](#) for details on the INIT:IMMEDIATE (Restart) function.

If you are already in single sweep, the INIT:CONT OFF command has no effect.

If you are already in Single Sweep, then pressing the Single key in the middle of a sweep does not restart the sweep or sequence. Similarly, pressing the Single key does not restart the sweep or sequence if the sweep is not in the idle state (for example, if you are taking a very slow sweep, or the analyzer is waiting for a trigger). Instead, it results in a message. "Already in Single, press Restart to initiate a new sweep or sequence". Even though pressing the Single key in the middle of a sweep does not restart the sweep, sending INIT:IMMEDIATE does reset it.

To take one more sweep without resetting the average count, increment the average count by 1, by pressing the step up key while **Average/Hold Number** is the active function, or sending the remote command CALC:AVER:TCON UP.

Source

Opens a menu of keys that access various source configuration menus and settings. In the test set, pressing this key also causes the central view area to change and display the Source Control Main view.

Key Path	Front-panel key
----------	-----------------

RF Output

This parameter sets the source RF power output state.

Key Path	Source
Remote Command	:OUTPut[:EXTernal][:STATe] ON OFF 1 0 :OUTPut[:EXTernal][:STATe]?
Example	OUTP OFF OUTP?
Notes	<p>The EXTERNAL node is shown in RD text so the SCPI remains the same between internal and external source control. However, for EXT we do not wish to document this node to the customer since we are controlling the internal source rather than the external source.</p> <p>This setting is for the independent mode and has no effect on the "List Sequencer" on page 1306. If the "Sequencer" on page 1307 is set to ON, the list sequencer controls the source output and this key will be grayed-out. And this setting will be none-forceful grey out on front panel to indicate out-of-scope. Non-forceful means user still can change this setting by SCPI but cannot change on front panel. When set to OFF will make source leave list sequencer and this setting will be black out and take effect immediately.</p> <p>When the RF Output is ON, an "RF" annunciator is displayed in the system settings panel. When the RF Output is turned Off, the RF annunciator is cleared. If the "Sequencer" on page 1307 is set to ON, the "RF" annunciator will be replaced by "SEQ" in the system settings panel, indicating that the output is controlled by the list sequencer.</p>
Preset	Off
Range	On Off
Initial S/W Revision	A.05.00

Amplitude

Allows you to access the Amplitude sub-menu.

Key Path	Source
Notes	<p>The sub-menu under this button is for independent mode and has no effect on "List Sequencer" on page 1306. If the "Sequencer" on page 1307 is set to ON, the list sequencer controls the source output and this key will be grayed-out on front panel to indicate out-of-scope. When you set "Sequencer" on page 1307 to Off will make source leave list sequencer and this button will be black out.</p>
Initial S/W Revision	A.05.00

RF Power

Allows you to adjust the power level of the source using the numeric keypad, step keys, or RPG. Pressing any digit, 0 through 9, on the numeric keypad brings up the unit terminator.

Please refer to the ["RF Power Range " on page 393](#) table below for the valid ranges.

Key Path	Source, Amplitude
Remote Command	:SOURce:POWer[:LEVel][:IMMediate][:AMPLitude] <ampl> :SOURce:POWer[:LEVel][:IMMediate][:AMPLitude]?
Example	:SOUR:POW -100 dBm
Notes	<p>Amplitude corrections can be specified for use with the source. In the event of amplitude corrections being applied, the valid ranges for the RF power do not change dependant on the current amplitude correction setting. If the combination of RF power + amplitude correction is higher or lower than the source output range, the Source Unleveled bit is set and the "Source Unleveled" indicator will appear on status panel to indicate that the source cannot maintain the output power that has been requested.</p> <p>When signal generator is unable to maintain the requested output level, the "Source Unleveled" indicator will appear on status panel. When the source output setting is restored to the normal range, the "Source Unleveled" is removed from status panel.</p> <p>Internal source has list sequence mode, which comprises of several steps which contain separate output power, frequency and waveform etc. When the source list sequence playing is complete, the last step keeps playing, and user can use this command to change the list sequence last step's output power.</p> <p>The multiport adapter RFIO TX ports and GPS ports cannot ensure power accuracy when power setting is lower than -130dBm, this power setting value is defined by the sum of RF Power setting and related amplitude correction value. But user settable value could be lower than this limit. When application detected there exists power setting lower than -130dBm on MPA RFIO TX ports, then popup warning message . When application detected there exists power setting lower than -130dBm on MPA GPS ports, then popup warning message . This is only warning message, and check is performed when RF is ON.</p>
Notes	The Min and Max value here defined UI settable amplitude range. This range is larger than actual amplitude range with level accuracy defined in spec.
Dependencies	The RF power is dependent on the RF output port and frequency, such that the current frequency and selected output port determine the valid range of power values.
Preset	-100 dBm
Min	The range of values depends on the current frequency and selected RF output port. Please refer to the "RF Power Range " on page 393 table below for the valid ranges.
Max	The range of values depends on the current frequency and selected RF output port. Please refer to the "RF Power Range " on page 393 table below for the valid ranges.
Initial S/W Revision	A.05.00

RF Power Range

RF Output Port	Frequency Range	Min Output Power	Max Output Power
High Power RF Out	10 MHz ≤ f ≤ 6 GHz	-150 dBm	20 dBm
RFIO 1 & RFIO 2	10 MHz ≤ f ≤ 6 GHz	-150 dBm	0 dBm
GPS (Note2)	10 MHz ≤ f ≤ 6 GHz	-150 dBm	0 dBm

Note: This is the UI power range, it's larger than actual spec.

Note2: GPS port is on the multiport adapter, or E6607C which has embedded MPA.

Set Reference Power

This key allows you to set the power reference. Pressing this key turns the power reference state to ON, sets the reference power value to the current RF output power, maintains this power at the RF output, and sets the displayed power to 0.00 dB. All subsequent RF power values entered under Source>Amplitude>RF Power are interpreted as being relative to this reference power.

When you use a power reference, the signal generator outputs an RF power that is set relative to the reference power by the value entered under Source>Amplitude>RF Power as follows:

Output power = reference power – entered power

Where:

reference power equals the original RF Power entered under Source>Amplitude>RF Power and set as the reference power

entered power equals a new value entered under Source>Amplitude>Amptd Offset

In addition, the displayed power value is the same as a new value entered under Source>Amplitude>RF Power.

NOTE

If Power Ref is set to ON with a reference value set, entering a value under Source>Amplitude>RF Power and pressing Set Reference Power will add that value to the existing Power Ref value.

If you wish to change the reference power value to a new value entered under Source>Amplitude>RF Power, first you must set Power Ref to OFF and then press Set Reference Power.

Key Path	Source, Amplitude
Dependencies	This key is unavailable, and is grayed out when the " List Sequencer " on page 1306 is turned ON.
Initial S/W Revision	A.05.00

Power Ref

This key allows you to toggle the state of the power reference.

When you use a power reference, the signal generator outputs an RF power that is set relative to the reference power by the value entered under Source>Amplitude>RF Power as follows:

Output power = reference power + entered power

Where:

reference power equals the original RF Power entered under Source>Amplitude>RF Power and set as the reference power

entered power equals a new value entered under Source>Amplitude>Amptd Offset

For more information on Reference Frequency refer to ["Set Reference Power " on page 1229](#)

Key Path	Source, Amplitude
Remote Command	:SOURce:POWer:REFeRence <ampl> :SOURce:POWer:REFeRence? :SOURce:POWer:REFeRence:STATe OFF ON 0 1 :SOURce:POWer:REFeRence:STATe?
Example	:SOUR:POW:REF 0.00 dBm :SOUR:POW:REF:STATe ON
Dependencies	This setting is unavailable and is grayed out when the "List Sequencer" on page 1306 is turned ON.
Couplings	This value is coupled to the "Set Reference Power " on page 1229 key such that pressing the Set Reference Power key updates the reference power with the current output power.
Preset	0.00 dBm OFF
Min	-125.00 dBm
Max	10.00 dBm
Initial S/W Revision	A.05.00

Amptd Offset

Allows you to specify the RF output power offset value.

When the amplitude offset is set to zero (0) and you set a new offset value (positive or negative), the displayed amplitude value will change as follows and the RF output power will not change:

Displayed value = output power + offset value

Where:

output power equals the original RF Power entered under Source>Amplitude>RF Power

offset value equals the value entered under Source>Amplitude>Amptd Offset

When the amplitude offset is set to a value other than zero (0) and you enter a new RF power value under Source>Amplitude>RF Power, the displayed power will be the same as the value entered and the RF output power will be equal to the value entered minus the offset value as follows:

Output power = entered power – offset power

Displayed Power = output power + offset power

Displayed power = entered power

Where:

entered power equals the amplitude entered under Source>Amplitude>RF Power

offset power equals the value previously entered and set under Source>Amplitude>Amptd Offset

Key Path	Source, Amplitude
Remote Command	:SOURce:POWer[:LEVel][:IMMediate]:OFFSet <rel_ampl> :SOURce:POWer[:LEVel][:IMMediate]:OFFSet?
Example	:SOUR:POW:OFFS 0.00 dB
Dependencies	This setting is unavailable, and is grayed out when the List Sequencer is turned ON.
Preset	0.00 dB
Min	-200.00 dB
Max	200.00 dB
Initial S/W Revision	A.05.00

Modulation

Allows you to toggle the state of the modulation.

Key Path	Source
Remote Command	:OUTPut:MODulation[:STATe] ON OFF 1 0 :OUTPut:MODulation[:STATe]?
Example	:OUTP:MOD OFF
Notes	This setting is for independent mode and has no effect on " List Sequencer " on page 1306. If the " Sequencer " on page 1307 is set to ON, the list sequencer controls the source output and this key will be grayed-out. And this setting will be none-forceful grey out on front panel to indicate out-of-scope. Non-forceful means user still can change this setting by SCPI but cannot change manually on front panel. When set to Off will make source leave list sequencer and this setting will be black out and take effect immediately. When the Modulation is ON, the "MOD" annunciator is displayed in the system settings panel. When the Modulation is turned Off, the "MOD" annunciator is cleared. If the " Sequencer " on page 1307 is set to ON, the "MOD" annunciator will be replaced by "SEQ" in the system settings panel indicating that the output is controlled by list sequencer.
Preset	Off
Range	On Off
Initial S/W Revision	A.05.00

Frequency

Allows you to access the Frequency sub-menu.

Key Path	Source
Notes	The sub-menu under this button is for independent mode and has no effect on " List Sequencer " on

[page 1306](#). If the "[Sequencer](#)" on [page 1307](#) is set to ON, the list sequencer controls the source output and this key will be grayed-out. And this button will be grey out on front panel to indicate out-of-scope. When setto Off will make source leave list sequencer and this button will be black out.

Initial S/W Revision A.05.00

Frequency

Allows you to set the RF Output Frequency. You can adjust the frequency of the source using the numeric keypad, step keys, or RPG. Pressing any digit, 0 through 9, on the numeric keypad brings up the unit terminator.

Key Path	Source, Frequency
Remote Command	:SOURce:FREQuency[:CW] <freq> :SOURce:FREQuency[:CW]?
Example	:SOUR:FREQ 1.00 GHz
Notes	Internal source has list sequence mode, which comprises of several steps which contain separate output power, frequency and waveform etc. When the source list sequence playing is complete, the last step keeps playing, and user can use this command to change the list sequence last step's output frequency.
Couplings	The frequency value is coupled to the current channel band and number, such that updates to the band and number will update the frequency value to the corresponding absolute frequency.
Preset	1.00 GHz If license F1A or 5WC is present, the default Center Frequency should be 2.412GHz.
Min	10.00 MHz
Max	Hardware Dependant: Option 503 = 3.6 GHz Option 504 = 3.8 GHz Option 506 = 6.00 GHz For E6640A, if license 5WC is present, the frequency range should be limited to: 1.1GHz–1.7GHz, 2.4GHz–2.5GHz, 4.8GHz–6.0GHz. If the user-defined frequency is outside of range, UI will report an error message called "Settings conflict; Frequency is outside available range".
Initial S/W Revision	A.05.00

Channel

The frequency of the source can be specified by a channel number of a given frequency band. This key allows you to specify the current channel number. For the appropriate range of channel numbers for a given frequency band, refer to the following tables: "[GSM/EDGE Channel Number Ranges](#)" on [page 397](#), "[W-CDMA Channel Number Ranges](#)" on [page 398](#), "[CDMA 2000 / 1xEVDO Channel Number Ranges](#)" on [page 399](#), and "[LTE FDD Channel Number Ranges](#)" on [page 401](#).

Key Path	Source, Frequency
Remote Command	:SOURce:FREQuency:CHANnels:NUMBer <int> :SOURce:FREQuency:CHANnels:NUMBer?
Example	:SOUR:FREQ:CHAN:NUMB 1
Notes	This key is grayed out when the "Radio Standard" on page 1241 is set to NONE. This key is grayed out on E6630A.
Dependencies	This key is grayed out when the "Radio Standard" on page 1241 is set to NONE. This key is grayed out on E6630A.
Couplings	The channel number is coupled to the frequency value when the "Radio Standard" on page 1241 is not set to NONE. When the frequency value is changed, the channel number will increase or decrease to match the new frequency. If the frequency is not at an exact match for a channel number, the nearest channel number is displayed along with a greater than or less than sign to indicate the frequency is above or below the channel number.
Preset	1
Min	Please refer to the tables below for the valid ranges.
Max	Please refer to the tables below for the valid ranges.
Initial S/W Revision	A.05.00

GSM/EDGE Channel Number Ranges

Band	Link (Device)	Range	Frequency (MHz)
P-GSM	Uplink (MS)	$1 \leq n \leq 124$	$890.0 + 0.2*n$
	Downlink (BS)	$1 \leq n \leq 124$	$935.0 + 0.2*n$
E-GSM	Uplink (MS)	$0 \leq n \leq 124$	$890.0 + 0.2*n$
		$975 \leq n \leq 1023$	$890.0 + 0.2*(n-1024)$
	Downlink (BS)	$0 \leq n \leq 124$	$935.0 + 0.2*n$
		$975 \leq n \leq 1023$	$935.0 + 0.2*(n-1024)$
DCS 1800	Uplink (MS)	$512 \leq n \leq 885$	$1710.200 + 0.20*(n-512)$
	Downlink (BS)	$512 \leq n \leq 885$	$1805.200 + 0.20*(n-512)$
PCS 1900	Uplink (MS)	$512 \leq n \leq 810$	$1850.200 + 0.2*(n-512)$
	Downlink (BS)	$512 \leq n \leq 810$	$1930.200 + 0.2*(n-512)$
R-GSM	Uplink (MS)	$0 \leq n \leq 124$	$890.0 + 0.2*n$
		$955 \leq n \leq 1023$	$890.0 + 0.2*(n-1024)$
	Downlink (BS)	$0 \leq n \leq 124$	$935.0 + 0.2*n$
		$955 \leq n \leq 1023$	$935.0 + 0.2*(n-1024)$
GSM 450	Uplink (MS)	$256 \leq n \leq 293$	$450.6 + 0.2*(n-259)$
	Downlink (BS)	$256 \leq n \leq 293$	$460.6 + 0.2*(n-259)$
GSM 480	Uplink (MS)	$306 \leq n \leq 340$	$479.000 + 0.20*(n-306)$

Band	Link (Device)	Range	Frequency (MHz)
GSM 850	Downlink (BS)	$306 \leq n \leq 340$	$489.000 + 0.20*(n-306)$
	Uplink (MS)	$128 \leq n \leq 251$	$824.200 + 0.20*(n-128)$
	Downlink (BS)	$128 \leq n \leq 251$	$869.200 + 0.20*(n-128)$
GSM 700	Uplink (MS)	$438 \leq n \leq 516$	$777.200 + 0.20*(n-438)$
	Downlink (BS)	$438 \leq n \leq 516$	$747.200 + 0.20*(n-438)$
T-GSM810	Uplink (MS)	$350 \leq n \leq 425$	$806.0 + 0.20*(n-350)$
	Downlink (BS)	$350 \leq n \leq 425$	$851.0 + 0.20*(n-350)$

W-CDMA Channel Number Ranges

Band	Link (Device)	Range	Frequency (MHz)
Band I	Downlink	$10562 \leq n \leq 10838$	$n \div 5$
	Uplink	$9612 \leq n \leq 9888$	$n \div 5$
Band II	Downlink	$412 \leq n \leq 687$	$n \div 5 + 1850.1$
		$9662 \leq n \leq 9938$	$n \div 5$
	Uplink	$12 \leq n \leq 287$	$n \div 5 + 1850.1$
Band III	Downlink	$350 \leq n \leq 425$	$n \div 5$
		Uplink	$1162 \leq n \leq 1513$
Band IV	Downlink	$937 \leq n \leq 1288$	$n \div 5 + 1525$
		Uplink	$537 \leq n \leq 1738$
	Uplink	$1887 \leq n \leq 2087$	$n \div 5 + 1735.1$
Band V	Downlink	$1312 \leq n \leq 1513$	$n \div 5 + 1450$
		$1662 \leq n \leq 1862$	$n \div 5 + 1380.1$
	Uplink	$1007 \leq n \leq 1087$	$n \div 5 + 670.1$
Band VI	Downlink	$4357 \leq n \leq 4458$	$n \div 5$
		Uplink	$782 \leq n \leq 862$
	Uplink	$4132 \leq n \leq 4233$	$n \div 5$
Band VII	Downlink	$1037 \leq n \leq 1062$	$n \div 5 + 670.1$
		$4387 \leq n \leq 4413$	$n \div 5$
	Uplink	$812 \leq n \leq 837$	$n \div 5 + 670.1$
Band VIII	Downlink	$4162 \leq n \leq 4188$	$n \div 5$
		Uplink	$2237 \leq n \leq 2563$
	Uplink	$2587 \leq n \leq 2912$	$n \div 5 + 2105.1$
Band VIII	Downlink	$2012 \leq n \leq 2338$	$n \div 5 + 2100$
		Uplink	$2362 \leq n \leq 2687$
Band VIII	Downlink	$2937 \leq n \leq 3088$	$n \div 5 + 340$
		Uplink	$2712 \leq n \leq 2863$

Band	Link (Device)	Range	Frequency (MHz)
Band IX	Downlink	$9237 \leq n \leq 9387$	$n \div 5$
	Uplink	$8762 \leq n \leq 8912$	$n \div 5$
Band X	Downlink	$3112 \leq n \leq 3388$	$n \div 5 + 1490$
		$3412 \leq n \leq 3687$	$n \div 5 + 1430.1$
	Uplink	$2887 \leq n \leq 3163$	$n \div 5 + 1135$
		$3187 \leq n \leq 3462$	$n \div 5 + 1075.1$
Band XI	Downlink	$3712 \leq n \leq 3812$	$n \div 5 + 736$
	Uplink	$3487 \leq n \leq 3587$	$n \div 5 + 733$
Band XII	Downlink	$3837 \leq n \leq 3903$	$n \div 5 - 37$
		$3927 \leq n \leq 3992$	$n \div 5 - 54.9$
	Uplink	$3612 \leq n \leq 3678$	$n \div 5 - 22$
		$3702 \leq n \leq 3767$	$n \div 5 - 39.9$
Band XIII	Downlink	$4017 \leq n \leq 4043$	$n \div 5 - 55$
		$4067 \leq n \leq 4092$	$n \div 5 - 64.9$
	Uplink	$3792 \leq n \leq 3818$	$n \div 5 + 21$
		$3702 \leq n \leq 3767$	$n \div 5 - 39.9$
Band XIV	Downlink	$4117 \leq n \leq 4143$	$n \div 5 - 63$
		$4167 \leq n \leq 4192$	$n \div 5 - 72.9$
	Uplink	$3892 \leq n \leq 3918$	$n \div 5 + 12$
		$3942 \leq n \leq 3967$	$n \div 5 + 2.1$
Band XIX	Downlink	$712 \leq n \leq 763$	$n \div 5 + 735$
		$787 \leq n \leq 837$	$n \div 5 + 720.1$
	Uplink	$312 \leq n \leq 363$	$n \div 5 + 770$
		$387 \leq n \leq 437$	$n \div 5 + 755.1$

CDMA 2000 / 1xEVDO Channel Number Ranges

Band	Link (Device)	Range	Frequency (MHz)
US Cellular	Uplink (MS, reverse link)	$1 \leq N \leq 799$	$0.030 \times N + 825.000$
		$991 \leq N \leq 1023$	$0.030 \times (N - 1023) + 825.000$
		$1024 \leq N \leq 1323$	$0.030 \times (N - 1024) + 815.040$
	Downlink (BS, forward link)	$1 \leq N \leq 799$	$0.030 \times N + 870.000$
		$991 \leq N \leq 1023$	$0.030 \times (N - 1023) + 870.000$
		$1024 \leq N \leq 1323$	$0.030 \times (N - 1024) + 860.040$
US PCS	Uplink (MS, reverse link)	$0 \leq N \leq 1199$	$1850.000 + 0.050 \times N$
	Downlink (BS, forward link)	$0 \leq N \leq 1199$	$1930.000 + 0.050 \times N$

Band	Link (Device)	Range	Frequency (MHz)
Japan Cellular Band	Uplink (MS, reverse link)	$1 \leq N \leq 799$	$0.0125 \times (N + 915.000)$
		$801 \leq N \leq 1039$	$0.0125 \times (N - 800) + 898.000$
		$1041 \leq N \leq 1199$	$0.0125 \times (N - 1040) + 887.000$
		$1201 \leq N \leq 1600$	$0.0125 \times (N - 1200) + 893.000$
	Downlink (BS, forward link)	$1 \leq N \leq 799$	$0.0125 \times (N + 860.000)$
		$801 \leq N \leq 1039$	$0.0125 \times (N - 800) + 843.000$
		$1041 \leq N \leq 1199$	$0.0125 \times (N - 1040) + 832.000$
		$1201 \leq N \leq 1600$	$0.0125 \times (N - 1200) + 838.000$
Korean PCS Band	Uplink (MS, reverse link)	$0 \leq N \leq 599$	$0.050 \times N + 1750.000$
	Downlink (BS, forward link)	$0 \leq N \leq 599$	$0.050 \times N + 1840.000$
NMT-450 Band	Uplink (MS, reverse link)	$1 \leq N \leq 400$	$0.025 \times (N - 1) + 450.000$
		$472 \leq N \leq 871$	$0.025 \times (N - 472) + 410.000$
		$1039 \leq N \leq 1473$	$0.020 \times (N - 1024) + 451.010$
		$1536 \leq N \leq 1715$	$0.025 \times (N - 1536) + 479.000$
		$1792 \leq N \leq 2016$	$0.020 \times (N - 1792) + 479.000$
	Downlink (BS, forward link)	$1 \leq N \leq 400$	$0.025 \times (N - 1) + 460.000$
		$472 \leq N \leq 871$	$0.025 \times (N - 472) + 420.000$
		$1039 \leq N \leq 1473$	$0.020 \times (N - 1024) + 461.010$
IMT-2000 Band	Uplink (MS, reverse link)	$0 \leq N \leq 1199$	$1920.000 + 0.050 \times N$
	Downlink (BS, forward link)	$0 \leq N \leq 1199$	$2100.000 + 0.050 \times N$
Upper 700 MHz Band	Uplink (MS, reverse link)	$0 \leq N \leq 240$	$776.000 + 0.050 \times N$
	Downlink (BS, forward link)	$0 \leq N \leq 240$	$746.000 + 0.050 \times N$
Secondary 800 MHz Band	Uplink (MS, reverse link)	$0 \leq N \leq 719$	$0.025 \times N + 806.000$
		$720 \leq N \leq 919$	$0.025 \times (N - 720) + 896.000$
	Downlink (BS, forward link)	$0 \leq N \leq 719$	$0.025 \times N + 851.000$
		$720 \leq N \leq 919$	$0.025 \times (N - 720) + 935.000$
2.5 GHz IMT Extension	Uplink (MS, reverse link)	$0 \leq N \leq 1399$	$2500.000 + 0.050 \times N$
	Downlink (BS, forward link)	$0 \leq N \leq 1399$	$2620.000 + 0.050 \times N$
US PCS 1.9 GHz	Uplink (MS, reverse link)	$0 \leq N \leq 1299$	$1850.000 + 0.050 \times N$

Band	Link (Device)	Range	Frequency (MHz)
AWS	Downlink (BS, forward link)	$0 \leq N \leq 1299$	$1930.000 + 0.050 \times N$
	Uplink (MS, reverse link)	$0 \leq N \leq 899$	$1710.000 + 0.050 \times N$
US 2.5 GHz	Downlink (BS, forward link)	$0 \leq N \leq 899$	$2100.000 + 0.050 \times N$
	Uplink (MS, reverse link)	$140 \leq N \leq 1459$	$2495.000 + 0.050 \times N$
700 Public Safety	Downlink (BS, forward link)	$140 \leq N \leq 1459$	$2617.000 + 0.050 \times N$
	Uplink (MS, reverse link)	$0 \leq N \leq 240$	$787.000 + 0.050 \times N$
C2K Lower 700	Downlink (BS, forward link)	$0 \leq N \leq 240$	$757.000 + 0.050 \times N$
	Uplink (MS, reverse link)	$0 \leq N \leq 360$	$698.000 + 0.050 \times N$
400 Euro PAMR	Downlink (BS, forward link)	$0 \leq N \leq 360$	$728.000 + 0.050 \times N$
	Uplink (MS, reverse link)	$1 \leq N \leq 400$	$0.025 \times (N-1) + 450.000$
	Uplink (MS, reverse link)	$472 \leq N \leq 871$	$0.025 \times (N-472) + 410.000$
	Uplink (MS, reverse link)	$1536 \leq N \leq 1715$	$0.025 \times (N-1536) + 479.000$
	Downlink (BS, forward link)	$1 \leq N \leq 400$	$0.025 \times (N-1) + 460.000$
	Downlink (BS, forward link)	$472 \leq N \leq 871$	$0.025 \times (N-472) + 420.000$
	Downlink (BS, forward link)	$1536 \leq N \leq 1715$	$0.025 \times (N-1536) + 489.000$
	Downlink (BS, forward link)		
800 PAMR	Uplink (MS, reverse link)	$0 \leq N \leq 239$	$870.0125 + 0.025 \times N$
	Downlink (BS, forward link)	$0 \leq N \leq 239$	$915.0125 + 0.025 \times N$

LTE FDD Channel Number Ranges

The carrier frequency in the uplink and downlink is designated by the E-UTRA Absolute Radio Frequency Channel Number (EARFCN) in the range 0 – 65535. The relation between EARFCN and the carrier frequency in MHz for the downlink is given by the following equation, where FDL_low and NOffs-DL are given in table 5.4.4-1 and NDL is the downlink EARFCN.

$$FDL = FDL_low + 0.1(NDL - NOffs-DL)$$

The relation between EARFCN and the carrier frequency in MHz for the uplink is given by the following equation where FUL_low and NOffs-UL are given in table 5.4.4-1 and NUL is the uplink EARFCN.

$$FUL = FUL_low + 0.1(NUL - NOffs-UL)$$

Band	Downlink		Uplink			
	FDL_low (MHz)	NOffs-DL	Range of NDL	FUL_low (MHz)	NOffs-UL	Range of NUL
1		2110	0	0 - 599	1920	18000 - 18599
2		1930	600	600 - 1199	1850	18600 - 19199
3		1805	1200	1200 - 1949	1710	19200 - 19949
4		2110	1950	1950 - 2399	1710	19950 - 20399
5		869	2400	2400 - 2649	824	20400 - 20649
6		875	2650	2650 - 2749	830	20650 - 20749
7		2620	2750	2750 - 3449	2500	20750 - 20449
8		925	3450	3450 - 3799	880	21450 - 21799
9		1844.9	3800	3800 - 4149	1749.9	21800 - 22149
10		2110	4150	4150 - 4749	1710	22150 - 22749
11		1475.9	4750	4750 - 4949	1427.9	22750 - 22949
12		729	5010	5010 - 5179	699	23010 - 23179
13		746	5180	5180 - 5279	777	23180 - 23279
14		758	5280	5280 - 5379	788	23280 - 23379
...						
17		734	5730	5730 - 5849	704	23730 - 23849
18		860	5850	5850 - 5999	815	23850 - 23999
19		875	6000	6000 - 6149	830	24000 - 24149
20		791	6150	6150 - 6449	832	24150 - 24449
21		1495.9	6450	6450 - 6599	1447.9	24450 - 24599
...						
24		1525	7700	7700 - 8039	1626.5	25700 - 26039
25		1930	8040	8040 - 8689	1850	26040 - 26689
26		859	8690	8690 - 9039	814	26690 - 27039
...						

Note: The channel numbers that designate carrier frequencies so close to the operating band edges that the carrier extends beyond the operating band edge shall not be used. This implies that the first 7, 15, 25, 50, 75 and 100 channel numbers at the lower operating band edge and the last 6, 14, 24, 49, 74 and 99 channel numbers at the upper operating band edge shall not be used for channel bandwidths of 1.4, 3, 5, 10, 15 and 20 MHz respectively.

LTE TDD Channel Number Ranges

The carrier frequency in the uplink and downlink is designated by the E-UTRA Absolute Radio Frequency Channel Number (EARFCN) in the range 0 – 65535. The relation between EARFCN and the carrier frequency in MHz for the downlink is given by the following equation, where FDL_low and NOffs-DL are given in table 5.4.4–1 and NDL is the downlink EARFCN.

$$FDL = FDL_low + 0.1(NDL - NOffs-DL)$$

The relation between EARFCN and the carrier frequency in MHz for the uplink is given by the following equation where FUL_low and NOffs-UL are given in table 5.4.4–1 and NUL is the uplink EARFCN.

$$FUL = FUL_low + 0.1(NUL - NOffs-UL)$$

Band	Downlink	Uplink				
FDL_low (MHz)	NOffs-DL	Range of NDL	FUL_low (MHz)	NOffs-UL	Range of NUL	
33	1900	36000	36000 –36199	1900	36000	36000 – 36199
34	2010	36200	36200 –36349	2010	36200	36200 – 36349
35	1850	36350	36350 –36949	1850	36350	36350 – 36949
36	1930	36950	36950 –37549	1930	36950	36950 – 37549
37	1910	37550	37550 –37749	1910	37550	37550 – 37749
38	2570	37750	37750 –38249	2570	37750	37750 – 38249
39	1880	38250	38250 –38649	1880	38250	38250 – 38649
40	2300	38650	38650 –39649	2300	38650	38650 – 39649
41	2496	39650	39650 – 41589	2496	39650	39650 – 41589
42	3400	41590	41590 – 43589	3400	41590	41590 – 43589
43	3600	43590	43590 – 45589	3600	43590	43590 – 45589

Note: The channel numbers that designate carrier frequencies so close to the operating band edges that the carrier extends beyond the operating band edge shall not be used. This implies that the first 7, 15, 25, 50, 75 and 100 channel numbers at the lower operating band edge and the last 6, 14, 24, 49, 74 and 99 channel numbers at the upper operating band edge shall not be used for channel bandwidths of 1.4, 3, 5, 10, 15 and 20 MHz respectively.

TDSCDMA Channel Number Ranges

1.28 Mcps TDD Option

No TX-RX frequency separation is required as Time Division Duplex (TDD) is employed. Each subframe consists of 7 main timeslots where all main timeslots (at least the first one) before the single switching point are allocated DL and all main timeslots (at least the last one) after the single switching point are allocated UL.

The nominal channel spacing is 1.6 MHz, but this can be adjusted to optimise performance in a particular deployment scenario.

The carrier frequency is designated by the UTRA absolute radio frequency channel number (UARFCN). The value of the UARFCN in the IMT2000 band is defined in the general case as follows:

$$N_t = 5 * F \quad 0.0 \text{ MHz} \leq F \leq 3276.6 \text{ MHz}$$

where F is the carrier frequency in MHz

Additional channels applicable to operation in the frequency band defined in sub-clause 5.2(d) are defined via the following UARFCN definition:

$$N_t = 5 * (F - 2150.1 \text{ MHz}) \quad 2572.5 \text{ MHz} \leq F \leq 2617.5 \text{ MHz}$$

UARFCN

1.28 Mcps TDD Option

The following UARFCN range shall be supported for each band:

**Table: UTRA Absolute Radio
Frequency Channel Number 1.28
Mcps TDD Option**

Frequency Band	Frequency Range	UARFCN Uplink and Downlink transmission
For operation in frequency band as defined in subclause 5.2 (a)	1900–1920 MHz	9504 to 9596
	2010–2025 MHz	10054 to 10121
For operation in frequency band as defined in subclause 5.2 (b)	1850–1910 MHz	9254 to 9546
	1930–1990 MHz	9654 to 9946
For operation in frequency band as defined in subclause 5.2 (c)	1910–1930 MHz	9554 to 9646
For operation in frequency band as defined in subclause 5.2 (d)	2570–2620 MHz	12854 to 13096
For operation in frequency band as defined in subclause 5.2 (e)	2300–2400 MHz	11504 to 11996
For operation in frequency band as defined in subclause 5.2 (f)	1880–1920 MHz	9404 to 9596

Radio Setup

Allows access to the sub-menus for selecting the radio standard and associated radio band. You can also set a frequency reference and offset.

This menu is greyed out when on E6630A. Radio band settings for GSM, cdma2000, and so on -- most of which are not actually supported in E6630A, which has three narrow frequency bands. So band settings are grayed out.

Key Path	Source, Frequency
Initial S/W Revision	A.05.00

Radio Standard

Allows access to the channel band sub-menus to select the desired radio standard. When you have selected the radio standard, you can then set an active channel band. The radio standard and the active channel band allow you to use channel numbers to set frequency automatically.

Key Path	Source, Frequency, Radio Setup
Remote Command	:SOURce:FREQuency:CHANnels:BAND NONE PGSM EGSM RGSM DCS1800 PCS1900 TGSM810 GSM450 GSM480 GSM700 GSM850 BANDI BANDII BANDIII BANDIV BANDV BANDVI BANDVII BANDVIII BANDIX BANDX BANDXI BANDXII BANDXIII BANDXIV BANDXIX USCELL USPCS JAPAN KOREAN NMT IMT2K UPPER SECOND PAMR400 PAMR800 IMTEXT PCS1DOT9G AWS US2DOT5G PUBLIC LOWER BAND1 BAND2 BAND3 BAND4 BAND5 BAND6 BAND7 BAND8 BAND10 BAND11 BAND12 BAND13 BAND14 BAND17 BAND18 BAND19 BAND20 BAND21 BAND24 BAND25 BAND26 BAND27 BAND28 BAND31 BAND33 BAND34 BAND35 BAND36 BAND37 BAND38 BAND39 BAND40 BAND41 BAND42 BAND43 BAND44 BANDA BANDB BANDC BANDD BANDE BANDF :SOURce:FREQuency:CHANnels:BAND?
Example	:SOUR:FREQ:CHAN:BAND PGSM
Notes	Set this setting to "NONE" will grey out "Channel" on page 1232 Channel
Initial S/W Revision	A.05.00

None

Selects no radio standard for use. When you have selected the radio standard to NONE, you cannot use channel numbers to set frequency automatically. You will need to set the frequency manually.

Key Path	Source, Frequency, Radio Setup, Radio Standard
Initial S/W Revision	A.05.00

GSM/EDGE

Sets GSM/EDGE as the radio standard for use and accesses the GSM/EDGE specific channel band sub-menus.

Key Path	Source, Frequency, Radio Setup, Radio Standard
Initial S/W Revision	A.05.00

P-GSM

Selects P-GSM as the active channel band.

Key Path	Source, Frequency, Radio Setup, Radio Standard, GSM/EDGE
Example	:SOUR:FREQ:CHAN:BAND PGSM
Initial S/W Revision	A.05.00

E-GSM

Selects E-GSM as the active channel band.

Key Path	Source, Frequency, Radio Setup, Radio Standard, GSM/EDGE
Example	:SOUR:FREQ:CHAN:BAND EGSM
Initial S/W Revision	A.05.00

R-GSM

Selects R-GSM as the active channel band.

Key Path	Source, Frequency, Radio Setup, Radio Standard, GSM/EDGE
Example	:SOUR:FREQ:CHAN:BAND RGSM
Initial S/W Revision	A.05.00

DCS 1800

Selects DCS 1800 as the active channel band.

Key Path	Source, Frequency, Radio Setup, Radio Standard, GSM/EDGE
Example	:SOUR:FREQ:CHAN:BAND DCS1800
Initial S/W Revision	A.05.00

PCS 1900

Selects PCS 1900 as the active channel band.

Key Path	Source, Frequency, Radio Setup, Radio Standard, GSM/EDGE
Example	:SOUR:FREQ:CHAN:BAND PCS1900
Initial S/W Revision	A.05.00

GSM 450

Selects GSM 450 as the active channel band.

Key Path	Source, Frequency, Radio Setup, Radio Standard, GSM/EDGE
Example	:SOUR:FREQ:CHAN:BAND GSM450
Initial S/W Revision	A.05.00

GSM 480

Selects GSM 480 as the active channel band.

Key Path	Source, Frequency, Radio Setup, Radio Standard, GSM/EDGE
Example	:SOUR:FREQ:CHAN:BAND GSM480
Initial S/W Revision	A.05.00

GSM 850

Selects GSM 850 as the active channel band.

Key Path	Source, Frequency, Radio Setup, Radio Standard, GSM/EDGE
Example	:SOUR:FREQ:CHAN:BAND GSM850
Initial S/W Revision	A.05.00

GSM 700

Selects GSM 700 as the active channel band.

Key Path	Source, Frequency, Radio Setup, Radio Standard, GSM/EDGE
Example	:SOUR:FREQ:CHAN:BAND GSM700
Initial S/W Revision	A.05.00

T-GSM 810

Selects T-GSM 810 as the active channel band.

Key Path	Source, Frequency, Radio Setup, Radio Standard, GSM/EDGE
Example	:SOUR:FREQ:CHAN:BAND T-GSM810
Initial S/W Revision	A.05.00

WCDMA

Sets WCDMA as the radio standard for use and accesses the W-CDMA specific channel band sub-menus.

Key Path	Source, Frequency, Radio Setup, Radio Standard
Initial S/W Revision	A.05.00

Band I

Selects Band I as the active channel band.

Key Path	Source, Frequency, Radio Setup, Radio Standard, WCDMA
Example	:SOUR:FREQ:CHAN:BAND BANDI
Initial S/W Revision	A.05.00

Band II

Selects Band II as the active channel band.

Key Path	Source, Frequency, Radio Setup, Radio Standard, WCDMA
Example	:SOUR:FREQ:CHAN:BAND BANDII
Initial S/W Revision	A.05.00

Band III

Selects Band III as the active channel band.

Key Path	Source, Frequency, Radio Setup, Radio Standard, WCDMA
Example	:SOUR:FREQ:CHAN:BAND BANDIII
Initial S/W Revision	A.05.00

Band IV

Selects Band IV as the active channel band.

Key Path	Source, Frequency, Radio Setup, Radio Standard, WCDMA
Example	:SOUR:FREQ:CHAN:BAND BANDIV
Initial S/W Revision	A.05.00

Band V

Selects Band V as the active channel band.

Key Path	Source, Frequency, Radio Setup, Radio Standard, WCDMA
Example	:SOUR:FREQ:CHAN:BAND BANDV
Initial S/W Revision	A.05.00

Band VI

Selects Band VI as the active channel band.

Key Path	Source, Frequency, Radio Setup, Radio Standard, WCDMA
Example	:SOUR:FREQ:CHAN:BAND BANDVI
Initial S/W Revision	A.05.00

Band VII

Selects Band VII as the active channel band.

Key Path	Source, Frequency, Radio Setup, Radio Standard, WCDMA
Example	:SOUR:FREQ:CHAN:BAND BANDVII
Initial S/W Revision	A.05.00

Band VIII

Selects Band VIII as the active channel band.

Key Path	Source, Frequency, Radio Setup, Radio Standard, WCDMA
Example	:SOUR:FREQ:CHAN:BAND BANDVIII
Initial S/W Revision	A.05.00

Band IX

Selects Band IX as the active channel band.

Key Path	Source, Frequency, Radio Setup, Radio Standard, WCDMA
Example	:SOUR:FREQ:CHAN:BAND BANDIX
Initial S/W Revision	A.05.00

Band X

Selects Band X as the active channel band.

Key Path	Source, Frequency, Radio Setup, Radio Standard, WCDMA
Example	:SOUR:FREQ:CHAN:BAND BANDX
Initial S/W Revision	A.05.00

Band XI

Selects Band XI as the active channel band.

Key Path	Source, Frequency, Radio Setup, Radio Standard, WCDMA
Example	:SOUR:FREQ:CHAN:BAND BANDXI
Initial S/W Revision	A.05.00

Band XII

Selects Band XII as the active channel band.

Key Path	Source, Frequency, Radio Setup, Radio Standard, WCDMA
Example	:SOUR:FREQ:CHAN:BAND BANDXII
Initial S/W Revision	A.05.00

Band XIII

Selects band XIII as the active channel band.

Key Path	Source, Frequency, Radio Setup, Radio Standard, WCDMA
Example	:SOUR:FREQ:CHAN:BAND BANDXIII
Initial S/W Revision	A.05.00

Band XIV

Selects Band XIV as the active channel band.

Key Path	Source, Frequency, Radio Setup, Radio Standard, WCDMA
Example	:SOUR:FREQ:CHAN:BAND BANDXIV
Initial S/W Revision	A.05.00

Band XIX

Selects Band XIX as the active channel band.

Key Path	Source, Frequency, Radio Setup, Radio Standard, WCDMA
Example	:SOUR:FREQ:CHAN:BAND BANDXIX
Initial S/W Revision	A.14.50

CDMA 2000 / 1xEVDO

Sets CDMA 2000 / 1xEVDO as the radio standard for use and accesses the CDMA 2000/1xEVDO specific channel band sub-menus.

Key Path	Source, Frequency, Radio Setup, Radio Standard
Initial S/W Revision	A.05.00

US CELL

Selects US Cell as the active channel band.

Key Path	Source, Frequency, Radio Setup, Radio Standard, CDMA 2000 / 1xEVDO
Example	:SOUR:FREQ:CHAN:BAND USCELL
Initial S/W Revision	A.05.00

US PCS

Selects US PCS as the active channel band.

Key Path	Source, Frequency, Radio Setup, Radio Standard, CDMA 2000 / 1xEVDO
Example	:SOUR:FREQ:CHAN:BAND PCS
Initial S/W Revision	A.05.00

Japan Cell

Selects Japan Cell as the active channel band.

Key Path	Source, Frequency, Radio Setup, Radio Standard, CDMA 2000 / 1xEVDO
Example	:SOUR:FREQ:CHAN:BAND JAPAN
Initial S/W Revision	A.05.00

Korean PCS

Selects Korean PCS as the active channel band.

Key Path	Source, Frequency, Radio Setup, Radio Standard, CDMA 2000 / 1xEVDO
Example	:SOUR:FREQ:CHAN:BAND KOREAN
Initial S/W Revision	A.05.00

NMT 450

Selects NMT 450 as the active channel band.

Key Path	Source, Frequency, Radio Setup, Radio Standard, CDMA 2000 / 1xEVDO
----------	--

Example	:SOUR:FREQ:CHAN:BAND NMT
Initial S/W Revision	A.05.00

IMT 2000

Selects IMT 2000 as the active channel band.

Key Path	Source, Frequency, Radio Setup, Radio Standard, CDMA 2000 / 1xEVDO
Example	:SOUR:FREQ:CHAN:BAND IMT2K
Initial S/W Revision	A.05.00

Upper 700

Selects Upper 700 as the active channel band.

Key Path	Source, Frequency, Radio Setup, Radio Standard, CDMA 2000 / 1xEVDO
Example	:SOUR:FREQ:CHAN:BAND UPPER
Initial S/W Revision	A.05.00

Secondary 800

Selects Secondary 800 as the active channel band.

Key Path	Source, Frequency, Radio Setup, Radio Standard, CDMA 2000 / 1xEVDO
Example	:SOUR:FREQ:CHAN:BAND SECOND
Initial S/W Revision	A.05.00

400 Euro PAMR

Selects 400 Euro PAMR as the active channel band.

Key Path	Source, Frequency, Radio Setup, Radio Standard, CDMA 2000 / 1xEVDO
Example	:SOUR:FREQ:CHAN:BAND PAMR400
Initial S/W Revision	A.05.00

800 PAMR

Selects 800 PAMR as the active channel band.

Key Path	Source, Frequency, Radio Setup, Radio Standard, CDMA 2000 / 1xEVDO
----------	--

Example	:SOUR:FREQ:CHAN:BAND PAMR800
Initial S/W Revision	A.05.00

2.5GHz IMT EXT

Selects 2.5 GHz IMT EXT as the active channel band.

Key Path	Source, Frequency, Radio Setup, Radio Standard, CDMA 2000 / 1xEVDO
Example	:SOUR:FREQ:CHAN:BAND IMTEXT
Initial S/W Revision	A.05.00

US PCS 1.9GHz

Selects US PCS 1.9 GHz as the active channel band.

Key Path	Source, Frequency, Radio Setup, Radio Standard, CDMA 2000 / 1xEVDO
Example	:SOUR:FREQ:CHAN:BAND PCS1DOT9G
Initial S/W Revision	A.05.00

AWS

Selects AWS as the active channel band.

Key Path	Source, Frequency, Radio Setup, Radio Standard, CDMA 2000 / 1xEVDO
Example	:SOUR:FREQ:CHAN:BAND AWS
Initial S/W Revision	A.05.00

US 2.5GHz

Selects US 2.5 GHz as the active channel band.

Key Path	Source, Frequency, Radio Setup, Radio Standard, CDMA 2000 / 1xEVDO
Example	:SOUR:FREQ:CHAN:BAND US2DOT5G
Initial S/W Revision	A.05.00

700 Public Safety

Selects 700 Public Safety as the active channel band.

Key Path	Source, Frequency, Radio Setup, Radio Standard, CDMA 2000 / 1xEVDO
----------	--

Example	:SOUR:FREQ:CHAN:BAND PUBLIC
Initial S/W Revision	A.05.00

C2K Lower 700

Selects C2K Lower 700 as the active channel band.

Key Path	Source, Frequency, Radio Setup, Radio Standard, CDMA 2000 / 1xEVDO
Example	:SOUR:FREQ:CHAN:BAND LOWER
Initial S/W Revision	A.05.00

LTE

Sets LTE FDD as the radio standard for use and accesses the LTE FDD specific channel band sub-menus..

Key Path	Source, Frequency, Radio Setup, Radio Standard
Initial S/W Revision	A.09.50

BAND 1

Selects BAND 1 as the band for the current step.

Key Path	Source, Frequency, Radio Setup, Radio Standard, LTE
Example	:SOUR:FREQ:CHAN:BAND BAND1
Initial S/W Revision	A.09.50

BAND 2

Selects BAND 2 as the band for the current step.

Key Path	Source, Frequency, Radio Setup, Radio Standard, LTE
Example	:SOUR:FREQ:CHAN:BAND BAND2
Initial S/W Revision	A.09.50

BAND 3

Selects BAND 3 as the band for the current step.

Key Path	Source, Frequency, Radio Setup, Radio Standard, LTE
Example	:SOUR:FREQ:CHAN:BAND BAND3
Initial S/W Revision	A.09.50

BAND 4

Selects BAND 4 as the band for the current step.

Key Path	Source, Frequency, Radio Setup, Radio Standard, LTE
Example	:SOUR:FREQ:CHAN:BAND BAND4
Initial S/W Revision	A.09.50

BAND 5

Selects BAND 5 as the band for the current step.

Key Path	Source, Frequency, Radio Setup, Radio Standard, LTE
Example	:SOUR:FREQ:CHAN:BAND BAND5
Initial S/W Revision	A.09.50

BAND 6

Selects BAND 6 as the band for the current step.

Key Path	Source, Frequency, Radio Setup, Radio Standard, LTE
Example	:SOUR:FREQ:CHAN:BAND BAND6
Initial S/W Revision	A.09.50

BAND 7

Selects BAND 7 as the band for the current step.

Key Path	Source, Frequency, Radio Setup, Radio Standard, LTE
Example	:SOUR:FREQ:CHAN:BAND BAND7
Initial S/W Revision	A.09.50

BAND 8

Selects BAND 8 as the band for the current step.

Key Path	Source, Frequency, Radio Setup, Radio Standard, LTE
Example	:SOUR:FREQ:CHAN:BAND BAND8
Initial S/W Revision	A.09.50

BAND 9

Selects BAND 9 as the band for the current step.

Key Path	Source, Frequency, Radio Setup, Radio Standard, LTE
Example	:SOUR:FREQ:CHAN:BAND BAND9
Initial S/W Revision	A.09.50

BAND 10

Selects BAND 10 as the band for the current step.

Key Path	Source, Frequency, Radio Setup, Radio Standard, LTE
Example	:SOUR:FREQ:CHAN:BAND BAND10
Initial S/W Revision	A.09.50

BAND 11

Selects BAND 11 as the band for the current step.

Key Path	Source, Frequency, Radio Setup, Radio Standard, LTE
Example	:SOUR:FREQ:CHAN:BAND BAND11
Initial S/W Revision	A.09.50

BAND 12

Selects BAND 12 as the band for the current step.

Key Path	Source, Frequency, Radio Setup, Radio Standard, LTE
Example	:SOUR:FREQ:CHAN:BAND BAND12
Initial S/W Revision	A.09.50

BAND 13

Selects BAND 13 as the band for the current step.

Key Path	Source, Frequency, Radio Setup, Radio Standard, LTE
Example	:SOUR:FREQ:CHAN:BAND BAND13
Initial S/W Revision	A.09.50

BAND 14

Selects BAND 14 as the band for the current step.

Key Path	Source, Frequency, Radio Setup, Radio Standard, LTE
Example	:SOUR:FREQ:CHAN:BAND BAND14
Initial S/W Revision	A.09.50

BAND 17

Selects BAND 17 as the band for the current step.

Key Path	Source, Frequency, Radio Setup, Radio Standard, LTE
Example	:SOUR:FREQ:CHAN:BAND BAND17
Initial S/W Revision	A.09.50

BAND 18

Selects BAND 18 as the band for the current step.

Key Path	Source, Frequency, Radio Setup, Radio Standard, LTE
Example	:SOUR:FREQ:CHAN:BAND BAND18
Initial S/W Revision	A.09.50

BAND 19

Selects BAND 19 as the band for the current step.

Key Path	Source, Frequency, Radio Setup, Radio Standard, LTE
Example	:SOUR:FREQ:CHAN:BAND BAND19
Initial S/W Revision	A.09.50

BAND 20

Selects BAND 20 as the band for the current step.

Key Path	Source, Frequency, Radio Setup, Radio Standard, LTE
Example	:SOUR:FREQ:CHAN:BAND BAND20
Initial S/W Revision	A.09.50

BAND 21

Selects BAND 21 as the band for the current step.

Key Path	Source, Frequency, Radio Setup, Radio Standard, LTE
Example	:SOUR:FREQ:CHAN:BAND BAND21
Initial S/W Revision	A.09.50

BAND 24

Selects BAND 24 as the band for the current step.

Key Path	Source, Frequency, Radio Setup, Radio Standard, LTE
Example	:SOUR:FREQ:CHAN:BAND BAND24
Initial S/W Revision	A.09.50

BAND 25

Selects BAND 25 as the band for the current step.

Key Path	Source, Frequency, Radio Setup, Radio Standard, LTE
Example	:SOUR:FREQ:CHAN:BAND BAND25
Initial S/W Revision	A.09.50

BAND 26

Selects BAND 26 as the band for the current step.

Key Path	Source, Frequency, Radio Setup, Radio Standard, LTE
Example	:SOUR:FREQ:CHAN:BAND BAND26
Initial S/W Revision	A.12.53

BAND 27

Selects BAND 27 as the band for the current step.

Key Path	Source, Frequency, Radio Setup, Radio Standard, LTE
Example	:SOUR:FREQ:CHAN:BAND BAND27
Initial S/W Revision	A.14.00

BAND 28

Selects BAND 28 as the band for the current step.

Key Path	Source, Frequency, Radio Setup, Radio Standard, LTE
Example	:SOUR:FREQ:CHAN:BAND BAND28
Initial S/W Revision	A.14.00

BAND 31

Selects BAND 31 as the band for the current step.

Key Path	Source, Frequency, Radio Setup, Radio Standard, LTE
Example	:SOUR:FREQ:CHAN:BAND BAND31
Initial S/W Revision	A.14.00

LTE TDD

Sets LTE TDD as the radio standard for use and accesses the LTE TDD specific channel band sub-menus..

Key Path	Source, Frequency, Radio Setup, Radio Standard
Initial S/W Revision	A.11.50

BAND 33

Selects BAND 33 as the band for the current step.

Key Path	Source, Frequency, Radio Setup, Radio Standard, LTE TDD
Example	:SOUR:FREQ:CHAN:BAND BAND33
Initial S/W Revision	A.11.50

BAND 34

Selects BAND 34 as the band for the current step.

Key Path	Source, Frequency, Radio Setup, Radio Standard, LTE TDD
Example	:SOUR:FREQ:CHAN:BAND BAND34
Initial S/W Revision	A.11.50

BAND 35

Selects BAND 35 as the band for the current step.

Key Path	Source, Frequency, Radio Setup, Radio Standard, LTE TDD
Example	:SOUR:FREQ:CHAN:BAND BAND35
Initial S/W Revision	A.11.50

BAND 36

Selects BAND 36 as the band for the current step.

Key Path	Source, Frequency, Radio Setup, Radio Standard, LTE TDD
Example	:SOUR:FREQ:CHAN:BAND BAND36
Initial S/W Revision	A.11.50

BAND 37

Selects BAND 37 as the band for the current step.

Key Path	Source, Frequency, Radio Setup, Radio Standard, LTE TDD
Example	:SOUR:FREQ:CHAN:BAND BAND37
Initial S/W Revision	A.11.50

BAND 38

Selects BAND 38 as the band for the current step.

Key Path	Source, Frequency, Radio Setup, Radio Standard, LTE TDD
Example	:SOUR:FREQ:CHAN:BAND BAND38
Initial S/W Revision	A.11.50

BAND 39

Selects BAND 39 as the band for the current step.

Key Path	Source, Frequency, Radio Setup, Radio Standard, LTE TDD
Example	:SOUR:FREQ:CHAN:BAND BAND39
Initial S/W Revision	A.11.50

BAND 40

Selects BAND 40 as the band for the current step.

Key Path	Source, Frequency, Radio Setup, Radio Standard, LTE TDD
Example	:SOUR:FREQ:CHAN:BAND BAND40
Initial S/W Revision	A.11.50

BAND 41

Selects BAND 41 as the band for the current step.

Key Path	Source, Frequency, Radio Setup, Radio Standard, LTE TDD
Example	:SOUR:FREQ:CHAN:BAND BAND41
Initial S/W Revision	A.11.50

BAND 42

Selects BAND 42 as the band for the current step.

Key Path	Source, Frequency, Radio Setup, Radio Standard, LTE TDD
Example	:SOUR:FREQ:CHAN:BAND BAND42
Initial S/W Revision	A.11.50

BAND 43

Selects BAND 43 as the band for the current step.

Key Path	Source, Frequency, Radio Setup, Radio Standard, LTE TDD
Example	:SOUR:FREQ:CHAN:BAND BAND43
Initial S/W Revision	A.11.50

BAND 44

Selects BAND 44 as the band for the current step.

Key Path	Source, Frequency, Radio Setup, Radio Standard, LTE TDD
Example	:SOUR:FREQ:CHAN:BAND BAND44
Initial S/W Revision	A.14.00

TDSCDMA

Sets TDSCDMA as the radio standard for use and accesses the TDSCDMA specific channel band sub-menus..

Key Path	Source, Frequency, Radio Setup, Radio Standard
Initial S/W Revision	A.11.50

BAND A

Selects BAND A as the band for the current step.

Key Path	Source, Frequency, Radio Setup, Radio Standard, TDSCDMA
Example	:SOUR:FREQ:CHAN:BAND BANDA
Initial S/W Revision	A.11.50

BAND B

Selects BAND B as the band for the current step.

Key Path	Source, Frequency, Radio Setup, Radio Standard, TDSCDMA
Example	:SOUR:FREQ:CHAN:BAND BANDB
Initial S/W Revision	A.11.50

BAND C

Selects BAND C as the band for the current step.

Key Path	Source, Frequency, Radio Setup, Radio Standard, TDSCDMA
Example	:SOUR:FREQ:CHAN:BAND BANDC
Initial S/W Revision	A.11.50

BAND D

Selects BAND D as the band for the current step.

Key Path	Source, Frequency, Radio Setup, Radio Standard, TDSCDMA
Example	:SOUR:FREQ:CHAN:BAND BANDD
Initial S/W Revision	A.11.50

BAND E

Selects BAND E as the band for the current step.

Key Path	Source, Frequency, Radio Setup, Radio Standard, TDSCDMA
----------	---

Example	:SOUR:FREQ:CHAN:BAND BANDE
Initial S/W Revision	A.11.50

BAND F

Selects BAND F as the band for the current step.

Key Path	Source, Frequency, Radio Setup, Radio Standard, TDSCDMA
Example	:SOUR:FREQ:CHAN:BAND BANDF
Initial S/W Revision	A.11.50

Radio Band Link

Allows you to specify the channel band type as either uplink or downlink link direction. This value is used in conjunction with the channel band and channel number to determine the absolute frequency output by the source. When set to “Uplink”, the source will calculate the uplink frequency using an uplink formula together with the selected channel band and channel number . When set to “Downlink”, the source will calculate the downlink frequency using a downlink formula together with the selected channel band and channel number.

Key Path	Source, Frequency, Radio Setup
Remote Command	:SOURce:RADio:BAND:LINK DOWN UP :SOURce:RADio:BAND:LINK?
Example	:SOUR:RAD:BAND:LINK UP
Preset	DOWN
Range	DOWN UP
Backwards Compatibility SCPI	:SOURce:RADio:DEVice BTS MS :SOURce:RADio:DEVice?
Backwards Compatibility Notes	BTS maps to the Downlink frequency MS maps to the Uplink frequency
Initial S/W Revision	A.05.00

Set Reference Frequency

This key allows you to set the frequency reference. Pressing this key turns the frequency reference state to ON, sets the reference frequency value to the current frequency, maintains this frequency at the RF output, and sets the displayed frequency to 0.00 Hz. All subsequent frequencies entered under Source>Frequency>Frequency are interpreted as being relative to this reference frequency.

When you use a frequency reference, the signal generator outputs a frequency that is set relative to the reference frequency by the value entered under Source>Frequency>Frequency as follows:

Output frequency = reference frequency - entered frequency

Where:

reference frequency equals the original RF frequency entered under Source>Frequency>Frequency and set as the reference frequency

entered frequency equals a new value entered under Source>Frequency>Frequency

In addition, the displayed frequency value will be the same as the value entered under Source>Frequency>Frequency.

NOTE

If Freq Reference is set to ON with a reference value set, entering a value under Source>Frequency>Frequency and pressing Set Frequency Reference will add that value to the existing Freq Reference value.

If you wish to change the reference frequency value to the new value entered under Source>Frequency>Frequency, first you must set Freq Reference to OFF and then press Set Frequency Reference.

Key Path	Source, Frequency
Remote Command	:SOURce:FREQuency:REFerence:SET
Example	:SOUR:FREQ:REF:SET
Dependencies	This setting is unavailable, and is grayed out when the List Sequencer is turned ON.
Initial S/W Revision	A.05.00

Freq Reference

This key allows you to toggle the state of the frequency reference. When the frequency reference state is ON, an annunciator is displayed on the main source view to indicate this state to the user.

When you use a frequency reference, the signal generator outputs a frequency that is set relative to the reference frequency by the value entered under Source>Frequency>Frequency as follows:

Output frequency = reference frequency + entered frequency

Where:

reference frequency equals the original RF frequency entered under Source>Frequency>Frequency and set as the reference frequency

entered frequency equals a new value entered under Source>Frequency>Frequency

For more information on Reference Frequency refer to ["Set Reference Frequency" on page 1259](#)

Key Path	Source, Frequency
Remote Command	:SOURce:FREQuency:REFerence <freq> :SOURce:FREQuency:REFerence? :SOURce:FREQuency:REFerence:STATe OFF ON 0 1 :SOURce:FREQuency:REFerence:STATe?
Example	:SOUR:FREQ:REF 0.00 Hz

	:SOUR:FREQ:REF:STATe ON
Dependencies	This setting is unavailable, and is grayed out when the List Sequencer is turned ON.
Couplings	The frequency reference state is coupled to the frequency reference set immediate action. When the reference set immediate action key is pressed, or the SCPI command issued, it turns the frequency reference state ON.
Preset	0.00 Hz OFF
Min	0.00 Hz
Max	Hardware Dependant: Option 503 = 3.6 GHz Option 504 = 3.8 GHz Option 506 = 6.00 GHz
Initial S/W Revision	A.05.00

Freq Offset

Allows you to specify the frequency offset value. When the frequency offset state is ON, an annunciator is displayed on the main source view to indicate this state to the user.

When the frequency offset is set to zero (0) and you set a new offset value, the displayed frequency value will change as follows and the RF output frequency will not change:

Displayed value = output frequency + offset value

Where:

output frequency equals the original frequency entered under Source>Frequency>Frequency

offset value equals the value entered under Source>Frequency>Freq Offset

When the frequency offset is set to a value other than zero (0) and you enter a new frequency value under Source>Frequency>Frequency, the displayed frequency will be the same as the value entered and the RF output frequency will be equal to the value entered minus the offset value as follows:

Output frequency = entered frequency – offset frequency

Displayed frequency = output frequency + offset frequency

Displayed frequency = entered frequency

Where:

entered frequency equals the frequency entered under Source>Frequency>Frequency

offset frequency equals the value previously entered and set under Source>Frequency>Freq Offset

Key Path	Source, Frequency
Remote Command	:SOURce:FREQuency:OFFSet <freq>

	:SOURce:FREQuency:OFFSet?
Example	:SOUR:FREQ:OFFS 0 Hz
Dependencies	This setting is unavailable, and is grayed out when the List Sequencer is turned ON.
Preset	0 Hz
Min	-100.00 GHz
Max	100.00 GHz
Initial S/W Revision	A.05.00

Modulation Setup

Allows access to the menus for setting up the available modulation types: "ARB" on page 1262, "AM" on page 1303, "FM" on page 1304, and "PM" on page 1305.

Key Path	Source
Initial S/W Revision	A.05.00

ARB

Allows you access to the ARB sub-menus.

Key Path	Source, Modulation Setup
Initial S/W Revision	A.05.00

ARB

Allows you to toggle the state of the ARB function. When the ARB is On, a "MOD" annunciator is displayed in the system settings panel. When the ARB is turned Off, the MOD annunciator is cleared

Key Path	Source, Modulation Setup, ARB
Remote Command	:SOURce:RADio:ARB[:STATe] ON OFF 1 0 :SOURce:RADio:ARB[:STATe]?
Example	:SOUR:RAD:ARB OFF :SOUR:RAD:ARB?
Notes	If the ARB is ON, a user then loads or deletes another file to ARB memory, the playing waveform segment may not keep phase continuity during the ARB memory operation. The waveform will be replayed after the ARB operation is finished.
Dependencies	This setting is for independent mode and has no effect on 3.3.8 list sequencer mode. Setting "Sequencer" on page 1307 Sequencer to On will put source enter list sequencer mode, and even if ARB state is On, the ARB file will not be played. Setting "Sequencer" on page 1307 Sequencer to Off will make source leave list sequencer mode, and this setting will take effect immediately.

The ARB can only be turned on when there is a waveform file selected for playback. On the GUI If no waveform is selected, this key is grayed out. If you send the SCPI command to turn the ARB on with no waveform selected for playback, the ARB state remains OFF and an error is generated. "-
When you try to recall a certain set of states in which the selected waveform is not in ARB memory and the ARB state is On, errors are reported

Preset	Off
Range	On Off
Initial S/W Revision	A.05.00

Select Waveform

Allows you to access to the waveform selection sub-menus.

Pressing this key changes the central view area to show the Waveform File Selection view.

Key Path	Source, Modulation Setup, ARB
Initial S/W Revision	A.05.00

Select Waveform

Allows you to select a waveform sequence or segment for the dual ARB to play.

NOTE: Selecting a waveform file does not result in automatic adjustments to burst timing (to compensate for the presence or absence of a Multiport Adapter); that adjustment occurs only when a waveform is loaded to ARB memory. See "Load Segment to ARB Memory" for more information about this adjustment.

Key Path	Source, Modulation Setup, ARB, Select Waveform
Remote Command	:SOURce:RADio:ARB:WAVeform <string> :SOURce:RADio:ARB:WAVeform?
Example	:SOUR:RAD:ARB:WAV "test_waveform.bin"
Notes	<p>If intended waveform is not in the memory yet, then issuing this command by SCPI will invoke ARB loading operation first, which involves a delay of unpredictable length. So this command should be followed by the query *OPC?, which holds off subsequent commands until the loading operating is complete.</p> <p><string> - specifies the name of the waveform segment or waveform sequence to be played by the ARB.</p> <p>When in Sequence Analyzer mode, and Include Source is Yes, if the you attempt to play a waveform sequence but not all the required waveform segments are in the ARB playback memory, the application will reject the loading operation with an error is generated .</p> <p>When Include Source is No, if you attempt to play a waveform sequence but not all the required waveform segments are contained in the ARB playback memory, the application will attempt to load the required segments from either the default directory of the current directory. If the ARB memory does not have enough space for all the waveform segments to be loaded, an error is generated and</p>

none of the waveform segments is loaded.

If the ARB is ON, and you attempt to play a waveform sequence but not all the waveform segments within the sequence could be found to be loaded into ARB memory, an error is generated. The selected waveform keeps the previous value and ARB state remains On.

If you specify a waveform segment over SCPI but the waveform segment is not present within ARB playback memory and cannot be found for auto loading within the current directory or the default directory, an error is generated and the file selection remains unchanged.

If you select a waveform for playback and the waveform requires a license that is not installed on the instrument, an error is generated.

If the ARB is ON and you load a file to ARB memory or delete a file from ARB memory, the playing waveform segment may not keep phase continuity during the ARB memory operation. The waveform will be replayed after the ARB operation is finished.

Initial S/W Revision	A.05.00
----------------------	---------

Segments on Hard Disk

Allows you access to the sub-menus for loading waveform segments from the hard disk into ARB memory. The default directory is: D: varb.

Pressing this key changes the current view to the Waveform Management View.

Key Path	Source, Modulation Setup, ARB, Select Waveform
----------	--

Initial S/W Revision	A.05.00
----------------------	---------

Load Segment To ARB Memory

Allows you to load the selected file into ARB memory. On the front panel you select the file for loading to the ARB memory by highlighting the desired file in the list. Using the SCPI command, you specify the file name on the HDD.

“NVWFM” (non-volatile storage) MSUS (Mass Storage Unit Specifier) is supported in the memory subsystem because the ARB memory cannot be accessed directly. Therefore, files must be downloaded to the instrument hard disk and then loaded into the ARB memory. “NVWFM” MSUS will be mapped to the default directory D: VARB. The SCPI command supports using either “NVWFM” MSUS or specifying a full path. For more information, see [Memory Subsystem \(Remote Command Only\)](#).

If a file of the same name already exists within ARB memory, it is overwritten. If you wish to load two segments of the same name, you must rename one of the segments before loading it into ARB memory. To rename a segment, you can either use Windows File Explorer, or the :MMEMory:COPY command.

NOTE: When a waveform file is loaded to ARB memory, burst timing adjustments are made automatically, based on whether or not a Multiport Adapter is connected to the test set and powered on. If the connection/power status of the Multiport Adapter is changed after a waveform file has been loaded, it needs to be loaded again.

Key Path	Source, Modulation Setup, ARB, Select Waveform, Segments on Hard Disk
----------	---

Remote Command	:SOURce:RADio:ARB:LOAD <string>
Example	:SOUR:RAD:ARB:LOAD "D: VARB\testwaveform.bin" or :SOUR:RAD:ARB:LOAD "NVWFM:testwaveform.bin"
Notes	<p>Because loading the file involves a delay of unpredictable length, this command should be followed by the query *OPC?, which holds off subsequent commands until the loading operating is complete.</p> <p><string> - specifies the path name of the file to load from the HDD into ARB memory. It could be a <full path + filename>, or <"NVWFM" MSUS + colon + filename>.</p> <p>When in Sequence Analyzer mode, and Include Source is Yes, an attempt to load a file to ARB memory will be rejected with an error.</p> <p>When Include Source is No and if there is insufficient free ARB memory to load the selected waveform, an error is generated. .</p> <p>If you specify a file over SCPI, but the file is not at the specified location, an error is generated.</p> <p>If you try to load a waveform file but the file contains less than 500 IQ samples, an error is generated.</p> <p>If you try to load a Signal Studio waveform "*.wfm" which contains invalid waveform header, an error is generated.</p> <p>If the ARB is ON when you load a file to ARB memory or delete a file from ARB memory, the playing waveform segment may not keep phase continuity during the ARB memory operation. The waveform will be replayed after the ARB operation is finished.</p> <p>ARB can be loaded into ARB memory even required licenses do not present on the instrument. In this case, a GUI only warning message -800, "Operation complete; Loaded <filename> successfully, but no license <required licenses> installed". User can install required licenses according to <required licenses> string to license it, or multi-pack license it.</p>
Initial S/W Revision	A.05.00

Load All To ARB Memory

Allows you to load all the segment files within the currently selected directory into ARB memory. If a file of the same name already exists within ARB memory, it is overwritten. If you wish to load two segments of the same name, you must rename one of the segments before loading it into ARB memory. To rename a segment, you can either use Windows File Explorer, or the :MEMory:COPI command.

NOTE: When a waveform file is loaded to ARB memory, burst timing adjustments are made automatically, based on whether or not a Multiport Adapter is connected to the test set and powered on. If the connection/power status of the Multiport Adapter is changed after a waveform file has been loaded, it needs to be loaded again.

Key Path	Source, Modulation Setup, ARB, Select Waveform, Segments on Hard Disk
Remote Command	:SOURce:RADio:ARB:LOAD:ALL <string>
Example	:SOUR:RAD:ARB:LOAD:ALL "D: varb"
Notes	<p><string> - specifies the directory on the HDD to load the files into ARB memory from.</p> <p>When in Sequence Analyzer mode, and Include Source is Yes, an attempt to load all files from a directory to ARB memory is rejected with an error.</p> <p>When Include Source is No and there is insufficient free ARB memory to load all the waveforms,</p>

when the ARB memory is full, the copy ceases, and an error is generated.
 If you specify a directory over SCPI, but the directory does not exist, an error is generated.
 If the ARB is ON, a user then loads or deletes file to ARB memory, the playing waveform segment may not keep phase continuity during the ARB memory operation. The waveform will be replayed after the ARB operation is finished.

Initial S/W Revision A.05.00

Change Directory...

Allows you to change the currently selected directory on the hard disk. Pressing this key opens a standard windows change directory dialog allowing you to select the new directory of interest.

The current directory is used for manually loading waveform segments into ARB memory for playback, and as a search location for waveform segments that are required to be loaded into ARB memory for playback of a waveform sequence or a list sequence.

Key Path Source, Modulation Setup, ARB, Select Waveform, Segments on Hard Disk

Notes No remote command, SCPI front panel only.

Initial S/W Revision A.05.00

Default Directory...

Allows you to change the default directory. It is used as a search location for waveform segments that are required to be loaded into ARB memory for playback of a waveform sequence, and as a search location for selecting waveforms using SCPI.

Key Path Source, Modulation Setup, ARB, Select Waveform, Segments on Hard Disk

Remote Command :SOURce:RADio:ARB:DEFault:DIRectory <string>
 :SOURce:RADio:ARB: DEFault:DIRectory?

Example :SOUR:RAD:ARB:DEF:DIR "D:\ArbFiles"
 :SOUR:RAD:ARB:DEF:DIR?

State Saved Persistent, survives a power cycle and a preset but not saved in the instrument state

Initial S/W Revision A.05.00

Segments in ARB Memory

Allows you access to the sub-menus for managing the files within ARB memory.

Key Path Source, Modulation Setup, ARB, Select Waveform

Initial S/W Revision A.05.00

Delete Segment From ARB Mem

Allows you to remove a segment from ARB playback memory.

Key Path	Source, Modulation Setup, ARB, Select Waveform, Segments in ARB Memory
Remote Command	:SOURce:RADio:ARB:DELeTe <string>
Example	:SOUR:RAD:ARB:DEL "testwaveform.bin"
Notes	<p><string> - specifies the waveform to be deleted from the ARB playback memory.</p> <p>When in Sequence Analyzer mode and Include Source is Yes, an attempt to delete a file from ARB memory is rejected with an error.</p> <p>When Include Source is No and you specify a file that does not exist within ARB memory, an error is generated.</p> <p>It is possible to delete files from within the ARB memory when the ARB is ON. However, if you attempt to delete the file that is currently playing an error is generated.</p> <p>It is possible to delete a file from within the ARB memory when the sequencer state is ON and the file is not being used by the List Sequencer. If you attempt to delete a file which is being used by the list sequencer, an error is generated.</p> <p>When sequencer state is On, even if ARB state is On, the selected waveform will not be played. In this case, if the selected waveform is not used in List Sequence, it can be deleted and the ARB state is turned Off.</p> <p>If the ARB is ON and you load a file to ARB memory or delete a file from ARB memory, the playing waveform segment may not keep phase continuity during the ARB memory operation. The waveform will be replayed after the ARB operation is finished.</p>
Initial S/W Revision	A.05.00

Delete All From ARB Memory

Allows you to remove all segments from ARB playback memory.

Key Path	Source, Modulation Setup, ARB, Select Waveform, Segments in ARB Memory
Remote Command	:SOURce:RADio:ARB:DELeTe:ALL
Example	:SOUR:RAD:ARB:DELeTe:ALL
Notes	<p>When in Sequence Analyzer mode and Include Source is Yes, an attempt to delete all files from ARB memory is rejected with an error.</p> <p>When Include Source is No and you attempt to delete all files from ARB memory when the ARB is currently playing a file, all files except the one playing are deleted and an error is generated.</p> <p>If you attempt to delete all files from ARB memory when there are waveform files used in "List Sequencer" on page 1306 and "Sequencer" on page 1307 state is ON, all files except the files currently being used in list sequencer are deleted, and an error is generated.</p> <p>If the ARB is ON and you load a file to ARB memory or delete a file from ARB memory, the playing waveform segment may not keep phase continuity during the ARB memory operation. The waveform will be replayed after the ARB operation is finished.</p>
Initial S/W Revision	A.05.00

Query ARB Memory File List (Remote Command Only)

Queries the test set for the list of waveform segments in the ARB memory.

NOTE

This command returns a string for waveform segment names in ARB memory. If you want a string list of waveform segments in the ARB memory, use ["Query ARB Memory Full File List \(Remote Command Only\)" on page 1268](#).

Remote Command	:SOURce:RADio:ARB:CATalog?
Example	:SOUR:RAD:ARB:CATalog?
Notes	The return data is in the following format: <integer> - memory used <integer> - memory free <string> ... - comma separated list of waveform segments within ARB memory
Initial S/W Revision	A.05.00

Query ARB Memory Full File List (Remote Command Only)

Queries the test set for the string list of waveform segments in the ARB memory. It returns a string list for waveform segment names in the ARB memory.

Remote Command	:SOURce:RADio:ARB:FCATalog?
Example	:SOUR:RAD:ARB:FCATalog?
Notes	The return data is in the following format: <integer> - memory used <integer> - memory free <integer> - file count in ARB memory <string>,<string>, ... <string> - comma separated string list of waveform segments within ARB memory Example: SOUR:RAD:ARB:FCAT? EXT returns: 27499,2069653,3,"c2k.wfm","gsm.wfm","wcdma.wfm"
Initial S/W Revision	A.09.00

ARB Setup

Allows access to the ARB setup sub-menus.

Key Path	Source, Modulation Setup, ARB
Initial S/W Revision	A.05.00

Sample Rate

Allows you to set the ARB waveform playback sample rate.

Key Path	Source, Modulation Setup, ARB, ARB Setup
Remote Command	:SOURce:RADio:ARB:SCLock:RATE <freq> :SOURce:RADio:ARB:SCLock:RATE?
Example	:SOUR:RAD:ARB:SCL:RATE 48.00 MHz
Notes	If there is a sample rate specified in the header of the waveform file, changing that sample rate is not recommended, as it may cause problems with burst timing.
Dependencies	When a new waveform is selected for playback the settings contained within the associated waveform header file are applied to the ARB. The sample rate is one of the values stored within the header file. If the newly selected waveform file has an associated header file, the sample rate is updated with the value from the header file. The sample rate will remain unchanged if the newly selected waveform does not have an associated header file.
Preset	125.00 MHz
Min	1.00 kHz
Max	125.00 MHz
Initial S/W Revision	A.05.00

Run-Time Scaling

Allows you to adjust the run-time scaling value. The run-time scaling value is applied in real-time while the waveform is playing.

Key Path	Source, Modulation Setup, ARB, ARB Setup
Remote Command	:SOURce:RADio:ARB:RSCaling <real> :SOURce:RADio:ARB:RSCaling?
Example	:SOUR:RAD:ARB:RSC 100.00
Notes	This setting cannot be set in E6640A. Grey out on menu and the value is fixed at 70.00%.
Dependencies	When a new waveform is selected for playback the settings contained within the associated waveform header file are applied to the ARB. The run-time scaling is one of the values stored within the header file. If the newly selected waveform file has an associated header file, the run-time scaling is updated with the value from the header file. The run-time scaling will remain unchanged if the newly selected waveform does not have an associated header file.
Preset	70.00 %
Min	1.00 %
Max	100.00 %
Initial S/W Revision	A.05.00

Baseband Freq Offset

Allows you to adjust the value by which the baseband frequency is offset relative to the carrier.

Key Path	Source, Modulation Setup, ARB, ARB Setup
Remote Command	:SOURce:RADio:ARB:BASEband:FREQuency:OFFSet <freq> :SOURce:RADio:ARB:BASEband:FREQuency:OFFSet?
Example	:SOUR:RAD:ARB:BAS:FREQ:OFFS 0.00 Hz
Dependencies	When a new waveform is selected for playback the settings contained within the associated waveform header file are applied to the ARB. The baseband frequency offset is one of the values stored within the header file. If the newly selected waveform file has an associated header file, the baseband frequency offset is updated with the value from the header file. The baseband frequency offset will remain unchanged if the newly selected waveform does not have an associated header file.
Preset	0.00 Hz
Min	-50.00 MHz
Max	50.00 MHz
Initial S/W Revision	A.05.00

Trigger Type

Allows access to the trigger type sub-menus. The setting for trigger type determines the behavior of the waveform when it plays.

Key Path	Source, Modulation Setup, ARB
Remote Command	:SOURce:RADio:ARB:TRIGger:TYPE CONTInuous SINGLE SADVance GATE :SOURce:RADio:ARB:TRIGger:TYPE?
Example	:SOUR:RAD:ARB:TRIG:TYPE CONT :SOUR:RAD:ARB:TRIG:TYPE?
Notes	Gated trigger type will be implemented at a later release
Preset	CONTInuous
Range	Continuous Single Seg Adv Gated
Initial S/W Revision	A.05.00

Continuous

Sets the active trigger type to Continuous. If Continuous is already selected as the active trigger type, pressing this key allows access to the continuous trigger type setup menu. In Continuous trigger mode, the waveform repeats continuously.

Key Path	Source, Modulation Setup, ARB, Trigger Type
Remote Command	:SOURce:RADio:ARB:TRIGger:TYPE:CONTInuous[:TYPE] FREE TRIGger RESet :SOURce:RADio:ARB:TRIGger:TYPE:CONTInuous[:TYPE]?
Example	:SOUR:RAD:ARB:TRIG:TYPE:CONT FREE
Preset	FREE

Range	Free Run Trigger + Run Reset + Run
Initial S/W Revision	A.05.00

Free Run

Selects Free Run as the trigger response for the continuous trigger type. Free Run sets the waveform generator to play a waveform sequence or segment continuously, without waiting for a trigger. In this mode, the waveform generator does not respond to triggers.

Key Path	Source, Modulation Setup, ARB, Trigger Type, Continuous
Example	:SOUR:RAD:ARB:TRIG:TYPE:CONT FREE
Initial S/W Revision	A.05.00

Trigger + Run

Sets Trigger and Run as the trigger response for the continuous trigger type. Trigger and Run sets the waveform generator to play a waveform sequence or segment continuously when the first trigger is received, and to ignore any subsequent triggers.

Key Path	Source, Modulation Setup, ARB, Trigger Type, Continuous
Example	:SOUR:RAD:ARB:TRIG:TYPE:CONT TRIG
Initial S/W Revision	A.05.00

Reset + Run

Sets Reset and Run as the trigger response for the continuous trigger type. Reset and Run sets the waveform generator to play a waveform sequence or segment continuously when the first trigger is received. Subsequent triggers reset the waveform sequence or segment to the start, and then play it continuously.

Key Path	Source, Modulation Setup, ARB, Trigger Type, Continuous
Example	:SOUR:RAD:ARB:TRIG:TYPE:CONT RES
Initial S/W Revision	A.05.00

Single

Sets the active trigger type to Single. If Single is already selected as the active trigger type, pressing this key allows access to the single trigger type setup menu. In Single trigger mode, the waveform plays once.

Key Path	Source, Modulation Setup, ARB, Trigger Type
Remote Command	:SOURce:RADio:ARB:RETRigger ON OFF IMMediate

	:SOURce:RADio:ARB:RETRigger?
Example	:SOUR:RAD:ARB:RETR OFF
Notes	ON: Buffered Trigger OFF: No Retrigger Immediate: Restart on Trigger This is defined as an enumerated SCPI command, with ON OFF being considered as enumerated types rather than Boolean. This means the query will return OFF instead of 0, and ON instead of 1.
Preset	ON
Range	No Retrigger Buffered Trigger Restart on Trigger
Initial S/W Revision	A.05.00

No Retrigger

Selects No Retrigger as the trigger response for single trigger type. No Retrigger sets the waveform generator to play a waveform sequence or segment once when a trigger is received. Any triggers then received during playback are ignored.

Key Path	Source, Modulation Setup, ARB, Trigger Type, Single
Example	:SOUR:RAD:ARB:RETR OFF
Initial S/W Revision	A.05.00

Buffered Trigger

Selects Buffered Trigger as the trigger response for single trigger type. Buffered Trigger sets the waveform generator to play a waveform sequence or segment once when a trigger is received. If a trigger is received during playback, the waveform generator plays the sequence or segment to the end, then plays the sequence or segment once more.

Key Path	Source, Modulation Setup, ARB, Trigger Type, Single
Example	:SOUR:RAD:ARB:RETR ON
Initial S/W Revision	A.05.00

Restart on Trigger

Selects Restart on Trigger as the trigger response for single trigger type. Restart on Trigger sets the waveform generator to play a waveform sequence or segment once when a trigger is received. If a trigger is received during playback, the waveform generator resets and plays the sequence or segment from the start.

Key Path	Source, Modulation Setup, ARB, Trigger Type, Single
Example	:SOUR:RAD:ARB:RETR IMM
Initial S/W Revision	A.05.00

Segment Advance

Sets the active trigger type to Segment Advance. If Segment Advance is already selected as the active trigger type, pressing this key allows access to the segment advance trigger type setup menu.

Segment Advance triggering allows you to control the playback of waveform segments within a waveform sequence. When a trigger is received the ARB advances to the next waveform segment within the waveform sequence. This type of triggering ignores the repetition count for the waveform segment within the waveform sequence. For example, if a waveform segment has a repetition count of 10 and you select single segment advance triggering mode, the waveform segment will only play once.

Segment Advance triggering can also be used for waveform segments only. In this situation the same waveform segment is played again when a trigger is received.

Key Path	Source, Modulation Setup, ARB, Trigger Type
Remote Command	:SOURce:RADio:ARB:TRIGger:TYPE:SADVance[:TYPE] Single CONTinuous :SOURce:RADio:ARB:TRIGger:TYPE:SADVance[:TYPE]?
Example	:SOUR:RAD:ARB:TRIG:TYPE:SADV SING
Preset	CONTinuous
Range	Single Continuous
Initial S/W Revision	A.05.00

Single

Selects Single as the trigger response for Segment Advance trigger type. With single selected, once a trigger is received a segment is played once. If a trigger is received during playback of a segment, the segment plays to completion and the next segment is played once.

Key Path	Source, Modulation Setup, ARB, Trigger Type, Segment Advance
Example	:SOUR:RAD:ARB:TRIG:TYPE:SADV SING
Initial S/W Revision	A.05.00

Continuous

Selects Continuous as the trigger response for Segment Advance trigger type. With continuous selected, once a trigger is received a segment is played continuously. When subsequent triggers are received, the currently playing segment plays to completion and then the next segment is played continuously.

Key Path	Source, Modulation Setup, ARB, Trigger Type, Segment Advance
Example	:SOUR:RAD:ARB:TRIG:TYPE:SADV CONT
Initial S/W Revision	A.05.00

Trigger Source

Allows access to the trigger source sub-menus. The trigger source setting determines how the source receives the trigger that starts the waveform playing. Therefore, this key is grayed out if the trigger type is free run, since free run triggers immediately with no trigger source required.

Key Path	Source, Modulation Setup, ARB
Remote Command	:SOURce:RADio:ARB:TRIGger[:SOURce] KEY BUS EXTernal2 :SOURce:RADio:ARB:TRIGger[:SOURce]?
Example	:SOUR:RAD:ARB:TRIGger KEY
Dependencies	This key is grayed out if the current trigger type is Continuous, Free Run.
Preset	EXTernal2
Range	Trigger Key Bus External 2
Initial S/W Revision	A.05.00

Trigger Key

Sets the current trigger source to the front panel Trigger key. When Trigger Key is selected, the waveform is triggered when you press the front panel Trigger key.

Key Path	Source, Modulation Setup, ARB, Trigger Source
Example	:SOUR:RAD:ARB:TRIGger KEY
Initial S/W Revision	A.05.00

Bus

Sets the current trigger source to Bus. Selecting Bus trigger source enables triggering over GPIB, LAN, or USB using the :SOURce:RADio:ARB:TRIGger:INITiate command.

Key Path	Source, Modulation Setup, ARB, Trigger Source
Example	:SOUR:RAD:ARB:TRIGger BUS
Initial S/W Revision	A.05.00

External 2

Sets the current trigger source to External 2. Selecting External 2 enables triggering a waveform by an externally applied signal.

Key Path	Source, Modulation Setup, ARB, Trigger Source
Example	:SOUR:RAD:ARB:TRIGger EXT2
Notes	Note: When on E6640A, trigger 2 is a bi-directional trigger port. So when trigger 2 has been configured as OUTPUT type, choosing External 2 as the input trigger for the current step will generate error.
Initial S/W Revision	A.05.00

Trigger Initiate

Used to initiate an immediate trigger event if the trigger source is set to Trigger Key.

Key Path	Source, Modulation Setup, ARB
Notes	No remote command, SCPI front panel only.
Initial S/W Revision	A.05.00

Waveform Sequences

Allows access to the waveform sequence sub-menus. Pressing this key changes the central view area to display the Waveform Sequence List view.

Key Path	Source, Modulation Setup, ARB
Notes	No remote command, SCPI front panel only.
Initial S/W Revision	A.05.00

Build New Sequence

Allows access to the sub-menus for creating a new waveform sequence. Pressing this key changes the central view area to display the Waveform Sequence Creation and Editing view.

Key Path	Source, Modulation Setup, ARB, Waveform Sequences
Notes	No remote command, SCPI front panel only.
Initial S/W Revision	A.05.00

Current Segment

Specifies the selected sequence segment that will be affected by the menu functions.

Key Path	Source, Modulation Setup, ARB, Waveform Sequences, Build New Sequence
Notes	No remote command, SCPI front panel only. This key is grayed out and unavailable if the sequence is currently empty.
Initial S/W Revision	A.05.00

Insert New Waveform

Allows you access to the sub-menu for inserting a new waveform segment or sequence. Pressing this key also changes the central display to show the Waveform File Selection View.

Key Path	Source, Modulation Setup, ARB, Waveform Sequences, Build New Sequence
Notes	No remote command, SCPI front panel only. Waveform segment name string length upper limit is 128 chars. Please do NOT insert waveform which name string exceeds 128 chars.
Initial S/W Revision	A.05.00

Insert Waveform

Inserts the currently highlighted waveform to the end of the waveform sequence. Pressing this key also returns you to the menus for creating or editing a sequence, and returns the central view to the sequence creation view.

Key Path	Source, Modulation Setup, ARB, Waveform Sequences, Build New Sequence, Insert New Waveform
Notes	No remote command, SCPI front panel only. Waveform segment name string length upper limit is 128 chars. Please do NOT insert waveform which name string exceeds 128 chars.
Initial S/W Revision	A.05.00

Segments on Hard Disk

Allows you access to the sub-menus for loading waveform segments from the hard disk into ARB memory. The default directory is: D: varb.

Pressing this key changes the current view to the Waveform Management View.

Key Path	Source, Modulation Setup, ARB, Select Waveform
Initial S/W Revision	A.05.00

Load Segment To ARB Memory

Allows you to load the selected file into ARB memory. On the front panel you select the file for loading to the ARB memory by highlighting the desired file in the list. Using the SCPI command, you specify the file name on the HDD.

“NVWFM” (non-volatile storage) MSUS (Mass Storage Unit Specifier) is supported in the memory subsystem because the ARB memory cannot be accessed directly. Therefore, files must be downloaded to the instrument hard disk and then loaded into the ARB memory. “NVWFM” MSUS will be mapped to the default directory D: VARB. The SCPI command supports using either “NVWFM” MSUS or specifying a full path. For more information, see [Memory Subsystem \(Remote Command Only\)](#).

If a file of the same name already exists within ARB memory, it is overwritten. If you wish to load two segments of the same name, you must rename one of the segments before loading it into ARB memory. To rename a segment, you can either use Windows File Explorer, or the :MMEMory:COPY command.

NOTE: When a waveform file is loaded to ARB memory, burst timing adjustments are made automatically, based on whether or not a Multiport Adapter is connected to the test set and powered on. If the connection/power status of the Multiport Adapter is changed after a waveform file has been loaded, it needs to be loaded again.

Key Path	Source, Modulation Setup, ARB, Select Waveform, Segments on Hard Disk
Remote Command	:SOURce:RADio:ARB:LOAD <string>
Example	:SOUR:RAD:ARB:LOAD "D: VARB\testwaveform.bin" or :SOUR:RAD:ARB:LOAD "NVWFM:testwaveform.bin"
Notes	<p>Because loading the file involves a delay of unpredictable length, this command should be followed by the query *OPC?, which holds off subsequent commands until the loading operation is complete.</p> <p><string> – specifies the path name of the file to load from the HDD into ARB memory. It could be a <full path + filename>, or <"NVWFM" MSUS + colon + filename>.</p> <p>When in Sequence Analyzer mode, and Include Source is Yes, an attempt to load a file to ARB memory will be rejected with an error.</p> <p>When Include Source is No and if there is insufficient free ARB memory to load the selected waveform, an error is generated. .</p> <p>If you specify a file over SCPI, but the file is not at the specified location, an error is generated.</p> <p>If you try to load a waveform file but the file contains less than 500 IQ samples, an error is generated.</p> <p>If you try to load a Signal Studio waveform "*.wfm" which contains invalid waveform header, an error is generated.</p> <p>If the ARB is ON when you load a file to ARB memory or delete a file from ARB memory, the playing waveform segment may not keep phase continuity during the ARB memory operation. The waveform will be replayed after the ARB operation is finished.</p> <p>ARB can be loaded into ARB memory even if required licenses do not present on the instrument. In this case, a GUI only warning message –800, "Operation complete; Loaded <filename> successfully, but no license <required licenses> installed". User can install required licenses according to <required licenses> string to license it, or multi-pack license it.</p>
Initial S/W Revision	A.05.00

Load All To ARB Memory

Allows you to load all the segment files within the currently selected directory into ARB memory. If a file of the same name already exists within ARB memory, it is overwritten. If you wish to load two segments of the same name, you must rename one of the segments before loading it into ARB memory. To rename a segment, you can either use Windows File Explorer, or the :MEMORY:COPY command.

NOTE: When a waveform file is loaded to ARB memory, burst timing adjustments are made automatically, based on whether or not a Multiport Adapter is connected to the test set and powered on. If the connection/power status of the Multiport Adapter is changed after a waveform file has been loaded, it needs to be loaded again.

Key Path	Source, Modulation Setup, ARB, Select Waveform, Segments on Hard Disk
Remote Command	:SOURce:RADio:ARB:LOAD:ALL <string>

Example	:SOUR:RAD:ARB:LOAD:ALL "D: varb"
Notes	<p><string> - specifies the directory on the HDD to load the files into ARB memory from.</p> <p>When in Sequence Analyzer mode, and Include Source is Yes, an attempt to load all files from a directory to ARB memory is rejected with an error.</p> <p>When Include Source is No and there is insufficient free ARB memory to load all the waveforms, when the ARB memory is full, the copy ceases, and an error is generated.</p> <p>If you specify a directory over SCPI, but the directory does not exist, an error is generated.</p> <p>If the ARB is ON, a user then loads or deletes file to ARB memory, the playing waveform segment may not keep phase continuity during the ARB memory operation. The waveform will be replayed after the ARB operation is finished.</p>
Initial S/W Revision	A.05.00

Change Directory...

Allows you to change the currently selected directory on the hard disk. Pressing this key opens a standard windows change directory dialog allowing you to select the new directory of interest.

The current directory is used for manually loading waveform segments into ARB memory for playback, and as a search location for waveform segments that are required to be loaded into ARB memory for playback of a waveform sequence or a list sequence.

Key Path	Source, Modulation Setup, ARB, Select Waveform, Segments on Hard Disk
Notes	No remote command, SCPIfront panel only.
Initial S/W Revision	A.05.00

Default Directory...

Allows you to change the default directory. It is used as a search location for waveform segments that are required to be loaded into ARB memory for playback of a waveform sequence, and as a search location for selecting waveforms using SCPI.

Key Path	Source, Modulation Setup, ARB, Select Waveform, Segments on Hard Disk
Remote Command	:SOURce:RADio:ARB:DEFault:DIRectory <string> :SOURce:RADio:ARB: DEFault:DIRectory?
Example	:SOUR:RAD:ARB:DEF:DIR "D:\ArbFiles" :SOUR:RAD:ARB:DEF:DIR?
State Saved	Persistent, survives a power cycle and a preset but not saved in the instrument state
Initial S/W Revision	A.05.00

Segments in ARB Memory

Allows you access to the sub-menus for managing the files within ARB memory.

Key Path	Source, Modulation Setup, ARB, Select Waveform
Initial S/W Revision	A.05.00

Delete Segment From ARB Mem

Allows you to remove a segment from ARB playback memory.

Key Path	Source, Modulation Setup, ARB, Select Waveform, Segments in ARB Memory
Remote Command	:SOURce:RADio:ARB:DELeTe <string>
Example	:SOUR:RAD:ARB:DEL "testwaveform.bin"
Notes	<p><string> - specifies the waveform to be deleted from the ARB playback memory.</p> <p>When in Sequence Analyzer mode and Include Source is Yes, an attempt to delete a file from ARB memory is rejected with an error.</p> <p>When Include Source is No and you specify a file that does not exist within ARB memory, an error is generated.</p> <p>It is possible to delete files from within the ARB memory when the ARB is ON. However, if you attempt to delete the file that is currently playing an error is generated.</p> <p>It is possible to delete a file from within the ARB memory when the sequencer state is ON and the file is not being used by the List Sequencer. If you attempt to delete a file which is being used by the list sequencer, an error is generated.</p> <p>When sequencer state is On, even if ARB state is On, the selected waveform will not be played. In this case, if the selected waveform is not used in List Sequence, it can be deleted and the ARB state is turned Off.</p> <p>If the ARB is ON and you load a file to ARB memory or delete a file from ARB memory, the playing waveform segment may not keep phase continuity during the ARB memory operation. The waveform will be replayed after the ARB operation is finished.</p>
Initial S/W Revision	A.05.00

Delete All From ARB Memory

Allows you to remove all segments from ARB playback memory.

Key Path	Source, Modulation Setup, ARB, Select Waveform, Segments in ARB Memory
Remote Command	:SOURce:RADio:ARB:DELeTe:ALL
Example	:SOUR:RAD:ARB:DELeTe:ALL
Notes	<p>When in Sequence Analyzer mode and Include Source is Yes, an attempt to delete all files from ARB memory is rejected with an error.</p> <p>When Include Source is No and you attempt to delete all files from ARB memory when the ARB is currently playing a file, all files except the one playing are deleted and an error is generated.</p> <p>If you attempt to delete all files from ARB memory when there are waveform files used in "List Sequencer" on page 1306 and "Sequencer" on page 1307 state is ON, all files except the files currently being used in list sequencer are deleted, and an error is generated.</p>

If the ARB is ON and you load a file to ARB memory or delete a file from ARB memory, the playing waveform segment may not keep phase continuity during the ARB memory operation. The waveform will be replayed after the ARB operation is finished.

Initial S/W Revision	A.05.00
----------------------	---------

Segments on Hard Disk

This key functions the same as ["Segments on Hard Disk" on page 1333](#).

Key Path	Source, Modulation Setup, ARB, Waveform Sequences, Build New Sequence, Insert New Waveform
----------	--

Initial S/W Revision	Prior to A.09.00
----------------------	------------------

Load Segment To ARB Memory

This key functions the same as ["Load Segment To ARB Memory" on page 1333](#).

Key Path	Source, Modulation Setup, ARB, Waveform Sequences, Build New Sequence, Insert New Waveform, Segment on Hard Drive
----------	---

Initial S/W Revision	Prior to A.09.00
----------------------	------------------

Load All To ARB Memory

This key functions the same as ["Load All To ARB Memory" on page 1334](#).

Key Path	Source, Modulation Setup, ARB, Waveform Sequences, Build New Sequence, Insert New Waveform, Segment on Hard Drive
----------	---

Initial S/W Revision	Prior to A.09.00
----------------------	------------------

Change Directory ...

This key functions the same as ["Change Directory..." on page 1335](#).

Key Path	Source, Modulation Setup, ARB, Waveform Sequences, Build New Sequence, Insert New Waveform, Segment on Hard Drive
----------	---

Initial S/W Revision	Prior to A.09.00
----------------------	------------------

Default Directory ...

This key functions the same as ["Default Directory..." on page 1335](#)

Key Path	Source, Modulation Setup, ARB, Waveform Sequences, Build New Sequence, Insert New Waveform, Segment on Hard Drive
----------	---

Initial S/W Revision	Prior to A.09.00
----------------------	------------------

Segments in ARB Memory

This key functions the same as ["Segments in ARB Memory" on page 1335](#).

Key Path	Source, Modulation Setup, ARB, Waveform Sequences, Build New Sequence, Insert New Waveform
Initial S/W Revision	Prior to A.09.00

Delete Segment From ARB Memory

This key functions the same as ["Delete Segment From ARB Mem" on page 1335](#).

Key Path	Source, Modulation Setup, ARB, Waveform Sequences, Build New Sequence, Insert New Waveform, Segment in ARB Memory
Initial S/W Revision	Prior to A.09.00

Delete All From ARB Memory

This key functions the same as ["Delete All From ARB Memory" on page 1336](#).

Key Path	Source, Modulation Setup, ARB, Waveform Sequences, Build New Sequence, Insert New Waveform, Segment in ARB Memory
Initial S/W Revision	Prior to A.09.00

Query ARB Memory File List (Remote Command Only)

This command functions the same as ["Query ARB Memory File List \(Remote Command Only\)" on page 1268](#).

Initial S/W Revision	Prior to A.09.00
----------------------	------------------

Edit Selected Waveform

Allows access to the sub-menus for editing the details of the currently selected waveform segment.

Key Path	Source, Modulation Setup, ARB, Waveform Sequences, Build New Sequence
Notes	No remote command, front panel only.
Initial S/W Revision	A.05.00

Repetitions

Allows you to specify the number of times the currently selected waveform is played within the sequence.

Key Path	Source, Modulation Setup, ARB, Waveform Sequences, Build New Sequence, Edit Selected Waveform
Notes	No remote command, SCPI front panel only.
Preset	1
Min	1
Max	65535
Initial S/W Revision	A.05.00

Marker 1

Allows you to enable or disable marker 1 for the currently selected waveform. For a waveform sequence, you can enable and disable markers on a per-segment basis, allowing you to output markers from some waveform segments within the sequence, but not for others.

Key Path	Source, Modulation Setup, ARB, Waveform Sequences, Build New Sequence, Edit Selected Waveform
Notes	No remote command, front panel only.
Preset	Enabled
Range	Enabled Disabled
Initial S/W Revision	A.05.00

Marker 2

Allows you to enable or disable marker 2 for the currently selected waveform. For a waveform sequence, you can enable and disable markers on a per-segment basis, allowing you to output markers from some waveform segments within the sequence, but not for others.

Key Path	Source, Modulation Setup, ARB, Waveform Sequences, Build New Sequence, Edit Selected Waveform
Notes	No remote command, front panel only.
Preset	Enabled
Range	Enabled Disabled
Initial S/W Revision	A.05.00

Marker 3

Allows you to enable or disable marker 3 for the currently selected waveform. For a waveform sequence, you can enable and disable markers on a per-segment basis, allowing you to output markers from some waveform segments within the sequence, but not for others.

Key Path	Source, Modulation Setup, ARB, Waveform Sequences, Build New Sequence, Edit Selected
----------	--

	Waveform
Notes	No remote command, front panel only.
Preset	Enabled
Range	Enabled Disabled
Initial S/W Revision	A.05.00

Marker 4

Allows you to enable or disable marker 4 for the currently selected waveform. For a waveform sequence, you can enable and disable markers on a per-segment basis, allowing you to output markers from some waveform segments within the sequence, but not for others.

Key Path	Source, Modulation Setup, ARB, Waveform Sequences, Build New Sequence, Edit Selected Waveform
Notes	No remote command, front panel only.
Preset	Enabled
Range	Enabled Disabled
Initial S/W Revision	A.05.00

Delete Segment

Allows you to delete the selected segment from the waveform sequence.

Key Path	Source, Modulation Setup, ARB, Waveform Sequences, Build New Sequence
Notes	No remote command, front panel only.
Initial S/W Revision	A.05.00

Save Sequence...

Pressing this key displays the “Save As” dialog. The sequence name is passed to the save as dialog to use as the filename for saving, and the directory the save as dialog will open into is the default waveform directory.

Key Path	Source, Modulation Setup, ARB, Waveform Sequences, Build New Sequence
Initial S/W Revision	A.05.00

Build New Sequence (Remote Command Only)

This command is the SCPI equivalent of the waveform sequence creation features described in ["Build New Sequence" on page 1275](#).

This command writes a waveform sequence file to the hard disk. You must specify the waveform sequence file path and filename which will be saved on the hard disk, and the waveform segment file path and name which will be nested into the waveform sequence file. You can utilize mass storage unit specifier (MSUS) “NVWFM” or use a real full path representation. See the example below. MSUS “NVWFM” is mapped to D: VARB directory on test set hard disk.

Any number of segments, up to a segment count limit of 64, can be used to create a sequence. Repeated segments are included in the count limit.

Each waveform segment name string length upper limit is 128 chars. Please do NOT insert waveform which name string exceeds 128 chars.

The internal source does not support nesting one waveform sequence file into another waveform sequence file.

Remote Command :SOURce:RADio:ARB:SEQuence[:MWAveform] <filename>, <waveform1>, <reps>,
NONE | M1 | M2 | M3 | M4 | M1M2 | M1M3 | M1M4 | M2M3 | M2M4 | M3M4 |
M1M2M3 | M1M2M4 | M1M3M4 | M2M3M4 | M1M2M3M4 | ALL, {<waveform2>,
<reps>, NONE | M1 | M2 | M3 | M4 | M1M2 | M1M3 | M1M4 | M2M3 | M2M4 |
M3M4 | M1M2M3 | M1M2M4 | M1M3M4 | M2M3M4 | M1M2M3M4 | ALL, } ...

(For additional description of each item, see Notes below "[For Setup SCPI](#)" on page 448 "[For Setup SCPI](#)".)

:SOURce:RADio:ARB:SEQuence[:MWAveform]? <filename>

(For additional description of each item, see Notes "[For Query SCPI](#)" on page 449 below.)

Example For setup:

```
>:SOUR:RAD:ARB:SEQ "NVWFM:testSeq1.seq", "NVWFM:wfmSegment1.wfm", 10, M2M3M4,  
"NVWFM:wfmSegment2.wfm", 20, M1 M3
```

Or

```
>:SOUR:RAD:ARB:SEQ "D: VARB\testSeq1.seq", "D: VARB\wfmSegment1.wfm", 10, M2M3M4, "D:  
VARB\wfmSegment2.wfm", 20, M1 M3
```

For query, must specify which waveform sequence file to query.

```
>:SOUR:RAD:ARB:SEQ? "NVWFM:testSeq1.seq"
```

Or

```
>:SOUR:RAD:ARB:SEQ? "D: VARB\testSeq1.seq",
```

Notes For Setup SCPI

For the Setup SCPI command, the parameters are:

<filename> - String Type

This variable specifies the path and name for the waveform sequence file. The path supports MSUS (NVWFM) or a real full path representation. See example.

<waveform1> - String Type

This variable specifies the path and name of the first existing waveform segment. The path supports MSUS (NVWFM) or a real full path representation. See example.

The segment file must reside within ARB playback memory before it can be played by the ARB player.

<reps> - Integer Type

This variable specifies the number of times a segment or sequence plays before moving on to the next segment or sequence.

<marker> - Enum Type

NONE – This choice disables all four markers for the waveform. Disabling markers means that the waveform sequence ignores the segments or sequence marker settings.

M1, M2, M3, M4 – these choices, either individually or a combination of them, enable the markers for the waveform segment or sequence. Markers not specified are ignored for that segment or sequence.

ALL – This choice enables all four markers in the waveform segment or sequence.

<waveform2> - String type.

This variable specifies the name of a second existing waveform segment. The path supports MSUS (NVWFM) and real full path representation both. See example.

The segment file must reside within ARB playback memory before it can be played by the ARB player.

<reps> same as above, for the 2nd waveform segment.

<marker> same as above, for the 2nd waveform segment.

You can insert several waveform segments into a waveform sequence file. Just repeat inserting waveform segments as described above.

Error Checks for Setup SCPI command:

If you do not specify a filename, or you use an unsupported MSUS (that is, not NVWFM), or have an error in the waveform sequence file path, an error is generated.

Notes

Error Checks for Query SCPI command: (Continued)

If the specified waveform sequence file name suffix is not “.seq”, error is generated.

If you use an unsupported MSUS (that is, not NVWFM), or have an error in the waveform segment file path, an error is generated.

If the first specified waveform file cannot be found, an error is generated.

If you nest one waveform sequence file into another waveform sequence file, an error is generated.

If the specified repetition value is larger than 65535 or smaller than 1, an error is generated.

If the specified marker type is unrecognized, an error is generated.

For Query SCPI

For the Query the parameters are:

<filename> - String type.

This variable specifies the path and name of the waveform sequence file being queried. The path supports MSUS (NVWFM) or a real full path representation. See example.

The return value is a <string>, which includes each waveform segment file name, repetitions, and marker type. For example:

```
>:SOUR:RAD:ARB:SEQ? "NVWFM:testSeq1.seq",
```

```
<"wfmSegment1. wfm, 10, ALL, wfmSegment2.wfm, 20, M1M3",
```

Error Checks for Query SCPI command:

If you do not specify a filename, an error is generated.

If the waveform sequence file name is empty, an error is generated.

If the specified waveform sequence file cannot be found, an error is generated.

Initial S/W Revision

A.05.00

Edit Selected Sequence

Allows access to the sub-menus for editing the sequence currently selected within the Waveform Sequence List view. Pressing this key changes the central view area to display the Waveform Sequence Creation and Editing view.

Key Path	Source, Modulation Setup, ARB, Waveform Sequences
Notes	No remote command, front panel only.
Initial S/W Revision	A.05.00

Current Directory...

Allows you to change the currently selected directory on the hard disk. Pressing this key opens a standard windows change directory dialog and allows you to select the new directory of interest.

Key Path	Source, Modulation Setup, ARB, Waveform Sequences
Notes	No remote command, front panel only.
Initial S/W Revision	A.05.00

Waveform Utilities

Allows you access to the waveform utilities sub-menus.

Key Path	Source, Modulation Setup, ARB
Initial S/W Revision	A.05.00

Multi-Pack Licenses

Allows you access to the Multi - Pack License sub-menus. Pressing this key also changes the central view area to display the Multi -Pack License Management view.

On modular instrument like E6630A or E6640A, multi-pack license operations are only allowed on the default module, i.e. "Left" module for E6630A or "TRX1" module for E6640A.

Key Path	Source, Modulation Setup, ARB, Waveform Utilities
Notes	If access multi-pack license sub-menu from modules other than "TRX1", an advisory message like "Please goto "TRX1" to operate multi-pack license" will display.
Dependencies	This key is only available if there is at least one Multi-pack license installed on the instrument.
Initial S/W Revision	A.05.00

Add Waveform

Pressing this key accesses the Add Waveform sub-menu. It also changes the central display area to display the Multi-Pack License Waveform Add view.

Key Path	Source, Modulation Setup, ARB, Waveform Utilities, Multi-Pack Licenses
Dependencies	This key is only available if there is at least one slot available within at least one multi-pack license.
Initial S/W Revision	A.05.00

Add Waveform

Allows you to add the currently selected waveform segment to a multi-pack license. The new waveform is added to the next available slot regardless of which slot was selected on the Multi-Pack License Management view.

Key Path	Source, Modulation Setup, ARB, Waveform Utilities, Multi-Pack Licenses, Add Waveform
Remote Command	:SYSTem:LKEY:WAVeform:ADD <string> or :SYSTem:LIcense[:FPACK]:WAVeform:ADD <string>
Example	SYST:LKEY:WAV:ADD "mywaveform.wfm" or SYST:LIC:WAV:ADD "mywaveform.wfm"
Notes	The second SCPI :SYSTem:LIcense[:FPACK]:WAVeform:ADD is provided to be consistent with the style of Agilent signal sources. You can use either one of them. Since adding a waveform segment to a Multi-Pack license causes the license slot to enter the trial period of only 48 hours, pressing this key causes a confirmation dialog to be displayed to ensure you do want to add the waveform segment to the Multi-Pack. If you attempt to license a waveform that is already licensed using another slot an error is generated. . If current module is not "TRX1" module, the key will grey out, and error message is generated "-221 Setting conflict; Not allowed on current module. Goto "TRX1" to operate multi-pack license" when invoking SCPI.
Dependencies	This key is only available if the currently selected file is a secure waveform requiring a license, and there is at least one slot available within at least one multi-pack license. If the waveform highlighted is a secure waveform, but is already licensed, this key will be unavailable.
Initial S/W Revision	A.05.00

Segments on Hard Disk

Allows you access to the sub-menus for loading waveform segments from the hard disk into ARB memory. The default directory is: D: varb.

Pressing this key changes the current view to the Waveform Management View.

Key Path	Source, Modulation Setup, ARB, Select Waveform
Initial S/W Revision	A.05.00

Load Segment To ARB Memory

Allows you to load the selected file into ARB memory. On the front panel you select the file for loading to the ARB memory by highlighting the desired file in the list. Using the SCPI command, you specify the file name on the HDD.

“NVWFM” (none-volatile storage) MSUS (Mass Storage Unit Specifier) is supported in the memory subsystem because the ARB memory cannot be accessed directly. Therefore, files must be downloaded to the instrument hard disk and then loaded into the ARB memory. “NVWFM” MSUS will be mapped to the default directory D: VARB. The SCPI command supports using either “NVWFM” MSUS or specifying a full path. For more information, see [Memory Subsystem \(Remote Command Only\)](#).

If a file of the same name already exists within ARB memory, it is overwritten. If you wish to load two segments of the same name, you must rename one of the segments before loading it into ARB memory. To rename a segment, you can either use Windows File Explorer, or the :MMEMory:COPI command.

NOTE: When a waveform file is loaded to ARB memory, burst timing adjustments are made automatically, based on whether or not a Multiport Adapter is connected to the test set and powered on. If the connection/power status of the Multiport Adapter is changed after a waveform file has been loaded, it needs to be loaded again.

Key Path	Source, Modulation Setup, ARB, Select Waveform, Segments on Hard Disk
Remote Command	:SOURce:RADio:ARB:LOAD <string>
Example	:SOUR:RAD:ARB:LOAD "D: VARB\testwaveform.bin" or :SOUR:RAD:ARB:LOAD "NVWFM:testwaveform.bin"
Notes	<p>Because loading the file involves a delay of unpredictable length, this command should be followed by the query *OPC?, which holds off subsequent commands until the loading operating is complete.</p> <p><string> – specifies the path name of the file to load from the HDD into ARB memory. It could be a <full path + filename>, or <“NVWFM” MSUS + colon + filename>.</p> <p>When in Sequence Analyzer mode, and Include Source is Yes, an attempt to load a file to ARB memory will be rejected with an error.</p> <p>When Include Source is No and if there is insufficient free ARB memory to load the selected waveform, an error is generated. .</p> <p>If you specify a file over SCPI, but the file is not at the specified location, an error is generated.</p> <p>If you try to load a waveform file but the file contains less than 500 IQ samples, an error is generated.</p> <p>If you try to load a Signal Studio waveform “*.wfm” which contains invalid waveform header, an error is generated.</p> <p>If the ARB is ON when you load a file to ARB memory or delete a file from ARB memory, the playing waveform segment may not keep phase continuity during the ARB memory operation. The waveform will be replayed after the ARB operation is finished.</p> <p>ARB can be loaded into ARB memory even required licenses do not present on the instrument. In this</p>

case, a GUI only warning message -800, "Operation complete; Loaded <filename> successfully, but no license <required licenses> installed". User can install required licenses according to <required licenses> string to license it, or multi-pack license it.

Initial S/W Revision A.05.00

Load All To ARB Memory

Allows you to load all the segment files within the currently selected directory into ARB memory. If a file of the same name already exists within ARB memory, it is overwritten. If you wish to load two segments of the same name, you must rename one of the segments before loading it into ARB memory. To rename a segment, you can either use Windows File Explorer, or the :MEMory:COPY command.

NOTE: When a waveform file is loaded to ARB memory, burst timing adjustments are made automatically, based on whether or not a Multiport Adapter is connected to the test set and powered on. If the connection/power status of the Multiport Adapter is changed after a waveform file has been loaded, it needs to be loaded again.

Key Path	Source, Modulation Setup, ARB, Select Waveform, Segments on Hard Disk
Remote Command	:SOURce:RADio:ARB:LOAD:ALL <string>
Example	:SOUR:RAD:ARB:LOAD:ALL "D: varb"
Notes	<p><string> - specifies the directory on the HDD to load the files into ARB memory from.</p> <p>When in Sequence Analyzer mode, and Include Source is Yes, an attempt to load all files from a directory to ARB memory is rejected with an error.</p> <p>When Include Source is No and there is insufficient free ARB memory to load all the waveforms, when the ARB memory is full, the copy ceases, and an error is generated.</p> <p>If you specify a directory over SCPI, but the directory does not exist, an error is generated.</p> <p>If the ARB is ON, a user then loads or deletes file to ARB memory, the playing waveform segment may not keep phase continuity during the ARB memory operation. The waveform will be replayed after the ARB operation is finished.</p>
Initial S/W Revision	A.05.00

Change Directory...

Allows you to change the currently selected directory on the hard disk. Pressing this key opens a standard windows change directory dialog allowing you to select the new directory of interest.

The current directory is used for manually loading waveform segments into ARB memory for playback, and as a search location for waveform segments that are required to be loaded into ARB memory for playback of a waveform sequence or a list sequence.

Key Path	Source, Modulation Setup, ARB, Select Waveform, Segments on Hard Disk
Notes	No remote command, SCPIfront panel only.
Initial S/W Revision	A.05.00

Default Directory...

Allows you to change the default directory. It is used as a search location for waveform segments that are required to be loaded into ARB memory for playback of a waveform sequence, and as a search location for selecting waveforms using SCPI.

Key Path	Source, Modulation Setup, ARB, Select Waveform, Segments on Hard Disk
Remote Command	:SOURce:RADio:ARB:DEFault:DIRectory <string> :SOURce:RADio:ARB: DEFault:DIRectory?
Example	:SOUR:RAD:ARB:DEF:DIR "D:\ArbFiles" :SOUR:RAD:ARB:DEF:DIR?
State Saved	Persistent, survives a power cycle and a preset but not saved in the instrument state
Initial S/W Revision	A.05.00

Segments on Hard Disk

This key functions the same as ["Segments on Hard Disk" on page 1333](#).

Key Path	Source, Modulation Setup, ARB, Waveform Utilities, Multi-Pack Licenses, Add Waveform
Initial S/W Revision	Prior to A.09.00

Load Segment To ARB Memory

This key functions the same as ["Load Segment To ARB Memory" on page 1333](#).

Key Path	Source, Modulation Setup, ARB, Waveform Utilities, Multi-Pack Licenses, Add Waveform, Segment on Hard Drive
Initial S/W Revision	Prior to A.09.00

Load All To ARB Memory

This key functions the same as ["Load All To ARB Memory" on page 1334](#).

Key Path	Source, Modulation Setup, ARB, Waveform Utilities, Multi-Pack Licenses, Add Waveform, Segment on Hard Drive
Initial S/W Revision	Prior to A.09.00

Change Directory ...

This key functions the same as ["Change Directory..." on page 1335](#).

Key Path	Source, Modulation Setup, ARB, Waveform Utilities, Multi-Pack Licenses, Add Waveform, Segment on Hard Drive
Initial S/W Revision	Prior to A.09.00

Default Directory ...

This key functions the same as ["Default Directory..." on page 1335](#)

Key Path	Source, Modulation Setup, ARB, Waveform Utilities, Multi-Pack Licenses, Add Waveform, Segment on Hard Drive
Initial S/W Revision	Prior to A.09.00

Replace Waveform

Pressing this key accesses the Replace Waveform submenu. It also changes the central display area to display the Multi-Pack License Waveform Add view.

Key Path	Source, Modulation Setup, ARB, Waveform Utilities, Multi-Pack Licenses
Dependencies	This key is only available if the currently selected slot is in the trial state.
Initial S/W Revision	A.05.00

Replace Waveform

Allows you to replace the waveform in the currently selected slot with the waveform currently selected in the Multi-Pack License Waveform Add view.

Key Path	Source, Modulation Setup, ARB, Waveform Utilities, Multi-Pack Licenses, Replace Waveform
Remote Command	:SYSTem:LKEY:WAVeform:REPLace <int>, <string> or :SYSTem:LIcense[:FPACK]:WAVeform:REPLace <int>, <string>
Example	SYST:LKEY:WAV:REPL 1, "myotherwaveform.wfm" or :SYST:LIC:WAV:REPL 1, "myotherwaveform.wfm"
Notes	The second SCPI :SYSTem:LIcense[:FPACK]:WAVeform:REPLace is provided to be consistent with the style of Agilent signal sources. You can use either one of them. If you attempt to license a waveform that is already licensed using another slot an error is generated. Waveform slot number <int> is positive. If you attempt to input a slot number less than or equals 0, an error is generated. If current module is not "TRX1" module, the key will grey out, and error message is generated "-221 Setting conflict; Not allowed on current module. Goto "TRX1" to operate multi-pack license" when invoking SCPI.
Initial S/W Revision	A.05.00

Segments on Hard Disk

This key functions the same as ["Segments on Hard Disk" on page 1333](#).

Key Path	Source, Modulation Setup, ARB, Waveform Utilities, Multi-Pack Licenses, Replace Waveform
Initial S/W Revision	Prior to A.09.00

Load Segment To ARB Memory

This key functions the same as ["Load Segment To ARB Memory" on page 1333](#).

Key Path	Source, Modulation Setup, ARB, Waveform Utilities, Multi-Pack Licenses, Replace Waveform, Segment on Hard Drive
Initial S/W Revision	Prior to A.09.00

Load All To ARB Memory

This key functions the same as ["Load All To ARB Memory" on page 1334](#).

Key Path	Source, Modulation Setup, ARB, Waveform Utilities, Multi-Pack Licenses, Replace Waveform, Segment on Hard Drive
Initial S/W Revision	Prior to A.09.00

Change Directory ...

This key functions the same as ["Change Directory..." on page 1335](#).

Key Path	Source, Modulation Setup, ARB, Waveform Utilities, Multi-Pack Licenses, Replace Waveform, Segment on Hard Drive
Initial S/W Revision	Prior to A.09.00

Default Directory ...

This key functions the same as ["Default Directory..." on page 1335](#)

Key Path	Source, Modulation Setup, ARB, Waveform Utilities, Multi-Pack Licenses, Replace Waveform, Segment on Hard Drive
Initial S/W Revision	Prior to A.09.00

Clear Waveform from Slot

Allows you to clear the waveform from the selected slot.

Key Path	Source, Modulation Setup, ARB, Waveform Utilities, Multi-Pack Licenses
Remote Command	:SYSTem:LKEY:WAVeform:CLEar <int> or :SYSTem:LICense[:FPACK]:WAVeform:CLEar <int>
Example	SYST:LKEY:WAV:CLE 1 or :SYST:LIC:WAV:CLE 1
Notes	The second SCPI :SYSTem:LICense[:FPACK]:WAVeform:CLEar is provided to be consistent with the style of Agilent signal sources. You can use either one of them. Waveform slot number <int> is positive. If you attempt to input a slot number less than or equals 0, an error is generated. If current module is not "TRX1" module, the key will grey out, and error message is generated "-221 Setting conflict; Not allowed on current module. Goto "TRX1" to operate multi-pack license" when invoking SCPI.
Dependencies	This key is only available if the currently selected slot is in the trial state.
Initial S/W Revision	A.05.00

Lock Waveform in Slot

If the selected slot is in the trial state or the lock required state, the waveform that occupies the slot is locked and permanently licensed.

Key Path	Source, Modulation Setup, ARB, Waveform Utilities, Multi-Pack Licenses
Remote Command	:SYSTem:LKEY:WAVeform:LOCK <int> or :SYSTem:LICense[:FPACK]:WAVeform:LOCK <int>
Example	SYST:LKEY:WAV:LOCK 1 or SYST:LIC:WAV:LOCK 1
Notes	The second SCPI :SYSTem:LICense[:FPACK]:WAVeform:LOCK is provided to be consistent with the style of Agilent signal sources. You can use either one of them. Waveform slot number <int> is positive. If you attempt to input a slot number less than or equals 0, an error is generated. If current module is not "TRX1" module, the key will grey out, and error message is generated "-221 Setting conflict; Not allowed on current module. Goto "TRX1" to operate multi-pack license" when invoking SCPI.
Dependencies	This key is only available if the currently selected slot is in the trial state or the lock required state.
Initial S/W Revision	A.05.00

Slot Status Query (Remote Command Only)

Returns the status of the specified slot.

Remote Command	:SYSTem:LKEY:WAVeform:STATus? <int> or :SYSTem:LICense[:FPACK]:WAVeform:STATus? <int>
Example	:SYST:LKEY:WAV:STAT? 1 <"Locked" or :SYST:LIC:WAV:STAT? 1 <"Locked"
Notes	The second SCPI :SYSTem:LICense[:FPACK]:WAVeform:STATus is provided to be consistent with the style of Agilent signal sources. You can use either one of them. Waveform slot number <int> is positive. If you attempt to input a slot number less than or equals 0, an error is generated. Result type is string. If input slot number exceeds total available slot number, "Nonexistent" is returned.
Range	"Locked" "Available" "Trail" "LockRequired" "Nonexistent"
Initial S/W Revision	A.05.00

Slots Free Query (Remote Command Only)

Returns the number of license slots free.

Remote Command	:SYSTem:LKEY:WAVeform:FREE? or :SYSTem:LICense[:FPACK]:WAVeform:FREE?
Example	:SYST:LKEY:WAV:FREE? or :SYST:LIC:WAV:FREE?
Notes	The second SCPI :SYSTem:LICense[:FPACK]:WAVeform:FREE is provided to be consistent with the style of Agilent signal sources. You can use either one of them.
Initial S/W Revision	A.05.00

Slot Used Query (Remote Command Only)

Returns the number of license slots used.

Remote Command	:SYSTem:LKEY:WAVeform:USED? or :SYSTem:LICense[:FPACK]:WAVeform:USED?
Example	:SYST:LKEY:WAV:USED?

	or :SYST:LIC:WAV:USED?
Notes	The second SCPI :SYSTem:LIcense[:FPACK]:WAVEform:USED is provided to be consistent with the style of Agilent signal sources. You can use either one of them.
Initial S/W Revision	A.05.00

Slot Waveform Name Query (Remote Command Only)

Returns the waveform name of the specified slot

Remote Command	:SYSTem:LKEY:WAVEform:NAME? <int> or :SYSTem:LIcense[:FPACK]:WAVEform:NAME? <int>
Example	:SYST:LKEY:WAV:NAME? 1 <"CDMA2K_22.wfm" or :SYST:LIC:WAV:NAME? 1 <"CDMA2K_22.wfm"
Notes	Waveform slot number <int> is positive. If you attempt to input a slot number less than or equals 0, an error is generated. Result type is string. If input slot number exceeds total available slot number, "Nonexistent" is returned. If no waveform stored in the specified slot, then empty string is returned.
Initial S/W Revision	A.12.00

Slot Waveform Unique ID Query (Remote Command Only)

Returns the waveform unique ID of the specified slot

Remote Command	:SYSTem:LKEY:WAVEform:UID? <int> or :SYSTem:LIcense[:FPACK]:WAVEform:UID? <int>
Example	:SYST:LKEY:WAV:UID? 2 <"1346752140" or :SYST:LIC:WAV:UID? 2 <"1346752140"
Notes	Waveform slot number <int> is positive. If you attempt to input a slot number less than or equals 0, an error is generated. Result type is string. If input slot number exceeds total available slot number, "Nonexistent" is returned.

	If no waveform stored in the specified slot, then "0" is returned
Initial S/W Revision	A.12.00

Locked Waveform Name List Query (Remote Command Only)

Returns the waveform name list of locked.

Remote Command	:SOURce:RADio:ARB:MPLicensed:NAME:LOCKed?
Example	SOUR:RAD:ARB:MPL:NAME:LOCKed? <"CDMA2K_27.wfm", "GSM_MCS1.WFM", "c2kWfm.wfm"
Initial S/W Revision	A.11.00

Locked Waveform Unique ID List Query (Remote Command Only)

Returns the waveform unique id list of locked.

Remote Command	:SOURce:RADio:ARB:MPLicensed:UID:LOCKed?
Example	SOUR:RAD:ARB:MPL:UID:LOCKed? <"2996927136", "3812603511", "3710986266"
Notes	Each Signal Studio waveform has a unique id recorded in header. So if the unique ids are same, that means they are same one waveform. So besides SCPI to query locked waveform name list, also provide a SCPI to query locked waveform unique id list
Initial S/W Revision	A.11.00

Marker Utilities

Allows access to the marker utilities sub-menus.

Key Path	Source, Modulation Setup, ARB
Initial S/W Revision	A.05.00

Marker Polarity

Allows access to the marker polarity sub-menu, which allows you to specify the polarity for the four markers. For a positive polarity, the marker signal is high during the marker points. For a negative marker polarity, the marker signal is high during the period of no marker points.

Key Path	Source, Modulation Setup, ARB, Marker Utilities
Initial S/W Revision	A.05.00

Mkr 1 Polarity

Allows you to set the polarity of marker 1.

Key Path	Source, Modulation Setup, ARB, Marker Utilities, Marker Polarity
Remote Command	:SOURce:RADio:ARB:MPOLarity:MARKer1 POSitive NEGative :SOURce:RADio:ARB:MPOLarity:MARKer1?
Example	:SOUR:RAD:ARB:MPOL:MARK1 NEG
Dependencies	When a new waveform is selected for playback the settings contained within the associated waveform header file are applied to the ARB. The marker polarity is one of the values stored within the header file. If the newly selected waveform file has an associated header file, the marker polarity is updated with the value from the header file. The marker polarity will remain unchanged if the newly selected waveform does not have an associated header file.
Preset	Pos
Range	Neg Pos
Initial S/W Revision	A.05.00

Mkr 2 Polarity

Allows you to set the polarity of marker 2.

Key Path	Source, Modulation Setup, ARB, Marker Utilities, Marker Polarity
Remote Command	:SOURce:RADio:ARB:MPOLarity:MARKer2 POSitive NEGative :SOURce:RADio:ARB:MPOLarity:MARKer2?
Example	:SOUR:RAD:ARB:MPOL:MARK2 NEG
Dependencies	When a new waveform is selected for playback the settings contained within the associated waveform header file are applied to the ARB. The marker polarity is one of the values stored within the header file. If the newly selected waveform file has an associated header file, the marker polarity is updated with the value from the header file. The marker polarity will remain unchanged if the newly selected waveform does not have an associated header file.
Preset	Pos
Range	Neg Pos
Initial S/W Revision	A.05.00

Mkr 3 Polarity

Allows you to set the polarity of marker 3.

Key Path	Source, Modulation Setup, ARB, Marker Utilities, Marker Polarity
Remote Command	:SOURce:RADio:ARB:MPOLarity:MARKer3 POSitive NEGative :SOURce:RADio:ARB:MPOLarity:MARKer3?
Example	:SOUR:RAD:ARB:MPOL:MARK3 NEG
Dependencies	When a new waveform is selected for playback the settings contained within the associated

	waveform header file are applied to the ARB. The marker polarity is one of the values stored within the header file. If the newly selected waveform file has an associated header file, the marker polarity is updated with the value from the header file. The marker polarity will remain unchanged if the newly selected waveform does not have an associated header file.
Preset	Pos
Range	Neg Pos
Initial S/W Revision	A.05.00

Mkr 4 Polarity

Allows you to set the polarity of marker 4.

Key Path	Source, Modulation Setup, ARB, Marker Utilities, Marker Polarity
Remote Command	:SOURce:RADio:ARB:MPOLarity:MARKer4 POSitive NEGative :SOURce:RADio:ARB:MPOLarity:MARKer4?
Example	:SOUR:RAD:ARB:MPOL:MARK4 NEG
Dependencies	When a new waveform is selected for playback the settings contained within the associated waveform header file are applied to the ARB. The marker polarity is one of the values stored within the header file. If the newly selected waveform file has an associated header file, the marker polarity is updated with the value from the header file. The marker polarity will remain unchanged if the newly selected waveform does not have an associated header file.
Preset	Pos
Range	Neg Pos
Initial S/W Revision	A.05.00

Marker Routing

Allows access to the marker routing sub-menus, which allow you to specify where the marker events are routed. It should be noted that the markers can also be routed to Trigger 1 Out and Trigger 2 Out, however this must be set up using the menus accessed by pressing the “Trigger” hard key.

Key Path	Source, Modulation Setup, ARB, Marker Utilities
Initial S/W Revision	A.05.00

Pulse/RF Blank

Allows you to select which marker is used for the pulse/RF blanking function. The pulse/RF blanking function blanks the RF when the marker signal goes low. The marker polarity determines when the marker signal is high. For a positive polarity, this is during the marker points. For a negative polarity, this is when there are no marker points.

Marker points should be set before using this function. Enabling this function without setting maker points may create a continuous low or high signal, dependant on the marker polarity. This causes either no RF output, or a continuous RF output.

Key Path	Source, Modulation Setup, ARB, Marker Utilities, Marker Routing
Remote Command	:SOURce:RADio:ARB:MDEStination:PULSe NONE M1 M2 M3 M4 :SOURce:RADio:ARB:MDEStination:PULSe?
Example	:SOUR:RAD:ARB:MDES:PULS NONE
Dependencies	When a new waveform is selected for playback the settings contained within the associated waveform header file are applied to the ARB. The pulse/RF blanking setting is one of the values stored within the header file. If the newly selected waveform file has an associated header file, the pulse/RF blanking setting is updated with the value from the header file. The pulse/RF blanking setting will remain unchanged if the newly selected waveform does not have an associated header file.
Range	None M1 M2 M3 M4
Initial S/W Revision	A.05.00

None

Sets no marker to be used for the pulse/RF blanking function, essentially turning the RF blanking function off.

Key Path	Source, Modulation Setup, ARB, Marker Utilities, Marker Routing, Pulse/RF Blank
Example	:SOUR:RAD:ARB:MDES:PULS NONE
Initial S/W Revision	A.05.00

Marker 1

Sets marker 1 to be used for the pulse/RF blanking function.

Key Path	Source, Modulation Setup, ARB, Marker Utilities, Marker Routing, Pulse/RF Blank
Example	:SOUR:RAD:ARB:MDES:PULS M1
Initial S/W Revision	A.05.00

Marker 2

Sets marker 2 to be used for the pulse/RF blanking function.

Key Path	Source, Modulation Setup, ARB, Marker Utilities, Marker Routing, Pulse/RF Blank
Example	:SOUR:RAD:ARB:MDES:PULS M2
Initial S/W Revision	A.05.00

Marker 3

Sets marker 3 to be used for the pulse/RF blanking function.

Key Path	Source, Modulation Setup, ARB, Marker Utilities, Marker Routing, Pulse/RF Blank
Example	:SOUR:RAD:ARB:MDES:PULS M3
Initial S/W Revision	A.05.00

Marker 4

Sets marker 4 to be used for the pulse/RF blanking function.

Key Path	Source, Modulation Setup, ARB, Marker Utilities, Marker Routing, Pulse/RF Blank
Example	:SOUR:RAD:ARB:MDES:PULS M4
Initial S/W Revision	A.05.00

ALC Hold

Allows you to specify which marker is routed for use within the ALC hold function. The ALC hold marker function holds the ALC circuitry at the average value of the sample points set by the marker.

The ALC hold function operates during the low periods of the marker signal. The marker polarity determines when the marker signal is high. For positive polarity, this is during the marker points. For a negative polarity, this is when there are no marker points.

Key Path	Source, Modulation Setup, ARB, Marker Utilities, Marker Routing
Remote Command	:SOURce:RADio:ARB:MDEStination:ALCHold NONE M1 M2 M3 M4 :SOURce:RADio:ARB:MDEStination:ALCHold?
Example	:SOUR:RAD:ARB:MDES:ALCH NONE
Dependencies	When a new waveform is selected for playback the settings contained within the associated waveform header file are applied to the ARB. The ALC hold setting is one of the values stored within the header file. If the newly selected waveform file has an associated header file, the ALC hold setting is updated with the value from the header file. The ALC hold setting will remain unchanged if the newly selected waveform does not have an associated header file.
Range	None M1 M2 M3 M4
Initial S/W Revision	A.05.00

None

Sets no marker to be used for the ALC hold function, essentially turning the ALC hold function off.

Key Path	Source, Modulation Setup, ARB, Marker Utilities, Marker Routing, ALC Hold
Example	:SOUR:RAD:ARB:MDES:PULS NONE
Initial S/W Revision	A.05.00

Marker 1

Sets marker 1 to be used for the ALC hold function.

Key Path	Source, Modulation Setup, ARB, Marker Utilities, Marker Routing, ALC Hold
Example	:SOUR:RAD:ARB:MDES:PULS M1
Initial S/W Revision	A.05.00

Marker 2

Sets marker 2 to be used for the ALC hold function.

Key Path	Source, Modulation Setup, ARB, Marker Utilities, Marker Routing, ALC Hold
Example	:SOUR:RAD:ARB:MDES:PULS M2
Initial S/W Revision	A.05.00

Marker 3

Sets marker 3 to be used for the ALC hold function.

Key Path	Source, Modulation Setup, ARB, Marker Utilities, Marker Routing, ALC Hold
Example	:SOUR:RAD:ARB:MDES:PULS M3
Initial S/W Revision	A.05.00

Marker 4

Sets marker 4 to be used for the ALC hold function.

Key Path	Source, Modulation Setup, ARB, Marker Utilities, Marker Routing, ALC Hold
Example	:SOUR:RAD:ARB:MDES:PULS M4
Initial S/W Revision	A.05.00

Header Utilities

Allows access to the header utilities sub-menu. Pressing this key also causes the central display area to change to display the File Header Information view.

Key Path	Source, Modulation Setup, ARB
Dependencies	This key is only available if there is currently a waveform selected for playback. If no waveform is selected, the key is grayed out.
Initial S/W Revision	A.05.00

Clear Header

Allows you to clear the header information from the file header associated with the currently selected waveform.

Key Path	Source, Modulation Setup, ARB, Header Utilities
Remote Command	:SOURce:RADio:ARB:HEADer:CLEar
Example	:SOUR:RAD:ARB:HEAD:CLE
Notes	Attempting to clear the header details via SCPI when no waveform was selected for playback will generate an error.
Initial S/W Revision	A.05.00

Save Setup To Header

Allows you to save new file header information details to the file.

Key Path	Source, Modulation Setup, ARB, Header Utilities
Remote Command	:SOURce:RADio:ARB:HEADer:SAVE
Example	:SOUR:RAD:ARB:HEAD:SAVE
Notes	Attempting to save the header details via SCPI when no waveform was selected for playback will generate an error.
Initial S/W Revision	A.05.00

Query Waveform Unique ID (Remote Command Only)

Each Signal Studio waveform contains a unique waveform ID, which recorded in the header. This command allows you to query the unique waveform ID from the header. This is a SCPI only command. User can also check [Error! Reference source not found.](#) for waveform unique ID display.

Remote Command	:MMEMory:HEADer:ID? "<file name>"
Example	:MMEM:HEAD:ID? "test.wfm" (query the waveform already loaded into the ARB memory) :MMEM:HEAD:ID? "D: VARB\test.wfm" (query the waveform on the hard disk by absolute path) :MMEM:HEAD:ID? "NVWFM:test.wfm" (query the waveform on the hard disk by MSUS)
Notes	SCPI query only. The queried waveform file can be in ARB memory, or on hard disk. If want to query ARB in ARB memory, then give out the file name directly. If want to query ARB on the hard disk, then absolute file path or MSUS should be given along with the file name. The valid MSUS is "NVWFM" which is mapped to D: VARB on hard disk. If the file cannot be found in ARB memory or on hard disk, an error is generated and value -1 is returned
Initial S/W Revision	A.09.00

Bus Trigger Command (Remote Command Only)

Used to initiate an immediate trigger event if the trigger source is set to Bus.

Remote Command	:SOURce:RADio:ARB:TRIGger:INITiate
Example	:SOUR:RAD:ARB:TRIG:INIT
Initial S/W Revision	A.05.00

AM

Allows access to the menu for configuring the Amplitude Modulation.

Key Path	Source, Modulation Setup
Initial S/W Revision	A.05.00

AM

Enables or disables the amplitude modulation.

Turning AM on when another modulation format is already on results in the previous modulation format being turned off and the generation of an error.

Key Path	Source, Modulation Setup, AM
Remote Command	:SOURce:AM:STATe :SOURce:AM:STATe?
Example	:SOUR:AM:STAT OFF
Preset	Off
Range	On Off
Initial S/W Revision	A.05.00

AM Depth

Allows you to set the amplitude modulation depth in percent.

Key Path	Source, Modulation Setup, AM
Remote Command	:SOURce:AM[:DEPTh] [:LINear] :SOURce:AM[:DEPTh] [:LINear]?
Example	:SOUR:AM 0.1
Preset	0.1 %
Min	0.1 %
Max	95.0 %
Initial S/W Revision	A.05.00

AM Rate

Allows you to set the internal amplitude modulation rate.

Key Path	Source, Modulation Setup, AM
Remote Command	:SOURce:AM:INTernal:FREQuency :SOURce:AM:INTernal:FREQuency?
Example	:SOUR:AM:INT:FREQ 40.0 Hz
Preset	400.0 Hz
Min	10 Hz
Max	40 kHz
Initial S/W Revision	A.05.00

FM

Allows access to the menu for configuring the frequency modulation.

Key Path	Source, Modulation Setup
Initial S/W Revision	A.05.00

FM

Enables or disables the frequency modulation.

Turning FM on when another modulation format is already on results in the previous modulation format being turned off and the generation of an error.

Key Path	Source, Modulation Setup, FM
Remote Command	:SOURce:FM:STATe :SOURce:FM:STATe?
Example	:SOUR:FM:STAT OFF
Preset	Off
Range	On Off
Initial S/W Revision	A.05.00

FM Deviation

Allows you to set the frequency modulation deviation.

Key Path	Source, Modulation Setup, FM
----------	------------------------------

Remote Command	:SOURce:FM[:DEVIation] :SOURce:FM[:DEVIation]?
Example	:SOUR:FM 1.00 kHz
Preset	1.00 Hz
Min	1.00 Hz
Max	100.00 kHz
Initial S/W Revision	A.05.00

FM Rate

Allows you to set the internal frequency modulation rate.

Key Path	Source, Modulation Setup, FM
Remote Command	:SOURce:FM:INTernal:FREQuency :SOURce:FM:INTernal:FREQuency?
Example	:SOUR:FM:INT:FREQ 40.0 Hz
Preset	400.0 Hz
Min	10 Hz
Max	40 kHz
Initial S/W Revision	A.05.00

PM

Allows access to the menu for configuring the phase modulation.

Key Path	Source, Modulation Setup
Initial S/W Revision	A.05.00

PM

Enables or disables the phase modulation.

Turning PM on when another modulation format is already on results in the previous modulation format being turned off and the generation of an error.

Key Path	Source, Modulation Setup, PM
Remote Command	:SOURce:PM:STATe :SOURce:PM:STATe?
Example	:SOUR:PM:STAT OFF

Preset	Off
Range	On Off
Initial S/W Revision	A.05.00

PM Deviation

Allows you to set the phase modulation deviation.

Key Path	Source, Modulation Setup, PM
Remote Command	:SOURce:PM[:DEVIation] :SOURce:PM[:DEVIation]?
Example	:SOUR:PM 1.00 rad
Preset	0.1 rad
Min	0.1 rad
Max	20.0 rad
Initial S/W Revision	A.05.00

PM Rate

Allows you to set the internal phase modulation rate.

Key Path	Source, Modulation Setup, PM
Remote Command	:SOURce:PM:INTernal:FREQuency :SOURce:PM:INTernal:FREQuency?
Example	:SOUR:PM:INT:FREQ 40.0 Hz
Preset	400.0 Hz
Min	10 Hz
Max	40 kHz
Initial S/W Revision	A.05.00

List Sequencer

Allows you access to the sub-menus for configuring the list sequencer.

List sequences allows you to enter frequencies and amplitudes at unequal intervals in nonlinear ascending, descending or random order. Each step within the list can also include its own waveform file for playback, step duration, trigger event and trigger output.

The complexities involved in configuring the list sequencer do not lend itself to manual configuration; hence the manual configuration for this feature is limited. For easier configuration of the list sequencer, it is recommended that you use either SCPI or load a tab delimited file containing the setup parameters in a

tabular form. The details of the SCPI for configuring the list sequencer can be found in "[Step Configuration \(Remote Command Only\)](#)" on page 1340.

Once the List Sequencer has been configured using the front panel, SCPI, or loading in a tab delimited file, the sequence must be initiated using the front panel Initiate Sequence key or the corresponding SCPI command.

Key Path	Source
Initial S/W Revision	A.05.00

Sequencer

Allows you to set the state of the list sequencer. When the list sequencer is on, the source is outputting the sequence defined by the sequencer. When the list sequencer is off, the source outputs a single waveform segment or sequence (independent mode) at a single frequency and amplitude.

Key Path	Source, List Sequencer
Remote Command	:SOURce:LIST[:STATe] ON OFF 1 0 :SOURce:LIST[:STATe]?
Example	:SOUR:LIST OFF
Notes	When the sequencer is set to ON, the list sequencer controls the output of the source.
Couplings	When in Sequence Analyzer mode and the list sequencer state is Off, Include Source is forced to No, and the Include Source key is grayed out. When in Sequence Analyzer mode and the list sequencer state is On, Include Source is available to set. And, an ARB memory related operation, like load or delete will be rejected.
Preset	Off
Range	On Off
Initial S/W Revision	A.05.00

Initiate Sequence

Pressing this key arms the sequence for single execution. Once the sequence is armed the source begins the sequence as soon as the trigger is received. If the trigger is set to Free Run, the sequence starts immediately.

Key Path	Source, List Sequencer
Remote Command	:SOURce:LIST:TRIGger[:IMMediate]
Example	:SOUR:LIST:TRIG
Notes	When in Sequence Analyzer mode and Include Source is Yes, the Initiate list sequencer operation is rejected, and the key is grayed out, since source list sequence request is sent to physics via Parallel batch by sequence analyzer. If the file needed by the sequencer is not already in ARB memory, the sequence cannot be initiated

	and an error will be generated. There is a blocking SCPI query which can be used to query if source list sequence being initiated successfully or not. (see " Query List Sequence Initiation Armed Status (Remote Command Only) " on page 1351 Query Source List Sequence Armed Status)
Dependencies	Under the Sequence Analyzer Mode, if Meas Setup->Include Source is set to YES, Source->List Sequencer->Initiate Sequence is disabled.
Initial S/W Revision	A.05.00

List Sequencer Setup

Allows you access to the list sequencer setup menus.

Key Path	Source, List Sequencer
----------	------------------------

Number of Steps

Allows you to specify the number of steps within the list sequence.

Key Path	Source, List Sequencer, List Sequencer Setup
Remote Command	:SOURce:LIST:NUMBer:STEPs <integer> :SOURce:LIST:NUMBer:STEPs?
Example	:SOUR:LIST:NUMB:STEP 1
Notes	Increasing the number of steps creates additional steps at the end of the list, with all the settings within the steps set to their default values. Decreasing the number of steps removes steps from the end of the list. The settings within the removed steps are not reset. This means that increasing the number of steps again would allow you to retrieve these steps.
Dependencies	The Step Count parameter is increased or decreased when you insert or delete a point from within the GUI interface to the sequencer.
Preset	1
Min	1
Max	1000
Initial S/W Revision	A.05.00

Current Step

Allows you to select the step number you wish to view or edit.

Key Path	Source, List Sequencer, List Sequencer Setup
----------	--

Notes	No remote command, front panel only.
Preset	1
Min	1
Max	Step Count
Initial S/W Revision	A.05.00

Insert Step Before

Allows you to insert a new step, containing default values, before the currently selected step. Inserting a step will automatically increase the Step Count parameter by 1. If sequence already reaches upper limit of 1000 steps, then insert more step will be rejected and popup error –221, “Setting Conflict; Cannot insert more steps, maximum number of steps reached”

Key Path	Source, List Sequencer, List Sequencer Setup
Notes	No remote command, front panel only. If the list already contains the maximum limit of 1000 steps, no operation will be made after pressing this key.
Initial S/W Revision	A.05.00

Delete Step

Allows you to delete the current step. Deleting a step will automatically decrease the Step Count parameter by 1. If sequence only has one step left, delete step will be rejected and popup error –221, “Setting conflict; Cannot delete current step, minimum number of steps reached”

Key Path	Source, List Sequencer, List Sequencer Setup
Notes	No remote command, Front Panel key only. If the list already contains the minimum limit of 1 step, no operation will be made after pressing this key
Initial S/W Revision	A.05.00

Clear List

Allows you to clear the list. Clearing the list sets the number of steps to the default value of 1 and sets the parameters for the only step to their default values.

Key Path	Source, List Sequencer, List Sequencer Setup
Initial S/W Revision	A.05.00

Step Trigger

Allows access to the sub-menu for selecting the trigger input for the current step.

Key Path	Source, List Sequencer, List Sequencer Setup
Remote Command	:SOURCE:LIST:STEP[1] 2 3...1000:SETup:INPut:TRIGger IMMEDIATE INTERNAL EXTERNAL2 KEY BUS EXTERNAL4 :SOURCE:LIST:STEP[1] 2 3...1000:SETup:INPut:TRIGger?
Example	:SOUR:LIST:STEP2:SET:INP:TRIG BUS :SOUR:LIST:STEP2:SET:INP:TRIG?
Notes	SCPI is supported after A.09.40
Preset	Free Run
Range	Free Run Internal Manual (Trigger Key) Bus External 2 EXTERNAL4
Initial S/W Revision	A.05.00

Free Run

Sets the trigger input for the current step to Free Run.

Key Path	Source, List Sequencer, List Sequencer Setup, Step Trigger
Example	:SOUR:LIST:STEP2:SET:INP:TRIG IMM
Notes	SCPI is supported after A.09.40
Initial S/W Revision	A.05.00

Internal

Sets the trigger input for the current step to Internal.

Key Path	Source, List Sequencer, List Sequencer Setup, Step Trigger
Example	:SOUR:LIST:STEP2:SET:INP:TRIG INT
Notes	SCPI is supported after A.09.40
Initial S/W Revision	A.05.00

Manual (Trigger Key)

Sets the trigger input for the current step to Manual (Trigger Key). Any step in the sequence set to Manual will cause the sequence execution to stop until the manual trigger key is pressed. Sending the Bus Trigger SCPI command will have no effect. At any point in the sequence where the list sequencer is paused waiting for a software trigger, a pop up dialog is displayed until the trigger event occurs.

Key Path	Source, List Sequencer, List Sequencer Setup, Step Trigger
Example	:SOUR:LIST:STEP2:SET:INP:TRIG KEY
Notes	SCPI is supported after A.09.40
Initial S/W Revision	A.05.00

Bus

Sets the trigger input for the current step to Bus. Any step in the sequence set to Bus will cause the sequence execution to stop until the Bus Trigger SCPI command is sent. Pressing the manual trigger key has no effect. At any point in the sequence where the list sequencer is paused waiting for a software trigger, a pop up dialog is displayed until the trigger event occurs.

Key Path	Source, List Sequencer, List Sequencer Setup, Step Trigger
Example	:SOUR:LIST:STEP2:SET:INP:TRIG BUS
Notes	SCPI is supported after A.09.40
Initial S/W Revision	A.05.00

External 2

Sets the trigger input for the current step to External 2.

Key Path	Source, List Sequencer, List Sequencer Setup, Step Trigger
Example	:SOUR:LIST:STEP2:SET:INP:TRIG EXT2
Notes	SCPI is supported after A.09.40
Notes	Note: When on E6640A, trigger 2 is a bi-directional trigger port. So when trigger 2 has been configured as OUTPUT type, choosing External 2 as the input trigger for the current step will generate error.
Initial S/W Revision	A.05.00

Transition Time

Allows you to specify the transition time for the current step.

The transition time is the amount of time allowed for the source to settle at the current frequency or amplitude value.

Transition Time should not be taken as additional time before or inside the Step Duration. You can set a value for the settling time to allow the source output frequency or amplitude to become stable. Make sure that during this period of time, you do not use the source output signal.

The following table lists recommended values for appropriate settling times to allow for changes within the source.

Value Changed	Recommended Transition Time
Frequency	500 μ s
Amplitude	100 μ s to within 0.1 dB 20 μ s to within 1.0 dB

If the Transition Time value is shorter than the time necessary for the hardware to settle and a List Sequence is initiated, a **warning** is generated.

If the Transition Time value is longer than the Step Duration, an error is generated when initiating a source list sequence. For source list sequence, transition time is included in the step duration length. If the Transition Time value is longer than the Step Duration Time, the real step duration length is extended to equal the transition time and cause a timing shift.

Key Path	Source, List Sequencer, List Sequencer Setup
Remote Command	:SOURce:LIST:STEP[1] 2 3...1000:SETup:TRANsition:TIME <time> :SOURce:LIST:STEP[1] 2 3...1000:SETup:TRANsition:TIME?
Example	:SOUR:LIST:STEP2:SET:TRAN:TIME 1ms :SOUR:LIST:STEP2:SET:TRAN:TIME?
Notes	SCPI is supported after A.09.40
Preset	1.0 ms
Min	0.0 ms
Max	4.0 ks
Initial S/W Revision	A.05.00

Radio Setup

Allows you access to the sub-menus for setting up the radio standard, band, and radio band link direction for the current step.

Key Path	Source, List Sequencer, List Sequencer Setup
Notes	No remote command, front panel only.
Initial S/W Revision	A.05.00

Radio Standard

Allows access to the sub-menus for selecting the radio standard and the associated radio band for use in the current step.

Key Path	Source, List Sequencer, List Sequencer Setup, Radio Setup
Remote Command	:SOURce:LIST:STEP[1] 2 3...1000:SETup:RADio:BAND NONE PGSM EGSM RGSM DCS1800 PCS1900 TGSM810 GSM450 GSM480 GSM700 GSM850 BANDI BANDII BANDIII BANDIV BANDV BANDVI BANDVII BANDVIII BANDIX BANDX BANDXI BANDXII BANDXIII BANDXIV BANDXIX USCELL USPCS JAPAN KOREAN NMT IMT2K UPPER SECOND PAMR400 PAMR800 IMTEXT PCS1DOT9G AWS US2DOT5G PUBLIC LOWER NONE BAND1 BAND2 BAND3 BAND4 BAND5 BAND6 BAND7 BAND8 BAND10 BAND11 BAND12 BAND13 BAND14 BAND17 BAND18 BAND19 BAND20 BAND21 BAND24 BAND25 BAND26 BAND27 BAND28 BAND31 BAND33 BAND34 BAND35 BAND36 BAND37 BAND38

BAND39 | BAND40 | BAND41 | BAND42 | BAND43 | BAND44 | BANDA | BANDB |
BANDC | BANDD | BANDE | BANDF

:SOURce:LIST:STEP[1]|2|3...1000:SETup: RADio:BAND?

Example :SOUR:LIST:STEP2:SET:RAD:BAND PGSM
:SOUR:LIST:STEP2:SET:RAD:BAND?

Notes SCPI is supported after A.09.40

Initial S/W Revision A.05.00

None

Selects no radio standard for use on the current step.

Key Path Source, List Sequencer, List Sequencer Setup, Radio Setup, Radio Standard

Example :SOUR:LIST:STEP2:SET:RAD:BAND NONE

Notes SCPI is supported after A.09.40

Initial S/W Revision A.05.00

GSM/EDGE

Pressing this key once selects GSM/EDGE as the radio standard and the current GSM/EDGE band as the active channel band. Pressing this key again allows access to the sub-menus for selecting a different GSM/EDGE band.

Key Path Source, List Sequencer, List Sequencer Setup, Radio Setup, Radio Standard

Initial S/W Revision A.05.00

P-GSM

Selects P-GSM as the band for the current step.

Key Path Source, List Sequencer, List Sequencer Setup, Radio Setup, Radio Standard, GSM/EDGE

Initial S/W Revision A.05.00

E-GSM

Selects E-GSM as the band for the current step.

Key Path Source, List Sequencer, List Sequencer Setup, Radio Setup, Radio Standard, GSM/EDGE

Initial S/W Revision A.05.00

R-GSM

Selects R-GSM as the band for the current step.

Key Path	Source, List Sequencer, List Sequencer Setup, Radio Setup, Radio Standard, GSM/EDGE
Initial S/W Revision	A.05.00

DCS 1800

Selects DCS 1800 as the band for the current step.

Key Path	Source, List Sequencer, List Sequencer Setup, Radio Setup, Radio Standard, GSM/EDGE
Initial S/W Revision	A.05.00

PCS 1900

Selects PCS 1900 as the band for the current step.

Key Path	Source, List Sequencer, List Sequencer Setup, Radio Setup, Radio Standard, GSM/EDGE
Initial S/W Revision	A.05.00

GSM 450

Selects GSM 450 as the band for the current step.

Key Path	Source, List Sequencer, List Sequencer Setup, Radio Setup, Radio Standard, GSM/EDGE
Initial S/W Revision	A.05.00

GSM 480

Selects GSM 480 as the band for the current step.

Key Path	Source, List Sequencer, List Sequencer Setup, Radio Setup, Radio Standard, GSM/EDGE
Initial S/W Revision	A.05.00

GSM 850

Selects GSM 850 as the band for the current step.

Key Path	Source, List Sequencer, List Sequencer Setup, Radio Setup, Radio Standard, GSM/EDGE
Initial S/W Revision	A.05.00

GSM 700

Selects GSM 700 as the band for the current step.

Key Path	Source, List Sequencer, List Sequencer Setup, Radio Setup, Radio Standard, GSM/EDGE
Initial S/W Revision	A.05.00

T-GSM 810

Selects T-GSM 810 as the band for the current step.

Key Path	Source, List Sequencer, List Sequencer Setup, Radio Setup, Radio Standard, GSM/EDGE
Initial S/W Revision	A.05.00

WCDMA

Pressing this key once selects WCDMA as the radio standard and the current WCDMA band as the active channel band. Pressing this key again allows access to the sub-menus for selecting a different WCDMA band.

Key Path	Source, List Sequencer, List Sequencer Setup, Radio Setup, Radio Standard
Initial S/W Revision	A.05.00

Band I

Selects Band I as the band for the current step.

Key Path	Source, List Sequencer, List Sequencer Setup, Radio Setup, Radio Standard, WCDMA
Initial S/W Revision	A.05.00

Band II

Selects Band II as the band for the current step.

Key Path	Source, List Sequencer, List Sequencer Setup, Radio Setup, Radio Standard, WCDMA
Initial S/W Revision	A.05.00

Band III

Selects Band III as the band for the current step.

Key Path	Source, List Sequencer, List Sequencer Setup, Radio Setup, Radio Standard, WCDMA
Initial S/W Revision	A.05.00

Band IV

Selects Band IV as the band for the current step.

Key Path	Source, List Sequencer, List Sequencer Setup, Radio Setup, Radio Standard, WCDMA
Initial S/W Revision	A.05.00

Band V

Selects Band V as the band for the current step.

Key Path	Source, List Sequencer, List Sequencer Setup, Radio Setup, Radio Standard, WCDMA
Initial S/W Revision	A.05.00

Band VI

Selects Band VI as the band for the current step.

Key Path	Source, List Sequencer, List Sequencer Setup, Radio Setup, Radio Standard, WCDMA
Initial S/W Revision	A.05.00

Band VII

Selects Band VII as the band for the current step.

Key Path	Source, List Sequencer, List Sequencer Setup, Radio Setup, Radio Standard, WCDMA
Initial S/W Revision	A.05.00

Band VIII

Selects Band VIII as the band for the current step.

Key Path	Source, List Sequencer, List Sequencer Setup, Radio Setup, Radio Standard, WCDMA
Initial S/W Revision	A.05.00

Band IX

Selects Band IX as the band for the current step.

Key Path	Source, List Sequencer, List Sequencer Setup, Radio Setup, Radio Standard, WCDMA
Initial S/W Revision	A.05.00

Band X

Selects Band X as the band for the current step.

Key Path	Source, List Sequencer, List Sequencer Setup, Radio Setup, Radio Standard, WCDMA
Initial S/W Revision	A.05.00

Band XI

Selects Band XI as the band for the current step.

Key Path	Source, List Sequencer, List Sequencer Setup, Radio Setup, Radio Standard, WCDMA
Initial S/W Revision	A.05.00

Band XII

Selects Band XII as the band for the current step.

Key Path	Source, List Sequencer, List Sequencer Setup, Radio Setup, Radio Standard, WCDMA
Initial S/W Revision	A.05.00

Band XIII

Selects Band XIII as the band for the current step.

Key Path	Source, List Sequencer, List Sequencer Setup, Radio Setup, Radio Standard, WCDMA
Initial S/W Revision	A.05.00

Band XIV

Selects Band XIV as the band for the current step.

Key Path	Source, List Sequencer, List Sequencer Setup, Radio Setup, Radio Standard, WCDMA
Initial S/W Revision	A.05.00

Band XIX

Selects Band XIX as the band for the current step.

Key Path	Source, List Sequencer, List Sequencer Setup, Radio Setup, Radio Standard, WCDMA
Initial S/W Revision	A.14.50

CDMA 2000 / 1xEVDO

Pressing this key once selects CDMA 2000/1xEVDO as the radio standard and the current CDMA 2000/1xEVDO band as the active channel band. Pressing this key again allows access to the sub-menus for selecting a different CDMA 2000/1xEVDO band.

Key Path	Source, List Sequencer, List Sequencer Setup, Radio Setup, Radio Standard
Initial S/W Revision	A.05.00

US CELL

Selects US Cell as the band for the current step.

Key Path	Source, List Sequencer, List Sequencer Setup, Radio Setup, Radio Standard, CDMA 2000 / 1xEVDO
Initial S/W Revision	A.05.00

US PCS

Selects US PCS as the band for the current step.

Key Path	Source, List Sequencer, List Sequencer Setup, Radio Setup, Radio Standard, CDMA 2000 / 1xEVDO
Initial S/W Revision	A.05.00

Japan Cell

Selects Japan Cell as the band for the current step.

Key Path	Source, List Sequencer, List Sequencer Setup, Radio Setup, Radio Standard, CDMA 2000 / 1xEVDO
Initial S/W Revision	A.05.00

Korean PCS

Selects Korean PCS as the band for the current step.

Key Path	Source, List Sequencer, List Sequencer Setup, Radio Setup, Radio Standard, CDMA 2000 / 1xEVDO
Initial S/W Revision	A.05.00

NMT 450

Selects NMT 450 as the band for the current step.

Key Path	Source, List Sequencer, List Sequencer Setup, Radio Setup, Radio Standard, CDMA 2000 / 1xEVDO
Initial S/W Revision	A.05.00

IMT 2000

Selects IMT 2000 as the band for the current step.

Key Path	Source, List Sequencer, List Sequencer Setup, Radio Setup, Radio Standard, CDMA 2000 / 1xEVDO
Initial S/W Revision	A.05.00

Upper 700

Selects Upper 700 as the band for the current step.

Key Path	Source, List Sequencer, List Sequencer Setup, Radio Setup, Radio Standard, CDMA 2000 / 1xEVDO
Initial S/W Revision	A.05.00

Secondary 800

Selects Secondary 800 as the band for the current step.

Key Path	Source, List Sequencer, List Sequencer Setup, Radio Setup, Radio Standard, CDMA 2000 / 1xEVDO
Initial S/W Revision	A.05.00

400 Euro PAMR

Selects 400 Euro PAMR as the band for the current step.

Key Path	Source, List Sequencer, List Sequencer Setup, Radio Setup, Radio Standard, CDMA 2000 / 1xEVDO
Initial S/W Revision	A.05.00

800 PAMR

Selects 800 PAMR as the band for the current step.

Key Path	Source, List Sequencer, List Sequencer Setup, Radio Setup, Radio Standard, CDMA 2000 / 1xEVDO
Initial S/W Revision	A.05.00

2.5GHz IMT EXT

Selects 2.5 GHz IMT EXT as the band for the current step.

Key Path	Source, List Sequencer, List Sequencer Setup, Radio Setup, Radio Standard, CDMA 2000 / 1xEVDO
Initial S/W Revision	A.05.00

US PCS 1.9GHz

Selects US PCS 1.9 GHz as the band for the current step.

Key Path	Source, List Sequencer, List Sequencer Setup, Radio Setup, Radio Standard, CDMA 2000 / 1xEVDO
Initial S/W Revision	A.05.00

AWS

Selects AWS as the band for the current step.

Key Path	Source, List Sequencer, List Sequencer Setup, Radio Setup, Radio Standard, CDMA 2000 / 1xEVDO
Initial S/W Revision	A.05.00

US 2.5GHz

Selects US 2.5 GHz as the band for the current step.

Key Path	Source, List Sequencer, List Sequencer Setup, Radio Setup, Radio Standard, CDMA 2000 / 1xEVDO
Initial S/W Revision	A.05.00

700 Public Safety

Selects 700 Public Safety as the band for the current step.

Key Path	Source, List Sequencer, List Sequencer Setup, Radio Setup, Radio Standard, CDMA 2000 / 1xEVDO
Initial S/W Revision	A.05.00

C2K Lower 700

Selects C2K Lower 700 as the band for the current step.

Key Path	Source, List Sequencer, List Sequencer Setup, Radio Setup, Radio Standard, CDMA 2000 / 1xEVDO
Initial S/W Revision	A.05.00

LTE

Pressing this key once selects LTE FDD as the radio standard and the current LTE FDD band as the active channel band. Pressing this key again allows access to the sub-menus for selecting a different LTE FDD band.

Key Path	Source, List Sequencer, List Sequencer Setup, Radio Setup, Radio Standard
Initial S/W Revision	A.09.50

BAND 1

Selects BAND 1 as the band for the current step.

Key Path	Source, List Sequencer, List Sequencer Setup, Radio Setup, Radio Standard, LTE
Initial S/W Revision	A.09.50

BAND 2

Selects BAND 2 as the band for the current step.

Key Path	Source, List Sequencer, List Sequencer Setup, Radio Setup, Radio Standard, LTE
Initial S/W Revision	A.09.50

BAND 3

Selects BAND 3 as the band for the current step.

Key Path	Source, List Sequencer, List Sequencer Setup, Radio Setup, Radio Standard, LTE
Initial S/W Revision	A.09.50

BAND 4

Selects BAND 4 as the band for the current step.

Key Path	Source, List Sequencer, List Sequencer Setup, Radio Setup, Radio Standard, LTE
Initial S/W Revision	A.09.50

BAND 5

Selects BAND 5 as the band for the current step.

Key Path	Source, List Sequencer, List Sequencer Setup, Radio Setup, Radio Standard, LTE
Initial S/W Revision	A.09.50

BAND 6

Selects BAND 6 as the band for the current step.

Key Path	Source, List Sequencer, List Sequencer Setup, Radio Setup, Radio Standard, LTE
Initial S/W Revision	A.09.50

BAND 7

Selects BAND 7 as the band for the current step.

Key Path	Source, List Sequencer, List Sequencer Setup, Radio Setup, Radio Standard, LTE
Initial S/W Revision	A.09.50

BAND 8

Selects BAND 8 as the band for the current step.

Key Path	Source, List Sequencer, List Sequencer Setup, Radio Setup, Radio Standard, LTE
Initial S/W Revision	A.09.50

BAND 9

Selects BAND 9 as the band for the current step.

Key Path	Source, List Sequencer, List Sequencer Setup, Radio Setup, Radio Standard, LTE
Initial S/W Revision	A.09.50

BAND 10

Selects BAND 10 as the band for the current step.

Key Path	Source, List Sequencer, List Sequencer Setup, Radio Setup, Radio Standard, LTE
Initial S/W Revision	A.09.50

BAND 11

Selects BAND 11 as the band for the current step.

Key Path	Source, List Sequencer, List Sequencer Setup, Radio Setup, Radio Standard, LTE
Initial S/W Revision	A.09.50

BAND 12

Selects BAND 12 as the band for the current step.

Key Path	Source, List Sequencer, List Sequencer Setup, Radio Setup, Radio Standard, LTE
Initial S/W Revision	A.09.50

BAND 13

Selects BAND 13 as the band for the current step.

Key Path	Source, List Sequencer, List Sequencer Setup, Radio Setup, Radio Standard, LTE
Initial S/W Revision	A.09.50

BAND 14

Selects BAND 14 as the band for the current step.

Key Path	Source, List Sequencer, List Sequencer Setup, Radio Setup, Radio Standard, LTE
Initial S/W Revision	A.09.50

BAND 17

Selects BAND 17 as the band for the current step.

Key Path	Source, List Sequencer, List Sequencer Setup, Radio Setup, Radio Standard, LTE
Initial S/W Revision	A.09.50

BAND 18

Selects BAND 18 as the band for the current step.

Key Path	Source, List Sequencer, List Sequencer Setup, Radio Setup, Radio Standard, LTE
Initial S/W Revision	A.09.50

BAND 19

Selects BAND 19 as the band for the current step.

Key Path	Source, List Sequencer, List Sequencer Setup, Radio Setup, Radio Standard, LTE
Initial S/W Revision	A.09.50

BAND 20

Selects BAND 20 as the band for the current step.

Key Path	Source, List Sequencer, List Sequencer Setup, Radio Setup, Radio Standard, LTE
Initial S/W Revision	A.09.50

BAND 21

Selects BAND 21 as the band for the current step.

Key Path	Source, List Sequencer, List Sequencer Setup, Radio Setup, Radio Standard, LTE
Initial S/W Revision	A.09.50

BAND 24

Selects BAND 24 as the band for the current step.

Key Path	Source, List Sequencer, List Sequencer Setup, Radio Setup, Radio Standard, LTE
Initial S/W Revision	A.09.50

BAND 25

Selects BAND 25 as the band for the current step.

Key Path	Source, List Sequencer, List Sequencer Setup, Radio Setup, Radio Standard, LTE
Initial S/W Revision	A.09.50

BAND 26

Selects BAND 26 as the band for the current step.

Key Path	Source, List Sequencer, List Sequencer Setup, Radio Setup, Radio Standard, LTE
Initial S/W Revision	A.12.53

BAND 27

Selects BAND 27 as the band for the current step.

Key Path	Source, List Sequencer, List Sequencer Setup, Radio Setup, Radio Standard, LTE
Initial S/W Revision	A.14.00

BAND 28

Selects BAND 28 as the band for the current step.

Key Path	Source, List Sequencer, List Sequencer Setup, Radio Setup, Radio Standard, LTE
Initial S/W Revision	A.14.00

BAND 31

Selects BAND 31 as the band for the current step.

Key Path	Source, List Sequencer, List Sequencer Setup, Radio Setup, Radio Standard, LTE
Initial S/W Revision	A.14.00

LTE TDD

Sets LTE TDD as the radio standard for use and accesses the LTE TDD specific channel band sub-menus..

Key Path	Source, Frequency, Radio Setup, Radio Standard
Initial S/W Revision	A.11.50

BAND 33

Selects BAND 33 as the band for the current step.

Key Path	Source, Frequency, Radio Setup, Radio Standard, LTE TDD
Example	:SOUR:FREQ:CHAN:BAND BAND33
Initial S/W Revision	A.11.50

BAND 34

Selects BAND 34 as the band for the current step.

Key Path	Source, Frequency, Radio Setup, Radio Standard, LTE TDD
Example	:SOUR:FREQ:CHAN:BAND BAND34
Initial S/W Revision	A.11.50

BAND 35

Selects BAND 35 as the band for the current step.

Key Path	Source, Frequency, Radio Setup, Radio Standard, LTE TDD
Example	:SOUR:FREQ:CHAN:BAND BAND35
Initial S/W Revision	A.11.50

BAND 36

Selects BAND 36 as the band for the current step.

Key Path	Source, Frequency, Radio Setup, Radio Standard, LTE TDD
Example	:SOUR:FREQ:CHAN:BAND BAND36
Initial S/W Revision	A.11.50

BAND 37

Selects BAND 37 as the band for the current step.

Key Path	Source, Frequency, Radio Setup, Radio Standard, LTE TDD
Example	:SOUR:FREQ:CHAN:BAND BAND37
Initial S/W Revision	A.11.50

BAND 38

Selects BAND 38 as the band for the current step.

Key Path	Source, Frequency, Radio Setup, Radio Standard, LTE TDD
Example	:SOUR:FREQ:CHAN:BAND BAND38
Initial S/W Revision	A.11.50

BAND 39

Selects BAND 39 as the band for the current step.

Key Path	Source, Frequency, Radio Setup, Radio Standard, LTE TDD
Example	:SOUR:FREQ:CHAN:BAND BAND39
Initial S/W Revision	A.11.50

BAND 40

Selects BAND 40 as the band for the current step.

Key Path	Source, Frequency, Radio Setup, Radio Standard, LTE TDD
Example	:SOUR:FREQ:CHAN:BAND BAND40
Initial S/W Revision	A.11.50

BAND 41

Selects BAND 41 as the band for the current step.

Key Path	Source, Frequency, Radio Setup, Radio Standard, LTE TDD
Example	:SOUR:FREQ:CHAN:BAND BAND41
Initial S/W Revision	A.11.50

BAND 42

Selects BAND 42 as the band for the current step.

Key Path	Source, Frequency, Radio Setup, Radio Standard, LTE TDD
Example	:SOUR:FREQ:CHAN:BAND BAND42
Initial S/W Revision	A.11.50

BAND 43

Selects BAND 43 as the band for the current step.

Key Path	Source, Frequency, Radio Setup, Radio Standard, LTE TDD
Example	:SOUR:FREQ:CHAN:BAND BAND43
Initial S/W Revision	A.11.50

BAND 44

Selects BAND 44 as the band for the current step.

Key Path	Source, List Sequencer, List Sequencer Setup, Radio Setup, Radio Standard, LTE TDD
Initial S/W Revision	A.14.00

TDSCDMA

Sets TDSCDMA as the radio standard for use and accesses the TDSCDMA specific channel band sub-menus..

Key Path	Source, Frequency, Radio Setup, Radio Standard
Initial S/W Revision	A.11.50

BAND A

Selects BAND A as the band for the current step.

Key Path	Source, Frequency, Radio Setup, Radio Standard, TDSCDMA
Example	:SOUR:FREQ:CHAN:BAND BANDA
Initial S/W Revision	A.11.50

BAND B

Selects BAND B as the band for the current step.

Key Path	Source, Frequency, Radio Setup, Radio Standard, TDSCDMA
Example	:SOUR:FREQ:CHAN:BAND BANDB
Initial S/W Revision	A.11.50

BAND C

Selects BAND C as the band for the current step.

Key Path	Source, Frequency, Radio Setup, Radio Standard, TDSCDMA
Example	:SOUR:FREQ:CHAN:BAND BANDC
Initial S/W Revision	A.11.50

BAND D

Selects BAND D as the band for the current step.

Key Path	Source, Frequency, Radio Setup, Radio Standard, TDSCDMA
Example	:SOUR:FREQ:CHAN:BAND BANDD
Initial S/W Revision	A.11.50

BAND E

Selects BAND E as the band for the current step.

Key Path	Source, Frequency, Radio Setup, Radio Standard, TDSCDMA
----------	---

Example	:SOUR:FREQ:CHAN:BAND BANDE
Initial S/W Revision	A.11.50

BAND F

Selects BAND F as the band for the current step.

Key Path	Source, Frequency, Radio Setup, Radio Standard, TDSCDMA
Example	:SOUR:FREQ:CHAN:BAND BANDF
Initial S/W Revision	A.11.50

Radio Band Link

Allows you to specify the radio band link direction for the steps within the list sequence. The link is used in conjunction with the channel band and channel number to determine the output frequency.

When set to “Uplink”, the source will calculate the uplink frequency according to an uplink formula together with selected channel band and channel number. When set to “Downlink”, the source will calculate the downlink frequency according to a downlink formula together with selected channel band and channel number.

Key Path	Source, List Sequencer, List Sequencer Setup, Radio Setup
Remote Command	:SOURce:LIST:STEP [1] 2 3...1000:SETup:RADio:BAND:LINK DOWN UP :SOURce:LIST:STEP [1] 2 3...1000:SETup:RADio:BAND:LINK?
Example	:SOUR:LIST:STEP2:SET:RAD:BAND:LINK UP :SOUR:LIST:STEP2:SET:RAD:BAND:LINK?
Notes	SCPI is supported after A.09.40
Preset	DOWN
Range	DOWN UP
Initial S/W Revision	A.05.00

Channel

Allows you to specify the frequency of the current step via a channel number.

Key Path	Source, List Sequencer, List Sequencer Setup
Remote Command	:SOURce:LIST:STEP [1] 2 3...1000:SETup:CNFRrequency <double> :SOURce:LIST:STEP [1] 2 3...1000:SETup:CNFRrequency?
Example	:SOUR:LIST:STEP2:SET:CNFR 124 :SOUR:LIST:STEP2:SET:CNFR?
Notes	SCPI is supported after A.09.40.

	This SCPI is used to setup channel number or frequency setting, according to current Radio Band setting. If Radio Band is "NONE", then it's frequency. If Radio Band is not "NONE", then it's channel number.
Couplings	The channel number is coupled to the step frequency value. When the step frequency value is changed, the channel number will increase or decrease to match the new step frequency. If the step frequency is not at an exact match for a channel number, the nearest channel number is displayed, along with a greater than, or less than sign to indicate the frequency is above or below the channel number.
Preset	1
Min	0 (Please refer to for valid ranges.)
Max	10838 (Please refer to for valid ranges.)
Initial S/W Revision	A.05.00

Frequency

Allows you to specify a frequency value for the current step.

Key Path	Source, List Sequencer, List Sequencer Setup
Remote Command	:SOURce:LIST:STEP[1] 2 3...1000:SETup:CNFRrequency <double> :SOURce:LIST:STEP[1] 2 3...1000:SETup:CNFRrequency?
Example	:SOUR:LIST:STEP2:SET:CNFR 1GHz :SOUR:LIST:STEP2:SET:CNFR?
Notes	SCPI is supported after A.09.40. This SCPI is used to setup channel number or frequency setting, according to current Radio Band setting. If Radio Band is "NONE", then it's frequency. If Radio Band is not "NONE", then it's channel number.
Couplings	The frequency value is coupled to the channel band and number for the step, such that updates to the radio band and channel number will update the frequency value to the corresponding absolute frequency. The reverse is also true, changing the frequency value causes the value of the channel number to be updated.
Preset	1.00 GHz
Min	10.00 MHz
Max	Hardware Dependant: Option 503 = 3.6 GHz Option 504 = 3.9 GHz Option 506 = 6.00 GHz
Initial S/W Revision	A.05.00

Power

Allows you to specify a power value for the current step.

Key Path	Source, List Sequencer, List Sequencer Setup
Remote Command	:SOURce:LIST:STEP[1] 2 3...1000:SETup:AMPLitude <double> :SOURce:LIST:STEP[1] 2 3...1000:SETup:AMPLitude?
Example	:SOUR:LIST:STEP2:SET:AMPL -50dBm :SOUR:LIST:STEP2:SET:AMPL?
Notes	SCPI is supported after A.09.40
Notes	<p>Amplitude corrections can be specified for use with the source. In the event of amplitude corrections being applied, the valid ranges for the RF power do not change dependant on the current amplitude correction setting. Instead, if the combination of RF power + amplitude correction is higher or lower than the source output range, the Source Unleveled bit is set and the “Source Unleveled” indicator will appear on status panel to indicate that the source cannot maintain the output power that has been requested.</p> <p>The multiport adapter RFIO TX ports and GPS ports cannot ensure power accuracy when power setting is lower than -130dBm, this power setting value is defined by the sum of RF Power setting and related amplitude correction value. But user settable value could be lower than this limit. When application detected there exists power setting lower than -130dBm on MPA RFIO TX ports, then popup warning message . When application detected there exists power setting lower than -130dBm on MPA GPS ports, then popup warning message . These are only warning messages, and check is performed when RF is ON.</p>
Notes	The Min and Max value here defined UI settable amplitude range. This range is larger than actual amplitude range with level accuracy defined in spec.
Dependencies	The RF power is dependent on the RF output port and frequency, such that the current frequency and selected output port determine the valid range of power values.
Preset	-100 dBm
Min	The range of values depends on the current frequency and selected RF output port. Please refer to "RF Power" on page 1228 and the table RF Power Range for the valid ranges.
Max	The range of values depends on the current frequency and selected RF output port. Please refer to "RF Power" on page 1228 and the table RF Power Range for the valid ranges.
Initial S/W Revision	A.05.00

Waveform

Allows you access to the sub-menus for selecting the waveform to be played back during the current step. Pressing this key also changes the central display area to show the Waveform File Selection view.

Key Path	Source, List Sequencer, List Sequencer Setup
Remote Command	:SOURce:LIST:STEP[1] 2 3...1000:SETup:WAVEform <string> :SOURce:LIST:STEP[1] 2 3...1000:SETup:WAVEform?
Example	:SOUR:LIST:STEP2:SET:WAV "CW" :SOUR:LIST:STEP2:SET:WAV?
Notes	SCPI is supported after A.09.40
Remote Command Notes	String type, takes “Off” “CW” “Cont” “waveform name”

Preset	CW
Range	Waveform Continue Previous CW Off
Initial S/W Revision	A.05.00

CW

Sets the current step to output a CW tone.

Key Path	Source, List Sequencer, List Sequencer Setup, Waveform
Example	:SOUR:LIST:STEP2:SET:WAV "CW"
Notes	SCPI is supported after A.09.40
Initial S/W Revision	A.05.00

Selected Waveform

Inserts the currently selected waveform in the waveform selection view as the waveform for playback during the current step.

Key Path	Source, List Sequencer, List Sequencer Setup, Waveform
Example	:SOUR:LIST:STEP2:SET:WAV "waveform name"
Notes	SCPI is supported after A.09.40 If the selected waveform contains header (which contains ARB play parameters), source list sequence will automatically apply header settings of the selected waveform in that step.
Initial S/W Revision	A.05.00

Continue Previous

Sets the current step to continue with playback of the waveform from the previous step. When continuing the previous waveform, the ARB playback will not pause while the source retunes to the new frequency or amplitude that may be defined for the new step.

Key Path	Source, List Sequencer, List Sequencer Setup, Waveform
Example	:SOUR:LIST:STEP2:SET:WAV "Cont"
Notes	SCPI is supported after A.09.40
Initial S/W Revision	A.05.00

Off

Disable RF output of the current step.

Key Path	Source, List Sequencer, List Sequencer Setup, Waveform
Example	:SOUR:LIST:STEP2:SET:WAV "Off"
Notes	SCPI is supported after A.09.40
Initial S/W Revision	A.05.00

Segments on Hard Disk

Allows you access to the sub-menus for loading waveform segments from the hard disk into ARB memory. The default directory is: D: varb.

Pressing this key changes the current view to the Waveform Management View.

Key Path	Source, Modulation Setup, ARB, Select Waveform
Initial S/W Revision	A.05.00

Load Segment To ARB Memory

Allows you to load the selected file into ARB memory. On the front panel you select the file for loading to the ARB memory by highlighting the desired file in the list. Using the SCPI command, you specify the file name on the HDD.

“NVWFM” (none-volatile storage) MSUS (Mass Storage Unit Specifier) is supported in the memory subsystem because the ARB memory cannot be accessed directly. Therefore, files must be downloaded to the instrument hard disk and then loaded into the ARB memory. “NVWFM” MSUS will be mapped to the default directory D: VARB. The SCPI command supports using either “NVWFM” MSUS or specifying a full path. For more information, see [Memory Subsystem \(Remote Command Only\)](#).

If a file of the same name already exists within ARB memory, it is overwritten. If you wish to load two segments of the same name, you must rename one of the segments before loading it into ARB memory. To rename a segment, you can either use Windows File Explorer, or the :MMEMory:COPY command.

NOTE: When a waveform file is loaded to ARB memory, burst timing adjustments are made automatically, based on whether or not a Multiport Adapter is connected to the test set and powered on. If the connection/power status of the Multiport Adapter is changed after a waveform file has been loaded, it needs to be loaded again.

Key Path	Source, Modulation Setup, ARB, Select Waveform, Segments on Hard Disk
Remote Command	:SOURce:RADio:ARB:LOAD <string>
Example	:SOUR:RAD:ARB:LOAD "D: VARB\testwaveform.bin" or :SOUR:RAD:ARB:LOAD "NVWFM:testwaveform.bin"
Notes	Because loading the file involves a delay of unpredictable length, this command should be followed by the query *OPC?, which holds off subsequent commands until the loading operating is complete. <string> – specifies the path name of the file to load from the HDD into ARB memory. It could be a <full path + filename>, or <"NVWFM" MSUS + colon + filename>.

When in Sequence Analyzer mode, and Include Source is Yes, an attempt to load a file to ARB memory will be rejected with an error.

When Include Source is No and if there is insufficient free ARB memory to load the selected waveform, an error is generated. .

If you specify a file over SCPI, but the file is not at the specified location, an error is generated.

If you try to load a waveform file but the file contains less than 500 IQ samples, an error is generated.

If you try to load a Signal Studio waveform “*.wfm” which contains invalid waveform header, an error is generated.

If the ARB is ON when you load a file to ARB memory or delete a file from ARB memory, the playing waveform segment may not keep phase continuity during the ARB memory operation. The waveform will be replayed after the ARB operation is finished.

ARB can be loaded into ARB memory even required licenses do not present on the instrument. In this case, a GUI only warning message -800, “Operation complete; Loaded <filename> successfully, but no license <required licenses> installed”. User can install required licenses according to <required licenses> string to license it, or multi-pack license it.

Initial S/W Revision A.05.00

Load All To ARB Memory

Allows you to load all the segment files within the currently selected directory into ARB memory. If a file of the same name already exists within ARB memory, it is overwritten. If you wish to load two segments of the same name, you must rename one of the segments before loading it into ARB memory. To rename a segment, you can either use Windows File Explorer, or the :MEMory:COpy command.

NOTE: When a waveform file is loaded to ARB memory, burst timing adjustments are made automatically, based on whether or not a Multiport Adapter is connected to the test set and powered on. If the connection/power status of the Multiport Adapter is changed after a waveform file has been loaded, it needs to be loaded again.

Key Path	Source, Modulation Setup, ARB, Select Waveform, Segments on Hard Disk
Remote Command	:SOURce:RADio:ARB:LOAD:ALL <string>
Example	:SOUR:RAD:ARB:LOAD:ALL “D: varb”
Notes	<p><string> - specifies the directory on the HDD to load the files into ARB memory from.</p> <p>When in Sequence Analyzer mode, and Include Source is Yes, an attempt to load all files from a directory to ARB memory is rejected with an error.</p> <p>When Include Source is No and there is insufficient free ARB memory to load all the waveforms, when the ARB memory is full, the copy ceases, and an error is generated.</p> <p>If you specify a directory over SCPI, but the directory does not exist, an error is generated.</p> <p>If the ARB is ON, a user then loads or deletes file to ARB memory, the playing waveform segment may not keep phase continuity during the ARB memory operation. The waveform will be replayed after the ARB operation is finished.</p>
Initial S/W Revision	A.05.00

Change Directory...

Allows you to change the currently selected directory on the hard disk. Pressing this key opens a standard windows change directory dialog allowing you to select the new directory of interest.

The current directory is used for manually loading waveform segments into ARB memory for playback, and as a search location for waveform segments that are required to be loaded into ARB memory for playback of a waveform sequence or a list sequence.

Key Path	Source, Modulation Setup, ARB, Select Waveform, Segments on Hard Disk
Notes	No remote command, SCPIfront panel only.
Initial S/W Revision	A.05.00

Default Directory...

Allows you to change the default directory. It is used as a search location for waveform segments that are required to be loaded into ARB memory for playback of a waveform sequence, and as a search location for selecting waveforms using SCPI.

Key Path	Source, Modulation Setup, ARB, Select Waveform, Segments on Hard Disk
Remote Command	:SOURce:RADio:ARB:DEFault:DIRectory <string> :SOURce:RADio:ARB: DEFault:DIRectory?
Example	:SOUR:RAD:ARB:DEF:DIR "D:\ArbFiles" :SOUR:RAD:ARB:DEF:DIR?
State Saved	Persistent, survives a power cycle and a preset but not saved in the instrument state
Initial S/W Revision	A.05.00

Segments in ARB Memory

Allows you access to the sub-menus for managing the files within ARB memory.

Key Path	Source, Modulation Setup, ARB, Select Waveform
Initial S/W Revision	A.05.00

Delete Segment From ARB Mem

Allows you to remove a segment from ARB playback memory.

Key Path	Source, Modulation Setup, ARB, Select Waveform, Segments in ARB Memory
Remote Command	:SOURce:RADio:ARB:DELeTe <string>
Example	:SOUR:RAD:ARB:DEL "testwaveform.bin"
Notes	<string> - specifies the waveform to be deleted from the ARB playback memory. When in Sequence Analyzer mode and Include Source is Yes, an attempt to delete a file from ARB

memory is rejected with an error.

When Include Source is No and you specify a file that does not exist within ARB memory, an error is generated.

It is possible to delete files from within the ARB memory when the ARB is ON. However, if you attempt to delete the file that is currently playing an error is generated.

It is possible to delete a file from within the ARB memory when the sequencer state is ON and the file is not being used by the List Sequencer. If you attempt to delete a file which is being used by the list sequencer, an error is generated.

When sequencer state is On, even if ARB state is On, the selected waveform will not be played. In this case, if the selected waveform is not used in List Sequence, it can be deleted and the ARB state is turned Off.

If the ARB is ON and you load a file to ARB memory or delete a file from ARB memory, the playing waveform segment may not keep phase continuity during the ARB memory operation. The waveform will be replayed after the ARB operation is finished.

Initial S/W Revision A.05.00

Delete All From ARB Memory

Allows you to remove all segments from ARB playback memory.

Key Path Source, Modulation Setup, ARB, Select Waveform, Segments in ARB Memory

Remote Command :SOURce:RADio:ARB:DELeTe:ALL

Example :SOUR:RAD:ARB:DELeTe:ALL

Notes When in Sequence Analyzer mode and Include Source is Yes, an attempt to delete all files from ARB memory is rejected with an error.

When Include Source is No and you attempt to delete all files from ARB memory when the ARB is currently playing a file, all files except the one playing are deleted and an error is generated.

If you attempt to delete all files from ARB memory when there are waveform files used in "[List Sequencer](#)" on page 1306 and "[Sequencer](#)" on page 1307 state is ON, all files except the files currently being used in list sequencer are deleted, and an error is generated.

If the ARB is ON and you load a file to ARB memory or delete a file from ARB memory, the playing waveform segment may not keep phase continuity during the ARB memory operation. The waveform will be replayed after the ARB operation is finished.

Initial S/W Revision A.05.00

Segments on Hard Disk

This key functions the same as "[Segments on Hard Disk](#)" on page 1333.

Key Path Source, List Sequencer, List Sequencer Setup, Waveform

Initial S/W Revision Prior to A.09.00

Load Segment To ARB Memory

This key functions the same as ["Load Segment To ARB Memory" on page 1333](#).

Key Path	Source, List Sequencer, List Sequencer Setup, Waveform, Segment on Hard Drive
Initial S/W Revision	Prior to A.09.00

Load All To ARB Memory

This key functions the same as ["Load All To ARB Memory" on page 1334](#).

Key Path	Source, List Sequencer, List Sequencer Setup, Waveform, Segment on Hard Drive
Initial S/W Revision	Prior to A.09.00

Change Directory ...

This key functions the same as ["Change Directory..." on page 1335](#).

Key Path	Source, List Sequencer, List Sequencer Setup, Waveform, Segment on Hard Drive
Initial S/W Revision	Prior to A.09.00

Default Directory ...

This key functions the same as ["Default Directory..." on page 1335](#)

Key Path	Source, List Sequencer, List Sequencer Setup, Waveform, Segment on Hard Drive
Initial S/W Revision	Prior to A.09.00

Segments in ARB Memory

This key functions the same as ["Segments in ARB Memory" on page 1335](#).

Key Path	Source, List Sequencer, List Sequencer Setup, Waveform, Segments in ARB Memory
Initial S/W Revision	Prior to A.09.00

Delete Segment From ARB Memory

This key functions the same as ["Delete Segment From ARB Mem" on page 1335](#).

Key Path	Source, List Sequencer, List Sequencer Setup, Waveform, Segments in ARB Memory, Segment in ARB Memory
Initial S/W Revision	Prior to A.09.00

Delete All From ARB Memory

This key functions the same as "Delete All From ARB Memory" on page 1336.

Key Path	Source, List Sequencer, List Sequencer Setup, Waveform, Segments in ARB Memory, Segment in ARB Memory
Initial S/W Revision	Prior to A.09.00

Step Duration

Allows access to the sub-menus for setting up the duration of play for the current step.

The duration can be set to be either the number of times for the ARB file associated with the sequence to play, or a specific time value, or continuous. If the step is set to play a CW tone, the step duration cannot be set to a play count.

Key Path	Source, List Sequencer, List Sequencer Setup
Remote Command	:SOURce:LIST:STEP[1] 2 3...1000:SETup:DURation:TYPE TIME COUNT CONTInuous CABort :SOURce:LIST:STEP[1] 2 3...1000:SETup:DURation:TYPE?
Example	:SOUR:LIST:STEP2:SET:DUR:TYPE TIME :SOUR:LIST:STEP2:SET:DUR:TYPE?
Notes	SCPI is supported after A.09.40
Notes	If "Step Duration" is set to "Time" or "Play Count" for the last step, the last step of ARB keeps playing as if set to "Continuous", until the set "Time" has expired or until the "Play Count" setting is reached. However, you can query Error! Reference source not found. Source Sweeping Condition Message to find out if the current list sequence is complete or not.
Range	Time Play Count Continuous Continuous Abort
Initial S/W Revision	A.05.00

Time

Sets the duration of the current step to be a time value for the length of time the step will play. Pressing this key again opens another menu which allows you to set the time value for the step duration.

Key Path	Source, List Sequencer, List Sequencer Setup, Step Duration
Example	:SOUR:LIST:STEP2:SET:DUR:TYPE TIME
Notes	SCPI is supported after A.09.40
Initial S/W Revision	A.05.00

Duration Time

Allows you to specify the length of time the current step will play.

When Step Duration is **Continuous Abort** this parameter specifies the maximum duration that the waveform will continue to play after a step trigger is received before the transition to the next waveform will occur. Duration is limited to a maximum of 20 seconds.

If the Transition Time value is longer than the Step Duration Time, an error is generated when initiating a source list sequence. For source list sequence, transition time is included in the step duration length (not occupy additional time). If the Transition Time value is longer than the Step Duration Time, the real step duration length is extended to equal the transition time and cause a timing shift. This check is also described in section **Error! Reference source not found.** List Sequence Step Validation.

Key Path	Source, List Sequencer, List Sequencer Setup, Step Duration, Time
Remote Command	:SOURce:LIST:STEP[1] 2 3...1000:SETup:DURation:TCOUNT <double> :SOURce:LIST:STEP[1] 2 3...1000:SETup:DURation:TCOUNT?
Example	:SOUR:LIST:STEP2:SET:DUR:TCO 1s :SOUR:LIST:STEP2:SET:DUR:TCO?
Notes	SCPI is supported after A.09.40 This SCPI is reused by "Play Count", "Duration Time" and "Continuous Abort" according to current Duration Type setting is "Play Count" or "Duration Time" or "Continuous Abort". If current "Duration Type" is "Continuous", then popup error -221, "Settings conflict; Cannot accept time or count input when step duration type is Continuous on step #"
Notes	If "Duration Time" is set for the last step, the last step of ARB keeps playing as if set to "Continuous" after set time expires. However, you can query Source Sweeping Condition Message (:STAT:OPER:COND?) to find out if the current list sequence is complete or not.
Preset	1.00 ms
Min	100 μ s
Max	1800 s
Initial S/W Revision	A.05.00

Play Count

Sets the duration of the current step to be an integer value for the number of times (play count) the ARB file is selected for playback during this step. For example, a 5 second ARB will be set to play 5 times during the step.

Key Path	Source, List Sequencer, List Sequencer Setup, Step Duration
Example	:SOUR:LIST:STEP2:SET:DUR:TYPE COUN
Notes	SCPI is supported after A.09.40 This key is unavailable and is grayed out if the current step is configured to CW tone rather than an ARB waveform.
Initial S/W Revision	A.05.00

Header Utilities

Allows access to the header utilities sub-menu. Pressing this key also causes the central display area to change to display the File Header Information view.

Key Path	Source, Modulation Setup, ARB
Dependencies	This key is only available if there is currently a waveform selected for playback. If no waveform is selected, the key is grayed out.
Initial S/W Revision	A.05.00

Continuous

Sets the current step to be played continuously until the next step starts. The waveform will always play completely before transitioning to the next step.

Key Path	Source, List Sequencer, List Sequencer Setup, Step Duration
Example	:SOUR:LIST:STEP2:SET:DUR:TYPE CONT
Notes	SCPI is supported after A.09.40
Initial S/W Revision	A.05.00

Output Trigger

Allows you to specify the trigger output for the current step. The trigger output signal is sent at the start of the step.

When select “On”, trigger event will occur on both Internal and External2 paths. Select “Off” will turn off trigger output.

Key Path	Source, List Sequencer, List Sequencer Setup
Remote Command	:SOURce:LIST:STEP[1] 2 3...1000:SETup:OUTPut:TRIGger ON OFF 1 0 :SOURce:LIST:STEP[1] 2 3...1000:SETup:OUTPut:TRIGger
Example	:SOUR:LIST:STEP2:SET:OUTP:TRIG ON :SOUR:LIST:STEP2:SET:OUTP:TRIG?
Notes	SCPI is supported after A.09.40
Preset	Off
Range	On Off
Initial S/W Revision	A.05.00

Step Configuration (Remote Command Only)

This SCPI command is used to configure the List Sequencer and is detailed in the table below. The command is defined such that you send one command per step, with the step number being specified as a subopcode of the SCPI command. Each command includes all the parameter settings for the step. As a step is setup, the values entered are run through several levels of validation.

Remote Command	:SOURce:LIST:STEP[1] 2 ... 4..1000:SETup IMMEDIATE INTernal KEY
-----------------------	---

```

BUS | EXTERNAL2, <time>, NONE | PGSM | EGSM | RGSM | DCS1800 | PCS1900
| TGSM810 | GSM450 | GSM480 | GSM700 | GSM850 | BANDI | BANDII |
BANDIII | BANDIV | BANDV | BANDVI | BANDVII | BANDVIII | BANDIX | BANDX
| BANDXI | BANDXII | BANDXIII | BANDXIV | BANDXIX | USCELL | USPCS |
JAPAN | KOREAN | NMT | IMT2K | UPPER | SECOND | PAMR400 | PAMR800 |
IMTEXT | PCS1DOT9G | AWS | US2DOT5G | PUBLIC | LOWER | NONE | BAND1 |
BAND2 | BAND3 | BAND4 | BAND5 | BAND6 | BAND7 | BAND8 | BAND10 | BAND11
| BAND12 | BAND13 | BAND14 | BAND17 | BAND18 | BAND19 | BAND20 | BAND21
| BAND24 | BAND25 | BAND26 | BAND33 | BAND34 | BAND35 | BAND36 | BAND37
| BAND38 | BAND39 | BAND40 | BAND41 | BAND42 | BAND43 | BANDA | BANDB |
BANDC | BANDD | BANDE | BANDF, DOWN | UP, <freq>, <ampl>, <string>,
TIME | COUNT | CONTinuous, <time>, ON | OFF | 1 | 0, [<int>],

:SOURce:LIST:STEP[1]|2|...|4..1000:SETup?

```

Example :SOUR:LIST:STEP1:SET INT, 1ms, PGSM, DOWN, 10, -25 dBm, "GSM_Test1.bin", TIME, 10ms, OFF, 255

Notes

The parameters are:

(There is a total of 11 items in each step, the following is a list of the items in the order they must appear in the remote command.)

1. Step Trigger <enum> – specifies the input trigger for the step. For details of the valid types of step trigger see ["Step Trigger" on page 1309](#).
 2. Transition Time <time> – specifies the transition time for the step in seconds. For details of the valid ranges for the transition time see ["Transition Time" on page 1311](#).
 3. Radio Band <enum> – specifies the radio band for the step. For details of the valid radio bands see ["Radio Setup" on page 1312](#).
 4. Radio Band Link <enum> – specifies the radio band link direction for the step. For details of the valid link types, see ["Radio Band Link" on page 1329](#).
 5. Frequency/Channel Number <freq>/<chan num> – specifies the frequency in Hz or the channel number for the step. The channel number and frequency are combined as one parameter that represents the frequency or channel number depending on the radio band setting. If the radio band is set to NONE, this value is interpreted as a frequency value in Hz. If the radio band is set to a valid band, this value is interpreted as a channel number. For details of the valid ranges for frequency and channel numbers, see ["Channel" on page 1329](#) and ["Frequency" on page 1330](#).
 6. Power <ampl> – specifies the output power for the step in dBm. For details of the valid ranges see ["Power" on page 1330](#).
 7. Waveform <string> – specifies the waveform for playback during the step. The step can output either a new ARB waveform, continue playback of the previous waveform, or output a CW tone. The options for specifying these are:
 - <filename> - plays the specified waveform from the start. The filename value is the name of the file within ARB playback memory, it does not include the windows path to the file on the HDD. If you enter a filename for a waveform that does not reside within ARB playback memory, an error is generated.
 - CONT – continues playback of the ARB file from the previous step
 - CW – outputs a CW tone
 - OFF – disable RF output
 8. Step Duration <enum> – specifies the duration of the step. The duration can be specified to be either time, or play count of the ARB file associated with the step, or continuous. If Waveform is set to "CW", this value cannot be set to Play Count and an error will be generated. If continuous is selected, the following Time or Count value is ignored. For further details of this setting, see ["Step](#)
-

	<p>Duration" on page 1338.</p> <p>9. Time or Count <time/int> – specifies time duration in seconds or play count of the ARB file associated with the step. For further details of this setting, including the valid ranges for the time or play count setting, "Time" on page 1338 and "Play Count" on page 1339.</p> <p>10. Output Trigger <Boolean> – specifies the output trigger for the step. For details of the ranges for this setting see "Output Trigger" on page 1340.</p>
Dependencies	<p>The range of subopcode values is 1 to 1000 and the value you enter is determined by the number of steps you have configured. For details see "Number of Steps" on page 1308.</p> <p>If you attempt to remotely set or query a subopcode that is out of range, an error is generated.</p>
Initial S/W Revision	A.05.00

Step Configuration of Step Trigger parameter list (Remote Command Only)

This SCPI command is to configure “Step Trigger” parameter array of the whole List Sequencer at one time. The number of array is same as step number defined in ["Number of Steps" on page 1308](#) Number of Steps. As a step is setup, the value entered run through several levels of validation.

Remote Command	<pre>:SOURce:LIST:SETup:INPut:TRIGger <enum>, <enum>, <enum>, ... :SOURce:LIST:SETup:INPut:TRIGger?</pre>
Example	<pre>:SOUR:LIST:SET:INP:TRIG IMM,INT,EXT2 :SOUR:LIST:SET:INP:TRIG?</pre>
Notes	<p>The command is to setup below parameter array of whole list sequence.</p> <p>Step Trigger <enum> – specifies the input trigger for the step. For details of the valid types of step trigger see "Step Trigger" on page 1309.</p> <p>If input parameter number exceeds the step number defined by "Number of Steps" on page 1308 Number of Steps then generate error ", and only those parametes whose index number falls in number of steps will be updated.</p>
Remote Command Notes	IMMEDIATE INTERNAL KEY BUS EXTERNAL2
Dependencies	<p>The range is 1 to 1000 which is determined by the number of steps you have configured. For details see "Number of Steps" on page 1308.</p>
Initial S/W Revision	A.09.40

Step Configuration of Transition Time parameter list (Remote Command Only)

This SCPI command is to configure “Transition Time” parameter array of the whole List Sequencer at one time. The number of array is same as step number defined in ["Number of Steps" on page 1308](#) Number of Steps. As a step is setup, the value entered run through several levels of validation.

Remote Command	<pre>:SOURce:LIST:SETup:TRANSition:TIME <time>, <time>, <time>, ... :SOURce:LIST:SETup:TRANSition:TIME?</pre>
Example	<pre>:SOUR:LIST:SET:TRAN:TIME 1ms,1ms,1ms</pre>

	:SOUR:LIST:SET:TRAN:TIME?
Notes	The command is to setup below parameter array of whole list sequence. Transition Time <time> – specifies the transition time for the step in seconds. For details of the valid ranges for the transition time see "Transition Time" on page 1311 If input parameter number exceeds the step number defined by "Number of Steps" on page 1308 Number of Steps then generate error ", and only those parameters whose index number falls in number of steps will be updated.
Dependencies	The range is 1 to 1000 which is determined by the number of steps you have configured. For details see "Number of Steps" on page 1308 .
Initial S/W Revision	A.09.40

Step Configuration of Radio Band parameter list (Remote Command Only)

This SCPI command is to configure "Radio Band" parameter array of the whole List Sequencer at one time. The number of array is same as step number defined in ["Number of Steps" on page 1308](#) Number of Steps. As a step is setup, the value entered run through several levels of validation.

R :SOURce:LIST:SETup:RADio:BAND <enum>, <enum>, <enum>, ...

e :SOURce:LIST:SETup:RADio:BAND?

m
o
t
e

C
o
m
m
a
n
d

E :SOUR:LIST:SET:RAD:BAND PGSM, EGSM, RGSM

X :SOUR:LIST:SET:RAD:BAND?

a
m
p
l
e

N The command is to setup below parameter array of whole list sequence.

O Radio Band <enum> – specifies the radio band for the step. For details of the valid radio bands see ["Radio Setup" on page 1312](#).

t If input parameter number exceeds the step number defined by ["Number of Steps" on page 1308](#) Number of Steps then
e generate error ", and only those parameters whose index number falls in number of steps will be updated.
s

R NONE|PGSM|EGSM|RGSM|DCS1800|PCS1900|TGSM810|GSM450|GSM480|GSM700|GSM850|BANDI|BANDII|BANDIII|BANDI
e V|BANDV|BANDVI|BANDVII|BANDVIII|BANDIX|BANDX|BANDXI|BANDXII|BANDXIII|BANDXIV|BANDXIX|USCELL|USPCS|JAPAN|KO
m REAN|NMT|IMT2K|UPPER|SECOND|PAMR400|PAMR800|IMTEXT|PCS1 DOT9G|AWS|US2DOT5G|PUBLIC|LOWER|NONE|BAND1|
BAND2|BAND3|BAND4|BAND5|BAND6|BAND7|BAND8|BAND10|BAND11|BAND12|BAND13|BAND14|BAND17|BAND18|BAND1

o 9|BAND20|BAND21|BAND24|BAND25|BAND26|BAND33|BAND34|BAND35|BAND36|BAND37|BAND38|BAND39|BAND40|BAN
t D41|BAND42|BAND43|BANDA|BANDB|BANDC|BANDD|BANDE|BANDF
e

C
o
m
m
a
n
d

N
o
t
e
s

D The range is 1 to 1000 which is determined by the number of steps you have configured. For details see "[Number of Steps](#)" on
e [page 1308](#).

p
e
n
d
e
n
c
i
e
s

I A.09.40

n
i
t
i
a
l

S
/
W

R
e
v
i
s
i
o
n

Step Configuration of Radio Band Link parameter list (Remote Command Only)

This SCPI command is to configure “Radio Band Link” parameter array of the whole List Sequencer at one time. The number of array is same as step number defined in ["Number of Steps" on page 1308](#) Number of Steps. As a step is setup, the value entered run through several levels of validation.

Remote Command	:SOURce:LIST:SETup:RADio:BAND:LINK <enum>, <enum>, <enum>, ... :SOURce:LIST:SETup:RADio:BAND:LINK?
Example	:SOUR:LIST:SET:RAD:BAND:LINK DOWN,UP,UP :SOUR:LIST:SET:RAD:BAND:LINK?
Notes	The command is to setup below parameter array of whole list sequence. Radio Band Link <enum> – specifies the radio band link direction for the step. For details of the valid link types, see "Radio Band Link" on page 1329 . If input parameter number exceeds the step number defined by "Number of Steps" on page 1308 Number of Steps then generate error ", and only those parametes whose index number falls in number of steps will be updated.
Remote Command Notes	DOWN UP
Dependencies	The range is 1 to 1000 which is determined by the number of steps you have configured. For details see "Number of Steps" on page 1308 .
Initial S/W Revision	A.09.40

Step Configuration of Frequency/Channel Number parameter list (Remote Command Only)

This SCPI command is to configure “Frequency” or “Channel Number” parameter array of the whole List Sequencer at one time. The number of array is same as step number defined in ["Number of Steps" on page 1308](#) Number of Steps. As a step is setup, the value entered run through several levels of validation.

Remote Command	:SOURce:LIST:SETup:CNFRequency <double>, <double>, <double>, ... :SOURce:LIST:SETup:CNFRequency?
Example	:SOUR:LIST:SET:CNFR 1GHz,100MHz,100MHz :SOUR:LIST:SET:CNFR? SOUR:LIST:SET:CNFR 124,124,124 :SOUR:LIST:SET:CNFR?
Notes	The command is to setup below parameter array of whole list sequence. Frequency/Channel Number <freq>/<chan num> – specifies the frequency in Hz or the channel number for the step. The channel number and frequency are combined as one parameter that represents the frequency or channel number depending on the radio band setting. If the radio band is set to NONE, this value is interpreted as a frequency value in Hz. If the radio band is set to a valid band, this value is interpreted as a channel number. For details of the valid ranges for frequency and channel numbers, see "Channel" on page 1329 and "Frequency" on page 1330 This SCPI is used to setup/query channel number or frequency setting, according to current Radio Band setting of that step. If Radio Band is “NONE”, then it’s frequency. If Radio Band is not “NONE”, then it’s channel number If input parameter number exceeds the step number defined by "Number of Steps" on page 1308 Number of Steps then generate error ", and only those parametes whose index number falls in

	legal step number will be updated.
Dependencies	The range is 1 to 1000 which is determined by the number of steps you have configured. For details see "Number of Steps" on page 1308 .
Initial S/W Revision	A.09.40

Step Configuration of Power parameter list (Remote Command Only)

This SCPI command is to configure “Power” parameter array of the whole List Sequencer at one time. The number of array is same as step number defined in ["Number of Steps" on page 1308](#) Number of Steps. As a step is setup, the value entered run through several levels of validation.

Remote Command	:SOURce:LIST:SETup:AMPLitude <ampl>, <ampl>, <ampl>, ... :SOURce:LIST:SETup:AMPLitude?
Example	:SOUR:LIST:SET:AMPL -50dBm,-40dBm,-30dBm :SOUR:LIST:SET:AMPL?
Notes	The command is to setup below parameter array of whole list sequence. Power <ampl> – specifies the output power for the step in dBm. For details of the valid ranges see "Power" on page 1330 . If input parameter number exceeds the step number defined by "Number of Steps" on page 1308 Number of Steps then generate error ", and only those parametes whose index number falls in legal step number will be updated.
Dependencies	The range is 1 to 1000 which is determined by the number of steps you have configured. For details see "Number of Steps" on page 1308 .
Initial S/W Revision	A.09.40

Step Configuration of Waveform parameter list (Remote Command Only)

This SCPI command is to configure “Waveform” parameter array of the whole List Sequencer at one time. The number of array is same as step number defined in ["Number of Steps" on page 1308](#) Number of Steps. As a step is setup, the value entered run through several levels of validation.

Remote Command	:SOURce:LIST:SETup:WAVeform <string>, <string>, <string>, ... :SOURce:LIST:SETup:WAVeform?
Example	:SOUR:LIST:SET:WAV "CW","Off","CONT" :SOUR:LIST:SET:WAV?
Notes	The command is to setup below parameter array of whole list sequence. Waveform <string> – specifies the waveform for playback during the step. The step can output either a new ARB waveform, continue playback of the previous waveform, or output a CW tone. The options for specifying these are: <filename> - plays the specified waveform from the start. The filename value is the name of the file within ARB playback memory, it is does not include the windows path to the file on the HDD. If you enter a filename for a waveform that does not reside within ARB playback memory, an error is generated.

	<p>CONT – continues playback of the ARB file from the previous step</p> <p>CW – outputs a CW tone</p> <p>OFF – disable RF output</p> <p>If input parameter number exceeds the step number defined by "Number of Steps" on page 1308 Number of Steps then generate error ", and only those parametes whose index number falls in number of steps will be updated.</p>
Dependencies	The range is 1 to 1000 which is determined by the number of steps you have configured. For details see " Number of Steps " on page 1308.
Range	"filename" "CW" "Off" "CONT"
Initial S/W Revision	A.09.40

Step Configuration of Step Duration parameter list (Remote Command Only)

This SCPI command is to configure "Step Duration" parameter array of the whole List Sequencer at one time. The number of array is same as step number defined in "[Number of Steps](#)" on page 1308 Number of Steps. As a step is setup, the value entered run through several levels of validation.

Remote Command	<pre>:SOURce:LIST:SETup:DURation:TYPE <enum>, <enum>, <enum>, ... :SOURce:LIST:SETup:DURation:TYPE?</pre>
Example	<pre>:SOUR:LIST:SET:DUR:TYPE COUN,TIME,CONT :SOUR:LIST:SET:DUR:TYPE?</pre>
Notes	<p>The command is to setup below parameter array of whole list sequence.</p> <p>Step Duration <enum> – specifies the duration of the step. The duration can be specified to be either time, or play count of the ARB file associated with the step, or continuous. If Waveform is set to "CW", this value cannot be set to Play Count and an error will be generated. If continuous is selected, the following Time or Count value is ignored. For further details of this setting, see "Step Duration" on page 1338.</p> <p>If input parameter number exceeds the step number defined by "Number of Steps" on page 1308 Number of Steps then generate error ", and only those parametes whose index number falls in number of steps will be updated.</p>
Remote Command Notes	TIME COUNT CONTinuous
Dependencies	The range is 1 to 1000 which is determined by the number of steps you have configured. For details see " Number of Steps " on page 1308.
Initial S/W Revision	A.09.40

Step Configuration of Duration Time or Play Count parameter list (Remote Command Only)

This SCPI command is to configure "Duration Time" or "Play Count" parameter array of the whole List Sequencer at one time. The number of array is same as step number defined in "[Number of Steps](#)" on page 1308 Number of Steps. As a step is setup, the value entered run through several levels of validation.

Remote Command	<pre>:SOURce:LIST:SETup:TOCount <time/int>, <time/int>, <time/int>, ... :SOURce:LIST:SETup:TOCount?</pre>
-----------------------	---

Example	:SOUR:LIST:SET:TOC 1s,2s,3s :SOUR:LIST:SET:TOC? :SOUR:LIST:SET:TOC 5,6,7 :SOUR:LIST:SET:TOC?
Notes	The command is to setup below parameter array of whole list sequence. Time or Count <time/int> – specifies time duration in seconds or play count of the ARB file associated with the step. For further details of this setting, including the valid ranges for the time or play count setting, " Time " on page 1338 and " Play Count " on page 1339. If input parameter number exceeds the step number defined by " Number of Steps " on page 1308 Number of Steps then generate error ", and only those parametes whose index number falls in number of steps will be updated. If current " Step Duration " on page 1338 is "Continuous", then generate error -221,"Settings conflict;Cannot accept time or count input when step duration type is Continuous on step #"
Dependencies	The range is 1 to 1000 which is determined by the number of steps you have configured. For details see " Number of Steps " on page 1308.
Initial S/W Revision	A.09.40

Step Configuration of Output Trigger parameter list (Remote Command Only)

This SCPI command is to configure "Output Trigger" parameter array of the whole List Sequencer at one time. The number of array is same as step number defined in "[Number of Steps](#)" on page 1308 Number of Steps. As a step is setup, the value entered run through several levels of validation.

Remote Command	:SOURce:LIST:SETup:OUTPut:TRIGger <bool>, <bool>, <bool>, ... :SOURce:LIST:SETup:OUTPut:TRIGger ?
Example	:SOUR:LIST:SET:OUTP:TRIG ON,OFF,ON :SOUR:LIST:SET:OUTP:TRIG?
Notes	The command is to setup below parameter array of whole list sequence. Output Trigger <Boolean> – specifies the output trigger for the step. For details of the ranges for this setting see " Output Trigger " on page 1340. If input parameter number exceeds the step number defined by " Number of Steps " on page 1308 Number of Steps then generate error ", and only those parametes whose index number falls in legal step number will be updated.
Remote Command Notes	ON OFF 1 0
Dependencies	The range is 1 to 1000 which is determined by the number of steps you have configured. For details see " Number of Steps " on page 1308.
Initial S/W Revision	A.09.40

Clear List (Remote Command Only)

This command is the SCPI equivalent of the Clear List UI feature described in.

Remote Command	:SOURce:LIST:SETup:CLEar
Example	:SOUR:LIST:SETup:CLE
Initial S/W Revision	A.05.00

Trigger Type

Allows access to the sub-menu for selecting the output trigger type for the list sequencer globally. It cannot be changed between different sequence steps.

Key Path	Source, List Sequencer
Remote Command	:SOURce:LIST:TRIGgerout:TYPe BEGinningofstep DATamarker
Example	:SOUR:LIST:TRIG:TYP BEG :SOUR:LIST:TRIG:TYP?
Notes	SCPI is supported after A.14.00
Preset	BEGinningofstep
Range	BEGinningofstep DATamarker
Initial S/W Revision	A.14.00

BeginningOfStep

Sets the output trigger type as BeginningOfStep for the whole source sequence.

Key Path	Source, List Sequencer, Trigger Type
Example	:SOUR:LIST:TRIG:TYP BEG
Notes	SCPI is supported after A.14.00
Initial S/W Revision	A.14.00

DataMarker

Sets the output trigger type as DataMarker for the whole source sequence. When DataMarker is selected, which marker to route is also needed to be set.

Key Path	Source, List Sequencer, Trigger Type
Example	:SOUR:LIST:TRIG:TYP DAT
Notes	SCPI is supported after A.14.00
Initial S/W Revision	A.14.00

Marker 1

Sets the output trigger maker routing to Marker 1 for DataMarker in the whole source sequence.

Key Path	Source, List Sequencer, Trigger Type, DataMarker
Example	:SOUR:LIST:TRIG:TYPE:MARK M1
Notes	SCPI is supported after A.14.00
Initial S/W Revision	A.14.00

Marker 2

Sets the output trigger maker routing to Marker 2 for DataMarker in the whole source sequence.

Key Path	Source, List Sequencer, Trigger Type, DataMarker
Example	:SOUR:LIST:TRIG:TYPE:MARK M2
Notes	SCPI is supported after A.14.00
Initial S/W Revision	A.14.00

Marker 3

Sets the output trigger maker routing to Marker 3 for DataMarker in the whole source sequence.

Key Path	Source, List Sequencer, Trigger Type, DataMarker
Example	:SOUR:LIST:TRIG:TYPE:MARK M3
Notes	SCPI is supported after A.14.00
Initial S/W Revision	A.14.00

Marker 4

Sets the output trigger maker routing to Marker 4 for DataMarker in the whole source sequence.

Key Path	Source, List Sequencer, Trigger Type, DataMarker
Example	:SOUR:LIST:TRIG:TYPE:MARK M4
Notes	SCPI is supported after A.14.00
Initial S/W Revision	A.14.00

Manual Trigger Now

Pressing this key provides a software trigger event to the list sequencer. During execution of sequence, if the sequencer is halted on any step that has been configured with a “Manual” step trigger, then this key press will cause the sequencer to continue and execute the step.

Key Path	Source, List Sequencer
Remote Command	No remote command, front panel only.
Initial S/W Revision	A.05.00

Remote Software Trigger (Remote command Only)

During execution of a list sequence, the sequence will halt and wait at any step that has Step Trigger set to "Bus". Sending this command will trigger the step and continue the sequence.

Remote Command	:SOURce:LIST:TRIGger:INITiate[:IMMediate]
Example	:SOUR:LIST:TRIG:INIT
Initial S/W Revision	A.05.00

Query List Sequence Initiation Armed Status (Remote Command Only)

This is a blocking SCPI query to determine if source list sequence being initiated successfully or not.

Remote Command	:SOURce:LIST:INITiation:ARMed?
Example	:SOUR:LIST:INIT:ARMed?
Notes	The return data is in the following format: Integer
Notes	Query only SCPI. Returning "1" if list sequence has been initiated successfully, returning "0" if not. Once get "0", you can use :SYST:ERR? to query what error happened. Just like "*OPC?", this command can be blocked until event/status "IsSourceSweeping" happens, and then returns. Doing so can help user's script query armed status only once during the time interval of the initiation. As an ancillary SCPI of existing SCPI ":SOUR:LIST:TRIGger[:IMMediate]" (see "Initiate Sequence" on page 1307 Initiate Sequence), the right usage of this command is to use it after ":SOUR:LIST:TRIG". If not, this command will return "1" immediately.
Notes	There is an alias SCPI ":SOURce:LIST:TRIGger:INITiation:ARMed?".
Initial S/W Revision	A.09.40

Source Preset

Allows you to preset the source settings to their default values.

Key Path	Source
Remote Command	:SOURce:PRESet
Example	:SOUR:PRES

SPAN X Scale

Activates and displays the Span function menu.

Key Path	Front-panel key
Initial S/W Revision	Prior to A.02.00

Span

Adjusts the Span of the RF Spectrum window.

Key Path	SPAN X Scale
Remote Command	[:SENSe] :AM FM PM FMSTereo:FREQuency:SPAN <freq> [:SENSe] :AM FM PM FMSTereo:FREQuency:SPAN?
Example	AM:FREQ:SPAN 2.122kHz AM:FREQ:SPAN?
Notes	Adjusts the Span of the RF Spectrum window.
Dependencies	The maximum value will be the maximum IF BW available in the instrument. For example, if the instrument has the options B25, B40, and B1X installed, the maximum available IF BW of the instrument is 140 MHz. Thus, the maximum Span is not limited to 25 MHz but is 140 MHz.
Preset	= AM/FM/PM = 75 kHz = FMST = 500 kHz
State Saved	Saved in instrument state
Min	10 Hz
Default Unit	Hz
Initial S/W Revision	Prior to A.02.00
Modified at S/W Revision	A.14.00

Sweep/Control

Activates a menu and selects Sweep Time as the active function. Sweep time is used by the Demod Waveform window, but this key is available in any view.

Key Path	Front-panel key
Initial S/W Revision	Prior to A.02.00

Demod Wfm Sweep Time

Selects the display length for the Demod Waveform window. This is commonly set to two sample lengths.

Key Path	Sweep/Control
Remote Command	[:SENSe] :AM FM PM FMSTereo:DWSweep:TIME <time> [:SENSe] :AM FM PM FMSTereo:DWSweep:TIME?
Example	AM:DWSW:TIME 50 ms AM:DWSW:TIME?
Preset	2 ms
State Saved	Saved in Instrument State
Min	1 μ s
Max	2 s
Initial S/W Revision	Prior to A.02.00
Modified at S/W Revision	A.10.00

Demod Time

Selects the minimum length of data acquisition used in demodulation. Increasing the demodulation time will result in more accurate metrics; reducing the demodulation time will result in a faster measurement.

The measurement might require more data than specified by the demodulation time. If the resolution bandwidth is low in the spectrum windows, or the demod waveform sweep time is high, then the data required for the measurement might be higher than the demodulation time.

If measurement speed is critical, make sure to increase the resolution bandwidth and reduce the demodulation waveform sweep time.

The Auto rules for the demodulation time will give the nominal specification performance if the sweep time is set to display two cycles of data.

Key Path	Sweep/Control
Remote Command	[:SENSe] :AM FM PM FMSTereo:DEMod:TIME <time> [:SENSe] :AM FM PM FMSTereo:DEMod:TIME? [:SENSe] :AM FM PM:DEMod:TIME:AUTO OFF ON 0 1

	[:SENSe] :AM FM PM:DEMod:TIME:AUTO?
Example	AM:DEM:TIME 50 ms AM:DEM:TIME?
Notes	If current Demod Time, Span and Channel BW settings combinations result in a required acquisition length is excess of the capacity of the analyzer, 4MSamples, gives a warning message "Settings Alert; Acquisition truncated".
Couplings	When in Auto mode, the demodulation time depends on the demodulation waveform sweep time. Lower
Preset	= AM/FM/PM = 72 ms = FMST = 280 ms ON
State Saved	Saved in instrument state
Min	1 μ s
Max	100 s
Initial S/W Revision	Prior to A.02.00
Modified at S/W Revision	A.14.00

System

See "System" on page 182

Trace/Detector

There are no menus under this key in the Analog Demod mode.

Key Path	Front-panel key
Initial S/W Revision	Prior to A.02.00

Trigger

See ["Trigger" on page 238](#)

Free Run

See ["Free Run " on page 245](#)

Video

See ["Video \(IF Envelope\) " on page 246](#)

Trigger Level

See ["Trigger Level " on page 246](#)

Trig Slope

See ["Trig Slope " on page 247](#)

Trig Delay

See ["Trig Delay " on page 248](#)

External 1

See ["External 1 " on page 264](#)

Trigger Level

See ["Trigger Level " on page 264](#)

Trig Slope

See ["Trig Slope " on page 265](#)

Trig Delay

See ["Trig Delay " on page 251](#)

Zero Span Delay Comp

See ["Zero Span Delay Comp On/Off" on page 252](#)

External 2

See ["External 2 " on page 266](#)

Trigger Level

See ["Trigger Level " on page 266](#)

Trig Slope

See ["Trig Slope " on page 267](#)

Trig Delay

See "[Trig Delay](#) " on page 254

Zero Span Delay Comp

See "[Zero Span Delay Comp On/Off](#)" on page 254

RF Burst

See "[RF Burst](#) " on page 267

Absolute Trigger

See "[Absolute Trigger Level](#)" on page 268

Relative Trigger

See "[Relative Trigger Level](#)" on page 257

Trig Slope

See "[Trigger Slope](#) " on page 269

Trig Delay

See "[Trig Delay](#) " on page 258

Periodic Timer

See "[Periodic Timer \(Frame Trigger\)](#) " on page 259

Period

See "[Period](#) " on page 260

Offset

See "[Offset](#) " on page 261

Offset Adjust (Remote Command Only)

See "[Offset Adjust \(Remote Command Only\)](#)" on page 262

Reset Offset Display

See "[Reset Offset Display](#) " on page 263

Sync Source

See "[Sync Source](#) " on page 263

Off

See "[Off](#) " on page 264

External 1

See "External 1 " on page 264

Trigger Level

See "Trigger Level " on page 264

Trig Slope

See "Trig Slope " on page 265

External 2

See "External 2 " on page 266

Trigger Level

See "Trigger Level " on page 266

Trig Slope

See "Trig Slope " on page 267

RF Burst

See "RF Burst " on page 267

Absolute Trigger

See "Absolute Trigger Level" on page 268

Trig Slope

See "Trigger Slope " on page 269

Trig Delay

See "Trig Delay" on page 269

Auto/Holdoff

See "Auto/Holdoff " on page 270

Auto Trig

See "Auto Trig " on page 270

Trig Holdoff

See "Trig Holdoff " on page 271

User Preset

Accesses a menu that gives you the following three choices:

- User Preset – recalls a state previously saved using the Save User Preset function.
- User Preset All Modes – presets all of the modes in the analyzer
- Save User Preset– saves the current state for the current mode

NOTE

In products that run multiple instances of the X-Series Application, all instances use the same location to save User Preset state. So Save User Preset of one instance will overwrite the Save User Preset of another instance.

Key Path	Front-panel key
Backwards Compatibility Notes	<p>User Preset is actually loading a state, and in legacy analyzers, it was possible to load a state without affecting the trace data, limit lines or correction data. Similarly it was possible to do a User Preset without affecting the trace data, limit lines or correction data.</p> <p>In the X-Series, “state” always includes all of this data; so whenever state is loaded, or User Preset is executed, all of the traces, limit lines and corrections are affected. Although this differs from previous behavior, it is desirable behavior, and should not cause adverse issues for users.</p> <p>On ESA and PSA, User Preset affected the entire instrument’s state. In the X-Series, User Preset only recalls the state for the active mode. There is a User Preset file for each mode. User Preset can never cause a mode switch as it can in legacy analyzers. If you want to recall all modes to their user preset file state, you will need to do a User Preset after mode switching into each mode.</p> <p>User Preset recalls mode state which can now include data like traces; whereas on ESA and PSA, User Preset did not affect data.</p>
Initial S/W Revision	Prior to A.02.00

User Preset

User Preset sets the state of the currently active mode back to the state that was previously saved for this mode using the Save User Preset menu key or the SCPI command, SYST:PRES:USER:SAV. It not only recalls the Mode Preset settings, but it also recalls all of the mode persistent settings, and the Input/Output system setting that existed at the time Save User Preset was executed.

If a Save User Preset has not been done at any time, User Preset recalls the default user preset file for the currently active mode. The default user preset files are created if, at power-on, a mode detects there is no user preset file. There will never be a scenario when there is no user preset file to restore. For each mode, the default user preset state is the same state that would be saved if a Save User Preset is performed in each mode right after doing a Restore Mode Default and after a Restore Input/Output Defaults.

The User Preset function does the following:

- Aborts the currently running measurement.
- Sets the mode State to the values defined by Save User Preset.
- Makes the saved measurement for the currently running mode the active measurement.
- Brings up the saved menu for the power-on mode.

- Clears the input and output buffers.
- Sets the Status Byte to 0.

Key Path	User Preset
Remote Command	:SYSTem:PRESet:USER
Example	:SYST:PRES:USER:SAVE:SYST:PRES:USER
Notes	:SYST:PRES:USER:SAVE is used to save the current state as the user preset state. Clears all pending OPC bits. The Status Byte is set to 0. Pressing the User Preset front-panel key while already in the User Preset menu will cause the User Preset to get executed
Couplings	A user preset will cause the currently running measurement to be aborted and cause the saved measurement to be active. Recalling a User Preset file has the same issues that recalling a Save State file has. Some settings may need to be limited and therefore re-coupled, since the capabilities of the mode may have changes when the User Preset file was last saved.
Initial S/W Revision	Prior to A.02.00

User Preset All Modes

Recalls all of the User Preset files for each mode, switches to the power-on mode, and activates the saved measurement from the power-on mode User Preset file.

NOTE

When the instrument is secured, all of the user preset files are converted back to their default user preset files.

The User Preset function does the following:

- Aborts the currently running measurement.
- Switches the Mode to the power-on mode.
- Restores the User Preset files for each mode.
- Makes the saved measurement for the power-on mode the active measurement.
- Brings up the saved menu for the power-on mode.
- Clears the input and output buffers.
- Sets the Status Byte to 0.

Key Path	User Preset
Remote Command	:SYSTem:PRESet:USER:ALL
Example	:SYST:PRES:USER:SAVE:SYST:PRES:USER:ALL
Notes	Clears all pending OPC bits. The Status Byte is set to 0. :SYST:PRES:USER:SAVE is used to save the current state as the user preset state.
Couplings	A user preset will cause the currently running measurement to be aborted, cause a mode switch to the power-on mode, and cause the saved measurement to be active in the power-on mode.

Recalling a User Preset file has the same issues that recalling a Save State file has. Some settings may need to be limited and therefore re-coupled, since the capabilities of the mode may have changes when the User Preset file was last saved.

Initial S/W Revision Prior to A.02.00

Save User Preset

Saves the currently active mode and its State. You can recall this User Preset file by pressing the User Preset menu key or sending the SYST:PRES:USER remote command. This same state is also saved by the Save State function.

Key Path	User Preset
Remote Command	:SYSTem:PRESet:USER:SAVE
Example	:SYST:PRES:USER:SAVE
Notes	:SYST:PRES:SAVE creates the same file as if the user requested a *SAV or a MMEM:STOR:STAT, except User Preset Save does not allow the user to specify the filename or the location of the file.
Initial S/W Revision	Prior to A.02.00

View/Display (AM/FM/ΦM)

The AM and PM measurements have four views. The primary view is called “Quad View” and displays all four of the view windows with the focus in the RF Spectrum window. This is the view seen after a Mode Preset. There are also three other views that combine one of the graphics windows with the metrics windows. Besides the above four views, the FM measurement has an additional view called “Attack/Release Time”. This view includes a RF envelope graphic window and an AF demod waveform (without interpolation) graphic window. The views can be selected from the View/Display menu.

These views are designed such that you can identify analog modulated carriers, determine whether the carrier is a commercial or other broadcast station, and analyze the modulating signal.

Key Path	Front-panel key
Remote Command	:DISPlay:AM FM PM:VIEW[:SElect] QUAD RFSpectrum DEMod AFSpectrum ARTime :DISPlay:AM FM PM:VIEW[:SElect]?
Example	:DISP:FM:VIEW DEM selects Demod Waveform & Metrics View for FM Demod measurement
Preset	QUAD (Focus in RF Spectrum Window)
State Saved	Saved in instrument state
Initial S/W Revision	Prior to A.02.00

Display

The Display menu is common to most measurements, and is used for configuring items on the display. Some Display menu settings apply to all the measurements in a mode, and some only to the current measurement. Those under the System Display Settings key apply to all measurements in all modes.

Key Path	Display
Key Path	View/Display
Initial S/W Revision	Prior to A.02.00

Annotation

Turns on and off various parts of the display annotation. The annotation is divided up into four categories:

1. Meas Bar: This is the measurement bar at the top of the screen. It does not include the settings panel or the Active Function. Turning off the Meas Bar turns off the settings panel and the Active Function. When the Meas Bar is off, the graticule area expands to fill the area formerly occupied by the Meas Bar.
2. Screen Annotation: this is the annotation and annunciation around the graticule, including any annotation on lines (such as the display line, the threshold line, etc.) This does NOT include the marker number or the N dB result. When off, the graticule expands to fill the entire graticule area.
3. Trace annotation: these are the labels on the traces, showing their detector (or their math mode).

4. Active Function annotation: this is the active function display in the meas bar, and all of the active function values displayed on softkeys.

See the figure below. Each type of annotation can be turned on and off individually.

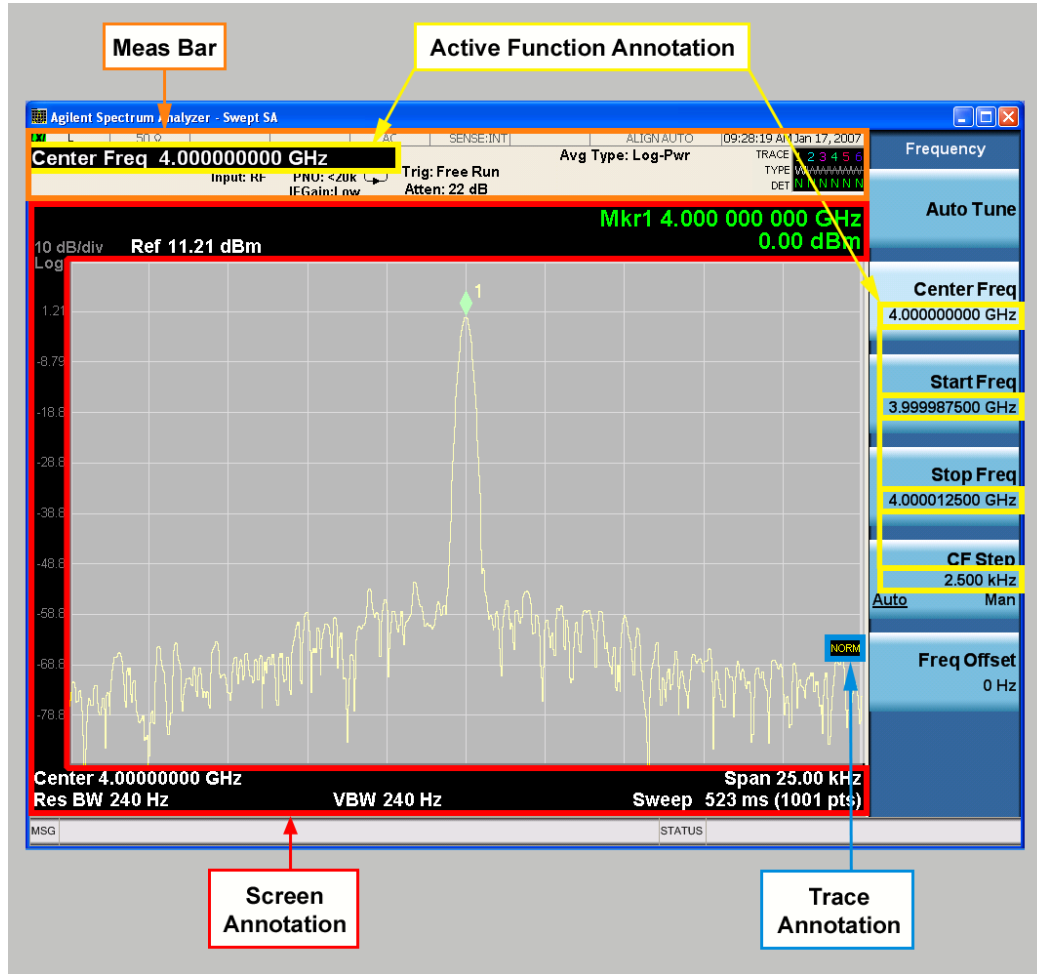

Key Path	View/Display, Display
Initial S/W Revision	Prior to A.02.00

Meas Bar On/Off

This function turns the Measurement Bar on and off, including the settings panel. When off, the graticule area expands to fill the area formerly occupied by the Measurement Bar.

Key Path	View/Display, Display, Annotation
Remote Command	:DISPlay:ANNotation:MBAR[:STATe] OFF ON 0 1 :DISPlay:ANNotation:MBAR[:STATe]?
Example	DISP:ANN:MBAR OFF

Dependencies	Grayed out and forced to OFF when System Display Settings, Annotation is set to Off.
Preset	On This should remain Off through a Preset when System DisplaySettings, Annotation is set to Off.
State Saved	Saved in instrument state.
Initial S/W Revision	Prior to A.02.00

Screen

This controls the display of the annunciation and annotation around the graticule, including any annotation on lines (such as the display line, the threshold line, etc.) and the y-axis annotation. This does NOT include marker annotation (or the N dB result). When off, the graticule expands to fill the entire graticule area, leaving only the 1.5% gap above the graticule as described in the Trace/Detector chapter.

Key Path	View/Display, Display, Annotation
Remote Command	:DISPlay:ANNotation:SCReen[:STATe] OFF ON 0 1 :DISPlay:ANNotation:SCReen[:STATe]?
Example	DISP:ANN:SCR OFF
Dependencies	Grayed-out and forced to OFF when System Display Settings, Annotation is set to Off.
Preset	On This should remain Off through a Preset when System DisplaySettings, Annotation is set to Off
State Saved	Saved in instrument state.
Initial S/W Revision	Prior to A.02.00

Active Function Values On/Off

Turns on and off the active function display in the Meas Bar, and all of the active function values displayed on the softkeys.

Note that all of the softkeys that have active functions have these numeric values blanked when this function is on. This is a security feature..

8 AM Demod Measurement
View/Display (AM/FM/ Φ M)

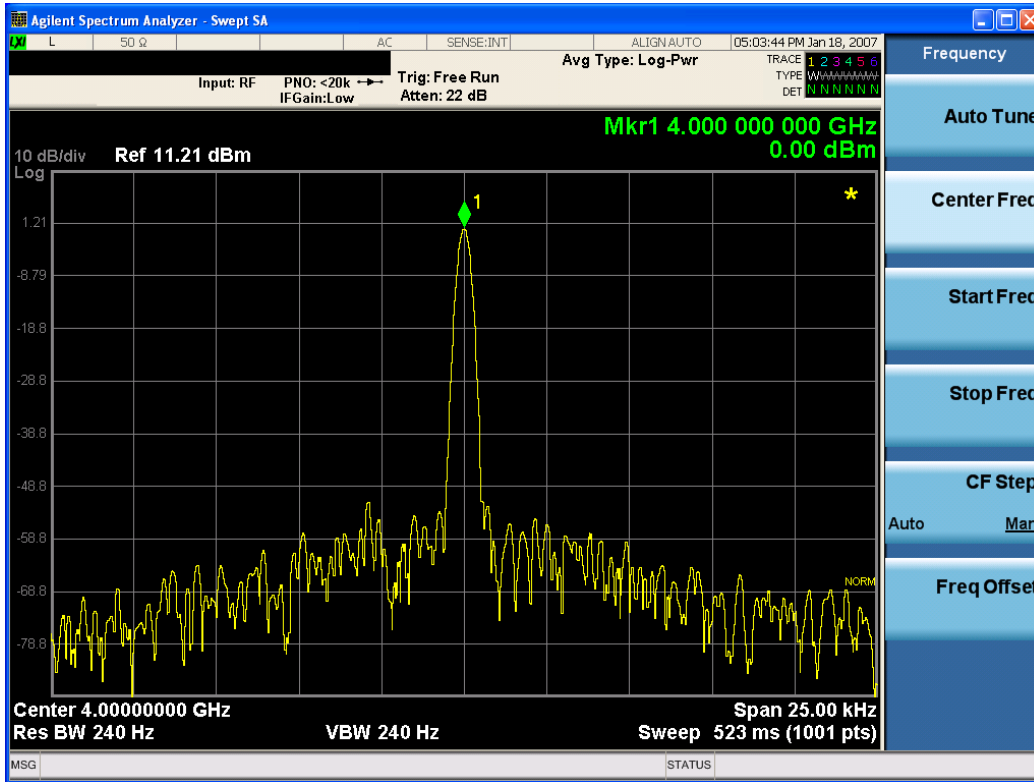

Key Path	View/Display, Display, Annotation
Remote Command	:DISPlay:ACTivefunc[:STATe] ON OFF 1 0 :DISPlay:ACTivefunc[:STATe]?
Example	DISP:ACT OFF
Dependencies	Grayed out and forced to OFF when System Display Settings, Annotation is set to Off.
Preset	On This should remain Off through a Preset when System DisplaySettings, Annotation is set to Off
State Saved	Saved in instrument state.
Initial S/W Revision	Prior to A.02.00

Title

Displays menu keys that enable you to change or clear a title on your display.

Key Path	View/Display, Display
Initial S/W Revision	Prior to A.02.00

Change Title

Writes a title into the "measurement name" field in the banner, for example, "Swept SA".

Press Change Title to enter a new title through the alpha editor. Press Enter or Return to complete the entry. Press ESC to cancel the entry and preserve your existing title.

The display title will replace the measurement name. It remains for this measurement until you press Change Title again, or you recall a state, or a Preset is performed. A title can also be cleared by pressing Title, Clear Title.

NOTE

Notice the inclusion of the <measurement> parameter in the command below. Because each measurement remembers the Display Title, the command must be qualified with the measurement name. For the Swept SA measurement this is not the case; no <measurement> parameter is used when changing the Display Title for the Swept SA measurement.

Key Path	View/Display, Display, Title
Mode	All
Remote Command	:DISPlay:<measurement>:ANNotation:TITLe:DATA <string> :DISPlay:<measurement>:ANNotation:TITLe:DATA?
Example	DISP:ANN:TITL:DATA "This Is My Title" This example is for the Swept SA measurement in the Spectrum Analyzer mode. The SANalyzer <measurement> name is not used. DISP:ACP:ANN:TITL:DATA "This Is My Title" This example is for Measurements other than Swept SA. Both set the title to: This Is My Title
Notes	Pressing this key cancels any active function. When a title is edited the previous title remains intact (it is not cleared) and the cursor goes at the end so that characters can be added or BKSP can be used to go back over previous characters.
Preset	No title (measurement name instead)
State Saved	Saved in instrument state.
Initial S/W Revision	Prior to A.02.00

Clear Title

Clears a title from the front-panel display. Once cleared, the title cannot be retrieved. After the title is cleared, the current Measurement Name replaces it in the title bar.

Key Path	View/Display, Display, Title
Example	The following commands clear the title and restore the measurement's original title: DISP:ANN:TITL:DATA "" This example is for the Swept SA measurement in the Spectrum Analyzer mode. The SANalyzer <measurement> name is not used. DISP:ACP:ANN:TITL:DATA "" This example is for ACP; in measurements other than Swept SA the measurement name is required.
Notes	Uses the :DISPlay:<measurement>:ANNotation:TITLe:DATA <string> command with an empty string (in the Swept SA, the <measurement> is omitted).
Preset	Performed on Preset.
Initial S/W Revision	Prior to A.02.00

Graticule

Pressing Graticule turns the display graticule On or Off. It also turns the graticule y-axis annotation on and off.

Key Path	View/Display, Display
Remote Command	:DISPlay:WINDow[1]:TRACe:GRATicule:GRID[:STATe] OFF ON 0 1 :DISPlay:WINDow[1]:TRACe:GRATicule:GRID[:STATe]?
Example	DISP:WIND:TRAC:GRAT:GRID OFF
Notes	The graticule is the set of horizontal and vertical lines that make up the grid/divisions for the x-axis and y-axis.
Preset	On
State Saved	Saved in instrument state
Initial S/W Revision	Prior to A.02.00

System Display Settings

These settings are "Mode Global" – they affect all modes and measurements and are reset only by Restore Misc Defaults or Restore System Defaults under System.

Key Path	View/Display, Display
Initial S/W Revision	Prior to A.02.00

Annotation Local Settings

This is a Mode Global override of the meas local annotation settings. When it is All Off, it forces ScreenAnnotation, Meas Bar, Trace, and Active Function Values settings to be OFF for all measurements in all modes. This provides the security based "annotation off" function of previous analyzers; hence it uses the legacy SCPI command.

When it is All Off, the Screen, Meas Bar, Trace, and Active Function Values keys under the Display, Annotation menu are grayed out and forced to Off. When Local Settings is selected, you are able to set the local annotation settings on a measurement by measurement basis.

Key Path	View/Display, Display, System Display Settings
Remote Command	:DISPlay:WINDow[1]:ANNotation[:ALL] OFF ON 0 1 :DISPlay:WINDow[1]:ANNotation[:ALL]?
Example	:DISP:WIND:ANN OFF
Preset	On (Set by Restore Misc Defaults)
State Saved	Not saved in instrument state.
Backwards Compatibility Notes	The WINDow parameter and optional subopcode is included for backwards compatibility but ignored – all windows are equally affected.
Initial S/W Revision	Prior to A.02.00

Themes

Accesses a menu of functions that enable you to choose the theme to be used when saving the screen image.

The **Themes** option is the same as the **Themes** option under the **Display** and **Page Setup** dialogs. It allows you to choose between themes to be used when saving the screen image.

Key Path	Save, Screen Image
Remote Command	:MMEMory:STORe:SCReen:THEMe TDColor TDMonochrome FCOlor FMONochrome :MMEMory:STORe:SCReen:THEMe?
Example	:MMEM:STOR:SCR:THEM TDM
Preset	3D Color; Is not part of Preset, but is reset by Restore Misc Defaults or Restore System Defaults All and survives subsequent running of the modes.
Readback	3D Color 3D Mono Flat Color Flat Mono
Backwards Compatibility Notes	In ESA and PSA we offer the choice of "Reverse Bitmap" or "Reverse Metafile" when saving screen images. This is much like the "Flat Color" theme available in X-Series. Also, if you selected Reverse Bitmap AND a black & white screen image, that would be much like "Flat Monochrome". In other words, each of the X-Series themes has a similar screen image type in ESA/PSA. But they are not identical.
Initial S/W Revision	Prior to A.02.00

3D Color

Selects a standard color theme with each object filled, shaded and colored as designed.

Key Path	Save, Screen Image, Themes
Example	MMEM:STOR:SCR:THEM TDC
Readback	3D Color
Initial S/W Revision	Prior to A.02.00

3D Monochrome

Selects a format that is like 3D color but shades of gray are used instead of colors.

Key Path	Save, Screen Image, Themes
Example	MMEM:STOR:SCR:THEM TDM
Readback	3D Mono
Initial S/W Revision	Prior to A.02.00

Flat Color

Selects a format that is best when the screen is to be printed on an ink printer.

Key Path	Save, Screen Image, Themes
Example	MMEM:STOR:SCR:THEM FCOL
Readback	Flat Color
Initial S/W Revision	Prior to A.02.00

Flat Monochrome

Selects a format that is like Flat Color. But only black is used (no colors, not even gray), and no fill.

Key Path	Save, Screen Image, Themes
Example	MMEM:STOR:SCR:THEM FMON
Readback	Flat Mono
Initial S/W Revision	Prior to A.02.00

Quad View

The Quad View displays each of the four fundamental windows of the Analog Demod mode. The basic window format is essentially the same for the 3 measurements. The main difference is the demodulation technique performed in the hardware and the specific metrics and units of the displayed results.

In general, there is little window-context sensitivity in the Analog Demod mode, that is, most of the variables have been designed so that they are unique to their window. The three variables that are window dependent are, Ref Value, Scale/Div, and Ref Position. These variables change to reflect the settings of the current window (the current window is always outlined in green).

The Quad View is shown below. For more information on the views, see ["RF Spectrum Window" on page 535](#), ["Demod Waveform Window" on page 535](#), ["AF Spectrum Window" on page 536](#), or ["Metrics Window" on page 536](#).

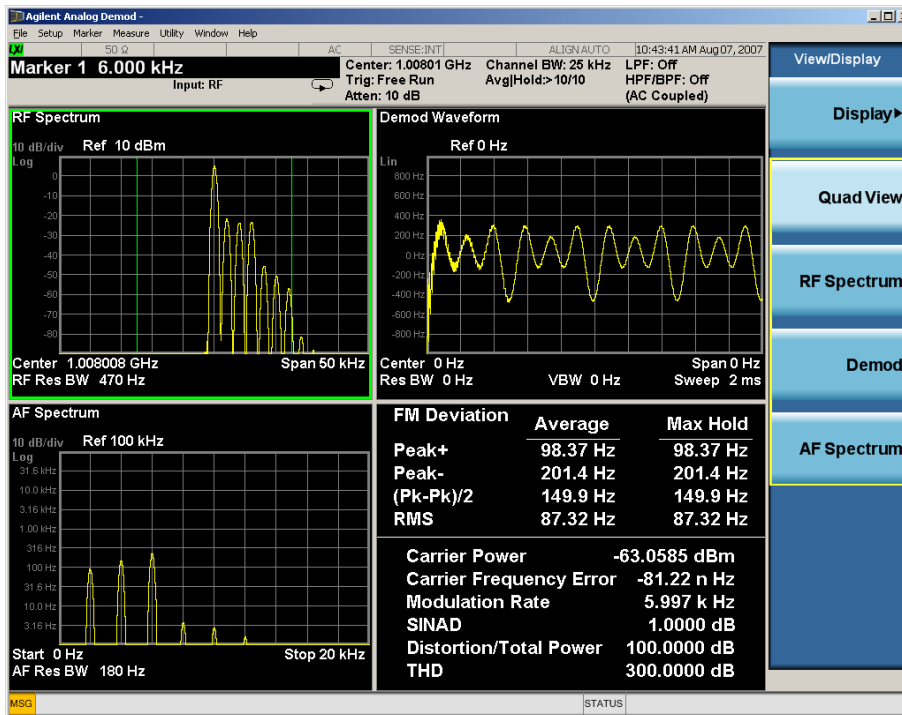

RF Spectrum Window

The RF Spectrum window shows a spectral display of the input RF signal with amplitude in the vertical Y axis and frequency in the horizontal X axis. The vertical axis is always scaled in dB, with units of dBm, with the Ref Value initially at the top of the vertical scale. This spectral display is basically identical to the frequency display of the Swept SA measurement; however it is always taken using an FFT. The span is restricted to 8 MHz and zero span is not allowed.

The RF Spectrum window provides a convenient way to identify broadcast stations by placing the signal of interest at the center frequency using this window and listening to the instrument's speaker. Demodulation is always performed at the center frequency of the RF Spectrum window; this is regarded as the application's center frequency and is annotated in the Measurement Bar.

In the RF Spectrum window, two green vertical lines are shown centered around the center frequency, with spacing equal to the Channel BW. If the Channel BW is wider than the span, they are not seen.

The Center Frequency, Span, and RF Res BW are annotated at the bottom of the RF Spectrum Window. The Ref Value and Scale/Div are annotated above the graticule.

Demod Waveform Window

In the Demod Waveform window, the demodulated signal is displayed in the time domain (zero span) with time on the horizontal X axis, and modulation depth (AM) or deviation (FM, Φ M) on the vertical Y axis.

In the Demod Waveform window the Y axis is linearly scaled in units of percent modulation for AM, frequency (Hz) for FM, or phase (radians) for Φ M. On a preset, the Ref Value is positioned in the center of the vertical scale.

Four traces are available in the Demod Waveform window. The Demod trace, in yellow, shows the current demodulation signal. The Demod Max trace, in cyan, shows the Max Hold value for each display point

bucket since the last restart and the Demod Min trace, in magenta, shows the Min Hold value for each display point bucket since the last restart. The Demod Average trace, in green, shows the averaged demodulation signal. If Averaging is turned off, only the Demod trace is displayed.

The Sweep Time is annotated at the bottom of the Demod Waveform Window. The Ref Value and Scale/Div are annotated above the graticule.

AF Spectrum Window

In the AF Spectrum window, the demodulated signal is displayed in the frequency domain with frequency on the X axis and amplitude on the Y axis.

The vertical axis is always scaled in dB with the Ref Value initially at the top of the vertical scale. The Y-Axis Unit is % for AM, Hz for FM, and radians for Φ M.

In this view you can observe the spectral components of the modulating signal. The preset Start Frequency of this window is 0 Hz. The AF Start Freq and AF Stop Freq are annotated at the bottom of the AF Spectrum Window, as is the AF Res BW.

The Ref Value and Scale/Div are annotated above the graticule.

It is only possible to show a spectrum to a maximum frequency of Channel BW / 2. For trace display points beyond that frequency, the value 1.0E-50 is plotted and returned in queries.

Metrics Window

The metrics window displays measurement results.

If averaging is turned on, the column marked “Current” is relabeled “Average” and the results in that column are averaged over successive measurements until the Average/Hold number is reached. Then, if not in Single measurement mode, the measurement continues, exponentially averaging in successive results. The Max Hold column shows the Maximum value the un-averaged metric has attained since the last Restart. The Max Hold column is removed when averaging is turned off.

The window title is “FM Deviation” in FM, “AM Mod Depth” in AM, and “ Φ M Radians” in Φ M.

Key Path	View/Display
Initial S/W Revision	Prior to A.02.00

RF Spectrum & Metrics View

This view shows the RF Spectrum window and the Metrics window displayed in a split screen mode with the RF Spectrum window taking up approximately $\frac{3}{4}$ of the display.

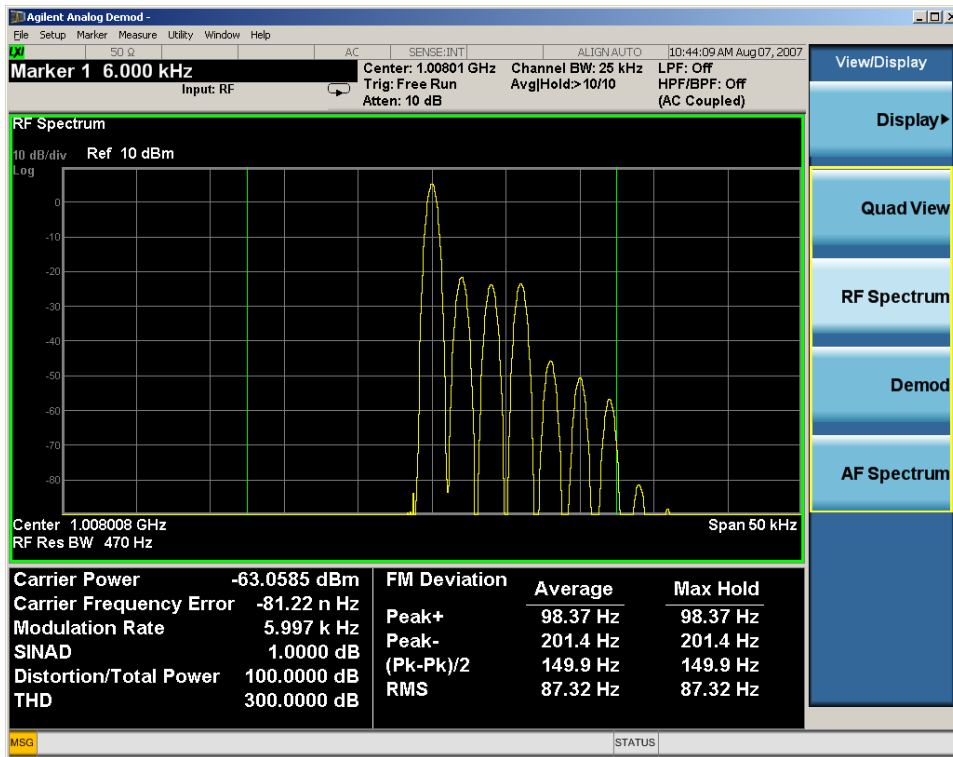

Key Path View/Display

Initial S/W Revision Prior to A.02.00

Demod Waveform & Metrics View

This view shows the Demod Waveform window and the Metrics windows displayed in a split screen mode with the Demod Waveform window taking up approximately ¾ of the display.

8 AM Demod Measurement View/Display (AM/FM/ Φ M)

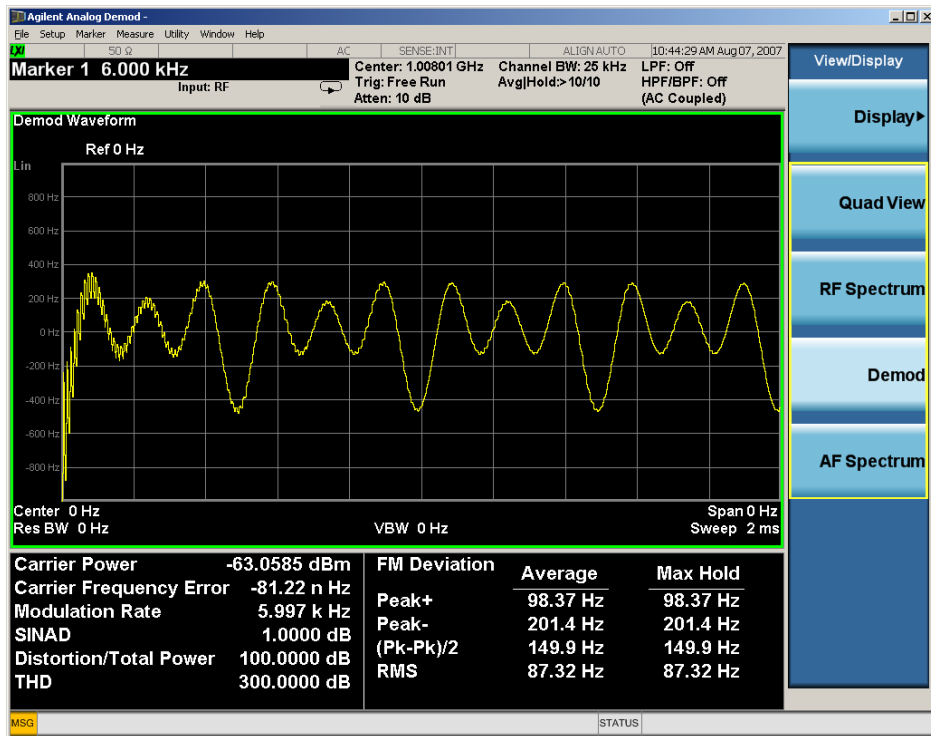

Key Path View/Display

Initial S/W Revision Prior to A.02.00

AF Spectrum & Metrics View

This view shows the AF Spectrum window and the Metrics windows displayed in a split screen mode with the AF Spectrum window taking up approximately $\frac{3}{4}$ of the display.

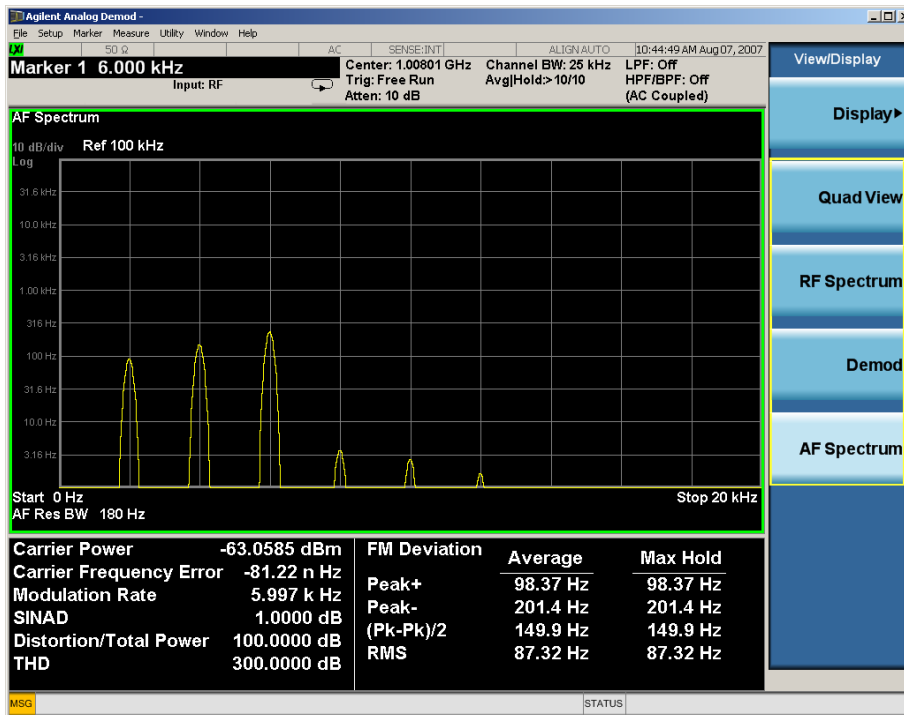

Key Path	View/Display
Initial S/W Revision	Prior to A.02.00

Metrics Settings

Accesses a menu used to control which metrics will be provided. This includes a 1-of-N menu which allows you to control which modulation magnitude metrics are displayed, as well as On/Off controls for Modulation Rate and SINAD/Distortion/THD. If speed is an issue, select only the metric(s) that is(are) required. If modulation magnitude is set to Peak+ Only, Pk-Pk/2 Only, or RMS Only, the other modulation magnitude metrics are loaded with not a number and show “---” in the metrics window.

Key Path	View/Display, Metrics Settings
Remote Command	:DISPlay:AM FM PM:VIEW:METRics:MMAGnitude ALL PPK PNPk RMS RMSRatio :DISPlay:AM FM PM:VIEW:METRics:MMAGnitude?
Example	DISP:AM:VIEW:METR:MMAG PPK Sets AM modulation magnitude to peak +. DISP:FM:VIEW:METR:MMAG RMSR Sets ratio reference and sets FM modulation magnitude to ratio display
Preset	ALL
State Saved	Saved in State
Initial S/W Revision	Prior to A.02.00
Modified at S/W Revision	A.05.00

Normal

Turns on all absolute modulation magnitude metrics. In the metrics window, Peak +, Peak -, Pk-Pk/2 and RMS results are provided.

Key Path	View/Display, Metrics Settings, Mod Magnitude
Example	:DISP:FMST:VIEW:METR:MMAG ALL
Notes	This key was labeled "All" in earlier releases
Initial S/W Revision	A.10.00

Peak+ Only

Turns on just the Peak+ metric in the portion of the metrics window that shows the modulation magnitude results.

Key Path	View/Display, Metrics Settings, Mod Magnitude
Example	:DISP:FMST:VIEW:METR:MMAG PPK
Initial S/W Revision	A.10.00

Pk-Pk/2 Only

Turns on just the Pk-Pk/2 metric in the portion of the metrics window that shows the modulation magnitude results. .

Key Path	View/Display, Metrics Settings, Mod Magnitude
Example	:DISP:FMST:VIEW:METR:MMAG PNPk
Initial S/W Revision	A.10.00

RMS Only

Turns on just the RMS metric in the portion of the metrics window that shows the modulation magnitude results.

Key Path	View/Display, Metrics Settings, Mod Magnitude
Example	:DISP:FMST:VIEW:METR:MMAG RMS
Initial S/W Revision	A.10.00

RMS Ratio

Turns on the display of RMS Ratio. In this mode, the only magnitude metrics that are displayed are the RMS metrics, but besides the display of RMS, the ratio (in dB) of the RMS modulation to its reference is

displayed, as well as the value of the reference, as shown in the display below:

FM Deviation		
	Average	Max Hold
RMS	12.69 kHz	14.19 kHz
RMS Ratio	1.89 dB	2.86 dB
Ratio Ref	10.20 kHz	
Carrier Power		-100.331 dBm
Carrier Frequency Error		180.5 Hz

Pressing the RMS Ratio key (or sending :DISP:FMST:VIEW:METR:MMAG RMSR) establishes the reference. Pressing it again (or sending the SCPI command again) establishes a new reference. Whenever this happens, the current value of RMS modulation from the left hand column (Current or Average) is taken as the new reference.

If, when the ratio is to be established, there is not a valid value being displayed to use as a reference, an error is generated, the RMS Ratio and Ratio Ref values display --- and queries of either return not a number (9.91 e37).

To turn off the ratio display, select one of the other Mod magnitude views.

Note that each measurement (AM, FM, PM, PM and FM Stereo) has its own reference; and the reference is remembered when you leave the measurement and return.

The ratio references are saved in State, and when the recalled state of Metrics Settings is RMS Ratio, the saved reference for the current measurement should be recalled and used, rather than establishing a new one.

Key Path	View/Display, Metrics Settings, Mod Magnitude
Example	:DISP:FMST:VIEW:METR:MMAG RMSR
Initial S/W Revision	A.10.00

Modulation Rate

Toggles the Modulation Rate metric on and off. When turned on, the Modulation Rate metric is provided. When turned off, the Modulation Rate metric is set to not a number and shows “---” in the metric window.

Key Path	View/Display, Metrics Settings
Remote Command	DISPlay:FMSTereo:VIEW:METRics:MRATe[:STATE] ON OFF 1 0 DISPlay:FMSTereo:VIEW:METRics:MRATe[:STATE]?
Example	DISP:FMST:VIEW:METR:MRAT OFF Sets FM Stereo modulation rate to off
Preset	On
State Saved	Saved in instrument state
Initial S/W Revision	A.10.00

SINAD, THD, Distortion

Toggles the distortion metrics – SINAD, Distortion and THD. When turned off, SINAD, Distortion and THD metrics are set to not a number and show “---” in the metric window.

SINAD is the ratio of total received power (the received signal-plus-noise-plus-distortion power) to the received noise-plus-distortion power. It is always expressed in decibel units. The rejection of the carrier from the noise-plus-distortion power measurement is usually not much more than 50 dB, thus limiting the maximum SINAD.

THD is the ratio of the root mean square voltage of the harmonics referenced to the fundamental voltage, expressed in % or dB. Note the differences with respect to Distortion. The denominator of the ratio is different and the items in the numerator do not include the noise between harmonics, just the harmonics themselves.

Distortion/Total Voltage (rms) is the ratio of unwanted received power (noise plus distortion) to the total received power, expressed in % or dB. Therefore, this metric is the negative of SINAD when expressed in decibels.

Key Path	View/Display, Metrics Settings
Remote Command	DISPlay:FMSTereo:VIEW:METRics:DISToRtion[:STATe] ON OFF 1 0 DISPlay:FMSTereo:VIEW:METRics:DISToRtion [:STATe]?
Example	DISP:FMST:VIEW:METRics:DIST OFF Sets FM Stereo modulation rate to off
Preset	On
State Saved	Saved in instrument state
Initial S/W Revision	A.10.00

Distortion & THD Unit

Changes the units of distortion and THD in the Metrics screen between % and dB units.

Key Path	View/Display
Remote Command	DISPlay:AM FM PM:VIEW:DISToRtion:UNIT DB PCT DISPlay:AM FM PM:VIEW:DISToRtion:UNIT?
Example	DISP:AM:VIEW:DIS:UNIT PCT Sets AM distortion and THD display to percent.
Preset	PCT
State Saved	Saved in State
Initial S/W Revision	Prior to A.02.00

9 FM Demod Measurement

For the FM Demod measurement, the analyzer will display the metrics results, such as FM deviation, modulation rate, carrier frequency error, SINAD, total harmonic distortion and carrier power. The analyzer can also display trace data of the RF spectrum, the AF spectrum, or the demod waveform.

NOTE

For Analog FM demod to work correctly, phase change from sample-to-sample cannot exceed 90 degrees.

If the Demod Min trace, Demod Max trace or Demod Average trace is queried using a Meas, Read or Fetch command when Average/Hold feature is turned off, the resulting data will be default values.

If any of the metrics are off, a SCPI query will return not a number and show “---“ in the metrics window. The metrics that can be turned off are: Modulation Rate, SINAD, Distortion, THD and all but one of the Deviations.

For more measurement related commands, see the SENSE subsystem, and the ["Remote Measurement Functions" on page 1121](#).

This topic contains the following sections:

["Measurement Commands for FM Demod " on page 544](#)

["Remote Command Results for FM Demod" on page 545](#)

Measurement Commands for FM Demod

Parameter Name	FM Meas/Read/Fetch Query Results
SCPI Command	:MEASure READ FETCh:FM[1] 0 2 3 4 5?
SCPI Example	MEAS:FM? FETCh:FM0? READ:FM5?
Setup	[COMPARE OFF]
Post Setup	[COMPARE ON]

Remote Command Results for FM Demod

Command	n	Return Value
:INITiate:FM	n/a	n/a
:CONFigure?	n/a	name of current measurement: "FM"
:CONFigure:FM	n/a	n/a (selects FM measurement in Meas Preset state)
:CONFigure:FM:NDEFault	n/a	n/a (selects FM measurement without affecting settings)
:FETCh:FM[n]? :MEASure:FM[n]? :READ:FM[n]?	0	This query returns the RF Spectrum trace data as a list of x,y pairs. The x-axis values are in units of Hz. The y-value units depend on the current view
	not specified or n=1	Returns the following comma-separated results: 1. The RF Spectrum window's center frequency 2. Carrier Power 3. Carrier Frequency Error 4. Modulation Rate 5. SINAD value 6. Distortion/Total Vrms (% - not ratio - or dB) 7. Total Harmonic Distortion(% - not ratio - or dB) 8. Deviation (Peak+) 9. Deviation (Peak-) 10. Deviation (Pk-Pk)/2 11. Deviation (RMS) 12. Deviation (Peak+) Max Hold 13. Deviation (Peak-) Max Hold 14. Deviation (Pk-Pk)/2 Max Hold 15. Deviation (RMS) Max Hold 16. SNR
	2	This query returns the Demod Min Trace data as a list of x,y pairs. The x-axis values are in units of seconds. The y-value units depend on the current view If Aver/Hold is off, all y-values are 1 GHz.
	3	This query returns the Demod Max Trace data as a list of x,y pairs. The x-axis values are in units of seconds. The y-value units depend on the current view If Aver/Hold is off, all y-values are -1 GHz.
	4	This query returns the Demod Trace data as a list of x,y pairs. The x-axis values are in units of seconds. The y-value units depend on the current view
	5	This query returns the Demod Average Trace data as a list of x,y pairs. The x-axis values are in units of seconds. The y-value units depend on the current view If Aver/Hold is off, all y-values are -1 GHz.

Command	n	Return Value
	6	This query returns the AF Spectrum Trace data as a list of x,y pairs. The x-axis values are in units of Hz. The y-value units depend on the current view
	7	Returns the following comma-separated results: 1. Deviation (RMS) 2. Deviation (RMS) Ratio 3. Ratio Reference
	8	Returns the Demod Waveform Trace data (without interpolation), as a series of floating trace point values, in Hz. The number of samples and the sample interval can be queried when n=10.
	9	Returns trace point values of the entire captured signal envelope trace data. These data points are floating point numbers representing the power of the signal (in dBm). There are N data points, where N is the number of samples. The number of samples and the sample interval can be queried when n=10.
	10	Returns the following scalar results: 1. Sample Interval is a floating point number representing the time between samples when using the trace queries (n=8 and n=9). 2. Number of samples is the number of data points in the Demod Waveform Trace (without interpolation). This number is useful when performing a query on the signal (when n=8 and n=9).
	11	Returns unprocessed I/Q trace data, as a series of trace point values, in volts. The I values are listed first in each pair, using the 0 through even-indexed values. The Q values are the odd-indexed values. The number of samples and the sample interval can be queried at n=12.
	12	Returns the following scalar results: 1. Sample Interval is a floating point number representing the time between samples when using the trace queries (n= 11). 2. Number of samples is the number of data points in the captured signal. This number is useful when performing a query on the signal (when n= 11).

Key Path	Meas
Initial S/W Revision	Prior to A.02.00

AMPTD Y Scale

Accesses a menu that enables you to set the reference level, attenuation, scale per division, reference position, and internal pre-amplifier parameters for your measurement.

Key Path	Front-panel key
Initial S/W Revision	Prior to A.02.00

Ref Value (FM)

The reference value specifies the amplitude of a signal displayed on the reference graticule line. The reference line is at the top, center, or bottom of the graticule, depending on the value of the Ref Position function.

Changing the reference value does not restart a measurement, but changes all displayed traces and markers to the new value. If a change to the reference value changes an auto-coupled attenuation value, the measurement restarts.

The Ref Value key applies only to the window with the focus. If the focus is on the Metrics window, the Ref Value key is unavailable.

Key Path	AMPTD Y Scale
Remote Command	:DISPlay:FM:WINDow[1] 2 ... 5:TRACe:Y[:SCALe]:RLEVel <real> :DISPlay:FM:WINDow[1] 2 ... 5:TRACe:Y[:SCALe]:RLEVel?
Example	DISP:FM:WIND:TRAC:Y:RLEV 20 dBm Sets the reference value in window 1 to 20 dBm.
Remote Command Notes	Regardless of the View, the windows are numbered as follows: 1. RF Spectrum 2. Demod Waveform 3. AF Spectrum 4. RF Envelope (Attack/Release Time view) 5. FM Demod Waveform (Attack/Release Time view) 6. Metrics
Couplings	The value is constrained within the MAX and MIN values, but is otherwise generally not adjusted. In window 3, this value depends on Scale Type. If Scale Type is Log, the value will be expressed in decibel units. For example, x Hz will be expressed as y dBHz, where $y = 20 * \log(x)$.
Preset	Demod Waveform 0 Hz AF Spectrum Scale Type is "Lin": 100 kHz Scale Type is "Log": 100 dBHz RF Envelope 0 dBm FM Demod Waveform 0 Hz

State Saved	Saved in instrument state
Min	RF Spectrum -170 dBm - Ext Gain Demod Waveform -10 GHz AF Spectrum Scale Type is "Lin": 1 Hz Scale Type is "Log": 0 dBHz RF Envelope-170 dBm FM Demod Waveform-10 GHz
Max	Demod Waveform 10 GHz RF Envelope30 dBm FM Demod Waveform10 GHz
Default Unit	depends on the current view
Initial S/W Revision	Prior to A.02.00
Modified at S/W Revision	A.14.00

Range

Represents the amplitude of the largest sinusoidal signal that could be present within the IF without being clipped by the ADC. For signals with high peak-to-average ratios, the range may need to exceed the rms signal power by a fair amount to avoid clipping.

Key Path	Range
Mode	BASIC
Remote Command	[:SENSe] :POWer [:RF] :RANGe <real> [:SENSe] :POWer [:RF] :RANGe?
Example	:POW:RANG 10.0 :POW:RANG?
Notes	The MIN and MAX values are affected by the External Gain parameters, and by the Center Frequency. (The hardware compensates for frequency response and alters the Range setting.)
Preset	0
State Saved	Saved in instrument state.
Min	-100
Max	100
Initial S/W Revision	A.12.50

Adjust Range For Min Clip

Sets the combination of attenuation and gain based on the current measured signal level so that clipping will be at a minimum.

This is an "immediate action" function, that is, it executes once, when the key is pressed.

This key is grayed out in measurements that do not support this functionality.

Key Path	AMPTD Y Scale, Attenuation
Remote Command	<code>[:SENSe] :POWer [:RF] :RANGe :OPTimize IMMEDIATE</code>
Initial S/W Revision	Prior to A.02.00
Modified at S/W Revision	A.03.00

Pre-Adjust for Min Clip

If this function is on, it does the adjustment described under Adjust Range For Min Clip each time a measurement restarts. Therefore, in Continuous measurement mode, it only executes before the first measurement.

Key Path	AMPTD Y Scale, Attenuation
Remote Command	<code>[:SENSe] :POWer [:RF] :RANGe :OPTimize :ATTenuation OFF ON ELECTrical COMBined</code> <code>[:SENSe] :POWer [:RF] :RANGe :OPTimize :ATTenuation?</code>
Notes	This parameter is shared with old XA platform which uses AutoAtten. To keep the backward compatibility, ELECTrical and COMBined still can be used. Then, upon receiving ELECTrical and COMBined, these enums will be interpreted as aliases of ON. Then, when queried, ON will be returned.
Preset	OFF for Swept SA measurement; ON for all other measurements that support Pre-Adjust for Min Clip
State Saved	Saved in instrument state
Initial S/W Revision	Prior to A.02.00
Modified at S/W Revision	A.03.00

Peak to Average

The Peak to Average Ratio is used with the Range setting to optimize the level control in the instrument. The value is the ratio, in dB, of the peak power to the average power of the signal to be measured. A ratio of 0 should be used for sinusoidal signals; for 802.11g OFDM signals use 9 dB.

All Applications (Modes) will show the current value of Peak to Average ratio on the softkey. However, some applications will not permit changing the value. In these situations the softkey will be grayed-out.

Key Path	AMPTD Y Scale, Range
Remote Command	<code>[:SENSe] :POWer [:RF] :RANGe :PARatio <real></code> <code>[:SENSe] :POWer [:RF] :RANGe :PARatio?</code>
Example	POW:RANG:PAR 12 dB
Notes	In some Applications (Modes) this parameter will be read-only; meaning the value will appear on the softkey and query via SCPI, but not changeable. In such applications the softkey will be grayed-out. Attempting to change the value via SCPI will be ignored and no error message will be generated.

Preset	10 dB
State Saved	Saved in instrument state
Min	0 dB
Max	20 dB
Initial S/W Revision	A.13.00

Mixer Level Offset

Mixer level offset is an advanced setting to adjust target Range at the input mixer which in turn affects the signal level in the instrument's IF. This setting can be used when additional optimization is needed after setting Peak to Average ratio. Positive values of offset optimize noise performance over distortion, negative values optimize distortion performance over noise.

Key Path	AMPTD Y Scale, Range
Remote Command	<code>[:SENSe] :POWer [:RF] :RANGe :MIXer :OFFSet <real></code> <code>[:SENSe] :POWer [:RF] :RANGe :MIXer :OFFSet ?</code>
Example	POW:RANG:MIX:OFFS -5 dB
Preset	0 dB
State Saved	Saved in instrument state
Min	-35 dB
Max	30 dB
Initial S/W Revision	A.13.00

Scale / Div (FM)

Sets the units per vertical graticule division on the display.

The Scale/Div key applies only to the window with the focus. If the focus is on the Metrics window, the Scale/Div key is unavailable.

Key Path	AMPTD Y Scale
Remote Command	<code>:DISPlay:FM:WINDow[1] 2 ... 5 :TRACe:Y[:SCALe]:PDIVision <real></code> <code>:DISPlay:FM:WINDow[1] 2 ... 5 :TRACe:Y[:SCALe]:PDIVision ?</code>
Example	DISP:FM:WIND:TRAC:Y:PDIV 5 DB
Remote Command Notes	Regardless of the View, the windows are numbered as follows: 1. RF Spectrum 2. Demod Waveform 3. AF Spectrum 4. RF Envelope (Attack/Release Time view) 5. FM Demod Waveform (Attack/Release Time view)

6. Metrics	
Preset	RF Spectrum 10 dB Demod Waveform 15 kHz AF Spectrum 10 dB RF Envelope 10 dB FM Demod Waveform 15 kHz
State Saved	Saved in State
Min	RF Spectrum 0.1 dB Demod Waveform 1 Hz AF Spectrum 0.1 dB RF Envelope 0.1 dB FM Demod Waveform 1 Hz
Max	RF Spectrum 20 dB Demod Waveform 1 GHz AF Spectrum 20 dB RF Envelope 20 dB FM Demod Waveform 1 GHz
Initial S/W Revision	Prior to A.02.00
Modified at S/W Revision	A.14.00

Ref Position

Positions the reference value at the top, center, or bottom of the Y Scale display. Changing the reference position does not change the reference value.

The Ref Position key applies only to the window with the focus. If the focus is on the Metrics window, the Ref Position key is unavailable.

Key Path	AMPTD Y Scale
Remote Command	<p>AM/PM/FM Stereo:</p> <pre>:DISPlay:AM PM FMSTereo:WINDow[1] 2 3:TRACe:Y[:SCALe]:RPOSition TOP CENTER BOTTom</pre> <p>:DISPlay:AM PM FMSTereo:WINDow[1] 2 3:TRACe:Y[:SCALe]:RPOSition?</p> <p>FM:</p> <pre>:DISPlay:FM:WINDow[1] 2 ... 5:TRACe:Y[:SCALe]:RPOSition TOP CENTER BOTTom</pre> <pre>:DISPlay:FM:WINDow[1] 2 ... 5:TRACe:Y[:SCALe]:RPOSition?</pre>
Example	DISP:AM:WIND:TRAC:Y:RPOS BOTT
Remote Command Notes	<p>AM/PM/FM Stereo:</p> <p>Regardless of the View, the windows are numbered as follows:</p> <ol style="list-style-type: none"> 1. RF Spectrum

	<ul style="list-style-type: none">2. Demod Waveform3. AF Spectrum4. Metrics FM: Regardless of the View, the windows are numbered as follows: <ul style="list-style-type: none">1. RF Spectrum2. Demod Waveform3. AF Spectrum4. RF Envelope (Attack/Release Time view)5. FM Demod Waveform (Attack/Release Time view)6. Metrics
Preset	RF Spectrum window: Top Demod Waveform window: Center AF Spectrum window: Top
State Saved	Saved in instrument state
Initial S/W Revision	Prior to A.02.00
Modified at S/W Revision	A.14.00

Auto Couple

The Auto Couple feature provides a quick and convenient way to automatically couple multiple instrument settings. This helps ensure accurate measurements and optimum dynamic range. When the Auto Couple feature is activated, either from the front panel or remotely, all parameters of the current measurement which have an Auto/Manual mode are set to Auto mode and all measurement settings dependent on (or coupled to) the Auto/Man parameters are automatically adjusted for optimal performance.

For Analog Demod, these parameters are:

- RF Res BW
- AF Res BW
- CF Step

Key Path	Front-panel key
Initial S/W Revision	Prior to A.02.00

BW

Opens a menu of keys that enable you to control the bandwidth functions of the application.

Key Path	Front-panel key
Initial S/W Revision	Prior to A.02.00

RF Res BW

Activates the RF Res BW function, which enables you to manually set the resolution bandwidth used in the RF Spectrum window.

Normally, the RF Res BW (Auto) key selects automatic coupling of the resolution bandwidth. To decouple the resolution bandwidth, press the RF Res BW key until Man is underlined, or enter a different value for the resolution bandwidth.

When the resolution bandwidth is manually selected, it may be returned to the coupled state by pressing the RF Res BW key until Auto is underlined. This may also be done by pressing the Auto Couple key or by performing a preset.

Only the Gaussian filter type is used.

Key Path	BW
Remote Command	<pre>[:SENSe] :AM FM PM FMSTereo:BANDwidth[:RESolution] <freq> [:SENSe] :AM FM PM FMSTereo:BANDwidth[:RESolution]? [:SENSe] :AM FM PM:BANDwidth[:RESolution]:AUTO OFF ON 0 1 [:SENSe] :AM FM PM:BANDwidth[:RESolution]:AUTO?</pre>
Example	<pre>AM:BAND 1 KHZ AM:BAND? AM:BAND:AUTO ON AM:BAND:AUTO?</pre>
Notes	Only certain discrete resolution bandwidths are available. For numeric entries, all RBW Types choose the nearest (arithmetically, on a linear scale, rounding up) available RBW to the value entered.
Couplings	<p>AM/FM/PM: In Auto, the 3 dB RBW of the desired filter is the closest possible choice to that given by Span divided by 106 (the Span: 3 dB RBW parameter), except that the range for auto-coupling is restricted to not exceed 3 MHz.</p> <p>FMST: In Auto, RBW is coupled to Span in the following ways: $RBW = Span / 500$ ($Span > 500$ kHz) $RBW = 1$ kHz ($100kHz \leq Span \leq 500$ kHz) $RBW = Span / 100$ ($Span < 100$ kHz)</p>
Preset	<p>AM/FM/PM: Preset is Auto, which results in a 680 Hz value since the preset span is 75 kHz and the Span/RBW ratio is 106</p> <p>FMST: Preset is Auto, which results in a 1 kHz value since the preset span is 500 kHz</p>
State Saved	Saved in Instrument state

Min	1 Hz
Max	8 MHz
Default Unit	Hz
Initial S/W Revision	Prior to A.02.00
Modified at S/W Revision	A.10.00

Channel BW

The Channel BW variable is used to determine the bandwidth used for the demodulation. The flat top filter type must be used for demodulation.

This parameter also controls the RBW hardware setting for the demodulation fed to the speaker.

Key Path	BW
Remote Command	[:SENSe] :AM FM PM FMSTereo:BANDwidth:CHANnel <freq> [:SENSe] :AM FM PM FMSTereo:BANDwidth:CHANnel?
Example	AM:BAND:CHAN 200 kHz
Notes	If the Channel BW is greater than 8 MHz, gives a warning message "Settings Alert; Analog Output Undefined".
Dependencies	The maximum value will be the maximum IF BW available in the instrument. For example, if the instrument has the options B25, B40, and B1X installed, the maximum available IF BW of the instrument is 140 MHz. Thus, the maximum Channel BW is not limited to 25 MHz but is 140 MHz.
Preset	= AM/FM/PM = 25 kHz = FMST = 400 kHz
State Saved	Saved in instrument state
Min	390 Hz
Max	When Option N9063A-AFP is installed, it depends on hardware: No Option = 10 MHz Option B25 = 25 MHz Option B40 = 40 MHz Option B85 = 85.0 MHz Option B1A = 125.0 MHz Option B1X = 140 MHz Option B1Y = 160 MHz
Default Unit	Hz
Initial S/W Revision	Prior to A.02.00
Modified at S/W Revision	A.10.00

AF Res BW

In the AF Spectrum window, the AF Res BW key is used to set the Resolution bandwidth of the FFT of the demodulated waveform.

The data acquisition uses the Channel BW value for hardware control during data acquisition, just as it does in the Demod Waveform window.

AF Res BW (Auto) selects automatic coupling of the AF Res BW to the AF Span (defined as AF Stop Freq – AF Start Freq) using the same factor of 106 used by the RF Res BW. To decouple the resolution bandwidth, press the AF Res BW key until Man is underlined, or enter a different value for the AF resolution bandwidth.

When the AF resolution bandwidth is manually selected, it may be returned to the coupled state by pressing the AF Res BW key until Auto is underlined. This may also be done by pressing the Auto Couple key or by performing a Preset.

Only the Gaussian filter type is used.

Key Path	BW
Remote Command	<pre>[:SENSe] :AM FM PM} FMSTereo:AFSPectrum:BANDwidth <freq> [:SENSe] :AM FM PM FMSTereo:AFSPectrum:BANDwidth? [:SENSe] :AM FM PM FMSTereo:AFSPectrum:BANDwidth:AUTO OFF ON 0 1 [:SENSe] :AM FM PM FMSTereo:AFSPectrum:BANDwidth:AUTO?</pre>
Example	<pre>AM:AFSP:BAND 1 KHZ AM:AFSP:BAND?</pre>
Notes	Only certain discrete resolution bandwidths are available. For numeric entries, all RBW Types choose the nearest (arithmetically, on a linear scale, rounding up) available RBW to the value entered.
Notes	For numeric entries, all RBW Types choose the nearest (arithmetically, on a linear scale, rounding up) available RBW to the value entered.
Remote Command Notes	The setting and querying of values depends on the current bandwidth type.
Couplings	In Auto, the 3 dB RBW of the desired filter is the closest possible choice to that given by Span divided by 106 (the Span: 3 dB RBW parameter), except that the range for auto-coupling is restricted to not exceed 3 MHz.
Preset	Preset is Auto, which results in a 180 Hz value since the preset span is 20 kHz and the Span/RBW ratio is 106
State Saved	Saved in Instrument State
Min	1 Hz
Max	8 MHz
Default Unit	Hz
Initial S/W Revision	Prior to A.02.00
Modified at S/W Revision	A.10.00

File

See "File" on page 176

FREQ Channel

Accesses a menu of keys that enable you to control the Frequency parameters of the instrument.

Key Path	Front-panel key
Initial S/W Revision	Prior to A.02.00

Center Frequency

Sets the frequency that corresponds to the horizontal center of the RF Spectrum window. While adjusting the Center Frequency the Span is held constant, this means that both the start frequency and the stop frequency will change.

The Center Frequency is retained as you go from measurement to measurement.

Key Path	FREQ Channel
Remote Command	<code>[:SENSe] :FREQuency:CENTer <freq></code> <code>[:SENSe] :FREQuency:CENTer?</code>
Example	FREQ:CENT 50MHz FREQ:CENT UP changes the center frequency to 150 MHz if you use FREQ:CENT:STEP 100MHz sets the center frequency step size to 100 MHz FREQ:CENT?
Dependencies	The Center Frequency can be limited by Start or Stop Freq limits, In addition, the Center Frequency can be limited if the Span is so large that Start or Stop hit their limit.
Couplings	When operating in “swept span”, any value of the Center Frequency or Span that is within the frequency range of the analyzer is allowed when the value is being set through the front panel numeric key pad or the SCPI command. The other parameter is forced to a different value if needed, to keep the Start and the Stop Frequencies within the analyzer frequency range
Preset	1.000 GHz
State Saved	Saved in instrument state
Min	Depends on instrument minimum frequency and the 10 Hz minimum span. If the knob or step keys are being used, it depends on the value of the other three interdependent parameters.
Max	Depends on the instrument’s maximum frequency and the 10 Hz minimum span. If the knob or step keys are being used, it depends on the value of the other three interdependent parameters.
Default Unit	Hz
Status Bits/OPC dependencies	Non-overlapped
Initial S/W Revision	Prior to A.02.00

CF Step

Changes the step size for the center frequency function. Once a step size has been selected and the center frequency function is active, the step keys (and the UP|DOWN parameters for the Center Frequency from remote commands) change the center frequency by the step-size value. The step size function is useful for finding harmonics and sidebands beyond the current frequency span of the analyzer.

Key Path	FREQ Channel
Remote Command	<pre>[:SENSe] :FREQuency:CENTer:STEP[:INCRement] <freq> [:SENSe] :FREQuency:CENTer:STEP[:INCRement]? [:SENSe] :FREQuency:CENTer:STEP:AUTO OFF ON 0 1 [:SENSe] :FREQuency:CENTer:STEP:AUTO?</pre>
Example	<pre>FREQ:CENT:STEP:AUTO ON FREQ:CENT:STEP 500MHz FREQ:CENT UP increases the current center frequency value by 500 MHz FREQ:CENT:STEP? FREQ:CENT:STEP:AUTO?</pre>
Remote Command Notes	Preset and Max values are dependent on Hardware Options (503, 508, 513, 526)
Dependencies	Span, RBW, Center frequency
Couplings	When auto-coupled in a non-zero span, the center frequency step size is set to 10% of the span. When auto-coupled in zero span, the center frequency step size is set to the equivalent -3 dB RBW value.
Preset	Auto
State Saved	Saved in State
Min	– (the maximum frequency of the instrument). For example, a 27 GHz max frequency instrument has a CF step range of +/- 27 GHz.
Max	The maximum frequency of the instrument. For example, 27 GHz max freq instrument has a CF step range of +/- 27 GHz.
Default Unit	Hz
Status Bits/OPC dependencies	Non-overlapped
Initial S/W Revision	Prior to A.02.00

AF Start Freq

Sets the frequency at the left side of the graticule in the AF Spectrum window. While adjusting the AF start frequency the AF stop frequency is held constant.

The AF Start Frequency is retained as you go from measurement to measurement.

Key Path	FREQ Channel
Remote Command	<pre>[:SENSe] :AM FM PM FMSTereo:AFSPectrum:FREQuency:START <freq> [:SENSe] :AM FM PM FMSTereo:AFSPectrum:FREQuency:START?</pre>

Example	AM:AFSP:FREQ:STAR 0 Hz
Dependencies	You cannot set the Start frequency > the Stop frequency. You cannot set the Start frequency = Stop frequency. You cannot set the Start Frequency to a value that would create a span of less than 10 Hz. If you try to do any of these, Stop Frequency will change to maintain a minimum value of 10 Hz for the difference between Start and Stop.
Preset	0 Hz
State Saved	Saved in instrument state
Min	0 Hz
Max	99.999990 MHz
Default Unit	Hz
Status Bits/OPC dependencies	Non-overlapped
Initial S/W Revision	Prior to A.02.00
Modified at S/W Revision	A.10.00

AF Stop Freq

Sets the frequency at the right side of the graticule in the AF Spectrum window. While adjusting the AF Stop Frequency the AF Start Frequency is held constant.

Key Path	FREQ Channel
Remote Command	[:SENSe] :AM FM PM FMSTereo:AFSPectrum:FREQuency:STOP <freq> [:SENSe] :AM FM PM FMSTereo:AFSPectrum:FREQuency:STOP?
Example	AM:AFSP:FREQ:STOP 20 kHz
Dependencies	You cannot set the Stop frequency < the Start frequency. You cannot set the Start frequency = Stop frequency. You cannot set the Stop Frequency to a value that would create a span of less than 10 Hz. If you try to do any of these, the Start Frequency will change to maintain a minimum value of 10 Hz for the difference between Start and Stop.
Preset	20 kHz
State Saved	Saved in instrument state
Min	10 Hz
Max	100 MHz
Default Unit	Hz
Status Bits/OPC dependencies	Non-overlapped
Initial S/W Revision	Prior to A.02.00
Modified at S/W Revision	A.10.00

Input/Output

See "Input/Output" on page 130

Marker

Accesses the Marker menu. A marker can be placed on a trace to allow the value of the trace at the marker point to be determined precisely. The functions in this menu include a 1-of-N selection of the control mode Normal, Delta, Fixed, or Off for the selected marker.

If the selected marker is Off, pressing the Marker key sets it to the selected window. If the metrics window is selected, the marker will appear in the first visible window (RF Spectrum if Quad View is selected).

The units of Delta Marker are window dependent. In the Spectrum windows they are dB, in the Demod Waveform window they are the same as the Y-Axis Unit. In this window, the delta marker is a linear difference rather than a ratio. For example, in FM, in the Demod Waveform window, the units of delta marker are Hz.

Control Mode

Key Path	Front-panel key
Remote Command	:CALCulate:AM FM PM FMSTereo:MARKer[1] 2 ... 12:MODE POSition DELTA FIXed OFF :CALCulate:AM FM PM FMSTereo:MARKer[1] 2 ... 12:MODE?
Example	CALC:AM:MARK:MODE POS turns on marker 1 in Normal mode
Remote Command Notes	This command (not the query) causes the specified marker to become selected.
Preset	OFF (all markers)
Initial S/W Revision	Prior to A.02.00
Modified at S/W Revision	A.10.00

Select Marker

Displays a menu with 12 markers available for selection for the current measurement.

Key Path	Marker
Notes	The selected marker is remembered even when not in the Marker menu and is used if a Search is initiated.
Preset	Marker 1
State Saved	The number of the selected marker is saved in instrument state.
Initial S/W Revision	Prior to A.02.00

Normal

Sets the control mode for the selected marker to Normal and turns on the active function for setting its value. If the selected marker was off, it is placed at the center of the screen on the trace specified by the marker's Trace attribute.

A Normal mode (POSition type) marker can be moved to any point on the X Axis by specifying its X Axis value. Its absolute Y Axis value is then the value of the trace point at that X Axis value.

Key Path	Marker
Example	: CALC: MARK: MODE POS sets Marker 1 to Normal.
Remote Command Notes	See the description under the " Marker " on page 1101 key.
Couplings	The marker addressed by this command becomes the selected marker on the front panel.
State Saved	The marker control mode (Normal, Delta, Fixed, Off) and X Axis value are saved in instrument state.
Initial S/W Revision	Prior to A.02.00

Delta

Sets the control mode for the selected marker to Delta and turns on the active function for setting its delta value. If the selected marker is off, the marker is placed at the center of the screen on the trace specified by the marker's Trace attribute.

In Delta mode the marker result shows the relative result between the selected (Delta) marker and its reference marker. A delta marker can be moved to any point on the X Axis by specifying its X Axis offset from a reference marker. Its absolute Y Axis value is then the value of the trace point at that X Axis value.

Key Path	Marker
Example	:CALC:MARK:MODE DELT sets marker 1 to Delta.
Remote Command Notes	See the description under the " Marker " on page 1101 key.
Couplings	Coupled to fix absolute X when turned On.
State Saved	The marker control mode (Normal, Delta, Fixed, Off) and X Axis value are saved in instrument state.
Initial S/W Revision	Prior to A.02.00

Fixed

Sets the control mode for the selected marker to Fixed. A fixed marker is fixed in the sense that it stays where you place it. It can be directly moved in both X and Y. It can be moved with a Peak Search. It can also be indirectly moved by re-zeroing the delta if it is a relative marker. If it is moved, it again becomes fixed at the X Axis point it moved to and it has a Y-axis result that it took on when it moved there. If a Normal or Delta marker is changed to Fixed it becomes fixed at the X Axis point it was at, and with the Y-axis result it had when it was set to Fixed.

Key Path	Marker
Initial S/W Revision	Prior to A.02.00

Marker X

Sets and queries a marker's X value.

Key Path	Marker, Fixed
----------	---------------

Remote Command	:CALCulate:AM FM PM FMSTereo:MARKer[1] 2 ... 12:X <time> <freq> :CALCulate:AM FM PM FMSTereo:MARKer[1] 2 ... 12:X?
Remote Command Notes	The query is returned in the fundamental units for the current marker X Axis scale. This command (not the query) causes the specified marker to become selected.
Preset	After a preset, all Markers are turned off, so a Marker X Axis Value query will return not a number (9.91 e37). When a Marker is on, the default value of the Marker X value is the center of the appropriate window.
Min	-9.9E+37
Max	9.9E+37
Initial S/W Revision	Prior to A.02.00
Modified at S/W Revision	A.10.00

Marker Y

Sets and queries a marker's Y axis value.

Key Path	Marker, Fixed
Remote Command	:CALCulate:AM FM PM FMSTereo:MARKer[1] 2 ... 12:Y <real> :CALCulate:AM FM PM FMSTereo:MARKer[1] 2 ... 12:Y?
Remote Command Notes	The query is returned in the fundamental units for the current marker Y Axis scale. This command (not the query) causes the specified marker to become selected.
Preset	Defaults to the measurement result at the default X value, or not a number (9.91 e37) if off or if off screen is Fixed.
Min	-9.9E+37
Max	9.9E+37
Initial S/W Revision	Prior to A.02.00
Modified at S/W Revision	A.10.00

Off

Turns off the selected marker. Turning the marker off does not affect which marker is selected.

Key Path	Marker
Example	: CALC: MARK: MODE OFF sets Marker 1 to Off.
Remote Command Notes	See the description under the " Marker " on page 1101 key.
State Saved	The marker control mode (Normal, Delta, Fixed, Off) is saved in instrument state.
Initial S/W Revision	Prior to A.02.00

Properties

Accesses a menu used to assign properties to the selected marker.

Key Path	Marker
Initial S/W Revision	Prior to A.02.00

Select Marker

Displays a menu with 12 markers available for selection for the current measurement.

Key Path	Marker, Properties
Notes	The selected marker is remembered even when not in the Marker menu and is used if a Search is initiated.
Preset	Marker 1
State Saved	The number of the selected marker is saved in instrument state.
Initial S/W Revision	Prior to A.02.00

Relative To

Selects the reference marker for a marker in Delta mode.

If a delta marker has a reference marker in a different window, the delta marker's mode changes to POS (for example, it becomes a normal marker).

Key Path	Marker, Properties
Remote Command	:CALCulate:AM FM PM FMSTereo:MARKer[1] 2 ... 12:REFerence <int> :CALCulate:AM FM PM FMSTereo:MARKer[1] 2 ... 12:REFerence?
Example	CALC:AM:MARK1:REF 2 Sets marker 1's reference marker to 2 and turns marker 1 on as a delta marker.
Remote Command Notes	This command (not the query) causes the specified marker to become selected.
Preset	By default, marker X is relative to marker X + 1 except for marker 12, which is relative to marker 1.
Min	1
Max	12
Initial S/W Revision	Prior to A.02.00
Modified at S/W Revision	A.10.00

AM/FM/ Φ M Marker Trace

Selects the trace on which to place the marker. A marker is associated with one and only one trace. This trace is used to determine the placement, result, and X Axis Scale of the marker. All markers have an

associated trace, even Fixed markers. It is from that trace that they determine their attributes and behaviors, and it is to that trace that they go when they become Normal or Delta markers.

In the AM/ΦM measurements, there are five named traces, and in the FM measurement, there are seven named traces. The RF Spectrum trace is the trace in the RF Spectrum window, and the AF Spectrum trace is the trace in the AF Spectrum window. There are four traces in the Demod Waveform window: Demod, Demod Avg, Demod Max, and Demod Min. The RF Envelope trace and the Demod Raw trace are from Attack/Release Time view which is only available in the FM measurement. The RF Envelope trace is in the RF Envelope window and the Demod Raw trace is in the FM Demod Waveform window. When Auto Init is on, the marker's trace attribute is re-determined automatically by the analyzer whenever the marker turns on (Normal, Delta, or Fixed) from an off state. The marker goes to the trace in the window that has the focus, or onto the RF spectrum window if the Metrics window has the focus. If in the Demod Waveform window, it goes to the Demod trace.

This command associates the marker with the specified trace. Setting the Marker Trace directly (whether the marker is on or off) will turn off Auto Init.

If the marker is not off, it moves the marker from the trace it was on to the new trace. If the new trace is in the same window, the marker goes to the same data point on the new trace. If the marker changes windows, it retains its relative horizontal positions in the new window. If it is a fixed marker, it will retain both relative horizontal and vertical position.

If the marker is off it stays off, but is now associated with the specified trace.

The query returns the name of the trace on which the marker is currently placed.

Key Path	Marker, Properties
Remote Command	:CALCulate:AM FM PM:MARKer[1] 2 ... 12:TRACe RFSpectrum AFSPpectrum DEMod DAVerage DMAXimum DMINimum RFENvelope DRAW :CALCulate:AM FM PM:MARKer[1] 2 ... 12:TRACe?
Example	:CALC:AM:MARK1:TRAC DEM places marker 1 on the Demod trace
Couplings	This is not affected by Auto Coupling. Sending the remote command causes the addressed marker to become selected. If ever a delta marker has a reference marker in a different window, the delta marker's mode changes to POS (for example, it becomes a normal marker). When Marker Trace Auto Init State is on, the marker trace will automatically be set whenever the marker is turned on.
Preset	RF Spectrum on a Preset or All Markers Off
State Saved	The Marker Trace for each marker is saved in instrument state.
Readback line	[Trace name, Auto Init] or [Trace Name, Manual]
Initial S/W Revision	Prior to A.02.00

RF Spectrum

Selects the input RF signal in the RF Spectrum window as the trace on which you want to place your marker. This trace is used to determine the placement, result, and X Axis Scale of the marker.

Key Path	Marker, Properties, Marker Trace
Example	:CALC:AM:MARK1:TRAC RFSP
Initial S/W Revision	Prior to A.02.00

Demod

Selects the current demodulated signal in the Demod Waveform window, shown in yellow, as the trace on which you want to place your marker. This trace is used to determine the placement, result, and X Axis Scale of the marker.

Key Path	Marker, Properties, Marker Trace
Example	:CALC:AM:MARK1:TRAC DEM
Initial S/W Revision	Prior to A.02.00

Demod Average

Selects the averaged demodulation signal in the Demod Waveform window, shown in green, as the trace on which you want to place your marker. This trace is used to determine the placement, result, and X Axis Scale of the marker.

Key Path	Marker, Properties, Marker Trace
Example	:CALC:AM:MARK1:TRAC DAV
Initial S/W Revision	Prior to A.02.00

Demod Max

Selects the Demod Max trace in the Demod Waveform window, shown in cyan, as the trace on which you want to place your marker. This trace shows the maximum hold value for each data point since the last restart.

Key Path	Marker, Properties, Marker Trace
Example	:CALC:AM:MARK1:TRAC DMAX
Initial S/W Revision	Prior to A.02.00

Demod Min

Selects the Demod Min trace in the Demod Waveform window, shown in magenta, as the trace on which you want to place your marker. This trace shows the minimum hold value for each data point since the last restart.

Key Path	Marker, Properties, Marker Trace
Example	:CALC:AM:MARK1:TRAC DMIN
Initial S/W Revision	Prior to A.02.00

AF Spectrum

Selects the demodulated signal in the AF Spectrum window as the trace on which you want to place your marker.

Key Path	Marker, Properties, Marker Trace
Example	:CALC:AM:MARK1:TRAC AFSP
Initial S/W Revision	Prior to A.02.00

Trace Auto Init

Selects whether the marker trace is automatically reset to the selected window when the marker is turned on or not.

Key Path	Marker, Properties, Trace
Remote Command	:CALCulate:AM FM PM FMSTereo:MARKer [1] 2 ... 12:TRACe:AUTO OFF ON 0 1 :CALCulate:AM FM PM FMSTereo:MARKer [1] 2 ... 12:TRACe:AUTO?
Example	:CALC:AM:MARK1:TRAC:AUTO 0 turns off auto-initialization of marker trace.
Preset	On
State Saved	Saved in instrument state.
Readback line	Trace name
Initial S/W Revision	Prior to A.02.00
Modified at S/W Revision	A.10.00

Lines

When on, displays a vertical line of graticule height and a horizontal line of graticule width, intersecting at the indicator point of the marker (that is, the center of the X or the bottom tip of the diamond). The lines are blue in color.

If the marker is off screen, the lines should be extended from the marker so that they go through the screen area if possible. This is really useful for off screen Fixed markers as it lets you see their amplitude even though they are off the X Axis.

Key Path	Marker, Properties
Remote Command	:CALCulate:AM FM PM FMSTereo:MARKer [1] 2 ... 12:LINEs[:STATe] OFF ON

	0 1
	:CALCulate:AM FM PM FMSTereo:MARKer[1] 2 ... 12:LINes[:STATe]?
Example	CALC:AM:MARK2:LIN ON turns Lines on for marker 2.
Couplings	Sending the remote command causes the addressed marker to become selected.
Preset	OFF
State Saved	Saved in instrument state
Initial S/W Revision	Prior to A.02.00
Modified at S/W Revision	A.10.00

All Markers Off

Turns off all markers.

Key Path	Marker
Remote Command	:CALCulate:AM FM PM FMSTereo:MARKer:AOff
Example	CALC:AM:MARK:AOff turns off all markers for the AM measurement
Couplings	Sets the selected marker to 1.
Initial S/W Revision	Prior to A.02.00
Modified at S/W Revision	A.10.00

Marker Function

There are no menus or marker functions under this key in the Analog Demod mode.

Key Path	Front-panel key
Initial S/W Revision	Prior to A.02.00

Marker To

Accesses a menu that contains only the marker center frequency key.

Key Path	Front-panel key
Initial S/W Revision	Prior to A.02.00

Mkr->CF

Sets the center frequency of the RF Spectrum window to the frequency of the selected marker. The marker stays at this frequency, so it moves to the center of the display.

In delta marker mode, this function sets the center frequency to the x-axis value of the delta marker.

Key Path	Marker ->
Remote Command	:CALCulate:AM FM PM FMSTereo:MARKer[1] 2 ... 12[:SET]:CENTer
Example	CALC:AM:MARK2:CENT sets the CF of the analyzer to the value of marker 2.
Remote Command Notes	Sending this command selects the sub-op coded marker. If the currently selected marker is not on when this key is pressed, it will be turned on at the center of the RF Spectrum trace as a normal type marker.
Dependencies	This function is unavailable (key is grayed out) unless the selected marker's trace is off, or on the RF Spectrum trace.
Couplings	All the usual couplings associated with setting Center Frequency apply (see "Center Frequency" on page 1097).
Initial S/W Revision	Prior to A.02.00
Modified at S/W Revision	A.10.00

Meas

The information in this section is common to all measurements. For key and remote command information for a specific measurement, refer to the section that describes the measurement of interest.

Measurements available under the Meas key are specific to the current Mode.

When viewing Help for measurements, note the following:

NOTE

Operation for some keys differs between measurements. The information displayed in Help pertains to the current measurement. To see how a key operates in a different measurement, exit Help (press the Cancel Esc key), select the measurement, then reenter Help (press the Help key) and press that key.

Key Path	Front-panel key
Initial S/W Revision	Prior to A.02.00

Remote Measurement Functions

This section contains the following topics:

["Measurement Group of Commands" on page 1122](#)

["Current Measurement Query \(Remote Command Only\)" on page 1124](#)

["Limit Test Current Results \(Remote Command Only\)" on page 1124](#)

["Data Query \(Remote Command Only\)" on page 1124](#)

["Calculate/Compress Trace Data Query \(Remote Command Only\)" on page 1125](#)

["Calculate Peaks of Trace Data \(Remote Command Only\)" on page 1130](#)

["Hardware-Accelerated Fast Power Measurement \(Remote Command Only\)" on page 1131](#)

["Format Data: Numeric Data \(Remote Command Only\)" on page 1145](#)

["Format Data: Byte Order \(Remote Command Only\)" on page 1146](#)

Initial S/W Revision	Prior to A.02.00
----------------------	------------------

Measurement Group of Commands

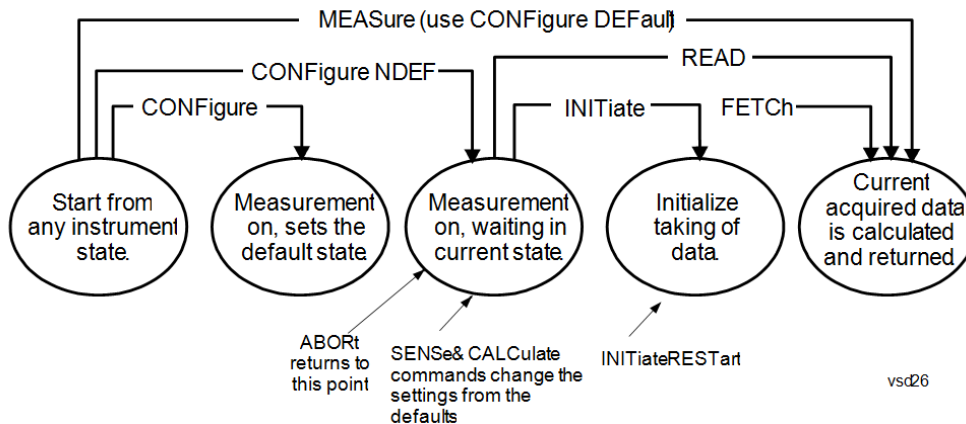

Measure Commands:

:MEASure:<measurement>[n]?

This is a fast single-command way to make a measurement using the factory default instrument settings. These are the settings and units that conform to the Mode Setup settings (e.g. radio standard) that you have currently selected.

- Stops the current measurement (if any) and sets up the instrument for the specified measurement using the factory defaults
- Initiates the data acquisition for the measurement
- Blocks other SCPI communication, waiting until the measurement is complete before returning results.
- If the function does averaging, it is turned on and the number of averages is set to 10.
- After the data is valid it returns the scalar results, or the trace data, for the specified measurement. The type of data returned may be defined by an [n] value that is sent with the command.
- The scalar measurement results will be returned if the optional [n] value is not included, or is set to 1. If the [n] value is set to a value other than 1, the selected trace data results will be returned. See each command for details of what types of scalar results or trace data results are available.
- ASCII is the default format for the data output. (Older versions of Spectrum Analysis and Phase Noise mode measurements only use ASCII.) The binary data formats should be used for handling large blocks of data since they are smaller and faster than the ASCII format. Refer to the FORMat:DATA command for more information.

If you need to change some of the measurement parameters from the factory default settings you can set up the measurement with the CONFigure command. Use the commands in the SENSe:<measurement> and CALCulate:<measurement> subsystems to change the settings. Then you can use the READ? command to initiate the measurement and query the results.

If you need to repeatedly make a given measurement with settings other than the factory defaults, you can use the commands in the SENSe:<measurement> and CALCulate:<measurement> subsystems to set up the measurement. Then use the READ? command to initiate the measurement and query results.

Measurement settings persist if you initiate a different measurement and then return to a previous one. Use READ:<measurement>? if you want to use those persistent settings. If you want to go back to the default settings, use MEASure:<measurement>?.

Configure Commands:

:CONFigure:<measurement>

This command stops the current measurement (if any) and sets up the instrument for the specified measurement using

the factory default instrument settings. It does not initiate the taking of measurement data unless INIT:CONTinuous is ON. If you change any measurement settings after using the CONFigure command, the READ command can be used to initiate a measurement without changing the settings back to their defaults.

In the Swept SA measurement in Spectrum Analyzer mode the CONFigure command also turns the averaging function on and sets the number of averages to 10 for all measurements.

:CONFigure: <measurement>: NDEFault stops the current measurement and changes to the specified measurement. It does not change the settings to the defaults. It does not initiate the taking of measurement data unless INIT:CONTinuous is ON.

The CONFigure? query returns the current measurement name.

The CONFigure:CATalog? query returns a quoted string of all licensed measurement names in the current mode. For example, "SAN, CHP, OBW, ACP, PST, TXP, SPUR, SEM, LIST".

Fetch Commands:

:FETCh:<measurement>[n]?

This command puts selected data from the most recent measurement into the output buffer. Use FETCh if you have already made a good measurement and you want to return several types of data (different [n] values, for example, both scalars and trace data) from a single measurement. FETCh saves you the time of re-making the measurement. You can only FETCh results from the measurement that is currently active, it will not change to a different measurement. An error message is reported if a measurement other than the current one is specified.

If you need to get new measurement data, use the READ command, which is equivalent to an INITiate followed by a FETCh.

The scalar measurement results will be returned if the optional [n] value is not included, or is set to 1. If the [n] value is set to a value other than 1, the selected trace data results will be returned. See each command for details of what types of scalar results or trace data results are available. The binary data formats should be used for handling large blocks of data since they are smaller and transfer faster than the ASCII format. (FORMat:DATA)

FETCh may be used to return results other than those specified with the original READ or MEASure command that you sent.

INITiate Commands:

:INITiate:<measurement>

This command is not available for measurements in all the instrument modes:

- Initiates a trigger cycle for the specified measurement, but does not output any data. You must then use the FETCh<meas> command to return data. If a measurement other than the current one is specified, the instrument will switch to that measurement and then initiate it.
 - For example, suppose you have previously initiated the ACP measurement, but now you are running the channel power measurement. If you send INIT:ACP? it will change from channel power to ACP and will initiate an ACP measurement.
 - Does not change any of the measurement settings. For example, if you have previously started the ACP measurement and you send INIT:ACP? it will initiate a new ACP measurement using the same instrument settings as the last time ACP was run.
 - If your selected measurement is currently active (in the idle state) it triggers the measurement, assuming the trigger conditions are met. Then it completes one trigger cycle. Depending upon the measurement and the number of averages, there may be multiple data acquisitions, with multiple trigger events, for one full trigger cycle. It also holds off additional commands on GPIB until the acquisition is complete.
-

READ Commands:

:READ:<measurement>[n]?

- Does not preset the measurement to the factory default settings. For example, if you have previously initiated the ACP
-

measurement and you send READ:ACP? it will initiate a new measurement using the same instrument settings.

- Initiates the measurement and puts valid data into the output buffer. If a measurement other than the current one is specified, the instrument will switch to that measurement before it initiates the measurement and returns results.
 - For example, suppose you have previously initiated the ACP measurement, but now you are running the channel power measurement. Then you send READ:ACP? It will change from channel power back to ACP and, using the previous ACP settings, will initiate the measurement and return results.
 - Blocks other SCPI communication, waiting until the measurement is complete before returning the results
 - If the optional [n] value is not included, or is set to 1, the scalar measurement results will be returned. If the [n] value is set to a value other than 1, the selected trace data results will be returned. See each command for details of what types of scalar results or trace data results are available. The binary data formats should be used when handling large blocks of data since they are smaller and faster than the ASCII format. (FORMat:DATA)
-

Initial S/W Revision	Prior to A.02.00
----------------------	------------------

Current Measurement Query (Remote Command Only)

This command returns the name of the measurement that is currently running.

Remote Command	:CONFigure?
-----------------------	-------------

Example	CONF?
----------------	-------

Initial S/W Revision	Prior to A.02.00
----------------------	------------------

Limit Test Current Results (Remote Command Only)

Queries the status of the current measurement limit testing. It returns a 0 if the measured results pass when compared with the current limits. It returns a 1 if the measured results fail any limit tests.

Remote Command	:CALCulate:CLIMits:FAIL?
-----------------------	--------------------------

Example	CALC:CLIM:FAIL? queries the current measurement to see if it fails the defined limits. Returns a 0 or 1: 0 it passes, 1 it fails.
----------------	--

Initial S/W Revision	Prior to A.02.00
----------------------	------------------

Data Query (Remote Command Only)

Returns the designated measurement data for the currently selected measurement and subopcode.

n = any valid subopcode for the current measurement. See the measurement command results table for your current measurement, for information about what data is returned for the subopcodes.

This command uses the data setting specified by the FORMat:BORDER and FORMat:DATA commands and can return real or ASCII data. (See the format command descriptions under Input/Output in the Analyzer Setup section.)

Remote Command	:CALCulate:DATA[n]?
Notes	The return trace depends on the measurement. In CALCulate:<meas>:DATA[n], n is any valid subopcode for the current measurement. It returns the same data as the FETCH:<measurement>? query where <measurement> is the current measurement.
Initial S/W Revision	Prior to A.02.00

Calculate/Compress Trace Data Query (Remote Command Only)

Returns compressed data for the currently selected measurement and sub-opcode [n].

n = any valid sub-opcode for that measurement. See the MEASure:<measurement>? command description of your specific measurement for information on the data that can be returned.

The data is returned in the current Y Axis Unit of the analyzer. The command is used with a sub-opcode <n> (default=1) to specify the trace. With trace queries, it is best if the analyzer is not sweeping during the query. Therefore, it is generally advisable to be in Single Sweep, or Update=Off.

This command is used to compress or decimate a long trace to extract and return only the desired data. A typical example would be to acquire N frames of GSM data and return the mean power of the first burst in each frame. The command can also be used to identify the best curve fit for the data.

Remote Command	:CALCulate:DATA<n>:COMPRESS? BLOCK CFIT MAXimum MINimum MEAN DMEan RMS RMSCubed SAMPLE SDEVIation PPHase [,<soffset> [,<length>[,<roffset>[,<rlimit>]]]]
Example	To query the mean power of a set of GSM bursts: Supply a signal that is a set of GSM bursts. Select the IQ Waveform measurement (in IQ Analyzer Mode). Set the sweep time to acquire at least one burst. Set the triggers such that acquisition happens at a known position relative to a burst. Then query the mean burst levels using, CALC:DATA2:COMP? MEAN, 24e-6, 526e-6 (These parameter values correspond to GSM signals, where 526e-6 is the length of the burst in the slot and you just want 1 burst.)
Notes	The command supports 5 parameters. Note that the last 4 (<soffset>, <length>, <roffset>, <rlimit>) are optional. But these optional parameters must be entered in the specified order. For example, if you want to specify <length>, then you must also specify <soffset>. See details below for a definition of each of these parameters. This command uses the data in the format specified by FORMat:DATA, returning either binary or ASCII data.
Initial S/W Revision	Prior to A.02.00

- BLOCK or block data - returns all the data points from the region of the trace data that you specify. For example, it could be used to return the data points of an input signal over several timeslots, excluding the portions of the trace data that you do not want. (This is x,y pairs for trace data and I,Q pairs for complex data.)

- CFIT or curve fit - applies curve fitting routines to the data. <soffset> and <length> are required to define the data that you want. <roffset> is an optional parameter for the desired order of the curve equation. The query will return the following values: the x-offset (in seconds) and the curve coefficients ((order + 1) values).

MIN, MAX, MEAN, DME, RMS, RMSC, SAMP, SDEV and PPH return one data value for each specified region (or <length>) of trace data, for as many regions as possible until you run out of trace data (using <roffset> to specify regions). Or they return the number of regions you specify (using <rlimit>) ignoring any data beyond that.

- MINimum - returns the minimum data point (y value) for the specified region(s) of trace data. For I/Q trace data, the minimum magnitude of the I/Q pairs is returned.
- MAXimum - returns the maximum data point (y value) for the specified region(s) of trace data. For I/Q trace data, the maximum magnitude of the I/Q pairs is returned.
- MEAN - returns a single value that is the arithmetic mean of the data point values (in dB/ dBm) for the specified region(s) of trace data. For I/Q trace data, the mean of the magnitudes of the I/Q pairs is returned. See the following equations.

•

NOTE

If the original trace data is in dB, this function returns the arithmetic mean of those log values, not log of the mean power which is a more useful value. The mean of the log is the better measurement technique when measuring CW signals in the presence of noise. The mean of the power, expressed in dB, is useful in power measurements such as Channel Power. To achieve the mean of the power, use the RMS option.

Equation 1

Mean Value of Data Points for Specified Region(s)

$$\text{MEAN} = \frac{1}{n} \sum_{X_i \in \text{region}(s)} X_i$$

where X_i is a data point value, and n is the number of data points in the specified region(s).

Equation 2

Mean Value of I/Q Data Pairs for Specified Region(s)

$$\text{MEAN} = \frac{1}{n} \sum_{X_i \in \text{region}(s)} |X_i|$$

where $|X_i|$ is the magnitude of an I/Q pair, and n is the number of I/Q pairs in the specified region(s).

- DMEan - returns a single value that is the mean power (in dB/ dBm) of the data point values for the specified region(s) of trace data. See the following equation:

Equation 3

DMEan Value of Data Points for Specified Region(s)

$$\text{DME} = 10 \times \log_{10} \left(\frac{1}{n} \sum_{X_i \in \text{region}(s)} 10^{\frac{X_i}{10}} \right)$$

- RMS - returns a single value that is the average power on a root-mean-squared voltage scale (arithmetic rms) of the data point values for the specified region(s) of trace data. See the following equation.

NOTE For I/Q trace data, the rms of the magnitudes of the I/Q pairs is returned. See the following equation. This function is very useful for I/Q trace data. However, if the original trace data is in dB, this function returns the rms of the log values which is not usually needed.

Equation 4

RMS Value of Data Points for Specified Region(s)

$$\text{RMS} = \sqrt{\frac{1}{n} \sum_{X_i \in \text{region}(s)} X_i^2}$$

where X_i is a data point value, and n is the number of data points in the specified region(s).

Equation 5

RMS Value of I/Q Data Pairs for Specified Region(s)

$$\text{RMS} = \sqrt{\frac{1}{n} \sum_{X_i \in \text{region}(s)} X_i X_i^*}$$

where X_i is the complex value representation of an I/Q pair, X_i^* its conjugate complex number, and n is the number of I/Q pairs in the specified region(s).

Once you have the rms value for a region of trace data (linear or I/Q), you may want to calculate the mean power. You must convert this rms value (peak volts) to power in dBm:

$$10 \times \log[10 \times (\text{rms value})^2]$$

- SAMPLe - returns the first data value (x,y pair) for the specified region(s) of trace data. For I/Q trace data, the first I/Q pair is returned.
- SDEViation - returns a single value that is the arithmetic standard deviation for the data point values for the specified region(s) of trace data. See the following equation.
- For I/Q trace data, the standard deviation of the magnitudes of the I/Q pairs is returned. See the following equation.

Equation 6

Standard Deviation of Data Point Values for Specified Region(s)

$$\text{SDEV} = \sqrt{\frac{1}{n} \sum_{X_i \in \text{region}(s)} (X_i - \bar{X})^2}$$

where X_i is a data point value, \bar{X} is the arithmetic mean of the data point values for the specified region (s), and n is the number of data points in the specified region(s).

$$\text{SDEV} = \sqrt{\frac{1}{n} \sum_{X_i \in \text{region}(s)} (|X_i| - \bar{X})^2}$$

where $|X_i|$ is the magnitude of an I/Q pair, \bar{X} is the mean of the magnitudes for the specified region(s), and n is the number of data points in the specified region(s).

- PPHase - returns the x,y pairs of both rms power (dBm) and arithmetic mean phase (radian) for every specified region and frequency offset (Hz). The number of pairs is defined by the specified number of regions. This parameter can be used for I/Q vector ($n=0$) in Waveform (time domain) measurement and all parameters are specified by data point in PPHase.

The rms power of the specified region may be expressed as:

$$\text{Power} = 10 \times \log [10 \times (\text{RMS I/Q value})] + 10.$$

The RMS I/Q value (peak volts) is:

$$\sqrt{\frac{1}{n} \sum_{X_i \in \text{region}} X_i X_i^*}$$

where X_i is the complex value representation of an I/Q pair, X_i^* its conjugate complex number, and n is the number of I/Q pairs in the specified region.

The arithmetic mean phase of the specified region may be expressed as:

$$\frac{1}{n} \sum_{Y_i \in \text{region}} Y_i$$

where Y_i is the unwrapped phase of I/Q pair with applying frequency correction and n is the number of I/Q pairs in the specified region.

The frequency correction is made by the frequency offset calculated by the arithmetic mean of every specified region's frequency offset. Each frequency offset is calculated by the least square method against the unwrapped phase of I/Q pair.

Sample Trace Data - Constant Envelope

(See below for explanation of variables.)

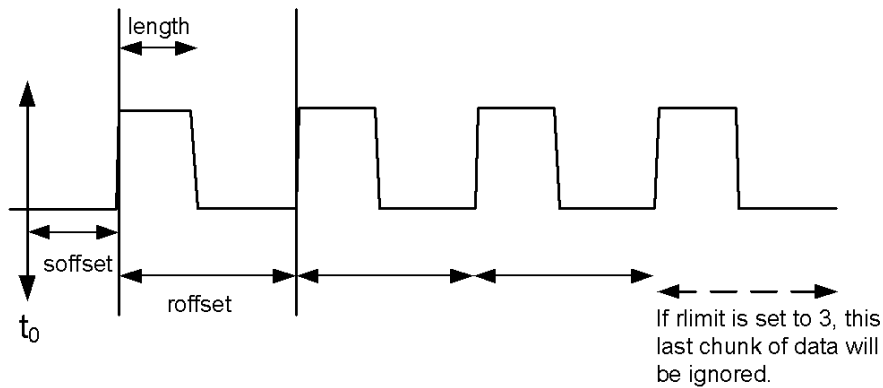

Sample Trace Data - Not Constant Envelope

(See below for explanation of variables.)

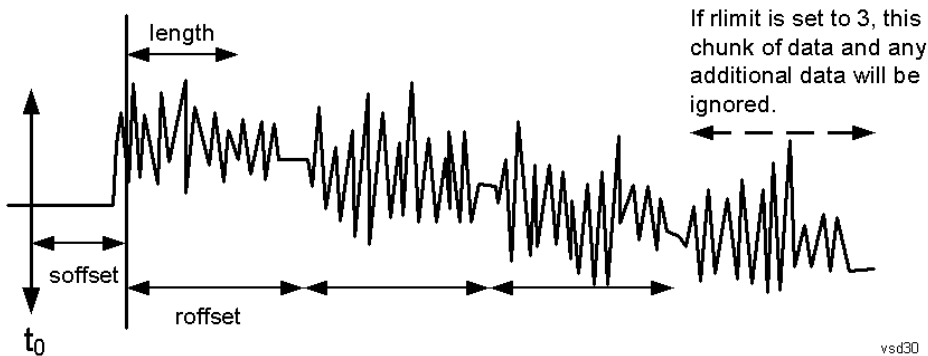

<soffset> - start offset is an optional real number. (It is in seconds for time-domain traces, and is a dimensionless index 0 to Npoints - 1, for frequency-domain traces). It specifies the amount of data at the beginning of the trace that will be ignored before the decimation process starts. It is the time or frequency change from the start of the trace to the point where you want to start using the data. The default value is zero.

<length> - is an optional real number. (It is in seconds for time-domain traces, and is a dimensionless index 0 to Npoints - 1, for frequency-domain traces). It defines how much data will be compressed into one value. This parameter has a default value equal to the current trace length.

<roffset> - repeat offset is an optional real number. (It is in seconds for time-domain traces, and is a dimensionless index 0 to Npoints - 1, for frequency-domain traces). It defines the beginning of the next field of trace elements to be compressed. This is relative to the beginning of the previous field. This parameter has a default value equal to the <length> variable. Note that this parameter is used for a completely different purpose when curve fitting (see CFIT above).

<rlimit> - repeat limit is an optional integer. It specifies the number of data items that you want returned. It will ignore any additional items beyond that number. You can use the Start offset and the Repeat limit to pick out exactly what part of the data you want to use. The default value is all the data.

Calculate Peaks of Trace Data (Remote Command Only)

Returns a list of all the peaks for the currently selected measurement and sub-opcode [n]. The peaks must meet the requirements of the peak threshold and excursion values.

n = any valid sub-opcode for the current measurement. See the MEASure:<measurement> command description of your specific measurement for information on the data that can be returned.

The command can only be used with specific sub-opcodes with measurement results that are trace data. Both real and complex traces can be searched, but complex traces are converted to magnitude in dBm. In many measurements the sub-opcode n=0, is the raw trace data which cannot be searched for peaks. And Sub-opcode n=1, is often calculated results values which also cannot be searched for peaks.

This command uses the data setting specified by the FORMat:BORDER and FORMat:DATA commands and can return real or ASCII data. If the format is set to INT,32, it returns REAL,32 data.

The command has four types of parameters:

- Threshold (in dBm)
- Excursion (in dB)
- Sorting order (amplitude, frequency, time)
- Optional in some measurements: Display line use (all, > display line, < display line)

Remote Command	<p>For Swept SA measurement:</p> <pre>:CALCulate:DATA[1] 2 ... 6:PEAKs? <threshold>,<excursion>[,AMPLitude FREQuency TIME[,ALL GTDLline LTDLine]]</pre> <p>For most other measurements:</p> <pre>:CALCulate:DATA[1] 2 ... 6:PEAKs? <threshold>,<excursion>[,AMPLitude FREQuency TIME]</pre>
-----------------------	---

Example	<p>Example for Swept SA measurement in Spectrum Analyzer Mode:</p> <p>CALC:DATA4:PEAK? -40, 10, FREQ, GTDL This will identify the peaks of trace 4 that are above -40 dBm, with excursions of at least 10 dB. The peaks are returned in order of increasing frequency, starting with the lowest frequency. Only the peaks that are above the display line are returned.</p> <p>Query Results 1:</p> <p>With FORMat:DATA REAL, 32 selected, it returns a list of floating-point numbers. The first value in the list is the number of peak points that are in the following list. A peak point consists of two values: a peak amplitude followed by its corresponding frequency (or time).</p> <p>If no peaks are found the peak list will consist of only the number of peaks, (0).</p>
----------------	---

Notes	<p><n> - is the trace that will be used</p> <p><threshold> - is the level below which trace data peaks are ignored. Note that the threshold value is required and is always used as a peak criterion. To effectively disable the threshold criterion for this command, provide a substantially low threshold value such as -200 dBm. Also note that the threshold value used in this command is independent of and has no effect on the threshold value stored under the Peak Criteria menu.</p> <p><excursion> - is the minimum amplitude variation (rise and fall) required for a signal to be identified as peak. Note that the excursion value is required and is always used as a peak criterion. To effectively disable the excursion criterion for this command, provide the minimum value of 0.0 dB. Also note that the excursion value used in this command is independent of and has no effect on the</p>
--------------	---

excursion value stored under the Peak Criteria menu.

Values must be provided for threshold and excursion. The sorting and display line parameters are optional (defaults are AMPLitude and ALL).

Note that there is always a Y-axis value for the display line, regardless of whether the display line state is on or off. It is the current Y-axis value of the display line which is used by this command to determine whether a peak should be reported

Sorting order:

AMPLitude - lists the peaks in order of descending amplitude, with the highest peak first (default if optional parameter not sent)

FREQuency - lists the peaks in order of occurrence, left to right across the x-axis.

TIME - lists the peaks in order of occurrence, left to right across the x-axis.

Peaks vs. Display Line:

ALL - lists all of the peaks found (default if optional parameter not sent).

GTDLine (greater than display line) - lists all of the peaks found above the display line.

LTDLine (less than display line) - lists all of the peaks found below the display line.

Initial S/W Revision	Prior to A.02.00
----------------------	------------------

Hardware-Accelerated Fast Power Measurement (Remote Command Only)

The Fast Power option (FP2) enables very fast channel power measurements for instruments with the prerequisite hardware (DP2 and/or B40). It accomplishes this by performing real-time overlapped FFTs at the hardware layer, using software for basic post-processing before returning the result to the user. The upshot of this approach is improved throughput for user applications that require many sequential power measurements.

The analysis bandwidth of FP2 is limited by the licenses in the instrument, but its maximum overall analysis bandwidth per acquisition is 40 MHz.

FP2 is remote-only, which means the instrument does not switch to any particular mode or measurement. FP2 commands can be sent while another application is in use on the front panel.

Each Fast Power measurement can be predefined using an array index, and up to 1,000 measurements can be stored. In the following documentation, instances of [1,2,...,999] can be substituted with a particular measurement index, e.g. CALC:FPOW:POW1?, CALC:FPOW:POW2?, CALC:FPOW:POW134?. In this way, power measurements can be defined one time in a batch, and then executed multiple times without having to redefine them, similar to “list mode” on other measurements.

In addition to basic channel power measurements, there are a number of other measurement “functions” for each channel, including peak power, peak frequency, and power spectral density. See the Function parameter for more information.

Reset Fast Power Measurement (Remote Command Only)

Resets the measurement configuration to the defaults.

Mode	All
Remote Command	:CALCulate:FPOWer:POWer [1, 2, ..., 999] :RESet
Example	:CALC:FPOW:POW1:RES

Notes	Option FP2 is required.
Initial S/W Revision	A.14.00

Define Fast Power Measurement (Remote Command Only)

Fast Power acquisitions are configured using the DEFine command. This command accepts a comma-delimited string of configuration parameters and their appropriate values, which are all specified in the subsection below.

Mode	All
Remote Command	:CALCulate:FPOWer:POWer[1,2,...,999]:DEFine "configuration string"
Example	:CALC:FPOW:POW1:DEF "CenterFrequency=2e9, AcquisitionTime=0.005"
Notes	See below for a list of measurement variables that can be defined in the configuration string.
Initial S/W Revision	A.14.00

Acquisition Time

Example	CALC:FPOW:POW1:DEF "AcquisitionTime=0.002"
Notes	The acquisition time parameter sets the time in which the entire spectrum is measured. An increase in the acquisition time yields an improvement in measurement repeatability.
Preset	0.001 s
Range	0 s to 1 s
Default Unit	Time (s)
Initial S/W Revision	A.14.00

Center Frequency

Example	CALC:FPOW:POW1:DEF "CenterFrequency=2e9"
Notes	The center frequency parameter sets the frequency in which the measurement is centered around. The OffsetFrequency parameter is calculated relative to the center frequency.
Preset	1 GHz
Range	0 Hz to maximum instrument frequency
Default Unit	Frequency (Hz)
Initial S/W Revision	A.14.00

DC Coupled

Example	CALC:FPOW:POW1:DEF "DCCoupled=True"
Notes	The DC coupled parameter allows the user to specify whether the DC blocking capacitor is utilized. Set parameter to true when measuring frequencies below 10 MHz.
Preset	False
Range	True (DC Coupled) or False (AC Coupled)
Default Unit	Boolean
Initial S/W Revision	A.14.00

DetectorType

Example	CALC:FPOW:POW1:DEF "DetectorType=Peak"
Notes	Option FP2 is required. The detector type parameter allows the user to choose whether a RMS average or peak value is used during the measurement.
Preset	RmsAverage
Range	RmsAverage, Peak
Initial S/W Revision	A.14.00

Do Noise Correction

Example	CALC:FPOW:POW1:DEF "DoNoiseCorrection=True"
Notes	When noise correction is enabled, the linear noise power contributed by the analyzer is subtracted from all measurements. This effectively lowers the noise floor of the analyzer. When noise correction is enabled, the first measurement for a given set of input parameters will take extra time. This is because the analyzer takes an extra acquisition with the RF input disconnected from the analyzer's front end to measure the noise of just the analyzer. The measured noise floor is stored in a cache so the noise acquisition will occur only once for the same state settings. In other words, if noise correction was turned on and the analyzer made an acquisition at frequency A, then frequency B, and back again to frequency A, the hidden initial noise floor acquisition would only occur for the first acquisition at frequency A and the cached noise floor would be used the second time frequency A was measured.
Preset	False
Range	True (enable noise correction) or False (disable noise correction)
Default Unit	Boolean
Initial S/W Revision	A.14.00

Do Spur Suppression

Example	CALC:FPOW:POW1:DEF "DoSpurSuppression=True"
Notes	<p>When measuring very low level signals, or when large out-of-band inputs are input into the analyzer, sometimes unwanted spurs and residuals can appear in the measured spectrum. Spur suppression is a method to help minimize the levels of these internally generated spurs and residuals.</p> <p>When spur suppression is enabled, the analyzer will automatically take two acquisitions using two different internal analog LO frequencies. The FFT spectrums from both acquisitions are combined by taking the minimum power between both traces on a per FFT bin basis. External signals will have the same amplitude for both traces and therefore will return the expected amplitudes. However, low level spurs and residuals generated internally to the analyzer tend to move to different FFT bins depending on the internal analog LO frequency used, and therefore tend to be suppressed using this spur suppression method.</p> <p>Because two acquisitions, rather than a single acquisition, are made when spur suppression is enabled, the measurement time will always be slower when spur suppression is enabled.</p>
Preset	False
Range	True (enable spur suppression) or False (disable spur suppression)
Default Unit	Boolean
Initial S/W Revision	A.14.00

Electronic Attenuator Bypass

Example	CALC:FPOW:POW1:DEF "ElecAttBypass =False"
Notes	The electronic attenuation bypass parameter allows the user to either utilize or bypass the electronic attenuator. The electronic attenuator is only available for frequencies up to 3.6 GHz. Set parameter to true when using frequencies above 3.6 GHz and set the parameter to false when using the preamp.
Preset	True
Range	True (bypass electronic attenuator) or False (use electronic attenuator)
Default Unit	Boolean
Initial S/W Revision	A.14.00

Electronic Attenuation

Example	CALC:FPOW:POW1:DEF "ElecAttenuation=10"
Notes	<p>Option EA3 is required.</p> <p>The electronic attenuation value parameter sets the amount of electrical attenuation from 0 to 24 dB (1 dB steps).</p> <p>Set "ElecAttBypass=False" to make sure the electronic attenuator path is enabled.</p>
Preset	0 dB
Range	0 - 24 dB (1 dB steps)

Default Unit	dB
Initial S/W Revision	A.14.00

IF Gain

Example	CALC:FPOW:POW1:DEF "IFGain=10"
Notes	The IF gain parameter allows the user to specify the gain at the IF stage anywhere from -6 to 16 dB (1 dB steps). This is an advanced feature, and for most cases this should remain at its default value of 0 dB.
Preset	0 dB
Range	-6 - 16 dB (1 dB steps)
Default Unit	dB
Initial S/W Revision	A.14.00

IF Type

Example	CALC:FPOW:POW1:DEF "IFType=B25M"
Notes	The IF type parameter allows the user to select between different IF paths. For example, if the signal is less than 25 MHz wide, then the user can select the B25M path to take advantage of additional filtering on this analog IF path.
Preset	B40M
Range	B10M, B25M, B40M
Initial S/W Revision	A.14.00

Include Power Spectrum

Example	CALC:FPOW:POW1:DEF "IncludePowerSpectrum=True"
Notes	The power spectrum parameter allows the user to read data on the entire spectrum for diagnostic purposes. It is not recommended for production use. See CALC:FPOW:POW[n]:READ2? for details on the binary format of the response.
Preset	False
Range	True (return both channel power and full power spectrum) or False (returns only channel power)
Default Unit	Boolean
Initial S/W Revision	A.14.00

Mechanical Attenuation

Example	CALC:FPOW:POW1:DEF "MechAttenuation=10"
Notes	The mechanical attenuation value parameter sets the amount of mechanical attenuation anywhere from 0 to 70 dB (2 dB steps).
Preset	0 dB
Range	0 – 70 dB (2 dB steps)
Default Unit	dB
Initial S/W Revision	A.14.00

Preamp Mode

Example	CALC:FPOW:POW1:DEF "PreAmpMode=Low"
Notes	The license for the appropriate preamp is required. The preamp mode parameter specifies whether the preamps are being utilized. Low allows any preamps up to 3.6 GHz, and Full allows all licensed preamps. Set "ElecAttBypass=True" in order to utilize any preamps.
Preset	Off
Range	Off, Low, Full
Initial S/W Revision	A.14.00

Resolution Bandwidth Mode

Example	CALC:FPOW:POW1:DEF "PreAmpMode=Low"
Notes	The resolution bandwidth mode parameter allows the user to choose whether the RBW filter is automatically or manually set. The BestSpeed value minimizes measurement time, while the Narrowest value minimizes RBW size (minimum of two FFT bins per RBW). To manually specify an RBW, set this parameter to Explicit, and set the ResolutionBW parameter to the desired value.
Preset	BestSpeed
Range	BestSpeed, Narrowest, Explicit
Initial S/W Revision	A.14.00

Resolution Bandwidth

Example	CALC:FPOW:POW1:DEF "ResolutionBW=25e3"
Notes	The resolution bandwidth parameter sets the 3-dB bandwidth of the RBW filter. The ResolutionBWMode parameter must be set to Explicit in order to manually set the RBW.

Preset	0 Hz
Default Unit	Hz
Initial S/W Revision	A.14.00

Trigger Delay

Example	CALC:FPOW:POW1:DEF "TriggerDelay=0.025"
Notes	The trigger delay parameter sets the time after an external trigger is detected until the measurement is performed.
Preset	0 s
Range	0 - 1 s
Default Unit	Seconds
Initial S/W Revision	A.14.00

Trigger Level

Example	CALC:FPOW:POW1:DEF "TriggerLevel=2"
Notes	The trigger level parameter sets the voltage value at which an external trigger is detected.
Preset	1.2 V
Range	-5 to 5 V
Default Unit	Volts
Initial S/W Revision	A.14.00

Trigger Slope

Example	CALC:FPOW:POW1:DEF "TriggerSlope=Negative"
Notes	The trigger slope parameter indicates the direction of the edge trigger voltage for detection.
Preset	Positive
Range	Positive, Negative
Initial S/W Revision	A.14.00

Trigger Source

Example	CALC:FPOW:POW1:DEF "TriggerSource=Ext1"
Notes	The trigger source parameter allows the user to choose between measurement's triggering freely or controlled by an external input. Ext1 and Ext2 correspond to Trigger 1 In and Trigger 2 In, respectively.
Preset	Free
Range	Free, Ext1, Ext2
Initial S/W Revision	A.14.00

Trigger Timeout

Example	CALC:FPOW:POW1:DEF "TriggerTimeout=0.1"
Notes	The trigger timeout parameter sets the time in which the analyzer will wait for a trigger before automatically performing the measurement.
Preset	1 s
Range	0 – 1 s
Default Unit	Seconds
Initial S/W Revision	A.14.00

Signal Input

Example	CALC:FPOW:POW1:DEF "SignalInput=Fp50MHzCW"
Notes	The signal input parameter allows the user to select between using the main RF input or the internal analyzer reference CW signal of 50 MHz.
Preset	FpMainRf
Range	FpMainRf, Fp50MHzCW
Initial S/W Revision	A.14.00

Use Preselector

Example	CALC:FPOW:POW1:DEF "UsePreSelector=True"
Notes	The preselector parameter allows the user to either utilize or bypass the front end tunable filter at frequencies above 3.6 GHz. For frequencies below 3.6 GHz, the preselector is automatically bypassed, so you do not need to set this parameter to False in those cases.
Preset	False
Range	True (use preselector above 3.6 GHz), or False (preselector bypassed)

Default Unit	Boolean
Initial S/W Revision	A.14.00

Channel Bandwidth Array

Example	CALC:FPOW:POW1:DEF "Bandwidth=[3.84e6, 5e6, 3.84e6]"
Notes	The bandwidth parameter array defines the bandwidth of each channel that will be measured. All array parameters should have the same number of elements. Alternatively, if all the elements are the same value, a single number with no square brackets can be used to define the parameter.
Preset	[1e6]
Range	0 to 40 MHz
Default Unit	Hz
Initial S/W Revision	A.14.00

Channel Filter Type Array

Example	CALC:FPOW:POW1:DEF "FilterType=[RRC, IBW, RRC]"
Notes	The filter type parameter allows the user to choose between an integration bandwidth (IBW) filter or a root-raised-cosine (RRC) filter. The integration bandwidth filter weighs all frequencies within the bandwidth equally. The root-raised-cosine filter has an associated shape parameter, defined by the FilterAlpha parameter. All array parameters should have the same number of elements. Alternatively, if all the elements are the same value, a single value with no square brackets can be used to define the parameter.
Preset	[IBW]
Range	IBW, RRC
Initial S/W Revision	A.14.00

Channel Filter Alpha Array

Example	CALC:FPOW:POW1:DEF "FilterAlpha=[0.5, 0.0, 0.5]"
Notes	The filter alpha parameter allows the user to adjust the alpha value associated with the root-raised-cosine (RRC) filter type. Set FilterType to RRC in order to utilize this parameter. All array parameters should have the same number of elements. Alternatively, if all the elements are the same value, a single number with no square brackets can be used to define the parameter.
Preset	[0.22]
Range	0.0 – 1.0
Initial S/W Revision	A.14.00

Channel Measurement Function Array

Example	CALC:FPOW:POW1:DEF "Function=[BandPower, PeakPower, BandPower]"
Notes	<p>This parameter array defines what measurement is being made for each individually-specified channel:</p> <p>BandPower: Total power within the specified bandwidth of the channel (dBm)</p> <p>BandDensity: Total power density within the specified bandwidth of the channel (dBm/Hz)</p> <p>PeakPower: The peak power value within the specified bandwidth of the channel (dBm)</p> <p>PeakFrequency: The frequency which corresponds to the peak power value within the specified bandwidth of the channel. This frequency is relative to the center frequency (Hz)</p> <p>XdBBandwidth: The half power (-3.01 dB) bandwidth of the highest amplitude signal that resides within the channel (Hz), dB is configurable using XdBBandwidth parameter</p> <p>OccupiedBandwidth: The bandwidth at which 99% of the total power resides within the channel (Hz), percentage configurable using OccupiedBandwidthPercent parameter</p> <p>All array parameters should have the same number of elements. Alternatively, if all the elements are the same value, a single value with no square brackets can be used to define the parameter.</p>
Preset	[BandPower]
Range	BandPower, BandDensity, PeakPower, PeakFrequency, XdBBandwidth, OccupiedBandwidth
Initial S/W Revision	A.14.00

Channel Offset Frequency Array

Example	CALC:FPOW:POW1:DEF "OffsetFrequency=[-5e6, 0, 5e6]"
Notes	<p>The offset frequency parameter array defines the difference between the center frequency to the center frequency of each channel.</p> <p>All array parameters should have the same number of elements.</p>
Preset	[0]
Range	0 to 20 MHz
Default Unit	Hz
Initial S/W Revision	A.14.00

Channel Occupied Bandwidth Percent Array

Example	CALC:FPOW:POW1:DEF "OccupiedBandwidthPercent =[0.95, 0.95, 0.95]"
Notes	<p>This parameter only applies for channels whose Function is set to OccupiedBandwidth. The occupied bandwidth percent parameter specifies the percent of total power in these channels. The valid range for this parameter is 0.0 to 1.0, where 1.0 represents 100%. The default for this parameter is 0.99, which will return the bandwidth that contains 99% of the total channel power.</p>

Preset	[0.99]
Range	0 - 1.0
Initial S/W Revision	A.14.00

Channel x-dB Bandwidth Array

Example	CALC:FPOW:POW1:DEF " XdBBandwidth =[-6.02, -3.01, -1.0]"
Notes	This parameter only applies for channels whose Function is set to XdBBandwidth. The X dB bandwidth parameter is used to specify the power relative to the peak channel power over which the bandwidth is calculated. The parameter value must be a negative number.
Preset	[-3.01]
Range	-200 to 0 dB
Default Unit	dB
Initial S/W Revision	A.14.00

Define Fast Power Measurement Query (Remote Command Only)

The DEFine? command is used to retrieve a list of all defined parameters in an ASCII string format

M	All
o	
d	
e	
R	:CALCulate:FPOWer:POWer[1,2,...,999]:DEFine?
e	
m	
o	
t	
e	
C	
o	
m	
m	
a	
n	
d	
E	:CALC:FPOW:POW1:DEF?
x	
a	
m	

p
l
e

N This command query is used to retrieve a list of all defined parameters in an ASCII format.

O The following is an example of the returned results:

S "DCCoupled=False,ElecAttBypass=True,ElecAttenuation=0,IFGain=0,MechAttenuation=0,PreAmpMode=Off,PreSelectorOffset=0,UsePreSelector=False,ExternalReferenceFrequency=1000000,FrequencyReferenceSource=AutoExternalFrequencyReference,IFType=B40M,LOMode=SLW,SignalInput=FpMainRf,AcquisitionTime=0.001,CenterFrequency=100000000,ResolutionBW=0,ResolutionBWMode=BestSpeed,DetectorType=RmsAverage,Bandwidth=[1000000],OffsetFrequency=[0],Function=[BandPower],FilterType=[IBW],FilterAlpha=[0.22],OccupiedBandwidthPercent=[0.99],XdBBandwidth=[-3.01],DoNoiseCorrection=False,DoSpurSuppression=False,MeasurementMethod=HardwareFFT,IncludePowerSpectrum=False,TriggerDelay=0,TriggerLevel=1.2,TriggerSlope=Positive,TriggerSource=Free,TriggerTimeout=1"

I A.14.00

n
i
t
i
a
l

S
/
W

R
e
v
i
s
i
o
n

Configure Fast Power Measurement (Remote Command Only)

The configure command begins hardware setup and returns immediately, with no acquisition made. This can be used in parallel with other hardware operations to effectively hide the hardware setup time.

Mode	All
Remote Command	:CALCulate:FPOWER:POWER[1,2,...,999]:CONFigure
Example	:CALC:FPOW:POW1:CONF
Notes	Option FP2 is required.
Initial S/W Revision	A.14.00

Initiate Fast Power Measurement (Remote Command Only)

The INITiate command begins an acquisition and returns immediately. The results of the measurement can be retrieved using FETCh.

Mode	All
Remote Command	:CALCulate:FPOWer:POWer[1,2,...,999]:INITiate
Example	:CALC:FPOW:POW1:INIT
Notes	Option FP2 is required.
Initial S/W Revision	A.14.00

Fetch Fast Power Measurement (Remote Command Only)

The FETCh command query is used to retrieve the results of an acquisition initiated by the INIT command. The returned results are in ASCII string format. The string begins and ends with quotation marks.

Mode	All
Remote Command	:CALCulate:FPOWer:POWer[1,2,...,999]:FETCh?
Example	:CALC:FPOW:POW1:FETC?
Notes	Option FP2 is required. Returns m comma-separated ASCII values, where m corresponds to the number of bandwidths defined. 1. Declared function return in the 1st specified channel 2. Declared function return in the 2nd specified channel ... m. Declared function return in the last specified channel The INIT and FETC? command sequence performs the same functionality of a single CALC:FPOW:POW[n]? query. Units of the returned values are dependent on the Function parameter for each channel.
Initial S/W Revision	A.14.00

Execute Fast Power Measurement (Remote Command Only)

This command query is used as shorthand for an INIT command immediately followed by a FETC? command. The returned results are in ASCII string format. The string begins and ends with quotation marks.

Mode	All
Remote Command	:CALCulate:FPOWer:POWer[1,2,...,999]?
Example	:CALC:FPOW:POW1?
Notes	Option FP2 is required. See notes for Fast Power Fetch for return format.
Initial S/W Revision	A.14.00

Binary Read Fast Power Measurement (Remote Command Only)

This command query is used as shorthand for an INIT command immediately followed by a FETC? command. The returned results are in a binary format.

Mode	All
Remote Command	:CALCulate:FPOWER:POWER[1,2,...,999]:READ? :CALCulate:FPOWER:POWER[1,2,...,999]:READ1?
Example	:CALC:FPOW:POW1:READ? :CALC:FPOW:POW1:READ1?
Notes	Option FP2 is required. Returns m 4 byte floating point binary values (Little-Endian), where m corresponds to the number of bandwidths defined.
Initial S/W Revision	A.14.00

Diagnostic Binary Read Fast Power Measurement (Remote Command Only)

This command query is used as shorthand for an INIT command immediately followed by a FETC? command. The returned results are in a binary format. This command is used primarily for diagnostic purposes to test for ADC overloads and to visibly inspect the spectrum.

Mode	All
Remote Command	:CALCulate:FPOWER:POWER[1,2,...,999]:READ2?
Example	:CALC:FPOW:POW1:READ2?
Notes	Option FP2 is required. Note: Spectrum data is only returned if the IncludePowerSpectrum parameter is set to True. If IncludePowerSpectrum is False, the number of spectrum points will be zero (0). Units of the returned values are dependent on the Function parameter per channel (e.g. dBm for BandPower, Hz for PeakFrequency). Returns binary data (Little-Endian) that contains information on m amount of channels, along with ADC over range and full spectrum data. The following is the binary format of the response. Bandwidth Return Value 1. Number of channels specified, m [4 byte int] 2. Declared function result for the 1st specified channel [4 byte float] 3. Declared function result for the 2nd specified channel [4 byte float] ... (m + 1). Declared function result for the last (mth) specified channel [4 byte float] ADC Over Range 1. ADC over-range occurred (1: true, 0: false) [2 byte short]

	<p>Spectrum Data</p> <ol style="list-style-type: none"> 1. Number of points in the spectrum data, k [4 byte int] 2. Start frequency of spectrum data (Hz) [8 byte double] 3. Step frequency of spectrum data (Hz) [8 byte double] 4. FFT bin at 1st point (dBm) [4 byte float] 5. FFT bin at 2nd point (dBm) [4 byte float] <p>...</p> <p>(k + 3). FFT bin at last (kth) point (dBm) [4 byte float]</p>
Initial S/W Revision	A.14.00

Format Data: Numeric Data (Remote Command Only)

This command specifies the format of the trace data input and output. It specifies the formats used for trace data during data transfer across any remote port. It affects only the data format for setting and querying trace data for the :TRACe[:DATA], TRACe[:DATA]?, :CALCulate:DATA[n]? and FETCh:SANalyzer[n]? commands and queries.

Remote Command	<pre>:FORMat [:TRACe] [:DATA] ASCii INTeger, 32 REAL, 32 REAL, 64 :FORMat [:TRACe] [:DATA] ?</pre>
Notes	<p>The query response is:</p> <p>ASCii: ASC,8 REAL,32: REAL,32 REAL,64: REAL,64 INTeger,32: INT,32</p> <p>When the numeric data format is REAL or ASCii, data is output in the current Y Axis unit. When the data format is INTeger, data is output in units of m dBm (.001 dBm).</p> <p>The INT,32 format returns binary 32-bit integer values in internal units (m dBm), in a definite length block.</p>
Dependencies	<p>Sending a data format spec with an invalid number (for example, INT,48) generates no error. The analyzer simply uses the default (8 for ASCii, 32 for INTeger, 32 for REAL).</p> <p>Sending data to the analyzer which does not conform to the current FORMat specified, results in an error. Sending ASCII data when a definite block is expected generates message -161 "Invalid Block Data" and sending a definite block when ASCII data is expected generates message -121 "Invalid Character in Number".</p>
Preset	ASCii
Backwards Compatibility Notes	Note that the INT,32 format is only applicable to the command, TRACe:DATA. This preserves backwards compatibility for the Swept SA measurement. For all other commands/queries which honor FORMat:DATA, if INT,32 is sent the analyzer will behave as though it were set to REAL,32.
Initial S/W Revision	Prior to A.02.00

The specs for each output type follow:

AScii - Amplitude values are in ASCII, in the current Y Axis Unit, one ASCII character per digit, values separated by commas, each value in the form:

SX.YYYYYEsZZ

Where:

S = sign (+ or -)

X = one digit to left of decimal point

Y = 5 digits to right of decimal point

E = E, exponent header

s = sign of exponent (+ or -)

ZZ = two digit exponent

REAL,32 - Binary 32-bit real values in the current Y Axis Unit, in a definite length block.

REAL,64 - Binary 64-bit real values in the current Y Axis Unit, in a definite length block.

Format Data: Byte Order (Remote Command Only)

This command selects the binary data byte order for data transfer and other queries. It controls whether binary data is transferred in normal or swapped mode. This command affects only the byte order for setting and querying trace data for the :TRACe[:DATA], TRACe[:DATA]? , :CALCulate:DATA[n]? and FETCh:SANalyzer[n]? commands and queries.

By definition any command that says it uses FORMat:DATA uses any format supported by FORMat:DATA.

The NORMal order is a byte sequence that begins with the most significant byte (MSB) first, and ends with the least significant byte (LSB) last in the sequence: 1|2|3|4. SWAPped order is when the byte sequence begins with the LSB first, and ends with the MSB last in the sequence: 4|3|2|1.

Remote Command	:FORMat:BORDER NORMal SWAPped :FORMat:BORDER?
Preset	NORMal
Initial S/W Revision	Prior to A.02.00

Meas Setup

Accesses a menu of keys that enable you to control specific parameters for the current measurement.

["Overview" on page 598](#)

["Set Parameters " on page 598](#)

Key Path	Front-panel key
Initial S/W Revision	Prior to A.02.00

Overview

This section describes the measurement setup features of the Analog Demod measurements.

Set Parameters

The following parameters are set as indicated and are not settable by the user, therefore they do not appear in any menus:

FFT IF Gain	Low (0 dB)
ADC Dither	On
Avg Mode	Exponential
Phase Noise Optimization	Auto

Auto Rules for Phase Noise Optimization:

Use "Optimize for $f < 20$ kHz" when the Channel BW < 120 kHz, otherwise use "Optimize for $f > 30$ kHz".

["Optimizing Measurement Speed" on page 598](#)

["Channel Bandwidth" on page 599](#)

["RF Spectrum Span " on page 599](#)

["RF Spectrum RBW / AF Spectrum RBW" on page 599](#)

["AF Waveform Sweep Time" on page 599](#)

["Filters and Annotation" on page 599](#)

Optimizing Measurement Speed

The speed of the analog demodulation measurements is driven largely by how much data must be acquired to satisfy the selected configuration.

Each measurement cycle generates all of the metrics and traces from a single acquisition, so there are several different settings which can affect the overall speed. Note that even though you may not be

viewing a particular result on the display, the result is available and its configuration and constraints are used to determine the acquisition settings.

Channel Bandwidth

This setting determines the sampling rate used by the measurement, higher bandwidths will result in larger data sets being acquired and processed. This should be set to the lowest value possible which allows your signal to be fully captured.

RF Spectrum Span

This setting is used in a similar way as the Channel Bandwidth in that it determines the sampling rate. As with channel bandwidth, it should be set as narrow as possible to capture the signal of interest.

RF Spectrum RBW / AF Spectrum RBW

These settings dictate a minimum acquisition time for the measurement. The Auto setting is recommended for optimal performance while maintaining measurement integrity. Narrower resolution bandwidths (RBWs) require longer acquisitions to achieve the resolution improvements.

AF Waveform Sweep Time

This setting sets another minimum acquisition time for the measurement. In many uses, the AF Spectrum RBW will dominate the determination of the data acquisition duration, but if the AF waveform view is not needed keeping its sweep time low will ensure that it does not negatively impact the throughput.

Filters and Annotation

You may choose to filter by frequency – choosing an optional low-pass filter and an optional high-pass filter – or may filter using a standard published band-pass filter (CCITT). Turning on a band-pass filter will automatically turn off the high-pass and low-pass filters; similarly, the band-pass filter will automatically turn off if you request either a high-pass or a low-pass filter.

Average/Hold Num

When turned on, the RF Spectrum and AF spectrum traces are averaged, and the Demod window shows an Average trace, a Max Hold trace, and a Min Hold trace in addition to the current trace. All metrics are averaged, and the metrics show an “Average” column and a “Max Hold” column.

The average feature for the Analog Demod measurement differs from other measurements in that the average type is fixed depending on the window as shown in the following table:

Window	Average Type
RF Spectrum	Pwr Average
Demod Waveform	Arithmetic Average
AF Spectrum	Log Average

For more details, see ["Average/Hold On/Off Functionality" on page 600](#).

Key Path	Meas Setup
----------	------------

Remote Command	[:SENSe]:AM FM PM FMSTereo:AVERage:COUNT <integer> [:SENSe]:AM FM PM FMSTereo:AVERage:COUNT? [:SENSe]:AM FM PM FMSTereo:AVERage[:STATe] ON OFF 1 0 [:SENSe]:AM FM PM FMSTereo:AVERage[:STATe]?
Example	AM:AVER:COUN 10
Preset	10 ON
State Saved	Saved in instrument state
Min	1
Max	9999
Initial S/W Revision	Prior to A.02.00
Modified at S/W Revision	A.10.00

Average/Hold On/Off Functionality

Average, Minhold, and Maxhold are coupled.

When Average/Hold is on:

- The RF Spectrum and AF Spectrum traces are averaged.
- The Demod Waveform window will display a current trace, an Average trace, a Max Hold trace, and a Min Hold trace.
- The Metrics window will display an “Average” column and a “Max Hold” column.
- Metrics will display to four significant digits.
- The Meas Bar will display the Average/Hold number (along with how many of those sweeps have been captured).
- Demod Min trace, Demod Max trace, and Demod Avg trace are maintained.
- The Max Hold column shows the maximum value the un-averaged metric has attained since the last Restart.

When Average/Max Hold is off:

- The RF Spectrum and AF Spectrum traces are not averaged.
- The Demod Waveform window will display only the demod trace.
- The Metrics window will display only a “Current” column.
- Metrics will display to two significant digits.
- The Meas Bar will not display the Average/Hold number.
- Max Hold metrics over SCPI will return SCPI not a number.

- Demod Min trace, Demod Max trace and Demod Avg trace will return default values in a Meas?, Read?, and Fetch? and when exported to a .csv file
- Max Hold column is blank.

Modulation Rate Periodic

The algorithms used by the instrument for demodulation have an improved speed/accuracy tradeoff when the modulation is both periodic (such as a sinusoidal test signal) and assumed to be periodic by the analysis system. Thus, “Yes” is best for periodic signals. When the modulation is aperiodic, such as voice or music or even multiple nonharmonically related tones, “No” gives better results.

Key Path	Meas Setup
Remote Command	<code>[:SENSe] :AM FM PM FMSTereo:PERIodic[:STATe] ON OFF 1 0</code> <code>[:SENSe] :AM FM PM FMSTereo:PERIodic[:STATe] ?</code>
Example	FM:PERI OFF
Preset	ON
State Saved	Saved in instrument state
Initial S/W Revision	A.12.00

Filters

Pressing this key displays the Filters menu, allowing you to control the post demodulation and de-emphasis filters.

If any filters are turned on and the filters cannot be applied, the error “161 Setting Modified; Filters not applied” will appear.

Key Path	Meas Setup
Initial S/W Revision	Prior to A.02.00

High Pass Filter (Post Demod)

This parameter allows you to adjust the post demodulation high pass filters. This filter allows you to remove unwanted low-frequency components from the modulated signal..

Key Path	Meas Setup, Filters
Remote Command	AM FM PM: <code>[:SENSe] :AM FM PM:HPFilter OFF HPF20 HPF50 HPF300 HPF400</code> <code>[:SENSe] :AM FM PM:HPFilter?</code>
	FM Stereo: <code>[:SENSe] :FMSTereo:HPFilter OFF HPF20 HPF50 HPF300</code> <code>[:SENSe] :FMSTereo:HPFilter?</code>

Example	FM:HPF HPF20
Remote Command Notes	<p>AM FM PM:</p> <p>Off = No filtering</p> <p>HPF20 = Use 20 Hz high pass filter</p> <p>HPF50 = Use 50 Hz high pass filter</p> <p>HPF300 = Use 300 Hz high pass filter</p> <p>HPF400 = Use 400 Hz high pass filter</p> <p>FM Stereo:</p> <p>Off = No filtering</p> <p>HPF20 = Use 20 Hz high pass filter</p> <p>HPF50 = Use 50 Hz high pass filter</p> <p>HPF300 = Use 300 Hz high pass filter</p>
Dependencies	The HPF400 is available only when Option N9063A-AFP is installed in AM/FM/PM.
Couplings	<p>AM/FM/PM:</p> <p>Turning on any high-pass filter will turn off bandpass filters.</p> <p>If a band-pass filter is turned off, the following advisory message is displayed:</p> <p>“Band-pass filter set to OFF”.</p> <p>If the band-pass filter was already off, no advisory message is displayed.</p> <p>FM Stereo:</p> <p>None</p>
Preset	Off (AM/FM/FM Stereo, HPF20 (PM))
State Saved	Saved in instrument state
Readback line	1-of-N selection
Initial S/W Revision	Prior to A.02.00
Modified at S/W Revision	A.14.00

Off

This selection turns the post demodulation high pass filter off.

Key Path	Meas Setup, HPF
Example	AM:HPF OFF
Notes	Annotation line (DC Coupled) appears in the Meas Bar, except if in the AM measurement.
Readback	Off
Initial S/W Revision	Prior to A.02.00

20 Hz

Sets the post demodulation high pass filter to 20 Hz. It is a 2-pole Butterworth filter, its 3 dB cutoff frequency is 20 Hz.

Key Path	Meas Setup, HPF
Example	AM:HPF HPF20
Readback	20 Hz
Initial S/W Revision	Prior to A.02.00

50 Hz

Sets the post demodulation high pass filter to 50 Hz. It is a 2-pole Butterworth filter, its 3 dB cutoff frequency is 50 Hz.

Key Path	Meas Setup, HPF
Example	AM:HPF HPF50
Readback	50 Hz
Initial S/W Revision	Prior to A.02.00

300 Hz

Sets the post demodulation high pass filter to 300 Hz. It is a 2-pole Butterworth filter, its 3 dB cutoff frequency is 300 Hz.

Key Path	Meas Setup, HPF
Example	AM:HPF HPF300
Readback	300 Hz
Initial S/W Revision	Prior to A.02.00

Lowpass Filter (Post Demod)

This parameter allows you to adjust the post demodulation low pass filter. The filter is useful in removing unwanted high frequency components of the modulating signal.

Key Path	Meas Setup, Filters
Remote Command	<p>AM FM PM:</p> <pre>[[:SENSe]:AM FM PM:LPFfilter OFF LPF300 LPF3K LPF15K LPF30K LPF80K LPF300K LPF100K MANual [:SENSe]:AM FM PM:LPFfilter?</pre> <p>FM Stereo:</p> <pre>[[:SENSe]:FMSTereo:LPFfilter OFF LPF300 LPF3K LPF15K LPF30K LPF80K LPF300K</pre>

	<code>[:SENSe] :FMSTereo:LPFilter?</code>
Example	FM:LPF LPF3K
Remote Command Notes	<p>AM FM PM:</p> <p>Off = No filtering</p> <p>LPF300 = Use 300 Hz low pass filter</p> <p>LPF3K = Use 3 kHz low pass filter</p> <p>LPF15K = Use 15 kHz low pass filter</p> <p>LPF30K = Use 30 kHz low pass filter</p> <p>LPF80K = Use 80 kHz low pass filter</p> <p>LPF300K = Use 300 kHz low pass filter</p> <p>LPF100K = Use >20 kHz low pass filter</p> <p>MANual=Use user-defined low pass filter</p> <p>FM Stereo:</p> <p>Off = No filtering</p> <p>LPF300 = Use 300 Hz low pass filter</p> <p>LPF3K = Use 3 kHz low pass filter</p> <p>LPF15K = Use 15 kHz low pass filter</p> <p>LPF30K = Use 30 kHz low pass filter</p> <p>LPF80K = Use 80 kHz low pass filter</p> <p>LPF300K = Use 300 kHz low pass filter</p>
Dependencies	<p>LPF key is unavailable (grayed out) when the band pass filter is not OFF.</p> <p>The following filters are available only when Option N9063A-AFP is installed in AM/FM/PM: LPF100K and MANual.</p>
Couplings	<p>AM/FM/PM:</p> <p>Turning on any low-pass filter will turn off band-pass filters.</p> <p>If a band-pass filter is turned off, the following advisory message is displayed: "Band-pass filter set to OFF".</p> <p>If the band-pass filter was already off, no advisory message is displayed.</p> <p>FM Stereo:</p> <p>None</p>
Preset	Off
State Saved	Saved in instrument state
Readback line	1-of-N selection
Initial S/W Revision	Prior to A.02.00
Modified at S/W Revision	A.14.00

Off

Turns the post demodulation low pass filter off.

Key Path	Meas Setup, Post Demod LPF
Example	AM:LPF OFF
Readback	Off
Initial S/W Revision	Prior to A.02.00

300 Hz

Sets the post demodulation low pass filter to 300 Hz. It is a 5-pole Butterworth filter, its 3 dB cutoff frequency is 300 Hz.

Key Path	Meas Setup, HPF/LPF
Example	AM:HPBP LPF300
Readback	300 Hz
Initial S/W Revision	Prior to A.02.00

3 kHz

Selects the 3 kHz post demodulation low pass filter. It is a 5-pole Butterworth filter, its 3 dB cutoff frequency is 3 kHz.

Key Path	Meas Setup, Post Demod LPF
Example	AM:LPF LPF3K
Readback	3 kHz
Initial S/W Revision	Prior to A.02.00

15 kHz

Selects the 15 kHz post demodulation low pass filter. It is a 5-pole Butterworth filter, its 3 dB cutoff frequency is 15 kHz.

Key Path	Meas Setup, Post Demod LPF
Example	AM:LPF LPF15K
Readback	15 kHz
Initial S/W Revision	Prior to A.02.00

30 kHz

Selects the 30 kHz post demodulation low pass filter. It is a 3-pole Butterworth filter, its 3 dB cutoff frequency is 30 kHz.

Key Path	Meas Setup, Post Demod LPF
Example	AM:LPF LPF30K
Readback	30 kHz
Initial S/W Revision	Prior to A.02.00

80 kHz

Selects the 80 kHz post demodulation low pass filter. It is a 3-pole Butterworth filter, its 3 dB cutoff frequency is 80 kHz.

Key Path	Meas Setup, Post Demod LPF
Example	AM:LPF LPF80K
Readback	80 kHz
Initial S/W Revision	Prior to A.02.00

300 kHz

Selects the 300 kHz post demodulation low pass filter. It is a 3-pole Butterworth filter, its 3 dB cutoff frequency is 300 kHz.

Key Path	Meas Setup, Post Demod LPF
Example	AM:LPF LPF300K
Readback	300 kHz
Initial S/W Revision	Prior to A.02.00

Band Pass Filter (Post Demod)

This parameter enables you to choose the post demodulation band pass filters, allowing you to apply industry-defined filters.

Key Path	Meas Setup, Filters
Remote Command	<p>AM FM PM:</p> <pre>[:SENSe]:AM FM PM:BPFilter OFF CCITT AWEighting CWEighting CMESsage CCIR1k CCIR2k CUNWeighting [:SENSe]:AM FM PM:BPFilter?</pre> <p>FM Stereo:</p> <pre>[:SENSe]:FMSTereo:BPFilter OFF CCITT AWAudio [:SENSe]:FMSTereo:BPFilter?</pre>

Example	FM:BPF CCITT
Remote Command Notes	<p>AM FM PM: Off = No filtering CCITT = Use CCITT filter AWEighting = Use A-Weighted Audio filter CWEighting = Use C-Weighted audio filter CMESage = Use C-Message audio filter CCIR1k = Use CCIR-1k Weighted audio filter CCIR2k = Use CCIR-2k Weighted audio filter CUNWeighting = Use CCIR Un-weighted audio filter</p> <p>FM Stereo: Off = No filtering CCITT = Use CCITT filter AWAudio = Use A-Weighted Audio filter</p>
Dependencies	The following filters are available only when Option N9063A-AFP is installed in AM/FM/PM: AWEighting, CWEighting, CMESage, CCIR1k, CCIR2k and CUNWeighting.
Couplings	<p>AM/FM/PM: Turning on any bandpass filter will turn off high-pass and low-pass filters. If a high-pass filter is turned off, the following advisory message is displayed: “High-pass filter set to OFF”. If a low-pass filter is turned off, the following advisory message is displayed: “Low-pass filter set to OFF”. If both are turned off, the following advisory message is displayed: “High-pass and Low-pass filters set to OFF”. If both high-pass and low-pass filters were already off, no advisory message is displayed.</p> <p>FM Stereo: None</p>
Preset	Off
State Saved	Saved in instrument state
Readback	1-of-N
Initial S/W Revision	Prior to A.02.00
Modified at S/W Revision	A.14.00

Off

Turns the post demodulation band-pass filter off.

Key Path	Meas Setup, BPF
Example	AM:BPF OFF
Readback	Off
Initial S/W Revision	Prior to A.02.00

CCITT

Sets the post demodulation band-pass filter to CCITT.

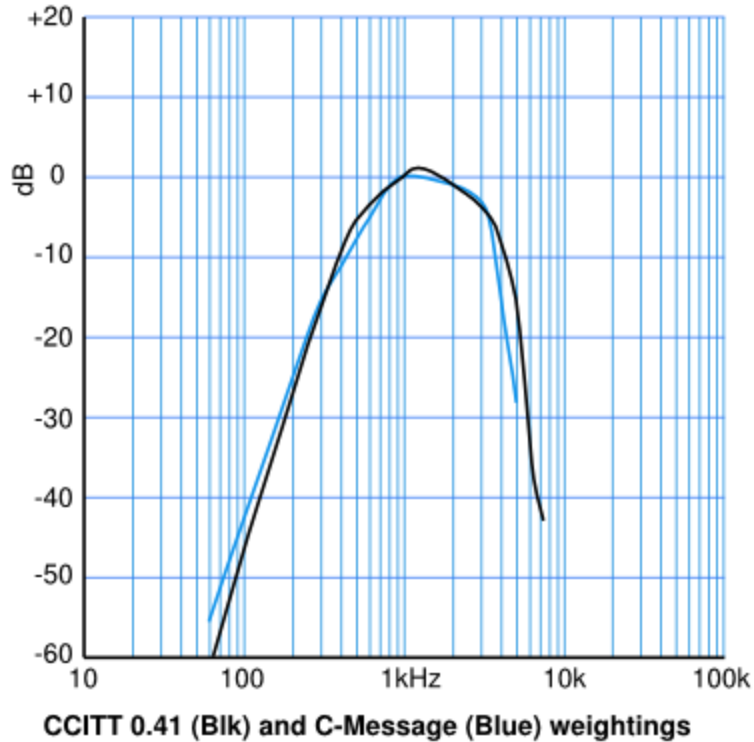

Key Path	Meas Setup, BPF
Example	AM:BPF CCITT
Readback	CCITT
Initial S/W Revision	Prior to A.02.00

De-emphasis (FM and FM Stereo Demod measurement only)

Controls a single-pole filter, usually 6 dB/octave roll off, to counter intentional pre-emphasis in the transmitter. When the De-emphasis state is OFF the hardware digital filter is bypassed, otherwise the setting is applied

US75 is recommended for US commercial FM 75 μ s pre-emphasis.

The De-emphasis key only appears in the Meas Setup menu for the FM and FM Stereo Demod measurements. It is unavailable for the AM and Φ M measurements.

Key Path	Meas Setup, Filters
----------	---------------------

Remote Command	<code>[:SENSe] :FM FMSTereo:DEEMphasis OFF US25 US50 US75 US750</code> <code>[:SENSe] :FM FMSTereo:DEEMphasis?</code>
Example	FM:DEEM US75 FM:DEEM?
Dependencies	Only available in FM and FM Stereo measurements. Unavailable for AM and PM
Preset	OFF
State Saved	Saved in instrument state
Readback line	1-of-N selection
Initial S/W Revision	Prior to A.02.00
Modified at S/W Revision	A.10.00

Off

Bypasses the De-emphasis filter.

Key Path	Meas Setup, Filters, De-emphasis
Example	FM:DEEM OFF
Readback	Off
Initial S/W Revision	Prior to A.02.00

25 μ s

Sets the De-emphasis time constant to 25 μ s.

Key Path	Meas Setup, Filters, De-emphasis
Example	FM:DEEM US25
Readback	25 μ s
Initial S/W Revision	Prior to A.02.00

50 μ s

Sets the De-emphasis time constant to 50 μ s.

Key Path	Meas Setup, Filters, De-emphasis
Example	FM:DEEM US50
Readback	50 μ s
Initial S/W Revision	Prior to A.02.00

75 μ s

Sets the De-emphasis time constant to 75 μ s.

Key Path	Meas Setup, Filters, De-emphasis
Example	FM:DEEM US75
Readback	75 μ s
Initial S/W Revision	Prior to A.02.00

750 μ s

Sets the De-emphasis time constant to 750 μ sec.

Key Path	Meas Setup, Filters, De-emphasis
Example	FM:DEEM US750
Readback	750 μ s
Initial S/W Revision	Prior to A.02.00

Demod to Speaker

Controls whether a demodulated audio signal is connected to the speaker or not. This allows the demodulated audio to be turned off without completely disabling (muting) the instrument speaker. When the Analog Demod application is running, the demodulated signal can be heard from the speaker as long as the “Demod to Speaker” function is set to On.

NOTE The Windows controls for speaker volume and mute must also be properly set.

This function is shared among all measurements in the mode, but not across other modes.

Key Path	Meas Setup
Remote Command	[:SENSe] :SPEaker [:STATe] ON OFF 1 0 [:SENSe] :SPEaker [:STATe] ?
Example	SPE OFF Disconnects demodulated audio from speaker circuit.
Preset	On
State Saved	Saved in instrument state
Initial S/W Revision	Prior to A.02.00

Auto BW & Scale

Automatically sets many measurement parameters by pressing one button, based upon the current signal under test. The feature requires that the center frequency be set to the signal of interest, and works best on stable periodic signals. The measurement is preset at the beginning of the Auto BW & Scale operation, with the exception that the user’s Center Frequency and audio Filters are maintained.

The signal is analyzed using an Occupied Bandwidth measurement to automatically set the RF Spectrum Span and Channel Bandwidth to good values. And then it sets the combination of mechanical and electronic attenuation based on the current measured signal level so that clipping will be at a minimum. Once these two steps are done, the software examines the demodulated signal and appropriately sets the Sweep Time and Demod Waveform Scale/Div.

There are no configurable parameters for Auto BW & Scale. The function is pre-configured to work with most real-world use cases.

Key Path	Meas Setup
Remote Command	[:SENSe] :AUToscale
Example	AUT
Initial S/W Revision	Prior to A.02.00

Meas Preset

Returns the variables in the current measurement to their preset values.

Key Path	Meas Setup
Initial S/W Revision	Prior to A.02.00

9 FM Demod Measurement
Mode

Mode

See ["Mode" on page 156](#)

Mode Preset

Returns the active mode to a known state.

Mode Preset does the following for the currently active mode:

- Aborts the currently running measurement.
- Brings up the default menu for the mode, with no active function.
- Sets measurement Global settings to their preset values for the active mode only.
- Activates the default measurement.
- Brings up the default menu for the mode.
- Clears the input and output buffers.
- Sets Status Byte to 0.

Mode Preset does not:

- Cause a mode switch
- Affect mode persistent settings
- Affect system settings
- See "[How-To Preset](#)" on page 614 for more information.

Key Path	Front-panel key
Remote Command	:SYSTem:PRESet
Example	:SYST:PRES
Notes	*RST is preferred over :SYST:PRES for remote operation. *RST does a Mode Preset, as done by the :SYST:PRES command, and it sets the measurement mode to Single measurement rather than Continuous for optimal remote control throughput. Clears all pending OPC bits. The Status Byte is set to 0.
Couplings	A Mode Preset aborts the currently running measurement, activates the default measurement, and gets the mode to a consistent state with all of the default couplings set.
Backwards Compatibility Notes	In the X-Series, the legacy "Factory Preset" has been replaced with Mode Preset, which only presets the currently active mode, not the entire instrument. In the X-Series, the way to preset the entire instrument is by using System, Restore System Defaults All, which behaves essentially the same way as restore System Defaults does on ESA and PSA. There is also no "Preset Type" as there is on the PSA. There is a green Mode Preset front-panel key that does a Mode Preset and a white-with-green-letters User Preset front-panel key that does a User Preset. The old PRESet:TYPE command is ignored (without generating an error), and SYST:PRES without a parameter does a Mode Preset, which should cover most backward code compatibility issues. The settings and correction data under the Input/Output front-panel key (examples: Input Z Corr, Ext Amp Gain, etc.) are no longer part of any Mode, so they will not be preset by a Mode Preset. They are preset using Restore Input/Output Defaults, Restore System Defaults All. Note that because User Preset does a Recall State, and all of these settings are saved in State, they ARE recalled when using

	User Preset.
Initial S/W Revision	Prior to A.02.00

How-To Preset

The table below shows all possible presets, their corresponding SCPI commands and front-panel access (key paths). Instrument settings depend on the current measurement context. Some settings are local to the current measurement, some are global (common) across all the measurements in the current mode, and some are global to all the available modes. In a similar way, restoring the settings to their preset state can be done within the different contexts.

Auto Couple - is a measurement local key. It sets all Auto/Man parameter couplings in the measurement to Auto. Any Auto/Man selection that is local to other measurements in the mode will not be affected.

Meas Preset - is a measurement local key. Meas Preset resets all the variables local to the current measurement except the persistent ones.

Mode Preset - resets all the current mode's measurement local and measurement global variables except the persistent ones.

Restore Mode Defaults - resets ALL the Mode variables (and all the Meas global and Meas local variables), including the persistent ones.

Type Of Preset	SCPI Command	Front Panel Access
Auto Couple	:COUPle ALL	Auto Couple front-panel key
Meas Preset	:CONFigure:<Measurement>	Meas Setup Menu
Mode Preset	:SYSTem:PRESet	Mode Preset (green key)
Restore Mode Defaults	:INSTrument:DEFault	Mode Setup Menu
Restore All Mode Defaults	:SYSTem:DEFault MODes	System Menu; Restore System Default Menu
*RST	*RST	not possible (Mode Preset with Single)
Restore Input/Output Defaults	:SYSTem:DEFault INPUt	System Menu; Restore System Default Menu
Restore Power On Defaults	:SYSTem:DEFault PON	System Menu; Restore System Default Menu
Restore Alignment Defaults	:SYSTem:DEFault ALIGN	System Menu; Restore System Default Menu
Restore Miscellaneous Defaults	:SYSTem:DEFault MISC	System Menu; Restore System Default Menu
Restore All System Defaults	:SYSTem:DEFault [ALL] :SYSTem:PRESet:PERsistent	System Menu; Restore System Default Menu
User Preset	:SYSTem:PRESet:USER	User Preset Menu
User Preset All Modes	:SYSTem:PRESet:USER:ALL	User Preset Menu

Power On Mode Preset	:SYSTem:PON:TYPE MODE	System Menu
Power On User Preset	:SYSTem:PON:TYPE USER	System Menu
Power On Last State	:SYSTem:PON:TYPE LAST	System Menu

Restore Mode Defaults

Resets the state for the currently active mode by resetting the mode persistent settings to their factory default values, clearing mode data and by performing a Mode Preset. This function will never cause a mode switch. This function performs a full preset for the currently active mode; whereas, Mode Preset performs a partial preset. Restore Mode Defaults does not affect any system settings. System settings are reset by the Restore System Defaults function. This function does reset mode data; as well as settings.

Key Path	Mode Setup
Remote Command	:INSTrument:DEFault
Example	:INST:DEF
Notes	Clears all pending OPC bits. The Status Byte is set to 0. A message comes up saying: "If you are sure, press key again".
Couplings	A Restore Mode Defaults will cause the currently running measurement to be aborted and causes the default measurement to be active. It gets the mode to a consistent state with all of the default couplings set.
Initial S/W Revision	Prior to A.02.00

Preset Type (Remote Command Only)

As stated in the Backward Compatibility section, to be compatible with ESA/PSA the PRESet:TYPE command will be implemented as a no-op.

Mode	All
Remote Command	:SYSTem:PRESet:TYPE FACTory MODE USER :SYSTem:PRESet:TYPE?
Example	:SYST:PRE:TYPE FACT
Notes	This command is supported for backward compatibility only. It is a no-op which does not change the behavior of any preset operation.
Preset	This is unaffected by Preset but is set to Mode on a "Restore System Defaults->All"
State Saved	No
Initial S/W Revision	Prior to A.02.00

Global Settings

Opens a menu that allows you to switch certain Meas Global parameters to a Mode Global state. These switches apply to all Modes that support global settings. No matter what Mode you are in when you set the “Global Center Frequency” switch to on, it applies to all Modes that support Global Settings.

Key Path	Mode Setup
Initial S/W Revision	Prior to A.02.00

Global Center Freq

The software maintains a Mode Global value called “Global Center Freq”.

When the Global Center Freq key is switched to On in any mode, the current mode’s center frequency is copied into the Global Center Frequency, and from then on all modes that support global settings use the Global Center Frequency. So you can switch between any of these modes and the Center Freq will remain unchanged.

Adjusting the Center Freq of any mode which supports Global Settings, while Global Center Freq is On, will modify the Global Center Frequency.

When Global Center Freq is turned Off, the Center Freq of the current mode is unchanged, but now the Center Freq of each mode is once again independent.

When Mode Preset is pressed while Global Center Freq is On, the Global Center Freq is preset to the preset Center Freq of the current mode.

This function is reset to Off when the Restore Defaults key is pressed in the Global Settings menu, or when System, Restore Defaults, All Modes is pressed.

Key Path	Mode Setup, Global Settings
Scope	Mode Global
Remote Command	:INSTRument:COUPle:FREQuency:CENTer ALL NONE :INSTRument:COUPle:FREQuency:CENTer?
Example	INST:COUP:FREQ:CENT ALL INST:COUP:FREQ:CENT?
Preset	Set to Off on Global Settings, Restore Defaults and System, Restore Defaults, All Modes
Range	On Off
Initial S/W Revision	Prior to A.02.00

Remote Command	:GLOBal:FREQuency:CENTer[:STATe] 1 0 ON OFF :GLOBal:FREQuency:CENTer[:STATe]?
Preset	Off
Initial S/W Revision	Prior to A.02.00

Restore Defaults

This key resets all of the functions in the Global Settings menu to Off. This also occurs when System, Restore Defaults, All Modes is pressed.

Key Path	Mode Setup, Global Settings
Remote Command	:INSTrument:COUPle:DEFault
Example	INST:COUP:DEF
Backwards Compatibility SCPI	:GLOBal:DEFault
Initial S/W Revision	Prior to A.02.00

Peak Search

Displays the Peak Search menu and places the selected marker on the trace point with the maximum y-axis value for that marker's trace.

Key Path	Front-panel key
Remote Command	:CALCulate:AM FM PM FMSTereo:MARKer[1] 2 ... 12:MAXimum
Example	CALC:AM:MARK2:MAX
Initial S/W Revision	Prior to A.02.00
Modified at S/W Revision	A.10.00

Next Peak

Moves the selected marker to the peak that has the next highest amplitude less than the current marker value. If there is no valid peak lower than the current marker position, an error is generated and the marker is not moved.

If the selected marker was off, then it is turned on as a normal marker and a peak search is performed. In Analog Demod, the Peak Threshold and Peak Excursion functions are both OFF. If there is no valid peak, an error is generated and the marker is not moved. If the selected marker was off, then it is turned on as a normal marker and a peak search is performed.

Key Path	Peak Search
Remote Command	:CALCulate:AM FM PM FMSTereo:MARKer[1] 2 ... 12:MAXimum:NEXT
Example	CALC:AM:MARK2:MAX:NEXT Selects marker 2 and moves it to the peak that is closest in amplitude to the current peak, but the next lower value.
Remote Command Notes	Sending this command selects the specified marker
State Saved	Not part of instrument saved state
Initial S/W Revision	Prior to A.02.00
Modified at S/W Revision	A.10.00

Pk-Pk Search

Finds and displays the amplitude and frequency (or time, if on a time domain trace) differences between the highest and lowest y-axis value. It places the selected marker on the minimum value on its selected trace and it places that marker's reference marker on the peak of its selected trace. This function turns on the reference marker and sets its mode to Fixed if it is not already on. (These markers may be on two different traces.)

When peak-to-peak search is successful, a message is displayed on the message line.

If the selected marker is off, a delta type marker is turned on and the peak-to-peak search is done. If the selected marker is on, but it is not a delta marker, then it is changed to delta, which turns on the reference marker if needed. It then performs the peak-to-peak function.

Key Path	Peak Search
Remote Command	:CALCulate:AM FM PM FMSTereo:MARKer[1] 2 ... 12:PTPeak
Example	CALC:AM:MARK:PTP CALC:AM:MARK:Y? Queries the delta amplitude value for marker 1.
Notes	Turns on the Marker Δ active function.
Remote Command Notes	Sending this command selects the specified marker.
Couplings	Selected marker becomes a delta marker if not already in delta mode..
State Saved	Not part of instrument saved state
Initial S/W Revision	Prior to A.02.00
Modified at S/W Revision	A.10.00

Min Search

Moves the selected marker to the minimum y-axis value on the current trace. If the selected marker is off, it is turned on before the minimum search is performed.

Key Path	Peak Search
Remote Command	:CALCulate:AM FM PM FMSTereo:MARKer[1] 2 ... 12:MINimum
Example	CALC:AM:MARK:MIN selects marker 1 and moves it to the minimum amplitude value.
Remote Command Notes	Sending this command selects the specified marker.
State Saved	Not part of instrument saved state
Initial S/W Revision	Prior to A.02.00
Modified at S/W Revision	A.10.00

9 FM Demod Measurement
Print

Print

See "Print" on page 181

Quick Save

The Quick Save front-panel key repeats the most recent save that was performed from the Save menu, with the following exceptions:

- Register saves are not remembered as Saves for the purpose of the Quick Save function
- If the current measurement does not support the last non-register save that was performed, an informational message is generated, “File type not supported for this measurement”

Quick Save repeats the last type of qualified save (that is, a save qualified by the above criteria) in the last save directory by creating a unique filename using the Auto File Naming algorithm described below.

If Quick Save is pressed after startup and before any qualified Save has been performed, the Quick Save function performs a Screen Image save using the current settings for Screen Image saves (current theme, current directory), which then becomes the “last save” for the purpose of subsequent Quick Saves.

The Auto File Naming feature automatically generates a file name for use when saving a file. The filename consists of a prefix and suffix separated by a dot, as is standard for the Windows® file system. A default prefix exists for each of the available file types:

Type	Default Prefix	Menu
State	State_	(Save/Recall)
Trace + State	State_	(Save/Recall)
Screen	Screen_	(Save/Recall)
Amplitude Corrections	Ampcor_	(Import/Export)
Traces	Trace_	(Import/Export)
Limit Lines	LLine_	(Import/Export)
Measurement Result	MeasR_	(Import/Export)
Capture Buffer	CapBuf_	(Import/Export)

A four digit number is appended to the prefix to create a unique file name. The numbering sequence starts at 0000 within each Mode for each file type and updates incrementally to 9999, then wraps to 0000 again. It remembers where it was through a Mode Preset and when leaving and returning to the Mode. It is reset by Restore Misc Defaults and Restore System Defaults and subsequent running of the instrument application. So, for example, the first auto file name generated for State files is State_0000.state. The next is State_0001, and so forth.

One of the key features of Auto File Name is that we guarantee that the Auto File Name will never conflict with an existing file. The algorithm looks for the next available number. If it gets to 9999, then it looks for holes. If it find no holes, that is no more numbers are available, it gives an error.

For example, if when we get to State_0010.state there is already a State_0010.state file in the current directory, it advances the counter to State_0011.state to ensure that no conflict will exist (and then it verifies that State_0011.state also does not exist in the current directory and advances again if it does, and so forth).

If you enter a file name for a given file type, then the prefix becomes the filename you entered instead of the default prefix, followed by an underscore. The last four letters (the suffix) are the 4-digit number.

For example, if you save a measurement results file as “fred.csv”, then the next auto file name chosen for a measurement results save will be fred_0000.csv.

NOTE Although 0000 is used in the example above, the number that is used is actually the current number in the Meas Results sequence, that is, the number that would have been used if you had not entered your own file name.

NOTE If the filename you entered ends with _dddd, where d=any number, making it look just like an auto file name, then the next auto file name picks up where you left off with the suffix being dddd + 1.

Key Path	Front-panel key
Notes	No remote command for this key specifically.
Initial S/W Revision	Prior to A.02.00

State

The Recall State menu lets you choose a register or file from which to recall the state.

The content of a state file includes all of the settings and data required to return the analyzer as closely as possible to the Mode it was in, with the exact settings that were in place, when the save occurred. The Mode settings in each state file include the settings that are affected by Mode Preset, as well as the additional settings affected by Restore Mode Defaults; all of the Mode’s settings. In addition, all of the settings of the Input/Output system are included, even though they are outside of the Mode’s state, because they are needed to restore the complete setup. Persistent System settings (for example, GPIB address) are not affected by either a Mode Preset or Restore Mode Defaults, nor are they included in a saved State file.

Since each state file is only for one Mode, the settings for other Modes are unaffected when it is loaded. Recall State will cause a mode switch if the state being recalled is not from the current active mode.

After the recall completes, the message "File <filename> recalled" or “Recalled State Register <register number>” is displayed.

For rapid recalls, the State menu lists 16 registers that you can choose from to recall. Pressing a Register key initiates the recall. You can also select a file from which to recall.

The default path for all State Files is:

My Documents\<mode name>\state

where <mode name> is the parameter used to select the mode with the INST:SEL command (for example, SA for the Spectrum Analyzer).

See "[More Information](#)" on page 623.

Key Path	Recall
----------	--------

Mode	All
Remote Command	:MMEMory:LOAD:STATe <filename>
Example	:MMEM:LOAD:STAT "myState.state" This recalls the file myState.state on the default path
Example	MMEM:LOAD:STAT "MyStateFile.state" This loads the state file data (on the default file directory path) into the instrument state.
Notes	<p>When you pick a file to recall, the analyzer first verifies that the file is recallable in the current instrument by checking the software version and model number of the instrument. If everything matches, a full recall proceeds by aborting the currently running measurement, clearing any pending operations, and then loading the State from the saved state file. You can open state files from any mode, so recalling a State file switches to the mode that was active when the save occurred. After switching to the mode of the saved state file, mode settings and data (if any for the mode) are loaded with values from the saved file. The saved measurement of the mode becomes the newly active measurement and the data relevant to the measurement (if there is any) is recalled.</p> <ul style="list-style-type: none"> • If there is a mismatch between file version or model number or instrument version or model number, the recall function tries to recall as much as possible and returns a warning message. It may limit settings that differ based on model number, licensing or version number. <p>After recalling the state, the Recall State function does the following:</p> <ul style="list-style-type: none"> • Makes the saved measurement for the mode the active measurement. • Clears the input and output buffers. • Status Byte is set to 0. • Executes a *CLS <p>If the file specified is empty an error is generated. If the specified file does not exist, another error is generated. If there is a mismatch between the file and the proper file type, an error is generated. If there is a mismatch between file version or model number or instrument version or model number, a warning is displayed. Then it returns to the State menu and File Open dialog goes away.</p> <p>After the Recall, the analyzer exits the Recall menu and returns to the previous menu.</p>
Backwards Compatibility SCPI	:MMEMory:LOAD:STATe 1,<filename> For backwards compatibility, the above syntax is supported. The "1" is simply ignored.
Initial S/W Revision	Prior to A.02.00

More Information

In measurements that support saving Traces, for example, Swept SA, the Trace data is saved along with the State in the State file. When recalling the State, the Trace data is recalled as well. Traces are recalled exactly as they were stored, including the writing mode and update and display modes. If a Trace was updating and visible when the State was saved, it will come back updating and visible, and its data will be rewritten right away. When you use State to save and recall traces, any trace whose data must be preserved should be placed in View or Blank mode before saving.

The following table describes the Trace Save and Recall possibilities:

You want to recall state and one trace's data, leaving other traces	Save Trace+State from 1 trace. Make sure that no other traces are	On Recall, specify the trace you want to load the one trace's data
---	--	--

unaffected.	updating (they should all be in View or Blank mode) when the save is performed.	into. This trace will load in View. All other traces' data will be unaffected, although their trace mode will be as it was when the state save was performed.
You want to recall all traces	Save Trace+State from ALL traces.	On Recall, all traces will come back in View (or Blank if they were in Blank or Background when saved)
You want all traces to load exactly as they were when saved.	Save State	On recall, all traces' mode and data will be exactly as they were when saved. Any traces that were updating will have their data immediately overwritten.

From File...

When you press “From File”, the analyzer brings up a Windows dialog and a menu entitled “File Open.” This menu allows you to navigate to the various fields in the Windows dialog without using a keyboard or mouse. The Tab and Arrow keys can also be used for dialog navigation.

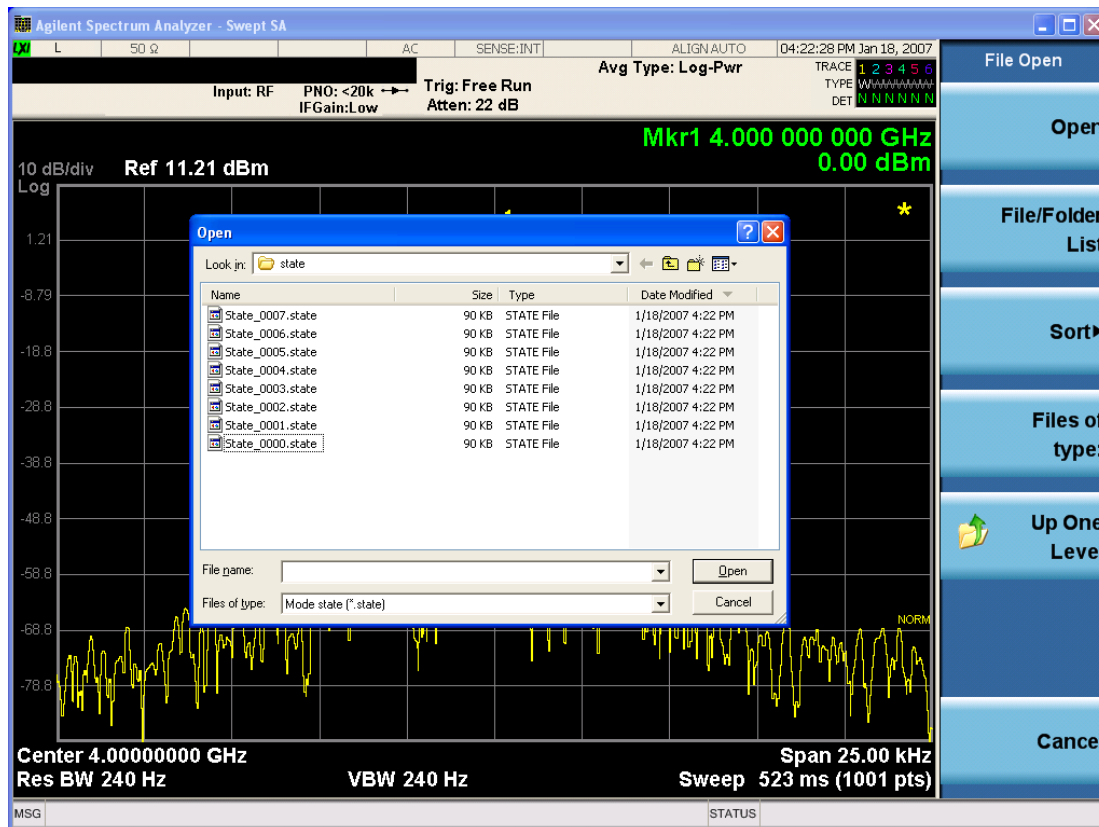

Listed below are the functions of the various fields in the dialog, and the corresponding softkeys:

Open

Performs the recall of the specified file. While the recall is being performed, the floppy icon appears briefly in the Meas bar.

File/Folder List

Enables you to navigate to the center of the dialog that contains the list of files and folders. Once here you can get information about the file and use the tab keys to navigate to the other fields in the dialog, such as Look In.

Look In

The Look In field shows the path from which the file will be recalled and allows you to change the path using the up and down arrow keys to navigate to other paths; the Enter key to open a directory; and the Backspace key to go back one directory. The **Look In field** first uses the last path from the Save As dialog **Save In:** path for that same file type. There is no softkey for directly navigating to the Look In field, but you can use the left tab to get here from the File/Folder List.

User specified paths are remembered when you leave and return to a Mode and are reset back to the default using Restore Mode Defaults.

Sort

Accesses a menu that enables you to sort the files within the File Open dialog. Only one sorting type can be selected at a time and the sorting happens immediately. The sorting types are By Date, By Name, By extension, and By Size.

Files of Type

This field shows the file suffix for the type of file you have selected to recall. For example, if you navigated here while recalling State, "Mode state (*.state)" is in the field. If you navigated here while recalling Trace, ""Mode state (*.trace)" is in the field. If you navigated here while importing a trace data file, "Trace Data (*.csv)" is in the field. For some file types, there is more than one choice in the dropdown menu, which you can select by using the up and down arrow keys and Enter.

Up One Level

This key corresponds to the icon of a folder with the up arrow that is in the tool bar of the dialog. When pressed, it causes the file and folder list to navigate up one level in the directory structure. The Backspace key does the same thing.

Cancel

This key corresponds to the Cancel selection in the dialog. It causes the current **Open** request to be cancelled. The ESC key does the same thing.

Key Path	Recall, State
Notes	Brings up the Open dialog for recalling a State Save Type
Initial S/W Revision	Prior to A.02.00

Edit Register Names

You may enter a custom name on any of the Register keys, to help you remember what you are using that state to save. To do this, press the Edit Register Names key, choose the register whose name you wish to edit, and then enter the desired label using the Alpha Editor or an external PC keyboard.

The maximum number of characters that can be added is 30. In most cases, 30 characters will fit on two lines of the key.

For more information and the SCPI command, see Edit Register Names under the Save, State function.

Key Path	Recall, State
Mode	All
Dependencies	N9060A-7FP or N9060B-2FP license required to edit the register names. When the feature is not licensed, sending the SCPI command generates an error, -221, "Settings conflict;Option not available"
Initial S/W Revision	A.11.00

Register 1 thru Register 16

Selecting any one of these register keys causes the State of the mode from the specified Register to be recalled. Each of the register keys annotates whether it is empty or at what date and time it was last modified. In addition, you can use the Edit Register Names key under Save, State to enter custom names for each register.

NOTE

In products that run multiple instances of the X-Series Application, recalling the same register name on each instance is a way to share setups between the instances.

Registers are shared by all modes, so recalling from any one of the registers will cause a mode switch to the mode that was active when the save to the Register occurred.

Although these 16 registers are the only registers available from the front panel, there are 128 state registers available in the instrument. Registers 17-128 are only available from the SCPI interface, using the *RCL command.

After the recall completes, the message "Register <register number> recalled" appears in the message bar. If you are in the Spectrum Analyzer Mode, and you are recalling a register that was saved in the Spectrum Analyzer Mode, then after the recall, you will still be in the Recall Register menu. If the Recall causes you to switch modes, then after the Recall, you will be in the Frequency menu.

If a requested register is empty an error is generated.

Key Path	Recall, State
Example	*RCL 1
Range	1-16 from front panel, 1-128 from SCPI
Readback	Date and time with seconds resolution are displayed on the key OR A custom name of up to 30 characters entered using the Save, State,Edit Register Names key

	OR “(empty)” if no prior save operation has been performed to this register.
Initial S/W Revision	Prior to A.02.00
Modified at S/W Revision	Prior to A.11.00

Register 1 thru Register 16

Selecting any one of these register keys causes the State of the mode from the specified Register to be recalled. Each of the register keys annotates whether it is empty or at what date and time it was last modified. In addition, you can use the Edit Register Names key under Save, State to enter custom names for each register.

NOTE In products that run multiple instances of the X-Series Application, recalling the same register name on each instance is a way to share setups between the instances.

Registers are shared by all modes, so recalling from any one of the registers will cause a mode switch to the mode that was active when the save to the Register occurred.

Although these 16 registers are the only registers available from the front panel, there are 128 state registers available in the instrument. Registers 17–128 are only available from the SCPI interface, using the *RCL command.

After the recall completes, the message "Register <register number> recalled" appears in the message bar. If you are in the Spectrum Analyzer Mode, and you are recalling a register that was saved in the Spectrum Analyzer Mode, then after the recall, you will still be in the Recall Register menu. If the Recall causes you to switch modes, then after the Recall, you will be in the Frequency menu.

If a requested register is empty an error is generated.

Key Path	Recall, State
Example	*RCL 1
Range	1–16 from front panel, 1–128 from SCPI
Readback	Date and time with seconds resolution are displayed on the key OR A custom name of up to 30 characters entered using the Save, State, Edit Register Names key OR “(empty)” if no prior save operation has been performed to this register.
Initial S/W Revision	Prior to A.02.00
Modified at S/W Revision	Prior to A.11.00

Restart

The Restart function restarts the current sweep, or measurement, or set of averaged/held sweeps or measurements. If you are Paused, pressing Restart does a Resume.

The Restart function is accessed in several ways:

- Pressing the Restart key
- Sending the remote command INIT:IMMediate
- Sending the remote command INIT:REStart

See "[More Information](#)" on page 628

Key Path	Front-panel key
Remote Command	:INITiate[:IMMediate] :INITiate:REStart
Example	:INIT:IMM :INIT:REST
Notes	:INITiate:REStart and :INITiate:IMMediate perform exactly the same function.
Couplings	Resets average/hold count k. For the first sweep overwrites all active (update=on) traces with new current data. For application modes, it resets other parameters as required by the measurement.
Status Bits/OPC dependencies	This is an Overlapped command. The STATus:OPERation register bits 0 through 8 are cleared. The STATus:QUESTionable register bit 9 (INTegrity sum) is cleared. The SWEEPING bit is set. The MEASURING bit is set.
Backwards Compatibility Notes	For Spectrum Analysis mode in ESA and PSA, the Restart hardkey and the INITiate:REStart command restart trace averages (displayed average count reset to 1) for a trace in Clear Write, but did not restart Max Hold and Min Hold. In the X-Series, the Restart hardkey and the INITiate:REStart command restart not only Trace Average, but MaxHold and MinHold traces as well. For wireless comms modes in ESA and PSA, the Restart hardkey and the INITiate:REStart command restart every measurement, which includes all traces and numeric results. There is no change to this operation.
Initial S/W Revision	Prior to A.02.00

More Information

The **Restart** function first aborts the current sweep/measurement as quickly as possible. It then resets the sweep and trigger systems, sets up the measurement and initiates a new data measurement sequence with a new data acquisition (sweep) taken once the trigger condition is met.

If the analyzer is in the process of aligning when **Restart** is executed, the alignment finishes before the restart function is performed.

Even when set for Single operation, multiple sweeps may be taken when Restart is pressed (for example, when averaging/holding is on). Thus when we say that **Restart** "restarts a measurement," we may mean:

- It restarts the current sweep
- It restarts the current measurement
- It restarts the current set of sweeps if any trace is in Trace Average, Max Hold or Min Hold
- It restarts the current set of measurements if Averaging, or Max Hold, or Min Hold is on for the measurement
- depending on the current settings.

With **Average/Hold Number** (in **Meas Setup** menu) set to 1, or Averaging off, or no trace in Trace Average or Hold, a single sweep is equivalent to a single measurement. A single sweep is taken after the trigger condition is met; and the analyzer stops sweeping once that sweep has completed. However, with **Average/Hold Number** >1 and at least one trace set to **Trace Average, Max Hold, or Min Hold (SA Measurement)** or **Averaging on (most other measurements)**, multiple sweeps/data acquisitions are taken for a single measurement. The trigger condition must be met prior to each sweep. The sweep is stopped when the average count k equals the number N set for **Average/Hold Number**. A measurement average usually applies to all traces, marker results, and numeric results; but sometimes it only applies to the numeric results.

Once the full set of sweeps has been taken, the analyzer will go to idle state. To take one more sweep without resetting the average count, increment the average count by 1, by pressing the step up key while **Average/Hold Number** is the active function, or sending the remote command `CALC:AVER:TCON UP`.

Save

The Save menu lets you choose what you want to save and where you want to save it. Among the types of files you can save are **States**, **Traces**, and **Screen Images**. In addition, an Export (Data) option lets you save a number of data types as CSV files for easy import into Excel and other spreadsheet programs.

Key Path	Front-panel key
Mode	All
Notes	No remote command for this key specifically, but the :MMEM:STORe command is available for specific file types. An example is :MMEM:STOR:STATe <filename>.
Initial S/W Revision	Prior to A.02.00

State

The Save State menu lets you choose a register or file for saving the state.

NOTE

In products that run multiple instances of the X-Series Application, all instances share the same register and file location where you want to save the state.

The content of a state file includes all of the settings and data required to return the analyzer as closely as possible to the Mode it was in, with the exact settings which were in place, when the save occurred. The Mode settings in each state file include the settings that are affected by Mode Preset, as well as the additional settings affected by Restore Mode Defaults; all of the Mode's settings. In addition, all of the settings of the Input/Output system are included, even though they are outside of the Mode's state, because they are needed to restore the complete setup. Persistent System settings (for example, Verbose SCPI) are not affected by either Mode Preset or Restore Mode Defaults, nor are they included in a saved State file.

After the save completes, the message "File <filename> saved" or "State Register <register number> saved" is displayed.

For rapid saving, the State menu lists 16 registers to save to. Pressing a Register key initiates the save. You can also select a file to save to.

The default path for all State Files is:

My Documents\<<mode name>\state

where <mode name> is the parameter used to select the mode with the INST:SEL command (for example, SA for the Spectrum Analyzer).

Key Path	Save
Mode	All
Remote Command	:MMEMory:STORe:STATe <filename>
Example	MMEM:STOR:STATe "MyStateFile.state" This stores the current instrument state data in the file MyStateFile.state in the default directory.
Notes	Both single and double quotes are supported for any filename parameter over remote.

After saving to a register, that register's menu key is updated with the date the time, unless a custom label has been entered for that key.

After saving to a register, you remain in the Save State menu, so that you can see the Register key update. After saving to a file, the analyzer automatically returns to the previous menu and any Save As dialog goes away.

Backwards Compatibility SCPI :MMEMory:STORe:STATe 1,<filename>

For backwards compatibility, the above syntax is supported. The "1" is simply ignored. The command is sequential.

Initial S/W Revision Prior to A.02.00

To File . . .

When you press "To File", the analyzer brings up a Windows dialog and a menu entitled "Save As." This menu allows you to navigate to the various fields in the Windows dialog without using a keyboard or mouse. The Tab and Arrow keys can also be used for dialog navigation.

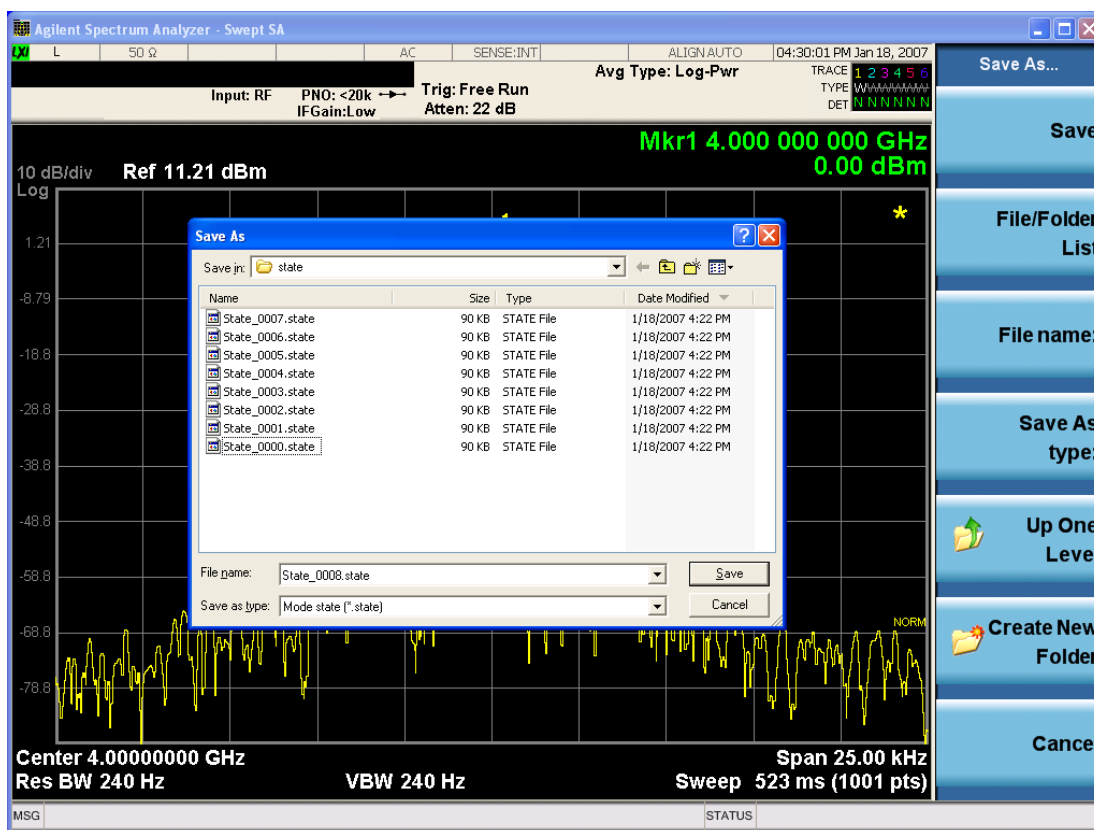

The Listed below

are the functions of the various fields in the dialog, and the corresponding softkeys:

Save

Performs the save to the specified file of the selected type. If the file already exists, a dialog will appear that allows you to replace the existing file by selecting OK, or you can Cancel the request. If you select OK,

the file will be overwritten. Using the C: drive is strongly discouraged, since it runs the risk of being overwritten during an instrument software upgrade.

While the save is being performed, the floppy icon appears briefly in the Meas bar.

File/Folder List

Enables you to navigate to the center of the dialog that contains the list of files and folders. Once here you can get information about the file and use the tab keys to navigate to the other fields in the dialog, such as Save In.

Save In

The Save In field shows the path to which the file will be saved and allows you to change the path using the up and down arrow keys to navigate to other paths; the Enter key to open a directory; and the Backspace key to go back one directory. The **Save In field** defaults to the default path for this type of file and remembers the last path you used to save this type of file. There is no softkey for directly navigating to the Save In field but you can use left tab to get here from the File/Folder List.

User specified paths are remembered when you leave and return to a Mode and are reset back to the default using Restore Mode Defaults.

File Name

The File Name field is initially loaded with an automatically generated filename specific to the appropriate Save Type. The automatically generated filename is guaranteed not to conflict with any filename currently in the directory. You may replace or modify this filename using the File Name key. See the ["Quick Save " on page 1171](#) documentation for more on the automatic file naming algorithm.

When you press the File Name key the analyzer displays the Alpha Editor. Use the knob to choose the letter to add and the front-panel Enter key to add the letter to the file name. The BK character moves you back and the FW character moves you forward in the filename. The Select key on the front panel generates a space character. When you are done entering the filename press the Done softkey. This returns back to the **File Open** dialog and menu, but does not cause the save to occur.

Save As Type

This field shows the file suffix for the type of file you have selected to save. For example, if you navigated here while saving State, "Mode state (*.state)" is in the field. If you navigated here from saving Trace, ""Mode state (*.trace)" is in the field. If you navigated here while exporting a trace data file, "Trace Data (*.csv)" is in the field. For some file types, there is more than one choice in the dropdown, which you can select by using the up and down arrow keys and Enter.

Up One Level

This key corresponds to the icon of a folder with the up arrow that is in the tool bar of the dialog. When pressed, it causes the file and folder list to navigate up one level in the directory structure. The Backspace key does the same thing.

Create New Folder

This key corresponds to the icon of a folder with the "*" that is in the tool bar of the dialog. When pressed, a new folder is created in the current directory with the name **New Folder** and you can enter a new folder name using the Alpha Editor.

Cancel

This key corresponds to the Cancel selection in the dialog. It causes the current **Save As** request to be cancelled. The ESC key does the same thing.

Key Path	Save, State
Mode	All
Notes	Brings up Save As dialog for saving a State Save Type
Initial S/W Revision	Prior to A.02.00

Edit Register Names

You may enter a custom name on any of the Register keys, to help you remember what you are using that state to save. To do this, press the Edit Register Names key, choose the register whose name you wish to edit, and then enter the desired label using the Alpha Editor or an external PC keyboard.

The maximum number of characters that can be added is 30. In most cases, 30 characters will fit on two lines of the key.

See ["More Information" on page 633](#)

Key Path	Save, State
Mode	All
Remote Command	:MMEMory:REGister:STATe:LABel <reg number>,"label" :MMEMory:REGister:STATe:LABel? <reg number>
Example	:MMEM:REG:STAT:LAB 1,"my label"
Notes	<reg number> is an integer from 1 to 16. If the SCPI specifies an invalid register number an error message is generated, -222,"Data out of range;Invalid register label number" "label" is a string from 0 to 30 characters in length. If a label exceeds 30 characters, an error message is generated, -150,"String data error;Label clipped to 30 characters" "label" of length 0 erases the custom label and restores the default (time and date) label. E.g.: :MMEM:REG:STAT:LAB 1,""
Dependencies	N9060A-7FP or N9060B-2FP license required to edit the register names. When the feature is not licensed, sending this command generates an error, -221,"Settings conflict;Option not available"
Preset	The names are unaffected by Preset or power cycle but are set to the default label (time and date) on a "Restore System Defaults->Misc"
Initial S/W Revision	A.11.00

More Information

When you edit one of the register names, the time and date field will be replaced by the custom name.

If you delete all the characters in the custom name, it restores the default (time and date).

The register names are stored within the state files, but they are not part of the instrument state; that is, once you have edited a register name, loading a new state will not change that register name. Another

consequence of this is that the names will be persistent through a power cycle. Also, if a named state file is transferred to another analyzer, it will bring its custom name along with it.

If you try to edit the name of an empty register, the analyzer will first save the state to have a file to put the name in. If you load a named state file into an analyzer with older firmware it will ignore the metadata.

The *SAV and *RCL commands will not be affected by the custom register names, nor will the MMEM commands.

Register 1 thru Register 16

Selecting any one of these register menu keys causes the State of the currently active mode to be saved to the specified Register. The registers are provided for rapid saving and recalling, since you do not need to specify a filename or navigate to a file. Each of the register menu keys annotates whether it is empty or at what date and time it was last modified. In addition, you can use the Edit Register Names key to enter custom names for each register.

NOTE

In products that run multiple instances of the X-Series Application, save with different register name if you do not want to overwrite the register of another running instance.

Although these 16 registers are the only registers available from the front panel, there are 128 state registers available in the instrument. Registers 17–128 are only available from the SCPI interface, using the *SAV command.

There is one set of 128 state registers in the instrument, not one set for each Mode. When a state is saved, the Mode it was saved from is saved with it; then when it is recalled, the instrument switches to that Mode.

After the save completes, the corresponding register menu key annotation is updated with the date and time and the message "Register <register number> saved" is displayed.

Key Path	Save, State
Mode	All
Example	*SAV 1
Range	1–16 from front panel, 1–128 from SCPI
Readback	Date and time with seconds resolution are displayed on the key OR A custom name of up to 30 characters entered using the Edit Register Names key OR “(empty)” if no prior save operation has been performed to this register.
Initial S/W Revision	Prior to A.02.00
Modified at S/W Revision	A.11.00

Register 1 thru Register 16

Selecting any one of these register menu keys causes the State of the currently active mode to be saved to the specified Register. The registers are provided for rapid saving and recalling, since you do not need to specify a filename or navigate to a file. Each of the register menu keys annotates whether it is empty or at

what date and time it was last modified. In addition, you can use the Edit Register Names key to enter custom names for each register.

NOTE In products that run multiple instances of the X-Series Application, save with different register name if you do not want to overwrite the register of another running instance.

Although these 16 registers are the only registers available from the front panel, there are 128 state registers available in the instrument. Registers 17–128 are only available from the SCPI interface, using the *SAV command.

There is one set of 128 state registers in the instrument, not one set for each Mode. When a state is saved, the Mode it was saved from is saved with it; then when it is recalled, the instrument switches to that Mode.

After the save completes, the corresponding register menu key annotation is updated with the date and time and the message "Register <register number> saved" is displayed.

Key Path	Save, State
Mode	All
Example	*SAV 1
Range	1–16 from front panel, 1–128 from SCPI
Readback	Date and time with seconds resolution are displayed on the key OR A custom name of up to 30 characters entered using the Edit Register Names key OR “(empty)” if no prior save operation has been performed to this register.
Initial S/W Revision	Prior to A.02.00
Modified at S/W Revision	A.11.00

Mass Storage Catalog (Remote Command Only)

Key path	SCPI Only
Remote Command	:MMEMory:CATalog? [<directory_name>]
Notes	The string must be a valid logical path. Queries disk usage information (drive capacity, free space available) and obtains a list of files and directories in a specified directory in the following format: <numeric_value>,<numeric_value>,{<file_entry>} It returns two numeric parameters and as many strings as there are files and directories. The first parameter indicates the total amount of storage currently used in bytes. The second parameter indicates the total amount of storage available, also in bytes. The <file_entry> is a string. Each <file_entry> indicates the name, type, and size of one file in the directory list: <file_name>,<file_type>,<file_size> As the windows file system has an extension that indicates file type, <file_type> is always empty. <file_size> provides the size of the file in bytes. For directories, <file_entry> is surrounded by square brackets and both <file_type> and <file_size> are empty
Initial S/W Revision	Prior to A.02.00

Mass Storage Change Directory (Remote Command Only)

Key path	SCPI Only
Remote Command	:MMEMory:CDIRectory [<directory_name>] :MMEMory:CDIRectory?
Notes	The string must be a valid logical path. Changes the default directory for a mass memory file system. The <directory_name> parameter is a string. If no parameter is specified, the directory is set to the *RST value. At *RST, this value is set to the default user data storage area, that is defined as System.Environment.SpecialFolder.Personal. Query returns full path of the default directory.
Initial S/W Revision	Prior to A.02.00

Mass Storage Copy (Remote Command Only)

Key path	SCPI Only
Remote Command	:MMEMory:COPY <string>,<string>[,<string>,<string>]
Notes	The string must be a valid logical path. Copies an existing file to a new file or an existing directory to a new directory. Two forms of parameters are allowed. The first form has two parameters. In this form, the first parameter specifies the source, and the second parameter specifies the destination. The second form has four parameters. In this form, the first and third parameters specify the source. The second and fourth parameters specify the directories. The first pair of parameters specifies the source. The second pair specifies the destination. An error is generated if the source doesn't exist or the destination file already exists. This command will generate an "access denied" error if the destination is a restricted folder (e.g., C:\Windows) and the current user does not have Power User or Administrator privileges.

Mass Storage Device Copy (Remote Command Only)

This command transfers data to/from a file and a peripheral device.

Key path	SCPI Only
Remote Command	:MMEMory:COPY:DEvice <source_string>,<dest_string>
Notes	The strings must be a valid logical path or a valid device keyword. If the dest_string is a device keyword, the data is copied from the source file to the device. If the source_string is a device keyword, the data is copied to the source file from the device. Valid device keywords are: SNS (smart noise source) An error is generated if the file or device is not found.

Mass Storage Delete (Remote Command Only)

Key path	SCPI Only
Remote Command	:MMEMory:DELeTe <file_name>[,<directory_name>]
Notes	The string must be a valid logical path. Removes a file from the specified directory. The <file_name> parameter specifies the file name to be removed. This command will generate an “access denied” error if the file is in a restricted folder (e.g., C:\Windows) and the current user does not have Power User or Administrator privileges.
Initial S/W Revision	Prior to A.02.00

Mass Storage Data (Remote Command Only)

Creates a file containing the specified data OR queries the data from an existing file.

Key path	SCPI Only
Remote Command	:MMEMory:DATA <file_name>, <data> :MMEMory:DATA? <file_name>
Notes	The string must be a valid logical path. The command form is MMEMory:DATA <file_name>,<data>. It loads <data> into the file <file_name>. <data> is in 488.2 block format. <file_name> is string data. The query form is MMEMory:DATA? <file_name> with the response being the associated <data> in block format.
Initial S/W Revision	Prior to A.02.00

Mass Storage Make Directory (Remote Command Only)

Key path	SCPI Only
Remote Command	:MMEMory:MDIRectory <directory_name>
Notes	The string must be a valid logical path. Creates a new directory. The <directory_name> parameter specifies the name to be created. This command will generate an “access denied” error if the new directory would be in a restricted folder (e.g., C:\Windows) and the current user does not have Power User or Administrator privileges.
Initial S/W Revision	Prior to A.02.00

Mass Storage Move (Remote Command Only)

Key path	SCPI Only
Remote Command	:MMEMory:MOVE <string>,<string>[,<string>,<string>]
Notes	The string must be a valid logical path. Moves an existing file to a new file or an existing directory to a new directory.

Two forms of parameters are allowed. The first form has two parameters. In this form, the first parameter specifies the source, and the second parameter specifies the destination.

The second form has four parameters. In this form, the first and third parameters specify the source. The second and fourth parameters specify the directories. The first pair of parameters specifies the source. The second pair specifies the destination. An error is generated if the source doesn't exist or the destination file already exists.

This command will generate an "access denied" error if the destination is a restricted folder (e.g., C:\Windows) and the current user does not have Power User or Administrator privileges.

Initial S/W Revision Prior to A.02.00

Mass Storage Remove Directory (Remote Command Only)

Key path SCPI Only

Remote Command :MMEMory:RDIRECTory <directory_name>

Notes

The string must be a valid logical path.

Removes a directory. The <directory_name> parameter specifies the directory name to be removed. All files and directories under the specified directory shall also be removed.

This command will generate an "access denied" error if the folder is a restricted folder (e.g., C:\Windows) or is in a restricted folder and the current user does not have Power User or Administrator privileges.

Initial S/W Revision Prior to A.02.00

Sequences

These keys allow you to save a Tab separated or CSV file of the setup parameters required to build a Sequence.

In order to save you must select the Save As button and choose a destination folder.

Key Path Save, Sequences

Mode All

Remote Command :MMEM:STOR:SEQ:ences: | SLIST | ALIST | SAAList | SSTep
"MySequence.txt"

Example :MMEM:STOR:SEQ:SLIST "MySequence.txt"

Notes

Available file types are:

- CSV (Comma delimited) (*.csv)
- Text (Tab delimited) (*.txt)

Initial S/W Revision A.05.00

Source Sequence

The list of parameters, that configure steps, that makes up a sequence for the Source.

The Source sequence is a sequence of flexible configurable steps that can be set anywhere in the instruments frequency range.

Key Path	Save, Sequences
Example	:MMEM:STOR:SEQ:SLIS "MySequence.txt"
Dependencies	Only available in XOBT
Initial S/W Revision	A.05.00

Save As . . .

This menu lets you select the location where you can save the Sequence. This menu is a standard Windows® dialog with Save As menu keys. The "File Name" field in the Save As dialog is initially loaded with an automatically generated filename specific to the appropriate Save Type. The automatically generated filename is guaranteed not to conflict with any filename currently in the directory. You may replace or modify this filename using the File Name softkey. See the Quick Save key documentation for more on the automatic file naming algorithm.

The default path for all Sequence Files is:

My Documents\Sequences

Key Path	Save, Sequences
Mode	All
Notes	Brings up Save As dialog for saving a Sequence Save Type
Initial S/W Revision	A.05.00

Data

The Analog Demod Mode Export Data options include Traces and Measurement Results.

Key Path	Save, Data
Remote Command Notes	No SCPI command directly controls the Data Type that this key controls. The Data Type is included as part of the MMEM:STOR commands.
Preset	Trace; is not affected by a Preset, but is reset during Restore Mode Defaults and survives Power cycles.
State Saved	Saved in instrument state.
Readback line	1-of-N selection
Initial S/W Revision	Prior to A.02.00

AM/FM/ΦM Trace

Selects Trace as the data type to be exported with this save request. This key brings up the Trace menu that enables you to select one of the following traces:

- RF Spectrum (RFSPectrum)
- Demod (DEMod)
- Demod Avg (DAverage)
- Demod Max (DMAXimum)
- Demod Min (DMINimum)
- AF Spectrum (AFSPectrum)
- RF Envelope (RFENvelope) --- only available in FM measurement
- Demod Raw (DRAW) --- only available in FM measurement

Once you select a trace, the menu returns back to the Data menu and the name of the selected trace is annotated on the Trace key. Now that you have selected exactly what needs to be saved, to trigger a save of the selected trace, you must select the Save As key in the Data menu.

If the Demod Min trace, Demod Max trace, or Demod Avg trace is exported when the Average/Hold Num feature is turned off, the resulting data will be default values.

The trace data file is a .csv file containing the data for one trace, suitable for import into spreadsheet software. There is a header block, followed by metadata that includes the parameters necessary to recreate the measurement, followed by a DATA block that contains the x,y data for the specified trace. Each line in the metadata includes the parameter, followed by a comma, followed by the parameter value. The metadata includes the following information:

Parameter	
Measurement †	AM FM PM
Trace	AM PM: AF Spectrum RF Spectrum Demod Demod Ave Demod Min Demod Max FM: AF Spectrum RF Spectrum Demod Demod Ave Demod Min Demod Max RF Envelope Demod Raw
X Axis Unit	Hz S
Y Axis Unit	dBm % Hz Rad
Center Frequency †	[units of Hz]
Channel BW †	[units of Hz]
Average State †	Off On
Average Count	#
HPF/BPF †	Off HPF20 HPF50 HPF300 HPF400 CCITT AWEighting

	CWEighting CMESsage CCIR1 k CCIR2k CUNWeighting
LPF †	Off LPF300 LPF3K LPF10K LPF15K LPF30K LPF80K LPF300K LPF100K M500K
Attenuation †	[units of dB]
RF Coupling †	AC DC
Ref Level	[units of Y Axis Unit]
RF Span †	[units of Hz]
RF Res Bandwidth †	[units of Hz]
Sweep Time †	[units of S]
AF Start Freq	[units of Hz]
AF Stop Freq †	[units of Hz]
AF Res Bandwidth †	[units of Hz]
Trigger Source †	Off Ext1 Ext2
Trigger Level †	[units of V]
Trigger Slope †	Positive Negative
Trigger Delay †	[units of S]
PreAmp State †	Off On
PreAmp Band †	Low High
Input Z Correction †	50 75
RF Calibrator	Off 50 MHz 4.8 GHz Comb
External Gain	[units of dB]
Auto Carrier Frequency †	Off On
Auto Carrier Phase †	Off On

† Changing this parameter requires a measurement restart.

Note that all metadata is stored for each trace. After the metadata, the keyword DATA occurs on its own line, followed by the data (one X, Y pair per line).

Key Path	Save, Data
Notes	The first key press selects traces out of the 1-of-N file type options. The second key press brings up the Traces menu so you can select which trace you want to export.
Preset	RF Spectrum; is not affected by a Preset, but is reset during Restore Mode Defaults and survives Power cycles.
State Saved	Saved in instrument state.

Readback	Selected Trace table
Readback line	RF Spectrum, Demod, Demod Avg, Demod Max, Demod Min, AF Spectrum, RF Envelope, Demod Raw
Initial S/W Revision	Prior to A.02.00

Measurement Results

Pressing this key selects Meas Results as the data type to be exported. Pressing the key a second time brings up the Meas Results menu, which allows you to select which **Meas Result** to save. In the Swept SA measurement, there are three types of Measurement Results files: Peak Table, Marker Table and Spectrogram.

See "[Meas Results File Contents](#)" on page 642.

See "[Marker Table](#)" on page 643.

See "[Peak Table](#)" on page 645.

See Spectrogram

Remote Command	:MMEMory:STORe:RESults:MTABle PTABle SPECTrogram <filename>
Example	:MMEM:STOR:RES:MTAB "myResults.csv" Saves the results from the current marker table to the file myResults.csv in the current path. :MMEM:STOR:RES:PTAB "myResults.csv" Saves the results from the current peak table to the file myResults.csv in the current path. :MMEM:STOR:RES:SPEC "myResults.csv" Saves the results from the current Spectrogram display to the file myResults.csv in the current path. The default path is My Documents\SA\data\SAN\results
Notes	If the save is initiated via SCPI, and the file already exists, the file will be overwritten. Using the C: drive is strongly discouraged, since it runs the risk of being overwritten during an instrument software upgrade. Both single and double quotes are supported for any filename parameter over SCPI.
Dependencies	If a save of Marker Table results is requested and the Marker Table is not on, no file is saved and a message is generated If a save of Peak Table results is requested and the Peak Table is not on, no file is saved and a message is generated If a save of Spectrogram results is requested and the Spectrogram is not on, no file is saved and a message is generated. The Spectrogram choice only appears if option EDP is licensed.
Preset	Not part of Preset, but is reset to Peak Table by Restore Mode Defaults. Survives a shutdown.
Initial S/W Revision	Prior to A.02.00

Meas Results File Contents

All files are .csv files. The following section details the data in each file type.

Marker Table

This section discusses the Marker Table Meas Results file format.

Imagine that, at the point where a Marker Table Meas Result is requested, the following screen is showing:

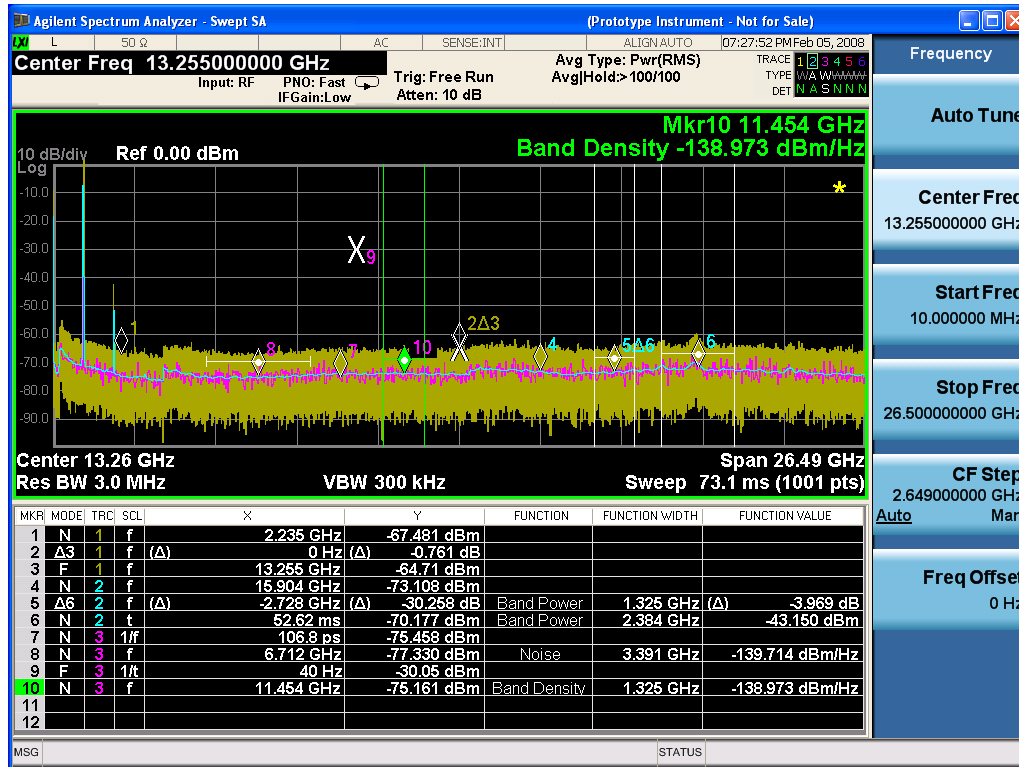

Then the Meas Results file, when opened, would show the following data:

MeasurementR result	
Swept SA	
A.01.40_R0017	N9020A
526 B25 PFR P26 EA3	1
Result Type	Marker Table
Ref Level	0
Number of Points	1001
Sweep Time	0.0662666 67
Start Frequency	10000000
Stop Frequency	26500000 000

Average Count	0
Average Type	LogPower (Video)
RBW	3000000
RBW Filter	Gaussian
RBW Filter BW	3dB
VBW	3000000
Sweep Type	Swept
X Axis Scale	Lin
PreAmp State	Off
PreAmp Band	Low
Trigger Source	Free
Trigger Level	1.2
Trigger Slope	Positive
Trigger Delay	1.00E-06
Phase Noise Optimization	Fast
Swept If Gain	Low
FFT If Gain	Autorange
RF Coupling	AC
FFT Width	411900
Ext Ref	10000000
Input	RF
RF Calibrator	Off
Attenuation	10
Ref Level Offset	0
External Gain	0
X Axis Units	Hz
Y Axis Units	dBm

DATA									
MKR	MODE	TRC	SCL	X	Y	FUNCTI ON	FUNCTIO N WIDTH	FUNCTI ON VALUE	FUNCTI ON UNIT
1	Normal	1	Frequ ncy	2.2350E+ 09	- 67.4 81	Off	0.0000E+ 00	0	None
2	Delta3	1	Frequ ncy	0.0000E+ 00	- 0.76 1	Off	0.0000E+ 00	0	None

3	Fixed	1	Frequency	1.3255E+10	-64.71	Off	0.0000E+00	0	None
4	Normal	2	Frequency	1.5904E+10	-73.108	Off	0.0000E+00	0	None
5	Delta7	2	Frequency	-2.7280E+09	-30.258	Band Power	1.3250E+06	-3.969	dB
6	Normal	2	Time	5.2620E-02	-70.177	Band Power	2.3840E+06	-43.15	dBm
7	Normal	3	Period	1.0680E-10	-75.458	Off	0.0000E+00	0	None
8	Normal	3	Frequency	6.7120E+09	-77.33	Noise	3.3910E+06	-139.714	dBm/Hz
9	Fixed	3	Inverse Time	4.0000E+01	-30.05	Off	0.0000E+00	0	None
10	Normal	3	Frequency	1.1454E+10	-75.161	Band Density	1.3250E+06	-138.973	dBm/Hz
11	Off	1	Frequency	0.0000E+00	0	Off	0.0000E+00	0	None
12	Off	1	Frequency	0.0000E+00	0	Off	0.0000E+00	0	None

The numbers appear in the file exactly as they appear onscreen. If it says 11.454 GHz onscreen, then in the file it is 11.454E+09.

The metadata header is very similar to the metadata used in the trace data .csv files. See Trace File Contents. The only new information concerns the 1-of-N fields in the marker table itself.

Peak Table

This section discusses the Peak Table Meas Results file format.

Imagine that, at the point where a Marker Table Meas Result is requested, the following screen is showing:

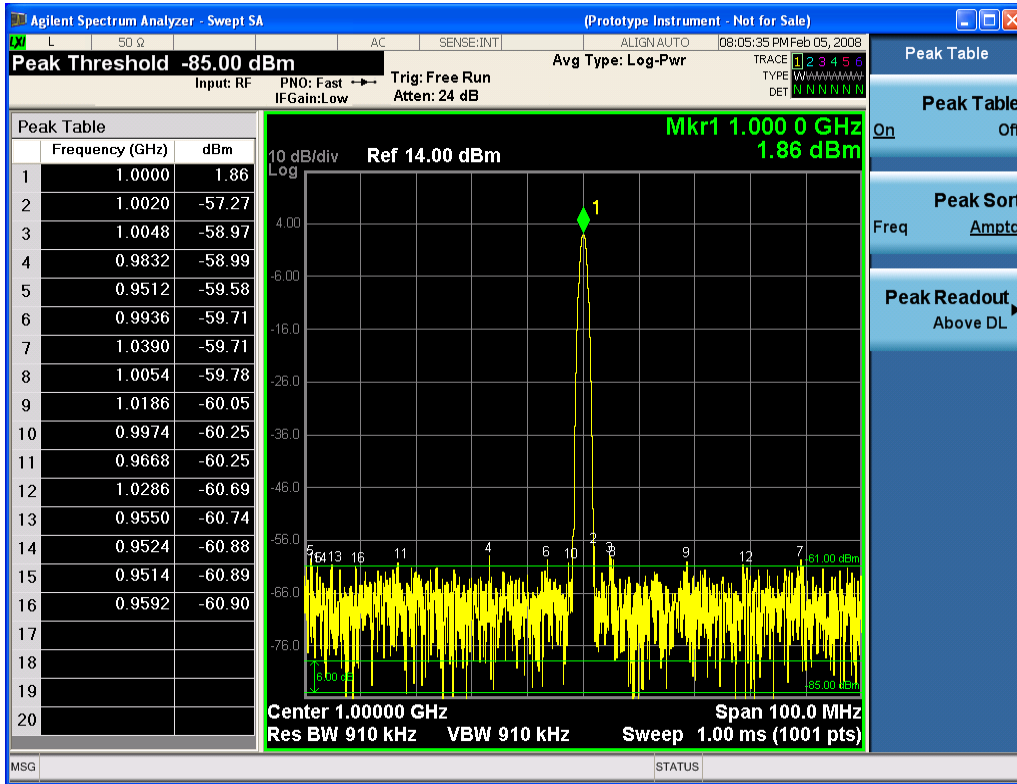

Then the Meas Results file, when opened, would show the header data (the same as for the Marker Table except that the Result Type is Peak Table) ending with a few fields of specific interest to Peak Table users:

- Peak Threshold
- Peak Threshold State (On|Off)
- Peak Excursion
- Peak Excursion State (On|Off)
- Display Line
- Peak Readout (All|AboveDL|BelowDL)
- Peak Sort (Freq|Amptd)

These fields are then followed by the data for the Peak Table itself.

Note that the label for the Frequency column changes to Time in 0 span.

Here is what the table for the above display looks like:

MeasurementResult	
Swept SA	
A.01.40_R0017	N9020A
526 B25 PFR P26 EA3	1

Result Type	Peak Table
Ref Level	0
Number of Points	1001
Sweep Time	0.066266667
Start Frequency	10000000
Stop Frequency	26500000000
Average Count	0
Average Type	LogPower(Video)
RBW	3000000
RBW Filter	Gaussian
RBW Filter BW	3dB
VBW	3000000
Sweep Type	Swept
X Axis Scale	Lin
PreAmp State	Off
PreAmp Band	Low
Trigger Source	Free
Trigger Level	1.2
Trigger Slope	Positive
Trigger Delay	1.00E-06
Phase Noise Optimization	Fast
Swept If Gain	Low
FFT If Gain	Autorange
RF Coupling	AC
FFT Width	411900
Ext Ref	10000000
Input	RF
RF Calibrator	Off
Attenuation	10
Ref Level Offset	0
External Gain	0
X Axis Units	Hz
Y Axis Units	dBm
Peak Threshold	-85
Peak Threshold State	On
Peak Excursion	6
Peak Excursion State	On

Display Line	-61	
Peak Readout	AboveDL	
Peak Sort	Amptd	
DATA		
Peak	Frequency	Amplitude
1	1.0000E+06	1.86
2	1.0020E+06	-57.27
3	1.0048E+06	-58.97
4	9.8320E+05	-58.99
5	9.5120E+05	-59.58
6	9.9360E+05	-59.71
7	1.0390E+06	-59.71
8	1.0054E+06	-59.78
9	1.1086E+06	-60.05
10	9.9740E+05	-60.25
11	9.6680E+05	-60.25
12	1.0286E+06	-60.69
13	9.5500E+05	-60.74
14	9.5240E+05	-60.88
15	9.5140E+05	-60.89
16	9.5920E+05	-60.90
17		
18		
19		
20		

Spectrogram

This section discusses the Spectrogram Results file format. The Spectrogram choice only appears if option EDP is licensed.

The Spectrogram results are the same as a Trace data export, except that instead of having just one trace's data, all 300 traces appear one after the other.

Each trace has its own data mark; the data for Spectrogram Trace 0 follows the row marked DATA, the data for Spectrogram Trace 1 follows the row marked DATA1, for Spectrogram Trace 2 follows the row marked DATA2, and so on.

Each DATA row has a timestamp in the second column (as of firmware revision A.11.01). So, for example, if Trace 0 had a relative start time of 1729.523 sec, then the first DATA row would look like this:

DATA,1729.523

And if Trace 13 had a relative start time of 100.45 sec, then the fourteenth data row would look like:

DATA13,100.453

To find the absolute time for the relative timestamps of each trace, the last row before the first DATA row gives the absolute start time of the Spectrogram, in the form YYYYMMDDHHMMSS

So, for example, if the absolute start time is 13:23:45:678 on January 30, 2012, this row would look like:

Start Time,20120130132345678

NOTE:

NOTE The resolution of the absolute time stored is 1 ms, which matches up with the fact that the fastest sweep time is also 1 ms. However, there is no specification for the absolute accuracy of the clock in the analyzer, nor is there any facility provided to allow the user to set this time to any particular degree of accuracy.

Traces that have not yet been filled in the Spectrogram display are empty; there is no DATA header for them. The file ends after the last non-empty trace.

Imagine that, at the point where a Spectrogram Meas Result is requested, the following screen is showing:

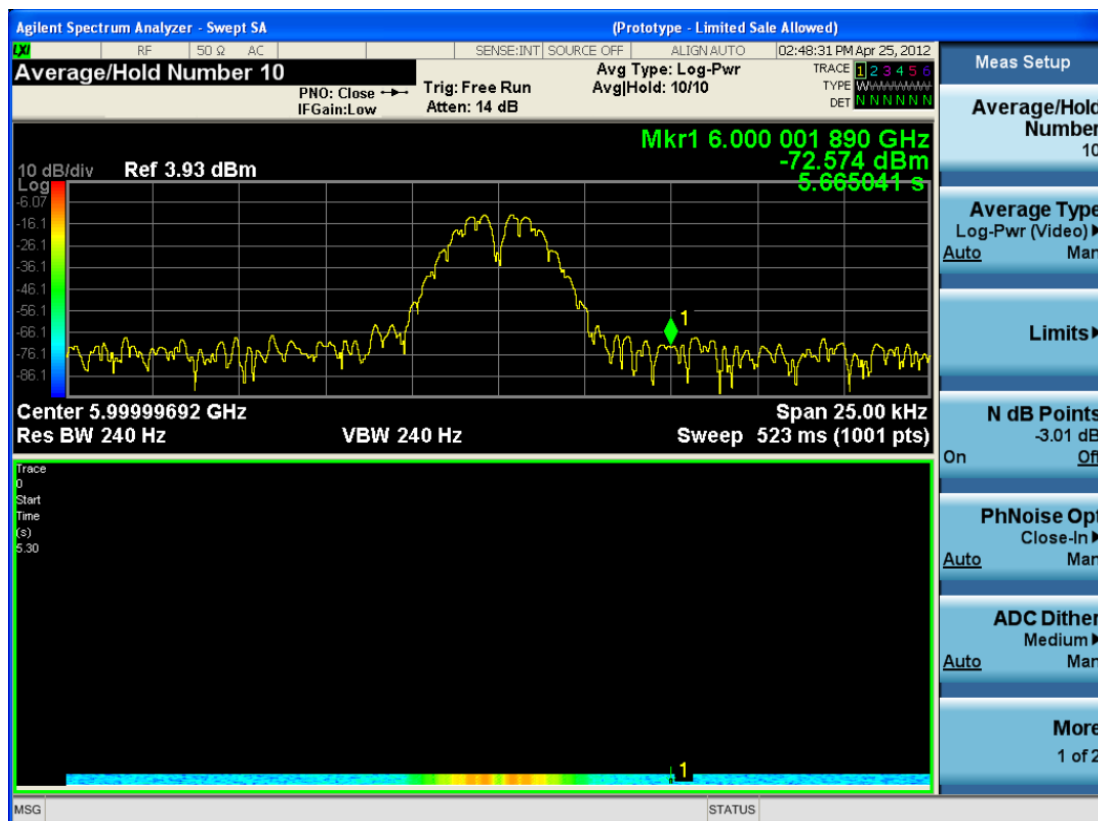

For the purpose of this example, we have set the Average/Hold Number to 10, thus we have only traces 0 thru 10. The Spectrogram was started at 02:28:08:700 pm on April 25, 2012 (that is, 700 ms after 2:28:08 pm), although the screen dump itself shows a different time, as it was taken ten minutes after the Spectrogram data. Trace 0 is showing a start time of 5.30 seconds, meaning 5.3 seconds after the Spectrogram started (trace 10 has a start time of 0, as it was the first trace taken but has now rolled up into the tenth trace slot).

The Meas Results file, when opened, shows the header data and ten traces of trace data. Below is an extract from the result file for the above display. Note the start time of 20120425142808700 showing in the last row before the first DATA row, and the relative time of 5.299231048 showing in the first DATA row:

Result Type	Spectrogram
MeasResult	
Swept SA	
A.11.00.01	N9020A
503 508 513 526 ALL ALV B1C B1X B25 B2X B40 BAB BBA CR3 CRP DP2 DRD EA3 EDP EMC EP1 ERC ESC ESP EXM FSA HBA K03 LFE MPB P03 P08 P13 P26 PFR RTL RTS S40 SB1 SEC SM1 UK6 YAS YAV	1
Segment	0
Number of Points	1001
Sweep Time	0.523333333
Start Frequency	5999984415
Stop Frequency	6000009415
Average Count	0
Average Type	LogPower(Video)
RBW	240
RBW Filter	Gaussian
RBW Filter BW	3dB
VBW	240
Sweep Type	Swept
X Axis Scale	Lin
PreAmp State	Off
PreAmp Band	Low
Trigger Source	Free
Trigger Level	1.2
Trigger Slope	Positive
Trigger Delay	0
Phase Noise Optimization	Wide
Swept If Gain	Low

Result Type	Spectrogram
FFT If Gain	Autorange
RF Coupling	AC
FFT Width	411900
Ext Ref	10000000
Input	RF
RF Calibrator	Off
Attenuation	14
Ref Level Offset	0
External Gain	0
Trace Type	Clearwrite
Detector	Normal
Trace Math	Off
Trace Math Oper1	Trace5
Trace Math Oper2	Trace6
Trace Math Offset	0
Trace Name	Trace1
X Axis Units	Hz
Y Axis Units	dBm
Start Time	20120425142808700
DATA	5.299231048
5999984415	-76.34749519
5999984440	-77.28097006
5999984465	-75.32317869
5999984490	-73.64417681
5999984515	-72.67154604

○
○
○

6000009315	-77.94423277
6000009340	-79.51829697
6000009365	-78.46108961
6000009390	-78.46108957
6000009415	-76.59570596
DATA2	4.708697055

5999984415	-80.98197882
5999984440	-80.98197879
5999984465	-75.83142132
5999984490	-74.02712079
5999984515	-73.57213005

- o
- o
- o

6000009315	-75.9183103
6000009340	-79.53787488
6000009365	-78.82602191
6000009390	-78.82602188
6000009415	-76.37486709
DATA10	0
5999984415	-75.56751112
5999984440	-75.76485645
5999984465	-76.67718717
5999984490	-78.79238489
5999984515	-83.72680212

- o
- o
- o

6000009315	-71.3942461
6000009340	-72.28308332
6000009365	-73.92684489
6000009390	-75.45548832
6000009415	-75.17904815

Save As . . .

When you press “Save As”, the analyzer brings up a Windows dialog and a menu entitled “**Save As.**” This menu allows you to navigate to the various fields in the Windows dialog without using a keyboard or mouse. The Tab and Arrow keys can also be used for dialog navigation.

See "To File . . ." on page 1181 in Save, State for a full description of this dialog and menu.

The default path for saving files is:

For all of the Trace Data Files:

My Documents\`<mode name>`\data\traces

For all of the Limit Data Files:

My Documents\`<mode name>`\data\limits

For all of the Measurement Results Data Files:

My Documents\`<mode name>`\data\`<measurement name>`\results

For all of the Capture Buffer Data Files:

My Documents\`<mode name>`\data\captureBuffer

Key Path	Save, Data
Mode	All
Notes	The key location is mode-dependent and will vary. Brings up the Save As dialog for saving a <code><mode specific></code> Save Type. The save is performed immediately and does not wait until the measurement is complete.
Initial S/W Revision	Prior to A.02.00

Screen Image

Pressing Screen Image accesses a menu of functions that enable you to specify a format and location for the saved screen image. It brings up a menu that allows you to specify the color scheme of the Screen Image (Themes) or navigate to the Save As dialog to perform the actual save.

Screen Image files contain an exact representation of the analyzer display. They cannot be loaded back onto the analyzer, but they can be loaded into your PC for use in many popular applications.

The image to be saved is actually captured when the Save front panel key is pressed, and kept in temporary storage to be used if you ask for a Screen Image save. When the Screen Image key is pressed, a "thumbnail" of the captured image is displayed, as shown below:

9 FM Demod Measurement Save

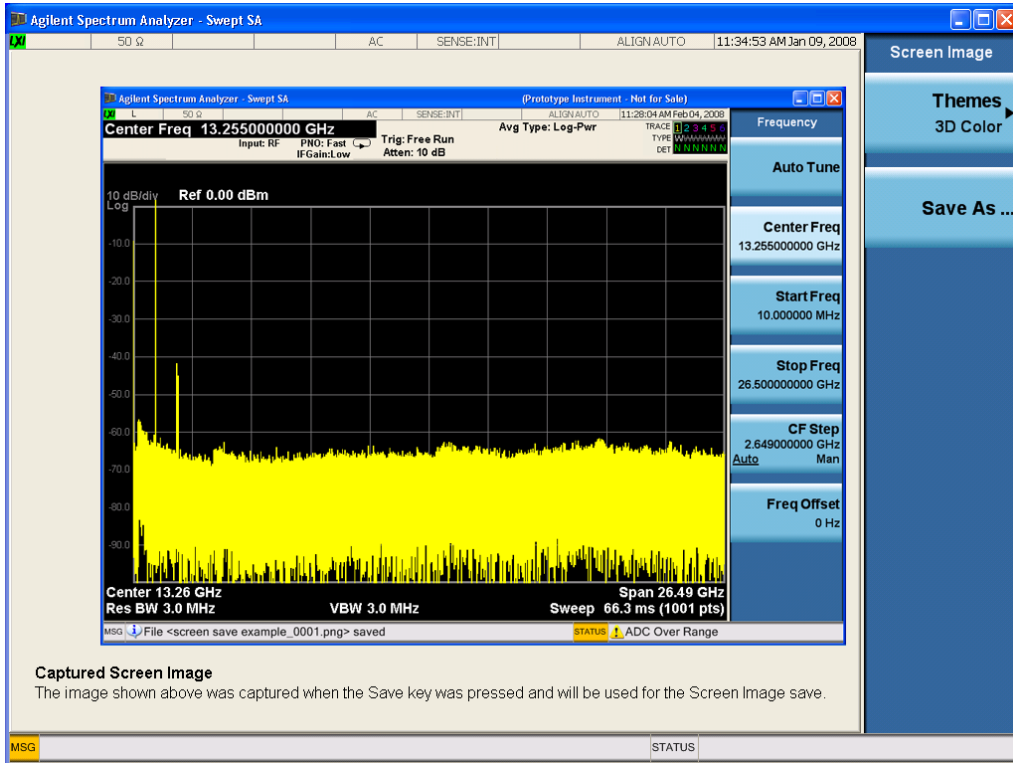

When you continue on into the Save As menu and complete the Screen Image save, the image depicted in the thumbnail is the one that gets saved, showing the menus that were on the screen before going into the Save menus. The save is performed immediately and does not wait until the measurement is complete.

After you have completed the save, the Quick Save front-panel key lets you quickly repeat the last save performed, using an auto-named file, with the current screen data.

NOTE

For versions previous to A.01.55, if you initiate a screen image save by navigating through the Save menus, the image that is saved will contain the Save menu softkeys, not the menus and the active function that were on the screen when you first pressed the Save front panel key.

Key Path	Save
Mode	All
Remote Command	:MMEMory:STORe:SCReen <filename>
Example	:MMEM:STOR:SCR "myScreen.png" This stores the current screen image in the file MyScreenFile.png in the default directory.
Initial S/W Revision	Prior to A.02.00

Themes

Accesses a menu of functions that enable you to choose the theme to be used when saving the screen image.

The **Themes** option is the same as the **Themes** option under the **Display** and **Page Setup** dialogs. It allows you to choose between themes to be used when saving the screen image.

Key Path	Save, Screen Image
Remote Command	:MMEMory:STORe:SCReen:THEMe TDColor TDMonochrome FCOLOR FMONochrome :MMEMory:STORe:SCReen:THEMe?
Example	:MMEM:STOR:SCR:THEM TDM
Preset	3D Color; Is not part of Preset, but is reset by Restore Misc Defaults or Restore System Defaults All and survives subsequent running of the modes.
Readback	3D Color 3D Mono Flat Color Flat Mono
Backwards Compatibility Notes	In ESA and PSA we offer the choice of "Reverse Bitmap" or "Reverse Metafile" when saving screen images. This is much like the "Flat Color" theme available in X-Series. Also, if you selected Reverse Bitmap AND a black & white screen image, that would be much like "Flat Monochrome". In other words, each of the X-Series themes has a similar screen image type in ESA/PSA. But they are not identical.
Initial S/W Revision	Prior to A.02.00

3D Color

Selects a standard color theme with each object filled, shaded and colored as designed.

Key Path	Save, Screen Image, Themes
Example	MMEM:STOR:SCR:THEM TDC
Readback	3D Color
Initial S/W Revision	Prior to A.02.00

3D Monochrome

Selects a format that is like 3D color but shades of gray are used instead of colors.

Key Path	Save, Screen Image, Themes
Example	MMEM:STOR:SCR:THEM TDM
Readback	3D Mono
Initial S/W Revision	Prior to A.02.00

Flat Color

Selects a format that is best when the screen is to be printed on an ink printer.

Key Path	Save, Screen Image, Themes
----------	----------------------------

Example	MMEM:STOR:SCR:THEM FCOL
Readback	Flat Color
Initial S/W Revision	Prior to A.02.00

Flat Monochrome

Selects a format that is like Flat Color. But only black is used (no colors, not even gray), and no fill.

Key Path	Save, Screen Image, Themes
Example	MMEM:STOR:SCR:THEM FMON
Readback	Flat Mono
Initial S/W Revision	Prior to A.02.00

Save As...

When you press "Save As", the analyzer brings up a Windows dialog and a menu entitled "**Save As.**" This menu allows you to navigate to the various fields in the Windows dialog without using a keyboard or mouse. The Tab and Arrow keys can also be used for dialog navigation.

See "[To File . . .](#)" on page 1181 in Save, State for a full description of this dialog and menu.

The default path for Screen Images is

My Documents\`<mode name>`\screen.

where `<mode name>` is the parameter used to select the mode with the INST:SEL command (for example, SA for the Spectrum Analyzer).

Key Path	Save, Screen Image
Notes	Brings up Save As dialog for saving a Screen Image Save Type
Initial S/W Revision	Prior to A.02.00

Single (Single Measurement/Sweep)

Sets the analyzer for Single measurement operation. The single/continuous state is Meas Global, so the setting will affect all the measurements. If you are Paused, pressing Single does a Resume.

See "[More Information](#)" on page 657

Key Path	Front-panel key
Example	:INIT:CONT OFF
Notes	See Cont key description.
Backwards Compatibility Notes	<p>For Spectrum Analysis mode in ESA and PSA, the Single hardkey and the INITiate:IMM switched from continuous measurement to single measurement and restarted sweeps and averages (displayed average count reset to 1), but did not restart Max Hold and Min Hold. In the X-Series, the Single hardkey and the INITiate:IMM command initiate a sweep/ measurement/ average sequence/hold sequence including MaxHold and MinHold.</p> <p>For Spectrum Analysis mode in ESA and PSA, the Single hardkey restarted the sweep regardless of whether or not you were in an active sweep or sweep sequence. In the X-Series, Restart does this but Single only restarts the sweep or sweep sequence if you are in the idle state.</p> <p>INIT[:IMM] in ESA & PSA Spectrum Analysis Mode does an implied ABORT. In some other PSA Modes, INIT[:IMM] is ignored if not in the idle state. . The X-Series follows the ESA/PSA SA Mode model, which may cause some Modes to have compatibility problems.</p>
Initial S/W Revision	Prior to A.02.00

More Information

See "[Restart](#)" on page 1178 for details on the INIT:IMMEDIATE (Restart) function.

If you are already in single sweep, the INIT:CONT OFF command has no effect.

If you are already in Single Sweep, then pressing the Single key in the middle of a sweep does not restart the sweep or sequence. Similarly, pressing the Single key does not restart the sweep or sequence if the sweep is not in the idle state (for example, if you are taking a very slow sweep, or the analyzer is waiting for a trigger). Instead, it results in a message. "Already in Single, press Restart to initiate a new sweep or sequence". Even though pressing the Single key in the middle of a sweep does not restart the sweep, sending INIT:IMMEDIATE does reset it.

To take one more sweep without resetting the average count, increment the average count by 1, by pressing the step up key while **Average/Hold Number** is the active function, or sending the remote command CALC:AVER:TCON UP.

Source

Opens a menu of keys that access various source configuration menus and settings. In the test set, pressing this key also causes the central view area to change and display the Source Control Main view.

Key Path	Front-panel key
----------	-----------------

RF Output

This parameter sets the source RF power output state.

Key Path	Source
Remote Command	:OUTPut[:EXTErnal][:STATe] ON OFF 1 0 :OUTPut[:EXTErnal][:STATe]?
Example	OUTP OFF OUTP?
Notes	<p>The EXTErnal node is shown in RD text so the SCPI remains the same between internal and external source control. However, for EXT we do not wish to document this node to the customer since we are controlling the internal source rather than the external source.</p> <p>This setting is for the independent mode and has no effect on the "List Sequencer" on page 1306. If the "Sequencer" on page 1307 is set to ON, the list sequencer controls the source output and this key will be grayed-out. And this setting will be none-forceful grey out on front panel to indicate out-of-scope. Non-forceful means user still can change this setting by SCPI but cannot change on front panel. When set to OFF will make source leave list sequencer and this setting will be black out and take effect immediately.</p> <p>When the RF Output is ON, an "RF" annunciator is displayed in the system settings panel. When the RF Output is turned Off, the RF annunciator is cleared. If the "Sequencer" on page 1307 is set to ON, the "RF" annunciator will be replaced by "SEQ" in the system settings panel, indicating that the output is controlled by the list sequencer.</p>
Preset	Off
Range	On Off
Initial S/W Revision	A.05.00

Amplitude

Allows you to access the Amplitude sub-menu.

Key Path	Source
Notes	<p>The sub-menu under this button is for independent mode and has no effect on "List Sequencer" on page 1306. If the "Sequencer" on page 1307 is set to ON, the list sequencer controls the source output and this key will be grayed-out on front panel to indicate out-of-scope. When you set "Sequencer" on page 1307 to Off will make source leave list sequencer and this button will be black out.</p>
Initial S/W Revision	A.05.00

RF Power

Allows you to adjust the power level of the source using the numeric keypad, step keys, or RPG. Pressing any digit, 0 through 9, on the numeric keypad brings up the unit terminator.

Please refer to the "RF Power Range " on page 660 table below for the valid ranges.

Key Path	Source, Amplitude
Remote Command	:SOURce:POWer[:LEVel][:IMMediate][:AMPLitude] <ampl> :SOURce:POWer[:LEVel][:IMMediate][:AMPLitude]?
Example	:SOUR:POW -100 dBm
Notes	<p>Amplitude corrections can be specified for use with the source. In the event of amplitude corrections being applied, the valid ranges for the RF power do not change dependant on the current amplitude correction setting. If the combination of RF power + amplitude correction is higher or lower than the source output range, the Source Unleveled bit is set and the "Source Unleveled" indicator will appear on status panel to indicate that the source cannot maintain the output power that has been requested.</p> <p>When signal generator is unable to maintain the requested output level, the "Source Unleveled" indicator will appear on status panel. When the source output setting is restored to the normal range, the "Source Unleveled" is removed from status panel.</p> <p>Internal source has list sequence mode, which comprises of several steps which contain separate output power, frequency and waveform etc. When the source list sequence playing is complete, the last step keeps playing, and user can use this command to change the list sequence last step's output power.</p> <p>The multiport adapter RFIO TX ports and GPS ports cannot ensure power accuracy when power setting is lower than -130dBm, this power setting value is defined by the sum of RF Power setting and related amplitude correction value. But user settable value could be lower than this limit. When application detected there exists power setting lower than -130dBm on MPA RFIO TX ports, then popup warning message . When application detected there exists power setting lower than -130dBm on MPA GPS ports, then popup warning message . This is only warning message, and check is performed when RF is ON.</p>
Notes	The Min and Max value here defined UI settable amplitude range. This range is larger than actual amplitude range with level accuracy defined in spec.
Dependencies	The RF power is dependent on the RF output port and frequency, such that the current frequency and selected output port determine the valid range of power values.
Preset	-100 dBm
Min	The range of values depends on the current frequency and selected RF output port. Please refer to the "RF Power Range " on page 660 table below for the valid ranges.
Max	The range of values depends on the current frequency and selected RF output port. Please refer to the "RF Power Range " on page 660 table below for the valid ranges.
Initial S/W Revision	A.05.00

RF Power Range

RF Output Port	Frequency Range	Min Output Power	Max Output Power
High Power RF Out	10 MHz ≤ f ≤ 6 GHz	-150 dBm	20 dBm
RFIO 1 & RFIO 2	10 MHz ≤ f ≤ 6 GHz	-150 dBm	0 dBm
GPS (Note2)	10 MHz ≤ f ≤ 6 GHz	-150 dBm	0 dBm

Note: This is the UI power range, it's larger than actual spec.

Note2: GPS port is on the multiport adapter, or E6607C which has embedded MPA.

Set Reference Power

This key allows you to set the power reference. Pressing this key turns the power reference state to ON, sets the reference power value to the current RF output power, maintains this power at the RF output, and sets the displayed power to 0.00 dB. All subsequent RF power values entered under Source>Amplitude>RF Power are interpreted as being relative to this reference power.

When you use a power reference, the signal generator outputs an RF power that is set relative to the reference power by the value entered under Source>Amplitude>RF Power as follows:

Output power = reference power – entered power

Where:

reference power equals the original RF Power entered under Source>Amplitude>RF Power and set as the reference power

entered power equals a new value entered under Source>Amplitude>Amptd Offset

In addition, the displayed power value is the same as a new value entered under Source>Amplitude>RF Power.

NOTE

If Power Ref is set to ON with a reference value set, entering a value under Source>Amplitude>RF Power and pressing Set Reference Power will add that value to the existing Power Ref value.

If you wish to change the reference power value to a new value entered under Source>Amplitude>RF Power, first you must set Power Ref to OFF and then press Set Reference Power.

Key Path	Source, Amplitude
Dependencies	This key is unavailable, and is grayed out when the "List Sequencer" on page 1306 is turned ON.
Initial S/W Revision	A.05.00

Power Ref

This key allows you to toggle the state of the power reference.

When you use a power reference, the signal generator outputs an RF power that is set relative to the reference power by the value entered under Source>Amplitude>RF Power as follows:

Output power = reference power + entered power

Where:

reference power equals the original RF Power entered under Source>Amplitude>RF Power and set as the reference power

entered power equals a new value entered under Source>Amplitude>Amptd Offset

For more information on Reference Frequency refer to ["Set Reference Power " on page 1229](#)

Key Path	Source, Amplitude
Remote Command	:SOURce:POWer:REFeRence <ampl> :SOURce:POWer:REFeRence? :SOURce:POWer:REFeRence:STATe OFF ON 0 1 :SOURce:POWer:REFeRence:STATe?
Example	:SOUR:POW:REF 0.00 dBm :SOUR:POW:REF:STATe ON
Dependencies	This setting is unavailable and is grayed out when the "List Sequencer" on page 1306 is turned ON.
Couplings	This value is coupled to the "Set Reference Power " on page 1229 key such that pressing the Set Reference Power key updates the reference power with the current output power.
Preset	0.00 dBm OFF
Min	-125.00 dBm
Max	10.00 dBm
Initial S/W Revision	A.05.00

Amptd Offset

Allows you to specify the RF output power offset value.

When the amplitude offset is set to zero (0) and you set a new offset value (positive or negative), the displayed amplitude value will change as follows and the RF output power will not change:

Displayed value = output power + offset value

Where:

output power equals the original RF Power entered under Source>Amplitude>RF Power

offset value equals the value entered under Source>Amplitude>Amptd Offset

When the amplitude offset is set to a value other than zero (0) and you enter a new RF power value under Source>Amplitude>RF Power, the displayed power will be the same as the value entered and the RF output power will be equal to the value entered minus the offset value as follows:

Output power = entered power – offset power

Displayed Power = output power + offset power

Displayed power = entered power

Where:

entered power equals the amplitude entered under Source>Amplitude>RF Power

offset power equals the value previously entered and set under Source>Amplitude>Amptd Offset

Key Path	Source, Amplitude
Remote Command	:SOURce:POWer[:LEVel][:IMMediate]:OFFSet <rel_ampl> :SOURce:POWer[:LEVel][:IMMediate]:OFFSet?
Example	:SOUR:POW:OFFS 0.00 dB
Dependencies	This setting is unavailable, and is grayed out when the List Sequencer is turned ON.
Preset	0.00 dB
Min	-200.00 dB
Max	200.00 dB
Initial S/W Revision	A.05.00

Modulation

Allows you to toggle the state of the modulation.

Key Path	Source
Remote Command	:OUTPut:MODulation[:STATe] ON OFF 1 0 :OUTPut:MODulation[:STATe]?
Example	:OUTP:MOD OFF
Notes	This setting is for independent mode and has no effect on " List Sequencer " on page 1306. If the " Sequencer " on page 1307 is set to ON, the list sequencer controls the source output and this key will be grayed-out. And this setting will be none-forceful grey out on front panel to indicate out-of-scope. Non-forceful means user still can change this setting by SCPI but cannot change manually on front panel. When set to Off will make source leave list sequencer and this setting will be black out and take effect immediately. When the Modulation is ON, the "MOD" annunciator is displayed in the system settings panel. When the Modulation is turned Off, the "MOD" annunciator is cleared. If the " Sequencer " on page 1307 is set to ON, the "MOD" annunciator will be replaced by "SEQ" in the system settings panel indicating that the output is controlled by list sequencer.
Preset	Off
Range	On Off
Initial S/W Revision	A.05.00

Frequency

Allows you to access the Frequency sub-menu.

Key Path	Source
Notes	The sub-menu under this button is for independent mode and has no effect on " List Sequencer " on

[page 1306](#). If the ["Sequencer" on page 1307](#) is set to ON, the list sequencer controls the source output and this key will be grayed-out. And this button will be grey out on front panel to indicate out-of-scope. When set to Off will make source leave list sequencer and this button will be black out.

Initial S/W Revision A.05.00

Frequency

Allows you to set the RF Output Frequency. You can adjust the frequency of the source using the numeric keypad, step keys, or RPG. Pressing any digit, 0 through 9, on the numeric keypad brings up the unit terminator.

Key Path	Source, Frequency
Remote Command	:SOURce:FREQuency[:CW] <freq> :SOURce:FREQuency[:CW] ?
Example	:SOUR:FREQ 1.00 GHz
Notes	Internal source has list sequence mode, which comprises of several steps which contain separate output power, frequency and waveform etc. When the source list sequence playing is complete, the last step keeps playing, and user can use this command to change the list sequence last step's output frequency.
Couplings	The frequency value is coupled to the current channel band and number, such that updates to the band and number will update the frequency value to the corresponding absolute frequency.
Preset	1.00 GHz If license F1A or 5WC is present, the default Center Frequency should be 2.412GHz.
Min	10.00 MHz
Max	Hardware Dependant: Option 503 = 3.6 GHz Option 504 = 3.8 GHz Option 506 = 6.00 GHz For E6640A, if license 5WC is present, the frequency range should be limited to: 1.1GHz-1.7GHz, 2.4GHz-2.5GHz, 4.8GHz-6.0GHz. If the user-defined frequency is outside of range, UI will report an error message called "Settings conflict; Frequency is outside available range".
Initial S/W Revision	A.05.00

Channel

The frequency of the source can be specified by a channel number of a given frequency band. This key allows you to specify the current channel number. For the appropriate range of channel numbers for a given frequency band, refer to the following tables: ["GSM/EDGE Channel Number Ranges" on page 664](#), ["W-CDMA Channel Number Ranges" on page 665](#), ["CDMA 2000 / 1xEVDO Channel Number Ranges" on page 666](#), and ["LTE FDD Channel Number Ranges" on page 668](#).

Key Path	Source, Frequency
Remote Command	:SOURCE:FREQUENCY:CHANNELS:NUMBER <int> :SOURCE:FREQUENCY:CHANNELS:NUMBER?
Example	:SOUR:FREQ:CHAN:NUMB 1
Notes	This key is grayed out when the "Radio Standard" on page 1241 is set to NONE. This key is grayed out on E6630A.
Dependencies	This key is grayed out when the "Radio Standard" on page 1241 is set to NONE. This key is grayed out on E6630A.
Couplings	The channel number is coupled to the frequency value when the "Radio Standard" on page 1241 is not set to NONE. When the frequency value is changed, the channel number will increase or decrease to match the new frequency. If the frequency is not at an exact match for a channel number, the nearest channel number is displayed along with a greater than or less than sign to indicate the frequency is above or below the channel number.
Preset	1
Min	Please refer to the tables below for the valid ranges.
Max	Please refer to the tables below for the valid ranges.
Initial S/W Revision	A.05.00

GSM/EDGE Channel Number Ranges

Band	Link (Device)	Range	Frequency (MHz)
P-GSM	Uplink (MS)	$1 \leq n \leq 124$	$890.0 + 0.2*n$
	Downlink (BS)	$1 \leq n \leq 124$	$935.0 + 0.2*n$
E-GSM	Uplink (MS)	$0 \leq n \leq 124$	$890.0 + 0.2*n$
		$975 \leq n \leq 1023$	$890.0 + 0.2*(n-1024)$
	Downlink (BS)	$0 \leq n \leq 124$	$935.0 + 0.2*n$
		$975 \leq n \leq 1023$	$935.0 + 0.2*(n-1024)$
DCS 1800	Uplink (MS)	$512 \leq n \leq 885$	$1710.200 + 0.20*(n-512)$
	Downlink (BS)	$512 \leq n \leq 885$	$1805.200 + 0.20*(n-512)$
PCS 1900	Uplink (MS)	$512 \leq n \leq 810$	$1850.200 + 0.2*(n-512)$
	Downlink (BS)	$512 \leq n \leq 810$	$1930.200 + 0.2*(n-512)$
R-GSM	Uplink (MS)	$0 \leq n \leq 124$	$890.0 + 0.2*n$
		$955 \leq n \leq 1023$	$890.0 + 0.2*(n-1024)$
	Downlink (BS)	$0 \leq n \leq 124$	$935.0 + 0.2*n$
		$955 \leq n \leq 1023$	$935.0 + 0.2*(n-1024)$
GSM 450	Uplink (MS)	$256 \leq n \leq 293$	$450.6 + 0.2*(n-259)$
	Downlink (BS)	$256 \leq n \leq 293$	$460.6 + 0.2*(n-259)$
GSM 480	Uplink (MS)	$306 \leq n \leq 340$	$479.000 + 0.20*(n-306)$

Band	Link (Device)	Range	Frequency (MHz)
GSM 850	Downlink (BS)	$306 \leq n \leq 340$	$489.000 + 0.20*(n-306)$
	Uplink (MS)	$128 \leq n \leq 251$	$824.200 + 0.20*(n-128)$
	Downlink (BS)	$128 \leq n \leq 251$	$869.200 + 0.20*(n-128)$
GSM 700	Uplink (MS)	$438 \leq n \leq 516$	$777.200 + 0.20*(n-438)$
	Downlink (BS)	$438 \leq n \leq 516$	$747.200 + 0.20*(n-438)$
T-GSM810	Uplink (MS)	$350 \leq n \leq 425$	$806.0 + 0.20*(n-350)$
	Downlink (BS)	$350 \leq n \leq 425$	$851.0 + 0.20*(n-350)$

W-CDMA Channel Number Ranges

Band	Link (Device)	Range	Frequency (MHz)
Band I	Downlink	$10562 \leq n \leq 10838$	$n \div 5$
	Uplink	$9612 \leq n \leq 9888$	$n \div 5$
Band II	Downlink	$412 \leq n \leq 687$	$n \div 5 + 1850.1$
		$9662 \leq n \leq 9938$	$n \div 5$
	Uplink	$12 \leq n \leq 287$ $350 \leq n \leq 425$	$n \div 5 + 1850.1$ $n \div 5$
Band III	Downlink	$1162 \leq n \leq 1513$	$n \div 5 + 1575$
	Uplink	$937 \leq n \leq 1288$	$n \div 5 + 1525$
Band IV	Downlink	$537 \leq n \leq 1738$	$n \div 5 + 1805$
		$1887 \leq n \leq 2087$	$n \div 5 + 1735.1$
	Uplink	$1312 \leq n \leq 1513$ $1662 \leq n \leq 1862$	$n \div 5 + 1450$ $n \div 5 + 1380.1$
Band V	Downlink	$1007 \leq n \leq 1087$	$n \div 5 + 670.1$
		$4357 \leq n \leq 4458$	$n \div 5$
	Uplink	$782 \leq n \leq 862$ $4132 \leq n \leq 4233$	$n \div 5 + 670.1$ $n \div 5$
Band VI	Downlink	$1037 \leq n \leq 1062$	$n \div 5 + 670.1$
		$4387 \leq n \leq 4413$	$n \div 5$
	Uplink	$812 \leq n \leq 837$ $4162 \leq n \leq 4188$	$n \div 5 + 670.1$ $n \div 5$
Band VII	Downlink	$2237 \leq n \leq 2563$	$n \div 5 + 2175$
		$2587 \leq n \leq 2912$	$n \div 5 + 2105.1$
	Uplink	$2012 \leq n \leq 2338$ $2362 \leq n \leq 2687$	$n \div 5 + 2100$ $n \div 5 + 2030.1$
Band VIII	Downlink	$2937 \leq n \leq 3088$	$n \div 5 + 340$
	Uplink	$2712 \leq n \leq 2863$	$n \div 5 + 340$

Band	Link (Device)	Range	Frequency (MHz)
Band IX	Downlink	$9237 \leq n \leq 9387$	$n \div 5$
	Uplink	$8762 \leq n \leq 8912$	$n \div 5$
Band X	Downlink	$3112 \leq n \leq 3388$	$n \div 5 + 1490$
		$3412 \leq n \leq 3687$	$n \div 5 + 1430.1$
	Uplink	$2887 \leq n \leq 3163$	$n \div 5 + 1135$
		$3187 \leq n \leq 3462$	$n \div 5 + 1075.1$
Band XI	Downlink	$3712 \leq n \leq 3812$	$n \div 5 + 736$
	Uplink	$3487 \leq n \leq 3587$	$n \div 5 + 733$
Band XII	Downlink	$3837 \leq n \leq 3903$	$n \div 5 - 37$
		$3927 \leq n \leq 3992$	$n \div 5 - 54.9$
	Uplink	$3612 \leq n \leq 3678$	$n \div 5 - 22$
		$3702 \leq n \leq 3767$	$n \div 5 - 39.9$
Band XIII	Downlink	$4017 \leq n \leq 4043$	$n \div 5 - 55$
		$4067 \leq n \leq 4092$	$n \div 5 - 64.9$
	Uplink	$3792 \leq n \leq 3818$	$n \div 5 + 21$
		$3702 \leq n \leq 3767$	$n \div 5 - 39.9$
Band XIV	Downlink	$4117 \leq n \leq 4143$	$n \div 5 - 63$
		$4167 \leq n \leq 4192$	$n \div 5 - 72.9$
	Uplink	$3892 \leq n \leq 3918$	$n \div 5 + 12$
		$3942 \leq n \leq 3967$	$n \div 5 + 2.1$
Band XIX	Downlink	$712 \leq n \leq 763$	$n \div 5 + 735$
		$787 \leq n \leq 837$	$n \div 5 + 720.1$
	Uplink	$312 \leq n \leq 363$	$n \div 5 + 770$
		$387 \leq n \leq 437$	$n \div 5 + 755.1$

CDMA 2000 / 1xEVDO Channel Number Ranges

Band	Link (Device)	Range	Frequency (MHz)
US Cellular	Uplink (MS, reverse link)	$1 \leq N \leq 799$	$0.030 \times N + 825.000$
		$991 \leq N \leq 1023$	$0.030 \times (N - 1023) + 825.000$
		$1024 \leq N \leq 1323$	$0.030 \times (N - 1024) + 815.040$
	Downlink (BS, forward link)	$1 \leq N \leq 799$	$0.030 \times N + 870.000$
		$991 \leq N \leq 1023$	$0.030 \times (N - 1023) + 870.000$
		$1024 \leq N \leq 1323$	$0.030 \times (N - 1024) + 860.040$
US PCS	Uplink (MS, reverse link)	$0 \leq N \leq 1199$	$1850.000 + 0.050 \times N$
	Downlink (BS, forward link)	$0 \leq N \leq 1199$	$1930.000 + 0.050 \times N$

Band	Link (Device)	Range	Frequency (MHz)
Japan Cellular Band	Uplink (MS, reverse link)	$1 \leq N \leq 799$	$0.0125 \times (N + 915.000)$
		$801 \leq N \leq 1039$	$0.0125 \times (N - 800) + 898.000$
		$1041 \leq N \leq 1199$	$0.0125 \times (N - 1040) + 887.000$
		$1201 \leq N \leq 1600$	$0.0125 \times (N - 1200) + 893.000$
	Downlink (BS, forward link)	$1 \leq N \leq 799$	$0.0125 \times (N + 860.000)$
		$801 \leq N \leq 1039$	$0.0125 \times (N - 800) + 843.000$
		$1041 \leq N \leq 1199$	$0.0125 \times (N - 1040) + 832.000$
		$1201 \leq N \leq 1600$	$0.0125 \times (N - 1200) + 838.000$
Korean PCS Band	Uplink (MS, reverse link)	$0 \leq N \leq 599$	$0.050 \times N + 1750.000$
	Downlink (BS, forward link)	$0 \leq N \leq 599$	$0.050 \times N + 1840.000$
NMT-450 Band	Uplink (MS, reverse link)	$1 \leq N \leq 400$	$0.025 \times (N - 1) + 450.000$
		$472 \leq N \leq 871$	$0.025 \times (N - 472) + 410.000$
		$1039 \leq N \leq 1473$	$0.020 \times (N - 1024) + 451.010$
		$1536 \leq N \leq 1715$	$0.025 \times (N - 1536) + 479.000$
	Downlink (BS, forward link)	$1 \leq N \leq 400$	$0.025 \times (N - 1) + 460.000$
		$472 \leq N \leq 871$	$0.025 \times (N - 472) + 420.000$
		$1039 \leq N \leq 1473$	$0.020 \times (N - 1024) + 461.010$
		$1536 \leq N \leq 1715$	$0.025 \times (N - 1536) + 489.000$
IMT-2000 Band	Uplink (MS, reverse link)	$0 \leq N \leq 1199$	$1920.000 + 0.050 \times N$
	Downlink (BS, forward link)	$0 \leq N \leq 1199$	$2100.000 + 0.050 \times N$
Upper 700 MHz Band	Uplink (MS, reverse link)	$0 \leq N \leq 240$	$776.000 + 0.050 \times N$
	Downlink (BS, forward link)	$0 \leq N \leq 240$	$746.000 + 0.050 \times N$
Secondary 800 MHz Band	Uplink (MS, reverse link)	$0 \leq N \leq 719$	$0.025 \times N + 806.000$
		$720 \leq N \leq 919$	$0.025 \times (N - 720) + 896.000$
	Downlink (BS, forward link)	$0 \leq N \leq 719$	$0.025 \times N + 851.000$
		$720 \leq N \leq 919$	$0.025 \times (N - 720) + 935.000$
2.5 GHz IMT Extension	Uplink (MS, reverse link)	$0 \leq N \leq 1399$	$2500.000 + 0.050 \times N$
	Downlink (BS, forward link)	$0 \leq N \leq 1399$	$2620.000 + 0.050 \times N$
US PCS 1.9 GHz	Uplink (MS, reverse link)	$0 \leq N \leq 1299$	$1850.000 + 0.050 \times N$

Band	Link (Device)	Range	Frequency (MHz)
AWS	Downlink (BS, forward link)	$0 \leq N \leq 1299$	$1930.000 + 0.050 \times N$
	Uplink (MS, reverse link)	$0 \leq N \leq 899$	$1710.000 + 0.050 \times N$
US 2.5 GHz	Downlink (BS, forward link)	$0 \leq N \leq 899$	$2100.000 + 0.050 \times N$
	Uplink (MS, reverse link)	$140 \leq N \leq 1459$	$2495.000 + 0.050 \times N$
700 Public Safety	Downlink (BS, forward link)	$140 \leq N \leq 1459$	$2617.000 + 0.050 \times N$
	Uplink (MS, reverse link)	$0 \leq N \leq 240$	$787.000 + 0.050 \times N$
C2K Lower 700	Downlink (BS, forward link)	$0 \leq N \leq 240$	$757.000 + 0.050 \times N$
	Uplink (MS, reverse link)	$0 \leq N \leq 360$	$698.000 + 0.050 \times N$
400 Euro PAMR	Downlink (BS, forward link)	$0 \leq N \leq 360$	$728.000 + 0.050 \times N$
	Uplink (MS, reverse link)	$1 \leq N \leq 400$	$0.025 \times (N-1) + 450.000$
	Uplink (MS, reverse link)	$472 \leq N \leq 871$	$0.025 \times (N-472) + 410.000$
	Uplink (MS, reverse link)	$1536 \leq N \leq 1715$	$0.025 \times (N-1536) + 479.000$
	Downlink (BS, forward link)	$1 \leq N \leq 400$	$0.025 \times (N-1) + 460.000$
	Downlink (BS, forward link)	$472 \leq N \leq 871$	$0.025 \times (N-472) + 420.000$
	Downlink (BS, forward link)	$1536 \leq N \leq 1715$	$0.025 \times (N-1536) + 489.000$
	Downlink (BS, forward link)		
800 PAMR	Uplink (MS, reverse link)	$0 \leq N \leq 239$	$870.0125 + 0.025 \times N$
	Downlink (BS, forward link)	$0 \leq N \leq 239$	$915.0125 + 0.025 \times N$

LTE FDD Channel Number Ranges

The carrier frequency in the uplink and downlink is designated by the E-UTRA Absolute Radio Frequency Channel Number (EARFCN) in the range 0 – 65535. The relation between EARFCN and the carrier frequency in MHz for the downlink is given by the following equation, where FDL_low and NOffs-DL are given in table 5.4.4–1 and NDL is the downlink EARFCN.

$$FDL = FDL_low + 0.1(NDL - NOffs-DL)$$

The relation between EARFCN and the carrier frequency in MHz for the uplink is given by the following equation where FUL_low and NOffs-UL are given in table 5.4.4-1 and NUL is the uplink EARFCN.

$$FUL = FUL_low + 0.1(NUL - NOffs-UL)$$

Band	Downlink		Uplink			
	FDL_low (MHz)	NOffs-DL	Range of ND L	FUL_low (MHz)	NOffs-UL	Range of NUL
1		2110	0	0 - 599	1920	18000 - 18599
2		1930	600	600 - 1199	1850	18600 - 19199
3		1805	1200	1200 - 1949	1710	19200 - 19949
4		2110	1950	1950 - 2399	1710	19950 - 20399
5		869	2400	2400 - 2649	824	20400 - 20649
6		875	2650	2650 - 2749	830	20650 - 20749
7		2620	2750	2750 - 3449	2500	20750 - 20449
8		925	3450	3450 - 3799	880	21450 - 21799
9		1844.9	3800	3800 - 4149	1749.9	21800 - 22149
10		2110	4150	4150 - 4749	1710	22150 - 22749
11		1475.9	4750	4750 - 4949	1427.9	22750 - 22949
12		729	5010	5010 - 5179	699	23010 - 23179
13		746	5180	5180 - 5279	777	23180 - 23279
14		758	5280	5280 - 5379	788	23280 - 23379
...						
17		734	5730	5730 - 5849	704	23730 - 23849
18		860	5850	5850 - 5999	815	23850 - 23999
19		875	6000	6000 - 6149	830	24000 - 24149
20		791	6150	6150 - 6449	832	24150 - 24449
21		1495.9	6450	6450 - 6599	1447.9	24450 - 24599
...						
24		1525	7700	7700 - 8039	1626.5	25700 - 26039
25		1930	8040	8040 - 8689	1850	26040 - 26689
26		859	8690	8690 - 9039	814	26690 - 27039
...						

Note: The channel numbers that designate carrier frequencies so close to the operating band edges that the carrier extends beyond the operating band edge shall not be used. This implies that the first 7, 15, 25, 50, 75 and 100 channel numbers at the lower operating band edge and the last 6, 14, 24, 49, 74 and 99 channel numbers at the upper operating band edge shall not be used for channel bandwidths of 1.4, 3, 5, 10, 15 and 20 MHz respectively.

LTE TDD Channel Number Ranges

The carrier frequency in the uplink and downlink is designated by the E-UTRA Absolute Radio Frequency Channel Number (EARFCN) in the range 0 – 65535. The relation between EARFCN and the carrier frequency in MHz for the downlink is given by the following equation, where FDL_low and NOffs-DL are given in table 5.4.4–1 and NDL is the downlink EARFCN.

$$FDL = FDL_low + 0.1(NDL - NOffs-DL)$$

The relation between EARFCN and the carrier frequency in MHz for the uplink is given by the following equation where FUL_low and NOffs-UL are given in table 5.4.4–1 and NUL is the uplink EARFCN.

$$FUL = FUL_low + 0.1(NUL - NOffs-UL)$$

Band	Downlink		Uplink			
	FDL_low (MHz)	NOffs-DL	Range of NDL	FUL_low (MHz)	NOffs-UL	Range of NUL
33		1900	36000	36000 – 36199	1900	36000 – 36199
34		2010	36200	36200 – 36349	2010	36200 – 36349
35		1850	36350	36350 – 36949	1850	36350 – 36949
36		1930	36950	36950 – 37549	1930	36950 – 37549
37		1910	37550	37550 – 37749	1910	37550 – 37749
38		2570	37750	37750 – 38249	2570	37750 – 38249
39		1880	38250	38250 – 38649	1880	38250 – 38649
40		2300	38650	38650 – 39649	2300	38650 – 39649
41		2496	39650	39650 – 41589	2496	39650 – 41589
42		3400	41590	41590 – 43589	3400	41590 – 43589
43		3600	43590	43590 – 45589	3600	43590 – 45589

Note: The channel numbers that designate carrier frequencies so close to the operating band edges that the carrier extends beyond the operating band edge shall not be used. This implies that the first 7, 15, 25, 50, 75 and 100 channel numbers at the lower operating band edge and the last 6, 14, 24, 49, 74 and 99 channel numbers at the upper operating band edge shall not be used for channel bandwidths of 1.4, 3, 5, 10, 15 and 20 MHz respectively.

TDSCDMA Channel Number Ranges

1.28 Mcps TDD Option

No TX-RX frequency separation is required as Time Division Duplex (TDD) is employed. Each subframe consists of 7 main timeslots where all main timeslots (at least the first one) before the single switching point are allocated DL and all main timeslots (at least the last one) after the single switching point are allocated UL.

The nominal channel spacing is 1.6 MHz, but this can be adjusted to optimise performance in a particular deployment scenario.

The carrier frequency is designated by the UTRA absolute radio frequency channel number (UARFCN). The value of the UARFCN in the IMT2000 band is defined in the general case as follows:

$$N_t = 5 * F \quad 0.0 \text{ MHz} \leq F \leq 3276.6 \text{ MHz}$$

where F is the carrier frequency in MHz

Additional channels applicable to operation in the frequency band defined in sub-clause 5.2(d) are defined via the following UARFCN definition:

$$N_t = 5 * (F - 2150.1 \text{ MHz}) \quad 2572.5 \text{ MHz} \leq F \leq 2617.5 \text{ MHz}$$

UARFCN

1.28 Mcps TDD Option

The following UARFCN range shall be supported for each band:

Table: UTRA Absolute Radio

Frequency Channel Number 1.28

Mcps TDD Option

Frequency Band	Frequency Range	UARFCN Uplink and Downlink transmission
For operation in frequency band as defined in subclause 5.2 (a)	1900–1920 MHz	9504 to 9596
	2010–2025 MHz	10054 to 10121
For operation in frequency band as defined in subclause 5.2 (b)	1850–1910 MHz	9254 to 9546
	1930–1990 MHz	9654 to 9946
For operation in frequency band as defined in subclause 5.2 (c)	1910–1930 MHz	9554 to 9646
For operation in frequency band as defined in subclause 5.2 (d)	2570–2620 MHz	12854 to 13096
For operation in frequency band as defined in subclause 5.2 (e)	2300–2400 MHz	11504 to 11996
For operation in frequency band as defined in subclause 5.2 (f)	1880–1920 MHz	9404 to 9596

Radio Setup

Allows access to the sub-menus for selecting the radio standard and associated radio band. You can also set a frequency reference and offset.

This menu is greyed out when on E6630A. Radio band settings for GSM, cdma2000, and so on -- most of which are not actually supported in E6630A, which has three narrow frequency bands. So band settings are grayed out.

Key Path	Source, Frequency
Initial S/W Revision	A.05.00

Radio Standard

Allows access to the channel band sub-menus to select the desired radio standard. When you have selected the radio standard, you can then set an active channel band. The radio standard and the active channel band allow you to use channel numbers to set frequency automatically.

Key Path	Source, Frequency, Radio Setup
Remote Command	:SOURce:FREQuency:CHANnels:BAND NONE PGSM EGSM RGSM DCS1800 PCS1900 TGSM810 GSM450 GSM480 GSM700 GSM850 BANDI BANDII BANDIII BANDIV BANDV BANDVI BANDVII BANDVIII BANDIX BANDX BANDXI BANDXII BANDXIII BANDXIV BANDXIX USCELL USPCS JAPAN KOREAN NMT IMT2K UPPER SECOND PAMR400 PAMR800 IMTEXT PCS1DOT9G AWS US2DOT5G PUBLIC LOWER BAND1 BAND2 BAND3 BAND4 BAND5 BAND6 BAND7 BAND8 BAND10 BAND11 BAND12 BAND13 BAND14 BAND17 BAND18 BAND19 BAND20 BAND21 BAND24 BAND25 BAND26 BAND27 BAND28 BAND31 BAND33 BAND34 BAND35 BAND36 BAND37 BAND38 BAND39 BAND40 BAND41 BAND42 BAND43 BAND44 BANDA BANDB BANDC BANDD BANDE BANDF :SOURce:FREQuency:CHANnels:BAND?
Example	:SOUR:FREQ:CHAN:BAND PGSM
Notes	Set this setting to "NONE" will grey out "Channel" on page 1232 Channel
Initial S/W Revision	A.05.00

None

Selects no radio standard for use. When you have selected the radio standard to NONE, you cannot use channel numbers to set frequency automatically. You will need to set the frequency manually.

Key Path	Source, Frequency, Radio Setup, Radio Standard
Initial S/W Revision	A.05.00

GSM/EDGE

Sets GSM/EDGE as the radio standard for use and accesses the GSM/EDGE specific channel band sub-menus.

Key Path	Source, Frequency, Radio Setup, Radio Standard
Initial S/W Revision	A.05.00

P-GSM

Selects P-GSM as the active channel band.

Key Path	Source, Frequency, Radio Setup, Radio Standard, GSM/EDGE
Example	:SOUR:FREQ:CHAN:BAND PGSM
Initial S/W Revision	A.05.00

E-GSM

Selects E-GSM as the active channel band.

Key Path	Source, Frequency, Radio Setup, Radio Standard, GSM/EDGE
Example	:SOUR:FREQ:CHAN:BAND EGSM
Initial S/W Revision	A.05.00

R-GSM

Selects R-GSM as the active channel band.

Key Path	Source, Frequency, Radio Setup, Radio Standard, GSM/EDGE
Example	:SOUR:FREQ:CHAN:BAND RGSM
Initial S/W Revision	A.05.00

DCS 1800

Selects DCS 1800 as the active channel band.

Key Path	Source, Frequency, Radio Setup, Radio Standard, GSM/EDGE
Example	:SOUR:FREQ:CHAN:BAND DCS1800
Initial S/W Revision	A.05.00

PCS 1900

Selects PCS 1900 as the active channel band.

Key Path	Source, Frequency, Radio Setup, Radio Standard, GSM/EDGE
Example	:SOUR:FREQ:CHAN:BAND PCS1900
Initial S/W Revision	A.05.00

GSM 450

Selects GSM 450 as the active channel band.

Key Path	Source, Frequency, Radio Setup, Radio Standard, GSM/EDGE
Example	:SOUR:FREQ:CHAN:BAND GSM450
Initial S/W Revision	A.05.00

GSM 480

Selects GSM 480 as the active channel band.

Key Path	Source, Frequency, Radio Setup, Radio Standard, GSM/EDGE
Example	:SOUR:FREQ:CHAN:BAND GSM480
Initial S/W Revision	A.05.00

GSM 850

Selects GSM 850 as the active channel band.

Key Path	Source, Frequency, Radio Setup, Radio Standard, GSM/EDGE
Example	:SOUR:FREQ:CHAN:BAND GSM850
Initial S/W Revision	A.05.00

GSM 700

Selects GSM 700 as the active channel band.

Key Path	Source, Frequency, Radio Setup, Radio Standard, GSM/EDGE
Example	:SOUR:FREQ:CHAN:BAND GSM700
Initial S/W Revision	A.05.00

T-GSM 810

Selects T-GSM 810 as the active channel band.

Key Path	Source, Frequency, Radio Setup, Radio Standard, GSM/EDGE
Example	:SOUR:FREQ:CHAN:BAND T-GSM810
Initial S/W Revision	A.05.00

WCDMA

Sets WCDMA as the radio standard for use and accesses the W-CDMA specific channel band sub-menus.

Key Path	Source, Frequency, Radio Setup, Radio Standard
Initial S/W Revision	A.05.00

Band I

Selects Band I as the active channel band.

Key Path	Source, Frequency, Radio Setup, Radio Standard, WCDMA
Example	:SOUR:FREQ:CHAN:BAND BANDI
Initial S/W Revision	A.05.00

Band II

Selects Band II as the active channel band.

Key Path	Source, Frequency, Radio Setup, Radio Standard, WCDMA
Example	:SOUR:FREQ:CHAN:BAND BANDII
Initial S/W Revision	A.05.00

Band III

Selects Band III as the active channel band.

Key Path	Source, Frequency, Radio Setup, Radio Standard, WCDMA
Example	:SOUR:FREQ:CHAN:BAND BANDIII
Initial S/W Revision	A.05.00

Band IV

Selects Band IV as the active channel band.

Key Path	Source, Frequency, Radio Setup, Radio Standard, WCDMA
Example	:SOUR:FREQ:CHAN:BAND BANDIV
Initial S/W Revision	A.05.00

Band V

Selects Band V as the active channel band.

Key Path	Source, Frequency, Radio Setup, Radio Standard, WCDMA
Example	:SOUR:FREQ:CHAN:BAND BANDV
Initial S/W Revision	A.05.00

Band VI

Selects Band VI as the active channel band.

Key Path	Source, Frequency, Radio Setup, Radio Standard, WCDMA
Example	:SOUR:FREQ:CHAN:BAND BANDVI
Initial S/W Revision	A.05.00

Band VII

Selects Band VII as the active channel band.

Key Path	Source, Frequency, Radio Setup, Radio Standard, WCDMA
Example	:SOUR:FREQ:CHAN:BAND BANDVII
Initial S/W Revision	A.05.00

Band VIII

Selects Band VIII as the active channel band.

Key Path	Source, Frequency, Radio Setup, Radio Standard, WCDMA
Example	:SOUR:FREQ:CHAN:BAND BANDVIII
Initial S/W Revision	A.05.00

Band IX

Selects Band IX as the active channel band.

Key Path	Source, Frequency, Radio Setup, Radio Standard, WCDMA
Example	:SOUR:FREQ:CHAN:BAND BANDIX
Initial S/W Revision	A.05.00

Band X

Selects Band X as the active channel band.

Key Path	Source, Frequency, Radio Setup, Radio Standard, WCDMA
Example	:SOUR:FREQ:CHAN:BAND BANDX
Initial S/W Revision	A.05.00

Band XI

Selects Band XI as the active channel band.

Key Path	Source, Frequency, Radio Setup, Radio Standard, WCDMA
Example	:SOUR:FREQ:CHAN:BAND BANDXI
Initial S/W Revision	A.05.00

Band XII

Selects Band XII as the active channel band.

Key Path	Source, Frequency, Radio Setup, Radio Standard, WCDMA
Example	:SOUR:FREQ:CHAN:BAND BANDXII
Initial S/W Revision	A.05.00

Band XIII

Selects band XIII as the active channel band.

Key Path	Source, Frequency, Radio Setup, Radio Standard, WCDMA
Example	:SOUR:FREQ:CHAN:BAND BANDXIII
Initial S/W Revision	A.05.00

Band XIV

Selects Band XIV as the active channel band.

Key Path	Source, Frequency, Radio Setup, Radio Standard, WCDMA
Example	:SOUR:FREQ:CHAN:BAND BANDXIV
Initial S/W Revision	A.05.00

Band XIX

Selects Band XIX as the active channel band.

Key Path	Source, Frequency, Radio Setup, Radio Standard, WCDMA
Example	:SOUR:FREQ:CHAN:BAND BANDXIX
Initial S/W Revision	A.14.50

CDMA 2000 / 1xEVDO

Sets CDMA 2000 / 1XEVDO as the radio standard for use and accesses the CDMA 2000/1xEVDO specific channel band sub-menus.

Key Path	Source, Frequency, Radio Setup, Radio Standard
Initial S/W Revision	A.05.00

US CELL

Selects US Cell as the active channel band.

Key Path	Source, Frequency, Radio Setup, Radio Standard, CDMA 2000 / 1xEVDO
Example	:SOUR:FREQ:CHAN:BAND USCELL
Initial S/W Revision	A.05.00

US PCS

Selects US PCS as the active channel band.

Key Path	Source, Frequency, Radio Setup, Radio Standard, CDMA 2000 / 1xEVDO
Example	:SOUR:FREQ:CHAN:BAND PCS
Initial S/W Revision	A.05.00

Japan Cell

Selects Japan Cell as the active channel band.

Key Path	Source, Frequency, Radio Setup, Radio Standard, CDMA 2000 / 1xEVDO
Example	:SOUR:FREQ:CHAN:BAND JAPAN
Initial S/W Revision	A.05.00

Korean PCS

Selects Korean PCS as the active channel band.

Key Path	Source, Frequency, Radio Setup, Radio Standard, CDMA 2000 / 1xEVDO
Example	:SOUR:FREQ:CHAN:BAND KOREAN
Initial S/W Revision	A.05.00

NMT 450

Selects NMT 450 as the active channel band.

Key Path	Source, Frequency, Radio Setup, Radio Standard, CDMA 2000 / 1xEVDO
----------	--

Example	:SOUR:FREQ:CHAN:BAND NMT
Initial S/W Revision	A.05.00

IMT 2000

Selects IMT 2000 as the active channel band.

Key Path	Source, Frequency, Radio Setup, Radio Standard, CDMA 2000 / 1xEVDO
Example	:SOUR:FREQ:CHAN:BAND IMT2K
Initial S/W Revision	A.05.00

Upper 700

Selects Upper 700 as the active channel band.

Key Path	Source, Frequency, Radio Setup, Radio Standard, CDMA 2000 / 1xEVDO
Example	:SOUR:FREQ:CHAN:BAND UPPER
Initial S/W Revision	A.05.00

Secondary 800

Selects Secondary 800 as the active channel band.

Key Path	Source, Frequency, Radio Setup, Radio Standard, CDMA 2000 / 1xEVDO
Example	:SOUR:FREQ:CHAN:BAND SECOND
Initial S/W Revision	A.05.00

400 Euro PAMR

Selects 400 Euro PAMR as the active channel band.

Key Path	Source, Frequency, Radio Setup, Radio Standard, CDMA 2000 / 1xEVDO
Example	:SOUR:FREQ:CHAN:BAND PAMR400
Initial S/W Revision	A.05.00

800 PAMR

Selects 800 PAMR as the active channel band.

Key Path	Source, Frequency, Radio Setup, Radio Standard, CDMA 2000 / 1xEVDO
----------	--

Example	:SOUR:FREQ:CHAN:BAND PAMR800
Initial S/W Revision	A.05.00

2.5GHz IMT EXT

Selects 2.5 GHz IMT EXT as the active channel band.

Key Path	Source, Frequency, Radio Setup, Radio Standard, CDMA 2000 / 1xEVDO
Example	:SOUR:FREQ:CHAN:BAND IMTEXT
Initial S/W Revision	A.05.00

US PCS 1.9GHz

Selects US PCS 1.9 GHz as the active channel band.

Key Path	Source, Frequency, Radio Setup, Radio Standard, CDMA 2000 / 1xEVDO
Example	:SOUR:FREQ:CHAN:BAND PCS1DOT9G
Initial S/W Revision	A.05.00

AWS

Selects AWS as the active channel band.

Key Path	Source, Frequency, Radio Setup, Radio Standard, CDMA 2000 / 1xEVDO
Example	:SOUR:FREQ:CHAN:BAND AWS
Initial S/W Revision	A.05.00

US 2.5GHz

Selects US 2.5 GHz as the active channel band.

Key Path	Source, Frequency, Radio Setup, Radio Standard, CDMA 2000 / 1xEVDO
Example	:SOUR:FREQ:CHAN:BAND US2DOT5G
Initial S/W Revision	A.05.00

700 Public Safety

Selects 700 Public Safety as the active channel band.

Key Path	Source, Frequency, Radio Setup, Radio Standard, CDMA 2000 / 1xEVDO
----------	--

Example	:SOUR:FREQ:CHAN:BAND PUBLIC
Initial S/W Revision	A.05.00

C2K Lower 700

Selects C2K Lower 700 as the active channel band.

Key Path	Source, Frequency, Radio Setup, Radio Standard, CDMA 2000 / 1xEVDO
Example	:SOUR:FREQ:CHAN:BAND LOWER
Initial S/W Revision	A.05.00

LTE

Sets LTE FDD as the radio standard for use and accesses the LTE FDD specific channel band sub-menus..

Key Path	Source, Frequency, Radio Setup, Radio Standard
Initial S/W Revision	A.09.50

BAND 1

Selects BAND 1 as the band for the current step.

Key Path	Source, Frequency, Radio Setup, Radio Standard, LTE
Example	:SOUR:FREQ:CHAN:BAND BAND1
Initial S/W Revision	A.09.50

BAND 2

Selects BAND 2 as the band for the current step.

Key Path	Source, Frequency, Radio Setup, Radio Standard, LTE
Example	:SOUR:FREQ:CHAN:BAND BAND2
Initial S/W Revision	A.09.50

BAND 3

Selects BAND 3 as the band for the current step.

Key Path	Source, Frequency, Radio Setup, Radio Standard, LTE
Example	:SOUR:FREQ:CHAN:BAND BAND3
Initial S/W Revision	A.09.50

BAND 4

Selects BAND 4 as the band for the current step.

Key Path	Source, Frequency, Radio Setup, Radio Standard, LTE
Example	:SOUR:FREQ:CHAN:BAND BAND4
Initial S/W Revision	A.09.50

BAND 5

Selects BAND 5 as the band for the current step.

Key Path	Source, Frequency, Radio Setup, Radio Standard, LTE
Example	:SOUR:FREQ:CHAN:BAND BAND5
Initial S/W Revision	A.09.50

BAND 6

Selects BAND 6 as the band for the current step.

Key Path	Source, Frequency, Radio Setup, Radio Standard, LTE
Example	:SOUR:FREQ:CHAN:BAND BAND6
Initial S/W Revision	A.09.50

BAND 7

Selects BAND 7 as the band for the current step.

Key Path	Source, Frequency, Radio Setup, Radio Standard, LTE
Example	:SOUR:FREQ:CHAN:BAND BAND7
Initial S/W Revision	A.09.50

BAND 8

Selects BAND 8 as the band for the current step.

Key Path	Source, Frequency, Radio Setup, Radio Standard, LTE
Example	:SOUR:FREQ:CHAN:BAND BAND8
Initial S/W Revision	A.09.50

BAND 9

Selects BAND 9 as the band for the current step.

Key Path	Source, Frequency, Radio Setup, Radio Standard, LTE
Example	:SOUR:FREQ:CHAN:BAND BAND9
Initial S/W Revision	A.09.50

BAND 10

Selects BAND 10 as the band for the current step.

Key Path	Source, Frequency, Radio Setup, Radio Standard, LTE
Example	:SOUR:FREQ:CHAN:BAND BAND10
Initial S/W Revision	A.09.50

BAND 11

Selects BAND 11 as the band for the current step.

Key Path	Source, Frequency, Radio Setup, Radio Standard, LTE
Example	:SOUR:FREQ:CHAN:BAND BAND11
Initial S/W Revision	A.09.50

BAND 12

Selects BAND 12 as the band for the current step.

Key Path	Source, Frequency, Radio Setup, Radio Standard, LTE
Example	:SOUR:FREQ:CHAN:BAND BAND12
Initial S/W Revision	A.09.50

BAND 13

Selects BAND 13 as the band for the current step.

Key Path	Source, Frequency, Radio Setup, Radio Standard, LTE
Example	:SOUR:FREQ:CHAN:BAND BAND13
Initial S/W Revision	A.09.50

BAND 14

Selects BAND 14 as the band for the current step.

Key Path	Source, Frequency, Radio Setup, Radio Standard, LTE
Example	:SOUR:FREQ:CHAN:BAND BAND14
Initial S/W Revision	A.09.50

BAND 17

Selects BAND 17 as the band for the current step.

Key Path	Source, Frequency, Radio Setup, Radio Standard, LTE
Example	:SOUR:FREQ:CHAN:BAND BAND17
Initial S/W Revision	A.09.50

BAND 18

Selects BAND 18 as the band for the current step.

Key Path	Source, Frequency, Radio Setup, Radio Standard, LTE
Example	:SOUR:FREQ:CHAN:BAND BAND18
Initial S/W Revision	A.09.50

BAND 19

Selects BAND 19 as the band for the current step.

Key Path	Source, Frequency, Radio Setup, Radio Standard, LTE
Example	:SOUR:FREQ:CHAN:BAND BAND19
Initial S/W Revision	A.09.50

BAND 20

Selects BAND 20 as the band for the current step.

Key Path	Source, Frequency, Radio Setup, Radio Standard, LTE
Example	:SOUR:FREQ:CHAN:BAND BAND20
Initial S/W Revision	A.09.50

BAND 21

Selects BAND 21 as the band for the current step.

Key Path	Source, Frequency, Radio Setup, Radio Standard, LTE
Example	:SOUR:FREQ:CHAN:BAND BAND21
Initial S/W Revision	A.09.50

BAND 24

Selects BAND 24 as the band for the current step.

Key Path	Source, Frequency, Radio Setup, Radio Standard, LTE
Example	:SOUR:FREQ:CHAN:BAND BAND24
Initial S/W Revision	A.09.50

BAND 25

Selects BAND 25 as the band for the current step.

Key Path	Source, Frequency, Radio Setup, Radio Standard, LTE
Example	:SOUR:FREQ:CHAN:BAND BAND25
Initial S/W Revision	A.09.50

BAND 26

Selects BAND 26 as the band for the current step.

Key Path	Source, Frequency, Radio Setup, Radio Standard, LTE
Example	:SOUR:FREQ:CHAN:BAND BAND26
Initial S/W Revision	A.12.53

BAND 27

Selects BAND 27 as the band for the current step.

Key Path	Source, Frequency, Radio Setup, Radio Standard, LTE
Example	:SOUR:FREQ:CHAN:BAND BAND27
Initial S/W Revision	A.14.00

BAND 28

Selects BAND 28 as the band for the current step.

Key Path	Source, Frequency, Radio Setup, Radio Standard, LTE
Example	:SOUR:FREQ:CHAN:BAND BAND28
Initial S/W Revision	A.14.00

BAND 31

Selects BAND 31 as the band for the current step.

Key Path	Source, Frequency, Radio Setup, Radio Standard, LTE
Example	:SOUR:FREQ:CHAN:BAND BAND31
Initial S/W Revision	A.14.00

LTE TDD

Sets LTE TDD as the radio standard for use and accesses the LTE TDD specific channel band sub-menus..

Key Path	Source, Frequency, Radio Setup, Radio Standard
Initial S/W Revision	A.11.50

BAND 33

Selects BAND 33 as the band for the current step.

Key Path	Source, Frequency, Radio Setup, Radio Standard, LTE TDD
Example	:SOUR:FREQ:CHAN:BAND BAND33
Initial S/W Revision	A.11.50

BAND 34

Selects BAND 34 as the band for the current step.

Key Path	Source, Frequency, Radio Setup, Radio Standard, LTE TDD
Example	:SOUR:FREQ:CHAN:BAND BAND34
Initial S/W Revision	A.11.50

BAND 35

Selects BAND 35 as the band for the current step.

Key Path	Source, Frequency, Radio Setup, Radio Standard, LTE TDD
Example	:SOUR:FREQ:CHAN:BAND BAND35
Initial S/W Revision	A.11.50

BAND 36

Selects BAND 36 as the band for the current step.

Key Path	Source, Frequency, Radio Setup, Radio Standard, LTE TDD
Example	:SOUR:FREQ:CHAN:BAND BAND36
Initial S/W Revision	A.11.50

BAND 37

Selects BAND 37 as the band for the current step.

Key Path	Source, Frequency, Radio Setup, Radio Standard, LTE TDD
Example	:SOUR:FREQ:CHAN:BAND BAND37
Initial S/W Revision	A.11.50

BAND 38

Selects BAND 38 as the band for the current step.

Key Path	Source, Frequency, Radio Setup, Radio Standard, LTE TDD
Example	:SOUR:FREQ:CHAN:BAND BAND38
Initial S/W Revision	A.11.50

BAND 39

Selects BAND 39 as the band for the current step.

Key Path	Source, Frequency, Radio Setup, Radio Standard, LTE TDD
Example	:SOUR:FREQ:CHAN:BAND BAND39
Initial S/W Revision	A.11.50

BAND 40

Selects BAND 40 as the band for the current step.

Key Path	Source, Frequency, Radio Setup, Radio Standard, LTE TDD
Example	:SOUR:FREQ:CHAN:BAND BAND40
Initial S/W Revision	A.11.50

BAND 41

Selects BAND 41 as the band for the current step.

Key Path	Source, Frequency, Radio Setup, Radio Standard, LTE TDD
Example	:SOUR:FREQ:CHAN:BAND BAND41
Initial S/W Revision	A.11.50

BAND 42

Selects BAND 42 as the band for the current step.

Key Path	Source, Frequency, Radio Setup, Radio Standard, LTE TDD
Example	:SOUR:FREQ:CHAN:BAND BAND42
Initial S/W Revision	A.11.50

BAND 43

Selects BAND 43 as the band for the current step.

Key Path	Source, Frequency, Radio Setup, Radio Standard, LTE TDD
Example	:SOUR:FREQ:CHAN:BAND BAND43
Initial S/W Revision	A.11.50

BAND 44

Selects BAND 44 as the band for the current step.

Key Path	Source, Frequency, Radio Setup, Radio Standard, LTE TDD
Example	:SOUR:FREQ:CHAN:BAND BAND44
Initial S/W Revision	A.14.00

TDSCDMA

Sets TDSCDMA as the radio standard for use and accesses the TDSCDMA specific channel band sub-menus..

Key Path	Source, Frequency, Radio Setup, Radio Standard
Initial S/W Revision	A.11.50

BAND A

Selects BAND A as the band for the current step.

Key Path	Source, Frequency, Radio Setup, Radio Standard, TDSCDMA
Example	:SOUR:FREQ:CHAN:BAND BANDA
Initial S/W Revision	A.11.50

BAND B

Selects BAND B as the band for the current step.

Key Path	Source, Frequency, Radio Setup, Radio Standard, TDSCDMA
Example	:SOUR:FREQ:CHAN:BAND BANDB
Initial S/W Revision	A.11.50

BAND C

Selects BAND C as the band for the current step.

Key Path	Source, Frequency, Radio Setup, Radio Standard, TDSCDMA
Example	:SOUR:FREQ:CHAN:BAND BANDC
Initial S/W Revision	A.11.50

BAND D

Selects BAND D as the band for the current step.

Key Path	Source, Frequency, Radio Setup, Radio Standard, TDSCDMA
Example	:SOUR:FREQ:CHAN:BAND BANDD
Initial S/W Revision	A.11.50

BAND E

Selects BAND E as the band for the current step.

Key Path	Source, Frequency, Radio Setup, Radio Standard, TDSCDMA
----------	---

Example	:SOUR:FREQ:CHAN:BAND BANDE
Initial S/W Revision	A.11.50

BAND F

Selects BAND F as the band for the current step.

Key Path	Source, Frequency, Radio Setup, Radio Standard, TDSCDMA
Example	:SOUR:FREQ:CHAN:BAND BANDF
Initial S/W Revision	A.11.50

Radio Band Link

Allows you to specify the channel band type as either uplink or downlink link direction. This value is used in conjunction with the channel band and channel number to determine the absolute frequency output by the source. When set to “Uplink”, the source will calculate the uplink frequency using an uplink formula together with the selected channel band and channel number . When set to “Downlink”, the source will calculate the downlink frequency using a downlink formula together with the selected channel band and channel number.

Key Path	Source, Frequency, Radio Setup
Remote Command	:SOURce:RADio:BAND:LINK DOWN UP :SOURce:RADio:BAND:LINK?
Example	:SOUR:RAD:BAND:LINK UP
Preset	DOWN
Range	DOWN UP
Backwards Compatibility SCPI	:SOURce:RADio:DEVIce BTS MS :SOURce:RADio:DEVIce?
Backwards Compatibility Notes	BTS maps to the Downlink frequency MS maps to the Uplink frequency
Initial S/W Revision	A.05.00

Set Reference Frequency

This key allows you to set the frequency reference. Pressing this key turns the frequency reference state to ON, sets the reference frequency value to the current frequency, maintains this frequency at the RF output, and sets the displayed frequency to 0.00 Hz. All subsequent frequencies entered under Source>Frequency>Frequency are interpreted as being relative to this reference frequency.

When you use a frequency reference, the signal generator outputs a frequency that is set relative to the reference frequency by the value entered under Source>Frequency>Frequency as follows:

Output frequency = reference frequency - entered frequency

Where:

reference frequency equals the original RF frequency entered under Source>Frequency>Frequency and set as the reference frequency

entered frequency equals a new value entered under Source>Frequency>Frequency

In addition, the displayed frequency value will be the same as the value entered under Source>Frequency>Frequency.

NOTE

If Freq Reference is set to ON with a reference value set, entering a value under Source>Frequency>Frequency and pressing Set Frequency Reference will add that value to the existing Freq Reference value.

If you wish to change the reference frequency value to the new value entered under Source>Frequency>Frequency, first you must set Freq Reference to OFF and then press Set Frequency Reference.

Key Path	Source, Frequency
Remote Command	:SOURce:FREQuency:REFeRence:SET
Example	:SOUR:FREQ:REF:SET
Dependencies	This setting is unavailable, and is grayed out when the List Sequencer is turned ON.
Initial S/W Revision	A.05.00

Freq Reference

This key allows you to toggle the state of the frequency reference. When the frequency reference state is ON, an annunciator is displayed on the main source view to indicate this state to the user.

When you use a frequency reference, the signal generator outputs a frequency that is set relative to the reference frequency by the value entered under Source>Frequency>Frequency as follows:

Output frequency = reference frequency + entered frequency

Where:

reference frequency equals the original RF frequency entered under Source>Frequency>Frequency and set as the reference frequency

entered frequency equals a new value entered under Source>Frequency>Frequency

For more information on Reference Frequency refer to ["Set Reference Frequency" on page 1259](#)

Key Path	Source, Frequency
Remote Command	:SOURce:FREQuency:REFeRence <freq> :SOURce:FREQuency:REFeRence? :SOURce:FREQuency:REFeRence:STATe OFF ON 0 1 :SOURce:FREQuency:REFeRence:STATe?
Example	:SOUR:FREQ:REF 0.00 Hz

	:SOUR:FREQ:REF:STATe ON
Dependencies	This setting is unavailable, and is grayed out when the List Sequencer is turned ON.
Couplings	The frequency reference state is coupled to the frequency reference set immediate action. When the reference set immediate action key is pressed, or the SCPI command issued, it turns the frequency reference state ON.
Preset	0.00 Hz OFF
Min	0.00 Hz
Max	Hardware Dependant: Option 503 = 3.6 GHz Option 504 = 3.8 GHz Option 506 = 6.00 GHz
Initial S/W Revision	A.05.00

Freq Offset

Allows you to specify the frequency offset value. When the frequency offset state is ON, an annunciator is displayed on the main source view to indicate this state to the user.

When the frequency offset is set to zero (0) and you set a new offset value, the displayed frequency value will change as follows and the RF output frequency will not change:

Displayed value = output frequency + offset value

Where:

output frequency equals the original frequency entered under Source>Frequency>Frequency

offset value equals the value entered under Source>Frequency>Freq Offset

When the frequency offset is set to a value other than zero (0) and you enter a new frequency value under Source>Frequency>Frequency, the displayed frequency will be the same as the value entered and the RF output frequency will be equal to the value entered minus the offset value as follows:

Output frequency = entered frequency – offset frequency

Displayed frequency = output frequency + offset frequency

Displayed frequency = entered frequency

Where:

entered frequency equals the frequency entered under Source>Frequency>Frequency

offset frequency equals the value previously entered and set under Source>Frequency>Freq Offset

Key Path	Source, Frequency
Remote Command	:SOURce:FREQuency:OFFSet <freq>

	:SOURce:FREQuency:OFFSet?
Example	:SOUR:FREQ:OFFS 0 Hz
Dependencies	This setting is unavailable, and is grayed out when the List Sequencer is turned ON.
Preset	0 Hz
Min	-100.00 GHz
Max	100.00 GHz
Initial S/W Revision	A.05.00

Modulation Setup

Allows access to the menus for setting up the available modulation types: "ARB" on page 1262, "AM" on page 1303, "FM" on page 1304, and "PM" on page 1305.

Key Path	Source
Initial S/W Revision	A.05.00

ARB

Allows you access to the ARB sub-menus.

Key Path	Source, Modulation Setup
Initial S/W Revision	A.05.00

ARB

Allows you to toggle the state of the ARB function. When the ARB is On, a "MOD" annunciator is displayed in the system settings panel. When the ARB is turned Off, the MOD annunciator is cleared

Key Path	Source, Modulation Setup, ARB
Remote Command	:SOURce:RADio:ARB[:STATe] ON OFF 1 0 :SOURce:RADio:ARB[:STATe]?
Example	:SOUR:RAD:ARB OFF :SOUR:RAD:ARB?
Notes	If the ARB is ON, a user then loads or deletes another file to ARB memory, the playing waveform segment may not keep phase continuity during the ARB memory operation. The waveform will be replayed after the ARB operation is finished.
Dependencies	This setting is for independent mode and has no effect on 3.3.8 list sequencer mode. Setting "Sequencer" on page 1307 Sequencer to On will put source enter list sequencer mode, and even if ARB state is On, the ARB file will not be played. Setting "Sequencer" on page 1307 Sequencer to Off will make source leave list sequencer mode, and this setting will take effect immediately.

The ARB can only be turned on when there is a waveform file selected for playback. On the GUI if no waveform is selected, this key is grayed out. If you send the SCPI command to turn the ARB on with no waveform selected for playback, the ARB state remains OFF and an error is generated. “-

When you try to recall a certain set of states in which the selected waveform is not in ARB memory and the ARB state is On, errors are reported

Preset	Off
Range	On Off
Initial S/W Revision	A.05.00

Select Waveform

Allows you to access to the waveform selection sub-menus.

Pressing this key changes the central view area to show the Waveform File Selection view.

Key Path	Source, Modulation Setup, ARB
Initial S/W Revision	A.05.00

Select Waveform

Allows you to select a waveform sequence or segment for the dual ARB to play.

NOTE: Selecting a waveform file does not result in automatic adjustments to burst timing (to compensate for the presence or absence of a Multiport Adapter); that adjustment occurs only when a waveform is loaded to ARB memory. See "Load Segment to ARB Memory" for more information about this adjustment.

Key Path	Source, Modulation Setup, ARB, Select Waveform
Remote Command	:SOURce:RADio:ARB:WAVeform <string> :SOURce:RADio:ARB:WAVeform?
Example	:SOUR:RAD:ARB:WAV "test_waveform.bin"
Notes	<p>If intended waveform is not in the memory yet, then issuing this command by SCPI will invoke ARB loading operation first, which involves a delay of unpredictable length. So this command should be followed by the query *OPC?, which holds off subsequent commands until the loading operating is complete.</p> <p><string> - specifies the name of the waveform segment or waveform sequence to be played by the ARB.</p> <p>When in Sequence Analyzer mode, and Include Source is Yes, if the you attempt to play a waveform sequence but not all the required waveform segments are in the ARB playback memory, the application will reject the loading operation with an error is generated .</p> <p>When Include Source is No, if you attempt to play a waveform sequence but not all the required waveform segments are contained in the ARB playback memory, the application will attempt to load the required segments from either the default directory of the current directory. If the ARB memory does not have enough space for all the waveform segments to be loaded, an error is generated and</p>

none of the waveform segments is loaded.

If the ARB is ON, and you attempt to play a waveform sequence but not all the waveform segments within the sequence could be found to be loaded into ARB memory, an error is generated. The selected waveform keeps the previous value and ARB state remains On.

If you specify a waveform segment over SCPI but the waveform segment is not present within ARB playback memory and cannot be found for auto loading within the current directory or the default directory, an error is generated and the file selection remains unchanged.

If you select a waveform for playback and the waveform requires a license that is not installed on the instrument, an error is generated.

If the ARB is ON and you load a file to ARB memory or delete a file from ARB memory, the playing waveform segment may not keep phase continuity during the ARB memory operation. The waveform will be replayed after the ARB operation is finished.

Initial S/W Revision	A.05.00
----------------------	---------

Segments on Hard Disk

Allows you access to the sub-menus for loading waveform segments from the hard disk into ARB memory. The default directory is: D: varb.

Pressing this key changes the current view to the Waveform Management View.

Key Path	Source, Modulation Setup, ARB, Select Waveform
----------	--

Initial S/W Revision	A.05.00
----------------------	---------

Load Segment To ARB Memory

Allows you to load the selected file into ARB memory. On the front panel you select the file for loading to the ARB memory by highlighting the desired file in the list. Using the SCPI command, you specify the file name on the HDD.

“NVWFM” (non-volatile storage) MSUS (Mass Storage Unit Specifier) is supported in the memory subsystem because the ARB memory cannot be accessed directly. Therefore, files must be downloaded to the instrument hard disk and then loaded into the ARB memory. “NVWFM” MSUS will be mapped to the default directory D: VARB. The SCPI command supports using either “NVWFM” MSUS or specifying a full path. For more information, see [Memory Subsystem \(Remote Command Only\)](#).

If a file of the same name already exists within ARB memory, it is overwritten. If you wish to load two segments of the same name, you must rename one of the segments before loading it into ARB memory. To rename a segment, you can either use Windows File Explorer, or the :MMEMory:COPY command.

NOTE: When a waveform file is loaded to ARB memory, burst timing adjustments are made automatically, based on whether or not a Multiport Adapter is connected to the test set and powered on. If the connection/power status of the Multiport Adapter is changed after a waveform file has been loaded, it needs to be loaded again.

Key Path	Source, Modulation Setup, ARB, Select Waveform, Segments on Hard Disk
----------	---

Remote Command	:SOURce:RADio:ARB:LOAD <string>
Example	:SOUR:RAD:ARB:LOAD "D: VARB\testwaveform.bin" or :SOUR:RAD:ARB:LOAD "NVWFM:testwaveform.bin"
Notes	<p>Because loading the file involves a delay of unpredictable length, this command should be followed by the query *OPC?, which holds off subsequent commands until the loading operating is complete.</p> <p><string> - specifies the path name of the file to load from the HDD into ARB memory. It could be a <full path + filename>, or <"NVWFM" MSUS + colon + filename>.</p> <p>When in Sequence Analyzer mode, and Include Source is Yes, an attempt to load a file to ARB memory will be rejected with an error.</p> <p>When Include Source is No and if there is insufficient free ARB memory to load the selected waveform, an error is generated. .</p> <p>If you specify a file over SCPI, but the file is not at the specified location, an error is generated.</p> <p>If you try to load a waveform file but the file contains less than 500 IQ samples, an error is generated.</p> <p>If you try to load a Signal Studio waveform "*.wfm" which contains invalid waveform header, an error is generated.</p> <p>If the ARB is ON when you load a file to ARB memory or delete a file from ARB memory, the playing waveform segment may not keep phase continuity during the ARB memory operation. The waveform will be replayed after the ARB operation is finished.</p> <p>ARB can be loaded into ARB memory even required licenses do not present on the instrument. In this case, a GUI only warning message -800, "Operation complete; Loaded <filename> successfully, but no license <required licenses> installed". User can install required licenses according to <required licenses> string to license it, or multi-pack license it.</p>
Initial S/W Revision	A.05.00

Load All To ARB Memory

Allows you to load all the segment files within the currently selected directory into ARB memory. If a file of the same name already exists within ARB memory, it is overwritten. If you wish to load two segments of the same name, you must rename one of the segments before loading it into ARB memory. To rename a segment, you can either use Windows File Explorer, or the :MEMory:COPY command.

NOTE: When a waveform file is loaded to ARB memory, burst timing adjustments are made automatically, based on whether or not a Multiport Adapter is connected to the test set and powered on. If the connection/power status of the Multiport Adapter is changed after a waveform file has been loaded, it needs to be loaded again.

Key Path	Source, Modulation Setup, ARB, Select Waveform, Segments on Hard Disk
Remote Command	:SOURce:RADio:ARB:LOAD:ALL <string>
Example	:SOUR:RAD:ARB:LOAD:ALL "D: varb"
Notes	<p><string> - specifies the directory on the HDD to load the files into ARB memory from.</p> <p>When in Sequence Analyzer mode, and Include Source is Yes, an attempt to load all files from a directory to ARB memory is rejected with an error.</p> <p>When Include Source is No and there is insufficient free ARB memory to load all the waveforms,</p>

when the ARB memory is full, the copy ceases, and an error is generated.
 If you specify a directory over SCPI, but the directory does not exist, an error is generated.
 If the ARB is ON, a user then loads or deletes file to ARB memory, the playing waveform segment may not keep phase continuity during the ARB memory operation. The waveform will be replayed after the ARB operation is finished.

Initial S/W Revision	A.05.00
----------------------	---------

Change Directory...

Allows you to change the currently selected directory on the hard disk. Pressing this key opens a standard windows change directory dialog allowing you to select the new directory of interest.

The current directory is used for manually loading waveform segments into ARB memory for playback, and as a search location for waveform segments that are required to be loaded into ARB memory for playback of a waveform sequence or a list sequence.

Key Path	Source, Modulation Setup, ARB, Select Waveform, Segments on Hard Disk
Notes	No remote command, SCPI front panel only.
Initial S/W Revision	A.05.00

Default Directory...

Allows you to change the default directory. It is used as a search location for waveform segments that are required to be loaded into ARB memory for playback of a waveform sequence, and as a search location for selecting waveforms using SCPI.

Key Path	Source, Modulation Setup, ARB, Select Waveform, Segments on Hard Disk
Remote Command	:SOURce:RADio:ARB:DEFault:DIRectory <string> :SOURce:RADio:ARB: DEFault:DIRectory?
Example	:SOUR:RAD:ARB:DEF:DIR "D:\ArbFiles" :SOUR:RAD:ARB:DEF:DIR?
State Saved	Persistent, survives a power cycle and a preset but not saved in the instrument state
Initial S/W Revision	A.05.00

Segments in ARB Memory

Allows you access to the sub-menus for managing the files within ARB memory.

Key Path	Source, Modulation Setup, ARB, Select Waveform
Initial S/W Revision	A.05.00

Delete Segment From ARB Mem

Allows you to remove a segment from ARB playback memory.

Key Path	Source, Modulation Setup, ARB, Select Waveform, Segments in ARB Memory
Remote Command	:SOURce:RADio:ARB:DELeTe <string>
Example	:SOUR:RAD:ARB:DEL "testwaveform.bin"
Notes	<p><string> - specifies the waveform to be deleted from the ARB playback memory.</p> <p>When in Sequence Analyzer mode and Include Source is Yes, an attempt to delete a file from ARB memory is rejected with an error.</p> <p>When Include Source is No and you specify a file that does not exist within ARB memory, an error is generated.</p> <p>It is possible to delete files from within the ARB memory when the ARB is ON. However, if you attempt to delete the file that is currently playing an error is generated.</p> <p>It is possible to delete a file from within the ARB memory when the sequencer state is ON and the file is not being used by the List Sequencer. If you attempt to delete a file which is being used by the list sequencer, an error is generated.</p> <p>When sequencer state is On, even if ARB state is On, the selected waveform will not be played. In this case, if the selected waveform is not used in List Sequence, it can be deleted and the ARB state is turned Off.</p> <p>If the ARB is ON and you load a file to ARB memory or delete a file from ARB memory, the playing waveform segment may not keep phase continuity during the ARB memory operation. The waveform will be replayed after the ARB operation is finished.</p>
Initial S/W Revision	A.05.00

Delete All From ARB Memory

Allows you to remove all segments from ARB playback memory.

Key Path	Source, Modulation Setup, ARB, Select Waveform, Segments in ARB Memory
Remote Command	:SOURce:RADio:ARB:DELeTe:ALL
Example	:SOUR:RAD:ARB:DELeTe:ALL
Notes	<p>When in Sequence Analyzer mode and Include Source is Yes, an attempt to delete all files from ARB memory is rejected with an error.</p> <p>When Include Source is No and you attempt to delete all files from ARB memory when the ARB is currently playing a file, all files except the one playing are deleted and an error is generated.</p> <p>If you attempt to delete all files from ARB memory when there are waveform files used in "List Sequencer" on page 1306 and "Sequencer" on page 1307 state is ON, all files except the files currently being used in list sequencer are deleted, and an error is generated.</p> <p>If the ARB is ON and you load a file to ARB memory or delete a file from ARB memory, the playing waveform segment may not keep phase continuity during the ARB memory operation. The waveform will be replayed after the ARB operation is finished.</p>
Initial S/W Revision	A.05.00

Query ARB Memory File List (Remote Command Only)

Queries the test set for the list of waveform segments in the ARB memory.

NOTE

This command returns a string for waveform segment names in ARB memory. If you want a string list of waveform segments in the ARB memory, use "[Query ARB Memory Full File List \(Remote Command Only\)](#)" on page 1268.

Remote Command	:SOURce:RADio:ARB:CATalog?
Example	:SOUR:RAD:ARB:CATalog?
Notes	The return data is in the following format: <integer> - memory used <integer> - memory free <string> ... - comma separated list of waveform segments within ARB memory
Initial S/W Revision	A.05.00

Query ARB Memory Full File List (Remote Command Only)

Queries the test set for the string list of waveform segments in the ARB memory. It returns a string list for waveform segment names in the ARB memory.

Remote Command	:SOURce:RADio:ARB:FCATalog?
Example	:SOUR:RAD:ARB:FCATalog?
Notes	The return data is in the following format: <integer> - memory used <integer> - memory free <integer> - file count in ARB memory <string>,<string>, ... <string> - comma separated string list of waveform segments within ARB memory Example: SOUR:RAD:ARB:FCAT? EXT returns: 27499,2069653,3,"c2k.wfm","gsm.wfm","wcdma.wfm"
Initial S/W Revision	A.09.00

ARB Setup

Allows access to the ARB setup sub-menus.

Key Path	Source, Modulation Setup, ARB
Initial S/W Revision	A.05.00

Sample Rate

Allows you to set the ARB waveform playback sample rate.

Key Path	Source, Modulation Setup, ARB, ARB Setup
Remote Command	:SOURce:RADio:ARB:SCLock:RATE <freq> :SOURce:RADio:ARB:SCLock:RATE?
Example	:SOUR:RAD:ARB:SCL:RATE 48.00 MHz
Notes	If there is a sample rate specified in the header of the waveform file, changing that sample rate is not recommended, as it may cause problems with burst timing.
Dependencies	When a new waveform is selected for playback the settings contained within the associated waveform header file are applied to the ARB. The sample rate is one of the values stored within the header file. If the newly selected waveform file has an associated header file, the sample rate is updated with the value from the header file. The sample rate will remain unchanged if the newly selected waveform does not have an associated header file.
Preset	125.00 MHz
Min	1.00 kHz
Max	125.00 MHz
Initial S/W Revision	A.05.00

Run-Time Scaling

Allows you to adjust the run-time scaling value. The run-time scaling value is applied in real-time while the waveform is playing.

Key Path	Source, Modulation Setup, ARB, ARB Setup
Remote Command	:SOURce:RADio:ARB:RSCaling <real> :SOURce:RADio:ARB:RSCaling?
Example	:SOUR:RAD:ARB:RSC 100.00
Notes	This setting cannot be set in E6640A. Grey out on menu and the value is fixed at 70.00%.
Dependencies	When a new waveform is selected for playback the settings contained within the associated waveform header file are applied to the ARB. The run-time scaling is one of the values stored within the header file. If the newly selected waveform file has an associated header file, the run-time scaling is updated with the value from the header file. The run-time scaling will remain unchanged if the newly selected waveform does not have an associated header file.
Preset	70.00 %
Min	1.00 %
Max	100.00 %
Initial S/W Revision	A.05.00

Baseband Freq Offset

Allows you to adjust the value by which the baseband frequency is offset relative to the carrier.

Key Path	Source, Modulation Setup, ARB, ARB Setup
Remote Command	:SOURce:RADio:ARB:BASEband:FREQuency:OFFSet <freq> :SOURce:RADio:ARB:BASEband:FREQuency:OFFSet?
Example	:SOUR:RAD:ARB:BAS:FREQ:OFFS 0.00 Hz
Dependencies	When a new waveform is selected for playback the settings contained within the associated waveform header file are applied to the ARB. The baseband frequency offset is one of the values stored within the header file. If the newly selected waveform has an associated header file, the baseband frequency offset is updated with the value from the header file. The baseband frequency offset will remain unchanged if the newly selected waveform does not have an associated header file.
Preset	0.00 Hz
Min	-50.00 MHz
Max	50.00 MHz
Initial S/W Revision	A.05.00

Trigger Type

Allows access to the trigger type sub-menus. The setting for trigger type determines the behavior of the waveform when it plays.

Key Path	Source, Modulation Setup, ARB
Remote Command	:SOURce:RADio:ARB:TRIGger:TYPE CONTInuous SINGLE SADVance GATE :SOURce:RADio:ARB:TRIGger:TYPE?
Example	:SOUR:RAD:ARB:TRIG:TYPE CONT :SOUR:RAD:ARB:TRIG:TYPE?
Notes	Gated trigger type will be implemented at a later release
Preset	CONTInuous
Range	Continuous Single Seg Adv Gated
Initial S/W Revision	A.05.00

Continuous

Sets the active trigger type to Continuous. If Continuous is already selected as the active trigger type, pressing this key allows access to the continuous trigger type setup menu. In Continuous trigger mode, the waveform repeats continuously.

Key Path	Source, Modulation Setup, ARB, Trigger Type
Remote Command	:SOURce:RADio:ARB:TRIGger:TYPE:CONTInuous[:TYPE] FREE TRIGger RESet :SOURce:RADio:ARB:TRIGger:TYPE:CONTInuous[:TYPE]?
Example	:SOUR:RAD:ARB:TRIG:TYPE:CONT FREE
Preset	FREE

Range	Free Run Trigger + Run Reset + Run
Initial S/W Revision	A.05.00

Free Run

Selects Free Run as the trigger response for the continuous trigger type. Free Run sets the waveform generator to play a waveform sequence or segment continuously, without waiting for a trigger. In this mode, the waveform generator does not respond to triggers.

Key Path	Source, Modulation Setup, ARB, Trigger Type, Continuous
Example	:SOUR:RAD:ARB:TRIG:TYPE:CONT FREE
Initial S/W Revision	A.05.00

Trigger + Run

Sets Trigger and Run as the trigger response for the continuous trigger type. Trigger and Run sets the waveform generator to play a waveform sequence or segment continuously when the first trigger is received, and to ignore any subsequent triggers.

Key Path	Source, Modulation Setup, ARB, Trigger Type, Continuous
Example	:SOUR:RAD:ARB:TRIG:TYPE:CONT TRIG
Initial S/W Revision	A.05.00

Reset + Run

Sets Reset and Run as the trigger response for the continuous trigger type. Reset and Run sets the waveform generator to play a waveform sequence or segment continuously when the first trigger is received. Subsequent triggers reset the waveform sequence or segment to the start, and then play it continuously.

Key Path	Source, Modulation Setup, ARB, Trigger Type, Continuous
Example	:SOUR:RAD:ARB:TRIG:TYPE:CONT RES
Initial S/W Revision	A.05.00

Single

Sets the active trigger type to Single. If Single is already selected as the active trigger type, pressing this key allows access to the single trigger type setup menu. In Single trigger mode, the waveform plays once.

Key Path	Source, Modulation Setup, ARB, Trigger Type
Remote Command	:SOURce:RADio:ARB:RETRigger ON OFF IMMediate

	:SOURce:RADio:ARB:RETRigger?
Example	:SOUR:RAD:ARB:RETR OFF
Notes	ON: Buffered Trigger OFF: No Retrigger Immediate: Restart on Trigger This is defined as an enumerated SCPI command, with ON OFF being considered as enumerated types rather than Boolean. This means the query will return OFF instead of 0, and ON instead of 1.
Preset	ON
Range	No Retrigger Buffered Trigger Restart on Trigger
Initial S/W Revision	A.05.00

No Retrigger

Selects No Retrigger as the trigger response for single trigger type. No Retrigger sets the waveform generator to play a waveform sequence or segment once when a trigger is received. Any triggers then received during playback are ignored.

Key Path	Source, Modulation Setup, ARB, Trigger Type, Single
Example	:SOUR:RAD:ARB:RETR OFF
Initial S/W Revision	A.05.00

Buffered Trigger

Selects Buffered Trigger as the trigger response for single trigger type. Buffered Trigger sets the waveform generator to play a waveform sequence or segment once when a trigger is received. If a trigger is received during playback, the waveform generator plays the sequence or segment to the end, then plays the sequence or segment once more.

Key Path	Source, Modulation Setup, ARB, Trigger Type, Single
Example	:SOUR:RAD:ARB:RETR ON
Initial S/W Revision	A.05.00

Restart on Trigger

Selects Restart on Trigger as the trigger response for single trigger type. Restart on Trigger sets the waveform generator to play a waveform sequence or segment once when a trigger is received. If a trigger is received during playback, the waveform generator resets and plays the sequence or segment from the start.

Key Path	Source, Modulation Setup, ARB, Trigger Type, Single
Example	:SOUR:RAD:ARB:RETR IMM
Initial S/W Revision	A.05.00

Segment Advance

Sets the active trigger type to Segment Advance. If Segment Advance is already selected as the active trigger type, pressing this key allows access to the segment advance trigger type setup menu.

Segment Advance triggering allows you to control the playback of waveform segments within a waveform sequence. When a trigger is received the ARB advances to the next waveform segment within the waveform sequence. This type of triggering ignores the repetition count for the waveform segment within the waveform sequence. For example, if a waveform segment has a repetition count of 10 and you select single segment advance triggering mode, the waveform segment will only play once.

Segment Advance triggering can also be used for waveform segments only. In this situation the same waveform segment is played again when a trigger is received.

Key Path	Source, Modulation Setup, ARB, Trigger Type
Remote Command	:SOURce:RADio:ARB:TRIGger:TYPE:SADVance[:TYPE] SINGLE CONTInuous :SOURce:RADio:ARB:TRIGger:TYPE:SADVance[:TYPE]?
Example	:SOUR:RAD:ARB:TRIG:TYPE:SADV SING
Preset	CONTInuous
Range	Single Continuous
Initial S/W Revision	A.05.00

Single

Selects Single as the trigger response for Segment Advance trigger type. With single selected, once a trigger is received a segment is played once. If a trigger is received during playback of a segment, the segment plays to completion and the next segment is played once.

Key Path	Source, Modulation Setup, ARB, Trigger Type, Segment Advance
Example	:SOUR:RAD:ARB:TRIG:TYPE:SADV SING
Initial S/W Revision	A.05.00

Continuous

Selects Continuous as the trigger response for Segment Advance trigger type. With continuous selected, once a trigger is received a segment is played continuously. When subsequent triggers are received, the currently playing segment plays to completion and then the next segment is played continuously.

Key Path	Source, Modulation Setup, ARB, Trigger Type, Segment Advance
Example	:SOUR:RAD:ARB:TRIG:TYPE:SADV CONT
Initial S/W Revision	A.05.00

Trigger Source

Allows access to the trigger source sub-menus. The trigger source setting determines how the source receives the trigger that starts the waveform playing. Therefore, this key is grayed out if the trigger type is free run, since free run triggers immediately with no trigger source required.

Key Path	Source, Modulation Setup, ARB
Remote Command	:SOURce:RADio:ARB:TRIGger[:SOURce] KEY BUS EXTernal2 :SOURce:RADio:ARB:TRIGger[:SOURce]?
Example	:SOUR:RAD:ARB:TRIGger KEY
Dependencies	This key is grayed out if the current trigger type is Continuous, Free Run.
Preset	EXTernal2
Range	Trigger Key Bus External 2
Initial S/W Revision	A.05.00

Trigger Key

Sets the current trigger source to the front panel Trigger key. When Trigger Key is selected, the waveform is triggered when you press the front panel Trigger key.

Key Path	Source, Modulation Setup, ARB, Trigger Source
Example	:SOUR:RAD:ARB:TRIGger KEY
Initial S/W Revision	A.05.00

Bus

Sets the current trigger source to Bus. Selecting Bus trigger source enables triggering over GPIB, LAN, or USB using the :SOURce:RADio:ARB:TRIGger:INITiate command.

Key Path	Source, Modulation Setup, ARB, Trigger Source
Example	:SOUR:RAD:ARB:TRIGger BUS
Initial S/W Revision	A.05.00

External 2

Sets the current trigger source to External 2. Selecting External 2 enables triggering a waveform by an externally applied signal.

Key Path	Source, Modulation Setup, ARB, Trigger Source
Example	:SOUR:RAD:ARB:TRIGger EXT2
Notes	Note: When on E6640A, trigger 2 is a bi-directional trigger port. So when trigger 2 has been configured as OUTPUT type, choosing External 2 as the input trigger for the current step will generate error.
Initial S/W Revision	A.05.00

Trigger Initiate

Used to initiate an immediate trigger event if the trigger source is set to Trigger Key.

Key Path	Source, Modulation Setup, ARB
Notes	No remote command, SCPI front panel only.
Initial S/W Revision	A.05.00

Waveform Sequences

Allows access to the waveform sequence sub-menus. Pressing this key changes the central view area to display the Waveform Sequence List view.

Key Path	Source, Modulation Setup, ARB
Notes	No remote command, SCPI front panel only.
Initial S/W Revision	A.05.00

Build New Sequence

Allows access to the sub-menus for creating a new waveform sequence. Pressing this key changes the central view area to display the Waveform Sequence Creation and Editing view.

Key Path	Source, Modulation Setup, ARB, Waveform Sequences
Notes	No remote command, SCPI front panel only.
Initial S/W Revision	A.05.00

Current Segment

Specifies the selected sequence segment that will be affected by the menu functions.

Key Path	Source, Modulation Setup, ARB, Waveform Sequences, Build New Sequence
Notes	No remote command, SCPI front panel only. This key is grayed out and unavailable if the sequence is currently empty.
Initial S/W Revision	A.05.00

Insert New Waveform

Allows you access to the sub-menu for inserting a new waveform segment or sequence. Pressing this key also changes the central display to show the Waveform File Selection View.

Key Path	Source, Modulation Setup, ARB, Waveform Sequences, Build New Sequence
Notes	No remote command, SCPIfront panel only. Waveform segment name string length upper limit is 128 chars. Please do NOT insert waveform which name string exceeds 128 chars.
Initial S/W Revision	A.05.00

Insert Waveform

Inserts the currently highlighted waveform to the end of the waveform sequence. Pressing this key also returns you to the menus for creating or editing a sequence, and returns the central view to the sequence creation view.

Key Path	Source, Modulation Setup, ARB, Waveform Sequences, Build New Sequence, Insert New Waveform
Notes	No remote command, SCPIfront panel only. Waveform segment name string length upper limit is 128 chars. Please do NOT insert waveform which name string exceeds 128 chars.
Initial S/W Revision	A.05.00

Segments on Hard Disk

Allows you access to the sub-menus for loading waveform segments from the hard disk into ARB memory. The default directory is: D: varb.

Pressing this key changes the current view to the Waveform Management View.

Key Path	Source, Modulation Setup, ARB, Select Waveform
Initial S/W Revision	A.05.00

Load Segment To ARB Memory

Allows you to load the selected file into ARB memory. On the front panel you select the file for loading to the ARB memory by highlighting the desired file in the list. Using the SCPI command, you specify the file name on the HDD.

“NVWFM” (none-volatile storage) MSUS (Mass Storage Unit Specifier) is supported in the memory subsystem because the ARB memory cannot be accessed directly. Therefore, files must be downloaded to the instrument hard disk and then loaded into the ARB memory. “NVWFM” MSUS will be mapped to the default directory D: VARB. The SCPI command supports using either “NVWFM” MSUS or specifying a full path. For more information, see [Memory Subsystem \(Remote Command Only\)](#).

If a file of the same name already exists within ARB memory, it is overwritten. If you wish to load two segments of the same name, you must rename one of the segments before loading it into ARB memory. To rename a segment, you can either use Windows File Explorer, or the :MMEMORY:COPY command.

NOTE: When a waveform file is loaded to ARB memory, burst timing adjustments are made automatically, based on whether or not a Multiport Adapter is connected to the test set and powered on. If the connection/power status of the Multiport Adapter is changed after a waveform file has been loaded, it needs to be loaded again.

Key Path	Source, Modulation Setup, ARB, Select Waveform, Segments on Hard Disk
Remote Command	:SOURce:RADio:ARB:LOAD <string>
Example	:SOUR:RAD:ARB:LOAD "D: VARB\testwaveform.bin" or :SOUR:RAD:ARB:LOAD "NVWFM:testwaveform.bin"
Notes	<p>Because loading the file involves a delay of unpredictable length, this command should be followed by the query *OPC?, which holds off subsequent commands until the loading operating is complete.</p> <p><string> – specifies the path name of the file to load from the HDD into ARB memory. It could be a <full path + filename>, or <"NVWFM" MSUS + colon + filename>.</p> <p>When in Sequence Analyzer mode, and Include Source is Yes, an attempt to load a file to ARB memory will be rejected with an error.</p> <p>When Include Source is No and if there is insufficient free ARB memory to load the selected waveform, an error is generated. .</p> <p>If you specify a file over SCPI, but the file is not at the specified location, an error is generated.</p> <p>If you try to load a waveform file but the file contains less than 500 IQ samples, an error is generated.</p> <p>If you try to load a Signal Studio waveform "*.wfm" which contains invalid waveform header, an error is generated.</p> <p>If the ARB is ON when you load a file to ARB memory or delete a file from ARB memory, the playing waveform segment may not keep phase continuity during the ARB memory operation. The waveform will be replayed after the ARB operation is finished.</p> <p>ARB can be loaded into ARB memory even required licenses do not present on the instrument. In this case, a GUI only warning message –800, "Operation complete; Loaded <filename> successfully, but no license <required licenses> installed". User can install required licenses according to <required licenses> string to license it, or multi-pack license it.</p>
Initial S/W Revision	A.05.00

Load All To ARB Memory

Allows you to load all the segment files within the currently selected directory into ARB memory. If a file of the same name already exists within ARB memory, it is overwritten. If you wish to load two segments of the same name, you must rename one of the segments before loading it into ARB memory. To rename a segment, you can either use Windows File Explorer, or the :MEMory:COpy command.

NOTE: When a waveform file is loaded to ARB memory, burst timing adjustments are made automatically, based on whether or not a Multiport Adapter is connected to the test set and powered on. If the connection/power status of the Multiport Adapter is changed after a waveform file has been loaded, it needs to be loaded again.

Key Path	Source, Modulation Setup, ARB, Select Waveform, Segments on Hard Disk
Remote Command	:SOURce:RADio:ARB:LOAD:ALL <string>

Example	:SOUR:RAD:ARB:LOAD:ALL "D: varb"
Notes	<p><string> - specifies the directory on the HDD to load the files into ARB memory from.</p> <p>When in Sequence Analyzer mode, and Include Source is Yes, an attempt to load all files from a directory to ARB memory is rejected with an error.</p> <p>When Include Source is No and there is insufficient free ARB memory to load all the waveforms, when the ARB memory is full, the copy ceases, and an error is generated.</p> <p>If you specify a directory over SCPI, but the directory does not exist, an error is generated.</p> <p>If the ARB is ON, a user then loads or deletes file to ARB memory, the playing waveform segment may not keep phase continuity during the ARB memory operation. The waveform will be replayed after the ARB operation is finished.</p>
Initial S/W Revision	A.05.00

Change Directory...

Allows you to change the currently selected directory on the hard disk. Pressing this key opens a standard windows change directory dialog allowing you to select the new directory of interest.

The current directory is used for manually loading waveform segments into ARB memory for playback, and as a search location for waveform segments that are required to be loaded into ARB memory for playback of a waveform sequence or a list sequence.

Key Path	Source, Modulation Setup, ARB, Select Waveform, Segments on Hard Disk
Notes	No remote command, SCPIfront panel only.
Initial S/W Revision	A.05.00

Default Directory...

Allows you to change the default directory. It is used as a search location for waveform segments that are required to be loaded into ARB memory for playback of a waveform sequence, and as a search location for selecting waveforms using SCPI.

Key Path	Source, Modulation Setup, ARB, Select Waveform, Segments on Hard Disk
Remote Command	:SOURce:RADio:ARB:DEFault:DIRectory <string> :SOURce:RADio:ARB: DEFault:DIRectory?
Example	:SOUR:RAD:ARB:DEF:DIR "D:\ArbFiles" :SOUR:RAD:ARB:DEF:DIR?
State Saved	Persistent, survives a power cycle and a preset but not saved in the instrument state
Initial S/W Revision	A.05.00

Segments in ARB Memory

Allows you access to the sub-menus for managing the files within ARB memory.

Key Path	Source, Modulation Setup, ARB, Select Waveform
Initial S/W Revision	A.05.00

Delete Segment From ARB Mem

Allows you to remove a segment from ARB playback memory.

Key Path	Source, Modulation Setup, ARB, Select Waveform, Segments in ARB Memory
Remote Command	:SOURce:RADio:ARB:DELeTe <string>
Example	:SOUR:RAD:ARB:DEL "testwaveform.bin"
Notes	<p><string> - specifies the waveform to be deleted from the ARB playback memory.</p> <p>When in Sequence Analyzer mode and Include Source is Yes, an attempt to delete a file from ARB memory is rejected with an error.</p> <p>When Include Source is No and you specify a file that does not exist within ARB memory, an error is generated.</p> <p>It is possible to delete files from within the ARB memory when the ARB is ON. However, if you attempt to delete the file that is currently playing an error is generated.</p> <p>It is possible to delete a file from within the ARB memory when the sequencer state is ON and the file is not being used by the List Sequencer. If you attempt to delete a file which is being used by the list sequencer, an error is generated.</p> <p>When sequencer state is On, even if ARB state is On, the selected waveform will not be played. In this case, if the selected waveform is not used in List Sequence, it can be deleted and the ARB state is turned Off.</p> <p>If the ARB is ON and you load a file to ARB memory or delete a file from ARB memory, the playing waveform segment may not keep phase continuity during the ARB memory operation. The waveform will be replayed after the ARB operation is finished.</p>
Initial S/W Revision	A.05.00

Delete All From ARB Memory

Allows you to remove all segments from ARB playback memory.

Key Path	Source, Modulation Setup, ARB, Select Waveform, Segments in ARB Memory
Remote Command	:SOURce:RADio:ARB:DELeTe:ALL
Example	:SOUR:RAD:ARB:DELeTe:ALL
Notes	<p>When in Sequence Analyzer mode and Include Source is Yes, an attempt to delete all files from ARB memory is rejected with an error.</p> <p>When Include Source is No and you attempt to delete all files from ARB memory when the ARB is currently playing a file, all files except the one playing are deleted and an error is generated.</p> <p>If you attempt to delete all files from ARB memory when there are waveform files used in "List Sequencer" on page 1306 and "Sequencer" on page 1307 state is ON, all files except the files currently being used in list sequencer are deleted, and an error is generated.</p>

If the ARB is ON and you load a file to ARB memory or delete a file from ARB memory, the playing waveform segment may not keep phase continuity during the ARB memory operation. The waveform will be replayed after the ARB operation is finished.

Initial S/W Revision	A.05.00
----------------------	---------

Segments on Hard Disk

This key functions the same as "[Segments on Hard Disk](#)" on page 1333.

Key Path	Source, Modulation Setup, ARB, Waveform Sequences, Build New Sequence, Insert New Waveform
Initial S/W Revision	Prior to A.09.00

Load Segment To ARB Memory

This key functions the same as "[Load Segment To ARB Memory](#)" on page 1333.

Key Path	Source, Modulation Setup, ARB, Waveform Sequences, Build New Sequence, Insert New Waveform, Segment on Hard Drive
Initial S/W Revision	Prior to A.09.00

Load All To ARB Memory

This key functions the same as "[Load All To ARB Memory](#)" on page 1334.

Key Path	Source, Modulation Setup, ARB, Waveform Sequences, Build New Sequence, Insert New Waveform, Segment on Hard Drive
Initial S/W Revision	Prior to A.09.00

Change Directory ...

This key functions the same as "[Change Directory...](#)" on page 1335.

Key Path	Source, Modulation Setup, ARB, Waveform Sequences, Build New Sequence, Insert New Waveform, Segment on Hard Drive
Initial S/W Revision	Prior to A.09.00

Default Directory ...

This key functions the same as "[Default Directory...](#)" on page 1335

Key Path	Source, Modulation Setup, ARB, Waveform Sequences, Build New Sequence, Insert New Waveform, Segment on Hard Drive
Initial S/W Revision	Prior to A.09.00

Segments in ARB Memory

This key functions the same as ["Segments in ARB Memory" on page 1335](#).

Key Path	Source, Modulation Setup, ARB, Waveform Sequences, Build New Sequence, Insert New Waveform
Initial S/W Revision	Prior to A.09.00

Delete Segment From ARB Memory

This key functions the same as ["Delete Segment From ARB Mem" on page 1335](#).

Key Path	Source, Modulation Setup, ARB, Waveform Sequences, Build New Sequence, Insert New Waveform, Segment in ARB Memory
Initial S/W Revision	Prior to A.09.00

Delete All From ARB Memory

This key functions the same as ["Delete All From ARB Memory" on page 1336](#).

Key Path	Source, Modulation Setup, ARB, Waveform Sequences, Build New Sequence, Insert New Waveform, Segment in ARB Memory
Initial S/W Revision	Prior to A.09.00

Query ARB Memory File List (Remote Command Only)

This command functions the same as ["Query ARB Memory File List \(Remote Command Only\)" on page 1268](#).

Initial S/W Revision	Prior to A.09.00
----------------------	------------------

Edit Selected Waveform

Allows access to the sub-menus for editing the details of the currently selected waveform segment.

Key Path	Source, Modulation Setup, ARB, Waveform Sequences, Build New Sequence
Notes	No remote command, front panel only.
Initial S/W Revision	A.05.00

Repetitions

Allows you to specify the number of times the currently selected waveform is played within the sequence.

Key Path	Source, Modulation Setup, ARB, Waveform Sequences, Build New Sequence, Edit Selected Waveform
Notes	No remote command, SCPI front panel only.
Preset	1
Min	1
Max	65535
Initial S/W Revision	A.05.00

Marker 1

Allows you to enable or disable marker 1 for the currently selected waveform. For a waveform sequence, you can enable and disable markers on a per-segment basis, allowing you to output markers from some waveform segments within the sequence, but not for others.

Key Path	Source, Modulation Setup, ARB, Waveform Sequences, Build New Sequence, Edit Selected Waveform
Notes	No remote command, front panel only.
Preset	Enabled
Range	Enabled Disabled
Initial S/W Revision	A.05.00

Marker 2

Allows you to enable or disable marker 2 for the currently selected waveform. For a waveform sequence, you can enable and disable markers on a per-segment basis, allowing you to output markers from some waveform segments within the sequence, but not for others.

Key Path	Source, Modulation Setup, ARB, Waveform Sequences, Build New Sequence, Edit Selected Waveform
Notes	No remote command, front panel only.
Preset	Enabled
Range	Enabled Disabled
Initial S/W Revision	A.05.00

Marker 3

Allows you to enable or disable marker 3 for the currently selected waveform. For a waveform sequence, you can enable and disable markers on a per-segment basis, allowing you to output markers from some waveform segments within the sequence, but not for others.

Key Path	Source, Modulation Setup, ARB, Waveform Sequences, Build New Sequence, Edit Selected
----------	--

	Waveform
Notes	No remote command, front panel only.
Preset	Enabled
Range	Enabled Disabled
Initial S/W Revision	A.05.00

Marker 4

Allows you to enable or disable marker 4 for the currently selected waveform. For a waveform sequence, you can enable and disable markers on a per-segment basis, allowing you to output markers from some waveform segments within the sequence, but not for others.

Key Path	Source, Modulation Setup, ARB, Waveform Sequences, Build New Sequence, Edit Selected Waveform
Notes	No remote command, front panel only.
Preset	Enabled
Range	Enabled Disabled
Initial S/W Revision	A.05.00

Delete Segment

Allows you to delete the selected segment from the waveform sequence.

Key Path	Source, Modulation Setup, ARB, Waveform Sequences, Build New Sequence
Notes	No remote command, front panel only.
Initial S/W Revision	A.05.00

Save Sequence...

Pressing this key displays the "Save As" dialog. The sequence name is passed to the save as dialog to use as the filename for saving, and the directory the save as dialog will open into is the default waveform directory.

Key Path	Source, Modulation Setup, ARB, Waveform Sequences, Build New Sequence
Initial S/W Revision	A.05.00

Build New Sequence (Remote Command Only)

This command is the SCPI equivalent of the waveform sequence creation features described in "[Build New Sequence](#)" on page 1275.

This command writes a waveform sequence file to the hard disk. You must specify the waveform sequence file path and filename which will be saved on the hard disk, and the waveform segment file path and name which will be nested into the waveform sequence file. You can utilize mass storage unit specifier (MSUS) “NVWFM” or use a real full path representation. See the example below. MSUS “NVWFM” is mapped to D: VARB directory on test set hard disk.

Any number of segments, up to a segment count limit of 64, can be used to create a sequence. Repeated segments are included in the count limit.

Each waveform segment name string length upper limit is 128 chars. Please do NOT insert waveform which name string exceeds 128 chars.

The internal source does not support nesting one waveform sequence file into another waveform sequence file.

Remote Command :SOURce:RADio:ARB:SEQuence[:MWAVeform] <filename>, <waveform1>, <reps>, NONE | M1 | M2 | M3 | M4 | M1M2 | M1M3 | M1M4 | M2M3 | M2M4 | M3M4 | M1M2M3 | M1M2M4 | M1M3M4 | M2M3M4 | M1M2M3M4 | ALL, {<waveform2>, <reps>, NONE | M1 | M2 | M3 | M4 | M1M2 | M1M3 | M1M4 | M2M3 | M2M4 | M3M4 | M1M2M3 | M1M2M4 | M1M3M4 | M2M3M4 | M1M2M3M4 | ALL, } ...

(For additional description of each item, see Notes below ["For Setup SCPI" on page 715](#) "For Setup SCPI".)

:SOURce:RADio:ARB:SEQuence[:MWAVeform]? <filename>

(For additional description of each item, see Notes ["For Query SCPI" on page 716](#) below.)

Example For setup:

```
>:SOUR:RAD:ARB:SEQ "NVWFM:testSeq1.seq", "NVWFM:wfmSegment1.wfm", 10, M2M3M4, "NVWFM:wfmSegment2.wfm", 20, M1M3
```

Or

```
>:SOUR:RAD:ARB:SEQ "D: VARB\testSeq1.seq", " D: VARB\wfmSegment1.wfm", 10, M2M3M4, " D: VARB\wfmSegment2.wfm", 20, M1M3
```

For query, must specify which waveform sequence file to query.

```
>:SOUR:RAD:ARB:SEQ? "NVWFM:testSeq1.seq"
```

Or

```
>:SOUR:RAD:ARB:SEQ? "D: VARB\testSeq1.seq",
```

Notes

For Setup SCPI

For the Setup SCPI command, the parameters are:

<filename> - String Type

This variable specifies the path and name for the waveform sequence file. The path supports MSUS (NVWFM) or a real full path representation. See example.

<waveform1> - String Type

This variable specifies the path and name of the first existing waveform segment. The path supports MSUS (NVWFM) or a real full path representation. See example.

The segment file must reside within ARB playback memory before it can be played by the ARB player.

<reps> - Integer Type

This variable specifies the number of times a segment or sequence plays before moving on to the next segment or sequence.

<marker> - Enum Type

NONE - This choice disables all four markers for the waveform. Disabling markers means that the waveform sequence ignores the segments or sequence marker settings.

M1, M2, M3, M4 - these choices, either individually or a combination of them, enable the markers for the waveform segment or sequence. Markers not specified are ignored for that segment or sequence.

ALL - This choice enables all four markers in the waveform segment or sequence.

<waveform2> - String type.

This variable specifies the name of a second existing waveform segment. The path supports MSUS (NVWFM) and real full path representation both. See example.

The segment file must reside within ARB playback memory before it can be played by the ARB player.

<reps> same as above, for the 2nd waveform segment.

<marker> same as above, for the 2nd waveform segment.

You can insert several waveform segments into a waveform sequence file. Just repeat inserting waveform segments as described above.

Error Checks for Setup SCPI command:

If you do not specify a filename, or you use an unsupported MSUS (that is, not NVWFM), or have an error in the waveform sequence file path, an error is generated.

Notes

Error Checks for Query SCPI command: (Continued)

If the specified waveform sequence file name suffix is not ".seq", error is generated.

If you use an unsupported MSUS (that is, not NVWFM), or have an error in the waveform segment file path, an error is generated.

If the first specified waveform file cannot be found, an error is generated.

If you nest one waveform sequence file into another waveform sequence file, an error is generated.

If the specified repetition value is larger than 65535 or smaller than 1, an error is generated.

If the specified marker type is unrecognized, an error is generated.

For Query SCPI

For the Query the parameters are:

<filename> - String type.

This variable specifies the path and name of the waveform sequence file being queried. The path supports MSUS (NVWFM) or a real full path representation. See example.

The return value is a <string>, which includes each waveform segment file name, repetitions, and marker type. For example:

>:SOUR:RAD:ARB:SEQ? "NVWFM:testSeq1.seq",

<"wfmSegment1.wfm, 10, ALL, wfmSegment2.wfm, 20, M1M3",

Error Checks for Query SCPI command:

If you do not specify a filename, an error is generated.

If the waveform sequence file name is empty, an error is generated.

If the specified waveform sequence file cannot be found, an error is generated.

Initial S/W Revision

A.05.00

Edit Selected Sequence

Allows access to the sub-menus for editing the sequence currently selected within the Waveform Sequence List view. Pressing this key changes the central view area to display the Waveform Sequence Creation and Editing view.

Key Path	Source, Modulation Setup, ARB, Waveform Sequences
Notes	No remote command, front panel only.
Initial S/W Revision	A.05.00

Current Directory...

Allows you to change the currently selected directory on the hard disk. Pressing this key opens a standard windows change directory dialog and allows you to select the new directory of interest.

Key Path	Source, Modulation Setup, ARB, Waveform Sequences
Notes	No remote command, front panel only.
Initial S/W Revision	A.05.00

Waveform Utilities

Allows you access to the waveform utilities sub-menus.

Key Path	Source, Modulation Setup, ARB
Initial S/W Revision	A.05.00

Multi-Pack Licenses

Allows you access to the Multi - Pack License sub-menus. Pressing this key also changes the central view area to display the Multi -Pack License Management view.

On modular instrument like E6630A or E6640A, multi-pack license operations are only allowed on the default module, i.e. "Left" module for E6630A or "TRX1" module for E6640A.

Key Path	Source, Modulation Setup, ARB, Waveform Utilities
Notes	If access multi-pack license sub-menu from modules other than "TRX1", an advisory message like "Please goto "TRX1" to operate multi-pack license" will display.
Dependencies	This key is only available if there is at least one Multi-pack license installed on the instrument.
Initial S/W Revision	A.05.00

Add Waveform

Pressing this key accesses the Add Waveform sub-menu. It also changes the central display area to display the Multi-Pack License Waveform Add view.

Key Path	Source, Modulation Setup, ARB, Waveform Utilities, Multi-Pack Licenses
Dependencies	This key is only available if there is at least one slot available within at least one multi-pack license.
Initial S/W Revision	A.05.00

Add Waveform

Allows you to add the currently selected waveform segment to a multi-pack license. The new waveform is added to the next available slot regardless of which slot was selected on the Multi-Pack License Management view.

Key Path	Source, Modulation Setup, ARB, Waveform Utilities, Multi-Pack Licenses, Add Waveform
Remote Command	:SYSTem:LKEY:WAVeform:ADD <string> or :SYSTem:LIcense[:FPACK]:WAVeform:ADD <string>
Example	SYST:LKEY:WAV:ADD "mywaveform.wfm" or SYST:LIC:WAV:ADD "mywaveform.wfm"
Notes	The second SCPI :SYSTem:LIcense[:FPACK]:WAVeform:ADD is provided to be consistent with the style of Agilent signal sources. You can use either one of them. Since adding a waveform segment to a Multi-Pack license causes the license slot to enter the trial period of only 48 hours, pressing this key causes a confirmation dialog to be displayed to ensure you do want to add the waveform segment to the Multi-Pack. If you attempt to license a waveform that is already licensed using another slot an error is generated. . If current module is not "TRX1" module, the key will grey out, and error message is generated "-221 Setting conflict; Not allowed on current module. Goto "TRX1" to operate multi-pack license" when invoking SCPI.
Dependencies	This key is only available if the currently selected file is a secure waveform requiring a license, and there is at least one slot available within at least one multi-pack license. If the waveform highlighted is a secure waveform, but is already licensed, this key will be unavailable.
Initial S/W Revision	A.05.00

Segments on Hard Disk

Allows you access to the sub-menus for loading waveform segments from the hard disk into ARB memory. The default directory is: D: varb.

Pressing this key changes the current view to the Waveform Management View.

Key Path	Source, Modulation Setup, ARB, Select Waveform
Initial S/W Revision	A.05.00

Load Segment To ARB Memory

Allows you to load the selected file into ARB memory. On the front panel you select the file for loading to the ARB memory by highlighting the desired file in the list. Using the SCPI command, you specify the file name on the HDD.

“NVWFM” (none-volatile storage) MSUS (Mass Storage Unit Specifier) is supported in the memory subsystem because the ARB memory cannot be accessed directly. Therefore, files must be downloaded to the instrument hard disk and then loaded into the ARB memory. “NVWFM” MSUS will be mapped to the default directory D: VARB. The SCPI command supports using either “NVWFM” MSUS or specifying a full path. For more information, see [Memory Subsystem \(Remote Command Only\)](#).

If a file of the same name already exists within ARB memory, it is overwritten. If you wish to load two segments of the same name, you must rename one of the segments before loading it into ARB memory. To rename a segment, you can either use Windows File Explorer, or the :MMEMory:COPY command.

NOTE: When a waveform file is loaded to ARB memory, burst timing adjustments are made automatically, based on whether or not a Multiport Adapter is connected to the test set and powered on. If the connection/power status of the Multiport Adapter is changed after a waveform file has been loaded, it needs to be loaded again.

Key Path	Source, Modulation Setup, ARB, Select Waveform, Segments on Hard Disk
Remote Command	:SOURce:RADio:ARB:LOAD <string>
Example	:SOUR:RAD:ARB:LOAD "D: VARB\testwaveform.bin" or :SOUR:RAD:ARB:LOAD "NVWFM:testwaveform.bin"
Notes	<p>Because loading the file involves a delay of unpredictable length, this command should be followed by the query *OPC?, which holds off subsequent commands until the loading operating is complete.</p> <p><string> – specifies the path name of the file to load from the HDD into ARB memory. It could be a <full path + filename>, or <“NVWFM” MSUS + colon + filename>.</p> <p>When in Sequence Analyzer mode, and Include Source is Yes, an attempt to load a file to ARB memory will be rejected with an error.</p> <p>When Include Source is No and if there is insufficient free ARB memory to load the selected waveform, an error is generated. .</p> <p>If you specify a file over SCPI, but the file is not at the specified location, an error is generated.</p> <p>If you try to load a waveform file but the file contains less than 500 IQ samples, an error is generated.</p> <p>If you try to load a Signal Studio waveform “*.wfm” which contains invalid waveform header, an error is generated.</p> <p>If the ARB is ON when you load a file to ARB memory or delete a file from ARB memory, the playing waveform segment may not keep phase continuity during the ARB memory operation. The waveform will be replayed after the ARB operation is finished.</p> <p>ARB can be loaded into ARB memory even required licenses do not present on the instrument. In this</p>

case, a GUI only warning message -800, "Operation complete; Loaded <filename> successfully, but no license <required licenses> installed". User can install required licenses according to <required licenses> string to license it, or multi-pack license it.

Initial S/W Revision	A.05.00
----------------------	---------

Load All To ARB Memory

Allows you to load all the segment files within the currently selected directory into ARB memory. If a file of the same name already exists within ARB memory, it is overwritten. If you wish to load two segments of the same name, you must rename one of the segments before loading it into ARB memory. To rename a segment, you can either use Windows File Explorer, or the :MEMory:COPY command.

NOTE: When a waveform file is loaded to ARB memory, burst timing adjustments are made automatically, based on whether or not a Multiport Adapter is connected to the test set and powered on. If the connection/power status of the Multiport Adapter is changed after a waveform file has been loaded, it needs to be loaded again.

Key Path	Source, Modulation Setup, ARB, Select Waveform, Segments on Hard Disk
----------	---

Remote Command	:SOURce:RADio:ARB:LOAD:ALL <string>
----------------	-------------------------------------

Example	:SOUR:RAD:ARB:LOAD:ALL "D: varb"
---------	----------------------------------

Notes	<p><string> - specifies the directory on the HDD to load the files into ARB memory from.</p> <p>When in Sequence Analyzer mode, and Include Source is Yes, an attempt to load all files from a directory to ARB memory is rejected with an error.</p> <p>When Include Source is No and there is insufficient free ARB memory to load all the waveforms, when the ARB memory is full, the copy ceases, and an error is generated.</p> <p>If you specify a directory over SCPI, but the directory does not exist, an error is generated.</p> <p>If the ARB is ON, a user then loads or deletes file to ARB memory, the playing waveform segment may not keep phase continuity during the ARB memory operation. The waveform will be replayed after the ARB operation is finished.</p>
-------	---

Initial S/W Revision	A.05.00
----------------------	---------

Change Directory...

Allows you to change the currently selected directory on the hard disk. Pressing this key opens a standard windows change directory dialog allowing you to select the new directory of interest.

The current directory is used for manually loading waveform segments into ARB memory for playback, and as a search location for waveform segments that are required to be loaded into ARB memory for playback of a waveform sequence or a list sequence.

Key Path	Source, Modulation Setup, ARB, Select Waveform, Segments on Hard Disk
----------	---

Notes	No remote command, SCPIfront panel only.
-------	--

Initial S/W Revision	A.05.00
----------------------	---------

Default Directory...

Allows you to change the default directory. It is used as a search location for waveform segments that are required to be loaded into ARB memory for playback of a waveform sequence, and as a search location for selecting waveforms using SCPI.

Key Path	Source, Modulation Setup, ARB, Select Waveform, Segments on Hard Disk
Remote Command	:SOURce:RADio:ARB:DEFault:DIRectory <string> :SOURce:RADio:ARB: DEFault:DIRectory?
Example	:SOUR:RAD:ARB:DEF:DIR "D:\ArbFiles" :SOUR:RAD:ARB:DEF:DIR?
State Saved	Persistent, survives a power cycle and a preset but not saved in the instrument state
Initial S/W Revision	A.05.00

Segments on Hard Disk

This key functions the same as ["Segments on Hard Disk" on page 1333](#).

Key Path	Source, Modulation Setup, ARB, Waveform Utilities, Multi-Pack Licenses, Add Waveform
Initial S/W Revision	Prior to A.09.00

Load Segment To ARB Memory

This key functions the same as ["Load Segment To ARB Memory" on page 1333](#).

Key Path	Source, Modulation Setup, ARB, Waveform Utilities, Multi-Pack Licenses, Add Waveform, Segment on Hard Drive
Initial S/W Revision	Prior to A.09.00

Load All To ARB Memory

This key functions the same as ["Load All To ARB Memory" on page 1334](#).

Key Path	Source, Modulation Setup, ARB, Waveform Utilities, Multi-Pack Licenses, Add Waveform, Segment on Hard Drive
Initial S/W Revision	Prior to A.09.00

Change Directory ...

This key functions the same as ["Change Directory..." on page 1335](#).

Key Path	Source, Modulation Setup, ARB, Waveform Utilities, Multi-Pack Licenses, Add Waveform, Segment on Hard Drive
Initial S/W Revision	Prior to A.09.00

Default Directory ...

This key functions the same as ["Default Directory..." on page 1335](#)

Key Path	Source, Modulation Setup, ARB, Waveform Utilities, Multi-Pack Licenses, Add Waveform, Segment on Hard Drive
Initial S/W Revision	Prior to A.09.00

Replace Waveform

Pressing this key accesses the Replace Waveform submenu. It also changes the central display area to display the Multi-Pack License Waveform Add view.

Key Path	Source, Modulation Setup, ARB, Waveform Utilities, Multi-Pack Licenses
Dependencies	This key is only available if the currently selected slot is in the trial state.
Initial S/W Revision	A.05.00

Replace Waveform

Allows you to replace the waveform in the currently selected slot with the waveform currently selected in the Multi-Pack License Waveform Add view.

Key Path	Source, Modulation Setup, ARB, Waveform Utilities, Multi-Pack Licenses, Replace Waveform
Remote Command	:SYSTem:LKEY:WAVeform:REPLace <int>, <string> or :SYSTem:LICense[:FPACK]:WAVeform:REPLace <int>, <string>
Example	SYST:LKEY:WAV:REPL 1, "myotherwaveform.wfm" or :SYST:LIC:WAV:REPL 1, "myotherwaveform.wfm"
Notes	The second SCPI :SYSTem:LICense[:FPACK]:WAVeform:REPLace is provided to be consistent with the style of Agilent signal sources. You can use either one of them. If you attempt to license a waveform that is already licensed using another slot an error is generated. Waveform slot number <int> is positive. If you attempt to input a slot number less than or equals 0, an error is generated. If current module is not "TRX1" module, the key will grey out, and error message is generated "-221 Setting conflict; Not allowed on current module. Goto "TRX1" to operate multi-pack license" when invoking SCPI.
Initial S/W Revision	A.05.00

Segments on Hard Disk

This key functions the same as ["Segments on Hard Disk" on page 1333](#).

Key Path	Source, Modulation Setup, ARB, Waveform Utilities, Multi-Pack Licenses, Replace Waveform
Initial S/W Revision	Prior to A.09.00

Load Segment To ARB Memory

This key functions the same as ["Load Segment To ARB Memory" on page 1333](#).

Key Path	Source, Modulation Setup, ARB, Waveform Utilities, Multi-Pack Licenses, Replace Waveform, Segment on Hard Drive
Initial S/W Revision	Prior to A.09.00

Load All To ARB Memory

This key functions the same as ["Load All To ARB Memory" on page 1334](#).

Key Path	Source, Modulation Setup, ARB, Waveform Utilities, Multi-Pack Licenses, Replace Waveform, Segment on Hard Drive
Initial S/W Revision	Prior to A.09.00

Change Directory ...

This key functions the same as ["Change Directory..." on page 1335](#).

Key Path	Source, Modulation Setup, ARB, Waveform Utilities, Multi-Pack Licenses, Replace Waveform, Segment on Hard Drive
Initial S/W Revision	Prior to A.09.00

Default Directory ...

This key functions the same as ["Default Directory..." on page 1335](#)

Key Path	Source, Modulation Setup, ARB, Waveform Utilities, Multi-Pack Licenses, Replace Waveform, Segment on Hard Drive
Initial S/W Revision	Prior to A.09.00

Clear Waveform from Slot

Allows you to clear the waveform from the selected slot.

Key Path	Source, Modulation Setup, ARB, Waveform Utilities, Multi-Pack Licenses
Remote Command	:SYSTem:LKEY:WAVeform:CLEar <int> or :SYSTem:LICense[:FPACK]:WAVeform:CLEar <int>
Example	SYST:LKEY:WAV:CLE 1 or :SYST:LIC:WAV:CLE 1
Notes	The second SCPI :SYSTem:LICense[:FPACK]:WAVeform:CLEar is provided to be consistent with the style of Agilent signal sources. You can use either one of them. Waveform slot number <int> is positive. If you attempt to input a slot number less than or equals 0, an error is generated. If current module is not "TRX1" module, the key will grey out, and error message is generated "-221 Setting conflict; Not allowed on current module. Goto "TRX1" to operate multi-pack license" when invoking SCPI.
Dependencies	This key is only available if the currently selected slot is in the trial state.
Initial S/W Revision	A.05.00

Lock Waveform in Slot

If the selected slot is in the trial state or the lock required state, the waveform that occupies the slot is locked and permanently licensed.

Key Path	Source, Modulation Setup, ARB, Waveform Utilities, Multi-Pack Licenses
Remote Command	:SYSTem:LKEY:WAVeform:LOCK <int> or :SYSTem:LICense[:FPACK]:WAVeform:LOCK <int>
Example	SYST:LKEY:WAV:LOCK 1 or SYST:LIC:WAV:LOCK 1
Notes	The second SCPI :SYSTem:LICense[:FPACK]:WAVeform:LOCK is provided to be consistent with the style of Agilent signal sources. You can use either one of them. Waveform slot number <int> is positive. If you attempt to input a slot number less than or equals 0, an error is generated. If current module is not "TRX1" module, the key will grey out, and error message is generated "-221 Setting conflict; Not allowed on current module. Goto "TRX1" to operate multi-pack license" when invoking SCPI.
Dependencies	This key is only available if the currently selected slot is in the trial state or the lock required state.
Initial S/W Revision	A.05.00

Slot Status Query (Remote Command Only)

Returns the status of the specified slot.

Remote Command	:SYSTem:LKEY:WAVeform:STATus? <int> or :SYSTem:LICense[:FPACK]:WAVeform:STATus? <int>
Example	:SYST:LKEY:WAV:STAT? 1 <"Locked" or :SYST:LIC:WAV:STAT? 1 <"Locked"
Notes	The second SCPI :SYSTem:LICense[:FPACK]:WAVeform:STATus is provided to be consistent with the style of Agilent signal sources. You can use either one of them. Waveform slot number <int> is positive. If you attempt to input a slot number less than or equals 0, an error is generated. Result type is string. If input slot number exceeds total available slot number, "Nonexistent" is returned.
Range	"Locked" "Available" "Trail" "LockRequired" "Nonexistent"
Initial S/W Revision	A.05.00

Slots Free Query (Remote Command Only)

Returns the number of license slots free.

Remote Command	:SYSTem:LKEY:WAVeform:FREE? or :SYSTem:LICense[:FPACK]:WAVeform:FREE?
Example	:SYST:LKEY:WAV:FREE? or :SYST:LIC:WAV:FREE?
Notes	The second SCPI :SYSTem:LICense[:FPACK]:WAVeform:FREE is provided to be consistent with the style of Agilent signal sources. You can use either one of them.
Initial S/W Revision	A.05.00

Slot Used Query (Remote Command Only)

Returns the number of license slots used.

Remote Command	:SYSTem:LKEY:WAVeform:USED? or :SYSTem:LICense[:FPACK]:WAVeform:USED?
Example	:SYST:LKEY:WAV:USED?

	or :SYST:LIC:WAV:USED?
Notes	The second SCPI :SYSTem:LIcense[:FPACK]:WAVeform:USED is provided to be consistent with the style of Agilent signal sources. You can use either one of them.
Initial S/W Revision	A.05.00

Slot Waveform Name Query (Remote Command Only)

Returns the waveform name of the specified slot

Remote Command	:SYSTem:LKEY:WAVeform:NAME? <int> or :SYSTem:LIcense[:FPACK]:WAVeform:NAME? <int>
Example	:SYST:LKEY:WAV:NAME? 1 <"CDMA2K_22.wfm" or :SYST:LIC:WAV:NAME? 1 <"CDMA2K_22.wfm"
Notes	Waveform slot number <int> is positive. If you attempt to input a slot number less than or equals 0, an error is generated. Result type is string. If input slot number exceeds total available slot number, "Nonexistent" is returned. If no waveform stored in the specified slot, then empty string is returned.
Initial S/W Revision	A.12.00

Slot Waveform Unique ID Query (Remote Command Only)

Returns the waveform unique ID of the specified slot

Remote Command	:SYSTem:LKEY:WAVeform:UID? <int> or :SYSTem:LIcense[:FPACK]:WAVeform:UID? <int>
Example	:SYST:LKEY:WAV:UID? 2 <"1346752140" or :SYST:LIC:WAV:UID? 2 <"1346752140"
Notes	Waveform slot number <int> is positive. If you attempt to input a slot number less than or equals 0, an error is generated. Result type is string. If input slot number exceeds total available slot number, "Nonexistent" is returned.

If no waveform stored in the specified slot, then "0" is returned

Initial S/W Revision A.12.00

Locked Waveform Name List Query (Remote Command Only)

Returns the waveform name list of locked.

Remote Command :SOURce:RADio:ARB:MPLicensed:NAME:LOCKed?

Example SOUR:RAD:ARB:MPL:NAME:LOCKed?
 <"CDMA2K_27.wfm", "GSM_MCS1.WFM", "c2kWfm.wfm"

Initial S/W Revision A.11.00

Locked Waveform Unique ID List Query (Remote Command Only)

Returns the waveform unique id list of locked.

Remote Command :SOURce:RADio:ARB:MPLicensed:UID:LOCKed?

Example SOUR:RAD:ARB:MPL:UID:LOCKed?
 <"2996927136", "3812603511", "3710986266"

Notes Each Signal Studio waveform has a unique id recorded in header. So if the unique ids are same, that means they are same one waveform. So besides SCPI to query locked waveform name list, also provide a SCPI to query locked waveform unique id list

Initial S/W Revision A.11.00

Marker Utilities

Allows access to the marker utilities sub-menus.

Key Path Source, Modulation Setup, ARB

Initial S/W Revision A.05.00

Marker Polarity

Allows access to the marker polarity sub-menu, which allows you to specify the polarity for the four markers. For a positive polarity, the marker signal is high during the marker points. For a negative marker polarity, the marker signal is high during the period of no marker points.

Key Path Source, Modulation Setup, ARB, Marker Utilities

Initial S/W Revision A.05.00

Mkr 1 Polarity

Allows you to set the polarity of marker 1.

Key Path	Source, Modulation Setup, ARB, Marker Utilities, Marker Polarity
Remote Command	:SOURce:RADio:ARB:MPOLarity:MARKer1 POSitive NEGative :SOURce:RADio:ARB:MPOLarity:MARKer1?
Example	:SOUR:RAD:ARB:MPOL:MARK1 NEG
Dependencies	When a new waveform is selected for playback the settings contained within the associated waveform header file are applied to the ARB. The marker polarity is one of the values stored within the header file. If the newly selected waveform file has an associated header file, the marker polarity is updated with the value from the header file. The marker polarity will remain unchanged if the newly selected waveform does not have an associated header file.
Preset	Pos
Range	Neg Pos
Initial S/W Revision	A.05.00

Mkr 2 Polarity

Allows you to set the polarity of marker 2.

Key Path	Source, Modulation Setup, ARB, Marker Utilities, Marker Polarity
Remote Command	:SOURce:RADio:ARB:MPOLarity:MARKer2 POSitive NEGative :SOURce:RADio:ARB:MPOLarity:MARKer2?
Example	:SOUR:RAD:ARB:MPOL:MARK2 NEG
Dependencies	When a new waveform is selected for playback the settings contained within the associated waveform header file are applied to the ARB. The marker polarity is one of the values stored within the header file. If the newly selected waveform file has an associated header file, the marker polarity is updated with the value from the header file. The marker polarity will remain unchanged if the newly selected waveform does not have an associated header file.
Preset	Pos
Range	Neg Pos
Initial S/W Revision	A.05.00

Mkr 3 Polarity

Allows you to set the polarity of marker 3.

Key Path	Source, Modulation Setup, ARB, Marker Utilities, Marker Polarity
Remote Command	:SOURce:RADio:ARB:MPOLarity:MARKer3 POSitive NEGative :SOURce:RADio:ARB:MPOLarity:MARKer3?
Example	:SOUR:RAD:ARB:MPOL:MARK3 NEG
Dependencies	When a new waveform is selected for playback the settings contained within the associated

waveform header file are applied to the ARB. The marker polarity is one of the values stored within the header file. If the newly selected waveform file has an associated header file, the marker polarity is updated with the value from the header file. The marker polarity will remain unchanged if the newly selected waveform does not have an associated header file.

Preset	Pos
Range	Neg Pos
Initial S/W Revision	A.05.00

Mkr 4 Polarity

Allows you to set the polarity of marker 4.

Key Path	Source, Modulation Setup, ARB, Marker Utilities, Marker Polarity
Remote Command	:SOURce:RADio:ARB:MPOLarity:MARKer4 POSitive NEGative :SOURce:RADio:ARB:MPOLarity:MARKer4?
Example	:SOUR:RAD:ARB:MPOL:MARK4 NEG
Dependencies	When a new waveform is selected for playback the settings contained within the associated waveform header file are applied to the ARB. The marker polarity is one of the values stored within the header file. If the newly selected waveform file has an associated header file, the marker polarity is updated with the value from the header file. The marker polarity will remain unchanged if the newly selected waveform does not have an associated header file.
Preset	Pos
Range	Neg Pos
Initial S/W Revision	A.05.00

Marker Routing

Allows access to the marker routing sub-menus, which allow you to specify where the marker events are routed. It should be noted that the markers can also be routed to Trigger 1 Out and Trigger 2 Out, however this must be set up using the menus accessed by pressing the “Trigger” hard key.

Key Path	Source, Modulation Setup, ARB, Marker Utilities
Initial S/W Revision	A.05.00

Pulse/RF Blank

Allows you to select which marker is used for the pulse/RF blanking function. The pulse/RF blanking function blanks the RF when the marker signal goes low. The marker polarity determines when the marker signal is high. For a positive polarity, this is during the marker points. For a negative polarity, this is when there are no marker points.

Marker points should be set before using this function. Enabling this function without setting marker points may create a continuous low or high signal, dependant on the marker polarity. This causes either no RF output, or a continuous RF output.

Key Path	Source, Modulation Setup, ARB, Marker Utilities, Marker Routing
Remote Command	:SOURce:RADio:ARB:MDEStination:PULSe NONE M1 M2 M3 M4 :SOURce:RADio:ARB:MDEStination:PULSe?
Example	:SOUR:RAD:ARB:MDES:PULS NONE
Dependencies	When a new waveform is selected for playback the settings contained within the associated waveform header file are applied to the ARB. The pulse/RF blanking setting is one of the values stored within the header file. If the newly selected waveform file has an associated header file, the pulse/RF blanking setting is updated with the value from the header file. The pulse/RF blanking setting will remain unchanged if the newly selected waveform does not have an associated header file.
Range	None M1 M2 M3 M4
Initial S/W Revision	A.05.00

None

Sets no marker to be used for the pulse/RF blanking function, essentially turning the RF blanking function off.

Key Path	Source, Modulation Setup, ARB, Marker Utilities, Marker Routing, Pulse/RF Blank
Example	:SOUR:RAD:ARB:MDES:PULS NONE
Initial S/W Revision	A.05.00

Marker 1

Sets marker 1 to be used for the pulse/RF blanking function.

Key Path	Source, Modulation Setup, ARB, Marker Utilities, Marker Routing, Pulse/RF Blank
Example	:SOUR:RAD:ARB:MDES:PULS M1
Initial S/W Revision	A.05.00

Marker 2

Sets marker 2 to be used for the pulse/RF blanking function.

Key Path	Source, Modulation Setup, ARB, Marker Utilities, Marker Routing, Pulse/RF Blank
Example	:SOUR:RAD:ARB:MDES:PULS M2
Initial S/W Revision	A.05.00

Marker 3

Sets marker 3 to be used for the pulse/RF blanking function.

Key Path	Source, Modulation Setup, ARB, Marker Utilities, Marker Routing, Pulse/RF Blank
Example	:SOUR:RAD:ARB:MDES:PULS M3
Initial S/W Revision	A.05.00

Marker 4

Sets marker 4 to be used for the pulse/RF blanking function.

Key Path	Source, Modulation Setup, ARB, Marker Utilities, Marker Routing, Pulse/RF Blank
Example	:SOUR:RAD:ARB:MDES:PULS M4
Initial S/W Revision	A.05.00

ALC Hold

Allows you to specify which marker is routed for use within the ALC hold function. The ALC hold marker function holds the ALC circuitry at the average value of the sample points set by the marker.

The ALC hold function operates during the low periods of the marker signal. The marker polarity determines when the marker signal is high. For positive polarity, this is during the marker points. For a negative polarity, this is when there are no marker points.

Key Path	Source, Modulation Setup, ARB, Marker Utilities, Marker Routing
Remote Command	:SOURce:RADio:ARB:MDEStination:ALCHold NONE M1 M2 M3 M4 :SOURce:RADio:ARB:MDEStination:ALCHold?
Example	:SOUR:RAD:ARB:MDES:ALCH NONE
Dependencies	When a new waveform is selected for playback the settings contained within the associated waveform header file are applied to the ARB. The ALC hold setting is one of the values stored within the header file. If the newly selected waveform file has an associated header file, the ALC hold setting is updated with the value from the header file. The ALC hold setting will remain unchanged if the newly selected waveform does not have an associated header file.
Range	None M1 M2 M3 M4
Initial S/W Revision	A.05.00

None

Sets no marker to be used for the ALC hold function, essentially turning the ALC hold function off.

Key Path	Source, Modulation Setup, ARB, Marker Utilities, Marker Routing, ALC Hold
Example	:SOUR:RAD:ARB:MDES:PULS NONE
Initial S/W Revision	A.05.00

Marker 1

Sets marker 1 to be used for the ALC hold function.

Key Path	Source, Modulation Setup, ARB, Marker Utilities, Marker Routing, ALC Hold
Example	:SOUR:RAD:ARB:MDES:PULS M1
Initial S/W Revision	A.05.00

Marker 2

Sets marker 2 to be used for the ALC hold function.

Key Path	Source, Modulation Setup, ARB, Marker Utilities, Marker Routing, ALC Hold
Example	:SOUR:RAD:ARB:MDES:PULS M2
Initial S/W Revision	A.05.00

Marker 3

Sets marker 3 to be used for the ALC hold function.

Key Path	Source, Modulation Setup, ARB, Marker Utilities, Marker Routing, ALC Hold
Example	:SOUR:RAD:ARB:MDES:PULS M3
Initial S/W Revision	A.05.00

Marker 4

Sets marker 4 to be used for the ALC hold function.

Key Path	Source, Modulation Setup, ARB, Marker Utilities, Marker Routing, ALC Hold
Example	:SOUR:RAD:ARB:MDES:PULS M4
Initial S/W Revision	A.05.00

Header Utilities

Allows access to the header utilities sub-menu. Pressing this key also causes the central display area to change to display the File Header Information view.

Key Path	Source, Modulation Setup, ARB
Dependencies	This key is only available if there is currently a waveform selected for playback. If no waveform is selected, the key is grayed out.
Initial S/W Revision	A.05.00

Clear Header

Allows you to clear the header information from the file header associated with the currently selected waveform.

Key Path	Source, Modulation Setup, ARB, Header Utilities
Remote Command	:SOURce:RADio:ARB:HEADer:CLEar
Example	:SOUR:RAD:ARB:HEAD:CLE
Notes	Attempting to clear the header details via SCPI when no waveform was selected for playback will generate an error.
Initial S/W Revision	A.05.00

Save Setup To Header

Allows you to save new file header information details to the file.

Key Path	Source, Modulation Setup, ARB, Header Utilities
Remote Command	:SOURce:RADio:ARB:HEADer:SAVE
Example	:SOUR:RAD:ARB:HEAD:SAVE
Notes	Attempting to save the header details via SCPI when no waveform was selected for playback will generate an error.
Initial S/W Revision	A.05.00

Query Waveform Unique ID (Remote Command Only)

Each Signal Studio waveform contains a unique waveform ID, which recorded in the header. This command allows you to query the unique waveform ID from the header. This is a SCPI only command. User can also check [Error! Reference source not found.](#) for waveform unique ID display.

Remote Command	:MMEMory:HEADer:ID? "<file name>"
Example	:MMEM:HEAD:ID? "test.wfm" (query the waveform already loaded into the ARB memory) :MMEM:HEAD:ID? "D: VARB\test.wfm" (query the waveform on the hard disk by absolute path) :MMEM:HEAD:ID? "NVWFM:test.wfm" (query the waveform on the hard disk by MSUS)
Notes	SCPI query only. The queried waveform file can be in ARB memory, or on hard disk. If want to query ARB in ARB memory, then give out the file name directly. If want to query ARB on the hard disk, then absolute file path or MSUS should be given along with the file name. The valid MSUS is "NVWFM" which is mapped to D: VARB on hard disk. If the file cannot be found in ARB memory or on hard disk, an error is generated and value -1 is returned
Initial S/W Revision	A.09.00

Bus Trigger Command (Remote Command Only)

Used to initiate an immediate trigger event if the trigger source is set to Bus.

Remote Command	:SOURce:RADio:ARB:TRIGger:INITiate
Example	:SOUR:RAD:ARB:TRIG:INIT
Initial S/W Revision	A.05.00

AM

Allows access to the menu for configuring the Amplitude Modulation.

Key Path	Source, Modulation Setup
Initial S/W Revision	A.05.00

AM

Enables or disables the amplitude modulation.

Turning AM on when another modulation format is already on results in the previous modulation format being turned off and the generation of an error.

Key Path	Source, Modulation Setup, AM
Remote Command	:SOURce:AM:STATe :SOURce:AM:STATe?
Example	:SOUR:AM:STAT OFF
Preset	Off
Range	On Off
Initial S/W Revision	A.05.00

AM Depth

Allows you to set the amplitude modulation depth in percent.

Key Path	Source, Modulation Setup, AM
Remote Command	:SOURce:AM[:DEPTh] [:LINear] :SOURce:AM[:DEPTh] [:LINear]?
Example	:SOUR:AM 0.1
Preset	0.1 %
Min	0.1 %
Max	95.0 %
Initial S/W Revision	A.05.00

AM Rate

Allows you to set the internal amplitude modulation rate.

Key Path	Source, Modulation Setup, AM
Remote Command	:SOURce:AM:INTernal:FREQuency :SOURce:AM:INTernal:FREQuency?
Example	:SOUR:AM:INT:FREQ 40.0 Hz
Preset	400.0 Hz
Min	10 Hz
Max	40 kHz
Initial S/W Revision	A.05.00

FM

Allows access to the menu for configuring the frequency modulation.

Key Path	Source, Modulation Setup
Initial S/W Revision	A.05.00

FM

Enables or disables the frequency modulation.

Turning FM on when another modulation format is already on results in the previous modulation format being turned off and the generation of an error.

Key Path	Source, Modulation Setup, FM
Remote Command	:SOURce:FM:STATe :SOURce:FM:STATe?
Example	:SOUR:FM:STAT OFF
Preset	Off
Range	On Off
Initial S/W Revision	A.05.00

FM Deviation

Allows you to set the frequency modulation deviation.

Key Path	Source, Modulation Setup, FM
----------	------------------------------

Remote Command	:SOURce:FM[:DEVIation] :SOURce:FM[:DEVIation]?
Example	:SOUR:FM 1.00 kHz
Preset	1.00 Hz
Min	1.00 Hz
Max	100.00 kHz
Initial S/W Revision	A.05.00

FM Rate

Allows you to set the internal frequency modulation rate.

Key Path	Source, Modulation Setup, FM
Remote Command	:SOURce:FM:INTernal:FREQuency :SOURce:FM:INTernal:FREQuency?
Example	:SOUR:FM:INT:FREQ 40.0 Hz
Preset	400.0 Hz
Min	10 Hz
Max	40 kHz
Initial S/W Revision	A.05.00

PM

Allows access to the menu for configuring the phase modulation.

Key Path	Source, Modulation Setup
Initial S/W Revision	A.05.00

PM

Enables or disables the phase modulation.

Turning PM on when another modulation format is already on results in the previous modulation format being turned off and the generation of an error.

Key Path	Source, Modulation Setup, PM
Remote Command	:SOURce:PM:STATe :SOURce:PM:STATe?
Example	:SOUR:PM:STAT OFF

Preset	Off
Range	On Off
Initial S/W Revision	A.05.00

PM Deviation

Allows you to set the phase modulation deviation.

Key Path	Source, Modulation Setup, PM
Remote Command	:SOURce:PM[:DEVIation] :SOURce:PM[:DEVIation]?
Example	:SOUR:PM 1.00 rad
Preset	0.1 rad
Min	0.1 rad
Max	20.0 rad
Initial S/W Revision	A.05.00

PM Rate

Allows you to set the internal phase modulation rate.

Key Path	Source, Modulation Setup, PM
Remote Command	:SOURce:PM:INTernal:FREQuency :SOURce:PM:INTernal:FREQuency?
Example	:SOUR:PM:INT:FREQ 40.0 Hz
Preset	400.0 Hz
Min	10 Hz
Max	40 kHz
Initial S/W Revision	A.05.00

List Sequencer

Allows you access to the sub-menus for configuring the list sequencer.

List sequences allows you to enter frequencies and amplitudes at unequal intervals in nonlinear ascending, descending or random order. Each step within the list can also include its own waveform file for playback, step duration, trigger event and trigger output.

The complexities involved in configuring the list sequencer do not lend itself to manual configuration; hence the manual configuration for this feature is limited. For easier configuration of the list sequencer, it is recommended that you use either SCPI or load a tab delimited file containing the setup parameters in a

tabular form. The details of the SCPI for configuring the list sequencer can be found in "[Step Configuration \(Remote Command Only\)](#)" on page 1340.

Once the List Sequencer has been configured using the front panel, SCPI, or loading in a tab delimited file, the sequence must be initiated using the front panel Initiate Sequence key or the corresponding SCPI command.

Key Path	Source
Initial S/W Revision	A.05.00

Sequencer

Allows you to set the state of the list sequencer. When the list sequencer is on, the source is outputting the sequence defined by the sequencer. When the list sequencer is off, the source outputs a single waveform segment or sequence (independent mode) at a single frequency and amplitude.

Key Path	Source, List Sequencer
Remote Command	:SOURce:LIST[:STATe] ON OFF 1 0 :SOURce:LIST[:STATe] ?
Example	:SOUR:LIST OFF
Notes	When the sequencer is set to ON, the list sequencer controls the output of the source.
Couplings	When in Sequence Analyzer mode and the list sequencer state is Off, Include Source is forced to No, and the Include Source key is grayed out. When in Sequence Analyzer mode and the list sequencer state is On, Include Source is available to set. And, an ARB memory related operation, like load or delete will be rejected.
Preset	Off
Range	On Off
Initial S/W Revision	A.05.00

Initiate Sequence

Pressing this key arms the sequence for single execution. Once the sequence is armed the source begins the sequence as soon as the trigger is received. If the trigger is set to Free Run, the sequence starts immediately.

Key Path	Source, List Sequencer
Remote Command	:SOURce:LIST:TRIGger[:IMMediate]
Example	:SOUR:LIST:TRIG
Notes	When in Sequence Analyzer mode and Include Source is Yes, the Initiate list sequencer operation is rejected, and the key is grayed out, since source list sequence request is sent to physics via Parallel batch by sequence analyzer. If the file needed by the sequencer is not already in ARB memory, the sequence cannot be initiated

	and an error will be generated. There is a blocking SCPI query which can be used to query if source list sequence being initiated successfully or not. (see " Query List Sequence Initiation Armed Status (Remote Command Only) " on page 1351 Query Source List Sequence Armed Status)
Dependencies	Under the Sequence Analyzer Mode, if Meas Setup->Include Source is set to YES, Source->List Sequencer->Initiate Sequence is disabled.
Initial S/W Revision	A.05.00

List Sequencer Setup

Allows you access to the list sequencer setup menus.

Key Path	Source, List Sequencer
----------	------------------------

Number of Steps

Allows you to specify the number of steps within the list sequence.

Key Path	Source, List Sequencer, List Sequencer Setup
Remote Command	:SOURce:LIST:NUMBer:STEPs <integer> :SOURce:LIST:NUMBer:STEPs?
Example	:SOUR:LIST:NUMB:STEP 1
Notes	Increasing the number of steps creates additional steps at the end of the list, with all the settings within the steps set to their default values. Decreasing the number of steps removes steps from the end of the list. The settings within the removed steps are not reset. This means that increasing the number of steps again would allow you to retrieve these steps.
Dependencies	The Step Count parameter is increased or decreased when you insert or delete a point from within the GUI interface to the sequencer.
Preset	1
Min	1
Max	1000
Initial S/W Revision	A.05.00

Current Step

Allows you to select the step number you wish to view or edit.

Key Path	Source, List Sequencer, List Sequencer Setup
----------	--

Notes	No remote command, front panel only.
Preset	1
Min	1
Max	Step Count
Initial S/W Revision	A.05.00

Insert Step Before

Allows you to insert a new step, containing default values, before the currently selected step. Inserting a step will automatically increase the Step Count parameter by 1. If sequence already reaches upper limit of 1000 steps, then insert more step will be rejected and popup error -221, "Setting Conflict; Cannot insert more steps, maximum number of steps reached"

Key Path	Source, List Sequencer, List Sequencer Setup
Notes	No remote command, front panel only. If the list already contains the maximum limit of 1000 steps, no operation will be made after pressing this key.
Initial S/W Revision	A.05.00

Delete Step

Allows you to delete the current step. Deleting a step will automatically decrease the Step Count parameter by 1. If sequence only has one step left, delete step will be rejected and popup error -221, "Setting conflict; Cannot delete current step, minimum number of steps reached"

Key Path	Source, List Sequencer, List Sequencer Setup
Notes	No remote command, Front Panel key only. If the list already contains the minimum limit of 1 step, no operation will be made after pressing this key
Initial S/W Revision	A.05.00

Clear List

Allows you to clear the list. Clearing the list sets the number of steps to the default value of 1 and sets the parameters for the only step to their default values.

Key Path	Source, List Sequencer, List Sequencer Setup
Initial S/W Revision	A.05.00

Step Trigger

Allows access to the sub-menu for selecting the trigger input for the current step.

Key Path	Source, List Sequencer, List Sequencer Setup
Remote Command	:SOURce:LIST:STEP[1] 2 3...1000:SETup:INPut:TRIGger IMMEDIATE INTernal EXTernal2 KEY BUS EXTernal4 :SOURce:LIST:STEP[1] 2 3...1000:SETup:INPut:TRIGger?
Example	:SOUR:LIST:STEP2:SET:INP:TRIG BUS :SOUR:LIST:STEP2:SET:INP:TRIG?
Notes	SCPI is supported after A.09.40
Preset	Free Run
Range	Free Run Internal Manual (Trigger Key) Bus External 2 EXTernal4
Initial S/W Revision	A.05.00

Free Run

Sets the trigger input for the current step to Free Run.

Key Path	Source, List Sequencer, List Sequencer Setup, Step Trigger
Example	:SOUR:LIST:STEP2:SET:INP:TRIG IMM
Notes	SCPI is supported after A.09.40
Initial S/W Revision	A.05.00

Internal

Sets the trigger input for the current step to Internal.

Key Path	Source, List Sequencer, List Sequencer Setup, Step Trigger
Example	:SOUR:LIST:STEP2:SET:INP:TRIG INT
Notes	SCPI is supported after A.09.40
Initial S/W Revision	A.05.00

Manual (Trigger Key)

Sets the trigger input for the current step to Manual (Trigger Key). Any step in the sequence set to Manual will cause the sequence execution to stop until the manual trigger key is pressed. Sending the Bus Trigger SCPI command will have no effect. At any point in the sequence where the list sequencer is paused waiting for a software trigger, a pop up dialog is displayed until the trigger event occurs.

Key Path	Source, List Sequencer, List Sequencer Setup, Step Trigger
Example	:SOUR:LIST:STEP2:SET:INP:TRIG KEY
Notes	SCPI is supported after A.09.40
Initial S/W Revision	A.05.00

Bus

Sets the trigger input for the current step to Bus. Any step in the sequence set to Bus will cause the sequence execution to stop until the Bus Trigger SCPI command is sent. Pressing the manual trigger key has no effect. At any point in the sequence where the list sequencer is paused waiting for a software trigger, a pop up dialog is displayed until the trigger event occurs.

Key Path	Source, List Sequencer, List Sequencer Setup, Step Trigger
Example	:SOUR:LIST:STEP2:SET:INP:TRIG BUS
Notes	SCPI is supported after A.09.40
Initial S/W Revision	A.05.00

External 2

Sets the trigger input for the current step to External 2.

Key Path	Source, List Sequencer, List Sequencer Setup, Step Trigger
Example	:SOUR:LIST:STEP2:SET:INP:TRIG EXT2
Notes	SCPI is supported after A.09.40
Notes	Note: When on E6640A, trigger 2 is a bi-directional trigger port. So when trigger 2 has been configured as OUTPUT type, choosing External 2 as the input trigger for the current step will generate error.
Initial S/W Revision	A.05.00

Transition Time

Allows you to specify the transition time for the current step.

The transition time is the amount of time allowed for the source to settle at the current frequency or amplitude value.

Transition Time should not be taken as additional time before or inside the Step Duration. You can set a value for the settling time to allow the source output frequency or amplitude to become stable. Make sure that during this period of time, you do not use the source output signal.

The following table lists recommended values for appropriate settling times to allow for changes within the source.

Value Changed	Recommended Transition Time
Frequency	500 μ s
Amplitude	100 μ s to within 0.1 dB 20 μ s to within 1.0 dB

If the Transition Time value is shorter than the time necessary for the hardware to settle and a List Sequence is initiated, a **warning** is generated.

If the Transition Time value is longer than the Step Duration, an error is generated when initiating a source list sequence. For source list sequence, transition time is included in the step duration length. If the Transition Time value is longer than the Step Duration Time, the real step duration length is extended to equal the transition time and cause a timing shift.

Key Path	Source, List Sequencer, List Sequencer Setup
Remote Command	:SOURce:LIST:STEP[1] 2 3...1000:SETup:TRANsition:TIME <time> :SOURce:LIST:STEP[1] 2 3...1000:SETup:TRANsition:TIME?
Example	:SOUR:LIST:STEP2:SET:TRAN:TIME 1ms :SOUR:LIST:STEP2:SET:TRAN:TIME?
Notes	SCPI is supported after A.09.40
Preset	1.0 ms
Min	0.0 ms
Max	4.0 ks
Initial S/W Revision	A.05.00

Radio Setup

Allows you access to the sub-menus for setting up the radio standard, band, and radio band link direction for the current step.

Key Path	Source, List Sequencer, List Sequencer Setup
Notes	No remote command, front panel only.
Initial S/W Revision	A.05.00

Radio Standard

Allows access to the sub-menus for selecting the radio standard and the associated radio band for use in the current step.

Key Path	Source, List Sequencer, List Sequencer Setup, Radio Setup
Remote Command	:SOURce:LIST:STEP[1] 2 3...1000:SETup:RADio:BAND NONE PGSM EGSM RGSM DCS1800 PCS1900 TGSM810 GSM450 GSM480 GSM700 GSM850 BANDI BANDII BANDIII BANDIV BANDV BANDVI BANDVII BANDVIII BANDIX BANDX BANDXI BANDXII BANDXIII BANDXIV BANDXIX USCELL USPCS JAPAN KOREAN NMT IMT2K UPPER SECOND PAMR400 PAMR800 IMTEXT PCS1DOT9G AWS US2DOT5G PUBLIC LOWER NONE BAND1 BAND2 BAND3 BAND4 BAND5 BAND6 BAND7 BAND8 BAND10 BAND11 BAND12 BAND13 BAND14 BAND17 BAND18 BAND19 BAND20 BAND21 BAND24 BAND25 BAND26 BAND27 BAND28 BAND31 BAND33 BAND34 BAND35 BAND36 BAND37 BAND38

	BAND39 BAND40 BAND41 BAND42 BAND43 BAND44 BANDA BANDB BANDC BANDD BANDE BANDF :SOURce:LIST:STEP[1] 2 3...1000:SETup: RADio:BAND?
Example	:SOUR:LIST:STEP2:SET:RAD:BAND PGSM :SOUR:LIST:STEP2:SET:RAD:BAND?
Notes	SCPI is supported after A.09.40
Initial S/W Revision	A.05.00

None

Selects no radio standard for use on the current step.

Key Path	Source, List Sequencer, List Sequencer Setup, Radio Setup, Radio Standard
Example	:SOUR:LIST:STEP2:SET:RAD:BAND NONE
Notes	SCPI is supported after A.09.40
Initial S/W Revision	A.05.00

GSM/EDGE

Pressing this key once selects GSM/EDGE as the radio standard and the current GSM/EDGE band as the active channel band. Pressing this key again allows access to the sub-menus for selecting a different GSM/EDGE band.

Key Path	Source, List Sequencer, List Sequencer Setup, Radio Setup, Radio Standard
Initial S/W Revision	A.05.00

P-GSM

Selects P-GSM as the band for the current step.

Key Path	Source, List Sequencer, List Sequencer Setup, Radio Setup, Radio Standard, GSM/EDGE
Initial S/W Revision	A.05.00

E-GSM

Selects E-GSM as the band for the current step.

Key Path	Source, List Sequencer, List Sequencer Setup, Radio Setup, Radio Standard, GSM/EDGE
Initial S/W Revision	A.05.00

R-GSM

Selects R-GSM as the band for the current step.

Key Path	Source, List Sequencer, List Sequencer Setup, Radio Setup, Radio Standard, GSM/EDGE
Initial S/W Revision	A.05.00

DCS 1800

Selects DCS 1800 as the band for the current step.

Key Path	Source, List Sequencer, List Sequencer Setup, Radio Setup, Radio Standard, GSM/EDGE
Initial S/W Revision	A.05.00

PCS 1900

Selects PCS 1900 as the band for the current step.

Key Path	Source, List Sequencer, List Sequencer Setup, Radio Setup, Radio Standard, GSM/EDGE
Initial S/W Revision	A.05.00

GSM 450

Selects GSM 450 as the band for the current step.

Key Path	Source, List Sequencer, List Sequencer Setup, Radio Setup, Radio Standard, GSM/EDGE
Initial S/W Revision	A.05.00

GSM 480

Selects GSM 480 as the band for the current step.

Key Path	Source, List Sequencer, List Sequencer Setup, Radio Setup, Radio Standard, GSM/EDGE
Initial S/W Revision	A.05.00

GSM 850

Selects GSM 850 as the band for the current step.

Key Path	Source, List Sequencer, List Sequencer Setup, Radio Setup, Radio Standard, GSM/EDGE
Initial S/W Revision	A.05.00

GSM 700

Selects GSM 700 as the band for the current step.

Key Path	Source, List Sequencer, List Sequencer Setup, Radio Setup, Radio Standard, GSM/EDGE
Initial S/W Revision	A.05.00

T-GSM 810

Selects T-GSM 810 as the band for the current step.

Key Path	Source, List Sequencer, List Sequencer Setup, Radio Setup, Radio Standard, GSM/EDGE
Initial S/W Revision	A.05.00

WCDMA

Pressing this key once selects WCDMA as the radio standard and the current WCDMA band as the active channel band. Pressing this key again allows access to the sub-menus for selecting a different WCDMA band.

Key Path	Source, List Sequencer, List Sequencer Setup, Radio Setup, Radio Standard
Initial S/W Revision	A.05.00

Band I

Selects Band I as the band for the current step.

Key Path	Source, List Sequencer, List Sequencer Setup, Radio Setup, Radio Standard, WCDMA
Initial S/W Revision	A.05.00

Band II

Selects Band II as the band for the current step.

Key Path	Source, List Sequencer, List Sequencer Setup, Radio Setup, Radio Standard, WCDMA
Initial S/W Revision	A.05.00

Band III

Selects Band III as the band for the current step.

Key Path	Source, List Sequencer, List Sequencer Setup, Radio Setup, Radio Standard, WCDMA
Initial S/W Revision	A.05.00

Band IV

Selects Band IV as the band for the current step.

Key Path	Source, List Sequencer, List Sequencer Setup, Radio Setup, Radio Standard, WCDMA
Initial S/W Revision	A.05.00

Band V

Selects Band V as the band for the current step.

Key Path	Source, List Sequencer, List Sequencer Setup, Radio Setup, Radio Standard, WCDMA
Initial S/W Revision	A.05.00

Band VI

Selects Band VI as the band for the current step.

Key Path	Source, List Sequencer, List Sequencer Setup, Radio Setup, Radio Standard, WCDMA
Initial S/W Revision	A.05.00

Band VII

Selects Band VII as the band for the current step.

Key Path	Source, List Sequencer, List Sequencer Setup, Radio Setup, Radio Standard, WCDMA
Initial S/W Revision	A.05.00

Band VIII

Selects Band VIII as the band for the current step.

Key Path	Source, List Sequencer, List Sequencer Setup, Radio Setup, Radio Standard, WCDMA
Initial S/W Revision	A.05.00

Band IX

Selects Band IX as the band for the current step.

Key Path	Source, List Sequencer, List Sequencer Setup, Radio Setup, Radio Standard, WCDMA
Initial S/W Revision	A.05.00

Band X

Selects Band X as the band for the current step.

Key Path	Source, List Sequencer, List Sequencer Setup, Radio Setup, Radio Standard, WCDMA
Initial S/W Revision	A.05.00

Band XI

Selects Band XI as the band for the current step.

Key Path	Source, List Sequencer, List Sequencer Setup, Radio Setup, Radio Standard, WCDMA
Initial S/W Revision	A.05.00

Band XII

Selects Band XII as the band for the current step.

Key Path	Source, List Sequencer, List Sequencer Setup, Radio Setup, Radio Standard, WCDMA
Initial S/W Revision	A.05.00

Band XIII

Selects Band XIII as the band for the current step.

Key Path	Source, List Sequencer, List Sequencer Setup, Radio Setup, Radio Standard, WCDMA
Initial S/W Revision	A.05.00

Band XIV

Selects Band XIV as the band for the current step.

Key Path	Source, List Sequencer, List Sequencer Setup, Radio Setup, Radio Standard, WCDMA
Initial S/W Revision	A.05.00

Band XIX

Selects Band XIX as the band for the current step.

Key Path	Source, List Sequencer, List Sequencer Setup, Radio Setup, Radio Standard, WCDMA
Initial S/W Revision	A.14.50

CDMA 2000 / 1xEVDO

Pressing this key once selects CDMA 2000/1xEVDO as the radio standard and the current CDMA 2000/1xEVDO band as the active channel band. Pressing this key again allows access to the sub-menus for selecting a different CDMA 2000/1xEVDO band.

Key Path	Source, List Sequencer, List Sequencer Setup, Radio Setup, Radio Standard
Initial S/W Revision	A.05.00

US CELL

Selects US Cell as the band for the current step.

Key Path	Source, List Sequencer, List Sequencer Setup, Radio Setup, Radio Standard, CDMA 2000 / 1xEVDO
Initial S/W Revision	A.05.00

US PCS

Selects US PCS as the band for the current step.

Key Path	Source, List Sequencer, List Sequencer Setup, Radio Setup, Radio Standard, CDMA 2000 / 1xEVDO
Initial S/W Revision	A.05.00

Japan Cell

Selects Japan Cell as the band for the current step.

Key Path	Source, List Sequencer, List Sequencer Setup, Radio Setup, Radio Standard, CDMA 2000 / 1xEVDO
Initial S/W Revision	A.05.00

Korean PCS

Selects Korean PCS as the band for the current step.

Key Path	Source, List Sequencer, List Sequencer Setup, Radio Setup, Radio Standard, CDMA 2000 / 1xEVDO
Initial S/W Revision	A.05.00

NMT 450

Selects NMT 450 as the band for the current step.

Key Path	Source, List Sequencer, List Sequencer Setup, Radio Setup, Radio Standard, CDMA 2000 / 1xEVDO
Initial S/W Revision	A.05.00

IMT 2000

Selects IMT 2000 as the band for the current step.

Key Path	Source, List Sequencer, List Sequencer Setup, Radio Setup, Radio Standard, CDMA 2000 / 1xEVDO
Initial S/W Revision	A.05.00

Upper 700

Selects Upper 700 as the band for the current step.

Key Path	Source, List Sequencer, List Sequencer Setup, Radio Setup, Radio Standard, CDMA 2000 / 1xEVDO
Initial S/W Revision	A.05.00

Secondary 800

Selects Secondary 800 as the band for the current step.

Key Path	Source, List Sequencer, List Sequencer Setup, Radio Setup, Radio Standard, CDMA 2000 / 1xEVDO
Initial S/W Revision	A.05.00

400 Euro PAMR

Selects 400 Euro PAMR as the band for the current step.

Key Path	Source, List Sequencer, List Sequencer Setup, Radio Setup, Radio Standard, CDMA 2000 / 1xEVDO
Initial S/W Revision	A.05.00

800 PAMR

Selects 800 PAMR as the band for the current step.

Key Path	Source, List Sequencer, List Sequencer Setup, Radio Setup, Radio Standard, CDMA 2000 / 1xEVDO
Initial S/W Revision	A.05.00

2.5GHz IMT EXT

Selects 2.5 GHz IMT EXT as the band for the current step.

Key Path	Source, List Sequencer, List Sequencer Setup, Radio Setup, Radio Standard, CDMA 2000 / 1xEVDO
Initial S/W Revision	A.05.00

US PCS 1.9GHz

Selects US PCS 1.9 GHz as the band for the current step.

Key Path	Source, List Sequencer, List Sequencer Setup, Radio Setup, Radio Standard, CDMA 2000 / 1xEVDO
Initial S/W Revision	A.05.00

AWS

Selects AWS as the band for the current step.

Key Path	Source, List Sequencer, List Sequencer Setup, Radio Setup, Radio Standard, CDMA 2000 / 1xEVDO
Initial S/W Revision	A.05.00

US 2.5GHz

Selects US 2.5 GHz as the band for the current step.

Key Path	Source, List Sequencer, List Sequencer Setup, Radio Setup, Radio Standard, CDMA 2000 / 1xEVDO
Initial S/W Revision	A.05.00

700 Public Safety

Selects 700 Public Safety as the band for the current step.

Key Path	Source, List Sequencer, List Sequencer Setup, Radio Setup, Radio Standard, CDMA 2000 / 1xEVDO
Initial S/W Revision	A.05.00

C2K Lower 700

Selects C2K Lower 700 as the band for the current step.

Key Path	Source, List Sequencer, List Sequencer Setup, Radio Setup, Radio Standard, CDMA 2000 / 1xEVDO
Initial S/W Revision	A.05.00

LTE

Pressing this key once selects LTE FDD as the radio standard and the current LTE FDD band as the active channel band. Pressing this key again allows access to the sub-menus for selecting a different LTE FDD band.

Key Path	Source, List Sequencer, List Sequencer Setup, Radio Setup, Radio Standard
Initial S/W Revision	A.09.50

BAND 1

Selects BAND 1 as the band for the current step.

Key Path	Source, List Sequencer, List Sequencer Setup, Radio Setup, Radio Standard, LTE
Initial S/W Revision	A.09.50

BAND 2

Selects BAND 2 as the band for the current step.

Key Path	Source, List Sequencer, List Sequencer Setup, Radio Setup, Radio Standard, LTE
Initial S/W Revision	A.09.50

BAND 3

Selects BAND 3 as the band for the current step.

Key Path	Source, List Sequencer, List Sequencer Setup, Radio Setup, Radio Standard, LTE
Initial S/W Revision	A.09.50

BAND 4

Selects BAND 4 as the band for the current step.

Key Path	Source, List Sequencer, List Sequencer Setup, Radio Setup, Radio Standard, LTE
Initial S/W Revision	A.09.50

BAND 5

Selects BAND 5 as the band for the current step.

Key Path	Source, List Sequencer, List Sequencer Setup, Radio Setup, Radio Standard, LTE
Initial S/W Revision	A.09.50

BAND 6

Selects BAND 6 as the band for the current step.

Key Path	Source, List Sequencer, List Sequencer Setup, Radio Setup, Radio Standard, LTE
Initial S/W Revision	A.09.50

BAND 7

Selects BAND 7 as the band for the current step.

Key Path	Source, List Sequencer, List Sequencer Setup, Radio Setup, Radio Standard, LTE
Initial S/W Revision	A.09.50

BAND 8

Selects BAND 8 as the band for the current step.

Key Path	Source, List Sequencer, List Sequencer Setup, Radio Setup, Radio Standard, LTE
Initial S/W Revision	A.09.50

BAND 9

Selects BAND 9 as the band for the current step.

Key Path	Source, List Sequencer, List Sequencer Setup, Radio Setup, Radio Standard, LTE
Initial S/W Revision	A.09.50

BAND 10

Selects BAND 10 as the band for the current step.

Key Path	Source, List Sequencer, List Sequencer Setup, Radio Setup, Radio Standard, LTE
Initial S/W Revision	A.09.50

BAND 11

Selects BAND 11 as the band for the current step.

Key Path	Source, List Sequencer, List Sequencer Setup, Radio Setup, Radio Standard, LTE
Initial S/W Revision	A.09.50

BAND 12

Selects BAND 12 as the band for the current step.

Key Path	Source, List Sequencer, List Sequencer Setup, Radio Setup, Radio Standard, LTE
Initial S/W Revision	A.09.50

BAND 13

Selects BAND 13 as the band for the current step.

Key Path	Source, List Sequencer, List Sequencer Setup, Radio Setup, Radio Standard, LTE
Initial S/W Revision	A.09.50

BAND 14

Selects BAND 14 as the band for the current step.

Key Path	Source, List Sequencer, List Sequencer Setup, Radio Setup, Radio Standard, LTE
Initial S/W Revision	A.09.50

BAND 17

Selects BAND 17 as the band for the current step.

Key Path	Source, List Sequencer, List Sequencer Setup, Radio Setup, Radio Standard, LTE
Initial S/W Revision	A.09.50

BAND 18

Selects BAND 18 as the band for the current step.

Key Path	Source, List Sequencer, List Sequencer Setup, Radio Setup, Radio Standard, LTE
Initial S/W Revision	A.09.50

BAND 19

Selects BAND 19 as the band for the current step.

Key Path	Source, List Sequencer, List Sequencer Setup, Radio Setup, Radio Standard, LTE
Initial S/W Revision	A.09.50

BAND 20

Selects BAND 20 as the band for the current step.

Key Path	Source, List Sequencer, List Sequencer Setup, Radio Setup, Radio Standard, LTE
Initial S/W Revision	A.09.50

BAND 21

Selects BAND 21 as the band for the current step.

Key Path	Source, List Sequencer, List Sequencer Setup, Radio Setup, Radio Standard, LTE
Initial S/W Revision	A.09.50

BAND 24

Selects BAND 24 as the band for the current step.

Key Path	Source, List Sequencer, List Sequencer Setup, Radio Setup, Radio Standard, LTE
Initial S/W Revision	A.09.50

BAND 25

Selects BAND 25 as the band for the current step.

Key Path	Source, List Sequencer, List Sequencer Setup, Radio Setup, Radio Standard, LTE
Initial S/W Revision	A.09.50

BAND 26

Selects BAND 26 as the band for the current step.

Key Path	Source, List Sequencer, List Sequencer Setup, Radio Setup, Radio Standard, LTE
Initial S/W Revision	A.12.53

BAND 27

Selects BAND 27 as the band for the current step.

Key Path	Source, List Sequencer, List Sequencer Setup, Radio Setup, Radio Standard, LTE
Initial S/W Revision	A.14.00

BAND 28

Selects BAND 28 as the band for the current step.

Key Path	Source, List Sequencer, List Sequencer Setup, Radio Setup, Radio Standard, LTE
Initial S/W Revision	A.14.00

BAND 31

Selects BAND 31 as the band for the current step.

Key Path	Source, List Sequencer, List Sequencer Setup, Radio Setup, Radio Standard, LTE
Initial S/W Revision	A.14.00

LTE TDD

Sets LTE TDD as the radio standard for use and accesses the LTE TDD specific channel band sub-menus..

Key Path	Source, Frequency, Radio Setup, Radio Standard
Initial S/W Revision	A.11.50

BAND 33

Selects BAND 33 as the band for the current step.

Key Path	Source, Frequency, Radio Setup, Radio Standard, LTE TDD
Example	:SOUR:FREQ:CHAN:BAND BAND33
Initial S/W Revision	A.11.50

BAND 34

Selects BAND 34 as the band for the current step.

Key Path	Source, Frequency, Radio Setup, Radio Standard, LTE TDD
Example	:SOUR:FREQ:CHAN:BAND BAND34
Initial S/W Revision	A.11.50

BAND 35

Selects BAND 35 as the band for the current step.

Key Path	Source, Frequency, Radio Setup, Radio Standard, LTE TDD
Example	:SOUR:FREQ:CHAN:BAND BAND35
Initial S/W Revision	A.11.50

BAND 36

Selects BAND 36 as the band for the current step.

Key Path	Source, Frequency, Radio Setup, Radio Standard, LTE TDD
Example	:SOUR:FREQ:CHAN:BAND BAND36
Initial S/W Revision	A.11.50

BAND 37

Selects BAND 37 as the band for the current step.

Key Path	Source, Frequency, Radio Setup, Radio Standard, LTE TDD
Example	:SOUR:FREQ:CHAN:BAND BAND37
Initial S/W Revision	A.11.50

BAND 38

Selects BAND 38 as the band for the current step.

Key Path	Source, Frequency, Radio Setup, Radio Standard, LTE TDD
Example	:SOUR:FREQ:CHAN:BAND BAND38
Initial S/W Revision	A.11.50

BAND 39

Selects BAND 39 as the band for the current step.

Key Path	Source, Frequency, Radio Setup, Radio Standard, LTE TDD
Example	:SOUR:FREQ:CHAN:BAND BAND39
Initial S/W Revision	A.11.50

BAND 40

Selects BAND 40 as the band for the current step.

Key Path	Source, Frequency, Radio Setup, Radio Standard, LTE TDD
Example	:SOUR:FREQ:CHAN:BAND BAND40
Initial S/W Revision	A.11.50

BAND 41

Selects BAND 41 as the band for the current step.

Key Path	Source, Frequency, Radio Setup, Radio Standard, LTE TDD
Example	:SOUR:FREQ:CHAN:BAND BAND41
Initial S/W Revision	A.11.50

BAND 42

Selects BAND 42 as the band for the current step.

Key Path	Source, Frequency, Radio Setup, Radio Standard, LTE TDD
Example	:SOUR:FREQ:CHAN:BAND BAND42
Initial S/W Revision	A.11.50

BAND 43

Selects BAND 43 as the band for the current step.

Key Path	Source, Frequency, Radio Setup, Radio Standard, LTE TDD
Example	:SOUR:FREQ:CHAN:BAND BAND43
Initial S/W Revision	A.11.50

BAND 44

Selects BAND 44 as the band for the current step.

Key Path	Source, List Sequencer, List Sequencer Setup, Radio Setup, Radio Standard, LTE TDD
Initial S/W Revision	A.14.00

TDSCDMA

Sets TDSCDMA as the radio standard for use and accesses the TDSCDMA specific channel band sub-menus..

Key Path	Source, Frequency, Radio Setup, Radio Standard
Initial S/W Revision	A.11.50

BAND A

Selects BAND A as the band for the current step.

Key Path	Source, Frequency, Radio Setup, Radio Standard, TDSCDMA
Example	:SOUR:FREQ:CHAN:BAND BANDA
Initial S/W Revision	A.11.50

BAND B

Selects BAND B as the band for the current step.

Key Path	Source, Frequency, Radio Setup, Radio Standard, TDSCDMA
Example	:SOUR:FREQ:CHAN:BAND BANDB
Initial S/W Revision	A.11.50

BAND C

Selects BAND C as the band for the current step.

Key Path	Source, Frequency, Radio Setup, Radio Standard, TDSCDMA
Example	:SOUR:FREQ:CHAN:BAND BANDC
Initial S/W Revision	A.11.50

BAND D

Selects BAND D as the band for the current step.

Key Path	Source, Frequency, Radio Setup, Radio Standard, TDSCDMA
Example	:SOUR:FREQ:CHAN:BAND BANDD
Initial S/W Revision	A.11.50

BAND E

Selects BAND E as the band for the current step.

Key Path	Source, Frequency, Radio Setup, Radio Standard, TDSCDMA
----------	---

Example	:SOUR:FREQ:CHAN:BAND BANDE
Initial S/W Revision	A.11.50

BAND F

Selects BAND F as the band for the current step.

Key Path	Source, Frequency, Radio Setup, Radio Standard, TDSCDMA
Example	:SOUR:FREQ:CHAN:BAND BANDF
Initial S/W Revision	A.11.50

Radio Band Link

Allows you to specify the radio band link direction for the steps within the list sequence. The link is used in conjunction with the channel band and channel number to determine the output frequency.

When set to “Uplink”, the source will calculate the uplink frequency according to an uplink formula together with selected channel band and channel number. When set to “Downlink”, the source will calculate the downlink frequency according to a downlink formula together with selected channel band and channel number.

Key Path	Source, List Sequencer, List Sequencer Setup, Radio Setup
Remote Command	:SOURce:LIST:STEP [1] 2 3...1000:SETup:RADio:BAND:LINK DOWN UP :SOURce:LIST:STEP [1] 2 3...1000:SETup:RADio:BAND:LINK?
Example	:SOUR:LIST:STEP2:SET:RAD:BAND:LINK UP :SOUR:LIST:STEP2:SET:RAD:BAND:LINK?
Notes	SCPI is supported after A.09.40
Preset	DOWN
Range	DOWN UP
Initial S/W Revision	A.05.00

Channel

Allows you to specify the frequency of the current step via a channel number.

Key Path	Source, List Sequencer, List Sequencer Setup
Remote Command	:SOURce:LIST:STEP [1] 2 3...1000:SETup:CNFRequency <double> :SOURce:LIST:STEP [1] 2 3...1000:SETup:CNFRequency?
Example	:SOUR:LIST:STEP2:SET:CNFR 124 :SOUR:LIST:STEP2:SET:CNFR?
Notes	SCPI is supported after A.09.40.

	This SCPI is used to setup channel number or frequency setting, according to current Radio Band setting. If Radio Band is "NONE", then it's frequency. If Radio Band is not "NONE", then it's channel number.
Couplings	The channel number is coupled to the step frequency value. When the step frequency value is changed, the channel number will increase or decrease to match the new step frequency. If the step frequency is not at an exact match for a channel number, the nearest channel number is displayed, along with a greater than, or less than sign to indicate the frequency is above or below the channel number.
Preset	1
Min	0 (Please refer to for valid ranges.)
Max	10838 (Please refer to for valid ranges.)
Initial S/W Revision	A.05.00

Frequency

Allows you to specify a frequency value for the current step.

Key Path	Source, List Sequencer, List Sequencer Setup
Remote Command	:SOURce:LIST:STEP[1] 2 3...1000:SETup:CNFRfrequency <double> :SOURce:LIST:STEP[1] 2 3...1000:SETup:CNFRfrequency?
Example	:SOUR:LIST:STEP2:SET:CNFR 1GHz :SOUR:LIST:STEP2:SET:CNFR?
Notes	SCPI is supported after A.09.40. This SCPI is used to setup channel number or frequency setting, according to current Radio Band setting. If Radio Band is "NONE", then it's frequency. If Radio Band is not "NONE", then it's channel number.
Couplings	The frequency value is coupled to the channel band and number for the step, such that updates to the radio band and channel number will update the frequency value to the corresponding absolute frequency. The reverse is also true, changing the frequency value causes the value of the channel number to be updated.
Preset	1.00 GHz
Min	10.00 MHz
Max	Hardware Dependant: Option 503 = 3.6 GHz Option 504 = 3.9 GHz Option 506 = 6.00 GHz
Initial S/W Revision	A.05.00

Power

Allows you to specify a power value for the current step.

Key Path	Source, List Sequencer, List Sequencer Setup
Remote Command	:SOURCE:LIST:STEP[1] 2 3...1000:SETup:AMPLitude <double> :SOURCE:LIST:STEP[1] 2 3...1000:SETup:AMPLitude?
Example	:SOUR:LIST:STEP2:SET:AMPL -50dBm :SOUR:LIST:STEP2:SET:AMPL?
Notes	SCPI is supported after A.09.40
Notes	<p>Amplitude corrections can be specified for use with the source. In the event of amplitude corrections being applied, the valid ranges for the RF power do not change dependant on the current amplitude correction setting. Instead, if the combination of RF power + amplitude correction is higher or lower than the source output range, the Source Unleveled bit is set and the “Source Unleveled” indicator will appear on status panel to indicate that the source cannot maintain the output power that has been requested.</p> <p>The multiport adapter RFIO TX ports and GPS ports cannot ensure power accuracy when power setting is lower than -130dBm, this power setting value is defined by the sum of RF Power setting and related amplitude correction value. But user settable value could be lower than this limit. When application detected there exists power setting lower than -130dBm on MPA RFIO TX ports, then popup warning message . When application detected there exists power setting lower than -130dBm on MPA GPS ports, then popup warning message . These are only warning messages, and check is performed when RF is ON.</p>
Notes	The Min and Max value here defined UI settable amplitude range. This range is larger than actual amplitude range with level accuracy defined in spec.
Dependencies	The RF power is dependent on the RF output port and frequency, such that the current frequency and selected output port determine the valid range of power values.
Preset	-100 dBm
Min	The range of values depends on the current frequency and selected RF output port. Please refer to "RF Power" on page 1228 and the table RF Power Range for the valid ranges.
Max	The range of values depends on the current frequency and selected RF output port. Please refer to "RF Power" on page 1228 and the table RF Power Range for the valid ranges.
Initial S/W Revision	A.05.00

Waveform

Allows you access to the sub-menus for selecting the waveform to be played back during the current step. Pressing this key also changes the central display area to show the Waveform File Selection view.

Key Path	Source, List Sequencer, List Sequencer Setup
Remote Command	:SOURCE:LIST:STEP[1] 2 3...1000:SETup:WAVEform <string> :SOURCE:LIST:STEP[1] 2 3...1000:SETup:WAVEform?
Example	:SOUR:LIST:STEP2:SET:WAV "CW" :SOUR:LIST:STEP2:SET:WAV?
Notes	SCPI is supported after A.09.40
Remote Command Notes	String type, takes "Off" "CW" "Cont" "waveform name"

Preset	CW
Range	Waveform Continue Previous CW Off
Initial S/W Revision	A.05.00

CW

Sets the current step to output a CW tone.

Key Path	Source, List Sequencer, List Sequencer Setup, Waveform
Example	:SOUR:LIST:STEP2:SET:WAV "CW"
Notes	SCPI is supported after A.09.40
Initial S/W Revision	A.05.00

Selected Waveform

Inserts the currently selected waveform in the waveform selection view as the waveform for playback during the current step.

Key Path	Source, List Sequencer, List Sequencer Setup, Waveform
Example	:SOUR:LIST:STEP2:SET:WAV "waveform name"
Notes	SCPI is supported after A.09.40 If the selected waveform contains header (which contains ARB play parameters), source list sequence will automatically apply header settings of the selected waveform in that step.
Initial S/W Revision	A.05.00

Continue Previous

Sets the current step to continue with playback of the waveform from the previous step. When continuing the previous waveform, the ARB playback will not pause while the source retunes to the new frequency or amplitude that may be defined for the new step.

Key Path	Source, List Sequencer, List Sequencer Setup, Waveform
Example	:SOUR:LIST:STEP2:SET:WAV "Cont"
Notes	SCPI is supported after A.09.40
Initial S/W Revision	A.05.00

Off

Disable RF output of the current step.

Key Path	Source, List Sequencer, List Sequencer Setup, Waveform
Example	:SOUR:LIST:STEP2:SET:WAV "Off"
Notes	SCPI is supported after A.09.40
Initial S/W Revision	A.05.00

Segments on Hard Disk

Allows you access to the sub-menus for loading waveform segments from the hard disk into ARB memory. The default directory is: D: varb.

Pressing this key changes the current view to the Waveform Management View.

Key Path	Source, Modulation Setup, ARB, Select Waveform
Initial S/W Revision	A.05.00

Load Segment To ARB Memory

Allows you to load the selected file into ARB memory. On the front panel you select the file for loading to the ARB memory by highlighting the desired file in the list. Using the SCPI command, you specify the file name on the HDD.

“NVWFM” (none-volatile storage) MSUS (Mass Storage Unit Specifier) is supported in the memory subsystem because the ARB memory cannot be accessed directly. Therefore, files must be downloaded to the instrument hard disk and then loaded into the ARB memory. “NVWFM” MSUS will be mapped to the default directory D: VARB. The SCPI command supports using either “NVWFM” MSUS or specifying a full path. For more information, see [Memory Subsystem \(Remote Command Only\)](#).

If a file of the same name already exists within ARB memory, it is overwritten. If you wish to load two segments of the same name, you must rename one of the segments before loading it into ARB memory. To rename a segment, you can either use Windows File Explorer, or the :MMEMORY:COPY command.

NOTE: When a waveform file is loaded to ARB memory, burst timing adjustments are made automatically, based on whether or not a Multiport Adapter is connected to the test set and powered on. If the connection/power status of the Multiport Adapter is changed after a waveform file has been loaded, it needs to be loaded again.

Key Path	Source, Modulation Setup, ARB, Select Waveform, Segments on Hard Disk
Remote Command	:SOURce:RADio:ARB:LOAD <string>
Example	:SOUR:RAD:ARB:LOAD "D: VARB\testwaveform.bin" or :SOUR:RAD:ARB:LOAD "NVWFM:testwaveform.bin"
Notes	Because loading the file involves a delay of unpredictable length, this command should be followed by the query *OPC?, which holds off subsequent commands until the loading operating is complete. <string> – specifies the path name of the file to load from the HDD into ARB memory. It could be a <full path + filename>, or <"NVWFM" MSUS + colon + filename>.

When in Sequence Analyzer mode, and Include Source is Yes, an attempt to load a file to ARB memory will be rejected with an error.

When Include Source is No and if there is insufficient free ARB memory to load the selected waveform, an error is generated. .

If you specify a file over SCPI, but the file is not at the specified location, an error is generated.

If you try to load a waveform file but the file contains less than 500 IQ samples, an error is generated.

If you try to load a Signal Studio waveform “*.wfm” which contains invalid waveform header, an error is generated.

If the ARB is ON when you load a file to ARB memory or delete a file from ARB memory, the playing waveform segment may not keep phase continuity during the ARB memory operation. The waveform will be replayed after the ARB operation is finished.

ARB can be loaded into ARB memory even required licenses do not present on the instrument. In this case, a GUI only warning message -800, “Operation complete; Loaded <filename> successfully, but no license <required licenses> installed”. User can install required licenses according to <required licenses> string to license it, or multi-pack license it.

Initial S/W Revision A.05.00

Load All To ARB Memory

Allows you to load all the segment files within the currently selected directory into ARB memory. If a file of the same name already exists within ARB memory, it is overwritten. If you wish to load two segments of the same name, you must rename one of the segments before loading it into ARB memory. To rename a segment, you can either use Windows File Explorer, or the :MEMORY:COPY command.

NOTE: When a waveform file is loaded to ARB memory, burst timing adjustments are made automatically, based on whether or not a Multiport Adapter is connected to the test set and powered on. If the connection/power status of the Multiport Adapter is changed after a waveform file has been loaded, it needs to be loaded again.

Key Path	Source, Modulation Setup, ARB, Select Waveform, Segments on Hard Disk
Remote Command	:SOURce:RADio:ARB:LOAD:ALL <string>
Example	:SOUR:RAD:ARB:LOAD:ALL "D: varb"
Notes	<p><string> - specifies the directory on the HDD to load the files into ARB memory from.</p> <p>When in Sequence Analyzer mode, and Include Source is Yes, an attempt to load all files from a directory to ARB memory is rejected with an error.</p> <p>When Include Source is No and there is insufficient free ARB memory to load all the waveforms, when the ARB memory is full, the copy ceases, and an error is generated.</p> <p>If you specify a directory over SCPI, but the directory does not exist, an error is generated.</p> <p>If the ARB is ON, a user then loads or deletes file to ARB memory, the playing waveform segment may not keep phase continuity during the ARB memory operation. The waveform will be replayed after the ARB operation is finished.</p>

Initial S/W Revision A.05.00

Change Directory...

Allows you to change the currently selected directory on the hard disk. Pressing this key opens a standard windows change directory dialog allowing you to select the new directory of interest.

The current directory is used for manually loading waveform segments into ARB memory for playback, and as a search location for waveform segments that are required to be loaded into ARB memory for playback of a waveform sequence or a list sequence.

Key Path	Source, Modulation Setup, ARB, Select Waveform, Segments on Hard Disk
Notes	No remote command, SCPIfront panel only.
Initial S/W Revision	A.05.00

Default Directory...

Allows you to change the default directory. It is used as a search location for waveform segments that are required to be loaded into ARB memory for playback of a waveform sequence, and as a search location for selecting waveforms using SCPI.

Key Path	Source, Modulation Setup, ARB, Select Waveform, Segments on Hard Disk
Remote Command	:SOURce:RADio:ARB:DEFault:DIRectory <string> :SOURce:RADio:ARB: DEFault:DIRectory?
Example	:SOUR:RAD:ARB:DEF:DIR "D:\ArbFiles" :SOUR:RAD:ARB:DEF:DIR?
State Saved	Persistent, survives a power cycle and a preset but not saved in the instrument state
Initial S/W Revision	A.05.00

Segments in ARB Memory

Allows you access to the sub-menus for managing the files within ARB memory.

Key Path	Source, Modulation Setup, ARB, Select Waveform
Initial S/W Revision	A.05.00

Delete Segment From ARB Mem

Allows you to remove a segment from ARB playback memory.

Key Path	Source, Modulation Setup, ARB, Select Waveform, Segments in ARB Memory
Remote Command	:SOURce:RADio:ARB:DELeTe <string>
Example	:SOUR:RAD:ARB:DEL "testwaveform.bin"
Notes	<string> - specifies the waveform to be deleted from the ARB playback memory. When in Sequence Analyzer mode and Include Source is Yes, an attempt to delete a file from ARB

memory is rejected with an error.

When Include Source is No and you specify a file that does not exist within ARB memory, an error is generated.

It is possible to delete files from within the ARB memory when the ARB is ON. However, if you attempt to delete the file that is currently playing an error is generated.

It is possible to delete a file from within the ARB memory when the sequencer state is ON and the file is not being used by the List Sequencer. If you attempt to delete a file which is being used by the list sequencer, an error is generated.

When sequencer state is On, even if ARB state is On, the selected waveform will not be played. In this case, if the selected waveform is not used in List Sequence, it can be deleted and the ARB state is turned Off.

If the ARB is ON and you load a file to ARB memory or delete a file from ARB memory, the playing waveform segment may not keep phase continuity during the ARB memory operation. The waveform will be replayed after the ARB operation is finished.

Initial S/W Revision A.05.00

Delete All From ARB Memory

Allows you to remove all segments from ARB playback memory.

Key Path Source, Modulation Setup, ARB, Select Waveform, Segments in ARB Memory

Remote Command :SOURce:RADio:ARB:DELeTe:ALL

Example :SOUR:RAD:ARB:DELeTe:ALL

Notes When in Sequence Analyzer mode and Include Source is Yes, an attempt to delete all files from ARB memory is rejected with an error.

When Include Source is No and you attempt to delete all files from ARB memory when the ARB is currently playing a file, all files except the one playing are deleted and an error is generated.

If you attempt to delete all files from ARB memory when there are waveform files used in "[List Sequencer](#)" on page 1306 and "[Sequencer](#)" on page 1307 state is ON, all files except the files currently being used in list sequencer are deleted, and an error is generated.

If the ARB is ON and you load a file to ARB memory or delete a file from ARB memory, the playing waveform segment may not keep phase continuity during the ARB memory operation. The waveform will be replayed after the ARB operation is finished.

Initial S/W Revision A.05.00

Segments on Hard Disk

This key functions the same as "[Segments on Hard Disk](#)" on page 1333.

Key Path Source, List Sequencer, List Sequencer Setup, Waveform

Initial S/W Revision Prior to A.09.00

Load Segment To ARB Memory

This key functions the same as "[Load Segment To ARB Memory](#)" on page 1333.

Key Path	Source, List Sequencer, List Sequencer Setup, Waveform, Segment on Hard Drive
Initial S/W Revision	Prior to A.09.00

Load All To ARB Memory

This key functions the same as "[Load All To ARB Memory](#)" on page 1334.

Key Path	Source, List Sequencer, List Sequencer Setup, Waveform, Segment on Hard Drive
Initial S/W Revision	Prior to A.09.00

Change Directory ...

This key functions the same as "[Change Directory...](#)" on page 1335.

Key Path	Source, List Sequencer, List Sequencer Setup, Waveform, Segment on Hard Drive
Initial S/W Revision	Prior to A.09.00

Default Directory ...

This key functions the same as "[Default Directory...](#)" on page 1335

Key Path	Source, List Sequencer, List Sequencer Setup, Waveform, Segment on Hard Drive
Initial S/W Revision	Prior to A.09.00

Segments in ARB Memory

This key functions the same as "[Segments in ARB Memory](#)" on page 1335.

Key Path	Source, List Sequencer, List Sequencer Setup, Waveform, Segments in ARB Memory
Initial S/W Revision	Prior to A.09.00

Delete Segment From ARB Memory

This key functions the same as "[Delete Segment From ARB Mem](#)" on page 1335.

Key Path	Source, List Sequencer, List Sequencer Setup, Waveform, Segments in ARB Memory, Segment in ARB Memory
Initial S/W Revision	Prior to A.09.00

Delete All From ARB Memory

This key functions the same as "Delete All From ARB Memory" on page 1336.

Key Path	Source, List Sequencer, List Sequencer Setup, Waveform, Segments in ARB Memory, Segment in ARB Memory
Initial S/W Revision	Prior to A.09.00

Step Duration

Allows access to the sub-menus for setting up the duration of play for the current step.

The duration can be set to be either the number of times for the ARB file associated with the sequence to play, or a specific time value, or continuous. If the step is set to play a CW tone, the step duration cannot be set to a play count.

Key Path	Source, List Sequencer, List Sequencer Setup
Remote Command	:SOURce:LIST:STEP[1] 2 3...1000:SETup:DURation:TYPE TIME COUNT CONTInuous CABort :SOURce:LIST:STEP[1] 2 3...1000:SETup:DURation:TYPE?
Example	:SOUR:LIST:STEP2:SET:DUR:TYPE TIME :SOUR:LIST:STEP2:SET:DUR:TYPE?
Notes	SCPI is supported after A.09.40
Notes	If "Step Duration" is set to "Time" or "Play Count" for the last step, the last step of ARB keeps playing as if set to "Continuous", until the set "Time" has expired or until the "Play Count" setting is reached. However, you can query Error! Reference source not found. Source Sweeping Condition Message to find out if the current list sequence is complete or not.
Range	Time Play Count Continuous Continuous Abort
Initial S/W Revision	A.05.00

Time

Sets the duration of the current step to be a time value for the length of time the step will play. Pressing this key again opens another menu which allows you to set the time value for the step duration.

Key Path	Source, List Sequencer, List Sequencer Setup, Step Duration
Example	:SOUR:LIST:STEP2:SET:DUR:TYPE TIME
Notes	SCPI is supported after A.09.40
Initial S/W Revision	A.05.00

Duration Time

Allows you to specify the length of time the current step will play.

When Step Duration is **Continuous Abort** this parameter specifies the maximum duration that the waveform will continue to play after a step trigger is received before the transition to the next waveform will occur. Duration is limited to a maximum of 20 seconds.

If the Transition Time value is longer than the Step Duration Time, an error is generated when initiating a source list sequence. For source list sequence, transition time is included in the step duration length (not occupy additional time). If the Transition Time value is longer than the Step Duration Time, the real step duration length is extended to equal the transition time and cause a timing shift. This check is also described in section **Error! Reference source not found.** List Sequence Step Validation.

Key Path	Source, List Sequencer, List Sequencer Setup, Step Duration, Time
Remote Command	:SOURce:LIST:STEP [1] 2 3...1000:SETup:DURation:TCOut <double> :SOURce:LIST:STEP [1] 2 3...1000:SETup:DURation:TCOut?
Example	:SOUR:LIST:STEP2:SET:DUR:TCO 1s :SOUR:LIST:STEP2:SET:DUR:TCO?
Notes	SCPI is supported after A.09.40 This SCPI is reused by "Play Count", "Duration Time" and "Continuous Abort" according to current Duration Type setting is "Play Count" or "Duration Time" or "Continuous Abort". If current "Duration Type" is "Continuous", then popup error -221, "Settings conflict;Cannot accept time or count input when step duration type is Continuous on step #"
Notes	If "Duration Time" is set for the last step, the last step of ARB keeps playing as if set to "Continuous" after set time expires. However, you can query Source Sweeping Condition Message (:STAT:OPER:COND?) to find out if the current list sequence is complete or not.
Preset	1.00 ms
Min	100 µs
Max	1800 s
Initial S/W Revision	A.05.00

Play Count

Sets the duration of the current step to be an integer value for the number of times (play count) the ARB file is selected for playback during this step. For example, a 5 second ARB will be set to play 5 times during the step.

Key Path	Source, List Sequencer, List Sequencer Setup, Step Duration
Example	:SOUR:LIST:STEP2:SET:DUR:TYPE COUN
Notes	SCPI is supported after A.09.40 This key is unavailable and is grayed out if the current step is configured to CW tone rather than an ARB waveform.
Initial S/W Revision	A.05.00

Header Utilities

Allows access to the header utilities sub-menu. Pressing this key also causes the central display area to change to display the File Header Information view.

Key Path	Source, Modulation Setup, ARB
Dependencies	This key is only available if there is currently a waveform selected for playback. If no waveform is selected, the key is grayed out.
Initial S/W Revision	A.05.00

Continuous

Sets the current step to be played continuously until the next step starts. The waveform will always play completely before transitioning to the next step.

Key Path	Source, List Sequencer, List Sequencer Setup, Step Duration
Example	:SOUR:LIST:STEP2:SET:DUR:TYPE CONT
Notes	SCPI is supported after A.09.40
Initial S/W Revision	A.05.00

Output Trigger

Allows you to specify the trigger output for the current step. The trigger output signal is sent at the start of the step.

When select “On”, trigger event will occur on both Internal and External2 paths. Select “Off” will turn off trigger output.

Key Path	Source, List Sequencer, List Sequencer Setup
Remote Command	:SOURce:LIST:STEP[1] 2 3...1000:SETup:OUTPut:TRIGger ON OFF 1 0 :SOURce:LIST:STEP[1] 2 3...1000:SETup:OUTPut:TRIGger
Example	:SOUR:LIST:STEP2:SET:OUTP:TRIG ON :SOUR:LIST:STEP2:SET:OUTP:TRIG?
Notes	SCPI is supported after A.09.40
Preset	Off
Range	On Off
Initial S/W Revision	A.05.00

Step Configuration (Remote Command Only)

This SCPI command is used to configure the List Sequencer and is detailed in the table below. The command is defined such that you send one command per step, with the step number being specified as a subopcode of the SCPI command. Each command includes all the parameter settings for the step. As a step is setup, the values entered are run through several levels of validation.

Remote Command	:SOURce:LIST:STEP[1] 2 ... 4..1000:SETup IMMEDIATE INTERNAL KEY
-----------------------	---

```
BUS | EXTERNAL2, <time>, NONE | PGSM | EGSM | RGSM | DCS1800 | PCS1900
| TGSM810 | GSM450 | GSM480 | GSM700 | GSM850 | BANDI | BANDII |
BANDIII | BANDIV | BANDV | BANDVI | BANDVII | BANDVIII | BANDIX | BANDX
| BANDXI | BANDXII | BANDXIII | BANDXIV | BANDXIX | USCELL | USPCS |
JAPAN | KOREAN | NMT | IMT2K | UPPER | SECOND | PAMR400 | PAMR800 |
IMTEXT | PCS1DOT9G | AWS | US2DOT5G | PUBLIC | LOWER | NONE | BAND1 |
BAND2 | BAND3 | BAND4 | BAND5 | BAND6 | BAND7 | BAND8 | BAND10 | BAND11
| BAND12 | BAND13 | BAND14 | BAND17 | BAND18 | BAND19 | BAND20 | BAND21
| BAND24 | BAND25 | BAND26 | BAND33 | BAND34 | BAND35 | BAND36 | BAND37
| BAND38 | BAND39 | BAND40 | BAND41 | BAND42 | BAND43 | BANDA | BANDB |
BANDC | BANDD | BANDE | BANDE, DOWN | UP, <freq>, <ampl>, <string>,
TIME | COUNT | CONTINUOUS, <time>, ON | OFF | 1 | 0, [<int>],

:SOURce:LIST:STEP[1]|2|...|4..1000:SETup?
```

Example :SOUR:LIST:STEP1:SET INT, 1ms, PGSM, DOWN, 10, -25 dBm, "GSM_Test1.bin", TIME, 10ms, OFF, 255

Notes The parameters are:
(There is a total of 11 items in each step, the following is a list of the items in the order they must appear in the remote command.)

1. Step Trigger **<enum>** – specifies the input trigger for the step. For details of the valid types of step trigger see ["Step Trigger" on page 1309](#).
2. Transition Time **<time>** – specifies the transition time for the step in seconds. For details of the valid ranges for the transition time see ["Transition Time" on page 1311](#).
3. Radio Band **<enum>** – specifies the radio band for the step. For details of the valid radio bands see ["Radio Setup" on page 1312](#).
4. Radio Band Link **<enum>** – specifies the radio band link direction for the step. For details of the valid link types, see ["Radio Band Link" on page 1329](#).
5. Frequency/Channel Number **<freq>/<chan num>** – specifies the frequency in Hz or the channel number for the step. The channel number and frequency are combined as one parameter that represents the frequency or channel number depending on the radio band setting. If the radio band is set to NONE, this value is interpreted as a frequency value in Hz. If the radio band is set to a valid band, this value is interpreted as a channel number. For details of the valid ranges for frequency and channel numbers, see ["Channel" on page 1329](#) and ["Frequency" on page 1330](#).
6. Power **<ampl>** – specifies the output power for the step in dBm. For details of the valid ranges see ["Power" on page 1330](#).
7. Waveform **<string>** – specifies the waveform for playback during the step. The step can output either a new ARB waveform, continue playback of the previous waveform, or output a CW tone. The options for specifying these are:
 - <filename> - plays the specified waveform from the start. The filename value is the name of the file within ARB playback memory, it does not include the windows path to the file on the HDD. If you enter a filename for a waveform that does not reside within ARB playback memory, an error is generated.
 - CONT – continues playback of the ARB file from the previous step
 - CW – outputs a CW tone
 - OFF – disable RF output
8. Step Duration **<enum>** – specifies the duration of the step. The duration can be specified to be either time, or play count of the ARB file associated with the step, or continuous. If Waveform is set to "CW", this value cannot be set to Play Count and an error will be generated. If continuous is selected, the following Time or Count value is ignored. For further details of this setting, see ["Step](#)

[Duration" on page 1338.](#)

9. Time or Count <time/int> – specifies time duration in seconds or play count of the ARB file associated with the step. For further details of this setting, including the valid ranges for the time or play count setting, ["Time" on page 1338](#) and ["Play Count" on page 1339](#).

10. Output Trigger <Boolean> – specifies the output trigger for the step. For details of the ranges for this setting see ["Output Trigger" on page 1340](#).

Dependencies	The range of subopcode values is 1 to 1000 and the value you enter is determined by the number of steps you have configured. For details see "Number of Steps" on page 1308 . If you attempt to remotely set or query a subopcode that is out of range, an error is generated.
Initial S/W Revision	A.05.00

Step Configuration of Step Trigger parameter list (Remote Command Only)

This SCPI command is to configure “Step Trigger” parameter array of the whole List Sequencer at one time. The number of array is same as step number defined in ["Number of Steps" on page 1308](#) Number of Steps. As a step is setup, the value entered run through several levels of validation.

Remote Command	:SOURce:LIST:SETup:INPut:TRIGger <enum>, <enum>, <enum>, ... :SOURce:LIST:SETup:INPut:TRIGger?
Example	:SOUR:LIST:SET:INP:TRIG IMM,INT,EXT2 :SOUR:LIST:SET:INP:TRIG?
Notes	The command is to setup below parameter array of whole list sequence. Step Trigger <enum> – specifies the input trigger for the step. For details of the valid types of step trigger see "Step Trigger" on page 1309 . If input parameter number exceeds the step number defined by "Number of Steps" on page 1308 Number of Steps then generate error ", and only those parametes whose index number falls in number of steps will be updated.
Remote Command Notes	IMMediate INTerna KEY BUS EXTerna2
Dependencies	The range is 1 to 1000 which is determined by the number of steps you have configured. For details see "Number of Steps" on page 1308 .
Initial S/W Revision	A.09.40

Step Configuration of Transition Time parameter list (Remote Command Only)

This SCPI command is to configure “Transition Time” parameter array of the whole List Sequencer at one time. The number of array is same as step number defined in ["Number of Steps" on page 1308](#) Number of Steps. As a step is setup, the value entered run through several levels of validation.

Remote Command	:SOURce:LIST:SETup:TRANSition:TIME <time>, <time>, <time>, ... :SOURce:LIST:SETup:TRANSition:TIME?
Example	:SOUR:LIST:SET:TRAN:TIME 1ms,1ms,1ms

	:SOUR:LIST:SET:TRAN:TIME?
Notes	<p>The command is to setup below parameter array of whole list sequence.</p> <p>Transition Time <time> – specifies the transition time for the step in seconds. For details of the valid ranges for the transition time see "Transition Time" on page 1311</p> <p>If input parameter number exceeds the step number defined by "Number of Steps" on page 1308 Number of Steps then generate error ", and only those parameters whose index number falls in number of steps will be updated.</p>
Dependencies	The range is 1 to 1000 which is determined by the number of steps you have configured. For details see "Number of Steps" on page 1308 .
Initial S/W Revision	A.09.40

Step Configuration of Radio Band parameter list (Remote Command Only)

This SCPI command is to configure "Radio Band" parameter array of the whole List Sequencer at one time. The number of array is same as step number defined in ["Number of Steps" on page 1308](#) Number of Steps. As a step is setup, the value entered run through several levels of validation.

R :SOURce:LIST:SETup:RADio:BAND <enum>, <enum>, <enum>, ...

e :SOURce:LIST:SETup:RADio:BAND?

m
o
t
e

C
o
m
m
a
n
d

E :SOUR:LIST:SET:RAD:BAND PGSM, EGSM, RGSM

x :SOUR:LIST:SET:RAD:BAND?

a
m
p
l
e

N The command is to setup below parameter array of whole list sequence.

o Radio Band <enum> – specifies the radio band for the step. For details of the valid radio bands see ["Radio Setup" on page 1312](#).

t If input parameter number exceeds the step number defined by ["Number of Steps" on page 1308](#) Number of Steps then
e generate error ", and only those parameters whose index number falls in number of steps will be updated.
s

R NONE|PGSM|EGSM|RGSM|DCS1800|PCS1900|TGSM810|GSM450|GSM480|GSM700|GSM850|BANDI|BANDII|BANDIII|BANDI
e V|BANDV|BANDVI|BANDVII|BANDVIII|BANDIX|BANDX|BANDXI|BANDXII|BANDXIII|BANDXIV|BANDXIX|USCELL|USPCS|JAPAN|KO
m REAN|NMT|IMT2K|UPPER|SECOND|PAMR400|PAMR800|IMTEXT|PCS1 DOT9G|AWS|US2DOT5G|PUBLIC|LOWER|NONE|BAND1|
BAND2|BAND3|BAND4|BAND5|BAND6|BAND7|BAND8|BAND10|BAND11|BAND12|BAND13|BAND14|BAND17|BAND18|BAND1

o 9|BAND20|BAND21|BAND24|BAND25|BAND26|BAND33|BAND34|BAND35|BAND36|BAND37|BAND38|BAND39|BAND40|BAN
t D41|BAND42|BAND43|BANDA|BANDB|BANDC|BANDD|BANDE|BANDF
e

C
o
m
m
a
n
d

N
o
t
e
s

D The range is 1 to 1000 which is determined by the number of steps you have configured. For details see "[Number of Steps](#)" on
e [page 1308](#).

p
e
n
d
e
n
c
i
e
s

I A.09.40

n
i
t
i
a
l

S
/
W

R
e
v
i
s
i
o
n

Step Configuration of Radio Band Link parameter list (Remote Command Only)

This SCPI command is to configure “Radio Band Link” parameter array of the whole List Sequencer at one time. The number of array is same as step number defined in ["Number of Steps" on page 1308](#) Number of Steps. As a step is setup, the value entered run through several levels of validation.

Remote Command	:SOURce:LIST:SETup:RADio:BAND:LINK <enum>, <enum>, <enum>, ... :SOURce:LIST:SETup:RADio:BAND:LINK?
Example	:SOUR:LIST:SET:RAD:BAND:LINK DOWN,UP,UP :SOUR:LIST:SET:RAD:BAND:LINK?
Notes	The command is to setup below parameter array of whole list sequence. Radio Band Link <enum> – specifies the radio band link direction for the step. For details of the valid link types, see "Radio Band Link" on page 1329 . If input parameter number exceeds the step number defined by "Number of Steps" on page 1308 Number of Steps then generate error ", and only those parametes whose index number falls in number of steps will be updated.
Remote Command Notes	DOWN UP
Dependencies	The range is 1 to 1000 which is determined by the number of steps you have configured. For details see "Number of Steps" on page 1308 .
Initial S/W Revision	A.09.40

Step Configuration of Frequency/Channel Number parameter list (Remote Command Only)

This SCPI command is to configure “Frequency” or “Channel Number” parameter array of the whole List Sequencer at one time. The number of array is same as step number defined in ["Number of Steps" on page 1308](#) Number of Steps. As a step is setup, the value entered run through several levels of validation.

Remote Command	:SOURce:LIST:SETup:CNFRrequency <double>, <double>, <double>, ... :SOURce:LIST:SETup:CNFRrequency?
Example	:SOUR:LIST:SET:CNFR 1GHz,100MHz,100MHz :SOUR:LIST:SET:CNFR? SOUR:LIST:SET:CNFR 124,124,124 :SOUR:LIST:SET:CNFR?
Notes	The command is to setup below parameter array of whole list sequence. Frequency/Channel Number <freq>/<chan num> – specifies the frequency in Hz or the channel number for the step. The channel number and frequency are combined as one parameter that represents the frequency or channel number depending on the radio band setting. If the radio band is set to NONE, this value is interpreted as a frequency value in Hz. If the radio band is set to a valid band, this value is interpreted as a channel number. For details of the valid ranges for frequency and channel numbers, see "Channel" on page 1329 and "Frequency" on page 1330 . This SCPI is used to setup/query channel number or frequency setting, according to current Radio Band setting of that step. If Radio Band is “NONE”, then it’s frequency. If Radio Band is not “NONE”, then it’s channel number If input parameter number exceeds the step number defined by "Number of Steps" on page 1308 Number of Steps then generate error ", and only those parametes whose index number falls in

	legal step number will be updated.
Dependencies	The range is 1 to 1000 which is determined by the number of steps you have configured. For details see "Number of Steps" on page 1308 .
Initial S/W Revision	A.09.40

Step Configuration of Power parameter list (Remote Command Only)

This SCPI command is to configure “Power” parameter array of the whole List Sequencer at one time. The number of array is same as step number defined in ["Number of Steps" on page 1308](#) Number of Steps. As a step is setup, the value entered run through several levels of validation.

Remote Command	:SOURce:LIST:SETup:AMPLitude <ampl>, <ampl>, <ampl>, ... :SOURce:LIST:SETup:AMPLitude?
Example	:SOUR:LIST:SET:AMPL -50dBm,-40dBm,-30dBm :SOUR:LIST:SET:AMPL?
Notes	The command is to setup below parameter array of whole list sequence. Power <ampl> – specifies the output power for the step in dBm. For details of the valid ranges see "Power" on page 1330 . If input parameter number exceeds the step number defined by "Number of Steps" on page 1308 Number of Steps then generate error ", and only those parametes whose index number falls in legal step number will be updated.
Dependencies	The range is 1 to 1000 which is determined by the number of steps you have configured. For details see "Number of Steps" on page 1308 .
Initial S/W Revision	A.09.40

Step Configuration of Waveform parameter list (Remote Command Only)

This SCPI command is to configure “Waveform” parameter array of the whole List Sequencer at one time. The number of array is same as step number defined in ["Number of Steps" on page 1308](#) Number of Steps. As a step is setup, the value entered run through several levels of validation.

Remote Command	:SOURce:LIST:SETup:WAVEform <string>, <string>, <string>, ... :SOURce:LIST:SETup:WAVEform?
Example	:SOUR:LIST:SET:WAV "CW","Off","CONT" :SOUR:LIST:SET:WAV?
Notes	The command is to setup below parameter array of whole list sequence. Waveform <string> – specifies the waveform for playback during the step. The step can output either a new ARB waveform, continue playback of the previous waveform, or output a CW tone. The options for specifying these are: <filename> - plays the specified waveform from the start. The filename value is the name of the file within ARB playback memory, it is does not include the windows path to the file on the HDD. If you enter a filename for a waveform that does not reside within ARB playback memory, an error is generated.

	<p>CONT – continues playback of the ARB file from the previous step</p> <p>CW – outputs a CW tone</p> <p>OFF – disable RF output</p> <p>If input parameter number exceeds the step number defined by "Number of Steps" on page 1308 Number of Steps then generate error ", and only those parametes whose index number falls in number of steps will be updated.</p>
Dependencies	The range is 1 to 1000 which is determined by the number of steps you have configured. For details see "Number of Steps" on page 1308.
Range	"filename" "CW" "Off" "CONT"
Initial S/W Revision	A.09.40

Step Configuration of Step Duration parameter list (Remote Command Only)

This SCPI command is to configure "Step Duration" parameter array of the whole List Sequencer at one time. The number of array is same as step number defined in "Number of Steps" on page 1308 Number of Steps. As a step is setup, the value entered run through several levels of validation.

Remote Command	<pre>:SOURce:LIST:SETup:DURation:TYPE <enum>, <enum>, <enum>, ... :SOURce:LIST:SETup:DURation:TYPE?</pre>
Example	<pre>:SOUR:LIST:SET:DUR:TYPE COUN,TIME,CONT :SOUR:LIST:SET:DUR:TYPE?</pre>
Notes	<p>The command is to setup below parameter array of whole list sequence.</p> <p>Step Duration <enum> – specifies the duration of the step. The duration can be specified to be either time, or play count of the ARB file associated with the step, or continuous. If Waveform is set to "CW", this value cannot be set to Play Count and an error will be generated. If continuous is selected, the following Time or Count value is ignored. For further details of this setting, see "Step Duration" on page 1338.</p> <p>If input parameter number exceeds the step number defined by "Number of Steps" on page 1308 Number of Steps then generate error ", and only those parametes whose index number falls in number of steps will be updated.</p>
Remote Command Notes	TIME COUNT CONTinuous
Dependencies	The range is 1 to 1000 which is determined by the number of steps you have configured. For details see "Number of Steps" on page 1308.
Initial S/W Revision	A.09.40

Step Configuration of Duration Time or Play Count parameter list (Remote Command Only)

This SCPI command is to configure "Duration Time" or "Play Count" parameter array of the whole List Sequencer at one time. The number of array is same as step number defined in "Number of Steps" on page 1308 Number of Steps. As a step is setup, the value entered run through several levels of validation.

Remote Command	<pre>:SOURce:LIST:SETup:TOCount <time/int>, <time/int>, <time/int>, ... :SOURce:LIST:SETup:TOCount?</pre>
-----------------------	---

Example	:SOUR:LIST:SET:TOC 1s,2s,3s :SOUR:LIST:SET:TOC? :SOUR:LIST:SET:TOC 5,6,7 :SOUR:LIST:SET:TOC?
Notes	The command is to setup below parameter array of whole list sequence. Time or Count <time/int> – specifies time duration in seconds or play count of the ARB file associated with the step. For further details of this setting, including the valid ranges for the time or play count setting, " Time " on page 1338 and " Play Count " on page 1339. If input parameter number exceeds the step number defined by " Number of Steps " on page 1308 Number of Steps then generate error ", and only those parametes whose index number falls in number of steps will be updated. If current " Step Duration " on page 1338 is "Continuous", then generate error -221,"Settings conflict;Cannot accept time or count input when step duration type is Continuous on step #"
Dependencies	The range is 1 to 1000 which is determined by the number of steps you have configured. For details see " Number of Steps " on page 1308.
Initial S/W Revision	A.09.40

Step Configuration of Output Trigger parameter list (Remote Command Only)

This SCPI command is to configure "Output Trigger" parameter array of the whole List Sequencer at one time. The number of array is same as step number defined in "[Number of Steps](#)" on page 1308 Number of Steps. As a step is setup, the value entered run through several levels of validation.

Remote Command	:SOURce:LIST:SETup:OUTPut:TRIGger <bool>, <bool>, <bool>, ... :SOURce:LIST:SETup:OUTPut:TRIGger ?
Example	:SOUR:LIST:SET:OUTP:TRIG ON,OFF,ON :SOUR:LIST:SET:OUTP:TRIG?
Notes	The command is to setup below parameter array of whole list sequence. Output Trigger <Boolean> – specifies the output trigger for the step. For details of the ranges for this setting see " Output Trigger " on page 1340. If input parameter number exceeds the step number defined by " Number of Steps " on page 1308 Number of Steps then generate error ", and only those parametes whose index number falls in legal step number will be updated.
Remote Command Notes	ON OFF 1 0
Dependencies	The range is 1 to 1000 which is determined by the number of steps you have configured. For details see " Number of Steps " on page 1308.
Initial S/W Revision	A.09.40

Clear List (Remote Command Only)

This command is the SCPI equivalent of the Clear List UI featuredescribed in.

Remote Command	:SOURce:LIST:SETup:CLEar
Example	:SOUR:LIST:SETup:CLE
Initial S/W Revision	A.05.00

Trigger Type

Allows access to the sub-menu for selecting the output trigger type for the list sequencer globally. It cannot be changed between different sequence steps.

Key Path	Source, List Sequencer
Remote Command	:SOURce:LIST:TRIGgerout:TYPE BEGinningofstep DATamarker
Example	:SOUR:LIST:TRIG:TYP BEG :SOUR:LIST:TRIG:TYP?
Notes	SCPI is supported after A.14.00
Preset	BEGinningofstep
Range	BEGinningofstep DATamarker
Initial S/W Revision	A.14.00

BeginningOfStep

Sets the output trigger type as BeginningOfStep for the whole source sequence.

Key Path	Source, List Sequencer, Trigger Type
Example	:SOUR:LIST:TRIG:TYP BEG
Notes	SCPI is supported after A.14.00
Initial S/W Revision	A.14.00

DataMarker

Sets the output trigger type as DataMarker for the whole source sequence. When DataMarker is selected, which marker to route is also needed to be set.

Key Path	Source, List Sequencer, Trigger Type
Example	:SOUR:LIST:TRIG:TYP DAT
Notes	SCPI is supported after A.14.00
Initial S/W Revision	A.14.00

Marker 1

Sets the output trigger maker routing to Marker 1 for DataMarker in the whole source sequence.

Key Path	Source, List Sequencer, Trigger Type, DataMarker
Example	:SOUR:LIST:TRIG:TYPE:MARK M1
Notes	SCPI is supported after A.14.00
Initial S/W Revision	A.14.00

Marker 2

Sets the output trigger maker routing to Marker 2 for DataMarker in the whole source sequence.

Key Path	Source, List Sequencer, Trigger Type, DataMarker
Example	:SOUR:LIST:TRIG:TYPE:MARK M2
Notes	SCPI is supported after A.14.00
Initial S/W Revision	A.14.00

Marker 3

Sets the output trigger maker routing to Marker 3 for DataMarker in the whole source sequence.

Key Path	Source, List Sequencer, Trigger Type, DataMarker
Example	:SOUR:LIST:TRIG:TYPE:MARK M3
Notes	SCPI is supported after A.14.00
Initial S/W Revision	A.14.00

Marker 4

Sets the output trigger maker routing to Marker 4 for DataMarker in the whole source sequence.

Key Path	Source, List Sequencer, Trigger Type, DataMarker
Example	:SOUR:LIST:TRIG:TYPE:MARK M4
Notes	SCPI is supported after A.14.00
Initial S/W Revision	A.14.00

Manual Trigger Now

Pressing this key provides a software trigger event to the list sequencer. During execution of sequence, if the sequencer is halted on any step that has been configured with a “Manual” step trigger, then this key press will cause the sequencer to continue and execute the step.

Key Path	Source, List Sequencer
Remote Command	No remote command, front panel only.
Initial S/W Revision	A.05.00

Remote Software Trigger (Remote command Only)

During execution of a list sequence, the sequence will halt and wait at any step that has Step Trigger set to "Bus". Sending this command will trigger the step and continue the sequence.

Remote Command	:SOURce:LIST:TRIGger:INITiate[:IMMediate]
Example	:SOUR:LIST:TRIG:INIT
Initial S/W Revision	A.05.00

Query List Sequence Initiation Armed Status (Remote Command Only)

This is a blocking SCPI query to determine if source list sequence being initiated successfully or not.

Remote Command	:SOURce:LIST:INITiation:ARMed?
Example	:SOUR:LIST:INIT:ARMed?
Notes	The return data is in the following format: Integer
Notes	Query only SCPI. Returning "1" if list sequence has been initiated successfully, returning "0" if not. Once get "0", you can use :SYST:ERR? to query what error happened. Just like "*OPC?", this command can be blocked until event/status "IsSourceSweeping" happens, and then returns. Doing so can help user's script query armed status only once during the time interval of the initiation. As an ancillary SCPI of existing SCPI ":SOUR:LIST:TRIGger[:IMMediate]" (see "Initiate Sequence" on page 1307 Initiate Sequence), the right usage of this command is to use it after ":SOUR:LIST:TRIG". If not, this command will return "1" immediately.
Notes	There is an alias SCPI ":SOURce:LIST:TRIGger:INITiation:ARMed?".
Initial S/W Revision	A.09.40

Source Preset

Allows you to preset the source settings to their default values.

Key Path	Source
Remote Command	:SOURce:PRESet
Example	:SOUR:PRES

SPAN X Scale

Activates and displays the Span function menu.

Key Path	Front-panel key
Initial S/W Revision	Prior to A.02.00

Span

Adjusts the Span of the RF Spectrum window.

Key Path	SPAN X Scale
Remote Command	[:SENSe] :AM FM PM FMSTereo:FREQuency:SPAN <freq> [:SENSe] :AM FM PM FMSTereo:FREQuency:SPAN?
Example	AM:FREQ:SPAN 2.122kHz AM:FREQ:SPAN?
Notes	Adjusts the Span of the RF Spectrum window.
Dependencies	The maximum value will be the maximum IF BW available in the instrument. For example, if the instrument has the options B25, B40, and B1X installed, the maximum available IF BW of the instrument is 140 MHz. Thus, the maximum Span is not limited to 25 MHz but is 140 MHz.
Preset	= AM/FM/PM = 75 kHz = FMST = 500 kHz
State Saved	Saved in instrument state
Min	10 Hz
Default Unit	Hz
Initial S/W Revision	Prior to A.02.00
Modified at S/W Revision	A.14.00

Sweep/Control

Activates a menu and selects Sweep Time as the active function. Sweep time is used by the Demod Waveform window, but this key is available in any view.

Key Path	Front-panel key
Initial S/W Revision	Prior to A.02.00

Demod Wfm Sweep Time

Selects the display length for the Demod Waveform window. This is commonly set to two sample lengths.

Key Path	Sweep/Control
Remote Command	[:SENSe] :AM FM PM FMSTereo:DWSweep:TIME <time> [:SENSe] :AM FM PM FMSTereo:DWSweep:TIME?
Example	AM:DWSW:TIME 50 ms AM:DWSW:TIME?
Preset	2 ms
State Saved	Saved in Instrument State
Min	1 μ s
Max	2 s
Initial S/W Revision	Prior to A.02.00
Modified at S/W Revision	A.10.00

Demod Time

Selects the minimum length of data acquisition used in demodulation. Increasing the demodulation time will result in more accurate metrics; reducing the demodulation time will result in a faster measurement.

The measurement might require more data than specified by the demodulation time. If the resolution bandwidth is low in the spectrum windows, or the demod waveform sweep time is high, then the data required for the measurement might be higher than the demodulation time.

If measurement speed is critical, make sure to increase the resolution bandwidth and reduce the demodulation waveform sweep time.

The Auto rules for the demodulation time will give the nominal specification performance if the sweep time is set to display two cycles of data.

Key Path	Sweep/Control
Remote Command	[:SENSe] :AM FM PM FMSTereo:DEMod:TIME <time> [:SENSe] :AM FM PM FMSTereo:DEMod:TIME? [:SENSe] :AM FM PM:DEMod:TIME:AUTO OFF ON 0 1

	[:SENSe] :AM FM PM:DEMod:TIME:AUTO?
Example	AM:DEM:TIME 50 ms AM:DEM:TIME?
Notes	If current Demod Time, Span and Channel BW settings combinations result in a required acquisition length is excess of the capacity of the analyzer, 4MSamples, gives a warning message "Settings Alert; Acquisition truncated".
Couplings	When in Auto mode, the demodulation time depends on the demodulation waveform sweep time. Lower
Preset	= AM/FM/PM = 72 ms = FMST = 280 ms ON
State Saved	Saved in instrument state
Min	1 μ s
Max	100 s
Initial S/W Revision	Prior to A.02.00
Modified at S/W Revision	A.14.00

System

See "[System](#)" on page 182

Trace/Detector

There are no menus under this key in the Analog Demod mode.

Key Path	Front-panel key
Initial S/W Revision	Prior to A.02.00

Trigger

See ["Trigger" on page 238](#)

Free Run

See ["Free Run " on page 245](#)

Video

See ["Video \(IF Envelope\) " on page 246](#)

Trigger Level

See ["Trigger Level " on page 246](#)

Trig Slope

See ["Trig Slope " on page 247](#)

Trig Delay

See ["Trig Delay " on page 248](#)

External 1

See ["External 1 " on page 264](#)

Trigger Level

See ["Trigger Level " on page 264](#)

Trig Slope

See ["Trig Slope " on page 265](#)

Trig Delay

See ["Trig Delay " on page 251](#)

Zero Span Delay Comp

See ["Zero Span Delay Comp On/Off" on page 252](#)

External 2

See ["External 2 " on page 266](#)

Trigger Level

See ["Trigger Level " on page 266](#)

Trig Slope

See ["Trig Slope " on page 267](#)

Trig Delay

See ["Trig Delay "](#) on page 254

Zero Span Delay Comp

See ["Zero Span Delay Comp On/Off"](#) on page 254

RF Burst

See ["RF Burst "](#) on page 267

Absolute Trigger

See ["Absolute Trigger Level"](#) on page 268

Relative Trigger

See ["Relative Trigger Level"](#) on page 257

Trig Slope

See ["Trigger Slope "](#) on page 269

Trig Delay

See ["Trig Delay "](#) on page 258

Periodic Timer

See ["Periodic Timer \(Frame Trigger\) "](#) on page 259

Period

See ["Period "](#) on page 260

Offset

See ["Offset "](#) on page 261

Offset Adjust (Remote Command Only)

See ["Offset Adjust \(Remote Command Only\)"](#) on page 262

Reset Offset Display

See ["Reset Offset Display "](#) on page 263

Sync Source

See ["Sync Source "](#) on page 263

Off

See ["Off "](#) on page 264

External 1

See ["External 1 "](#) on page 264

Trigger Level

See ["Trigger Level "](#) on page 264

Trig Slope

See ["Trig Slope "](#) on page 265

External 2

See ["External 2 "](#) on page 266

Trigger Level

See ["Trigger Level "](#) on page 266

Trig Slope

See ["Trig Slope "](#) on page 267

RF Burst

See ["RF Burst "](#) on page 267

Absolute Trigger

See ["Absolute Trigger Level"](#) on page 268

Trig Slope

See ["Trigger Slope "](#) on page 269

Trig Delay

See ["Trig Delay"](#) on page 269

Auto/Holdoff

See ["Auto/Holdoff "](#) on page 270

Auto Trig

See ["Auto Trig "](#) on page 270

Trig Holdoff

See ["Trig Holdoff "](#) on page 271

User Preset

Accesses a menu that gives you the following three choices:

- User Preset – recalls a state previously saved using the Save User Preset function.
- User Preset All Modes – presets all of the modes in the analyzer
- Save User Preset– saves the current state for the current mode

NOTE

In products that run multiple instances of the X-Series Application, all instances use the same location to save User Preset state. So Save User Preset of one instance will overwrite the Save User Preset of another instance.

Key Path	Front-panel key
Backwards Compatibility Notes	<p>User Preset is actually loading a state, and in legacy analyzers, it was possible to load a state without affecting the trace data, limit lines or correction data. Similarly it was possible to do a User Preset without affecting the trace data, limit lines or correction data.</p> <p>In the X-Series, “state” always includes all of this data; so whenever state is loaded, or User Preset is executed, all of the traces, limit lines and corrections are affected. Although this differs from previous behavior, it is desirable behavior, and should not cause adverse issues for users.</p> <p>On ESA and PSA, User Preset affected the entire instrument’s state. In the X-Series, User Preset only recalls the state for the active mode. There is a User Preset file for each mode. User Preset can never cause a mode switch as it can in legacy analyzers. If you want to recall all modes to their user preset file state, you will need to do a User Preset after mode switching into each mode.</p> <p>User Preset recalls mode state which can now include data like traces; whereas on ESA and PSA, User Preset did not affect data.</p>
Initial S/W Revision	Prior to A.02.00

User Preset

User Preset sets the state of the currently active mode back to the state that was previously saved for this mode using the Save User Preset menu key or the SCPI command, SYST:PRES:USER:SAV. It not only recalls the Mode Preset settings, but it also recalls all of the mode persistent settings, and the Input/Output system setting that existed at the time Save User Preset was executed.

If a Save User Preset has not been done at any time, User Preset recalls the default user preset file for the currently active mode. The default user preset files are created if, at power-on, a mode detects there is no user preset file. There will never be a scenario when there is no user preset file to restore. For each mode, the default user preset state is the same state that would be saved if a Save User Preset is performed in each mode right after doing a Restore Mode Default and after a Restore Input/Output Defaults.

The User Preset function does the following:

- Aborts the currently running measurement.
- Sets the mode State to the values defined by Save User Preset.
- Makes the saved measurement for the currently running mode the active measurement.
- Brings up the saved menu for the power-on mode.

- Clears the input and output buffers.
- Sets the Status Byte to 0.

Key Path	User Preset
Remote Command	:SYSTem:PRESet:USER
Example	:SYST:PRES:USER:SAVE:SYST:PRES:USER
Notes	:SYST:PRES:USER:SAVE is used to save the current state as the user preset state. Clears all pending OPC bits. The Status Byte is set to 0. Pressing the User Preset front-panel key while already in the User Preset menu will cause the User Preset to get executed
Couplings	A user preset will cause the currently running measurement to be aborted and cause the saved measurement to be active. Recalling a User Preset file has the same issues that recalling a Save State file has. Some settings may need to be limited and therefore re-coupled, since the capabilities of the mode may have changes when the User Preset file was last saved.
Initial S/W Revision	Prior to A.02.00

User Preset All Modes

Recalls all of the User Preset files for each mode, switches to the power-on mode, and activates the saved measurement from the power-on mode User Preset file.

NOTE

When the instrument is secured, all of the user preset files are converted back to their default user preset files.

The User Preset function does the following:

- Aborts the currently running measurement.
- Switches the Mode to the power-on mode.
- Restores the User Preset files for each mode.
- Makes the saved measurement for the power-on mode the active measurement.
- Brings up the saved menu for the power-on mode.
- Clears the input and output buffers.
- Sets the Status Byte to 0.

Key Path	User Preset
Remote Command	:SYSTem:PRESet:USER:ALL
Example	:SYST:PRES:USER:SAVE:SYST:PRES:USER:ALL
Notes	Clears all pending OPC bits. The Status Byte is set to 0. :SYST:PRES:USER:SAVE is used to save the current state as the user preset state.
Couplings	A user preset will cause the currently running measurement to be aborted, cause a mode switch to the power-on mode, and cause the saved measurement to be active in the power-on mode.

Recalling a User Preset file has the same issues that recalling a Save State file has. Some settings may need to be limited and therefore re-coupled, since the capabilities of the mode may have changes when the User Preset file was last saved.

Initial S/W Revision Prior to A.02.00

Save User Preset

Saves the currently active mode and its State. You can recall this User Preset file by pressing the User Preset menu key or sending the SYST:PRES:USER remote command. This same state is also saved by the Save State function.

Key Path	User Preset
Remote Command	:SYSTem:PRESet:USER:SAVE
Example	:SYST:PRES:USER:SAVE
Notes	:SYST:PRES:SAVE creates the same file as if the user requested a *SAV or a MMEM:STOR:STAT, except User Preset Save does not allow the user to specify the filename or the location of the file.
Initial S/W Revision	Prior to A.02.00

View/Display (AM/FM/ Φ M)

The AM and PM measurements have four views. The primary view is called “Quad View” and displays all four of the view windows with the focus in the RF Spectrum window. This is the view seen after a Mode Preset. There are also three other views that combine one of the graphics windows with the metrics windows. Besides the above four views, the FM measurement has an additional view called “Attack/Release Time”. This view includes a RF envelope graphic window and an AF demod waveform (without interpolation) graphic window. The views can be selected from the View/Display menu.

These views are designed such that you can identify analog modulated carriers, determine whether the carrier is a commercial or other broadcast station, and analyze the modulating signal.

Key Path	Front-panel key
Remote Command	:DISPlay:AM FM PM:VIEW[:SElect] QUAD RFSpectrum DEMod AFSpectrum ARTIME :DISPlay:AM FM PM:VIEW[:SElect]?
Example	:DISP:FM:VIEW DEM selects Demod Waveform & Metrics View for FM Demod measurement
Preset	QUAD (Focus in RF Spectrum Window)
State Saved	Saved in instrument state
Initial S/W Revision	Prior to A.02.00

Display

The Display menu is common to most measurements, and is used for configuring items on the display. Some Display menu settings apply to all the measurements in a mode, and some only to the current measurement. Those under the System Display Settings key apply to all measurements in all modes.

Key Path	Display
Key Path	View/Display
Initial S/W Revision	Prior to A.02.00

Annotation

Turns on and off various parts of the display annotation. The annotation is divided up into four categories:

1. Meas Bar: This is the measurement bar at the top of the screen. It does not include the settings panel or the Active Function. Turning off the Meas Bar turns off the settings panel and the Active Function. When the Meas Bar is off, the graticule area expands to fill the area formerly occupied by the Meas Bar.
2. Screen Annotation: this is the annotation and annunciation around the graticule, including any annotation on lines (such as the display line, the threshold line, etc.) This does NOT include the marker number or the N dB result. When off, the graticule expands to fill the entire graticule area.
3. Trace annotation: these are the labels on the traces, showing their detector (or their math mode).

4. Active Function annotation: this is the active function display in the meas bar, and all of the active function values displayed on softkeys.

See the figure below. Each type of annotation can be turned on and off individually.

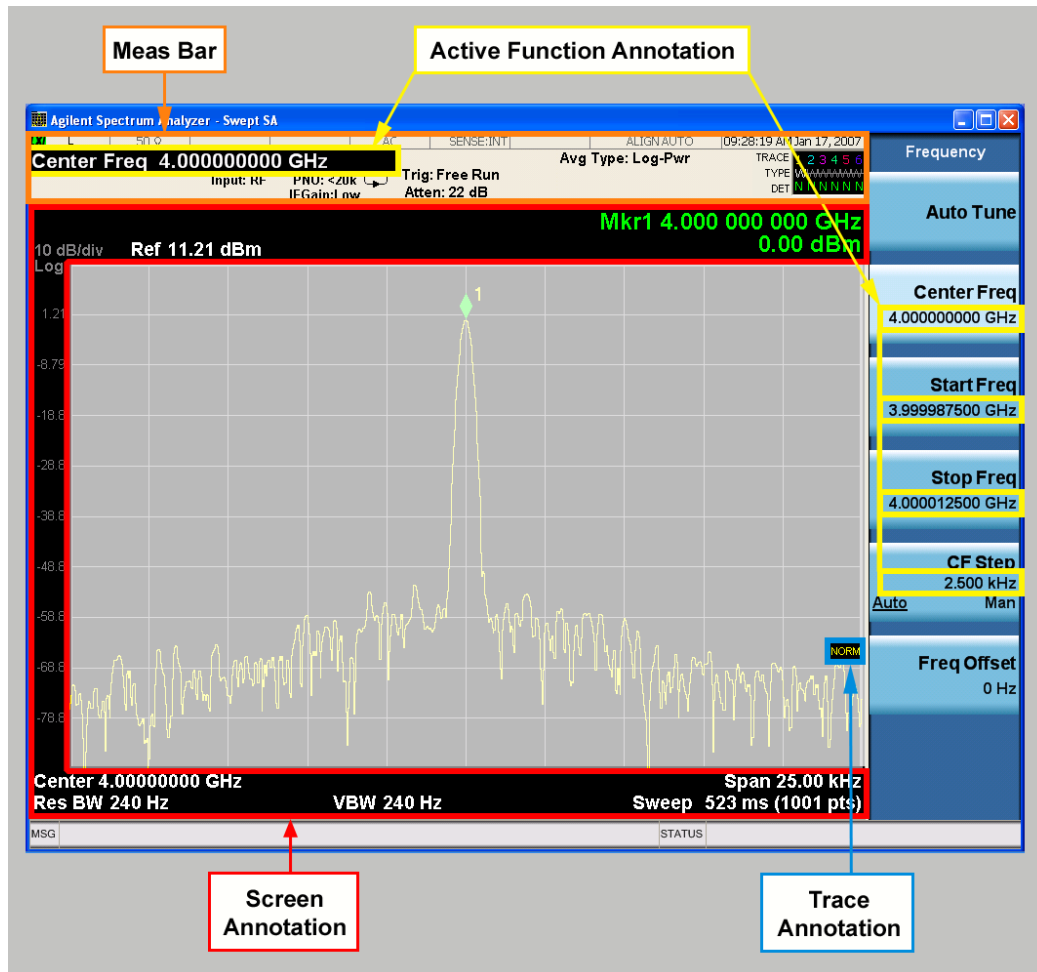

Key Path	View/Display, Display
Initial S/W Revision	Prior to A.02.00

Meas Bar On/Off

This function turns the Measurement Bar on and off, including the settings panel. When off, the graticule area expands to fill the area formerly occupied by the Measurement Bar.

Key Path	View/Display, Display, Annotation
Remote Command	:DISPlay:ANNotation:MBAR[:STATe] OFF ON 0 1 :DISPlay:ANNotation:MBAR[:STATe]?
Example	DISP:ANN:MBAR OFF

Dependencies	Grayed out and forced to OFF when System Display Settings, Annotation is set to Off.
Preset	On This should remain Off through a Preset when System DisplaySettings, Annotation is set to Off.
State Saved	Saved in instrument state.
Initial S/W Revision	Prior to A.02.00

Screen

This controls the display of the annunciation and annotation around the graticule, including any annotation on lines (such as the display line, the threshold line, etc.) and the y-axis annotation. This does NOT include marker annotation (or the N dB result). When off, the graticule expands to fill the entire graticule area, leaving only the 1.5% gap above the graticule as described in the Trace/Detector chapter.

Key Path	View/Display, Display, Annotation
Remote Command	:DISPlay:ANNotation:SCReen[:STATe] OFF ON 0 1 :DISPlay:ANNotation:SCReen[:STATe]?
Example	DISP:ANN:SCR OFF
Dependencies	Grayed-out and forced to OFF when System Display Settings, Annotation is set to Off.
Preset	On This should remain Off through a Preset when System DisplaySettings, Annotation is set to Off
State Saved	Saved in instrument state.
Initial S/W Revision	Prior to A.02.00

Active Function Values On/Off

Turns on and off the active function display in the Meas Bar, and all of the active function values displayed on the softkeys.

Note that all of the softkeys that have active functions have these numeric values blanked when this function is on. This is a security feature..

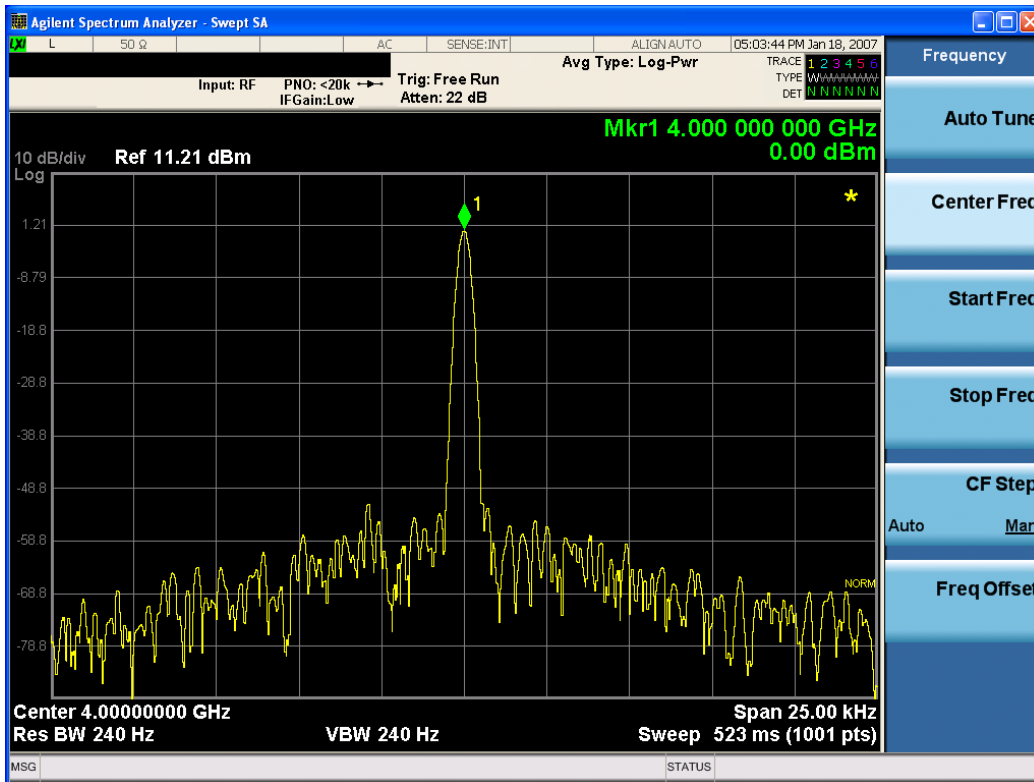

Key Path	View/Display, Display, Annotation
Remote Command	:DISPlay:ACTivefunc[:STATE] ON OFF 1 0 :DISPlay:ACTivefunc[:STATE]?
Example	DISP:ACT OFF
Dependencies	Grayed out and forced to OFF when System Display Settings, Annotation is set to Off.
Preset	On This should remain Off through a Preset when System DisplaySettings, Annotation is set to Off
State Saved	Saved in instrument state.
Initial S/W Revision	Prior to A.02.00

Title

Displays menu keys that enable you to change or clear a title on your display.

Key Path	View/Display, Display
Initial S/W Revision	Prior to A.02.00

Change Title

Writes a title into the "measurement name" field in the banner, for example, "Swept SA".

Press Change Title to enter a new title through the alpha editor. Press Enter or Return to complete the entry. Press ESC to cancel the entry and preserve your existing title.

The display title will replace the measurement name. It remains for this measurement until you press Change Title again, or you recall a state, or a Preset is performed. A title can also be cleared by pressing Title, Clear Title.

NOTE

Notice the inclusion of the <measurement> parameter in the command below. Because each measurement remembers the Display Title, the command must be qualified with the measurement name. For the Swept SA measurement this is not the case; no <measurement> parameter is used when changing the Display Title for the Swept SA measurement.

Key Path	View/Display, Display, Title
Mode	All
Remote Command	:DISPlay:<measurement>:ANNotation:TITLe:DATA <string> :DISPlay:<measurement>:ANNotation:TITLe:DATA?
Example	DISP:ANN:TITL:DATA "This Is My Title" This example is for the Swept SA measurement in the Spectrum Analyzer mode. The SANalyzer <measurement> name is not used. DISP:ACP:ANN:TITL:DATA "This Is My Title" This example is for Measurements other than Swept SA. Both set the title to: This Is My Title
Notes	Pressing this key cancels any active function. When a title is edited the previous title remains intact (it is not cleared) and the cursor goes at the end so that characters can be added or BKSP can be used to go back over previous characters.
Preset	No title (measurement name instead)
State Saved	Saved in instrument state.
Initial S/W Revision	Prior to A.02.00

Clear Title

Clears a title from the front-panel display. Once cleared, the title cannot be retrieved. After the title is cleared, the current Measurement Name replaces it in the title bar.

Key Path	View/Display, Display, Title
Example	The following commands clear the title and restore the measurement's original title: DISP:ANN:TITL:DATA "" This example is for the Swept SA measurement in the Spectrum Analyzer mode. The SANalyzer <measurement> name is not used. DISP:ACP:ANN:TITL:DATA "" This example is for ACP; in measurements other than Swept SA the measurement name is required.
Notes	Uses the :DISPlay:<measurement>:ANNotation:TITLe:DATA <string> command with an empty string (in the Swept SA, the <measurement> is omitted).
Preset	Performed on Preset.
Initial S/W Revision	Prior to A.02.00

Graticule

Pressing Graticule turns the display graticule On or Off. It also turns the graticule y-axis annotation on and off.

Key Path	View/Display, Display
Remote Command	:DISPlay:WINDow[1]:TRACe:GRATicule:GRID[:STATe] OFF ON 0 1 :DISPlay:WINDow[1]:TRACe:GRATicule:GRID[:STATe]?
Example	DISP:WIND:TRAC:GRAT:GRID OFF
Notes	The graticule is the set of horizontal and vertical lines that make up the grid/divisions for the x-axis and y-axis.
Preset	On
State Saved	Saved in instrument state
Initial S/W Revision	Prior to A.02.00

System Display Settings

These settings are "Mode Global" – they affect all modes and measurements and are reset only by Restore Misc Defaults or Restore System Defaults under System.

Key Path	View/Display, Display
Initial S/W Revision	Prior to A.02.00

Annotation Local Settings

This is a Mode Global override of the meas local annotation settings. When it is All Off, it forces ScreenAnnotation, Meas Bar, Trace, and Active Function Values settings to be OFF for all measurements in all modes. This provides the security based "annotation off" function of previous analyzers; hence it uses the legacy SCPI command.

When it is All Off, the Screen, Meas Bar, Trace, and Active Function Values keys under the Display, Annotation menu are grayed out and forced to Off. When Local Settings is selected, you are able to set the local annotation settings on a measurement by measurement basis.

Key Path	View/Display, Display, System Display Settings
Remote Command	:DISPlay:WINDow[1]:ANNOtation[:ALL] OFF ON 0 1 :DISPlay:WINDow[1]:ANNOtation[:ALL]?
Example	:DISP:WIND:ANN OFF
Preset	On (Set by Restore Misc Defaults)
State Saved	Not saved in instrument state.
Backwards Compatibility Notes	The WINDow parameter and optional subopcode is included for backwards compatibility but ignored – all windows are equally affected.
Initial S/W Revision	Prior to A.02.00

Themes

Accesses a menu of functions that enable you to choose the theme to be used when saving the screen image.

The **Themes** option is the same as the **Themes** option under the **Display** and **Page Setup** dialogs. It allows you to choose between themes to be used when saving the screen image.

Key Path	Save, Screen Image
Remote Command	:MMEMory:STORe:SCReen:THEMe TDColor TDMonochrome FCOLor FMONochrome :MMEMory:STORe:SCReen:THEMe?
Example	:MMEM:STOR:SCR:THEM TDM
Preset	3D Color; Is not part of Preset, but is reset by Restore Misc Defaults or Restore System Defaults All and survives subsequent running of the modes.
Readback	3D Color 3D Mono Flat Color Flat Mono
Backwards Compatibility Notes	In ESA and PSA we offer the choice of "Reverse Bitmap" or "Reverse Metafile" when saving screen images. This is much like the "Flat Color" theme available in X-Series. Also, if you selected Reverse Bitmap AND a black & white screen image, that would be much like "Flat Monochrome". In other words, each of the X-Series themes has a similar screen image type in ESA/PSA. But they are not identical.
Initial S/W Revision	Prior to A.02.00

3D Color

Selects a standard color theme with each object filled, shaded and colored as designed.

Key Path	Save, Screen Image, Themes
Example	MMEM:STOR:SCR:THEM TDC
Readback	3D Color
Initial S/W Revision	Prior to A.02.00

3D Monochrome

Selects a format that is like 3D color but shades of gray are used instead of colors.

Key Path	Save, Screen Image, Themes
Example	MMEM:STOR:SCR:THEM TDM
Readback	3D Mono
Initial S/W Revision	Prior to A.02.00

Flat Color

Selects a format that is best when the screen is to be printed on an ink printer.

Key Path	Save, Screen Image, Themes
Example	MMEM:STOR:SCR:THEM FCOL
Readback	Flat Color
Initial S/W Revision	Prior to A.02.00

Flat Monochrome

Selects a format that is like Flat Color. But only black is used (no colors, not even gray), and no fill.

Key Path	Save, Screen Image, Themes
Example	MMEM:STOR:SCR:THEM FMON
Readback	Flat Mono
Initial S/W Revision	Prior to A.02.00

Quad View

The Quad View displays each of the four fundamental windows of the Analog Demod mode. The basic window format is essentially the same for the 3 measurements. The main difference is the demodulation technique performed in the hardware and the specific metrics and units of the displayed results.

In general, there is little window-context sensitivity in the Analog Demod mode, that is, most of the variables have been designed so that they are unique to their window. The three variables that are window dependent are, Ref Value, Scale/Div, and Ref Position. These variables change to reflect the settings of the current window (the current window is always outlined in green).

The Quad View is shown below. For more information on the views, see ["RF Spectrum Window" on page 802](#), ["Demod Waveform Window" on page 802](#), ["AF Spectrum Window" on page 803](#), or ["Metrics Window" on page 803](#).

9 FM Demod Measurement View/Display (AM/FM/ Φ M)

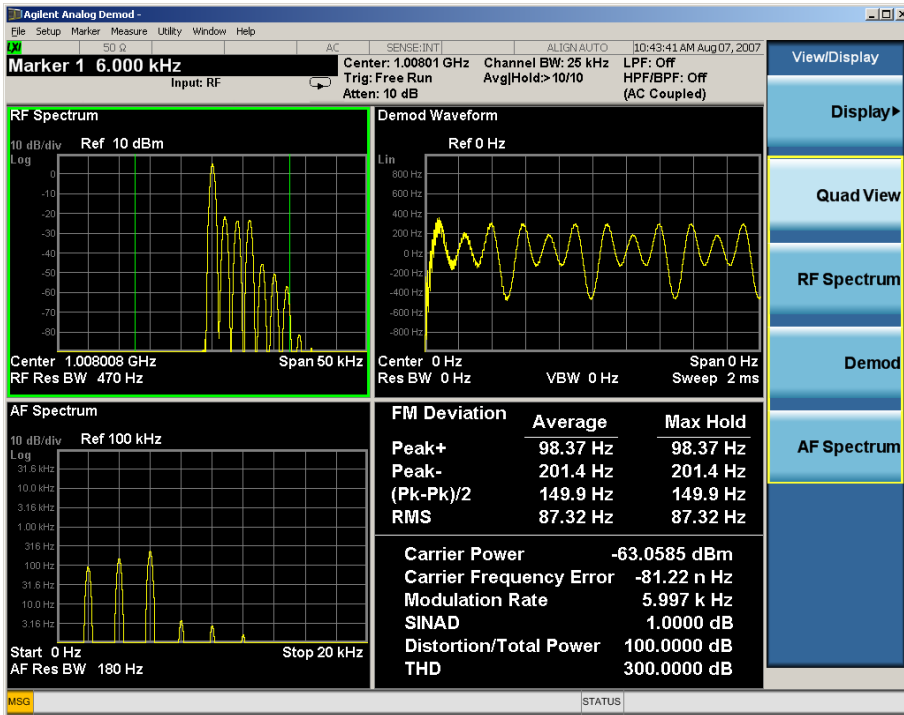

RF Spectrum Window

The RF Spectrum window shows a spectral display of the input RF signal with amplitude in the vertical Y axis and frequency in the horizontal X axis. The vertical axis is always scaled in dB, with units of dBm, with the Ref Value initially at the top of the vertical scale. This spectral display is basically identical to the frequency display of the Swept SA measurement; however it is always taken using an FFT. The span is restricted to 8 MHz and zero span is not allowed.

The RF Spectrum window provides a convenient way to identify broadcast stations by placing the signal of interest at the center frequency using this window and listening to the instrument's speaker. Demodulation is always performed at the center frequency of the RF Spectrum window; this is regarded as the application's center frequency and is annotated in the Measurement Bar.

In the RF Spectrum window, two green vertical lines are shown centered around the center frequency, with spacing equal to the Channel BW. If the Channel BW is wider than the span, they are not seen.

The Center Frequency, Span, and RF Res BW are annotated at the bottom of the RF Spectrum Window. The Ref Value and Scale/Div are annotated above the graticule.

Demod Waveform Window

In the Demod Waveform window, the demodulated signal is displayed in the time domain (zero span) with time on the horizontal X axis, and modulation depth (AM) or deviation (FM, Φ M) on the vertical Y axis.

In the Demod Waveform window the Y axis is linearly scaled in units of percent modulation for AM, frequency (Hz) for FM, or phase (radians) for Φ M. On a preset, the Ref Value is positioned in the center of the vertical scale.

Four traces are available in the Demod Waveform window. The Demod trace, in yellow, shows the current demodulation signal. The Demod Max trace, in cyan, shows the Max Hold value for each display point

bucket since the last restart and the Demod Min trace, in magenta, shows the Min Hold value for each display point bucket since the last restart. The Demod Average trace, in green, shows the averaged demodulation signal. If Averaging is turned off, only the Demod trace is displayed.

The Sweep Time is annotated at the bottom of the Demod Waveform Window. The Ref Value and Scale/Div are annotated above the graticule.

AF Spectrum Window

In the AF Spectrum window, the demodulated signal is displayed in the frequency domain with frequency on the X axis and amplitude on the Y axis.

The vertical axis is always scaled in dB with the Ref Value initially at the top of the vertical scale. The Y-Axis Unit is % for AM, Hz for FM, and radians for Φ M.

In this view you can observe the spectral components of the modulating signal. The preset Start Frequency of this window is 0 Hz. The AF Start Freq and AF Stop Freq are annotated at the bottom of the AF Spectrum Window, as is the AF Res BW.

The Ref Value and Scale/Div are annotated above the graticule.

It is only possible to show a spectrum to a maximum frequency of Channel BW / 2. For trace display points beyond that frequency, the value 1.0E-50 is plotted and returned in queries.

Metrics Window

The metrics window displays measurement results.

If averaging is turned on, the column marked “Current” is relabeled “Average” and the results in that column are averaged over successive measurements until the Average/Hold number is reached. Then, if not in Single measurement mode, the measurement continues, exponentially averaging in successive results. The Max Hold column shows the Maximum value the un-averaged metric has attained since the last Restart. The Max Hold column is removed when averaging is turned off.

The window title is “FM Deviation” in FM, “AM Mod Depth” in AM, and “ Φ M Radians” in Φ M.

Key Path	View/Display
Initial S/W Revision	Prior to A.02.00

RF Spectrum & Metrics View

This view shows the RF Spectrum window and the Metrics window displayed in a split screen mode with the RF Spectrum window taking up approximately $\frac{3}{4}$ of the display.

9 FM Demod Measurement View/Display (AM/FM/ Φ M)

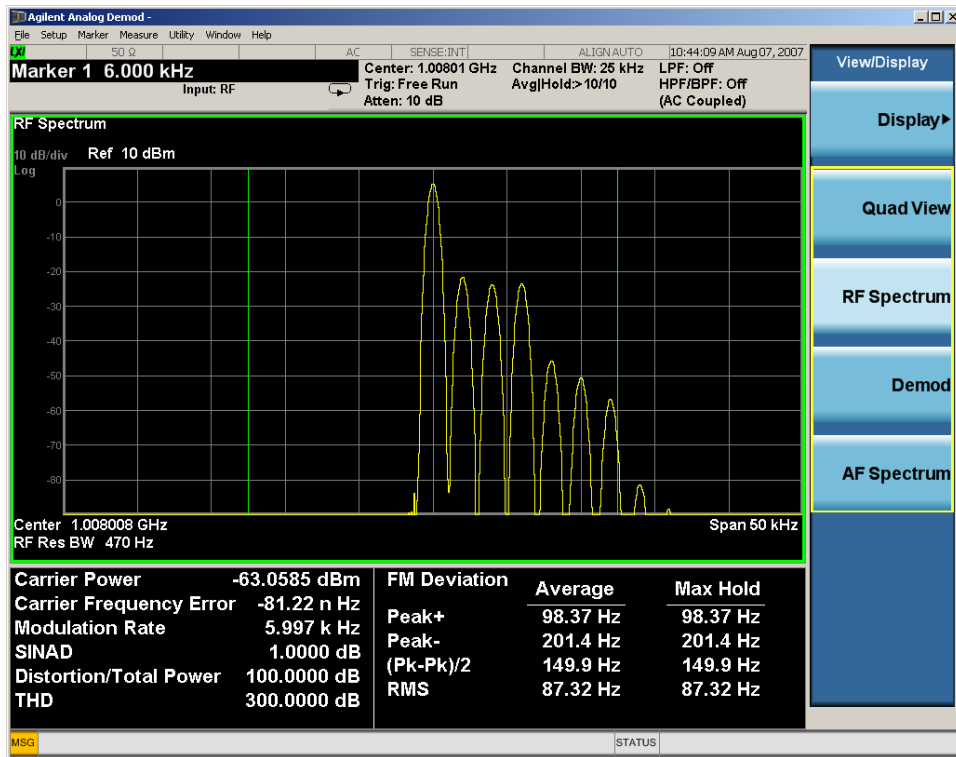

Key Path View/Display

Initial S/W Revision Prior to A.02.00

Demod Waveform & Metrics View

This view shows the Demod Waveform window and the Metrics windows displayed in a split screen mode with the Demod Waveform window taking up approximately $\frac{3}{4}$ of the display.

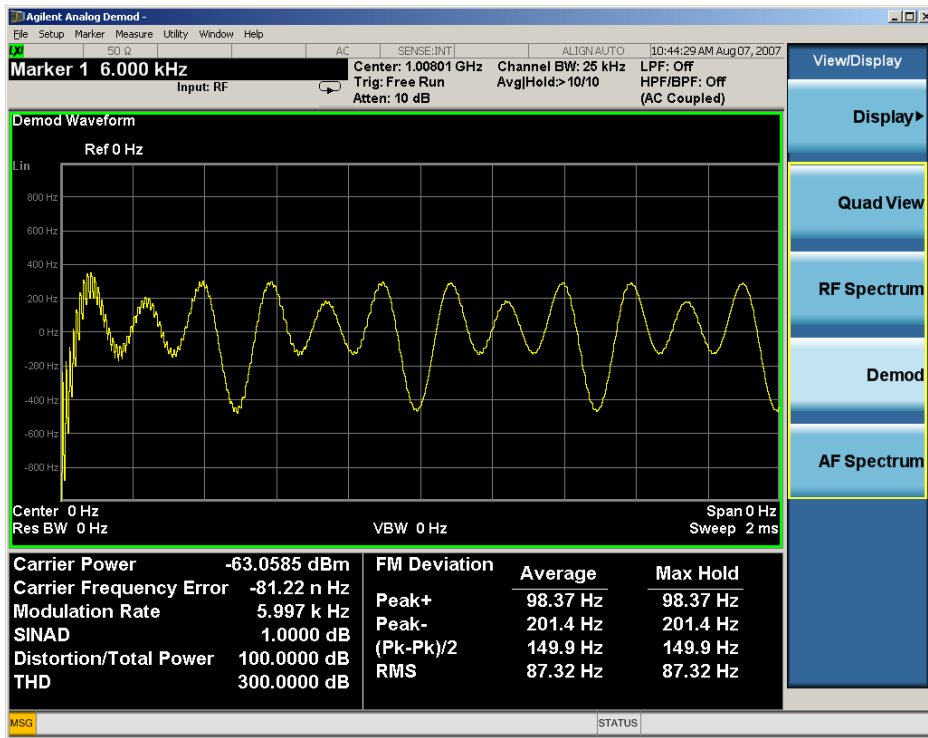

Key Path	View/Display
Initial S/W Revision	Prior to A.02.00

AF Spectrum & Metrics View

This view shows the AF Spectrum window and the Metrics windows displayed in a split screen mode with the AF Spectrum window taking up approximately $\frac{3}{4}$ of the display.

9 FM Demod Measurement View/Display (AM/FM/ Φ M)

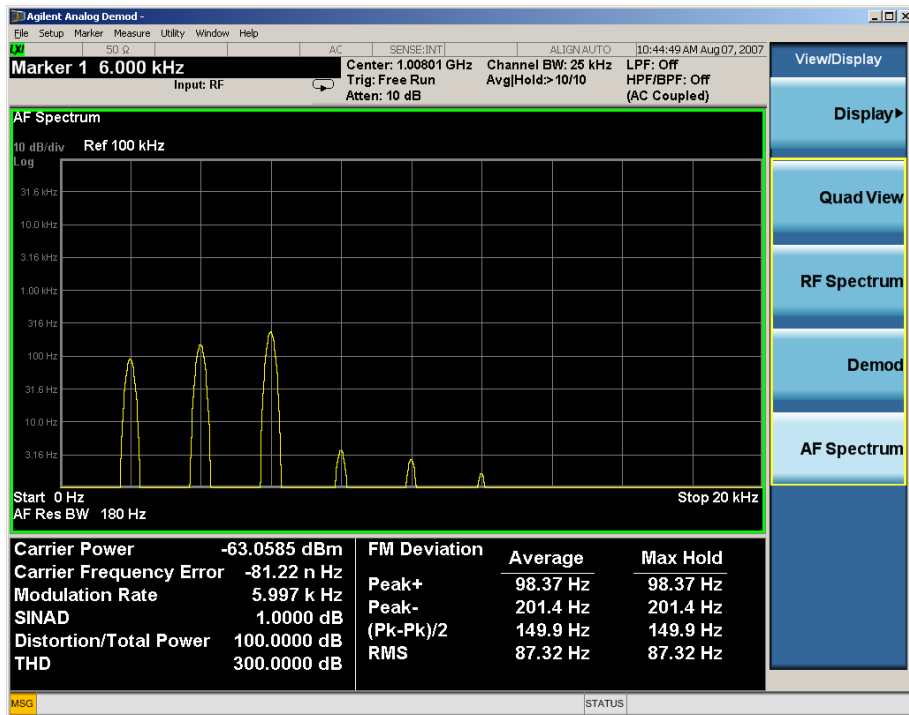

Key Path	View/Display
Initial S/W Revision	Prior to A.02.00

Metrics Settings

Accesses a menu used to control which metrics will be provided. This includes a 1-of-N menu which allows you to control which modulation magnitude metrics are displayed, as well as On/Off controls for Modulation Rate and SINAD/Distortion/THD. If speed is an issue, select only the metric(s) that is(are) required. If modulation magnitude is set to Peak+ Only, Pk-Pk/2 Only, or RMS Only, the other modulation magnitude metrics are loaded with not a number and show "----" in the metrics window.

Key Path	View/Display, Metrics Settings
Remote Command	:DISPlay:AM FM PM:VIEW:METRics:MMAGnitude ALL PPK PNPk RMS RMSRatio :DISPlay:AM FM PM:VIEW:METRics:MMAGnitude?
Example	DISP:AM:VIEW:METR:MMAG PPK Sets AM modulation magnitude to peak +. DISP:FM:VIEW:METR:MMAG RMSR Sets ratio reference and sets FM modulation magnitude to ratio display
Preset	ALL
State Saved	Saved in State
Initial S/W Revision	Prior to A.02.00
Modified at S/W Revision	A.05.00

Normal

Turns on all absolute modulation magnitude metrics. In the metrics window, Peak +, Peak -, Pk-Pk/2 and RMS results are provided.

Key Path	View/Display, Metrics Settings, Mod Magnitude
Example	:DISP:FMST:VIEW:METR:MMAG ALL
Notes	This key was labeled "All" in earlier releases
Initial S/W Revision	A.10.00

Peak+ Only

Turns on just the Peak+ metric in the portion of the metrics window that shows the modulation magnitude results.

Key Path	View/Display, Metrics Settings, Mod Magnitude
Example	:DISP:FMST:VIEW:METR:MMAG PPK
Initial S/W Revision	A.10.00

Pk-Pk/2 Only

Turns on just the Pk-Pk/2 metric in the portion of the metrics window that shows the modulation magnitude results. .

Key Path	View/Display, Metrics Settings, Mod Magnitude
Example	:DISP:FMST:VIEW:METR:MMAG PNPk
Initial S/W Revision	A.10.00

RMS Only

Turns on just the RMS metric in the portion of the metrics window that shows the modulation magnitude results.

Key Path	View/Display, Metrics Settings, Mod Magnitude
Example	:DISP:FMST:VIEW:METR:MMAG RMS
Initial S/W Revision	A.10.00

RMS Ratio

Turns on the display of RMS Ratio. In this mode, the only magnitude metrics that are displayed are the RMS metrics, but besides the display of RMS, the ratio (in dB) of the RMS modulation to its reference is

displayed, as well as the value of the reference, as shown in the display below:

FM Deviation		
	Average	Max Hold
RMS	12.69 kHz	14.19 kHz
RMS Ratio	1.89 dB	2.86 dB
Ratio Ref	10.20 kHz	
Carrier Power -100.331 dBm		
Carrier Frequency Error 180.5 Hz		

Pressing the RMS Ratio key (or sending :DISP:FMST:VIEW:METR:MMAG RMSR) establishes the reference. Pressing it again (or sending the SCPI command again) establishes a new reference. Whenever this happens, the current value of RMS modulation from the left hand column (Current or Average) is taken as the new reference.

If, when the ratio is to be established, there is not a valid value being displayed to use as a reference, an error is generated, the RMS Ratio and Ratio Ref values display --- and queries of either return not a number (9.91 e37).

To turn off the ratio display, select one of the other Mod magnitude views.

Note that each measurement (AM, FM, PM, PM and FM Stereo) has its own reference; and the reference is remembered when you leave the measurement and return.

The ratio references are saved in State, and when the recalled state of Metrics Settings is RMS Ratio, the saved reference for the current measurement should be recalled and used, rather than establishing a new one.

Key Path	View/Display, Metrics Settings, Mod Magnitude
Example	:DISP:FMST:VIEW:METR:MMAG RMSR
Initial S/W Revision	A.10.00

Modulation Rate

Toggles the Modulation Rate metric on and off. When turned on, the Modulation Rate metric is provided. When turned off, the Modulation Rate metric is set to not a number and shows “---” in the metric window.

Key Path	View/Display, Metrics Settings
Remote Command	DISPlay:FMSTereo:VIEW:METRics:MRATe[:STATe] ON OFF 1 0 DISPlay:FMSTereo:VIEW:METRics:MRATe[:STATe]?
Example	DISP:FMST:VIEW:METR:MRAT OFF Sets FM Stereo modulation rate to off
Preset	On
State Saved	Saved in instrument state
Initial S/W Revision	A.10.00

SINAD, THD, Distortion

Toggles the distortion metrics – SINAD, Distortion and THD. When turned off, SINAD, Distortion and THD metrics are set to not a number and show “---” in the metric window.

SINAD is the ratio of total received power (the received signal-plus-noise-plus-distortion power) to the received noise-plus-distortion power. It is always expressed in decibel units. The rejection of the carrier from the noise-plus-distortion power measurement is usually not much more than 50 dB, thus limiting the maximum SINAD.

THD is the ratio of the root mean square voltage of the harmonics referenced to the fundamental voltage, expressed in % or dB. Note the differences with respect to Distortion. The denominator of the ratio is different and the items in the numerator do not include the noise between harmonics, just the harmonics themselves.

Distortion/Total Voltage (rms) is the ratio of unwanted received power (noise plus distortion) to the total received power, expressed in % or dB. Therefore, this metric is the negative of SINAD when expressed in decibels.

Key Path	View/Display, Metrics Settings
Remote Command	DISPlay:FMSTereo:VIEW:METRics:DISToRtion[:STATe] ON OFF 1 0 DISPlay:FMSTereo:VIEW:METRics:DISToRtion [:STATe]?
Example	DISP:FMST:VIEW:METRics:DIST OFF Sets FM Stereo modulation rate to off
Preset	On
State Saved	Saved in instrument state
Initial S/W Revision	A.10.00

Distortion & THD Unit

Changes the units of distortion and THD in the Metrics screen between % and dB units.

Key Path	View/Display
Remote Command	DISPlay:AM FM PM:VIEW:DISToRtion:UNIT DB PCT DISPlay:AM FM PM:VIEW:DISToRtion:UNIT?
Example	DISP:AM:VIEW:DIS:UNIT PCT Sets AM distortion and THD display to percent.
Preset	PCT
State Saved	Saved in State
Initial S/W Revision	Prior to A.02.00

10 Φ M Demod Measurement

For the PM Demod measurement, the analyzer will display the metrics results, such as deviation, modulation rate, carrier frequency error, SINAD, total harmonic distortion and carrier power. The analyzer can also display trace data of the RF spectrum, the AF spectrum, or the demod waveform.

If the Demod Min trace, Demod Max trace or Demod Average trace is queried using a Meas, Read or Fetch command when the Average/Hold feature is turned off, the resulting data will be default values.

If any of the metrics are off, a SCPI query will return not a number and show “---“ in the metrics window. The metrics that can be turned off are: Modulation Rate, SINAD, Distortion, THD and all but one of the Deviations.

For more measurement related commands, see the SENSE subsystem, and the ["Remote Measurement Functions" on page 1121](#).

This topic contains the following sections:

[" \$\Phi\$ M Demod Measurement " on page 811](#)

[" \$\Phi\$ M Demod Measurement " on page 811](#)

Measurement Commands for PM Demod

Parameter Name	PM Meas/Read/Fetch Query Results
SCPI Command	:MEASure READ FETCh:PM[1] 0 2 3 4 5?
SCPI Example	MEAS:PM? FETCh:PM0? READ:PM5?
Setup	[COMPARE OFF]
Post Setup	[COMPARE ON]

Remote Command Results for PM Demod

Command	n	Return Value
:INITiate:PM	n/a	n/a
:CONFigure?	n/a	name of current measurement: "PM"
:CONFigure:PM	n/a	n/a (selects PM measurement in Meas Preset state)
:CONFigure:PM:NDEFault	n/a	n/a (selects PM measurement without affecting settings)
:FETCh:PM[n]? :MEASure:PM[n]? :READ:PM[n]?	0	This query returns the RF Spectrum trace data as a list of x,y pairs. The x-axis values are in units of Hz. The y-value units depend on the current view
	not specified or n=1	Returns the following comma-separated results: 1. The RF Spectrum window's center frequency 2. Carrier Power 3. Carrier Frequency Error 4. Modulation Rate 5. SINAD value 6. Distortion/Total Vrms (% - not ratio - or dB) 7. Total Harmonic Distortion(% - not ratio - or dB) 8. Deviation (Peak+) 9. Deviation (Peak-) 10. Deviation (Pk-Pk)/2 11. Deviation (RMS) 12. Deviation (Peak+) Max Hold 13. Deviation (Peak-) Max Hold 14. Deviation (Pk-Pk)/2 Max Hold 15. Deviation (RMS) Max Hold 16. SNR
	2	This query returns the Demod Min Trace data as a list of x,y pairs. The x-axis values are in units of seconds. The y-value units depend on the current view If Aver/Hold is off, all y-values are 10 k.
	3	This query returns the Demod Max Trace data as a list of x,y pairs. The x-axis values are in units of seconds. The y-value units depend on the current view If Aver/Hold is off, all y-values are -10 k.
	4	This query returns the Demod Trace data as a list of x,y pairs. The x-axis values are in units of seconds. The y-value units depend on the current view
	5	This query returns the Demod Average Trace data as a list of x,y pairs. The x-axis values are in units of seconds. The y-value units depend on the current view If Aver/Hold is off, all y-values are -10 k.

Command	n	Return Value
	6	This query returns the AF Spectrum Trace data as a list of x,y pairs. The x-axis values are in units of Hz. The y-value units depend on the current view
	7	Returns the following comma-separated results: 1. Deviation (RMS) 2. Deviation (RMS) Ratio 3. Ratio Reference
	8	Returns the Demod Waveform Trace data (without interpolation), as a series of floating trace point values, in radians or degree depend on Y Axis Unit. The number of samples and the sample interval can be queried when n=10.
	9	Reserved.
	10	Returns the following scalar results: 1. Sample Interval is a floating point number representing the time between samples when using the trace queries (n=8). 2. Number of samples is the number of data points in the Demod Waveform Trace (without interpolation). This number is useful when performing a query on the signal (when n=8).
	11	Returns unprocessed I/Q trace data, as a series of trace point values, in volts. The I values are listed first in each pair, using the 0 through even-indexed values. The Q values are the odd-indexed values. The number of samples and the sample interval can be queried when n=12.
	12	Returns the following scalar results: 1. Sample Interval is a floating point number representing the time between samples when using the trace queries (n=11). 2. Number of samples is the number of data points in the captured signal. This number is useful when performing a query on the signal (when n=11).

Key Path	Meas
Initial S/W Revision	Prior to A.02.00

AMPTD Y Scale

Accesses a menu that enables you to set the reference level, attenuation, scale per division, reference position, and internal pre-amplifier parameters for your measurement.

Key Path	Front-panel key
Initial S/W Revision	Prior to A.02.00

Ref Value (PM)

The reference value specifies the amplitude of a signal displayed on the reference graticule line. The reference line is at the top, center, or bottom of the graticule, depending on the value of the Ref Position function.

Changing the reference value does not restart a measurement, but changes all displayed traces and markers to the new value. If a change to the reference value changes an auto-coupled attenuation value, the measurement restarts.

The Ref Value key applies only to the window with the focus. If the focus is on the Metrics window, the Ref Value key is unavailable.

Key Path	AMPTD Y Scale
Remote Command	:DISPlay:PM:WINDow[1] 2 3:TRACe:Y[:SCALe]:RLEVel <real> :DISPlay:PM:WINDow[1] 2 3:TRACe:Y[:SCALe]:RLEVel?
Example	DISP:PM:WIND:TRAC:Y:RLEV 20 dBm Sets the reference value in window 1 to 20 dBm.
Remote Command Notes	Regardless of the View, the windows are numbered as follows: 1. RF Spectrum 2. Demod Waveform 3. AF Spectrum 4. Metrics
Couplings	The value is constrained within the MAX and MIN values, but is otherwise generally not adjusted. In window 2, this value depends on Y Axis Unit. In window 3, this value depends on Y Axis Unit and Scale Type. If Scale Type is Log, the value will be expressed in decibel units. For example, x radians (degree) will be expressed as y dBrad (dBdeg), where $y = 20 * \log(x)$.
Preset	Demod Waveform Y Axis Unit is "rad": 0 rad Y Axis Unit is "deg": 0 deg AF Spectrum Y Axis Unit is "rad": 6.28 rad Y Axis Unit is "deg": 360 deg
State Saved	Saved in instrument state

Min	RF Spectrum -170 dBm - Ext Gain Demod Waveform Y Axis Unit is "rad": -10 krad Y Axis Unit is "deg": -572957 deg AF Spectrum Y Axis Unit is "rad": 100 urad Y Axis Unit is "deg": 0.006 deg
Max	Demod Waveform Y Axis Unit is "rad": 10 krad Y Axis Unit is "deg": 572957 deg AF Spectrum Y Axis Unit is "rad": 10 krad Y Axis Unit is "deg": 572957 deg
Default Unit	depends on the current view
Initial S/W Revision	Prior to A.02.00
Modified at S/W Revision	A.14.00

Range

Represents the amplitude of the largest sinusoidal signal that could be present within the IF without being clipped by the ADC. For signals with high peak-to-average ratios, the range may need to exceed the rms signal power by a fair amount to avoid clipping.

Key Path	Range
Mode	BASIC
Remote Command	<code>[:SENSe]:POWer[:RF]:RANGe <real></code> <code>[:SENSe]:POWer[:RF]:RANGe?</code>
Example	<code>:POW:RANG 10.0</code> <code>:POW:RANG?</code>
Notes	The MIN and MAX values are affected by the External Gain parameters, and by the Center Frequency. (The hardware compensates for frequency response and alters the Range setting.)
Preset	0
State Saved	Saved in instrument state.
Min	-100
Max	100
Initial S/W Revision	A.12.50

Adjust Range For Min Clip

Sets the combination of attenuation and gain based on the current measured signal level so that clipping will be at a minimum.

This is an "immediate action" function, that is, it executes once, when the key is pressed.

This key is grayed out in measurements that do not support this functionality.

Key Path	AMPTD Y Scale, Attenuation
Remote Command	<code>[:SENSe] :POWer [:RF] :RANGe :OPTimize IMMEDIATE</code>
Initial S/W Revision	Prior to A.02.00
Modified at S/W Revision	A.03.00

Pre-Adjust for Min Clip

If this function is on, it does the adjustment described under Adjust Range For Min Clip each time a measurement restarts. Therefore, in Continuous measurement mode, it only executes before the first measurement.

Key Path	AMPTD Y Scale, Attenuation
Remote Command	<code>[:SENSe] :POWer [:RF] :RANGe :OPTimize :ATTenuation OFF ON ELECTrical COMBined</code> <code>[:SENSe] :POWer [:RF] :RANGe :OPTimize :ATTenuation?</code>
Notes	This parameter is shared with old XA platform which uses AutoAtten. To keep the backward compatibility, ELECTrical and COMBined still can be used. Then, upon receiving ELECTrical and COMBined, these enums will be interpreted as aliases of ON. Then, when queried, ON will be returned.
Preset	OFF for Swept SA measurement; ON for all other measurements that support Pre-Adjust for Min Clip
State Saved	Saved in instrument state
Initial S/W Revision	Prior to A.02.00
Modified at S/W Revision	A.03.00

Peak to Average

The Peak to Average Ratio is used with the Range setting to optimize the level control in the instrument. The value is the ratio, in dB, of the peak power to the average power of the signal to be measured. A ratio of 0 should be used for sinusoidal signals; for 802.11g OFDM signals use 9 dB.

All Applications (Modes) will show the current value of Peak to Average ratio on the softkey. However, some applications will not permit changing the value. In these situations the softkey will be grayed-out.

Key Path	AMPTD Y Scale, Range
Remote Command	<code>[:SENSe] :POWer [:RF] :RANGe :PARatio <real></code> <code>[:SENSe] :POWer [:RF] :RANGe :PARatio?</code>
Example	POW:RANG:PAR 12 dB
Notes	In some Applications (Modes) this parameter will be read-only; meaning the value will appear on the softkey and query via SCPI, but not changeable. In such applications the softkey will be grayed-out. Attempting to change the value via SCPI will be ignored and no error message will be generated.

Preset	10 dB
State Saved	Saved in instrument state
Min	0 dB
Max	20 dB
Initial S/W Revision	A.13.00

Mixer Level Offset

Mixer level offset is an advanced setting to adjust target Range at the input mixer which in turn affects the signal level in the instrument's IF. This setting can be used when additional optimization is needed after setting Peak to Average ratio. Positive values of offset optimize noise performance over distortion, negative values optimize distortion performance over noise.

Key Path	AMPTD Y Scale, Range
Remote Command	<code>[:SENSE] :POWER [:RF] :RANGE :MIXer :OFFSet <real></code> <code>[:SENSE] :POWER [:RF] :RANGE :MIXer :OFFSet?</code>
Example	POW:RANG:MIX:OFFS -5 dB
Preset	0 dB
State Saved	Saved in instrument state
Min	-35 dB
Max	30 dB
Initial S/W Revision	A.13.00

Scale / Div (PM)

Sets the units per vertical graticule division on the display.

The Scale/Div key applies only to the window with the focus. If the focus is on the Metrics window, the Scale/Div key is unavailable.

Key Path	AMPTD Y Scale
Remote Command	<code>:DISPlay:PM:WINDow[1] 2 3 :TRACe:Y [:SCALe] :PDIVision <real></code> <code>:DISPlay:PM:WINDow[1] 2 3 :TRACe:Y [:SCALe] :PDIVision?</code>
Example	DISP:PM:WIND:TRAC:Y:PDIV 5 DB
Remote Command Notes	Regardless of the View, the windows are numbered as follows: 1. RF Spectrum 2. Demod Waveform 3. AF Spectrum 4. Metrics
Preset	RF Spectrum 1 0 dB

	Demod Waveform Y Axis Unit is "rad": 1 rad Y Axis Unit is "deg": 57.296 deg AF Spectrum 10 dB
State Saved	Saved in State
Min	RF Spectrum 0.1 dB Demod Waveform Y Axis Unit is "rad": 1 rad Y Axis Unit is "deg": 0.573 deg AF Spectrum 0.1 dB
Max	RF Spectrum 20 dB Demod Waveform Y Axis Unit is "rad": 1 krad Y Axis Unit is "deg": 57295.780 deg AF Spectrum 20 dB
Initial S/W Revision	Prior to A.02.00
Modified at S/W Revision	A.14.00

Ref Position

Positions the reference value at the top, center, or bottom of the Y Scale display. Changing the reference position does not change the reference value.

The Ref Position key applies only to the window with the focus. If the focus is on the Metrics window, the Ref Position key is unavailable.

Key Path	AMPTD Y Scale
Remote Command	AM/PM/FM Stereo: :DISPlay:AM PM FMSTereo:WINDow[1] 2 3:TRACe:Y[:SCALe]:RPOSition TOP CENTER BOTTom :DISPlay:AM PM FMSTereo:WINDow[1] 2 3:TRACe:Y[:SCALe]:RPOSition? FM: :DISPlay:FM:WINDow[1] 2 ... 5:TRACe:Y[:SCALe]:RPOSition TOP CENTER BOTTom :DISPlay:FM:WINDow[1] 2 ... 5:TRACe:Y[:SCALe]:RPOSition?
Example	DISP:AM:WIND:TRAC:Y:RPOS BOTT
Remote Command Notes	AM/PM/FM Stereo: Regardless of the View, the windows are numbered as follows: 1. RF Spectrum 2. Demod Waveform 3. AF Spectrum 4. Metrics FM: Regardless of the View, the windows are numbered as follows:

	1. RF Spectrum 2. Demod Waveform 3. AF Spectrum 4. RF Envelope (Attack/Release Time view) 5. FM Demod Waveform (Attack/Release Time view) 6. Metrics
Preset	RF Spectrum window: Top Demod Waveform window: Center AF Spectrum window: Top
State Saved	Saved in instrument state
Initial S/W Revision	Prior to A.02.00
Modified at S/W Revision	A.14.00

Auto Couple

The Auto Couple feature provides a quick and convenient way to automatically couple multiple instrument settings. This helps ensure accurate measurements and optimum dynamic range. When the Auto Couple feature is activated, either from the front panel or remotely, all parameters of the current measurement which have an Auto/Manual mode are set to Auto mode and all measurement settings dependent on (or coupled to) the Auto/Man parameters are automatically adjusted for optimal performance.

For Analog Demod, these parameters are:

- RF Res BW
- AF Res BW
- CF Step

Key Path	Front-panel key
Initial S/W Revision	Prior to A.02.00

BW

Opens a menu of keys that enable you to control the bandwidth functions of the application.

Key Path	Front-panel key
Initial S/W Revision	Prior to A.02.00

RF Res BW

Activates the RF Res BW function, which enables you to manually set the resolution bandwidth used in the RF Spectrum window.

Normally, the RF Res BW (Auto) key selects automatic coupling of the resolution bandwidth. To decouple the resolution bandwidth, press the RF Res BW key until Man is underlined, or enter a different value for the resolution bandwidth.

When the resolution bandwidth is manually selected, it may be returned to the coupled state by pressing the RF Res BW key until Auto is underlined. This may also be done by pressing the Auto Couple key or by performing a preset.

Only the Gaussian filter type is used.

Key Path	BW
Remote Command	<pre>[:SENSe] :AM FM PM FMSTereo:BANDwidth[:RESolution] <freq> [:SENSe] :AM FM PM FMSTereo:BANDwidth[:RESolution]? [:SENSe] :AM FM PM:BANDwidth[:RESolution]:AUTO OFF ON 0 1 [:SENSe] :AM FM PM:BANDwidth[:RESolution]:AUTO?</pre>
Example	<pre>AM:BAND 1 KHZ AM:BAND? AM:BAND:AUTO ON AM:BAND:AUTO?</pre>
Notes	Only certain discrete resolution bandwidths are available. For numeric entries, all RBW Types choose the nearest (arithmetically, on a linear scale, rounding up) available RBW to the value entered.
Couplings	<p>AM/FM/PM: In Auto, the 3 dB RBW of the desired filter is the closest possible choice to that given by Span divided by 106 (the Span: 3 dB RBW parameter), except that the range for auto-coupling is restricted to not exceed 3 MHz.</p> <p>FMST: In Auto, RBW is coupled to Span in the following ways: $RBW = Span / 500$ ($Span > 500$ kHz) $RBW = 1$ kHz ($100kHz \leq Span \leq 500$ kHz) $RBW = Span / 100$ ($Span < 100$ kHz)</p>
Preset	<p>AM/FM/PM: Preset is Auto, which results in a 680 Hz value since the preset span is 75 kHz and the Span/RBW ratio is 106</p> <p>FMST: Preset is Auto, which results in a 1 kHz value since the preset span is 500 kHz</p>
State Saved	Saved in Instrument state

Min	1 Hz
Max	8 MHz
Default Unit	Hz
Initial S/W Revision	Prior to A.02.00
Modified at S/W Revision	A.10.00

Channel BW

The Channel BW variable is used to determine the bandwidth used for the demodulation. The flat top filter type must be used for demodulation.

This parameter also controls the RBW hardware setting for the demodulation fed to the speaker.

Key Path	BW
Remote Command	[:SENSe] :AM FM PM FMSTereo:BANDwidth:CHANnel <freq> [:SENSe] :AM FM PM FMSTereo:BANDwidth:CHANnel?
Example	AM:BAND:CHAN 200 kHz
Notes	If the Channel BW is greater than 8 MHz, gives a warning message "Settings Alert; Analog Output Undefined".
Dependencies	The maximum value will be the maximum IF BW available in the instrument. For example, if the instrument has the options B25, B40, and B1X installed, the maximum available IF BW of the instrument is 140 MHz. Thus, the maximum Channel BW is not limited to 25 MHz but is 140 MHz.
Preset	= AM/FM/PM = 25 kHz = FMST = 400 kHz
State Saved	Saved in instrument state
Min	390 Hz
Max	When Option N9063A-AFP is installed, it depends on hardware: No Option = 10 MHz Option B25 = 25 MHz Option B40 = 40 MHz Option B85 = 85.0 MHz Option B1A = 125.0 MHz Option B1X = 140 MHz Option B1Y = 160 MHz
Default Unit	Hz
Initial S/W Revision	Prior to A.02.00
Modified at S/W Revision	A.10.00

AF Res BW

In the AF Spectrum window, the AF Res BW key is used to set the Resolution bandwidth of the FFT of the demodulated waveform.

The data acquisition uses the Channel BW value for hardware control during data acquisition, just as it does in the Demod Waveform window.

AF Res BW (Auto) selects automatic coupling of the AF Res BW to the AF Span (defined as AF Stop Freq – AF Start Freq) using the same factor of 106 used by the RF Res BW. To decouple the resolution bandwidth, press the AF Res BW key until Man is underlined, or enter a different value for the AF resolution bandwidth.

When the AF resolution bandwidth is manually selected, it may be returned to the coupled state by pressing the AF Res BW key until Auto is underlined. This may also be done by pressing the Auto Couple key or by performing a Preset.

Only the Gaussian filter type is used.

Key Path	BW
Remote Command	<pre>[:SENSe] :AM FM PM} FMSTereo:AFSPepectrum:BA NDwidth <freq> [:SENSe] :AM FM PM FMSTereo:AFSPepectrum:BA NDwidth? [:SENSe] :AM FM PM FMSTereo:AFSPepectrum:BA NDwidth:AUTO OFF ON 0 1 [:SENSe] :AM FM PM FMSTereo:AFSPepectrum:BA NDwidth:AUTO?</pre>
Example	<pre>AM:AFSP:BA ND 1 KHZ AM:AFSP:BA ND?</pre>
Notes	Only certain discrete resolution bandwidths are available. For numeric entries, all RBW Types choose the nearest (arithmetically, on a linear scale, rounding up) available RBW to the value entered.
Notes	For numeric entries, all RBW Types choose the nearest (arithmetically, on a linear scale, rounding up) available RBW to the value entered.
Remote Command Notes	The setting and querying of values depends on the current bandwidth type.
Couplings	In Auto, the 3 dB RBW of the desired filter is the closest possible choice to that given by Span divided by 106 (the Span: 3 dB RBW parameter), except that the range for auto-coupling is restricted to not exceed 3 MHz.
Preset	Preset is Auto, which results in a 180 Hz value since the preset span is 20 kHz and the Span/RBW ratio is 106
State Saved	Saved in Instrument State
Min	1 Hz
Max	8 MHz
Default Unit	Hz
Initial S/W Revision	Prior to A.02.00
Modified at S/W Revision	A.10.00

Cont (Continuous Measurement/Sweep)

Sets the analyzer for Continuous measurement operation. The single/continuous state is Meas Global so the setting will affect all measurements. If you are Paused, pressing Cont does a Resume.

Key Path	Front-panel key
Remote Command	:INITiate:CONTinuous OFF ON 0 1 :INITiate:CONTinuous?
Example	:INIT:CONT 0 puts analyzer in Single measurement operation. :INIT:CONT 1 puts analyzer in Continuous measurement operation
Preset	ON (Note that SYST:PRESet sets INIT:CONT to ON but *RST sets INIT:CONT to OFF)
State Saved	Saved in instrument state
Backwards Compatibility Notes	For Spectrum Analysis mode in ESA and PSA, there is no Cont hardkey, instead there is a Sweep Single/Cont key. In these analyzers, switching the Sweep Single/Cont key from Single to Cont restarts averages (displayed average count reset to 1), but does not restart Max Hold and Min Hold. The X-Series has Single and Cont keys in place of the SweepSingleCont key. In the X-Series, if in single measurement, the Cont key (and INIT:CONT ON) switches to continuous measurement, but never restarts a measurement and never resets a sweep.
Initial S/W Revision	Prior to A.02.00

In Swept SA Measurement (Spectrum Analysis Mode):

The analyzer takes repetitive sweeps, averages, measurements, etc., when in Continuous mode. When the average count reaches the Average/Hold Number the count stops incrementing, but the analyzer keeps sweeping. See the Trace/Detector section for the averaging formula used both before and after the Average/Hold Number is reached. The trigger condition must be met prior to each sweep. The type of trace processing for multiple sweeps, is set under the Trace/Detector key, with choices of Trace Average, Max Hold, or Min Hold.

In Other Measurements/Modes:

With Avg/Hold Num (in the Meas Setup menu) set to Off or set to On with a value of 1, a sweep is taken after the trigger condition is met; and the analyzer continues to take new sweeps after the current sweep has completed and the trigger condition is again met. However, with Avg/Hold Num set to On with a value >1, multiple sweeps (data acquisitions) are taken for the measurement. The trigger condition must be met prior to each sweep. The sweep is not stopped when the average count k equals the number N set for Avg/Hold Num is reached, but the number k stops incrementing. A measurement average usually applies to all traces, marker results, and numeric results. But sometimes it only applies to the numeric results.

If the analyzer is in Single measurement, pressing the Cont key does not change k and does not cause the sweep to be reset; the only action is to put the analyzer into Continuous measurement operation.

If it is already in continuous sweep:

the INIT:CONT 1 command has no effect

10 Φ M Demod Measurement
Cont (Continuous Measurement/Sweep)

the INIT:CONT 0 command will place the analyzer in Single Sweep but will have no effect on the current sequence until $k = N$, at which point the current sequence will stop and the instrument will go to the idle state.

File

See "File" on page 176

FREQ Channel

Accesses a menu of keys that enable you to control the Frequency parameters of the instrument.

Key Path	Front-panel key
Initial S/W Revision	Prior to A.02.00

Center Frequency

Sets the frequency that corresponds to the horizontal center of the RF Spectrum window. While adjusting the Center Frequency the Span is held constant, this means that both the start frequency and the stop frequency will change.

The Center Frequency is retained as you go from measurement to measurement.

Key Path	FREQ Channel
Remote Command	<code>[:SENSe] :FREQuency:CENTer <freq></code> <code>[:SENSe] :FREQuency:CENTer?</code>
Example	FREQ:CENT 50MHz FREQ:CENT UP changes the center frequency to 150 MHz if you use FREQ:CENT:STEP 100MHz sets the center frequency step size to 100 MHz FREQ:CENT?
Dependencies	The Center Frequency can be limited by Start or Stop Freq limits, In addition, the Center Frequency can be limited if the Span is so large that Start or Stop hit their limit.
Couplings	When operating in “swept span”, any value of the Center Frequency or Span that is within the frequency range of the analyzer is allowed when the value is being set through the front panel numeric key pad or the SCPI command. The other parameter is forced to a different value if needed, to keep the Start and the Stop Frequencies within the analyzer frequency range
Preset	1.000 GHz
State Saved	Saved in instrument state
Min	Depends on instrument minimum frequency and the 10 Hz minimum span. If the knob or step keys are being used, it depends on the value of the other three interdependent parameters.
Max	Depends on the instrument’s maximum frequency and the 10 Hz minimum span. If the knob or step keys are being used, it depends on the value of the other three interdependent parameters.
Default Unit	Hz
Status Bits/OPC dependencies	Non-overlapped
Initial S/W Revision	Prior to A.02.00

CF Step

Changes the step size for the center frequency function. Once a step size has been selected and the center frequency function is active, the step keys (and the UP|DOWN parameters for the Center Frequency from remote commands) change the center frequency by the step-size value. The step size function is useful for finding harmonics and sidebands beyond the current frequency span of the analyzer.

Key Path	FREQ Channel
Remote Command	<pre>[:SENSe] :FREQuency:CENTer:STEP [:INCRement] <freq> [:SENSe] :FREQuency:CENTer:STEP [:INCRement] ? [:SENSe] :FREQuency:CENTer:STEP:AUTO OFF ON 0 1 [:SENSe] :FREQuency:CENTer:STEP:AUTO?</pre>
Example	<pre>FREQ:CENT:STEP:AUTO ON FREQ:CENT:STEP 500MHz FREQ:CENT UP increases the current center frequency value by 500 MHz FREQ:CENT:STEP? FREQ:CENT:STEP:AUTO?</pre>
Remote Command Notes	Preset and Max values are dependent on Hardware Options (503, 508, 513, 526)
Dependencies	Span, RBW, Center frequency
Couplings	When auto-coupled in a non-zero span, the center frequency step size is set to 10% of the span. When auto-coupled in zero span, the center frequency step size is set to the equivalent -3 dB RBW value.
Preset	Auto
State Saved	Saved in State
Min	– (the maximum frequency of the instrument). For example, a 27 GHz max frequency instrument has a CF step range of +/- 27 GHz.
Max	The maximum frequency of the instrument. For example, 27 GHz max freq instrument has a CF step range of +/- 27 GHz.
Default Unit	Hz
Status Bits/OPC dependencies	Non-overlapped
Initial S/W Revision	Prior to A.02.00

AF Start Freq

Sets the frequency at the left side of the graticule in the AF Spectrum window. While adjusting the AF start frequency the AF stop frequency is held constant.

The AF Start Frequency is retained as you go from measurement to measurement.

Key Path	FREQ Channel
Remote Command	<pre>[:SENSe] :AM FM PM FMSTereo:AFSPectrum:FREQuency:START <freq> [:SENSe] :AM FM PM FMSTereo:AFSPectrum:FREQuency:START?</pre>

Example	AM:AFSP:FREQ:STAR 0 Hz
Dependencies	You cannot set the Start frequency > the Stop frequency. You cannot set the Start frequency = Stop frequency. You cannot set the Start Frequency to a value that would create a span of less than 10 Hz. If you try to do any of these, Stop Frequency will change to maintain a minimum value of 10 Hz for the difference between Start and Stop.
Preset	0 Hz
State Saved	Saved in instrument state
Min	0 Hz
Max	99.999990 MHz
Default Unit	Hz
Status Bits/OPC dependencies	Non-overlapped
Initial S/W Revision	Prior to A.02.00
Modified at S/W Revision	A.10.00

AF Stop Freq

Sets the frequency at the right side of the graticule in the AF Spectrum window. While adjusting the AF Stop Frequency the AF Start Frequency is held constant.

Key Path	FREQ Channel
Remote Command	[:SENSe] :AM FM PM FMSTereo:AFSPectrum:FREQuency:STOP <freq> [:SENSe] :AM FM PM FMSTereo:AFSPectrum:FREQuency:STOP?
Example	AM:AFSP:FREQ:STOP 20 kHz
Dependencies	You cannot set the Stop frequency < the Start frequency. You cannot set the Start frequency = Stop frequency. You cannot set the Stop Frequency to a value that would create a span of less than 10 Hz. If you try to do any of these, the Start Frequency will change to maintain a minimum value of 10 Hz for the difference between Start and Stop.
Preset	20 kHz
State Saved	Saved in instrument state
Min	10 Hz
Max	100 MHz
Default Unit	Hz
Status Bits/OPC dependencies	Non-overlapped
Initial S/W Revision	Prior to A.02.00
Modified at S/W Revision	A.10.00

Input/Output

See "Input/Output" on page 130

Marker

Accesses the Marker menu. A marker can be placed on a trace to allow the value of the trace at the marker point to be determined precisely. The functions in this menu include a 1-of-N selection of the control mode Normal, Delta, Fixed, or Off for the selected marker.

If the selected marker is Off, pressing the Marker key sets it to the selected window. If the metrics window is selected, the marker will appear in the first visible window (RF Spectrum if Quad View is selected).

The units of Delta Marker are window dependent. In the Spectrum windows they are dB, in the Demod Waveform window they are the same as the Y-Axis Unit. In this window, the delta marker is a linear difference rather than a ratio. For example, in FM, in the Demod Waveform window, the units of delta marker are Hz.

Control Mode

Key Path	Front-panel key
Remote Command	:CALCulate:AM FM PM FMSTereo:MARKer[1] 2 ... 12:MODE POSition DELTA FIXed OFF :CALCulate:AM FM PM FMSTereo:MARKer[1] 2 ... 12:MODE?
Example	CALC:AM:MARK:MODE POS turns on marker 1 in Normal mode
Remote Command Notes	This command (not the query) causes the specified marker to become selected.
Preset	OFF (all markers)
Initial S/W Revision	Prior to A.02.00
Modified at S/W Revision	A.10.00

Select Marker

Displays a menu with 12 markers available for selection for the current measurement.

Key Path	Marker
Notes	The selected marker is remembered even when not in the Marker menu and is used if a Search is initiated.
Preset	Marker 1
State Saved	The number of the selected marker is saved in instrument state.
Initial S/W Revision	Prior to A.02.00

Normal

Sets the control mode for the selected marker to Normal and turns on the active function for setting its value. If the selected marker was off, it is placed at the center of the screen on the trace specified by the marker's Trace attribute.

A Normal mode (POSition type) marker can be moved to any point on the X Axis by specifying its X Axis value. Its absolute Y Axis value is then the value of the trace point at that X Axis value.

Key Path	Marker
Example	: CALC: MARK: MODE POS sets Marker 1 to Normal.
Remote Command Notes	See the description under the "Marker" on page 1101 key.
Couplings	The marker addressed by this command becomes the selected marker on the front panel.
State Saved	The marker control mode (Normal, Delta, Fixed, Off) and X Axis value are saved in instrument state.
Initial S/W Revision	Prior to A.02.00

Delta

Sets the control mode for the selected marker to Delta and turns on the active function for setting its delta value. If the selected marker is off, the marker is placed at the center of the screen on the trace specified by the marker's Trace attribute.

In Delta mode the marker result shows the relative result between the selected (Delta) marker and its reference marker. A delta marker can be moved to any point on the X Axis by specifying its X Axis offset from a reference marker. Its absolute Y Axis value is then the value of the trace point at that X Axis value.

Key Path	Marker
Example	:CALC:MARK:MODE DELT sets marker 1 to Delta.
Remote Command Notes	See the description under the "Marker" on page 1101 key.
Couplings	Coupled to fix absolute X when turned On.
State Saved	The marker control mode (Normal, Delta, Fixed, Off) and X Axis value are saved in instrument state.
Initial S/W Revision	Prior to A.02.00

Fixed

Sets the control mode for the selected marker to Fixed. A fixed marker is fixed in the sense that it stays where you place it. It can be directly moved in both X and Y. It can be moved with a Peak Search. It can also be indirectly moved by re-zeroing the delta if it is a relative marker. If it is moved, it again becomes fixed at the X Axis point it moved to and it has a Y-axis result that it took on when it moved there. If a Normal or Delta marker is changed to Fixed it becomes fixed at the X Axis point it was at, and with the Y-axis result it had when it was set to Fixed.

Key Path	Marker
Initial S/W Revision	Prior to A.02.00

Marker X

Sets and queries a marker's X value.

Key Path	Marker, Fixed
----------	---------------

Remote Command	:CALCulate:AM FM PM FMSTereo:MARKer[1] 2 ... 12:X <time> <freq> :CALCulate:AM FM PM FMSTereo:MARKer[1] 2 ... 12:X?
Remote Command Notes	The query is returned in the fundamental units for the current marker X Axis scale. This command (not the query) causes the specified marker to become selected.
Preset	After a preset, all Markers are turned off, so a Marker X Axis Value query will return not a number (9.91 e37). When a Marker is on, the default value of the Marker X value is the center of the appropriate window.
Min	-9.9E+37
Max	9.9E+37
Initial S/W Revision	Prior to A.02.00
Modified at S/W Revision	A.10.00

Marker Y

Sets and queries a marker's Y axis value.

Key Path	Marker, Fixed
Remote Command	:CALCulate:AM FM PM FMSTereo:MARKer[1] 2 ... 12:Y <real> :CALCulate:AM FM PM FMSTereo:MARKer[1] 2 ... 12:Y?
Remote Command Notes	The query is returned in the fundamental units for the current marker Y Axis scale. This command (not the query) causes the specified marker to become selected.
Preset	Defaults to the measurement result at the default X value, or not a number (9.91 e37) if off or if off screen is Fixed.
Min	-9.9E+37
Max	9.9E+37
Initial S/W Revision	Prior to A.02.00
Modified at S/W Revision	A.10.00

Off

Turns off the selected marker. Turning the marker off does not affect which marker is selected.

Key Path	Marker
Example	:CALC: MARK: MODE OFF sets Marker 1 to Off.
Remote Command Notes	See the description under the " Marker " on page 1101 key.
State Saved	The marker control mode (Normal, Delta, Fixed, Off) is saved in instrument state.
Initial S/W Revision	Prior to A.02.00

Properties

Accesses a menu used to assign properties to the selected marker.

Key Path	Marker
Initial S/W Revision	Prior to A.02.00

Select Marker

Displays a menu with 12 markers available for selection for the current measurement.

Key Path	Marker, Properties
Notes	The selected marker is remembered even when not in the Marker menu and is used if a Search is initiated.
Preset	Marker 1
State Saved	The number of the selected marker is saved in instrument state.
Initial S/W Revision	Prior to A.02.00

Relative To

Selects the reference marker for a marker in Delta mode.

If a delta marker has a reference marker in a different window, the delta marker's mode changes to POS (for example, it becomes a normal marker).

Key Path	Marker, Properties
Remote Command	:CALCulate:AM FM PM FMSTereo:MARKer[1] 2 ... 12:REFerence <int> :CALCulate:AM FM PM FMSTereo:MARKer[1] 2 ... 12:REFerence?
Example	CALC:AM:MARK1:REF 2 Sets marker 1's reference marker to 2 and turns marker 1 on as a delta marker.
Remote Command Notes	This command (not the query) causes the specified marker to become selected.
Preset	By default, marker X is relative to marker X + 1 except for marker 12, which is relative to marker 1.
Min	1
Max	12
Initial S/W Revision	Prior to A.02.00
Modified at S/W Revision	A.10.00

AM/FM/ Φ M Marker Trace

Selects the trace on which to place the marker. A marker is associated with one and only one trace. This trace is used to determine the placement, result, and X Axis Scale of the marker. All markers have an

associated trace, even Fixed markers. It is from that trace that they determine their attributes and behaviors, and it is to that trace that they go when they become Normal or Delta markers.

In the AM/ Φ M measurements, there are five named traces, and in the FM measurement, there are seven named traces. The RF Spectrum trace is the trace in the RF Spectrum window, and the AF Spectrum trace is the trace in the AF Spectrum window. There are four traces in the Demod Waveform window: Demod, Demod Avg, Demod Max, and Demod Min. The RF Envelope trace and the Demod Raw trace are from Attack/Release Time view which is only available in the FM measurement. The RF Envelope trace is in the RF Envelope window and the Demod Raw trace is in the FM Demod Waveform window. When Auto Init is on, the marker's trace attribute is re-determined automatically by the analyzer whenever the marker turns on (Normal, Delta, or Fixed) from an off state. The marker goes to the trace in the window that has the focus, or onto the RF spectrum window if the Metrics window has the focus. If in the Demod Waveform window, it goes to the Demod trace.

This command associates the marker with the specified trace. Setting the Marker Trace directly (whether the marker is on or off) will turn off Auto Init.

If the marker is not off, it moves the marker from the trace it was on to the new trace. If the new trace is in the same window, the marker goes to the same data point on the new trace. If the marker changes windows, it retains its relative horizontal positions in the new window. If it is a fixed marker, it will retain both relative horizontal and vertical position.

If the marker is off it stays off, but is now associated with the specified trace.

The query returns the name of the trace on which the marker is currently placed.

Key Path	Marker, Properties
Remote Command	:CALCulate:AM FM PM:MARKer[1] 2 ... 12:TRACe RFSpectrum AFSPpectrum DEMod DAVerage DMAXimum DMINimum RFENvelope DRAW :CALCulate:AM FM PM:MARKer[1] 2 ... 12:TRACe?
Example	:CALC:AM:MARK1:TRAC DEM places marker 1 on the Demod trace
Couplings	This is not affected by Auto Coupling. Sending the remote command causes the addressed marker to become selected. If ever a delta marker has a reference marker in a different window, the delta marker's mode changes to POS (for example, it becomes a normal marker). When Marker Trace Auto Init State is on, the marker trace will automatically be set whenever the marker is turned on.
Preset	RF Spectrum on a Preset or All Markers Off
State Saved	The Marker Trace for each marker is saved in instrument state.
Readback line	[Trace name, Auto Init] or [Trace Name, Manual]
Initial S/W Revision	Prior to A.02.00

RF Spectrum

Selects the input RF signal in the RF Spectrum window as the trace on which you want to place your marker. This trace is used to determine the placement, result, and X Axis Scale of the marker.

Key Path	Marker, Properties, Marker Trace
Example	:CALC:AM:MARK1:TRAC RFSP
Initial S/W Revision	Prior to A.02.00

Demod

Selects the current demodulated signal in the Demod Waveform window, shown in yellow, as the trace on which you want to place your marker. This trace is used to determine the placement, result, and X Axis Scale of the marker.

Key Path	Marker, Properties, Marker Trace
Example	:CALC:AM:MARK1:TRAC DEM
Initial S/W Revision	Prior to A.02.00

Demod Average

Selects the averaged demodulation signal in the Demod Waveform window, shown in green, as the trace on which you want to place your marker. This trace is used to determine the placement, result, and X Axis Scale of the marker.

Key Path	Marker, Properties, Marker Trace
Example	:CALC:AM:MARK1:TRAC DAV
Initial S/W Revision	Prior to A.02.00

Demod Max

Selects the Demod Max trace in the Demod Waveform window, shown in cyan, as the trace on which you want to place your marker. This trace shows the maximum hold value for each data point since the last restart.

Key Path	Marker, Properties, Marker Trace
Example	:CALC:AM:MARK1:TRAC DMAX
Initial S/W Revision	Prior to A.02.00

Demod Min

Selects the Demod Min trace in the Demod Waveform window, shown in magenta, as the trace on which you want to place your marker. This trace shows the minimum hold value for each data point since the last restart.

Key Path	Marker, Properties, Marker Trace
Example	:CALC:AM:MARK1:TRAC DMIN
Initial S/W Revision	Prior to A.02.00

AF Spectrum

Selects the demodulated signal in the AF Spectrum window as the trace on which you want to place your marker.

Key Path	Marker, Properties, Marker Trace
Example	:CALC:AM:MARK1:TRAC AFSP
Initial S/W Revision	Prior to A.02.00

Trace Auto Init

Selects whether the marker trace is automatically reset to the selected window when the marker is turned on or not.

Key Path	Marker, Properties, Trace
Remote Command	:CALCulate:AM FM PM FMSTereo:MARKer [1] 2 ... 12:TRACe:AUTO OFF ON 0 1 :CALCulate:AM FM PM FMSTereo:MARKer [1] 2 ... 12:TRACe:AUTO?
Example	:CALC:AM:MARK1:TRAC:AUTO 0 turns off auto-initialization of marker trace.
Preset	On
State Saved	Saved in instrument state.
Readback line	Trace name
Initial S/W Revision	Prior to A.02.00
Modified at S/W Revision	A.10.00

Lines

When on, displays a vertical line of graticule height and a horizontal line of graticule width, intersecting at the indicator point of the marker (that is, the center of the X or the bottom tip of the diamond). The lines are blue in color.

If the marker is off screen, the lines should be extended from the marker so that they go through the screen area if possible. This is really useful for off screen Fixed markers as it lets you see their amplitude even though they are off the X Axis.

Key Path	Marker, Properties
Remote Command	:CALCulate:AM FM PM FMSTereo:MARKer [1] 2 ... 12:LINEs[:STATe] OFF ON

	0 1
	:CALCulate:AM FM PM FMSTereo:MARKer[1] 2 ... 12:LINes[:STATe]?
Example	CALC:AM:MARK2:LIN ON turns Lines on for marker 2.
Couplings	Sending the remote command causes the addressed marker to become selected.
Preset	OFF
State Saved	Saved in instrument state
Initial S/W Revision	Prior to A.02.00
Modified at S/W Revision	A.10.00

All Markers Off

Turns off all markers.

Key Path	Marker
Remote Command	:CALCulate:AM FM PM FMSTereo:MARKer:AOff
Example	CALC:AM:MARK:AOff turns off all markers for the AM measurement
Couplings	Sets the selected marker to 1.
Initial S/W Revision	Prior to A.02.00
Modified at S/W Revision	A.10.00

Marker Function

There are no menus or marker functions under this key in the Analog Demod mode.

Key Path	Front-panel key
Initial S/W Revision	Prior to A.02.00

Marker To

Accesses a menu that contains only the marker center frequency key.

Key Path	Front-panel key
Initial S/W Revision	Prior to A.02.00

Mkr->CF

Sets the center frequency of the RF Spectrum window to the frequency of the selected marker. The marker stays at this frequency, so it moves to the center of the display.

In delta marker mode, this function sets the center frequency to the x-axis value of the delta marker.

Key Path	Marker ->
Remote Command	:CALCulate:AM FM PM FMSTereo:MARKer[1] 2 ... 12[:SET]:CENTer
Example	CALC:AM:MARK2:CENT sets the CF of the analyzer to the value of marker 2.
Remote Command Notes	Sending this command selects the sub-op coded marker. If the currently selected marker is not on when this key is pressed, it will be turned on at the center of the RF Spectrum trace as a normal type marker.
Dependencies	This function is unavailable (key is grayed out) unless the selected marker's trace is off, or on the RF Spectrum trace.
Couplings	All the usual couplings associated with setting Center Frequency apply (see " Center Frequency " on page 1097).
Initial S/W Revision	Prior to A.02.00
Modified at S/W Revision	A.10.00

Meas

The information in this section is common to all measurements. For key and remote command information for a specific measurement, refer to the section that describes the measurement of interest.

Measurements available under the Meas key are specific to the current Mode.

When viewing Help for measurements, note the following:

NOTE

Operation for some keys differs between measurements. The information displayed in Help pertains to the current measurement. To see how a key operates in a different measurement, exit Help (press the Cancel Esc key), select the measurement, then reenter Help (press the Help key) and press that key.

Key Path	Front-panel key
Initial S/W Revision	Prior to A.02.00

Remote Measurement Functions

This section contains the following topics:

["Measurement Group of Commands" on page 1122](#)

["Current Measurement Query \(Remote Command Only\)" on page 1124](#)

["Limit Test Current Results \(Remote Command Only\)" on page 1124](#)

["Data Query \(Remote Command Only\)" on page 1124](#)

["Calculate/Compress Trace Data Query \(Remote Command Only\)" on page 1125](#)

["Calculate Peaks of Trace Data \(Remote Command Only\)" on page 1130](#)

["Hardware-Accelerated Fast Power Measurement \(Remote Command Only\)" on page 1131](#)

["Format Data: Numeric Data \(Remote Command Only\)" on page 1145](#)

["Format Data: Byte Order \(Remote Command Only\)" on page 1146](#)

Initial S/W Revision	Prior to A.02.00
----------------------	------------------

Measurement Group of Commands

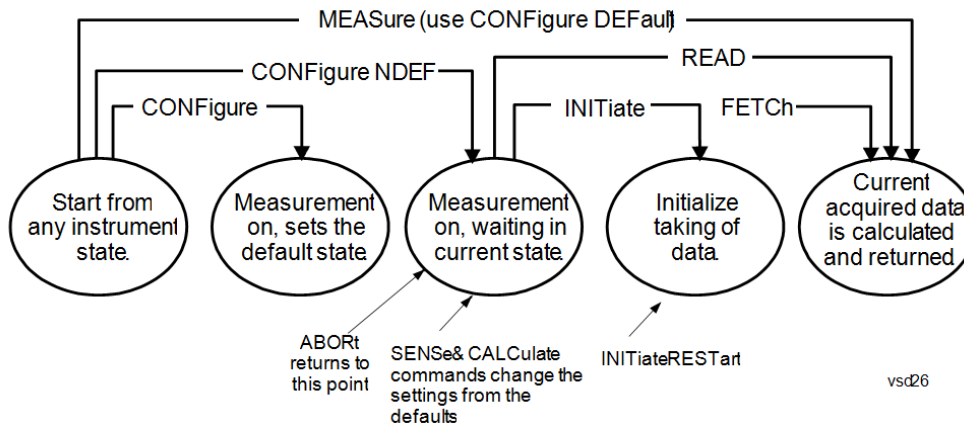

Measure Commands:

:MEASure:<measurement>[n]?

This is a fast single-command way to make a measurement using the factory default instrument settings. These are the settings and units that conform to the Mode Setup settings (e.g. radio standard) that you have currently selected.

- Stops the current measurement (if any) and sets up the instrument for the specified measurement using the factory defaults
- Initiates the data acquisition for the measurement
- Blocks other SCPI communication, waiting until the measurement is complete before returning results.
- If the function does averaging, it is turned on and the number of averages is set to 10.
- After the data is valid it returns the scalar results, or the trace data, for the specified measurement. The type of data returned may be defined by an [n] value that is sent with the command.
- The scalar measurement results will be returned if the optional [n] value is not included, or is set to 1. If the [n] value is set to a value other than 1, the selected trace data results will be returned. See each command for details of what types of scalar results or trace data results are available.
- ASCII is the default format for the data output. (Older versions of Spectrum Analysis and Phase Noise mode measurements only use ASCII.) The binary data formats should be used for handling large blocks of data since they are smaller and faster than the ASCII format. Refer to the FORMat:DATA command for more information.

If you need to change some of the measurement parameters from the factory default settings you can set up the measurement with the CONFIgure command. Use the commands in the SENSe:<measurement> and CALCulate:<measurement> subsystems to change the settings. Then you can use the READ? command to initiate the measurement and query the results.

If you need to repeatedly make a given measurement with settings other than the factory defaults, you can use the commands in the SENSe:<measurement> and CALCulate:<measurement> subsystems to set up the measurement. Then use the READ? command to initiate the measurement and query results.

Measurement settings persist if you initiate a different measurement and then return to a previous one. Use READ:<measurement>? if you want to use those persistent settings. If you want to go back to the default settings, use MEASure:<measurement>?.

Configure Commands:

:CONFIgure:<measurement>

This command stops the current measurement (if any) and sets up the instrument for the specified measurement using

the factory default instrument settings. It does not initiate the taking of measurement data unless INIT:CONTinuous is ON. If you change any measurement settings after using the CONFigure command, the READ command can be used to initiate a measurement without changing the settings back to their defaults.

In the Swept SA measurement in Spectrum Analyzer mode the CONFigure command also turns the averaging function on and sets the number of averages to 10 for all measurements.

:CONFigure: <measurement>: NDEFault stops the current measurement and changes to the specified measurement. It does not change the settings to the defaults. It does not initiate the taking of measurement data unless INIT:CONTinuous is ON.

The CONFigure? query returns the current measurement name.

The CONFigure:CATalog? query returns a quoted string of all licensed measurement names in the current mode. For example, "SAN, CHP, OBW, ACP, PST, TXP, SPUR, SEM, LIST".

Fetch Commands:

:FETCh:<measurement>[n]?

This command puts selected data from the most recent measurement into the output buffer. Use FETCh if you have already made a good measurement and you want to return several types of data (different [n] values, for example, both scalars and trace data) from a single measurement. FETCh saves you the time of re-making the measurement. You can only FETCh results from the measurement that is currently active, it will not change to a different measurement. An error message is reported if a measurement other than the current one is specified.

If you need to get new measurement data, use the READ command, which is equivalent to an INITiate followed by a FETCh.

The scalar measurement results will be returned if the optional [n] value is not included, or is set to 1. If the [n] value is set to a value other than 1, the selected trace data results will be returned. See each command for details of what types of scalar results or trace data results are available. The binary data formats should be used for handling large blocks of data since they are smaller and transfer faster than the ASCII format. (FORMat:DATA)

FETCh may be used to return results other than those specified with the original READ or MEASure command that you sent.

INITiate Commands:

:INITiate:<measurement>

This command is not available for measurements in all the instrument modes:

- Initiates a trigger cycle for the specified measurement, but does not output any data. You must then use the FETCh<meas> command to return data. If a measurement other than the current one is specified, the instrument will switch to that measurement and then initiate it.
 - For example, suppose you have previously initiated the ACP measurement, but now you are running the channel power measurement. If you send INIT:ACP? it will change from channel power to ACP and will initiate an ACP measurement.
 - Does not change any of the measurement settings. For example, if you have previously started the ACP measurement and you send INIT:ACP? it will initiate a new ACP measurement using the same instrument settings as the last time ACP was run.
 - If your selected measurement is currently active (in the idle state) it triggers the measurement, assuming the trigger conditions are met. Then it completes one trigger cycle. Depending upon the measurement and the number of averages, there may be multiple data acquisitions, with multiple trigger events, for one full trigger cycle. It also holds off additional commands on GPIB until the acquisition is complete.
-

READ Commands:

:READ:<measurement>[n]?

- Does not preset the measurement to the factory default settings. For example, if you have previously initiated the ACP
-

measurement and you send READ:ACP? it will initiate a new measurement using the same instrument settings.

- Initiates the measurement and puts valid data into the output buffer. If a measurement other than the current one is specified, the instrument will switch to that measurement before it initiates the measurement and returns results.
 - For example, suppose you have previously initiated the ACP measurement, but now you are running the channel power measurement. Then you send READ:ACP? It will change from channel power back to ACP and, using the previous ACP settings, will initiate the measurement and return results.
 - Blocks other SCPI communication, waiting until the measurement is complete before returning the results
 - If the optional [n] value is not included, or is set to 1, the scalar measurement results will be returned. If the [n] value is set to a value other than 1, the selected trace data results will be returned. See each command for details of what types of scalar results or trace data results are available. The binary data formats should be used when handling large blocks of data since they are smaller and faster than the ASCII format. (FORMat:DATA)
-

Initial S/W Revision	Prior to A.02.00
----------------------	------------------

Current Measurement Query (Remote Command Only)

This command returns the name of the measurement that is currently running.

Remote Command	:CONFigure?
-----------------------	-------------

Example	CONF?
----------------	-------

Initial S/W Revision	Prior to A.02.00
----------------------	------------------

Limit Test Current Results (Remote Command Only)

Queries the status of the current measurement limit testing. It returns a 0 if the measured results pass when compared with the current limits. It returns a 1 if the measured results fail any limit tests.

Remote Command	:CALCulate:CLIMits:FAIL?
-----------------------	--------------------------

Example	CALC:CLIM:FAIL? queries the current measurement to see if it fails the defined limits. Returns a 0 or 1: 0 it passes, 1 it fails.
----------------	--

Initial S/W Revision	Prior to A.02.00
----------------------	------------------

Data Query (Remote Command Only)

Returns the designated measurement data for the currently selected measurement and subopcode.

n = any valid subopcode for the current measurement. See the measurement command results table for your current measurement, for information about what data is returned for the subopcodes.

This command uses the data setting specified by the FORMat:BORDER and FORMat:DATA commands and can return real or ASCII data. (See the format command descriptions under Input/Output in the Analyzer Setup section.)

Remote Command	:CALCulate:DATA[n]?
Notes	The return trace depends on the measurement. In CALCulate:<meas>:DATA[n], n is any valid subopcode for the current measurement. It returns the same data as the FETCH:<measurement>? query where <measurement> is the current measurement.
Initial S/W Revision	Prior to A.02.00

Calculate/Compress Trace Data Query (Remote Command Only)

Returns compressed data for the currently selected measurement and sub-opcode [n].

n = any valid sub-opcode for that measurement. See the MEASure:<measurement>? command description of your specific measurement for information on the data that can be returned.

The data is returned in the current Y Axis Unit of the analyzer. The command is used with a sub-opcode <n> (default=1) to specify the trace. With trace queries, it is best if the analyzer is not sweeping during the query. Therefore, it is generally advisable to be in Single Sweep, or Update=Off.

This command is used to compress or decimate a long trace to extract and return only the desired data. A typical example would be to acquire N frames of GSM data and return the mean power of the first burst in each frame. The command can also be used to identify the best curve fit for the data.

Remote Command	:CALCulate:DATA<n>:COMPRESS? BLOCK CFIT MAXimum MINimum MEAN DMEan RMS RMSCubed SAMPLE SDEViation PPHase [,<soffset> [,<length>[,<roffset>[,<rlimit>]]]]
Example	To query the mean power of a set of GSM bursts: Supply a signal that is a set of GSM bursts. Select the IQ Waveform measurement (in IQ Analyzer Mode). Set the sweep time to acquire at least one burst. Set the triggers such that acquisition happens at a known position relative to a burst. Then query the mean burst levels using, CALC:DATA2:COMP? MEAN, 24e-6, 526e-6 (These parameter values correspond to GSM signals, where 526e-6 is the length of the burst in the slot and you just want 1 burst.)
Notes	The command supports 5 parameters. Note that the last 4 (<soffset>, <length>, <roffset>, <rlimit>) are optional. But these optional parameters must be entered in the specified order. For example, if you want to specify <length>, then you must also specify <soffset>. See details below for a definition of each of these parameters. This command uses the data in the format specified by FORMat:DATA, returning either binary or ASCII data.
Initial S/W Revision	Prior to A.02.00

- BLOCK or block data - returns all the data points from the region of the trace data that you specify. For example, it could be used to return the data points of an input signal over several timeslots, excluding the portions of the trace data that you do not want. (This is x,y pairs for trace data and I,Q pairs for complex data.)

- CFIT or curve fit - applies curve fitting routines to the data. <soffset> and <length> are required to define the data that you want. <roffset> is an optional parameter for the desired order of the curve equation. The query will return the following values: the x-offset (in seconds) and the curve coefficients ((order + 1) values).

MIN, MAX, MEAN, DME, RMS, RMSC, SAMP, SDEV and PPH return one data value for each specified region (or <length>) of trace data, for as many regions as possible until you run out of trace data (using <roffset> to specify regions). Or they return the number of regions you specify (using <rlimit>) ignoring any data beyond that.

- MINimum - returns the minimum data point (y value) for the specified region(s) of trace data. For I/Q trace data, the minimum magnitude of the I/Q pairs is returned.
- MAXimum - returns the maximum data point (y value) for the specified region(s) of trace data. For I/Q trace data, the maximum magnitude of the I/Q pairs is returned.
- MEAN - returns a single value that is the arithmetic mean of the data point values (in dB/ dBm) for the specified region(s) of trace data. For I/Q trace data, the mean of the magnitudes of the I/Q pairs is returned. See the following equations.

-

NOTE

If the original trace data is in dB, this function returns the arithmetic mean of those log values, not log of the mean power which is a more useful value. The mean of the log is the better measurement technique when measuring CW signals in the presence of noise. The mean of the power, expressed in dB, is useful in power measurements such as Channel Power. To achieve the mean of the power, use the RMS option.

Equation 1

Mean Value of Data Points for Specified Region(s)

$$\text{MEAN} = \frac{1}{n} \sum_{X_i \in \text{region}(s)} X_i$$

where X_i is a data point value, and n is the number of data points in the specified region(s).

Equation 2

Mean Value of I/Q Data Pairs for Specified Region(s)

$$\text{MEAN} = \frac{1}{n} \sum_{X_i \in \text{region}(s)} |X_i|$$

where $|X_i|$ is the magnitude of an I/Q pair, and n is the number of I/Q pairs in the specified region(s).

- DMEan - returns a single value that is the mean power (in dB/ dBm) of the data point values for the specified region(s) of trace data. See the following equation:

Equation 3

DMEan Value of Data Points for Specified Region(s)

$$DME = 10 \times \log_{10} \left(\frac{1}{n} \sum_{X_i \in \text{region}(s)} 10^{\frac{X_i}{10}} \right)$$

- RMS - returns a single value that is the average power on a root-mean-squared voltage scale (arithmetic rms) of the data point values for the specified region(s) of trace data. See the following equation.

NOTE For I/Q trace data, the rms of the magnitudes of the I/Q pairs is returned. See the following equation. This function is very useful for I/Q trace data. However, if the original trace data is in dB, this function returns the rms of the log values which is not usually needed.

Equation 4

RMS Value of Data Points for Specified Region(s)

$$RMS = \sqrt{\frac{1}{n} \sum_{X_i \in \text{region}(s)} X_i^2}$$

where X_i is a data point value, and n is the number of data points in the specified region(s).

Equation 5

RMS Value of I/Q Data Pairs for Specified Region(s)

$$RMS = \sqrt{\frac{1}{n} \sum_{X_i \in \text{region}(s)} X_i X_i^*}$$

where X_i is the complex value representation of an I/Q pair, X_i^* its conjugate complex number, and n is the number of I/Q pairs in the specified region(s).

Once you have the rms value for a region of trace data (linear or I/Q), you may want to calculate the mean power. You must convert this rms value (peak volts) to power in dBm:

$$10 \times \log[10 \times (\text{rms value})^2]$$

- SAMPLe - returns the first data value (x,y pair) for the specified region(s) of trace data. For I/Q trace data, the first I/Q pair is returned.
- SDEVIation - returns a single value that is the arithmetic standard deviation for the data point values for the specified region(s) of trace data. See the following equation.
- For I/Q trace data, the standard deviation of the magnitudes of the I/Q pairs is returned. See the following equation.

Equation 6

Standard Deviation of Data Point Values for Specified Region(s)

$$\text{SDEV} = \sqrt{\frac{1}{n} \sum_{X_i \in \text{region}(s)} (X_i - \bar{X})^2}$$

where X_i is a data point value, \bar{X} is the arithmetic mean of the data point values for the specified region (s), and n is the number of data points in the specified region(s).

$$\text{SDEV} = \sqrt{\frac{1}{n} \sum_{X_i \in \text{region}(s)} (|X_i| - \bar{X})^2}$$

where $|X_i|$ is the magnitude of an I/Q pair, \bar{X} is the mean of the magnitudes for the specified region(s), and n is the number of data points in the specified region(s).

- PPHase - returns the x,y pairs of both rms power (dBm) and arithmetic mean phase (radian) for every specified region and frequency offset (Hz). The number of pairs is defined by the specified number of regions. This parameter can be used for I/Q vector ($n=0$) in Waveform (time domain) measurement and all parameters are specified by data point in PPHase.

The rms power of the specified region may be expressed as:

$$\text{Power} = 10 \times \log [10 \times (\text{RMS I/Q value})] + 10.$$

The RMS I/Q value (peak volts) is:

$$\sqrt{\frac{1}{n} \sum_{X_i \in \text{region}} X_i X_i^*}$$

where X_i is the complex value representation of an I/Q pair, X_i^* its conjugate complex number, and n is the number of I/Q pairs in the specified region.

The arithmetic mean phase of the specified region may be expressed as:

$$\frac{1}{n} \sum_{Y_i \in \text{region}} Y_i$$

where Y_i is the unwrapped phase of I/Q pair with applying frequency correction and n is the number of I/Q pairs in the specified region.

The frequency correction is made by the frequency offset calculated by the arithmetic mean of every specified region's frequency offset. Each frequency offset is calculated by the least square method against the unwrapped phase of I/Q pair.

Sample Trace Data - Constant Envelope

(See below for explanation of variables.)

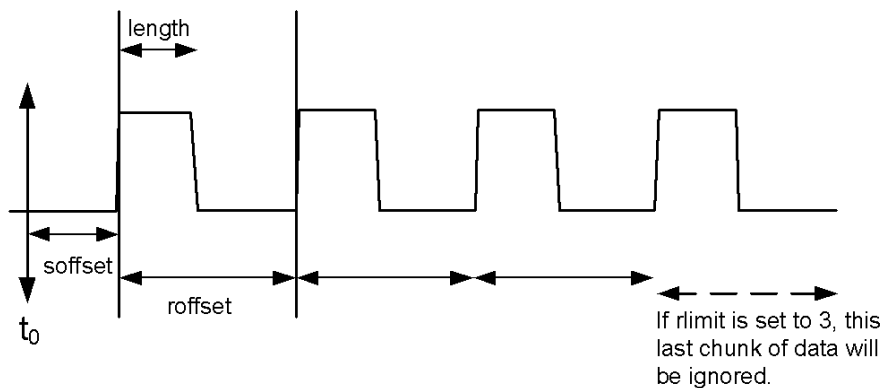

Sample Trace Data - Not Constant Envelope

(See below for explanation of variables.)

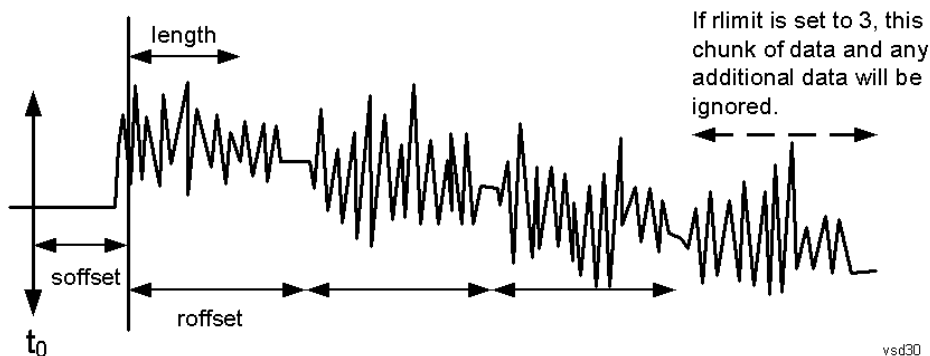

<soffset> - start offset is an optional real number. (It is in seconds for time-domain traces, and is a dimensionless index 0 to Npoints - 1, for frequency-domain traces). It specifies the amount of data at the beginning of the trace that will be ignored before the decimation process starts. It is the time or frequency change from the start of the trace to the point where you want to start using the data. The default value is zero.

<length> - is an optional real number. (It is in seconds for time-domain traces, and is a dimensionless index 0 to Npoints - 1, for frequency-domain traces). It defines how much data will be compressed into one value. This parameter has a default value equal to the current trace length.

<roffset> - repeat offset is an optional real number. (It is in seconds for time-domain traces, and is a dimensionless index 0 to Npoints - 1, for frequency-domain traces). It defines the beginning of the next field of trace elements to be compressed. This is relative to the beginning of the previous field. This parameter has a default value equal to the <length> variable. Note that this parameter is used for a completely different purpose when curve fitting (see CFIT above).

<rlimit> - repeat limit is an optional integer. It specifies the number of data items that you want returned. It will ignore any additional items beyond that number. You can use the Start offset and the Repeat limit to pick out exactly what part of the data you want to use. The default value is all the data.

Calculate Peaks of Trace Data (Remote Command Only)

Returns a list of all the peaks for the currently selected measurement and sub-opcode [n]. The peaks must meet the requirements of the peak threshold and excursion values.

n = any valid sub-opcode for the current measurement. See the MEASure:<measurement> command description of your specific measurement for information on the data that can be returned.

The command can only be used with specific sub-opcodes with measurement results that are trace data. Both real and complex traces can be searched, but complex traces are converted to magnitude in dBm. In many measurements the sub-opcode n=0, is the raw trace data which cannot be searched for peaks. And Sub-opcode n=1, is often calculated results values which also cannot be searched for peaks.

This command uses the data setting specified by the FORMat:BORDER and FORMat:DATA commands and can return real or ASCII data. If the format is set to INT,32, it returns REAL,32 data.

The command has four types of parameters:

- Threshold (in dBm)
- Excursion (in dB)
- Sorting order (amplitude, frequency, time)
- Optional in some measurements: Display line use (all, > display line, < display line)

Remote Command	<p>For Swept SA measurement:</p> <pre>:CALCulate:DATA[1] 2 ... 6:PEAKs? <threshold>,<excursion>[,AMPLitude FREQuency TIME[,ALL GTDLline LTDLine]]</pre> <p>For most other measurements:</p> <pre>:CALCulate:DATA[1] 2 ... 6:PEAKs? <threshold>,<excursion>[,AMPLitude FREQuency TIME]</pre>
-----------------------	---

Example	<p>Example for Swept SA measurement in Spectrum Analyzer Mode:</p> <p>CALC:DATA4:PEAK? -40, 10, FREQ, GTDL This will identify the peaks of trace 4 that are above -40 dBm, with excursions of at least 10 dB. The peaks are returned in order of increasing frequency, starting with the lowest frequency. Only the peaks that are above the display line are returned.</p> <p>Query Results 1:</p> <p>With FORMat:DATA REAL, 32 selected, it returns a list of floating-point numbers. The first value in the list is the number of peak points that are in the following list. A peak point consists of two values: a peak amplitude followed by its corresponding frequency (or time).</p> <p>If no peaks are found the peak list will consist of only the number of peaks, (0).</p>
----------------	---

Notes	<p><n> - is the trace that will be used</p> <p><threshold> - is the level below which trace data peaks are ignored. Note that the threshold value is required and is always used as a peak criterion. To effectively disable the threshold criterion for this command, provide a substantially low threshold value such as -200 dBm. Also note that the threshold value used in this command is independent of and has no effect on the threshold value stored under the Peak Criteria menu.</p> <p><excursion> - is the minimum amplitude variation (rise and fall) required for a signal to be identified as peak. Note that the excursion value is required and is always used as a peak criterion. To effectively disable the excursion criterion for this command, provide the minimum value of 0.0 dB. Also note that the excursion value used in this command is independent of and has no effect on the</p>
--------------	---

excursion value stored under the Peak Criteria menu.

Values must be provided for threshold and excursion. The sorting and display line parameters are optional (defaults are AMPLitude and ALL).

Note that there is always a Y-axis value for the display line, regardless of whether the display line state is on or off. It is the current Y-axis value of the display line which is used by this command to determine whether a peak should be reported
Sorting order:

AMPLitude - lists the peaks in order of descending amplitude, with the highest peak first (default if optional parameter not sent)

FREQuency - lists the peaks in order of occurrence, left to right across the x-axis.

TIME - lists the peaks in order of occurrence, left to right across the x-axis.

Peaks vs. Display Line:

ALL - lists all of the peaks found (default if optional parameter not sent).

GTDLine (greater than display line) - lists all of the peaks found above the display line.

LTDLine (less than display line) - lists all of the peaks found below the display line.

Initial S/W Revision	Prior to A.02.00
----------------------	------------------

Hardware-Accelerated Fast Power Measurement (Remote Command Only)

The Fast Power option (FP2) enables very fast channel power measurements for instruments with the prerequisite hardware (DP2 and/or B40). It accomplishes this by performing real-time overlapped FFTs at the hardware layer, using software for basic post-processing before returning the result to the user. The upshot of this approach is improved throughput for user applications that require many sequential power measurements.

The analysis bandwidth of FP2 is limited by the licenses in the instrument, but its maximum overall analysis bandwidth per acquisition is 40 MHz.

FP2 is remote-only, which means the instrument does not switch to any particular mode or measurement. FP2 commands can be sent while another application is in use on the front panel.

Each Fast Power measurement can be predefined using an array index, and up to 1,000 measurements can be stored. In the following documentation, instances of [1,2,...,999] can be substituted with a particular measurement index, e.g. CALC:FPOW:POW1?, CALC:FPOW:POW2?, CALC:FPOW:POW134?. In this way, power measurements can be defined one time in a batch, and then executed multiple times without having to redefine them, similar to “list mode” on other measurements.

In addition to basic channel power measurements, there are a number of other measurement “functions” for each channel, including peak power, peak frequency, and power spectral density. See the Function parameter for more information.

Reset Fast Power Measurement (Remote Command Only)

Resets the measurement configuration to the defaults.

Mode	All
Remote Command	:CALCulate:FPOWer:POWer [1, 2, ..., 999] :RESet
Example	:CALC:FPOW:POW1:RES

Notes	Option FP2 is required.
Initial S/W Revision	A.14.00

Define Fast Power Measurement (Remote Command Only)

Fast Power acquisitions are configured using the DEFine command. This command accepts a comma-delimited string of configuration parameters and their appropriate values, which are all specified in the subsection below.

Mode	All
Remote Command	:CALCulate:FPOWer:POWer[1,2,...,999]:DEFine "configuration string"
Example	:CALC:FPOW:POW1:DEF "CenterFrequency=2e9, AcquisitionTime=0.005"
Notes	See below for a list of measurement variables that can be defined in the configuration string.
Initial S/W Revision	A.14.00

Acquisition Time

Example	CALC:FPOW:POW1:DEF "AcquisitionTime=0.002"
Notes	The acquisition time parameter sets the time in which the entire spectrum is measured. An increase in the acquisition time yields an improvement in measurement repeatability.
Preset	0.001 s
Range	0 s to 1 s
Default Unit	Time (s)
Initial S/W Revision	A.14.00

Center Frequency

Example	CALC:FPOW:POW1:DEF "CenterFrequency=2e9"
Notes	The center frequency parameter sets the frequency in which the measurement is centered around. The OffsetFrequency parameter is calculated relative to the center frequency.
Preset	1 GHz
Range	0 Hz to maximum instrument frequency
Default Unit	Frequency (Hz)
Initial S/W Revision	A.14.00

DC Coupled

Example	CALC:FPOW:POW1:DEF "DCCoupled=True"
Notes	The DC coupled parameter allows the user to specify whether the DC blocking capacitor is utilized. Set parameter to true when measuring frequencies below 10 MHz.
Preset	False
Range	True (DC Coupled) or False (AC Coupled)
Default Unit	Boolean
Initial S/W Revision	A.14.00

DetectorType

Example	CALC:FPOW:POW1:DEF "DetectorType=Peak"
Notes	Option FP2 is required. The detector type parameter allows the user to choose whether a RMS average or peak value is used during the measurement.
Preset	RmsAverage
Range	RmsAverage, Peak
Initial S/W Revision	A.14.00

Do Noise Correction

Example	CALC:FPOW:POW1:DEF "DoNoiseCorrection=True"
Notes	When noise correction is enabled, the linear noise power contributed by the analyzer is subtracted from all measurements. This effectively lowers the noise floor of the analyzer. When noise correction is enabled, the first measurement for a given set of input parameters will take extra time. This is because the analyzer takes an extra acquisition with the RF input disconnected from the analyzer's front end to measure the noise of just the analyzer. The measured noise floor is stored in a cache so the noise acquisition will occur only once for the same state settings. In other words, if noise correction was turned on and the analyzer made an acquisition at frequency A, then frequency B, and back again to frequency A, the hidden initial noise floor acquisition would only occur for the first acquisition at frequency A and the cached noise floor would be used the second time frequency A was measured.
Preset	False
Range	True (enable noise correction) or False (disable noise correction)
Default Unit	Boolean
Initial S/W Revision	A.14.00

Do Spur Suppression

Example	CALC:FPOW:POW1:DEF "DoSpurSuppression=True"
Notes	<p>When measuring very low level signals, or when large out-of-band inputs are input into the analyzer, sometimes unwanted spurs and residuals can appear in the measured spectrum. Spur suppression is a method to help minimize the levels of these internally generated spurs and residuals.</p> <p>When spur suppression is enabled, the analyzer will automatically take two acquisitions using two different internal analog LO frequencies. The FFT spectrums from both acquisitions are combined by taking the minimum power between both traces on a per FFT bin basis. External signals will have the same amplitude for both traces and therefore will return the expected amplitudes. However, low level spurs and residuals generated internally to the analyzer tend to move to different FFT bins depending on the internal analog LO frequency used, and therefore tend to be suppressed using this spur suppression method.</p> <p>Because two acquisitions, rather than a single acquisition, are made when spur suppression is enabled, the measurement time will always be slower when spur suppression is enabled.</p>
Preset	False
Range	True (enable spur suppression) or False (disable spur suppression)
Default Unit	Boolean
Initial S/W Revision	A.14.00

Electronic Attenuator Bypass

Example	CALC:FPOW:POW1:DEF "ElecAttBypass =False"
Notes	The electronic attenuation bypass parameter allows the user to either utilize or bypass the electronic attenuator. The electronic attenuator is only available for frequencies up to 3.6 GHz. Set parameter to true when using frequencies above 3.6 GHz and set the parameter to false when using the preamp.
Preset	True
Range	True (bypass electronic attenuator) or False (use electronic attenuator)
Default Unit	Boolean
Initial S/W Revision	A.14.00

Electronic Attenuation

Example	CALC:FPOW:POW1:DEF "ElecAttenuation=10"
Notes	<p>Option EA3 is required.</p> <p>The electronic attenuation value parameter sets the amount of electrical attenuation from 0 to 24 dB (1 dB steps).</p> <p>Set "ElecAttBypass=False" to make sure the electronic attenuator path is enabled.</p>
Preset	0 dB
Range	0 - 24 dB (1 dB steps)

Default Unit	dB
Initial S/W Revision	A.14.00

IF Gain

Example	CALC:FPOW:POW1:DEF "IFGain=10"
Notes	The IF gain parameter allows the user to specify the gain at the IF stage anywhere from -6 to 16 dB (1 dB steps). This is an advanced feature, and for most cases this should remain at its default value of 0 dB.
Preset	0 dB
Range	-6 - 16 dB (1 dB steps)
Default Unit	dB
Initial S/W Revision	A.14.00

IF Type

Example	CALC:FPOW:POW1:DEF "IFType=B25M"
Notes	The IF type parameter allows the user to select between different IF paths. For example, if the signal is less than 25 MHz wide, then the user can select the B25M path to take advantage of additional filtering on this analog IF path.
Preset	B40M
Range	B10M, B25M, B40M
Initial S/W Revision	A.14.00

Include Power Spectrum

Example	CALC:FPOW:POW1:DEF "IncludePowerSpectrum=True"
Notes	The power spectrum parameter allows the user to read data on the entire spectrum for diagnostic purposes. It is not recommended for production use. See CALC:FPOW:POW[n]:READ2? for details on the binary format of the response.
Preset	False
Range	True (return both channel power and full power spectrum) or False (returns only channel power)
Default Unit	Boolean
Initial S/W Revision	A.14.00

Mechanical Attenuation

Example	CALC:FPOW:POW1:DEF "MechAttenuation=10"
Notes	The mechanical attenuation value parameter sets the amount of mechanical attenuation anywhere from 0 to 70 dB (2 dB steps).
Preset	0 dB
Range	0 – 70 dB (2 dB steps)
Default Unit	dB
Initial S/W Revision	A.14.00

Preamp Mode

Example	CALC:FPOW:POW1:DEF "PreAmpMode=Low"
Notes	The license for the appropriate preamp is required. The preamp mode parameter specifies whether the preamps are being utilized. Low allows any preamps up to 3.6 GHz, and Full allows all licensed preamps. Set "ElecAttBypass=True" in order to utilize any preamps.
Preset	Off
Range	Off, Low, Full
Initial S/W Revision	A.14.00

Resolution Bandwidth Mode

Example	CALC:FPOW:POW1:DEF "PreAmpMode=Low"
Notes	The resolution bandwidth mode parameter allows the user to choose whether the RBW filter is automatically or manually set. The BestSpeed value minimizes measurement time, while the Narrowest value minimizes RBW size (minimum of two FFT bins per RBW). To manually specify an RBW, set this parameter to Explicit, and set the ResolutionBW parameter to the desired value.
Preset	BestSpeed
Range	BestSpeed, Narrowest, Explicit
Initial S/W Revision	A.14.00

Resolution Bandwidth

Example	CALC:FPOW:POW1:DEF "ResolutionBW=25e3"
Notes	The resolution bandwidth parameter sets the 3-dB bandwidth of the RBW filter. The ResolutionBWMode parameter must be set to Explicit in order to manually set the RBW.

Preset	0 Hz
Default Unit	Hz
Initial S/W Revision	A.14.00

Trigger Delay

Example	CALC:FPOW:POW1:DEF "TriggerDelay=0.025"
Notes	The trigger delay parameter sets the time after an external trigger is detected until the measurement is performed.
Preset	0 s
Range	0 - 1 s
Default Unit	Seconds
Initial S/W Revision	A.14.00

Trigger Level

Example	CALC:FPOW:POW1:DEF "TriggerLevel=2"
Notes	The trigger level parameter sets the voltage value at which an external trigger is detected.
Preset	1.2 V
Range	-5 to 5 V
Default Unit	Volts
Initial S/W Revision	A.14.00

Trigger Slope

Example	CALC:FPOW:POW1:DEF "TriggerSlope=Negative"
Notes	The trigger slope parameter indicates the direction of the edge trigger voltage for detection.
Preset	Positive
Range	Positive, Negative
Initial S/W Revision	A.14.00

Trigger Source

Example	CALC:FPOW:POW1:DEF "TriggerSource=Ext1"
Notes	The trigger source parameter allows the user to choose between measurement's triggering freely or controlled by an external input. Ext1 and Ext2 correspond to Trigger 1 In and Trigger 2 In, respectively.
Preset	Free
Range	Free, Ext1, Ext2
Initial S/W Revision	A.14.00

Trigger Timeout

Example	CALC:FPOW:POW1:DEF "TriggerTimeout=0.1"
Notes	The trigger timeout parameter sets the time in which the analyzer will wait for a trigger before automatically performing the measurement.
Preset	1 s
Range	0 – 1 s
Default Unit	Seconds
Initial S/W Revision	A.14.00

Signal Input

Example	CALC:FPOW:POW1:DEF "SignalInput=Fp50MHzCW"
Notes	The signal input parameter allows the user to select between using the main RF input or the internal analyzer reference CW signal of 50 MHz.
Preset	FpMainRf
Range	FpMainRf, Fp50MHzCW
Initial S/W Revision	A.14.00

Use Preselector

Example	CALC:FPOW:POW1:DEF "UsePreSelector=True"
Notes	The preselector parameter allows the user to either utilize or bypass the front end tunable filter at frequencies above 3.6 GHz. For frequencies below 3.6 GHz, the preselector is automatically bypassed, so you do not need to set this parameter to False in those cases.
Preset	False
Range	True (use preselector above 3.6 GHz), or False (preselector bypassed)

Default Unit	Boolean
Initial S/W Revision	A.14.00

Channel Bandwidth Array

Example	CALC:FPOW:POW1:DEF "Bandwidth=[3.84e6, 5e6, 3.84e6]"
Notes	The bandwidth parameter array defines the bandwidth of each channel that will be measured. All array parameters should have the same number of elements. Alternatively, if all the elements are the same value, a single number with no square brackets can be used to define the parameter.
Preset	[1e6]
Range	0 to 40 MHz
Default Unit	Hz
Initial S/W Revision	A.14.00

Channel Filter Type Array

Example	CALC:FPOW:POW1:DEF "FilterType=[RRC, IBW, RRC]"
Notes	The filter type parameter allows the user to choose between an integration bandwidth (IBW) filter or a root-raised-cosine (RRC) filter. The integration bandwidth filter weighs all frequencies within the bandwidth equally. The root-raised-cosine filter has an associated shape parameter, defined by the FilterAlpha parameter. All array parameters should have the same number of elements. Alternatively, if all the elements are the same value, a single value with no square brackets can be used to define the parameter.
Preset	[IBW]
Range	IBW, RRC
Initial S/W Revision	A.14.00

Channel Filter Alpha Array

Example	CALC:FPOW:POW1:DEF "FilterAlpha=[0.5, 0.0, 0.5]"
Notes	The filter alpha parameter allows the user to adjust the alpha value associated with the root-raised-cosine (RRC) filter type. Set FilterType to RRC in order to utilize this parameter. All array parameters should have the same number of elements. Alternatively, if all the elements are the same value, a single number with no square brackets can be used to define the parameter.
Preset	[0.22]
Range	0.0 – 1.0
Initial S/W Revision	A.14.00

Channel Measurement Function Array

Example	CALC:FPOW:POW1:DEF "Function=[BandPower, PeakPower, BandPower]"
Notes	<p>This parameter array defines what measurement is being made for each individually-specified channel:</p> <p>BandPower: Total power within the specified bandwidth of the channel (dBm)</p> <p>BandDensity: Total power density within the specified bandwidth of the channel (dBm/Hz)</p> <p>PeakPower: The peak power value within the specified bandwidth of the channel (dBm)</p> <p>PeakFrequency: The frequency which corresponds to the peak power value within the specified bandwidth of the channel. This frequency is relative to the center frequency (Hz)</p> <p>XdBBandwidth: The half power (-3.01 dB) bandwidth of the highest amplitude signal that resides within the channel (Hz), dB is configurable using XdBBandwidth parameter</p> <p>OccupiedBandwidth: The bandwidth at which 99% of the total power resides within the channel (Hz), percentage configurable using OccupiedBandwidthPercent parameter</p> <p>All array parameters should have the same number of elements. Alternatively, if all the elements are the same value, a single value with no square brackets can be used to define the parameter.</p>
Preset	[BandPower]
Range	BandPower, BandDensity, PeakPower, PeakFrequency, XdBBandwidth, OccupiedBandwidth
Initial S/W Revision	A.14.00

Channel Offset Frequency Array

Example	CALC:FPOW:POW1:DEF "OffsetFrequency=[-5e6, 0, 5e6]"
Notes	<p>The offset frequency parameter array defines the difference between the center frequency to the center frequency of each channel.</p> <p>All array parameters should have the same number of elements.</p>
Preset	[0]
Range	0 to 20 MHz
Default Unit	Hz
Initial S/W Revision	A.14.00

Channel Occupied Bandwidth Percent Array

Example	CALC:FPOW:POW1:DEF "OccupiedBandwidthPercent =[0.95, 0.95, 0.95]"
Notes	<p>This parameter only applies for channels whose Function is set to OccupiedBandwidth. The occupied bandwidth percent parameter specifies the percent of total power in these channels. The valid range for this parameter is 0.0 to 1.0, where 1.0 represents 100%. The default for this parameter is 0.99, which will return the bandwidth that contains 99% of the total channel power.</p>

Preset	[0.99]
Range	0 - 1.0
Initial S/W Revision	A.14.00

Channel x-dB Bandwidth Array

Example	CALC:FPOW:POW1:DEF " XdBBandwidth =[-6.02, -3.01, -1.0]"
Notes	This parameter only applies for channels whose Function is set to XdBBandwidth. The X dB bandwidth parameter is used to specify the power relative to the peak channel power over which the bandwidth is calculated. The parameter value must be a negative number.
Preset	[-3.01]
Range	-200 to 0 dB
Default Unit	dB
Initial S/W Revision	A.14.00

Define Fast Power Measurement Query (Remote Command Only)

The DEFine? command is used to retrieve a list of all defined parameters in an ASCII string format

M	All
o	
d	
e	
R	:CALCulate:FPOWer:POWer[1,2,...,999]:DEFine?
e	
m	
o	
t	
e	
C	
o	
m	
m	
a	
n	
d	
E	:CALC:FPOW:POW1:DEF?
x	
a	
m	

p
l
e

N This command query is used to retrieve a list of all defined parameters in an ASCII format.

O The following is an example of the returned results:

S "DCCoupled=False,ElecAttBypass=True,ElecAttenuation=0,IFGain=0,MechAttenuation=0,PreAmpMode=Off,PreSelectorOffset=0,UsePreSelector=False,ExternalReferenceFrequency=1000000,FrequencyReferenceSource=AutoExternalFrequencyReference,IFType=B40M,LOMode=SLW,SignalInput=FpMainRf,AcquisitionTime=0.001,CenterFrequency=100000000,ResolutionBW=0,ResolutionBWMode=BestSpeed,DetectorType=RmsAverage,Bandwidth=[1000000],OffsetFrequency=[0],Function=[BandPower],FilterType=[IBW],FilterAlpha=[0.22],OccupiedBandwidthPercent=[0.99],XdBBandwidth=[-3.01],DoNoiseCorrection=False,DoSpurSuppression=False,MeasurementMethod=HardwareFFT,IncludePowerSpectrum=False,TriggerDelay=0,TriggerLevel=1.2,TriggerSlope=Positive,TriggerSource=Free,TriggerTimeout=1"

I A.14.00

n
i
t
i
a
l

S
/
W

R
e
v
i
s
i
o
n

Configure Fast Power Measurement (Remote Command Only)

The configure command begins hardware setup and returns immediately, with no acquisition made. This can be used in parallel with other hardware operations to effectively hide the hardware setup time.

Mode	All
Remote Command	:CALCulate:FPOWER:POWER[1,2,...,999]:CONFigure
Example	:CALC:FPOW:POW1:CONF
Notes	Option FP2 is required.
Initial S/W Revision	A.14.00

Initiate Fast Power Measurement (Remote Command Only)

The INITiate command begins an acquisition and returns immediately. The results of the measurement can be retrieved using FETCh.

Mode	All
Remote Command	:CALCulate:FPOWer:POWer[1,2,...,999]:INITiate
Example	:CALC:FPOW:POW1:INIT
Notes	Option FP2 is required.
Initial S/W Revision	A.14.00

Fetch Fast Power Measurement (Remote Command Only)

The FETCh command query is used to retrieve the results of an acquisition initiated by the INIT command. The returned results are in ASCII string format. The string begins and ends with quotation marks.

Mode	All
Remote Command	:CALCulate:FPOWer:POWer[1,2,...,999]:FETCh?
Example	:CALC:FPOW:POW1:FETC?
Notes	Option FP2 is required. Returns m comma-separated ASCII values, where m corresponds to the number of bandwidths defined. 1. Declared function return in the 1st specified channel 2. Declared function return in the 2nd specified channel ... m. Declared function return in the last specified channel The INIT and FETC? command sequence performs the same functionality of a single CALC:FPOW:POW[n]? query. Units of the returned values are dependent on the Function parameter for each channel.
Initial S/W Revision	A.14.00

Execute Fast Power Measurement (Remote Command Only)

This command query is used as shorthand for an INIT command immediately followed by a FETC? command. The returned results are in ASCII string format. The string begins and ends with quotation marks.

Mode	All
Remote Command	:CALCulate:FPOWer:POWer[1,2,...,999]?
Example	:CALC:FPOW:POW1?
Notes	Option FP2 is required. See notes for Fast Power Fetch for return format.
Initial S/W Revision	A.14.00

Binary Read Fast Power Measurement (Remote Command Only)

This command query is used as shorthand for an INIT command immediately followed by a FETC? command. The returned results are in a binary format.

Mode	All
Remote Command	:CALCulate:FPOWER:POWER[1,2,...,999]:READ? :CALCulate:FPOWER:POWER[1,2,...,999]:READ1?
Example	:CALC:FPOW:POW1:READ? :CALC:FPOW:POW1:READ1?
Notes	Option FP2 is required. Returns m 4 byte floating point binary values (Little-Endian), where m corresponds to the number of bandwidths defined.
Initial S/W Revision	A.14.00

Diagnostic Binary Read Fast Power Measurement (Remote Command Only)

This command query is used as shorthand for an INIT command immediately followed by a FETC? command. The returned results are in a binary format. This command is used primarily for diagnostic purposes to test for ADC overloads and to visibly inspect the spectrum.

Mode	All
Remote Command	:CALCulate:FPOWER:POWER[1,2,...,999]:READ2?
Example	:CALC:FPOW:POW1:READ2?
Notes	Option FP2 is required. Note: Spectrum data is only returned if the IncludePowerSpectrum parameter is set to True. If IncludePowerSpectrum is False, the number of spectrum points will be zero (0). Units of the returned values are dependent on the Function parameter per channel (e.g. dBm for BandPower, Hz for PeakFrequency). Returns binary data (Little-Endian) that contains information on m amount of channels, along with ADC over range and full spectrum data. The following is the binary format of the response. Bandwidth Return Value 1. Number of channels specified, m [4 byte int] 2. Declared function result for the 1st specified channel [4 byte float] 3. Declared function result for the 2nd specified channel [4 byte float] ... (m + 1). Declared function result for the last (mth) specified channel [4 byte float] ADC Over Range 1. ADC over-range occurred (1: true, 0: false) [2 byte short]

	<p>Spectrum Data</p> <ol style="list-style-type: none"> 1. Number of points in the spectrum data, k [4 byte int] 2. Start frequency of spectrum data (Hz) [8 byte double] 3. Step frequency of spectrum data (Hz) [8 byte double] 4. FFT bin at 1st point (dBm) [4 byte float] 5. FFT bin at 2nd point (dBm) [4 byte float] ... (k + 3). FFT bin at last (kth) point (dBm) [4 byte float]
Initial S/W Revision	A.14.00

Format Data: Numeric Data (Remote Command Only)

This command specifies the format of the trace data input and output. It specifies the formats used for trace data during data transfer across any remote port. It affects only the data format for setting and querying trace data for the :TRACe[:DATA], TRACe[:DATA]?, :CALCulate:DATA[n]? and FETCh:SANalyzer[n]? commands and queries.

Remote Command	<pre>:FORMat [:TRACe] [:DATA] ASCii INTEger,32 REAL,32 REAL,64 :FORMat [:TRACe] [:DATA] ?</pre>
Notes	<p>The query response is:</p> <p>ASCii: ASC,8 REAL,32: REAL,32 REAL,64: REAL,64 INTEger,32: INT,32</p> <p>When the numeric data format is REAL or ASCii, data is output in the current Y Axis unit. When the data format is INTEger, data is output in units of m dBm (.001 dBm).</p> <p>The INT,32 format returns binary 32-bit integer values in internal units (m dBm), in a definite length block.</p>
Dependencies	<p>Sending a data format spec with an invalid number (for example, INT,48) generates no error. The analyzer simply uses the default (8 for ASCii, 32 for INTEger, 32 for REAL).</p> <p>Sending data to the analyzer which does not conform to the current FORMat specified, results in an error. Sending ASCII data when a definite block is expected generates message -161 "Invalid Block Data" and sending a definite block when ASCII data is expected generates message -121 "Invalid Character in Number".</p>
Preset	ASCii
Backwards Compatibility Notes	Note that the INT,32 format is only applicable to the command, TRACe:DATA. This preserves backwards compatibility for the Swept SA measurement. For all other commands/queries which honor FORMat:DATA, if INT,32 is sent the analyzer will behave as though it were set to REAL,32.
Initial S/W Revision	Prior to A.02.00

The specs for each output type follow:

AScii - Amplitude values are in ASCII, in the current Y Axis Unit, one ASCII character per digit, values separated by commas, each value in the form:

SX.YYYYYEsZZ

Where:

S = sign (+ or -)

X = one digit to left of decimal point

Y = 5 digits to right of decimal point

E = E, exponent header

s = sign of exponent (+ or -)

ZZ = two digit exponent

REAL,32 - Binary 32-bit real values in the current Y Axis Unit, in a definite length block.

REAL,64 - Binary 64-bit real values in the current Y Axis Unit, in a definite length block.

Format Data: Byte Order (Remote Command Only)

This command selects the binary data byte order for data transfer and other queries. It controls whether binary data is transferred in normal or swapped mode. This command affects only the byte order for setting and querying trace data for the :TRACe[:DATA], TRACe[:DATA]? , :CALCulate:DATA[n]? and FETCh:SANalyzer[n]? commands and queries.

By definition any command that says it uses FORMat:DATA uses any format supported by FORMat:DATA.

The NORMal order is a byte sequence that begins with the most significant byte (MSB) first, and ends with the least significant byte (LSB) last in the sequence: 1|2|3|4. SWAPped order is when the byte sequence begins with the LSB first, and ends with the MSB last in the sequence: 4|3|2|1.

Remote Command	:FORMat:BORDER NORMal SWAPped :FORMat:BORDER?
Preset	NORMal
Initial S/W Revision	Prior to A.02.00

Meas Setup

Accesses a menu of keys that enable you to control specific parameters for the current measurement.

["Overview" on page 868](#)

["Set Parameters " on page 868](#)

Key Path	Front-panel key
Initial S/W Revision	Prior to A.02.00

Overview

This section describes the measurement setup features of the Analog Demod measurements.

Set Parameters

The following parameters are set as indicated and are not settable by the user, therefore they do not appear in any menus:

FFT IF Gain	Low (0 dB)
ADC Dither	On
Avg Mode	Exponential
Phase Noise Optimization	Auto

Auto Rules for Phase Noise Optimization:

Use "Optimize for $f < 20$ kHz" when the Channel BW < 120 kHz, otherwise use "Optimize for $f > 30$ kHz".

["Optimizing Measurement Speed" on page 868](#)

["Channel Bandwidth" on page 869](#)

["RF Spectrum Span " on page 869](#)

["RF Spectrum RBW / AF Spectrum RBW" on page 869](#)

["AF Waveform Sweep Time" on page 869](#)

["Filters and Annotation" on page 869](#)

Optimizing Measurement Speed

The speed of the analog demodulation measurements is driven largely by how much data must be acquired to satisfy the selected configuration.

Each measurement cycle generates all of the metrics and traces from a single acquisition, so there are several different settings which can affect the overall speed. Note that even though you may not be

viewing a particular result on the display, the result is available and its configuration and constraints are used to determine the acquisition settings.

Channel Bandwidth

This setting determines the sampling rate used by the measurement, higher bandwidths will result in larger data sets being acquired and processed. This should be set to the lowest value possible which allows your signal to be fully captured.

RF Spectrum Span

This setting is used in a similar way as the Channel Bandwidth in that it determines the sampling rate. As with channel bandwidth, it should be set as narrow as possible to capture the signal of interest.

RF Spectrum RBW / AF Spectrum RBW

These settings dictate a minimum acquisition time for the measurement. The Auto setting is recommended for optimal performance while maintaining measurement integrity. Narrower resolution bandwidths (RBWs) require longer acquisitions to achieve the resolution improvements.

AF Waveform Sweep Time

This setting sets another minimum acquisition time for the measurement. In many uses, the AF Spectrum RBW will dominate the determination of the data acquisition duration, but if the AF waveform view is not needed keeping its sweep time low will ensure that it does not negatively impact the throughput.

Filters and Annotation

You may choose to filter by frequency – choosing an optional low-pass filter and an optional high-pass filter – or may filter using a standard published band-pass filter (CCITT). Turning on a band-pass filter will automatically turn off the high-pass and low-pass filters; similarly, the band-pass filter will automatically turn off if you request either a high-pass or a low-pass filter.

Average/Hold Num

When turned on, the RF Spectrum and AF spectrum traces are averaged, and the Demod window shows an Average trace, a Max Hold trace, and a Min Hold trace in addition to the current trace. All metrics are averaged, and the metrics show an “Average” column and a “Max Hold” column.

The average feature for the Analog Demod measurement differs from other measurements in that the average type is fixed depending on the window as shown in the following table:

Window	Average Type
RF Spectrum	Pwr Average
Demod Waveform	Arithmetic Average
AF Spectrum	Log Average

For more details, see ["Average/Hold On/Off Functionality" on page 870](#).

Key Path	Meas Setup
----------	------------

Remote Command	[:SENSe] :AM FM PM FMSTereo :AVERage :COUNt <integer> [:SENSe] :AM FM PM FMSTereo :AVERage :COUNt ? [:SENSe] :AM FM PM FMSTereo :AVERage [:STATe] ON OFF 1 0 [:SENSe] :AM FM PM FMSTereo :AVERage [:STATe] ?
Example	AM:AVER:COUN 10
Preset	10 ON
State Saved	Saved in instrument state
Min	1
Max	9999
Initial S/W Revision	Prior to A.02.00
Modified at S/W Revision	A.10.00

Average/Hold On/Off Functionality

Average, Minhold, and Maxhold are coupled.

When Average/Hold is on:

- The RF Spectrum and AF Spectrum traces are averaged.
- The Demod Waveform window will display a current trace, an Average trace, a Max Hold trace, and a Min Hold trace.
- The Metrics window will display an “Average” column and a “Max Hold” column.
- Metrics will display to four significant digits.
- The Meas Bar will display the Average/Hold number (along with how many of those sweeps have been captured).
- Demod Min trace, Demod Max trace, and Demod Avg trace are maintained.
- The Max Hold column shows the maximum value the un-averaged metric has attained since the last Restart.

When Average/Max Hold is off:

- The RF Spectrum and AF Spectrum traces are not averaged.
- The Demod Waveform window will display only the demod trace.
- The Metrics window will display only a “Current” column.
- Metrics will display to two significant digits.
- The Meas Bar will not display the Average/Hold number.
- Max Hold metrics over SCPI will return SCPI not a number.

- Demod Min trace, Demod Max trace and Demod Avg trace will return default values in a Meas?, Read?, and Fetch? and when exported to a .csv file
- Max Hold column is blank.

Modulation Rate Periodic

The algorithms used by the instrument for demodulation have an improved speed/accuracy tradeoff when the modulation is both periodic (such as a sinusoidal test signal) and assumed to be periodic by the analysis system. Thus, “Yes” is best for periodic signals. When the modulation is aperiodic, such as voice or music or even multiple nonharmonically related tones, “No” gives better results.

Key Path	Meas Setup
Remote Command	<code>[:SENSe] :AM FM PM FMSTereo:PERIodic[:STATe] ON OFF 1 0</code> <code>[:SENSe] :AM FM PM FMSTereo:PERIodic[:STATe] ?</code>
Example	FM:PERI OFF
Preset	ON
State Saved	Saved in instrument state
Initial S/W Revision	A.12.00

Filters

Pressing this key displays the Filters menu, allowing you to control the post demodulation and de-emphasis filters.

If any filters are turned on and the filters cannot be applied, the error “161 Setting Modified; Filters not applied” will appear.

Key Path	Meas Setup
Initial S/W Revision	Prior to A.02.00

High Pass Filter (Post Demod)

This parameter allows you to adjust the post demodulation high pass filters. This filter allows you to remove unwanted low-frequency components from the modulated signal..

Key Path	Meas Setup, Filters
Remote Command	AM FM PM: <code>[:SENSe] :AM FM PM:HPFilter OFF HPF20 HPF50 HPF300 HPF400</code> <code>[:SENSe] :AM FM PM:HPFilter ?</code>
	FM Stereo: <code>[:SENSe] :FMSTereo:HPFilter OFF HPF20 HPF50 HPF300</code> <code>[:SENSe] :FMSTereo:HPFilter ?</code>

Example	FM:HPF HPF20
Remote Command Notes	<p>AM FM PM: Off = No filtering HPF20 = Use 20 Hz high pass filter HPF50 = Use 50 Hz high pass filter HPF300 = Use 300 Hz high pass filter HPF400 = Use 400 Hz high pass filter</p> <p>FM Stereo: Off = No filtering HPF20 = Use 20 Hz high pass filter HPF50 = Use 50 Hz high pass filter HPF300 = Use 300 Hz high pass filter</p>
Dependencies	The HPF400 is available only when Option N9063A-AFP is installed in AM/FM/PM.
Couplings	<p>AM/FM/PM: Turning on any high-pass filter will turn off bandpass filters. If a band-pass filter is turned off, the following advisory message is displayed: “Band-pass filter set to OFF”. If the band-pass filter was already off, no advisory message is displayed.</p> <p>FM Stereo: None</p>
Preset	Off (AM/FM/FM Stereo, HPF20 (PM))
State Saved	Saved in instrument state
Readback line	1-of-N selection
Initial S/W Revision	Prior to A.02.00
Modified at S/W Revision	A.14.00

Off

This selection turns the post demodulation high pass filter off.

Key Path	Meas Setup, HPF
Example	AM:HPF OFF
Notes	Annotation line (DC Coupled) appears in the Meas Bar, except if in the AM measurement.
Readback	Off
Initial S/W Revision	Prior to A.02.00

20 Hz

Sets the post demodulation high pass filter to 20 Hz. It is a 2-pole Butterworth filter, its 3 dB cutoff frequency is 20 Hz.

Key Path	Meas Setup, HPF
Example	AM:HPF HPF20
Readback	20 Hz
Initial S/W Revision	Prior to A.02.00

50 Hz

Sets the post demodulation high pass filter to 50 Hz. It is a 2-pole Butterworth filter, its 3 dB cutoff frequency is 50 Hz.

Key Path	Meas Setup, HPF
Example	AM:HPF HPF50
Readback	50 Hz
Initial S/W Revision	Prior to A.02.00

300 Hz

Sets the post demodulation high pass filter to 300 Hz. It is a 2-pole Butterworth filter, its 3 dB cutoff frequency is 300 Hz.

Key Path	Meas Setup, HPF
Example	AM:HPF HPF300
Readback	300 Hz
Initial S/W Revision	Prior to A.02.00

Lowpass Filter (Post Demod)

This parameter allows you to adjust the post demodulation low pass filter. The filter is useful in removing unwanted high frequency components of the modulating signal.

Key Path	Meas Setup, Filters
Remote Command	<p>AM FM PM: [:SENSe]:AM FM PM:LPFfilter OFF LPF300 LPF3K LPF15K LPF30K LPF80K LPF300K LPF100K MANual [:SENSe]:AM FM PM:LPFfilter?</p> <p>FM Stereo: [:SENSe]:FMSTereo:LPFfilter OFF LPF300 LPF3K LPF15K LPF30K LPF80K LPF300K</p>

	<code>[:SENSe] :FMSTereo:LPFilter?</code>
Example	FM:LPF LPF3K
Remote Command Notes	<p>AM FM PM:</p> <p>Off = No filtering</p> <p>LPF300 = Use 300 Hz low pass filter</p> <p>LPF3K = Use 3 kHz low pass filter</p> <p>LPF15K = Use 15 kHz low pass filter</p> <p>LPF30K = Use 30 kHz low pass filter</p> <p>LPF80K = Use 80 kHz low pass filter</p> <p>LPF300K = Use 300 kHz low pass filter</p> <p>LPF100K = Use >20 kHz low pass filter</p> <p>MANual=Use user-defined low pass filter</p> <p>FM Stereo:</p> <p>Off = No filtering</p> <p>LPF300 = Use 300 Hz low pass filter</p> <p>LPF3K = Use 3 kHz low pass filter</p> <p>LPF15K = Use 15 kHz low pass filter</p> <p>LPF30K = Use 30 kHz low pass filter</p> <p>LPF80K = Use 80 kHz low pass filter</p> <p>LPF300K = Use 300 kHz low pass filter</p>
Dependencies	<p>LPF key is unavailable (grayed out) when the band pass filter is not OFF.</p> <p>The following filters are available only when Option N9063A-AFP is installed in AM/FM/PM: LPF100K and MANual.</p>
Couplings	<p>AM/FM/PM:</p> <p>Turning on any low-pass filter will turn off band-pass filters.</p> <p>If a band-pass filter is turned off, the following advisory message is displayed: "Band-pass filter set to OFF".</p> <p>If the band-pass filter was already off, no advisory message is displayed.</p> <p>FM Stereo:</p> <p>None</p>
Preset	Off
State Saved	Saved in instrument state
Readback line	1-of-N selection
Initial S/W Revision	Prior to A.02.00
Modified at S/W Revision	A.14.00

Off

Turns the post demodulation low pass filter off.

Key Path	Meas Setup, Post Demod LPF
Example	AM:LPF OFF
Readback	Off
Initial S/W Revision	Prior to A.02.00

300 Hz

Sets the post demodulation low pass filter to 300 Hz. It is a 5-pole Butterworth filter, its 3 dB cutoff frequency is 300 Hz.

Key Path	Meas Setup, HPF/LPF
Example	AM:HPBP LPF300
Readback	300 Hz
Initial S/W Revision	Prior to A.02.00

3 kHz

Selects the 3 kHz post demodulation low pass filter. It is a 5-pole Butterworth filter, its 3 dB cutoff frequency is 3 kHz.

Key Path	Meas Setup, Post Demod LPF
Example	AM:LPF LPF3K
Readback	3 kHz
Initial S/W Revision	Prior to A.02.00

15 kHz

Selects the 15 kHz post demodulation low pass filter. It is a 5-pole Butterworth filter, its 3 dB cutoff frequency is 15 kHz.

Key Path	Meas Setup, Post Demod LPF
Example	AM:LPF LPF15K
Readback	15 kHz
Initial S/W Revision	Prior to A.02.00

30 kHz

Selects the 30 kHz post demodulation low pass filter. It is a 3-pole Butterworth filter, its 3 dB cutoff frequency is 30 kHz.

Key Path	Meas Setup, Post Demod LPF
Example	AM:LPF LPF30K
Readback	30 kHz
Initial S/W Revision	Prior to A.02.00

80 kHz

Selects the 80 kHz post demodulation low pass filter. It is a 3-pole Butterworth filter, its 3 dB cutoff frequency is 80 kHz.

Key Path	Meas Setup, Post Demod LPF
Example	AM:LPF LPF80K
Readback	80 kHz
Initial S/W Revision	Prior to A.02.00

300 kHz

Selects the 300 kHz post demodulation low pass filter. It is a 3-pole Butterworth filter, its 3 dB cutoff frequency is 300 kHz.

Key Path	Meas Setup, Post Demod LPF
Example	AM:LPF LPF300K
Readback	300 kHz
Initial S/W Revision	Prior to A.02.00

Band Pass Filter (Post Demod)

This parameter enables you to choose the post demodulation band pass filters, allowing you to apply industry-defined filters.

Key Path	Meas Setup, Filters
Remote Command	<p>AM FM PM:</p> <pre>[:SENSe]:AM FM PM:BPFilter OFF CCITT AWEighting CWEighting CMESsage CCIR1k CCIR2k CUNWeighting [:SENSe]:AM FM PM:BPFilter?</pre> <p>FM Stereo:</p> <pre>[:SENSe]:FMSTereo:BPFilter OFF CCITT AWAudio [:SENSe]:FMSTereo:BPFilter?</pre>

Example	FM:BPF CCITT
Remote Command Notes	<p>AM FM PM: Off = No filtering CCITT = Use CCITT filter AWEighting = Use A-Weighted Audio filter CWEighting = Use C-Weighted audio filter CMESage = Use C-Message audio filter CCIR1k = Use CCIR-1k Weighted audio filter CCIR2k = Use CCIR-2k Weighted audio filter CUNWeighting = Use CCIR Un-weighted audio filter</p> <p>FM Stereo: Off = No filtering CCITT = Use CCITT filter AWAudio = Use A-Weighted Audio filter</p>
Dependencies	The following filters are available only when Option N9063A-AFP is installed in AM/FM/PM: AWEighting, CWEighting, CMESage, CCIR1k, CCIR2k and CUNWeighting.
Couplings	<p>AM/FM/PM: Turning on any bandpass filter will turn off high-pass and low-pass filters. If a high-pass filter is turned off, the following advisory message is displayed: “High-pass filter set to OFF”. If a low-pass filter is turned off, the following advisory message is displayed: “Low-pass filter set to OFF”. If both are turned off, the following advisory message is displayed: “High-pass and Low-pass filters set to OFF”. If both high-pass and low-pass filters were already off, no advisory message is displayed.</p> <p>FM Stereo: None</p>
Preset	Off
State Saved	Saved in instrument state
Readback	1-of-N
Initial S/W Revision	Prior to A.02.00
Modified at S/W Revision	A.14.00

Off

Turns the post demodulation band-pass filter off.

Key Path	Meas Setup, BPF
Example	AM:BPF OFF
Readback	Off
Initial S/W Revision	Prior to A.02.00

CCITT

Sets the post demodulation band-pass filter to CCITT.

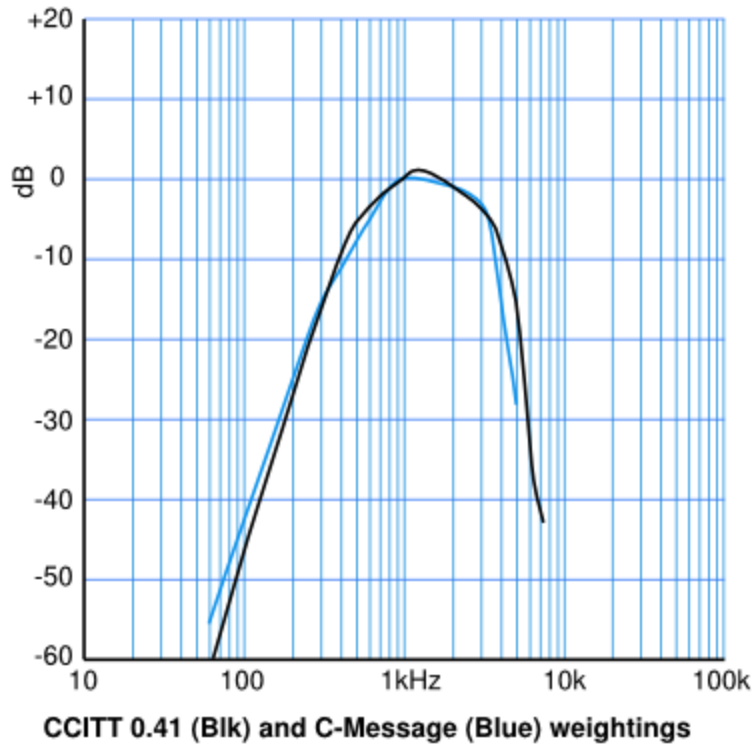

Key Path	Meas Setup, BPF
Example	AM:BPF CCITT
Readback	CCITT
Initial S/W Revision	Prior to A.02.00

Demod to Speaker

Controls whether a demodulated audio signal is connected to the speaker or not. This allows the demodulated audio to be turned off without completely disabling (muting) the instrument speaker. When the Analog Demod application is running, the demodulated signal can be heard from the speaker as long as the “Demod to Speaker” function is set to On.

NOTE The Windows controls for speaker volume and mute must also be properly set.

This function is shared among all measurements in the mode, but not across other modes.

Key Path	Meas Setup
----------	------------

Remote Command	<code>[:SENSe] :SPEaker [:STATe] ON OFF 1 0</code> <code>[:SENSe] :SPEaker [:STATe] ?</code>
Example	SPE OFF Disconnects demodulated audio from speaker circuit.
Preset	On
State Saved	Saved in instrument state
Initial S/W Revision	Prior to A.02.00

Auto BW & Scale

Automatically sets many measurement parameters by pressing one button, based upon the current signal under test. The feature requires that the center frequency be set to the signal of interest, and works best on stable periodic signals. The measurement is preset at the beginning of the Auto BW & Scale operation, with the exception that the user's Center Frequency and audio Filters are maintained.

The signal is analyzed using an Occupied Bandwidth measurement to automatically set the RF Spectrum Span and Channel Bandwidth to good values. And then it sets the combination of mechanical and electronic attenuation based on the current measured signal level so that clipping will be at a minimum. Once these two steps are done, the software examines the demodulated signal and appropriately sets the Sweep Time and Demod Waveform Scale/Div.

There are no configurable parameters for Auto BW & Scale. The function is pre-configured to work with most real-world use cases.

Key Path	Meas Setup
Remote Command	<code>[:SENSe] :AUToscale</code>
Example	AUT
Initial S/W Revision	Prior to A.02.00

Meas Preset

Returns the variables in the current measurement to their preset values.

Key Path	Meas Setup
Initial S/W Revision	Prior to A.02.00

10 Φ M Demod Measurement
Mode

Mode

See "[Mode](#)" on page 156

Mode Preset

Returns the active mode to a known state.

Mode Preset does the following for the currently active mode:

- Aborts the currently running measurement.
- Brings up the default menu for the mode, with no active function.
- Sets measurement Global settings to their preset values for the active mode only.
- Activates the default measurement.
- Brings up the default menu for the mode.
- Clears the input and output buffers.
- Sets Status Byte to 0.

Mode Preset does not:

- Cause a mode switch
- Affect mode persistent settings
- Affect system settings
- See "[How-To Preset](#)" on page 882 for more information.

Key Path	Front-panel key
Remote Command	:SYSTem:PRESet
Example	:SYST:PRES
Notes	*RST is preferred over :SYST:PRES for remote operation. *RST does a Mode Preset, as done by the :SYST:PRES command, and it sets the measurement mode to Single measurement rather than Continuous for optimal remote control throughput. Clears all pending OPC bits. The Status Byte is set to 0.
Couplings	A Mode Preset aborts the currently running measurement, activates the default measurement, and gets the mode to a consistent state with all of the default couplings set.
Backwards Compatibility Notes	In the X-Series, the legacy "Factory Preset" has been replaced with Mode Preset, which only presets the currently active mode, not the entire instrument. In the X-Series, the way to preset the entire instrument is by using System, Restore System Defaults All, which behaves essentially the same way as restore System Defaults does on ESA and PSA. There is also no "Preset Type" as there is on the PSA. There is a green Mode Preset front-panel key that does a Mode Preset and a white-with-green-letters User Preset front-panel key that does a User Preset. The old PRESet:TYPE command is ignored (without generating an error), and SYST:PRES without a parameter does a Mode Preset, which should cover most backward code compatibility issues. The settings and correction data under the Input/Output front-panel key (examples: Input Z Corr, Ext Amp Gain, etc.) are no longer part of any Mode, so they will not be preset by a Mode Preset. They are preset using Restore Input/Output Defaults, Restore System Defaults All. Note that because User Preset does a Recall State, and all of these settings are saved in State, they ARE recalled when using

	User Preset.
Initial S/W Revision	Prior to A.02.00

How-To Preset

The table below shows all possible presets, their corresponding SCPI commands and front-panel access (key paths). Instrument settings depend on the current measurement context. Some settings are local to the current measurement, some are global (common) across all the measurements in the current mode, and some are global to all the available modes. In a similar way, restoring the settings to their preset state can be done within the different contexts.

Auto Couple - is a measurement local key. It sets all Auto/Man parameter couplings in the measurement to Auto. Any Auto/Man selection that is local to other measurements in the mode will not be affected.

Meas Preset - is a measurement local key. Meas Preset resets all the variables local to the current measurement except the persistent ones.

Mode Preset - resets all the current mode's measurement local and measurement global variables except the persistent ones.

Restore Mode Defaults - resets ALL the Mode variables (and all the Meas global and Meas local variables), including the persistent ones.

Type Of Preset	SCPI Command	Front Panel Access
Auto Couple	:COUPle ALL	Auto Couple front-panel key
Meas Preset	:CONFigure:<Measurement>	Meas Setup Menu
Mode Preset	:SYSTem:PRESet	Mode Preset (green key)
Restore Mode Defaults	:INSTrument:DEFault	Mode Setup Menu
Restore All Mode Defaults	:SYSTem:DEFault MODes	System Menu; Restore System Default Menu
*RST	*RST	not possible (Mode Preset with Single)
Restore Input/Output Defaults	:SYSTem:DEFault INPUt	System Menu; Restore System Default Menu
Restore Power On Defaults	:SYSTem:DEFault PON	System Menu; Restore System Default Menu
Restore Alignment Defaults	:SYSTem:DEFault ALIGN	System Menu; Restore System Default Menu
Restore Miscellaneous Defaults	:SYSTem:DEFault MISC	System Menu; Restore System Default Menu
Restore All System Defaults	:SYSTem:DEFault [ALL] :SYSTem:PRESet:PERsistent	System Menu; Restore System Default Menu
User Preset	:SYSTem:PRESet:USER	User Preset Menu
User Preset All Modes	:SYSTem:PRESet:USER:ALL	User Preset Menu

Power On Mode Preset	:SYSTem:PON:TYPE MODE	System Menu
Power On User Preset	:SYSTem:PON:TYPE USER	System Menu
Power On Last State	:SYSTem:PON:TYPE LAST	System Menu

Restore Mode Defaults

Resets the state for the currently active mode by resetting the mode persistent settings to their factory default values, clearing mode data and by performing a Mode Preset. This function will never cause a mode switch. This function performs a full preset for the currently active mode; whereas, Mode Preset performs a partial preset. Restore Mode Defaults does not affect any system settings. System settings are reset by the Restore System Defaults function. This function does reset mode data; as well as settings.

Key Path	Mode Setup
Remote Command	:INSTrument:DEFault
Example	:INST:DEF
Notes	Clears all pending OPC bits. The Status Byte is set to 0. A message comes up saying: "If you are sure, press key again".
Couplings	A Restore Mode Defaults will cause the currently running measurement to be aborted and causes the default measurement to be active. It gets the mode to a consistent state with all of the default couplings set.
Initial S/W Revision	Prior to A.02.00

Preset Type (Remote Command Only)

As stated in the Backward Compatibility section, to be compatible with ESA/PSA the PRESet:TYPE command will be implemented as a no-op.

Mode	All
Remote Command	:SYSTem:PRESet:TYPE FACTory MODE USER :SYSTem:PRESet:TYPE?
Example	:SYST:PRES:TYPE FACT
Notes	This command is supported for backward compatibility only. It is a no-op which does not change the behavior of any preset operation.
Preset	This is unaffected by Preset but is set to Mode on a "Restore System Defaults->All"
State Saved	No
Initial S/W Revision	Prior to A.02.00

Global Settings

Opens a menu that allows you to switch certain Meas Global parameters to a Mode Global state. These switches apply to all Modes that support global settings. No matter what Mode you are in when you set the “Global Center Frequency” switch to on, it applies to all Modes that support Global Settings.

Key Path	Mode Setup
Initial S/W Revision	Prior to A.02.00

Global Center Freq

The software maintains a Mode Global value called “Global Center Freq”.

When the Global Center Freq key is switched to On in any mode, the current mode’s center frequency is copied into the Global Center Frequency, and from then on all modes that support global settings use the Global Center Frequency. So you can switch between any of these modes and the Center Freq will remain unchanged.

Adjusting the Center Freq of any mode which supports Global Settings, while Global Center Freq is On, will modify the Global Center Frequency.

When Global Center Freq is turned Off, the Center Freq of the current mode is unchanged, but now the Center Freq of each mode is once again independent.

When Mode Preset is pressed while Global Center Freq is On, the Global Center Freq is preset to the preset Center Freq of the current mode.

This function is reset to Off when the Restore Defaults key is pressed in the Global Settings menu, or when System, Restore Defaults, All Modes is pressed.

Key Path	Mode Setup, Global Settings
Scope	Mode Global
Remote Command	:INSTRument:COUPle:FREQuency:CENTer ALL NONE :INSTRument:COUPle:FREQuency:CENTer?
Example	INST:COUP:FREQ:CENT ALL INST:COUP:FREQ:CENT?
Preset	Set to Off on Global Settings, Restore Defaults and System, Restore Defaults, All Modes
Range	On Off
Initial S/W Revision	Prior to A.02.00

Remote Command	:GLOBal:FREQuency:CENTer[:STATe] 1 0 ON OFF :GLOBal:FREQuency:CENTer[:STATe]?
Preset	Off
Initial S/W Revision	Prior to A.02.00

Restore Defaults

This key resets all of the functions in the Global Settings menu to Off. This also occurs when System, Restore Defaults, All Modes is pressed.

Key Path	Mode Setup, Global Settings
Remote Command	:INSTrument:COUPle:DEFault
Example	INST:COUP:DEF
Backwards Compatibility SCPI	:GLOBal:DEFault
Initial S/W Revision	Prior to A.02.00

Peak Search

Displays the Peak Search menu and places the selected marker on the trace point with the maximum y-axis value for that marker's trace.

Key Path	Front-panel key
Remote Command	:CALCulate:AM FM PM FMSTereo:MARKer[1] 2 ... 12:MAXimum
Example	CALC:AM:MARK2:MAX
Initial S/W Revision	Prior to A.02.00
Modified at S/W Revision	A.10.00

Next Peak

Moves the selected marker to the peak that has the next highest amplitude less than the current marker value. If there is no valid peak lower than the current marker position, an error is generated and the marker is not moved.

If the selected marker was off, then it is turned on as a normal marker and a peak search is performed. In Analog Demod, the Peak Threshold and Peak Excursion functions are both OFF. If there is no valid peak, an error is generated and the marker is not moved. If the selected marker was off, then it is turned on as a normal marker and a peak search is performed.

Key Path	Peak Search
Remote Command	:CALCulate:AM FM PM FMSTereo:MARKer[1] 2 ... 12:MAXimum:NEXT
Example	CALC:AM:MARK2:MAX:NEXT Selects marker 2 and moves it to the peak that is closest in amplitude to the current peak, but the next lower value.
Remote Command Notes	Sending this command selects the specified marker
State Saved	Not part of instrument saved state
Initial S/W Revision	Prior to A.02.00
Modified at S/W Revision	A.10.00

Pk-Pk Search

Finds and displays the amplitude and frequency (or time, if on a time domain trace) differences between the highest and lowest y-axis value. It places the selected marker on the minimum value on its selected trace and it places that marker's reference marker on the peak of its selected trace. This function turns on the reference marker and sets its mode to Fixed if it is not already on. (These markers may be on two different traces.)

When peak-to-peak search is successful, a message is displayed on the message line.

If the selected marker is off, a delta type marker is turned on and the peak-to-peak search is done. If the selected marker is on, but it is not a delta marker, then it is changed to delta, which turns on the reference marker if needed. It then performs the peak-to-peak function.

Key Path	Peak Search
Remote Command	:CALCulate:AM FM PM FMSTereo:MARKer[1] 2 ... 12:PTPeak
Example	CALC:AM:MARK:PTP CALC:AM:MARK:Y? Queries the delta amplitude value for marker 1.
Notes	Turns on the Marker Δ active function.
Remote Command Notes	Sending this command selects the specified marker.
Couplings	Selected marker becomes a delta marker if not already in delta mode..
State Saved	Not part of instrument saved state
Initial S/W Revision	Prior to A.02.00
Modified at S/W Revision	A.10.00

Min Search

Moves the selected marker to the minimum y-axis value on the current trace. If the selected marker is off, it is turned on before the minimum search is performed.

Key Path	Peak Search
Remote Command	:CALCulate:AM FM PM FMSTereo:MARKer[1] 2 ... 12:MINimum
Example	CALC:AM:MARK:MIN selects marker 1 and moves it to the minimum amplitude value.
Remote Command Notes	Sending this command selects the specified marker.
State Saved	Not part of instrument saved state
Initial S/W Revision	Prior to A.02.00
Modified at S/W Revision	A.10.00

10 Φ M Demod Measurement
Print

Print

See "Print" on page 181

Quick Save

The Quick Save front-panel key repeats the most recent save that was performed from the Save menu, with the following exceptions:

- Register saves are not remembered as Saves for the purpose of the Quick Save function
- If the current measurement does not support the last non-register save that was performed, an informational message is generated, “File type not supported for this measurement”

Quick Save repeats the last type of qualified save (that is, a save qualified by the above criteria) in the last save directory by creating a unique filename using the Auto File Naming algorithm described below.

If Quick Save is pressed after startup and before any qualified Save has been performed, the Quick Save function performs a Screen Image save using the current settings for Screen Image saves (current theme, current directory), which then becomes the “last save” for the purpose of subsequent Quick Saves.

The Auto File Naming feature automatically generates a file name for use when saving a file. The filename consists of a prefix and suffix separated by a dot, as is standard for the Windows® file system. A default prefix exists for each of the available file types:

Type	Default Prefix	Menu
State	State_	(Save/Recall)
Trace + State	State_	(Save/Recall)
Screen	Screen_	(Save/Recall)
Amplitude Corrections	Ampcor_	(Import/Export)
Traces	Trace_	(Import/Export)
Limit Lines	LLine_	(Import/Export)
Measurement Result	MeasR_	(Import/Export)
Capture Buffer	CapBuf_	(Import/Export)

A four digit number is appended to the prefix to create a unique file name. The numbering sequence starts at 0000 within each Mode for each file type and updates incrementally to 9999, then wraps to 0000 again. It remembers where it was through a Mode Preset and when leaving and returning to the Mode. It is reset by Restore Misc Defaults and Restore System Defaults and subsequent running of the instrument application. So, for example, the first auto file name generated for State files is State_0000.state. The next is State_0001, and so forth.

One of the key features of Auto File Name is that we guarantee that the Auto File Name will never conflict with an existing file. The algorithm looks for the next available number. If it gets to 9999, then it looks for holes. If it find no holes, that is no more numbers are available, it gives an error.

For example, if when we get to State_0010.state there is already a State_0010.state file in the current directory, it advances the counter to State_0011.state to ensure that no conflict will exist (and then it verifies that State_0011.state also does not exist in the current directory and advances again if it does, and so forth).

If you enter a file name for a given file type, then the prefix becomes the filename you entered instead of the default prefix, followed by an underscore. The last four letters (the suffix) are the 4-digit number.

For example, if you save a measurement results file as “fred.csv”, then the next auto file name chosen for a measurement results save will be fred_0000.csv.

NOTE Although 0000 is used in the example above, the number that is used is actually the current number in the Meas Results sequence, that is, the number that would have been used if you had not entered your own file name.

NOTE If the filename you entered ends with _dddd, where d=any number, making it look just like an auto file name, then the next auto file name picks up where you left off with the suffix being dddd + 1.

Key Path	Front-panel key
Notes	No remote command for this key specifically.
Initial S/W Revision	Prior to A.02.00

State

The Recall State menu lets you choose a register or file from which to recall the state.

The content of a state file includes all of the settings and data required to return the analyzer as closely as possible to the Mode it was in, with the exact settings that were in place, when the save occurred. The Mode settings in each state file include the settings that are affected by Mode Preset, as well as the additional settings affected by Restore Mode Defaults; all of the Mode’s settings. In addition, all of the settings of the Input/Output system are included, even though they are outside of the Mode’s state, because they are needed to restore the complete setup. Persistent System settings (for example, GPIB address) are not affected by either a Mode Preset or Restore Mode Defaults, nor are they included in a saved State file.

Since each state file is only for one Mode, the settings for other Modes are unaffected when it is loaded. Recall State will cause a mode switch if the state being recalled is not from the current active mode.

After the recall completes, the message "File <filename> recalled" or “Recalled State Register <register number>” is displayed.

For rapid recalls, the State menu lists 16 registers that you can choose from to recall. Pressing a Register key initiates the recall. You can also select a file from which to recall.

The default path for all State Files is:

My Documents\<<mode name>\state

where <mode name> is the parameter used to select the mode with the INST:SEL command (for example, SA for the Spectrum Analyzer).

See "[More Information](#)" on page 891.

Key Path	Recall
----------	--------

Mode	All
Remote Command	:MMEMory:LOAD:STATe <filename>
Example	:MMEM:LOAD:STAT "myState.state" This recalls the file myState.state on the default path
Example	MMEM:LOAD:STAT "MyStateFile.state" This loads the state file data (on the default file directory path) into the instrument state.
Notes	<p>When you pick a file to recall, the analyzer first verifies that the file is recallable in the current instrument by checking the software version and model number of the instrument. If everything matches, a full recall proceeds by aborting the currently running measurement, clearing any pending operations, and then loading the State from the saved state file. You can open state files from any mode, so recalling a State file switches to the mode that was active when the save occurred. After switching to the mode of the saved state file, mode settings and data (if any for the mode) are loaded with values from the saved file. The saved measurement of the mode becomes the newly active measurement and the data relevant to the measurement (if there is any) is recalled.</p> <ul style="list-style-type: none"> • If there is a mismatch between file version or model number or instrument version or model number, the recall function tries to recall as much as possible and returns a warning message. It may limit settings that differ based on model number, licensing or version number. <p>After recalling the state, the Recall State function does the following:</p> <ul style="list-style-type: none"> • Makes the saved measurement for the mode the active measurement. • Clears the input and output buffers. • Status Byte is set to 0. • Executes a *CLS <p>If the file specified is empty an error is generated. If the specified file does not exist, another error is generated. If there is a mismatch between the file and the proper file type, an error is generated. If there is a mismatch between file version or model number or instrument version or model number, a warning is displayed. Then it returns to the State menu and File Open dialog goes away.</p> <p>After the Recall, the analyzer exits the Recall menu and returns to the previous menu.</p>
Backwards Compatibility SCPI	:MMEMory:LOAD:STATe 1,<filename> For backwards compatibility, the above syntax is supported. The "1" is simply ignored.
Initial S/W Revision	Prior to A.02.00

More Information

In measurements that support saving Traces, for example, Swept SA, the Trace data is saved along with the State in the State file. When recalling the State, the Trace data is recalled as well. Traces are recalled exactly as they were stored, including the writing mode and update and display modes. If a Trace was updating and visible when the State was saved, it will come back updating and visible, and its data will be rewritten right away. When you use State to save and recall traces, any trace whose data must be preserved should be placed in View or Blank mode before saving.

The following table describes the Trace Save and Recall possibilities:

You want to recall state and one trace's data, leaving other traces	Save Trace+State from 1 trace. Make sure that no other traces are	On Recall, specify the trace you want to load the one trace's data
---	--	--

unaffected.	updating (they should all be in View or Blank mode) when the save is performed.	into. This trace will load in View. All other traces' data will be unaffected, although their trace mode will be as it was when the state save was performed.
You want to recall all traces	Save Trace+State from ALL traces.	On Recall, all traces will come back in View (or Blank if they were in Blank or Background when saved)
You want all traces to load exactly as they were when saved.	Save State	On recall, all traces' mode and data will be exactly as they were when saved. Any traces that were updating will have their data immediately overwritten.

From File...

When you press “From File”, the analyzer brings up a Windows dialog and a menu entitled “File Open.” This menu allows you to navigate to the various fields in the Windows dialog without using a keyboard or mouse. The Tab and Arrow keys can also be used for dialog navigation.

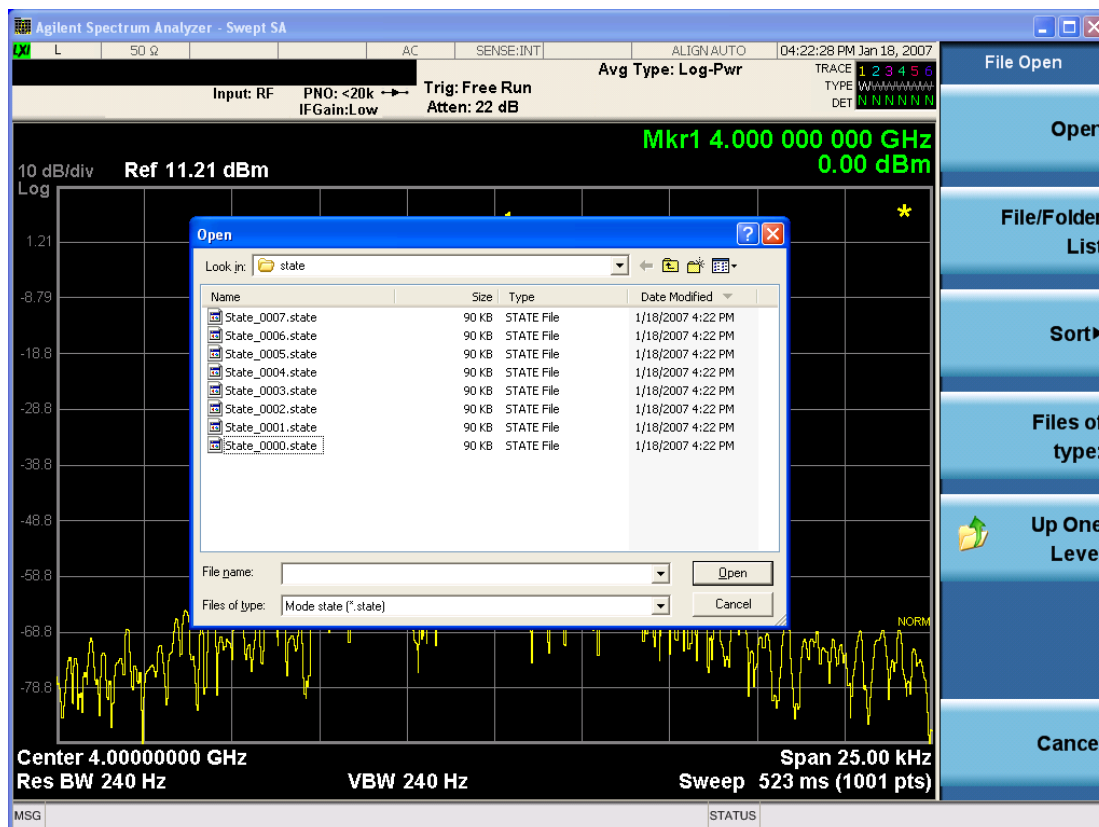

Listed below are the functions of the various fields in the dialog, and the corresponding softkeys:

Open

Performs the recall of the specified file. While the recall is being performed, the floppy icon appears briefly in the Meas bar.

File/Folder List

Enables you to navigate to the center of the dialog that contains the list of files and folders. Once here you can get information about the file and use the tab keys to navigate to the other fields in the dialog, such as Look In.

Look In

The Look In field shows the path from which the file will be recalled and allows you to change the path using the up and down arrow keys to navigate to other paths; the Enter key to open a directory; and the Backspace key to go back one directory. The **Look In field** first uses the last path from the Save As dialog **Save In:** path for that same file type. There is no softkey for directly navigating to the Look In field, but you can use the left tab to get here from the File/Folder List.

User specified paths are remembered when you leave and return to a Mode and are reset back to the default using Restore Mode Defaults.

Sort

Accesses a menu that enables you to sort the files within the File Open dialog. Only one sorting type can be selected at a time and the sorting happens immediately. The sorting types are By Date, By Name, By extension, and By Size.

Files of Type

This field shows the file suffix for the type of file you have selected to recall. For example, if you navigated here while recalling State, "Mode state (*.state)" is in the field. If you navigated here while recalling Trace, ""Mode state (*.trace)" is in the field. If you navigated here while importing a trace data file, "Trace Data (*.csv)" is in the field. For some file types, there is more than one choice in the dropdown menu, which you can select by using the up and down arrow keys and Enter.

Up One Level

This key corresponds to the icon of a folder with the up arrow that is in the tool bar of the dialog. When pressed, it causes the file and folder list to navigate up one level in the directory structure. The Backspace key does the same thing.

Cancel

This key corresponds to the Cancel selection in the dialog. It causes the current **Open** request to be cancelled. The ESC key does the same thing.

Key Path	Recall, State
Notes	Brings up the Open dialog for recalling a State Save Type
Initial S/W Revision	Prior to A.02.00

Edit Register Names

You may enter a custom name on any of the Register keys, to help you remember what you are using that state to save. To do this, press the Edit Register Names key, choose the register whose name you wish to edit, and then enter the desired label using the Alpha Editor or an external PC keyboard.

The maximum number of characters that can be added is 30. In most cases, 30 characters will fit on two lines of the key.

For more information and the SCPI command, see Edit Register Names under the Save, State function.

Key Path	Recall, State
Mode	All
Dependencies	N9060A-7FP or N9060B-2FP license required to edit the register names. When the feature is not licensed, sending the SCPI command generates an error, -221, "Settings conflict;Option not available"
Initial S/W Revision	A.11.00

Register 1 thru Register 16

Selecting any one of these register keys causes the State of the mode from the specified Register to be recalled. Each of the register keys annotates whether it is empty or at what date and time it was last modified. In addition, you can use the Edit Register Names key under Save, State to enter custom names for each register.

NOTE

In products that run multiple instances of the X-Series Application, recalling the same register name on each instance is a way to share setups between the instances.

Registers are shared by all modes, so recalling from any one of the registers will cause a mode switch to the mode that was active when the save to the Register occurred.

Although these 16 registers are the only registers available from the front panel, there are 128 state registers available in the instrument. Registers 17-128 are only available from the SCPI interface, using the *RCL command.

After the recall completes, the message "Register <register number> recalled" appears in the message bar. If you are in the Spectrum Analyzer Mode, and you are recalling a register that was saved in the Spectrum Analyzer Mode, then after the recall, you will still be in the Recall Register menu. If the Recall causes you to switch modes, then after the Recall, you will be in the Frequency menu.

If a requested register is empty an error is generated.

Key Path	Recall, State
Example	*RCL 1
Range	1-16 from front panel, 1-128 from SCPI
Readback	Date and time with seconds resolution are displayed on the key OR A custom name of up to 30 characters entered using the Save, State,Edit Register Names key

	OR “(empty)” if no prior save operation has been performed to this register.
Initial S/W Revision	Prior to A.02.00
Modified at S/W Revision	Prior to A.11.00

Register 1 thru Register 16

Selecting any one of these register keys causes the State of the mode from the specified Register to be recalled. Each of the register keys annotates whether it is empty or at what date and time it was last modified. In addition, you can use the Edit Register Names key under Save, State to enter custom names for each register.

NOTE In products that run multiple instances of the X-Series Application, recalling the same register name on each instance is a way to share setups between the instances.

Registers are shared by all modes, so recalling from any one of the registers will cause a mode switch to the mode that was active when the save to the Register occurred.

Although these 16 registers are the only registers available from the front panel, there are 128 state registers available in the instrument. Registers 17–128 are only available from the SCPI interface, using the *RCL command.

After the recall completes, the message "Register <register number> recalled" appears in the message bar. If you are in the Spectrum Analyzer Mode, and you are recalling a register that was saved in the Spectrum Analyzer Mode, then after the recall, you will still be in the Recall Register menu. If the Recall causes you to switch modes, then after the Recall, you will be in the Frequency menu.

If a requested register is empty an error is generated.

Key Path	Recall, State
Example	*RCL 1
Range	1–16 from front panel, 1–128 from SCPI
Readback	Date and time with seconds resolution are displayed on the key OR A custom name of up to 30 characters entered using the Save, State, Edit Register Names key OR “(empty)” if no prior save operation has been performed to this register.
Initial S/W Revision	Prior to A.02.00
Modified at S/W Revision	Prior to A.11.00

Restart

The Restart function restarts the current sweep, or measurement, or set of averaged/held sweeps or measurements. If you are Paused, pressing Restart does a Resume.

The Restart function is accessed in several ways:

- Pressing the Restart key
- Sending the remote command INIT:IMMEDIATE
- Sending the remote command INIT:RESTART

See "[More Information](#)" on page 896

Key Path	Front-panel key
Remote Command	:INITiate[:IMMEDIATE] :INITiate:RESTART
Example	:INIT:IMM :INIT:REST
Notes	:INITiate:RESTART and :INITiate:IMMEDIATE perform exactly the same function.
Couplings	Resets average/hold count k. For the first sweep overwrites all active (update=on) traces with new current data. For application modes, it resets other parameters as required by the measurement.
Status Bits/OPC dependencies	This is an Overlapped command. The STATUS:OPERation register bits 0 through 8 are cleared. The STATUS:QUESTionable register bit 9 (INTEGRITY sum) is cleared. The SWEEPING bit is set. The MEASURING bit is set.
Backwards Compatibility Notes	For Spectrum Analysis mode in ESA and PSA, the Restart hardkey and the INITiate:RESTART command restart trace averages (displayed average count reset to 1) for a trace in Clear Write, but did not restart Max Hold and Min Hold. In the X-Series, the Restart hardkey and the INITiate:RESTART command restart not only Trace Average, but MaxHold and MinHold traces as well. For wireless comms modes in ESA and PSA, the Restart hardkey and the INITiate:RESTART command restart every measurement, which includes all traces and numeric results. There is no change to this operation.
Initial S/W Revision	Prior to A.02.00

More Information

The **Restart** function first aborts the current sweep/measurement as quickly as possible. It then resets the sweep and trigger systems, sets up the measurement and initiates a new data measurement sequence with a new data acquisition (sweep) taken once the trigger condition is met.

If the analyzer is in the process of aligning when **Restart** is executed, the alignment finishes before the restart function is performed.

Even when set for Single operation, multiple sweeps may be taken when Restart is pressed (for example, when averaging/holding is on). Thus when we say that **Restart** "restarts a measurement," we may mean:

- It restarts the current sweep
- It restarts the current measurement
- It restarts the current set of sweeps if any trace is in Trace Average, Max Hold or Min Hold
- It restarts the current set of measurements if Averaging, or Max Hold, or Min Hold is on for the measurement
- depending on the current settings.

With **Average/Hold Number** (in **Meas Setup** menu) set to 1, or Averaging off, or no trace in Trace Average or Hold, a single sweep is equivalent to a single measurement. A single sweep is taken after the trigger condition is met; and the analyzer stops sweeping once that sweep has completed. However, with **Average/Hold Number** >1 and at least one trace set to **Trace Average, Max Hold, or Min Hold (SA Measurement)** or **Averaging on (most other measurements)**, multiple sweeps/data acquisitions are taken for a single measurement. The trigger condition must be met prior to each sweep. The sweep is stopped when the average count k equals the number N set for **Average/Hold Number**. A measurement average usually applies to all traces, marker results, and numeric results; but sometimes it only applies to the numeric results.

Once the full set of sweeps has been taken, the analyzer will go to idle state. To take one more sweep without resetting the average count, increment the average count by 1, by pressing the step up key while **Average/Hold Number** is the active function, or sending the remote command `CALC:AVER:TCON UP`.

Save

The Save menu lets you choose what you want to save and where you want to save it. Among the types of files you can save are **States**, **Traces**, and **Screen Images**. In addition, an Export (Data) option lets you save a number of data types as CSV files for easy import into Excel and other spreadsheet programs.

Key Path	Front-panel key
Mode	All
Notes	No remote command for this key specifically, but the :MMEM:STORe command is available for specific file types. An example is :MMEM:STOR:STATe <filename>.
Initial S/W Revision	Prior to A.02.00

State

The Save State menu lets you choose a register or file for saving the state.

NOTE

In products that run multiple instances of the X-Series Application, all instances share the same register and file location where you want to save the state.

The content of a state file includes all of the settings and data required to return the analyzer as closely as possible to the Mode it was in, with the exact settings which were in place, when the save occurred. The Mode settings in each state file include the settings that are affected by Mode Preset, as well as the additional settings affected by Restore Mode Defaults; all of the Mode's settings. In addition, all of the settings of the Input/Output system are included, even though they are outside of the Mode's state, because they are needed to restore the complete setup. Persistent System settings (for example, Verbose SCPI) are not affected by either Mode Preset or Restore Mode Defaults, nor are they included in a saved State file.

After the save completes, the message "File <filename> saved" or "State Register <register number> saved" is displayed.

For rapid saving, the State menu lists 16 registers to save to. Pressing a Register key initiates the save. You can also select a file to save to.

The default path for all State Files is:

My Documents\<<mode name>\state

where <mode name> is the parameter used to select the mode with the INST:SEL command (for example, SA for the Spectrum Analyzer).

Key Path	Save
Mode	All
Remote Command	:MMEMory:STORe:STATe <filename>
Example	MMEM:STOR:STATe "MyStateFile.state" This stores the current instrument state data in the file MyStateFile.state in the default directory.
Notes	Both single and double quotes are supported for any filename parameter over remote.

After saving to a register, that register's menu key is updated with the date the time, unless a custom label has been entered for that key.

After saving to a register, you remain in the Save State menu, so that you can see the Register key update. After saving to a file, the analyzer automatically returns to the previous menu and any Save As dialog goes away.

Backwards Compatibility SCPI :MMEMory:STORe:STATe 1,<filename>

For backwards compatibility, the above syntax is supported. The "1" is simply ignored. The command is sequential.

Initial S/W Revision Prior to A.02.00

To File . . .

When you press "To File", the analyzer brings up a Windows dialog and a menu entitled "Save As." This menu allows you to navigate to the various fields in the Windows dialog without using a keyboard or mouse. The Tab and Arrow keys can also be used for dialog navigation.

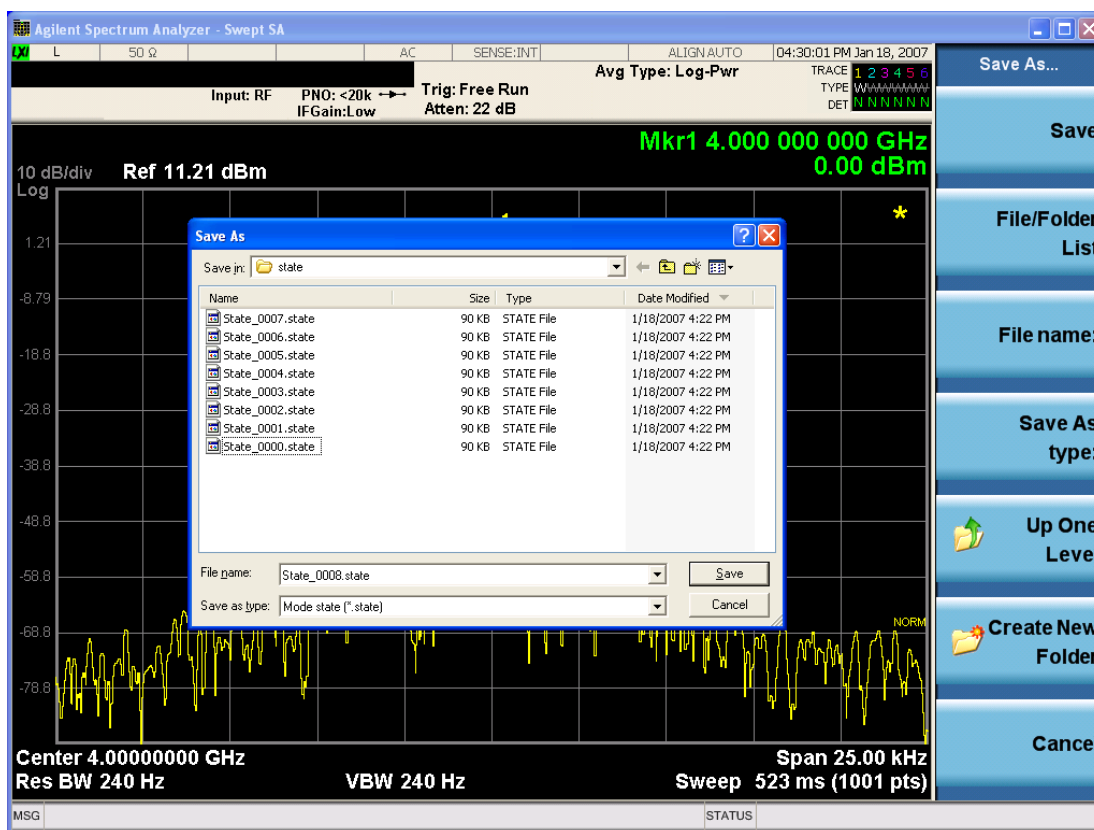

The Listed below

are the functions of the various fields in the dialog, and the corresponding softkeys:

Save

Performs the save to the specified file of the selected type. If the file already exists, a dialog will appear that allows you to replace the existing file by selecting OK, or you can Cancel the request. If you select OK,

the file will be overwritten. Using the C: drive is strongly discouraged, since it runs the risk of being overwritten during an instrument software upgrade.

While the save is being performed, the floppy icon appears briefly in the Meas bar.

File/Folder List

Enables you to navigate to the center of the dialog that contains the list of files and folders. Once here you can get information about the file and use the tab keys to navigate to the other fields in the dialog, such as Save In.

Save In

The Save In field shows the path to which the file will be saved and allows you to change the path using the up and down arrow keys to navigate to other paths; the Enter key to open a directory; and the Backspace key to go back one directory. The **Save In field** defaults to the default path for this type of file and remembers the last path you used to save this type of file. There is no softkey for directly navigating to the Save In field but you can use left tab to get here from the File/Folder List.

User specified paths are remembered when you leave and return to a Mode and are reset back to the default using Restore Mode Defaults.

File Name

The File Name field is initially loaded with an automatically generated filename specific to the appropriate Save Type. The automatically generated filename is guaranteed not to conflict with any filename currently in the directory. You may replace or modify this filename using the File Name key. See the ["Quick Save " on page 1171](#) documentation for more on the automatic file naming algorithm.

When you press the File Name key the analyzer displays the Alpha Editor. Use the knob to choose the letter to add and the front-panel Enter key to add the letter to the file name. The BK character moves you back and the FW character moves you forward in the filename. The Select key on the front panel generates a space character. When you are done entering the filename press the Done softkey. This returns back to the **File Open** dialog and menu, but does not cause the save to occur.

Save As Type

This field shows the file suffix for the type of file you have selected to save. For example, if you navigated here while saving State, "Mode state (*.state)" is in the field. If you navigated here from saving Trace, ""Mode state (*.trace)" is in the field. If you navigated here while exporting a trace data file, "Trace Data (*.csv)" is in the field. For some file types, there is more than one choice in the dropdown, which you can select by using the up and down arrow keys and Enter.

Up One Level

This key corresponds to the icon of a folder with the up arrow that is in the tool bar of the dialog. When pressed, it causes the file and folder list to navigate up one level in the directory structure. The Backspace key does the same thing.

Create New Folder

This key corresponds to the icon of a folder with the "*" that is in the tool bar of the dialog. When pressed, a new folder is created in the current directory with the name **New Folder** and you can enter a new folder name using the Alpha Editor.

Cancel

This key corresponds to the Cancel selection in the dialog. It causes the current **Save As** request to be cancelled. The ESC key does the same thing.

Key Path	Save, State
Mode	All
Notes	Brings up Save As dialog for saving a State Save Type
Initial S/W Revision	Prior to A.02.00

Edit Register Names

You may enter a custom name on any of the Register keys, to help you remember what you are using that state to save. To do this, press the Edit Register Names key, choose the register whose name you wish to edit, and then enter the desired label using the Alpha Editor or an external PC keyboard.

The maximum number of characters that can be added is 30. In most cases, 30 characters will fit on two lines of the key.

See "[More Information](#)" on page 901

Key Path	Save, State
Mode	All
Remote Command	:MMEMory:REGister:STATe:LABel <reg number>,"label" :MMEMory:REGister:STATe:LABel? <reg number>
Example	:MMEM:REG:STAT:LAB 1,"my label"
Notes	<reg number> is an integer from 1 to 16. If the SCPI specifies an invalid register number an error message is generated, -222,"Data out of range;Invalid register label number" "label" is a string from 0 to 30 characters in length. If a label exceeds 30 characters, an error message is generated, -150,"String data error;Label clipped to 30 characters" "label" of length 0 erases the custom label and restores the default (time and date) label. E.g.: :MMEM:REG:STAT:LAB 1,""
Dependencies	N9060A-7FP or N9060B-2FP license required to edit the register names. When the feature is not licensed, sending this command generates an error, -221,"Settings conflict;Option not available"
Preset	The names are unaffected by Preset or power cycle but are set to the default label (time and date) on a "Restore System Defaults->Misc"
Initial S/W Revision	A.11.00

More Information

When you edit one of the register names, the time and date field will be replaced by the custom name.

If you delete all the characters in the custom name, it restores the default (time and date).

The register names are stored within the state files, but they are not part of the instrument state; that is, once you have edited a register name, loading a new state will not change that register name. Another

consequence of this is that the names will be persistent through a power cycle. Also, if a named state file is transferred to another analyzer, it will bring its custom name along with it.

If you try to edit the name of an empty register, the analyzer will first save the state to have a file to put the name in. If you load a named state file into an analyzer with older firmware it will ignore the metadata.

The *SAV and *RCL commands will not be affected by the custom register names, nor will the MMEM commands.

Register 1 thru Register 16

Selecting any one of these register menu keys causes the State of the currently active mode to be saved to the specified Register. The registers are provided for rapid saving and recalling, since you do not need to specify a filename or navigate to a file. Each of the register menu keys annotates whether it is empty or at what date and time it was last modified. In addition, you can use the Edit Register Names key to enter custom names for each register.

NOTE

In products that run multiple instances of the X-Series Application, save with different register name if you do not want to overwrite the register of another running instance.

Although these 16 registers are the only registers available from the front panel, there are 128 state registers available in the instrument. Registers 17–128 are only available from the SCPI interface, using the *SAV command.

There is one set of 128 state registers in the instrument, not one set for each Mode. When a state is saved, the Mode it was saved from is saved with it; then when it is recalled, the instrument switches to that Mode.

After the save completes, the corresponding register menu key annotation is updated with the date and time and the message "Register <register number> saved" is displayed.

Key Path	Save, State
Mode	All
Example	*SAV 1
Range	1–16 from front panel, 1–128 from SCPI
Readback	Date and time with seconds resolution are displayed on the key OR A custom name of up to 30 characters entered using the Edit Register Names key OR “(empty)” if no prior save operation has been performed to this register.
Initial S/W Revision	Prior to A.02.00
Modified at S/W Revision	A.11.00

Register 1 thru Register 16

Selecting any one of these register menu keys causes the State of the currently active mode to be saved to the specified Register. The registers are provided for rapid saving and recalling, since you do not need to specify a filename or navigate to a file. Each of the register menu keys annotates whether it is empty or at

what date and time it was last modified. In addition, you can use the Edit Register Names key to enter custom names for each register.

NOTE In products that run multiple instances of the X-Series Application, save with different register name if you do not want to overwrite the register of another running instance.

Although these 16 registers are the only registers available from the front panel, there are 128 state registers available in the instrument. Registers 17–128 are only available from the SCPI interface, using the *SAV command.

There is one set of 128 state registers in the instrument, not one set for each Mode. When a state is saved, the Mode it was saved from is saved with it; then when it is recalled, the instrument switches to that Mode.

After the save completes, the corresponding register menu key annotation is updated with the date and time and the message "Register <register number> saved" is displayed.

Key Path	Save, State
Mode	All
Example	*SAV 1
Range	1–16 from front panel, 1–128 from SCPI
Readback	Date and time with seconds resolution are displayed on the key OR A custom name of up to 30 characters entered using the Edit Register Names key OR “(empty)” if no prior save operation has been performed to this register.
Initial S/W Revision	Prior to A.02.00
Modified at S/W Revision	A.11.00

Mass Storage Catalog (Remote Command Only)

Key path	SCPI Only
Remote Command	:MMEMory:CATalog? [<directory_name>]
Notes	The string must be a valid logical path. Queries disk usage information (drive capacity, free space available) and obtains a list of files and directories in a specified directory in the following format: <numeric_value>,<numeric_value>,{<file_entry>} It returns two numeric parameters and as many strings as there are files and directories. The first parameter indicates the total amount of storage currently used in bytes. The second parameter indicates the total amount of storage available, also in bytes. The <file_entry> is a string. Each <file_entry> indicates the name, type, and size of one file in the directory list: <file_name>,<file_type>,<file_size> As the windows file system has an extension that indicates file type, <file_type> is always empty. <file_size> provides the size of the file in bytes. For directories, <file_entry> is surrounded by square brackets and both <file_type> and <file_size> are empty
Initial S/W Revision	Prior to A.02.00

Mass Storage Change Directory (Remote Command Only)

Key path	SCPI Only
Remote Command	:MMEMory:CDIRectory [<directory_name>] :MMEMory:CDIRectory?
Notes	The string must be a valid logical path. Changes the default directory for a mass memory file system. The <directory_name> parameter is a string. If no parameter is specified, the directory is set to the *RST value. At *RST, this value is set to the default user data storage area, that is defined as System.Environment.SpecialFolder.Personal. Query returns full path of the default directory.
Initial S/W Revision	Prior to A.02.00

Mass Storage Copy (Remote Command Only)

Key path	SCPI Only
Remote Command	:MMEMory:COPY <string>,<string>[,<string>,<string>]
Notes	The string must be a valid logical path. Copies an existing file to a new file or an existing directory to a new directory. Two forms of parameters are allowed. The first form has two parameters. In this form, the first parameter specifies the source, and the second parameter specifies the destination. The second form has four parameters. In this form, the first and third parameters specify the source. The second and fourth parameters specify the directories. The first pair of parameters specifies the source. The second pair specifies the destination. An error is generated if the source doesn't exist or the destination file already exists. This command will generate an "access denied" error if the destination is a restricted folder (e.g., C:\Windows) and the current user does not have Power User or Administrator privileges.

Mass Storage Device Copy (Remote Command Only)

This command transfers data to/from a file and a peripheral device.

Key path	SCPI Only
Remote Command	:MMEMory:COPY:DEvice <source_string>,<dest_string>
Notes	The strings must be a valid logical path or a valid device keyword. If the dest_string is a device keyword, the data is copied from the source file to the device. If the source_string is a device keyword, the data is copied to the source file from the device. Valid device keywords are: SNS (smart noise source) An error is generated if the file or device is not found.

Mass Storage Delete (Remote Command Only)

Key path	SCPI Only
Remote Command	:MMEMory:DELeTe <file_name>[,<directory_name>]
Notes	The string must be a valid logical path. Removes a file from the specified directory. The <file_name> parameter specifies the file name to be removed. This command will generate an “access denied” error if the file is in a restricted folder (e.g., C:\Windows) and the current user does not have Power User or Administrator privileges.
Initial S/W Revision	Prior to A.02.00

Mass Storage Data (Remote Command Only)

Creates a file containing the specified data OR queries the data from an existing file.

Key path	SCPI Only
Remote Command	:MMEMory:DATA <file_name>, <data> :MMEMory:DATA? <file_name>
Notes	The string must be a valid logical path. The command form is MMEMory:DATA <file_name>,<data>. It loads <data> into the file <file_name>. <data> is in 488.2 block format. <file_name> is string data. The query form is MMEMory:DATA? <file_name> with the response being the associated <data> in block format.
Initial S/W Revision	Prior to A.02.00

Mass Storage Make Directory (Remote Command Only)

Key path	SCPI Only
Remote Command	:MMEMory:MDIRectory <directory_name>
Notes	The string must be a valid logical path. Creates a new directory. The <directory_name> parameter specifies the name to be created. This command will generate an “access denied” error if the new directory would be in a restricted folder (e.g., C:\Windows) and the current user does not have Power User or Administrator privileges.
Initial S/W Revision	Prior to A.02.00

Mass Storage Move (Remote Command Only)

Key path	SCPI Only
Remote Command	:MMEMory:MOVE <string>,<string>[,<string>,<string>]
Notes	The string must be a valid logical path. Moves an existing file to a new file or an existing directory to a new directory.

Two forms of parameters are allowed. The first form has two parameters. In this form, the first parameter specifies the source, and the second parameter specifies the destination.

The second form has four parameters. In this form, the first and third parameters specify the source. The second and fourth parameters specify the directories. The first pair of parameters specifies the source. The second pair specifies the destination. An error is generated if the source doesn't exist or the destination file already exists.

This command will generate an "access denied" error if the destination is a restricted folder (e.g., C:\Windows) and the current user does not have Power User or Administrator privileges.

Initial S/W Revision	Prior to A.02.00
----------------------	------------------

Mass Storage Remove Directory (Remote Command Only)

Key path	SCPI Only
Remote Command	:MMEMory:RDIRECTory <directory_name>
Notes	The string must be a valid logical path. Removes a directory. The <directory_name> parameter specifies the directory name to be removed. All files and directories under the specified directory shall also be removed. This command will generate an "access denied" error if the folder is a restricted folder (e.g., C:\Windows) or is in a restricted folder and the current user does not have Power User or Administrator privileges.

Initial S/W Revision	Prior to A.02.00
----------------------	------------------

Sequences

These keys allow you to save a Tab separated or CSV file of the setup parameters required to build a Sequence.

In order to save you must select the Save As button and choose a destination folder.

Key Path	Save, Sequences
Mode	All
Remote Command	:MMEM:STOR:SEQ:ences: SLIST ALIST SAAList SSTep "MySequence.txt"
Example	:MMEM:STOR:SEQ:SLIST "MySequence.txt"
Notes	Available file types are: –CSV (Comma delimited) (*.csv) –Text (Tab delimited) (*.txt)

Initial S/W Revision	A.05.00
----------------------	---------

Source Sequence

The list of parameters, that configure steps, that makes up a sequence for the Source.

The Source sequence is a sequence of flexible configurable steps that can be set anywhere in the instruments frequency range.

Key Path	Save, Sequences
Example	:MMEM:STOR:SEQ:SLIS "MySequence.txt"
Dependencies	Only available in XOBT
Initial S/W Revision	A.05.00

Save As . . .

This menu lets you select the location where you can save the Sequence. This menu is a standard Windows® dialog with Save As menu keys. The "File Name" field in the Save As dialog is initially loaded with an automatically generated filename specific to the appropriate Save Type. The automatically generated filename is guaranteed not to conflict with any filename currently in the directory. You may replace or modify this filename using the File Name softkey. See the Quick Save key documentation for more on the automatic file naming algorithm.

The default path for all Sequence Files is:

My Documents\Sequences

Key Path	Save, Sequences
Mode	All
Notes	Brings up Save As dialog for saving a Sequence Save Type
Initial S/W Revision	A.05.00

Data

The Analog Demod Mode Export Data options include Traces and Measurement Results.

Key Path	Save, Data
Remote Command Notes	No SCPI command directly controls the Data Type that this key controls. The Data Type is included as part of the MMEM:STOR commands.
Preset	Trace; is not affected by a Preset, but is reset during Restore Mode Defaults and survives Power cycles.
State Saved	Saved in instrument state.
Readback line	1-of-N selection
Initial S/W Revision	Prior to A.02.00

AM/FM/ Φ M Trace

Selects Trace as the data type to be exported with this save request. This key brings up the Trace menu that enables you to select one of the following traces:

- RF Spectrum (RFSPectrum)
- Demod (DEMod)
- Demod Avg (DAverage)
- Demod Max (DMAXimum)
- Demod Min (DMINimum)
- AF Spectrum (AFSPectrum)
- RF Envelope (RFENvelope) --- only available in FM measurement
- Demod Raw (DRAW) --- only available in FM measurement

Once you select a trace, the menu returns back to the Data menu and the name of the selected trace is annotated on the Trace key. Now that you have selected exactly what needs to be saved, to trigger a save of the selected trace, you must select the Save As key in the Data menu.

If the Demod Min trace, Demod Max trace, or Demod Avg trace is exported when the Average/Hold Num feature is turned off, the resulting data will be default values.

The trace data file is a .csv file containing the data for one trace, suitable for import into spreadsheet software. There is a header block, followed by metadata that includes the parameters necessary to recreate the measurement, followed by a DATA block that contains the x,y data for the specified trace. Each line in the metadata includes the parameter, followed by a comma, followed by the parameter value. The metadata includes the following information:

Parameter	
Measurement †	AM FM PM
Trace	AM PM: AF Spectrum RF Spectrum Demod Demod Ave Demod Min Demod Max FM: AF Spectrum RF Spectrum Demod Demod Ave Demod Min Demod Max RF Envelope Demod Raw
X Axis Unit	Hz S
Y Axis Unit	dBm % Hz Rad
Center Frequency †	[units of Hz]
Channel BW †	[units of Hz]
Average State †	Off On
Average Count	#
HPF/BPF †	Off HPF20 HPF50 HPF300 HPF400 CCITT AWEighting

	CWEighting CMESsage CCIR1k CCIR2k CUNWeighting
LPF †	Off LPF300 LPF3K LPF10K LPF15K LPF30K LPF80K LPF300K LPF100K M500K
Attenuation †	[units of dB]
RF Coupling †	AC DC
Ref Level	[units of Y Axis Unit]
RF Span †	[units of Hz]
RF Res Bandwidth †	[units of Hz]
Sweep Time †	[units of S]
AF Start Freq	[units of Hz]
AF Stop Freq †	[units of Hz]
AF Res Bandwidth †	[units of Hz]
Trigger Source †	Off Ext1 Ext2
Trigger Level †	[units of V]
Trigger Slope †	Positive Negative
Trigger Delay †	[units of S]
PreAmp State †	Off On
PreAmp Band †	Low High
Input Z Correction †	50 75
RF Calibrator	Off 50 MHz 4.8 GHz Comb
External Gain	[units of dB]
Auto Carrier Frequency †	Off On
Auto Carrier Phase †	Off On

† Changing this parameter requires a measurement restart.

Note that all metadata is stored for each trace. After the metadata, the keyword DATA occurs on its own line, followed by the data (one X, Y pair per line).

Key Path	Save, Data
Notes	The first key press selects traces out of the 1-of-N file type options. The second key press brings up the Traces menu so you can select which trace you want to export.
Preset	RF Spectrum; is not affected by a Preset, but is reset during Restore Mode Defaults and survives Power cycles.
State Saved	Saved in instrument state.

Readback	Selected Trace table
Readback line	RF Spectrum, Demod, Demod Avg, Demod Max, Demod Min, AF Spectrum, RF Envelope, Demod Raw
Initial S/W Revision	Prior to A.02.00

Measurement Results

Pressing this key selects Meas Results as the data type to be exported. Pressing the key a second time brings up the Meas Results menu, which allows you to select which **Meas Result** to save. In the Swept SA measurement, there are three types of Measurement Results files: Peak Table, Marker Table and Spectrogram.

See "[Meas Results File Contents](#)" on page 910.

See "[Marker Table](#)" on page 911.

See "[Peak Table](#)" on page 913.

See Spectrogram

Remote Command	:MMEMory:STORe:RESults:MTABle PTABle SPEctrogram <filename>
Example	:MMEM:STOR:RES:MTAB "myResults.csv" Saves the results from the current marker table to the file myResults.csv in the current path. :MMEM:STOR:RES:PTAB "myResults.csv" Saves the results from the current peak table to the file myResults.csv in the current path. :MMEM:STOR:RES:SPEC "myResults.csv" Saves the results from the current Spectrogram display to the file myResults.csv in the current path. The default path is My Documents\SA\data\SAN\results
Notes	If the save is initiated via SCPI, and the file already exists, the file will be overwritten. Using the C: drive is strongly discouraged, since it runs the risk of being overwritten during an instrument software upgrade. Both single and double quotes are supported for any filename parameter over SCPI.
Dependencies	If a save of Marker Table results is requested and the Marker Table is not on, no file is saved and a message is generated If a save of Peak Table results is requested and the Peak Table is not on, no file is saved and a message is generated If a save of Spectrogram results is requested and the Spectrogram is not on, no file is saved and a message is generated. The Spectrogram choice only appears if option EDP is licensed.
Preset	Not part of Preset, but is reset to Peak Table by Restore Mode Defaults. Survives a shutdown.
Initial S/W Revision	Prior to A.02.00

Meas Results File Contents

All files are .csv files. The following section details the data in each file type.

Marker Table

This section discusses the Marker Table Meas Results file format.

Imagine that, at the point where a Marker Table Meas Result is requested, the following screen is showing:

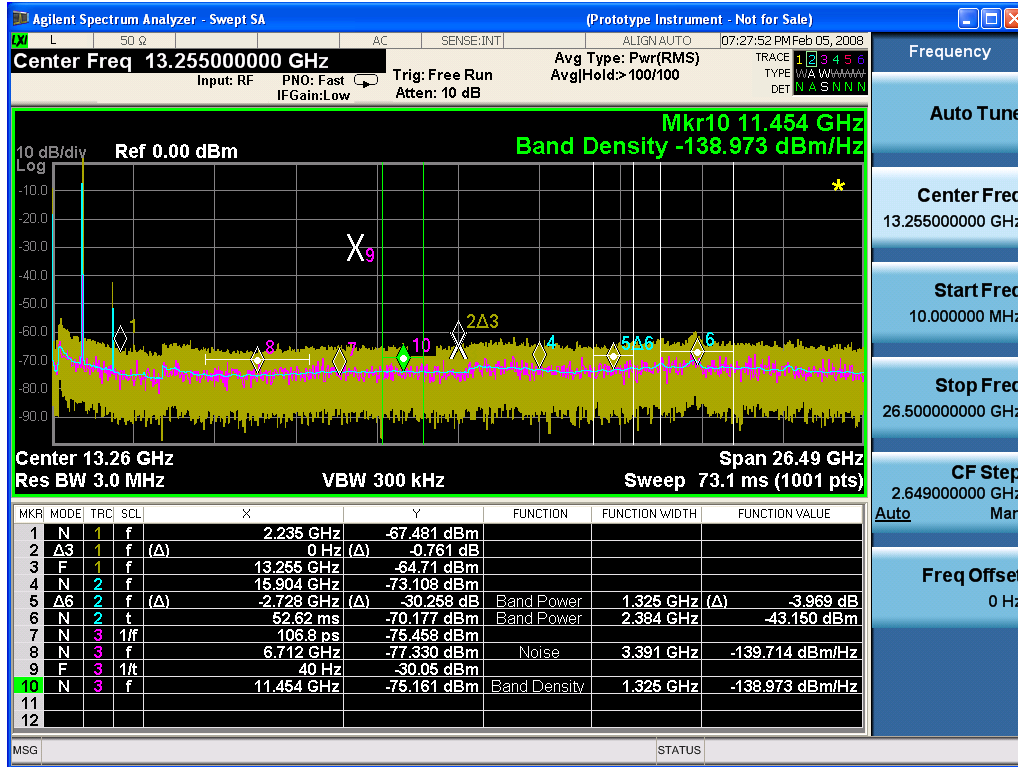

Then the Meas Results file, when opened, would show the following data:

MeasurementR	
result	
Swept SA	
A.01.40_R0017	N9020A
526 B25 PFR	1
P26 EA3	
Result Type	Marker Table
Ref Level	0
Number of Points	1001
Sweep Time	0.0662666 67
Start Frequency	10000000
Stop Frequency	26500000 000

Average Count	0
Average Type	LogPower (Video)
RBW	3000000
RBW Filter	Gaussian
RBW Filter BW	3dB
VBW	3000000
Sweep Type	Swept
X Axis Scale	Lin
PreAmp State	Off
PreAmp Band	Low
Trigger Source	Free
Trigger Level	1.2
Trigger Slope	Positive
Trigger Delay	1.00E-06
Phase Noise Optimization	Fast
Swept If Gain	Low
FFT If Gain	Autorange
RF Coupling	AC
FFT Width	411900
Ext Ref	10000000
Input	RF
RF Calibrator	Off
Attenuation	10
Ref Level Offset	0
External Gain	0
X Axis Units	Hz
Y Axis Units	dBm

DATA									
MKR	MODE	TRC	SCL	X	Y	FUNCTION	FUNCTION WIDTH	FUNCTION VALUE	FUNCTION UNIT
1	Normal	1	Frequency	2.2350E+09	-67.481	Off	0.0000E+00	0	None
2	Delta3	1	Frequency	0.0000E+00	-0.761	Off	0.0000E+00	0	None

3	Fixed	1	Freque ncy	1.3255E+ 10	- 64.7 1	Off	0.0000E+ 00	0	None
4	Normal	2	Freque ncy	1.5904E+ 10	- 73.1 08	Off	0.0000E+ 00	0	None
5	Delta7	2	Freque ncy	- 2.7280E+ 09	- 30.2 58	Band Power	1.3250E+ 06	-3.969	dB
6	Normal	2	Time	5.2620E- 02	- 70.1 77	Band Power	2.3840E+ 06	-43.15	dBm
7	Normal	3	Period	1.0680E- 10	- 75.4 58	Off	0.0000E+ 00	0	None
8	Normal	3	Freque ncy	6.7120E+ 09	- 77.3 3	Noise	3.3910E+ 06	- 139.71 4	dBm/Hz
9	Fixed	3	Inverse Time	4.0000E+ 01	- 30.0 5	Off	0.0000E+ 00	0	None
10	Normal	3	Freque ncy	1.1454E+ 10	- 75.1 61	Band Density	1.3250E+ 06	- 138.97 3	dBm/Hz
11	Off	1	Freque ncy	0.0000E+ 00	0	Off	0.0000E+ 00	0	None
12	Off	1	Freque ncy	0.0000E+ 00	0	Off	0.0000E+ 00	0	None

The numbers appear in the file exactly as they appear onscreen. If it says 11.454 GHz onscreen, then in the file it is 11.454E+09.

The metadata header is very similar to the metadata used in the trace data .csv files. See Trace File Contents. The only new information concerns the 1-of-N fields in the marker table itself.

Peak Table

This section discusses the Peak Table Meas Results file format.

Imagine that, at the point where a Marker Table Meas Result is requested, the following screen is showing:

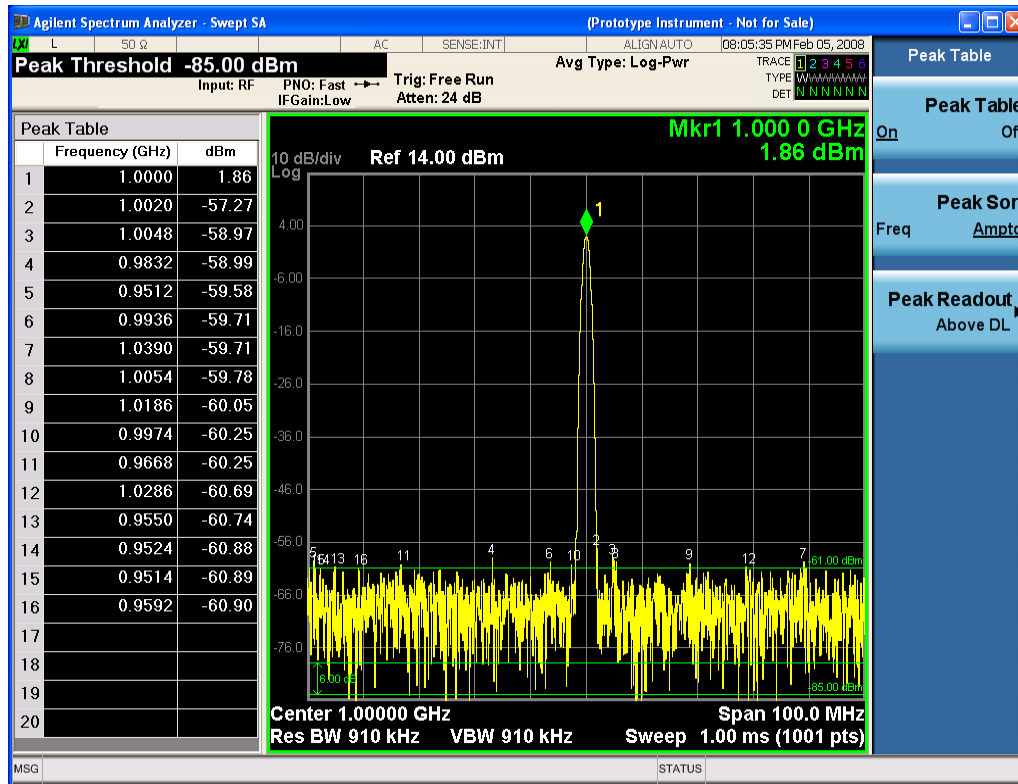

Then the Meas Results file, when opened, would show the header data (the same as for the Marker Table except that the Result Type is Peak Table) ending with a few fields of specific interest to Peak Table users:

- Peak Threshold
- Peak Threshold State (On|Off)
- Peak Excursion
- Peak Excursion State (On|Off)
- Display Line
- Peak Readout (All|AboveDL|BelowDL)
- Peak Sort (Freq|Amptd)

These fields are then followed by the data for the Peak Table itself.

Note that the label for the Frequency column changes to Time in 0 span.

Here is what the table for the above display looks like:

MeasurementResult	
Swept SA	
A.01.40_R0017	N9020A
526 B25 PFR P26 EA3	1

Result Type	Peak Table
Ref Level	0
Number of Points	1001
Sweep Time	0.066266667
Start Frequency	10000000
Stop Frequency	26500000000
Average Count	0
Average Type	LogPower(Video)
RBW	3000000
RBW Filter	Gaussian
RBW Filter BW	3dB
VBW	3000000
Sweep Type	Swept
X Axis Scale	Lin
PreAmp State	Off
PreAmp Band	Low
Trigger Source	Free
Trigger Level	1.2
Trigger Slope	Positive
Trigger Delay	1.00E-06
Phase Noise Optimization	Fast
Swept If Gain	Low
FFT If Gain	Autorange
RF Coupling	AC
FFT Width	411900
Ext Ref	10000000
Input	RF
RF Calibrator	Off
Attenuation	10
Ref Level Offset	0
External Gain	0
X Axis Units	Hz
Y Axis Units	dBm
Peak Threshold	-85
Peak Threshold State	On
Peak Excursion	6
Peak Excursion State	On

Display Line	-61	
Peak Readout	AboveDL	
Peak Sort	Amptd	
DATA		
Peak	Frequency	Amplitude
1	1.0000E+06	1.86
2	1.0020E+06	-57.27
3	1.0048E+06	-58.97
4	9.8320E+05	-58.99
5	9.5120E+05	-59.58
6	9.9360E+05	-59.71
7	1.0390E+06	-59.71
8	1.0054E+06	-59.78
9	1.1086E+06	-60.05
10	9.9740E+05	-60.25
11	9.6680E+05	-60.25
12	1.0286E+06	-60.69
13	9.5500E+05	-60.74
14	9.5240E+05	-60.88
15	9.5140E+05	-60.89
16	9.5920E+05	-60.90
17		
18		
19		
20		

Spectrogram

This section discusses the Spectrogram Results file format. The Spectrogram choice only appears if option EDP is licensed.

The Spectrogram results are the same as a Trace data export, except that instead of having just one trace's data, all 300 traces appear one after the other.

Each trace has its own data mark; the data for Spectrogram Trace 0 follows the row marked DATA, the data for Spectrogram Trace 1 follows the row marked DATA1, for Spectrogram Trace 2 follows the row marked DATA2, and so on.

Each DATA row has a timestamp in the second column (as of firmware revision A.11.01). So, for example, if Trace 0 had a relative start time of 1729.523 sec, then the first DATA row would look like this:

DATA,1729.523

And if Trace 13 had a relative start time of 100.45 sec, then the fourteenth data row would look like:

DATA13,100.453

To find the absolute time for the relative timestamps of each trace, the last row before the first DATA row gives the absolute start time of the Spectrogram, in the form YYYYMMDDHHMMSS

So, for example, if the absolute start time is 13:23:45:678 on January 30, 2012, this row would look like:

Start Time,20120130132345678

NOTE:

NOTE The resolution of the absolute time stored is 1 ms, which matches up with the fact that the fastest sweep time is also 1 ms. However, there is no specification for the absolute accuracy of the clock in the analyzer, nor is there any facility provided to allow the user to set this time to any particular degree of accuracy.

Traces that have not yet been filled in the Spectrogram display are empty; there is no DATA header for them. The file ends after the last non-empty trace.

Imagine that, at the point where a Spectrogram Meas Result is requested, the following screen is showing:

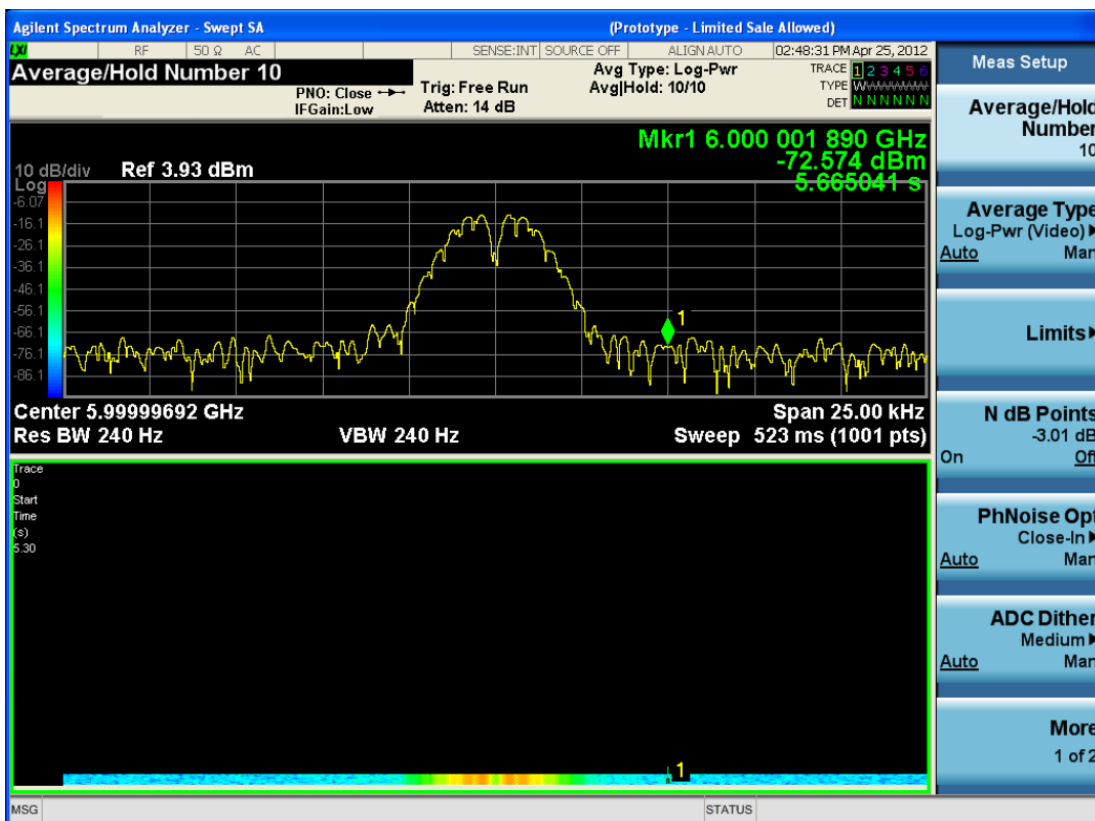

For the purpose of this example, we have set the Average/Hold Number to 10, thus we have only traces 0 thru 10. The Spectrogram was started at 02:28:08:700 pm on April 25, 2012 (that is, 700 ms after 2:28:08 pm), although the screen dump itself shows a different time, as it was taken ten minutes after the Spectrogram data. Trace 0 is showing a start time of 5.30 seconds, meaning 5.3 seconds after the Spectrogram started (trace 10 has a start time of 0, as it was the first trace taken but has now rolled up into the tenth trace slot).

The Meas Results file, when opened, shows the header data and ten traces of trace data. Below is an extract from the result file for the above display. Note the start time of 20120425142808700 showing in the last row before the first DATA row, and the relative time of 5.299231048 showing in the first DATA row:

Result Type	Spectrogram
MeasResult	
Swept SA	
A.11.00.01	N9020A
503 508 513 526 ALL ALV B1C B1X B25 B2X B40 BAB BBA CR3 CRP DP2 DRD EA3 EDP EMC EP1 ERC ESC ESP EXM FSA HBA K03 LFE MPB P03 P08 P13 P26 PFR RTL RTS S40 SB1 SEC SM1 UK6 YAS YAV	1
Segment	0
Number of Points	1001
Sweep Time	0.523333333
Start Frequency	5999984415
Stop Frequency	6000009415
Average Count	0
Average Type	LogPower(Video)
RBW	240
RBW Filter	Gaussian
RBW Filter BW	3dB
VBW	240
Sweep Type	Swept
X Axis Scale	Lin
PreAmp State	Off
PreAmp Band	Low
Trigger Source	Free
Trigger Level	1.2
Trigger Slope	Positive
Trigger Delay	0
Phase Noise Optimization	Wide
Swept If Gain	Low

Result Type	Spectrogram
FFT If Gain	Autorange
RF Coupling	AC
FFT Width	411900
Ext Ref	10000000
Input	RF
RF Calibrator	Off
Attenuation	14
Ref Level Offset	0
External Gain	0
Trace Type	Clearwrite
Detector	Normal
Trace Math	Off
Trace Math Oper1	Trace5
Trace Math Oper2	Trace6
Trace Math Offset	0
Trace Name	Trace1
X Axis Units	Hz
Y Axis Units	dBm
Start Time	20120425142808700
DATA	5.299231048
5999984415	-76.34749519
5999984440	-77.28097006
5999984465	-75.32317869
5999984490	-73.64417681
5999984515	-72.67154604

○
○
○

6000009315	-77.94423277
6000009340	-79.51829697
6000009365	-78.46108961
6000009390	-78.46108957
6000009415	-76.59570596
DATA2	4.708697055

5999984415	-80.98197882
5999984440	-80.98197879
5999984465	-75.83142132
5999984490	-74.02712079
5999984515	-73.57213005

o
o
o

6000009315	-75.9183103
6000009340	-79.53787488
6000009365	-78.82602191
6000009390	-78.82602188
6000009415	-76.37486709
DATA10	0
5999984415	-75.56751112
5999984440	-75.76485645
5999984465	-76.67718717
5999984490	-78.79238489
5999984515	-83.72680212

o
o
o

6000009315	-71.3942461
6000009340	-72.28308332
6000009365	-73.92684489
6000009390	-75.45548832
6000009415	-75.17904815

Save As . . .

When you press “Save As”, the analyzer brings up a Windows dialog and a menu entitled “**Save As.**” This menu allows you to navigate to the various fields in the Windows dialog without using a keyboard or mouse. The Tab and Arrow keys can also be used for dialog navigation.

See "To File . . ." on page 1181 in Save, State for a full description of this dialog and menu.

The default path for saving files is:

For all of the Trace Data Files:

My Documents\`<mode name>`\data\traces

For all of the Limit Data Files:

My Documents\`<mode name>`\data\limits

For all of the Measurement Results Data Files:

My Documents\`<mode name>`\data\`<measurement name>`\results

For all of the Capture Buffer Data Files:

My Documents\`<mode name>`\data\captureBuffer

Key Path	Save, Data
Mode	All
Notes	The key location is mode-dependent and will vary. Brings up the Save As dialog for saving a <code><mode specific></code> Save Type. The save is performed immediately and does not wait until the measurement is complete.
Initial S/W Revision	Prior to A.02.00

Screen Image

Pressing Screen Image accesses a menu of functions that enable you to specify a format and location for the saved screen image. It brings up a menu that allows you to specify the color scheme of the Screen Image (Themes) or navigate to the Save As dialog to perform the actual save.

Screen Image files contain an exact representation of the analyzer display. They cannot be loaded back onto the analyzer, but they can be loaded into your PC for use in many popular applications.

The image to be saved is actually captured when the Save front panel key is pressed, and kept in temporary storage to be used if you ask for a Screen Image save. When the Screen Image key is pressed, a "thumbnail" of the captured image is displayed, as shown below:

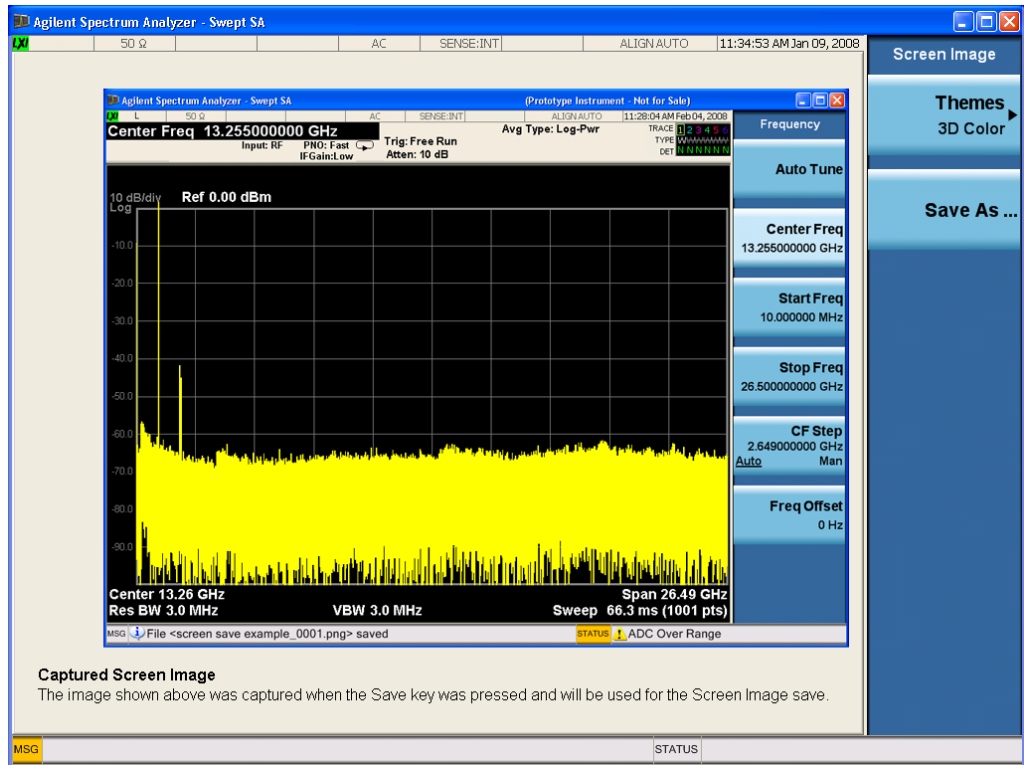

When you continue on into the Save As menu and complete the Screen Image save, the image depicted in the thumbnail is the one that gets saved, showing the menus that were on the screen before going into the Save menus. The save is performed immediately and does not wait until the measurement is complete.

After you have completed the save, the Quick Save front-panel key lets you quickly repeat the last save performed, using an auto-named file, with the current screen data.

NOTE

For versions previous to A.01.55, if you initiate a screen image save by navigating through the Save menus, the image that is saved will contain the Save menu softkeys, not the menus and the active function that were on the screen when you first pressed the Save front panel key.

Key Path	Save
Mode	All
Remote Command	:MMEMory:STORe:SCReen <filename>
Example	:MMEM:STOR:SCR "myScreen.png" This stores the current screen image in the file MyScreenFile.png in the default directory.
Initial S/W Revision	Prior to A.02.00

Themes

Accesses a menu of functions that enable you to choose the theme to be used when saving the screen image.

The **Themes** option is the same as the **Themes** option under the **Display** and **Page Setup** dialogs. It allows you to choose between themes to be used when saving the screen image.

Key Path	Save, Screen Image
Remote Command	:MMEMory:STORe:SCReen:THEMe TDColor TDMonochrome FCOLOR FMONochrome :MMEMory:STORe:SCReen:THEMe?
Example	:MMEM:STOR:SCR:THEM TDM
Preset	3D Color; Is not part of Preset, but is reset by Restore Misc Defaults or Restore System Defaults All and survives subsequent running of the modes.
Readback	3D Color 3D Mono Flat Color Flat Mono
Backwards Compatibility Notes	In ESA and PSA we offer the choice of "Reverse Bitmap" or "Reverse Metafile" when saving screen images. This is much like the "Flat Color" theme available in X-Series. Also, if you selected Reverse Bitmap AND a black & white screen image, that would be much like "Flat Monochrome". In other words, each of the X-Series themes has a similar screen image type in ESA/PSA. But they are not identical.
Initial S/W Revision	Prior to A.02.00

3D Color

Selects a standard color theme with each object filled, shaded and colored as designed.

Key Path	Save, Screen Image, Themes
Example	MMEM:STOR:SCR:THEM TDC
Readback	3D Color
Initial S/W Revision	Prior to A.02.00

3D Monochrome

Selects a format that is like 3D color but shades of gray are used instead of colors.

Key Path	Save, Screen Image, Themes
Example	MMEM:STOR:SCR:THEM TDM
Readback	3D Mono
Initial S/W Revision	Prior to A.02.00

Flat Color

Selects a format that is best when the screen is to be printed on an ink printer.

Key Path	Save, Screen Image, Themes
----------	----------------------------

Example	MMEM:STOR:SCR:THEM FCOL
Readback	Flat Color
Initial S/W Revision	Prior to A.02.00

Flat Monochrome

Selects a format that is like Flat Color. But only black is used (no colors, not even gray), and no fill.

Key Path	Save, Screen Image, Themes
Example	MMEM:STOR:SCR:THEM FMON
Readback	Flat Mono
Initial S/W Revision	Prior to A.02.00

Save As...

When you press "Save As", the analyzer brings up a Windows dialog and a menu entitled "**Save As.**" This menu allows you to navigate to the various fields in the Windows dialog without using a keyboard or mouse. The Tab and Arrow keys can also be used for dialog navigation.

See "[To File . . .](#)" on page 1181 in Save, State for a full description of this dialog and menu.

The default path for Screen Images is

My Documents\`<mode name>`\screen.

where `<mode name>` is the parameter used to select the mode with the INST:SEL command (for example, SA for the Spectrum Analyzer).

Key Path	Save, Screen Image
Notes	Brings up Save As dialog for saving a Screen Image Save Type
Initial S/W Revision	Prior to A.02.00

Single (Single Measurement/Sweep)

Sets the analyzer for Single measurement operation. The single/continuous state is Meas Global, so the setting will affect all the measurements. If you are Paused, pressing Single does a Resume.

See "[More Information](#)" on page 925

Key Path	Front-panel key
Example	:INIT:CONT OFF
Notes	See Cont key description.
Backwards Compatibility Notes	<p>For Spectrum Analysis mode in ESA and PSA, the Single hardkey and the INITiate:IMM switched from continuous measurement to single measurement and restarted sweeps and averages (displayed average count reset to 1), but did not restart Max Hold and Min Hold. In the X-Series, the Single hardkey and the INITiate:IMM command initiate a sweep/ measurement/ average sequence/hold sequence including MaxHold and MinHold.</p> <p>For Spectrum Analysis mode in ESA and PSA, the Single hardkey restarted the sweep regardless of whether or not you were in an active sweep or sweep sequence. In the X-Series, Restart does this but Single only restarts the sweep or sweep sequence if you are in the idle state.</p> <p>INIT[:IMM] in ESA & PSA Spectrum Analysis Mode does an implied ABORT. In some other PSA Modes, INIT[:IMM] is ignored if not in the idle state. . The X-Series follows the ESA/PSA SA Mode model, which may cause some Modes to have compatibility problems.</p>
Initial S/W Revision	Prior to A.02.00

More Information

See "[Restart](#)" on page 1178 for details on the INIT:IMMEDIATE (Restart) function.

If you are already in single sweep, the INIT:CONT OFF command has no effect.

If you are already in Single Sweep, then pressing the Single key in the middle of a sweep does not restart the sweep or sequence. Similarly, pressing the Single key does not restart the sweep or sequence if the sweep is not in the idle state (for example, if you are taking a very slow sweep, or the analyzer is waiting for a trigger). Instead, it results in a message. "Already in Single, press Restart to initiate a new sweep or sequence". Even though pressing the Single key in the middle of a sweep does not restart the sweep, sending INIT:IMMEDIATE does reset it.

To take one more sweep without resetting the average count, increment the average count by 1, by pressing the step up key while **Average/Hold Number** is the active function, or sending the remote command CALC:AVER:TCON UP.

Source

Opens a menu of keys that access various source configuration menus and settings. In the test set, pressing this key also causes the central view area to change and display the Source Control Main view.

Key Path	Front-panel key
----------	-----------------

RF Output

This parameter sets the source RF power output state.

Key Path	Source
Remote Command	:OUTPut[:EXTErnal][:STATe] ON OFF 1 0 :OUTPut[:EXTErnal][:STATe]?
Example	OUTP OFF OUTP?
Notes	<p>The EXTErnal node is shown in RD text so the SCPI remains the same between internal and external source control. However, for EXT we do not wish to document this node to the customer since we are controlling the internal source rather than the external source.</p> <p>This setting is for the independent mode and has no effect on the "List Sequencer" on page 1306. If the "Sequencer" on page 1307 is set to ON, the list sequencer controls the source output and this key will be grayed-out. And this setting will be none-forceful grey out on front panel to indicate out-of-scope. Non-forceful means user still can change this setting by SCPI but cannot change on front panel. When set to OFF will make source leave list sequencer and this setting will be black out and take effect immediately.</p> <p>When the RF Output is ON, an "RF" annunciator is displayed in the system settings panel. When the RF Output is turned Off, the RF annunciator is cleared. If the "Sequencer" on page 1307 is set to ON, the "RF" annunciator will be replaced by "SEQ" in the system settings panel, indicating that the output is controlled by the list sequencer.</p>
Preset	Off
Range	On Off
Initial S/W Revision	A.05.00

Amplitude

Allows you to access the Amplitude sub-menu.

Key Path	Source
Notes	<p>The sub-menu under this button is for independent mode and has no effect on "List Sequencer" on page 1306. If the "Sequencer" on page 1307 is set to ON, the list sequencer controls the source output and this key will be grayed-out on front panel to indicate out-of-scope. When you set "Sequencer" on page 1307 to Off will make source leave list sequencer and this button will be black out.</p>
Initial S/W Revision	A.05.00

RF Power

Allows you to adjust the power level of the source using the numeric keypad, step keys, or RPG. Pressing any digit, 0 through 9, on the numeric keypad brings up the unit terminator.

Please refer to the "RF Power Range " on page 928 table below for the valid ranges.

Key Path	Source, Amplitude
Remote Command	:SOURce:POWer[:LEVel][:IMMediate][:AMPLitude] <ampl> :SOURce:POWer[:LEVel][:IMMediate][:AMPLitude]?
Example	:SOUR:POW -100 dBm
Notes	<p>Amplitude corrections can be specified for use with the source. In the event of amplitude corrections being applied, the valid ranges for the RF power do not change dependant on the current amplitude correction setting. If the combination of RF power + amplitude correction is higher or lower than the source output range, the Source Unleveled bit is set and the "Source Unleveled" indicator will appear on status panel to indicate that the source cannot maintain the output power that has been requested.</p> <p>When signal generator is unable to maintain the requested output level, the "Source Unleveled" indicator will appear on status panel. When the source output setting is restored to the normal range, the "Source Unleveled" is removed from status panel.</p> <p>Internal source has list sequence mode, which comprises of several steps which contain separate output power, frequency and waveform etc. When the source list sequence playing is complete, the last step keeps playing, and user can use this command to change the list sequence last step's output power.</p> <p>The multiport adapter RFIO TX ports and GPS ports cannot ensure power accuracy when power setting is lower than -130dBm, this power setting value is defined by the sum of RF Power setting and related amplitude correction value. But user settable value could be lower than this limit. When application detected there exists power setting lower than -130dBm on MPA RFIO TX ports, then popup warning message . When application detected there exists power setting lower than -130dBm on MPA GPS ports, then popup warning message . This is only warning message, and check is performed when RF is ON.</p>
Notes	The Min and Max value here defined UI settable amplitude range. This range is larger than actual amplitude range with level accuracy defined in spec.
Dependencies	The RF power is dependent on the RF output port and frequency, such that the current frequency and selected output port determine the valid range of power values.
Preset	-100 dBm
Min	The range of values depends on the current frequency and selected RF output port. Please refer to the "RF Power Range " on page 928 table below for the valid ranges.
Max	The range of values depends on the current frequency and selected RF output port. Please refer to the "RF Power Range " on page 928 table below for the valid ranges.
Initial S/W Revision	A.05.00

RF Power Range

RF Output Port	Frequency Range	Min Output Power	Max Output Power
High Power RF Out	10 MHz \leq f \leq 6 GHz	-150 dBm	20 dBm
RFIO 1 & RFIO 2	10 MHz \leq f \leq 6 GHz	-150 dBm	0 dBm
GPS (Note2)	10 MHz \leq f \leq 6 GHz	-150 dBm	0 dBm

Note: This is the UI power range, it's larger than actual spec.

Note2: GPS port is on the multiport adapter, or E6607C which has embedded MPA.

Set Reference Power

This key allows you to set the power reference. Pressing this key turns the power reference state to ON, sets the reference power value to the current RF output power, maintains this power at the RF output, and sets the displayed power to 0.00 dB. All subsequent RF power values entered under Source>Amplitude>RF Power are interpreted as being relative to this reference power.

When you use a power reference, the signal generator outputs an RF power that is set relative to the reference power by the value entered under Source>Amplitude>RF Power as follows:

Output power = reference power – entered power

Where:

reference power equals the original RF Power entered under Source>Amplitude>RF Power and set as the reference power

entered power equals a new value entered under Source>Amplitude>Amptd Offset

In addition, the displayed power value is the same as a new value entered under Source>Amplitude>RF Power.

NOTE

If Power Ref is set to ON with a reference value set, entering a value under Source>Amplitude>RF Power and pressing Set Reference Power will add that value to the existing Power Ref value.

If you wish to change the reference power value to a new value entered under Source>Amplitude>RF Power, first you must set Power Ref to OFF and then press Set Reference Power.

Key Path	Source, Amplitude
Dependencies	This key is unavailable, and is grayed out when the "List Sequencer" on page 1306 is turned ON.
Initial S/W Revision	A.05.00

Power Ref

This key allows you to toggle the state of the power reference.

When you use a power reference, the signal generator outputs an RF power that is set relative to the reference power by the value entered under Source>Amplitude>RF Power as follows:

Output power = reference power + entered power

Where:

reference power equals the original RF Power entered under Source>Amplitude>RF Power and set as the reference power

entered power equals a new value entered under Source>Amplitude>Amptd Offset

For more information on Reference Frequency refer to ["Set Reference Power " on page 1229](#)

Key Path	Source, Amplitude
Remote Command	:SOURce:POWer:REFeRence <ampl> :SOURce:POWer:REFeRence? :SOURce:POWer:REFeRence:STATe OFF ON 0 1 :SOURce:POWer:REFeRence:STATe?
Example	:SOUR:POW:REF 0.00 dBm :SOUR:POW:REF:STATe ON
Dependencies	This setting is unavailable and is grayed out when the "List Sequencer" on page 1306 is turned ON.
Couplings	This value is coupled to the "Set Reference Power " on page 1229 key such that pressing the Set Reference Power key updates the reference power with the current output power.
Preset	0.00 dBm OFF
Min	-125.00 dBm
Max	10.00 dBm
Initial S/W Revision	A.05.00

Amptd Offset

Allows you to specify the RF output power offset value.

When the amplitude offset is set to zero (0) and you set a new offset value (positive or negative), the displayed amplitude value will change as follows and the RF output power will not change:

Displayed value = output power + offset value

Where:

output power equals the original RF Power entered under Source>Amplitude>RF Power

offset value equals the value entered under Source>Amplitude>Amptd Offset

When the amplitude offset is set to a value other than zero (0) and you enter a new RF power value under Source>Amplitude>RF Power, the displayed power will be the same as the value entered and the RF output power will be equal to the value entered minus the offset value as follows:

Output power = entered power – offset power

Displayed Power = output power + offset power

Displayed power = entered power

Where:

entered power equals the amplitude entered under Source>Amplitude>RF Power

offset power equals the value previously entered and set under Source>Amplitude>Amptd Offset

Key Path	Source, Amplitude
Remote Command	:SOURce:POWer[:LEVel][:IMMediate]:OFFSet <rel_ampl> :SOURce:POWer[:LEVel][:IMMediate]:OFFSet?
Example	:SOUR:POW:OFFS 0.00 dB
Dependencies	This setting is unavailable, and is grayed out when the List Sequencer is turned ON.
Preset	0.00 dB
Min	-200.00 dB
Max	200.00 dB
Initial S/W Revision	A.05.00

Modulation

Allows you to toggle the state of the modulation.

Key Path	Source
Remote Command	:OUTPut:MODulation[:STATe] ON OFF 1 0 :OUTPut:MODulation[:STATe]?
Example	:OUTP:MOD OFF
Notes	This setting is for independent mode and has no effect on " List Sequencer " on page 1306. If the " Sequencer " on page 1307 is set to ON, the list sequencer controls the source output and this key will be grayed-out. And this setting will be none-forceful grey out on front panel to indicate out-of-scope. Non-forceful means user still can change this setting by SCPI but cannot change manually on front panel. When set to Off will make source leave list sequencer and this setting will be black out and take effect immediately. When the Modulation is ON, the "MOD" annunciator is displayed in the system settings panel. When the Modulation is turned Off, the "MOD" annunciator is cleared. If the " Sequencer " on page 1307 is set to ON, the "MOD" annunciator will be replaced by "SEQ" in the system settings panel indicating that the output is controlled by list sequencer.
Preset	Off
Range	On Off
Initial S/W Revision	A.05.00

Frequency

Allows you to access the Frequency sub-menu.

Key Path	Source
Notes	The sub-menu under this button is for independent mode and has no effect on " List Sequencer " on

[page 1306](#). If the ["Sequencer" on page 1307](#) is set to ON, the list sequencer controls the source output and this key will be grayed-out. And this button will be grey out on front panel to indicate out-of-scope. When set to Off will make source leave list sequencer and this button will be black out.

Initial S/W Revision A.05.00

Frequency

Allows you to set the RF Output Frequency. You can adjust the frequency of the source using the numeric keypad, step keys, or RPG. Pressing any digit, 0 through 9, on the numeric keypad brings up the unit terminator.

Key Path	Source, Frequency
Remote Command	:SOURce:FREQuency[:CW] <freq> :SOURce:FREQuency[:CW] ?
Example	:SOUR:FREQ 1.00 GHz
Notes	Internal source has list sequence mode, which comprises of several steps which contain separate output power, frequency and waveform etc. When the source list sequence playing is complete, the last step keeps playing, and user can use this command to change the list sequence last step's output frequency.
Couplings	The frequency value is coupled to the current channel band and number, such that updates to the band and number will update the frequency value to the corresponding absolute frequency.
Preset	1.00 GHz If license F1A or 5WC is present, the default Center Frequency should be 2.412GHz.
Min	10.00 MHz
Max	Hardware Dependant: Option 503 = 3.6 GHz Option 504 = 3.8 GHz Option 506 = 6.00 GHz For E6640A, if license 5WC is present, the frequency range should be limited to: 1.1GHz-1.7GHz, 2.4GHz-2.5GHz, 4.8GHz-6.0GHz. If the user-defined frequency is outside of range, UI will report an error message called "Settings conflict; Frequency is outside available range".
Initial S/W Revision	A.05.00

Channel

The frequency of the source can be specified by a channel number of a given frequency band. This key allows you to specify the current channel number. For the appropriate range of channel numbers for a given frequency band, refer to the following tables: ["GSM/EDGE Channel Number Ranges" on page 932](#), ["W-CDMA Channel Number Ranges" on page 933](#), ["CDMA 2000 / 1xEVDO Channel Number Ranges" on page 934](#), and ["LTE FDD Channel Number Ranges" on page 936](#).

Key Path	Source, Frequency
Remote Command	:SOURCE:FREQUENCY:CHANNELS:NUMBER <int> :SOURCE:FREQUENCY:CHANNELS:NUMBER?
Example	:SOUR:FREQ:CHAN:NUMB 1
Notes	This key is grayed out when the "Radio Standard" on page 1241 is set to NONE. This key is grayed out on E6630A.
Dependencies	This key is grayed out when the "Radio Standard" on page 1241 is set to NONE. This key is grayed out on E6630A.
Couplings	The channel number is coupled to the frequency value when the "Radio Standard" on page 1241 is not set to NONE. When the frequency value is changed, the channel number will increase or decrease to match the new frequency. If the frequency is not at an exact match for a channel number, the nearest channel number is displayed along with a greater than or less than sign to indicate the frequency is above or below the channel number.
Preset	1
Min	Please refer to the tables below for the valid ranges.
Max	Please refer to the tables below for the valid ranges.
Initial S/W Revision	A.05.00

GSM/EDGE Channel Number Ranges

Band	Link (Device)	Range	Frequency (MHz)
P-GSM	Uplink (MS)	$1 \leq n \leq 124$	$890.0 + 0.2*n$
	Downlink (BS)	$1 \leq n \leq 124$	$935.0 + 0.2*n$
E-GSM	Uplink (MS)	$0 \leq n \leq 124$	$890.0 + 0.2*n$
		$975 \leq n \leq 1023$	$890.0 + 0.2*(n-1024)$
	Downlink (BS)	$0 \leq n \leq 124$	$935.0 + 0.2*n$
		$975 \leq n \leq 1023$	$935.0 + 0.2*(n-1024)$
DCS 1800	Uplink (MS)	$512 \leq n \leq 885$	$1710.200 + 0.20*(n-512)$
	Downlink (BS)	$512 \leq n \leq 885$	$1805.200 + 0.20*(n-512)$
PCS 1900	Uplink (MS)	$512 \leq n \leq 810$	$1850.200 + 0.2*(n-512)$
	Downlink (BS)	$512 \leq n \leq 810$	$1930.200 + 0.2*(n-512)$
R-GSM	Uplink (MS)	$0 \leq n \leq 124$	$890.0 + 0.2*n$
		$955 \leq n \leq 1023$	$890.0 + 0.2*(n-1024)$
	Downlink (BS)	$0 \leq n \leq 124$	$935.0 + 0.2*n$
		$955 \leq n \leq 1023$	$935.0 + 0.2*(n-1024)$
GSM 450	Uplink (MS)	$256 \leq n \leq 293$	$450.6 + 0.2*(n-259)$
	Downlink (BS)	$256 \leq n \leq 293$	$460.6 + 0.2*(n-259)$
GSM 480	Uplink (MS)	$306 \leq n \leq 340$	$479.000 + 0.20*(n-306)$

Band	Link (Device)	Range	Frequency (MHz)
GSM 850	Downlink (BS)	$306 \leq n \leq 340$	$489.000 + 0.20*(n-306)$
	Uplink (MS)	$128 \leq n \leq 251$	$824.200 + 0.20*(n-128)$
GSM 700	Downlink (BS)	$128 \leq n \leq 251$	$869.200 + 0.20*(n-128)$
	Uplink (MS)	$438 \leq n \leq 516$	$777.200 + 0.20*(n-438)$
T-GSM810	Downlink (BS)	$438 \leq n \leq 516$	$747.200 + 0.20*(n-438)$
	Uplink (MS)	$350 \leq n \leq 425$	$806.0 + 0.20*(n-350)$
	Downlink (BS)	$350 \leq n \leq 425$	$851.0 + 0.20*(n-350)$

W-CDMA Channel Number Ranges

Band	Link (Device)	Range	Frequency (MHz)
Band I	Downlink	$10562 \leq n \leq 10838$	$n \div 5$
	Uplink	$9612 \leq n \leq 9888$	$n \div 5$
Band II	Downlink	$412 \leq n \leq 687$	$n \div 5 + 1850.1$
		$9662 \leq n \leq 9938$	$n \div 5$
	Uplink	$12 \leq n \leq 287$	$n \div 5 + 1850.1$
Band III	Downlink	$350 \leq n \leq 425$	$n \div 5$
	Downlink	$1162 \leq n \leq 1513$	$n \div 5 + 1575$
Band IV	Uplink	$937 \leq n \leq 1288$	$n \div 5 + 1525$
	Downlink	$537 \leq n \leq 1738$	$n \div 5 + 1805$
Band V	Downlink	$1887 \leq n \leq 2087$	$n \div 5 + 1735.1$
		Uplink	$1312 \leq n \leq 1513$
	Downlink	$1662 \leq n \leq 1862$	$n \div 5 + 1380.1$
Band VI	Downlink	$1007 \leq n \leq 1087$	$n \div 5 + 670.1$
		$4357 \leq n \leq 4458$	$n \div 5$
	Uplink	$782 \leq n \leq 862$	$n \div 5 + 670.1$
Band VII	Downlink	$4132 \leq n \leq 4233$	$n \div 5$
		Downlink	$1037 \leq n \leq 1062$
	Uplink	$4387 \leq n \leq 4413$	$n \div 5$
Band VIII	Downlink	$812 \leq n \leq 837$	$n \div 5 + 670.1$
		$4162 \leq n \leq 4188$	$n \div 5$
	Downlink	$2237 \leq n \leq 2563$	$n \div 5 + 2175$
Band IX	Downlink	$2587 \leq n \leq 2912$	$n \div 5 + 2105.1$
		Uplink	$2012 \leq n \leq 2338$
	Downlink	$2362 \leq n \leq 2687$	$n \div 5 + 2030.1$
Band X	Downlink	$2937 \leq n \leq 3088$	$n \div 5 + 340$
	Uplink	$2712 \leq n \leq 2863$	$n \div 5 + 340$

Band	Link (Device)	Range	Frequency (MHz)
Band IX	Downlink	$9237 \leq n \leq 9387$	$n \div 5$
	Uplink	$8762 \leq n \leq 8912$	$n \div 5$
Band X	Downlink	$3112 \leq n \leq 3388$	$n \div 5 + 1490$
		$3412 \leq n \leq 3687$	$n \div 5 + 1430.1$
	Uplink	$2887 \leq n \leq 3163$	$n \div 5 + 1135$
		$3187 \leq n \leq 3462$	$n \div 5 + 1075.1$
Band XI	Downlink	$3712 \leq n \leq 3812$	$n \div 5 + 736$
	Uplink	$3487 \leq n \leq 3587$	$n \div 5 + 733$
Band XII	Downlink	$3837 \leq n \leq 3903$	$n \div 5 - 37$
		$3927 \leq n \leq 3992$	$n \div 5 - 54.9$
	Uplink	$3612 \leq n \leq 3678$	$n \div 5 - 22$
		$3702 \leq n \leq 3767$	$n \div 5 - 39.9$
Band XIII	Downlink	$4017 \leq n \leq 4043$	$n \div 5 - 55$
		$4067 \leq n \leq 4092$	$n \div 5 - 64.9$
	Uplink	$3792 \leq n \leq 3818$	$n \div 5 + 21$
		$3702 \leq n \leq 3767$	$n \div 5 - 39.9$
Band XIV	Downlink	$4117 \leq n \leq 4143$	$n \div 5 - 63$
		$4167 \leq n \leq 4192$	$n \div 5 - 72.9$
	Uplink	$3892 \leq n \leq 3918$	$n \div 5 + 12$
		$3942 \leq n \leq 3967$	$n \div 5 + 2.1$
Band XIX	Downlink	$712 \leq n \leq 763$	$n \div 5 + 735$
		$787 \leq n \leq 837$	$n \div 5 + 720.1$
	Uplink	$312 \leq n \leq 363$	$n \div 5 + 770$
		$387 \leq n \leq 437$	$n \div 5 + 755.1$

CDMA 2000 / 1xEVDO Channel Number Ranges

Band	Link (Device)	Range	Frequency (MHz)
US Cellular	Uplink (MS, reverse link)	$1 \leq N \leq 799$	$0.030 \times N + 825.000$
		$991 \leq N \leq 1023$	$0.030 \times (N - 1023) + 825.000$
		$1024 \leq N \leq 1323$	$0.030 \times (N - 1024) + 815.040$
	Downlink (BS, forward link)	$1 \leq N \leq 799$	$0.030 \times N + 870.000$
		$991 \leq N \leq 1023$	$0.030 \times (N - 1023) + 870.000$
		$1024 \leq N \leq 1323$	$0.030 \times (N - 1024) + 860.040$
US PCS	Uplink (MS, reverse link)	$0 \leq N \leq 1199$	$1850.000 + 0.050 \times N$
	Downlink (BS, forward link)	$0 \leq N \leq 1199$	$1930.000 + 0.050 \times N$

Band	Link (Device)	Range	Frequency (MHz)
Japan Cellular Band	Uplink (MS, reverse link)	$1 \leq N \leq 799$	$0.0125 \times (N + 915.000)$
		$801 \leq N \leq 1039$	$0.0125 \times (N - 800) + 898.000$
		$1041 \leq N \leq 1199$	$0.0125 \times (N - 1040) + 887.000$
		$1201 \leq N \leq 1600$	$0.0125 \times (N - 1200) + 893.000$
	Downlink (BS, forward link)	$1 \leq N \leq 799$	$0.0125 \times (N + 860.000)$
		$801 \leq N \leq 1039$	$0.0125 \times (N - 800) + 843.000$
		$1041 \leq N \leq 1199$	$0.0125 \times (N - 1040) + 832.000$
		$1201 \leq N \leq 1600$	$0.0125 \times (N - 1200) + 838.000$
Korean PCS Band	Uplink (MS, reverse link)	$0 \leq N \leq 599$	$0.050 \times N + 1750.000$
	Downlink (BS, forward link)	$0 \leq N \leq 599$	$0.050 \times N + 1840.000$
NMT-450 Band	Uplink (MS, reverse link)	$1 \leq N \leq 400$	$0.025 \times (N - 1) + 450.000$
		$472 \leq N \leq 871$	$0.025 \times (N - 472) + 410.000$
		$1039 \leq N \leq 1473$	$0.020 \times (N - 1024) + 451.010$
		$1536 \leq N \leq 1715$	$0.025 \times (N - 1536) + 479.000$
	Downlink (BS, forward link)	$1 \leq N \leq 400$	$0.025 \times (N - 1) + 460.000$
		$472 \leq N \leq 871$	$0.025 \times (N - 472) + 420.000$
		$1039 \leq N \leq 1473$	$0.020 \times (N - 1024) + 461.010$
		$1536 \leq N \leq 1715$	$0.025 \times (N - 1536) + 489.000$
IMT-2000 Band	Uplink (MS, reverse link)	$0 \leq N \leq 1199$	$1920.000 + 0.050 \times N$
	Downlink (BS, forward link)	$0 \leq N \leq 1199$	$2100.000 + 0.050 \times N$
Upper 700 MHz Band	Uplink (MS, reverse link)	$0 \leq N \leq 240$	$776.000 + 0.050 \times N$
	Downlink (BS, forward link)	$0 \leq N \leq 240$	$746.000 + 0.050 \times N$
Secondary 800 MHz Band	Uplink (MS, reverse link)	$0 \leq N \leq 719$	$0.025 \times N + 806.000$
		$720 \leq N \leq 919$	$0.025 \times (N - 720) + 896.000$
	Downlink (BS, forward link)	$0 \leq N \leq 719$	$0.025 \times N + 851.000$
		$720 \leq N \leq 919$	$0.025 \times (N - 720) + 935.000$
2.5 GHz IMT Extension	Uplink (MS, reverse link)	$0 \leq N \leq 1399$	$2500.000 + 0.050 \times N$
	Downlink (BS, forward link)	$0 \leq N \leq 1399$	$2620.000 + 0.050 \times N$
US PCS 1.9 GHz	Uplink (MS, reverse link)	$0 \leq N \leq 1299$	$1850.000 + 0.050 \times N$

Band	Link (Device)	Range	Frequency (MHz)
AWS	Downlink (BS, forward link)	$0 \leq N \leq 1299$	$1930.000 + 0.050 \times N$
	Uplink (MS, reverse link)	$0 \leq N \leq 899$	$1710.000 + 0.050 \times N$
US 2.5 GHz	Downlink (BS, forward link)	$0 \leq N \leq 899$	$2100.000 + 0.050 \times N$
	Uplink (MS, reverse link)	$140 \leq N \leq 1459$	$2495.000 + 0.050 \times N$
700 Public Safety	Downlink (BS, forward link)	$140 \leq N \leq 1459$	$2617.000 + 0.050 \times N$
	Uplink (MS, reverse link)	$0 \leq N \leq 240$	$787.000 + 0.050 \times N$
C2K Lower 700	Downlink (BS, forward link)	$0 \leq N \leq 240$	$757.000 + 0.050 \times N$
	Uplink (MS, reverse link)	$0 \leq N \leq 360$	$698.000 + 0.050 \times N$
400 Euro PAMR	Downlink (BS, forward link)	$0 \leq N \leq 360$	$728.000 + 0.050 \times N$
	Uplink (MS, reverse link)	$1 \leq N \leq 400$	$0.025 \times (N-1) + 450.000$
	Uplink (MS, reverse link)	$472 \leq N \leq 871$	$0.025 \times (N-472) + 410.000$
	Uplink (MS, reverse link)	$1536 \leq N \leq 1715$	$0.025 \times (N-1536) + 479.000$
	Downlink (BS, forward link)	$1 \leq N \leq 400$	$0.025 \times (N-1) + 460.000$
	Downlink (BS, forward link)	$472 \leq N \leq 871$	$0.025 \times (N-472) + 420.000$
	Downlink (BS, forward link)	$1536 \leq N \leq 1715$	$0.025 \times (N-1536) + 489.000$
	Downlink (BS, forward link)		
800 PAMR	Uplink (MS, reverse link)	$0 \leq N \leq 239$	$870.0125 + 0.025 \times N$
	Downlink (BS, forward link)	$0 \leq N \leq 239$	$915.0125 + 0.025 \times N$

LTE FDD Channel Number Ranges

The carrier frequency in the uplink and downlink is designated by the E-UTRA Absolute Radio Frequency Channel Number (EARFCN) in the range 0 – 65535. The relation between EARFCN and the carrier frequency in MHz for the downlink is given by the following equation, where FDL_low and NOffs-DL are given in table 5.4.4–1 and ND L is the downlink EARFCN.

$$FDL = FDL_low + 0.1(NDL - NOffs-DL)$$

The relation between EARFCN and the carrier frequency in MHz for the uplink is given by the following equation where FUL_low and NOffs-UL are given in table 5.4.4-1 and NUL is the uplink EARFCN.

$$FUL = FUL_low + 0.1(NUL - NOffs-UL)$$

Band	Downlink		Uplink			
	FDL_low (MHz)	NOffs-DL	Range of ND L	FUL_low (MHz)	NOffs-UL	Range of NUL
1		2110	0	0 - 599	1920	18000 - 18599
2		1930	600	600 - 1199	1850	18600 - 19199
3		1805	1200	1200 - 1949	1710	19200 - 19949
4		2110	1950	1950 - 2399	1710	19950 - 20399
5		869	2400	2400 - 2649	824	20400 - 20649
6		875	2650	2650 - 2749	830	20650 - 20749
7		2620	2750	2750 - 3449	2500	20750 - 20449
8		925	3450	3450 - 3799	880	21450 - 21799
9		1844.9	3800	3800 - 4149	1749.9	21800 - 22149
10		2110	4150	4150 - 4749	1710	22150 - 22749
11		1475.9	4750	4750 - 4949	1427.9	22750 - 22949
12		729	5010	5010 - 5179	699	23010 - 23179
13		746	5180	5180 - 5279	777	23180 - 23279
14		758	5280	5280 - 5379	788	23280 - 23379
...						
17		734	5730	5730 - 5849	704	23730 - 23849
18		860	5850	5850 - 5999	815	23850 - 23999
19		875	6000	6000 - 6149	830	24000 - 24149
20		791	6150	6150 - 6449	832	24150 - 24449
21		1495.9	6450	6450 - 6599	1447.9	24450 - 24599
...						
24		1525	7700	7700 - 8039	1626.5	25700 - 26039
25		1930	8040	8040 - 8689	1850	26040 - 26689
26		859	8690	8690 - 9039	814	26690 - 27039
...						

Note: The channel numbers that designate carrier frequencies so close to the operating band edges that the carrier extends beyond the operating band edge shall not be used. This implies that the first 7, 15, 25, 50, 75 and 100 channel numbers at the lower operating band edge and the last 6, 14, 24, 49, 74 and 99 channel numbers at the upper operating band edge shall not be used for channel bandwidths of 1.4, 3, 5, 10, 15 and 20 MHz respectively.

LTE TDD Channel Number Ranges

The carrier frequency in the uplink and downlink is designated by the E-UTRA Absolute Radio Frequency Channel Number (EARFCN) in the range 0 – 65535. The relation between EARFCN and the carrier frequency in MHz for the downlink is given by the following equation, where FDL_low and NOffs-DL are given in table 5.4.4–1 and NDL is the downlink EARFCN.

$$FDL = FDL_low + 0.1(NDL - NOffs-DL)$$

The relation between EARFCN and the carrier frequency in MHz for the uplink is given by the following equation where FUL_low and NOffs-UL are given in table 5.4.4–1 and NUL is the uplink EARFCN.

$$FUL = FUL_low + 0.1(NUL - NOffs-UL)$$

Band	Downlink		Uplink			
	FDL_low (MHz)	NOffs-DL	Range of NDL	FUL_low (MHz)	NOffs-UL	Range of NUL
33		1900	36000	36000 – 36199	1900	36000 – 36199
34		2010	36200	36200 – 36349	2010	36200 – 36349
35		1850	36350	36350 – 36949	1850	36350 – 36949
36		1930	36950	36950 – 37549	1930	36950 – 37549
37		1910	37550	37550 – 37749	1910	37550 – 37749
38		2570	37750	37750 – 38249	2570	37750 – 38249
39		1880	38250	38250 – 38649	1880	38250 – 38649
40		2300	38650	38650 – 39649	2300	38650 – 39649
41		2496	39650	39650 – 41589	2496	39650 – 41589
42		3400	41590	41590 – 43589	3400	41590 – 43589
43		3600	43590	43590 – 45589	3600	43590 – 45589

Note: The channel numbers that designate carrier frequencies so close to the operating band edges that the carrier extends beyond the operating band edge shall not be used. This implies that the first 7, 15, 25, 50, 75 and 100 channel numbers at the lower operating band edge and the last 6, 14, 24, 49, 74 and 99 channel numbers at the upper operating band edge shall not be used for channel bandwidths of 1.4, 3, 5, 10, 15 and 20 MHz respectively.

TDSCDMA Channel Number Ranges

1.28 Mcps TDD Option

No TX-RX frequency separation is required as Time Division Duplex (TDD) is employed. Each subframe consists of 7 main timeslots where all main timeslots (at least the first one) before the single switching point are allocated DL and all main timeslots (at least the last one) after the single switching point are allocated UL.

The nominal channel spacing is 1.6 MHz, but this can be adjusted to optimise performance in a particular deployment scenario.

The carrier frequency is designated by the UTRA absolute radio frequency channel number (UARFCN). The value of the UARFCN in the IMT2000 band is defined in the general case as follows:

$$N_t = 5 * F \quad 0.0 \text{ MHz} \leq F \leq 3276.6 \text{ MHz}$$

where F is the carrier frequency in MHz

Additional channels applicable to operation in the frequency band defined in sub-clause 5.2(d) are defined via the following UARFCN definition:

$$N_t = 5 * (F - 2150.1 \text{ MHz}) \quad 2572.5 \text{ MHz} \leq F \leq 2617.5 \text{ MHz}$$

UARFCN

1.28 Mcps TDD Option

The following UARFCN range shall be supported for each band:

**Table: UTRA Absolute Radio
Frequency Channel Number 1.28
Mcps TDD Option**

Frequency Band	Frequency Range	UARFCN Uplink and Downlink transmission
For operation in frequency band as defined in subclause 5.2 (a)	1900–1920 MHz	9504 to 9596
	2010–2025 MHz	10054 to 10121
For operation in frequency band as defined in subclause 5.2 (b)	1850–1910 MHz	9254 to 9546
	1930–1990 MHz	9654 to 9946
For operation in frequency band as defined in subclause 5.2 (c)	1910–1930 MHz	9554 to 9646
For operation in frequency band as defined in subclause 5.2 (d)	2570–2620 MHz	12854 to 13096
For operation in frequency band as defined in subclause 5.2 (e)	2300–2400 MHz	11504 to 11996
For operation in frequency band as defined in subclause 5.2 (f)	1880–1920 MHz	9404 to 9596

Radio Setup

Allows access to the sub-menus for selecting the radio standard and associated radio band. You can also set a frequency reference and offset.

This menu is greyed out when on E6630A. Radio band settings for GSM, cdma2000, and so on -- most of which are not actually supported in E6630A, which has three narrow frequency bands. So band settings are grayed out.

Key Path	Source, Frequency
Initial S/W Revision	A.05.00

Radio Standard

Allows access to the channel band sub-menus to select the desired radio standard. When you have selected the radio standard, you can then set an active channel band. The radio standard and the active channel band allow you to use channel numbers to set frequency automatically.

Key Path	Source, Frequency, Radio Setup
Remote Command	:SOURce:FREQuency:CHANnels:BAND NONE PGSM EGSM RGSM DCS1800 PCS1900 TGSM810 GSM450 GSM480 GSM700 GSM850 BANDI BANDII BANDIII BANDIV BANDV BANDVI BANDVII BANDVIII BANDIX BANDX BANDXI BANDXII BANDXIII BANDXIV BANDXIX USCELL USPCS JAPAN KOREAN NMT IMT2K UPPER SECOND PAMR400 PAMR800 IMTEXT PCS1DOT9G AWS US2DOT5G PUBLIC LOWER BAND1 BAND2 BAND3 BAND4 BAND5 BAND6 BAND7 BAND8 BAND10 BAND11 BAND12 BAND13 BAND14 BAND17 BAND18 BAND19 BAND20 BAND21 BAND24 BAND25 BAND26 BAND27 BAND28 BAND31 BAND33 BAND34 BAND35 BAND36 BAND37 BAND38 BAND39 BAND40 BAND41 BAND42 BAND43 BAND44 BANDA BANDB BANDC BANDD BANDE BANDF :SOURce:FREQuency:CHANnels:BAND?
Example	:SOUR:FREQ:CHAN:BAND PGSM
Notes	Set this setting to "NONE" will grey out "Channel" on page 1232 Channel
Initial S/W Revision	A.05.00

None

Selects no radio standard for use. When you have selected the radio standard to NONE, you cannot use channel numbers to set frequency automatically. You will need to set the frequency manually.

Key Path	Source, Frequency, Radio Setup, Radio Standard
Initial S/W Revision	A.05.00

GSM/EDGE

Sets GSM/EDGE as the radio standard for use and accesses the GSM/EDGE specific channel band sub-menus.

Key Path	Source, Frequency, Radio Setup, Radio Standard
Initial S/W Revision	A.05.00

P-GSM

Selects P-GSM as the active channel band.

Key Path	Source, Frequency, Radio Setup, Radio Standard, GSM/EDGE
Example	:SOUR:FREQ:CHAN:BAND PGSM
Initial S/W Revision	A.05.00

E-GSM

Selects E-GSM as the active channel band.

Key Path	Source, Frequency, Radio Setup, Radio Standard, GSM/EDGE
Example	:SOUR:FREQ:CHAN:BAND EGSM
Initial S/W Revision	A.05.00

R-GSM

Selects R-GSM as the active channel band.

Key Path	Source, Frequency, Radio Setup, Radio Standard, GSM/EDGE
Example	:SOUR:FREQ:CHAN:BAND RGSM
Initial S/W Revision	A.05.00

DCS 1800

Selects DCS 1800 as the active channel band.

Key Path	Source, Frequency, Radio Setup, Radio Standard, GSM/EDGE
Example	:SOUR:FREQ:CHAN:BAND DCS1800
Initial S/W Revision	A.05.00

PCS 1900

Selects PCS 1900 as the active channel band.

Key Path	Source, Frequency, Radio Setup, Radio Standard, GSM/EDGE
Example	:SOUR:FREQ:CHAN:BAND PCS1900
Initial S/W Revision	A.05.00

GSM 450

Selects GSM 450 as the active channel band.

Key Path	Source, Frequency, Radio Setup, Radio Standard, GSM/EDGE
Example	:SOUR:FREQ:CHAN:BAND GSM450
Initial S/W Revision	A.05.00

GSM 480

Selects GSM 480 as the active channel band.

Key Path	Source, Frequency, Radio Setup, Radio Standard, GSM/EDGE
Example	:SOUR:FREQ:CHAN:BAND GSM480
Initial S/W Revision	A.05.00

GSM 850

Selects GSM 850 as the active channel band.

Key Path	Source, Frequency, Radio Setup, Radio Standard, GSM/EDGE
Example	:SOUR:FREQ:CHAN:BAND GSM850
Initial S/W Revision	A.05.00

GSM 700

Selects GSM 700 as the active channel band.

Key Path	Source, Frequency, Radio Setup, Radio Standard, GSM/EDGE
Example	:SOUR:FREQ:CHAN:BAND GSM700
Initial S/W Revision	A.05.00

T-GSM 810

Selects T-GSM 810 as the active channel band.

Key Path	Source, Frequency, Radio Setup, Radio Standard, GSM/EDGE
Example	:SOUR:FREQ:CHAN:BAND T-GSM810
Initial S/W Revision	A.05.00

WCDMA

Sets WCDMA as the radio standard for use and accesses the W-CDMA specific channel band sub-menus.

Key Path	Source, Frequency, Radio Setup, Radio Standard
Initial S/W Revision	A.05.00

Band I

Selects Band I as the active channel band.

Key Path	Source, Frequency, Radio Setup, Radio Standard, WCDMA
Example	:SOUR:FREQ:CHAN:BAND BANDI
Initial S/W Revision	A.05.00

Band II

Selects Band II as the active channel band.

Key Path	Source, Frequency, Radio Setup, Radio Standard, WCDMA
Example	:SOUR:FREQ:CHAN:BAND BANDII
Initial S/W Revision	A.05.00

Band III

Selects Band III as the active channel band.

Key Path	Source, Frequency, Radio Setup, Radio Standard, WCDMA
Example	:SOUR:FREQ:CHAN:BAND BANDIII
Initial S/W Revision	A.05.00

Band IV

Selects Band IV as the active channel band.

Key Path	Source, Frequency, Radio Setup, Radio Standard, WCDMA
Example	:SOUR:FREQ:CHAN:BAND BANDIV
Initial S/W Revision	A.05.00

Band V

Selects Band V as the active channel band.

Key Path	Source, Frequency, Radio Setup, Radio Standard, WCDMA
Example	:SOUR:FREQ:CHAN:BAND BANDV
Initial S/W Revision	A.05.00

Band VI

Selects Band VI as the active channel band.

Key Path	Source, Frequency, Radio Setup, Radio Standard, WCDMA
Example	:SOUR:FREQ:CHAN:BAND BANDVI
Initial S/W Revision	A.05.00

Band VII

Selects Band VII as the active channel band.

Key Path	Source, Frequency, Radio Setup, Radio Standard, WCDMA
Example	:SOUR:FREQ:CHAN:BAND BANDVII
Initial S/W Revision	A.05.00

Band VIII

Selects Band VIII as the active channel band.

Key Path	Source, Frequency, Radio Setup, Radio Standard, WCDMA
Example	:SOUR:FREQ:CHAN:BAND BANDVIII
Initial S/W Revision	A.05.00

Band IX

Selects Band IX as the active channel band.

Key Path	Source, Frequency, Radio Setup, Radio Standard, WCDMA
Example	:SOUR:FREQ:CHAN:BAND BANDIX
Initial S/W Revision	A.05.00

Band X

Selects Band X as the active channel band.

Key Path	Source, Frequency, Radio Setup, Radio Standard, WCDMA
Example	:SOUR:FREQ:CHAN:BAND BANDX
Initial S/W Revision	A.05.00

Band XI

Selects Band XI as the active channel band.

Key Path	Source, Frequency, Radio Setup, Radio Standard, WCDMA
Example	:SOUR:FREQ:CHAN:BAND BANDXI
Initial S/W Revision	A.05.00

Band XII

Selects Band XII as the active channel band.

Key Path	Source, Frequency, Radio Setup, Radio Standard, WCDMA
Example	:SOUR:FREQ:CHAN:BAND BANDXII
Initial S/W Revision	A.05.00

Band XIII

Selects band XIII as the active channel band.

Key Path	Source, Frequency, Radio Setup, Radio Standard, WCDMA
Example	:SOUR:FREQ:CHAN:BAND BANDXIII
Initial S/W Revision	A.05.00

Band XIV

Selects Band XIV as the active channel band.

Key Path	Source, Frequency, Radio Setup, Radio Standard, WCDMA
Example	:SOUR:FREQ:CHAN:BAND BANDXIV
Initial S/W Revision	A.05.00

Band XIX

Selects Band XIX as the active channel band.

Key Path	Source, Frequency, Radio Setup, Radio Standard, WCDMA
Example	:SOUR:FREQ:CHAN:BAND BANDXIX
Initial S/W Revision	A.14.50

CDMA 2000 / 1xEVDO

Sets CDMA 2000 / 1XEVDO as the radio standard for use and accesses the CDMA 2000/1xEVDO specific channel band sub-menus.

Key Path	Source, Frequency, Radio Setup, Radio Standard
Initial S/W Revision	A.05.00

US CELL

Selects US Cell as the active channel band.

Key Path	Source, Frequency, Radio Setup, Radio Standard, CDMA 2000 / 1xEVDO
Example	:SOUR:FREQ:CHAN:BAND USCELL
Initial S/W Revision	A.05.00

US PCS

Selects US PCS as the active channel band.

Key Path	Source, Frequency, Radio Setup, Radio Standard, CDMA 2000 / 1xEVDO
Example	:SOUR:FREQ:CHAN:BAND PCS
Initial S/W Revision	A.05.00

Japan Cell

Selects Japan Cell as the active channel band.

Key Path	Source, Frequency, Radio Setup, Radio Standard, CDMA 2000 / 1xEVDO
Example	:SOUR:FREQ:CHAN:BAND JAPAN
Initial S/W Revision	A.05.00

Korean PCS

Selects Korean PCS as the active channel band.

Key Path	Source, Frequency, Radio Setup, Radio Standard, CDMA 2000 / 1xEVDO
Example	:SOUR:FREQ:CHAN:BAND KOREAN
Initial S/W Revision	A.05.00

NMT 450

Selects NMT 450 as the active channel band.

Key Path	Source, Frequency, Radio Setup, Radio Standard, CDMA 2000 / 1xEVDO
----------	--

Example	:SOUR:FREQ:CHAN:BAND NMT
Initial S/W Revision	A.05.00

IMT 2000

Selects IMT 2000 as the active channel band.

Key Path	Source, Frequency, Radio Setup, Radio Standard, CDMA 2000 / 1xEVDO
Example	:SOUR:FREQ:CHAN:BAND IMT2K
Initial S/W Revision	A.05.00

Upper 700

Selects Upper 700 as the active channel band.

Key Path	Source, Frequency, Radio Setup, Radio Standard, CDMA 2000 / 1xEVDO
Example	:SOUR:FREQ:CHAN:BAND UPPER
Initial S/W Revision	A.05.00

Secondary 800

Selects Secondary 800 as the active channel band.

Key Path	Source, Frequency, Radio Setup, Radio Standard, CDMA 2000 / 1xEVDO
Example	:SOUR:FREQ:CHAN:BAND SECOND
Initial S/W Revision	A.05.00

400 Euro PAMR

Selects 400 Euro PAMR as the active channel band.

Key Path	Source, Frequency, Radio Setup, Radio Standard, CDMA 2000 / 1xEVDO
Example	:SOUR:FREQ:CHAN:BAND PAMR400
Initial S/W Revision	A.05.00

800 PAMR

Selects 800 PAMR as the active channel band.

Key Path	Source, Frequency, Radio Setup, Radio Standard, CDMA 2000 / 1xEVDO
----------	--

Example	:SOUR:FREQ:CHAN:BAND PAMR800
Initial S/W Revision	A.05.00

2.5GHz IMT EXT

Selects 2.5 GHz IMT EXT as the active channel band.

Key Path	Source, Frequency, Radio Setup, Radio Standard, CDMA 2000 / 1xEVDO
Example	:SOUR:FREQ:CHAN:BAND IMTEXT
Initial S/W Revision	A.05.00

US PCS 1.9GHz

Selects US PCS 1.9 GHz as the active channel band.

Key Path	Source, Frequency, Radio Setup, Radio Standard, CDMA 2000 / 1xEVDO
Example	:SOUR:FREQ:CHAN:BAND PCS1DOT9G
Initial S/W Revision	A.05.00

AWS

Selects AWS as the active channel band.

Key Path	Source, Frequency, Radio Setup, Radio Standard, CDMA 2000 / 1xEVDO
Example	:SOUR:FREQ:CHAN:BAND AWS
Initial S/W Revision	A.05.00

US 2.5GHz

Selects US 2.5 GHz as the active channel band.

Key Path	Source, Frequency, Radio Setup, Radio Standard, CDMA 2000 / 1xEVDO
Example	:SOUR:FREQ:CHAN:BAND US2DOT5G
Initial S/W Revision	A.05.00

700 Public Safety

Selects 700 Public Safety as the active channel band.

Key Path	Source, Frequency, Radio Setup, Radio Standard, CDMA 2000 / 1xEVDO
----------	--

Example	:SOUR:FREQ:CHAN:BAND PUBLIC
Initial S/W Revision	A.05.00

C2K Lower 700

Selects C2K Lower 700 as the active channel band.

Key Path	Source, Frequency, Radio Setup, Radio Standard, CDMA 2000 / 1xEVDO
Example	:SOUR:FREQ:CHAN:BAND LOWER
Initial S/W Revision	A.05.00

LTE

Sets LTE FDD as the radio standard for use and accesses the LTE FDD specific channel band sub-menus..

Key Path	Source, Frequency, Radio Setup, Radio Standard
Initial S/W Revision	A.09.50

BAND 1

Selects BAND 1 as the band for the current step.

Key Path	Source, Frequency, Radio Setup, Radio Standard, LTE
Example	:SOUR:FREQ:CHAN:BAND BAND1
Initial S/W Revision	A.09.50

BAND 2

Selects BAND 2 as the band for the current step.

Key Path	Source, Frequency, Radio Setup, Radio Standard, LTE
Example	:SOUR:FREQ:CHAN:BAND BAND2
Initial S/W Revision	A.09.50

BAND 3

Selects BAND 3 as the band for the current step.

Key Path	Source, Frequency, Radio Setup, Radio Standard, LTE
Example	:SOUR:FREQ:CHAN:BAND BAND3
Initial S/W Revision	A.09.50

BAND 4

Selects BAND 4 as the band for the current step.

Key Path	Source, Frequency, Radio Setup, Radio Standard, LTE
Example	:SOUR:FREQ:CHAN:BAND BAND4
Initial S/W Revision	A.09.50

BAND 5

Selects BAND 5 as the band for the current step.

Key Path	Source, Frequency, Radio Setup, Radio Standard, LTE
Example	:SOUR:FREQ:CHAN:BAND BAND5
Initial S/W Revision	A.09.50

BAND 6

Selects BAND 6 as the band for the current step.

Key Path	Source, Frequency, Radio Setup, Radio Standard, LTE
Example	:SOUR:FREQ:CHAN:BAND BAND6
Initial S/W Revision	A.09.50

BAND 7

Selects BAND 7 as the band for the current step.

Key Path	Source, Frequency, Radio Setup, Radio Standard, LTE
Example	:SOUR:FREQ:CHAN:BAND BAND7
Initial S/W Revision	A.09.50

BAND 8

Selects BAND 8 as the band for the current step.

Key Path	Source, Frequency, Radio Setup, Radio Standard, LTE
Example	:SOUR:FREQ:CHAN:BAND BAND8
Initial S/W Revision	A.09.50

BAND 9

Selects BAND 9 as the band for the current step.

Key Path	Source, Frequency, Radio Setup, Radio Standard, LTE
Example	:SOUR:FREQ:CHAN:BAND BAND9
Initial S/W Revision	A.09.50

BAND 10

Selects BAND 10 as the band for the current step.

Key Path	Source, Frequency, Radio Setup, Radio Standard, LTE
Example	:SOUR:FREQ:CHAN:BAND BAND10
Initial S/W Revision	A.09.50

BAND 11

Selects BAND 11 as the band for the current step.

Key Path	Source, Frequency, Radio Setup, Radio Standard, LTE
Example	:SOUR:FREQ:CHAN:BAND BAND11
Initial S/W Revision	A.09.50

BAND 12

Selects BAND 12 as the band for the current step.

Key Path	Source, Frequency, Radio Setup, Radio Standard, LTE
Example	:SOUR:FREQ:CHAN:BAND BAND12
Initial S/W Revision	A.09.50

BAND 13

Selects BAND 13 as the band for the current step.

Key Path	Source, Frequency, Radio Setup, Radio Standard, LTE
Example	:SOUR:FREQ:CHAN:BAND BAND13
Initial S/W Revision	A.09.50

BAND 14

Selects BAND 14 as the band for the current step.

Key Path	Source, Frequency, Radio Setup, Radio Standard, LTE
Example	:SOUR:FREQ:CHAN:BAND BAND14
Initial S/W Revision	A.09.50

BAND 17

Selects BAND 17 as the band for the current step.

Key Path	Source, Frequency, Radio Setup, Radio Standard, LTE
Example	:SOUR:FREQ:CHAN:BAND BAND17
Initial S/W Revision	A.09.50

BAND 18

Selects BAND 18 as the band for the current step.

Key Path	Source, Frequency, Radio Setup, Radio Standard, LTE
Example	:SOUR:FREQ:CHAN:BAND BAND18
Initial S/W Revision	A.09.50

BAND 19

Selects BAND 19 as the band for the current step.

Key Path	Source, Frequency, Radio Setup, Radio Standard, LTE
Example	:SOUR:FREQ:CHAN:BAND BAND19
Initial S/W Revision	A.09.50

BAND 20

Selects BAND 20 as the band for the current step.

Key Path	Source, Frequency, Radio Setup, Radio Standard, LTE
Example	:SOUR:FREQ:CHAN:BAND BAND20
Initial S/W Revision	A.09.50

BAND 21

Selects BAND 21 as the band for the current step.

Key Path	Source, Frequency, Radio Setup, Radio Standard, LTE
Example	:SOUR:FREQ:CHAN:BAND BAND21
Initial S/W Revision	A.09.50

BAND 24

Selects BAND 24 as the band for the current step.

Key Path	Source, Frequency, Radio Setup, Radio Standard, LTE
Example	:SOUR:FREQ:CHAN:BAND BAND24
Initial S/W Revision	A.09.50

BAND 25

Selects BAND 25 as the band for the current step.

Key Path	Source, Frequency, Radio Setup, Radio Standard, LTE
Example	:SOUR:FREQ:CHAN:BAND BAND25
Initial S/W Revision	A.09.50

BAND 26

Selects BAND 26 as the band for the current step.

Key Path	Source, Frequency, Radio Setup, Radio Standard, LTE
Example	:SOUR:FREQ:CHAN:BAND BAND26
Initial S/W Revision	A.12.53

BAND 27

Selects BAND 27 as the band for the current step.

Key Path	Source, Frequency, Radio Setup, Radio Standard, LTE
Example	:SOUR:FREQ:CHAN:BAND BAND27
Initial S/W Revision	A.14.00

BAND 28

Selects BAND 28 as the band for the current step.

Key Path	Source, Frequency, Radio Setup, Radio Standard, LTE
Example	:SOUR:FREQ:CHAN:BAND BAND28
Initial S/W Revision	A.14.00

BAND 31

Selects BAND 31 as the band for the current step.

Key Path	Source, Frequency, Radio Setup, Radio Standard, LTE
Example	:SOUR:FREQ:CHAN:BAND BAND31
Initial S/W Revision	A.14.00

LTE TDD

Sets LTE TDD as the radio standard for use and accesses the LTE TDD specific channel band sub-menus..

Key Path	Source, Frequency, Radio Setup, Radio Standard
Initial S/W Revision	A.11.50

BAND 33

Selects BAND 33 as the band for the current step.

Key Path	Source, Frequency, Radio Setup, Radio Standard, LTE TDD
Example	:SOUR:FREQ:CHAN:BAND BAND33
Initial S/W Revision	A.11.50

BAND 34

Selects BAND 34 as the band for the current step.

Key Path	Source, Frequency, Radio Setup, Radio Standard, LTE TDD
Example	:SOUR:FREQ:CHAN:BAND BAND34
Initial S/W Revision	A.11.50

BAND 35

Selects BAND 35 as the band for the current step.

Key Path	Source, Frequency, Radio Setup, Radio Standard, LTE TDD
Example	:SOUR:FREQ:CHAN:BAND BAND35
Initial S/W Revision	A.11.50

BAND 36

Selects BAND 36 as the band for the current step.

Key Path	Source, Frequency, Radio Setup, Radio Standard, LTE TDD
Example	:SOUR:FREQ:CHAN:BAND BAND36
Initial S/W Revision	A.11.50

BAND 37

Selects BAND 37 as the band for the current step.

Key Path	Source, Frequency, Radio Setup, Radio Standard, LTE TDD
Example	:SOUR:FREQ:CHAN:BAND BAND37
Initial S/W Revision	A.11.50

BAND 38

Selects BAND 38 as the band for the current step.

Key Path	Source, Frequency, Radio Setup, Radio Standard, LTE TDD
Example	:SOUR:FREQ:CHAN:BAND BAND38
Initial S/W Revision	A.11.50

BAND 39

Selects BAND 39 as the band for the current step.

Key Path	Source, Frequency, Radio Setup, Radio Standard, LTE TDD
Example	:SOUR:FREQ:CHAN:BAND BAND39
Initial S/W Revision	A.11.50

BAND 40

Selects BAND 40 as the band for the current step.

Key Path	Source, Frequency, Radio Setup, Radio Standard, LTE TDD
Example	:SOUR:FREQ:CHAN:BAND BAND40
Initial S/W Revision	A.11.50

BAND 41

Selects BAND 41 as the band for the current step.

Key Path	Source, Frequency, Radio Setup, Radio Standard, LTE TDD
Example	:SOUR:FREQ:CHAN:BAND BAND41
Initial S/W Revision	A.11.50

BAND 42

Selects BAND 42 as the band for the current step.

Key Path	Source, Frequency, Radio Setup, Radio Standard, LTE TDD
Example	:SOUR:FREQ:CHAN:BAND BAND42
Initial S/W Revision	A.11.50

BAND 43

Selects BAND 43 as the band for the current step.

Key Path	Source, Frequency, Radio Setup, Radio Standard, LTE TDD
Example	:SOUR:FREQ:CHAN:BAND BAND43
Initial S/W Revision	A.11.50

BAND 44

Selects BAND 44 as the band for the current step.

Key Path	Source, Frequency, Radio Setup, Radio Standard, LTE TDD
Example	:SOUR:FREQ:CHAN:BAND BAND44
Initial S/W Revision	A.14.00

TDSCDMA

Sets TDSCDMA as the radio standard for use and accesses the TDSCDMA specific channel band sub-menus..

Key Path	Source, Frequency, Radio Setup, Radio Standard
Initial S/W Revision	A.11.50

BAND A

Selects BAND A as the band for the current step.

Key Path	Source, Frequency, Radio Setup, Radio Standard, TDSCDMA
Example	:SOUR:FREQ:CHAN:BAND BANDA
Initial S/W Revision	A.11.50

BAND B

Selects BAND B as the band for the current step.

Key Path	Source, Frequency, Radio Setup, Radio Standard, TDSCDMA
Example	:SOUR:FREQ:CHAN:BAND BANDB
Initial S/W Revision	A.11.50

BAND C

Selects BAND C as the band for the current step.

Key Path	Source, Frequency, Radio Setup, Radio Standard, TDSCDMA
Example	:SOUR:FREQ:CHAN:BAND BANDC
Initial S/W Revision	A.11.50

BAND D

Selects BAND D as the band for the current step.

Key Path	Source, Frequency, Radio Setup, Radio Standard, TDSCDMA
Example	:SOUR:FREQ:CHAN:BAND BANDD
Initial S/W Revision	A.11.50

BAND E

Selects BAND E as the band for the current step.

Key Path	Source, Frequency, Radio Setup, Radio Standard, TDSCDMA
----------	---

Example	:SOUR:FREQ:CHAN:BAND BANDE
Initial S/W Revision	A.11.50

BAND F

Selects BAND F as the band for the current step.

Key Path	Source, Frequency, Radio Setup, Radio Standard, TDSCDMA
Example	:SOUR:FREQ:CHAN:BAND BANDF
Initial S/W Revision	A.11.50

Radio Band Link

Allows you to specify the channel band type as either uplink or downlink link direction. This value is used in conjunction with the channel band and channel number to determine the absolute frequency output by the source. When set to “Uplink”, the source will calculate the uplink frequency using an uplink formula together with the selected channel band and channel number . When set to “Downlink”, the source will calculate the downlink frequency using a downlink formula together with the selected channel band and channel number.

Key Path	Source, Frequency, Radio Setup
Remote Command	:SOURce:RADio:BAND:LINK DOWN UP :SOURce:RADio:BAND:LINK?
Example	:SOUR:RAD:BAND:LINK UP
Preset	DOWN
Range	DOWN UP
Backwards Compatibility SCPI	:SOURce:RADio:DEVIce BTS MS :SOURce:RADio:DEVIce?
Backwards Compatibility Notes	BTS maps to the Downlink frequency MS maps to the Uplink frequency
Initial S/W Revision	A.05.00

Set Reference Frequency

This key allows you to set the frequency reference. Pressing this key turns the frequency reference state to ON, sets the reference frequency value to the current frequency, maintains this frequency at the RF output, and sets the displayed frequency to 0.00 Hz. All subsequent frequencies entered under Source>Frequency>Frequency are interpreted as being relative to this reference frequency.

When you use a frequency reference, the signal generator outputs a frequency that is set relative to the reference frequency by the value entered under Source>Frequency>Frequency as follows:

Output frequency = reference frequency - entered frequency

Where:

reference frequency equals the original RF frequency entered under Source>Frequency>Frequency and set as the reference frequency

entered frequency equals a new value entered under Source>Frequency>Frequency

In addition, the displayed frequency value will be the same as the value entered under Source>Frequency>Frequency.

NOTE

If Freq Reference is set to ON with a reference value set, entering a value under Source>Frequency>Frequency and pressing Set Frequency Reference will add that value to the existing Freq Reference value.

If you wish to change the reference frequency value to the new value entered under Source>Frequency>Frequency, first you must set Freq Reference to OFF and then press Set Frequency Reference.

Key Path	Source, Frequency
Remote Command	:SOURce:FREQuency:REFeRence:SET
Example	:SOUR:FREQ:REF:SET
Dependencies	This setting is unavailable, and is grayed out when the List Sequencer is turned ON.
Initial S/W Revision	A.05.00

Freq Reference

This key allows you to toggle the state of the frequency reference. When the frequency reference state is ON, an annunciator is displayed on the main source view to indicate this state to the user.

When you use a frequency reference, the signal generator outputs a frequency that is set relative to the reference frequency by the value entered under Source>Frequency>Frequency as follows:

Output frequency = reference frequency + entered frequency

Where:

reference frequency equals the original RF frequency entered under Source>Frequency>Frequency and set as the reference frequency

entered frequency equals a new value entered under Source>Frequency>Frequency

For more information on Reference Frequency refer to ["Set Reference Frequency" on page 1259](#)

Key Path	Source, Frequency
Remote Command	:SOURce:FREQuency:REFeRence <freq> :SOURce:FREQuency:REFeRence? :SOURce:FREQuency:REFeRence:STATe OFF ON 0 1 :SOURce:FREQuency:REFeRence:STATe?
Example	:SOUR:FREQ:REF 0.00 Hz

	:SOUR:FREQ:REF:STATe ON
Dependencies	This setting is unavailable, and is grayed out when the List Sequencer is turned ON.
Couplings	The frequency reference state is coupled to the frequency reference set immediate action. When the reference set immediate action key is pressed, or the SCPI command issued, it turns the frequency reference state ON.
Preset	0.00 Hz OFF
Min	0.00 Hz
Max	Hardware Dependant: Option 503 = 3.6 GHz Option 504 = 3.8 GHz Option 506 = 6.00 GHz
Initial S/W Revision	A.05.00

Freq Offset

Allows you to specify the frequency offset value. When the frequency offset state is ON, an annunciator is displayed on the main source view to indicate this state to the user.

When the frequency offset is set to zero (0) and you set a new offset value, the displayed frequency value will change as follows and the RF output frequency will not change:

Displayed value = output frequency + offset value

Where:

output frequency equals the original frequency entered under Source>Frequency>Frequency

offset value equals the value entered under Source>Frequency>Freq Offset

When the frequency offset is set to a value other than zero (0) and you enter a new frequency value under Source>Frequency>Frequency, the displayed frequency will be the same as the value entered and the RF output frequency will be equal to the value entered minus the offset value as follows:

Output frequency = entered frequency – offset frequency

Displayed frequency = output frequency + offset frequency

Displayed frequency = entered frequency

Where:

entered frequency equals the frequency entered under Source>Frequency>Frequency

offset frequency equals the value previously entered and set under Source>Frequency>Freq Offset

Key Path	Source, Frequency
Remote Command	:SOURce:FREQuency:OFFSet <freq>

	:SOURce:FREQuency:OFFSet?
Example	:SOUR:FREQ:OFFS 0 Hz
Dependencies	This setting is unavailable, and is grayed out when the List Sequencer is turned ON.
Preset	0 Hz
Min	-100.00 GHz
Max	100.00 GHz
Initial S/W Revision	A.05.00

Modulation Setup

Allows access to the menus for setting up the available modulation types: "ARB" on page 1262, "AM" on page 1303, "FM" on page 1304, and "PM" on page 1305.

Key Path	Source
Initial S/W Revision	A.05.00

ARB

Allows you access to the ARB sub-menus.

Key Path	Source, Modulation Setup
Initial S/W Revision	A.05.00

ARB

Allows you to toggle the state of the ARB function. When the ARB is On, a "MOD" annunciator is displayed in the system settings panel. When the ARB is turned Off, the MOD annunciator is cleared

Key Path	Source, Modulation Setup, ARB
Remote Command	:SOURce:RADio:ARB[:STATe] ON OFF 1 0 :SOURce:RADio:ARB[:STATe]?
Example	:SOUR:RAD:ARB OFF :SOUR:RAD:ARB?
Notes	If the ARB is ON, a user then loads or deletes another file to ARB memory, the playing waveform segment may not keep phase continuity during the ARB memory operation. The waveform will be replayed after the ARB operation is finished.
Dependencies	This setting is for independent mode and has no effect on 3.3.8 list sequencer mode. Setting "Sequencer" on page 1307 Sequencer to On will put source enter list sequencer mode, and even if ARB state is On, the ARB file will not be played. Setting "Sequencer" on page 1307 Sequencer to Off will make source leave list sequencer mode, and this setting will take effect immediately.

The ARB can only be turned on when there is a waveform file selected for playback. On the GUI if no waveform is selected, this key is grayed out. If you send the SCPI command to turn the ARB on with no waveform selected for playback, the ARB state remains OFF and an error is generated. “-

When you try to recall a certain set of states in which the selected waveform is not in ARB memory and the ARB state is On, errors are reported

Preset	Off
Range	On Off
Initial S/W Revision	A.05.00

Select Waveform

Allows you to access to the waveform selection sub-menus.

Pressing this key changes the central view area to show the Waveform File Selection view.

Key Path	Source, Modulation Setup, ARB
Initial S/W Revision	A.05.00

Select Waveform

Allows you to select a waveform sequence or segment for the dual ARB to play.

NOTE: Selecting a waveform file does not result in automatic adjustments to burst timing (to compensate for the presence or absence of a Multiport Adapter); that adjustment occurs only when a waveform is loaded to ARB memory. See "Load Segment to ARB Memory" for more information about this adjustment.

Key Path	Source, Modulation Setup, ARB, Select Waveform
Remote Command	:SOURce:RADio:ARB:WAVeform <string> :SOURce:RADio:ARB:WAVeform?
Example	:SOUR:RAD:ARB:WAV "test_waveform.bin"
Notes	<p>If intended waveform is not in the memory yet, then issuing this command by SCPI will invoke ARB loading operation first, which involves a delay of unpredictable length. So this command should be followed by the query *OPC?, which holds off subsequent commands until the loading operating is complete.</p> <p><string> - specifies the name of the waveform segment or waveform sequence to be played by the ARB.</p> <p>When in Sequence Analyzer mode, and Include Source is Yes, if the you attempt to play a waveform sequence but not all the required waveform segments are in the ARB playback memory, the application will reject the loading operation with an error is generated .</p> <p>When Include Source is No, if you attempt to play a waveform sequence but not all the required waveform segments are contained in the ARB playback memory, the application will attempt to load the required segments from either the default directory of the current directory. If the ARB memory does not have enough space for all the waveform segments to be loaded, an error is generated and</p>

none of the waveform segments is loaded.

If the ARB is ON, and you attempt to play a waveform sequence but not all the waveform segments within the sequence could be found to be loaded into ARB memory, an error is generated. The selected waveform keeps the previous value and ARB state remains On.

If you specify a waveform segment over SCPI but the waveform segment is not present within ARB playback memory and cannot be found for auto loading within the current directory or the default directory, an error is generated and the file selection remains unchanged.

If you select a waveform for playback and the waveform requires a license that is not installed on the instrument, an error is generated.

If the ARB is ON and you load a file to ARB memory or delete a file from ARB memory, the playing waveform segment may not keep phase continuity during the ARB memory operation. The waveform will be replayed after the ARB operation is finished.

Initial S/W Revision	A.05.00
----------------------	---------

Segments on Hard Disk

Allows you access to the sub-menus for loading waveform segments from the hard disk into ARB memory. The default directory is: D: varb.

Pressing this key changes the current view to the Waveform Management View.

Key Path	Source, Modulation Setup, ARB, Select Waveform
----------	--

Initial S/W Revision	A.05.00
----------------------	---------

Load Segment To ARB Memory

Allows you to load the selected file into ARB memory. On the front panel you select the file for loading to the ARB memory by highlighting the desired file in the list. Using the SCPI command, you specify the file name on the HDD.

“NVWFM” (non-volatile storage) MSUS (Mass Storage Unit Specifier) is supported in the memory subsystem because the ARB memory cannot be accessed directly. Therefore, files must be downloaded to the instrument hard disk and then loaded into the ARB memory. “NVWFM” MSUS will be mapped to the default directory D: VARB. The SCPI command supports using either “NVWFM” MSUS or specifying a full path. For more information, see [Memory Subsystem \(Remote Command Only\)](#).

If a file of the same name already exists within ARB memory, it is overwritten. If you wish to load two segments of the same name, you must rename one of the segments before loading it into ARB memory. To rename a segment, you can either use Windows File Explorer, or the :MMEMory:COPY command.

NOTE: When a waveform file is loaded to ARB memory, burst timing adjustments are made automatically, based on whether or not a Multiport Adapter is connected to the test set and powered on. If the connection/power status of the Multiport Adapter is changed after a waveform file has been loaded, it needs to be loaded again.

Key Path	Source, Modulation Setup, ARB, Select Waveform, Segments on Hard Disk
----------	---

Remote Command	:SOURCE:RADio:ARB:LOAD <string>
Example	:SOUR:RAD:ARB:LOAD "D: VARB\testwaveform.bin" or :SOUR:RAD:ARB:LOAD "NVWFM:testwaveform.bin"
Notes	<p>Because loading the file involves a delay of unpredictable length, this command should be followed by the query *OPC?, which holds off subsequent commands until the loading operating is complete.</p> <p><string> - specifies the path name of the file to load from the HDD into ARB memory. It could be a <full path + filename>, or <"NVWFM" MSUS + colon + filename>.</p> <p>When in Sequence Analyzer mode, and Include Source is Yes, an attempt to load a file to ARB memory will be rejected with an error.</p> <p>When Include Source is No and if there is insufficient free ARB memory to load the selected waveform, an error is generated. .</p> <p>If you specify a file over SCPI, but the file is not at the specified location, an error is generated.</p> <p>If you try to load a waveform file but the file contains less than 500 IQ samples, an error is generated.</p> <p>If you try to load a Signal Studio waveform "*.wfm" which contains invalid waveform header, an error is generated.</p> <p>If the ARB is ON when you load a file to ARB memory or delete a file from ARB memory, the playing waveform segment may not keep phase continuity during the ARB memory operation. The waveform will be replayed after the ARB operation is finished.</p> <p>ARB can be loaded into ARB memory even required licenses do not present on the instrument. In this case, a GUI only warning message -800, "Operation complete; Loaded <filename> successfully, but no license <required licenses> installed". User can install required licenses according to <required licenses> string to license it, or multi-pack license it.</p>
Initial S/W Revision	A.05.00

Load All To ARB Memory

Allows you to load all the segment files within the currently selected directory into ARB memory. If a file of the same name already exists within ARB memory, it is overwritten. If you wish to load two segments of the same name, you must rename one of the segments before loading it into ARB memory. To rename a segment, you can either use Windows File Explorer, or the :MEMORY:COPY command.

NOTE: When a waveform file is loaded to ARB memory, burst timing adjustments are made automatically, based on whether or not a Multiport Adapter is connected to the test set and powered on. If the connection/power status of the Multiport Adapter is changed after a waveform file has been loaded, it needs to be loaded again.

Key Path	Source, Modulation Setup, ARB, Select Waveform, Segments on Hard Disk
Remote Command	:SOURCE:RADio:ARB:LOAD:ALL <string>
Example	:SOUR:RAD:ARB:LOAD:ALL "D: varb"
Notes	<p><string> - specifies the directory on the HDD to load the files into ARB memory from.</p> <p>When in Sequence Analyzer mode, and Include Source is Yes, an attempt to load all files from a directory to ARB memory is rejected with an error.</p> <p>When Include Source is No and there is insufficient free ARB memory to load all the waveforms,</p>

when the ARB memory is full, the copy ceases, and an error is generated.
 If you specify a directory over SCPI, but the directory does not exist, an error is generated.
 If the ARB is ON, a user then loads or deletes file to ARB memory, the playing waveform segment may not keep phase continuity during the ARB memory operation. The waveform will be replayed after the ARB operation is finished.

Initial S/W Revision	A.05.00
----------------------	---------

Change Directory...

Allows you to change the currently selected directory on the hard disk. Pressing this key opens a standard windows change directory dialog allowing you to select the new directory of interest.

The current directory is used for manually loading waveform segments into ARB memory for playback, and as a search location for waveform segments that are required to be loaded into ARB memory for playback of a waveform sequence or a list sequence.

Key Path	Source, Modulation Setup, ARB, Select Waveform, Segments on Hard Disk
Notes	No remote command, SCPI front panel only.
Initial S/W Revision	A.05.00

Default Directory...

Allows you to change the default directory. It is used as a search location for waveform segments that are required to be loaded into ARB memory for playback of a waveform sequence, and as a search location for selecting waveforms using SCPI.

Key Path	Source, Modulation Setup, ARB, Select Waveform, Segments on Hard Disk
Remote Command	:SOURce:RADio:ARB:DEFault:DIRectory <string> :SOURce:RADio:ARB: DEFault:DIRectory?
Example	:SOUR:RAD:ARB:DEF:DIR "D:\ArbFiles" :SOUR:RAD:ARB:DEF:DIR?
State Saved	Persistent, survives a power cycle and a preset but not saved in the instrument state
Initial S/W Revision	A.05.00

Segments in ARB Memory

Allows you access to the sub-menus for managing the files within ARB memory.

Key Path	Source, Modulation Setup, ARB, Select Waveform
Initial S/W Revision	A.05.00

Delete Segment From ARB Mem

Allows you to remove a segment from ARB playback memory.

Key Path	Source, Modulation Setup, ARB, Select Waveform, Segments in ARB Memory
Remote Command	:SOURce:RADio:ARB:DELeTe <string>
Example	:SOUR:RAD:ARB:DEL "testwaveform.bin"
Notes	<p><string> - specifies the waveform to be deleted from the ARB playback memory.</p> <p>When in Sequence Analyzer mode and Include Source is Yes, an attempt to delete a file from ARB memory is rejected with an error.</p> <p>When Include Source is No and you specify a file that does not exist within ARB memory, an error is generated.</p> <p>It is possible to delete files from within the ARB memory when the ARB is ON. However, if you attempt to delete the file that is currently playing an error is generated.</p> <p>It is possible to delete a file from within the ARB memory when the sequencer state is ON and the file is not being used by the List Sequencer. If you attempt to delete a file which is being used by the list sequencer, an error is generated.</p> <p>When sequencer state is On, even if ARB state is On, the selected waveform will not be played. In this case, if the selected waveform is not used in List Sequence, it can be deleted and the ARB state is turned Off.</p> <p>If the ARB is ON and you load a file to ARB memory or delete a file from ARB memory, the playing waveform segment may not keep phase continuity during the ARB memory operation. The waveform will be replayed after the ARB operation is finished.</p>
Initial S/W Revision	A.05.00

Delete All From ARB Memory

Allows you to remove all segments from ARB playback memory.

Key Path	Source, Modulation Setup, ARB, Select Waveform, Segments in ARB Memory
Remote Command	:SOURce:RADio:ARB:DELeTe:ALL
Example	:SOUR:RAD:ARB:DELeTe:ALL
Notes	<p>When in Sequence Analyzer mode and Include Source is Yes, an attempt to delete all files from ARB memory is rejected with an error.</p> <p>When Include Source is No and you attempt to delete all files from ARB memory when the ARB is currently playing a file, all files except the one playing are deleted and an error is generated.</p> <p>If you attempt to delete all files from ARB memory when there are waveform files used in "List Sequencer" on page 1306 and "Sequencer" on page 1307 state is ON, all files except the files currently being used in list sequencer are deleted, and an error is generated.</p> <p>If the ARB is ON and you load a file to ARB memory or delete a file from ARB memory, the playing waveform segment may not keep phase continuity during the ARB memory operation. The waveform will be replayed after the ARB operation is finished.</p>
Initial S/W Revision	A.05.00

Query ARB Memory File List (Remote Command Only)

Queries the test set for the list of waveform segments in the ARB memory.

NOTE

This command returns a string for waveform segment names in ARB memory. If you want a string list of waveform segments in the ARB memory, use "[Query ARB Memory Full File List \(Remote Command Only\)](#)" on page 1268.

Remote Command	:SOURce:RADio:ARB:CATalog?
Example	:SOUR:RAD:ARB:CATalog?
Notes	The return data is in the following format: <integer> - memory used <integer> - memory free <string> ... - comma separated list of waveform segments within ARB memory
Initial S/W Revision	A.05.00

Query ARB Memory Full File List (Remote Command Only)

Queries the test set for the string list of waveform segments in the ARB memory. It returns a string list for waveform segment names in the ARB memory.

Remote Command	:SOURce:RADio:ARB:FCATalog?
Example	:SOUR:RAD:ARB:FCATalog?
Notes	The return data is in the following format: <integer> - memory used <integer> - memory free <integer> - file count in ARB memory <string>,<string>, ... <string> - comma separated string list of waveform segments within ARB memory Example: SOUR:RAD:ARB:FCAT? EXT returns: 27499,2069653,3,"c2k.wfm","gsm.wfm","wcdma.wfm"
Initial S/W Revision	A.09.00

ARB Setup

Allows access to the ARB setup sub-menus.

Key Path	Source, Modulation Setup, ARB
Initial S/W Revision	A.05.00

Sample Rate

Allows you to set the ARB waveform playback sample rate.

Key Path	Source, Modulation Setup, ARB, ARB Setup
Remote Command	:SOURce:RADio:ARB:SCLock:RATE <freq> :SOURce:RADio:ARB:SCLock:RATE?
Example	:SOUR:RAD:ARB:SCL:RATE 48.00 MHz
Notes	If there is a sample rate specified in the header of the waveform file, changing that sample rate is not recommended, as it may cause problems with burst timing.
Dependencies	When a new waveform is selected for playback the settings contained within the associated waveform header file are applied to the ARB. The sample rate is one of the values stored within the header file. If the newly selected waveform file has an associated header file, the sample rate is updated with the value from the header file. The sample rate will remain unchanged if the newly selected waveform does not have an associated header file.
Preset	125.00 MHz
Min	1.00 kHz
Max	125.00 MHz
Initial S/W Revision	A.05.00

Run-Time Scaling

Allows you to adjust the run-time scaling value. The run-time scaling value is applied in real-time while the waveform is playing.

Key Path	Source, Modulation Setup, ARB, ARB Setup
Remote Command	:SOURce:RADio:ARB:RSCaling <real> :SOURce:RADio:ARB:RSCaling?
Example	:SOUR:RAD:ARB:RSC 100.00
Notes	This setting cannot be set in E6640A. Grey out on menu and the value is fixed at 70.00%.
Dependencies	When a new waveform is selected for playback the settings contained within the associated waveform header file are applied to the ARB. The run-time scaling is one of the values stored within the header file. If the newly selected waveform file has an associated header file, the run-time scaling is updated with the value from the header file. The run-time scaling will remain unchanged if the newly selected waveform does not have an associated header file.
Preset	70.00 %
Min	1.00 %
Max	100.00 %
Initial S/W Revision	A.05.00

Baseband Freq Offset

Allows you to adjust the value by which the baseband frequency is offset relative to the carrier.

Key Path	Source, Modulation Setup, ARB, ARB Setup
Remote Command	:SOURce:RADio:ARB:BASEband:FREQuency:OFFSet <freq> :SOURce:RADio:ARB:BASEband:FREQuency:OFFSet?
Example	:SOUR:RAD:ARB:BAS:FREQ:OFFS 0.00 Hz
Dependencies	When a new waveform is selected for playback the settings contained within the associated waveform header file are applied to the ARB. The baseband frequency offset is one of the values stored within the header file. If the newly selected waveform has an associated header file, the baseband frequency offset is updated with the value from the header file. The baseband frequency offset will remain unchanged if the newly selected waveform does not have an associated header file.
Preset	0.00 Hz
Min	-50.00 MHz
Max	50.00 MHz
Initial S/W Revision	A.05.00

Trigger Type

Allows access to the trigger type sub-menus. The setting for trigger type determines the behavior of the waveform when it plays.

Key Path	Source, Modulation Setup, ARB
Remote Command	:SOURce:RADio:ARB:TRIGger:TYPE CONTInuous SINGLE SADVance GATE :SOURce:RADio:ARB:TRIGger:TYPE?
Example	:SOUR:RAD:ARB:TRIG:TYPE CONT :SOUR:RAD:ARB:TRIG:TYPE?
Notes	Gated trigger type will be implemented at a later release
Preset	CONTInuous
Range	Continuous Single Seg Adv Gated
Initial S/W Revision	A.05.00

Continuous

Sets the active trigger type to Continuous. If Continuous is already selected as the active trigger type, pressing this key allows access to the continuous trigger type setup menu. In Continuous trigger mode, the waveform repeats continuously.

Key Path	Source, Modulation Setup, ARB, Trigger Type
Remote Command	:SOURce:RADio:ARB:TRIGger:TYPE:CONTInuous[:TYPE] FREE TRIGger RESet :SOURce:RADio:ARB:TRIGger:TYPE:CONTInuous[:TYPE]?
Example	:SOUR:RAD:ARB:TRIG:TYPE:CONT FREE
Preset	FREE

Range	Free Run Trigger + Run Reset + Run
Initial S/W Revision	A.05.00

Free Run

Selects Free Run as the trigger response for the continuous trigger type. Free Run sets the waveform generator to play a waveform sequence or segment continuously, without waiting for a trigger. In this mode, the waveform generator does not respond to triggers.

Key Path	Source, Modulation Setup, ARB, Trigger Type, Continuous
Example	:SOUR:RAD:ARB:TRIG:TYPE:CONT FREE
Initial S/W Revision	A.05.00

Trigger + Run

Sets Trigger and Run as the trigger response for the continuous trigger type. Trigger and Run sets the waveform generator to play a waveform sequence or segment continuously when the first trigger is received, and to ignore any subsequent triggers.

Key Path	Source, Modulation Setup, ARB, Trigger Type, Continuous
Example	:SOUR:RAD:ARB:TRIG:TYPE:CONT TRIG
Initial S/W Revision	A.05.00

Reset + Run

Sets Reset and Run as the trigger response for the continuous trigger type. Reset and Run sets the waveform generator to play a waveform sequence or segment continuously when the first trigger is received. Subsequent triggers reset the waveform sequence or segment to the start, and then play it continuously.

Key Path	Source, Modulation Setup, ARB, Trigger Type, Continuous
Example	:SOUR:RAD:ARB:TRIG:TYPE:CONT RES
Initial S/W Revision	A.05.00

Single

Sets the active trigger type to Single. If Single is already selected as the active trigger type, pressing this key allows access to the single trigger type setup menu. In Single trigger mode, the waveform plays once.

Key Path	Source, Modulation Setup, ARB, Trigger Type
Remote Command	:SOURce:RADio:ARB:RETRigger ON OFF IMMediate

	:SOURce:RADio:ARB:RETRigger?
Example	:SOUR:RAD:ARB:RETR OFF
Notes	ON: Buffered Trigger OFF: No Retrigger Immediate: Restart on Trigger This is defined as an enumerated SCPI command, with ON OFF being considered as enumerated types rather than Boolean. This means the query will return OFF instead of 0, and ON instead of 1.
Preset	ON
Range	No Retrigger Buffered Trigger Restart on Trigger
Initial S/W Revision	A.05.00

No Retrigger

Selects No Retrigger as the trigger response for single trigger type. No Retrigger sets the waveform generator to play a waveform sequence or segment once when a trigger is received. Any triggers then received during playback are ignored.

Key Path	Source, Modulation Setup, ARB, Trigger Type, Single
Example	:SOUR:RAD:ARB:RETR OFF
Initial S/W Revision	A.05.00

Buffered Trigger

Selects Buffered Trigger as the trigger response for single trigger type. Buffered Trigger sets the waveform generator to play a waveform sequence or segment once when a trigger is received. If a trigger is received during playback, the waveform generator plays the sequence or segment to the end, then plays the sequence or segment once more.

Key Path	Source, Modulation Setup, ARB, Trigger Type, Single
Example	:SOUR:RAD:ARB:RETR ON
Initial S/W Revision	A.05.00

Restart on Trigger

Selects Restart on Trigger as the trigger response for single trigger type. Restart on Trigger sets the waveform generator to play a waveform sequence or segment once when a trigger is received. If a trigger is received during playback, the waveform generator resets and plays the sequence or segment from the start.

Key Path	Source, Modulation Setup, ARB, Trigger Type, Single
Example	:SOUR:RAD:ARB:RETR IMM
Initial S/W Revision	A.05.00

Segment Advance

Sets the active trigger type to Segment Advance. If Segment Advance is already selected as the active trigger type, pressing this key allows access to the segment advance trigger type setup menu.

Segment Advance triggering allows you to control the playback of waveform segments within a waveform sequence. When a trigger is received the ARB advances to the next waveform segment within the waveform sequence. This type of triggering ignores the repetition count for the waveform segment within the waveform sequence. For example, if a waveform segment has a repetition count of 10 and you select single segment advance triggering mode, the waveform segment will only play once.

Segment Advance triggering can also be used for waveform segments only. In this situation the same waveform segment is played again when a trigger is received.

Key Path	Source, Modulation Setup, ARB, Trigger Type
Remote Command	:SOURce:RADio:ARB:TRIGger:TYPE:SADVance[:TYPE] SINGLE CONTInuous :SOURce:RADio:ARB:TRIGger:TYPE:SADVance[:TYPE]?
Example	:SOUR:RAD:ARB:TRIG:TYPE:SADV SING
Preset	CONTInuous
Range	Single Continuous
Initial S/W Revision	A.05.00

Single

Selects Single as the trigger response for Segment Advance trigger type. With single selected, once a trigger is received a segment is played once. If a trigger is received during playback of a segment, the segment plays to completion and the next segment is played once.

Key Path	Source, Modulation Setup, ARB, Trigger Type, Segment Advance
Example	:SOUR:RAD:ARB:TRIG:TYPE:SADV SING
Initial S/W Revision	A.05.00

Continuous

Selects Continuous as the trigger response for Segment Advance trigger type. With continuous selected, once a trigger is received a segment is played continuously. When subsequent triggers are received, the currently playing segment plays to completion and then the next segment is played continuously.

Key Path	Source, Modulation Setup, ARB, Trigger Type, Segment Advance
Example	:SOUR:RAD:ARB:TRIG:TYPE:SADV CONT
Initial S/W Revision	A.05.00

Trigger Source

Allows access to the trigger source sub-menus. The trigger source setting determines how the source receives the trigger that starts the waveform playing. Therefore, this key is grayed out if the trigger type is free run, since free run triggers immediately with no trigger source required.

Key Path	Source, Modulation Setup, ARB
Remote Command	:SOURce:RADio:ARB:TRIGger[:SOURce] KEY BUS EXTernal2 :SOURce:RADio:ARB:TRIGger[:SOURce]?
Example	:SOUR:RAD:ARB:TRIGger KEY
Dependencies	This key is grayed out if the current trigger type is Continuous, Free Run.
Preset	EXTernal2
Range	Trigger Key Bus External 2
Initial S/W Revision	A.05.00

Trigger Key

Sets the current trigger source to the front panel Trigger key. When Trigger Key is selected, the waveform is triggered when you press the front panel Trigger key.

Key Path	Source, Modulation Setup, ARB, Trigger Source
Example	:SOUR:RAD:ARB:TRIGger KEY
Initial S/W Revision	A.05.00

Bus

Sets the current trigger source to Bus. Selecting Bus trigger source enables triggering over GPIB, LAN, or USB using the :SOURce:RADio:ARB:TRIGger:INITiate command.

Key Path	Source, Modulation Setup, ARB, Trigger Source
Example	:SOUR:RAD:ARB:TRIGger BUS
Initial S/W Revision	A.05.00

External 2

Sets the current trigger source to External 2. Selecting External 2 enables triggering a waveform by an externally applied signal.

Key Path	Source, Modulation Setup, ARB, Trigger Source
Example	:SOUR:RAD:ARB:TRIGger EXT2
Notes	Note: When on E6640A, trigger 2 is a bi-directional trigger port. So when trigger 2 has been configured as OUTPUT type, choosing External 2 as the input trigger for the current step will generate error.
Initial S/W Revision	A.05.00

Trigger Initiate

Used to initiate an immediate trigger event if the trigger source is set to Trigger Key.

Key Path	Source, Modulation Setup, ARB
Notes	No remote command, SCPI front panel only.
Initial S/W Revision	A.05.00

Waveform Sequences

Allows access to the waveform sequence sub-menus. Pressing this key changes the central view area to display the Waveform Sequence List view.

Key Path	Source, Modulation Setup, ARB
Notes	No remote command, SCPI front panel only.
Initial S/W Revision	A.05.00

Build New Sequence

Allows access to the sub-menus for creating a new waveform sequence. Pressing this key changes the central view area to display the Waveform Sequence Creation and Editing view.

Key Path	Source, Modulation Setup, ARB, Waveform Sequences
Notes	No remote command, SCPI front panel only.
Initial S/W Revision	A.05.00

Current Segment

Specifies the selected sequence segment that will be affected by the menu functions.

Key Path	Source, Modulation Setup, ARB, Waveform Sequences, Build New Sequence
Notes	No remote command, SCPI front panel only. This key is grayed out and unavailable if the sequence is currently empty.
Initial S/W Revision	A.05.00

Insert New Waveform

Allows you access to the sub-menu for inserting a new waveform segment or sequence. Pressing this key also changes the central display to show the Waveform File Selection View.

Key Path	Source, Modulation Setup, ARB, Waveform Sequences, Build New Sequence
Notes	No remote command, SCPIfront panel only. Waveform segment name string length upper limit is 128 chars. Please do NOT insert waveform which name string exceeds 128 chars.
Initial S/W Revision	A.05.00

Insert Waveform

Inserts the currently highlighted waveform to the end of the waveform sequence. Pressing this key also returns you to the menus for creating or editing a sequence, and returns the central view to the sequence creation view.

Key Path	Source, Modulation Setup, ARB, Waveform Sequences, Build New Sequence, Insert New Waveform
Notes	No remote command, SCPIfront panel only. Waveform segment name string length upper limit is 128 chars. Please do NOT insert waveform which name string exceeds 128 chars.
Initial S/W Revision	A.05.00

Segments on Hard Disk

Allows you access to the sub-menus for loading waveform segments from the hard disk into ARB memory. The default directory is: D: varb.

Pressing this key changes the current view to the Waveform Management View.

Key Path	Source, Modulation Setup, ARB, Select Waveform
Initial S/W Revision	A.05.00

Load Segment To ARB Memory

Allows you to load the selected file into ARB memory. On the front panel you select the file for loading to the ARB memory by highlighting the desired file in the list. Using the SCPI command, you specify the file name on the HDD.

“NVWFM” (none-volatile storage) MSUS (Mass Storage Unit Specifier) is supported in the memory subsystem because the ARB memory cannot be accessed directly. Therefore, files must be downloaded to the instrument hard disk and then loaded into the ARB memory. “NVWFM” MSUS will be mapped to the default directory D: VARB. The SCPI command supports using either “NVWFM” MSUS or specifying a full path. For more information, see [Memory Subsystem \(Remote Command Only\)](#).

If a file of the same name already exists within ARB memory, it is overwritten. If you wish to load two segments of the same name, you must rename one of the segments before loading it into ARB memory. To rename a segment, you can either use Windows File Explorer, or the :MMEMORY:COPY command.

NOTE: When a waveform file is loaded to ARB memory, burst timing adjustments are made automatically, based on whether or not a Multiport Adapter is connected to the test set and powered on. If the connection/power status of the Multiport Adapter is changed after a waveform file has been loaded, it needs to be loaded again.

Key Path	Source, Modulation Setup, ARB, Select Waveform, Segments on Hard Disk
Remote Command	:SOURce:RADio:ARB:LOAD <string>
Example	:SOUR:RAD:ARB:LOAD "D: VARB\testwaveform.bin" or :SOUR:RAD:ARB:LOAD "NVWFM:testwaveform.bin"
Notes	<p>Because loading the file involves a delay of unpredictable length, this command should be followed by the query *OPC?, which holds off subsequent commands until the loading operating is complete.</p> <p><string> – specifies the path name of the file to load from the HDD into ARB memory. It could be a <full path + filename>, or <"NVWFM" MSUS + colon + filename>.</p> <p>When in Sequence Analyzer mode, and Include Source is Yes, an attempt to load a file to ARB memory will be rejected with an error.</p> <p>When Include Source is No and if there is insufficient free ARB memory to load the selected waveform, an error is generated. .</p> <p>If you specify a file over SCPI, but the file is not at the specified location, an error is generated.</p> <p>If you try to load a waveform file but the file contains less than 500 IQ samples, an error is generated.</p> <p>If you try to load a Signal Studio waveform "*.wfm" which contains invalid waveform header, an error is generated.</p> <p>If the ARB is ON when you load a file to ARB memory or delete a file from ARB memory, the playing waveform segment may not keep phase continuity during the ARB memory operation. The waveform will be replayed after the ARB operation is finished.</p> <p>ARB can be loaded into ARB memory even required licenses do not present on the instrument. In this case, a GUI only warning message –800, "Operation complete; Loaded <filename> successfully, but no license <required licenses> installed". User can install required licenses according to <required licenses> string to license it, or multi-pack license it.</p>
Initial S/W Revision	A.05.00

Load All To ARB Memory

Allows you to load all the segment files within the currently selected directory into ARB memory. If a file of the same name already exists within ARB memory, it is overwritten. If you wish to load two segments of the same name, you must rename one of the segments before loading it into ARB memory. To rename a segment, you can either use Windows File Explorer, or the :MEMory:COPY command.

NOTE: When a waveform file is loaded to ARB memory, burst timing adjustments are made automatically, based on whether or not a Multiport Adapter is connected to the test set and powered on. If the connection/power status of the Multiport Adapter is changed after a waveform file has been loaded, it needs to be loaded again.

Key Path	Source, Modulation Setup, ARB, Select Waveform, Segments on Hard Disk
Remote Command	:SOURce:RADio:ARB:LOAD:ALL <string>

Example	:SOUR:RAD:ARB:LOAD:ALL "D: varb"
Notes	<p><string> - specifies the directory on the HDD to load the files into ARB memory from.</p> <p>When in Sequence Analyzer mode, and Include Source is Yes, an attempt to load all files from a directory to ARB memory is rejected with an error.</p> <p>When Include Source is No and there is insufficient free ARB memory to load all the waveforms, when the ARB memory is full, the copy ceases, and an error is generated.</p> <p>If you specify a directory over SCPI, but the directory does not exist, an error is generated.</p> <p>If the ARB is ON, a user then loads or deletes file to ARB memory, the playing waveform segment may not keep phase continuity during the ARB memory operation. The waveform will be replayed after the ARB operation is finished.</p>
Initial S/W Revision	A.05.00

Change Directory...

Allows you to change the currently selected directory on the hard disk. Pressing this key opens a standard windows change directory dialog allowing you to select the new directory of interest.

The current directory is used for manually loading waveform segments into ARB memory for playback, and as a search location for waveform segments that are required to be loaded into ARB memory for playback of a waveform sequence or a list sequence.

Key Path	Source, Modulation Setup, ARB, Select Waveform, Segments on Hard Disk
Notes	No remote command, SCPIfront panel only.
Initial S/W Revision	A.05.00

Default Directory...

Allows you to change the default directory. It is used as a search location for waveform segments that are required to be loaded into ARB memory for playback of a waveform sequence, and as a search location for selecting waveforms using SCPI.

Key Path	Source, Modulation Setup, ARB, Select Waveform, Segments on Hard Disk
Remote Command	:SOURce:RADio:ARB:DEFault:DIRectory <string> :SOURce:RADio:ARB: DEFault:DIRectory?
Example	:SOUR:RAD:ARB:DEF:DIR "D:\ArbFiles" :SOUR:RAD:ARB:DEF:DIR?
State Saved	Persistent, survives a power cycle and a preset but not saved in the instrument state
Initial S/W Revision	A.05.00

Segments in ARB Memory

Allows you access to the sub-menus for managing the files within ARB memory.

Key Path	Source, Modulation Setup, ARB, Select Waveform
Initial S/W Revision	A.05.00

Delete Segment From ARB Mem

Allows you to remove a segment from ARB playback memory.

Key Path	Source, Modulation Setup, ARB, Select Waveform, Segments in ARB Memory
Remote Command	:SOURce:RADio:ARB:DELeTe <string>
Example	:SOUR:RAD:ARB:DEL "testwaveform.bin"
Notes	<p><string> - specifies the waveform to be deleted from the ARB playback memory.</p> <p>When in Sequence Analyzer mode and Include Source is Yes, an attempt to delete a file from ARB memory is rejected with an error.</p> <p>When Include Source is No and you specify a file that does not exist within ARB memory, an error is generated.</p> <p>It is possible to delete files from within the ARB memory when the ARB is ON. However, if you attempt to delete the file that is currently playing an error is generated.</p> <p>It is possible to delete a file from within the ARB memory when the sequencer state is ON and the file is not being used by the List Sequencer. If you attempt to delete a file which is being used by the list sequencer, an error is generated.</p> <p>When sequencer state is On, even if ARB state is On, the selected waveform will not be played. In this case, if the selected waveform is not used in List Sequence, it can be deleted and the ARB state is turned Off.</p> <p>If the ARB is ON and you load a file to ARB memory or delete a file from ARB memory, the playing waveform segment may not keep phase continuity during the ARB memory operation. The waveform will be replayed after the ARB operation is finished.</p>
Initial S/W Revision	A.05.00

Delete All From ARB Memory

Allows you to remove all segments from ARB playback memory.

Key Path	Source, Modulation Setup, ARB, Select Waveform, Segments in ARB Memory
Remote Command	:SOURce:RADio:ARB:DELeTe:ALL
Example	:SOUR:RAD:ARB:DELeTe:ALL
Notes	<p>When in Sequence Analyzer mode and Include Source is Yes, an attempt to delete all files from ARB memory is rejected with an error.</p> <p>When Include Source is No and you attempt to delete all files from ARB memory when the ARB is currently playing a file, all files except the one playing are deleted and an error is generated.</p> <p>If you attempt to delete all files from ARB memory when there are waveform files used in "List Sequencer" on page 1306 and "Sequencer" on page 1307 state is ON, all files except the files currently being used in list sequencer are deleted, and an error is generated.</p>

If the ARB is ON and you load a file to ARB memory or delete a file from ARB memory, the playing waveform segment may not keep phase continuity during the ARB memory operation. The waveform will be replayed after the ARB operation is finished.

Initial S/W Revision	A.05.00
----------------------	---------

Segments on Hard Disk

This key functions the same as "[Segments on Hard Disk](#)" on page 1333.

Key Path	Source, Modulation Setup, ARB, Waveform Sequences, Build New Sequence, Insert New Waveform
Initial S/W Revision	Prior to A.09.00

Load Segment To ARB Memory

This key functions the same as "[Load Segment To ARB Memory](#)" on page 1333.

Key Path	Source, Modulation Setup, ARB, Waveform Sequences, Build New Sequence, Insert New Waveform, Segment on Hard Drive
Initial S/W Revision	Prior to A.09.00

Load All To ARB Memory

This key functions the same as "[Load All To ARB Memory](#)" on page 1334.

Key Path	Source, Modulation Setup, ARB, Waveform Sequences, Build New Sequence, Insert New Waveform, Segment on Hard Drive
Initial S/W Revision	Prior to A.09.00

Change Directory ...

This key functions the same as "[Change Directory...](#)" on page 1335.

Key Path	Source, Modulation Setup, ARB, Waveform Sequences, Build New Sequence, Insert New Waveform, Segment on Hard Drive
Initial S/W Revision	Prior to A.09.00

Default Directory ...

This key functions the same as "[Default Directory...](#)" on page 1335

Key Path	Source, Modulation Setup, ARB, Waveform Sequences, Build New Sequence, Insert New Waveform, Segment on Hard Drive
Initial S/W Revision	Prior to A.09.00

Segments in ARB Memory

This key functions the same as ["Segments in ARB Memory" on page 1335](#).

Key Path	Source, Modulation Setup, ARB, Waveform Sequences, Build New Sequence, Insert New Waveform
Initial S/W Revision	Prior to A.09.00

Delete Segment From ARB Memory

This key functions the same as ["Delete Segment From ARB Mem" on page 1335](#).

Key Path	Source, Modulation Setup, ARB, Waveform Sequences, Build New Sequence, Insert New Waveform, Segment in ARB Memory
Initial S/W Revision	Prior to A.09.00

Delete All From ARB Memory

This key functions the same as ["Delete All From ARB Memory" on page 1336](#).

Key Path	Source, Modulation Setup, ARB, Waveform Sequences, Build New Sequence, Insert New Waveform, Segment in ARB Memory
Initial S/W Revision	Prior to A.09.00

Query ARB Memory File List (Remote Command Only)

This command functions the same as ["Query ARB Memory File List \(Remote Command Only\)" on page 1268](#).

Initial S/W Revision	Prior to A.09.00
----------------------	------------------

Edit Selected Waveform

Allows access to the sub-menus for editing the details of the currently selected waveform segment.

Key Path	Source, Modulation Setup, ARB, Waveform Sequences, Build New Sequence
Notes	No remote command, front panel only.
Initial S/W Revision	A.05.00

Repetitions

Allows you to specify the number of times the currently selected waveform is played within the sequence.

Key Path	Source, Modulation Setup, ARB, Waveform Sequences, Build New Sequence, Edit Selected Waveform
Notes	No remote command, SCPI front panel only.
Preset	1
Min	1
Max	65535
Initial S/W Revision	A.05.00

Marker 1

Allows you to enable or disable marker 1 for the currently selected waveform. For a waveform sequence, you can enable and disable markers on a per-segment basis, allowing you to output markers from some waveform segments within the sequence, but not for others.

Key Path	Source, Modulation Setup, ARB, Waveform Sequences, Build New Sequence, Edit Selected Waveform
Notes	No remote command, front panel only.
Preset	Enabled
Range	Enabled Disabled
Initial S/W Revision	A.05.00

Marker 2

Allows you to enable or disable marker 2 for the currently selected waveform. For a waveform sequence, you can enable and disable markers on a per-segment basis, allowing you to output markers from some waveform segments within the sequence, but not for others.

Key Path	Source, Modulation Setup, ARB, Waveform Sequences, Build New Sequence, Edit Selected Waveform
Notes	No remote command, front panel only.
Preset	Enabled
Range	Enabled Disabled
Initial S/W Revision	A.05.00

Marker 3

Allows you to enable or disable marker 3 for the currently selected waveform. For a waveform sequence, you can enable and disable markers on a per-segment basis, allowing you to output markers from some waveform segments within the sequence, but not for others.

Key Path	Source, Modulation Setup, ARB, Waveform Sequences, Build New Sequence, Edit Selected
----------	--

	Waveform
Notes	No remote command, front panel only.
Preset	Enabled
Range	Enabled Disabled
Initial S/W Revision	A.05.00

Marker 4

Allows you to enable or disable marker 4 for the currently selected waveform. For a waveform sequence, you can enable and disable markers on a per-segment basis, allowing you to output markers from some waveform segments within the sequence, but not for others.

Key Path	Source, Modulation Setup, ARB, Waveform Sequences, Build New Sequence, Edit Selected Waveform
Notes	No remote command, front panel only.
Preset	Enabled
Range	Enabled Disabled
Initial S/W Revision	A.05.00

Delete Segment

Allows you to delete the selected segment from the waveform sequence.

Key Path	Source, Modulation Setup, ARB, Waveform Sequences, Build New Sequence
Notes	No remote command, front panel only.
Initial S/W Revision	A.05.00

Save Sequence...

Pressing this key displays the "Save As" dialog. The sequence name is passed to the save as dialog to use as the filename for saving, and the directory the save as dialog will open into is the default waveform directory.

Key Path	Source, Modulation Setup, ARB, Waveform Sequences, Build New Sequence
Initial S/W Revision	A.05.00

Build New Sequence (Remote Command Only)

This command is the SCPI equivalent of the waveform sequence creation features described in "[Build New Sequence](#)" on page 1275.

This command writes a waveform sequence file to the hard disk. You must specify the waveform sequence file path and filename which will be saved on the hard disk, and the waveform segment file path and name which will be nested into the waveform sequence file. You can utilize mass storage unit specifier (MSUS) "NVWFM" or use a real full path representation. See the example below. MSUS "NVWFM" is mapped to D:VARB directory on test set hard disk.

Any number of segments, up to a segment count limit of 64, can be used to create a sequence. Repeated segments are included in the count limit.

Each waveform segment name string length upper limit is 128 chars. Please do NOT insert waveform which name string exceeds 128 chars.

The internal source does not support nesting one waveform sequence file into another waveform sequence file.

Remote Command :SOURce:RADio:ARB:SEQuence[:MWAVeform] <filename>, <waveform1>, <reps>, NONE | M1 | M2 | M3 | M4 | M1M2 | M1M3 | M1M4 | M2M3 | M2M4 | M3M4 | M1M2M3 | M1M2M4 | M1M3M4 | M2M3M4 | M1M2M3M4 | ALL, {<waveform2>, <reps>, NONE | M1 | M2 | M3 | M4 | M1M2 | M1M3 | M1M4 | M2M3 | M2M4 | M3M4 | M1M2M3 | M1M2M4 | M1M3M4 | M2M3M4 | M1M2M3M4 | ALL, } ...

(For additional description of each item, see Notes below "[For Setup SCPI](#)" on page 983 "[For Setup SCPI](#)".)

:SOURce:RADio:ARB:SEQuence[:MWAVeform]? <filename>

(For additional description of each item, see Notes "[For Query SCPI](#)" on page 984 below.)

Example For setup:

```
>:SOUR:RAD:ARB:SEQ "NVWFM:testSeq1.seq", "NVWFM:wfmSegment1.wfm", 10, M2M3M4, "NVWFM:wfmSegment2.wfm", 20, M1M3
```

Or

```
>:SOUR:RAD:ARB:SEQ "D: VARB\testSeq1.seq", " D: VARB\wfmSegment1.wfm", 10, M2M3M4, " D: VARB\wfmSegment2.wfm", 20, M1M3
```

For query, must specify which waveform sequence file to query.

```
>:SOUR:RAD:ARB:SEQ? "NVWFM:testSeq1.seq"
```

Or

```
>:SOUR:RAD:ARB:SEQ? "D: VARB\testSeq1.seq",
```

Notes

For Setup SCPI

For the Setup SCPI command, the parameters are:

<filename> - String Type

This variable specifies the path and name for the waveform sequence file. The path supports MSUS (NVWFM) or a real full path representation. See example.

<waveform1> - String Type

This variable specifies the path and name of the first existing waveform segment. The path supports MSUS (NVWFM) or a real full path representation. See example.

The segment file must reside within ARB playback memory before it can be played by the ARB player.

<reps> - Integer Type

This variable specifies the number of times a segment or sequence plays before moving on to the next segment or sequence.

<marker> - Enum Type

NONE - This choice disables all four markers for the waveform. Disabling markers means that the waveform sequence ignores the segments or sequence marker settings.

M1, M2, M3, M4 - these choices, either individually or a combination of them, enable the markers for the waveform segment or sequence. Markers not specified are ignored for that segment or sequence.

ALL - This choice enables all four markers in the waveform segment or sequence.

<waveform2> - String type.

This variable specifies the name of a second existing waveform segment. The path supports MSUS (NVWFM) and real full path representation both. See example.

The segment file must reside within ARB playback memory before it can be played by the ARB player.

<reps> same as above, for the 2nd waveform segment.

<marker> same as above, for the 2nd waveform segment.

You can insert several waveform segments into a waveform sequence file. Just repeat inserting waveform segments as described above.

Error Checks for Setup SCPI command:

If you do not specify a filename, or you use an unsupported MSUS (that is, not NVWFM), or have an error in the waveform sequence file path, an error is generated.

Notes

Error Checks for Query SCPI command: (Continued)

If the specified waveform sequence file name suffix is not ".seq", error is generated.

If you use an unsupported MSUS (that is, not NVWFM), or have an error in the waveform segment file path, an error is generated.

If the first specified waveform file cannot be found, an error is generated.

If you nest one waveform sequence file into another waveform sequence file, an error is generated.

If the specified repetition value is larger than 65535 or smaller than 1, an error is generated.

If the specified marker type is unrecognized, an error is generated.

For Query SCPI

For the Query the parameters are:

<filename> - String type.

This variable specifies the path and name of the waveform sequence file being queried. The path supports MSUS (NVWFM) or a real full path representation. See example.

The return value is a <string>, which includes each waveform segment file name, repetitions, and marker type. For example:

>:SOUR:RAD:ARB:SEQ? "NVWFM:testSeq1.seq",

<"wfmSegment1.wfm, 10, ALL, wfmSegment2.wfm, 20, M1M3",

Error Checks for Query SCPI command:

If you do not specify a filename, an error is generated.

If the waveform sequence file name is empty, an error is generated.

If the specified waveform sequence file cannot be found, an error is generated.

Initial S/W Revision

A.05.00

Edit Selected Sequence

Allows access to the sub-menus for editing the sequence currently selected within the Waveform Sequence List view. Pressing this key changes the central view area to display the Waveform Sequence Creation and Editing view.

Key Path	Source, Modulation Setup, ARB, Waveform Sequences
Notes	No remote command, front panel only.
Initial S/W Revision	A.05.00

Current Directory...

Allows you to change the currently selected directory on the hard disk. Pressing this key opens a standard windows change directory dialog and allows you to select the new directory of interest.

Key Path	Source, Modulation Setup, ARB, Waveform Sequences
Notes	No remote command, front panel only.
Initial S/W Revision	A.05.00

Waveform Utilities

Allows you access to the waveform utilities sub-menus.

Key Path	Source, Modulation Setup, ARB
Initial S/W Revision	A.05.00

Multi-Pack Licenses

Allows you access to the Multi - Pack License sub-menus. Pressing this key also changes the central view area to display the Multi -Pack License Management view.

On modular instrument like E6630A or E6640A, multi-pack license operations are only allowed on the default module, i.e. "Left" module for E6630A or "TRX1" module for E6640A.

Key Path	Source, Modulation Setup, ARB, Waveform Utilities
Notes	If access multi-pack license sub-menu from modules other than "TRX1", an advisory message like "Please goto "TRX1" to operate multi-pack license" will display.
Dependencies	This key is only available if there is at least one Multi-pack license installed on the instrument.
Initial S/W Revision	A.05.00

Add Waveform

Pressing this key accesses the Add Waveform sub-menu. It also changes the central display area to display the Multi-Pack License Waveform Add view.

Key Path	Source, Modulation Setup, ARB, Waveform Utilities, Multi-Pack Licenses
Dependencies	This key is only available if there is at least one slot available within at least one multi-pack license.
Initial S/W Revision	A.05.00

Add Waveform

Allows you to add the currently selected waveform segment to a multi-pack license. The new waveform is added to the next available slot regardless of which slot was selected on the Multi-Pack License Management view.

Key Path	Source, Modulation Setup, ARB, Waveform Utilities, Multi-Pack Licenses, Add Waveform
Remote Command	:SYSTem:LKEY:WAVeform:ADD <string> or :SYSTem:LIcense[:FPACK]:WAVeform:ADD <string>
Example	SYST:LKEY:WAV:ADD "mywaveform.wfm" or SYST:LIC:WAV:ADD "mywaveform.wfm"
Notes	The second SCPI :SYSTem:LIcense[:FPACK]:WAVeform:ADD is provided to be consistent with the style of Agilent signal sources. You can use either one of them. Since adding a waveform segment to a Multi-Pack license causes the license slot to enter the trial period of only 48 hours, pressing this key causes a confirmation dialog to be displayed to ensure you do want to add the waveform segment to the Multi-Pack. If you attempt to license a waveform that is already licensed using another slot an error is generated. . If current module is not "TRX1" module, the key will grey out, and error message is generated "-221 Setting conflict; Not allowed on current module. Goto "TRX1" to operate multi-pack license" when invoking SCPI.
Dependencies	This key is only available if the currently selected file is a secure waveform requiring a license, and there is at least one slot available within at least one multi-pack license. If the waveform highlighted is a secure waveform, but is already licensed, this key will be unavailable.
Initial S/W Revision	A.05.00

Segments on Hard Disk

Allows you access to the sub-menus for loading waveform segments from the hard disk into ARB memory. The default directory is: D: varb.

Pressing this key changes the current view to the Waveform Management View.

Key Path	Source, Modulation Setup, ARB, Select Waveform
Initial S/W Revision	A.05.00

Load Segment To ARB Memory

Allows you to load the selected file into ARB memory. On the front panel you select the file for loading to the ARB memory by highlighting the desired file in the list. Using the SCPI command, you specify the file name on the HDD.

“NVWFM” (none-volatile storage) MSUS (Mass Storage Unit Specifier) is supported in the memory subsystem because the ARB memory cannot be accessed directly. Therefore, files must be downloaded to the instrument hard disk and then loaded into the ARB memory. “NVWFM” MSUS will be mapped to the default directory D: VARB. The SCPI command supports using either “NVWFM” MSUS or specifying a full path. For more information, see [Memory Subsystem \(Remote Command Only\)](#).

If a file of the same name already exists within ARB memory, it is overwritten. If you wish to load two segments of the same name, you must rename one of the segments before loading it into ARB memory. To rename a segment, you can either use Windows File Explorer, or the :MMEMory:COPI command.

NOTE: When a waveform file is loaded to ARB memory, burst timing adjustments are made automatically, based on whether or not a Multiport Adapter is connected to the test set and powered on. If the connection/power status of the Multiport Adapter is changed after a waveform file has been loaded, it needs to be loaded again.

Key Path	Source, Modulation Setup, ARB, Select Waveform, Segments on Hard Disk
Remote Command	:SOURce:RADio:ARB:LOAD <string>
Example	:SOUR:RAD:ARB:LOAD "D: VARB\testwaveform.bin" or :SOUR:RAD:ARB:LOAD "NVWFM:testwaveform.bin"
Notes	<p>Because loading the file involves a delay of unpredictable length, this command should be followed by the query *OPC?, which holds off subsequent commands until the loading operating is complete.</p> <p><string> – specifies the path name of the file to load from the HDD into ARB memory. It could be a <full path + filename>, or <“NVWFM” MSUS + colon + filename>.</p> <p>When in Sequence Analyzer mode, and Include Source is Yes, an attempt to load a file to ARB memory will be rejected with an error.</p> <p>When Include Source is No and if there is insufficient free ARB memory to load the selected waveform, an error is generated. .</p> <p>If you specify a file over SCPI, but the file is not at the specified location, an error is generated.</p> <p>If you try to load a waveform file but the file contains less than 500 IQ samples, an error is generated.</p> <p>If you try to load a Signal Studio waveform “*.wfm” which contains invalid waveform header, an error is generated.</p> <p>If the ARB is ON when you load a file to ARB memory or delete a file from ARB memory, the playing waveform segment may not keep phase continuity during the ARB memory operation. The waveform will be replayed after the ARB operation is finished.</p> <p>ARB can be loaded into ARB memory even required licenses do not present on the instrument. In this</p>

case, a GUI only warning message -800, "Operation complete; Loaded <filename> successfully, but no license <required licenses> installed". User can install required licenses according to <required licenses> string to license it, or multi-pack license it.

Initial S/W Revision A.05.00

Load All To ARB Memory

Allows you to load all the segment files within the currently selected directory into ARB memory. If a file of the same name already exists within ARB memory, it is overwritten. If you wish to load two segments of the same name, you must rename one of the segments before loading it into ARB memory. To rename a segment, you can either use Windows File Explorer, or the :MEMory:COPY command.

NOTE: When a waveform file is loaded to ARB memory, burst timing adjustments are made automatically, based on whether or not a Multiport Adapter is connected to the test set and powered on. If the connection/power status of the Multiport Adapter is changed after a waveform file has been loaded, it needs to be loaded again.

Key Path Source, Modulation Setup, ARB, Select Waveform, Segments on Hard Disk

Remote Command :SOURce:RADio:ARB:LOAD:ALL <string>

Example :SOUR:RAD:ARB:LOAD:ALL "D: varb"

Notes

- <string> - specifies the directory on the HDD to load the files into ARB memory from.
- When in Sequence Analyzer mode, and Include Source is Yes, an attempt to load all files from a directory to ARB memory is rejected with an error.
- When Include Source is No and there is insufficient free ARB memory to load all the waveforms, when the ARB memory is full, the copy ceases, and an error is generated.
- If you specify a directory over SCPI, but the directory does not exist, an error is generated.
- If the ARB is ON, a user then loads or deletes file to ARB memory, the playing waveform segment may not keep phase continuity during the ARB memory operation. The waveform will be replayed after the ARB operation is finished.

Initial S/W Revision A.05.00

Change Directory...

Allows you to change the currently selected directory on the hard disk. Pressing this key opens a standard windows change directory dialog allowing you to select the new directory of interest.

The current directory is used for manually loading waveform segments into ARB memory for playback, and as a search location for waveform segments that are required to be loaded into ARB memory for playback of a waveform sequence or a list sequence.

Key Path Source, Modulation Setup, ARB, Select Waveform, Segments on Hard Disk

Notes No remote command, SCPIfront panel only.

Initial S/W Revision A.05.00

Default Directory...

Allows you to change the default directory. It is used as a search location for waveform segments that are required to be loaded into ARB memory for playback of a waveform sequence, and as a search location for selecting waveforms using SCPI.

Key Path	Source, Modulation Setup, ARB, Select Waveform, Segments on Hard Disk
Remote Command	:SOURce:RADio:ARB:DEFault:DIRectory <string> :SOURce:RADio:ARB: DEFault:DIRectory?
Example	:SOUR:RAD:ARB:DEF:DIR "D:\ArbFiles" :SOUR:RAD:ARB:DEF:DIR?
State Saved	Persistent, survives a power cycle and a preset but not saved in the instrument state
Initial S/W Revision	A.05.00

Segments on Hard Disk

This key functions the same as ["Segments on Hard Disk" on page 1333](#).

Key Path	Source, Modulation Setup, ARB, Waveform Utilities, Multi-Pack Licenses, Add Waveform
Initial S/W Revision	Prior to A.09.00

Load Segment To ARB Memory

This key functions the same as ["Load Segment To ARB Memory" on page 1333](#).

Key Path	Source, Modulation Setup, ARB, Waveform Utilities, Multi-Pack Licenses, Add Waveform, Segment on Hard Drive
Initial S/W Revision	Prior to A.09.00

Load All To ARB Memory

This key functions the same as ["Load All To ARB Memory" on page 1334](#).

Key Path	Source, Modulation Setup, ARB, Waveform Utilities, Multi-Pack Licenses, Add Waveform, Segment on Hard Drive
Initial S/W Revision	Prior to A.09.00

Change Directory ...

This key functions the same as ["Change Directory..." on page 1335](#).

Key Path	Source, Modulation Setup, ARB, Waveform Utilities, Multi-Pack Licenses, Add Waveform, Segment on Hard Drive
Initial S/W Revision	Prior to A.09.00

Default Directory ...

This key functions the same as ["Default Directory..." on page 1335](#)

Key Path	Source, Modulation Setup, ARB, Waveform Utilities, Multi-Pack Licenses, Add Waveform, Segment on Hard Drive
Initial S/W Revision	Prior to A.09.00

Replace Waveform

Pressing this key accesses the Replace Waveform submenu. It also changes the central display area to display the Multi-Pack License Waveform Add view.

Key Path	Source, Modulation Setup, ARB, Waveform Utilities, Multi-Pack Licenses
Dependencies	This key is only available if the currently selected slot is in the trial state.
Initial S/W Revision	A.05.00

Replace Waveform

Allows you to replace the waveform in the currently selected slot with the waveform currently selected in the Multi-Pack License Waveform Add view.

Key Path	Source, Modulation Setup, ARB, Waveform Utilities, Multi-Pack Licenses, Replace Waveform
Remote Command	:SYSTem:LKEY:WAVeform:REPLace <int>, <string> or :SYSTem:LIcense[:FPACK]:WAVeform:REPLace <int>, <string>
Example	SYST:LKEY:WAV:REPL 1, "myotherwaveform.wfm" or :SYST:LIC:WAV:REPL 1, "myotherwaveform.wfm"
Notes	The second SCPI :SYSTem:LIcense[:FPACK]:WAVeform:REPLace is provided to be consistent with the style of Agilent signal sources. You can use either one of them. If you attempt to license a waveform that is already licensed using another slot an error is generated. Waveform slot number <int> is positive. If you attempt to input a slot number less than or equals 0, an error is generated. If current module is not "TRX1" module, the key will grey out, and error message is generated "-221 Setting conflict; Not allowed on current module. Goto "TRX1" to operate multi-pack license" when invoking SCPI.
Initial S/W Revision	A.05.00

Segments on Hard Disk

This key functions the same as ["Segments on Hard Disk" on page 1333](#).

Key Path	Source, Modulation Setup, ARB, Waveform Utilities, Multi-Pack Licenses, Replace Waveform
Initial S/W Revision	Prior to A.09.00

Load Segment To ARB Memory

This key functions the same as ["Load Segment To ARB Memory" on page 1333](#).

Key Path	Source, Modulation Setup, ARB, Waveform Utilities, Multi-Pack Licenses, Replace Waveform, Segment on Hard Drive
Initial S/W Revision	Prior to A.09.00

Load All To ARB Memory

This key functions the same as ["Load All To ARB Memory" on page 1334](#).

Key Path	Source, Modulation Setup, ARB, Waveform Utilities, Multi-Pack Licenses, Replace Waveform, Segment on Hard Drive
Initial S/W Revision	Prior to A.09.00

Change Directory ...

This key functions the same as ["Change Directory..." on page 1335](#).

Key Path	Source, Modulation Setup, ARB, Waveform Utilities, Multi-Pack Licenses, Replace Waveform, Segment on Hard Drive
Initial S/W Revision	Prior to A.09.00

Default Directory ...

This key functions the same as ["Default Directory..." on page 1335](#)

Key Path	Source, Modulation Setup, ARB, Waveform Utilities, Multi-Pack Licenses, Replace Waveform, Segment on Hard Drive
Initial S/W Revision	Prior to A.09.00

Clear Waveform from Slot

Allows you to clear the waveform from the selected slot.

Key Path	Source, Modulation Setup, ARB, Waveform Utilities, Multi-Pack Licenses
Remote Command	:SYSTem:LKEY:WAVeform:CLEar <int> or :SYSTem:LICense[:FPACK]:WAVeform:CLEar <int>
Example	SYST:LKEY:WAV:CLE 1 or :SYST:LIC:WAV:CLE 1
Notes	The second SCPI :SYSTem:LICense[:FPACK]:WAVeform:CLEar is provided to be consistent with the style of Agilent signal sources. You can use either one of them. Waveform slot number <int> is positive. If you attempt to input a slot number less than or equals 0, an error is generated. If current module is not "TRX1" module, the key will grey out, and error message is generated "-221 Setting conflict; Not allowed on current module. Goto "TRX1" to operate multi-pack license" when invoking SCPI.
Dependencies	This key is only available if the currently selected slot is in the trial state.
Initial S/W Revision	A.05.00

Lock Waveform in Slot

If the selected slot is in the trial state or the lock required state, the waveform that occupies the slot is locked and permanently licensed.

Key Path	Source, Modulation Setup, ARB, Waveform Utilities, Multi-Pack Licenses
Remote Command	:SYSTem:LKEY:WAVeform:LOCK <int> or :SYSTem:LICense[:FPACK]:WAVeform:LOCK <int>
Example	SYST:LKEY:WAV:LOCK 1 or SYST:LIC:WAV:LOCK 1
Notes	The second SCPI :SYSTem:LICense[:FPACK]:WAVeform:LOCK is provided to be consistent with the style of Agilent signal sources. You can use either one of them. Waveform slot number <int> is positive. If you attempt to input a slot number less than or equals 0, an error is generated. If current module is not "TRX1" module, the key will grey out, and error message is generated "-221 Setting conflict; Not allowed on current module. Goto "TRX1" to operate multi-pack license" when invoking SCPI.
Dependencies	This key is only available if the currently selected slot is in the trial state or the lock required state.
Initial S/W Revision	A.05.00

Slot Status Query (Remote Command Only)

Returns the status of the specified slot.

Remote Command	:SYSTem:LKEY:WAVeform:STATus? <int> or :SYSTem:LICense[:FPACK]:WAVeform:STATus? <int>
Example	:SYST:LKEY:WAV:STAT? 1 <"Locked" or :SYST:LIC:WAV:STAT? 1 <"Locked"
Notes	The second SCPI :SYSTem:LICense[:FPACK]:WAVeform:STATus is provided to be consistent with the style of Agilent signal sources. You can use either one of them. Waveform slot number <int> is positive. If you attempt to input a slot number less than or equals 0, an error is generated. Result type is string. If input slot number exceeds total available slot number, "Nonexistent" is returned.
Range	"Locked" "Available" "Trail" "LockRequired" "Nonexistent"
Initial S/W Revision	A.05.00

Slots Free Query (Remote Command Only)

Returns the number of license slots free.

Remote Command	:SYSTem:LKEY:WAVeform:FREE? or :SYSTem:LICense[:FPACK]:WAVeform:FREE?
Example	:SYST:LKEY:WAV:FREE? or :SYST:LIC:WAV:FREE?
Notes	The second SCPI :SYSTem:LICense[:FPACK]:WAVeform:FREE is provided to be consistent with the style of Agilent signal sources. You can use either one of them.
Initial S/W Revision	A.05.00

Slot Used Query (Remote Command Only)

Returns the number of license slots used.

Remote Command	:SYSTem:LKEY:WAVeform:USED? or :SYSTem:LICense[:FPACK]:WAVeform:USED?
Example	:SYST:LKEY:WAV:USED?

	or :SYST:LIC:WAV:USED?
Notes	The second SCPI :SYSTem:LIcense[:FPACK]:WAVeform:USED is provided to be consistent with the style of Agilent signal sources. You can use either one of them.
Initial S/W Revision	A.05.00

Slot Waveform Name Query (Remote Command Only)

Returns the waveform name of the specified slot

Remote Command	:SYSTem:LKEY:WAVeform:NAME? <int> or :SYSTem:LIcense[:FPACK]:WAVeform:NAME? <int>
Example	:SYST:LKEY:WAV:NAME? 1 <"CDMA2K_22.wfm" or :SYST:LIC:WAV:NAME? 1 <"CDMA2K_22.wfm"
Notes	Waveform slot number <int> is positive. If you attempt to input a slot number less than or equals 0, an error is generated. Result type is string. If input slot number exceeds total available slot number, "Nonexistent" is returned. If no waveform stored in the specified slot, then empty string is returned.
Initial S/W Revision	A.12.00

Slot Waveform Unique ID Query (Remote Command Only)

Returns the waveform unique ID of the specified slot

Remote Command	:SYSTem:LKEY:WAVeform:UID? <int> or :SYSTem:LIcense[:FPACK]:WAVeform:UID? <int>
Example	:SYST:LKEY:WAV:UID? 2 <"1346752140" or :SYST:LIC:WAV:UID? 2 <"1346752140"
Notes	Waveform slot number <int> is positive. If you attempt to input a slot number less than or equals 0, an error is generated. Result type is string. If input slot number exceeds total available slot number, "Nonexistent" is returned.

If no waveform stored in the specified slot, then "0" is returned

Initial S/W Revision A.12.00

Locked Waveform Name List Query (Remote Command Only)

Returns the waveform name list of locked.

Remote Command :SOURce:RADio:ARB:MPLicensed:NAME:LOCKed?

Example SOUR:RAD:ARB:MPL:NAME:LOCKed?
 <"CDMA2K_27.wfm", "GSM_MCS1.WFM", "c2kWfm.wfm"

Initial S/W Revision A.11.00

Locked Waveform Unique ID List Query (Remote Command Only)

Returns the waveform unique id list of locked.

Remote Command :SOURce:RADio:ARB:MPLicensed:UID:LOCKed?

Example SOUR:RAD:ARB:MPL:UID:LOCKed?
 <"2996927136", "3812603511", "3710986266"

Notes Each Signal Studio waveform has a unique id recorded in header. So if the unique ids are same, that means they are same one waveform. So besides SCPI to query locked waveform name list, also provide a SCPI to query locked waveform unique id list

Initial S/W Revision A.11.00

Marker Utilities

Allows access to the marker utilities sub-menus.

Key Path Source, Modulation Setup, ARB

Initial S/W Revision A.05.00

Marker Polarity

Allows access to the marker polarity sub-menu, which allows you to specify the polarity for the four markers. For a positive polarity, the marker signal is high during the marker points. For a negative marker polarity, the marker signal is high during the period of no marker points.

Key Path Source, Modulation Setup, ARB, Marker Utilities

Initial S/W Revision A.05.00

Mkr 1 Polarity

Allows you to set the polarity of marker 1.

Key Path	Source, Modulation Setup, ARB, Marker Utilities, Marker Polarity
Remote Command	:SOURce:RADio:ARB:MPOLarity:MARKer1 POSitive NEGative :SOURce:RADio:ARB:MPOLarity:MARKer1?
Example	:SOUR:RAD:ARB:MPOL:MARK1 NEG
Dependencies	When a new waveform is selected for playback the settings contained within the associated waveform header file are applied to the ARB. The marker polarity is one of the values stored within the header file. If the newly selected waveform file has an associated header file, the marker polarity is updated with the value from the header file. The marker polarity will remain unchanged if the newly selected waveform does not have an associated header file.
Preset	Pos
Range	Neg Pos
Initial S/W Revision	A.05.00

Mkr 2 Polarity

Allows you to set the polarity of marker 2.

Key Path	Source, Modulation Setup, ARB, Marker Utilities, Marker Polarity
Remote Command	:SOURce:RADio:ARB:MPOLarity:MARKer2 POSitive NEGative :SOURce:RADio:ARB:MPOLarity:MARKer2?
Example	:SOUR:RAD:ARB:MPOL:MARK2 NEG
Dependencies	When a new waveform is selected for playback the settings contained within the associated waveform header file are applied to the ARB. The marker polarity is one of the values stored within the header file. If the newly selected waveform file has an associated header file, the marker polarity is updated with the value from the header file. The marker polarity will remain unchanged if the newly selected waveform does not have an associated header file.
Preset	Pos
Range	Neg Pos
Initial S/W Revision	A.05.00

Mkr 3 Polarity

Allows you to set the polarity of marker 3.

Key Path	Source, Modulation Setup, ARB, Marker Utilities, Marker Polarity
Remote Command	:SOURce:RADio:ARB:MPOLarity:MARKer3 POSitive NEGative :SOURce:RADio:ARB:MPOLarity:MARKer3?
Example	:SOUR:RAD:ARB:MPOL:MARK3 NEG
Dependencies	When a new waveform is selected for playback the settings contained within the associated

waveform header file are applied to the ARB. The marker polarity is one of the values stored within the header file. If the newly selected waveform file has an associated header file, the marker polarity is updated with the value from the header file. The marker polarity will remain unchanged if the newly selected waveform does not have an associated header file.

Preset	Pos
Range	Neg Pos
Initial S/W Revision	A.05.00

Mkr 4 Polarity

Allows you to set the polarity of marker 4.

Key Path	Source, Modulation Setup, ARB, Marker Utilities, Marker Polarity
Remote Command	:SOURce:RADio:ARB:MPOLarity:MARKer4 POSitive NEGative :SOURce:RADio:ARB:MPOLarity:MARKer4?
Example	:SOUR:RAD:ARB:MPOL:MARK4 NEG
Dependencies	When a new waveform is selected for playback the settings contained within the associated waveform header file are applied to the ARB. The marker polarity is one of the values stored within the header file. If the newly selected waveform file has an associated header file, the marker polarity is updated with the value from the header file. The marker polarity will remain unchanged if the newly selected waveform does not have an associated header file.
Preset	Pos
Range	Neg Pos
Initial S/W Revision	A.05.00

Marker Routing

Allows access to the marker routing sub-menus, which allow you to specify where the marker events are routed. It should be noted that the markers can also be routed to Trigger 1 Out and Trigger 2 Out, however this must be set up using the menus accessed by pressing the “Trigger” hard key.

Key Path	Source, Modulation Setup, ARB, Marker Utilities
Initial S/W Revision	A.05.00

Pulse/RF Blank

Allows you to select which marker is used for the pulse/RF blanking function. The pulse/RF blanking function blanks the RF when the marker signal goes low. The marker polarity determines when the marker signal is high. For a positive polarity, this is during the marker points. For a negative polarity, this is when there are no marker points.

Marker points should be set before using this function. Enabling this function without setting maker points may create a continuous low or high signal, dependant on the marker polarity. This causes either no RF output, or a continuous RF output.

Key Path	Source, Modulation Setup, ARB, Marker Utilities, Marker Routing
Remote Command	:SOURce:RADio:ARB:MDEStination:PULSe NONE M1 M2 M3 M4 :SOURce:RADio:ARB:MDEStination:PULSe?
Example	:SOUR:RAD:ARB:MDES:PULS NONE
Dependencies	When a new waveform is selected for playback the settings contained within the associated waveform header file are applied to the ARB. The pulse/RF blanking setting is one of the values stored within the header file. If the newly selected waveform file has an associated header file, the pulse/RF blanking setting is updated with the value from the header file. The pulse/RF blanking setting will remain unchanged if the newly selected waveform does not have an associated header file.
Range	None M1 M2 M3 M4
Initial S/W Revision	A.05.00

None

Sets no marker to be used for the pulse/RF blanking function, essentially turning the RF blanking function off.

Key Path	Source, Modulation Setup, ARB, Marker Utilities, Marker Routing, Pulse/RF Blank
Example	:SOUR:RAD:ARB:MDES:PULS NONE
Initial S/W Revision	A.05.00

Marker 1

Sets marker 1 to be used for the pulse/RF blanking function.

Key Path	Source, Modulation Setup, ARB, Marker Utilities, Marker Routing, Pulse/RF Blank
Example	:SOUR:RAD:ARB:MDES:PULS M1
Initial S/W Revision	A.05.00

Marker 2

Sets marker 2 to be used for the pulse/RF blanking function.

Key Path	Source, Modulation Setup, ARB, Marker Utilities, Marker Routing, Pulse/RF Blank
Example	:SOUR:RAD:ARB:MDES:PULS M2
Initial S/W Revision	A.05.00

Marker 3

Sets marker 3 to be used for the pulse/RF blanking function.

Key Path	Source, Modulation Setup, ARB, Marker Utilities, Marker Routing, Pulse/RF Blank
Example	:SOUR:RAD:ARB:MDES:PULS M3
Initial S/W Revision	A.05.00

Marker 4

Sets marker 4 to be used for the pulse/RF blanking function.

Key Path	Source, Modulation Setup, ARB, Marker Utilities, Marker Routing, Pulse/RF Blank
Example	:SOUR:RAD:ARB:MDES:PULS M4
Initial S/W Revision	A.05.00

ALC Hold

Allows you to specify which marker is routed for use within the ALC hold function. The ALC hold marker function holds the ALC circuitry at the average value of the sample points set by the marker.

The ALC hold function operates during the low periods of the marker signal. The marker polarity determines when the marker signal is high. For positive polarity, this is during the marker points. For a negative polarity, this is when there are no maker points.

Key Path	Source, Modulation Setup, ARB, Marker Utilities, Marker Routing
Remote Command	:SOURce:RADio:ARB:MDEStination:ALCHold NONE M1 M2 M3 M4 :SOURce:RADio:ARB:MDEStination:ALCHold?
Example	:SOUR:RAD:ARB:MDES:ALCH NONE
Dependencies	When a new waveform is selected for playback the settings contained within the associated waveform header file are applied to the ARB. The ALC hold setting is one of the values stored within the header file. If the newly selected waveform file has an associated header file, the ALC hold setting is updated with the value from the header file. The ALC hold setting will remain unchanged if the newly selected waveform does not have an associated header file.
Range	None M1 M2 M3 M4
Initial S/W Revision	A.05.00

None

Sets no marker to be used for the ALC hold function, essentially turning the ALC hold function off.

Key Path	Source, Modulation Setup, ARB, Marker Utilities, Marker Routing, ALC Hold
Example	:SOUR:RAD:ARB:MDES:PULS NONE
Initial S/W Revision	A.05.00

Marker 1

Sets marker 1 to be used for the ALC hold function.

Key Path	Source, Modulation Setup, ARB, Marker Utilities, Marker Routing, ALC Hold
Example	:SOUR:RAD:ARB:MDES:PULS M1
Initial S/W Revision	A.05.00

Marker 2

Sets marker 2 to be used for the ALC hold function.

Key Path	Source, Modulation Setup, ARB, Marker Utilities, Marker Routing, ALC Hold
Example	:SOUR:RAD:ARB:MDES:PULS M2
Initial S/W Revision	A.05.00

Marker 3

Sets marker 3 to be used for the ALC hold function.

Key Path	Source, Modulation Setup, ARB, Marker Utilities, Marker Routing, ALC Hold
Example	:SOUR:RAD:ARB:MDES:PULS M3
Initial S/W Revision	A.05.00

Marker 4

Sets marker 4 to be used for the ALC hold function.

Key Path	Source, Modulation Setup, ARB, Marker Utilities, Marker Routing, ALC Hold
Example	:SOUR:RAD:ARB:MDES:PULS M4
Initial S/W Revision	A.05.00

Header Utilities

Allows access to the header utilities sub-menu. Pressing this key also causes the central display area to change to display the File Header Information view.

Key Path	Source, Modulation Setup, ARB
Dependencies	This key is only available if there is currently a waveform selected for playback. If no waveform is selected, the key is grayed out.
Initial S/W Revision	A.05.00

Clear Header

Allows you to clear the header information from the file header associated with the currently selected waveform.

Key Path	Source, Modulation Setup, ARB, Header Utilities
Remote Command	:SOURce:RADio:ARB:HEADer:CLEar
Example	:SOUR:RAD:ARB:HEAD:CLE
Notes	Attempting to clear the header details via SCPI when no waveform was selected for playback will generate an error.
Initial S/W Revision	A.05.00

Save Setup To Header

Allows you to save new file header information details to the file.

Key Path	Source, Modulation Setup, ARB, Header Utilities
Remote Command	:SOURce:RADio:ARB:HEADer:SAVE
Example	:SOUR:RAD:ARB:HEAD:SAVE
Notes	Attempting to save the header details via SCPI when no waveform was selected for playback will generate an error.
Initial S/W Revision	A.05.00

Query Waveform Unique ID (Remote Command Only)

Each Signal Studio waveform contains a unique waveform ID, which recorded in the header. This command allows you to query the unique waveform ID from the header. This is a SCPI only command. User can also check [Error! Reference source not found.](#) for waveform unique ID display.

Remote Command	:MMEMory:HEADer:ID? "<file name>"
Example	:MMEM:HEAD:ID? "test.wfm" (query the waveform already loaded into the ARB memory) :MMEM:HEAD:ID? "D: VARB\test.wfm" (query the waveform on the hard disk by absolute path) :MMEM:HEAD:ID? "NVWFM:test.wfm" (query the waveform on the hard disk by MSUS)
Notes	SCPI query only. The queried waveform file can be in ARB memory, or on hard disk. If want to query ARB in ARB memory, then give out the file name directly. If want to query ARB on the hard disk, then absolute file path or MSUS should be given along with the file name. The valid MSUS is "NVWFM" which is mapped to D: VARB on hard disk. If the file cannot be found in ARB memory or on hard disk, an error is generated and value -1 is returned
Initial S/W Revision	A.09.00

Bus Trigger Command (Remote Command Only)

Used to initiate an immediate trigger event if the trigger source is set to Bus.

Remote Command	:SOURce:RADio:ARB:TRIGger:INITiate
Example	:SOUR:RAD:ARB:TRIG:INIT
Initial S/W Revision	A.05.00

AM

Allows access to the menu for configuring the Amplitude Modulation.

Key Path	Source, Modulation Setup
Initial S/W Revision	A.05.00

AM

Enables or disables the amplitude modulation.

Turning AM on when another modulation format is already on results in the previous modulation format being turned off and the generation of an error.

Key Path	Source, Modulation Setup, AM
Remote Command	:SOURce:AM:STATe :SOURce:AM:STATe?
Example	:SOUR:AM:STAT OFF
Preset	Off
Range	On Off
Initial S/W Revision	A.05.00

AM Depth

Allows you to set the amplitude modulation depth in percent.

Key Path	Source, Modulation Setup, AM
Remote Command	:SOURce:AM[:DEPTh] [:LINear] :SOURce:AM[:DEPTh] [:LINear]?
Example	:SOUR:AM 0.1
Preset	0.1 %
Min	0.1 %
Max	95.0 %
Initial S/W Revision	A.05.00

AM Rate

Allows you to set the internal amplitude modulation rate.

Key Path	Source, Modulation Setup, AM
Remote Command	:SOURce:AM:INTernal:FREQuency :SOURce:AM:INTernal:FREQuency?
Example	:SOUR:AM:INT:FREQ 40.0 Hz
Preset	400.0 Hz
Min	10 Hz
Max	40 kHz
Initial S/W Revision	A.05.00

FM

Allows access to the menu for configuring the frequency modulation.

Key Path	Source, Modulation Setup
Initial S/W Revision	A.05.00

FM

Enables or disables the frequency modulation.

Turning FM on when another modulation format is already on results in the previous modulation format being turned off and the generation of an error.

Key Path	Source, Modulation Setup, FM
Remote Command	:SOURce:FM:STATe :SOURce:FM:STATe?
Example	:SOUR:FM:STAT OFF
Preset	Off
Range	On Off
Initial S/W Revision	A.05.00

FM Deviation

Allows you to set the frequency modulation deviation.

Key Path	Source, Modulation Setup, FM
----------	------------------------------

Remote Command	:SOURce:FM[:DEVIation] :SOURce:FM[:DEVIation]?
Example	:SOUR:FM 1.00 kHz
Preset	1.00 Hz
Min	1.00 Hz
Max	100.00 kHz
Initial S/W Revision	A.05.00

FM Rate

Allows you to set the internal frequency modulation rate.

Key Path	Source, Modulation Setup, FM
Remote Command	:SOURce:FM:INTernal:FREQuency :SOURce:FM:INTernal:FREQuency?
Example	:SOUR:FM:INT:FREQ 40.0 Hz
Preset	400.0 Hz
Min	10 Hz
Max	40 kHz
Initial S/W Revision	A.05.00

PM

Allows access to the menu for configuring the phase modulation.

Key Path	Source, Modulation Setup
Initial S/W Revision	A.05.00

PM

Enables or disables the phase modulation.

Turning PM on when another modulation format is already on results in the previous modulation format being turned off and the generation of an error.

Key Path	Source, Modulation Setup, PM
Remote Command	:SOURce:PM:STATe :SOURce:PM:STATe?
Example	:SOUR:PM:STAT OFF

Preset	Off
Range	On Off
Initial S/W Revision	A.05.00

PM Deviation

Allows you to set the phase modulation deviation.

Key Path	Source, Modulation Setup, PM
Remote Command	:SOURce:PM[:DEVIation] :SOURce:PM[:DEVIation]?
Example	:SOUR:PM 1.00 rad
Preset	0.1 rad
Min	0.1 rad
Max	20.0 rad
Initial S/W Revision	A.05.00

PM Rate

Allows you to set the internal phase modulation rate.

Key Path	Source, Modulation Setup, PM
Remote Command	:SOURce:PM:INTernal:FREQuency :SOURce:PM:INTernal:FREQuency?
Example	:SOUR:PM:INT:FREQ 40.0 Hz
Preset	400.0 Hz
Min	10 Hz
Max	40 kHz
Initial S/W Revision	A.05.00

List Sequencer

Allows you access to the sub-menus for configuring the list sequencer.

List sequences allows you to enter frequencies and amplitudes at unequal intervals in nonlinear ascending, descending or random order. Each step within the list can also include its own waveform file for playback, step duration, trigger event and trigger output.

The complexities involved in configuring the list sequencer do not lend itself to manual configuration; hence the manual configuration for this feature is limited. For easier configuration of the list sequencer, it is recommended that you use either SCPI or load a tab delimited file containing the setup parameters in a

tabular form. The details of the SCPI for configuring the list sequencer can be found in "[Step Configuration \(Remote Command Only\)](#)" on page 1340.

Once the List Sequencer has been configured using the front panel, SCPI, or loading in a tab delimited file, the sequence must be initiated using the front panel Initiate Sequence key or the corresponding SCPI command.

Key Path	Source
Initial S/W Revision	A.05.00

Sequencer

Allows you to set the state of the list sequencer. When the list sequencer is on, the source is outputting the sequence defined by the sequencer. When the list sequencer is off, the source outputs a single waveform segment or sequence (independent mode) at a single frequency and amplitude.

Key Path	Source, List Sequencer
Remote Command	:SOURce:LIST[:STATe] ON OFF 1 0 :SOURce:LIST[:STATe] ?
Example	:SOUR:LIST OFF
Notes	When the sequencer is set to ON, the list sequencer controls the output of the source.
Couplings	When in Sequence Analyzer mode and the list sequencer state is Off, Include Source is forced to No, and the Include Source key is grayed out. When in Sequence Analyzer mode and the list sequencer state is On, Include Source is available to set. And, an ARB memory related operation, like load or delete will be rejected.
Preset	Off
Range	On Off
Initial S/W Revision	A.05.00

Initiate Sequence

Pressing this key arms the sequence for single execution. Once the sequence is armed the source begins the sequence as soon as the trigger is received. If the trigger is set to Free Run, the sequence starts immediately.

Key Path	Source, List Sequencer
Remote Command	:SOURce:LIST:TRIGger[:IMMediate]
Example	:SOUR:LIST:TRIG
Notes	When in Sequence Analyzer mode and Include Source is Yes, the Initiate list sequencer operation is rejected, and the key is grayed out, since source list sequence request is sent to physics via Parallel batch by sequence analyzer. If the file needed by the sequencer is not already in ARB memory, the sequence cannot be initiated

	and an error will be generated. There is a blocking SCPI query which can be used to query if source list sequence being initiated successfully or not. (see " Query List Sequence Initiation Armed Status (Remote Command Only) " on page 1351 Query Source List Sequence Armed Status)
Dependencies	Under the Sequence Analyzer Mode, if Meas Setup->Include Source is set to YES, Source->List Sequencer->Initiate Sequence is disabled.
Initial S/W Revision	A.05.00

List Sequencer Setup

Allows you access to the list sequencer setup menus.

Key Path	Source, List Sequencer
----------	------------------------

Number of Steps

Allows you to specify the number of steps within the list sequence.

Key Path	Source, List Sequencer, List Sequencer Setup
Remote Command	:SOURce:LIST:NUMBer:STEPs <integer> :SOURce:LIST:NUMBer:STEPs?
Example	:SOUR:LIST:NUMB:STEP 1
Notes	Increasing the number of steps creates additional steps at the end of the list, with all the settings within the steps set to their default values. Decreasing the number of steps removes steps from the end of the list. The settings within the removed steps are not reset. This means that increasing the number of steps again would allow you to retrieve these steps.
Dependencies	The Step Count parameter is increased or decreased when you insert or delete a point from within the GUI interface to the sequencer.
Preset	1
Min	1
Max	1000
Initial S/W Revision	A.05.00

Current Step

Allows you to select the step number you wish to view or edit.

Key Path	Source, List Sequencer, List Sequencer Setup
----------	--

Notes	No remote command, front panel only.
Preset	1
Min	1
Max	Step Count
Initial S/W Revision	A.05.00

Insert Step Before

Allows you to insert a new step, containing default values, before the currently selected step. Inserting a step will automatically increase the Step Count parameter by 1. If sequence already reaches upper limit of 1000 steps, then insert more step will be rejected and popup error -221, "Setting Conflict; Cannot insert more steps, maximum number of steps reached"

Key Path	Source, List Sequencer, List Sequencer Setup
Notes	No remote command, front panel only. If the list already contains the maximum limit of 1000 steps, no operation will be made after pressing this key.
Initial S/W Revision	A.05.00

Delete Step

Allows you to delete the current step. Deleting a step will automatically decrease the Step Count parameter by 1. If sequence only has one step left, delete step will be rejected and popup error -221, "Setting conflict; Cannot delete current step, minimum number of steps reached"

Key Path	Source, List Sequencer, List Sequencer Setup
Notes	No remote command, Front Panel key only. If the list already contains the minimum limit of 1 step, no operation will be made after pressing this key
Initial S/W Revision	A.05.00

Clear List

Allows you to clear the list. Clearing the list sets the number of steps to the default value of 1 and sets the parameters for the only step to their default values.

Key Path	Source, List Sequencer, List Sequencer Setup
Initial S/W Revision	A.05.00

Step Trigger

Allows access to the sub-menu for selecting the trigger input for the current step.

Key Path	Source, List Sequencer, List Sequencer Setup
Remote Command	:SOURce:LIST:STEP[1] 2 3...1000:SETup:INPut:TRIGger IMMEDIATE INTernal EXTernal2 KEY BUS EXTernal4 :SOURce:LIST:STEP[1] 2 3...1000:SETup:INPut:TRIGger?
Example	:SOUR:LIST:STEP2:SET:INP:TRIG BUS :SOUR:LIST:STEP2:SET:INP:TRIG?
Notes	SCPI is supported after A.09.40
Preset	Free Run
Range	Free Run Internal Manual (Trigger Key) Bus External 2 EXTernal4
Initial S/W Revision	A.05.00

Free Run

Sets the trigger input for the current step to Free Run.

Key Path	Source, List Sequencer, List Sequencer Setup, Step Trigger
Example	:SOUR:LIST:STEP2:SET:INP:TRIG IMM
Notes	SCPI is supported after A.09.40
Initial S/W Revision	A.05.00

Internal

Sets the trigger input for the current step to Internal.

Key Path	Source, List Sequencer, List Sequencer Setup, Step Trigger
Example	:SOUR:LIST:STEP2:SET:INP:TRIG INT
Notes	SCPI is supported after A.09.40
Initial S/W Revision	A.05.00

Manual (Trigger Key)

Sets the trigger input for the current step to Manual (Trigger Key). Any step in the sequence set to Manual will cause the sequence execution to stop until the manual trigger key is pressed. Sending the Bus Trigger SCPI command will have no effect. At any point in the sequence where the list sequencer is paused waiting for a software trigger, a pop up dialog is displayed until the trigger event occurs.

Key Path	Source, List Sequencer, List Sequencer Setup, Step Trigger
Example	:SOUR:LIST:STEP2:SET:INP:TRIG KEY
Notes	SCPI is supported after A.09.40
Initial S/W Revision	A.05.00

Bus

Sets the trigger input for the current step to Bus. Any step in the sequence set to Bus will cause the sequence execution to stop until the Bus Trigger SCPI command is sent. Pressing the manual trigger key has no effect. At any point in the sequence where the list sequencer is paused waiting for a software trigger, a pop up dialog is displayed until the trigger event occurs.

Key Path	Source, List Sequencer, List Sequencer Setup, Step Trigger
Example	:SOUR:LIST:STEP2:SET:INP:TRIG BUS
Notes	SCPI is supported after A.09.40
Initial S/W Revision	A.05.00

External 2

Sets the trigger input for the current step to External 2.

Key Path	Source, List Sequencer, List Sequencer Setup, Step Trigger
Example	:SOUR:LIST:STEP2:SET:INP:TRIG EXT2
Notes	SCPI is supported after A.09.40
Notes	Note: When on E6640A, trigger 2 is a bi-directional trigger port. So when trigger 2 has been configured as OUTPUT type, choosing External 2 as the input trigger for the current step will generate error.
Initial S/W Revision	A.05.00

Transition Time

Allows you to specify the transition time for the current step.

The transition time is the amount of time allowed for the source to settle at the current frequency or amplitude value.

Transition Time should not be taken as additional time before or inside the Step Duration. You can set a value for the settling time to allow the source output frequency or amplitude to become stable. Make sure that during this period of time, you do not use the source output signal.

The following table lists recommended values for appropriate settling times to allow for changes within the source.

Value Changed	Recommended Transition Time
Frequency	500 μ s
Amplitude	100 μ s to within 0.1 dB 20 μ s to within 1.0 dB

If the Transition Time value is shorter than the time necessary for the hardware to settle and a List Sequence is initiated, a **warning** is generated.

If the Transition Time value is longer than the Step Duration, an error is generated when initiating a source list sequence. For source list sequence, transition time is included in the step duration length. If the Transition Time value is longer than the Step Duration Time, the real step duration length is extended to equal the transition time and cause a timing shift.

Key Path	Source, List Sequencer, List Sequencer Setup
Remote Command	:SOURce:LIST:STEP[1] 2 3...1000:SETup:TRANsition:TIME <time> :SOURce:LIST:STEP[1] 2 3...1000:SETup:TRANsition:TIME?
Example	:SOUR:LIST:STEP2:SET:TRAN:TIME 1ms :SOUR:LIST:STEP2:SET:TRAN:TIME?
Notes	SCPI is supported after A.09.40
Preset	1.0 ms
Min	0.0 ms
Max	4.0 ks
Initial S/W Revision	A.05.00

Radio Setup

Allows you access to the sub-menus for setting up the radio standard, band, and radio band link direction for the current step.

Key Path	Source, List Sequencer, List Sequencer Setup
Notes	No remote command, front panel only.
Initial S/W Revision	A.05.00

Radio Standard

Allows access to the sub-menus for selecting the radio standard and the associated radio band for use in the current step.

Key Path	Source, List Sequencer, List Sequencer Setup, Radio Setup
Remote Command	:SOURce:LIST:STEP[1] 2 3...1000:SETup:RADio:BAND NONE PGSM EGSM RGSM DCS1800 PCS1900 TGSM810 GSM450 GSM480 GSM700 GSM850 BANDI BANDII BANDIII BANDIV BANDV BANDVI BANDVII BANDVIII BANDIX BANDX BANDXI BANDXII BANDXIII BANDXIV BANDXIX USCELL USPCS JAPAN KOREAN NMT IMT2K UPPER SECOND PAMR400 PAMR800 IMTEXT PCS1DOT9G AWS US2DOT5G PUBLIC LOWER NONE BAND1 BAND2 BAND3 BAND4 BAND5 BAND6 BAND7 BAND8 BAND10 BAND11 BAND12 BAND13 BAND14 BAND17 BAND18 BAND19 BAND20 BAND21 BAND24 BAND25 BAND26 BAND27 BAND28 BAND31 BAND33 BAND34 BAND35 BAND36 BAND37 BAND38

	BAND39 BAND40 BAND41 BAND42 BAND43 BAND44 BANDA BANDB BANDC BANDD BANDE BANDF :SOURce:LIST:STEP[1] 2 3...1000:SETup: RADio:BAND?
Example	:SOUR:LIST:STEP2:SET:RAD:BAND PGSM :SOUR:LIST:STEP2:SET:RAD:BAND?
Notes	SCPI is supported after A.09.40
Initial S/W Revision	A.05.00

None

Selects no radio standard for use on the current step.

Key Path	Source, List Sequencer, List Sequencer Setup, Radio Setup, Radio Standard
Example	:SOUR:LIST:STEP2:SET:RAD:BAND NONE
Notes	SCPI is supported after A.09.40
Initial S/W Revision	A.05.00

GSM/EDGE

Pressing this key once selects GSM/EDGE as the radio standard and the current GSM/EDGE band as the active channel band. Pressing this key again allows access to the sub-menus for selecting a different GSM/EDGE band.

Key Path	Source, List Sequencer, List Sequencer Setup, Radio Setup, Radio Standard
Initial S/W Revision	A.05.00

P-GSM

Selects P-GSM as the band for the current step.

Key Path	Source, List Sequencer, List Sequencer Setup, Radio Setup, Radio Standard, GSM/EDGE
Initial S/W Revision	A.05.00

E-GSM

Selects E-GSM as the band for the current step.

Key Path	Source, List Sequencer, List Sequencer Setup, Radio Setup, Radio Standard, GSM/EDGE
Initial S/W Revision	A.05.00

R-GSM

Selects R-GSM as the band for the current step.

Key Path	Source, List Sequencer, List Sequencer Setup, Radio Setup, Radio Standard, GSM/EDGE
Initial S/W Revision	A.05.00

DCS 1800

Selects DCS 1800 as the band for the current step.

Key Path	Source, List Sequencer, List Sequencer Setup, Radio Setup, Radio Standard, GSM/EDGE
Initial S/W Revision	A.05.00

PCS 1900

Selects PCS 1900 as the band for the current step.

Key Path	Source, List Sequencer, List Sequencer Setup, Radio Setup, Radio Standard, GSM/EDGE
Initial S/W Revision	A.05.00

GSM 450

Selects GSM 450 as the band for the current step.

Key Path	Source, List Sequencer, List Sequencer Setup, Radio Setup, Radio Standard, GSM/EDGE
Initial S/W Revision	A.05.00

GSM 480

Selects GSM 480 as the band for the current step.

Key Path	Source, List Sequencer, List Sequencer Setup, Radio Setup, Radio Standard, GSM/EDGE
Initial S/W Revision	A.05.00

GSM 850

Selects GSM 850 as the band for the current step.

Key Path	Source, List Sequencer, List Sequencer Setup, Radio Setup, Radio Standard, GSM/EDGE
Initial S/W Revision	A.05.00

GSM 700

Selects GSM 700 as the band for the current step.

Key Path	Source, List Sequencer, List Sequencer Setup, Radio Setup, Radio Standard, GSM/EDGE
Initial S/W Revision	A.05.00

T-GSM 810

Selects T-GSM 810 as the band for the current step.

Key Path	Source, List Sequencer, List Sequencer Setup, Radio Setup, Radio Standard, GSM/EDGE
Initial S/W Revision	A.05.00

WCDMA

Pressing this key once selects WCDMA as the radio standard and the current WCDMA band as the active channel band. Pressing this key again allows access to the sub-menus for selecting a different WCDMA band.

Key Path	Source, List Sequencer, List Sequencer Setup, Radio Setup, Radio Standard
Initial S/W Revision	A.05.00

Band I

Selects Band I as the band for the current step.

Key Path	Source, List Sequencer, List Sequencer Setup, Radio Setup, Radio Standard, WCDMA
Initial S/W Revision	A.05.00

Band II

Selects Band II as the band for the current step.

Key Path	Source, List Sequencer, List Sequencer Setup, Radio Setup, Radio Standard, WCDMA
Initial S/W Revision	A.05.00

Band III

Selects Band III as the band for the current step.

Key Path	Source, List Sequencer, List Sequencer Setup, Radio Setup, Radio Standard, WCDMA
Initial S/W Revision	A.05.00

Band IV

Selects Band IV as the band for the current step.

Key Path	Source, List Sequencer, List Sequencer Setup, Radio Setup, Radio Standard, WCDMA
Initial S/W Revision	A.05.00

Band V

Selects Band V as the band for the current step.

Key Path	Source, List Sequencer, List Sequencer Setup, Radio Setup, Radio Standard, WCDMA
Initial S/W Revision	A.05.00

Band VI

Selects Band VI as the band for the current step.

Key Path	Source, List Sequencer, List Sequencer Setup, Radio Setup, Radio Standard, WCDMA
Initial S/W Revision	A.05.00

Band VII

Selects Band VII as the band for the current step.

Key Path	Source, List Sequencer, List Sequencer Setup, Radio Setup, Radio Standard, WCDMA
Initial S/W Revision	A.05.00

Band VIII

Selects Band VIII as the band for the current step.

Key Path	Source, List Sequencer, List Sequencer Setup, Radio Setup, Radio Standard, WCDMA
Initial S/W Revision	A.05.00

Band IX

Selects Band IX as the band for the current step.

Key Path	Source, List Sequencer, List Sequencer Setup, Radio Setup, Radio Standard, WCDMA
Initial S/W Revision	A.05.00

Band X

Selects Band X as the band for the current step.

Key Path	Source, List Sequencer, List Sequencer Setup, Radio Setup, Radio Standard, WCDMA
Initial S/W Revision	A.05.00

Band XI

Selects Band XI as the band for the current step.

Key Path	Source, List Sequencer, List Sequencer Setup, Radio Setup, Radio Standard, WCDMA
Initial S/W Revision	A.05.00

Band XII

Selects Band XII as the band for the current step.

Key Path	Source, List Sequencer, List Sequencer Setup, Radio Setup, Radio Standard, WCDMA
Initial S/W Revision	A.05.00

Band XIII

Selects Band XIII as the band for the current step.

Key Path	Source, List Sequencer, List Sequencer Setup, Radio Setup, Radio Standard, WCDMA
Initial S/W Revision	A.05.00

Band XIV

Selects Band XIV as the band for the current step.

Key Path	Source, List Sequencer, List Sequencer Setup, Radio Setup, Radio Standard, WCDMA
Initial S/W Revision	A.05.00

Band XIX

Selects Band XIX as the band for the current step.

Key Path	Source, List Sequencer, List Sequencer Setup, Radio Setup, Radio Standard, WCDMA
Initial S/W Revision	A.14.50

CDMA 2000 / 1xEVDO

Pressing this key once selects CDMA 2000/1xEVDO as the radio standard and the current CDMA 2000/1xEVDO band as the active channel band. Pressing this key again allows access to the sub-menus for selecting a different CDMA 2000/1xEVDO band.

Key Path	Source, List Sequencer, List Sequencer Setup, Radio Setup, Radio Standard
Initial S/W Revision	A.05.00

US CELL

Selects US Cell as the band for the current step.

Key Path	Source, List Sequencer, List Sequencer Setup, Radio Setup, Radio Standard, CDMA 2000 / 1xEVDO
Initial S/W Revision	A.05.00

US PCS

Selects US PCS as the band for the current step.

Key Path	Source, List Sequencer, List Sequencer Setup, Radio Setup, Radio Standard, CDMA 2000 / 1xEVDO
Initial S/W Revision	A.05.00

Japan Cell

Selects Japan Cell as the band for the current step.

Key Path	Source, List Sequencer, List Sequencer Setup, Radio Setup, Radio Standard, CDMA 2000 / 1xEVDO
Initial S/W Revision	A.05.00

Korean PCS

Selects Korean PCS as the band for the current step.

Key Path	Source, List Sequencer, List Sequencer Setup, Radio Setup, Radio Standard, CDMA 2000 / 1xEVDO
Initial S/W Revision	A.05.00

NMT 450

Selects NMT 450 as the band for the current step.

Key Path	Source, List Sequencer, List Sequencer Setup, Radio Setup, Radio Standard, CDMA 2000 / 1xEVDO
Initial S/W Revision	A.05.00

IMT 2000

Selects IMT 2000 as the band for the current step.

Key Path	Source, List Sequencer, List Sequencer Setup, Radio Setup, Radio Standard, CDMA 2000 / 1xEVDO
Initial S/W Revision	A.05.00

Upper 700

Selects Upper 700 as the band for the current step.

Key Path	Source, List Sequencer, List Sequencer Setup, Radio Setup, Radio Standard, CDMA 2000 / 1xEVDO
Initial S/W Revision	A.05.00

Secondary 800

Selects Secondary 800 as the band for the current step.

Key Path	Source, List Sequencer, List Sequencer Setup, Radio Setup, Radio Standard, CDMA 2000 / 1xEVDO
Initial S/W Revision	A.05.00

400 Euro PAMR

Selects 400 Euro PAMR as the band for the current step.

Key Path	Source, List Sequencer, List Sequencer Setup, Radio Setup, Radio Standard, CDMA 2000 / 1xEVDO
Initial S/W Revision	A.05.00

800 PAMR

Selects 800 PAMR as the band for the current step.

Key Path	Source, List Sequencer, List Sequencer Setup, Radio Setup, Radio Standard, CDMA 2000 / 1xEVDO
Initial S/W Revision	A.05.00

2.5GHz IMT EXT

Selects 2.5 GHz IMT EXT as the band for the current step.

Key Path	Source, List Sequencer, List Sequencer Setup, Radio Setup, Radio Standard, CDMA 2000 / 1xEVDO
Initial S/W Revision	A.05.00

US PCS 1.9GHz

Selects US PCS 1.9 GHz as the band for the current step.

Key Path	Source, List Sequencer, List Sequencer Setup, Radio Setup, Radio Standard, CDMA 2000 / 1xEVDO
Initial S/W Revision	A.05.00

AWS

Selects AWS as the band for the current step.

Key Path	Source, List Sequencer, List Sequencer Setup, Radio Setup, Radio Standard, CDMA 2000 / 1xEVDO
Initial S/W Revision	A.05.00

US 2.5GHz

Selects US 2.5 GHz as the band for the current step.

Key Path	Source, List Sequencer, List Sequencer Setup, Radio Setup, Radio Standard, CDMA 2000 / 1xEVDO
Initial S/W Revision	A.05.00

700 Public Safety

Selects 700 Public Safety as the band for the current step.

Key Path	Source, List Sequencer, List Sequencer Setup, Radio Setup, Radio Standard, CDMA 2000 / 1xEVDO
Initial S/W Revision	A.05.00

C2K Lower 700

Selects C2K Lower 700 as the band for the current step.

Key Path	Source, List Sequencer, List Sequencer Setup, Radio Setup, Radio Standard, CDMA 2000 / 1xEVDO
Initial S/W Revision	A.05.00

LTE

Pressing this key once selects LTE FDD as the radio standard and the current LTE FDD band as the active channel band. Pressing this key again allows access to the sub-menus for selecting a different LTE FDD band.

Key Path	Source, List Sequencer, List Sequencer Setup, Radio Setup, Radio Standard
Initial S/W Revision	A.09.50

BAND 1

Selects BAND 1 as the band for the current step.

Key Path	Source, List Sequencer, List Sequencer Setup, Radio Setup, Radio Standard, LTE
Initial S/W Revision	A.09.50

BAND 2

Selects BAND 2 as the band for the current step.

Key Path	Source, List Sequencer, List Sequencer Setup, Radio Setup, Radio Standard, LTE
Initial S/W Revision	A.09.50

BAND 3

Selects BAND 3 as the band for the current step.

Key Path	Source, List Sequencer, List Sequencer Setup, Radio Setup, Radio Standard, LTE
Initial S/W Revision	A.09.50

BAND 4

Selects BAND 4 as the band for the current step.

Key Path	Source, List Sequencer, List Sequencer Setup, Radio Setup, Radio Standard, LTE
Initial S/W Revision	A.09.50

BAND 5

Selects BAND 5 as the band for the current step.

Key Path	Source, List Sequencer, List Sequencer Setup, Radio Setup, Radio Standard, LTE
Initial S/W Revision	A.09.50

BAND 6

Selects BAND 6 as the band for the current step.

Key Path	Source, List Sequencer, List Sequencer Setup, Radio Setup, Radio Standard, LTE
Initial S/W Revision	A.09.50

BAND 7

Selects BAND 7 as the band for the current step.

Key Path	Source, List Sequencer, List Sequencer Setup, Radio Setup, Radio Standard, LTE
Initial S/W Revision	A.09.50

BAND 8

Selects BAND 8 as the band for the current step.

Key Path	Source, List Sequencer, List Sequencer Setup, Radio Setup, Radio Standard, LTE
Initial S/W Revision	A.09.50

BAND 9

Selects BAND 9 as the band for the current step.

Key Path	Source, List Sequencer, List Sequencer Setup, Radio Setup, Radio Standard, LTE
Initial S/W Revision	A.09.50

BAND 10

Selects BAND 10 as the band for the current step.

Key Path	Source, List Sequencer, List Sequencer Setup, Radio Setup, Radio Standard, LTE
Initial S/W Revision	A.09.50

BAND 11

Selects BAND 11 as the band for the current step.

Key Path	Source, List Sequencer, List Sequencer Setup, Radio Setup, Radio Standard, LTE
Initial S/W Revision	A.09.50

BAND 12

Selects BAND 12 as the band for the current step.

Key Path	Source, List Sequencer, List Sequencer Setup, Radio Setup, Radio Standard, LTE
Initial S/W Revision	A.09.50

BAND 13

Selects BAND 13 as the band for the current step.

Key Path	Source, List Sequencer, List Sequencer Setup, Radio Setup, Radio Standard, LTE
Initial S/W Revision	A.09.50

BAND 14

Selects BAND 14 as the band for the current step.

Key Path	Source, List Sequencer, List Sequencer Setup, Radio Setup, Radio Standard, LTE
Initial S/W Revision	A.09.50

BAND 17

Selects BAND 17 as the band for the current step.

Key Path	Source, List Sequencer, List Sequencer Setup, Radio Setup, Radio Standard, LTE
Initial S/W Revision	A.09.50

BAND 18

Selects BAND 18 as the band for the current step.

Key Path	Source, List Sequencer, List Sequencer Setup, Radio Setup, Radio Standard, LTE
Initial S/W Revision	A.09.50

BAND 19

Selects BAND 19 as the band for the current step.

Key Path	Source, List Sequencer, List Sequencer Setup, Radio Setup, Radio Standard, LTE
Initial S/W Revision	A.09.50

BAND 20

Selects BAND 20 as the band for the current step.

Key Path	Source, List Sequencer, List Sequencer Setup, Radio Setup, Radio Standard, LTE
Initial S/W Revision	A.09.50

BAND 21

Selects BAND 21 as the band for the current step.

Key Path	Source, List Sequencer, List Sequencer Setup, Radio Setup, Radio Standard, LTE
Initial S/W Revision	A.09.50

BAND 24

Selects BAND 24 as the band for the current step.

Key Path	Source, List Sequencer, List Sequencer Setup, Radio Setup, Radio Standard, LTE
Initial S/W Revision	A.09.50

BAND 25

Selects BAND 25 as the band for the current step.

Key Path	Source, List Sequencer, List Sequencer Setup, Radio Setup, Radio Standard, LTE
Initial S/W Revision	A.09.50

BAND 26

Selects BAND 26 as the band for the current step.

Key Path	Source, List Sequencer, List Sequencer Setup, Radio Setup, Radio Standard, LTE
Initial S/W Revision	A.12.53

BAND 27

Selects BAND 27 as the band for the current step.

Key Path	Source, List Sequencer, List Sequencer Setup, Radio Setup, Radio Standard, LTE
Initial S/W Revision	A.14.00

BAND 28

Selects BAND 28 as the band for the current step.

Key Path	Source, List Sequencer, List Sequencer Setup, Radio Setup, Radio Standard, LTE
Initial S/W Revision	A.14.00

BAND 31

Selects BAND 31 as the band for the current step.

Key Path	Source, List Sequencer, List Sequencer Setup, Radio Setup, Radio Standard, LTE
Initial S/W Revision	A.14.00

LTE TDD

Sets LTE TDD as the radio standard for use and accesses the LTE TDD specific channel band sub-menus..

Key Path	Source, Frequency, Radio Setup, Radio Standard
Initial S/W Revision	A.11.50

BAND 33

Selects BAND 33 as the band for the current step.

Key Path	Source, Frequency, Radio Setup, Radio Standard, LTE TDD
Example	:SOUR:FREQ:CHAN:BAND BAND33
Initial S/W Revision	A.11.50

BAND 34

Selects BAND 34 as the band for the current step.

Key Path	Source, Frequency, Radio Setup, Radio Standard, LTE TDD
Example	:SOUR:FREQ:CHAN:BAND BAND34
Initial S/W Revision	A.11.50

BAND 35

Selects BAND 35 as the band for the current step.

Key Path	Source, Frequency, Radio Setup, Radio Standard, LTE TDD
Example	:SOUR:FREQ:CHAN:BAND BAND35
Initial S/W Revision	A.11.50

BAND 36

Selects BAND 36 as the band for the current step.

Key Path	Source, Frequency, Radio Setup, Radio Standard, LTE TDD
Example	:SOUR:FREQ:CHAN:BAND BAND36
Initial S/W Revision	A.11.50

BAND 37

Selects BAND 37 as the band for the current step.

Key Path	Source, Frequency, Radio Setup, Radio Standard, LTE TDD
Example	:SOUR:FREQ:CHAN:BAND BAND37
Initial S/W Revision	A.11.50

BAND 38

Selects BAND 38 as the band for the current step.

Key Path	Source, Frequency, Radio Setup, Radio Standard, LTE TDD
Example	:SOUR:FREQ:CHAN:BAND BAND38
Initial S/W Revision	A.11.50

BAND 39

Selects BAND 39 as the band for the current step.

Key Path	Source, Frequency, Radio Setup, Radio Standard, LTE TDD
Example	:SOUR:FREQ:CHAN:BAND BAND39
Initial S/W Revision	A.11.50

BAND 40

Selects BAND 40 as the band for the current step.

Key Path	Source, Frequency, Radio Setup, Radio Standard, LTE TDD
Example	:SOUR:FREQ:CHAN:BAND BAND40
Initial S/W Revision	A.11.50

BAND 41

Selects BAND 41 as the band for the current step.

Key Path	Source, Frequency, Radio Setup, Radio Standard, LTE TDD
Example	:SOUR:FREQ:CHAN:BAND BAND41
Initial S/W Revision	A.11.50

BAND 42

Selects BAND 42 as the band for the current step.

Key Path	Source, Frequency, Radio Setup, Radio Standard, LTE TDD
Example	:SOUR:FREQ:CHAN:BAND BAND42
Initial S/W Revision	A.11.50

BAND 43

Selects BAND 43 as the band for the current step.

Key Path	Source, Frequency, Radio Setup, Radio Standard, LTE TDD
Example	:SOUR:FREQ:CHAN:BAND BAND43
Initial S/W Revision	A.11.50

BAND 44

Selects BAND 44 as the band for the current step.

Key Path	Source, List Sequencer, List Sequencer Setup, Radio Setup, Radio Standard, LTE TDD
Initial S/W Revision	A.14.00

TDSCDMA

Sets TDSCDMA as the radio standard for use and accesses the TDSCDMA specific channel band sub-menus..

Key Path	Source, Frequency, Radio Setup, Radio Standard
Initial S/W Revision	A.11.50

BAND A

Selects BAND A as the band for the current step.

Key Path	Source, Frequency, Radio Setup, Radio Standard, TDSCDMA
Example	:SOUR:FREQ:CHAN:BAND BANDA
Initial S/W Revision	A.11.50

BAND B

Selects BAND B as the band for the current step.

Key Path	Source, Frequency, Radio Setup, Radio Standard, TDSCDMA
Example	:SOUR:FREQ:CHAN:BAND BANDB
Initial S/W Revision	A.11.50

BAND C

Selects BAND C as the band for the current step.

Key Path	Source, Frequency, Radio Setup, Radio Standard, TDSCDMA
Example	:SOUR:FREQ:CHAN:BAND BANDC
Initial S/W Revision	A.11.50

BAND D

Selects BAND D as the band for the current step.

Key Path	Source, Frequency, Radio Setup, Radio Standard, TDSCDMA
Example	:SOUR:FREQ:CHAN:BAND BANDD
Initial S/W Revision	A.11.50

BAND E

Selects BAND E as the band for the current step.

Key Path	Source, Frequency, Radio Setup, Radio Standard, TDSCDMA
----------	---

Example	:SOUR:FREQ:CHAN:BAND BANDE
Initial S/W Revision	A.11.50

BAND F

Selects BAND F as the band for the current step.

Key Path	Source, Frequency, Radio Setup, Radio Standard, TDSCDMA
Example	:SOUR:FREQ:CHAN:BAND BANDF
Initial S/W Revision	A.11.50

Radio Band Link

Allows you to specify the radio band link direction for the steps within the list sequence. The link is used in conjunction with the channel band and channel number to determine the output frequency.

When set to “Uplink”, the source will calculate the uplink frequency according to an uplink formula together with selected channel band and channel number. When set to “Downlink”, the source will calculate the downlink frequency according to a downlink formula together with selected channel band and channel number.

Key Path	Source, List Sequencer, List Sequencer Setup, Radio Setup
Remote Command	:SOURce:LIST:STEP [1] 2 3...1000:SETup:RADio:BAND:LINK DOWN UP :SOURce:LIST:STEP [1] 2 3...1000:SETup:RADio:BAND:LINK?
Example	:SOUR:LIST:STEP2:SET:RAD:BAND:LINK UP :SOUR:LIST:STEP2:SET:RAD:BAND:LINK?
Notes	SCPI is supported after A.09.40
Preset	DOWN
Range	DOWN UP
Initial S/W Revision	A.05.00

Channel

Allows you to specify the frequency of the current step via a channel number.

Key Path	Source, List Sequencer, List Sequencer Setup
Remote Command	:SOURce:LIST:STEP [1] 2 3...1000:SETup:CNFRequency <double> :SOURce:LIST:STEP [1] 2 3...1000:SETup:CNFRequency?
Example	:SOUR:LIST:STEP2:SET:CNFR 124 :SOUR:LIST:STEP2:SET:CNFR?
Notes	SCPI is supported after A.09.40.

	This SCPI is used to setup channel number or frequency setting, according to current Radio Band setting. If Radio Band is "NONE", then it's frequency. If Radio Band is not "NONE", then it's channel number.
Couplings	The channel number is coupled to the step frequency value. When the step frequency value is changed, the channel number will increase or decrease to match the new step frequency. If the step frequency is not at an exact match for a channel number, the nearest channel number is displayed, along with a greater than, or less than sign to indicate the frequency is above or below the channel number.
Preset	1
Min	0 (Please refer to for valid ranges.)
Max	10838 (Please refer to for valid ranges.)
Initial S/W Revision	A.05.00

Frequency

Allows you to specify a frequency value for the current step.

Key Path	Source, List Sequencer, List Sequencer Setup
Remote Command	:SOURce:LIST:STEP[1] 2 3...1000:SETup:CNFRfrequency <double> :SOURce:LIST:STEP[1] 2 3...1000:SETup:CNFRfrequency?
Example	:SOUR:LIST:STEP2:SET:CNFR 1GHz :SOUR:LIST:STEP2:SET:CNFR?
Notes	SCPI is supported after A.09.40. This SCPI is used to setup channel number or frequency setting, according to current Radio Band setting. If Radio Band is "NONE", then it's frequency. If Radio Band is not "NONE", then it's channel number.
Couplings	The frequency value is coupled to the channel band and number for the step, such that updates to the radio band and channel number will update the frequency value to the corresponding absolute frequency. The reverse is also true, changing the frequency value causes the value of the channel number to be updated.
Preset	1.00 GHz
Min	10.00 MHz
Max	Hardware Dependant: Option 503 = 3.6 GHz Option 504 = 3.9 GHz Option 506 = 6.00 GHz
Initial S/W Revision	A.05.00

Power

Allows you to specify a power value for the current step.

Key Path	Source, List Sequencer, List Sequencer Setup
Remote Command	:SOURCE:LIST:STEP[1] 2 3...1000:SETup:AMPLitude <double> :SOURCE:LIST:STEP[1] 2 3...1000:SETup:AMPLitude?
Example	:SOUR:LIST:STEP2:SET:AMPL -50dBm :SOUR:LIST:STEP2:SET:AMPL?
Notes	SCPI is supported after A.09.40
Notes	<p>Amplitude corrections can be specified for use with the source. In the event of amplitude corrections being applied, the valid ranges for the RF power do not change dependant on the current amplitude correction setting. Instead, if the combination of RF power + amplitude correction is higher or lower than the source output range, the Source Unleveled bit is set and the "Source Unleveled" indicator will appear on status panel to indicate that the source cannot maintain the output power that has been requested.</p> <p>The multiport adapter RFIO TX ports and GPS ports cannot ensure power accuracy when power setting is lower than -130dBm, this power setting value is defined by the sum of RF Power setting and related amplitude correction value. But user settable value could be lower than this limit. When application detected there exists power setting lower than -130dBm on MPA RFIO TX ports, then popup warning message . When application detected there exists power setting lower than -130dBm on MPA GPS ports, then popup warning message . These are only warning messages, and check is performed when RF is ON.</p>
Notes	The Min and Max value here defined UI settable amplitude range. This range is larger than actual amplitude range with level accuracy defined in spec.
Dependencies	The RF power is dependent on the RF output port and frequency, such that the current frequency and selected output port determine the valid range of power values.
Preset	-100 dBm
Min	The range of values depends on the current frequency and selected RF output port. Please refer to "RF Power" on page 1228 and the table RF Power Range for the valid ranges.
Max	The range of values depends on the current frequency and selected RF output port. Please refer to "RF Power" on page 1228 and the table RF Power Range for the valid ranges.
Initial S/W Revision	A.05.00

Waveform

Allows you access to the sub-menus for selecting the waveform to be played back during the current step. Pressing this key also changes the central display area to show the Waveform File Selection view.

Key Path	Source, List Sequencer, List Sequencer Setup
Remote Command	:SOURCE:LIST:STEP[1] 2 3...1000:SETup:WAVeform <string> :SOURCE:LIST:STEP[1] 2 3...1000:SETup:WAVeform?
Example	:SOUR:LIST:STEP2:SET:WAV "CW" :SOUR:LIST:STEP2:SET:WAV?
Notes	SCPI is supported after A.09.40
Remote Command Notes	String type, takes "Off" "CW" "Cont" "waveform name"

Preset	CW
Range	Waveform Continue Previous CW Off
Initial S/W Revision	A.05.00

CW

Sets the current step to output a CW tone.

Key Path	Source, List Sequencer, List Sequencer Setup, Waveform
Example	:SOUR:LIST:STEP2:SET:WAV "CW"
Notes	SCPI is supported after A.09.40
Initial S/W Revision	A.05.00

Selected Waveform

Inserts the currently selected waveform in the waveform selection view as the waveform for playback during the current step.

Key Path	Source, List Sequencer, List Sequencer Setup, Waveform
Example	:SOUR:LIST:STEP2:SET:WAV "waveform name"
Notes	SCPI is supported after A.09.40 If the selected waveform contains header (which contains ARB play parameters), source list sequence will automatically apply header settings of the selected waveform in that step.
Initial S/W Revision	A.05.00

Continue Previous

Sets the current step to continue with playback of the waveform from the previous step. When continuing the previous waveform, the ARB playback will not pause while the source retunes to the new frequency or amplitude that may be defined for the new step.

Key Path	Source, List Sequencer, List Sequencer Setup, Waveform
Example	:SOUR:LIST:STEP2:SET:WAV "Cont"
Notes	SCPI is supported after A.09.40
Initial S/W Revision	A.05.00

Off

Disable RF output of the current step.

Key Path	Source, List Sequencer, List Sequencer Setup, Waveform
Example	:SOUR:LIST:STEP2:SET:WAV "Off"
Notes	SCPI is supported after A.09.40
Initial S/W Revision	A.05.00

Segments on Hard Disk

Allows you access to the sub-menus for loading waveform segments from the hard disk into ARB memory. The default directory is: D: varb.

Pressing this key changes the current view to the Waveform Management View.

Key Path	Source, Modulation Setup, ARB, Select Waveform
Initial S/W Revision	A.05.00

Load Segment To ARB Memory

Allows you to load the selected file into ARB memory. On the front panel you select the file for loading to the ARB memory by highlighting the desired file in the list. Using the SCPI command, you specify the file name on the HDD.

“NVWFM” (none-volatile storage) MSUS (Mass Storage Unit Specifier) is supported in the memory subsystem because the ARB memory cannot be accessed directly. Therefore, files must be downloaded to the instrument hard disk and then loaded into the ARB memory. “NVWFM” MSUS will be mapped to the default directory D: VARB. The SCPI command supports using either “NVWFM” MSUS or specifying a full path. For more information, see [Memory Subsystem \(Remote Command Only\)](#).

If a file of the same name already exists within ARB memory, it is overwritten. If you wish to load two segments of the same name, you must rename one of the segments before loading it into ARB memory. To rename a segment, you can either use Windows File Explorer, or the :MMEMORY:COPY command.

NOTE: When a waveform file is loaded to ARB memory, burst timing adjustments are made automatically, based on whether or not a Multiport Adapter is connected to the test set and powered on. If the connection/power status of the Multiport Adapter is changed after a waveform file has been loaded, it needs to be loaded again.

Key Path	Source, Modulation Setup, ARB, Select Waveform, Segments on Hard Disk
Remote Command	:SOURce:RADio:ARB:LOAD <string>
Example	:SOUR:RAD:ARB:LOAD "D: VARB\testwaveform.bin" or :SOUR:RAD:ARB:LOAD "NVWFM:testwaveform.bin"
Notes	Because loading the file involves a delay of unpredictable length, this command should be followed by the query *OPC?, which holds off subsequent commands until the loading operating is complete. <string> – specifies the path name of the file to load from the HDD into ARB memory. It could be a <full path + filename>, or <"NVWFM" MSUS + colon + filename>.

When in Sequence Analyzer mode, and Include Source is Yes, an attempt to load a file to ARB memory will be rejected with an error.

When Include Source is No and if there is insufficient free ARB memory to load the selected waveform, an error is generated. .

If you specify a file over SCPI, but the file is not at the specified location, an error is generated.

If you try to load a waveform file but the file contains less than 500 IQ samples, an error is generated.

If you try to load a Signal Studio waveform “*.wfm” which contains invalid waveform header, an error is generated.

If the ARB is ON when you load a file to ARB memory or delete a file from ARB memory, the playing waveform segment may not keep phase continuity during the ARB memory operation. The waveform will be replayed after the ARB operation is finished.

ARB can be loaded into ARB memory even required licenses do not present on the instrument. In this case, a GUI only warning message -800, “Operation complete; Loaded <filename> successfully, but no license <required licenses> installed”. User can install required licenses according to <required licenses> string to license it, or multi-pack license it.

Initial S/W Revision	A.05.00
----------------------	---------

Load All To ARB Memory

Allows you to load all the segment files within the currently selected directory into ARB memory. If a file of the same name already exists within ARB memory, it is overwritten. If you wish to load two segments of the same name, you must rename one of the segments before loading it into ARB memory. To rename a segment, you can either use Windows File Explorer, or the :MEMORY:COPY command.

NOTE: When a waveform file is loaded to ARB memory, burst timing adjustments are made automatically, based on whether or not a Multiport Adapter is connected to the test set and powered on. If the connection/power status of the Multiport Adapter is changed after a waveform file has been loaded, it needs to be loaded again.

Key Path	Source, Modulation Setup, ARB, Select Waveform, Segments on Hard Disk
Remote Command	:SOURce:RADio:ARB:LOAD:ALL <string>
Example	:SOUR:RAD:ARB:LOAD:ALL "D: varb"
Notes	<p><string> - specifies the directory on the HDD to load the files into ARB memory from.</p> <p>When in Sequence Analyzer mode, and Include Source is Yes, an attempt to load all files from a directory to ARB memory is rejected with an error.</p> <p>When Include Source is No and there is insufficient free ARB memory to load all the waveforms, when the ARB memory is full, the copy ceases, and an error is generated.</p> <p>If you specify a directory over SCPI, but the directory does not exist, an error is generated.</p> <p>If the ARB is ON, a user then loads or deletes file to ARB memory, the playing waveform segment may not keep phase continuity during the ARB memory operation. The waveform will be replayed after the ARB operation is finished.</p>
Initial S/W Revision	A.05.00

Change Directory...

Allows you to change the currently selected directory on the hard disk. Pressing this key opens a standard windows change directory dialog allowing you to select the new directory of interest.

The current directory is used for manually loading waveform segments into ARB memory for playback, and as a search location for waveform segments that are required to be loaded into ARB memory for playback of a waveform sequence or a list sequence.

Key Path	Source, Modulation Setup, ARB, Select Waveform, Segments on Hard Disk
Notes	No remote command, SCPIfront panel only.
Initial S/W Revision	A.05.00

Default Directory...

Allows you to change the default directory. It is used as a search location for waveform segments that are required to be loaded into ARB memory for playback of a waveform sequence, and as a search location for selecting waveforms using SCPI.

Key Path	Source, Modulation Setup, ARB, Select Waveform, Segments on Hard Disk
Remote Command	:SOURce:RADio:ARB:DEFault:DIRectory <string> :SOURce:RADio:ARB: DEFault:DIRectory?
Example	:SOUR:RAD:ARB:DEF:DIR "D:\ArbFiles" :SOUR:RAD:ARB:DEF:DIR?
State Saved	Persistent, survives a power cycle and a preset but not saved in the instrument state
Initial S/W Revision	A.05.00

Segments in ARB Memory

Allows you access to the sub-menus for managing the files within ARB memory.

Key Path	Source, Modulation Setup, ARB, Select Waveform
Initial S/W Revision	A.05.00

Delete Segment From ARB Mem

Allows you to remove a segment from ARB playback memory.

Key Path	Source, Modulation Setup, ARB, Select Waveform, Segments in ARB Memory
Remote Command	:SOURce:RADio:ARB:DELeTe <string>
Example	:SOUR:RAD:ARB:DEL "testwaveform.bin"
Notes	<string> - specifies the waveform to be deleted from the ARB playback memory. When in Sequence Analyzer mode and Include Source is Yes, an attempt to delete a file from ARB

memory is rejected with an error.

When Include Source is No and you specify a file that does not exist within ARB memory, an error is generated.

It is possible to delete files from within the ARB memory when the ARB is ON. However, if you attempt to delete the file that is currently playing an error is generated.

It is possible to delete a file from within the ARB memory when the sequencer state is ON and the file is not being used by the List Sequencer. If you attempt to delete a file which is being used by the list sequencer, an error is generated.

When sequencer state is On, even if ARB state is On, the selected waveform will not be played. In this case, if the selected waveform is not used in List Sequence, it can be deleted and the ARB state is turned Off.

If the ARB is ON and you load a file to ARB memory or delete a file from ARB memory, the playing waveform segment may not keep phase continuity during the ARB memory operation. The waveform will be replayed after the ARB operation is finished.

Initial S/W Revision A.05.00

Delete All From ARB Memory

Allows you to remove all segments from ARB playback memory.

Key Path Source, Modulation Setup, ARB, Select Waveform, Segments in ARB Memory

Remote Command :SOURce:RADio:ARB:DELeTe:ALL

Example :SOUR:RAD:ARB:DELeTe:ALL

Notes When in Sequence Analyzer mode and Include Source is Yes, an attempt to delete all files from ARB memory is rejected with an error.

When Include Source is No and you attempt to delete all files from ARB memory when the ARB is currently playing a file, all files except the one playing are deleted and an error is generated.

If you attempt to delete all files from ARB memory when there are waveform files used in "[List Sequencer](#)" on page 1306 and "[Sequencer](#)" on page 1307 state is ON, all files except the files currently being used in list sequencer are deleted, and an error is generated.

If the ARB is ON and you load a file to ARB memory or delete a file from ARB memory, the playing waveform segment may not keep phase continuity during the ARB memory operation. The waveform will be replayed after the ARB operation is finished.

Initial S/W Revision A.05.00

Segments on Hard Disk

This key functions the same as "[Segments on Hard Disk](#)" on page 1333.

Key Path Source, List Sequencer, List Sequencer Setup, Waveform

Initial S/W Revision Prior to A.09.00

Load Segment To ARB Memory

This key functions the same as "[Load Segment To ARB Memory](#)" on page 1333.

Key Path	Source, List Sequencer, List Sequencer Setup, Waveform, Segment on Hard Drive
Initial S/W Revision	Prior to A.09.00

Load All To ARB Memory

This key functions the same as "[Load All To ARB Memory](#)" on page 1334.

Key Path	Source, List Sequencer, List Sequencer Setup, Waveform, Segment on Hard Drive
Initial S/W Revision	Prior to A.09.00

Change Directory ...

This key functions the same as "[Change Directory...](#)" on page 1335.

Key Path	Source, List Sequencer, List Sequencer Setup, Waveform, Segment on Hard Drive
Initial S/W Revision	Prior to A.09.00

Default Directory ...

This key functions the same as "[Default Directory...](#)" on page 1335

Key Path	Source, List Sequencer, List Sequencer Setup, Waveform, Segment on Hard Drive
Initial S/W Revision	Prior to A.09.00

Segments in ARB Memory

This key functions the same as "[Segments in ARB Memory](#)" on page 1335.

Key Path	Source, List Sequencer, List Sequencer Setup, Waveform, Segments in ARB Memory
Initial S/W Revision	Prior to A.09.00

Delete Segment From ARB Memory

This key functions the same as "[Delete Segment From ARB Mem](#)" on page 1335.

Key Path	Source, List Sequencer, List Sequencer Setup, Waveform, Segments in ARB Memory, Segment in ARB Memory
Initial S/W Revision	Prior to A.09.00

Delete All From ARB Memory

This key functions the same as "Delete All From ARB Memory" on page 1336.

Key Path	Source, List Sequencer, List Sequencer Setup, Waveform, Segments in ARB Memory, Segment in ARB Memory
Initial S/W Revision	Prior to A.09.00

Step Duration

Allows access to the sub-menus for setting up the duration of play for the current step.

The duration can be set to be either the number of times for the ARB file associated with the sequence to play, or a specific time value, or continuous. If the step is set to play a CW tone, the step duration cannot be set to a play count.

Key Path	Source, List Sequencer, List Sequencer Setup
Remote Command	:SOURce:LIST:STEP[1] 2 3...1000:SETup:DURation:TYPE TIME COUNT CONTInuous CABort :SOURce:LIST:STEP[1] 2 3...1000:SETup:DURation:TYPE?
Example	:SOUR:LIST:STEP2:SET:DUR:TYPE TIME :SOUR:LIST:STEP2:SET:DUR:TYPE?
Notes	SCPI is supported after A.09.40
Notes	If "Step Duration" is set to "Time" or "Play Count" for the last step, the last step of ARB keeps playing as if set to "Continuous", until the set "Time" has expired or until the "Play Count" setting is reached. However, you can query Error! Reference source not found. Source Sweeping Condition Message to find out if the current list sequence is complete or not.
Range	Time Play Count Continuous Continuous Abort
Initial S/W Revision	A.05.00

Time

Sets the duration of the current step to be a time value for the length of time the step will play. Pressing this key again opens another menu which allows you to set the time value for the step duration.

Key Path	Source, List Sequencer, List Sequencer Setup, Step Duration
Example	:SOUR:LIST:STEP2:SET:DUR:TYPE TIME
Notes	SCPI is supported after A.09.40
Initial S/W Revision	A.05.00

Duration Time

Allows you to specify the length of time the current step will play.

When Step Duration is **Continuous Abort** this parameter specifies the maximum duration that the waveform will continue to play after a step trigger is received before the transition to the next waveform will occur. Duration is limited to a maximum of 20 seconds.

If the Transition Time value is longer than the Step Duration Time, an error is generated when initiating a source list sequence. For source list sequence, transition time is included in the step duration length (not occupy additional time). If the Transition Time value is longer than the Step Duration Time, the real step duration length is extended to equal the transition time and cause a timing shift. This check is also described in section **Error! Reference source not found.** List Sequence Step Validation.

Key Path	Source, List Sequencer, List Sequencer Setup, Step Duration, Time
Remote Command	:SOURce:LIST:STEP [1] 2 3...1000:SETup:DURation:TCOut <double> :SOURce:LIST:STEP [1] 2 3...1000:SETup:DURation:TCOut?
Example	:SOUR:LIST:STEP2:SET:DUR:TCO 1s :SOUR:LIST:STEP2:SET:DUR:TCO?
Notes	SCPI is supported after A.09.40 This SCPI is reused by "Play Count", "Duration Time" and "Continuous Abort" according to current Duration Type setting is "Play Count" or "Duration Time" or "Continuous Abort". If current "Duration Type" is "Continuous", then popup error -221, "Settings conflict;Cannot accept time or count input when step duration type is Continuous on step #"
Notes	If "Duration Time" is set for the last step, the last step of ARB keeps playing as if set to "Continuous" after set time expires. However, you can query Source Sweeping Condition Message (:STAT:OPER:COND?) to find out if the current list sequence is complete or not.
Preset	1.00 ms
Min	100 μ s
Max	1800 s
Initial S/W Revision	A.05.00

Play Count

Sets the duration of the current step to be an integer value for the number of times (play count) the ARB file is selected for playback during this step. For example, a 5 second ARB will be set to play 5 times during the step.

Key Path	Source, List Sequencer, List Sequencer Setup, Step Duration
Example	:SOUR:LIST:STEP2:SET:DUR:TYPE COUN
Notes	SCPI is supported after A.09.40 This key is unavailable and is grayed out if the current step is configured to CW tone rather than an ARB waveform.
Initial S/W Revision	A.05.00

Header Utilities

Allows access to the header utilities sub-menu. Pressing this key also causes the central display area to change to display the File Header Information view.

Key Path	Source, Modulation Setup, ARB
Dependencies	This key is only available if there is currently a waveform selected for playback. If no waveform is selected, the key is grayed out.
Initial S/W Revision	A.05.00

Continuous

Sets the current step to be played continuously until the next step starts. The waveform will always play completely before transitioning to the next step.

Key Path	Source, List Sequencer, List Sequencer Setup, Step Duration
Example	:SOUR:LIST:STEP2:SET:DUR:TYPE CONT
Notes	SCPI is supported after A.09.40
Initial S/W Revision	A.05.00

Output Trigger

Allows you to specify the trigger output for the current step. The trigger output signal is sent at the start of the step.

When select “On”, trigger event will occur on both Internal and External2 paths. Select “Off” will turn off trigger output.

Key Path	Source, List Sequencer, List Sequencer Setup
Remote Command	:SOURce:LIST:STEP[1] 2 3...1000:SETup:OUTPut:TRIGger ON OFF 1 0 :SOURce:LIST:STEP[1] 2 3...1000:SETup:OUTPut:TRIGger
Example	:SOUR:LIST:STEP2:SET:OUTP:TRIG ON :SOUR:LIST:STEP2:SET:OUTP:TRIG?
Notes	SCPI is supported after A.09.40
Preset	Off
Range	On Off
Initial S/W Revision	A.05.00

Step Configuration (Remote Command Only)

This SCPI command is used to configure the List Sequencer and is detailed in the table below. The command is defined such that you send one command per step, with the step number being specified as a subopcode of the SCPI command. Each command includes all the parameter settings for the step. As a step is setup, the values entered are run through several levels of validation.

Remote Command	:SOURce:LIST:STEP[1] 2 ... 4..1000:SETup IMMEDIATE INTernal KEY
-----------------------	---

```
BUS | EXTERNAL2, <time>, NONE | PGSM | EGSM | RGSM | DCS1800 | PCS1900
| TGSM810 | GSM450 | GSM480 | GSM700 | GSM850 | BANDI | BANDII |
BANDIII | BANDIV | BANDV | BANDVI | BANDVII | BANDVIII | BANDIX | BANDX
| BANDXI | BANDXII | BANDXIII | BANDXIV | BANDXIX | USCELL | USPCS |
JAPAN | KOREAN | NMT | IMT2K | UPPER | SECOND | PAMR400 | PAMR800 |
IMTEXT | PCS1DOT9G | AWS | US2DOT5G | PUBLIC | LOWER | NONE | BAND1 |
BAND2 | BAND3 | BAND4 | BAND5 | BAND6 | BAND7 | BAND8 | BAND10 | BAND11
| BAND12 | BAND13 | BAND14 | BAND17 | BAND18 | BAND19 | BAND20 | BAND21
| BAND24 | BAND25 | BAND26 | BAND33 | BAND34 | BAND35 | BAND36 | BAND37
| BAND38 | BAND39 | BAND40 | BAND41 | BAND42 | BAND43 | BANDA | BANDB |
BANDC | BANDD | BANDE | BANDE, DOWN | UP, <freq>, <ampl>, <string>,
TIME | COUNT | CONTINUOUS, <time>, ON | OFF | 1 | 0, [<int>],
:SOURce:LIST:STEP[1]|2|...|4..1000:SETup?
```

Example :SOUR:LIST:STEP1:SET INT, 1ms, PGSM, DOWN, 10, -25 dBm, "GSM_Test1.bin", TIME, 10ms, OFF, 255

Notes

The parameters are:

(There is a total of 11 items in each step, the following is a list of the items in the order they must appear in the remote command.)

1. Step Trigger **<enum>** – specifies the input trigger for the step. For details of the valid types of step trigger see ["Step Trigger" on page 1309](#).
 2. Transition Time **<time>** – specifies the transition time for the step in seconds. For details of the valid ranges for the transition time see ["Transition Time" on page 1311](#).
 3. Radio Band **<enum>** – specifies the radio band for the step. For details of the valid radio bands see ["Radio Setup" on page 1312](#).
 4. Radio Band Link **<enum>** – specifies the radio band link direction for the step. For details of the valid link types, see ["Radio Band Link" on page 1329](#).
 5. Frequency/Channel Number **<freq>/<chan num>** – specifies the frequency in Hz or the channel number for the step. The channel number and frequency are combined as one parameter that represents the frequency or channel number depending on the radio band setting. If the radio band is set to NONE, this value is interpreted as a frequency value in Hz. If the radio band is set to a valid band, this value is interpreted as a channel number. For details of the valid ranges for frequency and channel numbers, see ["Channel" on page 1329](#) and ["Frequency" on page 1330](#).
 6. Power **<ampl>** – specifies the output power for the step in dBm. For details of the valid ranges see ["Power" on page 1330](#).
 7. Waveform **<string>** – specifies the waveform for playback during the step. The step can output either a new ARB waveform, continue playback of the previous waveform, or output a CW tone. The options for specifying these are:
 - <filename> - plays the specified waveform from the start. The filename value is the name of the file within ARB playback memory, it does not include the windows path to the file on the HDD. If you enter a filename for a waveform that does not reside within ARB playback memory, an error is generated.
 - CONT – continues playback of the ARB file from the previous step
 - CW – outputs a CW tone
 - OFF – disable RF output
 8. Step Duration **<enum>** – specifies the duration of the step. The duration can be specified to be either time, or play count of the ARB file associated with the step, or continuous. If Waveform is set to "CW", this value cannot be set to Play Count and an error will be generated. If continuous is selected, the following Time or Count value is ignored. For further details of this setting, see ["Step](#)
-

[Duration" on page 1338.](#)

9. Time or Count <time/int> – specifies time duration in seconds or play count of the ARB file associated with the step. For further details of this setting, including the valid ranges for the time or play count setting, ["Time" on page 1338](#) and ["Play Count" on page 1339](#).

10. Output Trigger <Boolean> – specifies the output trigger for the step. For details of the ranges for this setting see ["Output Trigger" on page 1340](#).

Dependencies	The range of subopcode values is 1 to 1000 and the value you enter is determined by the number of steps you have configured. For details see "Number of Steps" on page 1308 . If you attempt to remotely set or query a subopcode that is out of range, an error is generated.
Initial S/W Revision	A.05.00

Step Configuration of Step Trigger parameter list (Remote Command Only)

This SCPI command is to configure “Step Trigger” parameter array of the whole List Sequencer at one time. The number of array is same as step number defined in ["Number of Steps" on page 1308](#) Number of Steps. As a step is setup, the value entered run through several levels of validation.

Remote Command	:SOURce:LIST:SETup:INPut:TRIGger <enum>, <enum>, <enum>, ... :SOURce:LIST:SETup:INPut:TRIGger?
Example	:SOUR:LIST:SET:INP:TRIG IMM,INT,EXT2 :SOUR:LIST:SET:INP:TRIG?
Notes	The command is to setup below parameter array of whole list sequence. Step Trigger <enum> – specifies the input trigger for the step. For details of the valid types of step trigger see "Step Trigger" on page 1309 . If input parameter number exceeds the step number defined by "Number of Steps" on page 1308 Number of Steps then generate error ", and only those parametes whose index number falls in number of steps will be updated.
Remote Command Notes	IMMediate INTerna KEY BUS EXTerna2
Dependencies	The range is 1 to 1000 which is determined by the number of steps you have configured. For details see "Number of Steps" on page 1308 .
Initial S/W Revision	A.09.40

Step Configuration of Transition Time parameter list (Remote Command Only)

This SCPI command is to configure “Transition Time” parameter array of the whole List Sequencer at one time. The number of array is same as step number defined in ["Number of Steps" on page 1308](#) Number of Steps. As a step is setup, the value entered run through several levels of validation.

Remote Command	:SOURce:LIST:SETup:TRANSition:TIME <time>, <time>, <time>, ... :SOURce:LIST:SETup:TRANSition:TIME?
Example	:SOUR:LIST:SET:TRAN:TIME 1ms,1ms,1ms

	:SOUR:LIST:SET:TRAN:TIME?
Notes	<p>The command is to setup below parameter array of whole list sequence.</p> <p>Transition Time <time> – specifies the transition time for the step in seconds. For details of the valid ranges for the transition time see "Transition Time" on page 1311</p> <p>If input parameter number exceeds the step number defined by "Number of Steps" on page 1308 Number of Steps then generate error ", and only those parameters whose index number falls in number of steps will be updated.</p>
Dependencies	The range is 1 to 1000 which is determined by the number of steps you have configured. For details see "Number of Steps" on page 1308 .
Initial S/W Revision	A.09.40

Step Configuration of Radio Band parameter list (Remote Command Only)

This SCPI command is to configure "Radio Band" parameter array of the whole List Sequencer at one time. The number of array is same as step number defined in ["Number of Steps" on page 1308](#) Number of Steps. As a step is setup, the value entered run through several levels of validation.

R :SOURce:LIST:SETup:RADio:BAND <enum>, <enum>, <enum>, ...

e :SOURce:LIST:SETup:RADio:BAND?

m
o
t
e

C
o
m
m
a
n
d

E :SOUR:LIST:SET:RAD:BAND PGSM, EGSM, RGSM

x :SOUR:LIST:SET:RAD:BAND?

a
m
p
l
e

N The command is to setup below parameter array of whole list sequence.

o Radio Band <enum> – specifies the radio band for the step. For details of the valid radio bands see ["Radio Setup" on page 1312](#).

t If input parameter number exceeds the step number defined by ["Number of Steps" on page 1308](#) Number of Steps then
e generate error ", and only those parameters whose index number falls in number of steps will be updated.
s

R NONE|PGSM|EGSM|RGSM|DCS1800|PCS1900|TGSM810|GSM450|GSM480|GSM700|GSM850|BANDI|BANDII|BANDIII|BANDI
e V|BANDV|BANDVI|BANDVII|BANDVIII|BANDIX|BANDX|BANDXI|BANDXII|BANDXIII|BANDXIV|BANDXIX|USCELL|USPCS|JAPAN|KO
m REAN|NMT|IMT2K|UPPER|SECOND|PAMR400|PAMR800|IMTEXT|PCS1 DOT9G|AWS|US2DOT5G|PUBLIC|LOWER|NONE|BAND1|
BAND2|BAND3|BAND4|BAND5|BAND6|BAND7|BAND8|BAND10|BAND11|BAND12|BAND13|BAND14|BAND17|BAND18|BAND1

o 9|BAND20|BAND21|BAND24|BAND25|BAND26|BAND33|BAND34|BAND35|BAND36|BAND37|BAND38|BAND39|BAND40|BAN
t D41|BAND42|BAND43|BANDA|BANDB|BANDC|BANDD|BANDE|BANDF
e

C
o
m
m
a
n
d

N
o
t
e
s

D The range is 1 to 1000 which is determined by the number of steps you have configured. For details see "[Number of Steps](#)" on
e [page 1308](#).

p
e
n
d
e
n
c
i
e
s

I A.09.40

n
i
t
i
a
l

S
/
W

R
e
v
i
s
i
o
n

Step Configuration of Radio Band Link parameter list (Remote Command Only)

This SCPI command is to configure “Radio Band Link” parameter array of the whole List Sequencer at one time. The number of array is same as step number defined in ["Number of Steps" on page 1308](#) Number of Steps. As a step is setup, the value entered run through several levels of validation.

Remote Command	:SOURce:LIST:SETup:RADio:BAND:LINK <enum>, <enum>, <enum>, ... :SOURce:LIST:SETup:RADio:BAND:LINK?
Example	:SOUR:LIST:SET:RAD:BAND:LINK DOWN,UP,UP :SOUR:LIST:SET:RAD:BAND:LINK?
Notes	The command is to setup below parameter array of whole list sequence. Radio Band Link <enum> – specifies the radio band link direction for the step. For details of the valid link types, see "Radio Band Link" on page 1329 . If input parameter number exceeds the step number defined by "Number of Steps" on page 1308 Number of Steps then generate error ", and only those parametes whose index number falls in number of steps will be updated.
Remote Command Notes	DOWN UP
Dependencies	The range is 1 to 1000 which is determined by the number of steps you have configured. For details see "Number of Steps" on page 1308 .
Initial S/W Revision	A.09.40

Step Configuration of Frequency/Channel Number parameter list (Remote Command Only)

This SCPI command is to configure “Frequency” or “Channel Number” parameter array of the whole List Sequencer at one time. The number of array is same as step number defined in ["Number of Steps" on page 1308](#) Number of Steps. As a step is setup, the value entered run through several levels of validation.

Remote Command	:SOURce:LIST:SETup:CNFRrequency <double>, <double>, <double>, ... :SOURce:LIST:SETup:CNFRrequency?
Example	:SOUR:LIST:SET:CNFR 1GHz,100MHz,100MHz :SOUR:LIST:SET:CNFR? SOUR:LIST:SET:CNFR 124,124,124 :SOUR:LIST:SET:CNFR?
Notes	The command is to setup below parameter array of whole list sequence. Frequency/Channel Number <freq>/<chan num> – specifies the frequency in Hz or the channel number for the step. The channel number and frequency are combined as one parameter that represents the frequency or channel number depending on the radio band setting. If the radio band is set to NONE, this value is interpreted as a frequency value in Hz. If the radio band is set to a valid band, this value is interpreted as a channel number. For details of the valid ranges for frequency and channel numbers, see "Channel" on page 1329 and "Frequency" on page 1330 . This SCPI is used to setup/query channel number or frequency setting, according to current Radio Band setting of that step. If Radio Band is “NONE”, then it’s frequency. If Radio Band is not “NONE”, then it’s channel number If input parameter number exceeds the step number defined by "Number of Steps" on page 1308 Number of Steps then generate error ", and only those parametes whose index number falls in

	legal step number will be updated.
Dependencies	The range is 1 to 1000 which is determined by the number of steps you have configured. For details see " Number of Steps " on page 1308.
Initial S/W Revision	A.09.40

Step Configuration of Power parameter list (Remote Command Only)

This SCPI command is to configure "Power" parameter array of the whole List Sequencer at one time. The number of array is same as step number defined in "[Number of Steps](#)" on page 1308 Number of Steps. As a step is setup, the value entered run through several levels of validation.

Remote Command	:SOURce:LIST:SETup:AMPLitude <ampl>, <ampl>, <ampl>, ... :SOURce:LIST:SETup:AMPLitude?
Example	:SOUR:LIST:SET:AMPL -50dBm,-40dBm,-30dBm :SOUR:LIST:SET:AMPL?
Notes	The command is to setup below parameter array of whole list sequence. Power <ampl> - specifies the output power for the step in dBm. For details of the valid ranges see " Power " on page 1330. If input parameter number exceeds the step number defined by " Number of Steps " on page 1308 Number of Steps then generate error ", and only those parametes whose index number falls in legal step number will be updated.
Dependencies	The range is 1 to 1000 which is determined by the number of steps you have configured. For details see " Number of Steps " on page 1308.
Initial S/W Revision	A.09.40

Step Configuration of Waveform parameter list (Remote Command Only)

This SCPI command is to configure "Waveform" parameter array of the whole List Sequencer at one time. The number of array is same as step number defined in "[Number of Steps](#)" on page 1308 Number of Steps. As a step is setup, the value entered run through several levels of validation.

Remote Command	:SOURce:LIST:SETup:WAVEform <string>, <string>, <string>, ... :SOURce:LIST:SETup:WAVEform?
Example	:SOUR:LIST:SET:WAV "CW","Off","CONT" :SOUR:LIST:SET:WAV?
Notes	The command is to setup below parameter array of whole list sequence. Waveform <string> - specifies the waveform for playback during the step. The step can output either a new ARB waveform, continue playback of the previous waveform, or output a CW tone. The options for specifying these are: <filename> - plays the specified waveform from the start. The filename value is the name of the file within ARB playback memory, it is does not include the windows path to the file on the HDD. If you enter a filename for a waveform that does not reside within ARB playback memory, an error is generated.

	<p>CONT – continues playback of the ARB file from the previous step</p> <p>CW – outputs a CW tone</p> <p>OFF – disable RF output</p> <p>If input parameter number exceeds the step number defined by "Number of Steps" on page 1308 Number of Steps then generate error ", and only those parametes whose index number falls in number of steps will be updated.</p>
Dependencies	The range is 1 to 1000 which is determined by the number of steps you have configured. For details see "Number of Steps" on page 1308.
Range	"filename" "CW" "Off" "CONT"
Initial S/W Revision	A.09.40

Step Configuration of Step Duration parameter list (Remote Command Only)

This SCPI command is to configure "Step Duration" parameter array of the whole List Sequencer at one time. The number of array is same as step number defined in "Number of Steps" on page 1308 Number of Steps. As a step is setup, the value entered run through several levels of validation.

Remote Command	<pre>:SOURce:LIST:SETup:DURation:TYPE <enum>, <enum>, <enum>, ... :SOURce:LIST:SETup:DURation:TYPE?</pre>
Example	<pre>:SOUR:LIST:SET:DUR:TYPE COUN,TIME,CONT :SOUR:LIST:SET:DUR:TYPE?</pre>
Notes	<p>The command is to setup below parameter array of whole list sequence.</p> <p>Step Duration <enum> – specifies the duration of the step. The duration can be specified to be either time, or play count of the ARB file associated with the step, or continuous. If Waveform is set to "CW", this value cannot be set to Play Count and an error will be generated. If continuous is selected, the following Time or Count value is ignored. For further details of this setting, see "Step Duration" on page 1338.</p> <p>If input parameter number exceeds the step number defined by "Number of Steps" on page 1308 Number of Steps then generate error ", and only those parametes whose index number falls in number of steps will be updated.</p>
Remote Command Notes	TIME COUNT CONTinuous
Dependencies	The range is 1 to 1000 which is determined by the number of steps you have configured. For details see "Number of Steps" on page 1308.
Initial S/W Revision	A.09.40

Step Configuration of Duration Time or Play Count parameter list (Remote Command Only)

This SCPI command is to configure "Duration Time" or "Play Count" parameter array of the whole List Sequencer at one time. The number of array is same as step number defined in "Number of Steps" on page 1308 Number of Steps. As a step is setup, the value entered run through several levels of validation.

Remote Command	<pre>:SOURce:LIST:SETup:TOCount <time/int>, <time/int>, <time/int>, ... :SOURce:LIST:SETup:TOCount?</pre>
-----------------------	---

Example	:SOUR:LIST:SET:TOC 1s,2s,3s :SOUR:LIST:SET:TOC? :SOUR:LIST:SET:TOC 5,6,7 :SOUR:LIST:SET:TOC?
Notes	The command is to setup below parameter array of whole list sequence. Time or Count <time/int> – specifies time duration in seconds or play count of the ARB file associated with the step. For further details of this setting, including the valid ranges for the time or play count setting, " Time " on page 1338 and " Play Count " on page 1339. If input parameter number exceeds the step number defined by " Number of Steps " on page 1308 Number of Steps then generate error ", and only those parametes whose index number falls in number of steps will be updated. If current " Step Duration " on page 1338 is "Continuous", then generate error -221,"Settings conflict;Cannot accept time or count input when step duration type is Continuous on step #"
Dependencies	The range is 1 to 1000 which is determined by the number of steps you have configured. For details see " Number of Steps " on page 1308.
Initial S/W Revision	A.09.40

Step Configuration of Output Trigger parameter list (Remote Command Only)

This SCPI command is to configure "Output Trigger" parameter array of the whole List Sequencer at one time. The number of array is same as step number defined in "[Number of Steps](#)" on page 1308 Number of Steps. As a step is setup, the value entered run through several levels of validation.

Remote Command	:SOURce:LIST:SETup:OUTPut:TRIGger <bool>, <bool>, <bool>, ... :SOURce:LIST:SETup:OUTPut:TRIGger ?
Example	:SOUR:LIST:SET:OUTP:TRIG ON,OFF,ON :SOUR:LIST:SET:OUTP:TRIG?
Notes	The command is to setup below parameter array of whole list sequence. Output Trigger <Boolean> – specifies the output trigger for the step. For details of the ranges for this setting see " Output Trigger " on page 1340. If input parameter number exceeds the step number defined by " Number of Steps " on page 1308 Number of Steps then generate error ", and only those parametes whose index number falls in legal step number will be updated.
Remote Command Notes	ON OFF 1 0
Dependencies	The range is 1 to 1000 which is determined by the number of steps you have configured. For details see " Number of Steps " on page 1308.
Initial S/W Revision	A.09.40

Clear List (Remote Command Only)

This command is the SCPI equivalent of the Clear List UI featuredescribed in.

Remote Command	:SOURce:LIST:SETup:CLEar
Example	:SOUR:LIST:SETup:CLE
Initial S/W Revision	A.05.00

Trigger Type

Allows access to the sub-menu for selecting the output trigger type for the list sequencer globally. It cannot be changed between different sequence steps.

Key Path	Source, List Sequencer
Remote Command	:SOURce:LIST:TRIGgerout:TYPE BEGinningofstep DATamarker
Example	:SOUR:LIST:TRIG:TYP BEG :SOUR:LIST:TRIG:TYP?
Notes	SCPI is supported after A.14.00
Preset	BEGinningofstep
Range	BEGinningofstep DATamarker
Initial S/W Revision	A.14.00

BeginningOfStep

Sets the output trigger type as BeginningOfStep for the whole source sequence.

Key Path	Source, List Sequencer, Trigger Type
Example	:SOUR:LIST:TRIG:TYP BEG
Notes	SCPI is supported after A.14.00
Initial S/W Revision	A.14.00

DataMarker

Sets the output trigger type as DataMarker for the whole source sequence. When DataMarker is selected, which marker to route is also needed to be set.

Key Path	Source, List Sequencer, Trigger Type
Example	:SOUR:LIST:TRIG:TYP DAT
Notes	SCPI is supported after A.14.00
Initial S/W Revision	A.14.00

Marker 1

Sets the output trigger maker routing to Marker 1 for DataMarker in the whole source sequence.

Key Path	Source, List Sequencer, Trigger Type, DataMarker
Example	:SOUR:LIST:TRIG:TYPE:MARK M1
Notes	SCPI is supported after A.14.00
Initial S/W Revision	A.14.00

Marker 2

Sets the output trigger maker routing to Marker 2 for DataMarker in the whole source sequence.

Key Path	Source, List Sequencer, Trigger Type, DataMarker
Example	:SOUR:LIST:TRIG:TYPE:MARK M2
Notes	SCPI is supported after A.14.00
Initial S/W Revision	A.14.00

Marker 3

Sets the output trigger maker routing to Marker 3 for DataMarker in the whole source sequence.

Key Path	Source, List Sequencer, Trigger Type, DataMarker
Example	:SOUR:LIST:TRIG:TYPE:MARK M3
Notes	SCPI is supported after A.14.00
Initial S/W Revision	A.14.00

Marker 4

Sets the output trigger maker routing to Marker 4 for DataMarker in the whole source sequence.

Key Path	Source, List Sequencer, Trigger Type, DataMarker
Example	:SOUR:LIST:TRIG:TYPE:MARK M4
Notes	SCPI is supported after A.14.00
Initial S/W Revision	A.14.00

Manual Trigger Now

Pressing this key provides a software trigger event to the list sequencer. During execution of sequence, if the sequencer is halted on any step that has been configured with a “Manual” step trigger, then this key press will cause the sequencer to continue and execute the step.

Key Path	Source, List Sequencer
Remote Command	No remote command, front panel only.
Initial S/W Revision	A.05.00

Remote Software Trigger (Remote command Only)

During execution of a list sequence, the sequence will halt and wait at any step that has Step Trigger set to “Bus”. Sending this command will trigger the step and continue the sequence.

Remote Command	:SOURce:LIST:TRIGger:INITiate[:IMMediate]
Example	:SOUR:LIST:TRIG:INIT
Initial S/W Revision	A.05.00

Query List Sequence Initiation Armed Status (Remote Command Only)

This is a blocking SCPI query to determine if source list sequence being initiated successfully or not.

Remote Command	:SOURce:LIST:INITiation:ARMed?
Example	:SOUR:LIST:INIT:ARMed?
Notes	The return data is in the following format: Integer
Notes	Query only SCPI. Returning “1” if list sequence has been initiated successfully, returning “0” if not. Once get “0”, you can use :SYST:ERR? to query what error happened. Just like “*OPC?”, this command can be blocked until event/status “IsSourceSweeping” happens, and then returns. Doing so can help user’s script query armed status only once during the time interval of the initiation. As an ancillary SCPI of existing SCPI “:SOUR:LIST:TRIGger[:IMMediate]” (see "Initiate Sequence" on page 1307 Initiate Sequence), the right usage of this command is to use it after “:SOUR:LIST:TRIG”. If not, this command will return “1” immediately.
Notes	There is an alias SCPI “:SOURce:LIST:TRIGger:INITiation:ARMed?”.
Initial S/W Revision	A.09.40

Source Preset

Allows you to preset the source settings to their default values.

Key Path	Source
Remote Command	:SOURce:PRESet
Example	:SOUR:PRES

SPAN X Scale

Activates and displays the Span function menu.

Key Path	Front-panel key
Initial S/W Revision	Prior to A.02.00

Span

Adjusts the Span of the RF Spectrum window.

Key Path	SPAN X Scale
Remote Command	[:SENSe] :AM FM PM FMSTereo:FREQuency:SPAN <freq> [:SENSe] :AM FM PM FMSTereo:FREQuency:SPAN?
Example	AM:FREQ:SPAN 2.122kHz AM:FREQ:SPAN?
Notes	Adjusts the Span of the RF Spectrum window.
Dependencies	The maximum value will be the maximum IF BW available in the instrument. For example, if the instrument has the options B25, B40, and B1X installed, the maximum available IF BW of the instrument is 140 MHz. Thus, the maximum Span is not limited to 25 MHz but is 140 MHz.
Preset	= AM/FM/PM = 75 kHz = FMST = 500 kHz
State Saved	Saved in instrument state
Min	10 Hz
Default Unit	Hz
Initial S/W Revision	Prior to A.02.00
Modified at S/W Revision	A.14.00

Sweep/Control

Activates a menu and selects Sweep Time as the active function. Sweep time is used by the Demod Waveform window, but this key is available in any view.

Key Path	Front-panel key
Initial S/W Revision	Prior to A.02.00

Demod Wfm Sweep Time

Selects the display length for the Demod Waveform window. This is commonly set to two sample lengths.

Key Path	Sweep/Control
Remote Command	[:SENSe] :AM FM PM FMSTereo:DWSweep:TIME <time> [:SENSe] :AM FM PM FMSTereo:DWSweep:TIME?
Example	AM:DWSW:TIME 50 ms AM:DWSW:TIME?
Preset	2 ms
State Saved	Saved in Instrument State
Min	1 μ s
Max	2 s
Initial S/W Revision	Prior to A.02.00
Modified at S/W Revision	A.10.00

Demod Time

Selects the minimum length of data acquisition used in demodulation. Increasing the demodulation time will result in more accurate metrics; reducing the demodulation time will result in a faster measurement.

The measurement might require more data than specified by the demodulation time. If the resolution bandwidth is low in the spectrum windows, or the demod waveform sweep time is high, then the data required for the measurement might be higher than the demodulation time.

If measurement speed is critical, make sure to increase the resolution bandwidth and reduce the demodulation waveform sweep time.

The Auto rules for the demodulation time will give the nominal specification performance if the sweep time is set to display two cycles of data.

Key Path	Sweep/Control
Remote Command	[:SENSe] :AM FM PM FMSTereo:DEMod:TIME <time> [:SENSe] :AM FM PM FMSTereo:DEMod:TIME? [:SENSe] :AM FM PM:DEMod:TIME:AUTO OFF ON 0 1

	[:SENSe] :AM FM PM:DEMod:TIME:AUTO?
Example	AM:DEM:TIME 50 ms AM:DEM:TIME?
Notes	If current Demod Time, Span and Channel BW settings combinations result in a required acquisition length is excess of the capacity of the analyzer, 4MSamples, gives a warning message "Settings Alert; Acquisition truncated".
Couplings	When in Auto mode, the demodulation time depends on the demodulation waveform sweep time. Lower
Preset	= AM/FM/PM = 72 ms = FMST = 280 ms ON
State Saved	Saved in instrument state
Min	1 μ s
Max	100 s
Initial S/W Revision	Prior to A.02.00
Modified at S/W Revision	A.14.00

10 Φ M Demod Measurement
System

System

See "[System](#)" on page 182

Trace/Detector

There are no menus under this key in the Analog Demod mode.

Key Path	Front-panel key
Initial S/W Revision	Prior to A.02.00

Trigger

See ["Trigger" on page 238](#)

Free Run

See ["Free Run " on page 245](#)

Video

See ["Video \(IF Envelope\) " on page 246](#)

Trigger Level

See ["Trigger Level " on page 246](#)

Trig Slope

See ["Trig Slope " on page 247](#)

Trig Delay

See ["Trig Delay " on page 248](#)

External 1

See ["External 1 " on page 264](#)

Trigger Level

See ["Trigger Level " on page 264](#)

Trig Slope

See ["Trig Slope " on page 265](#)

Trig Delay

See ["Trig Delay " on page 251](#)

Zero Span Delay Comp

See ["Zero Span Delay Comp On/Off" on page 252](#)

External 2

See ["External 2 " on page 266](#)

Trigger Level

See ["Trigger Level " on page 266](#)

Trig Slope

See ["Trig Slope " on page 267](#)

Trig Delay

See "Trig Delay " on page 254

Zero Span Delay Comp

See "Zero Span Delay Comp On/Off" on page 254

RF Burst

See "RF Burst " on page 267

Absolute Trigger

See "Absolute Trigger Level" on page 268

Relative Trigger

See "Relative Trigger Level" on page 257

Trig Slope

See "Trigger Slope " on page 269

Trig Delay

See "Trig Delay " on page 258

Periodic Timer

See "Periodic Timer (Frame Trigger) " on page 259

Period

See "Period " on page 260

Offset

See "Offset " on page 261

Offset Adjust (Remote Command Only)

See "Offset Adjust (Remote Command Only)" on page 262

Reset Offset Display

See "Reset Offset Display " on page 263

Sync Source

See "Sync Source " on page 263

Off

See "Off " on page 264

External 1

See "External 1 " on page 264

Trigger Level

See "Trigger Level " on page 264

Trig Slope

See "Trig Slope " on page 265

External 2

See "External 2 " on page 266

Trigger Level

See "Trigger Level " on page 266

Trig Slope

See "Trig Slope " on page 267

RF Burst

See "RF Burst " on page 267

Absolute Trigger

See "Absolute Trigger Level" on page 268

Trig Slope

See "Trigger Slope " on page 269

Trig Delay

See "Trig Delay" on page 269

Auto/Holdoff

See "Auto/Holdoff " on page 270

Auto Trig

See "Auto Trig " on page 270

Trig Holdoff

See "Trig Holdoff " on page 271

User Preset

Accesses a menu that gives you the following three choices:

- User Preset – recalls a state previously saved using the Save User Preset function.
- User Preset All Modes – presets all of the modes in the analyzer
- Save User Preset– saves the current state for the current mode

NOTE

In products that run multiple instances of the X-Series Application, all instances use the same location to save User Preset state. So Save User Preset of one instance will overwrite the Save User Preset of another instance.

Key Path	Front-panel key
Backwards Compatibility Notes	<p>User Preset is actually loading a state, and in legacy analyzers, it was possible to load a state without affecting the trace data, limit lines or correction data. Similarly it was possible to do a User Preset without affecting the trace data, limit lines or correction data.</p> <p>In the X-Series, “state” always includes all of this data; so whenever state is loaded, or User Preset is executed, all of the traces, limit lines and corrections are affected. Although this differs from previous behavior, it is desirable behavior, and should not cause adverse issues for users.</p> <p>On ESA and PSA, User Preset affected the entire instrument’s state. In the X-Series, User Preset only recalls the state for the active mode. There is a User Preset file for each mode. User Preset can never cause a mode switch as it can in legacy analyzers. If you want to recall all modes to their user preset file state, you will need to do a User Preset after mode switching into each mode.</p> <p>User Preset recalls mode state which can now include data like traces; whereas on ESA and PSA, User Preset did not affect data.</p>
Initial S/W Revision	Prior to A.02.00

User Preset

User Preset sets the state of the currently active mode back to the state that was previously saved for this mode using the Save User Preset menu key or the SCPI command, SYST:PRES:USER:SAV. It not only recalls the Mode Preset settings, but it also recalls all of the mode persistent settings, and the Input/Output system setting that existed at the time Save User Preset was executed.

If a Save User Preset has not been done at any time, User Preset recalls the default user preset file for the currently active mode. The default user preset files are created if, at power-on, a mode detects there is no user preset file. There will never be a scenario when there is no user preset file to restore. For each mode, the default user preset state is the same state that would be saved if a Save User Preset is performed in each mode right after doing a Restore Mode Default and after a Restore Input/Output Defaults.

The User Preset function does the following:

- Aborts the currently running measurement.
- Sets the mode State to the values defined by Save User Preset.
- Makes the saved measurement for the currently running mode the active measurement.
- Brings up the saved menu for the power-on mode.

- Clears the input and output buffers.
- Sets the Status Byte to 0.

Key Path	User Preset
Remote Command	:SYSTem:PRESet:USER
Example	:SYST:PRES:USER:SAVE:SYST:PRES:USER
Notes	:SYST:PRES:USER:SAVE is used to save the current state as the user preset state. Clears all pending OPC bits. The Status Byte is set to 0. Pressing the User Preset front-panel key while already in the User Preset menu will cause the User Preset to get executed
Couplings	A user preset will cause the currently running measurement to be aborted and cause the saved measurement to be active. Recalling a User Preset file has the same issues that recalling a Save State file has. Some settings may need to be limited and therefore re-coupled, since the capabilities of the mode may have changes when the User Preset file was last saved.
Initial S/W Revision	Prior to A.02.00

User Preset All Modes

Recalls all of the User Preset files for each mode, switches to the power-on mode, and activates the saved measurement from the power-on mode User Preset file.

NOTE

When the instrument is secured, all of the user preset files are converted back to their default user preset files.

The User Preset function does the following:

- Aborts the currently running measurement.
- Switches the Mode to the power-on mode.
- Restores the User Preset files for each mode.
- Makes the saved measurement for the power-on mode the active measurement.
- Brings up the saved menu for the power-on mode.
- Clears the input and output buffers.
- Sets the Status Byte to 0.

Key Path	User Preset
Remote Command	:SYSTem:PRESet:USER:ALL
Example	:SYST:PRES:USER:SAVE:SYST:PRES:USER:ALL
Notes	Clears all pending OPC bits. The Status Byte is set to 0. :SYST:PRES:USER:SAVE is used to save the current state as the user preset state.
Couplings	A user preset will cause the currently running measurement to be aborted, cause a mode switch to the power-on mode, and cause the saved measurement to be active in the power-on mode.

Recalling a User Preset file has the same issues that recalling a Save State file has. Some settings may need to be limited and therefore re-coupled, since the capabilities of the mode may have changes when the User Preset file was last saved.

Initial S/W Revision Prior to A.02.00

Save User Preset

Saves the currently active mode and its State. You can recall this User Preset file by pressing the User Preset menu key or sending the SYST:PRES:USER remote command. This same state is also saved by the Save State function.

Key Path	User Preset
Remote Command	:SYSTem:PRESet:USER:SAVE
Example	:SYST:PRES:USER:SAVE
Notes	:SYST:PRES:SAVE creates the same file as if the user requested a *SAV or a MMEM:STOR:STAT, except User Preset Save does not allow the user to specify the filename or the location of the file.
Initial S/W Revision	Prior to A.02.00

View/Display (AM/FM/ Φ M)

The AM and PM measurements have four views. The primary view is called “Quad View” and displays all four of the view windows with the focus in the RF Spectrum window. This is the view seen after a Mode Preset. There are also three other views that combine one of the graphics windows with the metrics windows. Besides the above four views, the FM measurement has an additional view called “Attack/Release Time”. This view includes a RF envelope graphic window and an AF demod waveform (without interpolation) graphic window. The views can be selected from the View/Display menu.

These views are designed such that you can identify analog modulated carriers, determine whether the carrier is a commercial or other broadcast station, and analyze the modulating signal.

Key Path	Front-panel key
Remote Command	:DISPlay:AM FM PM:VIEW[:SElect] QUAD RFSpectrum DEMod AFSpectrum ARTime :DISPlay:AM FM PM:VIEW[:SElect]?
Example	:DISP:FM:VIEW DEM selects Demod Waveform & Metrics View for FM Demod measurement
Preset	QUAD (Focus in RF Spectrum Window)
State Saved	Saved in instrument state
Initial S/W Revision	Prior to A.02.00

Display

The Display menu is common to most measurements, and is used for configuring items on the display. Some Display menu settings apply to all the measurements in a mode, and some only to the current measurement. Those under the System Display Settings key apply to all measurements in all modes.

Key Path	Display
Key Path	View/Display
Initial S/W Revision	Prior to A.02.00

Annotation

Turns on and off various parts of the display annotation. The annotation is divided up into four categories:

1. Meas Bar: This is the measurement bar at the top of the screen. It does not include the settings panel or the Active Function. Turning off the Meas Bar turns off the settings panel and the Active Function. When the Meas Bar is off, the graticule area expands to fill the area formerly occupied by the Meas Bar.
2. Screen Annotation: this is the annotation and annunciation around the graticule, including any annotation on lines (such as the display line, the threshold line, etc.) This does NOT include the marker number or the N dB result. When off, the graticule expands to fill the entire graticule area.
3. Trace annotation: these are the labels on the traces, showing their detector (or their math mode).

4. Active Function annotation: this is the active function display in the meas bar, and all of the active function values displayed on softkeys.

See the figure below. Each type of annotation can be turned on and off individually.

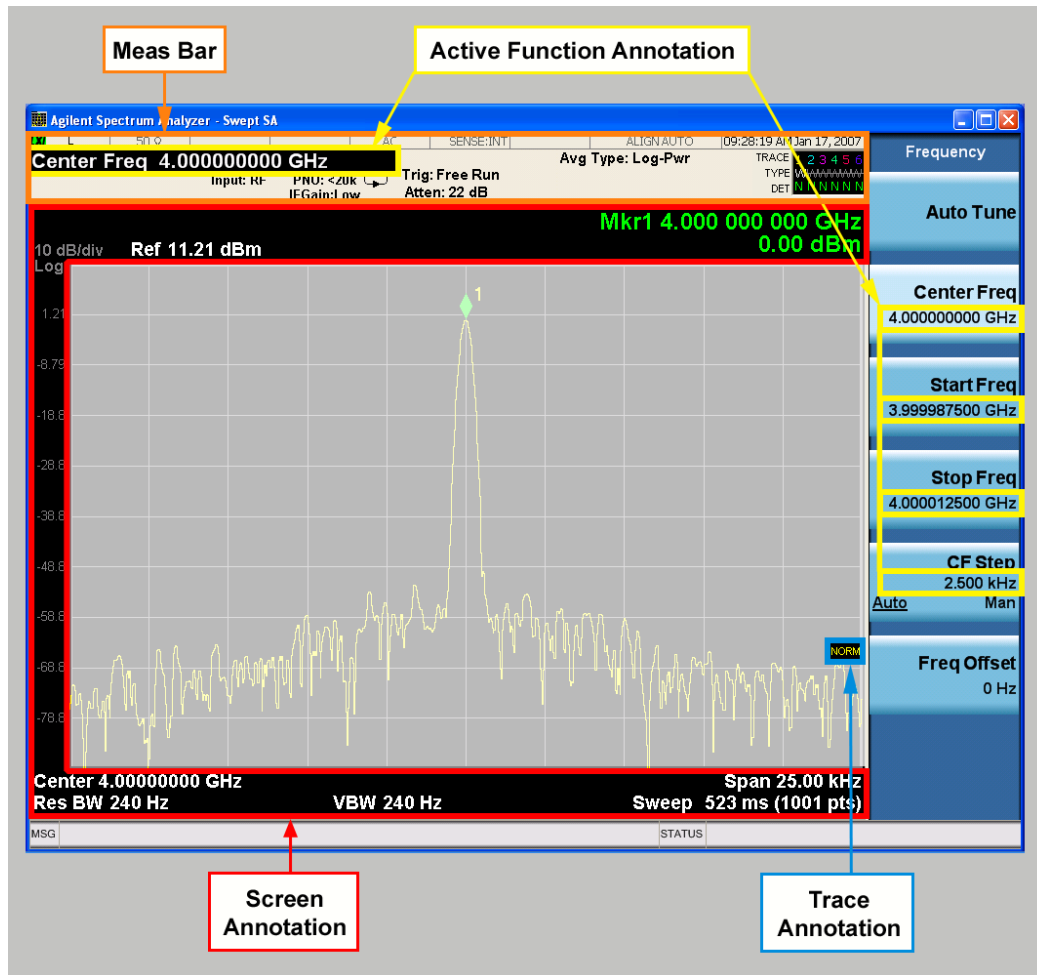

Key Path	View/Display, Display
Initial S/W Revision	Prior to A.02.00

Meas Bar On/Off

This function turns the Measurement Bar on and off, including the settings panel. When off, the graticule area expands to fill the area formerly occupied by the Measurement Bar.

Key Path	View/Display, Display, Annotation
Remote Command	:DISPlay:ANNotation:MBAR[:STATe] OFF ON 0 1 :DISPlay:ANNotation:MBAR[:STATe]?
Example	DISP:ANN:MBAR OFF

Dependencies	Grayed out and forced to OFF when System Display Settings, Annotation is set to Off.
Preset	On This should remain Off through a Preset when System DisplaySettings, Annotation is set to Off.
State Saved	Saved in instrument state.
Initial S/W Revision	Prior to A.02.00

Screen

This controls the display of the annunciation and annotation around the graticule, including any annotation on lines (such as the display line, the threshold line, etc.) and the y-axis annotation. This does NOT include marker annotation (or the N dB result). When off, the graticule expands to fill the entire graticule area, leaving only the 1.5% gap above the graticule as described in the Trace/Detector chapter.

Key Path	View/Display, Display, Annotation
Remote Command	:DISPlay:ANNotation:SCReen[:STATe] OFF ON 0 1 :DISPlay:ANNotation:SCReen[:STATe]?
Example	DISP:ANN:SCR OFF
Dependencies	Grayed-out and forced to OFF when System Display Settings, Annotation is set to Off.
Preset	On This should remain Off through a Preset when System DisplaySettings, Annotation is set to Off
State Saved	Saved in instrument state.
Initial S/W Revision	Prior to A.02.00

Active Function Values On/Off

Turns on and off the active function display in the Meas Bar, and all of the active function values displayed on the softkeys.

Note that all of the softkeys that have active functions have these numeric values blanked when this function is on. This is a security feature..

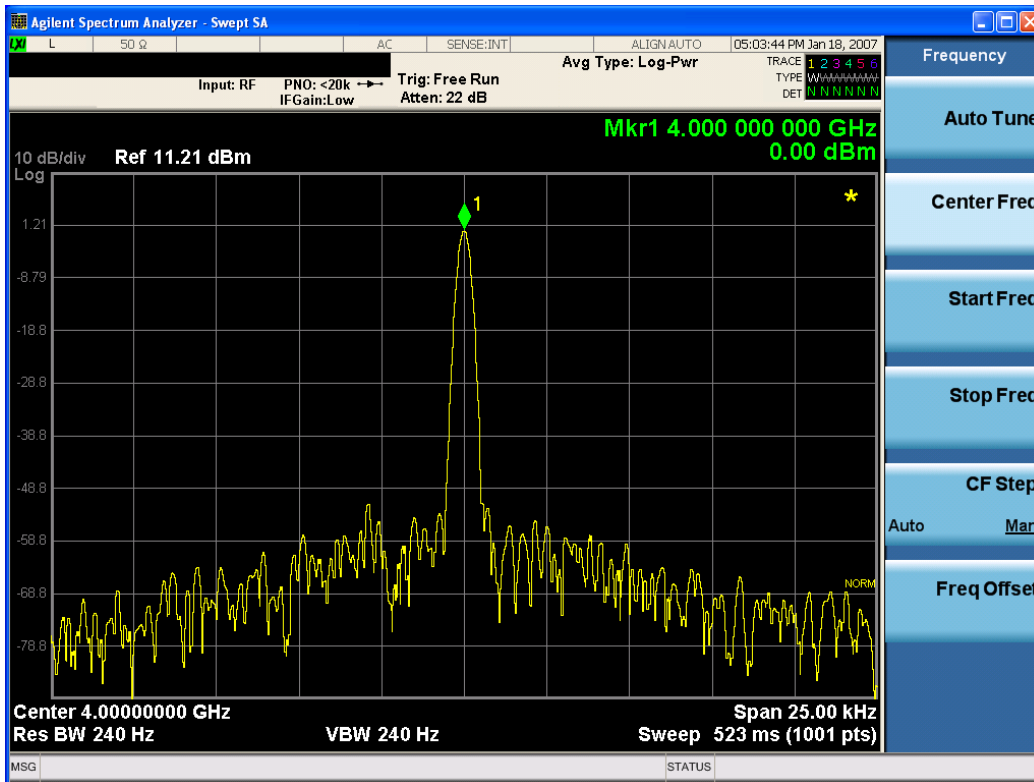

Key Path	View/Display, Display, Annotation
Remote Command	:DISPlay:ACTivefunc[:STATE] ON OFF 1 0 :DISPlay:ACTivefunc[:STATE]?
Example	DISP:ACT OFF
Dependencies	Grayed out and forced to OFF when System Display Settings, Annotation is set to Off.
Preset	On This should remain Off through a Preset when System DisplaySettings, Annotation is set to Off
State Saved	Saved in instrument state.
Initial S/W Revision	Prior to A.02.00

Title

Displays menu keys that enable you to change or clear a title on your display.

Key Path	View/Display, Display
Initial S/W Revision	Prior to A.02.00

Change Title

Writes a title into the "measurement name" field in the banner, for example, "Swept SA".

Press Change Title to enter a new title through the alpha editor. Press Enter or Return to complete the entry. Press ESC to cancel the entry and preserve your existing title.

The display title will replace the measurement name. It remains for this measurement until you press Change Title again, or you recall a state, or a Preset is performed. A title can also be cleared by pressing Title, Clear Title.

NOTE

Notice the inclusion of the <measurement> parameter in the command below. Because each measurement remembers the Display Title, the command must be qualified with the measurement name. For the Swept SA measurement this is not the case; no <measurement> parameter is used when changing the Display Title for the Swept SA measurement.

Key Path	View/Display, Display, Title
Mode	All
Remote Command	:DISPlay:<measurement>:ANNotation:TITLe:DATA <string> :DISPlay:<measurement>:ANNotation:TITLe:DATA?
Example	DISP:ANN:TITL:DATA "This Is My Title" This example is for the Swept SA measurement in the Spectrum Analyzer mode. The SANalyzer <measurement> name is not used. DISP:ACP:ANN:TITL:DATA "This Is My Title" This example is for Measurements other than Swept SA. Both set the title to: This Is My Title
Notes	Pressing this key cancels any active function. When a title is edited the previous title remains intact (it is not cleared) and the cursor goes at the end so that characters can be added or BKSP can be used to go back over previous characters.
Preset	No title (measurement name instead)
State Saved	Saved in instrument state.
Initial S/W Revision	Prior to A.02.00

Clear Title

Clears a title from the front-panel display. Once cleared, the title cannot be retrieved. After the title is cleared, the current Measurement Name replaces it in the title bar.

Key Path	View/Display, Display, Title
Example	The following commands clear the title and restore the measurement's original title: DISP:ANN:TITL:DATA "" This example is for the Swept SA measurement in the Spectrum Analyzer mode. The SANalyzer <measurement> name is not used. DISP:ACP:ANN:TITL:DATA "" This example is for ACP; in measurements other than Swept SA the measurement name is required.
Notes	Uses the :DISPlay:<measurement>:ANNotation:TITLe:DATA <string> command with an empty string (in the Swept SA, the <measurement> is omitted).
Preset	Performed on Preset.
Initial S/W Revision	Prior to A.02.00

Graticule

Pressing Graticule turns the display graticule On or Off. It also turns the graticule y-axis annotation on and off.

Key Path	View/Display, Display
Remote Command	:DISPlay:WINDow[1]:TRACe:GRATicule:GRID[:STATe] OFF ON 0 1 :DISPlay:WINDow[1]:TRACe:GRATicule:GRID[:STATe]?
Example	DISP:WIND:TRAC:GRAT:GRID OFF
Notes	The graticule is the set of horizontal and vertical lines that make up the grid/divisions for the x-axis and y-axis.
Preset	On
State Saved	Saved in instrument state
Initial S/W Revision	Prior to A.02.00

System Display Settings

These settings are "Mode Global" – they affect all modes and measurements and are reset only by Restore Misc Defaults or Restore System Defaults under System.

Key Path	View/Display, Display
Initial S/W Revision	Prior to A.02.00

Annotation Local Settings

This is a Mode Global override of the meas local annotation settings. When it is All Off, it forces ScreenAnnotation, Meas Bar, Trace, and Active Function Values settings to be OFF for all measurements in all modes. This provides the security based "annotation off" function of previous analyzers; hence it uses the legacy SCPI command.

When it is All Off, the Screen, Meas Bar, Trace, and Active Function Values keys under the Display, Annotation menu are grayed out and forced to Off. When Local Settings is selected, you are able to set the local annotation settings on a measurement by measurement basis.

Key Path	View/Display, Display, System Display Settings
Remote Command	:DISPlay:WINDow[1]:ANNOtation[:ALL] OFF ON 0 1 :DISPlay:WINDow[1]:ANNOtation[:ALL]?
Example	:DISP:WIND:ANN OFF
Preset	On (Set by Restore Misc Defaults)
State Saved	Not saved in instrument state.
Backwards Compatibility Notes	The WINDow parameter and optional subopcode is included for backwards compatibility but ignored – all windows are equally affected.
Initial S/W Revision	Prior to A.02.00

Themes

Accesses a menu of functions that enable you to choose the theme to be used when saving the screen image.

The **Themes** option is the same as the **Themes** option under the **Display** and **Page Setup** dialogs. It allows you to choose between themes to be used when saving the screen image.

Key Path	Save, Screen Image
Remote Command	:MMEMory:STORe:SCReen:THEMe TDColor TDMonochrome FCOLor FMONochrome :MMEMory:STORe:SCReen:THEMe?
Example	:MMEM:STOR:SCR:THEM TDM
Preset	3D Color; Is not part of Preset, but is reset by Restore Misc Defaults or Restore System Defaults All and survives subsequent running of the modes.
Readback	3D Color 3D Mono Flat Color Flat Mono
Backwards Compatibility Notes	In ESA and PSA we offer the choice of "Reverse Bitmap" or "Reverse Metafile" when saving screen images. This is much like the "Flat Color" theme available in X-Series. Also, if you selected Reverse Bitmap AND a black & white screen image, that would be much like "Flat Monochrome". In other words, each of the X-Series themes has a similar screen image type in ESA/PSA. But they are not identical.
Initial S/W Revision	Prior to A.02.00

3D Color

Selects a standard color theme with each object filled, shaded and colored as designed.

Key Path	Save, Screen Image, Themes
Example	MMEM:STOR:SCR:THEM TDC
Readback	3D Color
Initial S/W Revision	Prior to A.02.00

3D Monochrome

Selects a format that is like 3D color but shades of gray are used instead of colors.

Key Path	Save, Screen Image, Themes
Example	MMEM:STOR:SCR:THEM TDM
Readback	3D Mono
Initial S/W Revision	Prior to A.02.00

Flat Color

Selects a format that is best when the screen is to be printed on an ink printer.

Key Path	Save, Screen Image, Themes
Example	MMEM:STOR:SCR:THEM FCOL
Readback	Flat Color
Initial S/W Revision	Prior to A.02.00

Flat Monochrome

Selects a format that is like Flat Color. But only black is used (no colors, not even gray), and no fill.

Key Path	Save, Screen Image, Themes
Example	MMEM:STOR:SCR:THEM FMON
Readback	Flat Mono
Initial S/W Revision	Prior to A.02.00

Quad View

The Quad View displays each of the four fundamental windows of the Analog Demod mode. The basic window format is essentially the same for the 3 measurements. The main difference is the demodulation technique performed in the hardware and the specific metrics and units of the displayed results.

In general, there is little window-context sensitivity in the Analog Demod mode, that is, most of the variables have been designed so that they are unique to their window. The three variables that are window dependent are, Ref Value, Scale/Div, and Ref Position. These variables change to reflect the settings of the current window (the current window is always outlined in green).

The Quad View is shown below. For more information on the views, see "[RF Spectrum Window](#)" on page 1070, "[Demod Waveform Window](#)" on page 1070, "[AF Spectrum Window](#)" on page 1071, or "[Metrics Window](#)" on page 1071.

10 Φ M Demod Measurement View/Display (AM/FM/ Φ M)

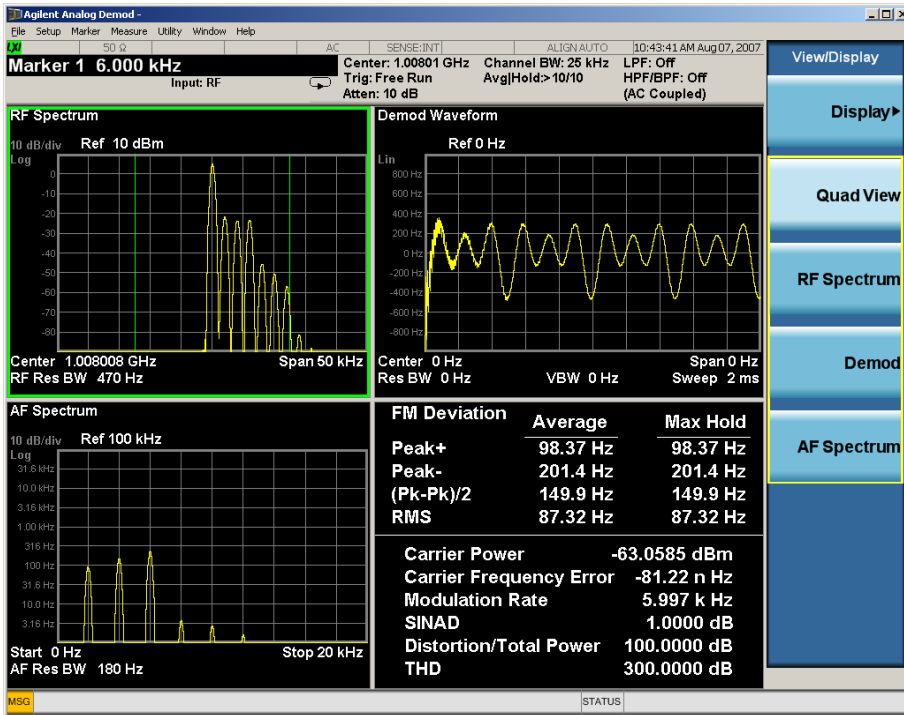

RF Spectrum Window

The RF Spectrum window shows a spectral display of the input RF signal with amplitude in the vertical Y axis and frequency in the horizontal X axis. The vertical axis is always scaled in dB, with units of dBm, with the Ref Value initially at the top of the vertical scale. This spectral display is basically identical to the frequency display of the Swept SA measurement; however it is always taken using an FFT. The span is restricted to 8 MHz and zero span is not allowed.

The RF Spectrum window provides a convenient way to identify broadcast stations by placing the signal of interest at the center frequency using this window and listening to the instrument's speaker. Demodulation is always performed at the center frequency of the RF Spectrum window; this is regarded as the application's center frequency and is annotated in the Measurement Bar.

In the RF Spectrum window, two green vertical lines are shown centered around the center frequency, with spacing equal to the Channel BW. If the Channel BW is wider than the span, they are not seen.

The Center Frequency, Span, and RF Res BW are annotated at the bottom of the RF Spectrum Window. The Ref Value and Scale/Div are annotated above the graticule.

Demod Waveform Window

In the Demod Waveform window, the demodulated signal is displayed in the time domain (zero span) with time on the horizontal X axis, and modulation depth (AM) or deviation (FM, Φ M) on the vertical Y axis.

In the Demod Waveform window the Y axis is linearly scaled in units of percent modulation for AM, frequency (Hz) for FM, or phase (radians) for Φ M. On a preset, the Ref Value is positioned in the center of the vertical scale.

Four traces are available in the Demod Waveform window. The Demod trace, in yellow, shows the current demodulation signal. The Demod Max trace, in cyan, shows the Max Hold value for each display point

bucket since the last restart and the Demod Min trace, in magenta, shows the Min Hold value for each display point bucket since the last restart. The Demod Average trace, in green, shows the averaged demodulation signal. If Averaging is turned off, only the Demod trace is displayed.

The Sweep Time is annotated at the bottom of the Demod Waveform Window. The Ref Value and Scale/Div are annotated above the graticule.

AF Spectrum Window

In the AF Spectrum window, the demodulated signal is displayed in the frequency domain with frequency on the X axis and amplitude on the Y axis.

The vertical axis is always scaled in dB with the Ref Value initially at the top of the vertical scale. The Y-Axis Unit is % for AM, Hz for FM, and radians for Φ M.

In this view you can observe the spectral components of the modulating signal. The preset Start Frequency of this window is 0 Hz. The AF Start Freq and AF Stop Freq are annotated at the bottom of the AF Spectrum Window, as is the AF Res BW.

The Ref Value and Scale/Div are annotated above the graticule.

It is only possible to show a spectrum to a maximum frequency of Channel BW / 2. For trace display points beyond that frequency, the value 1.0E-50 is plotted and returned in queries.

Metrics Window

The metrics window displays measurement results.

If averaging is turned on, the column marked “Current” is relabeled “Average” and the results in that column are averaged over successive measurements until the Average/Hold number is reached. Then, if not in Single measurement mode, the measurement continues, exponentially averaging in successive results. The Max Hold column shows the Maximum value the un-averaged metric has attained since the last Restart. The Max Hold column is removed when averaging is turned off.

The window title is “FM Deviation” in FM, “AM Mod Depth” in AM, and “ Φ M Radians” in Φ M.

Key Path	View/Display
Initial S/W Revision	Prior to A.02.00

RF Spectrum & Metrics View

This view shows the RF Spectrum window and the Metrics window displayed in a split screen mode with the RF Spectrum window taking up approximately $\frac{3}{4}$ of the display.

10 Φ M Demod Measurement
View/Display (AM/FM/ Φ M)

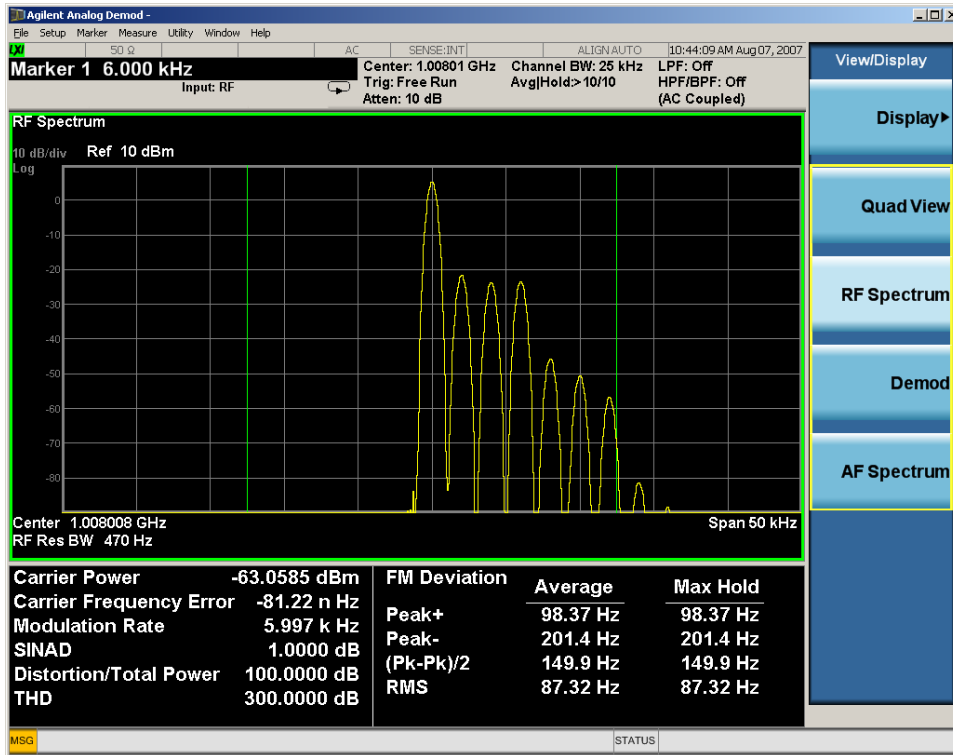

Key Path View/Display

Initial S/W Revision Prior to A.02.00

Demod Waveform & Metrics View

This view shows the Demod Waveform window and the Metrics windows displayed in a split screen mode with the Demod Waveform window taking up approximately ¾ of the display.

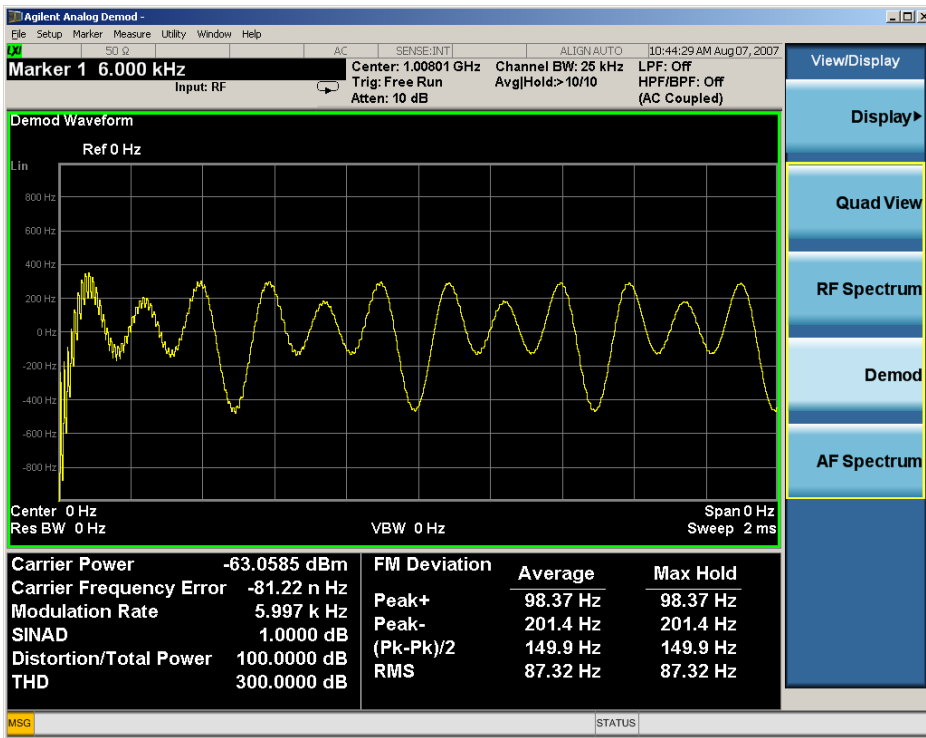

Key Path	View/Display
Initial S/W Revision	Prior to A.02.00

AF Spectrum & Metrics View

This view shows the AF Spectrum window and the Metrics windows displayed in a split screen mode with the AF Spectrum window taking up approximately $\frac{3}{4}$ of the display.

10 Φ M Demod Measurement
View/Display (AM/FM/ Φ M)

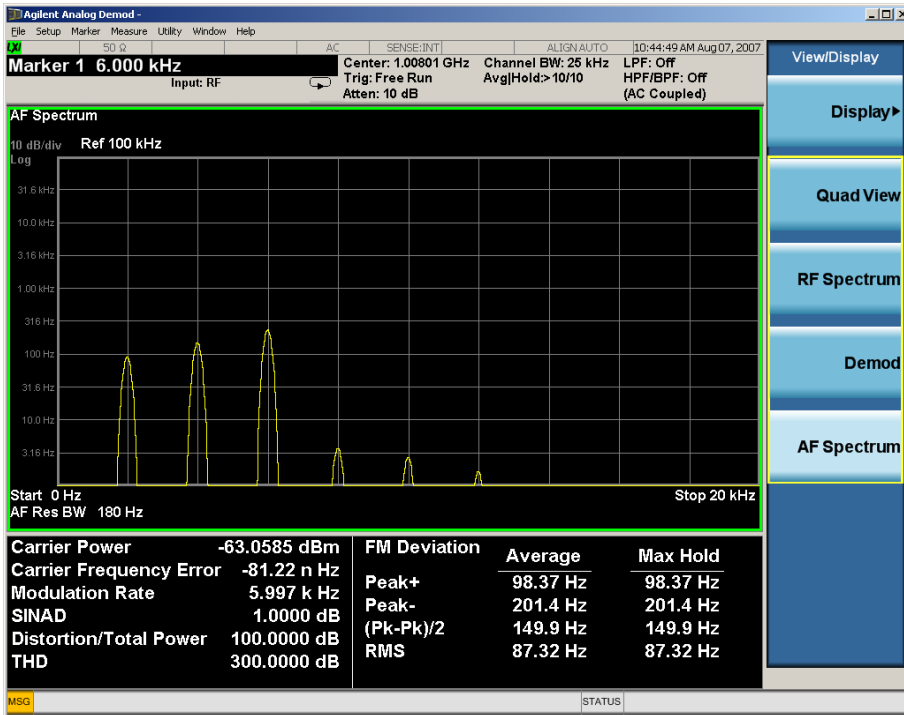

Key Path	View/Display
Initial S/W Revision	Prior to A.02.00

Metrics Settings

Accesses a menu used to control which metrics will be provided. This includes a 1-of-N menu which allows you to control which modulation magnitude metrics are displayed, as well as On/Off controls for Modulation Rate and SINAD/Distortion/THD. If speed is an issue, select only the metric(s) that is(are) required. If modulation magnitude is set to Peak+ Only, Pk-Pk/2 Only, or RMS Only, the other modulation magnitude metrics are loaded with not a number and show “---” in the metrics window.

Key Path	View/Display, Metrics Settings
Remote Command	:DISPlay:AM FM PM:VIEW:METRics:MMAGnitude ALL PPK PNPk RMS RMSRatio :DISPlay:AM FM PM:VIEW:METRics:MMAGnitude?
Example	DISP:AM:VIEW:METR:MMAG PPK Sets AM modulation magnitude to peak +. DISP:FM:VIEW:METR:MMAG RMSR Sets ratio reference and sets FM modulation magnitude to ratio display
Preset	ALL
State Saved	Saved in State
Initial S/W Revision	Prior to A.02.00
Modified at S/W Revision	A.05.00

Normal

Turns on all absolute modulation magnitude metrics. In the metrics window, Peak +, Peak -, Pk-Pk/2 and RMS results are provided.

Key Path	View/Display, Metrics Settings, Mod Magnitude
Example	:DISP:FMST:VIEW:METR:MMAG ALL
Notes	This key was labeled "All" in earlier releases
Initial S/W Revision	A.10.00

Peak+ Only

Turns on just the Peak+ metric in the portion of the metrics window that shows the modulation magnitude results.

Key Path	View/Display, Metrics Settings, Mod Magnitude
Example	:DISP:FMST:VIEW:METR:MMAG PPK
Initial S/W Revision	A.10.00

Pk-Pk/2 Only

Turns on just the Pk-Pk/2 metric in the portion of the metrics window that shows the modulation magnitude results. .

Key Path	View/Display, Metrics Settings, Mod Magnitude
Example	:DISP:FMST:VIEW:METR:MMAG PNPk
Initial S/W Revision	A.10.00

RMS Only

Turns on just the RMS metric in the portion of the metrics window that shows the modulation magnitude results.

Key Path	View/Display, Metrics Settings, Mod Magnitude
Example	:DISP:FMST:VIEW:METR:MMAG RMS
Initial S/W Revision	A.10.00

RMS Ratio

Turns on the display of RMS Ratio. In this mode, the only magnitude metrics that are displayed are the RMS metrics, but besides the display of RMS, the ratio (in dB) of the RMS modulation to its reference is

displayed, as well as the value of the reference, as shown in the display below:

FM Deviation		
	Average	Max Hold
RMS	12.69 kHz	14.19 kHz
RMS Ratio	1.89 dB	2.86 dB
Ratio Ref	10.20 kHz	
<hr/>		
Carrier Power	-100.331 dBm	
Carrier Frequency Error	180.5 Hz	

Pressing the RMS Ratio key (or sending :DISP:FMST:VIEW:METR:MMAG RMSR) establishes the reference. Pressing it again (or sending the SCPI command again) establishes a new reference. Whenever this happens, the current value of RMS modulation from the left hand column (Current or Average) is taken as the new reference.

If, when the ratio is to be established, there is not a valid value being displayed to use as a reference, an error is generated, the RMS Ratio and Ratio Ref values display --- and queries of either return not a number (9.91 e37).

To turn off the ratio display, select one of the other Mod magnitude views.

Note that each measurement (AM, FM, PM, PM and FM Stereo) has its own reference; and the reference is remembered when you leave the measurement and return.

The ratio references are saved in State, and when the recalled state of Metrics Settings is RMS Ratio, the saved reference for the current measurement should be recalled and used, rather than establishing a new one.

Key Path	View/Display, Metrics Settings, Mod Magnitude
Example	:DISP:FMST:VIEW:METR:MMAG RMSR
Initial S/W Revision	A.10.00

Modulation Rate

Toggles the Modulation Rate metric on and off. When turned on, the Modulation Rate metric is provided. When turned off, the Modulation Rate metric is set to not a number and shows “---“ in the metric window.

Key Path	View/Display, Metrics Settings
Remote Command	DISPlay:FMSTereo:VIEW:METRics:MRATe[:STATe] ON OFF 1 0 DISPlay:FMSTereo:VIEW:METRics:MRATe[:STATe]?
Example	DISP:FMST:VIEW:METR:MRAT OFF Sets FM Stereo modulation rate to off
Preset	On
State Saved	Saved in instrument state
Initial S/W Revision	A.10.00

SINAD, THD, Distortion

Toggles the distortion metrics – SINAD, Distortion and THD. When turned off, SINAD, Distortion and THD metrics are set to not a number and show “---” in the metric window.

SINAD is the ratio of total received power (the received signal-plus-noise-plus-distortion power) to the received noise-plus-distortion power. It is always expressed in decibel units. The rejection of the carrier from the noise-plus-distortion power measurement is usually not much more than 50 dB, thus limiting the maximum SINAD.

THD is the ratio of the root mean square voltage of the harmonics referenced to the fundamental voltage, expressed in % or dB. Note the differences with respect to Distortion. The denominator of the ratio is different and the items in the numerator do not include the noise between harmonics, just the harmonics themselves.

Distortion/Total Voltage (rms) is the ratio of unwanted received power (noise plus distortion) to the total received power, expressed in % or dB. Therefore, this metric is the negative of SINAD when expressed in decibels.

Key Path	View/Display, Metrics Settings
Remote Command	DISPlay:FMSTereo:VIEW:METRics:DISToRtion[:STATe] ON OFF 1 0 DISPlay:FMSTereo:VIEW:METRics:DISToRtion [:STATe]?
Example	DISP:FMST:VIEW:METRics:DIST OFF Sets FM Stereo modulation rate to off
Preset	On
State Saved	Saved in instrument state
Initial S/W Revision	A.10.00

Distortion & THD Unit

Changes the units of distortion and THD in the Metrics screen between % and dB units.

Key Path	View/Display
Remote Command	DISPlay:AM FM PM:VIEW:DISToRtion:UNIT DB PCT DISPlay:AM FM PM:VIEW:DISToRtion:UNIT?
Example	DISP:AM:VIEW:DIS:UNIT PCT Sets AM distortion and THD display to percent.
Preset	PCT
State Saved	Saved in State
Initial S/W Revision	Prior to A.02.00

11 FM Stereo Measurement

For the FM Stereo Demod measurement, the analyzer will display the metrics results, such as FM deviation, modulation rate, carrier frequency error, SINAD, total harmonic distortion and carrier power. The analyzer can also display trace data of the RF spectrum, the AF spectrum, the demod waveform, or the L/R channel waveform/spectrum.

If the Demod Min trace, Demod Max trace or Demod Average trace is queried using a Meas, Read or Fetch command when the Average/Hold feature is turned off, the resulting data will be default values.

If any of the metrics are off, a SCPI query will return not a number and show “---“ in the metrics window. The metrics that can be turned off are: Modulation Rate, SINAD, Distortion, THD and all but one of the Deviations.

For more measurement related commands, see the SENSE subsystem, and the ["Remote Measurement Functions" on page 1121](#).

This topic contains the following sections:

["Measurement Commands for FM Stereo Demod" on page 1080](#)

["Remote Command Results for FM Stereo Demod" on page 1081](#)

Measurement Commands for FM Stereo Demod

Parameter Name	FM Stereo Meas/Read/Fetch Query Results
SCPI Command	:MEASure READ FETCh:FMSTereo[1] 0 2 3 4 5?
SCPI Example	MEAS:FMST? FETCh:FMST0? READ:FMST5?
Setup	[COMPARE OFF]
Post Setup	[COMPARE ON]

Remote Command Results for FM Stereo Demod

Command	n	Return Value
INITiate:FMSTereo	n/a	n/a
CONFigure?	n/a	name of current measurement: "FMST"
CONFigure:FMSTereo	n/a	n/a (selects FM Stereo measurement in Meas Preset state)
CONFigure:FMSTereo:NDEFault	n/a	n/a (selects FM Stereo measurement without affecting settings)
FETCh:FMSTereo[n]?	0	This query returns the RF Spectrum trace data as a list of x,y pairs. The x-axis values are in units of Hz. The y-value units depend on the current view
MEASure:FMSTereo[n]?		
READ:FMSTereo[n]?	not specified or n=1	Returns the following comma-separated results: 1. The RF Spectrum window's center frequency 2. RF Carrier Power 3. RF Carrier Frequency Error 4. 38 kHz Carrier Frequency Error 5. 38 kHz Carrier Phase Error 6. Left To Right 7. Mono To Stereo 8. MPX SINAD value 9. MPX Distortion/Total Vrms (% - not ratio - or dB) 10. MPX Deviation (Peak+) 11. MPX Deviation (Peak-) 12. MPX Deviation (Pk-Pk)/2 13. MPX Deviation (RMS) 14. MPX Deviation (Peak+) Max Hold 15. MPX Deviation (Peak-) Max Hold 16. MPX Deviation (Pk-Pk)/2 Max Hold 17. MPX Deviation (RMS) Max Hold 18. Mono Modulation Frequency 19. Mono SINAD value 20. Mono Distortion/Total Vrms (% - not ratio - or dB) 21. Mono Deviation (Peak+) 22. Mono Deviation (Peak-) 23. Mono Deviation (Pk-Pk)/2 24. Mono Deviation (RMS) 25. Mono Deviation (Peak+) Max Hold 26. Mono Deviation (Peak-) Max Hold 27. Mono Deviation (Pk-Pk)/2 Max Hold 28. Mono Deviation (RMS) Max Hold 29. Stereo Modulation Frequency

Command	n	Return Value
		30. Stereo Deviation (Peak+)
		31. Stereo Deviation (Peak-)
		32. Stereo Deviation (Pk-Pk)/2
		33. Stereo Deviation (RMS)
		34. Stereo Deviation (Peak+) Max Hold
		35. Stereo Deviation (Peak-) Max Hold
		36. Stereo Deviation (Pk-Pk)/2 Max Hold
		37. Stereo Deviation (RMS) Max Hold
		38. Left Modulation Frequency
		39. Left SINAD value
		40. Left Distortion/Total Vrms (% - not ratio - or dB)
		41. Left Total Harmonic Distortion(% - not ratio - or dB)
		42. Left Deviation (Peak+)
		43. Left Deviation (Peak-)
		44. Left Deviation (Pk-Pk)/2
		45. Left Deviation (RMS)
		46. Left Deviation (Peak+) Max Hold
		47. Left Deviation (Peak-) Max Hold
		48. Left Deviation (Pk-Pk)/2 Max Hold
		49. Left Deviation (RMS) Max Hold
		50. Right Modulation Frequency
		51. Right SINAD value
		52. Right Distortion/Total Vrms (% - not ratio - or dB)
		53. Right Total Harmonic Distortion(% - not ratio - or dB)
		54. Right Deviation (Peak+)
		55. Right Deviation (Peak-)
		56. Right Deviation (Pk-Pk)/2
		57. Right Deviation (RMS)
		58. Right Deviation (Peak+) Max Hold
		59. Right Deviation (Peak-) Max Hold
		60. Right Deviation (Pk-Pk)/2 Max Hold
		61. Right Deviation (RMS) Max Hold
		62. Pilot Modulation Frequency
		63. Pilot Deviation (Peak+)
		64. Pilot Deviation (Peak-)
		65. Pilot Deviation (Pk-Pk)/2
		66. Pilot Deviation (RMS)
		67. Pilot Deviation (Peak+) Max Hold
		68. Pilot Deviation (Peak-) Max Hold
		69. Pilot Deviation (Pk-Pk)/2 Max Hold

Command	n	Return Value
		70. Pilot Deviation (RMS) Max Hold
		71. RDS Deviation (Peak+)
		72. RDS Deviation (Peak-)
		73. RDS Deviation (Pk-Pk)/2
		74. RDS Deviation (RMS)
		75. RDS Deviation (Peak+) Max Hold
		76. RDS Deviation (Peak-) Max Hold
		77. RDS Deviation (Pk-Pk)/2 Max Hold
		78. RDS Deviation (RMS) Max Hold
		79. RDS Error Block Count
		80. RDS Total Block Count
		81. RDS BLER (Block Error Rate)
	2	This query returns the MPX Demod Min Trace data as a list of x,y pairs. The x-axis values are in units of seconds. The y-value units depend on the current view If Aver/Hold is off, all y-values are 1 GHz.
	3	This query returns the MPX Demod Max Trace data as a list of x,y pairs. The x-axis values are in units of seconds. The y-value units depend on the current view If Aver/Hold is off, all y-values are -1 GHz.
	4	This query returns the MPX Demod Trace data as a list of x,y pairs. The x-axis values are in units of seconds. The y-value units depend on the current view
	5	This query returns the MPX Demod Average Trace data as a list of x,y pairs. The x-axis values are in units of seconds. The y-value units depend on the current view If Aver/Hold is off, all y-values are -1 GHz.
	6	This query returns the MPX AF Spectrum Trace data as a list of x,y pairs. The x-axis values are in units of Hz. The y-value units depend on the current view
	7	This query returns the Mono Demod Min Trace data as a list of x,y pairs. The x-axis values are in units of seconds. The y-value units depend on the current view If Aver/Hold is off, all y-values are 1 GHz.
	8	This query returns the Mono Demod Max Trace data as a list of x,y pairs. The x-axis values are in units of seconds. The y-value units depend on the current view If Aver/Hold is off, all y-values are -1 GHz.
	9	This query returns the Mono Demod Trace data as a list of x,y pairs. The x-axis values are in units of seconds. The y-value units depend on the current view
	10	This query returns the Mono Demod Average Trace data as a list of x,y

Command	n	Return Value
		pairs. The x-axis values are in units of seconds. The y-value units depend on the current view If Aver/Hold is off, all y-values are -1 GHz.
	11	This query returns the Mono AF Spectrum Trace data as a list of x,y pairs. The x-axis values are in units of Hz. The y-value units depend on the current view
	12	This query returns the Stereo Demod Min Trace data as a list of x,y pairs. The x-axis values are in units of seconds. The y-value units depend on the current view If Aver/Hold is off, all y-values are 1 GHz.
	13	This query returns the Stereo Demod Max Trace data as a list of x,y pairs. The x-axis values are in units of seconds. The y-value units depend on the current view If Aver/Hold is off, all y-values are -1 GHz.
	14	This query returns the Stereo Demod Trace data as a list of x,y pairs. The x-axis values are in units of seconds. The y-value units depend on the current view
	15	This query returns the Stereo Demod Average Trace data as a list of x,y pairs. The x-axis values are in units of seconds. The y-value units depend on the current view If Aver/Hold is off, all y-values are -1 GHz.
	16	This query returns the Stereo AF Spectrum Trace data as a list of x,y pairs. The x-axis values are in units of Hz. The y-value units depend on the current view
	17	This query returns the Left Demod Min Trace data as a list of x,y pairs. The x-axis values are in units of seconds. The y-value units depend on the current view If Aver/Hold is off, all y-values are 1 GHz.
	18	This query returns the Left Demod Max Trace data as a list of x,y pairs. The x-axis values are in units of seconds. The y-value units depend on the current view If Aver/Hold is off, all y-values are -1 GHz.
	19	This query returns the Left Demod Trace data as a list of x,y pairs. The x-axis values are in units of seconds. The y-value units depend on the current view
	20	This query returns the Left Demod Average Trace data as a list of x,y pairs. The x-axis values are in units of seconds. The y-value units depend on the current view If Aver/Hold is off, all y-values are -1 GHz.
	21	This query returns the Left AF Spectrum Trace data as a list of x,y pairs. The x-axis values are in units of Hz. The y-value units depend on the current view
	22	This query returns the Right Demod Min Trace data as a list of x,y

Command	n	Return Value
		pairs. The x-axis values are in units of seconds. The y-value units depend on the current view If Aver/Hold is off, all y-values are 1 GHz.
	23	This query returns the Right Demod Max Trace data as a list of x,y pairs. The x-axis values are in units of seconds. The y-value units depend on the current view If Aver/Hold is off, all y-values are -1 GHz.
	24	This query returns the Right Demod Trace data as a list of x,y pairs. The x-axis values are in units of seconds. The y-value units depend on the current view
	25	This query returns the Right Demod Average Trace data as a list of x,y pairs. The x-axis values are in units of seconds. The y-value units depend on the current view If Aver/Hold is off, all y-values are -1 GHz.
	26	This query returns the Right AF Spectrum Trace data as a list of x,y pairs. The x-axis values are in units of Hz. The y-value units depend on the current view
	27	Returns the following comma-separated results: <ol style="list-style-type: none"> 1. MPX Deviation (RMS) 2. MPX Deviation (RMS) Ratio 3. MPX Ratio Referenced 4. Mono Deviation (RMS) 5. Mono Deviation (RMS) Ratio 6. Mono Ratio Referenced 7. Stereo Deviation (RMS) 8. Stereo Deviation (RMS) Ratio 9. Stereo Ratio Referenced 10. Left Deviation (RMS) 11. Left Deviation (RMS) Ratio 12. Left Ratio Referenced 13. Right Deviation (RMS) 14. Right Deviation (RMS) Ratio 15. Right Ratio Referenced 16. Pilot Deviation (RMS) 17. Pilot Deviation (RMS) Ratio 18. Pilot Ratio Referenced 19. RDS Deviation (RMS) 20. RDS Deviation (RMS) Ratio 21. RDS Ratio Referenced

11 FM Stereo Measurement

Key Path	Meas
Initial S/W Revision	A.10.00

AMPTD Y Scale

Accesses a menu that enables you to set the reference level, attenuation, scale per division, reference position, and internal pre-amplifier parameters for your measurement.

Key Path	Front-panel key
Initial S/W Revision	Prior to A.02.00

Ref Value (FM Stereo)

The reference value specifies the amplitude of a signal displayed on the reference graticule line. The reference line is at the top, center, or bottom of the graticule, depending on the value of the Ref Position function.

Changing the reference value does not restart a measurement, but changes all displayed traces and markers to the new value. If a change to the reference value changes an auto-coupled attenuation value, the measurement restarts.

The Ref Value key applies only to the window with the focus. If the focus is on the Metrics window, the Ref Value key is unavailable.

Key Path	AMPTD Y Scale
Remote Command	:DISPlay:FMSTereo:WINDow[1] 2 3:TRACe:Y[:SCALE]:RLEVel <real> :DISPlay:FMSTereo:WINDow[1] 2 3:TRACe:Y[:SCALE]:RLEVel?
Example	DISP:FMST:WIND:TRAC:Y:RLEV 20 dBm Sets the reference value in window 1 to 20 dBm.
Remote Command Notes	Regardless of the View, the windows are numbered as follows: 1. RF Spectrum 2. Demod Waveform 3. AF Spectrum 4. Metrics
Couplings	The value is constrained within the MAX and MIN values, but is otherwise generally not adjusted.
Preset	Demod Waveform 0 Hz AF Spectrum 100 kHz
State Saved	Saved in instrument state
Min	RF Spectrum -170 dBm - Ext Gain Demod Waveform -10 GHz AF Spectrum 1 Hz
Max	RF Spectrum 30 dBm Demod Waveform 10 GHz AF Spectrum 1 GHz

Default Unit	depends on the current view
Initial S/W Revision	Prior to A.02.00
Modified at S/W Revision	A.14.00

Scale / Div (FM Stereo)

Sets the units per vertical graticule division on the display.

The Scale/Div key applies only to the window with the focus. If the focus is on the Metrics window, the Scale/Div key is unavailable.

Key Path	AMPTD Y Scale
Remote Command	:DISPlay:FMSTereo:WINDow[1] 2 3:TRACe:Y[:SCALe]:PDIVision <real> :DISPlay:FMSTereo:WINDow[1] 2 3:TRACe:Y[:SCALe]:PDIVision?
Example	DISP:FMST:WIND:TRAC:Y:PDIV 5 DB
Remote Command Notes	Regardless of the View, the windows are numbered as follows: 1. RF Spectrum 2. Demod Waveform 3. AF Spectrum 4. Metrics
Preset	RF Spectrum 10 dB Demod Waveform 15 kHz AF Spectrum 10 dB
State Saved	Saved in State
Min	RF Spectrum 0.1 dB Demod Waveform 1 Hz AF Spectrum 0.1 dB
Max	RF Spectrum 20 dB Demod Waveform 1 GHz AF Spectrum 20 dB
Initial S/W Revision	Prior to A.02.00
Modified at S/W Revision	A.14.00

Ref Position

Positions the reference value at the top, center, or bottom of the Y Scale display. Changing the reference position does not change the reference value.

The Ref Position key applies only to the window with the focus. If the focus is on the Metrics window, the Ref Position key is unavailable.

Key Path	AMPTD Y Scale
Remote Command	<p>AM/PM/FM Stereo:</p> <pre>:DISPlay:AM PM FMSTereo:WINDow[1] 2 3:TRACe:Y[:SCALe]:RPOSition TOP CENTer BOTTom :DISPlay:AM PM FMSTereo:WINDow[1] 2 3:TRACe:Y[:SCALe]:RPOSition?</pre> <p>FM:</p> <pre>:DISPlay:FM:WINDow[1] 2 ... 5:TRACe:Y[:SCALe]:RPOSition TOP CENTer BOTTom :DISPlay:FM:WINDow[1] 2 ... 5:TRACe:Y[:SCALe]:RPOSition?</pre>
Example	DISP:AM:WIND:TRAC:Y:RPOS BOTT
Remote Command Notes	<p>AM/PM/FM Stereo:</p> <p>Regardless of the View, the windows are numbered as follows:</p> <ol style="list-style-type: none"> 1. RF Spectrum 2. Demod Waveform 3. AF Spectrum 4. Metrics <p>FM:</p> <p>Regardless of the View, the windows are numbered as follows:</p> <ol style="list-style-type: none"> 1. RF Spectrum 2. Demod Waveform 3. AF Spectrum 4. RF Envelope (Attack/Release Time view) 5. FM Demod Waveform (Attack/Release Time view) 6. Metrics
Preset	<p>RF Spectrum window: Top</p> <p>Demod Waveform window: Center</p> <p>AF Spectrum window: Top</p>
State Saved	Saved in instrument state
Initial S/W Revision	Prior to A.02.00
Modified at S/W Revision	A.14.00

Auto Couple

The Auto Couple feature provides a quick and convenient way to automatically couple multiple instrument settings. This helps ensure accurate measurements and optimum dynamic range. When the Auto Couple feature is activated, either from the front panel or remotely, all parameters of the current measurement which have an Auto/Manual mode are set to Auto mode and all measurement settings dependent on (or coupled to) the Auto/Man parameters are automatically adjusted for optimal performance.

For Analog Demod, these parameters are:

- RF Res BW
- AF Res BW
- CF Step

Key Path	Front-panel key
Initial S/W Revision	Prior to A.02.00

BW

Opens a menu of keys that enable you to control the bandwidth functions of the application.

Key Path	Front-panel key
Initial S/W Revision	Prior to A.02.00

RF Res BW

Activates the RF Res BW function, which enables you to manually set the resolution bandwidth used in the RF Spectrum window.

Normally, the RF Res BW (Auto) key selects automatic coupling of the resolution bandwidth. To decouple the resolution bandwidth, press the RF Res BW key until Man is underlined, or enter a different value for the resolution bandwidth.

When the resolution bandwidth is manually selected, it may be returned to the coupled state by pressing the RF Res BW key until Auto is underlined. This may also be done by pressing the Auto Couple key or by performing a preset.

Only the Gaussian filter type is used.

Key Path	BW
Remote Command	<pre>[:SENSe] :AM FM PM FMSTereo:BANDwidth[:RESolution] <freq> [:SENSe] :AM FM PM FMSTereo:BANDwidth[:RESolution]? [:SENSe] :AM FM PM:BANDwidth[:RESolution]:AUTO OFF ON 0 1 [:SENSe] :AM FM PM:BANDwidth[:RESolution]:AUTO?</pre>
Example	<pre>AM:BAND 1 KHZ AM:BAND? AM:BAND:AUTO ON AM:BAND:AUTO?</pre>
Notes	Only certain discrete resolution bandwidths are available. For numeric entries, all RBW Types choose the nearest (arithmetically, on a linear scale, rounding up) available RBW to the value entered.
Couplings	<p>AM/FM/PM: In Auto, the 3 dB RBW of the desired filter is the closest possible choice to that given by Span divided by 106 (the Span: 3 dB RBW parameter), except that the range for auto-coupling is restricted to not exceed 3 MHz.</p> <p>FMST: In Auto, RBW is coupled to Span in the following ways: $RBW = Span / 500$ (Span > 500 kHz) $RBW = 1 \text{ kHz}$ (100kHz <= Span <= 500 kHz) $RBW = Span / 100$ (Span < 100 kHz)</p>
Preset	<p>AM/FM/PM: Preset is Auto, which results in a 680 Hz value since the preset span is 75 kHz and the Span/RBW ratio is 106</p> <p>FMST: Preset is Auto, which results in a 1 kHz value since the preset span is 500 kHz</p>
State Saved	Saved in Instrument state

Min	1 Hz
Max	8 MHz
Default Unit	Hz
Initial S/W Revision	Prior to A.02.00
Modified at S/W Revision	A.10.00

Channel BW

The Channel BW variable is used to determine the bandwidth used for the demodulation. The flat top filter type must be used for demodulation.

This parameter also controls the RBW hardware setting for the demodulation fed to the speaker.

Key Path	BW
Remote Command	<code>[:SENSe] :AM FM PM FMSTereo:BANDwidth:CHANnel <freq></code> <code>[:SENSe] :AM FM PM FMSTereo:BANDwidth:CHANnel?</code>
Example	AM:BAND:CHAN 200 kHz
Notes	If the Channel BW is greater than 8 MHz, gives a warning message "Settings Alert; Analog Output Undefined".
Dependencies	The maximum value will be the maximum IF BW available in the instrument. For example, if the instrument has the options B25, B40, and B1X installed, the maximum available IF BW of the instrument is 140 MHz. Thus, the maximum Channel BW is not limited to 25 MHz but is 140 MHz.
Preset	= AM/FM/PM = 25 kHz = FMST = 400 kHz
State Saved	Saved in instrument state
Min	390 Hz
Max	When Option N9063A-AFP is installed, it depends on hardware: No Option = 10 MHz Option B25 = 25 MHz Option B40 = 40 MHz Option B85 = 85.0 MHz Option B1A = 125.0 MHz Option B1X = 140 MHz Option B1Y = 160 MHz
Default Unit	Hz
Initial S/W Revision	Prior to A.02.00
Modified at S/W Revision	A.10.00

AF Res BW

In the AF Spectrum window, the AF Res BW key is used to set the Resolution bandwidth of the FFT of the demodulated waveform.

The data acquisition uses the Channel BW value for hardware control during data acquisition, just as it does in the Demod Waveform window.

AF Res BW (Auto) selects automatic coupling of the AF Res BW to the AF Span (defined as AF Stop Freq – AF Start Freq) using the same factor of 106 used by the RF Res BW. To decouple the resolution bandwidth, press the AF Res BW key until Man is underlined, or enter a different value for the AF resolution bandwidth.

When the AF resolution bandwidth is manually selected, it may be returned to the coupled state by pressing the AF Res BW key until Auto is underlined. This may also be done by pressing the Auto Couple key or by performing a Preset.

Only the Gaussian filter type is used.

Key Path	BW
Remote Command	<pre>[:SENSe] :AM FM PM FMSTereo:AFSPectrum:BANDwidth <freq> [:SENSe] :AM FM PM FMSTereo:AFSPectrum:BANDwidth? [:SENSe] :AM FM PM FMSTereo:AFSPectrum:BANDwidth:AUTO OFF ON 0 1 [:SENSe] :AM FM PM FMSTereo:AFSPectrum:BANDwidth:AUTO?</pre>
Example	<pre>AM:AFSP:BAND 1 KHZ AM:AFSP:BAND?</pre>
Notes	Only certain discrete resolution bandwidths are available. For numeric entries, all RBW Types choose the nearest (arithmetically, on a linear scale, rounding up) available RBW to the value entered.
Notes	For numeric entries, all RBW Types choose the nearest (arithmetically, on a linear scale, rounding up) available RBW to the value entered.
Remote Command Notes	The setting and querying of values depends on the current bandwidth type.
Couplings	In Auto, the 3 dB RBW of the desired filter is the closest possible choice to that given by Span divided by 106 (the Span: 3 dB RBW parameter), except that the range for auto-coupling is restricted to not exceed 3 MHz.
Preset	Preset is Auto, which results in a 180 Hz value since the preset span is 20 kHz and the Span/RBW ratio is 106
State Saved	Saved in Instrument State
Min	1 Hz
Max	8 MHz
Default Unit	Hz
Initial S/W Revision	Prior to A.02.00
Modified at S/W Revision	A.10.00

Cont (Continuous Measurement/Sweep)

Sets the analyzer for Continuous measurement operation. The single/continuous state is Meas Global so the setting will affect all measurements. If you are Paused, pressing Cont does a Resume.

Key Path	Front-panel key
Remote Command	:INITiate:CONTinuous OFF ON 0 1 :INITiate:CONTinuous?
Example	:INIT:CONT 0 puts analyzer in Single measurement operation. :INIT:CONT 1 puts analyzer in Continuous measurement operation
Preset	ON (Note that SYST:PRESet sets INIT:CONT to ON but *RST sets INIT:CONT to OFF)
State Saved	Saved in instrument state
Backwards Compatibility Notes	For Spectrum Analysis mode in ESA and PSA, there is no Cont hardkey, instead there is a Sweep Single/Cont key. In these analyzers, switching the Sweep Single/Cont key from Single to Cont restarts averages (displayed average count reset to 1), but does not restart Max Hold and Min Hold. The X-Series has Single and Cont keys in place of the SweepSingleCont key. In the X-Series, if in single measurement, the Cont key (and INIT:CONT ON) switches to continuous measurement, but never restarts a measurement and never resets a sweep.
Initial S/W Revision	Prior to A.02.00

In Swept SA Measurement (Spectrum Analysis Mode):

The analyzer takes repetitive sweeps, averages, measurements, etc., when in Continuous mode. When the average count reaches the Average/Hold Number the count stops incrementing, but the analyzer keeps sweeping. See the Trace/Detector section for the averaging formula used both before and after the Average/Hold Number is reached. The trigger condition must be met prior to each sweep. The type of trace processing for multiple sweeps, is set under the Trace/Detector key, with choices of Trace Average, Max Hold, or Min Hold.

In Other Measurements/Modes:

With Avg/Hold Num (in the Meas Setup menu) set to Off or set to On with a value of 1, a sweep is taken after the trigger condition is met; and the analyzer continues to take new sweeps after the current sweep has completed and the trigger condition is again met. However, with Avg/Hold Num set to On with a value >1, multiple sweeps (data acquisitions) are taken for the measurement. The trigger condition must be met prior to each sweep. The sweep is not stopped when the average count k equals the number N set for Avg/Hold Num is reached, but the number k stops incrementing. A measurement average usually applies to all traces, marker results, and numeric results. But sometimes it only applies to the numeric results.

If the analyzer is in Single measurement, pressing the Cont key does not change k and does not cause the sweep to be reset; the only action is to put the analyzer into Continuous measurement operation.

If it is already in continuous sweep:

the INIT:CONT 1 command has no effect

the INIT:CONT 0 command will place the analyzer in Single Sweep but will have no effect on the current sequence until $k = N$, at which point the current sequence will stop and the instrument will go to the idle state.

11 FM Stereo Measurement
File

File

See "File" on page 176

FREQ Channel

Accesses a menu of keys that enable you to control the Frequency parameters of the instrument.

Key Path	Front-panel key
Initial S/W Revision	Prior to A.02.00

Center Frequency

Sets the frequency that corresponds to the horizontal center of the RF Spectrum window. While adjusting the Center Frequency the Span is held constant, this means that both the start frequency and the stop frequency will change.

The Center Frequency is retained as you go from measurement to measurement.

Key Path	FREQ Channel
Remote Command	<code>[:SENSe] :FREQuency:CENTer <freq></code> <code>[:SENSe] :FREQuency:CENTer?</code>
Example	FREQ:CENT 50MHz FREQ:CENT UP changes the center frequency to 150 MHz if you use FREQ:CENT:STEP 100MHz sets the center frequency step size to 100 MHz FREQ:CENT?
Dependencies	The Center Frequency can be limited by Start or Stop Freq limits, In addition, the Center Frequency can be limited if the Span is so large that Start or Stop hit their limit.
Couplings	When operating in “swept span”, any value of the Center Frequency or Span that is within the frequency range of the analyzer is allowed when the value is being set through the front panel numeric key pad or the SCPI command. The other parameter is forced to a different value if needed, to keep the Start and the Stop Frequencies within the analyzer frequency range
Preset	1.000 GHz
State Saved	Saved in instrument state
Min	Depends on instrument minimum frequency and the 10 Hz minimum span. If the knob or step keys are being used, it depends on the value of the other three interdependent parameters.
Max	Depends on the instrument’s maximum frequency and the 10 Hz minimum span. If the knob or step keys are being used, it depends on the value of the other three interdependent parameters.
Default Unit	Hz
Status Bits/OPC dependencies	Non-overlapped
Initial S/W Revision	Prior to A.02.00

CF Step

Changes the step size for the center frequency function. Once a step size has been selected and the center frequency function is active, the step keys (and the UP|DOWN parameters for the Center Frequency from remote commands) change the center frequency by the step-size value. The step size function is useful for finding harmonics and sidebands beyond the current frequency span of the analyzer.

Key Path	FREQ Channel
Remote Command	[:SENSe]:FREQuency:CENTer:STEP[:INCRement] <freq> [:SENSe]:FREQuency:CENTer:STEP[:INCRement]? [:SENSe]:FREQuency:CENTer:STEP:AUTO OFF ON 0 1 [:SENSe]:FREQuency:CENTer:STEP:AUTO?
Example	FREQ:CENT:STEP:AUTO ON FREQ:CENT:STEP 500MHz FREQ:CENT UP increases the current center frequency value by 500 MHz FREQ:CENT:STEP? FREQ:CENT:STEP:AUTO?
Remote Command Notes	Preset and Max values are dependent on Hardware Options (503, 508, 513, 526)
Dependencies	Span, RBW, Center frequency
Couplings	When auto-coupled in a non-zero span, the center frequency step size is set to 10% of the span. When auto-coupled in zero span, the center frequency step size is set to the equivalent -3 dB RBW value.
Preset	Auto
State Saved	Saved in State
Min	- (the maximum frequency of the instrument). For example, a 27 GHz max frequency instrument has a CF step range of +/- 27 GHz.
Max	The maximum frequency of the instrument. For example, 27 GHz max freq instrument has a CF step range of +/- 27 GHz.
Default Unit	Hz
Status Bits/OPC dependencies	Non-overlapped
Initial S/W Revision	Prior to A.02.00

AF Start Freq

Sets the frequency at the left side of the graticule in the AF Spectrum window. While adjusting the AF start frequency the AF stop frequency is held constant.

The AF Start Frequency is retained as you go from measurement to measurement.

Key Path	FREQ Channel
Remote Command	[:SENSe]:AM FM PM FMSTereo:AFSPectrum:FREQuency:START <freq> [:SENSe]:AM FM PM FMSTereo:AFSPectrum:FREQuency:START?

Example	AM:AFSP:FREQ:STAR 0 Hz
Dependencies	You cannot set the Start frequency > the Stop frequency. You cannot set the Start frequency = Stop frequency. You cannot set the Start Frequency to a value that would create a span of less than 10 Hz. If you try to do any of these, Stop Frequency will change to maintain a minimum value of 10 Hz for the difference between Start and Stop.
Preset	0 Hz
State Saved	Saved in instrument state
Min	0 Hz
Max	99.999990 MHz
Default Unit	Hz
Status Bits/OPC dependencies	Non-overlapped
Initial S/W Revision	Prior to A.02.00
Modified at S/W Revision	A.10.00

AF Stop Freq

Sets the frequency at the right side of the graticule in the AF Spectrum window. While adjusting the AF Stop Frequency the AF Start Frequency is held constant.

Key Path	FREQ Channel
Remote Command	[:SENSe] :AM FM PM FMSTereo:AFSPectrum:FREQuency:STOP <freq> [:SENSe] :AM FM PM FMSTereo:AFSPectrum:FREQuency:STOP?
Example	AM:AFSP:FREQ:STOP 20 kHz
Dependencies	You cannot set the Stop frequency < the Start frequency. You cannot set the Start frequency = Stop frequency. You cannot set the Stop Frequency to a value that would create a span of less than 10 Hz. If you try to do any of these, the Start Frequency will change to maintain a minimum value of 10 Hz for the difference between Start and Stop.
Preset	20 kHz
State Saved	Saved in instrument state
Min	10 Hz
Max	100 MHz
Default Unit	Hz
Status Bits/OPC dependencies	Non-overlapped
Initial S/W Revision	Prior to A.02.00
Modified at S/W Revision	A.10.00

11 FM Stereo Measurement
Input/Output

Input/Output

See "[Input/Output](#)" on page 130

Marker

Accesses the Marker menu. A marker can be placed on a trace to allow the value of the trace at the marker point to be determined precisely. The functions in this menu include a 1-of-N selection of the control mode Normal, Delta, Fixed, or Off for the selected marker.

If the selected marker is Off, pressing the Marker key sets it to the selected window. If the metrics window is selected, the marker will appear in the first visible window (RF Spectrum if Quad View is selected).

The units of Delta Marker are window dependent. In the Spectrum windows they are dB, in the Demod Waveform window they are the same as the Y-Axis Unit. In this window, the delta marker is a linear difference rather than a ratio. For example, in FM, in the Demod Waveform window, the units of delta marker are Hz.

Control Mode

Key Path	Front-panel key
Remote Command	:CALCulate:AM FM PM FMSTereo:MARKer[1] 2 ... 12:MODE POSition DELTa FIXed OFF :CALCulate:AM FM PM FMSTereo:MARKer[1] 2 ... 12:MODE?
Example	CALC:AM:MARK:MODE POS turns on marker 1 in Normal mode
Remote Command Notes	This command (not the query) causes the specified marker to become selected.
Preset	OFF (all markers)
Initial S/W Revision	Prior to A.02.00
Modified at S/W Revision	A.10.00

Select Marker

Displays a menu with 12 markers available for selection for the current measurement.

Key Path	Marker
Notes	The selected marker is remembered even when not in the Marker menu and is used if a Search is initiated.
Preset	Marker 1
State Saved	The number of the selected marker is saved in instrument state.
Initial S/W Revision	Prior to A.02.00

Normal

Sets the control mode for the selected marker to Normal and turns on the active function for setting its value. If the selected marker was off, it is placed at the center of the screen on the trace specified by the marker's Trace attribute.

A Normal mode (POSition type) marker can be moved to any point on the X Axis by specifying its X Axis value. Its absolute Y Axis value is then the value of the trace point at that X Axis value.

Key Path	Marker
Example	: CALC: MARK: MODE POS sets Marker 1 to Normal.
Remote Command Notes	See the description under the " Marker " on page 1101 key.
Couplings	The marker addressed by this command becomes the selected marker on the front panel.
State Saved	The marker control mode (Normal, Delta, Fixed, Off) and X Axis value are saved in instrument state.
Initial S/W Revision	Prior to A.02.00

Delta

Sets the control mode for the selected marker to Delta and turns on the active function for setting its delta value. If the selected marker is off, the marker is placed at the center of the screen on the trace specified by the marker's Trace attribute.

In Delta mode the marker result shows the relative result between the selected (Delta) marker and its reference marker. A delta marker can be moved to any point on the X Axis by specifying its X Axis offset from a reference marker. Its absolute Y Axis value is then the value of the trace point at that X Axis value.

Key Path	Marker
Example	:CALC:MARK:MODE DELT sets marker 1 to Delta.
Remote Command Notes	See the description under the " Marker " on page 1101 key.
Couplings	Coupled to fix absolute X when turned On.
State Saved	The marker control mode (Normal, Delta, Fixed, Off) and X Axis value are saved in instrument state.
Initial S/W Revision	Prior to A.02.00

Fixed

Sets the control mode for the selected marker to Fixed. A fixed marker is fixed in the sense that it stays where you place it. It can be directly moved in both X and Y. It can be moved with a Peak Search. It can also be indirectly moved by re-zeroing the delta if it is a relative marker. If it is moved, it again becomes fixed at the X Axis point it moved to and it has a Y-axis result that it took on when it moved there. If a Normal or Delta marker is changed to Fixed it becomes fixed at the X Axis point it was at, and with the Y-axis result it had when it was set to Fixed.

Key Path	Marker
Initial S/W Revision	Prior to A.02.00

Marker X

Sets and queries a marker's X value.

Key Path	Marker, Fixed
----------	---------------

Remote Command	:CALCulate:AM FM PM FMSTereo:MARKer[1] 2 ... 12:X <time> <freq> :CALCulate:AM FM PM FMSTereo:MARKer[1] 2 ... 12:X?
Remote Command Notes	The query is returned in the fundamental units for the current marker X Axis scale. This command (not the query) causes the specified marker to become selected.
Preset	After a preset, all Markers are turned off, so a Marker X Axis Value query will return not a number (9.91 e37). When a Marker is on, the default value of the Marker X value is the center of the appropriate window.
Min	-9.9E+37
Max	9.9E+37
Initial S/W Revision	Prior to A.02.00
Modified at S/W Revision	A.10.00

Marker Y

Sets and queries a marker's Y axis value.

Key Path	Marker, Fixed
Remote Command	:CALCulate:AM FM PM FMSTereo:MARKer[1] 2 ... 12:Y <real> :CALCulate:AM FM PM FMSTereo:MARKer[1] 2 ... 12:Y?
Remote Command Notes	The query is returned in the fundamental units for the current marker Y Axis scale. This command (not the query) causes the specified marker to become selected.
Preset	Defaults to the measurement result at the default X value, or not a number (9.91 e37) if off or if off screen is Fixed.
Min	-9.9E+37
Max	9.9E+37
Initial S/W Revision	Prior to A.02.00
Modified at S/W Revision	A.10.00

Off

Turns off the selected marker. Turning the marker off does not affect which marker is selected.

Key Path	Marker
Example	: CALC: MARK: MODE OFF sets Marker 1 to Off.
Remote Command Notes	See the description under the " Marker " on page 1101 key.
State Saved	The marker control mode (Normal, Delta, Fixed, Off) is saved in instrument state.
Initial S/W Revision	Prior to A.02.00

Properties

Accesses a menu used to assign properties to the selected marker.

Key Path	Marker
Initial S/W Revision	Prior to A.02.00

Select Marker

Displays a menu with 12 markers available for selection for the current measurement.

Key Path	Marker, Properties
Notes	The selected marker is remembered even when not in the Marker menu and is used if a Search is initiated.
Preset	Marker 1
State Saved	The number of the selected marker is saved in instrument state.
Initial S/W Revision	Prior to A.02.00

Relative To

Selects the reference marker for a marker in Delta mode.

If a delta marker has a reference marker in a different window, the delta marker's mode changes to POS (for example, it becomes a normal marker).

Key Path	Marker, Properties
Remote Command	:CALCulate:AM FM PM FMSTereo:MARKer[1] 2 ... 12:REFerence <int> :CALCulate:AM FM PM FMSTereo:MARKer[1] 2 ... 12:REFerence?
Example	CALC:AM:MARK1:REF 2 Sets marker 1's reference marker to 2 and turns marker 1 on as a delta marker.
Remote Command Notes	This command (not the query) causes the specified marker to become selected.
Preset	By default, marker X is relative to marker X + 1 except for marker 12, which is relative to marker 1.
Min	1
Max	12
Initial S/W Revision	Prior to A.02.00
Modified at S/W Revision	A.10.00

FM Stereo Marker Trace

Selects the trace on which to place the marker. A marker is associated with one and only one trace. This trace is used to determine the placement, result, and X Axis Scale of the marker. All markers have an

associated trace, even Fixed markers. It is from that trace that they determine their attributes and behaviors, and it is to that trace that they go when they become Normal or Delta markers.

In the Analog Demod mode FM Stereo Measurement, there are 26 named traces. The RF Spectrum trace is the trace in the RF Spectrum window of MPX view. The Spectrum trace is the trace in the Spectrum window of the five views (MPX/Mono (L+R)/Stereo (L-R)/Left/Right). There are four kinds of traces in the Demod Waveform window of the five views (MPX/Mono (L+R)/Stereo (L-R)/Left/Right): Demod, Demod Avg, Demod Max, and Demod Min.

When Auto Init is on, the marker's trace attribute is re-determined automatically by the analyzer whenever the marker turns on (Normal, Delta, or Fixed) from an off state. The marker goes to the trace in the window that has the focus, or onto the RF spectrum window if the Metrics window has the focus. If in the Demod Waveform window, it goes to the Demod trace.

This command associates the marker with the specified trace. Setting the Marker Trace directly (whether the marker is on or off) will turn off Auto Init.

If the marker is not off, it moves the marker from the trace it was on to the new trace. If the new trace is in the same window, the marker goes to the same data point on the new trace. If the marker changes windows, it retains its relative horizontal positions in the new window. If it is a fixed marker, it will retain both relative horizontal and vertical position.

If the marker is off it stays off, but is now associated with the specified trace.

The query returns the name of the trace on which the marker is currently placed.

Key Path	Marker, Properties
Remote Command	:CALCulate:FMSTereo:MARKer[1] 2 ... 12:TRACe RFSpectrum AFSPpectrum DEMod DAVerage DMAXimum DMINimum MDEMod MDAverage MMAXimum MMINimum MSpectrum SDEMod SDAverage SMAXimum SMINimum SSpectrum LDEMod LDAverage LMAXimum LMINimum LSpectrum RDEMod RDAverage RMAXimum RMINimum RSPpectrum :CALCulate:FMSTereo:MARKer[1] 2 ... 12:TRACe?
Example	:CALC:FMST:MARK1:TRAC DEM places marker 1 on the Demod trace
Couplings	This is not affected by Auto Coupling. Sending the remote command causes the addressed marker to become selected. If ever a delta marker has a reference marker in a different window, the delta marker's mode changes to POS (for example, it becomes a normal marker). When Marker Trace Auto Init State is on, the marker trace will automatically be set whenever the marker is turned on.
Preset	RF Spectrum on a Preset or All Markers Off
State Saved	The Marker Trace for each marker is saved in instrument state.
Readback line	[Trace name, Auto Init] or [Trace Name, Manual]
Initial S/W Revision	A.10.00

FM Stereo Marker Trace

Selects the trace on which to place the marker. A marker is associated with one and only one trace. This trace is used to determine the placement, result, and X Axis Scale of the marker. All markers have an associated trace, even Fixed markers. It is from that trace that they determine their attributes and behaviors, and it is to that trace that they go when they become Normal or Delta markers.

In the Analog Demod mode FM Stereo Measurement, there are 26 named traces. The RF Spectrum trace is the trace in the RF Spectrum window of MPX view. The Spectrum trace is the trace in the Spectrum window of the five views (MPX/Mono (L+R)/Stereo (L-R)/Left/Right). There are four kinds of traces in the Demod Waveform window of the five views (MPX/Mono (L+R)/Stereo (L-R)/Left/Right): Demod, Demod Avg, Demod Max, and Demod Min.

When Auto Init is on, the marker's trace attribute is re-determined automatically by the analyzer whenever the marker turns on (Normal, Delta, or Fixed) from an off state. The marker goes to the trace in the window that has the focus, or onto the RF spectrum window if the Metrics window has the focus. If in the Demod Waveform window, it goes to the Demod trace.

This command associates the marker with the specified trace. Setting the Marker Trace directly (whether the marker is on or off) will turn off Auto Init.

If the marker is not off, it moves the marker from the trace it was on to the new trace. If the new trace is in the same window, the marker goes to the same data point on the new trace. If the marker changes windows, it retains its relative horizontal positions in the new window. If it is a fixed marker, it will retain both relative horizontal and vertical position.

If the marker is off it stays off, but is now associated with the specified trace.

The query returns the name of the trace on which the marker is currently placed.

Key Path	Marker, Properties
Remote Command	:CALCulate:FMSTereo:MARKer[1] 2 ... 12:TRACe RFSpectrum AFSPpectrum DEMod DAVerage DMAXimum DMINimum MDEMod MDAVerage MMAXimum MMINimum MSPpectrum SDEMod SDAVerage SMAXimum SMINimum SSPpectrum LDEMod LDAVerage LMAXimum LMINimum LSPpectrum RDEMod RDAVerage RMAXimum RMINimum RSPpectrum :CALCulate:FMSTereo:MARKer[1] 2 ... 12:TRACe?
Example	:CALC:FMST:MARK1:TRAC DEM places marker 1 on the Demod trace
Couplings	This is not affected by Auto Coupling. Sending the remote command causes the addressed marker to become selected. If ever a delta marker has a reference marker in a different window, the delta marker's mode changes to POS (for example, it becomes a normal marker). When Marker Trace Auto Init State is on, the marker trace will automatically be set whenever the marker is turned on.
Preset	RF Spectrum on a Preset or All Markers Off
State Saved	The Marker Trace for each marker is saved in instrument state.
Readback line	[Trace name, Auto Init] or [Trace Name, Manual]
Initial S/W Revision	A.10.00

RF Spectrum

Selects the input RF signal in the RF Spectrum window as the trace that you want your marker to be placed on. This trace is used to determine the placement, result, and X Axis Scale of the marker.

Key Path	Marker, Properties, Marker Trace, MPX
Example	:CALC:FMST:MARK1:TRAC RFSP
Initial S/W Revision	A.10.00

Demod

Selects the current demodulated signal in the MPX Waveform window, shown in yellow, as the trace that you want your marker to be placed on. This trace is used to determine the placement, result, and X Axis Scale of the marker.

Key Path	Marker, Properties, Marker Trace, MPX
Example	:CALC:FMST:MARK1:TRAC DEM
Initial S/W Revision	A.10.00

Demod Average

Selects the averaged demodulation signal in the MPX Waveform window, shown in green, as the trace that you want your marker to be placed on. This trace is used to determine the placement, result, and X Axis Scale of the marker.

Key Path	Marker, Properties, Marker Trace, MPX
Example	:CALC:FMST:MARK1:TRAC DAV
Initial S/W Revision	A.10.00

Demod Max

Selects the Demod Max trace in the MPX Waveform window, shown in cyan, as the trace that you want your marker to be placed on. This trace shows the maximum hold value for each data point since the last restart.

Key Path	Marker, Properties, Marker Trace, MPX
Example	:CALC:FMST:MARK1:TRAC DMAX
Initial S/W Revision	A.10.00

Demod Min

Selects the Demod Min trace in the MPX Waveform window, shown in magenta, as the trace that you want your marker to be placed on. This trace shows the minimum hold value for each data point since the last

restart.

Key Path	Marker, Properties, Marker Trace, MPX
Example	:CALC:FMST:MARK1:TRAC DMIN
Initial S/W Revision	A.10.00

Spectrum

Selects the spectrum signal in the MPX Spectrum window as the trace that you want your marker to be placed on.

Key Path	Marker, Properties, Marker Trace, MPX
Example	:CALC:FMST:MARK1:TRAC AFSP
Initial S/W Revision	A.10.00

FM Stereo Marker Trace

Selects the trace on which to place the marker. A marker is associated with one and only one trace. This trace is used to determine the placement, result, and X Axis Scale of the marker. All markers have an associated trace, even Fixed markers. It is from that trace that they determine their attributes and behaviors, and it is to that trace that they go when they become Normal or Delta markers.

In the Analog Demod mode FM Stereo Measurement, there are 26 named traces. The RF Spectrum trace is the trace in the RF Spectrum window of MPX view. The Spectrum trace is the trace in the Spectrum window of the five views (MPX/Mono (L+R)/Stereo (L-R)/Left/Right). There are four kinds of traces in the Demod Waveform window of the five views (MPX/Mono (L+R)/Stereo (L-R)/Left/Right): Demod, Demod Avg, Demod Max, and Demod Min.

When Auto Init is on, the marker's trace attribute is re-determined automatically by the analyzer whenever the marker turns on (Normal, Delta, or Fixed) from an off state. The marker goes to the trace in the window that has the focus, or onto the RF spectrum window if the Metrics window has the focus. If in the Demod Waveform window, it goes to the Demod trace.

This command associates the marker with the specified trace. Setting the Marker Trace directly (whether the marker is on or off) will turn off Auto Init.

If the marker is not off, it moves the marker from the trace it was on to the new trace. If the new trace is in the same window, the marker goes to the same data point on the new trace. If the marker changes windows, it retains its relative horizontal positions in the new window. If it is a fixed marker, it will retain both relative horizontal and vertical position.

If the marker is off it stays off, but is now associated with the specified trace.

The query returns the name of the trace on which the marker is currently placed.

Key Path	Marker, Properties
Remote Command	:CALCulate:FMSTereo:MARKer[1] 2 ... 12:TRACe RFSpectrum AFSPpectrum DEMod DAVerage DMAXimum DMINimum MDEMod MDAVerage MMAXimum

| MMINimum | MSpectrum | SDEMod | SDAverage | SMAXimum | SMINimum |
 SSpectrum | LDEMod | LDAverage | LMAXimum | LMINimum | LSpectrum |
 RDEMod | RDAverage | RMAXimum | RMINimum | RSpectrum
 :CALCulate:FMSTereo:MARKer[1]|2|...|12:TRACe?

Example	:CALC:FMST:MARK1:TRAC DEM places marker 1 on the Demod trace
Couplings	This is not affected by Auto Coupling. Sending the remote command causes the addressed marker to become selected. If ever a delta marker has a reference marker in a different window, the delta marker's mode changes to POS (for example, it becomes a normal marker). When Marker Trace Auto Init State is on, the marker trace will automatically be set whenever the marker is turned on.
Preset	RF Spectrum on a Preset or All Markers Off
State Saved	The Marker Trace for each marker is saved in instrument state.
Readback line	[Trace name, Auto Init] or [Trace Name, Manual]
Initial S/W Revision	A.10.00

Demod

Selects the current demodulated signal in the Mono (L+R) Waveform window, shown in yellow, as the trace that you want your marker to be placed on. This trace is used to determine the placement, result, and X Axis Scale of the marker.

Key Path	Marker, Properties, Marker Trace, Mono
Example	:CALC:FMST:MARK1:TRAC MDEM
Initial S/W Revision	A.10.00

Demod Average

Selects the averaged demodulation signal in the Mono (L+R) Waveform window, shown in green, as the trace that you want your marker to be placed on. This trace is used to determine the placement, result, and X Axis Scale of the marker.

Key Path	Marker, Properties, Marker Trace, Mono
Example	:CALC:FMST:MARK1:TRAC MDAV
Initial S/W Revision	A.10.00

Demod Max

Selects the Demod Max trace in the Mono (L+R) Waveform window, shown in cyan, as the trace that you want your marker to be placed on. This trace shows the maximum hold value for each data point since the last restart.

Key Path	Marker, Properties, Marker Trace, Mono
Example	:CALC:FMST:MARK1:TRAC MMAX
Initial S/W Revision	A.10.00

Demod Min

Selects the Demod Min trace in the Mono (L+R) Waveform window, shown in magenta, as the trace that you want your marker to be placed on. This trace shows the minimum hold value for each data point since the last restart.

Key Path	Marker, Properties, Marker Trace, Mono
Example	:CALC:FMST:MARK1:TRAC MMIN
Initial S/W Revision	A.10.00

Spectrum

Selects the spectrum signal in the Mono (L+R) Spectrum window as the trace that you want your marker to be placed on.

Key Path	Marker, Properties, Marker Trace, Mono
Example	:CALC:FMST:MARK1:TRAC MSP
Initial S/W Revision	A.10.00

FM Stereo Marker Trace

Selects the trace on which to place the marker. A marker is associated with one and only one trace. This trace is used to determine the placement, result, and X Axis Scale of the marker. All markers have an associated trace, even Fixed markers. It is from that trace that they determine their attributes and behaviors, and it is to that trace that they go when they become Normal or Delta markers.

In the Analog Demod mode FM Stereo Measurement, there are 26 named traces. The RF Spectrum trace is the trace in the RF Spectrum window of MPX view. The Spectrum trace is the trace in the Spectrum window of the five views (MPX/Mono (L+R)/Stereo (L-R)/Left/Right). There are four kinds of traces in the Demod Waveform window of the five views (MPX/Mono (L+R)/Stereo (L-R)/Left/Right): Demod, Demod Avg, Demod Max, and Demod Min.

When Auto Init is on, the marker's trace attribute is re-determined automatically by the analyzer whenever the marker turns on (Normal, Delta, or Fixed) from an off state. The marker goes to the trace in the window that has the focus, or onto the RF spectrum window if the Metrics window has the focus. If in the Demod Waveform window, it goes to the Demod trace.

This command associates the marker with the specified trace. Setting the Marker Trace directly (whether the marker is on or off) will turn off Auto Init.

If the marker is not off, it moves the marker from the trace it was on to the new trace. If the new trace is in the same window, the marker goes to the same data point on the new trace. If the marker changes windows, it retains its relative horizontal positions in the new window. If it is a fixed marker, it will retain both relative horizontal and vertical position.

If the marker is off it stays off, but is now associated with the specified trace.

The query returns the name of the trace on which the marker is currently placed.

Key Path	Marker, Properties
Remote Command	:CALCulate:FMSTereo:MARKer[1] 2 ... 12:TRACe RFSpectrum AFSpectrum DEMod DAVerage DMAXimum DMINimum MDEMod MDAverage MMAXimum MMINimum MSpectrum SDEMod SDAverage SMAXimum SMINimum SSpectrum LDEMod LDAverage LMAXimum LMINimum LSpectrum RDEMod RDAverage RMAXimum RMINimum RSpectrum :CALCulate:FMSTereo:MARKer[1] 2 ... 12:TRACe?
Example	:CALC:FMST:MARK1:TRAC DEM places marker 1 on the Demod trace
Couplings	This is not affected by Auto Coupling. Sending the remote command causes the addressed marker to become selected. If ever a delta marker has a reference marker in a different window, the delta marker's mode changes to POS (for example, it becomes a normal marker). When Marker Trace Auto Init State is on, the marker trace will automatically be set whenever the marker is turned on.
Preset	RF Spectrum on a Preset or All Markers Off
State Saved	The Marker Trace for each marker is saved in instrument state.
Readback line	[Trace name, Auto Init] or [Trace Name, Manual]
Initial S/W Revision	A.10.00

Demod

Selects the current demodulated signal in the Stereo (L-R) Waveform window, shown in yellow, as the trace that you want your marker to be placed on. This trace is used to determine the placement, result, and X Axis Scale of the marker.

Key Path	Marker, Properties, Marker Trace, Stereo
Example	:CALC:FMST:MARK1:TRAC SDEM
Initial S/W Revision	A.10.00

Demod Average

Selects the averaged demodulation signal in the Stereo (L-R) Waveform window, shown in green, as the trace that you want your marker to be placed on. This trace is used to determine the placement, result, and X Axis Scale of the marker.

Key Path	Marker, Properties, Marker Trace, Stereo
-----------------	---

Example	:CALC:FMST:MARK1:TRAC SDAV
Initial S/W Revision	A.10.00

Demod Max

Selects the Demod Max trace in the Stereo (L-R) Waveform window, shown in cyan, as the trace that you want your marker to be placed on. This trace shows the maximum hold value for each data point since the last restart.

Key Path	Marker, Properties, Marker Trace, Stereo
Example	:CALC:FMST:MARK1:TRAC SMAX
Initial S/W Revision	A.10.00

Demod Min

Selects the Demod Min trace in the Stereo (L-R) Waveform window, shown in magenta, as the trace that you want your marker to be placed on. This trace shows the minimum hold value for each data point since the last restart.

Key Path	Marker, Properties, Marker Trace, Stereo
Example	:CALC:FMST:MARK1:TRAC SMIN
Initial S/W Revision	A.10.00

Spectrum

Selects the spectrum signal in the Stereo (L-R) Spectrum window as the trace that you want your marker to be placed on.

Key Path	Marker, Properties, Marker Trace, Stereo
Example	:CALC:FMST:MARK1:TRAC SSP
Initial S/W Revision	A.10.00

FM Stereo Marker Trace

Selects the trace on which to place the marker. A marker is associated with one and only one trace. This trace is used to determine the placement, result, and X Axis Scale of the marker. All markers have an associated trace, even Fixed markers. It is from that trace that they determine their attributes and behaviors, and it is to that trace that they go when they become Normal or Delta markers.

In the Analog Demod mode FM Stereo Measurement, there are 26 named traces. The RF Spectrum trace is the trace in the RF Spectrum window of MPX view. The Spectrum trace is the trace in the Spectrum window of the five views (MPX/Mono (L+R)/Stereo (L-R)/Left/Right). There are four kinds of traces in the

Demod Waveform window of the five views (MPX/Mono (L+R)/Stereo (L-R)/Left/Right): Demod, Demod Avg, Demod Max, and Demod Min.

When Auto Init is on, the marker's trace attribute is re-determined automatically by the analyzer whenever the marker turns on (Normal, Delta, or Fixed) from an off state. The marker goes to the trace in the window that has the focus, or onto the RF spectrum window if the Metrics window has the focus. If in the Demod Waveform window, it goes to the Demod trace.

This command associates the marker with the specified trace. Setting the Marker Trace directly (whether the marker is on or off) will turn off Auto Init.

If the marker is not off, it moves the marker from the trace it was on to the new trace. If the new trace is in the same window, the marker goes to the same data point on the new trace. If the marker changes windows, it retains its relative horizontal positions in the new window. If it is a fixed marker, it will retain both relative horizontal and vertical position.

If the marker is off it stays off, but is now associated with the specified trace.

The query returns the name of the trace on which the marker is currently placed.

Key Path	Marker, Properties
Remote Command	:CALCulate:FMSTereo:MARKer[1] 2 ... 12:TRACe RFSpectrum AFSpectrum DEMod DAVerage DMAXimum DMINimum MDEMod MDAVerage MMAXimum MMINimum MSpectrum SDEMod SDAVerage SMAXimum SMINimum SSpectrum LDEMod LDAVerage LMAXimum LMINimum LSpectrum RDEMod RDAVerage RMAXimum RMINimum RSpectrum :CALCulate:FMSTereo:MARKer[1] 2 ... 12:TRACe?
Example	:CALC:FMST:MARK1:TRAC DEM places marker 1 on the Demod trace
Couplings	This is not affected by Auto Coupling. Sending the remote command causes the addressed marker to become selected. If ever a delta marker has a reference marker in a different window, the delta marker's mode changes to POS (for example, it becomes a normal marker). When Marker Trace Auto Init State is on, the marker trace will automatically be set whenever the marker is turned on.
Preset	RF Spectrum on a Preset or All Markers Off
State Saved	The Marker Trace for each marker is saved in instrument state.
Readback line	[Trace name, Auto Init] or [Trace Name, Manual]
Initial S/W Revision	A.10.00

Demod

Selects the current demodulated signal in the Left Waveform window, shown in yellow, as the trace that you want your marker to be placed on. This trace is used to determine the placement, result, and X Axis Scale of the marker.

Key Path	Marker, Properties, Marker Trace, Left
Example	:CALC:FMST:MARK1:TRAC LDEM
Initial S/W Revision	A.10.00

Demod Average

Selects the averaged demodulation signal in the Left Waveform window, shown in green, as the trace that you want your marker to be placed on. This trace is used to determine the placement, result, and X Axis Scale of the marker.

Key Path	Marker, Properties, Marker Trace, Left
Example	:CALC:FMST:MARK1:TRAC LDAV
Initial S/W Revision	A.10.00

Demod Max

Selects the Demod Max trace in the Left Waveform window, shown in cyan, as the trace that you want your marker to be placed on. This trace shows the maximum hold value for each data point since the last restart.

Key Path	Marker, Properties, Marker Trace, Left
Example	:CALC:FMST:MARK1:TRAC LMAX
Initial S/W Revision	A.10.00

Demod Min

Selects the Demod Min trace in the Left Waveform window, shown in magenta, as the trace that you want your marker to be placed on. This trace shows the minimum hold value for each data point since the last restart.

Key Path	Marker, Properties, Marker Trace, Left
Example	:CALC:FMST:MARK1:TRAC LMIN
Initial S/W Revision	A.10.00

Spectrum

Selects the Left spectrum trace in the Left Spectrum window as the trace that you want your marker to be placed on. This trace is used to determine the placement, result, and X Axis Scale of the marker.

Key Path	Marker, Properties, Marker Trace, Left
Example	:CALC:FMST:MARK1:TRAC LSP
Initial S/W Revision	A.10.00

FM Stereo Marker Trace

Selects the trace on which to place the marker. A marker is associated with one and only one trace. This trace is used to determine the placement, result, and X Axis Scale of the marker. All markers have an associated trace, even Fixed markers. It is from that trace that they determine their attributes and behaviors, and it is to that trace that they go when they become Normal or Delta markers.

In the Analog Demod mode FM Stereo Measurement, there are 26 named traces. The RF Spectrum trace is the trace in the RF Spectrum window of MPX view. The Spectrum trace is the trace in the Spectrum window of the five views (MPX/Mono (L+R)/Stereo (L-R)/Left/Right). There are four kinds of traces in the Demod Waveform window of the five views (MPX/Mono (L+R)/Stereo (L-R)/Left/Right): Demod, Demod Avg, Demod Max, and Demod Min.

When Auto Init is on, the marker's trace attribute is re-determined automatically by the analyzer whenever the marker turns on (Normal, Delta, or Fixed) from an off state. The marker goes to the trace in the window that has the focus, or onto the RF spectrum window if the Metrics window has the focus. If in the Demod Waveform window, it goes to the Demod trace.

This command associates the marker with the specified trace. Setting the Marker Trace directly (whether the marker is on or off) will turn off Auto Init.

If the marker is not off, it moves the marker from the trace it was on to the new trace. If the new trace is in the same window, the marker goes to the same data point on the new trace. If the marker changes windows, it retains its relative horizontal positions in the new window. If it is a fixed marker, it will retain both relative horizontal and vertical position.

If the marker is off it stays off, but is now associated with the specified trace.

The query returns the name of the trace on which the marker is currently placed.

Key Path	Marker, Properties
Remote Command	:CALCulate:FMSTereo:MARKer[1] 2 ... 12:TRACe RFSpectrum AFSpectrum DEMod DAVerage DMAXimum DMINimum MDEMod MDAVerage MMAXimum MMINimum MSpectrum SDEMod SDAVerage SMAXimum SMINimum SSpectrum LDEMod LDAVerage LMAXimum LMINimum LSpectrum RDEMod RDAVerage RMAXimum RMINimum RSpectrum :CALCulate:FMSTereo:MARKer[1] 2 ... 12:TRACe?
Example	:CALC:FMST:MARK1:TRAC DEM places marker 1 on the Demod trace
Couplings	This is not affected by Auto Coupling. Sending the remote command causes the addressed marker to become selected. If ever a delta marker has a reference marker in a different window, the delta marker's mode changes to POS (for example, it becomes a normal marker). When Marker Trace Auto Init State is on, the marker trace will automatically be set whenever the marker is turned on.
Preset	RF Spectrum on a Preset or All Markers Off
State Saved	The Marker Trace for each marker is saved in instrument state.
Readback line	[Trace name, Auto Init] or [Trace Name, Manual]
Initial S/W Revision	A.10.00

Demod

Selects the current demodulated signal in the Right Waveform window, shown in yellow, as the trace that you want your marker to be placed on. This trace is used to determine the placement, result, and X Axis Scale of the marker.

Key Path	Marker, Properties, Marker Trace, Right
Example	:CALC:FMST:MARK1:TRAC RDEM
Initial S/W Revision	A.10.00

Demod Average

Selects the averaged demodulation signal in the Right Waveform window, shown in green, as the trace that you want your marker to be placed on. This trace is used to determine the placement, result, and X Axis Scale of the marker.

Key Path	Marker, Properties, Marker Trace, Right
Example	:CALC:FMST:MARK1:TRAC RDAV
Initial S/W Revision	A.10.00

Demod Max

Selects the Demod Max trace in the Right Waveform window, shown in cyan, as the trace that you want your marker to be placed on. This trace shows the maximum hold value for each data point since the last restart.

Key Path	Marker, Properties, Marker Trace, Right
Example	:CALC:FMST:MARK1:TRAC RMAX
Initial S/W Revision	A.10.00

Demod Min

Selects the Demod Min trace in the Right Waveform window, shown in magenta, as the trace that you want your marker to be placed on. This trace shows the minimum hold value for each data point since the last restart.

Key Path	Marker, Properties, Marker Trace, Right
Example	:CALC:FMST:MARK1:TRAC RMIN
Initial S/W Revision	A.10.00

Spectrum

Selects the Right spectrum trace in the Right Spectrum window as the trace that you want your marker to be placed on. This trace is used to determine the placement, result, and X Axis Scale of the marker.

Key Path	Marker, Properties, Marker Trace, Right
Example	:CALC:FMST:MARK1:TRAC RSP
Initial S/W Revision	A.10.00

Trace Auto Init

Selects whether the marker trace is automatically reset to the selected window when the marker is turned on or not.

Key Path	Marker, Properties, Trace
Remote Command	:CALCulate:AM FM PM FMSTereo:MARKer [1] 2 ... 12:TRACe:AUTO OFF ON 0 1 :CALCulate:AM FM PM FMSTereo:MARKer [1] 2 ... 12:TRACe:AUTO?
Example	:CALC:AM:MARK1:TRAC:AUTO 0 turns off auto-initialization of marker trace.
Preset	On
State Saved	Saved in instrument state.
Readback line	Trace name
Initial S/W Revision	Prior to A.02.00
Modified at S/W Revision	A.10.00

Lines

When on, displays a vertical line of graticule height and a horizontal line of graticule width, intersecting at the indicator point of the marker (that is, the center of the X or the bottom tip of the diamond). The lines are blue in color.

If the marker is off screen, the lines should be extended from the marker so that they go through the screen area if possible. This is really useful for off screen Fixed markers as it lets you see their amplitude even though they are off the X Axis.

Key Path	Marker, Properties
Remote Command	:CALCulate:AM FM PM FMSTereo:MARKer [1] 2 ... 12:LINes[:STATe] OFF ON 0 1 :CALCulate:AM FM PM FMSTereo:MARKer [1] 2 ... 12:LINes[:STATe] ?
Example	CALC:AM:MARK2:LIN ON turns Lines on for marker 2.
Couplings	Sending the remote command causes the addressed marker to become selected.
Preset	OFF

State Saved	Saved in instrument state
Initial S/W Revision	Prior to A.02.00
Modified at S/W Revision	A.10.00

All Markers Off

Turns off all markers.

Key Path	Marker
Remote Command	:CALCulate:AM FM PM FMSTereo:MARKer:AOff
Example	CALC:AM:MARK:AOff turns off all markers for the AM measurement
Couplings	Sets the selected marker to 1.
Initial S/W Revision	Prior to A.02.00
Modified at S/W Revision	A.10.00

Marker Function

There are no menus or marker functions under this key in the Analog Demod mode.

Key Path	Front-panel key
Initial S/W Revision	Prior to A.02.00

Marker To

Accesses a menu that contains only the marker center frequency key.

Key Path	Front-panel key
Initial S/W Revision	Prior to A.02.00

Mkr->CF

Sets the center frequency of the RF Spectrum window to the frequency of the selected marker. The marker stays at this frequency, so it moves to the center of the display.

In delta marker mode, this function sets the center frequency to the x-axis value of the delta marker.

Key Path	Marker ->
Remote Command	:CALCulate:AM FM PM FMSTereo:MARKer[1] 2 ... 12[:SET]:CENTer
Example	CALC:AM:MARK2:CENT sets the CF of the analyzer to the value of marker 2.
Remote Command Notes	Sending this command selects the sub-op coded marker. If the currently selected marker is not on when this key is pressed, it will be turned on at the center of the RF Spectrum trace as a normal type marker.
Dependencies	This function is unavailable (key is grayed out) unless the selected marker's trace is off, or on the RF Spectrum trace.
Couplings	All the usual couplings associated with setting Center Frequency apply (see " Center Frequency " on page 1097).
Initial S/W Revision	Prior to A.02.00
Modified at S/W Revision	A.10.00

Meas

The information in this section is common to all measurements. For key and remote command information for a specific measurement, refer to the section that describes the measurement of interest.

Measurements available under the Meas key are specific to the current Mode.

When viewing Help for measurements, note the following:

NOTE

Operation for some keys differs between measurements. The information displayed in Help pertains to the current measurement. To see how a key operates in a different measurement, exit Help (press the Cancel Esc key), select the measurement, then reenter Help (press the Help key) and press that key.

Key Path	Front-panel key
Initial S/W Revision	Prior to A.02.00

Remote Measurement Functions

This section contains the following topics:

"Measurement Group of Commands" on page 1122

"Current Measurement Query (Remote Command Only)" on page 1124

"Limit Test Current Results (Remote Command Only)" on page 1124

"Data Query (Remote Command Only)" on page 1124

"Calculate/Compress Trace Data Query (Remote Command Only)" on page 1125

"Calculate Peaks of Trace Data (Remote Command Only)" on page 1130

"Hardware-Accelerated Fast Power Measurement (Remote Command Only)" on page 1131

"Format Data: Numeric Data (Remote Command Only)" on page 1145

"Format Data: Byte Order (Remote Command Only)" on page 1146

Initial S/W Revision	Prior to A.02.00
----------------------	------------------

Measurement Group of Commands

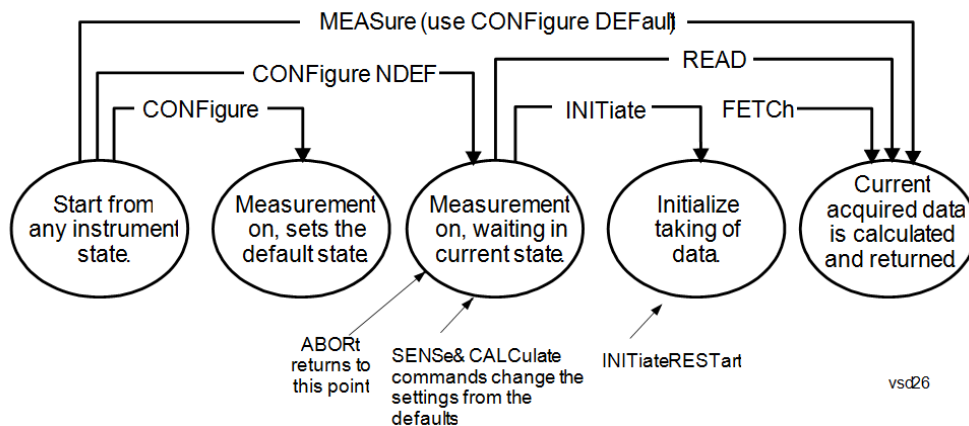

Measure Commands:

:MEASure:<measurement>[n]?

This is a fast single-command way to make a measurement using the factory default instrument settings. These are the settings and units that conform to the Mode Setup settings (e.g. radio standard) that you have currently selected.

- Stops the current measurement (if any) and sets up the instrument for the specified measurement using the factory defaults
- Initiates the data acquisition for the measurement
- Blocks other SCPI communication, waiting until the measurement is complete before returning results.
- If the function does averaging, it is turned on and the number of averages is set to 10.
- After the data is valid it returns the scalar results, or the trace data, for the specified measurement. The type of data returned may be defined by an [n] value that is sent with the command.
- The scalar measurement results will be returned if the optional [n] value is not included, or is set to 1. If the [n] value is set to a value other than 1, the selected trace data results will be returned. See each command for details of what types of scalar results or trace data results are available.
- ASCII is the default format for the data output. (Older versions of Spectrum Analysis and Phase Noise mode measurements only use ASCII.) The binary data formats should be used for handling large blocks of data since they are smaller and faster than the ASCII format. Refer to the FORMat:DATA command for more information.

If you need to change some of the measurement parameters from the factory default settings you can set up the measurement with the CONFIgure command. Use the commands in the SENSe:<measurement> and CALCulate:<measurement> subsystems to change the settings. Then you can use the READ? command to initiate the measurement and query the results.

If you need to repeatedly make a given measurement with settings other than the factory defaults, you can use the commands in the SENSe:<measurement> and CALCulate:<measurement> subsystems to set up the measurement. Then use the READ? command to initiate the measurement and query results.

Measurement settings persist if you initiate a different measurement and then return to a previous one. Use READ:<measurement>? if you want to use those persistent settings. If you want to go back to the default settings, use MEASure:<measurement>?.

Configure Commands:

:CONFIgure:<measurement>

This command stops the current measurement (if any) and sets up the instrument for the specified measurement using

the factory default instrument settings. It does not initiate the taking of measurement data unless INIT:CONTInuous is ON. If you change any measurement settings after using the CONFigure command, the READ command can be used to initiate a measurement without changing the settings back to their defaults.

In the Swept SA measurement in Spectrum Analyzer mode the CONFigure command also turns the averaging function on and sets the number of averages to 10 for all measurements.

:CONFigure: <measurement>: NDEFault stops the current measurement and changes to the specified measurement. It does not change the settings to the defaults. It does not initiate the taking of measurement data unless INIT:CONTInuous is ON.

The CONFigure? query returns the current measurement name.

The CONFigure:CATalog? query returns a quoted string of all licensed measurement names in the current mode. For example, "SAN, CHP, OBW, ACP, PST, TXP, SPUR, SEM, LIST".

Fetch Commands:

:FETCh:<measurement>[n]?

This command puts selected data from the most recent measurement into the output buffer. Use FETCh if you have already made a good measurement and you want to return several types of data (different [n] values, for example, both scalars and trace data) from a single measurement. FETCh saves you the time of re-making the measurement. You can only FETCh results from the measurement that is currently active, it will not change to a different measurement. An error message is reported if a measurement other than the current one is specified.

If you need to get new measurement data, use the READ command, which is equivalent to an INITiate followed by a FETCh.

The scalar measurement results will be returned if the optional [n] value is not included, or is set to 1. If the [n] value is set to a value other than 1, the selected trace data results will be returned. See each command for details of what types of scalar results or trace data results are available. The binary data formats should be used for handling large blocks of data since they are smaller and transfer faster than the ASCII format. (FORMat:DATA)

FETCh may be used to return results other than those specified with the original READ or MEASure command that you sent.

INITiate Commands:

:INITiate:<measurement>

This command is not available for measurements in all the instrument modes:

- Initiates a trigger cycle for the specified measurement, but does not output any data. You must then use the FETCh<meas> command to return data. If a measurement other than the current one is specified, the instrument will switch to that measurement and then initiate it.
- For example, suppose you have previously initiated the ACP measurement, but now you are running the channel power measurement. If you send INIT:ACP? it will change from channel power to ACP and will initiate an ACP measurement.
- Does not change any of the measurement settings. For example, if you have previously started the ACP measurement and you send INIT:ACP? it will initiate a new ACP measurement using the same instrument settings as the last time ACP was run.
- If your selected measurement is currently active (in the idle state) it triggers the measurement, assuming the trigger conditions are met. Then it completes one trigger cycle. Depending upon the measurement and the number of averages, there may be multiple data acquisitions, with multiple trigger events, for one full trigger cycle. It also holds off additional commands on GPIB until the acquisition is complete.

READ Commands:

:READ:<measurement>[n]?

- Does not preset the measurement to the factory default settings. For example, if you have previously initiated the ACP
-

measurement and you send READ:ACP? it will initiate a new measurement using the same instrument settings.

- Initiates the measurement and puts valid data into the output buffer. If a measurement other than the current one is specified, the instrument will switch to that measurement before it initiates the measurement and returns results.
 - For example, suppose you have previously initiated the ACP measurement, but now you are running the channel power measurement. Then you send READ:ACP? It will change from channel power back to ACP and, using the previous ACP settings, will initiate the measurement and return results.
 - Blocks other SCPI communication, waiting until the measurement is complete before returning the results
 - If the optional [n] value is not included, or is set to 1, the scalar measurement results will be returned. If the [n] value is set to a value other than 1, the selected trace data results will be returned. See each command for details of what types of scalar results or trace data results are available. The binary data formats should be used when handling large blocks of data since they are smaller and faster than the ASCII format. (FORMat:DATA)
-

Initial S/W Revision	Prior to A.02.00
----------------------	------------------

Current Measurement Query (Remote Command Only)

This command returns the name of the measurement that is currently running.

Remote Command	:CONFigure?
-----------------------	-------------

Example	CONF?
----------------	-------

Initial S/W Revision	Prior to A.02.00
----------------------	------------------

Limit Test Current Results (Remote Command Only)

Queries the status of the current measurement limit testing. It returns a 0 if the measured results pass when compared with the current limits. It returns a 1 if the measured results fail any limit tests.

Remote Command	:CALCulate:CLIMits:FAIL?
-----------------------	--------------------------

Example	CALC:CLIM:FAIL? queries the current measurement to see if it fails the defined limits. Returns a 0 or 1: 0 it passes, 1 it fails.
----------------	--

Initial S/W Revision	Prior to A.02.00
----------------------	------------------

Data Query (Remote Command Only)

Returns the designated measurement data for the currently selected measurement and subopcode.

n = any valid subopcode for the current measurement. See the measurement command results table for your current measurement, for information about what data is returned for the subopcodes.

This command uses the data setting specified by the FORMat:BORDER and FORMat:DATA commands and can return real or ASCII data. (See the format command descriptions under Input/Output in the Analyzer Setup section.)

Remote Command	:CALCulate:DATA[n]?
Notes	The return trace depends on the measurement. In CALCulate:<meas>:DATA[n], n is any valid subopcode for the current measurement. It returns the same data as the FETCH:<measurement>? query where <measurement> is the current measurement.
Initial S/W Revision	Prior to A.02.00

Calculate/Compress Trace Data Query (Remote Command Only)

Returns compressed data for the currently selected measurement and sub-opcode [n].

n = any valid sub-opcode for that measurement. See the MEASure:<measurement>? command description of your specific measurement for information on the data that can be returned.

The data is returned in the current Y Axis Unit of the analyzer. The command is used with a sub-opcode <n> (default=1) to specify the trace. With trace queries, it is best if the analyzer is not sweeping during the query. Therefore, it is generally advisable to be in Single Sweep, or Update=Off.

This command is used to compress or decimate a long trace to extract and return only the desired data. A typical example would be to acquire N frames of GSM data and return the mean power of the first burst in each frame. The command can also be used to identify the best curve fit for the data.

Remote Command	:CALCulate:DATA<n>:COMPRESS? BLOCK CFIT MAXimum MINimum MEAN DMEan RMS RMSCubed SAMPLE SDEVIation PPHase [,<soffset> [,<length>[,<roffset>[,<rlimit>]]]]
Example	To query the mean power of a set of GSM bursts: Supply a signal that is a set of GSM bursts. Select the IQ Waveform measurement (in IQ Analyzer Mode). Set the sweep time to acquire at least one burst. Set the triggers such that acquisition happens at a known position relative to a burst. Then query the mean burst levels using, CALC:DATA2:COMP? MEAN, 24e-6, 526e-6 (These parameter values correspond to GSM signals, where 526e-6 is the length of the burst in the slot and you just want 1 burst.)
Notes	The command supports 5 parameters. Note that the last 4 (<soffset>, <length>, <roffset>, <rlimit>) are optional. But these optional parameters must be entered in the specified order. For example, if you want to specify <length>, then you must also specify <soffset>. See details below for a definition of each of these parameters. This command uses the data in the format specified by FORMat:DATA, returning either binary or ASCII data.
Initial S/W Revision	Prior to A.02.00

- BLOCK or block data - returns all the data points from the region of the trace data that you specify. For example, it could be used to return the data points of an input signal over several timeslots, excluding the portions of the trace data that you do not want. (This is x,y pairs for trace data and I,Q pairs for complex data.)

- CFIT or curve fit - applies curve fitting routines to the data. <soffset> and <length> are required to define the data that you want. <roffset> is an optional parameter for the desired order of the curve equation. The query will return the following values: the x-offset (in seconds) and the curve coefficients ((order + 1) values).

MIN, MAX, MEAN, DME, RMS, RMSC, SAMP, SDEV and PPH return one data value for each specified region (or <length>) of trace data, for as many regions as possible until you run out of trace data (using <roffset> to specify regions). Or they return the number of regions you specify (using <rlimit>) ignoring any data beyond that.

- MINimum - returns the minimum data point (y value) for the specified region(s) of trace data. For I/Q trace data, the minimum magnitude of the I/Q pairs is returned.
- MAXimum - returns the maximum data point (y value) for the specified region(s) of trace data. For I/Q trace data, the maximum magnitude of the I/Q pairs is returned.
- MEAN - returns a single value that is the arithmetic mean of the data point values (in dB/ dBm) for the specified region(s) of trace data. For I/Q trace data, the mean of the magnitudes of the I/Q pairs is returned. See the following equations.

NOTE If the original trace data is in dB, this function returns the arithmetic mean of those log values, not log of the mean power which is a more useful value. The mean of the log is the better measurement technique when measuring CW signals in the presence of noise. The mean of the power, expressed in dB, is useful in power measurements such as Channel Power. To achieve the mean of the power, use the RMS option.

Equation 1

Mean Value of Data Points for Specified Region(s)

$$\text{MEAN} = \frac{1}{n} \sum_{X_i \in \text{region}(s)} X_i$$

where X_i is a data point value, and n is the number of data points in the specified region(s).

Equation 2

Mean Value of I/Q Data Pairs for Specified Region(s)

$$\text{MEAN} = \frac{1}{n} \sum_{X_i \in \text{region}(s)} |X_i|$$

where $|X_i|$ is the magnitude of an I/Q pair, and n is the number of I/Q pairs in the specified region(s).

- DMEan - returns a single value that is the mean power (in dB/ dBm) of the data point values for the specified region(s) of trace data. See the following equation:

Equation 3

DMEan Value of Data Points for Specified Region(s)

$$\text{DME} = 10 \times \log_{10} \left(\frac{1}{n} \sum_{X_i \in \text{region}(s)} 10^{\frac{X_i}{10}} \right)$$

- RMS - returns a single value that is the average power on a root-mean-squared voltage scale (arithmetic rms) of the data point values for the specified region(s) of trace data. See the following equation.

NOTE

For I/Q trace data, the rms of the magnitudes of the I/Q pairs is returned. See the following equation. This function is very useful for I/Q trace data. However, if the original trace data is in dB, this function returns the rms of the log values which is not usually needed.

Equation 4

RMS Value of Data Points for Specified Region(s)

$$\text{RMS} = \sqrt{\frac{1}{n} \sum_{X_i \in \text{region}(s)} X_i^2}$$

where X_i is a data point value, and n is the number of data points in the specified region(s).

Equation 5

RMS Value of I/Q Data Pairs for Specified Region(s)

$$\text{RMS} = \sqrt{\frac{1}{n} \sum_{X_i \in \text{region}(s)} X_i X_i^*}$$

where X_i is the complex value representation of an I/Q pair, X_i^* its conjugate complex number, and n is the number of I/Q pairs in the specified region(s).

Once you have the rms value for a region of trace data (linear or I/Q), you may want to calculate the mean power. You must convert this rms value (peak volts) to power in dBm:

$$10 \times \log[10 \times (\text{rms value})^2]$$

- SAMPLe - returns the first data value (x,y pair) for the specified region(s) of trace data. For I/Q trace data, the first I/Q pair is returned.
- SDEViation - returns a single value that is the arithmetic standard deviation for the data point values for the specified region(s) of trace data. See the following equation.
- For I/Q trace data, the standard deviation of the magnitudes of the I/Q pairs is returned. See the following equation.

Equation 6

Standard Deviation of Data Point Values for Specified Region(s)

$$\text{SDEV} = \sqrt{\frac{1}{n} \sum_{X_i \in \text{region}(s)} (X_i - \bar{X})^2}$$

where X_i is a data point value, \bar{X} is the arithmetic mean of the data point values for the specified region (s), and n is the number of data points in the specified region(s).

$$\text{SDEV} = \sqrt{\frac{1}{n} \sum_{X_i \in \text{region}(s)} (|X_i| - \bar{X})^2}$$

where $|X_i|$ is the magnitude of an I/Q pair, \bar{X} is the mean of the magnitudes for the specified region(s), and n is the number of data points in the specified region(s).

- PPHase - returns the x,y pairs of both rms power (dBm) and arithmetic mean phase (radian) for every specified region and frequency offset (Hz). The number of pairs is defined by the specified number of regions. This parameter can be used for I/Q vector ($n=0$) in Waveform (time domain) measurement and all parameters are specified by data point in PPHase.

The rms power of the specified region may be expressed as:

$$\text{Power} = 10 \times \log [10 \times (\text{RMS I/Q value})] + 10.$$

The RMS I/Q value (peak volts) is:

$$\sqrt{\frac{1}{n} \sum_{X_i \in \text{region}} X_i X_i^*}$$

where X_i is the complex value representation of an I/Q pair, X_i^* its conjugate complex number, and n is the number of I/Q pairs in the specified region.

The arithmetic mean phase of the specified region may be expressed as:

$$\frac{1}{n} \sum_{Y_i \in \text{region}} Y_i$$

where Y_i is the unwrapped phase of I/Q pair with applying frequency correction and n is the number of I/Q pairs in the specified region.

The frequency correction is made by the frequency offset calculated by the arithmetic mean of every specified region's frequency offset. Each frequency offset is calculated by the least square method against the unwrapped phase of I/Q pair.

Sample Trace Data - Constant Envelope

(See below for explanation of variables.)

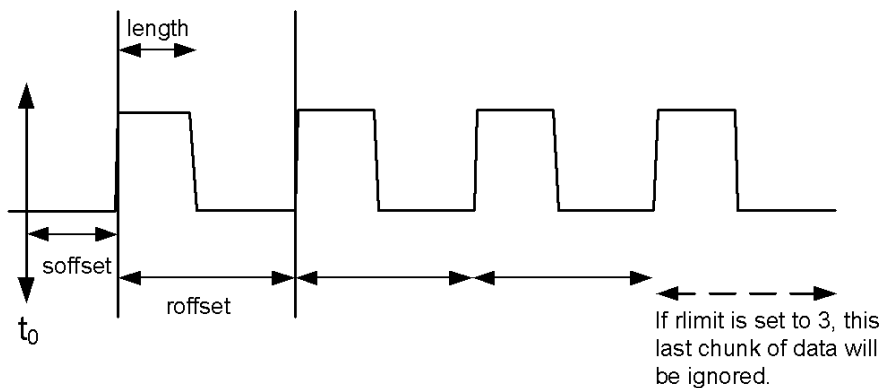

Sample Trace Data - Not Constant Envelope

(See below for explanation of variables.)

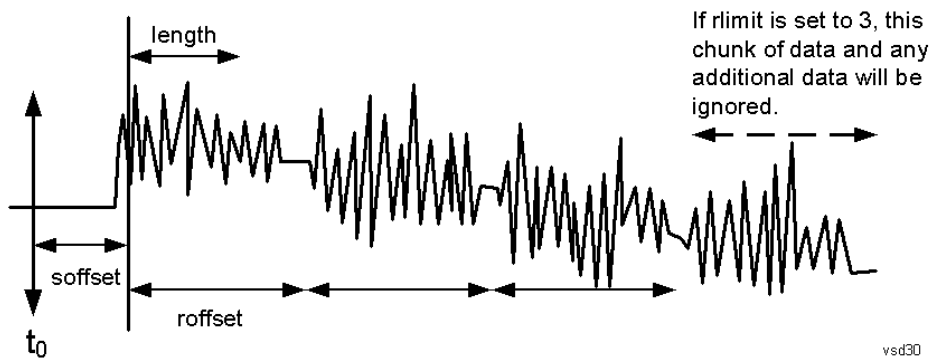

<soffset> - start offset is an optional real number. (It is in seconds for time-domain traces, and is a dimensionless index 0 to Npoints - 1, for frequency-domain traces). It specifies the amount of data at the beginning of the trace that will be ignored before the decimation process starts. It is the time or frequency change from the start of the trace to the point where you want to start using the data. The default value is zero.

<length> - is an optional real number. (It is in seconds for time-domain traces, and is a dimensionless index 0 to Npoints - 1, for frequency-domain traces). It defines how much data will be compressed into one value. This parameter has a default value equal to the current trace length.

<roffset> - repeat offset is an optional real number. (It is in seconds for time-domain traces, and is a dimensionless index 0 to Npoints - 1, for frequency-domain traces). It defines the beginning of the next field of trace elements to be compressed. This is relative to the beginning of the previous field. This parameter has a default value equal to the <length> variable. Note that this parameter is used for a completely different purpose when curve fitting (see CFIT above).

<rlimit> - repeat limit is an optional integer. It specifies the number of data items that you want returned. It will ignore any additional items beyond that number. You can use the Start offset and the Repeat limit to pick out exactly what part of the data you want to use. The default value is all the data.

Calculate Peaks of Trace Data (Remote Command Only)

Returns a list of all the peaks for the currently selected measurement and sub-opcode [n]. The peaks must meet the requirements of the peak threshold and excursion values.

n = any valid sub-opcode for the current measurement. See the MEASure:<measurement> command description of your specific measurement for information on the data that can be returned.

The command can only be used with specific sub-opcodes with measurement results that are trace data. Both real and complex traces can be searched, but complex traces are converted to magnitude in dBm. In many measurements the sub-opcode n=0, is the raw trace data which cannot be searched for peaks. And Sub-opcode n=1, is often calculated results values which also cannot be searched for peaks.

This command uses the data setting specified by the FORMat:BORDER and FORMat:DATA commands and can return real or ASCII data. If the format is set to INT,32, it returns REAL,32 data.

The command has four types of parameters:

- Threshold (in dBm)
- Excursion (in dB)
- Sorting order (amplitude, frequency, time)
- Optional in some measurements: Display line use (all, > display line, < display line)

Remote Command	<p>For Swept SA measurement:</p> <pre>:CALCulate:DATA[1] 2 ... 6:PEAKs? <threshold>,<excursion>[,AMPLitude FREQuency TIME[,ALL GTDLine LTDLine]]</pre> <p>For most other measurements:</p> <pre>:CALCulate:DATA[1] 2 ... 6:PEAKs? <threshold>,<excursion>[,AMPLitude FREQuency TIME]</pre>
-----------------------	--

Example	<p>Example for Swept SA measurement in Spectrum Analyzer Mode:</p> <p>CALC:DATA4:PEAK? -40, 10, FREQ, GTDL This will identify the peaks of trace 4 that are above -40 dBm, with excursions of at least 10 dB. The peaks are returned in order of increasing frequency, starting with the lowest frequency. Only the peaks that are above the display line are returned.</p> <p>Query Results 1:</p> <p>With FORMat:DATA REAL, 32 selected, it returns a list of floating-point numbers. The first value in the list is the number of peak points that are in the following list. A peak point consists of two values: a peak amplitude followed by its corresponding frequency (or time).</p> <p>If no peaks are found the peak list will consist of only the number of peaks, (0).</p>
----------------	---

Notes	<p><n> - is the trace that will be used</p> <p><threshold> - is the level below which trace data peaks are ignored. Note that the threshold value is required and is always used as a peak criterion. To effectively disable the threshold criterion for this command, provide a substantially low threshold value such as -200 dBm. Also note that the threshold value used in this command is independent of and has no effect on the threshold value stored under the Peak Criteria menu.</p> <p><excursion> - is the minimum amplitude variation (rise and fall) required for a signal to be identified as peak. Note that the excursion value is required and is always used as a peak criterion. To effectively disable the excursion criterion for this command, provide the minimum value of 0.0 dB. Also note that the excursion value used in this command is independent of and has no effect on the</p>
--------------	---

excursion value stored under the Peak Criteria menu.

Values must be provided for threshold and excursion. The sorting and display line parameters are optional (defaults are AMPLitude and ALL).

Note that there is always a Y-axis value for the display line, regardless of whether the display line state is on or off. It is the current Y-axis value of the display line which is used by this command to determine whether a peak should be reported

Sorting order:

AMPLitude - lists the peaks in order of descending amplitude, with the highest peak first (default if optional parameter not sent)

FREQuency - lists the peaks in order of occurrence, left to right across the x-axis.

TIME - lists the peaks in order of occurrence, left to right across the x-axis.

Peaks vs. Display Line:

ALL - lists all of the peaks found (default if optional parameter not sent).

GTDLine (greater than display line) - lists all of the peaks found above the display line.

LTDLine (less than display line) - lists all of the peaks found below the display line.

Initial S/W Revision	Prior to A.02.00
----------------------	------------------

Hardware-Accelerated Fast Power Measurement (Remote Command Only)

The Fast Power option (FP2) enables very fast channel power measurements for instruments with the prerequisite hardware (DP2 and/or B40). It accomplishes this by performing real-time overlapped FFTs at the hardware layer, using software for basic post-processing before returning the result to the user. The upshot of this approach is improved throughput for user applications that require many sequential power measurements.

The analysis bandwidth of FP2 is limited by the licenses in the instrument, but its maximum overall analysis bandwidth per acquisition is 40 MHz.

FP2 is remote-only, which means the instrument does not switch to any particular mode or measurement. FP2 commands can be sent while another application is in use on the front panel.

Each Fast Power measurement can be predefined using an array index, and up to 1,000 measurements can be stored. In the following documentation, instances of [1,2,...,999] can be substituted with a particular measurement index, e.g. CALC:FPOW:POW1?, CALC:FPOW:POW2?, CALC:FPOW:POW134?. In this way, power measurements can be defined one time in a batch, and then executed multiple times without having to redefine them, similar to “list mode” on other measurements.

In addition to basic channel power measurements, there are a number of other measurement “functions” for each channel, including peak power, peak frequency, and power spectral density. See the Function parameter for more information.

Reset Fast Power Measurement (Remote Command Only)

Resets the measurement configuration to the defaults.

Mode	All
Remote Command	:CALCulate:FPOWer:POWer[1,2,...,999]:RESet
Example	:CALC:FPOW:POW1:RES

Notes	Option FP2 is required.
Initial S/W Revision	A.14.00

Define Fast Power Measurement (Remote Command Only)

Fast Power acquisitions are configured using the DEFine command. This command accepts a comma-delimited string of configuration parameters and their appropriate values, which are all specified in the subsection below.

Mode	All
Remote Command	:CALCulate:FPOWER:POWer[1,2,...,999]:DEFine "configuration string"
Example	:CALC:FPOW:POW1:DEF "CenterFrequency=2e9, AcquisitionTime=0.005"
Notes	See below for a list of measurement variables that can be defined in the configuration string.
Initial S/W Revision	A.14.00

Acquisition Time

Example	CALC:FPOW:POW1:DEF "AcquisitionTime=0.002"
Notes	The acquisition time parameter sets the time in which the entire spectrum is measured. An increase in the acquisition time yields an improvement in measurement repeatability.
Preset	0.001 s
Range	0 s to 1 s
Default Unit	Time (s)
Initial S/W Revision	A.14.00

Center Frequency

Example	CALC:FPOW:POW1:DEF "CenterFrequency=2e9"
Notes	The center frequency parameter sets the frequency in which the measurement is centered around. The OffsetFrequency parameter is calculated relative to the center frequency.
Preset	1 GHz
Range	0 Hz to maximum instrument frequency
Default Unit	Frequency (Hz)
Initial S/W Revision	A.14.00

DC Coupled

Example	CALC:FPOW:POW1:DEF "DCCoupled=True"
Notes	The DC coupled parameter allows the user to specify whether the DC blocking capacitor is utilized. Set parameter to true when measuring frequencies below 10 MHz.
Preset	False
Range	True (DC Coupled) or False (AC Coupled)
Default Unit	Boolean
Initial S/W Revision	A.14.00

DetectorType

Example	CALC:FPOW:POW1:DEF "DetectorType=Peak"
Notes	Option FP2 is required. The detector type parameter allows the user to choose whether a RMS average or peak value is used during the measurement.
Preset	RmsAverage
Range	RmsAverage, Peak
Initial S/W Revision	A.14.00

Do Noise Correction

Example	CALC:FPOW:POW1:DEF "DoNoiseCorrection=True"
Notes	When noise correction is enabled, the linear noise power contributed by the analyzer is subtracted from all measurements. This effectively lowers the noise floor of the analyzer. When noise correction is enabled, the first measurement for a given set of input parameters will take extra time. This is because the analyzer takes an extra acquisition with the RF input disconnected from the analyzer's front end to measure the noise of just the analyzer. The measured noise floor is stored in a cache so the noise acquisition will occur only once for the same state settings. In other words, if noise correction was turned on and the analyzer made an acquisition at frequency A, then frequency B, and back again to frequency A, the hidden initial noise floor acquisition would only occur for the first acquisition at frequency A and the cached noise floor would be used the second time frequency A was measured.
Preset	False
Range	True (enable noise correction) or False (disable noise correction)
Default Unit	Boolean
Initial S/W Revision	A.14.00

Do Spur Suppression

Example	CALC:FPOW:POW1:DEF "DoSpurSuppression=True"
Notes	<p>When measuring very low level signals, or when large out-of-band inputs are input into the analyzer, sometimes unwanted spurs and residuals can appear in the measured spectrum. Spur suppression is a method to help minimize the levels of these internally generated spurs and residuals.</p> <p>When spur suppression is enabled, the analyzer will automatically take two acquisitions using two different internal analog LO frequencies. The FFT spectrums from both acquisitions are combined by taking the minimum power between both traces on a per FFT bin basis. External signals will have the same amplitude for both traces and therefore will return the expected amplitudes. However, low level spurs and residuals generated internally to the analyzer tend to move to different FFT bins depending on the internal analog LO frequency used, and therefore tend to be suppressed using this spur suppression method.</p> <p>Because two acquisitions, rather than a single acquisition, are made when spur suppression is enabled, the measurement time will always be slower when spur suppression is enabled.</p>
Preset	False
Range	True (enable spur suppression) or False (disable spur suppression)
Default Unit	Boolean
Initial S/W Revision	A.14.00

Electronic Attenuator Bypass

Example	CALC:FPOW:POW1:DEF "ElecAttBypass =False"
Notes	The electronic attenuation bypass parameter allows the user to either utilize or bypass the electronic attenuator. The electronic attenuator is only available for frequencies up to 3.6 GHz. Set parameter to true when using frequencies above 3.6 GHz and set the parameter to false when using the preamp.
Preset	True
Range	True (bypass electronic attenuator) or False (use electronic attenuator)
Default Unit	Boolean
Initial S/W Revision	A.14.00

Electronic Attenuation

Example	CALC:FPOW:POW1:DEF "ElecAttenuation=10"
Notes	<p>Option EA3 is required.</p> <p>The electronic attenuation value parameter sets the amount of electrical attenuation from 0 to 24 dB (1 dB steps).</p> <p>Set "ElecAttBypass=False" to make sure the electronic attenuator path is enabled.</p>
Preset	0 dB
Range	0 – 24 dB (1 dB steps)

Default Unit	dB
Initial S/W Revision	A.14.00

IF Gain

Example	CALC:FPOW:POW1:DEF "IFGain=10"
Notes	The IF gain parameter allows the user to specify the gain at the IF stage anywhere from -6 to 16 dB (1 dB steps). This is an advanced feature, and for most cases this should remain at its default value of 0 dB.
Preset	0 dB
Range	-6 - 16 dB (1 dB steps)
Default Unit	dB
Initial S/W Revision	A.14.00

IF Type

Example	CALC:FPOW:POW1:DEF "IFType=B25M"
Notes	The IF type parameter allows the user to select between different IF paths. For example, if the signal is less than 25 MHz wide, then the user can select the B25M path to take advantage of additional filtering on this analog IF path.
Preset	B40M
Range	B10M, B25M, B40M
Initial S/W Revision	A.14.00

Include Power Spectrum

Example	CALC:FPOW:POW1:DEF "IncludePowerSpectrum=True"
Notes	The power spectrum parameter allows the user to read data on the entire spectrum for diagnostic purposes. It is not recommended for production use. See CALC:FPOW:POW[n]:READ2? for details on the binary format of the response.
Preset	False
Range	True (return both channel power and full power spectrum) or False (returns only channel power)
Default Unit	Boolean
Initial S/W Revision	A.14.00

Mechanical Attenuation

Example	CALC:FPOW:POW1:DEF "MechAttenuation=10"
Notes	The mechanical attenuation value parameter sets the amount of mechanical attenuation anywhere from 0 to 70 dB (2 dB steps).
Preset	0 dB
Range	0 – 70 dB (2 dB steps)
Default Unit	dB
Initial S/W Revision	A.14.00

Preamp Mode

Example	CALC:FPOW:POW1:DEF "PreAmpMode=Low"
Notes	The license for the appropriate preamp is required. The preamp mode parameter specifies whether the preamps are being utilized. Low allows any preamps up to 3.6 GHz, and Full allows all licensed preamps. Set "ElecAttBypass=True" in order to utilize any preamps.
Preset	Off
Range	Off, Low, Full
Initial S/W Revision	A.14.00

Resolution Bandwidth Mode

Example	CALC:FPOW:POW1:DEF "PreAmpMode=Low"
Notes	The resolution bandwidth mode parameter allows the user to choose whether the RBW filter is automatically or manually set. The BestSpeed value minimizes measurement time, while the Narrowest value minimizes RBW size (minimum of two FFT bins per RBW). To manually specify an RBW, set this parameter to Explicit, and set the ResolutionBW parameter to the desired value.
Preset	BestSpeed
Range	BestSpeed, Narrowest, Explicit
Initial S/W Revision	A.14.00

Resolution Bandwidth

Example	CALC:FPOW:POW1:DEF "ResolutionBW=25e3"
Notes	The resolution bandwidth parameter sets the 3-dB bandwidth of the RBW filter. The ResolutionBWMode parameter must be set to Explicit in order to manually set the RBW.

Preset	0 Hz
Default Unit	Hz
Initial S/W Revision	A.14.00

Trigger Delay

Example	CALC:FPOW:POW1:DEF "TriggerDelay=0.025"
Notes	The trigger delay parameter sets the time after an external trigger is detected until the measurement is performed.
Preset	0 s
Range	0 – 1 s
Default Unit	Seconds
Initial S/W Revision	A.14.00

Trigger Level

Example	CALC:FPOW:POW1:DEF "TriggerLevel=2"
Notes	The trigger level parameter sets the voltage value at which an external trigger is detected.
Preset	1.2 V
Range	-5 to 5 V
Default Unit	Volts
Initial S/W Revision	A.14.00

Trigger Slope

Example	CALC:FPOW:POW1:DEF "TriggerSlope=Negative"
Notes	The trigger slope parameter indicates the direction of the edge trigger voltage for detection.
Preset	Positive
Range	Positive, Negative
Initial S/W Revision	A.14.00

Trigger Source

Example	CALC:FPOW:POW1:DEF "TriggerSource=Ext1"
Notes	The trigger source parameter allows the user to choose between measurement's triggering freely or controlled by an external input. Ext1 and Ext2 correspond to Trigger 1 In and Trigger 2 In, respectively.
Preset	Free
Range	Free, Ext1, Ext2
Initial S/W Revision	A.14.00

Trigger Timeout

Example	CALC:FPOW:POW1:DEF "TriggerTimeout=0.1"
Notes	The trigger timeout parameter sets the time in which the analyzer will wait for a trigger before automatically performing the measurement.
Preset	1 s
Range	0 - 1 s
Default Unit	Seconds
Initial S/W Revision	A.14.00

Signal Input

Example	CALC:FPOW:POW1:DEF "SignalInput=Fp50MHzCW"
Notes	The signal input parameter allows the user to select between using the main RF input or the internal analyzer reference CW signal of 50 MHz.
Preset	FpMainRf
Range	FpMainRf, Fp50MHzCW
Initial S/W Revision	A.14.00

Use Preselector

Example	CALC:FPOW:POW1:DEF "UsePreSelector=True"
Notes	The preselector parameter allows the user to either utilize or bypass the front end tunable filter at frequencies above 3.6 GHz. For frequencies below 3.6 GHz, the preselector is automatically bypassed, so you do not need to set this parameter to False in those cases.
Preset	False
Range	True (use preselector above 3.6 GHz), or False (preselector bypassed)

Default Unit	Boolean
Initial S/W Revision	A.14.00

Channel Bandwidth Array

Example	CALC:FPOW:POW1:DEF "Bandwidth=[3.84e6, 5e6, 3.84e6]"
Notes	The bandwidth parameter array defines the bandwidth of each channel that will be measured. All array parameters should have the same number of elements. Alternatively, if all the elements are the same value, a single number with no square brackets can be used to define the parameter.
Preset	[1 e6]
Range	0 to 40 MHz
Default Unit	Hz
Initial S/W Revision	A.14.00

Channel Filter Type Array

Example	CALC:FPOW:POW1:DEF "FilterType=[RRC, IBW, RRC]"
Notes	The filter type parameter allows the user to choose between an integration bandwidth (IBW) filter or a root-raised-cosine (RRC) filter. The integration bandwidth filter weighs all frequencies within the bandwidth equally. The root-raised-cosine filter has an associated shape parameter, defined by the FilterAlpha parameter. All array parameters should have the same number of elements. Alternatively, if all the elements are the same value, a single value with no square brackets can be used to define the parameter.
Preset	[IBW]
Range	IBW, RRC
Initial S/W Revision	A.14.00

Channel Filter Alpha Array

Example	CALC:FPOW:POW1:DEF "FilterAlpha=[0.5, 0.0, 0.5]"
Notes	The filter alpha parameter allows the user to adjust the alpha value associated with the root-raised-cosine (RRC) filter type. Set FilterType to RRC in order to utilize this parameter. All array parameters should have the same number of elements. Alternatively, if all the elements are the same value, a single number with no square brackets can be used to define the parameter.
Preset	[0.22]
Range	0.0 – 1.0
Initial S/W Revision	A.14.00

Channel Measurement Function Array

Example	CALC:FPOW:POW1:DEF "Function=[BandPower, PeakPower, BandPower]"
Notes	<p>This parameter array defines what measurement is being made for each individually-specified channel:</p> <p>BandPower: Total power within the specified bandwidth of the channel (dBm)</p> <p>BandDensity: Total power density within the specified bandwidth of the channel (dBm/Hz)</p> <p>PeakPower: The peak power value within the specified bandwidth of the channel (dBm)</p> <p>PeakFrequency: The frequency which corresponds to the peak power value within the specified bandwidth of the channel. This frequency is relative to the center frequency (Hz)</p> <p>XdBBandwidth: The half power (-3.01 dB) bandwidth of the highest amplitude signal that resides within the channel (Hz), dB is configurable using XdBBandwidth parameter</p> <p>OccupiedBandwidth: The bandwidth at which 99% of the total power resides within the channel (Hz), percentage configurable using OccupiedBandwidthPercent parameter</p> <p>All array parameters should have the same number of elements. Alternatively, if all the elements are the same value, a single value with no square brackets can be used to define the parameter.</p>
Preset	[BandPower]
Range	BandPower, BandDensity, PeakPower, PeakFrequency, XdBBandwidth, OccupiedBandwidth
Initial S/W Revision	A.14.00

Channel Offset Frequency Array

Example	CALC:FPOW:POW1:DEF "OffsetFrequency=[-5e6, 0, 5e6]"
Notes	<p>The offset frequency parameter array defines the difference between the center frequency to the center frequency of each channel.</p> <p>All array parameters should have the same number of elements.</p>
Preset	[0]
Range	0 to 20 MHz
Default Unit	Hz
Initial S/W Revision	A.14.00

Channel Occupied Bandwidth Percent Array

Example	CALC:FPOW:POW1:DEF "OccupiedBandwidthPercent =[0.95, 0.95, 0.95]"
Notes	<p>This parameter only applies for channels whose Function is set to OccupiedBandwidth. The occupied bandwidth percent parameter specifies the percent of total power in these channels. The valid range for this parameter is 0.0 to 1.0, where 1.0 represents 100%. The default for this parameter is 0.99, which will return the bandwidth that contains 99% of the total channel power.</p>

Preset	[0.99]
Range	0 – 1.0
Initial S/W Revision	A.14.00

Channel x-dB Bandwidth Array

Example	CALC:FPOW:POW1:DEF " XdBBandwidth =[-6.02, -3.01, -1.0]"
Notes	This parameter only applies for channels whose Function is set to XdBBandwidth. The X dB bandwidth parameter is used to specify the power relative to the peak channel power over which the bandwidth is calculated. The parameter value must be a negative number.
Preset	[-3.01]
Range	-200 to 0 dB
Default Unit	dB
Initial S/W Revision	A.14.00

Define Fast Power Measurement Query (Remote Command Only)

The DEFine? command is used to retrieve a list of all defined parameters in an ASCII string format

M o d e	All
R e m o t e	:CALCulate:FPOWER:POWER[1,2,...,999]:DEFine?
C o m m a n d	
E x a m	:CALC:FPOW:POW1:DEF?

```

p
l
e
N This command query is used to retrieve a list of all defined parameters in an ASCII format.
o The following is an example of the returned results:
t "DCCoupled=False,ElecAttBypass=True,ElecAttenuation=0,IFGain=0,MechAttenuation=0,PreAmpMode=Off,PreSelectorOffset
e =0,UsePreSelector=False,ExternalReferenceFrequency=10000000,FrequencyReferenceSource=AutoExternalFrequencyRefer
s ence,IFType=B40M,LOMode=SLW,SignalInput=FpMainRf,AcquisitionTime=0.001,CenterFrequency=1000000000,Resolution
BW=0,ResolutionBWMode=BestSpeed,DetectorType=RmsAverage,Bandwidth=[1000000],OffsetFrequency=[0],Function=
[BandPower],FilterType=[IBW],FilterAlpha=[0.22],OccupiedBandwidthPercent=[0.99],XdBBandwidth=[-
3.01],DoNoiseCorrection=False,DoSpurSuppression=False,MeasurementMethod=HardwareFFT,IncludePowerSpectrum=False
e,TriggerDelay=0,TriggerLevel=1.2,TriggerSlope=Positive,TriggerSource=Free,TriggerTimeout=1"
I A.14.00
n
i
t
i
a
l
S
/
W
R
e
v
i
s
i
o
n

```

Configure Fast Power Measurement (Remote Command Only)

The configure command begins hardware setup and returns immediately, with no acquisition made. This can be used in parallel with other hardware operations to effectively hide the hardware setup time.

Mode	All
Remote Command	:CALCulate:FPOWer:POWer[1,2,...,999]:CONFigure
Example	:CALC:FPOW:POW1:CONF
Notes	Option FP2 is required.
Initial S/W Revision	A.14.00

Initiate Fast Power Measurement (Remote Command Only)

The INITiate command begins an acquisition and returns immediately. The results of the measurement can be retrieved using FETCh.

Mode	All
Remote Command	:CALCulate:FPOWER:POWER[1,2,...,999]:INITiate
Example	:CALC:FPOW:POW1:INIT
Notes	Option FP2 is required.
Initial S/W Revision	A.14.00

Fetch Fast Power Measurement (Remote Command Only)

The FETCh command query is used to retrieve the results of an acquisition initiated by the INIT command. The returned results are in ASCII string format. The string begins and ends with quotation marks.

Mode	All
Remote Command	:CALCulate:FPOWER:POWER[1,2,...,999]:FETCh?
Example	:CALC:FPOW:POW1:FETC?
Notes	Option FP2 is required. Returns m comma-separated ASCII values, where m corresponds to the number of bandwidths defined. 1. Declared function return in the 1st specified channel 2. Declared function return in the 2nd specified channel ... m. Declared function return in the last specified channel The INIT and FETC? command sequence performs the same functionality of a single CALC:FPOW:POW[n]? query. Units of the returned values are dependent on the Function parameter for each channel.
Initial S/W Revision	A.14.00

Execute Fast Power Measurement (Remote Command Only)

This command query is used as shorthand for an INIT command immediately followed by a FETC? command. The returned results are in ASCII string format. The string begins and ends with quotation marks.

Mode	All
Remote Command	:CALCulate:FPOWER:POWER[1,2,...,999]?
Example	:CALC:FPOW:POW1?
Notes	Option FP2 is required. See notes for Fast Power Fetch for return format.
Initial S/W Revision	A.14.00

Binary Read Fast Power Measurement (Remote Command Only)

This command query is used as shorthand for an INIT command immediately followed by a FETC? command. The returned results are in a binary format.

Mode	All
Remote Command	:CALCulate:FPOWER:POWER[1,2,...,999]:READ? :CALCulate:FPOWER:POWER[1,2,...,999]:READ1?
Example	:CALC:FPOW:POW1:READ? :CALC:FPOW:POW1:READ1?
Notes	Option FP2 is required. Returns m 4 byte floating point binary values (Little-Endian), where m corresponds to the number of bandwidths defined.
Initial S/W Revision	A.14.00

Diagnostic Binary Read Fast Power Measurement (Remote Command Only)

This command query is used as shorthand for an INIT command immediately followed by a FETC? command. The returned results are in a binary format. This command is used primarily for diagnostic purposes to test for ADC overloads and to visibly inspect the spectrum.

Mode	All
Remote Command	:CALCulate:FPOWER:Power[1,2,...,999]:READ2?
Example	:CALC:FPOW:POW1:READ2?
Notes	Option FP2 is required. Note: Spectrum data is only returned if the IncludePowerSpectrum parameter is set to True. If IncludePowerSpectrum is False, the number of spectrum points will be zero (0). Units of the returned values are dependent on the Function parameter per channel (e.g. dBm for BandPower, Hz for PeakFrequency). Returns binary data (Little-Endian) that contains information on m amount of channels, along with ADC over range and full spectrum data. The following is the binary format of the response. Bandwidth Return Value 1. Number of channels specified, m [4 byte int] 2. Declared function result for the 1st specified channel [4 byte float] 3. Declared function result for the 2nd specified channel [4 byte float] ... (m + 1). Declared function result for the last (mth) specified channel [4 byte float] ADC Over Range 1. ADC over-range occurred (1: true, 0: false) [2 byte short]

	<p>Spectrum Data</p> <ol style="list-style-type: none"> 1. Number of points in the spectrum data, k [4 byte int] 2. Start frequency of spectrum data (Hz) [8 byte double] 3. Step frequency of spectrum data (Hz) [8 byte double] 4. FFT bin at 1st point (dBm) [4 byte float] 5. FFT bin at 2nd point (dBm) [4 byte float] ... (k + 3). FFT bin at last (kth) point (dBm) [4 byte float]
Initial S/W Revision	A.14.00

Format Data: Numeric Data (Remote Command Only)

This command specifies the format of the trace data input and output. It specifies the formats used for trace data during data transfer across any remote port. It affects only the data format for setting and querying trace data for the :TRACe[:DATA], TRACe[:DATA]?, :CALCulate:DATA[n]? and FETCh:SANalyzer[n]? commands and queries.

Remote Command	<pre>:FORMat[:TRACe][:DATA] ASCii INTeger,32 REAL,32 REAL,64 :FORMat[:TRACe][:DATA]?</pre>
Notes	<p>The query response is:</p> <pre>ASCii: ASC,8 REAL,32: REAL,32 REAL,64: REAL,64 INTeger,32: INT,32</pre> <p>When the numeric data format is REAL or ASCii, data is output in the current Y Axis unit. When the data format is INTeger, data is output in units of m dBm (.001 dBm).</p> <p>The INT,32 format returns binary 32-bit integer values in internal units (m dBm), in a definite length block.</p>
Dependencies	<p>Sending a data format spec with an invalid number (for example, INT,48) generates no error. The analyzer simply uses the default (8 for ASCii, 32 for INTeger, 32 for REAL).</p> <p>Sending data to the analyzer which does not conform to the current FORMat specified, results in an error. Sending ASCII data when a definite block is expected generates message -161 "Invalid Block Data" and sending a definite block when ASCII data is expected generates message -121 "Invalid Character in Number".</p>
Preset	ASCii
Backwards Compatibility Notes	Note that the INT,32 format is only applicable to the command, TRACe:DATA. This preserves backwards compatibility for the Swept SA measurement. For all other commands/queries which honor FORMat:DATA, if INT,32 is sent the analyzer will behave as though it were set to REAL,32.
Initial S/W Revision	Prior to A.02.00

The specs for each output type follow:

AScii - Amplitude values are in ASCII, in the current Y Axis Unit, one ASCII character per digit, values separated by commas, each value in the form:

SX.YYYYYEsZZ

Where:

S = sign (+ or -)

X = one digit to left of decimal point

Y = 5 digits to right of decimal point

E = E, exponent header

s = sign of exponent (+ or -)

ZZ = two digit exponent

REAL,32 - Binary 32-bit real values in the current Y Axis Unit, in a definite length block.

REAL,64 - Binary 64-bit real values in the current Y Axis Unit, in a definite length block.

Format Data: Byte Order (Remote Command Only)

This command selects the binary data byte order for data transfer and other queries. It controls whether binary data is transferred in normal or swapped mode. This command affects only the byte order for setting and querying trace data for the :TRACe[:DATA], TRACe[:DATA]? , :CALCulate:DATA[n]? and FETCh:SANalyzer[n]? commands and queries.

By definition any command that says it uses FORMat:DATA uses any format supported by FORMat:DATA.

The NORMal order is a byte sequence that begins with the most significant byte (MSB) first, and ends with the least significant byte (LSB) last in the sequence: 1|2|3|4. SWAPped order is when the byte sequence begins with the LSB first, and ends with the MSB last in the sequence: 4|3|2|1.

Remote Command	:FORMat:BORDER NORMAL SWAPped :FORMat:BORDER?
Preset	NORMal
Initial S/W Revision	Prior to A.02.00

Meas Setup

Accesses a menu of keys that enable you to control specific parameters for the current measurement.

["Overview" on page 1147](#)

["Set Parameters " on page 1147](#)

Key Path	Front-panel key
Initial S/W Revision	Prior to A.02.00

Overview

This section describes the measurement setup features of the Analog Demod measurements.

Set Parameters

The following parameters are set as indicated and are not settable by the user, therefore they do not appear in any menus:

FFT IF Gain	Low (0 dB)
ADC Dither	On
Avg Mode	Exponential
Phase Noise Optimization	Auto

Auto Rules for Phase Noise Optimization:

Use "Optimize for $f < 20$ kHz" when the Channel BW < 120 kHz, otherwise use "Optimize for $f > 30$ kHz".

["Optimizing Measurement Speed" on page 1147](#)

["Channel Bandwidth" on page 1148](#)

["RF Spectrum Span " on page 1148](#)

["RF Spectrum RBW / AF Spectrum RBW" on page 1148](#)

["AF Waveform Sweep Time" on page 1148](#)

["Filters and Annotation" on page 1148](#)

Optimizing Measurement Speed

The speed of the analog demodulation measurements is driven largely by how much data must be acquired to satisfy the selected configuration.

Each measurement cycle generates all of the metrics and traces from a single acquisition, so there are several different settings which can affect the overall speed. Note that even though you may not be

viewing a particular result on the display, the result is available and its configuration and constraints are used to determine the acquisition settings.

Channel Bandwidth

This setting determines the sampling rate used by the measurement, higher bandwidths will result in larger data sets being acquired and processed. This should be set to the lowest value possible which allows your signal to be fully captured.

RF Spectrum Span

This setting is used in a similar way as the Channel Bandwidth in that it determines the sampling rate. As with channel bandwidth, it should be set as narrow as possible to capture the signal of interest.

RF Spectrum RBW / AF Spectrum RBW

These settings dictate a minimum acquisition time for the measurement. The Auto setting is recommended for optimal performance while maintaining measurement integrity. Narrower resolution bandwidths (RBWs) require longer acquisitions to achieve the resolution improvements.

AF Waveform Sweep Time

This setting sets another minimum acquisition time for the measurement. In many uses, the AF Spectrum RBW will dominate the determination of the data acquisition duration, but if the AF waveform view is not needed keeping its sweep time low will ensure that it does not negatively impact the throughput.

Filters and Annotation

You may choose to filter by frequency – choosing an optional low-pass filter and an optional high-pass filter – or may filter using a standard published band-pass filter (CCITT). Turning on a band-pass filter will automatically turn off the high-pass and low-pass filters; similarly, the band-pass filter will automatically turn off if you request either a high-pass or a low-pass filter.

Average/Hold Num

When turned on, the RF Spectrum and AF spectrum traces are averaged, and the Demod window shows an Average trace, a Max Hold trace, and a Min Hold trace in addition to the current trace. All metrics are averaged, and the metrics show an “Average” column and a “Max Hold” column.

The average feature for the Analog Demod measurement differs from other measurements in that the average type is fixed depending on the window as shown in the following table:

Window	Average Type
RF Spectrum	Pwr Average
Demod Waveform	Arithmetic Average
AF Spectrum	Log Average

For more details, see ["Average/Hold On/Off Functionality" on page 1149](#).

Key Path	Meas Setup
----------	------------

Remote Command	[:SENSe]:AM FM PM FMSTereo:AVERAge:COUNT <integer> [:SENSe]:AM FM PM FMSTereo:AVERAge:COUNT? [:SENSe]:AM FM PM FMSTereo:AVERAge[:STATe] ON OFF 1 0 [:SENSe]:AM FM PM FMSTereo:AVERAge[:STATe]?
Example	AM:AVER:COUN 10
Preset	10 ON
State Saved	Saved in instrument state
Min	1
Max	9999
Initial S/W Revision	Prior to A.02.00
Modified at S/W Revision	A.10.00

Average/Hold On/Off Functionality

Average, Minhold, and Maxhold are coupled.

When Average/Hold is on:

- The RF Spectrum and AF Spectrum traces are averaged.
- The Demod Waveform window will display a current trace, an Average trace, a Max Hold trace, and a Min Hold trace.
- The Metrics window will display an “Average” column and a “Max Hold” column.
- Metrics will display to four significant digits.
- The Meas Bar will display the Average/Hold number (along with how many of those sweeps have been captured).
- Demod Min trace, Demod Max trace, and Demod Avg trace are maintained.
- The Max Hold column shows the maximum value the un-averaged metric has attained since the last Restart.

When Average/Max Hold is off:

- The RF Spectrum and AF Spectrum traces are not averaged.
- The Demod Waveform window will display only the demod trace.
- The Metrics window will display only a “Current” column.
- Metrics will display to two significant digits.
- The Meas Bar will not display the Average/Hold number.
- Max Hold metrics over SCPI will return SCPI not a number.

- Demod Min trace, Demod Max trace and Demod Avg trace will return default values in a Meas?, Read?, and Fetch? and when exported to a .csv file
- Max Hold column is blank.

Modulation Rate Periodic

The algorithms used by the instrument for demodulation have an improved speed/accuracy tradeoff when the modulation is both periodic (such as a sinusoidal test signal) and assumed to be periodic by the analysis system. Thus, “Yes” is best for periodic signals. When the modulation is aperiodic, such as voice or music or even multiple nonharmonically related tones, “No” gives better results.

Key Path	Meas Setup
Remote Command	[:SENSe] :AM FM PM FMSTereo:PERIodic[:STATe] ON OFF 1 0 [:SENSe] :AM FM PM FMSTereo:PERIodic[:STATe] ?
Example	FM:PERI OFF
Preset	ON
State Saved	Saved in instrument state
Initial S/W Revision	A.12.00

Filters

Pressing this key displays the Filters menu, allowing you to control the post demodulation and de-emphasis filters.

If any filters are turned on and the filters cannot be applied, the error “161 Setting Modified; Filters not applied” will appear.

Key Path	Meas Setup
Initial S/W Revision	Prior to A.02.00

High Pass Filter (Post Demod)

This parameter allows you to adjust the post demodulation high pass filters. This filter allows you to remove unwanted low-frequency components from the modulated signal..

Key Path	Meas Setup, Filters
Remote Command	AM FM PM: [:SENSe] :AM FM PM:HPFilter OFF HPF20 HPF50 HPF300 HPF400 [:SENSe] :AM FM PM:HPFilter? FM Stereo: [:SENSe] :FMSTereo:HPFilter OFF HPF20 HPF50 HPF300 [:SENSe] :FMSTereo:HPFilter?

Example	FM:HPF HPF20
Remote Command Notes	<p>AM FM PM: Off = No filtering HPF20 = Use 20 Hz high pass filter HPF50 = Use 50 Hz high pass filter HPF300 = Use 300 Hz high pass filter HPF400 = Use 400 Hz high pass filter</p> <p>FM Stereo: Off = No filtering HPF20 = Use 20 Hz high pass filter HPF50 = Use 50 Hz high pass filter HPF300 = Use 300 Hz high pass filter</p>
Dependencies	The HPF400 is available only when Option N9063A-AFP is installed in AM/FM/PM.
Couplings	<p>AM/FM/PM: Turning on any high-pass filter will turn off bandpass filters. If a band-pass filter is turned off, the following advisory message is displayed: “Band-pass filter set to OFF”. If the band-pass filter was already off, no advisory message is displayed.</p> <p>FM Stereo: None</p>
Preset	Off (AM/FM/FM Stereo, HPF20 (PM))
State Saved	Saved in instrument state
Readback line	1-of-N selection
Initial S/W Revision	Prior to A.02.00
Modified at S/W Revision	A.14.00

Off

This selection turns the post demodulation high pass filter off.

Key Path	Meas Setup, HPF
Example	AM:HPF OFF
Notes	Annotation line (DC Coupled) appears in the Meas Bar, except if in the AM measurement.
Readback	Off
Initial S/W Revision	Prior to A.02.00

20 Hz

Sets the post demodulation high pass filter to 20 Hz. It is a 2-pole Butterworth filter, its 3 dB cutoff frequency is 20 Hz.

Key Path	Meas Setup, HPF
Example	AM:HPF HPF20
Readback	20 Hz
Initial S/W Revision	Prior to A.02.00

50 Hz

Sets the post demodulation high pass filter to 50 Hz. It is a 2-pole Butterworth filter, its 3 dB cutoff frequency is 50 Hz.

Key Path	Meas Setup, HPF
Example	AM:HPF HPF50
Readback	50 Hz
Initial S/W Revision	Prior to A.02.00

300 Hz

Sets the post demodulation high pass filter to 300 Hz. It is a 2-pole Butterworth filter, its 3 dB cutoff frequency is 300 Hz.

Key Path	Meas Setup, HPF
Example	AM:HPF HPF300
Readback	300 Hz
Initial S/W Revision	Prior to A.02.00

Lowpass Filter (Post Demod)

This parameter allows you to adjust the post demodulation low pass filter. The filter is useful in removing unwanted high frequency components of the modulating signal.

Key Path	Meas Setup, Filters
Remote Command	<p>AM FM PM:</p> <pre>[:SENSe]:AM FM PM:LPFilter OFF LPF300 LPF3K LPF15K LPF30K LPF80K LPF300K LPF100K MANual</pre> <p>[:SENSe]:AM FM PM:LPFilter?</p> <p>FM Stereo:</p> <pre>[:SENSe]:FMSTereo:LPFilter OFF LPF300 LPF3K LPF15K LPF30K LPF80K LPF300K</pre>

	[:SENSe] :FMSTereo:LPFilter?
Example	FM:LPF LPF3K
Remote Command Notes	<p>AM FM PM:</p> <p>Off = No filtering</p> <p>LPF300 = Use 300 Hz low pass filter</p> <p>LPF3K = Use 3 kHz low pass filter</p> <p>LPF15K = Use 15 kHz low pass filter</p> <p>LPF30K = Use 30 kHz low pass filter</p> <p>LPF80K = Use 80 kHz low pass filter</p> <p>LPF300K = Use 300 kHz low pass filter</p> <p>LPF100K = Use >20 kHz low pass filter</p> <p>MANual=Use user-defined low pass filter</p> <p>FM Stereo:</p> <p>Off = No filtering</p> <p>LPF300 = Use 300 Hz low pass filter</p> <p>LPF3K = Use 3 kHz low pass filter</p> <p>LPF15K = Use 15 kHz low pass filter</p> <p>LPF30K = Use 30 kHz low pass filter</p> <p>LPF80K = Use 80 kHz low pass filter</p> <p>LPF300K = Use 300 kHz low pass filter</p>
Dependencies	<p>LPF key is unavailable (grayed out) when the band pass filter is not OFF.</p> <p>The following filters are available only when Option N9063A-AFP is installed in AM/FM/PM: LPF100K and MANual.</p>
Couplings	<p>AM/FM/PM:</p> <p>Turning on any low-pass filter will turn off band-pass filters.</p> <p>If a band-pass filter is turned off, the following advisory message is displayed: "Band-pass filter set to OFF".</p> <p>If the band-pass filter was already off, no advisory message is displayed.</p> <p>FM Stereo:</p> <p>None</p>
Preset	Off
State Saved	Saved in instrument state
Readback line	1-of-N selection
Initial S/W Revision	Prior to A.02.00
Modified at S/W Revision	A.14.00

Off

Turns the post demodulation low pass filter off.

Key Path	Meas Setup, Post Demod LPF
Example	AM:LPF OFF
Readback	Off
Initial S/W Revision	Prior to A.02.00

300 Hz

Sets the post demodulation low pass filter to 300 Hz. It is a 5-pole Butterworth filter, its 3 dB cutoff frequency is 300 Hz.

Key Path	Meas Setup, HPF/LPF
Example	AM:HPBP LPF300
Readback	300 Hz
Initial S/W Revision	Prior to A.02.00

3 kHz

Selects the 3 kHz post demodulation low pass filter. It is a 5-pole Butterworth filter, its 3 dB cutoff frequency is 3 kHz.

Key Path	Meas Setup, Post Demod LPF
Example	AM:LPF LPF3K
Readback	3 kHz
Initial S/W Revision	Prior to A.02.00

15 kHz

Selects the 15 kHz post demodulation low pass filter. It is a 5-pole Butterworth filter, its 3 dB cutoff frequency is 15 kHz.

Key Path	Meas Setup, Post Demod LPF
Example	AM:LPF LPF15K
Readback	15 kHz
Initial S/W Revision	Prior to A.02.00

30 kHz

Selects the 30 kHz post demodulation low pass filter. It is a 3-pole Butterworth filter, its 3 dB cutoff frequency is 30 kHz.

Key Path	Meas Setup, Post Demod LPF
Example	AM:LPF LPF30K
Readback	30 kHz
Initial S/W Revision	Prior to A.02.00

80 kHz

Selects the 80 kHz post demodulation low pass filter. It is a 3-pole Butterworth filter, its 3 dB cutoff frequency is 80 kHz.

Key Path	Meas Setup, Post Demod LPF
Example	AM:LPF LPF80K
Readback	80 kHz
Initial S/W Revision	Prior to A.02.00

300 kHz

Selects the 300 kHz post demodulation low pass filter. It is a 3-pole Butterworth filter, its 3 dB cutoff frequency is 300 kHz.

Key Path	Meas Setup, Post Demod LPF
Example	AM:LPF LPF300K
Readback	300 kHz
Initial S/W Revision	Prior to A.02.00

Band Pass Filter (Post Demod)

This parameter enables you to choose the post demodulation band pass filters, allowing you to apply industry-defined filters.

Key Path	Meas Setup, Filters
Remote Command	<p>AM FM PM:</p> <pre>[[:SENSe]:AM FM PM:BPFfilter OFF CCITT AWEighting CWEighting CMESsage CCIR1k CCIR2k CUNWeighting</pre> <p>[[:SENSe]:AM FM PM:BPFfilter?</p> <p>FM Stereo:</p> <pre>[[:SENSe]:FMSTereo:BPFfilter OFF CCITT AWAudio</pre> <p>[[:SENSe]:FMSTereo:BPFfilter?</p>

Example	FM:BPF CCITT
Remote Command Notes	<p>AM FM PM: Off = No filtering CCITT = Use CCITT filter AWEighting = Use A-Weighted Audio filter CWEighting = Use C-Weighted audio filter CMESsage = Use C-Message audio filter CCIR1k = Use CCIR-1k Weighted audio filter CCIR2k = Use CCIR-2k Weighted audio filter CUNWeighting = Use CCIR Un-weighted audio filter</p> <p>FM Stereo: Off = No filtering CCITT = Use CCITT filter AWAudio = Use A-Weighted Audio filter</p>
Dependencies	The following filters are available only when Option N9063A-AFP is installed in AM/FM/PM: AWEighting, CWEighting, CMESsage, CCIR1k, CCIR2k and CUNWeighting.
Couplings	<p>AM/FM/PM: Turning on any bandpass filter will turn off high-pass and low-pass filters. If a high-pass filter is turned off, the following advisory message is displayed: “High-pass filter set to OFF”. If a low-pass filter is turned off, the following advisory message is displayed: “Low-pass filter set to OFF”. If both are turned off, the following advisory message is displayed: “High-pass and Low-pass filters set to OFF”. If both high-pass and low-pass filters were already off, no advisory message is displayed.</p> <p>FM Stereo: None</p>
Preset	Off
State Saved	Saved in instrument state
Readback	1-of-N
Initial S/W Revision	Prior to A.02.00
Modified at S/W Revision	A.14.00

Off

Turns the post demodulation band-pass filter off.

Key Path	Meas Setup, BPF
Example	AM:BPF OFF
Readback	Off
Initial S/W Revision	Prior to A.02.00

CCITT

Sets the post demodulation band-pass filter to CCITT.

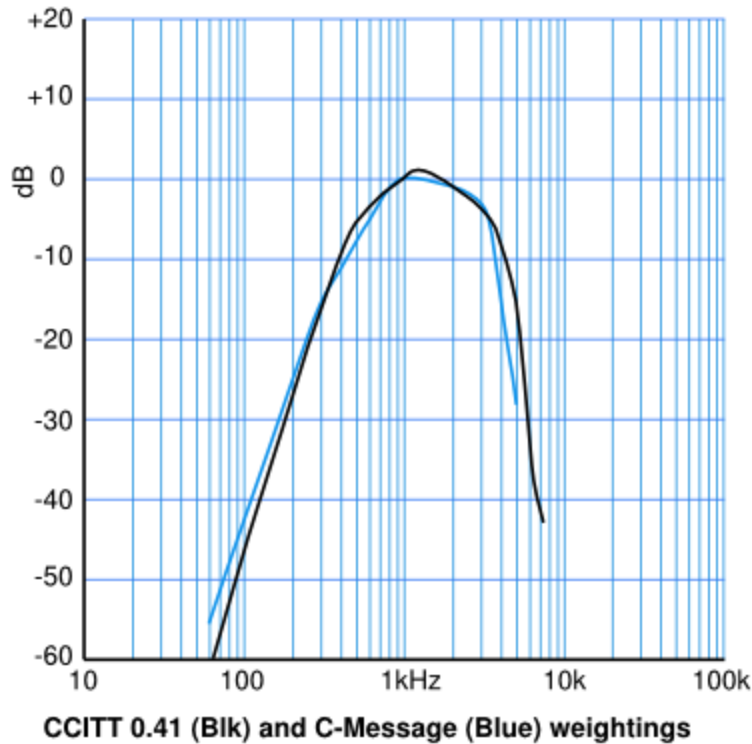

Key Path	Meas Setup, BPF
Example	AM:BPF CCITT
Readback	CCITT
Initial S/W Revision	Prior to A.02.00

De-emphasis (FM and FM Stereo Demod measurement only)

Controls a single-pole filter, usually 6 dB/octave roll off, to counter intentional pre-emphasis in the transmitter. When the De-emphasis state is OFF the hardware digital filter is bypassed, otherwise the setting is applied

US75 is recommended for US commercial FM 75 μ s pre-emphasis.

The De-emphasis key only appears in the Meas Setup menu for the FM and FM Stereo Demod measurements. It is unavailable for the AM and Φ M measurements.

Key Path	Meas Setup, Filters
----------	---------------------

Remote Command	<code>[:SENSe] :FM FMSTereo:DEEMphasis OFF US25 US50 US75 US750</code> <code>[:SENSe] :FM FMSTereo:DEEMphasis?</code>
Example	FM:DEEM US75 FM:DEEM?
Dependencies	Only available in FM and FM Stereo measurements. Unavailable for AM and PM
Preset	OFF
State Saved	Saved in instrument state
Readback line	1-of-N selection
Initial S/W Revision	Prior to A.02.00
Modified at S/W Revision	A.10.00

Off

Bypasses the De-emphasis filter.

Key Path	Meas Setup, Filters, De-emphasis
Example	FM:DEEM OFF
Readback	Off
Initial S/W Revision	Prior to A.02.00

25 μ s

Sets the De-emphasis time constant to 25 μ s.

Key Path	Meas Setup, Filters, De-emphasis
Example	FM:DEEM US25
Readback	25 μ s
Initial S/W Revision	Prior to A.02.00

50 μ s

Sets the De-emphasis time constant to 50 μ s.

Key Path	Meas Setup, Filters, De-emphasis
Example	FM:DEEM US50
Readback	50 μ s
Initial S/W Revision	Prior to A.02.00

75 μ s

Sets the De-emphasis time constant to 75 μ s.

Key Path	Meas Setup, Filters, De-emphasis
Example	FM:DEEM US75
Readback	75 μ s
Initial S/W Revision	Prior to A.02.00

750 μ s

Sets the De-emphasis time constant to 750 μ sec.

Key Path	Meas Setup, Filters, De-emphasis
Example	FM:DEEM US750
Readback	750 μ s
Initial S/W Revision	Prior to A.02.00

Demod to Speaker

Controls whether a demodulated audio signal is connected to the speaker or not. This allows the demodulated audio to be turned off without completely disabling (muting) the instrument speaker. When the Analog Demod application is running, the demodulated signal can be heard from the speaker as long as the “Demod to Speaker” function is set to On.

NOTE The Windows controls for speaker volume and mute must also be properly set.

This function is shared among all measurements in the mode, but not across other modes.

Key Path	Meas Setup
Remote Command	[:SENSe] :SPEaker [:STATe] ON OFF 1 0 [:SENSe] :SPEaker [:STATe] ?
Example	SPE OFF Disconnects demodulated audio from speaker circuit.
Preset	On
State Saved	Saved in instrument state
Initial S/W Revision	Prior to A.02.00

Advanced

Accesses a menu to specify advanced settings for the FM Stereo measurement. This key and sub menu are only valid in the FM Stereo measurement.

Key Path	Meas Setup
Initial S/W Revision	A.10.00

BLER Block Count

Sets BLER Block Count. It is used to control the stop time of BLER Calculation. When the total block count exceeds the value of BLER Block Count for the first time, the calculation of BLER will stop.

Key Path	Meas Setup, Advanced
Remote Command	[:SENSe] : FMSTereo : BLER : COUNT <real> [:SENSe] : FMSTereo : BLER : COUNT ?
Example	FMST:BLER:COUN 1.0e8 FMST:BLER:COUN?
Preset	1.0e8
State Saved	Saved in instrument state.
Min	1
Max	1.0e+307
Initial S/W Revision	A.10.00

Ref Deviation

Sets the FM reference deviation.

Key Path	Meas Setup, Advanced
Remote Command	[:SENSe] : FMSTereo : RDEViation <freq> [:SENSe] : FMSTereo : RDEViation ?
Example	FMST:RDEV 75e3 FMST:RDEV?
Preset	75 kHz
State Saved	Saved in instrument state.
Min	15 kHz
Max	150 kHz
Initial S/W Revision	A.10.00

SINAD MPX BW

Sets the bandwidth of the MPX signal to calculate SINAD.

Key Path	Meas Setup, Advanced
Remote Command	CALCulate:FMSTereo:MPX[:BANDwidth] <freq> CALCulate:FMSTereo:MPX[:BANDwidth]?
Example	CALC:FMST:MPX 53e3 CALC:FMST:MPX?
Preset	53 kHz
State Saved	Saved in instrument state.
Min	0 kHz
Max	58 kHz
Initial S/W Revision	A.10.00

SINAD Mono BW

Sets the bandwidth of the Mono signal to calculate SINAD.

Key Path	Meas Setup, Advanced
Remote Command	CALCulate:FMSTereo:MONO[:BANDwidth] <freq> CALCulate:FMSTereo:MONO[:BANDwidth]?
Example	CALC:FMST:MONO 16e3 CALC:FMST:MONO?
Preset	16 kHz
State Saved	Saved in instrument state.
Min	0 kHz
Max	16 kHz
Initial S/W Revision	A.10.00

Meas Preset

Returns the variables in the current measurement to their preset values.

Key Path	Meas Setup
Initial S/W Revision	Prior to A.02.00

11 FM Stereo Measurement
Mode

Mode

See "[Mode](#)" on page 156

Mode Preset

Returns the active mode to a known state.

Mode Preset does the following for the currently active mode:

- Aborts the currently running measurement.
- Brings up the default menu for the mode, with no active function.
- Sets measurement Global settings to their preset values for the active mode only.
- Activates the default measurement.
- Brings up the default menu for the mode.
- Clears the input and output buffers.
- Sets Status Byte to 0.

Mode Preset does not:

- Cause a mode switch
- Affect mode persistent settings
- Affect system settings
- See "[How-To Preset](#)" on page 1164 for more information.

Key Path	Front-panel key
Remote Command	:SYSTem:PRESet
Example	:SYST:PRES
Notes	*RST is preferred over :SYST:PRES for remote operation. *RST does a Mode Preset, as done by the :SYST:PRES command, and it sets the measurement mode to Single measurement rather than Continuous for optimal remote control throughput. Clears all pending OPC bits. The Status Byte is set to 0.
Couplings	A Mode Preset aborts the currently running measurement, activates the default measurement, and gets the mode to a consistent state with all of the default couplings set.
Backwards Compatibility Notes	In the X-Series, the legacy "Factory Preset" has been replaced with Mode Preset, which only presets the currently active mode, not the entire instrument. In the X-Series, the way to preset the entire instrument is by using System, Restore System Defaults All, which behaves essentially the same way as restore System Defaults does on ESA and PSA. There is also no "Preset Type" as there is on the PSA. There is a green Mode Preset front-panel key that does a Mode Preset and a white-with-green-letters User Preset front-panel key that does a User Preset. The old PRESet:TYPE command is ignored (without generating an error), and SYST:PRES without a parameter does a Mode Preset, which should cover most backward code compatibility issues. The settings and correction data under the Input/Output front-panel key (examples: Input Z Corr, Ext Amp Gain, etc.) are no longer part of any Mode, so they will not be preset by a Mode Preset. They are preset using Restore Input/Output Defaults, Restore System Defaults All. Note that because User Preset does a Recall State, and all of these settings are saved in State, they ARE recalled when using

	User Preset.
Initial S/W Revision	Prior to A.02.00

How-To Preset

The table below shows all possible presets, their corresponding SCPI commands and front-panel access (key paths). Instrument settings depend on the current measurement context. Some settings are local to the current measurement, some are global (common) across all the measurements in the current mode, and some are global to all the available modes. In a similar way, restoring the settings to their preset state can be done within the different contexts.

Auto Couple - is a measurement local key. It sets all Auto/Man parameter couplings in the measurement to Auto. Any Auto/Man selection that is local to other measurements in the mode will not be affected.

Meas Preset - is a measurement local key. Meas Preset resets all the variables local to the current measurement except the persistent ones.

Mode Preset - resets all the current mode's measurement local and measurement global variables except the persistent ones.

Restore Mode Defaults - resets ALL the Mode variables (and all the Meas global and Meas local variables), including the persistent ones.

Type Of Preset	SCPI Command	Front Panel Access
Auto Couple	:COUPle ALL	Auto Couple front-panel key
Meas Preset	:CONFigure:<Measurement>	Meas Setup Menu
Mode Preset	:SYSTem:PRESet	Mode Preset (green key)
Restore Mode Defaults	:INSTrument:DEFault	Mode Setup Menu
Restore All Mode Defaults	:SYSTem:DEFault MODes	System Menu; Restore System Default Menu
*RST	*RST	not possible (Mode Preset with Single)
Restore Input/Output Defaults	:SYSTem:DEFault INPUt	System Menu; Restore System Default Menu
Restore Power On Defaults	:SYSTem:DEFault PON	System Menu; Restore System Default Menu
Restore Alignment Defaults	:SYSTem:DEFault ALIGN	System Menu; Restore System Default Menu
Restore Miscellaneous Defaults	:SYSTem:DEFault MISC	System Menu; Restore System Default Menu
Restore All System Defaults	:SYSTem:DEFault [ALL] :SYSTem:PRESet:PERsistent	System Menu; Restore System Default Menu
User Preset	:SYSTem:PRESet:USER	User Preset Menu
User Preset All Modes	:SYSTem:PRESet:USER:ALL	User Preset Menu

Power On Mode Preset	:SYSTem:PON:TYPE MODE	System Menu
Power On User Preset	:SYSTem:PON:TYPE USER	System Menu
Power On Last State	:SYSTem:PON:TYPE LAST	System Menu

Restore Mode Defaults

Resets the state for the currently active mode by resetting the mode persistent settings to their factory default values, clearing mode data and by performing a Mode Preset. This function will never cause a mode switch. This function performs a full preset for the currently active mode; whereas, Mode Preset performs a partial preset. Restore Mode Defaults does not affect any system settings. System settings are reset by the Restore System Defaults function. This function does reset mode data; as well as settings.

Key Path	Mode Setup
Remote Command	:INSTrument:DEFault
Example	:INST:DEF
Notes	Clears all pending OPC bits. The Status Byte is set to 0. A message comes up saying: "If you are sure, press key again".
Couplings	A Restore Mode Defaults will cause the currently running measurement to be aborted and causes the default measurement to be active. It gets the mode to a consistent state with all of the default couplings set.
Initial S/W Revision	Prior to A.02.00

Preset Type (Remote Command Only)

As stated in the Backward Compatibility section, to be compatible with ESA/PSA the PRESet:TYPE command will be implemented as a no-op.

Mode	All
Remote Command	:SYSTem:PRESet:TYPE FACTory MODE USER :SYSTem:PRESet:TYPE?
Example	:SYST:PRE:TYPE FACT
Notes	This command is supported for backward compatibility only. It is a no-op which does not change the behavior of any preset operation.
Preset	This is unaffected by Preset but is set to Mode on a "Restore System Defaults->All"
State Saved	No
Initial S/W Revision	Prior to A.02.00

Global Settings

Opens a menu that allows you to switch certain Meas Global parameters to a Mode Global state. These switches apply to all Modes that support global settings. No matter what Mode you are in when you set the “Global Center Frequency” switch to on, it applies to all Modes that support Global Settings.

Key Path	Mode Setup
Initial S/W Revision	Prior to A.02.00

Global Center Freq

The software maintains a Mode Global value called “Global Center Freq”.

When the Global Center Freq key is switched to On in any mode, the current mode’s center frequency is copied into the Global Center Frequency, and from then on all modes that support global settings use the Global Center Frequency. So you can switch between any of these modes and the Center Freq will remain unchanged.

Adjusting the Center Freq of any mode which supports Global Settings, while Global Center Freq is On, will modify the Global Center Frequency.

When Global Center Freq is turned Off, the Center Freq of the current mode is unchanged, but now the Center Freq of each mode is once again independent.

When Mode Preset is pressed while Global Center Freq is On, the Global Center Freq is preset to the preset Center Freq of the current mode.

This function is reset to Off when the Restore Defaults key is pressed in the Global Settings menu, or when System, Restore Defaults, All Modes is pressed.

Key Path	Mode Setup, Global Settings
Scope	Mode Global
Remote Command	:INSTRument:COUPle:FREQuency:CENTer ALL NONE :INSTRument:COUPle:FREQuency:CENTer?
Example	INST:COUP:FREQ:CENT ALL INST:COUP:FREQ:CENT?
Preset	Set to Off on Global Settings, Restore Defaults and System, Restore Defaults, All Modes
Range	On Off
Initial S/W Revision	Prior to A.02.00

Remote Command	:GLOBal:FREQuency:CENTer[:STATe] 1 0 ON OFF :GLOBal:FREQuency:CENTer[:STATe]?
Preset	Off
Initial S/W Revision	Prior to A.02.00

Restore Defaults

This key resets all of the functions in the Global Settings menu to Off. This also occurs when System, Restore Defaults, All Modes is pressed.

Key Path	Mode Setup, Global Settings
Remote Command	:INSTrument:COUPle:DEFault
Example	INST:COUP:DEF
Backwards Compatibility SCPI	:GLOBal:DEFault
Initial S/W Revision	Prior to A.02.00

Peak Search

Displays the Peak Search menu and places the selected marker on the trace point with the maximum y-axis value for that marker's trace.

Key Path	Front-panel key
Remote Command	:CALCulate:AM FM PM FMSTereo:MARKer[1] 2 ... 12:MAXimum
Example	CALC:AM:MARK2:MAX
Initial S/W Revision	Prior to A.02.00
Modified at S/W Revision	A.10.00

Next Peak

Moves the selected marker to the peak that has the next highest amplitude less than the current marker value. If there is no valid peak lower than the current marker position, an error is generated and the marker is not moved.

If the selected marker was off, then it is turned on as a normal marker and a peak search is performed. In Analog Demod, the Peak Threshold and Peak Excursion functions are both OFF. If there is no valid peak, an error is generated and the marker is not moved. If the selected marker was off, then it is turned on as a normal marker and a peak search is performed.

Key Path	Peak Search
Remote Command	:CALCulate:AM FM PM FMSTereo:MARKer[1] 2 ... 12:MAXimum:NEXT
Example	CALC:AM:MARK2:MAX:NEXT Selects marker 2 and moves it to the peak that is closest in amplitude to the current peak, but the next lower value.
Remote Command Notes	Sending this command selects the specified marker
State Saved	Not part of instrument saved state
Initial S/W Revision	Prior to A.02.00
Modified at S/W Revision	A.10.00

Pk-Pk Search

Finds and displays the amplitude and frequency (or time, if on a time domain trace) differences between the highest and lowest y-axis value. It places the selected marker on the minimum value on its selected trace and it places that marker's reference marker on the peak of its selected trace. This function turns on the reference marker and sets its mode to Fixed if it is not already on. (These markers may be on two different traces.)

When peak-to-peak search is successful, a message is displayed on the message line.

If the selected marker is off, a delta type marker is turned on and the peak-to-peak search is done. If the selected marker is on, but it is not a delta marker, then it is changed to delta, which turns on the reference marker if needed. It then performs the peak-to-peak function.

Key Path	Peak Search
Remote Command	:CALCulate:AM FM PM FMSTereo:MARKer[1] 2 ... 12:PTPeak
Example	CALC:AM:MARK:PTP CALC:AM:MARK:Y? Queries the delta amplitude value for marker 1.
Notes	Turns on the Marker Δ active function.
Remote Command Notes	Sending this command selects the specified marker.
Couplings	Selected marker becomes a delta marker if not already in delta mode..
State Saved	Not part of instrument saved state
Initial S/W Revision	Prior to A.02.00
Modified at S/W Revision	A.10.00

Min Search

Moves the selected marker to the minimum y-axis value on the current trace. If the selected marker is off, it is turned on before the minimum search is performed.

Key Path	Peak Search
Remote Command	:CALCulate:AM FM PM FMSTereo:MARKer[1] 2 ... 12:MINimum
Example	CALC:AM:MARK:MIN selects marker 1 and moves it to the minimum amplitude value.
Remote Command Notes	Sending this command selects the specified marker.
State Saved	Not part of instrument saved state
Initial S/W Revision	Prior to A.02.00
Modified at S/W Revision	A.10.00

11 FM Stereo Measurement
Print

Print

See ["Print" on page 181](#)

Quick Save

The Quick Save front-panel key repeats the most recent save that was performed from the Save menu, with the following exceptions:

- Register saves are not remembered as Saves for the purpose of the Quick Save function
- If the current measurement does not support the last non-register save that was performed, an informational message is generated, “File type not supported for this measurement”

Quick Save repeats the last type of qualified save (that is, a save qualified by the above criteria) in the last save directory by creating a unique filename using the Auto File Naming algorithm described below.

If Quick Save is pressed after startup and before any qualified Save has been performed, the Quick Save function performs a Screen Image save using the current settings for Screen Image saves (current theme, current directory), which then becomes the “last save” for the purpose of subsequent Quick Saves.

The Auto File Naming feature automatically generates a file name for use when saving a file. The filename consists of a prefix and suffix separated by a dot, as is standard for the Windows® file system. A default prefix exists for each of the available file types:

Type	Default Prefix	Menu
State	State_	(Save/Recall)
Trace + State	State_	(Save/Recall)
Screen	Screen_	(Save/Recall)
Amplitude Corrections	Ampcor_	(Import/Export)
Traces	Trace_	(Import/Export)
Limit Lines	LLine_	(Import/Export)
Measurement Result	MeasR_	(Import/Export)
Capture Buffer	CapBuf_	(Import/Export)

A four digit number is appended to the prefix to create a unique file name. The numbering sequence starts at 0000 within each Mode for each file type and updates incrementally to 9999, then wraps to 0000 again. It remembers where it was through a Mode Preset and when leaving and returning to the Mode. It is reset by Restore Misc Defaults and Restore System Defaults and subsequent running of the instrument application. So, for example, the first auto file name generated for State files is State_0000.state. The next is State_0001, and so forth.

One of the key features of Auto File Name is that we guarantee that the Auto File Name will never conflict with an existing file. The algorithm looks for the next available number. If it gets to 9999, then it looks for holes. If it find no holes, that is no more numbers are available, it gives an error.

For example, if when we get to State_0010.state there is already a State_0010.state file in the current directory, it advances the counter to State_0011.state to ensure that no conflict will exist (and then it verifies that State_0011.state also does not exist in the current directory and advances again if it does, and so forth).

If you enter a file name for a given file type, then the prefix becomes the filename you entered instead of the default prefix, followed by an underscore. The last four letters (the suffix) are the 4-digit number.

For example, if you save a measurement results file as “fred.csv”, then the next auto file name chosen for a measurement results save will be fred_0000.csv.

NOTE Although 0000 is used in the example above, the number that is used is actually the current number in the Meas Results sequence, that is, the number that would have been used if you had not entered your own file name.

NOTE If the filename you entered ends with _dddd, where d=any number, making it look just like an auto file name, then the next auto file name picks up where you left off with the suffix being dddd + 1.

Key Path	Front-panel key
Notes	No remote command for this key specifically.
Initial S/W Revision	Prior to A.02.00

State

The Recall State menu lets you choose a register or file from which to recall the state.

The content of a state file includes all of the settings and data required to return the analyzer as closely as possible to the Mode it was in, with the exact settings that were in place, when the save occurred. The Mode settings in each state file include the settings that are affected by Mode Preset, as well as the additional settings affected by Restore Mode Defaults; all of the Mode’s settings. In addition, all of the settings of the Input/Output system are included, even though they are outside of the Mode’s state, because they are needed to restore the complete setup. Persistent System settings (for example, GPIB address) are not affected by either a Mode Preset or Restore Mode Defaults, nor are they included in a saved State file.

Since each state file is only for one Mode, the settings for other Modes are unaffected when it is loaded. Recall State will cause a mode switch if the state being recalled is not from the current active mode.

After the recall completes, the message "File <filename> recalled" or “Recalled State Register <register number>” is displayed.

For rapid recalls, the State menu lists 16 registers that you can choose from to recall. Pressing a Register key initiates the recall. You can also select a file from which to recall.

The default path for all State Files is:

My Documents\<mode name>\state

where <mode name> is the parameter used to select the mode with the INST:SEL command (for example, SA for the Spectrum Analyzer).

See "[More Information](#)" on page 1173.

Key Path	Recall
----------	--------

Mode	All
Remote Command	:MMEMory:LOAD:STATe <filename>
Example	:MMEM:LOAD:STAT "myState.state" This recalls the file myState.state on the default path
Example	MMEM:LOAD:STAT "MyStateFile.state" This loads the state file data (on the default file directory path) into the instrument state.
Notes	<p>When you pick a file to recall, the analyzer first verifies that the file is recallable in the current instrument by checking the software version and model number of the instrument. If everything matches, a full recall proceeds by aborting the currently running measurement, clearing any pending operations, and then loading the State from the saved state file. You can open state files from any mode, so recalling a State file switches to the mode that was active when the save occurred. After switching to the mode of the saved state file, mode settings and data (if any for the mode) are loaded with values from the saved file. The saved measurement of the mode becomes the newly active measurement and the data relevant to the measurement (if there is any) is recalled.</p> <ul style="list-style-type: none"> • If there is a mismatch between file version or model number or instrument version or model number, the recall function tries to recall as much as possible and returns a warning message. It may limit settings that differ based on model number, licensing or version number. <p>After recalling the state, the Recall State function does the following:</p> <ul style="list-style-type: none"> • Makes the saved measurement for the mode the active measurement. • Clears the input and output buffers. • Status Byte is set to 0. • Executes a *CLS <p>If the file specified is empty an error is generated. If the specified file does not exist, another error is generated. If there is a mismatch between the file and the proper file type, an error is generated. If there is a mismatch between file version or model number or instrument version or model number, a warning is displayed. Then it returns to the State menu and File Open dialog goes away.</p> <p>After the Recall, the analyzer exits the Recall menu and returns to the previous menu.</p>
Backwards Compatibility SCPI	:MMEMory:LOAD:STATe 1,<filename> For backwards compatibility, the above syntax is supported. The "1" is simply ignored.
Initial S/W Revision	Prior to A.02.00

More Information

In measurements that support saving Traces, for example, Swept SA, the Trace data is saved along with the State in the State file. When recalling the State, the Trace data is recalled as well. Traces are recalled exactly as they were stored, including the writing mode and update and display modes. If a Trace was updating and visible when the State was saved, it will come back updating and visible, and its data will be rewritten right away. When you use State to save and recall traces, any trace whose data must be preserved should be placed in View or Blank mode before saving.

The following table describes the Trace Save and Recall possibilities:

You want to recall state and one trace's data, leaving other traces	Save Trace+State from 1 trace. Make sure that no other traces are	On Recall, specify the trace you want to load the one trace's data
---	--	--

unaffected.	updating (they should all be in View or Blank mode) when the save is performed.	into. This trace will load in View. All other traces' data will be unaffected, although their trace mode will be as it was when the state save was performed.
You want to recall all traces	Save Trace+State from ALL traces.	On Recall, all traces will come back in View (or Blank if they were in Blank or Background when saved)
You want all traces to load exactly as they were when saved.	Save State	On recall, all traces' mode and data will be exactly as they were when saved. Any traces that were updating will have their data immediately overwritten.

From File...

When you press “From File”, the analyzer brings up a Windows dialog and a menu entitled “File Open.” This menu allows you to navigate to the various fields in the Windows dialog without using a keyboard or mouse. The Tab and Arrow keys can also be used for dialog navigation.

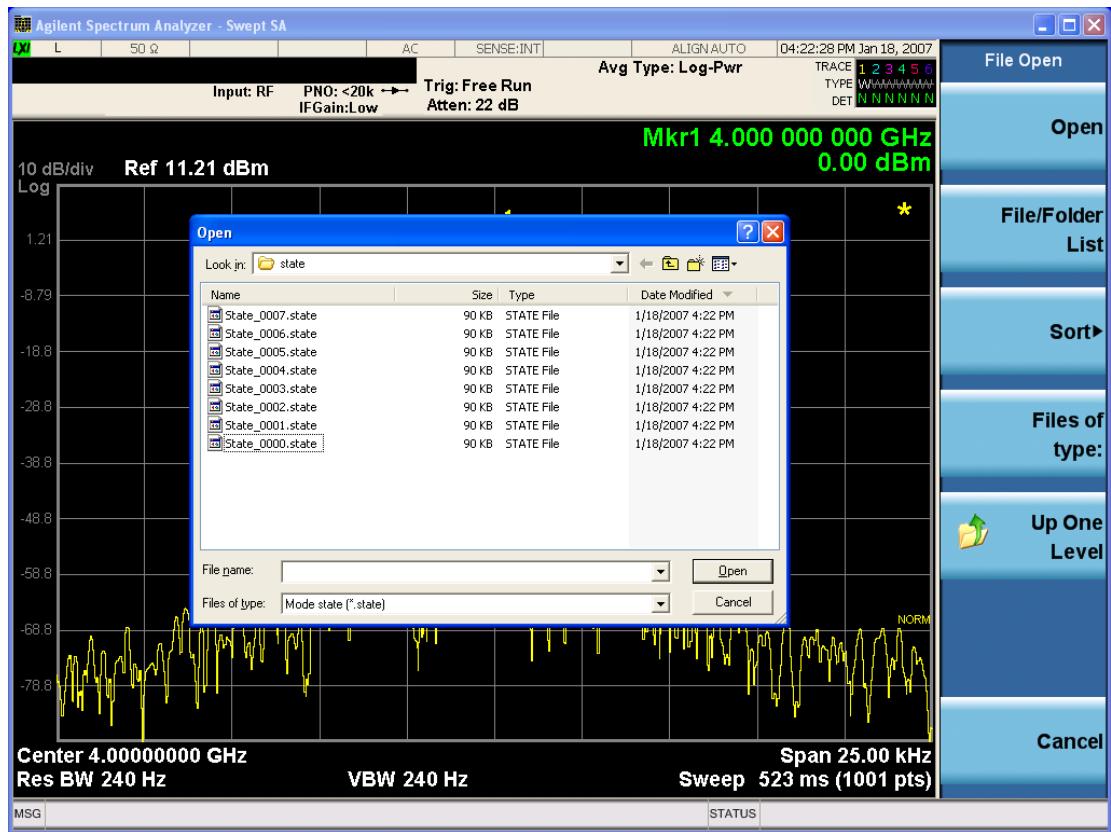

Listed below are the functions of the various fields in the dialog, and the corresponding softkeys:

Open

Performs the recall of the specified file. While the recall is being performed, the floppy icon appears briefly in the Meas bar.

File/Folder List

Enables you to navigate to the center of the dialog that contains the list of files and folders. Once here you can get information about the file and use the tab keys to navigate to the other fields in the dialog, such as Look In.

Look In

The Look In field shows the path from which the file will be recalled and allows you to change the path using the up and down arrow keys to navigate to other paths; the Enter key to open a directory; and the Backspace key to go back one directory. The **Look In field** first uses the last path from the Save As dialog **Save In:** path for that same file type. There is no softkey for directly navigating to the Look In field, but you can use the left tab to get here from the File/Folder List.

User specified paths are remembered when you leave and return to a Mode and are reset back to the default using Restore Mode Defaults.

Sort

Accesses a menu that enables you to sort the files within the File Open dialog. Only one sorting type can be selected at a time and the sorting happens immediately. The sorting types are By Date, By Name, By extension, and By Size.

Files of Type

This field shows the file suffix for the type of file you have selected to recall. For example, if you navigated here while recalling State, "Mode state (*.state)" is in the field. If you navigated here while recalling Trace, ""Mode state (*.trace)" is in the field. If you navigated here while importing a trace data file, "Trace Data (*.csv)" is in the field. For some file types, there is more than one choice in the dropdown menu, which you can select by using the up and down arrow keys and Enter.

Up One Level

This key corresponds to the icon of a folder with the up arrow that is in the tool bar of the dialog. When pressed, it causes the file and folder list to navigate up one level in the directory structure. The Backspace key does the same thing.

Cancel

This key corresponds to the Cancel selection in the dialog. It causes the current **Open** request to be cancelled. The ESC key does the same thing.

Key Path	Recall, State
Notes	Brings up the Open dialog for recalling a State Save Type
Initial S/W Revision	Prior to A.02.00

Edit Register Names

You may enter a custom name on any of the Register keys, to help you remember what you are using that state to save. To do this, press the Edit Register Names key, choose the register whose name you wish to edit, and then enter the desired label using the Alpha Editor or an external PC keyboard.

The maximum number of characters that can be added is 30. In most cases, 30 characters will fit on two lines of the key.

For more information and the SCPI command, see Edit Register Names under the Save, State function.

Key Path	Recall, State
Mode	All
Dependencies	N9060A-7FP or N9060B-2FP license required to edit the register names. When the feature is not licensed, sending the SCPI command generates an error, -221, "Settings conflict;Option not available"
Initial S/W Revision	A.11.00

Register 1 thru Register 16

Selecting any one of these register keys causes the State of the mode from the specified Register to be recalled. Each of the register keys annotates whether it is empty or at what date and time it was last modified. In addition, you can use the Edit Register Names key under Save, State to enter custom names for each register.

NOTE

In products that run multiple instances of the X-Series Application, recalling the same register name on each instance is a way to share setups between the instances.

Registers are shared by all modes, so recalling from any one of the registers will cause a mode switch to the mode that was active when the save to the Register occurred.

Although these 16 registers are the only registers available from the front panel, there are 128 state registers available in the instrument. Registers 17-128 are only available from the SCPI interface, using the *RCL command.

After the recall completes, the message "Register <register number> recalled" appears in the message bar. If you are in the Spectrum Analyzer Mode, and you are recalling a register that was saved in the Spectrum Analyzer Mode, then after the recall, you will still be in the Recall Register menu. If the Recall causes you to switch modes, then after the Recall, you will be in the Frequency menu.

If a requested register is empty an error is generated.

Key Path	Recall, State
Example	*RCL 1
Range	1-16 from front panel, 1-128 from SCPI
Readback	Date and time with seconds resolution are displayed on the key OR A custom name of up to 30 characters entered using the Save, State, Edit Register Names key

	OR “(empty)” if no prior save operation has been performed to this register.
Initial S/W Revision	Prior to A.02.00
Modified at S/W Revision	Prior to A.11.00

Register 1 thru Register 16

Selecting any one of these register keys causes the State of the mode from the specified Register to be recalled. Each of the register keys annotates whether it is empty or at what date and time it was last modified. In addition, you can use the Edit Register Names key under Save, State to enter custom names for each register.

NOTE In products that run multiple instances of the X-Series Application, recalling the same register name on each instance is a way to share setups between the instances.

Registers are shared by all modes, so recalling from any one of the registers will cause a mode switch to the mode that was active when the save to the Register occurred.

Although these 16 registers are the only registers available from the front panel, there are 128 state registers available in the instrument. Registers 17–128 are only available from the SCPI interface, using the *RCL command.

After the recall completes, the message "Register <register number> recalled" appears in the message bar. If you are in the Spectrum Analyzer Mode, and you are recalling a register that was saved in the Spectrum Analyzer Mode, then after the recall, you will still be in the Recall Register menu. If the Recall causes you to switch modes, then after the Recall, you will be in the Frequency menu.

If a requested register is empty an error is generated.

Key Path	Recall, State
Example	*RCL 1
Range	1–16 from front panel, 1–128 from SCPI
Readback	Date and time with seconds resolution are displayed on the key OR A custom name of up to 30 characters entered using the Save, State, Edit Register Names key OR “(empty)” if no prior save operation has been performed to this register.
Initial S/W Revision	Prior to A.02.00
Modified at S/W Revision	Prior to A.11.00

Restart

The Restart function restarts the current sweep, or measurement, or set of averaged/held sweeps or measurements. If you are Paused, pressing Restart does a Resume.

The Restart function is accessed in several ways:

- Pressing the Restart key
- Sending the remote command INIT:IMMEDIATE
- Sending the remote command INIT:RESTART

See "[More Information](#)" on page 1178

Key Path	Front-panel key
Remote Command	:INITiate[:IMMEDIATE] :INITiate:RESTART
Example	:INIT:IMM :INIT:REST
Notes	:INITiate:RESTART and :INITiate:IMMEDIATE perform exactly the same function.
Couplings	Resets average/hold count k. For the first sweep overwrites all active (update=on) traces with new current data. For application modes, it resets other parameters as required by the measurement.
Status Bits/OPC dependencies	This is an Overlapped command. The STATus:OPERation register bits 0 through 8 are cleared. The STATus:QUESTionable register bit 9 (INTEgrity sum) is cleared. The SWEEPING bit is set. The MEASURING bit is set.
Backwards Compatibility Notes	For Spectrum Analysis mode in ESA and PSA, the Restart hardkey and the INITiate:RESTART command restart trace averages (displayed average count reset to 1) for a trace in Clear Write, but did not restart Max Hold and Min Hold. In the X-Series, the Restart hardkey and the INITiate:RESTART command restart not only Trace Average, but MaxHold and MinHold traces as well. For wireless comms modes in ESA and PSA, the Restart hardkey and the INITiate:RESTART command restart every measurement, which includes all traces and numeric results. There is no change to this operation.
Initial S/W Revision	Prior to A.02.00

More Information

The **Restart** function first aborts the current sweep/measurement as quickly as possible. It then resets the sweep and trigger systems, sets up the measurement and initiates a new data measurement sequence with a new data acquisition (sweep) taken once the trigger condition is met.

If the analyzer is in the process of aligning when **Restart** is executed, the alignment finishes before the restart function is performed.

Even when set for Single operation, multiple sweeps may be taken when Restart is pressed (for example, when averaging/holding is on). Thus when we say that **Restart** "restarts a measurement," we may mean:

- It restarts the current sweep
- It restarts the current measurement
- It restarts the current set of sweeps if any trace is in Trace Average, Max Hold or Min Hold
- It restarts the current set of measurements if Averaging, or Max Hold, or Min Hold is on for the measurement
- depending on the current settings.

With **Average/Hold Number** (in **Meas Setup** menu) set to 1, or Averaging off, or no trace in Trace Average or Hold, a single sweep is equivalent to a single measurement. A single sweep is taken after the trigger condition is met; and the analyzer stops sweeping once that sweep has completed. However, with **Average/Hold Number** >1 and at least one trace set to **Trace Average, Max Hold, or Min Hold (SA Measurement)** or **Averaging on (most other measurements)**, multiple sweeps/data acquisitions are taken for a single measurement. The trigger condition must be met prior to each sweep. The sweep is stopped when the average count k equals the number N set for **Average/Hold Number**. A measurement average usually applies to all traces, marker results, and numeric results; but sometimes it only applies to the numeric results.

Once the full set of sweeps has been taken, the analyzer will go to idle state. To take one more sweep without resetting the average count, increment the average count by 1, by pressing the step up key while **Average/Hold Number** is the active function, or sending the remote command `CALC:AVER:TCON UP`.

Save

The Save menu lets you choose what you want to save and where you want to save it. Among the types of files you can save are **States**, **Traces**, and **Screen Images**. In addition, an Export (Data) option lets you save a number of data types as CSV files for easy import into Excel and other spreadsheet programs.

Key Path	Front-panel key
Mode	All
Notes	No remote command for this key specifically, but the :MMEM:STORe command is available for specific file types. An example is :MMEM:STOR:STATe <filename>.
Initial S/W Revision	Prior to A.02.00

State

The Save State menu lets you choose a register or file for saving the state.

NOTE In products that run multiple instances of the X-Series Application, all instances share the same register and file location where you want to save the state.

The content of a state file includes all of the settings and data required to return the analyzer as closely as possible to the Mode it was in, with the exact settings which were in place, when the save occurred. The Mode settings in each state file include the settings that are affected by Mode Preset, as well as the additional settings affected by Restore Mode Defaults; all of the Mode's settings. In addition, all of the settings of the Input/Output system are included, even though they are outside of the Mode's state, because they are needed to restore the complete setup. Persistent System settings (for example, Verbose SCPI) are not affected by either Mode Preset or Restore Mode Defaults, nor are they included in a saved State file.

After the save completes, the message "File <filename> saved" or "State Register <register number> saved" is displayed.

For rapid saving, the State menu lists 16 registers to save to. Pressing a Register key initiates the save. You can also select a file to save to.

The default path for all State Files is:

My Documents\<<mode name>\state

where <mode name> is the parameter used to select the mode with the INST:SEL command (for example, SA for the Spectrum Analyzer).

Key Path	Save
Mode	All
Remote Command	:MMEMory:STORe:STATe <filename>
Example	MMEM:STOR:STATe "MyStateFile.state" This stores the current instrument state data in the file MyStateFile.state in the default directory.
Notes	Both single and double quotes are supported for any filename parameter over remote.

After saving to a register, that register's menu key is updated with the date the time, unless a custom label has been entered for that key.

After saving to a register, you remain in the Save State menu, so that you can see the Register key update. After saving to a file, the analyzer automatically returns to the previous menu and any Save As dialog goes away.

Backwards Compatibility SCPI :MMEMory:STORe:STATe 1,<filename>

For backwards compatibility, the above syntax is supported. The "1" is simply ignored. The command is sequential.

Initial S/W Revision Prior to A.02.00

To File . . .

When you press "To File", the analyzer brings up a Windows dialog and a menu entitled "Save As." This menu allows you to navigate to the various fields in the Windows dialog without using a keyboard or mouse. The Tab and Arrow keys can also be used for dialog navigation.

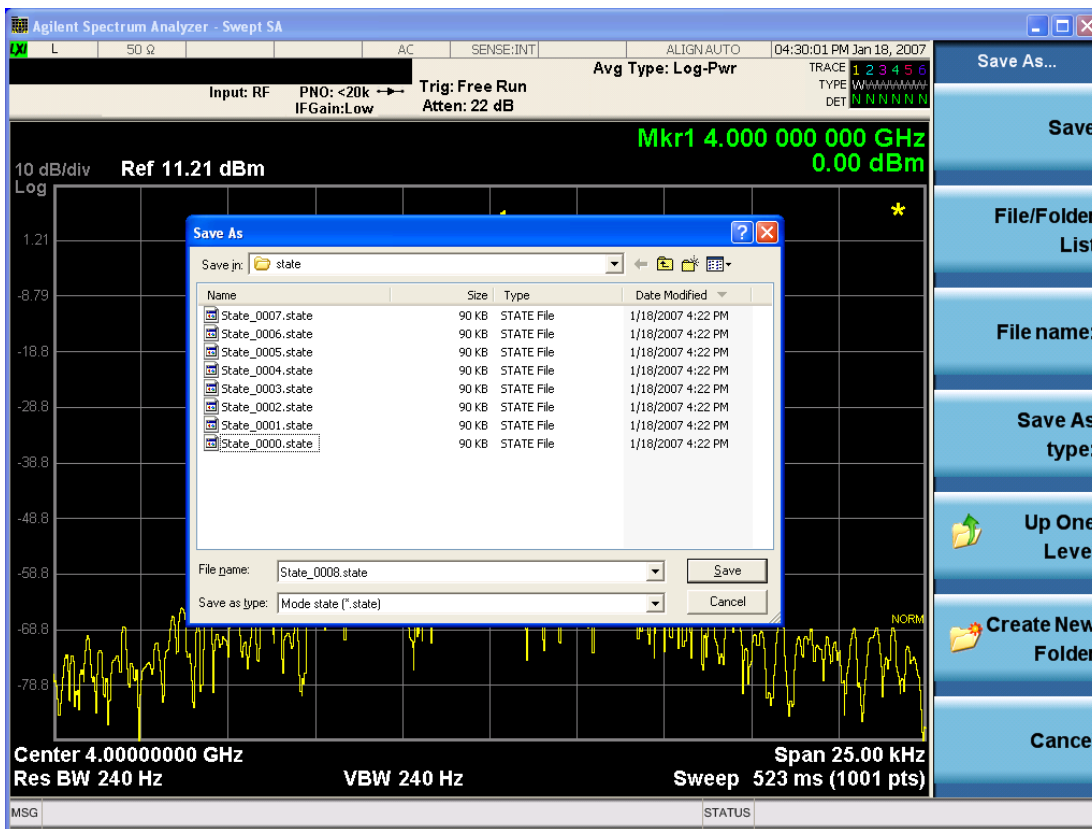

The Listed below

are the functions of the various fields in the dialog, and the corresponding softkeys:

Save

Performs the save to the specified file of the selected type. If the file already exists, a dialog will appear that allows you to replace the existing file by selecting OK, or you can Cancel the request. If you select OK,

the file will be overwritten. Using the C: drive is strongly discouraged, since it runs the risk of being overwritten during an instrument software upgrade.

While the save is being performed, the floppy icon appears briefly in the Meas bar.

File/Folder List

Enables you to navigate to the center of the dialog that contains the list of files and folders. Once here you can get information about the file and use the tab keys to navigate to the other fields in the dialog, such as Save In.

Save In

The Save In field shows the path to which the file will be saved and allows you to change the path using the up and down arrow keys to navigate to other paths; the Enter key to open a directory; and the Backspace key to go back one directory. The **Save In field** defaults to the default path for this type of file and remembers the last path you used to save this type of file. There is no softkey for directly navigating to the Save In field but you can use left tab to get here from the File/Folder List.

User specified paths are remembered when you leave and return to a Mode and are reset back to the default using Restore Mode Defaults.

File Name

The File Name field is initially loaded with an automatically generated filename specific to the appropriate Save Type. The automatically generated filename is guaranteed not to conflict with any filename currently in the directory. You may replace or modify this filename using the File Name key. See the ["Quick Save " on page 1171](#) documentation for more on the automatic file naming algorithm.

When you press the File Name key the analyzer displays the Alpha Editor. Use the knob to choose the letter to add and the front-panel Enter key to add the letter to the file name. The BK character moves you back and the FW character moves you forward in the filename. The Select key on the front panel generates a space character. When you are done entering the filename press the Done softkey. This returns back to the **File Open** dialog and menu, but does not cause the save to occur.

Save As Type

This field shows the file suffix for the type of file you have selected to save. For example, if you navigated here while saving State, "Mode state (*.state)" is in the field. If you navigated here from saving Trace, ""Mode state (*.trace)" is in the field. If you navigated here while exporting a trace data file, "Trace Data (*.csv)" is in the field. For some file types, there is more than one choice in the dropdown, which you can select by using the up and down arrow keys and Enter.

Up One Level

This key corresponds to the icon of a folder with the up arrow that is in the tool bar of the dialog. When pressed, it causes the file and folder list to navigate up one level in the directory structure. The Backspace key does the same thing.

Create New Folder

This key corresponds to the icon of a folder with the "*" that is in the tool bar of the dialog. When pressed, a new folder is created in the current directory with the name **New Folder** and you can enter a new folder name using the Alpha Editor.

Cancel

This key corresponds to the Cancel selection in the dialog. It causes the current **Save As** request to be cancelled. The ESC key does the same thing.

Key Path	Save, State
Mode	All
Notes	Brings up Save As dialog for saving a State Save Type
Initial S/W Revision	Prior to A.02.00

Edit Register Names

You may enter a custom name on any of the Register keys, to help you remember what you are using that state to save. To do this, press the Edit Register Names key, choose the register whose name you wish to edit, and then enter the desired label using the Alpha Editor or an external PC keyboard.

The maximum number of characters that can be added is 30. In most cases, 30 characters will fit on two lines of the key.

See "[More Information](#)" on page 1183

Key Path	Save, State
Mode	All
Remote Command	:MMEMory:REGister:STATe:LABel <reg number>,"label" :MMEMory:REGister:STATe:LABel? <reg number>
Example	:MMEM:REG:STAT:LAB 1,"my label"
Notes	<reg number> is an integer from 1 to 16. If the SCPI specifies an invalid register number an error message is generated, -222,"Data out of range;Invalid register label number" "label" is a string from 0 to 30 characters in length. If a label exceeds 30 characters, an error message is generated, -150,"String data error;Label clipped to 30 characters" "label" of length 0 erases the custom label and restores the default (time and date) label. E.g.: :MMEM:REG:STAT:LAB 1,""
Dependencies	N9060A-7FP or N9060B-2FP license required to edit the register names. When the feature is not licensed, sending this command generates an error, -221,"Settings conflict;Option not available"
Preset	The names are unaffected by Preset or power cycle but are set to the default label (time and date) on a "Restore System Defaults->Misc"
Initial S/W Revision	A.11.00

More Information

When you edit one of the register names, the time and date field will be replaced by the custom name.

If you delete all the characters in the custom name, it restores the default (time and date).

The register names are stored within the state files, but they are not part of the instrument state; that is, once you have edited a register name, loading a new state will not change that register name. Another

consequence of this is that the names will be persistent through a power cycle. Also, if a named state file is transferred to another analyzer, it will bring its custom name along with it.

If you try to edit the name of an empty register, the analyzer will first save the state to have a file to put the name in. If you load a named state file into an analyzer with older firmware it will ignore the metadata.

The *SAV and *RCL commands will not be affected by the custom register names, nor will the MMEM commands.

Register 1 thru Register 16

Selecting any one of these register menu keys causes the State of the currently active mode to be saved to the specified Register. The registers are provided for rapid saving and recalling, since you do not need to specify a filename or navigate to a file. Each of the register menu keys annotates whether it is empty or at what date and time it was last modified. In addition, you can use the Edit Register Names key to enter custom names for each register.

NOTE

In products that run multiple instances of the X-Series Application, save with different register name if you do not want to overwrite the register of another running instance.

Although these 16 registers are the only registers available from the front panel, there are 128 state registers available in the instrument. Registers 17–128 are only available from the SCPI interface, using the *SAV command.

There is one set of 128 state registers in the instrument, not one set for each Mode. When a state is saved, the Mode it was saved from is saved with it; then when it is recalled, the instrument switches to that Mode.

After the save completes, the corresponding register menu key annotation is updated with the date and time and the message "Register <register number> saved" is displayed.

Key Path	Save, State
Mode	All
Example	*SAV 1
Range	1–16 from front panel, 1–128 from SCPI
Readback	Date and time with seconds resolution are displayed on the key OR A custom name of up to 30 characters entered using the Edit Register Names key OR “(empty)” if no prior save operation has been performed to this register.
Initial S/W Revision	Prior to A.02.00
Modified at S/W Revision	A.11.00

Register 1 thru Register 16

Selecting any one of these register menu keys causes the State of the currently active mode to be saved to the specified Register. The registers are provided for rapid saving and recalling, since you do not need to specify a filename or navigate to a file. Each of the register menu keys annotates whether it is empty or at

what date and time it was last modified. In addition, you can use the Edit Register Names key to enter custom names for each register.

NOTE In products that run multiple instances of the X-Series Application, save with different register name if you do not want to overwrite the register of another running instance.

Although these 16 registers are the only registers available from the front panel, there are 128 state registers available in the instrument. Registers 17–128 are only available from the SCPI interface, using the *SAV command.

There is one set of 128 state registers in the instrument, not one set for each Mode. When a state is saved, the Mode it was saved from is saved with it; then when it is recalled, the instrument switches to that Mode.

After the save completes, the corresponding register menu key annotation is updated with the date and time and the message "Register <register number> saved" is displayed.

Key Path	Save, State
Mode	All
Example	*SAV 1
Range	1–16 from front panel, 1–128 from SCPI
Readback	Date and time with seconds resolution are displayed on the key OR A custom name of up to 30 characters entered using the Edit Register Names key OR “(empty)” if no prior save operation has been performed to this register.
Initial S/W Revision	Prior to A.02.00
Modified at S/W Revision	A.11.00

Mass Storage Catalog (Remote Command Only)

Key path	SCPI Only
Remote Command	:MMEMory:CATalog? [<directory_name>]
Notes	The string must be a valid logical path. Queries disk usage information (drive capacity, free space available) and obtains a list of files and directories in a specified directory in the following format: <numeric_value>,<numeric_value>,{<file_entry>} It returns two numeric parameters and as many strings as there are files and directories. The first parameter indicates the total amount of storage currently used in bytes. The second parameter indicates the total amount of storage available, also in bytes. The <file_entry> is a string. Each <file_entry> indicates the name, type, and size of one file in the directory list: <file_name>,<file_type>,<file_size> As the windows file system has an extension that indicates file type, <file_type> is always empty. <file_size> provides the size of the file in bytes. For directories, <file_entry> is surrounded by square brackets and both <file_type> and <file_size> are empty
Initial S/W Revision	Prior to A.02.00

Mass Storage Change Directory (Remote Command Only)

Key path	SCPI Only
Remote Command	:MMEMory:CDIRectory [<directory_name>] :MMEMory:CDIRectory?
Notes	The string must be a valid logical path. Changes the default directory for a mass memory file system. The <directory_name> parameter is a string. If no parameter is specified, the directory is set to the *RST value. At *RST, this value is set to the default user data storage area, that is defined as System.Environment.SpecialFolder.Personal. Query returns full path of the default directory.
Initial S/W Revision	Prior to A.02.00

Mass Storage Copy (Remote Command Only)

Key path	SCPI Only
Remote Command	:MMEMory:COPY <string>,<string>[,<string>,<string>]
Notes	The string must be a valid logical path. Copies an existing file to a new file or an existing directory to a new directory. Two forms of parameters are allowed. The first form has two parameters. In this form, the first parameter specifies the source, and the second parameter specifies the destination. The second form has four parameters. In this form, the first and third parameters specify the source. The second and fourth parameters specify the directories. The first pair of parameters specifies the source. The second pair specifies the destination. An error is generated if the source doesn't exist or the destination file already exists. This command will generate an "access denied" error if the destination is a restricted folder (e.g., C:\Windows) and the current user does not have Power User or Administrator privileges.

Mass Storage Device Copy (Remote Command Only)

This command transfers data to/from a file and a peripheral device.

Key path	SCPI Only
Remote Command	:MMEMory:COPY:DEvice <source_string>,<dest_string>
Notes	The strings must be a valid logical path or a valid device keyword. If the dest_string is a device keyword, the data is copied from the source file to the device. If the source_string is a device keyword, the data is copied to the source file from the device. Valid device keywords are: SNS (smart noise source) An error is generated if the file or device is not found.

Mass Storage Delete (Remote Command Only)

Key path	SCPI Only
Remote Command	:MMEMory:DELeTe <file_name>[,<directory_name>]
Notes	The string must be a valid logical path. Removes a file from the specified directory. The <file_name> parameter specifies the file name to be removed. This command will generate an “access denied” error if the file is in a restricted folder (e.g., C:\Windows) and the current user does not have Power User or Administrator privileges.
Initial S/W Revision	Prior to A.02.00

Mass Storage Data (Remote Command Only)

Creates a file containing the specified data OR queries the data from an existing file.

Key path	SCPI Only
Remote Command	:MMEMory:DATA <file_name>, <data> :MMEMory:DATA? <file_name>
Notes	The string must be a valid logical path. The command form is MMEMory:DATA <file_name>,<data>. It loads <data> into the file <file_name>. <data> is in 488.2 block format. <file_name> is string data. The query form is MMEMory:DATA? <file_name> with the response being the associated <data> in block format.
Initial S/W Revision	Prior to A.02.00

Mass Storage Make Directory (Remote Command Only)

Key path	SCPI Only
Remote Command	:MMEMory:MDIRectory <directory_name>
Notes	The string must be a valid logical path. Creates a new directory. The <directory_name> parameter specifies the name to be created. This command will generate an “access denied” error if the new directory would be in a restricted folder (e.g., C:\Windows) and the current user does not have Power User or Administrator privileges.
Initial S/W Revision	Prior to A.02.00

Mass Storage Move (Remote Command Only)

Key path	SCPI Only
Remote Command	:MMEMory:MOVE <string>,<string>[,<string>,<string>]
Notes	The string must be a valid logical path. Moves an existing file to a new file or an existing directory to a new directory.

Two forms of parameters are allowed. The first form has two parameters. In this form, the first parameter specifies the source, and the second parameter specifies the destination.

The second form has four parameters. In this form, the first and third parameters specify the source. The second and fourth parameters specify the directories. The first pair of parameters specifies the source. The second pair specifies the destination. An error is generated if the source doesn't exist or the destination file already exists.

This command will generate an "access denied" error if the destination is a restricted folder (e.g., C:\Windows) and the current user does not have Power User or Administrator privileges.

Initial S/W Revision Prior to A.02.00

Mass Storage Remove Directory (Remote Command Only)

Key path SCPI Only

Remote Command :MMEMory:RDIRECTory <directory_name>

Notes

The string must be a valid logical path.

Removes a directory. The <directory_name> parameter specifies the directory name to be removed. All files and directories under the specified directory shall also be removed.

This command will generate an "access denied" error if the folder is a restricted folder (e.g., C:\Windows) or is in a restricted folder and the current user does not have Power User or Administrator privileges.

Initial S/W Revision Prior to A.02.00

Sequences

These keys allow you to save a Tab separated or CSV file of the setup parameters required to build a Sequence.

In order to save you must select the Save As button and choose a destination folder.

Key Path Save, Sequences

Mode All

Remote Command :MMEM:STOR:SEQ:ences: | SLIST | ALIST | SAAList | SSTep
"MySequence.txt"

Example :MMEM:STOR:SEQ:SLIST "MySequence.txt"

Notes

Available file types are:

- CSV (Comma delimited) (*.csv)
- Text (Tab delimited) (*.txt)

Initial S/W Revision A.05.00

Source Sequence

The list of parameters, that configure steps, that makes up a sequence for the Source.

The Source sequence is a sequence of flexible configurable steps that can be set anywhere in the instruments frequency range.

Key Path	Save, Sequences
Example	:MMEM:STOR:SEQ:SLIS "MySequence.txt"
Dependencies	Only available in XOBT
Initial S/W Revision	A.05.00

Save As . . .

This menu lets you select the location where you can save the Sequence. This menu is a standard Windows® dialog with Save As menu keys. The "File Name" field in the Save As dialog is initially loaded with an automatically generated filename specific to the appropriate Save Type. The automatically generated filename is guaranteed not to conflict with any filename currently in the directory. You may replace or modify this filename using the File Name softkey. See the Quick Save key documentation for more on the automatic file naming algorithm.

The default path for all Sequence Files is:

My Documents\Sequences

Key Path	Save, Sequences
Mode	All
Notes	Brings up Save As dialog for saving a Sequence Save Type
Initial S/W Revision	A.05.00

Data

The Analog Demod Mode Export Data options include Traces and Measurement Results.

Key Path	Save, Data
Remote Command Notes	No SCPI command directly controls the Data Type that this key controls. The Data Type is included as part of the MMEM:STOR commands.
Preset	Trace; is not affected by a Preset, but is reset during Restore Mode Defaults and survives Power cycles.
State Saved	Saved in instrument state.
Readback line	1-of-N selection
Initial S/W Revision	Prior to A.02.00

FM Stereo Trace

Selects Trace as the data type to be exported with this save request. This key brings up the Trace menu that enables you to select one of the following traces:

- RF Spectrum(RFSpectrum)
- MPX Demod(DEMod)
- MPX Demod Avg(DAVERAGE)
- MPX Demod Max(DMAXimum)
- MPX Demod Min(DMINimum)
- MPX Spectrum(AFSpectrum)
- Mono Demod(MDEMod)
- Mono Demod Avg(MDAVERAGE)
- Mono Demod Max(MMAXimum)
- Mono Demod Min(MMINimum)
- Mono Spectrum(MSpectrum)
- Stereo Demod(SDEMod)
- Stereo Demod Avg(SDAVERAGE)
- Stereo Demod Max(SMAXimum)
- Stereo Demod Min(SMINimum)
- Stereo Spectrum(SSpectrum)
- Left Demod(LDEMod)
- Left Demod Avg(LDAVERAGE)
- Left Demod Max(LMAXimum)
- Left Demod Min(LMINimum)
- Left Spectrum(LSpectrum)
- Right Demod(RDEMod)
- Right Demod Avg(RDAVERAGE)
- Right Demod Max(RMAXimum)
- Right Demod Min(RMINimum)
- Right Spectrum(RSpectrum)

Once you select a trace, the menu returns back to the Data menu and the name of the selected trace is annotated on the Trace key. Now that you have selected exactly what needs to be saved, to trigger a save of the selected trace, you must select the Save As key in the Data menu.

If the Demod Min trace, Demod Max trace, or Demod Avg trace is exported when the Average/Hold Num feature is turned off, the resulting data will be default values.

The trace data file is a .csv file containing the data for one trace, suitable for import into spreadsheet software. There is a header block, followed by metadata that includes the parameters necessary to recreate the measurement, followed by a DATA block that contains the x,y data for the specified trace. Each line in the metadata includes the parameter, followed by a comma, followed by the parameter value. The metadata includes the following information:

Measurement †	FM Stereo
Trace	RF Spectrum MPX Demod MPX Demod Ave MPX Demod Min MPX Demod Max MPX Spectrum Mono Demod Mono Demod Ave Mono Demod Min Mono Demod Max Mono Spectrum Stereo Demod Stereo Demod Ave Stereo Demod Min Stereo Demod Max Stereo Spectrum Left Demod Left Demod Ave Left Demod Min Left Demod Max Left Spectrum Right Demod Right Demod Ave Right Demod Min Right Demod Max Right Spectrum
X Axis Unit	Hz S
Y Axis Unit	dBm % Hz Rad
Center Frequency †	[units of Hz]
Channel BW †	[units of Hz]
Average State †	Off On
Average Count	#
HPF/BPF †	Off HPF20 HPF50 HPF300 CCITT A-Weighted
LPF †	Off LPF300 LPF3K LPF15K LPF30K LPF80K LPF300K
Attenuation †	[units of dB]
RF Coupling †	AC DC
Ref Level	[units of Y Axis Unit]
RF Span †	[units of Hz]
RF Res Bandwidth †	[units of Hz]
Sweep Time †	[units of S]
AF Start Freq	[units of Hz]
AF Stop Freq †	[units of Hz]
AF Res Bandwidth †	[units of Hz]
Trigger Source †	Off Ext1 Ext2
Trigger Level †	[units of V]
Trigger Slope †	Positive Negative
Trigger Delay †	[units of S]

PreAmp State †	Off On
PreAmp Band †	Low High
Input Z Correction †	50 75
RF Calibrator	Off 50 MHz 4.8 GHz Comb
External Gain	[units of dB]

† Changing this parameter requires a measurement restart.

Note that all metadata is stored for each trace. After the metadata, the keyword DATA occurs on its own line, followed by the data (one X, Y pair per line).

Key Path	Save, Data
Key Path	Save, Data
Notes	The first key press selects traces out of the 1-of-N file type options. The second key press brings up the Traces menu so you can select which trace you want to export.
Preset	RF Spectrum; is not affected by a Preset, but is reset during Restore Mode Defaults and survives Power cycles.
State Saved	Saved in instrument state.
Readback	Selected Trace table
Readback line	RF Spectrum, MPX Demod, MPX Demod Avg, MPX Demod Max, MPX Demod Min, MPX Spectrum, Mono Demod, Mono Demod Avg, Mono Demod Max, Mono Demod Min, Mono Spectrum, Stereo Demod, Stereo Demod Avg, Stereo Demod Max, Stereo Demod Min, Stereo Spectrum, Left Demod, Left Demod Avg, Left Demod Max, Left Demod Min, Left Spectrum, Right Demod, Right Demod Avg, Right Demod Max, Right Demod Min, Right Spectrum
Initial S/W Revision	A.10.00

FM Stereo Trace

Selects Trace as the data type to be exported with this save request. This key brings up the Trace menu that enables you to select one of the following traces:

- RF Spectrum(RFSpectrum)
- MPX Demod(DEMod)
- MPX Demod Avg(DAVERAGE)
- MPX Demod Max(DMAXimum)
- MPX Demod Min(DMINimum)
- MPX Spectrum(AFSpectrum)
- Mono Demod(MDEMod)
- Mono Demod Avg(MDAVERAGE)

- Mono Demod Max(MMAXimum)
- Mono Demod Min(MMINimum)
- Mono Spectrum(MSPpectrum)
- Stereo Demod(SDEMod)
- Stereo Demod Avg(SDAverage)
- Stereo Demod Max(SMAXimum)
- Stereo Demod Min(SMINimum)
- Stereo Spectrum(SSpectrum)
- Left Demod(LDEMod)
- Left Demod Avg(LDAverage)
- Left Demod Max(LMAXimum)
- Left Demod Min(LMINimum)
- Left Spectrum(LSPpectrum)
- Right Demod(RDEMod)
- Right Demod Avg(RDAverage)
- Right Demod Max(RMAXimum)
- Right Demod Min(RMINimum)
- Right Spectrum(RSPpectrum)

Once you select a trace, the menu returns back to the Data menu and the name of the selected trace is annotated on the Trace key. Now that you have selected exactly what needs to be saved, to trigger a save of the selected trace, you must select the Save As key in the Data menu.

If the Demod Min trace, Demod Max trace, or Demod Avg trace is exported when the Average/Hold Num feature is turned off, the resulting data will be default values.

The trace data file is a .csv file containing the data for one trace, suitable for import into spreadsheet software. There is a header block, followed by metadata that includes the parameters necessary to recreate the measurement, followed by a DATA block that contains the x,y data for the specified trace. Each line in the metadata includes the parameter, followed by a comma, followed by the parameter value. The metadata includes the following information:

Measurement †	FM Stereo
Trace	RF Spectrum MPX Demod MPX Demod Ave MPX Demod Min MPX Demod Max MPX Spectrum Mono Demod Mono Demod Ave Mono Demod Min Mono Demod Max Mono Spectrum Stereo Demod Stereo Demod Ave Stereo Demod Min Stereo Demod Max Stereo Spectrum Left

	Demod Left Demod Ave Left Demod Min Left Demod Max Left Spectrum Right Demod Right Demod Ave Right Demod Min Right Demod Max Right Spectrum
X Axis Unit	Hz S
Y Axis Unit	dBm %/Hz Rad
Center Frequency †	[units of Hz]
Channel BW †	[units of Hz]
Average State †	Off On
Average Count	#
HPF/BPF †	Off HPF20 HPF50 HPF300 CCITT A-Weighted
LPF †	Off LPF300 LPF3K LPF15K LPF30K LPF80K LPF300K
Attenuation †	[units of dB]
RF Coupling †	AC DC
Ref Level	[units of Y Axis Unit]
RF Span †	[units of Hz]
RF Res Bandwidth †	[units of Hz]
Sweep Time †	[units of S]
AF Start Freq	[units of Hz]
AF Stop Freq †	[units of Hz]
AF Res Bandwidth †	[units of Hz]
Trigger Source †	Off Ext1 Ext2
Trigger Level †	[units of V]
Trigger Slope †	Positive Negative
Trigger Delay †	[units of S]
PreAmp State †	Off On
PreAmp Band †	Low High
Input Z Correction †	50 75
RF Calibrator	Off 50 MHz 4.8 GHz Comb
External Gain	[units of dB]

† Changing this parameter requires a measurement restart.

Note that all metadata is stored for each trace. After the metadata, the keyword DATA occurs on its own line, followed by the data (one X, Y pair per line).

Key Path	Save, Data
Key Path	Save, Data

Notes	The first key press selects traces out of the 1-of-N file type options. The second key press brings up the Traces menu so you can select which trace you want to export.
Preset	RF Spectrum; is not affected by a Preset, but is reset during Restore Mode Defaults and survives Power cycles.
State Saved	Saved in instrument state.
Readback	Selected Trace table
Readback line	RF Spectrum, MPX Demod, MPX Demod Avg, MPX Demod Max, MPX Demod Min, MPX Spectrum, Mono Demod, Mono Demod Avg, Mono Demod Max, Mono Demod Min, Mono Spectrum, Stereo Demod, Stereo Demod Avg, Stereo Demod Max, Stereo Demod Min, Stereo Spectrum, Left Demod, Left Demod Avg, Left Demod Max, Left Demod Min, Left Spectrum, Right Demod, Right Demod Avg, Right Demod Max, Right Demod Min, Right Spectrum
Initial S/W Revision	A.10.00

RF Spectrum

Selects the input RF signal in the RF Spectrum window as the trace to save.

Key Path	Save, Data, Trace, MPX
Initial S/W Revision	A.10.00

Demod

Selects the current demodulated signal in the MPX Waveform window, shown in yellow, as the trace to save.

Key Path	Save, Data, Trace, MPX
Initial S/W Revision	A.10.00

Demod Average

Selects the averaged demodulation signal in the MPX Waveform window, shown in green, as the trace to save.

Key Path	Save, Data, Trace, MPX
Initial S/W Revision	A.10.00

Demod Max

Selects the Demod Max trace in the MPX Waveform window, shown in cyan, as the trace to save.

Key Path	Save, Data, Trace, MPX
Initial S/W Revision	A.10.00

Demod Min

Selects the Demod Min trace in the MPX Waveform window, shown in magenta, as the trace to save.

Key Path	Save, Data, Trace, MPX
Initial S/W Revision	A.10.00

Spectrum

Selects the spectrum signal in the MPX Spectrum window as the trace to save.

Key Path	Save, Data, Trace, MPX
Initial S/W Revision	A.10.00

FM Stereo Trace

Selects Trace as the data type to be exported with this save request. This key brings up the Trace menu that enables you to select one of the following traces:

- RF Spectrum(RFSpectrum)
- MPX Demod(DEMod)
- MPX Demod Avg(DAVERAGE)
- MPX Demod Max(DMAXimum)
- MPX Demod Min(DMINimum)
- MPX Spectrum(AFSpectrum)
- Mono Demod(MDEMod)
- Mono Demod Avg(MDAVERAGE)
- Mono Demod Max(MMAXimum)
- Mono Demod Min(MMINimum)
- Mono Spectrum(MSPpectrum)
- Stereo Demod(SDEMod)
- Stereo Demod Avg(SDAVERAGE)
- Stereo Demod Max(SMAXimum)
- Stereo Demod Min(SMINimum)
- Stereo Spectrum(SSpectrum)
- Left Demod(LDEMod)

- Left Demod Avg(LDAverage)
- Left Demod Max(LMAXimum)
- Left Demod Min(LMINimum)
- Left Spectrum(LSPpectrum)
- Right Demod(RDEMod)
- Right Demod Avg(RDAverage)
- Right Demod Max(RMAXimum)
- Right Demod Min(RMINimum)
- Right Spectrum(RSPpectrum)

Once you select a trace, the menu returns back to the Data menu and the name of the selected trace is annotated on the Trace key. Now that you have selected exactly what needs to be saved, to trigger a save of the selected trace, you must select the Save As key in the Data menu.

If the Demod Min trace, Demod Max trace, or Demod Avg trace is exported when the Average/Hold Num feature is turned off, the resulting data will be default values.

The trace data file is a .csv file containing the data for one trace, suitable for import into spreadsheet software. There is a header block, followed by metadata that includes the parameters necessary to recreate the measurement, followed by a DATA block that contains the x,y data for the specified trace. Each line in the metadata includes the parameter, followed by a comma, followed by the parameter value. The metadata includes the following information:

Measurement †	FM Stereo
Trace	RF Spectrum MPX Demod MPX Demod Ave MPX Demod Min MPX Demod Max MPX Spectrum Mono Demod Mono Demod Ave Mono Demod Min Mono Demod Max Mono Spectrum Stereo Demod Stereo Demod Ave Stereo Demod Min Stereo Demod Max Stereo Spectrum Left Demod Left Demod Ave Left Demod Min Left Demod Max Left Spectrum Right Demod Right Demod Ave Right Demod Min Right Demod Max Right Spectrum
X Axis Unit	Hz S
Y Axis Unit	dBm % Hz Rad
Center Frequency †	[units of Hz]
Channel BW †	[units of Hz]
Average State †	Off On
Average Count	#
HPF/BPF †	Off HPF20 HPF50 HPF300 CCITT A-Weighted

LPF †	Off LPF300 LPF3K LPF15K LPF30K LPF80K LPF300K
Attenuation †	[units of dB]
RF Coupling †	AC DC
Ref Level	[units of Y Axis Unit]
RF Span †	[units of Hz]
RF Res Bandwidth †	[units of Hz]
Sweep Time †	[units of S]
AF Start Freq	[units of Hz]
AF Stop Freq †	[units of Hz]
AF Res Bandwidth †	[units of Hz]
Trigger Source †	Off Ext1 Ext2
Trigger Level †	[units of V]
Trigger Slope †	Positive Negative
Trigger Delay †	[units of S]
PreAmp State †	Off On
PreAmp Band †	Low High
Input Z Correction †	50 75
RF Calibrator	Off 50 MHz 4.8 GHz Comb
External Gain	[units of dB]

† Changing this parameter requires a measurement restart.

Note that all metadata is stored for each trace. After the metadata, the keyword DATA occurs on its own line, followed by the data (one X, Y pair per line).

Key Path	Save, Data
Key Path	Save, Data
Notes	The first key press selects traces out of the 1-of-N file type options. The second key press brings up the Traces menu so you can select which trace you want to export.
Preset	RF Spectrum; is not affected by a Preset, but is reset during Restore Mode Defaults and survives Power cycles.
State Saved	Saved in instrument state.
Readback	Selected Trace table
Readback line	RF Spectrum, MPX Demod, MPX Demod Avg, MPX Demod Max, MPX Demod Min, MPX Spectrum, Mono Demod, Mono Demod Avg, Mono Demod Max, Mono Demod Min, Mono Spectrum, Stereo Demod, Stereo Demod Avg, Stereo Demod Max, Stereo Demod Min, Stereo Spectrum, Left Demod, Left Demod Avg, Left Demod Max, Left Demod Min, Left Spectrum, Right Demod, Right Demod Avg, Right Demod Max, Right Demod Min, Right Spectrum
Initial S/W Revision	A.10.00

Demod

Selects the current demodulated signal in the Mono (L+R) Waveform window, shown in yellow, as the trace to save.

Key Path	Save, Data, Trace, Mono (L+R)
Initial S/W Revision	A.10.00

Demod Average

Selects the averaged demodulation signal in the Mono (L+R) Waveform window, shown in green, as the trace to save.

Key Path	Save, Data, Trace, Mono (L+R)
Initial S/W Revision	A.10.00

Demod Max

Selects the Demod Max trace in the Mono (L+R) Waveform window, shown in cyan, as the trace to save.

Key Path	Save, Data, Trace, Mono (L+R)
Initial S/W Revision	A.10.00

Demod Min

Selects the Demod Min trace in the Mono (L+R) Waveform window, shown in magenta, as the trace to save.

Key Path	Save, Data, Trace, Mono (L+R)
Initial S/W Revision	A.10.00

Spectrum

Selects the spectrum signal in the Mono (L+R) Spectrum window as the trace to save.

Key Path	Save, Data, Trace, Mono (L+R)
Initial S/W Revision	A.10.00

FM Stereo Trace

Selects Trace as the data type to be exported with this save request. This key brings up the Trace menu that enables you to select one of the following traces:

RF Spectrum(RFSpectrum)

MPX Demod(DEMod)
MPX Demod Avg(DAVERAGE)
MPX Demod Max(DMAXimum)
MPX Demod Min(DMINimum)
MPX Spectrum(AFSpectrum)
Mono Demod(MDEMod)
Mono Demod Avg(MDAVERAGE)
Mono Demod Max(MMAXimum)
Mono Demod Min(MMINimum)
Mono Spectrum(MSPpectrum)
Stereo Demod(SDEMod)
Stereo Demod Avg(SDAVERAGE)
Stereo Demod Max(SMAXimum)
Stereo Demod Min(SMINimum)
Stereo Spectrum(SSpectrum)
Left Demod(LDEMod)
Left Demod Avg(LDAVERAGE)
Left Demod Max(LMAXimum)
Left Demod Min(LMINimum)
Left Spectrum(LSPpectrum)
Right Demod(RDEMod)
Right Demod Avg(RDAVERAGE)
Right Demod Max(RMAXimum)
Right Demod Min(RMINimum)
Right Spectrum(RSPpectrum)

Once you select a trace, the menu returns back to the Data menu and the name of the selected trace is annotated on the Trace key. Now that you have selected exactly what needs to be saved, to trigger a save of the selected trace, you must select the Save As key in the Data menu.

If the Demod Min trace, Demod Max trace, or Demod Avg trace is exported when the Average/Hold Num feature is turned off, the resulting data will be default values.

The trace data file is a .csv file containing the data for one trace, suitable for import into spreadsheet software. There is a header block, followed by metadata that includes the parameters necessary to recreate the measurement, followed by a DATA block that contains the x,y data for the specified trace.

Each line in the metadata includes the parameter, followed by a comma, followed by the parameter value. The metadata includes the following information:

Measurement †	FM Stereo
Trace	RF Spectrum MPX Demod MPX Demod Ave MPX Demod Min MPX Demod Max MPX Spectrum Mono Demod Mono Demod Ave Mono Demod Min Mono Demod Max Mono Spectrum Stereo Demod Stereo Demod Ave Stereo Demod Min Stereo Demod Max Stereo Spectrum Left Demod Left Demod Ave Left Demod Min Left Demod Max Left Spectrum Right Demod Right Demod Ave Right Demod Min Right Demod Max Right Spectrum
X Axis Unit	Hz S
Y Axis Unit	dBm % Hz Rad
Center Frequency †	[units of Hz]
Channel BW †	[units of Hz]
Average State †	Off On
Average Count	#
HPF/BPF †	Off HPF20 HPF50 HPF300 CCITT A-Weighted
LPF †	Off LPF300 LPF3K LPF15K LPF30K LPF80K LPF300K
Attenuation †	[units of dB]
RF Coupling †	AC DC
Ref Level	[units of Y Axis Unit]
RF Span †	[units of Hz]
RF Res Bandwidth †	[units of Hz]
Sweep Time †	[units of S]
AF Start Freq	[units of Hz]
AF Stop Freq †	[units of Hz]
AF Res Bandwidth †	[units of Hz]
Trigger Source †	Off Ext1 Ext2
Trigger Level †	[units of V]
Trigger Slope †	Positive Negative
Trigger Delay †	[units of S]
PreAmp State †	Off On
PreAmp Band †	Low High
Input Z Correction †	50 75
RF Calibrator	Off 50 MHz 4.8 GHz Comb
External Gain	[units of dB]

† Changing this parameter requires a measurement restart.

Note that all metadata is stored for each trace. After the metadata, the keyword DATA occurs on its own line, followed by the data (one X, Y pair per line).

Key Path	Save, Data
Key Path	Save, Data
Notes	The first key press selects traces out of the 1-of-N file type options. The second key press brings up the Traces menu so you can select which trace you want to export.
Preset	RF Spectrum; is not affected by a Preset, but is reset during Restore Mode Defaults and survives Power cycles.
State Saved	Saved in instrument state.
Readback	Selected Trace table
Readback line	RF Spectrum, MPX Demod, MPX Demod Avg, MPX Demod Max, MPX Demod Min, MPX Spectrum, Mono Demod, Mono Demod Avg, Mono Demod Max, Mono Demod Min, Mono Spectrum, Stereo Demod, Stereo Demod Avg, Stereo Demod Max, Stereo Demod Min, Stereo Spectrum, Left Demod, Left Demod Avg, Left Demod Max, Left Demod Min, Left Spectrum, Right Demod, Right Demod Avg, Right Demod Max, Right Demod Min, Right Spectrum
Initial S/W Revision	A.10.00

Demod

Selects the current demodulated signal in the Stereo (L-R) Waveform window, shown in yellow, as the trace to save.

Key Path	Save, Data, Trace, Stereo (L-R)
Initial S/W Revision	A.10.00

Demod Average

Selects the averaged demodulation signal in the Stereo (L-R) Waveform window, shown in green, as the trace to save.

Key Path	Save, Data, Trace, Stereo (L-R)
Initial S/W Revision	A.10.00

Demod Max

Selects the Demod Max trace in the Stereo (L-R) Waveform window, shown in cyan, as the trace to save.

Key Path	Save, Data, Trace, Stereo (L-R)
Initial S/W Revision	A.10.00

Demod Min

Selects the Demod Min trace in the Stereo (L-R) Waveform window, shown in magenta, as the trace to save.

Key Path	Save, Data, Trace, Stereo (L-R)
Initial S/W Revision	A.10.00

Spectrum

Selects the spectrum signal in the Stereo (L-R) Spectrum window as the trace to save.

Key Path	Save, Data, Trace, Stereo (L-R)
Initial S/W Revision	A.10.00

FM Stereo Trace

Selects Trace as the data type to be exported with this save request. This key brings up the Trace menu that enables you to select one of the following traces:

- RF Spectrum(RFSpectrum)
- MPX Demod(DEMod)
- MPX Demod Avg(DAVERAGE)
- MPX Demod Max(DMAXimum)
- MPX Demod Min(DMINimum)
- MPX Spectrum(AFSPpectrum)
- Mono Demod(MDEMod)
- Mono Demod Avg(MDAVERAGE)
- Mono Demod Max(MMAXimum)
- Mono Demod Min(MMINimum)
- Mono Spectrum(MSPpectrum)
- Stereo Demod(SDEMod)
- Stereo Demod Avg(SDAVERAGE)
- Stereo Demod Max(SMAXimum)
- Stereo Demod Min(SMINimum)
- Stereo Spectrum(SSpectrum)
- Left Demod(LDEMod)

- Left Demod Avg(LDAverage)
- Left Demod Max(LMAXimum)
- Left Demod Min(LMINimum)
- Left Spectrum(LSPpectrum)
- Right Demod(RDEMod)
- Right Demod Avg(RDAverage)
- Right Demod Max(RMAXimum)
- Right Demod Min(RMINimum)
- Right Spectrum(RSPpectrum)

Once you select a trace, the menu returns back to the Data menu and the name of the selected trace is annotated on the Trace key. Now that you have selected exactly what needs to be saved, to trigger a save of the selected trace, you must select the Save As key in the Data menu.

If the Demod Min trace, Demod Max trace, or Demod Avg trace is exported when the Average/Hold Num feature is turned off, the resulting data will be default values.

The trace data file is a .csv file containing the data for one trace, suitable for import into spreadsheet software. There is a header block , followed by metadata that includes the parameters necessary to recreate the measurement, followed by a DATA block that contains the x,y data for the specified trace. Each line in the metadata includes the parameter, followed by a comma, followed by the parameter value. The metadata includes the following information:

Measurement †	FM Stereo
Trace	RF Spectrum MPX Demod MPX Demod Ave MPX Demod Min MPX Demod Max MPX Spectrum Mono Demod Mono Demod Ave Mono Demod Min Mono Demod Max Mono Spectrum Stereo Demod Stereo Demod Ave Stereo Demod Min Stereo Demod Max Stereo Spectrum Left Demod Left Demod Ave Left Demod Min Left Demod Max Left Spectrum Right Demod Right Demod Ave Right Demod Min Right Demod Max Right Spectrum
X Axis Unit	Hz S
Y Axis Unit	dBm % Hz Rad
Center Frequency †	[units of Hz]
Channel BW †	[units of Hz]
Average State †	Off On
Average Count	#
HPF/BPF †	Off HPF20 HPF50 HPF300 CCITT A-Weighted

LPF †	Off LPF300 LPF3K LPF15K LPF30K LPF80K LPF300K
Attenuation †	[units of dB]
RF Coupling †	AC DC
Ref Level	[units of Y Axis Unit]
RF Span †	[units of Hz]
RF Res Bandwidth †	[units of Hz]
Sweep Time †	[units of S]
AF Start Freq	[units of Hz]
AF Stop Freq †	[units of Hz]
AF Res Bandwidth †	[units of Hz]
Trigger Source †	Off Ext1 Ext2
Trigger Level †	[units of V]
Trigger Slope †	Positive Negative
Trigger Delay †	[units of S]
PreAmp State †	Off On
PreAmp Band †	Low High
Input Z Correction †	50 75
RF Calibrator	Off 50 MHz 4.8 GHz Comb
External Gain	[units of dB]

† Changing this parameter requires a measurement restart.

Note that all metadata is stored for each trace. After the metadata, the keyword DATA occurs on its own line, followed by the data (one X, Y pair per line).

Key Path	Save, Data
Key Path	Save, Data
Notes	The first key press selects traces out of the 1-of-N file type options. The second key press brings up the Traces menu so you can select which trace you want to export.
Preset	RF Spectrum; is not affected by a Preset, but is reset during Restore Mode Defaults and survives Power cycles.
State Saved	Saved in instrument state.
Readback	Selected Trace table
Readback line	RF Spectrum, MPX Demod, MPX Demod Avg, MPX Demod Max, MPX Demod Min, MPX Spectrum, Mono Demod, Mono Demod Avg, Mono Demod Max, Mono Demod Min, Mono Spectrum, Stereo Demod, Stereo Demod Avg, Stereo Demod Max, Stereo Demod Min, Stereo Spectrum, Left Demod, Left Demod Avg, Left Demod Max, Left Demod Min, Left Spectrum, Right Demod, Right Demod Avg, Right Demod Max, Right Demod Min, Right Spectrum
Initial S/W Revision	A.10.00

Demod

Selects the current demodulated signal in the Left Waveform window, shown in yellow, as the trace to save.

Key Path	Save, Data, Trace, Left
Initial S/W Revision	A.10.00

Demod Average

Selects the averaged demodulation signal in the Left Waveform window, shown in green, as the trace to save.

Key Path	Save, Data, Trace, Left
Initial S/W Revision	A.10.00

Demod Max

Selects the Demod Max trace in the Left Waveform window, shown in cyan, as the trace to save.

Key Path	Save, Data, Trace, Left
Initial S/W Revision	A.10.00

Demod Min

Selects the Demod Min trace in the Left Waveform window, shown in magenta, as the trace to save.

Key Path	Save, Data, Trace, Left
Initial S/W Revision	A.10.00

Spectrum

Selects the spectrum signal in the Left Spectrum window as the trace to save.

Key Path	Save, Data, Trace, Left
Initial S/W Revision	A.10.00

FM Stereo Trace

Selects Trace as the data type to be exported with this save request. This key brings up the Trace menu that enables you to select one of the following traces:

RF Spectrum(RFSpectrum)

MPX Demod(DEMod)
MPX Demod Avg(DAVerage)
MPX Demod Max(DMAXimum)
MPX Demod Min(DMINimum)
MPX Spectrum(AFSPpectrum)
Mono Demod(MDEMod)
Mono Demod Avg(MDAverage)
Mono Demod Max(MMAXimum)
Mono Demod Min(MMINimum)
Mono Spectrum(MSPpectrum)
Stereo Demod(SDEMod)
Stereo Demod Avg(SDAverage)
Stereo Demod Max(SMAXimum)
Stereo Demod Min(SMINimum)
Stereo Spectrum(SSpectrum)
Left Demod(LDEMod)
Left Demod Avg(LDAverage)
Left Demod Max(LMAXimum)
Left Demod Min(LMINimum)
Left Spectrum(LSPpectrum)
Right Demod(RDEMod)
Right Demod Avg(RDAverage)
Right Demod Max(RMAXimum)
Right Demod Min(RMINimum)
Right Spectrum(RSPpectrum)

Once you select a trace, the menu returns back to the Data menu and the name of the selected trace is annotated on the Trace key. Now that you have selected exactly what needs to be saved, to trigger a save of the selected trace, you must select the Save As key in the Data menu.

If the Demod Min trace, Demod Max trace, or Demod Avg trace is exported when the Average/Hold Num feature is turned off, the resulting data will be default values.

The trace data file is a .csv file containing the data for one trace, suitable for import into spreadsheet software. There is a header block, followed by metadata that includes the parameters necessary to recreate the measurement, followed by a DATA block that contains the x,y data for the specified trace.

Each line in the metadata includes the parameter, followed by a comma, followed by the parameter value. The metadata includes the following information:

Measurement †	FM Stereo
Trace	RF Spectrum MPX Demod MPX Demod Ave MPX Demod Min MPX Demod Max MPX Spectrum Mono Demod Mono Demod Ave Mono Demod Min Mono Demod Max Mono Spectrum Stereo Demod Stereo Demod Ave Stereo Demod Min Stereo Demod Max Stereo Spectrum Left Demod Left Demod Ave Left Demod Min Left Demod Max Left Spectrum Right Demod Right Demod Ave Right Demod Min Right Demod Max Right Spectrum
X Axis Unit	Hz S
Y Axis Unit	dBm % Hz Rad
Center Frequency †	[units of Hz]
Channel BW †	[units of Hz]
Average State †	Off On
Average Count	#
HPF/BPF †	Off HPF20 HPF50 HPF300 CCITT A-Weighted
LPF †	Off LPF300 LPF3K LPF15K LPF30K LPF80K LPF300K
Attenuation †	[units of dB]
RF Coupling †	AC DC
Ref Level	[units of Y Axis Unit]
RF Span †	[units of Hz]
RF Res Bandwidth †	[units of Hz]
Sweep Time †	[units of S]
AF Start Freq	[units of Hz]
AF Stop Freq †	[units of Hz]
AF Res Bandwidth †	[units of Hz]
Trigger Source †	Off Ext1 Ext2
Trigger Level †	[units of V]
Trigger Slope †	Positive Negative
Trigger Delay †	[units of S]
PreAmp State †	Off On
PreAmp Band †	Low High
Input Z Correction †	50 75
RF Calibrator	Off 50 MHz 4.8 GHz Comb
External Gain	[units of dB]

† Changing this parameter requires a measurement restart.

Note that all metadata is stored for each trace. After the metadata, the keyword DATA occurs on its own line, followed by the data (one X, Y pair per line).

Key Path	Save, Data
Key Path	Save, Data
Notes	The first key press selects traces out of the 1-of-N file type options. The second key press brings up the Traces menu so you can select which trace you want to export.
Preset	RF Spectrum; is not affected by a Preset, but is reset during Restore Mode Defaults and survives Power cycles.
State Saved	Saved in instrument state.
Readback	Selected Trace table
Readback line	RF Spectrum, MPX Demod, MPX Demod Avg, MPX Demod Max, MPX Demod Min, MPX Spectrum, Mono Demod, Mono Demod Avg, Mono Demod Max, Mono Demod Min, Mono Spectrum, Stereo Demod, Stereo Demod Avg, Stereo Demod Max, Stereo Demod Min, Stereo Spectrum, Left Demod, Left Demod Avg, Left Demod Max, Left Demod Min, Left Spectrum, Right Demod, Right Demod Avg, Right Demod Max, Right Demod Min, Right Spectrum
Initial S/W Revision	A.10.00

Demod

Selects the current demodulated signal in the Right Waveform window, shown in yellow, as the trace to save.

Key Path	Save, Data, Trace, Right
Initial S/W Revision	A.10.00

Demod Average

Selects the averaged demodulation signal in the Right Waveform window, shown in green, as the trace to save.

Key Path	Save, Data, Trace, Right
Initial S/W Revision	A.10.00

Demod Max

Selects the Demod Max trace in the Right Waveform window, shown in cyan, as the trace to save.

Key Path	Save, Data, Trace, Right
Initial S/W Revision	A.10.00

Demod Min

Selects the Demod Min trace in the Right Waveform window, shown in magenta, as the trace to save.

Key Path	Save, Data, Trace, Right
Initial S/W Revision	A.10.00

Spectrum

Selects the spectrum signal in the Right Spectrum window as the trace to save.

Key Path	Save, Data, Trace, Right
Initial S/W Revision	A.10.00

Measurement Results

Pressing this key selects Meas Results as the data type to be exported. Pressing the key a second time brings up the Meas Results menu, which allows you to select which **Meas Result** to save. In the Swept SA measurement, there are three types of Measurement Results files: Peak Table, Marker Table and Spectrogram.

See "[Meas Results File Contents](#)" on page 1211.

See "[Marker Table](#)" on page 1211.

See "[Peak Table](#)" on page 1214.

See Spectrogram

Remote Command	:MMEMory:STORe:RESuLts:MTABle PTABle SPECTrogram <filename>
Example	:MMEM:STOR:RES:MTAB "myResults.csv" Saves the results from the current marker table to the file myResults.csv in the current path. :MMEM:STOR:RES:PTAB "myResults.csv" Saves the results from the current peak table to the file myResults.csv in the current path. :MMEM:STOR:RES:SPEC "myResults.csv" Saves the results from the current Spectrogram display to the file myResults.csv in the current path. The default path is My Documents\SA\data\SAN\results
Notes	If the save is initiated via SCPI, and the file already exists, the file will be overwritten. Using the C: drive is strongly discouraged, since it runs the risk of being overwritten during an instrument software upgrade. Both single and double quotes are supported for any filename parameter over SCPI.
Dependencies	If a save of Marker Table results is requested and the Marker Table is not on, no file is saved and a message is generated If a save of Peak Table results is requested and the Peak Table is not on, no file is saved and a message is generated

If a save of Spectrogram results is requested and the Spectrogram is not on, no file is saved and a message is generated.

The Spectrogram choice only appears if option EDP is licensed.

Preset Not part of Preset, but is reset to Peak Table by Restore Mode Defaults. Survives a shutdown.

Initial S/W Revision Prior to A.02.00

Meas Results File Contents

All files are .csv files. The following section details the data in each file type.

Marker Table

This section discusses the Marker Table Meas Results file format.

Imagine that, at the point where a Marker Table Meas Result is requested, the following screen is showing:

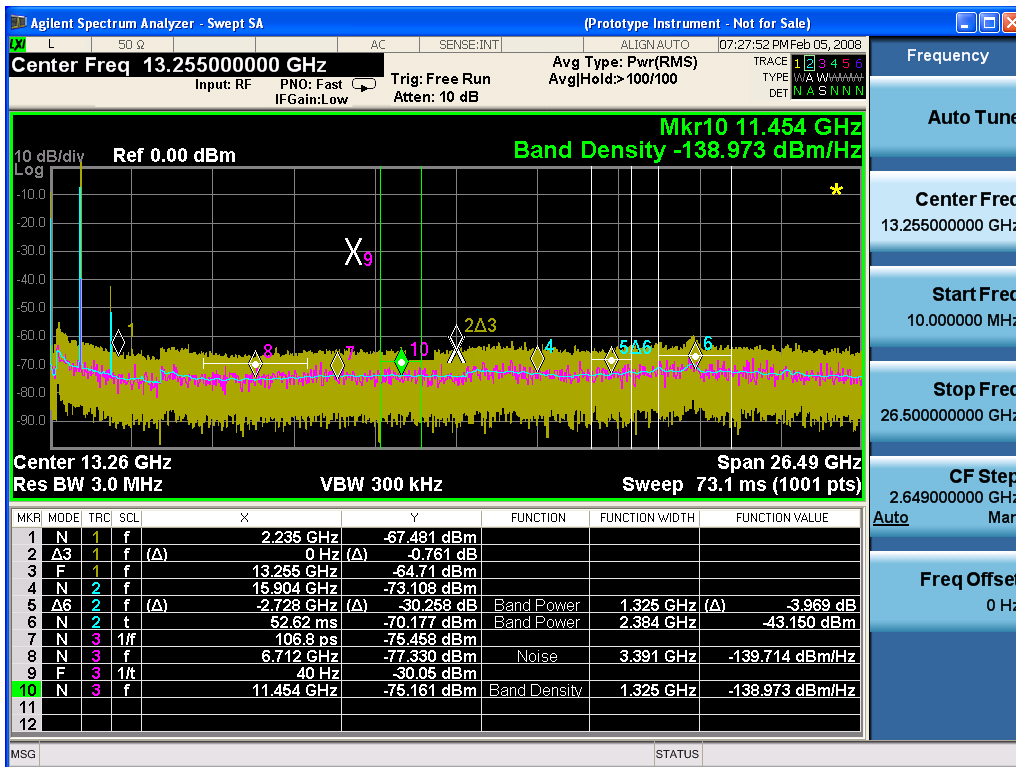

Then the Meas Results file, when opened, would show the following data:

MeasurementR
result

Swept SA

A.01.40_R0017 N9020A

526 B25 PFR 1

P26 EA3	
Result Type	Marker Table
Ref Level	0
Number of Points	1001
Sweep Time	0.0662666 67
Start Frequency	10000000
Stop Frequency	26500000 000
Average Count	0
Average Type	LogPower (Video)
RBW	3000000
RBW Filter	Gaussian
RBW Filter BW	3dB
VBW	3000000
Sweep Type	Swept
X Axis Scale	Lin
PreAmp State	Off
PreAmp Band	Low
Trigger Source	Free
Trigger Level	1.2
Trigger Slope	Positive
Trigger Delay	1.00E-06
Phase Noise Optimization	Fast
Swept If Gain	Low
FFT If Gain	Autorange
RF Coupling	AC
FFT Width	411900
Ext Ref	10000000
Input	RF
RF Calibrator	Off
Attenuation	10
Ref Level Offset	0
External Gain	0

X Axis Units	Hz								
Y Axis Units	dBm								
DATA									
MKR	MODE	TRC	SCL	X	Y	FUNCTI ON	FUNCTIO N WIDTH	FUNCTI ON VALUE	FUNCTI ON UNIT
1	Normal	1	Freque ncy	2.2350E+ 09	- 67.4 81	Off	0.0000E+ 00	0	None
2	Delta3	1	Freque ncy	0.0000E+ 00	- 0.76 1	Off	0.0000E+ 00	0	None
3	Fixed	1	Freque ncy	1.3255E+ 10	- 64.7 1	Off	0.0000E+ 00	0	None
4	Normal	2	Freque ncy	1.5904E+ 10	- 73.1 08	Off	0.0000E+ 00	0	None
5	Delta7	2	Freque ncy	- 2.7280E+ 09	- 30.2 58	Band Power	1.3250E+ 06	-3.969	dB
6	Normal	2	Time	5.2620E- 02	- 70.1 77	Band Power	2.3840E+ 06	-43.15	dBm
7	Normal	3	Period	1.0680E- 10	- 75.4 58	Off	0.0000E+ 00	0	None
8	Normal	3	Freque ncy	6.7120E+ 09	- 77.3 3	Noise	3.3910E+ 06	- 139.71 4	dBm/Hz
9	Fixed	3	Inverse Time	4.0000E+ 01	- 30.0 5	Off	0.0000E+ 00	0	None
10	Normal	3	Freque ncy	1.1454E+ 10	- 75.1 61	Band Density	1.3250E+ 06	- 138.97 3	dBm/Hz
11	Off	1	Freque ncy	0.0000E+ 00	0	Off	0.0000E+ 00	0	None
12	Off	1	Freque ncy	0.0000E+ 00	0	Off	0.0000E+ 00	0	None

The numbers appear in the file exactly as they appear onscreen. If it says 11.454 GHz onscreen, then in the file it is 11.454E+09.

The metadata header is very similar to the metadata used in the trace data .csv files. See Trace File Contents. The only new information concerns the 1-of-N fields in the marker table itself.

Peak Table

This section discusses the Peak Table Meas Results file format.

Imagine that, at the point where a Marker Table Meas Result is requested, the following screen is showing:

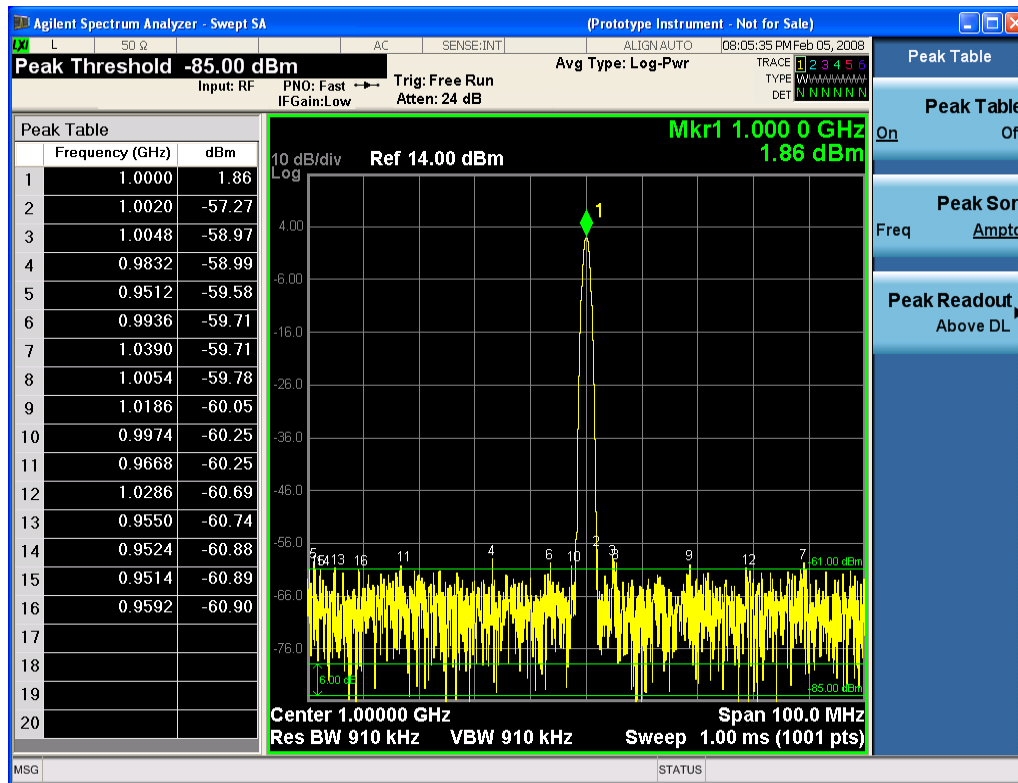

Then the Meas Results file, when opened, would show the header data (the same as for the Marker Table except that the Result Type is Peak Table) ending with a few fields of specific interest to Peak Table users:

- Peak Threshold
- Peak Threshold State (On|Off)
- Peak Excursion
- Peak Excursion State (On|Off)
- Display Line
- Peak Readout (All|AboveDL|BelowDL)
- Peak Sort (Freq|Amptd)

These fields are then followed by the data for the Peak Table itself.

Note that the label for the Frequency column changes to Time in 0 span.

Here is what the table for the above display looks like:

MeasurementResult	
Swept SA	
A.01.40_R0017	N9020A
526 B25 PFR P26 EA3	1
Result Type	Peak Table
Ref Level	0
Number of Points	1001
Sweep Time	0.066266667
Start Frequency	10000000
Stop Frequency	26500000000
Average Count	0
Average Type	LogPower(Video)
RBW	3000000
RBW Filter	Gaussian
RBW Filter BW	3dB
VBW	3000000
Sweep Type	Swept
X Axis Scale	Lin
PreAmp State	Off
PreAmp Band	Low
Trigger Source	Free
Trigger Level	1.2
Trigger Slope	Positive
Trigger Delay	1.00E-06
Phase Noise Optimization	Fast
Swept If Gain	Low
FFT If Gain	Autorange
RF Coupling	AC
FFT Width	411900
Ext Ref	10000000
Input	RF
RF Calibrator	Off
Attenuation	10
Ref Level Offset	0
External Gain	0
X Axis Units	Hz
Y Axis Units	dBm

Peak Threshold	-85	
Peak Threshold State	On	
Peak Excursion	6	
Peak Excursion State	On	
Display Line	-61	
Peak Readout	AboveDL	
Peak Sort	Amptd	
DATA		
Peak	Frequency	Amplitude
1	1.0000E+06	1.86
2	1.0020E+06	-57.27
3	1.0048E+06	-58.97
4	9.8320E+05	-58.99
5	9.5120E+05	-59.58
6	9.9360E+05	-59.71
7	1.0390E+06	-59.71
8	1.0054E+06	-59.78
9	1.1086E+06	-60.05
10	9.9740E+05	-60.25
11	9.6680E+05	-60.25
12	1.0286E+06	-60.69
13	9.5500E+05	-60.74
14	9.5240E+05	-60.88
15	9.5140E+05	-60.89
16	9.5920E+05	-60.90
17		
18		
19		
20		

Spectrogram

This section discusses the Spectrogram Results file format. The Spectrogram choice only appears if option EDP is licensed.

The Spectrogram results are the same as a Trace data export, except that instead of having just one trace's data, all 300 traces appear one after the other.

.

Each trace has its own data mark; the data for Spectrogram Trace 0 follows the row marked DATA, the data for Spectrogram Trace 1 follows the row marked DATA1, for Spectrogram Trace 2 follows the row marked DATA2, and so on.

Each DATA row has a timestamp in the second column (as of firmware revision A.11.01). So, for example, if Trace 0 had a relative start time of 1729.523 sec, then the first DATA row would look like this:

```
DATA,1729.523
```

And if Trace 13 had a relative start time of 100.45 sec, then the fourteenth data row would look like:

```
DATA13,100.453
```

To find the absolute time for the relative timestamps of each trace, the last row before the first DATA row gives the absolute start time of the Spectrogram, in the form YYYYMMDDHHMMSS

So, for example, if the absolute start time is 13:23:45:678 on January 30, 2012, this row would look like:

```
Start Time,20120130132345678
```

NOTE:

NOTE

The resolution of the absolute time stored is 1 ms, which matches up with the fact that the fastest sweep time is also 1 ms. However, there is no specification for the absolute accuracy of the clock in the analyzer, nor is there any facility provided to allow the user to set this time to any particular degree of accuracy.

Traces that have not yet been filled in the Spectrogram display are empty; there is no DATA header for them. The file ends after the last non-empty trace.

Imagine that, at the point where a Spectrogram Meas Result is requested, the following screen is showing:

11 FM Stereo Measurement
Save

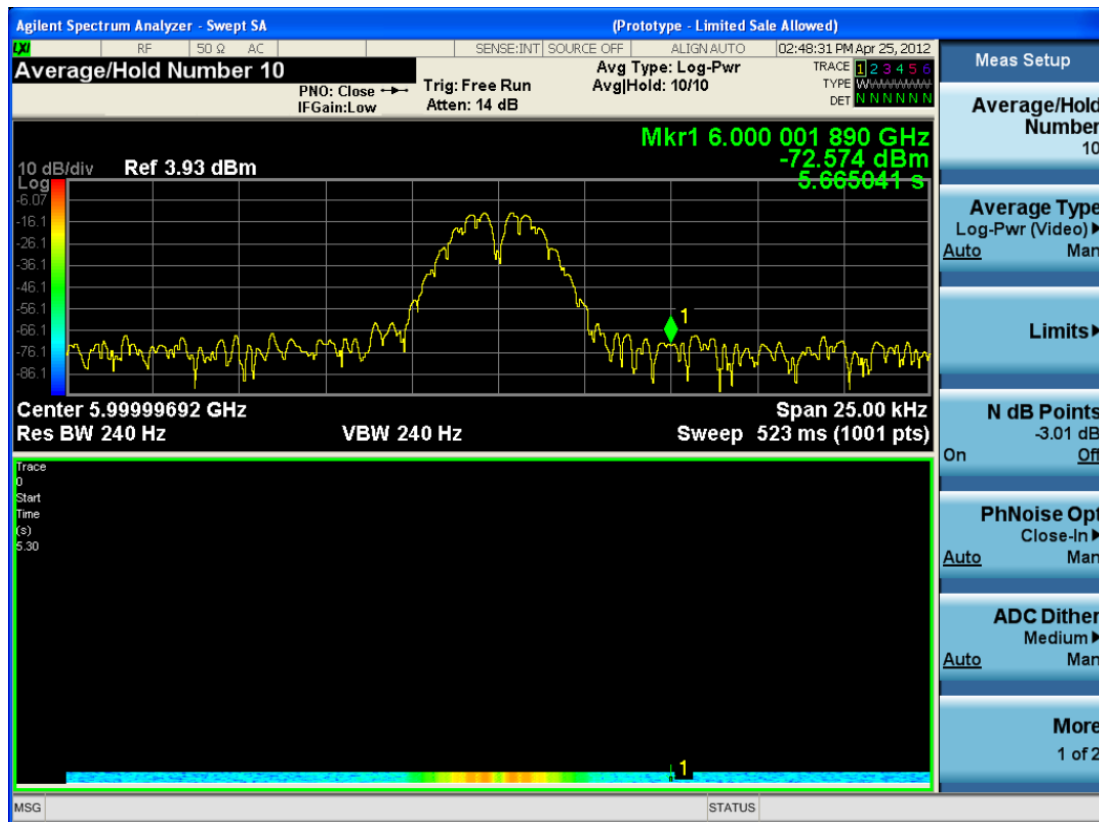

For the purpose of this example, we have set the Average/Hold Number to 10, thus we have only traces 0 thru 10. The Spectrogram was started at 02:28:08:700 pm on April 25, 2012 (that is, 700 ms after 2:28:08 pm), although the screen dump itself shows a different time, as it was taken ten minutes after the Spectrogram data. Trace 0 is showing a start time of 5.30 seconds, meaning 5.3 seconds after the Spectrogram started (trace 10 has a start time of 0, as it was the first trace taken but has now rolled up into the tenth trace slot).

The Meas Results file, when opened, shows the header data and ten traces of trace data. Below is an extract from the result file for the above display. Note the start time of 20120425142808700 showing in the last row before the first DATA row, and the relative time of 5.299231048 showing in the first DATA row:

Result Type	Spectrogram
MeasResult	
Swept SA	
A.11.00.01	N9020A
503 508 513 526 ALL ALV B1C B1X B25 B2X B40 BAB BBA CR3 CRP DP2 DRD EA3 EDP EMC EP1 ERC ESC ESP EXM FSA HBA K03 LFE MPB P03 P08 P13 P26 PFR RTL RTS S40 SB1 SEC SM1 UK6 YAS YAV	1
Segment	0

Result Type	Spectrogram
Number of Points	1001
Sweep Time	0.523333333
Start Frequency	5999984415
Stop Frequency	6000009415
Average Count	0
Average Type	LogPower(Video)
RBW	240
RBW Filter	Gaussian
RBW Filter BW	3dB
VBW	240
Sweep Type	Swept
X Axis Scale	Lin
PreAmp State	Off
PreAmp Band	Low
Trigger Source	Free
Trigger Level	1.2
Trigger Slope	Positive
Trigger Delay	0
Phase Noise Optimization	Wide
Swept If Gain	Low
FFT If Gain	Autorange
RF Coupling	AC
FFT Width	411900
Ext Ref	10000000
Input	RF
RF Calibrator	Off
Attenuation	14
Ref Level Offset	0
External Gain	0
Trace Type	Clearwrite
Detector	Normal
Trace Math	Off
Trace Math Oper1	Trace5
Trace Math Oper2	Trace6
Trace Math Offset	0
Trace Name	Trace1

Result Type	Spectrogram
X Axis Units	Hz
Y Axis Units	dBm
Start Time	20120425142808700
DATA	5.299231048
5999984415	-76.34749519
5999984440	-77.28097006
5999984465	-75.32317869
5999984490	-73.64417681
5999984515	-72.67154604

O
 O
 O

6000009315	-77.94423277
6000009340	-79.51829697
6000009365	-78.46108961
6000009390	-78.46108957
6000009415	-76.59570596
DATA2	4.708697055
5999984415	-80.98197882
5999984440	-80.98197879
5999984465	-75.83142132
5999984490	-74.02712079
5999984515	-73.57213005

O
 O
 O

6000009315	-75.9183103
6000009340	-79.53787488
6000009365	-78.82602191
6000009390	-78.82602188
6000009415	-76.37486709

DATA10	0
5999984415	-75.56751112
5999984440	-75.76485645
5999984465	-76.67718717
5999984490	-78.79238489
5999984515	-83.72680212

o
o
o

6000009315	-71.3942461
6000009340	-72.28308332
6000009365	-73.92684489
6000009390	-75.45548832
6000009415	-75.17904815

Save As . . .

When you press “Save As”, the analyzer brings up a Windows dialog and a menu entitled “**Save As.**” This menu allows you to navigate to the various fields in the Windows dialog without using a keyboard or mouse. The Tab and Arrow keys can also be used for dialog navigation.

See "[To File . . .](#)" on page 1181 in Save, State for a full description of this dialog and menu.

The default path for saving files is:

For all of the Trace Data Files:

My Documents\`<mode name>`\data\traces

For all of the Limit Data Files:

My Documents\`<mode name>`\data\limits

For all of the Measurement Results Data Files:

My Documents\`<mode name>`\data\`<measurement name>`\results

For all of the Capture Buffer Data Files:

My Documents\`<mode name>`\data\captureBuffer

Key Path	Save, Data
Mode	All

Notes	<p>The key location is mode-dependent and will vary.</p> <p>Brings up the Save As dialog for saving a <mode specific> Save Type. The save is performed immediately and does not wait until the measurement is complete.</p>
Initial S/W Revision	Prior to A.02.00

Screen Image

Pressing Screen Image accesses a menu of functions that enable you to specify a format and location for the saved screen image. It brings up a menu that allows you to specify the color scheme of the Screen Image (Themes) or navigate to the Save As dialog to perform the actual save.

Screen Image files contain an exact representation of the analyzer display. They cannot be loaded back onto the analyzer, but they can be loaded into your PC for use in many popular applications.

The image to be saved is actually captured when the Save front panel key is pressed, and kept in temporary storage to be used if you ask for a Screen Image save. When the Screen Image key is pressed, a "thumbnail" of the captured image is displayed, as shown below:

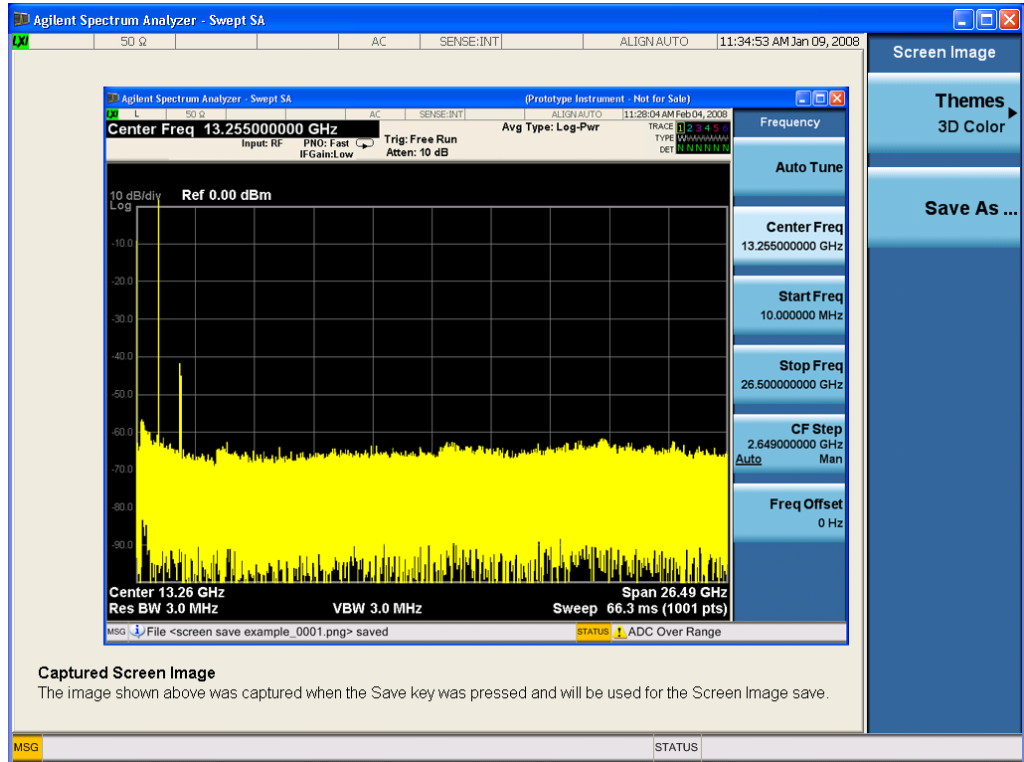

When you continue on into the Save As menu and complete the Screen Image save, the image depicted in the thumbnail is the one that gets saved, showing the menus that were on the screen before going into the Save menus. The save is performed immediately and does not wait until the measurement is complete.

After you have completed the save, the Quick Save front-panel key lets you quickly repeat the last save performed, using an auto-named file, with the current screen data.

NOTE

For versions previous to A.01.55, if you initiate a screen image save by navigating through the Save menus, the image that is saved will contain the Save menu softkeys, not the menus and the active function that were on the screen when you first pressed the Save front panel key.

Key Path	Save
Mode	All
Remote Command	:MMEMory:STORe:SCReen <filename>
Example	:MMEM:STOR:SCR "myScreen.png" This stores the current screen image in the file MyScreenFile.png in the default directory.
Initial S/W Revision	Prior to A.02.00

Themes

Accesses a menu of functions that enable you to choose the theme to be used when saving the screen image.

The **Themes** option is the same as the **Themes** option under the **Display** and **Page Setup** dialogs. It allows you to choose between themes to be used when saving the screen image.

Key Path	Save, Screen Image
Remote Command	:MMEMory:STORe:SCReen:THEMe TDColor TDMonochrome FColor FMONochrome :MMEMory:STORe:SCReen:THEMe?
Example	:MMEM:STOR:SCR:THEM TDM
Preset	3D Color; Is not part of Preset, but is reset by Restore Misc Defaults or Restore System Defaults All and survives subsequent running of the modes.
Readback	3D Color 3D Mono Flat Color Flat Mono
Backwards Compatibility Notes	In ESA and PSA we offer the choice of "Reverse Bitmap" or "Reverse Metafile" when saving screen images. This is much like the "Flat Color" theme available in X-Series. Also, if you selected Reverse Bitmap AND a black & white screen image, that would be much like "Flat Monochrome". In other words, each of the X-Series themes has a similar screen image type in ESA/PSA. But they are not identical.
Initial S/W Revision	Prior to A.02.00

3D Color

Selects a standard color theme with each object filled, shaded and colored as designed.

Key Path	Save, Screen Image, Themes
Example	MMEM:STOR:SCR:THEM TDC
Readback	3D Color
Initial S/W Revision	Prior to A.02.00

3D Monochrome

Selects a format that is like 3D color but shades of gray are used instead of colors.

Key Path	Save, Screen Image, Themes
Example	MMEM:STOR:SCR:THEM TDM
Readback	3D Mono
Initial S/W Revision	Prior to A.02.00

Flat Color

Selects a format that is best when the screen is to be printed on an ink printer.

Key Path	Save, Screen Image, Themes
Example	MMEM:STOR:SCR:THEM FCOL
Readback	Flat Color
Initial S/W Revision	Prior to A.02.00

Flat Monochrome

Selects a format that is like Flat Color. But only black is used (no colors, not even gray), and no fill.

Key Path	Save, Screen Image, Themes
Example	MMEM:STOR:SCR:THEM FMON
Readback	Flat Mono
Initial S/W Revision	Prior to A.02.00

Save As...

When you press "Save As", the analyzer brings up a Windows dialog and a menu entitled "**Save As.**" This menu allows you to navigate to the various fields in the Windows dialog without using a keyboard or mouse. The Tab and Arrow keys can also be used for dialog navigation.

See "[To File . . .](#)" on page 1181 in Save, State for a full description of this dialog and menu.

The default path for Screen Images is

My Documents\`<mode name>`\screen.

where `<mode name>` is the parameter used to select the mode with the INST:SEL command (for example, SA for the Spectrum Analyzer).

Key Path	Save, Screen Image
Notes	Brings up Save As dialog for saving a Screen Image Save Type
Initial S/W Revision	Prior to A.02.00

Single (Single Measurement/Sweep)

Sets the analyzer for Single measurement operation. The single/continuous state is Meas Global, so the setting will affect all the measurements. If you are Paused, pressing Single does a Resume.

See ["More Information" on page 1226](#)

Key Path	Front-panel key
Example	:INIT:CONT OFF
Notes	See Cont key description.
Backwards Compatibility Notes	<p>For Spectrum Analysis mode in ESA and PSA, the Single hardkey and the INITiate:IMM switched from continuous measurement to single measurement and restarted sweeps and averages (displayed average count reset to 1), but did not restart Max Hold and Min Hold. In the X-Series, the Single hardkey and the INITiate:IMM command initiate a sweep/ measurement/ average sequence/hold sequence including MaxHold and MinHold.</p> <p>For Spectrum Analysis mode in ESA and PSA, the Single hardkey restarted the sweep regardless of whether or not you were in an active sweep or sweep sequence. In the X-Series, Restart does this but Single only restarts the sweep or sweep sequence if you are in the idle state.</p> <p>INIT[:IMM] in ESA & PSA Spectrum Analysis Mode does an implied ABORT. In some other PSA Modes, INIT[:IMM] is ignored if not in the idle state. . The X-Series follows the ESA/PSA SA Mode model, which may cause some Modes to have compatibility problems.</p>
Initial S/W Revision	Prior to A.02.00

More Information

See ["Restart" on page 1178](#) for details on the INIT:IMMEDIATE (Restart) function.

If you are already in single sweep, the INIT:CONT OFF command has no effect.

If you are already in Single Sweep, then pressing the Single key in the middle of a sweep does not restart the sweep or sequence. Similarly, pressing the Single key does not restart the sweep or sequence if the sweep is not in the idle state (for example, if you are taking a very slow sweep, or the analyzer is waiting for a trigger). Instead, it results in a message. "Already in Single, press Restart to initiate a new sweep or sequence". Even though pressing the Single key in the middle of a sweep does not restart the sweep, sending INIT:IMMEDIATE does reset it.

To take one more sweep without resetting the average count, increment the average count by 1, by pressing the step up key while **Average/Hold Number** is the active function, or sending the remote command CALC:AVER:TCON UP.

Source

Opens a menu of keys that access various source configuration menus and settings. In the test set, pressing this key also causes the central view area to change and display the Source Control Main view.

Key Path	Front-panel key
----------	-----------------

RF Output

This parameter sets the source RF power output state.

Key Path	Source
Remote Command	:OUTPut[:EXTernal][:STATe] ON OFF 1 0 :OUTPut[:EXTernal][:STATe]?
Example	OUTP OFF OUTP?
Notes	<p>The EXTERNAL node is shown in RD text so the SCPI remains the same between internal and external source control. However, for EXT we do not wish to document this node to the customer since we are controlling the internal source rather than the external source.</p> <p>This setting is for the independent mode and has no effect on the "List Sequencer" on page 1306. If the "Sequencer" on page 1307 is set to ON, the list sequencer controls the source output and this key will be grayed-out. And this setting will be none-forceful grey out on front panel to indicate out-of-scope. Non-forceful means user still can change this setting by SCPI but cannot change on front panel. When set to OFF will make source leave list sequencer and this setting will be black out and take effect immediately.</p> <p>When the RF Output is ON, an "RF" annunciator is displayed in the system settings panel. When the RF Output is turned Off, the RF annunciator is cleared. If the "Sequencer" on page 1307 is set to ON, the "RF" annunciator will be replaced by "SEQ" in the system settings panel, indicating that the output is controlled by the list sequencer.</p>
Preset	Off
Range	On Off
Initial S/W Revision	A.05.00

Amplitude

Allows you to access the Amplitude sub-menu.

Key Path	Source
Notes	<p>The sub-menu under this button is for independent mode and has no effect on "List Sequencer" on page 1306. If the "Sequencer" on page 1307 is set to ON, the list sequencer controls the source output and this key will be grayed-out on front panel to indicate out-of-scope. When you set "Sequencer" on page 1307 to Off will make source leave list sequencer and this button will be black out.</p>
Initial S/W Revision	A.05.00

RF Power

Allows you to adjust the power level of the source using the numeric keypad, step keys, or RPG. Pressing any digit, 0 through 9, on the numeric keypad brings up the unit terminator.

Please refer to the "[RF Power Range](#) " on page 1229 table below for the valid ranges.

Key Path	Source, Amplitude
Remote Command	:SOURce:POWer[:LEVel][:IMMediate][:AMPLitude] <ampl> :SOURce:POWer[:LEVel][:IMMediate][:AMPLitude]?
Example	:SOUR:POW -100 dBm
Notes	<p>Amplitude corrections can be specified for use with the source. In the event of amplitude corrections being applied, the valid ranges for the RF power do not change dependant on the current amplitude correction setting. If the combination of RF power + amplitude correction is higher or lower than the source output range, the Source Unleveled bit is set and the "Source Unleveled" indicator will appear on status panel to indicate that the source cannot maintain the output power that has been requested.</p> <p>When signal generator is unable to maintain the requested output level, the "Source Unleveled" indicator will appear on status panel. When the source output setting is restored to the normal range, the "Source Unleveled" is removed from status panel.</p> <p>Internal source has list sequence mode, which comprises of several steps which contain separate output power, frequency and waveform etc. When the source list sequence playing is complete, the last step keeps playing, and user can use this command to change the list sequence last step's output power.</p> <p>The multiport adapter RFIO TX ports and GPS ports cannot ensure power accuracy when power setting is lower than -130dBm, this power setting value is defined by the sum of RF Power setting and related amplitude correction value. But user settable value could be lower than this limit. When application detected there exists power setting lower than -130dBm on MPA RFIO TX ports, then popup warning message . When application detected there exists power setting lower than -130dBm on MPA GPS ports, then popup warning message . This is only warning message, and check is performed when RF is ON.</p>
Notes	The Min and Max value here defined UI settable amplitude range. This range is larger than actual amplitude range with level accuracy defined in spec.
Dependencies	The RF power is dependent on the RF output port and frequency, such that the current frequency and selected output port determine the valid range of power values.
Preset	-100 dBm
Min	The range of values depends on the current frequency and selected RF output port. Please refer to the " RF Power Range " on page 1229 table below for the valid ranges.
Max	The range of values depends on the current frequency and selected RF output port. Please refer to the " RF Power Range " on page 1229 table below for the valid ranges.
Initial S/W Revision	A.05.00

RF Power Range

RF Output Port	Frequency Range	Min Output Power	Max Output Power
High Power RF Out	10 MHz ≤ f ≤ 6 GHz	-150 dBm	20 dBm
RFIO 1 & RFIO 2	10 MHz ≤ f ≤ 6 GHz	-150 dBm	0 dBm
GPS (Note2)	10 MHz ≤ f ≤ 6 GHz	-150 dBm	0 dBm

Note: This is the UI power range, it's larger than actual spec.

Note2: GPS port is on the multiport adapter, or E6607C which has embedded MPA.

Set Reference Power

This key allows you to set the power reference. Pressing this key turns the power reference state to ON, sets the reference power value to the current RF output power, maintains this power at the RF output, and sets the displayed power to 0.00 dB. All subsequent RF power values entered under Source>Amplitude>RF Power are interpreted as being relative to this reference power.

When you use a power reference, the signal generator outputs an RF power that is set relative to the reference power by the value entered under Source>Amplitude>RF Power as follows:

Output power = reference power – entered power

Where:

reference power equals the original RF Power entered under Source>Amplitude>RF Power and set as the reference power

entered power equals a new value entered under Source>Amplitude>Amptd Offset

In addition, the displayed power value is the same as a new value entered under Source>Amplitude>RF Power.

NOTE

If Power Ref is set to ON with a reference value set, entering a value under Source>Amplitude>RF Power and pressing Set Reference Power will add that value to the existing Power Ref value.

If you wish to change the reference power value to a new value entered under Source>Amplitude>RF Power, first you must set Power Ref to OFF and then press Set Reference Power.

Key Path	Source, Amplitude
Dependencies	This key is unavailable, and is grayed out when the " List Sequencer " on page 1306 is turned ON.
Initial S/W Revision	A.05.00

Power Ref

This key allows you to toggle the state of the power reference.

When you use a power reference, the signal generator outputs an RF power that is set relative to the reference power by the value entered under Source>Amplitude>RF Power as follows:

Output power = reference power + entered power

Where:

reference power equals the original RF Power entered under Source>Amplitude>RF Power and set as the reference power

entered power equals a new value entered under Source>Amplitude>Amptd Offset

For more information on Reference Frequency refer to ["Set Reference Power " on page 1229](#)

Key Path	Source, Amplitude
Remote Command	:SOURce:POWer:REFeRence <ampl> :SOURce:POWer:REFeRence? :SOURce:POWer:REFeRence:STATe OFF ON 0 1 :SOURce:POWer:REFeRence:STATe?
Example	:SOUR:POW:REF 0.00 dBm :SOUR:POW:REF:STATe ON
Dependencies	This setting is unavailable and is grayed out when the "List Sequencer" on page 1306 is turned ON.
Couplings	This value is coupled to the "Set Reference Power " on page 1229 key such that pressing the Set Reference Power key updates the reference power with the current output power.
Preset	0.00 dBm OFF
Min	-125.00 dBm
Max	10.00 dBm
Initial S/W Revision	A.05.00

Amptd Offset

Allows you to specify the RF output power offset value.

When the amplitude offset is set to zero (0) and you set a new offset value (positive or negative), the displayed amplitude value will change as follows and the RF output power will not change:

Displayed value = output power + offset value

Where:

output power equals the original RF Power entered under Source>Amplitude>RF Power

offset value equals the value entered under Source>Amplitude>Amptd Offset

When the amplitude offset is set to a value other than zero (0) and you enter a new RF power value under Source>Amplitude>RF Power, the displayed power will be the same as the value entered and the RF output power will be equal to the value entered minus the offset value as follows:

Output power = entered power – offset power

Displayed Power = output power + offset power

Displayed power = entered power

Where:

entered power equals the amplitude entered under Source>Amplitude>RF Power

offset power equals the value previously entered and set under Source>Amplitude>Amptd Offset

Key Path	Source, Amplitude
Remote Command	:SOURce:POWer[:LEVel][:IMMediate]:OFFSet <rel_ampl> :SOURce:POWer[:LEVel][:IMMediate]:OFFSet?
Example	:SOUR:POW:OFFS 0.00 dB
Dependencies	This setting is unavailable, and is grayed out when the List Sequencer is turned ON.
Preset	0.00 dB
Min	-200.00 dB
Max	200.00 dB
Initial S/W Revision	A.05.00

Modulation

Allows you to toggle the state of the modulation.

Key Path	Source
Remote Command	:OUTPut:MODulation[:STATe] ON OFF 1 0 :OUTPut:MODulation[:STATe]?
Example	:OUTP:MOD OFF
Notes	This setting is for independent mode and has no effect on " List Sequencer " on page 1306. If the " Sequencer " on page 1307 is set to ON, the list sequencer controls the source output and this key will be grayed-out. And this setting will be none-forceful grey out on front panel to indicate out-of-scope. Non-forceful means user still can change this setting by SCPI but cannot change manually on front panel. When set to Off will make source leave list sequencer and this setting will be black out and take effect immediately. When the Modulation is ON, the "MOD" annunciator is displayed in the system settings panel. When the Modulation is turned Off, the "MOD" annunciator is cleared. If the " Sequencer " on page 1307 is set to ON, the "MOD" annunciator will be replaced by "SEQ" in the system settings panel indicating that the output is controlled by list sequencer.
Preset	Off
Range	On Off
Initial S/W Revision	A.05.00

Frequency

Allows you to access the Frequency sub-menu.

Key Path	Source
Notes	The sub-menu under this button is for independent mode and has no effect on " List Sequencer " on

[page 1306](#). If the "[Sequencer](#)" on [page 1307](#) is set to ON, the list sequencer controls the source output and this key will be grayed-out. And this button will be grey out on front panel to indicate out-of-scope. When set to Off will make source leave list sequencer and this button will be black out.

Initial S/W Revision A.05.00

Frequency

Allows you to set the RF Output Frequency. You can adjust the frequency of the source using the numeric keypad, step keys, or RPG. Pressing any digit, 0 through 9, on the numeric keypad brings up the unit terminator.

Key Path	Source, Frequency
Remote Command	:SOURce:FREQuency[:CW] <freq> :SOURce:FREQuency[:CW]?
Example	:SOUR:FREQ 1.00 GHz
Notes	Internal source has list sequence mode, which comprises of several steps which contain separate output power, frequency and waveform etc. When the source list sequence playing is complete, the last step keeps playing, and user can use this command to change the list sequence last step's output frequency.
Couplings	The frequency value is coupled to the current channel band and number, such that updates to the band and number will update the frequency value to the corresponding absolute frequency.
Preset	1.00 GHz If license F1A or 5WC is present, the default Center Frequency should be 2.412GHz.
Min	10.00 MHz
Max	Hardware Dependant: Option 503 = 3.6 GHz Option 504 = 3.8 GHz Option 506 = 6.00 GHz For E6640A, if license 5WC is present, the frequency range should be limited to: 1.1GHz–1.7GHz, 2.4GHz–2.5GHz, 4.8GHz–6.0GHz. If the user-defined frequency is outside of range, UI will report an error message called "Settings conflict; Frequency is outside available range".
Initial S/W Revision	A.05.00

Channel

The frequency of the source can be specified by a channel number of a given frequency band. This key allows you to specify the current channel number. For the appropriate range of channel numbers for a given frequency band, refer to the following tables: "[GSM/EDGE Channel Number Ranges](#)" on [page 1233](#), "[W-CDMA Channel Number Ranges](#)" on [page 1234](#), "[CDMA 2000 / 1xEVDO Channel Number Ranges](#)" on [page 1235](#), and "[LTE FDD Channel Number Ranges](#)" on [page 1237](#).

Key Path	Source, Frequency
Remote Command	:SOURce:FREQuency:CHANnels:NUMBer <int> :SOURce:FREQuency:CHANnels:NUMBer?
Example	:SOUR:FREQ:CHAN:NUMB 1
Notes	This key is grayed out when the "Radio Standard" on page 1241 is set to NONE. This key is grayed out on E6630A.
Dependencies	This key is grayed out when the "Radio Standard" on page 1241 is set to NONE. This key is grayed out on E6630A.
Couplings	The channel number is coupled to the frequency value when the "Radio Standard" on page 1241 is not set to NONE. When the frequency value is changed, the channel number will increase or decrease to match the new frequency. If the frequency is not at an exact match for a channel number, the nearest channel number is displayed along with a greater than or less than sign to indicate the frequency is above or below the channel number.
Preset	1
Min	Please refer to the tables below for the valid ranges.
Max	Please refer to the tables below for the valid ranges.
Initial S/W Revision	A.05.00

GSM/EDGE Channel Number Ranges

Band	Link (Device)	Range	Frequency (MHz)
P-GSM	Uplink (MS)	$1 \leq n \leq 124$	$890.0 + 0.2*n$
	Downlink (BS)	$1 \leq n \leq 124$	$935.0 + 0.2*n$
E-GSM	Uplink (MS)	$0 \leq n \leq 124$	$890.0 + 0.2*n$
		$975 \leq n \leq 1023$	$890.0 + 0.2*(n-1024)$
	Downlink (BS)	$0 \leq n \leq 124$	$935.0 + 0.2*n$
		$975 \leq n \leq 1023$	$935.0 + 0.2*(n-1024)$
DCS 1800	Uplink (MS)	$512 \leq n \leq 885$	$1710.200 + 0.20*(n-512)$
	Downlink (BS)	$512 \leq n \leq 885$	$1805.200 + 0.20*(n-512)$
PCS 1900	Uplink (MS)	$512 \leq n \leq 810$	$1850.200 + 0.2*(n-512)$
	Downlink (BS)	$512 \leq n \leq 810$	$1930.200 + 0.2*(n-512)$
R-GSM	Uplink (MS)	$0 \leq n \leq 124$	$890.0 + 0.2*n$
		$955 \leq n \leq 1023$	$890.0 + 0.2*(n-1024)$
	Downlink (BS)	$0 \leq n \leq 124$	$935.0 + 0.2*n$
		$955 \leq n \leq 1023$	$935.0 + 0.2*(n-1024)$
GSM 450	Uplink (MS)	$256 \leq n \leq 293$	$450.6 + 0.2*(n-259)$
	Downlink (BS)	$256 \leq n \leq 293$	$460.6 + 0.2*(n-259)$
GSM 480	Uplink (MS)	$306 \leq n \leq 340$	$479.000 + 0.20*(n-306)$

Band	Link (Device)	Range	Frequency (MHz)
GSM 850	Downlink (BS)	$306 \leq n \leq 340$	$489.000 + 0.20*(n-306)$
	Uplink (MS)	$128 \leq n \leq 251$	$824.200 + 0.20*(n-128)$
GSM 700	Downlink (BS)	$128 \leq n \leq 251$	$869.200 + 0.20*(n-128)$
	Uplink (MS)	$438 \leq n \leq 516$	$777.200 + 0.20*(n-438)$
T-GSM810	Downlink (BS)	$438 \leq n \leq 516$	$747.200 + 0.20*(n-438)$
	Uplink (MS)	$350 \leq n \leq 425$	$806.0 + 0.20*(n-350)$
	Downlink (BS)	$350 \leq n \leq 425$	$851.0 + 0.20*(n-350)$

W-CDMA Channel Number Ranges

Band	Link (Device)	Range	Frequency (MHz)
Band I	Downlink	$10562 \leq n \leq 10838$	$n \div 5$
	Uplink	$9612 \leq n \leq 9888$	$n \div 5$
Band II	Downlink	$412 \leq n \leq 687$	$n \div 5 + 1850.1$
		$9662 \leq n \leq 9938$	$n \div 5$
	Uplink	$12 \leq n \leq 287$	$n \div 5 + 1850.1$
Band III	Downlink	$350 \leq n \leq 425$	$n \div 5$
	Uplink	$1162 \leq n \leq 1513$	$n \div 5 + 1575$
Band IV	Downlink	$937 \leq n \leq 1288$	$n \div 5 + 1525$
		$537 \leq n \leq 1738$	$n \div 5 + 1805$
	Uplink	$1887 \leq n \leq 2087$	$n \div 5 + 1735.1$
Band V	Downlink	$1312 \leq n \leq 1513$	$n \div 5 + 1450$
		$1662 \leq n \leq 1862$	$n \div 5 + 1380.1$
	Uplink	$1007 \leq n \leq 1087$	$n \div 5 + 670.1$
Band VI	Downlink	$4357 \leq n \leq 4458$	$n \div 5$
		$782 \leq n \leq 862$	$n \div 5 + 670.1$
	Uplink	$4132 \leq n \leq 4233$	$n \div 5$
Band VII	Downlink	$1037 \leq n \leq 1062$	$n \div 5 + 670.1$
		$4387 \leq n \leq 4413$	$n \div 5$
	Uplink	$812 \leq n \leq 837$	$n \div 5 + 670.1$
Band VIII	Downlink	$4162 \leq n \leq 4188$	$n \div 5$
		$2237 \leq n \leq 2563$	$n \div 5 + 2175$
	Uplink	$2587 \leq n \leq 2912$	$n \div 5 + 2105.1$
Band VIII	Downlink	$2012 \leq n \leq 2338$	$n \div 5 + 2100$
		$2362 \leq n \leq 2687$	$n \div 5 + 2030.1$
Band VIII	Downlink	$2937 \leq n \leq 3088$	$n \div 5 + 340$
	Uplink	$2712 \leq n \leq 2863$	$n \div 5 + 340$

Band	Link (Device)	Range	Frequency (MHz)
Band IX	Downlink	$9237 \leq n \leq 9387$	$n \div 5$
	Uplink	$8762 \leq n \leq 8912$	$n \div 5$
Band X	Downlink	$3112 \leq n \leq 3388$	$n \div 5 + 1490$
		$3412 \leq n \leq 3687$	$n \div 5 + 1430.1$
	Uplink	$2887 \leq n \leq 3163$	$n \div 5 + 1135$
		$3187 \leq n \leq 3462$	$n \div 5 + 1075.1$
Band XI	Downlink	$3712 \leq n \leq 3812$	$n \div 5 + 736$
	Uplink	$3487 \leq n \leq 3587$	$n \div 5 + 733$
Band XII	Downlink	$3837 \leq n \leq 3903$	$n \div 5 - 37$
		$3927 \leq n \leq 3992$	$n \div 5 - 54.9$
	Uplink	$3612 \leq n \leq 3678$	$n \div 5 - 22$
		$3702 \leq n \leq 3767$	$n \div 5 - 39.9$
Band XIII	Downlink	$4017 \leq n \leq 4043$	$n \div 5 - 55$
		$4067 \leq n \leq 4092$	$n \div 5 - 64.9$
	Uplink	$3792 \leq n \leq 3818$	$n \div 5 + 21$
		$3702 \leq n \leq 3767$	$n \div 5 - 39.9$
Band XIV	Downlink	$4117 \leq n \leq 4143$	$n \div 5 - 63$
		$4167 \leq n \leq 4192$	$n \div 5 - 72.9$
	Uplink	$3892 \leq n \leq 3918$	$n \div 5 + 12$
		$3942 \leq n \leq 3967$	$n \div 5 + 2.1$
Band XIX	Downlink	$712 \leq n \leq 763$	$n \div 5 + 735$
		$787 \leq n \leq 837$	$n \div 5 + 720.1$
	Uplink	$312 \leq n \leq 363$	$n \div 5 + 770$
		$387 \leq n \leq 437$	$n \div 5 + 755.1$

CDMA 2000 / 1xEVDO Channel Number Ranges

Band	Link (Device)	Range	Frequency (MHz)
US Cellular	Uplink (MS, reverse link)	$1 \leq N \leq 799$	$0.030 \times N + 825.000$
		$991 \leq N \leq 1023$	$0.030 \times (N - 1023) + 825.000$
		$1024 \leq N \leq 1323$	$0.030 \times (N - 1024) + 815.040$
	Downlink (BS, forward link)	$1 \leq N \leq 799$	$0.030 \times N + 870.000$
		$991 \leq N \leq 1023$	$0.030 \times (N - 1023) + 870.000$
		$1024 \leq N \leq 1323$	$0.030 \times (N - 1024) + 860.040$
US PCS	Uplink (MS, reverse link)	$0 \leq N \leq 1199$	$1850.000 + 0.050 \times N$
	Downlink (BS, forward link)	$0 \leq N \leq 1199$	$1930.000 + 0.050 \times N$

Band	Link (Device)	Range	Frequency (MHz)
Japan Cellular Band	Uplink (MS, reverse link)	$1 \leq N \leq 799$	$0.0125 \times (N + 915.000)$
		$801 \leq N \leq 1039$	$0.0125 \times (N - 800) + 898.000$
		$1041 \leq N \leq 1199$	$0.0125 \times (N - 1040) + 887.000$
		$1201 \leq N \leq 1600$	$0.0125 \times (N - 1200) + 893.000$
	Downlink (BS, forward link)	$1 \leq N \leq 799$	$0.0125 \times (N + 860.000)$
		$801 \leq N \leq 1039$	$0.0125 \times (N - 800) + 843.000$
		$1041 \leq N \leq 1199$	$0.0125 \times (N - 1040) + 832.000$
		$1201 \leq N \leq 1600$	$0.0125 \times (N - 1200) + 838.000$
Korean PCS Band	Uplink (MS, reverse link)	$0 \leq N \leq 599$	$0.050 \times N + 1750.000$
	Downlink (BS, forward link)	$0 \leq N \leq 599$	$0.050 \times N + 1840.000$
NMT-450 Band	Uplink (MS, reverse link)	$1 \leq N \leq 400$	$0.025 \times (N - 1) + 450.000$
		$472 \leq N \leq 871$	$0.025 \times (N - 472) + 410.000$
		$1039 \leq N \leq 1473$	$0.020 \times (N - 1024) + 451.010$
		$1536 \leq N \leq 1715$	$0.025 \times (N - 1536) + 479.000$
		$1792 \leq N \leq 2016$	$0.020 \times (N - 1792) + 479.000$
	Downlink (BS, forward link)	$1 \leq N \leq 400$	$0.025 \times (N - 1) + 460.000$
		$472 \leq N \leq 871$	$0.025 \times (N - 472) + 420.000$
		$1039 \leq N \leq 1473$	$0.020 \times (N - 1024) + 461.010$
IMT-2000 Band	Uplink (MS, reverse link)	$0 \leq N \leq 1199$	$1920.000 + 0.050 \times N$
	Downlink (BS, forward link)	$0 \leq N \leq 1199$	$2100.000 + 0.050 \times N$
Upper 700 MHz Band	Uplink (MS, reverse link)	$0 \leq N \leq 240$	$776.000 + 0.050 \times N$
	Downlink (BS, forward link)	$0 \leq N \leq 240$	$746.000 + 0.050 \times N$
Secondary 800 MHz Band	Uplink (MS, reverse link)	$0 \leq N \leq 719$	$0.025 \times N + 806.000$
		$720 \leq N \leq 919$	$0.025 \times (N - 720) + 896.000$
	Downlink (BS, forward link)	$0 \leq N \leq 719$	$0.025 \times N + 851.000$
		$720 \leq N \leq 919$	$0.025 \times (N - 720) + 935.000$
2.5 GHz IMT Extension	Uplink (MS, reverse link)	$0 \leq N \leq 1399$	$2500.000 + 0.050 \times N$
	Downlink (BS, forward link)	$0 \leq N \leq 1399$	$2620.000 + 0.050 \times N$
US PCS 1.9 GHz	Uplink (MS, reverse link)	$0 \leq N \leq 1299$	$1850.000 + 0.050 \times N$

Band	Link (Device)	Range	Frequency (MHz)
AWS	Downlink (BS, forward link)	$0 \leq N \leq 1299$	$1930.000 + 0.050 \times N$
	Uplink (MS, reverse link)	$0 \leq N \leq 899$	$1710.000 + 0.050 \times N$
US 2.5 GHz	Downlink (BS, forward link)	$0 \leq N \leq 899$	$2100.000 + 0.050 \times N$
	Uplink (MS, reverse link)	$140 \leq N \leq 1459$	$2495.000 + 0.050 \times N$
700 Public Safety	Downlink (BS, forward link)	$140 \leq N \leq 1459$	$2617.000 + 0.050 \times N$
	Uplink (MS, reverse link)	$0 \leq N \leq 240$	$787.000 + 0.050 \times N$
C2K Lower 700	Downlink (BS, forward link)	$0 \leq N \leq 240$	$757.000 + 0.050 \times N$
	Uplink (MS, reverse link)	$0 \leq N \leq 360$	$698.000 + 0.050 \times N$
400 Euro PAMR	Downlink (BS, forward link)	$0 \leq N \leq 360$	$728.000 + 0.050 \times N$
	Uplink (MS, reverse link)	$1 \leq N \leq 400$	$0.025 \times (N-1) + 450.000$
	Uplink (MS, reverse link)	$472 \leq N \leq 871$	$0.025 \times (N-472) + 410.000$
	Uplink (MS, reverse link)	$1536 \leq N \leq 1715$	$0.025 \times (N-1536) + 479.000$
	Downlink (BS, forward link)	$1 \leq N \leq 400$	$0.025 \times (N-1) + 460.000$
	Downlink (BS, forward link)	$472 \leq N \leq 871$	$0.025 \times (N-472) + 420.000$
	Downlink (BS, forward link)	$1536 \leq N \leq 1715$	$0.025 \times (N-1536) + 489.000$
	Downlink (BS, forward link)		
800 PAMR	Uplink (MS, reverse link)	$0 \leq N \leq 239$	$870.0125 + 0.025 \times N$
	Downlink (BS, forward link)	$0 \leq N \leq 239$	$915.0125 + 0.025 \times N$

LTE FDD Channel Number Ranges

The carrier frequency in the uplink and downlink is designated by the E-UTRA Absolute Radio Frequency Channel Number (EARFCN) in the range 0 – 65535. The relation between EARFCN and the carrier frequency in MHz for the downlink is given by the following equation, where FDL_low and NOffs-DL are given in table 5.4.4-1 and NDL is the downlink EARFCN.

$$FDL = FDL_low + 0.1(NDL - NOffs-DL)$$

The relation between EARFCN and the carrier frequency in MHz for the uplink is given by the following equation where FUL_low and NOffs-UL are given in table 5.4.4-1 and NUL is the uplink EARFCN.

$$FUL = FUL_low + 0.1(NUL - NOffs-UL)$$

Band	Downlink		Uplink			
	FDL_low (MHz)	NOffs-DL	Range of NDL	FUL_low (MHz)	NOffs-UL	Range of NUL
1		2110	0	0 - 599	1920	18000 - 18599
2		1930	600	600 - 1199	1850	18600 - 19199
3		1805	1200	1200 - 1949	1710	19200 - 19949
4		2110	1950	1950 - 2399	1710	19950 - 20399
5		869	2400	2400 - 2649	824	20400 - 20649
6		875	2650	2650 - 2749	830	20650 - 20749
7		2620	2750	2750 - 3449	2500	20750 - 20449
8		925	3450	3450 - 3799	880	21450 - 21799
9		1844.9	3800	3800 - 4149	1749.9	21800 - 22149
10		2110	4150	4150 - 4749	1710	22150 - 22749
11		1475.9	4750	4750 - 4949	1427.9	22750 - 22949
12		729	5010	5010 - 5179	699	23010 - 23179
13		746	5180	5180 - 5279	777	23180 - 23279
14		758	5280	5280 - 5379	788	23280 - 23379
...						
17		734	5730	5730 - 5849	704	23730 - 23849
18		860	5850	5850 - 5999	815	23850 - 23999
19		875	6000	6000 - 6149	830	24000 - 24149
20		791	6150	6150 - 6449	832	24150 - 24449
21		1495.9	6450	6450 - 6599	1447.9	24450 - 24599
...						
24		1525	7700	7700 - 8039	1626.5	25700 - 26039
25		1930	8040	8040 - 8689	1850	26040 - 26689
26		859	8690	8690 - 9039	814	26690 - 27039
...						

Note: The channel numbers that designate carrier frequencies so close to the operating band edges that the carrier extends beyond the operating band edge shall not be used. This implies that the first 7, 15, 25, 50, 75 and 100 channel numbers at the lower operating band edge and the last 6, 14, 24, 49, 74 and 99 channel numbers at the upper operating band edge shall not be used for channel bandwidths of 1.4, 3, 5, 10, 15 and 20 MHz respectively.

LTE TDD Channel Number Ranges

The carrier frequency in the uplink and downlink is designated by the E-UTRA Absolute Radio Frequency Channel Number (EARFCN) in the range 0 – 65535. The relation between EARFCN and the carrier frequency in MHz for the downlink is given by the following equation, where FDL_low and NOffs-DL are given in table 5.4.4–1 and NDL is the downlink EARFCN.

$$FDL = FDL_low + 0.1(NDL - NOffs-DL)$$

The relation between EARFCN and the carrier frequency in MHz for the uplink is given by the following equation where FUL_low and NOffs-UL are given in table 5.4.4–1 and NUL is the uplink EARFCN.

$$FUL = FUL_low + 0.1(NUL - NOffs-UL)$$

Band	Downlink	Uplink		Downlink	Uplink	
FDL_low (MHz)	NOffs-DL	Range of NDL	FUL_low (MHz)	NOffs-UL	Range of NUL	
33	1900	36000	36000 – 36199	1900	36000	36000 – 36199
34	2010	36200	36200 – 36349	2010	36200	36200 – 36349
35	1850	36350	36350 – 36949	1850	36350	36350 – 36949
36	1930	36950	36950 – 37549	1930	36950	36950 – 37549
37	1910	37550	37550 – 37749	1910	37550	37550 – 37749
38	2570	37750	37750 – 38249	2570	37750	37750 – 38249
39	1880	38250	38250 – 38649	1880	38250	38250 – 38649
40	2300	38650	38650 – 39649	2300	38650	38650 – 39649
41	2496	39650	39650 – 41589	2496	39650	39650 – 41589
42	3400	41590	41590 – 43589	3400	41590	41590 – 43589
43	3600	43590	43590 – 45589	3600	43590	43590 – 45589

Note: The channel numbers that designate carrier frequencies so close to the operating band edges that the carrier extends beyond the operating band edge shall not be used. This implies that the first 7, 15, 25, 50, 75 and 100 channel numbers at the lower operating band edge and the last 6, 14, 24, 49, 74 and 99 channel numbers at the upper operating band edge shall not be used for channel bandwidths of 1.4, 3, 5, 10, 15 and 20 MHz respectively.

TDSCDMA Channel Number Ranges

1.28 Mcps TDD Option

No TX-RX frequency separation is required as Time Division Duplex (TDD) is employed. Each subframe consists of 7 main timeslots where all main timeslots (at least the first one) before the single switching point are allocated DL and all main timeslots (at least the last one) after the single switching point are allocated UL.

The nominal channel spacing is 1.6 MHz, but this can be adjusted to optimise performance in a particular deployment scenario.

The carrier frequency is designated by the UTRA absolute radio frequency channel number (UARFCN). The value of the UARFCN in the IMT2000 band is defined in the general case as follows:

$$N_t = 5 * F \quad 0.0 \text{ MHz} \leq F \leq 3276.6 \text{ MHz}$$

where F is the carrier frequency in MHz

Additional channels applicable to operation in the frequency band defined in sub-clause 5.2(d) are defined via the following UARFCN definition:

$$N_t = 5 * (F - 2150.1 \text{ MHz}) \quad 2572.5 \text{ MHz} \leq F \leq 2617.5 \text{ MHz}$$

UARFCN

1.28 Mcps TDD Option

The following UARFCN range shall be supported for each band:

**Table: UTRA Absolute Radio
Frequency Channel Number 1.28
Mcps TDD Option**

Frequency Band	Frequency Range	UARFCN Uplink and Downlink transmission
For operation in frequency band as defined in subclause 5.2 (a)	1900–1920 MHz	9504 to 9596
	2010–2025 MHz	10054 to 10121
For operation in frequency band as defined in subclause 5.2 (b)	1850–1910 MHz	9254 to 9546
	1930–1990 MHz	9654 to 9946
For operation in frequency band as defined in subclause 5.2 (c)	1910–1930 MHz	9554 to 9646
For operation in frequency band as defined in subclause 5.2 (d)	2570–2620 MHz	12854 to 13096
For operation in frequency band as defined in subclause 5.2 (e)	2300–2400 MHz	11504 to 11996
For operation in frequency band as defined in subclause 5.2 (f)	1880–1920 MHz	9404 to 9596

Radio Setup

Allows access to the sub-menus for selecting the radio standard and associated radio band. You can also set a frequency reference and offset.

This menu is greyed out when on E6630A. Radio band settings for GSM, cdma2000, and so on -- most of which are not actually supported in E6630A, which has three narrow frequency bands. So band settings are grayed out.

Key Path	Source, Frequency
Initial S/W Revision	A.05.00

Radio Standard

Allows access to the channel band sub-menus to select the desired radio standard. When you have selected the radio standard, you can then set an active channel band. The radio standard and the active channel band allow you to use channel numbers to set frequency automatically.

Key Path	Source, Frequency, Radio Setup
Remote Command	:SOURce:FREQuency:CHANnels:BAND NONE PGSM EGSM RGSM DCS1800 PCS1900 TGSM810 GSM450 GSM480 GSM700 GSM850 BANDI BANDII BANDIII BANDIV BANDV BANDVI BANDVII BANDVIII BANDIX BANDX BANDXI BANDXII BANDXIII BANDXIV BANDXIX USCELL USPCS JAPAN KOREAN NMT IMT2K UPPER SECOND PAMR400 PAMR800 IMTEXT PCS1DOT9G AWS US2DOT5G PUBLIC LOWER BAND1 BAND2 BAND3 BAND4 BAND5 BAND6 BAND7 BAND8 BAND10 BAND11 BAND12 BAND13 BAND14 BAND17 BAND18 BAND19 BAND20 BAND21 BAND24 BAND25 BAND26 BAND27 BAND28 BAND31 BAND33 BAND34 BAND35 BAND36 BAND37 BAND38 BAND39 BAND40 BAND41 BAND42 BAND43 BAND44 BANDA BANDB BANDC BANDD BANDE BANDF :SOURce:FREQuency:CHANnels:BAND?
Example	:SOUR:FREQ:CHAN:BAND PGSM
Notes	Set this setting to "NONE" will grey out "Channel" on page 1232 Channel
Initial S/W Revision	A.05.00

None

Selects no radio standard for use. When you have selected the radio standard to NONE, you cannot use channel numbers to set frequency automatically. You will need to set the frequency manually.

Key Path	Source, Frequency, Radio Setup, Radio Standard
Initial S/W Revision	A.05.00

GSM/EDGE

Sets GSM/EDGE as the radio standard for use and accesses the GSM/EDGE specific channel band sub-menus.

Key Path	Source, Frequency, Radio Setup, Radio Standard
Initial S/W Revision	A.05.00

P-GSM

Selects P-GSM as the active channel band.

Key Path	Source, Frequency, Radio Setup, Radio Standard, GSM/EDGE
Example	:SOUR:FREQ:CHAN:BAND PGSM
Initial S/W Revision	A.05.00

E-GSM

Selects E-GSM as the active channel band.

Key Path	Source, Frequency, Radio Setup, Radio Standard, GSM/EDGE
Example	:SOUR:FREQ:CHAN:BAND EGSM
Initial S/W Revision	A.05.00

R-GSM

Selects R-GSM as the active channel band.

Key Path	Source, Frequency, Radio Setup, Radio Standard, GSM/EDGE
Example	:SOUR:FREQ:CHAN:BAND RGSM
Initial S/W Revision	A.05.00

DCS 1800

Selects DCS 1800 as the active channel band.

Key Path	Source, Frequency, Radio Setup, Radio Standard, GSM/EDGE
Example	:SOUR:FREQ:CHAN:BAND DCS1800
Initial S/W Revision	A.05.00

PCS 1900

Selects PCS 1900 as the active channel band.

Key Path	Source, Frequency, Radio Setup, Radio Standard, GSM/EDGE
Example	:SOUR:FREQ:CHAN:BAND PCS1900
Initial S/W Revision	A.05.00

GSM 450

Selects GSM 450 as the active channel band.

Key Path	Source, Frequency, Radio Setup, Radio Standard, GSM/EDGE
Example	:SOUR:FREQ:CHAN:BAND GSM450
Initial S/W Revision	A.05.00

GSM 480

Selects GSM 480 as the active channel band.

Key Path	Source, Frequency, Radio Setup, Radio Standard, GSM/EDGE
Example	:SOUR:FREQ:CHAN:BAND GSM480
Initial S/W Revision	A.05.00

GSM 850

Selects GSM 850 as the active channel band.

Key Path	Source, Frequency, Radio Setup, Radio Standard, GSM/EDGE
Example	:SOUR:FREQ:CHAN:BAND GSM850
Initial S/W Revision	A.05.00

GSM 700

Selects GSM 700 as the active channel band.

Key Path	Source, Frequency, Radio Setup, Radio Standard, GSM/EDGE
Example	:SOUR:FREQ:CHAN:BAND GSM700
Initial S/W Revision	A.05.00

T-GSM 810

Selects T-GSM 810 as the active channel band.

Key Path	Source, Frequency, Radio Setup, Radio Standard, GSM/EDGE
Example	:SOUR:FREQ:CHAN:BAND T-GSM810
Initial S/W Revision	A.05.00

WCDMA

Sets WCDMA as the radio standard for use and accesses the W-CDMA specific channel band sub-menus.

Key Path	Source, Frequency, Radio Setup, Radio Standard
Initial S/W Revision	A.05.00

Band I

Selects Band I as the active channel band.

Key Path	Source, Frequency, Radio Setup, Radio Standard, WCDMA
Example	:SOUR:FREQ:CHAN:BAND BANDI
Initial S/W Revision	A.05.00

Band II

Selects Band II as the active channel band.

Key Path	Source, Frequency, Radio Setup, Radio Standard, WCDMA
Example	:SOUR:FREQ:CHAN:BAND BANDII
Initial S/W Revision	A.05.00

Band III

Selects Band III as the active channel band.

Key Path	Source, Frequency, Radio Setup, Radio Standard, WCDMA
Example	:SOUR:FREQ:CHAN:BAND BANDIII
Initial S/W Revision	A.05.00

Band IV

Selects Band IV as the active channel band.

Key Path	Source, Frequency, Radio Setup, Radio Standard, WCDMA
Example	:SOUR:FREQ:CHAN:BAND BANDIV
Initial S/W Revision	A.05.00

Band V

Selects Band V as the active channel band.

Key Path	Source, Frequency, Radio Setup, Radio Standard, WCDMA
Example	:SOUR:FREQ:CHAN:BAND BANDV
Initial S/W Revision	A.05.00

Band VI

Selects Band VI as the active channel band.

Key Path	Source, Frequency, Radio Setup, Radio Standard, WCDMA
Example	:SOUR:FREQ:CHAN:BAND BANDVI
Initial S/W Revision	A.05.00

Band VII

Selects Band VII as the active channel band.

Key Path	Source, Frequency, Radio Setup, Radio Standard, WCDMA
Example	:SOUR:FREQ:CHAN:BAND BANDVII
Initial S/W Revision	A.05.00

Band VIII

Selects Band VIII as the active channel band.

Key Path	Source, Frequency, Radio Setup, Radio Standard, WCDMA
Example	:SOUR:FREQ:CHAN:BAND BANDVIII
Initial S/W Revision	A.05.00

Band IX

Selects Band IX as the active channel band.

Key Path	Source, Frequency, Radio Setup, Radio Standard, WCDMA
Example	:SOUR:FREQ:CHAN:BAND BANDIX
Initial S/W Revision	A.05.00

Band X

Selects Band X as the active channel band.

Key Path	Source, Frequency, Radio Setup, Radio Standard, WCDMA
Example	:SOUR:FREQ:CHAN:BAND BANDX
Initial S/W Revision	A.05.00

Band XI

Selects Band XI as the active channel band.

Key Path	Source, Frequency, Radio Setup, Radio Standard, WCDMA
Example	:SOUR:FREQ:CHAN:BAND BANDXI
Initial S/W Revision	A.05.00

Band XII

Selects Band XII as the active channel band.

Key Path	Source, Frequency, Radio Setup, Radio Standard, WCDMA
Example	:SOUR:FREQ:CHAN:BAND BANDXII
Initial S/W Revision	A.05.00

Band XIII

Selects band XIII as the active channel band.

Key Path	Source, Frequency, Radio Setup, Radio Standard, WCDMA
Example	:SOUR:FREQ:CHAN:BAND BANDXIII
Initial S/W Revision	A.05.00

Band XIV

Selects Band XIV as the active channel band.

Key Path	Source, Frequency, Radio Setup, Radio Standard, WCDMA
Example	:SOUR:FREQ:CHAN:BAND BANDXIV
Initial S/W Revision	A.05.00

Band XIX

Selects Band XIX as the active channel band.

Key Path	Source, Frequency, Radio Setup, Radio Standard, WCDMA
Example	:SOUR:FREQ:CHAN:BAND BANDXIX
Initial S/W Revision	A.14.50

CDMA 2000 / 1xEVDO

Sets CDMA 2000 / 1xEVDO as the radio standard for use and accesses the CDMA 2000/1xEVDO specific channel band sub-menus.

Key Path	Source, Frequency, Radio Setup, Radio Standard
Initial S/W Revision	A.05.00

US CELL

Selects US Cell as the active channel band.

Key Path	Source, Frequency, Radio Setup, Radio Standard, CDMA 2000 / 1xEVDO
Example	:SOUR:FREQ:CHAN:BAND USCELL
Initial S/W Revision	A.05.00

US PCS

Selects US PCS as the active channel band.

Key Path	Source, Frequency, Radio Setup, Radio Standard, CDMA 2000 / 1xEVDO
Example	:SOUR:FREQ:CHAN:BAND PCS
Initial S/W Revision	A.05.00

Japan Cell

Selects Japan Cell as the active channel band.

Key Path	Source, Frequency, Radio Setup, Radio Standard, CDMA 2000 / 1xEVDO
Example	:SOUR:FREQ:CHAN:BAND JAPAN
Initial S/W Revision	A.05.00

Korean PCS

Selects Korean PCS as the active channel band.

Key Path	Source, Frequency, Radio Setup, Radio Standard, CDMA 2000 / 1xEVDO
Example	:SOUR:FREQ:CHAN:BAND KOREAN
Initial S/W Revision	A.05.00

NMT 450

Selects NMT 450 as the active channel band.

Key Path	Source, Frequency, Radio Setup, Radio Standard, CDMA 2000 / 1xEVDO
----------	--

Example	:SOUR:FREQ:CHAN:BAND NMT
Initial S/W Revision	A.05.00

IMT 2000

Selects IMT 2000 as the active channel band.

Key Path	Source, Frequency, Radio Setup, Radio Standard, CDMA 2000 / 1xEVDO
Example	:SOUR:FREQ:CHAN:BAND IMT2K
Initial S/W Revision	A.05.00

Upper 700

Selects Upper 700 as the active channel band.

Key Path	Source, Frequency, Radio Setup, Radio Standard, CDMA 2000 / 1xEVDO
Example	:SOUR:FREQ:CHAN:BAND UPPER
Initial S/W Revision	A.05.00

Secondary 800

Selects Secondary 800 as the active channel band.

Key Path	Source, Frequency, Radio Setup, Radio Standard, CDMA 2000 / 1xEVDO
Example	:SOUR:FREQ:CHAN:BAND SECOND
Initial S/W Revision	A.05.00

400 Euro PAMR

Selects 400 Euro PAMR as the active channel band.

Key Path	Source, Frequency, Radio Setup, Radio Standard, CDMA 2000 / 1xEVDO
Example	:SOUR:FREQ:CHAN:BAND PAMR400
Initial S/W Revision	A.05.00

800 PAMR

Selects 800 PAMR as the active channel band.

Key Path	Source, Frequency, Radio Setup, Radio Standard, CDMA 2000 / 1xEVDO
----------	--

Example	:SOUR:FREQ:CHAN:BAND PAMR800
Initial S/W Revision	A.05.00

2.5GHz IMT EXT

Selects 2.5 GHz IMT EXT as the active channel band.

Key Path	Source, Frequency, Radio Setup, Radio Standard, CDMA 2000 / 1xEVDO
Example	:SOUR:FREQ:CHAN:BAND IMTEXT
Initial S/W Revision	A.05.00

US PCS 1.9GHz

Selects US PCS 1.9 GHz as the active channel band.

Key Path	Source, Frequency, Radio Setup, Radio Standard, CDMA 2000 / 1xEVDO
Example	:SOUR:FREQ:CHAN:BAND PCS1DOT9G
Initial S/W Revision	A.05.00

AWS

Selects AWS as the active channel band.

Key Path	Source, Frequency, Radio Setup, Radio Standard, CDMA 2000 / 1xEVDO
Example	:SOUR:FREQ:CHAN:BAND AWS
Initial S/W Revision	A.05.00

US 2.5GHz

Selects US 2.5 GHz as the active channel band.

Key Path	Source, Frequency, Radio Setup, Radio Standard, CDMA 2000 / 1xEVDO
Example	:SOUR:FREQ:CHAN:BAND US2DOT5G
Initial S/W Revision	A.05.00

700 Public Safety

Selects 700 Public Safety as the active channel band.

Key Path	Source, Frequency, Radio Setup, Radio Standard, CDMA 2000 / 1xEVDO
----------	--

Example	:SOUR:FREQ:CHAN:BAND PUBLIC
Initial S/W Revision	A.05.00

C2K Lower 700

Selects C2K Lower 700 as the active channel band.

Key Path	Source, Frequency, Radio Setup, Radio Standard, CDMA 2000 / 1xEVDO
Example	:SOUR:FREQ:CHAN:BAND LOWER
Initial S/W Revision	A.05.00

LTE

Sets LTE FDD as the radio standard for use and accesses the LTE FDD specific channel band sub-menus..

Key Path	Source, Frequency, Radio Setup, Radio Standard
Initial S/W Revision	A.09.50

BAND 1

Selects BAND 1 as the band for the current step.

Key Path	Source, Frequency, Radio Setup, Radio Standard, LTE
Example	:SOUR:FREQ:CHAN:BAND BAND1
Initial S/W Revision	A.09.50

BAND 2

Selects BAND 2 as the band for the current step.

Key Path	Source, Frequency, Radio Setup, Radio Standard, LTE
Example	:SOUR:FREQ:CHAN:BAND BAND2
Initial S/W Revision	A.09.50

BAND 3

Selects BAND 3 as the band for the current step.

Key Path	Source, Frequency, Radio Setup, Radio Standard, LTE
Example	:SOUR:FREQ:CHAN:BAND BAND3
Initial S/W Revision	A.09.50

BAND 4

Selects BAND 4 as the band for the current step.

Key Path	Source, Frequency, Radio Setup, Radio Standard, LTE
Example	:SOUR:FREQ:CHAN:BAND BAND4
Initial S/W Revision	A.09.50

BAND 5

Selects BAND 5 as the band for the current step.

Key Path	Source, Frequency, Radio Setup, Radio Standard, LTE
Example	:SOUR:FREQ:CHAN:BAND BAND5
Initial S/W Revision	A.09.50

BAND 6

Selects BAND 6 as the band for the current step.

Key Path	Source, Frequency, Radio Setup, Radio Standard, LTE
Example	:SOUR:FREQ:CHAN:BAND BAND6
Initial S/W Revision	A.09.50

BAND 7

Selects BAND 7 as the band for the current step.

Key Path	Source, Frequency, Radio Setup, Radio Standard, LTE
Example	:SOUR:FREQ:CHAN:BAND BAND7
Initial S/W Revision	A.09.50

BAND 8

Selects BAND 8 as the band for the current step.

Key Path	Source, Frequency, Radio Setup, Radio Standard, LTE
Example	:SOUR:FREQ:CHAN:BAND BAND8
Initial S/W Revision	A.09.50

BAND 9

Selects BAND 9 as the band for the current step.

Key Path	Source, Frequency, Radio Setup, Radio Standard, LTE
Example	:SOUR:FREQ:CHAN:BAND BAND9
Initial S/W Revision	A.09.50

BAND 10

Selects BAND 10 as the band for the current step.

Key Path	Source, Frequency, Radio Setup, Radio Standard, LTE
Example	:SOUR:FREQ:CHAN:BAND BAND10
Initial S/W Revision	A.09.50

BAND 11

Selects BAND 11 as the band for the current step.

Key Path	Source, Frequency, Radio Setup, Radio Standard, LTE
Example	:SOUR:FREQ:CHAN:BAND BAND11
Initial S/W Revision	A.09.50

BAND 12

Selects BAND 12 as the band for the current step.

Key Path	Source, Frequency, Radio Setup, Radio Standard, LTE
Example	:SOUR:FREQ:CHAN:BAND BAND12
Initial S/W Revision	A.09.50

BAND 13

Selects BAND 13 as the band for the current step.

Key Path	Source, Frequency, Radio Setup, Radio Standard, LTE
Example	:SOUR:FREQ:CHAN:BAND BAND13
Initial S/W Revision	A.09.50

BAND 14

Selects BAND 14 as the band for the current step.

Key Path	Source, Frequency, Radio Setup, Radio Standard, LTE
Example	:SOUR:FREQ:CHAN:BAND BAND14
Initial S/W Revision	A.09.50

BAND 17

Selects BAND 17 as the band for the current step.

Key Path	Source, Frequency, Radio Setup, Radio Standard, LTE
Example	:SOUR:FREQ:CHAN:BAND BAND17
Initial S/W Revision	A.09.50

BAND 18

Selects BAND 18 as the band for the current step.

Key Path	Source, Frequency, Radio Setup, Radio Standard, LTE
Example	:SOUR:FREQ:CHAN:BAND BAND18
Initial S/W Revision	A.09.50

BAND 19

Selects BAND 19 as the band for the current step.

Key Path	Source, Frequency, Radio Setup, Radio Standard, LTE
Example	:SOUR:FREQ:CHAN:BAND BAND19
Initial S/W Revision	A.09.50

BAND 20

Selects BAND 20 as the band for the current step.

Key Path	Source, Frequency, Radio Setup, Radio Standard, LTE
Example	:SOUR:FREQ:CHAN:BAND BAND20
Initial S/W Revision	A.09.50

BAND 21

Selects BAND 21 as the band for the current step.

Key Path	Source, Frequency, Radio Setup, Radio Standard, LTE
Example	:SOUR:FREQ:CHAN:BAND BAND21
Initial S/W Revision	A.09.50

BAND 24

Selects BAND 24 as the band for the current step.

Key Path	Source, Frequency, Radio Setup, Radio Standard, LTE
Example	:SOUR:FREQ:CHAN:BAND BAND24
Initial S/W Revision	A.09.50

BAND 25

Selects BAND 25 as the band for the current step.

Key Path	Source, Frequency, Radio Setup, Radio Standard, LTE
Example	:SOUR:FREQ:CHAN:BAND BAND25
Initial S/W Revision	A.09.50

BAND 26

Selects BAND 26 as the band for the current step.

Key Path	Source, Frequency, Radio Setup, Radio Standard, LTE
Example	:SOUR:FREQ:CHAN:BAND BAND26
Initial S/W Revision	A.12.53

BAND 27

Selects BAND 27 as the band for the current step.

Key Path	Source, Frequency, Radio Setup, Radio Standard, LTE
Example	:SOUR:FREQ:CHAN:BAND BAND27
Initial S/W Revision	A.14.00

BAND 28

Selects BAND 28 as the band for the current step.

Key Path	Source, Frequency, Radio Setup, Radio Standard, LTE
Example	:SOUR:FREQ:CHAN:BAND BAND28
Initial S/W Revision	A.14.00

BAND 31

Selects BAND 31 as the band for the current step.

Key Path	Source, Frequency, Radio Setup, Radio Standard, LTE
Example	:SOUR:FREQ:CHAN:BAND BAND31
Initial S/W Revision	A.14.00

LTE TDD

Sets LTE TDD as the radio standard for use and accesses the LTE TDD specific channel band sub-menus..

Key Path	Source, Frequency, Radio Setup, Radio Standard
Initial S/W Revision	A.11.50

BAND 33

Selects BAND 33 as the band for the current step.

Key Path	Source, Frequency, Radio Setup, Radio Standard, LTE TDD
Example	:SOUR:FREQ:CHAN:BAND BAND33
Initial S/W Revision	A.11.50

BAND 34

Selects BAND 34 as the band for the current step.

Key Path	Source, Frequency, Radio Setup, Radio Standard, LTE TDD
Example	:SOUR:FREQ:CHAN:BAND BAND34
Initial S/W Revision	A.11.50

BAND 35

Selects BAND 35 as the band for the current step.

Key Path	Source, Frequency, Radio Setup, Radio Standard, LTE TDD
Example	:SOUR:FREQ:CHAN:BAND BAND35
Initial S/W Revision	A.11.50

BAND 36

Selects BAND 36 as the band for the current step.

Key Path	Source, Frequency, Radio Setup, Radio Standard, LTE TDD
Example	:SOUR:FREQ:CHAN:BAND BAND36
Initial S/W Revision	A.11.50

BAND 37

Selects BAND 37 as the band for the current step.

Key Path	Source, Frequency, Radio Setup, Radio Standard, LTE TDD
Example	:SOUR:FREQ:CHAN:BAND BAND37
Initial S/W Revision	A.11.50

BAND 38

Selects BAND 38 as the band for the current step.

Key Path	Source, Frequency, Radio Setup, Radio Standard, LTE TDD
Example	:SOUR:FREQ:CHAN:BAND BAND38
Initial S/W Revision	A.11.50

BAND 39

Selects BAND 39 as the band for the current step.

Key Path	Source, Frequency, Radio Setup, Radio Standard, LTE TDD
Example	:SOUR:FREQ:CHAN:BAND BAND39
Initial S/W Revision	A.11.50

BAND 40

Selects BAND 40 as the band for the current step.

Key Path	Source, Frequency, Radio Setup, Radio Standard, LTE TDD
Example	:SOUR:FREQ:CHAN:BAND BAND40
Initial S/W Revision	A.11.50

BAND 41

Selects BAND 41 as the band for the current step.

Key Path	Source, Frequency, Radio Setup, Radio Standard, LTE TDD
Example	:SOUR:FREQ:CHAN:BAND BAND41
Initial S/W Revision	A.11.50

BAND 42

Selects BAND 42 as the band for the current step.

Key Path	Source, Frequency, Radio Setup, Radio Standard, LTE TDD
Example	:SOUR:FREQ:CHAN:BAND BAND42
Initial S/W Revision	A.11.50

BAND 43

Selects BAND 43 as the band for the current step.

Key Path	Source, Frequency, Radio Setup, Radio Standard, LTE TDD
Example	:SOUR:FREQ:CHAN:BAND BAND43
Initial S/W Revision	A.11.50

BAND 44

Selects BAND 44 as the band for the current step.

Key Path	Source, Frequency, Radio Setup, Radio Standard, LTE TDD
Example	:SOUR:FREQ:CHAN:BAND BAND44
Initial S/W Revision	A.14.00

TDSCDMA

Sets TDSCDMA as the radio standard for use and accesses the TDSCDMA specific channel band sub-menus..

Key Path	Source, Frequency, Radio Setup, Radio Standard
Initial S/W Revision	A.11.50

BAND A

Selects BAND A as the band for the current step.

Key Path	Source, Frequency, Radio Setup, Radio Standard, TDSCDMA
Example	:SOUR:FREQ:CHAN:BAND BANDA
Initial S/W Revision	A.11.50

BAND B

Selects BAND B as the band for the current step.

Key Path	Source, Frequency, Radio Setup, Radio Standard, TDSCDMA
Example	:SOUR:FREQ:CHAN:BAND BANDB
Initial S/W Revision	A.11.50

BAND C

Selects BAND C as the band for the current step.

Key Path	Source, Frequency, Radio Setup, Radio Standard, TDSCDMA
Example	:SOUR:FREQ:CHAN:BAND BANDC
Initial S/W Revision	A.11.50

BAND D

Selects BAND D as the band for the current step.

Key Path	Source, Frequency, Radio Setup, Radio Standard, TDSCDMA
Example	:SOUR:FREQ:CHAN:BAND BANDD
Initial S/W Revision	A.11.50

BAND E

Selects BAND E as the band for the current step.

Key Path	Source, Frequency, Radio Setup, Radio Standard, TDSCDMA
----------	---

Example	:SOUR:FREQ:CHAN:BAND BANDE
Initial S/W Revision	A.11.50

BAND F

Selects BAND F as the band for the current step.

Key Path	Source, Frequency, Radio Setup, Radio Standard, TDSCDMA
Example	:SOUR:FREQ:CHAN:BAND BANDF
Initial S/W Revision	A.11.50

Radio Band Link

Allows you to specify the channel band type as either uplink or downlink link direction. This value is used in conjunction with the channel band and channel number to determine the absolute frequency output by the source. When set to “Uplink”, the source will calculate the uplink frequency using an uplink formula together with the selected channel band and channel number . When set to “Downlink”, the source will calculate the downlink frequency using a downlink formula together with the selected channel band and channel number.

Key Path	Source, Frequency, Radio Setup
Remote Command	:SOURce:RADio:BAND:LINK DOWN UP :SOURce:RADio:BAND:LINK?
Example	:SOUR:RAD:BAND:LINK UP
Preset	DOWN
Range	DOWN UP
Backwards Compatibility SCPI	:SOURce:RADio:DEVice BTS MS :SOURce:RADio:DEVice?
Backwards Compatibility Notes	BTS maps to the Downlink frequency MS maps to the Uplink frequency
Initial S/W Revision	A.05.00

Set Reference Frequency

This key allows you to set the frequency reference. Pressing this key turns the frequency reference state to ON, sets the reference frequency value to the current frequency, maintains this frequency at the RF output, and sets the displayed frequency to 0.00 Hz. All subsequent frequencies entered under Source>Frequency>Frequency are interpreted as being relative to this reference frequency.

When you use a frequency reference, the signal generator outputs a frequency that is set relative to the reference frequency by the value entered under Source>Frequency>Frequency as follows:

Output frequency = reference frequency - entered frequency

Where:

reference frequency equals the original RF frequency entered under Source>Frequency>Frequency and set as the reference frequency

entered frequency equals a new value entered under Source>Frequency>Frequency

In addition, the displayed frequency value will be the same as the value entered under Source>Frequency>Frequency.

NOTE

If Freq Reference is set to ON with a reference value set, entering a value under Source>Frequency>Frequency and pressing Set Frequency Reference will add that value to the existing Freq Reference value.

If you wish to change the reference frequency value to the new value entered under Source>Frequency>Frequency, first you must set Freq Reference to OFF and then press Set Frequency Reference.

Key Path	Source, Frequency
Remote Command	:SOURce:FREQuency:REFerence:SET
Example	:SOUR:FREQ:REF:SET
Dependencies	This setting is unavailable, and is grayed out when the List Sequencer is turned ON.
Initial S/W Revision	A.05.00

Freq Reference

This key allows you to toggle the state of the frequency reference. When the frequency reference state is ON, an annunciator is displayed on the main source view to indicate this state to the user.

When you use a frequency reference, the signal generator outputs a frequency that is set relative to the reference frequency by the value entered under Source>Frequency>Frequency as follows:

Output frequency = reference frequency + entered frequency

Where:

reference frequency equals the original RF frequency entered under Source>Frequency>Frequency and set as the reference frequency

entered frequency equals a new value entered under Source>Frequency>Frequency

For more information on Reference Frequency refer to ["Set Reference Frequency" on page 1259](#)

Key Path	Source, Frequency
Remote Command	:SOURce:FREQuency:REFerence <freq> :SOURce:FREQuency:REFerence? :SOURce:FREQuency:REFerence:STATe OFF ON 0 1 :SOURce:FREQuency:REFerence:STATe?
Example	:SOUR:FREQ:REF 0.00 Hz

	:SOUR:FREQ:REF:STATe ON
Dependencies	This setting is unavailable, and is grayed out when the List Sequencer is turned ON.
Couplings	The frequency reference state is coupled to the frequency reference set immediate action. When the reference set immediate action key is pressed, or the SCPI command issued, it turns the frequency reference state ON.
Preset	0.00 Hz OFF
Min	0.00 Hz
Max	Hardware Dependant: Option 503 = 3.6 GHz Option 504 = 3.8 GHz Option 506 = 6.00 GHz
Initial S/W Revision	A.05.00

Freq Offset

Allows you to specify the frequency offset value. When the frequency offset state is ON, an annunciator is displayed on the main source view to indicate this state to the user.

When the frequency offset is set to zero (0) and you set a new offset value, the displayed frequency value will change as follows and the RF output frequency will not change:

Displayed value = output frequency + offset value

Where:

output frequency equals the original frequency entered under Source>Frequency>Frequency

offset value equals the value entered under Source>Frequency>Freq Offset

When the frequency offset is set to a value other than zero (0) and you enter a new frequency value under Source>Frequency>Frequency, the displayed frequency will be the same as the value entered and the RF output frequency will be equal to the value entered minus the offset value as follows:

Output frequency = entered frequency – offset frequency

Displayed frequency = output frequency + offset frequency

Displayed frequency = entered frequency

Where:

entered frequency equals the frequency entered under Source>Frequency>Frequency

offset frequency equals the value previously entered and set under Source>Frequency>Freq Offset

Key Path	Source, Frequency
Remote Command	:SOURce:FREQuency:OFFSet <freq>

	:SOURce:FREQuency:OFFSet?
Example	:SOUR:FREQ:OFFS 0 Hz
Dependencies	This setting is unavailable, and is grayed out when the List Sequencer is turned ON.
Preset	0 Hz
Min	-100.00 GHz
Max	100.00 GHz
Initial S/W Revision	A.05.00

Modulation Setup

Allows access to the menus for setting up the available modulation types: "ARB" on page 1262, "AM" on page 1303, "FM" on page 1304, and "PM" on page 1305.

Key Path	Source
Initial S/W Revision	A.05.00

ARB

Allows you access to the ARB sub-menus.

Key Path	Source, Modulation Setup
Initial S/W Revision	A.05.00

ARB

Allows you to toggle the state of the ARB function. When the ARB is On, a "MOD" annunciator is displayed in the system settings panel. When the ARB is turned Off, the MOD annunciator is cleared

Key Path	Source, Modulation Setup, ARB
Remote Command	:SOURce:RADio:ARB[:STATe] ON OFF 1 0 :SOURce:RADio:ARB[:STATe]?
Example	:SOUR:RAD:ARB OFF :SOUR:RAD:ARB?
Notes	If the ARB is ON, a user then loads or deletes another file to ARB memory, the playing waveform segment may not keep phase continuity during the ARB memory operation. The waveform will be replayed after the ARB operation is finished.
Dependencies	This setting is for independent mode and has no effect on 3.3.8 list sequencer mode. Setting "Sequencer" on page 1307 Sequencer to On will put source enter list sequencer mode, and even if ARB state is On, the ARB file will not be played. Setting "Sequencer" on page 1307 Sequencer to Off will make source leave list sequencer mode, and this setting will take effect immediately.

The ARB can only be turned on when there is a waveform file selected for playback. On the GUI If no waveform is selected, this key is grayed out. If you send the SCPI command to turn the ARB on with no waveform selected for playback, the ARB state remains OFF and an error is generated. “-

When you try to recall a certain set of states in which the selected waveform is not in ARB memory and the ARB state is On, errors are reported

Preset	Off
Range	On Off
Initial S/W Revision	A.05.00

Select Waveform

Allows you to access to the waveform selection sub-menus.

Pressing this key changes the central view area to show the Waveform File Selection view.

Key Path	Source, Modulation Setup, ARB
Initial S/W Revision	A.05.00

Select Waveform

Allows you to select a waveform sequence or segment for the dual ARB to play.

NOTE: Selecting a waveform file does not result in automatic adjustments to burst timing (to compensate for the presence or absence of a Multiport Adapter); that adjustment occurs only when a waveform is loaded to ARB memory. See "Load Segment to ARB Memory" for more information about this adjustment.

Key Path	Source, Modulation Setup, ARB, Select Waveform
Remote Command	:SOURce:RADio:ARB:WAVeform <string> :SOURce:RADio:ARB:WAVeform?
Example	:SOUR:RAD:ARB:WAV "test_waveform.bin"
Notes	<p>If intended waveform is not in the memory yet, then issuing this command by SCPI will invoke ARB loading operation first, which involves a delay of unpredictable length. So this command should be followed by the query *OPC?, which holds off subsequent commands until the loading operating is complete.</p> <p><string> - specifies the name of the waveform segment or waveform sequence to be played by the ARB.</p> <p>When in Sequence Analyzer mode, and Include Source is Yes, if the you attempt to play a waveform sequence but not all the required waveform segments are in the ARB playback memory, the application will reject the loading operation with an error is generated .</p> <p>When Include Source is No, if you attempt to play a waveform sequence but not all the required waveform segments are contained in the ARB playback memory, the application will attempt to load the required segments from either the default directory of the current directory. If the ARB memory does not have enough space for all the waveform segments to be loaded, an error is generated and</p>

none of the waveform segments is loaded.

If the ARB is ON, and you attempt to play a waveform sequence but not all the waveform segments within the sequence could be found to be loaded into ARB memory, an error is generated. The selected waveform keeps the previous value and ARB state remains On.

If you specify a waveform segment over SCPI but the waveform segment is not present within ARB playback memory and cannot be found for auto loading within the current directory or the default directory, an error is generated and the file selection remains unchanged.

If you select a waveform for playback and the waveform requires a license that is not installed on the instrument, an error is generated.

If the ARB is ON and you load a file to ARB memory or delete a file from ARB memory, the playing waveform segment may not keep phase continuity during the ARB memory operation. The waveform will be replayed after the ARB operation is finished.

Initial S/W Revision	A.05.00
----------------------	---------

Segments on Hard Disk

Allows you access to the sub-menus for loading waveform segments from the hard disk into ARB memory. The default directory is: D: varb.

Pressing this key changes the current view to the Waveform Management View.

Key Path	Source, Modulation Setup, ARB, Select Waveform
----------	--

Initial S/W Revision	A.05.00
----------------------	---------

Load Segment To ARB Memory

Allows you to load the selected file into ARB memory. On the front panel you select the file for loading to the ARB memory by highlighting the desired file in the list. Using the SCPI command, you specify the file name on the HDD.

“NVWFM” (non-volatile storage) MSUS (Mass Storage Unit Specifier) is supported in the memory subsystem because the ARB memory cannot be accessed directly. Therefore, files must be downloaded to the instrument hard disk and then loaded into the ARB memory. “NVWFM” MSUS will be mapped to the default directory D: VARB. The SCPI command supports using either “NVWFM” MSUS or specifying a full path. For more information, see [Memory Subsystem \(Remote Command Only\)](#).

If a file of the same name already exists within ARB memory, it is overwritten. If you wish to load two segments of the same name, you must rename one of the segments before loading it into ARB memory. To rename a segment, you can either use Windows File Explorer, or the :MMEMory:COPY command.

NOTE: When a waveform file is loaded to ARB memory, burst timing adjustments are made automatically, based on whether or not a Multiport Adapter is connected to the test set and powered on. If the connection/power status of the Multiport Adapter is changed after a waveform file has been loaded, it needs to be loaded again.

Key Path	Source, Modulation Setup, ARB, Select Waveform, Segments on Hard Disk
----------	---

Remote Command	:SOURce:RADio:ARB:LOAD <string>
Example	:SOUR:RAD:ARB:LOAD "D: VARB\testwaveform.bin" or :SOUR:RAD:ARB:LOAD "NVWFM:testwaveform.bin"
Notes	<p>Because loading the file involves a delay of unpredictable length, this command should be followed by the query *OPC?, which holds off subsequent commands until the loading operating is complete.</p> <p><string> - specifies the path name of the file to load from the HDD into ARB memory. It could be a <full path + filename>, or <"NVWFM" MSUS + colon + filename>.</p> <p>When in Sequence Analyzer mode, and Include Source is Yes, an attempt to load a file to ARB memory will be rejected with an error.</p> <p>When Include Source is No and if there is insufficient free ARB memory to load the selected waveform, an error is generated. .</p> <p>If you specify a file over SCPI, but the file is not at the specified location, an error is generated.</p> <p>If you try to load a waveform file but the file contains less than 500 IQ samples, an error is generated.</p> <p>If you try to load a Signal Studio waveform "*.wfm" which contains invalid waveform header, an error is generated.</p> <p>If the ARB is ON when you load a file to ARB memory or delete a file from ARB memory, the playing waveform segment may not keep phase continuity during the ARB memory operation. The waveform will be replayed after the ARB operation is finished.</p> <p>ARB can be loaded into ARB memory even required licenses do not present on the instrument. In this case, a GUI only warning message -800, "Operation complete; Loaded <filename> successfully, but no license <required licenses> installed". User can install required licenses according to <required licenses> string to license it, or multi-pack license it.</p>
Initial S/W Revision	A.05.00

Load All To ARB Memory

Allows you to load all the segment files within the currently selected directory into ARB memory. If a file of the same name already exists within ARB memory, it is overwritten. If you wish to load two segments of the same name, you must rename one of the segments before loading it into ARB memory. To rename a segment, you can either use Windows File Explorer, or the :MEMory:COPI command.

NOTE: When a waveform file is loaded to ARB memory, burst timing adjustments are made automatically, based on whether or not a Multiport Adapter is connected to the test set and powered on. If the connection/power status of the Multiport Adapter is changed after a waveform file has been loaded, it needs to be loaded again.

Key Path	Source, Modulation Setup, ARB, Select Waveform, Segments on Hard Disk
Remote Command	:SOURce:RADio:ARB:LOAD:ALL <string>
Example	:SOUR:RAD:ARB:LOAD:ALL "D: varb"
Notes	<p><string> - specifies the directory on the HDD to load the files into ARB memory from.</p> <p>When in Sequence Analyzer mode, and Include Source is Yes, an attempt to load all files from a directory to ARB memory is rejected with an error.</p> <p>When Include Source is No and there is insufficient free ARB memory to load all the waveforms,</p>

when the ARB memory is full, the copy ceases, and an error is generated.
 If you specify a directory over SCPI, but the directory does not exist, an error is generated.
 If the ARB is ON, a user then loads or deletes file to ARB memory, the playing waveform segment may not keep phase continuity during the ARB memory operation. The waveform will be replayed after the ARB operation is finished.

Initial S/W Revision A.05.00

Change Directory...

Allows you to change the currently selected directory on the hard disk. Pressing this key opens a standard windows change directory dialog allowing you to select the new directory of interest.

The current directory is used for manually loading waveform segments into ARB memory for playback, and as a search location for waveform segments that are required to be loaded into ARB memory for playback of a waveform sequence or a list sequence.

Key Path Source, Modulation Setup, ARB, Select Waveform, Segments on Hard Disk

Notes No remote command, SCPI front panel only.

Initial S/W Revision A.05.00

Default Directory...

Allows you to change the default directory. It is used as a search location for waveform segments that are required to be loaded into ARB memory for playback of a waveform sequence, and as a search location for selecting waveforms using SCPI.

Key Path Source, Modulation Setup, ARB, Select Waveform, Segments on Hard Disk

Remote Command :SOURce:RADio:ARB:DEFault:DIRectory <string>
 :SOURce:RADio:ARB: DEFault:DIRectory?

Example :SOUR:RAD:ARB:DEF:DIR "D:\ArbFiles"
 :SOUR:RAD:ARB:DEF:DIR?

State Saved Persistent, survives a power cycle and a preset but not saved in the instrument state

Initial S/W Revision A.05.00

Segments in ARB Memory

Allows you access to the sub-menus for managing the files within ARB memory.

Key Path Source, Modulation Setup, ARB, Select Waveform

Initial S/W Revision A.05.00

Delete Segment From ARB Mem

Allows you to remove a segment from ARB playback memory.

Key Path	Source, Modulation Setup, ARB, Select Waveform, Segments in ARB Memory
Remote Command	:SOURce:RADio:ARB:DELeTe <string>
Example	:SOUR:RAD:ARB:DEL "testwaveform.bin"
Notes	<p><string> - specifies the waveform to be deleted from the ARB playback memory.</p> <p>When in Sequence Analyzer mode and Include Source is Yes, an attempt to delete a file from ARB memory is rejected with an error.</p> <p>When Include Source is No and you specify a file that does not exist within ARB memory, an error is generated.</p> <p>It is possible to delete files from within the ARB memory when the ARB is ON. However, if you attempt to delete the file that is currently playing an error is generated.</p> <p>It is possible to delete a file from within the ARB memory when the sequencer state is ON and the file is not being used by the List Sequencer. If you attempt to delete a file which is being used by the list sequencer, an error is generated.</p> <p>When sequencer state is On, even if ARB state is On, the selected waveform will not be played. In this case, if the selected waveform is not used in List Sequence, it can be deleted and the ARB state is turned Off.</p> <p>If the ARB is ON and you load a file to ARB memory or delete a file from ARB memory, the playing waveform segment may not keep phase continuity during the ARB memory operation. The waveform will be replayed after the ARB operation is finished.</p>
Initial S/W Revision	A.05.00

Delete All From ARB Memory

Allows you to remove all segments from ARB playback memory.

Key Path	Source, Modulation Setup, ARB, Select Waveform, Segments in ARB Memory
Remote Command	:SOURce:RADio:ARB:DELeTe:ALL
Example	:SOUR:RAD:ARB:DELeTe:ALL
Notes	<p>When in Sequence Analyzer mode and Include Source is Yes, an attempt to delete all files from ARB memory is rejected with an error.</p> <p>When Include Source is No and you attempt to delete all files from ARB memory when the ARB is currently playing a file, all files except the one playing are deleted and an error is generated.</p> <p>If you attempt to delete all files from ARB memory when there are waveform files used in "List Sequencer" on page 1306 and "Sequencer" on page 1307 state is ON, all files except the files currently being used in list sequencer are deleted, and an error is generated.</p> <p>If the ARB is ON and you load a file to ARB memory or delete a file from ARB memory, the playing waveform segment may not keep phase continuity during the ARB memory operation. The waveform will be replayed after the ARB operation is finished.</p>
Initial S/W Revision	A.05.00

Query ARB Memory File List (Remote Command Only)

Queries the test set for the list of waveform segments in the ARB memory.

NOTE

This command returns a string for waveform segment names in ARB memory. If you want a string list of waveform segments in the ARB memory, use **"Query ARB Memory Full File List (Remote Command Only)" on page 1268.**

Remote Command	:SOURce:RADio:ARB:CATalog?
Example	:SOUR:RAD:ARB:CATalog?
Notes	The return data is in the following format: <integer> - memory used <integer> - memory free <string> ... - comma separated list of waveform segments within ARB memory
Initial S/W Revision	A.05.00

Query ARB Memory Full File List (Remote Command Only)

Queries the test set for the string list of waveform segments in the ARB memory. It returns a string list for waveform segment names in the ARB memory.

Remote Command	:SOURce:RADio:ARB:FCATalog?
Example	:SOUR:RAD:ARB:FCATalog?
Notes	The return data is in the following format: <integer> - memory used <integer> - memory free <integer> - file count in ARB memory <string>,<string>, ... <string> - comma separated string list of waveform segments within ARB memory Example: SOUR:RAD:ARB:FCAT? EXT returns: 27499,2069653,3,"c2k.wfm","gsm.wfm","wcdma.wfm"
Initial S/W Revision	A.09.00

ARB Setup

Allows access to the ARB setup sub-menus.

Key Path	Source, Modulation Setup, ARB
Initial S/W Revision	A.05.00

Sample Rate

Allows you to set the ARB waveform playback sample rate.

Key Path	Source, Modulation Setup, ARB, ARB Setup
Remote Command	:SOURce:RADio:ARB:SCLock:RATE <freq> :SOURce:RADio:ARB:SCLock:RATE?
Example	:SOUR:RAD:ARB:SCL:RATE 48.00 MHz
Notes	If there is a sample rate specified in the header of the waveform file, changing that sample rate is not recommended, as it may cause problems with burst timing.
Dependencies	When a new waveform is selected for playback the settings contained within the associated waveform header file are applied to the ARB. The sample rate is one of the values stored within the header file. If the newly selected waveform file has an associated header file, the sample rate is updated with the value from the header file. The sample rate will remain unchanged if the newly selected waveform does not have an associated header file.
Preset	125.00 MHz
Min	1.00 kHz
Max	125.00 MHz
Initial S/W Revision	A.05.00

Run-Time Scaling

Allows you to adjust the run-time scaling value. The run-time scaling value is applied in real-time while the waveform is playing.

Key Path	Source, Modulation Setup, ARB, ARB Setup
Remote Command	:SOURce:RADio:ARB:RSCaling <real> :SOURce:RADio:ARB:RSCaling?
Example	:SOUR:RAD:ARB:RSC 100.00
Notes	This setting cannot be set in E6640A. Grey out on menu and the value is fixed at 70.00%.
Dependencies	When a new waveform is selected for playback the settings contained within the associated waveform header file are applied to the ARB. The run-time scaling is one of the values stored within the header file. If the newly selected waveform file has an associated header file, the run-time scaling is updated with the value from the header file. The run-time scaling will remain unchanged if the newly selected waveform does not have an associated header file.
Preset	70.00 %
Min	1.00 %
Max	100.00 %
Initial S/W Revision	A.05.00

Baseband Freq Offset

Allows you to adjust the value by which the baseband frequency is offset relative to the carrier.

Key Path	Source, Modulation Setup, ARB, ARB Setup
Remote Command	:SOURce:RADio:ARB:BASEband:FREQuency:OFFSet <freq> :SOURce:RADio:ARB:BASEband:FREQuency:OFFSet?
Example	:SOUR:RAD:ARB:BAS:FREQ:OFFS 0.00 Hz
Dependencies	When a new waveform is selected for playback the settings contained within the associated waveform header file are applied to the ARB. The baseband frequency offset is one of the values stored within the header file. If the newly selected waveform file has an associated header file, the baseband frequency offset is updated with the value from the header file. The baseband frequency offset will remain unchanged if the newly selected waveform does not have an associated header file.
Preset	0.00 Hz
Min	-50.00 MHz
Max	50.00 MHz
Initial S/W Revision	A.05.00

Trigger Type

Allows access to the trigger type sub-menus. The setting for trigger type determines the behavior of the waveform when it plays.

Key Path	Source, Modulation Setup, ARB
Remote Command	:SOURce:RADio:ARB:TRIGger:TYPE CONTInuous SINGLE SADVance GATE :SOURce:RADio:ARB:TRIGger:TYPE?
Example	:SOUR:RAD:ARB:TRIG:TYPE CONT :SOUR:RAD:ARB:TRIG:TYPE?
Notes	Gated trigger type will be implemented at a later release
Preset	CONTInuous
Range	Continuous Single Seg Adv Gated
Initial S/W Revision	A.05.00

Continuous

Sets the active trigger type to Continuous. If Continuous is already selected as the active trigger type, pressing this key allows access to the continuous trigger type setup menu. In Continuous trigger mode, the waveform repeats continuously.

Key Path	Source, Modulation Setup, ARB, Trigger Type
Remote Command	:SOURce:RADio:ARB:TRIGger:TYPE:CONTInuous[:TYPE] FREE TRIGger RESet :SOURce:RADio:ARB:TRIGger:TYPE:CONTInuous[:TYPE]?
Example	:SOUR:RAD:ARB:TRIG:TYPE:CONT FREE
Preset	FREE

Range	Free Run Trigger + Run Reset + Run
Initial S/W Revision	A.05.00

Free Run

Selects Free Run as the trigger response for the continuous trigger type. Free Run sets the waveform generator to play a waveform sequence or segment continuously, without waiting for a trigger. In this mode, the waveform generator does not respond to triggers.

Key Path	Source, Modulation Setup, ARB, Trigger Type, Continuous
Example	:SOUR:RAD:ARB:TRIG:TYPE:CONT FREE
Initial S/W Revision	A.05.00

Trigger + Run

Sets Trigger and Run as the trigger response for the continuous trigger type. Trigger and Run sets the waveform generator to play a waveform sequence or segment continuously when the first trigger is received, and to ignore any subsequent triggers.

Key Path	Source, Modulation Setup, ARB, Trigger Type, Continuous
Example	:SOUR:RAD:ARB:TRIG:TYPE:CONT TRIG
Initial S/W Revision	A.05.00

Reset + Run

Sets Reset and Run as the trigger response for the continuous trigger type. Reset and Run sets the waveform generator to play a waveform sequence or segment continuously when the first trigger is received. Subsequent triggers reset the waveform sequence or segment to the start, and then play it continuously.

Key Path	Source, Modulation Setup, ARB, Trigger Type, Continuous
Example	:SOUR:RAD:ARB:TRIG:TYPE:CONT RES
Initial S/W Revision	A.05.00

Single

Sets the active trigger type to Single. If Single is already selected as the active trigger type, pressing this key allows access to the single trigger type setup menu. In Single trigger mode, the waveform plays once.

Key Path	Source, Modulation Setup, ARB, Trigger Type
Remote Command	:SOURce:RADio:ARB:RETRigger ON OFF IMMediate

	:SOURce:RADio:ARB:RETRigger?
Example	:SOUR:RAD:ARB:RETR OFF
Notes	ON: Buffered Trigger OFF: No Retrigger Immediate: Restart on Trigger This is defined as an enumerated SCPI command, with ON OFF being considered as enumerated types rather than Boolean. This means the query will return OFF instead of 0, and ON instead of 1.
Preset	ON
Range	No Retrigger Buffered Trigger Restart on Trigger
Initial S/W Revision	A.05.00

No Retrigger

Selects No Retrigger as the trigger response for single trigger type. No Retrigger sets the waveform generator to play a waveform sequence or segment once when a trigger is received. Any triggers then received during playback are ignored.

Key Path	Source, Modulation Setup, ARB, Trigger Type, Single
Example	:SOUR:RAD:ARB:RETR OFF
Initial S/W Revision	A.05.00

Buffered Trigger

Selects Buffered Trigger as the trigger response for single trigger type. Buffered Trigger sets the waveform generator to play a waveform sequence or segment once when a trigger is received. If a trigger is received during playback, the waveform generator plays the sequence or segment to the end, then plays the sequence or segment once more.

Key Path	Source, Modulation Setup, ARB, Trigger Type, Single
Example	:SOUR:RAD:ARB:RETR ON
Initial S/W Revision	A.05.00

Restart on Trigger

Selects Restart on Trigger as the trigger response for single trigger type. Restart on Trigger sets the waveform generator to play a waveform sequence or segment once when a trigger is received. If a trigger is received during playback, the waveform generator resets and plays the sequence or segment from the start.

Key Path	Source, Modulation Setup, ARB, Trigger Type, Single
Example	:SOUR:RAD:ARB:RETR IMM
Initial S/W Revision	A.05.00

Segment Advance

Sets the active trigger type to Segment Advance. If Segment Advance is already selected as the active trigger type, pressing this key allows access to the segment advance trigger type setup menu.

Segment Advance triggering allows you to control the playback of waveform segments within a waveform sequence. When a trigger is received the ARB advances to the next waveform segment within the waveform sequence. This type of triggering ignores the repetition count for the waveform segment within the waveform sequence. For example, if a waveform segment has a repetition count of 10 and you select single segment advance triggering mode, the waveform segment will only play once.

Segment Advance triggering can also be used for waveform segments only. In this situation the same waveform segment is played again when a trigger is received.

Key Path	Source, Modulation Setup, ARB, Trigger Type
Remote Command	:SOURce:RADio:ARB:TRIGger:TYPE:SADVance[:TYPE] Single CONTinuous :SOURce:RADio:ARB:TRIGger:TYPE:SADVance[:TYPE]?
Example	:SOUR:RAD:ARB:TRIG:TYPE:SADV SING
Preset	CONTinuous
Range	Single Continuous
Initial S/W Revision	A.05.00

Single

Selects Single as the trigger response for Segment Advance trigger type. With single selected, once a trigger is received a segment is played once. If a trigger is received during playback of a segment, the segment plays to completion and the next segment is played once.

Key Path	Source, Modulation Setup, ARB, Trigger Type, Segment Advance
Example	:SOUR:RAD:ARB:TRIG:TYPE:SADV SING
Initial S/W Revision	A.05.00

Continuous

Selects Continuous as the trigger response for Segment Advance trigger type. With continuous selected, once a trigger is received a segment is played continuously. When subsequent triggers are received, the currently playing segment plays to completion and then the next segment is played continuously.

Key Path	Source, Modulation Setup, ARB, Trigger Type, Segment Advance
Example	:SOUR:RAD:ARB:TRIG:TYPE:SADV CONT
Initial S/W Revision	A.05.00

Trigger Source

Allows access to the trigger source sub-menus. The trigger source setting determines how the source receives the trigger that starts the waveform playing. Therefore, this key is grayed out if the trigger type is free run, since free run triggers immediately with no trigger source required.

Key Path	Source, Modulation Setup, ARB
Remote Command	:SOURce:RADio:ARB:TRIGger[:SOURce] KEY BUS EXTernal2 :SOURce:RADio:ARB:TRIGger[:SOURce]?
Example	:SOUR:RAD:ARB:TRIGger KEY
Dependencies	This key is grayed out if the current trigger type is Continuous, Free Run.
Preset	EXTernal2
Range	Trigger Key Bus External 2
Initial S/W Revision	A.05.00

Trigger Key

Sets the current trigger source to the front panel Trigger key. When Trigger Key is selected, the waveform is triggered when you press the front panel Trigger key.

Key Path	Source, Modulation Setup, ARB, Trigger Source
Example	:SOUR:RAD:ARB:TRIGger KEY
Initial S/W Revision	A.05.00

Bus

Sets the current trigger source to Bus. Selecting Bus trigger source enables triggering over GPIB, LAN, or USB using the :SOURce:RADio:ARB:TRIGger:INITiate command.

Key Path	Source, Modulation Setup, ARB, Trigger Source
Example	:SOUR:RAD:ARB:TRIGger BUS
Initial S/W Revision	A.05.00

External 2

Sets the current trigger source to External 2. Selecting External 2 enables triggering a waveform by an externally applied signal.

Key Path	Source, Modulation Setup, ARB, Trigger Source
Example	:SOUR:RAD:ARB:TRIGger EXT2
Notes	Note: When on E6640A, trigger 2 is a bi-directional trigger port. So when trigger 2 has been configured as OUTPUT type, choosing External 2 as the input trigger for the current step will generate error.
Initial S/W Revision	A.05.00

Trigger Initiate

Used to initiate an immediate trigger event if the trigger source is set to Trigger Key.

Key Path	Source, Modulation Setup, ARB
Notes	No remote command, SCPI front panel only.
Initial S/W Revision	A.05.00

Waveform Sequences

Allows access to the waveform sequence sub-menus. Pressing this key changes the central view area to display the Waveform Sequence List view.

Key Path	Source, Modulation Setup, ARB
Notes	No remote command, SCPI front panel only.
Initial S/W Revision	A.05.00

Build New Sequence

Allows access to the sub-menus for creating a new waveform sequence. Pressing this key changes the central view area to display the Waveform Sequence Creation and Editing view.

Key Path	Source, Modulation Setup, ARB, Waveform Sequences
Notes	No remote command, SCPI front panel only.
Initial S/W Revision	A.05.00

Current Segment

Specifies the selected sequence segment that will be affected by the menu functions.

Key Path	Source, Modulation Setup, ARB, Waveform Sequences, Build New Sequence
Notes	No remote command, SCPI front panel only. This key is grayed out and unavailable if the sequence is currently empty.
Initial S/W Revision	A.05.00

Insert New Waveform

Allows you access to the sub-menu for inserting a new waveform segment or sequence. Pressing this key also changes the central display to show the Waveform File Selection View.

Key Path	Source, Modulation Setup, ARB, Waveform Sequences, Build New Sequence
Notes	No remote command, SCPI front panel only. Waveform segment name string length upper limit is 128 chars. Please do NOT insert waveform which name string exceeds 128 chars.
Initial S/W Revision	A.05.00

Insert Waveform

Inserts the currently highlighted waveform to the end of the waveform sequence. Pressing this key also returns you to the menus for creating or editing a sequence, and returns the central view to the sequence creation view.

Key Path	Source, Modulation Setup, ARB, Waveform Sequences, Build New Sequence, Insert New Waveform
Notes	No remote command, SCPI front panel only. Waveform segment name string length upper limit is 128 chars. Please do NOT insert waveform which name string exceeds 128 chars.
Initial S/W Revision	A.05.00

Segments on Hard Disk

Allows you access to the sub-menus for loading waveform segments from the hard disk into ARB memory. The default directory is: D: varb.

Pressing this key changes the current view to the Waveform Management View.

Key Path	Source, Modulation Setup, ARB, Select Waveform
Initial S/W Revision	A.05.00

Load Segment To ARB Memory

Allows you to load the selected file into ARB memory. On the front panel you select the file for loading to the ARB memory by highlighting the desired file in the list. Using the SCPI command, you specify the file name on the HDD.

“NVWFM” (none-volatile storage) MSUS (Mass Storage Unit Specifier) is supported in the memory subsystem because the ARB memory cannot be accessed directly. Therefore, files must be downloaded to the instrument hard disk and then loaded into the ARB memory. “NVWFM” MSUS will be mapped to the default directory D: VARB. The SCPI command supports using either “NVWFM” MSUS or specifying a full path. For more information, see [Memory Subsystem \(Remote Command Only\)](#).

If a file of the same name already exists within ARB memory, it is overwritten. If you wish to load two segments of the same name, you must rename one of the segments before loading it into ARB memory. To rename a segment, you can either use Windows File Explorer, or the :MMEMORY:COPY command.

NOTE: When a waveform file is loaded to ARB memory, burst timing adjustments are made automatically, based on whether or not a Multiport Adapter is connected to the test set and powered on. If the connection/power status of the Multiport Adapter is changed after a waveform file has been loaded, it needs to be loaded again.

Key Path	Source, Modulation Setup, ARB, Select Waveform, Segments on Hard Disk
Remote Command	:SOURce:RADio:ARB:LOAD <string>
Example	:SOUR:RAD:ARB:LOAD "D: VARB\testwaveform.bin" or :SOUR:RAD:ARB:LOAD "NVWFM:testwaveform.bin"
Notes	<p>Because loading the file involves a delay of unpredictable length, this command should be followed by the query *OPC?, which holds off subsequent commands until the loading operation is complete.</p> <p><string> – specifies the path name of the file to load from the HDD into ARB memory. It could be a <full path + filename>, or <"NVWFM" MSUS + colon + filename>.</p> <p>When in Sequence Analyzer mode, and Include Source is Yes, an attempt to load a file to ARB memory will be rejected with an error.</p> <p>When Include Source is No and if there is insufficient free ARB memory to load the selected waveform, an error is generated. .</p> <p>If you specify a file over SCPI, but the file is not at the specified location, an error is generated.</p> <p>If you try to load a waveform file but the file contains less than 500 IQ samples, an error is generated.</p> <p>If you try to load a Signal Studio waveform "*.wfm" which contains invalid waveform header, an error is generated.</p> <p>If the ARB is ON when you load a file to ARB memory or delete a file from ARB memory, the playing waveform segment may not keep phase continuity during the ARB memory operation. The waveform will be replayed after the ARB operation is finished.</p> <p>ARB can be loaded into ARB memory even if required licenses do not present on the instrument. In this case, a GUI only warning message –800, "Operation complete; Loaded <filename> successfully, but no license <required licenses> installed". User can install required licenses according to <required licenses> string to license it, or multi-pack license it.</p>
Initial S/W Revision	A.05.00

Load All To ARB Memory

Allows you to load all the segment files within the currently selected directory into ARB memory. If a file of the same name already exists within ARB memory, it is overwritten. If you wish to load two segments of the same name, you must rename one of the segments before loading it into ARB memory. To rename a segment, you can either use Windows File Explorer, or the :MEMory:COPY command.

NOTE: When a waveform file is loaded to ARB memory, burst timing adjustments are made automatically, based on whether or not a Multiport Adapter is connected to the test set and powered on. If the connection/power status of the Multiport Adapter is changed after a waveform file has been loaded, it needs to be loaded again.

Key Path	Source, Modulation Setup, ARB, Select Waveform, Segments on Hard Disk
Remote Command	:SOURce:RADio:ARB:LOAD:ALL <string>

Example	:SOUR:RAD:ARB:LOAD:ALL "D: varb"
Notes	<p><string> - specifies the directory on the HDD to load the files into ARB memory from.</p> <p>When in Sequence Analyzer mode, and Include Source is Yes, an attempt to load all files from a directory to ARB memory is rejected with an error.</p> <p>When Include Source is No and there is insufficient free ARB memory to load all the waveforms, when the ARB memory is full, the copy ceases, and an error is generated.</p> <p>If you specify a directory over SCPI, but the directory does not exist, an error is generated.</p> <p>If the ARB is ON, a user then loads or deletes file to ARB memory, the playing waveform segment may not keep phase continuity during the ARB memory operation. The waveform will be replayed after the ARB operation is finished.</p>
Initial S/W Revision	A.05.00

Change Directory...

Allows you to change the currently selected directory on the hard disk. Pressing this key opens a standard windows change directory dialog allowing you to select the new directory of interest.

The current directory is used for manually loading waveform segments into ARB memory for playback, and as a search location for waveform segments that are required to be loaded into ARB memory for playback of a waveform sequence or a list sequence.

Key Path	Source, Modulation Setup, ARB, Select Waveform, Segments on Hard Disk
Notes	No remote command, SCPIfront panel only.
Initial S/W Revision	A.05.00

Default Directory...

Allows you to change the default directory. It is used as a search location for waveform segments that are required to be loaded into ARB memory for playback of a waveform sequence, and as a search location for selecting waveforms using SCPI.

Key Path	Source, Modulation Setup, ARB, Select Waveform, Segments on Hard Disk
Remote Command	:SOURce:RADio:ARB:DEFault:DIRectory <string> :SOURce:RADio:ARB: DEFault:DIRectory?
Example	:SOUR:RAD:ARB:DEF:DIR "D:\ArbFiles" :SOUR:RAD:ARB:DEF:DIR?
State Saved	Persistent, survives a power cycle and a preset but not saved in the instrument state
Initial S/W Revision	A.05.00

Segments in ARB Memory

Allows you access to the sub-menus for managing the files within ARB memory.

Key Path	Source, Modulation Setup, ARB, Select Waveform
Initial S/W Revision	A.05.00

Delete Segment From ARB Mem

Allows you to remove a segment from ARB playback memory.

Key Path	Source, Modulation Setup, ARB, Select Waveform, Segments in ARB Memory
Remote Command	:SOURce:RADio:ARB:DELeTe <string>
Example	:SOUR:RAD:ARB:DEL "testwaveform.bin"
Notes	<p><string> - specifies the waveform to be deleted from the ARB playback memory.</p> <p>When in Sequence Analyzer mode and Include Source is Yes, an attempt to delete a file from ARB memory is rejected with an error.</p> <p>When Include Source is No and you specify a file that does not exist within ARB memory, an error is generated.</p> <p>It is possible to delete files from within the ARB memory when the ARB is ON. However, if you attempt to delete the file that is currently playing an error is generated.</p> <p>It is possible to delete a file from within the ARB memory when the sequencer state is ON and the file is not being used by the List Sequencer. If you attempt to delete a file which is being used by the list sequencer, an error is generated.</p> <p>When sequencer state is On, even if ARB state is On, the selected waveform will not be played. In this case, if the selected waveform is not used in List Sequence, it can be deleted and the ARB state is turned Off.</p> <p>If the ARB is ON and you load a file to ARB memory or delete a file from ARB memory, the playing waveform segment may not keep phase continuity during the ARB memory operation. The waveform will be replayed after the ARB operation is finished.</p>
Initial S/W Revision	A.05.00

Delete All From ARB Memory

Allows you to remove all segments from ARB playback memory.

Key Path	Source, Modulation Setup, ARB, Select Waveform, Segments in ARB Memory
Remote Command	:SOURce:RADio:ARB:DELeTe:ALL
Example	:SOUR:RAD:ARB:DELeTe:ALL
Notes	<p>When in Sequence Analyzer mode and Include Source is Yes, an attempt to delete all files from ARB memory is rejected with an error.</p> <p>When Include Source is No and you attempt to delete all files from ARB memory when the ARB is currently playing a file, all files except the one playing are deleted and an error is generated.</p> <p>If you attempt to delete all files from ARB memory when there are waveform files used in "List Sequencer" on page 1306 and "Sequencer" on page 1307 state is ON, all files except the files currently being used in list sequencer are deleted, and an error is generated.</p>

If the ARB is ON and you load a file to ARB memory or delete a file from ARB memory, the playing waveform segment may not keep phase continuity during the ARB memory operation. The waveform will be replayed after the ARB operation is finished.

Initial S/W Revision	A.05.00
----------------------	---------

Segments on Hard Disk

This key functions the same as ["Segments on Hard Disk" on page 1333](#).

Key Path	Source, Modulation Setup, ARB, Waveform Sequences, Build New Sequence, Insert New Waveform
----------	--

Initial S/W Revision	Prior to A.09.00
----------------------	------------------

Load Segment To ARB Memory

This key functions the same as ["Load Segment To ARB Memory" on page 1333](#).

Key Path	Source, Modulation Setup, ARB, Waveform Sequences, Build New Sequence, Insert New Waveform, Segment on Hard Drive
----------	---

Initial S/W Revision	Prior to A.09.00
----------------------	------------------

Load All To ARB Memory

This key functions the same as ["Load All To ARB Memory" on page 1334](#).

Key Path	Source, Modulation Setup, ARB, Waveform Sequences, Build New Sequence, Insert New Waveform, Segment on Hard Drive
----------	---

Initial S/W Revision	Prior to A.09.00
----------------------	------------------

Change Directory ...

This key functions the same as ["Change Directory..." on page 1335](#).

Key Path	Source, Modulation Setup, ARB, Waveform Sequences, Build New Sequence, Insert New Waveform, Segment on Hard Drive
----------	---

Initial S/W Revision	Prior to A.09.00
----------------------	------------------

Default Directory ...

This key functions the same as ["Default Directory..." on page 1335](#)

Key Path	Source, Modulation Setup, ARB, Waveform Sequences, Build New Sequence, Insert New Waveform, Segment on Hard Drive
----------	---

Initial S/W Revision	Prior to A.09.00
----------------------	------------------

Segments in ARB Memory

This key functions the same as ["Segments in ARB Memory" on page 1335](#).

Key Path	Source, Modulation Setup, ARB, Waveform Sequences, Build New Sequence, Insert New Waveform
Initial S/W Revision	Prior to A.09.00

Delete Segment From ARB Memory

This key functions the same as ["Delete Segment From ARB Mem" on page 1335](#).

Key Path	Source, Modulation Setup, ARB, Waveform Sequences, Build New Sequence, Insert New Waveform, Segment in ARB Memory
Initial S/W Revision	Prior to A.09.00

Delete All From ARB Memory

This key functions the same as ["Delete All From ARB Memory" on page 1336](#).

Key Path	Source, Modulation Setup, ARB, Waveform Sequences, Build New Sequence, Insert New Waveform, Segment in ARB Memory
Initial S/W Revision	Prior to A.09.00

Query ARB Memory File List (Remote Command Only)

This command functions the same as ["Query ARB Memory File List \(Remote Command Only\)" on page 1268](#).

Initial S/W Revision	Prior to A.09.00
----------------------	------------------

Edit Selected Waveform

Allows access to the sub-menus for editing the details of the currently selected waveform segment.

Key Path	Source, Modulation Setup, ARB, Waveform Sequences, Build New Sequence
Notes	No remote command, front panel only.
Initial S/W Revision	A.05.00

Repetitions

Allows you to specify the number of times the currently selected waveform is played within the sequence.

Key Path	Source, Modulation Setup, ARB, Waveform Sequences, Build New Sequence, Edit Selected Waveform
Notes	No remote command, SCPI front panel only.
Preset	1
Min	1
Max	65535
Initial S/W Revision	A.05.00

Marker 1

Allows you to enable or disable marker 1 for the currently selected waveform. For a waveform sequence, you can enable and disable markers on a per-segment basis, allowing you to output markers from some waveform segments within the sequence, but not for others.

Key Path	Source, Modulation Setup, ARB, Waveform Sequences, Build New Sequence, Edit Selected Waveform
Notes	No remote command, front panel only.
Preset	Enabled
Range	Enabled Disabled
Initial S/W Revision	A.05.00

Marker 2

Allows you to enable or disable marker 2 for the currently selected waveform. For a waveform sequence, you can enable and disable markers on a per-segment basis, allowing you to output markers from some waveform segments within the sequence, but not for others.

Key Path	Source, Modulation Setup, ARB, Waveform Sequences, Build New Sequence, Edit Selected Waveform
Notes	No remote command, front panel only.
Preset	Enabled
Range	Enabled Disabled
Initial S/W Revision	A.05.00

Marker 3

Allows you to enable or disable marker 3 for the currently selected waveform. For a waveform sequence, you can enable and disable markers on a per-segment basis, allowing you to output markers from some waveform segments within the sequence, but not for others.

Key Path	Source, Modulation Setup, ARB, Waveform Sequences, Build New Sequence, Edit Selected
----------	--

	Waveform
Notes	No remote command, front panel only.
Preset	Enabled
Range	Enabled Disabled
Initial S/W Revision	A.05.00

Marker 4

Allows you to enable or disable marker 4 for the currently selected waveform. For a waveform sequence, you can enable and disable markers on a per-segment basis, allowing you to output markers from some waveform segments within the sequence, but not for others.

Key Path	Source, Modulation Setup, ARB, Waveform Sequences, Build New Sequence, Edit Selected Waveform
Notes	No remote command, front panel only.
Preset	Enabled
Range	Enabled Disabled
Initial S/W Revision	A.05.00

Delete Segment

Allows you to delete the selected segment from the waveform sequence.

Key Path	Source, Modulation Setup, ARB, Waveform Sequences, Build New Sequence
Notes	No remote command, front panel only.
Initial S/W Revision	A.05.00

Save Sequence...

Pressing this key displays the "Save As" dialog. The sequence name is passed to the save as dialog to use as the filename for saving, and the directory the save as dialog will open into is the default waveform directory.

Key Path	Source, Modulation Setup, ARB, Waveform Sequences, Build New Sequence
Initial S/W Revision	A.05.00

Build New Sequence (Remote Command Only)

This command is the SCPI equivalent of the waveform sequence creation features described in ["Build New Sequence" on page 1275](#).

This command writes a waveform sequence file to the hard disk. You must specify the waveform sequence file path and filename which will be saved on the hard disk, and the waveform segment file path and name which will be nested into the waveform sequence file. You can utilize mass storage unit specifier (MSUS) “NVWFM” or use a real full path representation. See the example below. MSUS “NVWFM” is mapped to D: VARB directory on test set hard disk.

Any number of segments, up to a segment count limit of 64, can be used to create a sequence. Repeated segments are included in the count limit.

Each waveform segment name string length upper limit is 128 chars. Please do NOT insert waveform which name string exceeds 128 chars.

The internal source does not support nesting one waveform sequence file into another waveform sequence file.

Remote Command :SOURce:RADio:ARB:SEQuence[:MWAveform] <filename>, <waveform1>, <reps>, NONE | M1 | M2 | M3 | M4 | M1M2 | M1M3 | M1M4 | M2M3 | M2M4 | M3M4 | M1M2M3 | M1M2M4 | M1M3M4 | M2M3M4 | M1M2M3M4 | ALL, {<waveform2>, <reps>, NONE | M1 | M2 | M3 | M4 | M1M2 | M1M3 | M1M4 | M2M3 | M2M4 | M3M4 | M1M2M3 | M1M2M4 | M1M3M4 | M2M3M4 | M1M2M3M4 | ALL, } ...

(For additional description of each item, see Notes below "[For Setup SCPI](#)" on page 1284 "[For Setup SCPI](#)".)

:SOURce:RADio:ARB:SEQuence[:MWAveform]? <filename>

(For additional description of each item, see Notes "[For Query SCPI](#)" on page 1285 below.)

Example For setup:

```
>:SOUR:RAD:ARB:SEQ "NVWFM:testSeq1.seq", "NVWFM:wfmSegment1.wfm", 10, M2M3M4, "NVWFM:wfmSegment2.wfm", 20, M1 M3
```

Or

```
>:SOUR:RAD:ARB:SEQ "D: VARB\testSeq1.seq", "D: VARB\wfmSegment1.wfm", 10, M2M3M4, "D: VARB\wfmSegment2.wfm", 20, M1 M3
```

For query, must specify which waveform sequence file to query.

```
>:SOUR:RAD:ARB:SEQ? "NVWFM:testSeq1.seq"
```

Or

```
>:SOUR:RAD:ARB:SEQ? "D: VARB\testSeq1.seq",
```

Notes

For Setup SCPI

For the Setup SCPI command, the parameters are:

<filename> - String Type

This variable specifies the path and name for the waveform sequence file. The path supports MSUS (NVWFM) or a real full path representation. See example.

<waveform1> - String Type

This variable specifies the path and name of the first existing waveform segment. The path supports MSUS (NVWFM) or a real full path representation. See example.

The segment file must reside within ARB playback memory before it can be played by the ARB player.

<reps> - Integer Type

This variable specifies the number of times a segment or sequence plays before moving on to the next segment or sequence.

<marker> - Enum Type

NONE – This choice disables all four markers for the waveform. Disabling markers means that the waveform sequence ignores the segments or sequence marker settings.

M1, M2, M3, M4 – these choices, either individually or a combination of them, enable the markers for the waveform segment or sequence. Markers not specified are ignored for that segment or sequence.

ALL – This choice enables all four markers in the waveform segment or sequence.

<waveform2> - String type.

This variable specifies the name of a second existing waveform segment. The path supports MSUS (NVWFM) and real full path representation both. See example.

The segment file must reside within ARB playback memory before it can be played by the ARB player.

<reps> same as above, for the 2nd waveform segment.

<marker> same as above, for the 2nd waveform segment.

You can insert several waveform segments into a waveform sequence file. Just repeat inserting waveform segments as described above.

Error Checks for Setup SCPI command:

If you do not specify a filename, or you use an unsupported MSUS (that is, not NVWFM), or have an error in the waveform sequence file path, an error is generated.

Notes

Error Checks for Query SCPI command: (Continued)

If the specified waveform sequence file name suffix is not “.seq”, error is generated.

If you use an unsupported MSUS (that is, not NVWFM), or have an error in the waveform segment file path, an error is generated.

If the first specified waveform file cannot be found, an error is generated.

If you nest one waveform sequence file into another waveform sequence file, an error is generated.

If the specified repetition value is larger than 65535 or smaller than 1, an error is generated.

If the specified marker type is unrecognized, an error is generated.

For Query SCPI

For the Query the parameters are:

<filename> - String type.

This variable specifies the path and name of the waveform sequence file being queried. The path supports MSUS (NVWFM) or a real full path representation. See example.

The return value is a <string>, which includes each waveform segment file name, repetitions, and marker type. For example:

```
>:SOUR:RAD:ARB:SEQ? "NVWFM:testSeq1.seq",
```

```
<"wfmSegment1. wfm, 10, ALL, wfmSegment2.wfm, 20, M1M3",
```

Error Checks for Query SCPI command:

If you do not specify a filename, an error is generated.

If the waveform sequence file name is empty, an error is generated.

If the specified waveform sequence file cannot be found, an error is generated.

Initial S/W Revision

A.05.00

Edit Selected Sequence

Allows access to the sub-menus for editing the sequence currently selected within the Waveform Sequence List view. Pressing this key changes the central view area to display the Waveform Sequence Creation and Editing view.

Key Path	Source, Modulation Setup, ARB, Waveform Sequences
Notes	No remote command, front panel only.
Initial S/W Revision	A.05.00

Current Directory...

Allows you to change the currently selected directory on the hard disk. Pressing this key opens a standard windows change directory dialog and allows you to select the new directory of interest.

Key Path	Source, Modulation Setup, ARB, Waveform Sequences
Notes	No remote command, front panel only.
Initial S/W Revision	A.05.00

Waveform Utilities

Allows you access to the waveform utilities sub-menus.

Key Path	Source, Modulation Setup, ARB
Initial S/W Revision	A.05.00

Multi-Pack Licenses

Allows you access to the Multi - Pack License sub-menus. Pressing this key also changes the central view area to display the Multi -Pack License Management view.

On modular instrument like E6630A or E6640A, multi-pack license operations are only allowed on the default module, i.e. "Left" module for E6630A or "TRX1" module for E6640A.

Key Path	Source, Modulation Setup, ARB, Waveform Utilities
Notes	If access multi-pack license sub-menu from modules other than "TRX1", an advisory message like "Please goto "TRX1" to operate multi-pack license" will display.
Dependencies	This key is only available if there is at least one Multi-pack license installed on the instrument.
Initial S/W Revision	A.05.00

Add Waveform

Pressing this key accesses the Add Waveform sub-menu. It also changes the central display area to display the Multi-Pack License Waveform Add view.

Key Path	Source, Modulation Setup, ARB, Waveform Utilities, Multi-Pack Licenses
Dependencies	This key is only available if there is at least one slot available within at least one multi-pack license.
Initial S/W Revision	A.05.00

Add Waveform

Allows you to add the currently selected waveform segment to a multi-pack license. The new waveform is added to the next available slot regardless of which slot was selected on the Multi-Pack License Management view.

Key Path	Source, Modulation Setup, ARB, Waveform Utilities, Multi-Pack Licenses, Add Waveform
Remote Command	:SYSTem:LKEY:WAVeform:ADD <string> or :SYSTem:LIcense[:FPACK]:WAVeform:ADD <string>
Example	SYST:LKEY:WAV:ADD "mywaveform.wfm" or SYST:LIC:WAV:ADD "mywaveform.wfm"
Notes	The second SCPI :SYSTem:LIcense[:FPACK]:WAVeform:ADD is provided to be consistent with the style of Agilent signal sources. You can use either one of them. Since adding a waveform segment to a Multi-Pack license causes the license slot to enter the trial period of only 48 hours, pressing this key causes a confirmation dialog to be displayed to ensure you do want to add the waveform segment to the Multi-Pack. If you attempt to license a waveform that is already licensed using another slot an error is generated. . If current module is not "TRX1" module, the key will grey out, and error message is generated "-221 Setting conflict; Not allowed on current module. Goto "TRX1" to operate multi-pack license" when invoking SCPI.
Dependencies	This key is only available if the currently selected file is a secure waveform requiring a license, and there is at least one slot available within at least one multi-pack license. If the waveform highlighted is a secure waveform, but is already licensed, this key will be unavailable.
Initial S/W Revision	A.05.00

Segments on Hard Disk

Allows you access to the sub-menus for loading waveform segments from the hard disk into ARB memory. The default directory is: D: varb.

Pressing this key changes the current view to the Waveform Management View.

Key Path	Source, Modulation Setup, ARB, Select Waveform
Initial S/W Revision	A.05.00

Load Segment To ARB Memory

Allows you to load the selected file into ARB memory. On the front panel you select the file for loading to the ARB memory by highlighting the desired file in the list. Using the SCPI command, you specify the file name on the HDD.

“NVWFM” (none-volatile storage) MSUS (Mass Storage Unit Specifier) is supported in the memory subsystem because the ARB memory cannot be accessed directly. Therefore, files must be downloaded to the instrument hard disk and then loaded into the ARB memory. “NVWFM” MSUS will be mapped to the default directory D: VARB. The SCPI command supports using either “NVWFM” MSUS or specifying a full path. For more information, see [Memory Subsystem \(Remote Command Only\)](#).

If a file of the same name already exists within ARB memory, it is overwritten. If you wish to load two segments of the same name, you must rename one of the segments before loading it into ARB memory. To rename a segment, you can either use Windows File Explorer, or the :MMEMory:COpy command.

NOTE: When a waveform file is loaded to ARB memory, burst timing adjustments are made automatically, based on whether or not a Multiport Adapter is connected to the test set and powered on. If the connection/power status of the Multiport Adapter is changed after a waveform file has been loaded, it needs to be loaded again.

Key Path	Source, Modulation Setup, ARB, Select Waveform, Segments on Hard Disk
Remote Command	:SOURce:RADio:ARB:LOAD <string>
Example	:SOUR:RAD:ARB:LOAD "D: VARB\testwaveform.bin" or :SOUR:RAD:ARB:LOAD "NVWFM:testwaveform.bin"
Notes	<p>Because loading the file involves a delay of unpredictable length, this command should be followed by the query *OPC?, which holds off subsequent commands until the loading operating is complete.</p> <p><string> – specifies the path name of the file to load from the HDD into ARB memory. It could be a <full path + filename>, or <“NVWFM” MSUS + colon + filename>.</p> <p>When in Sequence Analyzer mode, and Include Source is Yes, an attempt to load a file to ARB memory will be rejected with an error.</p> <p>When Include Source is No and if there is insufficient free ARB memory to load the selected waveform, an error is generated. .</p> <p>If you specify a file over SCPI, but the file is not at the specified location, an error is generated.</p> <p>If you try to load a waveform file but the file contains less than 500 IQ sampes, an error is generated.</p> <p>If you try to load a Signal Studio waveform “*.wfm” which contains invalid waveform header, an error is generated.</p> <p>If the ARB is ON when you load afile to ARB memory or delete a file from ARB memory, the playing waveform segment may not keep phase continuity during the ARB memory operation. The waveform will be replayed after the ARB operation is finished.</p> <p>ARB can be loaded into ARB memory even required licenses do not present on the instrument. In this</p>

case, a GUI only warning message -800, "Operation complete; Loaded <filename> successfully, but no license <required licenses> installed". User can install required licenses according to <required licenses> string to license it, or multi-pack license it.

Initial S/W Revision	A.05.00
----------------------	---------

Load All To ARB Memory

Allows you to load all the segment files within the currently selected directory into ARB memory. If a file of the same name already exists within ARB memory, it is overwritten. If you wish to load two segments of the same name, you must rename one of the segments before loading it into ARB memory. To rename a segment, you can either use Windows File Explorer, or the :MEMory:COpy command.

NOTE: When a waveform file is loaded to ARB memory, burst timing adjustments are made automatically, based on whether or not a Multiport Adapter is connected to the test set and powered on. If the connection/power status of the Multiport Adapter is changed after a waveform file has been loaded, it needs to be loaded again.

Key Path	Source, Modulation Setup, ARB, Select Waveform, Segments on Hard Disk
Remote Command	:SOURce:RADio:ARB:LOAD:ALL <string>
Example	:SOUR:RAD:ARB:LOAD:ALL "D: varb"
Notes	<p><string> - specifies the directory on the HDD to load the files into ARB memory from.</p> <p>When in Sequence Analyzer mode, and Include Source is Yes, an attempt to load all files from a directory to ARB memory is rejected with an error.</p> <p>When Include Source is No and there is insufficient free ARB memory to load all the waveforms, when the ARB memory is full, the copy ceases, and an error is generated.</p> <p>If you specify a directory over SCPI, but the directory does not exist, an error is generated.</p> <p>If the ARB is ON, a user then loads or deletes file to ARB memory, the playing waveform segment may not keep phase continuity during the ARB memory operation. The waveform will be replayed after the ARB operation is finished.</p>
Initial S/W Revision	A.05.00

Change Directory...

Allows you to change the currently selected directory on the hard disk. Pressing this key opens a standard windows change directory dialog allowing you to select the new directory of interest.

The current directory is used for manually loading waveform segments into ARB memory for playback, and as a search location for waveform segments that are required to be loaded into ARB memory for playback of a waveform sequence or a list sequence.

Key Path	Source, Modulation Setup, ARB, Select Waveform, Segments on Hard Disk
Notes	No remote command, SCPIfront panel only.
Initial S/W Revision	A.05.00

Default Directory...

Allows you to change the default directory. It is used as a search location for waveform segments that are required to be loaded into ARB memory for playback of a waveform sequence, and as a search location for selecting waveforms using SCPI.

Key Path	Source, Modulation Setup, ARB, Select Waveform, Segments on Hard Disk
Remote Command	:SOURce:RADio:ARB:DEFault:DIRectory <string> :SOURce:RADio:ARB: DEFault:DIRectory?
Example	:SOUR:RAD:ARB:DEF:DIR "D:\ArbFiles" :SOUR:RAD:ARB:DEF:DIR?
State Saved	Persistent, survives a power cycle and a preset but not saved in the instrument state
Initial S/W Revision	A.05.00

Segments on Hard Disk

This key functions the same as ["Segments on Hard Disk" on page 1333](#).

Key Path	Source, Modulation Setup, ARB, Waveform Utilities, Multi-Pack Licenses, Add Waveform
Initial S/W Revision	Prior to A.09.00

Load Segment To ARB Memory

This key functions the same as ["Load Segment To ARB Memory" on page 1333](#).

Key Path	Source, Modulation Setup, ARB, Waveform Utilities, Multi-Pack Licenses, Add Waveform, Segment on Hard Drive
Initial S/W Revision	Prior to A.09.00

Load All To ARB Memory

This key functions the same as ["Load All To ARB Memory" on page 1334](#).

Key Path	Source, Modulation Setup, ARB, Waveform Utilities, Multi-Pack Licenses, Add Waveform, Segment on Hard Drive
Initial S/W Revision	Prior to A.09.00

Change Directory ...

This key functions the same as ["Change Directory..." on page 1335](#).

Key Path	Source, Modulation Setup, ARB, Waveform Utilities, Multi-Pack Licenses, Add Waveform, Segment on Hard Drive
Initial S/W Revision	Prior to A.09.00

Default Directory ...

This key functions the same as ["Default Directory..." on page 1335](#)

Key Path	Source, Modulation Setup, ARB, Waveform Utilities, Multi-Pack Licenses, Add Waveform, Segment on Hard Drive
Initial S/W Revision	Prior to A.09.00

Replace Waveform

Pressing this key accesses the Replace Waveform submenu. It also changes the central display area to display the Multi-Pack License Waveform Add view.

Key Path	Source, Modulation Setup, ARB, Waveform Utilities, Multi-Pack Licenses
Dependencies	This key is only available if the currently selected slot is in the trial state.
Initial S/W Revision	A.05.00

Replace Waveform

Allows you to replace the waveform in the currently selected slot with the waveform currently selected in the Multi-Pack License Waveform Add view.

Key Path	Source, Modulation Setup, ARB, Waveform Utilities, Multi-Pack Licenses, Replace Waveform
Remote Command	:SYSTem:LKEY:WAVeform:REPLace <int>, <string> or :SYSTem:LIcense[:FPACK]:WAVeform:REPLace <int>, <string>
Example	SYST:LKEY:WAV:REPL 1, "myotherwaveform.wfm" or :SYST:LIC:WAV:REPL 1, "myotherwaveform.wfm"
Notes	The second SCPI :SYSTem:LIcense[:FPACK]:WAVeform:REPLace is provided to be consistent with the style of Agilent signal sources. You can use either one of them. If you attempt to license a waveform that is already licensed using another slot an error is generated. Waveform slot number <int> is positive. If you attempt to input a slot number less than or equals 0, an error is generated. If current module is not "TRX1" module, the key will grey out, and error message is generated "-221 Setting conflict; Not allowed on current module. Goto "TRX1" to operate multi-pack license" when invoking SCPI.
Initial S/W Revision	A.05.00

Segments on Hard Disk

This key functions the same as ["Segments on Hard Disk" on page 1333](#).

Key Path	Source, Modulation Setup, ARB, Waveform Utilities, Multi-Pack Licenses, Replace Waveform
Initial S/W Revision	Prior to A.09.00

Load Segment To ARB Memory

This key functions the same as ["Load Segment To ARB Memory" on page 1333](#).

Key Path	Source, Modulation Setup, ARB, Waveform Utilities, Multi-Pack Licenses, Replace Waveform, Segment on Hard Drive
Initial S/W Revision	Prior to A.09.00

Load All To ARB Memory

This key functions the same as ["Load All To ARB Memory" on page 1334](#).

Key Path	Source, Modulation Setup, ARB, Waveform Utilities, Multi-Pack Licenses, Replace Waveform, Segment on Hard Drive
Initial S/W Revision	Prior to A.09.00

Change Directory ...

This key functions the same as ["Change Directory..." on page 1335](#).

Key Path	Source, Modulation Setup, ARB, Waveform Utilities, Multi-Pack Licenses, Replace Waveform, Segment on Hard Drive
Initial S/W Revision	Prior to A.09.00

Default Directory ...

This key functions the same as ["Default Directory..." on page 1335](#)

Key Path	Source, Modulation Setup, ARB, Waveform Utilities, Multi-Pack Licenses, Replace Waveform, Segment on Hard Drive
Initial S/W Revision	Prior to A.09.00

Clear Waveform from Slot

Allows you to clear the waveform from the selected slot.

Key Path	Source, Modulation Setup, ARB, Waveform Utilities, Multi-Pack Licenses
Remote Command	:SYSTem:LKEY:WAVeform:CLEar <int> or :SYSTem:LICense[:FPACK]:WAVeform:CLEar <int>
Example	SYST:LKEY:WAV:CLE 1 or :SYST:LIC:WAV:CLE 1
Notes	The second SCPI :SYSTem:LICense[:FPACK]:WAVeform:CLEar is provided to be consistent with the style of Agilent signal sources. You can use either one of them. Waveform slot number <int> is positive. If you attempt to input a slot number less than or equals 0, an error is generated. If current module is not "TRX1" module, the key will grey out, and error message is generated "-221 Setting conflict; Not allowed on current module. Goto "TRX1" to operate multi-pack license" when invoking SCPI.
Dependencies	This key is only available if the currently selected slot is in the trial state.
Initial S/W Revision	A.05.00

Lock Waveform in Slot

If the selected slot is in the trial state or the lock required state, the waveform that occupies the slot is locked and permanently licensed.

Key Path	Source, Modulation Setup, ARB, Waveform Utilities, Multi-Pack Licenses
Remote Command	:SYSTem:LKEY:WAVeform:LOCK <int> or :SYSTem:LICense[:FPACK]:WAVeform:LOCK <int>
Example	SYST:LKEY:WAV:LOCK 1 or SYST:LIC:WAV:LOCK 1
Notes	The second SCPI :SYSTem:LICense[:FPACK]:WAVeform:LOCK is provided to be consistent with the style of Agilent signal sources. You can use either one of them. Waveform slot number <int> is positive. If you attempt to input a slot number less than or equals 0, an error is generated. If current module is not "TRX1" module, the key will grey out, and error message is generated "-221 Setting conflict; Not allowed on current module. Goto "TRX1" to operate multi-pack license" when invoking SCPI.
Dependencies	This key is only available if the currently selected slot is in the trial state or the lock required state.
Initial S/W Revision	A.05.00

Slot Status Query (Remote Command Only)

Returns the status of the specified slot.

Remote Command	:SYSTem:LKEY:WAVeform:STATus? <int> or :SYSTem:LIcense[:FPACK]:WAVeform:STATus? <int>
Example	:SYST:LKEY:WAV:STAT? 1 <"Locked" or :SYST:LIC:WAV:STAT? 1 <"Locked"
Notes	The second SCPI :SYSTem:LIcense[:FPACK]:WAVeform:STATus is provided to be consistent with the style of Agilent signal sources. You can use either one of them. Waveform slot number <int> is positive. If you attempt to input a slot number less than or equals 0, an error is generated. Result type is string. If input slot number exceeds total available slot number, "Nonexistent" is returned.
Range	"Locked" "Available" "Trail" "LockRequired" "Nonexistent"
Initial S/W Revision	A.05.00

Slots Free Query (Remote Command Only)

Returns the number of license slots free.

Remote Command	:SYSTem:LKEY:WAVeform:FREE? or :SYSTem:LIcense[:FPACK]:WAVeform:FREE?
Example	:SYST:LKEY:WAV:FREE? or :SYST:LIC:WAV:FREE?
Notes	The second SCPI :SYSTem:LIcense[:FPACK]:WAVeform:FREE is provided to be consistent with the style of Agilent signal sources. You can use either one of them.
Initial S/W Revision	A.05.00

Slot Used Query (Remote Command Only)

Returns the number of license slots used.

Remote Command	:SYSTem:LKEY:WAVeform:USED? or :SYSTem:LIcense[:FPACK]:WAVeform:USED?
Example	:SYST:LKEY:WAV:USED?

	or :SYSTem:LiC:WAV:USED?
Notes	The second SCPI :SYSTem:LiCense[:FPACK]:WAVeform:USED is provided to be consistent with the style of Agilent signal sources. You can use either one of them.
Initial S/W Revision	A.05.00

Slot Waveform Name Query (Remote Command Only)

Returns the waveform name of the specified slot

Remote Command	:SYSTem:LKEY:WAVeform:NAME? <int> or :SYSTem:LiCense[:FPACK]:WAVeform:NAME? <int>
Example	:SYST:LKEY:WAV:NAME? 1 <"CDMA2K_22.wfm" or :SYST:LiC:WAV:NAME? 1 <"CDMA2K_22.wfm"
Notes	Waveform slot number <int> is positive. If you attempt to input a slot number less than or equals 0, an error is generated. Result type is string. If input slot number exceeds total available slot number, "Nonexistent" is returned. If no waveform stored in the specified slot, then empty string is returned.
Initial S/W Revision	A.12.00

Slot Waveform Unique ID Query (Remote Command Only)

Returns the waveform unique ID of the specified slot

Remote Command	:SYSTem:LKEY:WAVeform:UID? <int> or :SYSTem:LiCense[:FPACK]:WAVeform:UID? <int>
Example	:SYST:LKEY:WAV:UID? 2 <"1346752140" or :SYST:LiC:WAV:UID? 2 <"1346752140"
Notes	Waveform slot number <int> is positive. If you attempt to input a slot number less than or equals 0, an error is generated. Result type is string. If input slot number exceeds total available slot number, "Nonexistent" is returned.

	If no waveform stored in the specified slot, then "0" is returned
Initial S/W Revision	A.12.00

Locked Waveform Name List Query (Remote Command Only)

Returns the waveform name list of locked.

Remote Command	:SOURce:RADio:ARB:MPLicensed:NAME:LOCKed?
Example	SOUR:RAD:ARB:MPL:NAME:LOCKed? <"CDMA2K_27.wfm", "GSM_MCS1.WFM", "c2kWfm.wfm"
Initial S/W Revision	A.11.00

Locked Waveform Unique ID List Query (Remote Command Only)

Returns the waveform unique id list of locked.

Remote Command	:SOURce:RADio:ARB:MPLicensed:UID:LOCKed?
Example	SOUR:RAD:ARB:MPL:UID:LOCKed? <"2996927136", "3812603511", "3710986266"
Notes	Each Signal Studio waveform has a unique id recorded in header. So if the unique ids are same, that means they are same one waveform. So besides SCPI to query locked waveform name list, also provide a SCPI to query locked waveform unique id list
Initial S/W Revision	A.11.00

Marker Utilities

Allows access to the marker utilities sub-menus.

Key Path	Source, Modulation Setup, ARB
Initial S/W Revision	A.05.00

Marker Polarity

Allows access to the marker polarity sub-menu, which allows you to specify the polarity for the four markers. For a positive polarity, the marker signal is high during the marker points. For a negative marker polarity, the marker signal is high during the period of no marker points.

Key Path	Source, Modulation Setup, ARB, Marker Utilities
Initial S/W Revision	A.05.00

Mkr 1 Polarity

Allows you to set the polarity of marker 1.

Key Path	Source, Modulation Setup, ARB, Marker Utilities, Marker Polarity
Remote Command	:SOURce:RADio:ARB:MPOLarity:MARKer1 POSitive NEGative :SOURce:RADio:ARB:MPOLarity:MARKer1?
Example	:SOUR:RAD:ARB:MPOL:MARK1 NEG
Dependencies	When a new waveform is selected for playback the settings contained within the associated waveform header file are applied to the ARB. The marker polarity is one of the values stored within the header file. If the newly selected waveform file has an associated header file, the marker polarity is updated with the value from the header file. The marker polarity will remain unchanged if the newly selected waveform does not have an associated header file.
Preset	Pos
Range	Neg Pos
Initial S/W Revision	A.05.00

Mkr 2 Polarity

Allows you to set the polarity of marker 2.

Key Path	Source, Modulation Setup, ARB, Marker Utilities, Marker Polarity
Remote Command	:SOURce:RADio:ARB:MPOLarity:MARKer2 POSitive NEGative :SOURce:RADio:ARB:MPOLarity:MARKer2?
Example	:SOUR:RAD:ARB:MPOL:MARK2 NEG
Dependencies	When a new waveform is selected for playback the settings contained within the associated waveform header file are applied to the ARB. The marker polarity is one of the values stored within the header file. If the newly selected waveform file has an associated header file, the marker polarity is updated with the value from the header file. The marker polarity will remain unchanged if the newly selected waveform does not have an associated header file.
Preset	Pos
Range	Neg Pos
Initial S/W Revision	A.05.00

Mkr 3 Polarity

Allows you to set the polarity of marker 3.

Key Path	Source, Modulation Setup, ARB, Marker Utilities, Marker Polarity
Remote Command	:SOURce:RADio:ARB:MPOLarity:MARKer3 POSitive NEGative :SOURce:RADio:ARB:MPOLarity:MARKer3?
Example	:SOUR:RAD:ARB:MPOL:MARK3 NEG
Dependencies	When a new waveform is selected for playback the settings contained within the associated

	waveform header file are applied to the ARB. The marker polarity is one of the values stored within the header file. If the newly selected waveform file has an associated header file, the marker polarity is updated with the value from the header file. The marker polarity will remain unchanged if the newly selected waveform does not have an associated header file.
Preset	Pos
Range	Neg Pos
Initial S/W Revision	A.05.00

Mkr 4 Polarity

Allows you to set the polarity of marker 4.

Key Path	Source, Modulation Setup, ARB, Marker Utilities, Marker Polarity
Remote Command	:SOURce:RADio:ARB:MPOLarity:MARKer4 POSitive NEGative :SOURce:RADio:ARB:MPOLarity:MARKer4?
Example	:SOUR:RAD:ARB:MPOL:MARK4 NEG
Dependencies	When a new waveform is selected for playback the settings contained within the associated waveform header file are applied to the ARB. The marker polarity is one of the values stored within the header file. If the newly selected waveform file has an associated header file, the marker polarity is updated with the value from the header file. The marker polarity will remain unchanged if the newly selected waveform does not have an associated header file.
Preset	Pos
Range	Neg Pos
Initial S/W Revision	A.05.00

Marker Routing

Allows access to the marker routing sub-menus, which allow you to specify where the marker events are routed. It should be noted that the markers can also be routed to Trigger 1 Out and Trigger 2 Out, however this must be set up using the menus accessed by pressing the “Trigger” hard key.

Key Path	Source, Modulation Setup, ARB, Marker Utilities
Initial S/W Revision	A.05.00

Pulse/RF Blank

Allows you to select which marker is used for the pulse/RF blanking function. The pulse/RF blanking function blanks the RF when the marker signal goes low. The marker polarity determines when the marker signal is high. For a positive polarity, this is during the marker points. For a negative polarity, this is when there are no marker points.

Marker points should be set before using this function. Enabling this function without setting maker points may create a continuous low or high signal, dependant on the marker polarity. This causes either no RF output, or a continuous RF output.

Key Path	Source, Modulation Setup, ARB, Marker Utilities, Marker Routing
Remote Command	:SOURce:RADio:ARB:MDEStination:PULSe NONE M1 M2 M3 M4 :SOURce:RADio:ARB:MDEStination:PULSe?
Example	:SOUR:RAD:ARB:MDES:PULS NONE
Dependencies	When a new waveform is selected for playback the settings contained within the associated waveform header file are applied to the ARB. The pulse/RF blanking setting is one of the values stored within the header file. If the newly selected waveform file has an associated header file, the pulse/RF blanking setting is updated with the value from the header file. The pulse/RF blanking setting will remain unchanged if the newly selected waveform does not have an associated header file.
Range	None M1 M2 M3 M4
Initial S/W Revision	A.05.00

None

Sets no marker to be used for the pulse/RF blanking function, essentially turning the RF blanking function off.

Key Path	Source, Modulation Setup, ARB, Marker Utilities, Marker Routing, Pulse/RF Blank
Example	:SOUR:RAD:ARB:MDES:PULS NONE
Initial S/W Revision	A.05.00

Marker 1

Sets marker 1 to be used for the pulse/RF blanking function.

Key Path	Source, Modulation Setup, ARB, Marker Utilities, Marker Routing, Pulse/RF Blank
Example	:SOUR:RAD:ARB:MDES:PULS M1
Initial S/W Revision	A.05.00

Marker 2

Sets marker 2 to be used for the pulse/RF blanking function.

Key Path	Source, Modulation Setup, ARB, Marker Utilities, Marker Routing, Pulse/RF Blank
Example	:SOUR:RAD:ARB:MDES:PULS M2
Initial S/W Revision	A.05.00

Marker 3

Sets marker 3 to be used for the pulse/RF blanking function.

Key Path	Source, Modulation Setup, ARB, Marker Utilities, Marker Routing, Pulse/RF Blank
Example	:SOUR:RAD:ARB:MDES:PULS M3
Initial S/W Revision	A.05.00

Marker 4

Sets marker 4 to be used for the pulse/RF blanking function.

Key Path	Source, Modulation Setup, ARB, Marker Utilities, Marker Routing, Pulse/RF Blank
Example	:SOUR:RAD:ARB:MDES:PULS M4
Initial S/W Revision	A.05.00

ALC Hold

Allows you to specify which marker is routed for use within the ALC hold function. The ALC hold marker function holds the ALC circuitry at the average value of the sample points set by the marker.

The ALC hold function operates during the low periods of the marker signal. The marker polarity determines when the marker signal is high. For positive polarity, this is during the marker points. For a negative polarity, this is when there are no marker points.

Key Path	Source, Modulation Setup, ARB, Marker Utilities, Marker Routing
Remote Command	:SOURce:RADio:ARB:MDEStination:ALCHold NONE M1 M2 M3 M4 :SOURce:RADio:ARB:MDEStination:ALCHold?
Example	:SOUR:RAD:ARB:MDES:ALCH NONE
Dependencies	When a new waveform is selected for playback the settings contained within the associated waveform header file are applied to the ARB. The ALC hold setting is one of the values stored within the header file. If the newly selected waveform file has an associated header file, the ALC hold setting is updated with the value from the header file. The ALC hold setting will remain unchanged if the newly selected waveform does not have an associated header file.
Range	None M1 M2 M3 M4
Initial S/W Revision	A.05.00

None

Sets no marker to be used for the ALC hold function, essentially turning the ALC hold function off.

Key Path	Source, Modulation Setup, ARB, Marker Utilities, Marker Routing, ALC Hold
Example	:SOUR:RAD:ARB:MDES:PULS NONE
Initial S/W Revision	A.05.00

Marker 1

Sets marker 1 to be used for the ALC hold function.

Key Path	Source, Modulation Setup, ARB, Marker Utilities, Marker Routing, ALC Hold
Example	:SOUR:RAD:ARB:MDES:PULS M1
Initial S/W Revision	A.05.00

Marker 2

Sets marker 2 to be used for the ALC hold function.

Key Path	Source, Modulation Setup, ARB, Marker Utilities, Marker Routing, ALC Hold
Example	:SOUR:RAD:ARB:MDES:PULS M2
Initial S/W Revision	A.05.00

Marker 3

Sets marker 3 to be used for the ALC hold function.

Key Path	Source, Modulation Setup, ARB, Marker Utilities, Marker Routing, ALC Hold
Example	:SOUR:RAD:ARB:MDES:PULS M3
Initial S/W Revision	A.05.00

Marker 4

Sets marker 4 to be used for the ALC hold function.

Key Path	Source, Modulation Setup, ARB, Marker Utilities, Marker Routing, ALC Hold
Example	:SOUR:RAD:ARB:MDES:PULS M4
Initial S/W Revision	A.05.00

Header Utilities

Allows access to the header utilities sub-menu. Pressing this key also causes the central display area to change to display the File Header Information view.

Key Path	Source, Modulation Setup, ARB
Dependencies	This key is only available if there is currently a waveform selected for playback. If no waveform is selected, the key is grayed out.
Initial S/W Revision	A.05.00

Clear Header

Allows you to clear the header information from the file header associated with the currently selected waveform.

Key Path	Source, Modulation Setup, ARB, Header Utilities
Remote Command	:SOURce:RADio:ARB:HEADer:CLEar
Example	:SOUR:RAD:ARB:HEAD:CLE
Notes	Attempting to clear the header details via SCPI when no waveform was selected for playback will generate an error.
Initial S/W Revision	A.05.00

Save Setup To Header

Allows you to save new file header information details to the file.

Key Path	Source, Modulation Setup, ARB, Header Utilities
Remote Command	:SOURce:RADio:ARB:HEADer:SAVE
Example	:SOUR:RAD:ARB:HEAD:SAVE
Notes	Attempting to save the header details via SCPI when no waveform was selected for playback will generate an error.
Initial S/W Revision	A.05.00

Query Waveform Unique ID (Remote Command Only)

Each Signal Studio waveform contains a unique waveform ID, which recorded in the header. This command allows you to query the unique waveform ID from the header. This is a SCPI only command. User can also check [Error! Reference source not found.](#) for waveform unique ID display.

Remote Command	:MMEMory:HEADer:ID? "<file name>"
Example	:MMEM:HEAD:ID? "test.wfm" (query the waveform already loaded into the ARB memory) :MMEM:HEAD:ID? "D: VARB\test.wfm" (query the waveform on the hard disk by absolute path) :MMEM:HEAD:ID? "NVWFM:test.wfm" (query the waveform on the hard disk by MSUS)
Notes	SCPI query only. The queried waveform file can be in ARB memory, or on hard disk. If want to query ARB in ARB memory, then give out the file name directly. If want to query ARB on the hard disk, then absolute file path or MSUS should be given along with the file name. The valid MSUS is "NVWFM" which is mapped to D: VARB on hard disk. If the file cannot be found in ARB memory or on hard disk, an error is generated and value -1 is returned
Initial S/W Revision	A.09.00

Bus Trigger Command (Remote Command Only)

Used to initiate an immediate trigger event if the trigger source is set to Bus.

Remote Command	:SOURce:RADio:ARB:TRIGger:INITiate
Example	:SOUR:RAD:ARB:TRIG:INIT
Initial S/W Revision	A.05.00

AM

Allows access to the menu for configuring the Amplitude Modulation.

Key Path	Source, Modulation Setup
Initial S/W Revision	A.05.00

AM

Enables or disables the amplitude modulation.

Turning AM on when another modulation format is already on results in the previous modulation format being turned off and the generation of an error.

Key Path	Source, Modulation Setup, AM
Remote Command	:SOURce:AM:STATe :SOURce:AM:STATe?
Example	:SOUR:AM:STAT OFF
Preset	Off
Range	On Off
Initial S/W Revision	A.05.00

AM Depth

Allows you to set the amplitude modulation depth in percent.

Key Path	Source, Modulation Setup, AM
Remote Command	:SOURce:AM[:DEPTh] [:LINear] :SOURce:AM[:DEPTh] [:LINear]?
Example	:SOUR:AM 0.1
Preset	0.1 %
Min	0.1 %
Max	95.0 %
Initial S/W Revision	A.05.00

AM Rate

Allows you to set the internal amplitude modulation rate.

Key Path	Source, Modulation Setup, AM
Remote Command	:SOURce:AM:INTernal:FREQuency :SOURce:AM:INTernal:FREQuency?
Example	:SOUR:AM:INT:FREQ 40.0 Hz
Preset	400.0 Hz
Min	10 Hz
Max	40 kHz
Initial S/W Revision	A.05.00

FM

Allows access to the menu for configuring the frequency modulation.

Key Path	Source, Modulation Setup
Initial S/W Revision	A.05.00

FM

Enables or disables the frequency modulation.

Turning FM on when another modulation format is already on results in the previous modulation format being turned off and the generation of an error.

Key Path	Source, Modulation Setup, FM
Remote Command	:SOURce:FM:STATe :SOURce:FM:STATe?
Example	:SOUR:FM:STAT OFF
Preset	Off
Range	On Off
Initial S/W Revision	A.05.00

FM Deviation

Allows you to set the frequency modulation deviation.

Key Path	Source, Modulation Setup, FM
----------	------------------------------

Remote Command	:SOURce:FM[:DEVIation] :SOURce:FM[:DEVIation]?
Example	:SOUR:FM 1.00 kHz
Preset	1.00 Hz
Min	1.00 Hz
Max	100.00 kHz
Initial S/W Revision	A.05.00

FM Rate

Allows you to set the internal frequency modulation rate.

Key Path	Source, Modulation Setup, FM
Remote Command	:SOURce:FM:INTernal:FREQuency :SOURce:FM:INTernal:FREQuency?
Example	:SOUR:FM:INT:FREQ 40.0 Hz
Preset	400.0 Hz
Min	10 Hz
Max	40 kHz
Initial S/W Revision	A.05.00

PM

Allows access to the menu for configuring the phase modulation.

Key Path	Source, Modulation Setup
Initial S/W Revision	A.05.00

PM

Enables or disables the phase modulation.

Turning PM on when another modulation format is already on results in the previous modulation format being turned off and the generation of an error.

Key Path	Source, Modulation Setup, PM
Remote Command	:SOURce:PM:STATe :SOURce:PM:STATe?
Example	:SOUR:PM:STAT OFF

Preset	Off
Range	On Off
Initial S/W Revision	A.05.00

PM Deviation

Allows you to set the phase modulation deviation.

Key Path	Source, Modulation Setup, PM
Remote Command	:SOURce:PM[:DEVIation] :SOURce:PM[:DEVIation]?
Example	:SOUR:PM 1.00 rad
Preset	0.1 rad
Min	0.1 rad
Max	20.0 rad
Initial S/W Revision	A.05.00

PM Rate

Allows you to set the internal phase modulation rate.

Key Path	Source, Modulation Setup, PM
Remote Command	:SOURce:PM:INTernal:FREQuency :SOURce:PM:INTernal:FREQuency?
Example	:SOUR:PM:INT:FREQ 40.0 Hz
Preset	400.0 Hz
Min	10 Hz
Max	40 kHz
Initial S/W Revision	A.05.00

List Sequencer

Allows you access to the sub-menus for configuring the list sequencer.

List sequences allows you to enter frequencies and amplitudes at unequal intervals in nonlinear ascending, descending or random order. Each step within the list can also include its own waveform file for playback, step duration, trigger event and trigger output.

The complexities involved in configuring the list sequencer do not lend itself to manual configuration; hence the manual configuration for this feature is limited. For easier configuration of the list sequencer, it is recommended that you use either SCPI or load a tab delimited file containing the setup parameters in a

tabular form. The details of the SCPI for configuring the list sequencer can be found in "[Step Configuration \(Remote Command Only\)](#)" on page 1340.

Once the List Sequencer has been configured using the front panel, SCPI, or loading in a tab delimited file, the sequence must be initiated using the front panel Initiate Sequence key or the corresponding SCPI command.

Key Path	Source
Initial S/W Revision	A.05.00

Sequencer

Allows you to set the state of the list sequencer. When the list sequencer is on, the source is outputting the sequence defined by the sequencer. When the list sequencer is off, the source outputs a single waveform segment or sequence (independent mode) at a single frequency and amplitude.

Key Path	Source, List Sequencer
Remote Command	:SOURce:LIST[:STATe] ON OFF 1 0 :SOURce:LIST[:STATe]?
Example	:SOUR:LIST OFF
Notes	When the sequencer is set to ON, the list sequencer controls the output of the source.
Couplings	When in Sequence Analyzer mode and the list sequencer state is Off, Include Source is forced to No, and the Include Source key is grayed out. When in Sequence Analyzer mode and the list sequencer state is On, Include Source is available to set. And, an ARB memory related operation, like load or delete will be rejected.
Preset	Off
Range	On Off
Initial S/W Revision	A.05.00

Initiate Sequence

Pressing this key arms the sequence for single execution. Once the sequence is armed the source begins the sequence as soon as the trigger is received. If the trigger is set to Free Run, the sequence starts immediately.

Key Path	Source, List Sequencer
Remote Command	:SOURce:LIST:TRIGger[:IMMediate]
Example	:SOUR:LIST:TRIG
Notes	When in Sequence Analyzer mode and Include Source is Yes, the Initiate list sequencer operation is rejected, and the key is grayed out, since source list sequence request is sent to physics via Parallel batch by sequence analyzer. If the file needed by the sequencer is not already in ARB memory, the sequence cannot be initiated

	and an error will be generated. There is a blocking SCPI query which can be used to query if source list sequence being initiated successfully or not. (see " Query List Sequence Initiation Armed Status (Remote Command Only) " on page 1351 Query Source List Sequence Armed Status)
Dependencies	Under the Sequence Analyzer Mode, if Meas Setup->Include Source is set to YES, Source->List Sequencer->Initiate Sequence is disabled.
Initial S/W Revision	A.05.00

List Sequencer Setup

Allows you access to the list sequencer setup menus.

Key Path	Source, List Sequencer
----------	------------------------

Number of Steps

Allows you to specify the number of steps within the list sequence.

Key Path	Source, List Sequencer, List Sequencer Setup
Remote Command	:SOURce:LIST:NUMBer:STEPs <integer> :SOURce:LIST:NUMBer:STEPs?
Example	:SOUR:LIST:NUMB:STEP 1
Notes	Increasing the number of steps creates additional steps at the end of the list, with all the settings within the steps set to their default values. Decreasing the number of steps removes steps from the end of the list. The settings within the removed steps are not reset. This means that increasing the number of steps again would allow you to retrieve these steps.
Dependencies	The Step Count parameter is increased or decreased when you insert or delete a point from within the GUI interface to the sequencer.
Preset	1
Min	1
Max	1000
Initial S/W Revision	A.05.00

Current Step

Allows you to select the step number you wish to view or edit.

Key Path	Source, List Sequencer, List Sequencer Setup
----------	--

Notes	No remote command, front panel only.
Preset	1
Min	1
Max	Step Count
Initial S/W Revision	A.05.00

Insert Step Before

Allows you to insert a new step, containing default values, before the currently selected step. Inserting a step will automatically increase the Step Count parameter by 1. If sequence already reaches upper limit of 1000 steps, then insert more step will be rejected and popup error –221, “Setting Conflict; Cannot insert more steps, maximum number of steps reached”

Key Path	Source, List Sequencer, List Sequencer Setup
Notes	No remote command, front panel only. If the list already contains the maximum limit of 1000 steps, no operation will be made after pressing this key.
Initial S/W Revision	A.05.00

Delete Step

Allows you to delete the current step. Deleting a step will automatically decrease the Step Count parameter by 1. If sequence only has one step left, delete step will be rejected and popup error –221, “Setting conflict; Cannot delete current step, minimum number of steps reached”

Key Path	Source, List Sequencer, List Sequencer Setup
Notes	No remote command, Front Panel key only. If the list already contains the minimum limit of 1 step, no operation will be made after pressing this key
Initial S/W Revision	A.05.00

Clear List

Allows you to clear the list. Clearing the list sets the number of steps to the default value of 1 and sets the parameters for the only step to their default values.

Key Path	Source, List Sequencer, List Sequencer Setup
Initial S/W Revision	A.05.00

Step Trigger

Allows access to the sub-menu for selecting the trigger input for the current step.

Key Path	Source, List Sequencer, List Sequencer Setup
Remote Command	:SOURCE:LIST:STEP[1] 2 3...1000:SETup:INPut:TRIGger IMMEDIATE INTERNAL EXTERNAL2 KEY BUS EXTERNAL4 :SOURCE:LIST:STEP[1] 2 3...1000:SETup:INPut:TRIGger?
Example	:SOUR:LIST:STEP2:SET:INP:TRIG BUS :SOUR:LIST:STEP2:SET:INP:TRIG?
Notes	SCPI is supported after A.09.40
Preset	Free Run
Range	Free Run Internal Manual (Trigger Key) Bus External 2 EXTERNAL4
Initial S/W Revision	A.05.00

Free Run

Sets the trigger input for the current step to Free Run.

Key Path	Source, List Sequencer, List Sequencer Setup, Step Trigger
Example	:SOUR:LIST:STEP2:SET:INP:TRIG IMM
Notes	SCPI is supported after A.09.40
Initial S/W Revision	A.05.00

Internal

Sets the trigger input for the current step to Internal.

Key Path	Source, List Sequencer, List Sequencer Setup, Step Trigger
Example	:SOUR:LIST:STEP2:SET:INP:TRIG INT
Notes	SCPI is supported after A.09.40
Initial S/W Revision	A.05.00

Manual (Trigger Key)

Sets the trigger input for the current step to Manual (Trigger Key). Any step in the sequence set to Manual will cause the sequence execution to stop until the manual trigger key is pressed. Sending the Bus Trigger SCPI command will have no effect. At any point in the sequence where the list sequencer is paused waiting for a software trigger, a pop up dialog is displayed until the trigger event occurs.

Key Path	Source, List Sequencer, List Sequencer Setup, Step Trigger
Example	:SOUR:LIST:STEP2:SET:INP:TRIG KEY
Notes	SCPI is supported after A.09.40
Initial S/W Revision	A.05.00

Bus

Sets the trigger input for the current step to Bus. Any step in the sequence set to Bus will cause the sequence execution to stop until the Bus Trigger SCPI command is sent. Pressing the manual trigger key has no effect. At any point in the sequence where the list sequencer is paused waiting for a software trigger, a pop up dialog is displayed until the trigger event occurs.

Key Path	Source, List Sequencer, List Sequencer Setup, Step Trigger
Example	:SOUR:LIST:STEP2:SET:INP:TRIG BUS
Notes	SCPI is supported after A.09.40
Initial S/W Revision	A.05.00

External 2

Sets the trigger input for the current step to External 2.

Key Path	Source, List Sequencer, List Sequencer Setup, Step Trigger
Example	:SOUR:LIST:STEP2:SET:INP:TRIG EXT2
Notes	SCPI is supported after A.09.40
Notes	Note: When on E6640A, trigger 2 is a bi-directional trigger port. So when trigger 2 has been configured as OUTPUT type, choosing External 2 as the input trigger for the current step will generate error.
Initial S/W Revision	A.05.00

Transition Time

Allows you to specify the transition time for the current step.

The transition time is the amount of time allowed for the source to settle at the current frequency or amplitude value.

Transition Time should not be taken as additional time before or inside the Step Duration. You can set a value for the settling time to allow the source output frequency or amplitude to become stable. Make sure that during this period of time, you do not use the source output signal.

The following table lists recommended values for appropriate settling times to allow for changes within the source.

Value Changed	Recommended Transition Time
Frequency	500 μ s
Amplitude	100 μ s to within 0.1 dB 20 μ s to within 1.0 dB

If the Transition Time value is shorter than the time necessary for the hardware to settle and a List Sequence is initiated, a **warning** is generated.

If the Transition Time value is longer than the Step Duration, an error is generated when initiating a source list sequence. For source list sequence, transition time is included in the step duration length. If the Transition Time value is longer than the Step Duration Time, the real step duration length is extended to equal the transition time and cause a timing shift.

Key Path	Source, List Sequencer, List Sequencer Setup
Remote Command	:SOURce:LIST:STEP[1] 2 3...1000:SETup:TRANsition:TIME <time> :SOURce:LIST:STEP[1] 2 3...1000:SETup:TRANsition:TIME?
Example	:SOUR:LIST:STEP2:SET:TRAN:TIME 1ms :SOUR:LIST:STEP2:SET:TRAN:TIME?
Notes	SCPI is supported after A.09.40
Preset	1.0 ms
Min	0.0 ms
Max	4.0 ks
Initial S/W Revision	A.05.00

Radio Setup

Allows you access to the sub-menus for setting up the radio standard, band, and radio band link direction for the current step.

Key Path	Source, List Sequencer, List Sequencer Setup
Notes	No remote command, front panel only.
Initial S/W Revision	A.05.00

Radio Standard

Allows access to the sub-menus for selecting the radio standard and the associated radio band for use in the current step.

Key Path	Source, List Sequencer, List Sequencer Setup, Radio Setup
Remote Command	:SOURce:LIST:STEP[1] 2 3...1000:SETup:RADio:BAND NONE PGSM EGSM RGSM DCS1800 PCS1900 TGSM810 GSM450 GSM480 GSM700 GSM850 BANDI BANDII BANDIII BANDIV BANDV BANDVI BANDVII BANDVIII BANDIX BANDX BANDXI BANDXII BANDXIII BANDXIV BANDXIX USCELL USPCS JAPAN KOREAN NMT IMT2K UPPER SECOND PAMR400 PAMR800 IMTEXT PCS1DOT9G AWS US2DOT5G PUBLIC LOWER NONE BAND1 BAND2 BAND3 BAND4 BAND5 BAND6 BAND7 BAND8 BAND10 BAND11 BAND12 BAND13 BAND14 BAND17 BAND18 BAND19 BAND20 BAND21 BAND24 BAND25 BAND26 BAND27 BAND28 BAND31 BAND33 BAND34 BAND35 BAND36 BAND37 BAND38

BAND39 | BAND40 | BAND41 | BAND42 | BAND43 | BAND44 | BANDA | BANDB |
BANDC | BANDD | BANDE | BANDF

:SOURce:LIST:STEP[1]|2|3...1000:SETup: RADio:BAND?

Example :SOUR:LIST:STEP2:SET:RAD:BAND PGSM
:SOUR:LIST:STEP2:SET:RAD:BAND?

Notes SCPI is supported after A.09.40

Initial S/W Revision A.05.00

None

Selects no radio standard for use on the current step.

Key Path Source, List Sequencer, List Sequencer Setup, Radio Setup, Radio Standard

Example :SOUR:LIST:STEP2:SET:RAD:BAND NONE

Notes SCPI is supported after A.09.40

Initial S/W Revision A.05.00

GSM/EDGE

Pressing this key once selects GSM/EDGE as the radio standard and the current GSM/EDGE band as the active channel band. Pressing this key again allows access to the sub-menus for selecting a different GSM/EDGE band.

Key Path Source, List Sequencer, List Sequencer Setup, Radio Setup, Radio Standard

Initial S/W Revision A.05.00

P-GSM

Selects P-GSM as the band for the current step.

Key Path Source, List Sequencer, List Sequencer Setup, Radio Setup, Radio Standard, GSM/EDGE

Initial S/W Revision A.05.00

E-GSM

Selects E-GSM as the band for the current step.

Key Path Source, List Sequencer, List Sequencer Setup, Radio Setup, Radio Standard, GSM/EDGE

Initial S/W Revision A.05.00

R-GSM

Selects R-GSM as the band for the current step.

Key Path	Source, List Sequencer, List Sequencer Setup, Radio Setup, Radio Standard, GSM/EDGE
Initial S/W Revision	A.05.00

DCS 1800

Selects DCS 1800 as the band for the current step.

Key Path	Source, List Sequencer, List Sequencer Setup, Radio Setup, Radio Standard, GSM/EDGE
Initial S/W Revision	A.05.00

PCS 1900

Selects PCS 1900 as the band for the current step.

Key Path	Source, List Sequencer, List Sequencer Setup, Radio Setup, Radio Standard, GSM/EDGE
Initial S/W Revision	A.05.00

GSM 450

Selects GSM 450 as the band for the current step.

Key Path	Source, List Sequencer, List Sequencer Setup, Radio Setup, Radio Standard, GSM/EDGE
Initial S/W Revision	A.05.00

GSM 480

Selects GSM 480 as the band for the current step.

Key Path	Source, List Sequencer, List Sequencer Setup, Radio Setup, Radio Standard, GSM/EDGE
Initial S/W Revision	A.05.00

GSM 850

Selects GSM 850 as the band for the current step.

Key Path	Source, List Sequencer, List Sequencer Setup, Radio Setup, Radio Standard, GSM/EDGE
Initial S/W Revision	A.05.00

GSM 700

Selects GSM 700 as the band for the current step.

Key Path	Source, List Sequencer, List Sequencer Setup, Radio Setup, Radio Standard, GSM/EDGE
Initial S/W Revision	A.05.00

T-GSM 810

Selects T-GSM 810 as the band for the current step.

Key Path	Source, List Sequencer, List Sequencer Setup, Radio Setup, Radio Standard, GSM/EDGE
Initial S/W Revision	A.05.00

WCDMA

Pressing this key once selects WCDMA as the radio standard and the current WCDMA band as the active channel band. Pressing this key again allows access to the sub-menus for selecting a different WCDMA band.

Key Path	Source, List Sequencer, List Sequencer Setup, Radio Setup, Radio Standard
Initial S/W Revision	A.05.00

Band I

Selects Band I as the band for the current step.

Key Path	Source, List Sequencer, List Sequencer Setup, Radio Setup, Radio Standard, WCDMA
Initial S/W Revision	A.05.00

Band II

Selects Band II as the band for the current step.

Key Path	Source, List Sequencer, List Sequencer Setup, Radio Setup, Radio Standard, WCDMA
Initial S/W Revision	A.05.00

Band III

Selects Band III as the band for the current step.

Key Path	Source, List Sequencer, List Sequencer Setup, Radio Setup, Radio Standard, WCDMA
Initial S/W Revision	A.05.00

Band IV

Selects Band IV as the band for the current step.

Key Path	Source, List Sequencer, List Sequencer Setup, Radio Setup, Radio Standard, WCDMA
Initial S/W Revision	A.05.00

Band V

Selects Band V as the band for the current step.

Key Path	Source, List Sequencer, List Sequencer Setup, Radio Setup, Radio Standard, WCDMA
Initial S/W Revision	A.05.00

Band VI

Selects Band VI as the band for the current step.

Key Path	Source, List Sequencer, List Sequencer Setup, Radio Setup, Radio Standard, WCDMA
Initial S/W Revision	A.05.00

Band VII

Selects Band VII as the band for the current step.

Key Path	Source, List Sequencer, List Sequencer Setup, Radio Setup, Radio Standard, WCDMA
Initial S/W Revision	A.05.00

Band VIII

Selects Band VIII as the band for the current step.

Key Path	Source, List Sequencer, List Sequencer Setup, Radio Setup, Radio Standard, WCDMA
Initial S/W Revision	A.05.00

Band IX

Selects Band IX as the band for the current step.

Key Path	Source, List Sequencer, List Sequencer Setup, Radio Setup, Radio Standard, WCDMA
Initial S/W Revision	A.05.00

Band X

Selects Band X as the band for the current step.

Key Path	Source, List Sequencer, List Sequencer Setup, Radio Setup, Radio Standard, WCDMA
Initial S/W Revision	A.05.00

Band XI

Selects Band XI as the band for the current step.

Key Path	Source, List Sequencer, List Sequencer Setup, Radio Setup, Radio Standard, WCDMA
Initial S/W Revision	A.05.00

Band XII

Selects Band XII as the band for the current step.

Key Path	Source, List Sequencer, List Sequencer Setup, Radio Setup, Radio Standard, WCDMA
Initial S/W Revision	A.05.00

Band XIII

Selects Band XIII as the band for the current step.

Key Path	Source, List Sequencer, List Sequencer Setup, Radio Setup, Radio Standard, WCDMA
Initial S/W Revision	A.05.00

Band XIV

Selects Band XIV as the band for the current step.

Key Path	Source, List Sequencer, List Sequencer Setup, Radio Setup, Radio Standard, WCDMA
Initial S/W Revision	A.05.00

Band XIX

Selects Band XIX as the band for the current step.

Key Path	Source, List Sequencer, List Sequencer Setup, Radio Setup, Radio Standard, WCDMA
Initial S/W Revision	A.14.50

CDMA 2000 / 1xEVDO

Pressing this key once selects CDMA 2000/1xEVDO as the radio standard and the current CDMA 2000/1xEVDO band as the active channel band. Pressing this key again allows access to the sub-menus for selecting a different CDMA 2000/1xEVDO band.

Key Path	Source, List Sequencer, List Sequencer Setup, Radio Setup, Radio Standard
Initial S/W Revision	A.05.00

US CELL

Selects US Cell as the band for the current step.

Key Path	Source, List Sequencer, List Sequencer Setup, Radio Setup, Radio Standard, CDMA 2000 / 1xEVDO
Initial S/W Revision	A.05.00

US PCS

Selects US PCS as the band for the current step.

Key Path	Source, List Sequencer, List Sequencer Setup, Radio Setup, Radio Standard, CDMA 2000 / 1xEVDO
Initial S/W Revision	A.05.00

Japan Cell

Selects Japan Cell as the band for the current step.

Key Path	Source, List Sequencer, List Sequencer Setup, Radio Setup, Radio Standard, CDMA 2000 / 1xEVDO
Initial S/W Revision	A.05.00

Korean PCS

Selects Korean PCS as the band for the current step.

Key Path	Source, List Sequencer, List Sequencer Setup, Radio Setup, Radio Standard, CDMA 2000 / 1xEVDO
Initial S/W Revision	A.05.00

NMT 450

Selects NMT 450 as the band for the current step.

Key Path	Source, List Sequencer, List Sequencer Setup, Radio Setup, Radio Standard, CDMA 2000 / 1xEVDO
Initial S/W Revision	A.05.00

IMT 2000

Selects IMT 2000 as the band for the current step.

Key Path	Source, List Sequencer, List Sequencer Setup, Radio Setup, Radio Standard, CDMA 2000 / 1xEVDO
Initial S/W Revision	A.05.00

Upper 700

Selects Upper 700 as the band for the current step.

Key Path	Source, List Sequencer, List Sequencer Setup, Radio Setup, Radio Standard, CDMA 2000 / 1xEVDO
Initial S/W Revision	A.05.00

Secondary 800

Selects Secondary 800 as the band for the current step.

Key Path	Source, List Sequencer, List Sequencer Setup, Radio Setup, Radio Standard, CDMA 2000 / 1xEVDO
Initial S/W Revision	A.05.00

400 Euro PAMR

Selects 400 Euro PAMR as the band for the current step.

Key Path	Source, List Sequencer, List Sequencer Setup, Radio Setup, Radio Standard, CDMA 2000 / 1xEVDO
Initial S/W Revision	A.05.00

800 PAMR

Selects 800 PAMR as the band for the current step.

Key Path	Source, List Sequencer, List Sequencer Setup, Radio Setup, Radio Standard, CDMA 2000 / 1xEVDO
Initial S/W Revision	A.05.00

2.5GHz IMT EXT

Selects 2.5 GHz IMT EXT as the band for the current step.

11 FM Stereo Measurement
Source

Key Path	Source, List Sequencer, List Sequencer Setup, Radio Setup, Radio Standard, CDMA 2000 / 1xEVDO
Initial S/W Revision	A.05.00

US PCS 1.9GHz

Selects US PCS 1.9 GHz as the band for the current step.

Key Path	Source, List Sequencer, List Sequencer Setup, Radio Setup, Radio Standard, CDMA 2000 / 1xEVDO
Initial S/W Revision	A.05.00

AWS

Selects AWS as the band for the current step.

Key Path	Source, List Sequencer, List Sequencer Setup, Radio Setup, Radio Standard, CDMA 2000 / 1xEVDO
Initial S/W Revision	A.05.00

US 2.5GHz

Selects US 2.5 GHz as the band for the current step.

Key Path	Source, List Sequencer, List Sequencer Setup, Radio Setup, Radio Standard, CDMA 2000 / 1xEVDO
Initial S/W Revision	A.05.00

700 Public Safety

Selects 700 Public Safety as the band for the current step.

Key Path	Source, List Sequencer, List Sequencer Setup, Radio Setup, Radio Standard, CDMA 2000 / 1xEVDO
Initial S/W Revision	A.05.00

C2K Lower 700

Selects C2K Lower 700 as the band for the current step.

Key Path	Source, List Sequencer, List Sequencer Setup, Radio Setup, Radio Standard, CDMA 2000 / 1xEVDO
Initial S/W Revision	A.05.00

LTE

Pressing this key once selects LTE FDD as the radio standard and the current LTE FDD band as the active channel band. Pressing this key again allows access to the sub-menus for selecting a different LTE FDD band.

Key Path	Source, List Sequencer, List Sequencer Setup, Radio Setup, Radio Standard
Initial S/W Revision	A.09.50

BAND 1

Selects BAND 1 as the band for the current step.

Key Path	Source, List Sequencer, List Sequencer Setup, Radio Setup, Radio Standard, LTE
Initial S/W Revision	A.09.50

BAND 2

Selects BAND 2 as the band for the current step.

Key Path	Source, List Sequencer, List Sequencer Setup, Radio Setup, Radio Standard, LTE
Initial S/W Revision	A.09.50

BAND 3

Selects BAND 3 as the band for the current step.

Key Path	Source, List Sequencer, List Sequencer Setup, Radio Setup, Radio Standard, LTE
Initial S/W Revision	A.09.50

BAND 4

Selects BAND 4 as the band for the current step.

Key Path	Source, List Sequencer, List Sequencer Setup, Radio Setup, Radio Standard, LTE
Initial S/W Revision	A.09.50

BAND 5

Selects BAND 5 as the band for the current step.

Key Path	Source, List Sequencer, List Sequencer Setup, Radio Setup, Radio Standard, LTE
Initial S/W Revision	A.09.50

BAND 6

Selects BAND 6 as the band for the current step.

Key Path	Source, List Sequencer, List Sequencer Setup, Radio Setup, Radio Standard, LTE
Initial S/W Revision	A.09.50

BAND 7

Selects BAND 7 as the band for the current step.

Key Path	Source, List Sequencer, List Sequencer Setup, Radio Setup, Radio Standard, LTE
Initial S/W Revision	A.09.50

BAND 8

Selects BAND 8 as the band for the current step.

Key Path	Source, List Sequencer, List Sequencer Setup, Radio Setup, Radio Standard, LTE
Initial S/W Revision	A.09.50

BAND 9

Selects BAND 9 as the band for the current step.

Key Path	Source, List Sequencer, List Sequencer Setup, Radio Setup, Radio Standard, LTE
Initial S/W Revision	A.09.50

BAND 10

Selects BAND 10 as the band for the current step.

Key Path	Source, List Sequencer, List Sequencer Setup, Radio Setup, Radio Standard, LTE
Initial S/W Revision	A.09.50

BAND 11

Selects BAND 11 as the band for the current step.

Key Path	Source, List Sequencer, List Sequencer Setup, Radio Setup, Radio Standard, LTE
Initial S/W Revision	A.09.50

BAND 12

Selects BAND 12 as the band for the current step.

Key Path	Source, List Sequencer, List Sequencer Setup, Radio Setup, Radio Standard, LTE
Initial S/W Revision	A.09.50

BAND 13

Selects BAND 13 as the band for the current step.

Key Path	Source, List Sequencer, List Sequencer Setup, Radio Setup, Radio Standard, LTE
Initial S/W Revision	A.09.50

BAND 14

Selects BAND 14 as the band for the current step.

Key Path	Source, List Sequencer, List Sequencer Setup, Radio Setup, Radio Standard, LTE
Initial S/W Revision	A.09.50

BAND 17

Selects BAND 17 as the band for the current step.

Key Path	Source, List Sequencer, List Sequencer Setup, Radio Setup, Radio Standard, LTE
Initial S/W Revision	A.09.50

BAND 18

Selects BAND 18 as the band for the current step.

Key Path	Source, List Sequencer, List Sequencer Setup, Radio Setup, Radio Standard, LTE
Initial S/W Revision	A.09.50

BAND 19

Selects BAND 19 as the band for the current step.

Key Path	Source, List Sequencer, List Sequencer Setup, Radio Setup, Radio Standard, LTE
Initial S/W Revision	A.09.50

BAND 20

Selects BAND 20 as the band for the current step.

Key Path	Source, List Sequencer, List Sequencer Setup, Radio Setup, Radio Standard, LTE
Initial S/W Revision	A.09.50

BAND 21

Selects BAND 21 as the band for the current step.

Key Path	Source, List Sequencer, List Sequencer Setup, Radio Setup, Radio Standard, LTE
Initial S/W Revision	A.09.50

BAND 24

Selects BAND 24 as the band for the current step.

Key Path	Source, List Sequencer, List Sequencer Setup, Radio Setup, Radio Standard, LTE
Initial S/W Revision	A.09.50

BAND 25

Selects BAND 25 as the band for the current step.

Key Path	Source, List Sequencer, List Sequencer Setup, Radio Setup, Radio Standard, LTE
Initial S/W Revision	A.09.50

BAND 26

Selects BAND 26 as the band for the current step.

Key Path	Source, List Sequencer, List Sequencer Setup, Radio Setup, Radio Standard, LTE
Initial S/W Revision	A.12.53

BAND 27

Selects BAND 27 as the band for the current step.

Key Path	Source, List Sequencer, List Sequencer Setup, Radio Setup, Radio Standard, LTE
Initial S/W Revision	A.14.00

BAND 28

Selects BAND 28 as the band for the current step.

Key Path	Source, List Sequencer, List Sequencer Setup, Radio Setup, Radio Standard, LTE
Initial S/W Revision	A.14.00

BAND 31

Selects BAND 31 as the band for the current step.

Key Path	Source, List Sequencer, List Sequencer Setup, Radio Setup, Radio Standard, LTE
Initial S/W Revision	A.14.00

LTE TDD

Sets LTE TDD as the radio standard for use and accesses the LTE TDD specific channel band sub-menus..

Key Path	Source, Frequency, Radio Setup, Radio Standard
Initial S/W Revision	A.11.50

BAND 33

Selects BAND 33 as the band for the current step.

Key Path	Source, Frequency, Radio Setup, Radio Standard, LTE TDD
Example	:SOUR:FREQ:CHAN:BAND BAND33
Initial S/W Revision	A.11.50

BAND 34

Selects BAND 34 as the band for the current step.

Key Path	Source, Frequency, Radio Setup, Radio Standard, LTE TDD
Example	:SOUR:FREQ:CHAN:BAND BAND34
Initial S/W Revision	A.11.50

BAND 35

Selects BAND 35 as the band for the current step.

Key Path	Source, Frequency, Radio Setup, Radio Standard, LTE TDD
Example	:SOUR:FREQ:CHAN:BAND BAND35
Initial S/W Revision	A.11.50

BAND 36

Selects BAND 36 as the band for the current step.

Key Path	Source, Frequency, Radio Setup, Radio Standard, LTE TDD
Example	:SOUR:FREQ:CHAN:BAND BAND36
Initial S/W Revision	A.11.50

BAND 37

Selects BAND 37 as the band for the current step.

Key Path	Source, Frequency, Radio Setup, Radio Standard, LTE TDD
Example	:SOUR:FREQ:CHAN:BAND BAND37
Initial S/W Revision	A.11.50

BAND 38

Selects BAND 38 as the band for the current step.

Key Path	Source, Frequency, Radio Setup, Radio Standard, LTE TDD
Example	:SOUR:FREQ:CHAN:BAND BAND38
Initial S/W Revision	A.11.50

BAND 39

Selects BAND 39 as the band for the current step.

Key Path	Source, Frequency, Radio Setup, Radio Standard, LTE TDD
Example	:SOUR:FREQ:CHAN:BAND BAND39
Initial S/W Revision	A.11.50

BAND 40

Selects BAND 40 as the band for the current step.

Key Path	Source, Frequency, Radio Setup, Radio Standard, LTE TDD
Example	:SOUR:FREQ:CHAN:BAND BAND40
Initial S/W Revision	A.11.50

BAND 41

Selects BAND 41 as the band for the current step.

Key Path	Source, Frequency, Radio Setup, Radio Standard, LTE TDD
Example	:SOUR:FREQ:CHAN:BAND BAND41
Initial S/W Revision	A.11.50

BAND 42

Selects BAND 42 as the band for the current step.

Key Path	Source, Frequency, Radio Setup, Radio Standard, LTE TDD
Example	:SOUR:FREQ:CHAN:BAND BAND42
Initial S/W Revision	A.11.50

BAND 43

Selects BAND 43 as the band for the current step.

Key Path	Source, Frequency, Radio Setup, Radio Standard, LTE TDD
Example	:SOUR:FREQ:CHAN:BAND BAND43
Initial S/W Revision	A.11.50

BAND 44

Selects BAND 44 as the band for the current step.

Key Path	Source, List Sequencer, List Sequencer Setup, Radio Setup, Radio Standard, LTE TDD
Initial S/W Revision	A.14.00

TDSCDMA

Sets TDSCDMA as the radio standard for use and accesses the TDSCDMA specific channel band sub-menus..

Key Path	Source, Frequency, Radio Setup, Radio Standard
Initial S/W Revision	A.11.50

BAND A

Selects BAND A as the band for the current step.

Key Path	Source, Frequency, Radio Setup, Radio Standard, TDSCDMA
Example	:SOUR:FREQ:CHAN:BAND BANDA
Initial S/W Revision	A.11.50

BAND B

Selects BAND B as the band for the current step.

Key Path	Source, Frequency, Radio Setup, Radio Standard, TDSCDMA
Example	:SOUR:FREQ:CHAN:BAND BANDB
Initial S/W Revision	A.11.50

BAND C

Selects BAND C as the band for the current step.

Key Path	Source, Frequency, Radio Setup, Radio Standard, TDSCDMA
Example	:SOUR:FREQ:CHAN:BAND BANDC
Initial S/W Revision	A.11.50

BAND D

Selects BAND D as the band for the current step.

Key Path	Source, Frequency, Radio Setup, Radio Standard, TDSCDMA
Example	:SOUR:FREQ:CHAN:BAND BANDD
Initial S/W Revision	A.11.50

BAND E

Selects BAND E as the band for the current step.

Key Path	Source, Frequency, Radio Setup, Radio Standard, TDSCDMA
----------	---

Example	:SOUR:FREQ:CHAN:BAND BANDE
Initial S/W Revision	A.11.50

BAND F

Selects BAND F as the band for the current step.

Key Path	Source, Frequency, Radio Setup, Radio Standard, TDSCDMA
Example	:SOUR:FREQ:CHAN:BAND BANDF
Initial S/W Revision	A.11.50

Radio Band Link

Allows you to specify the radio band link direction for the steps within the list sequence. The link is used in conjunction with the channel band and channel number to determine the output frequency.

When set to “Uplink”, the source will calculate the uplink frequency according to an uplink formula together with selected channel band and channel number. When set to “Downlink”, the source will calculate the downlink frequency according to a downlink formula together with selected channel band and channel number.

Key Path	Source, List Sequencer, List Sequencer Setup, Radio Setup
Remote Command	:SOURce:LIST:STEP [1] 2 3...1000:SETup:RADio:BAND:LINK DOWN UP :SOURce:LIST:STEP [1] 2 3...1000:SETup:RADio:BAND:LINK?
Example	:SOUR:LIST:STEP2:SET:RAD:BAND:LINK UP :SOUR:LIST:STEP2:SET:RAD:BAND:LINK?
Notes	SCPI is supported after A.09.40
Preset	DOWN
Range	DOWN UP
Initial S/W Revision	A.05.00

Channel

Allows you to specify the frequency of the current step via a channel number.

Key Path	Source, List Sequencer, List Sequencer Setup
Remote Command	:SOURce:LIST:STEP [1] 2 3...1000:SETup:CNFRrequency <double> :SOURce:LIST:STEP [1] 2 3...1000:SETup:CNFRrequency?
Example	:SOUR:LIST:STEP2:SET:CNFR 124 :SOUR:LIST:STEP2:SET:CNFR?
Notes	SCPI is supported after A.09.40.

	This SCPI is used to setup channel number or frequency setting, according to current Radio Band setting. If Radio Band is "NONE", then it's frequency. If Radio Band is not "NONE", then it's channel number.
Couplings	The channel number is coupled to the step frequency value. When the step frequency value is changed, the channel number will increase or decrease to match the new step frequency. If the step frequency is not at an exact match for a channel number, the nearest channel number is displayed, along with a greater than, or less than sign to indicate the frequency is above or below the channel number.
Preset	1
Min	0 (Please refer to for valid ranges.)
Max	10838 (Please refer to for valid ranges.)
Initial S/W Revision	A.05.00

Frequency

Allows you to specify a frequency value for the current step.

Key Path	Source, List Sequencer, List Sequencer Setup
Remote Command	:SOURce:LIST:STEP[1] 2 3...1000:SETup:CNFRfrequency <double> :SOURce:LIST:STEP[1] 2 3...1000:SETup:CNFRfrequency?
Example	:SOUR:LIST:STEP2:SET:CNFR 1GHz :SOUR:LIST:STEP2:SET:CNFR?
Notes	SCPI is supported after A.09.40. This SCPI is used to setup channel number or frequency setting, according to current Radio Band setting. If Radio Band is "NONE", then it's frequency. If Radio Band is not "NONE", then it's channel number.
Couplings	The frequency value is coupled to the channel band and number for the step, such that updates to the radio band and channel number will update the frequency value to the corresponding absolute frequency. The reverse is also true, changing the frequency value causes the value of the channel number to be updated.
Preset	1.00 GHz
Min	10.00 MHz
Max	Hardware Dependant: Option 503 = 3.6 GHz Option 504 = 3.9 GHz Option 506 = 6.00 GHz
Initial S/W Revision	A.05.00

Power

Allows you to specify a power value for the current step.

Key Path	Source, List Sequencer, List Sequencer Setup
Remote Command	:SOURce:LIST:STEP[1] 2 3...1000:SETup:AMPLitude <double> :SOURce:LIST:STEP[1] 2 3...1000:SETup:AMPLitude?
Example	:SOUR:LIST:STEP2:SET:AMPL -50dBm :SOUR:LIST:STEP2:SET:AMPL?
Notes	SCPI is supported after A.09.40
Notes	<p>Amplitude corrections can be specified for use with the source. In the event of amplitude corrections being applied, the valid ranges for the RF power do not change dependant on the current amplitude correction setting. Instead, if the combination of RF power + amplitude correction is higher or lower than the source output range, the Source Unleveled bit is set and the “Source Unleveled” indicator will appear on status panel to indicate that the source cannot maintain the output power that has been requested.</p> <p>The multiport adapter RFIO TX ports and GPS ports cannot ensure power accuracy when power setting is lower than -130dBm, this power setting value is defined by the sum of RF Power setting and related amplitude correction value. But user settable value could be lower than this limit. When application detected there exists power setting lower than -130dBm on MPA RFIO TX ports, then popup warning message . When application detected there exists power setting lower than -130dBm on MPA GPS ports, then popup warning message . These are only warning messages, and check is performed when RF is ON.</p>
Notes	The Min and Max value here defined UI settable amplitude range. This range is larger than actual amplitude range with level accuracy defined in spec.
Dependencies	The RF power is dependent on the RF output port and frequency, such that the current frequency and selected output port determine the valid range of power values.
Preset	-100 dBm
Min	The range of values depends on the current frequency and selected RF output port. Please refer to "RF Power" on page 1228 and the table RF Power Range for the valid ranges.
Max	The range of values depends on the current frequency and selected RF output port. Please refer to "RF Power" on page 1228 and the table RF Power Range for the valid ranges.
Initial S/W Revision	A.05.00

Waveform

Allows you access to the sub-menus for selecting the waveform to be played back during the current step. Pressing this key also changes the central display area to show the Waveform File Selection view.

Key Path	Source, List Sequencer, List Sequencer Setup
Remote Command	:SOURce:LIST:STEP[1] 2 3...1000:SETup:WAVEform <string> :SOURce:LIST:STEP[1] 2 3...1000:SETup:WAVEform?
Example	:SOUR:LIST:STEP2:SET:WAV "CW" :SOUR:LIST:STEP2:SET:WAV?
Notes	SCPI is supported after A.09.40
Remote Command Notes	String type, takes “Off” “CW” “Cont” “waveform name”

11 FM Stereo Measurement Source

Preset	CW
Range	Waveform Continue Previous CW Off
Initial S/W Revision	A.05.00

CW

Sets the current step to output a CW tone.

Key Path	Source, List Sequencer, List Sequencer Setup, Waveform
Example	:SOUR:LIST:STEP2:SET:WAV "CW"
Notes	SCPI is supported after A.09.40
Initial S/W Revision	A.05.00

Selected Waveform

Inserts the currently selected waveform in the waveform selection view as the waveform for playback during the current step.

Key Path	Source, List Sequencer, List Sequencer Setup, Waveform
Example	:SOUR:LIST:STEP2:SET:WAV "waveform name"
Notes	SCPI is supported after A.09.40 If the selected waveform contains header (which contains ARB play parameters), source list sequence will automatically apply header settings of the selected waveform in that step.
Initial S/W Revision	A.05.00

Continue Previous

Sets the current step to continue with playback of the waveform from the previous step. When continuing the previous waveform, the ARB playback will not pause while the source retunes to the new frequency or amplitude that may be defined for the new step.

Key Path	Source, List Sequencer, List Sequencer Setup, Waveform
Example	:SOUR:LIST:STEP2:SET:WAV "Cont"
Notes	SCPI is supported after A.09.40
Initial S/W Revision	A.05.00

Off

Disable RF output of the current step.

Key Path	Source, List Sequencer, List Sequencer Setup, Waveform
Example	:SOUR:LIST:STEP2:SET:WAV "Off"
Notes	SCPI is supported after A.09.40
Initial S/W Revision	A.05.00

Segments on Hard Disk

Allows you access to the sub-menus for loading waveform segments from the hard disk into ARB memory. The default directory is: D: varb.

Pressing this key changes the current view to the Waveform Management View.

Key Path	Source, Modulation Setup, ARB, Select Waveform
Initial S/W Revision	A.05.00

Load Segment To ARB Memory

Allows you to load the selected file into ARB memory. On the front panel you select the file for loading to the ARB memory by highlighting the desired file in the list. Using the SCPI command, you specify the file name on the HDD.

“NVWFM” (none-volatile storage) MSUS (Mass Storage Unit Specifier) is supported in the memory subsystem because the ARB memory cannot be accessed directly. Therefore, files must be downloaded to the instrument hard disk and then loaded into the ARB memory. “NVWFM” MSUS will be mapped to the default directory D: VARB. The SCPI command supports using either “NVWFM” MSUS or specifying a full path. For more information, see [Memory Subsystem \(Remote Command Only\)](#).

If a file of the same name already exists within ARB memory, it is overwritten. If you wish to load two segments of the same name, you must rename one of the segments before loading it into ARB memory. To rename a segment, you can either use Windows File Explorer, or the :MMEMory:COPY command.

NOTE: When a waveform file is loaded to ARB memory, burst timing adjustments are made automatically, based on whether or not a Multiport Adapter is connected to the test set and powered on. If the connection/power status of the Multiport Adapter is changed after a waveform file has been loaded, it needs to be loaded again.

Key Path	Source, Modulation Setup, ARB, Select Waveform, Segments on Hard Disk
Remote Command	:SOURce:RADio:ARB:LOAD <string>
Example	:SOUR:RAD:ARB:LOAD "D: VARB\testwaveform.bin" or :SOUR:RAD:ARB:LOAD "NVWFM:testwaveform.bin"
Notes	Because loading the file involves a delay of unpredictable length, this command should be followed by the query *OPC?, which holds off subsequent commands until the loading operating is complete. <string> – specifies the path name of the file to load from the HDD into ARB memory. It could be a <full path + filename>, or <"NVWFM" MSUS + colon + filename>.

When in Sequence Analyzer mode, and Include Source is Yes, an attempt to load a file to ARB memory will be rejected with an error.

When Include Source is No and if there is insufficient free ARB memory to load the selected waveform, an error is generated. .

If you specify a file over SCPI, but the file is not at the specified location, an error is generated.

If you try to load a waveform file but the file contains less than 500 IQ samples, an error is generated.

If you try to load a Signal Studio waveform "*.wfm" which contains invalid waveform header, an error is generated.

If the ARB is ON when you load a file to ARB memory or delete a file from ARB memory, the playing waveform segment may not keep phase continuity during the ARB memory operation. The waveform will be replayed after the ARB operation is finished.

ARB can be loaded into ARB memory even required licenses do not present on the instrument. In this case, a GUI only warning message -800, "Operation complete; Loaded <filename> successfully, but no license <required licenses> installed". User can install required licenses according to <required licenses> string to license it, or multi-pack license it.

Initial S/W Revision A.05.00

Load All To ARB Memory

Allows you to load all the segment files within the currently selected directory into ARB memory. If a file of the same name already exists within ARB memory, it is overwritten. If you wish to load two segments of the same name, you must rename one of the segments before loading it into ARB memory. To rename a segment, you can either use Windows File Explorer, or the :MEMory:COpy command.

NOTE: When a waveform file is loaded to ARB memory, burst timing adjustments are made automatically, based on whether or not a Multiport Adapter is connected to the test set and powered on. If the connection/power status of the Multiport Adapter is changed after a waveform file has been loaded, it needs to be loaded again.

Key Path Source, Modulation Setup, ARB, Select Waveform, Segments on Hard Disk

Remote Command :SOURce:RADio:ARB:LOAD:ALL <string>

Example :SOUR:RAD:ARB:LOAD:ALL "D: varb"

Notes

<string> - specifies the directory on the HDD to load the files into ARB memory from.

When in Sequence Analyzer mode, and Include Source is Yes, an attempt to load all files from a directory to ARB memory is rejected with an error.

When Include Source is No and there is insufficient free ARB memory to load all the waveforms, when the ARB memory is full, the copy ceases, and an error is generated.

If you specify a directory over SCPI, but the directory does not exist, an error is generated.

If the ARB is ON, a user then loads or deletes file to ARB memory, the playing waveform segment may not keep phase continuity during the ARB memory operation. The waveform will be replayed after the ARB operation is finished.

Initial S/W Revision A.05.00

Change Directory...

Allows you to change the currently selected directory on the hard disk. Pressing this key opens a standard windows change directory dialog allowing you to select the new directory of interest.

The current directory is used for manually loading waveform segments into ARB memory for playback, and as a search location for waveform segments that are required to be loaded into ARB memory for playback of a waveform sequence or a list sequence.

Key Path	Source, Modulation Setup, ARB, Select Waveform, Segments on Hard Disk
Notes	No remote command, SCPI front panel only.
Initial S/W Revision	A.05.00

Default Directory...

Allows you to change the default directory. It is used as a search location for waveform segments that are required to be loaded into ARB memory for playback of a waveform sequence, and as a search location for selecting waveforms using SCPI.

Key Path	Source, Modulation Setup, ARB, Select Waveform, Segments on Hard Disk
Remote Command	:SOURce:RADio:ARB:DEFault:DIRectory <string> :SOURce:RADio:ARB: DEFault:DIRectory?
Example	:SOUR:RAD:ARB:DEF:DIR "D:\ArbFiles" :SOUR:RAD:ARB:DEF:DIR?
State Saved	Persistent, survives a power cycle and a preset but not saved in the instrument state
Initial S/W Revision	A.05.00

Segments in ARB Memory

Allows you access to the sub-menus for managing the files within ARB memory.

Key Path	Source, Modulation Setup, ARB, Select Waveform
Initial S/W Revision	A.05.00

Delete Segment From ARB Mem

Allows you to remove a segment from ARB playback memory.

Key Path	Source, Modulation Setup, ARB, Select Waveform, Segments in ARB Memory
Remote Command	:SOURce:RADio:ARB:DELeTe <string>
Example	:SOUR:RAD:ARB:DEL "testwaveform.bin"
Notes	<string> - specifies the waveform to be deleted from the ARB playback memory. When in Sequence Analyzer mode and Include Source is Yes, an attempt to delete a file from ARB

memory is rejected with an error.

When Include Source is No and you specify a file that does not exist within ARB memory, an error is generated.

It is possible to delete files from within the ARB memory when the ARB is ON. However, if you attempt to delete the file that is currently playing an error is generated.

It is possible to delete a file from within the ARB memory when the sequencer state is ON and the file is not being used by the List Sequencer. If you attempt to delete a file which is being used by the list sequencer, an error is generated.

When sequencer state is On, even if ARB state is On, the selected waveform will not be played. In this case, if the selected waveform is not used in List Sequence, it can be deleted and the ARB state is turned Off.

If the ARB is ON and you load a file to ARB memory or delete a file from ARB memory, the playing waveform segment may not keep phase continuity during the ARB memory operation. The waveform will be replayed after the ARB operation is finished.

Initial S/W Revision A.05.00

Delete All From ARB Memory

Allows you to remove all segments from ARB playback memory.

Key Path Source, Modulation Setup, ARB, Select Waveform, Segments in ARB Memory

Remote Command :SOURce:RADio:ARB:DELeTe:ALL

Example :SOUR:RAD:ARB:DELeTe:ALL

Notes When in Sequence Analyzer mode and Include Source is Yes, an attempt to delete all files from ARB memory is rejected with an error.

When Include Source is No and you attempt to delete all files from ARB memory when the ARB is currently playing a file, all files except the one playing are deleted and an error is generated.

If you attempt to delete all files from ARB memory when there are waveform files used in "[List Sequencer](#)" on page 1306 and "[Sequencer](#)" on page 1307 state is ON, all files except the files currently being used in list sequencer are deleted, and an error is generated.

If the ARB is ON and you load a file to ARB memory or delete a file from ARB memory, the playing waveform segment may not keep phase continuity during the ARB memory operation. The waveform will be replayed after the ARB operation is finished.

Initial S/W Revision A.05.00

Segments on Hard Disk

This key functions the same as "[Segments on Hard Disk](#)" on page 1333.

Key Path Source, List Sequencer, List Sequencer Setup, Waveform

Initial S/W Revision Prior to A.09.00

Load Segment To ARB Memory

This key functions the same as ["Load Segment To ARB Memory" on page 1333](#).

Key Path	Source, List Sequencer, List Sequencer Setup, Waveform, Segment on Hard Drive
Initial S/W Revision	Prior to A.09.00

Load All To ARB Memory

This key functions the same as ["Load All To ARB Memory" on page 1334](#).

Key Path	Source, List Sequencer, List Sequencer Setup, Waveform, Segment on Hard Drive
Initial S/W Revision	Prior to A.09.00

Change Directory ...

This key functions the same as ["Change Directory..." on page 1335](#).

Key Path	Source, List Sequencer, List Sequencer Setup, Waveform, Segment on Hard Drive
Initial S/W Revision	Prior to A.09.00

Default Directory ...

This key functions the same as ["Default Directory..." on page 1335](#)

Key Path	Source, List Sequencer, List Sequencer Setup, Waveform, Segment on Hard Drive
Initial S/W Revision	Prior to A.09.00

Segments in ARB Memory

This key functions the same as ["Segments in ARB Memory" on page 1335](#).

Key Path	Source, List Sequencer, List Sequencer Setup, Waveform, Segments in ARB Memory
Initial S/W Revision	Prior to A.09.00

Delete Segment From ARB Memory

This key functions the same as ["Delete Segment From ARB Mem" on page 1335](#).

Key Path	Source, List Sequencer, List Sequencer Setup, Waveform, Segments in ARB Memory, Segment in ARB Memory
Initial S/W Revision	Prior to A.09.00

Delete All From ARB Memory

This key functions the same as "Delete All From ARB Memory" on page 1336.

Key Path	Source, List Sequencer, List Sequencer Setup, Waveform, Segments in ARB Memory, Segment in ARB Memory
Initial S/W Revision	Prior to A.09.00

Step Duration

Allows access to the sub-menus for setting up the duration of play for the current step.

The duration can be set to be either the number of times for the ARB file associated with the sequence to play, or a specific time value, or continuous. If the step is set to play a CW tone, the step duration cannot be set to a play count.

Key Path	Source, List Sequencer, List Sequencer Setup
Remote Command	:SOURce:LIST:STEP[1] 2 3...1000:SETup:DURation:TYPE TIME COUNT CONTInuous CABort :SOURce:LIST:STEP[1] 2 3...1000:SETup:DURation:TYPE?
Example	:SOUR:LIST:STEP2:SET:DUR:TYPE TIME :SOUR:LIST:STEP2:SET:DUR:TYPE?
Notes	SCPI is supported after A.09.40
Notes	If "Step Duration" is set to "Time" or "Play Count" for the last step, the last step of ARB keeps playing as if set to "Continuous", until the set "Time" has expired or until the "Play Count" setting is reached. However, you can query Error! Reference source not found. Source Sweeping Condition Message to find out if the current list sequence is complete or not.
Range	Time Play Count Continuous Continuous Abort
Initial S/W Revision	A.05.00

Time

Sets the duration of the current step to be a time value for the length of time the step will play. Pressing this key again opens another menu which allows you to set the time value for the step duration.

Key Path	Source, List Sequencer, List Sequencer Setup, Step Duration
Example	:SOUR:LIST:STEP2:SET:DUR:TYPE TIME
Notes	SCPI is supported after A.09.40
Initial S/W Revision	A.05.00

Duration Time

Allows you to specify the length of time the current step will play.

When Step Duration is **Continuous Abort** this parameter specifies the maximum duration that the waveform will continue to play after a step trigger is received before the transition to the next waveform will occur. Duration is limited to a maximum of 20 seconds.

If the Transition Time value is longer than the Step Duration Time, an error is generated when initiating a source list sequence. For source list sequence, transition time is included in the step duration length (not occupy additional time). If the Transition Time value is longer than the Step Duration Time, the real step duration length is extended to equal the transition time and cause a timing shift. This check is also described in section **Error! Reference source not found.** List Sequence Step Validation.

Key Path	Source, List Sequencer, List Sequencer Setup, Step Duration, Time
Remote Command	:SOURce:LIST:STEP[1] 2 3...1000:SETup:DURation:TCOUNT <double> :SOURce:LIST:STEP[1] 2 3...1000:SETup:DURation:TCOUNT?
Example	:SOUR:LIST:STEP2:SET:DUR:TCO 1s :SOUR:LIST:STEP2:SET:DUR:TCO?
Notes	SCPI is supported after A.09.40 This SCPI is reused by "Play Count", "Duration Time" and "Continuous Abort" according to current Duration Type setting is "Play Count" or "Duration Time" or "Continuous Abort". If current "Duration Type" is "Continuous", then popup error -221, "Settings conflict; Cannot accept time or count input when step duration type is Continuous on step #"
Notes	If "Duration Time" is set for the last step, the last step of ARB keeps playing as if set to "Continuous" after set time expires. However, you can query Source Sweeping Condition Message (:STAT:OPER:COND?) to find out if the current list sequence is complete or not.
Preset	1.00 ms
Min	100 μs
Max	1800 s
Initial S/W Revision	A.05.00

Play Count

Sets the duration of the current step to be an integer value for the number of times (play count) the ARB file is selected for playback during this step. For example, a 5 second ARB will be set to play 5 times during the step.

Key Path	Source, List Sequencer, List Sequencer Setup, Step Duration
Example	:SOUR:LIST:STEP2:SET:DUR:TYPE COUN
Notes	SCPI is supported after A.09.40 This key is unavailable and is grayed out if the current step is configured to CW tone rather than an ARB waveform.
Initial S/W Revision	A.05.00

Header Utilities

Allows access to the header utilities sub-menu. Pressing this key also causes the central display area to change to display the File Header Information view.

Key Path	Source, Modulation Setup, ARB
Dependencies	This key is only available if there is currently a waveform selected for playback. If no waveform is selected, the key is grayed out.
Initial S/W Revision	A.05.00

Continuous

Sets the current step to be played continuously until the next step starts. The waveform will always play completely before transitioning to the next step.

Key Path	Source, List Sequencer, List Sequencer Setup, Step Duration
Example	:SOUR:LIST:STEP2:SET:DUR:TYPE CONT
Notes	SCPI is supported after A.09.40
Initial S/W Revision	A.05.00

Output Trigger

Allows you to specify the trigger output for the current step. The trigger output signal is sent at the start of the step.

When select “On”, trigger event will occur on both Internal and External2 paths. Select “Off” will turn off trigger output.

Key Path	Source, List Sequencer, List Sequencer Setup
Remote Command	:SOURce:LIST:STEP[1] 2 3...1000:SETup:OUTPut:TRIGger ON OFF 1 0 :SOURce:LIST:STEP[1] 2 3...1000:SETup:OUTPut:TRIGger
Example	:SOUR:LIST:STEP2:SET:OUTP:TRIG ON :SOUR:LIST:STEP2:SET:OUTP:TRIG?
Notes	SCPI is supported after A.09.40
Preset	Off
Range	On Off
Initial S/W Revision	A.05.00

Step Configuration (Remote Command Only)

This SCPI command is used to configure the List Sequencer and is detailed in the table below. The command is defined such that you send one command per step, with the step number being specified as a subopcode of the SCPI command. Each command includes all the parameter settings for the step. As a step is setup, the values entered are run through several levels of validation.

Remote Command	:SOURce:LIST:STEP[1] 2 ... 4..1000:SETup IMMEDIATE INTernal KEY
-----------------------	---

```
BUS | EXTERNAL2, <time>, NONE | PGSM | EGSM | RGSM | DCS1800 | PCS1900
| TGSM810 | GSM450 | GSM480 | GSM700 | GSM850 | BANDI | BANDII |
BANDIII | BANDIV | BANDV | BANDVI | BANDVII | BANDVIII | BANDIX | BANDX
| BANDXI | BANDXII | BANDXIII | BANDXIV | BANDXIX | USCELL | USPCS |
JAPAN | KOREAN | NMT | IMT2K | UPPER | SECOND | PAMR400 | PAMR800 |
IMTEXT | PCS1DOT9G | AWS | US2DOT5G | PUBLIC | LOWER | NONE | BAND1 |
BAND2 | BAND3 | BAND4 | BAND5 | BAND6 | BAND7 | BAND8 | BAND10 | BAND11
| BAND12 | BAND13 | BAND14 | BAND17 | BAND18 | BAND19 | BAND20 | BAND21
| BAND24 | BAND25 | BAND26 | BAND33 | BAND34 | BAND35 | BAND36 | BAND37
| BAND38 | BAND39 | BAND40 | BAND41 | BAND42 | BAND43 | BANDA | BANDB |
BANDC | BANDD | BANDE | BANDF, DOWN | UP, <freq>, <ampl>, <string>,
TIME | COUNT | CONTinuous, <time>, ON | OFF | 1 | 0, [<int>],
:SOURce:LIST:STEP[1]|2|...|4..1000:SETup?
```

Example :SOUR:LIST:STEP1:SET INT, 1ms, PGSM, DOWN, 10, -25 dBm, "GSM_Test1.bin", TIME, 10ms, OFF, 255

Notes

The parameters are:

(There is a total of 11 items in each step, the following is a list of the items in the order they must appear in the remote command.)

1. Step Trigger **<enum>** – specifies the input trigger for the step. For details of the valid types of step trigger see ["Step Trigger" on page 1309](#).
 2. Transition Time **<time>** – specifies the transition time for the step in seconds. For details of the valid ranges for the transition time see ["Transition Time" on page 1311](#).
 3. Radio Band **<enum>** – specifies the radio band for the step. For details of the valid radio bands see ["Radio Setup" on page 1312](#).
 4. Radio Band Link **<enum>** – specifies the radio band link direction for the step. For details of the valid link types, see ["Radio Band Link" on page 1329](#).
 5. Frequency/Channel Number **<freq>/<chan num>** – specifies the frequency in Hz or the channel number for the step. The channel number and frequency are combined as one parameter that represents the frequency or channel number depending on the radio band setting. If the radio band is set to NONE, this value is interpreted as a frequency value in Hz. If the radio band is set to a valid band, this value is interpreted as a channel number. For details of the valid ranges for frequency and channel numbers, see ["Channel" on page 1329](#) and ["Frequency" on page 1330](#).
 6. Power **<ampl>** – specifies the output power for the step in dBm. For details of the valid ranges see ["Power" on page 1330](#).
 7. Waveform **<string>** – specifies the waveform for playback during the step. The step can output either a new ARB waveform, continue playback of the previous waveform, or output a CW tone. The options for specifying these are:
 - <filename> - plays the specified waveform from the start. The filename value is the name of the file within ARB playback memory, it does not include the windows path to the file on the HDD. If you enter a filename for a waveform that does not reside within ARB playback memory, an error is generated.
 - CONT – continues playback of the ARB file from the previous step
 - CW – outputs a CW tone
 - OFF – disable RF output
 8. Step Duration **<enum>** – specifies the duration of the step. The duration can be specified to be either time, or play count of the ARB file associated with the step, or continuous. If Waveform is set to "CW", this value cannot be set to Play Count and an error will be generated. If continuous is selected, the following Time or Count value is ignored. For further details of this setting, see ["Step](#)
-

	<p>Duration" on page 1338.</p> <p>9. Time or Count <time/int> – specifies time duration in seconds or play count of the ARB file associated with the step. For further details of this setting, including the valid ranges for the time or play count setting, "Time" on page 1338 and "Play Count" on page 1339.</p> <p>10. Output Trigger <Boolean> – specifies the output trigger for the step. For details of the ranges for this setting see "Output Trigger" on page 1340.</p>
Dependencies	<p>The range of subopcode values is 1 to 1000 and the value you enter is determined by the number of steps you have configured. For details see "Number of Steps" on page 1308.</p> <p>If you attempt to remotely set or query a subopcode that is out of range, an error is generated.</p>
Initial S/W Revision	A.05.00

Step Configuration of Step Trigger parameter list (Remote Command Only)

This SCPI command is to configure “Step Trigger” parameter array of the whole List Sequencer at one time. The number of array is same as step number defined in "**Number of Steps" on page 1308** Number of Steps. As a step is setup, the value entered run through several levels of validation.

Remote Command	<pre>:SOURce:LIST:SETup:INPut:TRIGger <enum>, <enum>, <enum>, ... :SOURce:LIST:SETup:INPut:TRIGger?</pre>
Example	<pre>:SOUR:LIST:SET:INP:TRIG IMM,INT,EXT2 :SOUR:LIST:SET:INP:TRIG?</pre>
Notes	<p>The command is to setup below parameter array of whole list sequence.</p> <p>Step Trigger <enum> – specifies the input trigger for the step. For details of the valid types of step trigger see "Step Trigger" on page 1309.</p> <p>If input parameter number exceeds the step number defined by "Number of Steps" on page 1308Number of Steps then generate error ", and only those parametes whose index number falls in number of steps will be updated.</p>
Remote Command Notes	IMMEDIATE INTERNAL KEY BUS EXTERNAL2
Dependencies	<p>The range is 1 to 1000 which is determined by the number of steps you have configured. For details see "Number of Steps" on page 1308.</p>
Initial S/W Revision	A.09.40

Step Configuration of Transition Time parameter list (Remote Command Only)

This SCPI command is to configure “Transition Time” parameter array of the whole List Sequencer at one time. The number of array is same as step number defined in "**Number of Steps" on page 1308** Number of Steps. As a step is setup, the value entered run through several levels of validation.

Remote Command	<pre>:SOURce:LIST:SETup:TRANSition:TIME <time>, <time>, <time>, ... :SOURce:LIST:SETup:TRANSition:TIME?</pre>
Example	<pre>:SOUR:LIST:SET:TRAN:TIME 1ms,1ms,1ms</pre>

	:SOUR:LIST:SET:TRAN:TIME?
Notes	The command is to setup below parameter array of whole list sequence. Transition Time <time> – specifies the transition time for the step in seconds. For details of the valid ranges for the transition time see "Transition Time" on page 1311 If input parameter number exceeds the step number defined by "Number of Steps" on page 1308 Number of Steps then generate error ", and only those parameters whose index number falls in number of steps will be updated.
Dependencies	The range is 1 to 1000 which is determined by the number of steps you have configured. For details see "Number of Steps" on page 1308 .
Initial S/W Revision	A.09.40

Step Configuration of Radio Band parameter list (Remote Command Only)

This SCPI command is to configure “Radio Band” parameter array of the whole List Sequencer at one time. The number of array is same as step number defined in ["Number of Steps" on page 1308](#) Number of Steps. As a step is setup, the value entered run through several levels of validation.

R	:SOURce:LIST:SETup:RADio:BAND <enum>, <enum>, <enum>, ...
e	:SOURce:LIST:SETup:RADio:BAND?
m	
o	
t	
e	
C	
o	
m	
m	
a	
n	
d	
E	:SOUR:LIST:SET:RAD:BAND PGSM, EGSM, RGSM
X	:SOUR:LIST:SET:RAD:BAND?
a	
m	
p	
l	
e	
N	The command is to setup below parameter array of whole list sequence.
O	Radio Band <enum> – specifies the radio band for the step. For details of the valid radio bands see "Radio Setup" on page 1312 .
t	If input parameter number exceeds the step number defined by "Number of Steps" on page 1308 Number of Steps then
e	generate error ", and only those parameters whose index number falls in number of steps will be updated.
s	
R	NONE PGSM EGSM RGSM DCS1800 PCS1900 TGSM810 GSM450 GSM480 GSM700 GSM850 BANDI BANDII BANDIII BANDI
e	V BANDV BANDVI BANDVII BANDVIII BANDIX BANDX BANDXI BANDXII BANDXIII BANDXIV BANDXIX USCELL USPCS JAPAN KO
m	REAN NMT IMT2K UPPER SECOND PAMR400 PAMR800 IMTEXT PCS1 DOT9G AWS US2DOT5G PUBLIC LOWER NONE BAND1
	BAND2 BAND3 BAND4 BAND5 BAND6 BAND7 BAND8 BAND10 BAND11 BAND12 BAND13 BAND14 BAND17 BAND18 BAND1

o 9|BAND20|BAND21|BAND24|BAND25|BAND26|BAND33|BAND34|BAND35|BAND36|BAND37|BAND38|BAND39|BAND40|BAN
t D41|BAND42|BAND43|BANDA|BANDB|BANDC|BANDD|BANDE|BANDF
e

C
o
m
m
a
n
d

N
o
t
e
s

D The range is 1 to 1000 which is determined by the number of steps you have configured. For details see "[Number of Steps](#)" on
e [page 1308](#).

p
e
n
d
e
n
c
i
e
s

I A.09.40

n
i
t
i
a
l

S
/
W

R
e
v
i
s
i
o
n

Step Configuration of Radio Band Link parameter list (Remote Command Only)

This SCPI command is to configure “Radio Band Link” parameter array of the whole List Sequencer at one time. The number of array is same as step number defined in ["Number of Steps" on page 1308](#) Number of Steps. As a step is setup, the value entered run through several levels of validation.

Remote Command	:SOURce:LIST:SETup:RADio:BAND:LINK <enum>, <enum>, <enum>, ... :SOURce:LIST:SETup:RADio:BAND:LINK?
Example	:SOUR:LIST:SET:RAD:BAND:LINK DOWN,UP,UP :SOUR:LIST:SET:RAD:BAND:LINK?
Notes	The command is to setup below parameter array of whole list sequence. Radio Band Link <enum> – specifies the radio band link direction for the step. For details of the valid link types, see "Radio Band Link" on page 1329 . If input parameter number exceeds the step number defined by "Number of Steps" on page 1308 Number of Steps then generate error ", and only those parametes whose index number falls in number of steps will be updated.
Remote Command Notes	DOWN UP
Dependencies	The range is 1 to 1000 which is determined by the number of steps you have configured. For details see "Number of Steps" on page 1308 .
Initial S/W Revision	A.09.40

Step Configuration of Frequency/Channel Number parameter list (Remote Command Only)

This SCPI command is to configure “Frequency” or “Channel Number” parameter array of the whole List Sequencer at one time. The number of array is same as step number defined in ["Number of Steps" on page 1308](#) Number of Steps. As a step is setup, the value entered run through several levels of validation.

Remote Command	:SOURce:LIST:SETup:CNFRequency <double>, <double>, <double>, ... :SOURce:LIST:SETup:CNFRequency?
Example	:SOUR:LIST:SET:CNFR 1GHz,100MHz,100MHz :SOUR:LIST:SET:CNFR? SOUR:LIST:SET:CNFR 124,124,124 :SOUR:LIST:SET:CNFR?
Notes	The command is to setup below parameter array of whole list sequence. Frequency/Channel Number <freq>/<chan num> – specifies the frequency in Hz or the channel number for the step. The channel number and frequency are combined as one parameter that represents the frequency or channel number depending on the radio band setting. If the radio band is set to NONE, this value is interpreted as a frequency value in Hz. If the radio band is set to a valid band, this value is interpreted as a channel number. For details of the valid ranges for frequency and channel numbers, see "Channel" on page 1329 and "Frequency" on page 1330 This SCPI is used to setup/query channel number or frequency setting, according to current Radio Band setting of that step. If Radio Band is “NONE”, then it’s frequency. If Radio Band is not “NONE”, then it’s channel number If input parameter number exceeds the step number defined by "Number of Steps" on page 1308 Number of Steps then generate error ", and only those parametes whose index number falls in

	legal step number will be updated.
Dependencies	The range is 1 to 1000 which is determined by the number of steps you have configured. For details see "Number of Steps" on page 1308 .
Initial S/W Revision	A.09.40

Step Configuration of Power parameter list (Remote Command Only)

This SCPI command is to configure “Power” parameter array of the whole List Sequencer at one time. The number of array is same as step number defined in ["Number of Steps" on page 1308](#) Number of Steps. As a step is setup, the value entered run through several levels of validation.

Remote Command	:SOURce:LIST:SETup:AMPLitude <ampl>, <ampl>, <ampl>, ... :SOURce:LIST:SETup:AMPLitude?
Example	:SOUR:LIST:SET:AMPL -50dBm,-40dBm,-30dBm :SOUR:LIST:SET:AMPL?
Notes	The command is to setup below parameter array of whole list sequence. Power <ampl> – specifies the output power for the step in dBm. For details of the valid ranges see "Power" on page 1330 . If input parameter number exceeds the step number defined by "Number of Steps" on page 1308 Number of Steps then generate error ", and only those parametes whose index number falls in legal step number will be updated.
Dependencies	The range is 1 to 1000 which is determined by the number of steps you have configured. For details see "Number of Steps" on page 1308 .
Initial S/W Revision	A.09.40

Step Configuration of Waveform parameter list (Remote Command Only)

This SCPI command is to configure “Waveform” parameter array of the whole List Sequencer at one time. The number of array is same as step number defined in ["Number of Steps" on page 1308](#) Number of Steps. As a step is setup, the value entered run through several levels of validation.

Remote Command	:SOURce:LIST:SETup:WAVeform <string>, <string>, <string>, ... :SOURce:LIST:SETup:WAVeform?
Example	:SOUR:LIST:SET:WAV "CW","Off","CONT" :SOUR:LIST:SET:WAV?
Notes	The command is to setup below parameter array of whole list sequence. Waveform <string> – specifies the waveform for playback during the step. The step can output either a new ARB waveform, continue playback of the previous waveform, or output a CW tone. The options for specifying these are: <filename> - plays the specified waveform from the start. The filename value is the name of the file within ARB playback memory, it is does not include the windows path to the file on the HDD. If you enter a filename for a waveform that does not reside within ARB playback memory, an error is generated.

	<p>CONT – continues playback of the ARB file from the previous step</p> <p>CW – outputs a CW tone</p> <p>OFF – disable RF output</p> <p>If input parameter number exceeds the step number defined by "Number of Steps" on page 1308 Number of Steps then generate error ", and only those parametes whose index number falls in number of steps will be updated.</p>
Dependencies	The range is 1 to 1000 which is determined by the number of steps you have configured. For details see " Number of Steps " on page 1308.
Range	"filename" "CW" "Off" "CONT"
Initial S/W Revision	A.09.40

Step Configuration of Step Duration parameter list (Remote Command Only)

This SCPI command is to configure "Step Duration" parameter array of the whole List Sequencer at one time. The number of array is same as step number defined in "[Number of Steps](#)" on page 1308 Number of Steps. As a step is setup, the value entered run through several levels of validation.

Remote Command	<pre>:SOURce:LIST:SETup:DURation:TYPE <enum>, <enum>, <enum>, ... :SOURce:LIST:SETup:DURation:TYPE?</pre>
Example	<pre>:SOUR:LIST:SET:DUR:TYPE COUN,TIME,CONT :SOUR:LIST:SET:DUR:TYPE?</pre>
Notes	<p>The command is to setup below parameter array of whole list sequence.</p> <p>Step Duration <enum> – specifies the duration of the step. The duration can be specified to be either time, or play count of the ARB file associated with the step, or continuous. If Waveform is set to "CW", this value cannot be set to Play Count and an error will be generated. If continuous is selected, the following Time or Count value is ignored. For further details of this setting, see "Step Duration" on page 1338.</p> <p>If input parameter number exceeds the step number defined by "Number of Steps" on page 1308 Number of Steps then generate error ", and only those parametes whose index number falls in number of steps will be updated.</p>
Remote Command Notes	TIME COUNT CONTinuous
Dependencies	The range is 1 to 1000 which is determined by the number of steps you have configured. For details see " Number of Steps " on page 1308.
Initial S/W Revision	A.09.40

Step Configuration of Duration Time or Play Count parameter list (Remote Command Only)

This SCPI command is to configure "Duration Time" or "Play Count" parameter array of the whole List Sequencer at one time. The number of array is same as step number defined in "[Number of Steps](#)" on page 1308 Number of Steps. As a step is setup, the value entered run through several levels of validation.

Remote Command	<pre>:SOURce:LIST:SETup:TOCount <time/int>, <time/int>, <time/int>, ... :SOURce:LIST:SETup:TOCount?</pre>
-----------------------	---

Example	:SOUR:LIST:SET:TOC 1s,2s,3s :SOUR:LIST:SET:TOC? :SOUR:LIST:SET:TOC 5,6,7 :SOUR:LIST:SET:TOC?
Notes	The command is to setup below parameter array of whole list sequence. Time or Count <time/int> – specifies time duration in seconds or play count of the ARB file associated with the step. For further details of this setting, including the valid ranges for the time or play count setting, " Time " on page 1338 and " Play Count " on page 1339. If input parameter number exceeds the step number defined by " Number of Steps " on page 1308 Number of Steps then generate error ", and only those parametes whose index number falls in number of steps will be updated. If current " Step Duration " on page 1338 is "Continuous", then generate error -221,"Settings conflict;Cannot accept time or count input when step duration type is Continuous on step #"
Dependencies	The range is 1 to 1000 which is determined by the number of steps you have configured. For details see " Number of Steps " on page 1308.
Initial S/W Revision	A.09.40

Step Configuration of Output Trigger parameter list (Remote Command Only)

This SCPI command is to configure "Output Trigger" parameter array of the whole List Sequencer at one time. The number of array is same as step number defined in "[Number of Steps](#)" on page 1308 Number of Steps. As a step is setup, the value entered run through several levels of validation.

Remote Command	:SOURce:LIST:SETup:OUTPut:TRIGger <bool>, <bool>, <bool>, ... :SOURce:LIST:SETup:OUTPut:TRIGger ?
Example	:SOUR:LIST:SET:OUTP:TRIG ON,OFF,ON :SOUR:LIST:SET:OUTP:TRIG?
Notes	The command is to setup below parameter array of whole list sequence. Output Trigger <Boolean> – specifies the output trigger for the step. For details of the ranges for this setting see " Output Trigger " on page 1340. If input parameter number exceeds the step number defined by " Number of Steps " on page 1308 Number of Steps then generate error ", and only those parametes whose index number falls in legal step number will be updated.
Remote Command Notes	ON OFF 1 0
Dependencies	The range is 1 to 1000 which is determined by the number of steps you have configured. For details see " Number of Steps " on page 1308.
Initial S/W Revision	A.09.40

Clear List (Remote Command Only)

This command is the SCPI equivalent of the Clear List UI feature described in.

Remote Command	:SOURce:LIST:SETup:CLEar
Example	:SOUR:LIST:SETup:CLE
Initial S/W Revision	A.05.00

Trigger Type

Allows access to the sub-menu for selecting the output trigger type for the list sequencer globally. It cannot be changed between different sequence steps.

Key Path	Source, List Sequencer
Remote Command	:SOURce:LIST:TRIGgerout:TYPe BEGinningofstep DATamarker
Example	:SOUR:LIST:TRIG:TYP BEG :SOUR:LIST:TRIG:TYP?
Notes	SCPI is supported after A.14.00
Preset	BEGinningofstep
Range	BEGinningofstep DATamarker
Initial S/W Revision	A.14.00

BeginningOfStep

Sets the output trigger type as BeginningOfStep for the whole source sequence.

Key Path	Source, List Sequencer, Trigger Type
Example	:SOUR:LIST:TRIG:TYP BEG
Notes	SCPI is supported after A.14.00
Initial S/W Revision	A.14.00

DataMarker

Sets the output trigger type as DataMarker for the whole source sequence. When DataMarker is selected, which marker to route is also needed to be set.

Key Path	Source, List Sequencer, Trigger Type
Example	:SOUR:LIST:TRIG:TYP DAT
Notes	SCPI is supported after A.14.00
Initial S/W Revision	A.14.00

Marker 1

Sets the output trigger maker routing to Marker 1 for DataMarker in the whole source sequence.

Key Path	Source, List Sequencer, Trigger Type, DataMarker
Example	:SOUR:LIST:TRIG:TYPE:MARK M1
Notes	SCPI is supported after A.14.00
Initial S/W Revision	A.14.00

Marker 2

Sets the output trigger maker routing to Marker 2 for DataMarker in the whole source sequence.

Key Path	Source, List Sequencer, Trigger Type, DataMarker
Example	:SOUR:LIST:TRIG:TYPE:MARK M2
Notes	SCPI is supported after A.14.00
Initial S/W Revision	A.14.00

Marker 3

Sets the output trigger maker routing to Marker 3 for DataMarker in the whole source sequence.

Key Path	Source, List Sequencer, Trigger Type, DataMarker
Example	:SOUR:LIST:TRIG:TYPE:MARK M3
Notes	SCPI is supported after A.14.00
Initial S/W Revision	A.14.00

Marker 4

Sets the output trigger maker routing to Marker 4 for DataMarker in the whole source sequence.

Key Path	Source, List Sequencer, Trigger Type, DataMarker
Example	:SOUR:LIST:TRIG:TYPE:MARK M4
Notes	SCPI is supported after A.14.00
Initial S/W Revision	A.14.00

Manual Trigger Now

Pressing this key provides a software trigger event to the list sequencer. During execution of sequence, if the sequencer is halted on any step that has been configured with a “Manual” step trigger, then this key press will cause the sequencer to continue and execute the step.

Key Path	Source, List Sequencer
Remote Command	No remote command, front panel only.
Initial S/W Revision	A.05.00

Remote Software Trigger (Remote command Only)

During execution of a list sequence, the sequence will halt and wait at any step that has Step Trigger set to "Bus". Sending this command will trigger the step and continue the sequence.

Remote Command	:SOURce:LIST:TRIGger:INITiate[:IMMediate]
Example	:SOUR:LIST:TRIG:INIT
Initial S/W Revision	A.05.00

Query List Sequence Initiation Armed Status (Remote Command Only)

This is a blocking SCPI query to determine if source list sequence being initiated successfully or not.

Remote Command	:SOURce:LIST:INITiation:ARMed?
Example	:SOUR:LIST:INIT:ARMed?
Notes	The return data is in the following format: Integer
Notes	Query only SCPI. Returning "1" if list sequence has been initiated successfully, returning "0" if not. Once get "0", you can use :SYST:ERR? to query what error happened. Just like "*OPC?", this command can be blocked until event/status "IsSourceSweeping" happens, and then returns. Doing so can help user's script query armed status only once during the time interval of the initiation. As an ancillary SCPI of existing SCPI ":SOUR:LIST:TRIGger[:IMMediate]" (see "Initiate Sequence" on page 1307 Initiate Sequence), the right usage of this command is to use it after ":SOUR:LIST:TRIG". If not, this command will return "1" immediately.
Notes	There is an alias SCPI ":SOURce:LIST:TRIGger:INITiation:ARMed?".
Initial S/W Revision	A.09.40

Source Preset

Allows you to preset the source settings to their default values.

Key Path	Source
Remote Command	:SOURce:PRESet
Example	:SOUR:PRES

SPAN X Scale

Activates and displays the Span function menu.

Key Path	Front-panel key
Initial S/W Revision	Prior to A.02.00

Span

Adjusts the Span of the RF Spectrum window.

Key Path	SPAN X Scale
Remote Command	[:SENSe] :AM FM PM FMSTereo:FREQuency:SPAN <freq> [:SENSe] :AM FM PM FMSTereo:FREQuency:SPAN?
Example	AM:FREQ:SPAN 2.122kHz AM:FREQ:SPAN?
Notes	Adjusts the Span of the RF Spectrum window.
Dependencies	The maximum value will be the maximum IF BW available in the instrument. For example, if the instrument has the options B25, B40, and B1X installed, the maximum available IF BW of the instrument is 140 MHz. Thus, the maximum Span is not limited to 25 MHz but is 140 MHz.
Preset	= AM/FM/PM = 75 kHz = FMST = 500 kHz
State Saved	Saved in instrument state
Min	10 Hz
Default Unit	Hz
Initial S/W Revision	Prior to A.02.00
Modified at S/W Revision	A.14.00

Sweep/Control

Activates a menu and selects Sweep Time as the active function. Sweep time is used by the Demod Waveform window, but this key is available in any view.

Key Path	Front-panel key
Initial S/W Revision	Prior to A.02.00

Demod Wfm Sweep Time

Selects the display length for the Demod Waveform window. This is commonly set to two sample lengths.

Key Path	Sweep/Control
Remote Command	[:SENSe] :AM FM PM FMSTereo:DWSweep:TIME <time> [:SENSe] :AM FM PM FMSTereo:DWSweep:TIME?
Example	AM:DWSW:TIME 50 ms AM:DWSW:TIME?
Preset	2 ms
State Saved	Saved in Instrument State
Min	1 μ s
Max	2 s
Initial S/W Revision	Prior to A.02.00
Modified at S/W Revision	A.10.00

Demod Time

Selects the minimum length of data acquisition used in demodulation. Increasing the demodulation time will result in more accurate metrics; reducing the demodulation time will result in a faster measurement.

The measurement might require more data than specified by the demodulation time. If the resolution bandwidth is low in the spectrum windows, or the demod waveform sweep time is high, then the data required for the measurement might be higher than the demodulation time.

If measurement speed is critical, make sure to increase the resolution bandwidth and reduce the demodulation waveform sweep time.

The Auto rules for the demodulation time will give the nominal specification performance if the sweep time is set to display two cycles of data.

Key Path	Sweep/Control
Remote Command	[:SENSe] :AM FM PM FMSTereo:DEMod:TIME <time> [:SENSe] :AM FM PM FMSTereo:DEMod:TIME? [:SENSe] :AM FM PM:DEMod:TIME:AUTO OFF ON 0 1

	[:SENSe] :AM FM PM:DEMod:TIME:AUTO?
Example	AM:DEMod:TIME 50 ms AM:DEMod:TIME?
Notes	If current Demod Time, Span and Channel BW settings combinations result in a required acquisition length is excess of the capacity of the analyzer, 4MSamples, gives a warning message "Settings Alert; Acquisition truncated".
Couplings	When in Auto mode, the demodulation time depends on the demodulation waveform sweep time. Lower
Preset	= AM/FM/PM = 72 ms = FMST = 280 ms ON
State Saved	Saved in instrument state
Min	1 μ s
Max	100 s
Initial S/W Revision	Prior to A.02.00
Modified at S/W Revision	A.14.00

System

See "System" on page 182

Trace/Detector

There are no menus under this key in the Analog Demod mode.

Key Path	Front-panel key
Initial S/W Revision	Prior to A.02.00

Trigger

See ["Trigger" on page 238](#)

Free Run

See ["Free Run " on page 245](#)

Video

See ["Video \(IF Envelope\) " on page 246](#)

Trigger Level

See ["Trigger Level " on page 246](#)

Trig Slope

See ["Trig Slope " on page 247](#)

Trig Delay

See ["Trig Delay " on page 248](#)

External 1

See ["External 1 " on page 264](#)

Trigger Level

See ["Trigger Level " on page 264](#)

Trig Slope

See ["Trig Slope " on page 265](#)

Trig Delay

See ["Trig Delay " on page 251](#)

Zero Span Delay Comp

See ["Zero Span Delay Comp On/Off" on page 252](#)

External 2

See ["External 2 " on page 266](#)

Trigger Level

See ["Trigger Level " on page 266](#)

Trig Slope

See ["Trig Slope " on page 267](#)

Trig Delay

See "[Trig Delay](#) " on page 254

Zero Span Delay Comp

See "[Zero Span Delay Comp On/Off](#)" on page 254

RF Burst

See "[RF Burst](#) " on page 267

Absolute Trigger

See "[Absolute Trigger Level](#)" on page 268

Relative Trigger

See "[Relative Trigger Level](#)" on page 257

Trig Slope

See "[Trigger Slope](#) " on page 269

Trig Delay

See "[Trig Delay](#) " on page 258

Periodic Timer

See "[Periodic Timer \(Frame Trigger\)](#) " on page 259

Period

See "[Period](#) " on page 260

Offset

See "[Offset](#) " on page 261

Offset Adjust (Remote Command Only)

See "[Offset Adjust \(Remote Command Only\)](#)" on page 262

Reset Offset Display

See "[Reset Offset Display](#) " on page 263

Sync Source

See "[Sync Source](#) " on page 263

Off

See "[Off](#) " on page 264

External 1

See "External 1 " on page 264

Trigger Level

See "Trigger Level " on page 264

Trig Slope

See "Trig Slope " on page 265

External 2

See "External 2 " on page 266

Trigger Level

See "Trigger Level " on page 266

Trig Slope

See "Trig Slope " on page 267

RF Burst

See "RF Burst " on page 267

Absolute Trigger

See "Absolute Trigger Level" on page 268

Trig Slope

See "Trigger Slope " on page 269

Trig Delay

See "Trig Delay" on page 269

Auto/Holdoff

See "Auto/Holdoff " on page 270

Auto Trig

See "Auto Trig " on page 270

Trig Holdoff

See "Trig Holdoff " on page 271

User Preset

Accesses a menu that gives you the following three choices:

- User Preset – recalls a state previously saved using the Save User Preset function.
- User Preset All Modes – presets all of the modes in the analyzer
- Save User Preset– saves the current state for the current mode

NOTE

In products that run multiple instances of the X-Series Application, all instances use the same location to save User Preset state. So Save User Preset of one instance will overwrite the Save User Preset of another instance.

Key Path	Front-panel key
Backwards Compatibility Notes	<p>User Preset is actually loading a state, and in legacy analyzers, it was possible to load a state without affecting the trace data, limit lines or correction data. Similarly it was possible to do a User Preset without affecting the trace data, limit lines or correction data.</p> <p>In the X-Series, “state” always includes all of this data; so whenever state is loaded, or User Preset is executed, all of the traces, limit lines and corrections are affected. Although this differs from previous behavior, it is desirable behavior, and should not cause adverse issues for users.</p> <p>On ESA and PSA, User Preset affected the entire instrument’s state. In the X-Series, User Preset only recalls the state for the active mode. There is a User Preset file for each mode. User Preset can never cause a mode switch as it can in legacy analyzers. If you want to recall all modes to their user preset file state, you will need to do a User Preset after mode switching into each mode.</p> <p>User Preset recalls mode state which can now include data like traces; whereas on ESA and PSA, User Preset did not affect data.</p>
Initial S/W Revision	Prior to A.02.00

User Preset

User Preset sets the state of the currently active mode back to the state that was previously saved for this mode using the Save User Preset menu key or the SCPI command, SYST:PRES:USER:SAV. It not only recalls the Mode Preset settings, but it also recalls all of the mode persistent settings, and the Input/Output system setting that existed at the time Save User Preset was executed.

If a Save User Preset has not been done at any time, User Preset recalls the default user preset file for the currently active mode. The default user preset files are created if, at power-on, a mode detects there is no user preset file. There will never be a scenario when there is no user preset file to restore. For each mode, the default user preset state is the same state that would be saved if a Save User Preset is performed in each mode right after doing a Restore Mode Default and after a Restore Input/Output Defaults.

The User Preset function does the following:

- Aborts the currently running measurement.
- Sets the mode State to the values defined by Save User Preset.
- Makes the saved measurement for the currently running mode the active measurement.
- Brings up the saved menu for the power-on mode.

- Clears the input and output buffers.
- Sets the Status Byte to 0.

Key Path	User Preset
Remote Command	:SYSTem:PRESet:USER
Example	:SYST:PRES:USER:SAVE:SYST:PRES:USER
Notes	:SYST:PRES:USER:SAVE is used to save the current state as the user preset state. Clears all pending OPC bits. The Status Byte is set to 0. Pressing the User Preset front-panel key while already in the User Preset menu will cause the User Preset to get executed
Couplings	A user preset will cause the currently running measurement to be aborted and cause the saved measurement to be active. Recalling a User Preset file has the same issues that recalling a Save State file has. Some settings may need to be limited and therefore re-coupled, since the capabilities of the mode may have changes when the User Preset file was last saved.
Initial S/W Revision	Prior to A.02.00

User Preset All Modes

Recalls all of the User Preset files for each mode, switches to the power-on mode, and activates the saved measurement from the power-on mode User Preset file.

NOTE

When the instrument is secured, all of the user preset files are converted back to their default user preset files.

The User Preset function does the following:

- Aborts the currently running measurement.
- Switches the Mode to the power-on mode.
- Restores the User Preset files for each mode.
- Makes the saved measurement for the power-on mode the active measurement.
- Brings up the saved menu for the power-on mode.
- Clears the input and output buffers.
- Sets the Status Byte to 0.

Key Path	User Preset
Remote Command	:SYSTem:PRESet:USER:ALL
Example	:SYST:PRES:USER:SAVE:SYST:PRES:USER:ALL
Notes	Clears all pending OPC bits. The Status Byte is set to 0. :SYST:PRES:USER:SAVE is used to save the current state as the user preset state.
Couplings	A user preset will cause the currently running measurement to be aborted, cause a mode switch to the power-on mode, and cause the saved measurement to be active in the power-on mode.

Recalling a User Preset file has the same issues that recalling a Save State file has. Some settings may need to be limited and therefore re-coupled, since the capabilities of the mode may have changes when the User Preset file was last saved.

Initial S/W Revision Prior to A.02.00

Save User Preset

Saves the currently active mode and its State. You can recall this User Preset file by pressing the User Preset menu key or sending the SYST:PRES:USER remote command. This same state is also saved by the Save State function.

Key Path	User Preset
Remote Command	:SYSTem:PRESet:USER:SAVE
Example	:SYST:PRES:USER:SAVE
Notes	:SYST:PRES:SAVE creates the same file as if the user requested a *SAV or a MMEM:STOR:STAT, except User Preset Save does not allow the user to specify the filename or the location of the file.
Initial S/W Revision	Prior to A.02.00

View/Display (FM Stereo)

The primary view is called “MPX View” and displays RF Spectrum, MPX Demod Waveform, MPX Spectrum, and Metrics. This is the view seen after a Mode Preset. There are also six other views. Mono view displays Waveform, Spectrum, and Metrics of mono signal. Stereo view displays Waveform, Spectrum, and Metrics of stereo signal. Left view displays Waveform, Spectrum, and Metrics of the left-channel signal. Right view displays Waveform, Spectrum, and Metrics of right-channel signal. RDS/RBDS view displays the decoded RDS bits. Result Metrics Summary view displays all the results together in one view. The views can be selected from the View/Display menu.

These views are designed such that you can identify analog modulated carriers, determine whether the carrier is a commercial or other broadcast station, and analyze the modulating signal.

Key Path	Front-panel key
Remote Command	:DISPlay:FMSTereo:VIEW[:SElect] MPX MONO STEReo LEFT RIGHT RDS NRESults :DISPlay:FMSTereo:VIEW[:SElect]?
Example	:DISP:FMST:VIEW MPX selects MPX View for FM Stereo Demod measurement
Preset	MPX (Focus in RF Spectrum Window)
State Saved	Saved in instrument state
Initial S/W Revision	A.10.00

Display

The Display menu is common to most measurements, and is used for configuring items on the display. Some Display menu settings apply to all the measurements in a mode, and some only to the current measurement. Those under the System Display Settings key apply to all measurements in all modes.

Key Path	Display
Key Path	View/Display
Initial S/W Revision	Prior to A.02.00

Annotation

Turns on and off various parts of the display annotation. The annotation is divided up into four categories:

1. Meas Bar: This is the measurement bar at the top of the screen. It does not include the settings panel or the Active Function. Turning off the Meas Bar turns off the settings panel and the Active Function. When the Meas Bar is off, the graticule area expands to fill the area formerly occupied by the Meas Bar.
2. Screen Annotation: this is the annotation and annunciation around the graticule, including any annotation on lines (such as the display line, the threshold line, etc.) This does NOT include the marker number or the N dB result. When off, the graticule expands to fill the entire graticule area.
3. Trace annotation: these are the labels on the traces, showing their detector (or their math mode).

4. Active Function annotation: this is the active function display in the meas bar, and all of the active function values displayed on softkeys.

See the figure below. Each type of annotation can be turned on and off individually.

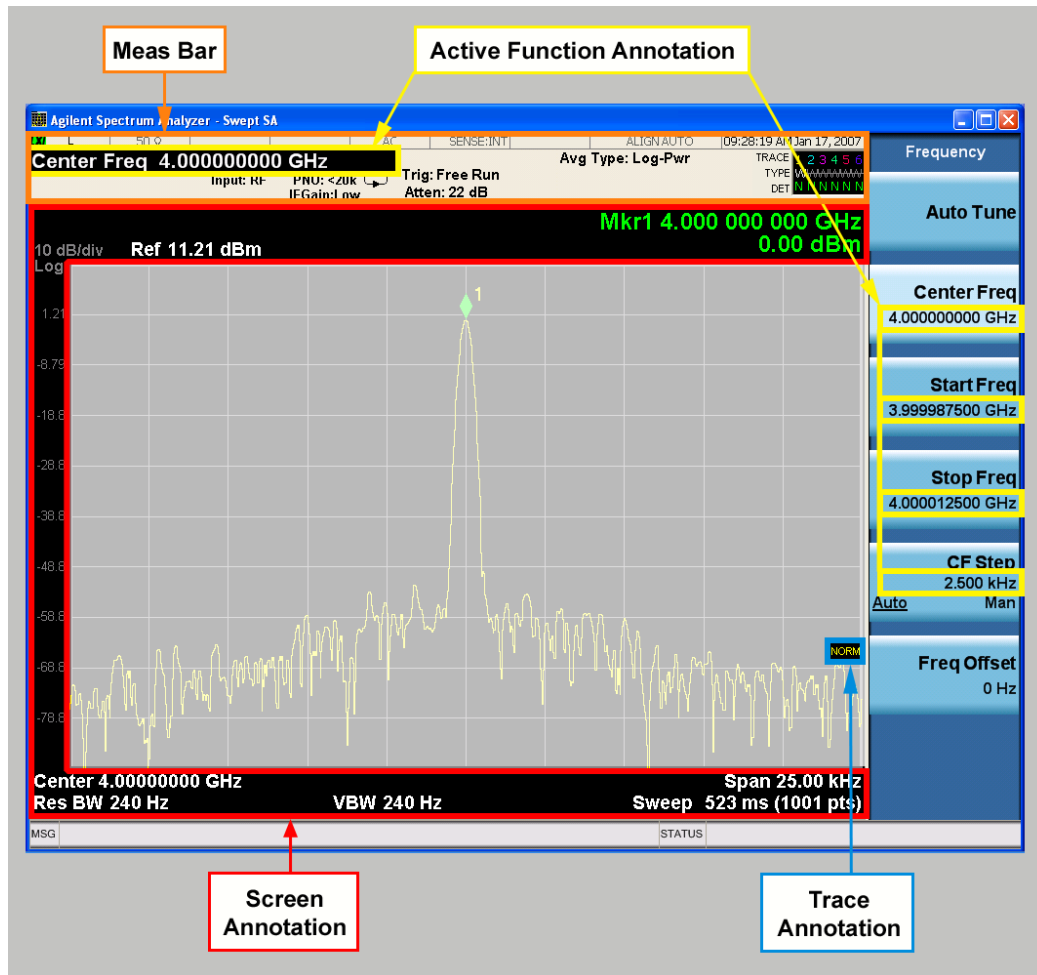

Key Path	View/Display, Display
Initial S/W Revision	Prior to A.02.00

Meas Bar On/Off

This function turns the Measurement Bar on and off, including the settings panel. When off, the graticule area expands to fill the area formerly occupied by the Measurement Bar.

Key Path	View/Display, Display, Annotation
Remote Command	:DISPlay:ANNotation:MBAR[:STATe] OFF ON 0 1 :DISPlay:ANNotation:MBAR[:STATe]?
Example	DISP:ANN:MBAR OFF

Dependencies	Grayed out and forced to OFF when System Display Settings, Annotation is set to Off.
Preset	On This should remain Off through a Preset when System DisplaySettings, Annotation is set to Off.
State Saved	Saved in instrument state.
Initial S/W Revision	Prior to A.02.00

Screen

This controls the display of the annunciation and annotation around the graticule, including any annotation on lines (such as the display line, the threshold line, etc.) and the y-axis annotation. This does NOT include marker annotation (or the N dB result). When off, the graticule expands to fill the entire graticule area, leaving only the 1.5% gap above the graticule as described in the Trace/Detector chapter.

Key Path	View/Display, Display, Annotation
Remote Command	:DISPlay:ANNotation:SCReen[:STATe] OFF ON 0 1 :DISPlay:ANNotation:SCReen[:STATe]?
Example	DISP:ANN:SCR OFF
Dependencies	Grayed-out and forced to OFF when System Display Settings, Annotation is set to Off.
Preset	On This should remain Off through a Preset when System DisplaySettings, Annotation is set to Off
State Saved	Saved in instrument state.
Initial S/W Revision	Prior to A.02.00

Active Function Values On/Off

Turns on and off the active function display in the Meas Bar, and all of the active function values displayed on the softkeys.

Note that all of the softkeys that have active functions have these numeric values blanked when this function is on. This is a security feature..

11 FM Stereo Measurement
View/Display (FM Stereo)

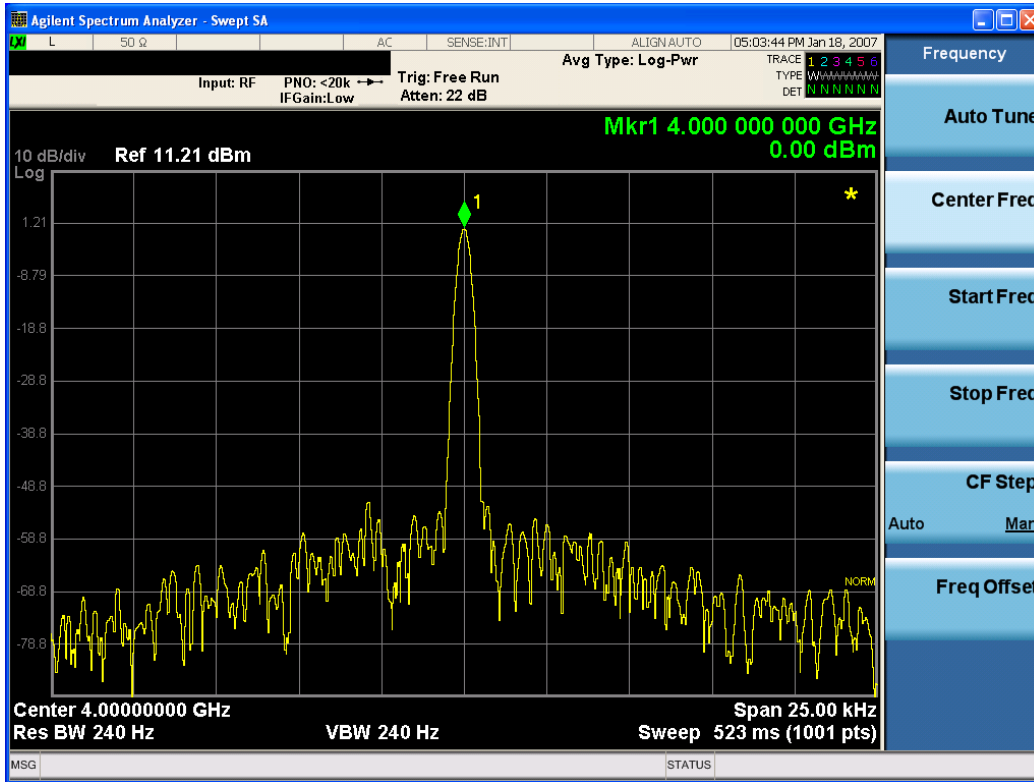

Key Path	View/Display, Display, Annotation
Remote Command	:DISPlay:ACTivefunc[:STATe] ON OFF 1 0 :DISPlay:ACTivefunc[:STATe]?
Example	DISP:ACT OFF
Dependencies	Grayed out and forced to OFF when System Display Settings, Annotation is set to Off.
Preset	On This should remain Off through a Preset when System DisplaySettings, Annotation is set to Off
State Saved	Saved in instrument state.
Initial S/W Revision	Prior to A.02.00

Title

Displays menu keys that enable you to change or clear a title on your display.

Key Path	View/Display, Display
Initial S/W Revision	Prior to A.02.00

Change Title

Writes a title into the "measurement name" field in the banner, for example, "Swept SA".

Press Change Title to enter a new title through the alpha editor. Press Enter or Return to complete the entry. Press ESC to cancel the entry and preserve your existing title.

The display title will replace the measurement name. It remains for this measurement until you press Change Title again, or you recall a state, or a Preset is performed. A title can also be cleared by pressing Title, Clear Title.

NOTE

Notice the inclusion of the <measurement> parameter in the command below. Because each measurement remembers the Display Title, the command must be qualified with the measurement name. For the Swept SA measurement this is not the case; no <measurement> parameter is used when changing the Display Title for the Swept SA measurement.

Key Path	View/Display, Display, Title
Mode	All
Remote Command	:DISPlay:<measurement>:ANNotation:TITLe:DATA <string> :DISPlay:<measurement>:ANNotation:TITLe:DATA?
Example	DISP:ANN:TITL:DATA "This Is My Title" This example is for the Swept SA measurement in the Spectrum Analyzer mode. The SANalyzer <measurement> name is not used. DISP:ACP:ANN:TITL:DATA "This Is My Title" This example is for Measurements other than Swept SA. Both set the title to: This Is My Title
Notes	Pressing this key cancels any active function. When a title is edited the previous title remains intact (it is not cleared) and the cursor goes at the end so that characters can be added or BKSP can be used to go back over previous characters.
Preset	No title (measurement name instead)
State Saved	Saved in instrument state.
Initial S/W Revision	Prior to A.02.00

Clear Title

Clears a title from the front-panel display. Once cleared, the title cannot be retrieved. After the title is cleared, the current Measurement Name replaces it in the title bar.

Key Path	View/Display, Display, Title
Example	The following commands clear the title and restore the measurement's original title: DISP:ANN:TITL:DATA "" This example is for the Swept SA measurement in the Spectrum Analyzer mode. The SANalyzer <measurement> name is not used. DISP:ACP:ANN:TITL:DATA "" This example is for ACP; in measurements other than Swept SA the measurement name is required.
Notes	Uses the :DISPlay:<measurement>:ANNotation:TITLe:DATA <string> command with an empty string (in the Swept SA, the <measurement> is omitted).
Preset	Performed on Preset.
Initial S/W Revision	Prior to A.02.00

Graticule

Pressing Graticule turns the display graticule On or Off. It also turns the graticule y-axis annotation on and off.

Key Path	View/Display, Display
Remote Command	:DISPlay:WINDow[1]:TRACe:GRATicule:GRID[:STATe] OFF ON 0 1 :DISPlay:WINDow[1]:TRACe:GRATicule:GRID[:STATe]?
Example	DISP:WIND:TRAC:GRAT:GRID OFF
Notes	The graticule is the set of horizontal and vertical lines that make up the grid/divisions for the x-axis and y-axis.
Preset	On
State Saved	Saved in instrument state
Initial S/W Revision	Prior to A.02.00

System Display Settings

These settings are "Mode Global" – they affect all modes and measurements and are reset only by Restore Misc Defaults or Restore System Defaults under System.

Key Path	View/Display, Display
Initial S/W Revision	Prior to A.02.00

Annotation Local Settings

This is a Mode Global override of the meas local annotation settings. When it is All Off, it forces ScreenAnnotation, Meas Bar, Trace, and Active Function Values settings to be OFF for all measurements in all modes. This provides the security based "annotation off" function of previous analyzers; hence it uses the legacy SCPI command.

When it is All Off, the Screen, Meas Bar, Trace, and Active Function Values keys under the Display, Annotation menu are grayed out and forced to Off. When Local Settings is selected, you are able to set the local annotation settings on a measurement by measurement basis.

Key Path	View/Display, Display, System Display Settings
Remote Command	:DISPlay:WINDow[1]:ANNotation[:ALL] OFF ON 0 1 :DISPlay:WINDow[1]:ANNotation[:ALL]?
Example	:DISP:WIND:ANN OFF
Preset	On (Set by Restore Misc Defaults)
State Saved	Not saved in instrument state.
Backwards Compatibility Notes	The WINDow parameter and optional subopcode is included for backwards compatibility but ignored – all windows are equally affected.
Initial S/W Revision	Prior to A.02.00

Themes

Accesses a menu of functions that enable you to choose the theme to be used when saving the screen image.

The **Themes** option is the same as the **Themes** option under the **Display** and **Page Setup** dialogs. It allows you to choose between themes to be used when saving the screen image.

Key Path	Save, Screen Image
Remote Command	:MMEMory:STORe:SCReen:THEMe TDColor TDMonochrome FCOLor FMONochrome :MMEMory:STORe:SCReen:THEMe?
Example	:MMEM:STOR:SCR:THEM TDM
Preset	3D Color; Is not part of Preset, but is reset by Restore Misc Defaults or Restore System Defaults All and survives subsequent running of the modes.
Readback	3D Color 3D Mono Flat Color Flat Mono
Backwards Compatibility Notes	In ESA and PSA we offer the choice of "Reverse Bitmap" or "Reverse Metafile" when saving screen images. This is much like the "Flat Color" theme available in X-Series. Also, if you selected Reverse Bitmap AND a black & white screen image, that would be much like "Flat Monochrome". In other words, each of the X-Series themes has a similar screen image type in ESA/PSA. But they are not identical.
Initial S/W Revision	Prior to A.02.00

3D Color

Selects a standard color theme with each object filled, shaded and colored as designed.

Key Path	Save, Screen Image, Themes
Example	MMEM:STOR:SCR:THEM TDC
Readback	3D Color
Initial S/W Revision	Prior to A.02.00

3D Monochrome

Selects a format that is like 3D color but shades of gray are used instead of colors.

Key Path	Save, Screen Image, Themes
Example	MMEM:STOR:SCR:THEM TDM
Readback	3D Mono
Initial S/W Revision	Prior to A.02.00

Flat Color

Selects a format that is best when the screen is to be printed on an ink printer.

Key Path	Save, Screen Image, Themes
Example	MMEM:STOR:SCR:THEM FCOL
Readback	Flat Color
Initial S/W Revision	Prior to A.02.00

Flat Monochrome

Selects a format that is like Flat Color. But only black is used (no colors, not even gray), and no fill.

Key Path	Save, Screen Image, Themes
Example	MMEM:STOR:SCR:THEM FMON
Readback	Flat Mono
Initial S/W Revision	Prior to A.02.00

MPX View

The MPX View displays RF Spectrum, Demod Waveform, AF Spectrum, and Metrics of the multiplex signal.

In general, there is little window-context sensitivity in the Analog Demod mode, that is, most of the variables have been designed so that they are unique to their window. The three variables that are window dependent are, Ref Value, Scale/Div, and Ref Position. These variables change to reflect the settings of the current window (the current window is always outlined in green).

The MPX View is shown below. For more information on the views, see ["RF Spectrum Window" on page 1070](#), ["Demod Waveform Window" on page 1070](#), ["AF Spectrum Window" on page 1071](#), or ["Metrics Window" on page 1071](#).

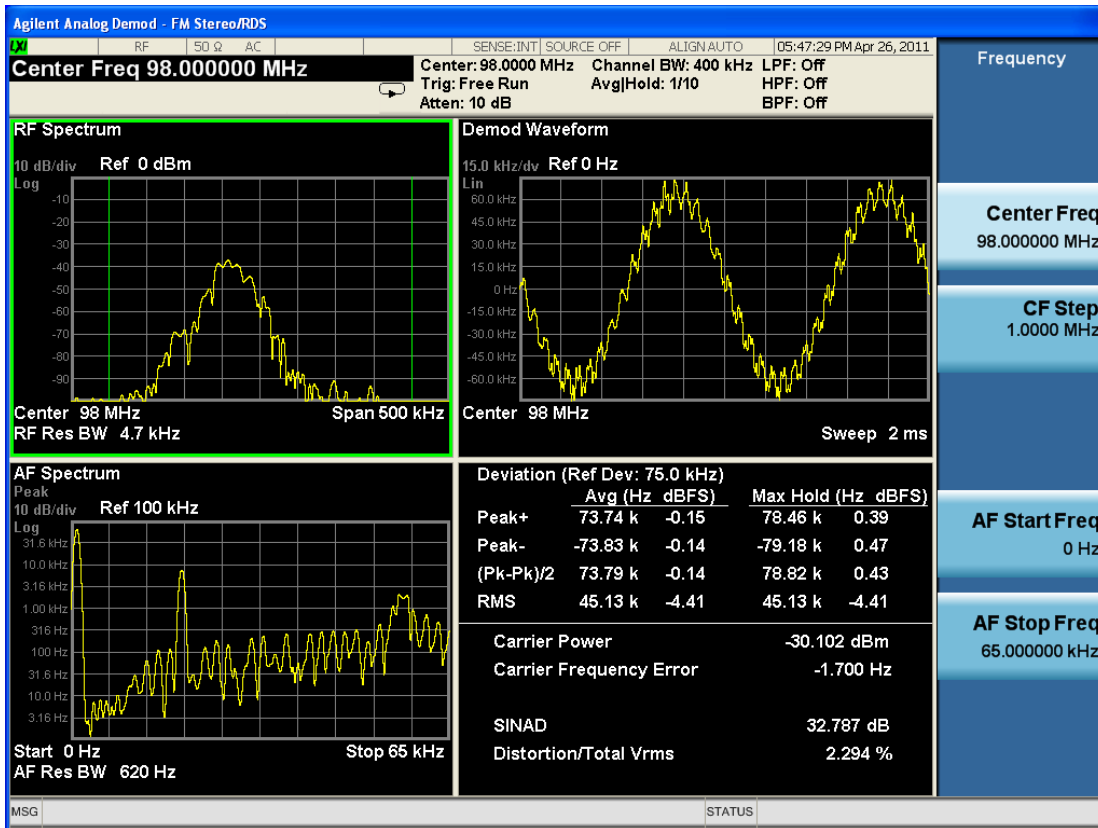

RF Spectrum Window

The RF Spectrum window shows a spectral display of the input RF signal with amplitude in the vertical Y axis and frequency in the horizontal X axis. The vertical axis is always scaled in dB, with units of dBm, with the Ref Value initially at the top of the vertical scale. This spectral display is basically identical to the Swept SA measurement's frequency display; however it is always taken using an FFT. Its span is restricted to 8 MHz. Zero span is not allowed.

The RF Spectrum window provides a convenient way to identify broadcast stations by placing the signal of interest at the center frequency using this window and listening to the instrument's speaker. Demodulation is always performed at the center frequency of the RF Spectrum window; this is regarded as the application's center frequency and is annotated in the Measurement Bar.

In the RF Spectrum window, two green vertical lines are shown centered around the center frequency, with spacing equal to the Channel BW. If the Channel BW is wider than the span, they are not seen.

The Center Frequency, Span, and RF Res BW are annotated at the bottom of the RF Spectrum Window. The Ref Value and Scale/Div are annotated above the graticule.

Demod Waveform Window

In the Demod Waveform window, the demodulated signal is displayed in the time domain (zero span) with time on the horizontal X axis, and deviation on the vertical Y axis.

In the Demod Waveform window the Y axis is linearly scaled in units of frequency (Hz). On a preset, the Ref Value is positioned in the center of the vertical scale.

Four traces are available in the Demod Waveform window. The Demod trace, in yellow, shows the current demodulation signal. The Demod Max trace, in cyan, shows the Max Hold value for each display point since the last restart and the Demod Min trace, in magenta, shows the Min Hold value for each display point since the last restart. The Demod Average trace, in green, shows the averaged demodulation signal. If Averaging is turned off, only the Demod trace is displayed.

The Sweep Time is annotated at the bottom of the Demod Waveform Window. The Ref Value and Scale/Div are annotated above the graticule.

Spectrum Window

In the Spectrum window, the demodulated signal is displayed in the frequency domain with frequency on the X axis and amplitude on the Y axis.

The vertical axis is always scaled in dB with the Ref Value initially at the top of the vertical scale. The Y-Axis Unit is Hz.

In this view you can observe the spectral components of the modulating signal. The preset Start Frequency of this window is 0 Hz. The AF Start Freq and AF Stop Freq are annotated at the bottom of the AF Spectrum Window, as is the AF Res BW.

The Ref Value and Scale/Div are annotated above the graticule.

It is only possible to show a spectrum to a maximum frequency of Channel BW / 2. For trace display points buckets beyond that frequency, the value 1.0E-50 is plotted and returned in queries.

Metrics Window

The metrics window displays measurement results..

If averaging is turned on, the column marked “Current” is relabeled “Average” and the results in that column are averaged over successive measurements until the Average/Hold number is reached. Then, if not in Single measurement mode, the measurement continues, exponentially averaging in successive results. The Max Hold column shows the Maximum value the un-averaged metric has attained since the last Restart. The Max Hold column is removed when averaging is turned off.

The window title is “FM Deviation”.

Key Path	View/Display
Initial S/W Revision	A.10.00

Mono (L+R) View

This view shows the Waveform, Spectrum, and the Metrics of the mono (L+R) signal.

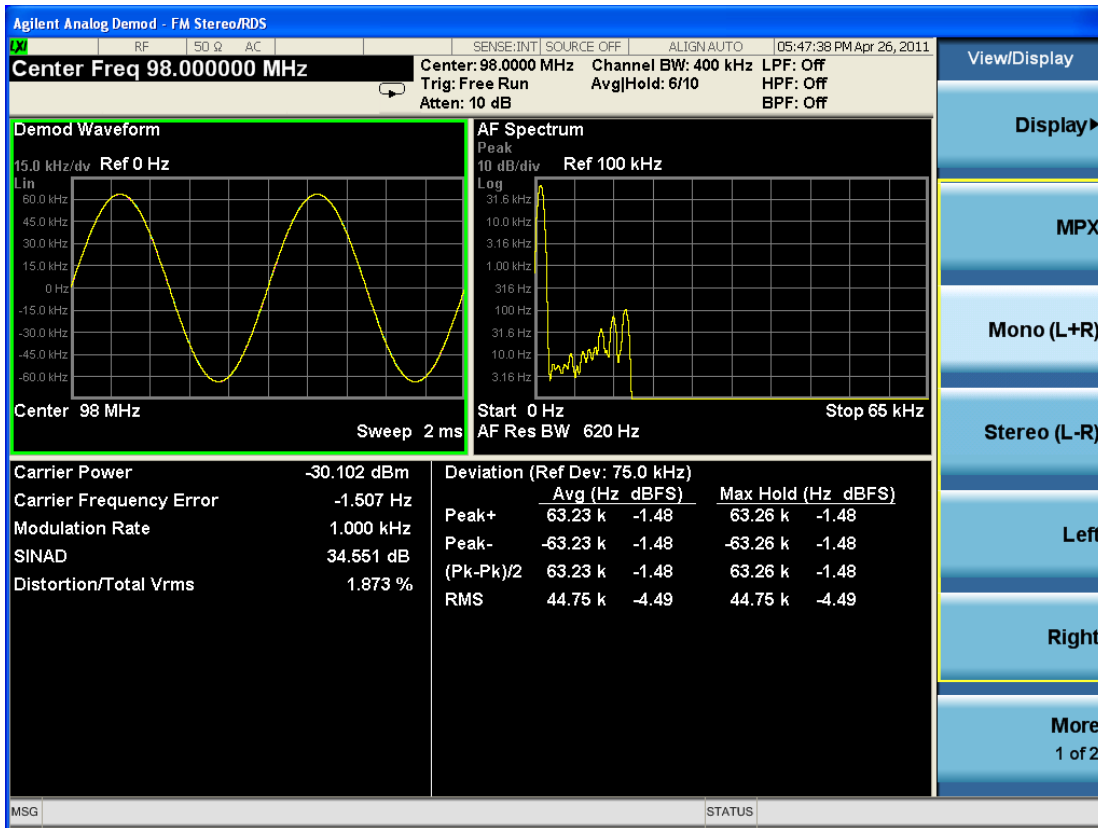

Key Path View/Display

Initial S/W Revision A.10.00

Stereo (L-R) View

This view shows the Waveform, Spectrum, and the Metrics of the stereo (L-R) signal.

11 FM Stereo Measurement
View/Display (FM Stereo)

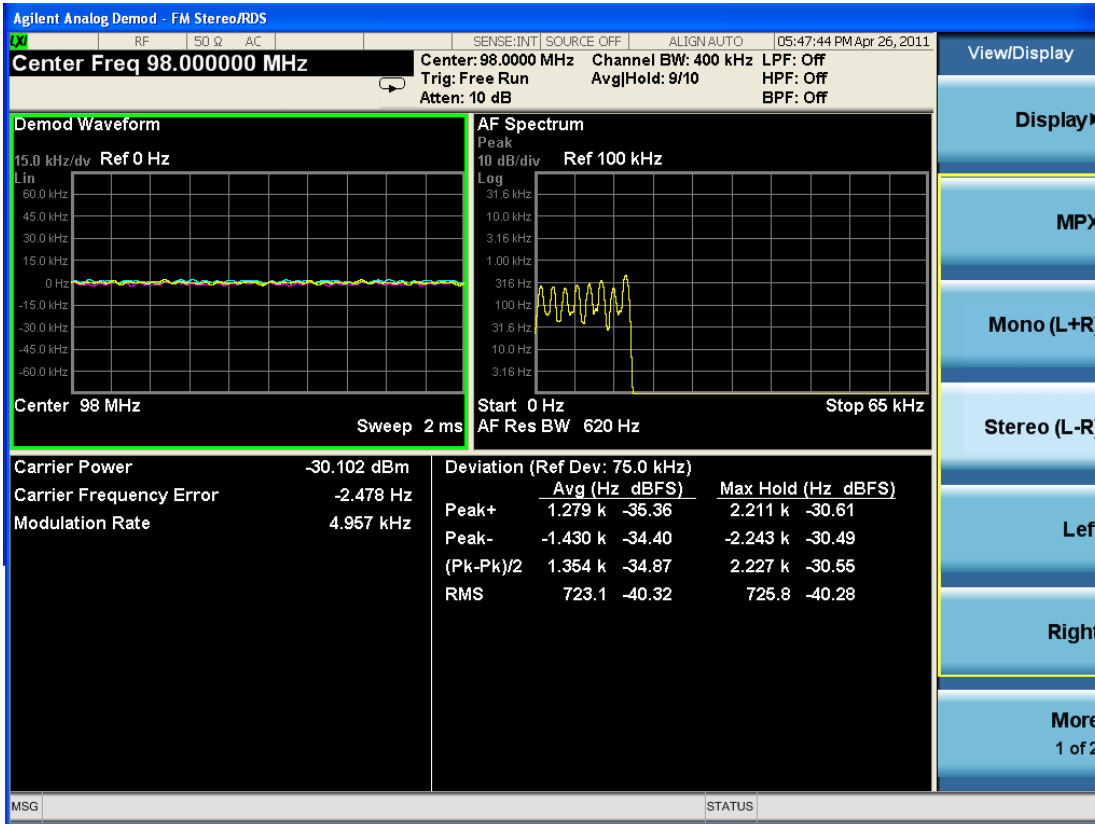

Key Path	View/Display
Initial S/W Revision	A.10.00

Left View

This view shows the Waveform, Spectrum, and the Metrics of the left audio signal.

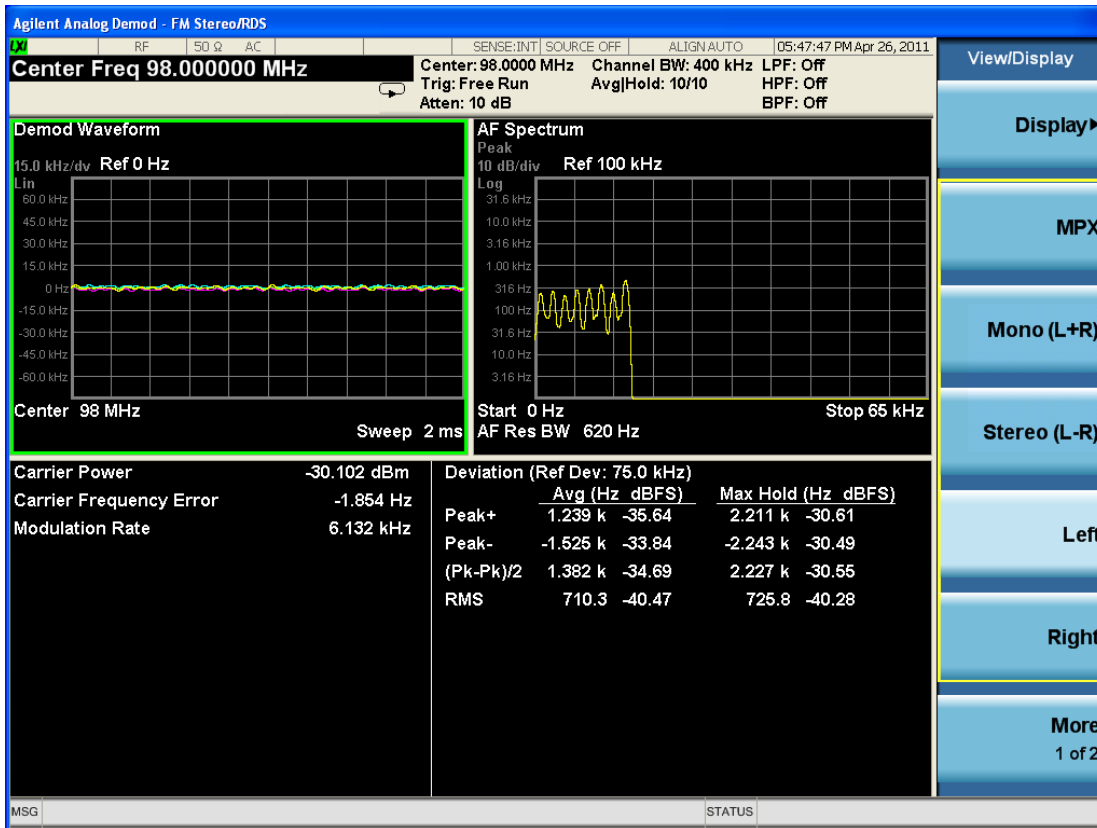

Key Path View/Display

Initial S/W Revision A.10.00

Right View

This view shows the Waveform, Spectrum, and the Metrics of the right audio signal.

11 FM Stereo Measurement
View/Display (FM Stereo)

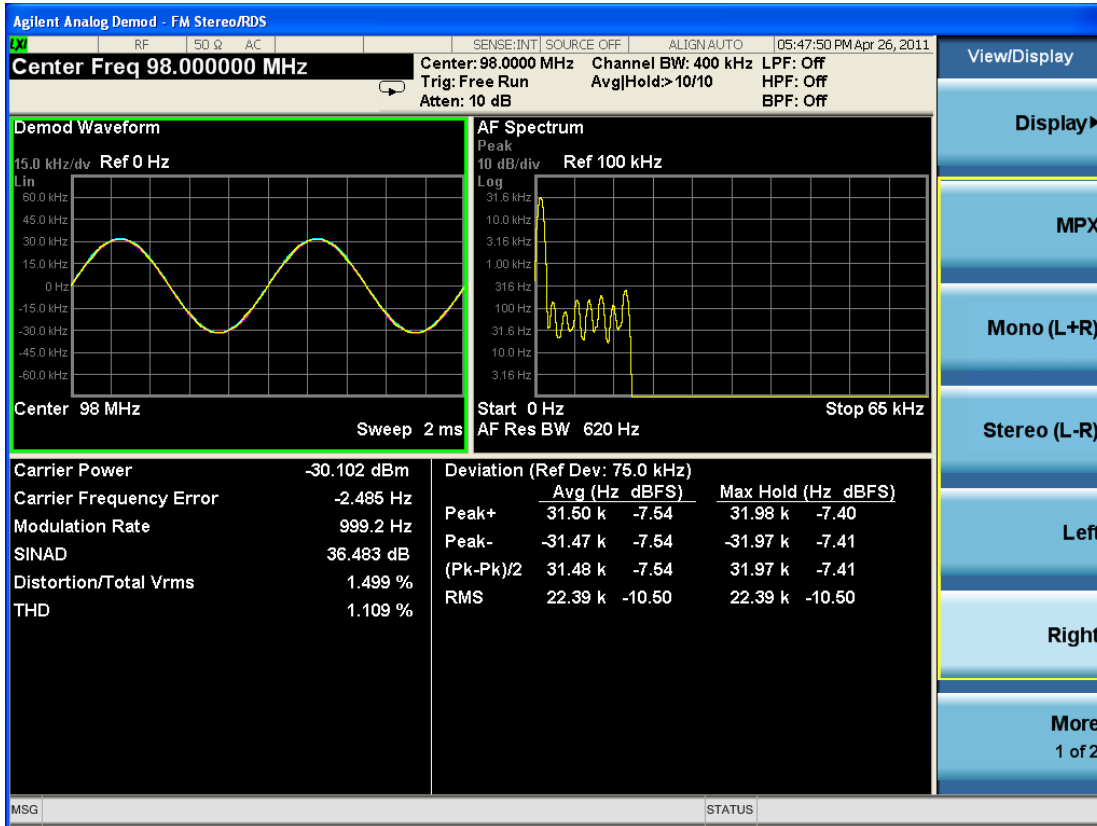

Key Path	View/Display
Initial S/W Revision	A.10.00

RDS/RBDS View

This view shows the RDS bits.

The screenshot displays the 'RDS/RBDS Decoding Results' view in the Agilent Analog Demod software. The interface includes a top status bar with parameters like Center Freq (98.00000 MHz), Channel BW (400 kHz), and various filter settings. The main display area is divided into sections for BLER (0.00E+000), Information Bits (a binary string), and tuning/switching information. A right-hand sidebar contains navigation buttons for 'View/Display', 'RDS/RBDS', 'Result Metrics', 'Distortion THD Unit', 'Metrics Settings', and 'More'. The bottom status bar shows a file save message and a status indicator.

Key Path	View/Display
Initial S/W Revision	A.10.00

Result Metrics Summary View

This view shows all the results together in one view.

11 FM Stereo Measurement
View/Display (FM Stereo)

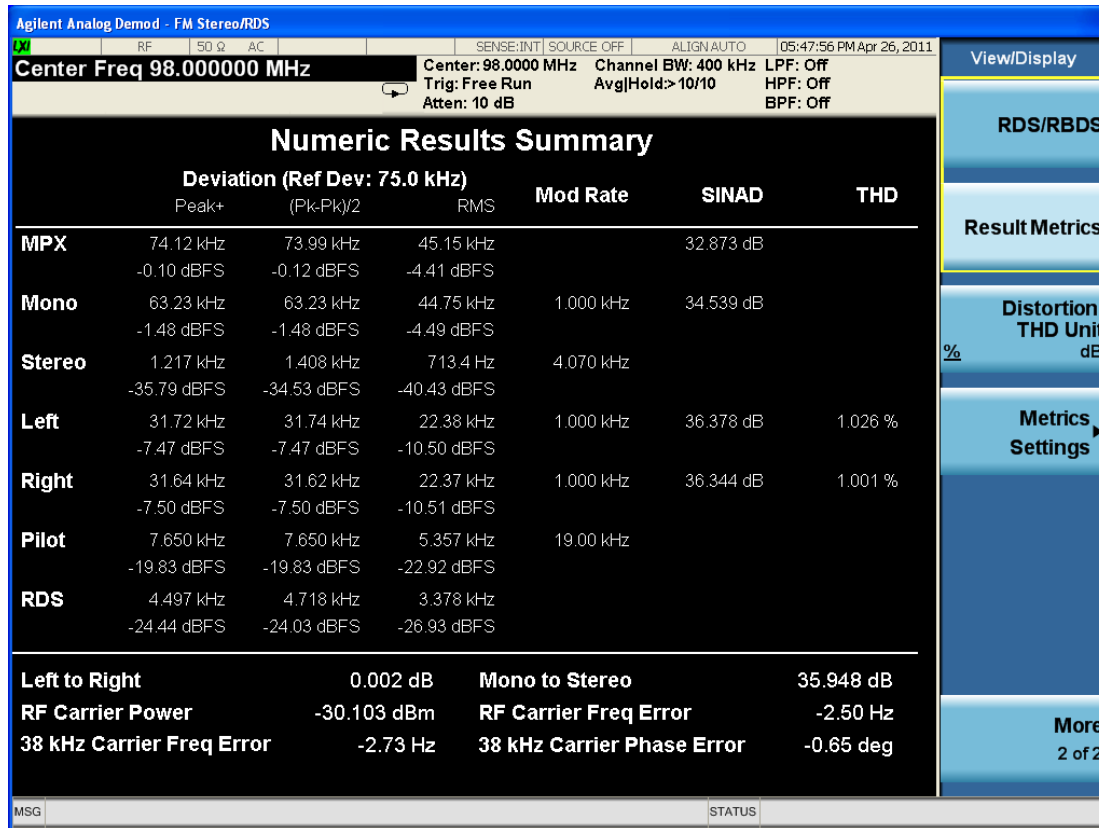

Key Path	View/Display
Initial S/W Revision	A.10.00

Distortion & THD Unit

Changes the units of distortion and THD in the Metrics screen between % and dB units.

Key Path	View/Display
Remote Command	DISPlay:FMSTereo:VIEW:DISToRtion:UNIT DB PCT DISPlay:FMSTereo:VIEW:DISToRtion:UNIT?
Example	DISP:FMST:VIEW:DIST:UNIT PCT Sets FM Stereo distortion and THD display to percent.
Preset	PCT
State Saved	Saved in State
Initial S/W Revision	A.10.00

Metrics Settings

Accesses a menu used to control which metrics will be provided. This includes a 1-of-N menu which allows you to control which modulation magnitude metrics are displayed, as well as On/Off controls for

Modulation Rate and SINAD/Distortion/THD. If speed is an issue, select only the metric(s) that is(are) required. If modulation magnitude is set to Peak+ Only, Pk-Pk/2 Only, or RMS Only, the other modulation magnitude metrics are loaded with not a number and show “---“ in the metrics window.

Key Path	View/Display, Metrics Settings
Remote Command	:DISPlay:AM FM PM:VIEW:METRics:MMAGnitude ALL PPK PNPk RMS RMSRatio :DISPlay:AM FM PM:VIEW:METRics:MMAGnitude?
Example	DISP:AM:VIEW:METR:MMAG PPK Sets AM modulation magnitude to peak +. DISP:FM:VIEW:METR:MMAG RMSR Sets ratio reference and sets FM modulation magnitude to ratio display
Preset	ALL
State Saved	Saved in State
Initial S/W Revision	Prior to A.02.00
Modified at S/W Revision	A.05.00

Normal

Turns on all absolute modulation magnitude metrics. In the metrics window, Peak +, Peak -, Pk-Pk/2 and RMS results are provided.

Key Path	View/Display, Metrics Settings, Mod Magnitude
Example	:DISP:FMST:VIEW:METR:MMAG ALL
Notes	This key was labeled “All” in earlier releases
Initial S/W Revision	A.10.00

Peak+ Only

Turns on just the Peak+ metric in the portion of the metrics window that shows the modulation magnitude results.

Key Path	View/Display, Metrics Settings, Mod Magnitude
Example	:DISP:FMST:VIEW:METR:MMAG PPK
Initial S/W Revision	A.10.00

Pk-Pk/2 Only

Turns on just the Pk-Pk/2 metric in the portion of the metrics window that shows the modulation magnitude results. .

Key Path	View/Display, Metrics Settings, Mod Magnitude
-----------------	---

Example	:DISP:FMST:VIEW:METR:MMAG PNP
Initial S/W Revision	A.10.00

RMS Only

Turns on just the RMS metric in the portion of the metrics window that shows the modulation magnitude results.

Key Path	View/Display, Metrics Settings, Mod Magnitude
Example	:DISP:FMST:VIEW:METR:MMAG RMS
Initial S/W Revision	A.10.00

RMS Ratio

Turns on the display of RMS Ratio. In this mode, the only magnitude metrics that are displayed are the RMS metrics, but besides the display of RMS, the ratio (in dB) of the RMS modulation to its reference is displayed, as well as the value of the reference, as shown in the display below:

FM Deviation	Average	Max Hold
RMS	12.69 kHz	14.19 kHz
RMS Ratio	1.89 dB	2.86 dB
Ratio Ref	10.20 kHz	
<hr/>		
Carrier Power	-100.331 dBm	
Carrier Frequency Error	180.5 Hz	

Pressing the RMS Ratio key (or sending :DISP:FMST:VIEW:METR:MMAG RMSR) establishes the reference. Pressing it again (or sending the SCPI command again) establishes a new reference. Whenever this happens, the current value of RMS modulation from the left hand column (Current or Average) is taken as the new reference.

If, when the ratio is to be established, there is not a valid value being displayed to use as a reference, an error is generated, the RMS Ratio and Ratio Ref values display --- and queries of either return not a number (9.91 e37).

To turn off the ratio display, select one of the other Mod magnitude views.

Note that each measurement (AM, FM, PM, PM and FM Stereo) has its own reference; and the reference is remembered when you leave the measurement and return.

The ratio references are saved in State, and when the recalled state of Metrics Settings is RMS Ratio, the saved reference for the current measurement should be recalled and used, rather than establishing a new one.

Key Path	View/Display, Metrics Settings, Mod Magnitude
-----------------	---

Example	:DISP:FMST:VIEW:METR:MMAG RMSR
Initial S/W Revision	A.10.00

Modulation Rate

Toggles the Modulation Rate metric on and off. When turned on, the Modulation Rate metric is provided. When turned off, the Modulation Rate metric is set to not a number and shows “---” in the metric window.

Key Path	View/Display, Metrics Settings
Remote Command	DISPlay:FMSTereo:VIEW:METRics:MRATe[:STATe] ON OFF 1 0 DISPlay:FMSTereo:VIEW:METRics:MRATe[:STATe]?
Example	DISP:FMST:VIEW:METR:MRAT OFF Sets FM Stereo modulation rate to off
Preset	On
State Saved	Saved in instrument state
Initial S/W Revision	A.10.00

SINAD, THD, Distortion

Toggles the distortion metrics – SINAD, Distortion and THD. When turned off, SINAD, Distortion and THD metrics are set to not a number and show “---” in the metric window.

SINAD is the ratio of total received power (the received signal-plus-noise-plus-distortion power) to the received noise-plus-distortion power. It is always expressed in decibel units. The rejection of the carrier from the noise-plus-distortion power measurement is usually not much more than 50 dB, thus limiting the maximum SINAD.

THD is the ratio of the root mean square voltage of the harmonics referenced to the fundamental voltage, expressed in % or dB. Note the differences with respect to Distortion. The denominator of the ratio is different and the items in the numerator do not include the noise between harmonics, just the harmonics themselves.

Distortion/Total Voltage (rms) is the ratio of unwanted received power (noise plus distortion) to the total received power, expressed in % or dB. Therefore, this metric is the negative of SINAD when expressed in decibels.

Key Path	View/Display, Metrics Settings
Remote Command	DISPlay:FMSTereo:VIEW:METRics:DISToRtion[:STATe] ON OFF 1 0 DISPlay:FMSTereo:VIEW:METRics:DISToRtion[:STATe]?
Example	DISP:FMST:VIEW:METRics:DIST OFF Sets FM Stereo modulation rate to off
Preset	On
State Saved	Saved in instrument state
Initial S/W Revision	A.10.00

11 FM Stereo Measurement
View/Display (FM Stereo)

12 Metrics

Metrics

In all views, the display is split into a signal display window and a numeric results (metrics) window. The metrics window displays carrier and modulation metrics and is similar to the numeric windows common in the SA communications measurements such as Channel Power and Occupied Bandwidth. The metrics associated with the 3 Demod measurements and their metrics including units are shown below.

For the Modulation Depth/FM Deviation/ Φ M Deviation metrics, two columns are displayed.

Column 1: Averaging off - shows the metrics in real time, that is, the value from the last measurement.

Averaging on - shows the average value of the metric since the last restart. This uses the arithmetic average:

$$\text{New avg} = ((K-1) \text{Old avg} + \text{New data})/K$$

where K is the average counter

Column 2: Only displayed if Aver/Hold Num is on - shows the maximum value that the non-averaged metric has taken on since the last time the measurement was restarted, known as the "Max Hold" value (note: for the Peak(-) metric, Max Hold reads the negative of the absolute value of the maximum value. For example, if the absolute value of Peak- got up to 80 kHz, the Max Hold column would read -80 kHz)

Metric	Units			
	AM	FM	Φ M	FM Stereo
Carrier Power - the average power detected at the carrier frequency, averaged over integer periods of the modulation frequency	(dBm or W)	(dBm or W)	(dBm or W)	(dBm)
Carrier Frequency Error - represents the difference between the instrument's tuned center frequency and the detected carrier's frequency. This does not apply to AM signals.	N/A	(Hz)	(Hz)	(Hz)
Modulation Rate - represents the frequency of the detected modulation. This is also sometimes known as Modulation Frequency.	(Hz)	(Hz)	(Hz)	(Hz) for Left, Right, and Pilot
SINAD - represents the ratio of total received power (the received signal-plus-noise-plus-distortion power) to the received noise-plus-distortion power. It is always expressed in decibel units. The rejection of the carrier from the noise-plus-distortion power measurement is usually not much more than 50 dB, thus limiting the maximum SINAD.	(dB)	(dB)	(dB)	(dB) for MPX, Mono, Left, and Right
Distortion/Total Vrms - represents the ratio of unwanted received rms voltage (noise combined with distortion) to the total received rms voltage, expressed in % or dB on the display and over SCPI. Therefore, this metric is the negative of SINAD when expressed in decibels. When expressed in %, the SCPI value is a true percentage, thus 100 times as large as the ratio	(dB or %)	(dB or %)	(dB or %)	(dB or %) for MPX, Mono, Left, and Right

– for example, 99% would return as 99, not as 0.99.				
THD - represents the ratio of the root mean square voltage of the harmonics referenced to the fundamental voltage, expressed in % or dB on the display and over SCPI. Note the difference with respect to Distortion. The denominator of the ratio is different and the items in the numerator do not include the noise between harmonics, just the harmonics themselves. When expressed in %, the SCPI value is a true percentage, thus 100 times as large as the ratio – for example, 99% would return as 99, not as 0.99.	(dB or %)	(dB or %)	(dB or %)	(dB or %) for Left, and Right
AM Mod Depth Peak (+) - the maximum AM modulation depth in units of % during the acquisition period. When averaging is on, column 1 includes averaging of peaks through the acquisition period – this significantly improves the SNR when measuring cyclic signals. If averaging is off, column 1 shows simply the highest peak. Column 2 always shows the maximum of the highest peak. Note that in amplitude modulation, the modulation depth (also known as % modulation or modulation index) is the amount of voltage deviation the modulated signal has relative to its original un-modulated level. Modulation depth of 100% means the peak voltage doubles, which in turn implies the peak power quadruples.	(%)	N/A	N/A	N/A
AM Mod Depth Peak (-) – represents the minimum value of AM modulation depth in units of % during the acquisition period. Not the absolute value, but the negative value.	(%)	N/A	N/A	N/A
AM Mod Depth (Pk - Pk)/2 – half the difference between the AM modulation depth Peak+ and Peak-.	(%)	N/A	N/A	N/A
AM Mod Depth RMS - represents the Root Mean Square AM modulation depth in units of % during the acquisition period.	(%)	N/A	N/A	N/A
Deviation Peak (+) - represents the maximum frequency (FM) or phase (PM) deviation during the acquisition period. When averaging is on, column 1 includes averaging of peaks through the acquisition period – this significantly improves the SNR when measuring cyclic signals. If averaging is off, column 1 shows simply the highest peak. Column 2 always shows the maximum of the highest peak.	N/A	(Hz)	(rad or deg)	(Hz) for MPX, Mono, Stereo, Left, Right, Pilot, and RDS
Deviation Peak (-) - the minimum frequency (FM) or phase (PM) deviation during the acquisition period.	N/A	(Hz)	(rad or deg)	(Hz) for MPX, Mono, Stereo, Left, Right, Pilot, and RDS
Deviation (Pk-Pk)/2 - half the difference between the modulation depth Peak+ and Peak-.	N/A	(Hz)	(rad or deg)	(Hz) for MPX, Mono,

				Stereo, Left, Right, Pilot, and RDS
Deviation RMS - the Root Mean Square frequency (FM) or phase (PM) deviation during the acquisition period.	N/A	(Hz)	(rad deg)	(Hz) for MPX, Mono, Stereo, Left, Right, Pilot, and RDS
RMS Ratio - the ratio between the displayed value of RMS modulation and the Ratio Reference (see below). Only appears when RMS Ratio is selected under View/Display, Metrics Settings.	(dB)	(dB)	(dB)	(dB) for MPX, Mono, Stereo, Left, Right, Pilot, and RDS
Ratio Ref - the reference value being used for the Ratio display. The reference is set whenever the ratio metric is selected (see View/Display, Metrics Settings, RMS Ratio). Only appears when RMS Ratio is selected (see above)	(%)	(Hz)	(rad deg)	(Hz) for MPX, Mono, Stereo, Left, Right, Pilot, and RDS
Left to Right - represents the ratio of the left-channel signal power to the right-channel signal power. This only applies to FM Stereo signals.	N/A	N/A	N/A	(dB)
Mono to Stereo - represents the ratio of the mono signal power to the stereo signal power. This only applies to FM Stereo signals.	N/A	N/A	N/A	(dB)
38 kHz Carrier Freq Error This only applies to FM Stereo signals.	N/A	N/A	N/A	(Hz)
38 kHz Carrier Phase Error This only applies to FM Stereo signals.	N/A	N/A	N/A	(deg)