

Keysight WirelessTest Set

This help file provides documentation for the following products:
E6640A EXM Wireless Test Set

V9082B LTE TDD
Measurement
Application User's &
Programmer's
Reference

Notices

© Keysight Technologies, Inc.
2014

No part of this manual may be reproduced in any form or by any means (including electronic storage and retrieval or translation into a foreign language) without prior agreement and written consent from Keysight Technologies, Inc. as governed by United States and international copyright laws.

Manual Part Number
NV9082-90001

Edition

September 2014
Printed in USA
Keysight Technologies, Inc.
5301 Stevens Creek Blvd.
Santa Clara, CA 95052 USA

Warranty

The material contained in this document is provided “as is,” and is subject to being changed, without notice, in future editions. Further, to the maximum extent permitted by applicable law, Keysight disclaims all warranties, either express or implied, with regard to this manual and any information contained herein, including but not limited to the implied warranties of merchantability and fitness for a particular purpose. Keysight shall not be liable for errors or for incidental or consequential damages in connection with the furnishing, use, or performance of this document or of any

information contained herein. Should Keysight and the user have a separate written agreement with warranty terms covering the material in this document that conflict with these terms, the warranty terms in the separate agreement shall control.

Technology Licenses

The hardware and/or software described in this document are furnished under a license and may be used or copied only in accordance with the terms of such license.

Restricted Rights

Legend

If software is for use in the performance of a U.S. Government prime contract or subcontract, Software is delivered and licensed as “Commercial computer software” as defined in DFAR 252.227-7014 (June 1995), or as a “commercial item” as defined in FAR 2.101(a) or as “Restricted computer software” as defined in FAR 52.227-19 (June 1987) or any equivalent agency regulation or contract clause. Use, duplication or disclosure of Software is subject to Keysight Technologies’ standard commercial license terms, and non-DOD Departments and Agencies of the U.S. Government will receive no greater than Restricted Rights as defined in FAR 52.227-19(c)(1-2) (June 1987). U.S. Government users will receive no greater than Limited Rights as defined in FAR 52.227-

14 (June 1987) or DFAR 252.227-7015 (b)(2) (November 1995), as applicable in any technical data.

Safety Notices

CAUTION

A CAUTION notice denotes a hazard. It calls attention to an operating procedure, practice, or the like that, if not correctly performed or adhered to, could result in damage to the product or loss of important data. Do not proceed beyond a CAUTION notice until the indicated conditions are fully understood and met.

WARNING

A WARNING notice denotes a hazard. It calls attention to an operating procedure, practice, or the like that, if not correctly performed or adhered to, could result in personal injury or death. Do not proceed beyond a WARNING notice until the indicated conditions are fully understood and met.

Table of Contents

V9082B LTE TDD Measurement Application User's & Programmer's Reference	i
Table of Contents	iii
1 About the Test Set	71
Installing Application Software	72
Viewing a License Key	72
Obtaining and Installing a License Key	72
Updating Measurement Application Software	72
EXM Options and Accessories	74
Front-Panel Features	75
Display Annotations	76
Rear-Panel Features	77
Window Control Keys	78
Virtual Front Panel	78
Windows Control Menu	78
Multi-Window	79
Zoom	79
Next Window	79
Mouse and Keyboard Control	81
Right-Click	81
PC Keyboard	83
Instrument Security & Memory Volatility	86
2 About the LTE TDD Measurement Application	87
What Does the LTE TDD Application Do?	88
3 Programming the Test Set	89
What Programming Information is Available?	90
List of SCPI Commands	91
STATus Subsystem	132
Detailed Description	132
What Are Status Registers	132
What Are Status Register SCPI Commands	133
How to Use the Status Registers	134
Using a Status Register	135
Using the Service Request (SRQ) Method	136
Generating a Service Request	136
Status Register System	137
The Status Byte Register	138
Standard Event Status Register	140
Operation and Questionable Status Registers	142
Operation Status Register	142
Questionable Status Register	142

STATus Subsystem Command Descriptions	143
Operation Register	143
Operation Condition Query	143
Operation Enable	144
Operation Event Query	144
Operation Negative Transition	144
Operation Positive Transition	145
Preset the Status Byte	145
Questionable Register	146
Questionable Condition	146
Questionable Enable	146
Questionable Event Query	147
Questionable Negative Transition	147
Questionable Positive Transition	147
Questionable Calibration Register	148
Questionable Calibration Condition	148
Questionable Calibration Enable	148
Questionable Calibration Event Query	149
Questionable Calibration Negative Transition	149
Questionable Calibration Positive Transition	150
Questionable Calibration Skipped Register	150
Questionable Calibration Skipped Condition	150
Questionable Calibration Skipped Enable	151
Questionable Calibration Skipped Event Query	151
Questionable Calibration Skipped Negative Transition	152
Questionable Calibration Skipped Positive Transition	152
Questionable Calibration Extended Failure Register	152
Questionable Calibration Extended Failure Condition	153
Questionable Calibration Extended Failure Enable	153
Questionable Calibration Extended Failure Event Query	153
Questionable Calibration Extended Failure Negative Transition	154
Questionable Calibration Extended Failure Positive Transition	154
Questionable Calibration Extended Needed Register	155
Questionable Calibration Extended Needed Condition	155
Questionable Calibration Extended Needed Enable	155
Questionable Calibration Extended Needed Event Query	156
Questionable Calibration Extended Needed Negative Transition	156
Questionable Calibration Extended Needed Positive Transition	157
Questionable Frequency Register	157
Questionable Frequency Condition	157
Questionable Frequency Enable	158
Questionable Frequency Event Query	158
Questionable Frequency Negative Transition	158

Questionable Frequency Positive Transition	159
Questionable Integrity Register	159
Questionable Integrity Condition	159
Questionable Integrity Enable	160
Questionable Integrity Event Query	160
Questionable Integrity Negative Transition	161
Questionable Integrity Positive Transition	161
Questionable Integrity Signal Register	161
Questionable Integrity Signal Condition	162
Questionable Integrity Signal Enable	162
Questionable Integrity Signal Event Query	163
Questionable Integrity Signal Negative Transition	163
Questionable Integrity Signal Positive Transition	163
Questionable Integrity Uncalibrated Register	164
Questionable Integrity Uncalibrated Condition	164
Questionable Integrity Uncalibrated Enable	164
Questionable Integrity Uncalibrated Event Query	165
Questionable Integrity Uncalibrated Negative Transition	165
Questionable Integrity Uncalibrated Positive Transition	166
Questionable Power Register	166
Questionable Power Condition	166
Questionable Power Enable	167
Questionable Power Event Query	167
Questionable Power Negative Transition	168
Questionable Power Positive Transition	168
Questionable Temperature Register	168
Questionable Temperature Condition	169
Questionable Temperature Enable	169
Questionable Temperature Event Query	169
Questionable Temperature Negative Transition	170
Questionable Temperature Positive Transition	170
Common Commands	172
All (Daily use)	172
Clear Status	174
Standard Event Status Enable	175
Standard Event Status Register Query	175
Identification Query	176
Operation Complete	176
Query Instrument Options	177
Recall Instrument State	177
*RST (Remote Command Only)	178
Save Instrument State	178
Service Request Enable	179

Status Byte Query	179
Trigger	179
Self Test Query	180
Wait-to-Continue	180
4 Input/Output Functions	181
Input/Output	182
Input/Output variables - Preset behavior	183
RF Input	184
Input Z Correction	184
RF Input Port	185
RF Input	186
RFIO1	186
RFIO2	186
External Gain	187
Ext Preamp	187
More Information	188
MS	189
BTS	190
Restore Input/Output Defaults	191
Corrections	191
Select Correction	192
Correction On/Off	192
Properties	193
Select Correction	193
Antenna Unit	194
Frequency Interpolation	196
Description	198
Comment	198
RF Port	198
Edit	201
Navigate	202
Frequency	203
Amplitude	203
Insert Point Below	203
Delete Point	203
Delete Correction	203
Apply Corrections	204
Delete All Corrections	204
Remote Correction Data Set Commands	205
Set (Replace) Data (Remote Command Only)	205
Merge Correction Data (Remote Command Only)	205
Freq Ref In	206
Sense	208

Internal	208
External	208
Ext Ref Freq	209
RF Output & Test Set Config	209
RF Output	210
RF Output	210
RFIO1	211
RFIO2	211
HalfDuplex Config	211
RF Input	211
RF Output	212
Output Config	212
Trig Out	212
Polarity	213
Off	213
Sweeping (HSWP)	214
Measuring	214
Main Trigger	214
Gate Trigger	214
Gate	215
Odd/Even Trace Point	215
Trig Out	215
Off	216
Source Marker 1	216
Source Marker 2	216
Source Marker 3	216
Source Marker 4	217
Analog Out	217
More Information	217
Auto	218
Off	218
LISN Control	218
V-network (Remote Command Only)	218
Phase (Remote Command Only)	219
150 kHz Highpass (Remote Command Only)	219
Protective Earth (Remote Command Only)	220
5 Mode Functions	221
Mode	222
More Information	223
Sequence Analyzer	224
IQ Analyzer (Basic)	224
W-CDMA with HSPA+	225
GSM/EDGE/EDGE Evo	225

Analog Demod	225
Bluetooth	226
TD-SCDMA with HSPA/8PSK	226
cdma2000	226
1xEV-DO	226
WLAN	227
89601 VSA	227
LTE-Advanced FDD	228
LTE-Advanced TDD	228
802.16 OFDMA (WiMAX/WiBro)	229
Application Mode Number Selection (Remote Command Only)	229
Application Mode Catalog Query (Remote Command Only)	230
Application Identification (Remote Commands Only)	231
Current Application Model	231
Current Application Revision	231
Current Application Options	232
Application Identification Catalog (Remote Commands Only)	232
Application Catalog Number of Entries	232
Application Catalog Model Numbers	232
Application Catalog Revision	233
Application Catalog Options	233
Detailed List of Modes	234
1xEV-DO	234
802.16 OFDMA (WiMAX/WiBro)	234
89601 VSA	234
Analog Demod	235
Bluetooth	235
cdma2000	236
GSM/EDGE/EDGE Evo	236
IQ Analyzer (Basic)	236
LTE	237
LTE TDD	237
LTE-Advanced FDD	237
LTE-Advanced TDD	238
Sequence Analyzer	238
TD-SCDMA with HSPA/8PSK	239
W-CDMA with HSPA+	239
WLAN	239
Global Settings	239
Global Center Freq	240
Restore Defaults	241
Mode Setup	242
Direction	242

Preset to Standard	242
System Bandwidth	243
UL/DL Allocation	243
Dw/GP/Up Len	244
Component Carrier Setup	244
Num Component Carriers	245
Configure Component Carriers	245
Component Carrier	245
Measure Carrier	246
Freq Offset	246
Bandwidth Setup	247
Demod	250
UL/DL Allocation	251
Dw/GP/Up Len	252
Component Carriers Allocation	252
Non-Contiguous Allocation	253
Allocation Break Pt Carrier	253
Carrier Ref Freq	254
RF Bandwidth (Remote Command Only)	255
RF Bandwidth Center (Remote Command Only)	255
Sub-block Center (Remote Command Only)	255
Sub-block Bandwidth (Remote Command Only)	256
Sub-block Gap (Remote Command Only)	256
Pre-defined Parameters	256
Analysis Slot for LTEATDD	257
Meas Interval	257
CP Length	258
Measure PRACH/SRS for LTEATDD	258
Reference Configuration	259
Global Settings	259
Global Center Freq	260
Restore Defaults	260
Intermod	261
Interference Pwr Present	261
Freq Offset from Edge	261
Span	262
Offset Side	262
Non-Contiguous Interference Region	263
Restore Mode Defaults	263
Preset Type (Remote Command Only)	263
6 System Functions	265
File	266
File Explorer	266

Print	267
Maximize/Restore Down	267
Maximize	267
Restore Down	267
Page Setup	267
Print	268
Restore Down	269
Minimize	269
Exit	270
Print	271
System	272
Show	272
Errors	272
Previous Page	273
Next Page	274
History	274
Verbose SCPI On/Off	274
Refresh	275
Clear Error Queue	275
Status	275
Input Overload Enable (Remote Command Only)	275
Power Up (Remote Command Only)	276
System	276
Show System contents (Remote Command Only)	277
Computer System description (Remote Command Only)	277
Hardware	278
System Remote Commands (Remote Commands Only)	278
System Powerdown (Remote Command Only)	279
List installed Options (Remote Command Only)	279
Lock the Front-panel keys (Remote Command Only)	279
List SCPI Commands (Remote Command Only)	280
SCPI Version Query (Remote Command Only)	280
Date (Remote Command Only)	280
Time (Remote Command Only)	281
Module Name (Remote Command Only)	281
Module Index (Remote Command Only)	282
Module Mnemonic (Remote Command Only)	282
Module List (Remote Command Only)	282
Module Enable (Remote Command Only)	283
Module Default (Remote Command Only)	284
Module Model Number (Remote Command Only)	284
Module Model Serial Number (Remote Command Only)	285
Power On	285

Mode and Input/Output Defaults	286
User Preset	286
Last State	286
Power On Application	287
Configure Applications	288
Preloading Applications	288
Access to Configure Applications utility	289
Virtual memory usage	289
Select All	289
Deselect All	290
Move Up	290
Move Down	290
Select/Deselect	290
Save Changes and Exit	290
Exit Without Saving	291
Restore Power On Defaults	291
Configure Applications - Instrument boot-up	292
Configure Applications - Windows desktop	292
Configure Applications - Remote Commands	292
Configuration list (Remote Command Only)	293
Configuration Memory Available (Remote Command Only)	293
Configuration Memory Total (Remote Command Only)	293
Configuration Memory Used (Remote Command Only)	293
Configuration Application Memory (Remote Command Only)	294
Alignments	294
Align Now	294
All (Daily use)	294
All but RF	297
RF (Weekly use)	298
Source (Weekly use)	300
IF Alignment (Weekly use) (Remote Command Only)	301
Show Alignment Statistics	302
Restore Align Defaults	305
Execute Expired Alignments (Remote Command Only)	306
I/O Config	307
SCPI LAN	307
SCPI Telnet	307
SCPI Socket	307
SICL Server	308
HiSLIP Server	309
SCPI Socket Control Port (Remote Command Only)	309
System IDN Response	310
Factory	310

User	310
Restore Defaults	311
Restore Input/Output Defaults	312
Restore Power On Defaults	312
Restore Align Defaults	313
Restore Misc Defaults	313
Restore Mode Defaults (All Modes)	315
All	315
Control Panel...	316
Licensing...	317
Security	319
USB	319
Read-Write	320
Read only	320
Diagnostics	320
Show Hardware Statistics	320
SCPI for Show Hardware Statistics (Remote Commands Only)	321
Self test	322
All Self Test	322
FEC Self Test	322
Show Result	322
Internet Explorer...	324
7 Trigger Functions	327
Trigger	328
Trigger Source Presets	329
RF Trigger Source	332
I/Q Trigger Source	333
More Information	334
Free Run	335
Video (IF Envelope)	336
Trigger Level	336
Trig Slope	337
Trig Delay	338
External 1	339
Trigger Level	340
Trig Slope	340
Trig Delay	341
Zero Span Delay Comp On/Off	342
External 2	342
Trigger Level	343
Trig Slope	343
Trig Delay	344
Zero Span Delay Comp On/Off	344

RF Burst	345
Absolute Trigger Level	346
Relative Trigger Level	347
Trigger Slope	348
Trig Delay	348
Periodic Timer (Frame Trigger)	349
Period	350
Offset	351
Reset Offset Display	352
Sync Source	352
Off	353
External 1	353
External 2	355
RF Burst	356
Trig Delay	359
Auto/Holdoff	359
Auto Trig	359
Trig Holdoff	360
Holdoff Type	361
8 Channel Power Measurement	363
AMPTD Y Scale	367
Ref Value	367
Range	367
Range	368
Adjust Range For Min Clip	368
Pre-Adjust for Min Clip	368
Peak to Average	369
Mixer Level Offset	369
Scale/Div	370
Ref Position	370
Auto Scaling	371
Auto Couple	372
More Information	372
Auto/Man Active Function keys	372
Auto/Man 1-of-N keys	372
BW	374
Res BW	374
Video BW	375
Filter Type	377
Cont (Continuous Measurement/Sweep)	378
File	380
FREQ Channel	381
Carrier Ref Freq	381

Input/Output	383
Marker	384
Select Marker	384
Marker Type	384
Properties	385
Select Marker	385
Relative To	385
All Markers Off	385
Marker X Axis Value (Remote Command Only)	386
Marker X Axis Position (Remote Command Only)	386
Marker Y Axis Value (Remote Command only)	387
Backward Compatibility SCPI Commands	387
Marker Function	389
Marker To	390
Meas	391
Remote Measurement Functions	391
Measurement Group of Commands	392
Current Measurement Query (Remote Command Only)	394
Limit Test Current Results (Remote Command Only)	394
Data Query (Remote Command Only)	394
Calculate/Compress Trace Data Query (Remote Command Only)	395
Calculate Peaks of Trace Data (Remote Command Only)	400
Hardware-Accelerated Fast Power Measurement (Remote Command Only)	401
Reset Fast Power Measurement (Remote Command Only)	401
Define Fast Power Measurement (Remote Command Only)	402
Define Fast Power Measurement Query (Remote Command Only)	411
Configure Fast Power Measurement (Remote Command Only)	412
Initiate Fast Power Measurement (Remote Command Only)	413
Fetch Fast Power Measurement (Remote Command Only)	413
Execute Fast Power Measurement (Remote Command Only)	413
Binary Read Fast Power Measurement (Remote Command Only)	414
Diagnostic Binary Read Fast Power Measurement (Remote Command Only)	414
Format Data: Numeric Data (Remote Command Only)	415
Format Data: Byte Order (Remote Command Only)	416
Meas Setup	417
Avg/Hold Num	417
Avg Mode	418
PSD Unit	419
Meas Preset	419
Mode	420
Mode Preset	421
How-To Preset	422
Mode Setup	424

Peak Search	425
Print	426
Quick Save	427
Recall	429
State	429
More Information	430
From File...	431
Edit Register Names	433
Register 1 thru Register 16	433
Register 1 thru Register 16	434
Sequences	434
Source Sequence	435
Open...	435
Data (Import)	435
Component Carrier Setup	436
Masks	438
Open...	439
Restart	440
More Information	440
Save	442
State	442
To File . . .	443
Edit Register Names	445
More Information	445
Register 1 thru Register 16	446
Register 1 thru Register 16	446
Mass Storage Catalog (Remote Command Only)	447
Mass Storage Change Directory (Remote Command Only)	448
Mass Storage Copy (Remote Command Only)	448
Mass Storage Device Copy (Remote Command Only)	448
Mass Storage Delete (Remote Command Only)	449
Mass Storage Data (Remote Command Only)	449
Mass Storage Make Directory (Remote Command Only)	449
Mass Storage Move (Remote Command Only)	449
Mass Storage Remove Directory (Remote Command Only)	450
Sequences	450
Source Sequence	451
Save As . . .	451
Data (Export)	451
Export Trace Data	452
Trace 1	453
Trace 2	453
Trace 3	453

Trace 4	453
Trace 5	453
Trace 6	454
Include Header	454
Measurement Results	454
Save As . . .	457
Screen Image	457
Themes	459
3D Color	459
3D Monochrome	459
Flat Color	459
Flat Monochrome	460
Save As...	460
Single (Single Measurement/Sweep)	461
More Information	461
Source	462
RF Output	462
Amplitude	462
RF Power	463
RF Power Range	464
Set Reference Power	464
Power Ref	464
Amptd Offset	465
Modulation	466
Frequency	466
Frequency	467
Channel	467
GSM/EDGE Channel Number Ranges	468
W-CDMA Channel Number Ranges	469
CDMA 2000 / 1xEVDO Channel Number Ranges	470
LTE FDD Channel Number Ranges	472
LTE TDD Channel Number Ranges	474
TDSCDMA Channel Number Ranges	474
Radio Setup	475
Radio Standard	476
Radio Band Link	494
Set Reference Frequency	494
Freq Reference	495
Freq Offset	496
Modulation Setup	497
ARB	497
ARB	497
Select Waveform	498

ARB Setup	503
Trigger Type	505
Trigger Source	509
Trigger Initiate	510
Waveform Sequences	510
Waveform Utilities	521
Marker Utilities	531
Header Utilities	536
Bus Trigger Command (Remote Command Only)	538
AM	538
AM	538
AM Depth	538
AM Rate	539
FM	539
FM	539
FM Deviation	539
FM Rate	540
PM	540
PM	540
PM Deviation	541
PM Rate	541
List Sequencer	541
Sequencer	542
Initiate Sequence	542
List Sequencer Setup	543
Number of Steps	543
Current Step	543
Insert Step Before	544
Delete Step	544
Clear List	544
Step Trigger	544
Transition Time	546
Radio Setup	547
Channel	564
Frequency	565
Power	565
Waveform	566
Step Duration	573
Output Trigger	575
Step Configuration (Remote Command Only)	575
Clear List (Remote Command Only)	583
Trigger Type	584
BeginningOfStep	584

DataMarker	584
Manual Trigger Now	585
Remote Software Trigger (Remote command Only)	586
Query List Sequence Initiation Armed Status (Remote Command Only)	586
Source Preset	586
Span X Scale	587
Sweep/Control	588
Acq Time	588
Sweep Setup	589
Auto Sweep Time Rules	589
Pause	590
Gate	590
Gate On/Off	590
Gate View On/Off	591
Gate View Setup	594
Gate View Acquisition Time	594
Gate View Start Time	594
Gate Delay	595
Gate Length	595
Gate Source	596
Video (IF Envelope)	597
External 1	599
External 2	601
RF Burst	603
Periodic Timer (Frame Trigger)	606
Auto/Holdoff	617
Gate Preset (Remote Command Only)	619
Gate Level (Remote Command Only)	619
Gate Polarity (Remote Command Only)	619
Points	620
System	622
Trace/Detector	623
Trace Type	623
Detector	623
Auto	624
Detector Selection	624
Trigger	626
Free Run	626
Video	626
Trigger Level	626
Trig Slope	626
Trig Delay	626
External 1	626

Trigger Level	626
Trig Slope	626
Trig Delay	626
Zero Span Delay Comp	626
External 2	626
Trigger Level	626
Trig Slope	626
Trig Delay	627
Zero Span Delay Comp	627
RF Burst	627
Absolute Trigger	627
Relative Trigger	627
Trig Slope	627
Trig Delay	627
Periodic Timer	627
Period	627
Offset	627
Reset Offset Display	627
Sync Source	627
Off	627
External 1	627
External 2	628
RF Burst	628
Trig Delay	628
Auto/Holdoff	628
Auto Trig	628
Trig Holdoff	628
Holdoff Type	628
User Preset	629
User Preset	629
User Preset All Modes	630
Save User Preset	631
View/Display	632
View selection by name (MSR and LTE-Advanced FDD/TDD only)	634
Selects the results view. The following SCPI command allows you to select the desired measurement view by enumeration.	634
Selects the results view. The following SCPI command allows you to select the desired measurement view by enumeration.	635
View selection by name (DTMB (CTTB), DVB-T/H only)	635
View selection by name (ISDB-T, CMMB only)	636
Display	636
Annotation	636
Meas Bar On/Off	637

Screen	638
Active Function Values On/Off	638
Title	639
Change Title	639
Clear Title	640
Graticule	641
System Display Settings	641
Annotation Local Settings	641
Themes	642
Power Results (Only for MSR and LTE-Advanced FDD/TDD)	643
Traces Window	644
Results Window for MSR	644
Carrier Info (Only for MSR and LTE-Advanced FDD/TDD)	645
Traces Window	646
Results Window	646
Carrier Freq (Only for MSR and LTE-Advanced FDD/TDD)	647
Bar Graph	647
9 Occupied Bandwidth Measurement	649
AMPTD Y Scale (Amplitude/Y Scale)	652
Ref Value	652
Range	652
Range	653
Adjust Range For Min Clip	653
Pre-Adjust for Min Clip	653
Peak to Average	654
Mixer Level Offset	654
Scale/Div	655
Ref Position	655
Auto Scaling	656
Presel Center	657
Presel Adjust	657
Auto Couple	658
More Information	658
Auto/Man Active Function keys	658
Auto/Man 1-of-N keys	658
BW	660
Res BW	660
Video BW	661
Filter Type	662
Cont (Continuous Measurement/Sweep)	664
File	666
FREQ Channel	667
Carrier Ref Freq	667

Input/Output	669
Marker	670
Select Marker	670
Select Marker	670
Marker Type	670
Properties	671
Select Marker	671
Select Marker	671
Relative To	671
All Markers Off	672
Marker X Axis Value (Remote Command Only)	672
Marker X Axis Position (Remote Command Only)	673
Marker Y Axis Value (Remote Command Only)	673
Backward Compatibility SCPI Commands	674
Marker Function	675
Marker To	676
Meas	677
Remote Measurement Functions	677
Measurement Group of Commands	678
Current Measurement Query (Remote Command Only)	680
Limit Test Current Results (Remote Command Only)	680
Data Query (Remote Command Only)	680
Calculate/Compress Trace Data Query (Remote Command Only)	681
Calculate Peaks of Trace Data (Remote Command Only)	686
Hardware-Accelerated Fast Power Measurement (Remote Command Only)	687
Reset Fast Power Measurement (Remote Command Only)	687
Define Fast Power Measurement (Remote Command Only)	688
Define Fast Power Measurement Query (Remote Command Only)	697
Configure Fast Power Measurement (Remote Command Only)	698
Initiate Fast Power Measurement (Remote Command Only)	699
Fetch Fast Power Measurement (Remote Command Only)	699
Execute Fast Power Measurement (Remote Command Only)	699
Binary Read Fast Power Measurement (Remote Command Only)	700
Diagnostic Binary Read Fast Power Measurement (Remote Command Only)	700
Format Data: Numeric Data (Remote Command Only)	701
Format Data: Byte Order (Remote Command Only)	702
Meas Setup	703
Avg/Hold Num	703
Avg Mode	704
Occ BW % Pwr	704
x dB	705
Limit (for all modes except MSR)	706
Meas Preset	707

Max Hold (Remote Command Only)	707
Mode	709
Mode Preset	710
How-To Preset	711
Mode Setup	713
Peak Search	714
Print	715
Quick Save	716
Recall	718
State	718
More Information	719
From File...	720
Edit Register Names	722
Register 1 thru Register 16	722
Register 1 thru Register 16	723
Sequences	723
Source Sequence	724
Open...	724
Data (Import)	724
Component Carrier Setup	725
Masks	727
Open...	728
Restart	729
More Information	729
Save	731
State	731
To File . . .	732
Edit Register Names	734
More Information	734
Register 1 thru Register 16	735
Register 1 thru Register 16	735
Mass Storage Catalog (Remote Command Only)	736
Mass Storage Change Directory (Remote Command Only)	737
Mass Storage Copy (Remote Command Only)	737
Mass Storage Device Copy (Remote Command Only)	737
Mass Storage Delete (Remote Command Only)	738
Mass Storage Data (Remote Command Only)	738
Mass Storage Make Directory (Remote Command Only)	738
Mass Storage Move (Remote Command Only)	738
Mass Storage Remove Directory (Remote Command Only)	739
Sequences	739
Source Sequence	740
Save As . . .	740

Data (Export)	740
Export Trace Data	741
Trace 1	742
Trace 2	742
Trace 3	742
Trace 4	742
Trace 5	742
Trace 6	743
Include Header	743
Measurement Results	743
Meas Results File Definition	744
Meas Results File Example	745
Save As . . .	746
Screen Image	747
Themes	748
3D Color	748
3D Monochrome	748
Flat Color	749
Flat Monochrome	749
Save As...	749
Single (Single Measurement/Sweep)	750
More Information	750
Source	751
RF Output	751
Amplitude	751
RF Power	752
RF Power Range	753
Set Reference Power	753
Power Ref	753
Amptd Offset	754
Modulation	755
Frequency	755
Frequency	756
Channel	756
GSM/EDGE Channel Number Ranges	757
W-CDMA Channel Number Ranges	758
CDMA 2000 / 1xEVDO Channel Number Ranges	759
LTE FDD Channel Number Ranges	761
LTE TDD Channel Number Ranges	763
TDSCDMA Channel Number Ranges	763
Radio Setup	764
Radio Standard	765
Radio Band Link	783

Set Reference Frequency	783
Freq Reference	784
Freq Offset	785
Modulation Setup	786
ARB	786
ARB	786
Select Waveform	787
ARB Setup	792
Trigger Type	794
Trigger Source	798
Trigger Initiate	799
Waveform Sequences	799
Waveform Utilities	810
Marker Utilities	820
Header Utilities	825
Bus Trigger Command (Remote Command Only)	827
AM	827
AM	827
AM Depth	827
AM Rate	828
FM	828
FM	828
FM Deviation	828
FM Rate	829
PM	829
PM	829
PM Deviation	830
PM Rate	830
List Sequencer	830
Sequencer	831
Initiate Sequence	831
List Sequencer Setup	832
Number of Steps	832
Current Step	832
Insert Step Before	833
Delete Step	833
Clear List	833
Step Trigger	833
Transition Time	835
Radio Setup	836
Channel	853
Frequency	854
Power	854

Waveform	855
Step Duration	862
Output Trigger	864
Step Configuration (Remote Command Only)	864
Clear List (Remote Command Only)	872
Trigger Type	873
BeginningOfStep	873
DataMarker	873
Manual Trigger Now	874
Remote Software Trigger (Remote command Only)	875
Query List Sequence Initiation Armed Status (Remote Command Only)	875
Source Preset	875
Span X Scale	876
Span	876
Last Span	877
Sweep/Control	878
Acq Time	878
Sweep Setup	879
Auto Sweep Time Rules	879
Pause	879
Gate	880
Gate On/Off	880
Gate View On/Off	881
Gate View Setup	884
Gate View Acquisition Time	884
Gate View Start Time	884
Gate Delay	885
Gate Length	885
Gate Source	886
Video (IF Envelope)	887
External 1	889
External 2	891
RF Burst	893
Periodic Timer (Frame Trigger)	896
Auto/Holdoff	907
Gate Preset (Remote Command Only)	909
Gate Level (Remote Command Only)	909
Gate Polarity (Remote Command Only)	909
Points	910
System	912
Trace/Detector	913
Trace Type	913
Detector	913

Table of Contents

Auto	914
Detector Selection	914
Trigger	916
Free Run	916
Video	916
Trigger Level	916
Trig Slope	916
Trig Delay	916
External 1	916
Trigger Level	916
Trig Slope	916
Trig Delay	916
Zero Span Delay Comp	916
External 2	916
Trigger Level	916
Trig Slope	916
Trig Delay	917
Zero Span Delay Comp	917
RF Burst	917
Absolute Trigger	917
Relative Trigger	917
Trig Slope	917
Trig Delay	917
Periodic Timer	917
Period	917
Offset	917
Reset Offset Display	917
Sync Source	917
Off	917
External 1	917
External 2	918
RF Burst	918
Trig Delay	918
Auto/Holdoff	918
Auto Trig	918
Trig Holdoff	918
Holdoff Type	918
User Preset	919
User Preset	919
User Preset All Modes	920
Save User Preset	921
View/Display	922
Spectrum View	922

Display	925
Annotation	925
Meas Bar On/Off	926
Screen	927
Active Function Values On/Off	927
Title	928
Change Title	928
Clear Title	929
Graticule	930
System Display Settings	930
Annotation Local Settings	930
Themes	931
10 ACP Measurement	933
AMPTD Y Scale	940
Ref Value	940
Range	940
Range	941
Adjust Range For Min Clip	941
Pre-Adjust for Min Clip	941
Peak to Average	942
Mixer Level Offset	942
Scale/Div	943
Ref Position	943
Auto Scaling	944
Auto Couple	945
More Information	945
Auto/Man Active Function keys	945
Auto/Man 1-of-N keys	945
BW	947
Res BW	947
Video BW	948
RBW Control	949
Filter Type	949
Filter BW	950
Cont (Continuous Measurement/Sweep)	952
File	954
FREQ Channel	955
Carrier Ref Freq	955
Input/Output	957
Marker	958
Select Marker	958
Marker Type	958
Properties	959

Select Marker	959
Relative To	959
Marker Trace	960
Couple Markers	961
Marker All Off	961
Marker X Axis Value (Remote Command only)	961
Marker X Axis Position (Remote Command only)	962
Marker Y Axis Value (Remote Command only)	963
Backward Compatibility Remote Commands	963
Marker Function	964
Marker To	965
Meas	966
Remote Measurement Functions	966
Measurement Group of Commands	967
Current Measurement Query (Remote Command Only)	969
Limit Test Current Results (Remote Command Only)	969
Data Query (Remote Command Only)	969
Calculate/Compress Trace Data Query (Remote Command Only)	970
Calculate Peaks of Trace Data (Remote Command Only)	975
Hardware-Accelerated Fast Power Measurement (Remote Command Only)	976
Reset Fast Power Measurement (Remote Command Only)	976
Define Fast Power Measurement (Remote Command Only)	977
Define Fast Power Measurement Query (Remote Command Only)	986
Configure Fast Power Measurement (Remote Command Only)	987
Initiate Fast Power Measurement (Remote Command Only)	988
Fetch Fast Power Measurement (Remote Command Only)	988
Execute Fast Power Measurement (Remote Command Only)	988
Binary Read Fast Power Measurement (Remote Command Only)	989
Diagnostic Binary Read Fast Power Measurement (Remote Command Only)	989
Format Data: Numeric Data (Remote Command Only)	990
Format Data: Byte Order (Remote Command Only)	991
Meas Setup	992
Average/Hold Number	992
Avg Mode	993
Offset/Limits	993
Select Offset	993
Offset Freq	994
Integ BW	996
Offset BW	997
Res BW	997
Video BW	999
RBW Control	1000
Limits	1002

Select Offset	1002
Abs Limit	1002
Rel Lim (Car)	1003
Rel Limit (PSD)	1006
Fail Mask	1007
Offset Side	1009
Method for Offset	1009
Method for Offset	1010
Offset Frequency Define	1012
Carrier Result	1012
Meas Method	1013
Meas Type	1014
PSD Ref	1015
Limit Test	1015
Meas Preset	1016
Offset RRC Weighting (Backward Compatibility SCPI)	1017
Offset Filter Alpha (Backward Compatibility SCPI)	1017
Method for Carrier (Backward Compatibility SCPI)	1018
Mode	1020
Mode Preset	1021
How-To Preset	1022
Mode Setup	1024
Peak Search	1025
Next Peak	1025
Next Pk Right	1025
Next Pk Left	1026
Marker Delta	1026
Pk-Pk Search	1026
Min Search	1026
Print	1028
Quick Save	1029
Recall	1031
State	1031
More Information	1032
From File...	1033
Edit Register Names	1035
Register 1 thru Register 16	1035
Register 1 thru Register 16	1036
Sequences	1036
Source Sequence	1037
Open...	1037
Data (Import)	1037
Component Carrier Setup	1038

Table of Contents

Masks	1040
Open...	1041
Restart	1042
More Information	1042
Save	1044
State	1044
To File . . .	1045
Edit Register Names	1047
More Information	1047
Register 1 thru Register 16	1048
Register 1 thru Register 16	1048
Mass Storage Catalog (Remote Command Only)	1049
Mass Storage Change Directory (Remote Command Only)	1050
Mass Storage Copy (Remote Command Only)	1050
Mass Storage Device Copy (Remote Command Only)	1050
Mass Storage Delete (Remote Command Only)	1051
Mass Storage Data (Remote Command Only)	1051
Mass Storage Make Directory (Remote Command Only)	1051
Mass Storage Move (Remote Command Only)	1051
Mass Storage Remove Directory (Remote Command Only)	1052
Sequences	1052
Source Sequence	1053
Save As . . .	1053
Data (Export)	1053
Export Trace Data	1054
Trace 1	1055
Trace 2	1055
Trace 3	1055
Trace 4	1055
Trace 5	1055
Trace 6	1056
Include Header	1056
Measurement Results	1056
Save As . . .	1064
Screen Image	1065
Themes	1066
3D Color	1066
3D Monochrome	1067
Flat Color	1067
Flat Monochrome	1067
Save As...	1067
Single (Single Measurement/Sweep)	1069
More Information	1069

Source	1070
RF Output	1070
Amplitude	1070
RF Power	1071
RF Power Range	1072
Set Reference Power	1072
Power Ref	1072
Amptd Offset	1073
Modulation	1074
Frequency	1074
Frequency	1075
Channel	1075
GSM/EDGE Channel Number Ranges	1076
W-CDMA Channel Number Ranges	1077
CDMA 2000 / 1xEVDO Channel Number Ranges	1078
LTE FDD Channel Number Ranges	1080
LTE TDD Channel Number Ranges	1082
TDSCDMA Channel Number Ranges	1082
Radio Setup	1083
Radio Standard	1084
Radio Band Link	1102
Set Reference Frequency	1102
Freq Reference	1103
Freq Offset	1104
Modulation Setup	1105
ARB	1105
ARB	1105
Select Waveform	1106
ARB Setup	1111
Trigger Type	1113
Trigger Source	1117
Trigger Initiate	1118
Waveform Sequences	1118
Waveform Utilities	1129
Marker Utilities	1139
Header Utilities	1144
Bus Trigger Command (Remote Command Only)	1146
AM	1146
AM	1146
AM Depth	1146
AM Rate	1147
FM	1147
FM	1147

Table of Contents

FM Deviation	1147
FM Rate	1148
PM	1148
PM	1148
PM Deviation	1149
PM Rate	1149
List Sequencer	1149
Sequencer	1150
Initiate Sequence	1150
List Sequencer Setup	1151
Number of Steps	1151
Current Step	1151
Insert Step Before	1152
Delete Step	1152
Clear List	1152
Step Trigger	1152
Transition Time	1154
Radio Setup	1155
Channel	1172
Frequency	1173
Power	1173
Waveform	1174
Step Duration	1181
Output Trigger	1183
Step Configuration (Remote Command Only)	1183
Clear List (Remote Command Only)	1191
Trigger Type	1192
BeginningOfStep	1192
DataMarker	1192
Manual Trigger Now	1193
Remote Software Trigger (Remote command Only)	1194
Query List Sequence Initiation Armed Status (Remote Command Only)	1194
Source Preset	1194
SPAN X Scale	1195
Span	1195
Last Span	1196
Sweep/Control	1197
Acq Time	1197
Sweep Setup	1198
Auto Sweep Time Rules	1198
Pause	1198
Gate	1199
Gate On/Off	1199

Gate View On/Off	1200
Gate View Setup	1203
Gate View Acquisition Time	1203
Gate View Start Time	1203
Gate Delay	1204
Gate Length	1204
Gate Source	1205
Video (IF Envelope)	1206
External 1	1208
External 2	1210
RF Burst	1212
Periodic Timer (Frame Trigger)	1215
Auto/Holdoff	1226
Gate Preset (Remote Command Only)	1228
Gate Level (Remote Command Only)	1228
Gate Polarity (Remote Command Only)	1228
Points	1229
System	1230
Trace/Detector	1231
Select Trace (Front-panel Only)	1231
Trace Type	1231
View/Blank	1232
Detector	1233
Auto	1234
Detector Selection	1234
Trigger	1236
Free Run	1236
Video	1236
Trigger Level	1236
Trig Slope	1236
Trig Delay	1236
External 1	1236
Trigger Level	1236
Trig Slope	1236
Trig Delay	1236
Zero Span Delay Comp	1236
External 2	1236
Trigger Level	1236
Trig Slope	1236
Trig Delay	1237
Zero Span Delay Comp	1237
RF Burst	1237
Absolute Trigger	1237

Relative Trigger	1237
Trig Slope	1237
Trig Delay	1237
Periodic Timer	1237
Period	1237
Offset	1237
Reset Offset Display	1237
Sync Source	1237
Off	1237
External 1	1237
External 2	1238
RF Burst	1238
Trig Delay	1238
Auto/Holdoff	1238
Auto Trig	1238
Trig Holdoff	1238
Holdoff Type	1238
User Preset	1239
User Preset	1239
User Preset All Modes	1240
Save User Preset	1241
View/Display	1242
Spectrum Window	1244
Results Window	1244
Display	1246
Annotation	1246
Meas Bar On/Off	1247
Screen	1248
Active Function Values On/Off	1248
Title	1249
Change Title	1249
Clear Title	1250
Graticule	1251
System Display Settings	1251
Annotation Local Settings	1251
Themes	1252
Bar Graph	1253
11 Spectrum Emission Mask Measurement	1255
AMPTD Y Scale	1273
Ref Value	1273
Range	1273
Range	1274
Adjust Range For Min Clip	1274

Pre-Adjust for Min Clip	1274
Peak to Average	1275
Mixer Level Offset	1275
Scale/Div	1276
Ref Position	1276
Auto Scaling	1277
Auto Couple	1278
More Information	1278
Auto/Man Active Function keys	1278
Auto/Man 1-of-N keys	1278
BW	1280
Filter Type	1280
Cont (Continuous Measurement/Sweep)	1281
File	1283
FREQ Channel	1284
Carrier Ref Freq	1284
Input/Output	1286
Marker	1287
Select Marker	1287
Marker Type	1287
Couple Markers	1288
All Markers Off	1288
Marker X Axis Value (Remote Command Only)	1288
Marker X Axis Position (Remote Command Only)	1289
Marker Y Axis Value (Remote Command Only)	1290
Marker Function	1291
Marker To	1292
Meas	1293
Remote Measurement Functions	1293
Measurement Group of Commands	1294
Current Measurement Query (Remote Command Only)	1296
Limit Test Current Results (Remote Command Only)	1296
Data Query (Remote Command Only)	1296
Calculate/Compress Trace Data Query (Remote Command Only)	1297
Calculate Peaks of Trace Data (Remote Command Only)	1302
Hardware-Accelerated Fast Power Measurement (Remote Command Only)	1303
Reset Fast Power Measurement (Remote Command Only)	1303
Define Fast Power Measurement (Remote Command Only)	1304
Define Fast Power Measurement Query (Remote Command Only)	1313
Configure Fast Power Measurement (Remote Command Only)	1314
Initiate Fast Power Measurement (Remote Command Only)	1315
Fetch Fast Power Measurement (Remote Command Only)	1315
Execute Fast Power Measurement (Remote Command Only)	1315

Binary Read Fast Power Measurement (Remote Command Only)	1316
Diagnostic Binary Read Fast Power Measurement (Remote Command Only)	1316
Format Data: Numeric Data (Remote Command Only)	1317
Format Data: Byte Order (Remote Command Only)	1318
Meas Setup	1319
Avg/Hold Num	1319
Meas Type	1319
Ref Channel	1320
Acq Time	1320
Res BW	1321
Video BW	1323
VBW/RBW	1324
Power Ref (Only for MSR and LTE-Advanced FDD/TDD)	1325
Carrier Index (Only for MSR and LTE-Advanced FDD/TDD)	1326
Manual (Only for MSR and LTE-Advanced FDD/TDD)	1327
Offset/Limits	1327
Select Offset	1328
Start Freq	1328
Stop Freq	1330
Acq Time	1332
Offset Side	1333
Res BW	1334
Meas BW	1335
Video BW	1337
VBW/RBW	1338
Limits	1339
Select Offset	1339
Abs Start	1339
Abs Stop	1341
Rel Start	1343
Rel Stop	1345
Fail Mask	1347
Offset Freq Define	1348
Inner Offset/Limits (Only for MSR and LTE-Advanced FDD/TDD)	1352
Select Offset	1352
Start Freq	1353
Stop Freq	1354
Acq Time	1354
Offset Side	1355
Res BW	1356
Meas BW	1357
Video BW	1358
VBW/RBW	1359

Limits	1360
Select Offset	1360
Abs Start	1360
Abs Stop	1361
Rel Start	1362
Rel Stop	1363
Fail Mask	1364
Offset Freq Define	1365
Cumulate Mask	1368
Cumulate Mask Stop Frequency	1368
Non-Contiguous Meas Region	1369
Method	1369
Filter Alpha	1370
Meas Preset	1371
Mode	1372
Mode Preset	1373
How-To Preset	1374
Mode Setup	1376
Peak Search	1377
Print	1378
Quick Save	1379
Recall	1381
State	1381
More Information	1382
From File...	1383
Edit Register Names	1385
Register 1 thru Register 16	1385
Register 1 thru Register 16	1386
Sequences	1386
Source Sequence	1387
Open...	1387
Data (Import)	1387
Component Carrier Setup	1388
Masks	1390
Open...	1391
Restart	1392
More Information	1392
Save	1394
State	1394
To File . . .	1395
Edit Register Names	1397
More Information	1397
Register 1 thru Register 16	1398

Register 1 thru Register 16	1398
Mass Storage Catalog (Remote Command Only)	1399
Mass Storage Change Directory (Remote Command Only)	1400
Mass Storage Copy (Remote Command Only)	1400
Mass Storage Device Copy (Remote Command Only)	1400
Mass Storage Delete (Remote Command Only)	1401
Mass Storage Data (Remote Command Only)	1401
Mass Storage Make Directory (Remote Command Only)	1401
Mass Storage Move (Remote Command Only)	1401
Mass Storage Remove Directory (Remote Command Only)	1402
Sequences	1402
Source Sequence	1403
Save As . . .	1403
Data (Export)	1403
Export Trace Data	1404
Trace 1	1405
Trace 2	1405
Trace 3	1405
Trace 4	1405
Trace 5	1405
Trace 6	1406
Include Header	1406
Measurement Results	1406
Meas Results File Contents	1407
Save As . . .	1416
Screen Image	1416
Themes	1418
3D Color	1418
3D Monochrome	1418
Flat Color	1419
Flat Monochrome	1419
Save As...	1419
Single (Single Measurement/Sweep)	1420
More Information	1420
Source	1421
RF Output	1421
Amplitude	1421
RF Power	1422
RF Power Range	1423
Set Reference Power	1423
Power Ref	1423
Amptd Offset	1424
Modulation	1425

Frequency	1425
Frequency	1426
Channel	1426
GSM/EDGE Channel Number Ranges	1427
W-CDMA Channel Number Ranges	1428
CDMA 2000 / 1xEVDO Channel Number Ranges	1429
LTE FDD Channel Number Ranges	1431
LTE TDD Channel Number Ranges	1433
TDSCDMA Channel Number Ranges	1433
Radio Setup	1434
Radio Standard	1435
Radio Band Link	1453
Set Reference Frequency	1453
Freq Reference	1454
Freq Offset	1455
Modulation Setup	1456
ARB	1456
ARB	1456
Select Waveform	1457
ARB Setup	1462
Trigger Type	1464
Trigger Source	1468
Trigger Initiate	1469
Waveform Sequences	1469
Waveform Utilities	1480
Marker Utilities	1490
Header Utilities	1495
Bus Trigger Command (Remote Command Only)	1497
AM	1497
AM	1497
AM Depth	1497
AM Rate	1498
FM	1498
FM	1498
FM Deviation	1498
FM Rate	1499
PM	1499
PM	1499
PM Deviation	1500
PM Rate	1500
List Sequencer	1500
Sequencer	1501
Initiate Sequence	1501

List Sequencer Setup	1502
Number of Steps	1502
Current Step	1502
Insert Step Before	1503
Delete Step	1503
Clear List	1503
Step Trigger	1503
Transition Time	1505
Radio Setup	1506
Channel	1523
Frequency	1524
Power	1524
Waveform	1525
Step Duration	1532
Output Trigger	1534
Step Configuration (Remote Command Only)	1534
Clear List (Remote Command Only)	1542
Trigger Type	1543
BeginningOfStep	1543
DataMarker	1543
Manual Trigger Now	1544
Remote Software Trigger (Remote command Only)	1545
Query List Sequence Initiation Armed Status (Remote Command Only)	1545
Source Preset	1545
Span X Scale	1546
Ref Value	1546
Scale/Div	1546
Ref Position	1547
Auto Scaling	1547
Sweep/Control	1549
Pause	1549
Gate	1549
Gate On/Off	1549
Gate View On/Off	1550
Gate View Setup	1553
Gate View Acquisition Time	1553
Gate View Start Time	1554
Gate Delay	1554
Gate Length	1555
Gate Source	1555
Video (IF Envelope)	1556
External 1	1558
External 2	1560

RF Burst	1562
Periodic Timer (Frame Trigger)	1566
Auto/Holdoff	1577
Gate Preset (Remote Command Only)	1578
Gate Level (Remote Command Only)	1578
Gate Polarity (Remote Command Only)	1579
System	1580
Trace/Detector	1581
Trace Type	1581
Chan Detector	1581
Chan Detector Auto	1582
Chan Detector Selection	1582
Offset Detector	1583
Offset Detector Auto	1583
Offset Detector Selection	1584
Trigger	1585
Free Run	1585
Video	1585
Trigger Level	1585
Trig Slope	1585
Trig Delay	1585
External 1	1585
Trigger Level	1585
Trig Slope	1585
Trig Delay	1585
Zero Span Delay Comp	1585
External 2	1585
Trigger Level	1585
Trig Slope	1585
Trig Delay	1586
Zero Span Delay Comp	1586
RF Burst	1586
Absolute Trigger	1586
Relative Trigger	1586
Trig Slope	1586
Trig Delay	1586
Periodic Timer	1586
Period	1586
Offset	1586
Reset Offset Display	1586
Sync Source	1586
Off	1586
External 1	1586

External 2	1587
RF Burst	1587
Trig Delay	1587
Auto/Holdoff	1587
Auto Trig	1587
Trig Holdoff	1587
Holdoff Type	1587
User Preset	1588
User Preset	1588
User Preset All Modes	1589
Save User Preset	1590
View/Display	1591
View Selection by Name (Remote Command Only)	1591
Views Selection by Number (Remote Command only)	1591
Display	1592
Annotation	1592
Meas Bar On/Off	1594
Screen	1594
Active Function Values On/Off	1594
Title	1595
Change Title	1595
Clear Title	1596
Graticule	1597
System Display Settings	1597
Annotation Local Settings	1597
Themes	1598
Abs Pwr Freq	1599
Abs Peak Pwr & Freq (Total Pwr Ref)	1599
Trace Window	1600
Results Window	1600
Abs Peak Pwr & Freq (PSD Ref)	1601
Trace Window	1601
Results Window	1602
Abs Peak Pwr & Freq (Spectrum Pk Ref)	1602
Trace Window	1603
Results Window	1603
Rel Pwr Freq	1604
Rel Peak Pwr & Freq (Total Pwr Ref)	1604
Trace Window	1605
Results Window	1605
Rel Peak Pwr & Freq (PSD Ref)	1606
Trace Window	1606
Results Window	1607

Rel Peak Pwr & Freq (Spectrum Pk Ref)	1607
Trace Window	1608
Results Window	1608
Integrated Power	1609
Integrated Power (Total Pwr Ref)	1609
Trace Window	1611
Results Window	1611
Integrated Power (PSD Ref)	1612
Trace Window	1613
Results Window	1613
Integrated Power (Spectrum Pk Ref)	1614
Trace Window	1615
Results Window	1615
Carrier Info (MSR and LTE-Advanced FDD/TDD Only)	1616
Carrier Freq (MSR and LTE-Advanced FDD/TDD Only)	1618
Limit Lines	1618
12 Transmit On/Off Power Measurement Functions	1619
Amplitude (AMPTD) Y Scale	1625
Range	1625
Range	1625
Adjust Range For Min Clip	1625
Pre-Adjust for Min Clip	1626
Peak to Average	1626
Mixer Level Offset	1627
Ref Value	1627
Ref Value (Burst View)	1627
Ref Value (Rise & Fall view)	1628
Scale/Div	1628
Scale/Div(Burst View)	1628
Scale/Div (Rise & Fall view)	1629
Ref Position	1630
Ref Position(Burst View)	1630
Ref Position (Rise & Fall view)	1630
Auto Scale	1631
Auto Scale(Burst View)	1631
Auto Scale (Rise & Fall view)	1631
Auto Couple	1633
More Information	1633
Auto/Man Active Function keys	1633
Auto/Man 1-of-N keys	1633
BW	1635
Cont (Continuous Measurement/Sweep)	1637
File	1639

FREQ Channel	1640
Carrier Ref Freq	1640
Input/Output	1642
Marker	1643
Select Marker	1643
Marker Type	1643
Properties	1644
Select Marker	1644
Relative To	1644
Marker Trace	1645
Couple Marker	1645
All Markers Off	1645
Marker X Axis Value (Remote Command Only)	1646
Marker X Axis Position (Remote Command only)	1646
Marker Y Axis Value (Remote Command only)	1647
Maker State (Remote Command Only)	1647
Marker Fctn	1649
Marker To	1650
Meas	1651
Remote Measurement Functions	1651
Measurement Group of Commands	1652
Current Measurement Query (Remote Command Only)	1654
Limit Test Current Results (Remote Command Only)	1654
Data Query (Remote Command Only)	1654
Calculate/Compress Trace Data Query (Remote Command Only)	1655
Calculate Peaks of Trace Data (Remote Command Only)	1660
Hardware-Accelerated Fast Power Measurement (Remote Command Only)	1661
Reset Fast Power Measurement (Remote Command Only)	1661
Define Fast Power Measurement (Remote Command Only)	1662
Define Fast Power Measurement Query (Remote Command Only)	1671
Configure Fast Power Measurement (Remote Command Only)	1672
Initiate Fast Power Measurement (Remote Command Only)	1673
Fetch Fast Power Measurement (Remote Command Only)	1673
Execute Fast Power Measurement (Remote Command Only)	1673
Binary Read Fast Power Measurement (Remote Command Only)	1674
Diagnostic Binary Read Fast Power Measurement (Remote Command Only)	1674
Format Data: Numeric Data (Remote Command Only)	1675
Format Data: Byte Order (Remote Command Only)	1676
Meas Setup	1677
Avg/Hold Num	1677
Avg Mode	1677
Avg Type	1678
Ramp Time Length	1678

Limits	1679
Max Ramp Down Time	1679
Max Ramp Up Time	1680
Downlink Off Power	1680
Uplink Off Power	1681
Threshold	1681
Ramp Up Start Level	1681
Ramp Up End Level	1682
Ramp Down Start Level	1682
Ramp Down End Level	1683
Meas Preset	1683
Mode	1684
Mode Preset	1685
How-To Preset	1686
Mode Setup	1688
Peak Search	1689
Print	1690
Quick Save	1691
Recall	1693
State	1693
More Information	1694
From File...	1695
Edit Register Names	1697
Register 1 thru Register 16	1697
Register 1 thru Register 16	1698
Sequences	1698
Source Sequence	1699
Open...	1699
Data (Import)	1699
Component Carrier Setup	1700
Masks	1702
Open...	1703
Restart	1704
More Information	1704
Save	1706
State	1706
To File . . .	1707
Edit Register Names	1709
More Information	1709
Register 1 thru Register 16	1710
Register 1 thru Register 16	1710
Mass Storage Catalog (Remote Command Only)	1711
Mass Storage Change Directory (Remote Command Only)	1712

Mass Storage Copy (Remote Command Only)	1712
Mass Storage Device Copy (Remote Command Only)	1712
Mass Storage Delete (Remote Command Only)	1713
Mass Storage Data (Remote Command Only)	1713
Mass Storage Make Directory (Remote Command Only)	1713
Mass Storage Move (Remote Command Only)	1713
Mass Storage Remove Directory (Remote Command Only)	1714
Sequences	1714
Source Sequence	1715
Save As . . .	1715
Data (Export)	1715
Export Trace Data	1716
Trace 1	1717
Trace 2	1717
Trace 3	1717
Trace 4	1717
Trace 5	1717
Trace 6	1718
Include Header	1718
Measurement Results	1718
Meas Results File Contents	1719
Marker Table	1719
Peak Table	1722
Spectrogram	1724
Save As . . .	1729
Screen Image	1730
Themes	1731
3D Color	1731
3D Monochrome	1732
Flat Color	1732
Flat Monochrome	1732
Save As...	1732
Single (Single Measurement/Sweep)	1734
More Information	1734
Source	1735
RF Output	1735
Amplitude	1735
RF Power	1736
RF Power Range	1737
Set Reference Power	1737
Power Ref	1737
Amptd Offset	1738
Modulation	1739

Frequency	1739
Frequency	1740
Channel	1740
GSM/EDGE Channel Number Ranges	1741
W-CDMA Channel Number Ranges	1742
CDMA 2000 / 1xEVDO Channel Number Ranges	1743
LTE FDD Channel Number Ranges	1745
LTE TDD Channel Number Ranges	1747
TDSCDMA Channel Number Ranges	1747
Radio Setup	1748
Radio Standard	1749
Radio Band Link	1767
Set Reference Frequency	1767
Freq Reference	1768
Freq Offset	1769
Modulation Setup	1770
ARB	1770
ARB	1770
Select Waveform	1771
ARB Setup	1776
Trigger Type	1778
Trigger Source	1782
Trigger Initiate	1783
Waveform Sequences	1783
Waveform Utilities	1794
Marker Utilities	1804
Header Utilities	1809
Bus Trigger Command (Remote Command Only)	1811
AM	1811
AM	1811
AM Depth	1811
AM Rate	1812
FM	1812
FM	1812
FM Deviation	1812
FM Rate	1813
PM	1813
PM	1813
PM Deviation	1814
PM Rate	1814
List Sequencer	1814
Sequencer	1815
Initiate Sequence	1815

List Sequencer Setup	1816
Number of Steps	1816
Current Step	1816
Insert Step Before	1817
Delete Step	1817
Clear List	1817
Step Trigger	1817
Transition Time	1819
Radio Setup	1820
Channel	1837
Frequency	1838
Power	1838
Waveform	1839
Step Duration	1846
Output Trigger	1848
Step Configuration (Remote Command Only)	1848
Clear List (Remote Command Only)	1856
Trigger Type	1857
BeginningOfStep	1857
DataMarker	1857
Manual Trigger Now	1858
Remote Software Trigger (Remote command Only)	1859
Query List Sequence Initiation Armed Status (Remote Command Only)	1859
Source Preset	1859
SPAN X Scale	1860
Ref Value	1860
Ref Value(Burst View)	1860
Ref Value(Rise & Fall view)	1860
Scale/Div	1861
Scale/Div(Burst View)	1861
Scale/Div(Rise & Fall View)	1862
Ref Position	1862
Ref Position(Burst View)	1862
Ref Position(Rise & Fall View)	1863
Auto Scale	1863
Auto Scale(Burst View)	1863
Auto Scale(Rise & Fall View)	1864
Sweep/Control	1865
Pause/Resume	1865
Abort (Remote Command Only)	1865
System	1867
Trace/Detector	1868
Max Hold Trace	1868

Min Hold Trace	1868
Trigger	1870
Free Run	1870
Video	1870
Trigger Level	1870
Trig Slope	1870
Trig Delay	1870
External 1	1870
Trigger Level	1870
Trig Slope	1870
Trig Delay	1870
Zero Span Delay Comp	1870
External 2	1870
Trigger Level	1870
Trig Slope	1870
Trig Delay	1871
Zero Span Delay Comp	1871
RF Burst	1871
Absolute Trigger	1871
Relative Trigger	1871
Trig Slope	1871
Trig Delay	1871
Periodic Timer	1871
Period	1871
Offset	1871
Offset Adjust (Remote Command Only)	1871
Reset Offset Display	1871
Sync Source	1871
Off	1871
External 1	1872
External 2	1872
RF Burst	1872
Trig Delay	1872
Auto/Holdoff	1872
Auto Trig	1872
Trig Holdoff	1872
Holdoff Type	1872
User Preset	1873
User Preset	1873
User Preset All Modes	1874
Save User Preset	1875
View/Display	1876
Display	1877

Annotation	1877
Meas Bar On/Off	1878
Screen	1879
Active Function Values On/Off	1879
Title	1880
Change Title	1880
Clear Title	1881
Graticule	1882
System Display Settings	1882
Annotation Local Settings	1882
Themes	1883
Burst View	1884
RF Envelope window	1885
Result Metrics window	1885
Trigger Lines	1888
Burst Lines	1888
Limit Mask	1888
Rise & Fall View	1889
Ramp Lines	1890
Scroll	1891
Prev Page	1891
Next Page	1891
Scroll Up	1891
Scroll Down	1892
First Page	1892
Last Page	1892
Display	1892
13 LTE-Advanced Modulation Analysis Measurement	1893
AMPTD (Amplitude) Y Scale	1903
Y Auto Scale	1903
Range	1903
Range	1903
Adjust Range For Min Clip	1904
Pre-Adjust for Min Clip	1904
Peak to Average	1905
Mixer Level Offset	1905
Select Trace	1906
Couple Ref to Range	1907
Y Reference Value	1907
Y Scale Per Division	1908
Y Reference: Position	1908
Reference Line	1909
Y Unit Preference	1909

Y Log Ratio	1910
Vector Horiz Center	1911
Copy Y Scale	1911
Y Auto Scale	1912
Attenuation	1912
Select Trace	1912
Couple Ref to Range	1912
Y Reference Value	1912
Y Scale Per Division	1912
Y Reference: Position	1912
Reference Line	1912
Y Unit Preference	1912
Y Log Ratio	1912
Vector Horiz Center	1912
Copy Y Scale	1912
Auto Couple	1913
More Information	1913
Auto/Man Active Function keys	1913
Auto/Man 1-of-N keys	1913
BW	1915
Cont (Continuous Measurement/Sweep)	1916
File	1918
FREQ Channel	1919
Carrier Ref Freq	1919
Input/Output	1921
Marker	1922
Select Marker	1922
Control Mode	1923
Marker Properties	1923
Select Marker	1923
Relative To	1924
Complex Format	1924
Marker Trace	1925
Marker Count	1926
Marker Table	1926
Marker Position	1927
Marker X	1927
SCPI only X position commands	1928
Marker Z	1929
Marker Y	1930
Marker Y Imag (Imaginary)	1932
Couple Markers	1932
All Markers Off	1933

Normal (Position)	1933
Delta	1934
Fixed	1935
Off	1935
Coupling of Delta and Reference Markers	1935
Marker -> (Marker To)	1937
Mkr -> CF (Center Frequency)	1937
Mkr -> CF Step	1937
Mkr -> Start	1938
Mkr -> Stop	1938
Mkr Delta -> Span	1938
Mkr -> Ref Lvl	1938
Counter -> CF (Center Frequency)	1939
Mkr Delta -> CF (Center Frequency)	1939
Marker Function	1940
Select Marker	1940
Band/Interval Power	1941
Frequency-domain data	1941
Time-domain data	1941
Band Power Calculation	1941
Band/Interval Density	1943
Frequency-domain data	1943
Time-domain data	1943
Band Density Calculation	1943
Band Adjust	1944
Band/Interval Center	1944
Band/Interval Span	1945
Band/Interval Left	1945
Band/Interval Right	1946
Band Power and Delta Markers	1946
Meas	1948
Remote Measurement Functions	1948
Measurement Group of Commands	1949
Current Measurement Query (Remote Command Only)	1951
Limit Test Current Results (Remote Command Only)	1951
Data Query (Remote Command Only)	1951
Calculate/Compress Trace Data Query (Remote Command Only)	1952
Calculate Peaks of Trace Data (Remote Command Only)	1957
Hardware-Accelerated Fast Power Measurement (Remote Command Only)	1958
Reset Fast Power Measurement (Remote Command Only)	1958
Define Fast Power Measurement (Remote Command Only)	1959
Define Fast Power Measurement Query (Remote Command Only)	1968
Configure Fast Power Measurement (Remote Command Only)	1969

Initiate Fast Power Measurement (Remote Command Only)	1970
Fetch Fast Power Measurement (Remote Command Only)	1970
Execute Fast Power Measurement (Remote Command Only)	1970
Binary Read Fast Power Measurement (Remote Command Only)	1971
Diagnostic Binary Read Fast Power Measurement (Remote Command Only)	1971
Format Data: Numeric Data (Remote Command Only)	1972
Format Data: Byte Order (Remote Command Only)	1973
Meas Setup	1974
Component Carrier	1974
Sync/Format Setup (Downlink)	1975
Sync Type	1975
P-SS	1976
C-RS	1976
RS-PRS	1977
Cell ID	1977
Tx Antenna	1979
Number of C-RS Ports	1979
Reference C-RS Port	1980
Antenna Detect Threshold	1983
P-SS/S-SS Antenna Port	1983
Include Inactive Antenna Paths	1985
MIMO Decoding	1986
3GPP MIMO Decoding	1986
No Decoding	1987
PDSCH Cell Specific Ratio	1988
Meas Time Setup	1989
Result Length	1989
Meas Offset Slot	1990
Meas Offset Symbol	1990
Meas Interval Slot	1991
Meas Interval Symbol	1991
Analysis Start Boundary	1992
Frame	1993
Half-Frame	1993
SubFrame	1993
Slot	1993
Chan Profile Setup (Downlink)	1994
Detection	1994
RB Auto Detect Mode	1995
Auto Detect Power Levels In Power Mode	1995
Auto Detect Power Levels	1997
Round to Standard Values	1998
Number of Expected DL Users	1999

Composite Include	2000
Include All	2000
Exclude All	2001
Include Channels	2001
Include P-SS	2001
Include S-SS	2002
Include PBCH	2002
Include PCFICH	2003
Include PHICH	2003
Include C-RS	2004
Include PDCCH	2004
Include P-RS	2005
Include MBSFN-RS	2005
Include PMCH	2006
Include CSI-RS	2006
Include Non Allocation	2007
Include Users (Downlink)	2008
User	2008
Include PDSCH	2008
Include Decoded PDSCH	2009
Include QPSK	2009
Include 16QAM	2010
Include 64QAM	2011
Edit Control Channels	2011
Edit User Mapping (Downlink)	2012
OK/Cancel	2014
Copy Auto -> Manual	2015
Copy CC To	2016
Decode	2016
Decode Type	2017
PBCH Decoding	2017
PCFICH Decoding	2018
PDCCH Decoding	2019
PDSCH Decoding	2020
PUSCH Decoding	2021
PUCCH Decoding	2022
DCI Format Detection Include	2023
RNTI Range	2024
RA-RNTI Range Min Value	2024
RA-RNTI Range Max Value	2025
TPC-RNTI Range Min Value	2026
TPC-RNTI Range Max Value	2027
DCI Format 2 PMI Config	2028

Latest PMI Report on PUSCH using 1 Layer	2029
Latest PMI Report on PUSCH using 2 Layers	2030
Latest PMI Report on PUSCH using 3 Layers	2030
Latest PMI Report on PUSCH using 4 Layers	2031
PUSCH Decode Parameters	2032
Info Size parameter	2032
Offset Index parameter	2032
PUSCH HARQ-ACK	2033
PUSCH RI	2035
PUSCH CQI/PMI	2037
PUCCH Decode Parameters	2039
Info Size parameter	2039
PUCCH HARQ-ACK	2039
PUCCH CQI/PMI	2041
ACK/NACK Feedback Mode	2042
ACK/NACK Feedback Mode	2043
Advanced	2043
Cyclic Prefix Length (Downlink)	2043
Auto	2044
Normal	2045
Extended	2045
Cyclic Prefix Length (Uplink)	2045
Auto	2046
Normal	2047
Extended	2047
Extended Freq Lock Range	2047
Equalizer Training	2048
Off	2049
RS	2050
RS + Data	2050
Moving Average Filter	2050
MIMO Channel Frequency Normalize	2052
Equalizer Training Mode	2052
Symbol Timing Adjust	2053
Max of EVM Window Start/End	2054
Min of EVM in Start/End	2054
EVM Window Start	2055
EVM Window End	2055
EVM Window Center	2055
% FFT Size	2055
EVM Window Length	2056
3GPP	2057
EVM Window Length Custom	2057

Result Format	2058
Report EVM in dB	2058
Report Relative Power Levels	2059
Power Boost Normalize	2060
UE-RS Weights	2061
Time Scale Factor	2064
Multi Carrier Filter	2065
EVM Minimization	2065
EVM Minimization Items	2066
EVM Minimization by Timing	2067
EVM Minimization by Frequency/Phase	2068
EVM Minimization by Amplitude	2068
EVM Minimization by IQ Offset	2069
EVM Minimization by IQ Imbalance	2069
Exclude EVM Transient Time	2070
Opposite Direction Active	2071
Antenna Element Spacing	2071
Number of Antenna Elements	2072
Limits	2073
Spectrum Flatness Mask	2073
Avg Number	2076
Average Setup	2077
Average Type	2077
Fast Average	2078
Update Rate	2079
Adjust Attenuation for each CC	2079
Meas Preset	2080
Mode	2081
Mode Preset	2082
How-To Preset	2083
Mode Setup	2085
Peak Search	2086
Select Marker	2086
Next Peak (Next Lower Amptd)	2087
Next Higher Amptd	2087
Next Right	2088
Next Left	2088
Mkr -> CF (Center Frequency)	2088
Continuous Peak Search	2089
Min Search	2089
Mkr -> Ref Lvl (Reference Level)	2090
Print	2091
Quick Save	2092

Recall	2094
State	2094
More Information	2095
From File...	2096
Edit Register Names	2098
Register 1 thru Register 16	2098
Register 1 thru Register 16	2099
Sequences	2099
Source Sequence	2100
Open...	2100
Data (Import)	2100
Component Carrier Setup	2101
Import Trace Data	2103
Data 1	2104
Data 2	2104
Data 3	2105
Data 4	2105
Data 5	2105
Data 6	2105
Display in Selected Trace	2105
Masks	2106
Open...	2106
Restart	2108
More Information	2108
Save	2110
State	2110
To File . . .	2111
Edit Register Names	2113
More Information	2113
Register 1 thru Register 16	2114
Register 1 thru Register 16	2114
Mass Storage Catalog (Remote Command Only)	2115
Mass Storage Change Directory (Remote Command Only)	2116
Mass Storage Copy (Remote Command Only)	2116
Mass Storage Device Copy (Remote Command Only)	2116
Mass Storage Delete (Remote Command Only)	2117
Mass Storage Data (Remote Command Only)	2117
Mass Storage Make Directory (Remote Command Only)	2117
Mass Storage Move (Remote Command Only)	2117
Mass Storage Remove Directory (Remote Command Only)	2118
Sequences	2118
Source Sequence	2119
Save As . . .	2119

Data (Export)	2119
Export Trace Data	2120
Trace 1	2121
Trace 2	2121
Trace 3	2121
Trace 4	2121
Trace 5	2121
Trace 6	2122
Include Header	2122
Measurement Results	2122
Meas Results File Contents	2123
Marker Table	2123
Peak Table	2126
Spectrogram	2128
Save As . . .	2133
Screen Image	2134
Themes	2135
3D Color	2135
3D Monochrome	2136
Flat Color	2136
Flat Monochrome	2136
Save As...	2136
Single (Single Measurement/Sweep)	2138
More Information	2138
Source	2139
RF Output	2139
Amplitude	2139
RF Power	2140
RF Power Range	2141
Set Reference Power	2141
Power Ref	2141
Amptd Offset	2142
Modulation	2143
Frequency	2143
Frequency	2144
Channel	2144
GSM/EDGE Channel Number Ranges	2145
W-CDMA Channel Number Ranges	2146
CDMA 2000 / 1xEVDO Channel Number Ranges	2147
LTE FDD Channel Number Ranges	2149
LTE TDD Channel Number Ranges	2151
TDSCDMA Channel Number Ranges	2151
Radio Setup	2152

Radio Standard	2153
Radio Band Link	2171
Set Reference Frequency	2171
Freq Reference	2172
Freq Offset	2173
Modulation Setup	2174
ARB	2174
ARB	2174
Select Waveform	2175
ARB Setup	2180
Trigger Type	2182
Trigger Source	2186
Trigger Initiate	2187
Waveform Sequences	2187
Waveform Utilities	2198
Marker Utilities	2208
Header Utilities	2213
Bus Trigger Command (Remote Command Only)	2215
AM	2215
AM	2215
AM Depth	2215
AM Rate	2216
FM	2216
FM	2216
FM Deviation	2216
FM Rate	2217
PM	2217
PM	2217
PM Deviation	2218
PM Rate	2218
List Sequencer	2218
Sequencer	2219
Initiate Sequence	2219
List Sequencer Setup	2220
Number of Steps	2220
Current Step	2220
Insert Step Before	2221
Delete Step	2221
Clear List	2221
Step Trigger	2221
Transition Time	2223
Radio Setup	2224
Channel	2241

Frequency	2242
Power	2242
Waveform	2243
Step Duration	2250
Output Trigger	2252
Step Configuration (Remote Command Only)	2252
Clear List (Remote Command Only)	2260
Trigger Type	2261
BeginningOfStep	2261
DataMarker	2261
Manual Trigger Now	2262
Remote Software Trigger (Remote command Only)	2263
Query List Sequence Initiation Armed Status (Remote Command Only)	2263
Source Preset	2263
SPAN X Scale	2264
Select Trace	2264
X Scale	2265
X Reference Value	2266
X Width	2266
X Reference Position	2267
Freq Annotation	2267
All Frequency Points	2268
Copy X Scale	2268
Sweep / Control	2270
System	2271
Trace/Detector	2272
Select Trace	2272
CC For Selected Trace	2273
Component Carrier	2273
Data	2274
Pre Demod	2276
Spectrum	2276
Inst Spectrum	2277
Search Time	2277
Time	2277
Raw Main Time	2277
Demod	2277
IQ Meas	2278
IQ Ref	2278
IQ Meas Time	2278
IQ Ref Time	2279
IQ Freq Meas	2279
IQ Freq Ref	2279

Detected Allocations	2280
Demod Err (Error)	2280
Error Vector Time	2280
RMS Error Vector Time	2281
Error Vector Spectrum	2281
RMS Error Vector Spectrum	2281
Common Tracking Error	2282
RB Error Mag Spectrum	2282
RB Error Mag Time	2282
RB Power Spectrum	2282
RB Power vs Time	2283
Freq Err Per Slot	2283
IQ Offset Per Slot	2283
In-band Emissions	2283
Tables	2284
Error Summary	2284
Frame Summary	2287
Cross-Carrier Summary	2291
Symbols	2291
Decoded Symbol Table	2292
DL Decode Info	2292
UL Decode Info	2292
UE-RS Weights	2293
Response	2293
Eq Ch Frequency Response	2294
Inst Eq Ch Freq Resp	2294
Eq Ch Freq Resp Diff	2294
Inst Eq Ch Freq Resp Diff	2294
Eq Impulse Response	2295
Eq Ch Freq Resp Per Slot	2295
MIMO	2295
Info Table	2295
Ch Freq Resp	2296
Ch Freq Resp Diff	2296
Eq Impulse Resp	2297
MIMO Common Tracking Error	2297
No Data	2297
Format	2297
CC For All Traces	2299
Copy CC To	2299
Digital Demod Trace Setup	2300
Symbol Shape	2300
Ideal State Shape	2301

Ideal State Size	2301
Symbol Table Format	2302
Time Unit	2303
Freq Unit	2303
Eye Length	2304
Avg Line	2304
Copy to Data Register	2305
Phase/Delay Properties	2306
Phase/Trellis Offset	2306
Unwrap Phase Ref	2307
Group Delay Aperture	2307
Trace Indicator Info	2308
Limit Test (SCPI Only)	2308
Trigger	2310
Free Run	2310
Video	2310
Trigger Level	2310
Trig Slope	2310
Trig Delay	2310
External 1	2310
Trigger Level	2310
Trig Slope	2310
Trig Delay	2310
Zero Span Delay Comp	2310
External 2	2310
Trigger Level	2310
Trig Slope	2310
Trig Delay	2311
Zero Span Delay Comp	2311
RF Burst	2311
Absolute Trigger	2311
Relative Trigger	2311
Trig Slope	2311
Trig Delay	2311
Periodic Timer	2311
Period	2311
Offset	2311
Offset Adjust (Remote Command Only)	2311
Reset Offset Display	2311
Sync Source	2311
Off	2311
External 1	2312
External 2	2312

RF Burst	2312
Trig Delay	2312
Auto/Holdoff	2312
Auto Trig	2312
Trig Holdoff	2312
Holdoff Type	2312
User Preset	2313
User Preset	2313
User Preset All Modes	2314
Save User Preset	2315
View/Display	2316
Display	2316
Annotation	2316
Meas Bar On/Off	2317
Screen	2318
Active Function Values On/Off	2318
Title	2319
Change Title	2319
Clear Title	2320
Graticule	2321
System Display Settings	2321
Annotation Local Settings	2321
Themes	2322
Layout	2323
Component Carrier	2326
Preset View: Basic	2326
Preset View: Meas Summary	2327
Preset View: RB Slot Meas	2328
Preset View: Subcarrier Meas	2329
Preset View: MIMO Summary	2330
Preset View: Cross-Carriers	2331
14 Conformance EVM	2333
AMPTD Y Scale	2340
Range	2340
Range	2340
Adjust Range For Min Clip	2341
Pre-Adjust for Min Clip	2341
Peak to Average	2341
Mixer Level Offset	2342
Auto Couple	2343
More Information	2343
Auto/Man Active Function keys	2343
Auto/Man 1-of-N keys	2343

BW	2345
Cont (Continuous Measurement/Sweep)	2346
File	2348
FREQ Channel	2349
Carrier Ref Freq	2349
Input/Output	2351
Marker	2352
Marker > (Marker To)	2353
Marker Fctn	2354
Meas	2355
Remote Measurement Functions	2355
Measurement Group of Commands	2356
Current Measurement Query (Remote Command Only)	2358
Limit Test Current Results (Remote Command Only)	2358
Data Query (Remote Command Only)	2358
Calculate/Compress Trace Data Query (Remote Command Only)	2359
Calculate Peaks of Trace Data (Remote Command Only)	2364
Hardware-Accelerated Fast Power Measurement (Remote Command Only)	2365
Reset Fast Power Measurement (Remote Command Only)	2365
Define Fast Power Measurement (Remote Command Only)	2366
Define Fast Power Measurement Query (Remote Command Only)	2375
Configure Fast Power Measurement (Remote Command Only)	2376
Initiate Fast Power Measurement (Remote Command Only)	2377
Fetch Fast Power Measurement (Remote Command Only)	2377
Execute Fast Power Measurement (Remote Command Only)	2377
Binary Read Fast Power Measurement (Remote Command Only)	2378
Diagnostic Binary Read Fast Power Measurement (Remote Command Only)	2378
Format Data: Numeric Data (Remote Command Only)	2379
Format Data: Byte Order (Remote Command Only)	2380
Meas Setup	2381
Average/Hold Number	2381
Meas Method (when 85 MHz or wider analysis bandwidth option is installed)	2381
Fast Mode Limitation	2382
Copy from Mod Analysis Measurement	2384
Meas Preset	2384
EVM Minimization by IQ Imbalance	2384
IQ Imbalance Frequency Compensation	2385
Result Values	2385
Downlink Result Output Selection	2385
Uplink Result Output Selection	2387
Downlink Set All Results	2388
Uplink Set All Results	2389
Get Measurement Item List	2389

Mode	2390
Mode Preset	2391
How-To Preset	2392
Mode Setup	2394
Peak Search	2395
Print	2396
Quick Save	2397
Recall	2399
State	2399
More Information	2400
From File...	2401
Edit Register Names	2403
Register 1 thru Register 16	2403
Register 1 thru Register 16	2404
Sequences	2404
Source Sequence	2405
Open...	2405
Data (Import)	2405
Component Carrier Setup	2406
Masks	2408
Open...	2409
Restart	2410
More Information	2410
Save	2412
State	2412
To File . . .	2413
Edit Register Names	2415
More Information	2415
Register 1 thru Register 16	2416
Register 1 thru Register 16	2416
Mass Storage Catalog (Remote Command Only)	2417
Mass Storage Change Directory (Remote Command Only)	2418
Mass Storage Copy (Remote Command Only)	2418
Mass Storage Device Copy (Remote Command Only)	2418
Mass Storage Delete (Remote Command Only)	2419
Mass Storage Data (Remote Command Only)	2419
Mass Storage Make Directory (Remote Command Only)	2419
Mass Storage Move (Remote Command Only)	2419
Mass Storage Remove Directory (Remote Command Only)	2420
Sequences	2420
Source Sequence	2421
Save As . . .	2421
Data (Export)	2421

Export Trace Data	2422
Trace 1	2423
Trace 2	2423
Trace 3	2423
Trace 4	2423
Trace 5	2423
Trace 6	2424
Include Header	2424
Measurement Results	2424
Meas Results File Contents	2425
Marker Table	2425
Peak Table	2428
Spectrogram	2430
Save As . . .	2435
Screen Image	2436
Themes	2437
3D Color	2437
3D Monochrome	2438
Flat Color	2438
Flat Monochrome	2438
Save As...	2438
Single (Single Measurement/Sweep)	2440
More Information	2440
Source	2441
RF Output	2441
Amplitude	2441
RF Power	2442
RF Power Range	2443
Set Reference Power	2443
Power Ref	2443
Amptd Offset	2444
Modulation	2445
Frequency	2445
Frequency	2446
Channel	2446
GSM/EDGE Channel Number Ranges	2447
W-CDMA Channel Number Ranges	2448
CDMA 2000 / 1xEVDO Channel Number Ranges	2449
LTE FDD Channel Number Ranges	2451
LTE TDD Channel Number Ranges	2453
TDSCDMA Channel Number Ranges	2453
Radio Setup	2454
Radio Standard	2455

Radio Band Link	2473
Set Reference Frequency	2473
Freq Reference	2474
Freq Offset	2475
Modulation Setup	2476
ARB	2476
ARB	2476
Select Waveform	2477
ARB Setup	2482
Trigger Type	2484
Trigger Source	2488
Trigger Initiate	2489
Waveform Sequences	2489
Waveform Utilities	2500
Marker Utilities	2510
Header Utilities	2515
Bus Trigger Command (Remote Command Only)	2517
AM	2517
AM	2517
AM Depth	2517
AM Rate	2518
FM	2518
FM	2518
FM Deviation	2518
FM Rate	2519
PM	2519
PM	2519
PM Deviation	2520
PM Rate	2520
List Sequencer	2520
Sequencer	2521
Initiate Sequence	2521
List Sequencer Setup	2522
Number of Steps	2522
Current Step	2522
Insert Step Before	2523
Delete Step	2523
Clear List	2523
Step Trigger	2523
Transition Time	2525
Radio Setup	2526
Channel	2543
Frequency	2544

Table of Contents

Power	2544
Waveform	2545
Step Duration	2552
Output Trigger	2554
Step Configuration (Remote Command Only)	2554
Clear List (Remote Command Only)	2562
Trigger Type	2563
BeginningOfStep	2563
DataMarker	2563
Manual Trigger Now	2564
Remote Software Trigger (Remote command Only)	2565
Query List Sequence Initiation Armed Status (Remote Command Only)	2565
Source Preset	2565
SPAN X Scale	2566
Sweep/Control	2567
System	2568
Trace/Detector	2569
Trigger	2570
Free Run	2570
Video	2570
Trigger Level	2570
Trig Slope	2570
Trig Delay	2570
External 1	2570
Trigger Level	2570
Trig Slope	2570
Trig Delay	2570
Zero Span Delay Comp	2570
External 2	2570
Trigger Level	2570
Trig Slope	2570
Trig Delay	2571
Zero Span Delay Comp	2571
RF Burst	2571
Absolute Trigger	2571
Relative Trigger	2571
Trig Slope	2571
Trig Delay	2571
Periodic Timer	2571
Period	2571
Offset	2571
Offset Adjust (Remote Command Only)	2571
Reset Offset Display	2571

Sync Source	2571
Off	2571
External 1	2572
External 2	2572
RF Burst	2572
Trig Delay	2572
Auto/Holdoff	2572
Auto Trig	2572
Trig Holdoff	2572
Holdoff Type	2572
User Preset	2573
User Preset	2573
User Preset All Modes	2574
Save User Preset	2575
View Selection	2576
Display	2576
Annotation	2576
Meas Bar On/Off	2577
Screen	2578
Active Function Values On/Off	2578
Title	2579
Change Title	2579
Clear Title	2580
Graticule	2581
System Display Settings	2581
Annotation Local Settings	2581
Themes	2582
Show All Items	2583
Value	2583
Result Metrics view	2583
Component Carrier	2584
Copy CC To	2585
RF Envelope view	2585
15 Remote SCPI Commands and Data Queries	2587
:READ and :FETCh Commands	2588
:CALCulate:DATA	2591
:CALCulate:DATA:RAW	2593
:CALCulate:DATA:RAW:COMPLex	2594
:CALCulate:DATA:POINts commands	2595
:CALCulate:DATA:TABL commands	2596
Query Table Data as Number	2597
Query Table Data as String	2597
Query Table Names	2598

Table of Contents

Query Table Units	2598
:CALCulate:DATA:HEADer commands	2600
Query Header Names	2600
Query Header Type	2600
Query Header as String	2601
Query Numeric Header	2601
:CALC:CLIMits:FAIL?	2602
IQ Data Transfers	2603
Fast Capture Length	2604
Fast Capture Word Length	2604
Initiate Fast Capture	2605
Fast Capture Block	2605
Fast Capture Pointer	2606
Fetch Fast Capture	2606
Input Sample Rate Query	2607
Parameter Update Enable	2608

1 About the Test Set

The X-Series E6640A EXM Wireless Test Set is a one-box tester consisting of instruments loaded into a M9018A PXI mainframe with a front impact cover. The mainframe has a common PC controller (located on the far left) and M9300A PXI Frequency Reference (located in the center of the rack). The test set has one to four Keysight M9430A TRX (transmit/receive) instruments installed.

Each TRX includes a signal analyzer and a signal source, both of which interface with the front panel of the test set through an input/output matrix, and is run by its own instance of the XSA firmware application (a fully loaded test set shows four independent XSA windows on its monitor display).

The E6640A can be configured to test cellular products with a standard 40 MHz of analysis bandwidth. It could also be configured to test Wireless products with 80 or 160 MHz of analysis bandwidth. If your requirement is to test both, the TRX instruments can be configured to test both products.

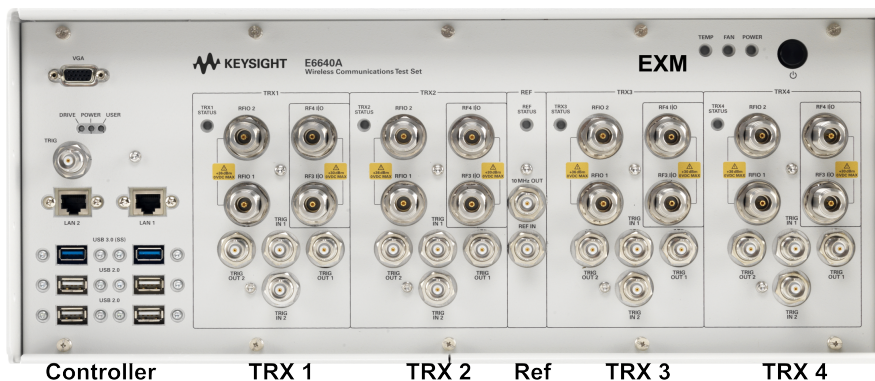

Installing Application Software

If you want to install a measurement application after your initial hardware purchase, you need only to license it. All of the available applications are loaded in your test set at the time of purchase.

Thus, when you purchase a new application, you will receive an entitlement certificate that you can use to obtain a license key for that application. To activate the new measurement application, enter the license key that you obtain into the test set.

For the latest information on Keysight X-series measurement applications and upgrade kits, visit the following internet URL.

<http://www.keysight.com/find/e6640a>

Viewing a License Key

Measurement applications that you purchased with your instrument have been installed and activated at the factory before shipment. The instrument requires a unique License Key for every measurement application purchased. The license key is a hexadecimal string that is specific to your measurement application, instrument model number and serial number. It enables you to install, or reactivate, that particular application.

Press **System, Show, System** to display the measurement applications that are currently licensed in your analyzer.

Go to the following location to view the license keys for the installed measurement applications:

C:\Program Files\Agilent\Licensing

You may want to keep a copy of your license key in a secure location. To do this, you can print out a copy of the display showing the license numbers. If you should lose your license key, call your nearest Keysight Technologies service or sales office for assistance.

Obtaining and Installing a License Key

If you purchase an additional application that requires installation, you will receive an "Entitlement Certificate", which may be redeemed for a license key for one instrument. To obtain your license key, follow the instructions that accompany the certificate.

Installing a license key for the selected application can be done automatically using a USB memory device. To do this, you copy the license file to the USB memory device, at the root level. Follow the instructions that come with your software installation kit.

Installing a license key can also be done manually using the built-in license management application, which may be found via the instrument front panel keys at **System, Licensing. . .**, or on-disk at:

C:\Programming Files\Agilent\Licensing

You can also use these procedures to reinstall a license key that has been accidentally deleted, or lost due to a memory failure.

Updating Measurement Application Software

All the software applications were loaded at the time of original instrument manufacture. It is a good idea to regularly update your software with the latest available version. This helps to ensure that you receive

any improvements and expanded functionality.

Because the software was loaded at the initial purchase, further additional measurement applications may now be available. If the application you are interested in licensing is not available, you will need to do a software update. (To display a list of installed applications, press **System, Show, System.**)

Check the appropriate page of the Keysight web site for the latest available software versions, according to the name of your instrument, as follows:

http://www.keysight.com/find/E6640A_software

You can load the updated software package into the analyzer either from a USB drive or directly from the internet. An automatic loading program is included with the files.

EXM Options and Accessories

You can view an online list of available Options and Accessories for your instrument as follows:

1. Browse to one of the following URLs, according to the product name of your analyzer:
www.keysight.com/find/e6640a
2. The home page for your instrument appears (in some cases, you may see an initial splash screen containing a button named View the Webpage, which you should click to display the home page).
3. Locate the **Options & Accessories** tab, as highlighted in the example below, which shows the home page for the E6640A.

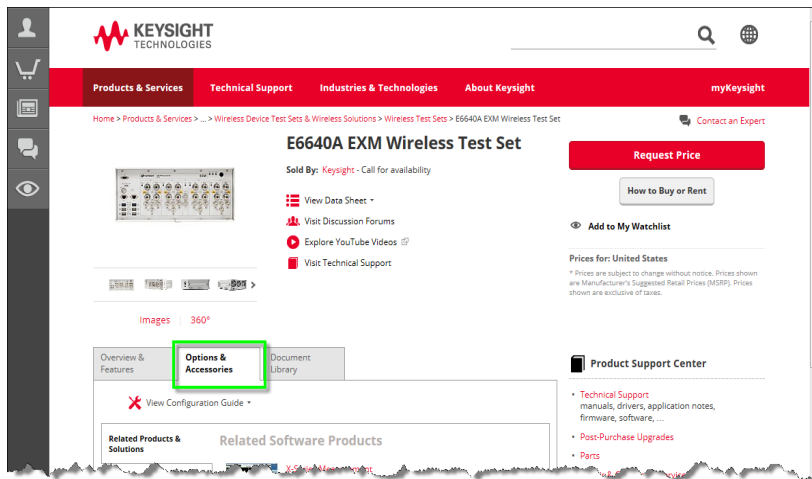

4. Click the **Options & Accessories** tab, to display a list of available options and accessories for your instrument.

Front-Panel Features

The instrument Front-panel features are fully detailed in the section "Front-Panel Features" (under the chapter "Front and Rear Panel Features") of the document:

Latest available on line document: [E6640A Getting Started Guide](#)

Embedded PDF installed with the latest firmware revision:

If you are viewing this information as a Help file in the instrument, then you can click on the link above to open the PDF document.

Display Annotations

Display Annotations are fully detailed under the chapter "Front and Rear Panel Features" of the document:

Latest available on line document: [E6640A Getting Started Guide](#)

Embedded PDF installed with the latest firmware revision:

If you are viewing this information as a Help file in the instrument, then you can click on the links above to open the PDF document.

Rear-Panel Features

The instrument's Rear-panel features are fully detailed in the section "Rear-Panel Features" (under the chapter "Front and Rear Panel Features") of the document:

Latest available on line document: [E6640A Getting Started Guide](#)

Embedded PDF installed with the latest firmware revision:

If you are viewing this information as a Help file in the instrument, then you can click on the link above to open the PDF document.

Window Control Keys

The instrument provides three virtual-front-panel keys or four menu items for controlling windows.

Virtual Front Panel

The virtual-front-panel keys are Multi Window, Zoom, and Next Window. These are all “immediate action” keys.



Windows Control Menu

The menu items are Zoom, Split Screen, Next [Window], and Full screen. These are all “immediate action” menu selections. Zoom and Full Screen are toggle functions.

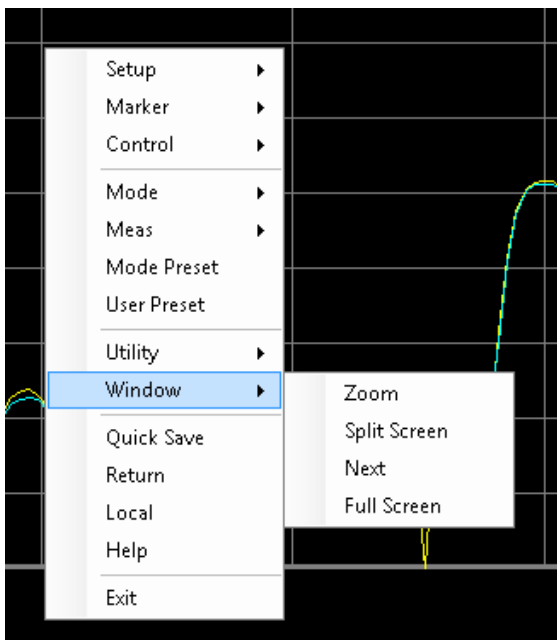

Multi-Window



The Multi Window front-panel key will toggle you back and forth between the Normal View and the last Multi Window View (Zone Span, Trace Zoom or Spectrogram) that you were in, when using the Swept SA measurement of the Spectrum Analyzer Mode. It remembers which View you were in through a Preset. This “previous view” is set to Zone Span on a Restore Mode Defaults.

Key Path	Front-panel key
Initial S/W Revision	Prior to A.02.00

Zoom

Zoom is a toggle function. Pressing this key once increases the size of the selected window. Pressing the key again returns the window to the original size.

When Zoom is on for a window, that window will get the entire primary display area. The zoomed window, since it is the selected window, is outlined in green.

Zoom is local to each Measurement. Each Measurement remembers its Zoom state. The Zoom state of each Measurement is part of the Mode’s state.

NOTE

Data acquisition and processing for the other windows continues while a window is zoomed, as does all SCPI communication with the other windows.

Remote Command	:DISPlay:WINDow:FORMat:ZOOM
Remote Command	:DISPlay:WINDow:FORMat:TILE
Example	:DISP:WIND:FORM:ZOOM sets zoomed :DISP:WIND:FORM:TILE sets un-zoomed
Preset	TILE
Initial S/W Revision	Prior to A.02.00

Next Window

Selects the next window of the current view. When the Next Window key is pressed, the next window in the order of precedence becomes selected. If the selected window was zoomed, the next window will also be zoomed.

The window numbers are as follows. Note that these numbers also determine the order of precedence (that is, Next Window goes from 1 to 2, then 2 to 3, etc.):

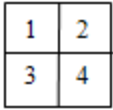

Four window display

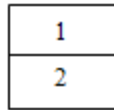

Two window display

RTSA measurements:

Only two windows are available in the Spectrogram view under the Spectrum measurement and up to three windows are available in the Power vs. Time measurement, depending on the view set up.

Remote Command	:DISPlay:WINDow[:SElect] <number> :DISPlay:WINDow[:SElect]?
Example	:DISP:WIND 1
Preset	1
Min	1
Max	If <number> is greater than the number of windows, limit to <number of windows>
Initial S/W Revision	Prior to A.02.00

One and only one window is always selected. The selected window has the focus; this means that all window-specific key presses apply only to that window. You can tell which window is selected by the thick green border around it. If a window is not selected, its boundary is gray.

If a window in a multi-window display is zoomed it is still outlined in green. If there is only one window, the green outline is not used. This allows the user to distinguish between a zoomed window and a display with only one window.

The selected window is local to each Measurement. Each Measurement remembers which window is selected. The selected window for each Measurement is remembered in Mode state.

NOTE When this key is pressed in Help Mode, it toggles focus between the table of contents window and the topic pane window.

Mouse and Keyboard Control

If you do not have access to the instrument front-panel, there are several ways that a mouse and PC Keyboard can give you access to functions normally accessed using the front-panel keys.

For instrument lacking a physical front panel display, you can watch the instrument display via external monitor or remote desktop connection

Right-Click

If you plug in a mouse and right-click on the analyzer screen, a menu will appear as below:

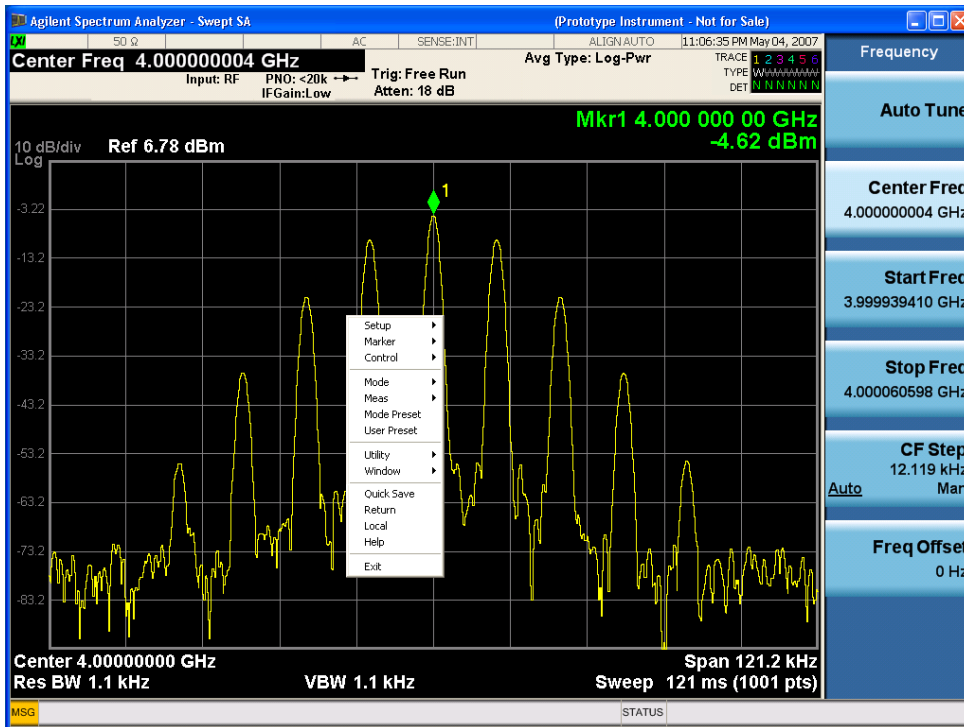

Placing the mouse on one of the rows marked with a right arrow symbol will cause that row to expand, as for example below where the mouse is hovered over the “Utility” row:

1 About the Test Set
 Mouse and Keyboard Control

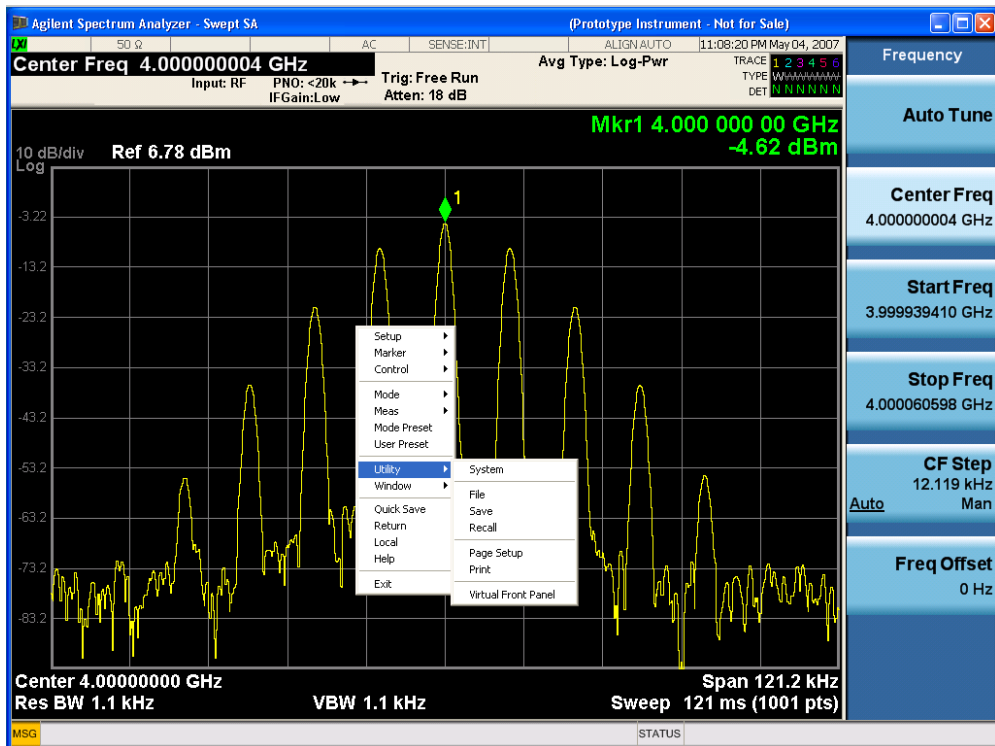

This method can be used to access any of the front-panel keys by using a mouse; as for example if you are accessing the instrument through Remote Desktop.

The array of keys thus available is shown below:

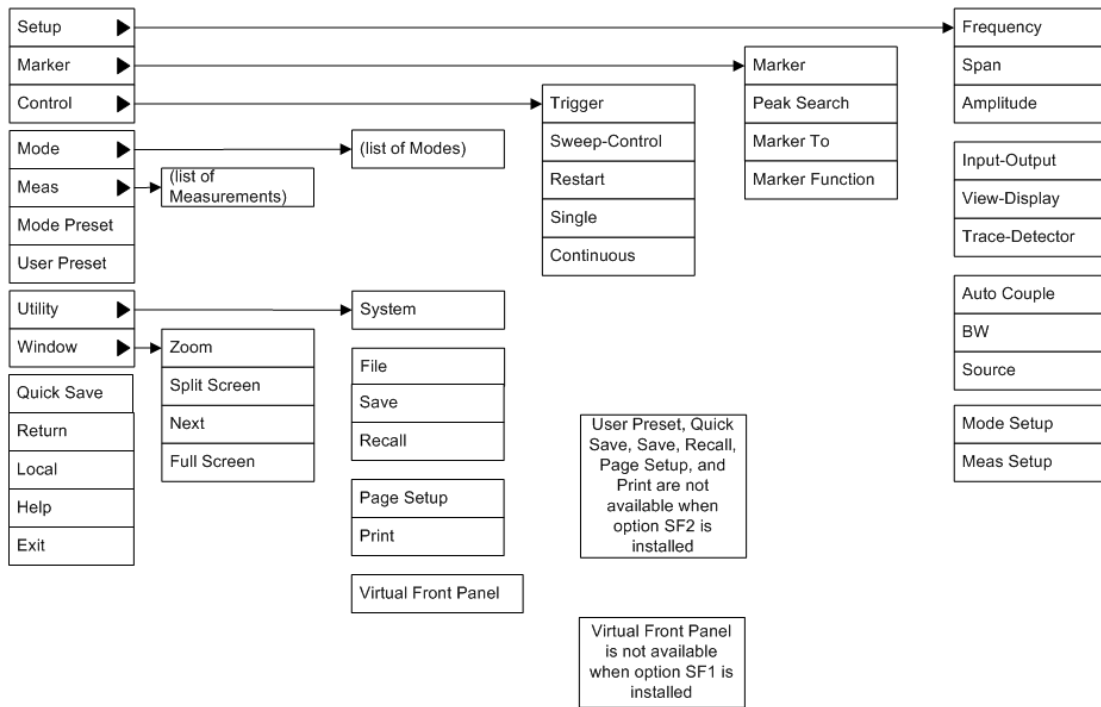

PC Keyboard

If you have a PC keyboard plugged in (or via Remote Desktop), certain key codes on the PC keyboard map to front-panel keys on the GPSA front panel. These key codes are shown below:

Front-panel key	Key code
Frequency	CTRL+SHIFT+F
Span	CTRL+SHIFT+S
Amplitude	CTRL+SHIFT+A
Input/Output	CTRL+SHIFT+O
View/Display	CTRL+SHIFT+V
Trace/Detector	CTRL+ALT+T
Auto Couple	CTRL+SHIFT+C
Bandwidth	CTRL+ALT+B
Source	CTRL+ALT-U
Marker	CTRL+ALT+K
Peak Search	CTRL+ALT+P
Marker To	CTRL+ALT+N
Marker Function	CTRL+ALT+F
System	CTRL+SHIFT+Y
Quick Save	CTRL+Q
Save	CTRL+S
Recall	CTRL+R
Mode Preset	CTRL+M
User Preset	CTRL+U
Print	CTRL+P
File	CTRL+SHIFT+L
Mode	CTRL+SHIFT+M
Measure	CTRL+ALT+M
Mode Setup	CTRL+SHIFT+E
Meas Setup	CTRL+ALT+E
Trigger	CTRL+SHIFT+T
Sweep/Control	CTRL+SHIFT+W
Restart	CTRL+ALT+R
Single	CTRL+ALT+S
Cont	CTRL+ALT+C
Zoom	CTRL+SHIFT+Z
Next Window	CTRL+SHIFT+N
Split Screen	CTRL+L

1 About the Test Set
 Mouse and Keyboard Control

Front-panel key	Key code
Full Screen	CTRL+SHIFT+B
Return	CTRL+SHIFT+R
Mute	Mute
Inc Audio	Volume Up
Dec Audio	Volume Down
Help	F1
Control	CTRL
Alt	ALT
Enter	Return
Cancel	Esc
Del	Delete
Backspace	Backspace
Select	Space
Up Arrow	Up
Down Arrow	Down
Left Arrow	Left
Right Arrow	Right
Menu key 1	CTRL+SHIFT+F1
Menu key 2	CTRL+SHIFT+F2
Menu key 3	CTRL+SHIFT+F3
Menu key 4	CTRL+SHIFT+F4
Menu key 5	CTRL+SHIFT+F5
Menu key 6	CTRL+SHIFT+F6
Menu key 7	CTRL+SHIFT+F7
Backspace	BACKSPACE
Enter	ENTER
Tab	Tab
1	1
2	2
3	3
4	4
5	5
6	6
7	7
8	8
9	9
0	0

This is a pictorial view of the table:

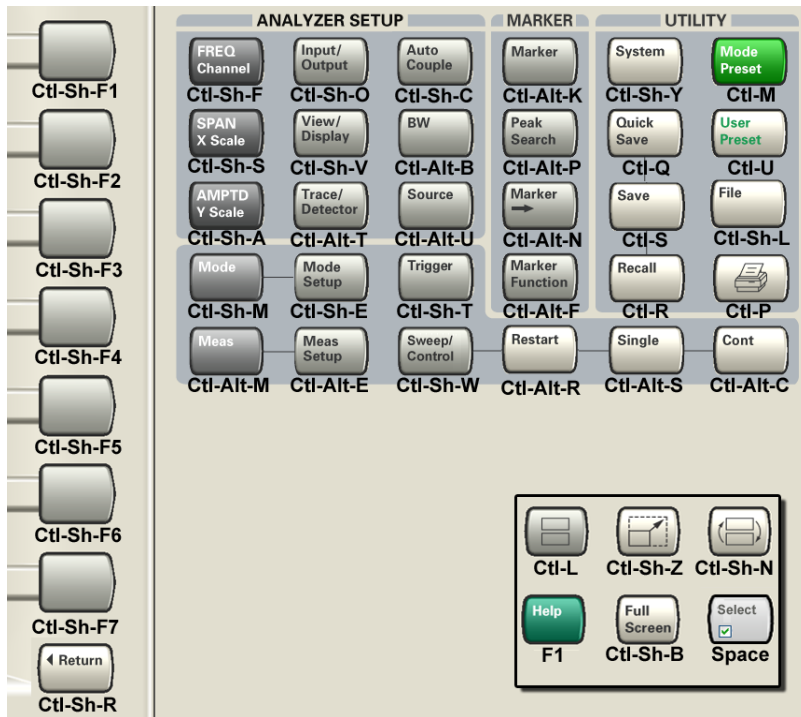

Instrument Security & Memory Volatility

If you are using the instrument in a secure environment, you may need details of how to clear or sanitize its memory, in compliance with published security standards of the United States Department of Defense, or other similar authorities.

For X-Series test sets, this information is contained in the document "Security Features and Document of Volatility". This document is not included in the instrument on-disk library, but it may be downloaded from the Keysight web site.

To obtain a copy of the document, click on or browse to the following URL:

<http://www.keysight.com/find/security>

To locate and download the document, select Model Number, for example "E6607A", then click "Submit". Then, follow the on-screen instructions to download the file.

(Undefined variable: Primary.ProductName)
LTE TDD Measurement Application Reference

2 About the LTE TDD Measurement Application

This chapter provides overall information on LTE TDD communications systems, and describes LTE TDD measurements made by the test set.

What Does the LTE TDD Application Do?

This test set can be used for testing a LTE TDD downlink and uplink signals complying with the standards listed below. Because they are continually changed, each release will support the most recent version of these standards:

- 3GPP TS 36.201 V8.3.0 (2009-03) Physical Layer General Description
- 3GPP TS 36.211 V8.6.0 (2009-03) Physical Channels and Modulation
- 3GPP TS 36.212 V8.6.0 (2009-03) Multiplexing and Channel Coding
- 3GPP TS 36.213 V8.6.0 (2009-03) Physical Layer Procedures
- 3GPP TS 36.214 V8.6.0 (2009-03) Physical Layer Measurements
- 3GPP TS 36.101 V8.5.1 (2009-03) UE Radio Transmission and Reception
- 3GPP TS 36.104 V8.5.0 (2009-03) BS Radio Transmission and Reception
- 3GPP TS 36.141 V8.2.0 (2009-03) BS Conformance Testing
- 3GPP TS 36.521-1 V8.1.0 (2009-03) UE Conformance Testing

The instrument automatically makes these measurements using the measurement methods and limits defined in the documents. The detailed results displayed by the measurements enable you to analyze LTE TDD signals performance. You may alter the measurement parameters for specific analysis.

This test set makes the following 10 measurements providing power measurements and modulation analysis for the LTE TDD signals:

- Channel Power
- Occupied BW
- Adjacent Channel Power (ACP)
- Spectrum Emission Mask
- Transmit On/Off Power
- Modulation Analysis
- Conformance EVM

3 Programming the Test Set

This section provides introductory information about the programming documentation included with your product.

"What Programming Information is Available?" on page 90

"STATus Subsystem " on page 132

"Common Commands" on page 172

What Programming Information is Available?

The X-Series Documentation can be accessed through the Additional Documentation page in the instrument Help system. It can also be found online at: <http://www.keysight.com/find/exm>.

The following resources are available to help you create programs for automating your X-Series measurements:

Resource	Description
X-Series Programmer's Guide	Provides general SCPI programming information on the following topics: <ul style="list-style-type: none">• Programming the X-Series Applications• Programming fundamentals• Programming examples Note that SCPI command descriptions for measurement applications are not in this book, but are in the User's and Programmer's Reference.
User's and Programmer's Reference manuals	Describes all front-panel keys and softkeys, including SCPI commands for a measurement application. Note that: <ul style="list-style-type: none">• Each measurement application has its own User's and Programmer's Reference.• The content in this manual is duplicated in the analyzer's Help (the Help that you see for a key is identical to what you see in this manual).
Embedded Help in your instrument	Describes all front-panel keys and softkeys, including SCPI commands, for a measurement application. Note that the content that you see in Help when you press a key is identical to what you see in the User's and Programmer's Reference.
X-Series Getting Started Guide	Provides valuable sections related to programming including: <ul style="list-style-type: none">• Licensing New Measurement Application Software - After Initial Purchase• Configuring instrument LAN Hostname, IP Address, and Gateway Address• Using the Windows XP Remote Desktop to connect to the instrument remotely• Using the Embedded Web Server Telnet connection to communicate SCPI This printed document is shipped with the instrument.
Keysight Application Notes	Printable PDF versions of pertinent application notes.
Keysight VISA User's Guide	Describes the Keysight Virtual Instrument Software Architecture (VISA) library and shows how to use it to develop I/O applications and instrument drivers on Windows PCs.

List of SCPI Commands

```

*CAL?
*CLS
*ESE <integer>
*ESE?
*ESR?
*IDN?
*OPC
*OPC?
*OPT?
*RCL <register#>
*RST
*SAV <register#>
*SRE <integer>
*SRE?
*STB?
*TRG
*TST?
*WAI
ABORT
CALC:EVM:DATA4:TABL:STR? "FreqErr"
CALCulate:<meas>:DATA[1] | 2 | ... | 4?[Y | X | XY[, OFF | ON | 0 | 1] |
LL | UL]
CALCulate:<meas>:DATA[1] | 2 | ... | 4:HEADer:NAMes?
CALCulate:<meas>:DATA[1] | 2 | ... | 4:HEADer[:NUMBer]? <string>
CALCulate:<meas>:DATA[1] | 2 | ... | 4:HEADer:STRing? <string>
CALCulate:<meas>:DATA[1] | 2 | ... | 4:HEADer:TYPE? <string>
CALCulate:<meas>:DATA[1] | 2 | ... | 4:POINts? [OFF | ON | 0 | 1]
CALCulate:<meas>:DATA[1] | 2 | ... | 4:RAW?
CALCulate:<meas>:DATA[1] | 2 | ... | 4:RAW:COMPLex?
CALCulate:<meas>:DATA[1] | 2 | ... | 4:RAW:POINts?
CALCulate:<meas>:DATA[1] | 2 | ... | 4:TABLE:NAMes?
CALCulate:<meas>:DATA[1] | 2 | ... | 4:TABLE[:NUMBer]? [<string>]
CALCulate:<meas>:DATA[1] | 2 | ... | 4:TABLE:STRing? [<string>]
CALCulate:<meas>:DATA[1] | 2 | ... | 4:TABLE:UNIT?
CALCulate:<meas>:MARKer:AOFF
CALCulate:<meas>:MARKer[1] | 2 | ... | 12:CFORMat RECTangular | POLar
CALCulate:<meas>:MARKer[1] | 2 | ... | 12:CFORMat?
CALCulate:<meas>:MARKer:COUple[:STATe] OFF | ON | 0 | 1
CALCulate:<meas>:MARKer:COUple[:STATe]?
CALCulate:<meas>:MARKer[1] | 2 | ... | 12:CPSeArch[:STATe] ON | OFF | 1 | 0
CALCulate:<meas>:MARKer[1] | 2 | ... | 12:CPSeArch[:STATe]?
CALCulate:<meas>:MARKer[1] | 2 | ... | 12:FCOUNt[:STATe] OFF | ON | 0 | 1
CALCulate:<meas>:MARKer[1] | 2 | ... | 12:FCOUNt[:STATe]?
CALCulate:<meas>:MARKer[1] | 2 | ... | 12:FCOUNt:X?
CALCulate:<meas>:MARKer[1] | 2 | ... | 12:FUNCTion BPOWER | BDENsity | =OFF
CALCulate:<meas>:MARKer[1] | 2 | ... | 12:FUNCTion?
CALCulate:<meas>:MARKer[1] | 2 | ... | 12:FUNCTion:BAND:CENTer <real>
CALCulate:<meas>:MARKer[1] | 2 | ... | 12:FUNCTion:BAND:CENTer?
CALCulate:<meas>:MARKer[1] | 2 | ... | 12:FUNCTion:BAND:LEFT <real>
CALCulate:<meas>:MARKer[1] | 2 | ... | 12:FUNCTion:BAND:LEFT?

```

3 Programming the Test Set

List of SCPI Commands

```
CALCulate:<meas>:MARKer[1]|2|...|12:FUNction:BAND:RIGHT <real>
CALCulate:<meas>:MARKer[1]|2|...|12:FUNction:BAND:RIGHT?
CALCulate:<meas>:MARKer[1]|2|...|12:FUNction:BAND:SPAN <real>
CALCulate:<meas>:MARKer[1]|2|...|12:FUNction:BAND:SPAN?
CALCulate:<meas>:MARKer[1]|2|...|12:FUNction:BDENsity:CTYPe MEAN | RMS
CALCulate:<meas>:MARKer[1]|2|...|12:FUNction:BDENsity:CTYPe?
CALCulate:<meas>:MARKer[1]|2|...|12:FUNction:BPOWer:CTYPe MEAN | RMS
CALCulate:<meas>:MARKer[1]|2|...|12:FUNction:BPOWer:CTYPe?
CALCulate:<meas>:MARKer[1]|2|...|12:MAXimum
CALCulate:<meas>:MARKer[1]|2|...|12:MAXimum:LEFT
CALCulate:<meas>:MARKer[1]|2|...|12:MAXimum:NEXT
CALCulate:<meas>:MARKer[1]|2|...|12:MAXimum:PREVIOUS
CALCulate:<meas>:MARKer[1]|2|...|12:MAXimum:RIGHT
CALCulate:<meas>:MARKer[1]|2|...|12:MINimum
CALCulate:<meas>:MARKer[1]|2|...|12:MODE POSition | DELTa | FIXed | =OFF
CALCulate:<meas>:MARKer[1]|2|...|12:MODE?
CALCulate:<meas>:MARKer[1]|2|...|12:REFerence <integer>
CALCulate:<meas>:MARKer[1]|2|...|12:REFerence?
CALCulate:<meas>:MARKer:TABLE[:STATE] OFF | ON | 0 | 1
CALCulate:<meas>:MARKer:TABLE[:STATE]?
CALCulate:<meas>:MARKer[1]|2|...|12:TRACe <integer>
CALCulate:<meas>:MARKer[1]|2|...|12:TRACe?
CALCulate:<meas>:MARKer[1]|2|...|12:X <real>
CALCulate:<meas>:MARKer[1]|2|...|12:X?
CALCulate:<meas>:MARKer[1]|2|...|12[:X]:POSition <real>
CALCulate:<meas>:MARKer[1]|2|...|12[:X]:POSition?
CALCulate:<meas>:MARKer[1]|2|...|12:X:UNIT?
CALCulate:<meas>:MARKer[1]|2|...|12:Y:IMAGinary <real>
CALCulate:<meas>:MARKer[1]|2|...|12:Y:IMAGinary?
CALCulate:<meas>:MARKer[1]|2|...|12:Y[:REAL] <real>
CALCulate:<meas>:MARKer[1]|2|...|12:Y[:REAL]?
CALCulate:<meas>:MARKer[1]|2|...|12:Y:UNIT?
CALCulate:<meas>:MARKer[1]|2|...|12:Z <real>
CALCulate:<meas>:MARKer[1]|2|...|12:Z?
CALCulate:<meas>:MARKer[1]|2|...|12:Z:UNIT?
CALCulate:<meas>:TRACe[1]|2|...|4:LIMit:VISible OFF | ON | 0 | 1
CALCulate:<meas>:TRACe[1]|2|...|4:LIMit:VISible?
CALCulate:ACPower:LIMit:STATE OFF | ON | 0 | 1
CALCulate:ACPower:LIMit:STATE?
CALCulate:ACPower:MARKer:AOFF
CALCulate:ACPower:MARKer:COUPle[:STATE] ON | OFF | 1 | 0
CALCulate:ACPower:MARKer:COUPle[:STATE]?
CALCulate:ACPower:MARKer[1]|2|...|12:FUNction:RESult?
CALCulate:ACPower:MARKer[1]|2|...|12:MAXimum
CALCulate:ACPower:MARKer[1]|2|...|12:MAXimum:LEFT
CALCulate:ACPower:MARKer[1]|2|...|12:MAXimum:NEXT
CALCulate:ACPower:MARKer[1]|2|...|12:MAXimum:RIGHT
CALCulate:ACPower:MARKer[1]|2|...|12:MINimum
CALCulate:ACPower:MARKer[1]|2|...|12:MODE POSition | DELTa | OFF
CALCulate:ACPower:MARKer[1]|2|...|12:MODE?
CALCulate:ACPower:MARKer[1]|2|...|12:PTPeak
CALCulate:ACPower:MARKer[1]|2|...|12:REFerence <integer>
CALCulate:ACPower:MARKer[1]|2|...|12:REFerence?
```



```

CALCulate:ACPower:MARKer[1]|2|...|12:STATE OFF | ON | 0 | 1
CALCulate:ACPower:MARKer[1]|2|...|12:STATE?
CALCulate:ACPower:MARKer[1]|2|...|12:TRACe 1 | 2 | 3
CALCulate:ACPower:MARKer[1]|2|...|12:TRACe?
CALCulate:ACPower:MARKer[1]|2|...|12:X <freq>
CALCulate:ACPower:MARKer[1]|2|...|12:X?
CALCulate:ACPower:MARKer[1]|2|...|12:X:POSition <real>
CALCulate:ACPower:MARKer[1]|2|...|12:X:POSition?
CALCulate:ACPower:MARKer[1]|2|...|12:Y?
CALCulate:ACPower:OFFSet[:OUTer]:LIST:LIMit:NEGative[:UPPer]:DATA <real>,
...
CALCulate:ACPower:OFFSet[:OUTer]:LIST:LIMit:NEGative[:UPPer]:DATA?
CALCulate:ACPower:OFFSet[:OUTer]:LIST:LIMit:POSitive[:UPPer]:DATA <real>,
...
CALCulate:ACPower:OFFSet[:OUTer]:LIST:LIMit:POSitive[:UPPer]:DATA?
CALCulate:CEVM:RESult:NAMes?
CALCulate:CHPower:MARKer:AOFF
CALCulate:CHPower:MARKer[1]|2|...|12:MAXimum
CALCulate:CHPower:MARKer[1]|2|...|12:MODE POSition | DELTA | OFF
CALCulate:CHPower:MARKer[1]|2|...|12:MODE?
CALCulate:CHPower:MARKer[1]|2|...|12:REFerence <integer>
CALCulate:CHPower:MARKer[1]|2|...|12:REFerence?
CALCulate:CHPower:MARKer[1]|2|...|12:STATE OFF | ON | 0 | 1
CALCulate:CHPower:MARKer[1]|2|...|12:STATE?
CALCulate:CHPower:MARKer[1]|2|...|12:X <real>
CALCulate:CHPower:MARKer[1]|2|...|12:X?
CALCulate:CHPower:MARKer[1]|2|...|12:X:POSition <real>
CALCulate:CHPower:MARKer[1]|2|...|12:X:POSition?
CALCulate:CHPower:MARKer[1]|2|...|12:Y?
CALCulate:CLIMits:FAIL?
CALCulate:DATA<n>:COMPRESS? BLOCK | CFIT | MAXimum | MINimum | MEAN |
DMEan | RMS | RMScubed | SAMPLE | SDEViation | PPHase[, <soffset>[,
<length>[, <roffset>[, <rlimit>]]]]
CALCulate:DATA[n]?
CALCulate:DATA[1]|2|...|6:PEAKs? <threshold>, <excursion>[, AMPLitude |
FREQuency | TIME[, ALL | GTDLine | LTDLine]]
CALCulate:DATA[1]|2|...|6:PEAKs? <threshold>, <excursion>[, AMPLitude |
FREQuency | TIME]
CALCulate:DATA:REGister:ALL:REMove
CALCulate:DATA:REGister[1]|2|...|6:EMPTy?
CALCulate:DATA:REGister[1]|2|...|6:REMove
CALCulate:EVM:DATA<n>:TABLE:NAMes?
CALCulate:EVM:DATA<n>:TABLE:STRing?
CALCulate:EVM:DATA<n>:TABLE:UNIT?
CALCulate:FPOWER:POWER[1,2,...,999]?
CALCulate:FPOWER:POWER[1,2,...,999]:CONFigure
CALCulate:FPOWER:POWER[1,2,...,999]:DEFine "configurationstring"
CALCulate:FPOWER:POWER[1,2,...,999]:DEFine?
CALCulate:FPOWER:POWER[1,2,...,999]:FETCh?
CALCulate:FPOWER:POWER[1,2,...,999]:INITiate
CALCulate:FPOWER:POWER[1,2,...,999]:READ2?
CALCulate:FPOWER:POWER[1,2,...,999]:READ1?

```

3 Programming the Test Set

List of SCPI Commands

```
CALCulate:FPOWER:POWER[1,2,...,999]:READ?
CALCulate:FPOWER:POWER[1,2,...,999]:RESet
CALCulate:MCPower:OFFSet:LIST:LIMit:NEGAtive[:UPPer]:DATA (PSAPowerSuite)
CALCulate:MCPower:OFFSet:LIST:LIMit:POSitive[:UPPer]:DATA (PSAPowerSuite)
CALCulate:OBWidth:LIMit:FBLimit <freq>
CALCulate:OBWidth:LIMit:FBLimit?
CALCulate:OBWidth:LIMit[:TEST] ON | OFF | 1 | 0
CALCulate:OBWidth:LIMit[:TEST]?
CALCulate:OBWidth:MARKer:AOff
CALCulate:OBWidth:MARKer[1]|2|...|12:MAXimum
CALCulate:OBWidth:MARKer[1]|2|...|12:MODE POSition | DELTa | OFF
CALCulate:OBWidth:MARKer[1]|2|...|12:MODE?
CALCulate:OBWidth:MARKer[1]|2|...|12:REFerence <integer>
CALCulate:OBWidth:MARKer[1]|2|...|12:REFerence?
CALCulate:OBWidth:MARKer[1]|2|...|12:STATE OFF | ON | 0 | 1
CALCulate:OBWidth:MARKer[1]|2|...|12:STATE?
CALCulate:OBWidth:MARKer[1]|2|...|12:X <freq>
CALCulate:OBWidth:MARKer[1]|2|...|12:X?
CALCulate:OBWidth:MARKer[1]|2|...|12:X:POSition <real>
CALCulate:OBWidth:MARKer[1]|2|...|12:X:POSition?
CALCulate:OBWidth:MARKer[1]|2|...|12:Y?
CALCulate:PVTime:MARKer:AOff
CALCulate:PVTime:MARKer:COUple[:STATE] ON | OFF | 1 | 0
CALCulate:PVTime:MARKer:COUple[:STATE]?
CALCulate:PVTime:MARKer[1]|2|...|12:MAXimum
CALCulate:PVTime:MARKer[1]|2|...|12:MODE POSition | DELTa | OFF
CALCulate:PVTime:MARKer[1]|2|...|12:MODE?
CALCulate:PVTime:MARKer[1]|2|...|12:REFerence <integer>
CALCulate:PVTime:MARKer[1]|2|...|12:REFerence?
CALCulate:PVTime:MARKer[1]|2|...|12:STATE OFF | ON | 0 | 1
CALCulate:PVTime:MARKer[1]|2|...|12:STATE?
CALCulate:PVTime:MARKer[1]|2|...|12:TRACe RFENvelope | MAXHold | MINHold
CALCulate:PVTime:MARKer[1]|2|...|12:TRACe?
CALCulate:PVTime:MARKer[1]|2|...|12:X <real>
CALCulate:PVTime:MARKer[1]|2|...|12:X?
CALCulate:PVTime:MARKer[1]|2|...|12:X:POSition <real>
CALCulate:PVTime:MARKer[1]|2|...|12:X:POSition?
CALCulate:PVTime:MARKer[1]|2|...|12:Y?
CALCulate:SEMask:LLINE:STATE ON | OFF | 1 | 0
CALCulate:SEMask:LLINE:STATE?
CALCulate:SEMask:MARKer:AOff
CALCulate:SEMask:MARKer:COUple[:STATE] ON | OFF | 1 | 0
CALCulate:SEMask:MARKer:COUple[:STATE]?
CALCulate:SEMask:MARKer[1]|2|...|12:FUNcTION:RESult?
CALCulate:SEMask:MARKer[1]|2|...|12:MODE POSition | OFF
CALCulate:SEMask:MARKer[1]|2|...|12:MODE?
CALCulate:SEMask:MARKer[1]|2|...|12:X <freq>
CALCulate:SEMask:MARKer[1]|2|...|12:X?
CALCulate:SEMask:MARKer[1]|2|...|12:X:POSition <real>
CALCulate:SEMask:MARKer[1]|2|...|12:X:POSition?
CALCulate:SEMask:MARKer[1]|2|...|12:Y?
CALibration[:ALL]
CALibration[:ALL]?
```

```

CALibration[:ALL]:NPENding
CALibration:EXPIred?
CALibration:IF
CALibration:IF?
CALibration:IF:NPENding
CALibration:INTernal:SOURce[:ALL]
CALibration:INTernal:SOURce[:ALL]?
CALibration:INTernal:SOURce[:ALL]:NPENding
CALibration:NRF
CALibration:NRF?
CALibration:NRF:NPENding
CALibration:RF
CALibration:RF?
CALibration:RF:NPENding
CALibration:TEMPerature:CURRent?
CALibration:TEMPerature:LALL?
CALibration:TEMPerature:LIF?
CALibration:TEMPerature:LRF?
CALibration:TEMPerature:SOURce:LALL?
CALibration:TIME:LALL?
CALibration:TIME:LIF?
CALibration:TIME:LRF?
CALibration:TIME:SOURce:LALL?
CONF FSC
CONFigure?
CONFigure:ACP
CONFigure:ACP:NDEFault
CONFigure:ACPower
CONFigure:CEVM
CONFigure:CEVM:NDEFault
CONFigure:CHPower
CONFigure:CHPower
CONFigure:CHPower:NDEFault
CONFigure:EVM
CONFigure:OBWidth
CONFigure:OBWidth
CONFigure:OBWidth:NDEFault
CONFigure:PVTime
CONFigure:PVTime
CONFigure:PVTime:NDEFault
CONFigure:SEMask
CONFigure:SEMask
CONFigure:SEMask:NDEFault
COUple ALL | NONE
DISPlay:<meas>:AFPoints OFF | ON | 0 | 1
DISPlay:<meas>:AFPoints?
DISPlay:<meas>:FANNotation CSPan | SSTop
DISPlay:<meas>:FANNotation?
DISPlay:<meas>:TRACe[1]|2|...|4:COPIY D1 | D2 | D3 | D4 | D5 | D6
DISPlay:<meas>:TRACe[1]|2|...|4:DDEMod:ALIN?
DISPlay:<meas>:TRACe[1]|2|...|4:DDEMod:ALINe OFF | ON | 0 | 1
DISPlay:<meas>:TRACe[1]|2|...|4:DDEMod:EYE:COUNT <real>
DISPlay:<meas>:TRACe[1]|2|...|4:DDEMod:EYE:COUNT?

```

3 Programming the Test Set

List of SCPI Commands

```

DISPlay:<meas>:TRACe[1]|2|...|4:DDEMod:SYMBOL BARS | DOTS | OFF
DISPlay:<meas>:TRACe[1]|2|...|4:DDEMod:SYMBOL?
DISPlay:<meas>:TRACe[1]|2|...|4:DDEMod:SYMBOL:FORMAt HEXadecimal | BINary
DISPlay:<meas>:TRACe[1]|2|...|4:DDEMod:SYMBOL:FORMAt?
DISPlay:<meas>:TRACe[1]|2|...|4:DDEMod:SYMBOL:SHAPE CIRCle | CROSS | OFF
DISPlay:<meas>:TRACe[1]|2|...|4:DDEMod:SYMBOL:SHAPE?
DISPlay:<meas>:TRACe[1]|2|...|4:DDEMod:SYMBOL:SIZE <real>
DISPlay:<meas>:TRACe[1]|2|...|4:DDEMod:SYMBOL:SIZE?
DISPlay:<meas>:TRACe[1]|2|...|4:DDEMod:UNIT:FREQuency CARRier | HZ
DISPlay:<meas>:TRACe[1]|2|...|4:DDEMod:UNIT:FREQuency?
DISPlay:<meas>:TRACe[1]|2|...|4:DDEMod:UNIT:TIME SEC | SYMBOL
DISPlay:<meas>:TRACe[1]|2|...|4:DDEMod:UNIT:TIME?
DISPlay:<meas>:TRACe[1]|2|...|4:FORMAt MLOG | MLINear | REAL | IMAGinary |
VECTor | CONS | PHASE | UPHase | IEYE | QEYE | TRELlis | GDElay |
MLGLinear
DISPlay:<meas>:TRACe[1]|2|...|4:FORMAt?
DISPlay:<meas>:TRACe[1]|2|...|4:FORMAt:DElay:APERture <real>
DISPlay:<meas>:TRACe[1]|2|...|4:FORMAt:DElay:APERture?
DISPlay:<meas>:TRACe[1]|2|...|4:FORMAt:PHASE:OFFSet <real>
DISPlay:<meas>:TRACe[1]|2|...|4:FORMAt:PHASE:OFFSet?
DISPlay:<meas>:TRACe[1]|2|...|4:FORMAt:PHASE:UNWRap:REFerence <real>
DISPlay:<meas>:TRACe[1]|2|...|4:FORMAt:PHASE:UNWRap:REFerence?
DISPlay:<meas>:TRACe[1]|2|...|4:RLINE OFF | ON | 0 |
1:DISPlay:<meas>:TRACe[1]|2|...|4:RLINE?
DISPlay:<meas>:TRACe[1]|2|...|4:VHCenter <real>
DISPlay:<meas>:TRACe[1]|2|...|4:VHCenter?
DISPlay:<meas>:TRACe[1]|2|...|4:X[:SCALE]:COUPle OFF | ON | 0 | 1
DISPlay:<meas>:TRACe[1]|2|...|4:X[:SCALE]:COUPle?
DISPlay:<meas>:TRACe[1]|2|...|4:X[:SCALE]:RLEVel <real>
DISPlay:<meas>:TRACe[1]|2|...|4:X[:SCALE]:RLEVel?
DISPlay:<meas>:TRACe[1]|2|...|4:X[:SCALE]:RPOSITION LEFT | CENTER | RIGHT
DISPlay:<meas>:TRACe[1]|2|...|4:X[:SCALE]:RPOSITION?
DISPlay:<meas>:TRACe[1]|2|...|4:X[:SCALE]:SPAN <real>
DISPlay:<meas>:TRACe[1]|2|...|4:X[:SCALE]:SPAN?
DISPlay:<meas>:TRACe[1]|2|...|4:Y:LRATio <real>
DISPlay:<meas>:TRACe[1]|2|...|4:Y:LRATio?
DISPlay:<meas>:TRACe[1]|2|...|4:Y[:SCALE]:AUTO:ONCE
DISPlay:<meas>:TRACe[1]|2|...|4:Y[:SCALE]:PDIVision <real>
DISPlay:<meas>:TRACe[1]|2|...|4:Y[:SCALE]:PDIVision?
DISPlay:<meas>:TRACe[1]|2|...|4:Y[:SCALE]:RLEVel <real>
DISPlay:<meas>:TRACe[1]|2|...|4:Y[:SCALE]:RLEVel?
DISPlay:<meas>:TRACe[1]|2|...|4:Y[:SCALE]:RLEVel:AUTO OFF | ON | 0 | 1
DISPlay:<meas>:TRACe[1]|2|...|4:Y[:SCALE]:RLEVel:AUTO?
DISPlay:<meas>:TRACe[1]|2|...|4:Y[:SCALE]:RPOSITION TOP | CENTER | BOTTom
DISPlay:<meas>:TRACe[1]|2|...|4:Y[:SCALE]:RPOSITION?
DISPlay:<meas>:TRACe[1]|2|...|4:Y:UNIT?
DISPlay:<meas>:TRACe[1]|2|...|4:Y:UNIT:PREFerence AUTO | PEAK | RMS |
POWER | MRMS
DISPlay:<meas>:TRACe[1]|2|...|4:Y:UNIT:PREFerence?
DISPlay:<meas>:WINDow:FORMAt SINGLE | TWO | TRI | QUAD
DISPlay:<meas>:WINDow:FORMAt SINGLE | TWO | TRI | QUAD | GR2X3 | GR3X2
DISPlay:<meas>:WINDow:FORMAt?

```

```

DISPlay:<meas>:WINDow:FORMat?
DISPlay:<measurement>:ANNOtation:TITLe:DATA <string>
DISPlay:<measurement>:ANNOtation:TITLe:DATA?
DISPlay:ACPower:VIEW[1]:WINDow[1]:BGRaph OFF | ON | 0 | 1
DISPlay:ACPower:VIEW[1]:WINDow[1]:BGRaph?
DISPlay:ACPower:VIEW[1]:WINDow[1]:TRACe:Y[:SCALe]:COUPlE 0 | 1 | OFF | ON
DISPlay:ACPower:VIEW[1]:WINDow[1]:TRACe:Y[:SCALe]:COUPlE?
DISPlay:ACPower:VIEW[1]:WINDow[1]:TRACe:Y[:SCALe]:PDIVision <rel_ampl>
DISPlay:ACPower:VIEW[1]:WINDow[1]:TRACe:Y[:SCALe]:PDIVision?
DISPlay:ACPower:VIEW[1]:WINDow[1]:TRACe:Y[:SCALe]:RLEVel <real>
DISPlay:ACPower:VIEW[1]:WINDow[1]:TRACe:Y[:SCALe]:RLEVel?
DISPlay:ACPower:VIEW[1]:WINDow[1]:TRACe:Y[:SCALe]:RPOStion TOP | CENTER |
BOTTom
DISPlay:ACPower:VIEW[1]:WINDow[1]:TRACe:Y[:SCALe]:RPOStion?
DISPlay:ACTivefunc[:STATe] ON | OFF | 1 | 0
DISPlay:ACTivefunc[:STATe]?
DISPlay:ANNOtation:MBAR[:STATe] OFF | ON | 0 | 1
DISPlay:ANNOtation:MBAR[:STATe]?
DISPlay:ANNOtation:SCREen[:STATe] OFF | ON | 0 | 1
DISPlay:ANNOtation:SCREen[:STATe]?
DISPlay:CEVM:VIEW[:SELEct] MLISt | PARAmeter | RESult | RFENvelope
DISPlay:CEVM:VIEW[:SELEct] MLISt | PARAmeter | RESult | RFENvelope
DISPlay:CEVM:VIEW[:SELEct]?
DISPlay:CHPower:VIEW:NSELEct <integer>
DISPlay:CHPower:VIEW:NSELEct?
DISPlay:CHPower:VIEW[:SELEct] RFSpectrum | SHOULder | MASK
DISPlay:CHPower:VIEW[:SELEct] RFSpectrum | SHOULder
DISPlay:CHPower:VIEW[:SELEct] PRESult | CINformation
DISPlay:CHPower:VIEW[:SELEct]?
DISPlay:CHPower:VIEW[:SELEct]?
DISPlay:CHPower:VIEW[:SELEct]?
DISPlay:CHPower:VIEW[1]:WINDow[1]:BGRaph ON | OFF | 1 | 0
DISPlay:CHPower:VIEW[1]:WINDow[1]:BGRaph?
DISPlay:CHPower:VIEW:WINDow:CINformation:FREQuency OFFSet | ABSolute
DISPlay:CHPower:VIEW:WINDow:CINformation:FREQuency?
DISPlay:CHPower:VIEW[1]:WINDow[1]:TRACe:Y[:SCALe]:COUPlE 0 | 1 | OFF | ON
DISPlay:CHPower:VIEW[1]:WINDow[1]:TRACe:Y[:SCALe]:COUPlE?
DISPlay:CHPower:VIEW[1]:WINDow[1]:TRACe:Y[:SCALe]:PDIVision <rel_ampl>
DISPlay:CHPower:VIEW[1]:WINDow[1]:TRACe:Y[:SCALe]:PDIVision?
DISPlay:CHPower:VIEW[1]:WINDow[1]:TRACe:Y[:SCALe]:RLEVel <real>
DISPlay:CHPower:VIEW[1]:WINDow[1]:TRACe:Y[:SCALe]:RLEVel?
DISPlay:CHPower:VIEW[1]:WINDow[1]:TRACe:Y[:SCALe]:RPOStion TOP | CENTER |
BOTTom
DISPlay:CHPower:VIEW[1]:WINDow[1]:TRACe:Y[:SCALe]:RPOStion?
DISPlay:EVM:TRACe:ALL:SELEcted CC0 | CC1 | CC2 | CC3 | CC4
DISPlay:EVM:TRACe1|2|3|4|5|6:SELEcted CC0 | CC1 | CC2 | CC3 | CC4
DISPlay:EVM:TRACe1|2|3|4|5|6:SELEcted?
DISPlay:EVM:VIEW:PRESet MIMO
DISPlay:EVM:VIEW:PRESet SUBCarrier
DISPlay:EVM:VIEW:PRESet BASic
DISPlay:EVM:VIEW:PRESet CROSS
DISPlay:EVM:VIEW:PRESet RBSLot
DISPlay:EVM:VIEW:PRESet SUMMary

```

3 Programming the Test Set

List of SCPI Commands

```
DISPlay:OBWidth:VIEW[1]:WINDow[1]:TRACe:Y[:SCALe]:COUPle 0 | 1 | OFF | ON
DISPlay:OBWidth:VIEW[1]:WINDow[1]:TRACe:Y[:SCALe]:COUPle?
DISPlay:OBWidth:VIEW[1]:WINDow[1]:TRACe:Y[:SCALe]:PDIVision <rel_ampl>
DISPlay:OBWidth:VIEW[1]:WINDow[1]:TRACe:Y[:SCALe]:PDIVision?
DISPlay:OBWidth:VIEW[1]:WINDow[1]:TRACe:Y[:SCALe]:RLEVel <real>
DISPlay:OBWidth:VIEW[1]:WINDow[1]:TRACe:Y[:SCALe]:RLEVel?
DISPlay:OBWidth:VIEW[1]:WINDow[1]:TRACe:Y[:SCALe]:RPOSition TOP | CENTer |
BOTTom
DISPlay:OBWidth:VIEW[1]:WINDow[1]:TRACe:Y[:SCALe]:RPOSition?
DISPlay:PVTime:RAMP[:STATE] OFF | ON | 0 | 1
DISPlay:PVTime:RAMP[:STATE]?
DISPlay:PVTime:VIEW:NSElect <integer>
DISPlay:PVTime:VIEW:NSElect?
DISPlay:PVTime:VIEW[:SElect] ALL | BOTH
DISPlay:PVTime:VIEW[:SElect]?
DISPlay:PVTime:VIEW[1]:WINDow[1]:BLINes[:STATE] ON | OFF | 1 | 0
DISPlay:PVTime:VIEW[1]:WINDow[1]:BLINes[:STATE]?
DISPlay:PVTime:VIEW[1]:WINDow[1]:LIMit:MASK OFF | ON | 0 | 1
DISPlay:PVTime:VIEW[1]:WINDow[1]:LIMit:MASK?
DISPlay:PVTime:VIEW[1]:WINDow[1]:TRACe:MAXHold[:STATE] ON | OFF | 1 | 0
DISPlay:PVTime:VIEW[1]:WINDow[1]:TRACe:MAXHold[:STATE]?
DISPlay:PVTime:VIEW[1]:WINDow[1]:TRACe:MINHold[:STATE] ON | OFF | 1 | 0
DISPlay:PVTime:VIEW[1]:WINDow[1]:TRACe:MINHold[:STATE]?
DISPlay:PVTime:VIEW[1]:WINDow[1]:TRACe:X[:SCALe]:COUPle 0 | 1 | OFF | ON
DISPlay:PVTime:VIEW2:WINDow[1]|2:TRACe:X[:SCALe]:COUPle 0 | 1 | OFF | ON
DISPlay:PVTime:VIEW[1]:WINDow[1]:TRACe:X[:SCALe]:COUPle?
DISPlay:PVTime:VIEW2:WINDow[1]|2:TRACe:X[:SCALe]:COUPle?
DISPlay:PVTime:VIEW2:WINDow[1]|2:TRACe:X[:SCALe]:PDIVision <time>
DISPlay:PVTime:VIEW[1]:WINDow[1]:TRACe:X[:SCALe]:PDIVision <time>
DISPlay:PVTime:VIEW[1]:WINDow[1]:TRACe:X[:SCALe]:PDIVision?
DISPlay:PVTime:VIEW2:WINDow[1]|2:TRACe:X[:SCALe]:PDIVision?
DISPlay:PVTime:VIEW[1]:WINDow[1]:TRACe:X[:SCALe]:RLEVel <time>
DISPlay:PVTime:VIEW2:WINDow[1]|2:TRACe:X[:SCALe]:RLEVel <time>
DISPlay:PVTime:VIEW[1]:WINDow[1]:TRACe:X[:SCALe]:RLEVel?
DISPlay:PVTime:VIEW2:WINDow[1]|2:TRACe:X[:SCALe]:RLEVel?
DISPlay:PVTime:VIEW[1]:WINDow[1]:TRACe:X[:SCALe]:RPOSition LEFT | CENTer |
RIGHT
DISPlay:PVTime:VIEW2:WINDow[1]|2:TRACe:X[:SCALe]:RPOSition LEFT | CENTer |
RIGHT
DISPlay:PVTime:VIEW[1]:WINDow[1]:TRACe:X[:SCALe]:RPOSition?
DISPlay:PVTime:VIEW2:WINDow[1]|2:TRACe:X[:SCALe]:RPOSition?
DISPlay:PVTime:VIEW2:WINDow[1]|2:TRACe:Y[:SCALe]:COUPle 0 | 1 | OFF | ON
DISPlay:PVTime:VIEW[1]:WINDow[1]:TRACe:Y[:SCALe]:COUPle 0 | 1 | OFF | ON
DISPlay:PVTime:VIEW[1]:WINDow[1]:TRACe:Y[:SCALe]:COUPle?
DISPlay:PVTime:VIEW2:WINDow[1]|2:TRACe:Y[:SCALe]:COUPle?
DISPlay:PVTime:VIEW2:WINDow[1]|2:TRACe:Y[:SCALe]:PDIVision <rel_ampl>
DISPlay:PVTime:VIEW[1]:WINDow[1]:TRACe:Y[:SCALe]:PDIVision <rel_ampl>
DISPlay:PVTime:VIEW2:WINDow[1]|2:TRACe:Y[:SCALe]:PDIVision?
DISPlay:PVTime:VIEW[1]:WINDow[1]:TRACe:Y[:SCALe]:PDIVision?
DISPlay:PVTime:VIEW[1]:WINDow[1]:TRACe:Y[:SCALe]:RLEVel <real>
DISPlay:PVTime:VIEW2:WINDow[1]|2:TRACe:Y[:SCALe]:RLEVel <real>
DISPlay:PVTime:VIEW[1]:WINDow[1]:TRACe:Y[:SCALe]:RLEVel?
```

```

DISPlay:PVTime:VIEW2:WINDow[1]|2:TRACe:Y[:SCALe]:RLEVel?
DISPlay:PVTime:VIEW[1]:WINDow[1]:TRACe:Y[:SCALe]:RPOStion TOP | CENTer |
BOTTOm
DISPlay:PVTime:VIEW2:WINDow[1]|2:TRACe:Y[:SCALe]:RPOStion TOP | CENTer |
BOTTOm
DISPlay:PVTime:VIEW2:WINDow[1]|2:TRACe:Y[:SCALe]:RPOStion?
DISPlay:PVTime:VIEW[1]:WINDow[1]:TRACe:Y[:SCALe]:RPOStion?
DISPlay:PVTime:VIEW[1]:WINDow[1]:TRIGger[:STATe] ON | OFF | 1 | 0
DISPlay:PVTime:VIEW[1]:WINDow[1]:TRIGger[:STATe]?
DISPlay:SEMask:VIEW:NSElect <integer>
DISPlay:SEMask:VIEW:NSElect?
DISPlay:SEMask:VIEW[:SElect] APFReq | RPFReq | IPOWer | CINformation
DISPlay:SEMask:VIEW[:SElect]?
DISPlay:SEMask:VIEW[1]:WINDow[1]:CINformation:FREQuency OFFSet | ABSolute
DISPlay:SEMask:VIEW[1]:WINDow[1]:CINformation:FREQuency?
DISPlay:SEMask:VIEW[1]:WINDow[1]:TRACe:X[:SCALe]:COUPle 0 | 1 | OFF | ON
DISPlay:SEMask:VIEW[1]:WINDow[1]:TRACe:X[:SCALe]:COUPle?
DISPlay:SEMask:VIEW[1]:WINDow[1]:TRACe:X[:SCALe]:PDIVision ?
DISPlay:SEMask:VIEW[1]:WINDow[1]:TRACe:X[:SCALe]:PDIVision <freq>
DISPlay:SEMask:VIEW[1]:WINDow[1]:TRACe:X[:SCALe]:RLEVel <freq>
DISPlay:SEMask:VIEW[1]:WINDow[1]:TRACe:X[:SCALe]:RLEVel?
DISPlay:SEMask:VIEW[1]:WINDow[1]:TRACe:X[:SCALe]:RPOStion LEFT | CENTer |
RIGHT
DISPlay:SEMask:VIEW[1]:WINDow[1]:TRACe:X[:SCALe]:RPOStion?
DISPlay:SEMask:VIEW[1]:WINDow[1]:TRACe:Y[:SCALe]:COUPle 0 | 1 | ON | OFF
DISPlay:SEMask:VIEW[1]:WINDow[1]:TRACe:Y[:SCALe]:COUPle?
DISPlay:SEMask:VIEW[1]:WINDow[1]:TRACe:Y[:SCALe]:PDIVision <rel_ampl>
DISPlay:SEMask:VIEW[1]:WINDow[1]:TRACe:Y[:SCALe]:PDIVision?
DISPlay:SEMask:VIEW[1]:WINDow[1]:TRACe:Y[:SCALe]:RLEVel <real>
DISPlay:SEMask:VIEW[1]:WINDow[1]:TRACe:Y[:SCALe]:RLEVel?
DISPlay:SEMask:VIEW[1]:WINDow[1]:TRACe:Y[:SCALe]:RPOStion TOP | CENTer |
BOTTOm
DISPlay:SEMask:VIEW[1]:WINDow[1]:TRACe:Y[:SCALe]:RPOStion?
DISPlay:WINDow[1]:ANNotation[:ALL] OFF | ON | 0 | 1
DISPlay:WINDow[1]:ANNotation[:ALL]?
DISPlay:WINDow:FORMat:TILE
DISPlay:WINDow:FORMat:ZOOM
DISPlay:WINDow[:SElect] <number>
DISPlay:WINDow[:SElect]?
DISPlay:WINDow[1]:TRACe:GRATicule:GRID[:STATe] OFF | ON | 0 | 1
DISPlay:WINDow[1]:TRACe:GRATicule:GRID[:STATe]?
FEED:RF:PORT:OUTP RFIO1
FETCh:<meas>[n]?
FETCh:ACP[n]?
FETCh:CEVM[n]?
FETCh:CHPower:CHPower?
FETCh:CHPower:DENSity?
FETCh:CHPower[n]?
FETCh:EVM[n]?
FETCh:FCAPture?
FETCh:OBwidth:FERRor?
FETCh:OBwidth[n]?

```

3 Programming the Test Set

List of SCPI Commands

```
FETCh:OBWidth:OBWidth?
FETCh:OBWidth:XDB?
FETCh:PVTime[n]?
FETCh:SEMask[n]?
FORMat:BORDER NORMAL | SWAPped
FORMat:BORDER?
FORMat[:TRACE][:DATA] ASCii | INTeger, 32 | REAL, 32 | REAL, 64
FORMat[:TRACE][:DATA]?
GLOBal:DEFault
GLOBal:FREQuency:CENTer[:STATE] 1 | 0 | ON | OFF
GLOBal:FREQuency:CENTer[:STATE]?
HCOpy:ABORT
HCOpy[:IMMEDIATE]
INITiate:ACP
INITiate:CEVM
INITiate:CHPower
INITiate:CONTinuous OFF | ON | 0 | 1
INITiate:CONTinuous?
INITiate:EVM
INITiate:FCAPture
INITiate[:IMMEDIATE]
INITiate:OBWidth
INITiate:PAUSE
INITiate:PVTime
INITiate:REStart
INITiate:RESume
INITiate:SEMask
INPut<1|2>:TYPE INPUT1 | INPUT2
INPut<1|2>:TYPE?
INPut[1]|2:LISN:FILTer:HPAS[:STATE] ON | OFF
INPut[1]|2:LISN:FILTer:HPAS[:STATE]?
INPut[1]|2:LISN:PEARth GROunded | FLOating
INPut[1]|2:LISN:PEARth?
INPut[1]|2:LISN:PHASe L1 | L2 | L3 | N
INPut[1]|2:LISN:PHASe?
INPut[1]|2:LISN[:TYPE] FOURphase | ESH2Z5 | ENV216 | OFF
INPut[1]|2:LISN[:TYPE]?
INPut:MIXer EXTernal | INTernal
INPut:MIXer?
INST:NSEL 102
INST:NSEL 105
INSTrument:CATalog?
INSTrument:COUPle:DEFault
INSTrument:COUPle:FREQuency:CENTer ALL | NONE
INSTrument:COUPle:FREQuency:CENTer?
INSTrument:DEFault
INSTrument:NSElect <integer>
INSTrument:NSElect?
INSTrument[:SElect] RECeiver
INSTrument[:SElect] GSM
INSTrument[:SElect] SANalyzer
INSTrument[:SElect] SA | RTSA | SEQAN | EMI | BASIC | WCDMA | EDGEgsm |
WIMAXOFDMA | VSA | PNOISE | NFIGure | ADEMOD | BTooth | TDSCDMA | CDMA2K |
```



```

CDMA1XEV | LTE | LTETDD | LTEAFDD | LTEATDD | MSR | DVB | DTMB | DCATV |
ISDBT | CMMB | WLAN | CWLAN | CWIMAXOFDM | WIMAXFIXED | IDEN | RLC |
SCPILC | VSA89601
INSTrument[:SElect] 'SA' | 'PNOISE' | 'EDGE' | 'GSM' | 'BASIC'
INSTrument[:SElect]?
INST:SEL LTE
INST:SEL LTETDD
INST:SEL SCPILC
INST:SEL EMI
MEASure:ACP[n]?
MEASure:CEVM[n]?
MEASure:CHPower:CHPower?
MEASure:CHPower:DENSity?
MEASure:CHPower[n]?
MEASure:EVM[n]?
MEASure:OBWidth:FERRor?
MEASure:OBWidth[n]?
MEASure:OBWidth:OBWidth?
MEASure:OBWidth:XDB?
MEASure:PVTime[n]?
MEASure:SEMask[n]?
MMEMory:CATalog? [<directory_name>]
MMEMory:CDIRectory [<directory_name>]
MMEMory:CDIRectory?
MMEMory:COpy <string>, <string>[, <string>, <string>]
MMEMory:COpy:DEvIce <source_string>, <dest_string>
MMEMory:DATA <file_name>, <data>
MMEMory:DATA? <file_name>
MMEMory:DELeTe <file_name>[, <directory_name>]
MMEMory:HEADer:ID? "<filename>"
MMEMory:LOAD:EVMSetup <string>
MMEMory:LOAD:MASK <string>
MMEMory:LOAD:SEQuences:| SLISt | ALISt | SAALISt | "MySequence.txt"
MMEMory:LOAD:SEtUp ALL | CC0 | CC1 | CC2 | CC3 | CC4, <string>
MMEMory:LOAD:SSSetup <string>
MMEMory:LOAD:STATe 1, <filename>
MMEMory:LOAD:STATe <filename>
MMEMory:LOAD:TRAcE:DATA D1 | D2 | D3 | D4 | D5 | D6, <filename>[, CSV |
TXT | SDF | MAT4 | MAT | HDF5 | BIN]
MMEMory:LOAD:VSASetup <string>
MMEMory:MDIRectory <directory_name>
MMEMory:MOve <string>, <string>[, <string>, <string>]
MMEMory:RDIRectory <directory_name>
MMEMory:REGISter:STATe:LAbel <regnumber>, "label"
MMEMory:REGISter:STATe:LAbel? <regnumber>
MMEMory:STORe:RESuLts <string>
MMEMory:STORe:RESuLts <string>
MMEMory:STORe:RESuLts <string>
MMEMory:STORe:RESuLts <string>
MMEMory:STORe:RESuLts:MTAbLe|PTAbLe|SPECTrogram <filename>
MMEMory:STORe:SCReen <filename>
MMEMory:STORe:SCReen:THEME TDColor | TDMonochrome | FCOLor | FMONochrome

```

3 Programming the Test Set

List of SCPI Commands

```
MMEMory:STORe:SCReen:THEME?
MMEMory:STORe:STATe 1, <filename>
MMEMory:STORe:STATe <filename>
MMEMory:STORe:TRACe:DATA TRACE1 | TRACE2 | TRACE3 | TRACE4 | TRACE5 |
TRACE6, "<filename>"[, CSV | TXT | SDF | MAT4 | MAT | HDF5 | BIN[, OFF |
ON | 0 | 1]]
MMEM:STOR:SEQuences:| SLIST | ALIST | SAALIST | SSTEP"MySequence.txt"
OUTPut:ANALog OFF | SVIDeo | LOGVIDeo | LINVIDeo | DAUDio
OUTPut:ANALog?
OUTPut:ANALog:AUTO OFF | ON | 0 | 1
OUTPut:ANALog:AUTO?
OUTPut[:EXTeRnal][:STATe] ON | OFF | 1 | 0
OUTPut[:EXTeRnal][:STATe]?
OUTPut:MODulation[:STATe] ON | OFF | 1 | 0
OUTPut:MODulation[:STATe]?
READ:<meas>[n]?
READ:ACP[n]?
READ:CEVM[n]?
READ:CHPower:CHPower?
READ:CHPower:DENSity
READ:CHPower[n]?
READ:EVM[n]?
READ:OBWidth:FERRor?
READ:OBWidth[n]?
READ:OBWidth:OBWidth?
READ:OBWidth:XDB?
READ:PVTime[n]?
READ:SEMAsk[n]?
[:SENSe]:<meas>:AVERAge:COUNT <integer>
[:SENSe]:<meas>:AVERAge:COUNT?
[:SENSe]:<meas>:AVERAge:FAST OFF | ON | 0 | 1
[:SENSe]:<meas>:AVERAge:FAST?
[:SENSe]:<meas>:AVERAge:FAST:URATe <integer>
[:SENSe]:<meas>:AVERAge:FAST:URATe?
[:SENSe]:<meas>:AVERAge:FAST:URATe:AUTO OFF | ON | 0 | 1
[:SENSe]:<meas>:AVERAge:FAST:URATe:AUTO?
[:SENSe]:<meas>:AVERAge[:STATe] OFF | ON | 0 | 1
[:SENSe]:<meas>:AVERAge[:STATe]?
[:SENSe]:<meas>:AVERAge:TYPE RMS | MAXimum
[:SENSe]:<meas>:AVERAge:TYPE RMS | TIME | MAXimum
[:SENSe]:<meas>:AVERAge:TYPE?
[:SENSe]:<meas>:PUPDate:ENABle OFF | ON | 0 | 1
[:SENSe]:<meas>:PUPDate:ENABle?
[:SENSe]:<meas>:SWEep:ISRATe?
[:SENSe]:<measurEmEnt>:TRIGger:SOURce IF
[:SENSe]:<measurEmEnt>:TRIGger:SOURce
[:SENSe]:ACPower:AVERAge:COUNT <integer>
[:SENSe]:ACPower:AVERAge:COUNT?
[:SENSe]:ACPower:AVERAge[:STATe] OFF | ON | 0 | 1
[:SENSe]:ACPower:AVERAge[:STATe]?
[:SENSe]:ACPower:AVERAge:TCONtrol EXPonential | REPeat
[:SENSe]:ACPower:AVERAge:TCONtrol?
[:SENSe]:ACPower:BANDwidth[:RESolution] <freq>
```

```

[:SENSE]:ACPower:BANDwidth[:RESolution]?
[:SENSE]:ACPower:BANDwidth[:RESolution]:AUTO ON | OFF | 1 | 0
[:SENSE]:ACPower:BANDwidth[:RESolution]:AUTO?
[:SENSE]:ACPower:BANDwidth:SHAPE GAUSSian | FLATtop
[:SENSE]:ACPower:BANDwidth:SHAPE?
[:SENSE]:ACPower:BANDwidth:TYPE DB3 | DB6
[:SENSE]:ACPower:BANDwidth:TYPE?
[:SENSE]:ACPower:BANDwidth:VIDeo <freq>
[:SENSE]:ACPower:BANDwidth:VIDeo?
[:SENSE]:ACPower:BANDwidth:VIDeo:AUTO OFF | ON | 0 | 1
[:SENSE]:ACPower:BANDwidth:VIDeo:AUTO?
[:SENSE]:ACPower:BWIDth[:RESolution]
[:SENSE]:ACPower:BWIDth:SHAPE
[:SENSE]:ACPower:BWIDth:TYPE
[:SENSE]:ACPower:BWIDth:VIDeo
[:SENSE]:ACPower:CARRier[1]|2:LIST:BANDwidth[:INTegration]
[:SENSE]:ACPower:CARRier[1]|2:LIST:BWIDth[:INTegration]
[:SENSE]:ACPower:CARRier[1]|2:LIST:METHOD IBW | RRC, ...
[:SENSE]:ACPower:CARRier[1]|2:LIST:METHOD?
[:SENSE]:ACPower:DETEctor:AUTO ON | OFF | 1 | 0
[:SENSE]:ACPower:DETEctor:AUTO?
[:SENSE]:ACPower:DETEctor[:FUNCTION] AVERage | NEGative | NORMal |
POSitive | SAMple
[:SENSE]:ACPower:DETEctor[:FUNCTION]?
[:SENSE]:ACPower:FILTer[:RRC]:ALPHa <real>
[:SENSE]:ACPower:FILTer[:RRC]:ALPHa?
[:SENSE]:ACPower:FILTer[:RRC][:STATE] OFF | ON | 0 | 1
[:SENSE]:ACPower:FILTer[:RRC][:STATE]?
[:SENSE]:ACPower:FREQuency:SPAN <freq>
[:SENSE]:ACPower:FREQuency:SPAN?
[:SENSE]:ACPower:FREQuency:SPAN:PREVIOUS
[:SENSE]:ACPower:LIMit[:STATE]
[:SENSE]:ACPower:METHod IBW | IBWRange | FAST | RBW
[:SENSE]:ACPower:METHod?
[:SENSE]:ACPower:OFFSet[1]|2:LIST:BWIDth[:INTegration]
[:SENSE]:ACPower:OFFSet[1]|2:LIST:BWIDth:RESolution
[:SENSE]:ACPower:OFFSet[1]|2:LIST:BWIDth:SHAPE
[:SENSE]:ACPower:OFFSet[1]|2:LIST:BWIDth:TYPE
[:SENSE]:ACPower:OFFSet[1]|2:LIST:BWIDth:VIDeo
[:SENSE]:ACPower:OFFSet[1]|2[:OUTer]:LIST:ABSolute <real>, ...
[:SENSE]:ACPower:OFFSet[1]|2[:OUTer]:LIST:ABSolute?
[:SENSE]:ACPower:OFFSet[1]|2[:OUTer]:LIST:BANDwidth[:INTegration] <freq>,
...
[:SENSE]:ACPower:OFFSet[1]|2[:OUTer]:LIST:BANDwidth[:INTegration]?
[:SENSE]:ACPower:OFFSet[1]|2[:OUTer]:LIST:BANDwidth:RESolution <freq>, ...
[:SENSE]:ACPower:OFFSet[1]|2[:OUTer]:LIST:BANDwidth:RESolution?
[:SENSE]:ACPower:OFFSet[1]|2[:OUTer]:LIST:BANDwidth:RESolution:AUTO
ON|OFF|1|0, ...
[:SENSE]:ACPower:OFFSet[1]|2[:OUTer]:LIST:BANDwidth:RESolution:AUTO?
[:SENSE]:ACPower:OFFSet[1]|2[:OUTer]:LIST:BANDwidth:SHAPE
GAUSSian|FLATtop, ...
[:SENSE]:ACPower:OFFSet[1]|2[:OUTer]:LIST:BANDwidth:SHAPE?

```

3 Programming the Test Set

List of SCPI Commands

```

[:SENSe]:ACPower:OFFSet[1]|2[:OUTer]:LIST:BANDwidth:TYPE DB3|DB6, ...
[:SENSe]:ACPower:OFFSet[1]|2[:OUTer]:LIST:BANDwidth:TYPE?
[:SENSe]:ACPower:OFFSet[1]|2[:OUTer]:LIST:BANDwidth:VIDeo <freq>, ...
[:SENSe]:ACPower:OFFSet[1]|2[:OUTer]:LIST:BANDwidth:VIDeo?
[:SENSe]:ACPower:OFFSet[1]|2[:OUTer]:LIST:BANDwidth:VIDeo:AUTO OFF|ON|0|1,
...
[:SENSe]:ACPower:OFFSet[1]|2[:OUTer]:LIST:BANDwidth:VIDeo:AUTO?
[:SENSe]:ACPower:OFFSet[1]|2[:OUTer]:LIST:FILTer:ALPHa <real>, ...
[:SENSe]:ACPower:OFFSet[1]|2[:OUTer]:LIST:FILTer:ALPHa?
[:SENSe]:ACPower:OFFSet[1]|2[:OUTer]:LIST:FILTer[:RRC][:STATE] ON|OFF|1|0,
...
[:SENSe]:ACPower:OFFSet[1]|2[:OUTer]:LIST:FILTer[:RRC][:STATE]?
[:SENSe]:ACPower:OFFSet[1]|2[:OUTer]:LIST[:FREQuency] <freq>, ...
[:SENSe]:ACPower:OFFSet[1]|2[:OUTer]:LIST[:FREQuency]?
[:SENSe]:ACPower:OFFSet[1]|2[:OUTer]:LIST:RCARrier <real>, ...
[:SENSe]:ACPower:OFFSet[1]|2[:OUTer]:LIST:RCARrier?
[:SENSe]:ACPower:OFFSet[1]|2[:OUTer]:LIST:RPSDensity <rel_ampl>, ...
[:SENSe]:ACPower:OFFSet[1]|2[:OUTer]:LIST:RPSDensity?
[:SENSe]:ACPower:OFFSet[1]|2[:OUTer]:LIST:SIDE NEGative|BOTH|POSitive, ...
[:SENSe]:ACPower:OFFSet[1]|2[:OUTer]:LIST:SIDE?
[:SENSe]:ACPower:OFFSet[1]|2[:OUTer]:LIST:STATE OFF|ON|0|1, ...
[:SENSe]:ACPower:OFFSet[1]|2[:OUTer]:LIST:STATE?
[:SENSe]:ACPower:OFFSet[1]|2[:OUTer]:LIST:TEST ABSolute|AND|OR|RELative,
...
[:SENSe]:ACPower:OFFSet[1]|2[:OUTer]:LIST:TEST?
[:SENSe]:ACPower:OFFSet[1]|2[:OUTer]:TYPE CTOCenter | CTOEdge | ETOCenter
| ETOEdge
[:SENSe]:ACPower:OFFSet[1]|2[:OUTer]:TYPE?
[:SENSe]:ACPower:SWEep:POINTs <integer>
[:SENSe]:ACPower:SWEep:POINTs?
[:SENSe]:ACPower:SWEep:TIME <time>
[:SENSe]:ACPower:SWEep:TIME?
[:SENSe]:ACPower:SWEep:TIME:AUTO OFF | ON | 0 | 1
[:SENSe]:ACPower:SWEep:TIME:AUTO?
[:SENSe]:ACPower:SWEep:TIME:AUTO:RULEs NORMAl | ACCuracy
[:SENSe]:ACPower:SWEep:TIME:AUTO:RULEs?
[:SENSe]:ACPower:TYPE TPreF | PSDRef
[:SENSe]:ACPower:TYPE?
[:SENSe]:ACPR:AVERAge:COUNT
[:SENSe]:ACPR:AVERAge:TCONtrol
[:SENSe]:ACPR:FILTer[:RRC]:ALPHa
[:SENSe]:ACPR:FILTer[:RRC][:STATE]
[:SENSe]:ACPR:OFFSet[1]|2:LIST:ABSolute (PSAW-CDMA, PSAcDMA2000)
[:SENSe]:ACPR:OFFSet[1]|2:LIST:BANDwidth
[:SENSe]:ACPR:OFFSet[1]|2:LIST:BWIDth
[:SENSe]:ACPR:SWEep:DETEctor[:FUNction]
[:SENSe]:ACPR:SWEep:TYPE
[:SENSe]:ACPR:TRIGger:SOURce
[:SENSe]:ACP:SWEep:BANDwidth|BWIDth[:RESolution] (PSAW-CDMA, PSAcDMA2000)
[:SENSe]:CCARrier<n>:FREQuency:OFFSet <freq>
[:SENSe]:CCARrier<n>:FREQuency:OFFSet?
[:SENSe]:CCARrier0|1|2|3|4:ACPower:BANDwidth[1]|2:INTegration <freq>

```

```

[:SENSE]:CCARrier0|1|2|3|4:ACPower:BANDwidth[1]|2:INTEgration?
[:SENSE]:CCARrier0|1|2|3|4:CHPower:BANDwidth:INTEgration <freq>
[:SENSE]:CCARrier0|1|2|3|4:CHPower:BANDwidth:INTEgration?
[:SENSE]:CCARrier:CONFIg:ALLocation CONTiguous | NCONTiguous
[:SENSE]:CCARrier:CONFIg:ALLocation?
[:SENSE]:CCARrier:CONFIg:ALLocation:NCONTiguous:ABPoint CC0 | CC1 | CC2 |
CC3 | CC4
[:SENSE]:CCARrier:CONFIg:ALLocation:NCONTiguous:ABPoint ?
[:SENSE]:CCARrier:COUNT <integer>
[:SENSE]:CCARrier:COUNT?
[:SENSE]:CCARrier0|1|2|3|4:RADio:STANdard:BANDwidth
[:SENSE]:CCARrier0|1|2|3|4:RADio:STANdard:BANDwidth?
[:SENSE]:CCARrier0|1|2|3|4:RADio:STANdard:DGPU CONF0 | CONF1 | CONF2 |
CONF3 | CONF4 | CONF5 | CONF6 | CONF7 | CONF8 | CONF9
[:SENSE]:CCARrier0|1|2|3|4:RADio:STANdard:DGPU?
[:SENSE]:CCARrier0|1|2|3|4:RADio:STANdard:ULDL CONF0 | CONF1 | CONF2 |
CONF3 | CONF4 | CONF5 | CONF6
[:SENSE]:CCARrier0|1|2|3|4:RADio:STANdard:ULDL?
[:SENSE]:CCARrier:REFerence <freq>
[:SENSE]:CCARrier:REFerence?
[:SENSE]:CCARrier:RFBWidth?
[:SENSE]:CCARrier:RFBWidth:CENTEr?
[:SENSE]:CCARrier:SBLock[1]|2:BWIDth?
[:SENSE]:CCARrier:SBLock[1]|2:CENTEr?
[:SENSE]:CCARrier:SBLock:GAP?
[:SENSE]:CCARrier0|1|2|3|4:SEMAsk:BANDwidth[1]|2:INTEgration <freq>
[:SENSE]:CCARrier0|1|2|3|4:SEMAsk:BANDwidth[1]|2:INTEgration?
[:SENSE]:CCARrier0|1|2|3|4:SPECTrum NORMAl | INVert
[:SENSE]:CCARrier0|1|2|3|4:SPECTrum?
[:SENSE]:CCARrier0|1|2|3|4[:STATE] OFF | ON | 0 | 1
[:SENSE]:CCARrier0|1|2|3|4[:STATE]?
[:SENSE]:CEVM:AVERAge:COUNT <integer>
[:SENSE]:CEVM:AVERAge:COUNT?
[:SENSE]:CEVM:AVERAge[:STATE] OFF | ON | 0 | 1
[:SENSE]:CEVM:AVERAge[:STATE]?
[:SENSE]:CEVM:CCARrier0|1|2|3|4:EVMMinimize:IQIMbalance OFF | ON | 0 | 1
[:SENSE]:CEVM:CCARrier0|1|2|3|4:EVMMinimize:IQIMbalance?
[:SENSE]:CEVM:CCARrier0|1|2|3|4:IFBW <freq>
[:SENSE]:CEVM:CCARrier0|1|2|3|4:IFBW?
[:SENSE]:CEVM:CCARrier0|1|2|3|4:IQIMbalance:FCOMpen ON | OFF
[:SENSE]:CEVM:CCARrier0|1|2|3|4:IQIMbalance:FCOMpen?
[:SENSE]:CEVM:DLINK:RESUlt ON | OFF | 0 | 1, ...
[:SENSE]:CEVM:DLINK:RESUlt?
[:SENSE]:CEVM:DLINK:RESUlt:ALL ON | OFF | 0 | 1
[:SENSE]:CEVM:EQUalizer:TRAIning
[:SENSE]:CEVM:EVM:COPI[:IMMediate]
[:SENSE]:CEVM:EVMMinimize:IQIMbalance
[:SENSE]:CEVM:IFBW
[:SENSE]:CEVM:IQIMbalance:FCOMpen
[:SENSE]:CEVM:METhod NORMAl | FAST
[:SENSE]:CEVM:METhod?
[:SENSE]:CEVM:SELEcted CC0 | CC1 | CC2 | CC3 | CC4

```

3 Programming the Test Set

List of SCPI Commands

```
[ :SENSe ] :CEVM:SElected?
[ :SENSe ] :CEVM:ULINK:PROFile:USER:HOPping:GROup
[ :SENSe ] :CEVM:ULINK:PROFile:USER1|50:HOPping:SEquence
[ :SENSe ] :CEVM:ULINK:PROFile:USER:PUSch
[ :SENSe ] :CEVM:ULINK:PROFile:USER:PUSch:ACTive
[ :SENSe ] :CEVM:ULINK:PROFile:USER:PUSch:ADD:SLOT
[ :SENSe ] :CEVM:ULINK:PROFile:USER:PUSch:DMRS
[ :SENSe ] :CEVM:ULINK:PROFile:USER:PUSch:DMRS:ONE
[ :SENSe ] :CEVM:ULINK:PROFile:USER:PUSch:DMRS:PARams
[ :SENSe ] :CEVM:ULINK:PROFile:USER:PUSch:DMRS:TWO
[ :SENSe ] :CEVM:ULINK:PROFile:USER:PUSch:DSS
[ :SENSe ] :CEVM:ULINK:PROFile:USER:PUSch:FHOPping
[ :SENSe ] :CEVM:ULINK:PROFile:USER1|50:PUSch:MODulation:TYPE
[ :SENSe ] :CEVM:ULINK:PROFile:USER:PUSch:RB:END
[ :SENSe ] :CEVM:ULINK:PROFile:USER:PUSch:RB:END:COUple
[ :SENSe ] :CEVM:ULINK:PROFile:USER:PUSch:RB:START
[ :SENSe ] :CEVM:ULINK:PROFile:USER:PUSch:RB:START:COUple
[ :SENSe ] :CEVM:ULINK:PROFile:USER:PUSch:SSlot
[ :SENSe ] :CEVM:ULINK:PROFile:USER:PUSch:SSlot:AUTO
[ :SENSe ] :CEVM:ULINK:RESult ON | OFF | 0 | 1, ...
[ :SENSe ] :CEVM:ULINK:RESult?
[ :SENSe ] :CEVM:ULINK:RESult:ALL ON | OFF | 0 | 1
[ :SENSe ] :CHPower:AVERage:COUNT <integer>
[ :SENSe ] :CHPower:AVERage:COUNT?
[ :SENSe ] :CHPower:AVERage[:STATE] ON | OFF | 1 | 0
[ :SENSe ] :CHPower:AVERage[:STATE]?
[ :SENSe ] :CHPower:AVERage:TCONtrol EXPonential | REPeat
[ :SENSe ] :CHPower:AVERage:TCONtrol?
[ :SENSe ] :CHPower:BANDwidth:INTEgration
[ :SENSe ] :CHPower:BANDwidth[:RESolution] <bandwidth>
[ :SENSe ] :CHPower:BANDwidth[:RESolution]?
[ :SENSe ] :CHPower:BANDwidth[:RESolution]:AUTO ON | OFF | 1 | 0
[ :SENSe ] :CHPower:BANDwidth[:RESolution]:AUTO?
[ :SENSe ] :CHPower:BANDwidth:SHApe GAUSSian | FLATtop
[ :SENSe ] :CHPower:BANDwidth:SHApe?
[ :SENSe ] :CHPower:BANDwidth:VIDeo <bandwidth>
[ :SENSe ] :CHPower:BANDwidth:VIDeo?
[ :SENSe ] :CHPower:BANDwidth:VIDeo:AUTO ON | OFF | 1 | 0
[ :SENSe ] :CHPower:BANDwidth:VIDeo:AUTO?
[ :SENSe ] :CHPower:BWIDth:INTEgration
[ :SENSe ] :CHPower:BWIDth[:RESolution]
[ :SENSe ] :CHPower:BWIDth:SHApe
[ :SENSe ] :CHPower:DETEctor:AUTO ON | OFF | 1 | 0
[ :SENSe ] :CHPower:DETEctor:AUTO?
[ :SENSe ] :CHPower:DETEctor[:FUNction] NORMal | AVERage | POSitive | SAMPlE
| NEGative
[ :SENSe ] :CHPower:DETEctor[:FUNction]?
[ :SENSe ] :CHPower:SWEep:POINts <integer>
[ :SENSe ] :CHPower:SWEep:POINts?
[ :SENSe ] :CHPower:SWEep:TIME <time>
[ :SENSe ] :CHPower:SWEep:TIME?
[ :SENSe ] :CHPower:SWEep:TIME:AUTO OFF | ON | 0 | 1
[ :SENSe ] :CHPower:SWEep:TIME:AUTO?
```

```

[:SENSE]:CHPower:SWEep:TIME:AUTO:RULEs NORMal | ACCuracy
[:SENSE]:CHPower:SWEep:TIME:AUTO:RULEs?
[:SENSE]:CORRection:BTS[:RF]:GAIN <rel_ampl>
[:SENSE]:CORRection:BTS[:RF]:GAIN?
[:SENSE]:CORRection:BTS[:RF]:LOSS <rel_ampl>
[:SENSE]:CORRection:BTS[:RF]:LOSS?
[:SENSE]:CORRection:CSET:ALL:DELeTe
[:SENSE]:CORRection:CSET:ALL[:STATE] ON | OFF | 1 | 0
[:SENSE]:CORRection:CSET:ALL[:STATE]?
[:SENSE]:CORRection:CSET[1]:ANTenna[:UNIT] GAUSS | PTESla | UVM | UAM | UA
| NOConversion
[:SENSE]:CORRection:CSET[1]:ANTenna[:UNIT]?
[:SENSE]:CORRection:CSET[1]|2|...|8:COMMeNt "text"
[:SENSE]:CORRection:CSET[1]|2|...|8:COMMeNt?
[:SENSE]:CORRection:CSET[1]|2|...|8:DATA <freq>, <ampl>, ...
[:SENSE]:CORRection:CSET[1]|2|...|8:DATA?
[:SENSE]:CORRection:CSET[1]|2|...|8:DATA:MERGe <freq>, <ampl>, ...
[:SENSE]:CORRection:CSET[1]|2|...|6:DELeTe
[:SENSE]:CORRection:CSET[1]|2|...|8:DESCription "text"
[:SENSE]:CORRection:CSET[1]|2|...|8:DESCription?
[:SENSE]:CORRection:CSET[1]|2|...|8:RF:PORT RFIN | RFIO1 | RFIO2 | RFOut |
GPSout | GNSSout | RFIO3 | RFIO4
[:SENSE]:CORRection:CSET[1]|2|...|8:RF:PORT?
[:SENSE]:CORRection:CSET[1]|2|...|8:RF:PORT:RFIO2 SOURce | ANALyzer | BOTH
[:SENSE]:CORRection:CSET[1]|2|...|8:RF:PORT:RFIO1 SOURce | ANALyzer | BOTH
[:SENSE]:CORRection:CSET[1]|2|...|8:RF:PORT:RFIO2?
[:SENSE]:CORRection:CSET[1]|2|...|8:RF:PORT:RFIO1?
[:SENSE]:CORRection:CSET[1]|2|...|8[:STATE] ON | OFF | 1 | 0
[:SENSE]:CORRection:CSET[1]|2|...|8[:STATE]?
[:SENSE]:CORRection:CSET[1]|2|...|8:X:SPACing LINear | LOGarithmic
[:SENSE]:CORRection:CSET[1]|2|...|8:X:SPACing?
[:SENSE]:CORRection:IMPedance[:INPut][:MAGNitude] 50 | 75
[:SENSE]:CORRection:IMPedance[:INPut][:MAGNitude]?
[:SENSE]:CORRection:MS[:RF]:GAIN <rel_ampl>
[:SENSE]:CORRection:MS[:RF]:GAIN?
[:SENSE]:CORRection:MS[:RF]:LOSS <rel_ampl>
[:SENSE]:CORRection:MS[:RF]:LOSS?
[:SENSE]:CORRection:OFFSet[:MAGNitude]
[:SENSE]:CORRection:SA[:RF]:GAIN <rel_ampl>
[:SENSE]:CORRection:SA[:RF]:GAIN?
[:SENSE]:EBWidth:AVERAge:COUNT
[:SENSE]:EBWidth:FREQuency:SPAN
[:SENSE]:EBWidth:MAXHold
[:SENSE]:EBWidth:XDB
[:SENSE]:EVM:CCARrier0|1|2|3|4:DLINK:AENumber <integer>
[:SENSE]:EVM:CCARrier0|1|2|3|4:DLINK:AENumber?
[:SENSE]:EVM:CCARrier0|1|2|3|4:DLINK:AESPacing <double>
[:SENSE]:EVM:CCARrier0|1|2|3|4:DLINK:AESPacing?
[:SENSE]:EVM:CCARrier0|1|2|3|4:DLINK:DECode:DFINclude F1F1B | F1F1D | F1 |
F1B | F1D
[:SENSE]:EVM:CCARrier0|1|2|3|4:DLINK:DECode:DFINclude?
[:SENSE]:EVM:CCARrier0|1|2|3|4:DLINK:DECode:DFTWo:PRFour <integer>

```

3 Programming the Test Set

List of SCPI Commands

```
[ :SENSe]:EVM:CCARrier0|1|2|3|4:DLINK:DECode:DFTWo:PRFour?
[ :SENSe]:EVM:CCARrier0|1|2|3|4:DLINK:DECode:DFTWo:PRONe <integer>
[ :SENSe]:EVM:CCARrier0|1|2|3|4:DLINK:DECode:DFTWo:PRONe?
[ :SENSe]:EVM:CCARrier0|1|2|3|4:DLINK:DECode:DFTWo:PRTHree <integer>
[ :SENSe]:EVM:CCARrier0|1|2|3|4:DLINK:DECode:DFTWo:PRTHree?
[ :SENSe]:EVM:CCARrier0|1|2|3|4:DLINK:DECode:DFTWo:PRTWo <integer>
[ :SENSe]:EVM:CCARrier0|1|2|3|4:DLINK:DECode:DFTWo:PRTWo?
[ :SENSe]:EVM:CCARrier0|1|2|3|4:DLINK:DECode:PBCH NONE | DESCrambled |
DRMatched | DECoded
[ :SENSe]:EVM:CCARrier0|1|2|3|4:DLINK:DECode:PBCH?
[ :SENSe]:EVM:CCARrier0|1|2|3|4:DLINK:DECode:PCFich NONE | DESCrambled |
DECoded
[ :SENSe]:EVM:CCARrier0|1|2|3|4:DLINK:DECode:PCFich?
[ :SENSe]:EVM:CCARrier0|1|2|3|4:DLINK:DECode:PDCCh NONE | DEMapped |
DINterleaved | DESCrambled | DRMatched | DECoded
[ :SENSe]:EVM:CCARrier0|1|2|3|4:DLINK:DECode:PDCCh?
[ :SENSe]:EVM:CCARrier0|1|2|3|4:DLINK:DECode:PDSCh NONE | DESCrambled |
DRMatched | DCBLock | DTBLock
[ :SENSe]:EVM:CCARrier0|1|2|3|4:DLINK:DECode:PDSCh?
[ :SENSe]:EVM:CCARrier0|1|2|3|4:DLINK:DECode:RNTI:MAXimum:RA <integer>
[ :SENSe]:EVM:CCARrier0|1|2|3|4:DLINK:DECode:RNTI:MAXimum:RA?
[ :SENSe]:EVM:CCARrier0|1|2|3|4:DLINK:DECode:RNTI:MAXimum:TPC <integer>
[ :SENSe]:EVM:CCARrier0|1|2|3|4:DLINK:DECode:RNTI:MAXimum:TPC?
[ :SENSe]:EVM:CCARrier0|1|2|3|4:DLINK:DECode:RNTI:MINimum:RA <integer>
[ :SENSe]:EVM:CCARrier0|1|2|3|4:DLINK:DECode:RNTI:MINimum:RA?
[ :SENSe]:EVM:CCARrier0|1|2|3|4:DLINK:DECode:RNTI:MINimum:TPC <integer>
[ :SENSe]:EVM:CCARrier0|1|2|3|4:DLINK:DECode:RNTI:MINimum:TPC?
[ :SENSe]:EVM:CCARrier0|1|2|3|4:DLINK:PDSCh:CSRatio R1 | PB0 | PB1 | PB2 |
PB3
[ :SENSe]:EVM:CCARrier0|1|2|3|4:DLINK:PDSCh:CSRatio?
[ :SENSe]:EVM:CCARrier0|1|2|3|4:DLINK:PROFile:AUTO[:DETECT]:POWER OFF | ON
| 0 | 1
[ :SENSe]:EVM:CCARrier0|1|2|3|4:DLINK:PROFile:AUTO[:DETECT]:POWER?
[ :SENSe]:EVM:CCARrier0|1|2|3|4:DLINK:PROFile:AUTO[:DETECT]:POWER:PMODE OFF
| ON | 0 | 1
[ :SENSe]:EVM:CCARrier0|1|2|3|4:DLINK:PROFile:AUTO[:DETECT]:POWER:PMODE?
[ :SENSe]:EVM:CCARrier0|1|2|3|4:DLINK:PROFile:AUTO[:DETECT]:POWER:ROUND OFF
| ON | 0 | 1
[ :SENSe]:EVM:CCARrier0|1|2|3|4:DLINK:PROFile:AUTO[:DETECT]:POWER:ROUND?
[ :SENSe]:EVM:CCARrier0|1|2|3|4:DLINK:PROFile:COUNT?
[ :SENSe]:EVM:CCARrier0|1|2|3|4:DLINK:PROFile:CSIRs INCLude | EXCLude
[ :SENSe]:EVM:CCARrier0|1|2|3|4:DLINK:PROFile:CSIRs?
[ :SENSe]:EVM:CCARrier0|1|2|3|4:DLINK:PROFile:EUSers:COUNT <integer>
[ :SENSe]:EVM:CCARrier0|1|2|3|4:DLINK:PROFile:EUSers:COUNT?
[ :SENSe]:EVM:CCARrier0|1|2|3|4:DLINK:PROFile:EXCLude:ALL
[ :SENSe]:EVM:CCARrier0|1|2|3|4:DLINK:PROFile:INCLude:ALL
[ :SENSe]:EVM:CCARrier0|1|2|3|4:DLINK:PROFile:MBSFn INCLude | EXCLude
[ :SENSe]:EVM:CCARrier0|1|2|3|4:DLINK:PROFile:MBSFn?
[ :SENSe]:EVM:CCARrier0|1|2|3|4:DLINK:PROFile:PBCH INCLude | EXCLude
[ :SENSe]:EVM:CCARrier0|1|2|3|4:DLINK:PROFile:PBCH?
[ :SENSe]:EVM:CCARrier0|1|2|3|4:DLINK:PROFile:PCFich INCLude | EXCLude
[ :SENSe]:EVM:CCARrier0|1|2|3|4:DLINK:PROFile:PCFich?
```



```

[:SENSe]:EVM:CCARrier0|1|2|3|4:DLINK:PROFile:PDCCh INCLude | EXCLude
[:SENSe]:EVM:CCARrier0|1|2|3|4:DLINK:PROFile:PDCCh?
[:SENSe]:EVM:CCARrier0|1|2|3|4:DLINK:PROFile:PHICH INCLude | EXCLude
[:SENSe]:EVM:CCARrier0|1|2|3|4:DLINK:PROFile:PHICH?
[:SENSe]:EVM:CCARrier0|1|2|3|4:DLINK:PROFile:PMCH INCLude | EXCLude
[:SENSe]:EVM:CCARrier0|1|2|3|4:DLINK:PROFile:PMCH?
[:SENSe]:EVM:CCARrier0|1|2|3|4:DLINK:PROFile:PRS INCLude | EXCLude
[:SENSe]:EVM:CCARrier0|1|2|3|4:DLINK:PROFile:PRS?
[:SENSe]:EVM:CCARrier0|1|2|3|4:DLINK:PROFile:PSS INCLude | EXCLude
[:SENSe]:EVM:CCARrier0|1|2|3|4:DLINK:PROFile:PSS?
[:SENSe]:EVM:CCARrier0|1|2|3|4:DLINK:PROFile:QAM64 INCLude | EXCLude
[:SENSe]:EVM:CCARrier0|1|2|3|4:DLINK:PROFile:QAM16 INCLude | EXCLude
[:SENSe]:EVM:CCARrier0|1|2|3|4:DLINK:PROFile:QAM64?
[:SENSe]:EVM:CCARrier0|1|2|3|4:DLINK:PROFile:QAM16?
[:SENSe]:EVM:CCARrier0|1|2|3|4:DLINK:PROFile:QPSK INCLude | EXCLude
[:SENSe]:EVM:CCARrier0|1|2|3|4:DLINK:PROFile:QPSK?
[:SENSe]:EVM:CCARrier0|1|2|3|4:DLINK:PROFile:RS INCLude | EXCLude
[:SENSe]:EVM:CCARrier0|1|2|3|4:DLINK:PROFile:RS?
[:SENSe]:EVM:CCARrier0|1|2|3|4:DLINK:PROFile:SSS INCLude | EXCLude
[:SENSe]:EVM:CCARrier0|1|2|3|4:DLINK:PROFile:SSS?
[:SENSe]:EVM:CCARrier0|1|2|3|4:DLINK:PROFile:USER<n>:DECodeD:PDSCh INCLude
| EXCLude
[:SENSe]:EVM:CCARrier0|1|2|3|4:DLINK:PROFile:USER<n>:DECodeD:PDSCh?
[:SENSe]:EVM:CCARrier0|1|2|3|4:DLINK:PROFile:USER<n>:PDSCh INCLude |
EXCLude
[:SENSe]:EVM:CCARrier0|1|2|3|4:DLINK:PROFile:USER<n>:PDSCh?
[:SENSe]:EVM:CCARrier0|1|2|3|4:DLINK:PROFile:USER<n>:PDSCh:COUNT?
[:SENSe]:EVM:CCARrier0|1|2|3|4:DLINK:SYNC:ANTenna:DETECT:THReshold <rel_
ampl>
[:SENSe]:EVM:CCARrier0|1|2|3|4:DLINK:SYNC:ANTenna:DETECT:THReshold?
[:SENSe]:EVM:CCARrier0|1|2|3|4:DLINK:SYNC:ANTenna:INACTive:PATHs INCLude |
EXCLude
[:SENSe]:EVM:CCARrier0|1|2|3|4:DLINK:SYNC:ANTenna:INACTive:PATHs?
[:SENSe]:EVM:CCARrier0|1|2|3|4:DLINK:SYNC:ANTenna:NUMBER ANT1 | ANT2 |
ANT4
[:SENSe]:EVM:CCARrier0|1|2|3|4:DLINK:SYNC:ANTenna:NUMBER?
[:SENSe]:EVM:CCARrier0|1|2|3|4:DLINK:SYNC:ANTenna:PORT P0 | P1 | P2 | P3
[:SENSe]:EVM:CCARrier0|1|2|3|4:DLINK:SYNC:ANTenna:PORT?
[:SENSe]:EVM:CCARrier0|1|2|3|4:DLINK:SYNC:ANTenna:PORT:AUTO OFF | ON | 0 |
1
[:SENSe]:EVM:CCARrier0|1|2|3|4:DLINK:SYNC:ANTenna:PORT:AUTO?
[:SENSe]:EVM:CCARrier0|1|2|3|4:DLINK:SYNC:CID <integer>
[:SENSe]:EVM:CCARrier0|1|2|3|4:DLINK:SYNC:CID?
[:SENSe]:EVM:CCARrier0|1|2|3|4:DLINK:SYNC:CID:AUTO OFF | ON | 0 | 1
[:SENSe]:EVM:CCARrier0|1|2|3|4:DLINK:SYNC:CID:AUTO?
[:SENSe]:EVM:CCARrier0|1|2|3|4:DLINK:SYNC:CPLength AUTO | NORMAl |
EXTended
[:SENSe]:EVM:CCARrier0|1|2|3|4:DLINK:SYNC:CPLength?
[:SENSe]:EVM:CCARrier0|1|2|3|4:DLINK:SYNC:CPLength:AUTO OFF | ON | 0 | 1
[:SENSe]:EVM:CCARrier0|1|2|3|4:DLINK:SYNC:CPLength:AUTO OFF | ON | 0 | 1
[:SENSe]:EVM:CCARrier0|1|2|3|4:DLINK:SYNC:CPLength:AUTO?
[:SENSe]:EVM:CCARrier0|1|2|3|4:DLINK:SYNC:CPLength:AUTO?

```

3 Programming the Test Set
List of SCPI Commands

```

[:SENSe]:EVM:CCARrier0|1|2|3|4:DLINK:SYNC:MIMO:DECoding NONE | GPPMimo
[:SENSe]:EVM:CCARrier0|1|2|3|4:DLINK:SYNC:MIMO:DECoding?
[:SENSe]:EVM:CCARrier0|1|2|3|4:DLINK:SYNC:RSPRs GPP | CUSTom
[:SENSe]:EVM:CCARrier0|1|2|3|4:DLINK:SYNC:RSPRs?
[:SENSe]:EVM:CCARrier0|1|2|3|4:DLINK:SYNC:SS:ANTenna:PORT P0 | P1 | P2 |
P3 | APORTs
[:SENSe]:EVM:CCARrier0|1|2|3|4:DLINK:SYNC:SS:ANTenna:PORT?
[:SENSe]:EVM:CCARrier0|1|2|3|4:DLINK:SYNC:TYPE PSS | RS
[:SENSe]:EVM:CCARrier0|1|2|3|4:DLINK:SYNC:TYPE?
[:SENSe]:EVM:CCARrier0|1|2|3|4:DLINK:UERS:CFRCompen OFF | ON | 0 | 1
[:SENSe]:EVM:CCARrier0|1|2|3|4:DLINK:UERS:CFRCompen?
[:SENSe]:EVM:CCARrier0|1|2|3|4:DLINK:UERS:WEIGhts:DISPlay PSUBcarrier |
PRB | PUSer
[:SENSe]:EVM:CCARrier0|1|2|3|4:DLINK:UERS:WEIGhts:DISPlay?
[:SENSe]:EVM:CCARrier0|1|2|3|4:DLINK:UERS:WEIGhts:RIFormat OFF | ON | 0 |
1
[:SENSe]:EVM:CCARrier0|1|2|3|4:DLINK:UERS:WEIGhts:RIFormat?
[:SENSe]:EVM:CCARrier0|1|2|3|4:EETTime OFF | ON | 0 | 1
[:SENSe]:EVM:CCARrier0|1|2|3|4:EETTime?
[:SENSe]:EVM:CCARrier0|1|2|3|4:EQUalizer:TRAINing OFF | RS | RSD
[:SENSe]:EVM:CCARrier0|1|2|3|4:EQUalizer:TRAINing?
[:SENSe]:EVM:CCARrier0|1|2|3|4:EQUalizer:TRAINing:MAFilter OFF | ON | 0 |
1
[:SENSe]:EVM:CCARrier0|1|2|3|4:EQUalizer:TRAINing:MAFilter OFF | ON | 0 |
1
[:SENSe]:EVM:CCARrier0|1|2|3|4:EQUalizer:TRAINing:MAFilter?
[:SENSe]:EVM:CCARrier0|1|2|3|4:EQUalizer:TRAINing:MAFilter?
[:SENSe]:EVM:CCARrier0|1|2|3|4:EQUalizer:TRAINing:MAFilter:LENGth
<integer>
[:SENSe]:EVM:CCARrier0|1|2|3|4:EQUalizer:TRAINing:MAFilter:LENGth?
[:SENSe]:EVM:CCARrier0|1|2|3|4:EQUalizer:TRAINing:MCFNormalize OFF | ON |
0 | 1
[:SENSe]:EVM:CCARrier0|1|2|3|4:EQUalizer:TRAINing:MCFNormalize?
[:SENSe]:EVM:CCARrier0|1|2|3|4:EQUalizer:TRAINing:MODE ZFORcing | LSQuares
[:SENSe]:EVM:CCARrier0|1|2|3|4:EQUalizer:TRAINing:MODE?
[:SENSe]:EVM:CCARrier0|1|2|3|4:EVMMinimize OFF | GPP | TRACKing
[:SENSe]:EVM:CCARrier0|1|2|3|4:EVMMinimize?
[:SENSe]:EVM:CCARrier0|1|2|3|4:EVMMinimize:AMPLitude OFF | ON | 0 | 1
[:SENSe]:EVM:CCARrier0|1|2|3|4:EVMMinimize:AMPLitude?
[:SENSe]:EVM:CCARrier0|1|2|3|4:EVMMinimize:FREQuency OFF | ON | 0 | 1
[:SENSe]:EVM:CCARrier0|1|2|3|4:EVMMinimize:FREQuency?
[:SENSe]:EVM:CCARrier0|1|2|3|4:EVMMinimize:IQIMbalance OFF | ON | 0 | 1
[:SENSe]:EVM:CCARrier0|1|2|3|4:EVMMinimize:IQIMbalance?
[:SENSe]:EVM:CCARrier0|1|2|3|4:EVMMinimize:IQOffset OFF | ON | 0 | 1
[:SENSe]:EVM:CCARrier0|1|2|3|4:EVMMinimize:IQOffset?
[:SENSe]:EVM:CCARrier0|1|2|3|4:EVMMinimize:TIMing OFF | ON | 0 | 1
[:SENSe]:EVM:CCARrier0|1|2|3|4:EVMMinimize:TIMing?
[:SENSe]:EVM:CCARrier0|1|2|3|4:EXTended:FREQuency:LOCK:RANGe OFF | ON | 0
| 1
[:SENSe]:EVM:CCARrier0|1|2|3|4:EXTended:FREQuency:LOCK:RANGe?
[:SENSe]:EVM:CCARrier0|1|2|3|4:MCFilter:STATe OFF | ON | 0 | 1
[:SENSe]:EVM:CCARrier0|1|2|3|4:MCFilter:STATe?

```

```

[:SENSE]:EVM:CCARrier0|1|2|3|4:ODActive OFF | ON | 0 | 1
[:SENSE]:EVM:CCARrier0|1|2|3|4:ODActive?
[:SENSE]:EVM:CCARrier0|1|2|3|4:PIlot:TRACk:AMPLitude
[:SENSE]:EVM:CCARrier0|1|2|3|4:PIlot:TRACk:PHASE
[:SENSE]:EVM:CCARrier0|1|2|3|4:PIlot:TRACk:TIMing
[:SENSE]:EVM:CCARrier0|1|2|3|4:POWER:BOOST:NORMALize OFF | ON | 0 | 1
[:SENSE]:EVM:CCARrier0|1|2|3|4:POWER:BOOST:NORMALize?
[:SENSE]:EVM:CCARrier0|1|2|3|4:PROFile:COPI[:IMMediate]
[:SENSE]:EVM:CCARrier0|1|2|3|4:PROFile:NAlocation INCLude | EXCLude
[:SENSE]:EVM:CCARrier0|1|2|3|4:PROFile:NAlocation?
[:SENSE]:EVM:CCARrier0|1|2|3|4:REPort:DB OFF | ON | 0 | 1
[:SENSE]:EVM:CCARrier0|1|2|3|4:REPort:DB?
[:SENSE]:EVM:CCARrier0|1|2|3|4:REPort:POWER:RELative OFF | ON | 0 | 1
[:SENSE]:EVM:CCARrier0|1|2|3|4:REPort:POWER:RELative?
[:SENSE]:EVM:CCARrier0|1|2|3|4:SYMBOL:TIMing:ADJust MAX | MIN | START |
END | CENTER | FFTSize
[:SENSE]:EVM:CCARrier0|1|2|3|4:SYMBOL:TIMing:ADJust?
[:SENSE]:EVM:CCARrier0|1|2|3|4:SYMBOL:TIMing:ADJust:USER <percent>
[:SENSE]:EVM:CCARrier0|1|2|3|4:SYMBOL:TIMing:ADJust:USER?
[:SENSE]:EVM:CCARrier0|1|2|3|4:TIME:ASBoundary FRAME | HALF | SUB | SLOT
[:SENSE]:EVM:CCARrier0|1|2|3|4:TIME:ASBoundary?
[:SENSE]:EVM:CCARrier0|1|2|3|4:TIME:INTerval:SLOT <integer>
[:SENSE]:EVM:CCARrier0|1|2|3|4:TIME:INTerval:SLOT?
[:SENSE]:EVM:CCARrier0|1|2|3|4:TIME:INTerval:SYMBOL <integer>
[:SENSE]:EVM:CCARrier0|1|2|3|4:TIME:INTerval:SYMBOL?
[:SENSE]:EVM:CCARrier0|1|2|3|4:TIME:OFFSet:SLOT <integer>
[:SENSE]:EVM:CCARrier0|1|2|3|4:TIME:OFFSet:SLOT?
[:SENSE]:EVM:CCARrier0|1|2|3|4:TIME:OFFSet:SYMBOL <integer>
[:SENSE]:EVM:CCARrier0|1|2|3|4:TIME:OFFSet:SYMBOL?
[:SENSE]:EVM:CCARrier0|1|2|3|4:TIME:RESult:LENGth <integer>
[:SENSE]:EVM:CCARrier0|1|2|3|4:TIME:RESult:LENGth?
[:SENSE]:EVM:CCARrier0|1|2|3|4:TIME:SCALE:FACTor <value>
[:SENSE]:EVM:CCARrier0|1|2|3|4:TIME:SCALE:FACTor?
[:SENSE]:EVM:CCARrier0|1|2|3|4:ULINK:DECode:ANFMode MULTiplexing |
BUNDling
[:SENSE]:EVM:CCARrier0|1|2|3|4:ULINK:DECode:ANFMode?
[:SENSE]:EVM:CCARrier0|1|2|3|4:ULINK:DECode:PUCCh NONE | DESCrambled |
DECoded
[:SENSE]:EVM:CCARrier0|1|2|3|4:ULINK:DECode:PUCCh?
[:SENSE]:EVM:CCARrier0|1|2|3|4:ULINK:DECode:PUCCh:CQI:ISIZe <integer>
[:SENSE]:EVM:CCARrier0|1|2|3|4:ULINK:DECode:PUCCh:CQI:ISIZe?
[:SENSE]:EVM:CCARrier0|1|2|3|4:ULINK:DECode:PUCCh:CQI:ISIZe:AUTO OFF | ON
| 0 | 1
[:SENSE]:EVM:CCARrier0|1|2|3|4:ULINK:DECode:PUCCh:CQI:ISIZe:AUTO?
[:SENSE]:EVM:CCARrier0|1|2|3|4:ULINK:DECode:PUCCh:HARQ:ISIZe <integer>
[:SENSE]:EVM:CCARrier0|1|2|3|4:ULINK:DECode:PUCCh:HARQ:ISIZe?
[:SENSE]:EVM:CCARrier0|1|2|3|4:ULINK:DECode:PUCCh:HARQ:ISIZe:AUTO OFF | ON
| 0 | 1
[:SENSE]:EVM:CCARrier0|1|2|3|4:ULINK:DECode:PUCCh:HARQ:ISIZe:AUTO?
[:SENSE]:EVM:CCARrier0|1|2|3|4:ULINK:DECode:PUSCh NONE | DESCrambled |
DRMatched | DCBLock | DTBBlock
[:SENSE]:EVM:CCARrier0|1|2|3|4:ULINK:DECode:PUSCh?

```

3 Programming the Test Set

List of SCPI Commands

```

[:SENSe]:EVM:CCARrier0|1|2|3|4:ULINK:DECode:PUSCh:CQI:ISize <integer>
[:SENSe]:EVM:CCARrier0|1|2|3|4:ULINK:DECode:PUSCh:CQI:ISize?
[:SENSe]:EVM:CCARrier0|1|2|3|4:ULINK:DECode:PUSCh:CQI:ISize:AUTO OFF | ON
| 0 | 1
[:SENSe]:EVM:CCARrier0|1|2|3|4:ULINK:DECode:PUSCh:CQI:ISize:AUTO?
[:SENSe]:EVM:CCARrier0|1|2|3|4:ULINK:DECode:PUSCh:CQI:OFFSet <integer>
[:SENSe]:EVM:CCARrier0|1|2|3|4:ULINK:DECode:PUSCh:CQI:OFFSet?
[:SENSe]:EVM:CCARrier0|1|2|3|4:ULINK:DECode:PUSCh:HARQ:ISize <integer>
[:SENSe]:EVM:CCARrier0|1|2|3|4:ULINK:DECode:PUSCh:HARQ:ISize?
[:SENSe]:EVM:CCARrier0|1|2|3|4:ULINK:DECode:PUSCh:HARQ:ISize:AUTO OFF | ON
| 0 | 1
[:SENSe]:EVM:CCARrier0|1|2|3|4:ULINK:DECode:PUSCh:HARQ:ISize:AUTO?
[:SENSe]:EVM:CCARrier0|1|2|3|4:ULINK:DECode:PUSCh:HARQ:OFFSet <integer>
[:SENSe]:EVM:CCARrier0|1|2|3|4:ULINK:DECode:PUSCh:HARQ:OFFSet?
[:SENSe]:EVM:CCARrier0|1|2|3|4:ULINK:DECode:PUSCh:RI:ISize <integer>
[:SENSe]:EVM:CCARrier0|1|2|3|4:ULINK:DECode:PUSCh:RI:ISize?
[:SENSe]:EVM:CCARrier0|1|2|3|4:ULINK:DECode:PUSCh:RI:ISize:AUTO OFF | ON |
0 | 1
[:SENSe]:EVM:CCARrier0|1|2|3|4:ULINK:DECode:PUSCh:RI:ISize:AUTO?
[:SENSe]:EVM:CCARrier0|1|2|3|4:ULINK:DECode:PUSCh:RI:OFFSet <integer>
[:SENSe]:EVM:CCARrier0|1|2|3|4:ULINK:DECode:PUSCh:RI:OFFSet?
[:SENSe]:EVM:CCARrier0|1|2|3|4:ULINK:FLATness:CHANnel:CONDition NORMAL |
EXTreme
[:SENSe]:EVM:CCARrier0|1|2|3|4:ULINK:FLATness:CHANnel:CONDition?
[:SENSe]:EVM:CCARrier0|1|2|3|4:ULINK:FREQuency:CENTer <freq>
[:SENSe]:EVM:CCARrier0|1|2|3|4:ULINK:FREQuency:CENTer?
[:SENSe]:EVM:CCARrier0|1|2|3|4:ULINK:FREQuency:HIGH <freq>
[:SENSe]:EVM:CCARrier0|1|2|3|4:ULINK:FREQuency:HIGH?
[:SENSe]:EVM:CCARrier0|1|2|3|4:ULINK:FREQuency:LOW <freq>START
[:SENSe]:EVM:CCARrier0|1|2|3|4:ULINK:FREQuency:LOW?
[:SENSe]:EVM:CCARrier0|1|2|3|4:ULINK:SYNC:CPLength AUTO | NORMAL |
EXTended
[:SENSe]:EVM:CCARrier0|1|2|3|4:ULINK:SYNC:CPLength?
[:SENSe]:EVM:CCARrier0|1|2|3|4:ULINK:SYNC:CPLength:AUTO OFF | ON | 0 | 1
[:SENSe]:EVM:CCARrier0|1|2|3|4:ULINK:SYNC:CPLength:AUTO OFF | ON | 0 | 1
[:SENSe]:EVM:CCARrier0|1|2|3|4:ULINK:SYNC:CPLength:AUTO?
[:SENSe]:EVM:CCARrier0|1|2|3|4:ULINK:SYNC:CPLength:AUTO?
[:SENSe]:EVM:CCARrier0|1|2|3|4:ULINK:SYNC:IQOComp
[:SENSe]:EVM:CCARrier0|1|2|3|4:WINDow:LENGth GPP | CUSTom
[:SENSe]:EVM:CCARrier0|1|2|3|4:WINDow:LENGth?
[:SENSe]:EVM:CCARrier0|1|2|3|4:WINDow:LENGth:CUSTom <int>
[:SENSe]:EVM:CCARrier0|1|2|3|4:WINDow:LENGth:CUSTom?
[:SENSe]:EVM:COpy CC0 | CC1 | CC2 | CC3 | CC4 | All
[:SENSe]:EVM:DLINK:AENumber
[:SENSe]:EVM:DLINK:AESpacing
[:SENSe]:EVM:DLINK:DECode:DFINclude
[:SENSe]:EVM:DLINK:DECode:DFTWo:PRFour
[:SENSe]:EVM:DLINK:DECode:DFTWo:PRONE
[:SENSe]:EVM:DLINK:DECode:DFTWo:PRTThree
[:SENSe]:EVM:DLINK:DECode:DFTWo:PRTWo
[:SENSe]:EVM:DLINK:DECode:PBCH
[:SENSe]:EVM:DLINK:DECode:PCFich

```

```

[:SENSe]:EVM:DLINK:DECode:PDCCh
[:SENSe]:EVM:DLINK:DECode:PDSch
[:SENSe]:EVM:DLINK:DECode:RNTI:MAXimum:RA
[:SENSe]:EVM:DLINK:DECode:RNTI:MAXimum:TPC
[:SENSe]:EVM:DLINK:DECode:RNTI:MINimum:RA
[:SENSe]:EVM:DLINK:DECode:RNTI:MINimum:TPC
[:SENSe]:EVM:DLINK:PDSch:CSRatio
[:SENSe]:EVM:DLINK:PROFile:AUTO[:DETECT]:MODE POWER | DECODED
[:SENSe]:EVM:DLINK:PROFile:AUTO[:DETECT]:MODE?
[:SENSe]:EVM:DLINK:PROFile:AUTO[:DETECT]:POWER
[:SENSe]:EVM:DLINK:PROFile:AUTO[:DETECT]:POWER OFF | ON | 0 | 1
[:SENSe]:EVM:DLINK:PROFile:AUTO[:DETECT]:POWER?
[:SENSe]:EVM:DLINK:PROFile:AUTO[:DETECT]:POWER:PMODE OFF | ON | 0 | 1
[:SENSe]:EVM:DLINK:PROFile:AUTO[:DETECT]:POWER:PMODE
[:SENSe]:EVM:DLINK:PROFile:AUTO[:DETECT]:POWER:PMODE?
[:SENSe]:EVM:DLINK:PROFile:AUTO[:DETECT]:POWER:ROUND
[:SENSe]:EVM:DLINK:PROFile:COUNt
[:SENSe]:EVM:DLINK:PROFile:CSIRs
[:SENSe]:EVM:DLINK:PROFile:EUSers:COUNt
[:SENSe]:EVM:DLINK:PROFile:EXCLude:ALL
[:SENSe]:EVM:DLINK:PROFile:INCLude:ALL
[:SENSe]:EVM:DLINK:PROFile:MBSFn
[:SENSe]:EVM:DLINK:PROFile:PBCH
[:SENSe]:EVM:DLINK:PROFile:PCFich
[:SENSe]:EVM:DLINK:PROFile:PDCCh
[:SENSe]:EVM:DLINK:PROFile:PHICH
[:SENSe]:EVM:DLINK:PROFile:PMCH
[:SENSe]:EVM:DLINK:PROFile:PRS
[:SENSe]:EVM:DLINK:PROFile:PSS
[:SENSe]:EVM:DLINK:PROFile:QAM16
[:SENSe]:EVM:DLINK:PROFile:QAM64
[:SENSe]:EVM:DLINK:PROFile:QPSK
[:SENSe]:EVM:DLINK:PROFile:RS
[:SENSe]:EVM:DLINK:PROFile:SSS
[:SENSe]:EVM:DLINK:PROFile:USER<n>:DECODED:PDSch
[:SENSe]:EVM:DLINK:PROFile:USER<n>:PDSch
[:SENSe]:EVM:DLINK:PROFile:USER<n>:PDSch:COUNt
[:SENSe]:EVM:DLINK:SYNC:ANTenna:DETECT:THReshold
[:SENSe]:EVM:DLINK:SYNC:ANTenna:INACTIVE:PATHs
[:SENSe]:EVM:DLINK:SYNC:ANTenna:NUMBer
[:SENSe]:EVM:DLINK:SYNC:ANTenna:PORT
[:SENSe]:EVM:DLINK:SYNC:ANTenna:PORT:AUTO
[:SENSe]:EVM:DLINK:SYNC:CID
[:SENSe]:EVM:DLINK:SYNC:CID:AUTO
[:SENSe]:EVM:DLINK:SYNC:CPLength
[:SENSe]:EVM:DLINK:SYNC:MIMO:DECoding
[:SENSe]:EVM:DLINK:SYNC:RSPR
[:SENSe]:EVM:DLINK:SYNC:SS:ANTenna:PORT
[:SENSe]:EVM:DLINK:SYNC:TYPE
[:SENSe]:EVM:DLINK:UERS:CFRCompen
[:SENSe]:EVM:DLINK:UERS:WEIGHTs:DISPlay PSUBcarrier | PRB | PUSer
[:SENSe]:EVM:DLINK:UERS:WEIGHTs:DISPlay
[:SENSe]:EVM:DLINK:UERS:WEIGHTs:DISPlay?

```

3 Programming the Test Set

List of SCPI Commands

```
[ :SENSe ] :EVM:DLINK:UERS:WEIGhts:RIFormat
[ :SENSe ] :EVM:EETTime
[ :SENSe ] :EVM:EQUalizer:TRaining
[ :SENSe ] :EVM:EQUalizer:TRaining:MAFilter:LENGth
[ :SENSe ] :EVM:EQUalizer:TRaining:MCFNormalize
[ :SENSe ] :EVM:EQUalizer:TRaining:MODE
[ :SENSe ] :EVM:EQUalizer:TRaining:MODE ZFORcing | LSQuares
[ :SENSe ] :EVM:EQUalizer:TRaining:MODE?
[ :SENSe ] :EVM:EVMMinimize
[ :SENSe ] :EVM:EVMMinimize:AMPLitude
[ :SENSe ] :EVM:EVMMinimize:FREQuency
[ :SENSe ] :EVM:EVMMinimize:IQIMbalance
[ :SENSe ] :EVM:EVMMinimize:IQOFFset
[ :SENSe ] :EVM:EVMMinimize:TIMing
[ :SENSe ] :EVM:EXTended:FREQuency:LOCK:RANGE
[ :SENSe ] :EVM:MCFilter:STATE OFF | ON | 0 | 1
[ :SENSe ] :EVM:ODActive
[ :SENSe ] :EVM:PILot:TRACk:AMPLitude
[ :SENSe ] :EVM:PILot:TRACk:PHASe
[ :SENSe ] :EVM:PILot:TRACk:TIMing
[ :SENSe ] :EVM:POWEr:BOOSt:NORMalize
[ :SENSe ] :EVM:PROFile:AUTO[:DETEct] OFF | ON | 0 | 1
[ :SENSe ] :EVM:PROFile:AUTO[:DETEct]?
[ :SENSe ] :EVM:PROFile:COPI[:IMMediate]
[ :SENSe ] :EVM:PROFile:NALLocation
[ :SENSe ] :EVM:RANGE:OPTimize CC0 | CC1 | CC2 | CC3 | CC4 | All
[ :SENSe ] :EVM:RANGE:OPTimize?
[ :SENSe ] :EVM:REPort:DB
[ :SENSe ] :EVM:REPort:POWEr:RELative
[ :SENSe ] :EVM:SELEcted CC0 | CC1 | CC2 | CC3 | CC4
[ :SENSe ] :EVM:SELEcted?
[ :SENSe ] :EVM:SYMBOL:TIMing:ADJust
[ :SENSe ] :EVM:SYMBOL:TIMing:ADJust:USER
[ :SENSe ] :EVM:TIME:ASBoundary
[ :SENSe ] :EVM:TIME:INTerval:SLOT
[ :SENSe ] :EVM:TIME:INTerval:SYMBOL
[ :SENSe ] :EVM:TIME:OFFSet:SLOT
[ :SENSe ] :EVM:TIME:OFFSet:SYMBOL
[ :SENSe ] :EVM:TIME:RESult:LENGth
[ :SENSe ] :EVM:TIME:SCALE:FACTor
[ :SENSe ] :EVM:ULINK:DECode:ANFMode
[ :SENSe ] :EVM:ULINK:DECode:ANFMode MULTiplexing | BUNDling
[ :SENSe ] :EVM:ULINK:DECode:ANFMode?
[ :SENSe ] :EVM:ULINK:DECode:PUCCh
[ :SENSe ] :EVM:ULINK:DECode:PUCCh:CQI:ISIZe
[ :SENSe ] :EVM:ULINK:DECode:PUCCh:CQI:ISIZe:AUTO
[ :SENSe ] :EVM:ULINK:DECode:PUCCh:HARQ:ISIZe
[ :SENSe ] :EVM:ULINK:DECode:PUCCh:HARQ:ISIZe:AUTO
[ :SENSe ] :EVM:ULINK:DECode:PUSCh
[ :SENSe ] :EVM:ULINK:DECode:PUSCh:CQI:ISIZe
[ :SENSe ] :EVM:ULINK:DECode:PUSCh:CQI:ISIZe:AUTO
[ :SENSe ] :EVM:ULINK:DECode:PUSCh:CQI:OFFSet
[ :SENSe ] :EVM:ULINK:DECode:PUSCh:HARQ:ISIZe
```

```

[:SENSE]:EVM:ULINK:DECode:PUSCh:HARQ:ISize:AUTO
[:SENSE]:EVM:ULINK:DECode:PUSCh:HARQ:OFFSet
[:SENSE]:EVM:ULINK:DECode:PUSCh:RI:ISize
[:SENSE]:EVM:ULINK:DECode:PUSCh:RI:OFFSet
[:SENSE]:EVM:ULINK:FLATness:CHANnel:CONDition
[:SENSE]:EVM:ULINK:FREQuency:CENTer
[:SENSE]:EVM:ULINK:FREQuency:HIGH
[:SENSE]:EVM:ULINK:FREQuency:LOW
[:SENSE]:EVM:ULINK:SYNC:CPLength
[:SENSE]:EVM:ULINK:SYNC:CPLength:AUTO
[:SENSE]:EVM:ULINK:WINDow:LENGth:CUSTom
[:SENSE]:EVM:WINDow:LENGth
[:SENSE]:FCAPture:BLOCK <integer>
[:SENSE]:FCAPture:BLOCK?
[:SENSE]:FCAPture:LENGth <integer>
[:SENSE]:FCAPture:LENGth?
[:SENSE]:FCAPture:POINter <integer>
[:SENSE]:FCAPture:POINter?
[:SENSE]:FCAPture:WLENGth AUTO | BIT32 | BIT64
[:SENSE]:FCAPture:WLENGth?
[:SENSE]:FEED IQ | IONLy | QONLy
[:SENSE]:FEED RF | AIQ | EMIXer
[:SENSE]:FEED AREFERENCE
[:SENSE]:FEED?
[:SENSE]:FEED?
[:SENSE]:FEED:RF:PORT[:INPut] RFIN | RFIN2 | RFIO1 | RFIO2 | RFIO3 | RFIO4
[:SENSE]:FEED:RF:PORT[:INPut]?
[:SENSE]:FEED:RF:PORT:OUTPut RFOut | RFIO1 | RFIO2 | GPSout | GNSSout |
RFIO3 | RFIO4
[:SENSE]:FEED:RF:PORT:OUTPut?
[:SENSE]:HDUPlex:PORT:INPut RFIO3 | RFIO4
[:SENSE]:HDUPlex:PORT:OUTPut RFIO3 | RFIO4
[:SENSE]:MCPower:AVERAge:COUNT (PSAPowerSuite, PSAW-CDMA, PSAcdma2000)
[:SENSE]:MCPower:FILTer[:RRC]:ALPHa
[:SENSE]:MCPower:FILTer[:RRC][:STATE]
[:SENSE]:MCPower:LIMit[:STATE]
[:SENSE]:MCPower:METHod (PSAPowerSuite)
[:SENSE]:MCPower:OFFSet[1]|2:LIST:ABSolute (PSAW-CDMA)
[:SENSE]:MCPower:OFFSet[1]|2:LIST:BANDwidth[:INTEgration] (PSAPowerSuite)
[:SENSE]:MCPower:OFFSet[1]|2:LIST:BWIDth[:INTEgration] (PSAPowerSuite)
[:SENSE]:MCPower:OFFSet[1]|2:LIST[:FREQuency] (PSAPowerSuite)
[:SENSE]:MCPower:OFFSet[1]|2:LIST:RCARrier (PSAWCDMA)
[:SENSE]:MCPower:OFFSet[1]|2:LIST:TEST
[:SENSE]:OBwidth:AVERAge:COUNT <integer>
[:SENSE]:OBwidth:AVERAge:COUNT?
[:SENSE]:OBwidth:AVERAge[:STATE] ON | OFF | 1 | 0
[:SENSE]:OBwidth:AVERAge[:STATE]?
[:SENSE]:OBwidth:AVERAge:TCONtrol EXPONential | REPEAT
[:SENSE]:OBwidth:AVERAge:TCONtrol?
[:SENSE]:OBwidth:BANDwidth[:RESolution] <bandwidth>
[:SENSE]:OBwidth:BANDwidth[:RESolution]?
[:SENSE]:OBwidth:BANDwidth[:RESolution]:AUTO ON | OFF | 1 | 0
[:SENSE]:OBwidth:BANDwidth[:RESolution]:AUTO?

```

3 Programming the Test Set

List of SCPI Commands

```
[ :SENSe]:OBWidth:BANDwidth:SHApe GAUSSian | FLATtop
[ :SENSe]:OBWidth:BANDwidth:SHApe?
[ :SENSe]:OBWidth:BANDwidth:VIDeo <bandwidth>
[ :SENSe]:OBWidth:BANDwidth:VIDeo?
[ :SENSe]:OBWidth:BANDwidth:VIDeo:AUTO ON | OFF | 1 | 0
[ :SENSe]:OBWidth:BANDwidth:VIDeo:AUTO?
[ :SENSe]:OBWidth:BWIDth[:RESolution]
[ :SENSe]:OBWidth:BWIDth:SHApe
[ :SENSe]:OBWidth:BWIDth:VIDeo
[ :SENSe]:OBWidth:DETEctor:AUTO ON | OFF | 1 | 0
[ :SENSe]:OBWidth:DETEctor:AUTO?
[ :SENSe]:OBWidth:DETEctor[:FUNction] NORMAl | AVERAge | POSitive | SAMPlE
| NEGative
[ :SENSe]:OBWidth:DETEctor[:FUNction]?
[ :SENSe]:OBWidth:FREQuency:SPAN <freq>
[ :SENSe]:OBWidth:FREQuency:SPAN?
[ :SENSe]:OBWidth:FREQuency:SPAN:AUTO ON | OFF | 0 | 1
[ :SENSe]:OBWidth:FREQuency:SPAN:AUTO?
[ :SENSe]:OBWidth:FREQuency:SPAN:PREVious
[ :SENSe]:OBWidth:MAXHold ON | OFF | 1 | 0
[ :SENSe]:OBWidth:MAXHold?
[ :SENSe]:OBWidth:PERCent <real>
[ :SENSe]:OBWidth:PERCent?
[ :SENSe]:OBWidth:SWEep:POINts <integer>
[ :SENSe]:OBWidth:SWEep:POINts?
[ :SENSe]:OBWidth:SWEep:TIME <time>
[ :SENSe]:OBWidth:SWEep:TIME?
[ :SENSe]:OBWidth:SWEep:TIME:AUTO OFF | ON | 0 | 1
[ :SENSe]:OBWidth:SWEep:TIME:AUTO?
[ :SENSe]:OBWidth:SWEep:TIME:AUTO:RULEs NORMAl | ACCuracy
[ :SENSe]:OBWidth:SWEep:TIME:AUTO:RULEs?
[ :SENSe]:OBWidth:XDB <rel_ampl>
[ :SENSe]:OBWidth:XDB?
[ :SENSe]:POWER[:RF]:RANGE <real>
[ :SENSe]:POWER[:RF]:RANGE?
[ :SENSe]:POWER[:RF]:RANGE:MIXer:OFFSet <real>
[ :SENSe]:POWER[:RF]:RANGE:MIXer:OFFSet?
[ :SENSe]:POWER[:RF]:RANGE:OPTimize IMMEDIATE
[ :SENSe]:POWER[:RF]:RANGE:OPTimize:ATTenuation OFF | ON | ELECTrical |
COMBined
[ :SENSe]:POWER[:RF]:RANGE:OPTimize:ATTenuation?
[ :SENSe]:POWER[:RF]:RANGE:PARatio <real>
[ :SENSe]:POWER[:RF]:RANGE:PARatio?
[ :SENSe]:PVTime:AVERAge:COUNT <integer>
[ :SENSe]:PVTime:AVERAge:COUNT?
[ :SENSe]:PVTime:AVERAge[:STATE] OFF | ON | 0 | 1
[ :SENSe]:PVTime:AVERAge[:STATE]?
[ :SENSe]:PVTime:AVERAge:TCONtrol EXPonential | REPEAT
[ :SENSe]:PVTime:AVERAge:TCONtrol?
[ :SENSe]:PVTime:AVERAge:TYPE LOG | LPOWER | RMS | POWER
[ :SENSe]:PVTime:AVERAge:TYPE?
[ :SENSe]:PVTime:BANDwidth <freq>
[ :SENSe]:PVTime:BANDwidth?
```



```

[:SENSe]:PVTime:CPLength (LTE)
[:SENSe]:PVTime:LIMit:POFF:DLINK <real>
[:SENSe]:PVTime:LIMit:POFF:DLINK? [:SENSe]:PVTime:LIMit:POFF:DLINK?
[:SENSe]:PVTime:LIMit:POFF:ULINK <real>
[:SENSe]:PVTime:LIMit:POFF:ULINK?
[:SENSe]:PVTime:LIMit:RAMP:DRTime <time>
[:SENSe]:PVTime:LIMit:RAMP:DRTime? [:SENSe]:PVTime:LIMit:RAMP:DRTime?
[:SENSe]:PVTime:LIMit:RAMP:URTime <time>
[:SENSe]:PVTime:LIMit:RAMP:URTime?
[:SENSe]:PVTime:MINterval (LTE)
[:SENSe]:PVTime:RAMP:SEARCh:LENGth <time>
[:SENSe]:PVTime:RAMP:SEARCh:LENGth?
[:SENSe]:PVTime:THReshold:DOWN:END <rel_ampl>
[:SENSe]:PVTime:THReshold:DOWN:END?
[:SENSe]:PVTime:THReshold:DOWN:START <rel_ampl>
[:SENSe]:PVTime:THReshold:DOWN:START?
[:SENSe]:PVTime:THReshold:UP:END <rel_ampl>
[:SENSe]:PVTime:THReshold:UP:END?
[:SENSe]:PVTime:THReshold:UP:START <rel_ampl>
[:SENSe]:PVTime:THReshold:UP:START?
[:SENSe]:RADio:CPLength NORMAl | EXTended
[:SENSe]:RADio:CPLength?
[:SENSe]:RADio:IMODulation:INTerference:FREQuency:OFFSet <freq>
[:SENSe]:RADio:IMODulation:INTerference:FREQuency:OFFSet?
[:SENSe]:RADio:IMODulation:INTerference:REGion INNER | OUTER
[:SENSe]:RADio:IMODulation:INTerference:REGion?
[:SENSe]:RADio:IMODulation:INTerference:SIDE NEGative | POSitive
[:SENSe]:RADio:IMODulation:INTerference:SIDE?
[:SENSe]:RADio:IMODulation:INTerference:SPAN <freq>
[:SENSe]:RADio:IMODulation:INTerference:SPAN?
[:SENSe]:RADio:IMODulation:INTerference[:STATe] OFF | ON | 0 | 1
[:SENSe]:RADio:IMODulation:INTerference[:STATe]?
[:SENSe]:RADio:MEASure OFF | PPF0 | PPF1 | PPF2 | PPF3 | PPF4 | SRS | DSRS
[:SENSe]:RADio:MEASure?
[:SENSe]:RADio:MINterval <integer>
[:SENSe]:RADio:MINterval
[:SENSe]:RADio:RCONfig CC0 | CC1 | CC2 | CC3 | CC4
[:SENSe]:RADio:RCONfig?
[:SENSe]:RADio:SLOT TS0 | TS1 | DPTS1 | UPTS1 | TS4 | TS5 | TS6 | TS7 |
TS8 | TS9 | TS10 | TS11 | TS12 | TS13 | TS14 | TS15 | TS16 | TS17 | TS18 |
TS19
[:SENSe]:RADio:SLOT? //LTEATDD//
[:SENSe]:RADio:STANdard:BANDwidth
[:SENSe]:RADio:STANdard:DGPU
[:SENSe]:RADio:STANdard:DIRection DLINK | ULINK
[:SENSe]:RADio:STANdard:DIRection?
[:SENSe]:RADio:STANdard:PRESet B1M4 | B3M | B5M | B10M | B15M | B20M
[:SENSe]:RADio:STANdard:PRESet:DGPU
[:SENSe]:RADio:STANdard:PRESet:DGPU?
[:SENSe]:RADio:STANdard:PRESet:ULDL
[:SENSe]:RADio:STANdard:PRESet:ULDL?
[:SENSe]:RADio:STANdard:ULDL
[:SENSe]:ROSCillator:EXTernal:FREQuency <freq>

```

```

[:SENSe]:ROSCillator:EXTErnal:FREQuency?
[:SENSe]:ROSCillator:SOURce INTernal | EXTErnal
[:SENSe]:ROSCillator:SOURce?
[:SENSe]:ROSCillator:SOURce:TYPE INTernal | EXTErnal | SENSE | PULSE
[:SENSe]:ROSCillator:SOURce:TYPE?
[:SENSe]:SEMAsk:AVERAge:COUNT <integer>
[:SENSe]:SEMAsk:AVERAge:COUNT?
[:SENSe]:SEMAsk:AVERAge[:STATE] ON | OFF | 1 | 0
[:SENSe]:SEMAsk:AVERAge[:STATE]?
[:SENSe]:SEMAsk:BANDwidth[1]|2:INTEgration
[:SENSe]:SEMAsk:BANDwidth[1]|2[:RESolution] <bandwidth>
[:SENSe]:SEMAsk:BANDwidth[1]|2[:RESolution]?
[:SENSe]:SEMAsk:BANDwidth[1]|2[:RESolution]:AUTO OFF | ON | 1 | 0
[:SENSe]:SEMAsk:BANDwidth[1]|2[:RESolution]:AUTO?
[:SENSe]:SEMAsk:BANDwidth:SHAPE ASENse | GAUSSian | FLATtop
[:SENSe]:SEMAsk:BANDwidth:SHAPE?
[:SENSe]:SEMAsk:BANDwidth[1]|2:VIDEo <bandwidth>
[:SENSe]:SEMAsk:BANDwidth[1]|2:VIDEo?
[:SENSe]:SEMAsk:BANDwidth[1]|2:VIDEo:AUTO OFF | ON | 1 | 0
[:SENSe]:SEMAsk:BANDwidth[1]|2:VIDEo:AUTO?
[:SENSe]:SEMAsk:BANDwidth[1]|2:VIDEo:RATio <real>
[:SENSe]:SEMAsk:BANDwidth[1]|2:VIDEo:RATio
[:SENSe]:SEMAsk:BANDwidth[1]|2:VIDEo:RATio:AUTO OFF | ON | 1 | 0
[:SENSe]:SEMAsk:BANDwidth[1]|2:VIDEo:RATio:AUTO?
[:SENSe]:SEMAsk:BWIDth[1]|2[:RESolution]
[:SENSe]:SEMAsk:BWIDth[1]|2:VIDEo
[:SENSe]:SEMAsk:BWIDth[1]|2:VIDEo:RATio
[:SENSe]:SEMAsk:CARRier:INDex <integer>
[:SENSe]:SEMAsk:CARRier:INDex?
[:SENSe]:SEMAsk:CARRier:PREFErence:TYPE LRCarriers | MPCarrier | CINDEX |
MANual | MPCSubblock | RFBandwidth
[:SENSe]:SEMAsk:CARRier:PREFErence:TYPE?
[:SENSe]:SEMAsk:DETEctor:CARRier:AUTO ON | OFF | 1 | 0
[:SENSe]:SEMAsk:DETEctor:CARRier:AUTO?
[:SENSe]:SEMAsk:DETEctor:CARRier[:FUNction] AVERAge | NEGAtive | NORMAl |
POSitive | SAMPLe
[:SENSe]:SEMAsk:DETEctor:CARRier[:FUNction]?
[:SENSe]:SEMAsk:DETEctor:OFFSet:AUTO ON | OFF | 1 | 0
[:SENSe]:SEMAsk:DETEctor:OFFSet:AUTO?
[:SENSe]:SEMAsk:DETEctor:OFFSet[:FUNction] AVERAge | NEGAtive | NORMAl |
POSitive | SAMPLe
[:SENSe]:SEMAsk:DETEctor:OFFSet[:FUNction]?
[:SENSe]:SEMAsk:FILTEr[:RRC]:ALPHa <real>
[:SENSe]:SEMAsk:FILTEr[:RRC]:ALPHa?
[:SENSe]:SEMAsk:FILTEr[:RRC][:STATE] OFF | ON | 0 | 1
[:SENSe]:SEMAsk:FILTEr[:RRC][:STATE]?
[:SENSe]:SEMAsk:NCONtiguous:REGion INNer | OUTer
[:SENSe]:SEMAsk:NCONtiguous:REGion?
[:SENSe]:SEMAsk:OFFSet[1]|2:INNer:CMASK:FREQuency:STOP <freq>
[:SENSe]:SEMAsk:OFFSet[1]|2:INNer:CMASK:FREQuency:STOP?
[:SENSe]:SEMAsk:OFFSet[1]|2:INNer:CMASK[:STATE] ON | OFF | 0 | 1
[:SENSe]:SEMAsk:OFFSet[1]|2:INNer:CMASK[:STATE]?

```

```

[:SENSE]:SEMask:OFFSet[1]|2:INNER:LIST:BANDwidth:IMULti <integer>, ...
[:SENSE]:SEMask:OFFSet[1]|2:INNER:LIST:BANDwidth:IMULti?
[:SENSE]:SEMask:OFFSet[1]|2:INNER:LIST:BANDwidth[:RESolution] <bandwidth>,
...
[:SENSE]:SEMask:OFFSet[1]|2:INNER:LIST:BANDwidth[:RESolution]?
[:SENSE]:SEMask:OFFSet[1]|2:INNER:LIST:BANDwidth[:RESolution]:AUTO OFF |
ON | 1 | 0, ...
[:SENSE]:SEMask:OFFSet[1]|2:INNER:LIST:BANDwidth[:RESolution]:AUTO?
[:SENSE]:SEMask:OFFSet[1]|2:INNER:LIST:BANDwidth:VIDEo <freq>, ...
[:SENSE]:SEMask:OFFSet[1]|2:INNER:LIST:BANDwidth:VIDEo?
[:SENSE]:SEMask:OFFSet[1]|2:INNER:LIST:BANDwidth:VIDEo:AUTO OFF | ON | 0 |
1, ...
[:SENSE]:SEMask:OFFSet[1]|2:INNER:LIST:BANDwidth:VIDEo:AUTO?
[:SENSE]:SEMask:OFFSet[1]|2:INNER:LIST:BANDwidth:VIDEo:RATio <real>, ...
[:SENSE]:SEMask:OFFSet[1]|2:INNER:LIST:BANDwidth:VIDEo:RATio?
[:SENSE]:SEMask:OFFSet[1]|2:INNER:LIST:BANDwidth:VIDEo:RATio:AUTO OFF | ON
| 0 | 1, ...
[:SENSE]:SEMask:OFFSet[1]|2:INNER:LIST:BANDwidth:VIDEo:RATio:AUTO?
[:SENSE]:SEMask:OFFSet[1]|2:INNER:LIST:FREQuency:START <freq>, ...
[:SENSE]:SEMask:OFFSet[1]|2:INNER:LIST:FREQuency:START?
[:SENSE]:SEMask:OFFSet[1]|2:INNER:LIST:FREQuency:STOP <freq>, ...
[:SENSE]:SEMask:OFFSet[1]|2:INNER:LIST:FREQuency:STOP?
[:SENSE]:SEMask:OFFSet[1]|2:INNER:LIST:SIDE BOTH | NEGAtive | POSitive,
...
[:SENSE]:SEMask:OFFSet[1]|2:INNER:LIST:SIDE?
[:SENSE]:SEMask:OFFSet[1]|2:INNER:LIST:START:ABSolute <real>, ...
[:SENSE]:SEMask:OFFSet[1]|2:INNER:LIST:START:ABSolute?
[:SENSE]:SEMask:OFFSet[1]|2:INNER:LIST:START:RCARrier <rel_ampl>, ...
[:SENSE]:SEMask:OFFSet[1]|2:INNER:LIST:START:RCARrier?
[:SENSE]:SEMask:OFFSet[1]|2:INNER:LIST:STATe ON | OFF | 1 | 0, ...
[:SENSE]:SEMask:OFFSet[1]|2:INNER:LIST:STATe?
[:SENSE]:SEMask:OFFSet[1]|2:INNER:LIST:STOP:ABSolute <real>, ...
[:SENSE]:SEMask:OFFSet[1]|2:INNER:LIST:STOP:ABSolute?
[:SENSE]:SEMask:OFFSet[1]|2:INNER:LIST:STOP:ABSolute:COUple ON | OFF | 1 |
0, ...
[:SENSE]:SEMask:OFFSet[1]|2:INNER:LIST:STOP:ABSolute:COUple?
[:SENSE]:SEMask:OFFSet[1]|2:INNER:LIST:STOP:RCARrier <rel_ampl>, ...
[:SENSE]:SEMask:OFFSet[1]|2:INNER:LIST:STOP:RCARrier?
[:SENSE]:SEMask:OFFSet[1]|2:INNER:LIST:STOP:RCARrier:COUple ON | OFF | 1 |
0, ...
[:SENSE]:SEMask:OFFSet[1]|2:INNER:LIST:STOP:RCARrier:COUple?
[:SENSE]:SEMask:OFFSet[1]|2:INNER:LIST:SWEep:TIME <time>, ...
[:SENSE]:SEMask:OFFSet[1]|2:INNER:LIST:SWEep:TIME?
[:SENSE]:SEMask:OFFSet[1]|2:INNER:LIST:SWEep:TIME:AUTO ON | OFF | 1 | 0,
...
[:SENSE]:SEMask:OFFSet[1]|2:INNER:LIST:SWEep:TIME:AUTO?
[:SENSE]:SEMask:OFFSet[1]|2:INNER:LIST:TEST ABSolute | AND | OR |
RELAtive, ...
[:SENSE]:SEMask:OFFSet[1]|2:INNER:LIST:TEST?
[:SENSE]:SEMask:OFFSet[1]|2:INNER:TYPE CTC | CTOE | ETOC | ETOE | STOC |
STOE
[:SENSE]:SEMask:OFFSet[1]|2:INNER:TYPE?

```

3 Programming the Test Set
List of SCPI Commands

```

[:SENSe]:SEMAsk:OFFSet[1]|2:LIST:BWIDth:IMULti
[:SENSe]:SEMAsk:OFFSet[1]|2:LIST:BWIDth[:RESolution]
[:SENSe]:SEMAsk:OFFSet[1]|2:LIST:BWIDth:VIDeo
[:SENSe]:SEMAsk:OFFSet[1]|2:LIST:SWEep[:TIME]
[:SENSe]:SEMAsk:OFFSet[1]|2[:OUTer]:LIST:BANDwidth:IMULti <integer>, ...
[:SENSe]:SEMAsk:OFFSet[1]|2[:OUTer]:LIST:BANDwidth:IMULti?
[:SENSe]:SEMAsk:OFFSet[1]|2[:OUTer]:LIST:BANDwidth[:RESolution]
<bandwidth>, ...
[:SENSe]:SEMAsk:OFFSet[1]|2[:OUTer]:LIST:BANDwidth[:RESolution]?
[:SENSe]:SEMAsk:OFFSet[1]|2[:OUTer]:LIST:BANDwidth[:RESolution]:AUTO OFF |
ON | 1 | 0, ...
[:SENSe]:SEMAsk:OFFSet[1]|2[:OUTer]:LIST:BANDwidth[:RESolution]:AUTO?
[:SENSe]:SEMAsk:OFFSet[1]|2[:OUTer]:LIST:BANDwidth:VIDeo <freq>, ...
[:SENSe]:SEMAsk:OFFSet[1]|2[:OUTer]:LIST:BANDwidth:VIDeo?
[:SENSe]:SEMAsk:OFFSet[1]|2[:OUTer]:LIST:BANDwidth:VIDeo:AUTO OFF | ON | 0
| 1, ...
[:SENSe]:SEMAsk:OFFSet[1]|2[:OUTer]:LIST:BANDwidth:VIDeo:AUTO?
[:SENSe]:SEMAsk:OFFSet[1]|2[:OUTer]:LIST:BANDwidth:VIDeo:RATio <real>, ...
[:SENSe]:SEMAsk:OFFSet[1]|2[:OUTer]:LIST:BANDwidth:VIDeo:RATio?
[:SENSe]:SEMAsk:OFFSet[1]|2[:OUTer]:LIST:BANDwidth:VIDeo:RATio:AUTO OFF |
ON | 0 | 1, ...
[:SENSe]:SEMAsk:OFFSet[1]|2[:OUTer]:LIST:BANDwidth:VIDeo:RATio:AUTO?
[:SENSe]:SEMAsk:OFFSet[1]|2[:OUTer]:LIST:FREQuency:START <freq>, ...
[:SENSe]:SEMAsk:OFFSet[1]|2[:OUTer]:LIST:FREQuency:START?
[:SENSe]:SEMAsk:OFFSet[1]|2[:OUTer]:LIST:FREQuency:STOP <freq>, ...
[:SENSe]:SEMAsk:OFFSet[1]|2[:OUTer]:LIST:FREQuency:STOP?
[:SENSe]:SEMAsk:OFFSet[1]|2[:OUTer]:LIST:SIDE BOTH | NEGative | POSitive,
...
[:SENSe]:SEMAsk:OFFSet[1]|2[:OUTer]:LIST:SIDE?
[:SENSe]:SEMAsk:OFFSet[1]|2[:OUTer]:LIST:START:ABSolute <real>, ...
[:SENSe]:SEMAsk:OFFSet[1]|2[:OUTer]:LIST:START:ABSolute?
[:SENSe]:SEMAsk:OFFSet[1]|2[:OUTer]:LIST:START:RCARrier <rel_ampl>, ...
[:SENSe]:SEMAsk:OFFSet[1]|2[:OUTer]:LIST:START:RCARrier?
[:SENSe]:SEMAsk:OFFSet[1]|2[:OUTer]:LIST:STATe ON | OFF | 1 | 0, ...
[:SENSe]:SEMAsk:OFFSet[1]|2[:OUTer]:LIST:STATe?
[:SENSe]:SEMAsk:OFFSet[1]|2[:OUTer]:LIST:STOP:ABSolute <real>, ...
[:SENSe]:SEMAsk:OFFSet[1]|2[:OUTer]:LIST:STOP:ABSolute?
[:SENSe]:SEMAsk:OFFSet[1]|2[:OUTer]:LIST:STOP:ABSolute:COUPLE ON | OFF | 1
| 0, ...
[:SENSe]:SEMAsk:OFFSet[1]|2[:OUTer]:LIST:STOP:ABSolute:COUPLE?
[:SENSe]:SEMAsk:OFFSet[1]|2[:OUTer]:LIST:STOP:RCARrier <rel_ampl>, ...
[:SENSe]:SEMAsk:OFFSet[1]|2[:OUTer]:LIST:STOP:RCARrier?
[:SENSe]:SEMAsk:OFFSet[1]|2[:OUTer]:LIST:STOP:RCARrier:COUPLE ON | OFF | 1
| 0, ...
[:SENSe]:SEMAsk:OFFSet[1]|2[:OUTer]:LIST:STOP:RCARrier:COUPLE?
[:SENSe]:SEMAsk:OFFSet[1]|2[:OUTer]:LIST:SWEep:TIME <time>, ...
[:SENSe]:SEMAsk:OFFSet[1]|2[:OUTer]:LIST:SWEep:TIME?
[:SENSe]:SEMAsk:OFFSet[1]|2[:OUTer]:LIST:SWEep:TIME:AUTO ON | OFF | 1 | 0,
...
[:SENSe]:SEMAsk:OFFSet[1]|2[:OUTer]:LIST:SWEep:TIME:AUTO?
[:SENSe]:SEMAsk:OFFSet[1]|2[:OUTer]:LIST:TEST ABSolute | AND | OR |
RElative, ...

```

```

[:SENSE]:SEMask:OFFSet[1]|2[:OUTer]:LIST:TEST?
[:SENSE]:SEMask:SWEEP[1]|2:TIME <time>
[:SENSE]:SEMask:SWEEP[1]|2:TIME?
[:SENSE]:SEMask:SWEEP[1]|2:TIME:AUTO OFF | 0 | ON | 1
[:SENSE]:SEMask:SWEEP[1]|2:TIME:AUTO?
[:SENSE]:SEMask:TYPE PSDRef | TPreF | SPRef
[:SENSE]:SEMask:TYPE?
[:SENSE]:SPEcTrum
[:SENSE]:SWEEP:EGATE:DELay <time>
[:SENSE]:SWEEP:EGATE:DELay?
[:SENSE]:SWEEP:EGATE:EXTErnal[1]|2:LEVEl <voltage>
[:SENSE]:SWEEP:EGATE:EXTErnal[1]|2:LEVEl?
[:SENSE]:SWEEP:EGATE:LENGth <time>
[:SENSE]:SWEEP:EGATE:LENGth?
[:SENSE]:SWEEP:EGATE:POLarity NEGative | POSitive
[:SENSE]:SWEEP:EGATE:POLarity?
[:SENSE]:SWEEP:EGATE:SOURce EXTErnal1 | EXTErnal2 | LINE | FRAME | RFBurst
[:SENSE]:SWEEP:EGATE:SOURce?
[:SENSE]:SWEEP:EGATE[:STATE] OFF | ON | 0 | 1
[:SENSE]:SWEEP:EGATE[:STATE]?
[:SENSE]:SWEEP:EGATE:TIME <time>
[:SENSE]:SWEEP:EGATE:TIME?
[:SENSE]:SWEEP:EGATE:VIEW ON | OFF | 1 | 0
[:SENSE]:SWEEP:EGATE:VIEW?
[:SENSE]:SWEEP:EGATE:VIEW:STARt <time>
[:SENSE]:SWEEP:EGATE:VIEW:STARt?
[:SENSE]:SWEEP:TIME:GATE:LEVEl HIGH | LOW
[:SENSE]:SWEEP:TIME:GATE:LEVEl?
SOURce:AM[:DEPTh][:LINEar]
SOURce:AM[:DEPTh][:LINEar]?
SOURce:AM:INTernAl:FREQuency
SOURce:AM:INTernAl:FREQuency?
SOURce:AM:STATE
SOURce:AM:STATE?
SOURce:FM[:DEVIation]
SOURce:FM[:DEVIation]?
SOURce:FM:INTernAl:FREQuency
SOURce:FM:INTernAl:FREQuency?
SOURce:FM:STATE
SOURce:FM:STATE?
SOURce:FREQuency:CHANnELs:BAND NONE | PGSM | EGSM | RGSM | DCS1800 |
PCS1900 | TGSM810 | GSM450 | GSM480 | GSM700 | GSM850 | BANDI | BANDII |
BANDIII | BANDIV | BANDV | BANDVI | BANDVII | BANDVIII | BANDIX | BANDX |
BANDXI | BANDXII | BANDXIII | BANDXIV | BANDXIX | USCELL | USPCS | JAPAN |
KOREAN | NMT | IMT2K | UPPER | SECOND | PAMR400 | PAMR800 | IMTEXT |
PCS1DOT9G | AWS | US2DOT5G | PUBLIC | LOWER | BAND1 | BAND2 | BAND3 |
BAND4 | BAND5 | BAND6 | BAND7 | BAND8 | BAND10 | BAND11 | BAND12 | BAND13
| BAND14 | BAND17 | BAND18 | BAND19 | BAND20 | BAND21 | BAND24 | BAND25 |
BAND26 | BAND27 | BAND28 | BAND31 | BAND33 | BAND34 | BAND35 | BAND36 |
BAND37 | BAND38 | BAND39 | BAND40 | BAND41 | BAND42 | BAND43 | BAND44 |
BANDA | BANDB | BANDC | BANDD | BANDE | BANDF
SOURce:FREQuency:CHANnELs:BAND?

```

```

SOURCE:FREQUENCY:CHANNELS:NUMBER <int>
SOURCE:FREQUENCY:CHANNELS:NUMBER?
SOURCE:FREQUENCY[:CW] <freq>
SOURCE:FREQUENCY[:CW]?
SOURCE:FREQUENCY:OFFSET <freq>
SOURCE:FREQUENCY:OFFSET?
SOURCE:FREQUENCY:REFERENCE <freq>
SOURCE:FREQUENCY:REFERENCE?
SOURCE:FREQUENCY:REFERENCE:SET
SOURCE:FREQUENCY:REFERENCE:STATE OFF | ON | 0 | 1
SOURCE:FREQUENCY:REFERENCE:STATE?
SOURCE:LIST:INITIATION:ARMED?
SOURCE:LIST:NUMBER:STEPS <integer>
SOURCE:LIST:NUMBER:STEPS?
SOURCE:LIST:SETUP:AMPLITUDE <ampl>, <ampl>, <ampl>, ...
SOURCE:LIST:SETUP:AMPLITUDE?
SOURCE:LIST:SETUP:CLEAR
SOURCE:LIST:SETUP:CNFFREQUENCY <double>, <double>, <double>, ...
SOURCE:LIST:SETUP:CNFFREQUENCY?
SOURCE:LIST:SETUP:DURATION:TYPE <enum>, <enum>, <enum>, ...
SOURCE:LIST:SETUP:DURATION:TYPE?
SOURCE:LIST:SETUP:INPUT:TRIGGER <enum>, <enum>, <enum>, ...
SOURCE:LIST:SETUP:INPUT:TRIGGER?
SOURCE:LIST:SETUP:OUTPUT:TRIGGER <bool>, <bool>, <bool>, ...
SOURCE:LIST:SETUP:OUTPUT:TRIGGER ?
SOURCE:LIST:SETUP:RADIO:BAND <enum>, <enum>, <enum>, ...
SOURCE:LIST:SETUP:RADIO:BAND?
SOURCE:LIST:SETUP:RADIO:BAND:LINK <enum>, <enum>, <enum>, ...
SOURCE:LIST:SETUP:RADIO:BAND:LINK?
SOURCE:LIST:SETUP:TOCOUNT <time/int>, <time/int>, <time/int>, ...
SOURCE:LIST:SETUP:TOCOUNT?
SOURCE:LIST:SETUP:TRANSITION:TIME <time>, <time>, <time>, ...
SOURCE:LIST:SETUP:TRANSITION:TIME?
SOURCE:LIST:SETUP:WAVEFORM <string>, <string>, <string>, ...
SOURCE:LIST:SETUP:WAVEFORM?
SOURCE:LIST[:STATE] ON | OFF | 1 | 0
SOURCE:LIST[:STATE]?
SOURCE:LIST:STEP[1]|2|...|4..1000:SETUP IMMEDIATE | INTERNAL | KEY | BUS |
EXTERNAL2, <time>, NONE | PGSM | EGSM | RGSM | DCS1800 | PCS1900 | TGSM810
| GSM450 | GSM480 | GSM700 | GSM850 | BANDI | BANDII | BANDIII | BANDIV |
BANDV | BANDVI | BANDVII | BANDVIII | BANDIX | BANDX | BANDXI | BANDXII |
BANDXIII | BANDXIV | BANDXIX | USCELL | USPCS | JAPAN | KOREAN | NMT |
IMT2K | UPPER | SECOND | PAMR400 | PAMR800 | IMTEXT | PCS1DOT9G | AWS |
US2DOT5G | PUBLIC | LOWER | NONE | BAND1 | BAND2 | BAND3 | BAND4 | BAND5 |
BAND6 | BAND7 | BAND8 | BAND10 | BAND11 | BAND12 | BAND13 | BAND14 |
BAND17 | BAND18 | BAND19 | BAND20 | BAND21 | BAND24 | BAND25 | BAND26 |
BAND33 | BAND34 | BAND35 | BAND36 | BAND37 | BAND38 | BAND39 | BAND40 |
BAND41 | BAND42 | BAND43 | BANDA | BANDB | BANDC | BANDD | BANDE | BANDF,
DOWN | UP, <freq>, <ampl>, <string>, TIME | COUNT | CONTINUOUS, <time>, ON
| OFF | 1 | 0, [<int>],
SOURCE:LIST:STEP[1]|2|...|4..1000:SETUP?
SOURCE:LIST:STEP[1]|2|3...1000:SETUP:AMPLITUDE <double>

```

```

SOURCE:LIST:STEP[1]|2|3...1000:SETup:AMPLitude?
SOURCE:LIST:STEP[1]|2|3...1000:SETup:CNFRequency <double>
SOURCE:LIST:STEP[1]|2|3...1000:SETup:CNFRequency <double>
SOURCE:LIST:STEP[1]|2|3...1000:SETup:CNFRequency?
SOURCE:LIST:STEP[1]|2|3...1000:SETup:CNFRequency?
SOURCE:LIST:STEP[1]|2|3...1000:SETup:DURation:TCOunt <double>
SOURCE:LIST:STEP[1]|2|3...1000:SETup:DURation:TCOunt?
SOURCE:LIST:STEP[1]|2|3...1000:SETup:DURation:TYPE TIME | COUNt |
CONTinuous | CABort
SOURCE:LIST:STEP[1]|2|3...1000:SETup:DURation:TYPE?
SOURCE:LIST:STEP[1]|2|3...1000:SETup:INPut:TRIGger IMMEDIATE | INTernal |
EXTernal2 | KEY | BUS | EXTernal4
SOURCE:LIST:STEP[1]|2|3...1000:SETup:INPut:TRIGger?
SOURCE:LIST:STEP[1]|2|3...1000:SETup:OUTPut:TRIGger
SOURCE:LIST:STEP[1]|2|3...1000:SETup:OUTPut:TRIGger ON | OFF | 1 | 0
SOURCE:LIST:STEP[1]|2|3...1000:SETup:RADio:BAND NONE | PGSM | EGSM | RGSM
| DCS1800 | PCS1900 | TGSM810 | GSM450 | GSM480 | GSM700 | GSM850 | BANDI
| BANDII | BANDIII | BANDIV | BANDV | BANDVI | BANDVII | BANDVIII | BANDIX
| BANDX | BANDXI | BANDXII | BANDXIII | BANDXIV | BANDXIX | USCELL | USPCS
| JAPAN | KOREAN | NMT | IMT2K | UPPER | SECOND | PAMR400 | PAMR800 |
IMTEXT | PCS1DOT9G | AWS | US2DOT5G | PUBLIC | LOWER | NONE | BAND1 |
BAND2 | BAND3 | BAND4 | BAND5 | BAND6 | BAND7 | BAND8 | BAND10 | BAND11 |
BAND12 | BAND13 | BAND14 | BAND17 | BAND18 | BAND19 | BAND20 | BAND21 |
BAND24 | BAND25 | BAND26 | BAND27 | BAND28 | BAND31 | BAND33 | BAND34 |
BAND35 | BAND36 | BAND37 | BAND38 | BAND39 | BAND40 | BAND41 | BAND42 |
BAND43 | BAND44 | BANDA | BANDB | BANDC | BANDD | BANDE | BANDF
SOURCE:LIST:STEP[1]|2|3...1000:SETup:RADio:BAND?
SOURCE:LIST:STEP[1]|2|3...1000:SETup:RADio:BAND:LINK DOWN | UP
SOURCE:LIST:STEP[1]|2|3...1000:SETup:RADio:BAND:LINK?
SOURCE:LIST:STEP[1]|2|3...1000:SETup:TRANSition:TIME <time>
SOURCE:LIST:STEP[1]|2|3...1000:SETup:TRANSition:TIME?
SOURCE:LIST:STEP[1]|2|3...1000:SETup:WAVEform <string>
SOURCE:LIST:STEP[1]|2|3...1000:SETup:WAVEform?
SOURCE:LIST:TRIGger[:IMMEDIATE]
SOURCE:LIST:TRIGger:INITiate[:IMMEDIATE]
SOURCE:LIST:TRIGgerout:TYPE BEGinningofstep | DATAmarker
SOURCE:PM[:DEVIation]
SOURCE:PM[:DEVIation]?
SOURCE:PM:INTernal:FREQuency
SOURCE:PM:INTernal:FREQuency?
SOURCE:PM:STATe
SOURCE:PM:STATe?
SOURCE:POWER[:LEVel][:IMMEDIATE][:AMPLitude] <ampl>
SOURCE:POWER[:LEVel][:IMMEDIATE][:AMPLitude]?
SOURCE:POWER[:LEVel][:IMMEDIATE]:OFFSet <rel_ampl>
SOURCE:POWER[:LEVel][:IMMEDIATE]:OFFSet?
SOURCE:POWER:REFerence <ampl>
SOURCE:POWER:REFerence?
SOURCE:POWER:REFerence:STATe OFF | ON | 0 | 1
SOURCE:POWER:REFerence:STATe?
SOURCE:PRESet
SOURCE:RADio:ARB:BASEband:FREQuency:OFFSet <freq>

```

3 Programming the Test Set

List of SCPI Commands

```
SOURce:RADio:ARB:BASEband:FREQuency:OFFSet?
SOURce:RADio:ARB:CATalog?
SOURce:RADio:ARB:DEFault:DIRectory <string>
SOURce:RADio:ARB:DEFault:DIRectory?
SOURce:RADio:ARB:DELeTe <string>
SOURce:RADio:ARB:DELeTe:ALL
SOURce:RADio:ARB:FCATalog?
SOURce:RADio:ARB:HEADer:CLEar
SOURce:RADio:ARB:HEADer:SAVE
SOURce:RADio:ARB:LOAD <string>
SOURce:RADio:ARB:LOAD:ALL <string>
SOURce:RADio:ARB:MDESTination:ALCHold NONE | M1 | M2 | M3 | M4
SOURce:RADio:ARB:MDESTination:ALCHold?
SOURce:RADio:ARB:MDESTination:PULSe NONE | M1 | M2 | M3 | M4
SOURce:RADio:ARB:MDESTination:PULSe?
SOURce:RADio:ARB:MPLicensed:NAME:LOCKed?
SOURce:RADio:ARB:MPLicensed:UID:LOCKed?
SOURce:RADio:ARB:MPOLarity:MARKer4 POSitive | NEGative
SOURce:RADio:ARB:MPOLarity:MARKer2 POSitive | NEGative
SOURce:RADio:ARB:MPOLarity:MARKer3 POSitive | NEGative
SOURce:RADio:ARB:MPOLarity:MARKer1 POSitive | NEGative
SOURce:RADio:ARB:MPOLarity:MARKer2?
SOURce:RADio:ARB:MPOLarity:MARKer4?
SOURce:RADio:ARB:MPOLarity:MARKer3?
SOURce:RADio:ARB:MPOLarity:MARKer1?
SOURce:RADio:ARB:RETRigger ON | OFF | IMMEDIATE
SOURce:RADio:ARB:RETRigger?
SOURce:RADio:ARB:RSCaling <real>
SOURce:RADio:ARB:RSCaling?
SOURce:RADio:ARB:SCLock:RATE <freq>
SOURce:RADio:ARB:SCLock:RATE?
SOURce:RADio:ARB:SEQuence[:MWAVEform] <filename>, <waveform1>, <reps>,
NONE | M1 | M2 | M3 | M4 | M1M2 | M1M3 | M1M4 | M2M3 | M2M4 | M3M4 |
M1M2M3 | M1M2M4 | M1M3M4 | M2M3M4 | M1M2M3M4 | ALL, {<waveform2>, <reps>,
NONE | M1 | M2 | M3 | M4 | M1M2 | M1M3 | M1M4 | M2M3 | M2M4 | M3M4 |
M1M2M3 | M1M2M4 | M1M3M4 | M2M3M4 | M1M2M3M4 | ALL, }...
SOURce:RADio:ARB:SEQuence[:MWAVEform]? <filename>
SOURce:RADio:ARB[:STATe] ON | OFF | 1 | 0
SOURce:RADio:ARB[:STATe]?
SOURce:RADio:ARB:TRIGger:INITiate
SOURce:RADio:ARB:TRIGger[:SOURce] KEY | BUS | EXTERNAL2
SOURce:RADio:ARB:TRIGger[:SOURce]?
SOURce:RADio:ARB:TRIGger:TYPE CONTinuous | SINGLE | SADVanceGATE
SOURce:RADio:ARB:TRIGger:TYPE?
SOURce:RADio:ARB:TRIGger:TYPE:CONTinuous[:TYPE] FREE | TRIGger | RESet
SOURce:RADio:ARB:TRIGger:TYPE:CONTinuous[:TYPE]?
SOURce:RADio:ARB:TRIGger:TYPE:SADVance[:TYPE] SINGLE | CONTinuous
SOURce:RADio:ARB:TRIGger:TYPE:SADVance[:TYPE]?
SOURce:RADio:ARB:WAVEform <string>
SOURce:RADio:ARB:WAVEform?
SOURce:RADio:BAND:LINK DOWN | UP
SOURce:RADio:BAND:LINK?
```



```

SOURCE:RADio:DEvIce BTS | MS
SOURCE:RADio:DEvIce?
STATUS:OPERation:CONDition?
STATUS:OPERation:ENABle <integer>
STATUS:OPERation:ENABle?
STATUS:OPERation[:EVENT]?
STATUS:OPERation:NTRansition <integer>
STATUS:OPERation:NTRansition?
STATUS:OPERation:PTRansition <integer>
STATUS:OPERation:PTRansition?
STATUS:PRESet
STATUS:QUEStionable:CALibration:CONDition?
STATUS:QUEStionable:CALibration:ENABle <integer>
STATUS:QUEStionable:CALibration:ENABle?
STATUS:QUEStionable:CALibration[:EVENT]?
STATUS:QUEStionable:CALibration:EXTended:FAILure:CONDition?
STATUS:QUEStionable:CALibration:EXTended:FAILure:ENABle <integer>
STATUS:QUEStionable:CALibration:EXTended:FAILure:ENABle?
STATUS:QUEStionable:CALibration:EXTended:FAILure[:EVENT]?
STATUS:QUEStionable:CALibration:EXTended:FAILure:NTRansition <integer>
STATUS:QUEStionable:CALibration:EXTended:FAILure:NTRansition?
STATUS:QUEStionable:CALibration:EXTended:FAILure:PTRansition <integer>
STATUS:QUEStionable:CALibration:EXTended:FAILure:PTRansition?
STATUS:QUEStionable:CALibration:EXTended:NEEDed:CONDition?
STATUS:QUEStionable:CALibration:EXTended:NEEDed:ENABle <integer>
STATUS:QUEStionable:CALibration:EXTended:NEEDed:ENABle?
STATUS:QUEStionable:CALibration:EXTended:NEEDed[:EVENT]?
STATUS:QUEStionable:CALibration:EXTended:NEEDed:NTRansition <integer>
STATUS:QUEStionable:CALibration:EXTended:NEEDed:NTRansition?
STATUS:QUEStionable:CALibration:EXTended:NEEDed:PTRansition <integer>
STATUS:QUEStionable:CALibration:EXTended:NEEDed:PTRansition?
STATUS:QUEStionable:CALibration:NTRansition <integer>
STATUS:QUEStionable:CALibration:NTRansition?
STATUS:QUEStionable:CALibration:PTRansition <integer>
STATUS:QUEStionable:CALibration:PTRansition?
STATUS:QUEStionable:CALibration:SKIPped:CONDition?
STATUS:QUEStionable:CALibration:SKIPped:ENABle <integer>
STATUS:QUEStionable:CALibration:SKIPped:ENABle?
STATUS:QUEStionable:CALibration:SKIPped[:EVENT]?
STATUS:QUEStionable:CALibration:SKIPped:NTRansition <integer>
STATUS:QUEStionable:CALibration:SKIPped:NTRansition?
STATUS:QUEStionable:CALibration:SKIPped:PTRansition <integer>
STATUS:QUEStionable:CALibration:SKIPped:PTRansition?
STATUS:QUEStionable:CONDition?
STATUS:QUEStionable:ENABle <integer>
STATUS:QUEStionable:ENABle?
STATUS:QUEStionable[:EVENT]?
STATUS:QUEStionable:FREQuency:CONDition?
STATUS:QUEStionable:FREQuency:ENABle <integer>
STATUS:QUEStionable:FREQuency:ENABle?
STATUS:QUEStionable:FREQuency[:EVENT]?
STATUS:QUEStionable:FREQuency:NTRansition <integer>
STATUS:QUEStionable:FREQuency:NTRansition?

```

```
STATUS:QUESTIONABLE:FREQUENCY:PTRANSITION <integer>
STATUS:QUESTIONABLE:FREQUENCY:PTRANSITION?
STATUS:QUESTIONABLE:INTEGRITY:CONDITION?
STATUS:QUESTIONABLE:INTEGRITY:ENABLE <integer>
STATUS:QUESTIONABLE:INTEGRITY:ENABLE?
STATUS:QUESTIONABLE:INTEGRITY[:EVENT]?
STATUS:QUESTIONABLE:INTEGRITY:NTRANSITION <integer>
STATUS:QUESTIONABLE:INTEGRITY:NTRANSITION?
STATUS:QUESTIONABLE:INTEGRITY:PTRANSITION <integer>
STATUS:QUESTIONABLE:INTEGRITY:PTRANSITION?
STATUS:QUESTIONABLE:INTEGRITY:SIGNAL:CONDITION?
STATUS:QUESTIONABLE:INTEGRITY:SIGNAL:ENABLE <integer>
STATUS:QUESTIONABLE:INTEGRITY:SIGNAL:ENABLE?
STATUS:QUESTIONABLE:INTEGRITY:SIGNAL[:EVENT]?
STATUS:QUESTIONABLE:INTEGRITY:SIGNAL:NTRANSITION <integer>
STATUS:QUESTIONABLE:INTEGRITY:SIGNAL:NTRANSITION?
STATUS:QUESTIONABLE:INTEGRITY:SIGNAL:PTRANSITION <integer>
STATUS:QUESTIONABLE:INTEGRITY:SIGNAL:PTRANSITION?
STATUS:QUESTIONABLE:INTEGRITY:UNCALIBRATED:CONDITION?
STATUS:QUESTIONABLE:INTEGRITY:UNCALIBRATED:ENABLE
STATUS:QUESTIONABLE:INTEGRITY:UNCALIBRATED:ENABLE?
STATUS:QUESTIONABLE:INTEGRITY:UNCALIBRATED[:EVENT]?
STATUS:QUESTIONABLE:INTEGRITY:UNCALIBRATED:NTRANSITION <integer>
STATUS:QUESTIONABLE:INTEGRITY:UNCALIBRATED:NTRANSITION?
STATUS:QUESTIONABLE:INTEGRITY:UNCALIBRATED:PTRANSITION <integer>
STATUS:QUESTIONABLE:INTEGRITY:UNCALIBRATED:PTRANSITION?
STATUS:QUESTIONABLE:NTRANSITION <integer>
STATUS:QUESTIONABLE:NTRANSITION?
STATUS:QUESTIONABLE:POWER:CONDITION?
STATUS:QUESTIONABLE:POWER:ENABLE <integer>
STATUS:QUESTIONABLE:POWER:ENABLE?
STATUS:QUESTIONABLE:POWER[:EVENT]?
STATUS:QUESTIONABLE:POWER:NTRANSITION <integer>
STATUS:QUESTIONABLE:POWER:NTRANSITION?
STATUS:QUESTIONABLE:POWER:PTRANSITION <integer>
STATUS:QUESTIONABLE:POWER:PTRANSITION?
STATUS:QUESTIONABLE:PTRANSITION <integer>
STATUS:QUESTIONABLE:PTRANSITION?
STATUS:QUESTIONABLE:TEMPERATURE:CONDITION?
STATUS:QUESTIONABLE:TEMPERATURE:ENABLE <integer>
STATUS:QUESTIONABLE:TEMPERATURE:ENABLE?
STATUS:QUESTIONABLE:TEMPERATURE[:EVENT]?
STATUS:QUESTIONABLE:TEMPERATURE:NTRANSITION <integer>
STATUS:QUESTIONABLE:TEMPERATURE:NTRANSITION?
STATUS:QUESTIONABLE:TEMPERATURE:PTRANSITION <integer>
STATUS:QUESTIONABLE:TEMPERATURE:PTRANSITION?
SYSTEM:APPLICATION:CATALOG[:NAME]?
SYSTEM:APPLICATION:CATALOG[:NAME]:COUNT?
SYSTEM:APPLICATION:CATALOG:OPTION? <model>
SYSTEM:APPLICATION:CATALOG:REVISION? <model>
SYSTEM:APPLICATION[:CURRENT][:NAME]?
SYSTEM:APPLICATION[:CURRENT]:OPTION?
SYSTEM:APPLICATION[:CURRENT]:REVISION?
```

```

SYSTEM:COMMunicate:LAN:SCPI:HISLip:ENABle OFF | ON | 0 | 1
SYSTEM:COMMunicate:LAN:SCPI:HISLip:ENABle?
SYSTEM:COMMunicate:LAN:SCPI:SICL:ENABle OFF | ON | 0 | 1
SYSTEM:COMMunicate:LAN:SCPI:SICL:ENABle?
SYSTEM:COMMunicate:LAN:SCPI:SOCKeT:CONTRol?
SYSTEM:COMMunicate:LAN:SCPI:SOCKeT:ENABle OFF | ON | 0 | 1
SYSTEM:COMMunicate:LAN:SCPI:SOCKeT:ENABle?
SYSTEM:COMMunicate:LAN:SCPI:TELNet:ENABle OFF | ON | 0 | 1
SYSTEM:COMMunicate:LAN:SCPI:TELNet:ENABle?
SYSTEM:CONFigure[:SYSTEM]?
SYSTEM:CSYSTEM?
SYSTEM:DATE "<year>, <month>, <day>"
SYSTEM:DATE?
SYSTEM:DEFault [ALL] | ALIGn | INPut | MISC | MODes | PON
SYSTEM:ERRor[:NEXT]?
SYSTEM:ERRor:OVERload[:STATE] 0 | 1 | OFF | ON
SYSTEM:ERRor:PUP?
SYSTEM:ERRor:VERBose OFF | ON | 0 | 1
SYSTEM:ERRor:VERBose?
SYSTEM:HELP:HEADers?
SYSTEM:HID?
SYSTEM:IDN <string>
SYSTEM:IDN?
SYSTEM:KLOCK OFF | ON | 0 | 1
SYSTEM:KLOCK?
SYSTEM:LICense[:FPACK]:WAVEform:ADD <string>
SYSTEM:LICense[:FPACK]:WAVEform:CLEar <int>
SYSTEM:LICense[:FPACK]:WAVEform:FREE?
SYSTEM:LICense[:FPACK]:WAVEform:LOCK <int>
SYSTEM:LICense[:FPACK]:WAVEform:NAME? <int>
SYSTEM:LICense[:FPACK]:WAVEform:REPLace <int>, <string>
SYSTEM:LICense[:FPACK]:WAVEform:STATus? <int>
SYSTEM:LICense[:FPACK]:WAVEform:UID? <int>
SYSTEM:LICense[:FPACK]:WAVEform:USED?
SYSTEM:LKEY <"OptionInfo">, <"LicenseInfo">
SYSTEM:LKEY? <"OptionInfo">
SYSTEM:LKEY:DELeTe <"OptionInfo">, <"LicenseInfo">
SYSTEM:LKEY:LIST?
SYSTEM:LKEY:WAVEform:ADD <string>
SYSTEM:LKEY:WAVEform:CLEar <int>
SYSTEM:LKEY:WAVEform:FREE?
SYSTEM:LKEY:WAVEform:LOCK <int>
SYSTEM:LKEY:WAVEform:NAME? <int>
SYSTEM:LKEY:WAVEform:REPLace <int>, <string>
SYSTEM:LKEY:WAVEform:STATus? <int>
SYSTEM:LKEY:WAVEform:UID? <int>
SYSTEM:LKEY:WAVEform:USED?
SYSTEM:MODule:DEFault "<mnemonic>"
SYSTEM:MODule:DEFault?
SYSTEM:MODule:ENABle "<mnemonic>", 0 | 1
SYSTEM:MODule:ENABle? "<mnemonic>"
SYSTEM:MODule:INDex?
SYSTEM:MODule:LIST?

```

3 Programming the Test Set

List of SCPI Commands

```
SYSTem:MODule:MNEMonic?
SYSTem:MODule:MODEl?
SYSTem:MODule:NAME?
SYSTem:MODule:SERial?
SYSTem:OPTions?
SYSTem:PDOWn [NORMAL | FORCE]
SYSTem:PON:APPLication:LLIST <stringofINSTRument:SElectnames>
SYSTem:PON:APPLication:LLIST?
SYSTem:PON:APPLication:VMEMory[:AVAIlable]?
SYSTem:PON:APPLication:VMEMory:TOTAL?
SYSTem:PON:APPLication:VMEMory:USED?
SYSTem:PON:APPLication:VMEMory:USED:NAME? <INSTRument:SElectname>
SYSTem:PON:MODE SA | BASIC | ADEMOD | NFIGURE | PNOISE | CDMA2K | TDSCDMA
| VSA | VSA89601 | WCDMA | WIMAXOFDMA
SYSTem:PON:MODE?
SYSTem:PON:TIME?
SYSTem:PON:TYPE PRESet
SYSTem:PON:TYPE MODE | USER | LAST
SYSTem:PON:TYPE?
SYSTem:PRESet
SYSTem:PRESet:TYPE FACTory | MODE | USER
SYSTem:PRESet:TYPE?
SYSTem:PRESet:USER
SYSTem:PRESet:USER:ALL
SYSTem:PRESet:USER:SAVE
SYSTem:PRINT:THEME TDColor | TDMonochrome | FCOLor | FMONochrome
SYSTem:PRINT:THEME?
SYSTem:PUP:PROcEss
SYSTem:SECurity:USB:WPRotect[:ENABLE] ON | OFF | 0 | 1
SYSTem:SECurity:USB:WPRotect[:ENABLE]?
SYSTem:SHOW OFF | ERRor | SYSTem | HARDware | LXI | HWStAtistics |
ALIGNment | SOFTware | CAPplication
SYSTem:SHOW?
SYSTem:TEST:WCTS:[ALL]
SYSTem:TEST:WCTS:FEC
SYSTem:TEST:WCTS:FEC:RESult?
SYSTem:TEST:WCTS:SHOW:RESult FEC
SYSTem:TIME "<hour>, <minute>, <second>"
SYSTem:TIME?
SYSTem:VERSion?
TRACe[1]|2|3:ACPowEr:DISPlay[:STATe] ON | OFF | 0 | 1
TRACe[1]|2|3:ACPowEr:DISPlay[:STATe]?
TRACe[1]|2|3:ACPowEr:TYPE WRITe | AVERAge | MAXHold | MINHold
TRACe[1]|2|3:ACPowEr:TYPE?
TRACe[1]|2|3:ACPowEr:UPDate[:STATe] ON | OFF | 0 | 1
TRACe[1]|2|3:ACPowEr:UPDate[:STATe]?
TRACe:CHPowEr:TYPE WRITe | AVERAge | MAXHold | MINHold
TRACe:CHPowEr:TYPE?
TRACe:OBWidth:TYPE WRITe | AVERAge | MAXHold | MINHold
TRACe:OBWidth:TYPE?
TRACe:SEMAsk:TYPE WRITe | AVERAge | MAXHold | MINHold
TRACe:SEMAsk:TYPE?
```

```

TRIGger:<measurement>[:SEQuence]:IQ:SOURce EXTernal1 | EXTernal2 |
IMMediate | IQMag | IDEMod | QDEMod | IINPut | QINPut | AIQMag
TRIGger:<measurement>[:SEQuence]:IQ:SOURce?
TRIGger:<measurement>[:SEQuence]:RF:SOURce EXTernal1 | EXTernal2 |
IMMediate | LINE | FRAME | RFBurst | VIDEo | IF | ALARm | LAN | TV
TRIGger:<measurement>[:SEQuence]:RF:SOURce?
TRIGger:<measurement>[:SEQuence]:SOURce EXTernal1 | EXTernal2 | IMMediate
| LINE | FRAME | RFBurst | VIDEo | IF | ALARm | LAN | IQMag | IDEMod |
QDEMod | IINPut | QINPut | AIQMag | TV
TRIGger:<measurement>[:SEQuence]:SOURce?
TRIGger[:SEQuence]:ATRigger <time>
TRIGger[:SEQuence]:ATRigger?
TRIGger[:SEQuence]:ATRigger:STATE OFF | ON | 0 | 1
TRIGger[:SEQuence]:ATRigger:STATE?
TRIGger[:SEQuence]:DELay <time>
TRIGger[:SEQuence]:DELay?
TRIGger[:SEQuence]:DELay:STATE OFF | ON | 0 | 1
TRIGger[:SEQuence]:DELay:STATE?
TRIGger[:SEQuence]:EXTernal2:DELay <time>
TRIGger[:SEQuence]:EXTernal:DELay
TRIGger[:SEQuence]:EXTernal1:DELay <time>
TRIGger[:SEQuence]:EXTernal1:DELay?
TRIGger[:SEQuence]:EXTernal2:DELay?
TRIGger[:SEQuence]:EXTernal2:DELay:COMPensation OFF | ON | 0 | 1
TRIGger[:SEQuence]:EXTernal1:DELay:COMPensation OFF | ON | 0 | 1
TRIGger[:SEQuence]:EXTernal1:DELay:COMPensation?
TRIGger[:SEQuence]:EXTernal2:DELay:COMPensation?
TRIGger[:SEQuence]:EXTernal1:DELay:STATE OFF | ON | 0 | 1
TRIGger[:SEQuence]:EXTernal2:DELay:STATE OFF | ON | 0 | 1
TRIGger[:SEQuence]:EXTernal2:DELay:STATE?
TRIGger[:SEQuence]:EXTernal1:DELay:STATE?
TRIGger[:SEQuence]:EXTernal:LEVel
TRIGger[:SEQuence]:EXTernal2:LEVel
TRIGger[:SEQuence]:EXTernal1:LEVel <level>
TRIGger[:SEQuence]:EXTernal1:LEVel?
TRIGger[:SEQuence]:EXTernal2:LEVel?
TRIGger[:SEQuence]:EXTernal2:SLOPe POSitive | NEGative
TRIGger[:SEQuence]:EXTernal:SLOPe
TRIGger[:SEQuence]:EXTernal1:SLOPe POSitive | NEGative
TRIGger[:SEQuence]:EXTernal2:SLOPe?
TRIGger[:SEQuence]:EXTernal1:SLOPe?
TRIGger[:SEQuence]:FRAME:ADJust <time>
TRIGger[:SEQuence]:FRAME:DELay <time>
TRIGger[:SEQuence]:FRAME:DELay?
TRIGger[:SEQuence]:FRAME:DELay:STATE OFF | ON | 0 | 1
TRIGger[:SEQuence]:FRAME:DELay:STATE?
TRIGger[:SEQuence]:FRAME:EXTernal1:LEVel
TRIGger[:SEQuence]:FRAME:EXTernal2:LEVel
TRIGger[:SEQuence]:FRAME:EXTernal2:SLOPe
TRIGger[:SEQuence]:FRAME:EXTernal1:SLOPe
TRIGger[:SEQuence]:FRAME:OFFSet <time>
TRIGger[:SEQuence]:FRAME:OFFSet?

```

3 Programming the Test Set

List of SCPI Commands

```
TRIGger[:SEquence]:FRAME:OFFSet:DISPlay:RESet
TRIGger[:SEquence]:FRAME:PERiod <time>
TRIGger[:SEquence]:FRAME:PERiod?
TRIGger[:SEquence]:FRAME:RFBurst:LEVel:ABSolute
TRIGger[:SEquence]:FRAME:RFBurst:SLOPe
TRIGger[:SEquence]:FRAME:SYNC EXTernal1 | EXTernal2 | RFBurst | OFF
TRIGger[:SEquence]:FRAME:SYNC EXTernal
TRIGger[:SEquence]:FRAME:SYNC?
TRIGger[:SEquence]:FRAME:SYNC:HOLDOff <time>
TRIGger[:SEquence]:FRAME:SYNC:HOLDOff?
TRIGger[:SEquence]:FRAME:SYNC:HOLDOff:STATE OFF | ON | 0 | 1
TRIGger[:SEquence]:FRAME:SYNC:HOLDOff:STATE?
TRIGger[:SEquence]:HOLDOff <time>
TRIGger[:SEquence]:HOLDOff?
TRIGger[:SEquence]:HOLDOff:STATE OFF | ON | 0 | 1
TRIGger[:SEquence]:HOLDOff:STATE?
TRIGger[:SEquence]:HOLDOff:TYPE NORMAl | ABOVe | BELow
TRIGger[:SEquence]:HOLDOff:TYPE?
TRIGger[:SEquence]:IF:LEVel
TRIGger[:SEquence]:IF:LEVel?
TRIGger[:SEquence]:IF:SLOPe NEGative | POSitive
TRIGger[:SEquence]:IF:SLOPe?
TRIGger[:SEquence]:OFFSet <time>
TRIGger[:SEquence]:OFFSet?
TRIGger[:SEquence]:OFFSet:STATE OFF | ON | 0 | 1
TRIGger[:SEquence]:OFFSet:STATE?
TRIGger[:SEquence]:RFBurst:DElay <time>
TRIGger[:SEquence]:RFBurst:DElay?
TRIGger[:SEquence]:RFBurst:DElay:STATE OFF | ON | 0 | 1
TRIGger[:SEquence]:RFBurst:DElay:STATE?
TRIGger[:SEquence]:RFBurst:LEVel
TRIGger[:SEquence]:RFBurst:LEVel:ABSolute <ampl>
TRIGger[:SEquence]:RFBurst:LEVel:ABSolute?
TRIGger[:SEquence]:RFBurst:LEVel:RELative <rel_ampl>
TRIGger[:SEquence]:RFBurst:LEVel:RELative?
TRIGger[:SEquence]:RFBurst:LEVel:TYPE ABSolute | RELative
TRIGger[:SEquence]:RFBurst:LEVel:TYPE?
TRIGger[:SEquence]:RFBurst:SLOPe POSitive | NEGative
TRIGger[:SEquence]:RFBurst:SLOPe?
TRIGger[:SEquence]:SLOPe POSitive | NEGative
TRIGger[:SEquence]:SLOPe?
TRIGger[:SEquence]:SOURCe EXTernal
TRIGger[:SEquence]:VIDeo:DElay <time>
TRIGger[:SEquence]:VIDeo:DElay?
TRIGger[:SEquence]:VIDeo:DElay:STATE OFF | ON | 0 | 1
TRIGger[:SEquence]:VIDeo:DElay:STATE?
TRIGger[:SEquence]:VIDeo:LEVel <ampl>
TRIGger[:SEquence]:VIDeo:LEVel?
TRIGger[:SEquence]:VIDeo:SLOPe POSitive | NEGative
TRIGger[:SEquence]:VIDeo:SLOPe?
TRIGger|TRIGger1|TRIGger2[:SEquence]:OUTPut HSWP | MEASuring | MAIN | GATE
| GTRigger | OEVEN | SPOint | SSweep | SSETtled | S1Marker | S2Marker |
S3Marker | S4Marker | OFF
```

```
TRIGger|TRIGger1|TRIGger2[:SEQuence]:OUTPut?  
TRIGger|TRIGger1|TRIGger2[:SEQuence]:OUTPut:POLarity POSitive | NEGative  
TRIGger|TRIGger1|TRIGger2[:SEQuence]:OUTPut:POLarity?  
UNIT:ACPower:POWER:PSD DBMHZ | DBMMHZ  
UNIT:ACPower:POWER:PSD?  
UNIT:CHPower:POWER:PSD DBMHZ | DBMMHZ  
UNIT:CHPower:POWER:PSD?
```

STATus Subsystem

The following diagram shows the entire Status Register Subsystem implementation of the X Series instruments.

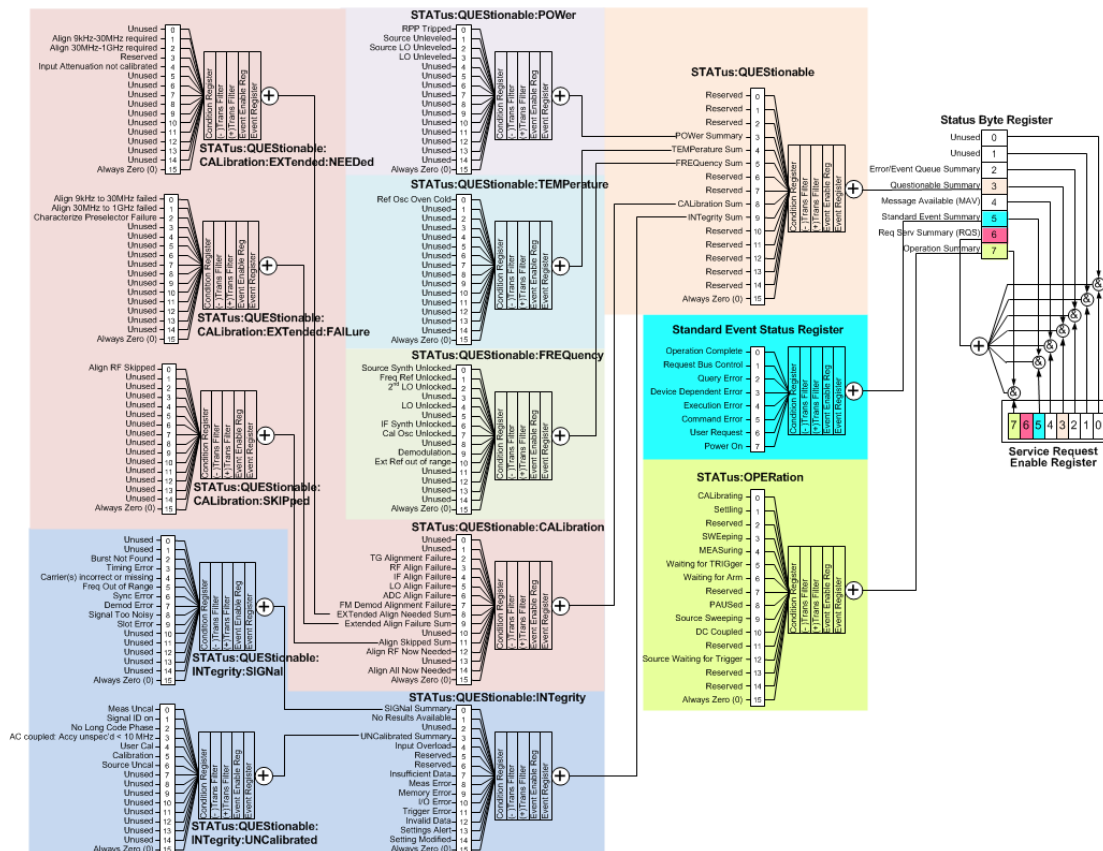

Detailed Description

The STATus subsystem remote commands set and query the status hardware registers. This system of registers monitors various events and conditions in the instrument. Software written to control the instrument may need to monitor some of these events and conditions.

NOTE

All status register commands are sequential. Most commands can be started immediately and will overlap with any existing commands that are already running. This is not true of status commands. All the commands in the spectrum analyzer are assumed to be overlapped unless a command description specifically says that it is sequential.

What Are Status Registers

The status system contains multiple registers that are arranged in a hierarchical order. The lower-level status registers propagate their data to the higher-level registers in the data structures by means of summary bits. The status byte register is at the top of the hierarchy and contains general status information for the instrument's events and conditions. All other individual registers are used to determine the specific events or conditions. For a diagram of the registers and their interconnections, see above.

The operation and questionable status registers are sets of registers that monitor the overall instrument condition. They are accessed with the STATus:OPERation and STATus:QUEStionable commands in the STATus command subsystem. Each register set is made up of five registers:

- Condition Register—It reports the real-time state of the signals monitored by this register set. There is no latching or buffering for a condition register.
- Positive Transition Register—This filter register controls which signals will set a bit in the event register when the signal makes a low to high transition (when the condition bit changes from 0 to 1).
- Negative Transition Register—This filter register controls which signals will set a bit in the event register when the signal makes a high to low transition (when the condition bit changes from 1 to 0).
- Event Register—It latches any signal state changes, in the way specified by the filter registers. Bits in the event register are never cleared by signal state changes. Event registers are cleared when read. They are also cleared by *CLS and by presetting the instrument.
- Event Enable Register—It controls which of the bits, being set in the event register, will be summarized as a single output for the register set. Summary bits are then used by the next higher register.

The STATus:QUEStionable registers report abnormal operating conditions. The status register hierarchy is:

1. The summary outputs from the six STATus:QUEStionable:<keyword> detail registers are inputs to the STATus:QUEStionable register.
2. The summary output from the STATus:QUEStionable register is an input to the Status Byte Register. See the overall system in Figure at the beginning of this section.

The STATus:OPERation register set has no summarized inputs. The inputs to the STATus:OPERation:CONDition register indicate the real time state of the instrument. The STATus:OPERation:EVENT register summary output is an input to the Status Byte Register.

What Are Status Register SCPI Commands

Most monitoring of the instrument conditions is done at the highest level using the IEEE common commands indicated below. Complete command descriptions are available in the IEEE commands section at the beginning of the language reference. Individual status registers can be set and queried using the commands in the STATus subsystem of the language reference.

- *CLS (clear status) clears the status byte by emptying the error queue and clearing all the event registers.
- *ESE, *ESE? (event status enable) sets and queries the bits in the enable register part of the standard event status register.
- *ESR? (event status register) queries and clears the event register part of the standard event status register.
- *OPC, *OPC? (operation complete) sets the standard event status register to monitor the completion of all commands. The query stops any new commands from being processed until the current processing is complete, then returns a '1'.
- *PSC, *PSC? (power-on state clear) sets the power-on state so that it clears the service request enable register and the event status enable register at power on.
- *SRE, *SRE? (service request enable) sets and queries the value of the service request enable register.

- *STB? (status byte) queries the value of the status byte register without erasing its contents.

How to Use the Status Registers

A program often needs to be able to detect and manage error conditions or changes in instrument status. There are two methods you can use to programmatically access the information in status registers:

- The polling method
- The service request (SRQ) method

In the polling method, the instrument has a passive role. It only tells the controller that conditions have changed when the controller asks the right question. In the SRQ method, the instrument takes a more active role. It tells the controller when there has been a condition change without the controller asking. Either method allows you to monitor one or more conditions.

The polling method works well if you do not need to know about changes the moment they occur. The SRQ method should be used if you must know immediately when a condition changes. To detect a change using the polling method, the program must repeatedly read the registers.

Use the SRQ method when:

- you need time-critical notification of changes
- you are monitoring more than one device which supports SRQs
- you need to have the controller do something else while waiting
- you can't afford the performance penalty inherent to polling

Use polling when:

- your programming language/development environment does not support SRQ interrupts
- you want to write a simple, single-purpose program and don't want the added complexity of setting up an SRQ handler
- To monitor a condition:
 - a. Determine which register contains the bit that reports the condition.
 - b. Send the unique SCPI query that reads that register.
 - c. Examine the bit to see if the condition has changed.

You can monitor conditions in different ways.

- Check the current instrument hardware and firmware status.

Do this by querying the condition registers which continuously monitor status. These registers represent the current state of the instrument. Bits in a condition register are updated in real time. When the condition monitored by a particular bit becomes true, the bit is set to 1. When the condition becomes false, the bit is reset to 0.

- Monitor a particular condition (bit).

You can enable a particular bit(s), using the event enable register. The instrument will then monitor that particular condition(s). If the bit becomes true (0 to 1 transition) in the event register, it will stay set until the

event register is cleared. Querying the event register allows you to detect that this condition occurred even if the condition no longer exists. The event register can only be cleared by querying it or sending the *CLS command.

- Monitor a particular type of change in a condition (bit).
 - The transition registers are preset to register if the condition goes from 0 to 1 (false to true, or a positive transition).
 - This can be changed so the selected condition is detected if the bit goes from 1 to 0 (true to false, or a negative transition).
 - It can also be set for both types of transitions occurring.
 - Or it can be set for neither transition. If both transition registers are set to 0 for a particular bit position, that bit will not be set in the event register for either type of change.

Using a Status Register

Each bit in a register is represented by a numerical value based on its location. See figure below. This number is sent with the command to enable a particular bit. If you want to enable more than one bit, you would send the sum of all the bits that you want to monitor.

Figure: Status Register Bit Values

Decimal Value																
	32768	16384	8192	4096	2048	1024	512	256	128	64	32	16	8	4	2	1
Bit Number	15	14	13	12	11	10	9	8	7	6	5	4	3	2	1	0

STATus:OPERation:ENABLE < num >
STATus:OPERation:ENABLE?

Standard Operation Event Enable Register

ck730a

Bit 15 is not used to report status.

Example 1:

1. To enable bit 0 and bit 6 of standard event status register, you would send the command *ESE 65 because $1 + 64 = 65$.
2. The results of a query are evaluated in a similar way. If the *STB? command returns a decimal value of 140, ($140 = 128 + 8 + 4$) then bit 7 is true, bit 3 is true and bit 2 is true.

Example 2:

1. Suppose you want to know if an Auto-trigger Timeout occurs, but you only cared about that specific condition. So you would want to know what was happening with bit 10 in the Status Questionable Integrity register, and not about any other bits.

2. It's usually a good idea to start by clearing all the status registers with *CLS.
3. Sending the STAT:QUES:INT:ENAB 1024 command lets you monitor only bit 10 events, instead of the default monitoring all the bits in the register. The register default is for positive transition events (0 to 1 transition). That is, when an auto-trigger timeout occurs. If instead, you wanted to know when the Auto-trigger timeout condition is cleared, then you would set the STAT:QUES:INT:PTR 0 and the STAT:QUES:INT:NTR 32767.
4. So now the only output from the Status Questionable Integrity register will come from a bit 10 positive transition. That output goes to the Integrity Sum bit 9 of the Status Questionable register.
5. You can do a similar thing with this register to only look at bit 9 using, STAT:QUES:ENAB 512.
6. The Status Questionable register output goes to the "Status Questionable Summary" bit 3 of the Status Byte Register. The output from this register can be enabled using the *SRE 8 command.
7. Finally, you would use the serial polling functionality available for the particular bus/software that you are using to monitor the Status Byte Register. (You could also use *STB? to poll the Status Byte Register.)

Using the Service Request (SRQ) Method

Your language, bus, and programming environment must be able to support SRQ interrupts. (For example, BASIC used with VXI-11.3 (GPIB over LAN). When you monitor a condition with the SRQ method, you must:

1. Determine which bit monitors the condition.
2. Determine how that bit reports to the request service (RQS) bit of the status byte.
3. Send SCPI commands to enable the bit that monitors the condition and to enable the summary bits that report the condition to the RQS bit.
4. Enable the controller to respond to service requests.

When the condition changes, the instrument sets its RQS bit. The controller is informed of the change as soon as it occurs. As a result, the time the controller would otherwise have used to monitor the condition can be used to perform other tasks. Your program determines how the controller responds to the SRQ.

Generating a Service Request

To use the SRQ method, you must understand how service requests are generated. Bit 6 of the status byte register is the request service (RQS) bit. The *SRE command is used to configure the RQS bit to report changes in instrument status. When such a change occurs, the RQS bit is set. It is cleared when the status byte register is queried using *SRE? (with a serial poll.) It can be queried without erasing the contents with *STB?.

When a register set causes a summary bit in the status byte to change from 0 to 1, the instrument can initiate the service request (SRQ) process. However, the process is only initiated if both of the following conditions are true:

- The corresponding bit of the service request enable register is also set to 1.
- The instrument does not have a service request pending. (A service request is considered to be pending between the time the instrument's SRQ process is initiated and the time the controller reads the status byte register.)

The SRQ process sets the SRQ true. It also sets the status byte's request service (RQS) bit to 1. Both actions are necessary to inform the controller that the instrument requires service. Setting the SRQ line only informs the controller that some device on the bus requires service. Setting the RQS bit allows the controller to determine which instrument requires service.

If your program enables the controller to detect and respond to service requests, it should instruct the controller to perform a serial poll when the SRQ is set true. Each device on the bus returns the contents of its status byte register in response to this poll. The device who's RQS bit is set to 1 is the device that requested service.

When you read the instrument's status byte register with a serial poll, the RQS bit is reset to 0. Other bits in the register are not affected.

If the status register is configured to SRQ on end-of-measurement and the measurement is in continuous mode, then restarting a measurement (INIT command) can cause the measuring bit to pulse low. This causes an SRQ when you have not actually reached the "end-of-measurement" condition. To avoid this:

1. Set INITiate:CONTinuous off.
2. Set/enable the status registers.
3. Restart the measurement (send INIT).

Status Register System

The hardware status registers are combined to form the instrument status system. Specific status bits are assigned to monitor various aspects of the instrument operation and status. See the diagram of the status system above for information about the bit assignments and status register interconnections.

The Status Byte Register

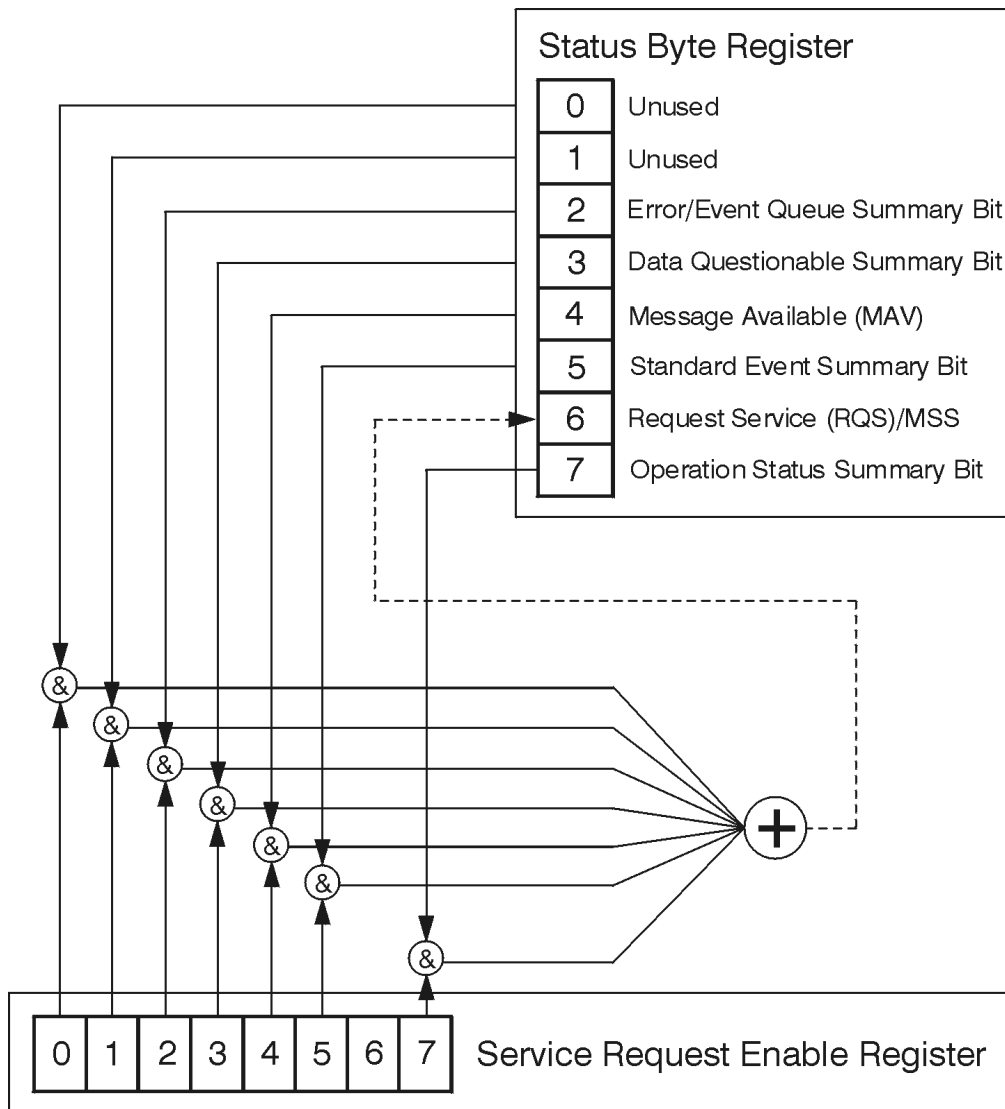

ck776a

The RQS bit is read and reset by a serial poll. The same bit position (MSS) is read, non-destructively by the *STB? command. If you serial poll bit 6 it is read as RQS, but if you send *STB it reads bit 6 as MSS. For more information refer to IEEE 488.2 standards, section 11.

Description	Standard Operation Status Summary Bit	Request Service (RQS) Summary Bit	Standard Event Status Summary Bit	Message Available (MAV)	Data Questionable Status Summary Bit	Error/Event Queue Summary Bit	Unused	Unused	
Bit Number	7	6	5	4	3	2	1	0	

*STB?

Status Byte Register

ck725a

Bit	Description
0, 1	These bits are always set to 0.
2	A 1 in this bit position indicates that the SCPI error queue is not empty which means that it contains at least one error message.
3	A 1 in this bit position indicates that the data questionable summary bit has been set. The data questionable event register can then be read to determine the specific condition that caused this bit to be set.
4	A 1 in this bit position indicates that the instrument has data ready in the output queue. There are no lower status groups that provide input to this bit.
5	A 1 in this bit position indicates that the standard event summary bit has been set. The standard event status register can then be read to determine the specific event that caused this bit to be set.
6	A 1 in this bit position indicates that the instrument has at least one reason to report a status change. This bit is also called the master summary status bit (MSS).
7	A 1 in this bit position indicates that the standard operation summary bit has been set. The standard operation event register can then be read to determine the specific condition that caused this bit to be set.

To query the status byte register, send the command *STB?. The response will be the decimal sum of the bits which are set to 1. For example, if bit number 7 and bit number 3 are set to 1, the decimal sum of the 2 bits is 128 plus 8. So the decimal value 136 is returned. The *STB command does not clear the status register.

In addition to the status byte register, the status byte group also contains the service request enable register. This register lets you choose which bits in the status byte register will trigger a service request.

Send the *SRE <integer> command where <integer> is the sum of the decimal values of the bits you want to enable plus the decimal value of bit 6. For example, assume that you want to enable bit 7 so that whenever the standard operation status register summary bit is set to 1 it will trigger a service request. Send the command *SRE 192 (because 192 = 128 + 64). You must always add 64 (the numeric value of RQS

bit 6) to your numeric sum when you enable any bits for a service request. The command *SRE? returns the decimal value of the sum of the bits previously enabled with the *SRE <integer> command.

The service request enable register presets to zeros (0).

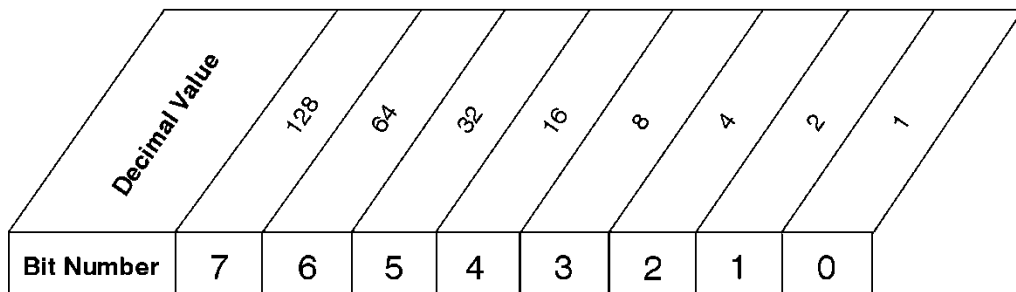

*SRE <num>
 *SRE?

Service Request Enable Register

ck726a

Standard Event Status Register

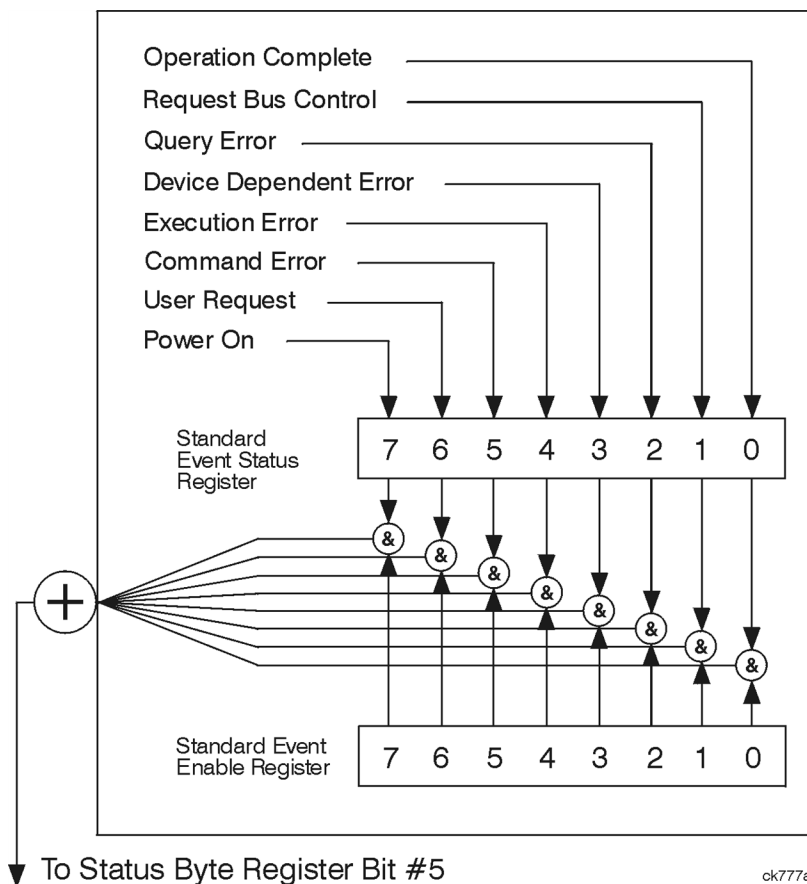

ck777a

The standard event status register contains the following bits:

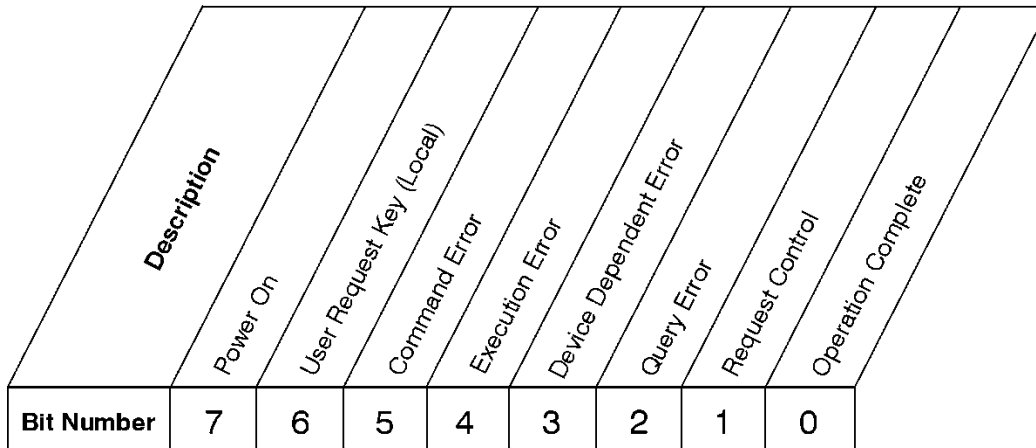

*ESR?

Standard Event Status Register

ck727a

Bit	Description
0	A 1 in this bit position indicates that all pending operations were completed following execution of the *OPC command.
1	This bit is for GPIB handshaking to request control. Currently it is set to 0 because there are no implementations where the spectrum analyzer controls another instrument.
2	A 1 in this bit position indicates that a query error has occurred. Query errors have SCPI error numbers from -499 to -400.
3	A 1 in this bit position indicates that a device dependent error has occurred. Device dependent errors have SCPI error numbers from -399 to -300 and 1 to 32767.
4	A 1 in this bit position indicates that an execution error has occurred. Execution errors have SCPI error numbers from -299 to -200.
5	A 1 in this bit position indicates that a command error has occurred. Command errors have SCPI error numbers from -199 to -100.
6	A 1 in this bit position indicates that the LOCAL key has been pressed. This is true even if the instrument is in local lockout mode.
7	A 1 in this bit position indicates that the instrument has been turned off and then on.

The standard event status register is used to determine the specific event that set bit 5 in the status byte register. To query the standard event status register, send the command *ESR?. The response will be the decimal sum of the bits which are enabled (set to 1). For example, if bit number 7 and bit number 3 are enabled, the decimal sum of the 2 bits is 128 plus 8. So the decimal value 136 is returned.

In addition to the standard event status register, the standard event status group also contains a standard event status enable register. This register lets you choose which bits in the standard event status register will set the summary bit (bit 5 of the status byte register) to 1. Send the *ESE <integer> command where <integer> is the sum of the decimal values of the bits you want to enable. For example, to enable bit 7 and bit 6 so that whenever either of those bits is set to 1, the standard event status summary bit of the status

byte register will be set to 1, send the command *ESE 192 (128 + 64). The command *ESE? returns the decimal value of the sum of the bits previously enabled with the *ESE <integer> command.

The standard event status enable register presets to zeros (0).

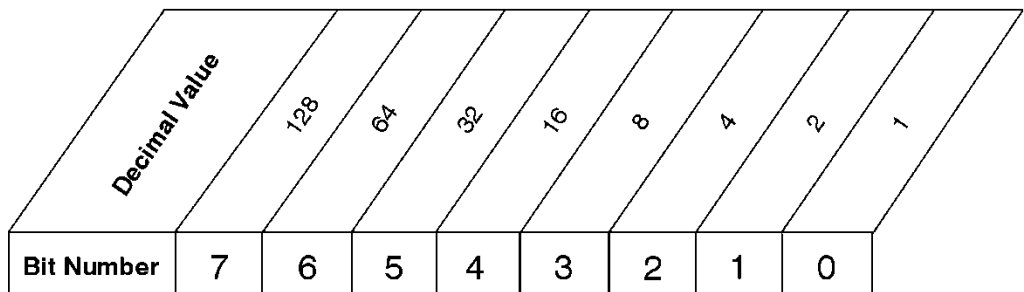

*ESE <num>
 *ESE?

Standard Event Status Enable Register

ck728a

Operation and Questionable Status Registers

The operation and questionable status registers are registers that monitor the overall instrument condition. They are accessed with the STATus:OPERation and STATus:QUEStionable commands in the STATus command subsystem. See the figure at the beginning of this chapter.

Operation Status Register

The operation status register monitors the current instrument measurement state. It checks to see if the instrument is calibrating, sweeping, or waiting for a trigger. For more information see the *OPC? command located in the IEEE Common Commands section.

Bit	Condition	Operation
0	Calibrating	The instrument is busy executing its Align Now process
3	Sweeping	The instrument is busy taking a sweep.
4	Measuring	The instrument is busy making a measurement. Measurements often require multiple sweeps. They are initiated by keys under the MEASURE key or with the MEASure group of commands. The bit is valid for most X-Series Modes.
5	Waiting for trigger	The instrument is waiting for the trigger conditions to be met, then it will trigger a sweep or measurement.

Questionable Status Register

The questionable status register monitors the instrument's condition to see if anything questionable has happened to it. It is looking for anything that might cause an error or a bad measurement like a hardware problem, an out of calibration situation, or a unusual signal. All the bits are summary bits from lower-level event registers.

Bit	Condition	Operation
-----	-----------	-----------

3	Power summary	The instrument hardware has detected a power unlevelled condition.
4	Temperature summary	The instrument is still warming up.
5	Frequency summary	The instrument hardware has detected an unlocked condition or a problem with the external frequency reference.
8	Calibration summary	The instrument has detected a hardware problem while doing the automatic internal alignment process.
9	Integrity summary	The instrument has detected a questionable measurement condition such as: bad timing, bad signal/data, timeout problem, signal overload, or "meas uncal".

STATus Subsystem Command Descriptions

The STATus subsystem controls the SCPI-defined instrument status reporting structures. Each status register has a set of five commands used for querying or masking that particular register.

Numeric values for bit patterns can be entered using decimal or hexadecimal representations. (i.e. 0 to 32767 is equivalent to #H0 to #H7FFF. It is also equal to all ones, 111111111111111) See the SCPI Basics information about using bit patterns for variable parameters.

Operation Register

"Operation Condition Query" on page 143

"Operation Enable" on page 144

"Operation Event Query" on page 144

"Operation Negative Transition" on page 144

"Operation Positive Transition" on page 145

Operation Condition Query

This query returns the decimal value of the sum of the bits in the Status Operation Condition register.

NOTE

The data in this register is continuously updated and reflects the current conditions.

Mode	All
Remote Command	:STATus:OPERation:CONDition?
Example	STAT:OPER:COND?
Preset	0
Status Bits/OPC dependencies	Sequential command
Initial S/W Revision	Prior to A.02.00

Operation Enable

This command determines which bits in the Operation Event register, will set the Operation Status Summary bit (bit 7) in the Status Byte Register. The variable <integer> is the sum of the decimal values of the bits you want to enable.

NOTE

The preset condition is to have all bits in this enable register set to 0. To have any Operation Events reported to the Status Byte Register, one or more bits need to be set to 1.

Mode	All
Remote Command	:STATus:OPERation:ENABle <integer> :STATus:OPERation:ENABle?
Example	STAT:OPER:ENAB 1 Sets the register so that Align Now operation will be reported to the Status Byte Register.
Preset	0
Min	0
Max	32767
Status Bits/OPC dependencies	Sequential command
Initial S/W Revision	Prior to A.02.00

Operation Event Query

This query returns the decimal value of the sum of the bits in the Operation Event register.

NOTE

The register requires that the associated PTR or NTR filters be set before a condition register bit can set a bit in the event register. The data in this register is latched until it is queried. Once queried, the register is cleared.

Mode	All
Remote Command	:STATus:OPERation[:EVENT]?
Example	STAT:OPER?
Preset	0
Status Bits/OPC dependencies	Sequential command
Initial S/W Revision	Prior to A.02.00

Operation Negative Transition

This command determines which bits in the Operation Condition register will set the corresponding bit in the Operation Event register when the condition register bit has a negative transition (1 to 0). The variable <integer> is the sum of the decimal values of the bits that you want to enable.

Mode	All
Remote Command	:STATus:OPERation:NTRansition <integer> :STATus:OPERation:NTRansition?
Example	STAT:OPER:NTR 1 Align Now operation complete will be reported to the Status Byte Register.
Preset	0
Min	0
Max	32767
Status Bits/OPC dependencies	Sequential command
Initial S/W Revision	Prior to A.02.00

Operation Positive Transition

This command determines which bits in the Operation Condition register will set the corresponding bit in the Operation Event register when the condition register bit has a positive transition (0 to 1). The variable <integer> is the sum of the decimal values of the bits that you want to enable.

Mode	All
Remote Command	:STATus:OPERation:PTRansition <integer> :STATus:OPERation:PTRansition?
Example	STAT:OPER:PTR 1 Align Now operation beginning will be reported to the Status Byte Register.
Preset	32767
Min	0
Max	32767
Status Bits/OPC dependencies	Sequential command
Initial S/W Revision	Prior to A.02.00

Preset the Status Byte

Sets bits in most of the enable and transition registers to their default state. It presets all the Transition Filters, Enable Registers, and the Error/Event Queue Enable. It has no effect on Event Registers, Error/Event QUEUE, IEEE 488.2 ESE, and SRE Registers as described in IEEE Standard 488.2–1992, IEEE Standard Codes, Formats, Protocols, and Common Commands for Use with ANSI/IEEE Std 488.1–1987. New York, NY, 1992.

Remote Command	:STATus:PRESet
Example	STAT:PREs
Initial S/W Revision	Prior to A.02.00

Questionable Register

"Questionable Condition " on page 146

"Questionable Enable " on page 146

"Questionable Event Query " on page 147

"Questionable Negative Transition " on page 147

"Questionable Positive Transition" on page 147

Questionable Condition

This query returns the decimal value of the sum of the bits in the Questionable Condition register.

NOTE

The data in this register is continuously updated and reflects the current conditions.

Mode	All
Remote Command	:STATus:QUEStionable:CONDition?
Example	STAT:QUES:COND?
Preset	0
Status Bits/OPC dependencies	Sequential command
Initial S/W Revision	Prior to A.02.00

Questionable Enable

This command determines which bits in the Questionable Event register will set the Questionable Status Summary bit (bit3) in the Status Byte Register. The variable <integer> is the sum of the decimal values of the bits you want to enable.

NOTE

The preset condition is all bits in this enable register set to 0. To have any Questionable Events reported to the Status Byte Register, one or more bits need to be set to 1. The Status Byte Event Register should be queried after each measurement to check the Questionable Status Summary (bit 3). If it is equal to 1, a condition during the test may have made the test results invalid. If it is equal to 0, this indicates that no hardware problem or measurement problem was detected by the analyzer.

Mode	All
Remote Command	:STATus:QUEStionable:ENABle <integer> :STATus:QUEStionable:ENABle?
Example	STAT:OPER:PTR 1 Align Now operation beginning will be reported to the Status Byte Register.
Preset	0
Min	0
Max	32767
Status Bits/OPC dependencies	Sequential command
Initial S/W Revision	Prior to A.02.00

Questionable Event Query

This query returns the decimal value of the sum of the bits in the Questionable Event register.

NOTE

The register requires that the associated PTR or NTR filters be set before a condition register bit can set a bit in the event register. The data in this register is latched until it is queried. Once queried, the register is cleared.

Mode	All
Remote Command	:STATus:QUESTionable[:EVENT]?
Example	STAT:QUES?
Preset	0
Status Bits/OPC dependencies	Sequential command
Initial S/W Revision	Prior to A.02.00

Questionable Negative Transition

This command determines which bits in the Questionable Condition register will set the corresponding bit in the Questionable Event register when the condition register bit has a negative transition (1 to 0). The variable <integer> is the sum of the decimal values of the bits that you want to enable.

Mode	All
Remote Command	:STATus:QUESTionable:NTRansition <integer> :STATus:QUESTionable:NTRansition?
Example	STAT:QUES:NTR 16 Temperature summary 'questionable cleared' will be reported to the Status Byte Register.
Preset	0
Min	0
Max	32767
Status Bits/OPC dependencies	Sequential command
Initial S/W Revision	Prior to A.02.00

Questionable Positive Transition

This command determines which bits in the Questionable Condition register will set the corresponding bit in the Questionable Event register when the condition register bit has a positive transition (0 to 1). The variable <integer> is the sum of the decimal values of the bits that you want to enable.

Mode	All
------	-----

Remote Command	:STATus:QUEStionable:PTRansition <integer> :STATus:QUEStionable:PTRansition?
Example	STAT:QUES:PTR 16 Temperature summary 'questionable asserted' will be reported to the Status Byte Register.
Preset	32767
Min	0
Max	32767
Status Bits/OPC dependencies	Sequential command
Initial S/W Revision	Prior to A.02.00

Questionable Calibration Register

"Questionable Calibration Condition " on page 148

"Questionable Calibration Enable " on page 148

"Questionable Calibration Event Query " on page 149

"Questionable Calibration Negative Transition " on page 149

"Questionable Calibration Positive Transition " on page 150

Questionable Calibration Condition

This query returns the decimal value of the sum of the bits in the Questionable Calibration Condition register.

NOTE

The data in this register is continuously updated and reflects the current conditions.

Mode	All
Remote Command	:STATus:QUEStionable:CALibration:CONDition?
Example	STAT:QUES:CAL:COND?
Preset	0
Status Bits/OPC dependencies	Sequential command
Initial S/W Revision	Prior to A.02.00

Questionable Calibration Enable

This command determines which bits in the Questionable Calibration Condition Register will set bits in the Questionable Calibration Event register, which also sets the Calibration Summary bit (bit 8) in the Questionable Register. The variable <integer> is the sum of the decimal values of the bits you want to enable.

Mode	All
Remote Command	:STATus:QUESTionable:CALibration:ENABle <integer> :STATus:QUESTionable:CALibration:ENABle?
Example	STAT:QUES:CAL:ENAB 16384 Can be used to query if an alignment is needed, if you have turned off the automatic alignment process.
Min	0
Max	32767
Status Bits/OPC dependencies	Sequential command
Initial S/W Revision	Prior to A.02.00

Questionable Calibration Event Query

This query returns the decimal value of the sum of the bits in the Questionable Calibration Event register.

NOTE

The register requires that the associated PTR or NTR filters be set before a condition register bit can set a bit in the event register. The data in this register is latched until it is queried. Once queried, the register is cleared.

Mode	All
Remote Command	:STATus:QUESTionable:CALibration[:EVENT]?
Example	STAT:QUES:CAL?
Preset	0
Status Bits/OPC dependencies	Sequential command
Initial S/W Revision	Prior to A.02.00

Questionable Calibration Negative Transition

This command determines which bits in the Questionable Calibration Condition register will set the corresponding bit in the Questionable Calibration Event register when the condition register bit has a negative transition (1 to 0). The variable <integer> is the sum of the decimal values of the bits that you want to enable.

Mode	All
Remote Command	:STATus:QUESTionable:CALibration:NTRansition <integer> :STATus:QUESTionable:CALibration:NTRansition?
Example	STAT:QUES:CAL:NTR 16384 Alignment is not required.
Preset	0
Min	0

Max	32767
Status Bits/OPC dependencies	Sequential command
Initial S/W Revision	Prior to A.02.00

Questionable Calibration Positive Transition

This command determines which bits in the Questionable Calibration Condition register will set the corresponding bit in the Questionable Calibration Event register when the condition register bit has a positive transition (0 to 1). The variable <integer> is the sum of the decimal values of the bits that you want to enable.

Mode	All
Remote Command	:STATus:QUESTionable:CALibration:PTRansition <integer> :STATus:QUESTionable:CALibration:PTRansition?
Example	STAT:QUES:CAL:PTR 16384 Alignment is required.
Preset	32767
Min	0
Max	32767
Status Bits/OPC dependencies	Sequential command
Initial S/W Revision	Prior to A.02.00

Questionable Calibration Skipped Register

"Questionable Calibration Skipped Condition " on page 150

"Questionable Calibration Skipped Enable " on page 151

"Questionable Calibration Skipped Event Query " on page 151

"Questionable Calibration Skipped Negative Transition " on page 152

"Questionable Calibration Skipped Positive Transition " on page 152

Questionable Calibration Skipped Condition

This query returns the decimal value of the sum of the bits in the Questionable Calibration Skipped Condition register.

NOTE The data in this register is continuously updated and reflects the current conditions.

Mode	All
Remote Command	:STATus:QUESTionable:CALibration:SKIpped:CONDition?

Example	STAT:QUES:CAL:SKIP:COND?
Preset	0
Status Bits/OPC dependencies	Sequential command
Initial S/W Revision	Prior to A.02.00

Questionable Calibration Skipped Enable

This command determines which bits in the Questionable Calibration Skipped Condition Register will set bits in the Questionable Calibration Skipped Event register, which also sets bit 11 of the Questionable Calibration Register. The variable <integer> is the sum of the decimal values of the bits you want to enable.

Mode	All
Remote Command	:STATus:QUESTionable:CALibration:SKIPped:ENABle <integer> :STATus:QUESTionable:CALibration:SKIPped:ENABle?
Example	STAT:QUES:CAL:SKIP:ENAB 1 Can be used to query if an EMI alignment skipped condition is detected
Preset	32767
Min	0
Max	32767
Status Bits/OPC dependencies	Sequential command
Initial S/W Revision	Prior to A.02.00

Questionable Calibration Skipped Event Query

This query returns the decimal value of the sum of the bits in the Questionable Calibration Event register.

NOTE The register requires that the associated PTR or NTR filters be set before a condition register bit can set a bit in the event register. The data in this register is latched until it is queried. Once queried, the register is cleared.

Mode	All
Remote Command	:STATus:QUESTionable:CALibration:SKIPped[:EVENT]?
Example	STAT:QUES:CAL:SKIP?
Preset	0
Status Bits/OPC dependencies	Sequential command
Initial S/W Revision	Prior to A.02.00

Questionable Calibration Skipped Negative Transition

This command determines which bits in the Questionable Calibration Skipped Condition register will set the corresponding bit in the Questionable Calibration Skipped Event register when the condition register bit has a negative transition (1 to 0). The variable <integer> is the sum of the decimal values of the bits that you want to enable.

Mode	All
Remote Command	:STATus:QUEStionable:CALibration:SKIpped:NTRansition <integer> :STATus:QUEStionable:CALibration:SKIpped:NTRansition?
Example	STAT:QUES:CAL:SKIP:NTR 1 Align RF skipped is not required.
Preset	0
Min	0
Max	32767
Status Bits/OPC dependencies	Sequential command
Initial S/W Revision	Prior to A.02.00

Questionable Calibration Skipped Positive Transition

This command determines which bits in the Questionable Calibration Skipped Condition register will set the corresponding bit in the Questionable Calibration Skipped Event register when the condition register bit has a positive transition (0 to 1). The variable <integer> is the sum of the decimal values of the bits that you want to enable.

Mode	All
Remote Command	:STATus:QUEStionable:CALibration:SKIpped:PTRansition <integer> :STATus:QUEStionable:CALibration:SKIpped:PTRansition?
Example	STAT:QUES:CAL:SKIP:PTR 1 Align RF skipped is required.
Preset	32767
Min	0
Max	32767
Status Bits/OPC dependencies	Sequential command
Initial S/W Revision	Prior to A.02.00

Questionable Calibration Extended Failure Register

"Questionable Calibration Extended Failure Condition " on page 153

"Questionable Calibration Extended Failure Enable " on page 153

"Questionable Calibration Extended Failure Event Query " on page 153

"Questionable Calibration Extended Failure Negative Transition " on page 154

"Questionable Calibration Extended Failure Positive Transition " on page 154

Questionable Calibration Extended Failure Condition

This query returns the decimal value of the sum of the bits in the Questionable Calibration Extended Failure Condition register.

NOTE The data in this register is continuously updated and reflects the current conditions.

Mode	All
Remote Command	:STATus:QUEStionable:CALibration:EXTended:FAILure:CONDition?
Example	STAT:QUES:CAL:EXT:FAIL:COND?
Preset	0
Status Bits/OPC dependencies	Sequential command
Initial S/W Revision	Prior to A.02.00

Questionable Calibration Extended Failure Enable

This command determines which bits in the Questionable Calibration Extended Failure Condition Register will set bits in the Questionable Calibration Extended Failure Event register, which also sets bit 9 of the Questionable Calibration Register. The variable <integer> is the sum of the decimal values of the bits you want to enable.

Mode	All
Remote Command	:STATus:QUEStionable:CALibration:EXTended:FAILure:ENABle <integer> :STATus:QUEStionable:CALibration:EXTended:FAILure:ENABle?
Example	STAT:QUES:CAL:EXT:FAIL:ENAB 1 Can be used to query if an EMI conducted alignment is needed.
Preset	32767
Min	0
Max	32767
Status Bits/OPC dependencies	Sequential command
Initial S/W Revision	Prior to A.02.00

Questionable Calibration Extended Failure Event Query

This query returns the decimal value of the sum of the bits in the Questionable Calibration Extended Failure Event register.

NOTE The register requires that the associated PTR or NTR filters be set before a condition register bit can set a bit in the event register. The data in this register is latched until it is queried. Once queried, the register is cleared.

Mode	All
Remote Command	:STATus:QUESTionable:CALibration:EXTended:FAILure[:EVENT]?
Example	STAT:QUES:CAL:EXT:FAIL?
Preset	0
Status Bits/OPC dependencies	Sequential command
Initial S/W Revision	Prior to A.02.00

Questionable Calibration Extended Failure Negative Transition

This command determines which bits in the Questionable Calibration Extended Failure Condition register will set the corresponding bit in the Questionable Calibration Extended Failure Event register when the condition register bit has a negative transition (1 to 0). The variable <integer> is the sum of the decimal values of the bits that you want to enable.

Mode	All
Remote Command	:STATus:QUESTionable:CALibration:EXTended:FAILure:NTRansition <integer> :STATus:QUESTionable:CALibration:EXTended:FAILure:NTRansition?
Example	STAT:QUES:CAL:EXT:FAIL:NTR 1 EMI conducted align failure is not required.
Preset	0
Min	0
Max	32767
Status Bits/OPC dependencies	Sequential command
Initial S/W Revision	Prior to A.02.00

Questionable Calibration Extended Failure Positive Transition

This command determines which bits in the Questionable Calibration Extended Failure Condition register will set the corresponding bit in the Questionable Calibration Extended Failure Event register when the condition register bit has a positive transition (0 to 1). The variable <integer> is the sum of the decimal values of the bits that you want to enable.

Mode	All
Remote Command	:STATus:QUESTionable:CALibration:EXTended:FAILure:PTRansition <integer> :STATus:QUESTionable:CALibration:EXTended:FAILure:PTRansition?
Example	STAT:QUES:CAL:EXT:FAIL:PTR 1 EMI conducted align failure is required.
Preset	32767
Min	0
Max	32767

Status Bits/OPC dependencies	Sequential command
Initial S/W Revision	Prior to A.02.00

Questionable Calibration Extended Needed Register

"Questionable Calibration Extended Needed Condition " on page 155

"Questionable Calibration Extended Needed Enable " on page 155

"Questionable Calibration Extended Needed Event Query " on page 156

"Questionable Calibration Extended Needed Negative Transition " on page 156

"Questionable Calibration Extended Needed Positive Transition " on page 157

Questionable Calibration Extended Needed Condition

This query returns the decimal value of the sum of the bits in the Questionable Calibration Extended Needed Condition register.

NOTE The data in this register is continuously updated and reflects the current conditions.

Mode	All
Remote Command	:STATus:QUESTionable:CALibration:EXTended:NEEDED:CONDition?
Example	STAT:QUES:CAL:EXT:NEED:COND?
Preset	0
Status Bits/OPC dependencies	Sequential command
Initial S/W Revision	Prior to A.02.00

Questionable Calibration Extended Needed Enable

This command determines which bits in the Questionable Calibration Extended Needed Condition Register will set bits in the Questionable Calibration Extended Needed Event register, which also sets bit 14 of the Questionable Calibration Register. The variable <integer> is the sum of the decimal values of the bits you want to enable.

Mode	All
Remote Command	:STATus:QUESTionable:CALibration:EXTended:NEEDED:ENABle <integer> :STATus:QUESTionable:CALibration:EXTended:NEEDED:ENABle?
Example	STAT:QUES:CAL:EXT:NEED:ENAB 2 Can be used to query if an EMI conducted alignment is needed.
Preset	32767
Min	0

Max	32767
Status Bits/OPC dependencies	Sequential command
Initial S/W Revision	Prior to A.02.00

Questionable Calibration Extended Needed Event Query

This query returns the decimal value of the sum of the bits in the Questionable Calibration Extended Needed Event register.

NOTE

The register requires that the associated PTR or NTR filters be set before a condition register bit can set a bit in the event register. The data in this register is latched until it is queried. Once queried, the register is cleared.

Mode	All
Remote Command	:STATus:QUESTionable:CALibration:EXTended:NEEDed[:EVENT]?
Example	STAT:QUES:CAL:EXT:NEED?
Preset	0
Status Bits/OPC dependencies	Sequential command
Initial S/W Revision	Prior to A.02.00

Questionable Calibration Extended Needed Negative Transition

This command determines which bits in the Questionable Calibration Extended Needed Condition register will set the corresponding bit in the Questionable Calibration Extended Needed Event register when the condition register bit has a negative transition (1 to 0). The variable <integer> is the sum of the decimal values of the bits that you want to enable.

Mode	All
Remote Command	:STATus:QUESTionable:CALibration:EXTended:NEEDed:NTRansition <integer> :STATus:QUESTionable:CALibration:EXTended:NEEDed:NTRansition?
Example	STAT:QUES:CAL:EXT:NEED:NTR 2 Align EMI conducted is not required.
Preset	0
Min	0
Max	32767
Status Bits/OPC dependencies	Sequential command
Initial S/W Revision	Prior to A.02.00

Questionable Calibration Extended Needed Positive Transition

This command determines which bits in the Questionable Calibration Extended Needed Condition register will set the corresponding bit in the Questionable Calibration Extended Needed Event register when the condition register bit has a positive transition (0 to 1). The variable <integer> is the sum of the decimal values of the bits that you want to enable.

Mode	All
Remote Command	:STATus:QUEStionable:CALibration:EXTended:NEEDED:PTRansition <integer> :STATus:QUEStionable:CALibration:EXTended:NEEDED:PTRansition?
Example	STAT:QUES:CAL:EXT:NEED:PTR 2 Align EMI conducted is required.
Preset	32767
Min	0
Max	32767
Status Bits/OPC dependencies	Sequential command
Initial S/W Revision	Prior to A.02.00

Questionable Frequency Register

"Questionable Frequency Condition " on page 157

"Questionable Frequency Enable " on page 158

"Questionable Frequency Event Query " on page 158

"Questionable Frequency Negative Transition " on page 158

"Questionable Frequency Positive Transition " on page 159

Questionable Frequency Condition

This query returns the decimal value of the sum of the bits in the Questionable Frequency Condition register.

NOTE

The data in this register is continuously updated and reflects the current conditions.

Mode	All
Remote Command	:STATus:QUEStionable:FREQuency:CONDition?
Example	STAT:QUES:FREQ:COND?
Preset	0
Status Bits/OPC dependencies	Sequential command
Initial S/W Revision	Prior to A.02.00

Questionable Frequency Enable

This command determines which bits in the Questionable Frequency Condition Register will set bits in the Questionable Frequency Event register, which also sets the Frequency Summary bit (bit 5) in the Questionable Register. The variable <integer> is the sum of the decimal values of the bits you want to enable.

Mode	All
Remote Command	:STATus:QUEStionable:FREQuency:ENABle <integer> :STATus:QUEStionable:FREQuency:ENABle?
Example	STAT:QUES:FREQ:ENAB 2 Frequency Reference Unlocked will be reported to the Frequency Summary of the Status Questionable register.
Preset	32767
Min	0
Max	32767
Status Bits/OPC dependencies	Sequential command
Initial S/W Revision	Prior to A.02.00

Questionable Frequency Event Query

This query returns the decimal value of the sum of the bits in the Questionable Frequency Event register.

NOTE

The register requires that the associated PTR or NTR filters be set before a condition register bit can set a bit in the event register. The data in this register is latched until it is queried. Once queried, the register is cleared.

Mode	All
Remote Command	:STATus:QUEStionable:FREQuency[:EVENT]?
Example	STAT:QUES:FREQ?
Preset	0
Status Bits/OPC dependencies	Sequential command
Initial S/W Revision	Prior to A.02.00

Questionable Frequency Negative Transition

This command determines which bits in the Questionable Frequency Condition register will set the corresponding bit in the Questionable Frequency Event register when the condition register bit has a negative transition (1 to 0). The variable <integer> is the sum of the decimal values of the bits that you want to enable.

Mode	All
------	-----

Remote Command	:STATus:QUESTionable:FREQuency:NTRansition <integer> :STATus:QUESTionable:FREQuency:NTRansition?
Example	STAT:QUES:FREQ:NTR 2 Frequency Reference 'regained lock' will be reported to the Frequency Summary of the Status Questionable register.
Preset	0
Min	0
Max	32767
Status Bits/OPC dependencies	Sequential command
Initial S/W Revision	Prior to A.02.00

Questionable Frequency Positive Transition

This command determines which bits in the Questionable Frequency Condition register will set the corresponding bit in the Questionable Frequency Event register when the condition register bit has a positive transition (0 to 1). The variable <integer> is the sum of the decimal values of the bits that you want to enable.

Mode	All
Remote Command	:STATus:QUESTionable:FREQuency:PTRansition <integer> :STATus:QUESTionable:FREQuency:PTRansition?
Example	STAT:QUES:FREQ:PTR 2 Frequency Reference 'became unlocked' will be reported to the Frequency Summary of the Status Questionable register.
Preset	32767
Min	0
Max	32767
Status Bits/OPC dependencies	Sequential command
Initial S/W Revision	Prior to A.02.00

Questionable Integrity Register

"Questionable Integrity Condition " on page 159

"Questionable Integrity Enable " on page 160

"Questionable Integrity Event Query " on page 160

"Questionable Integrity Negative Transition " on page 161

"Questionable Integrity Positive Transition " on page 161

Questionable Integrity Condition

This query returns the decimal value of the sum of the bits in the Questionable Integrity Condition register.

NOTE

The data in this register is continuously updated and reflects the current conditions.

Mode	All
Remote Command	:STATus:QUESTionable:INTEgrity:CONDition?
Example	STAT:QUES:INT:COND?
Preset	0
Status Bits/OPC dependencies	Sequential command
Initial S/W Revision	Prior to A.02.00

Questionable Integrity Enable

This command determines which bits in the Questionable Integrity Condition Register will set bits in the Questionable Integrity Event register, which also sets the Integrity Summary bit (bit 9) in the Questionable Register. The variable <integer> is the sum of the decimal values of the bits you want to enable.

Mode	All
Remote Command	:STATus:QUESTionable:INTEgrity:ENABle <integer> :STATus:QUESTionable:INTEgrity:ENABle?
Example	STAT:QUES:INT:ENAB 8 Measurement Uncalibrated Summary will be reported to the Integrity Summary of the Status Questionable register.
Preset	32767
Min	0
Max	32767
Status Bits/OPC dependencies	Sequential command
Initial S/W Revision	Prior to A.02.00

Questionable Integrity Event Query

This query returns the decimal value of the sum of the bits in the Questionable Integrity Event register.

NOTE

The register requires that the associated PTR or NTR filters be set before a condition register bit can set a bit in the event register. The data in this register is latched until it is queried. Once queried, the register is cleared.

Mode	All
Remote Command	:STATus:QUESTionable:INTEgrity[:EVENT]?
Example	STAT:QUES:INT?
Preset	0
Status Bits/OPC dependencies	Sequential command
Initial S/W Revision	Prior to A.02.00

Questionable Integrity Negative Transition

This command determines which bits in the Questionable Integrity Condition register will set the corresponding bit in the Questionable Integrity Event register when the condition register bit has a negative transition (1 to 0)

The variable <integer> is the sum of the decimal values of the bits that you want to enable.

Mode	All
Remote Command	:STATus:QUEStionable:INTEgrity:NTRansition <integer> :STATus:QUEStionable:INTEgrity:NTRansition?
Example	STAT:QUES:INT:NTR 8 Measurement 'regained calibration' Summary will be reported to the Integrity Summary of the Status Questionable register.
Preset	0
Min	0
Max	32767
Status Bits/OPC dependencies	Sequential command
Initial S/W Revision	Prior to A.02.00

Questionable Integrity Positive Transition

This command determines which bits in the Questionable Integrity Condition register will set the corresponding bit in the Questionable Integrity Event register when the condition register bit has a positive transition (0 to 1). The variable <integer> is the sum of the decimal values of the bits that you want to enable.

Mode	All
Remote Command	:STATus:QUEStionable:INTEgrity:PTRansition <integer> :STATus:QUEStionable:INTEgrity:PTRansition?
Example	STAT:QUES:INT:PTR 8 Measurement 'became uncalibrated' Summary will be reported to the Integrity Summary of the Status Questionable register.
Preset	32767
Min	0
Max	32767
Status Bits/OPC dependencies	Sequential command
Initial S/W Revision	Prior to A.02.00

Questionable Integrity Signal Register

"Questionable Integrity Signal Condition" on page 162

"Questionable Integrity Signal Enable" on page 162

"Questionable Integrity Signal Event Query" on page 163

"Questionable Integrity Signal Negative Transition" on page 163

"Questionable Integrity Signal Positive Transition" on page 163

Questionable Integrity Signal Condition

This query returns the decimal value of the sum of the bits in the Questionable Integrity Signal Condition register.

NOTE

The data in this register is continuously updated and reflects the current conditions.

Mode	All
Remote Command	:STATus:QUESTionable:INTEgrity:SIGNal:CONDition?
Example	STAT:QUES:INT:SIGN:COND?
Preset	0
Status Bits/OPC dependencies	Sequential command
Initial S/W Revision	Prior to A.02.00

Questionable Integrity Signal Enable

This command determines which bits in the Questionable Integrity Signal Condition Register will set bits in the Questionable Integrity Signal Event register, which also sets the Integrity Summary bit (bit 9) in the Questionable Register. The variable <integer> is the sum of the decimal values of the bits you want to enable.

Mode	All
Remote Command	:STATus:QUESTionable:INTEgrity:SIGNal:ENABle <integer> :STATus:QUESTionable:INTEgrity:SIGNal:ENABle?
Example	STAT:QUES:INT:SIGN:ENAB 4 Burst Not Found will be reported to the Integrity Summary of the Status Questionable register.
Preset	32767
Min	0
Max	32767
Status Bits/OPC dependencies	Sequential command
Initial S/W Revision	Prior to A.02.00

Questionable Integrity Signal Event Query

This query returns the decimal value of the sum of the bits in the Questionable Integrity Signal Event register.

NOTE

The register requires that the associated PTR or NTR filters be set before a condition register bit can set a bit in the event register. The data in this register is latched until it is queried. Once queried, the register is cleared.

Mode	All
Remote Command	:STATus:QUESTionable:INTEgrity:SIGNal[:EVENT]?
Example	STAT:QUES:INT:SIGN?
Preset	0
Status Bits/OPC dependencies	Sequential command
Initial S/W Revision	Prior to A.02.00

Questionable Integrity Signal Negative Transition

This command determines which bits in the Questionable Integrity Signal Condition register will set the corresponding bit in the Questionable Integrity Signal Event register when the condition register bit has a negative transition (1 to 0). The variable <integer> is the sum of the decimal values of the bits that you want to enable.

Mode	All
Remote Command	:STATus:QUESTionable:INTEgrity:SIGNal:NTRansition <integer> :STATus:QUESTionable:INTEgrity:SIGNal:NTRansition?
Example	STAT:QUES:INT:SIGN:NTR 4 Burst found will be reported to the Integrity Summary of the Status Questionable register.
Preset	0
Min	0
Max	32767
Status Bits/OPC dependencies	Sequential command
Initial S/W Revision	Prior to A.02.00

Questionable Integrity Signal Positive Transition

This command determines which bits in the Questionable Integrity Signal Condition register will set the corresponding bit in the Questionable Integrity Signal Event register when the condition register bit has a positive transition (0 to 1). The variable <integer> is the sum of the decimal values of the bits that you want to enable.

Mode	All
Remote Command	:STATus:QUEStionable:INTEgrity:SIGNal:PTRansition <integer> :STATus:QUEStionable:INTEgrity:SIGNal:PTRansition?
Example	STAT:QUES:INT:SIGN:PTR 4 Burst not found will be reported to the Integrity Summary of the Status Questionable register.
Preset	32767
Min	0
Max	32767
Status Bits/OPC dependencies	Sequential command
Initial S/W Revision	Prior to A.02.00

Questionable Integrity Uncalibrated Register

"Questionable Integrity Uncalibrated Condition " on page 164

"Questionable Integrity Uncalibrated Enable " on page 164

"Questionable Integrity Uncalibrated Event Query " on page 165

"Questionable Integrity Uncalibrated Negative Transition " on page 165

"Questionable Integrity Uncalibrated Positive Transition " on page 166

Questionable Integrity Uncalibrated Condition

This query returns the decimal value of the sum of the bits in the Questionable Integrity Uncalibrated Condition register.

NOTE

The data in this register is continuously updated and reflects the current conditions.

Mode	All
Remote Command	:STATus:QUEStionable:INTEgrity:UNCalibrated:CONDition?
Example	STAT:QUES:INT:UNC:COND?
Preset	0
Status Bits/OPC dependencies	Sequential command
Initial S/W Revision	Prior to A.02.00

Questionable Integrity Uncalibrated Enable

This command determines which bits in the Questionable Integrity Uncalibrated Condition Register will set bits in the Questionable Integrity Uncalibrated Event register, which also sets the Data Uncalibrated Summary bit (bit 3) in the Questionable Integrity Register. The variable <integer> is the sum of the decimal values of the bits you want to enable.

Mode	All
Remote Command	:STATus:QUESTionable:INTEgrity:UNCalibrated:ENABle :STATus:QUESTionable:INTEgrity:UNCalibrated:ENABle?
Example	STAT:QUES:INT:UNC:ENAB 1 Oversweep (Meas Uncal) will be reported to the Integrity Summary of the Status Questionable register.
Preset	32767
Min	0
Max	32767
Status Bits/OPC dependencies	Sequential command
Initial S/W Revision	Prior to A.02.00

Questionable Integrity Uncalibrated Event Query

This query returns the decimal value of the sum of the bits in the Questionable Integrity Uncalibrated Event register.

NOTE

The register requires that the associated PTR or NTR filters be set before a condition register bit can set a bit in the event register. The data in this register is latched until it is queried. Once queried, the register is cleared.

Mode	All
Remote Command	:STATus:QUESTionable:INTEgrity:UNCalibrated[:EVENT]?
Example	STAT:QUES:INT:UNC?
Preset	0
Status Bits/OPC dependencies	Sequential command
Initial S/W Revision	Prior to A.02.00

Questionable Integrity Uncalibrated Negative Transition

This command determines which bits in the Questionable Integrity Uncalibrated Condition register will set the corresponding bit in the Questionable Integrity Uncalibrated Event register when the condition register bit has a negative transition (1 to 0). The variable <integer> is the sum of the decimal values of the bits that you want to enable.

Mode	All
Remote Command	:STATus:QUESTionable:INTEgrity:UNCalibrated:NTRansition <integer> :STATus:QUESTionable:INTEgrity:UNCalibrated:NTRansition?
Example	STAT:QUES:INT:UNC:NTR 1 Oversweep cleared will be reported to the Integrity Summary of the Status Questionable register.

Preset	0
Min	0
Max	32767
Status Bits/OPC dependencies	Sequential command
Initial S/W Revision	Prior to A.02.00

Questionable Integrity Uncalibrated Positive Transition

This command determines which bits in the Questionable Integrity Uncalibrated Condition register will set the corresponding bit in the Questionable Integrity Uncalibrated Event register when the condition register bit has a positive transition (0 to 1). The variable <integer> is the sum of the decimal values of the bits that you want to enable.

Mode	All
Remote Command	:STATus:QUEStionable:INTEgrity:UNCalibrated:PTRansition <integer> :STATus:QUEStionable:INTEgrity:UNCalibrated:PTRansition?
Example	STAT:QUES:INT:UNC:PTR 1 Oversweep (Meas Uncal) occurred will be reported to the Integrity Summary of the Status Questionable register.
Preset	32767
Min	0
Max	32767
Status Bits/OPC dependencies	Sequential command
Initial S/W Revision	Prior to A.02.00

Questionable Power Register

"Questionable Power Condition " on page 166

"Questionable Power Enable " on page 167

"Questionable Power Event Query " on page 167

"Questionable Power Negative Transition " on page 168

"Questionable Power Positive Transition " on page 168

Questionable Power Condition

This query returns the decimal value of the sum of the bits in the Questionable Power Condition register.

NOTE

The data in this register is continuously updated and reflects the current conditions.

Mode	All
Remote Command	:STATus:QUESTionable:POWer:CONDition?
Example	STAT:QUES:POW:COND?
Preset	0
Status Bits/OPC dependencies	Sequential command
Initial S/W Revision	Prior to A.02.00

Questionable Power Enable

This command determines which bits in the Questionable Power Condition Register will set bits in the Questionable Power Event register, which also sets the Power Summary bit (bit 3) in the Questionable Register. The variable <integer> is the sum of the decimal values of the bits you want to enable.

Mode	All
Remote Command	:STATus:QUESTionable:POWer:ENABle <integer> :STATus:QUESTionable:POWer:ENABle?
Example	STAT:QUES:POW:ENAB 32 50 MHz Input Pwr too High for Cal will be reported to the Power Summary of the Status Questionable register.
Preset	32767
Min	0
Max	32767
Status Bits/OPC dependencies	Sequential command
Initial S/W Revision	Prior to A.02.00

Questionable Power Event Query

This query returns the decimal value of the sum of the bits in the Questionable Power Event register.

NOTE

The register requires that the associated PTR or NTR filters be set before a condition register bit can set a bit in the event register. The data in this register is latched until it is queried. Once queried, the register is cleared.

Mode	All
Remote Command	:STATus:QUESTionable:POWer[:EVENT]?
Example	STAT:QUES:POW?
Preset	0
Status Bits/OPC dependencies	Sequential command
Initial S/W Revision	Prior to A.02.00

Questionable Power Negative Transition

This command determines which bits in the Questionable Power Condition register will set the corresponding bit in the Questionable Power Event register when the condition register bit has a negative transition (1 to 0). The variable <integer> is the sum of the decimal values of the bits that you want to enable.

Mode	All
Remote Command	:STATus:QUESTionable:POWer:NTRansition <integer> :STATus:QUESTionable:POWer:NTRansition?
Example	STAT:QUES:POW:NTR 32 50 MHz Input Power became OK for Cal will be reported to the Power Summary of the Status Questionable register.
Preset	0
Min	0
Max	32767
Status Bits/OPC dependencies	Sequential command
Initial S/W Revision	Prior to A.02.00

Questionable Power Positive Transition

This command determines which bits in the Questionable Power Condition register will set the corresponding bit in the Questionable Power Event register when the condition register bit has a positive transition (0 to 1). The variable <integer> is the sum of the decimal values of the bits that you want to enable.

Mode	All
Remote Command	:STATus:QUESTionable:POWer:PTRansition <integer> :STATus:QUESTionable:POWer:PTRansition?>
Example	STAT:QUES:POW:PTR 32 50 MHz Input Power became too high for Cal will be reported to the Power Summary of the Status Questionable register.
Preset	32767
Min	0
Max	32767
Status Bits/OPC dependencies	Sequential command
Initial S/W Revision	Prior to A.02.00

Questionable Temperature Register

"Questionable Temperature Condition" on page 169

"Questionable Temperature Enable" on page 169

"Questionable Temperature Event Query" on page 169

"Questionable Temperature Negative Transition" on page 170

"Questionable Temperature Positive Transition" on page 170

Questionable Temperature Condition

This query returns the decimal value of the sum of the bits in the Questionable Temperature Condition register.

NOTE

The data in this register is continuously updated and reflects the current conditions.

Mode	All
Remote Command	:STATus:QUEStionable:TEMPerature:CONDition?
Example	STAT:QUES:TEMP:COND?
Preset	0
Status Bits/OPC dependencies	Sequential command
Initial S/W Revision	Prior to A.02.00

Questionable Temperature Enable

This command determines which bits in the Questionable Temperature Condition Register will set bits in the Questionable Temperature Event register, which also sets the Temperature Summary bit (bit 4) in the Questionable Register. The variable <integer> is the sum of the decimal values of the bits you want to enable.

Mode	All
Remote Command	:STATus:QUEStionable:TEMPerature:ENABle <integer> :STATus:QUEStionable:TEMPerature:ENABle?
Example	STAT:QUES:TEMP:ENAB 1 Reference Oscillator Oven Cold will be reported to the Temperature Summary of the Status Questionable register.
Preset	32767
Min	0
Max	32767
Status Bits/OPC dependencies	Sequential command
Initial S/W Revision	Prior to A.02.00

Questionable Temperature Event Query

This query returns the decimal value of the sum of the bits in the Questionable Temperature Event register.

NOTE

The register requires that the associated PTR or NTR filters be set before a condition register bit can set a bit in the event register. The data in this register is latched until it is queried. Once queried, the register is cleared

Mode	All
Remote Command	:STATus:QUEStionable:TEMPerature[:EVENT]?
Example	STAT:QUES:TEMP?
Preset	0
Status Bits/OPC dependencies	Sequential command
Initial S/W Revision	Prior to A.02.00

Questionable Temperature Negative Transition

This command determines which bits in the Questionable Temperature Condition register will set the corresponding bit in the Questionable Temperature Event register when the condition register bit has a negative transition (1 to 0). The variable <integer> is the sum of the decimal values of the bits that you want to enable.

Mode	All
Remote Command	:STATus:QUEStionable:TEMPerature:NTRansition <integer> :STATus:QUEStionable:TEMPerature:NTRansition?
Example	STAT:QUES:TEMP:NTR 1 Reference Oscillator Oven not cold will be reported to the Temperature Summary of the Status Questionable register.
Preset	0
Min	0
Max	32767
Status Bits/OPC dependencies	Sequential command
Initial S/W Revision	Prior to A.02.00

Questionable Temperature Positive Transition

This command determines which bits in the Questionable Temperature Condition register will set the corresponding bit in the Questionable Temperature Event register when the condition register bit has a positive transition (0 to 1). The variable <integer> is the sum of the decimal values of the bits that you want to enable.

Mode	All
Remote Command	:STATus:QUEStionable:TEMPerature:PTRansition <integer> :STATus:QUEStionable:TEMPerature:PTRansition?
Example	STAT:QUES:TEMP:PTR 1 Reference Oscillator Oven became cold will be reported to the

Temperature Summary of the Status Questionable register.	
Preset	32767
Min	0
Max	32767
Status Bits/OPC dependencies	Sequential command
Initial S/W Revision	Prior to A.02.00

Common Commands

- "All (Daily use)" on page 294
- "Clear Status " on page 174
- "Standard Event Status Enable " on page 175
- "Standard Event Status Register Query " on page 175
- "Identification Query " on page 176
- "Operation Complete " on page 176
- "Query Instrument Options " on page 177
- "Recall Instrument State " on page 177
- "*RST (Remote Command Only)" on page 178
- "Save Instrument State " on page 178
- "Service Request Enable " on page 179
- "Status Byte Query " on page 179
- "Trigger " on page 179
- "Self Test Query " on page 180
- "Wait-to-Continue " on page 180

All (Daily use)

Immediately executes an alignment of all subsystems which includes both the source and the analyzer in the TRX module. The "All" alignment is sufficient to maintain specified performance, provided that (1) the TRX's internal temperature has not drifted more than +/-5 degree C since the previous alignment, and (2) no more than 8 hours have elapsed since the previous "All" alignment., and (3) no more than 1 week has elapsed since these three alignments have all been run: IF, RF, and Source, and (4) a 45 minute warm-up period between power-up of the TRX and invoking the "All" alignment. The instrument stops any measurement currently underway, performs the alignment, then restarts the measurement from the beginning (similar to pressing the Restart key).

If an interfering user signal is present at the RF Input, the alignment is performed on all subsystems except the RF. After completion, the Error Condition message "Align skipped: 50 MHz interference" or "Align skipped: 4.8 GHz interference" is generated. In addition the Error Condition message "Align Now, RF required" is generated, and bits 11 and 12 are set in the Status Questionable Calibration register.

The query form of the remote commands (:CALibration[:ALL]? or *CAL?) invokes the alignment of all subsystems and returns a success or failure value. An interfering user signal is not grounds for failure; if the alignment was able to succeed on all portions but unable to align the RF because of an interfering signal, the resultant will be the success value.

Successful completion of Align Now, All will clear the "Align Now, All required" Error Condition, and clear bit 14 in the Status Questionable Calibration register. It will also begin the elapsed time counter for Last Align Now, All Time, and capture the Last Align Now, All Temperature.

If the Align RF subsystem succeeded in aligning (no interfering signal present), the elapsed time counter begins for Last Align Now, RF Time, and the temperature is captured for the Last Align Now, RF Temperature. In addition the Error Conditions “Align skipped: 50 MHz interference” and “Align skipped: 4.8 GHz interference” are cleared, the Error Condition “Align Now, RF required” is cleared, and bits 11 and 12 are cleared in the Status Questionable Calibration register

Align Now, All can be interrupted by pressing the Cancel (ESC) front-panel key or remotely with Device Clear followed by the :ABORT SCPI command. When this occurs the Error Condition message “Align Now, All required” is generated, and bit 14 is set in the Status Questionable Condition register. This is because new alignment data may be employed for an individual subsystem, but not a cohesive set of data for all subsystems.

In many cases, you might find it more convenient to change alignments to Normal, instead of executing Align Now, All. When the Auto Align process transitions to Normal, the analyzer will immediately start to update only the alignments that have expired, thus efficiently restoring the alignment process.

NOTE

In EXM, Source ARB play will be turned off and the source states will not be restored after Align Now, All.

Key Path	System, Alignments, Align Now
Mode	All
Remote Command	:CALibration[:ALL] :CALibration[:ALL]?
Example	:CAL
Notes	:CALibration[:ALL]? returns 0 if successful :CALibration[:ALL]? returns 1 if failed :CALibration[:ALL]? is the same as *CAL? While Align Now, All is performing the alignment, bit 0 in the Status Operation register is set. Completion, or termination, will clear bit 0 in the Status Operation register. This command is sequential; it must complete before further SCPI commands are processed. Interrupting the alignment from remote is accomplished by invoking Device Clear followed by the :ABORT command. Successful completion will clear bit 14 in the Status Questionable Calibration register. An interfering user signal is not grounds for failure of Align Now, All. However, bits 11 and 12 are set in the Status Questionable Calibration register to indicate Align Now, RF is required. An interfering user supplied signal will result in the instrument requiring an Align Now, RF with the interfering signal removed.
Couplings	Initializes the time for the Last Align Now, All Time. Records the temperature for the Last Align Now, All Temperature. If Align RF component succeeded, initializes the time for the Last Align Now, RF Time. If Align RF component succeeded, records the temperature for the Last Align Now, RF Temperature.
Status Bits/OPC dependencies	Bits 11, 12, or 14 may be set in the Status Questionable Calibration register.
Initial S/W Revision	Prior to A.02.00

Mode	All
Remote Command	*CAL?
Example	*CAL?
Notes	*CAL? returns 0 if successful *CAL? returns 1 if failed :CALibration[:ALL]? is the same as *CAL? See additional remarks described with :CALibration[:ALL]? Everything about :CALibration[:ALL]? is synonymous with *CAL? including all conditions, status register bits, and couplings
Initial S/W Revision	Prior to A.02.00

Mode	All
Remote Command	:CALibration[:ALL]:NPENding
Example	CAL:NPEN
Notes	:CALibration[:ALL]:NPENding is the same as :CALibration[:ALL] including all conditions, status register bits, except this scpi command does not BLOCK the scpi session, so the user should use status register bits to query if the calibration is successfully completed or not. Typical usage is: 1) :CALibration:ALL:NPENding (Start a calibration) 2) :STATus:OPERation:CONDition? (Check if the calibration is completed or not, If bit 0 is set, then the system is doing calibration, the user should repeat this scpi query until the bit is cleared) 3):STATus:QUEStionable:CALibration:CONDition? (Check if there are any errors/failures in previous calibration procedure
Initial S/W Revision	X.14.20

Clear Status

Clears the status byte register. It does this by emptying the error queue and clearing all bits in all of the event registers. The status byte register summarizes the states of the other registers. It is also responsible for generating service requests.

Key Path	No equivalent key. Related key System, Show Errors, Clear Error Queue
Remote Command	*CLS
Example	*CLS Clears the error queue and the Status Byte Register.
Notes	For related commands, see the SYSTem:ERRor[:NEXT]? command. See also the STATus:PRESet command and all commands in the STATus subsystem.
Status Bits/OPC dependencies	Resets all bits in all event registers to 0, which resets all the status byte register bits to 0 also.
Backwards Compatibility Notes	In general the status bits used in the X-Series status system will be backwards compatible with ESA and PSA. However, note that all conditions will generate events that go into the event log, and some

	will also generate status bits.
Initial S/W Revision	Prior to A.02.00

Standard Event Status Enable

Selects the desired bits from the standard event status enable register. This register monitors I/O errors and synchronization conditions such as operation complete, request control, query error, device dependent error, status execution error, command error, and power on. The selected bits are OR'd to become a summary bit (bit 5) in the byte register which can be queried.

The query returns the state of the standard event status enable register.

Key Path	No equivalent key. Related key System, Show Errors, Clear Error Queue
Remote Command	*ESE <integer> *ESE?
Example	*ESE 36 Enables the Standard Event Status Register to monitor query and command errors (bits 2 and 5). *ESE? Returns a 36 indicating that the query and command status bits are enabled.
Notes	For related commands, see the STATus subsystem and SYSTem:ERRor[:NEXT]? commands.
Preset	255
State Saved	Not saved in state.
Min	0
Max	255
Status Bits/OPC dependencies	Event Enable Register of the Standard Event Status Register.
Initial S/W Revision	Prior to A.02.00

Standard Event Status Register Query

Queries and clears the standard event status event register. (This is a destructive read.) The value returned is a hexadecimal number that reflects the current state (0/1) of all the bits in the register.

Remote Command	*ESR?
Example	*ESR? Returns a 1 if there is either a query or command error, otherwise it returns a zero.
Notes	For related commands, see the STATus subsystem commands.
Preset	0
Min	0
Max	255
Status Bits/OPC dependencies	Standard Event Status Register (bits 0 - 7).
Initial S/W Revision	Prior to A.02.00

Identification Query

Returns a string of instrument identification information. The string will contain the model number, serial number, and firmware revision.

The response is organized into four fields separated by commas. The field definitions are as follows:

- Manufacturer
- Model
- Serial number
- Firmware version

Key Path	No equivalent key. See related key System, Show System.
Remote Command	*IDN?
Example	*IDN? Returns instrument identification information, such as: Keysight Technologies, E6640A, US01020004, E.14.50
Initial S/W Revision	Prior to A.02.00
Modified at S/W Revision	x.14.50

Operation Complete

The *OPC command sets bit 0 in the standard event status register (SER) to “1” when pending operations have finished, that is when all overlapped commands are complete. It does not hold off subsequent operations. You can determine when the overlapped commands have completed either by polling the OPC bit in SER, or by setting up the status system such that a service request (SRQ) is asserted when the OPC bit is set.

The *OPC? query returns a “1” after all the current overlapped commands are complete. So it holds off subsequent commands until the "1" is returned, then the program continues. This query can be used to synchronize events of other instruments on the external bus.

Remote Command	*OPC *OPC?
Example	INIT:CONT 0 Selects single sweeping. INIT:IMM Initiates a sweep. *OPC? Holds off any further commands until the sweep is complete.
Status Bits/OPC dependencies	Not global to all remote ports or front panel. *OPC only considers operation that was initiated on the same port as the *OPC command was issued from. *OPC is an overlapped command, but *OPC? is sequential.
Backwards Compatibility Notes	1. The ESA/PSA/VSA products do not meet all the requirements for the *OPC command specified by IEEE 488.2. This is corrected for X-Series. This will sometimes cause behavior that is not backward compatible, but it will work as customers expect.

2. Commands such as, *OPC/*OPC?/*WAI/*RST used to be global. They considered front panel operation in conjunction with the GPIB functionality. Now they are evaluated on a per channel basis. That is, the various rear panel remote ports and the front panel i/o are all considered separately. Only the functionality initiated on the port where the *OPC was sent, is considered for its operation.

3. *OPC used to hold off until the operation bits were cleared. Now it holds off until all overlapping commands are completed. Also, earlier instruments did not wait for completion of all processes, only the ones identified here (in the STATus:OPERation register):

Calibrating: monitored by PSA, ESA, VSA (E4406A)

Sweeping: monitored by PSA, ESA, VSA (E4406A)

Waiting for Trigger: monitored by PSA, ESA, VSA (E4406A)

Measuring: monitored by PSA and ESA (but not in all Modes).

Paused: monitored by VSA (E4406A).

Printing: monitored by VSA (E4406A).

Mass memory busy: monitored by VSA (E4406A).

Initial S/W Revision	Prior to A.02.00
----------------------	------------------

Query Instrument Options

Returns a string of all the installed instrument options. It is a comma separated list with quotes, such as: "503,P03,PFR".

To be IEEE compliant, this command should return an arbitrary ascii variable that would not begin and end with quotes. But the quotes are needed to be backward compatible with previous SA products and software. So, the actual implementation will use arbitrary ascii. But quotes will be sent as the first and last ascii characters that are sent with the comma-separated option list.

Remote Command	*OPT?
-----------------------	-------

Initial S/W Revision	Prior to A.02.00
----------------------	------------------

Recall Instrument State

This command recalls the instrument state from the specified instrument memory register.

- If the state being loaded has a newer firmware revision than the revision of the instrument, no state is recalled and an error is reported
- If the state being loaded has an equal firmware revision than the revision of the instrument, the state will be loaded.
- If the state being loaded has an older firmware revision than the revision of the instrument, the instrument will only load the parts of the state that apply to the older revision.

Remote Command	*RCL <register #>
-----------------------	-------------------

Example	*RCL 7 Recalls the instrument state that is currently stored in register 7.
----------------	---

Notes	Registers 0 through 6 are accessible from the front panel in menu keys for Recall Registers.
Min	0
Max	127
Status Bits/OPC dependencies	The command is sequential.
Initial S/W Revision	Prior to A.02.00

*RST (Remote Command Only)

*RST is equivalent to :SYST:PRES;:INIT:CONT OFF, which is a Mode Preset in the Single measurement state. This remote command is preferred over Mode Preset remote command - :SYST:PRES, as optimal remote programming occurs with the instrument in the single measurement state.

Remote Command	*RST
Example	*RST
Notes	Sequential Clears all pending OPC bits and the Status Byte is set to 0.
Couplings	A *RST will cause the currently running measurement to be aborted and cause the default measurement to be active. *RST gets the mode to a consistent state with all of the default couplings set.
Backwards Compatibility Notes	In legacy analyzers *RST did not set the analyzer to Single, but in the X-Series it does, for compliance with the IEEE 488.2 specification. In the X-Series, *RST does not do a *CLS (clear the status bits and the error queue). In legacy analyzers, *RST used to do the equivalent of SYSTem:PRESet, *CLS and INITiate:CONTinuous OFF. But to be 488.2 compliant, *RST in the X-Series does not do a *CLS.
Initial S/W Revision	Prior to A.02.00

Save Instrument State

This command saves the current instrument state and mode to the specified instrument memory register.

Remote Command	*SAV <register #>
Example	*SAV 9 Saves the instrument state in register 9.
Notes	Registers 0 through 6 are accessible from the front panel in menu keys for Save Registers.
Min	0
Max	127
Status Bits/OPC dependencies	The command is sequential.
Initial S/W Revision	Prior to A.02.00

Service Request Enable

This command enables the desired bits of the service request enable register.

The query returns the value of the register, indicating which bits are currently enabled.

Remote Command	*SRE <integer> *SRE?
Example	*SRE 22 Enables bits 1, 2, and 4 in the service request enable register.
Notes	For related commands, see the STATus subsystem and SYSTem:ERRor[:NEXT]? commands.
Preset	0
Min	0
Max	255
Status Bits/OPC dependencies	Service Request Enable Register (all bits, 0 - 7).
Initial S/W Revision	Prior to A.02.00

Status Byte Query

Returns the value of the status byte register without erasing its contents.

Remote Command	*STB?
Example	*STB? Returns a decimal value for the bits in the status byte register. For example, if a 16 is returned, it indicates that bit 5 is set and one of the conditions monitored in the standard event status register is set.
Notes	See related command *CLS.
Status Bits/OPC dependencies	Status Byte Register (all bits, 0 - 7).
Initial S/W Revision	Prior to A.02.00

Trigger

This command triggers the instrument. Use the :TRIGger[:SEquence]:SOURce command to select the trigger source.

Key Path	No equivalent key. See related keys Single and Restart.
Remote Command	*TRG
Example	*TRG Triggers the instrument to take a sweep or start a measurement, depending on the current instrument settings.
Notes	See related command :INITiate:IMMEDIATE.
Initial S/W Revision	Prior to A.02.00

Self Test Query

This query performs the internal self-test routines and returns a number indicating the success of the testing. A zero is returned if the test is successful, 1 if it fails.

Remote Command	*TST?
Example	*TST? Runs the self-test routines and returns 0=passed, 1=some part failed.
Initial S/W Revision	Prior to A.02.00

Wait-to-Continue

This command causes the instrument to wait until all overlapped commands are completed before executing any additional commands. There is no query form for the command.

Remote Command	*WAI
Example	INIT:CONT OFF; INIT;*WAI Sets the instrument to single sweep. Starts a sweep and waits for its completion.
Status Bits/OPC dependencies	Not global to all remote ports or front panel. *OPC only considers operation that was initiated on the same port as the *OPC command was issued from.
Initial S/W Revision	Prior to A.02.00

(Undefined variable: Primary.ProductName)
LTE TDD Measurement Application Reference

4 Input/Output Functions

Input/Output

The Input/Output features are common across multiple Modes and Measurements. These common features are described in this section. See the Measurement description for information on features that are unique.

The Input/Output key accesses the keys that control the Input/Output parameters of the instrument. In general, these are functions associated with external connections to the analyzer, either to the inputs or the outputs. Since these connections tend to be fairly stable within a given setup, in general, the input/output settings do not change when you Preset the analyzer.

Other functions related to the input/output connections, but which tend to change on a measurement by measurement basis, can be found under the Trigger and AMPTD Y Scale keys. In addition, some of the digital I/O bus configurations can be found under the System key.

NOTE

The functions in the Input/Output menu are "global" (common) to all Modes (applications). But individual Input/Output functions only appear in a Mode if they apply to that Mode. Functions that apply to a Mode but not to all measurements in the Mode may be grayed-out in some measurements.

["Input/Output variables - Preset behavior" on page 183](#)

The Input Port selection is the first menu under the Input/Output key:

Key Path	Front-panel key
Remote Command	<code>[:SENSe] :FEED RF AIQ EMIXer</code> <code>[:SENSe] :FEED?</code>
Example	<code>:FEED RF</code> <code>:FEED?</code>
Couplings	The <code>[:SENSe] :FEED RF</code> command turns the calibrator OFF
Preset	This setting is unaffected by a Preset or power cycle. It survives a Mode Preset and mode changes. It is set to RF on a "Restore Input/Output Defaults" or "Restore System Defaults->All"
State Saved	Saved in instrument state
Backwards Compatibility SCPI	<code>[:SENSe] :FEED AREFERENCE</code> In the PSA the calibrator was one of the inputs and selected using the AREF parameter to the same <code>:FEED</code> command that switched the inputs. In the X-Series it is controlled in a separate menu and overrides the input selection. For code compatibility the <code>[:SENSe] :FEED AREFERENCE</code> command is provided, and is aliased to <code>[:SENSe] :FEED :AREF REF50</code> , which causes the input to be switched to the 50 MHz calibrator. The <code>[:SENSe] :FEED RF</code> command switches the input back to the RF port and turns the calibrator OFF, thus providing full compatibility with the PSA calibrator function. Note that after sending this, the query <code>[:SENSe] :FEED?</code> will NOT return "AREF" but instead the currently selected input.
Backwards Compatibility SCPI	<code>[:SENSe] :FEED IQ IONLy QONLy</code> <code>[:SENSe] :FEED?</code> The parameters <code>IQ IONLy QONLy</code> are supported for backwards compatibility with the E44406A. <code>[:SENSe] :FEED IQ</code> aliases to <code>[:SENSe] :FEED :IQ :TYPE IQ</code> <code>[:SENSe] :FEED IONLy</code> aliases to <code>[:SENSe] :FEED :IQ :TYPE IONLy</code>

	<p>[;SENSe]:FEED QONLY aliases to [;SENSe]:FEED:IQ:TYPE QONLY</p> <p>The query [;SENSe]:FEED? will always returns AIQ whatever the type of legacy parameters IQ IONLY QONLY has been used.</p>
Backwards Compatibility Notes	<p>Most of the settings in the X-Series Input/Output system, including External Gain, Amplitude Corrections settings and data, etc., are shared by all modes and are not changed by a mode switch. Furthermore, most variables in the Input/Output system key are not affected by Mode Preset. Both of these behaviors represent a departure from legacy behavior.</p> <p>In the X-Series. Input/Output settings are reset by using the "Restore Input/Output Defaults" function. They can also be reset to their default values through the System->Restore System Defaults-> In/Out Config key or through the System ->Restore System Defaults -> All key (and corresponding SCPI).</p> <p>While this matches most use cases better, it does create some code compatibility issues. For example, Amplitude Corrections are no longer turned off by a Mode Preset, but instead by using the "Restore Input/Output Defaults" key/SCPI.</p> <p>Although Input/Output settings are not part of each Mode's State, they are saved in the Save State files, so that all of the instrument settings can be recalled with Recall State, as in legacy instruments.</p>
Initial S/W Revision	Prior to A.02.00
Remote Command	<p>:INPut:MIxer EXTeRnal INTeRnal</p> <p>:INPut:MIxer?</p>
Example	<p>INP:MIX INT</p> <p>INP:MIX?</p>
Notes	<p>In legacy analyzers you choose between the Internal mixer or an External Mixer. In the X-Series, the External Mixer is one of the choices for the Input and is selected using the FEED command (:SENSe:FEED EXTMIxer).</p> <p>For compatibility, the INPut:MIxer EXTeRnal INTeRnal legacy command is mapped as follows:</p> <ol style="list-style-type: none"> 1. When INPut:MIxer EXTeRnal is received, SENSe:FEED EMIXer is executed. 2. When INPut:MIxer INTeRnal is received, SENSe:FEED RF is executed. 3. When INPut:MIxer? is received, the response will be INT if any input other than the external mixer is selected and EXT if the external mixer is selected
Preset	INT
Backwards Compatibility Notes	<p>PSA supports the following SCPI Command :</p> <p>:INPut:MIxer:TYPE PReselected UNPReselect</p> <p>:INPut:MIxer:TYPE?</p> <p>PXA does not support the :INPut:MIxer:TYPE command.</p>
Initial S/W Revision	A.08.01

Input/Output variables - Preset behavior

Virtually all the input/output settings are NOT a part of mode preset. They can be set to their default value

by one of the three ways:

- by using the Restore Input/Output Defaults key on the first page of the input/output menu,
- by using the System->Restore System Defaults->Input/Output Settings or,
- by using the System -> Restore System Defaults->All. Also, they survive a Preset and a Power cycle.

A very few of the Input/Output settings do respond to a Mode Preset; for example, if the Calibrator is on it turns off on a Preset, and if DC coupling is in effect it switches to AC on a Preset. These exceptions are made in the interest of reliability and usability, which overrides the need for absolute consistency. Exceptions are noted in the SCPI table for the excepted functions.

RF Input

Selects the front-panel RF input port to be the analyzer signal input. If RF is already selected, pressing this key accesses the RF input setup functions.

Key Path	Input/Output
Example	[:SENSe]:FEED RF
Couplings	The act of connecting the U7227A USB Preamplifier to one of the analyzer's USB ports will cause the Input to automatically switch to the RF Input. If the RF Calibrator is on, it is turned off. Subsequently disconnecting the USB Preamp from USB does not change the Input selection nor restore the previous selection.
Readback	The RF input port, RF coupling, and current input impedance settings appear on this key as: "XX, YY, ZZ" where XX is RF, RF2, RFIO1, RFIO2, depending on what input is selected (only appears on analyzers with multiple RF inputs) YY is AC or DC ZZ is 50Ω or 75Ω
Initial S/W Revision	Prior to A.02.00
Modified at S/W Revision	A.14.00

Input Z Correction

Sets the input impedance for unit conversions. This affects the results when the y-axis unit is voltage or current units (dBmV, dBμV, dBμA, V, A), but not when it is power units (dBm, W). The impedance you select is for computational purposes only, since the actual impedance is set by internal hardware to 50 ohms. Setting the computational input impedance to 75 ohms is useful when using a 75 ohm to 50 ohm adapter to measure a 75 ohm device on an analyzer with a 50 ohm input impedance.

There are a variety of ways to make 50 to 75 ohm transitions, such as impedance transformers or minimum loss pads. The choice of the solution that is best for your measurement situation requires balancing the amount of loss that you can tolerate with the amount of measurement frequency range that you need. If you are using one of these pads/adaptors with the Input Z Corr function, you might also want to use the Ext Gain key. This function is used to set a correction value to compensate for the gain (loss) through your pad. This correction factor is applied to the displayed measurement values.

Key Path	Input/Output, RF Input
Remote Command	<code>[:SENSe] :CORRection:IMPedance [:INPut] [:MAGNitude] 50 75</code> <code>[:SENSe] :CORRection:IMPedance [:INPut] [:MAGNitude] ?</code>
Example	CORR:IMP 75 sets the input impedance correction to 75 ohms. CORR:IMP?
Preset	This is unaffected by a Preset but is set to 50 ohms on a "Restore Input/Output Defaults" or "Restore System Defaults->All" Some instruments/options may have 75 ohms available.
State Saved	Saved in instrument state
Readback	50 Ω or 75 Ω . Current setting reads back to the RF key.
Initial S/W Revision	Prior to A.02.00

RF Input Port

Specifies the RF input port used. The RF Input Port key only appears on units with multiple inputs, and lets you switch between the two inputs.

Switching from the RF input port to one of the RFIO ports, on units that have them, changes the receiver performance of the instrument.

Key Path	Input/Output, RF Input
Remote Command	<code>[:SENSe] :FEED:RF:PORT [:INPut] RFIN RFIN2 RFIO1 RFIO2 RFIO3 RFIO4</code> <code>[:SENSe] :FEED:RF:PORT [:INPut] ?</code>
Example	:FEED:RF:PORT RFIN
Dependencies	This key only appears in models that support multiple inputs. If the SCPI command is sent with unsupported parameters in any other model, an error is generated, -221.1900, "Settings conflict;option not installed" When any input is selected in a measurement that does not support it, the "No result; Meas invalid with this input" error condition occurs, and the measurement returns invalid data when queried.
Preset	This is unaffected by Mode Preset but is set to RF on a "Restore Input/Output Defaults" or "Restore System Defaults -> All"
State Saved	Saved in instrument state
Readback	The current RF Input Port selected is read back to this key
Backwards Compatibility SCPI	<code>INPut<1 2>:TYPE INPUT1 INPUT2</code> <code>INPut<1 2>:TYPE?</code> Included for R&S ESU compatibility. In the MXE, the INPUT1 parameter is aliased to RFIN and the INPUT2 parameter is aliased to RFIN2
Initial S/W Revision	A.05.01
Modified at S/W Revision	A.14.00

RF Input

Specifies using the main RF port for the current measurement

Key Path	Input/Output, RF Input, RF Input Port
Example	:FEED:RF:PORT RFIN
Notes	On E6640A with hardware M9430A, if RF Input is selected as RF Input Port, you need to choose the settings in the Half Duplex Config menu to determine which port (RFIO3 or RFIO4) will be used. On E6640A with hardware M9431A, this setting is not supported. If the SCPI command is sent with this setting, an error is generated, -221, "Settings conflict;option not installed"
ReadBack	RF Input
Initial S/W Revision	A.05.01
Modified at S/W Revision	A.14.00

RFIO1

Specifies using the RFIO 1 port for the current measurement

Key Path	Input/Output, RF Input, RF Input Port
Example	:FEED:RF:PORT RFIO1
Dependencies	RFIO1 is not available inE6607C. If Multiport Adapter is ON, Select RF Input to RFIO1, an error message is generated: "-221, Settings conflict; RFIO1 or RFIO2 Port unavailable when Multiport Adapter is ON".
ReadBack	RFIO 1
Initial S/W Revision	A.05.01

RFIO2

Specifies using the RFIO 2 port for the current measurement

Key Path	Input/Output, RF Input, RF Input Port
Example	:FEED:RF:PORT RFIO2
Dependencies	RFIO2 is not available inE6607C. If Multiport Adapter is ON, Select RF Input to RFIO2, an error message is generated: "-221, Settings conflict; RFIO1 or RFIO2 Port unavailable when Multiport Adapter is ON".
ReadBack	RFIO 2
Initial S/W Revision	A.05.01

External Gain

Compensates for gain or loss in the measurement system outside the spectrum analyzer. The External Gain is subtracted from the amplitude readout (or the loss is added to the amplitude readout). So, the displayed signal level represents the signal level at the output of the device-under-test, which can be the input of an external device that provides gain or loss.

Entering an External Gain value does not affect the Reference Level, therefore the trace position on screen changes, as do all of the values represented by the trace data. Thus, the values of exported trace data, queried trace data, marker amplitudes, trace data used in calculations such as N dB points, trace math, peak threshold, etc., are all affected by External Gain. Changing the External Gain, even on a trace that is not updating, will immediately change all of the above, without new data needing to be taken.

NOTE

Changing the External Gain causes the analyzer to immediately stop the current sweep and prepare to begin a new sweep. The data will not change until the trace data updates because the offset is applied to the data as it is taken. If a trace is exported with a nonzero External Gain, the exported data will contain the trace data with the offset applied.

In the Spectrum Analyzer mode, a Preamp is the common external device providing gain or loss. In a measurement application mode like GSM or W-CDMA, the gain or loss could be from a BTS (Base Transceiver Station) or an MS (Mobile Station). So in the Spectrum Analyzer mode MS and BTS would be grayed out and the only choice would be Ext Preamp. Similarly in some of the digital communications applications, Ext Preamp will be grayed out and you would have a choice of MS or BTS.

Key Path	Input/Output
Couplings	The Ext Preamp, MS, and BS keys may be grayed out depending on which measurement is currently selected. If any of the grayed out keys are pressed, or the equivalent SCPI command is sent, an advisory message is generated.
Readback	1-of-N selection [variable]
Initial S/W Revision	Prior to A.02.00

Ext Preamp

This function is similar to the reference level offset function. Both affect the displayed signal level. Ref Lvl Offset is a mathematical offset only, no analyzer configuration is affected. Ext Preamp gain is used when determining the auto-coupled value of the Attenuator. The External Gain value and the Maximum Mixer Level settings are both part of the automatic setting equation for the RF attenuation setting. (10 dB of Attenuation is added for every 10 dB of External Gain.)

Note that the Ref Lvl Offset and Maximum Mixer Level are described in the Amplitude section. They are reset by the instrument Preset. The External Preamp Gain is reset by the "Restore Input/Output Defaults" or "Restore System Defaults->All functions. . The External Gain is subtracted from the amplitude readout so that the displayed signal level represents the signal level at the output of the device-under-test, which is the input of the external device that is providing gain or loss.

["More Information" on page 188](#)

Key Path	Input/Output, External Gain
----------	-----------------------------

Remote Command	<code>[:SENSe] :CORRection:SA[:RF]:GAIN <rel_ampl></code> <code>[:SENSe] :CORRection:SA[:RF]:GAIN?</code>
Example	CORR:SA:GAIN 10 sets the Ext Gain value to 10 dB CORR:SA:GAIN -10 sets the Ext Gain value to -10 dB (that is, an attenuation of 10 dB)
Notes	Does not auto return.
Dependencies	The reference level limits are determined in part by the External Gain/Atten, Max Mixer Level, and RF Atten. This key is grayed out in Modes that do not support External Gain
Preset	This is unaffected by Preset but is set to 0 dB on a "Restore Input/Output Defaults" or "Restore System Defaults->All"
State Saved	Saved in instrument state
Min	-120 dB
Max	120 dB
Readback	Preamp Gain, <Ext Gain value> dB
Backwards Compatibility SCPI	<code>[:SENSe] :CORRection:OFFSet[:MAGNitude]</code> The legacy "Ext Preamp Gain" key is now called "Ext Gain" and the sub-menu has choices of Ext Preamp MS BTS for backwards compatibility.
Initial S/W Revision	Prior to A.02.00
Modified at S/W Revision	A.14.00

More Information

The U7227A USB Preamplifier is an accessory for the X-Series Signal Analyzer that provides gain externally, and whose gain settings are automatically loaded into the analyzer over USB whenever it is connected to one of the analyzer's USB ports.

While the USB Preamplifier is plugged into one of the analyzer's USB ports, the analyzer will consider it to be in the signal path of the RF Input and will apply the calibration data from the USB Preamp to measurements taken at the RF Input (on 2 input boxes, it will be considered to be in the signal path of RF Input 1; it is not supported for RF Input 2).

The USB Preamplifier contains its own cal data. This includes a noise trace suitable for use with NFE, for those models which support NFE. The act of connecting the Preamp to USB will cause the cal data to be downloaded from the preamp. When this happens an informational message is provided saying "Cal data loaded from USB Preamp". The analyzer will then automatically apply the calibration factors loaded from the Preamp in any measurement that supports the USB Preamp.

The External Preamp Gain setting may still be used, even though it is not required for the USB Preamp (since the USB Preamp supplies its own gain data to the analyzer which is applied automatically). Connecting the USB Preamp does not change the External Preamp Gain setting, however unless you have another gain or attenuation element in the signal path, the appropriate setting for External Preamp Gain is 0 dB.

Overload detection and reporting will apply when the USB preamplifier is connected to USB. The USB Preamplifier has its own overload detector which reports overloads to the instrument over USB. This generates an error condition, "Input Overload;USB Preamp."

If, while the USB Preamp is connected to USB, a measurement is selected that does not support the USB preamplifier, the "No result; Meas invalid with Preamp" error condition is generated.

MS

Sets an external gain/attenuation value for MS (Mobile Station) tests.

Key Path	Input/Output, External Gain
Remote Command	<code>[:SENSe] :CORRection:MS[:RF]:GAIN <rel_ampl></code> <code>[:SENSe] :CORRection:MS[:RF]:GAIN?</code>
Example	CORR:MS:GAIN 10 sets the Ext Gain value to 10 dB CORR:MS:GAIN -10 sets the Ext Gain value to -10 dB (that is, a loss of 10 dB.)
Notes	Does not auto return.
Dependencies	The reference level limits are determined in part by the External Gain, Max Mixer Level, RF Atten This key is grayed out in modes that do not support MS.
Preset	This is unaffected by a Preset but is set to 0 dB on a "Restore Input/Output Defaults" or "Restore System Defaults->All"
State Saved	Saved in instrument state.
Min	-100 dB
Max	100 dB
Readback	MS, <Ext Gain value> dB
Initial S/W Revision	Prior to A.02.00

Remote Command	<code>[:SENSe] :CORRection:MS[:RF]:LOSS <rel_ampl></code> <code>[:SENSe] :CORRection:MS[:RF]:LOSS?</code>
Example	CORR:MS:LOSS 10 sets the Ext Gain value to -10 dB, and subsequently querying :LOSS will give 10 dB CORR:MS:LOSS -10 sets the Ext Gain value to 10 dB, and subsequently querying :LOSS will give -10 dB
Notes	A positive value of <rel_ampl> in the above command means a loss and a negative value indicates a gain. Anytime :LOSS is set it sets :GAIN to the negative value of the parameter sent. Anytime :LOSS is queried it gives the negative of :GAIN
Preset	This is unaffected by a Preset but is set to 0 dB on a "Restore Input/Output Defaults" or "Restore System Defaults->All"
Min	100 dB
Max	-100 dB
Initial S/W Revision	Prior to A.02.00

BTS

Sets an external attenuation value for BTS (Base Transceiver Station) tests.

Key Path	Input/Output, External Gain
Remote Command	<code>[:SENSe]:CORRection:BTS[:RF]:GAIN <rel_ampl></code> <code>[:SENSe]:CORRection:BTS[:RF]:GAIN?</code>
Example	<code>CORR:BTS:GAIN 10</code> sets the Ext Gain value to 10 dB <code>CORR:BTS:GAIN -10</code> sets the Ext Gain value to -10 dB (that is, a loss of 10 dB.)
Notes	Does not auto return.
Dependencies	The reference level limits are determined in part by the External Gain, Max Mixer Level, RF Atten This key is grayed out in modes that do not support BTS.
Preset	This is unaffected by a Preset but is set to 0 dB on a "Restore Input/Output Defaults" or "Restore System Defaults->All"
State Saved	Saved in instrument state.
Min	-100 dB
Max	100 dB
Readback	BTS, <Ext Gain value> dB
Initial S/W Revision	Prior to A.02.00

Remote Command	<code>[:SENSe]:CORRection:BTS[:RF]:LOSS <rel_ampl></code> <code>[:SENSe]:CORRection:BTS[:RF]:LOSS?</code>
Example	<code>CORR:BTS:LOSS 10</code> sets the Ext Gain value to -10 dB, and subsequently querying :LOSS will give 10 dB <code>CORR:BTS:LOSS -10</code> sets the Ext Gain value to 10 dB, and subsequently querying :LOSS will give -10 dB
Notes	A positive value of <rel_ampl> in the above command means a loss and a negative value indicates a gain. Anytime :LOSS is set it sets :GAIN to the negative value of the parameter sent. Anytime :LOSS is queried it gives the negative of :GAIN
Preset	This is unaffected by a Preset but is set to 0 dB on a "Restore Input/Output Defaults" or "Restore System Defaults->All"
Min	100 dB
Max	-100 dB
Initial S/W Revision	Prior to A.02.00

Restore Input/Output Defaults

This selection causes the group of settings and data associated with the Input/Output key to be a reset to their default values. In addition, when a Source is installed, licensed and selected, Restore Input/Output defaults will initiate a Source Preset.

This level of Restore System Defaults does not affect any other system settings or mode settings and does not cause a mode switch. All the features described in this section are reset using this key, including Input Corrections and Data (described in the Corrections section).

Key Path	Input/Output
Example	:SYST:DEF INP presets all the Input/Output variables to their factory default values.
Notes	Refer to the Utility Functions for information about Restore System Defaults and the complete description of the :SYSTem:DEFault INPut: command.
Initial S/W Revision	Prior to A.02.00

Corrections

This key accesses the Amplitude Corrections menu.

Amplitude Corrections arrays can be entered, sent over SCPI, or loaded from a file. They allow you to correct the response of the analyzer for various use cases. The X-series supports four separate Corrections arrays, each of which can contain up to 2000 points. They can be turned on and off individually and any or all can be on at the same time.

Trace data is in absolute units and corrections data is in relative units, but we want to be able to display trace data at the same time as corrections data. Therefore we establish a reference line to be used while building or editing a Corrections table. The reference line is halfway up the display and represents 0 dB of correction. It is labeled "0 dB CORREC". It is drawn in blue.

Corrections data is always in dB. Whatever dB value appears in the correction table represents the correction applied to that trace at that frequency. So if a table entry shows 30 dB that means we ADD 30 dB to each trace to correct it before displaying it.

In zero span, where the frequency is always the center frequency of the analyzer, we apply the (interpolated) correction for the center frequency to all points in the trace. In the event where there are two correction amplitudes at the center frequency, we apply the first one in the table.

Note that the corrections are applied as the data is taken; therefore, a trace in View (Update Off) will not be affected by changes made to the corrections table after the trace is put in View.

On the RF Input/Output panel, there are two full-duplex RF ports (RFIO1 and RFIO2), RF Input and RF Output. When RF Input is selected, it will correspond to one input port from two half-duplex RF ports (RFIO3 and RFIO4), and when RF Output is selected, it will correspond to one output port from two half-duplex RF ports (RFIO3 and RFIO4). So there are 8 sets of corrections in all that can be applied to the RF ports. Ports cannot share the same set of corrections but a single port can have multiple corrections applied to it. The correction data is applied to incoming signals as well as transmitted signals and is in the form of a list of spot frequencies and amplitude correction levels.

Key Path	Input/Output, Corrections
Mode	SA, I/Q Analyzer, Phase Noise, VXA, RTSA, EMI Receiver, DVB-T/H, DTMB, DVB-T/H, DTMB, W-CDMA, LTE & LTE-Adv FDD, LTE & LTE-Adv TDD, Sequence Analyzer, BTooth
Dependencies	This key will only appear if you have the proper option installed in your instrument. Amplitude correction may not be available in all modes; if a mode does not support amplitude correction, the Corrections key should be blanked while in that mode. If an application supports corrections but the current measurement does not, then the key should be grayed out in that measurement
Preset	Corrections arrays are reset (deleted) by Restore Input/Output Defaults. They survive shutdown and restarting of the analyzer application, which means they will survive a power cycle.
Initial S/W Revision	A.02.00
Modified at S/W Revision	x.14.50

Select Correction

Specifies the selected correction. The term "selected correction" is used throughout this document to specify which correction will be affected by the functions.

Key Path	Input/Output, Corrections
Mode	SA, I/Q Analyzer, Phase Noise, VXA, RTSA, EMI Receiver, DVB-T/H, DTMB, DVB-T/H, DTMB, W-CDMA, LTE & LTE-Adv FDD, LTE & LTE-Adv TDD, Sequence Analyzer, BTooth
Notes	The selected correction is remembered even when not in the correction menu.
Preset	Set to Correction 1 by Restore Input/Output Defaults
Readback	Correction 1 Correction 2 Correction 3 Correction 4 Correction 5 Correction 6 Correction 7 Correction 8
Initial S/W Revision	A.02.00
Modified at S/W Revision	x.14.50

Correction On/Off

Turning the Selected Correction from the OFF state to the ON state allows the values in it to be applied to the data. This state transition also automatically turns on "Apply Corrections" (sets it to ON), otherwise the correction would not take effect.

A new sweep is initiated if an amplitude correction is switched on or off. Note that changing, sending or loading corrections data does NOT directly initiate a sweep, however in general these operations will turn corrections on, which DOES initiate a sweep.

Key Path	Input/Output, Corrections
Remote Command	[[:SENSe]:CORRection:CSET[1] 2 ... 8[:STATe] ON OFF 1 0 [:SENSe]:CORRection:CSET[1] 2 ... 8[:STATe]?

Example	SENS:CORR:CSET1 ON
Dependencies	<p>Changing this from the OFF state to the ON state automatically turns on "Apply Corrections".</p> <p>Only the first correction array (Correction 1) supports antenna units. When this array is turned on, and it contains an Antenna Unit other than "None", the Y Axis Unit of the analyzer is forced to that Antenna Unit. All other Y Axis Unit choices are grayed out.</p> <p>Note that this means that a correction file with an Antenna Unit can only be loaded into the Corrections 1 register. Consequently only for Correction 1 does the dropdown in the Recall dialog include.ant, and if an attempt is made to load a correction file into any other Correction register which DOES contain an antenna unit, a Mass Storage error is generated.</p> <p>This command will generate an "Option not available" error unless you have the proper option installed in your instrument.</p>
Preset	Not affected by a Preset. Set to OFF by Restore Input/Output Defaults
State Saved	Saved in instrument state.
Backwards Compatibility Notes	Unlike legacy analyzers, Preset does not turn Corrections off (Restore Input/Output Defaults does).
Initial S/W Revision	A.02.00
Modified at S/W Revision	A.14.00

Properties

Accesses a menu that lets you set the properties of the selected correction.

Key Path	Input/Output, Corrections
Initial S/W Revision	A.02.00

Select Correction

Specifies the selected correction. The term "selected correction" is used throughout this document to specify which correction will be affected by the functions.

Key Path	Input/Output, Corrections
Mode	SA, I/Q Analyzer, Phase Noise, VXA, RTSA, EMI Receiver, DVB-T/H, DTMB, DVB-T/H, DTMB, W-CDMA, LTE & LTE-Adv FDD, LTE & LTE-Adv TDD, Sequence Analyzer, BTooth
Notes	The selected correction is remembered even when not in the correction menu.
Preset	Set to Correction 1 by Restore Input/Output Defaults
Readback	Correction 1 Correction 2 Correction 3 Correction 4 Correction 5 Correction 6 Correction 7 Correction 8
Initial S/W Revision	A.02.00
Modified at S/W Revision	x.14.50

Antenna Unit

For devices (like antennas) that make measurements of field strength or flux density, the correction array should contain within its values the appropriate conversion factors such that, when the data on the analyzer is presented in dB μ V, the display is calibrated in the appropriate units. The "Antenna Unit" used for the conversion is contained within the corrections array database. It may be specified or loaded in from an external file or SCPI.

When an array with an Antenna Unit other than "None" is turned on, the Y Axis Unit of the analyzer is forced to that unit. When this array is turned on, and it contains an Antenna Unit other than "None", the Y Axis Unit of the analyzer is forced to that Antenna Unit., and all other Y Axis Unit choices are grayed out.

Antenna Unit does not appear in all Modes that support Corrections. Only the modes listed in the Mode row of the table below support Antenna Units.

Key Path	Input/Output, Corrections, Properties
Mode	SA, I/Q Analyzer, Phase Noise, VXI, RTSA, EMI Receiver, DVB-T/H, DTMB, DVB-T/H, DTMB, W-CDMA, LTE & LTE-Adv FDD, LTE & LTE-Adv TDD, Sequence Analyzer, BTooth
Remote Command	[:SENSE] :CORRection:CSET [1] :ANTenna [:UNIT] GAUSS PTES1a UVM UAM UA NOConversion [:SENSE] :CORRection:CSET [1] :ANTenna [:UNIT] ?
Example	CORR:CSET:ANT GAUS
Dependencies	Only the first correction array (Correction 1) supports antenna units. Note that this means that a correction file with an Antenna Unit can only be loaded into the Corrections 1 register. Consequently only for Correction 1 does the dropdown in the Recall dialog include.ant, and if an attempt is made to load a correction file into any other Correction register which DOES contain an antenna unit, a Mass Storage error is generated.
Preset	Unaffected by Preset. Set to NOC by Restore Input/Output Defaults
State Saved	Saved in instrument state
Initial S/W Revision	A.02.00
Modified at S/W Revision	x.14.50

None

Selects no antenna unit for this Correction set. Thus no Y Axis unit will be forced.

Key Path	Input/Output, Corrections, Properties, Antenna Unit
Example	:CORR:CSET:ANT NOC
Readback	"None"
Initial S/W Revision	A.02.00

dB μ V/m

Sets the antenna unit to dB μ V/m. If this correction is turned on, and Apply Corrections is on, the Y Axis Unit will then be forced to dB μ V/m and all other Y Axis Unit selections will be grayed out.

Key Path	Input/Output, Corrections, Properties, Antenna Unit
Example	:CORR:CSET:ANT UVM
Readback	"dB μ V/m"
Initial S/W Revision	A.02.00

dB μ A/m

Sets the antenna unit to dB μ A/m. If this correction is turned on, and Apply Corrections is on, the Y Axis Unit will then be forced to dB μ A/m and all other Y Axis Unit selections will be grayed out.

Key Path	Input/Output, Corrections, Properties, Antenna Unit
Example	:CORR:CSET:ANT UVA
Readback	" dB μ A/m"
Initial S/W Revision	A.02.00

dBpT

Sets the antenna unit to dBpT. If this correction is turned on, and Apply Corrections is on, the Y Axis Unit will then be forced to dBpT and all other Y Axis Unit selections will be grayed out.

Key Path	Input/Output, Corrections, Properties, Antenna Unit
Example	:CORR:CSET:ANT PTES
Readback	"dBpT"
Initial S/W Revision	A.02.00

dBG

Sets the antenna unit to dBG. If this correction is turned on, and Apply Corrections is on, the Y Axis Unit will then be forced to dBG and all other Y Axis Unit selections will be grayed out.

Key Path	Input/Output, Corrections, Properties, Antenna Unit
Example	:CORR:CSET:ANT GAUS
Readback	" dBG"
Initial S/W Revision	A.02.00

dB μ A

Sets the antenna unit to dB μ A. If this correction is turned on, and Apply Corrections is on, the Y Axis Unit will then be forced to dB μ A and all other Y Axis Unit selections will be grayed out.

Key Path	Input/Output, Corrections, Properties, Antenna Unit
Example	:CORR:CSET:ANT UA
Readback	" dBμA"
Initial S/W Revision	A.11.00

Frequency Interpolation

This setting controls how the correction values per-bucket are calculated. We interpolate between frequencies in either the logarithmic or linear scale.

This setting is handled and stored individually per correction set.

See ["Interpolation" on page 196](#)

Key Path	Input/Output, Corrections, Properties
Remote Command	[:SENSe] :CORRection:CSET [1] 2 ... 8 :X:SPACing LINear LOGarithmic [:SENSe] :CORRection:CSET [1] 2 ... 8 :X:SPACing?
Example	CORR:CSET:X:SPAC LIN
Preset	Unaffected by a Preset. Set to Linear by Restore Input/Output Defaults.
State Saved	Saved in instrument state.
Initial S/W Revision	A.02.00
Modified at S/W Revision	A.14.00

Interpolation

For each bucket processed by the application, all of the correction factors at the frequency of interest (center frequency of each bucket) are summed and added to the amplitude. All trace operations and post processing treat this post-summation value as the true signal to use.

To effect this correction, the goal, for any particular start and stop frequency, is to build a correction trace, whose number of points matches the current Sweep Points setting of the instrument, which will be used to apply corrections on a bucket by bucket basis to the data traces.

For amplitudes that lie between two user specified frequency points, we interpolate to determine the amplitude value. You may select either linear or logarithmic interpolation between the frequencies.

If we interpolate on a log scale, we assume that the line between the two points is a straight line on the log scale. For example, let's say the two points are (2,4) and (20,1). A straight line between them on a log scale looks like:

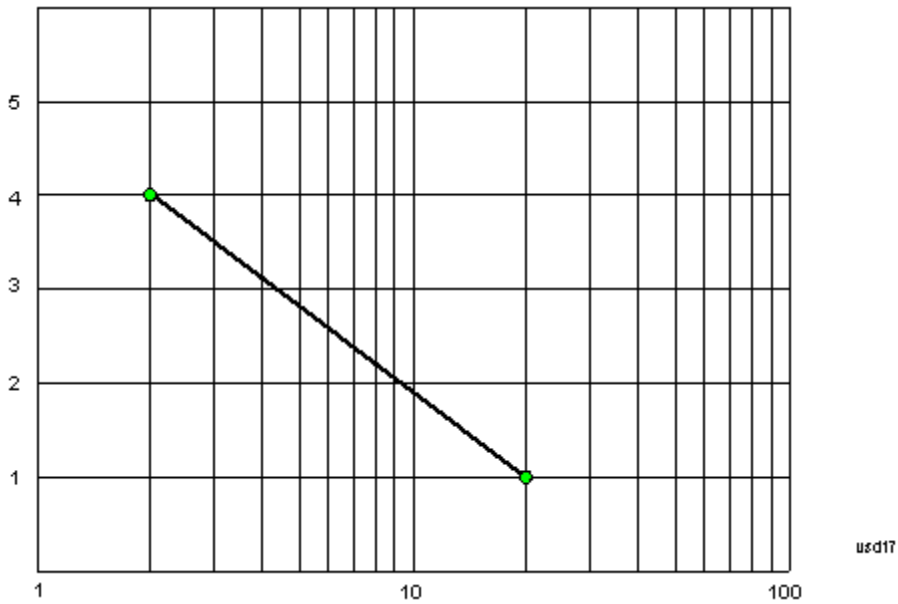

On a linear scale (like that of the spectrum analyzer), this translates to:



If we interpolate on a linear scale, we assume that the two points are connected by a straight line on the linear scale, as below:

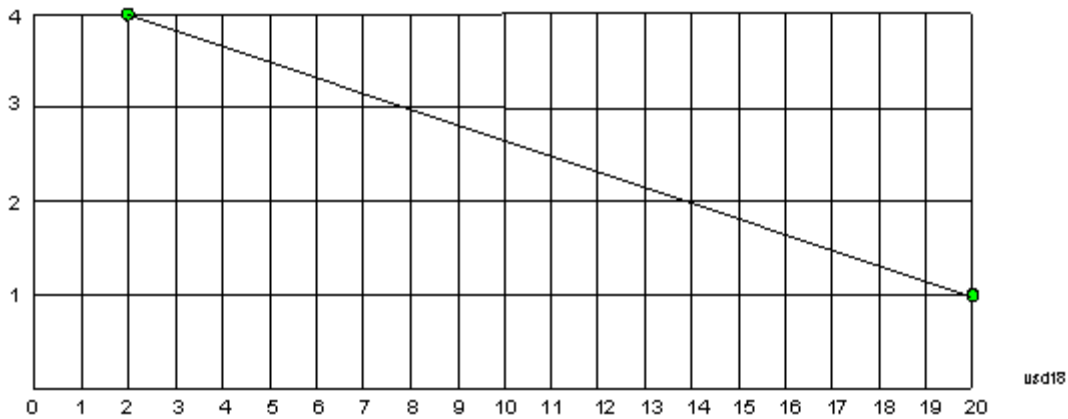

The correction to be used for each bucket is taken from the interpolated correction curve at the center of the bucket.

Description

Sets an ASCII description field which will be stored in an exported file. Can be displayed in the active function area by selecting as the active function, if desired to appear in a screen capture.

Key Path	Input/Output, Corrections, Properties
Remote Command	[[:SENSe]:CORRection:CSET[1] 2 ... 8:DESCRiption "text" [:SENSe]:CORRection:CSET[1] 2 ... 8:DESCRiption?
Example	:CORR:CSET1:DESC "11941A Antenna correction"
Notes	45 chars max; may not fit on display if max chars used
Preset	Unaffected by a Preset. Set to empty by Restore Input/Output Defaults
State Saved	Saved in instrument state.
Initial S/W Revision	A.02.00
Modified at S/W Revision	A.14.00

Comment

Sets an ASCII comment field which will be stored in an exported file. Can be displayed in the active function area by selecting as the active function, if desired to appear in a screen capture.

Key Path	Input/Output, Corrections, Properties
Remote Command	[[:SENSe]:CORRection:CSET[1] 2 ... 8:COMMent "text" [:SENSe]:CORRection:CSET[1] 2 ... 8:COMMent?
Example	:CORR:CSET1:COMM "this is a comment"
Notes	60 chars max; may not fit on display if max chars used
Preset	Unaffected by Preset. Set to empty by Restore Input/Output Defaults
State Saved	Saved in instrument state
Initial S/W Revision	A.02.00
Modified at S/W Revision	A.14.00

RF Port

Maps one of the sets of corrections to one of the IO ports.

Key Path	Input/Output, Corrections, Properties
Mode	SEQAN
Remote Command	[[:SENSe]:CORRection:CSET[1] 2 ... 8:RF:PORT RFIN RFIO1 RFIO2 RFOut GPSout GNSSout RFIO3 RFIO4 [:SENSe]:CORRection:CSET[1] 2 ... 8:RF:PORT?

Example	:CORR:CSET:RF:PORT RFIN
Remote Command Notes	
Dependencies	RFIO1 and RFIO2 are not available in E6607C and E6630A GPSout (GNSSout) are only available in E6607C and E6630A RFIO3 and RFIO4 are only available on E6640A with hardware M9431A. RFIN and RFOut are not available on E6640A with hardware M9431A
Couplings	
Preset	Unaffected by Preset. Set to RF by Restore Input/Output Defaults
State Saved	Saved in State
Initial S/W Revision	A.05.01
Modified at S/W Revision	A.14.00

RF Input

The port that the current corrections will be applied to.

Key Path	Input/Output, Corrections, Properties, RF Port
Example	:CORR:CSET:RF:PORT RFIN
Dependencies	Not available in E6607C Not available on E6640A with hardware M9431A
ReadBack	RF IN
Initial S/W Revision	A.05.01
Modified at S/W Revision	A.14.00

RFOut

The port that the current corrections will be applied to.

Key Path	Input/Output, Corrections, Properties, RF Port
Example	:CORR:CSET:RF:PORT RFO
Dependencies	Not available in E6607C Not available on E6640A with hardware M9431A
ReadBack	RFOut
Initial S/W Revision	A.05.01
Modified at S/W Revision	A.14.00

RFIO1

The port that the current corrections will be applied to. Pressing this key again allows the user access to the menu for specifying which internal device the corrections for RFIO 1 will be applied to.

Key Path	Input/Output, Corrections, Properties, RF Port
Remote Command	[[:SENSe]:CORRection:CSET[1] 2 ... 8:RF:PORT:RFIO1 SOURce ANALyzer BOTH [:SENSe]:CORRection:CSET[1] 2 ... 8:RF:PORT:RFIO1?
Example	:CORR:CSET:RF:PORT:RFIO1 BOTH
Preset	Both
State Saved	Saved in State

Correct Source

Sets the corrections for the RFIO1 port to be applied to the source.

Key Path	Input/Output, Corrections, Properties, RF Port
Example	:CORR:CSET:RF:PORT:RFIO1 SOUR
Readback	"Correct Source"

Correct Analyzer

Sets the corrections for the RFIO1 port to be applied to the analyzer.

Key Path	Input/Output, Corrections, Properties, RF Port
Example	:CORR:CSET:RF:PORT:RFIO1 ANAL
Readback	"Correct Analyzer"

Correct Source and Analyzer

Sets the corrections for the RFIO1 port to be applied to both the source and the analyzer.

Key Path	Input/Output, Corrections, Properties, RF Port
Example	:CORR:CSET:RF:PORT:RFIO1 BOTH
Readback	"Correct Source and Analyzer"

RFIO2

The port that the current corrections will be applied to. Pressing this key again allows the user access to the menu for specifying which internal device the corrections for RFIO 2 will be applied to.

Key Path	Input/Output, Corrections, Properties, RF Port
Remote Command	[:SENSE] :CORRection:CSET [1] 2 . . . 8 :RF:PORT:RFIO2 SOURce ANALyzer BOTH [:SENSe] :CORRection:CSET [1] 2 . . . 8 :RF:PORT:RFIO2 ?
Example	:CORR:CSET:RF:PORT:RFIO2 BOTH
Preset	Both
State Saved	Saved in State

Correct Source

Sets the corrections for the RFIO2 port to be applied to the source.

Key Path	Input/Output, Corrections, Properties, RF Port
Example	:CORR:CSET:RF:PORT:RFIO2 SOUR
Readback	"Correct Source"

Correct Analyzer

Sets the corrections for the RFIO2 port to be applied to the analyzer.

Key Path	Input/Output, Corrections, Properties, RF Port
Example	:CORR:CSET:RF:PORT:RFIO2 ANAL
Readback	"Correct Analyzer"

Correct Source and Analyzer

Sets the corrections for the RFIO2 port to be applied to both the source and the analyzer.

Key Path	Input/Output, Corrections, Properties, RF Port
Example	:CORR:CSET:RF:PORT:RFIO2 BOTH
Readback	"Correct Source and Analyzer"

Edit

Invokes the integrated editing facility for this correction set.

When entering the menu, the editor window turns on, the selected correction is turned On, Apply Corrections is set to On, the amplitude scale is set to Log, and the Amplitude Correction ("Ampcor") trace is displayed. The actual, interpolated correction trace is shown in green for the selected correction. Note that since the actual interpolated correction is shown, the correction trace may have some curvature to it. This trace represents only the correction currently being edited, rather than the total, accumulated amplitude

correction for all amplitude corrections which are currently on, although the total, accumulated correction for all corrections which are turned on is still applied to the data traces.

Because corrections data is always in dB, but the Y-axis of the analyzer is in absolute units, it is necessary to establish a reference line for display of the Corrections data. The reference line is halfway up the display and represents 0 dB of correction. It is labeled "0 dB CORREC". It is drawn in blue.

Corrections data is always in dB. Whatever dB value appears in the correction table represents the correction to be applied to that trace at that frequency. So if a table entry shows 30 dB that means we ADD 30 dB to each trace to correct it before displaying it. By definition all points are connected. If a gap is desired for corrections data, enter 0 dB.

Note that a well-designed Corrections array should start at 0 dB and end at 0 dB. This is because whatever the high end point is will be extended to the top frequency of the instrument, and whatever the low end point is will be extended down to 0 Hz. So for a Corrections array to have no effect outside its range, you should start and end the array at 0 dB.

NOTE

The table editor will only operate properly if the analyzer is sweeping, because its updates are tied to the sweep system. Thus, you should not try to use the editor in single sweep, and it will be sluggish during compute-intensive operations like narrow-span FFT sweeps.

When exiting the edit menu (by using the Return key or by pressing an instrument front-panel key), the editor window turns off and the Ampcor trace is no longer displayed; however, Apply Corrections remains On, any correction that was on while in the editor remains on, and the amplitude scale returns to its previous setting.

Corrections arrays are not affected by a Preset, because they are in the Input/Output system. They also survive shutdown and restarting of the analyzer application, which means they will survive a power cycle.

When editing a correction, the editor remembers which correction and which element in the correction array you were editing, and returns you to that correction and that element when you return to the editor after leaving it.

Key Path	Input/Output, Corrections
Initial S/W Revision	A.02.00

Navigate

Lets you move through the table to edit the desired point.

Key Path	Input/Output, Corrections, Edit
Notes	There is no value readback on the key
Min	1
Max	2000
Initial S/W Revision	A.02.00

Frequency

Lets you edit the frequency of the current row.

Key Path	Input/Output, Corrections, Edit
Notes	There is no value readback on the key.
Min	0
Max	1 THz
Initial S/W Revision	A.02.00

Amplitude

Lets you edit the Amplitude of the current row.

Key Path	Input/Output, Corrections, Edit
Notes	There is no value readback on the key.
Min	-1000 dB
Max	1000 dB
Initial S/W Revision	A.02.00

Insert Point Below

Inserts a point below the current point. The new point is a copy of the current point and becomes the current point. The new point is not yet entered into the underlying table, and the data in the row is displayed in light gray.

Key Path	Input/Output, Corrections, Edit
Initial S/W Revision	A.02.00

Delete Point

Deletes the currently-selected point, whether or not that point is being edited, and selects the Navigate functionality. The point following the currently-selected point (or the point preceding if there is none) will be selected.

Key Path	Input/Output, Corrections, Edit
Initial S/W Revision	A.02.00

Delete Correction

Deletes the correction values for this set. When this key is pressed a prompt is placed on the screen that says "Please press Enter or OK key to delete correction. Press ESC or Cancel to close this dialog." The

deletion is only performed if you press OK or Enter.

Key Path	Input/Output, Corrections
Remote Command	[:SENSe] :CORRection:CSET [1] 2 ... 6 :DELete
Example	CORR:CSET:DEL CORR:CSET1:DEL CORR:CSET4:DEL
Notes	Pressing this key when no corrections are present is accepted without error.
Initial S/W Revision	A.02.00

Apply Corrections

Applies amplitude corrections, which are marked as ON to the measured data. If this is set to OFF, then no amplitude correction sets will be used, regardless of their individual on/off settings. If set to ON, the corrections that are marked as ON (see "[Correction On/Off](#)" on page 192) are used.

Key Path	Input/Output, Corrections
Remote Command	[:SENSe] :CORRection:CSET:ALL [:STATe] ON OFF 1 0 [:SENSe] :CORRection:CSET:ALL [:STATe] ?
Example	SENS:CORR:CSET:ALL OFF This command makes sure that no amplitude corrections are applied, regardless of their individual on/off settings.
Preset	Not affected by Preset. Set to OFF by Restore Input/Output Defaults
State Saved	Saved in instrument state.
Initial S/W Revision	A.02.00

Delete All Corrections

Erases all correction values for all 4 Amplitude Correction sets.

When this key is pressed a prompt is placed on the screen that says "Please press Enter or OK key to delete all corrections. Press ESC or Cancel to close this dialog." The deletion is only performed if you press OK or Enter.

Key Path	Input/Output, Corrections
Remote Command	[:SENSe] :CORRection:CSET:ALL:DELete
Example	CORR:CSET:ALL:DEL
Initial S/W Revision	A.02.00

Remote Correction Data Set Commands

This section describes the remote (SCPI) commands used to put values into correction sets. See the correction / table editor section of the Input/Output section for the information on front panel entry of correction data.

"Set (Replace) Data (Remote Command Only)" on page 205

"Merge Correction Data (Remote Command Only)" on page 205

Set (Replace) Data (Remote Command Only)

The command takes an ASCII series of alternating frequency and amplitude points, each value separated by commas.

The values sent in the command will totally replace all existing correction points in the specified set.

An Ampcor array can contain 2000 points maximum.

Remote Command	<code>[:SENSe] :CORRection:CSET[1] 2 ... 8:DATA <freq>, <ampl>, . . .</code> <code>[:SENSe] :CORRection:CSET[1] 2 ... 8:DATA?</code>
Example	<code>CORR:CSET1:DATA 10000000, -1.0, 20000000, 1.0</code> This defines two correction points at (10 MHz, -1.0 dB) and (20 MHz, 1.0 dB) for correction set 1.
Preset	Empty after Restore Input/Output Defaults. Survives a shutdown or restart of analyzer application (including a power cycle).
State Saved	Saved in instrument state.
Min	Freq: 0 Hz Amptd: -1000 dBm
Max	Freq: 1 THz Amptd: +1000 dBm
Initial S/W Revision	A.02.00
Modified at S/W Revision	A.14.00

Merge Correction Data (Remote Command Only)

The command takes an ASCII series of alternating frequency and amplitude points, each value separated by commas. The difference between this command and Set Data is that this merges new correction points into an existing set.

Any new point with the same frequency as an existing correction point will replace the existing point's amplitude with that of the new point.

An Ampcor array can contain 2000 total points, maximum.

Remote Command	<code>[:SENSe] :CORRection:CSET[1] 2 ... 8:DATA:MERGe <freq>, <ampl>, ...</code>
Example	<code>CORR:CSET1:DATA:MERGE 15000000, -5.0, 25000000, 5.0</code> This adds two correction points at (15 MHz, -5.0 dB) and (25 MHz, 5.0 dB) to whatever values already exist in correction set 1.

Preset	Empty after Restore Input/Output Defaults. Survives shutdown/restart of analyzer application (including power cycle)
Min	Freq: 0 Hz Amptd: -1000 dBm
Max	Freq: 1 THz Amptd: +1000 dBm
Initial S/W Revision	A.02.00
Modified at S/W Revision	A.14.00

Freq Ref In

Specifies the frequency reference as being the internal reference at the rear panel input labeled EXT REF IN, a 1 pulse per second signal at the EXT REF IN input, external reference or sensing the presence of a signal at the EXT REF IN input.

When the frequency reference is set to internal, the internal 10 MHz reference is used even if an external reference is connected.

When the frequency reference is set to external, the instrument will use the external reference. However, if there is no external signal present, or it is not within the proper amplitude range, a condition error message is generated. When the external signal becomes valid, the error is cleared.

When the frequency reference is set to Pulse, the instrument expects a 1 pulse per second signal at the EXT REF IN input. The instrument uses this signal to adjust the frequency of the internal reference.

If Sense is selected, the instrument checks whether a signal is present at the external reference connector. If it senses a signal within 5 ppm of the External Ref Freq (as set on the External Ref Freq softkey), it will automatically switch to the external reference. If it senses a 1 pulse per second signal, it enters Pulse mode, wherein the signal is used to adjust the internal reference. When no signal is present, it automatically switches to the internal reference. No message is generated as the reference switches between pulse, external and internal. The monitoring of the external reference occurs approximately on 1 millisecond intervals, and never occurs in the middle of a measurement acquisition, only at the end of the measurement (end of the request).

If for any reason the instrument's frequency reference is not able to obtain lock, Status bit 1 in the Questionable Frequency register will be true and a condition error message is generated. When lock is regained, Status bit 1 in the Questionable Frequency register will be cleared and the condition error will be cleared.

If an external frequency reference is being used, you must enter the frequency of the external reference if it is not exactly 10 MHz. The External Ref Freq key is provided for this purpose.

NOTE:

A common frequency reference module serves all instrument instances, but only one instance of the software application can change the reference input type (INT or EXT or SENSE). The software application allowed to change the reference input is called the controlling instance; by default, the left most instrument instance is the controlling instance. This can be changed in the config file "E66XXModules.config" located under the folder E:\Agilent\Instrument. For the non-controlling instance

(s) the reference input types (in SCPI commands, and in the Virtual Front Panel menus) are blanked and unavailable for use.

Key Path	Input/Output
Remote Command	<code>[:SENSe] :ROSCillator :SOURce :TYPE INTernal EXTernal SENSe PULSe</code> <code>[:SENSe] :ROSCillator :SOURce :TYPE?</code>
Dependencies	The PULSe parameter, and support of the 1 pps signal at the EXT REF IN input, are not available in firmware prior to A.13.00. They are also not available in some model numbers. If not available, the Pulse key will be blank, and sending the PULSe parameter via SCPI will generate an error:
Preset	This is unaffected by a Preset but is set to SENSe on a "Restore Input/Output Defaults" or "Restore System Defaults->All".
State Saved	Saved in instrument state.
Status Bits/OPC dependencies	STATus:QUEStionable:FREQUency bit 1 set if unlocked. Note: The status bit is not set for non-controlling instances. To determine if the frequency reference is unlocked, the controlling instance must be queried.
Backwards Compatibility Notes	Freq Ref In was not saved in state in the legacy instruments. It is a part of state in the X-Series.
Initial S/W Revision	Prior to A.02.00
Modified at S/W Revision	A.14.00

Remote Command	<code>[:SENSe] :ROSCillator :SOURce?</code>
Notes	The query <code>[SENSe]:ROSCillator:SOURce?</code> returns the current switch setting. This means: <ol style="list-style-type: none"> 1. If it was set to SENSe but there is no external reference nor 1 pps signal so the instrument is actually using the internal reference, then this query returns INTernal and not SENSe. 2. If it was set to SENSe and there is an external reference present, the query returns EXTernal and not SENSe. 3. If it was set to SENSe and there is a 1 pps signal present, the query returns PULSe and not SENSe. 4. If it was set to EXTernal, then the query returns "EXTernal" 5. If it was set to INTernal, then the query returns "INTernal". 6. If it was set to PULSe, then the query returns "PULSe" <p>Note: The SCPI query always returns "INTernal" for non-controlling instances.</p>
Preset	SENSe
Backwards Compatibility Notes	The query <code>[SENSe]:ROSCillator:SOURce?</code> was a query-only command in ESA which always returned whichever reference the instrument was using. The instrument automatically switched to the ext ref if it was present. In PSA (which had no sensing) the command <code>[SENSe]:ROSCillator:SOURce</code> set the reference (INT or EXT), so again its query returned the actual routing. Thus the query form of this command is 100% backwards compatible with both instruments.
Initial S/W Revision	Prior to A.02.00

Remote Command	<code>[:SENSe] :ROSCillator :SOURce INTernal EXTernal</code>
-----------------------	--

Notes	For PSA compatibility the command form is provided and is directly mapped to [:SENSe]:ROSCillator:SOURce:TYPE Note: The SCPI command does nothing for non-controlling instances.
Initial S/W Revision	Prior to A.02.00

Sense

If Sense is selected, the instrument checks whether a signal is present at the external reference connector. If it senses a signal within 5 ppm of the External Ref Freq (as set on the External Ref Freq softkey), it will use this signal as an External Reference. If it senses a 1 pulse per second signal, it will use this signal to adjust the internal reference by adjusting the User setting of the Timebase DAC. When no signal is present, it automatically switches to the internal reference.

Key Path	Input/Output, Freq Ref In
Example	:ROSC:SOUR:TYPE SENS
Couplings	If set to SENSE and the analyzer senses a 1 pulse per second signal, it sets the System, Alignments, Timebase DAC setting to "User". This setting survives Preset and Power Cycle but is set to "Calibrated" on a System, Restore Defaults, Align or a System, Restore Defaults, All
Readback	Sense
Initial S/W Revision	Prior to A.02.00
Modified at S/W Revision	A.14.00

Internal

The internal reference is used. A 1 pps signal at the EXT REF IN port, or a signal there between 1 and 50 MHz, will cause a warning triangle to appear in the settings panel next to the word "INTERNAL", but will otherwise be ignored.

Key Path	Input/Output, Freq Ref In
Example	:ROSC:SOUR:TYPE INT
Readback	Internal
Initial S/W Revision	Prior to A.02.00
Modified at S/W Revision	A.14.00

External

The external reference is used.

Key Path	Input/Output, Freq Ref In
Example	:ROSC:SOUR:TYPE EXT
Readback	External
Initial S/W Revision	Prior to A.02.00

Ext Ref Freq

This key tells the analyzer the frequency of the external reference. When the external reference is in use (either because the reference has been switched to External or because the Reference has been switched to Sense and there is a valid external reference present) this information is used by the analyzer to determine the internal settings needed to lock to that particular external reference signal.

For the instrument to stay locked, the value entered must be within 5 ppm of the actual external reference frequency. So it is important to get it close, or you risk an unlock condition.

Note that this value only affects the instrument's ability to lock. It does not affect any calculations or measurement results. See "Freq Offset" in the Frequency section for information on how to offset frequency values.

Key Path	Input/Output, Freq Ref In
Remote Command	<code>[:SENSe] :ROSCillator:EXTernal:FREQuency <freq></code> <code>[:SENSe] :ROSCillator:EXTernal:FREQuency?</code>
Example	ROSC:EXT:FREQ 20 MHz sets the external reference frequency to 20 MHz, but does not select the external reference. ROSC:SOUR:TYPE EXT selects the external reference.
Dependencies	Still available with Internal or Pulse selected, to allow setup for when External is in use. However, the setting has no effect if the Internal Reference is in use (Freq Ref In set to Internal, Pulse, or SENSE:INT or SENSE:PULSE).
Preset	This is unaffected by a Preset but is set to 10 MHz on a "Restore Input/Output Defaults" or "Restore System Defaults->All"
Min	1 MHz
Max	50 MHz
Default Unit	Hz
Initial S/W Revision	Prior to A.02.00
Modified at S/W Revision	A.14.00

RF Output & Test Set Config

The RF Output & Test Set Config key allows you to set the RF Output Port and multipoint adapter unit which is connected to the instrument by USB for download of calibration data and additional control.

This menu also allows you to set Trigger Config which is used to set the input/output type of the 4 Bi-directional Trigger ports.

Key Path	Input/Output
Preset	All settings under this key are returned to their default state when Restore Input/Output Defaults is pressed.
State Saved	Saved in State
Initial S/W Revision	A.09.49

RF Output

Specifies the RF Output Port used.

Switching from the RF Output port to one of the RFIO ports changes the transmitter performance of the instrument.

Key Path	Input/Output, RF Output & Test Set Config
Remote Command	[:SENSe] :FEED:RF:PORT:OUTPut RFOut RFIO1 RFIO2 GPSout GNSSout RFIO3 RFIO4 [:SENSe] :FEED:RF:PORT:OUTPut?
Example	:FEED:RF:PORT:OUTP RFIO1
Preset	This is unaffected by Mode Preset but is set to RFOut on a "Restore Input/Output Defaults" or "Restore System Defaults -> All"
State Saved	Saved in State
Readback	The current RF Output Port selected is read back to this key
Initial S/W Revision	A.05.01
Modified at S/W Revision	A.14.00

RF Output

The RF port that will be used for the current output.

Key Path	Input/Output, RF Output & Test Set Config, RF Output
Example	:FEED:RF:PORT:OUTP RFO
Notes	On E6640A with hardware M9430A, if RF Output is selected as RF Output Port, you need to choose the settings in the Half Duplex Config menu to determine which port (RFIO3 or RFIO4) will be used. On E6640A with hardware M9431A, this setting is not supported. If the SCPI command is sent with this setting, an error is generated, -221, "Settings conflict;option not installed"
ReadBack	RF Output
Initial S/W Revision	A.05.01
Modified at S/W Revision	A.14.00

RFIO1

The RF port that will be used for the current output

Key Path	Input/Output, RF Output & Test Set Config, RF Output
Example	:FEED:RF:PORT:OUTP RFIO1
Dependencies	Not available in E6607C.
ReadBack	RFIO1
Initial S/W Revision	A.05.01

RFIO2

The RF port that will be used for the current output

Key Path	Input/Output, RF Output & Test Set Config, RF Output
Example	:FEED:RF:PORT:OUTP RFIO2
Dependencies	Not available in E6607C.
ReadBack	RFIO2
Initial S/W Revision	A.05.01

HalfDuplex Config

The HalfDuplex Config key allows you to set “RF Input” of RF Input Port menu and ”RF Output” of RF Output Port menu, which will correspond to RFIO3 and RFIO4.

Key Path	Input/Output, RF Output & Test Set Config
Dependencies	This menu is available on E6640A with hardware M9430A. It's not available on E6640A with hardware M9431A.
State Saved	Saved in State
Initial S/W Revision	A.14.00

RF Input

Specify the RF Input port from RFIO3 and RFIO4.

Key Path	Input/Output, RF Output & Test Set Config, HalfDuplex Config
Remote Command	[:SENSe] :HDUPlex:PORT:INPut RFIO3 RFIO4
Example	:HDUPlex:PORT:INPut RFIO3 :HDUPlex:PORT:INPut?
Dependencies	If RFIO3 is selected as “RF Output”, then “RF Input” will be set to RFIO4 automatically. And if RFIO4

	is selected as “RF Output”, “RF Input” will be set to RFIO3 automatically.
Preset	RFIO3
State Saved	Saved in State
Initial S/W Revision	A.14.00

RF Output

Specify the RF Output port from RFIO3 and RFIO4.

Key Path	Input/Output, RF Output & Test Set Config, HalfDuplex Config
Remote Command	[:SENSe] :HDUPlex:PORT:OUTPut RFIO3 RFIO4
Example	:HDUPlex:PORT:OUTPut RFIO3 :HDUPlex:PORT:OUTPut?
Dependencies	If RFIO3 is selected as “RF Input”, then “RF Output” will be set to RFIO4 automatically. And if RFIO4 is selected as “RF Input”, “RF Output” will be set to RFIO3 automatically.
Preset	RFIO4
State Saved	Saved in State
Initial S/W Revision	A.14.00

Output Config

Accesses keys that configure various output settings, like the frequency reference output, trigger output and analog output.

Key Path	Input/Output
Backwards Compatibility Notes	In ESA there was not a user interface to enable the Video Output (Analog Output), Trigger Output, or Gate Output. In the X-Series each of these physical connectors requires configuration, thus the user interface has been added for X-Series, along with the potential for an output you think is always on to be switched off.
Initial S/W Revision	Prior to A.02.00

Trig Out

Select the type of output signal that will be output from the Trig 1 Out, or Trig 2 Out connectors.

Key Path	Input/Output, Output Config
Remote Command	:TRIGger TRIGger1 TRIGger2[:SEquence]:OUTPut HSWP MEASuring MAIN GATE GTRigger OEVEN SPOint SSweep SSETtled S1Marker S2Marker S3Marker S4Marker OFF :TRIGger TRIGger1 TRIGger2[:SEquence]:OUTPut?
Example	TRIG:OUTP HSWP

TRIG2:OUTP GATE	
Dependencies	The second Trigger output (Trig 2 Out) does not appear in all models; in models that do not support it, the Trig 2 Out key is blanked, and sending the SCPI command for this output generates an error, "Hardware missing; Not available for this model number" In models that do not support the Trigger 2 output, this error is returned if trying to set Trig 2 Out and a query of Trig 2 Out returns OFF.
Preset	Trigger 1: Sweeping (HSWP) Trigger 2: Gate This is unaffected by a Preset but is preset to the above values on a "Restore Input/Output Defaults" or "Restore System Defaults->All"
State Saved	Saved in instrument state
Initial S/W Revision	Prior to A.02.00

Polarity

Sets the output to the Trig 1 Out, or Trig 2 Out, connector to trigger on either the positive or negative polarity.

Key Path	Input/Output, Output Config, Trig 1/2 Output
Remote Command	:TRIGger TRIGger1 TRIGger2[:SEquence]:OUTPut:POLarity POSitive NEGative :TRIGger TRIGger1 TRIGger2[:SEquence]:OUTPut:POLarity?
Example	TRIG1:OUTP:POL POS
Preset	This is unaffected by a Preset but is set to POSitive on a "Restore Input/Output Defaults" or "Restore System Defaults->All"
State Saved	Saved in instrument state
Initial S/W Revision	Prior to A.02.00

Off

Selects no signal to be output to the Trig 1 Out, or Trig 2 Out, connector.

Key Path	Input/Output, Output Config, Trig 1/2 Output
Example	TRIG1:OUTP OFF
Readback	Off
Initial S/W Revision	Prior to A.02.00

Sweeping (HSWP)

Selects the Sweeping Trigger signal to be output to the Trig 1 Out, or Trig 2 Out, connector when a measurement is made. This signal has historically been known as "HSWP" (High = Sweeping), and is 5 V TTL level with 50 ohm output impedance.

Key Path	Input/Output, Output Config, Trig 1/2 Output
Example	TRIG1:OUTP HSWP
Readback	Sweeping
Initial S/W Revision	Prior to A.02.00

Measuring

Selects the Measuring trigger signal to be output to the Trig 1 Out, or Trig 2 Out, connector. This signal is true while the Measuring status bit is true.

Key Path	Input/Output, Output Config, Trig 1/2 Output
Example	TRIG1:OUTP MEAS
Readback	Measuring
Initial S/W Revision	Prior to A.02.00

Main Trigger

Selects the current instrument trigger signal to be output to the Trig 1 Out, or Trig 2 Out, connector.

Key Path	Input/Output, Output Config, Trig 1/2 Output
Example	TRIG1:OUTP MAIN
Readback	Main Trigger
Initial S/W Revision	Prior to A.02.00

Gate Trigger

Selects the gate trigger signal to be output to the Trig 1 Out, or Trig 2 Out, connector. This is the source of the gate timing, not the actual gate signal.

Key Path	Input/Output, Output Config, Trig 1/2 Output
Example	TRIG1:OUTP GTR
Readback	Gate Trigger
Initial S/W Revision	Prior to A.02.00

Gate

Selects the gate signal to be output to the Trig 1 Out, or Trig 2 Out, connector. The gate signal has been delayed and its length determined by delay and length settings. When the polarity is positive, a high on the Trig 1 Out, or Trig 2 Out, represents the time the gate is configured to pass the signal.

Key Path	Input/Output, Output Config, Trig 1/2 Output
Example	TRIG1:OUTP GATE
Readback	Gate
Initial S/W Revision	Prior to A.02.00

Odd/Even Trace Point

Selects either the odd or even trace points as the signal to be output to the Trig 1 Out, or Trig 2 Out, connector when performing swept spectrum analysis. When the polarity is positive, this output goes high during the time the analyzer is sweeping past the first point (Point 0) and every other following trace point. The opposite is true if the polarity is negative.

Key Path	Input/Output, Output Config, Trig 1/2 Output
Example	TRIG1:OUTP OEV
Readback	Odd/Even
Initial S/W Revision	Prior to A.02.00

Trig Out

Select the type of output signal that will be output from the Trig 1 Out, or Trig 2 Out connectors.

Key Path	Input/Output, Output Config
Remote Command	:TRIGger TRIGger1 TRIGger2[:SEquence]:OUTPut HSWP MEASuring MAIN GATE GTRigger OEVEN SPOint SSWeep SSEttled S1Marker S2Marker S3Marker S4Marker OFF :TRIGger TRIGger1 TRIGger2[:SEquence]:OUTPut?
Example	TRIG:OUTP HSWP TRIG2:OUTP GATE
Dependencies	The second Trigger output (Trig 2 Out) does not appear in all models; in models that do not support it, the Trig 2 Out key is blanked, and sending the SCPI command for this output generates an error, "Hardware missing; Not available for this model number" In models that do not support the Trigger 2 output, this error is returned if trying to set Trig 2 Out and a query of Trig 2 Out returns OFF.
Preset	Trigger 1: Sweeping (HSWP) Trigger 2: Gate This is unaffected by a Preset but is preset to the above values on a "Restore Input/Output Defaults" or "Restore System Defaults->All"

State Saved	Saved in instrument state
Initial S/W Revision	Prior to A.02.00

Off

Selects no signal to be output to the Trig 1 Out, or Trig 2 Out, connector.

Key Path	Input/Output, Output Config, Trig 1/2 Output
Example	TRIG1:OUTP OFF
Readback	Off
Initial S/W Revision	Prior to A.02.00

Source Marker 1

Trigger output at marker 1 in current playing Waveform file.

Key Path	Input/Output, Output Config, Trig 1/2 Output
Example	:TRIG1:OUTP S1M
ReadBack	Marker 1
Initial S/W Revision	A.05.01

Source Marker 2

Trigger output at marker 2 in current playing Waveform file.

Key Path	Input/Output, Output Config, Trig 1/2 Output
Example	:TRIG1:OUTP S2M
ReadBack	Marker 2
Initial S/W Revision	A.05.01

Source Marker 3

Trigger output at marker 3 in current playing Waveform file.

Key Path	Input/Output, Output Config, Trig 1/2 Output
Example	:TRIG1:OUTP S3M
ReadBack	Marker 3
Initial S/W Revision	A.05.01

Source Marker 4

Trigger output at marker 4 in current playing Waveform file.

Key Path	Input/Output, Output Config, Trig 1/2 Output
Example	:TRIG1:OUTP S4M
ReadBack	Marker 4
Initial S/W Revision	A.05.01

Analog Out

This menu lets you control which signal is fed to the “Analog Out” connector on the analyzer rear panel.

See ["More Information" on page 217](#)

Key Path	Input/Output, Output Config
Remote Command	:OUTPut:ANALog OFF SVIDeo LOGVidEo LINVidEo DAUDio :OUTPut:ANALog?
Example	OUTP:ANAL SVIDeo ! causes the analog output type to be Screen Video
Preset	This is unaffected by Preset but is set to DAUDio on a "Restore Input/Output Defaults" or "Restore System Defaults->All
Preset	OFF
State Saved	Saved in Input/Output State
Readback line	1-of-N selection [variable]
Backwards Compatibility Notes	Prior to A.04.00, OFF was the default functionality except when in the Analog Demod application or with Tune and Listen, in which case it was DAUDio, and there was no selection menu. So for backwards compatibility with earlier X-Series firmware versions, Auto (:OUTP:ANAL:AUTO ON) will duplicate the prior behavior. The DNWB and SANalyzer parameters, which were legal in PSA but perform no function in the X-Series, are accepted without error.
Initial S/W Revision	A.04.00

More Information

The table below gives the range for each output.

Analog Out	Nominal Range		Notes
	exc. (10% overrange)	Scale Factor	
Off	0 V		
Screen Video	0 – 1 V open circuit	10%/division	8566 compatible
Log Video	0 – 1 V	1/(192.66 dB/V)	dB referenced to mixer level, 1V out for –10 dBm

Analog Out	Nominal Range exc. (10% overrange)	Scale Factor	Notes
	terminated		at the mixer.
Linear Video	0 – 1 V terminated	100%/V	Linear referenced to Ref Level, 1 V out for RF envelope at the Ref Level.
Demod Audio	(varies with analyzer setting)		

Auto

Selects the Auto state for the Analog Output menu. In this state, the Analog Output will automatically be set to the most sensible setting for the current mode or measurement.

If you make a selection manually from the Analog Out menu, this selection will remain in force until you change it (or re-select Auto), even if you go to a mode or measurement for which the selected output does not apply.

Key Path	Input/Output, Output Config, Analog Out
Remote Command	OUTPut:ANALog:AUTO OFF ON 0 1 OUTPut:ANALog:AUTO?
Example	OUTP:ANAL:AUTO ON
Preset	ON
State Saved	Saved in Input/Output State
Initial S/W Revision	A.04.00

Off

Turns off the analog output.

Key Path	Input/Output, Output Config, Analog Out
Example	OUTP:ANAL OFF ! causes the analog output to be off
Readback Text	Off
Initial S/W Revision	A.04.00

LISN Control

Enables you to access LISN related functions. LISN control is only available with option LSN indicating that the LISN IO board is installed. This is a remote query command only.

V-network (Remote Command Only)

Enables you to select the V-network that is controlled via the AUX IO port.

Remote Command	INPut [1] 2:LISN[:TYPE] FOURphase ESH2Z5 ENV216 OFF INPut [1] 2:LISN[:TYPE] ?
Example	:INP:LISN FOUR
Notes	FOURPhase and ESH2-Z5 R&S ESH2-Z5 (four phases and protective earth are controllable) ENV216 R&S ENV216 (two phases and highpass are controllable) OFF Remote control deactivated This query will return :- FOUR when ESH2-Z5 is selected.
Preset	Set to off on a "Restore Input/Output Defaults"
State Saved	Saved in instrument state
Initial S/W Revision	A.14.50

Phase (Remote Command Only)

This command enables you to select the phase of the V-network that is used, which is controlled via the AUX IO port. The permissible selection depends on the selected V-network.

Remote Command	INPut [1] 2:LISN:PHASe L1 L2 L3 N INPut [1] 2:LISN:PHASe?
Example	:INP:LISN:PHAS L1
Couplings	L2, L3 keys are grayed out when ENV216 is selected. If the grayed out key is pressed, an advisory message is generated. If the equivalent SCPI command is sent, this same message is generated as part of a "-224, Illegal parameter value; must apply ESH2Z5 to make this phase available" warning.
Preset	Set to N on a "Restore Input/Output Defaults"
State Saved	Saved in instrument state
Range	Phase N Phase L1 Phase L2 Phase L3 Only one phase can be selected.
Initial S/W Revision	A.14.50

150 kHz Highpass (Remote Command Only)

Controls highpass setting on the V-network.

Remote Command	INPut [1] 2:LISN:FILTer:HPAS[:STATE] ON OFF INPut [1] 2:LISN:FILTer:HPAS[:STATE] ?
Example	:INP:LISN:FILT:HPAS ON
Dependencies	Only available for ENV216 V-network . This key is grayed out when a V-network that is not ENV216

	is selected. If the grayed out key is pressed, an advisory message is generated. If the equivalent SCPI command is sent, this same message is generated as part of a “-221, Settings conflicts; LISN function not available” warning.
Preset	Set to off on a "Restore Input/Output Defaults"
State Saved	Saved in instrument state
Range	ON OFF
Initial S/W Revision	A.14.50

Protective Earth (Remote Command Only)

Enables you to set the Protective Earth setting that is controlled via the AUX IO port.

Remote Command	INPut [1] 2 : LISN : PEARth GROunded FLOating INPut [1] 2 : LISN : PEARth?
Example	:INP:LISN:PEAR GRO
Dependencies	Only available for ESH2Z5. This key is grayed out when a v-network other than ESH2Z5 is selected. If the grayed out key is pressed, an advisory message is generated. If the equivalent SCPI command is sent, this same message is generated as part of a “-221, Settings conflict; LISN function not available” warning.
Preset	Set to GRO on a "Restore Input/Output Defaults"
State Saved	Saved in instrument state
Range	GRO FLO
Initial S/W Revision	A.14.50

(Undefined variable: Primary.ProductName)
LTE TDD Measurement Application Reference

5 Mode Functions

Mode

The Mode key allows you to select the available measurement applications or “Modes”. Modes are a collection of measurement capabilities packaged together to provide an instrument personality that is specific to your measurement needs. Each application software product is ordered separately by Model Number and must be licensed to be available. Once an instrument mode is selected, only the commands that are valid for that mode can be executed.

NOTE

Key operation can be different between modes. The information displayed in Help is about the current mode.

To access Help for a different Mode you must first exit Help (by pressing the Cancel (Esc) key). Then select the desired mode and re-access Help.

For more information on Modes, preloading Modes, and memory requirements for Modes,

see ["More Information" on page 223](#)

Key Path	Front-panel key
Remote Command	:INSTrument[:SElect] SA RTSA SEQAN EMI BASIC WCDMA EDGE GSM WIMAX OFDMA VSA PNOISE NFIGure ADEMOD BTooth TDSCDMA CDMA2K CDMA1XEV LTE LTE TDD LTE AFDD LTE ATDD MSR DVB DTMB DCATV ISDBT CM MB WLAN CWLAN CWIMAX OFDM WIMAX FIXED IDEN RLC SCPI LC VSA89601 :INSTrument[:SElect]?
Example	:INST SA
Notes	The available parameters are dependent upon installed and licensed applications resident in the instrument. Parameters given here are an example, specific parameters are in the individual Application. A list of the valid mode choices is returned with the INST:CAT? Query.
Preset	This is unaffected by a Preset but is set on a “Restore System Defaults->All” to: SEQAN
State Saved	Saved in instrument state
Backwards Compatibility SCPI	:INSTrument[:SElect] GSM provided for backwards compatibility. Mapped to EDGE GSM.
Backwards Compatibility SCPI	:INSTrument[:SElect] SANalyzer provided for ESU compatibility. When this command is received, the analyzer aliases it to the following: INST:SEL SCPI LC This results in the analyzer being placed in SCPI Language Compatibility Mode, in order to emulate the ESU Spectrum Analyzer Mode.
Backwards Compatibility SCPI	:INSTrument[:SElect] RECeiver provided for ESU compatibility. When this command is received, the analyzer aliases it to the following: :INST:SEL EMI

	:CONF FSC
	This results in the analyzer being placed in the EMI Receiver Mode, running the Frequency Scan measurement, in order to emulate the ESU Receiver Mode.
Initial S/W Revision	Prior to A.02.00
Modified at S/W Revision	A.13.00

Example	:INST 'SA'
Notes	The query is not a quoted string. It is an enumeration as indicated in the Instrument Select table above. The command must be sequential: i.e. continued parsing of commands cannot proceed until the instrument select is complete and the resultant SCPI trees are available.
Backwards Compatibility SCPI	:INSTrument[:SElect] 'SA' 'PNOISE' 'EDGE' 'GSM' 'BASIC'
Initial S/W Revision	Prior to A.02.00

More Information

The Mode name appears on the banner after the word “Keysight” followed by the Measurement Title. For example, for the IQ Analyzer mode with the Complex Spectrum measurement running:

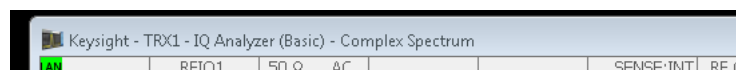

It is possible to specify the order in which the Modes appear in the Mode menu, using the Configure Applications utility (System, Power On, Configure Applications). It is also possible, using the same utility, to specify a subset of the available applications to load into memory at startup time, which can significantly decrease the startup time of the analyzer. During runtime, if an application that is not loaded into memory is selected (by either pressing that applications Mode key or sending that applications :INST:SEL command over SCPI), there will be a pause while the Application is loaded. During this pause a message box that says “Loading application, please wait...” is displayed.

Each application (Mode) that runs in the X-Series signal analyzers consumes virtual memory. The various applications consume varying amounts of virtual memory, and as more applications run, the memory consumption increases. Once an application is run, some of its memory remains allocated even when it is not running, and is not released until the analyzer program (xSA.exe) is shut down.

Keysight characterizes each Mode and assigns a memory usage quantity based on a conservative estimate. There is a limited amount of virtual memory available to applications (note that this is virtual memory and is independent of how much physical RAM is in the instrument). The instrument keeps track of how much memory is being used by all loaded applications – which includes those that preloaded at startup, and all of those that have been run since startup.

When you request a Mode that is not currently loaded, the instrument looks up the memory estimate for that Mode, and adds it to the residual total for all currently loaded Modes. If there is not enough virtual memory to load the Mode, a dialog box and menu will appear that gives you four options:

1. Close and restart the analyzer program without changing your configured preloads. This may free up enough memory to load the requested Mode, depending on your configured preloads
2. Clear out all preloads and close and restart the analyzer program with only the requested application preloaded, and with that application running. This choice is guaranteed to allow you to run the requested application; but you will lose your previously configured preloads. In addition, there may be little or no room for other applications, depending on the size of the requested application.
3. Bring up the Configure Applications utility in order to reconfigure the preloaded apps to make room for the applications you want to run (this will then require restarting the analyzer program with your new configuration). This is the recommended choice because it gives you full flexibility to select exactly what you want.
4. Exit the dialog box without doing anything, which means you will be unable to load the application you requested.

In each case except 4, this will cause the analyzer software to close, and you will lose all unsaved traces and results.

If you attempt to load a mode via SCPI that will exceed memory capacity, the Mode does not load and an error message is returned:

```
-225,"Out of memory;Insufficient resources to load Mode (mode name)"
```

where "mode name" is the SCPI parameter for the Mode in question, for example, SA for Spectrum Analyzer Mode.

Sequence Analyzer

Selects the Sequence Analyzer mode for sequenced measurements. Depending on licensed applications there may be a number of different measurements available in this mode. These measurements are all done on IQ captured data and can be set up to calculated on any part of the capture.

If you are using the Help feature, this mode must be currently active to access its detailed information. If it is not active, exit the Help feature (Esc key), select the mode, and re-access Help.

Key Path	Mode
Example	INST:SEL SEQAN INST:NSEL 400
Initial S/W Revision	A.05.01

IQ Analyzer (Basic)

The IQ Analyzer Mode makes general purpose frequency domain and time domain measurements. These measurements often use alternate hardware signal paths when compared with a similar measurement in the Signal Analysis Mode using the Swept SA measurement. These frequency domain and time domain measurements can be used to output I/Q data results when measuring complex modulated digital signals.

If you are using the Help feature, this mode must be currently active to access its detailed information. If it is not active, exit the Help feature (Esc key), select the mode, and re-access Help.

Key Path	Mode
Example	INST:SEL BASIC INST:NSEL 8
Initial S/W Revision	Prior to A.02.00

W-CDMA with HSPA+

Selects the W-CDMA with HSPA+ mode for general purpose measurements of signals following this standard. There are several measurements available in this mode.

If you are using the Help feature, this mode must be currently active to access its detailed information. If it is not active, exit the Help feature (Esc key), select the mode, and re-access Help.

Key Path	Mode
Example	INST:SEL WCDMA INST:NSEL 9
Initial S/W Revision	Prior to A.02.00

GSM/EDGE/EDGE Evo

Selects the GSM with EDGE mode for general purpose measurements of signals following this standard. There are several measurements available in this mode.

If you are using the Help feature, this mode must be currently active to access its detailed information. If it is not active, exit the Help feature (Esc key), select the mode, and re-access Help.

Key Path	Mode
Example	INST:SEL EDGE GSM INST:NSEL 13
Initial S/W Revision	Prior to A.02.00
Modified at S/W Revision	A.02.00

Analog Demod

Selects the Analog Demod mode for making measurements of AM, FM and phase modulated signals.

If you are using the Help feature, this mode must be currently active to access its detailed information. If it is not active, exit the Help feature (Esc key), select the mode, and re-access Help.

Key Path	Mode
Example	INST:SEL ADEMOM INST:NSEL 234
Initial S/W Revision	Prior to A.02.00

Bluetooth

Selects the Bluetooth mode for Bluetooth specific measurements. There are several measurements available in this mode.

If you are using the Help feature, this mode must be currently active to access its detailed information. If it is not active, exit the Help feature (Esc key), select the mode, and re-access Help.

Key Path	Mode
Example	INST:SEL BT INST:NSEL 228
Initial S/W Revision	A.06.01

TD-SCDMA with HSPA/8PSK

Selects the TD-SCDMA mode for general purpose measurements of signals following this standard. There are several measurements available in this mode.

If you are using the Help feature, this mode must be currently active to access its detailed information. If it is not active, exit the Help feature (Esc key), select the mode, and re-access Help.

Key Path	Mode
Example	INST:SEL TDSCDMA INST:NSEL 211
Initial S/W Revision	Prior to A.02.00

cdma2000

Selects the cdma2000 mode for general purpose measurements of signals following this standard. There are several measurements available in this mode.

If you are using the Help feature, this mode must be currently active to access its detailed information. If it is not active, exit the Help feature (Esc key), select the mode, and re-access Help.

Key Path	Mode
Example	INST:SEL CDMA2K INST:NSEL 10
Initial S/W Revision	Prior to A.02.00

1xEV-DO

Selects the 1xEV-DO mode for general purpose measurements of signals following this standard. There are several measurements available in this mode.

If you are using the Help feature, this mode must be currently active to access its detailed information. If it is not active, exit the Help feature (Esc key), select the mode, and re-access Help.

Key Path	Mode
Example	INST:SEL CDMA1XEV INST:NSEL 15
Initial S/W Revision	Prior to A.02.00

WLAN

Selects the WLAN mode for general purpose measurements of signals following this standard. There are several measurements available in this mode.

If you are using the Help feature, this mode must be currently active to access its detailed information. If it is not active, exit the Help feature (Esc key), select the mode, and re-access Help.

Key Path	Mode
Example	INST:SEL WLAN INST:NSEL 217
Initial S/W Revision	A.09.491

89601 VSA

Selecting the 89601 VSA mode will start the 89600 VSA software. The 89600 VSA software is powerful, PC-based software, offering the industry's most sophisticated general purpose and standards specific signal evaluation and troubleshooting tools for R&D engineers. Even for proprietary and non-standard signals in SATCOM or MILCOM applications, you can make signal quality measurements with customized IQ constellation. Reach deeper into signals, gather more data on signal problems, and gain greater insight.

- Over 35 general-purpose analog and digital demodulators ranging from 2FSK to 4096QAM
- Flexible and custom IQ and OFDM signal analysis for single carrier
- Standards specific modulation analysis including:
 - Cellular: GSM/EDGE, cdma2000, W-CDMA, TD-SCDMA, LTE(FDD/TDD),
 - LTE-Advanced and more
 - Wireless networking: 802.11a/b/g, 802.11n, 802.ac, 802.16 WiMAX (fixed/mobile), WiSUN (MR-FSK PHY)
 - RFID
 - Digital satellite video and other satellite signals, radar, LMDS
 - Up to 400K bin FFT, for the highest resolution spectrum analysis

- A full suite of time domain analysis tools, including signal capture and playback, time gating, and CCDF measurements
- 20 simultaneous trace displays and the industry's most complete set of marker functions
- Easy-to-use Microsoft ® Windows ® graphical user interface

For more information see the Agilent 89600 Series VSA web site at www.agilent.com/find/89600vsa

To learn more about how to use the 89600 VSA running in the X-Series, after the 89600 VSA software is running, open the 89600 VSA Help and open the "About Agilent X-Series Signal Analyzer with 89600 VSA Software" help topic.

Key Path	Mode
Example	INST:SEL VSA89601 INST:NSEL 101
Initial S/W Revision	Prior to A.02.00

LTE-Advanced FDD

As LTE-Advanced FDD and LTE modes are converged into one single application, the single softkey under Mode menu is designed to select the covered mode. The display mode of the LTE and LTE-Advanced FDD are distinguished by the licenses.

If you are using the Help feature, this mode must be currently active to access its detailed information. If it is not active, exit the Help feature (Esc key), select the mode, and re-access Help.

Key Path	Mode
Example	INST:SEL LTEAFDD INST:NSEL 107
Notes	When the N9080A/80B-1FP exists, the display mode name is LTE. When the N9080A/80B-1FP and N9080B-2FP all exist, the display mode name is LTE FDD & LTE-A FDD.
Backwards Compatibility SCPI	INST:SEL LTE INST:NSEL 102
Initial S/W Revision	A.14.00
Modified at S/W Revision	A.14.50

LTE-Advanced TDD

As LTE-Advanced TDD and LTE TDD modes are converged into one single application, the single softkey under Mode menu is designed to select the covered mode. The display mode of the LTE TDD and LTE-Advanced TDD are distinguished by the licenses.

If you are using the Help feature, this mode must be currently active to access its detailed information. If it is not active, exit the Help feature (Esc key), select the mode, and re-access Help.

Key Path	Mode
Example	INST:SEL LTEATDD INST:NSEL 108
Notes	When the N9082A/82B-1FP exists, the display mode name is LTE TDD. When the N9082A/82B-1FP and N9082B-2FP all exist, the display mode name is LTE TDD & LTE-A TDD.
Backwards Compatibility SCPI	INST:SEL LTETDD INST:NSEL 105
Initial S/W Revision	A.14.00
Modified at S/W Revision	A.14.50

802.16 OFDMA (WiMAX/WiBro)

Selects the OFDMA mode for general purpose measurements of WiMAX signals. There are several measurements available in this mode.

If you are using the Help feature, this mode must be currently active to access its detailed information. If it is not active, exit the Help feature (Esc key), select the mode, and re-access Help.

Key Path	Mode
Example	INST:SEL WIMAXOFDMA INST:NSEL 75
Initial S/W Revision	Prior to A.02.00

Application Mode Number Selection (Remote Command Only)

Select the measurement mode by its mode number. The actual available choices depend upon which applications are installed in your instrument. The modes appear in this table in the same order they appear in the Mode menu (if the order is not changed by the Configure Applications utility found in the System, Power On menu). See "[Detailed List of Modes](#)" on page 234 for Mode details.

The Mode Number is the parameter for use with the :INSTrument:NSElect command. The Mode Parameter is the parameter for use with the :INSTrument[:SElect] command.

Mode	Mode Number	Mode Parameter
Sequence Analyzer	400	SEQAN
I/Q Analyzer (Basic)	8	BASIC
WCDMA with HSPA+	9	WCDMA
GSM/EDGE/EDGE Evo	13	EDGE GSM
Analog Demod	234	ADEMOD

Bluetooth	228	BTooth
TD-SCDMA with HSPA/8PSK	211	TDSCDMA
cdma2000	10	CDMA2K
1xEV-DO	15	CDMA1XEV
LTE	102	LTE
LTE TDD	105	LTETDD
LTE-Advanced FDD	107	LTEAFDD
LTE-Advanced TDD	108	LTEATDD
WLAN	217	WLAN
802.16 OFDM (Fixed WiMAX)	104	WIMAXFIXED

Remote Command	:INSTrument:NSElect <integer> :INSTrument:NSElect?
Example	:INST:NSEL 1
Notes	SA mode is 1 The command must be sequential: i.e. continued parsing of commands cannot proceed until the instrument select is complete and the resultant SCPI trees are available.
Preset	Not affected by Preset. Set to default mode (1 for SA mode) following Restore System Defaults.
State Saved	Saved in instrument state
Initial S/W Revision	Prior to A.02.00

Application Mode Catalog Query (Remote Command Only)

Returns a string containing a comma separated list of names of all the installed and licensed measurement modes (applications). These names can only be used with the :INSTrument[:SElect] command.

Remote Command	:INSTrument:CATalog?
Example	:INST:CAT?
Notes	Query returns a quoted string of the installed and licensed modes separated with a comma. Example: "SA,PNOISE,WCDMA"
Backwards Compatibility Notes	VSA (E4406A) :INSTrument:CATalog? returned a list of installed INSTrument:SELECT items as a comma separated list of string values: "BASIC","GSM","EDGE GSM","CDMA","NADC","PDC","WCDMA","CDMA2K","CDMA1XEV","IDEN","WIDEN","WLAN","SERVICE" X-Series uses the ESA/PSA compatible query of a string contain comma separated values: "SA,PNOISE,NFIGURE,BASIC,CDMA,CDMA2K,WCDMA,CDMA1XEV,EDGE GSM,GSM,NADC,PDC,TDSCDMA,DMOD"

	ULATION,WLAN"
Initial S/W Revision	Prior to A.02.00

Application Identification (Remote Commands Only)

Each entry in the Mode Menu will have a Model Number and associated information: Version, and Options. This information is displayed in the Show System screen. The corresponding SCPI remote commands are defined here.

"Current Application Model " on page 231

"Current Application Revision" on page 231

"Current Application Options" on page 232

Current Application Model

Returns a string that is the Model Number of the currently selected application (mode).

Remote Command	:SYSTem:APPLication[:CURRent] [:NAME]?
Example	:SYST:APPL?
Notes	Query returns a quoted string that is the Model Number of the currently selected application (Mode). Example: "N9060A" String length is 6 characters.
Preset	Not affected by Preset
State Saved	Not saved in state, the value will be the selected application when a Save is done.
Initial S/W Revision	Prior to A.02.00

Current Application Revision

Returns a string that is the Revision of the currently selected application (mode).

Remote Command	:SYSTem:APPLication[:CURRent]:REVision?
Example	:SYST:APPL:REV?
Notes	Query returns a quoted string that is the Revision of the currently selected application (Mode). Example: "1.0.0.0" String length is a maximum of 23 characters. (each numeral can be an integer + 3 decimal points)
Preset	Not affected by a Preset
State Saved	Not saved in state, the value will be the selected application when a Save is done.
Initial S/W Revision	Prior to A.02.00

Current Application Options

Returns a string that is the Options list of the currently selected application (Mode).

Remote Command	:SYSTem:APPLication[:CURRent]:OPTion?
Example	:SYST:APPL:OPT?
Notes	Query returns a quoted string that is the Option list of the currently selected application (Mode). The format is the name as the *OPT? or SYSTem:OPTion command: a comma separated list of option identifiers. Example: "1FP,2FP" String length is a maximum of 255 characters.
Preset	Not affected by a Preset
State Saved	Not saved in state per se, the value will be the selected application when a Save is invoked.
Initial S/W Revision	Prior to A.02.00

Application Identification Catalog (Remote Commands Only)

A catalog of the installed and licensed applications (Modes) can be queried for their identification.

["Application Catalog Number of Entries" on page 232](#)

["Application Catalog Model Numbers" on page 232](#)

["Application Catalog Revision" on page 233](#)

["Application Catalog Options" on page 233](#)

Application Catalog Number of Entries

Returns the number of installed and licensed applications (Modes).

Remote Command	:SYSTem:APPLication:CATalog[:NAME]:COUNT?
Example	:SYST:APPL:CAT:COUN?
Preset	Not affected by Preset
State Saved	Not saved in instrument state.
Initial S/W Revision	Prior to A.02.00

Application Catalog Model Numbers

Returns a list of Model Numbers for the installed and licensed applications (Modes).

Remote Command	:SYSTem:APPLication:CATalog[:NAME]?
Example	:SYST:APPL:CAT?
Notes	Returned value is a quoted string of a comma separated list of Model Numbers. Example, if SAMS

	and Phase Noise are installed and licensed: "N9060A,N9068A" String length is COUNT * 7 - 1. (7 = Model Number length + 1 for comma. -1 = no comma for the 1st entry.)
Preset	Not affected by a Preset
State Saved	Not saved in instrument state.
Initial S/W Revision	Prior to A.02.00

Application Catalog Revision

Returns the Revision of the provided Model Number.

Remote Command	:SYSTem:APPLication:CATalog:REVision? <model>
Example	:SYST:APPL:CAT:REV? 'N9060A'
Notes	Returned value is a quoted string of revision for the provided Model Number. The revision will be a null-string ("") if the provided Model Number is not installed and licensed. Example, if SAMS is installed and licensed: "1.0.0.0"
Preset	Not affected by a Preset.
State Saved	Not saved in instrument state.
Initial S/W Revision	Prior to A.02.00

Application Catalog Options

Returns a list of Options for the provided Model Number

Remote Command	:SYSTem:APPLication:CATalog:OPTion? <model>
Example	:SYST:APPL:CAT:OPT? 'N9060A'
Notes	Returned value is a quoted string of a comma separated list of Options, in the same format as *OPT? or :SYSTem:OPTion?. If the provided Model Number is not installed and licensed a null-string ("") will be returned. Example, if SAMS is installed and licensed: "2FP" String length is a maximum of 255 characters.
Preset	Not affected by a Preset
State Saved	Not saved in instrument state.
Initial S/W Revision	Prior to A.02.00

Detailed List of Modes

This section contains an alphabetical list of Modes available in the X-Series, along with a brief description of each Mode.

Note that with the exception of the 89601 VSA, only licensed applications appear in the Mode menu. The 89601 will always appear, because it's licensing is handled differently.

1xEV-DO

Selects the 1xEV-DO mode for general purpose measurements of signals following this standard. There are several measurements available in this mode.

If you are using the Help feature, this mode must be currently active to access its detailed information. If it is not active, exit the Help feature (Esc key), select the mode, and re-access Help.

Key Path	Mode
Example	INST:SEL CDMA1XEV INST:NSEL 15
Initial S/W Revision	Prior to A.02.00

802.16 OFDMA (WiMAX/WiBro)

Selects the OFDMA mode for general purpose measurements of WiMAX signals. There are several measurements available in this mode.

If you are using the Help feature, this mode must be currently active to access its detailed information. If it is not active, exit the Help feature (Esc key), select the mode, and re-access Help.

Key Path	Mode
Example	INST:SEL WIMAXOFDMA INST:NSEL 75
Initial S/W Revision	Prior to A.02.00

89601 VSA

Selecting the 89601 VSA mode will start the 89600 VSA software. The 89600 VSA software is powerful, PC-based software, offering the industry's most sophisticated general purpose and standards specific signal evaluation and troubleshooting tools for R&D engineers. Even for proprietary and non-standard signals in SATCOM or MILCOM applications, you can make signal quality measurements with customized IQ constellation. Reach deeper into signals, gather more data on signal problems, and gain greater insight.

- Over 35 general-purpose analog and digital demodulators ranging from 2FSK to 4096QAM
- Flexible and custom IQ and OFDM signal analysis for single carrier
- Standards specific modulation analysis including:

- Cellular: GSM/EDGE, cdma2000, W-CDMA, TD-SCDMA, LTE(FDD/TDD),
- LTE-Advanced and more
- Wireless networking: 802.11a/b/g, 802.11n, 802.ac, 802.16 WiMAX (fixed/mobile), WiSUN (MR-FSK PHY)
- RFID
- Digital satellite video and other satellite signals, radar, LMDS
- Up to 400K bin FFT, for the highest resolution spectrum analysis
- A full suite of time domain analysis tools, including signal capture and playback, time gating, and CCDF measurements
- 20 simultaneous trace displays and the industry's most complete set of marker functions
- Easy-to-use Microsoft ® Windows ® graphical user interface

For more information see the Agilent 89600 Series VSA web site at www.agilent.com/find/89600vsa

To learn more about how to use the 89600 VSA running in the X-Series, after the 89600 VSA software is running, open the 89600 VSA Help and open the "About Agilent X-Series Signal Analyzer with 89600 VSA Software" help topic.

Key Path	Mode
Example	INST:SEL VSA89601 INST:NSEL 101
Initial S/W Revision	Prior to A.02.00

Analog Demod

Selects the Analog Demod mode for making measurements of AM, FM and phase modulated signals.

If you are using the Help feature, this mode must be currently active to access its detailed information. If it is not active, exit the Help feature (Esc key), select the mode, and re-access Help.

Key Path	Mode
Example	INST:SEL ADEMOM INST:NSEL 234
Initial S/W Revision	Prior to A.02.00

Bluetooth

Selects the Bluetooth mode for Bluetooth specific measurements. There are several measurements available in this mode.

If you are using the Help feature, this mode must be currently active to access its detailed information. If it is not active, exit the Help feature (Esc key), select the mode, and re-access Help.

Key Path	Mode
Example	INST:SEL BT INST:NSEL 228
Initial S/W Revision	A.06.01

cdma2000

Selects the cdma2000 mode for general purpose measurements of signals following this standard. There are several measurements available in this mode.

If you are using the Help feature, this mode must be currently active to access its detailed information. If it is not active, exit the Help feature (Esc key), select the mode, and re-access Help.

Key Path	Mode
Example	INST:SEL CDMA2K INST:NSEL 10
Initial S/W Revision	Prior to A.02.00

GSM/EDGE/EDGE Evo

Selects the GSM with EDGE mode for general purpose measurements of signals following this standard. There are several measurements available in this mode.

If you are using the Help feature, this mode must be currently active to access its detailed information. If it is not active, exit the Help feature (Esc key), select the mode, and re-access Help.

Key Path	Mode
Example	INST:SEL EDGE GSM INST:NSEL 13
Initial S/W Revision	Prior to A.02.00
Modified at S/W Revision	A.02.00

IQ Analyzer (Basic)

The IQ Analyzer Mode makes general purpose frequency domain and time domain measurements. These measurements often use alternate hardware signal paths when compared with a similar measurement in the Signal Analysis Mode using the Swept SA measurement. These frequency domain and time domain measurements can be used to output I/Q data results when measuring complex modulated digital signals.

If you are using the Help feature, this mode must be currently active to access its detailed information. If it is not active, exit the Help feature (Esc key), select the mode, and re-access Help.

Key Path	Mode
Example	INST:SEL BASIC INST:NSEL 8
Initial S/W Revision	Prior to A.02.00

LTE

Selects the LTE mode for general purpose measurements of signals following the LTE FDD standard. There are several measurements available in this mode.

If you are using the Help feature, this mode must be currently active to access its detailed information. If it is not active, exit the Help feature (Esc key), select the mode, and re-access Help.

Key Path	Mode
Example	INST:SEL LTE INST:NSEL 102
Initial S/W Revision	Prior to A.02.00

LTE TDD

Selects the LTE TDD mode for general purpose measurements of signals following the LTE TDD standard. There are several measurements available in this mode.

If you are using the Help feature, this mode must be currently active to access its detailed information. If it is not active, exit the Help feature (Esc key), select the mode, and re-access Help.

Key Path	Mode
Example	INST:SEL LTETDD INST:NSEL 105
Initial S/W Revision	A.03.00

LTE-Advanced FDD

As LTE-Advanced FDD and LTE modes are converged into one single application, the single softkey under Mode menu is designed to select the covered mode. The display mode of the LTE and LTE-Advanced FDD are distinguished by the licenses.

If you are using the Help feature, this mode must be currently active to access its detailed information. If it is not active, exit the Help feature (Esc key), select the mode, and re-access Help.

Key Path	Mode
Example	INST:SEL LTEAFDD INST:NSEL 107

Notes	When the N9080A/80B-1FP exists, the display mode name is LTE. When the N9080A/80B-1FP and N9080B-2FP all exist, the display mode name is LTE FDD & LTE-A FDD.
Backwards Compatibility SCPI	INST:SEL LTE INST:NSEL 102
Initial S/W Revision	A.14.00
Modified at S/W Revision	A.14.50

LTE-Advanced TDD

As LTE-Advanced TDD and LTE TDD modes are converged into one single application, the single softkey under Mode menu is designed to select the covered mode. The display mode of the LTE TDD and LTE-Advanced TDD are distinguished by the licenses.

If you are using the Help feature, this mode must be currently active to access its detailed information. If it is not active, exit the Help feature (Esc key), select the mode, and re-access Help.

Key Path	Mode
Example	INST:SEL LTEATDD INST:NSEL 108
Notes	When the N9082A/82B-1FP exists, the display mode name is LTE TDD. When the N9082A/82B-1FP and N9082B-2FP all exist, the display mode name is LTE TDD & LTE-A TDD.
Backwards Compatibility SCPI	INST:SEL LTETDD INST:NSEL 105
Initial S/W Revision	A.14.00
Modified at S/W Revision	A.14.50

Sequence Analyzer

Selects the Sequence Analyzer mode for sequenced measurements. Depending on licensed applications there may be a number of different measurements available in this mode. These measurements are all done on IQ captured data and can be set up to calculated on any part of the capture.

If you are using the Help feature, this mode must be currently active to access its detailed information. If it is not active, exit the Help feature (Esc key), select the mode, and re-access Help.

Key Path	Mode
Example	INST:SEL SEQAN INST:NSEL 400
Initial S/W Revision	A.05.01

TD-SCDMA with HSPA/8PSK

Selects the TD-SCDMA mode for general purpose measurements of signals following this standard. There are several measurements available in this mode.

If you are using the Help feature, this mode must be currently active to access its detailed information. If it is not active, exit the Help feature (Esc key), select the mode, and re-access Help.

Key Path	Mode
Example	INST:SEL TDSCDMA INST:NSEL 211
Initial S/W Revision	Prior to A.02.00

W-CDMA with HSPA+

Selects the W-CDMA with HSPA+ mode for general purpose measurements of signals following this standard. There are several measurements available in this mode.

If you are using the Help feature, this mode must be currently active to access its detailed information. If it is not active, exit the Help feature (Esc key), select the mode, and re-access Help.

Key Path	Mode
Example	INST:SEL WCDMA INST:NSEL 9
Initial S/W Revision	Prior to A.02.00

WLAN

Selects the WLAN mode for general purpose measurements of signals following this standard. There are several measurements available in this mode.

If you are using the Help feature, this mode must be currently active to access its detailed information. If it is not active, exit the Help feature (Esc key), select the mode, and re-access Help.

Key Path	Mode
Example	INST:SEL WLAN INST:NSEL 217
Initial S/W Revision	A.09.491

Global Settings

Opens a menu that allows you to switch certain Meas Global parameters to a Mode Global state. These switches apply to all Modes that support global settings. No matter what Mode you are in when you set the “Global Center Frequency” switch to on, it applies to all Modes that support Global Settings.

Key Path	Mode Setup
Initial S/W Revision	Prior to A.02.00

Global Center Freq

The software maintains a Mode Global value called “Global Center Freq”.

When the Global Center Freq key is switched to On in any mode, the current mode’s center frequency is copied into the Global Center Frequency, and from then on all modes that support global settings use the Global Center Frequency. So you can switch between any of these modes and the Center Freq will remain unchanged.

Adjusting the Center Freq of any mode which supports Global Settings, while Global Center Freq is On, will modify the Global Center Frequency.

When Global Center Freq is turned Off, the Center Freq of the current mode is unchanged, but now the Center Freq of each mode is once again independent.

When Mode Preset is pressed while Global Center Freq is On, the Global Center Freq is preset to the preset Center Freq of the current mode.

This function is reset to Off when the Restore Defaults key is pressed in the Global Settings menu, or when System, Restore Defaults, All Modes is pressed.

Key Path	Mode Setup, Global Settings
Scope	Mode Global
Remote Command	:INSTrument:COUPle:FREQuency:CENTer ALL NONE :INSTrument:COUPle:FREQuency:CENTer?
Example	INST:COUP:FREQ:CENT ALL INST:COUP:FREQ:CENT?
Preset	Set to Off on Global Settings, Restore Defaults and System, Restore Defaults, All Modes
Range	On Off
Initial S/W Revision	Prior to A.02.00

Remote Command	:GLOBal:FREQuency:CENTer[:STATe] 1 0 ON OFF :GLOBal:FREQuency:CENTer[:STATe]?
Preset	Off
Initial S/W Revision	Prior to A.02.00

Restore Defaults

This key resets all of the functions in the Global Settings menu to Off. This also occurs when System, Restore Defaults, All Modes is pressed.

Key Path	Mode Setup, Global Settings
Remote Command	:INSTrument:COUPle:DEFault
Example	INST:COUP:DEF
Backwards Compatibility SCPI	:GLOBal:DEFault
Initial S/W Revision	Prior to A.02.00

Mode Setup

This key accesses a menu to allow you to select mode parameters. These settings will be in effect for all measurements in the current mode.

Key Path	Front Panel Key
Initial S/W Revision	A.14.00

Direction

This key allows you to set the Direction of the signal being measured. The choice of link direction will determine the Sync/Format, Chan Profile and Time. Advanced menus will all change based on the link direction selected. Also, since downlink and uplink signals use OFDMA and SC-FDMA respectively, the list of trace results available and the default traces presented will also change based on the link direction parameter.

Key Path	Mode Setup
Mode	LTETDD, LTEAFDD
Remote Command	<code>[:SENSE] :RADio:STANdard:DIRection DLINK ULINK</code> <code>[:SENSE] :RADio:STANdard:DIRection?</code>
Example	RAD:STAN:DIR DLIN
Couplings	TDD: Changing in direction will affect the sync source of periodic trigger source or gate source. If direction is uplink, the sync source is RF burst. If direction is downlink, the sync source is External1. If direction is downlink, the menu Measure PRACH/SRS is disabled and the value is off. FDD/TDD: Changes in Direction affect many other modulation analysis setup parameters.
Preset	ULIN
State Saved	Saved in instrument state.
Range	Downlink Uplink For E6640A, the Direction is restricted to Uplink only, Downlink is not selectable.
Initial S/W Revision	A.14.00
Modified at S/W Revision	A.14.50

Preset to Standard

Key Path	Mode Setup
Mode	LTEATDD
Initial S/W Revision	A.14.50

System Bandwidth

Sets the parameters to the LTE standard .

Key Path	Mode Setup, Preset to Standard
Mode	LTEATDD, LTEAFDD
Remote Command	[:SENSe] :RADio:STANdard:PRESet B1M4 B3M B5M B10M B15M B20M
Example	RAD:STAN:PRES B5M
Couplings	Preset To Standard presets parameter values listed in section “Values for each Preset To Standard”. And the system bandwidth of each component carrier under the Component Carrier Setup will be preset to the selected one.
Preset	B5M
State Saved	Saved in instrument state.
Range	1.4 MHz (6 RB) 3 MHz (15 RB) 5 MHz (25 RB) 10 MHz (50 RB) 15 MHz (75 RB) 20 MHz (100 RB)
Readback	1.4 MHz (6 RB) 3 MHz (15 RB) 5 MHz (25 RB) 10 MHz (50 RB) 15 MHz (75 RB) 20 MHz (100 RB)
Initial S/W Revision	A.14.50

UL/DL Allocation

Set the TDD UL/DL Allocation parameter of each carrier to the selected value.

Key Path	Mode Setup, Preset to Standard
Mode	LTEATDD
Remote Command	[:SENSe] :RADio:STANdard:PRESet:ULDL CONF0 CONF1 CONF2 CONF3 CONF4 CONF5 CONF6 [:SENSe] :RADio:STANdard:PRESet:ULDL?
Example	RAD:STAN:PRES:ULDL CONF0
Notes	CONF0: Configuration 0 (DSUUUDSUUU) CONF1: Configuration 1 (DSUUDDSUUD) CONF2: Configuration 2 (DSUDDDSUDD) CONF3: Configuration 3 (DSUUUDDDDDD) CONF4: Configuration 4 (DSUUDDDDDDD) CONF5: Configuration 5 (DSUDDDDDDDD) CONF6: Configuration 6 (DSUUUDSUUD)
Dependencies	When the setting is selected, the ULDL Alloc per component carrier under the Component carrier Setup will be preset to the selected value.
Preset	CONF0
State Saved	Saved in instrument state.
Range	Configuration 0 Configuration 1 Configuration 2 Configuration 3 Configuration 4 Configuration 5 Configuration 6

Readback	Configuration 0(DSUUUDSUUU) Configuration 1(DSUUDDSUUD) Configuration 2(DSUDDDSUDD) Configuration 3(DSUUDDDDDD) Configuration 4(DSUUDDDDDD) Configuration 5(DSUDDDDDDDD) Configuration 6(DSUUUDSUUD)
Initial S/W Revision	A.14.50

Dw/GP/Up Len

Set the TDD special sub-frame configuration of each component carrier to the selected value.

Key Path	Mode Setup, Preset to Standard
Mode	LTEATDD
Remote Command	[:SENSe] :RADio:STANdard:PRESet:DGPU CONF0 CONF1 CONF2 CONF3 CONF4 CONF5 CONF6 CONF7 CONF8 CONF9 [:SENSe] :RADio:STANdard:PRESet:DGPU?
Example	RAD:STAN:PRES:DGPU CONF0
Notes	CONF0: Configuration 0 CONF1: Configuration 1 CONF2: Configuration 2 CONF3: Configuration 3 CONF4: Configuration 4 CONF5: Configuration 5 CONF6: Configuration 6 CONF7: Configuration 7 CONF8: Configuration 8 CONF9: Configuration 9
Dependencies	When the setting is selected, the Dw/GP/Up Len per Component Carrier under the Component Carrier Setup will be preset to the selected value. The special sub-frame configuration 9 is only enabled when it is LTE-Advanced TDD.
Preset	CONF0
State Saved	Saved in instrument state.
Range	Configuration 0 Configuration 1 Configuration 2 Configuration 3 Configuration 4 Configuration 5 Configuration 6 Configuration 7 Configuration 8 Configuration 9
Readback	Configuration 0 Configuration 1 Configuration 2 Configuration 3 Configuration 4 Configuration 5 Configuration 6 Configuration 7 Configuration 8 Configuration 9
Initial S/W Revision	A.14.50

Component Carrier Setup

Accesses the Component Carrier Setup menu.

Key Path	Mode Setup
Initial S/W Revision	A.14.50

Num Component Carriers

Specifies how many component carriers are included in LTE-Advanced TDD/FDD measurements. . Each component carrier complies to the LTE specifications. The LTE-Advanced TDD/FDD supports the maximum of five component carriers, so the maximum transmission bandwidth is up to 100MHz. See [Error! Reference source not found.](#) for more information

Key Path	Mode Setup, Component Carrier Setup
Mode	LTEATDD, LTEAFDD
Measurement	All
Remote Command	[:SENSe] :CCARrier :COUNT <integer> [:SENSe] :CCARrier :COUNT?
Example	CCAR:COUN 1 CCAR:COUN?
Notes	The max number of Component carriers can be set greater than one with 9080B/9082B-2FP license.
Preset	1
State Saved	Saved in instrument state.
Min	1
Max	5
Initial S/W Revision	A.14.00

Configure Component Carriers

Accesses a menu of commonly used component carrier configuration parameters.

Key Path	Mode Setup, Component Carrier Setup
Initial S/W Revision	A.14.00

Component Carrier

Selects which component carrier's configuration menu is displayed. When some component carrier is selected, its corresponding parameters are displayed and can be configured.

Key Path	Mode Setup, Component Carrier Setup, Configure Component Carriers
Mode	LTEATDD, LTEAFDD

Notes	The options CC1~CC4 can be enabled with 9080B/9082B-2FP license.
Dependencies	Component Carrier is coupled to Number of Component Carriers. For example, Component Carrier list will include CC0~CC1 if the number of Component Carriers is 2.
Preset	CC0
State Saved	No
Range	CC0 CC1 CC2 CC3 CC4
Readback	CC0 CC1 CC2 CC3 CC4
Initial S/W Revision	A.14.00
Modified at S/W Revision	A.14.50

Measure Carrier

Sets whether to measure this component carrier or not.

Key Path	Mode Setup, Component Carrier Setup, Configure Component Carriers
Mode	LTEATDD, LTEAFDD
Remote Command	<code>[:SENSe] :CCARrier0 1 2 3 4 [:STATe] OFF ON 0 1</code> <code>[:SENSe] :CCARrier0 1 2 3 4 [:STATe] ?</code>
Example	CCAR0 ON CCAR0?
Notes	The command is used with a sub-op code <n> (default=0) to specify the component carrier for configuration. The range of the sub-op code is determined by the number of component carriers.
Preset	ON
State Saved	Saved in instrument state
Range	On Off
Initial S/W Revision	A.14.00

Freq Offset

Sets the component carrier center frequency as offset from the Carrier Ref Frequency.

Key Path	Mode Setup, Component Carrier Setup, Configure Component Carriers
Mode	LTEATDD, LTEAFDD
Remote Command	<code>[:SENSe] :CCARrier<n> :FREQuency:OFFSet <freq></code> <code>[:SENSe] :CCARrier<n> :FREQuency:OFFSet ?</code>
Example	CCAR4:FREQ:OFFS 10MHz CCAR4:FREQ:OFFS?
Notes	The command is used with a sub-op code <n> (default=0) to specify the component carrier for configuration. The range of the sub-op code is determined by the number of component carriers.

Preset	0Hz
State Saved	Saved in instrument state
Min	-3.5GHz
Max	3.5GHz
Initial S/W Revision	A.14.00

Bandwidth Setup

Enables you to set the parameters relevant to the bandwidth for each component carrier

Key Path	Mode Setup, Component Carrier Setup, Configure Component Carriers
Readback	The currently selected System Bandwidth
Initial S/W Revision	A.14.00

System Bandwidth

Enables you to set the system bandwidth of each component carrier for LTE-Advanced signal (which also determines the total number of resource blocks for Modulation Analysis measurement).

Key Path	FREQ Channel, Component Carrier Setup, Configure Component Carriers, Bandwidth Setup
Mode	LTEATDD, LTEAFDD
Remote Command	[:SENSe] :CCARrier0 1 2 3 4 :RADio :STANdard :BANDwidth B1M4 B3M B5M B10M B15M B20M [:SENSe] :CCARrier0 1 2 3 4 :RADio :STANdard :BANDwidth?
Example	CCAR4:RAD:STAN:BAND B5M
Preset	B5M
State Saved	Saved in instrument state.
Range	1.4 MHz (6 RB) 3 MHz (15 RB) 5 MHz (25 RB) 10 MHz (50 RB) 15 MHz (75 RB) 20 MHz (100 RB)
Readback	The currently selected System Bandwidth
Backwards Compatibility SCPI	[:SENSe] :RADio :STANdard :BANDwidth
Initial S/W Revision	A.14.00
Modified at S/W Revision	A.14.50

CHP Integ BW

Specifies the range of integration used in calculating the power in the component carrier s in the CHP measurement.

Key Path	Mode Setup, Component Carrier Setup, Configure Component Carriers, Bandwidth Setup												
Mode	LTEATDD, LTEAFDD												
Remote Command	<code>[:SENSe] :CCARrier0 1 2 3 4:CHPower:BANDwidth:INTEgration <freq></code> <code>[:SENSe] :CCARrier0 1 2 3 4:CHPower:BANDwidth:INTEgration?</code>												
Example	CCAR0:CHP:BAND:INT 20MHz CCAR0:CHP:BAND:INT?												
Notes	You must be in the LTEATDD/LTEAFDD mode to use this command. Use :INSTRument:SElect to set the mode.												
Couplings	When System Bandwidth of the parameter set is changed, the value of this parameter also changes as shown in the following table. Note that you cannot set the value exceeding the corresponding System Bandwidth.												
	<table border="1"> <tr> <td>1.4 MHz (B1M4)</td> <td>1.4 MHz</td> </tr> <tr> <td>3 MHz (B3M)</td> <td>3 MHz</td> </tr> <tr> <td>5 MHz (B5M)</td> <td>5 MHz</td> </tr> <tr> <td>10 MHz (B10M)</td> <td>10 MHz</td> </tr> <tr> <td>15 MHz (B15M)</td> <td>15 MHz</td> </tr> <tr> <td>20 MHz (B20M)</td> <td>20 MHz</td> </tr> </table>	1.4 MHz (B1M4)	1.4 MHz	3 MHz (B3M)	3 MHz	5 MHz (B5M)	5 MHz	10 MHz (B10M)	10 MHz	15 MHz (B15M)	15 MHz	20 MHz (B20M)	20 MHz
1.4 MHz (B1M4)	1.4 MHz												
3 MHz (B3M)	3 MHz												
5 MHz (B5M)	5 MHz												
10 MHz (B10M)	10 MHz												
15 MHz (B15M)	15 MHz												
20 MHz (B20M)	20 MHz												
Preset	5 MHz												
State Saved	Saved in instrument state.												
Min	100 kHz												
Max	20 MHz												
Backwards Compatibility SCPI	<code>[:SENSe] :CHPower:BANDwidth:INTEgration</code> <code>[:SENSe] :CHPower:BWIDth:INTEgration</code>												
Initial S/W Revision	A.14.00												
Modified at S/W Revision	A.14.50												

ACP Measurement Noise Bandwidth

Specifies the Measurement Noise Bandwidth used to calculate the power in the component carriers in the ACP measurement.

Key Path	Mode Setup, Component Carrier Setup, Configure Component Carriers, Bandwidth Setup
Mode	LTEATDD, LTEAFDD
Remote Command	<code>[:SENSe] :CCARrier0 1 2 3 4:ACPpower:BANDwidth[1] 2:INTEgration <freq></code> <code>[:SENSe] :CCARrier0 1 2 3 4:ACPpower:BANDwidth[1] 2:INTEgration?</code>
Example	CCAR0:ACP:BAND:INT 20MHz

	CCAR0:ACP:BAND:INT?																		
Notes	Carrier sub op code, 1 is for BTS, 2 for MS. Default is BTS. You must be in the LTEATDD/LTEAFDD mode. Use :INSTrument:SElect to set the mode.																		
Couplings	When System Bandwidth of the parameter set is changed, the value of this parameter also changes as shown in the following table. Note that you cannot set the value exceeding the corresponding System Bandwidth.																		
	<table border="1"> <tr> <td>1.4 MHz (B1M4)</td> <td>1.095 MHz</td> <td>1.08 MHz</td> </tr> <tr> <td>3 MHz (B3M)</td> <td>2.715 MHz</td> <td>2.7 MHz</td> </tr> <tr> <td>5 MHz (B5M)</td> <td>4.515 MHz</td> <td>4.5 MHz</td> </tr> <tr> <td>10 MHz (B10M)</td> <td>9.015 MHz</td> <td>9.0 MHz</td> </tr> <tr> <td>15 MHz (B15M)</td> <td>13.515 MHz</td> <td>13.5 MHz</td> </tr> <tr> <td>20 MHz (B20M)</td> <td>18.015 MHz</td> <td>18.0 MHz</td> </tr> </table>	1.4 MHz (B1M4)	1.095 MHz	1.08 MHz	3 MHz (B3M)	2.715 MHz	2.7 MHz	5 MHz (B5M)	4.515 MHz	4.5 MHz	10 MHz (B10M)	9.015 MHz	9.0 MHz	15 MHz (B15M)	13.515 MHz	13.5 MHz	20 MHz (B20M)	18.015 MHz	18.0 MHz
1.4 MHz (B1M4)	1.095 MHz	1.08 MHz																	
3 MHz (B3M)	2.715 MHz	2.7 MHz																	
5 MHz (B5M)	4.515 MHz	4.5 MHz																	
10 MHz (B10M)	9.015 MHz	9.0 MHz																	
15 MHz (B15M)	13.515 MHz	13.5 MHz																	
20 MHz (B20M)	18.015 MHz	18.0 MHz																	
Preset	4.515 MHz 4.5 MHz																		
State Saved	Saved in instrument state.																		
Min	100 kHz																		
Max	20 MHz																		
Backwards Compatibility SCPI	[:SENSe]:ACPower:CARRier[1] 2:LIST:BANDwidth[:INTEgration] [:SENSe]:ACPower:CARRier[1] 2:LIST:BWIDth[:INTEgration]																		
Initial S/W Revision	A.14.00																		
Modified at S/W Revision	A.14.50																		

SEM Integ BW

Specifies the integration bandwidth used to calculate the power in the component carriers in SEM measurement.

Key Path	Mode Setup, Component Carrier Setup, Configure Component Carriers, Bandwidth Setup
Mode	LTEATDD, LTEAFDD
Remote Command	[:SENSe]:CCARrier0 1 2 3 4:SEMAsk:BANDwidth[1] 2:INTEgration <freq> [:SENSe]:CCARrier0 1 2 3 4:SEMAsk:BANDwidth[1] 2:INTEgration?
Example	CCAR0:SEM:BAND:INT 20MHz CCAR0:SEM:BAND:INT?
Notes	Bandwidth sub op code, 1 is for BTS, 2 for MS. Default is BTS. You must be in the LTEATDD/LTEAFDD mode to use this command. Use :INSTrument:SElect to set the mode.

Couplings	When System Bandwidth of the parameter set is changed, the value of this parameter also changes as shown in the following table. Note that you cannot set the value exceeding the corresponding System Bandwidth.																		
	<table border="1"> <tr> <td>1.4 MHz (B1M4)</td> <td>1.095 MHz</td> <td>1.08 MHz</td> </tr> <tr> <td>3 MHz (B3M)</td> <td>2.715 MHz</td> <td>2.7 MHz</td> </tr> <tr> <td>5 MHz (B5M)</td> <td>4.515 MHz</td> <td>4.5 MHz</td> </tr> <tr> <td>10 MHz (B10M)</td> <td>9.015 MHz</td> <td>9.0 MHz</td> </tr> <tr> <td>15 MHz (B15M)</td> <td>13.515 MHz</td> <td>13.5 MHz</td> </tr> <tr> <td>20 MHz (B20M)</td> <td>18.015 MHz</td> <td>18.0 MHz</td> </tr> </table>	1.4 MHz (B1M4)	1.095 MHz	1.08 MHz	3 MHz (B3M)	2.715 MHz	2.7 MHz	5 MHz (B5M)	4.515 MHz	4.5 MHz	10 MHz (B10M)	9.015 MHz	9.0 MHz	15 MHz (B15M)	13.515 MHz	13.5 MHz	20 MHz (B20M)	18.015 MHz	18.0 MHz
1.4 MHz (B1M4)	1.095 MHz	1.08 MHz																	
3 MHz (B3M)	2.715 MHz	2.7 MHz																	
5 MHz (B5M)	4.515 MHz	4.5 MHz																	
10 MHz (B10M)	9.015 MHz	9.0 MHz																	
15 MHz (B15M)	13.515 MHz	13.5 MHz																	
20 MHz (B20M)	18.015 MHz	18.0 MHz																	
Preset	4.515 MHz 4.5 MHz																		
State Saved	Saved in instrument state.																		
Min	100 kHz																		
Max	20 MHz																		
Backwards Compatibility SCPI	[:SENSe] :SEMask :BANDwidth [1] 2 :INTEgration																		
Initial S/W Revision	A.14.00																		
Modified at S/W Revision	A.14.50																		

Demod

Accesses a menu that enables you to select parameters used in demodulation measurements.

Key Path	Mode Setup, Component Carrier Setup, Configure Component Carriers,
Initial S/W Revision	A.14.00

Spectrum

Determines if the spectrum of the incoming data is mirrored or not. The actual mirroring is accomplished by conjugating the complex time data.

Note that only the Modulation Analysis measurement and Conformance EVM measurement support this feature.

Key Path	Mode Setup, Component Carrier Setup, Configure Component Carriers, Demod
Mode	LTEAFDD, LTEATDD
Remote Command	[:SENSe] :CCARrier0 1 2 3 4 :SPEctrum NORMal INVert [:SENSe] :CCARrier0 1 2 3 4 :SPEctrum?
Example	CCARO:SPEC INV

	CCAR0:SPEC?
Preset	NORM
State Saved	Saved in instrument state.
Range	Normal Invert
Backwards Compatibility SCPI	[:SENSe] :SPECtrum
Initial S/W Revision	A.14.00
Modified at S/W Revision	A.14.50

UL/DL Allocation

This key allows you to set the Uplink and Downlink allocation configuration of the signal being measured. The choice of link direction will determine which slot in the frame is used for uplink transmission, and which slot for downlink transmission.

Key Path	Mode Setup, Component Carrier Setup, Configure Component Carriers
Mode	LTETDD
Remote Command	[:SENSe] :CCARrier0 1 2 3 4:RADio:STANdard:ULDL CONF0 CONF1 CONF2 CONF3 CONF4 CONF5 CONF6 [:SENSe] :CCARrier0 1 2 3 4:RADio:STANdard:ULDL?
Example	CCAR0:RAD:STAN:ULDL CONF0
Notes	CONF0: Configuration 0 (DSUUUDSUUU) CONF1: Configuration 1 (DSUUDDSUUD) CONF2: Configuration 2 (DSUDDDSUDD) CONF3: Configuration 3 (DSUUUDDDDDD) CONF4: Configuration 4 (DSUUDDDDDDD) CONF5: Configuration 5 (DSUDDDDDDDD) CONF6: Configuration 6 (DSUUUDSUUD)
Preset	CONF0
State Saved	Saved in instrument state.
Range	Configuration 0 Configuration 1 Configuration 2 Configuration 3 Configuration 4 Configuration 5 Configuration 6
Backwards Compatibility SCPI	[:SENSe] :RADio:STANdard:ULDL
Initial S/W Revision	A.14.00
Modified at S/W Revision	A.14.50

Dw/GP/Up Len

This key allows you to set the DwPTS/GP/UpPTS length configuration of the signal being measured. The choice of link direction will determine the length of DwPTS, GP and UpPTS in the Special Subframe.

Key Path	Mode Setup, Component Carrier Setup, Configure Component Carriers
Mode	LTETDD
Remote Command	[:SENSe] :CCARrier0 1 2 3 4:RADio:STANdard:DGPU CONF0 CONF1 CONF2 CONF3 CONF4 CONF5 CONF6 CONF7 CONF8 CONF9 [:SENSe] :CCARrier0 1 2 3 4:RADio:STANdard:DGPU?
Example	CCAR0:RAD:STAN:DGPU CONF0
Notes	CONF0: Configuration 0 CONF1: Configuration 1 CONF2: Configuration 2 CONF3: Configuration 3 CONF4: Configuration 4 CONF5: Configuration 5 CONF6: Configuration 6 CONF7: Configuration 7 CONF8: Configuration 8 CONF9: Configuration 9
Dependencies	The special sub-frame configuration 9 is only enabled when it is LTE-Advanced TDD.
Preset	CONF0
State Saved	Saved in instrument state.
Range	Configuration 0 Configuration 1 Configuration 2 Configuration 3 Configuration 4 Configuration 5 Configuration 6 Configuration 7 Configuration 8 Configuration 9
Backwards Compatibility SCPI	[:SENSe] :RADio:STANdard:DGPU
Initial S/W Revision	A.14.00
Modified at S/W Revision	A.14.50

Component Carriers Allocation

Specifies the carrier frequency allocation. There are two types of allocation, contiguous and non-contiguous. Non-Contiguous frequency allocation is defined as an allocation where two sub-blocks are separated with a sub-block gap.

Contiguous – All the component carriers belong to one block and no sub-block gap exists.

Non-Contiguous – Component carriers are separated into two sub-blocks. Allocation Break Pt Carrier determines how sub-blocks are configured.

Key Path	Mode Setup, Component Carrier Setup
Mode	LTEATDD, LTEAFDD

Scope	Meas Global
Remote Command	[:SENSe] :CCARrier:CONFig:ALLocation CONTiguous NCONtiguous [:SENSe] :CCARrier:CONFig:ALLocation?
Example	CCAR:CONF:ALL CONT CCAR:CONF:ALL?
Preset	CONtiguous
State Saved	Saved in instrument state.
Range	Contiguous Non-Contiguous
Initial S/W Revision	A.14.00

Non-Contiguous Allocation

Opens a menu that enables you to set a non-contiguous parameter.

Key Path	Mode Setup, Component Carrier Setup, Component Carriers Alloc
Readback Text	Break at <Component carrier>
Initial S/W Revision	A.14.00

Allocation Break Pt Carrier

Specifies an allocation break point in non-contiguous carrier allocation. First sub-block starts from the lowest frequency carrier and stops at the allocation break point carrier. Next sub-block starts from the next upper frequency carrier and ends at the highest frequency carrier.

one example is shown below. In the example carrier indices are not in the order of carrier frequency. In the example, Allocation Break Pt Carrier is CC1. It means that sub-block 1 ends at carrier CC1 and sub-block 2 starts at carrier CC4. Sub-block gap is located between carrier CC1 and CC4.

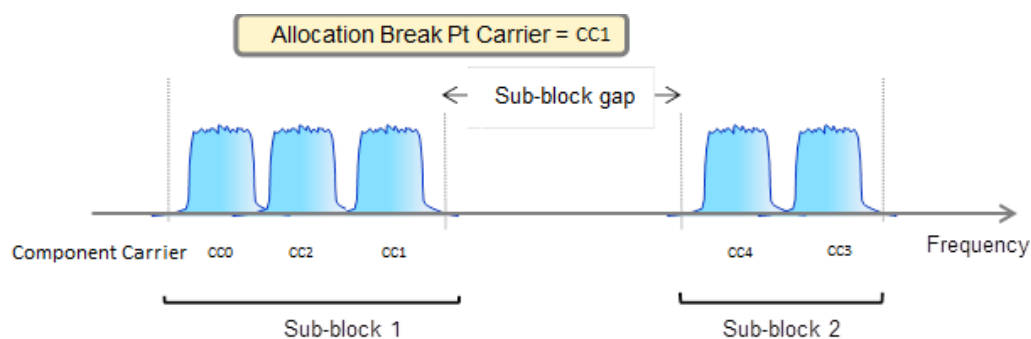

Key Path	Mode Setup, Component Carrier Setup, Component Carriers Alloc, Non-Contiguous
Scope	Meas Global
Remote Command	[:SENSe] :CCARrier:CONFig:ALLocation:NCONtiguous:ABPoint CC0 CC1 CC2 CC3 CC4

	<code>[:SENSe] :CCARrier :CONFig :ALLocation :NCONtiguous :ABPoint ?</code>
Example	<code>CCAR:CONF:ALL:NCON:ABP CC0</code> <code>CCAR:CONF:ALL:NCON:ABP?</code>
Notes	The options CC1~CC4 can be enabled with 9080B/9082B-2FP license.
Dependencies	Allocation Break Point is coupled to Number of Component Carriers. For example, Allocation Break Point list will include CC0~CC1 if the number of Component Carriers is 2.
Preset	CC0
State Saved	Saved in instrument state.
Range	CC0 CC1 CC2 CC3 CC4
Initial S/W Revision	A.14.00
Modified at S/W Revision	A.14.50

Carrier Ref Freq

Sets carrier reference frequency. The center frequencies of carriers are defined as offset frequency from this value.

If the following conditions are satisfied at the same time:

- the Number of Component Carrier equals to 1
- the Center Freq Offset equals to 0 Hz
- the mode of the Center Freq is Auto

the Center Freq is equivalent to Carrier Ref Freq.

When the Center Freq changes in such conditions, the mode of the Center Freq keeps as Auto and the Carrier Ref Freq will be changed to same value. The major purpose of this coupling is to keep BWCC with legacy LTE/LTE TDD, in which `:SENSe:FREQuency:CENTer` is used to set up the Frequency of the measurement.

Key Path	FREQ Channel Mode Setup, Component Carrier Setup
Mode	LTEATDD, LTEAFDD
Measurement	All
Remote Command	<code>[:SENSe] :CCARrier :REFerence <freq></code> <code>[:SENSe] :CCARrier :REFerence?</code>
Example	<code>CCAR:REF 2GHz</code> <code>CCAR:REF?</code>
Notes	In order to easily configure component carriers, the key is also placed in the Mode Setup.
Preset	1GHz
State Saved	Saved in instrument state
Min	Depends on instrument minimum center frequency. Same as Center Freq

Max	Depends on instrument maximum center frequency. Same as Center Freq
Initial S/W Revision	A.14.00
Modified at S/W Revision	A.14.50

RF Bandwidth (Remote Command Only)

Returns the RF bandwidth calculated from the outermost component carriers and their Foffset.

Key Path	SCPI only
Mode	LTEATDD,LTEAFDD
Remote Command	<code>[:SENSe] :CCARrier :RFBWidth?</code>
Example	CCAR:RFBW?
Preset	Calculated from preset values of component carrier config parameters
State Saved	No
Initial S/W Revision	A.14.00

RF Bandwidth Center (Remote Command Only)

Returns the center frequency of RF bandwidth.

Key Path	SCPI only
Mode	LTEATDD,LTEAFDD
Remote Command	<code>[:SENSe] :CCARrier :RFBWidth :CENTer?</code>
Example	CCAR:RFBW:CEN?
Preset	Calculated from preset values of component carrier config parameters
State Saved	No
Initial S/W Revision	A.14.00

Sub-block Center (Remote Command Only)

Returns the center frequency of one sub-block when Component Carrier Allocation is Non-Contiguous.

Key Path	SCPI only
Mode	LTEATDD,LTEAFDD
Remote Command	<code>[:SENSe] :CCARrier :SBLock [1] 2 :CENTer?</code>
Example	CCAR:SBL:CEN?
Notes	When Component Carrier Allocation is Contiguous, 9.91E+37 is returned.
Preset	Calculated from preset values of component carrier config parameters

State Saved	No
Initial S/W Revision	A.14.00

Sub-block Bandwidth (Remote Command Only)

Returns the bandwidth of one sub-block calculated from outermost component carriers of this sub-block and its corresponding Foffset when Component Carrier Allocation is Non-Contiguous.

Key Path	SCPI only
Mode	LTEATDD,LTEAFDD
Remote Command	[:SENSe] :CCARrier:SBLock[1] 2 :BWIDth?
Example	CCAR:SBL:BWID?
Notes	When Component Carrier Allocation is Contiguous, 9.91E+37 is returned.
Preset	Calculated from preset values of component carrier config parameters
State Saved	No
Initial S/W Revision	A.14.00

Sub-block Gap (Remote Command Only)

Returns the frequency gap between two consecutive sub-blocks within an RF bandwidth when Component Carrier Allocation is Non-Contiguous.

Key Path	SCPI only
Mode	LTEATDD,LTEAFDD
Remote Command	[:SENSe] :CCARrier:SBLock:GAP?
Example	CCAR:SBL:GAP?
Notes	When Component Carrier Allocation is Contiguous, 9.91E+37 is returned.
Preset	Calculated from preset values of component carrier config parameters
State Saved	No
Initial S/W Revision	A.14.00

Pre-defined Parameters

On the LTE-Advanced TDD Mode, the parameters under this key will impact the gate or trigger length and delay of below measurements:

- Monitor Spectrum
- Channel Power
- ACP

- Power Stat CCDF
- Occupied BW
- Spectrum Emission Mask
- Spurious Emission

On the LTE-Advanced FDD Mode, Pre-defined Parameters are used in the Transmit On/Off Power measurement.

Key Path	Mode Setup
Mode	LTEATDD, LTEAFDD
Couplings	The key is disabled in LTE-Advanced FDD downlink.
Initial S/W Revision	A.14.00

Analysis Slot for LTEATDD

This parameter specifies the starting analysis slot. The measurement will adjust the gate delay or trigger delay according to this parameter.

Key Path	Mode Setup, Pre-defined Parameters
Mode	LTETDD
Remote Command	[:SENSe]:RADio:SLOT TS0 TS1 DPTS1 UPTS1 TS4 TS5 TS6 TS7 TS8 TS9 TS10 TS11 TS12 TS13 TS14 TS15 TS16 TS17 TS18 TS19 [:SENSe]:RADio:SLOT? //LTEATDD//
Example	RAD:SLOT TS0
Couplings	Measurement's gate length or meas interval will couple to the parameter.
Preset	TS0
State Saved	Saved in instrument state.
Range	TS0 TS1 DwPTS1 UpPTS1 TS4 TS5 TS6 TS7 TS8 TS9 TS10 TS11 TS12(DwPTS2) TS13(UpPTS2) TS14 TS15 TS16 TS17 TS18 TS19
Initial S/W Revision	A.14.00

Meas Interval

This parameter specifies the desired slots count that needs to be analyzed. The measurement will adjust the gate length or meas interval according to this parameter.

Key Path	Mode Setup, Pre-defined Parameters
Mode	LTETDD, LTEAFDD
Remote Command	[:SENSe]:RADio:MINInterval <integer> [:SENSe]:RADio:MINInterval

Example	:RAD:MINT 1
Notes	The backwards compatible SCPI command “[:SENSe]:PVTime:MINTerval” is available in LTE FDD & LTE-A FDD application.
Couplings	This key is disable when the “Measure PRACH” is in scope and its value is not off, then the actual meas interval is the length PRACH or SRS channel.
Preset	1
State Saved	Saved in instrument state.
Min	1
Max	20
Backwards Compatibility SCPI	[:SENSe]:PVTime:MINTerval (LTE)
Initial S/W Revision	A.14.00
Modified at S/W Revision	A.14.50

CP Length

This parameter specifies whether the cyclic prefix is configured as Normal or Extended for power measurement. The parameter will affect the gate length or meas interval parameters.

Key Path	Mode Setup, Pre-defined Parameters
Mode	LTETDD, LTEAFDD
Remote Command	[:SENSe]:RADio:CPLength NORMal EXTended [:SENSe]:RADio:CPLength?
Example	RAD:CPL NORM
Notes	The backwards compatible SCPI command “[:SENSe]:PVTime:CPLength” is available in LTE FDD & LTE-A FDD application.
Preset	NORMal
State Saved	Saved in instrument state.
Range	Normal Extended
Backwards Compatibility SCPI	[:SENSe]:PVTime:CPLength (LTE)
Initial S/W Revision	A.14.00
Modified at S/W Revision	A.14.50

Measure PRACH/SRS for LTEATDD

This key specifies whether the analysis slot is used for PRACH channel or SRS and the PRACH preamble format of the analysis slot.

The measurement will adjust the gate length or meas interval according to this parameter.

Key Path	Mode Setup, Pre-defined Parameters
Mode	LTETDD
Remote Command	[:SENSe] :RADio:MEASure OFF PPF0 PPF1 PPF2 PPF3 PPF4 SRS DSRS [:SENSe] :RADio:MEASure?
Example	RAD:MEAS OFF
Couplings	If direction is downlink, the key is disabled and the value is set to off. If this key value is not off, Meas Interval is disabled.
Preset	OFF
State Saved	Saved in instrument state.
Range	Off Preamble 0 Preamble 1 Preamble 2 Preamble 3 Preamble 4 SRS DSRS
Initial S/W Revision	A.14.00

Reference Configuration

This key specifies which component carrier's ULDL Allocation Configuration and Dw/Up Length Configuration settings are used to adjust time slot to be measured automatically.

Key Path	Mode Setup, Pre-defined Parameters
Mode	LTETDD, LTEAFDD
Remote Command	[:SENSe] :RADio:RCONfig CC0 CC1 CC2 CC3 CC4 [:SENSe] :RADio:RCONfig?
Example	RAD:RCON CC0
Notes	The options CC1~CC4 can be enabled with 9080B/9082B-2FP license.
Dependencies	Reference Configuration is coupled to Number of Component Carriers. For example, reference configuration list will include CC0~CC1 if the number of Component Carriers is 2.
Preset	CC0
State Saved	Saved in instrument state.
Range	CC0 CC1 CC2 CC3 CC4
Initial S/W Revision	A.14.00
Modified at S/W Revision	A.14.50

Global Settings

Opens a menu that allows you to switch certain Meas Global parameters to a Mode Global state. These switches apply to all Modes that support global settings. No matter what Mode you are in when you set the "Global Center Frequency" switch to on, it applies to all Modes that support Global Settings.

Key Path	Mode Setup
Initial S/W Revision	Prior to A.02.00

Global Center Freq

The software maintains a Mode Global value called “Global Center Freq”.

When the Global Center Freq key is switched to On in any mode, the current mode’s center frequency is copied into the Global Center Frequency, and from then on all modes that support global settings use the Global Center Frequency. So you can switch between any of these modes and the Center Freq will remain unchanged.

Adjusting the Center Freq of any mode which supports Global Settings, while Global Center Freq is On, will modify the Global Center Frequency.

When Global Center Freq is turned Off, the Center Freq of the current mode is unchanged, but now the Center Freq of each mode is once again independent.

When Mode Preset is pressed while Global Center Freq is On, the Global Center Freq is preset to the preset Center Freq of the current mode.

This function is reset to Off when the Restore Defaults key is pressed in the Global Settings menu, or when System, Restore Defaults, All Modes is pressed.

Key Path	Mode Setup, Global Settings
Scope	Mode Global
Remote Command	:INSTrument:COUPle:FREQuency:CENTer ALL NONE :INSTrument:COUPle:FREQuency:CENTer?
Example	INST:COUP:FREQ:CENT ALL INST:COUP:FREQ:CENT?
Preset	Set to Off on Global Settings, Restore Defaults and System, Restore Defaults, All Modes
Range	On Off
Initial S/W Revision	Prior to A.02.00

Remote Command	:GLOBal:FREQuency:CENTer[:STATe] 1 0 ON OFF :GLOBal:FREQuency:CENTer[:STATe]?
Preset	Off
Initial S/W Revision	Prior to A.02.00

Restore Defaults

This key resets all of the functions in the Global Settings menu to Off. This also occurs when System, Restore Defaults, All Modes is pressed.

Key Path	Mode Setup, Global Settings
----------	-----------------------------

Remote Command	:INSTRUMENT:COUPLE:DEFAULT
Example	INST:COUP:DEF
Backwards Compatibility SCPI	:GLOBal:DEFAULT
Initial S/W Revision	Prior to A.02.00

Intermod

In order to measure transmitter intermodulation performance (Refer to the description at), the parameters for intermodulation interference signal are provided as below:

Key Path	Mode Setup
Mode	LTEATDD,LTEAFDD
Measurement	ACP,Sepctrum Emission Mask,Spurious Emission
Initial S/W Revision	A.14.00

Interference Pwr Present

Sets whether interference signal for the intermodulation tests exists or not. If exists, limits are not evaluated over the interference signal frequency range specified by the span and the center frequency parameters in Adjacent Channel, Spectrum Emission Mask and Spurious Emissions.

Key Path	Mode Setup, Intermod
Remote Command	[:SENSe] :RADio:IMODulation:INTerference[:STATE] OFF ON 0 1 [:SENSe] :RADio:IMODulation:INTerference[:STATE]?
Example	RAD:IMOD:INT 1 RAD:IMOD:INT?
Preset	OFF
State Saved	Saved in instrument state
Range	Yes No
Initial S/W Revision	A.14.00

Freq Offset from Edge

Sets the center frequency of the interference signal for intermodulation tests. The frequency is set as offset frequency from the BS RF bandwidth edge. Interference Offset Side determines on which side of the BS RF bandwidth the interference signal exists.

Key Path	Mode Setup, Intermod
Remote Command	[:SENSe] :RADio:IMODulation:INTerference:FREQuency:OFFSet <freq>

	<code>[:SENSe] :RADio :IMODulation :INTerference :FREQuency :OFFSet ?</code>
Example	<code>RAD:IMOD:INT:FREQ:OFFS 5MHz</code> <code>RAD:IMOD:INT:FREQ:OFFS?</code>
Preset	5MHz
State Saved	Saved in instrument state
Min	0 Hz
Max	20.0 MHz
Initial S/W Revision	A.14.00

Span

Sets the span of the interference signal for intermodulation tests.

Key Path	Mode Setup, Intermod
Remote Command	<code>[:SENSe] :RADio :IMODulation :INTerference :SPAN <freq></code> <code>[:SENSe] :RADio :IMODulation :INTerference :SPAN?</code>
Example	<code>RAD:IMOD:INT:SPAN 5MHz</code> <code>RAD:IMOD:INT:SPAN?</code>
Preset	5MHz
State Saved	Saved in instrument state
Min	200 kHz
Max	20.0 MHz
Initial S/W Revision	A.14.00

Offset Side

Sets which side of the BS RF bandwidth the interference signal exists on.

Key Path	Mode Setup, Intermod
Remote Command	<code>[:SENSe] :RADio :IMODulation :INTerference :SIDE NEGative POSitive</code> <code>[:SENSe] :RADio :IMODulation :INTerference :SIDE?</code>
Example	<code>RAD:IMOD:INT:SIDE POS</code> <code>RAD:IMOD:INT:SIDE?</code>
Preset	POSitive
State Saved	Saved in instrument state
Initial S/W Revision	A.14.00

Non-Contiguous Interference Region

Sets the region the interfering signal exists at in the Non-Contiguous mode

Inner – The interfering signal exists at the inner region. This setting is only effective when Carrier Alloc is Non-Contiguous. When in Contiguous, the interference region is always outside regardless of the selection of this parameter.

Outer – The interfering signal exists at either of the outer regions.

Key Path	Mode Setup, Intermod
Remote Command	[:SENSe] :RADio:IMODulation:INTerference:REGion INNER OUTer [:SENSe] :RADio:IMODulation:INTerference:REGion?
Example	RAD:IMOD:INT:REG OUT RAD:IMOD:INT:REG?
Preset	OUTer
State Saved	Saved in instrument state
Initial S/W Revision	A.14.00

Restore Mode Defaults

Resets the state for the currently active mode by resetting the mode persistent settings to their factory default values, clearing mode data and by performing a Mode Preset. This function will never cause a mode switch. This function performs a full preset for the currently active mode; whereas, Mode Preset performs a partial preset. Restore Mode Defaults does not affect any system settings. System settings are reset by the Restore System Defaults function. This function does reset mode data; as well as settings.

Key Path	Mode Setup
Remote Command	:INSTrument:DEFault
Example	:INST:DEF
Notes	Clears all pending OPC bits. The Status Byte is set to 0. A message comes up saying: "If you are sure, press key again".
Couplings	A Restore Mode Defaults will cause the currently running measurement to be aborted and causes the default measurement to be active. It gets the mode to a consistent state with all of the default couplings set.
Initial S/W Revision	Prior to A.02.00

Preset Type (Remote Command Only)

As stated in the Backward Compatibility section, to be compatible with ESA/PSA the PRESet:TYPE command will be implemented as a no-op.

Mode	All
Remote Command	:SYSTem:PRESet:TYPE FACTory MODE USER

	:SYSTem:PRESet:TYPE?
Example	:SYST:PRES:TYPE FACT
Notes	This command is supported for backward compatibility only. It is a no-op which does not change the behavior of any preset operation.
Preset	This is unaffected by Preset but is set to Mode on a "Restore System Defaults->All"
State Saved	No
Initial S/W Revision	Prior to A.02.00

6 System Functions

File

Opens a menu that enables you to access various standard and custom Windows functions. Press any other front-panel key to exit

Key Path	Front-panel key
Initial S/W Revision	Prior to A.02.00

File Explorer

Opens the standard Windows File Explorer. The File Explorer opens in the My Documents directory for the current user.

The File Explorer is a separate Windows application, so to return to the analyzer once you are in the File Explorer, you may either:

Exit the File Explorer by clicking on the red X in the upper right corner, with a mouse

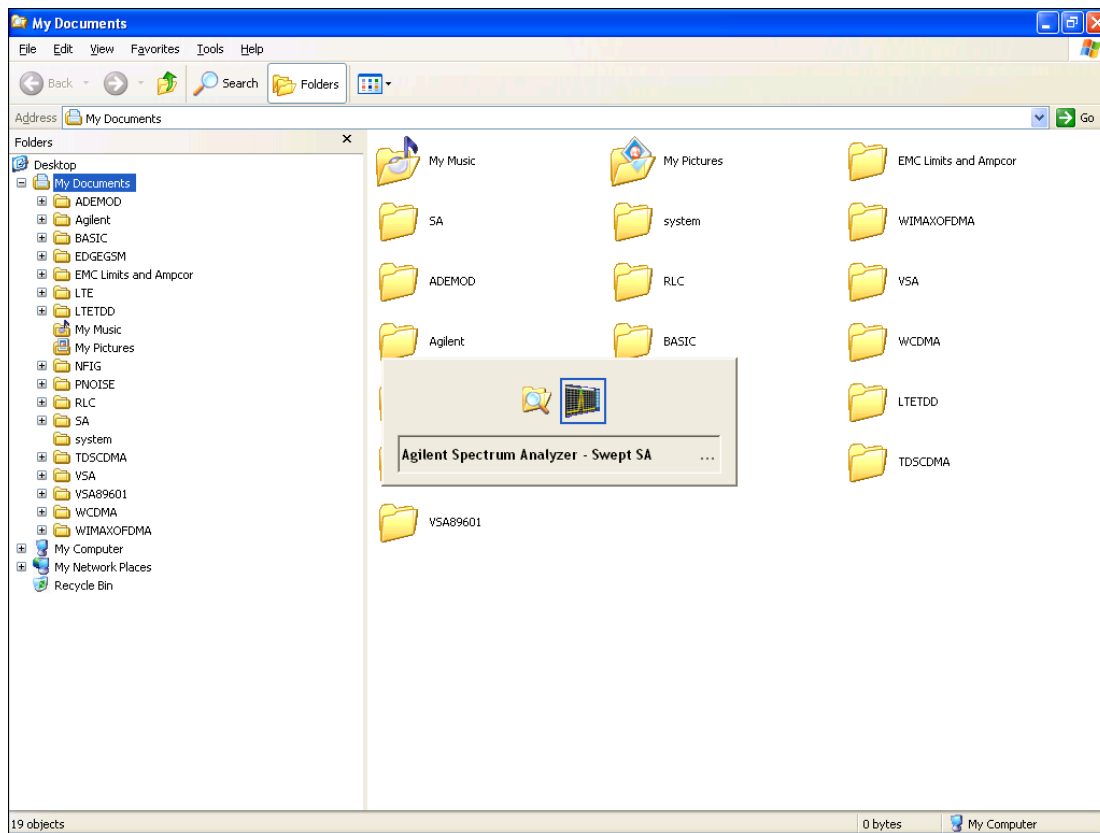

Or use Alt-Tab: press and hold the Alt key and press and release the Tab key until the Analyzer logo is showing in the window in the center of the screen, as shown above, then release the Alt key.

The ability to access File Explorer is not available if Option SF1 is installed.

Key Path	File
Initial S/W Revision	Prior to A.02.00

Print

The Print key opens a Print dialog for configured printing (for example, to the printer of your choice). Refer to your Microsoft Windows Operating System manual for more information.

Maximize/Restore Down

These keys allow the Instrument Application to be maximized and then restored to its prior state. Only one of the two keys is visible at a time. When not already maximized the Maximize Application key is visible, and when maximized, the Restore Down Application key is visible and replaces the Maximize Application key.

Maximize

This key allows you to Maximize the Instrument Application, which causes the analyzer display to fill the screen. Once the application is maximized, this key is replaced by the Restore Down key.

Key Path	File
Mode	All
Notes	No equivalent remote command for this key.
State Saved	No
Initial S/W Revision	A.05.01

Restore Down

This key allows you to Restore Down the Instrument Application and reverses the action taken by Maximize. This key is only visible when the application has been maximized, and after the Restore Down action has been completed this key is replaced by the Maximize key.

Key Path	File
Mode	All
Notes	No equivalent remote command for this key.
State Saved	No
Initial S/W Revision	A.05.01

Page Setup

The Page Setup key brings up a Windows Page Setup dialog that allows you to control aspects of the pages sent to the printer when the PRINT hardkey is pressed.

Key Path	File
Initial S/W Revision	Prior to A.02.00

Paper size, the printer paper source, the page orientation and the margins are all settable. Just like any standard Windows dialog, you may navigate the dialog using the front-panel keys, or a mouse. There are no SCPI commands for controlling these parameters.

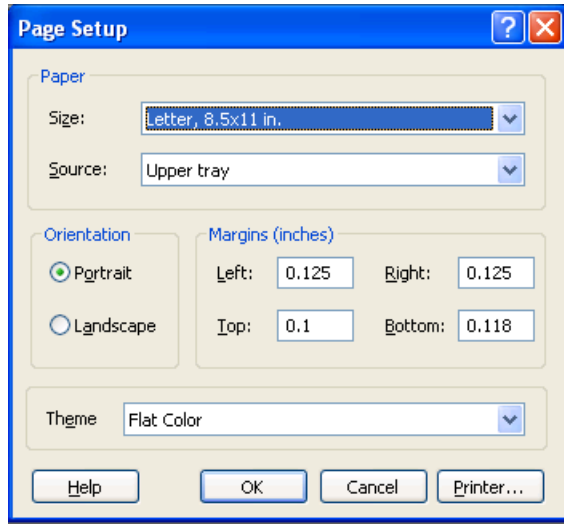

Also contained in this dialog is a drop-down control that lets you select the Theme to use when printing. For more on Themes, see information under View/Display, Display, System Display Settings, Theme. The Theme control has a corresponding SCPI command.

Parameter Name	Print Themes
Parameter Type	Enum
Mode	All
Remote Command	:SYSTem:PRINT:THEMe TDCOLOR TDMonochrome FCOLOR FMONochrome :SYSTem:PRINT:THEMe?
Example	:SYST:PRIN:THEM FCOL
Setup	:SYSTem:DEFault MISC
Preset	FCOL; not part of Preset, but is reset by Restore Misc Defaults or Restore System Defaults All and survives subsequent running of the modes.
State Saved	No
Initial S/W Revision	Prior to A.02.00

Print

This front-panel key is equivalent to performing a File, Print, OK. It immediately performs the currently configured Print to the Default printer.

The :HCOPY command is equivalent to pressing the PRINT key. The HCOPY:ABORT command can be used to abort a print which is already in progress. Sending HCOPY:ABORT will cause the analyzer to stop sending data to the printer, although the printer may continue or even complete the print, depending on how much data was sent to the printer before the user sent the ABORT command.

Key Path	Front-panel key
Remote Command	:HCOPY[:IMMEDIATE]
Initial S/W Revision	Prior to A.02.00

Key Path	SCPI command only
Remote Command	:HCOPY:ABORT
Initial S/W Revision	Prior to A.02.00

Restore Down

This key allows you to Restore Down the Instrument Application and reverses the action taken by Maximize. This key is only visible when the application has been maximized, and after the Restore Down action has been completed this key is replaced by the Maximize key.

Key Path	File
Mode	All
Notes	No equivalent remote command for this key.
State Saved	No
Initial S/W Revision	A.05.01

Minimize

The Minimize key causes the analyzer display to disappear down into the task bar, allowing you to see the

Windows Desktop. You can use Alt-Tab (press and hold the Alt  key and press and release the Tab key) to restore the analyzer display.

Key Path	File
Mode	All
Notes	No equivalent remote command for this key.
State Saved	No
Initial S/W Revision	A.05.01

Exit

This key, when pressed, will exit the Instrument Application. A dialog box is used to confirm that you intended to exit the application:

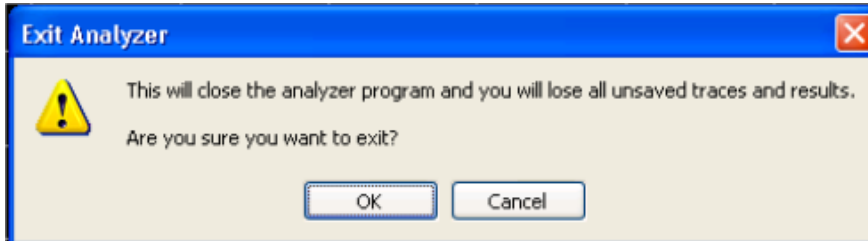

Key Path	File
Mode	All
Notes	The Instrument Application will close. No further SCPI commands can be sent. Use with caution!
Initial S/W Revision	Prior to A.02.00

Print

This front-panel key is equivalent to performing a File, Print, OK. It immediately performs the currently configured Print to the Default printer.

The :HCOPY command is equivalent to pressing the PRINT key. The HCOPY:ABORT command can be used to abort a print which is already in progress. Sending HCOPY:ABORT will cause the analyzer to stop sending data to the printer, although the printer may continue or even complete the print, depending on how much data was sent to the printer before the user sent the ABORT command.

Key Path	Front-panel key
Remote Command	:HCOPY[:IMMEDIATE]
Initial S/W Revision	Prior to A.02.00

Key Path	SCPI command only
Remote Command	:HCOPY:ABORT
Initial S/W Revision	Prior to A.02.00

System

Opens a menu of keys that access various configuration menus and dialogs.

Key Path	Front-panel key
Notes	No remote command for this key specifically.
Initial S/W Revision	Prior to A.02.00

Show

Accesses a menu of choices that enable you to select the information window you want to view.

Key Path	System
Mode	All
Remote Command	:SYSTem:SHOW OFF ERRor SYSTem HARDware LXI HWSTatistics ALIGNment SOFTware CAPplication :SYSTem:SHOW?
Example	:SYST:SHOW SYST
Notes	This command displays (or exits) the various System information screens.
Preset	OFF
State Saved	No
Range	OFF ERRor SYSTem HARDware LXI HWSTatistics ALIGNment SOFTware CAPplication
Initial S/W Revision	Prior to A.02.00

Errors

There are two modes for the Errors selection, History and Status.

The list of errors displayed in the Errors screen does not automatically refresh. You must press the Refresh key or leave the screen and return to it to refresh it.

History brings up a screen displaying the event log in chronological order, with the newest event at the top. The history queue can hold up to 100 messages (if a message has a repeat count greater than 1 it only counts once against this number of 100). Note that this count bears no relation to the size of the SCPI queue. If the queue extends onto a second page, a scroll bar appears to allow scrolling with a mouse. Time is displayed to the second.

Status brings up a screen summarizing the status conditions currently in effect. Note that the time is displayed to the second.

The fields on the Errors display are:

Type (unlabeled) - Displays the icon identifying the event or condition as an error or warning.

ID - Displays the error number.

Message - Displays the message text.

Repeat (RPT) - This field shows the number of consecutive instances of the event, uninterrupted by other events. If an event occurs 5 times with no other intervening event, the value of repeat will be 5.

If the value of Repeat is 1 the field does not display. If the value of Repeat is >1, the time and date shown are those of the most recent occurrence. If the value of repeat reaches 999,999 it stops there.

Time - Shows the most recent time (including the date) at which the event occurred.

Key Path	System, Show
Mode	All
Remote Command	:SYSTem:ERRor[:NEXT]?
Example	:SYST:ERR?
Notes	The return string has the format: “<Error Number>,<Error>” Where <Error Number> and <Error> are those shown on the Show Errors screen
Backwards Compatibility Notes	In some legacy analyzers, the Repeat field shows the number of times the message has repeated since the last time the error queue was cleared. In the X-Series, the Repeat field shows the number of times the error has repeated since the last intervening error. So the count may very well be different than in the past even for identical signal conditions Unlike previous analyzers, in the X-Series all errors are reported through the Message or Status lines and are logged to the event queue. They never appear as text in the graticule area (as they sometimes do in previous analyzers) and they are never displayed in the settings panel at the top of the screen (as they sometimes do, by changing color, in previous analyzers). As a consequence of the above, the user can only see one status condition (the most recently generated) without looking at the queue. In the past, at least in the Spectrum Analyzer, multiple status conditions might display on the right side of the graticule. In general, there is no backwards compatibility specified or guaranteed between the error numbers in the X-Series and those of earlier products. Error, event, and status processing code in customers' software will probably need to be rewritten to work with X-Series. In the legacy analyzers, some conditions report as errors and others simply turn on status bits. Conditions that report as errors often report over and over as long as the condition exists. In the X-series, all conditions report as start and stop events. Consequently, software that repeatedly queries for a condition error until it stops reporting will have to be rewritten for the X-series.
Initial S/W Revision	Prior to A.02.00

Previous Page

See ["Next Page" on page 274.](#)

Key Path	System, Show, Errors
Initial S/W Revision	Prior to A.02.00

Next Page

Next Page and Previous Page menu keys move you between pages of the log, if it fills more than one page. These keys are grayed out in some cases:

- If on the last page of the log, the Next Page key is grayed-out
- If on the first page of the log, the Previous Page key is grayed-out.
- If there is only one page, both keys are grayed out.

Key Path	System, Show, Errors
Initial S/W Revision	Prior to A.02.00

History

The History and Status keys select the Errors view. The Status key has a second line that shows a number in [square brackets]. This is the number of currently open status items.

Key Path	System, Show, Errors
Initial S/W Revision	Prior to A.02.00

Verbose SCPI On/Off

When you turn Verbose SCPI on, additional information is returned when you send the :SYSTem:ERRor? query. The additional information consists of the characters that stimulated the error. This can aid you in debugging your test programs by indicating where in the parsing of a SCPI command the instrument encountered an invalid command or query.

Specifically, with Verbose SCPI on, the SYSTem:ERRor? query is expanded to show the SCPI data received, with the indicator <Err> at the point in the stream that the error occurred.

Verbose SCPI has no effect on the Show Errors screen or front panel Message Line; it only changes the response to the :SYST:ERR? query.

See the example below, where the invalid command "SENS:BOGUS" is sent:

Normal response to :SYST:ERR (using the Telnet window):

```
SCPI> SENS:BOGUS
```

```
SCPI> SYST:ERR?
```

```
-113,"Undefined header"
```

Now after turning on Verbose SCPI:

```
SCPI> SYST:BOGUS
```

```
SCPI> SYST:ERR?
```

```
-113,"Undefined header;SYST:BOGUS<Err>"
```

Key Path	System, Show, Errors
Mode	All
Remote Command	:SYSTem:ERRor:VERBose OFF ON 0 1 :SYSTem:ERRor:VERBose?
Example	:SYST:ERR:VERB ON
Preset	This is unaffected by Preset but is set to OFF on a "Restore System Defaults->Misc"
State Saved	No
Range	On Off
Initial S/W Revision	Prior to A.02.00

Refresh

When pressed, refreshes the Show Errors display.

Key Path	System, Show, Errors
Initial S/W Revision	Prior to A.02.00

Clear Error Queue

This clears all errors in all error queues.

Note the following:

- Clear Error Queue does not affect the current status conditions.
- Mode Preset does not clear the error queue.
- Restore System Defaults will clear all error queues.
- *CLS only clears the queue if it is sent remotely and *RST does not affect any error queue.
- Switching modes does not affect any error queues.

Key Path	System, Show, Errors
Initial S/W Revision	Prior to A.02.00

Status

See "[History](#)" on page 274.

Input Overload Enable (Remote Command Only)

Input Overload errors are reported using the Input Overload status bit (bit 12 in the Measurement Integrity status register). Input Overloads (for example, ADC Overload errors) can come and go with great frequency, generating many error events (for example, for signals just on the verge of overload), and so are

not put into the SCPI error queue by default. Normally the status bit is the only way for detecting these errors remotely.

It is possible to enable Input Overload reporting to the SCPI queue, by issuing the :SYSTem:ERRor:OVERload ON command. To return to the default state, issue the :SYSTem:ERRor:OVERload OFF command. In either case, Input Overloads always set the status bit.

NOTE

For versions of firmware before A.10.01, the Input Overload was only a Warning and so was never available in the SCPI queue, although it did set the status bit. For A.10.01 and later, the Input Overload is an error and can be enabled to the SCPI queue using this command.

Key Path	SCPI only
Remote Command	:SYSTem:ERRor:OVERload[:STATe] 0 1 OFF ON
Example	:SYST:ERR:OVER 1 Enable overload errors
Preset	Set to OFF by Restore Misc Defaults (no Overload errors go to SCPI)
State Saved	Saved in instrument state.
Initial S/W Revision	A.10.01

Power Up (Remote Command Only)

This serves to show the errors encountered during the application boot-up, such as: mismatch FW-FPGA, missing Calibration data, missing hardware and construction errors.

Remote Command	:SYSTem:ERRor:PUP?
Notes	<p>If no error occurs, the return value will be: "No Power Up Errors." Return Value: <list of error strings>. <List of error strings> is an <IEEE488 Block> format. Return Value Example: "Power up errors, see details in Windows Event Log" "Unmatched FPGA Version(s), See details in Windows Event Log"</p>
Initial S/W Revision	E.14.30

System

The System screen is formatted into three groupings: product descriptive information, options tied to the hardware, and software products:

```

<Product Name> <Product Description>
Product Number: N9020A
Serial Number: US46220924
Firmware Revision: A.01.01
Computer Name: <hostname>
Host ID: N9020A,US44220924

N9020A-503      Frequency Range to 3.6 GHz
N9020A-PFR      Precision Frequency Reference
N9020A-P03      Preamp 3.6 GHz

N9060A-2FP      Spectrum Analysis Measurement Suite  1.0.0.0
N9073A-1FP      WCDMA                               1.0.0.0
N9073A-2FP      WCDMA with HSDPA                       1.0.0.0

```

The Previous Page is grayed-out if the first page of information is presently displayed. The Next Page menu key is grayed-out if the last page of information is presently displayed.

Key Path	System, Show
Mode	All
Example	SYST:SHOW SYST
Backwards Compatibility Notes	The hardware statistics that are displayed in the PSA Show System screen have been moved to a dedicated Show Hardware Statistics screen in the Service Menu.
Initial S/W Revision	Prior to A.02.00

Show System contents (Remote Command Only)

A remote command is available to obtain the contents of the Show System screen (the entire contents, not just the currently displayed page).

Remote Command	:SYSTem:CONFigure[:SYSTem]?
Example	:SYST:CONF?
Notes	The output is an IEEE Block format of the Show System contents. Each line is separated with a new-line character.
Initial S/W Revision	Prior to A.02.00

Computer System description (Remote Command Only)

A remote command is available to obtain the Computer System description. The Computer System is the operating system and patch level as reported by operating system.

Remote Command	:SYSTem:CSYSem?
Example	:SYST:CSYS?
Notes	The return value is the Computer System name and service pack level.
Initial S/W Revision	Prior to A.12.00

Hardware

The show hardware screen is used to view details of the installed hardware. This information can be used to determine versions of hardware assemblies and field programmable devices, in the advent of future upgrades or potential repair needs.

The screen is formatted into two groupings: product descriptive information and hardware information. The hardware information is listed in a table format:

Hardware Information									
Agilent EXM Wireless Test Set									
Product Number: E6640A									
Serial Number: US12341234									
Instrument S/W Revision: E.14.00_R0133									
Revision Date: 1/23/2014 10:33:35 AM									
Assembly Name	Part #	Serial #	Matl Rev	Rev	OF Rev	Hw Id	Cal Date	Cal Interval	Misc
Reference	M9300A	MY53000146				0165			
Reference Carrier	M9300A	W1312-63281-23-1306-00076		01	1.2.1	0166			
Reference Plugin	M9300A	W1312-63386-30-1306-00038		01	1.3.0	0167			
Wideband Digitizer	M943063005	111111111111	001	0	0	138			
Downconverter	M943063006	111111111111	001	0	A	139			
RFIO	M943063009	111111111111	001	0	A	140			
Power Supply	M943063002	111111111111	001	0	A	141			
M9430 TRX	1234567890	SN12344321	0	0	0	142	2013.10.02	2 years	
Baseband Generator	M943063007	111111111111	002	0	0	136			
ModulatorSrcOutput	M943063008	111111111111	001	0	A	137			

The Previous Page is grayed-out if the first page of information is presently displayed. The Next Page menu key is grayed-out if the last page is information is presently displayed.

Key Path	System, Show
Mode	All
Example	SYST:SHOW HARD
Initial S/W Revision	Prior to A.02.00

System Remote Commands (Remote Commands Only)

The commands in this section have no front-panel key equivalent.

"System Powerdown (Remote Command Only)" on page 279

"List installed Options (Remote Command Only)" on page 279

"Lock the Front-panel keys (Remote Command Only)" on page 279

"List SCPI Commands (Remote Command Only)" on page 280

"SCPI Version Query (Remote Command Only)" on page 280

"Date (Remote Command Only)" on page 280

"Time (Remote Command Only)" on page 281

Initial S/W Revision	Prior to A.02.00
----------------------	------------------

System Powerdown (Remote Command Only)

Remote Command	SYSTem:PDOWn [NORMal FORCe]
-----------------------	-----------------------------

Notes	Shuts down the instrument in the normal way (NORMal) or forced way (FORCe). In case there is another application with modified data pending for saving, the application prompt the user. The system waits until the user responds in the normal mode. It will go off after 20 seconds of wait in the force mode and all data will be lost.
-------	--

List installed Options (Remote Command Only)

Lists the installed options that pertain to the instrument (signal analyzer). .

Mode	All
------	-----

Remote Command	:SYSTem:OPTions?
-----------------------	------------------

Example	:SYST:OPT?
----------------	------------

Notes	The return string is a comma separated list of the installed options. For example: "503,P03,PFR" :SYSTem:OPTions? and *OPT? are the same.
-------	---

State Saved	No
-------------	----

Initial S/W Revision	Prior to A.02.00
----------------------	------------------

Lock the Front-panel keys (Remote Command Only)

Disables the instrument keyboard to prevent local input when the instrument is controlled remotely. Annunciation showing a "K" for 'Klock" (keyboard lock) alerts the local user that the keyboard is locked. Klock is similar to the GPIB Local Lockout function; namely that no front-panel keys are active with the exception of the Power Standby key. (The instrument is allowed to be turned-off if Klock is ON.) The Klock command is used in remote control situations where Local Lockout cannot be used.

Although primary intent of Klock is to lock-out the front panel, it will lock-out externally connected keyboards through USB. Klock has no effect on externally connected pointing devices (mice).

The front panel 'Local' key (Cancel/Esc) has no effect if Klock is ON.

Mode	All
Remote Command	:SYSTem:KLOCK OFF ON 0 1 :SYSTem:KLOCK?
Example	:SYST:KLOC ON
Notes	Keyboard lock remains in effect until turned-off or the instrument is power-cycled
Preset	Initialized to OFF at startup, unaffected by Preset
State Saved	No
Initial S/W Revision	Prior to A.02.00

List SCPI Commands (Remote Command Only)

Outputs a list of the valid SCPI commands for the currently selected Mode.

Remote Command	:SYSTem:HELP:HEADers?
Example	:SYST:HELP:HEAD?
Notes	The output is an IEEE Block format with each command separated with the New-Line character (hex 0x0A)
Initial S/W Revision	Prior to A.02.00

SCPI Version Query (Remote Command Only)

Returns the SCPI version number with which the instrument complies. The SCPI industry standard changes regularly. This command indicates the version used when the instrument SCPI commands were defined.

Remote Command	:SYSTem:VERSion?
Example	:SYST:VERS?
Initial S/W Revision	Prior to A.02.00

Date (Remote Command Only)

The recommended access to the Date, Time, and Time zone of the instrument is through the Windows native control (Control Panel or accessing the Task Bar). You may also access this information remotely, as shown in this command and Time (below).

Sets or queries the date in the instrument.

Mode	All
Remote Command	:SYSTem:DATE "<year>,<month>,<day>" :SYSTem:DATE?

Example	:SYST:DATE "2006,05,26"
Notes	<p><year> is the four digit representation of year. (for example, 2006)</p> <p><month> is the two digit representation of year. (for example. 01 to 12)</p> <p><day> is the two digit representation of day. (for example, 01 to 28, 29, 30, or 31) depending on the month and year</p> <p>Unless the current account has Power User or Administrator privileges, an error will be generated by this command and no action will be taken.</p>
Initial S/W Revision	Prior to A.02.00

Time (Remote Command Only)

Sets or queries the time in the instrument.

Mode	All
Remote Command	:SYSTem:TIME "<hour>,<minute>,<second>" :SYSTem:TIME?
Example	:SYST:TIME "13,05,26"
Notes	<p><hour> is the two digit representation of the hour in 24 hour format</p> <p><minute> is the two digit representation of minute</p> <p><second> is the two digit representation of second</p> <p>Unless the current account has Power User or Administrator privileges, an error will be generated by this command and no action will be taken.</p>
Initial S/W Revision	Prior to A.02.00

Module Name (Remote Command Only)

Query only. This will return the name of the instance as displayed on the xSA main window.

Mode	All
Remote Command	:SYSTem:MODule:NAME?
Example	:SYST:MOD:NAME?
Notes	<p>If the first instance displays on the xSA main window, the return string is "TRX1". If the second instance displays on the main window, the return string is "TRX2". If the third instance displays on the main window, the return string is "TRX3". If the fourth instance displays on the main window, the return string is "TRX4".</p>
Preset	Not affected by Preset, reset to "Left" with Restore System Defaults Misc.
State Saved	No
Initial S/W Revision	A.13.80

Module Index (Remote Command Only)

Query only. This will return the index of this xSA instance. This index is used as the device number in a VISA address (“hslip#”).

Mode	All
Remote Command	:SYSTem:MODule:INDeX?
Example	:SYST:MOD:IND?
Notes	It returns 0 if this instance’s device number in a VISA address is 0. It returns 1 if this instance’s device number in a VISA address is 1. It returns 2 if this instance’s device number in a VISA address is 2. It returns 3 if this instance’s device number in a VISA address is 3.
Preset	Not affected by Preset, reset to 0 with Restore System Defaults Misc.
State Saved	No
Initial S/W Revision	A.13.80

Module Mnemonic (Remote Command Only)

Query only. This will return the mnemonic of the instance as used in the command line “/Process:<mnemonic>” argument.

Mode	All
Remote Command	:SYSTem:MODule:MNEMonic?
Example	:SYST:MOD:MNEM?
Notes	This will return the mnemonic of the instance as used in the command line “/Process:<mnemonic>” argument.
Preset	Not affected by Preset and Restore System Defaults Misc.
State Saved	No
Initial S/W Revision	A.13.80

Module List (Remote Command Only)

Query only. This will return the list of defined mnemonics that can be used in the command line “/Process:<mnemonic>” argument with corresponding configuration information. The comma separated return values are: mnemonic, display name, Enabled/Disabled, VISA device id (instr# or hslip#), telnet port, socket port, Physics port, Physics configuration tag.

Mode	All
Remote Command	:SYSTem:MODule:LIST?
Example	:SYST:MOD:LIST?
Notes	Example:

it returns:

```
TRX1,TRX1,Enabled,0,5023,5025,3574,E6640AModules.config#TRX1
TRX2,TRX2,Disabled,1,5123,5125,3575,E6640AModules.config#TRX2
TRX3,TRX3,Disabled,2,5223,5225,3576,E6640AModules.config#TRX3
TRX4,TRX4,Disabled,3,5323,5325,3577,E6640AModules.config#TRX4
```

Preset	Not affected by Preset, reset to 0 with Restore System Defaults Misc.
State Saved	No
Initial S/W Revision	A.13.80

Module Enable (Remote Command Only)

Query and command. The query SYST:MOD:ENAB? "<mnemonic>" returns "0" for disabled, "1" for enabled. The command SYST:MOD:ENAB "<mnemonic>" 0|1 will disable/enable the configuration.

Notes: Enabling a configuration that does not have a HW will result in run-time errors when trying to start that configuration. Trying to disable the default configuration will result in the error: -221, "Setting conflict:Cannot disable default process configuration '<mnemonic>'".

Example:

```
}
```

```
SCPI>>syst:mod:enab? "TRX1"
```

```
<<1
```

```
SCPI>>syst:mod:enab? "TRX2"
```

```
<<0
```

```
SCPI>>syst:err?
```

```
<<+0,"No error"
```

```
SCPI>>syst:mod:enab "TRX1",0
```

```
SCPI>>syst:err?
```

```
<<-221,"Settings conflict;Cannot disable default process configuration 'TRX1'"
```

Mode	All
Remote Command	:SYSTem:MODule:ENABle? "<mnemonic>" :SYSTem:MODule:ENABle "<mnemonic>",0 1

Example

```
:SYST:MOD:ENAB? "TRX1"  
:SYST:MOD:ENAB "TRX4",0
```

Preset	Not affected by Preset and Restore System Defaults Misc.
State Saved	No
Initial S/W Revision	A.13.80

Module Default (Remote Command Only)

Query and command. The query SYST:MOD:DEF? returns the mnemonic of the default configuration. The command SYST:MOD:DEF "mnemonic" will set that configuration as the default. If the configuration was disabled, the module default command on it will enable this configuration.

Example:

```
SCPI>>syst:mod:def?
<<"TRX1"
SCPI>>syst:mod:enab "TRX2",0
SCPI>>syst:mod:enab? "TRX2"
<<0
SCPI>>syst:mod:def "TRX2"
SCPI>>syst:mod:enab? "TRX2"
<<1
SCPI>>syst:mod:def?
<<"TRX2"
```

Mode	All
Remote Command	:SYSTem:MODule:DEFault? :SYSTem:MODule:DEFault "<mnemonic>"
Example	:SYST:MOD:DEF? :SYST:MOD:DEF "TRX1"

Preset	Not affected by Preset, reset to "Left" with Restore System Defaults Misc.
State Saved	No
Initial S/W Revision	A.13.80

Module Model Number (Remote Command Only)

Query only. The query ":SYST:MODule:MODEl?" will return model number of the current module.

Mode	All
-------------	-----

Remote Command	:SYSTem:MODule:MODEl?
Example	:SYSTem:MODule:MODEl?
Notes	This query will return model number. e.g. "M9430A"
Preset	Not affected by Preset,
State Saved	No
Initial S/W Revision	E.14.14

Module Model Serial Number (Remote Command Only)

Query only. The query ":SYST: MODule:SERial?" will return model serial number of the current module.

Mode	All
Remote Command	:SYSTem:MODule:SERial?
Example	:SYSTem:MODule:SERial?
Notes	This query will return model serial number like "SN12344321"
Preset	Not affected by Preset
State Saved	No
Initial S/W Revision	E.14.14

Power On

Enables you to select how the instrument should power on. The options are: Mode and Input/Output Defaults, User Preset and Last State.

NOTE In products that run multiple instances of the X-Series Application, the same Power On type is shared between all the instances.

Key Path	System
Mode	All
Remote Command	:SYSTem:PON:TYPE MODE USER LAST :SYSTem:PON:TYPE?
Example	:SYST:PON:TYPE MODE
Preset	This is unaffected by a Preset but is set to Mode on a "Restore System Defaults->All"
State Saved	No
Backwards Compatibility SCPI	:SYSTem:PON:TYPE PRESet the "PRESet" parameter is supported for backward compatibility only and behaves the same as MODE.
Backwards Compatibility Notes	The Preset Type key in legacy analyzers has been removed, and the Power On toggle key has been replaced by this 1-of-N key in the System menu.
Initial S/W Revision	Prior to A.02.00

Mode and Input/Output Defaults

When the analyzer is powered on in Mode and Input/Output Defaults, it performs a Restore Mode Defaults to all modes in the instrument and also performs a Restore Input/Output Defaults.

Persistent parameters (such as Amplitude Correction tables or Limit tables) are not affected at power on, even though they are normally cleared by Restore Input/Output Defaults and/or Restore Mode Defaults.

Key Path	System, Power On
Mode	All
Example	SYST:PON:TYPE MODE
Readback Text	Defaults
Initial S/W Revision	Prior to A.02.00

User Preset

Sets Power On to User Preset. When the analyzer is powered on in User Preset, it will User Preset each mode and switch to the power-on mode. Power On User Preset will not affect any settings beyond what a normal User Preset affects.

NOTE

In products that run multiple instances of the X-Series Application, the same User Preset is shared between all the instances.

An instrument could never power up for the first time in User Preset.

Key Path	System, Power On
Mode	All
Example	SYST:PON:TYPE USER
Readback Text	User Preset
Backwards Compatibility Notes	Power On User Preset will cause the instrument to power up in the power-on mode, not the last mode the instrument was in prior to shut down. Also, Power On User Preset will User Preset all modes. This does not exactly match legacy behavior.
Initial S/W Revision	Prior to A.02.00

Last State

Sets Power On to **Last**. When the analyzer is powered on, it will put all modes in the last state they were in prior to when the analyzer was put into Power Standby and it will wake up in the mode it was last in prior to powering off the instrument. The saving of the active mode prior to shutdown happens behind the scenes when a controlled shutdown is requested by using the front panel power Standby key or by using the remote command SYSTem:PDOWn. The non-active modes are saved as they are deactivated and recalled by Power On Last State.

NOTE

In products that run multiple instances of the X-Series Application, each instance has a unique Last State. An instrument can never power up for the first time in Last.

If line power to the analyzer is interrupted, for example by pulling the line cord plug or by switching off power to a test rack, Power On Last State may not work properly. For proper operation, Power On Last State depends on you shutting down the instrument using the Standby key or the SYSTem:PDOWn SCPI command. This will ensure the last state of each mode is saved and can be recalled during a power up.

Key Path	System, Power On
Mode	All
Example	SYST:PON:TYPE LAST
Notes	Power on Last State only works if you have done a controlled shutdown prior to powering on in Last. If a controlled shutdown is not done when in Power On Last State, the instrument will power up in the last active mode, but it may not power up in the active mode's last state. If an invalid mode state is detected, a Mode Preset will occur. To control the shutdown under remote control use the :SYSTem:PDOWn command.
Readback Text	Last State
Backwards Compatibility Notes	It is no longer possible to power-up the analyzer in the last mode the analyzer was running with that mode in the preset state. (ESA/PSA SYST:PRESET:TYPE MODE with SYST:PON:PRESET) You can power-on the analyzer in the last mode the instrument was running in its last state (SYST:PON:TYPE LAST), or you can specify the mode to power-up in its preset state (SYST:PON:MODE <mode>).
Initial S/W Revision	Prior to A.02.00

Power On Application

Accesses a menu that lists the available Modes and lets you select which Mode is to be the power-on application.

This application is used for Power On Type “Mode and Input/Output Defaults” and Restore System Defaults All.

NOTE

In products that run multiple instances of the X-Series Application, the same Power On Application is shared between all the instances.

Key Path	System, Power On
Mode	All
Remote Command	:SYSTem:PON:MODE SA BASIC ADEMOD NFIGURE PNOISE CDMA2K TDSCDMA VSA VSA89601 WCDMA WIMAXOFDMA :SYSTem:PON:MODE?
Example	SYST:PON:MODE SA
Notes	The list of possible modes (and remote parameters) to choose from is dependent on which modes are installed in the instrument.
Preset	This is unaffected by a Preset but is set on a “Restore System Defaults->All” to: SEQAN

State Saved	No
Initial S/W Revision	Prior to A.02.00

Configure Applications

The Configure Applications utility can be used to:

- select applications for preload
- determine how many applications can fit in memory at one time
- specify the order of the Modes in the Mode menu.

This utility consists of a window with instructions, a set of “Select Application” checkboxes, a “fuel bar” style memory gauge, and keys that help you set up your configuration.

NOTE

In products that run multiple instances of the X-Series Application, the same Configure Applications Utility is shared between all the instances.

For more information, see the following topics:

["Preloading Applications" on page 288](#)

["Access to Configure Applications utility" on page 289](#)

["Virtual memory usage" on page 289](#)

Key Path	System, Power On
Example	:SYST:SHOW CAPP Displays the Config Applications screen
Initial S/W Revision	A.02.00

Preloading Applications

During runtime, if a Mode that is not preloaded is selected using the Mode menu or sending SCPI commands, there will be a pause while the Application is loaded. During this pause a message that says “Loading application, please wait ...” is displayed. Once loaded, the application stays loaded, so the next time you select it during a session, there is no delay.

Preloading enables you to “preload” at startup, to eliminate the runtime delay. Preloading an application will cause it to be loaded into the analyzer’s memory when the analyzer program starts up. If you do this, the delay will increase the time it takes to start up the analyzer program, but this may be preferable to having to wait the first time you select an application. Note that, once an application is loaded into memory, it cannot be unloaded without exiting and restarting the analyzer program.

Note that there are more applications available for the X-Series than can fit into Windows Virtual Memory. By allowing you to choose which licensed applications to load at startup, the Configure Applications utility allows you to make optimal use of your memory.

Access to Configure Applications utility

A version of the utility runs the first time you power up the analyzer after purchasing it from Keysight. The utility automatically configures preloads so that as many licensed applications as possible are preloaded while keeping the total estimated virtual memory usage below the limit. This auto-configuration only takes place at the very first run, and after analyzer software upgrades.

You may, at any time, manually call up the Configure Applications utility by pressing System, Power On, Configure Applications, to find a configuration that works best for you, and then restart the analyzer program.

The utility may also be called if, during operation of the analyzer, you attempt to load more applications than can fit in memory at once.

Virtual memory usage

There are more applications available for the X-Series than can fit into memory at any one time, so the Configure Applications utility includes a memory tracker that serves two purposes:

1. It will not let you preload more applications than will fit into memory at once.
2. You can determine how many of your favorite applications can reside in memory at one time.

The utility provides a graphical representation of the amount of memory (note that the memory in question here is Virtual memory and is a limitation imposed by the operating system, not by the amount of physical memory you have in your analyzer). You select applications to preload by checking the boxes on the left. Checked applications preload at startup. The colored fuel bar indicates the total memory required when all the checked applications are loaded (either preloaded or selected during runtime).

Here is what the fuel bar colors mean:

RED: the applications you have selected cannot all fit into the analyzer's memory. You must deselect applications until the fuel bar turns yellow.

YELLOW: the applications you have selected can all fit into the analyzer's memory, but there is less than 10% of the memory left, probably not enough to load any other applications, either via preload or by selecting a Mode while the analyzer is running..

GREEN: The indicator is green when <90% of the memory limit is consumed. This means the applications you have selected can all fit into the analyzer's memory with room to spare. You will likely be able to load one or more other applications without running out of memory.

Select All

Marks all applications in the selection list. This allows you to enable all applications licensed on the instrument for pre-loading, or is a convenience for selecting all applications in one operation and then letting you deselect individual applications.

Key Path	System, Power On, Configure Applications
Initial S/W Revision	A.02.00

Deselect All

Clears the marks from all applications in the selection list, except the Power On application. The Power On application cannot be eliminated from the pre-load list.

Key Path	System, Power On, Configure Applications
Initial S/W Revision	A.02.00

Move Up

The application list is the order that applications appear in the Mode Menu. This key enables you to shift the selected application up in the list, thus moving the selected application earlier in the Mode Menu.

Key Path	System, Power On, Configure Applications
Initial S/W Revision	A.02.00

Move Down

The application list is the order that applications appear in the Mode Menu. This key enables you to shift the selected application down in the list, thus moving the selected application later in the Mode Menu.

Key Path	System, Power On, Configure Applications
Initial S/W Revision	A.02.00

Select/Deselect

Toggles the currently highlighted application in the list.

Key Path	System, Power On, Configure Applications
Initial S/W Revision	A.02.00

Save Changes and Exit

Applies the configuration of the applications list. The marked applications will be pre-loaded in memory the next time the instrument application is started, and the order of the applications in the list will be the order of the applications in the Mode Menu.

After saving your changes, the analyzer asks you if you would like it to restart so that your changes can take effect (see dialog box, below). If you choose not to restart, the changes will not take effect until the next time you shut down and restart the analyzer.

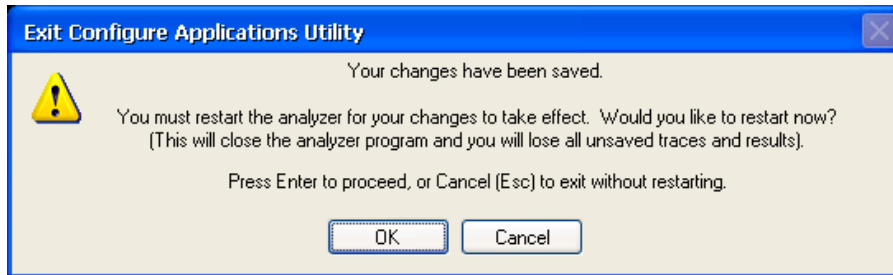

Key Path	System, Power On, Configure Applications
Remote Command	:SYSTem:PUP:PROcEss
Example	:SYST:PUP:PROC This is the SCPI command for restarting the analyzer. You must Wait after this command for the instrument application to restart
Notes	The softkey will be grayed-out when the virtual memory of the selected applications exceeds 100% of the limit.
Notes	You cannot use *WAI or *OPC? to synchronize operation after a restart. This command stops and restarts the instrument application, thus the SCPI operation is terminated and restarted. A remote program must use fixed wait time to resume sending commands to the instrument. The wait time will be dependent upon which applications are pre-loaded.
Initial S/W Revision	A.02.00
Modified at S/W Revision	A.04.00

Exit Without Saving

Pressing this key will exit the Configure Applications utility without saving your changes.

Key Path	System, Power On, Configure Applications
Initial S/W Revision	A.02.00
Modified at S/W Revision	A.04.00

Restore Power On Defaults

This selection causes the Power On Type and Power On Application settings to be a reset to their default values. This level of Restore System Defaults does not affect any other system settings, mode settings and does not cause a mode switch. The Power On key, under the Restore System Defaults menu, causes the same action.

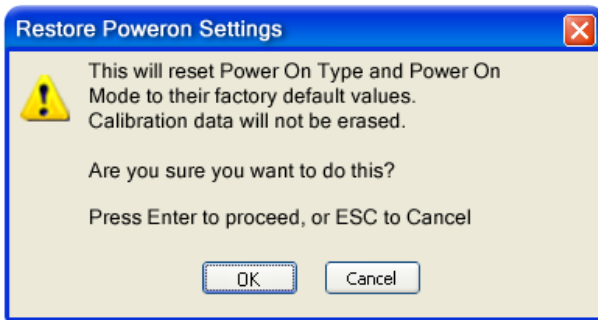

If you press any key other than OK or Enter, it is construed as a Cancel, because the only path that will actually cause the reset to be executed is through OK or Enter.

Key Path	System, Power On
Example	:SYST:DEF PON
Initial S/W Revision	Prior to A.02.00

Configure Applications - Instrument boot-up

At start-up of the analyzer program a dialog box similar to the one under the System, Power On, Configure Applications key will be displayed allowing you to choose which licensed applications are to be loaded. This dialog will only be displayed if the memory required to pre-load all of the licensed applications exceeds the Virtual Memory available.

Configure Applications - Windows desktop

The Configure Applications Utility may be run from the Windows Desktop. The utility is launched by double-



clicking the icon on the desktop, which brings-up a dialog box similar to the one under the System, Power On, Configure Applications key, allowing you to choose which licensed applications are to be loaded when the analyzer program starts up. This dialog box has mouse buttons on it that do the job the softkeys normally do in the System, Power On, Configure Applications menu.

NOTE

In products that run multiple instances of the X-Series Application, the same Configure Applications Utility launched from the Windows Desktop will apply to all the instances.

Configure Applications - Remote Commands

The following topics provide details on using remote commands to configure the list of applications you want to load into the instrument memory or query the Virtual Memory utilization for your applications.

- "Configuration list (Remote Command Only)" on page 293
- "Configuration Memory Available (Remote Command Only)" on page 293
- "Configuration Memory Total (Remote Command Only)" on page 293
- "Configuration Memory Used (Remote Command Only)" on page 293

- "Configuration Application Memory (Remote Command Only)" on page 294

Configuration list (Remote Command Only)

This remote command is used to set or query the list of applications to be loaded in-memory.

Remote Command	:SYSTem:PON:APPLication:LLISt <string of INSTRument:SElect names> :SYSTem:PON:APPLication:LLISt?
Example	:SYST:PON:APPL:LLIS "SA,BASIC,WCDMA"
Notes	<string of INSTRument:SElect names> are from the enums of the :INSTRument:SElect command. The order of the <INSTRument:SElect names> is the order that the applications are loaded into memory, and the order that they appear in the Mode Menu. Error message -225 "Out of Memory" is reported when more applications are listed than can reside in Virtual Memory. When this occurs, the existing applications load list is unchanged.
Preset	Not affected by Preset
State Saved	Not saved in instrument state
Initial S/W Revision	A.02.00

Configuration Memory Available (Remote Command Only)

This remote command is used to query the amount of Virtual Memory remaining.

Remote Command	:SYSTem:PON:APPLication:VMEMory[:AVAIlable]?
Example	:SYST:PON:APPL:VMEM?
Preset	Not affected by Preset
Initial S/W Revision	A.02.00

Configuration Memory Total (Remote Command Only)

This remote command is used to query the limit of Virtual Memory allowed for applications.

Remote Command	:SYSTem:PON:APPLication:VMEMory:TOTal?
Example	:SYST:PON:APPL:VMEM:TOT?
Preset	Not affected by Preset
Initial S/W Revision	A.02.00

Configuration Memory Used (Remote Command Only)

This remote command is a query of the amount of Virtual Memory used by all measurement applications.

Remote Command	:SYSTem:PON:APPLication:VMEMory:USED?
Example	:SYST:PON:APPL:VMEM:USED?

Preset	Not affected by Preset
Initial S/W Revision	A.02.00

Configuration Application Memory (Remote Command Only)

This remote command is used to query the amount of Virtual Memory a particular application consumes.

Remote Command	:SYSTem:PON:APPLication:VMEMory:USED:NAME? <INSTrument:SElect name>
Example	:SYST:PON:APPL:VMEM:USED:NAME? CDMA2K
Notes	<INSTrument:SElect name> is from the enums of the :INSTrument:SElect command Value returned will be 0 (zero) if the name provided is invalid.
Preset	Not affected by Preset
Initial S/W Revision	Prior to A.02.00

Alignments

The Alignments Menu controls and displays the automatic alignment of the instrument, and provides the ability to restore the default alignment values.

The current setting of the alignment system is displayed in the system Settings Panel along the top of the display, including a warning icon for conditions that may cause specifications to be impacted.



Key Path	System
Initial S/W Revision	Prior to A.02.00

Align Now

Accesses alignment processes that are immediate action operations. They perform complete operations and run until they are complete.

Key Path	System, Alignments
Initial S/W Revision	Prior to A.02.00

All (Daily use)

Immediately executes an alignment of all subsystems which includes both the source and the analyzer in the TRX module. The “All” alignment is sufficient to maintain specified performance, provided that (1) the TRX’s internal temperature has not drifted more than +/-5 degree C since the previous alignment, and (2) no more than 8 hours have elapsed since the previous “All” alignment., and (3) no more than 1 week has elapsed since these three alignments have all been run: IF, RF, and Source, and (4) a 45 minute warm-up

period between power-up of the TRX and invoking the “All” alignment. The instrument stops any measurement currently underway, performs the alignment, then restarts the measurement from the beginning (similar to pressing the Restart key).

If an interfering user signal is present at the RF Input, the alignment is performed on all subsystems except the RF. After completion, the Error Condition message “Align skipped: 50 MHz interference” or “Align skipped: 4.8 GHz interference” is generated. In addition the Error Condition message “Align Now, RF required” is generated, and bits 11 and 12 are set in the Status Questionable Calibration register.

The query form of the remote commands (:CALibration[:ALL]? or *CAL?) invokes the alignment of all subsystems and returns a success or failure value. An interfering user signal is not grounds for failure; if the alignment was able to succeed on all portions but unable to align the RF because of an interfering signal, the resultant will be the success value.

Successful completion of Align Now, All will clear the “Align Now, All required” Error Condition, and clear bit 14 in the Status Questionable Calibration register. It will also begin the elapsed time counter for Last Align Now, All Time, and capture the Last Align Now, All Temperature.

If the Align RF subsystem succeeded in aligning (no interfering signal present), the elapsed time counter begins for Last Align Now, RF Time, and the temperature is captured for the Last Align Now, RF Temperature. In addition the Error Conditions “Align skipped: 50 MHz interference” and “Align skipped: 4.8 GHz interference” are cleared, the Error Condition “Align Now, RF required” is cleared, and bits 11 and 12 are cleared in the Status Questionable Calibration register.

Align Now, All can be interrupted by pressing the Cancel (ESC) front-panel key or remotely with Device Clear followed by the :ABORt SCPI command. When this occurs the Error Condition message “Align Now, All required” is generated, and bit 14 is set in the Status Questionable Condition register. This is because new alignment data may be employed for an individual subsystem, but not a cohesive set of data for all subsystems.

In many cases, you might find it more convenient to change alignments to Normal, instead of executing Align Now, All. When the Auto Align process transitions to Normal, the analyzer will immediately start to update only the alignments that have expired, thus efficiently restoring the alignment process.

NOTE

In EXM, Source ARB play will be turned off and the source states will not be restored after Align Now, All.

Key Path	System, Alignments, Align Now
Mode	All
Remote Command	:CALibration[:ALL] :CALibration[:ALL]?
Example	:CAL
Notes	:CALibration[:ALL]? returns 0 if successful :CALibration[:ALL]? returns 1 if failed :CALibration[:ALL]? is the same as *CAL? While Align Now, All is performing the alignment, bit 0 in the Status Operation register is set. Completion, or termination, will clear bit 0 in the Status Operation register. This command is sequential; it must complete before further SCPI commands are processed. Interrupting the alignment from remote is accomplished by invoking Device Clear followed by the :ABORt command.

	<p>Successful completion will clear bit 14 in the Status Questionable Calibration register.</p> <p>An interfering user signal is not grounds for failure of Align Now, All. However, bits 11 and 12 are set in the Status Questionable Calibration register to indicate Align Now, RF is required.</p> <p>An interfering user supplied signal will result in the instrument requiring an Align Now, RF with the interfering signal removed.</p>
Couplings	<p>Initializes the time for the Last Align Now, All Time.</p> <p>Records the temperature for the Last Align Now, All Temperature.</p> <p>If Align RF component succeeded, initializes the time for the Last Align Now, RF Time.</p> <p>If Align RF component succeeded, records the temperature for the Last Align Now, RF Temperature.</p>
Status Bits/OPC dependencies	Bits 11, 12, or 14 may be set in the Status Questionable Calibration register.
Initial S/W Revision	Prior to A.02.00

Mode	All
Remote Command	*CAL?
Example	*CAL?
Notes	<p>*CAL? returns 0 if successful</p> <p>*CAL? returns 1 if failed</p> <p>:CALibration[:ALL]? is the same as *CAL?</p> <p>See additional remarks described with :CALibration[:ALL]?</p> <p>Everything about :CALibration[:ALL]? is synonymous with *CAL? including all conditions, status register bits, and couplings</p>
Initial S/W Revision	Prior to A.02.00

Mode	All
Remote Command	:CALibration[:ALL]:NPENding
Example	CAL:NPEN
Notes	<p>:CALibration[:ALL]:NPENding is the same as :CALibration[:ALL] including all conditions, status register bits, except this scpi command does not BLOCK the scpi session, so the user should use status register bits to query if the calibration is successfully completed or not.</p> <p>Typical usage is:</p> <ol style="list-style-type: none"> 1) :CALibration:ALL:NPENding (Start a calibration) 2) :STATus:OPERation:CONDition? (Check if the calibration is completed or not, If bit 0 is set, then the system is doing calibration, the user should repeat this scpi query until the bit is cleared) 3) :STATus:QUEStionable:CALibration:CONDition? (Check if there are any errors/failures in previous calibration procedure)
Initial S/W Revision	X.14.20

All but RF

Immediately executes an alignment of all subsystems except the RF subsystem which includes both the source and the analyzer in the TRX module. The instrument will stop any measurement currently underway, perform the alignment, and then restart the measurement from the beginning (similar to pressing the Restart key). This can be used to align portions of the instrument that are not impacted by an interfering user input signal.

This operation might be chosen instead of All if you do not want the device under test to experience a large change in input impedance, such as a temporary open circuit at the analyzer input.

The query form of the remote commands (:CALibration:NRF?) will invoke the alignment and return a success or failure value.

Successful completion of Align Now, All but RF will clear the “Align Now, All required” Error Condition, and clear bit 14 in the Status Questionable Calibration register. If “Align Now, All required” was in effect prior to executing the All but RF, the Error Condition message “Align Now, RF required” is generated and bit 12 in the Status Questionable Calibration register is set. It will also begin the elapsed time counter for Last Align Now, All Time, and capture the Last Align Now, All Temperature.

Align Now, All but RF can be interrupted by pressing the Cancel (ESC) front-panel key or remotely with Device Clear followed by the :ABORt SCPI command. When this occurs the Error Condition message “Align Now, All required” is generated, and bit 14 is set in the Status Questionable Condition register. This is because new alignment data may be used for an individual subsystem, but not a full new set of data for all subsystems.

NOTE

In EXM, Source ARB play will be turned off and the source states will not be restored after Align Now, All but RF.

Key Path	System, Alignments, Align Now
Mode	All
Remote Command	:CALibration:NRF :CALibration:NRF?
Example	:CAL:NRF
Notes	:CALibration:NRF? returns 0 if successful :CALibration:NRF? returns 1 if failed While Align Now, All but RF is performing the alignment, bit 0 in the Status Operation register is set. Completion, or termination, will clear bit 0 in the Status Operation register. This command is sequential; it must complete before further SCPI commands are processed. Interrupting the alignment from remote is accomplished by invoking Device Clear followed by the :ABORt command. Successful completion will clear bit 14 in the Status Questionable Calibration register and set bit 12 if invoked with “Align Now, All required”.
Couplings	Initializes the time for the Last Align Now, All Time. Records the temperature for the Last Align Now, All Temperature.
Status Bits/OPC dependencies	Bits 12 or 14 may be set in the Status Questionable Calibration register.
Initial S/W Revision	Prior to A.02.00

Mode	All
Remote Command	:CALibration:NRF:NPENding
Example	CAL:NRF:NPEN
Notes	:CALibration:NRF:NPENding is the same as :CALibration:NRF including all conditions, status register bits, except that this scpi command does not BLOCK the scpi session, so the user should use status register bits to query if the calibration is successfully completed or not. Typical usage is: 1):CALibration:NRF:NPENding (start theAll but RF calibration) 2):STATus:OPERation:CONDition? (If bit 0 is set, then the system is doing calibration, the user should do re-query until this bit is cleared) 3):STATus:QUEStionable:CALibration:CONDition? (to check if there are any errors/failures in previous calibration procedure)
Initial S/W Revision	X.14.20

RF (Weekly use)

Immediately executes an alignment of the RF subsystem which includes both the source and the analyzer in the TRX module . The instrument stops any measurement currently underway, performs the alignment, then restarts the measurement from the beginning (similar to pressing the Restart key).

This alignment corrects slow-rate drift which does not impair specifications for time periods shorter than one week. Thus, it is required to perform this alignment on a weekly basis to maintain specifications. This alignment typically takes >2 minutes to complete.

This operation might be desirable if the alignments had been set to not include RF alignments, or if previous RF alignments could not complete because of interference which has since been removed.

If an interfering user signal is present at the RF Input, the alignment will terminate and generate the Error Condition message “Align skipped: 50 MHz interference” or “Align skipped: 4.8 GHz interference”, and Error Condition “Align Now, RF required”. In addition, bits 11 and 12 will be set in the Status Questionable Calibration register.

The query form of the remote commands (:CALibration:RF?) will invoke the alignment of the RF subsystem and return a success or failure value. An interfering user signal is grounds for failure.

Successful completion of Align Now, RF will begin the elapsed time counter for Last Align Now, RF Time, and capture the Last Align Now, RF Temperature.

Align Now, RF can be interrupted by pressing the Cancel (ESC) front-panel key or remotely with Device Clear followed by the :ABORt SCPI command. When this occurs, the Error Condition message “Align Now, RF required” is generated, and bit 12 is set in the Status Questionable Condition register. None of the new alignment data is used.

NOTE

In EXM, Source ARB play will be turned off and the source states will not be restored after Align Now, All but RF.

Key Path	System, Alignments, Align Now
Mode	All
Remote Command	:CALibration:RF :CALibration:RF?
Example	:CAL:RF
Notes	<p>:CALibration:RF? returns 0 if successful</p> <p>:CALibration:RF? returns 1 if failed (including interfering user signal)</p> <p>While Align Now, RF is performing the alignment, bit 0 in the Status Operation register is set. Completion, or termination, will clear bit 0 in the Status Operation register.</p> <p>This command is sequential; it must complete before further SCPI commands are processed. Interrupting the alignment from remote is accomplished by invoking Device Clear followed by the :ABORt command.</p> <p>Successful completion clears the Error Conditions “Align skipped: 50 MHz interference” and “Align skipped: 4800 MHz interference” and the Error Conditions “Align RF failed” and “Align Now, RF required”, and clears bits 3, 11, and 12 in the Status Questionable Calibration register.</p> <p>A failure encountered during alignment will generate the Error Condition message “Align RF failed” and set bit 3 in the Status Questionable Calibration register.</p> <p>An interfering user signal will result in bits 11 and 12 to be set in the Status Questionable Calibration register to indicate Align Now, RF is required.</p> <p>An interfering user supplied signal will result in the instrument requiring an Align Now, RF with the interfering signal removed.</p>
Couplings	<p>Initializes the time for the Last Align Now, RF Time.</p> <p>Records the temperature for the Last Align Now, RF Temperature.</p>
Status Bits/OPC dependencies	Bits 11, 12, or 14 may be set in the Status Questionable Calibration register.
Initial S/W Revision	Prior to A.02.00
Mode	All
Remote Command	:CALibration:RF:NPENding
Example	CAL:RF:NPEN
Notes	<p>:CALibration:RF:NPENding is the same as :CALibration:RF including all conditions, status register bits, except that this scpi command does not BLOCK the scpi session, so the user should use status register bits to query if the calibration is successfully completed or not.</p> <p>Typical usage is:</p> <ol style="list-style-type: none"> 1):CALibration:RF:NPENding (Start a RF calibration) 2):STATus:OPERation:CONDition? (If bit 0 is set, then the system is doing calibration, the user should do re-query until this bit is cleared) 3):STATus:QUESTionable:CALibration:CONDition? (to check if there are any errors/failures in previous calibration procedure)
Initial S/W Revision	X.14.20

Source (Weekly use)

Accesses source alignment processes that are immediate action operations. They perform complete operations and run until they are complete.

Immediately executes an IQ alignment, and power level alignment. The instrument stops any sequence of the source, performs the alignment, then restarts the sequence from the beginning.

This alignment corrects slow-rate drift which does not impair specifications for time periods shorter than one week. Thus, it is required to perform this alignment on a weekly basis to maintain specifications. This alignment typically takes >2 minutes to complete.

There is no alert available for the source alignment. The operators have the responsibility to check temperature shift since last Align Now, Source to determine if the source alignment needs to be executed.

Key Path	System, Alignments, Align Now
Mode	All
Remote Command	:CALibration:INTernal:SOURce[:ALL] :CALibration:INTernal:SOURce[:ALL]?
Example	:CAL:INT:SOUR
Notes	:CAL:SOUR? Initiates an Alignment and returns 0 if successful :CAL:SOUR? Initiates an Alignment and returns 1 if failed
Couplings	Initializes the time for the Last Align Source Now, All Time. Records the temperature for the Last Align Source Now, All Temperature.
Initial S/W Revision	A.05.00

Mode	All
Remote Command	:CALibration:INTernal:SOURce[:ALL]:NPENding
Example	CAL:INT:SOUR:NPEN
Notes	:CALibration:INTernal:SOURce[:ALL]:NPENding is the same as :CALibration:INTernal:SOURce[:ALL] including all conditions, status register bits, except that this scpi command does not BLOCK the scpi session, so the user should use status register bits to query if the calibration is successfully completed or not. Typical usage is: 1):CALibration:INTernal:SOURce:NPENding (start an internal source calibration) 2):STATus:OPERation:CONDition? (Check if the calibration is completed or not, If bit 0 is set, then the system is doing calibration, the user should repeat this scpi query until the bit is cleared) 3):STATus:QUEStionable:CALibration:EXTended:FAILure:CONDition? (Check if bit 14 is set or not. If this bit is set, that means there are some errors in previous internal source calibration)
Initial S/W Revision	X.14.20

IF Alignment (Weekly use) (Remote Command Only)

Immediately executes an alignment of the IF subsystem which includes both the source and the analyzer in the TRX module. The instrument stops any measurement currently underway, perform the alignment, and then restart the measurement from the beginning (similar to pressing the Restart key). This alignment corrects slow-rate which the drift does not impair specifications for time periods shorter than one week. Thus, it is required to perform this alignment on a weekly basis to maintain specifications. This alignment typically takes >4 minutes to complete.

A failure of IF will set the Error Condition “Align IF failed” and set bit 4 in the Status Questionable Calibration register. A failure will not employ new IF alignment data.

Successful completion of IF will clear the Error Condition “Align IF failed” and clear bit 6 in the Status Questionable Calibration register.

Align IF can be interrupted by pressing the Cancel (ESC) front-panel key or from remote with Device Clear followed by the :ABORt SCPI command. When this occurs, no new IF alignment data will be employed.

The query form of the remote commands (:CALibration:IF?) will invoke the alignment of the IF subsystem and return a success or failure value.

Note: In EXM, Source ARB play will be turned off and the source states will not be restored after IF Alignment.

Mode	All
Remote Command	:CALibration:IF :CALibration:IF?
Example	:CAL:IF
Notes	:CALibration:IF? returns 0 if successful :CALibration:IF? returns 1 if failed While Align Now, IF is performing the alignment, bit 0 in the Status Operation register is set. Completion, or termination, will clear bit 0 in the Status Operation register. This command is sequential; it must complete before further SCPI commands are processed. Interrupting the alignment from remote is accomplished by invoking Device Clear followed by the :ABORt command. Successful completion will clear bit 14 in the Status Questionable Calibration register.
Preset	Not affected by Preset and Restore System Defaults Misc.
State Saved	No
Initial S/W Revision	E.14.00

Mode	All
Remote Command	:CALibration:IF:NPENding
Example	CAL:IF:NPEN
Notes	:CALibration:IF:NPENding is the same as :CALibration:IF including all conditions, status register bits, except that this scpi command does not BLOCK the scpi session, so the user should use status register bits to query if the calibration is successfully

completed or not.

Typical usage is:

- 1) :CALibration:IF:NPending (Start a IF calibration)
- 2) :STATus:OPERation:CONDition? (Check if the calibration is completed or not, If bit 0 is set, then the system is doing calibration, the user should repeat this scpi query until the bit is cleared)
- 3):STATus:QUEStionable:CALibration:CONDition? (Check if bit 4 is set or not. If this bit is set, that means there are some errors in previous internal source calibration)

Initial S/W Revision X.14.20

Show Alignment Statistics

Shows alignment information you can use to ensure that the instrument is operating in a specific manner. The Show Alignment Statistics screen is where you can view time and temperature information.

Values which are displayed are only updated when the Show Alignment Statistics screen is invoked, they are not updated while the Show Alignment Statistics screen is being displayed. The remote commands that access this information obtain current values.

An example of the Show Alignment Statistics screen would be similar to:

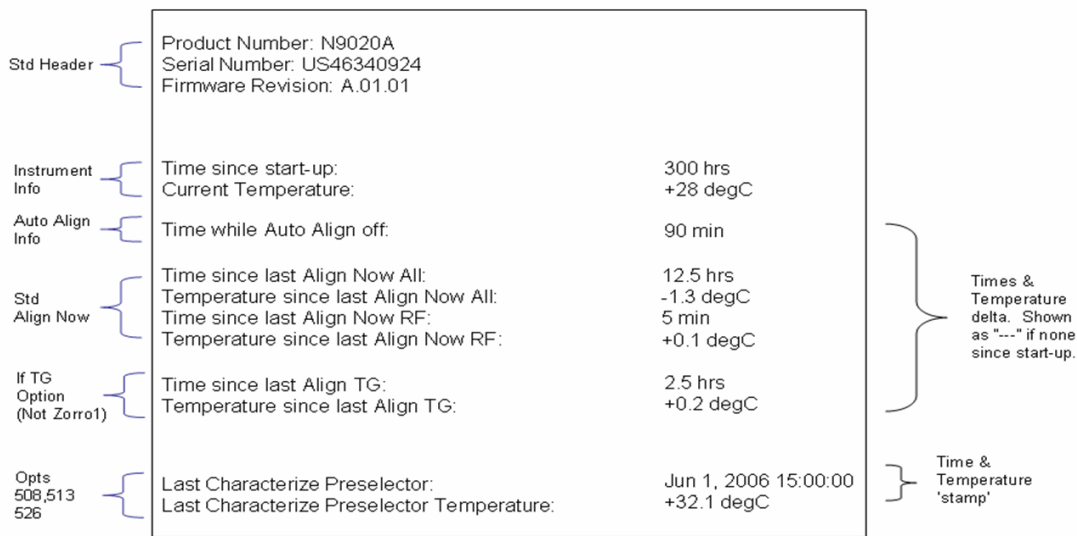

A successful Align Now, RF will set the Last Align RF temperature to the current temperature, and reset the Last Align RF time. A successful Align Now, All or Align Now, All but RF will set the Last Align Now All temperature to the current temperature, and reset the Last Align Now All time. A successful Align Now, All will also reset the Last Align RF items if the RF portion of the Align Now succeeded.

Key Path	System, Alignments
Mode	All
Notes	The values displayed on the screen are only updated upon entry to the screen and not updated while

	the screen is being displayed.
Initial S/W Revision	Prior to A.02.00

Key Path	Visual annotation in the Show Alignment Statistics screen
Mode	All
Remote Command	:SYSTem:PON:TIME?
Example	:SYST:PON:TIME?
Notes	Value is the time since the most recent start-up in seconds.
State Saved	No
Initial S/W Revision	Prior to A.02.00

Key Path	Visual annotation in the Show Alignment Statistics screen
Mode	All
Remote Command	:CALibration:TEMPerature:CURRent?
Example	:CAL:TEMP:CURR?
Notes	Value is in degrees Centigrade. Value is invalid if using default alignment data (Align Now, All required)
State Saved	No
Initial S/W Revision	Prior to A.02.00

Key Path	Visual annotation in the Show Alignment Statistics screen
Mode	All
Remote Command	:CALibration:TIME:LALL?
Example	:CAL:TIME:LALL?
Notes	Value is the elapsed time, in seconds, since the last successful Align Now, All or Align Now, All but RF was executed.
State Saved	No
Initial S/W Revision	Prior to A.02.00

Key Path	Visual annotation in the Show Alignment Statistics screen
Mode	All
Remote Command	:CALibration:TEMPerature:LALL?
Example	:CAL:TEMP:LALL?
Notes	Value is in degrees Centigrade at which the last successful Align Now, All or Align Now, All but RF

	was executed.
State Saved	No
Initial S/W Revision	Prior to A.02.00

Key Path	Visual annotation in the Show Alignment Statistics screen
Mode	All
Remote Command	:CALibration:TIME:LRF?
Example	:CAL:TIME:LRF?
Notes	Value is the elapsed time, in seconds, since the last successful Align Now, RF was executed, either individually or as a component of Align Now, All.
State Saved	No
Initial S/W Revision	Prior to A.02.00

Key Path	Visual annotation in the Show Alignment Statistics screen
Mode	All
Remote Command	:CALibration:TEMPerature:LRF?
Example	:CAL:TEMP:LRF?
Notes	Value is in degrees Centigrade at which the last successful Align Now, RF was executed, either individually or as a component of Align Now, All.
State Saved	No
Initial S/W Revision	Prior to A.02.00

Key Path	SCPI Only
Mode	All
Remote Command	:CALibration:TIME:LIF?
Example	:CAL:TIME:LIF?
Notes	Value is the elapsed time, in seconds, since the last successful Align IF was executed.
State Saved	No
Initial S/W Revision	A.14.50

Key Path	SCPI Only
Mode	All
Remote Command	:CALibration:TEMPerature:LIF?

Example	:CAL:TEMP:LIF?
Notes	Value is in degrees Centigrade at which the last successful Align IF was executed.
State Saved	No
Initial S/W Revision	A.14.50

Key Path	Visual annotation in the Show Alignment Statistics screen
Mode	All
Remote Command	:CALibration:TIME:SOURce:LALL?
Example	:CAL:TIME:SOUR:LALL?
Notes	Value is the date and time of the last successful Align Now, Source was performed on the instrument.
State Saved	No
Initial S/W Revision	A.05.00

Key Path	Visual annotation in the Show Alignment Statistics screen
Mode	All
Remote Command	:CALibration:TEMPerature:SOURce: LALL?
Example	:CAL:TEMP:SOUR:LALL?
Notes	Value is in degrees Centigrade at which the last successful Align Now, Source was performed on the instrument.
State Saved	No
Initial S/W Revision	A.05.00

Restore Align Defaults

Initializes the alignment user interface settings, not alignment data, to the factory default values. Align Now, All must be executed if the value of the Timebase DAC results in a change.

For front panel operation, you are prompted to confirm action before setting the alignment parameters to factory defaults:

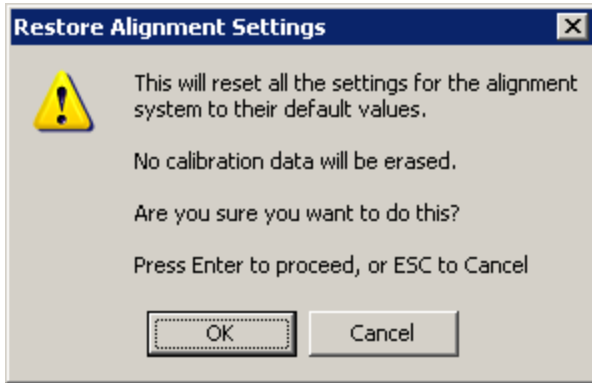

The parameters affected are:

Parameter	Setting
Timebase DAC	Calibrated
Timebase DAC setting	Calibrated value
Auto Align State	Normal (if the instrument is not operating with default alignment data, Off otherwise)
Auto Align All but RF	Off
Auto Align Alert	Time & Temperature

Key Path	System, Alignments
Mode	All
Example	:SYST:DEF ALIG
Notes	Alignment processing that results as the transition to Auto Alignment Normal will be executed sequentially; thus *OPC? or *WAI will wait until the alignment processing is complete.
Initial S/W Revision	Prior to A.02.00

Execute Expired Alignments (Remote Command Only)

Alignments can be expired in the situation where Auto Align is in the state of Partial or Off. This feature runs the alignments that have expired. This is different than performing an Align All, Now operation. Align All, Now performs an alignment of all subsystems regardless of whether they are needed or not, with Execute Expired Alignments, only the individual subsystems that have become due are aligned.

Mode	All
Remote Command	:CALibration:EXPIred?
Example	:CAL:EXP?
Notes	:CALibration:EXPIred? returns 0 if successful :CALibration:EXPIred? returns 1 if failed
Initial S/W Revision	Prior to A.02.00

I/O Config

Activates a menu for identifying and changing the I/O configuration for remote control.

Key Path	System
Initial S/W Revision	Prior to A.02.00

SCPI LAN

Activates a menu for identifying and changing the SCPI over a LAN configuration. There are a number of different ways to send SCPI remote commands to the instrument over LAN. It can be a problem to have multiple users simultaneously accessing the instrument over the LAN. These keys limit that somewhat by disabling the telnet, socket, and/or SICL capability.

NOTE

Telnet port 5023, socket port 5025, SICL server 0 and HiSLIP server 0 will be assigned to first instance; Telnet port 5123, socket port 5125, SICL server 1 and HiSLIP server 1 will be assigned to second instance; Telnet port 5223, socket port 5225, SICL server 2 and HiSLIP server 2 will be assigned to third instance; Telnet port 5323, socket port 5325, SICL server 3 and HiSLIP server 3 will be assigned to the fourth instance.

Key Path	System, I/O Config
Initial S/W Revision	Prior to A.02.00

SCPI Telnet

Turns the SCPI LAN telnet capability On or Off allowing you to limit SCPI access over LAN through telnet.

Key Path	System, I/O Config, SCPI LAN
Mode	All
Remote Command	:SYSTem:COMMunicate:LAN:SCPI:TELNet:ENABle OFF ON 0 1 :SYSTem:COMMunicate:LAN:SCPI:TELNet:ENABle?
Example	:SYST:COMM:LAN:SCPI:TELN:ENAB OFF
Preset	This is unaffected by Preset but is set to ON with a "Restore System Defaults->Misc"
State Saved	No
Range	On Off
Initial S/W Revision	Prior to A.02.00

SCPI Socket

Turns the capability of establishing Socket LAN sessions On or Off. This allows you to limit SCPI access over LAN through socket sessions.

Key Path	System, I/O Config, SCPI LAN
Mode	All
Remote Command	:SYSTem:COMMunicate:LAN:SCPI:SOCKet:ENABle OFF ON 0 1 :SYSTem:COMMunicate:LAN:SCPI:SOCKet:ENABle?
Example	:SYST:COMM:LAN:SCPI:SOCK:ENAB OFF
Preset	This is unaffected by a Preset but is set to ON with a “Restore System Defaults->Misc”
State Saved	No
Range	On Off
Initial S/W Revision	Prior to A.02.00

SICL Server

Turns the SICL server capability On or Off, enabling you to limit SCPI access over LAN through the SICL server. (SICL IEEE 488.2 protocol.)

Parameter	Description	Setting
Maximum Connections	The maximum number of connections that can be accessed simultaneously	5
Instrument Name	The name (same as the remote SICL address) of your analyzer	inst0
Instrument Logical Unit	The unique integer assigned to your analyzer when using SICL LAN	8
Emulated GPIB Name	The name (same as the remote SICL address) of the device used when communicating with your analyzer	gpib7
Emulated GPIB Logical Unit	The unique integer assigned to your device when it is being controlled using SICL LAN	8
Emulated GPIB Address	The emulated GPIB address assigned to your transmitter tester when it is a SICL server (the same as your GPIB address)	18

Key Path	System, I/O Config, SCPI LAN
Mode	All
Remote Command	:SYSTem:COMMunicate:LAN:SCPI:SICL:ENABle OFF ON 0 1 :SYSTem:COMMunicate:LAN:SCPI:SICL:ENABle?
Example	:SYST:COMM:LAN:SCPI:SICL:ENAB OFF
Preset	This is unaffected by Preset, but is set to ON with a “Restore System Defaults->Misc”
State Saved	No
Range	On Off
Initial S/W Revision	Prior to A.02.00

HiSLIP Server

Turns the HiSLIP server capability On or Off, enabling you to limit SCPI access over LAN through the HiSLIP server.

HiSLIP stands for High Speed LAN Instrument Protocol and is part of the IVI–6.1 specification.

Here is an example of a VISA connection string used to connect to the HiSLIP Server on an X-Series Spectrum Analyzer:

```
TCPIP0::a-n9030a-93016::hislip0::INSTR
```

In the example above, hislip0 is the HiSLIP device name that VISA users must include in their HiSLIP VISA Address strings. Your HiSLIP device name may be different depending on your VISA settings.

Key Path	System, I/O Config, SCPI LAN
Mode	All
Remote Command	:SYSTem:COMMunicate:LAN:SCPI:HISLip:ENABle OFF ON 0 1 :SYSTem:COMMunicate:LAN:SCPI:HISLip:ENABle?
Example	:SYST:COMM:LAN:SCPI:HISL:ENAB OFF
Preset	This is unaffected by Preset, but is set to ON with a “Restore System Defaults-> Misc”
State Saved	No
Range	On Off
Initial S/W Revision	A.11.00

SCPI Socket Control Port (Remote Command Only)

Returns the TCP/IP port number of the control socket associated with the SCPI socket session. This query enables you to obtain the unique port number to open when a device clear is to be sent to the instrument. Every time a connection is made to the SCPI socket, the instrument creates a peer control socket. The port number for this socket is random. The user must use this command to obtain the port number of the control socket. To force a device clear on this socket, open the port and send the string “DCL ” to the instrument.

If this SCPI command is sent to a non SCPI Socket interface, then 0 is returned.

Mode	All
Remote Command	:SYSTem:COMMunicate:LAN:SCPI:SOCKet:CONTRol?
Example	:SYST:COMM:LAN:SCPI:SOCK:CONT?
Preset	This is unaffected by Preset or “Restore System Defaults-> Misc”.
State Saved	No
Range	0 to 65534
Min	0
Max	65534
Initial S/W Revision	Prior to A.02.00

System IDN Response

This key allows you to specify a response to the *IDN? query, or to return the analyzer to the Factory response if you have changed it.

To choose the factory-set response, press the Factory key.

To specify your own response, press the User key, and enter your desired response.

If your test software is expecting the response to indicate Agilent Technologies as the Manufacturer, you can conveniently configure the response by pressing the Agilent key.

Key Path	System, I/O Config
Mode	All
Remote Command	
Notes	<ul style="list-style-type: none"> • This affects the response given in all Modes of the Analyzer, unless the current Mode has also specified a custom response, in which case the current Mode's custom IDN response takes precedence over the System's, but only while that Mode is the current Mode.. • It survives shutdown and restart of the software and therefore survives a power cycle
Preset	This is unaffected by Preset but is set to Factory on a "Restore System Defaults->Misc"
State Saved	No
Initial S/W Revision	A.06.00
Modified at S/W Revision	x.14.50

Factory

This key selects the factory setting, for example:

"Agilent Technologies,E6640,MY00012345, E.14.50"

where the fields are manufacturer, model number, serial number, firmware revision.

Note: In products that run multiple instances of the X-Series Application, all instances use the same factory System IDN response.

Key Path	System, I/O Config, IDN Response
Example	:SYST:IDN:CONF FACT
Initial S/W Revision	A.06.0

User

This key allows you to specify your own response to the *IDN? query. You may enter your desired response with the Alpha Editor or a plugin PC keyboard.

When you press this key, the active function becomes the current User string with the cursor at the end. This makes it easy to edit the existing string.

If you enter a null string (for example, by clearing the User String while editing and then pressing Done) the analyzer automatically reverts to the Factory setting.

Note: In products that run multiple instances of the X-Series Application, all instances use the same User System IDN response.

Key Path	System, I/O Config, IDN Response
Example	:SYST:IDN:CONF USER
Initial S/W Revision	A.06.00

SYSTEM:IDN Response setting (Remote command)

This SCPI command is used to set or clear the User SYSTEM:IDN response.

Remote Command	:SYSTem:IDN <string> :SYSTem:IDN?
Notes	<ul style="list-style-type: none"> The format of the <string> must be four fields each separated by a comma, example: :SYST:IDN "XYZ Corp,Model 12,012345,A.01.01" The four fields are <manufacturer>, <model number>, <serial number>, <firmware revision>. Thus, the text within a field cannot contain a comma. This affects the response given in all Modes of the Analyzer, unless the current Mode has also specified a custom response, in which case the current Mode's custom IDN response takes precedence over the System's, but only while that Mode is the current Mode.. It survives shutdown and restart of the software and therefore survives a power cycle Null string as parameter restores the Factory setting, example: :SYST:IDN ""
Preset	This is unaffected by Preset but is set to the original factory setting on a "Restore System Defaults->Misc"
Initial S/W Revision	A.06.00

Restore Defaults

Provides incremental initialization of the system setting groups along with supporting a comprehensive reset of the entire instrument back to a factory default state. The menu selections are the groups of system settings and when one is selected, that particular group of system settings is reset back to their default values.

NOTE

In products that run multiple instances of the X-Series Application, all instances have the same factory default states for Restore Defaults.

Key Path	System
Mode	All
Remote Command	:SYSTem:DEFault [ALL] ALIGn INPut MISC MODes PON

Example	SYST:DEF
State Saved	No
Initial S/W Revision	Prior to A.02.00

Restore Input/Output Defaults

Causes the group of settings and data associated with Input/Output front-panel key to be a reset to their default values. This level of Restore System Defaults does not affect any other system settings, mode settings and does not cause a mode switch. .

Confirmation is required to restore the Input/Output setting. The confirmation dialog is:

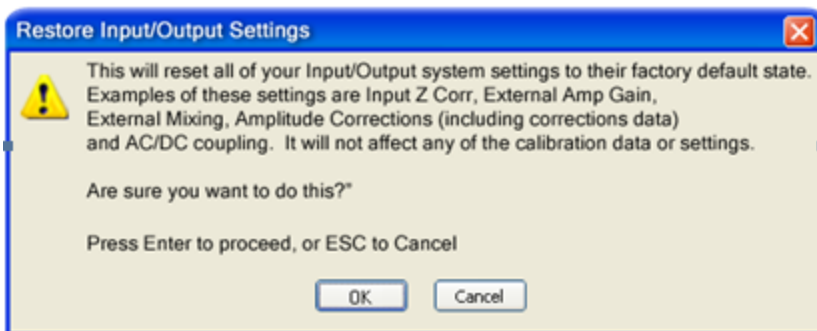

Key Path	System, Restore System Defaults
Example	:SYST:DEF INP
Initial S/W Revision	Prior to A.02.00

Restore Power On Defaults

This selection causes the Power On settings to be a reset to their default value. This level of Restore System Defaults does not affect any other system settings, mode settings and does not cause a mode switch. The Power On settings and their default values are Power On Type reset to Mode and Input/Output Defaults and Power On Application reset to whatever the factory set as its default value.

Confirmation is required to restore the factory default values. The confirmation dialog is:

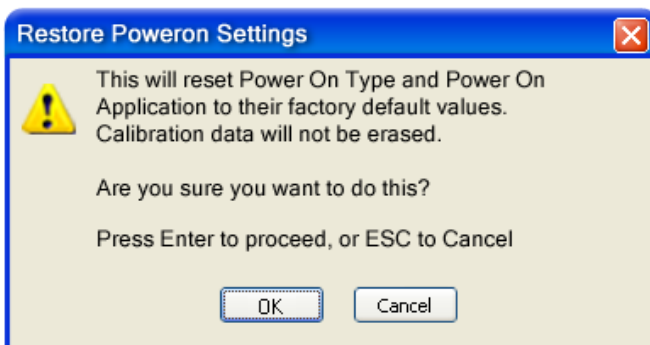

Key Path	System, Restore System Defaults
Example	:SYST:DEF PON
Initial S/W Revision	Prior to A.02.00

Restore Align Defaults

This selection causes the Alignment system settings to be a reset to their default values. This does not affect any Alignment data stored in the system. This level of Restore System Defaults does not affect any other system settings, mode settings and does not cause a mode switch.

After performing this function, it may impact the auto-alignment time of the instrument until a new alignment baseline has been established.

Confirmation is required to restore the factory default values. The confirmation dialog is:

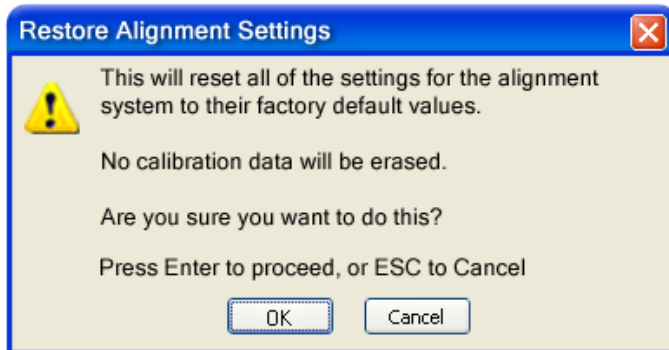

Key Path	System, Restore System Defaults
Example	:SYST:DEF ALIG
Initial S/W Revision	Prior to A.02.00

Restore Misc Defaults

This selection causes miscellaneous system settings to be reset to their default values. With this reset, you lose the GPIB address and it is reset to 18, so this should be used with caution. This level of Restore System Defaults does not affect any other system settings, mode settings and does not cause a mode switch. This miscellaneous group contains the rest of the settings that have not been part of the other Restore System Defaults groups. The following table is a complete list of settings associated with this group:

Miscellaneous Setting	Default Value
Verbose SCPI	Off
The SYST:PRES:TYPE	MODE
Auto File Name Number	000

Miscellaneous Setting	Default Value
Save Type	State
State Save To	Register 1
Screen Save To	SCREEN000.png
DISP:ENABle	ON
Full Screen	Off
SCPI Telnet	ON
SCPI Socket	ON
SICL Server	ON
Softkey Language	English
System Annotation	ON
Display Theme	TDColor
System IDN Response	Factory result of *IDN?
System IDN Response selection	Factory

Confirmation is required to restore the factory default values. The confirmation dialog is:

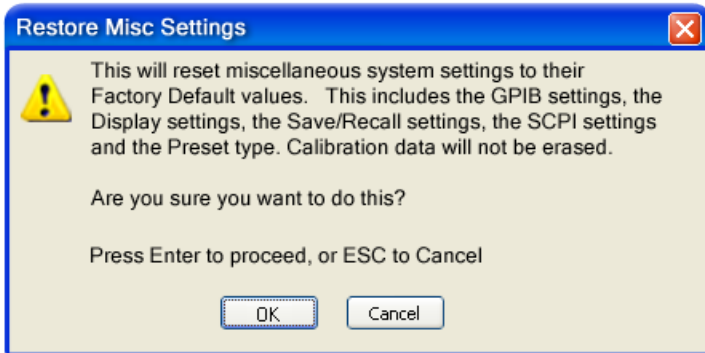

Key Path	System, Restore System Defaults
Example	:SYST:DEF MISC
Initial S/W Revision	Prior to A.02.00
Modified at S/W Revision	x.14.50

Restore Mode Defaults (All Modes)

This selection resets all of the modes in the instrument back to their default state just as a Restore Mode Defaults does and it switches the instrument to the power-on mode and causes the default measurement for the power-on mode to be active. This level of Restore System Defaults does not affect any system settings, but it does affect the state of all modes and does cause a mode switch unless the instrument was already in the power-on mode.

Confirmation is required to restore the factory default values. The confirmation dialog is:

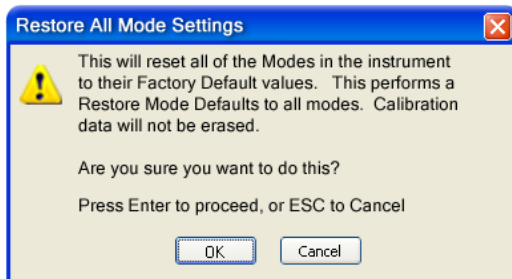

Key Path	System, Restore System Defaults
Example	:SYST:DEF MOD
Couplings	An All Mode will cause the currently running measurement to be aborted, mode switch to the power-on mode and activate the default measurement for the power-on mode.. It gets the mode to a consistent state with all of the default couplings set.
Initial S/W Revision	Prior to A.02.00

All

This performs a comprehensive reset of ALL analyzer settings to their factory default values. It resets all of the system setting groups, causes a Restore Mode Defaults for all modes in the instrument, and switches back to the power-on mode. It does not affect the User Preset file or any user saved files.

Confirmation is required to restore the factory default values. The confirmation dialog is:

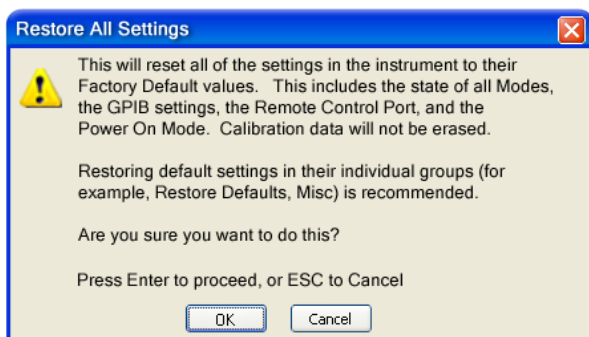

NOTE

If you are using an Keysight USB External Mixer, then you will need to perform a Refresh USB Mixer Connection after Restoring All Defaults.

Key Path	System, Restore System Defaults
Example	:SYST:DEF ALL
Notes	If using Keysight USB External Mixer, perform a Refresh USB Mixer Connection (SCPI command :MIX:BAND USB) following a Restore All Defaults.
Couplings	An All will cause the currently running measurement to be aborted and get all modes to a consistent state, so it is unnecessary to couple any settings.
Initial S/W Revision	Prior to A.02.00
Modified at S/W Revision	A.14.00

Control Panel...

Opens the Windows Control Panel. The Control Panel is used to configure certain elements of Windows that are not configured through the hardkey/softkey System menus.

NOTE This feature is not available if option SF1 is installed.

The Control Panel is a separate Windows application, so to return to the analyzer once you are in the Control Panel, you may either:

Exit the Control Panel by clicking on the red X in the upper right hand corner, with a mouse

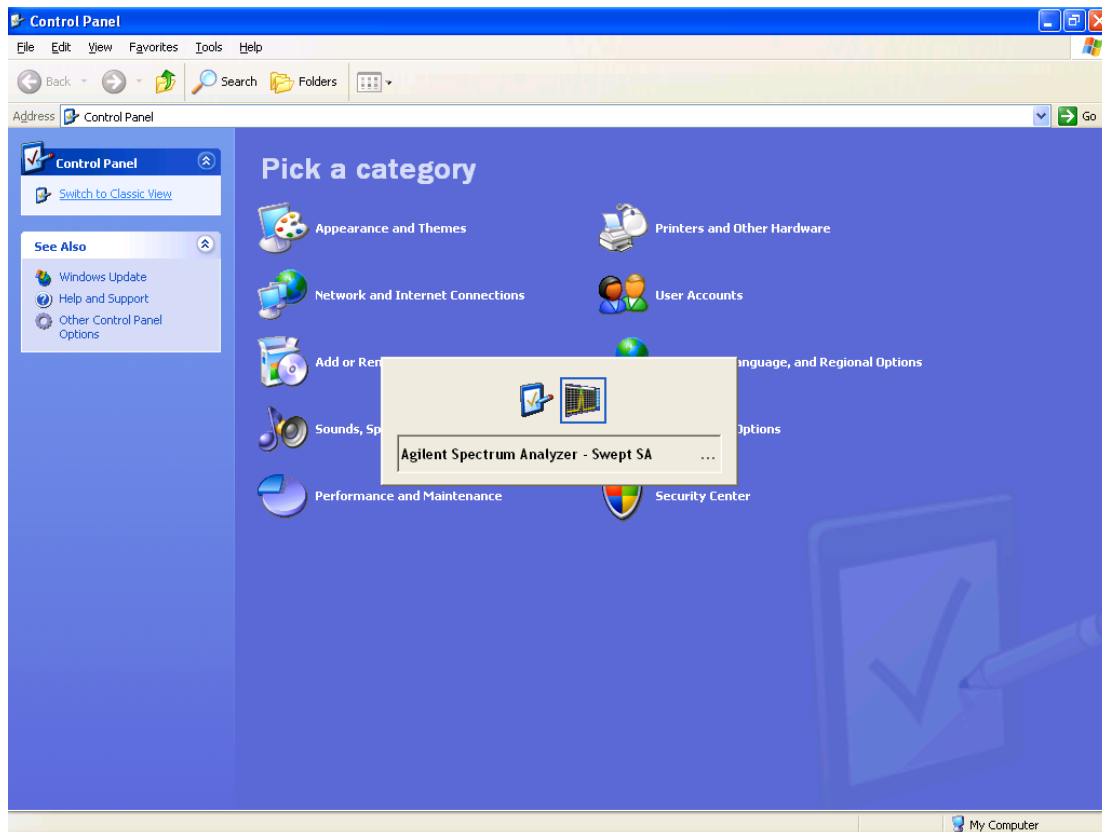



Or use Alt-Tab: press and hold the Alt key and press and release the Tab key until the Analyzer logo is showing in the window in the center of the screen, as above, then release the Alt key.

Key Path	System
Notes	No remote command for this key.
Initial S/W Revision	Prior to A.02.00

Licensing...

Opens the license explorer.

NOTE This feature is not available if option SF1 is installed.

For Help on this key, select Help in the menu bar at the top of the license explorer window.

Key Path	System
Notes	No equivalent remote command for this key.
Backwards Compatibility Notes	In ESA the SCPI command for displaying the Show Licenses screen is: :SYSTem:CONFigure:LKEY:STATe OFF ON 0 1 :SYSTem:CONFigure:LKEY:STATe? There are no equivalent SCPI commands in the X-Series for displaying the License Explorer.
Initial S/W Revision	Prior to A.02.00

Remote Command :SYSTem:LKEY <"OptionInfo">, <"LicenseInfo">

Example SYST:LKEY "N9073A-1FP",
"027253AD27F83CDA5673A9BA5F427FDA5E4F25AEB1017638211AC9F60D9C639FE539735909C551DE0A91"

Notes The <"OptionInfo"> contains the feature and the version. You must specify the feature but can omit the version. If you omit the version, the system regards it as the latest one, since the system knows which version is supported for each feature.

The <"LicenseInfo"> contains the signature, the expiration date, and serial number for transport if transportable. You must specify the signature, but you can omit the other information. If you omit the expiration date, the system regards it as permanent. If you omit the serial number, the system regards it as non-transportable. As a result, this supports reverse compatibility.

Initial S/W Revision Prior to A.02.00

Remote Command :SYSTem:LKEY:DELeTe <"OptionInfo">, <"LicenseInfo">

Example SYST:LKEY:DEL 'N9073A-1FP',
 "027253AD27F83CDA5673A9BA5F427FDA5E4F25AEB1017638211AC9F60D9C639FE539735909C551DE0
 A91"

Notes The <"OptionInfo"> contains the feature and the version. You must specify the feature but can omit the version. If you omit the version, the system regards it as the latest one, if more than one version is installed.

 The <"LicenseInfo"> contains the signature, the expiration date, and whether or not be transportable. You must specify the signature, but you can omit the other information. If you omit the expiration date, the system regards it as permanent. If you omit the transportability, the system regards it as non-transportable. As a result, this supports reverse compatibility.

Initial S/W Revision Prior to A.02.00

Remote Command :SYSTem:LKEY:LIST?

Notes

Return Value:

An <arbitrary block data> of all the installed instrument licenses.

The format of each license is as follows.

<Feature>,<Version>,<Signature>,<Expiration Date>,<Serial Number for Transport>

Return Value Example:

#3136

N9073A-1FP,1.000,B043920A51CA

N9060A-2FP,1.000,4D1D1164BE64

N9020A-508,1.000,389BC042F920

N9073A-1F1,1.000,5D71E9BA814C,13-aug-2005

<arbitrary block data> is:

#NMMM<data>

Where:

N is the number of digits that describes the number of MMM characters. For example if the data was 55 bytes, N would be 2.

MMM would be the ASCII representation of the number of bytes. In the previous example, N would be 55.

<data> ASCII contents of the data

Initial S/W Revision Prior to A.02.00

Remote Command :SYSTem:LKEY? <"OptionInfo">

Example SYST:LKEY? "N9073A-1FP"

Notes The <"OptionInfo"> contains the feature and the version. You must specify the feature but can omit the version. If you omit the version, the system regards it as the latest one.

Return Value:

<"LicenseInfo"> if the license is valid, null otherwise.

	<"LicenseInfo"> contains the signature, the expiration date, and serial number if transportable. Return Value Example: "B043920A51CA"
Initial S/W Revision	Prior to A.02.00

Remote Command	:SYSTem:HID?
Notes	Return value is the host ID as a string
Initial S/W Revision	Prior to A.02.00

Security

Accesses capabilities for operating the instrument in a security controlled environment.

Key Path	System
Initial S/W Revision	A.04.00

USB

The Windows operating system can be configured to disable write access to the USB ports for users who are in a secure environment where transferring data from the instrument is prohibited. This user interface is a convenient way for the customer to disable write access to USB.

Key Path	System, Security
Mode	All
Scope	Mode Global
Remote Command	:SYSTem:SECurity:USB:WPRotect[:ENABle] ON OFF 0 1 :SYSTem:SECurity:USB:WPRotect[:ENABle]?
Example	:SYST:SEC:USB:WPR ON Will set USB ports to Read-only
Notes	When the USB ports are in Read-only mode then no data can be stored to USB, including the internal USB memory used for a back-up location for the calibration data.
Dependencies	This key is grayed-out unless the current user has administrator privileges.
Preset	This is unaffected by Preset or any Restore System Defaults. An Agilent Recovery will set the USB to write protect OFF
State Saved	No
Range	Read-Write Read only
Initial S/W Revision	A.04.00

Read-Write

Selection for allowing full read-write access to the USB ports.

Key Path	System, Security, USB	
Example	:SYST:SEC:USB:WPR OFF	Will set USB ports to Read-Write
Initial S/W Revision	A.04.00	

Read only

Selection for disabling write access to the USB ports.

Key Path	System, Security, USB	
Example	:SYST:SEC:USB:WPR ON	Will set USB ports to Read only
Initial S/W Revision	A.04.00	

Diagnostics

The Diagnostics key in the System menu gives you access to basic diagnostic capabilities of the instrument.

Key Path	System
Initial S/W Revision	Prior to A.02.00

Show Hardware Statistics

Provides a display of various hardware statistics. The statistics include the following:

- High and Low temperature extremes
- Elapsed time that the instrument has been powered-on (odometer)

The display should appear listing the statistics, product number, serial number, and firmware revision.

Hardware Statistical Information	
Agilent MXA Signal Analyzer	
Product Number: N9020A	
Serial Number: US00061145	
Instrument S/W Revision: A.12.00	
Revision Date: 7/11/2012 12:11:10 PM	
Component Name	Value
MechAtten #1 Count Total	457304
Calibrator Switch Cycles	105953
AC/DC Switch Cycles	114240
2 dB #1 Mechanical Atten Cycles	112655
2 dB #2 Mechanical Atten Cycles	124456
MechAtten #2 Count Total	472265
6 dB Mechanical Atten Cycles	115302
10 dB Mechanical Atten Cycles	93602
20 dB Mechanical Atten Cycles	144781
30 dB Mechanical Atten Cycles	118580
Low Noise Path Switch	45668
Preselector Bypass Cycles	31133
High temperature operating extreme	45.75
Low temperature operating extreme	-23.9375
Elapsed Time (On-Time)(hours)	134164

In some CXA models this field is called "Fixed Aten"

Some CXA models omit these fields

Only shown if LNP installed

Only shown if MPB installed

The CXA models in which the AC/DC Switch field is called Fixed Aten and that omit the mechanical attenuation fields are the N9000A–503/507 models.

Modular HWs only have time and temperature information in Show Hardware Statistics.

The data will be updated only when the Show Hardware Statistics menu key is pressed, it will not be updated while the screen is displayed.

The tabular data should be directly printable.

Key Path	System, Diagnostics
Mode	All
Notes	The values displayed on the screen are only updated upon entry to the screen and not updated while the screen is being displayed.
Initial S/W Revision	Prior to A.02.00

SCPI for Show Hardware Statistics (Remote Commands Only)

Each of the hardware statistic items can be queried via SCPI.

- Error! Reference source not found.
- Error! Reference source not found.
- Error! Reference source not found.

Self test

This key gives you access to diagnostic capabilities for self tests of the instrument.

Key Path	System, Diagnostics
Initial S/W Revision	Prior to A.10.00

All Self Test

This key invokes all the self tests defined in the Diagnostics Self Test section.

Key Path	System, Diagnostics, Self Test
Remote Command	SYSTem:TEST:WCTS:[ALL]
Example	SYST:TEST:WCTS:[ALL]
Initial S/W Revision	A.12.50

FEC Self Test

This key invokes the EXT E6607C front end control self test. When operation is complete, the generated test summary information is appended to log file E:\Agilent\Instrument\FECTestLog.txt. This test summary file can be retrieved from the instrument using the MMEM set of SCPI command, once you have the fully qualified the path and file name.

If the self test fails, the following error message will be generated:

“-330, Self-test failed, see log file E:\Agilent\Instrument\FECTestLog.txt”

If the self test passes, an advisory message “FEC self-test completed successfully” is generated.

Key Path	System, Diagnostics, Self Test
Remote Command	SYSTem:TEST:WCTS:FEC
Example	SYST:TEST:WCTS:FEC
Notes	Access log with command : MMEM:DATA? "E:\ Agilent\Instrument\FECTestLog.txt"
Initial S/W Revision	A.12.50

Show Result

This key gives you access to show results of the following self tests:

- Source self-test results
- E6607C embedded MPA or E6640A/E6650A RFIO self-test results
- E6607C FEC self-test results

Key Path	System, Diagnostics, Self Test
Initial S/W Revision	A.12.50

FEC Self Test Results

Provides a display of last FEC test results, the display should appear listing model number, serial number and test time at the top of display, and then list test date/time, test name, measured value, valid range and pass/fail of each FEC test item, the tabular data should be directly printable.

Key Path	System, Diagnostics, Self Test, Show Results
Remote Command	SYSTem:TEST:WCTS:SHOW:RESult FEC
Example	SYST:TEST:WCTS:SHOW:RES FEC
Initial S/W Revision	A.12.50

The example of FEC self test result display is as follows:

FEC Self Test Results					
Produce Number: E6607C					
Serial Number: MY51380437					
Instrument S/W: 11/16/2012 2:51:19 PM					
FpgaVersionTest					
Date	Time(GMT)	Name	MeasValue	ValidRange	Result
11/23/2012	16:13:56	Analog_FPGA	16.000	>= 16.000	Pass
11/23/2012	16:13:56	Digital_FPGA	50.000	>= 46.000	Pass
11/23/2012	16:13:56	CRFS_FPGA	38.000	>= 38.000	Pass
PowerSupplyTest					
Date	Time(GMT)	Name	MeasValue	ValidRange	Result
11/23/2012	16:13:56	ABUS_+32CHK	31.904	30.900 - 32.900	Pass
11/23/2012	16:13:56	ABUS_+12CHK	12.296	10.800 - 13.200	Pass
11/23/2012	16:13:56	+10VA	9.935	9.600 - 10.200	Pass
11/23/2012	16:13:56	+5VA	4.995	4.900 - 5.100	Pass
11/23/2012	16:13:56	+3.3VA	3.299	3.200 - 3.400	Pass
11/23/2012	16:13:56	-3.3VA	-3.311	-3.400 - -3.200	Pass
11/23/2012	16:13:56	ACOM	0.00	-0.200 -	Pass

					0.200	
11/23/2012	16:13:56	-5VA	-5.036	-5.100 - - 4.900	Pass	
11/23/2012	16:13:56	-6.1VA	-5.880	-6.200 - - 5.700	Pass	
11/23/2012	16:13:56	-10VA	-10.116	-10.200 - - 9.800	Pass	
11/23/2012	16:13:56	ABUS_-2.5V_REF	-2.508	-2.520 - - 2.470	Pass	
11/23/2012	16:13:56	ABUS_+2.5V_REF	2.508	2.480 - 2.520	Pass	
11/23/2012	16:13:56	ABUS_-10VPALC	-10.047	-10.200 - - 9.800	Pass	
11/23/2012	16:13:57	ABUS_DET_MOD_FLT	18.000	7.800 - 100.000	Pass	

Show FEC Self Test Results contents (Remote Command Only)

A remote command is available to obtain the contents of the Show FEC Self Test Results screen (the entire contents, not just the currently displayed page).

Remote Command	SYSTem:TEST:WCTS:FEC:RESult?
Example	SYST:TEST:WCTS:FEC:RES?
Notes	The output is an IEEE Block format of the Show FEC Self Test Results contents. Each line is separated with a new-line character.
Initial S/W Revision	A.12.50

	Keysight Converged	PSA
IP Address	SYSTem:COMMunicate:LAN:ADDRess <string> SYSTem:COMMunicate:LAN:ADDRess?	:SYSTem:COMMunicate:LAN[;SELF]:IP <string> :SYSTem:COMMunicate:LAN[;SELF]:IP?
Gateway	SYSTem:COMMunicate:LAN:DGATeway <string> SYSTem:COMMunicate:LAN:DGATeway?	:SYSTem:COMMunicate:LAN[;SELF]:GATEway <string> :SYSTem:COMMunicate:LAN[;SELF]:GATEway?
Subnet Mask	SYSTem:COMMunicate:LAN:SMASK <string> SYSTem:COMMunicate:LAN:SMASK?	:SYSTem:COMMunicate:LAN[;SELF]:SUBNetmask <string> :SYSTem:COMMunicate:LAN[;SELF]:SUBNetmask?

Internet Explorer...

This key launches Microsoft Internet Explorer. A mouse and external keyboard are highly desired for using Internet Explorer. When Internet Explorer is running, close Internet Explorer to return focus to the Instrument Application (or use Alt-Tab).

Key Path	System
Mode	All
Notes	No equivalent remote command for this key.
Initial S/W Revision	A.05.01

(Undefined variable: Primary.ProductName)
LTE TDD Measurement Application Reference

7 Trigger Functions

Trigger

Accesses a menu of keys to control the selection of the trigger source and the setup of each of the trigger sources. The analyzer is designed to allow triggering from a number of different sources, for example, Free Run, Video, External, RF Burst, and so forth.

The TRIG:SOURCe command (below) will specify the trigger source for the currently selected input (RF or I/Q). If you change inputs, the new input remembers the trigger source it was last programmed to for the current measurement, and uses that trigger source. You can directly set the trigger source for each input using the TRIGger:RF:SOURce and TRIGger:IQ:SOURce commands (later in this section). When in External Mixing, the analyzer uses the RF trigger source.

Note the inclusion of the <measurement> parameter in the command below. Because each measurement remembers its own Trigger Source, the command must be qualified with the measurement name. Note that for the Swept SA measurement this is not the case; for backwards compatibility, no <measurement> parameter is used when setting the Trigger Source for the Swept SA measurement.

See ["Trigger Source Presets" on page 329](#)

See ["RF Trigger Source" on page 332](#)

See ["I/Q Trigger Source" on page 333](#)

See ["More Information" on page 334](#)

Key Path	Front-panel key
Remote Command	<pre>:TRIGger:<measurement>[:SEquence]:SOURce EXTernal1 EXTernal2 IMMediate LINE FRAMe RFBurst VIDeo IF ALARm LAN IQMag IDEMod QDEMod IINPut QINPut AIQMag TV :TRIGger:<measurement>[:SEquence]:SOURce?</pre> <p>where <measurement> is the measurement for which you wish to set the Source (blank for the Swept SA measurement)</p>
Example	<pre>TRIG:ACP:SOUR EXT1</pre> <p>Selects the external 1 trigger input for the ACP measurement and the selected input</p> <pre>TRIG:SOUR VID</pre> <p>Selects video triggering for the Swept SA (SANalyzer) measurement in the Spectrum Analyzer mode. For SAN, do not use the <measurement> keyword. Only send this form in the Spectrum Analyzer mode or you will get an Undefined Header error</p>
Notes	<p>Not all measurements have all the trigger sources available to them. Check the trigger source documentation for your specific measurement to see what sources are available.</p> <p>Not all trigger sources are available for each input. See the "RF Trigger Source" on page 332 and "I/Q Trigger Source" on page 333 commands for detailed information on which trigger sources are available for each input.</p> <p>Other trigger-related commands are found in the INITiate and ABORt SCPI command subsystems.</p> <p>*OPC should be used after requesting data. This will hold off any subsequent changes to the selected trigger source, until after the sweep is completed and the data is returned.</p> <p>Available ranges and presets can vary from mode to mode.</p>
Dependencies	<p>In some models, there is no second External input. In these models, the External 2 key is blanked and</p>

	the EXternal2 parameter will generate a "Hardware missing; Not available for this model number" message.
Preset	See table below
Status Bits/OPC dependencies	The Status Operation Register bit 5 "Waiting for Trigger" is set at the same time as the Sweeping or Measuring bit is set. It is cleared when the trigger actually occurs (that is, after the trigger event occurs and all the applicable trigger criteria have been met). A corresponding pop-up message ("Waiting for trigger") is generated if no trigger signal appears after approximately 2 sec. This message goes away when a trigger signal appears.
Backwards Compatibility SCPI	:TRIGger[:SEquence]:SOURce EXTernal For backward compatibility, the parameter EXTernal is mapped to EXTernal1
Backwards Compatibility SCPI	[:SENSe]:<measurement>:TRIGger:SOURce This backwards compatibility alias command is provided for ESA/PSA compatibility This backwards compatibility command does not apply to the Swept SA measurement, for that just use :TRIGger:SOURce This backwards compatibility command does not apply to the monitor spectrum, log plot and spot frequency measurements
Backwards Compatibility SCPI	[:SENSe]:<measurement>:TRIGger:SOURce IF In earlier instruments, the parameter IF was used by apps for the video trigger, so using the IF parameter selects VIDeo triggering. Sending IF in the command causes VID to be returned to a query.
Backwards Compatibility SCPI	[:SENSe]:ACPr:TRIGger:SOURce This backwards Compatibility SCPI command is provided to support the same functionality as [:SENSe]:ACPr:TRIGger:SOURce (PSA W-CDMA, PSA cdma2000 and PSA 1xEVDO) due to the fact that the ACPr node conflicts with the ACPower node.
Initial S/W Revision	Prior to A.02.00
Modified at S/W Revision	A.03.00

Trigger Source Presets

Here are the Trigger Source Presets for the various measurements:

Meas	Mode	Preset for RF	Preset for IQ	Notes
Swept SA	SA	IMM	IQ not supported	
CHP	SA, WCDMA, C2K, WIMAX OFDMA, 1xEVDO, DVB-T/H, DTMB, LTE, LTETDD, CMMB, ISDB-T, Digital Cable TV, MSR	IMM	IQ not supported	
OBW	SA, WCDMA, C2K, WIMAX OFDMA,	1xEVDO: EXT1 others: IMM	IQ not supported	For 1xEVDO mode, the trigger source is coupled with the gate state, as well as the gate

	TD-SCDMA, 1xEVDO, LTE, LTETDD, CMMB, ISDB-T, MSR			source. When the trigger source changes to RFBurst, External1 or External2, the gate state is set to on, and the gate source is set identically with the trigger source. When the trigger source changes to IMMEDIATE, VIDEO, LINE, FRAME or IF, the gate state is set to off.
CCDF	SA, WCDMA, C2K, WIMAX OFDMA, TD-SCDMA, 1xEV-DO, DVB-T/H, DTMB, LTE, LTETDD, CMMB, ISDB-T, Digital Cable TV, MSR	WIMAX OFDMA: RFBurst LTETDD: BTS: External 1 MS: Periodic Timer TD-SCDMA and 1xEV-DO: BTS: External 1 MS: RFBurst SA, WCDMA, C2K, LTE, CMMB, ISDB-T, DVB-T/H, DTMB, Digital Cable TV, MSR: IMMEDIATE	TD-SCDMA and 1xEV-DO: BTS: External 1 MS: IQMag LTETDD: BTS: External 1 MS: Periodic Timer Others: IMM	For TD-SCDMA: Trigger source is coupled with radio device. When radio device changes to BTS, trigger source will be changed to EXTERNAL1. When radio device changes to MS, trigger source will be set as RFBurst for RF or IQ Mag for BBIQ. When TriggerSource is RFBurst or IQ Mag, Measure Interval is grayed out.
ACP	SA, WCDMA, C2K, WIMAX OFDMA, TD-SCDMA, 1xEVDO, DVB-T/H, DTMB, LTE, LTETDD, CMMB, ISDB-T, Digital Cable TV, MSR	IMM	IQ not supported	
Tx Power	SA, GSM, TD-SCDMA	SA, GSM: RFBurst TD-SCDMA: EXTERNAL	IMM	TD-SCDMA doesn't support the Line and Periodic Timer parameters. When the mode is TD-SCDMA, if the Radio Device is switched to BTS, the value will be changed to External 1 and if the Radio device is switched to MS, the value will be changed to RFBurst
SPUR	SA, WCDMA, C2K, WIMAX OFDMA, TD-SCDMA, 1xEV-DO, DVB-T/H, LTE, LTETDD, MSR	IMM	IQ not supported	
SEM	SA, WCDMA, C2K, WIMAX OFDMA, TD-SCDMA, 1xEVDO, DVB-	1xEVDO(BTS): EXTERNAL1 All others: IMMEDIATE	IQ not supported	

	T/H, DTMB, LTE, LTETDD, CMMB, ISDB-T, Digital Cable TV, MSR			
CDP	WCDMA	IMM	IMM	
RHO	WCDMA	IMM	IMM	
PCON	WCDMA	IMM	IMM	
QPSK	WCDMA, C2K, 1xEVDO	All except CDMA1xEVDO: IMMediate CDMA1xEVDO: EXT1	IMM	
MON	All except SA and BASIC	IMM	IQ not supported	
WAV		LTETDD: BTS: External 1 MS: Periodic Timer GSM/EDGE: RFBurst All others: IMMediate	LTETDD: BTS: External 1 MS: Periodic Timer GSM/EDGE: IQMag All others: IMMediate	
PVT	WIMAXOFDMA	RFB	IMM	
EVM	WIMAXOFDMA, DVB-T/H, DTMB, LTE, LTETDD, CMMB, ISDB-T, Digital Cable TV	All but CMMB: IMM CMMB: Periodic Timer	All but CMMB: IMM CMMB: External 1	LTE, LTETDD supports Free Run, Video and External 1 only.
SPEC	BASIC	IMM	IMM	
LOG Plot	PN	IMM	IQ not supported	
Spot Freq	PN	IMM	IQ not supported	
GMSK PVT	EDGE/GSM	RFB	IMM	
GMSK PFER	EDGE/GSM	RFB	IQMag	
GMSK ORFS	EDGE/GSM	RF Burst	IQ not supported	
EDGE PVT	EDGE/GSM	RFB	IMM	

EDGE EVM	EDGE/GSM	RFB	IQMag
EDGE ORFS	EDGE/GSM	Periodic Timer	IQ not supported
Combined WCDMA	WCDMA	IMM	IQ not supported
Combined GSM	EDGE/GSM	RFB	IQ not supported
List Power Step	WCDMA, EDGE/GSM	IMM	IQ not supported
Transmit On/Off Power	LTETDD	LTETDD: BTS: External 1 MS: Periodic Timer	LTETDD: BTS: External 1 MS: Periodic Timer
Transmit Analysis	BLUETOOTH	RFB	IQ not supported
Adjacent Channel Power	BLUETOOTH	IMM	IQ not supported
LE In-band Emissions	BLUETOOTH	IMM	IQ not supported
EDR In-band Spurious Emissions	BLUETOOTH	Periodic Timer	IQ not supported
Conformance EVM	LTE, LTETDD, MSR	IMM	IMM

RF Trigger Source

The RF Trigger Source command selects the trigger to be used for the specified measurement when RF is the selected input. The RF trigger source can be queried and changed even while another input is selected, but it is inactive until RF becomes the selected input.

Note the inclusion of the <measurement> parameter in the command below. Because each measurement remembers its own Trigger Source, the command must be qualified with the measurement name. Note that for the Swept SA measurement this is not the case; for backwards compatibility, no <measurement> parameter is used when setting the Trigger Source for the Swept SA measurement.

Remote Command	<code>:TRIGger:<measurement>[:SEquence]:RF:SOURce EXTernal1 EXTernal2 IMMEDIATE LINE FRAME RFBurst VIDEO IF ALARm LAN TV</code> <code>:TRIGger:<measurement>[:SEquence]:RF:SOURce?</code>
Example	<code>TRIG:ACP:RF:SOUR EXT1</code> Selects the external 1 trigger input for the ACP measurement and the RF input

	<p>TRIG:RF:SOUR VID</p> <p>Selects video triggering for the SANalyzer measurement and the RF input. For SAN, do not use the <measurement> keyword.</p>
Notes	<p>Not all measurements have all the trigger sources available to them. Check the trigger source documentation for your specific measurement to see what sources are available.</p> <p>Not all trigger sources are available for each input. For the RF Trigger Source, the following trigger sources are available:</p> <ul style="list-style-type: none"> –IMMediate - free run triggering –VIDeo - triggers on the video signal level –LINE - triggers on the power line signal –EXTernal1 (or EXTernal) - triggers on an externally connected trigger source marked “Trigger 1 In” on the rear panel –EXTernal2 - triggers on an externally connected trigger source marked “Trigger 2 In” on the front panel. In some models, there is no second External input. In these models, the External 2 key is blanked and the EXTernal2 parameter will generate a “Hardware missing; Not available for this model number” message –RFBurst - triggers on the bursted frame –FRAMe - triggers on the periodic timer –IF (video) - same as video, for backwards compatibility only <p>*OPC should be used after requesting data. This will hold off any subsequent changes to the selected trigger source, until after the sweep is completed and the data is returned.</p> <p>Available ranges, and presets can vary from mode to mode.</p>
Status Bits/OPC dependencies	<p>The Status Operation Register bit 5 "Waiting for Trigger" is set at the same time as the Sweeping or Measuring bit is set. It is cleared when the trigger actually occurs (that is, after the trigger event occurs and all the applicable trigger criteria have been met). A corresponding pop-up message ("Waiting for trigger") is generated if no trigger signal appears after approximately 2 sec. This message goes away when a trigger signal appears.</p>
Initial S/W Revision	Prior to A.02.00

I/Q Trigger Source

This command selects the trigger to be used for the specified measurement when I/Q (which requires option BBA) is the selected input. The I/Q trigger source can be queried and changed even while another input is selected, but it is inactive until I/Q becomes the selected input.

Remote Command	<pre>:TRIGger:<measurement>[:SEquence]:IQ:SOURce EXTernal1 EXTernal2 IMMediate IQMag IDEMod QDEMod IINPut QINPut AIQMag :TRIGger:<measurement>[:SEquence]:IQ:SOURce?</pre>
Example	<p>TRIG:WAVeform:SOUR IQM</p> <p>Selects I/Q magnitude triggering for the IQ Waveform measurement and the I/Q input</p>
Notes	<p>Not all measurements have all the trigger sources available to them. Check the trigger source documentation for your specific measurement to see what sources are available.</p> <p>Not all trigger sources are available for each input. For the I/Q Trigger Source, the following trigger sources are available:</p>

	<ul style="list-style-type: none"> –IMMediate - free run triggering –EXternal1 (or EXternal) - triggers on an externally connected trigger source on the rear panel –EXternal2 - triggers on an externally connected trigger source on the front panel –IQMag - triggers on the magnitude of the I/Q signal –IDEMod - triggers on the I/Q signal's demodulated I voltage –QDEMod - triggers on the I/Q signal's demodulated Q voltage –IINPut - triggers on the I channel's ADC voltage –QINPut - triggers on the Q channel's ADC voltage –AIQMag - triggers on the magnitude of the auxiliary receiver channel I/Q signal <p>*OPC should be used after requesting data. This will hold off any subsequent changes to the selected trigger source, until after the sweep is completed and the data is returned.</p> <p>Available ranges, and from mode to mode presets can vary</p>
Status Bits/OPC dependencies	The Status Operation Register bit 5 "Waiting for Trigger" is set at the same time as the Sweeping or Measuring bit is set. It is cleared when the trigger actually occurs (that is, after the trigger event occurs and all the applicable trigger criteria have been met). A corresponding pop-up message ("Waiting for trigger") is generated if no trigger signal appears after approximately 2 sec. This message goes away when a trigger signal appears.
Initial S/W Revision	Prior to A.02.00

More Information

The trigger menus let you select the trigger source and trigger settings for a sweep or measurement. In triggered operation (basically, any trigger source other than Free Run), the analyzer will begin a sweep or measurement only with the selected trigger conditions are met, generally when your trigger source signal meets the specified trigger level and polarity requirements. (In FFT measurements, the trigger controls when the data acquisition begins for FFT conversion.)

For each of the trigger sources, you may define a set of operational parameters or settings which will be applied when that source is selected as the current trigger source. Examples of these settings are Trigger Level, Trigger Delay, and Trigger Slope. You may apply different settings for each source; so, for example, you could have a Trigger Level of 1v for External 1 trigger and –10 dBm for Video trigger.

Once you have established the settings for a given trigger source, they generally will remain unchanged for that trigger source as you go from measurement to measurement within a Mode (although the settings do change as you go from Mode to Mode). Furthermore, the trigger settings within a Mode are the same for the **Trigger** menu, the **Gate Source** menu, and the **Sync Source** menu that is part of the **Periodic Timer Trigger Setup** menu. That is, if **Ext1** trigger level is set to 1v in the **Trigger** menu, it will appear as 1v in both the **Gate Source** and the **Sync Source** menus. For these reasons the trigger settings commands are not qualified with the measurement name, the way the trigger source commands are.

The settings setup menu can be accessed by pressing the key for the current trigger source a second time. For example, one press of Video selects the Video trigger as the source. The Video key becomes highlighted and the hollow arrow on the key turns black. Now a second press of the key takes you into the Video Trigger Setup menu.

Trigger Setup Parameters:

The following examples show trigger setup parameters using an external trigger source.

Example 1 illustrates the trigger conditions with negative slope and no trigger occurs during trigger Holdoff time.

Example 2 illustrates the trigger conditions with positive slope, trigger delay, and auto trigger time.

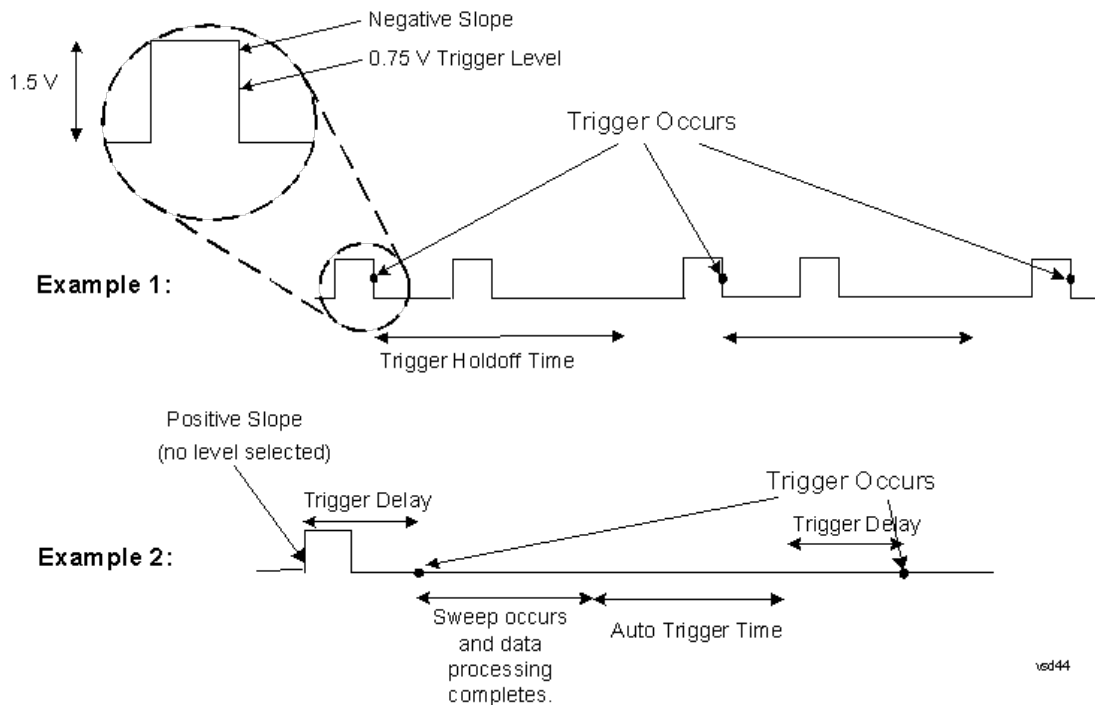

Free Run

Pressing this key, when it is not selected, selects free-run triggering. Free run triggering occurs immediately after the sweep/measurement is initiated.

Key Path	Trigger
Example	TRIG:SOUR IMM Swept SA measurement TRIG:<meas>:SOUR IMM Measurements other than Swept SA
State Saved	Saved in instrument state
Status Bits/OPC dependencies	The Status Operation Register bit 5 "Waiting for Trigger" is set at the same time as the Sweeping or Measuring bit is set. It is cleared when the trigger actually occurs (that is, after the trigger event occurs and all the applicable trigger criteria have been met). A corresponding pop-up message ("Waiting for trigger") is generated if no trigger signal appears after approximately 2 sec. This message goes away when a trigger signal appears.
Initial S/W Revision	Prior to A.02.00

Video (IF Envelope)

Pressing this key, when it is not selected, selects the video signal as the trigger. The Video trigger condition is met when the video signal (the filtered and detected version of the input signal, including both RBW and VBW filtering) crosses the video trigger level.

NOTE When the detector selected for all active traces is the average detector, the video signal for triggering does not include any VBW filtering.

The video trigger level is shown as a labeled line on the display. The line is displayed as long as video is the selected trigger source.

Pressing this key, when it is already selected, accesses the video trigger setup functions.

Key Path	Trigger
Example	TRIG:SOUR VID Swept SA measurement TRIG:<meas>:SOUR VID Measurements other than Swept SA
Notes	Log Plot and Spot Frequency measurements do not support Video Trigger
Dependencies	Video trigger is allowed in average detector mode.
State Saved	Saved in instrument state
Status Bits/OPC dependencies	The Status Operation Register bit 5 "Waiting for Trigger" is set at the same time as the Sweeping or Measuring bit is set. It is cleared when the trigger actually occurs (that is, after the trigger event occurs and all the applicable trigger criteria have been met). A corresponding pop-up message ("Waiting for trigger") is generated if no trigger signal appears after approximately 2 sec. This message goes away when a trigger signal appears.
Backwards Compatibility Notes	In the past, the Average detector was not available when Video triggering was on, and consequently, functions that set the detector to average (such as Marker Noise or Band/Intvl Power) were not available when the video trigger was on. Similarly, Video triggering was not available when the detector was Average. In the X-Series, these restrictions are removed.
Initial S/W Revision	Prior to A.02.00

Trigger Level

Sets a level for the video signal trigger. When the video signal crosses this level, with the chosen slope, the trigger occurs. This level is displayed with a horizontal line only if **Video** is the selected trigger source.

Key Path	Trigger, Video
Remote Command	:TRIGger[:SEquence]:VIDeo:LEVel <ampl> :TRIGger[:SEquence]:VIDeo:LEVel?
Example	TRIG:VID:LEV -40 dBm
Notes	When sweep type = FFT, the video trigger uses the amplitude envelope in a bandwidth wider than the FFT width as a trigger source. This might often be useful, but does not have the same relationship between the displayed trace and the trigger level as in swept triggering. Amplitude Corrections are not taken into account by the Video Trig Level. For example, if you have

given yourself effective gain with an amplitude correction factor, the Video Trigger will not fire until you have dropped the trigger line that far below the displayed signal level, rather than simply dropping it down to the displayed signal level.

Note that other corrections, specifically External Gain and Ref Level Offset, modify the actual trace data as it is taken and therefore ARE taken into account by Trig Level.

Couplings	This same level is used for the Video trigger source in the Trigger menu and for the Video selection in the Gate Source menu.
Preset	Set the Video Trigger Level -25 dBm on Preset. When the Video Trigger Level becomes the active function, if the value is off screen, set it to either the top or bottom of screen, depending on which direction off screen it was.
State Saved	Saved in instrument state
Min	-170 dBm
Max	+30 dBm
Default Unit	Depends on the current selected Y axis unit
Backwards Compatibility SCPI	:TRIGger[:SEquence]:IF:LEVel :TRIGger[:SEquence]:IF:LEVel?
Backwards Compatibility Notes	This alias is provided for backward compatibility with VSA/PSA comms apps.
Initial S/W Revision	Prior to A.02.00

Trig Slope

Controls the trigger polarity. It is set positive to trigger on a rising edge and negative to trigger on a falling edge.

Key Path	Trigger, Video
Remote Command	:TRIGger[:SEquence]:VIDeo:SLOPe POSitive NEGative :TRIGger[:SEquence]:VIDeo:SLOPe?
Example	TRIG:VID:SLOP NEG
Preset	POSitive
State Saved	Saved in instrument state
Backwards Compatibility SCPI	:TRIGger[:SEquence]:IF:SLOPe NEGative POSitive :TRIGger[:SEquence]:IF:SLOPe? For backward compatibility with VSA/PSA comms apps
Backwards Compatibility Notes	The legacy :TRIGger[:SEquence]:SLOPe command affects the slopes for the VID, LINE, EXT1, EXT2, and RFB triggers.
Initial S/W Revision	Prior to A.02.00

Remote Command	:TRIGger[:SEquence]:SLOPe POSitive NEGative :TRIGger[:SEquence]:SLOPe?
Example	TRIG:SLOP NEG
Preset	POSitive
State Saved	Saved in instrument state
Backwards Compatibility Notes	In ESA/PSA, the Trigger Slope was global to all triggers. In the X-Series, the slope can be set individually for each Trigger Source. For backward compatibility, the global SLOPe command updates all instances of trigger slope (VID, LINE, EXT1, EXT2, TV, RFB). The query returns the trigger slope setting of the currently selected trigger source.
Initial S/W Revision	Prior to A.02.00

Trig Delay

Controls a time delay during that the analyzer will wait to begin a sweep after meeting the trigger criteria. You can use negative delay to pre-trigger the instrument in the time domain or FFT, but not in swept spans.

Key Path	Trigger, Video
Remote Command	:TRIGger[:SEquence]:VIDeo:DELaY <time> :TRIGger[:SEquence]:VIDeo:DELaY? :TRIGger[:SEquence]:VIDeo:DELaY:STATe OFF ON 0 1 :TRIGger[:SEquence]:VIDeo:DELaY:STATe?
Example	TRIG:VID:DEL:STAT ON TRIG:VID:DEL 100 ms
Notes	Video trigger delay may be set to negative values, in time domain, FFT and even swept. It makes intuitive sense in time domain and works well in FFT mode where the bandwidth of the filter before the video trigger is about 1.25 span. In swept spans, negative settings of Trig Delay are treated as a zero setting within the internal hardware and the advisory message "Neg. Trig Delay unavailable in Swept Mode, zero delay used." is generated when such a delay is set.
Preset	Off, 1 us
State Saved	Saved in instrument state
Min	-150 ms
Max	+500 ms
Default Unit	s
Backwards Compatibility Notes	! For backward compatibility with VSA/PSA comms apps :TRIGger[:SEquence]:IF:DELaY :TRIGger[:SEquence]:DELaY The legacy :TRIGger[:SEquence]:DELaY command affects the delay for the VID, LINE, EXT1, EXT2, and RFB triggers.
Initial S/W Revision	Prior to A.02.00

Remote Command	:TRIGger[:SEquence]:DELay <time> :TRIGger[:SEquence]:DELay? :TRIGger[:SEquence]:DELay:STATE OFF ON 0 1 :TRIGger[:SEquence]:DELay:STATE?
Example	TRIG:DEL 1 ms
Preset	1 us
State Saved	Saved in instrument state
Backwards Compatibility Notes	In ESA/PSA, the Trigger Delay was global to all triggers. In the X-Series, the delay can be set individually for each Trigger Source. For backward compatibility, the global DELay command updates all instances of trigger slope (VID, LINE, EXT1, EXT2) except TV and RFBurst. The query returns the trigger delay setting of the currently selected trigger source.
Initial S/W Revision	Prior to A.02.00

Remote Command	:TRIGger[:SEquence]:OFFSet <time> :TRIGger[:SEquence]:OFFSet? :TRIGger[:SEquence]:OFFSet:STATE OFF ON 0 1 :TRIGger[:SEquence]:OFFSet:STATE?
Example	TRIG:OFFS ON TRIG:OFFS -100 ms
Notes	These are ESA commands for trigger offset that allowed you to use a positive or negative delay when in zero span and in a Res BW \geq 1 kHz. For ESA compatibility, X-series analyzers keep track of this offset and adds it to the Trigger Delay for VIDEo, LINE, EXTernal1 or EXTernal2 whenever the value is sent to the hardware, if in Zero Span and RBW \geq 1 kHz.
Preset	Off, 0 s
State Saved	Saved in instrument state
Min	-11 s
Max	+11 s
Initial S/W Revision	Prior to A.02.00

External 1

Pressing this key, when it is not selected, selects an external input signal as the trigger. A new sweep/measurement will start when the external trigger condition is met using the external 1 input connector on the rear panel.

Pressing this key, when it is already selected, accesses the external 1 trigger setup menu.

Key Path	Trigger
Example	TRIG:SOUR EXT1 Swept SA measurement TRIG:<meas>:SOUR EXT1 Measurements other than Swept SA

Dependencies	Grayed out if in use by Point Trigger in the Source Setup menu. Forced to Free Run if already selected and Point Trigger is set to External 1.
State Saved	Saved in instrument state
Status Bits/OPC dependencies	The Status Operation Register bit 5 "Waiting for Trigger" is set at the same time as the Sweeping or Measuring bit is set. It is cleared when the trigger actually occurs (that is, after the trigger event occurs and all the applicable trigger criteria have been met). A corresponding pop-up message ("Waiting for trigger") is generated if no trigger signal appears after approximately 2 sec. This message goes away when a trigger signal appears.
Initial S/W Revision	Prior to A.02.00

Trigger Level

Sets the value where the external 1 trigger input will trigger a new sweep/measurement.

Key Path	Trigger, External 1
Remote Command	:TRIGger[:SEquence]:EXTernal1:LEVel <level> :TRIGger[:SEquence]:EXTernal1:LEVel?
Example	TRIG:EXT1:LEV 0.4 V
Couplings	This same level is used for the Ext1 trigger source in the Trigger menu, for the Ext1 selection in the Periodic Timer sync source (in the Trigger menu and in the Gate Source menu), and also for the Ext1 selection in the Gate Source menu.
Preset	1.2 V
State Saved	Saved in instrument state
Min	-5 V
Max	5 V
Default Unit	V
Backwards Compatibility SCPI	:TRIGger[:SEquence]:EXTernal:LEVel For backward compatibility, the parameter EXTernal is mapped to EXTernal1
Backwards Compatibility SCPI	:TRIGger[:SEquence]:FRAME:EXTernal1:LEVel
Initial S/W Revision	Prior to A.02.00

Trig Slope

Controls the trigger polarity. It is set positive to trigger on a rising edge and negative to trigger on a falling edge.

Key Path	Trigger, External 1
Remote Command	:TRIGger[:SEquence]:EXTernal1:SLOPe POSitive NEGative

	:TRIGger[:SEquence]:EXTernal1:SLOPe?
Example	TRIG:EXT1:SLOP NEG
Couplings	This same slope is used in the Ext1 selection for the trigger source in the Trigger menu and for the period timer sync source (in the Trigger menu and in the Gate Source menu).
Preset	POSitive
State Saved	Saved in instrument state
Backwards Compatibility SCPI	:TRIGger[:SEquence]:EXTernal:SLOPe For backward compatibility, the parameter EXTernal is mapped to EXTernal1
Backwards Compatibility SCPI	:TRIGger[:SEquence]:FRAMe:EXTernal1:SLOPe
Backwards Compatibility Notes	The legacy :TRIGger[:SEquence]:SLOPe command affects the slopes for the VID, LINE, EXT1, EXT2, and RFB triggers.
Initial S/W Revision	Prior to A.02.00

Trig Delay

Controls a time delay during which the analyzer will wait to begin a sweep after meeting the trigger criteria. You can use negative delay to pre-trigger the instrument in time domain or FFT, but not in swept spans.

Key Path	Trigger, External 1
Remote Command	:TRIGger[:SEquence]:EXTernal1:DELAy <time> :TRIGger[:SEquence]:EXTernal1:DELAy? :TRIGger[:SEquence]:EXTernal1:DELAy:STATe OFF ON 0 1 :TRIGger[:SEquence]:EXTernal1:DELAy:STATe?
Example	TRIG:EXT1:DEL:STAT ON TRIG:EXT1:DEL 100 ms
Notes	Video trigger delay may be set to negative values, in time domain, FFT and even swept. It makes intuitive sense in time domain and works well in FFT mode where the bandwidth of the filter before the video trigger is about 1.25 span. In swept spans, negative settings of Trig Delay are treated as a zero setting within the internal hardware and the advisory message "Neg. Trig Delay unavailable in Swept Mode, zero delay used." is generated when such a delay is set.
Preset	Off, 1.000 us
State Saved	Saved in instrument state
Min	-150 ms
Max	+500 ms
Default Unit	s
Backwards Compatibility SCPI	:TRIGger[:SEquence]:EXTernal:DELAy For backward compatibility, the parameter EXTernal is mapped to EXTernal1
Backwards Compatibility	The legacy :TRIGger[:SEquence]:DELAy command affects the delay for the VID, LINE, EXT1, EXT2,

Notes	and RFB triggers. The legacy :TRIGger[:SEQuence]:OFFSet command is supported for the VIDEo, LINE, EXT1, and EXT2 triggers.
Initial S/W Revision	Prior to A.02.00

Zero Span Delay Comp On/Off

In zero span, there is a natural delay in the signal path, which comes from the RBW filter. This is usually desirable, as it allows you to trigger on events and also see those events, because the signal is delayed from the trigger event. However, in some cases it is desirable to eliminate this delay, so that trigger events line up exactly with the zero time point in zero span. You can use the Zero Span Delay Comp On/Off feature to enable or disable zero span delay compensation.

Key Path	Trigger, External 1
Remote Command	:TRIGger[:SEQuence]:EXTernal1:DELay:COMPensation OFF ON 0 1 :TRIGger[:SEQuence]:EXTernal1:DELay:COMPensation?
Example	TRIG:EXT1:DEL:COMP ON
Dependencies	No effect except in zero-span, but not locked out in nonzero spans. Blanked in modes that do not support zero-span measurements. If the SCPI command is sent when the key is blanked, an error is returned: -221, "Settings conflict; Feature not supported for this measurement" In analyzers shipping N9060A, this feature requires N9060A-7FP.
Preset	OFF
State Saved	Saved in instrument state
Initial S/W Revision	A.11.00

External 2

Pressing this key, when it is not selected, selects an external input signal as the trigger. A new sweep/measurement will start when the external trigger condition is met using the external 2 input connector. The external trigger 2 input connector is on the rear panel.

Pressing this key, when it is already selected, accesses the external 2 trigger setup menu.

Key Path	Trigger
Example	TRIG:SOUR EXT2 Swept SA measurement TRIG:<meas>:SOUR EXT2 Measurements other than Swept SA
Dependencies	In some models, there is no second External input. In these models, the External 2 key is blanked and the EXTernal2 parameter will generate a "Hardware missing; Not available for this model number" message. Grayed out if in use by Point Trigger in the Source Setup menu. Forced to Free Run if already selected and Point Trigger is set to External 2.

State Saved	Saved in instrument state
Status Bits/OPC dependencies	The Status Operation Register bit 5 "Waiting for Trigger" is set at the same time as the Sweeping or Measuring bit is set. It is cleared when the trigger actually occurs (that is, after the trigger event occurs and all the applicable trigger criteria have been met). A corresponding pop-up message ("Waiting for trigger") is generated if no trigger signal appears after approximately 2 sec. This message goes away when a trigger signal appears.
Initial S/W Revision	Prior to A.02.00
Modified at S/W Revision	A.03.00

Trigger Level

Sets the value where the external 2 trigger input will trigger a new sweep/measurement.

Key Path	Trigger, External 2
Remote Command	:TRIGger[:SEquence]:EXTernal2:LEVel :TRIGger[:SEquence]:EXTernal2:LEVel?
Example	TRIG:EXT2:LEV 1.1 V
Couplings	This same level is used for the Ext2 trigger source in the Trigger menu, for the Ext2 selection in the Periodic Timer sync source (in the Trigger menu and in the Gate Source menu), and also for the Ext2 selection in the Gate Source menu.
Preset	1.2 V
State Saved	Saved in instrument state
Min	-5 V
Max	5 V
Default Unit	V
Backwards Compatibility SCPI	:TRIGger[:SEquence]:FRAMe:EXTernal2:LEVel
Initial S/W Revision	Prior to A.02.00

Trig Slope

Controls the trigger polarity. It is set positive to trigger on a rising edge and negative to trigger on a falling edge.

Key Path	Trigger, External 2
Remote Command	:TRIGger[:SEquence]:EXTernal2:SLOPe POSitive NEGative :TRIGger[:SEquence]:EXTernal2:SLOPe?
Example	TRIG:EXT2:SLOP NEG
Couplings	This same slope is used in the Ext2 selection for the trigger source in the Trigger menu and for the period timer sync source (in the Trigger menu and in the Gate Source menu).

Preset	POSitive
State Saved	Saved in instrument state
Backwards Compatibility SCPI	:TRIGger[:SEQuence]:FRAMe:EXTernal2:SLOPe
Backwards Compatibility Notes	The legacy :TRIGger[:SEQuence]:SLOPe command affects the slopes for the VID, LINE, EXT1, EXT2, and RFB triggers.
Initial S/W Revision	Prior to A.02.00

Trig Delay

Controls a time delay during which the analyzer will wait to begin a sweep after meeting the trigger criteria. You can use negative delay to pre-trigger the instrument in time domain or FFT, but not in swept spans.

Key Path	Trigger, External 2
Remote Command	:TRIGger[:SEQuence]:EXTernal2:DELAy <time> :TRIGger[:SEQuence]:EXTernal2:DELAy? :TRIGger[:SEQuence]:EXTernal2:DELAy:STATe OFF ON 0 1 :TRIGger[:SEQuence]:EXTernal2:DELAy:STATe?
Example	TRIG:EXT2:DEL:STAT ON TRIG:EXT2:DEL 100 ms
Notes	Video trigger delay may be set to negative values, in time domain, FFT and even swept. It makes intuitive sense in time domain and works well in FFT mode where the bandwidth of the filter before the video trigger is about 1.25 span. In swept spans, negative settings of Trig Delay are treated as a zero setting within the internal hardware and the advisory message "Neg. Trig Delay unavailable in Swept Mode, zero delay used." is generated when such a delay is set.
Preset	Off, 1.000 us
State Saved	Saved in instrument state
Min	-150 ms
Max	500 ms
Default Unit	s
Backwards Compatibility Notes	The legacy :TRIGger[:SEQuence]:DELAy command affects the delay for the VID, LINE, EXT1, EXT2, and RFB triggers. The legacy :TRIGger[:SEQuence]:OFFSet command is supported for the VIDEo, LINE, EXT1, and EXT2 triggers.
Initial S/W Revision	Prior to A.02.00

Zero Span Delay Comp On/Off

In zero span, there is a natural delay in the signal path, which comes from the RBW filter. This is usually desirable, as it allows you to trigger on events and also see those events, because the signal is delayed

from the trigger event. However, in some cases it is desirable to eliminate this delay, so that trigger events line up exactly with the zero time point in zero span. You can use the Zero Span Delay Comp On/Off feature to enable or disable zero span delay compensation.

Key Path	Trigger, External 2
Remote Command	:TRIGger[:SEquence]:EXTernal2:DELay:COMPensation OFF ON 0 1 :TRIGger[:SEquence]:EXTernal2:DELay:COMPensation?
Example	TRIG:EXT2:DEL:COMP ON
Dependencies	No effect except in zero-span, but not locked out in nonzero spans. Blanked in modes that do not support zero-span measurements. If the SCPI command is sent when the key is blanked, an error is returned: -221, "Settings conflict; Feature not supported for this measurement" In analyzers shipping N9060A, this feature requires N9060A-7FP.
Preset	OFF
State Saved	Saved in instrument state
Initial S/W Revision	A.11.00

RF Burst

Pressing this key, when it is not selected, selects the RF Burst as the trigger. A new sweep/measurement will start when an RF burst envelope signal is identified from the signal at the RF Input connector. Pressing this key, when it is already selected, accesses the RF Burst trigger setup menu.

In some models, a variety of burst trigger circuitry is available, resulting in various available burst trigger bandwidths. The analyzer automatically chooses the appropriate trigger path based on the hardware configuration and other settings of the analyzer.

Key Path	Trigger
Example	TRIG:SOUR RFB Swept SA measurement TRIG:<meas>:SOUR RFB Measurements other than Swept SA
State Saved	Saved in instrument state
Status Bits/OPC dependencies	The Status Operation Register bit 5 "Waiting for Trigger" is set at the same time as the Sweeping or Measuring bit is set. It is cleared when the trigger actually occurs (that is, after the trigger event occurs and all the applicable trigger criteria have been met). A corresponding pop-up message ("Waiting for trigger") is generated if no trigger signal appears after approximately 2 sec. This message goes away when a trigger signal appears.
Backwards Compatibility Notes	The legacy command: :TRIGger[:SEquence]:RFBurst:FSElectivity[:STATe] OFF ON 0 1 is not supported in the X-Series, as the hardware to do Frequency Selective burst triggers does not exist in X-Series.
Initial S/W Revision	Prior to A.02.00
Modified at S/W Revision	A.04.00

Absolute Trigger Level

Sets the absolute trigger level for the RF burst envelope.

When using the External Mixing path, the Absolute Trigger Level is uncalibrated because the factory default was set to accommodate the expected IF levels for the RF path.

Key Path	Trigger, RF Burst
Scope	Meas Global
Remote Command	:TRIGger[:SEquence]:RFBurst:LEVel:ABSolute <ampl> :TRIGger[:SEquence]:RFBurst:LEVel:ABSolute?
Example	TRIG:RFB:LEV:ABS 10 dBm sets the trigger level of the RF burst envelope signal to the absolute level of 10 dBm
Notes	Sending this command does not switch the setting from relative to absolute; to switch it you need to send the :TRIGger[:SEquence]:RFBurst:LEVel:TYPE command, below. Amplitude Corrections are not taken into account by the Absolute Trigger Level. For example, if you have given yourself effective gain with an amplitude correction factor, the Absolute Trigger will not fire until you have set the trigger level that far below the displayed signal level, rather than simply to the displayed signal level. This is only true for Amplitude Corrections, not External Gain or Ref Level Offset functions. If mode is Bluetooth, the default value is -50 dBm.
Couplings	This same level is used for the RF Burst trigger source in the Trigger menu, for the RF Burst selection in the Periodic Timer sync source (in the Trigger menu and in the Gate Source menu), and also for the RF Burst selection in the Gate Source menu
Preset	-20 dBm
State Saved	Saved in instrument state
Min	-200 dBm
Max	100 dBm
Default Unit	depends on the current selected Y-Axis unit
Backwards Compatibility SCPI	:TRIGger[:SEquence]:FRAME:RFBurst:LEVel:ABSolute
Initial S/W Revision	Prior to A.02.00
Modified at S/W Revision	A.04.00

Key Path	Trigger, RF Burst
Remote Command	:TRIGger[:SEquence]:RFBurst:LEVel:TYPE ABSolute RELative :TRIGger[:SEquence]:RFBurst:LEVel:TYPE?
Example	TRIG:RFB:LEV:TYPE REL sets the trigger level type of the RF burst trigger to Relative.
Preset	ABSolute
State Saved	Saved in instrument state
Initial S/W Revision	Prior to A.02.00
Modified at S/W Revision	A.04.00

Relative Trigger Level

Sets the relative trigger level for the RF burst envelope.

In some models, the relative burst trigger function is implemented in hardware. In other models, without the advanced triggering hardware required, the relative burst trigger function is implemented in software in some measurements, and is unavailable in other measurements.

When implemented in software, the relative RF Burst trigger function is implemented as follows:

1. The measurement starts with the absolute RF Burst trigger setting. If it cannot get a trigger with that level, auto trigger fires and the acquisition starts anyway. After the acquisition, the measurement searches for the peak in the acquired waveform and saves it.
2. Now, in the next cycle of the measurement, the measurement determines a new absolute RF Burst level based on the peak value from the first measurement and the Relative RF Burst Trigger Level (always 0 or negative dB) set by the user. The following formula is used:
3. absolute RF Burst level = peak level of the previous acquisition + relative RF Burst level
4. If the new absolute RF Burst level differs from the previous by more than 0.5 dB, the new level is sent to the hardware; otherwise it is not updated (to avoid slowing down the acquisition)

Steps 2 and 3 repeat for subsequent measurements.

Key Path	Trigger, RF Burst
Scope	Meas Global
Remote Command	:TRIGger[:SEquence]:RFBurst:LEVel:RELative <rel_ampl> :TRIGger[:SEquence]:RFBurst:LEVel:RELative?
Example	TRIG:RFB:LEV:REL -10 dB sets the trigger level of the RF burst envelope signal to the relative level of -10 dB
Notes	Sending this command does not switch the setting from absolute to relative; to switch it you need to send the :TRIGger[:SEquence]:RFBurst:LEVel:TYPE command, above. The relative trigger level is not available in some measurements. In those measurements the RELative parameter, and the :TRIGger[:SEquence]:RFBurst:LEVel:TYPE command (above), will generate an error if sent.
Dependencies	This key is grayed out and Absolute Trigger Level selected if the required hardware is not present in your analyzer and the current measurement does not support Relative triggering.
Preset	-6 dB GSM: -25 dB
State Saved	Saved in instrument state
Min	-45 dB
Max	0 dB
Default Unit	dB or dBc
Backwards Compatibility SCPI	:TRIGger[:SEquence]:RFBurst:LEVel This legacy command is aliased to :TRIGger[:SEquence]:RFBurst:LEVel:RELative because the PSA

	had ONLY relative burst triggering
Initial S/W Revision	Prior to A.02.00
Modified at S/W Revision	A.04.00

Trigger Slope

It is set positive to trigger on a rising edge and negative to trigger on a falling edge.

Key Path	Trigger, RF Burst
Remote Command	:TRIGger[:SEquence]:RFBurst:SLOPe POSitive NEGative :TRIGger[:SEquence]:RFBurst:SLOPe?
Example	TRIG:RFB:SLOP NEG
Couplings	This same slope is used in the RF Burst selection for the trigger source in the Trigger menu and for the period timer sync source (in the Trigger menu and in the Gate Source menu).
Preset	POSitive
State Saved	Saved in instrument state
Backwards Compatibility SCPI	:TRIGger[:SEquence]:FRAME:RFBurst:SLOPe
Backwards Compatibility Notes	The legacy :TRIGger[:SEquence]:SLOPe command affects the slopes for the VID, LINE, EXT1, EXT2, and RFB triggers.
Initial S/W Revision	Prior to A.02.00

Trig Delay

Controls a time delay during which the analyzer will wait to begin a sweep after meeting the trigger criteria. You can use negative delay to pre-trigger the instrument in time domain or FFT, but not in swept spans.

Key Path	Trigger, RF Burst
Remote Command	:TRIGger[:SEquence]:RFBurst:DELAy <time> :TRIGger[:SEquence]:RFBurst:DELAy? :TRIGger[:SEquence]:RFBurst:DELAy:STATe OFF ON 0 1 :TRIGger[:SEquence]:RFBurst:DELAy:STATe?
Example	TRIG:RFB:DEL:STAT ON TRIG:RFB:DEL 100 ms
Notes	Video trigger delay may be set to negative values, in time domain, FFT and even swept. It makes intuitive sense in time domain and works well in FFT mode where the bandwidth of the filter before the video trigger is about 1.25 span. In swept spans, negative settings of Trig Delay are treated as a zero setting within the internal hardware and the advisory message "Neg. Trig Delay unavailable in Swept Mode, zero delay used." is generated when such a delay is set.

Preset	Off, 1.000 us
State Saved	Saved in instrument state
Min	-150 ms
Max	500 ms
Default Unit	s
Backwards Compatibility Notes	The legacy :TRIGger[:SEQuence]:DELay command affects the delay for the VID, LINE, EXT1, EXT2, and RFB triggers.
Initial S/W Revision	Prior to A.02.00

Periodic Timer (Frame Trigger)

Pressing this key, when it is not selected, selects the internal periodic timer signal as the trigger. Triggering occurrences are set by the **Period** parameter, which is modified by the **Sync Source** and **Offset**. Pressing this key, when it is already selected, accesses the periodic timer trigger setup functions.

If you do not have a sync source selected (it is Off), then the internal timer will not be synchronized with any external timing events.

Key Path	Trigger
Example	TRIG:SOUR FRAM Swept SA measurement TRIG:<meas>:SOUR FRAM Measurements other than Swept SA
State Saved	Saved in instrument state
Readback	[Sync: <value of Sync Source>], for example, [Sync: External 1]
Status Bits/OPC dependencies	The Status Operation Register bit 5 "Waiting for Trigger" is set at the same time as the Sweeping or Measuring bit is set. It is cleared when the trigger actually occurs (that is, after the trigger event occurs and all the applicable trigger criteria have been met). A corresponding pop-up message ("Waiting for trigger") is generated if no trigger signal appears after approximately 2 sec. This message goes away when a trigger signal appears.
Initial S/W Revision	Prior to A.02.00

Periodic Timer Triggering:

This feature selects the internal periodic timer signal as the trigger. Trigger occurrences are set by the **Periodic Timer** parameter, which is modified by the **Sync Source** and **Offset**.

The figure below shows the action of the periodic timer trigger. Before reviewing the figure, we'll explain some uses for the periodic trigger.

A common application is measuring periodic burst RF signals for which a trigger signal is not easily available. For example, we might be measuring a TDMA radio which bursts every 20 ms. Let's assume that the 20 ms period is very consistent. Let's also assume that we do not have an external trigger source available that is synchronized with the period, and that the signal-to-noise ratio of the signal is not high enough to provide a clean RF burst trigger at all of the analysis frequencies. For example, we might want to

measure spurious transmissions at an offset from the carrier that is larger than the bandwidth of the RF burst trigger. In this application, we can set the Periodic Timer to a 20.00 ms period and adjust the offset from that timer to position our trigger just where we want it. If we find that the 20.00 ms is not exactly right, we can adjust the period slightly to minimize the drift between the period timer and the signal to be measured.

A second way to use this feature would be to use **Sync Source** temporarily, instead of **Offset**. In this case, we might tune to the signal in a narrow span and use the RF Burst trigger to synchronize the periodic timer. Then we would turn the sync source off so that it would not miss-trigger. Miss-triggering can occur when we are tuned so far away from the RF burst trigger that it is no longer reliable.

A third example would be to synchronize to a signal that has a reference time element of much longer period than the period of interest. In some CDMA applications, it is useful to look at signals with a short periodicity, by synchronizing that periodicity to the "even-second clock" edge that happens every two seconds. Thus, we could connect the even-second clock trigger to Ext1 and use then Ext1 as the sync source for the periodic timer.

The figure below illustrates this third example. The top trace represents the even-second clock. It causes the periodic timer to synchronize with the leading edge shown. The analyzer trigger occurs at a time delayed by the accumulated offset from the period trigger event. The periodic timer continues to run, and triggers continue to occur, with a periodicity determined by the analyzer time base. The timer output (labeled "late event") will drift away from its ideal time due to imperfect matching between the time base of the signal being measured and the time base of the analyzer, and also because of imperfect setting of the period parameter. But the synchronization is restored on the next even-second clock event. ("Accumulated offset" is described in the in the **Offset** function section.)

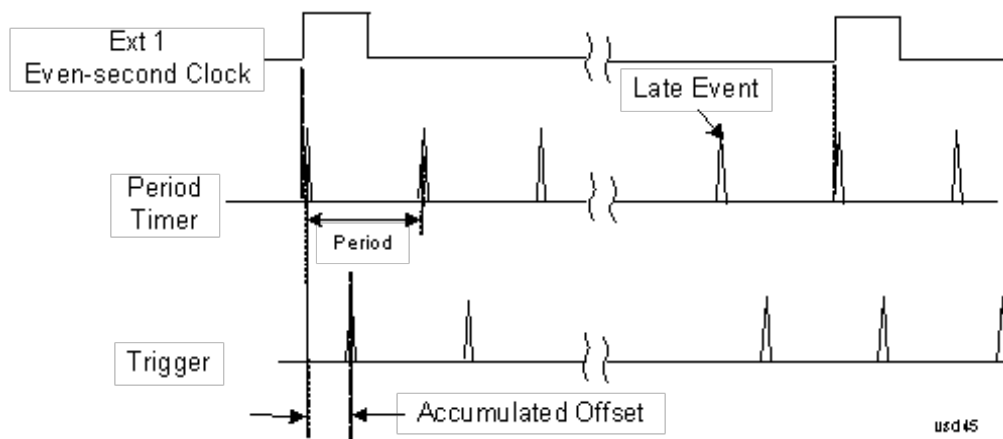

Period

Sets the period of the internal periodic timer clock. For digital communications signals, this is usually set to the frame period of your current input signal. In the case that sync source is not set to OFF, and the external sync source rate is changed for some reason, the periodic timer is synchronized at the every external synchronization pulse by resetting the internal state of the timer circuit.

Key Path	Trigger, Periodic Timer
Remote Command	:TRIGger[:SEquence]:FRAME:PERiod <time> :TRIGger[:SEquence]:FRAME:PERiod?

Example	TRIG:FRAM:PER 100 ms
Dependencies	The invalid data indicator turns on when the period is changed, until the next sweep/measurement completes.
Couplings	The same period is used in the Gate Source selection of the period timer.
Preset	20 ms GSM: 4.615383
State Saved	Saved in instrument state
Min	100.000 ns
Max	559.0000 ms
Default Unit	S
Initial S/W Revision	Prior to A.02.00

Offset

Adjusts the accumulated offset between the periodic timer events and the trigger event. Adjusting the accumulated offset is different than setting an offset, and requires explanation.

The periodic timer is usually not synchronized with any external events, so the timing of its output events has no absolute meaning. Since the timing relative to external events (RF signals) is important, you need to be able to adjust (offset) it. However, you have no direct way to see when the periodic timer events occur. All that you can see is the trigger timing. When you want to adjust the trigger timing, you will be changing the internal offset between the periodic timer events and the trigger event. Because the absolute value of that internal offset is unknown, we will just call that the accumulated offset. Whenever the Offset parameter is changed, you are changing that accumulated offset. You can reset the displayed offset using Reset Offset Display. Changing the display does not change the value of the accumulated offset, and you can still make additional changes to accumulated offset.

To avoid ambiguity, we define that an increase in the "offset" parameter, either from the knob or the SCPI adjust command, serves to delay the timing of the trigger event.

Key Path	Trigger, Periodic Timer
Remote Command	:TRIGger[:SEquence]:FRAMe:OFFSet <time> :TRIGger[:SEquence]:FRAMe:OFFSet?
Example	TRIG:FRAM:OFFS 1.2 ms
Notes	<p>The front panel interface (for example, the knob), and this command, adjust the accumulated offset, which is shown on the active function display. However, the actual amount sent to the hardware each time the offset is updated is the delta value, that is, the current accumulated offset value minus the previous accumulated offset value. Note that the accumulated offset value is essentially arbitrary; it represents the accumulated offset from the last time the offset was zeroed (with the Reset Offset Display key).</p> <p>Note that this command does not change the period of the trigger waveform. Note also that Offset is used only when the sync source is set to OFF, otherwise delay is used, see section "Trig Delay" on page 359.</p> <p>An increase in the "offset" parameter, either from the knob or the SCPI adjust command, serves to</p>

	delay the timing of the trigger event.
Notes	When the SCPI command is sent the value shown on the key (and the Active Function, if this happens to be the active function) is updated with the new value. However, the actual amount sent to the hardware is the delta value, that is, the current accumulated offset value minus the previous accumulated offset value. The SCPI query simply returns the value currently showing on the key.
Dependencies	The invalid data indicator turns on when the offset is changed, until the next sweep/measurement completes.
Couplings	The same offset is used in the Gate Source selection of the period timer.
Preset	0 s
State Saved	Saved in instrument state
Min	-10.000 s
Max	10.000 s
Default Unit	S
Initial S/W Revision	Prior to A.02.00

Reset Offset Display

Resets the value of the periodic trigger offset display setting to 0.0 seconds. The current displayed trigger location may include an offset value defined with the Offset key. Pressing this key redefines the currently displayed trigger location as the new trigger point that is 0.0 s offset. The Offset key can then be used to add offset relative to this new timing.

Key Path	Trigger, Periodic Timer
Remote Command	:TRIGger[:SEquence]:FRAMe:OFFSet:DISPlay:RESet
Example	TRIG:FRAM:OFFS:DISP:RES
Initial S/W Revision	Prior to A.02.00

Sync Source

Selects a signal source for you to synchronize your periodic timer trigger to, otherwise you are triggering at some arbitrary location in the frame. Synchronization reduces the precision requirements on the setting of the period.

For convenience you may adjust the level and slope of the selected sync source in a conditional branch setup menu accessed from the Sync Source menu. Note that these settings match those in the **Trigger** and **Gate Source** menus; that is, each trigger source has only one value of level and slope, regardless of which menu it is accessed from.

Key Path	Trigger, Periodic Timer
Remote Command	:TRIGger[:SEquence]:FRAMe:SYNC EXTernal1 EXTernal2 RFBurst OFF :TRIGger[:SEquence]:FRAMe:SYNC?

Example	TRIG:FRAM:SYNC EXT2
Dependencies	In some models, there is no second External input. In these models, the External 2 key is blanked and the EXTERNAL2 parameter will generate a "Hardware missing; Not available for this model number" message.
Preset	Off GSM/EDGE, MSR,LTE,LTETDD: RFBurst
State Saved	Saved in instrument state
Readback	The current setting is read back to this key and it is also Readback to the previous Periodic Timer trigger key.
Backwards Compatibility SCPI	:TRIGger[:SEquence]:FRAMe:SYNC EXTERNAL
Initial S/W Revision	Prior to A.02.00
Modified at S/W Revision	A.03.00, A.14.00

Off

Turns off the sync source for your periodic trigger. With the sync source off, the timing will drift unless the signal source frequency is locked to the analyzer frequency reference.

Key Path	Trigger, Periodic Timer, Sync Source
Example	TRIG:FRAM:SYNC OFF
Readback	Off
Initial S/W Revision	Prior to A.02.00

External 1

Pressing this key, when it is not selected, selects an external input signal as the trigger. A new sweep/measurement will start when the external trigger condition is met using the external 1 input connector on the rear panel.

Pressing this key, when it is already selected, accesses the external 1 trigger setup menu.

Key Path	Trigger
Example	TRIG:SOUR EXT1 Swept SA measurement TRIG:<meas>:SOUR EXT1 Measurements other than Swept SA
Dependencies	Grayed out if in use by Point Trigger in the Source Setup menu. Forced to Free Run if already selected and Point Trigger is set to External 1.
State Saved	Saved in instrument state
Status Bits/OPC dependencies	The Status Operation Register bit 5 "Waiting for Trigger" is set at the same time as the Sweeping or

Measuring bit is set. It is cleared when the trigger actually occurs (that is, after the trigger event occurs and all the applicable trigger criteria have been met). A corresponding pop-up message ("Waiting for trigger") is generated if no trigger signal appears after approximately 2 sec. This message goes away when a trigger signal appears.

Initial S/W Revision Prior to A.02.00

Trigger Level

Sets the value where the external 1 trigger input will trigger a new sweep/measurement.

Key Path	Trigger, External 1
Remote Command	:TRIGger[:SEquence]:EXTernal1:LEVel <level> :TRIGger[:SEquence]:EXTernal1:LEVel?
Example	TRIG:EXT1:LEV 0.4 V
Couplings	This same level is used for the Ext1 trigger source in the Trigger menu, for the Ext1 selection in the Periodic Timer sync source (in the Trigger menu and in the Gate Source menu), and also for the Ext1 selection in the Gate Source menu.
Preset	1.2 V
State Saved	Saved in instrument state
Min	-5 V
Max	5 V
Default Unit	V
Backwards Compatibility SCPI	:TRIGger[:SEquence]:EXTernal:LEVel
Backwards Compatibility SCPI	For backward compatibility, the parameter EXTernal is mapped to EXTernal1
Backwards Compatibility SCPI	:TRIGger[:SEquence]:FRAME:EXTernal1:LEVel
Initial S/W Revision	Prior to A.02.00

Trig Slope

Controls the trigger polarity. It is set positive to trigger on a rising edge and negative to trigger on a falling edge.

Key Path	Trigger, External 1
Remote Command	:TRIGger[:SEquence]:EXTernal1:SLOPe POSitive NEGative :TRIGger[:SEquence]:EXTernal1:SLOPe?
Example	TRIG:EXT1:SLOP NEG
Couplings	This same slope is used in the Ext1 selection for the trigger source in the Trigger menu and for the period timer sync source (in the Trigger menu and in the Gate Source menu).
Preset	POSitive

State Saved	Saved in instrument state
Backwards Compatibility SCPI	:TRIGger[:SEquence]:EXTernal:SLOPe For backward compatibility, the parameter EXTernal is mapped to EXTernal1
Backwards Compatibility SCPI	:TRIGger[:SEquence]:FRAME:EXTernal1:SLOPe
Backwards Compatibility Notes	The legacy :TRIGger[:SEquence]:SLOPe command affects the slopes for the VID, LINE, EXT1, EXT2, and RFB triggers.
Initial S/W Revision	Prior to A.02.00

External 2

Pressing this key, when it is not selected, selects an external input signal as the trigger. A new sweep/measurement will start when the external trigger condition is met using the external 2 input connector. The external trigger 2 input connector is on the rear panel.

Pressing this key, when it is already selected, accesses the external 2 trigger setup menu.

Key Path	Trigger
Example	TRIG:SOUR EXT2 Swept SA measurement TRIG:<meas>:SOUR EXT2 Measurements other than Swept SA
Dependencies	In some models, there is no second External input. In these models, the External 2 key is blanked and the EXTernal2 parameter will generate a "Hardware missing; Not available for this model number" message. Grayed out if in use by Point Trigger in the Source Setup menu. Forced to Free Run if already selected and Point Trigger is set to External 2.
State Saved	Saved in instrument state
Status Bits/OPC dependencies	The Status Operation Register bit 5 "Waiting for Trigger" is set at the same time as the Sweeping or Measuring bit is set. It is cleared when the trigger actually occurs (that is, after the trigger event occurs and all the applicable trigger criteria have been met). A corresponding pop-up message ("Waiting for trigger") is generated if no trigger signal appears after approximately 2 sec. This message goes away when a trigger signal appears.
Initial S/W Revision	Prior to A.02.00
Modified at S/W Revision	A.03.00

Trigger Level

Sets the value where the external 2 trigger input will trigger a new sweep/measurement.

Key Path	Trigger, External 2
Remote Command	:TRIGger[:SEquence]:EXTernal2:LEVel :TRIGger[:SEquence]:EXTernal2:LEVel?

Example	TRIG:EXT2:LEV 1.1 V
Couplings	This same level is used for the Ext2 trigger source in the Trigger menu, for the Ext2 selection in the Periodic Timer sync source (in the Trigger menu and in the Gate Source menu), and also for the Ext2 selection in the Gate Source menu.
Preset	1.2 V
State Saved	Saved in instrument state
Min	-5 V
Max	5 V
Default Unit	V
Backwards Compatibility SCPI	:TRIGger[:SEquence]:FRAMe:EXTernal2:LEVel
Initial S/W Revision	Prior to A.02.00

Trig Slope

Controls the trigger polarity. It is set positive to trigger on a rising edge and negative to trigger on a falling edge.

Key Path	Trigger, External 2
Remote Command	:TRIGger[:SEquence]:EXTernal2:SLOPe POSitive NEGative :TRIGger[:SEquence]:EXTernal2:SLOPe?
Example	TRIG:EXT2:SLOP NEG
Couplings	This same slope is used in the Ext2 selection for the trigger source in the Trigger menu and for the period timer sync source (in the Trigger menu and in the Gate Source menu).
Preset	POSitive
State Saved	Saved in instrument state
Backwards Compatibility SCPI	:TRIGger[:SEquence]:FRAMe:EXTernal2:SLOPe
Backwards Compatibility Notes	The legacy :TRIGger[:SEquence]:SLOPe command affects the slopes for the VID, LINE, EXT1, EXT2, and RFB triggers.
Initial S/W Revision	Prior to A.02.00

RF Burst

Pressing this key, when it is not selected, selects the RF Burst as the trigger. A new sweep/measurement will start when an RF burst envelope signal is identified from the signal at the RF Input connector. Pressing this key, when it is already selected, accesses the RF Burst trigger setup menu.

In some models, a variety of burst trigger circuitry is available, resulting in various available burst trigger bandwidths. The analyzer automatically chooses the appropriate trigger path based on the hardware configuration and other settings of the analyzer.

Key Path	Trigger
Example	TRIG:SOUR RFB Swept SA measurement TRIG:<meas>:SOUR RFB Measurements other than Swept SA
State Saved	Saved in instrument state
Status Bits/OPC dependencies	The Status Operation Register bit 5 "Waiting for Trigger" is set at the same time as the Sweeping or Measuring bit is set. It is cleared when the trigger actually occurs (that is, after the trigger event occurs and all the applicable trigger criteria have been met). A corresponding pop-up message ("Waiting for trigger") is generated if no trigger signal appears after approximately 2 sec. This message goes away when a trigger signal appears.
Backwards Compatibility Notes	The legacy command: :TRIGger[:SEQuence]:RFBurst:FSElectivity[:STATe] OFF ON 0 1 is not supported in the X-Series, as the hardware to do Frequency Selective burst triggers does not exist in X-Series.
Initial S/W Revision	Prior to A.02.00
Modified at S/W Revision	A.04.00

Absolute Trigger Level

Sets the absolute trigger level for the RF burst envelope.

When using the External Mixing path, the Absolute Trigger Level is uncalibrated because the factory default was set to accommodate the expected IF levels for the RF path.

Key Path	Trigger, RF Burst
Scope	Meas Global
Remote Command	:TRIGger[:SEQuence]:RFBurst:LEVel:ABSolute <ampl> :TRIGger[:SEQuence]:RFBurst:LEVel:ABSolute?
Example	TRIG:RFB:LEV:ABS 10 dBm sets the trigger level of the RF burst envelope signal to the absolute level of 10 dBm
Notes	Sending this command does not switch the setting from relative to absolute; to switch it you need to send the :TRIGger[:SEQuence]:RFBurst:LEVel:TYPE command, below. Amplitude Corrections are not taken into account by the Absolute Trigger Level. For example, if you have given yourself effective gain with an amplitude correction factor, the Absolute Trigger will not fire until you have set the trigger level that far below the displayed signal level, rather than simply to the displayed signal level. This is only true for Amplitude Corrections, not External Gain or Ref Level Offset functions. If mode is Bluetooth, the default value is -50 dBm.
Couplings	This same level is used for the RF Burst trigger source in the Trigger menu, for the RF Burst selection in the Periodic Timer sync source (in the Trigger menu and in the Gate Source menu), and also for the RF Burst selection in the Gate Source menu
Preset	-20 dBm

State Saved	Saved in instrument state
Min	-200 dBm
Max	100 dBm
Default Unit	depends on the current selected Y-Axis unit
Backwards Compatibility SCPI	:TRIGger[:SEquence]:FRAMe:RFBurst:LEVel:ABSolute
Initial S/W Revision	Prior to A.02.00
Modified at S/W Revision	A.04.00

Key Path	Trigger, RF Burst
Remote Command	:TRIGger[:SEquence]:RFBurst:LEVel:TYPE ABSolute RELative :TRIGger[:SEquence]:RFBurst:LEVel:TYPE?
Example	TRIG:RFB:LEV:TYPE REL sets the trigger level type of the RF burst trigger to Relative.
Preset	ABSolute
State Saved	Saved in instrument state
Initial S/W Revision	Prior to A.02.00
Modified at S/W Revision	A.04.00

Trigger Slope

It is set positive to trigger on a rising edge and negative to trigger on a falling edge.

Key Path	Trigger, RF Burst
Remote Command	:TRIGger[:SEquence]:RFBurst:SLOPe POSitive NEGative :TRIGger[:SEquence]:RFBurst:SLOPe?
Example	TRIG:RFB:SLOP NEG
Couplings	This same slope is used in the RF Burst selection for the trigger source in the Trigger menu and for the period timer sync source (in the Trigger menu and in the Gate Source menu).
Preset	POSitive
State Saved	Saved in instrument state
Backwards Compatibility SCPI	:TRIGger[:SEquence]:FRAMe:RFBurst:SLOPe
Backwards Compatibility Notes	The legacy :TRIGger[:SEquence]:SLOPe command affects the slopes for the VID, LINE, EXT1, EXT2, and RFB triggers.
Initial S/W Revision	Prior to A.02.00

Trig Delay

This setting delays the measurement timing relative to the Periodic Timer.

Key Path	Trigger, Periodic Timer
Remote Command	:TRIGger[:SEQuence]:FRAMe:DELay <time> :TRIGger[:SEQuence]:FRAMe:DELay? :TRIGger[:SEQuence]:FRAMe:DELay:STATe OFF ON 0 1 :TRIGger[:SEQuence]:FRAMe:DELay:STATe?
Notes	Note that delay is used when the sync source is not set to OFF. If the sync source is set to OFF, offset is used.
Preset	Off, 1.000 us
State Saved	Saved in instrument state
Min	-150 ms
Max	+500 ms
Default Unit	s
Initial S/W Revision	Prior to A.02.00

Auto/Holdoff

Opens up a menu that lets you adjust Auto Trigger and Trigger Holdoff parameters

Key Path	Trigger
Readback line	Displays a summary of the Auto Trig and Holdoff settings, in square brackets First line: Auto Off or Auto On Second Line: "Hldf" followed by: <ul style="list-style-type: none"> • If Holdoff is Off, readback Off • If Holdoff On and Type = Normal, readback value • If Holdoff On and Type = Above, readback value followed by AL • If Holdoff On and Type = Below, readback value followed by BL • If Holdoff Type selection is not supported by the current measurement, Holdoff Type is always Normal
Initial S/W Revision	A.02.00

Auto Trig

Sets the time that the analyzer will wait for the trigger conditions to be met. If they are not met after that much time, then the analyzer is triggered anyway.

Key Path	Trigger, Auto/Holdoff
Remote Command	:TRIGger[:SEQuence]:ATRigger <time>

	:TRIGger[:SEquence]:ATRigger?
	:TRIGger[:SEquence]:ATRigger:STATe OFF ON 0 1
	:TRIGger[:SEquence]:ATRigger:STATe?
Example	TRIG:ATR:STAT ON TRIG:ATR 100 ms
Notes	The "time that the analyzer will wait" starts when the analyzer is ready for a trigger, which may be hundreds of ms after the data acquisition for a sweep is done. The "time" ends when the trigger condition is satisfied, not when the delay ends.
Preset	Off, 100 ms
State Saved	Saved in instrument state
Min	1 ms
Max	100 s
Default Unit	s
Initial S/W Revision	Prior to A.02.00

Trig Holdoff

Sets the holdoff time between triggers. When the trigger condition is satisfied, the trigger occurs, the delay begins, and the holdoff time begins. New trigger conditions will be ignored until the holdoff time expires. For a free-running trigger, the holdoff value is the minimum time between triggers.

Key Path	Trigger, Auto/Holdoff
Remote Command	:TRIGger[:SEquence]:HOLDoFF <time> :TRIGger[:SEquence]:HOLDoFF? :TRIGger[:SEquence]:HOLDoFF:STATe OFF ON 0 1 :TRIGger[:SEquence]:HOLDoFF:STATe?
Example	TRIG:HOLD:STAT ON TRIG:HOLD 100 ms
Dependencies	Unavailable if the selected Input is BBIQ. If this is the case, the key is grayed out if it is pressed the informational message "Feature not supported for this Input" is displayed. If the SCPI command is sent, the error "Settings conflict; Feature not supported for this Input" is generated.
Preset	Off, 100 ms
State Saved	Saved in instrument state
Min	0 s
Max	0.5 s
Default Unit	s
Initial S/W Revision	Prior to A.02.00

Holdoff Type

Lets you set the Trigger Holdoff Type.

NOTE

Holdoff Type is not supported by all measurements. If the current measurement does not support it, this key will be blank and the Holdoff Type will be Normal. If the Holdoff Type SCPI is sent while in such a measurement, the SCPI will be accepted and the setting remembered, but it will have no effect until a measurement is in force that supports Holdoff Type.

Trigger Holdoff Type functionality:

- NORMAl
- This is the “oscilloscope” type of trigger holdoff, and is the setting when the Holdoff Type key does not appear. In this type of holdoff, no new trigger will be accepted until the holdoff interval has expired after the previous trigger.
- ABOVe
- If the trigger slope is positive, a trigger event is generated only if the signal characteristic of interest crosses the trigger threshold (with positive slope) and then remains above the threshold for at least the holdoff time. For negative slope, the trigger event is generated if the signal characteristic crosses the threshold (with negative slope) after having been above the threshold for at least the holdoff time. In either case, the trigger event is associated with the time the level was crossed.
- BELow
- If the trigger slope is positive, a trigger event is generated only if the signal characteristic of interest crosses the trigger threshold (with positive slope) after having been below the threshold for at least the holdoff time. For negative slope, the trigger event is generated if the signal characteristic crosses the threshold (with negative slope) and then remains below the threshold for at least the holdoff time. In either case, the trigger event is associated with the time the level was crossed.

Key Path	Trigger, Auto/Holdoff
Remote Command	:TRIGger[:SEquence]:HOLDoff:TYPE NORMAl ABOVe BELow :TRIGger[:SEquence]:HOLDoff:TYPE?
Example	TRIG:HOLD:TYPE NORM
Preset	All modes but GSM/EDGE: Normal GSM/EDGE: Below WLAN: Below
State Saved	Saved in instrument state
Initial S/W Revision	A.02.00

8 Channel Power Measurement

The Channel Power measurement is used to find the total power present in a specified bandwidth. The power spectral density (the power in the signal normalized to 1 Hz) is also reported (In WLAN mode or WLAN radio standard in SA mode, the peak power spectral density for 1 MHz is reported). For measurement results and views, see ["View/Display" on page 632](#).

This topic contains the following sections:

["Measurement Commands for Channel Power" on page 364](#)

["Remote CommandResults for Channel Power Measurement" on page 365](#)

Measurement Commands for Channel Power

These commands are used to measure the total rms power in a specified integration bandwidth.

Use `:INSTrument:SElect` to set the mode.

```
:CONFigure:CHPower
:CONFigure:CHPower:NDEFault
:INITiate:CHPower
:FETCh:CHPower[n]?
:MEASure:CHPower[n]?
:READ:CHPower[n]?
:FETCh:CHPower:CHPower?
:MEASure:CHPower:CHPower?
:READ:CHPower:CHPower?
:FETCh:CHPower:DENSity?
:MEASure:CHPower:DENSity?
:READ:CHPower:DENSity
```

For more measurement related commands, see the SENSE subsystem, and the section "[Remote Measurement Functions](#)" on page 2355.

Remote CommandResults for Channel Power Measurement

For WLAN, see [Error! Reference source not found.](#)

Command	Return Value
FETCh:CHPower[n]?	Refer to the table below.
MEASure:CHPower[n]?	
READ:CHPower[n]?	
FETCh:CHPower:CHPower?	Returns the Channel Power (dBm) (BW compatibility functionality)
MEASure:CHPower:CHPower?	
READ:CHPower:CHPower?	
FETCh:CHPower:DENSity?	Returns the Power Spectral Density (dBm/Hz) (BW compatibility functionality)
MEASure:CHPower:DENSity?	
READ:CHPower:DENSity?	

n	Results Returned
n=1 (or not specified)	Returns scalar results: <ol style="list-style-type: none"> 1. Channel Power is a floating point number representing the total channel power in the specified integration bandwidth. 2. PSD (Power Spectral Density) is the power in the specified unit bandwidth. The unit bandwidth is selected by the PSD Unit parameter in either dBm/Hz or dBm/MHz.
2	Returns floating point numbers that are the captured trace data of the power (in dBm/resolution BW) of the signal. The frequency span of the captured trace data is specified by the Span key.

Remote Command Results for WLAN Channel Power Measurement

n	Results Returned
n=1 (or not specified)	<p>Returns scalar results:</p> <p>When the radio standard is NOT WLAN 802.11ac 80 + 80 MHz:</p> <ol style="list-style-type: none"> 1. Channel Power is a floating point number representing the total channel power in the specified integration bandwidth. 2. PSD (Power Spectral Density) is the power in the specified unit bandwidth. The unit bandwidth is selected by the PSD Unit parameter in either dBm/Hz or dBm/MHz. <p>When the radio standard is WLAN 802.11ac 80 + 80 MHz:</p> <ol style="list-style-type: none"> 1. Channel Power of the carrier of which the center frequency is indicated by Freq Segment 1 is a floating point number representing the total channel power of the first segment in the specified integration bandwidth. 2. PSD (Power Spectral Density) of the carrier of which the center frequency is indicated by Freq Segment 1 is the power in the specified unit bandwidth of the first segment. The unit bandwidth is selected by the PSD Unit parameter in either dBm/Hz or dBm/MHz. 3. Channel Power of the carrier of which the center frequency is indicated by Freq Segment 2 is a floating point number representing the total channel power of the second segment in the specified integration bandwidth. 4. PSD (Power Spectral Density) of the carrier of which the center frequency is indicated by Freq Segment 2 is the power in the specified unit bandwidth of the second segment. The unit bandwidth is selected by the PSD Unit parameter in either dBm/Hz or dBm/MHz.
2	Returns floating point numbers that are the captured trace data of the power (in dBm/resolution BW) of the signal. The frequency span of the captured trace data is specified by the Span key.

Key Path	Meas
Mode	SA, WCDMA, C2K, WIMAX OFDMA, 1xEVDO, DVB-T/H, DTMB (CTTB), ISDB-T, CMMB, LTE, LTE-TDD, Digital Cable TV, WLAN, MSR, LTEAFDD, LTEATDD
Initial S/W Revision	Prior to A.02.00
Modified at S/W Revision	A.03.00

AMPTD Y Scale

Accesses a menu of functions that enable you to set the vertical scale parameters. The parameter values are measurement independent, except all Attenuation values and the Internal Preamp selection, which are the same across all measurements.

Key Path	Front-panel key
Initial S/W Revision	Prior to A.02.00

Ref Value

Sets the value for the absolute power reference. However, since the Auto Scaling is defaulted to On, this value is automatically determined by the measurement result. When you set a value manually, Auto Scaling automatically changes to Off.

Key Path	AMPTD Y Scale
Mode	SA, WCDMA, C2K, WIMAX OFDMA, 1xEVDO, DVB-T/H, DTMB (CTTB), ISDB-T, CMMB, LTE, LTETDD, Digital Cable TV, WLAN, MSR, LTEAFDD, LTEATDD
Remote Command	:DISPlay:CHPower:VIEW[1]:WINDow[1]:TRACe:Y[:SCALE]:RLEVel <real> :DISPlay:CHPower:VIEW[1]:WINDow[1]:TRACe:Y[:SCALE]:RLEVel?
Example	DISP:CHP:VIEW:WIND:TRAC:Y:RLEV 10 dBm DISP:CHP:VIEW:WIND:TRAC:Y:RLEV?
Notes	You must be in the Spectrum Analysis mode, W-CDMA mode, cdma2000 mode, DVB-T/H mode, DTMB (CTTB) mode, ISDB-T mode, CMMB mode, Digital Cable TV mode, LTD mode, LTE TDD mode, WLAN mode, 1xEVDO mode, MSR, LTE-Advanced FDD/TDD mode or WIMAX OFDMA mode to use this command. Use :INSTrument:SElect to set the mode.
Couplings	When the Auto Scaling is On, this value is automatically determined by the measurement result. When you set a value manually, Auto Scaling automatically changes to Off.
Preset	10.00 dBm
State Saved	Saved in instrument state.
Min	-250.00 dBm
Max	250.00 dBm
Initial S/W Revision	Prior to A.02.00
Modified at S/W Revision	A.02.00, A.03.00

Range

The Range menu allows setting amplitude controls of the instrument.

Key Path	AMPTD Y Scale
Scope	Meas Global
Initial S/W Revision	A.12.50

Range

Represents the amplitude of the largest sinusoidal signal that could be present within the IF without being clipped by the ADC. For signals with high peak-to-average ratios, the range may need to exceed the rms signal power by a fair amount to avoid clipping.

Key Path	Range
Mode	BASIC
Remote Command	<code>[:SENSe] :POWer [:RF] :RANGe <real></code> <code>[:SENSe] :POWer [:RF] :RANGe?</code>
Example	<code>:POW:RANG 10.0</code> <code>:POW:RANG?</code>
Notes	The MIN and MAX values are affected by the External Gain parameters, and by the Center Frequency. (The hardware compensates for frequency response and alters the Range setting.)
Preset	0
State Saved	Saved in instrument state.
Min	-100
Max	100
Initial S/W Revision	A.12.50

Adjust Range For Min Clip

Sets the combination of attenuation and gain based on the current measured signal level so that clipping will be at a minimum.

This is an "immediate action" function, that is, it executes once, when the key is pressed.

This key is grayed out in measurements that do not support this functionality.

Key Path	AMPTD Y Scale, Attenuation
Remote Command	<code>[:SENSe] :POWer [:RF] :RANGe:OPTimize IMMEDIATE</code>
Initial S/W Revision	Prior to A.02.00
Modified at S/W Revision	A.03.00

Pre-Adjust for Min Clip

If this function is on, it does the adjustment described under Adjust Range For Min Clip each time a measurement restarts. Therefore, in Continuous measurement mode, it only executes before the first measurement.

Key Path	AMPTD Y Scale, Attenuation
----------	----------------------------

Remote Command	<code>[:SENSe] :POWer [:RF] :RANGe :OPTimize :ATTenuation OFF ON ELECtrical COMBined</code> <code>[:SENSe] :POWer [:RF] :RANGe :OPTimize :ATTenuation ?</code>
Notes	This parameter is shared with old XA platform which uses AutoAtten. To keep the backward compatibility, ELECtrical and COMBined still can be used. Then, upon receiving ELECtrical and COMBined, these enums will be interpreted as aliases of ON. Then, when queried, ON will be returned.
Preset	OFF for Swept SA measurement; ON for all other measurements that support Pre-Adjust for Min Clip
State Saved	Saved in instrument state
Initial S/W Revision	Prior to A.02.00
Modified at S/W Revision	A.03.00

Peak to Average

The Peak to Average Ratio is used with the Range setting to optimize the level control in the instrument. The value is the ratio, in dB, of the peak power to the average power of the signal to be measured. A ratio of 0 should be used for sinusoidal signals; for 802.11g OFDM signals use 9 dB.

All Applications (Modes) will show the current value of Peak to Average ratio on the softkey. However, some applications will not permit changing the value. In these situations the softkey will be grayed-out.

Key Path	AMPTD Y Scale, Range
Remote Command	<code>[:SENSe] :POWer [:RF] :RANGe :PARatio <real></code> <code>[:SENSe] :POWer [:RF] :RANGe :PARatio ?</code>
Example	POW:RANG:PAR 12 dB
Notes	In some Applications (Modes) this parameter will be read-only; meaning the value will appear on the softkey and query via SCPI, but not changeable. In such applications the softkey will be grayed-out. Attempting to change the value via SCPI will be ignored and no error message will be generated.
Preset	10 dB
State Saved	Saved in instrument state
Min	0 dB
Max	20 dB
Initial S/W Revision	A.13.00

Mixer Level Offset

Mixer level offset is an advanced setting to adjust target Range at the input mixer which in turn affects the signal level in the instrument's IF. This setting can be used when additional optimization is needed after setting Peak to Average ratio. Positive values of offset optimize noise performance over distortion, negative values optimize distortion performance over noise.

Key Path	AMPTD Y Scale, Range
-----------------	----------------------

Remote Command	<code>[:SENSe] :POWer [:RF] :RANGe :MIXer :OFFSet <real></code> <code>[:SENSe] :POWer [:RF] :RANGe :MIXer :OFFSet?</code>
Example	<code>POW:RANG:MIX:OFFS -5 dB</code>
Preset	0 dB
State Saved	Saved in instrument state
Min	-35 dB
Max	30 dB
Initial S/W Revision	A.13.00

Scale/Div

Sets the units per division of the vertical scale in the logarithmic display. However, since the Auto Scaling is defaulted to On, this value is automatically determined by the measurement result. When you set a value manually, Auto Scaling automatically changes to Off.

Key Path	AMPTD Y Scale
Mode	SA, WCDMA, C2K, WIMAX OFDMA, 1xEVDO, DVB-T/H, DTMB (CTTB), ISDB-T, CMMB, LTE, LTETDD, Digital Cable TV, WLAN, MSR, LTEAFDD, LTEATDD
Remote Command	<code>:DISPlay:CHPower:VIEW[1]:WINDow[1]:TRACe:Y[:SCALe]:PDIVision <rel_amp1></code> <code>:DISPlay:CHPower:VIEW[1]:WINDow[1]:TRACe:Y[:SCALe]:PDIVision?</code>
Example	<code>DISP:CHP:VIEW:WIND:TRAC:Y:PDIV 2</code> <code>DISP:CHP:VIEW:WIND:TRAC:Y:PDIV?</code>
Notes	You must be in the Spectrum Analysis mode, W-CDMA mode, cdma2000 mode, DVB-T/H mode, DTMB (CTTB) mode, ISDB-T mode, CMMB mode, Digital Cable TV mode, LTE mode, LTE TDD mode, WLAN mode, 1xEVDO mode, MSR, LTE-Advanced FDD/TDD mode or WIMAX OFDMA mode to use this command. Use <code>:INSTrument:SElect</code> to set the mode.
Couplings	When the Auto Scaling is On, this value is automatically determined by the measurement result. When you set a value manually, Auto Scaling automatically changes to Off.
Preset	10.00 dB
State Saved	Saved in instrument state.
Min	0.10 dB
Max	20.00 dB
Initial S/W Revision	Prior to A.02.00
Modified at S/W Revision	A.02.00, A.03.00

Ref Position

Positions the reference level at the top, center, or bottom of the Y Scale display. Changing the reference position does not change the reference level value.

Key Path	AMPTD Y Scale
Mode	SA, WCDMA, C2K, WIMAX OFDMA, 1xEVDO, DVB-T/H, DTMB (CTTB), ISDB-T, CMMB, LTE, LTE-TDD, Digital Cable TV, WLAN, MSR, LTEAFDD, LTEATDD
Remote Command	:DISPlay:CHPower:VIEW[1]:WINDow[1]:TRACe:Y[:SCALe]:RPOSition TOP CENTER BOTTom :DISPlay:CHPower:VIEW[1]:WINDow[1]:TRACe:Y[:SCALe]:RPOSition?
Example	DISP:CHP:VIEW:WIND:TRAC:Y:RPOS CENT DISP:CHP:VIEW:WIND:TRAC:Y:RPOS?
Notes	You must be in the Spectrum Analysis mode, W-CDMA mode, cdma2000 mode, DVB-T/H mode, DTMB (CTTB) mode, ISDB-T mode, CMMB mode, Digital Cable TV mode, LTE mode, LTE TDD mode, WLAN mode, 1xEVDO mode, MSR, LTE-Advanced FDD/TDD mode or WIMAX OFDMA mode to use this command. Use :INSTRument:SElect to set the mode.
Preset	TOP
State Saved	Saved in instrument state.
Range	Top Ctr Bot
Initial S/W Revision	Prior to A.02.00
Modified at S/W Revision	A.02.00, A.03.00

Auto Scaling

Toggles the Auto Scaling function between On and Off.

Key Path	AMPTD Y Scale
Mode	SA, WCDMA, C2K, WIMAX OFDMA, 1xEVDO, DVB-T/H, DTMB (CTTB), ISDB-T, CMMB, LTE, LTE-TDD, Digital Cable TV, WLAN, MSR, LTEAFDD, LTEATDD
Remote Command	:DISPlay:CHPower:VIEW[1]:WINDow[1]:TRACe:Y[:SCALe]:COUPle 0 1 OFF ON :DISPlay:CHPower:VIEW[1]:WINDow[1]:TRACe:Y[:SCALe]:COUPle?
Example	DISP:CHP:VIEW:WIND:TRAC:Y:COUP OFF DISP:CHP:VIEW:WIND:TRAC:Y:COUP?
Couplings	When Auto Scaling is On, and the Restart front-panel key is pressed, this function automatically sets the scale per division to 10 dB and determines the reference values based on the measurement results. When you set a value to either Scale/Div or Ref Value manually, Auto Scaling automatically changes to Off.
Preset	1
State Saved	Saved in instrument state.
Range	On Off
Initial S/W Revision	Prior to A.02.00
Modified at S/W Revision	A.02.00, A.03.00

Auto Couple

The Auto Couple feature provides a quick and convenient way to automatically couple multiple instrument settings. This helps ensure accurate measurements and optimum dynamic range. When the Auto Couple feature is activated, either from the front panel or remotely, all parameters of the current measurement that have an Auto/Manual mode are set to Auto mode and all measurement settings dependent on (or coupled to) the Auto/Man parameters are automatically adjusted for optimal performance.

However, the Auto Couple key actions are confined to the current measurement only. It does not affect other measurements in the mode, and it does not affect markers, marker functions, or trace or display attributes.

See "[More Information](#)" on page 372

Key Path	Front-panel key
Remote Command	:COUPle ALL NONE
Example	:COUP ALL
Notes	:COUPle ALL puts all Auto/Man parameters in Auto mode (equivalent to pressing the Auto Couple key). :COUPLE NONE puts all Auto/Man parameters in manual mode. It decouples all the coupled instrument parameters and is not recommended for making measurements.
Initial S/W Revision	Prior to A.02.00

More Information

There are two types of functions that have Auto/Manual modes.

Auto/Man Active Function keys

An Auto/Man toggle key controls the binary state associated with an instrument parameter by toggling between Auto (where the parameter is automatically coupled to the other parameters it is dependent upon) and Man (where the parameter is controlled independent of the other parameters), as well as making the parameter the active function. The current mode is indicated on the softkey with either Auto or Man underlined as illustrated below.

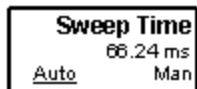

usd07

Auto/Man 1-of-N keys

An Auto/Man 1-of-N key allows you to manually pick from a list of parameter values, or place the function in Auto, in which case the value is automatically selected (and indicated) as shown below. If in Auto, Auto is underlined on the calling key. If in manual operation, manual is indicated on the calling key. But the calling key does not actually toggle the function, it simply opens the menu.

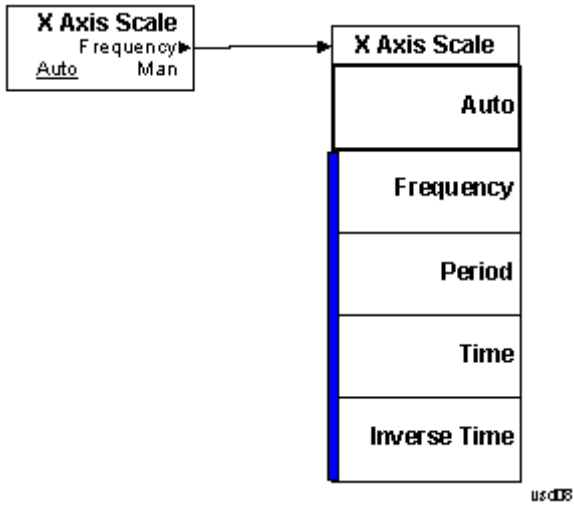

BW

Accesses a menu of functions that enable you to specify and control the video and resolution bandwidths. You can also select the type of filter for the measurement and set the filter bandwidth.

Key Path	Front-panel key
Initial S/W Revision	Prior to A.02.00

Res BW

Sets the value of the resolution bandwidth (RBW). If an unavailable bandwidth is entered with the numeric keypad, the closest available bandwidth is selected.

LTE-Advanced FDD/TDD Auto RBW:

Bandwidth	RBW (KHz)
1.4MHz	20
3MHz	43
5MHz	68
10MHz	150
15MHz	220
20MHz	270

the resolution bandwidth is predefined based on the corresponding bandwidth of the single LTE carrier, which is listed above. When ResBW mode is Auto, the narrowest RBW over the active carriers is selected for Multi-carriers.

Key Path	BW
Mode	SA, WCDMA, C2K, WIMAX OFDMA, 1xEVDO, DVB-T/H, DTMB (CTTB), ISDB-T, CMMB, LTE, LTETDD, Digital Cable TV, WLAN, MSR, LTEAFDD, LTEATDD
Remote Command	[:SENSe]:CHPower:BANDwidth[:RESolution] <bandwidth> [:SENSe]:CHPower:BANDwidth[:RESolution]? [:SENSe]:CHPower:BANDwidth[:RESolution]:AUTO ON OFF 1 0 [:SENSe]:CHPower:BANDwidth[:RESolution]:AUTO?
Example	CHP:BAND 5 MHz CHP:BAND? CHP:BAND:AUTO ON CHP:BAND:AUTO?
Notes	You must be in the Spectrum Analysis mode, W-CDMA mode, cdma2000 mode, DVB-T/H mode, DTMB (CTTB) mode, ISDB-T mode, CMMB mode, Digital Cable TV mode, LTE mode, LTE TDD mode, WLAN mode, 1xEVDO mode, MSR, LTE-Advanced FDD/TDD mode or WIMAX OFDMA mode to use this command. Use :INSTrument:SElect to set the mode.

Couplings	<p>Sweep time is coupled to the RBW. As the RBW changes, the sweep time (if set to Auto) is changed to maintain amplitude calibration.</p> <p>Video bandwidth (VBW) is coupled to the RBW. As the resolution bandwidth changes, the video bandwidth (if set to Auto) changes to maintain the ratio of VBW/RBW (10:1).</p> <p>When the Res BW is set to Auto, the resolution bandwidth is auto-coupled to the span. The ratio of Span/RBW is approximately 106:1 when auto coupled. When Res BW is set to Man, and the bandwidths are entered manually, these bandwidths are used regardless of other analyzer settings.</p>
Preset	<p>SA: Auto</p> <p>WCDMA: 240 kHz</p> <p>C2K: 24 kHz</p> <p>WIMAX OFDMA: 100kHz</p> <p>1xEVDO: 30kHz</p> <p>DVB-T/H: 3.9kHz</p> <p>DTMB (CTTB): 3.9kHz</p> <p>ISDB-T: 30kHz</p> <p>CMMB: 3.9kHz</p> <p>LTE: Auto</p> <p>LTETDD: Auto</p> <p>Digital Cable TV: 3.9kHz</p> <p>WLAN: 100 kHz</p> <p>MSR: 100kHz</p> <p>LTEAFDD/LTEATDD: Auto</p> <p>WCDMA, C2K, 1xEVDO, WIMAX OFDMA, DVB-T/H, DTMB (CTTB), ISDB-T, CMMB, Digital Cable TV, WLAN, MSR: OFF</p> <p>SA, LTE, LTETDD, LTEAFDD, LTEATDD: ON</p>
State Saved	Saved in instrument state.
Min	1 Hz
Max	8 MHz
Backwards Compatibility SCPI	[:SENSe] :CHPower:BWIDth[:RESolution]
Initial S/W Revision	Prior to A.02.00
Modified at S/W Revision	A.02.00, A.03.00

Video BW

Changes the analyzer post-detection filter (VBW).

Key Path	BW
Mode	SA, WCDMA, C2K, WIMAX OFDMA, 1xEVDO, DVB-T/H, DTMB (CTTB), ISDB-T, CMMB, LTE, LTETDD, Digital Cable TV, WLAN, MSR, LTEAFDD, LTEATDD
Remote Command	[:SENSe] :CHPower: BANDwidth:VIDeo <bandwidth>

	<pre>[:SENSe] :CHPower:BAWdwidth:VIDeo? [:SENSe] :CHPower:BAWdwidth:VIDeo:AUTO ON OFF 1 0 [:SENSe] :CHPower:BAWdwidth:VIDeo:AUTO?</pre>
Example	<pre>CHP:BAND:VID 2.4 MHz CHP:BAND:VID? CHP:BAND:VID:AUTO OFF CHP:BAND:VID:AUTO?</pre>
Notes	<p>You must be in the Spectrum Analysis mode, W-CDMA mode, cdma2000 mode, DVB-T/H mode, DTMB (CTTB) mode, ISDB-T mode, CMMB mode, Digital Cable TV mode, LTE mode, LTE TDD mode, WLAN mode, 1xEVDO mode, MSR,LTE-Advanced FDD/TDD mode or WIMAX OFDMA mode to use this command. Use :INSTrument:SElect to set the mode.</p>
Dependencies	See Couplings
Couplings	<p>Video bandwidth (VBW) is coupled to the RBW. As the resolution bandwidth changes, the video bandwidth (if set to Auto) changes to maintain the ratio set by VBW/RBW.</p> <p>Sweep Time is coupled to the Video Bandwidth (VBW). As the VBW is changed, the sweep time (when set to Auto) is changed to maintain amplitude calibration. This occurs because of common hardware between the two circuits, even though the Video BW filter is not actually “in-circuit” when the detector is set to Average. Because the purpose of the average detector and the VBW filter are the same, either can be used to reduce the variance of the result.</p> <p>Although the VBW filter is not “in-circuit” when using the average detector, the Video BW key can have an effect on (Auto) sweep time, and is not disabled. In this case, reducing the VBW setting increases the sweep time, which increases the averaging time, producing a lower-variance trace.</p> <p>When using the average detector with either Sweep Time set to Man, or in zero span, the VBW setting has no effect and is disabled (grayed out).</p> <p>When the video bandwidth is AUTO coupled, the video bandwidth value is set to: Resolution Bandwidth * Video Bandwidth to Resolution Bandwidth Ratio</p>
Preset	<pre>SA: Auto WCDMA: 2.4MHz C2K: 240 kHz WIMAX OFDMA: Auto 1xEVDO: 300 kHz DVB-T/H: 39kHz DTMB (CTTB): 39kHz ISDB-T: 300kHz CMMB: 39kHz LTE, MSR: Auto LTETDD: Auto LTEAFDD,LTEATDD:Auto Digital Cable TV: 39kHz WLAN: Auto ON</pre>

State Saved	Saved in instrument state.
Min	1 Hz
Max	50 MHz
Initial S/W Revision	Prior to A.02.00
Modified at S/W Revision	A.02.00, A.03.00

Filter Type

Selects the type of bandwidth filter that is used. The choices are Gaussian or Flat top.

Key Path	BW
Mode	SA, WCDMA, C2K, WIMAX OFDMA, 1xEVDO, DVB-T/H, DTMB (CTTB), ISDB-T, CMMB, LTE, LTE-TDD, Digital Cable TV, WLAN, MSR, LTEAFDD, LTEATDD
Remote Command	[:SENSe] :CHPower: BANDwidth: SHAPe GAUSSian FLATtop [:SENSe] :CHPower: BANDwidth: SHAPe?
Example	CHP: BAND: SHAP GAUS CHP: BAND: SHAP?
Preset	GAUSSian
State Saved	Saved in instrument state.
Range	Gaussian Flattop
Backwards Compatibility SCPI	[:SENSe] :CHPower: BWIDth: SHAPe
Initial S/W Revision	Prior to A.02.00
Modified at S/W Revision	A.02.00, A.03.00

Cont (Continuous Measurement/Sweep)

Sets the analyzer for Continuous measurement operation. The single/continuous state is Meas Global so the setting will affect all measurements. If you are Paused, pressing Cont does a Resume.

Key Path	Front-panel key
Remote Command	:INITiate:CONTinuous OFF ON 0 1 :INITiate:CONTinuous?
Example	:INIT:CONT 0 puts analyzer in Single measurement operation. :INIT:CONT 1 puts analyzer in Continuous measurement operation
Preset	ON (Note that SYST:PRESet sets INIT:CONT to ON but *RST sets INIT:CONT to OFF)
State Saved	Saved in instrument state
Backwards Compatibility Notes	For Spectrum Analysis mode in ESA and PSA, there is no Cont hardkey, instead there is a Sweep Single/Cont key. In these analyzers, switching the Sweep Single/Cont key from Single to Cont restarts averages (displayed average count reset to 1), but does not restart Max Hold and Min Hold. The X-Series has Single and Cont keys in place of the SweepSingleCont key. In the X-Series, if in single measurement, the Cont key (and INIT:CONT ON) switches to continuous measurement, but never restarts a measurement and never resets a sweep.
Initial S/W Revision	Prior to A.02.00

In Swept SA Measurement (Spectrum Analysis Mode):

The analyzer takes repetitive sweeps, averages, measurements, etc., when in Continuous mode. When the average count reaches the Average/Hold Number the count stops incrementing, but the analyzer keeps sweeping. See the Trace/Detector section for the averaging formula used both before and after the Average/Hold Number is reached. The trigger condition must be met prior to each sweep. The type of trace processing for multiple sweeps, is set under the Trace/Detector key, with choices of Trace Average, Max Hold, or Min Hold.

In Other Measurements/Modes:

With Avg/Hold Num (in the Meas Setup menu) set to Off or set to On with a value of 1, a sweep is taken after the trigger condition is met; and the analyzer continues to take new sweeps after the current sweep has completed and the trigger condition is again met. However, with Avg/Hold Num set to On with a value >1, multiple sweeps (data acquisitions) are taken for the measurement. The trigger condition must be met prior to each sweep. The sweep is not stopped when the average count k equals the number N set for Avg/Hold Num is reached, but the number k stops incrementing. A measurement average usually applies to all traces, marker results, and numeric results. But sometimes it only applies to the numeric results.

If the analyzer is in Single measurement, pressing the Cont key does not change k and does not cause the sweep to be reset; the only action is to put the analyzer into Continuous measurement operation.

If it is already in continuous sweep:

the INIT:CONT 1 command has no effect

the INIT:CONT 0 command will place the analyzer in Single Sweep but will have no effect on the current sequence until $k = N$, at which point the current sequence will stop and the instrument will go to the idle state.

8 Channel Power Measurement
File

File

See "File" on page 266

FREQ Channel

Accesses a menu of keys that allow you to control the Frequency and Channel parameters of the instrument.

Some features in the Frequency menu are the same for all measurements - they do not change as you change measurements. Settings like these are called "Meas Global" and are unaffected by Meas Preset. For example, the Center Freq setting is the same for all measurements - it does not change as you change measurements.

Key Path	Front Panel Key
Mode	LTETDD, LTEAFDD
Initial S/W Revision	A.14.00

Carrier Ref Freq

Sets carrier reference frequency. The center frequencies of carriers are defined as offset frequency from this value.

If the following conditions are satisfied at the same time:

- the Number of Component Carrier equals to 1
- the Center Freq Offset equals to 0 Hz
- the mode of the Center Freq is Auto

the Center Freq is equivalent to Carrier Ref Freq.

When the Center Freq changes in such conditions, the mode of the Center Freq keeps as Auto and the Carrier Ref Freq will be changed to same value. The major purpose of this coupling is to keep BWCC with legacy LTE/LTE TDD, in which :SENSe:FREQuency:CENTer is used to set up the Frequency of the measurement.

Key Path	FREQ Channel Mode Setup, Component Carrier Setup
Mode	LTEATDD, LTEAFDD
Measurement	All
Remote Command	<code>[:SENSe] :CCARrier:REFerence <freq></code> <code>[:SENSe] :CCARrier:REFerence?</code>
Example	CCAR:REF 2GHz CCAR:REF?
Notes	In order to easily configure component carriers, the key is also placed in the Mode Setup.
Preset	1GHz
State Saved	Saved in instrument state
Min	Depends on instrument minimum center frequency. Same as Center Freq
Max	Depends on instrument maximum center frequency. Same as Center Freq

8 Channel Power Measurement
FREQ Channel

Initial S/W Revision	A.14.00
Modified at S/W Revision	A.14.50

Input/Output

See ["Input/Output" on page 182](#)

Marker

Accesses a menu that enables you to select, set up and control the markers for the current measurement.

Key Path	Front-panel key
Initial S/W Revision	Prior to A.02.00

Select Marker

Displays 12 markers available for selection.

Key Path	Marker
Initial S/W Revision	Prior to A.02.00

Marker Type

Sets the marker control mode to Normal, Delta, Fixed or Off. All interactions and dependencies detailed under the key description are enforced when the remote command is sent. If the selected marker is Off, pressing Marker sets it to Normal and places it at the center of the screen on the trace determined by the Marker Trace rules. At the same time, Marker X Axis Value appears on the Active Function area.

The default active function is the active function for the currently selected marker control mode. If the current control mode is Off, there is no active function and the active function is turned off.

Key Path	Marker
Mode	SA, WCDMA, C2K, WIMAX OFDMA, 1xEVDO, DVB-T/H, DTMB (CTTB), ISDB-T, CMMB, LTE, LTETDD, Digital Cable TV, WLAN, MSR, LTEAFDD, LTEATDD
Remote Command	:CALCulate:CHPower:MARKer[1] 2 ... 12:MODE POSITION DELTa OFF :CALCulate:CHPower:MARKer[1] 2 ... 12:MODE?
Example	CALC:CHP:MARK3:MODE POS CALC:CHP:MARK3:MODE?
Notes	If the selected marker is Off, pressing Marker sets it to Normal and places it at the center of the screen on the trace determined by the Marker Trace rules. At the same time, Marker X Axis Value appears on the Active Function area. Default Active Function: the active function for the selected marker's current control mode. If the current control mode is Off, there is no active function and the active function is turned off. Active Function Display: the marker X axis value entered in the active function area displays the marker value to its full entered precision.
Preset	OFF
State Saved	Saved in instrument state.
Range	Normal Delta Off
Initial S/W Revision	Prior to A.02.00
Modified at S/W Revision	A.02.00, A.03.00

Properties

Accesses the marker properties menu.

Key Path	Marker
Initial S/W Revision	Prior to A.02.00

Select Marker

Displays 12 markers available for selection.

Key Path	Marker
Initial S/W Revision	Prior to A.02.00

Relative To

Sets the reference marker to which the selected marker is relative.

Key Path	Marker, Properties
Mode	SA, WCDMA, C2K, WIMAX OFDMA, 1xEVDO, DVB-T/H, DTMB (CTTB), ISDB-T, CMMB, LTE, LTETDD, Digital Cable TV, WLAN, MSR, LTEAFDD, LTEATDD
Remote Command	:CALCulate:CHPower:MARKer[1] 2 ... 12:REference <integer> :CALCulate:CHPower:MARKer[1] 2 ... 12:REference?
Example	CALC:CHP:MARK:REF 5 CALC:CHP:MARK:REF?
Notes	A marker cannot be relative to itself so that choice is grayed out, and if sent from SCPI generates error -221: "Settings conflict; marker cannot be relative to itself." When queried, a single value is returned (the specified marker numbers relative marker). You must be in the Spectrum Analysis or WCDMA mode to use this command. Use :INSTrument:SElect to set the mode.
Preset	2 3 4 5 6 7 8 9 10 11 12 1
State Saved	Saved in instrument state.
Min	1
Max	12
Initial S/W Revision	Prior to A.02.00
Modified at S/W Revision	A.02.00, A.03.00

All Markers Off

Turns off all markers.

Key Path	Marker
Mode	SA, WCDMA, C2K, WIMAX OFDMA, 1xEVDO, DVB-T/H, DTMB (CTTB), ISDB-T, CMMB, LTE, LTETDD, Digital Cable TV, WLAN, MSR, LTEAFDD, LTEATDD
Remote Command	:CALCulate:CHPower:MARKer:AOff
Example	CALC:CHP:MARK:AOff
Initial S/W Revision	Prior to A.02.00
Modified at S/W Revision	A.02.00, A.03.00

Marker X Axis Value (Remote Command Only)

Sets the marker X Axis value in the current marker X Axis Scale unit. It has no effect if the control mode is Off, but is the SCPI equivalent of entering an X value if the control mode is Normal, Delta, or Fixed.

Mode	SA, WCDMA, CDMA2K, WIMAXOFDMA, CDMA1XEV, DVB, DTMB, ISDBT, CMMB, LTE, LTETDD, DCATV, WLAN, MSR, LTEAFDD, LTEATDD
Remote Command	:CALCulate:CHPower:MARKer[1] 2 ... 12:X <real> :CALCulate:CHPower:MARKer[1] 2 ... 12:X?
Example	CALC:CHP:MARK3:X 0 CALC:CHP:MARK3:X?
Notes	The query returns the marker's absolute X Axis value if the control mode is Normal, or the offset from the marker's reference marker if the control mode is Delta. The query is returned in the fundamental units for the current marker X Axis scale: Hz for Frequency.
Preset	After a preset, all markers are turned OFF, so Marker X Axis Value query returns a not a number (NAN).
State Saved	Saved in instrument state.
Min	-9.9E+37
Max	9.9E+37
Initial S/W Revision	Prior to A.02.00
Modified at S/W Revision	A.02.00, A.03.00

Marker X Axis Position (Remote Command Only)

Sets the marker X Axis Scale position in trace points. This setting has no effect if the control mode is Off, but is the SCPI equivalent of entering a value if the control mode is Normal or Delta . The entered value is immediately translated into the current X Axis Scale units for setting the value of the marker.

Mode	SA, WCDMA, CDMA2K, WIMAXOFDMA, CDMA1XEV, DVB, DTMB, ISDBT, CMMB, LTE, LTETDD, DCATV, WLAN, MSR, LTEAFDD, LTEATDD
Remote Command	:CALCulate:CHPower:MARKer[1] 2 ... 12:X:POStion <real> :CALCulate:CHPower:MARKer[1] 2 ... 12:X:POStion?
Example	CALC:CHP:MARK10:X:POS 0

	CALC:CHP:MARK10:X:POS?
Notes	The query returns the marker's absolute X Axis value in trace points if the control mode is Normal, or the offset from the marker's reference marker in trace points if the control mode is Delta.
Preset	After a preset, all markers are turned OFF, so Marker X Axis Value query returns a not a number (NAN).
State Saved	Saved in instrument state.
Min	-9.9E+37
Max	9.9E+37
Initial S/W Revision	Prior to A.02.00
Modified at S/W Revision	A.02.00, A.03.00

Marker Y Axis Value (Remote Command only)

Returns the marker Y Axis value in the current marker Y Axis unit.

Mode	SA, WCDMA, CDMA2K, WIMAXOFDMA, CDMA1XEV, DVB, DTMB, ISDBT, CMMB, LTE, LTETDD, DCATV, WLAN, MSR, LTEAFDD, LTEATDD
Remote Command	:CALCulate:CHPower:MARKer[1] 2 ... 12:Y?
Example	CALC:CHP:MARK11:Y?
Preset	Result dependent on Markers setup and signal source.
State Saved	Saved in instrument state.
Initial S/W Revision	Prior to A.02.00
Modified at S/W Revision	A.02.00, A.03.00

Backward Compatibility SCPI Commands

Sets or queries the state of a marker. Setting a marker which is OFF to state ON or 1 puts it in Normal mode and places it at the center of the screen.

Mode	SA, WCDMA, CDMA2K, WIMAXOFDMA, CDMA1XEV, DVB, DTMB, ISDBT, CMMB, LTE, LTETDD, DCATV, WLAN, MSR, LTEAFDD, LTEATDD
Remote Command	:CALCulate:CHPower:MARKer[1] 2 ... 12:STATe OFF ON 0 1 :CALCulate:CHPower:MARKer[1] 2 ... 12:STATe?
Example	CALC:CHP:MARK3:STAT ON CALC:CHP:MARK3:STAT?
Preset	OFF
State Saved	Saved in instrument state.
Range	On Off
Initial S/W Revision	Prior to A.02.00
Modified at S/W Revision	A.02.00, A.03.00

Marker Function

There are no 'Marker Functions' supported in Channel Power, so this front-panel key displays a blank menu when pressed.

Key Path	Front-panel key
Initial S/W Revision	Prior to A.02.00

Marker To

There is no 'Marker To' functionality supported in Channel Power measurement, so this front-panel key displays a blank key menu when pressed.

Key Path	Front-panel key
Initial S/W Revision	Prior to A.02.00

Meas

The information in this section is common to all measurements. For key and remote command information for a specific measurement, refer to the section that describes the measurement of interest.

Measurements available under the Meas key are specific to the current Mode.

When viewing Help for measurements, note the following:

NOTE

Operation for some keys differs between measurements. The information displayed in Help pertains to the current measurement. To see how a key operates in a different measurement, exit Help (press the Cancel Esc key), select the measurement, then reenter Help (press the Help key) and press that key.

Key Path	Front-panel key
Initial S/W Revision	Prior to A.02.00

Remote Measurement Functions

This section contains the following topics:

"Measurement Group of Commands" on page 2356

"Current Measurement Query (Remote Command Only)" on page 2358

"Limit Test Current Results (Remote Command Only)" on page 2358

"Data Query (Remote Command Only)" on page 2358

"Calculate/Compress Trace Data Query (Remote Command Only)" on page 2359

"Calculate Peaks of Trace Data (Remote Command Only)" on page 2364

"Hardware-Accelerated Fast Power Measurement (Remote Command Only)" on page 2365

"Format Data: Numeric Data (Remote Command Only)" on page 2379

"Format Data: Byte Order (Remote Command Only)" on page 2380

Initial S/W Revision	Prior to A.02.00
----------------------	------------------

Measurement Group of Commands

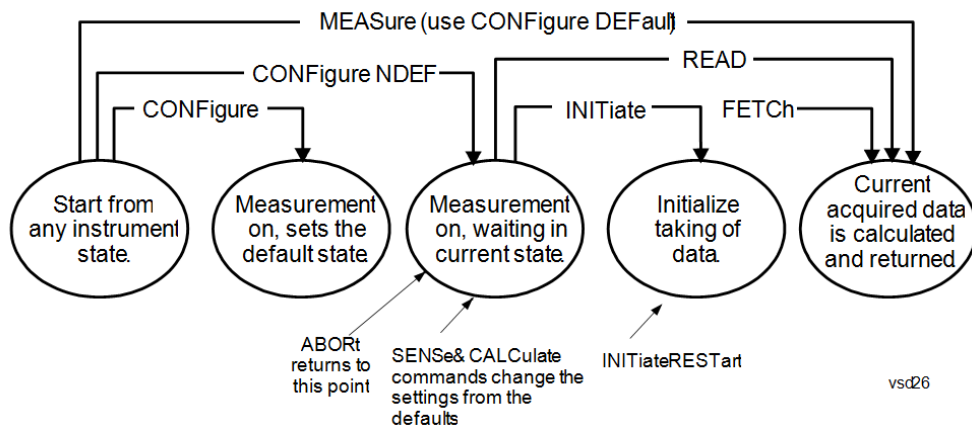

Measure Commands:

:MEASure:<measurement>[n]?

This is a fast single-command way to make a measurement using the factory default instrument settings. These are the settings and units that conform to the Mode Setup settings (e.g. radio standard) that you have currently selected.

- Stops the current measurement (if any) and sets up the instrument for the specified measurement using the factory defaults
- Initiates the data acquisition for the measurement
- Blocks other SCPI communication, waiting until the measurement is complete before returning results.
- If the function does averaging, it is turned on and the number of averages is set to 10.
- After the data is valid it returns the scalar results, or the trace data, for the specified measurement. The type of data returned may be defined by an [n] value that is sent with the command.
- The scalar measurement results will be returned if the optional [n] value is not included, or is set to 1. If the [n] value is set to a value other than 1, the selected trace data results will be returned. See each command for details of what types of scalar results or trace data results are available.
- ASCII is the default format for the data output. (Older versions of Spectrum Analysis and Phase Noise mode measurements only use ASCII.) The binary data formats should be used for handling large blocks of data since they are smaller and faster than the ASCII format. Refer to the FORMat:DATA command for more information.

If you need to change some of the measurement parameters from the factory default settings you can set up the measurement with the CONFigure command. Use the commands in the SENSe:<measurement> and CALCulate:<measurement> subsystems to change the settings. Then you can use the READ? command to initiate the measurement and query the results.

If you need to repeatedly make a given measurement with settings other than the factory defaults, you can use the commands in the SENSe:<measurement> and CALCulate:<measurement> subsystems to set up the measurement. Then use the READ? command to initiate the measurement and query results.

Measurement settings persist if you initiate a different measurement and then return to a previous one. Use READ:<measurement>? if you want to use those persistent settings. If you want to go back to the default settings, use MEASure:<measurement>?.

Configure Commands:

:CONFigure:<measurement>

This command stops the current measurement (if any) and sets up the instrument for the specified measurement using

the factory default instrument settings. It does not initiate the taking of measurement data unless INIT:CONTinuous is ON. If you change any measurement settings after using the CONFigure command, the READ command can be used to initiate a measurement without changing the settings back to their defaults.

In the Swept SA measurement in Spectrum Analyzer mode the CONFigure command also turns the averaging function on and sets the number of averages to 10 for all measurements.

:CONFigure: <measurement>: NDEFault stops the current measurement and changes to the specified measurement. It does not change the settings to the defaults. It does not initiate the taking of measurement data unless INIT:CONTinuous is ON.

The CONFigure? query returns the current measurement name.

The CONFigure:CATalog? query returns a quoted string of all licensed measurement names in the current mode. For example, "SAN, CHP, OBW, ACP, PST, TXP, SPUR, SEM, LIST".

Fetch Commands:

:FETCh:<measurement>[n]?

This command puts selected data from the most recent measurement into the output buffer. Use FETCh if you have already made a good measurement and you want to return several types of data (different [n] values, for example, both scalars and trace data) from a single measurement. FETCh saves you the time of re-making the measurement. You can only FETCh results from the measurement that is currently active, it will not change to a different measurement. An error message is reported if a measurement other than the current one is specified.

If you need to get new measurement data, use the READ command, which is equivalent to an INITiate followed by a FETCh.

The scalar measurement results will be returned if the optional [n] value is not included, or is set to 1. If the [n] value is set to a value other than 1, the selected trace data results will be returned. See each command for details of what types of scalar results or trace data results are available. The binary data formats should be used for handling large blocks of data since they are smaller and transfer faster than the ASCII format. (FORMat:DATA)

FETCh may be used to return results other than those specified with the original READ or MEASure command that you sent.

INITiate Commands:

:INITiate:<measurement>

This command is not available for measurements in all the instrument modes:

- Initiates a trigger cycle for the specified measurement, but does not output any data. You must then use the FETCh<meas> command to return data. If a measurement other than the current one is specified, the instrument will switch to that measurement and then initiate it.
 - For example, suppose you have previously initiated the ACP measurement, but now you are running the channel power measurement. If you send INIT:ACP? it will change from channel power to ACP and will initiate an ACP measurement.
 - Does not change any of the measurement settings. For example, if you have previously started the ACP measurement and you send INIT:ACP? it will initiate a new ACP measurement using the same instrument settings as the last time ACP was run.
 - If your selected measurement is currently active (in the idle state) it triggers the measurement, assuming the trigger conditions are met. Then it completes one trigger cycle. Depending upon the measurement and the number of averages, there may be multiple data acquisitions, with multiple trigger events, for one full trigger cycle. It also holds off additional commands on GPIB until the acquisition is complete.
-

READ Commands:

:READ:<measurement>[n]?

- Does not preset the measurement to the factory default settings. For example, if you have previously initiated the ACP
-

measurement and you send READ:ACP? it will initiate a new measurement using the same instrument settings.

- Initiates the measurement and puts valid data into the output buffer. If a measurement other than the current one is specified, the instrument will switch to that measurement before it initiates the measurement and returns results.
 - For example, suppose you have previously initiated the ACP measurement, but now you are running the channel power measurement. Then you send READ:ACP? It will change from channel power back to ACP and, using the previous ACP settings, will initiate the measurement and return results.
 - Blocks other SCPI communication, waiting until the measurement is complete before returning the results
 - If the optional [n] value is not included, or is set to 1, the scalar measurement results will be returned. If the [n] value is set to a value other than 1, the selected trace data results will be returned. See each command for details of what types of scalar results or trace data results are available. The binary data formats should be used when handling large blocks of data since they are smaller and faster than the ASCII format. (FORMat:DATA)
-

Initial S/W Revision	Prior to A.02.00
----------------------	------------------

Current Measurement Query (Remote Command Only)

This command returns the name of the measurement that is currently running.

Remote Command	:CONFigure?
-----------------------	-------------

Example	CONF?
----------------	-------

Initial S/W Revision	Prior to A.02.00
----------------------	------------------

Limit Test Current Results (Remote Command Only)

Queries the status of the current measurement limit testing. It returns a 0 if the measured results pass when compared with the current limits. It returns a 1 if the measured results fail any limit tests.

Remote Command	:CALCulate:CLIMits:FAIL?
-----------------------	--------------------------

Example	CALC:CLIM:FAIL? queries the current measurement to see if it fails the defined limits. Returns a 0 or 1: 0 it passes, 1 it fails.
----------------	--

Initial S/W Revision	Prior to A.02.00
----------------------	------------------

Data Query (Remote Command Only)

Returns the designated measurement data for the currently selected measurement and subopcode.

n = any valid subopcode for the current measurement. See the measurement command results table for your current measurement, for information about what data is returned for the subopcodes.

This command uses the data setting specified by the FORMat:BORDER and FORMat:DATA commands and can return real or ASCII data. (See the format command descriptions under Input/Output in the Analyzer Setup section.)

Remote Command	:CALCulate:DATA[n]?
Notes	The return trace depends on the measurement. In CALCulate:<meas>:DATA[n], n is any valid subopcode for the current measurement. It returns the same data as the FETCH:<measurement>? query where <measurement> is the current measurement.
Initial S/W Revision	Prior to A.02.00

Calculate/Compress Trace Data Query (Remote Command Only)

Returns compressed data for the currently selected measurement and sub-opcode [n].

n = any valid sub-opcode for that measurement. See the MEASure:<measurement>? command description of your specific measurement for information on the data that can be returned.

The data is returned in the current Y Axis Unit of the analyzer. The command is used with a sub-opcode <n> (default=1) to specify the trace. With trace queries, it is best if the analyzer is not sweeping during the query. Therefore, it is generally advisable to be in Single Sweep, or Update=Off.

This command is used to compress or decimate a long trace to extract and return only the desired data. A typical example would be to acquire N frames of GSM data and return the mean power of the first burst in each frame. The command can also be used to identify the best curve fit for the data.

Remote Command	:CALCulate:DATA<n>:COMPRESS? BLOCK CFIT MAXimum MINimum MEAN DMEan RMS RMSCubed SAMPLE SDEVIation PPHase [,<soffset> [,<length>[,<roffset>[,<rlimit>]]]]
Example	To query the mean power of a set of GSM bursts: Supply a signal that is a set of GSM bursts. Select the IQ Waveform measurement (in IQ Analyzer Mode). Set the sweep time to acquire at least one burst. Set the triggers such that acquisition happens at a known position relative to a burst. Then query the mean burst levels using, CALC:DATA2:COMP? MEAN, 24e-6, 526e-6 (These parameter values correspond to GSM signals, where 526e-6 is the length of the burst in the slot and you just want 1 burst.)
Notes	The command supports 5 parameters. Note that the last 4 (<soffset>, <length>, <roffset>, <rlimit>) are optional. But these optional parameters must be entered in the specified order. For example, if you want to specify <length>, then you must also specify <soffset>. See details below for a definition of each of these parameters. This command uses the data in the format specified by FORMat:DATA, returning either binary or ASCII data.
Initial S/W Revision	Prior to A.02.00

- BLOCK or block data - returns all the data points from the region of the trace data that you specify. For example, it could be used to return the data points of an input signal over several timeslots, excluding the portions of the trace data that you do not want. (This is x,y pairs for trace data and I,Q pairs for complex data.)

- CFIT or curve fit - applies curve fitting routines to the data. <soffset> and <length> are required to define the data that you want. <roffset> is an optional parameter for the desired order of the curve equation. The query will return the following values: the x-offset (in seconds) and the curve coefficients ((order + 1) values).

MIN, MAX, MEAN, DME, RMS, RMSC, SAMP, SDEV and PPH return one data value for each specified region (or <length>) of trace data, for as many regions as possible until you run out of trace data (using <roffset> to specify regions). Or they return the number of regions you specify (using <rlimit>) ignoring any data beyond that.

- MINimum - returns the minimum data point (y value) for the specified region(s) of trace data. For I/Q trace data, the minimum magnitude of the I/Q pairs is returned.
- MAXimum - returns the maximum data point (y value) for the specified region(s) of trace data. For I/Q trace data, the maximum magnitude of the I/Q pairs is returned.
- MEAN - returns a single value that is the arithmetic mean of the data point values (in dB/ dBm) for the specified region(s) of trace data. For I/Q trace data, the mean of the magnitudes of the I/Q pairs is returned. See the following equations.

NOTE If the original trace data is in dB, this function returns the arithmetic mean of those log values, not log of the mean power which is a more useful value. The mean of the log is the better measurement technique when measuring CW signals in the presence of noise. The mean of the power, expressed in dB, is useful in power measurements such as Channel Power. To achieve the mean of the power, use the RMS option.

Equation 1

Mean Value of Data Points for Specified Region(s)

$$\text{MEAN} = \frac{1}{n} \sum_{X_i \in \text{region}(s)} X_i$$

where X_i is a data point value, and n is the number of data points in the specified region(s).

Equation 2

Mean Value of I/Q Data Pairs for Specified Region(s)

$$\text{MEAN} = \frac{1}{n} \sum_{X_i \in \text{region}(s)} |X_i|$$

where $|X_i|$ is the magnitude of an I/Q pair, and n is the number of I/Q pairs in the specified region(s).

- DMEan - returns a single value that is the mean power (in dB/ dBm) of the data point values for the specified region(s) of trace data. See the following equation:

Equation 3

DMEan Value of Data Points for Specified Region(s)

$$\text{DME} = 10 \times \log_{10} \left(\frac{1}{n} \sum_{X_i \in \text{region}(s)} 10^{\frac{X_i}{10}} \right)$$

- RMS - returns a single value that is the average power on a root-mean-squared voltage scale (arithmetic rms) of the data point values for the specified region(s) of trace data. See the following equation.

NOTE

For I/Q trace data, the rms of the magnitudes of the I/Q pairs is returned. See the following equation. This function is very useful for I/Q trace data. However, if the original trace data is in dB, this function returns the rms of the log values which is not usually needed.

Equation 4

RMS Value of Data Points for Specified Region(s)

$$\text{RMS} = \sqrt{\frac{1}{n} \sum_{X_i \in \text{region}(s)} X_i^2}$$

where X_i is a data point value, and n is the number of data points in the specified region(s).

Equation 5

RMS Value of I/Q Data Pairs for Specified Region(s)

$$\text{RMS} = \sqrt{\frac{1}{n} \sum_{X_i \in \text{region}(s)} X_i X_i^*}$$

where X_i is the complex value representation of an I/Q pair, X_i^* its conjugate complex number, and n is the number of I/Q pairs in the specified region(s).

Once you have the rms value for a region of trace data (linear or I/Q), you may want to calculate the mean power. You must convert this rms value (peak volts) to power in dBm:

$$10 \times \log[10 \times (\text{rms value})^2]$$

- SAMPLe - returns the first data value (x,y pair) for the specified region(s) of trace data. For I/Q trace data, the first I/Q pair is returned.
- SDEViation - returns a single value that is the arithmetic standard deviation for the data point values for the specified region(s) of trace data. See the following equation.
- For I/Q trace data, the standard deviation of the magnitudes of the I/Q pairs is returned. See the following equation.

Equation 6

Standard Deviation of Data Point Values for Specified Region(s)

$$\text{SDEV} = \sqrt{\frac{1}{n} \sum_{X_i \in \text{region}(s)} (X_i - \bar{X})^2}$$

where X_i is a data point value, \bar{X} is the arithmetic mean of the data point values for the specified region (s), and n is the number of data points in the specified region(s).

$$\text{SDEV} = \sqrt{\frac{1}{n} \sum_{X_i \in \text{region}(s)} (|X_i| - \bar{X})^2}$$

where $|X_i|$ is the magnitude of an I/Q pair, \bar{X} is the mean of the magnitudes for the specified region(s), and n is the number of data points in the specified region(s).

- PPHase - returns the x,y pairs of both rms power (dBm) and arithmetic mean phase (radian) for every specified region and frequency offset (Hz). The number of pairs is defined by the specified number of regions. This parameter can be used for I/Q vector ($n=0$) in Waveform (time domain) measurement and all parameters are specified by data point in PPHase.

The rms power of the specified region may be expressed as:

$$\text{Power} = 10 \times \log [10 \times (\text{RMS I/Q value})] + 10.$$

The RMS I/Q value (peak volts) is:

$$\sqrt{\frac{1}{n} \sum_{X_i \in \text{region}} X_i X_i^*}$$

where X_i is the complex value representation of an I/Q pair, X_i^* its conjugate complex number, and n is the number of I/Q pairs in the specified region.

The arithmetic mean phase of the specified region may be expressed as:

$$\frac{1}{n} \sum_{Y_i \in \text{region}} Y_i$$

where Y_i is the unwrapped phase of I/Q pair with applying frequency correction and n is the number of I/Q pairs in the specified region.

The frequency correction is made by the frequency offset calculated by the arithmetic mean of every specified region's frequency offset. Each frequency offset is calculated by the least square method against the unwrapped phase of I/Q pair.

Sample Trace Data - Constant Envelope

(See below for explanation of variables.)

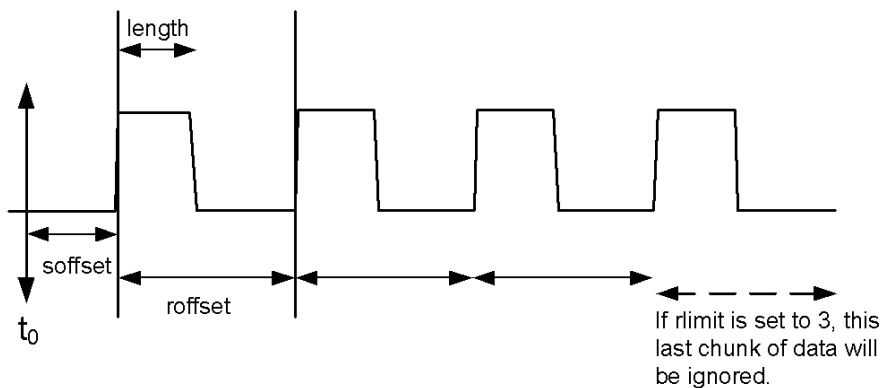

Sample Trace Data - Not Constant Envelope

(See below for explanation of variables.)

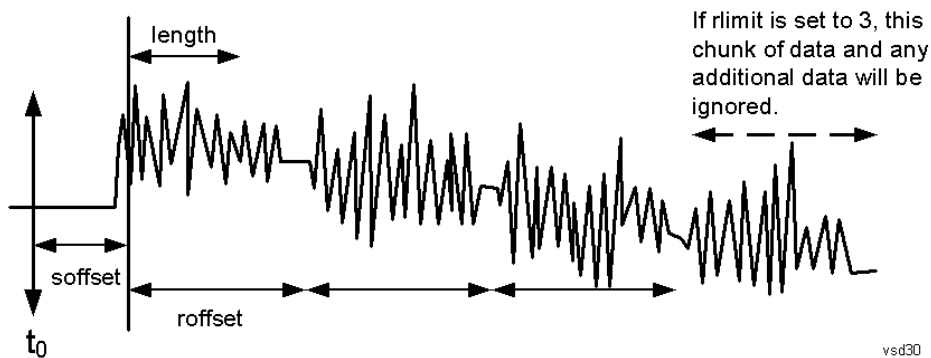

<soffset> - start offset is an optional real number. (It is in seconds for time-domain traces, and is a dimensionless index 0 to Npoints - 1, for frequency-domain traces). It specifies the amount of data at the beginning of the trace that will be ignored before the decimation process starts. It is the time or frequency change from the start of the trace to the point where you want to start using the data. The default value is zero.

<length> - is an optional real number. (It is in seconds for time-domain traces, and is a dimensionless index 0 to Npoints - 1, for frequency-domain traces). It defines how much data will be compressed into one value. This parameter has a default value equal to the current trace length.

<roffset> - repeat offset is an optional real number. (It is in seconds for time-domain traces, and is a dimensionless index 0 to Npoints - 1, for frequency-domain traces). It defines the beginning of the next field of trace elements to be compressed. This is relative to the beginning of the previous field. This parameter has a default value equal to the <length> variable. Note that this parameter is used for a completely different purpose when curve fitting (see CFIT above).

<rlimit> - repeat limit is an optional integer. It specifies the number of data items that you want returned. It will ignore any additional items beyond that number. You can use the Start offset and the Repeat limit to pick out exactly what part of the data you want to use. The default value is all the data.

Calculate Peaks of Trace Data (Remote Command Only)

Returns a list of all the peaks for the currently selected measurement and sub-opcode [n]. The peaks must meet the requirements of the peak threshold and excursion values.

n = any valid sub-opcode for the current measurement. See the MEASure:<measurement> command description of your specific measurement for information on the data that can be returned.

The command can only be used with specific sub-opcodes with measurement results that are trace data. Both real and complex traces can be searched, but complex traces are converted to magnitude in dBm. In many measurements the sub-opcode n=0, is the raw trace data which cannot be searched for peaks. And Sub-opcode n=1, is often calculated results values which also cannot be searched for peaks.

This command uses the data setting specified by the FORMat:BORDER and FORMat:DATA commands and can return real or ASCII data. If the format is set to INT,32, it returns REAL,32 data.

The command has four types of parameters:

- Threshold (in dBm)
- Excursion (in dB)
- Sorting order (amplitude, frequency, time)
- Optional in some measurements: Display line use (all, > display line, < display line)

Remote Command	<p>For Swept SA measurement:</p> <pre>:CALCulate:DATA[1] 2 ... 6:PEAKs? <threshold>,<excursion>[,AMPLitude FREQuency TIME[,ALL GTDLine LTDLine]]</pre> <p>For most other measurements:</p> <pre>:CALCulate:DATA[1] 2 ... 6:PEAKs? <threshold>,<excursion>[,AMPLitude FREQuency TIME]</pre>
-----------------------	--

Example	<p>Example for Swept SA measurement in Spectrum Analyzer Mode:</p> <p>CALC:DATA4:PEAK? -40, 10, FREQ, GTDL This will identify the peaks of trace 4 that are above -40 dBm, with excursions of at least 10 dB. The peaks are returned in order of increasing frequency, starting with the lowest frequency. Only the peaks that are above the display line are returned.</p> <p>Query Results 1:</p> <p>With FORMat:DATA REAL, 32 selected, it returns a list of floating-point numbers. The first value in the list is the number of peak points that are in the following list. A peak point consists of two values: a peak amplitude followed by its corresponding frequency (or time).</p> <p>If no peaks are found the peak list will consist of only the number of peaks, (0).</p>
----------------	---

Notes	<p><n> - is the trace that will be used</p> <p><threshold> - is the level below which trace data peaks are ignored. Note that the threshold value is required and is always used as a peak criterion. To effectively disable the threshold criterion for this command, provide a substantially low threshold value such as -200 dBm. Also note that the threshold value used in this command is independent of and has no effect on the threshold value stored under the Peak Criteria menu.</p> <p><excursion> - is the minimum amplitude variation (rise and fall) required for a signal to be identified as peak. Note that the excursion value is required and is always used as a peak criterion. To effectively disable the excursion criterion for this command, provide the minimum value of 0.0 dB. Also note that the excursion value used in this command is independent of and has no effect on the</p>
--------------	---

excursion value stored under the Peak Criteria menu.

Values must be provided for threshold and excursion. The sorting and display line parameters are optional (defaults are AMPLitude and ALL).

Note that there is always a Y-axis value for the display line, regardless of whether the display line state is on or off. It is the current Y-axis value of the display line which is used by this command to determine whether a peak should be reported

Sorting order:

AMPLitude - lists the peaks in order of descending amplitude, with the highest peak first (default if optional parameter not sent)

FREQUency - lists the peaks in order of occurrence, left to right across the x-axis.

TIME - lists the peaks in order of occurrence, left to right across the x-axis.

Peaks vs. Display Line:

ALL - lists all of the peaks found (default if optional parameter not sent).

GTDLine (greater than display line) - lists all of the peaks found above the display line.

LTDLine (less than display line) - lists all of the peaks found below the display line.

Initial S/W Revision	Prior to A.02.00
----------------------	------------------

Hardware-Accelerated Fast Power Measurement (Remote Command Only)

The Fast Power option (FP2) enables very fast channel power measurements for instruments with the prerequisite hardware (DP2 and/or B40). It accomplishes this by performing real-time overlapped FFTs at the hardware layer, using software for basic post-processing before returning the result to the user. The upshot of this approach is improved throughput for user applications that require many sequential power measurements.

The analysis bandwidth of FP2 is limited by the licenses in the instrument, but its maximum overall analysis bandwidth per acquisition is 40 MHz.

FP2 is remote-only, which means the instrument does not switch to any particular mode or measurement. FP2 commands can be sent while another application is in use on the front panel.

Each Fast Power measurement can be predefined using an array index, and up to 1,000 measurements can be stored. In the following documentation, instances of [1,2,...,999] can be substituted with a particular measurement index, e.g. CALC:FPOW:POW1?, CALC:FPOW:POW2?, CALC:FPOW:POW134?. In this way, power measurements can be defined one time in a batch, and then executed multiple times without having to redefine them, similar to “list mode” on other measurements.

In addition to basic channel power measurements, there are a number of other measurement “functions” for each channel, including peak power, peak frequency, and power spectral density. See the Function parameter for more information.

Reset Fast Power Measurement (Remote Command Only)

Resets the measurement configuration to the defaults.

Mode	All
Remote Command	:CALCulate:FPOWer:POWer[1,2,...,999]:RESet
Example	:CALC:FPOW:POW1:RES

Notes	Option FP2 is required.
Initial S/W Revision	A.14.00

Define Fast Power Measurement (Remote Command Only)

Fast Power acquisitions are configured using the DEFine command. This command accepts a comma-delimited string of configuration parameters and their appropriate values, which are all specified in the subsection below.

Mode	All
Remote Command	:CALCulate:FPOWER:POWer[1,2,...,999]:DEFine "configuration string"
Example	:CALC:FPOW:POW1:DEF "CenterFrequency=2e9, AcquisitionTime=0.005"
Notes	See below for a list of measurement variables that can be defined in the configuration string.
Initial S/W Revision	A.14.00

Acquisition Time

Example	CALC:FPOW:POW1:DEF "AcquisitionTime=0.002"
Notes	The acquisition time parameter sets the time in which the entire spectrum is measured. An increase in the acquisition time yields an improvement in measurement repeatability.
Preset	0.001 s
Range	0 s to 1 s
Default Unit	Time (s)
Initial S/W Revision	A.14.00

Center Frequency

Example	CALC:FPOW:POW1:DEF "CenterFrequency=2e9"
Notes	The center frequency parameter sets the frequency in which the measurement is centered around. The OffsetFrequency parameter is calculated relative to the center frequency.
Preset	1 GHz
Range	0 Hz to maximum instrument frequency
Default Unit	Frequency (Hz)
Initial S/W Revision	A.14.00

DC Coupled

Example	CALC:FPOW:POW1:DEF "DCCoupled=True"
Notes	The DC coupled parameter allows the user to specify whether the DC blocking capacitor is utilized. Set parameter to true when measuring frequencies below 10 MHz.
Preset	False
Range	True (DC Coupled) or False (AC Coupled)
Default Unit	Boolean
Initial S/W Revision	A.14.00

DetectorType

Example	CALC:FPOW:POW1:DEF "DetectorType=Peak"
Notes	Option FP2 is required. The detector type parameter allows the user to choose whether a RMS average or peak value is used during the measurement.
Preset	RmsAverage
Range	RmsAverage, Peak
Initial S/W Revision	A.14.00

Do Noise Correction

Example	CALC:FPOW:POW1:DEF "DoNoiseCorrection=True"
Notes	When noise correction is enabled, the linear noise power contributed by the analyzer is subtracted from all measurements. This effectively lowers the noise floor of the analyzer. When noise correction is enabled, the first measurement for a given set of input parameters will take extra time. This is because the analyzer takes an extra acquisition with the RF input disconnected from the analyzer's front end to measure the noise of just the analyzer. The measured noise floor is stored in a cache so the noise acquisition will occur only once for the same state settings. In other words, if noise correction was turned on and the analyzer made an acquisition at frequency A, then frequency B, and back again to frequency A, the hidden initial noise floor acquisition would only occur for the first acquisition at frequency A and the cached noise floor would be used the second time frequency A was measured.
Preset	False
Range	True (enable noise correction) or False (disable noise correction)
Default Unit	Boolean
Initial S/W Revision	A.14.00

Do Spur Suppression

Example	CALC:FPOW:POW1:DEF "DoSpurSuppression=True"
Notes	<p>When measuring very low level signals, or when large out-of-band inputs are input into the analyzer, sometimes unwanted spurs and residuals can appear in the measured spectrum. Spur suppression is a method to help minimize the levels of these internally generated spurs and residuals.</p> <p>When spur suppression is enabled, the analyzer will automatically take two acquisitions using two different internal analog LO frequencies. The FFT spectrums from both acquisitions are combined by taking the minimum power between both traces on a per FFT bin basis. External signals will have the same amplitude for both traces and therefore will return the expected amplitudes. However, low level spurs and residuals generated internally to the analyzer tend to move to different FFT bins depending on the internal analog LO frequency used, and therefore tend to be suppressed using this spur suppression method.</p> <p>Because two acquisitions, rather than a single acquisition, are made when spur suppression is enabled, the measurement time will always be slower when spur suppression is enabled.</p>
Preset	False
Range	True (enable spur suppression) or False (disable spur suppression)
Default Unit	Boolean
Initial S/W Revision	A.14.00

Electronic Attenuator Bypass

Example	CALC:FPOW:POW1:DEF "ElecAttBypass =False"
Notes	The electronic attenuation bypass parameter allows the user to either utilize or bypass the electronic attenuator. The electronic attenuator is only available for frequencies up to 3.6 GHz. Set parameter to true when using frequencies above 3.6 GHz and set the parameter to false when using the preamp.
Preset	True
Range	True (bypass electronic attenuator) or False (use electronic attenuator)
Default Unit	Boolean
Initial S/W Revision	A.14.00

Electronic Attenuation

Example	CALC:FPOW:POW1:DEF "ElecAttenuation=10"
Notes	<p>Option EA3 is required.</p> <p>The electronic attenuation value parameter sets the amount of electrical attenuation from 0 to 24 dB (1 dB steps).</p> <p>Set "ElecAttBypass=False" to make sure the electronic attenuator path is enabled.</p>
Preset	0 dB
Range	0 – 24 dB (1 dB steps)

Default Unit	dB
Initial S/W Revision	A.14.00

IF Gain

Example	CALC:FPOW:POW1:DEF "IFGain=10"
Notes	The IF gain parameter allows the user to specify the gain at the IF stage anywhere from -6 to 16 dB (1 dB steps). This is an advanced feature, and for most cases this should remain at its default value of 0 dB.
Preset	0 dB
Range	-6 - 16 dB (1 dB steps)
Default Unit	dB
Initial S/W Revision	A.14.00

IF Type

Example	CALC:FPOW:POW1:DEF "IFType=B25M"
Notes	The IF type parameter allows the user to select between different IF paths. For example, if the signal is less than 25 MHz wide, then the user can select the B25M path to take advantage of additional filtering on this analog IF path.
Preset	B40M
Range	B10M, B25M, B40M
Initial S/W Revision	A.14.00

Include Power Spectrum

Example	CALC:FPOW:POW1:DEF "IncludePowerSpectrum=True"
Notes	The power spectrum parameter allows the user to read data on the entire spectrum for diagnostic purposes. It is not recommended for production use. See CALC:FPOW:POW[n]:READ2? for details on the binary format of the response.
Preset	False
Range	True (return both channel power and full power spectrum) or False (returns only channel power)
Default Unit	Boolean
Initial S/W Revision	A.14.00

Mechanical Attenuation

Example	CALC:FPOW:POW1:DEF "MechAttenuation=10"
Notes	The mechanical attenuation value parameter sets the amount of mechanical attenuation anywhere from 0 to 70 dB (2 dB steps).
Preset	0 dB
Range	0 – 70 dB (2 dB steps)
Default Unit	dB
Initial S/W Revision	A.14.00

Preamp Mode

Example	CALC:FPOW:POW1:DEF "PreAmpMode=Low"
Notes	The license for the appropriate preamp is required. The preamp mode parameter specifies whether the preamps are being utilized. Low allows any preamps up to 3.6 GHz, and Full allows all licensed preamps. Set "ElecAttBypass=True" in order to utilize any preamps.
Preset	Off
Range	Off, Low, Full
Initial S/W Revision	A.14.00

Resolution Bandwidth Mode

Example	CALC:FPOW:POW1:DEF "PreAmpMode=Low"
Notes	The resolution bandwidth mode parameter allows the user to choose whether the RBW filter is automatically or manually set. The BestSpeed value minimizes measurement time, while the Narrowest value minimizes RBW size (minimum of two FFT bins per RBW). To manually specify an RBW, set this parameter to Explicit, and set the ResolutionBW parameter to the desired value.
Preset	BestSpeed
Range	BestSpeed, Narrowest, Explicit
Initial S/W Revision	A.14.00

Resolution Bandwidth

Example	CALC:FPOW:POW1:DEF "ResolutionBW=25e3"
Notes	The resolution bandwidth parameter sets the 3-dB bandwidth of the RBW filter. The ResolutionBWMode parameter must be set to Explicit in order to manually set the RBW.

Preset	0 Hz
Default Unit	Hz
Initial S/W Revision	A.14.00

Trigger Delay

Example	CALC:FPOW:POW1:DEF "TriggerDelay=0.025"
Notes	The trigger delay parameter sets the time after an external trigger is detected until the measurement is performed.
Preset	0 s
Range	0 – 1 s
Default Unit	Seconds
Initial S/W Revision	A.14.00

Trigger Level

Example	CALC:FPOW:POW1:DEF "TriggerLevel=2"
Notes	The trigger level parameter sets the voltage value at which an external trigger is detected.
Preset	1.2 V
Range	-5 to 5 V
Default Unit	Volts
Initial S/W Revision	A.14.00

Trigger Slope

Example	CALC:FPOW:POW1:DEF "TriggerSlope=Negative"
Notes	The trigger slope parameter indicates the direction of the edge trigger voltage for detection.
Preset	Positive
Range	Positive, Negative
Initial S/W Revision	A.14.00

Trigger Source

Example	CALC:FPOW:POW1:DEF "TriggerSource=Ext1"
Notes	The trigger source parameter allows the user to choose between measurement's triggering freely or controlled by an external input. Ext1 and Ext2 correspond to Trigger 1 In and Trigger 2 In, respectively.
Preset	Free
Range	Free, Ext1, Ext2
Initial S/W Revision	A.14.00

Trigger Timeout

Example	CALC:FPOW:POW1:DEF "TriggerTimeout=0.1"
Notes	The trigger timeout parameter sets the time in which the analyzer will wait for a trigger before automatically performing the measurement.
Preset	1 s
Range	0 - 1 s
Default Unit	Seconds
Initial S/W Revision	A.14.00

Signal Input

Example	CALC:FPOW:POW1:DEF "SignalInput=Fp50MHzCW"
Notes	The signal input parameter allows the user to select between using the main RF input or the internal analyzer reference CW signal of 50 MHz.
Preset	FpMainRf
Range	FpMainRf, Fp50MHzCW
Initial S/W Revision	A.14.00

Use Preselector

Example	CALC:FPOW:POW1:DEF "UsePreSelector=True"
Notes	The preselector parameter allows the user to either utilize or bypass the front end tunable filter at frequencies above 3.6 GHz. For frequencies below 3.6 GHz, the preselector is automatically bypassed, so you do not need to set this parameter to False in those cases.
Preset	False
Range	True (use preselector above 3.6 GHz), or False (preselector bypassed)

Default Unit	Boolean
Initial S/W Revision	A.14.00

Channel Bandwidth Array

Example	CALC:FPOW:POW1:DEF "Bandwidth=[3.84e6, 5e6, 3.84e6]"
Notes	The bandwidth parameter array defines the bandwidth of each channel that will be measured. All array parameters should have the same number of elements. Alternatively, if all the elements are the same value, a single number with no square brackets can be used to define the parameter.
Preset	[1 e6]
Range	0 to 40 MHz
Default Unit	Hz
Initial S/W Revision	A.14.00

Channel Filter Type Array

Example	CALC:FPOW:POW1:DEF "FilterType=[RRC, IBW, RRC]"
Notes	The filter type parameter allows the user to choose between an integration bandwidth (IBW) filter or a root-raised-cosine (RRC) filter. The integration bandwidth filter weighs all frequencies within the bandwidth equally. The root-raised-cosine filter has an associated shape parameter, defined by the FilterAlpha parameter. All array parameters should have the same number of elements. Alternatively, if all the elements are the same value, a single value with no square brackets can be used to define the parameter.
Preset	[IBW]
Range	IBW, RRC
Initial S/W Revision	A.14.00

Channel Filter Alpha Array

Example	CALC:FPOW:POW1:DEF "FilterAlpha=[0.5, 0.0, 0.5]"
Notes	The filter alpha parameter allows the user to adjust the alpha value associated with the root-raised-cosine (RRC) filter type. Set FilterType to RRC in order to utilize this parameter. All array parameters should have the same number of elements. Alternatively, if all the elements are the same value, a single number with no square brackets can be used to define the parameter.
Preset	[0.22]
Range	0.0 – 1.0
Initial S/W Revision	A.14.00

Channel Measurement Function Array

Example	CALC:FPOW:POW1:DEF "Function=[BandPower, PeakPower, BandPower]"
Notes	<p>This parameter array defines what measurement is being made for each individually-specified channel:</p> <p>BandPower: Total power within the specified bandwidth of the channel (dBm)</p> <p>BandDensity: Total power density within the specified bandwidth of the channel (dBm/Hz)</p> <p>PeakPower: The peak power value within the specified bandwidth of the channel (dBm)</p> <p>PeakFrequency: The frequency which corresponds to the peak power value within the specified bandwidth of the channel. This frequency is relative to the center frequency (Hz)</p> <p>XdBBandwidth: The half power (-3.01 dB) bandwidth of the highest amplitude signal that resides within the channel (Hz), dB is configurable using XdBBandwidth parameter</p> <p>OccupiedBandwidth: The bandwidth at which 99% of the total power resides within the channel (Hz), percentage configurable using OccupiedBandwidthPercent parameter</p> <p>All array parameters should have the same number of elements. Alternatively, if all the elements are the same value, a single value with no square brackets can be used to define the parameter.</p>
Preset	[BandPower]
Range	BandPower, BandDensity, PeakPower, PeakFrequency, XdBBandwidth, OccupiedBandwidth
Initial S/W Revision	A.14.00

Channel Offset Frequency Array

Example	CALC:FPOW:POW1:DEF "OffsetFrequency=[-5e6, 0, 5e6]"
Notes	<p>The offset frequency parameter array defines the difference between the center frequency to the center frequency of each channel.</p> <p>All array parameters should have the same number of elements.</p>
Preset	[0]
Range	0 to 20 MHz
Default Unit	Hz
Initial S/W Revision	A.14.00

Channel Occupied Bandwidth Percent Array

Example	CALC:FPOW:POW1:DEF "OccupiedBandwidthPercent =[0.95, 0.95, 0.95]"
Notes	<p>This parameter only applies for channels whose Function is set to OccupiedBandwidth. The occupied bandwidth percent parameter specifies the percent of total power in these channels. The valid range for this parameter is 0.0 to 1.0, where 1.0 represents 100%. The default for this parameter is 0.99, which will return the bandwidth that contains 99% of the total channel power.</p>

Preset	[0.99]
Range	0 – 1.0
Initial S/W Revision	A.14.00

Channel x-dB Bandwidth Array

Example	CALC:FPOW:POW1:DEF " XdBBandwidth =[-6.02, -3.01, -1.0]"
Notes	This parameter only applies for channels whose Function is set to XdBBandwidth. The X dB bandwidth parameter is used to specify the power relative to the peak channel power over which the bandwidth is calculated. The parameter value must be a negative number.
Preset	[-3.01]
Range	-200 to 0 dB
Default Unit	dB
Initial S/W Revision	A.14.00

Define Fast Power Measurement Query (Remote Command Only)

The DEFine? command is used to retrieve a list of all defined parameters in an ASCII string format

M o d e	All
R e m o t e C o m m a n d	:CALCulate:FPOWER:POWER[1,2,...,999]:DEFine?
E x a m	:CALC:FPOW:POW1:DEF?

```

p
l
e
N This command query is used to retrieve a list of all defined parameters in an ASCII format.
o The following is an example of the returned results:
t "DCCoupled=False,ElecAttBypass=True,ElecAttenuation=0,IFGain=0,MechAttenuation=0,PreAmpMode=Off,PreSelectorOffset
e =0,UsePreSelector=False,ExternalReferenceFrequency=10000000,FrequencyReferenceSource=AutoExternalFrequencyRefer
s ence,IFType=B40M,LOMode=SLW,SignalInput=FpMainRf,AcquisitionTime=0.001,CenterFrequency=1000000000,Resolution
BW=0,ResolutionBWMode=BestSpeed,DetectorType=RmsAverage,Bandwidth=[1000000],OffsetFrequency=[0],Function=
[BandPower],FilterType=[IBW],FilterAlpha=[0.22],OccupiedBandwidthPercent=[0.99],XdBBandwidth=[-
3.01],DoNoiseCorrection=False,DoSpurSuppression=False,MeasurementMethod=HardwareFFT,IncludePowerSpectrum=False,
e,TriggerDelay=0,TriggerLevel=1.2,TriggerSlope=Positive,TriggerSource=Free,TriggerTimeout=1"

I A.14.00
n
i
t
i
a
l

S
/
W

R
e
v
i
s
i
o
n

```

Configure Fast Power Measurement (Remote Command Only)

The configure command begins hardware setup and returns immediately, with no acquisition made. This can be used in parallel with other hardware operations to effectively hide the hardware setup time.

Mode	All
Remote Command	:CALCulate:FPOWER:POWER[1,2,...,999]:CONFigure
Example	:CALC:FPOW:POW1:CONF
Notes	Option FP2 is required.
Initial S/W Revision	A.14.00

Initiate Fast Power Measurement (Remote Command Only)

The INITiate command begins an acquisition and returns immediately. The results of the measurement can be retrieved using FETCh.

Mode	All
Remote Command	:CALCulate:FPOWER:POWER[1,2,...,999]:INITiate
Example	:CALC:FPOW:POW1:INIT
Notes	Option FP2 is required.
Initial S/W Revision	A.14.00

Fetch Fast Power Measurement (Remote Command Only)

The FETCh command query is used to retrieve the results of an acquisition initiated by the INIT command. The returned results are in ASCII string format. The string begins and ends with quotation marks.

Mode	All
Remote Command	:CALCulate:FPOWER:POWER[1,2,...,999]:FETCh?
Example	:CALC:FPOW:POW1:FETC?
Notes	Option FP2 is required. Returns m comma-separated ASCII values, where m corresponds to the number of bandwidths defined. 1. Declared function return in the 1st specified channel 2. Declared function return in the 2nd specified channel ... m. Declared function return in the last specified channel The INIT and FETC? command sequence performs the same functionality of a single CALC:FPOW:POW[n]? query. Units of the returned values are dependent on the Function parameter for each channel.
Initial S/W Revision	A.14.00

Execute Fast Power Measurement (Remote Command Only)

This command query is used as shorthand for an INIT command immediately followed by a FETC? command. The returned results are in ASCII string format. The string begins and ends with quotation marks.

Mode	All
Remote Command	:CALCulate:FPOWER:POWER[1,2,...,999]?
Example	:CALC:FPOW:POW1?
Notes	Option FP2 is required. See notes for Fast Power Fetch for return format.
Initial S/W Revision	A.14.00

Binary Read Fast Power Measurement (Remote Command Only)

This command query is used as shorthand for an INIT command immediately followed by a FETC? command. The returned results are in a binary format.

Mode	All
Remote Command	:CALCulate:FPOWER:POWER[1,2,...,999]:READ? :CALCulate:FPOWER:POWER[1,2,...,999]:READ1?
Example	:CALC:FPOW:POW1:READ? :CALC:FPOW:POW1:READ1?
Notes	Option FP2 is required. Returns m 4 byte floating point binary values (Little-Endian), where m corresponds to the number of bandwidths defined.
Initial S/W Revision	A.14.00

Diagnostic Binary Read Fast Power Measurement (Remote Command Only)

This command query is used as shorthand for an INIT command immediately followed by a FETC? command. The returned results are in a binary format. This command is used primarily for diagnostic purposes to test for ADC overloads and to visibly inspect the spectrum.

Mode	All
Remote Command	:CALCulate:FPOWER:Power[1,2,...,999]:READ2?
Example	:CALC:FPOW:POW1:READ2?
Notes	Option FP2 is required. Note: Spectrum data is only returned if the IncludePowerSpectrum parameter is set to True. If IncludePowerSpectrum is False, the number of spectrum points will be zero (0). Units of the returned values are dependent on the Function parameter per channel (e.g. dBm for BandPower, Hz for PeakFrequency). Returns binary data (Little-Endian) that contains information on m amount of channels, along with ADC over range and full spectrum data. The following is the binary format of the response. Bandwidth Return Value 1. Number of channels specified, m [4 byte int] 2. Declared function result for the 1st specified channel [4 byte float] 3. Declared function result for the 2nd specified channel [4 byte float] ... (m + 1). Declared function result for the last (mth) specified channel [4 byte float] ADC Over Range 1. ADC over-range occurred (1: true, 0: false) [2 byte short]

	<p>Spectrum Data</p> <ol style="list-style-type: none"> 1. Number of points in the spectrum data, k [4 byte int] 2. Start frequency of spectrum data (Hz) [8 byte double] 3. Step frequency of spectrum data (Hz) [8 byte double] 4. FFT bin at 1st point (dBm) [4 byte float] 5. FFT bin at 2nd point (dBm) [4 byte float] <p>...</p> <p>(k + 3). FFT bin at last (kth) point (dBm) [4 byte float]</p>
Initial S/W Revision	A.14.00

Format Data: Numeric Data (Remote Command Only)

This command specifies the format of the trace data input and output. It specifies the formats used for trace data during data transfer across any remote port. It affects only the data format for setting and querying trace data for the :TRACe[:DATA], TRACe[:DATA]?, :CALCulate:DATA[n]? and FETCh:SANalyzer[n]? commands and queries.

Remote Command	<pre>:FORMat[:TRACe][:DATA] ASCii INTeger,32 REAL,32 REAL,64 :FORMat[:TRACe][:DATA]?</pre>
Notes	<p>The query response is:</p> <pre>ASCii: ASC,8 REAL,32: REAL,32 REAL,64: REAL,64 INTeger,32: INT,32</pre> <p>When the numeric data format is REAL or ASCii, data is output in the current Y Axis unit. When the data format is INTeger, data is output in units of m dBm (.001 dBm).</p> <p>The INT,32 format returns binary 32-bit integer values in internal units (m dBm), in a definite length block.</p>
Dependencies	<p>Sending a data format spec with an invalid number (for example, INT,48) generates no error. The analyzer simply uses the default (8 for ASCii, 32 for INTeger, 32 for REAL).</p> <p>Sending data to the analyzer which does not conform to the current FORMat specified, results in an error. Sending ASCII data when a definite block is expected generates message -161 "Invalid Block Data" and sending a definite block when ASCII data is expected generates message -121 "Invalid Character in Number".</p>
Preset	ASCii
Backwards Compatibility Notes	Note that the INT,32 format is only applicable to the command, TRACe:DATA. This preserves backwards compatibility for the Swept SA measurement. For all other commands/queries which honor FORMat:DATA, if INT,32 is sent the analyzer will behave as though it were set to REAL,32.
Initial S/W Revision	Prior to A.02.00

The specs for each output type follow:

AScii - Amplitude values are in ASCII, in the current Y Axis Unit, one ASCII character per digit, values separated by commas, each value in the form:

SX.YYYYYEsZZ

Where:

S = sign (+ or -)

X = one digit to left of decimal point

Y = 5 digits to right of decimal point

E = E, exponent header

s = sign of exponent (+ or -)

ZZ = two digit exponent

REAL,32 - Binary 32-bit real values in the current Y Axis Unit, in a definite length block.

REAL,64 - Binary 64-bit real values in the current Y Axis Unit, in a definite length block.

Format Data: Byte Order (Remote Command Only)

This command selects the binary data byte order for data transfer and other queries. It controls whether binary data is transferred in normal or swapped mode. This command affects only the byte order for setting and querying trace data for the :TRACe[:DATA], TRACe[:DATA]? , :CALCulate:DATA[n]? and FETCh:SANalyzer[n]? commands and queries.

By definition any command that says it uses FORMat:DATA uses any format supported by FORMat:DATA.

The NORMal order is a byte sequence that begins with the most significant byte (MSB) first, and ends with the least significant byte (LSB) last in the sequence: 1|2|3|4. SWAPped order is when the byte sequence begins with the LSB first, and ends with the MSB last in the sequence: 4|3|2|1.

Remote Command	:FORMat:BORDER NORMAL SWAPped :FORMat:BORDER?
Preset	NORMal
Initial S/W Revision	Prior to A.02.00

Meas Setup

Displays the setup menu for the currently selected measurement. The parameters included in this menu are as follows.

- Averaging
- IF Gain
- Channel Power Span
- Integrated Bandwidth
- Filter Bandwidth
- Root Raised Cosine (RRC) Filter

Key Path	Front-panel key
Initial S/W Revision	Prior to A.02.00

Avg/Hold Num

Specifies the number of measurement averages used to calculate the measurement result. The average is displayed at the end of each sweep. After the specified number of average counts, the averaging mode (terminal control) setting determines the averaging action.

Key Path	Meas Setup
Mode	SA, WCDMA, C2K, WIMAX OFDMA, 1xEVDO, DVB-T/H, DTMB (CTTB), ISDB-T, CMMB, LTE, LTETDD, Digital Cable TV, WLAN, MSR, LTEAFDD, LTEATDD
Remote Command	[:SENSe]:CHPower:AVERage:COUNT <integer> [:SENSe]:CHPower:AVERage:COUNT? [:SENSe]:CHPower:AVERage[:STATe] ON OFF 1 0 [:SENSe]:CHPower:AVERage[:STATe]?
Example	CHP:AVER:COUN 15 CHP:AVER:COUN? CHP:AVER ON CHP:AVER?
Notes	You must be in the Spectrum Analysis mode, W-CDMA mode, cdma2000 mode, DVB-T/H mode, DTMB (CTTB) mode, ISDB-T mode, CMMB mode, Digital Cable TV mode, LTE mode, LTE TDD mode 1xEVDO mode or WIMAX OFDMA mode to use this command. Use :INSTRument:SElect to set the mode.
Preset	SA: 10 WCDMA: 200 WIMAX OFDMA, LTE, LTETDD, MSR: 200 CDMA2K: 20 1xEVDO: 20

	DVB-T/H: 20 DTMB (CTTB): 20 ISDB-T: 10 CMMB: 10 Digital Cable TV: 10 WLAN: 10 LTEAFDD, LTEATDD:200 ON
State Saved	Saved in instrument state.
Min	1
Max	10000
Initial S/W Revision	Prior to A.02.00
Modified at S/W Revision	A.02.00, A.03.00

Avg Mode

Allows you to select the type of termination control used for the averaging function. This determines the averaging action after the specified number of data acquisitions (average count) is reached.

When set to Exponential (Exp) the measurement averaging continues using the specified number of averages to compute each exponentially-weighted averaged value. The average is displayed at the end of each sweep.

When set to Repeat, the measurement resets the average counter each time the specified number of averages is reached.

Key Path	Meas Setup
Mode	SA, WCDMA, C2K, WIMAX OFDMA, 1xEVDO, DVB-T/H, DTMB (CTTB), ISDB-T, CMMB, LTE, LTEATDD, Digital Cable TV, WLAN, MSR, LTEAFDD, LTEATDD
Remote Command	[:SENSe] :CHPower:AVERage:TCONtrol EXPonential REPeat [:SENSe] :CHPower:AVERage:TCONtrol?
Example	CHP:AVER:TCON EXP CHP:AVER:TCON?
Notes	You must be in the Spectrum Analysis mode, W-CDMA mode, cdma2000 mode, DVB-T/H mode, DTMB (CTTB) mode, ISDB-T mode, CMMB mode, Digital Cable TV mode, LTE mode, LTE TDD mode, WLAN mode, 1xEVDO mode or WIMAX OFDMA mode to use this command. Use :INSTrument:SElect to set the mode.
Preset	EXP
State Saved	Saved in instrument state.
Range	Exp Repeat
Initial S/W Revision	Prior to A.02.00
Modified at S/W Revision	A.02.00, A.03.00

PSD Unit

Sets the unit bandwidth for Power Spectral Density. The available units are dBm/Hz and dBm/MHz.

Key Path	Meas Setup
Mode	SA, WCDMA, WIMAX OFDMA, 1xEVDO, DVB-T/H, DTMB (CTTB), LTE, LTE-TDD, Digital Cable TV, WLAN, MSR, LTEAFDD, LTEATDD
Remote Command	:UNIT:CHPower:POWer:PSD DBMHZ DBMMHZ :UNIT:CHPower:POWer:PSD?
Example	UNIT:CHP:POW:PSD DBMMHZ UNIT:CHP:POW:PSD?
Couplings	When the PSD unit is changed, the PSD result of the "MEAS READ FETCH:CHP1?" is also changed by the PSD unit basis (in either dBm/Hz or dBm/MHz).
Preset	DBMHZ WLAN: DBMMHZ
State Saved	Saved in instrument state.
Range	dBm/Hz dBm/MHz
Initial S/W Revision	Prior to A.02.00
Modified at S/W Revision	A.02.00, A.03.00

Meas Preset

Restores all the measurement parameters to their default values.

Key Path	Meas Setup
Mode	SA, WCDMA, C2K, WIMAX OFDMA, 1xEVDO, DVB-T/H, DTMB (CTTB), ISDB-T, CMMB, LTE, LTE-TDD, Digital Cable TV, WLAN, MSR, LTEAFDD, LTEATDD
Remote Command	:CONFigure:CHPower
Example	CONF:CHP
Initial S/W Revision	Prior to A.02.00
Modified at S/W Revision	A.02.00, A.03.00

8 Channel Power Measurement
Mode

Mode

See "[Mode](#)" on page 222

Mode Preset

Returns the active mode to a known state.

Mode Preset does the following for the currently active mode:

- Aborts the currently running measurement.
- Brings up the default menu for the mode, with no active function.
- Sets measurement Global settings to their preset values for the active mode only.
- Activates the default measurement.
- Brings up the default menu for the mode.
- Clears the input and output buffers.
- Sets Status Byte to 0.

Mode Preset does not:

- Cause a mode switch
- Affect mode persistent settings
- Affect system settings
- See "[How-To Preset](#)" on page 422 for more information.

Key Path	Front-panel key
Remote Command	:SYSTem:PRESet
Example	:SYST:PRES
Notes	*RST is preferred over :SYST:PRES for remote operation. *RST does a Mode Preset, as done by the :SYST:PRES command, and it sets the measurement mode to Single measurement rather than Continuous for optimal remote control throughput. Clears all pending OPC bits. The Status Byte is set to 0.
Couplings	A Mode Preset aborts the currently running measurement, activates the default measurement, and gets the mode to a consistent state with all of the default couplings set.
Backwards Compatibility Notes	In the X-Series, the legacy "Factory Preset" has been replaced with Mode Preset, which only presets the currently active mode, not the entire instrument. In the X-Series, the way to preset the entire instrument is by using System, Restore System Defaults All, which behaves essentially the same way as restore System Defaults does on ESA and PSA. There is also no "Preset Type" as there is on the PSA. There is a green Mode Preset front-panel key that does a Mode Preset and a white-with-green-letters User Preset front-panel key that does a User Preset. The old PRESet:TYPE command is ignored (without generating an error), and SYST:PRES without a parameter does a Mode Preset, which should cover most backward code compatibility issues. The settings and correction data under the Input/Output front-panel key (examples: Input Z Corr, Ext Amp Gain, etc.) are no longer part of any Mode, so they will not be preset by a Mode Preset. They are preset using Restore Input/Output Defaults, Restore System Defaults All. Note that because User Preset does a Recall State, and all of these settings are saved in State, they ARE recalled when using

	User Preset.
Initial S/W Revision	Prior to A.02.00

How-To Preset

The table below shows all possible presets, their corresponding SCPI commands and front-panel access (key paths). Instrument settings depend on the current measurement context. Some settings are local to the current measurement, some are global (common) across all the measurements in the current mode, and some are global to all the available modes. In a similar way, restoring the settings to their preset state can be done within the different contexts.

Auto Couple - is a measurement local key. It sets all Auto/Man parameter couplings in the measurement to Auto. Any Auto/Man selection that is local to other measurements in the mode will not be affected.

Meas Preset - is a measurement local key. Meas Preset resets all the variables local to the current measurement except the persistent ones.

Mode Preset - resets all the current mode's measurement local and measurement global variables except the persistent ones.

Restore Mode Defaults - resets ALL the Mode variables (and all the Meas global and Meas local variables), including the persistent ones.

Type Of Preset	SCPI Command	Front Panel Access
Auto Couple	:COUPle ALL	Auto Couple front-panel key
Meas Preset	:CONFigure:<Measurement>	Meas Setup Menu
Mode Preset	:SYSTem:PRESet	Mode Preset (green key)
Restore Mode Defaults	:INSTrument:DEFault	Mode Setup Menu
Restore All Mode Defaults	:SYSTem:DEFault MODes	System Menu; Restore System Default Menu
*RST	*RST	not possible (Mode Preset with Single)
Restore Input/Output Defaults	:SYSTem:DEFault INPUt	System Menu; Restore System Default Menu
Restore Power On Defaults	:SYSTem:DEFault PON	System Menu; Restore System Default Menu
Restore Alignment Defaults	:SYSTem:DEFault ALIGN	System Menu; Restore System Default Menu
Restore Miscellaneous Defaults	:SYSTem:DEFault MISC	System Menu; Restore System Default Menu
Restore All System Defaults	:SYSTem:DEFault [ALL] :SYSTem:PRESet:PERsistent	System Menu; Restore System Default Menu
User Preset	:SYSTem:PRESet:USER	User Preset Menu
User Preset All Modes	:SYSTem:PRESet:USER:ALL	User Preset Menu

Power On Mode Preset	:SYSTem:PON:TYPE MODE	System Menu
Power On User Preset	:SYSTem:PON:TYPE USER	System Menu
Power On Last State	:SYSTem:PON:TYPE LAST	System Menu

Mode Setup

See "[Mode Setup](#)" on page 242

Peak Search

Places the selected marker on the trace point with the maximum y-axis value. Pressing Peak Search with the selected marker Off causes the selected marker to be set to Normal, then a peak search is immediately performed.

Key Path	Front panel key
Mode	SA, WCDMA, C2K, WIMAX OFDMA, 1xEVDO, DVB-T/H, DTMB (CTTB), ISDB-T, CMMB, LTE, LTETDD, Digital Cable TV, WLAN, MSR, LTEAFDD, LTEATDD
Remote Command	:CALCulate:CHPower:MARKer[1] 2 ... 12:MAXimum
Example	CALC:CHP:MARK2:MAX
Initial S/W Revision	Prior to A.02.00
Modified at S/W Revision	A.02.00, A.03.00

8 Channel Power Measurement
Print

Print

See ["Print" on page 271](#)

Quick Save

The Quick Save front-panel key repeats the most recent save that was performed from the Save menu, with the following exceptions:

- Register saves are not remembered as Saves for the purpose of the Quick Save function
- If the current measurement does not support the last non-register save that was performed, an informational message is generated, “File type not supported for this measurement”

Quick Save repeats the last type of qualified save (that is, a save qualified by the above criteria) in the last save directory by creating a unique filename using the Auto File Naming algorithm described below.

If Quick Save is pressed after startup and before any qualified Save has been performed, the Quick Save function performs a Screen Image save using the current settings for Screen Image saves (current theme, current directory), which then becomes the “last save” for the purpose of subsequent Quick Saves.

The Auto File Naming feature automatically generates a file name for use when saving a file. The filename consists of a prefix and suffix separated by a dot, as is standard for the Windows® file system. A default prefix exists for each of the available file types:

Type	Default Prefix	Menu
State	State_	(Save/Recall)
Trace + State	State_	(Save/Recall)
Screen	Screen_	(Save/Recall)
Amplitude Corrections	Ampcor_	(Import/Export)
Traces	Trace_	(Import/Export)
Limit Lines	LLine_	(Import/Export)
Measurement Result	MeasR_	(Import/Export)
Capture Buffer	CapBuf_	(Import/Export)

A four digit number is appended to the prefix to create a unique file name. The numbering sequence starts at 0000 within each Mode for each file type and updates incrementally to 9999, then wraps to 0000 again. It remembers where it was through a Mode Preset and when leaving and returning to the Mode. It is reset by Restore Misc Defaults and Restore System Defaults and subsequent running of the instrument application. So, for example, the first auto file name generated for State files is State_0000.state. The next is State_0001, and so forth.

One of the key features of Auto File Name is that we guarantee that the Auto File Name will never conflict with an existing file. The algorithm looks for the next available number. If it gets to 9999, then it looks for holes. If it find no holes, that is no more numbers are available, it gives an error.

For example, if when we get to State_0010.state there is already a State_0010.state file in the current directory, it advances the counter to State_0011.state to ensure that no conflict will exist (and then it verifies that State_0011.state also does not exist in the current directory and advances again if it does, and so forth).

If you enter a file name for a given file type, then the prefix becomes the filename you entered instead of the default prefix, followed by an underscore. The last four letters (the suffix) are the 4-digit number.

For example, if you save a measurement results file as “fred.csv”, then the next auto file name chosen for a measurement results save will be fred_0000.csv.

NOTE

Although 0000 is used in the example above, the number that is used is actually the current number in the Meas Results sequence, that is, the number that would have been used if you had not entered your own file name.

NOTE

If the filename you entered ends with _dddd, where d=any number, making it look just like an auto file name, then the next auto file name picks up where you left off with the suffix being dddd + 1.

Key Path	Front-panel key
Notes	No remote command for this key specifically.
Initial S/W Revision	Prior to A.02.00

Recall

In the LTE-Advanced TDD/FDD modes, two types of recall functions are available under the Data menu: “Parameter Configuration per Component Carrier” and “Limit Mask”. Limit Mask enables setting a preset limit mask for Power Suite-based measurements, and currently it is available for the SEM, ACP and SPUR measurements in LTE-Advanced TDD/FDD modes.

Recalling the complicated RB settings specified in the test models of the standards and the LTE state file. And it can also recalls the parameters which have been set and saved for “Signal Studio Setup” or “89600 Vector Signal Analyzer” on the external platform .

Key Path	Front Panel Key
Mode	LTEATDD, LTEAFDD
Initial S/W Revision	A.14.00

State

The Recall State menu lets you choose a register or file from which to recall the state.

The content of a state file includes all of the settings and data required to return the analyzer as closely as possible to the Mode it was in, with the exact settings that were in place, when the save occurred. The Mode settings in each state file include the settings that are affected by Mode Preset, as well as the additional settings affected by Restore Mode Defaults; all of the Mode’s settings. In addition, all of the settings of the Input/Output system are included, even though they are outside of the Mode’s state, because they are needed to restore the complete setup. Persistent System settings (for example, GPIB address) are not affected by either a Mode Preset or Restore Mode Defaults, nor are they included in a saved State file.

Since each state file is only for one Mode, the settings for other Modes are unaffected when it is loaded. Recall State will cause a mode switch if the state being recalled is not from the current active mode.

After the recall completes, the message "File <filename> recalled" or “Recalled State Register <register number>” is displayed.

For rapid recalls, the State menu lists 16 registers that you can choose from to recall. Pressing a Register key initiates the recall. You can also select a file from which to recall.

The default path for all State Files is:

My Documents\<>mode name>\state

where <mode name> is the parameter used to select the mode with the INST:SEL command (for example, SA for the Spectrum Analyzer).

See "[More Information](#)" on page 430.

Key Path	Recall
Mode	All
Remote Command	:MMEMory:LOAD:STATe <filename>

Example	:MMEM:LOAD:STAT "myState.state" This recalls the file myState.state on the default path
Example	MMEM:LOAD:STAT "MyStateFile.state" This loads the state file data (on the default file directory path) into the instrument state.
Notes	<p>When you pick a file to recall, the analyzer first verifies that the file is recallable in the current instrument by checking the software version and model number of the instrument. If everything matches, a full recall proceeds by aborting the currently running measurement, clearing any pending operations, and then loading the State from the saved state file. You can open state files from any mode, so recalling a State file switches to the mode that was active when the save occurred. After switching to the mode of the saved state file, mode settings and data (if any for the mode) are loaded with values from the saved file. The saved measurement of the mode becomes the newly active measurement and the data relevant to the measurement (if there is any) is recalled.</p> <ul style="list-style-type: none"> • If there is a mismatch between file version or model number or instrument version or model number, the recall function tries to recall as much as possible and returns a warning message. It may limit settings that differ based on model number, licensing or version number. <p>After recalling the state, the Recall State function does the following:</p> <ul style="list-style-type: none"> • Makes the saved measurement for the mode the active measurement. • Clears the input and output buffers. • Status Byte is set to 0. • Executes a *CLS <p>If the file specified is empty an error is generated. If the specified file does not exist, another error is generated. If there is a mismatch between the file and the proper file type, an error is generated. If there is a mismatch between file version or model number or instrument version or model number, a warning is displayed. Then it returns to the State menu and File Open dialog goes away.</p> <p>After the Recall, the analyzer exits the Recall menu and returns to the previous menu.</p>
Backwards Compatibility SCPI	:MMEMory:LOAD:STATe 1,<filename> For backwards compatibility, the above syntax is supported. The "1" is simply ignored.
Initial S/W Revision	Prior to A.02.00

More Information

In measurements that support saving Traces, for example, Swept SA, the Trace data is saved along with the State in the State file. When recalling the State, the Trace data is recalled as well. Traces are recalled exactly as they were stored, including the writing mode and update and display modes. If a Trace was updating and visible when the State was saved, it will come back updating and visible, and its data will be rewritten right away. When you use State to save and recall traces, any trace whose data must be preserved should be placed in View or Blank mode before saving.

The following table describes the Trace Save and Recall possibilities:

You want to recall state and one trace's data, leaving other traces unaffected.	Save Trace+State from 1 trace. Make sure that no other traces are updating (they should all be in View or Blank mode) when the save is performed.	On Recall, specify the trace you want to load the one trace's data into. This trace will load in View. All other traces' data will be unaffected, although their trace
---	---	--

You want to recall all traces	Save Trace+State from ALL traces.	mode will be as it was when the state save was performed. On Recall, all traces will come back in View (or Blank if they were in Blank or Background when saved)
You want all traces to load exactly as they were when saved.	Save State	On recall, all traces' mode and data will be exactly as they were when saved. Any traces that were updating will have their data immediately overwritten.

From File...

When you press “From File”, the analyzer brings up a Windows dialog and a menu entitled “File Open.” This menu allows you to navigate to the various fields in the Windows dialog without using a keyboard or mouse. The Tab and Arrow keys can also be used for dialog navigation.

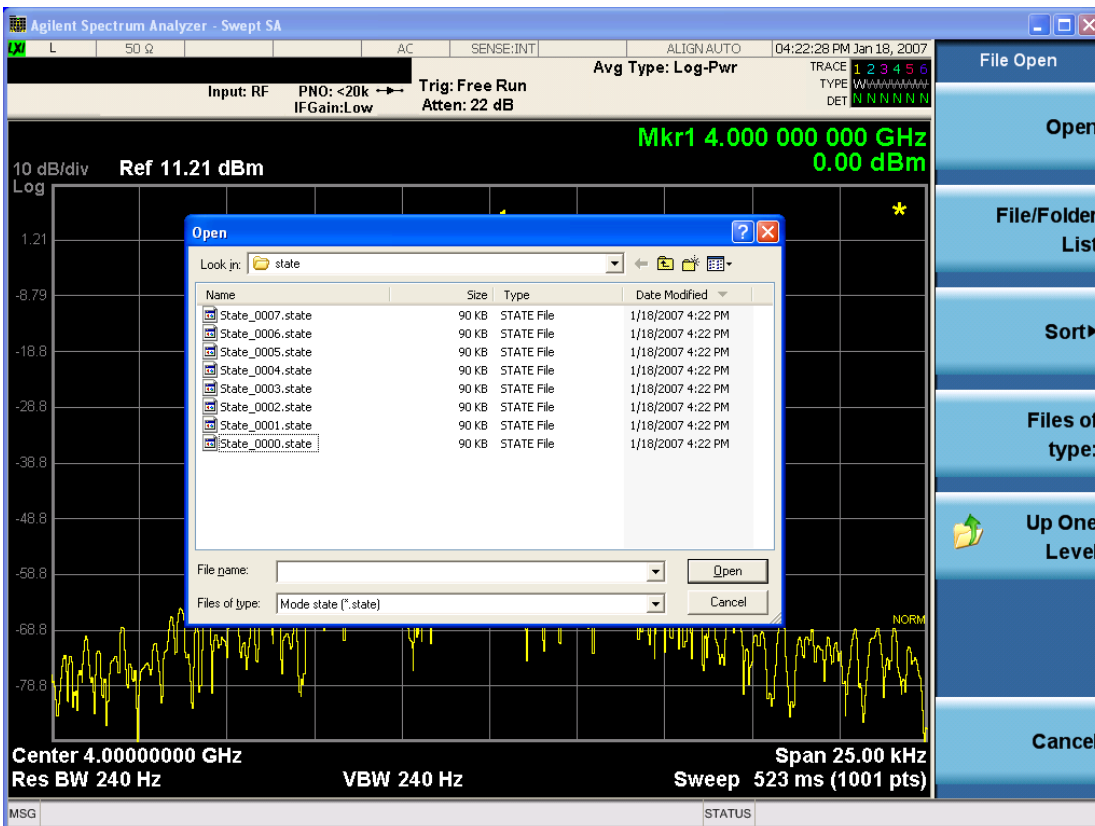

Listed below are the functions of the various fields in the dialog, and the corresponding softkeys:

Open

Performs the recall of the specified file. While the recall is being performed, the floppy icon appears briefly in the Meas bar.

File/Folder List

Enables you to navigate to the center of the dialog that contains the list of files and folders. Once here you can get information about the file and use the tab keys to navigate to the other fields in the dialog, such as Look In.

Look In

The Look In field shows the path from which the file will be recalled and allows you to change the path using the up and down arrow keys to navigate to other paths; the Enter key to open a directory; and the Backspace key to go back one directory. The **Look In field** first uses the last path from the Save As dialog **Save In:** path for that same file type. There is no softkey for directly navigating to the Look In field, but you can use the left tab to get here from the File/Folder List.

User specified paths are remembered when you leave and return to a Mode and are reset back to the default using Restore Mode Defaults.

Sort

Accesses a menu that enables you to sort the files within the File Open dialog. Only one sorting type can be selected at a time and the sorting happens immediately. The sorting types are By Date, By Name, By extension, and By Size.

Files of Type

This field shows the file suffix for the type of file you have selected to recall. For example, if you navigated here while recalling State, "Mode state (*.state)" is in the field. If you navigated here while recalling Trace, ""Mode state (*.trace)" is in the field. If you navigated here while importing a trace data file, "Trace Data (*.csv)" is in the field. For some file types, there is more than one choice in the dropdown menu, which you can select by using the up and down arrow keys and Enter.

Up One Level

This key corresponds to the icon of a folder with the up arrow that is in the tool bar of the dialog. When pressed, it causes the file and folder list to navigate up one level in the directory structure. The Backspace key does the same thing.

Cancel

This key corresponds to the Cancel selection in the dialog. It causes the current **Open** request to be cancelled. The ESC key does the same thing.

Key Path	Recall, State
Notes	Brings up the Open dialog for recalling a State Save Type
Initial S/W Revision	Prior to A.02.00

Edit Register Names

You may enter a custom name on any of the Register keys, to help you remember what you are using that state to save. To do this, press the Edit Register Names key, choose the register whose name you wish to edit, and then enter the desired label using the Alpha Editor or an external PC keyboard.

The maximum number of characters that can be added is 30. In most cases, 30 characters will fit on two lines of the key.

For more information and the SCPI command, see Edit Register Names under the Save, State function.

Key Path	Recall, State
Mode	All
Dependencies	N9060A-7FP or N9060B-2FP license required to edit the register names. When the feature is not licensed, sending the SCPI command generates an error, -221, "Settings conflict;Option not available"
Initial S/W Revision	A.11.00

Register 1 thru Register 16

Selecting any one of these register keys causes the State of the mode from the specified Register to be recalled. Each of the register keys annotates whether it is empty or at what date and time it was last modified. In addition, you can use the Edit Register Names key under Save, State to enter custom names for each register.

NOTE

In products that run multiple instances of the X-Series Application, recalling the same register name on each instance is a way to share setups between the instances.

Registers are shared by all modes, so recalling from any one of the registers will cause a mode switch to the mode that was active when the save to the Register occurred.

Although these 16 registers are the only registers available from the front panel, there are 128 state registers available in the instrument. Registers 17-128 are only available from the SCPI interface, using the *RCL command.

After the recall completes, the message "Register <register number> recalled" appears in the message bar. If you are in the Spectrum Analyzer Mode, and you are recalling a register that was saved in the Spectrum Analyzer Mode, then after the recall, you will still be in the Recall Register menu. If the Recall causes you to switch modes, then after the Recall, you will be in the Frequency menu.

If a requested register is empty an error is generated.

Key Path	Recall, State
Example	*RCL 1
Range	1-16 from front panel, 1-128 from SCPI
Readback	Date and time with seconds resolution are displayed on the key OR A custom name of up to 30 characters entered using the Save, State,Edit Register Names key

	OR “(empty)” if no prior save operation has been performed to this register.
Initial S/W Revision	Prior to A.02.00
Modified at S/W Revision	Prior to A.11.00

Register 1 thru Register 16

Selecting any one of these register keys causes the State of the mode from the specified Register to be recalled. Each of the register keys annotates whether it is empty or at what date and time it was last modified. In addition, you can use the Edit Register Names key under Save, State to enter custom names for each register.

NOTE In products that run multiple instances of the X-Series Application, recalling the same register name on each instance is a way to share setups between the instances.

Registers are shared by all modes, so recalling from any one of the registers will cause a mode switch to the mode that was active when the save to the Register occurred.

Although these 16 registers are the only registers available from the front panel, there are 128 state registers available in the instrument. Registers 17–128 are only available from the SCPI interface, using the *RCL command.

After the recall completes, the message "Register <register number> recalled" appears in the message bar. If you are in the Spectrum Analyzer Mode, and you are recalling a register that was saved in the Spectrum Analyzer Mode, then after the recall, you will still be in the Recall Register menu. If the Recall causes you to switch modes, then after the Recall, you will be in the Frequency menu.

If a requested register is empty an error is generated.

Key Path	Recall, State
Example	*RCL 1
Range	1–16 from front panel, 1–128 from SCPI
Readback	Date and time with seconds resolution are displayed on the key OR A custom name of up to 30 characters entered using the Save, State, Edit Register Names key OR “(empty)” if no prior save operation has been performed to this register.
Initial S/W Revision	Prior to A.02.00
Modified at S/W Revision	Prior to A.11.00

Sequences

These keys allow you to import a Tab separated or .txt file that will automatically setup all the parameters required for building a Sequence. The parameters will automatically be loaded into the Stated Sequencer.

Once selected, in order to import the selected Sequence Type you must select the Open key in the Source Sequence menu.

Key Path	Recall, Sequences
Mode	All
Remote Command	:MMEMory:LOAD:SEQ:Sequences: SLIS ALIS SAALIS "MySequence.txt"
Example	:MMEM:LOAD:SEQ:SLIS "MySequence.txt"
Notes	Available file types are: –CSV (Comma delimited) (*.csv) –Text (Tab delimited) (*.txt)
Initial S/W Revision	A.05.00

Source Sequence

The list of parameters, that configure steps, that makes up a sequence for the Source.

The Source sequence is a sequence of flexible configurable steps that can be set anywhere in the instruments frequency range.

Key Path	Recall, Sequences
Example	:MMEM:LOAD:SEQ:SLIS "MySequence.txt"
Dependencies	Only available in XOBT
Initial S/W Revision	A.05.00

Open...

When you press “Open”, the analyzer brings up a Windows dialog and a menu entitled “**File Open.**” This menu allows you to navigate to the various fields in the Windows dialog without using a keyboard or mouse. The Tab and Arrow keys can also be used for dialog navigation.

See "[From File...](#)" on page 2401 in Recall, State, for a full description of this dialog and menu.

Key Path	Recall, Data
Notes	The key location is mode-dependent and will vary. Brings up Open dialog for recalling a <mode specific> Save Type
Initial S/W Revision	Prior to A.02.00

Data (Import)

Importing a data file loads data that was previously saved from the current measurement or from other measurements and/or modes that produce compatible data files. The Import Menu only contains Data Types that are supported by the current measurement.

Since the commonly exported data files are in .csv format, the data can be edited by the user prior to importing. This allows you to export a data file, manipulate the data in Excel (the most common PC Application for manipulating .csv files) and then import it.

Importing Data loads measurement data from the specified file into the specified or default destination, depending on the data type selected. Selecting an Import Data menu key will not actually cause the importing to occur, since the analyzer still needs to know from where to get the data. Pressing the Open key in this menu brings up the Open dialog and Open menu that provides you with the options from where to recall the data. Once a filename has been selected or entered in the Open menu, the recall occurs as soon as the Open button is pressed.

Key Path	Recall
Mode	All
Notes	The menu is built from whatever data types are available for the mode. Some keys will be missing completely, so the key locations in the sub-menu will vary. No SCPI command directly controls the Data Type that this key controls. The Data Type is included in the MMEM:LOAD commands.
Dependencies	If a file type is not used by a certain measurement, it is grayed out for that measurement. The key for a file type will not show at all if there are no measurements in the Mode that support it.
Preset	Is not affected by Preset or shutdown, but is reset during Restore Mode Defaults
Readback	The data type that is currently selected
Initial S/W Revision	Prior to A.02.00

Component Carrier Setup

Enables you to import LTE-A setup files for all Component Carriers or the specified Component Carrier. Selecting this key displays a menu that enables you to select what the Component Carrier setup files to be imported. After making this selection, depress Open... and use the file dialog to select the file you wish to recall. The Key is valid for Conformance EVM measurements only.

It supports to the following import file formats

- LTE app state files (*.state)
- EVM Setup Files (*.evms)
- 89601 VSA Setup Files (*.set, *.setx)
- Signal Studio Setup Files (*.scp)

App State Files

Extension: state

The parameters of the LTE Modulation Analysis measurement can be imported to LTE-Advanced EVM and CEVM measurements from the LTE .state file. It depends on the parameter of the Component Carrier Setup to decide which component carriers' measurement parameters are affected.

Pressing OPEN under the Import Data menu will open the above directory from which you can select an LTE app state file.

EVM Setup Files

Extension: evms

It will recall LTE test model parameters specified in the standards to LTE-Advanced FDD/TDD EVM and CEVM measurements. It depends on the parameter of the Component Carrier Setup to decide which component carriers 'measurement parameters are affected.

The default path is My Documents\LTEATDD\LTEAFDD\data\evmsetup. Note that "My Documents" is an alias to a directory and its place differs depending on which user is logged in. At XSA start up, XSA will overwrite all of the EVM Setup files to the current user's "My Documents\LTEATDD\LTEAFDD\data\evmsetup" each time.

Pressing OPEN under the Import Data menu will open the above directory from which you can select an EVM Setup file.

You cannot read the contents of the provided EVM Setup file since it is a binary file.

89601 VSA Setup Files

Extension: set, setx

The 89600 Vector Signal Analyzer Setup file created using the 89600 Vector Signal Analyzer Option BHD (LTETDD|LTEFDD) can be imported as LTE-Advanced TDD/FDD EVM and CEVM parameter sets.

The 89600 Vector Signal Analyzer Setup file created using the 89600 Vector Signal Analyzer Option BHD (LTEATDD|LTEAFDD) can be imported as LTE-Advanced TDD/FDD EVM and CEVM parameter sets.

Which component carriers 'measurement parameters are affected depends on depends on the parameter of the Component Carrier Setup.

If the setup file is not loaded successfully, an error message, -230 "Data corrupt or stale", is issued with the specified file name.

Signal Studio Setup Files

Extension: scp

The Keysight Signal Studio setup file created using Signal Studio (N7624B/N7625B) can be imported as LTE-Advanced TDD/FDD parameter set.

Supported component carrier types are listed in the table below:

<i>Signal Studio</i>	<i>Carrier Type</i>
N7624B Signal Studio for 3GPP LTE	Advanced LTE FDD Downlink (2009-03)
	Advanced LTE FDD Downlink (2009-12)
	Advanced LTE FDD Downlink (2010-06)
	Advanced LTE FDD Uplink (2009-12)
	Advanced LTE FDD Uplink (2010-06)
	Basic LTE FDD Downlink (2009-03)
	Basic LTE FDD Downlink (2009-12)
	Basic LTE FDD Downlink (2010-06)
	Basic LTE FDD Uplink (2009-03)

	Basic LTE FDD Uplink (2009-12)
	Basic LTE FDD Uplink (2010-06)
	Basic LTE-A FDD Downlink (2010-12)
	Basic LTE-A FDD Uplink (2010-12)
	Basic LTE FDD R9 Downlink
	Basic LTE FDD R9 Uplink
	Advanced LTE FDD R9 Downlink
	Advanced LTE FDD R9 Uplink
	Basic LTE-A FDD R10 Downlink
	Basic LTE-A FDD R10 Uplink
N7625B Signal Studio for 3GPP LTE TDD	Advanced LTE TDD (2009-03)
	Advanced LTE TDD (2009-12)
	Basic LTE TDD (2009-03)
	Basic LTE TDD (2009-12)
	Basic LTE-A TDD (2010-01)
	Basic LTE-A TDD R10 (2010-12)

If the setup file is not loaded successfully, an error message, -230 "Data corrupt or stale", is issued with the specified file name.

Key Path	Recall, Data
Mode	LTEATDD, LTEAFDD
Remote Command	MME ^M emory:LOAD:SETup ALL CC0 CC1 CC2 CC3 CC4,<string>
Example	MME ^M :LOAD:SETup CC0,"LTE-A TDD.set"
Notes	The options CC1~CC4 can be enabled with 9080B/9082B-2FP license.
Notes	"ALL" is primarily used to LTE-A setup file for each component carrier including the number of component carriers. "CC*" is used to import LTE-A setup file for the specified component carrier.
Backwards Compatibility SCPI	MME ^M emory:LOAD:SSSetup <string> MME ^M emory:LOAD:VSASetup <string> MME ^M emory:LOAD:EVMSSetup <string>
Initial S/W Revision	A.14.00
Modified at S/W Revision	A.14.50

Masks

This key enables you to recall a preset mask file which contains Offset and Limit settings. Parameters except them will not be overwritten. You cannot change or create preset mask files since they are binary files. This key is valid for the Spectrum Emission Mask, ACP and Spurious Emissions measurements.

Default path: “My Documents\LTEATDD\LTEAFDD\data\masks”

Note that “**My Documents**” is an alias to a directory and its location depends on which user is logged in. At XSA start up, all of the limit mask files in the current user’s “My Documents\LTEATDD\LTEAFDD\data\masks” directory are overwritten.

File type: Binary

Filename: The filename follows the rule below with the words connected using underscores.

<Measurement>_<Condition>.mask

Where

<Measurement> Measurement the limit mask file is applied to: SEM, ACP or SPUR

<Condition> Condition. It depends on the measurement.

File extension: .mask

File Dialog Filter: Preset Mask Files (*.mask)

Selecting OPEN... under the Import Data menu opens the above directory enabling you to select a mask file.

Details of the masks are provided in the default folder of masks with the PDF extension.

Key Path	Recall, Data
Mode	LTEATDD, LTEAFDD
Remote Command	MMEemory:LOAD:MASK <string>
Example	MME:LOAD:MASK “ACP_BS\ACP_BS_3MHz_pairE-UTRA_CatA.mask”
Notes	Parameters related to Limit and Offset are overwritten by the contents of the preset mask file.
Initial S/W Revision	A.14.00

Open...

When you press “Open”, the analyzer brings up a Windows dialog and a menu entitled “**File Open.**” This menu allows you to navigate to the various fields in the Windows dialog without using a keyboard or mouse. The Tab and Arrow keys can also be used for dialog navigation.

See "[From File...](#)" on page 2401 in Recall, State, for a full description of this dialog and menu.

Key Path	Recall, Data
Notes	The key location is mode-dependent and will vary. Brings up Open dialog for recalling a <mode specific> Save Type
Initial S/W Revision	Prior to A.02.00

Restart

The Restart function restarts the current sweep, or measurement, or set of averaged/held sweeps or measurements. If you are Paused, pressing Restart does a Resume.

The Restart function is accessed in several ways:

- Pressing the Restart key
- Sending the remote command INIT:IMMEDIATE
- Sending the remote command INIT:RESTART

See "[More Information](#)" on page 440

Key Path	Front-panel key
Remote Command	:INITiate[:IMMEDIATE] :INITiate:RESTART
Example	:INIT:IMM :INIT:REST
Notes	:INITiate:RESTART and :INITiate:IMMEDIATE perform exactly the same function.
Couplings	Resets average/hold count k. For the first sweep overwrites all active (update=on) traces with new current data. For application modes, it resets other parameters as required by the measurement.
Status Bits/OPC dependencies	This is an Overlapped command. The STATus:OPERation register bits 0 through 8 are cleared. The STATus:QUESTionable register bit 9 (INTEgrity sum) is cleared. The SWEEPING bit is set. The MEASURING bit is set.
Backwards Compatibility Notes	For Spectrum Analysis mode in ESA and PSA, the Restart hardkey and the INITiate:RESTART command restart trace averages (displayed average count reset to 1) for a trace in Clear Write, but did not restart Max Hold and Min Hold. In the X-Series, the Restart hardkey and the INITiate:RESTART command restart not only Trace Average, but MaxHold and MinHold traces as well. For wireless comms modes in ESA and PSA, the Restart hardkey and the INITiate:RESTART command restart every measurement, which includes all traces and numeric results. There is no change to this operation.
Initial S/W Revision	Prior to A.02.00

More Information

The **Restart** function first aborts the current sweep/measurement as quickly as possible. It then resets the sweep and trigger systems, sets up the measurement and initiates a new data measurement sequence with a new data acquisition (sweep) taken once the trigger condition is met.

If the analyzer is in the process of aligning when **Restart** is executed, the alignment finishes before the restart function is performed.

Even when set for Single operation, multiple sweeps may be taken when Restart is pressed (for example, when averaging/holding is on). Thus when we say that **Restart** "restarts a measurement," we may mean:

- It restarts the current sweep
- It restarts the current measurement
- It restarts the current set of sweeps if any trace is in Trace Average, Max Hold or Min Hold
- It restarts the current set of measurements if Averaging, or Max Hold, or Min Hold is on for the measurement
- depending on the current settings.

With **Average/Hold Number** (in **Meas Setup** menu) set to 1, or Averaging off, or no trace in Trace Average or Hold, a single sweep is equivalent to a single measurement. A single sweep is taken after the trigger condition is met; and the analyzer stops sweeping once that sweep has completed. However, with **Average/Hold Number** >1 and at least one trace set to **Trace Average, Max Hold, or Min Hold (SA Measurement)** or **Averaging on (most other measurements)**, multiple sweeps/data acquisitions are taken for a single measurement. The trigger condition must be met prior to each sweep. The sweep is stopped when the average count k equals the number N set for **Average/Hold Number**. A measurement average usually applies to all traces, marker results, and numeric results; but sometimes it only applies to the numeric results.

Once the full set of sweeps has been taken, the analyzer will go to idle state. To take one more sweep without resetting the average count, increment the average count by 1, by pressing the step up key while **Average/Hold Number** is the active function, or sending the remote command `CALC:AVER:TCON UP`.

Save

The Save menu lets you choose what you want to save and where you want to save it. Among the types of files you can save are **States**, **Traces**, and **Screen Images**. In addition, an Export (Data) option lets you save a number of data types as CSV files for easy import into Excel and other spreadsheet programs.

Key Path	Front-panel key
Mode	All
Notes	No remote command for this key specifically, but the :MMEM:STORe command is available for specific file types. An example is :MMEM:STOR:STATe <filename>.
Initial S/W Revision	Prior to A.02.00

State

The Save State menu lets you choose a register or file for saving the state.

NOTE In products that run multiple instances of the X-Series Application, all instances share the same register and file location where you want to save the state.

The content of a state file includes all of the settings and data required to return the analyzer as closely as possible to the Mode it was in, with the exact settings which were in place, when the save occurred. The Mode settings in each state file include the settings that are affected by Mode Preset, as well as the additional settings affected by Restore Mode Defaults; all of the Mode's settings. In addition, all of the settings of the Input/Output system are included, even though they are outside of the Mode's state, because they are needed to restore the complete setup. Persistent System settings (for example, Verbose SCPI) are not affected by either Mode Preset or Restore Mode Defaults, nor are they included in a saved State file.

After the save completes, the message "File <filename> saved" or "State Register <register number> saved" is displayed.

For rapid saving, the State menu lists 16 registers to save to. Pressing a Register key initiates the save. You can also select a file to save to.

The default path for all State Files is:

My Documents\<<mode name>\state

where <mode name> is the parameter used to select the mode with the INST:SEL command (for example, SA for the Spectrum Analyzer).

Key Path	Save
Mode	All
Remote Command	:MMEMory:STORe:STATe <filename>
Example	MMEM:STOR:STATe "MyStateFile.state" This stores the current instrument state data in the file MyStateFile.state in the default directory.
Notes	Both single and double quotes are supported for any filename parameter over remote.

After saving to a register, that register's menu key is updated with the date the time, unless a custom label has been entered for that key.

After saving to a register, you remain in the Save State menu, so that you can see the Register key update. After saving to a file, the analyzer automatically returns to the previous menu and any Save As dialog goes away.

Backwards Compatibility SCPI :MMEMory:STORe:STATe 1,<filename>

For backwards compatibility, the above syntax is supported. The "1" is simply ignored. The command is sequential.

Initial S/W Revision Prior to A.02.00

To File . . .

When you press "To File", the analyzer brings up a Windows dialog and a menu entitled "Save As." This menu allows you to navigate to the various fields in the Windows dialog without using a keyboard or mouse. The Tab and Arrow keys can also be used for dialog navigation.

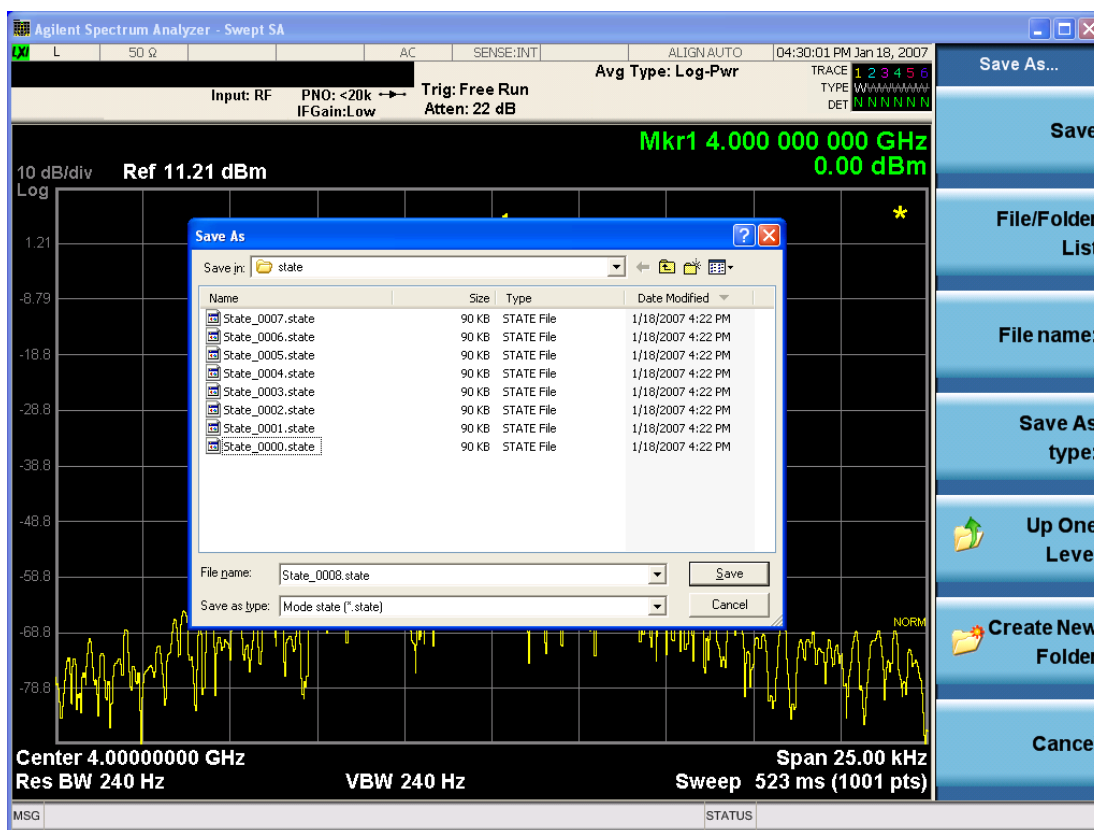

The Listed below

are the functions of the various fields in the dialog, and the corresponding softkeys:

Save

Performs the save to the specified file of the selected type. If the file already exists, a dialog will appear that allows you to replace the existing file by selecting OK, or you can Cancel the request. If you select OK,

the file will be overwritten. Using the C: drive is strongly discouraged, since it runs the risk of being overwritten during an instrument software upgrade.

While the save is being performed, the floppy icon appears briefly in the Meas bar.

File/Folder List

Enables you to navigate to the center of the dialog that contains the list of files and folders. Once here you can get information about the file and use the tab keys to navigate to the other fields in the dialog, such as Save In.

Save In

The Save In field shows the path to which the file will be saved and allows you to change the path using the up and down arrow keys to navigate to other paths; the Enter key to open a directory; and the Backspace key to go back one directory. The **Save In field** defaults to the default path for this type of file and remembers the last path you used to save this type of file. There is no softkey for directly navigating to the Save In field but you can use left tab to get here from the File/Folder List.

User specified paths are remembered when you leave and return to a Mode and are reset back to the default using Restore Mode Defaults.

File Name

The File Name field is initially loaded with an automatically generated filename specific to the appropriate Save Type. The automatically generated filename is guaranteed not to conflict with any filename currently in the directory. You may replace or modify this filename using the File Name key. See the ["Quick Save " on page 2397](#) documentation for more on the automatic file naming algorithm.

When you press the File Name key the analyzer displays the Alpha Editor. Use the knob to choose the letter to add and the front-panel Enter key to add the letter to the file name. The BK character moves you back and the FW character moves you forward in the filename. The Select key on the front panel generates a space character. When you are done entering the filename press the Done softkey. This returns back to the **File Open** dialog and menu, but does not cause the save to occur.

Save As Type

This field shows the file suffix for the type of file you have selected to save. For example, if you navigated here while saving State, "Mode state (*.state)" is in the field. If you navigated here from saving Trace, ""Mode state (*.trace)" is in the field. If you navigated here while exporting a trace data file, "Trace Data (*.csv)" is in the field. For some file types, there is more than one choice in the dropdown, which you can select by using the up and down arrow keys and Enter.

Up One Level

This key corresponds to the icon of a folder with the up arrow that is in the tool bar of the dialog. When pressed, it causes the file and folder list to navigate up one level in the directory structure. The Backspace key does the same thing.

Create New Folder

This key corresponds to the icon of a folder with the "*" that is in the tool bar of the dialog. When pressed, a new folder is created in the current directory with the name **New Folder** and you can enter a new folder name using the Alpha Editor.

Cancel

This key corresponds to the Cancel selection in the dialog. It causes the current **Save As** request to be cancelled. The ESC key does the same thing.

Key Path	Save, State
Mode	All
Notes	Brings up Save As dialog for saving a State Save Type
Initial S/W Revision	Prior to A.02.00

Edit Register Names

You may enter a custom name on any of the Register keys, to help you remember what you are using that state to save. To do this, press the Edit Register Names key, choose the register whose name you wish to edit, and then enter the desired label using the Alpha Editor or an external PC keyboard.

The maximum number of characters that can be added is 30. In most cases, 30 characters will fit on two lines of the key.

See ["More Information" on page 445](#)

Key Path	Save, State
Mode	All
Remote Command	:MMEMory:REGister:STATe:LABel <reg number>,"label" :MMEMory:REGister:STATe:LABel? <reg number>
Example	:MMEM:REG:STAT:LAB 1,"my label"
Notes	<reg number> is an integer from 1 to 16. If the SCPI specifies an invalid register number an error message is generated, -222,"Data out of range;Invalid register label number" "label" is a string from 0 to 30 characters in length. If a label exceeds 30 characters, an error message is generated, -150,"String data error;Label clipped to 30 characters" "label" of length 0 erases the custom label and restores the default (time and date) label. E.g.: :MMEM:REG:STAT:LAB 1,""
Dependencies	N9060A-7FP or N9060B-2FP license required to edit the register names. When the feature is not licensed, sending this command generates an error, -221,"Settings conflict;Option not available"
Preset	The names are unaffected by Preset or power cycle but are set to the default label (time and date) on a "Restore System Defaults->Misc"
Initial S/W Revision	A.11.00

More Information

When you edit one of the register names, the time and date field will be replaced by the custom name.

If you delete all the characters in the custom name, it restores the default (time and date).

The register names are stored within the state files, but they are not part of the instrument state; that is, once you have edited a register name, loading a new state will not change that register name. Another

consequence of this is that the names will be persistent through a power cycle. Also, if a named state file is transferred to another analyzer, it will bring its custom name along with it.

If you try to edit the name of an empty register, the analyzer will first save the state to have a file to put the name in. If you load a named state file into an analyzer with older firmware it will ignore the metadata.

The *SAV and *RCL commands will not be affected by the custom register names, nor will the MMEM commands.

Register 1 thru Register 16

Selecting any one of these register menu keys causes the State of the currently active mode to be saved to the specified Register. The registers are provided for rapid saving and recalling, since you do not need to specify a filename or navigate to a file. Each of the register menu keys annotates whether it is empty or at what date and time it was last modified. In addition, you can use the Edit Register Names key to enter custom names for each register.

NOTE

In products that run multiple instances of the X-Series Application, save with different register name if you do not want to overwrite the register of another running instance.

Although these 16 registers are the only registers available from the front panel, there are 128 state registers available in the instrument. Registers 17–128 are only available from the SCPI interface, using the *SAV command.

There is one set of 128 state registers in the instrument, not one set for each Mode. When a state is saved, the Mode it was saved from is saved with it; then when it is recalled, the instrument switches to that Mode.

After the save completes, the corresponding register menu key annotation is updated with the date and time and the message "Register <register number> saved" is displayed.

Key Path	Save, State
Mode	All
Example	*SAV 1
Range	1–16 from front panel, 1–128 from SCPI
Readback	Date and time with seconds resolution are displayed on the key OR A custom name of up to 30 characters entered using the Edit Register Names key OR “(empty)” if no prior save operation has been performed to this register.
Initial S/W Revision	Prior to A.02.00
Modified at S/W Revision	A.11.00

Register 1 thru Register 16

Selecting any one of these register menu keys causes the State of the currently active mode to be saved to the specified Register. The registers are provided for rapid saving and recalling, since you do not need to specify a filename or navigate to a file. Each of the register menu keys annotates whether it is empty or at

what date and time it was last modified. In addition, you can use the Edit Register Names key to enter custom names for each register.

NOTE In products that run multiple instances of the X-Series Application, save with different register name if you do not want to overwrite the register of another running instance.

Although these 16 registers are the only registers available from the front panel, there are 128 state registers available in the instrument. Registers 17–128 are only available from the SCPI interface, using the *SAV command.

There is one set of 128 state registers in the instrument, not one set for each Mode. When a state is saved, the Mode it was saved from is saved with it; then when it is recalled, the instrument switches to that Mode.

After the save completes, the corresponding register menu key annotation is updated with the date and time and the message "Register <register number> saved" is displayed.

Key Path	Save, State
Mode	All
Example	*SAV 1
Range	1–16 from front panel, 1–128 from SCPI
Readback	Date and time with seconds resolution are displayed on the key OR A custom name of up to 30 characters entered using the Edit Register Names key OR “(empty)” if no prior save operation has been performed to this register.
Initial S/W Revision	Prior to A.02.00
Modified at S/W Revision	A.11.00

Mass Storage Catalog (Remote Command Only)

Key path	SCPI Only
Remote Command	:MMEMory:CATalog? [<directory_name>]
Notes	The string must be a valid logical path. Queries disk usage information (drive capacity, free space available) and obtains a list of files and directories in a specified directory in the following format: <numeric_value>,<numeric_value>,{<file_entry>} It returns two numeric parameters and as many strings as there are files and directories. The first parameter indicates the total amount of storage currently used in bytes. The second parameter indicates the total amount of storage available, also in bytes. The <file_entry> is a string. Each <file_entry> indicates the name, type, and size of one file in the directory list: <file_name>,<file_type>,<file_size> As the windows file system has an extension that indicates file type, <file_type> is always empty. <file_size> provides the size of the file in bytes. For directories, <file_entry> is surrounded by square brackets and both <file_type> and <file_size> are empty
Initial S/W Revision	Prior to A.02.00

Mass Storage Change Directory (Remote Command Only)

Key path	SCPI Only
Remote Command	:MMEMory:CDIRectory [<directory_name>] :MMEMory:CDIRectory?
Notes	The string must be a valid logical path. Changes the default directory for a mass memory file system. The <directory_name> parameter is a string. If no parameter is specified, the directory is set to the *RST value. At *RST, this value is set to the default user data storage area, that is defined as System.Environment.SpecialFolder.Personal. Query returns full path of the default directory.
Initial S/W Revision	Prior to A.02.00

Mass Storage Copy (Remote Command Only)

Key path	SCPI Only
Remote Command	:MMEMory:COPY <string>,<string>[,<string>,<string>]
Notes	The string must be a valid logical path. Copies an existing file to a new file or an existing directory to a new directory. Two forms of parameters are allowed. The first form has two parameters. In this form, the first parameter specifies the source, and the second parameter specifies the destination. The second form has four parameters. In this form, the first and third parameters specify the source. The second and fourth parameters specify the directories. The first pair of parameters specifies the source. The second pair specifies the destination. An error is generated if the source doesn't exist or the destination file already exists. This command will generate an "access denied" error if the destination is a restricted folder (e.g., C:\Windows) and the current user does not have Power User or Administrator privileges.

Mass Storage Device Copy (Remote Command Only)

This command transfers data to/from a file and a peripheral device.

Key path	SCPI Only
Remote Command	:MMEMory:COPY:DEvice <source_string>,<dest_string>
Notes	The strings must be a valid logical path or a valid device keyword. If the dest_string is a device keyword, the data is copied from the source file to the device. If the source_string is a device keyword, the data is copied to the source file from the device. Valid device keywords are: SNS (smart noise source) An error is generated if the file or device is not found.

Mass Storage Delete (Remote Command Only)

Key path	SCPI Only
Remote Command	:MMEMory:DELeTe <file_name>[,<directory_name>]
Notes	The string must be a valid logical path. Removes a file from the specified directory. The <file_name> parameter specifies the file name to be removed. This command will generate an “access denied” error if the file is in a restricted folder (e.g., C:\Windows) and the current user does not have Power User or Administrator privileges.
Initial S/W Revision	Prior to A.02.00

Mass Storage Data (Remote Command Only)

Creates a file containing the specified data OR queries the data from an existing file.

Key path	SCPI Only
Remote Command	:MMEMory:DATA <file_name>, <data> :MMEMory:DATA? <file_name>
Notes	The string must be a valid logical path. The command form is MMEMory:DATA <file_name>,<data>. It loads <data> into the file <file_name>. <data> is in 488.2 block format. <file_name> is string data. The query form is MMEMory:DATA? <file_name> with the response being the associated <data> in block format.
Initial S/W Revision	Prior to A.02.00

Mass Storage Make Directory (Remote Command Only)

Key path	SCPI Only
Remote Command	:MMEMory:MDIRectory <directory_name>
Notes	The string must be a valid logical path. Creates a new directory. The <directory_name> parameter specifies the name to be created. This command will generate an “access denied” error if the new directory would be in a restricted folder (e.g., C:\Windows) and the current user does not have Power User or Administrator privileges.
Initial S/W Revision	Prior to A.02.00

Mass Storage Move (Remote Command Only)

Key path	SCPI Only
Remote Command	:MMEMory:MOVE <string>,<string>[,<string>,<string>]
Notes	The string must be a valid logical path. Moves an existing file to a new file or an existing directory to a new directory.

Two forms of parameters are allowed. The first form has two parameters. In this form, the first parameter specifies the source, and the second parameter specifies the destination.

The second form has four parameters. In this form, the first and third parameters specify the source. The second and fourth parameters specify the directories. The first pair of parameters specifies the source. The second pair specifies the destination. An error is generated if the source doesn't exist or the destination file already exists.

This command will generate an "access denied" error if the destination is a restricted folder (e.g., C:\Windows) and the current user does not have Power User or Administrator privileges.

Initial S/W Revision	Prior to A.02.00
----------------------	------------------

Mass Storage Remove Directory (Remote Command Only)

Key path	SCPI Only
----------	-----------

Remote Command	:MMEMory:RDIRECTory <directory_name>
-----------------------	--------------------------------------

Notes	<p>The string must be a valid logical path.</p> <p>Removes a directory. The <directory_name> parameter specifies the directory name to be removed. All files and directories under the specified directory shall also be removed.</p> <p>This command will generate an "access denied" error if the folder is a restricted folder (e.g., C:\Windows) or is in a restricted folder and the current user does not have Power User or Administrator privileges.</p>
-------	--

Initial S/W Revision	Prior to A.02.00
----------------------	------------------

Sequences

These keys allow you to save a Tab separated or CSV file of the setup parameters required to build a Sequence.

In order to save you must select the Save As button and choose a destination folder.

Key Path	Save, Sequences
----------	-----------------

Mode	All
------	-----

Remote Command	:MMEM:STOR:SEQ:SLIST SLIST ALIST SAALIST SSTep "MySequence.txt"
-----------------------	--

Example	:MMEM:STOR:SEQ:SLIST "MySequence.txt"
----------------	---------------------------------------

Notes	<p>Available file types are:</p> <ul style="list-style-type: none"> -CSV (Comma delimited) (*.csv) -Text (Tab delimited) (*.txt)
-------	--

Initial S/W Revision	A.05.00
----------------------	---------

Source Sequence

The list of parameters, that configure steps, that makes up a sequence for the Source.

The Source sequence is a sequence of flexible configurable steps that can be set anywhere in the instruments frequency range.

Key Path	Save, Sequences
Example	:MMEM:STOR:SEQ:SLIS "MySequence.txt"
Dependencies	Only available in XOBT
Initial S/W Revision	A.05.00

Save As . . .

This menu lets you select the location where you can save the Sequence. This menu is a standard Windows® dialog with Save As menu keys. The "File Name" field in the Save As dialog is initially loaded with an automatically generated filename specific to the appropriate Save Type. The automatically generated filename is guaranteed not to conflict with any filename currently in the directory. You may replace or modify this filename using the File Name softkey. See the Quick Save key documentation for more on the automatic file naming algorithm.

The default path for all Sequence Files is:

My Documents\Sequences

Key Path	Save, Sequences
Mode	All
Notes	Brings up Save As dialog for saving a Sequence Save Type
Initial S/W Revision	A.05.00

Data (Export)

Exporting a data file stores data from the current measurement to mass storage files. The Export Menu only contains data types that are supported by the current measurement.

Since the commonly exported data files are in .csv format, the data can be edited by you prior to importing. This allows you to export a data file, manipulate the data in Excel (the most common PC Application for manipulating .csv files) and then import it.

Selecting an Export Data menu key will not actually cause the exporting to occur, since the analyzer still needs to know where you wish to save the data. Pressing the Save As key in this menu brings up the Save As dialog and Save As menu that allows you to specify the destination file and directory. Once a filename has been selected or entered in the Open menu, the export will occur as soon as the Save key is pressed.

Key Path	Save
Mode	All

Notes	The menu is built from whatever data types are available for the mode. So the key locations in the sub menu will vary. No SCPI command directly controls the Data Type that this key controls. The Data Type is included in the MMEM:STORe commands.
Dependencies	If a file type is not used by a certain measurement, that type is grayed out for that measurement. The key for a file type will not show at all if there are no measurements in the Mode that support it.
Preset	Is not affected by a Preset or shutdown, but is reset during Restore Mode Defaults
Readback	The data type that is currently selected
Initial S/W Revision	Prior to A.02.00

Export Trace Data

Enables you to export trace data with (optional) associated headers. Selecting this key displays a menu that enables you to choose which Trace to save (default is the selected Trace) and whether or not to save headers with the data. The header information is used by the VXA application when saved trace data is recalled, and enables it to be displayed with the same formatting and scaling that it had when saved. If headers are not saved, the scaling and format are set to default values when the trace is recalled. After making these selections, press Save As... and use the file dialog to choose a file name and format for the saved data.

Trace data can be exported in several different formats. Text and comma-separated variable (CSV) formats are useful for viewing the data or importing it to a spreadsheet program. The other formats are binary and thus more compact. Trace data files can be recalled for viewing into other VXA, LTE, LTETDD, iDEN, or 89601 measurements.

Key Path	Save, Data (Export)
Mode	VSA, LTE, LTETDD, IDEN
Remote Command	:MMEMory:STORe:TRACe:DATA TRACE1 TRACE2 TRACE3 TRACE4 TRACE5 TRACE6, "<filename>" [,CSV TXT SDF MAT4 MAT HDF5 BIN[,OFF ON 0 1]]
Example	:MMEM:STOR:TRAC:DATA TRACE1, "TRC1.TXT", TXT, ON
Notes	The Save As... dialog box has the following format options when you are saving trace data: <ul style="list-style-type: none"> • CSV (Comma delimited) (*.csv) • SDF (Fast) (*.sdf;*.dat) • Text (Tab delimited) (*.txt) File format saved depends on selection. The appropriate file extension is appended to the filename if it is not supplied by the user. If the SCPI command includes just a file name, the file format is determined by the filename extension, which must be one of the choices above. *.sdf or an unrecognized extension chooses the SDF fast format. If the optional file format enumerator is included in the command, then this determines the file format and the file extension is ignored. The optional binary parameter determines if file headers are saved. The default is ON. If file headers are not wanted, use the optional "OFF" parameter. The optional Boolean parameter determines whether headers are saved in the file. By default the

headers are saved.

If you are not licensed to save a particular file type, then error -203.9010 is returned. If an invalid file format is specified or the file cannot be saved successfully, then error -25x is returned. If the save is successful, then advisory 0.1500 is shown.

State Saved	No
Readback	(Trace 1 Trace 2 Trace 3 Trace 4 Trace 5 Trace 6)(with without) headers

Trace 1

Selects the Trace 1 register as the destination for the imported data.

Key Path	Save, Data (Export), Trace
Mode	VSA, LTE, LTETDD, IDEN

Trace 2

Selects the Trace 2 register as the destination for the imported data.

Key Path	Save, Data (Export), Trace
Mode	VSA, LTE, LTETDD, IDEN

Trace 3

Selects the Trace 3 register as the destination for the imported data.

Key Path	Save, Data (Export), Trace
Mode	VSA, LTE, LTETDD, IDEN

Trace 4

Selects the Trace 4 register as the destination for the imported data.

Key Path	Save, Data (Export), Trace
Mode	VSA, LTE, LTETDD, IDEN

Trace 5

Selects the Trace 5 register as the destination for the imported data.

Key Path	Save, Data (Export), Trace
Mode	VSA, LTE, LTETDD, IDEN

Trace 6

Selects the Trace 6 register as the destination for the imported data.

Key Path	Save, Data (Export), Trace
Mode	VSA, LTE, LTETDD, IDEN

Include Header

Enables you to select whether or not the saved trace data includes header information describing scaling, formatting, etc.

Key Path	Save, Data (Export), Trace
Mode	VSA, LTE, LTETDD, IDEN
State Saved	No

Measurement Results

Pressing this key selects Meas Results as the data type to be exported.

The Meas Results file contains information which describes the current state of the analyzer. It is detailed in Meas Result File Contents below.

Key Path	Save, Data
Remote Command	:MMEMory:STORe:RESults <string>
Example	:MMEM:STOR:RES "MeasR_0000.csv"
Notes	<p>If the save is initiated via SCPI and the file already exists, the file will be overwritten.</p> <p>The SCPI command exports Channel Power measurement results to the file specified as the parameter in the current path. The default path is My Documents\<current mode>\data\chp\results.<="" p=""> <p>Using the C: drive is strongly discouraged, since it runs the risk of being overwritten during an instrument software upgrade.</p> <p>The SCPI parameter is a quoted string, which specifies the filename. Both single and double quotes are supported for any filename parameter over SCPI.</p> </current></p>
Dependencies	The current active measurement must be the Channel Power measurement to use this command.
Status Bits/OPC dependencies	Sequential – waits for the previous measurement to complete.
Initial S/W Revision	Prior to A.02.00

Meas Results File Contents

A Meas Results File contains measurement results with the following information.

- File ID string, which is “MeasResult”
- Measurement ID following Mode ID, which is “SA:CHP” for example.
- Firmware rev and model number
- Option string
- Auto Sweep Time Rules
- Average Mode
- Average Number
- Average State
- Center Frequency
- Detector
- Electrical Atten
- Electrical Atten State
- IFGain
- IFGainAuto
- Impedance
- Integ BW
- Internal Preamp
- Internal Preamp Band
- Mechanical Atten
- MechanicalAttenStepEnum
- PSD Unit
- Resolution Band Width
- Resolution Bandwidth Shape
- RRC Filter Alpha
- RRC Filter BW
- RRC Filter State
- Span
- Sweep Points
- Sweep Time
- Sweep Time Auto
- TriggerSource

- Video Bandwidth
- Y Axis Unit

The file contains these data followed by MeasResult1 and MeasResult2 that flag the start of the measurement results. Each line of Measurement Results consists of two comma separated values, MeasResult1 value and MeasResult2 value. MeasResult1 contains the same results as MEAS/READ/FETCH:CHPower1; MeasResult2, MEAS/READ/FETCH:CHPower2.

Exported file is .csv file. The Meas Results file, when imported into Excel, will show the following data:

MeasResult	
SA:CHP	
A.10.53	N9030A
526 ALV ATP B1X B1Y B25 B40 BBA CR3 CRP DCF DDA DP2 DRD EA3 EDP EMC EP1 ERC ESC ESP EXM FSA LFE LNP MAT MPB NFE NUL P26 PFR PNC RTL RTS S40 SB1 SEC SM1 TVT YAS YAV	1
Auto Sweep Time Rules	Normal
Average Mode	Exponential
Average Number	10
Average State	TRUE
Center Frequency	13255000000
Detector	Average
IFGain	FALSE
IFGainAuto	FALSE
Impedance	50
Integ BW	2000000
Internal Preamp	FALSE
Internal Preamp Band	Low
PSD Unit	DbmHz
Resolution Band Width	27000
Resolution Bandwidth Shape	Gaussian
RRC Filter Alpha	0.22
RRC Filter BW	3840000
RRC Filter State	FALSE
Span	3000000
Sweep Points	1001
Sweep Time	0.004933333
Sweep Time Auto	TRUE
TriggerSource	Free
Video Bandwidth	270000

Y Axis Unit	DecibelMilliwatt
MeasResult1	MeasResult2
-76.8141133132837	-95.29174
-139.824413269924	-94.99601
	-94.95281
	-95.17146

Save As . . .

When you press “Save As”, the analyzer brings up a Windows dialog and a menu entitled “**Save As.**” This menu allows you to navigate to the various fields in the Windows dialog without using a keyboard or mouse. The Tab and Arrow keys can also be used for dialog navigation.

See "[To File . . .](#)" on page 2413 in Save, State for a full description of this dialog and menu.

The default path for saving files is:

For all of the Trace Data Files:

My Documents\`<mode name>`\data\traces

For all of the Limit Data Files:

My Documents\`<mode name>`\data\limits

For all of the Measurement Results Data Files:

My Documents\`<mode name>`\data\`<measurement name>`\results

For all of the Capture Buffer Data Files:

My Documents\`<mode name>`\data\captureBuffer

Key Path	Save, Data
Mode	All
Notes	The key location is mode-dependent and will vary. Brings up the Save As dialog for saving a <code><mode specific></code> Save Type. The save is performed immediately and does not wait until the measurement is complete.
Initial S/W Revision	Prior to A.02.00

Screen Image

Pressing Screen Image accesses a menu of functions that enable you to specify a format and location for the saved screen image. It brings up a menu that allows you to specify the color scheme of the Screen Image (Themes) or navigate to the Save As dialog to perform the actual save.

Screen Image files contain an exact representation of the analyzer display. They cannot be loaded back onto the analyzer, but they can be loaded into your PC for use in many popular applications.

8 Channel Power Measurement

Save

The image to be saved is actually captured when the Save front panel key is pressed, and kept in temporary storage to be used if you ask for a Screen Image save. When the Screen Image key is pressed, a "thumbnail" of the captured image is displayed, as shown below:

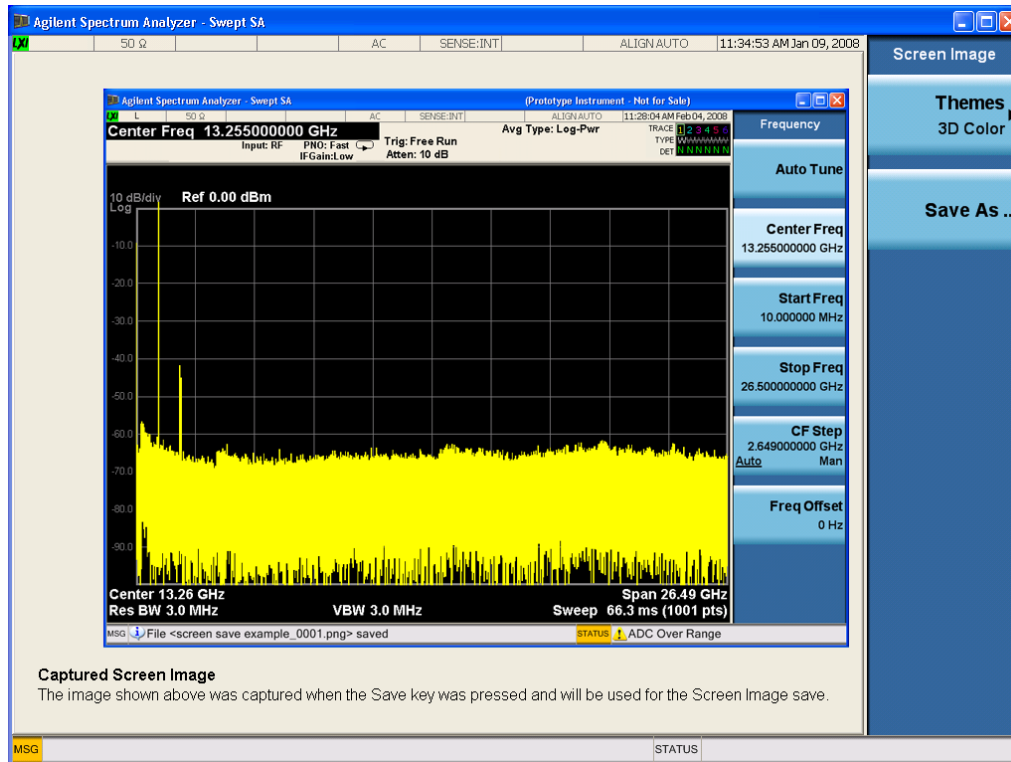

When you continue on into the Save As menu and complete the Screen Image save, the image depicted in the thumbnail is the one that gets saved, showing the menus that were on the screen before going into the Save menus. The save is performed immediately and does not wait until the measurement is complete.

After you have completed the save, the Quick Save front-panel key lets you quickly repeat the last save performed, using an auto-named file, with the current screen data.

NOTE

For versions previous to A.01.55, if you initiate a screen image save by navigating through the Save menus, the image that is saved will contain the Save menu softkeys, not the menus and the active function that were on the screen when you first pressed the Save front panel key.

Key Path	Save
Mode	All
Remote Command	:MMEMory:STORe:SCReen <filename>
Example	:MMEM:STOR:SCR "myScreen.png" This stores the current screen image in the file MyScreenFile.png in the default directory.
Initial S/W Revision	Prior to A.02.00

Themes

Accesses a menu of functions that enable you to choose the theme to be used when saving the screen image.

The **Themes** option is the same as the **Themes** option under the **Display** and **Page Setup** dialogs. It allows you to choose between themes to be used when saving the screen image.

Key Path	Save, Screen Image
Remote Command	:MMEMory:STORe:SCReen:THEMe TDColor TDMonochrome FCOLor FMONochrome :MMEMory:STORe:SCReen:THEMe?
Example	:MMEM:STOR:SCR:THEM TDM
Preset	3D Color; Is not part of Preset, but is reset by Restore Misc Defaults or Restore System Defaults All and survives subsequent running of the modes.
Readback	3D Color 3D Mono Flat Color Flat Mono
Backwards Compatibility Notes	In ESA and PSA we offer the choice of "Reverse Bitmap" or "Reverse Metafile" when saving screen images. This is much like the "Flat Color" theme available in X-Series. Also, if you selected Reverse Bitmap AND a black & white screen image, that would be much like "Flat Monochrome". In other words, each of the X-Series themes has a similar screen image type in ESA/PSA. But they are not identical.
Initial S/W Revision	Prior to A.02.00

3D Color

Selects a standard color theme with each object filled, shaded and colored as designed.

Key Path	Save, Screen Image, Themes
Example	MMEM:STOR:SCR:THEM TDC
Readback	3D Color
Initial S/W Revision	Prior to A.02.00

3D Monochrome

Selects a format that is like 3D color but shades of gray are used instead of colors.

Key Path	Save, Screen Image, Themes
Example	MMEM:STOR:SCR:THEM TDM
Readback	3D Mono
Initial S/W Revision	Prior to A.02.00

Flat Color

Selects a format that is best when the screen is to be printed on an ink printer.

Key Path	Save, Screen Image, Themes
Example	MMEM:STOR:SCR:THEM FCOL
Readback	Flat Color
Initial S/W Revision	Prior to A.02.00

Flat Monochrome

Selects a format that is like Flat Color. But only black is used (no colors, not even gray), and no fill.

Key Path	Save, Screen Image, Themes
Example	MMEM:STOR:SCR:THEM FMON
Readback	Flat Mono
Initial S/W Revision	Prior to A.02.00

Save As...

When you press “Save As”, the analyzer brings up a Windows dialog and a menu entitled “**Save As.**” This menu allows you to navigate to the various fields in the Windows dialog without using a keyboard or mouse. The Tab and Arrow keys can also be used for dialog navigation.

See ["To File . . ." on page 2413](#) in Save, State for a full description of this dialog and menu.

The default path for Screen Images is

My Documents\`<mode name>`\screen.

where `<mode name>` is the parameter used to select the mode with the INST:SEL command (for example, SA for the Spectrum Analyzer).

Key Path	Save, Screen Image
Notes	Brings up Save As dialog for saving a Screen Image Save Type
Initial S/W Revision	Prior to A.02.00

Single (Single Measurement/Sweep)

Sets the analyzer for Single measurement operation. The single/continuous state is Meas Global, so the setting will affect all the measurements. If you are Paused, pressing Single does a Resume.

See ["More Information" on page 461](#)

Key Path	Front-panel key
Example	:INIT:CONT OFF
Notes	See Cont key description.
Backwards Compatibility Notes	<p>For Spectrum Analysis mode in ESA and PSA, the Single hardkey and the INITiate:IMM switched from continuous measurement to single measurement and restarted sweeps and averages (displayed average count reset to 1), but did not restart Max Hold and Min Hold. In the X-Series, the Single hardkey and the INITiate:IMM command initiate a sweep/ measurement/ average sequence/hold sequence including MaxHold and MinHold.</p> <p>For Spectrum Analysis mode in ESA and PSA, the Single hardkey restarted the sweep regardless of whether or not you were in an active sweep or sweep sequence. In the X-Series, Restart does this but Single only restarts the sweep or sweep sequence if you are in the idle state.</p> <p>INIT[:IMM] in ESA & PSA Spectrum Analysis Mode does an implied ABORT. In some other PSA Modes, INIT[:IMM] is ignored if not in the idle state. . The X-Series follows the ESA/PSA SA Mode model, which may cause some Modes to have compatibility problems.</p>
Initial S/W Revision	Prior to A.02.00

More Information

See ["Restart" on page 2410](#) for details on the INIT:IMMEDIATE (Restart) function.

If you are already in single sweep, the INIT:CONT OFF command has no effect.

If you are already in Single Sweep, then pressing the Single key in the middle of a sweep does not restart the sweep or sequence. Similarly, pressing the Single key does not restart the sweep or sequence if the sweep is not in the idle state (for example, if you are taking a very slow sweep, or the analyzer is waiting for a trigger). Instead, it results in a message. "Already in Single, press Restart to initiate a new sweep or sequence". Even though pressing the Single key in the middle of a sweep does not restart the sweep, sending INIT:IMMEDIATE does reset it.

To take one more sweep without resetting the average count, increment the average count by 1, by pressing the step up key while **Average/Hold Number** is the active function, or sending the remote command CALC:AVER:TCON UP.

Source

Opens a menu of keys that access various source configuration menus and settings. In the test set, pressing this key also causes the central view area to change and display the Source Control Main view.

Key Path	Front-panel key
----------	-----------------

RF Output

This parameter sets the source RF power output state.

Key Path	Source
Remote Command	:OUTPut[:EXTErnal][:STATe] ON OFF 1 0 :OUTPut[:EXTErnal][:STATe]?
Example	OUTP OFF OUTP?
Notes	<p>The EXTErnal node is shown in RD text so the SCPI remains the same between internal and external source control. However, for EXT we do not wish to document this node to the customer since we are controlling the internal source rather than the external source.</p> <p>This setting is for the independent mode and has no effect on the "List Sequencer" on page 2520. If the "Sequencer" on page 2521 is set to ON, the list sequencer controls the source output and this key will be grayed-out. And this setting will be none-forceful grey out on front panel to indicate out-of-scope. Non-forceful means user still can change this setting by SCPI but cannot change on front panel. When set to OFF will make source leave list sequencer and this setting will be black out and take effect immediately.</p> <p>When the RF Output is ON, an "RF" annunciator is displayed in the system settings panel. When the RF Output is turned Off, the RF annunciator is cleared. If the "Sequencer" on page 2521 is set to ON, the "RF" annunciator will be replaced by "SEQ" in the system settings panel, indicating that the output is controlled by the list sequencer.</p>
Preset	Off
Range	On Off
Initial S/W Revision	A.05.00

Amplitude

Allows you to access the Amplitude sub-menu.

Key Path	Source
Notes	<p>The sub-menu under this button is for independent mode and has no effect on "List Sequencer" on page 2520. If the "Sequencer" on page 2521 is set to ON, the list sequencer controls the source output and this key will be grayed-out on front panel to indicate out-of-scope. When you set "Sequencer" on page 2521 to Off will make source leave list sequencer and this button will be black out.</p>
Initial S/W Revision	A.05.00

RF Power

Allows you to adjust the power level of the source using the numeric keypad, step keys, or RPG. Pressing any digit, 0 through 9, on the numeric keypad brings up the unit terminator.

Please refer to the "RF Power Range " on page 464 table below for the valid ranges.

Key Path	Source, Amplitude
Remote Command	:SOURce:POWer[:LEVel][:IMMediate][:AMPLitude] <ampl> :SOURce:POWer[:LEVel][:IMMediate][:AMPLitude]?
Example	:SOUR:POW -100 dBm
Notes	<p>Amplitude corrections can be specified for use with the source. In the event of amplitude corrections being applied, the valid ranges for the RF power do not change dependant on the current amplitude correction setting. If the combination of RF power + amplitude correction is higher or lower than the source output range, the Source Unleveled bit is set and the "Source Unleveled" indicator will appear on status panel to indicate that the source cannot maintain the output power that has been requested.</p> <p>When signal generator is unable to maintain the requested output level, the "Source Unleveled" indicator will appear on status panel. When the source output setting is restored to the normal range, the "Source Unleveled" is removed from status panel.</p> <p>Internal source has list sequence mode, which comprises of several steps which contain separate output power, frequency and waveform etc. When the source list sequence playing is complete, the last step keeps playing, and user can use this command to change the list sequence last step's output power.</p> <p>The multiport adapter RFIO TX ports and GPS ports cannot ensure power accuracy when power setting is lower than -130dBm, this power setting value is defined by the sum of RF Power setting and related amplitude correction value. But user settable value could be lower than this limit. When application detected there exists power setting lower than -130dBm on MPA RFIO TX ports, then popup warning message . When application detected there exists power setting lower than -130dBm on MPA GPS ports, then popup warning message . This is only warning message, and check is performed when RF is ON.</p>
Notes	The Min and Max value here defined UI settable amplitude range. This range is larger than actual amplitude range with level accuracy defined in spec.
Dependencies	The RF power is dependent on the RF output port and frequency, such that the current frequency and selected output port determine the valid range of power values.
Preset	-100 dBm
Min	The range of values depends on the current frequency and selected RF output port. Please refer to the "RF Power Range " on page 464 table below for the valid ranges.
Max	The range of values depends on the current frequency and selected RF output port. Please refer to the "RF Power Range " on page 464 table below for the valid ranges.
Initial S/W Revision	A.05.00

RF Power Range

RF Output Port	Frequency Range	Min Output Power	Max Output Power
High Power RF Out	10 MHz ≤ f ≤ 6 GHz	-150 dBm	20 dBm
RFIO 1 & RFIO 2	10 MHz ≤ f ≤ 6 GHz	-150 dBm	0 dBm
GPS (Note2)	10 MHz ≤ f ≤ 6 GHz	-150 dBm	0 dBm

Note: This is the UI power range, it's larger than actual spec.

Note2: GPS port is on the multiport adapter, or E6607C which has embedded MPA.

Set Reference Power

This key allows you to set the power reference. Pressing this key turns the power reference state to ON, sets the reference power value to the current RF output power, maintains this power at the RF output, and sets the displayed power to 0.00 dB. All subsequent RF power values entered under Source>Amplitude>RF Power are interpreted as being relative to this reference power.

When you use a power reference, the signal generator outputs an RF power that is set relative to the reference power by the value entered under Source>Amplitude>RF Power as follows:

Output power = reference power – entered power

Where:

reference power equals the original RF Power entered under Source>Amplitude>RF Power and set as the reference power

entered power equals a new value entered under Source>Amplitude>Amptd Offset

In addition, the displayed power value is the same as a new value entered under Source>Amplitude>RF Power.

NOTE

If Power Ref is set to ON with a reference value set, entering a value under Source>Amplitude>RF Power and pressing Set Reference Power will add that value to the existing Power Ref value.

If you wish to change the reference power value to a new value entered under Source>Amplitude>RF Power, first you must set Power Ref to OFF and then press Set Reference Power.

Key Path	Source, Amplitude
Dependencies	This key is unavailable, and is grayed out when the " List Sequencer " on page 2520 is turned ON.
Initial S/W Revision	A.05.00

Power Ref

This key allows you to toggle the state of the power reference.

When you use a power reference, the signal generator outputs an RF power that is set relative to the reference power by the value entered under Source>Amplitude>RF Power as follows:

Output power = reference power + entered power

Where:

reference power equals the original RF Power entered under Source>Amplitude>RF Power and set as the reference power

entered power equals a new value entered under Source>Amplitude>Amptd Offset

For more information on Reference Frequency refer to ["Set Reference Power " on page 2443](#)

Key Path	Source, Amplitude
Remote Command	:SOURce:POWer:REFerence <ampl> :SOURce:POWer:REFerence? :SOURce:POWer:REFerence:STATe OFF ON 0 1 :SOURce:POWer:REFerence:STATe?
Example	:SOUR:POW:REF 0.00 dBm :SOUR:POW:REF:STATe ON
Dependencies	This setting is unavailable and is grayed out when the "List Sequencer" on page 2520 is turned ON.
Couplings	This value is coupled to the "Set Reference Power " on page 2443 key such that pressing the Set Reference Power key updates the reference power with the current output power.
Preset	0.00 dBm OFF
Min	-125.00 dBm
Max	10.00 dBm
Initial S/W Revision	A.05.00

Amptd Offset

Allows you to specify the RF output power offset value.

When the amplitude offset is set to zero (0) and you set a new offset value (positive or negative), the displayed amplitude value will change as follows and the RF output power will not change:

Displayed value = output power + offset value

Where:

output power equals the original RF Power entered under Source>Amplitude>RF Power

offset value equals the value entered under Source>Amplitude>Amptd Offset

When the amplitude offset is set to a value other than zero (0) and you enter a new RF power value under Source>Amplitude>RF Power, the displayed power will be the same as the value entered and the RF output power will be equal to the value entered minus the offset value as follows:

Output power = entered power – offset power

Displayed Power = output power + offset power

Displayed power = entered power

Where:

entered power equals the amplitude entered under Source>Amplitude>RF Power

offset power equals the value previously entered and set under Source>Amplitude>Amptd Offset

Key Path	Source, Amplitude
Remote Command	:SOURce:POWer[:LEVel][:IMMediate]:OFFSet <rel_ampl> :SOURce:POWer[:LEVel][:IMMediate]:OFFSet?
Example	:SOUR:POW:OFFS 0.00 dB
Dependencies	This setting is unavailable, and is grayed out when the List Sequencer is turned ON.
Preset	0.00 dB
Min	-200.00 dB
Max	200.00 dB
Initial S/W Revision	A.05.00

Modulation

Allows you to toggle the state of the modulation.

Key Path	Source
Remote Command	:OUTPut:MODulation[:STATe] ON OFF 1 0 :OUTPut:MODulation[:STATe]?
Example	:OUTP:MOD OFF
Notes	This setting is for independent mode and has no effect on " List Sequencer " on page 2520. If the " Sequencer " on page 2521 is set to ON, the list sequencer controls the source output and this key will be grayed-out. And this setting will be none-forceful grey out on front panel to indicate out-of-scope. Non-forceful means user still can change this setting by SCPI but cannot change manually on front panel. When set to Off will make source leave list sequencer and this setting will be black out and take effect immediately. When the Modulation is ON, the "MOD" annunciator is displayed in the system settings panel. When the Modulation is turned Off, the "MOD" annunciator is cleared. If the " Sequencer " on page 2521 is set to ON, the "MOD" annunciator will be replaced by "SEQ" in the system settings panel indicating that the output is controlled by list sequencer.
Preset	Off
Range	On Off
Initial S/W Revision	A.05.00

Frequency

Allows you to access the Frequency sub-menu.

Key Path	Source
Notes	The sub-menu under this button is for independent mode and has no effect on " List Sequencer " on

[page 2520](#). If the ["Sequencer" on page 2521](#) is set to ON, the list sequencer controls the source output and this key will be grayed-out. And this button will be grey out on front panel to indicate out-of-scope. When set to Off will make source leave list sequencer and this button will be black out.

Initial S/W Revision A.05.00

Frequency

Allows you to set the RF Output Frequency. You can adjust the frequency of the source using the numeric keypad, step keys, or RPG. Pressing any digit, 0 through 9, on the numeric keypad brings up the unit terminator.

Key Path	Source, Frequency
Remote Command	:SOURce:FREQuency[:CW] <freq> :SOURce:FREQuency[:CW]?
Example	:SOUR:FREQ 1.00 GHz
Notes	Internal source has list sequence mode, which comprises of several steps which contain separate output power, frequency and waveform etc. When the source list sequence playing is complete, the last step keeps playing, and user can use this command to change the list sequence last step's output frequency.
Couplings	The frequency value is coupled to the current channel band and number, such that updates to the band and number will update the frequency value to the corresponding absolute frequency.
Preset	1.00 GHz If license F1A or 5WC is present, the default Center Frequency should be 2.412GHz.
Min	10.00 MHz
Max	Hardware Dependant: Option 503 = 3.6 GHz Option 504 = 3.8 GHz Option 506 = 6.00 GHz For E6640A, if license 5WC is present, the frequency range should be limited to: 1.1GHz-1.7GHz, 2.4GHz-2.5GHz, 4.8GHz-6.0GHz. If the user-defined frequency is outside of range, UI will report an error message called "Settings conflict; Frequency is outside available range".
Initial S/W Revision	A.05.00

Channel

The frequency of the source can be specified by a channel number of a given frequency band. This key allows you to specify the current channel number. For the appropriate range of channel numbers for a given frequency band, refer to the following tables: ["GSM/EDGE Channel Number Ranges" on page 468](#), ["W-CDMA Channel Number Ranges" on page 469](#), ["CDMA 2000 / 1xEVDO Channel Number Ranges" on page 470](#), and ["LTE FDD Channel Number Ranges" on page 472](#).

Key Path	Source, Frequency
Remote Command	:SOURCE:FREQUENCY:CHANNELS:NUMBER <int> :SOURCE:FREQUENCY:CHANNELS:NUMBER?
Example	:SOUR:FREQ:CHAN:NUMB 1
Notes	This key is grayed out when the "Radio Standard" on page 2455 is set to NONE. This key is grayed out on E6630A.
Dependencies	This key is grayed out when the "Radio Standard" on page 2455 is set to NONE. This key is grayed out on E6630A.
Couplings	The channel number is coupled to the frequency value when the "Radio Standard" on page 2455 is not set to NONE. When the frequency value is changed, the channel number will increase or decrease to match the new frequency. If the frequency is not at an exact match for a channel number, the nearest channel number is displayed along with a greater than or less than sign to indicate the frequency is above or below the channel number.
Preset	1
Min	Please refer to the tables below for the valid ranges.
Max	Please refer to the tables below for the valid ranges.
Initial S/W Revision	A.05.00

GSM/EDGE Channel Number Ranges

Band	Link (Device)	Range	Frequency (MHz)
P-GSM	Uplink (MS)	$1 \leq n \leq 124$	$890.0 + 0.2*n$
	Downlink (BS)	$1 \leq n \leq 124$	$935.0 + 0.2*n$
E-GSM	Uplink (MS)	$0 \leq n \leq 124$	$890.0 + 0.2*n$
		$975 \leq n \leq 1023$	$890.0 + 0.2*(n-1024)$
	Downlink (BS)	$0 \leq n \leq 124$	$935.0 + 0.2*n$
		$975 \leq n \leq 1023$	$935.0 + 0.2*(n-1024)$
DCS 1800	Uplink (MS)	$512 \leq n \leq 885$	$1710.200 + 0.20*(n-512)$
	Downlink (BS)	$512 \leq n \leq 885$	$1805.200 + 0.20*(n-512)$
PCS 1900	Uplink (MS)	$512 \leq n \leq 810$	$1850.200 + 0.2*(n-512)$
	Downlink (BS)	$512 \leq n \leq 810$	$1930.200 + 0.2*(n-512)$
R-GSM	Uplink (MS)	$0 \leq n \leq 124$	$890.0 + 0.2*n$
		$955 \leq n \leq 1023$	$890.0 + 0.2*(n-1024)$
	Downlink (BS)	$0 \leq n \leq 124$	$935.0 + 0.2*n$
		$955 \leq n \leq 1023$	$935.0 + 0.2*(n-1024)$
GSM 450	Uplink (MS)	$256 \leq n \leq 293$	$450.6 + 0.2*(n-259)$
	Downlink (BS)	$256 \leq n \leq 293$	$460.6 + 0.2*(n-259)$
GSM 480	Uplink (MS)	$306 \leq n \leq 340$	$479.000 + 0.20*(n-306)$

Band	Link (Device)	Range	Frequency (MHz)
GSM 850	Downlink (BS)	$306 \leq n \leq 340$	$489.000 + 0.20*(n-306)$
	Uplink (MS)	$128 \leq n \leq 251$	$824.200 + 0.20*(n-128)$
GSM 700	Downlink (BS)	$128 \leq n \leq 251$	$869.200 + 0.20*(n-128)$
	Uplink (MS)	$438 \leq n \leq 516$	$777.200 + 0.20*(n-438)$
T-GSM810	Downlink (BS)	$438 \leq n \leq 516$	$747.200 + 0.20*(n-438)$
	Uplink (MS)	$350 \leq n \leq 425$	$806.0 + 0.20*(n-350)$
	Downlink (BS)	$350 \leq n \leq 425$	$851.0 + 0.20*(n-350)$

W-CDMA Channel Number Ranges

Band	Link (Device)	Range	Frequency (MHz)
Band I	Downlink	$10562 \leq n \leq 10838$	$n \div 5$
	Uplink	$9612 \leq n \leq 9888$	$n \div 5$
Band II	Downlink	$412 \leq n \leq 687$	$n \div 5 + 1850.1$
		$9662 \leq n \leq 9938$	$n \div 5$
	Uplink	$12 \leq n \leq 287$	$n \div 5 + 1850.1$
Band III	Downlink	$350 \leq n \leq 425$	$n \div 5$
	Downlink	$1162 \leq n \leq 1513$	$n \div 5 + 1575$
Band IV	Uplink	$937 \leq n \leq 1288$	$n \div 5 + 1525$
	Downlink	$537 \leq n \leq 1738$	$n \div 5 + 1805$
Band V	Downlink	$1887 \leq n \leq 2087$	$n \div 5 + 1735.1$
		Uplink	$1312 \leq n \leq 1513$
	Downlink	$1662 \leq n \leq 1862$	$n \div 5 + 1380.1$
Band VI	Downlink	$1007 \leq n \leq 1087$	$n \div 5 + 670.1$
		$4357 \leq n \leq 4458$	$n \div 5$
	Uplink	$782 \leq n \leq 862$	$n \div 5 + 670.1$
Band VII	Downlink	$4132 \leq n \leq 4233$	$n \div 5$
		Downlink	$1037 \leq n \leq 1062$
	Uplink	$4387 \leq n \leq 4413$	$n \div 5$
Band VIII	Downlink	$812 \leq n \leq 837$	$n \div 5 + 670.1$
		$4162 \leq n \leq 4188$	$n \div 5$
	Downlink	$2237 \leq n \leq 2563$	$n \div 5 + 2175$
Band IX	Downlink	$2587 \leq n \leq 2912$	$n \div 5 + 2105.1$
		Uplink	$2012 \leq n \leq 2338$
	Downlink	$2362 \leq n \leq 2687$	$n \div 5 + 2030.1$
Band X	Downlink	$2937 \leq n \leq 3088$	$n \div 5 + 340$
	Uplink	$2712 \leq n \leq 2863$	$n \div 5 + 340$

Band	Link (Device)	Range	Frequency (MHz)
Band IX	Downlink	$9237 \leq n \leq 9387$	$n \div 5$
	Uplink	$8762 \leq n \leq 8912$	$n \div 5$
Band X	Downlink	$3112 \leq n \leq 3388$	$n \div 5 + 1490$
		$3412 \leq n \leq 3687$	$n \div 5 + 1430.1$
	Uplink	$2887 \leq n \leq 3163$	$n \div 5 + 1135$
		$3187 \leq n \leq 3462$	$n \div 5 + 1075.1$
Band XI	Downlink	$3712 \leq n \leq 3812$	$n \div 5 + 736$
	Uplink	$3487 \leq n \leq 3587$	$n \div 5 + 733$
Band XII	Downlink	$3837 \leq n \leq 3903$	$n \div 5 - 37$
		$3927 \leq n \leq 3992$	$n \div 5 - 54.9$
	Uplink	$3612 \leq n \leq 3678$	$n \div 5 - 22$
		$3702 \leq n \leq 3767$	$n \div 5 - 39.9$
Band XIII	Downlink	$4017 \leq n \leq 4043$	$n \div 5 - 55$
		$4067 \leq n \leq 4092$	$n \div 5 - 64.9$
	Uplink	$3792 \leq n \leq 3818$	$n \div 5 + 21$
		$3702 \leq n \leq 3767$	$n \div 5 - 39.9$
Band XIV	Downlink	$4117 \leq n \leq 4143$	$n \div 5 - 63$
		$4167 \leq n \leq 4192$	$n \div 5 - 72.9$
	Uplink	$3892 \leq n \leq 3918$	$n \div 5 + 12$
		$3942 \leq n \leq 3967$	$n \div 5 + 2.1$
Band XIX	Downlink	$712 \leq n \leq 763$	$n \div 5 + 735$
		$787 \leq n \leq 837$	$n \div 5 + 720.1$
	Uplink	$312 \leq n \leq 363$	$n \div 5 + 770$
		$387 \leq n \leq 437$	$n \div 5 + 755.1$

CDMA 2000 / 1xEVDO Channel Number Ranges

Band	Link (Device)	Range	Frequency (MHz)
US Cellular	Uplink (MS, reverse link)	$1 \leq N \leq 799$	$0.030 \times N + 825.000$
		$991 \leq N \leq 1023$	$0.030 \times (N - 1023) + 825.000$
		$1024 \leq N \leq 1323$	$0.030 \times (N - 1024) + 815.040$
	Downlink (BS, forward link)	$1 \leq N \leq 799$	$0.030 \times N + 870.000$
		$991 \leq N \leq 1023$	$0.030 \times (N - 1023) + 870.000$
		$1024 \leq N \leq 1323$	$0.030 \times (N - 1024) + 860.040$
US PCS	Uplink (MS, reverse link)	$0 \leq N \leq 1199$	$1850.000 + 0.050 \times N$
	Downlink (BS, forward link)	$0 \leq N \leq 1199$	$1930.000 + 0.050 \times N$

Band	Link (Device)	Range	Frequency (MHz)
Japan Cellular Band	Uplink (MS, reverse link)	$1 \leq N \leq 799$	$0.0125 \times (N + 915.000)$
		$801 \leq N \leq 1039$	$0.0125 \times (N - 800) + 898.000$
		$1041 \leq N \leq 1199$	$0.0125 \times (N - 1040) + 887.000$
		$1201 \leq N \leq 1600$	$0.0125 \times (N - 1200) + 893.000$
	Downlink (BS, forward link)	$1 \leq N \leq 799$	$0.0125 \times (N + 860.000)$
		$801 \leq N \leq 1039$	$0.0125 \times (N - 800) + 843.000$
		$1041 \leq N \leq 1199$	$0.0125 \times (N - 1040) + 832.000$
		$1201 \leq N \leq 1600$	$0.0125 \times (N - 1200) + 838.000$
Korean PCS Band	Uplink (MS, reverse link)	$0 \leq N \leq 599$	$0.050 \times N + 1750.000$
	Downlink (BS, forward link)	$0 \leq N \leq 599$	$0.050 \times N + 1840.000$
NMT-450 Band	Uplink (MS, reverse link)	$1 \leq N \leq 400$	$0.025 \times (N - 1) + 450.000$
		$472 \leq N \leq 871$	$0.025 \times (N - 472) + 410.000$
		$1039 \leq N \leq 1473$	$0.020 \times (N - 1024) + 451.010$
		$1536 \leq N \leq 1715$	$0.025 \times (N - 1536) + 479.000$
	Downlink (BS, forward link)	$1 \leq N \leq 400$	$0.025 \times (N - 1) + 460.000$
		$472 \leq N \leq 871$	$0.025 \times (N - 472) + 420.000$
		$1039 \leq N \leq 1473$	$0.020 \times (N - 1024) + 461.010$
		$1536 \leq N \leq 1715$	$0.025 \times (N - 1536) + 489.000$
IMT-2000 Band	Uplink (MS, reverse link)	$0 \leq N \leq 1199$	$1920.000 + 0.050 \times N$
	Downlink (BS, forward link)	$0 \leq N \leq 1199$	$2100.000 + 0.050 \times N$
Upper 700 MHz Band	Uplink (MS, reverse link)	$0 \leq N \leq 240$	$776.000 + 0.050 \times N$
	Downlink (BS, forward link)	$0 \leq N \leq 240$	$746.000 + 0.050 \times N$
Secondary 800 MHz Band	Uplink (MS, reverse link)	$0 \leq N \leq 719$	$0.025 \times N + 806.000$
		$720 \leq N \leq 919$	$0.025 \times (N - 720) + 896.000$
	Downlink (BS, forward link)	$0 \leq N \leq 719$	$0.025 \times N + 851.000$
		$720 \leq N \leq 919$	$0.025 \times (N - 720) + 935.000$
2.5 GHz IMT Extension	Uplink (MS, reverse link)	$0 \leq N \leq 1399$	$2500.000 + 0.050 \times N$
	Downlink (BS, forward link)	$0 \leq N \leq 1399$	$2620.000 + 0.050 \times N$
US PCS 1.9 GHz	Uplink (MS, reverse link)	$0 \leq N \leq 1299$	$1850.000 + 0.050 \times N$

Band	Link (Device)	Range	Frequency (MHz)
AWS	Downlink (BS, forward link)	$0 \leq N \leq 1299$	$1930.000 + 0.050 \times N$
	Uplink (MS, reverse link)	$0 \leq N \leq 899$	$1710.000 + 0.050 \times N$
US 2.5 GHz	Downlink (BS, forward link)	$0 \leq N \leq 899$	$2100.000 + 0.050 \times N$
	Uplink (MS, reverse link)	$140 \leq N \leq 1459$	$2495.000 + 0.050 \times N$
700 Public Safety	Downlink (BS, forward link)	$140 \leq N \leq 1459$	$2617.000 + 0.050 \times N$
	Uplink (MS, reverse link)	$0 \leq N \leq 240$	$787.000 + 0.050 \times N$
C2K Lower 700	Downlink (BS, forward link)	$0 \leq N \leq 240$	$757.000 + 0.050 \times N$
	Uplink (MS, reverse link)	$0 \leq N \leq 360$	$698.000 + 0.050 \times N$
400 Euro PAMR	Downlink (BS, forward link)	$0 \leq N \leq 360$	$728.000 + 0.050 \times N$
	Uplink (MS, reverse link)	$1 \leq N \leq 400$	$0.025 \times (N-1) + 450.000$
	Uplink (MS, reverse link)	$472 \leq N \leq 871$	$0.025 \times (N-472) + 410.000$
	Uplink (MS, reverse link)	$1536 \leq N \leq 1715$	$0.025 \times (N-1536) + 479.000$
	Downlink (BS, forward link)	$1 \leq N \leq 400$	$0.025 \times (N-1) + 460.000$
	Downlink (BS, forward link)	$472 \leq N \leq 871$	$0.025 \times (N-472) + 420.000$
	Downlink (BS, forward link)	$1536 \leq N \leq 1715$	$0.025 \times (N-1536) + 489.000$
	Downlink (BS, forward link)		
800 PAMR	Uplink (MS, reverse link)	$0 \leq N \leq 239$	$870.0125 + 0.025 \times N$
	Downlink (BS, forward link)	$0 \leq N \leq 239$	$915.0125 + 0.025 \times N$

LTE FDD Channel Number Ranges

The carrier frequency in the uplink and downlink is designated by the E-UTRA Absolute Radio Frequency Channel Number (EARFCN) in the range 0 – 65535. The relation between EARFCN and the carrier frequency in MHz for the downlink is given by the following equation, where FDL_low and NOffs-DL are given in table 5.4.4–1 and ND L is the downlink EARFCN.

$$FDL = FDL_low + 0.1(NDL - NOffs-DL)$$

The relation between EARFCN and the carrier frequency in MHz for the uplink is given by the following equation where FUL_low and NOffs-UL are given in table 5.4.4-1 and NUL is the uplink EARFCN.

$$FUL = FUL_low + 0.1(NUL - NOffs-UL)$$

Band	Downlink		Uplink			
	FDL_low (MHz)	NOffs-DL	Range of NDL	FUL_low (MHz)	NOffs-UL	Range of NUL
1		2110	0	0 - 599	1920	18000 - 18599
2		1930	600	600 - 1199	1850	18600 - 19199
3		1805	1200	1200 - 1949	1710	19200 - 19949
4		2110	1950	1950 - 2399	1710	19950 - 20399
5		869	2400	2400 - 2649	824	20400 - 20649
6		875	2650	2650 - 2749	830	20650 - 20749
7		2620	2750	2750 - 3449	2500	20750 - 20449
8		925	3450	3450 - 3799	880	21450 - 21799
9		1844.9	3800	3800 - 4149	1749.9	21800 - 22149
10		2110	4150	4150 - 4749	1710	22150 - 22749
11		1475.9	4750	4750 - 4949	1427.9	22750 - 22949
12		729	5010	5010 - 5179	699	23010 - 23179
13		746	5180	5180 - 5279	777	23180 - 23279
14		758	5280	5280 - 5379	788	23280 - 23379
...						
17		734	5730	5730 - 5849	704	23730 - 23849
18		860	5850	5850 - 5999	815	23850 - 23999
19		875	6000	6000 - 6149	830	24000 - 24149
20		791	6150	6150 - 6449	832	24150 - 24449
21		1495.9	6450	6450 - 6599	1447.9	24450 - 24599
...						
24		1525	7700	7700 - 8039	1626.5	25700 - 26039
25		1930	8040	8040 - 8689	1850	26040 - 26689
26		859	8690	8690 - 9039	814	26690 - 27039
...						

Note: The channel numbers that designate carrier frequencies so close to the operating band edges that the carrier extends beyond the operating band edge shall not be used. This implies that the first 7, 15, 25, 50, 75 and 100 channel numbers at the lower operating band edge and the last 6, 14, 24, 49, 74 and 99 channel numbers at the upper operating band edge shall not be used for channel bandwidths of 1.4, 3, 5, 10, 15 and 20 MHz respectively.

LTE TDD Channel Number Ranges

The carrier frequency in the uplink and downlink is designated by the E-UTRA Absolute Radio Frequency Channel Number (EARFCN) in the range 0 – 65535. The relation between EARFCN and the carrier frequency in MHz for the downlink is given by the following equation, where FDL_low and NOffs-DL are given in table 5.4.4–1 and NDL is the downlink EARFCN.

$$FDL = FDL_low + 0.1(NDL - NOffs-DL)$$

The relation between EARFCN and the carrier frequency in MHz for the uplink is given by the following equation where FUL_low and NOffs-UL are given in table 5.4.4–1 and NUL is the uplink EARFCN.

$$FUL = FUL_low + 0.1(NUL - NOffs-UL)$$

Band	Downlink		Uplink			
	FDL_low (MHz)	NOffs-DL	Range of NDL	FUL_low (MHz)	NOffs-UL	Range of NUL
33		1900	36000	36000 – 36199	1900	36000 – 36199
34		2010	36200	36200 – 36349	2010	36200 – 36349
35		1850	36350	36350 – 36949	1850	36350 – 36949
36		1930	36950	36950 – 37549	1930	36950 – 37549
37		1910	37550	37550 – 37749	1910	37550 – 37749
38		2570	37750	37750 – 38249	2570	37750 – 38249
39		1880	38250	38250 – 38649	1880	38250 – 38649
40		2300	38650	38650 – 39649	2300	38650 – 39649
41		2496	39650	39650 – 41589	2496	39650 – 41589
42		3400	41590	41590 – 43589	3400	41590 – 43589
43		3600	43590	43590 – 45589	3600	43590 – 45589

Note: The channel numbers that designate carrier frequencies so close to the operating band edges that the carrier extends beyond the operating band edge shall not be used. This implies that the first 7, 15, 25, 50, 75 and 100 channel numbers at the lower operating band edge and the last 6, 14, 24, 49, 74 and 99 channel numbers at the upper operating band edge shall not be used for channel bandwidths of 1.4, 3, 5, 10, 15 and 20 MHz respectively.

TDSCDMA Channel Number Ranges

1.28 Mcps TDD Option

No TX-RX frequency separation is required as Time Division Duplex (TDD) is employed. Each subframe consists of 7 main timeslots where all main timeslots (at least the first one) before the single switching point are allocated DL and all main timeslots (at least the last one) after the single switching point are allocated UL.

The nominal channel spacing is 1.6 MHz, but this can be adjusted to optimise performance in a particular deployment scenario.

The carrier frequency is designated by the UTRA absolute radio frequency channel number (UARFCN). The value of the UARFCN in the IMT2000 band is defined in the general case as follows:

$$N_t = 5 * F \quad 0.0 \text{ MHz} \leq F \leq 3276.6 \text{ MHz}$$

where F is the carrier frequency in MHz

Additional channels applicable to operation in the frequency band defined in sub-clause 5.2(d) are defined via the following UARFCN definition:

$$N_t = 5 * (F - 2150.1 \text{ MHz}) \quad 2572.5 \text{ MHz} \leq F \leq 2617.5 \text{ MHz}$$

UARFCN

1.28 Mcps TDD Option

The following UARFCN range shall be supported for each band:

Table: UTRA Absolute Radio

Frequency Channel Number 1.28

Mcps TDD Option

Frequency Band	Frequency Range	UARFCN Uplink and Downlink transmission
For operation in frequency band as defined in subclause 5.2 (a)	1900–1920 MHz	9504 to 9596
	2010–2025 MHz	10054 to 10121
For operation in frequency band as defined in subclause 5.2 (b)	1850–1910 MHz	9254 to 9546
	1930–1990 MHz	9654 to 9946
For operation in frequency band as defined in subclause 5.2 (c)	1910–1930 MHz	9554 to 9646
For operation in frequency band as defined in subclause 5.2 (d)	2570–2620 MHz	12854 to 13096
For operation in frequency band as defined in subclause 5.2 (e)	2300–2400 MHz	11504 to 11996
For operation in frequency band as defined in subclause 5.2 (f)	1880–1920 MHz	9404 to 9596

Radio Setup

Allows access to the sub-menus for selecting the radio standard and associated radio band. You can also set a frequency reference and offset.

This menu is greyed out when on E6630A. Radio band settings for GSM, cdma2000, and so on -- most of which are not actually supported in E6630A, which has three narrow frequency bands. So band settings are grayed out.

Key Path	Source, Frequency
Initial S/W Revision	A.05.00

Radio Standard

Allows access to the channel band sub-menus to select the desired radio standard. When you have selected the radio standard, you can then set an active channel band. The radio standard and the active channel band allow you to use channel numbers to set frequency automatically.

Key Path	Source, Frequency, Radio Setup
Remote Command	:SOURce:FREQuency:CHANnels:BAND NONE PGSM EGSM RGSM DCS1800 PCS1900 TGSM810 GSM450 GSM480 GSM700 GSM850 BANDI BANDII BANDIII BANDIV BANDV BANDVI BANDVII BANDVIII BANDIX BANDX BANDXI BANDXII BANDXIII BANDXIV BANDXIX USCELL USPCS JAPAN KOREAN NMT IMT2K UPPER SECOND PAMR400 PAMR800 IMTEXT PCS1DOT9G AWS US2DOT5G PUBLIC LOWER BAND1 BAND2 BAND3 BAND4 BAND5 BAND6 BAND7 BAND8 BAND10 BAND11 BAND12 BAND13 BAND14 BAND17 BAND18 BAND19 BAND20 BAND21 BAND24 BAND25 BAND26 BAND27 BAND28 BAND31 BAND33 BAND34 BAND35 BAND36 BAND37 BAND38 BAND39 BAND40 BAND41 BAND42 BAND43 BAND44 BANDA BANDB BANDC BANDD BANDE BANDF :SOURce:FREQuency:CHANnels:BAND?
Example	:SOUR:FREQ:CHAN:BAND PGSM
Notes	Set this setting to "NONE" will grey out "Channel" on page 2446 Channel
Initial S/W Revision	A.05.00

None

Selects no radio standard for use. When you have selected the radio standard to NONE, you cannot use channel numbers to set frequency automatically. You will need to set the frequency manually.

Key Path	Source, Frequency, Radio Setup, Radio Standard
Initial S/W Revision	A.05.00

GSM/EDGE

Sets GSM/EDGE as the radio standard for use and accesses the GSM/EDGE specific channel band sub-menus.

Key Path	Source, Frequency, Radio Setup, Radio Standard
Initial S/W Revision	A.05.00

P-GSM

Selects P-GSM as the active channel band.

Key Path	Source, Frequency, Radio Setup, Radio Standard, GSM/EDGE
Example	:SOUR:FREQ:CHAN:BAND PGSM
Initial S/W Revision	A.05.00

E-GSM

Selects E-GSM as the active channel band.

Key Path	Source, Frequency, Radio Setup, Radio Standard, GSM/EDGE
Example	:SOUR:FREQ:CHAN:BAND EGSM
Initial S/W Revision	A.05.00

R-GSM

Selects R-GSM as the active channel band.

Key Path	Source, Frequency, Radio Setup, Radio Standard, GSM/EDGE
Example	:SOUR:FREQ:CHAN:BAND RGSM
Initial S/W Revision	A.05.00

DCS 1800

Selects DCS 1800 as the active channel band.

Key Path	Source, Frequency, Radio Setup, Radio Standard, GSM/EDGE
Example	:SOUR:FREQ:CHAN:BAND DCS1800
Initial S/W Revision	A.05.00

PCS 1900

Selects PCS 1900 as the active channel band.

Key Path	Source, Frequency, Radio Setup, Radio Standard, GSM/EDGE
Example	:SOUR:FREQ:CHAN:BAND PCS1900
Initial S/W Revision	A.05.00

GSM 450

Selects GSM 450 as the active channel band.

Key Path	Source, Frequency, Radio Setup, Radio Standard, GSM/EDGE
Example	:SOUR:FREQ:CHAN:BAND GSM450
Initial S/W Revision	A.05.00

GSM 480

Selects GSM 480 as the active channel band.

Key Path	Source, Frequency, Radio Setup, Radio Standard, GSM/EDGE
Example	:SOUR:FREQ:CHAN:BAND GSM480
Initial S/W Revision	A.05.00

GSM 850

Selects GSM 850 as the active channel band.

Key Path	Source, Frequency, Radio Setup, Radio Standard, GSM/EDGE
Example	:SOUR:FREQ:CHAN:BAND GSM850
Initial S/W Revision	A.05.00

GSM 700

Selects GSM 700 as the active channel band.

Key Path	Source, Frequency, Radio Setup, Radio Standard, GSM/EDGE
Example	:SOUR:FREQ:CHAN:BAND GSM700
Initial S/W Revision	A.05.00

T-GSM 810

Selects T-GSM 810 as the active channel band.

Key Path	Source, Frequency, Radio Setup, Radio Standard, GSM/EDGE
Example	:SOUR:FREQ:CHAN:BAND T-GSM810
Initial S/W Revision	A.05.00

WCDMA

Sets WCDMA as the radio standard for use and accesses the W-CDMA specific channel band sub-menus.

Key Path	Source, Frequency, Radio Setup, Radio Standard
Initial S/W Revision	A.05.00

Band I

Selects Band I as the active channel band.

Key Path	Source, Frequency, Radio Setup, Radio Standard, WCDMA
Example	:SOUR:FREQ:CHAN:BAND BANDI
Initial S/W Revision	A.05.00

Band II

Selects Band II as the active channel band.

Key Path	Source, Frequency, Radio Setup, Radio Standard, WCDMA
Example	:SOUR:FREQ:CHAN:BAND BANDII
Initial S/W Revision	A.05.00

Band III

Selects Band III as the active channel band.

Key Path	Source, Frequency, Radio Setup, Radio Standard, WCDMA
Example	:SOUR:FREQ:CHAN:BAND BANDIII
Initial S/W Revision	A.05.00

Band IV

Selects Band IV as the active channel band.

Key Path	Source, Frequency, Radio Setup, Radio Standard, WCDMA
Example	:SOUR:FREQ:CHAN:BAND BANDIV
Initial S/W Revision	A.05.00

Band V

Selects Band V as the active channel band.

Key Path	Source, Frequency, Radio Setup, Radio Standard, WCDMA
Example	:SOUR:FREQ:CHAN:BAND BANDV
Initial S/W Revision	A.05.00

Band VI

Selects Band VI as the active channel band.

Key Path	Source, Frequency, Radio Setup, Radio Standard, WCDMA
Example	:SOUR:FREQ:CHAN:BAND BANDVI
Initial S/W Revision	A.05.00

Band VII

Selects Band VII as the active channel band.

Key Path	Source, Frequency, Radio Setup, Radio Standard, WCDMA
Example	:SOUR:FREQ:CHAN:BAND BANDVII
Initial S/W Revision	A.05.00

Band VIII

Selects Band VIII as the active channel band.

Key Path	Source, Frequency, Radio Setup, Radio Standard, WCDMA
Example	:SOUR:FREQ:CHAN:BAND BANDVIII
Initial S/W Revision	A.05.00

Band IX

Selects Band IX as the active channel band.

Key Path	Source, Frequency, Radio Setup, Radio Standard, WCDMA
Example	:SOUR:FREQ:CHAN:BAND BANDIX
Initial S/W Revision	A.05.00

Band X

Selects Band X as the active channel band.

Key Path	Source, Frequency, Radio Setup, Radio Standard, WCDMA
Example	:SOUR:FREQ:CHAN:BAND BANDX
Initial S/W Revision	A.05.00

Band XI

Selects Band XI as the active channel band.

Key Path	Source, Frequency, Radio Setup, Radio Standard, WCDMA
Example	:SOUR:FREQ:CHAN:BAND BANDXI
Initial S/W Revision	A.05.00

Band XII

Selects Band XII as the active channel band.

Key Path	Source, Frequency, Radio Setup, Radio Standard, WCDMA
Example	:SOUR:FREQ:CHAN:BAND BANDXII
Initial S/W Revision	A.05.00

Band XIII

Selects band XIII as the active channel band.

Key Path	Source, Frequency, Radio Setup, Radio Standard, WCDMA
Example	:SOUR:FREQ:CHAN:BAND BANDXIII
Initial S/W Revision	A.05.00

Band XIV

Selects Band XIV as the active channel band.

Key Path	Source, Frequency, Radio Setup, Radio Standard, WCDMA
Example	:SOUR:FREQ:CHAN:BAND BANDXIV
Initial S/W Revision	A.05.00

Band XIX

Selects Band XIX as the active channel band.

Key Path	Source, Frequency, Radio Setup, Radio Standard, WCDMA
Example	:SOUR:FREQ:CHAN:BAND BANDXIX
Initial S/W Revision	A.14.50

CDMA 2000 / 1xEVDO

Sets CDMA 2000 / 1XEVDO as the radio standard for use and accesses the CDMA 2000/1xEVDO specific channel band sub-menus.

Key Path	Source, Frequency, Radio Setup, Radio Standard
Initial S/W Revision	A.05.00

US CELL

Selects US Cell as the active channel band.

Key Path	Source, Frequency, Radio Setup, Radio Standard, CDMA 2000 / 1xEVDO
Example	:SOUR:FREQ:CHAN:BAND USCELL
Initial S/W Revision	A.05.00

US PCS

Selects US PCS as the active channel band.

Key Path	Source, Frequency, Radio Setup, Radio Standard, CDMA 2000 / 1xEVDO
Example	:SOUR:FREQ:CHAN:BAND PCS
Initial S/W Revision	A.05.00

Japan Cell

Selects Japan Cell as the active channel band.

Key Path	Source, Frequency, Radio Setup, Radio Standard, CDMA 2000 / 1xEVDO
Example	:SOUR:FREQ:CHAN:BAND JAPAN
Initial S/W Revision	A.05.00

Korean PCS

Selects Korean PCS as the active channel band.

Key Path	Source, Frequency, Radio Setup, Radio Standard, CDMA 2000 / 1xEVDO
Example	:SOUR:FREQ:CHAN:BAND KOREAN
Initial S/W Revision	A.05.00

NMT 450

Selects NMT 450 as the active channel band.

Key Path	Source, Frequency, Radio Setup, Radio Standard, CDMA 2000 / 1xEVDO
----------	--

Example	:SOUR:FREQ:CHAN:BAND NMT
Initial S/W Revision	A.05.00

IMT 2000

Selects IMT 2000 as the active channel band.

Key Path	Source, Frequency, Radio Setup, Radio Standard, CDMA 2000 / 1xEVDO
Example	:SOUR:FREQ:CHAN:BAND IMT2K
Initial S/W Revision	A.05.00

Upper 700

Selects Upper 700 as the active channel band.

Key Path	Source, Frequency, Radio Setup, Radio Standard, CDMA 2000 / 1xEVDO
Example	:SOUR:FREQ:CHAN:BAND UPPER
Initial S/W Revision	A.05.00

Secondary 800

Selects Secondary 800 as the active channel band.

Key Path	Source, Frequency, Radio Setup, Radio Standard, CDMA 2000 / 1xEVDO
Example	:SOUR:FREQ:CHAN:BAND SECOND
Initial S/W Revision	A.05.00

400 Euro PAMR

Selects 400 Euro PAMR as the active channel band.

Key Path	Source, Frequency, Radio Setup, Radio Standard, CDMA 2000 / 1xEVDO
Example	:SOUR:FREQ:CHAN:BAND PAMR400
Initial S/W Revision	A.05.00

800 PAMR

Selects 800 PAMR as the active channel band.

Key Path	Source, Frequency, Radio Setup, Radio Standard, CDMA 2000 / 1xEVDO
----------	--

Example	:SOUR:FREQ:CHAN:BAND PAMR800
Initial S/W Revision	A.05.00

2.5GHz IMT EXT

Selects 2.5 GHz IMT EXT as the active channel band.

Key Path	Source, Frequency, Radio Setup, Radio Standard, CDMA 2000 / 1xEVDO
Example	:SOUR:FREQ:CHAN:BAND IMTEXT
Initial S/W Revision	A.05.00

US PCS 1.9GHz

Selects US PCS 1.9 GHz as the active channel band.

Key Path	Source, Frequency, Radio Setup, Radio Standard, CDMA 2000 / 1xEVDO
Example	:SOUR:FREQ:CHAN:BAND PCS1DOT9G
Initial S/W Revision	A.05.00

AWS

Selects AWS as the active channel band.

Key Path	Source, Frequency, Radio Setup, Radio Standard, CDMA 2000 / 1xEVDO
Example	:SOUR:FREQ:CHAN:BAND AWS
Initial S/W Revision	A.05.00

US 2.5GHz

Selects US 2.5 GHz as the active channel band.

Key Path	Source, Frequency, Radio Setup, Radio Standard, CDMA 2000 / 1xEVDO
Example	:SOUR:FREQ:CHAN:BAND US2DOT5G
Initial S/W Revision	A.05.00

700 Public Safety

Selects 700 Public Safety as the active channel band.

Key Path	Source, Frequency, Radio Setup, Radio Standard, CDMA 2000 / 1xEVDO
----------	--

Example	:SOUR:FREQ:CHAN:BAND PUBLIC
Initial S/W Revision	A.05.00

C2K Lower 700

Selects C2K Lower 700 as the active channel band.

Key Path	Source, Frequency, Radio Setup, Radio Standard, CDMA 2000 / 1xEVDO
Example	:SOUR:FREQ:CHAN:BAND LOWER
Initial S/W Revision	A.05.00

LTE

Sets LTE FDD as the radio standard for use and accesses the LTE FDD specific channel band sub-menus..

Key Path	Source, Frequency, Radio Setup, Radio Standard
Initial S/W Revision	A.09.50

BAND 1

Selects BAND 1 as the band for the current step.

Key Path	Source, Frequency, Radio Setup, Radio Standard, LTE
Example	:SOUR:FREQ:CHAN:BAND BAND1
Initial S/W Revision	A.09.50

BAND 2

Selects BAND 2 as the band for the current step.

Key Path	Source, Frequency, Radio Setup, Radio Standard, LTE
Example	:SOUR:FREQ:CHAN:BAND BAND2
Initial S/W Revision	A.09.50

BAND 3

Selects BAND 3 as the band for the current step.

Key Path	Source, Frequency, Radio Setup, Radio Standard, LTE
Example	:SOUR:FREQ:CHAN:BAND BAND3
Initial S/W Revision	A.09.50

BAND 4

Selects BAND 4 as the band for the current step.

Key Path	Source, Frequency, Radio Setup, Radio Standard, LTE
Example	:SOUR:FREQ:CHAN:BAND BAND4
Initial S/W Revision	A.09.50

BAND 5

Selects BAND 5 as the band for the current step.

Key Path	Source, Frequency, Radio Setup, Radio Standard, LTE
Example	:SOUR:FREQ:CHAN:BAND BAND5
Initial S/W Revision	A.09.50

BAND 6

Selects BAND 6 as the band for the current step.

Key Path	Source, Frequency, Radio Setup, Radio Standard, LTE
Example	:SOUR:FREQ:CHAN:BAND BAND6
Initial S/W Revision	A.09.50

BAND 7

Selects BAND 7 as the band for the current step.

Key Path	Source, Frequency, Radio Setup, Radio Standard, LTE
Example	:SOUR:FREQ:CHAN:BAND BAND7
Initial S/W Revision	A.09.50

BAND 8

Selects BAND 8 as the band for the current step.

Key Path	Source, Frequency, Radio Setup, Radio Standard, LTE
Example	:SOUR:FREQ:CHAN:BAND BAND8
Initial S/W Revision	A.09.50

BAND 9

Selects BAND 9 as the band for the current step.

Key Path	Source, Frequency, Radio Setup, Radio Standard, LTE
Example	:SOUR:FREQ:CHAN:BAND BAND9
Initial S/W Revision	A.09.50

BAND 10

Selects BAND 10 as the band for the current step.

Key Path	Source, Frequency, Radio Setup, Radio Standard, LTE
Example	:SOUR:FREQ:CHAN:BAND BAND10
Initial S/W Revision	A.09.50

BAND 11

Selects BAND 11 as the band for the current step.

Key Path	Source, Frequency, Radio Setup, Radio Standard, LTE
Example	:SOUR:FREQ:CHAN:BAND BAND11
Initial S/W Revision	A.09.50

BAND 12

Selects BAND 12 as the band for the current step.

Key Path	Source, Frequency, Radio Setup, Radio Standard, LTE
Example	:SOUR:FREQ:CHAN:BAND BAND12
Initial S/W Revision	A.09.50

BAND 13

Selects BAND 13 as the band for the current step.

Key Path	Source, Frequency, Radio Setup, Radio Standard, LTE
Example	:SOUR:FREQ:CHAN:BAND BAND13
Initial S/W Revision	A.09.50

BAND 14

Selects BAND 14 as the band for the current step.

Key Path	Source, Frequency, Radio Setup, Radio Standard, LTE
Example	:SOUR:FREQ:CHAN:BAND BAND14
Initial S/W Revision	A.09.50

BAND 17

Selects BAND 17 as the band for the current step.

Key Path	Source, Frequency, Radio Setup, Radio Standard, LTE
Example	:SOUR:FREQ:CHAN:BAND BAND17
Initial S/W Revision	A.09.50

BAND 18

Selects BAND 18 as the band for the current step.

Key Path	Source, Frequency, Radio Setup, Radio Standard, LTE
Example	:SOUR:FREQ:CHAN:BAND BAND18
Initial S/W Revision	A.09.50

BAND 19

Selects BAND 19 as the band for the current step.

Key Path	Source, Frequency, Radio Setup, Radio Standard, LTE
Example	:SOUR:FREQ:CHAN:BAND BAND19
Initial S/W Revision	A.09.50

BAND 20

Selects BAND 20 as the band for the current step.

Key Path	Source, Frequency, Radio Setup, Radio Standard, LTE
Example	:SOUR:FREQ:CHAN:BAND BAND20
Initial S/W Revision	A.09.50

BAND 21

Selects BAND 21 as the band for the current step.

Key Path	Source, Frequency, Radio Setup, Radio Standard, LTE
Example	:SOUR:FREQ:CHAN:BAND BAND21
Initial S/W Revision	A.09.50

BAND 24

Selects BAND 24 as the band for the current step.

Key Path	Source, Frequency, Radio Setup, Radio Standard, LTE
Example	:SOUR:FREQ:CHAN:BAND BAND24
Initial S/W Revision	A.09.50

BAND 25

Selects BAND 25 as the band for the current step.

Key Path	Source, Frequency, Radio Setup, Radio Standard, LTE
Example	:SOUR:FREQ:CHAN:BAND BAND25
Initial S/W Revision	A.09.50

BAND 26

Selects BAND 26 as the band for the current step.

Key Path	Source, Frequency, Radio Setup, Radio Standard, LTE
Example	:SOUR:FREQ:CHAN:BAND BAND26
Initial S/W Revision	A.12.53

BAND 27

Selects BAND 27 as the band for the current step.

Key Path	Source, Frequency, Radio Setup, Radio Standard, LTE
Example	:SOUR:FREQ:CHAN:BAND BAND27
Initial S/W Revision	A.14.00

BAND 28

Selects BAND 28 as the band for the current step.

Key Path	Source, Frequency, Radio Setup, Radio Standard, LTE
Example	:SOUR:FREQ:CHAN:BAND BAND28
Initial S/W Revision	A.14.00

BAND 31

Selects BAND 31 as the band for the current step.

Key Path	Source, Frequency, Radio Setup, Radio Standard, LTE
Example	:SOUR:FREQ:CHAN:BAND BAND31
Initial S/W Revision	A.14.00

LTE TDD

Sets LTE TDD as the radio standard for use and accesses the LTE TDD specific channel band sub-menus..

Key Path	Source, Frequency, Radio Setup, Radio Standard
Initial S/W Revision	A.11.50

BAND 33

Selects BAND 33 as the band for the current step.

Key Path	Source, Frequency, Radio Setup, Radio Standard, LTE TDD
Example	:SOUR:FREQ:CHAN:BAND BAND33
Initial S/W Revision	A.11.50

BAND 34

Selects BAND 34 as the band for the current step.

Key Path	Source, Frequency, Radio Setup, Radio Standard, LTE TDD
Example	:SOUR:FREQ:CHAN:BAND BAND34
Initial S/W Revision	A.11.50

BAND 35

Selects BAND 35 as the band for the current step.

Key Path	Source, Frequency, Radio Setup, Radio Standard, LTE TDD
Example	:SOUR:FREQ:CHAN:BAND BAND35
Initial S/W Revision	A.11.50

BAND 36

Selects BAND 36 as the band for the current step.

Key Path	Source, Frequency, Radio Setup, Radio Standard, LTE TDD
Example	:SOUR:FREQ:CHAN:BAND BAND36
Initial S/W Revision	A.11.50

BAND 37

Selects BAND 37 as the band for the current step.

Key Path	Source, Frequency, Radio Setup, Radio Standard, LTE TDD
Example	:SOUR:FREQ:CHAN:BAND BAND37
Initial S/W Revision	A.11.50

BAND 38

Selects BAND 38 as the band for the current step.

Key Path	Source, Frequency, Radio Setup, Radio Standard, LTE TDD
Example	:SOUR:FREQ:CHAN:BAND BAND38
Initial S/W Revision	A.11.50

BAND 39

Selects BAND 39 as the band for the current step.

Key Path	Source, Frequency, Radio Setup, Radio Standard, LTE TDD
Example	:SOUR:FREQ:CHAN:BAND BAND39
Initial S/W Revision	A.11.50

BAND 40

Selects BAND 40 as the band for the current step.

Key Path	Source, Frequency, Radio Setup, Radio Standard, LTE TDD
Example	:SOUR:FREQ:CHAN:BAND BAND40
Initial S/W Revision	A.11.50

BAND 41

Selects BAND 41 as the band for the current step.

Key Path	Source, Frequency, Radio Setup, Radio Standard, LTE TDD
Example	:SOUR:FREQ:CHAN:BAND BAND41
Initial S/W Revision	A.11.50

BAND 42

Selects BAND 42 as the band for the current step.

Key Path	Source, Frequency, Radio Setup, Radio Standard, LTE TDD
Example	:SOUR:FREQ:CHAN:BAND BAND42
Initial S/W Revision	A.11.50

BAND 43

Selects BAND 43 as the band for the current step.

Key Path	Source, Frequency, Radio Setup, Radio Standard, LTE TDD
Example	:SOUR:FREQ:CHAN:BAND BAND43
Initial S/W Revision	A.11.50

BAND 44

Selects BAND 44 as the band for the current step.

Key Path	Source, Frequency, Radio Setup, Radio Standard, LTE TDD
Example	:SOUR:FREQ:CHAN:BAND BAND44
Initial S/W Revision	A.14.00

TDSCDMA

Sets TDSCDMA as the radio standard for use and accesses the TDSCDMA specific channel band sub-menus..

Key Path	Source, Frequency, Radio Setup, Radio Standard
Initial S/W Revision	A.11.50

BAND A

Selects BAND A as the band for the current step.

Key Path	Source, Frequency, Radio Setup, Radio Standard, TDSCDMA
Example	:SOUR:FREQ:CHAN:BAND BANDA
Initial S/W Revision	A.11.50

BAND B

Selects BAND B as the band for the current step.

Key Path	Source, Frequency, Radio Setup, Radio Standard, TDSCDMA
Example	:SOUR:FREQ:CHAN:BAND BANDB
Initial S/W Revision	A.11.50

BAND C

Selects BAND C as the band for the current step.

Key Path	Source, Frequency, Radio Setup, Radio Standard, TDSCDMA
Example	:SOUR:FREQ:CHAN:BAND BANDC
Initial S/W Revision	A.11.50

BAND D

Selects BAND D as the band for the current step.

Key Path	Source, Frequency, Radio Setup, Radio Standard, TDSCDMA
Example	:SOUR:FREQ:CHAN:BAND BANDD
Initial S/W Revision	A.11.50

BAND E

Selects BAND E as the band for the current step.

Key Path	Source, Frequency, Radio Setup, Radio Standard, TDSCDMA
----------	---

Example	:SOUR:FREQ:CHAN:BAND BANDE
Initial S/W Revision	A.11.50

BAND F

Selects BAND F as the band for the current step.

Key Path	Source, Frequency, Radio Setup, Radio Standard, TDSCDMA
Example	:SOUR:FREQ:CHAN:BAND BANDF
Initial S/W Revision	A.11.50

Radio Band Link

Allows you to specify the channel band type as either uplink or downlink link direction. This value is used in conjunction with the channel band and channel number to determine the absolute frequency output by the source. When set to “Uplink”, the source will calculate the uplink frequency using an uplink formula together with the selected channel band and channel number . When set to “Downlink”, the source will calculate the downlink frequency using a downlink formula together with the selected channel band and channel number.

Key Path	Source, Frequency, Radio Setup
Remote Command	:SOURce:RADio:BAND:LINK DOWN UP :SOURce:RADio:BAND:LINK?
Example	:SOUR:RAD:BAND:LINK UP
Preset	DOWN
Range	DOWN UP
Backwards Compatibility SCPI	:SOURce:RADio:DEVIce BTS MS :SOURce:RADio:DEVIce?
Backwards Compatibility Notes	BTS maps to the Downlink frequency MS maps to the Uplink frequency
Initial S/W Revision	A.05.00

Set Reference Frequency

This key allows you to set the frequency reference. Pressing this key turns the frequency reference state to ON, sets the reference frequency value to the current frequency, maintains this frequency at the RF output, and sets the displayed frequency to 0.00 Hz. All subsequent frequencies entered under Source>Frequency>Frequency are interpreted as being relative to this reference frequency.

When you use a frequency reference, the signal generator outputs a frequency that is set relative to the reference frequency by the value entered under Source>Frequency>Frequency as follows:

$$\text{Output frequency} = \text{reference frequency} - \text{entered frequency}$$

Where:

reference frequency equals the original RF frequency entered under Source>Frequency>Frequency and set as the reference frequency

entered frequency equals a new value entered under Source>Frequency>Frequency

In addition, the displayed frequency value will be the same as the value entered under Source>Frequency>Frequency.

NOTE

If Freq Reference is set to ON with a reference value set, entering a value under Source>Frequency>Frequency and pressing Set Frequency Reference will add that value to the existing Freq Reference value.

If you wish to change the reference frequency value to the new value entered under Source>Frequency>Frequency, first you must set Freq Reference to OFF and then press Set Frequency Reference.

Key Path	Source, Frequency
Remote Command	:SOURce:FREQuency:REFerence:SET
Example	:SOUR:FREQ:REF:SET
Dependencies	This setting is unavailable, and is grayed out when the List Sequencer is turned ON.
Initial S/W Revision	A.05.00

Freq Reference

This key allows you to toggle the state of the frequency reference. When the frequency reference state is ON, an annunciator is displayed on the main source view to indicate this state to the user.

When you use a frequency reference, the signal generator outputs a frequency that is set relative to the reference frequency by the value entered under Source>Frequency>Frequency as follows:

Output frequency = reference frequency + entered frequency

Where:

reference frequency equals the original RF frequency entered under Source>Frequency>Frequency and set as the reference frequency

entered frequency equals a new value entered under Source>Frequency>Frequency

For more information on Reference Frequency refer to ["Set Reference Frequency" on page 2473](#)

Key Path	Source, Frequency
Remote Command	:SOURce:FREQuency:REFerence <freq> :SOURce:FREQuency:REFerence? :SOURce:FREQuency:REFerence:STATe OFF ON 0 1 :SOURce:FREQuency:REFerence:STATe?
Example	:SOUR:FREQ:REF 0.00 Hz

	:SOUR:FREQ:REF:STATe ON
Dependencies	This setting is unavailable, and is grayed out when the List Sequencer is turned ON.
Couplings	The frequency reference state is coupled to the frequency reference set immediate action. When the reference set immediate action key is pressed, or the SCPI command issued, it turns the frequency reference state ON.
Preset	0.00 Hz OFF
Min	0.00 Hz
Max	Hardware Dependant: Option 503 = 3.6 GHz Option 504 = 3.8 GHz Option 506 = 6.00 GHz
Initial S/W Revision	A.05.00

Freq Offset

Allows you to specify the frequency offset value. When the frequency offset state is ON, an annunciator is displayed on the main source view to indicate this state to the user.

When the frequency offset is set to zero (0) and you set a new offset value, the displayed frequency value will change as follows and the RF output frequency will not change:

Displayed value = output frequency + offset value

Where:

output frequency equals the original frequency entered under Source>Frequency>Frequency

offset value equals the value entered under Source>Frequency>Freq Offset

When the frequency offset is set to a value other than zero (0) and you enter a new frequency value under Source>Frequency>Frequency, the displayed frequency will be the same as the value entered and the RF output frequency will be equal to the value entered minus the offset value as follows:

Output frequency = entered frequency – offset frequency

Displayed frequency = output frequency + offset frequency

Displayed frequency = entered frequency

Where:

entered frequency equals the frequency entered under Source>Frequency>Frequency

offset frequency equals the value previously entered and set under Source>Frequency>Freq Offset

Key Path	Source, Frequency
Remote Command	:SOURce:FREQuency:OFFSet <freq>

	:SOURce:FREQuency:OFFSet?
Example	:SOUR:FREQ:OFFS 0 Hz
Dependencies	This setting is unavailable, and is grayed out when the List Sequencer is turned ON.
Preset	0 Hz
Min	-100.00 GHz
Max	100.00 GHz
Initial S/W Revision	A.05.00

Modulation Setup

Allows access to the menus for setting up the available modulation types: "ARB" on page 2476, "AM" on page 2517, "FM" on page 2518, and "PM" on page 2519.

Key Path	Source
Initial S/W Revision	A.05.00

ARB

Allows you access to the ARB sub-menus.

Key Path	Source, Modulation Setup
Initial S/W Revision	A.05.00

ARB

Allows you to toggle the state of the ARB function. When the ARB is On, a "MOD" annunciator is displayed in the system settings panel. When the ARB is turned Off, the MOD annunciator is cleared

Key Path	Source, Modulation Setup, ARB
Remote Command	:SOURce:RADio:ARB[:STATe] ON OFF 1 0 :SOURce:RADio:ARB[:STATe]?
Example	:SOUR:RAD:ARB OFF :SOUR:RAD:ARB?
Notes	If the ARB is ON, a user then loads or deletes another file to ARB memory, the playing waveform segment may not keep phase continuity during the ARB memory operation. The waveform will be replayed after the ARB operation is finished.
Dependencies	This setting is for independent mode and has no effect on 3.3.8 list sequencer mode. Setting "Sequencer" on page 2521 Sequencer to On will put source enter list sequencer mode, and even if ARB state is On, the ARB file will not be played. Setting "Sequencer" on page 2521 Sequencer to Off will make source leave list sequencer mode, and this setting will take effect immediately.

The ARB can only be turned on when there is a waveform file selected for playback. On the GUI if no waveform is selected, this key is grayed out. If you send the SCPI command to turn the ARB on with no waveform selected for playback, the ARB state remains OFF and an error is generated. “-

When you try to recall a certain set of states in which the selected waveform is not in ARB memory and the ARB state is On, errors are reported

Preset	Off
Range	On Off
Initial S/W Revision	A.05.00

Select Waveform

Allows you to access to the waveform selection sub-menus.

Pressing this key changes the central view area to show the Waveform File Selection view.

Key Path	Source, Modulation Setup, ARB
Initial S/W Revision	A.05.00

Select Waveform

Allows you to select a waveform sequence or segment for the dual ARB to play.

NOTE: Selecting a waveform file does not result in automatic adjustments to burst timing (to compensate for the presence or absence of a Multiport Adapter); that adjustment occurs only when a waveform is loaded to ARB memory. See "Load Segment to ARB Memory" for more information about this adjustment.

Key Path	Source, Modulation Setup, ARB, Select Waveform
----------	--

Remote Command	:SOURce:RADio:ARB:WAVeform <string> :SOURce:RADio:ARB:WAVeform?
-----------------------	--

Example	:SOUR:RAD:ARB:WAV "test_waveform.bin"
----------------	---------------------------------------

Notes	<p>If intended waveform is not in the memory yet, then issuing this command by SCPI will invoke ARB loading operation first, which involves a delay of unpredictable length. So this command should be followed by the query *OPC?, which holds off subsequent commands until the loading operating is complete.</p> <p><string> - specifies the name of the waveform segment or waveform sequence to be played by the ARB.</p> <p>When in Sequence Analyzer mode, and Include Source is Yes, if the you attempt to play a waveform sequence but not all the required waveform segments are in the ARB playback memory, the application will reject the loading operation with an error is generated .</p> <p>When Include Source is No, if you attempt to play a waveform sequence but not all the required waveform segments are contained in the ARB playback memory, the application will attempt to load the required segments from either the default directory of the current directory. If the ARB memory does not have enough space for all the waveform segments to be loaded, an error is generated and</p>
--------------	--

none of the waveform segments is loaded.

If the ARB is ON, and you attempt to play a waveform sequence but not all the waveform segments within the sequence could be found to be loaded into ARB memory, an error is generated. The selected waveform keeps the previous value and ARB state remains On.

If you specify a waveform segment over SCPI but the waveform segment is not present within ARB playback memory and cannot be found for auto loading within the current directory or the default directory, an error is generated and the file selection remains unchanged.

If you select a waveform for playback and the waveform requires a license that is not installed on the instrument, an error is generated.

If the ARB is ON and you load a file to ARB memory or delete a file from ARB memory, the playing waveform segment may not keep phase continuity during the ARB memory operation. The waveform will be replayed after the ARB operation is finished.

Initial S/W Revision	A.05.00
----------------------	---------

Segments on Hard Disk

Allows you access to the sub-menus for loading waveform segments from the hard disk into ARB memory. The default directory is: D: varb.

Pressing this key changes the current view to the Waveform Management View.

Key Path	Source, Modulation Setup, ARB, Select Waveform
----------	--

Initial S/W Revision	A.05.00
----------------------	---------

Load Segment To ARB Memory

Allows you to load the selected file into ARB memory. On the front panel you select the file for loading to the ARB memory by highlighting the desired file in the list. Using the SCPI command, you specify the file name on the HDD.

“NVWFM” (non-volatile storage) MSUS (Mass Storage Unit Specifier) is supported in the memory subsystem because the ARB memory cannot be accessed directly. Therefore, files must be downloaded to the instrument hard disk and then loaded into the ARB memory. “NVWFM” MSUS will be mapped to the default directory D: VARB. The SCPI command supports using either “NVWFM” MSUS or specifying a full path. For more information, see [Memory Subsystem \(Remote Command Only\)](#).

If a file of the same name already exists within ARB memory, it is overwritten. If you wish to load two segments of the same name, you must rename one of the segments before loading it into ARB memory. To rename a segment, you can either use Windows File Explorer, or the :MMEMory:COPY command.

NOTE: When a waveform file is loaded to ARB memory, burst timing adjustments are made automatically, based on whether or not a Multiport Adapter is connected to the test set and powered on. If the connection/power status of the Multiport Adapter is changed after a waveform file has been loaded, it needs to be loaded again.

Key Path	Source, Modulation Setup, ARB, Select Waveform, Segments on Hard Disk
----------	---

Remote Command	:SOURCE:RADio:ARB:LOAD <string>
Example	:SOUR:RAD:ARB:LOAD "D: VARB\testwaveform.bin" or :SOUR:RAD:ARB:LOAD "NVWFM:testwaveform.bin"
Notes	<p>Because loading the file involves a delay of unpredictable length, this command should be followed by the query *OPC?, which holds off subsequent commands until the loading operating is complete.</p> <p><string> – specifies the path name of the file to load from the HDD into ARB memory. It could be a <full path + filename>, or <"NVWFM" MSUS + colon + filename>.</p> <p>When in Sequence Analyzer mode, and Include Source is Yes, an attempt to load a file to ARB memory will be rejected with an error.</p> <p>When Include Source is No and if there is insufficient free ARB memory to load the selected waveform, an error is generated. .</p> <p>If you specify a file over SCPI, but the file is not at the specified location, an error is generated.</p> <p>If you try to load a waveform file but the file contains less than 500 IQ samples, an error is generated.</p> <p>If you try to load a Signal Studio waveform "*.wfm" which contains invalid waveform header, an error is generated.</p> <p>If the ARB is ON when you load a file to ARB memory or delete a file from ARB memory, the playing waveform segment may not keep phase continuity during the ARB memory operation. The waveform will be replayed after the ARB operation is finished.</p> <p>ARB can be loaded into ARB memory even required licenses do not present on the instrument. In this case, a GUI only warning message –800, "Operation complete; Loaded <filename> successfully, but no license <required licenses> installed". User can install required licenses according to <required licenses> string to license it, or multi-pack license it.</p>
Initial S/W Revision	A.05.00

Load All To ARB Memory

Allows you to load all the segment files within the currently selected directory into ARB memory. If a file of the same name already exists within ARB memory, it is overwritten. If you wish to load two segments of the same name, you must rename one of the segments before loading it into ARB memory. To rename a segment, you can either use Windows File Explorer, or the :MEMORY:COPY command.

NOTE: When a waveform file is loaded to ARB memory, burst timing adjustments are made automatically, based on whether or not a Multiport Adapter is connected to the test set and powered on. If the connection/power status of the Multiport Adapter is changed after a waveform file has been loaded, it needs to be loaded again.

Key Path	Source, Modulation Setup, ARB, Select Waveform, Segments on Hard Disk
Remote Command	:SOURCE:RADio:ARB:LOAD:ALL <string>
Example	:SOUR:RAD:ARB:LOAD:ALL "D: varb"
Notes	<p><string> - specifies the directory on the HDD to load the files into ARB memory from.</p> <p>When in Sequence Analyzer mode, and Include Source is Yes, an attempt to load all files from a directory to ARB memory is rejected with an error.</p> <p>When Include Source is No and there is insufficient free ARB memory to load all the waveforms,</p>

when the ARB memory is full, the copy ceases, and an error is generated.
 If you specify a directory over SCPI, but the directory does not exist, an error is generated.
 If the ARB is ON, a user then loads or deletes file to ARB memory, the playing waveform segment may not keep phase continuity during the ARB memory operation. The waveform will be replayed after the ARB operation is finished.

Initial S/W Revision	A.05.00
----------------------	---------

Change Directory...

Allows you to change the currently selected directory on the hard disk. Pressing this key opens a standard windows change directory dialog allowing you to select the new directory of interest.

The current directory is used for manually loading waveform segments into ARB memory for playback, and as a search location for waveform segments that are required to be loaded into ARB memory for playback of a waveform sequence or a list sequence.

Key Path	Source, Modulation Setup, ARB, Select Waveform, Segments on Hard Disk
Notes	No remote command, SCPI front panel only.
Initial S/W Revision	A.05.00

Default Directory...

Allows you to change the default directory. It is used as a search location for waveform segments that are required to be loaded into ARB memory for playback of a waveform sequence, and as a search location for selecting waveforms using SCPI.

Key Path	Source, Modulation Setup, ARB, Select Waveform, Segments on Hard Disk
Remote Command	:SOURce:RADio:ARB:DEFault:DIRectory <string> :SOURce:RADio:ARB: DEFault:DIRectory?
Example	:SOUR:RAD:ARB:DEF:DIR "D:\ArbFiles" :SOUR:RAD:ARB:DEF:DIR?
State Saved	Persistent, survives a power cycle and a preset but not saved in the instrument state
Initial S/W Revision	A.05.00

Segments in ARB Memory

Allows you access to the sub-menus for managing the files within ARB memory.

Key Path	Source, Modulation Setup, ARB, Select Waveform
Initial S/W Revision	A.05.00

Delete Segment From ARB Mem

Allows you to remove a segment from ARB playback memory.

Key Path	Source, Modulation Setup, ARB, Select Waveform, Segments in ARB Memory
Remote Command	:SOURce:RADio:ARB:DELeTe <string>
Example	:SOUR:RAD:ARB:DEL "testwaveform.bin"
Notes	<p><string> - specifies the waveform to be deleted from the ARB playback memory.</p> <p>When in Sequence Analyzer mode and Include Source is Yes, an attempt to delete a file from ARB memory is rejected with an error.</p> <p>When Include Source is No and you specify a file that does not exist within ARB memory, an error is generated.</p> <p>It is possible to delete files from within the ARB memory when the ARB is ON. However, if you attempt to delete the file that is currently playing an error is generated.</p> <p>It is possible to delete a file from within the ARB memory when the sequencer state is ON and the file is not being used by the List Sequencer. If you attempt to delete a file which is being used by the list sequencer, an error is generated.</p> <p>When sequencer state is On, even if ARB state is On, the selected waveform will not be played. In this case, if the selected waveform is not used in List Sequence, it can be deleted and the ARB state is turned Off.</p> <p>If the ARB is ON and you load a file to ARB memory or delete a file from ARB memory, the playing waveform segment may not keep phase continuity during the ARB memory operation. The waveform will be replayed after the ARB operation is finished.</p>
Initial S/W Revision	A.05.00

Delete All From ARB Memory

Allows you to remove all segments from ARB playback memory.

Key Path	Source, Modulation Setup, ARB, Select Waveform, Segments in ARB Memory
Remote Command	:SOURce:RADio:ARB:DELeTe:ALL
Example	:SOUR:RAD:ARB:DELeTe:ALL
Notes	<p>When in Sequence Analyzer mode and Include Source is Yes, an attempt to delete all files from ARB memory is rejected with an error.</p> <p>When Include Source is No and you attempt to delete all files from ARB memory when the ARB is currently playing a file, all files except the one playing are deleted and an error is generated.</p> <p>If you attempt to delete all files from ARB memory when there are waveform files used in "List Sequencer" on page 2520 and "Sequencer" on page 2521 state is ON, all files except the files currently being used in list sequencer are deleted, and an error is generated.</p> <p>If the ARB is ON and you load a file to ARB memory or delete a file from ARB memory, the playing waveform segment may not keep phase continuity during the ARB memory operation. The waveform will be replayed after the ARB operation is finished.</p>
Initial S/W Revision	A.05.00

Query ARB Memory File List (Remote Command Only)

Queries the test set for the list of waveform segments in the ARB memory.

NOTE

This command returns a string for waveform segment names in ARB memory. If you want a string list of waveform segments in the ARB memory, use "[Query ARB Memory Full File List \(Remote Command Only\)](#)" on page 2482.

Remote Command	:SOURce:RADio:ARB:CATalog?
Example	:SOUR:RAD:ARB:CATalog?
Notes	The return data is in the following format: <integer> - memory used <integer> - memory free <string> ... - comma separated list of waveform segments within ARB memory
Initial S/W Revision	A.05.00

Query ARB Memory Full File List (Remote Command Only)

Queries the test set for the string list of waveform segments in the ARB memory. It returns a string list for waveform segment names in the ARB memory.

Remote Command	:SOURce:RADio:ARB:FCATalog?
Example	:SOUR:RAD:ARB:FCATalog?
Notes	The return data is in the following format: <integer> - memory used <integer> - memory free <integer> - file count in ARB memory <string>,<string>, ... <string> - comma separated string list of waveform segments within ARB memory Example: SOUR:RAD:ARB:FCAT? EXT returns: 27499,2069653,3,"c2k.wfm","gsm.wfm","wcdma.wfm"
Initial S/W Revision	A.09.00

ARB Setup

Allows access to the ARB setup sub-menus.

Key Path	Source, Modulation Setup, ARB
Initial S/W Revision	A.05.00

Sample Rate

Allows you to set the ARB waveform playback sample rate.

Key Path	Source, Modulation Setup, ARB, ARB Setup
Remote Command	:SOURce:RADio:ARB:SCLock:RATE <freq> :SOURce:RADio:ARB:SCLock:RATE?
Example	:SOUR:RAD:ARB:SCL:RATE 48.00 MHz
Notes	If there is a sample rate specified in the header of the waveform file, changing that sample rate is not recommended, as it may cause problems with burst timing.
Dependencies	When a new waveform is selected for playback the settings contained within the associated waveform header file are applied to the ARB. The sample rate is one of the values stored within the header file. If the newly selected waveform file has an associated header file, the sample rate is updated with the value from the header file. The sample rate will remain unchanged if the newly selected waveform does not have an associated header file.
Preset	125.00 MHz
Min	1.00 kHz
Max	125.00 MHz
Initial S/W Revision	A.05.00

Run-Time Scaling

Allows you to adjust the run-time scaling value. The run-time scaling value is applied in real-time while the waveform is playing.

Key Path	Source, Modulation Setup, ARB, ARB Setup
Remote Command	:SOURce:RADio:ARB:RSCaling <real> :SOURce:RADio:ARB:RSCaling?
Example	:SOUR:RAD:ARB:RSC 100.00
Notes	This setting cannot be set in E6640A. Grey out on menu and the value is fixed at 70.00%.
Dependencies	When a new waveform is selected for playback the settings contained within the associated waveform header file are applied to the ARB. The run-time scaling is one of the values stored within the header file. If the newly selected waveform file has an associated header file, the run-time scaling is updated with the value from the header file. The run-time scaling will remain unchanged if the newly selected waveform does not have an associated header file.
Preset	70.00 %
Min	1.00 %
Max	100.00 %
Initial S/W Revision	A.05.00

Baseband Freq Offset

Allows you to adjust the value by which the baseband frequency is offset relative to the carrier.

Key Path	Source, Modulation Setup, ARB, ARB Setup
Remote Command	:SOURce:RADio:ARB:BASEband:FREQuency:OFFSet <freq> :SOURce:RADio:ARB:BASEband:FREQuency:OFFSet?
Example	:SOUR:RAD:ARB:BAS:FREQ:OFFS 0.00 Hz
Dependencies	When a new waveform is selected for playback the settings contained within the associated waveform header file are applied to the ARB. The baseband frequency offset is one of the values stored within the header file. If the newly selected waveform has an associated header file, the baseband frequency offset is updated with the value from the header file. The baseband frequency offset will remain unchanged if the newly selected waveform does not have an associated header file.
Preset	0.00 Hz
Min	-50.00 MHz
Max	50.00 MHz
Initial S/W Revision	A.05.00

Trigger Type

Allows access to the trigger type sub-menus. The setting for trigger type determines the behavior of the waveform when it plays.

Key Path	Source, Modulation Setup, ARB
Remote Command	:SOURce:RADio:ARB:TRIGger:TYPE CONTinuous SINGLE SADVance GATE :SOURce:RADio:ARB:TRIGger:TYPE?
Example	:SOUR:RAD:ARB:TRIG:TYPE CONT :SOUR:RAD:ARB:TRIG:TYPE?
Notes	Gated trigger type will be implemented at a later release
Preset	CONTinuous
Range	Continuous Single Seg Adv Gated
Initial S/W Revision	A.05.00

Continuous

Sets the active trigger type to Continuous. If Continuous is already selected as the active trigger type, pressing this key allows access to the continuous trigger type setup menu. In Continuous trigger mode, the waveform repeats continuously.

Key Path	Source, Modulation Setup, ARB, Trigger Type
Remote Command	:SOURce:RADio:ARB:TRIGger:TYPE:CONTinuous[:TYPE] FREE TRIGger RESet :SOURce:RADio:ARB:TRIGger:TYPE:CONTinuous[:TYPE]?
Example	:SOUR:RAD:ARB:TRIG:TYPE:CONT FREE
Preset	FREE

Range	Free Run Trigger + Run Reset + Run
Initial S/W Revision	A.05.00

Free Run

Selects Free Run as the trigger response for the continuous trigger type. Free Run sets the waveform generator to play a waveform sequence or segment continuously, without waiting for a trigger. In this mode, the waveform generator does not respond to triggers.

Key Path	Source, Modulation Setup, ARB, Trigger Type, Continuous
Example	:SOUR:RAD:ARB:TRIG:TYPE:CONT FREE
Initial S/W Revision	A.05.00

Trigger + Run

Sets Trigger and Run as the trigger response for the continuous trigger type. Trigger and Run sets the waveform generator to play a waveform sequence or segment continuously when the first trigger is received, and to ignore any subsequent triggers.

Key Path	Source, Modulation Setup, ARB, Trigger Type, Continuous
Example	:SOUR:RAD:ARB:TRIG:TYPE:CONT TRIG
Initial S/W Revision	A.05.00

Reset + Run

Sets Reset and Run as the trigger response for the continuous trigger type. Reset and Run sets the waveform generator to play a waveform sequence or segment continuously when the first trigger is received. Subsequent triggers reset the waveform sequence or segment to the start, and then play it continuously.

Key Path	Source, Modulation Setup, ARB, Trigger Type, Continuous
Example	:SOUR:RAD:ARB:TRIG:TYPE:CONT RES
Initial S/W Revision	A.05.00

Single

Sets the active trigger type to Single. If Single is already selected as the active trigger type, pressing this key allows access to the single trigger type setup menu. In Single trigger mode, the waveform plays once.

Key Path	Source, Modulation Setup, ARB, Trigger Type
Remote Command	:SOURce:RADio:ARB:RETRigger ON OFF IMMediate

	:SOURce:RADio:ARB:RETRigger?
Example	:SOUR:RAD:ARB:RETR OFF
Notes	ON: Buffered Trigger OFF: No Retrigger Immediate: Restart on Trigger This is defined as an enumerated SCPI command, with ON OFF being considered as enumerated types rather than Boolean. This means the query will return OFF instead of 0, and ON instead of 1.
Preset	ON
Range	No Retrigger Buffered Trigger Restart on Trigger
Initial S/W Revision	A.05.00

No Retrigger

Selects No Retrigger as the trigger response for single trigger type. No Retrigger sets the waveform generator to play a waveform sequence or segment once when a trigger is received. Any triggers then received during playback are ignored.

Key Path	Source, Modulation Setup, ARB, Trigger Type, Single
Example	:SOUR:RAD:ARB:RETR OFF
Initial S/W Revision	A.05.00

Buffered Trigger

Selects Buffered Trigger as the trigger response for single trigger type. Buffered Trigger sets the waveform generator to play a waveform sequence or segment once when a trigger is received. If a trigger is received during playback, the waveform generator plays the sequence or segment to the end, then plays the sequence or segment once more.

Key Path	Source, Modulation Setup, ARB, Trigger Type, Single
Example	:SOUR:RAD:ARB:RETR ON
Initial S/W Revision	A.05.00

Restart on Trigger

Selects Restart on Trigger as the trigger response for single trigger type. Restart on Trigger sets the waveform generator to play a waveform sequence or segment once when a trigger is received. If a trigger is received during playback, the waveform generator resets and plays the sequence or segment from the start.

Key Path	Source, Modulation Setup, ARB, Trigger Type, Single
Example	:SOUR:RAD:ARB:RETR IMM
Initial S/W Revision	A.05.00

Segment Advance

Sets the active trigger type to Segment Advance. If Segment Advance is already selected as the active trigger type, pressing this key allows access to the segment advance trigger type setup menu.

Segment Advance triggering allows you to control the playback of waveform segments within a waveform sequence. When a trigger is received the ARB advances to the next waveform segment within the waveform sequence. This type of triggering ignores the repetition count for the waveform segment within the waveform sequence. For example, if a waveform segment has a repetition count of 10 and you select single segment advance triggering mode, the waveform segment will only play once.

Segment Advance triggering can also be used for waveform segments only. In this situation the same waveform segment is played again when a trigger is received.

Key Path	Source, Modulation Setup, ARB, Trigger Type
Remote Command	:SOURce:RADio:ARB:TRIGger:TYPE:SADVance[:TYPE] SINGLE CONTInuous :SOURce:RADio:ARB:TRIGger:TYPE:SADVance[:TYPE]?
Example	:SOUR:RAD:ARB:TRIG:TYPE:SADV SING
Preset	CONTInuous
Range	Single Continuous
Initial S/W Revision	A.05.00

Single

Selects Single as the trigger response for Segment Advance trigger type. With single selected, once a trigger is received a segment is played once. If a trigger is received during playback of a segment, the segment plays to completion and the next segment is played once.

Key Path	Source, Modulation Setup, ARB, Trigger Type, Segment Advance
Example	:SOUR:RAD:ARB:TRIG:TYPE:SADV SING
Initial S/W Revision	A.05.00

Continuous

Selects Continuous as the trigger response for Segment Advance trigger type. With continuous selected, once a trigger is received a segment is played continuously. When subsequent triggers are received, the currently playing segment plays to completion and then the next segment is played continuously.

Key Path	Source, Modulation Setup, ARB, Trigger Type, Segment Advance
Example	:SOUR:RAD:ARB:TRIG:TYPE:SADV CONT
Initial S/W Revision	A.05.00

Trigger Source

Allows access to the trigger source sub-menus. The trigger source setting determines how the source receives the trigger that starts the waveform playing. Therefore, this key is grayed out if the trigger type is free run, since free run triggers immediately with no trigger source required.

Key Path	Source, Modulation Setup, ARB
Remote Command	:SOURce:RADio:ARB:TRIGger[:SOURce] KEY BUS EXTernal2 :SOURce:RADio:ARB:TRIGger[:SOURce]?
Example	:SOUR:RAD:ARB:TRIGger KEY
Dependencies	This key is grayed out if the current trigger type is Continuous, Free Run.
Preset	EXTernal2
Range	Trigger Key Bus External 2
Initial S/W Revision	A.05.00

Trigger Key

Sets the current trigger source to the front panel Trigger key. When Trigger Key is selected, the waveform is triggered when you press the front panel Trigger key.

Key Path	Source, Modulation Setup, ARB, Trigger Source
Example	:SOUR:RAD:ARB:TRIGger KEY
Initial S/W Revision	A.05.00

Bus

Sets the current trigger source to Bus. Selecting Bus trigger source enables triggering over GPIB, LAN, or USB using the :SOURce:RADio:ARB:TRIGger:INITiate command.

Key Path	Source, Modulation Setup, ARB, Trigger Source
Example	:SOUR:RAD:ARB:TRIGger BUS
Initial S/W Revision	A.05.00

External 2

Sets the current trigger source to External 2. Selecting External 2 enables triggering a waveform by an externally applied signal.

Key Path	Source, Modulation Setup, ARB, Trigger Source
Example	:SOUR:RAD:ARB:TRIGger EXT2
Notes	Note: When on E6640A, trigger 2 is a bi-directional trigger port. So when trigger 2 has been configured as OUTPUT type, choosing External 2 as the input trigger for the current step will generate error.
Initial S/W Revision	A.05.00

Trigger Initiate

Used to initiate an immediate trigger event if the trigger source is set to Trigger Key.

Key Path	Source, Modulation Setup, ARB
Notes	No remote command, SCPI front panel only.
Initial S/W Revision	A.05.00

Waveform Sequences

Allows access to the waveform sequence sub-menus. Pressing this key changes the central view area to display the Waveform Sequence List view.

Key Path	Source, Modulation Setup, ARB
Notes	No remote command, SCPI front panel only.
Initial S/W Revision	A.05.00

Build New Sequence

Allows access to the sub-menus for creating a new waveform sequence. Pressing this key changes the central view area to display the Waveform Sequence Creation and Editing view.

Key Path	Source, Modulation Setup, ARB, Waveform Sequences
Notes	No remote command, SCPI front panel only.
Initial S/W Revision	A.05.00

Current Segment

Specifies the selected sequence segment that will be affected by the menu functions.

Key Path	Source, Modulation Setup, ARB, Waveform Sequences, Build New Sequence
Notes	No remote command, SCPI front panel only. This key is grayed out and unavailable if the sequence is currently empty.
Initial S/W Revision	A.05.00

Insert New Waveform

Allows you access to the sub-menu for inserting a new waveform segment or sequence. Pressing this key also changes the central display to show the Waveform File Selection View.

Key Path	Source, Modulation Setup, ARB, Waveform Sequences, Build New Sequence
Notes	No remote command, SCPI front panel only. Waveform segment name string length upper limit is 128 chars. Please do NOT insert waveform which name string exceeds 128 chars.
Initial S/W Revision	A.05.00

Insert Waveform

Inserts the currently highlighted waveform to the end of the waveform sequence. Pressing this key also returns you to the menus for creating or editing a sequence, and returns the central view to the sequence creation view.

Key Path	Source, Modulation Setup, ARB, Waveform Sequences, Build New Sequence, Insert New Waveform
Notes	No remote command, SCPI front panel only. Waveform segment name string length upper limit is 128 chars. Please do NOT insert waveform which name string exceeds 128 chars.
Initial S/W Revision	A.05.00

Segments on Hard Disk

Allows you access to the sub-menus for loading waveform segments from the hard disk into ARB memory. The default directory is: D: varb.

Pressing this key changes the current view to the Waveform Management View.

Key Path	Source, Modulation Setup, ARB, Select Waveform
Initial S/W Revision	A.05.00

Load Segment To ARB Memory

Allows you to load the selected file into ARB memory. On the front panel you select the file for loading to the ARB memory by highlighting the desired file in the list. Using the SCPI command, you specify the file name on the HDD.

“NVWFM” (non-volatile storage) MSUS (Mass Storage Unit Specifier) is supported in the memory subsystem because the ARB memory cannot be accessed directly. Therefore, files must be downloaded to the instrument hard disk and then loaded into the ARB memory. “NVWFM” MSUS will be mapped to the default directory D: VARB. The SCPI command supports using either “NVWFM” MSUS or specifying a full path. For more information, see [Memory Subsystem \(Remote Command Only\)](#).

If a file of the same name already exists within ARB memory, it is overwritten. If you wish to load two segments of the same name, you must rename one of the segments before loading it into ARB memory. To rename a segment, you can either use Windows File Explorer, or the :MMEMORY:COPY command.

NOTE: When a waveform file is loaded to ARB memory, burst timing adjustments are made automatically, based on whether or not a Multiport Adapter is connected to the test set and powered on. If the connection/power status of the Multiport Adapter is changed after a waveform file has been loaded, it needs to be loaded again.

Key Path	Source, Modulation Setup, ARB, Select Waveform, Segments on Hard Disk
Remote Command	:SOURce:RADio:ARB:LOAD <string>
Example	:SOUR:RAD:ARB:LOAD "D: VARB\testwaveform.bin" or :SOUR:RAD:ARB:LOAD "NVWFM:testwaveform.bin"
Notes	<p>Because loading the file involves a delay of unpredictable length, this command should be followed by the query *OPC?, which holds off subsequent commands until the loading operating is complete.</p> <p><string> – specifies the path name of the file to load from the HDD into ARB memory. It could be a <full path + filename>, or <"NVWFM" MSUS + colon + filename>.</p> <p>When in Sequence Analyzer mode, and Include Source is Yes, an attempt to load a file to ARB memory will be rejected with an error.</p> <p>When Include Source is No and if there is insufficient free ARB memory to load the selected waveform, an error is generated. .</p> <p>If you specify a file over SCPI, but the file is not at the specified location, an error is generated.</p> <p>If you try to load a waveform file but the file contains less than 500 IQ samples, an error is generated.</p> <p>If you try to load a Signal Studio waveform "*.wfm" which contains invalid waveform header, an error is generated.</p> <p>If the ARB is ON when you load a file to ARB memory or delete a file from ARB memory, the playing waveform segment may not keep phase continuity during the ARB memory operation. The waveform will be replayed after the ARB operation is finished.</p> <p>ARB can be loaded into ARB memory even required licenses do not present on the instrument. In this case, a GUI only warning message –800, "Operation complete; Loaded <filename> successfully, but no license <required licenses> installed". User can install required licenses according to <required licenses> string to license it, or multi-pack license it.</p>
Initial S/W Revision	A.05.00

Load All To ARB Memory

Allows you to load all the segment files within the currently selected directory into ARB memory. If a file of the same name already exists within ARB memory, it is overwritten. If you wish to load two segments of the same name, you must rename one of the segments before loading it into ARB memory. To rename a segment, you can either use Windows File Explorer, or the :MEMory:COPY command.

NOTE: When a waveform file is loaded to ARB memory, burst timing adjustments are made automatically, based on whether or not a Multiport Adapter is connected to the test set and powered on. If the connection/power status of the Multiport Adapter is changed after a waveform file has been loaded, it needs to be loaded again.

Key Path	Source, Modulation Setup, ARB, Select Waveform, Segments on Hard Disk
Remote Command	:SOURce:RADio:ARB:LOAD:ALL <string>

Example	:SOUR:RAD:ARB:LOAD:ALL "D: varb"
Notes	<p><string> - specifies the directory on the HDD to load the files into ARB memory from.</p> <p>When in Sequence Analyzer mode, and Include Source is Yes, an attempt to load all files from a directory to ARB memory is rejected with an error.</p> <p>When Include Source is No and there is insufficient free ARB memory to load all the waveforms, when the ARB memory is full, the copy ceases, and an error is generated.</p> <p>If you specify a directory over SCPI, but the directory does not exist, an error is generated.</p> <p>If the ARB is ON, a user then loads or deletes file to ARB memory, the playing waveform segment may not keep phase continuity during the ARB memory operation. The waveform will be replayed after the ARB operation is finished.</p>
Initial S/W Revision	A.05.00

Change Directory...

Allows you to change the currently selected directory on the hard disk. Pressing this key opens a standard windows change directory dialog allowing you to select the new directory of interest.

The current directory is used for manually loading waveform segments into ARB memory for playback, and as a search location for waveform segments that are required to be loaded into ARB memory for playback of a waveform sequence or a list sequence.

Key Path	Source, Modulation Setup, ARB, Select Waveform, Segments on Hard Disk
Notes	No remote command, SCPIfront panel only.
Initial S/W Revision	A.05.00

Default Directory...

Allows you to change the default directory. It is used as a search location for waveform segments that are required to be loaded into ARB memory for playback of a waveform sequence, and as a search location for selecting waveforms using SCPI.

Key Path	Source, Modulation Setup, ARB, Select Waveform, Segments on Hard Disk
Remote Command	:SOURce:RADio:ARB:DEFault:DIRectory <string> :SOURce:RADio:ARB: DEFault:DIRectory?
Example	:SOUR:RAD:ARB:DEF:DIR "D:\ArbFiles" :SOUR:RAD:ARB:DEF:DIR?
State Saved	Persistent, survives a power cycle and a preset but not saved in the instrument state
Initial S/W Revision	A.05.00

Segments in ARB Memory

Allows you access to the sub-menus for managing the files within ARB memory.

Key Path	Source, Modulation Setup, ARB, Select Waveform
Initial S/W Revision	A.05.00

Delete Segment From ARB Mem

Allows you to remove a segment from ARB playback memory.

Key Path	Source, Modulation Setup, ARB, Select Waveform, Segments in ARB Memory
Remote Command	:SOURce:RADio:ARB:DELeTe <string>
Example	:SOUR:RAD:ARB:DEL "testwaveform.bin"
Notes	<p><string> - specifies the waveform to be deleted from the ARB playback memory.</p> <p>When in Sequence Analyzer mode and Include Source is Yes, an attempt to delete a file from ARB memory is rejected with an error.</p> <p>When Include Source is No and you specify a file that does not exist within ARB memory, an error is generated.</p> <p>It is possible to delete files from within the ARB memory when the ARB is ON. However, if you attempt to delete the file that is currently playing an error is generated.</p> <p>It is possible to delete a file from within the ARB memory when the sequencer state is ON and the file is not being used by the List Sequencer. If you attempt to delete a file which is being used by the list sequencer, an error is generated.</p> <p>When sequencer state is On, even if ARB state is On, the selected waveform will not be played. In this case, if the selected waveform is not used in List Sequence, it can be deleted and the ARB state is turned Off.</p> <p>If the ARB is ON and you load a file to ARB memory or delete a file from ARB memory, the playing waveform segment may not keep phase continuity during the ARB memory operation. The waveform will be replayed after the ARB operation is finished.</p>
Initial S/W Revision	A.05.00

Delete All From ARB Memory

Allows you to remove all segments from ARB playback memory.

Key Path	Source, Modulation Setup, ARB, Select Waveform, Segments in ARB Memory
Remote Command	:SOURce:RADio:ARB:DELeTe:ALL
Example	:SOUR:RAD:ARB:DELeTe:ALL
Notes	<p>When in Sequence Analyzer mode and Include Source is Yes, an attempt to delete all files from ARB memory is rejected with an error.</p> <p>When Include Source is No and you attempt to delete all files from ARB memory when the ARB is currently playing a file, all files except the one playing are deleted and an error is generated.</p> <p>If you attempt to delete all files from ARB memory when there are waveform files used in "List Sequencer" on page 2520 and "Sequencer" on page 2521 state is ON, all files except the files currently being used in list sequencer are deleted, and an error is generated.</p>

If the ARB is ON and you load a file to ARB memory or delete a file from ARB memory, the playing waveform segment may not keep phase continuity during the ARB memory operation. The waveform will be replayed after the ARB operation is finished.

Initial S/W Revision	A.05.00
----------------------	---------

Segments on Hard Disk

This key functions the same as ["Segments on Hard Disk" on page 2547](#).

Key Path	Source, Modulation Setup, ARB, Waveform Sequences, Build New Sequence, Insert New Waveform
Initial S/W Revision	Prior to A.09.00

Load Segment To ARB Memory

This key functions the same as ["Load Segment To ARB Memory" on page 2547](#).

Key Path	Source, Modulation Setup, ARB, Waveform Sequences, Build New Sequence, Insert New Waveform, Segment on Hard Drive
Initial S/W Revision	Prior to A.09.00

Load All To ARB Memory

This key functions the same as ["Load All To ARB Memory" on page 2548](#).

Key Path	Source, Modulation Setup, ARB, Waveform Sequences, Build New Sequence, Insert New Waveform, Segment on Hard Drive
Initial S/W Revision	Prior to A.09.00

Change Directory ...

This key functions the same as ["Change Directory..." on page 2549](#).

Key Path	Source, Modulation Setup, ARB, Waveform Sequences, Build New Sequence, Insert New Waveform, Segment on Hard Drive
Initial S/W Revision	Prior to A.09.00

Default Directory ...

This key functions the same as ["Default Directory..." on page 2549](#)

Key Path	Source, Modulation Setup, ARB, Waveform Sequences, Build New Sequence, Insert New Waveform, Segment on Hard Drive
Initial S/W Revision	Prior to A.09.00

Segments in ARB Memory

This key functions the same as ["Segments in ARB Memory" on page 2549](#).

Key Path	Source, Modulation Setup, ARB, Waveform Sequences, Build New Sequence, Insert New Waveform
Initial S/W Revision	Prior to A.09.00

Delete Segment From ARB Memory

This key functions the same as ["Delete Segment From ARB Mem" on page 2549](#).

Key Path	Source, Modulation Setup, ARB, Waveform Sequences, Build New Sequence, Insert New Waveform, Segment in ARB Memory
Initial S/W Revision	Prior to A.09.00

Delete All From ARB Memory

This key functions the same as ["Delete All From ARB Memory" on page 2550](#).

Key Path	Source, Modulation Setup, ARB, Waveform Sequences, Build New Sequence, Insert New Waveform, Segment in ARB Memory
Initial S/W Revision	Prior to A.09.00

Query ARB Memory File List (Remote Command Only)

This command functions the same as ["Query ARB Memory File List \(Remote Command Only\)" on page 2482](#).

Initial S/W Revision	Prior to A.09.00
----------------------	------------------

Edit Selected Waveform

Allows access to the sub-menus for editing the details of the currently selected waveform segment.

Key Path	Source, Modulation Setup, ARB, Waveform Sequences, Build New Sequence
Notes	No remote command, front panel only.
Initial S/W Revision	A.05.00

Repetitions

Allows you to specify the number of times the currently selected waveform is played within the sequence.

Key Path	Source, Modulation Setup, ARB, Waveform Sequences, Build New Sequence, Edit Selected Waveform
Notes	No remote command, SCPI front panel only.
Preset	1
Min	1
Max	65535
Initial S/W Revision	A.05.00

Marker 1

Allows you to enable or disable marker 1 for the currently selected waveform. For a waveform sequence, you can enable and disable markers on a per-segment basis, allowing you to output markers from some waveform segments within the sequence, but not for others.

Key Path	Source, Modulation Setup, ARB, Waveform Sequences, Build New Sequence, Edit Selected Waveform
Notes	No remote command, front panel only.
Preset	Enabled
Range	Enabled Disabled
Initial S/W Revision	A.05.00

Marker 2

Allows you to enable or disable marker 2 for the currently selected waveform. For a waveform sequence, you can enable and disable markers on a per-segment basis, allowing you to output markers from some waveform segments within the sequence, but not for others.

Key Path	Source, Modulation Setup, ARB, Waveform Sequences, Build New Sequence, Edit Selected Waveform
Notes	No remote command, front panel only.
Preset	Enabled
Range	Enabled Disabled
Initial S/W Revision	A.05.00

Marker 3

Allows you to enable or disable marker 3 for the currently selected waveform. For a waveform sequence, you can enable and disable markers on a per-segment basis, allowing you to output markers from some waveform segments within the sequence, but not for others.

Key Path	Source, Modulation Setup, ARB, Waveform Sequences, Build New Sequence, Edit Selected
----------	--

	Waveform
Notes	No remote command, front panel only.
Preset	Enabled
Range	Enabled Disabled
Initial S/W Revision	A.05.00

Marker 4

Allows you to enable or disable marker 4 for the currently selected waveform. For a waveform sequence, you can enable and disable markers on a per-segment basis, allowing you to output markers from some waveform segments within the sequence, but not for others.

Key Path	Source, Modulation Setup, ARB, Waveform Sequences, Build New Sequence, Edit Selected Waveform
Notes	No remote command, front panel only.
Preset	Enabled
Range	Enabled Disabled
Initial S/W Revision	A.05.00

Delete Segment

Allows you to delete the selected segment from the waveform sequence.

Key Path	Source, Modulation Setup, ARB, Waveform Sequences, Build New Sequence
Notes	No remote command, front panel only.
Initial S/W Revision	A.05.00

Save Sequence...

Pressing this key displays the "Save As" dialog. The sequence name is passed to the save as dialog to use as the filename for saving, and the directory the save as dialog will open into is the default waveform directory.

Key Path	Source, Modulation Setup, ARB, Waveform Sequences, Build New Sequence
Initial S/W Revision	A.05.00

Build New Sequence (Remote Command Only)

This command is the SCPI equivalent of the waveform sequence creation features described in "[Build New Sequence](#)" on page 2489.

This command writes a waveform sequence file to the hard disk. You must specify the waveform sequence file path and filename which will be saved on the hard disk, and the waveform segment file path and name which will be nested into the waveform sequence file. You can utilize mass storage unit specifier (MSUS) “NVWFM” or use a real full path representation. See the example below. MSUS “NVWFM” is mapped to D:VARB directory on test set hard disk.

Any number of segments, up to a segment count limit of 64, can be used to create a sequence. Repeated segments are included in the count limit.

Each waveform segment name string length upper limit is 128 chars. Please do NOT insert waveform which name string exceeds 128 chars.

The internal source does not support nesting one waveform sequence file into another waveform sequence file.

Remote Command :SOURce:RADio:ARB:SEQuence[:MWAVeform] <filename>, <waveform1>, <reps>, NONE | M1 | M2 | M3 | M4 | M1M2 | M1M3 | M1M4 | M2M3 | M2M4 | M3M4 | M1M2M3 | M1M2M4 | M1M3M4 | M2M3M4 | M1M2M3M4 | ALL, {<waveform2>, <reps>, NONE | M1 | M2 | M3 | M4 | M1M2 | M1M3 | M1M4 | M2M3 | M2M4 | M3M4 | M1M2M3 | M1M2M4 | M1M3M4 | M2M3M4 | M1M2M3M4 | ALL, } ...

(For additional description of each item, see Notes below ["For Setup SCPI" on page 519](#) "For Setup SCPI".)

:SOURce:RADio:ARB:SEQuence[:MWAVeform]? <filename>

(For additional description of each item, see Notes ["For Query SCPI" on page 520](#) below.)

Example For setup:

```
>:SOUR:RAD:ARB:SEQ "NVWFM:testSeq1.seq", "NVWFM:wfmSegment1.wfm", 10, M2M3M4, "NVWFM:wfmSegment2.wfm", 20, M1M3
```

Or

```
>:SOUR:RAD:ARB:SEQ "D: VARB\testSeq1.seq", " D: VARB\wfmSegment1.wfm", 10, M2M3M4, " D: VARB\wfmSegment2.wfm", 20, M1M3
```

For query, must specify which waveform sequence file to query.

```
>:SOUR:RAD:ARB:SEQ? "NVWFM:testSeq1.seq"
```

Or

```
>:SOUR:RAD:ARB:SEQ? "D: VARB\testSeq1.seq",
```

Notes

For Setup SCPI

For the Setup SCPI command, the parameters are:

<filename> - String Type

This variable specifies the path and name for the waveform sequence file. The path supports MSUS (NVWFM) or a real full path representation. See example.

<waveform1> - String Type

This variable specifies the path and name of the first existing waveform segment. The path supports MSUS (NVWFM) or a real full path representation. See example.

The segment file must reside within ARB playback memory before it can be played by the ARB player.

<reps> - Integer Type

This variable specifies the number of times a segment or sequence plays before moving on to the next segment or sequence.

<marker> - Enum Type

NONE - This choice disables all four markers for the waveform. Disabling markers means that the waveform sequence ignores the segments or sequence marker settings.

M1, M2, M3, M4 - these choices, either individually or a combination of them, enable the markers for the waveform segment or sequence. Markers not specified are ignored for that segment or sequence.

ALL - This choice enables all four markers in the waveform segment or sequence.

<waveform2> - String type.

This variable specifies the name of a second existing waveform segment. The path supports MSUS (NVWFM) and real full path representation both. See example.

The segment file must reside within ARB playback memory before it can be played by the ARB player.

<reps> same as above, for the 2nd waveform segment.

<marker> same as above, for the 2nd waveform segment.

You can insert several waveform segments into a waveform sequence file. Just repeat inserting waveform segments as described above.

Error Checks for Setup SCPI command:

If you do not specify a filename, or you use an unsupported MSUS (that is, not NVWFM), or have an error in the waveform sequence file path, an error is generated.

Notes

Error Checks for Query SCPI command: (Continued)

If the specified waveform sequence file name suffix is not ".seq", error is generated.

If you use an unsupported MSUS (that is, not NVWFM), or have an error in the waveform segment file path, an error is generated.

If the first specified waveform file cannot be found, an error is generated.

If you nest one waveform sequence file into another waveform sequence file, an error is generated.

If the specified repetition value is larger than 65535 or smaller than 1, an error is generated.

If the specified marker type is unrecognized, an error is generated.

For Query SCPI

For the Query the parameters are:

<filename> - String type.

This variable specifies the path and name of the waveform sequence file being queried. The path supports MSUS (NVWFM) or a real full path representation. See example.

The return value is a <string>, which includes each waveform segment file name, repetitions, and marker type. For example:

>:SOUR:RAD:ARB:SEQ? "NVWFM:testSeq1.seq",

<"wfmSegment1.wfm, 10, ALL, wfmSegment2.wfm, 20, M1M3",

Error Checks for Query SCPI command:

If you do not specify a filename, an error is generated.

If the waveform sequence file name is empty, an error is generated.

If the specified waveform sequence file cannot be found, an error is generated.

Initial S/W Revision

A.05.00

Edit Selected Sequence

Allows access to the sub-menus for editing the sequence currently selected within the Waveform Sequence List view. Pressing this key changes the central view area to display the Waveform Sequence Creation and Editing view.

Key Path	Source, Modulation Setup, ARB, Waveform Sequences
Notes	No remote command, front panel only.
Initial S/W Revision	A.05.00

Current Directory...

Allows you to change the currently selected directory on the hard disk. Pressing this key opens a standard windows change directory dialog and allows you to select the new directory of interest.

Key Path	Source, Modulation Setup, ARB, Waveform Sequences
Notes	No remote command, front panel only.
Initial S/W Revision	A.05.00

Waveform Utilities

Allows you access to the waveform utilities sub-menus.

Key Path	Source, Modulation Setup, ARB
Initial S/W Revision	A.05.00

Multi-Pack Licenses

Allows you access to the Multi - Pack License sub-menus. Pressing this key also changes the central view area to display the Multi -Pack License Management view.

On modular instrument like E6630A or E6640A, multi-pack license operations are only allowed on the default module, i.e. “Left” module for E6630A or “TRX1” module for E6640A.

Key Path	Source, Modulation Setup, ARB, Waveform Utilities
Notes	If access multi-pack license sub-menu from modules other than “TRX1”, an advisory message like “Please goto “TRX1” to operate multi-pack license” will display.
Dependencies	This key is only available if there is at least one Multi-pack license installed on the instrument.
Initial S/W Revision	A.05.00

Add Waveform

Pressing this key accesses the Add Waveform sub-menu. It also changes the central display area to display the Multi-Pack License Waveform Add view.

Key Path	Source, Modulation Setup, ARB, Waveform Utilities, Multi-Pack Licenses
Dependencies	This key is only available if there is at least one slot available within at least one multi-pack license.
Initial S/W Revision	A.05.00

Add Waveform

Allows you to add the currently selected waveform segment to a multi-pack license. The new waveform is added to the next available slot regardless of which slot was selected on the Multi-Pack License Management view.

Key Path	Source, Modulation Setup, ARB, Waveform Utilities, Multi-Pack Licenses, Add Waveform
Remote Command	:SYSTem:LKEY:WAVeform:ADD <string> or :SYSTem:LIcense[:FPACK]:WAVeform:ADD <string>
Example	SYST:LKEY:WAV:ADD "mywaveform.wfm" or SYST:LIC:WAV:ADD "mywaveform.wfm"
Notes	The second SCPI :SYSTem:LIcense[:FPACK]:WAVeform:ADD is provided to be consistent with the style of Agilent signal sources. You can use either one of them. Since adding a waveform segment to a Multi-Pack license causes the license slot to enter the trial period of only 48 hours, pressing this key causes a confirmation dialog to be displayed to ensure you do want to add the waveform segment to the Multi-Pack. If you attempt to license a waveform that is already licensed using another slot an error is generated. . If current module is not "TRX1" module, the key will grey out, and error message is generated "-221 Setting conflict; Not allowed on current module. Goto "TRX1" to operate multi-pack license" when invoking SCPI.
Dependencies	This key is only available if the currently selected file is a secure waveform requiring a license, and there is at least one slot available within at least one multi-pack license. If the waveform highlighted is a secure waveform, but is already licensed, this key will be unavailable.
Initial S/W Revision	A.05.00

Segments on Hard Disk

Allows you access to the sub-menus for loading waveform segments from the hard disk into ARB memory. The default directory is: D: varb.

Pressing this key changes the current view to the Waveform Management View.

Key Path	Source, Modulation Setup, ARB, Select Waveform
Initial S/W Revision	A.05.00

Load Segment To ARB Memory

Allows you to load the selected file into ARB memory. On the front panel you select the file for loading to the ARB memory by highlighting the desired file in the list. Using the SCPI command, you specify the file name on the HDD.

“NVWFM” (none-volatile storage) MSUS (Mass Storage Unit Specifier) is supported in the memory subsystem because the ARB memory cannot be accessed directly. Therefore, files must be downloaded to the instrument hard disk and then loaded into the ARB memory. “NVWFM” MSUS will be mapped to the default directory D: VARB. The SCPI command supports using either “NVWFM” MSUS or specifying a full path. For more information, see [Memory Subsystem \(Remote Command Only\)](#).

If a file of the same name already exists within ARB memory, it is overwritten. If you wish to load two segments of the same name, you must rename one of the segments before loading it into ARB memory. To rename a segment, you can either use Windows File Explorer, or the :MMEMory:COPI command.

NOTE: When a waveform file is loaded to ARB memory, burst timing adjustments are made automatically, based on whether or not a Multiport Adapter is connected to the test set and powered on. If the connection/power status of the Multiport Adapter is changed after a waveform file has been loaded, it needs to be loaded again.

Key Path	Source, Modulation Setup, ARB, Select Waveform, Segments on Hard Disk
Remote Command	:SOURce:RADio:ARB:LOAD <string>
Example	:SOUR:RAD:ARB:LOAD "D: VARB\testwaveform.bin" or :SOUR:RAD:ARB:LOAD "NVWFM:testwaveform.bin"
Notes	<p>Because loading the file involves a delay of unpredictable length, this command should be followed by the query *OPC?, which holds off subsequent commands until the loading operation is complete.</p> <p><string> – specifies the path name of the file to load from the HDD into ARB memory. It could be a <full path + filename>, or <“NVWFM” MSUS + colon + filename>.</p> <p>When in Sequence Analyzer mode, and Include Source is Yes, an attempt to load a file to ARB memory will be rejected with an error.</p> <p>When Include Source is No and if there is insufficient free ARB memory to load the selected waveform, an error is generated. .</p> <p>If you specify a file over SCPI, but the file is not at the specified location, an error is generated.</p> <p>If you try to load a waveform file but the file contains less than 500 IQ samples, an error is generated.</p> <p>If you try to load a Signal Studio waveform “*.wfm” which contains invalid waveform header, an error is generated.</p> <p>If the ARB is ON when you load a file to ARB memory or delete a file from ARB memory, the playing waveform segment may not keep phase continuity during the ARB memory operation. The waveform will be replayed after the ARB operation is finished.</p> <p>ARB can be loaded into ARB memory even required licenses do not present on the instrument. In this</p>

	case, a GUI only warning message -800, "Operation complete; Loaded <filename> successfully, but no license <required licenses> installed". User can install required licenses according to <required licenses> string to license it, or multi-pack license it.
Initial S/W Revision	A.05.00

Load All To ARB Memory

Allows you to load all the segment files within the currently selected directory into ARB memory. If a file of the same name already exists within ARB memory, it is overwritten. If you wish to load two segments of the same name, you must rename one of the segments before loading it into ARB memory. To rename a segment, you can either use Windows File Explorer, or the :MEMory:COPY command.

NOTE: When a waveform file is loaded to ARB memory, burst timing adjustments are made automatically, based on whether or not a Multiport Adapter is connected to the test set and powered on. If the connection/power status of the Multiport Adapter is changed after a waveform file has been loaded, it needs to be loaded again.

Key Path	Source, Modulation Setup, ARB, Select Waveform, Segments on Hard Disk
Remote Command	:SOURce:RADio:ARB:LOAD:ALL <string>
Example	:SOUR:RAD:ARB:LOAD:ALL "D: varb"
Notes	<p><string> - specifies the directory on the HDD to load the files into ARB memory from.</p> <p>When in Sequence Analyzer mode, and Include Source is Yes, an attempt to load all files from a directory to ARB memory is rejected with an error.</p> <p>When Include Source is No and there is insufficient free ARB memory to load all the waveforms, when the ARB memory is full, the copy ceases, and an error is generated.</p> <p>If you specify a directory over SCPI, but the directory does not exist, an error is generated.</p> <p>If the ARB is ON, a user then loads or deletes file to ARB memory, the playing waveform segment may not keep phase continuity during the ARB memory operation. The waveform will be replayed after the ARB operation is finished.</p>
Initial S/W Revision	A.05.00

Change Directory...

Allows you to change the currently selected directory on the hard disk. Pressing this key opens a standard windows change directory dialog allowing you to select the new directory of interest.

The current directory is used for manually loading waveform segments into ARB memory for playback, and as a search location for waveform segments that are required to be loaded into ARB memory for playback of a waveform sequence or a list sequence.

Key Path	Source, Modulation Setup, ARB, Select Waveform, Segments on Hard Disk
Notes	No remote command, SCPIfront panel only.
Initial S/W Revision	A.05.00

Default Directory...

Allows you to change the default directory. It is used as a search location for waveform segments that are required to be loaded into ARB memory for playback of a waveform sequence, and as a search location for selecting waveforms using SCPI.

Key Path	Source, Modulation Setup, ARB, Select Waveform, Segments on Hard Disk
Remote Command	:SOURce:RADio:ARB:DEFault:DIRectory <string> :SOURce:RADio:ARB: DEFault:DIRectory?
Example	:SOUR:RAD:ARB:DEF:DIR "D:\ArbFiles" :SOUR:RAD:ARB:DEF:DIR?
State Saved	Persistent, survives a power cycle and a preset but not saved in the instrument state
Initial S/W Revision	A.05.00

Segments on Hard Disk

This key functions the same as ["Segments on Hard Disk" on page 2547](#).

Key Path	Source, Modulation Setup, ARB, Waveform Utilities, Multi-Pack Licenses, Add Waveform
Initial S/W Revision	Prior to A.09.00

Load Segment To ARB Memory

This key functions the same as ["Load Segment To ARB Memory" on page 2547](#).

Key Path	Source, Modulation Setup, ARB, Waveform Utilities, Multi-Pack Licenses, Add Waveform, Segment on Hard Drive
Initial S/W Revision	Prior to A.09.00

Load All To ARB Memory

This key functions the same as ["Load All To ARB Memory" on page 2548](#).

Key Path	Source, Modulation Setup, ARB, Waveform Utilities, Multi-Pack Licenses, Add Waveform, Segment on Hard Drive
Initial S/W Revision	Prior to A.09.00

Change Directory ...

This key functions the same as ["Change Directory..." on page 2549](#).

Key Path	Source, Modulation Setup, ARB, Waveform Utilities, Multi-Pack Licenses, Add Waveform, Segment on Hard Drive
Initial S/W Revision	Prior to A.09.00

Default Directory ...

This key functions the same as ["Default Directory..." on page 2549](#)

Key Path	Source, Modulation Setup, ARB, Waveform Utilities, Multi-Pack Licenses, Add Waveform, Segment on Hard Drive
Initial S/W Revision	Prior to A.09.00

Replace Waveform

Pressing this key accesses the Replace Waveform submenu. It also changes the central display area to display the Multi-Pack License Waveform Add view.

Key Path	Source, Modulation Setup, ARB, Waveform Utilities, Multi-Pack Licenses
Dependencies	This key is only available if the currently selected slot is in the trial state.
Initial S/W Revision	A.05.00

Replace Waveform

Allows you to replace the waveform in the currently selected slot with the waveform currently selected in the Multi-Pack License Waveform Add view.

Key Path	Source, Modulation Setup, ARB, Waveform Utilities, Multi-Pack Licenses, Replace Waveform
Remote Command	:SYSTem:LKEY:WAVeform:REPLace <int>, <string> or :SYSTem:LICense[:FPACK]:WAVeform:REPLace <int>, <string>
Example	SYST:LKEY:WAV:REPL 1, "myotherwaveform.wfm" or :SYST:LIC:WAV:REPL 1, "myotherwaveform.wfm"
Notes	The second SCPI :SYSTem:LICense[:FPACK]:WAVeform:REPLace is provided to be consistent with the style of Agilent signal sources. You can use either one of them. If you attempt to license a waveform that is already licensed using another slot an error is generated. Waveform slot number <int> is positive. If you attempt to input a slot number less than or equals 0, an error is generated. If current module is not "TRX1" module, the key will grey out, and error message is generated "-221 Setting conflict; Not allowed on current module. Goto "TRX1" to operate multi-pack license" when invoking SCPI.
Initial S/W Revision	A.05.00

Segments on Hard Disk

This key functions the same as ["Segments on Hard Disk" on page 2547](#).

Key Path	Source, Modulation Setup, ARB, Waveform Utilities, Multi-Pack Licenses, Replace Waveform
Initial S/W Revision	Prior to A.09.00

Load Segment To ARB Memory

This key functions the same as ["Load Segment To ARB Memory" on page 2547](#).

Key Path	Source, Modulation Setup, ARB, Waveform Utilities, Multi-Pack Licenses, Replace Waveform, Segment on Hard Drive
Initial S/W Revision	Prior to A.09.00

Load All To ARB Memory

This key functions the same as ["Load All To ARB Memory" on page 2548](#).

Key Path	Source, Modulation Setup, ARB, Waveform Utilities, Multi-Pack Licenses, Replace Waveform, Segment on Hard Drive
Initial S/W Revision	Prior to A.09.00

Change Directory ...

This key functions the same as ["Change Directory..." on page 2549](#).

Key Path	Source, Modulation Setup, ARB, Waveform Utilities, Multi-Pack Licenses, Replace Waveform, Segment on Hard Drive
Initial S/W Revision	Prior to A.09.00

Default Directory ...

This key functions the same as ["Default Directory..." on page 2549](#)

Key Path	Source, Modulation Setup, ARB, Waveform Utilities, Multi-Pack Licenses, Replace Waveform, Segment on Hard Drive
Initial S/W Revision	Prior to A.09.00

Clear Waveform from Slot

Allows you to clear the waveform from the selected slot.

Key Path	Source, Modulation Setup, ARB, Waveform Utilities, Multi-Pack Licenses
Remote Command	:SYSTem:LKEY:WAVeform:CLEar <int> or :SYSTem:LICense[:FPACK]:WAVeform:CLEar <int>
Example	SYST:LKEY:WAV:CLE 1 or :SYST:LIC:WAV:CLE 1
Notes	The second SCPI :SYSTem:LICense[:FPACK]:WAVeform:CLEar is provided to be consistent with the style of Agilent signal sources. You can use either one of them. Waveform slot number <int> is positive. If you attempt to input a slot number less than or equals 0, an error is generated. If current module is not "TRX1" module, the key will grey out, and error message is generated "-221 Setting conflict; Not allowed on current module. Goto "TRX1" to operate multi-pack license" when invoking SCPI.
Dependencies	This key is only available if the currently selected slot is in the trial state.
Initial S/W Revision	A.05.00

Lock Waveform in Slot

If the selected slot is in the trial state or the lock required state, the waveform that occupies the slot is locked and permanently licensed.

Key Path	Source, Modulation Setup, ARB, Waveform Utilities, Multi-Pack Licenses
Remote Command	:SYSTem:LKEY:WAVeform:LOCK <int> or :SYSTem:LICense[:FPACK]:WAVeform:LOCK <int>
Example	SYST:LKEY:WAV:LOCK 1 or SYST:LIC:WAV:LOCK 1
Notes	The second SCPI :SYSTem:LICense[:FPACK]:WAVeform:LOCK is provided to be consistent with the style of Agilent signal sources. You can use either one of them. Waveform slot number <int> is positive. If you attempt to input a slot number less than or equals 0, an error is generated. If current module is not "TRX1" module, the key will grey out, and error message is generated "-221 Setting conflict; Not allowed on current module. Goto "TRX1" to operate multi-pack license" when invoking SCPI.
Dependencies	This key is only available if the currently selected slot is in the trial state or the lock required state.
Initial S/W Revision	A.05.00

Slot Status Query (Remote Command Only)

Returns the status of the specified slot.

Remote Command	:SYSTem:LKEY:WAVeform:STATus? <int> or :SYSTem:LICense[:FPACK]:WAVeform:STATus? <int>
Example	:SYST:LKEY:WAV:STAT? 1 <"Locked" or :SYST:LIC:WAV:STAT? 1 <"Locked"
Notes	The second SCPI :SYSTem:LICense[:FPACK]:WAVeform:STATus is provided to be consistent with the style of Agilent signal sources. You can use either one of them. Waveform slot number <int> is positive. If you attempt to input a slot number less than or equals 0, an error is generated. Result type is string. If input slot number exceeds total available slot number, "Nonexistent" is returned.
Range	"Locked" "Available" "Trail" "LockRequired" "Nonexistent"
Initial S/W Revision	A.05.00

Slots Free Query (Remote Command Only)

Returns the number of license slots free.

Remote Command	:SYSTem:LKEY:WAVeform:FREE? or :SYSTem:LICense[:FPACK]:WAVeform:FREE?
Example	:SYST:LKEY:WAV:FREE? or :SYST:LIC:WAV:FREE?
Notes	The second SCPI :SYSTem:LICense[:FPACK]:WAVeform:FREE is provided to be consistent with the style of Agilent signal sources. You can use either one of them.
Initial S/W Revision	A.05.00

Slot Used Query (Remote Command Only)

Returns the number of license slots used.

Remote Command	:SYSTem:LKEY:WAVeform:USED? or :SYSTem:LICense[:FPACK]:WAVeform:USED?
Example	:SYST:LKEY:WAV:USED?

	or :SYST:LIC:WAV:USED?
Notes	The second SCPI :SYSTem:LIcense[:FPACK]:WAVeform:USED is provided to be consistent with the style of Agilent signal sources. You can use either one of them.
Initial S/W Revision	A.05.00

Slot Waveform Name Query (Remote Command Only)

Returns the waveform name of the specified slot

Remote Command	:SYSTem:LKEY:WAVeform:NAME? <int> or :SYSTem:LIcense[:FPACK]:WAVeform:NAME? <int>
Example	:SYST:LKEY:WAV:NAME? 1 <"CDMA2K_22.wfm" or :SYST:LIC:WAV:NAME? 1 <"CDMA2K_22.wfm"
Notes	Waveform slot number <int> is positive. If you attempt to input a slot number less than or equals 0, an error is generated. Result type is string. If input slot number exceeds total available slot number, "Nonexistent" is returned. If no waveform stored in the specified slot, then empty string is returned.
Initial S/W Revision	A.12.00

Slot Waveform Unique ID Query (Remote Command Only)

Returns the waveform unique ID of the specified slot

Remote Command	:SYSTem:LKEY:WAVeform:UID? <int> or :SYSTem:LIcense[:FPACK]:WAVeform:UID? <int>
Example	:SYST:LKEY:WAV:UID? 2 <"1346752140" or :SYST:LIC:WAV:UID? 2 <"1346752140"
Notes	Waveform slot number <int> is positive. If you attempt to input a slot number less than or equals 0, an error is generated. Result type is string. If input slot number exceeds total available slot number, "Nonexistent" is returned.

If no waveform stored in the specified slot, then "0" is returned

Initial S/W Revision A.12.00

Locked Waveform Name List Query (Remote Command Only)

Returns the waveform name list of locked.

Remote Command	:SOURce:RADio:ARB:MPLicensed:NAME:LOCKed?
Example	SOUR:RAD:ARB:MPL:NAME:LOCKed? <"CDMA2K_27.wfm", "GSM_MCS1.WFM", "c2kWfm.wfm">
Initial S/W Revision	A.11.00

Locked Waveform Unique ID List Query (Remote Command Only)

Returns the waveform unique id list of locked.

Remote Command	:SOURce:RADio:ARB:MPLicensed:UID:LOCKed?
Example	SOUR:RAD:ARB:MPL:UID:LOCKed? <"2996927136", "3812603511", "3710986266">
Notes	Each Signal Studio waveform has a unique id recorded in header. So if the unique ids are same, that means they are same one waveform. So besides SCPI to query locked waveform name list, also provide a SCPI to query locked waveform unique id list
Initial S/W Revision	A.11.00

Marker Utilities

Allows access to the marker utilities sub-menus.

Key Path	Source, Modulation Setup, ARB
Initial S/W Revision	A.05.00

Marker Polarity

Allows access to the marker polarity sub-menu, which allows you to specify the polarity for the four markers. For a positive polarity, the marker signal is high during the marker points. For a negative marker polarity, the marker signal is high during the period of no marker points.

Key Path	Source, Modulation Setup, ARB, Marker Utilities
Initial S/W Revision	A.05.00

Mkr 1 Polarity

Allows you to set the polarity of marker 1.

Key Path	Source, Modulation Setup, ARB, Marker Utilities, Marker Polarity
Remote Command	:SOURce:RADio:ARB:MPOLarity:MARKer1 POSitive NEGative :SOURce:RADio:ARB:MPOLarity:MARKer1?
Example	:SOUR:RAD:ARB:MPOL:MARK1 NEG
Dependencies	When a new waveform is selected for playback the settings contained within the associated waveform header file are applied to the ARB. The marker polarity is one of the values stored within the header file. If the newly selected waveform file has an associated header file, the marker polarity is updated with the value from the header file. The marker polarity will remain unchanged if the newly selected waveform does not have an associated header file.
Preset	Pos
Range	Neg Pos
Initial S/W Revision	A.05.00

Mkr 2 Polarity

Allows you to set the polarity of marker 2.

Key Path	Source, Modulation Setup, ARB, Marker Utilities, Marker Polarity
Remote Command	:SOURce:RADio:ARB:MPOLarity:MARKer2 POSitive NEGative :SOURce:RADio:ARB:MPOLarity:MARKer2?
Example	:SOUR:RAD:ARB:MPOL:MARK2 NEG
Dependencies	When a new waveform is selected for playback the settings contained within the associated waveform header file are applied to the ARB. The marker polarity is one of the values stored within the header file. If the newly selected waveform file has an associated header file, the marker polarity is updated with the value from the header file. The marker polarity will remain unchanged if the newly selected waveform does not have an associated header file.
Preset	Pos
Range	Neg Pos
Initial S/W Revision	A.05.00

Mkr 3 Polarity

Allows you to set the polarity of marker 3.

Key Path	Source, Modulation Setup, ARB, Marker Utilities, Marker Polarity
Remote Command	:SOURce:RADio:ARB:MPOLarity:MARKer3 POSitive NEGative :SOURce:RADio:ARB:MPOLarity:MARKer3?
Example	:SOUR:RAD:ARB:MPOL:MARK3 NEG
Dependencies	When a new waveform is selected for playback the settings contained within the associated

waveform header file are applied to the ARB. The marker polarity is one of the values stored within the header file. If the newly selected waveform file has an associated header file, the marker polarity is updated with the value from the header file. The marker polarity will remain unchanged if the newly selected waveform does not have an associated header file.

Preset	Pos
Range	Neg Pos
Initial S/W Revision	A.05.00

Mkr 4 Polarity

Allows you to set the polarity of marker 4.

Key Path	Source, Modulation Setup, ARB, Marker Utilities, Marker Polarity
Remote Command	:SOURce:RADio:ARB:MPOLarity:MARKer4 POSitive NEGative :SOURce:RADio:ARB:MPOLarity:MARKer4?
Example	:SOUR:RAD:ARB:MPOL:MARK4 NEG
Dependencies	When a new waveform is selected for playback the settings contained within the associated waveform header file are applied to the ARB. The marker polarity is one of the values stored within the header file. If the newly selected waveform file has an associated header file, the marker polarity is updated with the value from the header file. The marker polarity will remain unchanged if the newly selected waveform does not have an associated header file.
Preset	Pos
Range	Neg Pos
Initial S/W Revision	A.05.00

Marker Routing

Allows access to the marker routing sub-menus, which allow you to specify where the marker events are routed. It should be noted that the markers can also be routed to Trigger 1 Out and Trigger 2 Out, however this must be set up using the menus accessed by pressing the “Trigger” hard key.

Key Path	Source, Modulation Setup, ARB, Marker Utilities
Initial S/W Revision	A.05.00

Pulse/RF Blank

Allows you to select which marker is used for the pulse/RF blanking function. The pulse/RF blanking function blanks the RF when the marker signal goes low. The marker polarity determines when the marker signal is high. For a positive polarity, this is during the marker points. For a negative polarity, this is when there are no marker points.

Marker points should be set before using this function. Enabling this function without setting marker points may create a continuous low or high signal, dependant on the marker polarity. This causes either no RF output, or a continuous RF output.

Key Path	Source, Modulation Setup, ARB, Marker Utilities, Marker Routing
Remote Command	:SOURce:RADio:ARB:MDEStination:PULSe NONE M1 M2 M3 M4 :SOURce:RADio:ARB:MDEStination:PULSe?
Example	:SOUR:RAD:ARB:MDES:PULS NONE
Dependencies	When a new waveform is selected for playback the settings contained within the associated waveform header file are applied to the ARB. The pulse/RF blanking setting is one of the values stored within the header file. If the newly selected waveform file has an associated header file, the pulse/RF blanking setting is updated with the value from the header file. The pulse/RF blanking setting will remain unchanged if the newly selected waveform does not have an associated header file.
Range	None M1 M2 M3 M4
Initial S/W Revision	A.05.00

None

Sets no marker to be used for the pulse/RF blanking function, essentially turning the RF blanking function off.

Key Path	Source, Modulation Setup, ARB, Marker Utilities, Marker Routing, Pulse/RF Blank
Example	:SOUR:RAD:ARB:MDES:PULS NONE
Initial S/W Revision	A.05.00

Marker 1

Sets marker 1 to be used for the pulse/RF blanking function.

Key Path	Source, Modulation Setup, ARB, Marker Utilities, Marker Routing, Pulse/RF Blank
Example	:SOUR:RAD:ARB:MDES:PULS M1
Initial S/W Revision	A.05.00

Marker 2

Sets marker 2 to be used for the pulse/RF blanking function.

Key Path	Source, Modulation Setup, ARB, Marker Utilities, Marker Routing, Pulse/RF Blank
Example	:SOUR:RAD:ARB:MDES:PULS M2
Initial S/W Revision	A.05.00

Marker 3

Sets marker 3 to be used for the pulse/RF blanking function.

Key Path	Source, Modulation Setup, ARB, Marker Utilities, Marker Routing, Pulse/RF Blank
Example	:SOUR:RAD:ARB:MDES:PULS M3
Initial S/W Revision	A.05.00

Marker 4

Sets marker 4 to be used for the pulse/RF blanking function.

Key Path	Source, Modulation Setup, ARB, Marker Utilities, Marker Routing, Pulse/RF Blank
Example	:SOUR:RAD:ARB:MDES:PULS M4
Initial S/W Revision	A.05.00

ALC Hold

Allows you to specify which marker is routed for use within the ALC hold function. The ALC hold marker function holds the ALC circuitry at the average value of the sample points set by the marker.

The ALC hold function operates during the low periods of the marker signal. The marker polarity determines when the marker signal is high. For positive polarity, this is during the marker points. For a negative polarity, this is when there are no maker points.

Key Path	Source, Modulation Setup, ARB, Marker Utilities, Marker Routing
Remote Command	:SOURce:RADio:ARB:MDEStination:ALCHold NONE M1 M2 M3 M4 :SOURce:RADio:ARB:MDEStination:ALCHold?
Example	:SOUR:RAD:ARB:MDES:ALCH NONE
Dependencies	When a new waveform is selected for playback the settings contained within the associated waveform header file are applied to the ARB. The ALC hold setting is one of the values stored within the header file. If the newly selected waveform file has an associated header file, the ALC hold setting is updated with the value from the header file. The ALC hold setting will remain unchanged if the newly selected waveform does not have an associated header file.
Range	None M1 M2 M3 M4
Initial S/W Revision	A.05.00

None

Sets no marker to be used for the ALC hold function, essentially turning the ALC hold function off.

Key Path	Source, Modulation Setup, ARB, Marker Utilities, Marker Routing, ALC Hold
Example	:SOUR:RAD:ARB:MDES:PULS NONE
Initial S/W Revision	A.05.00

Marker 1

Sets marker 1 to be used for the ALC hold function.

Key Path	Source, Modulation Setup, ARB, Marker Utilities, Marker Routing, ALC Hold
Example	:SOUR:RAD:ARB:MDES:PULS M1
Initial S/W Revision	A.05.00

Marker 2

Sets marker 2 to be used for the ALC hold function.

Key Path	Source, Modulation Setup, ARB, Marker Utilities, Marker Routing, ALC Hold
Example	:SOUR:RAD:ARB:MDES:PULS M2
Initial S/W Revision	A.05.00

Marker 3

Sets marker 3 to be used for the ALC hold function.

Key Path	Source, Modulation Setup, ARB, Marker Utilities, Marker Routing, ALC Hold
Example	:SOUR:RAD:ARB:MDES:PULS M3
Initial S/W Revision	A.05.00

Marker 4

Sets marker 4 to be used for the ALC hold function.

Key Path	Source, Modulation Setup, ARB, Marker Utilities, Marker Routing, ALC Hold
Example	:SOUR:RAD:ARB:MDES:PULS M4
Initial S/W Revision	A.05.00

Header Utilities

Allows access to the header utilities sub-menu. Pressing this key also causes the central display area to change to display the File Header Information view.

Key Path	Source, Modulation Setup, ARB
Dependencies	This key is only available if there is currently a waveform selected for playback. If no waveform is selected, the key is grayed out.
Initial S/W Revision	A.05.00

Clear Header

Allows you to clear the header information from the file header associated with the currently selected waveform.

Key Path	Source, Modulation Setup, ARB, Header Utilities
Remote Command	:SOURce:RADio:ARB:HEADer:CLEar
Example	:SOUR:RAD:ARB:HEAD:CLE
Notes	Attempting to clear the header details via SCPI when no waveform was selected for playback will generate an error.
Initial S/W Revision	A.05.00

Save Setup To Header

Allows you to save new file header information details to the file.

Key Path	Source, Modulation Setup, ARB, Header Utilities
Remote Command	:SOURce:RADio:ARB:HEADer:SAVE
Example	:SOUR:RAD:ARB:HEAD:SAVE
Notes	Attempting to save the header details via SCPI when no waveform was selected for playback will generate an error.
Initial S/W Revision	A.05.00

Query Waveform Unique ID (Remote Command Only)

Each Signal Studio waveform contains a unique waveform ID, which recorded in the header. This command allows you to query the unique waveform ID from the header. This is a SCPI only command. User can also check [Error! Reference source not found.](#) for waveform unique ID display.

Remote Command	:MMEMory:HEADer:ID? "<file name>"
Example	:MMEM:HEAD:ID? "test.wfm" (query the waveform already loaded into the ARB memory) :MMEM:HEAD:ID? "D: VARB\test.wfm" (query the waveform on the hard disk by absolute path) :MMEM:HEAD:ID? "NVWFM:test.wfm" (query the waveform on the hard disk by MSUS)
Notes	SCPI query only. The queried waveform file can be in ARB memory, or on hard disk. If want to query ARB in ARB memory, then give out the file name directly. If want to query ARB on the hard disk, then absolute file path or MSUS should be given along with the file name. The valid MSUS is "NVWFM" which is mapped to D: VARB on hard disk. If the file cannot be found in ARB memory or on hard disk, an error is generated and value -1 is returned
Initial S/W Revision	A.09.00

Bus Trigger Command (Remote Command Only)

Used to initiate an immediate trigger event if the trigger source is set to Bus.

Remote Command	:SOURce:RADio:ARB:TRIGger:INITiate
Example	:SOUR:RAD:ARB:TRIG:INIT
Initial S/W Revision	A.05.00

AM

Allows access to the menu for configuring the Amplitude Modulation.

Key Path	Source, Modulation Setup
Initial S/W Revision	A.05.00

AM

Enables or disables the amplitude modulation.

Turning AM on when another modulation format is already on results in the previous modulation format being turned off and the generation of an error.

Key Path	Source, Modulation Setup, AM
Remote Command	:SOURce:AM:STATe :SOURce:AM:STATe?
Example	:SOUR:AM:STAT OFF
Preset	Off
Range	On Off
Initial S/W Revision	A.05.00

AM Depth

Allows you to set the amplitude modulation depth in percent.

Key Path	Source, Modulation Setup, AM
Remote Command	:SOURce:AM[:DEPTh] [:LINear] :SOURce:AM[:DEPTh] [:LINear]?
Example	:SOUR:AM 0.1
Preset	0.1 %
Min	0.1 %
Max	95.0 %
Initial S/W Revision	A.05.00

AM Rate

Allows you to set the internal amplitude modulation rate.

Key Path	Source, Modulation Setup, AM
Remote Command	:SOURce:AM:INTernal:FREQuency :SOURce:AM:INTernal:FREQuency?
Example	:SOUR:AM:INT:FREQ 40.0 Hz
Preset	400.0 Hz
Min	10 Hz
Max	40 kHz
Initial S/W Revision	A.05.00

FM

Allows access to the menu for configuring the frequency modulation.

Key Path	Source, Modulation Setup
Initial S/W Revision	A.05.00

FM

Enables or disables the frequency modulation.

Turning FM on when another modulation format is already on results in the previous modulation format being turned off and the generation of an error.

Key Path	Source, Modulation Setup, FM
Remote Command	:SOURce:FM:STATe :SOURce:FM:STATe?
Example	:SOUR:FM:STAT OFF
Preset	Off
Range	On Off
Initial S/W Revision	A.05.00

FM Deviation

Allows you to set the frequency modulation deviation.

Key Path	Source, Modulation Setup, FM
----------	------------------------------

Remote Command	:SOURce:FM[:DEVIation] :SOURce:FM[:DEVIation]?
Example	:SOUR:FM 1.00 kHz
Preset	1.00 Hz
Min	1.00 Hz
Max	100.00 kHz
Initial S/W Revision	A.05.00

FM Rate

Allows you to set the internal frequency modulation rate.

Key Path	Source, Modulation Setup, FM
Remote Command	:SOURce:FM:INTernal:FREQuency :SOURce:FM:INTernal:FREQuency?
Example	:SOUR:FM:INT:FREQ 40.0 Hz
Preset	400.0 Hz
Min	10 Hz
Max	40 kHz
Initial S/W Revision	A.05.00

PM

Allows access to the menu for configuring the phase modulation.

Key Path	Source, Modulation Setup
Initial S/W Revision	A.05.00

PM

Enables or disables the phase modulation.

Turning PM on when another modulation format is already on results in the previous modulation format being turned off and the generation of an error.

Key Path	Source, Modulation Setup, PM
Remote Command	:SOURce:PM:STATe :SOURce:PM:STATe?
Example	:SOUR:PM:STAT OFF

Preset	Off
Range	On Off
Initial S/W Revision	A.05.00

PM Deviation

Allows you to set the phase modulation deviation.

Key Path	Source, Modulation Setup, PM
Remote Command	:SOURce:PM[:DEVIation] :SOURce:PM[:DEVIation]?
Example	:SOUR:PM 1.00 rad
Preset	0.1 rad
Min	0.1 rad
Max	20.0 rad
Initial S/W Revision	A.05.00

PM Rate

Allows you to set the internal phase modulation rate.

Key Path	Source, Modulation Setup, PM
Remote Command	:SOURce:PM:INTernal:FREQuency :SOURce:PM:INTernal:FREQuency?
Example	:SOUR:PM:INT:FREQ 40.0 Hz
Preset	400.0 Hz
Min	10 Hz
Max	40 kHz
Initial S/W Revision	A.05.00

List Sequencer

Allows you access to the sub-menus for configuring the list sequencer.

List sequences allows you to enter frequencies and amplitudes at unequal intervals in nonlinear ascending, descending or random order. Each step within the list can also include its own waveform file for playback, step duration, trigger event and trigger output.

The complexities involved in configuring the list sequencer do not lend itself to manual configuration; hence the manual configuration for this feature is limited. For easier configuration of the list sequencer, it is recommended that you use either SCPI or load a tab delimited file containing the setup parameters in a

tabular form. The details of the SCPI for configuring the list sequencer can be found in "[Step Configuration \(Remote Command Only\)](#)" on page 2554.

Once the List Sequencer has been configured using the front panel, SCPI, or loading in a tab delimited file, the sequence must be initiated using the front panel Initiate Sequence key or the corresponding SCPI command.

Key Path	Source
Initial S/W Revision	A.05.00

Sequencer

Allows you to set the state of the list sequencer. When the list sequencer is on, the source is outputting the sequence defined by the sequencer. When the list sequencer is off, the source outputs a single waveform segment or sequence (independent mode) at a single frequency and amplitude.

Key Path	Source, List Sequencer
Remote Command	:SOURce:LIST[:STATe] ON OFF 1 0 :SOURce:LIST[:STATe] ?
Example	:SOUR:LIST OFF
Notes	When the sequencer is set to ON, the list sequencer controls the output of the source.
Couplings	When in Sequence Analyzer mode and the list sequencer state is Off, Include Source is forced to No, and the Include Source key is grayed out. When in Sequence Analyzer mode and the list sequencer state is On, Include Source is available to set. And, an ARB memory related operation, like load or delete will be rejected.
Preset	Off
Range	On Off
Initial S/W Revision	A.05.00

Initiate Sequence

Pressing this key arms the sequence for single execution. Once the sequence is armed the source begins the sequence as soon as the trigger is received. If the trigger is set to Free Run, the sequence starts immediately.

Key Path	Source, List Sequencer
Remote Command	:SOURce:LIST:TRIGger[:IMMediate]
Example	:SOUR:LIST:TRIG
Notes	When in Sequence Analyzer mode and Include Source is Yes, the Initiate list sequencer operation is rejected, and the key is grayed out, since source list sequence request is sent to physics via Parallel batch by sequence analyzer. If the file needed by the sequencer is not already in ARB memory, the sequence cannot be initiated

and an error will be generated.

There is a blocking SCPI query which can be used to query if source list sequence being initiated successfully or not. (see "[Query List Sequence Initiation Armed Status \(Remote Command Only\)](#)" on [page 2565](#) Query Source List Sequence Armed Status)

Dependencies	Under the Sequence Analyzer Mode, if Meas Setup->Include Source is set to YES, Source->List Sequencer->Initiate Sequence is disabled.
--------------	---

Initial S/W Revision	A.05.00
----------------------	---------

List Sequencer Setup

Allows you access to the list sequencer setup menus.

Key Path	Source, List Sequencer
----------	------------------------

Number of Steps

Allows you to specify the number of steps within the list sequence.

Key Path	Source, List Sequencer, List Sequencer Setup
----------	--

Remote Command	:SOURce:LIST:NUMBer:STEPs <integer> :SOURce:LIST:NUMBer:STEPs?
-----------------------	---

Example	:SOUR:LIST:NUMB:STEP 1
----------------	------------------------

Notes	Increasing the number of steps creates additional steps at the end of the list, with all the settings within the steps set to their default values. Decreasing the number of steps removes steps from the end of the list. The settings within the removed steps are not reset. This means that increasing the number of steps again would allow you to retrieve these steps.
-------	--

Dependencies	The Step Count parameter is increased or decreased when you insert or delete a point from within the GUI interface to the sequencer.
--------------	--

Preset	1
--------	---

Min	1
-----	---

Max	1000
-----	------

Initial S/W Revision	A.05.00
----------------------	---------

Current Step

Allows you to select the step number you wish to view or edit.

Key Path	Source, List Sequencer, List Sequencer Setup
----------	--

Notes	No remote command, front panel only.
Preset	1
Min	1
Max	Step Count
Initial S/W Revision	A.05.00

Insert Step Before

Allows you to insert a new step, containing default values, before the currently selected step. Inserting a step will automatically increase the Step Count parameter by 1. If sequence already reaches upper limit of 1000 steps, then insert more step will be rejected and popup error -221, "Setting Conflict; Cannot insert more steps, maximum number of steps reached"

Key Path	Source, List Sequencer, List Sequencer Setup
Notes	No remote command, front panel only. If the list already contains the maximum limit of 1000 steps, no operation will be made after pressing this key.
Initial S/W Revision	A.05.00

Delete Step

Allows you to delete the current step. Deleting a step will automatically decrease the Step Count parameter by 1. If sequence only has one step left, delete step will be rejected and popup error -221, "Setting conflict; Cannot delete current step, minimum number of steps reached"

Key Path	Source, List Sequencer, List Sequencer Setup
Notes	No remote command, Front Panel key only. If the list already contains the minimum limit of 1 step, no operation will be made after pressing this key
Initial S/W Revision	A.05.00

Clear List

Allows you to clear the list. Clearing the list sets the number of steps to the default value of 1 and sets the parameters for the only step to their default values.

Key Path	Source, List Sequencer, List Sequencer Setup
Initial S/W Revision	A.05.00

Step Trigger

Allows access to the sub-menu for selecting the trigger input for the current step.

Key Path	Source, List Sequencer, List Sequencer Setup
Remote Command	:SOURce:LIST:STEP[1] 2 3...1000:SETup:INPut:TRIGger IMMEDIATE INTernal EXTernal2 KEY BUS EXTernal4 :SOURce:LIST:STEP[1] 2 3...1000:SETup:INPut:TRIGger?
Example	:SOUR:LIST:STEP2:SET:INP:TRIG BUS :SOUR:LIST:STEP2:SET:INP:TRIG?
Notes	SCPI is supported after A.09.40
Preset	Free Run
Range	Free Run Internal Manual (Trigger Key) Bus External 2 EXTernal4
Initial S/W Revision	A.05.00

Free Run

Sets the trigger input for the current step to Free Run.

Key Path	Source, List Sequencer, List Sequencer Setup, Step Trigger
Example	:SOUR:LIST:STEP2:SET:INP:TRIG IMM
Notes	SCPI is supported after A.09.40
Initial S/W Revision	A.05.00

Internal

Sets the trigger input for the current step to Internal.

Key Path	Source, List Sequencer, List Sequencer Setup, Step Trigger
Example	:SOUR:LIST:STEP2:SET:INP:TRIG INT
Notes	SCPI is supported after A.09.40
Initial S/W Revision	A.05.00

Manual (Trigger Key)

Sets the trigger input for the current step to Manual (Trigger Key). Any step in the sequence set to Manual will cause the sequence execution to stop until the manual trigger key is pressed. Sending the Bus Trigger SCPI command will have no effect. At any point in the sequence where the list sequencer is paused waiting for a software trigger, a pop up dialog is displayed until the trigger event occurs.

Key Path	Source, List Sequencer, List Sequencer Setup, Step Trigger
Example	:SOUR:LIST:STEP2:SET:INP:TRIG KEY
Notes	SCPI is supported after A.09.40
Initial S/W Revision	A.05.00

Bus

Sets the trigger input for the current step to Bus. Any step in the sequence set to Bus will cause the sequence execution to stop until the Bus Trigger SCPI command is sent. Pressing the manual trigger key has no effect. At any point in the sequence where the list sequencer is paused waiting for a software trigger, a pop up dialog is displayed until the trigger event occurs.

Key Path	Source, List Sequencer, List Sequencer Setup, Step Trigger
Example	:SOUR:LIST:STEP2:SET:INP:TRIG BUS
Notes	SCPI is supported after A.09.40
Initial S/W Revision	A.05.00

External 2

Sets the trigger input for the current step to External 2.

Key Path	Source, List Sequencer, List Sequencer Setup, Step Trigger
Example	:SOUR:LIST:STEP2:SET:INP:TRIG EXT2
Notes	SCPI is supported after A.09.40
Notes	Note: When on E6640A, trigger 2 is a bi-directional trigger port. So when trigger 2 has been configured as OUTPUT type, choosing External 2 as the input trigger for the current step will generate error.
Initial S/W Revision	A.05.00

Transition Time

Allows you to specify the transition time for the current step.

The transition time is the amount of time allowed for the source to settle at the current frequency or amplitude value.

Transition Time should not be taken as additional time before or inside the Step Duration. You can set a value for the settling time to allow the source output frequency or amplitude to become stable. Make sure that during this period of time, you do not use the source output signal.

The following table lists recommended values for appropriate settling times to allow for changes within the source.

Value Changed	Recommended Transition Time
Frequency	500 μ s
Amplitude	100 μ s to within 0.1 dB 20 μ s to within 1.0 dB

If the Transition Time value is shorter than the time necessary for the hardware to settle and a List Sequence is initiated, a **warning** is generated.

If the Transition Time value is longer than the Step Duration, an error is generated when initiating a source list sequence. For source list sequence, transition time is included in the step duration length. If the Transition Time value is longer than the Step Duration Time, the real step duration length is extended to equal the transition time and cause a timing shift.

Key Path	Source, List Sequencer, List Sequencer Setup
Remote Command	:SOURce:LIST:STEP[1] 2 3...1000:SETup:TRANSition:TIME <time> :SOURce:LIST:STEP[1] 2 3...1000:SETup:TRANSition:TIME?
Example	:SOUR:LIST:STEP2:SET:TRAN:TIME 1ms :SOUR:LIST:STEP2:SET:TRAN:TIME?
Notes	SCPI is supported after A.09.40
Preset	1.0 ms
Min	0.0 ms
Max	4.0 ks
Initial S/W Revision	A.05.00

Radio Setup

Allows you access to the sub-menus for setting up the radio standard, band, and radio band link direction for the current step.

Key Path	Source, List Sequencer, List Sequencer Setup
Notes	No remote command, front panel only.
Initial S/W Revision	A.05.00

Radio Standard

Allows access to the sub-menus for selecting the radio standard and the associated radio band for use in the current step.

Key Path	Source, List Sequencer, List Sequencer Setup, Radio Setup
Remote Command	:SOURce:LIST:STEP[1] 2 3...1000:SETup:RADio:BAND NONE PGSM EGSM RGSM DCS1800 PCS1900 TGSM810 GSM450 GSM480 GSM700 GSM850 BANDI BANDII BANDIII BANDIV BANDV BANDVI BANDVII BANDVIII BANDIX BANDX BANDXI BANDXII BANDXIII BANDXIV BANDXIX USCELL USPCS JAPAN KOREAN NMT IMT2K UPPER SECOND PAMR400 PAMR800 IMTEXT PCS1DOT9G AWS US2DOT5G PUBLIC LOWER NONE BAND1 BAND2 BAND3 BAND4 BAND5 BAND6 BAND7 BAND8 BAND10 BAND11 BAND12 BAND13 BAND14 BAND17 BAND18 BAND19 BAND20 BAND21 BAND24 BAND25 BAND26 BAND27 BAND28 BAND31 BAND33 BAND34 BAND35 BAND36 BAND37 BAND38

8 Channel Power Measurement Source

	BAND39 BAND40 BAND41 BAND42 BAND43 BAND44 BANDA BANDB BANDC BANDD BANDE BANDF :SOURCE:LIST:STEP[1] 2 3...1000:SETup: RADio:BAND?
Example	:SOUR:LIST:STEP2:SET:RAD:BAND PGSM :SOUR:LIST:STEP2:SET:RAD:BAND?
Notes	SCPI is supported after A.09.40
Initial S/W Revision	A.05.00

None

Selects no radio standard for use on the current step.

Key Path	Source, List Sequencer, List Sequencer Setup, Radio Setup, Radio Standard
Example	:SOUR:LIST:STEP2:SET:RAD:BAND NONE
Notes	SCPI is supported after A.09.40
Initial S/W Revision	A.05.00

GSM/EDGE

Pressing this key once selects GSM/EDGE as the radio standard and the current GSM/EDGE band as the active channel band. Pressing this key again allows access to the sub-menus for selecting a different GSM/EDGE band.

Key Path	Source, List Sequencer, List Sequencer Setup, Radio Setup, Radio Standard
Initial S/W Revision	A.05.00

P-GSM

Selects P-GSM as the band for the current step.

Key Path	Source, List Sequencer, List Sequencer Setup, Radio Setup, Radio Standard, GSM/EDGE
Initial S/W Revision	A.05.00

E-GSM

Selects E-GSM as the band for the current step.

Key Path	Source, List Sequencer, List Sequencer Setup, Radio Setup, Radio Standard, GSM/EDGE
Initial S/W Revision	A.05.00

R-GSM

Selects R-GSM as the band for the current step.

Key Path	Source, List Sequencer, List Sequencer Setup, Radio Setup, Radio Standard, GSM/EDGE
Initial S/W Revision	A.05.00

DCS 1800

Selects DCS 1800 as the band for the current step.

Key Path	Source, List Sequencer, List Sequencer Setup, Radio Setup, Radio Standard, GSM/EDGE
Initial S/W Revision	A.05.00

PCS 1900

Selects PCS 1900 as the band for the current step.

Key Path	Source, List Sequencer, List Sequencer Setup, Radio Setup, Radio Standard, GSM/EDGE
Initial S/W Revision	A.05.00

GSM 450

Selects GSM 450 as the band for the current step.

Key Path	Source, List Sequencer, List Sequencer Setup, Radio Setup, Radio Standard, GSM/EDGE
Initial S/W Revision	A.05.00

GSM 480

Selects GSM 480 as the band for the current step.

Key Path	Source, List Sequencer, List Sequencer Setup, Radio Setup, Radio Standard, GSM/EDGE
Initial S/W Revision	A.05.00

GSM 850

Selects GSM 850 as the band for the current step.

Key Path	Source, List Sequencer, List Sequencer Setup, Radio Setup, Radio Standard, GSM/EDGE
Initial S/W Revision	A.05.00

GSM 700

Selects GSM 700 as the band for the current step.

Key Path	Source, List Sequencer, List Sequencer Setup, Radio Setup, Radio Standard, GSM/EDGE
Initial S/W Revision	A.05.00

T-GSM 810

Selects T-GSM 810 as the band for the current step.

Key Path	Source, List Sequencer, List Sequencer Setup, Radio Setup, Radio Standard, GSM/EDGE
Initial S/W Revision	A.05.00

WCDMA

Pressing this key once selects WCDMA as the radio standard and the current WCDMA band as the active channel band. Pressing this key again allows access to the sub-menus for selecting a different WCDMA band.

Key Path	Source, List Sequencer, List Sequencer Setup, Radio Setup, Radio Standard
Initial S/W Revision	A.05.00

Band I

Selects Band I as the band for the current step.

Key Path	Source, List Sequencer, List Sequencer Setup, Radio Setup, Radio Standard, WCDMA
Initial S/W Revision	A.05.00

Band II

Selects Band II as the band for the current step.

Key Path	Source, List Sequencer, List Sequencer Setup, Radio Setup, Radio Standard, WCDMA
Initial S/W Revision	A.05.00

Band III

Selects Band III as the band for the current step.

Key Path	Source, List Sequencer, List Sequencer Setup, Radio Setup, Radio Standard, WCDMA
Initial S/W Revision	A.05.00

Band IV

Selects Band IV as the band for the current step.

Key Path	Source, List Sequencer, List Sequencer Setup, Radio Setup, Radio Standard, WCDMA
Initial S/W Revision	A.05.00

Band V

Selects Band V as the band for the current step.

Key Path	Source, List Sequencer, List Sequencer Setup, Radio Setup, Radio Standard, WCDMA
Initial S/W Revision	A.05.00

Band VI

Selects Band VI as the band for the current step.

Key Path	Source, List Sequencer, List Sequencer Setup, Radio Setup, Radio Standard, WCDMA
Initial S/W Revision	A.05.00

Band VII

Selects Band VII as the band for the current step.

Key Path	Source, List Sequencer, List Sequencer Setup, Radio Setup, Radio Standard, WCDMA
Initial S/W Revision	A.05.00

Band VIII

Selects Band VIII as the band for the current step.

Key Path	Source, List Sequencer, List Sequencer Setup, Radio Setup, Radio Standard, WCDMA
Initial S/W Revision	A.05.00

Band IX

Selects Band IX as the band for the current step.

Key Path	Source, List Sequencer, List Sequencer Setup, Radio Setup, Radio Standard, WCDMA
Initial S/W Revision	A.05.00

Band X

Selects Band X as the band for the current step.

Key Path	Source, List Sequencer, List Sequencer Setup, Radio Setup, Radio Standard, WCDMA
Initial S/W Revision	A.05.00

Band XI

Selects Band XI as the band for the current step.

Key Path	Source, List Sequencer, List Sequencer Setup, Radio Setup, Radio Standard, WCDMA
Initial S/W Revision	A.05.00

Band XII

Selects Band XII as the band for the current step.

Key Path	Source, List Sequencer, List Sequencer Setup, Radio Setup, Radio Standard, WCDMA
Initial S/W Revision	A.05.00

Band XIII

Selects Band XIII as the band for the current step.

Key Path	Source, List Sequencer, List Sequencer Setup, Radio Setup, Radio Standard, WCDMA
Initial S/W Revision	A.05.00

Band XIV

Selects Band XIV as the band for the current step.

Key Path	Source, List Sequencer, List Sequencer Setup, Radio Setup, Radio Standard, WCDMA
Initial S/W Revision	A.05.00

Band XIX

Selects Band XIX as the band for the current step.

Key Path	Source, List Sequencer, List Sequencer Setup, Radio Setup, Radio Standard, WCDMA
Initial S/W Revision	A.14.50

CDMA 2000 / 1xEVDO

Pressing this key once selects CDMA 2000/1xEVDO as the radio standard and the current CDMA 2000/1xEVDO band as the active channel band. Pressing this key again allows access to the sub-menus for selecting a different CDMA 2000/1xEVDO band.

Key Path	Source, List Sequencer, List Sequencer Setup, Radio Setup, Radio Standard
Initial S/W Revision	A.05.00

US CELL

Selects US Cell as the band for the current step.

Key Path	Source, List Sequencer, List Sequencer Setup, Radio Setup, Radio Standard, CDMA 2000 / 1xEVDO
Initial S/W Revision	A.05.00

US PCS

Selects US PCS as the band for the current step.

Key Path	Source, List Sequencer, List Sequencer Setup, Radio Setup, Radio Standard, CDMA 2000 / 1xEVDO
Initial S/W Revision	A.05.00

Japan Cell

Selects Japan Cell as the band for the current step.

Key Path	Source, List Sequencer, List Sequencer Setup, Radio Setup, Radio Standard, CDMA 2000 / 1xEVDO
Initial S/W Revision	A.05.00

Korean PCS

Selects Korean PCS as the band for the current step.

Key Path	Source, List Sequencer, List Sequencer Setup, Radio Setup, Radio Standard, CDMA 2000 / 1xEVDO
Initial S/W Revision	A.05.00

NMT 450

Selects NMT 450 as the band for the current step.

Key Path	Source, List Sequencer, List Sequencer Setup, Radio Setup, Radio Standard, CDMA 2000 / 1xEVDO
Initial S/W Revision	A.05.00

IMT 2000

Selects IMT 2000 as the band for the current step.

Key Path	Source, List Sequencer, List Sequencer Setup, Radio Setup, Radio Standard, CDMA 2000 / 1xEVDO
Initial S/W Revision	A.05.00

Upper 700

Selects Upper 700 as the band for the current step.

Key Path	Source, List Sequencer, List Sequencer Setup, Radio Setup, Radio Standard, CDMA 2000 / 1xEVDO
Initial S/W Revision	A.05.00

Secondary 800

Selects Secondary 800 as the band for the current step.

Key Path	Source, List Sequencer, List Sequencer Setup, Radio Setup, Radio Standard, CDMA 2000 / 1xEVDO
Initial S/W Revision	A.05.00

400 Euro PAMR

Selects 400 Euro PAMR as the band for the current step.

Key Path	Source, List Sequencer, List Sequencer Setup, Radio Setup, Radio Standard, CDMA 2000 / 1xEVDO
Initial S/W Revision	A.05.00

800 PAMR

Selects 800 PAMR as the band for the current step.

Key Path	Source, List Sequencer, List Sequencer Setup, Radio Setup, Radio Standard, CDMA 2000 / 1xEVDO
Initial S/W Revision	A.05.00

2.5GHz IMT EXT

Selects 2.5 GHz IMT EXT as the band for the current step.

Key Path	Source, List Sequencer, List Sequencer Setup, Radio Setup, Radio Standard, CDMA 2000 / 1xEVDO
Initial S/W Revision	A.05.00

US PCS 1.9GHz

Selects US PCS 1.9 GHz as the band for the current step.

Key Path	Source, List Sequencer, List Sequencer Setup, Radio Setup, Radio Standard, CDMA 2000 / 1xEVDO
Initial S/W Revision	A.05.00

AWS

Selects AWS as the band for the current step.

Key Path	Source, List Sequencer, List Sequencer Setup, Radio Setup, Radio Standard, CDMA 2000 / 1xEVDO
Initial S/W Revision	A.05.00

US 2.5GHz

Selects US 2.5 GHz as the band for the current step.

Key Path	Source, List Sequencer, List Sequencer Setup, Radio Setup, Radio Standard, CDMA 2000 / 1xEVDO
Initial S/W Revision	A.05.00

700 Public Safety

Selects 700 Public Safety as the band for the current step.

Key Path	Source, List Sequencer, List Sequencer Setup, Radio Setup, Radio Standard, CDMA 2000 / 1xEVDO
Initial S/W Revision	A.05.00

C2K Lower 700

Selects C2K Lower 700 as the band for the current step.

Key Path	Source, List Sequencer, List Sequencer Setup, Radio Setup, Radio Standard, CDMA 2000 / 1xEVDO
Initial S/W Revision	A.05.00

LTE

Pressing this key once selects LTE FDD as the radio standard and the current LTE FDD band as the active channel band. Pressing this key again allows access to the sub-menus for selecting a different LTE FDD band.

Key Path	Source, List Sequencer, List Sequencer Setup, Radio Setup, Radio Standard
Initial S/W Revision	A.09.50

BAND 1

Selects BAND 1 as the band for the current step.

Key Path	Source, List Sequencer, List Sequencer Setup, Radio Setup, Radio Standard, LTE
Initial S/W Revision	A.09.50

BAND 2

Selects BAND 2 as the band for the current step.

Key Path	Source, List Sequencer, List Sequencer Setup, Radio Setup, Radio Standard, LTE
Initial S/W Revision	A.09.50

BAND 3

Selects BAND 3 as the band for the current step.

Key Path	Source, List Sequencer, List Sequencer Setup, Radio Setup, Radio Standard, LTE
Initial S/W Revision	A.09.50

BAND 4

Selects BAND 4 as the band for the current step.

Key Path	Source, List Sequencer, List Sequencer Setup, Radio Setup, Radio Standard, LTE
Initial S/W Revision	A.09.50

BAND 5

Selects BAND 5 as the band for the current step.

Key Path	Source, List Sequencer, List Sequencer Setup, Radio Setup, Radio Standard, LTE
Initial S/W Revision	A.09.50

BAND 6

Selects BAND 6 as the band for the current step.

Key Path	Source, List Sequencer, List Sequencer Setup, Radio Setup, Radio Standard, LTE
Initial S/W Revision	A.09.50

BAND 7

Selects BAND 7 as the band for the current step.

Key Path	Source, List Sequencer, List Sequencer Setup, Radio Setup, Radio Standard, LTE
Initial S/W Revision	A.09.50

BAND 8

Selects BAND 8 as the band for the current step.

Key Path	Source, List Sequencer, List Sequencer Setup, Radio Setup, Radio Standard, LTE
Initial S/W Revision	A.09.50

BAND 9

Selects BAND 9 as the band for the current step.

Key Path	Source, List Sequencer, List Sequencer Setup, Radio Setup, Radio Standard, LTE
Initial S/W Revision	A.09.50

BAND 10

Selects BAND 10 as the band for the current step.

Key Path	Source, List Sequencer, List Sequencer Setup, Radio Setup, Radio Standard, LTE
Initial S/W Revision	A.09.50

BAND 11

Selects BAND 11 as the band for the current step.

Key Path	Source, List Sequencer, List Sequencer Setup, Radio Setup, Radio Standard, LTE
Initial S/W Revision	A.09.50

BAND 12

Selects BAND 12 as the band for the current step.

Key Path	Source, List Sequencer, List Sequencer Setup, Radio Setup, Radio Standard, LTE
Initial S/W Revision	A.09.50

BAND 13

Selects BAND 13 as the band for the current step.

Key Path	Source, List Sequencer, List Sequencer Setup, Radio Setup, Radio Standard, LTE
Initial S/W Revision	A.09.50

BAND 14

Selects BAND 14 as the band for the current step.

Key Path	Source, List Sequencer, List Sequencer Setup, Radio Setup, Radio Standard, LTE
Initial S/W Revision	A.09.50

BAND 17

Selects BAND 17 as the band for the current step.

Key Path	Source, List Sequencer, List Sequencer Setup, Radio Setup, Radio Standard, LTE
Initial S/W Revision	A.09.50

BAND 18

Selects BAND 18 as the band for the current step.

Key Path	Source, List Sequencer, List Sequencer Setup, Radio Setup, Radio Standard, LTE
Initial S/W Revision	A.09.50

BAND 19

Selects BAND 19 as the band for the current step.

Key Path	Source, List Sequencer, List Sequencer Setup, Radio Setup, Radio Standard, LTE
Initial S/W Revision	A.09.50

BAND 20

Selects BAND 20 as the band for the current step.

Key Path	Source, List Sequencer, List Sequencer Setup, Radio Setup, Radio Standard, LTE
Initial S/W Revision	A.09.50

BAND 21

Selects BAND 21 as the band for the current step.

Key Path	Source, List Sequencer, List Sequencer Setup, Radio Setup, Radio Standard, LTE
Initial S/W Revision	A.09.50

BAND 24

Selects BAND 24 as the band for the current step.

Key Path	Source, List Sequencer, List Sequencer Setup, Radio Setup, Radio Standard, LTE
Initial S/W Revision	A.09.50

BAND 25

Selects BAND 25 as the band for the current step.

Key Path	Source, List Sequencer, List Sequencer Setup, Radio Setup, Radio Standard, LTE
Initial S/W Revision	A.09.50

BAND 26

Selects BAND 26 as the band for the current step.

Key Path	Source, List Sequencer, List Sequencer Setup, Radio Setup, Radio Standard, LTE
Initial S/W Revision	A.12.53

BAND 27

Selects BAND 27 as the band for the current step.

Key Path	Source, List Sequencer, List Sequencer Setup, Radio Setup, Radio Standard, LTE
Initial S/W Revision	A.14.00

BAND 28

Selects BAND 28 as the band for the current step.

Key Path	Source, List Sequencer, List Sequencer Setup, Radio Setup, Radio Standard, LTE
Initial S/W Revision	A.14.00

BAND 31

Selects BAND 31 as the band for the current step.

Key Path	Source, List Sequencer, List Sequencer Setup, Radio Setup, Radio Standard, LTE
Initial S/W Revision	A.14.00

LTE TDD

Sets LTE TDD as the radio standard for use and accesses the LTE TDD specific channel band sub-menus..

Key Path	Source, Frequency, Radio Setup, Radio Standard
Initial S/W Revision	A.11.50

BAND 33

Selects BAND 33 as the band for the current step.

Key Path	Source, Frequency, Radio Setup, Radio Standard, LTE TDD
Example	:SOUR:FREQ:CHAN:BAND BAND33
Initial S/W Revision	A.11.50

BAND 34

Selects BAND 34 as the band for the current step.

Key Path	Source, Frequency, Radio Setup, Radio Standard, LTE TDD
Example	:SOUR:FREQ:CHAN:BAND BAND34
Initial S/W Revision	A.11.50

BAND 35

Selects BAND 35 as the band for the current step.

Key Path	Source, Frequency, Radio Setup, Radio Standard, LTE TDD
Example	:SOUR:FREQ:CHAN:BAND BAND35
Initial S/W Revision	A.11.50

BAND 36

Selects BAND 36 as the band for the current step.

Key Path	Source, Frequency, Radio Setup, Radio Standard, LTE TDD
Example	:SOUR:FREQ:CHAN:BAND BAND36
Initial S/W Revision	A.11.50

BAND 37

Selects BAND 37 as the band for the current step.

Key Path	Source, Frequency, Radio Setup, Radio Standard, LTE TDD
Example	:SOUR:FREQ:CHAN:BAND BAND37
Initial S/W Revision	A.11.50

BAND 38

Selects BAND 38 as the band for the current step.

Key Path	Source, Frequency, Radio Setup, Radio Standard, LTE TDD
Example	:SOUR:FREQ:CHAN:BAND BAND38
Initial S/W Revision	A.11.50

BAND 39

Selects BAND 39 as the band for the current step.

Key Path	Source, Frequency, Radio Setup, Radio Standard, LTE TDD
Example	:SOUR:FREQ:CHAN:BAND BAND39
Initial S/W Revision	A.11.50

BAND 40

Selects BAND 40 as the band for the current step.

Key Path	Source, Frequency, Radio Setup, Radio Standard, LTE TDD
Example	:SOUR:FREQ:CHAN:BAND BAND40
Initial S/W Revision	A.11.50

BAND 41

Selects BAND 41 as the band for the current step.

Key Path	Source, Frequency, Radio Setup, Radio Standard, LTE TDD
Example	:SOUR:FREQ:CHAN:BAND BAND41
Initial S/W Revision	A.11.50

BAND 42

Selects BAND 42 as the band for the current step.

Key Path	Source, Frequency, Radio Setup, Radio Standard, LTE TDD
Example	:SOUR:FREQ:CHAN:BAND BAND42
Initial S/W Revision	A.11.50

BAND 43

Selects BAND 43 as the band for the current step.

Key Path	Source, Frequency, Radio Setup, Radio Standard, LTE TDD
Example	:SOUR:FREQ:CHAN:BAND BAND43
Initial S/W Revision	A.11.50

BAND 44

Selects BAND 44 as the band for the current step.

Key Path	Source, List Sequencer, List Sequencer Setup, Radio Setup, Radio Standard, LTE TDD
Initial S/W Revision	A.14.00

TDSCDMA

Sets TDSCDMA as the radio standard for use and accesses the TDSCDMA specific channel band sub-menus..

Key Path	Source, Frequency, Radio Setup, Radio Standard
Initial S/W Revision	A.11.50

BAND A

Selects BAND A as the band for the current step.

Key Path	Source, Frequency, Radio Setup, Radio Standard, TDSCDMA
Example	:SOUR:FREQ:CHAN:BAND BANDA
Initial S/W Revision	A.11.50

BAND B

Selects BAND B as the band for the current step.

Key Path	Source, Frequency, Radio Setup, Radio Standard, TDSCDMA
Example	:SOUR:FREQ:CHAN:BAND BANDB
Initial S/W Revision	A.11.50

BAND C

Selects BAND C as the band for the current step.

Key Path	Source, Frequency, Radio Setup, Radio Standard, TDSCDMA
Example	:SOUR:FREQ:CHAN:BAND BANDC
Initial S/W Revision	A.11.50

BAND D

Selects BAND D as the band for the current step.

Key Path	Source, Frequency, Radio Setup, Radio Standard, TDSCDMA
Example	:SOUR:FREQ:CHAN:BAND BANDD
Initial S/W Revision	A.11.50

BAND E

Selects BAND E as the band for the current step.

Key Path	Source, Frequency, Radio Setup, Radio Standard, TDSCDMA
----------	---

Example	:SOUR:FREQ:CHAN:BAND BANDE
Initial S/W Revision	A.11.50

BAND F

Selects BAND F as the band for the current step.

Key Path	Source, Frequency, Radio Setup, Radio Standard, TDSCDMA
Example	:SOUR:FREQ:CHAN:BAND BANDF
Initial S/W Revision	A.11.50

Radio Band Link

Allows you to specify the radio band link direction for the steps within the list sequence. The link is used in conjunction with the channel band and channel number to determine the output frequency.

When set to “Uplink”, the source will calculate the uplink frequency according to an uplink formula together with selected channel band and channel number. When set to “Downlink”, the source will calculate the downlink frequency according to a downlink formula together with selected channel band and channel number.

Key Path	Source, List Sequencer, List Sequencer Setup, Radio Setup
Remote Command	:SOURce:LIST:STEP [1] 2 3...1000:SETup:RADio:BAND:LINK DOWN UP :SOURce:LIST:STEP [1] 2 3...1000:SETup:RADio:BAND:LINK?
Example	:SOUR:LIST:STEP2:SET:RAD:BAND:LINK UP :SOUR:LIST:STEP2:SET:RAD:BAND:LINK?
Notes	SCPI is supported after A.09.40
Preset	DOWN
Range	DOWN UP
Initial S/W Revision	A.05.00

Channel

Allows you to specify the frequency of the current step via a channel number.

Key Path	Source, List Sequencer, List Sequencer Setup
Remote Command	:SOURce:LIST:STEP [1] 2 3...1000:SETup:CNFRequency <double> :SOURce:LIST:STEP [1] 2 3...1000:SETup:CNFRequency?
Example	:SOUR:LIST:STEP2:SET:CNFR 124 :SOUR:LIST:STEP2:SET:CNFR?
Notes	SCPI is supported after A.09.40.

	This SCPI is used to setup channel number or frequency setting, according to current Radio Band setting. If Radio Band is "NONE", then it's frequency. If Radio Band is not "NONE", then it's channel number.
Couplings	The channel number is coupled to the step frequency value. When the step frequency value is changed, the channel number will increase or decrease to match the new step frequency. If the step frequency is not at an exact match for a channel number, the nearest channel number is displayed, along with a greater than, or less than sign to indicate the frequency is above or below the channel number.
Preset	1
Min	0 (Please refer to for valid ranges.)
Max	10838 (Please refer to for valid ranges.)
Initial S/W Revision	A.05.00

Frequency

Allows you to specify a frequency value for the current step.

Key Path	Source, List Sequencer, List Sequencer Setup
Remote Command	:SOURce:LIST:STEP[1] 2 3...1000:SETup:CNFRfrequency <double> :SOURce:LIST:STEP[1] 2 3...1000:SETup:CNFRfrequency?
Example	:SOUR:LIST:STEP2:SET:CNFR 1GHz :SOUR:LIST:STEP2:SET:CNFR?
Notes	SCPI is supported after A.09.40. This SCPI is used to setup channel number or frequency setting, according to current Radio Band setting. If Radio Band is "NONE", then it's frequency. If Radio Band is not "NONE", then it's channel number.
Couplings	The frequency value is coupled to the channel band and number for the step, such that updates to the radio band and channel number will update the frequency value to the corresponding absolute frequency. The reverse is also true, changing the frequency value causes the value of the channel number to be updated.
Preset	1.00 GHz
Min	10.00 MHz
Max	Hardware Dependant: Option 503 = 3.6 GHz Option 504 = 3.9 GHz Option 506 = 6.00 GHz
Initial S/W Revision	A.05.00

Power

Allows you to specify a power value for the current step.

Key Path	Source, List Sequencer, List Sequencer Setup
Remote Command	:SOURCE:LIST:STEP[1] 2 3...1000:SETup:AMPLitude <double> :SOURCE:LIST:STEP[1] 2 3...1000:SETup:AMPLitude?
Example	:SOUR:LIST:STEP2:SET:AMPL -50dBm :SOUR:LIST:STEP2:SET:AMPL?
Notes	SCPI is supported after A.09.40
Notes	<p>Amplitude corrections can be specified for use with the source. In the event of amplitude corrections being applied, the valid ranges for the RF power do not change dependant on the current amplitude correction setting. Instead, if the combination of RF power + amplitude correction is higher or lower than the source output range, the Source Unleveled bit is set and the “Source Unleveled” indicator will appear on status panel to indicate that the source cannot maintain the output power that has been requested.</p> <p>The multiport adapter RFIO TX ports and GPS ports cannot ensure power accuracy when power setting is lower than -130dBm, this power setting value is defined by the sum of RF Power setting and related amplitude correction value. But user settable value could be lower than this limit. When application detected there exists power setting lower than -130dBm on MPA RFIO TX ports, then popup warning message . When application detected there exists power setting lower than -130dBm on MPA GPS ports, then popup warning message . These are only warning messages, and check is performed when RF is ON.</p>
Notes	The Min and Max value here defined UI settable amplitude range. This range is larger than actual amplitude range with level accuracy defined in spec.
Dependencies	The RF power is dependent on the RF output port and frequency, such that the current frequency and selected output port determine the valid range of power values.
Preset	-100 dBm
Min	The range of values depends on the current frequency and selected RF output port. Please refer to "RF Power" on page 2442 and the table RF Power Range for the valid ranges.
Max	The range of values depends on the current frequency and selected RF output port. Please refer to "RF Power" on page 2442 and the table RF Power Range for the valid ranges.
Initial S/W Revision	A.05.00

Waveform

Allows you access to the sub-menus for selecting the waveform to be played back during the current step. Pressing this key also changes the central display area to show the Waveform File Selection view.

Key Path	Source, List Sequencer, List Sequencer Setup
Remote Command	:SOURCE:LIST:STEP[1] 2 3...1000:SETup:WAVEform <string> :SOURCE:LIST:STEP[1] 2 3...1000:SETup:WAVEform?
Example	:SOUR:LIST:STEP2:SET:WAV "CW" :SOUR:LIST:STEP2:SET:WAV?
Notes	SCPI is supported after A.09.40
Remote Command Notes	String type, takes "Off" "CW" "Cont" "waveform name"

Preset	CW
Range	Waveform Continue Previous CW Off
Initial S/W Revision	A.05.00

CW

Sets the current step to output a CW tone.

Key Path	Source, List Sequencer, List Sequencer Setup, Waveform
Example	:SOUR:LIST:STEP2:SET:WAV "CW"
Notes	SCPI is supported after A.09.40
Initial S/W Revision	A.05.00

Selected Waveform

Inserts the currently selected waveform in the waveform selection view as the waveform for playback during the current step.

Key Path	Source, List Sequencer, List Sequencer Setup, Waveform
Example	:SOUR:LIST:STEP2:SET:WAV "waveform name"
Notes	SCPI is supported after A.09.40 If the selected waveform contains header (which contains ARB play parameters), source list sequence will automatically apply header settings of the selected waveform in that step.
Initial S/W Revision	A.05.00

Continue Previous

Sets the current step to continue with playback of the waveform from the previous step. When continuing the previous waveform, the ARB playback will not pause while the source retunes to the new frequency or amplitude that may be defined for the new step.

Key Path	Source, List Sequencer, List Sequencer Setup, Waveform
Example	:SOUR:LIST:STEP2:SET:WAV "Cont"
Notes	SCPI is supported after A.09.40
Initial S/W Revision	A.05.00

Off

Disable RF output of the current step.

Key Path	Source, List Sequencer, List Sequencer Setup, Waveform
Example	:SOUR:LIST:STEP2:SET:WAV "Off"
Notes	SCPI is supported after A.09.40
Initial S/W Revision	A.05.00

Segments on Hard Disk

Allows you access to the sub-menus for loading waveform segments from the hard disk into ARB memory. The default directory is: D: varb.

Pressing this key changes the current view to the Waveform Management View.

Key Path	Source, Modulation Setup, ARB, Select Waveform
Initial S/W Revision	A.05.00

Load Segment To ARB Memory

Allows you to load the selected file into ARB memory. On the front panel you select the file for loading to the ARB memory by highlighting the desired file in the list. Using the SCPI command, you specify the file name on the HDD.

“NVWFM” (none-volatile storage) MSUS (Mass Storage Unit Specifier) is supported in the memory subsystem because the ARB memory cannot be accessed directly. Therefore, files must be downloaded to the instrument hard disk and then loaded into the ARB memory. “NVWFM” MSUS will be mapped to the default directory D: VARB. The SCPI command supports using either “NVWFM” MSUS or specifying a full path. For more information, see [Memory Subsystem \(Remote Command Only\)](#).

If a file of the same name already exists within ARB memory, it is overwritten. If you wish to load two segments of the same name, you must rename one of the segments before loading it into ARB memory. To rename a segment, you can either use Windows File Explorer, or the :MMEMORY:COPY command.

NOTE: When a waveform file is loaded to ARB memory, burst timing adjustments are made automatically, based on whether or not a Multiport Adapter is connected to the test set and powered on. If the connection/power status of the Multiport Adapter is changed after a waveform file has been loaded, it needs to be loaded again.

Key Path	Source, Modulation Setup, ARB, Select Waveform, Segments on Hard Disk
Remote Command	:SOURce:RADio:ARB:LOAD <string>
Example	:SOUR:RAD:ARB:LOAD "D: VARB\testwaveform.bin" or :SOUR:RAD:ARB:LOAD "NVWFM:testwaveform.bin"
Notes	Because loading the file involves a delay of unpredictable length, this command should be followed by the query *OPC?, which holds off subsequent commands until the loading operating is complete. <string> – specifies the path name of the file to load from the HDD into ARB memory. It could be a <full path + filename>, or <"NVWFM" MSUS + colon + filename>.

When in Sequence Analyzer mode, and Include Source is Yes, an attempt to load a file to ARB memory will be rejected with an error.

When Include Source is No and if there is insufficient free ARB memory to load the selected waveform, an error is generated. .

If you specify a file over SCPI, but the file is not at the specified location, an error is generated.

If you try to load a waveform file but the file contains less than 500 IQ samples, an error is generated.

If you try to load a Signal Studio waveform “*.wfm” which contains invalid waveform header, an error is generated.

If the ARB is ON when you load a file to ARB memory or delete a file from ARB memory, the playing waveform segment may not keep phase continuity during the ARB memory operation. The waveform will be replayed after the ARB operation is finished.

ARB can be loaded into ARB memory even required licenses do not present on the instrument. In this case, a GUI only warning message -800, “Operation complete; Loaded <filename> successfully, but no license <required licenses> installed”. User can install required licenses according to <required licenses> string to license it, or multi-pack license it.

Initial S/W Revision	A.05.00
----------------------	---------

Load All To ARB Memory

Allows you to load all the segment files within the currently selected directory into ARB memory. If a file of the same name already exists within ARB memory, it is overwritten. If you wish to load two segments of the same name, you must rename one of the segments before loading it into ARB memory. To rename a segment, you can either use Windows File Explorer, or the :MEMORY:COPY command.

NOTE: When a waveform file is loaded to ARB memory, burst timing adjustments are made automatically, based on whether or not a Multiport Adapter is connected to the test set and powered on. If the connection/power status of the Multiport Adapter is changed after a waveform file has been loaded, it needs to be loaded again.

Key Path	Source, Modulation Setup, ARB, Select Waveform, Segments on Hard Disk
Remote Command	:SOURce:RADio:ARB:LOAD:ALL <string>
Example	:SOUR:RAD:ARB:LOAD:ALL “D: varb”
Notes	<p><string> - specifies the directory on the HDD to load the files into ARB memory from.</p> <p>When in Sequence Analyzer mode, and Include Source is Yes, an attempt to load all files from a directory to ARB memory is rejected with an error.</p> <p>When Include Source is No and there is insufficient free ARB memory to load all the waveforms, when the ARB memory is full, the copy ceases, and an error is generated.</p> <p>If you specify a directory over SCPI, but the directory does not exist, an error is generated.</p> <p>If the ARB is ON, a user then loads or deletes file to ARB memory, the playing waveform segment may not keep phase continuity during the ARB memory operation. The waveform will be replayed after the ARB operation is finished.</p>
Initial S/W Revision	A.05.00

Change Directory...

Allows you to change the currently selected directory on the hard disk. Pressing this key opens a standard windows change directory dialog allowing you to select the new directory of interest.

The current directory is used for manually loading waveform segments into ARB memory for playback, and as a search location for waveform segments that are required to be loaded into ARB memory for playback of a waveform sequence or a list sequence.

Key Path	Source, Modulation Setup, ARB, Select Waveform, Segments on Hard Disk
Notes	No remote command, SCPIfront panel only.
Initial S/W Revision	A.05.00

Default Directory...

Allows you to change the default directory. It is used as a search location for waveform segments that are required to be loaded into ARB memory for playback of a waveform sequence, and as a search location for selecting waveforms using SCPI.

Key Path	Source, Modulation Setup, ARB, Select Waveform, Segments on Hard Disk
Remote Command	:SOURce:RADio:ARB:DEFault:DIRectory <string> :SOURce:RADio:ARB: DEFault:DIRectory?
Example	:SOUR:RAD:ARB:DEF:DIR "D:\ArbFiles" :SOUR:RAD:ARB:DEF:DIR?
State Saved	Persistent, survives a power cycle and a preset but not saved in the instrument state
Initial S/W Revision	A.05.00

Segments in ARB Memory

Allows you access to the sub-menus for managing the files within ARB memory.

Key Path	Source, Modulation Setup, ARB, Select Waveform
Initial S/W Revision	A.05.00

Delete Segment From ARB Mem

Allows you to remove a segment from ARB playback memory.

Key Path	Source, Modulation Setup, ARB, Select Waveform, Segments in ARB Memory
Remote Command	:SOURce:RADio:ARB:DELeTe <string>
Example	:SOUR:RAD:ARB:DEL "testwaveform.bin"
Notes	<string> - specifies the waveform to be deleted from the ARB playback memory. When in Sequence Analyzer mode and Include Source is Yes, an attempt to delete a file from ARB

memory is rejected with an error.

When Include Source is No and you specify a file that does not exist within ARB memory, an error is generated.

It is possible to delete files from within the ARB memory when the ARB is ON. However, if you attempt to delete the file that is currently playing an error is generated.

It is possible to delete a file from within the ARB memory when the sequencer state is ON and the file is not being used by the List Sequencer. If you attempt to delete a file which is being used by the list sequencer, an error is generated.

When sequencer state is On, even if ARB state is On, the selected waveform will not be played. In this case, if the selected waveform is not used in List Sequence, it can be deleted and the ARB state is turned Off.

If the ARB is ON and you load a file to ARB memory or delete a file from ARB memory, the playing waveform segment may not keep phase continuity during the ARB memory operation. The waveform will be replayed after the ARB operation is finished.

Initial S/W Revision	A.05.00
----------------------	---------

Delete All From ARB Memory

Allows you to remove all segments from ARB playback memory.

Key Path	Source, Modulation Setup, ARB, Select Waveform, Segments in ARB Memory
Remote Command	:SOURce:RADio:ARB:DELeTe:ALL
Example	:SOUR:RAD:ARB:DELeTe:ALL
Notes	<p>When in Sequence Analyzer mode and Include Source is Yes, an attempt to delete all files from ARB memory is rejected with an error.</p> <p>When Include Source is No and you attempt to delete all files from ARB memory when the ARB is currently playing a file, all files except the one playing are deleted and an error is generated.</p> <p>If you attempt to delete all files from ARB memory when there are waveform files used in "List Sequencer" on page 2520 and "Sequencer" on page 2521 state is ON, all files except the files currently being used in list sequencer are deleted, and an error is generated.</p> <p>If the ARB is ON and you load a file to ARB memory or delete a file from ARB memory, the playing waveform segment may not keep phase continuity during the ARB memory operation. The waveform will be replayed after the ARB operation is finished.</p>
Initial S/W Revision	A.05.00

Segments on Hard Disk

This key functions the same as "[Segments on Hard Disk](#)" on page 2547.

Key Path	Source, List Sequencer, List Sequencer Setup, Waveform
Initial S/W Revision	Prior to A.09.00

Load Segment To ARB Memory

This key functions the same as "[Load Segment To ARB Memory](#)" on page 2547.

Key Path	Source, List Sequencer, List Sequencer Setup, Waveform, Segment on Hard Drive
Initial S/W Revision	Prior to A.09.00

Load All To ARB Memory

This key functions the same as "[Load All To ARB Memory](#)" on page 2548.

Key Path	Source, List Sequencer, List Sequencer Setup, Waveform, Segment on Hard Drive
Initial S/W Revision	Prior to A.09.00

Change Directory ...

This key functions the same as "[Change Directory...](#)" on page 2549.

Key Path	Source, List Sequencer, List Sequencer Setup, Waveform, Segment on Hard Drive
Initial S/W Revision	Prior to A.09.00

Default Directory ...

This key functions the same as "[Default Directory...](#)" on page 2549

Key Path	Source, List Sequencer, List Sequencer Setup, Waveform, Segment on Hard Drive
Initial S/W Revision	Prior to A.09.00

Segments in ARB Memory

This key functions the same as "[Segments in ARB Memory](#)" on page 2549.

Key Path	Source, List Sequencer, List Sequencer Setup, Waveform, Segments in ARB Memory
Initial S/W Revision	Prior to A.09.00

Delete Segment From ARB Memory

This key functions the same as "[Delete Segment From ARB Mem](#)" on page 2549.

Key Path	Source, List Sequencer, List Sequencer Setup, Waveform, Segments in ARB Memory, Segment in ARB Memory
Initial S/W Revision	Prior to A.09.00

Delete All From ARB Memory

This key functions the same as "Delete All From ARB Memory" on page 2550.

Key Path	Source, List Sequencer, List Sequencer Setup, Waveform, Segments in ARB Memory, Segment in ARB Memory
Initial S/W Revision	Prior to A.09.00

Step Duration

Allows access to the sub-menus for setting up the duration of play for the current step.

The duration can be set to be either the number of times for the ARB file associated with the sequence to play, or a specific time value, or continuous. If the step is set to play a CW tone, the step duration cannot be set to a play count.

Key Path	Source, List Sequencer, List Sequencer Setup
Remote Command	:SOURce:LIST:STEP[1] 2 3...1000:SETup:DURation:TYPE TIME COUNT CONTInuous CABort :SOURce:LIST:STEP[1] 2 3...1000:SETup:DURation:TYPE?
Example	:SOUR:LIST:STEP2:SET:DUR:TYPE TIME :SOUR:LIST:STEP2:SET:DUR:TYPE?
Notes	SCPI is supported after A.09.40
Notes	If "Step Duration" is set to "Time" or "Play Count" for the last step, the last step of ARB keeps playing as if set to "Continuous", until the set "Time" has expired or until the "Play Count" setting is reached. However, you can query Error! Reference source not found. Source Sweeping Condition Message to find out if the current list sequence is complete or not.
Range	Time Play Count Continuous Continuous Abort
Initial S/W Revision	A.05.00

Time

Sets the duration of the current step to be a time value for the length of time the step will play. Pressing this key again opens another menu which allows you to set the time value for the step duration.

Key Path	Source, List Sequencer, List Sequencer Setup, Step Duration
Example	:SOUR:LIST:STEP2:SET:DUR:TYPE TIME
Notes	SCPI is supported after A.09.40
Initial S/W Revision	A.05.00

Duration Time

Allows you to specify the length of time the current step will play.

When Step Duration is **Continuous Abort** this parameter specifies the maximum duration that the waveform will continue to play after a step trigger is received before the transition to the next waveform will occur. Duration is limited to a maximum of 20 seconds.

If the Transition Time value is longer than the Step Duration Time, an error is generated when initiating a source list sequence. For source list sequence, transition time is included in the step duration length (not occupy additional time). If the Transition Time value is longer than the Step Duration Time, the real step duration length is extended to equal the transition time and cause a timing shift. This check is also described in section **Error! Reference source not found.** List Sequence Step Validation.

Key Path	Source, List Sequencer, List Sequencer Setup, Step Duration, Time
Remote Command	:SOURce:LIST:STEP [1] 2 3...1000:SETup:DURation:TCOut <double> :SOURce:LIST:STEP [1] 2 3...1000:SETup:DURation:TCOut?
Example	:SOUR:LIST:STEP2:SET:DUR:TCO 1s :SOUR:LIST:STEP2:SET:DUR:TCO?
Notes	SCPI is supported after A.09.40 This SCPI is reused by "Play Count", "Duration Time" and "Continuous Abort" according to current Duration Type setting is "Play Count" or "Duration Time" or "Continuous Abort". If current "Duration Type" is "Continuous", then popup error -221, "Settings conflict; Cannot accept time or count input when step duration type is Continuous on step #"
Notes	If "Duration Time" is set for the last step, the last step of ARB keeps playing as if set to "Continuous" after set time expires. However, you can query Source Sweeping Condition Message (:STAT:OPER:COND?) to find out if the current list sequence is complete or not.
Preset	1.00 ms
Min	100 µs
Max	1800 s
Initial S/W Revision	A.05.00

Play Count

Sets the duration of the current step to be an integer value for the number of times (play count) the ARB file is selected for playback during this step. For example, a 5 second ARB will be set to play 5 times during the step.

Key Path	Source, List Sequencer, List Sequencer Setup, Step Duration
Example	:SOUR:LIST:STEP2:SET:DUR:TYPE COUN
Notes	SCPI is supported after A.09.40 This key is unavailable and is grayed out if the current step is configured to CW tone rather than an ARB waveform.
Initial S/W Revision	A.05.00

Header Utilities

Allows access to the header utilities sub-menu. Pressing this key also causes the central display area to change to display the File Header Information view.

Key Path	Source, Modulation Setup, ARB
Dependencies	This key is only available if there is currently a waveform selected for playback. If no waveform is selected, the key is grayed out.
Initial S/W Revision	A.05.00

Continuous

Sets the current step to be played continuously until the next step starts. The waveform will always play completely before transitioning to the next step.

Key Path	Source, List Sequencer, List Sequencer Setup, Step Duration
Example	:SOUR:LIST:STEP2:SET:DUR:TYPE CONT
Notes	SCPI is supported after A.09.40
Initial S/W Revision	A.05.00

Output Trigger

Allows you to specify the trigger output for the current step. The trigger output signal is sent at the start of the step.

When select “On”, trigger event will occur on both Internal and External2 paths. Select “Off” will turn off trigger output.

Key Path	Source, List Sequencer, List Sequencer Setup
Remote Command	:SOURce:LIST:STEP[1] 2 3...1000:SETup:OUTPut:TRIGger ON OFF 1 0 :SOURce:LIST:STEP[1] 2 3...1000:SETup:OUTPut:TRIGger
Example	:SOUR:LIST:STEP2:SET:OUTP:TRIG ON :SOUR:LIST:STEP2:SET:OUTP:TRIG?
Notes	SCPI is supported after A.09.40
Preset	Off
Range	On Off
Initial S/W Revision	A.05.00

Step Configuration (Remote Command Only)

This SCPI command is used to configure the List Sequencer and is detailed in the table below. The command is defined such that you send one command per step, with the step number being specified as a subopcode of the SCPI command. Each command includes all the parameter settings for the step. As a step is setup, the values entered are run through several levels of validation.

Remote Command	:SOURce:LIST:STEP[1] 2 ... 4..1000:SETup IMMEDIATE INTERNAL KEY
-----------------------	---

```
BUS | EXTERNAL2, <time>, NONE | PGSM | EGSM | RGSM | DCS1800 | PCS1900
| TGSM810 | GSM450 | GSM480 | GSM700 | GSM850 | BANDI | BANDII |
BANDIII | BANDIV | BANDV | BANDVI | BANDVII | BANDVIII | BANDIX | BANDX
| BANDXI | BANDXII | BANDXIII | BANDXIV | BANDXIX | USCELL | USPCS |
JAPAN | KOREAN | NMT | IMT2K | UPPER | SECOND | PAMR400 | PAMR800 |
IMTEXT | PCS1DOT9G | AWS | US2DOT5G | PUBLIC | LOWER | NONE | BAND1 |
BAND2 | BAND3 | BAND4 | BAND5 | BAND6 | BAND7 | BAND8 | BAND10 | BAND11
| BAND12 | BAND13 | BAND14 | BAND17 | BAND18 | BAND19 | BAND20 | BAND21
| BAND24 | BAND25 | BAND26 | BAND33 | BAND34 | BAND35 | BAND36 | BAND37
| BAND38 | BAND39 | BAND40 | BAND41 | BAND42 | BAND43 | BANDA | BANDB |
BANDC | BANDD | BANDE | BANDE, DOWN | UP, <freq>, <ampl>, <string>,
TIME | COUNT | CONTINUOUS, <time>, ON | OFF | 1 | 0, [<int>],

:SOURce:LIST:STEP[1]|2|...|4..1000:SETup?
```

Example :SOUR:LIST:STEP1:SET INT, 1ms, PGSM, DOWN, 10, -25 dBm, "GSM_Test1.bin", TIME, 10ms, OFF, 255

Notes

The parameters are:

(There is a total of 11 items in each step, the following is a list of the items in the order they must appear in the remote command.)

1. Step Trigger **<enum>** – specifies the input trigger for the step. For details of the valid types of step trigger see ["Step Trigger" on page 2523](#).
 2. Transition Time **<time>** – specifies the transition time for the step in seconds. For details of the valid ranges for the transition time see ["Transition Time" on page 2525](#).
 3. Radio Band **<enum>** – specifies the radio band for the step. For details of the valid radio bands see ["Radio Setup" on page 2526](#).
 4. Radio Band Link **<enum>** – specifies the radio band link direction for the step. For details of the valid link types, see ["Radio Band Link" on page 2543](#).
 5. Frequency/Channel Number **<freq>/<chan num>** – specifies the frequency in Hz or the channel number for the step. The channel number and frequency are combined as one parameter that represents the frequency or channel number depending on the radio band setting. If the radio band is set to NONE, this value is interpreted as a frequency value in Hz. If the radio band is set to a valid band, this value is interpreted as a channel number. For details of the valid ranges for frequency and channel numbers, see ["Channel" on page 2543](#) and ["Frequency" on page 2544](#).
 6. Power **<ampl>** – specifies the output power for the step in dBm. For details of the valid ranges see ["Power" on page 2544](#).
 7. Waveform **<string>** – specifies the waveform for playback during the step. The step can output either a new ARB waveform, continue playback of the previous waveform, or output a CW tone. The options for specifying these are:
 - <filename> - plays the specified waveform from the start. The filename value is the name of the file within ARB playback memory, it does not include the windows path to the file on the HDD. If you enter a filename for a waveform that does not reside within ARB playback memory, an error is generated.
 - CONT – continues playback of the ARB file from the previous step
 - CW – outputs a CW tone
 - OFF – disable RF output
 8. Step Duration **<enum>** – specifies the duration of the step. The duration can be specified to be either time, or play count of the ARB file associated with the step, or continuous. If Waveform is set to "CW", this value cannot be set to Play Count and an error will be generated. If continuous is selected, the following Time or Count value is ignored. For further details of this setting, see ["Step](#)
-

[Duration" on page 2552.](#)

9. Time or Count <time/int> – specifies time duration in seconds or play count of the ARB file associated with the step. For further details of this setting, including the valid ranges for the time or play count setting, ["Time" on page 2552](#) and ["Play Count" on page 2553](#).

10. Output Trigger <Boolean> – specifies the output trigger for the step. For details of the ranges for this setting see ["Output Trigger" on page 2554](#).

Dependencies	The range of subopcode values is 1 to 1000 and the value you enter is determined by the number of steps you have configured. For details see "Number of Steps" on page 2522 . If you attempt to remotely set or query a subopcode that is out of range, an error is generated.
Initial S/W Revision	A.05.00

Step Configuration of Step Trigger parameter list (Remote Command Only)

This SCPI command is to configure “Step Trigger” parameter array of the whole List Sequencer at one time. The number of array is same as step number defined in ["Number of Steps" on page 2522](#) Number of Steps. As a step is setup, the value entered run through several levels of validation.

Remote Command	:SOURce:LIST:SETup:INPut:TRIGger <enum>, <enum>, <enum>, ... :SOURce:LIST:SETup:INPut:TRIGger?
Example	:SOUR:LIST:SET:INP:TRIG IMM,INT,EXT2 :SOUR:LIST:SET:INP:TRIG?
Notes	The command is to setup below parameter array of whole list sequence. Step Trigger <enum> – specifies the input trigger for the step. For details of the valid types of step trigger see "Step Trigger" on page 2523 . If input parameter number exceeds the step number defined by "Number of Steps" on page 2522 Number of Steps then generate error ", and only those parametes whose index number falls in number of steps will be updated.
Remote Command Notes	IMMediate INTerna KEY BUS EXTerna2
Dependencies	The range is 1 to 1000 which is determined by the number of steps you have configured. For details see "Number of Steps" on page 2522 .
Initial S/W Revision	A.09.40

Step Configuration of Transition Time parameter list (Remote Command Only)

This SCPI command is to configure “Transition Time” parameter array of the whole List Sequencer at one time. The number of array is same as step number defined in ["Number of Steps" on page 2522](#) Number of Steps. As a step is setup, the value entered run through several levels of validation.

Remote Command	:SOURce:LIST:SETup:TRANSition:TIME <time>, <time>, <time>, ... :SOURce:LIST:SETup:TRANSition:TIME?
Example	:SOUR:LIST:SET:TRAN:TIME 1ms,1ms,1ms

	:SOUR:LIST:SET:TRAN:TIME?
Notes	<p>The command is to setup below parameter array of whole list sequence.</p> <p>Transition Time <time> – specifies the transition time for the step in seconds. For details of the valid ranges for the transition time see "Transition Time" on page 2525</p> <p>If input parameter number exceeds the step number defined by "Number of Steps" on page 2522 Number of Steps then generate error ", and only those parameters whose index number falls in number of steps will be updated.</p>
Dependencies	The range is 1 to 1000 which is determined by the number of steps you have configured. For details see "Number of Steps" on page 2522 .
Initial S/W Revision	A.09.40

Step Configuration of Radio Band parameter list (Remote Command Only)

This SCPI command is to configure "Radio Band" parameter array of the whole List Sequencer at one time. The number of array is same as step number defined in ["Number of Steps" on page 2522](#) Number of Steps. As a step is setup, the value entered run through several levels of validation.

R :SOURce:LIST:SETup:RADio:BAND <enum>, <enum>, <enum>, ...

e :SOURce:LIST:SETup:RADio:BAND?

m
o
t
e

C
o
m
m
a
n
d

E :SOUR:LIST:SET:RAD:BAND PGSM, EGSM, RGSM

x :SOUR:LIST:SET:RAD:BAND?

a
m
p
l
e

N The command is to setup below parameter array of whole list sequence.

o Radio Band <enum> – specifies the radio band for the step. For details of the valid radio bands see ["Radio Setup" on page 2526](#).

t If input parameter number exceeds the step number defined by ["Number of Steps" on page 2522](#) Number of Steps then
e generate error ", and only those parameters whose index number falls in number of steps will be updated.
s

R NONE|PGSM|EGSM|RGSM|DCS1800|PCS1900|TGSM810|GSM450|GSM480|GSM700|GSM850|BANDI|BANDII|BANDIII|BANDIV|BANDV|BANDVI|BANDVII|BANDVIII|BANDIX|BANDX|BANDXI|BANDXII|BANDXIII|BANDXIV|BANDXIX|USCELL|USPCS|JAPAN|KOREAN|NMT|IMT2K|UPPER|SECOND|PAMR400|PAMR800|IMTEXT|PCS1 DOT9G|AWS|US2DOT5G|PUBLIC|LOWER|NONE|BAND1|BAND2|BAND3|BAND4|BAND5|BAND6|BAND7|BAND8|BAND10|BAND11|BAND12|BAND13|BAND14|BAND17|BAND18|BAND1

o 9|BAND20|BAND21|BAND24|BAND25|BAND26|BAND33|BAND34|BAND35|BAND36|BAND37|BAND38|BAND39|BAND40|BAN
t D41|BAND42|BAND43|BANDA|BANDB|BANDC|BANDD|BANDE|BANDF
e

C
o
m
m
a
n
d

N
o
t
e
s

D The range is 1 to 1000 which is determined by the number of steps you have configured. For details see "[Number of Steps](#)" on
e [page 2522](#).

p
e
n
d
e
n
c
i
e
s

I A.09.40

n
i
t
i
a
l

S
/
W

R
e
v
i
s
i
o
n

Step Configuration of Radio Band Link parameter list (Remote Command Only)

This SCPI command is to configure “Radio Band Link” parameter array of the whole List Sequencer at one time. The number of array is same as step number defined in ["Number of Steps" on page 2522](#) Number of Steps. As a step is setup, the value entered run through several levels of validation.

Remote Command	:SOURce:LIST:SETup:RADio:BAND:LINK <enum>, <enum>, <enum>, ... :SOURce:LIST:SETup:RADio:BAND:LINK?
Example	:SOUR:LIST:SET:RAD:BAND:LINK DOWN,UP,UP :SOUR:LIST:SET:RAD:BAND:LINK?
Notes	The command is to setup below parameter array of whole list sequence. Radio Band Link <enum> – specifies the radio band link direction for the step. For details of the valid link types, see "Radio Band Link" on page 2543 . If input parameter number exceeds the step number defined by "Number of Steps" on page 2522 Number of Steps then generate error ", and only those parametes whose index number falls in number of steps will be updated.
Remote Command Notes	DOWN UP
Dependencies	The range is 1 to 1000 which is determined by the number of steps you have configured. For details see "Number of Steps" on page 2522 .
Initial S/W Revision	A.09.40

Step Configuration of Frequency/Channel Number parameter list (Remote Command Only)

This SCPI command is to configure “Frequency” or “Channel Number” parameter array of the whole List Sequencer at one time. The number of array is same as step number defined in ["Number of Steps" on page 2522](#) Number of Steps. As a step is setup, the value entered run through several levels of validation.

Remote Command	:SOURce:LIST:SETup:CNFRrequency <double>, <double>, <double>, ... :SOURce:LIST:SETup:CNFRrequency?
Example	:SOUR:LIST:SET:CNFR 1GHz,100MHz,100MHz :SOUR:LIST:SET:CNFR? SOUR:LIST:SET:CNFR 124,124,124 :SOUR:LIST:SET:CNFR?
Notes	The command is to setup below parameter array of whole list sequence. Frequency/Channel Number <freq>/<chan num> – specifies the frequency in Hz or the channel number for the step. The channel number and frequency are combined as one parameter that represents the frequency or channel number depending on the radio band setting. If the radio band is set to NONE, this value is interpreted as a frequency value in Hz. If the radio band is set to a valid band, this value is interpreted as a channel number. For details of the valid ranges for frequency and channel numbers, see "Channel" on page 2543 and "Frequency" on page 2544 This SCPI is used to setup/query channel number or frequency setting, according to current Radio Band setting of that step. If Radio Band is “NONE”, then it’s frequency. If Radio Band is not “NONE”, then it’s channel number If input parameter number exceeds the step number defined by "Number of Steps" on page 2522 Number of Steps then generate error ", and only those parametes whose index number falls in

	legal step number will be updated.
Dependencies	The range is 1 to 1000 which is determined by the number of steps you have configured. For details see "Number of Steps" on page 2522 .
Initial S/W Revision	A.09.40

Step Configuration of Power parameter list (Remote Command Only)

This SCPI command is to configure “Power” parameter array of the whole List Sequencer at one time. The number of array is same as step number defined in ["Number of Steps" on page 2522](#) Number of Steps. As a step is setup, the value entered run through several levels of validation.

Remote Command	:SOURce:LIST:SETup:AMPLitude <ampl>, <ampl>, <ampl>, ... :SOURce:LIST:SETup:AMPLitude?
Example	:SOUR:LIST:SET:AMPL -50dBm,-40dBm,-30dBm :SOUR:LIST:SET:AMPL?
Notes	The command is to setup below parameter array of whole list sequence. Power <ampl> – specifies the output power for the step in dBm. For details of the valid ranges see "Power" on page 2544 . If input parameter number exceeds the step number defined by "Number of Steps" on page 2522 Number of Steps then generate error ", and only those parametes whose index number falls in legal step number will be updated.
Dependencies	The range is 1 to 1000 which is determined by the number of steps you have configured. For details see "Number of Steps" on page 2522 .
Initial S/W Revision	A.09.40

Step Configuration of Waveform parameter list (Remote Command Only)

This SCPI command is to configure “Waveform” parameter array of the whole List Sequencer at one time. The number of array is same as step number defined in ["Number of Steps" on page 2522](#) Number of Steps. As a step is setup, the value entered run through several levels of validation.

Remote Command	:SOURce:LIST:SETup:WAVEform <string>, <string>, <string>, ... :SOURce:LIST:SETup:WAVEform?
Example	:SOUR:LIST:SET:WAV "CW","Off","CONT" :SOUR:LIST:SET:WAV?
Notes	The command is to setup below parameter array of whole list sequence. Waveform <string> – specifies the waveform for playback during the step. The step can output either a new ARB waveform, continue playback of the previous waveform, or output a CW tone. The options for specifying these are: <filename> - plays the specified waveform from the start. The filename value is the name of the file within ARB playback memory, it is does not include the windows path to the file on the HDD. If you enter a filename for a waveform that does not reside within ARB playback memory, an error is generated.

	<p>CONT – continues playback of the ARB file from the previous step</p> <p>CW – outputs a CW tone</p> <p>OFF – disable RF output</p> <p>If input parameter number exceeds the step number defined by "Number of Steps" on page 2522 Number of Steps then generate error ", and only those parametes whose index number falls in number of steps will be updated.</p>
Dependencies	The range is 1 to 1000 which is determined by the number of steps you have configured. For details see "Number of Steps" on page 2522.
Range	"filename" "CW" "Off" "CONT"
Initial S/W Revision	A.09.40

Step Configuration of Step Duration parameter list (Remote Command Only)

This SCPI command is to configure "Step Duration" parameter array of the whole List Sequencer at one time. The number of array is same as step number defined in "Number of Steps" on page 2522 Number of Steps. As a step is setup, the value entered run through several levels of validation.

Remote Command	<pre>:SOURce:LIST:SETup:DURation:TYPE <enum>, <enum>, <enum>, ... :SOURce:LIST:SETup:DURation:TYPE?</pre>
Example	<pre>:SOUR:LIST:SET:DUR:TYPE COUN,TIME,CONT :SOUR:LIST:SET:DUR:TYPE?</pre>
Notes	<p>The command is to setup below parameter array of whole list sequence.</p> <p>Step Duration <enum> – specifies the duration of the step. The duration can be specified to be either time, or play count of the ARB file associated with the step, or continuous. If Waveform is set to "CW", this value cannot be set to Play Count and an error will be generated. If continuous is selected, the following Time or Count value is ignored. For further details of this setting, see "Step Duration" on page 2552.</p> <p>If input parameter number exceeds the step number defined by "Number of Steps" on page 2522 Number of Steps then generate error ", and only those parametes whose index number falls in number of steps will be updated.</p>
Remote Command Notes	TIME COUNT CONTinuous
Dependencies	The range is 1 to 1000 which is determined by the number of steps you have configured. For details see "Number of Steps" on page 2522.
Initial S/W Revision	A.09.40

Step Configuration of Duration Time or Play Count parameter list (Remote Command Only)

This SCPI command is to configure "Duration Time" or "Play Count" parameter array of the whole List Sequencer at one time. The number of array is same as step number defined in "Number of Steps" on page 2522 Number of Steps. As a step is setup, the value entered run through several levels of validation.

Remote Command	<pre>:SOURce:LIST:SETup:TOCount <time/int>, <time/int>, <time/int>, ... :SOURce:LIST:SETup:TOCount?</pre>
-----------------------	---

Example	:SOUR:LIST:SET:TOC 1s,2s,3s :SOUR:LIST:SET:TOC? :SOUR:LIST:SET:TOC 5,6,7 :SOUR:LIST:SET:TOC?
Notes	The command is to setup below parameter array of whole list sequence. Time or Count <time/int> – specifies time duration in seconds or play count of the ARB file associated with the step. For further details of this setting, including the valid ranges for the time or play count setting, " Time " on page 2552 and " Play Count " on page 2553. If input parameter number exceeds the step number defined by " Number of Steps " on page 2522 Number of Steps then generate error ", and only those parametes whose index number falls in number of steps will be updated. If current " Step Duration " on page 2552 is "Continuous", then generate error -221,"Settings conflict;Cannot accept time or count input when step duration type is Continuous on step #"
Dependencies	The range is 1 to 1000 which is determined by the number of steps you have configured. For details see " Number of Steps " on page 2522.
Initial S/W Revision	A.09.40

Step Configuration of Output Trigger parameter list (Remote Command Only)

This SCPI command is to configure "Output Trigger" parameter array of the whole List Sequencer at one time. The number of array is same as step number defined in "[Number of Steps](#)" on page 2522 Number of Steps. As a step is setup, the value entered run through several levels of validation.

Remote Command	:SOURce:LIST:SETup:OUTPut:TRIGger <bool>, <bool>, <bool>, ... :SOURce:LIST:SETup:OUTPut:TRIGger ?
Example	:SOUR:LIST:SET:OUTP:TRIG ON,OFF,ON :SOUR:LIST:SET:OUTP:TRIG?
Notes	The command is to setup below parameter array of whole list sequence. Output Trigger <Boolean> – specifies the output trigger for the step. For details of the ranges for this setting see " Output Trigger " on page 2554. If input parameter number exceeds the step number defined by " Number of Steps " on page 2522 Number of Steps then generate error ", and only those parametes whose index number falls in legal step number will be updated.
Remote Command Notes	ON OFF 1 0
Dependencies	The range is 1 to 1000 which is determined by the number of steps you have configured. For details see " Number of Steps " on page 2522.
Initial S/W Revision	A.09.40

Clear List (Remote Command Only)

This command is the SCPI equivalent of the Clear List UI featuredescribed in.

Remote Command	:SOURce:LIST:SETup:CLEar
Example	:SOUR:LIST:SETup:CLE
Initial S/W Revision	A.05.00

Trigger Type

Allows access to the sub-menu for selecting the output trigger type for the list sequencer globally. It cannot be changed between different sequence steps.

Key Path	Source, List Sequencer
Remote Command	:SOURce:LIST:TRIGgerout:TYPE BEGinningofstep DATamarker
Example	:SOUR:LIST:TRIG:TYP BEG :SOUR:LIST:TRIG:TYP?
Notes	SCPI is supported after A.14.00
Preset	BEGinningofstep
Range	BEGinningofstep DATamarker
Initial S/W Revision	A.14.00

BeginningOfStep

Sets the output trigger type as BeginningOfStep for the whole source sequence.

Key Path	Source, List Sequencer, Trigger Type
Example	:SOUR:LIST:TRIG:TYP BEG
Notes	SCPI is supported after A.14.00
Initial S/W Revision	A.14.00

DataMarker

Sets the output trigger type as DataMarker for the whole source sequence. When DataMarker is selected, which marker to route is also needed to be set.

Key Path	Source, List Sequencer, Trigger Type
Example	:SOUR:LIST:TRIG:TYP DAT
Notes	SCPI is supported after A.14.00
Initial S/W Revision	A.14.00

Marker 1

Sets the output trigger maker routing to Marker 1 for DataMarker in the whole source sequence.

Key Path	Source, List Sequencer, Trigger Type, DataMarker
Example	:SOUR:LIST:TRIG:TYPE:MARK M1
Notes	SCPI is supported after A.14.00
Initial S/W Revision	A.14.00

Marker 2

Sets the output trigger maker routing to Marker 2 for DataMarker in the whole source sequence.

Key Path	Source, List Sequencer, Trigger Type, DataMarker
Example	:SOUR:LIST:TRIG:TYPE:MARK M2
Notes	SCPI is supported after A.14.00
Initial S/W Revision	A.14.00

Marker 3

Sets the output trigger maker routing to Marker 3 for DataMarker in the whole source sequence.

Key Path	Source, List Sequencer, Trigger Type, DataMarker
Example	:SOUR:LIST:TRIG:TYPE:MARK M3
Notes	SCPI is supported after A.14.00
Initial S/W Revision	A.14.00

Marker 4

Sets the output trigger maker routing to Marker 4 for DataMarker in the whole source sequence.

Key Path	Source, List Sequencer, Trigger Type, DataMarker
Example	:SOUR:LIST:TRIG:TYPE:MARK M4
Notes	SCPI is supported after A.14.00
Initial S/W Revision	A.14.00

Manual Trigger Now

Pressing this key provides a software trigger event to the list sequencer. During execution of sequence, if the sequencer is halted on any step that has been configured with a “Manual” step trigger, then this key press will cause the sequencer to continue and execute the step.

Key Path	Source, List Sequencer
Remote Command	No remote command, front panel only.
Initial S/W Revision	A.05.00

Remote Software Trigger (Remote command Only)

During execution of a list sequence, the sequence will halt and wait at any step that has Step Trigger set to "Bus". Sending this command will trigger the step and continue the sequence.

Remote Command	:SOURce:LIST:TRIGger:INITiate[:IMMediate]
Example	:SOUR:LIST:TRIG:INIT
Initial S/W Revision	A.05.00

Query List Sequence Initiation Armed Status (Remote Command Only)

This is a blocking SCPI query to determine if source list sequence being initiated successfully or not.

Remote Command	:SOURce:LIST:INITiation:ARMed?
Example	:SOUR:LIST:INIT:ARMed?
Notes	The return data is in the following format: Integer
Notes	Query only SCPI. Returning "1" if list sequence has been initiated successfully, returning "0" if not. Once get "0", you can use :SYST:ERR? to query what error happened. Just like "*OPC?", this command can be blocked until event/status "IsSourceSweeping" happens, and then returns. Doing so can help user's script query armed status only once during the time interval of the initiation. As an ancillary SCPI of existing SCPI ":SOUR:LIST:TRIGger[:IMMediate]" (see "Initiate Sequence" on page 2521 Initiate Sequence), the right usage of this command is to use it after ":SOUR:LIST:TRIG". If not, this command will return "1" immediately.
Notes	There is an alias SCPI ":SOURce:LIST:TRIGger:INITiation:ARMed?".
Initial S/W Revision	A.09.40

Source Preset

Allows you to preset the source settings to their default values.

Key Path	Source
Remote Command	:SOURce:PRESet
Example	:SOUR:PRES

Span X Scale

Accesses a menu of functions that enable you set the horizontal scale parameters.

Key Path	Front-panel key
Initial S/W Revision	Prior to A.02.00

Sweep/Control

Accesses a menu of functions that enable you to set up and control the acquisition time and source for the current measurement. See Key and Command Descriptions – Sweep/Control for more information.

Key Path	Front-panel key
Initial S/W Revision	Prior to A.02.00

Acq Time

Sets the acquisition time; acquisition time can be set manually or put in auto mode. The time value is the acquisition time for an individual FFT segment, not the cumulated time for all FFT segments in the measurement.

Key Path	Sweep/Control
Mode	SA, WCDMA, C2K, WIMAX OFDMA, 1xEVDO, DVB-T/H, DTMB (CTTB), ISDB-T, CMMB, LTE, LTETDD, Digital Cable TV, WLAN, MSR, LTEAFDD, LTEATDD
Remote Command	[:SENSe]:CHPower:SWEep:TIME <time> [:SENSe]:CHPower:SWEep:TIME? [:SENSe]:CHPower:SWEep:TIME:AUTO OFF ON 0 1 [:SENSe]:CHPower:SWEep:TIME:AUTO?
Example	CHP:SWE:TIME 25ms CHP:SWE:TIME? CHP:SWE:TIME:AUTO OFF CHP:SWE:TIME:AUTO?
Preset	SA, WIMAX OFDMA: Automatically Calculated WCDMA: 1.0 ms CDMA2K: 9.4ms 1xEVDO: 2.66ms DVB-T/H: Automatically Calculated DTMB (CTTB): Automatically Calculated ISDB-T: Automatically Calculated CMMB: Automatically Calculated LTE, MSR: Automatically Calculated LTETDD: Automatically Calculated Digital Cable TV: Automatically Calculated WLAN: Automatically Calculated LTEAFDD,LTEATDD:Automatically Calculated
State Saved	Saved in instrument state.
Min	100 ns

Max	4000 s
Initial S/W Revision	Prior to A.02.00
Modified at S/W Revision	A.02.00, A.03.00

Sweep Setup

Accesses a menu that enables you to set the sweep state for the current measurement.

Key Path	Sweep/Control
Initial S/W Revision	Prior to A.02.00

Auto Sweep Time Rules

Switches the analyzer between normal and accuracy sweep states.

Setting Auto Sweep Time to Accy results in slower sweep times, usually about three times as long, but yields better amplitude accuracy for CW signals. The instrument amplitude accuracy specifications only apply when Auto Sweep Time is set to Accy.

Additional amplitude errors which occur when Auto Sweep Time is set to Norm are usually well under 0.1 dB, though this is not guaranteed. Because of the faster sweep times and still low errors, Norm is the preferred setting of Auto Sweep Time. Auto Sweep Time is set to Norm on a Preset or Auto Couple. This means that in the Preset or Auto Coupled state, instrument amplitude accuracy specifications do not apply.

Key Path	Sweep/Control, Sweep Setup
Mode	SA, WCDMA, C2K, WIMAX OFDMA, 1xEVDO, DVB-T/H, DTMB (CTTB), ISDB-T, CMMB, LTE, LTE-TDD, Digital Cable TV, WLAN, MSR, LTEAFDD, LTEATDD
Remote Command	[:SENSe] :CHPower :SWEep :TIME :AUTO :RULEs NORMal ACCuracy [:SENSe] :CHPower :SWEep :TIME :AUTO :RULEs ?
Example	CHP:SWE:TIME:AUTO:RUL NORM CHP:SWE:TIME:AUTO:RUL?
Notes	In Zero Span, this key is irrelevant and inaccessible (because the whole Sweep Setup menu is grayed out in Zero Span), however its settings can be changed remotely with no error indication. Set to Norm when Auto Couple is pressed or sent remotely
Preset	NORMal
State Saved	Saved in instrument state.
Range	Norm Accy
Initial S/W Revision	Prior to A.02.00
Modified at S/W Revision	A.02.00, A.03.00

Pause

Pauses a measurement after the current data acquisition is complete. When Paused, the label on the key changes to Resume. Pressing the Resume key resumes the measurement at the point it was at when paused. See ["Pause/Resume" on page 1865](#) for more details.

Key Path	Sweep/Control
Initial S/W Revision	Prior to A.02.00

Gate

Accesses a menu that enables you to control the gating function. The Gate functionality is used to view signals best viewed by qualifying them with other events.

Gate setup parameters are the same for all measurements – they do not change as you change measurements. Settings like these are called “Meas Global” and are unaffected by Meas Preset.

Key Path	Sweep/Control
Scope	Meas Global
Readback	The state and method of Gate, as [Off, FFT] or [On, FFT]. Note that for measurements that only support gated FFT, the method is nonetheless read back, but always as FFT.
Initial S/W Revision	Prior to A.02.00

Gate On/Off

Turns the gate function on and off.

When the Gate Function is on, the selected Gate Method is used along with the gate settings and the signal at the gate source to control the sweep system with the gate signal. Not all measurements allow every type of Gate Methods.

When Gate is on, the annunciation in the measurement bar reflects that it is on and what method is used, as seen in the following "Gate: FFT" annunciator graphic.

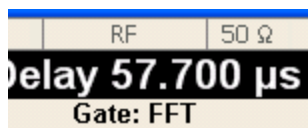

Key Path	Sweep/Control, Gate
Remote Command	[:SENSe] :SWEp:EGATe [:STATe] OFF ON 0 1 [:SENSe] :SWEp:EGATe [:STATe] ?
Example	SWE:EGAT ON SWE:EGAT?

Dependencies	<p>When in the ACP measurement:</p> <ul style="list-style-type: none"> • When Meas Method is RBW or FAST, this function is unavailable and the key is grayed out. • Whenever Gate is on, Meas Method, RBW or FAST is unavailable and keys for those are grayed out. • When Gate is on, Offset Res BW and Offset Video BW are ignored (if you set these values) and the measurement works as if all Offset Res BW and all Offset Video BW are coupled with the Res BW and the Video BW under the BW menu. When Gate is on, the Offset BW key in the Offset/Limit menu is grayed out.
Preset	Off LTETDD: On
State Saved	Saved in instrument state
Range	On Off
Backwards Compatibility SCPI	[:SENSe]:SWEep:TIME:GATE[:STATe] ESA compatibility
Backwards Compatibility Notes	In ESA, Trig Delay (On) and Gate (On) could not be active at the same time.. This dependency does not exist in PSA or in the X-Series.
Initial S/W Revision	Prior to A.02.00

Gate View On/Off

Turning on Gate View in the Swept SA measurement provides a single-window gate view display..

Turning on Gate View in other measurements shows the split-screen Gate View. In these measurements, when the Gate View is on, the regular view of the current measurement traces and results are reduced vertically to about 70% of the regular height. The Zero Span window, showing the positions of the Gate, is shown between the Measurement Bar and the reduced measurement window. By reducing the height of the measurement window, some of the annotation on the Data Display may not fit and is not shown.

Key Path	Sweep/Control, Gate
Remote Command	[:SENSe]:SWEep:EGATe:VIEW ON OFF 1 0 [:SENSe]:SWEep:EGATe:VIEW?
Example	SWE:EGAT:VIEW ON turns on the gate view.
Dependencies	<p>In the Swept SA measurement:</p> <p>In Gate View, the regular Acq Time key is grayed out . When pressed, the grayed out key puts up the informational message "Use Gate View Sweep Time in the Gate menu."</p> <p>In the other measurements:</p> <p>When you turn Gate View on, the lower window takes on the current state of the instrument. Upon leaving Gate View, the instrument takes on the state of the lower window.</p> <p>When you turn Gate View on, the upper window Acquisition Time is set to the gate view acquisition time.</p>
Couplings	<p>These couplings apply to the Swept SA measurement:</p> <ul style="list-style-type: none"> • When Gate View is turned on, the instrument is set to Zero Span.

- Gate View automatically turns off whenever a Span other than Zero is selected.
- Gate View automatically turns off if you press the Last Span key while in Gate View, and the instrument returns to the Span it was in before entering Gate View (even if that is Zero Span).
- When Gate View is turned on, the sweep time used is the gate view sweep time. This is set according to the rules in section "Gate View Setup " on page 1553
- When Gate View is turned off, Sweep Time is set to the normal Swept SA measurement sweep time.
- If Gate View is on and Gate is off, then turning on Gate turns off Gate View.

Preset	OFF
State Saved	Saved in instrument state
Range	On Off
Initial S/W Revision	Prior to A.02.00

A sample of the Gate View screen in the Swept SA measurement is shown in the following graphic :

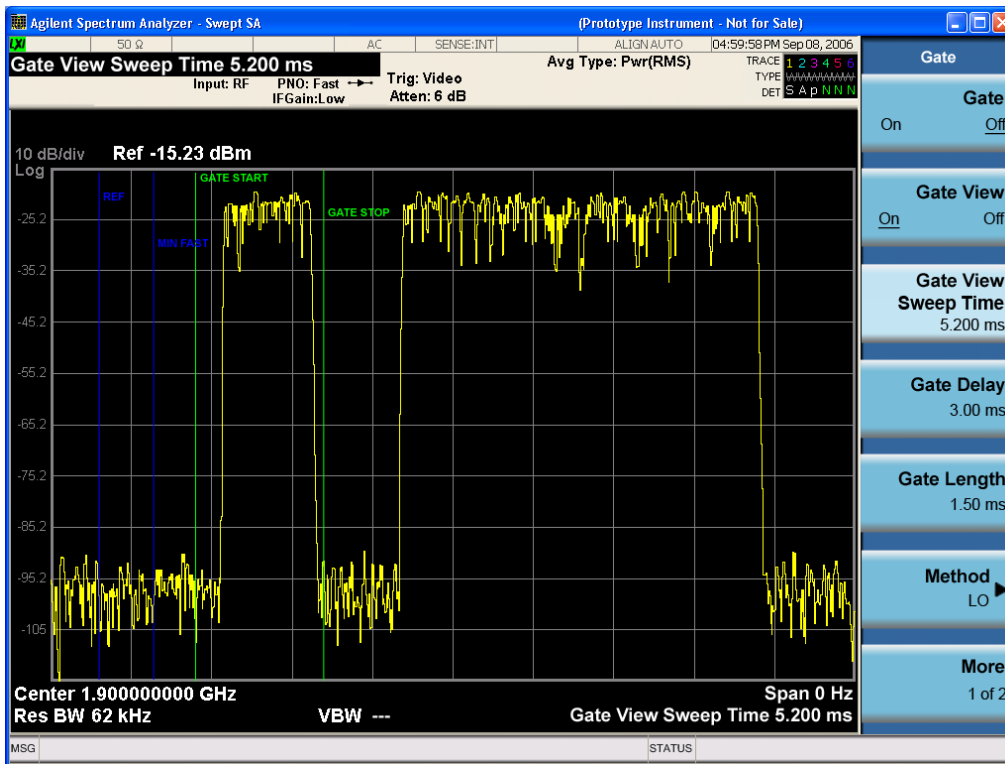

A sample of the Gate View screen in other measurements is shown in the following graphic . This example is for the ACP measurement:

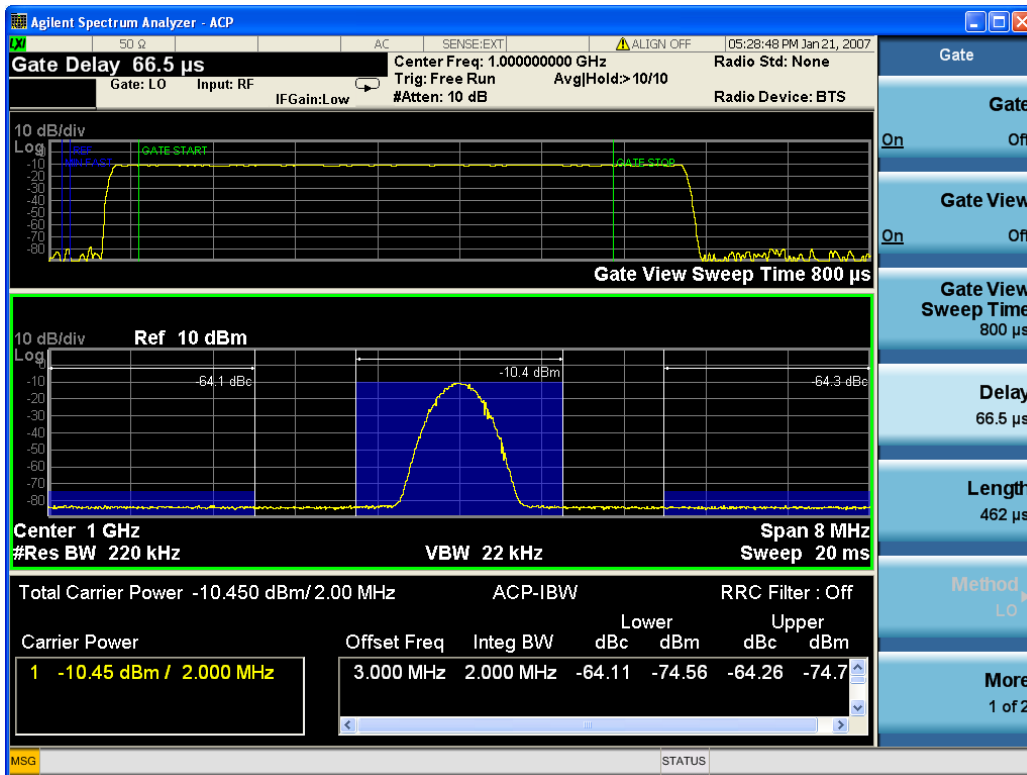

Turning Gate View off returns the analyzer to the Normal measurement view.

In the Swept SA, the normal measurement view is the single-window Swept SA view. When returning to this view, the Swept SA measurement returns to the Span it was in before entering **Gate View** (even if that is Zero Span).

The **Gate View** window is triggered from the Gate Source, with zero trigger delay. Also, when updating the **Gate View** window, the Gate itself must not operate. So it is internally shut off while the gate view window is being updated. For the Swept SA measurement, this means that the Gate is internally shut off whenever the gate view window is displayed. The measurement bar and softkeys continue to show the Trigger source for the main sweep window and give no indication that the Gate is shut off or that the Gate View window is triggered from the Gate Source.

When in **Gate View**, vertical lines are displayed in the Gate View window as follows:

- Green lines are displayed at the gate edges as follows: in Edge Gate, a line is shown for Delay and one for the end of the Gate period, defined by Length. You can adjust the position of the green lines by adjusting the gate length and the gate delay. These lines update in the Gate View window as the active function changes, even if the window is not being updated. In Gated FFT, their location is relative to the left edge of the screen.
- A blue line is displayed showing the delay reference, that is, the reference point for the Gate Delay within the Zero Span window. The blue line represents where (in time) the effective location of the gate start would be if the gate were programmed to zero delay.

Gate View Setup

Accesses a menu that enables you to setup parameters relevant to the Gate View

Key Path	Sweep/Control, Gate
Scope	Meas Global
Initial S/W Revision	A.10.00

Gate View Acquisition Time

Controls the acquisition time in the Gate View window. To provide an optimal view of the gate signal, the analyzer initializes Gate View Acq Time based on the current settings of Gate Delay and Gate Length.

Key Path	Sweep/Control, Gate, Gate View Setup
Remote Command	[:SENSe] :SWEep:EGATe:TIME <time> [:SENSe] :SWEep:EGATe:TIME?
Example	SWE:EGAT:TIME 500 ms
Dependencies	Gate View Acquisition Time is initialized: <ul style="list-style-type: none"> • On Preset (after initializing delay and length). • Every time the Gate Method is set/changed. <ol style="list-style-type: none"> 1. Compute the location of the "gate stop" line, which you know is at time $t = t_{min} + GateDelay + GateLength$.
Preset	519.3 μ s WiMAX OFDMA: 5 ms GSM/EDGE: 1 ms
State Saved	Saved in instrument state
Min	100 ns
Max	6000 s
Initial S/W Revision	Prior to A.02.00

Gate View Start Time

Controls the time at the left edge of the Gate View.

Key Path	Sweep/Control, Gate, Gate View Setup
Remote Command	[:SENSe] :SWEep:EGATe:VIEW:STARt <time> [:SENSe] :SWEep:EGATe:VIEW:STARt?
Example	SWE:EGAT:VIEW:STAR 10ms
Notes	Units of time are required or no units; otherwise an invalid suffix error message will be generated. See error -131.

Preset	0 ms
State Saved	Saved in instrument state
Min	0
Max	500 ms
Initial S/W Revision	A.10.00

Gate Delay

Controls the length of time from the time the gate condition goes True until the gate is turned on.

Key Path	Sweep/Control, Gate
Remote Command	[:SENSe] :SWEep:EGATe:DELay <time> [:SENSe] :SWEep:EGATe:DELay?
Example	SWE:EGAT:DELay 500ms SWE:EGAT:DELay?
Notes	Units of time are required or no units; otherwise an invalid suffix error message will be generated.
Preset	57.7 us WiMAX OFDMA: 71 us GSM/EDGE: 600 us WLAN: 500 us WLAN: 36 us
State Saved	Saved in instrument state
Min	0.0 us
Max	100 s
Backwards Compatibility SCPI	[:SENSe] :SWEep:TIME:GATE:DELay ESA compatibility
Initial S/W Revision	Prior to A.02.00

Gate Length

Controls the length of time that the gate is on after it opens.

Key Path	Sweep/Control, Gate
Remote Command	[:SENSe] :SWEep:EGATe:LENGth <time> [:SENSe] :SWEep:EGATe:LENGth?
Example	SWE:EGAT:LENG 1 SWE:EGAT:LENG?

Notes	Units of time are required or no units; otherwise an invalid suffix error message will be generated.
Preset	461.6 us WiMAX OFDMA: 50 us GSM/EDGE: 200 us WLAN: 1.54 ms WLAN: 32 us
State Saved	Saved in instrument state
Min	100 ns
Max	5 s
Backwards Compatibility SCPI	[:SENSe] :SWEep:TIME:GATE:LENGth ESA compatibility
Initial S/W Revision	Prior to A.02.00

Gate Source

The menus under the Gate Source key are the same as those under the Trigger key, with the exception that neither Free Run nor Video are available as Gate Source selections. However, a different SCPI command is used to select the Gate Source (see table below) because you may independently set the Gate Source and the Trigger Source.

Any changes to the settings in the setup menus under each Gate Source selection key (for example: Trigger Level, Trigger Delay, etc.) also affect the corresponding settings under the Trigger menu keys. The SCPI commands used for these are the same for Trigger and Gate, since there is only one setting which affects both Gate and Trigger. Example: to set the Trigger Level for External 1 you use the command :TRIG:EXT1:LEV regardless of whether you are using External 1 as a Trigger Source or a Gate Source.

Key Path	Sweep/Control, Gate
Remote Command	[:SENSe] :SWEep:EGATE:SOURce EXTernal1 EXTernal2 LINE FRAME RFBurst [:SENSe] :SWEep:EGATE:SOURce?
Dependencies	In some models, there is no second External input. In these models, the External 2 key is blanked and the EXTernal2 parameter will generate a "Hardware missing; Not available for this model number" error.
Preset	EXTernal 1 GSM/EDGE, MSR: FRAME LTETDD: EXTernal 1 When Direction is Downlink, FRAME when Direction is Uplink.
Initial S/W Revision	Prior to A.02.00
Modified at S/W Revision	A.03.00, A.14.00

Video (IF Envelope)

Pressing this key, when it is not selected, selects the video signal as the trigger. The Video trigger condition is met when the video signal (the filtered and detected version of the input signal, including both RBW and VBW filtering) crosses the video trigger level.

NOTE

When the detector selected for all active traces is the average detector, the video signal for triggering does not include any VBW filtering.

The video trigger level is shown as a labeled line on the display. The line is displayed as long as video is the selected trigger source.

Pressing this key, when it is already selected, accesses the video trigger setup functions.

Key Path	Trigger
Example	TRIG:SOUR VID Swept SA measurement TRIG:<meas>:SOUR VID Measurements other than Swept SA
Notes	Log Plot and Spot Frequency measurements do not support Video Trigger
Dependencies	Video trigger is allowed in average detector mode.
State Saved	Saved in instrument state
Status Bits/OPC dependencies	The Status Operation Register bit 5 "Waiting for Trigger" is set at the same time as the Sweeping or Measuring bit is set. It is cleared when the trigger actually occurs (that is, after the trigger event occurs and all the applicable trigger criteria have been met). A corresponding pop-up message ("Waiting for trigger") is generated if no trigger signal appears after approximately 2 sec. This message goes away when a trigger signal appears.
Backwards Compatibility Notes	In the past, the Average detector was not available when Video triggering was on, and consequently, functions that set the detector to average (such as Marker Noise or Band/Intvl Power) were not available when the video trigger was on. Similarly, Video triggering was not available when the detector was Average. In the X-Series, these restrictions are removed.
Initial S/W Revision	Prior to A.02.00

Trigger Level

Sets a level for the video signal trigger. When the video signal crosses this level, with the chosen slope, the trigger occurs. This level is displayed with a horizontal line only if **Video** is the selected trigger source.

Key Path	Trigger, Video
Remote Command	:TRIGger[:SEquence]:VIDeo:LEVel <ampl> :TRIGger[:SEquence]:VIDeo:LEVel?
Example	TRIG:VID:LEV -40 dBm
Notes	When sweep type = FFT, the video trigger uses the amplitude envelope in a bandwidth wider than the FFT width as a trigger source. This might often be useful, but does not have the same relationship between the displayed trace and the trigger level as in swept triggering. Amplitude Corrections are not taken into account by the Video Trig Level. For example, if you have given yourself effective gain with an amplitude correction factor, the Video Trigger will not fire until

you have dropped the trigger line that far below the displayed signal level, rather than simply dropping it down to the displayed signal level.
Note that other corrections, specifically External Gain and Ref Level Offset, modify the actual trace data as it is taken and therefore ARE taken into account by Trig Level.

Couplings	This same level is used for the Video trigger source in the Trigger menu and for the Video selection in the Gate Source menu.
Preset	Set the Video Trigger Level -25 dBm on Preset. When the Video Trigger Level becomes the active function, if the value is off screen, set it to either the top or bottom of screen, depending on which direction off screen it was.
State Saved	Saved in instrument state
Min	-170 dBm
Max	+30 dBm
Default Unit	Depends on the current selected Y axis unit
Backwards Compatibility SCPI	:TRIGger[:SEquence]:IF:LEVel :TRIGger[:SEquence]:IF:LEVel?
Backwards Compatibility Notes	This alias is provided for backward compatibility with VSA/PSA comms apps.
Initial S/W Revision	Prior to A.02.00

Trig Slope

Controls the trigger polarity. It is set positive to trigger on a rising edge and negative to trigger on a falling edge.

Key Path	Trigger, Video
Remote Command	:TRIGger[:SEquence]:VIDeo:SLOPe POSitive NEGative :TRIGger[:SEquence]:VIDeo:SLOPe?
Example	TRIG:VID:SLOP NEG
Preset	POSitive
State Saved	Saved in instrument state
Backwards Compatibility SCPI	:TRIGger[:SEquence]:IF:SLOPe NEGative POSitive :TRIGger[:SEquence]:IF:SLOPe? For backward compatibility with VSA/PSA comms apps
Backwards Compatibility Notes	The legacy :TRIGger[:SEquence]:SLOPe command affects the slopes for the VID, LINE, EXT1, EXT2, and RFB triggers.
Initial S/W Revision	Prior to A.02.00
Remote Command	:TRIGger[:SEquence]:SLOPe POSitive NEGative

	:TRIGger[:SEquence]:SLOPe?
Example	TRIG:SLOP NEG
Preset	POSitive
State Saved	Saved in instrument state
Backwards Compatibility Notes	In ESA/PSA, the Trigger Slope was global to all triggers. In the X-Series, the slope can be set individually for each Trigger Source. For backward compatibility, the global SLOPe command updates all instances of trigger slope (VID, LINE, EXT1, EXT2, TV, RFB). The query returns the trigger slope setting of the currently selected trigger source.
Initial S/W Revision	Prior to A.02.00

External 1

Pressing this key, when it is not selected, selects an external input signal as the trigger. A new sweep/measurement will start when the external trigger condition is met using the external 1 input connector on the rear panel.

Pressing this key, when it is already selected, accesses the external 1 trigger setup menu.

Key Path	Trigger
Example	TRIG:SOUR EXT1 Swept SA measurement TRIG:<meas>:SOUR EXT1 Measurements other than Swept SA
Dependencies	Grayed out if in use by Point Trigger in the Source Setup menu. Forced to Free Run if already selected and Point Trigger is set to External 1.
State Saved	Saved in instrument state
Status Bits/OPC dependencies	The Status Operation Register bit 5 "Waiting for Trigger" is set at the same time as the Sweeping or Measuring bit is set. It is cleared when the trigger actually occurs (that is, after the trigger event occurs and all the applicable trigger criteria have been met). A corresponding pop-up message ("Waiting for trigger") is generated if no trigger signal appears after approximately 2 sec. This message goes away when a trigger signal appears.
Initial S/W Revision	Prior to A.02.00

Trigger Level

Sets the value where the external 1 trigger input will trigger a new sweep/measurement.

Key Path	Trigger, External 1
Remote Command	:TRIGger[:SEquence]:EXTernal1:LEVel <level> :TRIGger[:SEquence]:EXTernal1:LEVel?
Example	TRIG:EXT1:LEV 0.4 V
Couplings	This same level is used for the Ext1 trigger source in the Trigger menu, for the Ext1 selection in the Periodic Timer sync source (in the Trigger menu and in the Gate Source menu), and also for the Ext1

	selection in the Gate Source menu.
Preset	1.2 V
State Saved	Saved in instrument state
Min	-5 V
Max	5 V
Default Unit	V
Backwards Compatibility SCPI	:TRIGger[:SEquence]:EXTernal:LEVel
Backwards Compatibility SCPI	For backward compatibility, the parameter EXTernal is mapped to EXTernal1
Backwards Compatibility SCPI	:TRIGger[:SEquence]:FRAMe:EXTernal1:LEVel
Initial S/W Revision	Prior to A.02.00

Trig Slope

Controls the trigger polarity. It is set positive to trigger on a rising edge and negative to trigger on a falling edge.

Key Path	Trigger, External 1
Remote Command	:TRIGger[:SEquence]:EXTernal1:SLOPe POSitive NEGative :TRIGger[:SEquence]:EXTernal1:SLOPe?
Example	TRIG:EXT1:SLOP NEG
Couplings	This same slope is used in the Ext1 selection for the trigger source in the Trigger menu and for the period timer sync source (in the Trigger menu and in the Gate Source menu).
Preset	POSitive
State Saved	Saved in instrument state
Backwards Compatibility SCPI	:TRIGger[:SEquence]:EXTernal:SLOPe
Backwards Compatibility SCPI	For backward compatibility, the parameter EXTernal is mapped to EXTernal1
Backwards Compatibility SCPI	:TRIGger[:SEquence]:FRAMe:EXTernal1:SLOPe
Backwards Compatibility Notes	The legacy :TRIGger[:SEquence]:SLOPe command affects the slopes for the VID, LINE, EXT1, EXT2, and RFB triggers.
Initial S/W Revision	Prior to A.02.00

Zero Span Delay Comp On/Off

In zero span, there is a natural delay in the signal path, which comes from the RBW filter. This is usually desirable, as it allows you to trigger on events and also see those events, because the signal is delayed from the trigger event. However, in some cases it is desirable to eliminate this delay, so that trigger events line up exactly with the zero time point in zero span. You can use the Zero Span Delay Comp On/Off feature to enable or disable zero span delay compensation.

Key Path	Trigger, External 1
Remote Command	:TRIGger[:SEquence]:EXTErnal1:DELAy:COMPensation OFF ON 0 1 :TRIGger[:SEquence]:EXTErnal1:DELAy:COMPensation?
Example	TRIG:EXT1:DEL:COMP ON
Dependencies	No effect except in zero-span, but not locked out in nonzero spans. Blanked in modes that do not support zero-span measurements. If the SCPI command is sent when the key is blanked, an error is returned: -221, "Settings conflict; Feature not supported for this measurement" In analyzers shipping N9060A, this feature requires N9060A-7FP.
Preset	OFF
State Saved	Saved in instrument state
Initial S/W Revision	A.11.00

External 2

Pressing this key, when it is not selected, selects an external input signal as the trigger. A new sweep/measurement will start when the external trigger condition is met using the external 2 input connector. The external trigger 2 input connector is on the rear panel.

Pressing this key, when it is already selected, accesses the external 2 trigger setup menu.

Key Path	Trigger
Example	TRIG:SOUR EXT2 Swept SA measurement TRIG:<meas>:SOUR EXT2 Measurements other than Swept SA
Dependencies	In some models, there is no second External input. In these models, the External 2 key is blanked and the EXTErnal2 parameter will generate a "Hardware missing; Not available for this model number" message. Grayed out if in use by Point Trigger in the Source Setup menu. Forced to Free Run if already selected and Point Trigger is set to External 2.
State Saved	Saved in instrument state
Status Bits/OPC dependencies	The Status Operation Register bit 5 "Waiting for Trigger" is set at the same time as the Sweeping or Measuring bit is set. It is cleared when the trigger actually occurs (that is, after the trigger event occurs and all the applicable trigger criteria have been met). A corresponding pop-up message ("Waiting for trigger") is generated if no trigger signal appears after approximately 2 sec. This message goes away when a trigger signal appears.
Initial S/W Revision	Prior to A.02.00
Modified at S/W Revision	A.03.00

Trigger Level

Sets the value where the external 2 trigger input will trigger a new sweep/measurement.

Key Path	Trigger, External 2
Remote Command	:TRIGger[:SEquence]:EXTernal2:LEVel :TRIGger[:SEquence]:EXTernal2:LEVel?
Example	TRIG:EXT2:LEV 1.1 V
Couplings	This same level is used for the Ext2 trigger source in the Trigger menu, for the Ext2 selection in the Periodic Timer sync source (in the Trigger menu and in the Gate Source menu), and also for the Ext2 selection in the Gate Source menu.
Preset	1.2 V
State Saved	Saved in instrument state
Min	-5 V
Max	5 V
Default Unit	V
Backwards Compatibility SCPI	:TRIGger[:SEquence]:FRAMe:EXTernal2:LEVel
Initial S/W Revision	Prior to A.02.00

Trig Slope

Controls the trigger polarity. It is set positive to trigger on a rising edge and negative to trigger on a falling edge.

Key Path	Trigger, External 2
Remote Command	:TRIGger[:SEquence]:EXTernal2:SLOPe POSitive NEGative :TRIGger[:SEquence]:EXTernal2:SLOPe?
Example	TRIG:EXT2:SLOP NEG
Couplings	This same slope is used in the Ext2 selection for the trigger source in the Trigger menu and for the period timer sync source (in the Trigger menu and in the Gate Source menu).
Preset	POSitive
State Saved	Saved in instrument state
Backwards Compatibility SCPI	:TRIGger[:SEquence]:FRAMe:EXTernal2:SLOPe
Backwards Compatibility Notes	The legacy :TRIGger[:SEquence]:SLOPe command affects the slopes for the VID, LINE, EXT1, EXT2, and RFB triggers.
Initial S/W Revision	Prior to A.02.00

Zero Span Delay Comp On/Off

In zero span, there is a natural delay in the signal path, which comes from the RBW filter. This is usually desirable, as it allows you to trigger on events and also see those events, because the signal is delayed from the trigger event. However, in some cases it is desirable to eliminate this delay, so that trigger

events line up exactly with the zero time point in zero span. You can use the Zero Span Delay Comp On/Off feature to enable or disable zero span delay compensation.

Key Path	Trigger, External 2
Remote Command	:TRIGger[:SEquence]:EXTernal2:DElay:COMPensation OFF ON 0 1 :TRIGger[:SEquence]:EXTernal2:DElay:COMPensation?
Example	TRIG:EXT2:DEL:COMP ON
Dependencies	No effect except in zero-span, but not locked out in nonzero spans. Blanked in modes that do not support zero-span measurements. If the SCPI command is sent when the key is blanked, an error is returned: -221, "Settings conflict; Feature not supported for this measurement" In analyzers shipping N9060A, this feature requires N9060A-7FP.
Preset	OFF
State Saved	Saved in instrument state
Initial S/W Revision	A.11.00

RF Burst

Pressing this key, when it is not selected, selects the RF Burst as the trigger. A new sweep/measurement will start when an RF burst envelope signal is identified from the signal at the RF Input connector. Pressing this key, when it is already selected, accesses the RF Burst trigger setup menu.

In some models, a variety of burst trigger circuitry is available, resulting in various available burst trigger bandwidths. The analyzer automatically chooses the appropriate trigger path based on the hardware configuration and other settings of the analyzer.

Key Path	Trigger
Example	TRIG:SOUR RFB Swept SA measurement TRIG:<meas>:SOUR RFB Measurements other than Swept SA
State Saved	Saved in instrument state
Status Bits/OPC dependencies	The Status Operation Register bit 5 "Waiting for Trigger" is set at the same time as the Sweeping or Measuring bit is set. It is cleared when the trigger actually occurs (that is, after the trigger event occurs and all the applicable trigger criteria have been met). A corresponding pop-up message ("Waiting for trigger") is generated if no trigger signal appears after approximately 2 sec. This message goes away when a trigger signal appears.
Backwards Compatibility Notes	The legacy command: :TRIGger[:SEquence]:RFBurst:FSElectivity[:STATe] OFF ON 0 1 is not supported in the X-Series, as the hardware to do Frequency Selective burst triggers does not exist in X-Series.
Initial S/W Revision	Prior to A.02.00
Modified at S/W Revision	A.04.00

Absolute Trigger Level

Sets the absolute trigger level for the RF burst envelope.

When using the External Mixing path, the Absolute Trigger Level is uncalibrated because the factory default was set to accommodate the expected IF levels for the RF path.

Key Path	Trigger, RF Burst
Scope	Meas Global
Remote Command	<code>:TRIGger[:SEquence]:RFBurst:LEVel:ABSolute <ampl></code> <code>:TRIGger[:SEquence]:RFBurst:LEVel:ABSolute?</code>
Example	TRIG:RFB:LEV:ABS 10 dBm sets the trigger level of the RF burst envelope signal to the absolute level of 10 dBm
Notes	Sending this command does not switch the setting from relative to absolute; to switch it you need to send the <code>:TRIGger[:SEquence]:RFBurst:LEVel:TYPE</code> command, below. Amplitude Corrections are not taken into account by the Absolute Trigger Level. For example, if you have given yourself effective gain with an amplitude correction factor, the Absolute Trigger will not fire until you have set the trigger level that far below the displayed signal level, rather than simply to the displayed signal level. This is only true for Amplitude Corrections, not External Gain or Ref Level Offset functions. If mode is Bluetooth, the default value is -50 dBm.
Couplings	This same level is used for the RF Burst trigger source in the Trigger menu, for the RF Burst selection in the Periodic Timer sync source (in the Trigger menu and in the Gate Source menu), and also for the RF Burst selection in the Gate Source menu
Preset	-20 dBm
State Saved	Saved in instrument state
Min	-200 dBm
Max	100 dBm
Default Unit	depends on the current selected Y-Axis unit
Backwards Compatibility SCPI	<code>:TRIGger[:SEquence]:FRAME:RFBurst:LEVel:ABSolute</code>
Initial S/W Revision	Prior to A.02.00
Modified at S/W Revision	A.04.00

Key Path	Trigger, RF Burst
Remote Command	<code>:TRIGger[:SEquence]:RFBurst:LEVel:TYPE ABSolute RELative</code> <code>:TRIGger[:SEquence]:RFBurst:LEVel:TYPE?</code>
Example	TRIG:RFB:LEV:TYPE REL sets the trigger level type of the RF burst trigger to Relative.
Preset	ABSolute
State Saved	Saved in instrument state
Initial S/W Revision	Prior to A.02.00
Modified at S/W Revision	A.04.00

Relative Trigger Level

Sets the relative trigger level for the RF burst envelope.

In some models, the relative burst trigger function is implemented in hardware. In other models, without the advanced triggering hardware required, the relative burst trigger function is implemented in software in some measurements, and is unavailable in other measurements.

When implemented in software, the relative RF Burst trigger function is implemented as follows:

1. The measurement starts with the absolute RF Burst trigger setting. If it cannot get a trigger with that level, auto trigger fires and the acquisition starts anyway. After the acquisition, the measurement searches for the peak in the acquired waveform and saves it.
2. Now, in the next cycle of the measurement, the measurement determines a new absolute RF Burst level based on the peak value from the first measurement and the Relative RF Burst Trigger Level (always 0 or negative dB) set by the user. The following formula is used:
3. absolute RF Burst level = peak level of the previous acquisition + relative RF Burst level
4. If the new absolute RF Burst level differs from the previous by more than 0.5 dB, the new level is sent to the hardware; otherwise it is not updated (to avoid slowing down the acquisition)

Steps 2 and 3 repeat for subsequent measurements.

Key Path	Trigger, RF Burst
Scope	Meas Global
Remote Command	:TRIGger[:SEquence]:RFBurst:LEVel:RELative <rel_ampl> :TRIGger[:SEquence]:RFBurst:LEVel:RELative?
Example	TRIG:RFB:LEV:REL -10 dB sets the trigger level of the RF burst envelope signal to the relative level of -10 dB
Notes	Sending this command does not switch the setting from absolute to relative; to switch it you need to send the :TRIGger[:SEquence]:RFBurst:LEVel:TYPE command, above. The relative trigger level is not available in some measurements. In those measurements the RELative parameter, and the :TRIGger[:SEquence]:RFBurst:LEVel:TYPE command (above), will generate an error if sent.
Dependencies	This key is grayed out and Absolute Trigger Level selected if the required hardware is not present in your analyzer and the current measurement does not support Relative triggering.
Preset	-6 dB GSM: -25 dB
State Saved	Saved in instrument state
Min	-45 dB
Max	0 dB
Default Unit	dB or dBc
Backwards Compatibility SCPI	:TRIGger[:SEquence]:RFBurst:LEVel This legacy command is aliased to :TRIGger[:SEquence]:RFBurst:LEVel:RELative because the PSA

	had ONLY relative burst triggering
Initial S/W Revision	Prior to A.02.00
Modified at S/W Revision	A.04.00

Trigger Slope

It is set positive to trigger on a rising edge and negative to trigger on a falling edge.

Key Path	Trigger, RF Burst
Remote Command	:TRIGger[:SEquence]:RFBurst:SLOPe POSitive NEGative :TRIGger[:SEquence]:RFBurst:SLOPe?
Example	TRIG:RFB:SLOP NEG
Couplings	This same slope is used in the RF Burst selection for the trigger source in the Trigger menu and for the period timer sync source (in the Trigger menu and in the Gate Source menu).
Preset	POSitive
State Saved	Saved in instrument state
Backwards Compatibility SCPI	:TRIGger[:SEquence]:FRAME:RFBurst:SLOPe
Backwards Compatibility Notes	The legacy :TRIGger[:SEquence]:SLOPe command affects the slopes for the VID, LINE, EXT1, EXT2, and RFB triggers.
Initial S/W Revision	Prior to A.02.00

Periodic Timer (Frame Trigger)

Pressing this key, when it is not selected, selects the internal periodic timer signal as the trigger. Triggering occurrences are set by the **Period** parameter, which is modified by the **Sync Source** and **Offset**. Pressing this key, when it is already selected, accesses the periodic timer trigger setup functions.

If you do not have a sync source selected (it is Off), then the internal timer will not be synchronized with any external timing events.

Key Path	Trigger
Example	TRIG:SOUR FRAM Swept SA measurement TRIG:<meas>:SOUR FRAM Measurements other than Swept SA
State Saved	Saved in instrument state
Readback	[Sync: <value of Sync Source>], for example, [Sync: External 1]
Status Bits/OPC dependencies	The Status Operation Register bit 5 "Waiting for Trigger" is set at the same time as the Sweeping or Measuring bit is set. It is cleared when the trigger actually occurs (that is, after the trigger event occurs and all the applicable trigger criteria have been met). A corresponding pop-up message ("Waiting for trigger") is generated if no trigger signal appears after approximately 2 sec. This message goes away when a trigger signal appears.
Initial S/W Revision	Prior to A.02.00

Periodic Timer Triggering:

This feature selects the internal periodic timer signal as the trigger. Trigger occurrences are set by the **Periodic Timer** parameter, which is modified by the **Sync Source** and **Offset**.

The figure below shows the action of the periodic timer trigger. Before reviewing the figure, we'll explain some uses for the periodic trigger.

A common application is measuring periodic burst RF signals for which a trigger signal is not easily available. For example, we might be measuring a TDMA radio which bursts every 20 ms. Let's assume that the 20 ms period is very consistent. Let's also assume that we do not have an external trigger source available that is synchronized with the period, and that the signal-to-noise ratio of the signal is not high enough to provide a clean RF burst trigger at all of the analysis frequencies. For example, we might want to measure spurious transmissions at an offset from the carrier that is larger than the bandwidth of the RF burst trigger. In this application, we can set the Periodic Timer to a 20.00 ms period and adjust the offset from that timer to position our trigger just where we want it. If we find that the 20.00 ms is not exactly right, we can adjust the period slightly to minimize the drift between the period timer and the signal to be measured.

A second way to use this feature would be to use **Sync Source** temporarily, instead of **Offset**. In this case, we might tune to the signal in a narrow span and use the RF Burst trigger to synchronize the periodic timer. Then we would turn the sync source off so that it would not miss-trigger. Miss-triggering can occur when we are tuned so far away from the RF burst trigger that it is no longer reliable.

A third example would be to synchronize to a signal that has a reference time element of much longer period than the period of interest. In some CDMA applications, it is useful to look at signals with a short periodicity, by synchronizing that periodicity to the "even-second clock" edge that happens every two seconds. Thus, we could connect the even-second clock trigger to Ext1 and use then Ext1 as the sync source for the periodic timer.

The figure below illustrates this third example. The top trace represents the even-second clock. It causes the periodic timer to synchronize with the leading edge shown. The analyzer trigger occurs at a time delayed by the accumulated offset from the period trigger event. The periodic timer continues to run, and triggers continue to occur, with a periodicity determined by the analyzer time base. The timer output (labeled "late event") will drift away from its ideal time due to imperfect matching between the time base of the signal being measured and the time base of the analyzer, and also because of imperfect setting of the period parameter. But the synchronization is restored on the next even-second clock event. ("Accumulated offset" is described in the in the **Offset** function section.)

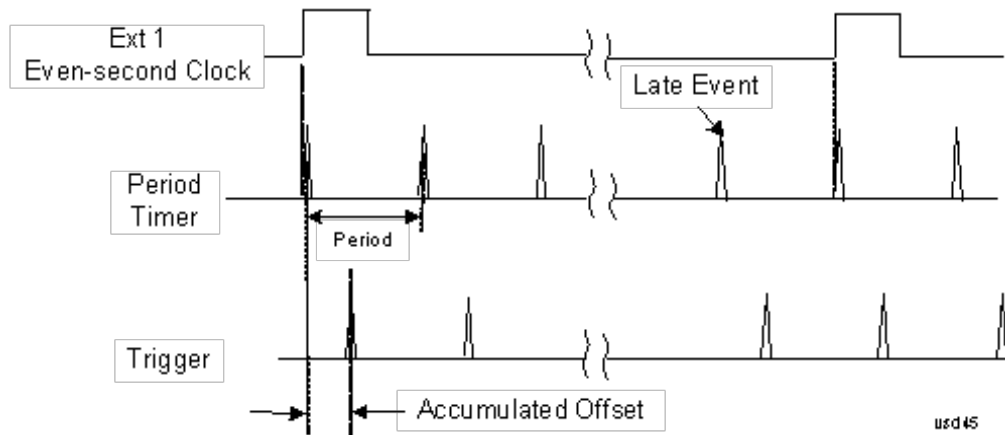

Period

Sets the period of the internal periodic timer clock. For digital communications signals, this is usually set to the frame period of your current input signal. In the case that sync source is not set to OFF, and the external sync source rate is changed for some reason, the periodic timer is synchronized at the every external synchronization pulse by resetting the internal state of the timer circuit.

Key Path	Trigger, Periodic Timer
Remote Command	:TRIGger[:SEquence]:FRAMe:PERiod <time> :TRIGger[:SEquence]:FRAMe:PERiod?
Example	TRIG:FRAM:PER 100 ms
Dependencies	The invalid data indicator turns on when the period is changed, until the next sweep/measurement completes.
Couplings	The same period is used in the Gate Source selection of the period timer.
Preset	20 ms GSM: 4.615383
State Saved	Saved in instrument state
Min	100.000 ns
Max	559.0000 ms
Default Unit	S
Initial S/W Revision	Prior to A.02.00

Offset

Adjusts the accumulated offset between the periodic timer events and the trigger event. Adjusting the accumulated offset is different than setting an offset, and requires explanation.

The periodic timer is usually not synchronized with any external events, so the timing of its output events has no absolute meaning. Since the timing relative to external events (RF signals) is important, you need to be able to adjust (offset) it. However, you have no direct way to see when the periodic timer events occur. All that you can see is the trigger timing. When you want to adjust the trigger timing, you will be changing the internal offset between the periodic timer events and the trigger event. Because the absolute value of

that internal offset is unknown, we will just call that the accumulated offset. Whenever the Offset parameter is changed, you are changing that accumulated offset. You can reset the displayed offset using Reset Offset Display. Changing the display does not change the value of the accumulated offset, and you can still make additional changes to accumulated offset.

To avoid ambiguity, we define that an increase in the "offset" parameter, either from the knob or the SCPI adjust command, serves to delay the timing of the trigger event.

Key Path	Trigger, Periodic Timer
Remote Command	:TRIGger[:SEquence]:FRAMe:OFFSet <time> :TRIGger[:SEquence]:FRAMe:OFFSet?
Example	TRIG:FRAM:OFFS 1.2 ms
Notes	<p>The front panel interface (for example, the knob), and this command, adjust the accumulated offset, which is shown on the active function display. However, the actual amount sent to the hardware each time the offset is updated is the delta value, that is, the current accumulated offset value minus the previous accumulated offset value. Note that the accumulated offset value is essentially arbitrary; it represents the accumulated offset from the last time the offset was zeroed (with the Reset Offset Display key).</p> <p>Note that this command does not change the period of the trigger waveform. Note also that Offset is used only when the sync source is set to OFF, otherwise delay is used, see section "Trig Delay" on page 359.</p> <p>An increase in the "offset" parameter, either from the knob or the SCPI adjust command, serves to delay the timing of the trigger event.</p>
Notes	<p>When the SCPI command is sent the value shown on the key (and the Active Function, if this happens to be the active function) is updated with the new value. However, the actual amount sent to the hardware is the delta value, that is, the current accumulated offset value minus the previous accumulated offset value.</p> <p>The SCPI query simply returns the value currently showing on the key.</p>
Dependencies	The invalid data indicator turns on when the offset is changed, until the next sweep/measurement completes.
Couplings	The same offset is used in the Gate Source selection of the period timer.
Preset	0 s
State Saved	Saved in instrument state
Min	-10.000 s
Max	10.000 s
Default Unit	S
Initial S/W Revision	Prior to A.02.00

Offset Adjust (Remote Command Only)

This remote command does not work at all like the related front panel keys. This command lets you advance the phase of the frame trigger by the amount you specify.

It does not change the period of the trigger waveform. If the command is sent multiple times, it advances the phase of the frame trigger an additional amount each time it is sent. Negative numbers are permitted.

Remote Command	:TRIGger[:SEquence]:FRAMe:ADJust <time>
Example	TRIG:FRAM:ADJ 1.2 ms
Notes	Note also that Offset is used only when the sync source is set to OFF, otherwise delay is used, see section "Trig Delay" on page 359 An increase in the "offset" parameter, either from the knob or the SCPI adjust command, serves to delay the timing of the trigger event.
Notes	The front panel interface (for example, the knob) and the :TRIG:FRAM:OFFS command adjust the accumulated offset, which is shown on the active function display. However, the actual amount sent to the hardware is the delta value, that is, the current offset value minus the previous offset value. When the SCPI command is sent the value shown on the key (and the Active Function, if this happens to be the active function) is updated by increasing it (or decreasing it if the value sent is negative) by the amount specified in the SCPI command. This is a "command only" SCPI command, with no query.
Dependencies	The invalid data indicator turns on when the offset is changed, until the next sweep/measurement completes.
Couplings	The same offset is used in the Gate Source selection of the period timer.
Preset	0 s
State Saved	Saved in instrument state
Min	-10.000 s
Max	10.000 s
Default Unit	S
Initial S/W Revision	Prior to A.02.00

Reset Offset Display

Resets the value of the periodic trigger offset display setting to 0.0 seconds. The current displayed trigger location may include an offset value defined with the Offset key. Pressing this key redefines the currently displayed trigger location as the new trigger point that is 0.0 s offset. The Offset key can then be used to add offset relative to this new timing.

Key Path	Trigger, Periodic Timer
Remote Command	:TRIGger[:SEquence]:FRAMe:OFFSet:DISPlay:RESet
Example	TRIG:FRAM:OFFS:DISP:RES
Initial S/W Revision	Prior to A.02.00

Sync Source

Selects a signal source for you to synchronize your periodic timer trigger to, otherwise you are triggering at some arbitrary location in the frame. Synchronization reduces the precision requirements on the setting of the period.

For convenience you may adjust the level and slope of the selected sync source in a conditional branch setup menu accessed from the Sync Source menu. Note that these settings match those in the **Trigger** and **Gate Source** menus; that is, each trigger source has only one value of level and slope, regardless of which menu it is accessed from.

Key Path	Trigger, Periodic Timer
Remote Command	:TRIGger[:SEquence]:FRAMe:SYNC EXTernal1 EXTernal2 RFBurst OFF :TRIGger[:SEquence]:FRAMe:SYNC?
Example	TRIG:FRAM:SYNC EXT2
Dependencies	In some models, there is no second External input. In these models, the External 2 key is blanked and the EXTernal2 parameter will generate a "Hardware missing; Not available for this model number" message.
Preset	Off GSM/EDGE, MSR,LTE,LTETDD: RFBurst
State Saved	Saved in instrument state
Readback	The current setting is read back to this key and it is also Readback to the previous Periodic Timer trigger key.
Backwards Compatibility SCPI	:TRIGger[:SEquence]:FRAMe:SYNC EXTernal For backward compatibility, the parameter EXTernal is mapped to EXTernal1
Initial S/W Revision	Prior to A.02.00
Modified at S/W Revision	A.03.00, A.14.00

Off

Turns off the sync source for your periodic trigger. With the sync source off, the timing will drift unless the signal source frequency is locked to the analyzer frequency reference.

Key Path	Trigger, Periodic Timer, Sync Source
Example	TRIG:FRAM:SYNC OFF
Readback	Off
Initial S/W Revision	Prior to A.02.00

External 1

Pressing this key, when it is not selected, selects an external input signal as the trigger. A new sweep/measurement will start when the external trigger condition is met using the external 1 input connector on the rear panel.

Pressing this key, when it is already selected, accesses the external 1 trigger setup menu.

Key Path	Trigger
Example	TRIG:SOUR EXT1 Swept SA measurement

	TRIG:<meas>:SOUR EXT1 Measurements other than Swept SA
Dependencies	Grayed out if in use by Point Trigger in the Source Setup menu. Forced to Free Run if already selected and Point Trigger is set to External 1.
State Saved	Saved in instrument state
Status Bits/OPC dependencies	The Status Operation Register bit 5 "Waiting for Trigger" is set at the same time as the Sweeping or Measuring bit is set. It is cleared when the trigger actually occurs (that is, after the trigger event occurs and all the applicable trigger criteria have been met). A corresponding pop-up message ("Waiting for trigger") is generated if no trigger signal appears after approximately 2 sec. This message goes away when a trigger signal appears.
Initial S/W Revision	Prior to A.02.00

Trigger Level

Sets the value where the external 1 trigger input will trigger a new sweep/measurement.

Key Path	Trigger, External 1
Remote Command	:TRIGger[:SEquence]:EXTernal1:LEVel <level> :TRIGger[:SEquence]:EXTernal1:LEVel?
Example	TRIG:EXT1:LEV 0.4 V
Couplings	This same level is used for the Ext1 trigger source in the Trigger menu, for the Ext1 selection in the Periodic Timer sync source (in the Trigger menu and in the Gate Source menu), and also for the Ext1 selection in the Gate Source menu.
Preset	1.2 V
State Saved	Saved in instrument state
Min	-5 V
Max	5 V
Default Unit	V
Backwards Compatibility SCPI	:TRIGger[:SEquence]:EXTernal:LEVel For backward compatibility, the parameter EXTernal is mapped to EXTernal1
Backwards Compatibility SCPI	:TRIGger[:SEquence]:FRAMe:EXTernal1:LEVel
Initial S/W Revision	Prior to A.02.00

Trig Slope

Controls the trigger polarity. It is set positive to trigger on a rising edge and negative to trigger on a falling edge.

Key Path	Trigger, External 1
Remote Command	:TRIGger[:SEquence]:EXTernal1:SLOPe POSitive NEGative

	:TRIGger[:SEQuence]:EXTernal1:SLOPe?
Example	TRIG:EXT1:SLOP NEG
Couplings	This same slope is used in the Ext1 selection for the trigger source in the Trigger menu and for the period timer sync source (in the Trigger menu and in the Gate Source menu).
Preset	POSitive
State Saved	Saved in instrument state
Backwards Compatibility SCPI	:TRIGger[:SEQuence]:EXTernal:SLOPe For backward compatibility, the parameter EXTernal is mapped to EXTernal1
Backwards Compatibility SCPI	:TRIGger[:SEQuence]:FRAMe:EXTernal1:SLOPe
Backwards Compatibility Notes	The legacy :TRIGger[:SEQuence]:SLOPe command affects the slopes for the VID, LINE, EXT1, EXT2, and RFB triggers.
Initial S/W Revision	Prior to A.02.00

External 2

Pressing this key, when it is not selected, selects an external input signal as the trigger. A new sweep/measurement will start when the external trigger condition is met using the external 2 input connector. The external trigger 2 input connector is on the rear panel.

Pressing this key, when it is already selected, accesses the external 2 trigger setup menu.

Key Path	Trigger
Example	TRIG:SOUR EXT2 Swept SA measurement TRIG:<meas>:SOUR EXT2 Measurements other than Swept SA
Dependencies	In some models, there is no second External input. In these models, the External 2 key is blanked and the EXTernal2 parameter will generate a "Hardware missing; Not available for this model number" message. Grayed out if in use by Point Trigger in the Source Setup menu. Forced to Free Run if already selected and Point Trigger is set to External 2.
State Saved	Saved in instrument state
Status Bits/OPC dependencies	The Status Operation Register bit 5 "Waiting for Trigger" is set at the same time as the Sweeping or Measuring bit is set. It is cleared when the trigger actually occurs (that is, after the trigger event occurs and all the applicable trigger criteria have been met). A corresponding pop-up message ("Waiting for trigger") is generated if no trigger signal appears after approximately 2 sec. This message goes away when a trigger signal appears.
Initial S/W Revision	Prior to A.02.00
Modified at S/W Revision	A.03.00

Trigger Level

Sets the value where the external 2 trigger input will trigger a new sweep/measurement.

Key Path	Trigger, External 2
Remote Command	:TRIGger[:SEquence]:EXTernal2:LEVel :TRIGger[:SEquence]:EXTernal2:LEVel?
Example	TRIG:EXT2:LEV 1.1 V
Couplings	This same level is used for the Ext2 trigger source in the Trigger menu, for the Ext2 selection in the Periodic Timer sync source (in the Trigger menu and in the Gate Source menu), and also for the Ext2 selection in the Gate Source menu.
Preset	1.2 V
State Saved	Saved in instrument state
Min	-5 V
Max	5 V
Default Unit	V
Backwards Compatibility SCPI	:TRIGger[:SEquence]:FRAMe:EXTernal2:LEVel
Initial S/W Revision	Prior to A.02.00

Trig Slope

Controls the trigger polarity. It is set positive to trigger on a rising edge and negative to trigger on a falling edge.

Key Path	Trigger, External 2
Remote Command	:TRIGger[:SEquence]:EXTernal2:SLOPe POSitive NEGative :TRIGger[:SEquence]:EXTernal2:SLOPe?
Example	TRIG:EXT2:SLOP NEG
Couplings	This same slope is used in the Ext2 selection for the trigger source in the Trigger menu and for the period timer sync source (in the Trigger menu and in the Gate Source menu).
Preset	POSitive
State Saved	Saved in instrument state
Backwards Compatibility SCPI	:TRIGger[:SEquence]:FRAMe:EXTernal2:SLOPe
Backwards Compatibility Notes	The legacy :TRIGger[:SEquence]:SLOPe command affects the slopes for the VID, LINE, EXT1, EXT2, and RFB triggers.
Initial S/W Revision	Prior to A.02.00

RF Burst

Pressing this key, when it is not selected, selects the RF Burst as the trigger. A new sweep/measurement will start when an RF burst envelope signal is identified from the signal at the RF Input connector. Pressing this key, when it is already selected, accesses the RF Burst trigger setup menu.

In some models, a variety of burst trigger circuitry is available, resulting in various available burst trigger bandwidths. The analyzer automatically chooses the appropriate trigger path based on the hardware configuration and other settings of the analyzer.

Key Path	Trigger
Example	TRIG:SOUR RFB Swept SA measurement TRIG:<meas>:SOUR RFB Measurements other than Swept SA
State Saved	Saved in instrument state
Status Bits/OPC dependencies	The Status Operation Register bit 5 "Waiting for Trigger" is set at the same time as the Sweeping or Measuring bit is set. It is cleared when the trigger actually occurs (that is, after the trigger event occurs and all the applicable trigger criteria have been met). A corresponding pop-up message ("Waiting for trigger") is generated if no trigger signal appears after approximately 2 sec. This message goes away when a trigger signal appears.
Backwards Compatibility Notes	The legacy command: :TRIGger[:SEquence]:RFBurst:FSElectivity[:STATe] OFF ON 0 1 is not supported in the X-Series, as the hardware to do Frequency Selective burst triggers does not exist in X-Series.
Initial S/W Revision	Prior to A.02.00
Modified at S/W Revision	A.04.00

Absolute Trigger Level

Sets the absolute trigger level for the RF burst envelope.

When using the External Mixing path, the Absolute Trigger Level is uncalibrated because the factory default was set to accommodate the expected IF levels for the RF path.

Key Path	Trigger, RF Burst
Scope	Meas Global
Remote Command	:TRIGger[:SEquence]:RFBurst:LEVel:ABSolute <ampl> :TRIGger[:SEquence]:RFBurst:LEVel:ABSolute?
Example	TRIG:RFB:LEV:ABS 10 dBm sets the trigger level of the RF burst envelope signal to the absolute level of 10 dBm
Notes	Sending this command does not switch the setting from relative to absolute; to switch it you need to send the :TRIGger[:SEquence]:RFBurst:LEVel:TYPE command, below. Amplitude Corrections are not taken into account by the Absolute Trigger Level. For example, if you have given yourself effective gain with an amplitude correction factor, the Absolute Trigger will not fire until you have set the trigger level that far below the displayed signal level, rather than simply to the displayed signal level. This is only true for Amplitude Corrections, not External Gain or Ref Level Offset functions. If mode is Bluetooth, the default value is -50 dBm.
Couplings	This same level is used for the RF Burst trigger source in the Trigger menu, for the RF Burst selection in the Periodic Timer sync source (in the Trigger menu and in the Gate Source menu), and also for the

	RF Burst selection in the Gate Source menu
Preset	-20 dBm
State Saved	Saved in instrument state
Min	-200 dBm
Max	100 dBm
Default Unit	depends on the current selected Y-Axis unit
Backwards Compatibility SCPI	:TRIGger[:SEquence]:FRAMe:RFBurst:LEVel:ABSolute
Initial S/W Revision	Prior to A.02.00
Modified at S/W Revision	A.04.00

Key Path	Trigger, RF Burst
Remote Command	:TRIGger[:SEquence]:RFBurst:LEVel:TYPE ABSolute RELative :TRIGger[:SEquence]:RFBurst:LEVel:TYPE?
Example	TRIG:RFB:LEV:TYPE REL sets the trigger level type of the RF burst trigger to Relative.
Preset	ABSolute
State Saved	Saved in instrument state
Initial S/W Revision	Prior to A.02.00
Modified at S/W Revision	A.04.00

Trigger Slope

It is set positive to trigger on a rising edge and negative to trigger on a falling edge.

Key Path	Trigger, RF Burst
Remote Command	:TRIGger[:SEquence]:RFBurst:SLOPe POSitive NEGative :TRIGger[:SEquence]:RFBurst:SLOPe?
Example	TRIG:RFB:SLOP NEG
Couplings	This same slope is used in the RF Burst selection for the trigger source in the Trigger menu and for the period timer sync source (in the Trigger menu and in the Gate Source menu).
Preset	POSitive
State Saved	Saved in instrument state
Backwards Compatibility SCPI	:TRIGger[:SEquence]:FRAMe:RFBurst:SLOPe
Backwards Compatibility Notes	The legacy :TRIGger[:SEquence]:SLOPe command affects the slopes for the VID, LINE, EXT1, EXT2, and RFB triggers.
Initial S/W Revision	Prior to A.02.00

Sync Holdoff

Sync Holdoff specifies the duration that the sync source signal must be kept false before the transition to true to be recognized as the sync timing. The periodic timer phase is aligned when the sync source signal becomes true, after the Holdoff time is satisfied.

A holdoff of 2 ms will work with most WiMAX signals, but there may be cases where the burst off duration is less than 1 ms and this value will need to be changed.

Key Path	Trigger, Periodic Timer
Remote Command	:TRIGger[:SEQuence]:FRAMe:SYNC:HOLDoff <time> :TRIGger[:SEQuence]:FRAMe:SYNC:HOLDoff? :TRIGger[:SEQuence]:FRAMe:SYNC:HOLDoff:STATe OFF ON 0 1 :TRIGger[:SEQuence]:FRAMe:SYNC:HOLDoff:STATe?
Preset	On, 1.000 ms
State Saved	Saved in instrument state
Min	0 ms
Max	+500 ms
Default Unit	s
Initial S/W Revision	Prior to A.02.00

Auto/Holdoff

Opens up a menu that lets you adjust Auto Trigger and Trigger Holdoff parameters

Key Path	Trigger
Readback line	Displays a summary of the Auto Trig and Holdoff settings, in square brackets First line: Auto Off or Auto On Second Line: "HldP" followed by: <ul style="list-style-type: none"> • If Holdoff is Off, readback Off • If Holdoff On and Type = Normal, readback value • If Holdoff On and Type = Above, readback value followed by AL • If Holdoff On and Type = Below, readback value followed by BL • If Holdoff Type selection is not supported by the current measurement, Holdoff Type is always Normal
Initial S/W Revision	A.02.00

Auto Trig

Sets the time that the analyzer will wait for the trigger conditions to be met. If they are not met after that much time, then the analyzer is triggered anyway.

Key Path	Trigger, Auto/Holdoff
Remote Command	:TRIGger[:SEquence]:ATRigger <time> :TRIGger[:SEquence]:ATRigger? :TRIGger[:SEquence]:ATRigger:STATe OFF ON 0 1 :TRIGger[:SEquence]:ATRigger:STATe?
Example	TRIG:ATR:STAT ON TRIG:ATR 100 ms
Notes	The "time that the analyzer will wait" starts when the analyzer is ready for a trigger, which may be hundreds of ms after the data acquisition for a sweep is done. The "time" ends when the trigger condition is satisfied, not when the delay ends.
Preset	Off, 100 ms
State Saved	Saved in instrument state
Min	1 ms
Max	100 s
Default Unit	s
Initial S/W Revision	Prior to A.02.00

Trig Holdoff

Sets the holdoff time between triggers. When the trigger condition is satisfied, the trigger occurs, the delay begins, and the holdoff time begins. New trigger conditions will be ignored until the holdoff time expires. For a free-running trigger, the holdoff value is the minimum time between triggers.

Key Path	Trigger, Auto/Holdoff
Remote Command	:TRIGger[:SEquence]:HOLDoff <time> :TRIGger[:SEquence]:HOLDoff? :TRIGger[:SEquence]:HOLDoff:STATe OFF ON 0 1 :TRIGger[:SEquence]:HOLDoff:STATe?
Example	TRIG:HOLD:STAT ON TRIG:HOLD 100 ms
Dependencies	Unavailable if the selected Input is BBIQ. If this is the case, the key is grayed out if it is pressed the informational message "Feature not supported for this Input" is displayed. If the SCPI command is sent, the error "Settings conflict; Feature not supported for this Input" is generated.
Preset	Off, 100 ms
State Saved	Saved in instrument state
Min	0 s
Max	0.5 s
Default Unit	s
Initial S/W Revision	Prior to A.02.00

Gate Preset (Remote Command Only)

Presets the time-gated spectrum analysis capability.

This command sets gate parameter values to the ESA preset values, as follows:

Gate trigger type = edge

Gate polarity = positive

Gate delay = 1 us

Gate length = 1 us

Remote Command	<code>[[:SENSe]:SWEep:TIME:GATE:PRESet</code> ESA Compatibility
Initial S/W Revision	Prior to A.02.00

Gate Level (Remote Command Only)

Sets the gate input transition point level for the external TRIGGER inputs on the front and rear panel. This is a legacy command for PSA compatibility. It is simply an alias to the equivalent trigger level command.

Remote Command	<code>[[:SENSe]:SWEep:EGATe:EXTernal[1] 2:LEVel <voltage></code> <code>[[:SENSe]:SWEep:EGATe:EXTernal[1] 2:LEVel?</code>
Notes	This command is simply an alias to <code>:TRIGger[:SEQuence]:EXTernal[1] 2:LEVel</code> For details refer
Initial S/W Revision	Prior to A.02.00

Gate Polarity (Remote Command Only)

Sets the polarity for the gate signal. This setup is now done using the gate trigger's slope setting.

When Positive (Pos) is selected, a positive-going edge (Edge) or a high voltage (Level) will satisfy the gate condition, after the delay set with the Gate Delay key. When Negative (Neg) is selected, a negative-going edge (Edge) or a low voltage (Level) will satisfy the gate condition after the delay.

Remote Command	<code>[[:SENSe]:SWEep:EGATe:POLarity</code> NEGative POSitive <code>[[:SENSe]:SWEep:EGATe:POLarity?</code>
Example	<code>SWE:EGAT:POL NEG</code> <code>SWE:EGAT:POL?</code>
Preset	POSitive
State Saved	Saved in instrument state
Backwards Compatibility SCPI	<code>[[:SENSe]:SWEep:TIME:GATE:POLarity</code> ESA compatibility
Initial S/W Revision	Prior to A.02.00

Remote Command	<code>[:SENSe] :SWEep:TIME:GATE:LEVel HIGH LOW</code> <code>[:SENSe] :SWEep:TIME:GATE:LEVel?</code> ESA compatibility
Preset	HIGH
Initial S/W Revision	Prior to A.02.00

Points

Sets the number of points per sweep. The resolution of setting the acquisition time depends on the number of points selected. If Preset is selected, the number of points per sweep defaults to 1001. The current value of points is displayed parenthetically, next to the acquisition time in the lower-right corner of the display.

Changing the number of points has several effects on the analyzer. Since markers are read at the point location, the marker reading may change. All trace data is cleared.

Key Path	Sweep/Control
Mode	SA, WCDMA, C2K, WIMAX OFDMA, 1xEVDO, DVB-T/H, DTMB (CTTB), ISDB-T, CMMB, LTE, LTETDD, Digital Cable TV, WLAN, MSR, LTEAFDD, LTEATDD
Remote Command	<code>[:SENSe] :CHPower:SWEep:POINts <integer></code> <code>[:SENSe] :CHPower:SWEep:POINts?</code>
Example	CHP:SWE:POIN 501 CHP:SWE:POIN?
Notes	Whenever the number of sweep points changes: All trace data is erased Any traces with Update Off also go to Display Off (like going from View to Blank in the older analyzers) Acquisition time is re-quantized Any limit lines that are on are updated If averaging/hold is on, averaging/hold starts over
Couplings	Whenever the number of sweep points changes, the acquisition time is re-quantized.
Preset	DVB-T/H: 2001 DTMB (CTTB): 2001 Other: 1001 ISDB-T: 2001 CMMB: 2001 1xEVDO: 512 Digital Cable TV: 2001
State Saved	Saved in instrument state.
Min	101

Max	20001
Initial S/W Revision	Prior to A.02.00
Modified at S/W Revision	A.02.00, A.03.00

System

See ["System" on page 272](#)

Trace/Detector

Accesses a menu of functions that enable you to control the detectors for the current measurement.

Key Path	Front-panel key
Initial S/W Revision	Prior to A.02.00

Trace Type

Allows you to select the type of trace you want to use for the current measurement. The first page of this menu contains a 1-of-N selection of the trace type (Clear Write, Average, Max Hold, Min Hold) for the selected trace.

Key Path	Trace/Detector
Mode	SA, WCDMA, C2K, WIMAX OFDMA, 1xEVDO, DVB-T/H, DTMB (CTTB), ISDB-T, CMMB, LTE, LTETDD, Digital Cable TV, WLAN, MSR, LTEAFDD, LTEATDD
Remote Command	:TRACe:CHPower:TYPE WRITe AVERAge MAXHold MINHold :TRACe:CHPower:TYPE?
Example	TRAC:CHP:TYPE WRIT TRAC:CHP:TYPE?
Notes	WRITe = Clear Write AVERAge = Average MAXHold = Maximum Hold MINHold = Minimum Hold
Couplings	When Detector setting is "Auto" ([:SENSe]:CHPower:DETECTOR:AUTO?), Detector ([:SENSe]:CHPower:DETECTOR[:FUNction]?) switches aligning with the switch of this parameter: "NORMal" with WRITe (Clear Write), "AVERAge" with AVERAge, "POSitive (peak)" with MAXHold, and "NEGative (peak)" with MINHold.
Preset	AVERAge
State Saved	Saved in instrument state.
Range	ClearWrite Average MaxHold MinHold
Initial S/W Revision	Prior to A.02.00
Modified at S/W Revision	A.02.00, A.03.00

Detector

Accesses a menu of functions that enable you to control the detectors for the current measurement. The following choices are available:

- Auto– the detector selected depends on marker functions, trace functions, average type, and the trace averaging function.

- Normal—the detector determines the peak of the CW-like signals, and it yields alternating maximums and minimums of noise-like signals. This is also referred to as Rosenfell detection.
- Average—the detector determines the average of the signal within the sweep points. The averaging method depends upon the Average Type selection (voltage, power or log scales).
- Peak—the detector determines the maximum of the signal within the sweep points.
- Sample—the detector indicates the instantaneous level of the signal at the center of the sweep points represented by each display point.
- Negative Peak—the detector determines the minimum of the signal within the sweep points.

Key Path	Detector
Initial S/W Revision	Prior to A.02.00

Auto

Sets the detector for the currently selected trace to Auto.

Key Path	Trace/Detector
Mode	SA, WCDMA, C2K, WIMAX OFDMA, 1xEVDO, DVB-T/H, DTMB (CTTB), ISDB-T, CMMB, LTE, LTETDD, Digital Cable TV, WLAN, MSR, LTEAFDD, LTEATDD
Remote Command	[[:SENSe]:CHPower:DETECTOR:AUTO ON OFF 1 0 [:SENSe]:CHPower:DETECTOR:AUTO?
Example	CHP:DET:AUTO ON CHP:DET:AUTO?
Couplings	When Detector setting is “Auto” ([[:SENSe]:CHPower:DETECTOR:AUTO?]), Detector ([[:SENSe]:CHPower:DETECTOR:FUNCTION?]) switches aligning with the switch of this parameter: “NORMal” with Clear Write, “AVERage” with AVERage, “POSitive (peak)” with MAXHold, and “NEGative (peak)” with MINHold.
Preset	Others: ON DVB-T/H, DTMB (CTTB), ISDB-T, CMMB, Digital Cable TV: OFF
State Saved	Saved in instrument state.
Initial S/W Revision	Prior to A.02.00
Modified at S/W Revision	A.02.00, A.03.00

Detector Selection

Selects a detector to be used by the analyzer for the current measurement.

Key Path	Trace/Detector
Mode	SA, WCDMA, C2K, WIMAX OFDMA, 1xEVDO, DVB-T/H, DTMB (CTTB), ISDB-T, CMMB, LTE, LTETDD, Digital Cable TV, WLAN, MSR, LTEAFDD, LTEATDD

Remote Command	[:SENSe]:CHPower:DETEctor[:FUNction] NORMal AVERAge POSitive SAMPle NEGative [:SENSe]:CHPower:DETEctor[:FUNction]?
Example	CHP:DET NORM CHP:DET?
Notes	<p>When you manually select a detector (instead of selecting Auto), that detector is used regardless of other analyzer settings.</p> <p>The Normal detector determines the peak of CW-like signals, and it yields alternating maximums and minimums of noise-like signals. This method of detection is also referred to as Rosenfell detection.</p> <p>The Average detector determines the average of the signal within the sweep points. The averaging method is Power Average (RMS).</p> <p>The Peak detector determines the maximum of the signal within the sweep points.</p> <p>The Sample detector indicates the instantaneous level of the signal at the center of the sweep points represented by each display point.</p> <p>The Negative Peak detector determines the minimum of the signal within the sweep points.</p>
Couplings	When Detector setting is "Auto" ([:SENSe]:CHPower:DETEctor:AUTO?), Detector ([:SENSe]:CHPower:DETEctor[:FUNction]?) switches aligning with the switch of this parameter: "NORMal" with Clear Write, "AVERAge" with AVERAge, "POSitive (peak)" with MAXHold, and "NEGative (peak)" with MINHold.
Preset	AVERAge
State Saved	Saved in instrument state.
Range	Normal Average Peak Sample Negative Peak
Initial S/W Revision	Prior to A.02.00
Modified at S/W Revision	A.02.00, A.03.00

Trigger

See ["Trigger" on page 328](#)

Free Run

See ["Free Run " on page 335](#)

Video

See ["Video \(IF Envelope\) " on page 1556](#)

Trigger Level

See ["Trigger Level " on page 1557](#)

Trig Slope

See ["Trig Slope " on page 1558](#)

Trig Delay

See ["Trig Delay " on page 338](#)

External 1

See ["External 1 " on page 1571](#)

Trigger Level

See ["Trigger Level " on page 1571](#)

Trig Slope

See ["Trig Slope " on page 1572](#)

Trig Delay

See ["Trig Delay " on page 341](#)

Zero Span Delay Comp

See ["Zero Span Delay Comp On/Off" on page 1560](#)

External 2

See ["External 2 " on page 1572](#)

Trigger Level

See ["Trigger Level " on page 1573](#)

Trig Slope

See ["Trig Slope " on page 1574](#)

Trig Delay

See ["Trig Delay "](#) on page 344

Zero Span Delay Comp

See ["Zero Span Delay Comp On/Off"](#) on page 1562

RF Burst

See ["RF Burst "](#) on page 1574

Absolute Trigger

See ["Absolute Trigger Level"](#) on page 1575

Relative Trigger

See ["Relative Trigger Level"](#) on page 1564

Trig Slope

See ["Trigger Slope "](#) on page 1576

Trig Delay

See ["Trig Delay "](#) on page 348

Periodic Timer

See ["Periodic Timer \(Frame Trigger\) "](#) on page 1566

Period

See ["Period "](#) on page 1567

Offset

See ["Offset "](#) on page 1568

Reset Offset Display

See ["Reset Offset Display "](#) on page 1570

Sync Source

See ["Sync Source "](#) on page 1570

Off

See ["Off "](#) on page 1571

External 1

See ["External 1 "](#) on page 1571

8 Channel Power Measurement Trigger

Trigger Level

See ["Trigger Level "](#) on page 1571

Trig Slope

See ["Trig Slope "](#) on page 1572

External 2

See ["External 2 "](#) on page 1572

Trigger Level

See ["Trigger Level "](#) on page 1573

Trig Slope

See ["Trig Slope "](#) on page 1574

RF Burst

See ["RF Burst "](#) on page 1574

Absolute Trigger

See ["Absolute Trigger Level"](#) on page 1575

Trig Slope

See ["Trigger Slope "](#) on page 1576

Trig Delay

See ["Trig Delay"](#) on page 359

Auto/Holdoff

See ["Auto/Holdoff "](#) on page 1577

Auto Trig

See ["Auto Trig "](#) on page 1577

Trig Holdoff

See ["Trig Holdoff "](#) on page 1578

Holdoff Type

See ["Holdoff Type"](#) on page 361

User Preset

Accesses a menu that gives you the following three choices:

- User Preset – recalls a state previously saved using the Save User Preset function.
- User Preset All Modes – presets all of the modes in the analyzer
- Save User Preset– saves the current state for the current mode

NOTE

In products that run multiple instances of the X-Series Application, all instances use the same location to save User Preset state. So Save User Preset of one instance will overwrite the Save User Preset of another instance.

Key Path	Front-panel key
Backwards Compatibility Notes	<p>User Preset is actually loading a state, and in legacy analyzers, it was possible to load a state without affecting the trace data, limit lines or correction data. Similarly it was possible to do a User Preset without affecting the trace data, limit lines or correction data.</p> <p>In the X-Series, “state” always includes all of this data; so whenever state is loaded, or User Preset is executed, all of the traces, limit lines and corrections are affected. Although this differs from previous behavior, it is desirable behavior, and should not cause adverse issues for users.</p> <p>On ESA and PSA, User Preset affected the entire instrument’s state. In the X-Series, User Preset only recalls the state for the active mode. There is a User Preset file for each mode. User Preset can never cause a mode switch as it can in legacy analyzers. If you want to recall all modes to their user preset file state, you will need to do a User Preset after mode switching into each mode.</p> <p>User Preset recalls mode state which can now include data like traces; whereas on ESA and PSA, User Preset did not affect data.</p>
Initial S/W Revision	Prior to A.02.00

User Preset

User Preset sets the state of the currently active mode back to the state that was previously saved for this mode using the Save User Preset menu key or the SCPI command, SYST:PRES:USER:SAV. It not only recalls the Mode Preset settings, but it also recalls all of the mode persistent settings, and the Input/Output system setting that existed at the time Save User Preset was executed.

If a Save User Preset has not been done at any time, User Preset recalls the default user preset file for the currently active mode. The default user preset files are created if, at power-on, a mode detects there is no user preset file. There will never be a scenario when there is no user preset file to restore. For each mode, the default user preset state is the same state that would be saved if a Save User Preset is performed in each mode right after doing a Restore Mode Default and after a Restore Input/Output Defaults.

The User Preset function does the following:

- Aborts the currently running measurement.
- Sets the mode State to the values defined by Save User Preset.
- Makes the saved measurement for the currently running mode the active measurement.
- Brings up the saved menu for the power-on mode.

- Clears the input and output buffers.
- Sets the Status Byte to 0.

Key Path	User Preset
Remote Command	:SYSTem:PRESet:USER
Example	:SYST:PRES:USER:SAVE:SYST:PRES:USER
Notes	:SYST:PRES:USER:SAVE is used to save the current state as the user preset state. Clears all pending OPC bits. The Status Byte is set to 0. Pressing the User Preset front-panel key while already in the User Preset menu will cause the User Preset to get executed
Couplings	A user preset will cause the currently running measurement to be aborted and cause the saved measurement to be active. Recalling a User Preset file has the same issues that recalling a Save State file has. Some settings may need to be limited and therefore re-coupled, since the capabilities of the mode may have changes when the User Preset file was last saved.
Initial S/W Revision	Prior to A.02.00

User Preset All Modes

Recalls all of the User Preset files for each mode, switches to the power-on mode, and activates the saved measurement from the power-on mode User Preset file.

NOTE

When the instrument is secured, all of the user preset files are converted back to their default user preset files.

The User Preset function does the following:

- Aborts the currently running measurement.
- Switches the Mode to the power-on mode.
- Restores the User Preset files for each mode.
- Makes the saved measurement for the power-on mode the active measurement.
- Brings up the saved menu for the power-on mode.
- Clears the input and output buffers.
- Sets the Status Byte to 0.

Key Path	User Preset
Remote Command	:SYSTem:PRESet:USER:ALL
Example	:SYST:PRES:USER:SAVE:SYST:PRES:USER:ALL
Notes	Clears all pending OPC bits. The Status Byte is set to 0. :SYST:PRES:USER:SAVE is used to save the current state as the user preset state.
Couplings	A user preset will cause the currently running measurement to be aborted, cause a mode switch to the power-on mode, and cause the saved measurement to be active in the power-on mode.

Recalling a User Preset file has the same issues that recalling a Save State file has. Some settings may need to be limited and therefore re-coupled, since the capabilities of the mode may have changes when the User Preset file was last saved.

Initial S/W Revision Prior to A.02.00

Save User Preset

Saves the currently active mode and its State. You can recall this User Preset file by pressing the User Preset menu key or sending the SYST:PRES:USER remote command. This same state is also saved by the Save State function.

Key Path	User Preset
Remote Command	:SYSTem:PRESet:USER:SAVE
Example	:SYST:PRES:USER:SAVE
Notes	:SYST:PRES:SAVE creates the same file as if the user requested a *SAV or a MMEM:STOR:STAT, except User Preset Save does not allow the user to specify the filename or the location of the file.
Initial S/W Revision	Prior to A.02.00

View/Display

Accesses a menu of functions that enable you to control the instrument display as well as turn the bar graph On and Off.

The results of the measurement can be displayed as a single spectrum trace view or displayed with a Bar Graph trace on the spectrum trace.

Spectrum View with Bar Graph off

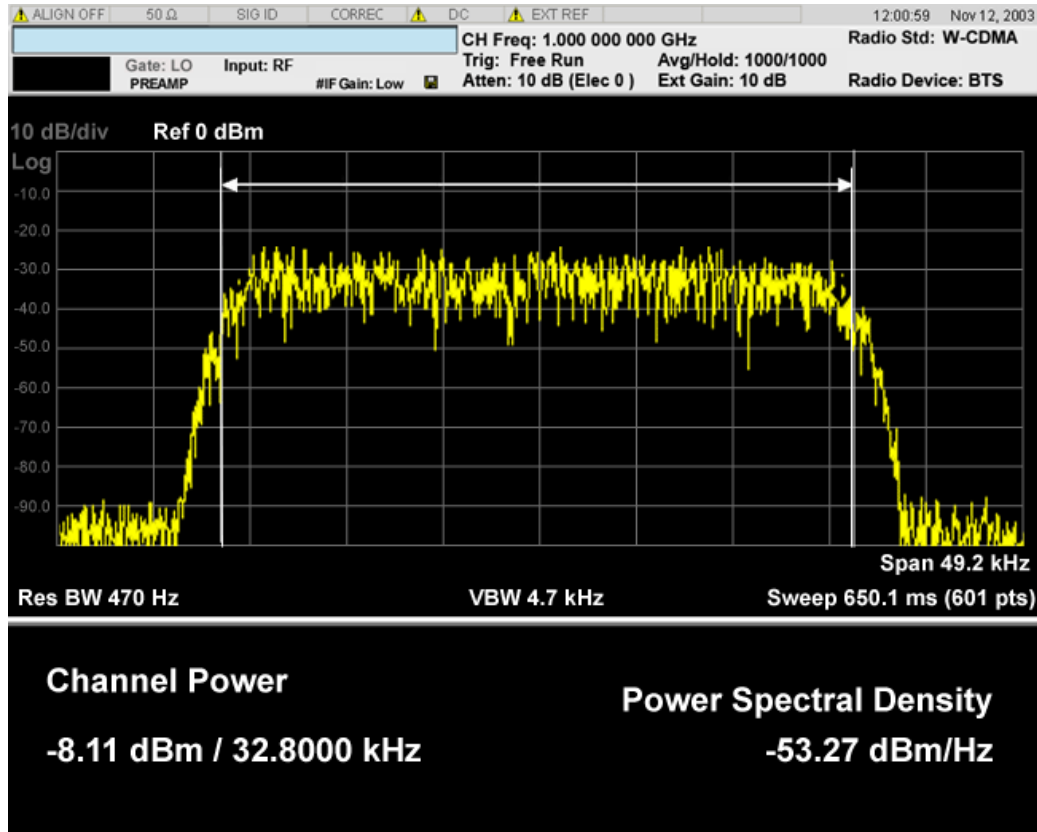

Spectrum View with Bar Graph on

This View is the same as the 'Spectrum' view, but has a blue bar between the markers that indicates the measured output power level. The bar graph is activated when the "Bar Graph" Soft Key is set to ON under the View/Display menu. The actual measured output power level is displayed on the display at the bottom of the bar.

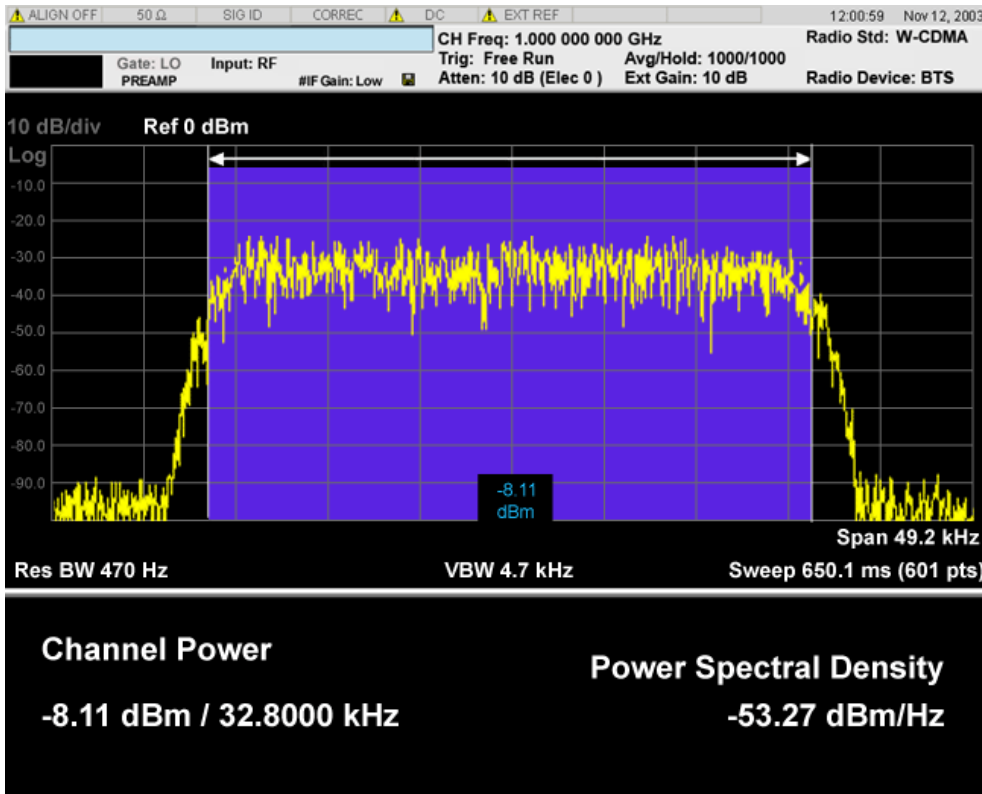

If the current mode is WLAN and the format is WLAN 802.11ac 80+80 MHz, the spectrum view is changed a little so that the results of both carrier segments can be displayed.

Spectrum View with Bar Graph off for WLAN 802.11ac (80 + 80 MHz):

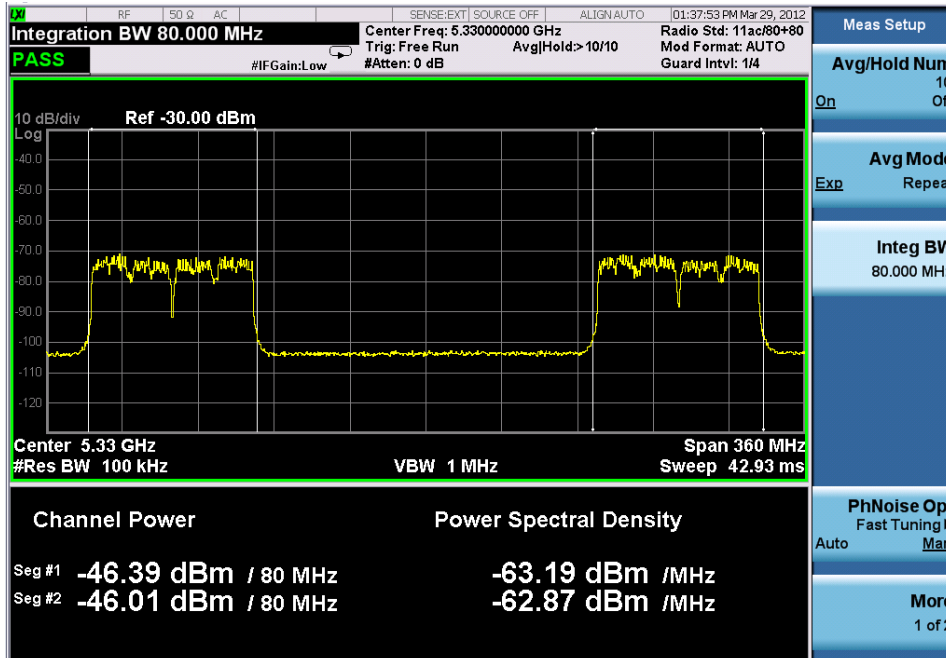

Spectrum View with Bar Graph on for WLAN 802.11ac (80 + 80 MHz):

8 Channel Power Measurement
View/Display

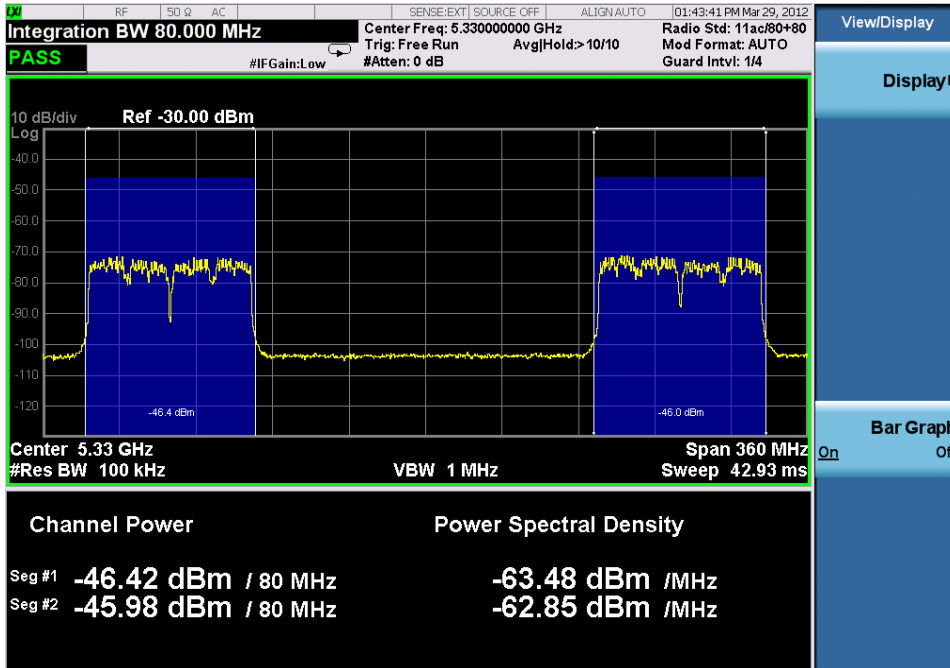

Power Results:

The spectrum trace and power bars are displayed in the upper window. Total carrier power, total PSD and total format carrier power are displayed in the lower window. Total format carrier power is total power of carriers of the same Radio Format. If there is no carrier of the corresponding format, it is not displayed. Thus items in the total format power table changes depending on the carrier configuration.

Carrier Info:

The lower window of Power Results view is replaced by the carrier info table in this view. Carrier center frequency can be displayed in either offset or absolute frequency depending on Carrier Freq. The table can be scrolled by Carrier Result on Meas Setup menu or by Select Carrier on Config Carriers menu. The highlighted row changes as either Carrier Result or Select Carrier is changed. The highlighted row and these keys are not coupled.

View selection by name (MSR and LTE-Advanced FDD/TDD only)

Selects the results view. The following SCPI command allows you to select the desired measurement view by enumeration.

Key Path	No equivalent front-panel key
Mode	MSR, LTEAFDD, LTEATDD
Remote Command	:DISPlay:CHPower:VIEW[:SElect] PRESult CINformation :DISPlay:CHPower:VIEW[:SElect]?
Example	:DISP:CHP:VIEW PRES :DISP:CHP:VIEW?
Preset	PRESult

State Saved	Saved in instrument state
Range	Power Results Carrier Info
Initial S/W Revision	A.10.00

Selects the results view. The following SCPI command allows you to select the desired measurement view by enumeration.

Key Path	No equivalent front-panel key
Mode	MSR, LTEAFDD, LTEATDD
Remote Command	:DISPlay:CHPower:VIEW:NSElect <integer> :DISPlay:CHPower:VIEW:NSElect?
Example	DISP:CHP:VIEW:NSEL 1 DISP:CHP:VIEW:NSEL?
Preset	1
State Saved	Saved in instrument state
Min	1
Max	2
Initial S/W Revision	A.10.00

View selection by name (DTMB (CTTB), DVB-T/H only)

Selects the results view. The following SCPI command allows you to select the desired measurement view by enumeration.

Key Path	No equivalent front-panel key
Mode	DVB-T/H, DTMB (CTTB)
Remote Command	:DISPlay:CHPower:VIEW[:SElect] RFSpectrum SHOUlder MASK :DISPlay:CHPower:VIEW[:SElect]?
Example	DISP:CHP:VIEW RFSP DISP:CHP:VIEW?
Preset	RFSpectrum
State Saved	Saved in instrument state.
Range	RF Spectrum Shoulder Attenuation Spectrum Mask
Initial S/W Revision	A.02.00

View selection by name (ISDB-T, CMMB only)

Selects the results view. The following SCPI command allows you to select the desired measurement view by enumeration.

Key Path	No equivalent front-panel key
Mode	ISDB-T, CMMB
Remote Command	:DISPlay:CHPower:VIEW[:SElect] RFSPectrum SHOUlder :DISPlay:CHPower:VIEW[:SElect]?
Example	DISP:CHP:VIEW RFSP DISP:CHP:VIEW?
Preset	RFSPectrum
State Saved	Saved in instrument state.
Range	RF Spectrum Shoulder Attenuation
Initial S/W Revision	A.03.00

Key Path	Front-panel key
Initial S/W Revision	Prior to A.02.00

Display

The Display menu is common to most measurements, and is used for configuring items on the display. Some Display menu settings apply to all the measurements in a mode, and some only to the current measurement. Those under the System Display Settings key apply to all measurements in all modes.

Key Path	Display
Key Path	View/Display
Initial S/W Revision	Prior to A.02.00

Annotation

Turns on and off various parts of the display annotation. The annotation is divided up into four categories:

1. Meas Bar: This is the measurement bar at the top of the screen. It does not include the settings panel or the Active Function. Turning off the Meas Bar turns off the settings panel and the Active Function. When the Meas Bar is off, the graticule area expands to fill the area formerly occupied by the Meas Bar.
2. Screen Annotation: this is the annotation and annunciation around the graticule, including any annotation on lines (such as the display line, the threshold line, etc.) This does NOT include the marker number or the N dB result. When off, the graticule expands to fill the entire graticule area.
3. Trace annotation: these are the labels on the traces, showing their detector (or their math mode).

4. Active Function annotation: this is the active function display in the meas bar, and all of the active function values displayed on softkeys.

See the figure below. Each type of annotation can be turned on and off individually.

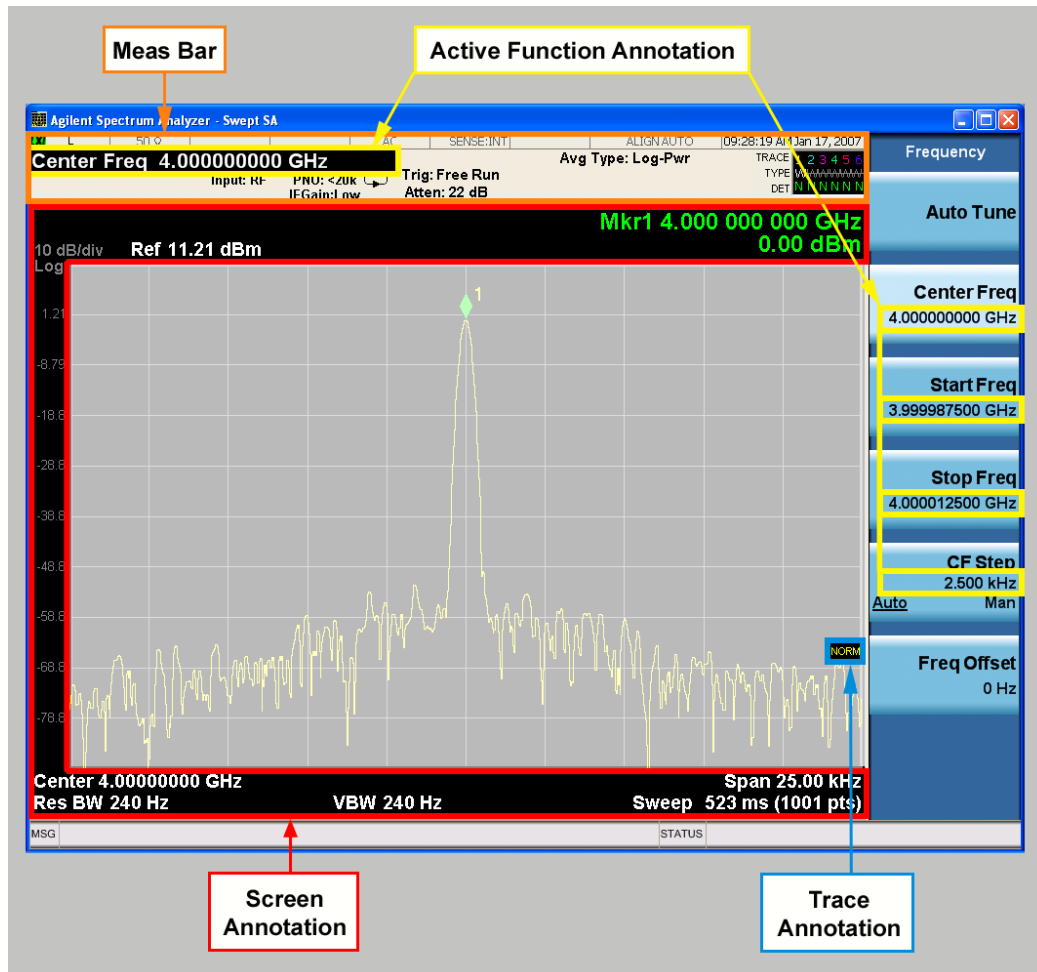

Key Path	View/Display, Display
Initial S/W Revision	Prior to A.02.00

Meas Bar On/Off

This function turns the Measurement Bar on and off, including the settings panel. When off, the graticule area expands to fill the area formerly occupied by the Measurement Bar.

Key Path	View/Display, Display, Annotation
Remote Command	:DISPlay:ANNotation:MBAR[:STATe] OFF ON 0 1 :DISPlay:ANNotation:MBAR[:STATe]?
Example	DISP:ANN:MBAR OFF

Dependencies	Grayed out and forced to OFF when System Display Settings, Annotation is set to Off.
Preset	On This should remain Off through a Preset when System DisplaySettings, Annotation is set to Off.
State Saved	Saved in instrument state.
Initial S/W Revision	Prior to A.02.00

Screen

This controls the display of the annunciation and annotation around the graticule, including any annotation on lines (such as the display line, the threshold line, etc.) and the y-axis annotation. This does NOT include marker annotation (or the N dB result). When off, the graticule expands to fill the entire graticule area, leaving only the 1.5% gap above the graticule as described in the Trace/Detector chapter.

Key Path	View/Display, Display, Annotation
Remote Command	:DISPlay:ANNotation:SCReen[:STATe] OFF ON 0 1 :DISPlay:ANNotation:SCReen[:STATe]?
Example	DISP:ANN:SCR OFF
Dependencies	Grayed-out and forced to OFF when System Display Settings, Annotation is set to Off.
Preset	On This should remain Off through a Preset when System DisplaySettings, Annotation is set to Off
State Saved	Saved in instrument state.
Initial S/W Revision	Prior to A.02.00

Active Function Values On/Off

Turns on and off the active function display in the Meas Bar, and all of the active function values displayed on the softkeys.

Note that all of the softkeys that have active functions have these numeric values blanked when this function is on. This is a security feature..

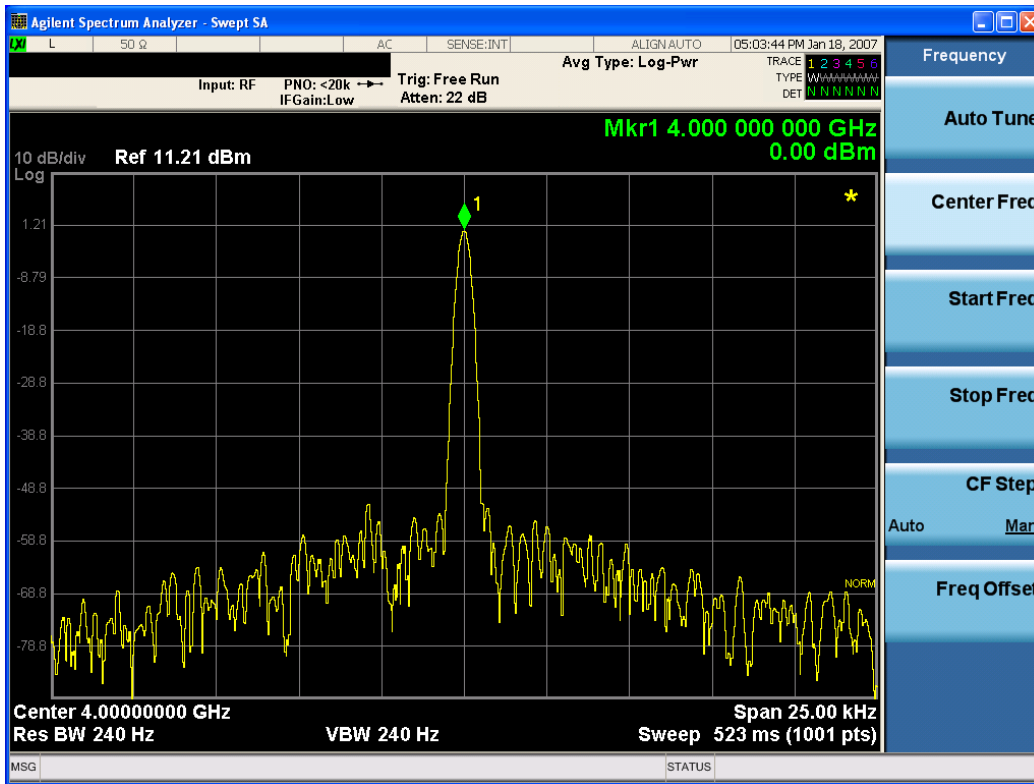

Key Path	View/Display, Display, Annotation
Remote Command	:DISPlay:ACTivefunc[:STATE] ON OFF 1 0 :DISPlay:ACTivefunc[:STATE]?
Example	DISP:ACT OFF
Dependencies	Grayed out and forced to OFF when System Display Settings, Annotation is set to Off.
Preset	On This should remain Off through a Preset when System DisplaySettings, Annotation is set to Off
State Saved	Saved in instrument state.
Initial S/W Revision	Prior to A.02.00

Title

Displays menu keys that enable you to change or clear a title on your display.

Key Path	View/Display, Display
Initial S/W Revision	Prior to A.02.00

Change Title

Writes a title into the "measurement name" field in the banner, for example, "Swept SA".

Press Change Title to enter a new title through the alpha editor. Press Enter or Return to complete the entry. Press ESC to cancel the entry and preserve your existing title.

The display title will replace the measurement name. It remains for this measurement until you press Change Title again, or you recall a state, or a Preset is performed. A title can also be cleared by pressing Title, Clear Title.

NOTE

Notice the inclusion of the <measurement> parameter in the command below. Because each measurement remembers the Display Title, the command must be qualified with the measurement name. For the Swept SA measurement this is not the case; no <measurement> parameter is used when changing the Display Title for the Swept SA measurement.

Key Path	View/Display, Display, Title
Mode	All
Remote Command	:DISPlay:<measurement>:ANNotation:TITLe:DATA <string> :DISPlay:<measurement>:ANNotation:TITLe:DATA?
Example	DISP:ANN:TITL:DATA "This Is My Title" This example is for the Swept SA measurement in the Spectrum Analyzer mode. The SANalyzer <measurement> name is not used. DISP:ACP:ANN:TITL:DATA "This Is My Title" This example is for Measurements other than Swept SA. Both set the title to: This Is My Title
Notes	Pressing this key cancels any active function. When a title is edited the previous title remains intact (it is not cleared) and the cursor goes at the end so that characters can be added or BKSP can be used to go back over previous characters.
Preset	No title (measurement name instead)
State Saved	Saved in instrument state.
Initial S/W Revision	Prior to A.02.00

Clear Title

Clears a title from the front-panel display. Once cleared, the title cannot be retrieved. After the title is cleared, the current Measurement Name replaces it in the title bar.

Key Path	View/Display, Display, Title
Example	The following commands clear the title and restore the measurement's original title: DISP:ANN:TITL:DATA "" This example is for the Swept SA measurement in the Spectrum Analyzer mode. The SANalyzer <measurement> name is not used. DISP:ACP:ANN:TITL:DATA "" This example is for ACP; in measurements other than Swept SA the measurement name is required.
Notes	Uses the :DISPlay:<measurement>:ANNotation:TITLe:DATA <string> command with an empty string (in the Swept SA, the <measurement> is omitted).
Preset	Performed on Preset.
Initial S/W Revision	Prior to A.02.00

Graticule

Pressing Graticule turns the display graticule On or Off. It also turns the graticule y-axis annotation on and off.

Key Path	View/Display, Display
Remote Command	:DISPlay:WINDow[1]:TRACe:GRATicule:GRID[:STATe] OFF ON 0 1 :DISPlay:WINDow[1]:TRACe:GRATicule:GRID[:STATe]?
Example	DISP:WIND:TRAC:GRAT:GRID OFF
Notes	The graticule is the set of horizontal and vertical lines that make up the grid/divisions for the x-axis and y-axis.
Preset	On
State Saved	Saved in instrument state
Initial S/W Revision	Prior to A.02.00

System Display Settings

These settings are "Mode Global" – they affect all modes and measurements and are reset only by Restore Misc Defaults or Restore System Defaults under System.

Key Path	View/Display, Display
Initial S/W Revision	Prior to A.02.00

Annotation Local Settings

This is a Mode Global override of the meas local annotation settings. When it is All Off, it forces ScreenAnnotation, Meas Bar, Trace, and Active Function Values settings to be OFF for all measurements in all modes. This provides the security based "annotation off" function of previous analyzers; hence it uses the legacy SCPI command.

When it is All Off, the Screen, Meas Bar, Trace, and Active Function Values keys under the Display, Annotation menu are grayed out and forced to Off. When Local Settings is selected, you are able to set the local annotation settings on a measurement by measurement basis.

Key Path	View/Display, Display, System Display Settings
Remote Command	:DISPlay:WINDow[1]:ANNotation[:ALL] OFF ON 0 1 :DISPlay:WINDow[1]:ANNotation[:ALL]?
Example	:DISP:WIND:ANN OFF
Preset	On (Set by Restore Misc Defaults)
State Saved	Not saved in instrument state.
Backwards Compatibility Notes	The WINDow parameter and optional subopcode is included for backwards compatibility but ignored – all windows are equally affected.
Initial S/W Revision	Prior to A.02.00

Themes

Accesses a menu of functions that enable you to choose the theme to be used when saving the screen image.

The **Themes** option is the same as the **Themes** option under the **Display** and **Page Setup** dialogs. It allows you to choose between themes to be used when saving the screen image.

Key Path	Save, Screen Image
Remote Command	:MMEMory:STORe:SCReen:THEMe TDColor TDMonochrome FCOLor FMONochrome :MMEMory:STORe:SCReen:THEMe?
Example	:MMEM:STOR:SCR:THEM TDM
Preset	3D Color; Is not part of Preset, but is reset by Restore Misc Defaults or Restore System Defaults All and survives subsequent running of the modes.
Readback	3D Color 3D Mono Flat Color Flat Mono
Backwards Compatibility Notes	In ESA and PSA we offer the choice of "Reverse Bitmap" or "Reverse Metafile" when saving screen images. This is much like the "Flat Color" theme available in X-Series. Also, if you selected Reverse Bitmap AND a black & white screen image, that would be much like "Flat Monochrome". In other words, each of the X-Series themes has a similar screen image type in ESA/PSA. But they are not identical.
Initial S/W Revision	Prior to A.02.00

3D Color

Selects a standard color theme with each object filled, shaded and colored as designed.

Key Path	Save, Screen Image, Themes
Example	MMEM:STOR:SCR:THEM TDC
Readback	3D Color
Initial S/W Revision	Prior to A.02.00

3D Monochrome

Selects a format that is like 3D color but shades of gray are used instead of colors.

Key Path	Save, Screen Image, Themes
Example	MMEM:STOR:SCR:THEM TDM
Readback	3D Mono
Initial S/W Revision	Prior to A.02.00

Flat Color

Selects a format that is best when the screen is to be printed on an ink printer.

Key Path	Save, Screen Image, Themes
Example	MMEM:STOR:SCR:THEM FCOL
Readback	Flat Color
Initial S/W Revision	Prior to A.02.00

Flat Monochrome

Selects a format that is like Flat Color. But only black is used (no colors, not even gray), and no fill.

Key Path	Save, Screen Image, Themes
Example	MMEM:STOR:SCR:THEM FMON
Readback	Flat Mono
Initial S/W Revision	Prior to A.02.00

Power Results (Only for MSR and LTE-Advanced FDD/TDD)

This view consists of the following two windows:

"Traces Window " on page 644 and "Results Window for MSR" on page 644

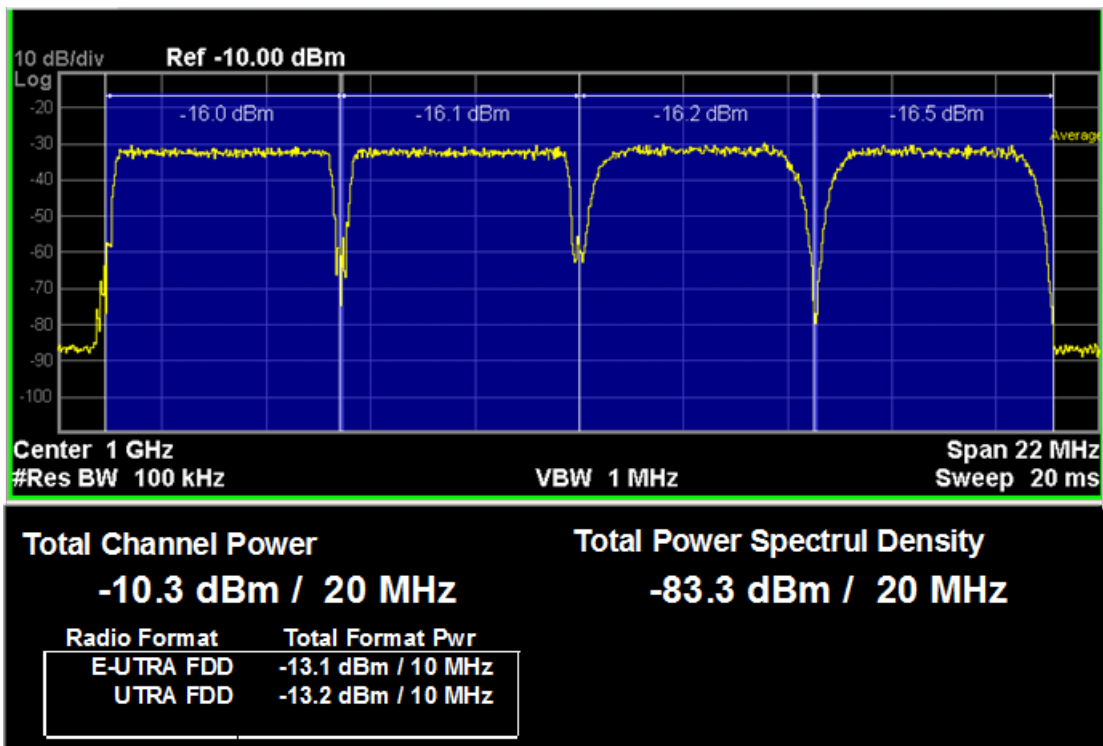

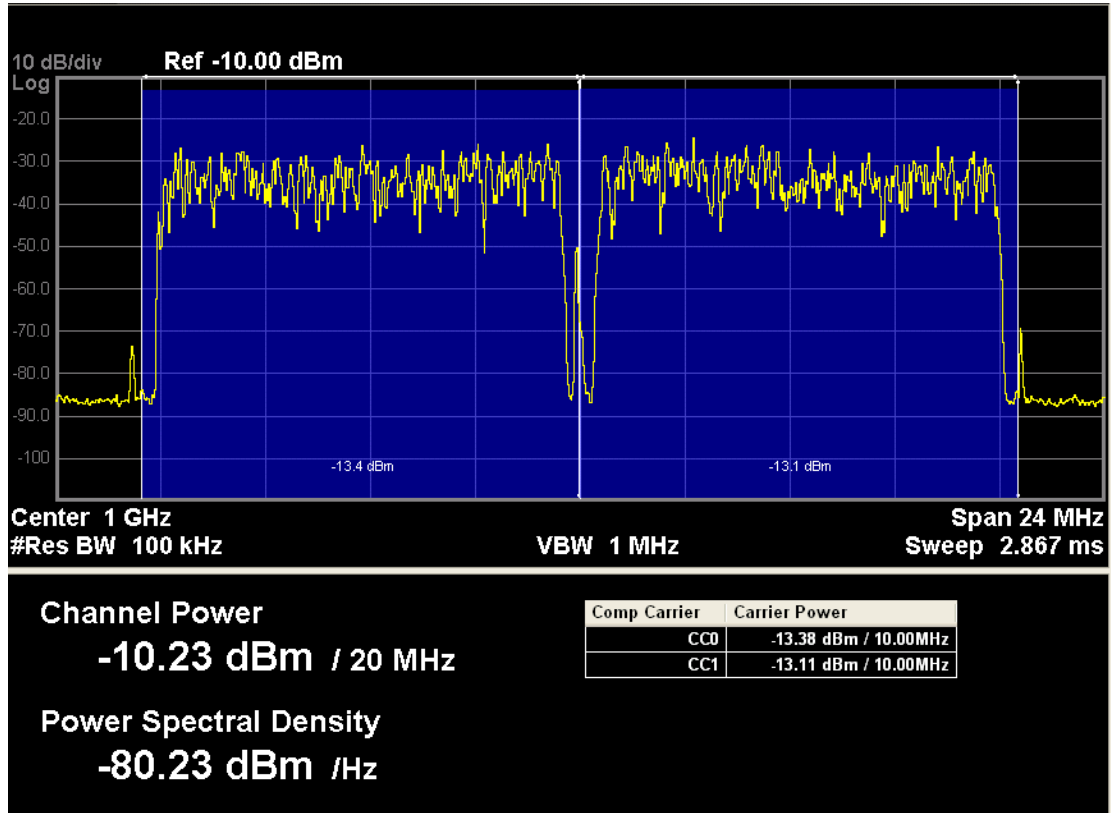

Figure 0-18 Power Results View of LTE-Advanced FDD/TDD CHP

Traces Window

Corresponding Trace	yellow - spectrum trace;
---------------------	--------------------------

Results Window for MSR

Name	Corresponding Results
Total Channel Power	n=1, 1st element Total channel power in the specified integration bandwidth
Total Power Spectral Density	n=1, 2nd element The power in the specified unit bandwidth
Total Format Pwr	n=4 Total powers of corresponding radio format

Results Window for LTE-Advanced FDD/TDD

Name	Corresponding Results
Total Channel Power	n=1, 1st element

	Total channel power in the specified integration bandwidth
Total Power Spectral Density	n=1, 2nd element The power in the specified unit bandwidth
Total Channel Power Per Component Carrier	n=3 Total Channel Power Per Component Carrier

Key Path	View/Display
Initial S/W Revision	A.14.00

Carrier Info (Only for MSR and LTE-Advanced FDD/TDD)

This view consists of the following two windows:

"Traces Window " on page 646 and "Results Window " on page 646

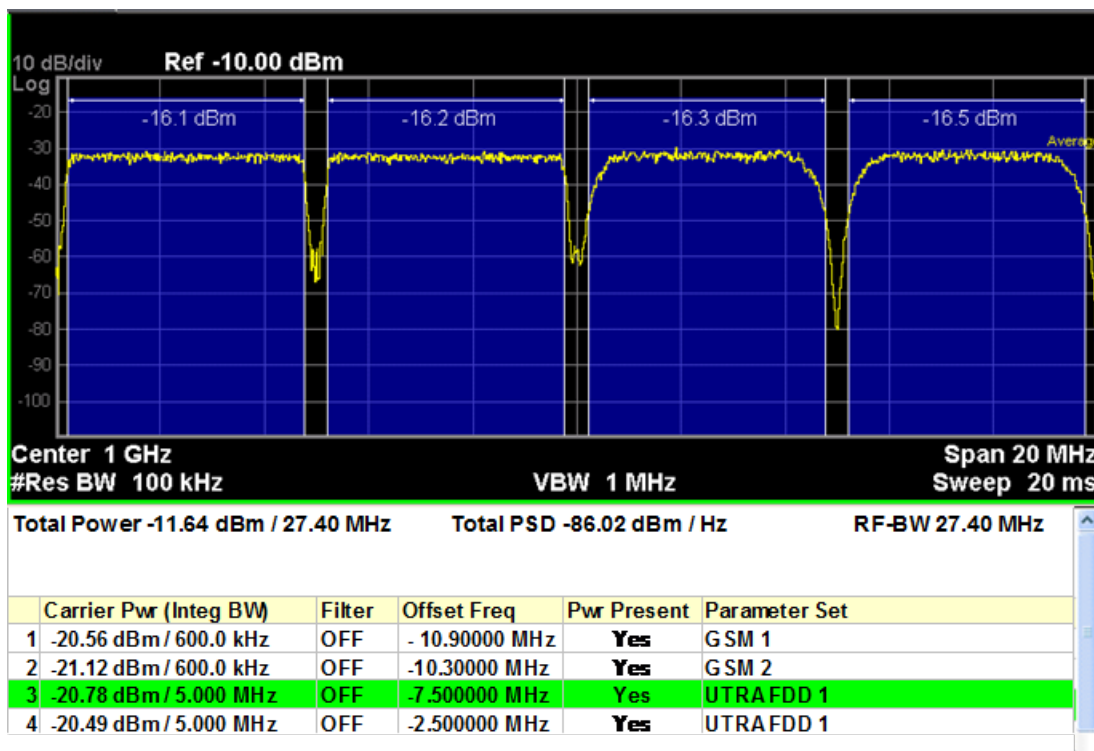

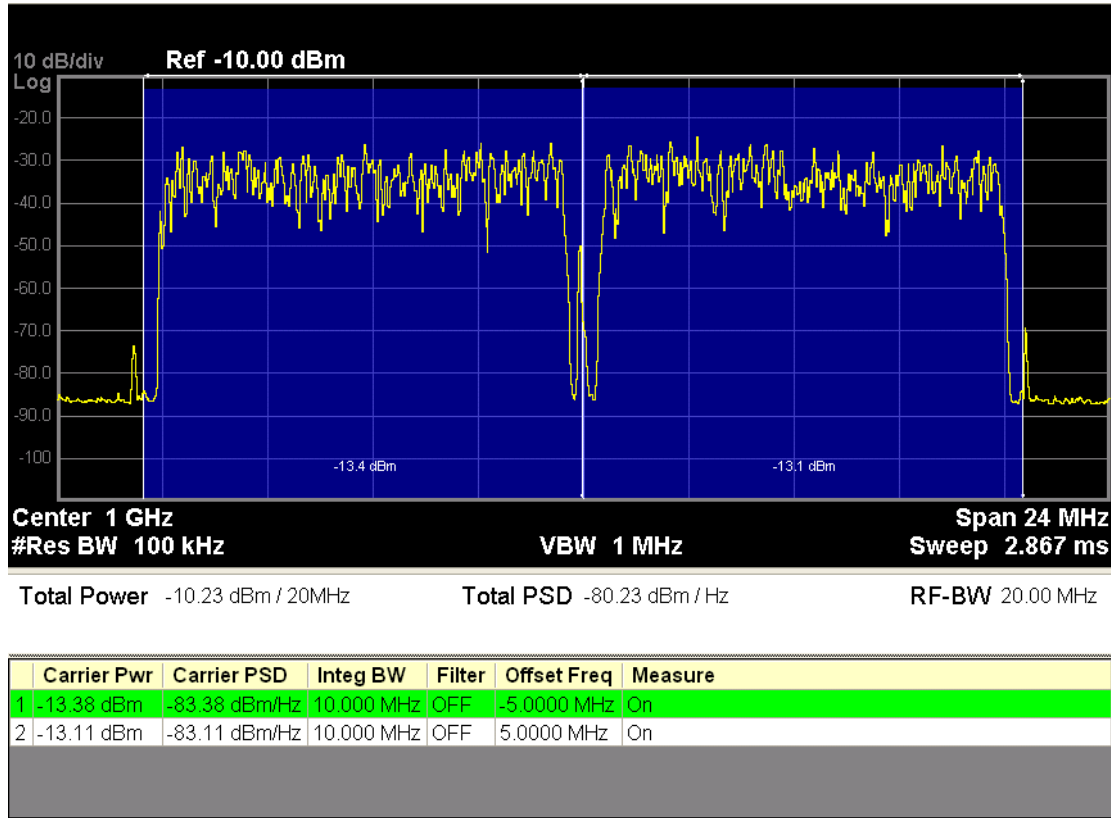

Figure 0-9 Carrier Info view of LTE-Advanced FDD/TDD CHP

Traces Window

Corresponding Trace	yellow - spectrum trace;
---------------------	--------------------------

Results Window

Name	Corresponding Results
Total Channel Power	n=1, 1st element Total channel power in the specified integration bandwidth
Total PSD	n=1, 2nd element The power in the specified unit bandwidth

Key Path	View/Display
Initial S/W Revision	A.14.00

Carrier Freq (Only for MSR and LTE-Advanced FDD/TDD)

Sets the carrier frequency display type.

Offset – The carrier center frequencies are displayed as offset from Carrier Ref Freq.

Absolute – The carrier center frequencies are displayed as absolute frequency.

Key Path	View/Display, Carrier Info
Mode	MSR, LTEAFDD, LTEATDD
Remote Command	:DISPlay:CHPower:VIEW:WINDow:CINFormation:FREQuency OFFSet ABSolute :DISPlay:CHPower:VIEW:WINDow:CINFormation:FREQuency?
Example	DISP:CHP:VIEW:WIND:CINF:FREQ ABS DISP:CHP:VIEW:WIND:CINF:FREQ?
Preset	OFFSet
State Saved	Saved in instrument state
Range	Offset Absolute
Initial S/W Revision	A.10.00

Bar Graph

Turns the Bar Graph On and Off.

Key Path	DVB-T/H, DTMB (CTTB), ISDB-T, CMMB: View/Display, RF SpectrumOthers: View/Display
Mode	SA, WCDMA, C2K, WIMAX OFDMA, 1xEVDO, DVB-T/H, DTMB (CTTB), ISDB-T, CMMB, LTE, LTE-TDD, Digital Cable TV, WLAN, MSR, LTEAFDD, LTEATDD
Remote Command	:DISPlay:CHPower:VIEW[1]:WINDow[1]:BGRaph ON OFF 1 0 :DISPlay:CHPower:VIEW[1]:WINDow[1]:BGRaph?
Example	DISP:CHP:VIEW:WIND:BGR ON DISP:CHP:VIEW:WIND:BGR?
Notes	You must be in the Spectrum Analysis mode, W-CDMA mode, cdma2000 mode, DVB-T/H mode, DTMB (CTTB) mode, ISDB-T mode, CMMB mode, Digital Cable TV mode, LTE mode, LTE TDD mode, WLAN mode, 1xEVDO mode, MSR, LTE-Advanced FDD/TDD mode or WIMAX OFDMA mode to use this command. Use :INSTrument:SElect to set the mode.
Preset	OFF
State Saved	Saved in instrument state.
Range	On Off
Initial S/W Revision	Prior to A.02.00
Modified at S/W Revision	A.02.00, A.03.00

9 Occupied Bandwidth Measurement

The Occupied Bandwidth measurement computes and displays the bandwidth occupied by a given percentage of the total mean power of a signal. For measurement results and views, see ["View/Display" on page 922](#).

This topic contains the following sections:

["Remote Commands for Occupied Bandwidth" on page 650](#)

["Remote Command Results for Occupied Bandwidth Measurement" on page 651](#)

Remote Commands for Occupied Bandwidth

The following commands and queries can be used to retrieve the measurement results:

```
:CONFigure:OBWidth  
:CONFigure:OBWidth:NDEFault  
:INITiate:OBWidth  
:FETCh:OBWidth[n]?  
:MEASure:OBWidth[n]?  
:READ:OBWidth[n]?  
:FETCh:OBWidth:OBWidth?  
:MEASure:OBWidth:OBWidth?  
:READ:OBWidth:OBWidth?  
:FETCh:OBWidth:FERRor?  
:MEASure:OBWidth:FERRor?  
:READ:OBWidth:FERRor?  
:FETCh:OBWidth:XDB?  
:MEASure:OBWidth:XDB?  
:READ:OBWidth:XDB?
```

See also the section, "[Remote Measurement Functions](#)" on page 2355.

Remote Command Results for Occupied Bandwidth Measurement

The following table describes the results returned by the FETCh:OBWidth[n]?, MEASure:OBWidth[n]?, and READ:OBWidth[n]? queries listed above, according to the index value n.

n	Results Returned
n=1 (or not specified)	Returns 7 scalar results, in the following order: <ol style="list-style-type: none"> 1. Occupied bandwidth - Hz 2. Total Power - dBm (Total Power will be obsolete in TD-SCDMA mode, this place will be replaced by NaN) 3. Span - Hz 4. Spectrum Trace Points - points 5. Res BW - Hz 6. Transmit Frequency Error Hz 7. x DB Bandwidth - Hz
2	Returns the frequency-domain spectrum trace (data array) for the entire frequency range being measured.

Key Path	Meas
Initial S/W Revision	Prior to A.02.00

AMPTD Y Scale (Amplitude/Y Scale)

Activates the Reference Value function and displays the Amplitude menu keys. These functions control how data on the vertical (Y) axis is displayed and control instrument settings that affect the vertical axis

See "[AMPTD Y Scale](#)" on page 2340 for more information.

Key Path	Front-panel key
Initial S/W Revision	Prior to A.02.00

Ref Value

Sets the absolute power reference value. However, since the Auto Scaling is defaulted to On, this value is automatically determined by the measurement result. When you set a value manually, Auto Scaling automatically changes to Off.

Key Path	AMPTD Y Scale
Mode	SA, WCDMA, C2K, WIMAX OFDMA, TD-SCDMA, 1xEVDO, ISDB-T, CMMB, LTE, LTETDD, BLUETOOTH, WLAN, MSR
Remote Command	:DISPlay:OBWidth:VIEW[1]:WINDow[1]:TRACe:Y[:SCALe]:RLEVel <real> :DISPlay:OBWidth:VIEW[1]:WINDow[1]:TRACe:Y[:SCALe]:RLEVel?
Example	DISP:OBW:VIEW:WIND:TRAC:Y:RLEV 125 DISP:OBW:VIEW:WIND:TRAC:Y:RLEV?
Notes	You must be in the Spectrum Analysis mode, W-CDMA mode, cdma2000 mode, TD-SCDMA mode, ISDB-T mode, CMMB mode, BLUETOOTH mode, LTE mode, LTE TDD mode, WLAN mode, 1xEVDO mode, MSR or WIMAX OFDMA mode to use this command. Use:INSTRument:SElect to set the mode.
Couplings	When the Auto Scaling is On, this value is automatically determined by the measurement result. When you set a value manually, Auto Scaling automatically changes to Off.
Preset	10.00 dBm
State Saved	Saved in instrument state.
Min	-250.00 dBm
Max	250.00 dBm
Initial S/W Revision	Prior to A.02.00
Modified at S/W Revision	A.03.00

Range

The Range menu allows setting amplitude controls of the instrument.

Key Path	AMPTD Y Scale
Scope	Meas Global
Initial S/W Revision	A.12.50

Range

Represents the amplitude of the largest sinusoidal signal that could be present within the IF without being clipped by the ADC. For signals with high peak-to-average ratios, the range may need to exceed the rms signal power by a fair amount to avoid clipping.

Key Path	Range
Mode	BASIC
Remote Command	<code>[:SENSe] :POWer [:RF] :RANGe <real></code> <code>[:SENSe] :POWer [:RF] :RANGe?</code>
Example	<code>:POW:RANG 10.0</code> <code>:POW:RANG?</code>
Notes	The MIN and MAX values are affected by the External Gain parameters, and by the Center Frequency. (The hardware compensates for frequency response and alters the Range setting.)
Preset	0
State Saved	Saved in instrument state.
Min	-100
Max	100
Initial S/W Revision	A.12.50

Adjust Range For Min Clip

Sets the combination of attenuation and gain based on the current measured signal level so that clipping will be at a minimum.

This is an "immediate action" function, that is, it executes once, when the key is pressed.

This key is grayed out in measurements that do not support this functionality.

Key Path	AMPTD Y Scale, Attenuation
Remote Command	<code>[:SENSe] :POWer [:RF] :RANGe:OPTimize IMMEDIATE</code>
Initial S/W Revision	Prior to A.02.00
Modified at S/W Revision	A.03.00

Pre-Adjust for Min Clip

If this function is on, it does the adjustment described under Adjust Range For Min Clip each time a measurement restarts. Therefore, in Continuous measurement mode, it only executes before the first measurement.

Key Path	AMPTD Y Scale, Attenuation
----------	----------------------------

Remote Command	<code>[:SENSe] :POWeR [:RF] :RANGe:OPTimize:ATTenuation OFF ON ELEctrical COMBined</code> <code>[:SENSe] :POWeR [:RF] :RANGe:OPTimize:ATTenuation?</code>
Notes	This parameter is shared with old XA platform which uses AutoAtten. To keep the backward compatibility, ELEctrical and COMBined still can be used. Then, upon receiving ELEctrical and COMBined, these enums will be interpreted as aliases of ON. Then, when queried, ON will be returned.
Preset	OFF for Swept SA measurement; ON for all other measurements that support Pre-Adjust for Min Clip
State Saved	Saved in instrument state
Initial S/W Revision	Prior to A.02.00
Modified at S/W Revision	A.03.00

Peak to Average

The Peak to Average Ratio is used with the Range setting to optimize the level control in the instrument. The value is the ratio, in dB, of the peak power to the average power of the signal to be measured. A ratio of 0 should be used for sinusoidal signals; for 802.11g OFDM signals use 9 dB.

All Applications (Modes) will show the current value of Peak to Average ratio on the softkey. However, some applications will not permit changing the value. In these situations the softkey will be grayed-out.

Key Path	AMPTD Y Scale, Range
Remote Command	<code>[:SENSe] :POWeR [:RF] :RANGe:PARatio <real></code> <code>[:SENSe] :POWeR [:RF] :RANGe:PARatio?</code>
Example	POW:RANG:PAR 12 dB
Notes	In some Applications (Modes) this parameter will be read-only; meaning the value will appear on the softkey and query via SCPI, but not changeable. In such applications the softkey will be grayed-out. Attempting to change the value via SCPI will be ignored and no error message will be generated.
Preset	10 dB
State Saved	Saved in instrument state
Min	0 dB
Max	20 dB
Initial S/W Revision	A.13.00

Mixer Level Offset

Mixer level offset is an advanced setting to adjust target Range at the input mixer which in turn affects the signal level in the instrument's IF. This setting can be used when additional optimization is needed after setting Peak to Average ratio. Positive values of offset optimize noise performance over distortion, negative values optimize distortion performance over noise.

Key Path	AMPTD Y Scale, Range
-----------------	----------------------

Remote Command	<code>[:SENSe] :POWer [:RF] :RANGe :MIXer :OFFSet <real></code> <code>[:SENSe] :POWer [:RF] :RANGe :MIXer :OFFSet ?</code>
Example	POW:RANG:MIX:OFFS -5 dB
Preset	0 dB
State Saved	Saved in instrument state
Min	-35 dB
Max	30 dB
Initial S/W Revision	A.13.00

Scale/Div

Sets the logarithmic units per vertical graticule division on the display. When the Auto Scaling is On, the Scale/Div is automatically determined by the measurement result. When you set a value manually, Auto Scaling is automatically toggled to Off.

Key Path	AMPTD Y Scale
Mode	SA, WCDMA, C2K, WIMAX OFDMA, TD-SCDMA, 1xEVDO, ISDB-T, CMMB, LTE, LTETDD, BLUETOOTH, WLAN, MSR
Remote Command	<code>:DISPlay:OBWidth:VIEW[1]:WINDow[1]:TRACe:Y[:SCALe]:PDIVision <rel_ampl></code> <code>:DISPlay:OBWidth:VIEW[1]:WINDow[1]:TRACe:Y[:SCALe]:PDIVision?</code>
Example	DISP:OBW:VIEW:WIND:TRAC:Y:PDIV 5 DISP:OBW:VIEW:WIND:TRAC:Y:PDIV?
Notes	You must be in the Spectrum Analysis mode, W-CDMA mode, cdma2000 mode, TD-SCDMA mode, ISDB-T mode, CMMB mode, LTE mode, LTE TDD mode, BLUETOOTH mode, WLAN mode, 1xEVDO mode, MSR or WIMAX OFDMA mode to use this command. Use :INSTRument:SElect to set the mode.
Couplings	When the Auto Scaling is On, this value is automatically determined by the measurement result. When you set a value manually, Auto Scaling automatically changes to Off.
Preset	10.00 dB
State Saved	Saved in instrument state.
Min	0.10 dB
Max	20.00 dB
Initial S/W Revision	Prior to A.02.00
Modified at S/W Revision	A.03.00

Ref Position

Positions the reference level at the top, center or bottom of the Y Scale display. Changing the reference position does not change the reference level value.

Key Path	AMPTD Y Scale
Mode	SA, WCDMA, C2K, WIMAX OFDMA, TD-SCDMA, 1xEVDO, ISDB-T, CMMB, LTE, LTETDD, BLUETOOTH, WLAN, MSR
Remote Command	:DISPlay:OBWidth:VIEW[1]:WINDow[1]:TRACe:Y[:SCALe]:RPOSition TOP CENTER BOTTom :DISPlay:OBWidth:VIEW[1]:WINDow[1]:TRACe:Y[:SCALe]:RPOSition?
Example	DISP:OBW:VIEW:WIND:TRAC:Y:RPOS BOTT DISP:OBW:VIEW:WIND:TRAC:Y:RPOS?
Notes	You must be in the Spectrum Analysis mode, W-CDMA mode, cdma2000 mode, TD-SCDMA mode, ISDB-T mode, CMMB mode, LTE mode, LTE TDD mode, BLUETOOTH mode, WLAN mode, 1xEVDO mode, MSR or WIMAX OFDMA mode to use this command. Use:INSTRument:SElect to set the mode.
Preset	TOP
State Saved	Saved in instrument state.
Range	Top Ctr Bot
Initial S/W Revision	Prior to A.02.00
Modified at S/W Revision	A.03.00

Auto Scaling

Allows you to toggle the Auto Scaling function between On and Off.

Key Path	AMPTD Y Scale
Mode	SA, WCDMA, C2K, WIMAX OFDMA, TD-SCDMA, 1xEVDO, ISDB-T, CMMB, LTE, LTETDD, BLUETOOTH, WLAN, MSR
Remote Command	:DISPlay:OBWidth:VIEW[1]:WINDow[1]:TRACe:Y[:SCALe]:COUPle 0 1 OFF ON :DISPlay:OBWidth:VIEW[1]:WINDow[1]:TRACe:Y[:SCALe]:COUPle?
Example	DISP:OBW:VIEW:WIND:TRAC:Y:COUP ON DISP:OBW:VIEW:WIND:TRAC:Y:COUP?
Couplings	When Auto Scaling is On, upon pressing the Restart front-panel key, this function automatically sets the scale per division to 10 dB and determines reference values based on the measurement results. When you set a value to either Scale/Div or Ref Value manually, Auto Scaling automatically changes to Off.
Preset	1
State Saved	Saved in instrument state.
Range	On Off
Initial S/W Revision	Prior to A.02.00
Modified at S/W Revision	A.03.00

Presel Center

When this key is pressed, the centering of the preselector filter is adjusted to optimize the amplitude accuracy at the frequency of the selected marker.

See Presel Center@3017 for more information.

Key Path	AMPTD/Y Scale
Initial S/W Revision	Prior to A.02.00

Presel Adjust

Allows you to manually adjust the preselector filter frequency to optimize its response to the signal of interest. This function is only available when Presel Center is available.

See Preselector Adjust@3020 for more information.

Key Path	AMPTD/Y Scale
Initial S/W Revision	Prior to A.02.00

Auto Couple

The Auto Couple feature provides a quick and convenient way to automatically couple multiple instrument settings. This helps ensure accurate measurements and optimum dynamic range. When the Auto Couple feature is activated, either from the front panel or remotely, all parameters of the current measurement that have an Auto/Manual mode are set to Auto mode and all measurement settings dependent on (or coupled to) the Auto/Man parameters are automatically adjusted for optimal performance.

However, the Auto Couple key actions are confined to the current measurement only. It does not affect other measurements in the mode, and it does not affect markers, marker functions, or trace or display attributes.

See "[More Information](#)" on page 658

Key Path	Front-panel key
Remote Command	:COUPle ALL NONE
Example	:COUP ALL
Notes	:COUPle ALL puts all Auto/Man parameters in Auto mode (equivalent to pressing the Auto Couple key). :COUPLE NONE puts all Auto/Man parameters in manual mode. It decouples all the coupled instrument parameters and is not recommended for making measurements.
Initial S/W Revision	Prior to A.02.00

More Information

There are two types of functions that have Auto/Manual modes.

Auto/Man Active Function keys

An Auto/Man toggle key controls the binary state associated with an instrument parameter by toggling between Auto (where the parameter is automatically coupled to the other parameters it is dependent upon) and Man (where the parameter is controlled independent of the other parameters), as well as making the parameter the active function. The current mode is indicated on the softkey with either Auto or Man underlined as illustrated below.



Auto/Man 1-of-N keys

An Auto/Man 1-of-N key allows you to manually pick from a list of parameter values, or place the function in Auto, in which case the value is automatically selected (and indicated) as shown below. If in Auto, Auto is underlined on the calling key. If in manual operation, manual is indicated on the calling key. But the calling key does not actually toggle the function, it simply opens the menu.

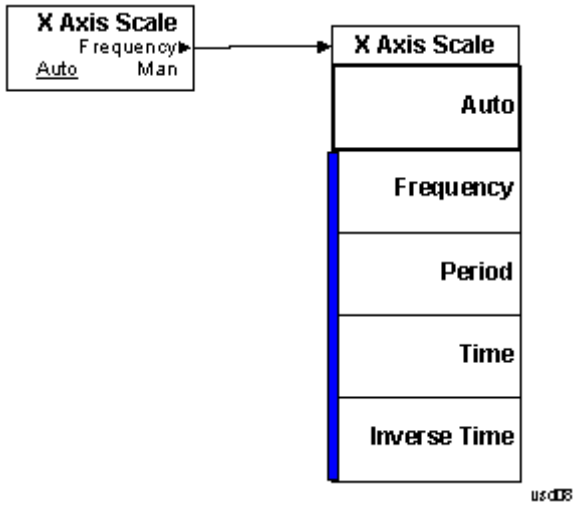

BW

Accesses a menu of functions that enable you to specify and control the video and resolution bandwidths. You can also select the type of filter for the measurement.

Key Path	Front-panel key
Initial S/W Revision	Prior to A.02.00

Res BW

Sets the resolution bandwidth for the current measurement. If an unavailable bandwidth is entered with the numeric keypad, the closest available bandwidth is selected.

Key Path	BW
Mode	SA, WCDMA, C2K, WIMAX OFDMA, TD-SCDMA, 1xEVDO, ISDB-T, CMMB, LTE, LTETDD, BLUETOOTH, WLAN, MSR
Remote Command	[:SENSe]:OBWidth:BANDwidth[:RESolution] <bandwidth> [:SENSe]:OBWidth:BANDwidth[:RESolution]? [:SENSe]:OBWidth:BANDwidth[:RESolution]:AUTO ON OFF 1 0 [:SENSe]:OBWidth:BANDwidth[:RESolution]:AUTO?
Example	OBW:BAND 250000 OBW:BAND? OBW:BAND:AUTO OFF OBW:BAND:AUTO?
Notes	You must be in the Spectrum Analysis mode, W-CDMA mode, cdma2000 mode, TD-SCDMA mode, ISDB-T mode, CMMB mode, LTE mode, LTE TDD mode, BLUETOOTH mode, WLAN mode, 1xEVDO mode, MSR or WIMAX OFDMA mode to use this command. Use:INSTRument:SElect to set the mode.
Couplings	Sweep time is coupled to RBW. As the RBW changes, the sweep time (if set to Auto) is changed to maintain amplitude calibration. Video bandwidth (VBW) is coupled to RBW. As the resolution bandwidth changes, the video bandwidth (if set to Auto) changes to maintain the ratio of VBW/RBW (10:1). When Res BW is set to Auto, the resolution bandwidth is auto-coupled to span. The ratio of Span/RBW is approximately 106:1 when auto coupled. When Res BW is set to Man, bandwidths are entered manually, and these bandwidths are used regardless of other analyzer settings.
Preset	SA: Auto WCDMA: 30 kHz CDMA2K: 12 kHz WIMAX OFDMA: 100 kHz TD-SCDMA: 30 kHz 1xEVDO: 30 kHz ISDB-T: 10 kHz

	CMMB: 3 kHz LTE: 30 kHz LTETDD: 30 kHz BLUETOOTH:10 kHz WLAN: 100kHz MSR: 30 kHz, SA: ON WCDMA, C2K, TD-SCDMA, WIMAX OFDMA, 1xEVDO , ISDB-T, CMMB, LTE, LTETDD, WLAN, MSR: OFF
State Saved	Saved in instrument state.
Min	1 Hz
Max	8 MHz
Backwards Compatibility SCPI	<code>[:SENSe] :OBwidth:BWIDth [:RESolution]</code>
Initial S/W Revision	Prior to A.02.00
Modified at S/W Revision	A.03.00

Video BW

Changes the analyzer post-detection filter.

Key Path	BW
Mode	SA, WCDMA, C2K, WIMAX OFDMA, TD-SCDMA, 1xEVDO, ISDB-T, CMMB, LTE, LTETDD, BLUETOOTH, WLAN, MSR
Remote Command	<code>[:SENSe] :OBwidth:Bandwidth:VIDeo <bandwidth></code> <code>[:SENSe] :OBwidth:Bandwidth:VIDeo?</code> <code>[:SENSe] :OBwidth:Bandwidth:VIDeo:AUTO ON OFF 1 0</code> <code>[:SENSe] :OBwidth:Bandwidth:VIDeo:AUTO?</code>
Example	<code>OBW:Band:VID 5 MHz</code> <code>OBW:Band:VID?</code> <code>OBW:Band:VID:AUTO ON</code> <code>OBW:Band:VID:AUTO?</code>
Notes	You must be in the Spectrum Analysis mode, W-CDMA mode, cdma2000 mode, TD-SCDMA mode, ISDB-T mode, CMMB mode, LTE mode, LTE TDD mode, BLUETOOTH mode, WLAN mode, 1xEVDO mode, MSR or WIMAX OFDMA mode to use this command. Use:INSTrument:SElect to set the mode.
Dependencies	When using the average detector with either Sweep Time set to Man, or in zero span, the VBW setting has no effect and is disabled (grayed out).
Couplings	Video bandwidth (VBW) is coupled to RBW. As the resolution bandwidth changes, the video bandwidth (if set to Auto) changes to maintain the ratio set by VBW/RBW. Sweep Time is coupled to Video Bandwidth (VBW). As the VBW is changed, the sweep time (when

set to Auto) is changed to maintain amplitude calibration. This occurs because of common hardware between the two circuits, even though the Video BW filter is not actually “in-circuit” when the detector is set to Average. Because the purpose of the average detector and the VBW filter are the same, either can be used to reduce the variance of the result.

Although the VBW filter is not “in-circuit” when using the average detector, the Video BW key can have an effect on (Auto) sweep time, and is not disabled. In this case, reducing the VBW setting increases the sweep time, which increases the averaging time, producing a lower-variance trace.

When the video bandwidth is AUTO coupled, the video bandwidth value is set to:

Resolution Bandwidth * Video Bandwidth to Resolution Bandwidth Ratio

Preset	SA, LTE, LTETDD, WLAN, MSR: Auto WCDMA: 300 kHz CDMA2K:120 kHz WIMAX OFDMA: 1 MHz TD-SCDMA: 300 kHz 1xEVDO: 300 kHz ISDB-T: 300 Hz CMMB: 3 kHz BLUETOOTH: 30 kHz ON ISDB-T, CMMB: OFF
State Saved	Saved in instrument state.
Min	1 Hz
Max	50 MHz
Backwards Compatibility SCPI	[:SENSe] :OBWidth:BWIDth:VIDeo
Initial S/W Revision	Prior to A.02.00
Modified at S/W Revision	A.03.00

Filter Type

Allows you to select the type of filter to be used for the current measurement. Besides the Gaussian filter shape, there are certain special filter types, such as Flat Top, that are desirable under certain conditions.

Key Path	BW
Mode	SA, WCDMA, C2K, WIMAX OFDMA, TD-SCDMA, 1xEVDO, ISDB-T, CMMB, LTE, LTETDD, BLUETOOTH, WLAN, MSR
Remote Command	[:SENSe] :OBWidth:BANDwidth:SHAPE GAUSSian FLATtop [:SENSe] :OBWidth:BANDwidth:SHAPE?
Example	OBW:BAND:SHAP GAUS OBW:BAND:SHAP?

Preset	GAUSSian
State Saved	Saved in instrument state.
Range	Gaussian Flattop
Backwards Compatibility SCPI	[:SENSe] :OBwidth :BWIDth :SHApe
Initial S/W Revision	Prior to A.02.00
Modified at S/W Revision	A.03.00

Cont (Continuous Measurement/Sweep)

Sets the analyzer for Continuous measurement operation. The single/continuous state is Meas Global so the setting will affect all measurements. If you are Paused, pressing Cont does a Resume.

Key Path	Front-panel key
Remote Command	:INITiate:CONTinuous OFF ON 0 1 :INITiate:CONTinuous?
Example	:INIT:CONT 0 puts analyzer in Single measurement operation. :INIT:CONT 1 puts analyzer in Continuous measurement operation
Preset	ON (Note that SYST:PRESet sets INIT:CONT to ON but *RST sets INIT:CONT to OFF)
State Saved	Saved in instrument state
Backwards Compatibility Notes	For Spectrum Analysis mode in ESA and PSA, there is no Cont hardkey, instead there is a Sweep Single/Cont key. In these analyzers, switching the Sweep Single/Cont key from Single to Cont restarts averages (displayed average count reset to 1), but does not restart Max Hold and Min Hold. The X-Series has Single and Cont keys in place of the SweepSingleCont key. In the X-Series, if in single measurement, the Cont key (and INIT:CONT ON) switches to continuous measurement, but never restarts a measurement and never resets a sweep.
Initial S/W Revision	Prior to A.02.00

In Swept SA Measurement (Spectrum Analysis Mode):

The analyzer takes repetitive sweeps, averages, measurements, etc., when in Continuous mode. When the average count reaches the Average/Hold Number the count stops incrementing, but the analyzer keeps sweeping. See the Trace/Detector section for the averaging formula used both before and after the Average/Hold Number is reached. The trigger condition must be met prior to each sweep. The type of trace processing for multiple sweeps, is set under the Trace/Detector key, with choices of Trace Average, Max Hold, or Min Hold.

In Other Measurements/Modes:

With Avg/Hold Num (in the Meas Setup menu) set to Off or set to On with a value of 1, a sweep is taken after the trigger condition is met; and the analyzer continues to take new sweeps after the current sweep has completed and the trigger condition is again met. However, with Avg/Hold Num set to On with a value >1, multiple sweeps (data acquisitions) are taken for the measurement. The trigger condition must be met prior to each sweep. The sweep is not stopped when the average count k equals the number N set for Avg/Hold Num is reached, but the number k stops incrementing. A measurement average usually applies to all traces, marker results, and numeric results. But sometimes it only applies to the numeric results.

If the analyzer is in Single measurement, pressing the Cont key does not change k and does not cause the sweep to be reset; the only action is to put the analyzer into Continuous measurement operation.

If it is already in continuous sweep:

the INIT:CONT 1 command has no effect

the INIT:CONT 0 command will place the analyzer in Single Sweep but will have no effect on the current sequence until $k = N$, at which point the current sequence will stop and the instrument will go to the idle state.

9 Occupied Bandwidth Measurement
File

File

See "File" on page 266

FREQ Channel

Accesses a menu of keys that allow you to control the Frequency and Channel parameters of the instrument.

Some features in the Frequency menu are the same for all measurements - they do not change as you change measurements. Settings like these are called "Meas Global" and are unaffected by Meas Preset. For example, the Center Freq setting is the same for all measurements - it does not change as you change measurements.

Key Path	Front Panel Key
Mode	LTETDD, LTEAFDD
Initial S/W Revision	A.14.00

Carrier Ref Freq

Sets carrier reference frequency. The center frequencies of carriers are defined as offset frequency from this value.

If the following conditions are satisfied at the same time:

- the Number of Component Carrier equals to 1
- the Center Freq Offset equals to 0 Hz
- the mode of the Center Freq is Auto

the Center Freq is equivalent to Carrier Ref Freq.

When the Center Freq changes in such conditions, the mode of the Center Freq keeps as Auto and the Carrier Ref Freq will be changed to same value. The major purpose of this coupling is to keep BWCC with legacy LTE/LTE TDD, in which :SENSe:FREQUency:CENTer is used to set up the Frequency of the measurement.

Key Path	FREQ Channel Mode Setup, Component Carrier Setup
Mode	LTEATDD, LTEAFDD
Measurement	All
Remote Command	<code>[:SENSe] :CCARrier:REFeRence <freq></code> <code>[:SENSe] :CCARrier:REFeRence?</code>
Example	CCAR:REF 2GHz CCAR:REF?
Notes	In order to easily configure component carriers, the key is also placed in the Mode Setup.
Preset	1GHz
State Saved	Saved in instrument state
Min	Depends on instrument minimum center frequency. Same as Center Freq
Max	Depends on instrument maximum center frequency. Same as Center Freq

9 Occupied Bandwidth Measurement
FREQ Channel

Initial S/W Revision	A.14.00
Modified at S/W Revision	A.14.50

Input/Output

See ["Input/Output" on page 182](#)

Marker

Accesses a menu that enables you to select, set up and control the markers for the current measurement.

Key Path	Front-panel key
Initial S/W Revision	Prior to A.02.00

Select Marker

Displays the menu keys that enable you to select, set up and control the markers for the current measurement

Key Path	Marker
Initial S/W Revision	Prior to A.02.00

Select Marker

Displays 12 markers available for selection.

Key Path	Marker, Properties
Initial S/W Revision	Prior to A.02.00

Marker Type

Sets the marker control mode to Normal, Delta or Off, If the selected marker is Off, pressing Marker sets it to Normal and places a single marker at the center of the display. At the same time, Marker X Axis Value appears on the Active Function area.

Key Path	Marker
Mode	SA, WCDMA, C2K, WIMAX OFDMA, TD-SCDMA, 1xEVDO, ISDB-T, CMMB, LTE, LTETDD, BLUETOOTH, WLAN, MSR
Remote Command	:CALCulate:OBWidth:MARKer[1] 2 ... 12:MODE POSition DELTa OFF :CALCulate:OBWidth:MARKer[1] 2 ... 12:MODE?
Example	CALC:OBW:MARK:MODE POS CALC:OBW:MARK:MODE?
Notes	If the selected marker is Off, pressing Marker sets it to Normal and places it at the center of the screen on the trace determined by the Marker Trace rules. At the same time, Marker X Axis Value appears on the Active Function area. Default Active Function: the active function for the selected marker's current control mode. If the current control mode is Off, there is no active function and the active function is turned off. Active Function Display: the marker X axis value entered in the active function area displays the marker value to its full entered precision.

Preset	OFF
State Saved	Saved in instrument state.
Range	Normal Delta Off
Initial S/W Revision	Prior to A.02.00
Modified at S/W Revision	A.03.00

Properties

Accesses the marker properties menu.

Key Path	Marker
Initial S/W Revision	Prior to A.02.00

Select Marker

Displays the menu keys that enable you to select, set up and control the markers for the current measurement

Key Path	Marker
Initial S/W Revision	Prior to A.02.00

Select Marker

Displays 12 markers available for selection.

Key Path	Marker, Properties
Initial S/W Revision	Prior to A.02.00

Relative To

Selects the desired marker. The selected marker will be relative to its reference marker.

Key Path	Marker, Properties
Mode	SA, WCDMA, C2K, WIMAX OFDMA, TD-SCDMA, 1xEVDO, ISDB-T, CMMB, LTE, LTETDD, BLUETOOTH, WLAN, MSR
Remote Command	:CALCulate:OBWidth:MARKer[1] 2 ... 12:REFerence <integer> :CALCulate:OBWidth:MARKer[1] 2 ... 12:REFerence?
Example	CALC:OBW:MARK:REF 2

	CALC:OBW:MARK:REF?
Notes	A marker cannot be relative to itself so that choice is grayed out, and if sent from SCPI generates error -221: "Settings conflict; marker cannot be relative to itself." When queried a single value is returned (the specified marker numbers relative marker). You must be in the Spectrum Analysis mode, WCDMA mode, TD-SCDMA mode, 1xEVDO mode, WIMAX OFDMA mode ISDB-T mode, WLAN mode, CMMB mode, LTE mode, LTETDD mode or BLUETOOTH mode to use this command. Use:INSTrument:SElect to set the mode.
Preset	2 3 4 5 6 7 8 9 10 11 12 1
State Saved	Saved in instrument state.
Min	1
Max	12
Readback	Current selected relative to marker number.
Initial S/W Revision	Prior to A.02.00
Modified at S/W Revision	A.03.00

All Markers Off

Turns off all markers.

Key Path	Marker
Mode	SA, WCDMA, C2K, WIMAX OFDMA, TD-SCDMA, 1xEVDO, ISDB-T, CMMB, LTE, LTETDD, BLUETOOTH, WLAN, MSR
Remote Command	:CALCulate:OBWidth:MARKer:AOff
Example	CALC:OBW:MARK:AOff
Initial S/W Revision	Prior to A.02.00
Modified at S/W Revision	A.03.00

Marker X Axis Value (Remote Command Only)

Sets the marker X Axis value in the current marker X Axis Scale unit. It has no effect if the control mode is Off.

Key Path	SCPI only
Mode	SA, WCDMA, C2K, WIMAX OFDMA, TD-SCDMA, 1xEVDO, ISDB-T, CMMB, LTE, LTETDD, BLUETOOTH, WLAN, MSR
Remote Command	:CALCulate:OBWidth:MARKer[1] 2 ... 12:X <freq> :CALCulate:OBWidth:MARKer[1] 2 ... 12:X?
Example	CALC:OBW:MARK3:X 0 CALC:OBW:MARK3:X?
Notes	The query returns the marker's absolute X Axis value if the control mode is Normal, or the offset from

	the marker's reference marker if the control mode is Delta. The query is returned in the fundamental units for the current marker X Axis scale: Hz for Frequency.
Preset	After a preset, all markers are turned OFF, so Marker X Axis Value query returns a not a number (NAN).
State Saved	No
Min	-9.9E+37
Max	9.9E+37
Initial S/W Revision	Prior to A.02.00
Modified at S/W Revision	A.03.00

Marker X Axis Position (Remote Command Only)

Sets the marker X position in trace points. It has no effect if the control mode is Off.

Key Path	SCPI only
Mode	SA, WCDMA, C2K, WIMAX OFDMA, TD-SCDMA, 1xEVDO, ISDB-T, CMMB, LTE, LTETDD, BLUETOOTH, WLAN, MSR
Remote Command	:CALCulate:OBWidth:MARKer[1] 2 ... 12:X:POSition <real> :CALCulate:OBWidth:MARKer[1] 2 ... 12:X:POSition?
Example	CALC:OBW:MARK10:X:POS 0 CALC:OBW:MARK10:X:POS?
Notes	The query returns the marker's absolute X Axis value in trace points if the control mode is Normal, or the offset from the marker's reference marker in trace points if the control mode is Delta.
Preset	After a preset, all markers are turned OFF, so Marker X Axis Value query returns a not a number (NAN).
State Saved	No
Min	-9.9E+37
Max	9.9E+37
Initial S/W Revision	Prior to A.02.00
Modified at S/W Revision	A.03.00

Marker Y Axis Value (Remote Command Only)

Returns the marker Y Axis value in the current marker Y Axis unit.

Key Path	SCPI only
Mode	SA, WCDMA, C2K, WIMAX OFDMA, TD-SCDMA, 1xEVDO, ISDB-T, CMMB, LTE, LTETDD, BLUETOOTH, WLAN, MSR
Remote Command	:CALCulate:OBWidth:MARKer[1] 2 ... 12:Y?

Example	CALC:OBW:MARK11:Y?
Preset	Result dependent on Markers setup and signal source.
State Saved	No
Min	-9.9E+37
Max	9.9E+37
Initial S/W Revision	Prior to A.02.00
Modified at S/W Revision	A.03.00

Backward Compatibility SCPI Commands

Sets or queries the state of a marker. Setting a marker which is OFF to state ON or 1 puts it in Normal mode and places it at the center of the screen.

Key Path	SCPI only
Mode	SA, WCDMA, C2K, WIMAX OFDMA, TD-SCDMA, 1xEVDO, ISDB-T, CMMB, LTE, LTETDD, BLUETOOTH, WLAN, MSR
Remote Command	:CALCulate:OBWidth:MARKer[1] 2 ... 12:STATe OFF ON 0 1 :CALCulate:OBWidth:MARKer[1] 2 ... 12:STATe?
Example	CALC:OBW:MARK3:STAT ON CALC:OBW:MARK3:STAT?
Preset	OFF
State Saved	Saved in instrument state.
Initial S/W Revision	Prior to A.02.00
Modified at S/W Revision	A.03.00

Marker Function

There are no 'Marker Functions' supported in this measurement. When pressed, this key displays a blank menu.

Key Path	Front panel key
Initial S/W Revision	Prior to A.02.00

Marker To

There is no 'Marker To' functionality supported in this measurement. When pressed, this key displays a blank menu.

Key Path	Front panel key
Initial S/W Revision	Prior to A.02.00

Meas

The information in this section is common to all measurements. For key and remote command information for a specific measurement, refer to the section that describes the measurement of interest.

Measurements available under the Meas key are specific to the current Mode.

When viewing Help for measurements, note the following:

NOTE

Operation for some keys differs between measurements. The information displayed in Help pertains to the current measurement. To see how a key operates in a different measurement, exit Help (press the Cancel Esc key), select the measurement, then reenter Help (press the Help key) and press that key.

Key Path	Front-panel key
Initial S/W Revision	Prior to A.02.00

Remote Measurement Functions

This section contains the following topics:

"Measurement Group of Commands" on page 2356

"Current Measurement Query (Remote Command Only)" on page 2358

"Limit Test Current Results (Remote Command Only)" on page 2358

"Data Query (Remote Command Only)" on page 2358

"Calculate/Compress Trace Data Query (Remote Command Only)" on page 2359

"Calculate Peaks of Trace Data (Remote Command Only)" on page 2364

"Hardware-Accelerated Fast Power Measurement (Remote Command Only)" on page 2365

"Format Data: Numeric Data (Remote Command Only)" on page 2379

"Format Data: Byte Order (Remote Command Only)" on page 2380

Initial S/W Revision	Prior to A.02.00
----------------------	------------------

Measurement Group of Commands

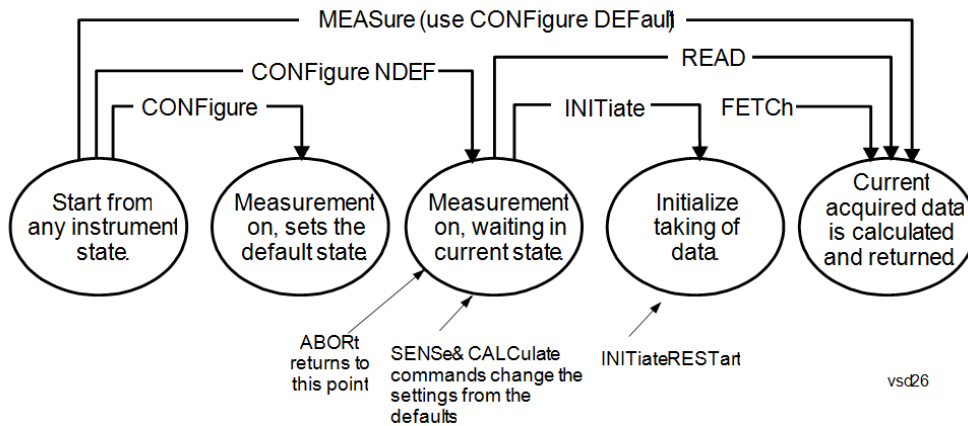

Measure Commands:

:MEASure:<measurement>[n]?

This is a fast single-command way to make a measurement using the factory default instrument settings. These are the settings and units that conform to the Mode Setup settings (e.g. radio standard) that you have currently selected.

- Stops the current measurement (if any) and sets up the instrument for the specified measurement using the factory defaults
- Initiates the data acquisition for the measurement
- Blocks other SCPI communication, waiting until the measurement is complete before returning results.
- If the function does averaging, it is turned on and the number of averages is set to 10.
- After the data is valid it returns the scalar results, or the trace data, for the specified measurement. The type of data returned may be defined by an [n] value that is sent with the command.
- The scalar measurement results will be returned if the optional [n] value is not included, or is set to 1. If the [n] value is set to a value other than 1, the selected trace data results will be returned. See each command for details of what types of scalar results or trace data results are available.
- ASCII is the default format for the data output. (Older versions of Spectrum Analysis and Phase Noise mode measurements only use ASCII.) The binary data formats should be used for handling large blocks of data since they are smaller and faster than the ASCII format. Refer to the FORMat:DATA command for more information.

If you need to change some of the measurement parameters from the factory default settings you can set up the measurement with the CONFigure command. Use the commands in the SENSe:<measurement> and CALCulate:<measurement> subsystems to change the settings. Then you can use the READ? command to initiate the measurement and query the results.

If you need to repeatedly make a given measurement with settings other than the factory defaults, you can use the commands in the SENSe:<measurement> and CALCulate:<measurement> subsystems to set up the measurement. Then use the READ? command to initiate the measurement and query results.

Measurement settings persist if you initiate a different measurement and then return to a previous one. Use READ:<measurement>? if you want to use those persistent settings. If you want to go back to the default settings, use MEASure:<measurement>?.

Configure Commands:

:CONFigure:<measurement>

This command stops the current measurement (if any) and sets up the instrument for the specified measurement using

the factory default instrument settings. It does not initiate the taking of measurement data unless INIT:CONTinuous is ON. If you change any measurement settings after using the CONFigure command, the READ command can be used to initiate a measurement without changing the settings back to their defaults.

In the Swept SA measurement in Spectrum Analyzer mode the CONFigure command also turns the averaging function on and sets the number of averages to 10 for all measurements.

:CONFigure: <measurement>: NDEFault stops the current measurement and changes to the specified measurement. It does not change the settings to the defaults. It does not initiate the taking of measurement data unless INIT:CONTinuous is ON.

The CONFigure? query returns the current measurement name.

The CONFigure:CATalog? query returns a quoted string of all licensed measurement names in the current mode. For example, "SAN, CHP, OBW, ACP, PST, TXP, SPUR, SEM, LIST".

Fetch Commands:

:FETCh:<measurement>[n]?

This command puts selected data from the most recent measurement into the output buffer. Use FETCh if you have already made a good measurement and you want to return several types of data (different [n] values, for example, both scalars and trace data) from a single measurement. FETCh saves you the time of re-making the measurement. You can only FETCh results from the measurement that is currently active, it will not change to a different measurement. An error message is reported if a measurement other than the current one is specified.

If you need to get new measurement data, use the READ command, which is equivalent to an INITiate followed by a FETCh.

The scalar measurement results will be returned if the optional [n] value is not included, or is set to 1. If the [n] value is set to a value other than 1, the selected trace data results will be returned. See each command for details of what types of scalar results or trace data results are available. The binary data formats should be used for handling large blocks of data since they are smaller and transfer faster than the ASCII format. (FORMat:DATA)

FETCh may be used to return results other than those specified with the original READ or MEASure command that you sent.

INITiate Commands:

:INITiate:<measurement>

This command is not available for measurements in all the instrument modes:

- Initiates a trigger cycle for the specified measurement, but does not output any data. You must then use the FETCh<meas> command to return data. If a measurement other than the current one is specified, the instrument will switch to that measurement and then initiate it.
- For example, suppose you have previously initiated the ACP measurement, but now you are running the channel power measurement. If you send INIT:ACP? it will change from channel power to ACP and will initiate an ACP measurement.
- Does not change any of the measurement settings. For example, if you have previously started the ACP measurement and you send INIT:ACP? it will initiate a new ACP measurement using the same instrument settings as the last time ACP was run.
- If your selected measurement is currently active (in the idle state) it triggers the measurement, assuming the trigger conditions are met. Then it completes one trigger cycle. Depending upon the measurement and the number of averages, there may be multiple data acquisitions, with multiple trigger events, for one full trigger cycle. It also holds off additional commands on GPIB until the acquisition is complete.

READ Commands:

:READ:<measurement>[n]?

- Does not preset the measurement to the factory default settings. For example, if you have previously initiated the ACP
-

measurement and you send READ:ACP? it will initiate a new measurement using the same instrument settings.

- Initiates the measurement and puts valid data into the output buffer. If a measurement other than the current one is specified, the instrument will switch to that measurement before it initiates the measurement and returns results.
 - For example, suppose you have previously initiated the ACP measurement, but now you are running the channel power measurement. Then you send READ:ACP? It will change from channel power back to ACP and, using the previous ACP settings, will initiate the measurement and return results.
 - Blocks other SCPI communication, waiting until the measurement is complete before returning the results
 - If the optional [n] value is not included, or is set to 1, the scalar measurement results will be returned. If the [n] value is set to a value other than 1, the selected trace data results will be returned. See each command for details of what types of scalar results or trace data results are available. The binary data formats should be used when handling large blocks of data since they are smaller and faster than the ASCII format. (FORMat:DATA)
-

Initial S/W Revision	Prior to A.02.00
----------------------	------------------

Current Measurement Query (Remote Command Only)

This command returns the name of the measurement that is currently running.

Remote Command	:CONFigure?
-----------------------	-------------

Example	CONF?
----------------	-------

Initial S/W Revision	Prior to A.02.00
----------------------	------------------

Limit Test Current Results (Remote Command Only)

Queries the status of the current measurement limit testing. It returns a 0 if the measured results pass when compared with the current limits. It returns a 1 if the measured results fail any limit tests.

Remote Command	:CALCulate:CLIMits:FAIL?
-----------------------	--------------------------

Example	CALC:CLIM:FAIL? queries the current measurement to see if it fails the defined limits. Returns a 0 or 1: 0 it passes, 1 it fails.
----------------	--

Initial S/W Revision	Prior to A.02.00
----------------------	------------------

Data Query (Remote Command Only)

Returns the designated measurement data for the currently selected measurement and subopcode.

n = any valid subopcode for the current measurement. See the measurement command results table for your current measurement, for information about what data is returned for the subopcodes.

This command uses the data setting specified by the FORMat:BORDER and FORMat:DATA commands and can return real or ASCII data. (See the format command descriptions under Input/Output in the Analyzer Setup section.)

Remote Command	:CALCulate:DATA[n]?
Notes	The return trace depends on the measurement. In CALCulate:<meas>:DATA[n], n is any valid subopcode for the current measurement. It returns the same data as the FETCH:<measurement>? query where <measurement> is the current measurement.
Initial S/W Revision	Prior to A.02.00

Calculate/Compress Trace Data Query (Remote Command Only)

Returns compressed data for the currently selected measurement and sub-opcode [n].

n = any valid sub-opcode for that measurement. See the MEASure:<measurement>? command description of your specific measurement for information on the data that can be returned.

The data is returned in the current Y Axis Unit of the analyzer. The command is used with a sub-opcode <n> (default=1) to specify the trace. With trace queries, it is best if the analyzer is not sweeping during the query. Therefore, it is generally advisable to be in Single Sweep, or Update=Off.

This command is used to compress or decimate a long trace to extract and return only the desired data. A typical example would be to acquire N frames of GSM data and return the mean power of the first burst in each frame. The command can also be used to identify the best curve fit for the data.

Remote Command	:CALCulate:DATA<n>:COMPRESS? BLOCK CFIT MAXimum MINimum MEAN DMEan RMS RMSCubed SAMPLE SDEVIation PPHase [,<soffset> [,<length>[,<roffset>[,<rlimit>]]]]
Example	To query the mean power of a set of GSM bursts: Supply a signal that is a set of GSM bursts. Select the IQ Waveform measurement (in IQ Analyzer Mode). Set the sweep time to acquire at least one burst. Set the triggers such that acquisition happens at a known position relative to a burst. Then query the mean burst levels using, CALC:DATA2:COMP? MEAN, 24e-6, 526e-6 (These parameter values correspond to GSM signals, where 526e-6 is the length of the burst in the slot and you just want 1 burst.)
Notes	The command supports 5 parameters. Note that the last 4 (<soffset>, <length>, <roffset>, <rlimit>) are optional. But these optional parameters must be entered in the specified order. For example, if you want to specify <length>, then you must also specify <soffset>. See details below for a definition of each of these parameters. This command uses the data in the format specified by FORMat:DATA, returning either binary or ASCII data.
Initial S/W Revision	Prior to A.02.00

- BLOCK or block data - returns all the data points from the region of the trace data that you specify. For example, it could be used to return the data points of an input signal over several timeslots, excluding the portions of the trace data that you do not want. (This is x,y pairs for trace data and I,Q pairs for complex data.)

- CFIT or curve fit - applies curve fitting routines to the data. <soffset> and <length> are required to define the data that you want. <roffset> is an optional parameter for the desired order of the curve equation. The query will return the following values: the x-offset (in seconds) and the curve coefficients ((order + 1) values).

MIN, MAX, MEAN, DME, RMS, RMSC, SAMP, SDEV and PPH return one data value for each specified region (or <length>) of trace data, for as many regions as possible until you run out of trace data (using <roffset> to specify regions). Or they return the number of regions you specify (using <rlimit>) ignoring any data beyond that.

- MINimum - returns the minimum data point (y value) for the specified region(s) of trace data. For I/Q trace data, the minimum magnitude of the I/Q pairs is returned.
- MAXimum - returns the maximum data point (y value) for the specified region(s) of trace data. For I/Q trace data, the maximum magnitude of the I/Q pairs is returned.
- MEAN - returns a single value that is the arithmetic mean of the data point values (in dB/ dBm) for the specified region(s) of trace data. For I/Q trace data, the mean of the magnitudes of the I/Q pairs is returned. See the following equations.

NOTE If the original trace data is in dB, this function returns the arithmetic mean of those log values, not log of the mean power which is a more useful value. The mean of the log is the better measurement technique when measuring CW signals in the presence of noise. The mean of the power, expressed in dB, is useful in power measurements such as Channel Power. To achieve the mean of the power, use the RMS option.

Equation 1

Mean Value of Data Points for Specified Region(s)

$$\text{MEAN} = \frac{1}{n} \sum_{X_i \in \text{region}(s)} X_i$$

where X_i is a data point value, and n is the number of data points in the specified region(s).

Equation 2

Mean Value of I/Q Data Pairs for Specified Region(s)

$$\text{MEAN} = \frac{1}{n} \sum_{X_i \in \text{region}(s)} |X_i|$$

where $|X_i|$ is the magnitude of an I/Q pair, and n is the number of I/Q pairs in the specified region(s).

- DMEan - returns a single value that is the mean power (in dB/ dBm) of the data point values for the specified region(s) of trace data. See the following equation:

Equation 3

DMEan Value of Data Points for Specified Region(s)

$$\text{DME} = 10 \times \log_{10} \left(\frac{1}{n} \sum_{X_i \in \text{region}(s)} 10^{\frac{X_i}{10}} \right)$$

- RMS - returns a single value that is the average power on a root-mean-squared voltage scale (arithmetic rms) of the data point values for the specified region(s) of trace data. See the following equation.

NOTE For I/Q trace data, the rms of the magnitudes of the I/Q pairs is returned. See the following equation. This function is very useful for I/Q trace data. However, if the original trace data is in dB, this function returns the rms of the log values which is not usually needed.

Equation 4

RMS Value of Data Points for Specified Region(s)

$$\text{RMS} = \sqrt{\frac{1}{n} \sum_{X_i \in \text{region}(s)} X_i^2}$$

where X_i is a data point value, and n is the number of data points in the specified region(s).

Equation 5

RMS Value of I/Q Data Pairs for Specified Region(s)

$$\text{RMS} = \sqrt{\frac{1}{n} \sum_{X_i \in \text{region}(s)} X_i X_i^*}$$

where X_i is the complex value representation of an I/Q pair, X_i^* its conjugate complex number, and n is the number of I/Q pairs in the specified region(s).

Once you have the rms value for a region of trace data (linear or I/Q), you may want to calculate the mean power. You must convert this rms value (peak volts) to power in dBm:

$$10 \times \log[10 \times (\text{rms value})^2]$$

- SAMPLe - returns the first data value (x,y pair) for the specified region(s) of trace data. For I/Q trace data, the first I/Q pair is returned.
- SDEViation - returns a single value that is the arithmetic standard deviation for the data point values for the specified region(s) of trace data. See the following equation.
- For I/Q trace data, the standard deviation of the magnitudes of the I/Q pairs is returned. See the following equation.

Equation 6

Standard Deviation of Data Point Values for Specified Region(s)

$$\text{SDEV} = \sqrt{\frac{1}{n} \sum_{X_i \in \text{region}(s)} (X_i - \bar{X})^2}$$

where X_i is a data point value, \bar{X} is the arithmetic mean of the data point values for the specified region (s), and n is the number of data points in the specified region(s).

$$\text{SDEV} = \sqrt{\frac{1}{n} \sum_{X_i \in \text{region}(s)} (|X_i| - \bar{X})^2}$$

where $|X_i|$ is the magnitude of an I/Q pair, \bar{X} is the mean of the magnitudes for the specified region(s), and n is the number of data points in the specified region(s).

- PPHase - returns the x,y pairs of both rms power (dBm) and arithmetic mean phase (radian) for every specified region and frequency offset (Hz). The number of pairs is defined by the specified number of regions. This parameter can be used for I/Q vector ($n=0$) in Waveform (time domain) measurement and all parameters are specified by data point in PPHase.

The rms power of the specified region may be expressed as:

$$\text{Power} = 10 \times \log [10 \times (\text{RMS I/Q value})] + 10.$$

The RMS I/Q value (peak volts) is:

$$\sqrt{\frac{1}{n} \sum_{X_i \in \text{region}} X_i X_i^*}$$

where X_i is the complex value representation of an I/Q pair, X_i^* its conjugate complex number, and n is the number of I/Q pairs in the specified region.

The arithmetic mean phase of the specified region may be expressed as:

$$\frac{1}{n} \sum_{Y_i \in \text{region}} Y_i$$

where Y_i is the unwrapped phase of I/Q pair with applying frequency correction and n is the number of I/Q pairs in the specified region.

The frequency correction is made by the frequency offset calculated by the arithmetic mean of every specified region's frequency offset. Each frequency offset is calculated by the least square method against the unwrapped phase of I/Q pair.

Sample Trace Data - Constant Envelope

(See below for explanation of variables.)

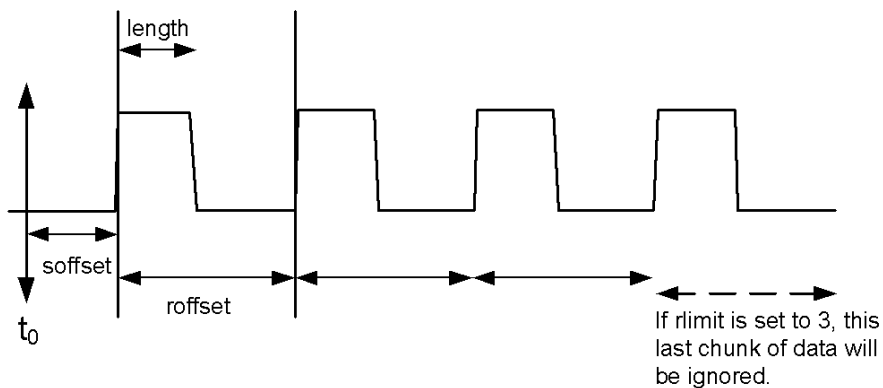

Sample Trace Data - Not Constant Envelope

(See below for explanation of variables.)

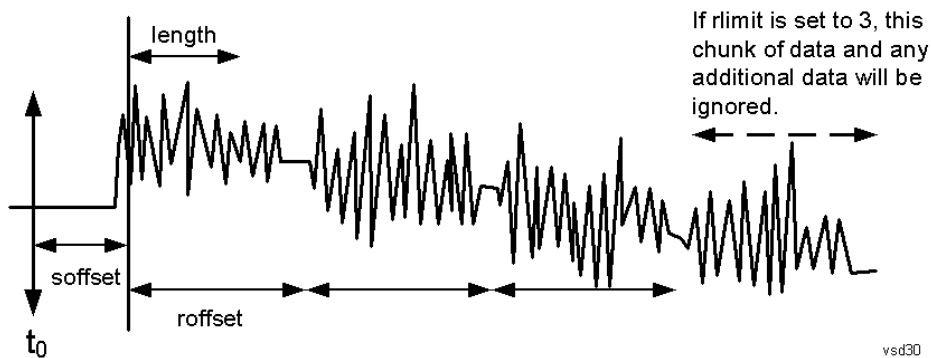

<soffset> - start offset is an optional real number. (It is in seconds for time-domain traces, and is a dimensionless index 0 to $N_{\text{points}} - 1$, for frequency-domain traces). It specifies the amount of data at the beginning of the trace that will be ignored before the decimation process starts. It is the time or frequency change from the start of the trace to the point where you want to start using the data. The default value is zero.

<length> - is an optional real number. (It is in seconds for time-domain traces, and is a dimensionless index 0 to $N_{\text{points}} - 1$, for frequency-domain traces). It defines how much data will be compressed into one value. This parameter has a default value equal to the current trace length.

<roffset> - repeat offset is an optional real number. (It is in seconds for time-domain traces, and is a dimensionless index 0 to $N_{\text{points}} - 1$, for frequency-domain traces). It defines the beginning of the next field of trace elements to be compressed. This is relative to the beginning of the previous field. This parameter has a default value equal to the <length> variable. Note that this parameter is used for a completely different purpose when curve fitting (see CFIT above).

<rlimit> - repeat limit is an optional integer. It specifies the number of data items that you want returned. It will ignore any additional items beyond that number. You can use the Start offset and the Repeat limit to pick out exactly what part of the data you want to use. The default value is all the data.

Calculate Peaks of Trace Data (Remote Command Only)

Returns a list of all the peaks for the currently selected measurement and sub-opcode [n]. The peaks must meet the requirements of the peak threshold and excursion values.

n = any valid sub-opcode for the current measurement. See the MEASure:<measurement> command description of your specific measurement for information on the data that can be returned.

The command can only be used with specific sub-opcodes with measurement results that are trace data. Both real and complex traces can be searched, but complex traces are converted to magnitude in dBm. In many measurements the sub-opcode n=0, is the raw trace data which cannot be searched for peaks. And Sub-opcode n=1, is often calculated results values which also cannot be searched for peaks.

This command uses the data setting specified by the FORMat:BORDER and FORMat:DATA commands and can return real or ASCII data. If the format is set to INT,32, it returns REAL,32 data.

The command has four types of parameters:

- Threshold (in dBm)
- Excursion (in dB)
- Sorting order (amplitude, frequency, time)
- Optional in some measurements: Display line use (all, > display line, < display line)

Remote Command	<p>For Swept SA measurement:</p> <pre>:CALCulate:DATA[1] 2 ... 6:PEAKs? <threshold>,<excursion>[,AMPLitude FREQuency TIME[,ALL GTDLine LTDLine]]</pre> <p>For most other measurements:</p> <pre>:CALCulate:DATA[1] 2 ... 6:PEAKs? <threshold>,<excursion>[,AMPLitude FREQuency TIME]</pre>
-----------------------	--

Example	<p>Example for Swept SA measurement in Spectrum Analyzer Mode:</p> <p>CALC:DATA4:PEAK? -40, 10, FREQ, GTDL This will identify the peaks of trace 4 that are above -40 dBm, with excursions of at least 10 dB. The peaks are returned in order of increasing frequency, starting with the lowest frequency. Only the peaks that are above the display line are returned.</p> <p>Query Results 1:</p> <p>With FORMat:DATA REAL, 32 selected, it returns a list of floating-point numbers. The first value in the list is the number of peak points that are in the following list. A peak point consists of two values: a peak amplitude followed by its corresponding frequency (or time).</p> <p>If no peaks are found the peak list will consist of only the number of peaks, (0).</p>
----------------	---

Notes	<p><n> - is the trace that will be used</p> <p><threshold> - is the level below which trace data peaks are ignored. Note that the threshold value is required and is always used as a peak criterion. To effectively disable the threshold criterion for this command, provide a substantially low threshold value such as -200 dBm. Also note that the threshold value used in this command is independent of and has no effect on the threshold value stored under the Peak Criteria menu.</p> <p><excursion> - is the minimum amplitude variation (rise and fall) required for a signal to be identified as peak. Note that the excursion value is required and is always used as a peak criterion. To effectively disable the excursion criterion for this command, provide the minimum value of 0.0 dB. Also note that the excursion value used in this command is independent of and has no effect on the</p>
--------------	---

excursion value stored under the Peak Criteria menu.

Values must be provided for threshold and excursion. The sorting and display line parameters are optional (defaults are AMPLitude and ALL).

Note that there is always a Y-axis value for the display line, regardless of whether the display line state is on or off. It is the current Y-axis value of the display line which is used by this command to determine whether a peak should be reported

Sorting order:

AMPLitude - lists the peaks in order of descending amplitude, with the highest peak first (default if optional parameter not sent)

FREQUency - lists the peaks in order of occurrence, left to right across the x-axis.

TIME - lists the peaks in order of occurrence, left to right across the x-axis.

Peaks vs. Display Line:

ALL - lists all of the peaks found (default if optional parameter not sent).

GTDLine (greater than display line) - lists all of the peaks found above the display line.

LTDLine (less than display line) - lists all of the peaks found below the display line.

Initial S/W Revision	Prior to A.02.00
----------------------	------------------

Hardware-Accelerated Fast Power Measurement (Remote Command Only)

The Fast Power option (FP2) enables very fast channel power measurements for instruments with the prerequisite hardware (DP2 and/or B40). It accomplishes this by performing real-time overlapped FFTs at the hardware layer, using software for basic post-processing before returning the result to the user. The upshot of this approach is improved throughput for user applications that require many sequential power measurements.

The analysis bandwidth of FP2 is limited by the licenses in the instrument, but its maximum overall analysis bandwidth per acquisition is 40 MHz.

FP2 is remote-only, which means the instrument does not switch to any particular mode or measurement. FP2 commands can be sent while another application is in use on the front panel.

Each Fast Power measurement can be predefined using an array index, and up to 1,000 measurements can be stored. In the following documentation, instances of [1,2,...,999] can be substituted with a particular measurement index, e.g. CALC:FPOW:POW1?, CALC:FPOW:POW2?, CALC:FPOW:POW134?. In this way, power measurements can be defined one time in a batch, and then executed multiple times without having to redefine them, similar to “list mode” on other measurements.

In addition to basic channel power measurements, there are a number of other measurement “functions” for each channel, including peak power, peak frequency, and power spectral density. See the Function parameter for more information.

Reset Fast Power Measurement (Remote Command Only)

Resets the measurement configuration to the defaults.

Mode	All
Remote Command	:CALCulate:FPOWer:POWer[1,2,...,999]:RESet
Example	:CALC:FPOW:POW1:RES

Notes	Option FP2 is required.
Initial S/W Revision	A.14.00

Define Fast Power Measurement (Remote Command Only)

Fast Power acquisitions are configured using the DEFine command. This command accepts a comma-delimited string of configuration parameters and their appropriate values, which are all specified in the subsection below.

Mode	All
Remote Command	:CALCulate:FPOWER:POWer[1,2,...,999]:DEFine "configuration string"
Example	:CALC:FPOW:POW1:DEF "CenterFrequency=2e9, AcquisitionTime=0.005"
Notes	See below for a list of measurement variables that can be defined in the configuration string.
Initial S/W Revision	A.14.00

Acquisition Time

Example	CALC:FPOW:POW1:DEF "AcquisitionTime=0.002"
Notes	The acquisition time parameter sets the time in which the entire spectrum is measured. An increase in the acquisition time yields an improvement in measurement repeatability.
Preset	0.001 s
Range	0 s to 1 s
Default Unit	Time (s)
Initial S/W Revision	A.14.00

Center Frequency

Example	CALC:FPOW:POW1:DEF "CenterFrequency=2e9"
Notes	The center frequency parameter sets the frequency in which the measurement is centered around. The OffsetFrequency parameter is calculated relative to the center frequency.
Preset	1 GHz
Range	0 Hz to maximum instrument frequency
Default Unit	Frequency (Hz)
Initial S/W Revision	A.14.00

DC Coupled

Example	CALC:FPOW:POW1:DEF "DCCoupled=True"
Notes	The DC coupled parameter allows the user to specify whether the DC blocking capacitor is utilized. Set parameter to true when measuring frequencies below 10 MHz.
Preset	False
Range	True (DC Coupled) or False (AC Coupled)
Default Unit	Boolean
Initial S/W Revision	A.14.00

DetectorType

Example	CALC:FPOW:POW1:DEF "DetectorType=Peak"
Notes	Option FP2 is required. The detector type parameter allows the user to choose whether a RMS average or peak value is used during the measurement.
Preset	RmsAverage
Range	RmsAverage, Peak
Initial S/W Revision	A.14.00

Do Noise Correction

Example	CALC:FPOW:POW1:DEF "DoNoiseCorrection=True"
Notes	When noise correction is enabled, the linear noise power contributed by the analyzer is subtracted from all measurements. This effectively lowers the noise floor of the analyzer. When noise correction is enabled, the first measurement for a given set of input parameters will take extra time. This is because the analyzer takes an extra acquisition with the RF input disconnected from the analyzer's front end to measure the noise of just the analyzer. The measured noise floor is stored in a cache so the noise acquisition will occur only once for the same state settings. In other words, if noise correction was turned on and the analyzer made an acquisition at frequency A, then frequency B, and back again to frequency A, the hidden initial noise floor acquisition would only occur for the first acquisition at frequency A and the cached noise floor would be used the second time frequency A was measured.
Preset	False
Range	True (enable noise correction) or False (disable noise correction)
Default Unit	Boolean
Initial S/W Revision	A.14.00

Do Spur Suppression

Example	CALC:FPOW:POW1:DEF "DoSpurSuppression=True"
Notes	<p>When measuring very low level signals, or when large out-of-band inputs are input into the analyzer, sometimes unwanted spurs and residuals can appear in the measured spectrum. Spur suppression is a method to help minimize the levels of these internally generated spurs and residuals.</p> <p>When spur suppression is enabled, the analyzer will automatically take two acquisitions using two different internal analog LO frequencies. The FFT spectrums from both acquisitions are combined by taking the minimum power between both traces on a per FFT bin basis. External signals will have the same amplitude for both traces and therefore will return the expected amplitudes. However, low level spurs and residuals generated internally to the analyzer tend to move to different FFT bins depending on the internal analog LO frequency used, and therefore tend to be suppressed using this spur suppression method.</p> <p>Because two acquisitions, rather than a single acquisition, are made when spur suppression is enabled, the measurement time will always be slower when spur suppression is enabled.</p>
Preset	False
Range	True (enable spur suppression) or False (disable spur suppression)
Default Unit	Boolean
Initial S/W Revision	A.14.00

Electronic Attenuator Bypass

Example	CALC:FPOW:POW1:DEF "ElecAttBypass =False"
Notes	The electronic attenuation bypass parameter allows the user to either utilize or bypass the electronic attenuator. The electronic attenuator is only available for frequencies up to 3.6 GHz. Set parameter to true when using frequencies above 3.6 GHz and set the parameter to false when using the preamp.
Preset	True
Range	True (bypass electronic attenuator) or False (use electronic attenuator)
Default Unit	Boolean
Initial S/W Revision	A.14.00

Electronic Attenuation

Example	CALC:FPOW:POW1:DEF "ElecAttenuation=10"
Notes	<p>Option EA3 is required.</p> <p>The electronic attenuation value parameter sets the amount of electrical attenuation from 0 to 24 dB (1 dB steps).</p> <p>Set "ElecAttBypass=False" to make sure the electronic attenuator path is enabled.</p>
Preset	0 dB
Range	0 – 24 dB (1 dB steps)

Default Unit	dB
Initial S/W Revision	A.14.00

IF Gain

Example	CALC:FPOW:POW1:DEF "IFGain=10"
Notes	The IF gain parameter allows the user to specify the gain at the IF stage anywhere from -6 to 16 dB (1 dB steps). This is an advanced feature, and for most cases this should remain at its default value of 0 dB.
Preset	0 dB
Range	-6 - 16 dB (1 dB steps)
Default Unit	dB
Initial S/W Revision	A.14.00

IF Type

Example	CALC:FPOW:POW1:DEF "IFType=B25M"
Notes	The IF type parameter allows the user to select between different IF paths. For example, if the signal is less than 25 MHz wide, then the user can select the B25M path to take advantage of additional filtering on this analog IF path.
Preset	B40M
Range	B10M, B25M, B40M
Initial S/W Revision	A.14.00

Include Power Spectrum

Example	CALC:FPOW:POW1:DEF "IncludePowerSpectrum=True"
Notes	The power spectrum parameter allows the user to read data on the entire spectrum for diagnostic purposes. It is not recommended for production use. See CALC:FPOW:POW[n]:READ2? for details on the binary format of the response.
Preset	False
Range	True (return both channel power and full power spectrum) or False (returns only channel power)
Default Unit	Boolean
Initial S/W Revision	A.14.00

Mechanical Attenuation

Example	CALC:FPOW:POW1:DEF "MechAttenuation=10"
Notes	The mechanical attenuation value parameter sets the amount of mechanical attenuation anywhere from 0 to 70 dB (2 dB steps).
Preset	0 dB
Range	0 – 70 dB (2 dB steps)
Default Unit	dB
Initial S/W Revision	A.14.00

Preamp Mode

Example	CALC:FPOW:POW1:DEF "PreAmpMode=Low"
Notes	The license for the appropriate preamp is required. The preamp mode parameter specifies whether the preamps are being utilized. Low allows any preamps up to 3.6 GHz, and Full allows all licensed preamps. Set "ElecAttBypass=True" in order to utilize any preamps.
Preset	Off
Range	Off, Low, Full
Initial S/W Revision	A.14.00

Resolution Bandwidth Mode

Example	CALC:FPOW:POW1:DEF "PreAmpMode=Low"
Notes	The resolution bandwidth mode parameter allows the user to choose whether the RBW filter is automatically or manually set. The BestSpeed value minimizes measurement time, while the Narrowest value minimizes RBW size (minimum of two FFT bins per RBW). To manually specify an RBW, set this parameter to Explicit, and set the ResolutionBW parameter to the desired value.
Preset	BestSpeed
Range	BestSpeed, Narrowest, Explicit
Initial S/W Revision	A.14.00

Resolution Bandwidth

Example	CALC:FPOW:POW1:DEF "ResolutionBW=25e3"
Notes	The resolution bandwidth parameter sets the 3-dB bandwidth of the RBW filter. The ResolutionBWMode parameter must be set to Explicit in order to manually set the RBW.

Preset	0 Hz
Default Unit	Hz
Initial S/W Revision	A.14.00

Trigger Delay

Example	CALC:FPOW:POW1:DEF "TriggerDelay=0.025"
Notes	The trigger delay parameter sets the time after an external trigger is detected until the measurement is performed.
Preset	0 s
Range	0 – 1 s
Default Unit	Seconds
Initial S/W Revision	A.14.00

Trigger Level

Example	CALC:FPOW:POW1:DEF "TriggerLevel=2"
Notes	The trigger level parameter sets the voltage value at which an external trigger is detected.
Preset	1.2 V
Range	-5 to 5 V
Default Unit	Volts
Initial S/W Revision	A.14.00

Trigger Slope

Example	CALC:FPOW:POW1:DEF "TriggerSlope=Negative"
Notes	The trigger slope parameter indicates the direction of the edge trigger voltage for detection.
Preset	Positive
Range	Positive, Negative
Initial S/W Revision	A.14.00

Trigger Source

Example	CALC:FPOW:POW1:DEF "TriggerSource=Ext1"
Notes	The trigger source parameter allows the user to choose between measurement's triggering freely or controlled by an external input. Ext1 and Ext2 correspond to Trigger 1 In and Trigger 2 In, respectively.
Preset	Free
Range	Free, Ext1, Ext2
Initial S/W Revision	A.14.00

Trigger Timeout

Example	CALC:FPOW:POW1:DEF "TriggerTimeout=0.1"
Notes	The trigger timeout parameter sets the time in which the analyzer will wait for a trigger before automatically performing the measurement.
Preset	1 s
Range	0 - 1 s
Default Unit	Seconds
Initial S/W Revision	A.14.00

Signal Input

Example	CALC:FPOW:POW1:DEF "SignalInput=Fp50MHzCW"
Notes	The signal input parameter allows the user to select between using the main RF input or the internal analyzer reference CW signal of 50 MHz.
Preset	FpMainRf
Range	FpMainRf, Fp50MHzCW
Initial S/W Revision	A.14.00

Use Preselector

Example	CALC:FPOW:POW1:DEF "UsePreSelector=True"
Notes	The preselector parameter allows the user to either utilize or bypass the front end tunable filter at frequencies above 3.6 GHz. For frequencies below 3.6 GHz, the preselector is automatically bypassed, so you do not need to set this parameter to False in those cases.
Preset	False
Range	True (use preselector above 3.6 GHz), or False (preselector bypassed)

Default Unit	Boolean
Initial S/W Revision	A.14.00

Channel Bandwidth Array

Example	CALC:FPOW:POW1:DEF "Bandwidth=[3.84e6, 5e6, 3.84e6]"
Notes	The bandwidth parameter array defines the bandwidth of each channel that will be measured. All array parameters should have the same number of elements. Alternatively, if all the elements are the same value, a single number with no square brackets can be used to define the parameter.
Preset	[1 e6]
Range	0 to 40 MHz
Default Unit	Hz
Initial S/W Revision	A.14.00

Channel Filter Type Array

Example	CALC:FPOW:POW1:DEF "FilterType=[RRC, IBW, RRC]"
Notes	The filter type parameter allows the user to choose between an integration bandwidth (IBW) filter or a root-raised-cosine (RRC) filter. The integration bandwidth filter weighs all frequencies within the bandwidth equally. The root-raised-cosine filter has an associated shape parameter, defined by the FilterAlpha parameter. All array parameters should have the same number of elements. Alternatively, if all the elements are the same value, a single value with no square brackets can be used to define the parameter.
Preset	[IBW]
Range	IBW, RRC
Initial S/W Revision	A.14.00

Channel Filter Alpha Array

Example	CALC:FPOW:POW1:DEF "FilterAlpha=[0.5, 0.0, 0.5]"
Notes	The filter alpha parameter allows the user to adjust the alpha value associated with the root-raised-cosine (RRC) filter type. Set FilterType to RRC in order to utilize this parameter. All array parameters should have the same number of elements. Alternatively, if all the elements are the same value, a single number with no square brackets can be used to define the parameter.
Preset	[0.22]
Range	0.0 – 1.0
Initial S/W Revision	A.14.00

Channel Measurement Function Array

Example	CALC:FPOW:POW1:DEF "Function=[BandPower, PeakPower, BandPower]"
Notes	<p>This parameter array defines what measurement is being made for each individually-specified channel:</p> <p>BandPower: Total power within the specified bandwidth of the channel (dBm)</p> <p>BandDensity: Total power density within the specified bandwidth of the channel (dBm/Hz)</p> <p>PeakPower: The peak power value within the specified bandwidth of the channel (dBm)</p> <p>PeakFrequency: The frequency which corresponds to the peak power value within the specified bandwidth of the channel. This frequency is relative to the center frequency (Hz)</p> <p>XdBBandwidth: The half power (-3.01 dB) bandwidth of the highest amplitude signal that resides within the channel (Hz), dB is configurable using XdBBandwidth parameter</p> <p>OccupiedBandwidth: The bandwidth at which 99% of the total power resides within the channel (Hz), percentage configurable using OccupiedBandwidthPercent parameter</p> <p>All array parameters should have the same number of elements. Alternatively, if all the elements are the same value, a single value with no square brackets can be used to define the parameter.</p>
Preset	[BandPower]
Range	BandPower, BandDensity, PeakPower, PeakFrequency, XdBBandwidth, OccupiedBandwidth
Initial S/W Revision	A.14.00

Channel Offset Frequency Array

Example	CALC:FPOW:POW1:DEF "OffsetFrequency=[-5e6, 0, 5e6]"
Notes	<p>The offset frequency parameter array defines the difference between the center frequency to the center frequency of each channel.</p> <p>All array parameters should have the same number of elements.</p>
Preset	[0]
Range	0 to 20 MHz
Default Unit	Hz
Initial S/W Revision	A.14.00

Channel Occupied Bandwidth Percent Array

Example	CALC:FPOW:POW1:DEF "OccupiedBandwidthPercent =[0.95, 0.95, 0.95]"
Notes	<p>This parameter only applies for channels whose Function is set to OccupiedBandwidth. The occupied bandwidth percent parameter specifies the percent of total power in these channels. The valid range for this parameter is 0.0 to 1.0, where 1.0 represents 100%. The default for this parameter is 0.99, which will return the bandwidth that contains 99% of the total channel power.</p>

Preset	[0.99]
Range	0 – 1.0
Initial S/W Revision	A.14.00

Channel x-dB Bandwidth Array

Example	CALC:FPOW:POW1:DEF " XdBBandwidth =[-6.02, -3.01, -1.0]"
Notes	This parameter only applies for channels whose Function is set to XdBBandwidth. The X dB bandwidth parameter is used to specify the power relative to the peak channel power over which the bandwidth is calculated. The parameter value must be a negative number.
Preset	[-3.01]
Range	-200 to 0 dB
Default Unit	dB
Initial S/W Revision	A.14.00

Define Fast Power Measurement Query (Remote Command Only)

The DEFine? command is used to retrieve a list of all defined parameters in an ASCII string format

M o d e	All
R e m o t e	:CALCulate:FPOWER:POWER[1,2,...,999]:DEFine?
C o m m a n d	
E x a m	:CALC:FPOW:POW1:DEF?

```

p
l
e
-----
N This command query is used to retrieve a list of all defined parameters in an ASCII format.
o The following is an example of the returned results:
t "DCCoupled=False,ElecAttBypass=True,ElecAttenuation=0,IFGain=0,MechAttenuation=0,PreAmpMode=Off,PreSelectorOffset
e =0,UsePreSelector=False,ExternalReferenceFrequency=10000000,FrequencyReferenceSource=AutoExternalFrequencyRefer
s ence,IFType=B40M,LOMode=SLW,SignalInput=FpMainRf,AcquisitionTime=0.001,CenterFrequency=1000000000,Resolution
BW=0,ResolutionBWMode=BestSpeed,DetectorType=RmsAverage,Bandwidth=[1000000],OffsetFrequency=[0],Function=
[BandPower],FilterType=[IBW],FilterAlpha=[0.22],OccupiedBandwidthPercent=[0.99],XdBBandwidth=[-
3.01],DoNoiseCorrection=False,DoSpurSuppression=False,MeasurementMethod=HardwareFFT,IncludePowerSpectrum=False
e,TriggerDelay=0,TriggerLevel=1.2,TriggerSlope=Positive,TriggerSource=Free,TriggerTimeout=1"
-----
I A.14.00
n
i
t
i
a
l

S
/
W

R
e
v
i
s
i
o
n

```

Configure Fast Power Measurement (Remote Command Only)

The configure command begins hardware setup and returns immediately, with no acquisition made. This can be used in parallel with other hardware operations to effectively hide the hardware setup time.

Mode	All
Remote Command	:CALCulate:FPOWER:POWER[1,2,...,999]:CONFigure
Example	:CALC:FPOW:POW1:CONF
Notes	Option FP2 is required.
Initial S/W Revision	A.14.00

Initiate Fast Power Measurement (Remote Command Only)

The INITiate command begins an acquisition and returns immediately. The results of the measurement can be retrieved using FETCh.

Mode	All
Remote Command	:CALCulate:FPOWER:POWER[1,2,...,999]:INITiate
Example	:CALC:FPOW:POW1:INIT
Notes	Option FP2 is required.
Initial S/W Revision	A.14.00

Fetch Fast Power Measurement (Remote Command Only)

The FETCh command query is used to retrieve the results of an acquisition initiated by the INIT command. The returned results are in ASCII string format. The string begins and ends with quotation marks.

Mode	All
Remote Command	:CALCulate:FPOWER:POWER[1,2,...,999]:FETCh?
Example	:CALC:FPOW:POW1:FETC?
Notes	Option FP2 is required. Returns m comma-separated ASCII values, where m corresponds to the number of bandwidths defined. 1. Declared function return in the 1st specified channel 2. Declared function return in the 2nd specified channel ... m. Declared function return in the last specified channel The INIT and FETC? command sequence performs the same functionality of a single CALC:FPOW:POW[n]? query. Units of the returned values are dependent on the Function parameter for each channel.
Initial S/W Revision	A.14.00

Execute Fast Power Measurement (Remote Command Only)

This command query is used as shorthand for an INIT command immediately followed by a FETC? command. The returned results are in ASCII string format. The string begins and ends with quotation marks.

Mode	All
Remote Command	:CALCulate:FPOWER:POWER[1,2,...,999]?
Example	:CALC:FPOW:POW1?
Notes	Option FP2 is required. See notes for Fast Power Fetch for return format.
Initial S/W Revision	A.14.00

Binary Read Fast Power Measurement (Remote Command Only)

This command query is used as shorthand for an INIT command immediately followed by a FETC? command. The returned results are in a binary format.

Mode	All
Remote Command	:CALCulate:FPOWER:POWER[1,2,...,999]:READ? :CALCulate:FPOWER:POWER[1,2,...,999]:READ1?
Example	:CALC:FPOW:POW1:READ? :CALC:FPOW:POW1:READ1?
Notes	Option FP2 is required. Returns m 4 byte floating point binary values (Little-Endian), where m corresponds to the number of bandwidths defined.
Initial S/W Revision	A.14.00

Diagnostic Binary Read Fast Power Measurement (Remote Command Only)

This command query is used as shorthand for an INIT command immediately followed by a FETC? command. The returned results are in a binary format. This command is used primarily for diagnostic purposes to test for ADC overloads and to visibly inspect the spectrum.

Mode	All
Remote Command	:CALCulate:FPOWER:POWER[1,2,...,999]:READ2?
Example	:CALC:FPOW:POW1:READ2?
Notes	Option FP2 is required. Note: Spectrum data is only returned if the IncludePowerSpectrum parameter is set to True. If IncludePowerSpectrum is False, the number of spectrum points will be zero (0). Units of the returned values are dependent on the Function parameter per channel (e.g. dBm for BandPower, Hz for PeakFrequency). Returns binary data (Little-Endian) that contains information on m amount of channels, along with ADC over range and full spectrum data. The following is the binary format of the response. Bandwidth Return Value 1. Number of channels specified, m [4 byte int] 2. Declared function result for the 1st specified channel [4 byte float] 3. Declared function result for the 2nd specified channel [4 byte float] ... (m + 1). Declared function result for the last (mth) specified channel [4 byte float] ADC Over Range 1. ADC over-range occurred (1: true, 0: false) [2 byte short]

	<p>Spectrum Data</p> <ol style="list-style-type: none"> 1. Number of points in the spectrum data, k [4 byte int] 2. Start frequency of spectrum data (Hz) [8 byte double] 3. Step frequency of spectrum data (Hz) [8 byte double] 4. FFT bin at 1st point (dBm) [4 byte float] 5. FFT bin at 2nd point (dBm) [4 byte float] <p>...</p> <p>(k + 3). FFT bin at last (kth) point (dBm) [4 byte float]</p>
Initial S/W Revision	A.14.00

Format Data: Numeric Data (Remote Command Only)

This command specifies the format of the trace data input and output. It specifies the formats used for trace data during data transfer across any remote port. It affects only the data format for setting and querying trace data for the :TRACe[:DATA], TRACe[:DATA]?, :CALCulate:DATA[n]? and FETCh:SANalyzer[n]? commands and queries.

Remote Command	<pre>:FORMat[:TRACe][:DATA] ASCii INTeger,32 REAL,32 REAL,64 :FORMat[:TRACe][:DATA]?</pre>
Notes	<p>The query response is:</p> <pre>ASCii: ASC,8 REAL,32: REAL,32 REAL,64: REAL,64 INTeger,32: INT,32</pre> <p>When the numeric data format is REAL or ASCii, data is output in the current Y Axis unit. When the data format is INTeger, data is output in units of m dBm (.001 dBm).</p> <p>The INT,32 format returns binary 32-bit integer values in internal units (m dBm), in a definite length block.</p>
Dependencies	<p>Sending a data format spec with an invalid number (for example, INT,48) generates no error. The analyzer simply uses the default (8 for ASCii, 32 for INTeger, 32 for REAL).</p> <p>Sending data to the analyzer which does not conform to the current FORMat specified, results in an error. Sending ASCII data when a definite block is expected generates message -161 "Invalid Block Data" and sending a definite block when ASCII data is expected generates message -121 "Invalid Character in Number".</p>
Preset	ASCii
Backwards Compatibility Notes	Note that the INT,32 format is only applicable to the command, TRACe:DATA. This preserves backwards compatibility for the Swept SA measurement. For all other commands/queries which honor FORMat:DATA, if INT,32 is sent the analyzer will behave as though it were set to REAL,32.
Initial S/W Revision	Prior to A.02.00

The specs for each output type follow:

AScii - Amplitude values are in ASCII, in the current Y Axis Unit, one ASCII character per digit, values separated by commas, each value in the form:

SX.YYYYYEsZZ

Where:

S = sign (+ or -)

X = one digit to left of decimal point

Y = 5 digits to right of decimal point

E = E, exponent header

s = sign of exponent (+ or -)

ZZ = two digit exponent

REAL,32 - Binary 32-bit real values in the current Y Axis Unit, in a definite length block.

REAL,64 - Binary 64-bit real values in the current Y Axis Unit, in a definite length block.

Format Data: Byte Order (Remote Command Only)

This command selects the binary data byte order for data transfer and other queries. It controls whether binary data is transferred in normal or swapped mode. This command affects only the byte order for setting and querying trace data for the :TRACe[:DATA], TRACe[:DATA]? , :CALCulate:DATA[n]? and FETCh:SANalyzer[n]? commands and queries.

By definition any command that says it uses FORMat:DATA uses any format supported by FORMat:DATA.

The NORMal order is a byte sequence that begins with the most significant byte (MSB) first, and ends with the least significant byte (LSB) last in the sequence: 1|2|3|4. SWAPped order is when the byte sequence begins with the LSB first, and ends with the MSB last in the sequence: 4|3|2|1.

Remote Command	:FORMat:BORDER NORMAL SWAPped :FORMat:BORDER?
Preset	NORMal
Initial S/W Revision	Prior to A.02.00

Meas Setup

Displays the setup menu for the current measurement. The measurement setup parameters include the number of measurement averages used to calculate the measurement result and the averaging mode. The setup menu also includes the option to reset the measurement settings to their factory defaults.

Key Path	Front-panel key
Initial S/W Revision	Prior to A.02.00

Avg/Hold Num

Specifies the number of measurement averages used when calculating the measurement result. The average is displayed at the end of each sweep.

Initiates an averaging routine that averages the sweep points in a number of successive sweeps, resulting in trace smoothing.

After the specified number of average counts, the average mode (termination control) setting determines the average action.

Key Path	Meas Setup
Mode	SA, WCDMA, C2K, WIMAX OFDMA, TD-SCDMA, 1xEVDO, ISDB-T, CMMB, LTE, LTETDD, BLUETOOTH, WLAN, MSR
Remote Command	[:SENSe]:OBWidth:AVERage:COUNT <integer> [:SENSe]:OBWidth:AVERage:COUNT? [:SENSe]:OBWidth:AVERage[:STATe] ON OFF 1 0 [:SENSe]:OBWidth:AVERage[:STATe]?
Example	OBW:AVER:COUN 1500 OBW:AVER:COUN? OBW:AVER ON OBW:AVER?
Notes	You must be in the Spectrum Analysis mode, W-CDMA mode, cdma2000 mode, TD-SCDMA mode, ISDB-T mode, CMMB mode, LTE mode, LTE TDD mode, BLUETOOTH mode, WLAN mode, 1xEVDO mode, MSR or WIMAX OFDMA mode to use this command. Use:INSTRument:SElect to set the mode.
Couplings	None Averaging state is coupled to Max Hold. If Max Hold is changed from Off to On, Averaging state is automatically set to On.
Preset	10 ON
State Saved	Saved in instrument state.
Min	1
Max	10000

Backwards Compatibility SCPI	<code>[:SENSe] :EBWidth :AVERage :COUnT</code>
Initial S/W Revision	Prior to A.02.00
Modified at S/W Revision	A.03.00

Avg Mode

Enables you to set the averaging mode.

- When set to Exponential (Exp) the measurement averaging continues using the specified number of averages to compute each averaged value. The average is displayed at the end of each sweep.
- When set to Repeat, the measurement resets the average counter each time the specified number of averages is reached.

Key Path	Meas Setup
Mode	SA, WCDMA, C2K, WIMAX OFDMA, TD-SCDMA , 1xEVDO, ISDB-T, CMMB, LTE, LTETDD, BLUETOOTH, WLAN, MSR
Remote Command	<code>[:SENSe] :OBWidth :AVERage :TCONtrol EXPonential REPEAT</code> <code>[:SENSe] :OBWidth :AVERage :TCONtrol ?</code>
Example	OBW:AVER:TCON REP OBW:AVER:TCON?
Notes	You must be in the Spectrum Analysis mode, W-CDMA mode, cdma2000 mode, TD-SCDMA mode, ISDB-T mode, CMMB mode, LTE mode, LTE TDD mode, BLUETOOTH mode, WLAN mode, 1xEVDO mode, MSR or WIMAX OFDMA mode to use this command. Use:INSTRument:SElect to set the mode.
Preset	EXP
State Saved	Saved in instrument state.
Range	Exp Repeat
Initial S/W Revision	Prior to A.02.00
Modified at S/W Revision	A.03.00

Occ BW % Pwr

Assigns the percentage of the total power that is measured within the Occupied Bandwidth for the current measurement. The resulting Occupied Bandwidth limits are displayed by markers placed on the frequencies of the specified percentage.

Key Path	Meas Setup
Mode	SA, WCDMA, C2K, WIMAX OFDMA, TD-SCDMA, 1xEVDO, ISDB-T, CMMB, LTE, LTETDD, BLUETOOTH, WLAN, MSR
Remote Command	<code>[:SENSe] :OBWidth :PERCent <real></code>

	<code>[:SENSe] :OBWidth :PERCent ?</code>
Example	OBW:PERC 75 OBW:PERC?
Notes	You must be in the Spectrum Analysis mode, W-CDMA mode, cdma2000 mode, TD-SCDMA mode, ISDB-T mode, CMMB mode, LTE mode, LTE TDD mode, BLUETOOTH mode, WLAN mode, 1xEVDO mode, MSR or WIMAX OFDMA mode to use this command. Use:INSTrument:SElect to set the mode. If Mode is BLUETOOTH, the key will be grayed out.
Preset	99.00
State Saved	Saved in instrument state.
Min	10
Max	99.99
Initial S/W Revision	Prior to A.02.00
Modified at S/W Revision	A.03.00

x dB

Sets the x dB value used for the "x dB bandwidth" result that measures the bandwidth between two points on the signal which is x dB down from the highest signal point within the OBW Span.

Key Path	Meas Setup
Mode	SA, WCDMA, C2K, WIMAX OFDMA, TD-SCDMA, 1xEVDO, ISDB-T, CMMB, LTE, LTETDD, BLUETOOTH, WLAN, MSR
Remote Command	<code>[:SENSe] :OBWidth :XDB <rel_ampl></code> <code>[:SENSe] :OBWidth :XDB ?</code>
Example	OBW:XDB -20 OBW:XDB?
Notes	You must be in the Spectrum Analysis mode, W-CDMA mode, cdma2000 mode, TD-SCDMA mode, ISDB-T mode, CMMB mode, LTE mode, LTE TDD mode, BLUETOOTH mode, WLAN mode, 1xEVDO mode, MSR or WIMAX OFDMA mode to use this command. Use:INSTrument:SElect to set the mode.
Preset	-26.0 dB BLUETOOTH: -20.0 dB.
State Saved	Saved in instrument state.
Min	-100.0 dB
Max	-0.1 dB
Backwards Compatibility SCPI	<code>[:SENSe] :EBWidth :XDB</code>
Initial S/W Revision	Prior to A.02.00
Modified at S/W Revision	A.03.00

Limit (for all modes except MSR)

Enables you to turn on or off limit checking at the specified frequency. For results that fail the limit test, a red FAIL appears in the measure bar.

Key Path	Meas Setup
Mode	SA, WCDMA, C2K, WIMAX OFDMA, TD-SCDMA, 1xEVDO, ISDB-T, CMMB, LTE, LTETDD, BLUETOOTH, WLAN
Remote Command	:CALCulate:OBWidth:LIMit:FBLimit <freq> :CALCulate:OBWidth:LIMit:FBLimit? :CALCulate:OBWidth:LIMit[:TEST] ON OFF 1 0 :CALCulate:OBWidth:LIMit[:TEST]?
Example	CALC:OBW:LIM:FBL 50 kHz CALC:OBW:LIM:FBL? CALC:OBW:LIM OFF CALC:OBW:LIM?
Notes	You must be in the Spectrum Analysis mode, W-CDMA mode, cdma2000 mode, TD-SCDMA mode, ISDB-T mode, CMMB mode, LTE mode, LTE TDD mode, BLUETOOTH mode, WLAN mode, 1xEVDO mode or WIMAX OFDMA mode to use this command. Use:INSTrument:SElect to set the mode.
Preset	SA, WCDMA: 5 MHz C2K: 1.48 MHz WIMAX OFDMA: 10 MHz TD-SCDMA: 1.6 MHz 1xEVDO: 1.48 MHz ISDB-T: 5.7 MHz CMMB: 7.512 MHz LTE, LTETDD: 5 MHz BLUETOOTH: 1 MHz WLAN: If Radio Std is 802.11a/g(OFDM/DSSS-OFDM): 20MHz If Radio Std is 802.11b: 25 MHz If Radio Std is 802.11n(20MHz): 20 MHz If Radio Std is 802.11n(40MHz): 40 MHz If Radio Std is 802.11ac(20MHz): 20 MHz If Radio Std is 802.11ac(40MHz): 40 MHz If Radio Std is 802.11ac(80MHz): 80 MHz If Radio Std is 802.11ac(160MHz): 160 MHz SA: OFF WCDMA, WIMAX OFDMA, TD-SCDMA, 1xEVDO, ISDB-T, CMMB, LTE, LTETDD: ON
State Saved	Saved in instrument state.
Min	1 kHz

Max	Depends on instrument maximum frequency.
Initial S/W Revision	Prior to A.02.00
Modified at S/W Revision	A.03.00

Meas Preset

Restores all measurement parameters to their default values.

Key Path	Meas Setup
Mode	SA, WCDMA, C2K, WIMAX OFDMA, TD-SCDMA, 1xEVDO, ISDB-T, CMMB, LTE, LTETDD, BLUETOOTH, WLAN, MSR
Remote Command	:CONFigure:OBWidth
Example	CONF:OBW
Initial S/W Revision	Prior to A.02.00
Modified at S/W Revision	A.03.00

Max Hold (Remote Command Only)

When On, Max Hold displays and holds the maximum responses of the current measurement. Turn Max Hold to Off to disable the maximum hold feature.

Key Path	SCPI Only
Mode	SA, WCDMA, C2K, WIMAX OFDMA, TD-SCDMA, 1xEVDO, ISDB-T, CMMB, LTE, LTETDD, BLUETOOTH, WLAN, MSR
Remote Command	[:SENSe] :OBWidth:MAXHold ON OFF 1 0 [:SENSe] :OBWidth:MAXHold?
Example	OBW:MAXH ON OBW:MAXH?
Notes	You must be in the Spectrum Analysis mode, W-CDMA mode, cdma2000 mode, TD-SCDMA mode, ISDB-T mode, CMMB mode, LTE mode, LTE TDD mode, BLUETOOTH mode, WLAN mode, 1xEVDO mode, MSR or WIMAX OFDMA mode to use this command. Use:INSTrument:SElect to set the mode.
Couplings	Max Hold is coupled to Average/Hold state. The Max Hold function is activated only if Average state is On. If Max Hold is changed to On when Average state is Off, Average state is automatically set to On.
Preset	OFF
State Saved	Saved in instrument state.
Range	On Off
Backwards Compatibility SCPI	[:SENSe] :EBWidth:MAXHold

9 Occupied Bandwidth Measurement
Meas Setup

Initial S/W Revision	Prior to A.02.00
Modified at S/W Revision	A.03.00

Mode

See "Mode" on page 222

Mode Preset

Returns the active mode to a known state.

Mode Preset does the following for the currently active mode:

- Aborts the currently running measurement.
- Brings up the default menu for the mode, with no active function.
- Sets measurement Global settings to their preset values for the active mode only.
- Activates the default measurement.
- Brings up the default menu for the mode.
- Clears the input and output buffers.
- Sets Status Byte to 0.

Mode Preset does not:

- Cause a mode switch
- Affect mode persistent settings
- Affect system settings
- See "[How-To Preset](#)" on page 711 for more information.

Key Path	Front-panel key
Remote Command	:SYSTem:PRESet
Example	:SYST:PRES
Notes	*RST is preferred over :SYST:PRES for remote operation. *RST does a Mode Preset, as done by the :SYST:PRES command, and it sets the measurement mode to Single measurement rather than Continuous for optimal remote control throughput. Clears all pending OPC bits. The Status Byte is set to 0.
Couplings	A Mode Preset aborts the currently running measurement, activates the default measurement, and gets the mode to a consistent state with all of the default couplings set.
Backwards Compatibility Notes	In the X-Series, the legacy "Factory Preset" has been replaced with Mode Preset, which only presets the currently active mode, not the entire instrument. In the X-Series, the way to preset the entire instrument is by using System, Restore System Defaults All, which behaves essentially the same way as restore System Defaults does on ESA and PSA. There is also no "Preset Type" as there is on the PSA. There is a green Mode Preset front-panel key that does a Mode Preset and a white-with-green-letters User Preset front-panel key that does a User Preset. The old PRESet:TYPE command is ignored (without generating an error), and SYST:PRES without a parameter does a Mode Preset, which should cover most backward code compatibility issues. The settings and correction data under the Input/Output front-panel key (examples: Input Z Corr, Ext Amp Gain, etc.) are no longer part of any Mode, so they will not be preset by a Mode Preset. They are preset using Restore Input/Output Defaults, Restore System Defaults All. Note that because User Preset does a Recall State, and all of these settings are saved in State, they ARE recalled when using

	User Preset.
Initial S/W Revision	Prior to A.02.00

How-To Preset

The table below shows all possible presets, their corresponding SCPI commands and front-panel access (key paths). Instrument settings depend on the current measurement context. Some settings are local to the current measurement, some are global (common) across all the measurements in the current mode, and some are global to all the available modes. In a similar way, restoring the settings to their preset state can be done within the different contexts.

Auto Couple - is a measurement local key. It sets all Auto/Man parameter couplings in the measurement to Auto. Any Auto/Man selection that is local to other measurements in the mode will not be affected.

Meas Preset - is a measurement local key. Meas Preset resets all the variables local to the current measurement except the persistent ones.

Mode Preset - resets all the current mode's measurement local and measurement global variables except the persistent ones.

Restore Mode Defaults - resets ALL the Mode variables (and all the Meas global and Meas local variables), including the persistent ones.

Type Of Preset	SCPI Command	Front Panel Access
Auto Couple	:COUPlE ALL	Auto Couple front-panel key
Meas Preset	:CONFIgure:<Measurement>	Meas Setup Menu
Mode Preset	:SYSTem:PRESet	Mode Preset (green key)
Restore Mode Defaults	:INSTrument:DEFault	Mode Setup Menu
Restore All Mode Defaults	:SYSTem:DEFault MODEs	System Menu; Restore System Default Menu
*RST	*RST	not possible (Mode Preset with Single)
Restore Input/Output Defaults	:SYSTem:DEFault INPut	System Menu; Restore System Default Menu
Restore Power On Defaults	:SYSTem:DEFault PON	System Menu; Restore System Default Menu
Restore Alignment Defaults	:SYSTem:DEFault ALIGn	System Menu; Restore System Default Menu
Restore Miscellaneous Defaults	:SYSTem:DEFault MISC	System Menu; Restore System Default Menu
Restore All System Defaults	:SYSTem:DEFault [ALL] :SYSTem:PRESet:PERSistent	System Menu; Restore System Default Menu
User Preset	:SYSTem:PRESet:USER	User Preset Menu
User Preset All Modes	:SYSTem:PRESet:USER:ALL	User Preset Menu

9 Occupied Bandwidth Measurement
Mode Preset

Power On Mode Preset	:SYSTem:PON:TYPE MODE	System Menu
Power On User Preset	:SYSTem:PON:TYPE USER	System Menu
Power On Last State	:SYSTem:PON:TYPE LAST	System Menu

Mode Setup

See ["Mode Setup" on page 242](#)

Peak Search

Places the selected marker on the trace point with the maximum y-axis value for that marker's trace. Pressing Peak Search with the selected marker off causes the selected marker to be set to Normal, then a peak search is immediately performed.

Key Path	Front panel key
Mode	SA, WCDMA, C2K, WIMAX OFDMA, TD-SCDMA, 1xEVDO, ISDB-T, CMMB, LTE, LTETDD, BLUETOOTH, WLAN, MSR
Remote Command	:CALCulate:OBWidth:MARKer[1] 2 ... 12:MAXimum
Example	CALC:OBW:MARK2:MAX
Initial S/W Revision	Prior to A.02.00
Modified at S/W Revision	A.03.00

Print

See "Print" on page 271

Quick Save

The Quick Save front-panel key repeats the most recent save that was performed from the Save menu, with the following exceptions:

- Register saves are not remembered as Saves for the purpose of the Quick Save function
- If the current measurement does not support the last non-register save that was performed, an informational message is generated, “File type not supported for this measurement”

Quick Save repeats the last type of qualified save (that is, a save qualified by the above criteria) in the last save directory by creating a unique filename using the Auto File Naming algorithm described below.

If Quick Save is pressed after startup and before any qualified Save has been performed, the Quick Save function performs a Screen Image save using the current settings for Screen Image saves (current theme, current directory), which then becomes the “last save” for the purpose of subsequent Quick Saves.

The Auto File Naming feature automatically generates a file name for use when saving a file. The filename consists of a prefix and suffix separated by a dot, as is standard for the Windows® file system. A default prefix exists for each of the available file types:

Type	Default Prefix	Menu
State	State_	(Save/Recall)
Trace + State	State_	(Save/Recall)
Screen	Screen_	(Save/Recall)
Amplitude Corrections	Ampcor_	(Import/Export)
Traces	Trace_	(Import/Export)
Limit Lines	LLine_	(Import/Export)
Measurement Result	MeasR_	(Import/Export)
Capture Buffer	CapBuf_	(Import/Export)

A four digit number is appended to the prefix to create a unique file name. The numbering sequence starts at 0000 within each Mode for each file type and updates incrementally to 9999, then wraps to 0000 again. It remembers where it was through a Mode Preset and when leaving and returning to the Mode. It is reset by Restore Misc Defaults and Restore System Defaults and subsequent running of the instrument application. So, for example, the first auto file name generated for State files is State_0000.state. The next is State_0001, and so forth.

One of the key features of Auto File Name is that we guarantee that the Auto File Name will never conflict with an existing file. The algorithm looks for the next available number. If it gets to 9999, then it looks for holes. If it find no holes, that is no more numbers are available, it gives an error.

For example, if when we get to State_0010.state there is already a State_0010.state file in the current directory, it advances the counter to State_0011.state to ensure that no conflict will exist (and then it verifies that State_0011.state also does not exist in the current directory and advances again if it does, and so forth).

If you enter a file name for a given file type, then the prefix becomes the filename you entered instead of the default prefix, followed by an underscore. The last four letters (the suffix) are the 4-digit number.

For example, if you save a measurement results file as “fred.csv”, then the next auto file name chosen for a measurement results save will be fred_0000.csv.

NOTE Although 0000 is used in the example above, the number that is used is actually the current number in the Meas Results sequence, that is, the number that would have been used if you had not entered your own file name.

NOTE If the filename you entered ends with _dddd, where d=any number, making it look just like an auto file name, then the next auto file name picks up where you left off with the suffix being dddd + 1.

Key Path	Front-panel key
Notes	No remote command for this key specifically.
Initial S/W Revision	Prior to A.02.00

Recall

In the LTE-Advanced TDD/FDD modes, two types of recall functions are available under the Data menu: “Parameter Configuration per Component Carrier” and “Limit Mask”. Limit Mask enables setting a preset limit mask for Power Suite-based measurements, and currently it is available for the SEM, ACP and SPUR measurements in LTE-Advanced TDD/FDD modes.

Recalling the complicated RB settings specified in the test models of the standards and the LTE state file. And it can also recalls the parameters which have been set and saved for “Signal Studio Setup” or “89600 Vector Signal Analyzer” on the external platform .

Key Path	Front Panel Key
Mode	LTEATDD, LTEAFDD
Initial S/W Revision	A.14.00

State

The Recall State menu lets you choose a register or file from which to recall the state.

The content of a state file includes all of the settings and data required to return the analyzer as closely as possible to the Mode it was in, with the exact settings that were in place, when the save occurred. The Mode settings in each state file include the settings that are affected by Mode Preset, as well as the additional settings affected by Restore Mode Defaults; all of the Mode’s settings. In addition, all of the settings of the Input/Output system are included, even though they are outside of the Mode’s state, because they are needed to restore the complete setup. Persistent System settings (for example, GPIB address) are not affected by either a Mode Preset or Restore Mode Defaults, nor are they included in a saved State file.

Since each state file is only for one Mode, the settings for other Modes are unaffected when it is loaded. Recall State will cause a mode switch if the state being recalled is not from the current active mode.

After the recall completes, the message "File <filename> recalled" or “Recalled State Register <register number>” is displayed.

For rapid recalls, the State menu lists 16 registers that you can choose from to recall. Pressing a Register key initiates the recall. You can also select a file from which to recall.

The default path for all State Files is:

My Documents\<mode name>\state

where <mode name> is the parameter used to select the mode with the INST:SEL command (for example, SA for the Spectrum Analyzer).

See "[More Information](#)" on page 719.

Key Path	Recall
Mode	All
Remote Command	:MMEMory:LOAD:STATe <filename>

Example	:MMEM:LOAD:STAT "myState.state" This recalls the file myState.state on the default path
Example	MMEM:LOAD:STAT "MyStateFile.state" This loads the state file data (on the default file directory path) into the instrument state.
Notes	<p>When you pick a file to recall, the analyzer first verifies that the file is recallable in the current instrument by checking the software version and model number of the instrument. If everything matches, a full recall proceeds by aborting the currently running measurement, clearing any pending operations, and then loading the State from the saved state file. You can open state files from any mode, so recalling a State file switches to the mode that was active when the save occurred. After switching to the mode of the saved state file, mode settings and data (if any for the mode) are loaded with values from the saved file. The saved measurement of the mode becomes the newly active measurement and the data relevant to the measurement (if there is any) is recalled.</p> <ul style="list-style-type: none"> • If there is a mismatch between file version or model number or instrument version or model number, the recall function tries to recall as much as possible and returns a warning message. It may limit settings that differ based on model number, licensing or version number. <p>After recalling the state, the Recall State function does the following:</p> <ul style="list-style-type: none"> • Makes the saved measurement for the mode the active measurement. • Clears the input and output buffers. • Status Byte is set to 0. • Executes a *CLS <p>If the file specified is empty an error is generated. If the specified file does not exist, another error is generated. If there is a mismatch between the file and the proper file type, an error is generated. If there is a mismatch between file version or model number or instrument version or model number, a warning is displayed. Then it returns to the State menu and File Open dialog goes away.</p> <p>After the Recall, the analyzer exits the Recall menu and returns to the previous menu.</p>
Backwards Compatibility SCPI	:MMEMory:LOAD:STATe 1,<filename> For backwards compatibility, the above syntax is supported. The "1" is simply ignored.
Initial S/W Revision	Prior to A.02.00

More Information

In measurements that support saving Traces, for example, Swept SA, the Trace data is saved along with the State in the State file. When recalling the State, the Trace data is recalled as well. Traces are recalled exactly as they were stored, including the writing mode and update and display modes. If a Trace was updating and visible when the State was saved, it will come back updating and visible, and its data will be rewritten right away. When you use State to save and recall traces, any trace whose data must be preserved should be placed in View or Blank mode before saving.

The following table describes the Trace Save and Recall possibilities:

You want to recall state and one trace's data, leaving other traces unaffected.	Save Trace+State from 1 trace. Make sure that no other traces are updating (they should all be in View or Blank mode) when the save is performed.	On Recall, specify the trace you want to load the one trace's data into. This trace will load in View. All other traces' data will be unaffected, although their trace
---	---	--

		mode will be as it was when the state save was performed.
You want to recall all traces	Save Trace+State from ALL traces.	On Recall, all traces will come back in View (or Blank if they were in Blank or Background when saved)
You want all traces to load exactly as they were when saved.	Save State	On recall, all traces' mode and data will be exactly as they were when saved. Any traces that were updating will have their data immediately overwritten.

From File...

When you press “From File”, the analyzer brings up a Windows dialog and a menu entitled “File Open.” This menu allows you to navigate to the various fields in the Windows dialog without using a keyboard or mouse. The Tab and Arrow keys can also be used for dialog navigation.

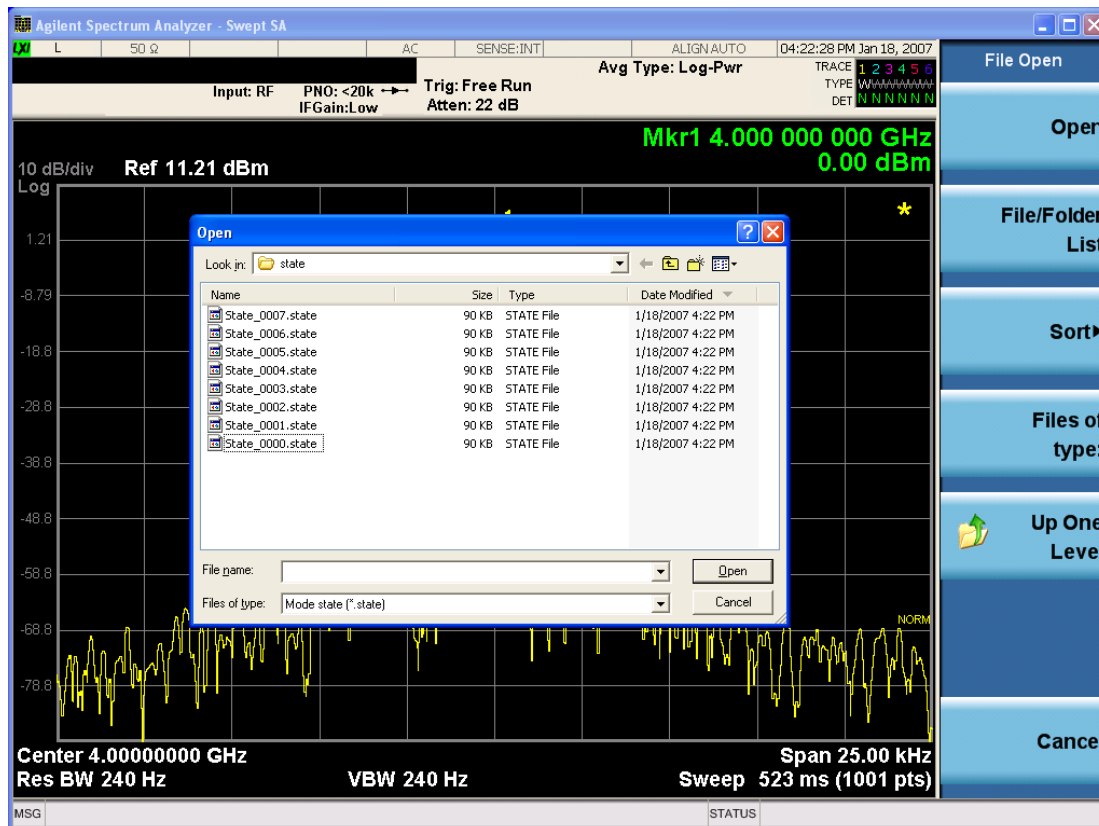

Listed below are the functions of the various fields in the dialog, and the corresponding softkeys:

Open

Performs the recall of the specified file. While the recall is being performed, the floppy icon appears briefly in the Meas bar.

File/Folder List

Enables you to navigate to the center of the dialog that contains the list of files and folders. Once here you can get information about the file and use the tab keys to navigate to the other fields in the dialog, such as Look In.

Look In

The Look In field shows the path from which the file will be recalled and allows you to change the path using the up and down arrow keys to navigate to other paths; the Enter key to open a directory; and the Backspace key to go back one directory. The **Look In field** first uses the last path from the Save As dialog **Save In:** path for that same file type. There is no softkey for directly navigating to the Look In field, but you can use the left tab to get here from the File/Folder List.

User specified paths are remembered when you leave and return to a Mode and are reset back to the default using Restore Mode Defaults.

Sort

Accesses a menu that enables you to sort the files within the File Open dialog. Only one sorting type can be selected at a time and the sorting happens immediately. The sorting types are By Date, By Name, By extension, and By Size.

Files of Type

This field shows the file suffix for the type of file you have selected to recall. For example, if you navigated here while recalling State, "Mode state (*.state)" is in the field. If you navigated here while recalling Trace, ""Mode state (*.trace)" is in the field. If you navigated here while importing a trace data file, "Trace Data (*.csv)" is in the field. For some file types, there is more than one choice in the dropdown menu, which you can select by using the up and down arrow keys and Enter.

Up One Level

This key corresponds to the icon of a folder with the up arrow that is in the tool bar of the dialog. When pressed, it causes the file and folder list to navigate up one level in the directory structure. The Backspace key does the same thing.

Cancel

This key corresponds to the Cancel selection in the dialog. It causes the current **Open** request to be cancelled. The ESC key does the same thing.

Key Path	Recall, State
Notes	Brings up the Open dialog for recalling a State Save Type
Initial S/W Revision	Prior to A.02.00

Edit Register Names

You may enter a custom name on any of the Register keys, to help you remember what you are using that state to save. To do this, press the Edit Register Names key, choose the register whose name you wish to edit, and then enter the desired label using the Alpha Editor or an external PC keyboard.

The maximum number of characters that can be added is 30. In most cases, 30 characters will fit on two lines of the key.

For more information and the SCPI command, see Edit Register Names under the Save, State function.

Key Path	Recall, State
Mode	All
Dependencies	N9060A-7FP or N9060B-2FP license required to edit the register names. When the feature is not licensed, sending the SCPI command generates an error, -221, "Settings conflict;Option not available"
Initial S/W Revision	A.11.00

Register 1 thru Register 16

Selecting any one of these register keys causes the State of the mode from the specified Register to be recalled. Each of the register keys annotates whether it is empty or at what date and time it was last modified. In addition, you can use the Edit Register Names key under Save, State to enter custom names for each register.

NOTE

In products that run multiple instances of the X-Series Application, recalling the same register name on each instance is a way to share setups between the instances.

Registers are shared by all modes, so recalling from any one of the registers will cause a mode switch to the mode that was active when the save to the Register occurred.

Although these 16 registers are the only registers available from the front panel, there are 128 state registers available in the instrument. Registers 17-128 are only available from the SCPI interface, using the *RCL command.

After the recall completes, the message "Register <register number> recalled" appears in the message bar. If you are in the Spectrum Analyzer Mode, and you are recalling a register that was saved in the Spectrum Analyzer Mode, then after the recall, you will still be in the Recall Register menu. If the Recall causes you to switch modes, then after the Recall, you will be in the Frequency menu.

If a requested register is empty an error is generated.

Key Path	Recall, State
Example	*RCL 1
Range	1-16 from front panel, 1-128 from SCPI
Readback	Date and time with seconds resolution are displayed on the key OR A custom name of up to 30 characters entered using the Save, State, Edit Register Names key

	OR “(empty)” if no prior save operation has been performed to this register.
Initial S/W Revision	Prior to A.02.00
Modified at S/W Revision	Prior to A.11.00

Register 1 thru Register 16

Selecting any one of these register keys causes the State of the mode from the specified Register to be recalled. Each of the register keys annotates whether it is empty or at what date and time it was last modified. In addition, you can use the Edit Register Names key under Save, State to enter custom names for each register.

NOTE In products that run multiple instances of the X-Series Application, recalling the same register name on each instance is a way to share setups between the instances.

Registers are shared by all modes, so recalling from any one of the registers will cause a mode switch to the mode that was active when the save to the Register occurred.

Although these 16 registers are the only registers available from the front panel, there are 128 state registers available in the instrument. Registers 17–128 are only available from the SCPI interface, using the *RCL command.

After the recall completes, the message "Register <register number> recalled" appears in the message bar. If you are in the Spectrum Analyzer Mode, and you are recalling a register that was saved in the Spectrum Analyzer Mode, then after the recall, you will still be in the Recall Register menu. If the Recall causes you to switch modes, then after the Recall, you will be in the Frequency menu.

If a requested register is empty an error is generated.

Key Path	Recall, State
Example	*RCL 1
Range	1–16 from front panel, 1–128 from SCPI
Readback	Date and time with seconds resolution are displayed on the key OR A custom name of up to 30 characters entered using the Save, State, Edit Register Names key OR “(empty)” if no prior save operation has been performed to this register.
Initial S/W Revision	Prior to A.02.00
Modified at S/W Revision	Prior to A.11.00

Sequences

These keys allow you to import a Tab separated or .txt file that will automatically setup all the parameters required for building a Sequence. The parameters will automatically be loaded into the Stated Sequencer.

Once selected, in order to import the selected Sequence Type you must select the Open key in the Source Sequence menu.

Key Path	Recall, Sequences
Mode	All
Remote Command	:MMEMory:LOAD:SEQuences: SLIS ALIS SAALIS "MySequence.txt"
Example	:MMEM:LOAD:SEQ:SLIS "MySequence.txt"
Notes	Available file types are: –CSV (Comma delimited) (*.csv) –Text (Tab delimited) (*.txt)
Initial S/W Revision	A.05.00

Source Sequence

The list of parameters, that configure steps, that makes up a sequence for the Source.

The Source sequence is a sequence of flexible configurable steps that can be set anywhere in the instruments frequency range.

Key Path	Recall,Sequences
Example	:MMEM:LOAD:SEQ:SLIS "MySequence.txt"
Dependencies	Only available in XOBT
Initial S/W Revision	A.05.00

Open...

When you press “Open”, the analyzer brings up a Windows dialog and a menu entitled “File Open.” This menu allows you to navigate to the various fields in the Windows dialog without using a keyboard or mouse. The Tab and Arrow keys can also be used for dialog navigation.

See "[From File...](#)" on page 2401 in Recall, State, for a full description of this dialog and menu.

Key Path	Recall, Data
Notes	The key location is mode-dependent and will vary. Brings up Open dialog for recalling a <mode specific> Save Type
Initial S/W Revision	Prior to A.02.00

Data (Import)

Importing a data file loads data that was previously saved from the current measurement or from other measurements and/or modes that produce compatible data files. The Import Menu only contains Data Types that are supported by the current measurement.

Since the commonly exported data files are in .csv format, the data can be edited by the user prior to importing. This allows you to export a data file, manipulate the data in Excel (the most common PC Application for manipulating .csv files) and then import it.

Importing Data loads measurement data from the specified file into the specified or default destination, depending on the data type selected. Selecting an Import Data menu key will not actually cause the importing to occur, since the analyzer still needs to know from where to get the data. Pressing the Open key in this menu brings up the Open dialog and Open menu that provides you with the options from where to recall the data. Once a filename has been selected or entered in the Open menu, the recall occurs as soon as the Open button is pressed.

Key Path	Recall
Mode	All
Notes	The menu is built from whatever data types are available for the mode. Some keys will be missing completely, so the key locations in the sub-menu will vary. No SCPI command directly controls the Data Type that this key controls. The Data Type is included in the MMEM:LOAD commands.
Dependencies	If a file type is not used by a certain measurement, it is grayed out for that measurement. The key for a file type will not show at all if there are no measurements in the Mode that support it.
Preset	Is not affected by Preset or shutdown, but is reset during Restore Mode Defaults
Readback	The data type that is currently selected
Initial S/W Revision	Prior to A.02.00

Component Carrier Setup

Enables you to import LTE-A setup files for all Component Carriers or the specified Component Carrier. Selecting this key displays a menu that enables you to select what the Component Carrier setup files to be imported. After making this selection, depress Open... and use the file dialog to select the file you wish to recall. The Key is valid for Conformance EVM measurements only.

It supports to the following import file formats

- LTE app state files (*.state)
- EVM Setup Files (*.evms)
- 89601 VSA Setup Files (*.set, *.setx)
- Signal Studio Setup Files (*.scp)

App State Files

Extension: state

The parameters of the LTE Modulation Analysis measurement can be imported to LTE-Advanced EVM and CEVM measurements from the LTE .state file. It depends on the parameter of the Component Carrier Setup to decide which component carriers' measurement parameters are affected.

Pressing OPEN under the Import Data menu will open the above directory from which you can select an LTE app state file.

EVM Setup Files

Extension: evms

It will recall LTE test model parameters specified in the standards to LTE-Advanced FDD/TDD EVM and CEVM measurements. It depends on the parameter of the Component Carrier Setup to decide which component carriers 'measurement parameters are affected.

The default path is My Documents\LTEATDD\LTEAFDD\data\evmsetup. Note that "My Documents" is an alias to a directory and its place differs depending on which user is logged in. At XSA start up, XSA will overwrite all of the EVM Setup files to the current user's "My Documents\LTEATDD\LTEAFDD\data\evmsetup" each time.

Pressing OPEN under the Import Data menu will open the above directory from which you can select an EVM Setup file.

You cannot read the contents of the provided EVM Setup file since it is a binary file.

89601 VSA Setup Files

Extension: set, setx

The 89600 Vector Signal Analyzer Setup file created using the 89600 Vector Signal Analyzer Option BHD (LTETDD\LTEFDD) can be imported as LTE-Advanced TDD/FDD EVM and CEVM parameter sets.

The 89600 Vector Signal Analyzer Setup file created using the 89600 Vector Signal Analyzer Option BHD (LTEATDD\LTEAFDD) can be imported as LTE-Advanced TDD/FDD EVM and CEVM parameter sets.

Which component carriers 'measurement parameters are affected depends on depends on the parameter of the Component Carrier Setup.

If the setup file is not loaded successfully, an error message, -230 "Data corrupt or stale", is issued with the specified file name.

Signal Studio Setup Files

Extension: scp

The Keysight Signal Studio setup file created using Signal Studio (N7624B/N7625B) can be imported as LTE-Advanced TDD/FDD parameter set.

Supported component carrier types are listed in the table below:

<i>Signal Studio</i>	<i>Carrier Type</i>
N7624B Signal Studio for 3GPP LTE	Advanced LTE FDD Downlink (2009-03)
	Advanced LTE FDD Downlink (2009-12)
	Advanced LTE FDD Downlink (2010-06)
	Advanced LTE FDD Uplink (2009-12)
	Advanced LTE FDD Uplink (2010-06)
	Basic LTE FDD Downlink (2009-03)
	Basic LTE FDD Downlink (2009-12)
	Basic LTE FDD Downlink (2010-06)
	Basic LTE FDD Uplink (2009-03)

	Basic LTE FDD Uplink (2009-12)
	Basic LTE FDD Uplink (2010-06)
	Basic LTE-A FDD Downlink (2010-12)
	Basic LTE-A FDD Uplink (2010-12)
	Basic LTE FDD R9 Downlink
	Basic LTE FDD R9 Uplink
	Advanced LTE FDD R9 Downlink
	Advanced LTE FDD R9 Uplink
	Basic LTE-A FDD R10 Downlink
	Basic LTE-A FDD R10 Uplink
N7625B Signal Studio for 3GPP LTE TDD	Advanced LTE TDD (2009-03)
	Advanced LTE TDD (2009-12)
	Basic LTE TDD (2009-03)
	Basic LTE TDD (2009-12)
	Basic LTE-A TDD (2010-01)
	Basic LTE-A TDD R10 (2010-12)

If the setup file is not loaded successfully, an error message, -230 “Data corrupt or stale”, is issued with the specified file name.

Key Path	Recall, Data
Mode	LTEATDD, LTEAFDD
Remote Command	MMEMemory:LOAD:SETup ALL CC0 CC1 CC2 CC3 CC4,<string>
Example	MMEMemory:LOAD:SETup CC0,"LTE-A TDD.set"
Notes	The options CC1~CC4 can be enabled with 9080B/9082B-2FP license.
Notes	“ALL” is primarily used to LTE-A setup file for each component carrier including the number of component carriers. “CC*” is used to import LTE-A setup file for the specified component carrier.
Backwards Compatibility SCPI	MMEMemory:LOAD:SSSetup <string> MMEMemory:LOAD:VSASetup <string> MMEMemory:LOAD:EVMSSetup <string>
Initial S/W Revision	A.14.00
Modified at S/W Revision	A.14.50

Masks

This key enables you to recall a preset mask file which contains Offset and Limit settings. Parameters except them will not be overwritten. You cannot change or create preset mask files since they are binary files. This key is valid for the Spectrum Emission Mask, ACP and Spurious Emissions measurements.

Default path: “My Documents\LTEATDD\LTEAFDD\data\masks”

Note that “**My Documents**” is an alias to a directory and its location depends on which user is logged in. At XSA start up, all of the limit mask files in the current user’s “My Documents\LTEATDD\LTEAFDD\data\masks” directory are overwritten.

File type: Binary

Filename: The filename follows the rule below with the words connected using underscores.

<Measurement>_<Condition>.mask

Where

<Measurement> Measurement the limit mask file is applied to: SEM, ACP or SPUR

<Condition> Condition. It depends on the measurement.

File extension: .mask

File Dialog Filter: Preset Mask Files (*.mask)

Selecting OPEN... under the Import Data menu opens the above directory enabling you to select a mask file.

Details of the masks are provided in the default folder of masks with the PDF extension.

Key Path	Recall, Data
Mode	LTEATDD, LTEAFDD
Remote Command	MME ^M emory:LOAD:MASK <string>
Example	MME:LOAD:MASK “ACP_BS\ACP_BS_3MHz_pairE-UTRA_CatA.mask”
Notes	Parameters related to Limit and Offset are overwritten by the contents of the preset mask file.
Initial S/W Revision	A.14.00

Open...

When you press “Open”, the analyzer brings up a Windows dialog and a menu entitled “**File Open.**” This menu allows you to navigate to the various fields in the Windows dialog without using a keyboard or mouse. The Tab and Arrow keys can also be used for dialog navigation.

See "[From File...](#)" on page 2401 in Recall, State, for a full description of this dialog and menu.

Key Path	Recall, Data
Notes	The key location is mode-dependent and will vary. Brings up Open dialog for recalling a <mode specific> Save Type
Initial S/W Revision	Prior to A.02.00

Restart

The Restart function restarts the current sweep, or measurement, or set of averaged/held sweeps or measurements. If you are Paused, pressing Restart does a Resume.

The Restart function is accessed in several ways:

- Pressing the Restart key
- Sending the remote command INIT:IMMEDIATE
- Sending the remote command INIT:RESTART

See "[More Information](#)" on page 729

Key Path	Front-panel key
Remote Command	:INITiate[:IMMEDIATE] :INITiate:RESTART
Example	:INIT:IMM :INIT:REST
Notes	:INITiate:RESTART and :INITiate:IMMEDIATE perform exactly the same function.
Couplings	Resets average/hold count k. For the first sweep overwrites all active (update=on) traces with new current data. For application modes, it resets other parameters as required by the measurement.
Status Bits/OPC dependencies	This is an Overlapped command. The STATUS:OPERation register bits 0 through 8 are cleared. The STATUS:QUESTIONable register bit 9 (INTEgrity sum) is cleared. The SWEEPING bit is set. The MEASURING bit is set.
Backwards Compatibility Notes	For Spectrum Analysis mode in ESA and PSA, the Restart hardkey and the INITiate:RESTART command restart trace averages (displayed average count reset to 1) for a trace in Clear Write, but did not restart Max Hold and Min Hold. In the X-Series, the Restart hardkey and the INITiate:RESTART command restart not only Trace Average, but MaxHold and MinHold traces as well. For wireless comms modes in ESA and PSA, the Restart hardkey and the INITiate:RESTART command restart every measurement, which includes all traces and numeric results. There is no change to this operation.
Initial S/W Revision	Prior to A.02.00

More Information

The **Restart** function first aborts the current sweep/measurement as quickly as possible. It then resets the sweep and trigger systems, sets up the measurement and initiates a new data measurement sequence with a new data acquisition (sweep) taken once the trigger condition is met.

If the analyzer is in the process of aligning when **Restart** is executed, the alignment finishes before the restart function is performed.

Even when set for Single operation, multiple sweeps may be taken when Restart is pressed (for example, when averaging/holding is on). Thus when we say that **Restart** "restarts a measurement," we may mean:

- It restarts the current sweep
- It restarts the current measurement
- It restarts the current set of sweeps if any trace is in Trace Average, Max Hold or Min Hold
- It restarts the current set of measurements if Averaging, or Max Hold, or Min Hold is on for the measurement
- depending on the current settings.

With **Average/Hold Number** (in **Meas Setup** menu) set to 1, or Averaging off, or no trace in Trace Average or Hold, a single sweep is equivalent to a single measurement. A single sweep is taken after the trigger condition is met; and the analyzer stops sweeping once that sweep has completed. However, with **Average/Hold Number** >1 and at least one trace set to **Trace Average, Max Hold, or Min Hold (SA Measurement)** or **Averaging on (most other measurements)**, multiple sweeps/data acquisitions are taken for a single measurement. The trigger condition must be met prior to each sweep. The sweep is stopped when the average count k equals the number N set for **Average/Hold Number**. A measurement average usually applies to all traces, marker results, and numeric results; but sometimes it only applies to the numeric results.

Once the full set of sweeps has been taken, the analyzer will go to idle state. To take one more sweep without resetting the average count, increment the average count by 1, by pressing the step up key while **Average/Hold Number** is the active function, or sending the remote command `CALC:AVER:TCON UP`.

Save

The Save menu lets you choose what you want to save and where you want to save it. Among the types of files you can save are **States**, **Traces**, and **Screen Images**. In addition, an Export (Data) option lets you save a number of data types as CSV files for easy import into Excel and other spreadsheet programs.

Key Path	Front-panel key
Mode	All
Notes	No remote command for this key specifically, but the :MMEM:STORe command is available for specific file types. An example is :MMEM:STOR:STATe <filename>.
Initial S/W Revision	Prior to A.02.00

State

The Save State menu lets you choose a register or file for saving the state.

NOTE

In products that run multiple instances of the X-Series Application, all instances share the same register and file location where you want to save the state.

The content of a state file includes all of the settings and data required to return the analyzer as closely as possible to the Mode it was in, with the exact settings which were in place, when the save occurred. The Mode settings in each state file include the settings that are affected by Mode Preset, as well as the additional settings affected by Restore Mode Defaults; all of the Mode's settings. In addition, all of the settings of the Input/Output system are included, even though they are outside of the Mode's state, because they are needed to restore the complete setup. Persistent System settings (for example, Verbose SCPI) are not affected by either Mode Preset or Restore Mode Defaults, nor are they included in a saved State file.

After the save completes, the message "File <filename> saved" or "State Register <register number> saved" is displayed.

For rapid saving, the State menu lists 16 registers to save to. Pressing a Register key initiates the save. You can also select a file to save to.

The default path for all State Files is:

My Documents\<<mode name>\state

where <mode name> is the parameter used to select the mode with the INST:SEL command (for example, SA for the Spectrum Analyzer).

Key Path	Save
Mode	All
Remote Command	:MMEMory:STORe:STATe <filename>
Example	MMEM:STOR:STATe "MyStateFile.state" This stores the current instrument state data in the file MyStateFile.state in the default directory.
Notes	Both single and double quotes are supported for any filename parameter over remote.

After saving to a register, that register's menu key is updated with the date the time, unless a custom label has been entered for that key.

After saving to a register, you remain in the Save State menu, so that you can see the Register key update. After saving to a file, the analyzer automatically returns to the previous menu and any Save As dialog goes away.

Backwards :MMEMory:STORE:STATe 1,<filename>

Compatibility SCPI For backwards compatibility, the above syntax is supported. The "1" is simply ignored. The command is sequential.

Initial S/W Revision Prior to A.02.00

To File . . .

When you press “To File”, the analyzer brings up a Windows dialog and a menu entitled “Save As.” This menu allows you to navigate to the various fields in the Windows dialog without using a keyboard or mouse. The Tab and Arrow keys can also be used for dialog navigation.

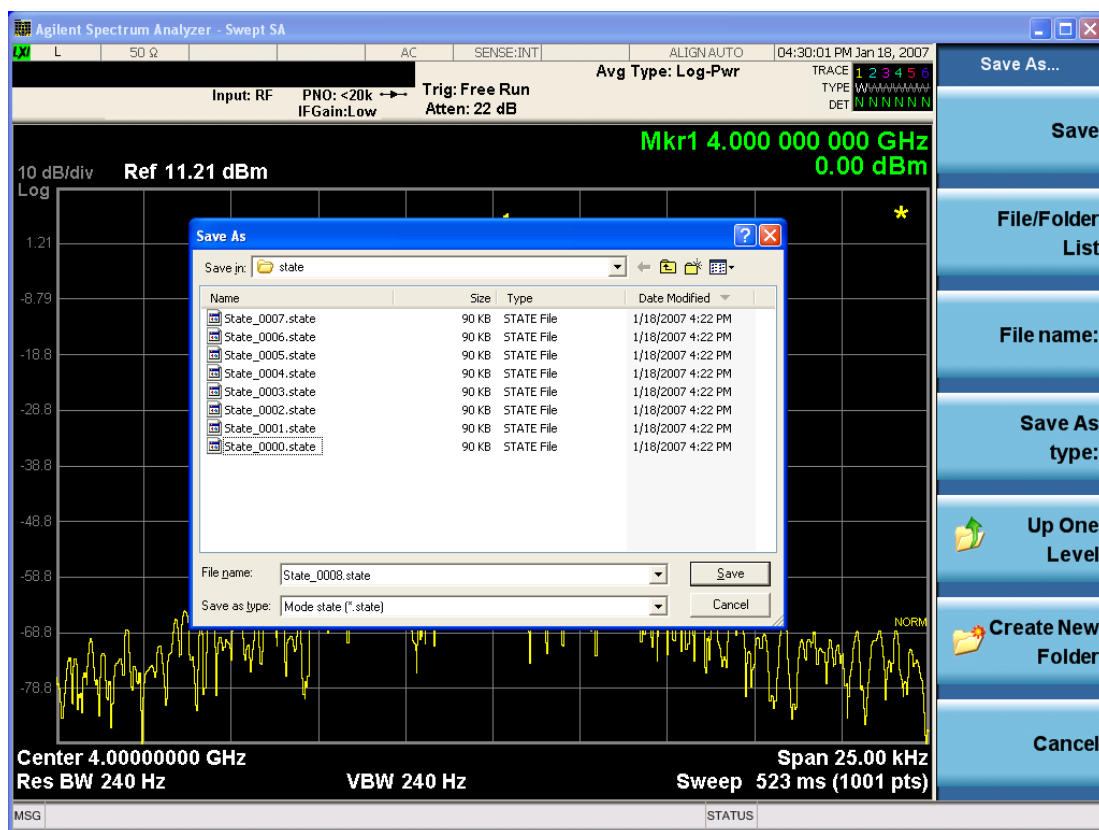

The Listed below

are the functions of the various fields in the dialog, and the corresponding softkeys:

Save

Performs the save to the specified file of the selected type. If the file already exists, a dialog will appear that allows you to replace the existing file by selecting OK, or you can Cancel the request. If you select OK,

the file will be overwritten. Using the C: drive is strongly discouraged, since it runs the risk of being overwritten during an instrument software upgrade.

While the save is being performed, the floppy icon appears briefly in the Meas bar.

File/Folder List

Enables you to navigate to the center of the dialog that contains the list of files and folders. Once here you can get information about the file and use the tab keys to navigate to the other fields in the dialog, such as Save In.

Save In

The Save In field shows the path to which the file will be saved and allows you to change the path using the up and down arrow keys to navigate to other paths; the Enter key to open a directory; and the Backspace key to go back one directory. The **Save In field** defaults to the default path for this type of file and remembers the last path you used to save this type of file. There is no softkey for directly navigating to the Save In field but you can use left tab to get here from the File/Folder List.

User specified paths are remembered when you leave and return to a Mode and are reset back to the default using Restore Mode Defaults.

File Name

The File Name field is initially loaded with an automatically generated filename specific to the appropriate Save Type. The automatically generated filename is guaranteed not to conflict with any filename currently in the directory. You may replace or modify this filename using the File Name key. See the ["Quick Save " on page 2397](#) documentation for more on the automatic file naming algorithm.

When you press the File Name key the analyzer displays the Alpha Editor. Use the knob to choose the letter to add and the front-panel Enter key to add the letter to the file name. The BK character moves you back and the FW character moves you forward in the filename. The Select key on the front panel generates a space character. When you are done entering the filename press the Done softkey. This returns back to the **File Open** dialog and menu, but does not cause the save to occur.

Save As Type

This field shows the file suffix for the type of file you have selected to save. For example, if you navigated here while saving State, "Mode state (*.state)" is in the field. If you navigated here from saving Trace, ""Mode state (*.trace)" is in the field. If you navigated here while exporting a trace data file, "Trace Data (*.csv)" is in the field. For some file types, there is more than one choice in the dropdown, which you can select by using the up and down arrow keys and Enter.

Up One Level

This key corresponds to the icon of a folder with the up arrow that is in the tool bar of the dialog. When pressed, it causes the file and folder list to navigate up one level in the directory structure. The Backspace key does the same thing.

Create New Folder

This key corresponds to the icon of a folder with the "*" that is in the tool bar of the dialog. When pressed, a new folder is created in the current directory with the name **New Folder** and you can enter a new folder name using the Alpha Editor.

Cancel

This key corresponds to the Cancel selection in the dialog. It causes the current **Save As** request to be cancelled. The ESC key does the same thing.

Key Path	Save, State
Mode	All
Notes	Brings up Save As dialog for saving a State Save Type
Initial S/W Revision	Prior to A.02.00

Edit Register Names

You may enter a custom name on any of the Register keys, to help you remember what you are using that state to save. To do this, press the Edit Register Names key, choose the register whose name you wish to edit, and then enter the desired label using the Alpha Editor or an external PC keyboard.

The maximum number of characters that can be added is 30. In most cases, 30 characters will fit on two lines of the key.

See ["More Information" on page 734](#)

Key Path	Save, State
Mode	All
Remote Command	:MMEMory:REGister:STATe:LABel <reg number>,"label" :MMEMory:REGister:STATe:LABel? <reg number>
Example	:MMEM:REG:STAT:LAB 1,"my label"
Notes	<reg number> is an integer from 1 to 16. If the SCPI specifies an invalid register number an error message is generated, -222,"Data out of range;Invalid register label number" "label" is a string from 0 to 30 characters in length. If a label exceeds 30 characters, an error message is generated, -150,"String data error;Label clipped to 30 characters" "label" of length 0 erases the custom label and restores the default (time and date) label. E.g.: :MMEM:REG:STAT:LAB 1,""
Dependencies	N9060A-7FP or N9060B-2FP license required to edit the register names. When the feature is not licensed, sending this command generates an error, -221,"Settings conflict;Option not available"
Preset	The names are unaffected by Preset or power cycle but are set to the default label (time and date) on a "Restore System Defaults->Misc"
Initial S/W Revision	A.11.00

More Information

When you edit one of the register names, the time and date field will be replaced by the custom name.

If you delete all the characters in the custom name, it restores the default (time and date).

The register names are stored within the state files, but they are not part of the instrument state; that is, once you have edited a register name, loading a new state will not change that register name. Another

consequence of this is that the names will be persistent through a power cycle. Also, if a named state file is transferred to another analyzer, it will bring its custom name along with it.

If you try to edit the name of an empty register, the analyzer will first save the state to have a file to put the name in. If you load a named state file into an analyzer with older firmware it will ignore the metadata.

The *SAV and *RCL commands will not be affected by the custom register names, nor will the MMEM commands.

Register 1 thru Register 16

Selecting any one of these register menu keys causes the State of the currently active mode to be saved to the specified Register. The registers are provided for rapid saving and recalling, since you do not need to specify a filename or navigate to a file. Each of the register menu keys annotates whether it is empty or at what date and time it was last modified. In addition, you can use the Edit Register Names key to enter custom names for each register.

NOTE

In products that run multiple instances of the X-Series Application, save with different register name if you do not want to overwrite the register of another running instance.

Although these 16 registers are the only registers available from the front panel, there are 128 state registers available in the instrument. Registers 17–128 are only available from the SCPI interface, using the *SAV command.

There is one set of 128 state registers in the instrument, not one set for each Mode. When a state is saved, the Mode it was saved from is saved with it; then when it is recalled, the instrument switches to that Mode.

After the save completes, the corresponding register menu key annotation is updated with the date and time and the message "Register <register number> saved" is displayed.

Key Path	Save, State
Mode	All
Example	*SAV 1
Range	1–16 from front panel, 1–128 from SCPI
Readback	Date and time with seconds resolution are displayed on the key OR A custom name of up to 30 characters entered using the Edit Register Names key OR “(empty)” if no prior save operation has been performed to this register.
Initial S/W Revision	Prior to A.02.00
Modified at S/W Revision	A.11.00

Register 1 thru Register 16

Selecting any one of these register menu keys causes the State of the currently active mode to be saved to the specified Register. The registers are provided for rapid saving and recalling, since you do not need to specify a filename or navigate to a file. Each of the register menu keys annotates whether it is empty or at

what date and time it was last modified. In addition, you can use the Edit Register Names key to enter custom names for each register.

NOTE In products that run multiple instances of the X-Series Application, save with different register name if you do not want to overwrite the register of another running instance.

Although these 16 registers are the only registers available from the front panel, there are 128 state registers available in the instrument. Registers 17–128 are only available from the SCPI interface, using the *SAV command.

There is one set of 128 state registers in the instrument, not one set for each Mode. When a state is saved, the Mode it was saved from is saved with it; then when it is recalled, the instrument switches to that Mode.

After the save completes, the corresponding register menu key annotation is updated with the date and time and the message "Register <register number> saved" is displayed.

Key Path	Save, State
Mode	All
Example	*SAV 1
Range	1–16 from front panel, 1–128 from SCPI
Readback	Date and time with seconds resolution are displayed on the key OR A custom name of up to 30 characters entered using the Edit Register Names key OR “(empty)” if no prior save operation has been performed to this register.
Initial S/W Revision	Prior to A.02.00
Modified at S/W Revision	A.11.00

Mass Storage Catalog (Remote Command Only)

Key path	SCPI Only
Remote Command	:MMEMory:CATalog? [<directory_name>]
Notes	The string must be a valid logical path. Queries disk usage information (drive capacity, free space available) and obtains a list of files and directories in a specified directory in the following format: <numeric_value>,<numeric_value>,{<file_entry>} It returns two numeric parameters and as many strings as there are files and directories. The first parameter indicates the total amount of storage currently used in bytes. The second parameter indicates the total amount of storage available, also in bytes. The <file_entry> is a string. Each <file_entry> indicates the name, type, and size of one file in the directory list: <file_name>,<file_type>,<file_size> As the windows file system has an extension that indicates file type, <file_type> is always empty. <file_size> provides the size of the file in bytes. For directories, <file_entry> is surrounded by square brackets and both <file_type> and <file_size> are empty
Initial S/W Revision	Prior to A.02.00

Mass Storage Change Directory (Remote Command Only)

Key path	SCPI Only
Remote Command	:MMEMory:CDIRectory [<directory_name>] :MMEMory:CDIRectory?
Notes	The string must be a valid logical path. Changes the default directory for a mass memory file system. The <directory_name> parameter is a string. If no parameter is specified, the directory is set to the *RST value. At *RST, this value is set to the default user data storage area, that is defined as System.Environment.SpecialFolder.Personal. Query returns full path of the default directory.
Initial S/W Revision	Prior to A.02.00

Mass Storage Copy (Remote Command Only)

Key path	SCPI Only
Remote Command	:MMEMory:COPY <string>,<string>[,<string>,<string>]
Notes	The string must be a valid logical path. Copies an existing file to a new file or an existing directory to a new directory. Two forms of parameters are allowed. The first form has two parameters. In this form, the first parameter specifies the source, and the second parameter specifies the destination. The second form has four parameters. In this form, the first and third parameters specify the source. The second and fourth parameters specify the directories. The first pair of parameters specifies the source. The second pair specifies the destination. An error is generated if the source doesn't exist or the destination file already exists. This command will generate an "access denied" error if the destination is a restricted folder (e.g., C:\Windows) and the current user does not have Power User or Administrator privileges.

Mass Storage Device Copy (Remote Command Only)

This command transfers data to/from a file and a peripheral device.

Key path	SCPI Only
Remote Command	:MMEMory:COPY:DEvice <source_string>,<dest_string>
Notes	The strings must be a valid logical path or a valid device keyword. If the dest_string is a device keyword, the data is copied from the source file to the device. If the source_string is a device keyword, the data is copied to the source file from the device. Valid device keywords are: SNS (smart noise source) An error is generated if the file or device is not found.

Mass Storage Delete (Remote Command Only)

Key path	SCPI Only
Remote Command	:MMEMory:DELeTe <file_name>[,<directory_name>]
Notes	The string must be a valid logical path. Removes a file from the specified directory. The <file_name> parameter specifies the file name to be removed. This command will generate an “access denied” error if the file is in a restricted folder (e.g., C:\Windows) and the current user does not have Power User or Administrator privileges.
Initial S/W Revision	Prior to A.02.00

Mass Storage Data (Remote Command Only)

Creates a file containing the specified data OR queries the data from an existing file.

Key path	SCPI Only
Remote Command	:MMEMory:DATA <file_name>, <data> :MMEMory:DATA? <file_name>
Notes	The string must be a valid logical path. The command form is MMEMory:DATA <file_name>,<data>. It loads <data> into the file <file_name>. <data> is in 488.2 block format. <file_name> is string data. The query form is MMEMory:DATA? <file_name> with the response being the associated <data> in block format.
Initial S/W Revision	Prior to A.02.00

Mass Storage Make Directory (Remote Command Only)

Key path	SCPI Only
Remote Command	:MMEMory:MDIRectory <directory_name>
Notes	The string must be a valid logical path. Creates a new directory. The <directory_name> parameter specifies the name to be created. This command will generate an “access denied” error if the new directory would be in a restricted folder (e.g., C:\Windows) and the current user does not have Power User or Administrator privileges.
Initial S/W Revision	Prior to A.02.00

Mass Storage Move (Remote Command Only)

Key path	SCPI Only
Remote Command	:MMEMory:MOVE <string>,<string>[,<string>,<string>]
Notes	The string must be a valid logical path. Moves an existing file to a new file or an existing directory to a new directory.

Two forms of parameters are allowed. The first form has two parameters. In this form, the first parameter specifies the source, and the second parameter specifies the destination.

The second form has four parameters. In this form, the first and third parameters specify the source. The second and fourth parameters specify the directories. The first pair of parameters specifies the source. The second pair specifies the destination. An error is generated if the source doesn't exist or the destination file already exists.

This command will generate an "access denied" error if the destination is a restricted folder (e.g., C:\Windows) and the current user does not have Power User or Administrator privileges.

Initial S/W Revision Prior to A.02.00

Mass Storage Remove Directory (Remote Command Only)

Key path SCPI Only

Remote Command :MMEMory:RDIRectory <directory_name>

Notes The string must be a valid logical path.

Removes a directory. The <directory_name> parameter specifies the directory name to be removed. All files and directories under the specified directory shall also be removed.

This command will generate an "access denied" error if the folder is a restricted folder (e.g., C:\Windows) or is in a restricted folder and the current user does not have Power User or Administrator privileges.

Initial S/W Revision Prior to A.02.00

Sequences

These keys allow you to save a Tab separated or CSV file of the setup parameters required to build a Sequence.

In order to save you must select the Save As button and choose a destination folder.

Key Path Save, Sequences

Mode All

Remote Command :MMEM:STOR:SEquences: | SLIST | ALIST | SAAList | SSTep
"MySequence.txt"

Example :MMEM:STOR:SEQ:SLIST "MySequence.txt"

Notes Available file types are:
–CSV (Comma delimited) (*.csv)
–Text (Tab delimited) (*.txt)

Initial S/W Revision A.05.00

Source Sequence

The list of parameters, that configure steps, that makes up a sequence for the Source.

The Source sequence is a sequence of flexible configurable steps that can be set anywhere in the instruments frequency range.

Key Path	Save, Sequences
Example	:MMEM:STOR:SEQ:SLIS "MySequence.txt"
Dependencies	Only available in XOBT
Initial S/W Revision	A.05.00

Save As . . .

This menu lets you select the location where you can save the Sequence. This menu is a standard Windows® dialog with Save As menu keys. The "File Name" field in the Save As dialog is initially loaded with an automatically generated filename specific to the appropriate Save Type. The automatically generated filename is guaranteed not to conflict with any filename currently in the directory. You may replace or modify this filename using the File Name softkey. See the Quick Save key documentation for more on the automatic file naming algorithm.

The default path for all Sequence Files is:

My Documents\Sequences

Key Path	Save, Sequences
Mode	All
Notes	Brings up Save As dialog for saving a Sequence Save Type
Initial S/W Revision	A.05.00

Data (Export)

Exporting a data file stores data from the current measurement to mass storage files. The Export Menu only contains data types that are supported by the current measurement.

Since the commonly exported data files are in .csv format, the data can be edited by you prior to importing. This allows you to export a data file, manipulate the data in Excel (the most common PC Application for manipulating .csv files) and then import it.

Selecting an Export Data menu key will not actually cause the exporting to occur, since the analyzer still needs to know where you wish to save the data. Pressing the Save As key in this menu brings up the Save As dialog and Save As menu that allows you to specify the destination file and directory. Once a filename has been selected or entered in the Open menu, the export will occur as soon as the Save key is pressed.

Key Path	Save
Mode	All

Notes	The menu is built from whatever data types are available for the mode. So the key locations in the sub menu will vary. No SCPI command directly controls the Data Type that this key controls. The Data Type is included in the MMEM:STORe commands.
Dependencies	If a file type is not used by a certain measurement, that type is grayed out for that measurement. The key for a file type will not show at all if there are no measurements in the Mode that support it.
Preset	Is not affected by a Preset or shutdown, but is reset during Restore Mode Defaults
Readback	The data type that is currently selected
Initial S/W Revision	Prior to A.02.00

Export Trace Data

Enables you to export trace data with (optional) associated headers. Selecting this key displays a menu that enables you to choose which Trace to save (default is the selected Trace) and whether or not to save headers with the data. The header information is used by the VXA application when saved trace data is recalled, and enables it to be displayed with the same formatting and scaling that it had when saved. If headers are not saved, the scaling and format are set to default values when the trace is recalled. After making these selections, press Save As... and use the file dialog to choose a file name and format for the saved data.

Trace data can be exported in several different formats. Text and comma-separated variable (CSV) formats are useful for viewing the data or importing it to a spreadsheet program. The other formats are binary and thus more compact. Trace data files can be recalled for viewing into other VXA, LTE, LTETDD, iDEN, or 89601 measurements.

Key Path	Save, Data (Export)
Mode	VSA, LTE, LTETDD, IDEN
Remote Command	:MMEMory:STORe:TRACe:DATA TRACE1 TRACE2 TRACE3 TRACE4 TRACE5 TRACE6, "<filename>"[,CSV TXT SDF MAT4 MAT HDF5 BIN[,OFF ON 0 1]]
Example	:MMEM:STOR:TRAC:DATA TRACE1, "TRC1.TXT", TXT, ON
Notes	The Save As... dialog box has the following format options when you are saving trace data: <ul style="list-style-type: none"> • CSV (Comma delimited) (*.csv) • SDF (Fast) (*.sdf;*.dat) • Text (Tab delimited) (*.txt) File format saved depends on selection. The appropriate file extension is appended to the filename if it is not supplied by the user. If the SCPI command includes just a file name, the file format is determined by the filename extension, which must be one of the choices above. *.sdf or an unrecognized extension chooses the SDF fast format. If the optional file format enumerator is included in the command, then this determines the file format and the file extension is ignored. The optional binary parameter determines if file headers are saved. The default is ON. If file headers are not wanted, use the optional "OFF" parameter. The optional Boolean parameter determines whether headers are saved in the file. By default the

	headers are saved. If you are not licensed to save a particular file type, then error -203.9010 is returned. If an invalid file format is specified or the file cannot be saved successfully, then error -25x is returned. If the save is successful, then advisory 0.1500 is shown.
State Saved	No
Readback	(Trace 1 Trace 2 Trace 3 Trace 4 Trace 5 Trace 6)(with without) headers

Trace 1

Selects the Trace 1 register as the destination for the imported data.

Key Path	Save, Data (Export), Trace
Mode	VSA, LTE, LTETDD, IDEN

Trace 2

Selects the Trace 2 register as the destination for the imported data.

Key Path	Save, Data (Export), Trace
Mode	VSA, LTE, LTETDD, IDEN

Trace 3

Selects the Trace 3 register as the destination for the imported data.

Key Path	Save, Data (Export), Trace
Mode	VSA, LTE, LTETDD, IDEN

Trace 4

Selects the Trace 4 register as the destination for the imported data.

Key Path	Save, Data (Export), Trace
Mode	VSA, LTE, LTETDD, IDEN

Trace 5

Selects the Trace 5 register as the destination for the imported data.

Key Path	Save, Data (Export), Trace
Mode	VSA, LTE, LTETDD, IDEN

Trace 6

Selects the Trace 6 register as the destination for the imported data.

Key Path	Save, Data (Export), Trace
Mode	VSA, LTE, LTETDD, IDEN

Include Header

Enables you to select whether or not the saved trace data includes header information describing scaling, formatting, etc.

Key Path	Save, Data (Export), Trace
Mode	VSA, LTE, LTETDD, IDEN
State Saved	No

Measurement Results

Pressing this key selects Meas Results as the data type to be exported.

The Meas Results file contains measurement result sets, plus information describing the current state of the analyzer, as detailed in ["Meas Results File Definition" on page 744](#) and ["Meas Results File Example" on page 745](#) below.

Key Path	Save, Data
Remote Command	:MMEMory:STORe:RESults <string>
Example	:MMEM:STOR:RES "MeasR_0000.csv"
Notes	<p>If the save is initiated via SCPI and the file already exists, the file will be overwritten.</p> <p>The SCPI command exports Occupied Bandwidth measurement results to the file specified as the parameter in the current path. The default path is My Documents\<current mode>\data\obw\results.<="" p=""> <p>Using the C: drive is strongly discouraged, since it runs the risk of being overwritten during an instrument software upgrade.</p> <p>The SCPI parameter is a quoted string that specifies the filename. Both single and double quotes are supported for any filename parameter over SCPI.</p> </current></p>
Dependencies	The current active measurement must be the Occupied Bandwidth measurement to use this command.
Status Bits/OPC dependencies	Sequential – waits for the previous measurement to complete
Initial S/W Revision	Prior to A.02.00

Meas Results File Definition

The content of a Meas Results File is defined in this section.

The first lines in the file consist of identification and instrument configuration details, as follows.

- File ID string, which is “MeasResult”
- Measurement ID following Mode ID, which is “SA:OBW” for example.
- Firmware rev and model number
- Option string
- Auto Sweep Time Rules
- Average Mode
- Average Number
- Average State
- Center Frequency
- Detector
- Electrical Atten
- Electrical Atten State
- IFGain
- IFGainAuto
- Internal Preamp
- Internal Preamp Band
- Limit
- Limit State
- Max Hold
- Mechanical Atten
- MechanicalAttenStepEnum
- OBW Percent Pwr
- Resolution Band Width
- Resolution Bandwidth Shape
- Span
- Sweep Points
- Sweep Time
- Sweep Time Auto

- TriggerSource
- Video Bandwidth
- x DB

The data above is followed in the file by a line containing “MeasResult1” and “MeasResult2”. This line forms a header for each set of measurement results, which appear in subsequent lines. Each line of Measurement Results consists of two comma-separated values, for MeasResult1 and MeasResult2 respectively.

The MeasResult1 set in the file corresponds to the data returned by MEAS|READ|FETCh:OBWidth1, and the MeasResult2 set corresponds to the data returned by MEAS|READ|FETCh:OBWidth2.

The exported file is in CSV format, with a .csv extension.

Meas Results File Example

When imported into Microsoft Excel, a typical Meas Results CSV file appears as shown in the example below.

MeasResult	
SA:OBW	
A.10.53	N9030A
526 ALV ATP B1X B1Y B25 B40 BBA CR3 CRP DCF DDA DP2 DRD EA3 EDP EMC EP1 ERC ESC ESP EXM FSA LFE LNP MAT MPB NFE NUL P26 PFR PNC RTL RTS S40 SB1 SEC SM1 TVT YAS YAV	1
Auto Sweep Time Rules	Normal
Average Mode	Exponential
Average Number	10
Average State	TRUE
Center Frequency	1.33E+10
Detector	Average
IFGain	FALSE
IFGainAuto	FALSE
Internal Preamp	FALSE
Internal Preamp Band	Low
Limit	5000000
Limit State	FALSE
Max Hold	FALSE
OBW Percent Pwr	99
Resolution Band Width	27000
Resolution Bandwidth Shape	Gaussian

Span	3000000
Sweep Points	1001
Sweep Time	0.004933
Sweep Time Auto	TRUE
TriggerSource	Free
Video Bandwidth	270000
x DB	-26
MeasResult1	MeasResult2
2971020.10835045	-94.3702543927405
-74.9741251886604	-94.1447790390963

Save As . . .

When you press “Save As”, the analyzer brings up a Windows dialog and a menu entitled “**Save As.**” This menu allows you to navigate to the various fields in the Windows dialog without using a keyboard or mouse. The Tab and Arrow keys can also be used for dialog navigation.

See "[To File . . .](#)" on page 2413 in Save, State for a full description of this dialog and menu.

The default path for saving files is:

For all of the Trace Data Files:

My Documents\<<mode name>\data\traces

For all of the Limit Data Files:

My Documents\<<mode name>\data\limits

For all of the Measurement Results Data Files:

My Documents\<<mode name>\data\<<measurement name>\results

For all of the Capture Buffer Data Files:

My Documents\<<mode name>\data\captureBuffer

Key Path	Save, Data
Mode	All
Notes	The key location is mode-dependent and will vary. Brings up the Save As dialog for saving a <mode specific> Save Type. The save is performed immediately and does not wait until the measurement is complete.
Initial S/W Revision	Prior to A.02.00

Screen Image

Pressing Screen Image accesses a menu of functions that enable you to specify a format and location for the saved screen image. It brings up a menu that allows you to specify the color scheme of the Screen Image (Themes) or navigate to the Save As dialog to perform the actual save.

Screen Image files contain an exact representation of the analyzer display. They cannot be loaded back onto the analyzer, but they can be loaded into your PC for use in many popular applications.

The image to be saved is actually captured when the Save front panel key is pressed, and kept in temporary storage to be used if you ask for a Screen Image save. When the Screen Image key is pressed, a "thumbnail" of the captured image is displayed, as shown below:

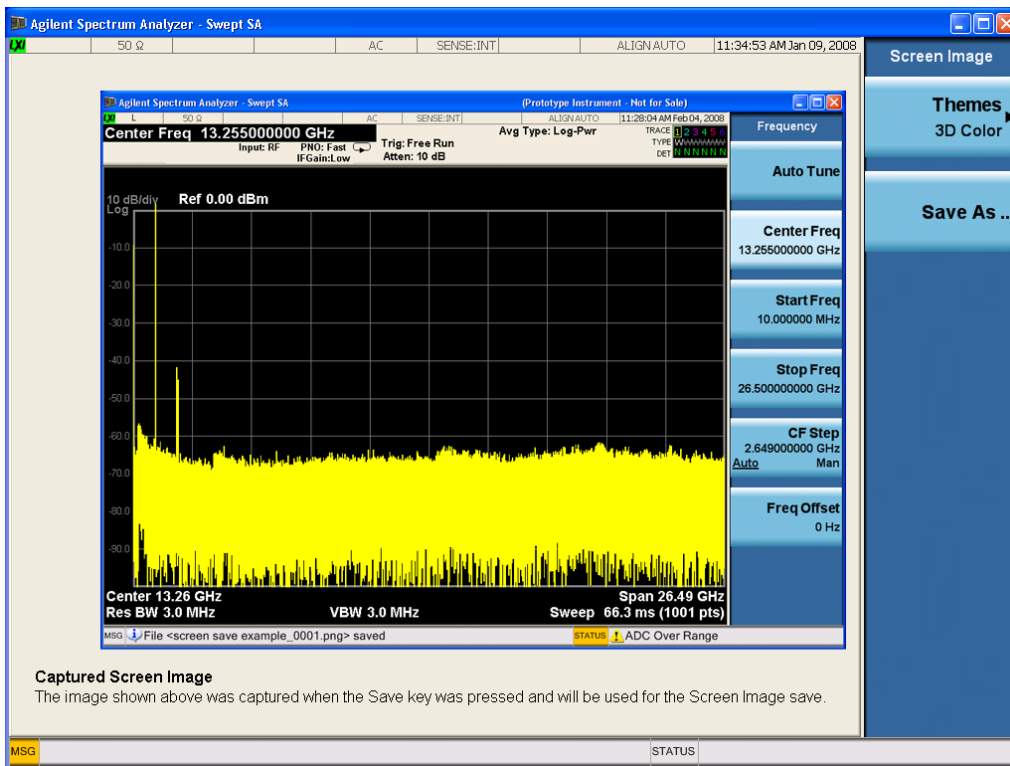

When you continue on into the Save As menu and complete the Screen Image save, the image depicted in the thumbnail is the one that gets saved, showing the menus that were on the screen before going into the Save menus. The save is performed immediately and does not wait until the measurement is complete.

After you have completed the save, the Quick Save front-panel key lets you quickly repeat the last save performed, using an auto-named file, with the current screen data.

NOTE

For versions previous to A.01.55, if you initiate a screen image save by navigating through the Save menus, the image that is saved will contain the Save menu softkeys, not the menus and the active function that were on the screen when you first pressed the Save front panel key.

Key Path	Save
Mode	All

Remote Command	:MMEMory:STORe:SCReen <filename>
Example	:MMEM:STOR:SCR "myScreen.png" This stores the current screen image in the file MyScreenFile.png in the default directory.
Initial S/W Revision	Prior to A.02.00

Themes

Accesses a menu of functions that enable you to choose the theme to be used when saving the screen image.

The **Themes** option is the same as the **Themes** option under the **Display** and **Page Setup** dialogs. It allows you to choose between themes to be used when saving the screen image.

Key Path	Save, Screen Image
Remote Command	:MMEMory:STORe:SCReen:THEMe TDColor TDMonochrome FCOLor FMONochrome :MMEMory:STORe:SCReen:THEMe?
Example	:MMEM:STOR:SCR:THEM TDM
Preset	3D Color; Is not part of Preset, but is reset by Restore Misc Defaults or Restore System Defaults All and survives subsequent running of the modes.
Readback	3D Color 3D Mono Flat Color Flat Mono
Backwards Compatibility Notes	In ESA and PSA we offer the choice of "Reverse Bitmap" or "Reverse Metafile" when saving screen images. This is much like the "Flat Color" theme available in X-Series. Also, if you selected Reverse Bitmap AND a black & white screen image, that would be much like "Flat Monochrome". In other words, each of the X-Series themes has a similar screen image type in ESA/PSA. But they are not identical.
Initial S/W Revision	Prior to A.02.00

3D Color

Selects a standard color theme with each object filled, shaded and colored as designed.

Key Path	Save, Screen Image, Themes
Example	MMEM:STOR:SCR:THEM TDC
Readback	3D Color
Initial S/W Revision	Prior to A.02.00

3D Monochrome

Selects a format that is like 3D color but shades of gray are used instead of colors.

Key Path	Save, Screen Image, Themes
Example	MMEM:STOR:SCR:THEM TDM
Readback	3D Mono
Initial S/W Revision	Prior to A.02.00

Flat Color

Selects a format that is best when the screen is to be printed on an ink printer.

Key Path	Save, Screen Image, Themes
Example	MMEM:STOR:SCR:THEM FCOL
Readback	Flat Color
Initial S/W Revision	Prior to A.02.00

Flat Monochrome

Selects a format that is like Flat Color. But only black is used (no colors, not even gray), and no fill.

Key Path	Save, Screen Image, Themes
Example	MMEM:STOR:SCR:THEM FMON
Readback	Flat Mono
Initial S/W Revision	Prior to A.02.00

Save As...

When you press "Save As", the analyzer brings up a Windows dialog and a menu entitled "**Save As.**" This menu allows you to navigate to the various fields in the Windows dialog without using a keyboard or mouse. The Tab and Arrow keys can also be used for dialog navigation.

See "[To File . . .](#)" on page 2413 in Save, State for a full description of this dialog and menu.

The default path for Screen Images is

My Documents\`<mode name>`\screen.

where `<mode name>` is the parameter used to select the mode with the INST:SEL command (for example, SA for the Spectrum Analyzer).

Key Path	Save, Screen Image
Notes	Brings up Save As dialog for saving a Screen Image Save Type
Initial S/W Revision	Prior to A.02.00

Single (Single Measurement/Sweep)

Sets the analyzer for Single measurement operation. The single/continuous state is Meas Global, so the setting will affect all the measurements. If you are Paused, pressing Single does a Resume.

See ["More Information" on page 750](#)

Key Path	Front-panel key
Example	:INIT:CONT OFF
Notes	See Cont key description.
Backwards Compatibility Notes	<p>For Spectrum Analysis mode in ESA and PSA, the Single hardkey and the INITiate:IMM switched from continuous measurement to single measurement and restarted sweeps and averages (displayed average count reset to 1), but did not restart Max Hold and Min Hold. In the X-Series, the Single hardkey and the INITiate:IMM command initiate a sweep/ measurement/ average sequence/hold sequence including MaxHold and MinHold.</p> <p>For Spectrum Analysis mode in ESA and PSA, the Single hardkey restarted the sweep regardless of whether or not you were in an active sweep or sweep sequence. In the X-Series, Restart does this but Single only restarts the sweep or sweep sequence if you are in the idle state.</p> <p>INIT[:IMM] in ESA & PSA Spectrum Analysis Mode does an implied ABORT. In some other PSA Modes, INIT[:IMM] is ignored if not in the idle state. . The X-Series follows the ESA/PSA SA Mode model, which may cause some Modes to have compatibility problems.</p>
Initial S/W Revision	Prior to A.02.00

More Information

See ["Restart" on page 2410](#) for details on the INIT:IMMEDIATE (Restart) function.

If you are already in single sweep, the INIT:CONT OFF command has no effect.

If you are already in Single Sweep, then pressing the Single key in the middle of a sweep does not restart the sweep or sequence. Similarly, pressing the Single key does not restart the sweep or sequence if the sweep is not in the idle state (for example, if you are taking a very slow sweep, or the analyzer is waiting for a trigger). Instead, it results in a message. "Already in Single, press Restart to initiate a new sweep or sequence". Even though pressing the Single key in the middle of a sweep does not restart the sweep, sending INIT:IMMEDIATE does reset it.

To take one more sweep without resetting the average count, increment the average count by 1, by pressing the step up key while **Average/Hold Number** is the active function, or sending the remote command CALC:AVER:TCON UP.

Source

Opens a menu of keys that access various source configuration menus and settings. In the test set, pressing this key also causes the central view area to change and display the Source Control Main view.

Key Path	Front-panel key
----------	-----------------

RF Output

This parameter sets the source RF power output state.

Key Path	Source
Remote Command	:OUTPut[:EXTernal][:STATe] ON OFF 1 0 :OUTPut[:EXTernal][:STATe]?
Example	OUTP OFF OUTP?
Notes	<p>The EXTERNAL node is shown in RD text so the SCPI remains the same between internal and external source control. However, for EXT we do not wish to document this node to the customer since we are controlling the internal source rather than the external source.</p> <p>This setting is for the independent mode and has no effect on the "List Sequencer" on page 2520. If the "Sequencer" on page 2521 is set to ON, the list sequencer controls the source output and this key will be grayed-out. And this setting will be none-forceful grey out on front panel to indicate out-of-scope. Non-forceful means user still can change this setting by SCPI but cannot change on front panel. When set to OFF will make source leave list sequencer and this setting will be black out and take effect immediately.</p> <p>When the RF Output is ON, an "RF" annunciator is displayed in the system settings panel. When the RF Output is turned Off, the RF annunciator is cleared. If the "Sequencer" on page 2521 is set to ON, the "RF" annunciator will be replaced by "SEQ" in the system settings panel, indicating that the output is controlled by the list sequencer.</p>
Preset	Off
Range	On Off
Initial S/W Revision	A.05.00

Amplitude

Allows you to access the Amplitude sub-menu.

Key Path	Source
Notes	<p>The sub-menu under this button is for independent mode and has no effect on "List Sequencer" on page 2520. If the "Sequencer" on page 2521 is set to ON, the list sequencer controls the source output and this key will be grayed-out on front panel to indicate out-of-scope. When you set "Sequencer" on page 2521 to Off will make source leave list sequencer and this button will be black out.</p>
Initial S/W Revision	A.05.00

RF Power

Allows you to adjust the power level of the source using the numeric keypad, step keys, or RPG. Pressing any digit, 0 through 9, on the numeric keypad brings up the unit terminator.

Please refer to the "[RF Power Range](#) " on page 753 table below for the valid ranges.

Key Path	Source, Amplitude
Remote Command	:SOURce:POWer[:LEVel][:IMMediate][:AMPLitude] <ampl> :SOURce:POWer[:LEVel][:IMMediate][:AMPLitude]?
Example	:SOUR:POW -100 dBm
Notes	<p>Amplitude corrections can be specified for use with the source. In the event of amplitude corrections being applied, the valid ranges for the RF power do not change dependant on the current amplitude correction setting. If the combination of RF power + amplitude correction is higher or lower than the source output range, the Source Unleveled bit is set and the "Source Unleveled" indicator will appear on status panel to indicate that the source cannot maintain the output power that has been requested.</p> <p>When signal generator is unable to maintain the requested output level, the "Source Unleveled" indicator will appear on status panel. When the source output setting is restored to the normal range, the "Source Unleveled" is removed from status panel.</p> <p>Internal source has list sequence mode, which comprises of several steps which contain separate output power, frequency and waveform etc. When the source list sequence playing is complete, the last step keeps playing, and user can use this command to change the list sequence last step's output power.</p> <p>The multiport adapter RFIO TX ports and GPS ports cannot ensure power accuracy when power setting is lower than -130dBm, this power setting value is defined by the sum of RF Power setting and related amplitude correction value. But user settable value could be lower than this limit. When application detected there exists power setting lower than -130dBm on MPA RFIO TX ports, then popup warning message . When application detected there exists power setting lower than -130dBm on MPA GPS ports, then popup warning message . This is only warning message, and check is performed when RF is ON.</p>
Notes	The Min and Max value here defined UI settable amplitude range. This range is larger than actual amplitude range with level accuracy defined in spec.
Dependencies	The RF power is dependent on the RF output port and frequency, such that the current frequency and selected output port determine the valid range of power values.
Preset	-100 dBm
Min	The range of values depends on the current frequency and selected RF output port. Please refer to the " RF Power Range " on page 753 table below for the valid ranges.
Max	The range of values depends on the current frequency and selected RF output port. Please refer to the " RF Power Range " on page 753 table below for the valid ranges.
Initial S/W Revision	A.05.00

RF Power Range

RF Output Port	Frequency Range	Min Output Power	Max Output Power
High Power RF Out	10 MHz ≤ f ≤ 6 GHz	-150 dBm	20 dBm
RFIO 1 & RFIO 2	10 MHz ≤ f ≤ 6 GHz	-150 dBm	0 dBm
GPS (Note2)	10 MHz ≤ f ≤ 6 GHz	-150 dBm	0 dBm

Note: This is the UI power range, it's larger than actual spec.

Note2: GPS port is on the multiport adapter, or E6607C which has embedded MPA.

Set Reference Power

This key allows you to set the power reference. Pressing this key turns the power reference state to ON, sets the reference power value to the current RF output power, maintains this power at the RF output, and sets the displayed power to 0.00 dB. All subsequent RF power values entered under Source>Amplitude>RF Power are interpreted as being relative to this reference power.

When you use a power reference, the signal generator outputs an RF power that is set relative to the reference power by the value entered under Source>Amplitude>RF Power as follows:

Output power = reference power – entered power

Where:

reference power equals the original RF Power entered under Source>Amplitude>RF Power and set as the reference power

entered power equals a new value entered under Source>Amplitude>Amptd Offset

In addition, the displayed power value is the same as a new value entered under Source>Amplitude>RF Power.

NOTE

If Power Ref is set to ON with a reference value set, entering a value under Source>Amplitude>RF Power and pressing Set Reference Power will add that value to the existing Power Ref value.

If you wish to change the reference power value to a new value entered under Source>Amplitude>RF Power, first you must set Power Ref to OFF and then press Set Reference Power.

Key Path	Source, Amplitude
Dependencies	This key is unavailable, and is grayed out when the " List Sequencer " on page 2520 is turned ON.
Initial S/W Revision	A.05.00

Power Ref

This key allows you to toggle the state of the power reference.

When you use a power reference, the signal generator outputs an RF power that is set relative to the reference power by the value entered under Source>Amplitude>RF Power as follows:

Output power = reference power + entered power

Where:

reference power equals the original RF Power entered under Source>Amplitude>RF Power and set as the reference power

entered power equals a new value entered under Source>Amplitude>Amptd Offset

For more information on Reference Frequency refer to ["Set Reference Power " on page 2443](#)

Key Path	Source, Amplitude
Remote Command	:SOURce:POWer:REFeRence <ampl> :SOURce:POWer:REFeRence? :SOURce:POWer:REFeRence:STATe OFF ON 0 1 :SOURce:POWer:REFeRence:STATe?
Example	:SOUR:POW:REF 0.00 dBm :SOUR:POW:REF:STATe ON
Dependencies	This setting is unavailable and is grayed out when the "List Sequencer" on page 2520 is turned ON.
Couplings	This value is coupled to the "Set Reference Power " on page 2443 key such that pressing the Set Reference Power key updates the reference power with the current output power.
Preset	0.00 dBm OFF
Min	-125.00 dBm
Max	10.00 dBm
Initial S/W Revision	A.05.00

Amptd Offset

Allows you to specify the RF output power offset value.

When the amplitude offset is set to zero (0) and you set a new offset value (positive or negative), the displayed amplitude value will change as follows and the RF output power will not change:

Displayed value = output power + offset value

Where:

output power equals the original RF Power entered under Source>Amplitude>RF Power

offset value equals the value entered under Source>Amplitude>Amptd Offset

When the amplitude offset is set to a value other than zero (0) and you enter a new RF power value under Source>Amplitude>RF Power, the displayed power will be the same as the value entered and the RF output power will be equal to the value entered minus the offset value as follows:

Output power = entered power – offset power

Displayed Power = output power + offset power

Displayed power = entered power

Where:

entered power equals the amplitude entered under Source>Amplitude>RF Power

offset power equals the value previously entered and set under Source>Amplitude>Amptd Offset

Key Path	Source, Amplitude
Remote Command	:SOURce:POWer[:LEVel][:IMMediate]:OFFSet <rel_ampl> :SOURce:POWer[:LEVel][:IMMediate]:OFFSet?
Example	:SOUR:POW:OFFS 0.00 dB
Dependencies	This setting is unavailable, and is grayed out when the List Sequencer is turned ON.
Preset	0.00 dB
Min	-200.00 dB
Max	200.00 dB
Initial S/W Revision	A.05.00

Modulation

Allows you to toggle the state of the modulation.

Key Path	Source
Remote Command	:OUTPut:MODulation[:STATe] ON OFF 1 0 :OUTPut:MODulation[:STATe]?
Example	:OUTP:MOD OFF
Notes	This setting is for independent mode and has no effect on " List Sequencer " on page 2520. If the " Sequencer " on page 2521 is set to ON, the list sequencer controls the source output and this key will be grayed-out. And this setting will be none-forceful grey out on front panel to indicate out-of-scope. Non-forceful means user still can change this setting by SCPI but cannot change manually on front panel. When set to Off will make source leave list sequencer and this setting will be black out and take effect immediately. When the Modulation is ON, the "MOD" annunciator is displayed in the system settings panel. When the Modulation is turned Off, the "MOD" annunciator is cleared. If the " Sequencer " on page 2521 is set to ON, the "MOD" annunciator will be replaced by "SEQ" in the system settings panel indicating that the output is controlled by list sequencer.
Preset	Off
Range	On Off
Initial S/W Revision	A.05.00

Frequency

Allows you to access the Frequency sub-menu.

Key Path	Source
Notes	The sub-menu under this button is for independent mode and has no effect on " List Sequencer " on

[page 2520](#). If the "[Sequencer](#)" on [page 2521](#) is set to ON, the list sequencer controls the source output and this key will be grayed-out. And this button will be grey out on front panel to indicate out-of-scope. When set to Off will make source leave list sequencer and this button will be black out.

Initial S/W Revision A.05.00

Frequency

Allows you to set the RF Output Frequency. You can adjust the frequency of the source using the numeric keypad, step keys, or RPG. Pressing any digit, 0 through 9, on the numeric keypad brings up the unit terminator.

Key Path	Source, Frequency
Remote Command	:SOURce:FREQuency[:CW] <freq> :SOURce:FREQuency[:CW]?
Example	:SOUR:FREQ 1.00 GHz
Notes	Internal source has list sequence mode, which comprises of several steps which contain separate output power, frequency and waveform etc. When the source list sequence playing is complete, the last step keeps playing, and user can use this command to change the list sequence last step's output frequency.
Couplings	The frequency value is coupled to the current channel band and number, such that updates to the band and number will update the frequency value to the corresponding absolute frequency.
Preset	1.00 GHz If license F1A or 5WC is present, the default Center Frequency should be 2.412GHz.
Min	10.00 MHz
Max	Hardware Dependant: Option 503 = 3.6 GHz Option 504 = 3.8 GHz Option 506 = 6.00 GHz For E6640A, if license 5WC is present, the frequency range should be limited to: 1.1GHz–1.7GHz, 2.4GHz–2.5GHz, 4.8GHz–6.0GHz. If the user-defined frequency is outside of range, UI will report an error message called "Settings conflict; Frequency is outside available range".
Initial S/W Revision	A.05.00

Channel

The frequency of the source can be specified by a channel number of a given frequency band. This key allows you to specify the current channel number. For the appropriate range of channel numbers for a given frequency band, refer to the following tables: "[GSM/EDGE Channel Number Ranges](#)" on [page 757](#), "[W-CDMA Channel Number Ranges](#)" on [page 758](#), "[CDMA 2000 / 1xEVDO Channel Number Ranges](#)" on [page 759](#), and "[LTE FDD Channel Number Ranges](#)" on [page 761](#).

Key Path	Source, Frequency
Remote Command	:SOURce:FREQuency:CHANnels:NUMBer <int> :SOURce:FREQuency:CHANnels:NUMBer?
Example	:SOUR:FREQ:CHAN:NUMB 1
Notes	This key is grayed out when the "Radio Standard" on page 2455 is set to NONE. This key is grayed out on E6630A.
Dependencies	This key is grayed out when the "Radio Standard" on page 2455 is set to NONE. This key is grayed out on E6630A.
Couplings	The channel number is coupled to the frequency value when the "Radio Standard" on page 2455 is not set to NONE. When the frequency value is changed, the channel number will increase or decrease to match the new frequency. If the frequency is not at an exact match for a channel number, the nearest channel number is displayed along with a greater than or less than sign to indicate the frequency is above or below the channel number.
Preset	1
Min	Please refer to the tables below for the valid ranges.
Max	Please refer to the tables below for the valid ranges.
Initial S/W Revision	A.05.00

GSM/EDGE Channel Number Ranges

Band	Link (Device)	Range	Frequency (MHz)
P-GSM	Uplink (MS)	$1 \leq n \leq 124$	$890.0 + 0.2*n$
	Downlink (BS)	$1 \leq n \leq 124$	$935.0 + 0.2*n$
E-GSM	Uplink (MS)	$0 \leq n \leq 124$	$890.0 + 0.2*n$
		$975 \leq n \leq 1023$	$890.0 + 0.2*(n-1024)$
	Downlink (BS)	$0 \leq n \leq 124$	$935.0 + 0.2*n$
		$975 \leq n \leq 1023$	$935.0 + 0.2*(n-1024)$
DCS 1800	Uplink (MS)	$512 \leq n \leq 885$	$1710.200 + 0.20*(n-512)$
	Downlink (BS)	$512 \leq n \leq 885$	$1805.200 + 0.20*(n-512)$
PCS 1900	Uplink (MS)	$512 \leq n \leq 810$	$1850.200 + 0.2*(n-512)$
	Downlink (BS)	$512 \leq n \leq 810$	$1930.200 + 0.2*(n-512)$
R-GSM	Uplink (MS)	$0 \leq n \leq 124$	$890.0 + 0.2*n$
		$955 \leq n \leq 1023$	$890.0 + 0.2*(n-1024)$
	Downlink (BS)	$0 \leq n \leq 124$	$935.0 + 0.2*n$
		$955 \leq n \leq 1023$	$935.0 + 0.2*(n-1024)$
GSM 450	Uplink (MS)	$256 \leq n \leq 293$	$450.6 + 0.2*(n-259)$
	Downlink (BS)	$256 \leq n \leq 293$	$460.6 + 0.2*(n-259)$
GSM 480	Uplink (MS)	$306 \leq n \leq 340$	$479.000 + 0.20*(n-306)$

Band	Link (Device)	Range	Frequency (MHz)
GSM 850	Downlink (BS)	$306 \leq n \leq 340$	$489.000 + 0.20*(n-306)$
	Uplink (MS)	$128 \leq n \leq 251$	$824.200 + 0.20*(n-128)$
GSM 700	Downlink (BS)	$128 \leq n \leq 251$	$869.200 + 0.20*(n-128)$
	Uplink (MS)	$438 \leq n \leq 516$	$777.200 + 0.20*(n-438)$
T-GSM810	Downlink (BS)	$438 \leq n \leq 516$	$747.200 + 0.20*(n-438)$
	Uplink (MS)	$350 \leq n \leq 425$	$806.0 + 0.20*(n-350)$
	Downlink (BS)	$350 \leq n \leq 425$	$851.0 + 0.20*(n-350)$

W-CDMA Channel Number Ranges

Band	Link (Device)	Range	Frequency (MHz)
Band I	Downlink	$10562 \leq n \leq 10838$	$n \div 5$
	Uplink	$9612 \leq n \leq 9888$	$n \div 5$
Band II	Downlink	$412 \leq n \leq 687$	$n \div 5 + 1850.1$
		$9662 \leq n \leq 9938$	$n \div 5$
	Uplink	$12 \leq n \leq 287$	$n \div 5 + 1850.1$
Band III	Downlink	$350 \leq n \leq 425$	$n \div 5$
	Uplink	$1162 \leq n \leq 1513$	$n \div 5 + 1575$
Band IV	Downlink	$937 \leq n \leq 1288$	$n \div 5 + 1525$
		$537 \leq n \leq 1738$	$n \div 5 + 1805$
	Uplink	$1887 \leq n \leq 2087$	$n \div 5 + 1735.1$
Band V	Downlink	$1312 \leq n \leq 1513$	$n \div 5 + 1450$
		$1662 \leq n \leq 1862$	$n \div 5 + 1380.1$
	Uplink	$1007 \leq n \leq 1087$	$n \div 5 + 670.1$
Band VI	Downlink	$4357 \leq n \leq 4458$	$n \div 5$
		$782 \leq n \leq 862$	$n \div 5 + 670.1$
	Uplink	$4132 \leq n \leq 4233$	$n \div 5$
Band VII	Downlink	$1037 \leq n \leq 1062$	$n \div 5 + 670.1$
		$4387 \leq n \leq 4413$	$n \div 5$
	Uplink	$812 \leq n \leq 837$	$n \div 5 + 670.1$
Band VIII	Downlink	$4162 \leq n \leq 4188$	$n \div 5$
		$2237 \leq n \leq 2563$	$n \div 5 + 2175$
	Uplink	$2587 \leq n \leq 2912$	$n \div 5 + 2105.1$
Band VIII	Downlink	$2012 \leq n \leq 2338$	$n \div 5 + 2100$
		$2362 \leq n \leq 2687$	$n \div 5 + 2030.1$
Band VIII	Downlink	$2937 \leq n \leq 3088$	$n \div 5 + 340$
	Uplink	$2712 \leq n \leq 2863$	$n \div 5 + 340$

Band	Link (Device)	Range	Frequency (MHz)
Band IX	Downlink	$9237 \leq n \leq 9387$	$n \div 5$
	Uplink	$8762 \leq n \leq 8912$	$n \div 5$
Band X	Downlink	$3112 \leq n \leq 3388$	$n \div 5 + 1490$
		$3412 \leq n \leq 3687$	$n \div 5 + 1430.1$
	Uplink	$2887 \leq n \leq 3163$	$n \div 5 + 1135$
		$3187 \leq n \leq 3462$	$n \div 5 + 1075.1$
Band XI	Downlink	$3712 \leq n \leq 3812$	$n \div 5 + 736$
	Uplink	$3487 \leq n \leq 3587$	$n \div 5 + 733$
Band XII	Downlink	$3837 \leq n \leq 3903$	$n \div 5 - 37$
		$3927 \leq n \leq 3992$	$n \div 5 - 54.9$
	Uplink	$3612 \leq n \leq 3678$	$n \div 5 - 22$
		$3702 \leq n \leq 3767$	$n \div 5 - 39.9$
Band XIII	Downlink	$4017 \leq n \leq 4043$	$n \div 5 - 55$
		$4067 \leq n \leq 4092$	$n \div 5 - 64.9$
	Uplink	$3792 \leq n \leq 3818$	$n \div 5 + 21$
		$3702 \leq n \leq 3767$	$n \div 5 - 39.9$
Band XIV	Downlink	$4117 \leq n \leq 4143$	$n \div 5 - 63$
		$4167 \leq n \leq 4192$	$n \div 5 - 72.9$
	Uplink	$3892 \leq n \leq 3918$	$n \div 5 + 12$
		$3942 \leq n \leq 3967$	$n \div 5 + 2.1$
Band XIX	Downlink	$712 \leq n \leq 763$	$n \div 5 + 735$
		$787 \leq n \leq 837$	$n \div 5 + 720.1$
	Uplink	$312 \leq n \leq 363$	$n \div 5 + 770$
		$387 \leq n \leq 437$	$n \div 5 + 755.1$

CDMA 2000 / 1xEVDO Channel Number Ranges

Band	Link (Device)	Range	Frequency (MHz)
US Cellular	Uplink (MS, reverse link)	$1 \leq N \leq 799$	$0.030 \times N + 825.000$
		$991 \leq N \leq 1023$	$0.030 \times (N - 1023) + 825.000$
		$1024 \leq N \leq 1323$	$0.030 \times (N - 1024) + 815.040$
	Downlink (BS, forward link)	$1 \leq N \leq 799$	$0.030 \times N + 870.000$
		$991 \leq N \leq 1023$	$0.030 \times (N - 1023) + 870.000$
		$1024 \leq N \leq 1323$	$0.030 \times (N - 1024) + 860.040$
US PCS	Uplink (MS, reverse link)	$0 \leq N \leq 1199$	$1850.000 + 0.050 \times N$
	Downlink (BS, forward link)	$0 \leq N \leq 1199$	$1930.000 + 0.050 \times N$

Band	Link (Device)	Range	Frequency (MHz)
Japan Cellular Band	Uplink (MS, reverse link)	$1 \leq N \leq 799$	$0.0125 \times (N + 915.000)$
		$801 \leq N \leq 1039$	$0.0125 \times (N - 800) + 898.000$
		$1041 \leq N \leq 1199$	$0.0125 \times (N - 1040) + 887.000$
		$1201 \leq N \leq 1600$	$0.0125 \times (N - 1200) + 893.000$
	Downlink (BS, forward link)	$1 \leq N \leq 799$	$0.0125 \times (N + 860.000)$
		$801 \leq N \leq 1039$	$0.0125 \times (N - 800) + 843.000$
		$1041 \leq N \leq 1199$	$0.0125 \times (N - 1040) + 832.000$
		$1201 \leq N \leq 1600$	$0.0125 \times (N - 1200) + 838.000$
Korean PCS Band	Uplink (MS, reverse link)	$0 \leq N \leq 599$	$0.050 \times N + 1750.000$
	Downlink (BS, forward link)	$0 \leq N \leq 599$	$0.050 \times N + 1840.000$
NMT-450 Band	Uplink (MS, reverse link)	$1 \leq N \leq 400$	$0.025 \times (N - 1) + 450.000$
		$472 \leq N \leq 871$	$0.025 \times (N - 472) + 410.000$
		$1039 \leq N \leq 1473$	$0.020 \times (N - 1024) + 451.010$
		$1536 \leq N \leq 1715$	$0.025 \times (N - 1536) + 479.000$
		$1792 \leq N \leq 2016$	$0.020 \times (N - 1792) + 479.000$
	Downlink (BS, forward link)	$1 \leq N \leq 400$	$0.025 \times (N - 1) + 460.000$
		$472 \leq N \leq 871$	$0.025 \times (N - 472) + 420.000$
		$1039 \leq N \leq 1473$	$0.020 \times (N - 1024) + 461.010$
IMT-2000 Band	Uplink (MS, reverse link)	$0 \leq N \leq 1199$	$1920.000 + 0.050 \times N$
	Downlink (BS, forward link)	$0 \leq N \leq 1199$	$2100.000 + 0.050 \times N$
Upper 700 MHz Band	Uplink (MS, reverse link)	$0 \leq N \leq 240$	$776.000 + 0.050 \times N$
	Downlink (BS, forward link)	$0 \leq N \leq 240$	$746.000 + 0.050 \times N$
Secondary 800 MHz Band	Uplink (MS, reverse link)	$0 \leq N \leq 719$	$0.025 \times N + 806.000$
		$720 \leq N \leq 919$	$0.025 \times (N - 720) + 896.000$
	Downlink (BS, forward link)	$0 \leq N \leq 719$	$0.025 \times N + 851.000$
		$720 \leq N \leq 919$	$0.025 \times (N - 720) + 935.000$
2.5 GHz IMT Extension	Uplink (MS, reverse link)	$0 \leq N \leq 1399$	$2500.000 + 0.050 \times N$
	Downlink (BS, forward link)	$0 \leq N \leq 1399$	$2620.000 + 0.050 \times N$
US PCS 1.9 GHz	Uplink (MS, reverse link)	$0 \leq N \leq 1299$	$1850.000 + 0.050 \times N$

Band	Link (Device)	Range	Frequency (MHz)
AWS	Downlink (BS, forward link)	$0 \leq N \leq 1299$	$1930.000 + 0.050 \times N$
	Uplink (MS, reverse link)	$0 \leq N \leq 899$	$1710.000 + 0.050 \times N$
US 2.5 GHz	Downlink (BS, forward link)	$0 \leq N \leq 899$	$2100.000 + 0.050 \times N$
	Uplink (MS, reverse link)	$140 \leq N \leq 1459$	$2495.000 + 0.050 \times N$
700 Public Safety	Downlink (BS, forward link)	$140 \leq N \leq 1459$	$2617.000 + 0.050 \times N$
	Uplink (MS, reverse link)	$0 \leq N \leq 240$	$787.000 + 0.050 \times N$
C2K Lower 700	Downlink (BS, forward link)	$0 \leq N \leq 240$	$757.000 + 0.050 \times N$
	Uplink (MS, reverse link)	$0 \leq N \leq 360$	$698.000 + 0.050 \times N$
400 Euro PAMR	Downlink (BS, forward link)	$0 \leq N \leq 360$	$728.000 + 0.050 \times N$
	Uplink (MS, reverse link)	$1 \leq N \leq 400$	$0.025 \times (N-1) + 450.000$
	Uplink (MS, reverse link)	$472 \leq N \leq 871$	$0.025 \times (N-472) + 410.000$
	Uplink (MS, reverse link)	$1536 \leq N \leq 1715$	$0.025 \times (N-1536) + 479.000$
	Downlink (BS, forward link)	$1 \leq N \leq 400$	$0.025 \times (N-1) + 460.000$
	Downlink (BS, forward link)	$472 \leq N \leq 871$	$0.025 \times (N-472) + 420.000$
	Downlink (BS, forward link)	$1536 \leq N \leq 1715$	$0.025 \times (N-1536) + 489.000$
	Downlink (BS, forward link)		
800 PAMR	Uplink (MS, reverse link)	$0 \leq N \leq 239$	$870.0125 + 0.025 \times N$
	Downlink (BS, forward link)	$0 \leq N \leq 239$	$915.0125 + 0.025 \times N$

LTE FDD Channel Number Ranges

The carrier frequency in the uplink and downlink is designated by the E-UTRA Absolute Radio Frequency Channel Number (EARFCN) in the range 0 – 65535. The relation between EARFCN and the carrier frequency in MHz for the downlink is given by the following equation, where FDL_low and NOffs-DL are given in table 5.4.4-1 and NDL is the downlink EARFCN.

$$FDL = FDL_low + 0.1(NDL - NOffs-DL)$$

The relation between EARFCN and the carrier frequency in MHz for the uplink is given by the following equation where FUL_low and NOffs-UL are given in table 5.4.4-1 and NUL is the uplink EARFCN.

$$FUL = FUL_low + 0.1(NUL - NOffs-UL)$$

Band	Downlink		Uplink			
	FDL_low (MHz)	NOffs-DL	Range of NDL	FUL_low (MHz)	NOffs-UL	Range of NUL
1		2110	0	0 - 599	1920	18000 - 18599
2		1930	600	600 - 1199	1850	18600 - 19199
3		1805	1200	1200 - 1949	1710	19200 - 19949
4		2110	1950	1950 - 2399	1710	19950 - 20399
5		869	2400	2400 - 2649	824	20400 - 20649
6		875	2650	2650 - 2749	830	20650 - 20749
7		2620	2750	2750 - 3449	2500	20750 - 20449
8		925	3450	3450 - 3799	880	21450 - 21799
9		1844.9	3800	3800 - 4149	1749.9	21800 - 22149
10		2110	4150	4150 - 4749	1710	22150 - 22749
11		1475.9	4750	4750 - 4949	1427.9	22750 - 22949
12		729	5010	5010 - 5179	699	23010 - 23179
13		746	5180	5180 - 5279	777	23180 - 23279
14		758	5280	5280 - 5379	788	23280 - 23379
...						
17		734	5730	5730 - 5849	704	23730 - 23849
18		860	5850	5850 - 5999	815	23850 - 23999
19		875	6000	6000 - 6149	830	24000 - 24149
20		791	6150	6150 - 6449	832	24150 - 24449
21		1495.9	6450	6450 - 6599	1447.9	24450 - 24599
...						
24		1525	7700	7700 - 8039	1626.5	25700 - 26039
25		1930	8040	8040 - 8689	1850	26040 - 26689
26		859	8690	8690 - 9039	814	26690 - 27039
...						

Note: The channel numbers that designate carrier frequencies so close to the operating band edges that the carrier extends beyond the operating band edge shall not be used. This implies that the first 7, 15, 25, 50, 75 and 100 channel numbers at the lower operating band edge and the last 6, 14, 24, 49, 74 and 99 channel numbers at the upper operating band edge shall not be used for channel bandwidths of 1.4, 3, 5, 10, 15 and 20 MHz respectively.

LTE TDD Channel Number Ranges

The carrier frequency in the uplink and downlink is designated by the E-UTRA Absolute Radio Frequency Channel Number (EARFCN) in the range 0 – 65535. The relation between EARFCN and the carrier frequency in MHz for the downlink is given by the following equation, where FDL_low and NOffs-DL are given in table 5.4.4–1 and NDL is the downlink EARFCN.

$$FDL = FDL_low + 0.1(NDL - NOffs-DL)$$

The relation between EARFCN and the carrier frequency in MHz for the uplink is given by the following equation where FUL_low and NOffs-UL are given in table 5.4.4–1 and NUL is the uplink EARFCN.

$$FUL = FUL_low + 0.1(NUL - NOffs-UL)$$

Band	Downlink		Uplink			
	FDL_low (MHz)	NOffs-DL	Range of NDL	FUL_low (MHz)	NOffs-UL	Range of NUL
33		1900	36000	36000 – 36199	1900	36000 – 36199
34		2010	36200	36200 – 36349	2010	36200 – 36349
35		1850	36350	36350 – 36949	1850	36350 – 36949
36		1930	36950	36950 – 37549	1930	36950 – 37549
37		1910	37550	37550 – 37749	1910	37550 – 37749
38		2570	37750	37750 – 38249	2570	37750 – 38249
39		1880	38250	38250 – 38649	1880	38250 – 38649
40		2300	38650	38650 – 39649	2300	38650 – 39649
41		2496	39650	39650 – 41589	2496	39650 – 41589
42		3400	41590	41590 – 43589	3400	41590 – 43589
43		3600	43590	43590 – 45589	3600	43590 – 45589

Note: The channel numbers that designate carrier frequencies so close to the operating band edges that the carrier extends beyond the operating band edge shall not be used. This implies that the first 7, 15, 25, 50, 75 and 100 channel numbers at the lower operating band edge and the last 6, 14, 24, 49, 74 and 99 channel numbers at the upper operating band edge shall not be used for channel bandwidths of 1.4, 3, 5, 10, 15 and 20 MHz respectively.

TDSCDMA Channel Number Ranges

1.28 Mcps TDD Option

No TX-RX frequency separation is required as Time Division Duplex (TDD) is employed. Each subframe consists of 7 main timeslots where all main timeslots (at least the first one) before the single switching point are allocated DL and all main timeslots (at least the last one) after the single switching point are allocated UL.

The nominal channel spacing is 1.6 MHz, but this can be adjusted to optimise performance in a particular deployment scenario.

The carrier frequency is designated by the UTRA absolute radio frequency channel number (UARFCN). The value of the UARFCN in the IMT2000 band is defined in the general case as follows:

$$N_t = 5 * F \quad 0.0 \text{ MHz} \leq F \leq 3276.6 \text{ MHz}$$

where F is the carrier frequency in MHz

Additional channels applicable to operation in the frequency band defined in sub-clause 5.2(d) are defined via the following UARFCN definition:

$$N_t = 5 * (F - 2150.1 \text{ MHz}) \quad 2572.5 \text{ MHz} \leq F \leq 2617.5 \text{ MHz}$$

UARFCN

1.28 Mcps TDD Option

The following UARFCN range shall be supported for each band:

**Table: UTRA Absolute Radio
Frequency Channel Number 1.28
Mcps TDD Option**

Frequency Band	Frequency Range	UARFCN Uplink and Downlink transmission
For operation in frequency band as defined in subclause 5.2 (a)	1900–1920 MHz	9504 to 9596
	2010–2025 MHz	10054 to 10121
For operation in frequency band as defined in subclause 5.2 (b)	1850–1910 MHz	9254 to 9546
	1930–1990 MHz	9654 to 9946
For operation in frequency band as defined in subclause 5.2 (c)	1910–1930 MHz	9554 to 9646
For operation in frequency band as defined in subclause 5.2 (d)	2570–2620 MHz	12854 to 13096
For operation in frequency band as defined in subclause 5.2 (e)	2300–2400 MHz	11504 to 11996
For operation in frequency band as defined in subclause 5.2 (f)	1880–1920 MHz	9404 to 9596

Radio Setup

Allows access to the sub-menus for selecting the radio standard and associated radio band. You can also set a frequency reference and offset.

This menu is greyed out when on E6630A. Radio band settings for GSM, cdma2000, and so on -- most of which are not actually supported in E6630A, which has three narrow frequency bands. So band settings are grayed out.

Key Path	Source, Frequency
Initial S/W Revision	A.05.00

Radio Standard

Allows access to the channel band sub-menus to select the desired radio standard. When you have selected the radio standard, you can then set an active channel band. The radio standard and the active channel band allow you to use channel numbers to set frequency automatically.

Key Path	Source, Frequency, Radio Setup
Remote Command	:SOURce:FREQuency:CHANnels:BAND NONE PGSM EGSM RGSM DCS1800 PCS1900 TGSM810 GSM450 GSM480 GSM700 GSM850 BANDI BANDII BANDIII BANDIV BANDV BANDVI BANDVII BANDVIII BANDIX BANDX BANDXI BANDXII BANDXIII BANDXIV BANDXIX USCELL USPCS JAPAN KOREAN NMT IMT2K UPPER SECOND PAMR400 PAMR800 IMTEXT PCS1DOT9G AWS US2DOT5G PUBLIC LOWER BAND1 BAND2 BAND3 BAND4 BAND5 BAND6 BAND7 BAND8 BAND10 BAND11 BAND12 BAND13 BAND14 BAND17 BAND18 BAND19 BAND20 BAND21 BAND24 BAND25 BAND26 BAND27 BAND28 BAND31 BAND33 BAND34 BAND35 BAND36 BAND37 BAND38 BAND39 BAND40 BAND41 BAND42 BAND43 BAND44 BANDA BANDB BANDC BANDD BANDE BANDF :SOURce:FREQuency:CHANnels:BAND?
Example	:SOUR:FREQ:CHAN:BAND PGSM
Notes	Set this setting to "NONE" will grey out "Channel" on page 2446 Channel
Initial S/W Revision	A.05.00

None

Selects no radio standard for use. When you have selected the radio standard to NONE, you cannot use channel numbers to set frequency automatically. You will need to set the frequency manually.

Key Path	Source, Frequency, Radio Setup, Radio Standard
Initial S/W Revision	A.05.00

GSM/EDGE

Sets GSM/EDGE as the radio standard for use and accesses the GSM/EDGE specific channel band sub-menus.

Key Path	Source, Frequency, Radio Setup, Radio Standard
Initial S/W Revision	A.05.00

P-GSM

Selects P-GSM as the active channel band.

Key Path	Source, Frequency, Radio Setup, Radio Standard, GSM/EDGE
Example	:SOUR:FREQ:CHAN:BAND PGSM
Initial S/W Revision	A.05.00

E-GSM

Selects E-GSM as the active channel band.

Key Path	Source, Frequency, Radio Setup, Radio Standard, GSM/EDGE
Example	:SOUR:FREQ:CHAN:BAND EGSM
Initial S/W Revision	A.05.00

R-GSM

Selects R-GSM as the active channel band.

Key Path	Source, Frequency, Radio Setup, Radio Standard, GSM/EDGE
Example	:SOUR:FREQ:CHAN:BAND RGSM
Initial S/W Revision	A.05.00

DCS 1800

Selects DCS 1800 as the active channel band.

Key Path	Source, Frequency, Radio Setup, Radio Standard, GSM/EDGE
Example	:SOUR:FREQ:CHAN:BAND DCS1800
Initial S/W Revision	A.05.00

PCS 1900

Selects PCS 1900 as the active channel band.

Key Path	Source, Frequency, Radio Setup, Radio Standard, GSM/EDGE
Example	:SOUR:FREQ:CHAN:BAND PCS1900
Initial S/W Revision	A.05.00

GSM 450

Selects GSM 450 as the active channel band.

Key Path	Source, Frequency, Radio Setup, Radio Standard, GSM/EDGE
Example	:SOUR:FREQ:CHAN:BAND GSM450
Initial S/W Revision	A.05.00

GSM 480

Selects GSM 480 as the active channel band.

Key Path	Source, Frequency, Radio Setup, Radio Standard, GSM/EDGE
Example	:SOUR:FREQ:CHAN:BAND GSM480
Initial S/W Revision	A.05.00

GSM 850

Selects GSM 850 as the active channel band.

Key Path	Source, Frequency, Radio Setup, Radio Standard, GSM/EDGE
Example	:SOUR:FREQ:CHAN:BAND GSM850
Initial S/W Revision	A.05.00

GSM 700

Selects GSM 700 as the active channel band.

Key Path	Source, Frequency, Radio Setup, Radio Standard, GSM/EDGE
Example	:SOUR:FREQ:CHAN:BAND GSM700
Initial S/W Revision	A.05.00

T-GSM 810

Selects T-GSM 810 as the active channel band.

Key Path	Source, Frequency, Radio Setup, Radio Standard, GSM/EDGE
Example	:SOUR:FREQ:CHAN:BAND T-GSM810
Initial S/W Revision	A.05.00

WCDMA

Sets WCDMA as the radio standard for use and accesses the W-CDMA specific channel band sub-menus.

Key Path	Source, Frequency, Radio Setup, Radio Standard
Initial S/W Revision	A.05.00

Band I

Selects Band I as the active channel band.

Key Path	Source, Frequency, Radio Setup, Radio Standard, WCDMA
Example	:SOUR:FREQ:CHAN:BAND BANDI
Initial S/W Revision	A.05.00

Band II

Selects Band II as the active channel band.

Key Path	Source, Frequency, Radio Setup, Radio Standard, WCDMA
Example	:SOUR:FREQ:CHAN:BAND BANDII
Initial S/W Revision	A.05.00

Band III

Selects Band III as the active channel band.

Key Path	Source, Frequency, Radio Setup, Radio Standard, WCDMA
Example	:SOUR:FREQ:CHAN:BAND BANDIII
Initial S/W Revision	A.05.00

Band IV

Selects Band IV as the active channel band.

Key Path	Source, Frequency, Radio Setup, Radio Standard, WCDMA
Example	:SOUR:FREQ:CHAN:BAND BANDIV
Initial S/W Revision	A.05.00

Band V

Selects Band V as the active channel band.

Key Path	Source, Frequency, Radio Setup, Radio Standard, WCDMA
Example	:SOUR:FREQ:CHAN:BAND BANDV
Initial S/W Revision	A.05.00

Band VI

Selects Band VI as the active channel band.

Key Path	Source, Frequency, Radio Setup, Radio Standard, WCDMA
Example	:SOUR:FREQ:CHAN:BAND BANDVI
Initial S/W Revision	A.05.00

Band VII

Selects Band VII as the active channel band.

Key Path	Source, Frequency, Radio Setup, Radio Standard, WCDMA
Example	:SOUR:FREQ:CHAN:BAND BANDVII
Initial S/W Revision	A.05.00

Band VIII

Selects Band VIII as the active channel band.

Key Path	Source, Frequency, Radio Setup, Radio Standard, WCDMA
Example	:SOUR:FREQ:CHAN:BAND BANDVIII
Initial S/W Revision	A.05.00

Band IX

Selects Band IX as the active channel band.

Key Path	Source, Frequency, Radio Setup, Radio Standard, WCDMA
Example	:SOUR:FREQ:CHAN:BAND BANDIX
Initial S/W Revision	A.05.00

Band X

Selects Band X as the active channel band.

Key Path	Source, Frequency, Radio Setup, Radio Standard, WCDMA
Example	:SOUR:FREQ:CHAN:BAND BANDX
Initial S/W Revision	A.05.00

Band XI

Selects Band XI as the active channel band.

Key Path	Source, Frequency, Radio Setup, Radio Standard, WCDMA
Example	:SOUR:FREQ:CHAN:BAND BANDXI
Initial S/W Revision	A.05.00

Band XII

Selects Band XII as the active channel band.

Key Path	Source, Frequency, Radio Setup, Radio Standard, WCDMA
Example	:SOUR:FREQ:CHAN:BAND BANDXII
Initial S/W Revision	A.05.00

Band XIII

Selects band XIII as the active channel band.

Key Path	Source, Frequency, Radio Setup, Radio Standard, WCDMA
Example	:SOUR:FREQ:CHAN:BAND BANDXIII
Initial S/W Revision	A.05.00

Band XIV

Selects Band XIV as the active channel band.

Key Path	Source, Frequency, Radio Setup, Radio Standard, WCDMA
Example	:SOUR:FREQ:CHAN:BAND BANDXIV
Initial S/W Revision	A.05.00

Band XIX

Selects Band XIX as the active channel band.

Key Path	Source, Frequency, Radio Setup, Radio Standard, WCDMA
Example	:SOUR:FREQ:CHAN:BAND BANDXIX
Initial S/W Revision	A.14.50

CDMA 2000 / 1xEVDO

Sets CDMA 2000 / 1xEVDO as the radio standard for use and accesses the CDMA 2000/1xEVDO specific channel band sub-menus.

Key Path	Source, Frequency, Radio Setup, Radio Standard
Initial S/W Revision	A.05.00

US CELL

Selects US Cell as the active channel band.

Key Path	Source, Frequency, Radio Setup, Radio Standard, CDMA 2000 / 1xEVDO
Example	:SOUR:FREQ:CHAN:BAND USCELL
Initial S/W Revision	A.05.00

US PCS

Selects US PCS as the active channel band.

Key Path	Source, Frequency, Radio Setup, Radio Standard, CDMA 2000 / 1xEVDO
Example	:SOUR:FREQ:CHAN:BAND PCS
Initial S/W Revision	A.05.00

Japan Cell

Selects Japan Cell as the active channel band.

Key Path	Source, Frequency, Radio Setup, Radio Standard, CDMA 2000 / 1xEVDO
Example	:SOUR:FREQ:CHAN:BAND JAPAN
Initial S/W Revision	A.05.00

Korean PCS

Selects Korean PCS as the active channel band.

Key Path	Source, Frequency, Radio Setup, Radio Standard, CDMA 2000 / 1xEVDO
Example	:SOUR:FREQ:CHAN:BAND KOREAN
Initial S/W Revision	A.05.00

NMT 450

Selects NMT 450 as the active channel band.

Key Path	Source, Frequency, Radio Setup, Radio Standard, CDMA 2000 / 1xEVDO
----------	--

Example	:SOUR:FREQ:CHAN:BAND NMT
Initial S/W Revision	A.05.00

IMT 2000

Selects IMT 2000 as the active channel band.

Key Path	Source, Frequency, Radio Setup, Radio Standard, CDMA 2000 / 1xEVDO
Example	:SOUR:FREQ:CHAN:BAND IMT2K
Initial S/W Revision	A.05.00

Upper 700

Selects Upper 700 as the active channel band.

Key Path	Source, Frequency, Radio Setup, Radio Standard, CDMA 2000 / 1xEVDO
Example	:SOUR:FREQ:CHAN:BAND UPPER
Initial S/W Revision	A.05.00

Secondary 800

Selects Secondary 800 as the active channel band.

Key Path	Source, Frequency, Radio Setup, Radio Standard, CDMA 2000 / 1xEVDO
Example	:SOUR:FREQ:CHAN:BAND SECOND
Initial S/W Revision	A.05.00

400 Euro PAMR

Selects 400 Euro PAMR as the active channel band.

Key Path	Source, Frequency, Radio Setup, Radio Standard, CDMA 2000 / 1xEVDO
Example	:SOUR:FREQ:CHAN:BAND PAMR400
Initial S/W Revision	A.05.00

800 PAMR

Selects 800 PAMR as the active channel band.

Key Path	Source, Frequency, Radio Setup, Radio Standard, CDMA 2000 / 1xEVDO
----------	--

Example	:SOUR:FREQ:CHAN:BAND PAMR800
Initial S/W Revision	A.05.00

2.5GHz IMT EXT

Selects 2.5 GHz IMT EXT as the active channel band.

Key Path	Source, Frequency, Radio Setup, Radio Standard, CDMA 2000 / 1xEVDO
Example	:SOUR:FREQ:CHAN:BAND IMTEXT
Initial S/W Revision	A.05.00

US PCS 1.9GHz

Selects US PCS 1.9 GHz as the active channel band.

Key Path	Source, Frequency, Radio Setup, Radio Standard, CDMA 2000 / 1xEVDO
Example	:SOUR:FREQ:CHAN:BAND PCS1DOT9G
Initial S/W Revision	A.05.00

AWS

Selects AWS as the active channel band.

Key Path	Source, Frequency, Radio Setup, Radio Standard, CDMA 2000 / 1xEVDO
Example	:SOUR:FREQ:CHAN:BAND AWS
Initial S/W Revision	A.05.00

US 2.5GHz

Selects US 2.5 GHz as the active channel band.

Key Path	Source, Frequency, Radio Setup, Radio Standard, CDMA 2000 / 1xEVDO
Example	:SOUR:FREQ:CHAN:BAND US2DOT5G
Initial S/W Revision	A.05.00

700 Public Safety

Selects 700 Public Safety as the active channel band.

Key Path	Source, Frequency, Radio Setup, Radio Standard, CDMA 2000 / 1xEVDO
----------	--

Example	:SOUR:FREQ:CHAN:BAND PUBLIC
Initial S/W Revision	A.05.00

C2K Lower 700

Selects C2K Lower 700 as the active channel band.

Key Path	Source, Frequency, Radio Setup, Radio Standard, CDMA 2000 / 1xEVDO
Example	:SOUR:FREQ:CHAN:BAND LOWER
Initial S/W Revision	A.05.00

LTE

Sets LTE FDD as the radio standard for use and accesses the LTE FDD specific channel band sub-menus..

Key Path	Source, Frequency, Radio Setup, Radio Standard
Initial S/W Revision	A.09.50

BAND 1

Selects BAND 1 as the band for the current step.

Key Path	Source, Frequency, Radio Setup, Radio Standard, LTE
Example	:SOUR:FREQ:CHAN:BAND BAND1
Initial S/W Revision	A.09.50

BAND 2

Selects BAND 2 as the band for the current step.

Key Path	Source, Frequency, Radio Setup, Radio Standard, LTE
Example	:SOUR:FREQ:CHAN:BAND BAND2
Initial S/W Revision	A.09.50

BAND 3

Selects BAND 3 as the band for the current step.

Key Path	Source, Frequency, Radio Setup, Radio Standard, LTE
Example	:SOUR:FREQ:CHAN:BAND BAND3
Initial S/W Revision	A.09.50

BAND 4

Selects BAND 4 as the band for the current step.

Key Path	Source, Frequency, Radio Setup, Radio Standard, LTE
Example	:SOUR:FREQ:CHAN:BAND BAND4
Initial S/W Revision	A.09.50

BAND 5

Selects BAND 5 as the band for the current step.

Key Path	Source, Frequency, Radio Setup, Radio Standard, LTE
Example	:SOUR:FREQ:CHAN:BAND BAND5
Initial S/W Revision	A.09.50

BAND 6

Selects BAND 6 as the band for the current step.

Key Path	Source, Frequency, Radio Setup, Radio Standard, LTE
Example	:SOUR:FREQ:CHAN:BAND BAND6
Initial S/W Revision	A.09.50

BAND 7

Selects BAND 7 as the band for the current step.

Key Path	Source, Frequency, Radio Setup, Radio Standard, LTE
Example	:SOUR:FREQ:CHAN:BAND BAND7
Initial S/W Revision	A.09.50

BAND 8

Selects BAND 8 as the band for the current step.

Key Path	Source, Frequency, Radio Setup, Radio Standard, LTE
Example	:SOUR:FREQ:CHAN:BAND BAND8
Initial S/W Revision	A.09.50

BAND 9

Selects BAND 9 as the band for the current step.

Key Path	Source, Frequency, Radio Setup, Radio Standard, LTE
Example	:SOUR:FREQ:CHAN:BAND BAND9
Initial S/W Revision	A.09.50

BAND 10

Selects BAND 10 as the band for the current step.

Key Path	Source, Frequency, Radio Setup, Radio Standard, LTE
Example	:SOUR:FREQ:CHAN:BAND BAND10
Initial S/W Revision	A.09.50

BAND 11

Selects BAND 11 as the band for the current step.

Key Path	Source, Frequency, Radio Setup, Radio Standard, LTE
Example	:SOUR:FREQ:CHAN:BAND BAND11
Initial S/W Revision	A.09.50

BAND 12

Selects BAND 12 as the band for the current step.

Key Path	Source, Frequency, Radio Setup, Radio Standard, LTE
Example	:SOUR:FREQ:CHAN:BAND BAND12
Initial S/W Revision	A.09.50

BAND 13

Selects BAND 13 as the band for the current step.

Key Path	Source, Frequency, Radio Setup, Radio Standard, LTE
Example	:SOUR:FREQ:CHAN:BAND BAND13
Initial S/W Revision	A.09.50

BAND 14

Selects BAND 14 as the band for the current step.

Key Path	Source, Frequency, Radio Setup, Radio Standard, LTE
Example	:SOUR:FREQ:CHAN:BAND BAND14
Initial S/W Revision	A.09.50

BAND 17

Selects BAND 17 as the band for the current step.

Key Path	Source, Frequency, Radio Setup, Radio Standard, LTE
Example	:SOUR:FREQ:CHAN:BAND BAND17
Initial S/W Revision	A.09.50

BAND 18

Selects BAND 18 as the band for the current step.

Key Path	Source, Frequency, Radio Setup, Radio Standard, LTE
Example	:SOUR:FREQ:CHAN:BAND BAND18
Initial S/W Revision	A.09.50

BAND 19

Selects BAND 19 as the band for the current step.

Key Path	Source, Frequency, Radio Setup, Radio Standard, LTE
Example	:SOUR:FREQ:CHAN:BAND BAND19
Initial S/W Revision	A.09.50

BAND 20

Selects BAND 20 as the band for the current step.

Key Path	Source, Frequency, Radio Setup, Radio Standard, LTE
Example	:SOUR:FREQ:CHAN:BAND BAND20
Initial S/W Revision	A.09.50

BAND 21

Selects BAND 21 as the band for the current step.

Key Path	Source, Frequency, Radio Setup, Radio Standard, LTE
Example	:SOUR:FREQ:CHAN:BAND BAND21
Initial S/W Revision	A.09.50

BAND 24

Selects BAND 24 as the band for the current step.

Key Path	Source, Frequency, Radio Setup, Radio Standard, LTE
Example	:SOUR:FREQ:CHAN:BAND BAND24
Initial S/W Revision	A.09.50

BAND 25

Selects BAND 25 as the band for the current step.

Key Path	Source, Frequency, Radio Setup, Radio Standard, LTE
Example	:SOUR:FREQ:CHAN:BAND BAND25
Initial S/W Revision	A.09.50

BAND 26

Selects BAND 26 as the band for the current step.

Key Path	Source, Frequency, Radio Setup, Radio Standard, LTE
Example	:SOUR:FREQ:CHAN:BAND BAND26
Initial S/W Revision	A.12.53

BAND 27

Selects BAND 27 as the band for the current step.

Key Path	Source, Frequency, Radio Setup, Radio Standard, LTE
Example	:SOUR:FREQ:CHAN:BAND BAND27
Initial S/W Revision	A.14.00

BAND 28

Selects BAND 28 as the band for the current step.

Key Path	Source, Frequency, Radio Setup, Radio Standard, LTE
Example	:SOUR:FREQ:CHAN:BAND BAND28
Initial S/W Revision	A.14.00

BAND 31

Selects BAND 31 as the band for the current step.

Key Path	Source, Frequency, Radio Setup, Radio Standard, LTE
Example	:SOUR:FREQ:CHAN:BAND BAND31
Initial S/W Revision	A.14.00

LTE TDD

Sets LTE TDD as the radio standard for use and accesses the LTE TDD specific channel band sub-menus..

Key Path	Source, Frequency, Radio Setup, Radio Standard
Initial S/W Revision	A.11.50

BAND 33

Selects BAND 33 as the band for the current step.

Key Path	Source, Frequency, Radio Setup, Radio Standard, LTE TDD
Example	:SOUR:FREQ:CHAN:BAND BAND33
Initial S/W Revision	A.11.50

BAND 34

Selects BAND 34 as the band for the current step.

Key Path	Source, Frequency, Radio Setup, Radio Standard, LTE TDD
Example	:SOUR:FREQ:CHAN:BAND BAND34
Initial S/W Revision	A.11.50

BAND 35

Selects BAND 35 as the band for the current step.

Key Path	Source, Frequency, Radio Setup, Radio Standard, LTE TDD
Example	:SOUR:FREQ:CHAN:BAND BAND35
Initial S/W Revision	A.11.50

BAND 36

Selects BAND 36 as the band for the current step.

Key Path	Source, Frequency, Radio Setup, Radio Standard, LTE TDD
Example	:SOUR:FREQ:CHAN:BAND BAND36
Initial S/W Revision	A.11.50

BAND 37

Selects BAND 37 as the band for the current step.

Key Path	Source, Frequency, Radio Setup, Radio Standard, LTE TDD
Example	:SOUR:FREQ:CHAN:BAND BAND37
Initial S/W Revision	A.11.50

BAND 38

Selects BAND 38 as the band for the current step.

Key Path	Source, Frequency, Radio Setup, Radio Standard, LTE TDD
Example	:SOUR:FREQ:CHAN:BAND BAND38
Initial S/W Revision	A.11.50

BAND 39

Selects BAND 39 as the band for the current step.

Key Path	Source, Frequency, Radio Setup, Radio Standard, LTE TDD
Example	:SOUR:FREQ:CHAN:BAND BAND39
Initial S/W Revision	A.11.50

BAND 40

Selects BAND 40 as the band for the current step.

Key Path	Source, Frequency, Radio Setup, Radio Standard, LTE TDD
Example	:SOUR:FREQ:CHAN:BAND BAND40
Initial S/W Revision	A.11.50

BAND 41

Selects BAND 41 as the band for the current step.

Key Path	Source, Frequency, Radio Setup, Radio Standard, LTE TDD
Example	:SOUR:FREQ:CHAN:BAND BAND41
Initial S/W Revision	A.11.50

BAND 42

Selects BAND 42 as the band for the current step.

Key Path	Source, Frequency, Radio Setup, Radio Standard, LTE TDD
Example	:SOUR:FREQ:CHAN:BAND BAND42
Initial S/W Revision	A.11.50

BAND 43

Selects BAND 43 as the band for the current step.

Key Path	Source, Frequency, Radio Setup, Radio Standard, LTE TDD
Example	:SOUR:FREQ:CHAN:BAND BAND43
Initial S/W Revision	A.11.50

BAND 44

Selects BAND 44 as the band for the current step.

Key Path	Source, Frequency, Radio Setup, Radio Standard, LTE TDD
Example	:SOUR:FREQ:CHAN:BAND BAND44
Initial S/W Revision	A.14.00

TDSCDMA

Sets TDSCDMA as the radio standard for use and accesses the TDSCDMA specific channel band sub-menus..

Key Path	Source, Frequency, Radio Setup, Radio Standard
Initial S/W Revision	A.11.50

BAND A

Selects BAND A as the band for the current step.

Key Path	Source, Frequency, Radio Setup, Radio Standard, TDSCDMA
Example	:SOUR:FREQ:CHAN:BAND BANDA
Initial S/W Revision	A.11.50

BAND B

Selects BAND B as the band for the current step.

Key Path	Source, Frequency, Radio Setup, Radio Standard, TDSCDMA
Example	:SOUR:FREQ:CHAN:BAND BANDB
Initial S/W Revision	A.11.50

BAND C

Selects BAND C as the band for the current step.

Key Path	Source, Frequency, Radio Setup, Radio Standard, TDSCDMA
Example	:SOUR:FREQ:CHAN:BAND BANDC
Initial S/W Revision	A.11.50

BAND D

Selects BAND D as the band for the current step.

Key Path	Source, Frequency, Radio Setup, Radio Standard, TDSCDMA
Example	:SOUR:FREQ:CHAN:BAND BANDD
Initial S/W Revision	A.11.50

BAND E

Selects BAND E as the band for the current step.

Key Path	Source, Frequency, Radio Setup, Radio Standard, TDSCDMA
----------	---

Example	:SOUR:FREQ:CHAN:BAND BANDE
Initial S/W Revision	A.11.50

BAND F

Selects BAND F as the band for the current step.

Key Path	Source, Frequency, Radio Setup, Radio Standard, TDSCDMA
Example	:SOUR:FREQ:CHAN:BAND BANDF
Initial S/W Revision	A.11.50

Radio Band Link

Allows you to specify the channel band type as either uplink or downlink link direction. This value is used in conjunction with the channel band and channel number to determine the absolute frequency output by the source. When set to “Uplink”, the source will calculate the uplink frequency using an uplink formula together with the selected channel band and channel number . When set to “Downlink”, the source will calculate the downlink frequency using a downlink formula together with the selected channel band and channel number.

Key Path	Source, Frequency, Radio Setup
Remote Command	:SOURce:RADio:BAND:LINK DOWN UP :SOURce:RADio:BAND:LINK?
Example	:SOUR:RAD:BAND:LINK UP
Preset	DOWN
Range	DOWN UP
Backwards Compatibility SCPI	:SOURce:RADio:DEVice BTS MS :SOURce:RADio:DEVice?
Backwards Compatibility Notes	BTS maps to the Downlink frequency MS maps to the Uplink frequency
Initial S/W Revision	A.05.00

Set Reference Frequency

This key allows you to set the frequency reference. Pressing this key turns the frequency reference state to ON, sets the reference frequency value to the current frequency, maintains this frequency at the RF output, and sets the displayed frequency to 0.00 Hz. All subsequent frequencies entered under Source>Frequency>Frequency are interpreted as being relative to this reference frequency.

When you use a frequency reference, the signal generator outputs a frequency that is set relative to the reference frequency by the value entered under Source>Frequency>Frequency as follows:

Output frequency = reference frequency - entered frequency

Where:

reference frequency equals the original RF frequency entered under Source>Frequency>Frequency and set as the reference frequency

entered frequency equals a new value entered under Source>Frequency>Frequency

In addition, the displayed frequency value will be the same as the value entered under Source>Frequency>Frequency.

NOTE

If Freq Reference is set to ON with a reference value set, entering a value under Source>Frequency>Frequency and pressing Set Frequency Reference will add that value to the existing Freq Reference value.

If you wish to change the reference frequency value to the new value entered under Source>Frequency>Frequency, first you must set Freq Reference to OFF and then press Set Frequency Reference.

Key Path	Source, Frequency
Remote Command	:SOURce:FREQuency:REFerence:SET
Example	:SOUR:FREQ:REF:SET
Dependencies	This setting is unavailable, and is grayed out when the List Sequencer is turned ON.
Initial S/W Revision	A.05.00

Freq Reference

This key allows you to toggle the state of the frequency reference. When the frequency reference state is ON, an annunciator is displayed on the main source view to indicate this state to the user.

When you use a frequency reference, the signal generator outputs a frequency that is set relative to the reference frequency by the value entered under Source>Frequency>Frequency as follows:

$$\text{Output frequency} = \text{reference frequency} + \text{entered frequency}$$

Where:

reference frequency equals the original RF frequency entered under Source>Frequency>Frequency and set as the reference frequency

entered frequency equals a new value entered under Source>Frequency>Frequency

For more information on Reference Frequency refer to ["Set Reference Frequency" on page 2473](#)

Key Path	Source, Frequency
Remote Command	:SOURce:FREQuency:REFerence <freq> :SOURce:FREQuency:REFerence? :SOURce:FREQuency:REFerence:STATe OFF ON 0 1 :SOURce:FREQuency:REFerence:STATe?
Example	:SOUR:FREQ:REF 0.00 Hz

	:SOUR:FREQ:REF:STATe ON
Dependencies	This setting is unavailable, and is grayed out when the List Sequencer is turned ON.
Couplings	The frequency reference state is coupled to the frequency reference set immediate action. When the reference set immediate action key is pressed, or the SCPI command issued, it turns the frequency reference state ON.
Preset	0.00 Hz OFF
Min	0.00 Hz
Max	Hardware Dependant: Option 503 = 3.6 GHz Option 504 = 3.8 GHz Option 506 = 6.00 GHz
Initial S/W Revision	A.05.00

Freq Offset

Allows you to specify the frequency offset value. When the frequency offset state is ON, an annunciator is displayed on the main source view to indicate this state to the user.

When the frequency offset is set to zero (0) and you set a new offset value, the displayed frequency value will change as follows and the RF output frequency will not change:

Displayed value = output frequency + offset value

Where:

output frequency equals the original frequency entered under Source>Frequency>Frequency

offset value equals the value entered under Source>Frequency>Freq Offset

When the frequency offset is set to a value other than zero (0) and you enter a new frequency value under Source>Frequency>Frequency, the displayed frequency will be the same as the value entered and the RF output frequency will be equal to the value entered minus the offset value as follows:

Output frequency = entered frequency – offset frequency

Displayed frequency = output frequency + offset frequency

Displayed frequency = entered frequency

Where:

entered frequency equals the frequency entered under Source>Frequency>Frequency

offset frequency equals the value previously entered and set under Source>Frequency>Freq Offset

Key Path	Source, Frequency
Remote Command	:SOURce:FREQuency:OFFSet <freq>

	:SOURce:FREQuency:OFFSet?
Example	:SOUR:FREQ:OFFS 0 Hz
Dependencies	This setting is unavailable, and is grayed out when the List Sequencer is turned ON.
Preset	0 Hz
Min	-100.00 GHz
Max	100.00 GHz
Initial S/W Revision	A.05.00

Modulation Setup

Allows access to the menus for setting up the available modulation types: "ARB" on page 2476, "AM" on page 2517, "FM" on page 2518, and "PM" on page 2519.

Key Path	Source
Initial S/W Revision	A.05.00

ARB

Allows you access to the ARB sub-menus.

Key Path	Source, Modulation Setup
Initial S/W Revision	A.05.00

ARB

Allows you to toggle the state of the ARB function. When the ARB is On, a "MOD" annunciator is displayed in the system settings panel. When the ARB is turned Off, the MOD annunciator is cleared

Key Path	Source, Modulation Setup, ARB
Remote Command	:SOURce:RADio:ARB[:STATe] ON OFF 1 0 :SOURce:RADio:ARB[:STATe]?
Example	:SOUR:RAD:ARB OFF :SOUR:RAD:ARB?
Notes	If the ARB is ON, a user then loads or deletes another file to ARB memory, the playing waveform segment may not keep phase continuity during the ARB memory operation. The waveform will be replayed after the ARB operation is finished.
Dependencies	This setting is for independent mode and has no effect on 3.3.8 list sequencer mode. Setting "Sequencer" on page 2521 Sequencer to On will put source enter list sequencer mode, and even if ARB state is On, the ARB file will not be played. Setting "Sequencer" on page 2521 Sequencer to Off will make source leave list sequencer mode, and this setting will take effect immediately.

The ARB can only be turned on when there is a waveform file selected for playback. On the GUI If no waveform is selected, this key is grayed out. If you send the SCPI command to turn the ARB on with no waveform selected for playback, the ARB state remains OFF and an error is generated. “-
When you try to recall a certain set of states in which the selected waveform is not in ARB memory and the ARB state is On, errors are reported

Preset	Off
Range	On Off
Initial S/W Revision	A.05.00

Select Waveform

Allows you to access to the waveform selection sub-menus.

Pressing this key changes the central view area to show the Waveform File Selection view.

Key Path	Source, Modulation Setup, ARB
Initial S/W Revision	A.05.00

Select Waveform

Allows you to select a waveform sequence or segment for the dual ARB to play.

NOTE: Selecting a waveform file does not result in automatic adjustments to burst timing (to compensate for the presence or absence of a Multiport Adapter); that adjustment occurs only when a waveform is loaded to ARB memory. See "Load Segment to ARB Memory" for more information about this adjustment.

Key Path	Source, Modulation Setup, ARB, Select Waveform
Remote Command	:SOURce:RADio:ARB:WAVeform <string> :SOURce:RADio:ARB:WAVeform?
Example	:SOUR:RAD:ARB:WAV "test_waveform.bin"
Notes	<p>If intended waveform is not in the memory yet, then issuing this command by SCPI will invoke ARB loading operation first, which involves a delay of unpredictable length. So this command should be followed by the query *OPC?, which holds off subsequent commands until the loading operating is complete.</p> <p><string> - specifies the name of the waveform segment or waveform sequence to be played by the ARB.</p> <p>When in Sequence Analyzer mode, and Include Source is Yes, if the you attempt to play a waveform sequence but not all the required waveform segments are in the ARB playback memory, the application will reject the loading operation with an error is generated .</p> <p>When Include Source is No, if you attempt to play a waveform sequence but not all the required waveform segments are contained in the ARB playback memory, the application will attempt to load the required segments from either the default directory of the current directory. If the ARB memory does not have enough space for all the waveform segments to be loaded, an error is generated and</p>

none of the waveform segments is loaded.

If the ARB is ON, and you attempt to play a waveform sequence but not all the waveform segments within the sequence could be found to be loaded into ARB memory, an error is generated. The selected waveform keeps the previous value and ARB state remains On.

If you specify a waveform segment over SCPI but the waveform segment is not present within ARB playback memory and cannot be found for auto loading within the current directory or the default directory, an error is generated and the file selection remains unchanged.

If you select a waveform for playback and the waveform requires a license that is not installed on the instrument, an error is generated.

If the ARB is ON and you load a file to ARB memory or delete a file from ARB memory, the playing waveform segment may not keep phase continuity during the ARB memory operation. The waveform will be replayed after the ARB operation is finished.

Initial S/W Revision	A.05.00
----------------------	---------

Segments on Hard Disk

Allows you access to the sub-menus for loading waveform segments from the hard disk into ARB memory. The default directory is: D: varb.

Pressing this key changes the current view to the Waveform Management View.

Key Path	Source, Modulation Setup, ARB, Select Waveform
----------	--

Initial S/W Revision	A.05.00
----------------------	---------

Load Segment To ARB Memory

Allows you to load the selected file into ARB memory. On the front panel you select the file for loading to the ARB memory by highlighting the desired file in the list. Using the SCPI command, you specify the file name on the HDD.

“NVWFM” (non-volatile storage) MSUS (Mass Storage Unit Specifier) is supported in the memory subsystem because the ARB memory cannot be accessed directly. Therefore, files must be downloaded to the instrument hard disk and then loaded into the ARB memory. “NVWFM” MSUS will be mapped to the default directory D: VARB. The SCPI command supports using either “NVWFM” MSUS or specifying a full path. For more information, see [Memory Subsystem \(Remote Command Only\)](#).

If a file of the same name already exists within ARB memory, it is overwritten. If you wish to load two segments of the same name, you must rename one of the segments before loading it into ARB memory. To rename a segment, you can either use Windows File Explorer, or the :MMEMory:COPY command.

NOTE: When a waveform file is loaded to ARB memory, burst timing adjustments are made automatically, based on whether or not a Multiport Adapter is connected to the test set and powered on. If the connection/power status of the Multiport Adapter is changed after a waveform file has been loaded, it needs to be loaded again.

Key Path	Source, Modulation Setup, ARB, Select Waveform, Segments on Hard Disk
----------	---

Remote Command	:SOURce:RADio:ARB:LOAD <string>
Example	:SOUR:RAD:ARB:LOAD "D: VARB\testwaveform.bin" or :SOUR:RAD:ARB:LOAD "NVWFM:testwaveform.bin"
Notes	<p>Because loading the file involves a delay of unpredictable length, this command should be followed by the query *OPC?, which holds off subsequent commands until the loading operating is complete.</p> <p><string> - specifies the path name of the file to load from the HDD into ARB memory. It could be a <full path + filename>, or <"NVWFM" MSUS + colon + filename>.</p> <p>When in Sequence Analyzer mode, and Include Source is Yes, an attempt to load a file to ARB memory will be rejected with an error.</p> <p>When Include Source is No and if there is insufficient free ARB memory to load the selected waveform, an error is generated. .</p> <p>If you specify a file over SCPI, but the file is not at the specified location, an error is generated.</p> <p>If you try to load a waveform file but the file contains less than 500 IQ samples, an error is generated.</p> <p>If you try to load a Signal Studio waveform "*.wfm" which contains invalid waveform header, an error is generated.</p> <p>If the ARB is ON when you load a file to ARB memory or delete a file from ARB memory, the playing waveform segment may not keep phase continuity during the ARB memory operation. The waveform will be replayed after the ARB operation is finished.</p> <p>ARB can be loaded into ARB memory even required licenses do not present on the instrument. In this case, a GUI only warning message -800, "Operation complete; Loaded <filename> successfully, but no license <required licenses> installed". User can install required licenses according to <required licenses> string to license it, or multi-pack license it.</p>
Initial S/W Revision	A.05.00

Load All To ARB Memory

Allows you to load all the segment files within the currently selected directory into ARB memory. If a file of the same name already exists within ARB memory, it is overwritten. If you wish to load two segments of the same name, you must rename one of the segments before loading it into ARB memory. To rename a segment, you can either use Windows File Explorer, or the :MEMory:COPI command.

NOTE: When a waveform file is loaded to ARB memory, burst timing adjustments are made automatically, based on whether or not a Multiport Adapter is connected to the test set and powered on. If the connection/power status of the Multiport Adapter is changed after a waveform file has been loaded, it needs to be loaded again.

Key Path	Source, Modulation Setup, ARB, Select Waveform, Segments on Hard Disk
Remote Command	:SOURce:RADio:ARB:LOAD:ALL <string>
Example	:SOUR:RAD:ARB:LOAD:ALL "D: varb"
Notes	<p><string> - specifies the directory on the HDD to load the files into ARB memory from.</p> <p>When in Sequence Analyzer mode, and Include Source is Yes, an attempt to load all files from a directory to ARB memory is rejected with an error.</p> <p>When Include Source is No and there is insufficient free ARB memory to load all the waveforms,</p>

when the ARB memory is full, the copy ceases, and an error is generated.
 If you specify a directory over SCPI, but the directory does not exist, an error is generated.
 If the ARB is ON, a user then loads or deletes file to ARB memory, the playing waveform segment may not keep phase continuity during the ARB memory operation. The waveform will be replayed after the ARB operation is finished.

Initial S/W Revision A.05.00

Change Directory...

Allows you to change the currently selected directory on the hard disk. Pressing this key opens a standard windows change directory dialog allowing you to select the new directory of interest.

The current directory is used for manually loading waveform segments into ARB memory for playback, and as a search location for waveform segments that are required to be loaded into ARB memory for playback of a waveform sequence or a list sequence.

Key Path Source, Modulation Setup, ARB, Select Waveform, Segments on Hard Disk

Notes No remote command, SCPI front panel only.

Initial S/W Revision A.05.00

Default Directory...

Allows you to change the default directory. It is used as a search location for waveform segments that are required to be loaded into ARB memory for playback of a waveform sequence, and as a search location for selecting waveforms using SCPI.

Key Path Source, Modulation Setup, ARB, Select Waveform, Segments on Hard Disk

Remote Command :SOURce:RADio:ARB:DEFault:DIRectory <string>
 :SOURce:RADio:ARB: DEFault:DIRectory?

Example :SOUR:RAD:ARB:DEF:DIR "D:\ArbFiles"
 :SOUR:RAD:ARB:DEF:DIR?

State Saved Persistent, survives a power cycle and a preset but not saved in the instrument state

Initial S/W Revision A.05.00

Segments in ARB Memory

Allows you access to the sub-menus for managing the files within ARB memory.

Key Path Source, Modulation Setup, ARB, Select Waveform

Initial S/W Revision A.05.00

Delete Segment From ARB Mem

Allows you to remove a segment from ARB playback memory.

Key Path	Source, Modulation Setup, ARB, Select Waveform, Segments in ARB Memory
Remote Command	:SOURce:RADio:ARB:DELeTe <string>
Example	:SOUR:RAD:ARB:DEL "testwaveform.bin"
Notes	<p><string> - specifies the waveform to be deleted from the ARB playback memory.</p> <p>When in Sequence Analyzer mode and Include Source is Yes, an attempt to delete a file from ARB memory is rejected with an error.</p> <p>When Include Source is No and you specify a file that does not exist within ARB memory, an error is generated.</p> <p>It is possible to delete files from within the ARB memory when the ARB is ON. However, if you attempt to delete the file that is currently playing an error is generated.</p> <p>It is possible to delete a file from within the ARB memory when the sequencer state is ON and the file is not being used by the List Sequencer. If you attempt to delete a file which is being used by the list sequencer, an error is generated.</p> <p>When sequencer state is On, even if ARB state is On, the selected waveform will not be played. In this case, if the selected waveform is not used in List Sequence, it can be deleted and the ARB state is turned Off.</p> <p>If the ARB is ON and you load a file to ARB memory or delete a file from ARB memory, the playing waveform segment may not keep phase continuity during the ARB memory operation. The waveform will be replayed after the ARB operation is finished.</p>
Initial S/W Revision	A.05.00

Delete All From ARB Memory

Allows you to remove all segments from ARB playback memory.

Key Path	Source, Modulation Setup, ARB, Select Waveform, Segments in ARB Memory
Remote Command	:SOURce:RADio:ARB:DELeTe:ALL
Example	:SOUR:RAD:ARB:DELeTe:ALL
Notes	<p>When in Sequence Analyzer mode and Include Source is Yes, an attempt to delete all files from ARB memory is rejected with an error.</p> <p>When Include Source is No and you attempt to delete all files from ARB memory when the ARB is currently playing a file, all files except the one playing are deleted and an error is generated.</p> <p>If you attempt to delete all files from ARB memory when there are waveform files used in "List Sequencer" on page 2520 and "Sequencer" on page 2521 state is ON, all files except the files currently being used in list sequencer are deleted, and an error is generated.</p> <p>If the ARB is ON and you load a file to ARB memory or delete a file from ARB memory, the playing waveform segment may not keep phase continuity during the ARB memory operation. The waveform will be replayed after the ARB operation is finished.</p>
Initial S/W Revision	A.05.00

Query ARB Memory File List (Remote Command Only)

Queries the test set for the list of waveform segments in the ARB memory.

NOTE

This command returns a string for waveform segment names in ARB memory. If you want a string list of waveform segments in the ARB memory, use **"Query ARB Memory Full File List (Remote Command Only)"** on page 2482.

Remote Command	:SOURce:RADio:ARB:CATalog?
Example	:SOUR:RAD:ARB:CATalog?
Notes	The return data is in the following format: <integer> - memory used <integer> - memory free <string> ... - comma separated list of waveform segments within ARB memory
Initial S/W Revision	A.05.00

Query ARB Memory Full File List (Remote Command Only)

Queries the test set for the string list of waveform segments in the ARB memory. It returns a string list for waveform segment names in the ARB memory.

Remote Command	:SOURce:RADio:ARB:FCATalog?
Example	:SOUR:RAD:ARB:FCATalog?
Notes	The return data is in the following format: <integer> - memory used <integer> - memory free <integer> - file count in ARB memory <string>,<string>, ... <string> - comma separated string list of waveform segments within ARB memory Example: SOUR:RAD:ARB:FCAT? EXT returns: 27499,2069653,3,"c2k.wfm","gsm.wfm","wcdma.wfm"
Initial S/W Revision	A.09.00

ARB Setup

Allows access to the ARB setup sub-menus.

Key Path	Source, Modulation Setup, ARB
Initial S/W Revision	A.05.00

Sample Rate

Allows you to set the ARB waveform playback sample rate.

Key Path	Source, Modulation Setup, ARB, ARB Setup
Remote Command	:SOURce:RADio:ARB:SCLock:RATE <freq> :SOURce:RADio:ARB:SCLock:RATE?
Example	:SOUR:RAD:ARB:SCL:RATE 48.00 MHz
Notes	If there is a sample rate specified in the header of the waveform file, changing that sample rate is not recommended, as it may cause problems with burst timing.
Dependencies	When a new waveform is selected for playback the settings contained within the associated waveform header file are applied to the ARB. The sample rate is one of the values stored within the header file. If the newly selected waveform file has an associated header file, the sample rate is updated with the value from the header file. The sample rate will remain unchanged if the newly selected waveform does not have an associated header file.
Preset	125.00 MHz
Min	1.00 kHz
Max	125.00 MHz
Initial S/W Revision	A.05.00

Run-Time Scaling

Allows you to adjust the run-time scaling value. The run-time scaling value is applied in real-time while the waveform is playing.

Key Path	Source, Modulation Setup, ARB, ARB Setup
Remote Command	:SOURce:RADio:ARB:RSCaling <real> :SOURce:RADio:ARB:RSCaling?
Example	:SOUR:RAD:ARB:RSC 100.00
Notes	This setting cannot be set in E6640A. Grey out on menu and the value is fixed at 70.00%.
Dependencies	When a new waveform is selected for playback the settings contained within the associated waveform header file are applied to the ARB. The run-time scaling is one of the values stored within the header file. If the newly selected waveform file has an associated header file, the run-time scaling is updated with the value from the header file. The run-time scaling will remain unchanged if the newly selected waveform does not have an associated header file.
Preset	70.00 %
Min	1.00 %
Max	100.00 %
Initial S/W Revision	A.05.00

Baseband Freq Offset

Allows you to adjust the value by which the baseband frequency is offset relative to the carrier.

Key Path	Source, Modulation Setup, ARB, ARB Setup
Remote Command	:SOURce:RADio:ARB:BASEband:FREQuency:OFFSet <freq> :SOURce:RADio:ARB:BASEband:FREQuency:OFFSet?
Example	:SOUR:RAD:ARB:BAS:FREQ:OFFS 0.00 Hz
Dependencies	When a new waveform is selected for playback the settings contained within the associated waveform header file are applied to the ARB. The baseband frequency offset is one of the values stored within the header file. If the newly selected waveform file has an associated header file, the baseband frequency offset is updated with the value from the header file. The baseband frequency offset will remain unchanged if the newly selected waveform does not have an associated header file.
Preset	0.00 Hz
Min	-50.00 MHz
Max	50.00 MHz
Initial S/W Revision	A.05.00

Trigger Type

Allows access to the trigger type sub-menus. The setting for trigger type determines the behavior of the waveform when it plays.

Key Path	Source, Modulation Setup, ARB
Remote Command	:SOURce:RADio:ARB:TRIGger:TYPE CONTInuous SINGLE SADVance GATE :SOURce:RADio:ARB:TRIGger:TYPE?
Example	:SOUR:RAD:ARB:TRIG:TYPE CONT :SOUR:RAD:ARB:TRIG:TYPE?
Notes	Gated trigger type will be implemented at a later release
Preset	CONTInuous
Range	Continuous Single Seg Adv Gated
Initial S/W Revision	A.05.00

Continuous

Sets the active trigger type to Continuous. If Continuous is already selected as the active trigger type, pressing this key allows access to the continuous trigger type setup menu. In Continuous trigger mode, the waveform repeats continuously.

Key Path	Source, Modulation Setup, ARB, Trigger Type
Remote Command	:SOURce:RADio:ARB:TRIGger:TYPE:CONTInuous[:TYPE] FREE TRIGger RESet :SOURce:RADio:ARB:TRIGger:TYPE:CONTInuous[:TYPE]?
Example	:SOUR:RAD:ARB:TRIG:TYPE:CONT FREE
Preset	FREE

Range	Free Run Trigger + Run Reset + Run
Initial S/W Revision	A.05.00

Free Run

Selects Free Run as the trigger response for the continuous trigger type. Free Run sets the waveform generator to play a waveform sequence or segment continuously, without waiting for a trigger. In this mode, the waveform generator does not respond to triggers.

Key Path	Source, Modulation Setup, ARB, Trigger Type, Continuous
Example	:SOUR:RAD:ARB:TRIG:TYPE:CONT FREE
Initial S/W Revision	A.05.00

Trigger + Run

Sets Trigger and Run as the trigger response for the continuous trigger type. Trigger and Run sets the waveform generator to play a waveform sequence or segment continuously when the first trigger is received, and to ignore any subsequent triggers.

Key Path	Source, Modulation Setup, ARB, Trigger Type, Continuous
Example	:SOUR:RAD:ARB:TRIG:TYPE:CONT TRIG
Initial S/W Revision	A.05.00

Reset + Run

Sets Reset and Run as the trigger response for the continuous trigger type. Reset and Run sets the waveform generator to play a waveform sequence or segment continuously when the first trigger is received. Subsequent triggers reset the waveform sequence or segment to the start, and then play it continuously.

Key Path	Source, Modulation Setup, ARB, Trigger Type, Continuous
Example	:SOUR:RAD:ARB:TRIG:TYPE:CONT RES
Initial S/W Revision	A.05.00

Single

Sets the active trigger type to Single. If Single is already selected as the active trigger type, pressing this key allows access to the single trigger type setup menu. In Single trigger mode, the waveform plays once.

Key Path	Source, Modulation Setup, ARB, Trigger Type
Remote Command	:SOURce:RADio:ARB:RETRigger ON OFF IMMediate

	:SOURce:RADio:ARB:RETRigger?
Example	:SOUR:RAD:ARB:RETR OFF
Notes	ON: Buffered Trigger OFF: No Retrigger Immediate: Restart on Trigger This is defined as an enumerated SCPI command, with ON OFF being considered as enumerated types rather than Boolean. This means the query will return OFF instead of 0, and ON instead of 1.
Preset	ON
Range	No Retrigger Buffered Trigger Restart on Trigger
Initial S/W Revision	A.05.00

No Retrigger

Selects No Retrigger as the trigger response for single trigger type. No Retrigger sets the waveform generator to play a waveform sequence or segment once when a trigger is received. Any triggers then received during playback are ignored.

Key Path	Source, Modulation Setup, ARB, Trigger Type, Single
Example	:SOUR:RAD:ARB:RETR OFF
Initial S/W Revision	A.05.00

Buffered Trigger

Selects Buffered Trigger as the trigger response for single trigger type. Buffered Trigger sets the waveform generator to play a waveform sequence or segment once when a trigger is received. If a trigger is received during playback, the waveform generator plays the sequence or segment to the end, then plays the sequence or segment once more.

Key Path	Source, Modulation Setup, ARB, Trigger Type, Single
Example	:SOUR:RAD:ARB:RETR ON
Initial S/W Revision	A.05.00

Restart on Trigger

Selects Restart on Trigger as the trigger response for single trigger type. Restart on Trigger sets the waveform generator to play a waveform sequence or segment once when a trigger is received. If a trigger is received during playback, the waveform generator resets and plays the sequence or segment from the start.

Key Path	Source, Modulation Setup, ARB, Trigger Type, Single
Example	:SOUR:RAD:ARB:RETR IMM
Initial S/W Revision	A.05.00

Segment Advance

Sets the active trigger type to Segment Advance. If Segment Advance is already selected as the active trigger type, pressing this key allows access to the segment advance trigger type setup menu.

Segment Advance triggering allows you to control the playback of waveform segments within a waveform sequence. When a trigger is received the ARB advances to the next waveform segment within the waveform sequence. This type of triggering ignores the repetition count for the waveform segment within the waveform sequence. For example, if a waveform segment has a repetition count of 10 and you select single segment advance triggering mode, the waveform segment will only play once.

Segment Advance triggering can also be used for waveform segments only. In this situation the same waveform segment is played again when a trigger is received.

Key Path	Source, Modulation Setup, ARB, Trigger Type
Remote Command	:SOURce:RADio:ARB:TRIGger:TYPE:SADVance[:TYPE] Single CONTInuous :SOURce:RADio:ARB:TRIGger:TYPE:SADVance[:TYPE]?
Example	:SOUR:RAD:ARB:TRIG:TYPE:SADV SING
Preset	CONTInuous
Range	Single Continuous
Initial S/W Revision	A.05.00

Single

Selects Single as the trigger response for Segment Advance trigger type. With single selected, once a trigger is received a segment is played once. If a trigger is received during playback of a segment, the segment plays to completion and the next segment is played once.

Key Path	Source, Modulation Setup, ARB, Trigger Type, Segment Advance
Example	:SOUR:RAD:ARB:TRIG:TYPE:SADV SING
Initial S/W Revision	A.05.00

Continuous

Selects Continuous as the trigger response for Segment Advance trigger type. With continuous selected, once a trigger is received a segment is played continuously. When subsequent triggers are received, the currently playing segment plays to completion and then the next segment is played continuously.

Key Path	Source, Modulation Setup, ARB, Trigger Type, Segment Advance
Example	:SOUR:RAD:ARB:TRIG:TYPE:SADV CONT
Initial S/W Revision	A.05.00

Trigger Source

Allows access to the trigger source sub-menus. The trigger source setting determines how the source receives the trigger that starts the waveform playing. Therefore, this key is grayed out if the trigger type is free run, since free run triggers immediately with no trigger source required.

Key Path	Source, Modulation Setup, ARB
Remote Command	:SOURce:RADio:ARB:TRIGger[:SOURce] KEY BUS EXTernal2 :SOURce:RADio:ARB:TRIGger[:SOURce]?
Example	:SOUR:RAD:ARB:TRIGger KEY
Dependencies	This key is grayed out if the current trigger type is Continuous, Free Run.
Preset	EXTernal2
Range	Trigger Key Bus External 2
Initial S/W Revision	A.05.00

Trigger Key

Sets the current trigger source to the front panel Trigger key. When Trigger Key is selected, the waveform is triggered when you press the front panel Trigger key.

Key Path	Source, Modulation Setup, ARB, Trigger Source
Example	:SOUR:RAD:ARB:TRIGger KEY
Initial S/W Revision	A.05.00

Bus

Sets the current trigger source to Bus. Selecting Bus trigger source enables triggering over GPIB, LAN, or USB using the :SOURce:RADio:ARB:TRIGger:INITiate command.

Key Path	Source, Modulation Setup, ARB, Trigger Source
Example	:SOUR:RAD:ARB:TRIGger BUS
Initial S/W Revision	A.05.00

External 2

Sets the current trigger source to External 2. Selecting External 2 enables triggering a waveform by an externally applied signal.

Key Path	Source, Modulation Setup, ARB, Trigger Source
Example	:SOUR:RAD:ARB:TRIGger EXT2
Notes	Note: When on E6640A, trigger 2 is a bi-directional trigger port. So when trigger 2 has been configured as OUTPUT type, choosing External 2 as the input trigger for the current step will generate error.
Initial S/W Revision	A.05.00

Trigger Initiate

Used to initiate an immediate trigger event if the trigger source is set to Trigger Key.

Key Path	Source, Modulation Setup, ARB
Notes	No remote command, SCPI front panel only.
Initial S/W Revision	A.05.00

Waveform Sequences

Allows access to the waveform sequence sub-menus. Pressing this key changes the central view area to display the Waveform Sequence List view.

Key Path	Source, Modulation Setup, ARB
Notes	No remote command, SCPI front panel only.
Initial S/W Revision	A.05.00

Build New Sequence

Allows access to the sub-menus for creating a new waveform sequence. Pressing this key changes the central view area to display the Waveform Sequence Creation and Editing view.

Key Path	Source, Modulation Setup, ARB, Waveform Sequences
Notes	No remote command, SCPI front panel only.
Initial S/W Revision	A.05.00

Current Segment

Specifies the selected sequence segment that will be affected by the menu functions.

Key Path	Source, Modulation Setup, ARB, Waveform Sequences, Build New Sequence
Notes	No remote command, SCPI front panel only. This key is grayed out and unavailable if the sequence is currently empty.
Initial S/W Revision	A.05.00

Insert New Waveform

Allows you access to the sub-menu for inserting a new waveform segment or sequence. Pressing this key also changes the central display to show the Waveform File Selection View.

Key Path	Source, Modulation Setup, ARB, Waveform Sequences, Build New Sequence
Notes	No remote command, SCPI front panel only. Waveform segment name string length upper limit is 128 chars. Please do NOT insert waveform which name string exceeds 128 chars.
Initial S/W Revision	A.05.00

Insert Waveform

Inserts the currently highlighted waveform to the end of the waveform sequence. Pressing this key also returns you to the menus for creating or editing a sequence, and returns the central view to the sequence creation view.

Key Path	Source, Modulation Setup, ARB, Waveform Sequences, Build New Sequence, Insert New Waveform
Notes	No remote command, SCPI front panel only. Waveform segment name string length upper limit is 128 chars. Please do NOT insert waveform which name string exceeds 128 chars.
Initial S/W Revision	A.05.00

Segments on Hard Disk

Allows you access to the sub-menus for loading waveform segments from the hard disk into ARB memory. The default directory is: D: varb.

Pressing this key changes the current view to the Waveform Management View.

Key Path	Source, Modulation Setup, ARB, Select Waveform
Initial S/W Revision	A.05.00

Load Segment To ARB Memory

Allows you to load the selected file into ARB memory. On the front panel you select the file for loading to the ARB memory by highlighting the desired file in the list. Using the SCPI command, you specify the file name on the HDD.

“NVWFM” (non-volatile storage) MSUS (Mass Storage Unit Specifier) is supported in the memory subsystem because the ARB memory cannot be accessed directly. Therefore, files must be downloaded to the instrument hard disk and then loaded into the ARB memory. “NVWFM” MSUS will be mapped to the default directory D: VARB. The SCPI command supports using either “NVWFM” MSUS or specifying a full path. For more information, see [Memory Subsystem \(Remote Command Only\)](#).

If a file of the same name already exists within ARB memory, it is overwritten. If you wish to load two segments of the same name, you must rename one of the segments before loading it into ARB memory. To rename a segment, you can either use Windows File Explorer, or the :MMEMory:COPY command.

NOTE: When a waveform file is loaded to ARB memory, burst timing adjustments are made automatically, based on whether or not a Multiport Adapter is connected to the test set and powered on. If the connection/power status of the Multiport Adapter is changed after a waveform file has been loaded, it needs to be loaded again.

Key Path	Source, Modulation Setup, ARB, Select Waveform, Segments on Hard Disk
Remote Command	:SOURce:RADio:ARB:LOAD <string>
Example	:SOUR:RAD:ARB:LOAD "D: VARB\testwaveform.bin" or :SOUR:RAD:ARB:LOAD "NVWFM:testwaveform.bin"
Notes	<p>Because loading the file involves a delay of unpredictable length, this command should be followed by the query *OPC?, which holds off subsequent commands until the loading operation is complete.</p> <p><string> – specifies the path name of the file to load from the HDD into ARB memory. It could be a <full path + filename>, or <"NVWFM" MSUS + colon + filename>.</p> <p>When in Sequence Analyzer mode, and Include Source is Yes, an attempt to load a file to ARB memory will be rejected with an error.</p> <p>When Include Source is No and if there is insufficient free ARB memory to load the selected waveform, an error is generated. .</p> <p>If you specify a file over SCPI, but the file is not at the specified location, an error is generated.</p> <p>If you try to load a waveform file but the file contains less than 500 IQ samples, an error is generated.</p> <p>If you try to load a Signal Studio waveform "*.wfm" which contains invalid waveform header, an error is generated.</p> <p>If the ARB is ON when you load a file to ARB memory or delete a file from ARB memory, the playing waveform segment may not keep phase continuity during the ARB memory operation. The waveform will be replayed after the ARB operation is finished.</p> <p>ARB can be loaded into ARB memory even if required licenses do not present on the instrument. In this case, a GUI only warning message –800, "Operation complete; Loaded <filename> successfully, but no license <required licenses> installed". User can install required licenses according to <required licenses> string to license it, or multi-pack license it.</p>
Initial S/W Revision	A.05.00

Load All To ARB Memory

Allows you to load all the segment files within the currently selected directory into ARB memory. If a file of the same name already exists within ARB memory, it is overwritten. If you wish to load two segments of the same name, you must rename one of the segments before loading it into ARB memory. To rename a segment, you can either use Windows File Explorer, or the :MEMORY:COPY command.

NOTE: When a waveform file is loaded to ARB memory, burst timing adjustments are made automatically, based on whether or not a Multiport Adapter is connected to the test set and powered on. If the connection/power status of the Multiport Adapter is changed after a waveform file has been loaded, it needs to be loaded again.

Key Path	Source, Modulation Setup, ARB, Select Waveform, Segments on Hard Disk
Remote Command	:SOURce:RADio:ARB:LOAD:ALL <string>

Example	:SOUR:RAD:ARB:LOAD:ALL "D: varb"
Notes	<p><string> - specifies the directory on the HDD to load the files into ARB memory from.</p> <p>When in Sequence Analyzer mode, and Include Source is Yes, an attempt to load all files from a directory to ARB memory is rejected with an error.</p> <p>When Include Source is No and there is insufficient free ARB memory to load all the waveforms, when the ARB memory is full, the copy ceases, and an error is generated.</p> <p>If you specify a directory over SCPI, but the directory does not exist, an error is generated.</p> <p>If the ARB is ON, a user then loads or deletes file to ARB memory, the playing waveform segment may not keep phase continuity during the ARB memory operation. The waveform will be replayed after the ARB operation is finished.</p>
Initial S/W Revision	A.05.00

Change Directory...

Allows you to change the currently selected directory on the hard disk. Pressing this key opens a standard windows change directory dialog allowing you to select the new directory of interest.

The current directory is used for manually loading waveform segments into ARB memory for playback, and as a search location for waveform segments that are required to be loaded into ARB memory for playback of a waveform sequence or a list sequence.

Key Path	Source, Modulation Setup, ARB, Select Waveform, Segments on Hard Disk
Notes	No remote command, SCPIfront panel only.
Initial S/W Revision	A.05.00

Default Directory...

Allows you to change the default directory. It is used as a search location for waveform segments that are required to be loaded into ARB memory for playback of a waveform sequence, and as a search location for selecting waveforms using SCPI.

Key Path	Source, Modulation Setup, ARB, Select Waveform, Segments on Hard Disk
Remote Command	:SOURce:RADio:ARB:DEFault:DIRectory <string> :SOURce:RADio:ARB: DEFault:DIRectory?
Example	:SOUR:RAD:ARB:DEF:DIR "D:\ArbFiles" :SOUR:RAD:ARB:DEF:DIR?
State Saved	Persistent, survives a power cycle and a preset but not saved in the instrument state
Initial S/W Revision	A.05.00

Segments in ARB Memory

Allows you access to the sub-menus for managing the files within ARB memory.

Key Path	Source, Modulation Setup, ARB, Select Waveform
Initial S/W Revision	A.05.00

Delete Segment From ARB Mem

Allows you to remove a segment from ARB playback memory.

Key Path	Source, Modulation Setup, ARB, Select Waveform, Segments in ARB Memory
Remote Command	:SOURce:RADio:ARB:DELeTe <string>
Example	:SOUR:RAD:ARB:DEL "testwaveform.bin"
Notes	<p><string> - specifies the waveform to be deleted from the ARB playback memory.</p> <p>When in Sequence Analyzer mode and Include Source is Yes, an attempt to delete a file from ARB memory is rejected with an error.</p> <p>When Include Source is No and you specify a file that does not exist within ARB memory, an error is generated.</p> <p>It is possible to delete files from within the ARB memory when the ARB is ON. However, if you attempt to delete the file that is currently playing an error is generated.</p> <p>It is possible to delete a file from within the ARB memory when the sequencer state is ON and the file is not being used by the List Sequencer. If you attempt to delete a file which is being used by the list sequencer, an error is generated.</p> <p>When sequencer state is On, even if ARB state is On, the selected waveform will not be played. In this case, if the selected waveform is not used in List Sequence, it can be deleted and the ARB state is turned Off.</p> <p>If the ARB is ON and you load a file to ARB memory or delete a file from ARB memory, the playing waveform segment may not keep phase continuity during the ARB memory operation. The waveform will be replayed after the ARB operation is finished.</p>
Initial S/W Revision	A.05.00

Delete All From ARB Memory

Allows you to remove all segments from ARB playback memory.

Key Path	Source, Modulation Setup, ARB, Select Waveform, Segments in ARB Memory
Remote Command	:SOURce:RADio:ARB:DELeTe:ALL
Example	:SOUR:RAD:ARB:DELeTe:ALL
Notes	<p>When in Sequence Analyzer mode and Include Source is Yes, an attempt to delete all files from ARB memory is rejected with an error.</p> <p>When Include Source is No and you attempt to delete all files from ARB memory when the ARB is currently playing a file, all files except the one playing are deleted and an error is generated.</p> <p>If you attempt to delete all files from ARB memory when there are waveform files used in "List Sequencer" on page 2520 and "Sequencer" on page 2521 state is ON, all files except the files currently being used in list sequencer are deleted, and an error is generated.</p>

If the ARB is ON and you load a file to ARB memory or delete a file from ARB memory, the playing waveform segment may not keep phase continuity during the ARB memory operation. The waveform will be replayed after the ARB operation is finished.

Initial S/W Revision	A.05.00
----------------------	---------

Segments on Hard Disk

This key functions the same as ["Segments on Hard Disk" on page 2547](#).

Key Path	Source, Modulation Setup, ARB, Waveform Sequences, Build New Sequence, Insert New Waveform
----------	--

Initial S/W Revision	Prior to A.09.00
----------------------	------------------

Load Segment To ARB Memory

This key functions the same as ["Load Segment To ARB Memory" on page 2547](#).

Key Path	Source, Modulation Setup, ARB, Waveform Sequences, Build New Sequence, Insert New Waveform, Segment on Hard Drive
----------	---

Initial S/W Revision	Prior to A.09.00
----------------------	------------------

Load All To ARB Memory

This key functions the same as ["Load All To ARB Memory" on page 2548](#).

Key Path	Source, Modulation Setup, ARB, Waveform Sequences, Build New Sequence, Insert New Waveform, Segment on Hard Drive
----------	---

Initial S/W Revision	Prior to A.09.00
----------------------	------------------

Change Directory ...

This key functions the same as ["Change Directory..." on page 2549](#).

Key Path	Source, Modulation Setup, ARB, Waveform Sequences, Build New Sequence, Insert New Waveform, Segment on Hard Drive
----------	---

Initial S/W Revision	Prior to A.09.00
----------------------	------------------

Default Directory ...

This key functions the same as ["Default Directory..." on page 2549](#)

Key Path	Source, Modulation Setup, ARB, Waveform Sequences, Build New Sequence, Insert New Waveform, Segment on Hard Drive
----------	---

Initial S/W Revision	Prior to A.09.00
----------------------	------------------

Segments in ARB Memory

This key functions the same as ["Segments in ARB Memory" on page 2549](#).

Key Path	Source, Modulation Setup, ARB, Waveform Sequences, Build New Sequence, Insert New Waveform
Initial S/W Revision	Prior to A.09.00

Delete Segment From ARB Memory

This key functions the same as ["Delete Segment From ARB Mem" on page 2549](#).

Key Path	Source, Modulation Setup, ARB, Waveform Sequences, Build New Sequence, Insert New Waveform, Segment in ARB Memory
Initial S/W Revision	Prior to A.09.00

Delete All From ARB Memory

This key functions the same as ["Delete All From ARB Memory" on page 2550](#).

Key Path	Source, Modulation Setup, ARB, Waveform Sequences, Build New Sequence, Insert New Waveform, Segment in ARB Memory
Initial S/W Revision	Prior to A.09.00

Query ARB Memory File List (Remote Command Only)

This command functions the same as ["Query ARB Memory File List \(Remote Command Only\)" on page 2482](#).

Initial S/W Revision	Prior to A.09.00
----------------------	------------------

Edit Selected Waveform

Allows access to the sub-menus for editing the details of the currently selected waveform segment.

Key Path	Source, Modulation Setup, ARB, Waveform Sequences, Build New Sequence
Notes	No remote command, front panel only.
Initial S/W Revision	A.05.00

Repetitions

Allows you to specify the number of times the currently selected waveform is played within the sequence.

Key Path	Source, Modulation Setup, ARB, Waveform Sequences, Build New Sequence, Edit Selected Waveform
Notes	No remote command, SCPI front panel only.
Preset	1
Min	1
Max	65535
Initial S/W Revision	A.05.00

Marker 1

Allows you to enable or disable marker 1 for the currently selected waveform. For a waveform sequence, you can enable and disable markers on a per-segment basis, allowing you to output markers from some waveform segments within the sequence, but not for others.

Key Path	Source, Modulation Setup, ARB, Waveform Sequences, Build New Sequence, Edit Selected Waveform
Notes	No remote command, front panel only.
Preset	Enabled
Range	Enabled Disabled
Initial S/W Revision	A.05.00

Marker 2

Allows you to enable or disable marker 2 for the currently selected waveform. For a waveform sequence, you can enable and disable markers on a per-segment basis, allowing you to output markers from some waveform segments within the sequence, but not for others.

Key Path	Source, Modulation Setup, ARB, Waveform Sequences, Build New Sequence, Edit Selected Waveform
Notes	No remote command, front panel only.
Preset	Enabled
Range	Enabled Disabled
Initial S/W Revision	A.05.00

Marker 3

Allows you to enable or disable marker 3 for the currently selected waveform. For a waveform sequence, you can enable and disable markers on a per-segment basis, allowing you to output markers from some waveform segments within the sequence, but not for others.

Key Path	Source, Modulation Setup, ARB, Waveform Sequences, Build New Sequence, Edit Selected
----------	--

	Waveform
Notes	No remote command, front panel only.
Preset	Enabled
Range	Enabled Disabled
Initial S/W Revision	A.05.00

Marker 4

Allows you to enable or disable marker 4 for the currently selected waveform. For a waveform sequence, you can enable and disable markers on a per-segment basis, allowing you to output markers from some waveform segments within the sequence, but not for others.

Key Path	Source, Modulation Setup, ARB, Waveform Sequences, Build New Sequence, Edit Selected Waveform
Notes	No remote command, front panel only.
Preset	Enabled
Range	Enabled Disabled
Initial S/W Revision	A.05.00

Delete Segment

Allows you to delete the selected segment from the waveform sequence.

Key Path	Source, Modulation Setup, ARB, Waveform Sequences, Build New Sequence
Notes	No remote command, front panel only.
Initial S/W Revision	A.05.00

Save Sequence...

Pressing this key displays the “Save As” dialog. The sequence name is passed to the save as dialog to use as the filename for saving, and the directory the save as dialog will open into is the default waveform directory.

Key Path	Source, Modulation Setup, ARB, Waveform Sequences, Build New Sequence
Initial S/W Revision	A.05.00

Build New Sequence (Remote Command Only)

This command is the SCPI equivalent of the waveform sequence creation features described in ["Build New Sequence" on page 2489](#).

This command writes a waveform sequence file to the hard disk. You must specify the waveform sequence file path and filename which will be saved on the hard disk, and the waveform segment file path and name which will be nested into the waveform sequence file. You can utilize mass storage unit specifier (MSUS) “NVWFM” or use a real full path representation. See the example below. MSUS “NVWFM” is mapped to D: VARB directory on test set hard disk.

Any number of segments, up to a segment count limit of 64, can be used to create a sequence. Repeated segments are included in the count limit.

Each waveform segment name string length upper limit is 128 chars. Please do NOT insert waveform which name string exceeds 128 chars.

The internal source does not support nesting one waveform sequence file into another waveform sequence file.

Remote Command :SOURce:RADio:ARB:SEQuence[:MWAveform] <filename>, <waveform1>, <reps>,
NONE | M1 | M2 | M3 | M4 | M1M2 | M1M3 | M1M4 | M2M3 | M2M4 | M3M4 |
M1M2M3 | M1M2M4 | M1M3M4 | M2M3M4 | M1M2M3M4 | ALL, {<waveform2>,
<reps>, NONE | M1 | M2 | M3 | M4 | M1M2 | M1M3 | M1M4 | M2M3 | M2M4 |
M3M4 | M1M2M3 | M1M2M4 | M1M3M4 | M2M3M4 | M1M2M3M4 | ALL, } ...

(For additional description of each item, see Notes below ["For Setup SCPI" on page 808](#) "For Setup SCPI".)

:SOURce:RADio:ARB:SEQuence[:MWAveform]? <filename>

(For additional description of each item, see Notes ["For Query SCPI" on page 809](#) below.)

Example For setup:

```
>:SOUR:RAD:ARB:SEQ "NVWFM:testSeq1.seq", "NVWFM:wfmSegment1.wfm", 10, M2M3M4,
"NVWFM:wfmSegment2.wfm", 20, M1 M3
```

Or

```
>:SOUR:RAD:ARB:SEQ "D: VARB\testSeq1.seq", "D: VARB\wfmSegment1.wfm", 10, M2M3M4, "D:
VARB\wfmSegment2.wfm", 20, M1 M3
```

For query, must specify which waveform sequence file to query.

```
>:SOUR:RAD:ARB:SEQ? "NVWFM:testSeq1.seq"
```

Or

```
>:SOUR:RAD:ARB:SEQ? "D: VARB\testSeq1.seq",
```

Notes

For Setup SCPI

For the Setup SCPI command, the parameters are:

<filename> - String Type

This variable specifies the path and name for the waveform sequence file. The path supports MSUS (NVWFM) or a real full path representation. See example.

<waveform1> - String Type

This variable specifies the path and name of the first existing waveform segment. The path supports MSUS (NVWFM) or a real full path representation. See example.

The segment file must reside within ARB playback memory before it can be played by the ARB player.

<reps> - Integer Type

This variable specifies the number of times a segment or sequence plays before moving on to the next segment or sequence.

<marker> - Enum Type

NONE – This choice disables all four markers for the waveform. Disabling markers means that the waveform sequence ignores the segments or sequence marker settings.

M1, M2, M3, M4 – these choices, either individually or a combination of them, enable the markers for the waveform segment or sequence. Markers not specified are ignored for that segment or sequence.

ALL – This choice enables all four markers in the waveform segment or sequence.

<waveform2> - String type.

This variable specifies the name of a second existing waveform segment. The path supports MSUS (NVWFM) and real full path representation both. See example.

The segment file must reside within ARB playback memory before it can be played by the ARB player.

<reps> same as above, for the 2nd waveform segment.

<marker> same as above, for the 2nd waveform segment.

You can insert several waveform segments into a waveform sequence file. Just repeat inserting waveform segments as described above.

Error Checks for Setup SCPI command:

If you do not specify a filename, or you use an unsupported MSUS (that is, not NVWFM), or have an error in the waveform sequence file path, an error is generated.

Notes

Error Checks for Query SCPI command: (Continued)

If the specified waveform sequence file name suffix is not “.seq”, error is generated.

If you use an unsupported MSUS (that is, not NVWFM), or have an error in the waveform segment file path, an error is generated.

If the first specified waveform file cannot be found, an error is generated.

If you nest one waveform sequence file into another waveform sequence file, an error is generated.

If the specified repetition value is larger than 65535 or smaller than 1, an error is generated.

If the specified marker type is unrecognized, an error is generated.

For Query SCPI

For the Query the parameters are:

<filename> - String type.

This variable specifies the path and name of the waveform sequence file being queried. The path supports MSUS (NVWFM) or a real full path representation. See example.

The return value is a <string>, which includes each waveform segment file name, repetitions, and marker type. For example:

>:SOUR:RAD:ARB:SEQ? “NVWFM:testSeq1.seq”,

<“wfmSegment1.wfm, 10, ALL, wfmSegment2.wfm, 20, M1M3”,

Error Checks for Query SCPI command:

If you do not specify a filename, an error is generated.

If the waveform sequence file name is empty, an error is generated.

If the specified waveform sequence file cannot be found, an error is generated.

Initial S/W Revision

A.05.00

Edit Selected Sequence

Allows access to the sub-menus for editing the sequence currently selected within the Waveform Sequence List view. Pressing this key changes the central view area to display the Waveform Sequence Creation and Editing view.

Key Path	Source, Modulation Setup, ARB, Waveform Sequences
Notes	No remote command, front panel only.
Initial S/W Revision	A.05.00

Current Directory...

Allows you to change the currently selected directory on the hard disk. Pressing this key opens a standard windows change directory dialog and allows you to select the new directory of interest.

Key Path	Source, Modulation Setup, ARB, Waveform Sequences
Notes	No remote command, front panel only.
Initial S/W Revision	A.05.00

Waveform Utilities

Allows you access to the waveform utilities sub-menus.

Key Path	Source, Modulation Setup, ARB
Initial S/W Revision	A.05.00

Multi-Pack Licenses

Allows you access to the Multi - Pack License sub-menus. Pressing this key also changes the central view area to display the Multi -Pack License Management view.

On modular instrument like E6630A or E6640A, multi-pack license operations are only allowed on the default module, i.e. "Left" module for E6630A or "TRX1" module for E6640A.

Key Path	Source, Modulation Setup, ARB, Waveform Utilities
Notes	If access multi-pack license sub-menu from modules other than "TRX1", an advisory message like "Please goto "TRX1" to operate multi-pack license" will display.
Dependencies	This key is only available if there is at least one Multi-pack license installed on the instrument.
Initial S/W Revision	A.05.00

Add Waveform

Pressing this key accesses the Add Waveform sub-menu. It also changes the central display area to display the Multi-Pack License Waveform Add view.

Key Path	Source, Modulation Setup, ARB, Waveform Utilities, Multi-Pack Licenses
Dependencies	This key is only available if there is at least one slot available within at least one multi-pack license.
Initial S/W Revision	A.05.00

Add Waveform

Allows you to add the currently selected waveform segment to a multi-pack license. The new waveform is added to the next available slot regardless of which slot was selected on the Multi-Pack License Management view.

Key Path	Source, Modulation Setup, ARB, Waveform Utilities, Multi-Pack Licenses, Add Waveform
Remote Command	:SYSTem:LKEY:WAVeform:ADD <string> or :SYSTem:LIcense[:FPACK]:WAVeform:ADD <string>
Example	SYST:LKEY:WAV:ADD "mywaveform.wfm" or SYST:LIC:WAV:ADD "mywaveform.wfm"
Notes	The second SCPI :SYSTem:LIcense[:FPACK]:WAVeform:ADD is provided to be consistent with the style of Agilent signal sources. You can use either one of them. Since adding a waveform segment to a Multi-Pack license causes the license slot to enter the trial period of only 48 hours, pressing this key causes a confirmation dialog to be displayed to ensure you do want to add the waveform segment to the Multi-Pack. If you attempt to license a waveform that is already licensed using another slot an error is generated. . If current module is not "TRX1" module, the key will grey out, and error message is generated "-221 Setting conflict; Not allowed on current module. Goto "TRX1" to operate multi-pack license" when invoking SCPI.
Dependencies	This key is only available if the currently selected file is a secure waveform requiring a license, and there is at least one slot available within at least one multi-pack license. If the waveform highlighted is a secure waveform, but is already licensed, this key will be unavailable.
Initial S/W Revision	A.05.00

Segments on Hard Disk

Allows you access to the sub-menus for loading waveform segments from the hard disk into ARB memory. The default directory is: D: varb.

Pressing this key changes the current view to the Waveform Management View.

Key Path	Source, Modulation Setup, ARB, Select Waveform
Initial S/W Revision	A.05.00

Load Segment To ARB Memory

Allows you to load the selected file into ARB memory. On the front panel you select the file for loading to the ARB memory by highlighting the desired file in the list. Using the SCPI command, you specify the file name on the HDD.

“NVWFM” (none-volatile storage) MSUS (Mass Storage Unit Specifier) is supported in the memory subsystem because the ARB memory cannot be accessed directly. Therefore, files must be downloaded to the instrument hard disk and then loaded into the ARB memory. “NVWFM” MSUS will be mapped to the default directory D: VARB. The SCPI command supports using either “NVWFM” MSUS or specifying a full path. For more information, see [Memory Subsystem \(Remote Command Only\)](#).

If a file of the same name already exists within ARB memory, it is overwritten. If you wish to load two segments of the same name, you must rename one of the segments before loading it into ARB memory. To rename a segment, you can either use Windows File Explorer, or the :MMEMory:COPI command.

NOTE: When a waveform file is loaded to ARB memory, burst timing adjustments are made automatically, based on whether or not a Multiport Adapter is connected to the test set and powered on. If the connection/power status of the Multiport Adapter is changed after a waveform file has been loaded, it needs to be loaded again.

Key Path	Source, Modulation Setup, ARB, Select Waveform, Segments on Hard Disk
Remote Command	:SOURce:RADio:ARB:LOAD <string>
Example	:SOUR:RAD:ARB:LOAD "D: VARB\testwaveform.bin" or :SOUR:RAD:ARB:LOAD "NVWFM:testwaveform.bin"
Notes	<p>Because loading the file involves a delay of unpredictable length, this command should be followed by the query *OPC?, which holds off subsequent commands until the loading operating is complete.</p> <p><string> – specifies the path name of the file to load from the HDD into ARB memory. It could be a <full path + filename>, or <“NVWFM” MSUS + colon + filename>.</p> <p>When in Sequence Analyzer mode, and Include Source is Yes, an attempt to load a file to ARB memory will be rejected with an error.</p> <p>When Include Source is No and if there is insufficient free ARB memory to load the selected waveform, an error is generated. .</p> <p>If you specify a file over SCPI, but the file is not at the specified location, an error is generated.</p> <p>If you try to load a waveform file but the file contains less than 500 IQ samples, an error is generated.</p> <p>If you try to load a Signal Studio waveform “*.wfm” which contains invalid waveform header, an error is generated.</p> <p>If the ARB is ON when you load a file to ARB memory or delete a file from ARB memory, the playing waveform segment may not keep phase continuity during the ARB memory operation. The waveform will be replayed after the ARB operation is finished.</p> <p>ARB can be loaded into ARB memory even required licenses do not present on the instrument. In this</p>

case, a GUI only warning message -800, "Operation complete; Loaded <filename> successfully, but no license <required licenses> installed". User can install required licenses according to <required licenses> string to license it, or multi-pack license it.

Initial S/W Revision A.05.00

Load All To ARB Memory

Allows you to load all the segment files within the currently selected directory into ARB memory. If a file of the same name already exists within ARB memory, it is overwritten. If you wish to load two segments of the same name, you must rename one of the segments before loading it into ARB memory. To rename a segment, you can either use Windows File Explorer, or the :MEMory:COpy command.

NOTE: When a waveform file is loaded to ARB memory, burst timing adjustments are made automatically, based on whether or not a Multiport Adapter is connected to the test set and powered on. If the connection/power status of the Multiport Adapter is changed after a waveform file has been loaded, it needs to be loaded again.

Key Path Source, Modulation Setup, ARB, Select Waveform, Segments on Hard Disk

Remote Command :SOURce:RADio:ARB:LOAD:ALL <string>

Example :SOUR:RAD:ARB:LOAD:ALL "D: varb"

Notes

- <string> - specifies the directory on the HDD to load the files into ARB memory from.
- When in Sequence Analyzer mode, and Include Source is Yes, an attempt to load all files from a directory to ARB memory is rejected with an error.
- When Include Source is No and there is insufficient free ARB memory to load all the waveforms, when the ARB memory is full, the copy ceases, and an error is generated.
- If you specify a directory over SCPI, but the directory does not exist, an error is generated.
- If the ARB is ON, a user then loads or deletes file to ARB memory, the playing waveform segment may not keep phase continuity during the ARB memory operation. The waveform will be replayed after the ARB operation is finished.

Initial S/W Revision A.05.00

Change Directory...

Allows you to change the currently selected directory on the hard disk. Pressing this key opens a standard windows change directory dialog allowing you to select the new directory of interest.

The current directory is used for manually loading waveform segments into ARB memory for playback, and as a search location for waveform segments that are required to be loaded into ARB memory for playback of a waveform sequence or a list sequence.

Key Path Source, Modulation Setup, ARB, Select Waveform, Segments on Hard Disk

Notes No remote command, SCPIfront panel only.

Initial S/W Revision A.05.00

Default Directory...

Allows you to change the default directory. It is used as a search location for waveform segments that are required to be loaded into ARB memory for playback of a waveform sequence, and as a search location for selecting waveforms using SCPI.

Key Path	Source, Modulation Setup, ARB, Select Waveform, Segments on Hard Disk
Remote Command	:SOURce:RADio:ARB:DEFault:DIRectory <string> :SOURce:RADio:ARB: DEFault:DIRectory?
Example	:SOUR:RAD:ARB:DEF:DIR "D:\ArbFiles" :SOUR:RAD:ARB:DEF:DIR?
State Saved	Persistent, survives a power cycle and a preset but not saved in the instrument state
Initial S/W Revision	A.05.00

Segments on Hard Disk

This key functions the same as ["Segments on Hard Disk" on page 2547](#).

Key Path	Source, Modulation Setup, ARB, Waveform Utilities, Multi-Pack Licenses, Add Waveform
Initial S/W Revision	Prior to A.09.00

Load Segment To ARB Memory

This key functions the same as ["Load Segment To ARB Memory" on page 2547](#).

Key Path	Source, Modulation Setup, ARB, Waveform Utilities, Multi-Pack Licenses, Add Waveform, Segment on Hard Drive
Initial S/W Revision	Prior to A.09.00

Load All To ARB Memory

This key functions the same as ["Load All To ARB Memory" on page 2548](#).

Key Path	Source, Modulation Setup, ARB, Waveform Utilities, Multi-Pack Licenses, Add Waveform, Segment on Hard Drive
Initial S/W Revision	Prior to A.09.00

Change Directory ...

This key functions the same as ["Change Directory..." on page 2549](#).

Key Path	Source, Modulation Setup, ARB, Waveform Utilities, Multi-Pack Licenses, Add Waveform, Segment on Hard Drive
Initial S/W Revision	Prior to A.09.00

Default Directory ...

This key functions the same as ["Default Directory..." on page 2549](#)

Key Path	Source, Modulation Setup, ARB, Waveform Utilities, Multi-Pack Licenses, Add Waveform, Segment on Hard Drive
Initial S/W Revision	Prior to A.09.00

Replace Waveform

Pressing this key accesses the Replace Waveform submenu. It also changes the central display area to display the Multi-Pack License Waveform Add view.

Key Path	Source, Modulation Setup, ARB, Waveform Utilities, Multi-Pack Licenses
Dependencies	This key is only available if the currently selected slot is in the trial state.
Initial S/W Revision	A.05.00

Replace Waveform

Allows you to replace the waveform in the currently selected slot with the waveform currently selected in the Multi-Pack License Waveform Add view.

Key Path	Source, Modulation Setup, ARB, Waveform Utilities, Multi-Pack Licenses, Replace Waveform
Remote Command	:SYSTem:LKEY:WAVeform:REPLace <int>, <string> or :SYSTem:LIcense[:FPACK]:WAVeform:REPLace <int>, <string>
Example	SYST:LKEY:WAV:REPL 1, "myotherwaveform.wfm" or :SYST:LIC:WAV:REPL 1, "myotherwaveform.wfm"
Notes	The second SCPI :SYSTem:LIcense[:FPACK]:WAVeform:REPLace is provided to be consistent with the style of Agilent signal sources. You can use either one of them. If you attempt to license a waveform that is already licensed using another slot an error is generated. Waveform slot number <int> is positive. If you attempt to input a slot number less than or equals 0, an error is generated. If current module is not "TRX1" module, the key will grey out, and error message is generated "-221 Setting conflict; Not allowed on current module. Goto "TRX1" to operate multi-pack license" when invoking SCPI.
Initial S/W Revision	A.05.00

Segments on Hard Disk

This key functions the same as ["Segments on Hard Disk" on page 2547](#).

Key Path	Source, Modulation Setup, ARB, Waveform Utilities, Multi-Pack Licenses, Replace Waveform
Initial S/W Revision	Prior to A.09.00

Load Segment To ARB Memory

This key functions the same as ["Load Segment To ARB Memory" on page 2547](#).

Key Path	Source, Modulation Setup, ARB, Waveform Utilities, Multi-Pack Licenses, Replace Waveform, Segment on Hard Drive
Initial S/W Revision	Prior to A.09.00

Load All To ARB Memory

This key functions the same as ["Load All To ARB Memory" on page 2548](#).

Key Path	Source, Modulation Setup, ARB, Waveform Utilities, Multi-Pack Licenses, Replace Waveform, Segment on Hard Drive
Initial S/W Revision	Prior to A.09.00

Change Directory ...

This key functions the same as ["Change Directory..." on page 2549](#).

Key Path	Source, Modulation Setup, ARB, Waveform Utilities, Multi-Pack Licenses, Replace Waveform, Segment on Hard Drive
Initial S/W Revision	Prior to A.09.00

Default Directory ...

This key functions the same as ["Default Directory..." on page 2549](#)

Key Path	Source, Modulation Setup, ARB, Waveform Utilities, Multi-Pack Licenses, Replace Waveform, Segment on Hard Drive
Initial S/W Revision	Prior to A.09.00

Clear Waveform from Slot

Allows you to clear the waveform from the selected slot.

Key Path	Source, Modulation Setup, ARB, Waveform Utilities, Multi-Pack Licenses
Remote Command	:SYSTem:LKEY:WAVeform:CLEar <int> or :SYSTem:LICense[:FPACK]:WAVeform:CLEar <int>
Example	SYST:LKEY:WAV:CLE 1 or :SYST:LIC:WAV:CLE 1
Notes	The second SCPI :SYSTem:LICense[:FPACK]:WAVeform:CLEar is provided to be consistent with the style of Agilent signal sources. You can use either one of them. Waveform slot number <int> is positive. If you attempt to input a slot number less than or equals 0, an error is generated. If current module is not "TRX1" module, the key will grey out, and error message is generated "-221 Setting conflict; Not allowed on current module. Goto "TRX1" to operate multi-pack license" when invoking SCPI.
Dependencies	This key is only available if the currently selected slot is in the trial state.
Initial S/W Revision	A.05.00

Lock Waveform in Slot

If the selected slot is in the trial state or the lock required state, the waveform that occupies the slot is locked and permanently licensed.

Key Path	Source, Modulation Setup, ARB, Waveform Utilities, Multi-Pack Licenses
Remote Command	:SYSTem:LKEY:WAVeform:LOCK <int> or :SYSTem:LICense[:FPACK]:WAVeform:LOCK <int>
Example	SYST:LKEY:WAV:LOCK 1 or SYST:LIC:WAV:LOCK 1
Notes	The second SCPI :SYSTem:LICense[:FPACK]:WAVeform:LOCK is provided to be consistent with the style of Agilent signal sources. You can use either one of them. Waveform slot number <int> is positive. If you attempt to input a slot number less than or equals 0, an error is generated. If current module is not "TRX1" module, the key will grey out, and error message is generated "-221 Setting conflict; Not allowed on current module. Goto "TRX1" to operate multi-pack license" when invoking SCPI.
Dependencies	This key is only available if the currently selected slot is in the trial state or the lock required state.
Initial S/W Revision	A.05.00

Slot Status Query (Remote Command Only)

Returns the status of the specified slot.

Remote Command	:SYSTem:LKEY:WAVeform:STATus? <int> or :SYSTem:LICense[:FPACK]:WAVeform:STATus? <int>
Example	:SYST:LKEY:WAV:STAT? 1 <"Locked" or :SYST:LIC:WAV:STAT? 1 <"Locked"
Notes	The second SCPI :SYSTem:LICense[:FPACK]:WAVeform:STATus is provided to be consistent with the style of Agilent signal sources. You can use either one of them. Waveform slot number <int> is positive. If you attempt to input a slot number less than or equals 0, an error is generated. Result type is string. If input slot number exceeds total available slot number, "Nonexistent" is returned.
Range	"Locked" "Available" "Trail" "LockRequired" "Nonexistent"
Initial S/W Revision	A.05.00

Slots Free Query (Remote Command Only)

Returns the number of license slots free.

Remote Command	:SYSTem:LKEY:WAVeform:FREE? or :SYSTem:LICense[:FPACK]:WAVeform:FREE?
Example	:SYST:LKEY:WAV:FREE? or :SYST:LIC:WAV:FREE?
Notes	The second SCPI :SYSTem:LICense[:FPACK]:WAVeform:FREE is provided to be consistent with the style of Agilent signal sources. You can use either one of them.
Initial S/W Revision	A.05.00

Slot Used Query (Remote Command Only)

Returns the number of license slots used.

Remote Command	:SYSTem:LKEY:WAVeform:USED? or :SYSTem:LICense[:FPACK]:WAVeform:USED?
Example	:SYST:LKEY:WAV:USED?

	or :SYST:LIC:WAV:USED?
Notes	The second SCPI :SYSTem:LIcense[:FPACK]:WAVeform:USED is provided to be consistent with the style of Agilent signal sources. You can use either one of them.
Initial S/W Revision	A.05.00

Slot Waveform Name Query (Remote Command Only)

Returns the waveform name of the specified slot

Remote Command	:SYSTem:LKEY:WAVeform:NAME? <int> or :SYSTem:LIcense[:FPACK]:WAVeform:NAME? <int>
Example	:SYST:LKEY:WAV:NAME? 1 <"CDMA2K_22.wfm" or :SYST:LIC:WAV:NAME? 1 <"CDMA2K_22.wfm"
Notes	Waveform slot number <int> is positive. If you attempt to input a slot number less than or equals 0, an error is generated. Result type is string. If input slot number exceeds total available slot number, "Nonexistent" is returned. If no waveform stored in the specified slot, then empty string is returned.
Initial S/W Revision	A.12.00

Slot Waveform Unique ID Query (Remote Command Only)

Returns the waveform unique ID of the specified slot

Remote Command	:SYSTem:LKEY:WAVeform:UID? <int> or :SYSTem:LIcense[:FPACK]:WAVeform:UID? <int>
Example	:SYST:LKEY:WAV:UID? 2 <"1346752140" or :SYST:LIC:WAV:UID? 2 <"1346752140"
Notes	Waveform slot number <int> is positive. If you attempt to input a slot number less than or equals 0, an error is generated. Result type is string. If input slot number exceeds total available slot number, "Nonexistent" is returned.

	If no waveform stored in the specified slot, then "0" is returned
Initial S/W Revision	A.12.00

Locked Waveform Name List Query (Remote Command Only)

Returns the waveform name list of locked.

Remote Command	:SOURce:RADio:ARB:MPLicensed:NAME:LOCKed?
Example	SOUR:RAD:ARB:MPL:NAME:LOCKed? <"CDMA2K_27.wfm", "GSM_MCS1.WFM", "c2kWfm.wfm"
Initial S/W Revision	A.11.00

Locked Waveform Unique ID List Query (Remote Command Only)

Returns the waveform unique id list of locked.

Remote Command	:SOURce:RADio:ARB:MPLicensed:UID:LOCKed?
Example	SOUR:RAD:ARB:MPL:UID:LOCKed? <"2996927136", "3812603511", "3710986266"
Notes	Each Signal Studio waveform has a unique id recorded in header. So if the unique ids are same, that means they are same one waveform. So besides SCPI to query locked waveform name list, also provide a SCPI to query locked waveform unique id list
Initial S/W Revision	A.11.00

Marker Utilities

Allows access to the marker utilities sub-menus.

Key Path	Source, Modulation Setup, ARB
Initial S/W Revision	A.05.00

Marker Polarity

Allows access to the marker polarity sub-menu, which allows you to specify the polarity for the four markers. For a positive polarity, the marker signal is high during the marker points. For a negative marker polarity, the marker signal is high during the period of no marker points.

Key Path	Source, Modulation Setup, ARB, Marker Utilities
Initial S/W Revision	A.05.00

Mkr 1 Polarity

Allows you to set the polarity of marker 1.

Key Path	Source, Modulation Setup, ARB, Marker Utilities, Marker Polarity
Remote Command	:SOURce:RADio:ARB:MPOLarity:MARKer1 POSitive NEGative :SOURce:RADio:ARB:MPOLarity:MARKer1?
Example	:SOUR:RAD:ARB:MPOL:MARK1 NEG
Dependencies	When a new waveform is selected for playback the settings contained within the associated waveform header file are applied to the ARB. The marker polarity is one of the values stored within the header file. If the newly selected waveform file has an associated header file, the marker polarity is updated with the value from the header file. The marker polarity will remain unchanged if the newly selected waveform does not have an associated header file.
Preset	Pos
Range	Neg Pos
Initial S/W Revision	A.05.00

Mkr 2 Polarity

Allows you to set the polarity of marker 2.

Key Path	Source, Modulation Setup, ARB, Marker Utilities, Marker Polarity
Remote Command	:SOURce:RADio:ARB:MPOLarity:MARKer2 POSitive NEGative :SOURce:RADio:ARB:MPOLarity:MARKer2?
Example	:SOUR:RAD:ARB:MPOL:MARK2 NEG
Dependencies	When a new waveform is selected for playback the settings contained within the associated waveform header file are applied to the ARB. The marker polarity is one of the values stored within the header file. If the newly selected waveform file has an associated header file, the marker polarity is updated with the value from the header file. The marker polarity will remain unchanged if the newly selected waveform does not have an associated header file.
Preset	Pos
Range	Neg Pos
Initial S/W Revision	A.05.00

Mkr 3 Polarity

Allows you to set the polarity of marker 3.

Key Path	Source, Modulation Setup, ARB, Marker Utilities, Marker Polarity
Remote Command	:SOURce:RADio:ARB:MPOLarity:MARKer3 POSitive NEGative :SOURce:RADio:ARB:MPOLarity:MARKer3?
Example	:SOUR:RAD:ARB:MPOL:MARK3 NEG
Dependencies	When a new waveform is selected for playback the settings contained within the associated

	waveform header file are applied to the ARB. The marker polarity is one of the values stored within the header file. If the newly selected waveform file has an associated header file, the marker polarity is updated with the value from the header file. The marker polarity will remain unchanged if the newly selected waveform does not have an associated header file.
Preset	Pos
Range	Neg Pos
Initial S/W Revision	A.05.00

Mkr 4 Polarity

Allows you to set the polarity of marker 4.

Key Path	Source, Modulation Setup, ARB, Marker Utilities, Marker Polarity
Remote Command	:SOURce:RADio:ARB:MPOLarity:MARKer4 POSitive NEGative :SOURce:RADio:ARB:MPOLarity:MARKer4?
Example	:SOUR:RAD:ARB:MPOL:MARK4 NEG
Dependencies	When a new waveform is selected for playback the settings contained within the associated waveform header file are applied to the ARB. The marker polarity is one of the values stored within the header file. If the newly selected waveform file has an associated header file, the marker polarity is updated with the value from the header file. The marker polarity will remain unchanged if the newly selected waveform does not have an associated header file.
Preset	Pos
Range	Neg Pos
Initial S/W Revision	A.05.00

Marker Routing

Allows access to the marker routing sub-menus, which allow you to specify where the marker events are routed. It should be noted that the markers can also be routed to Trigger 1 Out and Trigger 2 Out, however this must be set up using the menus accessed by pressing the “Trigger” hard key.

Key Path	Source, Modulation Setup, ARB, Marker Utilities
Initial S/W Revision	A.05.00

Pulse/RF Blank

Allows you to select which marker is used for the pulse/RF blanking function. The pulse/RF blanking function blanks the RF when the marker signal goes low. The marker polarity determines when the marker signal is high. For a positive polarity, this is during the marker points. For a negative polarity, this is when there are no marker points.

Marker points should be set before using this function. Enabling this function without setting maker points may create a continuous low or high signal, dependant on the marker polarity. This causes either no RF output, or a continuous RF output.

Key Path	Source, Modulation Setup, ARB, Marker Utilities, Marker Routing
Remote Command	:SOURce:RADio:ARB:MDEStination:PULSe NONE M1 M2 M3 M4 :SOURce:RADio:ARB:MDEStination:PULSe?
Example	:SOUR:RAD:ARB:MDES:PULS NONE
Dependencies	When a new waveform is selected for playback the settings contained within the associated waveform header file are applied to the ARB. The pulse/RF blanking setting is one of the values stored within the header file. If the newly selected waveform file has an associated header file, the pulse/RF blanking setting is updated with the value from the header file. The pulse/RF blanking setting will remain unchanged if the newly selected waveform does not have an associated header file.
Range	None M1 M2 M3 M4
Initial S/W Revision	A.05.00

None

Sets no marker to be used for the pulse/RF blanking function, essentially turning the RF blanking function off.

Key Path	Source, Modulation Setup, ARB, Marker Utilities, Marker Routing, Pulse/RF Blank
Example	:SOUR:RAD:ARB:MDES:PULS NONE
Initial S/W Revision	A.05.00

Marker 1

Sets marker 1 to be used for the pulse/RF blanking function.

Key Path	Source, Modulation Setup, ARB, Marker Utilities, Marker Routing, Pulse/RF Blank
Example	:SOUR:RAD:ARB:MDES:PULS M1
Initial S/W Revision	A.05.00

Marker 2

Sets marker 2 to be used for the pulse/RF blanking function.

Key Path	Source, Modulation Setup, ARB, Marker Utilities, Marker Routing, Pulse/RF Blank
Example	:SOUR:RAD:ARB:MDES:PULS M2
Initial S/W Revision	A.05.00

Marker 3

Sets marker 3 to be used for the pulse/RF blanking function.

Key Path	Source, Modulation Setup, ARB, Marker Utilities, Marker Routing, Pulse/RF Blank
Example	:SOUR:RAD:ARB:MDES:PULS M3
Initial S/W Revision	A.05.00

Marker 4

Sets marker 4 to be used for the pulse/RF blanking function.

Key Path	Source, Modulation Setup, ARB, Marker Utilities, Marker Routing, Pulse/RF Blank
Example	:SOUR:RAD:ARB:MDES:PULS M4
Initial S/W Revision	A.05.00

ALC Hold

Allows you to specify which marker is routed for use within the ALC hold function. The ALC hold marker function holds the ALC circuitry at the average value of the sample points set by the marker.

The ALC hold function operates during the low periods of the marker signal. The marker polarity determines when the marker signal is high. For positive polarity, this is during the marker points. For a negative polarity, this is when there are no marker points.

Key Path	Source, Modulation Setup, ARB, Marker Utilities, Marker Routing
Remote Command	:SOURce:RADio:ARB:MDEStination:ALCHold NONE M1 M2 M3 M4 :SOURce:RADio:ARB:MDEStination:ALCHold?
Example	:SOUR:RAD:ARB:MDES:ALCH NONE
Dependencies	When a new waveform is selected for playback the settings contained within the associated waveform header file are applied to the ARB. The ALC hold setting is one of the values stored within the header file. If the newly selected waveform file has an associated header file, the ALC hold setting is updated with the value from the header file. The ALC hold setting will remain unchanged if the newly selected waveform does not have an associated header file.
Range	None M1 M2 M3 M4
Initial S/W Revision	A.05.00

None

Sets no marker to be used for the ALC hold function, essentially turning the ALC hold function off.

Key Path	Source, Modulation Setup, ARB, Marker Utilities, Marker Routing, ALC Hold
Example	:SOUR:RAD:ARB:MDES:PULS NONE
Initial S/W Revision	A.05.00

Marker 1

Sets marker 1 to be used for the ALC hold function.

Key Path	Source, Modulation Setup, ARB, Marker Utilities, Marker Routing, ALC Hold
Example	:SOUR:RAD:ARB:MDES:PULS M1
Initial S/W Revision	A.05.00

Marker 2

Sets marker 2 to be used for the ALC hold function.

Key Path	Source, Modulation Setup, ARB, Marker Utilities, Marker Routing, ALC Hold
Example	:SOUR:RAD:ARB:MDES:PULS M2
Initial S/W Revision	A.05.00

Marker 3

Sets marker 3 to be used for the ALC hold function.

Key Path	Source, Modulation Setup, ARB, Marker Utilities, Marker Routing, ALC Hold
Example	:SOUR:RAD:ARB:MDES:PULS M3
Initial S/W Revision	A.05.00

Marker 4

Sets marker 4 to be used for the ALC hold function.

Key Path	Source, Modulation Setup, ARB, Marker Utilities, Marker Routing, ALC Hold
Example	:SOUR:RAD:ARB:MDES:PULS M4
Initial S/W Revision	A.05.00

Header Utilities

Allows access to the header utilities sub-menu. Pressing this key also causes the central display area to change to display the File Header Information view.

Key Path	Source, Modulation Setup, ARB
Dependencies	This key is only available if there is currently a waveform selected for playback. If no waveform is selected, the key is grayed out.
Initial S/W Revision	A.05.00

Clear Header

Allows you to clear the header information from the file header associated with the currently selected waveform.

Key Path	Source, Modulation Setup, ARB, Header Utilities
Remote Command	:SOURce:RADio:ARB:HEADer:CLEar
Example	:SOUR:RAD:ARB:HEAD:CLE
Notes	Attempting to clear the header details via SCPI when no waveform was selected for playback will generate an error.
Initial S/W Revision	A.05.00

Save Setup To Header

Allows you to save new file header information details to the file.

Key Path	Source, Modulation Setup, ARB, Header Utilities
Remote Command	:SOURce:RADio:ARB:HEADer:SAVE
Example	:SOUR:RAD:ARB:HEAD:SAVE
Notes	Attempting to save the header details via SCPI when no waveform was selected for playback will generate an error.
Initial S/W Revision	A.05.00

Query Waveform Unique ID (Remote Command Only)

Each Signal Studio waveform contains a unique waveform ID, which recorded in the header. This command allows you to query the unique waveform ID from the header. This is a SCPI only command. User can also check [Error! Reference source not found.](#) for waveform unique ID display.

Remote Command	:MMEMory:HEADer:ID? "<file name>"
Example	:MMEM:HEAD:ID? "test.wfm" (query the waveform already loaded into the ARB memory) :MMEM:HEAD:ID? "D: VARB\test.wfm" (query the waveform on the hard disk by absolute path) :MMEM:HEAD:ID? "NVWFM:test.wfm" (query the waveform on the hard disk by MSUS)
Notes	SCPI query only. The queried waveform file can be in ARB memory, or on hard disk. If want to query ARB in ARB memory, then give out the file name directly. If want to query ARB on the hard disk, then absolute file path or MSUS should be given along with the file name. The valid MSUS is "NVWFM" which is mapped to D: VARB on hard disk. If the file cannot be found in ARB memory or on hard disk, an error is generated.and value -1 is returned
Initial S/W Revision	A.09.00

Bus Trigger Command (Remote Command Only)

Used to initiate an immediate trigger event if the trigger source is set to Bus.

Remote Command	:SOURce:RADio:ARB:TRIGger:INITiate
Example	:SOUR:RAD:ARB:TRIG:INIT
Initial S/W Revision	A.05.00

AM

Allows access to the menu for configuring the Amplitude Modulation.

Key Path	Source, Modulation Setup
Initial S/W Revision	A.05.00

AM

Enables or disables the amplitude modulation.

Turning AM on when another modulation format is already on results in the previous modulation format being turned off and the generation of an error.

Key Path	Source, Modulation Setup, AM
Remote Command	:SOURce:AM:STATe :SOURce:AM:STATe?
Example	:SOUR:AM:STAT OFF
Preset	Off
Range	On Off
Initial S/W Revision	A.05.00

AM Depth

Allows you to set the amplitude modulation depth in percent.

Key Path	Source, Modulation Setup, AM
Remote Command	:SOURce:AM[:DEPTh] [:LINear] :SOURce:AM[:DEPTh] [:LINear]?
Example	:SOUR:AM 0.1
Preset	0.1 %
Min	0.1 %
Max	95.0 %
Initial S/W Revision	A.05.00

AM Rate

Allows you to set the internal amplitude modulation rate.

Key Path	Source, Modulation Setup, AM
Remote Command	:SOURce:AM:INTernal:FREQuency :SOURce:AM:INTernal:FREQuency?
Example	:SOUR:AM:INT:FREQ 40.0 Hz
Preset	400.0 Hz
Min	10 Hz
Max	40 kHz
Initial S/W Revision	A.05.00

FM

Allows access to the menu for configuring the frequency modulation.

Key Path	Source, Modulation Setup
Initial S/W Revision	A.05.00

FM

Enables or disables the frequency modulation.

Turning FM on when another modulation format is already on results in the previous modulation format being turned off and the generation of an error.

Key Path	Source, Modulation Setup, FM
Remote Command	:SOURce:FM:STATe :SOURce:FM:STATe?
Example	:SOUR:FM:STAT OFF
Preset	Off
Range	On Off
Initial S/W Revision	A.05.00

FM Deviation

Allows you to set the frequency modulation deviation.

Key Path	Source, Modulation Setup, FM
----------	------------------------------

Remote Command	:SOURce:FM[:DEVIation] :SOURce:FM[:DEVIation]?
Example	:SOUR:FM 1.00 kHz
Preset	1.00 Hz
Min	1.00 Hz
Max	100.00 kHz
Initial S/W Revision	A.05.00

FM Rate

Allows you to set the internal frequency modulation rate.

Key Path	Source, Modulation Setup, FM
Remote Command	:SOURce:FM:INTernal:FREQuency :SOURce:FM:INTernal:FREQuency?
Example	:SOUR:FM:INT:FREQ 40.0 Hz
Preset	400.0 Hz
Min	10 Hz
Max	40 kHz
Initial S/W Revision	A.05.00

PM

Allows access to the menu for configuring the phase modulation.

Key Path	Source, Modulation Setup
Initial S/W Revision	A.05.00

PM

Enables or disables the phase modulation.

Turning PM on when another modulation format is already on results in the previous modulation format being turned off and the generation of an error.

Key Path	Source, Modulation Setup, PM
Remote Command	:SOURce:PM:STATe :SOURce:PM:STATe?
Example	:SOUR:PM:STAT OFF

Preset	Off
Range	On Off
Initial S/W Revision	A.05.00

PM Deviation

Allows you to set the phase modulation deviation.

Key Path	Source, Modulation Setup, PM
Remote Command	:SOURce:PM[:DEVIation] :SOURce:PM[:DEVIation]?
Example	:SOUR:PM 1.00 rad
Preset	0.1 rad
Min	0.1 rad
Max	20.0 rad
Initial S/W Revision	A.05.00

PM Rate

Allows you to set the internal phase modulation rate.

Key Path	Source, Modulation Setup, PM
Remote Command	:SOURce:PM:INTernal:FREQuency :SOURce:PM:INTernal:FREQuency?
Example	:SOUR:PM:INT:FREQ 40.0 Hz
Preset	400.0 Hz
Min	10 Hz
Max	40 kHz
Initial S/W Revision	A.05.00

List Sequencer

Allows you access to the sub-menus for configuring the list sequencer.

List sequences allows you to enter frequencies and amplitudes at unequal intervals in nonlinear ascending, descending or random order. Each step within the list can also include its own waveform file for playback, step duration, trigger event and trigger output.

The complexities involved in configuring the list sequencer do not lend itself to manual configuration; hence the manual configuration for this feature is limited. For easier configuration of the list sequencer, it is recommended that you use either SCPI or load a tab delimited file containing the setup parameters in a

tabular form. The details of the SCPI for configuring the list sequencer can be found in "[Step Configuration \(Remote Command Only\)](#)" on page 2554.

Once the List Sequencer has been configured using the front panel, SCPI, or loading in a tab delimited file, the sequence must be initiated using the front panel Initiate Sequence key or the corresponding SCPI command.

Key Path	Source
Initial S/W Revision	A.05.00

Sequencer

Allows you to set the state of the list sequencer. When the list sequencer is on, the source is outputting the sequence defined by the sequencer. When the list sequencer is off, the source outputs a single waveform segment or sequence (independent mode) at a single frequency and amplitude.

Key Path	Source, List Sequencer
Remote Command	:SOURce:LIST[:STATe] ON OFF 1 0 :SOURce:LIST[:STATe]?
Example	:SOUR:LIST OFF
Notes	When the sequencer is set to ON, the list sequencer controls the output of the source.
Couplings	When in Sequence Analyzer mode and the list sequencer state is Off, Include Source is forced to No, and the Include Source key is grayed out. When in Sequence Analyzer mode and the list sequencer state is On, Include Source is available to set. And, an ARB memory related operation, like load or delete will be rejected.
Preset	Off
Range	On Off
Initial S/W Revision	A.05.00

Initiate Sequence

Pressing this key arms the sequence for single execution. Once the sequence is armed the source begins the sequence as soon as the trigger is received. If the trigger is set to Free Run, the sequence starts immediately.

Key Path	Source, List Sequencer
Remote Command	:SOURce:LIST:TRIGger[:IMMediate]
Example	:SOUR:LIST:TRIG
Notes	When in Sequence Analyzer mode and Include Source is Yes, the Initiate list sequencer operation is rejected, and the key is grayed out, since source list sequence request is sent to physics via Parallel batch by sequence analyzer. If the file needed by the sequencer is not already in ARB memory, the sequence cannot be initiated

	and an error will be generated. There is a blocking SCPI query which can be used to query if source list sequence being initiated successfully or not. (see " Query List Sequence Initiation Armed Status (Remote Command Only) " on page 2565 Query Source List Sequence Armed Status)
Dependencies	Under the Sequence Analyzer Mode, if Meas Setup->Include Source is set to YES, Source->List Sequencer->Initiate Sequence is disabled.
Initial S/W Revision	A.05.00

List Sequencer Setup

Allows you access to the list sequencer setup menus.

Key Path	Source, List Sequencer
----------	------------------------

Number of Steps

Allows you to specify the number of steps within the list sequence.

Key Path	Source, List Sequencer, List Sequencer Setup
Remote Command	:SOURce:LIST:NUMBer:STEPs <integer> :SOURce:LIST:NUMBer:STEPs?
Example	:SOUR:LIST:NUMB:STEP 1
Notes	Increasing the number of steps creates additional steps at the end of the list, with all the settings within the steps set to their default values. Decreasing the number of steps removes steps from the end of the list. The settings within the removed steps are not reset. This means that increasing the number of steps again would allow you to retrieve these steps.
Dependencies	The Step Count parameter is increased or decreased when you insert or delete a point from within the GUI interface to the sequencer.
Preset	1
Min	1
Max	1000
Initial S/W Revision	A.05.00

Current Step

Allows you to select the step number you wish to view or edit.

Key Path	Source, List Sequencer, List Sequencer Setup
----------	--

Notes	No remote command, front panel only.
Preset	1
Min	1
Max	Step Count
Initial S/W Revision	A.05.00

Insert Step Before

Allows you to insert a new step, containing default values, before the currently selected step. Inserting a step will automatically increase the Step Count parameter by 1. If sequence already reaches upper limit of 1000 steps, then insert more step will be rejected and popup error –221, “Setting Conflict; Cannot insert more steps, maximum number of steps reached”

Key Path	Source, List Sequencer, List Sequencer Setup
Notes	No remote command, front panel only. If the list already contains the maximum limit of 1000 steps, no operation will be made after pressing this key.
Initial S/W Revision	A.05.00

Delete Step

Allows you to delete the current step. Deleting a step will automatically decrease the Step Count parameter by 1. If sequence only has one step left, delete step will be rejected and popup error –221, “Setting conflict; Cannot delete current step, minimum number of steps reached”

Key Path	Source, List Sequencer, List Sequencer Setup
Notes	No remote command, Front Panel key only. If the list already contains the minimum limit of 1 step, no operation will be made after pressing this key
Initial S/W Revision	A.05.00

Clear List

Allows you to clear the list. Clearing the list sets the number of steps to the default value of 1 and sets the parameters for the only step to their default values.

Key Path	Source, List Sequencer, List Sequencer Setup
Initial S/W Revision	A.05.00

Step Trigger

Allows access to the sub-menu for selecting the trigger input for the current step.

Key Path	Source, List Sequencer, List Sequencer Setup
Remote Command	:SOURCE:LIST:STEP[1] 2 3...1000:SETup:INPut:TRIGger IMMEDIATE INTERNAL EXTERNAL2 KEY BUS EXTERNAL4 :SOURCE:LIST:STEP[1] 2 3...1000:SETup:INPut:TRIGger?
Example	:SOUR:LIST:STEP2:SET:INP:TRIG BUS :SOUR:LIST:STEP2:SET:INP:TRIG?
Notes	SCPI is supported after A.09.40
Preset	Free Run
Range	Free Run Internal Manual (Trigger Key) Bus External 2 EXTERNAL4
Initial S/W Revision	A.05.00

Free Run

Sets the trigger input for the current step to Free Run.

Key Path	Source, List Sequencer, List Sequencer Setup, Step Trigger
Example	:SOUR:LIST:STEP2:SET:INP:TRIG IMM
Notes	SCPI is supported after A.09.40
Initial S/W Revision	A.05.00

Internal

Sets the trigger input for the current step to Internal.

Key Path	Source, List Sequencer, List Sequencer Setup, Step Trigger
Example	:SOUR:LIST:STEP2:SET:INP:TRIG INT
Notes	SCPI is supported after A.09.40
Initial S/W Revision	A.05.00

Manual (Trigger Key)

Sets the trigger input for the current step to Manual (Trigger Key). Any step in the sequence set to Manual will cause the sequence execution to stop until the manual trigger key is pressed. Sending the Bus Trigger SCPI command will have no effect. At any point in the sequence where the list sequencer is paused waiting for a software trigger, a pop up dialog is displayed until the trigger event occurs.

Key Path	Source, List Sequencer, List Sequencer Setup, Step Trigger
Example	:SOUR:LIST:STEP2:SET:INP:TRIG KEY
Notes	SCPI is supported after A.09.40
Initial S/W Revision	A.05.00

Bus

Sets the trigger input for the current step to Bus. Any step in the sequence set to Bus will cause the sequence execution to stop until the Bus Trigger SCPI command is sent. Pressing the manual trigger key has no effect. At any point in the sequence where the list sequencer is paused waiting for a software trigger, a pop up dialog is displayed until the trigger event occurs.

Key Path	Source, List Sequencer, List Sequencer Setup, Step Trigger
Example	:SOUR:LIST:STEP2:SET:INP:TRIG BUS
Notes	SCPI is supported after A.09.40
Initial S/W Revision	A.05.00

External 2

Sets the trigger input for the current step to External 2.

Key Path	Source, List Sequencer, List Sequencer Setup, Step Trigger
Example	:SOUR:LIST:STEP2:SET:INP:TRIG EXT2
Notes	SCPI is supported after A.09.40
Notes	Note: When on E6640A, trigger 2 is a bi-directional trigger port. So when trigger 2 has been configured as OUTPUT type, choosing External 2 as the input trigger for the current step will generate error.
Initial S/W Revision	A.05.00

Transition Time

Allows you to specify the transition time for the current step.

The transition time is the amount of time allowed for the source to settle at the current frequency or amplitude value.

Transition Time should not be taken as additional time before or inside the Step Duration. You can set a value for the settling time to allow the source output frequency or amplitude to become stable. Make sure that during this period of time, you do not use the source output signal.

The following table lists recommended values for appropriate settling times to allow for changes within the source.

Value Changed	Recommended Transition Time
Frequency	500 μ s
Amplitude	100 μ s to within 0.1 dB 20 μ s to within 1.0 dB

If the Transition Time value is shorter than the time necessary for the hardware to settle and a List Sequence is initiated, a **warning** is generated.

If the Transition Time value is longer than the Step Duration, an error is generated when initiating a source list sequence. For source list sequence, transition time is included in the step duration length. If the Transition Time value is longer than the Step Duration Time, the real step duration length is extended to equal the transition time and cause a timing shift.

Key Path	Source, List Sequencer, List Sequencer Setup
Remote Command	:SOURce:LIST:STEP[1] 2 3...1000:SETup:TRANsition:TIME <time> :SOURce:LIST:STEP[1] 2 3...1000:SETup:TRANsition:TIME?
Example	:SOUR:LIST:STEP2:SET:TRAN:TIME 1ms :SOUR:LIST:STEP2:SET:TRAN:TIME?
Notes	SCPI is supported after A.09.40
Preset	1.0 ms
Min	0.0 ms
Max	4.0 ks
Initial S/W Revision	A.05.00

Radio Setup

Allows you access to the sub-menus for setting up the radio standard, band, and radio band link direction for the current step.

Key Path	Source, List Sequencer, List Sequencer Setup
Notes	No remote command, front panel only.
Initial S/W Revision	A.05.00

Radio Standard

Allows access to the sub-menus for selecting the radio standard and the associated radio band for use in the current step.

Key Path	Source, List Sequencer, List Sequencer Setup, Radio Setup
Remote Command	:SOURce:LIST:STEP[1] 2 3...1000:SETup:RADio:BAND NONE PGSM EGSM RGSM DCS1800 PCS1900 TGSM810 GSM450 GSM480 GSM700 GSM850 BANDI BANDII BANDIII BANDIV BANDV BANDVI BANDVII BANDVIII BANDIX BANDX BANDXI BANDXII BANDXIII BANDXIV BANDXIX USCELL USPCS JAPAN KOREAN NMT IMT2K UPPER SECOND PAMR400 PAMR800 IMTEXT PCS1DOT9G AWS US2DOT5G PUBLIC LOWER NONE BAND1 BAND2 BAND3 BAND4 BAND5 BAND6 BAND7 BAND8 BAND10 BAND11 BAND12 BAND13 BAND14 BAND17 BAND18 BAND19 BAND20 BAND21 BAND24 BAND25 BAND26 BAND27 BAND28 BAND31 BAND33 BAND34 BAND35 BAND36 BAND37 BAND38

	BAND39 BAND40 BAND41 BAND42 BAND43 BAND44 BANDA BANDB BANDC BANDD BANDE BANDF :SOURce:LIST:STEP[1] 2 3...1000:SETup: RADio:BAND?
Example	:SOUR:LIST:STEP2:SET:RAD:BAND PGSM :SOUR:LIST:STEP2:SET:RAD:BAND?
Notes	SCPI is supported after A.09.40
Initial S/W Revision	A.05.00

None

Selects no radio standard for use on the current step.

Key Path	Source, List Sequencer, List Sequencer Setup, Radio Setup, Radio Standard
Example	:SOUR:LIST:STEP2:SET:RAD:BAND NONE
Notes	SCPI is supported after A.09.40
Initial S/W Revision	A.05.00

GSM/EDGE

Pressing this key once selects GSM/EDGE as the radio standard and the current GSM/EDGE band as the active channel band. Pressing this key again allows access to the sub-menus for selecting a different GSM/EDGE band.

Key Path	Source, List Sequencer, List Sequencer Setup, Radio Setup, Radio Standard
Initial S/W Revision	A.05.00

P-GSM

Selects P-GSM as the band for the current step.

Key Path	Source, List Sequencer, List Sequencer Setup, Radio Setup, Radio Standard, GSM/EDGE
Initial S/W Revision	A.05.00

E-GSM

Selects E-GSM as the band for the current step.

Key Path	Source, List Sequencer, List Sequencer Setup, Radio Setup, Radio Standard, GSM/EDGE
Initial S/W Revision	A.05.00

R-GSM

Selects R-GSM as the band for the current step.

Key Path	Source, List Sequencer, List Sequencer Setup, Radio Setup, Radio Standard, GSM/EDGE
Initial S/W Revision	A.05.00

DCS 1800

Selects DCS 1800 as the band for the current step.

Key Path	Source, List Sequencer, List Sequencer Setup, Radio Setup, Radio Standard, GSM/EDGE
Initial S/W Revision	A.05.00

PCS 1900

Selects PCS 1900 as the band for the current step.

Key Path	Source, List Sequencer, List Sequencer Setup, Radio Setup, Radio Standard, GSM/EDGE
Initial S/W Revision	A.05.00

GSM 450

Selects GSM 450 as the band for the current step.

Key Path	Source, List Sequencer, List Sequencer Setup, Radio Setup, Radio Standard, GSM/EDGE
Initial S/W Revision	A.05.00

GSM 480

Selects GSM 480 as the band for the current step.

Key Path	Source, List Sequencer, List Sequencer Setup, Radio Setup, Radio Standard, GSM/EDGE
Initial S/W Revision	A.05.00

GSM 850

Selects GSM 850 as the band for the current step.

Key Path	Source, List Sequencer, List Sequencer Setup, Radio Setup, Radio Standard, GSM/EDGE
Initial S/W Revision	A.05.00

GSM 700

Selects GSM 700 as the band for the current step.

Key Path	Source, List Sequencer, List Sequencer Setup, Radio Setup, Radio Standard, GSM/EDGE
Initial S/W Revision	A.05.00

T-GSM 810

Selects T-GSM 810 as the band for the current step.

Key Path	Source, List Sequencer, List Sequencer Setup, Radio Setup, Radio Standard, GSM/EDGE
Initial S/W Revision	A.05.00

WCDMA

Pressing this key once selects WCDMA as the radio standard and the current WCDMA band as the active channel band. Pressing this key again allows access to the sub-menus for selecting a different WCDMA band.

Key Path	Source, List Sequencer, List Sequencer Setup, Radio Setup, Radio Standard
Initial S/W Revision	A.05.00

Band I

Selects Band I as the band for the current step.

Key Path	Source, List Sequencer, List Sequencer Setup, Radio Setup, Radio Standard, WCDMA
Initial S/W Revision	A.05.00

Band II

Selects Band II as the band for the current step.

Key Path	Source, List Sequencer, List Sequencer Setup, Radio Setup, Radio Standard, WCDMA
Initial S/W Revision	A.05.00

Band III

Selects Band III as the band for the current step.

Key Path	Source, List Sequencer, List Sequencer Setup, Radio Setup, Radio Standard, WCDMA
Initial S/W Revision	A.05.00

Band IV

Selects Band IV as the band for the current step.

Key Path	Source, List Sequencer, List Sequencer Setup, Radio Setup, Radio Standard, WCDMA
Initial S/W Revision	A.05.00

Band V

Selects Band V as the band for the current step.

Key Path	Source, List Sequencer, List Sequencer Setup, Radio Setup, Radio Standard, WCDMA
Initial S/W Revision	A.05.00

Band VI

Selects Band VI as the band for the current step.

Key Path	Source, List Sequencer, List Sequencer Setup, Radio Setup, Radio Standard, WCDMA
Initial S/W Revision	A.05.00

Band VII

Selects Band VII as the band for the current step.

Key Path	Source, List Sequencer, List Sequencer Setup, Radio Setup, Radio Standard, WCDMA
Initial S/W Revision	A.05.00

Band VIII

Selects Band VIII as the band for the current step.

Key Path	Source, List Sequencer, List Sequencer Setup, Radio Setup, Radio Standard, WCDMA
Initial S/W Revision	A.05.00

Band IX

Selects Band IX as the band for the current step.

Key Path	Source, List Sequencer, List Sequencer Setup, Radio Setup, Radio Standard, WCDMA
Initial S/W Revision	A.05.00

Band X

Selects Band X as the band for the current step.

Key Path	Source, List Sequencer, List Sequencer Setup, Radio Setup, Radio Standard, WCDMA
Initial S/W Revision	A.05.00

Band XI

Selects Band XI as the band for the current step.

Key Path	Source, List Sequencer, List Sequencer Setup, Radio Setup, Radio Standard, WCDMA
Initial S/W Revision	A.05.00

Band XII

Selects Band XII as the band for the current step.

Key Path	Source, List Sequencer, List Sequencer Setup, Radio Setup, Radio Standard, WCDMA
Initial S/W Revision	A.05.00

Band XIII

Selects Band XIII as the band for the current step.

Key Path	Source, List Sequencer, List Sequencer Setup, Radio Setup, Radio Standard, WCDMA
Initial S/W Revision	A.05.00

Band XIV

Selects Band XIV as the band for the current step.

Key Path	Source, List Sequencer, List Sequencer Setup, Radio Setup, Radio Standard, WCDMA
Initial S/W Revision	A.05.00

Band XIX

Selects Band XIX as the band for the current step.

Key Path	Source, List Sequencer, List Sequencer Setup, Radio Setup, Radio Standard, WCDMA
Initial S/W Revision	A.14.50

CDMA 2000 / 1xEVDO

Pressing this key once selects CDMA 2000/1xEVDO as the radio standard and the current CDMA 2000/1xEVDO band as the active channel band. Pressing this key again allows access to the sub-menus for selecting a different CDMA 2000/1xEVDO band.

Key Path	Source, List Sequencer, List Sequencer Setup, Radio Setup, Radio Standard
Initial S/W Revision	A.05.00

US CELL

Selects US Cell as the band for the current step.

Key Path	Source, List Sequencer, List Sequencer Setup, Radio Setup, Radio Standard, CDMA 2000 / 1xEVDO
Initial S/W Revision	A.05.00

US PCS

Selects US PCS as the band for the current step.

Key Path	Source, List Sequencer, List Sequencer Setup, Radio Setup, Radio Standard, CDMA 2000 / 1xEVDO
Initial S/W Revision	A.05.00

Japan Cell

Selects Japan Cell as the band for the current step.

Key Path	Source, List Sequencer, List Sequencer Setup, Radio Setup, Radio Standard, CDMA 2000 / 1xEVDO
Initial S/W Revision	A.05.00

Korean PCS

Selects Korean PCS as the band for the current step.

Key Path	Source, List Sequencer, List Sequencer Setup, Radio Setup, Radio Standard, CDMA 2000 / 1xEVDO
Initial S/W Revision	A.05.00

NMT 450

Selects NMT 450 as the band for the current step.

Key Path	Source, List Sequencer, List Sequencer Setup, Radio Setup, Radio Standard, CDMA 2000 / 1xEVDO
Initial S/W Revision	A.05.00

IMT 2000

Selects IMT 2000 as the band for the current step.

Key Path	Source, List Sequencer, List Sequencer Setup, Radio Setup, Radio Standard, CDMA 2000 / 1xEVDO
Initial S/W Revision	A.05.00

Upper 700

Selects Upper 700 as the band for the current step.

Key Path	Source, List Sequencer, List Sequencer Setup, Radio Setup, Radio Standard, CDMA 2000 / 1xEVDO
Initial S/W Revision	A.05.00

Secondary 800

Selects Secondary 800 as the band for the current step.

Key Path	Source, List Sequencer, List Sequencer Setup, Radio Setup, Radio Standard, CDMA 2000 / 1xEVDO
Initial S/W Revision	A.05.00

400 Euro PAMR

Selects 400 Euro PAMR as the band for the current step.

Key Path	Source, List Sequencer, List Sequencer Setup, Radio Setup, Radio Standard, CDMA 2000 / 1xEVDO
Initial S/W Revision	A.05.00

800 PAMR

Selects 800 PAMR as the band for the current step.

Key Path	Source, List Sequencer, List Sequencer Setup, Radio Setup, Radio Standard, CDMA 2000 / 1xEVDO
Initial S/W Revision	A.05.00

2.5GHz IMT EXT

Selects 2.5 GHz IMT EXT as the band for the current step.

Key Path	Source, List Sequencer, List Sequencer Setup, Radio Setup, Radio Standard, CDMA 2000 / 1xEVDO
Initial S/W Revision	A.05.00

US PCS 1.9GHz

Selects US PCS 1.9 GHz as the band for the current step.

Key Path	Source, List Sequencer, List Sequencer Setup, Radio Setup, Radio Standard, CDMA 2000 / 1xEVDO
Initial S/W Revision	A.05.00

AWS

Selects AWS as the band for the current step.

Key Path	Source, List Sequencer, List Sequencer Setup, Radio Setup, Radio Standard, CDMA 2000 / 1xEVDO
Initial S/W Revision	A.05.00

US 2.5GHz

Selects US 2.5 GHz as the band for the current step.

Key Path	Source, List Sequencer, List Sequencer Setup, Radio Setup, Radio Standard, CDMA 2000 / 1xEVDO
Initial S/W Revision	A.05.00

700 Public Safety

Selects 700 Public Safety as the band for the current step.

Key Path	Source, List Sequencer, List Sequencer Setup, Radio Setup, Radio Standard, CDMA 2000 / 1xEVDO
Initial S/W Revision	A.05.00

C2K Lower 700

Selects C2K Lower 700 as the band for the current step.

Key Path	Source, List Sequencer, List Sequencer Setup, Radio Setup, Radio Standard, CDMA 2000 / 1xEVDO
Initial S/W Revision	A.05.00

LTE

Pressing this key once selects LTE FDD as the radio standard and the current LTE FDD band as the active channel band. Pressing this key again allows access to the sub-menus for selecting a different LTE FDD band.

Key Path	Source, List Sequencer, List Sequencer Setup, Radio Setup, Radio Standard
Initial S/W Revision	A.09.50

BAND 1

Selects BAND 1 as the band for the current step.

Key Path	Source, List Sequencer, List Sequencer Setup, Radio Setup, Radio Standard, LTE
Initial S/W Revision	A.09.50

BAND 2

Selects BAND 2 as the band for the current step.

Key Path	Source, List Sequencer, List Sequencer Setup, Radio Setup, Radio Standard, LTE
Initial S/W Revision	A.09.50

BAND 3

Selects BAND 3 as the band for the current step.

Key Path	Source, List Sequencer, List Sequencer Setup, Radio Setup, Radio Standard, LTE
Initial S/W Revision	A.09.50

BAND 4

Selects BAND 4 as the band for the current step.

Key Path	Source, List Sequencer, List Sequencer Setup, Radio Setup, Radio Standard, LTE
Initial S/W Revision	A.09.50

BAND 5

Selects BAND 5 as the band for the current step.

Key Path	Source, List Sequencer, List Sequencer Setup, Radio Setup, Radio Standard, LTE
Initial S/W Revision	A.09.50

BAND 6

Selects BAND 6 as the band for the current step.

Key Path	Source, List Sequencer, List Sequencer Setup, Radio Setup, Radio Standard, LTE
Initial S/W Revision	A.09.50

BAND 7

Selects BAND 7 as the band for the current step.

Key Path	Source, List Sequencer, List Sequencer Setup, Radio Setup, Radio Standard, LTE
Initial S/W Revision	A.09.50

BAND 8

Selects BAND 8 as the band for the current step.

Key Path	Source, List Sequencer, List Sequencer Setup, Radio Setup, Radio Standard, LTE
Initial S/W Revision	A.09.50

BAND 9

Selects BAND 9 as the band for the current step.

Key Path	Source, List Sequencer, List Sequencer Setup, Radio Setup, Radio Standard, LTE
Initial S/W Revision	A.09.50

BAND 10

Selects BAND 10 as the band for the current step.

Key Path	Source, List Sequencer, List Sequencer Setup, Radio Setup, Radio Standard, LTE
Initial S/W Revision	A.09.50

BAND 11

Selects BAND 11 as the band for the current step.

Key Path	Source, List Sequencer, List Sequencer Setup, Radio Setup, Radio Standard, LTE
Initial S/W Revision	A.09.50

BAND 12

Selects BAND 12 as the band for the current step.

Key Path	Source, List Sequencer, List Sequencer Setup, Radio Setup, Radio Standard, LTE
Initial S/W Revision	A.09.50

BAND 13

Selects BAND 13 as the band for the current step.

Key Path	Source, List Sequencer, List Sequencer Setup, Radio Setup, Radio Standard, LTE
Initial S/W Revision	A.09.50

BAND 14

Selects BAND 14 as the band for the current step.

Key Path	Source, List Sequencer, List Sequencer Setup, Radio Setup, Radio Standard, LTE
Initial S/W Revision	A.09.50

BAND 17

Selects BAND 17 as the band for the current step.

Key Path	Source, List Sequencer, List Sequencer Setup, Radio Setup, Radio Standard, LTE
Initial S/W Revision	A.09.50

BAND 18

Selects BAND 18 as the band for the current step.

Key Path	Source, List Sequencer, List Sequencer Setup, Radio Setup, Radio Standard, LTE
Initial S/W Revision	A.09.50

BAND 19

Selects BAND 19 as the band for the current step.

Key Path	Source, List Sequencer, List Sequencer Setup, Radio Setup, Radio Standard, LTE
Initial S/W Revision	A.09.50

BAND 20

Selects BAND 20 as the band for the current step.

Key Path	Source, List Sequencer, List Sequencer Setup, Radio Setup, Radio Standard, LTE
Initial S/W Revision	A.09.50

BAND 21

Selects BAND 21 as the band for the current step.

Key Path	Source, List Sequencer, List Sequencer Setup, Radio Setup, Radio Standard, LTE
Initial S/W Revision	A.09.50

BAND 24

Selects BAND 24 as the band for the current step.

Key Path	Source, List Sequencer, List Sequencer Setup, Radio Setup, Radio Standard, LTE
Initial S/W Revision	A.09.50

BAND 25

Selects BAND 25 as the band for the current step.

Key Path	Source, List Sequencer, List Sequencer Setup, Radio Setup, Radio Standard, LTE
Initial S/W Revision	A.09.50

BAND 26

Selects BAND 26 as the band for the current step.

Key Path	Source, List Sequencer, List Sequencer Setup, Radio Setup, Radio Standard, LTE
Initial S/W Revision	A.12.53

BAND 27

Selects BAND 27 as the band for the current step.

Key Path	Source, List Sequencer, List Sequencer Setup, Radio Setup, Radio Standard, LTE
Initial S/W Revision	A.14.00

BAND 28

Selects BAND 28 as the band for the current step.

Key Path	Source, List Sequencer, List Sequencer Setup, Radio Setup, Radio Standard, LTE
Initial S/W Revision	A.14.00

BAND 31

Selects BAND 31 as the band for the current step.

Key Path	Source, List Sequencer, List Sequencer Setup, Radio Setup, Radio Standard, LTE
Initial S/W Revision	A.14.00

LTE TDD

Sets LTE TDD as the radio standard for use and accesses the LTE TDD specific channel band sub-menus..

Key Path	Source, Frequency, Radio Setup, Radio Standard
Initial S/W Revision	A.11.50

BAND 33

Selects BAND 33 as the band for the current step.

Key Path	Source, Frequency, Radio Setup, Radio Standard, LTE TDD
Example	:SOUR:FREQ:CHAN:BAND BAND33
Initial S/W Revision	A.11.50

BAND 34

Selects BAND 34 as the band for the current step.

Key Path	Source, Frequency, Radio Setup, Radio Standard, LTE TDD
Example	:SOUR:FREQ:CHAN:BAND BAND34
Initial S/W Revision	A.11.50

BAND 35

Selects BAND 35 as the band for the current step.

Key Path	Source, Frequency, Radio Setup, Radio Standard, LTE TDD
Example	:SOUR:FREQ:CHAN:BAND BAND35
Initial S/W Revision	A.11.50

BAND 36

Selects BAND 36 as the band for the current step.

Key Path	Source, Frequency, Radio Setup, Radio Standard, LTE TDD
Example	:SOUR:FREQ:CHAN:BAND BAND36
Initial S/W Revision	A.11.50

BAND 37

Selects BAND 37 as the band for the current step.

Key Path	Source, Frequency, Radio Setup, Radio Standard, LTE TDD
Example	:SOUR:FREQ:CHAN:BAND BAND37
Initial S/W Revision	A.11.50

BAND 38

Selects BAND 38 as the band for the current step.

Key Path	Source, Frequency, Radio Setup, Radio Standard, LTE TDD
Example	:SOUR:FREQ:CHAN:BAND BAND38
Initial S/W Revision	A.11.50

BAND 39

Selects BAND 39 as the band for the current step.

Key Path	Source, Frequency, Radio Setup, Radio Standard, LTE TDD
Example	:SOUR:FREQ:CHAN:BAND BAND39
Initial S/W Revision	A.11.50

BAND 40

Selects BAND 40 as the band for the current step.

Key Path	Source, Frequency, Radio Setup, Radio Standard, LTE TDD
Example	:SOUR:FREQ:CHAN:BAND BAND40
Initial S/W Revision	A.11.50

BAND 41

Selects BAND 41 as the band for the current step.

Key Path	Source, Frequency, Radio Setup, Radio Standard, LTE TDD
Example	:SOUR:FREQ:CHAN:BAND BAND41
Initial S/W Revision	A.11.50

BAND 42

Selects BAND 42 as the band for the current step.

Key Path	Source, Frequency, Radio Setup, Radio Standard, LTE TDD
Example	:SOUR:FREQ:CHAN:BAND BAND42
Initial S/W Revision	A.11.50

BAND 43

Selects BAND 43 as the band for the current step.

Key Path	Source, Frequency, Radio Setup, Radio Standard, LTE TDD
Example	:SOUR:FREQ:CHAN:BAND BAND43
Initial S/W Revision	A.11.50

BAND 44

Selects BAND 44 as the band for the current step.

Key Path	Source, List Sequencer, List Sequencer Setup, Radio Setup, Radio Standard, LTE TDD
Initial S/W Revision	A.14.00

TDSCDMA

Sets TDSCDMA as the radio standard for use and accesses the TDSCDMA specific channel band sub-menus..

Key Path	Source, Frequency, Radio Setup, Radio Standard
Initial S/W Revision	A.11.50

BAND A

Selects BAND A as the band for the current step.

Key Path	Source, Frequency, Radio Setup, Radio Standard, TDSCDMA
Example	:SOUR:FREQ:CHAN:BAND BANDA
Initial S/W Revision	A.11.50

BAND B

Selects BAND B as the band for the current step.

Key Path	Source, Frequency, Radio Setup, Radio Standard, TDSCDMA
Example	:SOUR:FREQ:CHAN:BAND BANDB
Initial S/W Revision	A.11.50

BAND C

Selects BAND C as the band for the current step.

Key Path	Source, Frequency, Radio Setup, Radio Standard, TDSCDMA
Example	:SOUR:FREQ:CHAN:BAND BANDC
Initial S/W Revision	A.11.50

BAND D

Selects BAND D as the band for the current step.

Key Path	Source, Frequency, Radio Setup, Radio Standard, TDSCDMA
Example	:SOUR:FREQ:CHAN:BAND BANDD
Initial S/W Revision	A.11.50

BAND E

Selects BAND E as the band for the current step.

Key Path	Source, Frequency, Radio Setup, Radio Standard, TDSCDMA
----------	---

Example	:SOUR:FREQ:CHAN:BAND BANDE
Initial S/W Revision	A.11.50

BAND F

Selects BAND F as the band for the current step.

Key Path	Source, Frequency, Radio Setup, Radio Standard, TDSCDMA
Example	:SOUR:FREQ:CHAN:BAND BANDF
Initial S/W Revision	A.11.50

Radio Band Link

Allows you to specify the radio band link direction for the steps within the list sequence. The link is used in conjunction with the channel band and channel number to determine the output frequency.

When set to “Uplink”, the source will calculate the uplink frequency according to an uplink formula together with selected channel band and channel number. When set to “Downlink”, the source will calculate the downlink frequency according to a downlink formula together with selected channel band and channel number.

Key Path	Source, List Sequencer, List Sequencer Setup, Radio Setup
Remote Command	:SOURce:LIST:STEP [1] 2 3...1000:SETup:RADio:BAND:LINK DOWN UP :SOURce:LIST:STEP [1] 2 3...1000:SETup:RADio:BAND:LINK?
Example	:SOUR:LIST:STEP2:SET:RAD:BAND:LINK UP :SOUR:LIST:STEP2:SET:RAD:BAND:LINK?
Notes	SCPI is supported after A.09.40
Preset	DOWN
Range	DOWN UP
Initial S/W Revision	A.05.00

Channel

Allows you to specify the frequency of the current step via a channel number.

Key Path	Source, List Sequencer, List Sequencer Setup
Remote Command	:SOURce:LIST:STEP [1] 2 3...1000:SETup:CNFRrequency <double> :SOURce:LIST:STEP [1] 2 3...1000:SETup:CNFRrequency?
Example	:SOUR:LIST:STEP2:SET:CNFR 124 :SOUR:LIST:STEP2:SET:CNFR?
Notes	SCPI is supported after A.09.40.

	This SCPI is used to setup channel number or frequency setting, according to current Radio Band setting. If Radio Band is "NONE", then it's frequency. If Radio Band is not "NONE", then it's channel number.
Couplings	The channel number is coupled to the step frequency value. When the step frequency value is changed, the channel number will increase or decrease to match the new step frequency. If the step frequency is not at an exact match for a channel number, the nearest channel number is displayed, along with a greater than, or less than sign to indicate the frequency is above or below the channel number.
Preset	1
Min	0 (Please refer to for valid ranges.)
Max	10838 (Please refer to for valid ranges.)
Initial S/W Revision	A.05.00

Frequency

Allows you to specify a frequency value for the current step.

Key Path	Source, List Sequencer, List Sequencer Setup
Remote Command	:SOURce:LIST:STEP[1] 2 3...1000:SETup:CNFRfrequency <double> :SOURce:LIST:STEP[1] 2 3...1000:SETup:CNFRfrequency?
Example	:SOUR:LIST:STEP2:SET:CNFR 1GHz :SOUR:LIST:STEP2:SET:CNFR?
Notes	SCPI is supported after A.09.40. This SCPI is used to setup channel number or frequency setting, according to current Radio Band setting. If Radio Band is "NONE", then it's frequency. If Radio Band is not "NONE", then it's channel number.
Couplings	The frequency value is coupled to the channel band and number for the step, such that updates to the radio band and channel number will update the frequency value to the corresponding absolute frequency. The reverse is also true, changing the frequency value causes the value of the channel number to be updated.
Preset	1.00 GHz
Min	10.00 MHz
Max	Hardware Dependant: Option 503 = 3.6 GHz Option 504 = 3.9 GHz Option 506 = 6.00 GHz
Initial S/W Revision	A.05.00

Power

Allows you to specify a power value for the current step.

Key Path	Source, List Sequencer, List Sequencer Setup
Remote Command	:SOURce:LIST:STEP[1] 2 3...1000:SETup:AMPLitude <double> :SOURce:LIST:STEP[1] 2 3...1000:SETup:AMPLitude?
Example	:SOUR:LIST:STEP2:SET:AMPL -50dBm :SOUR:LIST:STEP2:SET:AMPL?
Notes	SCPI is supported after A.09.40
Notes	<p>Amplitude corrections can be specified for use with the source. In the event of amplitude corrections being applied, the valid ranges for the RF power do not change dependant on the current amplitude correction setting. Instead, if the combination of RF power + amplitude correction is higher or lower than the source output range, the Source Unleveled bit is set and the “Source Unleveled” indicator will appear on status panel to indicate that the source cannot maintain the output power that has been requested.</p> <p>The multiport adapter RFIO TX ports and GPS ports cannot ensure power accuracy when power setting is lower than -130dBm, this power setting value is defined by the sum of RF Power setting and related amplitude correction value. But user settable value could be lower than this limit. When application detected there exists power setting lower than -130dBm on MPA RFIO TX ports, then popup warning message . When application detected there exists power setting lower than -130dBm on MPA GPS ports, then popup warning message . These are only warning messages, and check is performed when RF is ON.</p>
Notes	The Min and Max value here defined UI settable amplitude range. This range is larger than actual amplitude range with level accuracy defined in spec.
Dependencies	The RF power is dependent on the RF output port and frequency, such that the current frequency and selected output port determine the valid range of power values.
Preset	-100 dBm
Min	The range of values depends on the current frequency and selected RF output port. Please refer to "RF Power" on page 2442 and the table RF Power Range for the valid ranges.
Max	The range of values depends on the current frequency and selected RF output port. Please refer to "RF Power" on page 2442 and the table RF Power Range for the valid ranges.
Initial S/W Revision	A.05.00

Waveform

Allows you access to the sub-menus for selecting the waveform to be played back during the current step. Pressing this key also changes the central display area to show the Waveform File Selection view.

Key Path	Source, List Sequencer, List Sequencer Setup
Remote Command	:SOURce:LIST:STEP[1] 2 3...1000:SETup:WAVEform <string> :SOURce:LIST:STEP[1] 2 3...1000:SETup:WAVEform?
Example	:SOUR:LIST:STEP2:SET:WAV "CW" :SOUR:LIST:STEP2:SET:WAV?
Notes	SCPI is supported after A.09.40
Remote Command Notes	String type, takes “Off” “CW” “Cont” “waveform name”

Preset	CW
Range	Waveform Continue Previous CW Off
Initial S/W Revision	A.05.00

CW

Sets the current step to output a CW tone.

Key Path	Source, List Sequencer, List Sequencer Setup, Waveform
Example	:SOUR:LIST:STEP2:SET:WAV "CW"
Notes	SCPI is supported after A.09.40
Initial S/W Revision	A.05.00

Selected Waveform

Inserts the currently selected waveform in the waveform selection view as the waveform for playback during the current step.

Key Path	Source, List Sequencer, List Sequencer Setup, Waveform
Example	:SOUR:LIST:STEP2:SET:WAV "waveform name"
Notes	SCPI is supported after A.09.40 If the selected waveform contains header (which contains ARB play parameters), source list sequence will automatically apply header settings of the selected waveform in that step.
Initial S/W Revision	A.05.00

Continue Previous

Sets the current step to continue with playback of the waveform from the previous step. When continuing the previous waveform, the ARB playback will not pause while the source retunes to the new frequency or amplitude that may be defined for the new step.

Key Path	Source, List Sequencer, List Sequencer Setup, Waveform
Example	:SOUR:LIST:STEP2:SET:WAV "Cont"
Notes	SCPI is supported after A.09.40
Initial S/W Revision	A.05.00

Off

Disable RF output of the current step.

Key Path	Source, List Sequencer, List Sequencer Setup, Waveform
Example	:SOUR:LIST:STEP2:SET:WAV "Off"
Notes	SCPI is supported after A.09.40
Initial S/W Revision	A.05.00

Segments on Hard Disk

Allows you access to the sub-menus for loading waveform segments from the hard disk into ARB memory. The default directory is: D: varb.

Pressing this key changes the current view to the Waveform Management View.

Key Path	Source, Modulation Setup, ARB, Select Waveform
Initial S/W Revision	A.05.00

Load Segment To ARB Memory

Allows you to load the selected file into ARB memory. On the front panel you select the file for loading to the ARB memory by highlighting the desired file in the list. Using the SCPI command, you specify the file name on the HDD.

“NVWFM” (none-volatile storage) MSUS (Mass Storage Unit Specifier) is supported in the memory subsystem because the ARB memory cannot be accessed directly. Therefore, files must be downloaded to the instrument hard disk and then loaded into the ARB memory. “NVWFM” MSUS will be mapped to the default directory D: VARB. The SCPI command supports using either “NVWFM” MSUS or specifying a full path. For more information, see [Memory Subsystem \(Remote Command Only\)](#).

If a file of the same name already exists within ARB memory, it is overwritten. If you wish to load two segments of the same name, you must rename one of the segments before loading it into ARB memory. To rename a segment, you can either use Windows File Explorer, or the :MMEMory:COPY command.

NOTE: When a waveform file is loaded to ARB memory, burst timing adjustments are made automatically, based on whether or not a Multiport Adapter is connected to the test set and powered on. If the connection/power status of the Multiport Adapter is changed after a waveform file has been loaded, it needs to be loaded again.

Key Path	Source, Modulation Setup, ARB, Select Waveform, Segments on Hard Disk
Remote Command	:SOURce:RADio:ARB:LOAD <string>
Example	:SOUR:RAD:ARB:LOAD "D: VARB\testwaveform.bin" or :SOUR:RAD:ARB:LOAD "NVWFM:testwaveform.bin"
Notes	Because loading the file involves a delay of unpredictable length, this command should be followed by the query *OPC?, which holds off subsequent commands until the loading operating is complete. <string> – specifies the path name of the file to load from the HDD into ARB memory. It could be a <full path + filename>, or <"NVWFM" MSUS + colon + filename>.

When in Sequence Analyzer mode, and Include Source is Yes, an attempt to load a file to ARB memory will be rejected with an error.

When Include Source is No and if there is insufficient free ARB memory to load the selected waveform, an error is generated. .

If you specify a file over SCPI, but the file is not at the specified location, an error is generated.

If you try to load a waveform file but the file contains less than 500 IQ samples, an error is generated.

If you try to load a Signal Studio waveform “*.wfm” which contains invalid waveform header, an error is generated.

If the ARB is ON when you load a file to ARB memory or delete a file from ARB memory, the playing waveform segment may not keep phase continuity during the ARB memory operation. The waveform will be replayed after the ARB operation is finished.

ARB can be loaded into ARB memory even required licenses do not present on the instrument. In this case, a GUI only warning message -800, “Operation complete; Loaded <filename> successfully, but no license <required licenses> installed”. User can install required licenses according to <required licenses> string to license it, or multi-pack license it.

Initial S/W Revision A.05.00

Load All To ARB Memory

Allows you to load all the segment files within the currently selected directory into ARB memory. If a file of the same name already exists within ARB memory, it is overwritten. If you wish to load two segments of the same name, you must rename one of the segments before loading it into ARB memory. To rename a segment, you can either use Windows File Explorer, or the :MEMory:COpy command.

NOTE: When a waveform file is loaded to ARB memory, burst timing adjustments are made automatically, based on whether or not a Multiport Adapter is connected to the test set and powered on. If the connection/power status of the Multiport Adapter is changed after a waveform file has been loaded, it needs to be loaded again.

Key Path	Source, Modulation Setup, ARB, Select Waveform, Segments on Hard Disk
Remote Command	:SOURce:RADio:ARB:LOAD:ALL <string>
Example	:SOUR:RAD:ARB:LOAD:ALL “D: varb”
Notes	<p><string> - specifies the directory on the HDD to load the files into ARB memory from.</p> <p>When in Sequence Analyzer mode, and Include Source is Yes, an attempt to load all files from a directory to ARB memory is rejected with an error.</p> <p>When Include Source is No and there is insufficient free ARB memory to load all the waveforms, when the ARB memory is full, the copy ceases, and an error is generated.</p> <p>If you specify a directory over SCPI, but the directory does not exist, an error is generated.</p> <p>If the ARB is ON, a user then loads or deletes file to ARB memory, the playing waveform segment may not keep phase continuity during the ARB memory operation. The waveform will be replayed after the ARB operation is finished.</p>

Initial S/W Revision A.05.00

Change Directory...

Allows you to change the currently selected directory on the hard disk. Pressing this key opens a standard windows change directory dialog allowing you to select the new directory of interest.

The current directory is used for manually loading waveform segments into ARB memory for playback, and as a search location for waveform segments that are required to be loaded into ARB memory for playback of a waveform sequence or a list sequence.

Key Path	Source, Modulation Setup, ARB, Select Waveform, Segments on Hard Disk
Notes	No remote command, SCPI front panel only.
Initial S/W Revision	A.05.00

Default Directory...

Allows you to change the default directory. It is used as a search location for waveform segments that are required to be loaded into ARB memory for playback of a waveform sequence, and as a search location for selecting waveforms using SCPI.

Key Path	Source, Modulation Setup, ARB, Select Waveform, Segments on Hard Disk
Remote Command	:SOURce:RADio:ARB:DEFault:DIRectory <string> :SOURce:RADio:ARB: DEFault:DIRectory?
Example	:SOUR:RAD:ARB:DEF:DIR "D:\ArbFiles" :SOUR:RAD:ARB:DEF:DIR?
State Saved	Persistent, survives a power cycle and a preset but not saved in the instrument state
Initial S/W Revision	A.05.00

Segments in ARB Memory

Allows you access to the sub-menus for managing the files within ARB memory.

Key Path	Source, Modulation Setup, ARB, Select Waveform
Initial S/W Revision	A.05.00

Delete Segment From ARB Mem

Allows you to remove a segment from ARB playback memory.

Key Path	Source, Modulation Setup, ARB, Select Waveform, Segments in ARB Memory
Remote Command	:SOURce:RADio:ARB:DELeTe <string>
Example	:SOUR:RAD:ARB:DEL "testwaveform.bin"
Notes	<string> - specifies the waveform to be deleted from the ARB playback memory. When in Sequence Analyzer mode and Include Source is Yes, an attempt to delete a file from ARB

memory is rejected with an error. When Include Source is No and you specify a file that does not exist within ARB memory, an error is generated. It is possible to delete files from within the ARB memory when the ARB is ON. However, if you attempt to delete the file that is currently playing an error is generated. It is possible to delete a file from within the ARB memory when the sequencer state is ON and the file is not being used by the List Sequencer. If you attempt to delete a file which is being used by the list sequencer, an error is generated. When sequencer state is On, even if ARB state is On, the selected waveform will not be played. In this case, if the selected waveform is not used in List Sequence, it can be deleted and the ARB state is turned Off. If the ARB is ON and you load a file to ARB memory or delete a file from ARB memory, the playing waveform segment may not keep phase continuity during the ARB memory operation. The waveform will be replayed after the ARB operation is finished.
Initial S/W Revision A.05.00

Delete All From ARB Memory

Allows you to remove all segments from ARB playback memory.

Key Path	Source, Modulation Setup, ARB, Select Waveform, Segments in ARB Memory
Remote Command	:SOURce:RADio:ARB:DELeTe:ALL
Example	:SOUR:RAD:ARB:DELeTe:ALL
Notes	When in Sequence Analyzer mode and Include Source is Yes, an attempt to delete all files from ARB memory is rejected with an error. When Include Source is No and you attempt to delete all files from ARB memory when the ARB is currently playing a file, all files except the one playing are deleted and an error is generated. If you attempt to delete all files from ARB memory when there are waveform files used in " List Sequencer " on page 2520 and " Sequencer " on page 2521 state is ON, all files except the files currently being used in list sequencer are deleted, and an error is generated. If the ARB is ON and you load a file to ARB memory or delete a file from ARB memory, the playing waveform segment may not keep phase continuity during the ARB memory operation. The waveform will be replayed after the ARB operation is finished.
Initial S/W Revision A.05.00	

Segments on Hard Disk

This key functions the same as "[Segments on Hard Disk](#)" on page 2547.

Key Path	Source, List Sequencer, List Sequencer Setup, Waveform
Initial S/W Revision Prior to A.09.00	

Load Segment To ARB Memory

This key functions the same as ["Load Segment To ARB Memory" on page 2547](#).

Key Path	Source, List Sequencer, List Sequencer Setup, Waveform, Segment on Hard Drive
Initial S/W Revision	Prior to A.09.00

Load All To ARB Memory

This key functions the same as ["Load All To ARB Memory" on page 2548](#).

Key Path	Source, List Sequencer, List Sequencer Setup, Waveform, Segment on Hard Drive
Initial S/W Revision	Prior to A.09.00

Change Directory ...

This key functions the same as ["Change Directory..." on page 2549](#).

Key Path	Source, List Sequencer, List Sequencer Setup, Waveform, Segment on Hard Drive
Initial S/W Revision	Prior to A.09.00

Default Directory ...

This key functions the same as ["Default Directory..." on page 2549](#)

Key Path	Source, List Sequencer, List Sequencer Setup, Waveform, Segment on Hard Drive
Initial S/W Revision	Prior to A.09.00

Segments in ARB Memory

This key functions the same as ["Segments in ARB Memory" on page 2549](#).

Key Path	Source, List Sequencer, List Sequencer Setup, Waveform, Segments in ARB Memory
Initial S/W Revision	Prior to A.09.00

Delete Segment From ARB Memory

This key functions the same as ["Delete Segment From ARB Mem" on page 2549](#).

Key Path	Source, List Sequencer, List Sequencer Setup, Waveform, Segments in ARB Memory, Segment in ARB Memory
Initial S/W Revision	Prior to A.09.00

Delete All From ARB Memory

This key functions the same as ["Delete All From ARB Memory" on page 2550](#).

Key Path	Source, List Sequencer, List Sequencer Setup, Waveform, Segments in ARB Memory, Segment in ARB Memory
Initial S/W Revision	Prior to A.09.00

Step Duration

Allows access to the sub-menus for setting up the duration of play for the current step.

The duration can be set to be either the number of times for the ARB file associated with the sequence to play, or a specific time value, or continuous. If the step is set to play a CW tone, the step duration cannot be set to a play count.

Key Path	Source, List Sequencer, List Sequencer Setup
Remote Command	:SOURce:LIST:STEP[1] 2 3...1000:SETup:DURation:TYPE TIME COUNT CONTInuous CABort :SOURce:LIST:STEP[1] 2 3...1000:SETup:DURation:TYPE?
Example	:SOUR:LIST:STEP2:SET:DUR:TYPE TIME :SOUR:LIST:STEP2:SET:DUR:TYPE?
Notes	SCPI is supported after A.09.40
Notes	If "Step Duration" is set to "Time" or "Play Count" for the last step, the last step of ARB keeps playing as if set to "Continuous", until the set "Time" has expired or until the "Play Count" setting is reached. However, you can query Error! Reference source not found. Source Sweeping Condition Message to find out if the current list sequence is complete or not.
Range	Time Play Count Continuous Continuous Abort
Initial S/W Revision	A.05.00

Time

Sets the duration of the current step to be a time value for the length of time the step will play. Pressing this key again opens another menu which allows you to set the time value for the step duration.

Key Path	Source, List Sequencer, List Sequencer Setup, Step Duration
Example	:SOUR:LIST:STEP2:SET:DUR:TYPE TIME
Notes	SCPI is supported after A.09.40
Initial S/W Revision	A.05.00

Duration Time

Allows you to specify the length of time the current step will play.

When Step Duration is **Continuous Abort** this parameter specifies the maximum duration that the waveform will continue to play after a step trigger is received before the transition to the next waveform will occur. Duration is limited to a maximum of 20 seconds.

If the Transition Time value is longer than the Step Duration Time, an error is generated when initiating a source list sequence. For source list sequence, transition time is included in the step duration length (not occupy additional time). If the Transition Time value is longer than the Step Duration Time, the real step duration length is extended to equal the transition time and cause a timing shift. This check is also described in section **Error! Reference source not found.** List Sequence Step Validation.

Key Path	Source, List Sequencer, List Sequencer Setup, Step Duration, Time
Remote Command	:SOURce:LIST:STEP[1] 2 3...1000:SETup:DURation:TCOUNT <double> :SOURce:LIST:STEP[1] 2 3...1000:SETup:DURation:TCOUNT?
Example	:SOUR:LIST:STEP2:SET:DUR:TCO 1s :SOUR:LIST:STEP2:SET:DUR:TCO?
Notes	SCPI is supported after A.09.40 This SCPI is reused by "Play Count", "Duration Time" and "Continuous Abort" according to current Duration Type setting is "Play Count" or "Duration Time" or "Continuous Abort". If current "Duration Type" is "Continuous", then popup error -221, "Settings conflict; Cannot accept time or count input when step duration type is Continuous on step #"
Notes	If "Duration Time" is set for the last step, the last step of ARB keeps playing as if set to "Continuous" after set time expires. However, you can query Source Sweeping Condition Message (:STAT:OPER:COND?) to find out if the current list sequence is complete or not.
Preset	1.00 ms
Min	100 μs
Max	1800 s
Initial S/W Revision	A.05.00

Play Count

Sets the duration of the current step to be an integer value for the number of times (play count) the ARB file is selected for playback during this step. For example, a 5 second ARB will be set to play 5 times during the step.

Key Path	Source, List Sequencer, List Sequencer Setup, Step Duration
Example	:SOUR:LIST:STEP2:SET:DUR:TYPE COUN
Notes	SCPI is supported after A.09.40 This key is unavailable and is grayed out if the current step is configured to CW tone rather than an ARB waveform.
Initial S/W Revision	A.05.00

Header Utilities

Allows access to the header utilities sub-menu. Pressing this key also causes the central display area to change to display the File Header Information view.

Key Path	Source, Modulation Setup, ARB
Dependencies	This key is only available if there is currently a waveform selected for playback. If no waveform is selected, the key is grayed out.
Initial S/W Revision	A.05.00

Continuous

Sets the current step to be played continuously until the next step starts. The waveform will always play completely before transitioning to the next step.

Key Path	Source, List Sequencer, List Sequencer Setup, Step Duration
Example	:SOUR:LIST:STEP2:SET:DUR:TYPE CONT
Notes	SCPI is supported after A.09.40
Initial S/W Revision	A.05.00

Output Trigger

Allows you to specify the trigger output for the current step. The trigger output signal is sent at the start of the step.

When select “On”, trigger event will occur on both Internal and External2 paths. Select “Off” will turn off trigger output.

Key Path	Source, List Sequencer, List Sequencer Setup
Remote Command	:SOURce:LIST:STEP[1] 2 3...1000:SETup:OUTPut:TRIGger ON OFF 1 0 :SOURce:LIST:STEP[1] 2 3...1000:SETup:OUTPut:TRIGger
Example	:SOUR:LIST:STEP2:SET:OUTP:TRIG ON :SOUR:LIST:STEP2:SET:OUTP:TRIG?
Notes	SCPI is supported after A.09.40
Preset	Off
Range	On Off
Initial S/W Revision	A.05.00

Step Configuration (Remote Command Only)

This SCPI command is used to configure the List Sequencer and is detailed in the table below. The command is defined such that you send one command per step, with the step number being specified as a subopcode of the SCPI command. Each command includes all the parameter settings for the step. As a step is setup, the values entered are run through several levels of validation.

Remote Command	:SOURce:LIST:STEP[1] 2 ... 4..1000:SETup IMMEDIATE INTernal KEY
-----------------------	---

```
BUS | EXTERNAL2, <time>, NONE | PGSM | EGSM | RGSM | DCS1800 | PCS1900
| TGSM810 | GSM450 | GSM480 | GSM700 | GSM850 | BANDI | BANDII |
BANDIII | BANDIV | BANDV | BANDVI | BANDVII | BANDVIII | BANDIX | BANDX
| BANDXI | BANDXII | BANDXIII | BANDXIV | BANDXIX | USCELL | USPCS |
JAPAN | KOREAN | NMT | IMT2K | UPPER | SECOND | PAMR400 | PAMR800 |
IMTEXT | PCS1DOT9G | AWS | US2DOT5G | PUBLIC | LOWER | NONE | BAND1 |
BAND2 | BAND3 | BAND4 | BAND5 | BAND6 | BAND7 | BAND8 | BAND10 | BAND11
| BAND12 | BAND13 | BAND14 | BAND17 | BAND18 | BAND19 | BAND20 | BAND21
| BAND24 | BAND25 | BAND26 | BAND33 | BAND34 | BAND35 | BAND36 | BAND37
| BAND38 | BAND39 | BAND40 | BAND41 | BAND42 | BAND43 | BANDA | BANDB |
BANDC | BANDD | BANDE | BANDF, DOWN | UP, <freq>, <ampl>, <string>,
TIME | COUNT | CONTinuous, <time>, ON | OFF | 1 | 0, [<int>],
:SOURce:LIST:STEP[1]|2|...|4..1000:SETup?
```

Example :SOUR:LIST:STEP1:SET INT, 1ms, PGSM, DOWN, 10, -25 dBm, "GSM_Test1.bin", TIME, 10ms, OFF, 255

Notes

The parameters are:

(There is a total of 11 items in each step, the following is a list of the items in the order they must appear in the remote command.)

1. Step Trigger **<enum>** – specifies the input trigger for the step. For details of the valid types of step trigger see ["Step Trigger" on page 2523](#).
 2. Transition Time **<time>** – specifies the transition time for the step in seconds. For details of the valid ranges for the transition time see ["Transition Time" on page 2525](#).
 3. Radio Band **<enum>** – specifies the radio band for the step. For details of the valid radio bands see ["Radio Setup" on page 2526](#).
 4. Radio Band Link **<enum>** – specifies the radio band link direction for the step. For details of the valid link types, see ["Radio Band Link" on page 2543](#).
 5. Frequency/Channel Number **<freq>/<chan num>** – specifies the frequency in Hz or the channel number for the step. The channel number and frequency are combined as one parameter that represents the frequency or channel number depending on the radio band setting. If the radio band is set to NONE, this value is interpreted as a frequency value in Hz. If the radio band is set to a valid band, this value is interpreted as a channel number. For details of the valid ranges for frequency and channel numbers, see ["Channel" on page 2543](#) and ["Frequency" on page 2544](#).
 6. Power **<ampl>** – specifies the output power for the step in dBm. For details of the valid ranges see ["Power" on page 2544](#).
 7. Waveform **<string>** – specifies the waveform for playback during the step. The step can output either a new ARB waveform, continue playback of the previous waveform, or output a CW tone. The options for specifying these are:
 - <filename> - plays the specified waveform from the start. The filename value is the name of the file within ARB playback memory, it does not include the windows path to the file on the HDD. If you enter a filename for a waveform that does not reside within ARB playback memory, an error is generated.
 - CONT – continues playback of the ARB file from the previous step
 - CW – outputs a CW tone
 - OFF – disable RF output
 8. Step Duration **<enum>** – specifies the duration of the step. The duration can be specified to be either time, or play count of the ARB file associated with the step, or continuous. If Waveform is set to "CW", this value cannot be set to Play Count and an error will be generated. If continuous is selected, the following Time or Count value is ignored. For further details of this setting, see ["Step](#)
-

	<p>Duration" on page 2552.</p> <p>9. Time or Count <time/int> – specifies time duration in seconds or play count of the ARB file associated with the step. For further details of this setting, including the valid ranges for the time or play count setting, "Time" on page 2552 and "Play Count" on page 2553.</p> <p>10. Output Trigger <Boolean> – specifies the output trigger for the step. For details of the ranges for this setting see "Output Trigger" on page 2554.</p>
Dependencies	<p>The range of subopcode values is 1 to 1000 and the value you enter is determined by the number of steps you have configured. For details see "Number of Steps" on page 2522.</p> <p>If you attempt to remotely set or query a subopcode that is out of range, an error is generated.</p>
Initial S/W Revision	A.05.00

Step Configuration of Step Trigger parameter list (Remote Command Only)

This SCPI command is to configure “Step Trigger” parameter array of the whole List Sequencer at one time. The number of array is same as step number defined in "**Number of Steps" on page 2522** Number of Steps. As a step is setup, the value entered run through several levels of validation.

Remote Command	<pre>:SOURce:LIST:SETup:INPut:TRIGger <enum>, <enum>, <enum>, ... :SOURce:LIST:SETup:INPut:TRIGger?</pre>
Example	<pre>:SOUR:LIST:SET:INP:TRIG IMM,INT,EXT2 :SOUR:LIST:SET:INP:TRIG?</pre>
Notes	<p>The command is to setup below parameter array of whole list sequence.</p> <p>Step Trigger <enum> – specifies the input trigger for the step. For details of the valid types of step trigger see "Step Trigger" on page 2523.</p> <p>If input parameter number exceeds the step number defined by "Number of Steps" on page 2522Number of Steps then generate error ", and only those parametes whose index number falls in number of steps will be updated.</p>
Remote Command Notes	IMMEDIATE INTERNAL KEY BUS EXTERNAL2
Dependencies	<p>The range is 1 to 1000 which is determined by the number of steps you have configured. For details see "Number of Steps" on page 2522.</p>
Initial S/W Revision	A.09.40

Step Configuration of Transition Time parameter list (Remote Command Only)

This SCPI command is to configure “Transition Time” parameter array of the whole List Sequencer at one time. The number of array is same as step number defined in "**Number of Steps" on page 2522** Number of Steps. As a step is setup, the value entered run through several levels of validation.

Remote Command	<pre>:SOURce:LIST:SETup:TRANSition:TIME <time>, <time>, <time>, ... :SOURce:LIST:SETup:TRANSition:TIME?</pre>
Example	<pre>:SOUR:LIST:SET:TRAN:TIME 1ms,1ms,1ms</pre>

	:SOUR:LIST:SET:TRAN:TIME?
Notes	<p>The command is to setup below parameter array of whole list sequence.</p> <p>Transition Time <time> – specifies the transition time for the step in seconds. For details of the valid ranges for the transition time see "Transition Time" on page 2525</p> <p>If input parameter number exceeds the step number defined by "Number of Steps" on page 2522 Number of Steps then generate error ", and only those parameters whose index number falls in number of steps will be updated.</p>
Dependencies	The range is 1 to 1000 which is determined by the number of steps you have configured. For details see "Number of Steps" on page 2522 .
Initial S/W Revision	A.09.40

Step Configuration of Radio Band parameter list (Remote Command Only)

This SCPI command is to configure “Radio Band” parameter array of the whole List Sequencer at one time. The number of array is same as step number defined in ["Number of Steps" on page 2522](#) Number of Steps. As a step is setup, the value entered run through several levels of validation.

R	:SOURce:LIST:SETup:RADio:BAND <enum>, <enum>, <enum>, ...
e	:SOURce:LIST:SETup:RADio:BAND?
m	
o	
t	
e	
C	
o	
m	
m	
a	
n	
d	
E	:SOUR:LIST:SET:RAD:BAND PGSM, EGSM, RGSM
X	:SOUR:LIST:SET:RAD:BAND?
a	
m	
p	
l	
e	
N	The command is to setup below parameter array of whole list sequence.
O	Radio Band <enum> – specifies the radio band for the step. For details of the valid radio bands see "Radio Setup" on page 2526 .
t	If input parameter number exceeds the step number defined by "Number of Steps" on page 2522 Number of Steps then
e	generate error ", and only those parameters whose index number falls in number of steps will be updated.
s	
R	NONE PGSM EGSM RGSM DCS1800 PCS1900 TGSM810 GSM450 GSM480 GSM700 GSM850 BANDI BANDII BANDIII BANDI
e	V BANDV BANDVI BANDVII BANDVIII BANDIX BANDX BANDXI BANDXII BANDXIII BANDXIV BANDXIX USCELL USPCS JAPAN KO
m	REAN NMT IMT2K UPPER SECOND PAMR400 PAMR800 IMTEXT PCS1 DOT9G AWS US2DOT5G PUBLIC LOWER NONE BAND1
	BAND2 BAND3 BAND4 BAND5 BAND6 BAND7 BAND8 BAND10 BAND11 BAND12 BAND13 BAND14 BAND17 BAND18 BAND1

o 9|BAND20|BAND21|BAND24|BAND25|BAND26|BAND33|BAND34|BAND35|BAND36|BAND37|BAND38|BAND39|BAND40|BAN
t D41|BAND42|BAND43|BANDA|BANDB|BANDC|BANDD|BANDE|BANDF
e

C
o
m
m
a
n
d

N
o
t
e
s

D The range is 1 to 1000 which is determined by the number of steps you have configured. For details see "[Number of Steps](#)" on
e [page 2522](#).

p
e
n
d
e
n
c
i
e
s

I A.09.40

n
i
t
i
a
l

S
/
W

R
e
v
i
s
i
o
n

Step Configuration of Radio Band Link parameter list (Remote Command Only)

This SCPI command is to configure “Radio Band Link” parameter array of the whole List Sequencer at one time. The number of array is same as step number defined in ["Number of Steps" on page 2522](#) Number of Steps. As a step is setup, the value entered run through several levels of validation.

Remote Command	:SOURce:LIST:SETup:RADio:BAND:LINK <enum>, <enum>, <enum>, ... :SOURce:LIST:SETup:RADio:BAND:LINK?
Example	:SOUR:LIST:SET:RAD:BAND:LINK DOWN,UP,UP :SOUR:LIST:SET:RAD:BAND:LINK?
Notes	The command is to setup below parameter array of whole list sequence. Radio Band Link <enum> – specifies the radio band link direction for the step. For details of the valid link types, see "Radio Band Link" on page 2543 . If input parameter number exceeds the step number defined by "Number of Steps" on page 2522 Number of Steps then generate error ", and only those parametes whose index number falls in number of steps will be updated.
Remote Command Notes	DOWN UP
Dependencies	The range is 1 to 1000 which is determined by the number of steps you have configured. For details see "Number of Steps" on page 2522 .
Initial S/W Revision	A.09.40

Step Configuration of Frequency/Channel Number parameter list (Remote Command Only)

This SCPI command is to configure “Frequency” or “Channel Number” parameter array of the whole List Sequencer at one time. The number of array is same as step number defined in ["Number of Steps" on page 2522](#) Number of Steps. As a step is setup, the value entered run through several levels of validation.

Remote Command	:SOURce:LIST:SETup:CNFRequency <double>, <double>, <double>, ... :SOURce:LIST:SETup:CNFRequency?
Example	:SOUR:LIST:SET:CNFR 1GHz,100MHz,100MHz :SOUR:LIST:SET:CNFR? SOUR:LIST:SET:CNFR 124,124,124 :SOUR:LIST:SET:CNFR?
Notes	The command is to setup below parameter array of whole list sequence. Frequency/Channel Number <freq>/<chan num> – specifies the frequency in Hz or the channel number for the step. The channel number and frequency are combined as one parameter that represents the frequency or channel number depending on the radio band setting. If the radio band is set to NONE, this value is interpreted as a frequency value in Hz. If the radio band is set to a valid band, this value is interpreted as a channel number. For details of the valid ranges for frequency and channel numbers, see "Channel" on page 2543 and "Frequency" on page 2544 . This SCPI is used to setup/query channel number or frequency setting, according to current Radio Band setting of that step. If Radio Band is “NONE”, then it’s frequency. If Radio Band is not “NONE”, then it’s channel number If input parameter number exceeds the step number defined by "Number of Steps" on page 2522 Number of Steps then generate error ", and only those parametes whose index number falls in

	legal step number will be updated.
Dependencies	The range is 1 to 1000 which is determined by the number of steps you have configured. For details see "Number of Steps" on page 2522 .
Initial S/W Revision	A.09.40

Step Configuration of Power parameter list (Remote Command Only)

This SCPI command is to configure “Power” parameter array of the whole List Sequencer at one time. The number of array is same as step number defined in ["Number of Steps" on page 2522](#) Number of Steps. As a step is setup, the value entered run through several levels of validation.

Remote Command	:SOURce:LIST:SETup:AMPLitude <ampl>, <ampl>, <ampl>, ... :SOURce:LIST:SETup:AMPLitude?
Example	:SOUR:LIST:SET:AMPL -50dBm,-40dBm,-30dBm :SOUR:LIST:SET:AMPL?
Notes	The command is to setup below parameter array of whole list sequence. Power <ampl> – specifies the output power for the step in dBm. For details of the valid ranges see "Power" on page 2544 . If input parameter number exceeds the step number defined by "Number of Steps" on page 2522 Number of Steps then generate error ", and only those parametes whose index number falls in legal step number will be updated.
Dependencies	The range is 1 to 1000 which is determined by the number of steps you have configured. For details see "Number of Steps" on page 2522 .
Initial S/W Revision	A.09.40

Step Configuration of Waveform parameter list (Remote Command Only)

This SCPI command is to configure “Waveform” parameter array of the whole List Sequencer at one time. The number of array is same as step number defined in ["Number of Steps" on page 2522](#) Number of Steps. As a step is setup, the value entered run through several levels of validation.

Remote Command	:SOURce:LIST:SETup:WAVeform <string>, <string>, <string>, ... :SOURce:LIST:SETup:WAVeform?
Example	:SOUR:LIST:SET:WAV "CW","Off","CONT" :SOUR:LIST:SET:WAV?
Notes	The command is to setup below parameter array of whole list sequence. Waveform <string> – specifies the waveform for playback during the step. The step can output either a new ARB waveform, continue playback of the previous waveform, or output a CW tone. The options for specifying these are: <filename> - plays the specified waveform from the start. The filename value is the name of the file within ARB playback memory, it is does not include the windows path to the file on the HDD. If you enter a filename for a waveform that does not reside within ARB playback memory, an error is generated.

	<p>CONT – continues playback of the ARB file from the previous step</p> <p>CW – outputs a CW tone</p> <p>OFF – disable RF output</p> <p>If input parameter number exceeds the step number defined by "Number of Steps" on page 2522 Number of Steps then generate error ", and only those parametes whose index number falls in number of steps will be updated.</p>
Dependencies	The range is 1 to 1000 which is determined by the number of steps you have configured. For details see " Number of Steps " on page 2522.
Range	"filename" "CW" "Off" "CONT"
Initial S/W Revision	A.09.40

Step Configuration of Step Duration parameter list (Remote Command Only)

This SCPI command is to configure "Step Duration" parameter array of the whole List Sequencer at one time. The number of array is same as step number defined in "[Number of Steps](#)" on page 2522 Number of Steps. As a step is setup, the value entered run through several levels of validation.

Remote Command	<pre>:SOURce:LIST:SETup:DURation:TYPE <enum>, <enum>, <enum>, ... :SOURce:LIST:SETup:DURation:TYPE?</pre>
Example	<pre>:SOUR:LIST:SET:DUR:TYPE COUN,TIME,CONT :SOUR:LIST:SET:DUR:TYPE?</pre>
Notes	<p>The command is to setup below parameter array of whole list sequence.</p> <p>Step Duration <enum> – specifies the duration of the step. The duration can be specified to be either time, or play count of the ARB file associated with the step, or continuous. If Waveform is set to "CW", this value cannot be set to Play Count and an error will be generated. If continuous is selected, the following Time or Count value is ignored. For further details of this setting, see "Step Duration" on page 2552.</p> <p>If input parameter number exceeds the step number defined by "Number of Steps" on page 2522 Number of Steps then generate error ", and only those parametes whose index number falls in number of steps will be updated.</p>
Remote Command Notes	TIME COUNT CONTinuous
Dependencies	The range is 1 to 1000 which is determined by the number of steps you have configured. For details see " Number of Steps " on page 2522.
Initial S/W Revision	A.09.40

Step Configuration of Duration Time or Play Count parameter list (Remote Command Only)

This SCPI command is to configure "Duration Time" or "Play Count" parameter array of the whole List Sequencer at one time. The number of array is same as step number defined in "[Number of Steps](#)" on page 2522 Number of Steps. As a step is setup, the value entered run through several levels of validation.

Remote Command	<pre>:SOURce:LIST:SETup:TOCount <time/int>, <time/int>, <time/int>, ... :SOURce:LIST:SETup:TOCount?</pre>
-----------------------	---

Example	:SOUR:LIST:SET:TOC 1s,2s,3s :SOUR:LIST:SET:TOC? :SOUR:LIST:SET:TOC 5,6,7 :SOUR:LIST:SET:TOC?
Notes	The command is to setup below parameter array of whole list sequence. Time or Count <time/int> – specifies time duration in seconds or play count of the ARB file associated with the step. For further details of this setting, including the valid ranges for the time or play count setting, " Time " on page 2552 and " Play Count " on page 2553. If input parameter number exceeds the step number defined by " Number of Steps " on page 2522 Number of Steps then generate error ", and only those parametes whose index number falls in number of steps will be updated. If current " Step Duration " on page 2552 is "Continuous", then generate error -221,"Settings conflict;Cannot accept time or count input when step duration type is Continuous on step #"
Dependencies	The range is 1 to 1000 which is determined by the number of steps you have configured. For details see " Number of Steps " on page 2522.
Initial S/W Revision	A.09.40

Step Configuration of Output Trigger parameter list (Remote Command Only)

This SCPI command is to configure "Output Trigger" parameter array of the whole List Sequencer at one time. The number of array is same as step number defined in "[Number of Steps](#)" on page 2522 Number of Steps. As a step is setup, the value entered run through several levels of validation.

Remote Command	:SOURce:LIST:SETup:OUTPut:TRIGger <bool>, <bool>, <bool>, ... :SOURce:LIST:SETup:OUTPut:TRIGger ?
Example	:SOUR:LIST:SET:OUTP:TRIG ON,OFF,ON :SOUR:LIST:SET:OUTP:TRIG?
Notes	The command is to setup below parameter array of whole list sequence. Output Trigger <Boolean> – specifies the output trigger for the step. For details of the ranges for this setting see " Output Trigger " on page 2554. If input parameter number exceeds the step number defined by " Number of Steps " on page 2522 Number of Steps then generate error ", and only those parametes whose index number falls in legal step number will be updated.
Remote Command Notes	ON OFF 1 0
Dependencies	The range is 1 to 1000 which is determined by the number of steps you have configured. For details see " Number of Steps " on page 2522.
Initial S/W Revision	A.09.40

Clear List (Remote Command Only)

This command is the SCPI equivalent of the Clear List UI feature described in.

Remote Command	:SOURce:LIST:SETup:CLEar
Example	:SOUR:LIST:SETup:CLE
Initial S/W Revision	A.05.00

Trigger Type

Allows access to the sub-menu for selecting the output trigger type for the list sequencer globally. It cannot be changed between different sequence steps.

Key Path	Source, List Sequencer
Remote Command	:SOURce:LIST:TRIGgerout:TYPe BEGinningofstep DATamarker
Example	:SOUR:LIST:TRIG:TYP BEG :SOUR:LIST:TRIG:TYP?
Notes	SCPI is supported after A.14.00
Preset	BEGinningofstep
Range	BEGinningofstep DATamarker
Initial S/W Revision	A.14.00

BeginningOfStep

Sets the output trigger type as BeginningOfStep for the whole source sequence.

Key Path	Source, List Sequencer, Trigger Type
Example	:SOUR:LIST:TRIG:TYP BEG
Notes	SCPI is supported after A.14.00
Initial S/W Revision	A.14.00

DataMarker

Sets the output trigger type as DataMarker for the whole source sequence. When DataMarker is selected, which marker to route is also needed to be set.

Key Path	Source, List Sequencer, Trigger Type
Example	:SOUR:LIST:TRIG:TYP DAT
Notes	SCPI is supported after A.14.00
Initial S/W Revision	A.14.00

Marker 1

Sets the output trigger maker routing to Marker 1 for DataMarker in the whole source sequence.

Key Path	Source, List Sequencer, Trigger Type, DataMarker
Example	:SOUR:LIST:TRIG:TYPE:MARK M1
Notes	SCPI is supported after A.14.00
Initial S/W Revision	A.14.00

Marker 2

Sets the output trigger maker routing to Marker 2 for DataMarker in the whole source sequence.

Key Path	Source, List Sequencer, Trigger Type, DataMarker
Example	:SOUR:LIST:TRIG:TYPE:MARK M2
Notes	SCPI is supported after A.14.00
Initial S/W Revision	A.14.00

Marker 3

Sets the output trigger maker routing to Marker 3 for DataMarker in the whole source sequence.

Key Path	Source, List Sequencer, Trigger Type, DataMarker
Example	:SOUR:LIST:TRIG:TYPE:MARK M3
Notes	SCPI is supported after A.14.00
Initial S/W Revision	A.14.00

Marker 4

Sets the output trigger maker routing to Marker 4 for DataMarker in the whole source sequence.

Key Path	Source, List Sequencer, Trigger Type, DataMarker
Example	:SOUR:LIST:TRIG:TYPE:MARK M4
Notes	SCPI is supported after A.14.00
Initial S/W Revision	A.14.00

Manual Trigger Now

Pressing this key provides a software trigger event to the list sequencer. During execution of sequence, if the sequencer is halted on any step that has been configured with a “Manual” step trigger, then this key press will cause the sequencer to continue and execute the step.

Key Path	Source, List Sequencer
Remote Command	No remote command, front panel only.
Initial S/W Revision	A.05.00

Remote Software Trigger (Remote command Only)

During execution of a list sequence, the sequence will halt and wait at any step that has Step Trigger set to “Bus”. Sending this command will trigger the step and continue the sequence.

Remote Command	:SOURce:LIST:TRIGger:INITiate[:IMMediate]
Example	:SOUR:LIST:TRIG:INIT
Initial S/W Revision	A.05.00

Query List Sequence Initiation Armed Status (Remote Command Only)

This is a blocking SCPI query to determine if source list sequence being initiated successfully or not.

Remote Command	:SOURce:LIST:INITiation:ARMed?
Example	:SOUR:LIST:INIT:ARMed?
Notes	The return data is in the following format: Integer
Notes	Query only SCPI. Returning “1” if list sequence has been initiated successfully, returning “0” if not. Once get “0”, you can use :SYST:ERR? to query what error happened. Just like “*OPC?”, this command can be blocked until event/status “IsSourceSweeping” happens, and then returns. Doing so can help user’s script query armed status only once during the time interval of the initiation. As an ancillary SCPI of existing SCPI “:SOUR:LIST:TRIGger[:IMMediate]” (see "Initiate Sequence" on page 2521 Initiate Sequence), the right usage of this command is to use it after “:SOUR:LIST:TRIG”. If not, this command will return “1” immediately.
Notes	There is an alias SCPI “:SOURce:LIST:TRIGger:INITiation:ARMed?”.
Initial S/W Revision	A.09.40

Source Preset

Allows you to preset the source settings to their default values.

Key Path	Source
Remote Command	:SOURce:PRESet
Example	:SOUR:PRES

Span X Scale

Activates the Span function and displays the menu of span functions. The parameter values are measurement independent.

Key Path	Front-panel key
Initial S/W Revision	Prior to A.02.00

Span

Set the frequency of the occupied bandwidth span for the current measurement.

Key Path	Span X Scale
Mode	SA, WCDMA, C2K, WIMAX OFDMA, TD-SCDMA, 1xEVDO, ISDB-T, CMMB, LTE, LTETDD, BLUETOOTH, WLAN, MSR
Remote Command	[:SENSe] :OBWidth:FREQuency:SPAN <freq> [:SENSe] :OBWidth:FREQuency:SPAN? [:SENSe] :OBWidth:FREQuency:SPAN:AUTO ON OFF 0 1 [:SENSe] :OBWidth:FREQuency:SPAN:AUTO?
Example	OBW:FREQ:SPAN 2.4 MHz OBW:FREQ:SPAN? OBW:FREQ:SPAN:AUTO 0 OBW:FREQ:SPAN:AUTO?
Notes	Span Auto Detector ([:SENSe] :OBWidth:FREQuency:SPAN:AUTO) is only available in MSR mode. The BAF SCPI is MSR only.
Couplings	When changing the Occupied Bandwidth Span, the Resolution Bandwidth and Video Bandwidth are set to AUTO to prevent the span from clipping. This is only available in MSR mode.
Preset	SA: 3 MHz WCDMA: 10 MHz WIMAX OFDMA: 20 MHz CDMA2K: 2 MHz TD-SCDMA: 4.8 MHz 1xEVDO: 3.75 MHz ISDB-T: 20 MHz CMMB: 8 MHz LTE, LTETDD: 10 MHz BLUETOOTH:2 MHz WLAN: If Radio Std is 802.11a/g 802.11n(20MHz) 802.11ac(20MHz): 25 MHz If Radio Std is 802.11b: 30MHz

	If Radio Std is 802.11n(40MHz), 802.11ac (40MHz): 50 MHz If Radio Std is 802.11ac(80MHz): 100MHz If Radio Std is 802.11ac(160MHz): 200MHz MSR: 20MHz ON
State Saved	Saved in instrument state.
Min	100 Hz
Max	Hardware Maximum Span
Backwards Compatibility SCPI	[:SENSe] :EBwidth:FREQuency:SPAN
Initial S/W Revision	Prior to A.02.00
Modified at S/W Revision	A.03.00, A.10.00,

Last Span

Changes the measurement frequency span to previous measurement span setting. If there is no existing previous span value then the span remains unchanged.

Key Path	Span X Scale
Mode	SA, WCDMA, C2K, WIMAX OFDMA, ISDB-T, CMMB, LTE, LTETDD, BLUETOOTH, WLAN, MSR
Remote Command	[:SENSe] :OBwidth:FREQuency:SPAN:PREVIOUS
Example	OBW:FREQ:SPAN:PREV
Notes	You must be in the Spectrum Analysis mode, W-CDMA mode, ISDB-T mode, CMMB mode, LTE mode, LTE TDD mode, BLUETOOTH mode, WLAN mode, cdma2000 mode, MSR or WIMAX OFDMA mode to use this command. Use:INSTrument:SElect to set the mode.
Couplings	Selecting last span changes the measurement span value.
Initial S/W Revision	Prior to A.02.00
Modified at S/W Revision	A.03.00

Sweep/Control

Displays a menu of functions that enable you to set up and control the acquisition time and source for the current measurement.

For details about this key, see Sweep/Control.

Key Path	Front-panel key
Initial S/W Revision	Prior to A.02.00

Acq Time

Sets the acquisition time; acquisition time can be set manually or put in auto mode. The time value is the acquisition time for an individual FFT segment, not the cumulated time for all FFT segments in the measurement.

Key Path	Sweep/Control
Mode	SA, WCDMA, C2K, WIMAX OFDMA, TD-SCDMA, 1xEVDO, ISDB-T, CMMB, LTE, LTETDD, BLUETOOTH, WLAN, MSR
Remote Command	[:SENSe]:OBWidth:SWEep:TIME <time> [:SENSe]:OBWidth:SWEep:TIME? [:SENSe]:OBWidth:SWEep:TIME:AUTO OFF ON 0 1 [:SENSe]:OBWidth:SWEep:TIME:AUTO?
Example	OBW:SWE:TIME 50 ms OBW:SWE:TIME? OBW:SWE:TIME:AUTO ON OBW:SWE:TIME:AUTO?
Couplings	When you manually change the Time, this state automatically goes to 'Man'.
Preset	SA, WIMAX OFDMA, C2K, TD-SCDMA, 1xEVDO, ISDB-T, CMMB, LTE, LTETDD, BLUETOOTH, WLAN, MSR: Automatically Calculated WCDMA: 32.6 ms SA, WIMAX OFDMA, C2K, TD-SCDMA, 1xEVDO, ISDB-T, CMMB, LTE, LTETDD, WLAN, MSR: ON WCDMA: OFF
State Saved	Saved in instrument state.
Min	100 ns
Max	4000 s
Initial S/W Revision	Prior to A.02.00
Modified at S/W Revision	A.03.00

Sweep Setup

Accesses the sweep setup settings for the current measurement.

Key Path	Sweep/Control
Initial S/W Revision	Prior to A.02.00

Auto Sweep Time Rules

Switches the analyzer between normal and accuracy sweep states.

Setting Auto Sweep Time to Accy results in slower sweep times, usually about three times as long, but better amplitude accuracy for CW signals. The instrument amplitude accuracy specifications only apply when Auto Sweep Time is set to Accy.

Additional amplitude errors which occur when Auto Sweep Time is set to Norm are usually well under 0.1 dB, though this is not guaranteed. Because of the faster sweep times and still low errors, Norm is the preferred setting of Auto Sweep Time. Auto Sweep Time is set to Norm on a Preset or Auto Couple. This means that in the Preset or Auto Coupled state, instrument amplitude accuracy specifications do not apply.

Key Path	Sweep/Control, Sweep Setup
Mode	SA, WCDMA, C2K, WIMAX OFDMA, TD-SCDMA, 1xEVDO, ISDB-T, CMMB, LTE, LTETDD, BLUETOOTH, WLAN, MSR
Remote Command	[:SENSE] :OBWidth :SWEep :TIME :AUTO :RULEs NORMal ACCuracy [:SENSE] :OBWidth :SWEep :TIME :AUTO :RULEs ?
Example	OBW:SWE:TIME:AUTO:RUL NORM OBW:SWE:TIME:AUTO:RUL ?
Notes	Set to Norm when Auto Couple is pressed or sent remotely.
Preset	NORMal
State Saved	Saved in instrument state.
Range	Norm Accy
Initial S/W Revision	Prior to A.02.00
Modified at S/W Revision	A.03.00

Pause

Pauses the measurement after the current data acquisition is complete.

When Paused, the label on the key changes to Resume. Pressing Resume resumes the measurement at the point where it had been paused.

See "[Pause/Resume](#)" on page 1865 for more information.

Key Path	Sweep/Control
Initial S/W Revision	Prior to A.02.00

Gate

Accesses a menu that enables you to control the gating function. The Gate functionality is used to view signals best viewed by qualifying them with other events.

Gate setup parameters are the same for all measurements – they do not change as you change measurements. Settings like these are called “Meas Global” and are unaffected by Meas Preset.

Key Path	Sweep/Control
Scope	Meas Global
Readback	The state and method of Gate, as [Off, FFT] or [On, FFT]. Note that for measurements that only support gated FFT, the method is nonetheless read back, but always as FFT.
Initial S/W Revision	Prior to A.02.00

Gate On/Off

Turns the gate function on and off.

When the Gate Function is on, the selected Gate Method is used along with the gate settings and the signal at the gate source to control the sweep system with the gate signal. Not all measurements allow every type of Gate Methods.

When Gate is on, the annunciation in the measurement bar reflects that it is on and what method is used, as seen in the following "Gate: FFT" annunciator graphic.

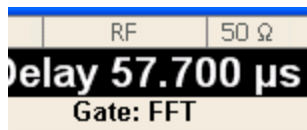

Key Path	Sweep/Control, Gate
Remote Command	[:SENSe] :SWEep:EGATe [:STATe] OFF ON 0 1 [:SENSe] :SWEep:EGATe [:STATe] ?
Example	SWE:EGAT ON SWE:EGAT?

Dependencies

When in the ACP measurement:

- When Meas Method is RBW or FAST, this function is unavailable and the key is grayed out.
- Whenever Gate is on, Meas Method, RBW or FAST is unavailable and keys for those are grayed out.
- When Gate is on, Offset Res BW and Offset Video BW are ignored (if you set these values) and the measurement works as if all Offset Res BW and all Offset Video BW are coupled with the Res BW and the Video BW under the BW menu. When Gate is on, the Offset BW key in the Offset/Limit

	menu is grayed out.
Preset	Off LTETDD: On
State Saved	Saved in instrument state
Range	On Off
Backwards Compatibility SCPI	[[:SENSe]:SWEep:TIME:GATE[:STATE] ESA compatibility
Backwards Compatibility Notes	In ESA, Trig Delay (On) and Gate (On) could not be active at the same time.. This dependency does not exist in PSA or in the X-Series.
Initial S/W Revision	Prior to A.02.00

Gate View On/Off

Turning on Gate View in the Swept SA measurement provides a single-window gate view display..

Turning on Gate View in other measurements shows the split-screen Gate View. In these measurements, when the Gate View is on, the regular view of the current measurement traces and results are reduced vertically to about 70% of the regular height. The Zero Span window, showing the positions of the Gate, is shown between the Measurement Bar and the reduced measurement window. By reducing the height of the measurement window, some of the annotation on the Data Display may not fit and is not shown.

Key Path	Sweep/Control, Gate
Remote Command	[[:SENSe]:SWEep:EGATe:VIEW ON OFF 1 0 [:SENSe]:SWEep:EGATe:VIEW?
Example	SWE:EGAT:VIEW ON turns on the gate view.
Dependencies	In the Swept SA measurement: In Gate View, the regular Acq Time key is grayed out . When pressed, the grayed out key puts up the informational message "Use Gate View Sweep Time in the Gate menu." In the other measurements: When you turn Gate View on, the lower window takes on the current state of the instrument. Upon leaving Gate View, the instrument takes on the state of the lower window. When you turn Gate View on, the upper window Acquisition Time is set to the gate view acquisition time.
Couplings	These couplings apply to the Swept SA measurement: <ul style="list-style-type: none"> • When Gate View is turned on, the instrument is set to Zero Span. • Gate View automatically turns off whenever a Span other than Zero is selected. • Gate View automatically turns off if you press the Last Span key while in Gate View, and the instrument returns to the Span it was in before entering Gate View (even if that is Zero Span). • When Gate View is turned on, the sweep time used is the gate view sweep time. This is set according to the rules in section "Gate View Setup" on page 1553 • When Gate View is turned off, Sweep Time is set to the normal Swept SA measurement sweep time.

- If Gate View is on and Gate is off, then turning on Gate turns off Gate View.

Preset	OFF
State Saved	Saved in instrument state
Range	On Off
Initial S/W Revision	Prior to A.02.00

A sample of the Gate View screen in the Swept SA measurement is shown in the following graphic :

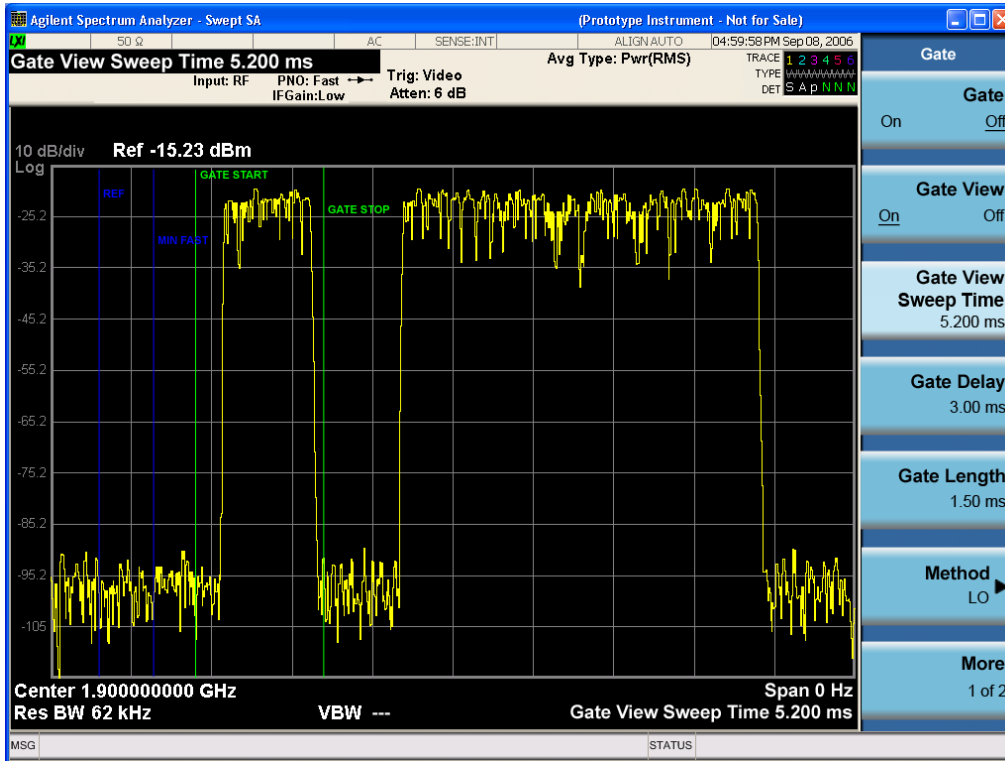

A sample of the Gate View screen in other measurements is shown in the following graphic . This example is for the ACP measurement:

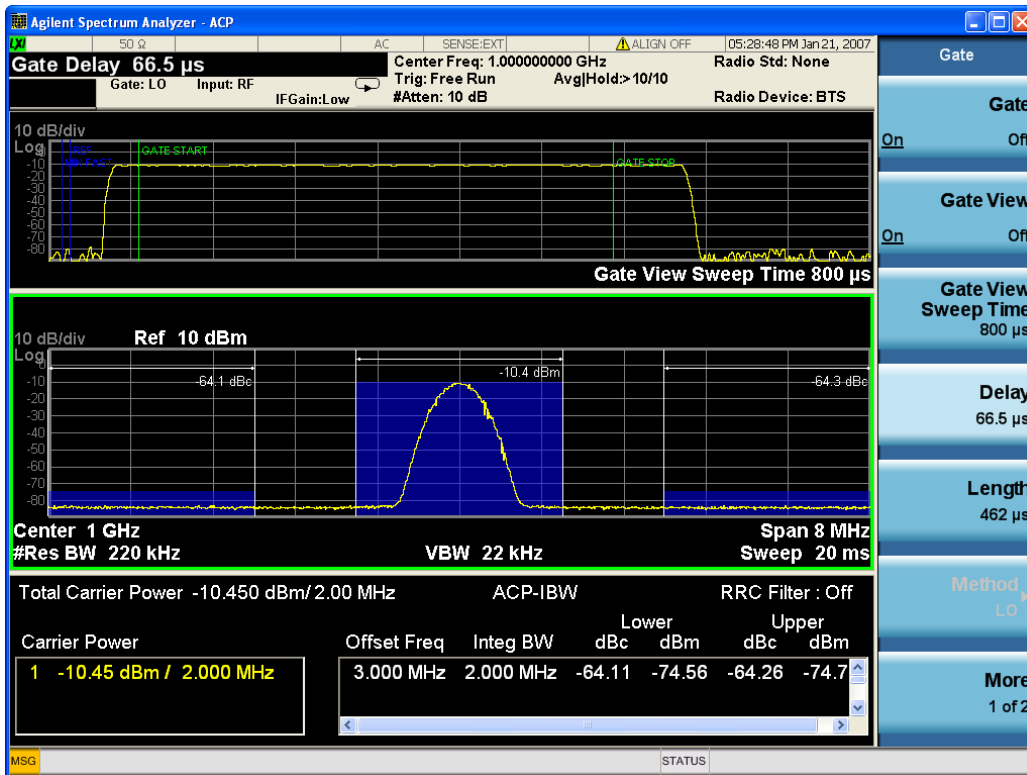

Turning Gate View off returns the analyzer to the Normal measurement view.

In the Swept SA, the normal measurement view is the single-window Swept SA view. When returning to this view, the Swept SA measurement returns to the Span it was in before entering **Gate View** (even if that is Zero Span).

The **Gate View** window is triggered from the Gate Source, with zero trigger delay. Also, when updating the **Gate View** window, the Gate itself must not operate. So it is internally shut off while the gate view window is being updated. For the Swept SA measurement, this means that the Gate is internally shut off whenever the gate view window is displayed. The measurement bar and softkeys continue to show the Trigger source for the main sweep window and give no indication that the Gate is shut off or that the Gate View window is triggered from the Gate Source.

When in **Gate View**, vertical lines are displayed in the Gate View window as follows:

- Green lines are displayed at the gate edges as follows: in Edge Gate, a line is shown for Delay and one for the end of the Gate period, defined by Length. You can adjust the position of the green lines by adjusting the gate length and the gate delay. These lines update in the Gate View window as the active function changes, even if the window is not being updated. In Gated FFT, their location is relative to the left edge of the screen.
- A blue line is displayed showing the delay reference, that is, the reference point for the Gate Delay within the Zero Span window. The blue line represents where (in time) the effective location of the gate start would be if the gate were programmed to zero delay.

Gate View Setup

Accesses a menu that enables you to setup parameters relevant to the Gate View

Key Path	Sweep/Control, Gate
Scope	Meas Global
Initial S/W Revision	A.10.00

Gate View Acquisition Time

Controls the acquisition time in the Gate View window. To provide an optimal view of the gate signal, the analyzer initializes Gate View Acq Time based on the current settings of Gate Delay and Gate Length.

Key Path	Sweep/Control, Gate, Gate View Setup
Remote Command	[:SENSe] :SWEep:EGATe:TIME <time> [:SENSe] :SWEep:EGATe:TIME?
Example	SWE:EGAT:TIME 500 ms
Dependencies	Gate View Acquisition Time is initialized: <ul style="list-style-type: none"> • On Preset (after initializing delay and length). • Every time the Gate Method is set/changed. <ol style="list-style-type: none"> 1. Compute the location of the "gate stop" line, which you know is at time $t = t_{min} + \text{GateDelay} + \text{GateLength}$.
Preset	519.3 μ s WiMAX OFDMA: 5 ms GSM/EDGE: 1 ms
State Saved	Saved in instrument state
Min	100 ns
Max	6000 s
Initial S/W Revision	Prior to A.02.00

Gate View Start Time

Controls the time at the left edge of the Gate View.

Key Path	Sweep/Control, Gate, Gate View Setup
Remote Command	[:SENSe] :SWEep:EGATe:VIEW:STARt <time> [:SENSe] :SWEep:EGATe:VIEW:STARt?
Example	SWE:EGAT:VIEW:STAR 10ms
Notes	Units of time are required or no units; otherwise an invalid suffix error message will be generated. See error -131.

Preset	0 ms
State Saved	Saved in instrument state
Min	0
Max	500 ms
Initial S/W Revision	A.10.00

Gate Delay

Controls the length of time from the time the gate condition goes True until the gate is turned on.

Key Path	Sweep/Control, Gate
Remote Command	[:SENSe] :SWEep:EGATe:DELay <time> [:SENSe] :SWEep:EGATe:DELay?
Example	SWE:EGAT:DELay 500ms SWE:EGAT:DELay?
Notes	Units of time are required or no units; otherwise an invalid suffix error message will be generated.
Preset	57.7 us WiMAX OFDMA: 71 us GSM/EDGE: 600 us WLAN: 500 us WLAN: 36 us
State Saved	Saved in instrument state
Min	0.0 us
Max	100 s
Backwards Compatibility SCPI	[:SENSe] :SWEep:TIME:GATE:DELay ESA compatibility
Initial S/W Revision	Prior to A.02.00

Gate Length

Controls the length of time that the gate is on after it opens.

Key Path	Sweep/Control, Gate
Remote Command	[:SENSe] :SWEep:EGATe:LENGth <time> [:SENSe] :SWEep:EGATe:LENGth?
Example	SWE:EGAT:LENG 1 SWE:EGAT:LENG?

Notes	Units of time are required or no units; otherwise an invalid suffix error message will be generated.
Preset	461.6 us WiMAX OFDMA: 50 us GSM/EDGE: 200 us WLAN: 1.54 ms WLAN: 32 us
State Saved	Saved in instrument state
Min	100 ns
Max	5 s
Backwards Compatibility SCPI	[:SENSe] :SWEep:TIME:GATE:LENGth ESA compatibility
Initial S/W Revision	Prior to A.02.00

Gate Source

The menus under the Gate Source key are the same as those under the Trigger key, with the exception that neither Free Run nor Video are available as Gate Source selections. However, a different SCPI command is used to select the Gate Source (see table below) because you may independently set the Gate Source and the Trigger Source.

Any changes to the settings in the setup menus under each Gate Source selection key (for example: Trigger Level, Trigger Delay, etc.) also affect the corresponding settings under the Trigger menu keys. The SCPI commands used for these are the same for Trigger and Gate, since there is only one setting which affects both Gate and Trigger. Example: to set the Trigger Level for External 1 you use the command :TRIG:EXT1:LEV regardless of whether you are using External 1 as a Trigger Source or a Gate Source.

Key Path	Sweep/Control, Gate
Remote Command	[:SENSe] :SWEep:EGATE:SOURce EXTernal1 EXTernal2 LINE FRAME RFBurst [:SENSe] :SWEep:EGATE:SOURce?
Dependencies	In some models, there is no second External input. In these models, the External 2 key is blanked and the EXTernal2 parameter will generate a "Hardware missing; Not available for this model number" error.
Preset	EXTernal 1 GSM/EDGE, MSR: FRAME LTETDD: EXTernal 1 When Direction is Downlink, FRAME when Direction is Uplink.
Initial S/W Revision	Prior to A.02.00
Modified at S/W Revision	A.03.00, A.14.00

Video (IF Envelope)

Pressing this key, when it is not selected, selects the video signal as the trigger. The Video trigger condition is met when the video signal (the filtered and detected version of the input signal, including both RBW and VBW filtering) crosses the video trigger level.

NOTE

When the detector selected for all active traces is the average detector, the video signal for triggering does not include any VBW filtering.

The video trigger level is shown as a labeled line on the display. The line is displayed as long as video is the selected trigger source.

Pressing this key, when it is already selected, accesses the video trigger setup functions.

Key Path	Trigger
Example	TRIG:SOUR VID Swept SA measurement TRIG:<meas>:SOUR VID Measurements other than Swept SA
Notes	Log Plot and Spot Frequency measurements do not support Video Trigger
Dependencies	Video trigger is allowed in average detector mode.
State Saved	Saved in instrument state
Status Bits/OPC dependencies	The Status Operation Register bit 5 "Waiting for Trigger" is set at the same time as the Sweeping or Measuring bit is set. It is cleared when the trigger actually occurs (that is, after the trigger event occurs and all the applicable trigger criteria have been met). A corresponding pop-up message ("Waiting for trigger") is generated if no trigger signal appears after approximately 2 sec. This message goes away when a trigger signal appears.
Backwards Compatibility Notes	In the past, the Average detector was not available when Video triggering was on, and consequently, functions that set the detector to average (such as Marker Noise or Band/Intvl Power) were not available when the video trigger was on. Similarly, Video triggering was not available when the detector was Average. In the X-Series, these restrictions are removed.
Initial S/W Revision	Prior to A.02.00

Trigger Level

Sets a level for the video signal trigger. When the video signal crosses this level, with the chosen slope, the trigger occurs. This level is displayed with a horizontal line only if **Video** is the selected trigger source.

Key Path	Trigger, Video
Remote Command	:TRIGger[:SEquence]:VIDeo:LEVel <ampl> :TRIGger[:SEquence]:VIDeo:LEVel?
Example	TRIG:VID:LEV -40 dBm
Notes	When sweep type = FFT, the video trigger uses the amplitude envelope in a bandwidth wider than the FFT width as a trigger source. This might often be useful, but does not have the same relationship between the displayed trace and the trigger level as in swept triggering. Amplitude Corrections are not taken into account by the Video Trig Level. For example, if you have given yourself effective gain with an amplitude correction factor, the Video Trigger will not fire until

you have dropped the trigger line that far below the displayed signal level, rather than simply dropping it down to the displayed signal level.
Note that other corrections, specifically External Gain and Ref Level Offset, modify the actual trace data as it is taken and therefore ARE taken into account by Trig Level.

Couplings	This same level is used for the Video trigger source in the Trigger menu and for the Video selection in the Gate Source menu.
Preset	Set the Video Trigger Level -25 dBm on Preset. When the Video Trigger Level becomes the active function, if the value is off screen, set it to either the top or bottom of screen, depending on which direction off screen it was.
State Saved	Saved in instrument state
Min	-170 dBm
Max	+30 dBm
Default Unit	Depends on the current selected Y axis unit
Backwards Compatibility SCPI	:TRIGger[:SEquence]:IF:LEVel :TRIGger[:SEquence]:IF:LEVel?
Backwards Compatibility Notes	This alias is provided for backward compatibility with VSA/PSA comms apps.
Initial S/W Revision	Prior to A.02.00

Trig Slope

Controls the trigger polarity. It is set positive to trigger on a rising edge and negative to trigger on a falling edge.

Key Path	Trigger, Video
Remote Command	:TRIGger[:SEquence]:VIDeo:SLOPe POSitive NEGative :TRIGger[:SEquence]:VIDeo:SLOPe?
Example	TRIG:VID:SLOP NEG
Preset	POSitive
State Saved	Saved in instrument state
Backwards Compatibility SCPI	:TRIGger[:SEquence]:IF:SLOPe NEGative POSitive :TRIGger[:SEquence]:IF:SLOPe? For backward compatibility with VSA/PSA comms apps
Backwards Compatibility Notes	The legacy :TRIGger[:SEquence]:SLOPe command affects the slopes for the VID, LINE, EXT1, EXT2, and RFB triggers.
Initial S/W Revision	Prior to A.02.00
Remote Command	:TRIGger[:SEquence]:SLOPe POSitive NEGative

	:TRIGger[:SEquence]:SLOPe?
Example	TRIG:SLOP NEG
Preset	POSitive
State Saved	Saved in instrument state
Backwards Compatibility Notes	In ESA/PSA, the Trigger Slope was global to all triggers. In the X-Series, the slope can be set individually for each Trigger Source. For backward compatibility, the global SLOPe command updates all instances of trigger slope (VID, LINE, EXT1, EXT2, TV, RFB). The query returns the trigger slope setting of the currently selected trigger source.
Initial S/W Revision	Prior to A.02.00

External 1

Pressing this key, when it is not selected, selects an external input signal as the trigger. A new sweep/measurement will start when the external trigger condition is met using the external 1 input connector on the rear panel.

Pressing this key, when it is already selected, accesses the external 1 trigger setup menu.

Key Path	Trigger
Example	TRIG:SOUR EXT1 Swept SA measurement TRIG:<meas>:SOUR EXT1 Measurements other than Swept SA
Dependencies	Grayed out if in use by Point Trigger in the Source Setup menu. Forced to Free Run if already selected and Point Trigger is set to External 1.
State Saved	Saved in instrument state
Status Bits/OPC dependencies	The Status Operation Register bit 5 "Waiting for Trigger" is set at the same time as the Sweeping or Measuring bit is set. It is cleared when the trigger actually occurs (that is, after the trigger event occurs and all the applicable trigger criteria have been met). A corresponding pop-up message ("Waiting for trigger") is generated if no trigger signal appears after approximately 2 sec. This message goes away when a trigger signal appears.
Initial S/W Revision	Prior to A.02.00

Trigger Level

Sets the value where the external 1 trigger input will trigger a new sweep/measurement.

Key Path	Trigger, External 1
Remote Command	:TRIGger[:SEquence]:EXTernal1:LEVel <level> :TRIGger[:SEquence]:EXTernal1:LEVel?
Example	TRIG:EXT1:LEV 0.4 V
Couplings	This same level is used for the Ext1 trigger source in the Trigger menu, for the Ext1 selection in the Periodic Timer sync source (in the Trigger menu and in the Gate Source menu), and also for the Ext1

	selection in the Gate Source menu.
Preset	1.2 V
State Saved	Saved in instrument state
Min	-5 V
Max	5 V
Default Unit	V
Backwards Compatibility SCPI	:TRIGger[:SEquence]:EXTernal:LEVel
Backwards Compatibility SCPI	For backward compatibility, the parameter EXTernal is mapped to EXTernal1
Backwards Compatibility SCPI	:TRIGger[:SEquence]:FRAMe:EXTernal1:LEVel
Initial S/W Revision	Prior to A.02.00

Trig Slope

Controls the trigger polarity. It is set positive to trigger on a rising edge and negative to trigger on a falling edge.

Key Path	Trigger, External 1
Remote Command	:TRIGger[:SEquence]:EXTernal1:SLOPe POSitive NEGative :TRIGger[:SEquence]:EXTernal1:SLOPe?
Example	TRIG:EXT1:SLOP NEG
Couplings	This same slope is used in the Ext1 selection for the trigger source in the Trigger menu and for the period timer sync source (in the Trigger menu and in the Gate Source menu).
Preset	POSitive
State Saved	Saved in instrument state
Backwards Compatibility SCPI	:TRIGger[:SEquence]:EXTernal:SLOPe
Backwards Compatibility SCPI	For backward compatibility, the parameter EXTernal is mapped to EXTernal1
Backwards Compatibility SCPI	:TRIGger[:SEquence]:FRAMe:EXTernal1:SLOPe
Backwards Compatibility Notes	The legacy :TRIGger[:SEquence]:SLOPe command affects the slopes for the VID, LINE, EXT1, EXT2, and RFB triggers.
Initial S/W Revision	Prior to A.02.00

Zero Span Delay Comp On/Off

In zero span, there is a natural delay in the signal path, which comes from the RBW filter. This is usually desirable, as it allows you to trigger on events and also see those events, because the signal is delayed from the trigger event. However, in some cases it is desirable to eliminate this delay, so that trigger events line up exactly with the zero time point in zero span. You can use the Zero Span Delay Comp On/Off feature to enable or disable zero span delay compensation.

Key Path	Trigger, External 1
Remote Command	:TRIGger[:SEquence]:EXTErnal1:DELAy:COMPensation OFF ON 0 1 :TRIGger[:SEquence]:EXTErnal1:DELAy:COMPensation?
Example	TRIG:EXT1:DEL:COMP ON
Dependencies	No effect except in zero-span, but not locked out in nonzero spans. Blanked in modes that do not support zero-span measurements. If the SCPI command is sent when the key is blanked, an error is returned: -221, "Settings conflict; Feature not supported for this measurement" In analyzers shipping N9060A, this feature requires N9060A-7FP.
Preset	OFF
State Saved	Saved in instrument state
Initial S/W Revision	A.11.00

External 2

Pressing this key, when it is not selected, selects an external input signal as the trigger. A new sweep/measurement will start when the external trigger condition is met using the external 2 input connector. The external trigger 2 input connector is on the rear panel.

Pressing this key, when it is already selected, accesses the external 2 trigger setup menu.

Key Path	Trigger
Example	TRIG:SOUR EXT2 Swept SA measurement TRIG:<meas>:SOUR EXT2 Measurements other than Swept SA
Dependencies	In some models, there is no second External input. In these models, the External 2 key is blanked and the EXTErnal2 parameter will generate a "Hardware missing; Not available for this model number" message. Grayed out if in use by Point Trigger in the Source Setup menu. Forced to Free Run if already selected and Point Trigger is set to External 2.
State Saved	Saved in instrument state
Status Bits/OPC dependencies	The Status Operation Register bit 5 "Waiting for Trigger" is set at the same time as the Sweeping or Measuring bit is set. It is cleared when the trigger actually occurs (that is, after the trigger event occurs and all the applicable trigger criteria have been met). A corresponding pop-up message ("Waiting for trigger") is generated if no trigger signal appears after approximately 2 sec. This message goes away when a trigger signal appears.
Initial S/W Revision	Prior to A.02.00
Modified at S/W Revision	A.03.00

Trigger Level

Sets the value where the external 2 trigger input will trigger a new sweep/measurement.

Key Path	Trigger, External 2
Remote Command	:TRIGger[:SEquence]:EXTernal2:LEVel :TRIGger[:SEquence]:EXTernal2:LEVel?
Example	TRIG:EXT2:LEV 1.1 V
Couplings	This same level is used for the Ext2 trigger source in the Trigger menu, for the Ext2 selection in the Periodic Timer sync source (in the Trigger menu and in the Gate Source menu), and also for the Ext2 selection in the Gate Source menu.
Preset	1.2 V
State Saved	Saved in instrument state
Min	-5 V
Max	5 V
Default Unit	V
Backwards Compatibility SCPI	:TRIGger[:SEquence]:FRAMe:EXTernal2:LEVel
Initial S/W Revision	Prior to A.02.00

Trig Slope

Controls the trigger polarity. It is set positive to trigger on a rising edge and negative to trigger on a falling edge.

Key Path	Trigger, External 2
Remote Command	:TRIGger[:SEquence]:EXTernal2:SLOPe POSitive NEGative :TRIGger[:SEquence]:EXTernal2:SLOPe?
Example	TRIG:EXT2:SLOP NEG
Couplings	This same slope is used in the Ext2 selection for the trigger source in the Trigger menu and for the period timer sync source (in the Trigger menu and in the Gate Source menu).
Preset	POSitive
State Saved	Saved in instrument state
Backwards Compatibility SCPI	:TRIGger[:SEquence]:FRAMe:EXTernal2:SLOPe
Backwards Compatibility Notes	The legacy :TRIGger[:SEquence]:SLOPe command affects the slopes for the VID, LINE, EXT1, EXT2, and RFB triggers.
Initial S/W Revision	Prior to A.02.00

Zero Span Delay Comp On/Off

In zero span, there is a natural delay in the signal path, which comes from the RBW filter. This is usually desirable, as it allows you to trigger on events and also see those events, because the signal is delayed from the trigger event. However, in some cases it is desirable to eliminate this delay, so that trigger

events line up exactly with the zero time point in zero span. You can use the Zero Span Delay Comp On/Off feature to enable or disable zero span delay compensation.

Key Path	Trigger, External 2
Remote Command	:TRIGger[:SEquence]:EXTernal2:DElay:COMPensation OFF ON 0 1 :TRIGger[:SEquence]:EXTernal2:DElay:COMPensation?
Example	TRIG:EXT2:DEL:COMP ON
Dependencies	No effect except in zero-span, but not locked out in nonzero spans. Blanked in modes that do not support zero-span measurements. If the SCPI command is sent when the key is blanked, an error is returned: -221, "Settings conflict; Feature not supported for this measurement" In analyzers shipping N9060A, this feature requires N9060A-7FP.
Preset	OFF
State Saved	Saved in instrument state
Initial S/W Revision	A.11.00

RF Burst

Pressing this key, when it is not selected, selects the RF Burst as the trigger. A new sweep/measurement will start when an RF burst envelope signal is identified from the signal at the RF Input connector. Pressing this key, when it is already selected, accesses the RF Burst trigger setup menu.

In some models, a variety of burst trigger circuitry is available, resulting in various available burst trigger bandwidths. The analyzer automatically chooses the appropriate trigger path based on the hardware configuration and other settings of the analyzer.

Key Path	Trigger
Example	TRIG:SOUR RFB Swept SA measurement TRIG:<meas>:SOUR RFB Measurements other than Swept SA
State Saved	Saved in instrument state
Status Bits/OPC dependencies	The Status Operation Register bit 5 "Waiting for Trigger" is set at the same time as the Sweeping or Measuring bit is set. It is cleared when the trigger actually occurs (that is, after the trigger event occurs and all the applicable trigger criteria have been met). A corresponding pop-up message ("Waiting for trigger") is generated if no trigger signal appears after approximately 2 sec. This message goes away when a trigger signal appears.
Backwards Compatibility Notes	The legacy command: :TRIGger[:SEquence]:RFBurst:FSElectivity[:STATe] OFF ON 0 1 is not supported in the X-Series, as the hardware to do Frequency Selective burst triggers does not exist in X-Series.
Initial S/W Revision	Prior to A.02.00
Modified at S/W Revision	A.04.00

Absolute Trigger Level

Sets the absolute trigger level for the RF burst envelope.

When using the External Mixing path, the Absolute Trigger Level is uncalibrated because the factory default was set to accommodate the expected IF levels for the RF path.

Key Path	Trigger, RF Burst
Scope	Meas Global
Remote Command	:TRIGger[:SEquence]:RFBurst:LEVel:ABSolute <ampl> :TRIGger[:SEquence]:RFBurst:LEVel:ABSolute?
Example	TRIG:RFB:LEV:ABS 10 dBm sets the trigger level of the RF burst envelope signal to the absolute level of 10 dBm
Notes	Sending this command does not switch the setting from relative to absolute; to switch it you need to send the :TRIGger[:SEquence]:RFBurst:LEVel:TYPE command, below. Amplitude Corrections are not taken into account by the Absolute Trigger Level. For example, if you have given yourself effective gain with an amplitude correction factor, the Absolute Trigger will not fire until you have set the trigger level that far below the displayed signal level, rather than simply to the displayed signal level. This is only true for Amplitude Corrections, not External Gain or Ref Level Offset functions. If mode is Bluetooth, the default value is -50 dBm.
Couplings	This same level is used for the RF Burst trigger source in the Trigger menu, for the RF Burst selection in the Periodic Timer sync source (in the Trigger menu and in the Gate Source menu), and also for the RF Burst selection in the Gate Source menu
Preset	-20 dBm
State Saved	Saved in instrument state
Min	-200 dBm
Max	100 dBm
Default Unit	depends on the current selected Y-Axis unit
Backwards Compatibility SCPI	:TRIGger[:SEquence]:FRAME:RFBurst:LEVel:ABSolute
Initial S/W Revision	Prior to A.02.00
Modified at S/W Revision	A.04.00

Key Path	Trigger, RF Burst
Remote Command	:TRIGger[:SEquence]:RFBurst:LEVel:TYPE ABSolute RELative :TRIGger[:SEquence]:RFBurst:LEVel:TYPE?
Example	TRIG:RFB:LEV:TYPE REL sets the trigger level type of the RF burst trigger to Relative.
Preset	ABSolute
State Saved	Saved in instrument state
Initial S/W Revision	Prior to A.02.00
Modified at S/W Revision	A.04.00

Relative Trigger Level

Sets the relative trigger level for the RF burst envelope.

In some models, the relative burst trigger function is implemented in hardware. In other models, without the advanced triggering hardware required, the relative burst trigger function is implemented in software in some measurements, and is unavailable in other measurements.

When implemented in software, the relative RF Burst trigger function is implemented as follows:

1. The measurement starts with the absolute RF Burst trigger setting. If it cannot get a trigger with that level, auto trigger fires and the acquisition starts anyway. After the acquisition, the measurement searches for the peak in the acquired waveform and saves it.
2. Now, in the next cycle of the measurement, the measurement determines a new absolute RF Burst level based on the peak value from the first measurement and the Relative RF Burst Trigger Level (always 0 or negative dB) set by the user. The following formula is used:
3. absolute RF Burst level = peak level of the previous acquisition + relative RF Burst level
4. If the new absolute RF Burst level differs from the previous by more than 0.5 dB, the new level is sent to the hardware; otherwise it is not updated (to avoid slowing down the acquisition)

Steps 2 and 3 repeat for subsequent measurements.

Key Path	Trigger, RF Burst
Scope	Meas Global
Remote Command	:TRIGger[:SEquence]:RFBurst:LEVel:RELative <rel_ampl> :TRIGger[:SEquence]:RFBurst:LEVel:RELative?
Example	TRIG:RFB:LEV:REL -10 dB sets the trigger level of the RF burst envelope signal to the relative level of -10 dB
Notes	Sending this command does not switch the setting from absolute to relative; to switch it you need to send the :TRIGger[:SEquence]:RFBurst:LEVel:TYPE command, above. The relative trigger level is not available in some measurements. In those measurements the RELative parameter, and the :TRIGger[:SEquence]:RFBurst:LEVel:TYPE command (above), will generate an error if sent.
Dependencies	This key is grayed out and Absolute Trigger Level selected if the required hardware is not present in your analyzer and the current measurement does not support Relative triggering.
Preset	-6 dB GSM: -25 dB
State Saved	Saved in instrument state
Min	-45 dB
Max	0 dB
Default Unit	dB or dBc
Backwards Compatibility SCPI	:TRIGger[:SEquence]:RFBurst:LEVel This legacy command is aliased to :TRIGger[:SEquence]:RFBurst:LEVel:RELative because the PSA

	had ONLY relative burst triggering
Initial S/W Revision	Prior to A.02.00
Modified at S/W Revision	A.04.00

Trigger Slope

It is set positive to trigger on a rising edge and negative to trigger on a falling edge.

Key Path	Trigger, RF Burst
Remote Command	:TRIGger[:SEquence]:RFBurst:SLOPe POSitive NEGative :TRIGger[:SEquence]:RFBurst:SLOPe?
Example	TRIG:RFB:SLOP NEG
Couplings	This same slope is used in the RF Burst selection for the trigger source in the Trigger menu and for the period timer sync source (in the Trigger menu and in the Gate Source menu).
Preset	POSitive
State Saved	Saved in instrument state
Backwards Compatibility SCPI	:TRIGger[:SEquence]:FRAME:RFBurst:SLOPe
Backwards Compatibility Notes	The legacy :TRIGger[:SEquence]:SLOPe command affects the slopes for the VID, LINE, EXT1, EXT2, and RFB triggers.
Initial S/W Revision	Prior to A.02.00

Periodic Timer (Frame Trigger)

Pressing this key, when it is not selected, selects the internal periodic timer signal as the trigger. Triggering occurrences are set by the **Period** parameter, which is modified by the **Sync Source** and **Offset**. Pressing this key, when it is already selected, accesses the periodic timer trigger setup functions.

If you do not have a sync source selected (it is Off), then the internal timer will not be synchronized with any external timing events.

Key Path	Trigger
Example	TRIG:SOUR FRAM Swept SA measurement TRIG:<meas>:SOUR FRAM Measurements other than Swept SA
State Saved	Saved in instrument state
Readback	[Sync: <value of Sync Source>], for example, [Sync: External 1]
Status Bits/OPC dependencies	The Status Operation Register bit 5 "Waiting for Trigger" is set at the same time as the Sweeping or Measuring bit is set. It is cleared when the trigger actually occurs (that is, after the trigger event occurs and all the applicable trigger criteria have been met). A corresponding pop-up message ("Waiting for trigger") is generated if no trigger signal appears after approximately 2 sec. This message goes away when a trigger signal appears.
Initial S/W Revision	Prior to A.02.00

Periodic Timer Triggering:

This feature selects the internal periodic timer signal as the trigger. Trigger occurrences are set by the **Periodic Timer** parameter, which is modified by the **Sync Source** and **Offset**.

The figure below shows the action of the periodic timer trigger. Before reviewing the figure, we'll explain some uses for the periodic trigger.

A common application is measuring periodic burst RF signals for which a trigger signal is not easily available. For example, we might be measuring a TDMA radio which bursts every 20 ms. Let's assume that the 20 ms period is very consistent. Let's also assume that we do not have an external trigger source available that is synchronized with the period, and that the signal-to-noise ratio of the signal is not high enough to provide a clean RF burst trigger at all of the analysis frequencies. For example, we might want to measure spurious transmissions at an offset from the carrier that is larger than the bandwidth of the RF burst trigger. In this application, we can set the Periodic Timer to a 20.00 ms period and adjust the offset from that timer to position our trigger just where we want it. If we find that the 20.00 ms is not exactly right, we can adjust the period slightly to minimize the drift between the period timer and the signal to be measured.

A second way to use this feature would be to use **Sync Source** temporarily, instead of **Offset**. In this case, we might tune to the signal in a narrow span and use the RF Burst trigger to synchronize the periodic timer. Then we would turn the sync source off so that it would not miss-trigger. Miss-triggering can occur when we are tuned so far away from the RF burst trigger that it is no longer reliable.

A third example would be to synchronize to a signal that has a reference time element of much longer period than the period of interest. In some CDMA applications, it is useful to look at signals with a short periodicity, by synchronizing that periodicity to the "even-second clock" edge that happens every two seconds. Thus, we could connect the even-second clock trigger to Ext1 and use then Ext1 as the sync source for the periodic timer.

The figure below illustrates this third example. The top trace represents the even-second clock. It causes the periodic timer to synchronize with the leading edge shown. The analyzer trigger occurs at a time delayed by the accumulated offset from the period trigger event. The periodic timer continues to run, and triggers continue to occur, with a periodicity determined by the analyzer time base. The timer output (labeled "late event") will drift away from its ideal time due to imperfect matching between the time base of the signal being measured and the time base of the analyzer, and also because of imperfect setting of the period parameter. But the synchronization is restored on the next even-second clock event. ("Accumulated offset" is described in the in the **Offset** function section.)

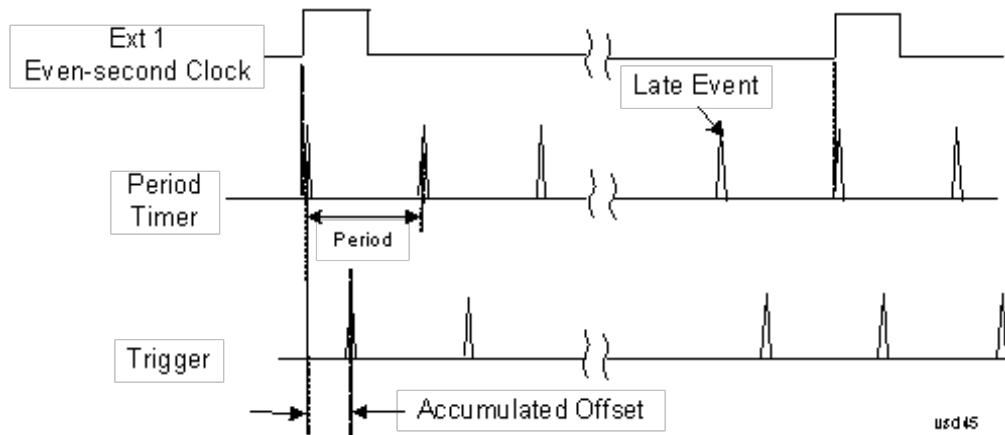

Period

Sets the period of the internal periodic timer clock. For digital communications signals, this is usually set to the frame period of your current input signal. In the case that sync source is not set to OFF, and the external sync source rate is changed for some reason, the periodic timer is synchronized at the every external synchronization pulse by resetting the internal state of the timer circuit.

Key Path	Trigger, Periodic Timer
Remote Command	:TRIGger[:SEquence]:FRAMe:PERiod <time> :TRIGger[:SEquence]:FRAMe:PERiod?
Example	TRIG:FRAM:PER 100 ms
Dependencies	The invalid data indicator turns on when the period is changed, until the next sweep/measurement completes.
Couplings	The same period is used in the Gate Source selection of the period timer.
Preset	20 ms GSM: 4.615383
State Saved	Saved in instrument state
Min	100.000 ns
Max	559.0000 ms
Default Unit	S
Initial S/W Revision	Prior to A.02.00

Offset

Adjusts the accumulated offset between the periodic timer events and the trigger event. Adjusting the accumulated offset is different than setting an offset, and requires explanation.

The periodic timer is usually not synchronized with any external events, so the timing of its output events has no absolute meaning. Since the timing relative to external events (RF signals) is important, you need to be able to adjust (offset) it. However, you have no direct way to see when the periodic timer events occur. All that you can see is the trigger timing. When you want to adjust the trigger timing, you will be changing the internal offset between the periodic timer events and the trigger event. Because the absolute value of

that internal offset is unknown, we will just call that the accumulated offset. Whenever the Offset parameter is changed, you are changing that accumulated offset. You can reset the displayed offset using Reset Offset Display. Changing the display does not change the value of the accumulated offset, and you can still make additional changes to accumulated offset.

To avoid ambiguity, we define that an increase in the "offset" parameter, either from the knob or the SCPI adjust command, serves to delay the timing of the trigger event.

Key Path	Trigger, Periodic Timer
Remote Command	:TRIGger[:SEquence]:FRAMe:OFFSet <time> :TRIGger[:SEquence]:FRAMe:OFFSet?
Example	TRIG:FRAM:OFFS 1.2 ms
Notes	The front panel interface (for example, the knob), and this command, adjust the accumulated offset, which is shown on the active function display. However, the actual amount sent to the hardware each time the offset is updated is the delta value, that is, the current accumulated offset value minus the previous accumulated offset value. Note that the accumulated offset value is essentially arbitrary; it represents the accumulated offset from the last time the offset was zeroed (with the Reset Offset Display key). Note that this command does not change the period of the trigger waveform. Note also that Offset is used only when the sync source is set to OFF, otherwise delay is used, see section "Trig Delay" on page 359 . An increase in the "offset" parameter, either from the knob or the SCPI adjust command, serves to delay the timing of the trigger event.
Notes	When the SCPI command is sent the value shown on the key (and the Active Function, if this happens to be the active function) is updated with the new value. However, the actual amount sent to the hardware is the delta value, that is, the current accumulated offset value minus the previous accumulated offset value. The SCPI query simply returns the value currently showing on the key.
Dependencies	The invalid data indicator turns on when the offset is changed, until the next sweep/measurement completes.
Couplings	The same offset is used in the Gate Source selection of the period timer.
Preset	0 s
State Saved	Saved in instrument state
Min	-10.000 s
Max	10.000 s
Default Unit	S
Initial S/W Revision	Prior to A.02.00

Offset Adjust (Remote Command Only)

This remote command does not work at all like the related front panel keys. This command lets you advance the phase of the frame trigger by the amount you specify.

It does not change the period of the trigger waveform. If the command is sent multiple times, it advances the phase of the frame trigger an additional amount each time it is sent. Negative numbers are permitted.

Remote Command	<code>:TRIGger[:SEquence]:FRAMe:ADJust <time></code>
Example	TRIG:FRAM:ADJ 1.2 ms
Notes	Note also that Offset is used only when the sync source is set to OFF, otherwise delay is used, see section "Trig Delay" on page 359 An increase in the "offset" parameter, either from the knob or the SCPI adjust command, serves to delay the timing of the trigger event.
Notes	The front panel interface (for example, the knob) and the :TRIG:FRAM:OFFS command adjust the accumulated offset, which is shown on the active function display. However, the actual amount sent to the hardware is the delta value, that is, the current offset value minus the previous offset value. When the SCPI command is sent the value shown on the key (and the Active Function, if this happens to be the active function) is updated by increasing it (or decreasing it if the value sent is negative) by the amount specified in the SCPI command. This is a "command only" SCPI command, with no query.
Dependencies	The invalid data indicator turns on when the offset is changed, until the next sweep/measurement completes.
Couplings	The same offset is used in the Gate Source selection of the period timer.
Preset	0 s
State Saved	Saved in instrument state
Min	-10.000 s
Max	10.000 s
Default Unit	S
Initial S/W Revision	Prior to A.02.00

Reset Offset Display

Resets the value of the periodic trigger offset display setting to 0.0 seconds. The current displayed trigger location may include an offset value defined with the Offset key. Pressing this key redefines the currently displayed trigger location as the new trigger point that is 0.0 s offset. The Offset key can then be used to add offset relative to this new timing.

Key Path	Trigger, Periodic Timer
Remote Command	<code>:TRIGger[:SEquence]:FRAMe:OFFSet:DISPlay:RESet</code>
Example	TRIG:FRAM:OFFS:DISP:RES
Initial S/W Revision	Prior to A.02.00

Sync Source

Selects a signal source for you to synchronize your periodic timer trigger to, otherwise you are triggering at some arbitrary location in the frame. Synchronization reduces the precision requirements on the setting of the period.

For convenience you may adjust the level and slope of the selected sync source in a conditional branch setup menu accessed from the Sync Source menu. Note that these settings match those in the **Trigger** and **Gate Source** menus; that is, each trigger source has only one value of level and slope, regardless of which menu it is accessed from.

Key Path	Trigger, Periodic Timer
Remote Command	:TRIGger[:SEquence]:FRAMe:SYNC EXTernal1 EXTernal2 RFBurst OFF :TRIGger[:SEquence]:FRAMe:SYNC?
Example	TRIG:FRAM:SYNC EXT2
Dependencies	In some models, there is no second External input. In these models, the External 2 key is blanked and the EXTernal2 parameter will generate a "Hardware missing; Not available for this model number" message.
Preset	Off GSM/EDGE, MSR,LTE,LTETDD: RFBurst
State Saved	Saved in instrument state
Readback	The current setting is read back to this key and it is also Readback to the previous Periodic Timer trigger key.
Backwards Compatibility SCPI	:TRIGger[:SEquence]:FRAMe:SYNC EXTernal For backward compatibility, the parameter EXTernal is mapped to EXTernal1
Initial S/W Revision	Prior to A.02.00
Modified at S/W Revision	A.03.00, A.14.00

Off

Turns off the sync source for your periodic trigger. With the sync source off, the timing will drift unless the signal source frequency is locked to the analyzer frequency reference.

Key Path	Trigger, Periodic Timer, Sync Source
Example	TRIG:FRAM:SYNC OFF
Readback	Off
Initial S/W Revision	Prior to A.02.00

External 1

Pressing this key, when it is not selected, selects an external input signal as the trigger. A new sweep/measurement will start when the external trigger condition is met using the external 1 input connector on the rear panel.

Pressing this key, when it is already selected, accesses the external 1 trigger setup menu.

Key Path	Trigger
Example	TRIG:SOUR EXT1 Swept SA measurement

	TRIG:<meas>:SOUR EXT1 Measurements other than Swept SA
Dependencies	Grayed out if in use by Point Trigger in the Source Setup menu. Forced to Free Run if already selected and Point Trigger is set to External 1.
State Saved	Saved in instrument state
Status Bits/OPC dependencies	The Status Operation Register bit 5 "Waiting for Trigger" is set at the same time as the Sweeping or Measuring bit is set. It is cleared when the trigger actually occurs (that is, after the trigger event occurs and all the applicable trigger criteria have been met). A corresponding pop-up message ("Waiting for trigger") is generated if no trigger signal appears after approximately 2 sec. This message goes away when a trigger signal appears.
Initial S/W Revision	Prior to A.02.00

Trigger Level

Sets the value where the external 1 trigger input will trigger a new sweep/measurement.

Key Path	Trigger, External 1
Remote Command	:TRIGger[:SEquence]:EXTernal:LEVel <level> :TRIGger[:SEquence]:EXTernal:LEVel?
Example	TRIG:EXT1:LEV 0.4 V
Couplings	This same level is used for the Ext1 trigger source in the Trigger menu, for the Ext1 selection in the Periodic Timer sync source (in the Trigger menu and in the Gate Source menu), and also for the Ext1 selection in the Gate Source menu.
Preset	1.2 V
State Saved	Saved in instrument state
Min	-5 V
Max	5 V
Default Unit	V
Backwards Compatibility SCPI	:TRIGger[:SEquence]:EXTernal:LEVel For backward compatibility, the parameter EXTernal is mapped to EXTernal1
Backwards Compatibility SCPI	:TRIGger[:SEquence]:FRAMe:EXTernal1:LEVel
Initial S/W Revision	Prior to A.02.00

Trig Slope

Controls the trigger polarity. It is set positive to trigger on a rising edge and negative to trigger on a falling edge.

Key Path	Trigger, External 1
Remote Command	:TRIGger[:SEquence]:EXTernal:SLOPe POSitive NEGative

	:TRIGger[:SEQuence]:EXTernal1:SLOPe?
Example	TRIG:EXT1:SLOP NEG
Couplings	This same slope is used in the Ext1 selection for the trigger source in the Trigger menu and for the period timer sync source (in the Trigger menu and in the Gate Source menu).
Preset	POSitive
State Saved	Saved in instrument state
Backwards Compatibility SCPI	:TRIGger[:SEQuence]:EXTernal:SLOPe For backward compatibility, the parameter EXTernal is mapped to EXTernal1
Backwards Compatibility SCPI	:TRIGger[:SEQuence]:FRAMe:EXTernal1:SLOPe
Backwards Compatibility Notes	The legacy :TRIGger[:SEQuence]:SLOPe command affects the slopes for the VID, LINE, EXT1, EXT2, and RFB triggers.
Initial S/W Revision	Prior to A.02.00

External 2

Pressing this key, when it is not selected, selects an external input signal as the trigger. A new sweep/measurement will start when the external trigger condition is met using the external 2 input connector. The external trigger 2 input connector is on the rear panel.

Pressing this key, when it is already selected, accesses the external 2 trigger setup menu.

Key Path	Trigger
Example	TRIG:SOUR EXT2 Swept SA measurement TRIG:<meas>:SOUR EXT2 Measurements other than Swept SA
Dependencies	In some models, there is no second External input. In these models, the External 2 key is blanked and the EXTernal2 parameter will generate a "Hardware missing; Not available for this model number" message. Grayed out if in use by Point Trigger in the Source Setup menu. Forced to Free Run if already selected and Point Trigger is set to External 2.
State Saved	Saved in instrument state
Status Bits/OPC dependencies	The Status Operation Register bit 5 "Waiting for Trigger" is set at the same time as the Sweeping or Measuring bit is set. It is cleared when the trigger actually occurs (that is, after the trigger event occurs and all the applicable trigger criteria have been met). A corresponding pop-up message ("Waiting for trigger") is generated if no trigger signal appears after approximately 2 sec. This message goes away when a trigger signal appears.
Initial S/W Revision	Prior to A.02.00
Modified at S/W Revision	A.03.00

Trigger Level

Sets the value where the external 2 trigger input will trigger a new sweep/measurement.

Key Path	Trigger, External 2
Remote Command	:TRIGger[:SEquence]:EXTernal2:LEVel :TRIGger[:SEquence]:EXTernal2:LEVel?
Example	TRIG:EXT2:LEV 1.1 V
Couplings	This same level is used for the Ext2 trigger source in the Trigger menu, for the Ext2 selection in the Periodic Timer sync source (in the Trigger menu and in the Gate Source menu), and also for the Ext2 selection in the Gate Source menu.
Preset	1.2 V
State Saved	Saved in instrument state
Min	-5 V
Max	5 V
Default Unit	V
Backwards Compatibility SCPI	:TRIGger[:SEquence]:FRAMe:EXTernal2:LEVel
Initial S/W Revision	Prior to A.02.00

Trig Slope

Controls the trigger polarity. It is set positive to trigger on a rising edge and negative to trigger on a falling edge.

Key Path	Trigger, External 2
Remote Command	:TRIGger[:SEquence]:EXTernal2:SLOPe POSitive NEGative :TRIGger[:SEquence]:EXTernal2:SLOPe?
Example	TRIG:EXT2:SLOP NEG
Couplings	This same slope is used in the Ext2 selection for the trigger source in the Trigger menu and for the period timer sync source (in the Trigger menu and in the Gate Source menu).
Preset	POSitive
State Saved	Saved in instrument state
Backwards Compatibility SCPI	:TRIGger[:SEquence]:FRAMe:EXTernal2:SLOPe
Backwards Compatibility Notes	The legacy :TRIGger[:SEquence]:SLOPe command affects the slopes for the VID, LINE, EXT1, EXT2, and RFB triggers.
Initial S/W Revision	Prior to A.02.00

RF Burst

Pressing this key, when it is not selected, selects the RF Burst as the trigger. A new sweep/measurement will start when an RF burst envelope signal is identified from the signal at the RF Input connector. Pressing this key, when it is already selected, accesses the RF Burst trigger setup menu.

In some models, a variety of burst trigger circuitry is available, resulting in various available burst trigger bandwidths. The analyzer automatically chooses the appropriate trigger path based on the hardware configuration and other settings of the analyzer.

Key Path	Trigger
Example	TRIG:SOUR RFB Swept SA measurement TRIG:<meas>:SOUR RFB Measurements other than Swept SA
State Saved	Saved in instrument state
Status Bits/OPC dependencies	The Status Operation Register bit 5 "Waiting for Trigger" is set at the same time as the Sweeping or Measuring bit is set. It is cleared when the trigger actually occurs (that is, after the trigger event occurs and all the applicable trigger criteria have been met). A corresponding pop-up message ("Waiting for trigger") is generated if no trigger signal appears after approximately 2 sec. This message goes away when a trigger signal appears.
Backwards Compatibility Notes	The legacy command: :TRIGger[:SEquence]:RFBurst:FSElectivity[:STATe] OFF ON 0 1 is not supported in the X-Series, as the hardware to do Frequency Selective burst triggers does not exist in X-Series.
Initial S/W Revision	Prior to A.02.00
Modified at S/W Revision	A.04.00

Absolute Trigger Level

Sets the absolute trigger level for the RF burst envelope.

When using the External Mixing path, the Absolute Trigger Level is uncalibrated because the factory default was set to accommodate the expected IF levels for the RF path.

Key Path	Trigger, RF Burst
Scope	Meas Global
Remote Command	:TRIGger[:SEquence]:RFBurst:LEVel:ABSolute <ampl> :TRIGger[:SEquence]:RFBurst:LEVel:ABSolute?
Example	TRIG:RFB:LEV:ABS 10 dBm sets the trigger level of the RF burst envelope signal to the absolute level of 10 dBm
Notes	Sending this command does not switch the setting from relative to absolute; to switch it you need to send the :TRIGger[:SEquence]:RFBurst:LEVel:TYPE command, below. Amplitude Corrections are not taken into account by the Absolute Trigger Level. For example, if you have given yourself effective gain with an amplitude correction factor, the Absolute Trigger will not fire until you have set the trigger level that far below the displayed signal level, rather than simply to the displayed signal level. This is only true for Amplitude Corrections, not External Gain or Ref Level Offset functions. If mode is Bluetooth, the default value is -50 dBm.
Couplings	This same level is used for the RF Burst trigger source in the Trigger menu, for the RF Burst selection in the Periodic Timer sync source (in the Trigger menu and in the Gate Source menu), and also for the

	RF Burst selection in the Gate Source menu
Preset	-20 dBm
State Saved	Saved in instrument state
Min	-200 dBm
Max	100 dBm
Default Unit	depends on the current selected Y-Axis unit
Backwards Compatibility SCPI	:TRIGger[:SEquence]:FRAMe:RFBurst:LEVel:ABSolute
Initial S/W Revision	Prior to A.02.00
Modified at S/W Revision	A.04.00

Key Path	Trigger, RF Burst
Remote Command	:TRIGger[:SEquence]:RFBurst:LEVel:TYPE ABSolute RELative :TRIGger[:SEquence]:RFBurst:LEVel:TYPE?
Example	TRIG:RFB:LEV:TYPE REL sets the trigger level type of the RF burst trigger to Relative.
Preset	ABSolute
State Saved	Saved in instrument state
Initial S/W Revision	Prior to A.02.00
Modified at S/W Revision	A.04.00

Trigger Slope

It is set positive to trigger on a rising edge and negative to trigger on a falling edge.

Key Path	Trigger, RF Burst
Remote Command	:TRIGger[:SEquence]:RFBurst:SLOPe POSitive NEGative :TRIGger[:SEquence]:RFBurst:SLOPe?
Example	TRIG:RFB:SLOP NEG
Couplings	This same slope is used in the RF Burst selection for the trigger source in the Trigger menu and for the period timer sync source (in the Trigger menu and in the Gate Source menu).
Preset	POSitive
State Saved	Saved in instrument state
Backwards Compatibility SCPI	:TRIGger[:SEquence]:FRAMe:RFBurst:SLOPe
Backwards Compatibility Notes	The legacy :TRIGger[:SEquence]:SLOPe command affects the slopes for the VID, LINE, EXT1, EXT2, and RFB triggers.
Initial S/W Revision	Prior to A.02.00

Sync Holdoff

Sync Holdoff specifies the duration that the sync source signal must be kept false before the transition to true to be recognized as the sync timing. The periodic timer phase is aligned when the sync source signal becomes true, after the Holdoff time is satisfied.

A holdoff of 2 ms will work with most WiMAX signals, but there may be cases where the burst off duration is less than 1 ms and this value will need to be changed.

Key Path	Trigger, Periodic Timer
Remote Command	:TRIGger[:SEQuence]:FRAMe:SYNC:HOLDoff <time> :TRIGger[:SEQuence]:FRAMe:SYNC:HOLDoff? :TRIGger[:SEQuence]:FRAMe:SYNC:HOLDoff:STATe OFF ON 0 1 :TRIGger[:SEQuence]:FRAMe:SYNC:HOLDoff:STATe?
Preset	On, 1.000 ms
State Saved	Saved in instrument state
Min	0 ms
Max	+500 ms
Default Unit	s
Initial S/W Revision	Prior to A.02.00

Auto/Holdoff

Opens up a menu that lets you adjust Auto Trigger and Trigger Holdoff parameters

Key Path	Trigger
Readback line	Displays a summary of the Auto Trig and Holdoff settings, in square brackets First line: Auto Off or Auto On Second Line: "HldP" followed by: <ul style="list-style-type: none"> • If Holdoff is Off, readback Off • If Holdoff On and Type = Normal, readback value • If Holdoff On and Type = Above, readback value followed by AL • If Holdoff On and Type = Below, readback value followed by BL • If Holdoff Type selection is not supported by the current measurement, Holdoff Type is always Normal
Initial S/W Revision	A.02.00

Auto Trig

Sets the time that the analyzer will wait for the trigger conditions to be met. If they are not met after that much time, then the analyzer is triggered anyway.

Key Path	Trigger, Auto/Holdoff
Remote Command	:TRIGger[:SEquence]:ATRigger <time> :TRIGger[:SEquence]:ATRigger? :TRIGger[:SEquence]:ATRigger:STATe OFF ON 0 1 :TRIGger[:SEquence]:ATRigger:STATe?
Example	TRIG:ATR:STAT ON TRIG:ATR 100 ms
Notes	The "time that the analyzer will wait" starts when the analyzer is ready for a trigger, which may be hundreds of ms after the data acquisition for a sweep is done. The "time" ends when the trigger condition is satisfied, not when the delay ends.
Preset	Off, 100 ms
State Saved	Saved in instrument state
Min	1 ms
Max	100 s
Default Unit	s
Initial S/W Revision	Prior to A.02.00

Trig Holdoff

Sets the holdoff time between triggers. When the trigger condition is satisfied, the trigger occurs, the delay begins, and the holdoff time begins. New trigger conditions will be ignored until the holdoff time expires. For a free-running trigger, the holdoff value is the minimum time between triggers.

Key Path	Trigger, Auto/Holdoff
Remote Command	:TRIGger[:SEquence]:HOLDoff <time> :TRIGger[:SEquence]:HOLDoff? :TRIGger[:SEquence]:HOLDoff:STATe OFF ON 0 1 :TRIGger[:SEquence]:HOLDoff:STATe?
Example	TRIG:HOLD:STAT ON TRIG:HOLD 100 ms
Dependencies	Unavailable if the selected Input is BBIQ. If this is the case, the key is grayed out if it is pressed the informational message "Feature not supported for this Input" is displayed. If the SCPI command is sent, the error "Settings conflict; Feature not supported for this Input" is generated.
Preset	Off, 100 ms
State Saved	Saved in instrument state
Min	0 s
Max	0.5 s
Default Unit	s
Initial S/W Revision	Prior to A.02.00

Gate Preset (Remote Command Only)

Presets the time-gated spectrum analysis capability.

This command sets gate parameter values to the ESA preset values, as follows:

Gate trigger type = edge

Gate polarity = positive

Gate delay = 1 us

Gate length = 1 us

Remote Command	<code>[[:SENSe]:SWEep:TIME:GATE:PRESet</code> ESA Compatibility
Initial S/W Revision	Prior to A.02.00

Gate Level (Remote Command Only)

Sets the gate input transition point level for the external TRIGGER inputs on the front and rear panel. This is a legacy command for PSA compatibility. It is simply an alias to the equivalent trigger level command.

Remote Command	<code>[[:SENSe]:SWEep:EGATe:EXTernal[1] 2:LEVel <voltage></code> <code>[[:SENSe]:SWEep:EGATe:EXTernal[1] 2:LEVel?</code>
Notes	This command is simply an alias to <code>:TRIGger[:SEQUence]:EXTernal[1] 2:LEVel</code> For details refer
Initial S/W Revision	Prior to A.02.00

Gate Polarity (Remote Command Only)

Sets the polarity for the gate signal. This setup is now done using the gate trigger's slope setting.

When Positive (Pos) is selected, a positive-going edge (Edge) or a high voltage (Level) will satisfy the gate condition, after the delay set with the Gate Delay key. When Negative (Neg) is selected, a negative-going edge (Edge) or a low voltage (Level) will satisfy the gate condition after the delay.

Remote Command	<code>[[:SENSe]:SWEep:EGATe:POLarity NEGative POSitive</code> <code>[[:SENSe]:SWEep:EGATe:POLarity?</code>
Example	<code>SWE:EGAT:POL NEG</code> <code>SWE:EGAT:POL?</code>
Preset	POSitive
State Saved	Saved in instrument state
Backwards Compatibility SCPI	<code>[[:SENSe]:SWEep:TIME:GATE:POLarity</code> ESA compatibility
Initial S/W Revision	Prior to A.02.00

Remote Command	<code>[:SENSe] :SWEep:TIME:GATE:LEVel HIGH LOW</code> <code>[:SENSe] :SWEep:TIME:GATE:LEVel?</code> ESA compatibility
Preset	HIGH
Initial S/W Revision	Prior to A.02.00

Points

Sets the number of points per sweep. The resolution of setting the acquisition time depends on the number of points selected. The current value of points is displayed parenthetically, next to the acquisition time in the lower-right corner of the display.

Key Path	Sweep/Control
Mode	SA, WCDMA, C2K, WIMAX OFDMA, TD-SCDMA, 1xEVDO, ISDB-T, CMMB, LTE, LTETDD, BLUETOOTH, WLAN, MSR
Remote Command	<code>[:SENSe] :OBWidth:SWEep:POINts <integer></code> <code>[:SENSe] :OBWidth:SWEep:POINts?</code>
Example	OBW:SWE:POIN 1500 OBW:SWE:POIN?
Notes	This function is not available when signal identification is set to On (external mixing). Affected by: log sweep Grayed out in measurements that don't support swept Blanked in modes that do not support swept. Whenever the number of sweep points change: - All trace data is erased - Any traces with Update Off also go to Display Off (like going from View to Blank in the older analyzers) - Sweep time is re-quantized - Any limit lines that are on are updated - If averaging/hold is on, averaging/hold starts over
Couplings	Whenever the number of sweep points change, the sweep time is re-quantized.
Preset	LTE, LTETDD, MSR: 2001 Other: 1001
State Saved	Saved in instrument state.
Min	101
Max	20001
Initial S/W Revision	Prior to A.02.00
Modified at S/W Revision	A.03.00

System

See "[System](#)" on page 272

Trace/Detector

Accesses a menu of functions that enable you to control the detectors for the current measurement.

Key Path	Front-panel key
Initial S/W Revision	Prior to A.02.00

Trace Type

Allows you to select the type of trace you want to use for the current measurement.

The first page of this menu contains a 1–of–N selection of the trace type (Clear Write, Average, Max Hold, Min Hold) for the selected trace.

Key Path	Trace/Detector
Mode	SA, WCDMA, C2K, WIMAX OFDMA, TD-SCDMA, 1xEVDO, ISDB-T, CMMB, LTE, LTETDD, BLUETOOTH, WLAN, MSR
Remote Command	:TRACe:OBWidth:TYPE WRITe AVERAge MAXHold MINHold :TRACe:OBWidth:TYPE?
Example	TRAC:OBW:TYPE MINH TRAC:OBW:TYPE?
Notes	WRITe = Clear Write AVERAge = Average MAXHold = Maximum Hold MINHold = Minimum Hold
Couplings	When Detector setting is “Auto” ([[:SENSe]:OBWidth:DETEctor:AUTO?]), Detector ([[:SENSe]:OBWidth:DETEctor:[FUNCTion]?) switches aligning with the switch of this parameter: “NORMal” with WRITe (Clear Write), “AVERAge” with AVERAge, “POSitive (peak)” with MAXHold, and “NEGative (peak)” with MINHold.
Preset	AVERAge BLUETOOTH: MAX HOLD.
State Saved	Saved in instrument state.
Range	WRITe AVERAge MAXHold MINHold
Initial S/W Revision	Prior to A.02.00
Modified at S/W Revision	A.03.00

Detector

Accesses a menu of functions that enables you to control the detectors for the current measurement. The following choices are available:

- **Auto**– the detector selected depends on marker functions, trace functions, average type, and the trace averaging function.

- **Normal**—the detector determines the peak of the CW-like signals, and it yields alternating maximums and minimums of noise-like signals. This is also referred to as Rosenfell detection.
- **Average**—the detector determines the average of the signal within the sweep points. The averaging method depends upon the Average Type selection (voltage, power or log scales).
- **Peak (Positive)**—the detector determines the maximum of the signal within the sweep points.
- **Sample**—the detector indicates the instantaneous level of the signal at the center of the sweep points represented by each display point.
- **Negative Peak**—the detector determines the minimum of the signal within the sweep points.

Key Path	Detector
Initial S/W Revision	Prior to A.02.00

Auto

When the detector choice is Auto, the analyzer selects the detector. The selected detector depends on marker functions, trace functions, and trace averaging functions for the current measurement.

Key Path	Trace/Detector
Remote Command	[[:SENSe]:OBWidth:DETECTOR:AUTO ON OFF 1 0 [:SENSe]:OBWidth:DETECTOR:AUTO?
Example	OBW:DET:AUTO ON OBW:DET:AUTO?
Couplings	When Detector setting is “Auto” ([[:SENSe]:OBWidth:DETECTOR:AUTO?]), Detector ([[:SENSe]:OBWidth:DETECTOR:FUNCTION?]) switches aligning with the switch of this parameter: “NORMal” with Clear Write, “AVERage” with AVERage, “POSitive (peak)” with MAXHold, and “NEGative (peak)” with MINHold.
Preset	ON ISDB-T: OFF
State Saved	Saved in instrument state.
Initial S/W Revision	Prior to A.02.00
Modified at S/W Revision	A.03.00

Detector Selection

Allows you to select a specific detector for the current measurement. When the detector choice is Auto, the analyzer selects the detector. The selected detector depends on marker functions, trace functions, and trace averaging functions for the current measurement.

Key Path	Trace/Detector
Mode	SA, WCDMA, C2K, WIMAX OFDMA, TD-SCDMA, 1xEVDO, ISDB-T, CMMB, LTE, LTETDD, BLUETOOTH, WLAN, MSR

Remote Command	[:SENSe]:OBWidth:DETEctor[:FUNction] NORMal AVERage POSitive SAMPle NEGative [:SENSe]:OBWidth:DETEctor[:FUNction]?
Example	OBW:DET NORM OBW:DET?
Notes	When you manually select a detector (instead of selecting Auto), that detector is used regardless of other analyzer settings. The detector choices are: The Normal detector determines the peak of CW-like signals, and it yields alternating maximums and minimums of noise-like signals. This is also referred to as Rosenfell detection. The Average detector determines the average of the signal within the sweep points. The averaging method is Power Average (RMS). The Peak detector determines the maximum of the signal within the sweep points. The Sample detector indicates the instantaneous level of the signal at the center of the sweep points represented by each display point. The Negative Peak detector determines the minimum of the signal within the sweep points.
Couplings	When Detector setting is "Auto" ([:SENSe]:OBWidth:DETEctor:AUTO?), Detector ([:SENSe]:OBWidth:DETEctor[:FUNction]?) switches aligning with the switch of this parameter: "NORMal" with Clear Write, "AVERage" with AVERage, "POSitive (peak)" with MAXHold, and "NEGative (peak)" with MINHold.
Preset	AVERage ISDB-T: Peak BLUETOOTH: Peak
State Saved	Saved in instrument state.
Range	Normal Average Peak Sample Negative Peak
Initial S/W Revision	Prior to A.02.00
Modified at S/W Revision	A.03.00

Trigger

See ["Trigger" on page 328](#)

Free Run

See ["Free Run " on page 335](#)

Video

See ["Video \(IF Envelope\) " on page 1556](#)

Trigger Level

See ["Trigger Level " on page 1557](#)

Trig Slope

See ["Trig Slope " on page 1558](#)

Trig Delay

See ["Trig Delay " on page 338](#)

External 1

See ["External 1 " on page 1571](#)

Trigger Level

See ["Trigger Level " on page 1571](#)

Trig Slope

See ["Trig Slope " on page 1572](#)

Trig Delay

See ["Trig Delay " on page 341](#)

Zero Span Delay Comp

See ["Zero Span Delay Comp On/Off" on page 1560](#)

External 2

See ["External 2 " on page 1572](#)

Trigger Level

See ["Trigger Level " on page 1573](#)

Trig Slope

See ["Trig Slope " on page 1574](#)

Trig Delay

See "Trig Delay " on page 344

Zero Span Delay Comp

See "Zero Span Delay Comp On/Off" on page 1562

RF Burst

See "RF Burst " on page 1574

Absolute Trigger

See "Absolute Trigger Level" on page 1575

Relative Trigger

See "Relative Trigger Level" on page 1564

Trig Slope

See "Trigger Slope " on page 1576

Trig Delay

See "Trig Delay " on page 348

Periodic Timer

See "Periodic Timer (Frame Trigger) " on page 1566

Period

See "Period " on page 1567

Offset

See "Offset " on page 1568

Reset Offset Display

See "Reset Offset Display " on page 1570

Sync Source

See "Sync Source " on page 1570

Off

See "Off " on page 1571

External 1

See "External 1 " on page 1571

Trigger Level

See ["Trigger Level "](#) on page 1571

Trig Slope

See ["Trig Slope "](#) on page 1572

External 2

See ["External 2 "](#) on page 1572

Trigger Level

See ["Trigger Level "](#) on page 1573

Trig Slope

See ["Trig Slope "](#) on page 1574

RF Burst

See ["RF Burst "](#) on page 1574

Absolute Trigger

See ["Absolute Trigger Level"](#) on page 1575

Trig Slope

See ["Trigger Slope "](#) on page 1576

Trig Delay

See ["Trig Delay"](#) on page 359

Auto/Holdoff

See ["Auto/Holdoff "](#) on page 1577

Auto Trig

See ["Auto Trig "](#) on page 1577

Trig Holdoff

See ["Trig Holdoff "](#) on page 1578

Holdoff Type

See ["Holdoff Type"](#) on page 361

User Preset

Accesses a menu that gives you the following three choices:

- User Preset – recalls a state previously saved using the Save User Preset function.
- User Preset All Modes – presets all of the modes in the analyzer
- Save User Preset– saves the current state for the current mode

NOTE

In products that run multiple instances of the X-Series Application, all instances use the same location to save User Preset state. So Save User Preset of one instance will overwrite the Save User Preset of another instance.

Key Path	Front-panel key
Backwards Compatibility Notes	<p>User Preset is actually loading a state, and in legacy analyzers, it was possible to load a state without affecting the trace data, limit lines or correction data. Similarly it was possible to do a User Preset without affecting the trace data, limit lines or correction data.</p> <p>In the X-Series, “state” always includes all of this data; so whenever state is loaded, or User Preset is executed, all of the traces, limit lines and corrections are affected. Although this differs from previous behavior, it is desirable behavior, and should not cause adverse issues for users.</p> <p>On ESA and PSA, User Preset affected the entire instrument’s state. In the X-Series, User Preset only recalls the state for the active mode. There is a User Preset file for each mode. User Preset can never cause a mode switch as it can in legacy analyzers. If you want to recall all modes to their user preset file state, you will need to do a User Preset after mode switching into each mode.</p> <p>User Preset recalls mode state which can now include data like traces; whereas on ESA and PSA, User Preset did not affect data.</p>
Initial S/W Revision	Prior to A.02.00

User Preset

User Preset sets the state of the currently active mode back to the state that was previously saved for this mode using the Save User Preset menu key or the SCPI command, SYST:PRES:USER:SAV. It not only recalls the Mode Preset settings, but it also recalls all of the mode persistent settings, and the Input/Output system setting that existed at the time Save User Preset was executed.

If a Save User Preset has not been done at any time, User Preset recalls the default user preset file for the currently active mode. The default user preset files are created if, at power-on, a mode detects there is no user preset file. There will never be a scenario when there is no user preset file to restore. For each mode, the default user preset state is the same state that would be saved if a Save User Preset is performed in each mode right after doing a Restore Mode Default and after a Restore Input/Output Defaults.

The User Preset function does the following:

- Aborts the currently running measurement.
- Sets the mode State to the values defined by Save User Preset.
- Makes the saved measurement for the currently running mode the active measurement.
- Brings up the saved menu for the power-on mode.

- Clears the input and output buffers.
- Sets the Status Byte to 0.

Key Path	User Preset
Remote Command	:SYSTem:PRESet:USER
Example	:SYST:PRES:USER:SAVE:SYST:PRES:USER
Notes	:SYST:PRES:USER:SAVE is used to save the current state as the user preset state. Clears all pending OPC bits. The Status Byte is set to 0. Pressing the User Preset front-panel key while already in the User Preset menu will cause the User Preset to get executed
Couplings	A user preset will cause the currently running measurement to be aborted and cause the saved measurement to be active. Recalling a User Preset file has the same issues that recalling a Save State file has. Some settings may need to be limited and therefore re-coupled, since the capabilities of the mode may have changes when the User Preset file was last saved.
Initial S/W Revision	Prior to A.02.00

User Preset All Modes

Recalls all of the User Preset files for each mode, switches to the power-on mode, and activates the saved measurement from the power-on mode User Preset file.

NOTE

When the instrument is secured, all of the user preset files are converted back to their default user preset files.

The User Preset function does the following:

- Aborts the currently running measurement.
- Switches the Mode to the power-on mode.
- Restores the User Preset files for each mode.
- Makes the saved measurement for the power-on mode the active measurement.
- Brings up the saved menu for the power-on mode.
- Clears the input and output buffers.
- Sets the Status Byte to 0.

Key Path	User Preset
Remote Command	:SYSTem:PRESet:USER:ALL
Example	:SYST:PRES:USER:SAVE:SYST:PRES:USER:ALL
Notes	Clears all pending OPC bits. The Status Byte is set to 0. :SYST:PRES:USER:SAVE is used to save the current state as the user preset state.
Couplings	A user preset will cause the currently running measurement to be aborted, cause a mode switch to the power-on mode, and cause the saved measurement to be active in the power-on mode.

Recalling a User Preset file has the same issues that recalling a Save State file has. Some settings may need to be limited and therefore re-coupled, since the capabilities of the mode may have changes when the User Preset file was last saved.

Initial S/W Revision Prior to A.02.00

Save User Preset

Saves the currently active mode and its State. You can recall this User Preset file by pressing the User Preset menu key or sending the SYST:PRES:USER remote command. This same state is also saved by the Save State function.

Key Path	User Preset
Remote Command	:SYSTem:PRESet:USER:SAVE
Example	:SYST:PRES:USER:SAVE
Notes	:SYST:PRES:SAVE creates the same file as if the user requested a *SAV or a MMEM: STOR:STAT, except User Preset Save does not allow the user to specify the filename or the location of the file.
Initial S/W Revision	Prior to A.02.00

View/Display

Accesses a menu of functions that enable you to set the view and display parameters for the current measurement.

There is a single results view available for this measurement. For more details, and samples of screen content for each supported mode, see "[Spectrum View](#)" on page 922 below.

The following result descriptions are available:

Occupied Bandwidth

The occupied bandwidth result is $f_2 - f_1$, where f_1 and f_2 are calculated.

Total Power

The total power is the power integrated in the specified span setting.

Transmit Freq Error

The transmit freq error (transmit frequency error) result is calculated as the difference between $(f_2+f_1)/2$ and the tuned center frequency of the signal, where f_1 and f_2 are calculated.

x dB Bandwidth

The x dB result is a bandwidth measured between two points on the signal which are a certain number of dBs down from the highest signal point within the OBW Span. For example, If the 'x dB' parameter is set to -26 dB, and the 'Occupied BW Span' is set to 10 MHz, then the maximum signal power level is first determined from the 10 MHz wide trace sweep. Next, the two furthest frequencies below (x_{db_f1}) and above (x_{db_f2}) the frequency of the maximum level occurrence are found where the signal level is 26 dB below the peak level. This calculation also uses linear interpolation to find the lower and upper carrier boundary point within the width of a sweep point (the span divided by the number of sweep points).

The x dB bandwidth is calculated to be $x_{db_f2} - x_{db_f1}$.

Spectrum View

NOTE

An asterisk next to the x dB bandwidth value indicates the results may not have been determined with optimal analyzer settings. If this result (emission bandwidth) is your primary interest, select Meas Setup, Max Hold, On. Then, change the detector mode to Peak. Acquiring peak data ensures accuracy of the result.

For SA, WCDMA, C2K, 1xEVDO, WIMAX OFDMA, WLAN modes:

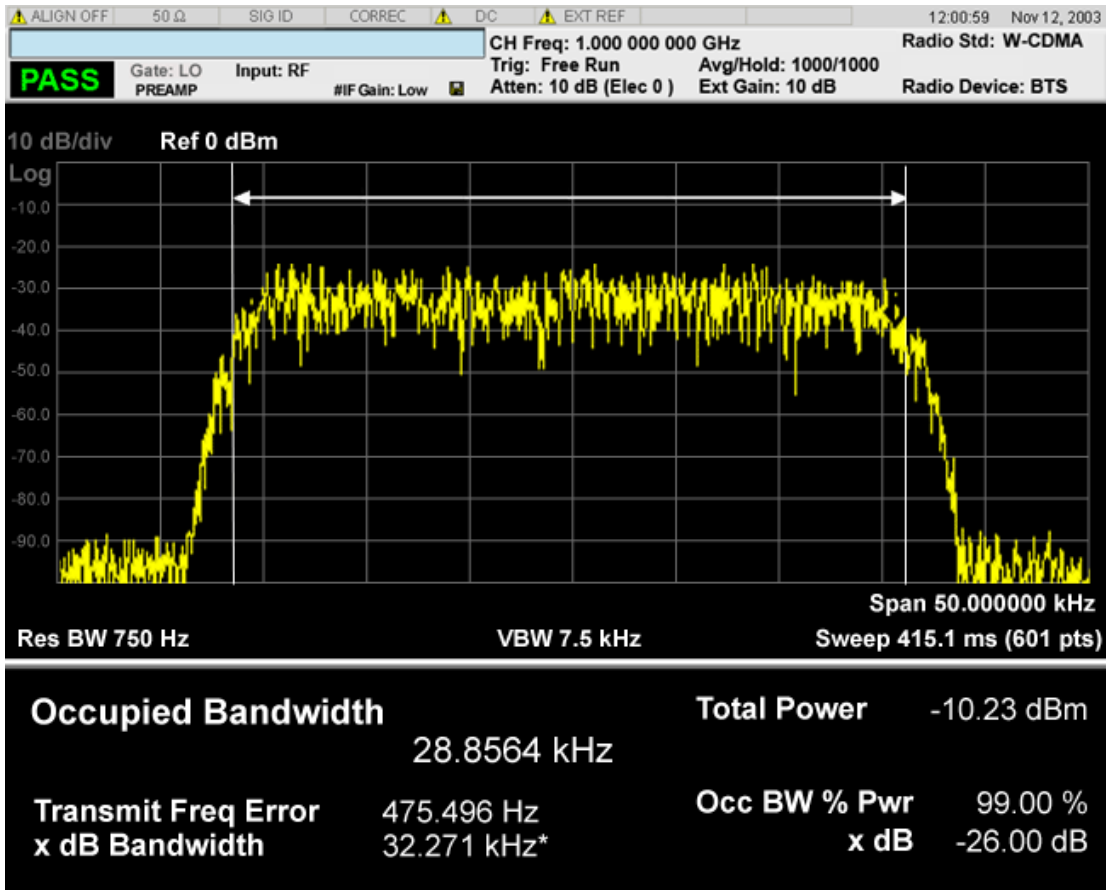

For TD-SCDMA mode only:

9 Occupied Bandwidth Measurement
View/Display

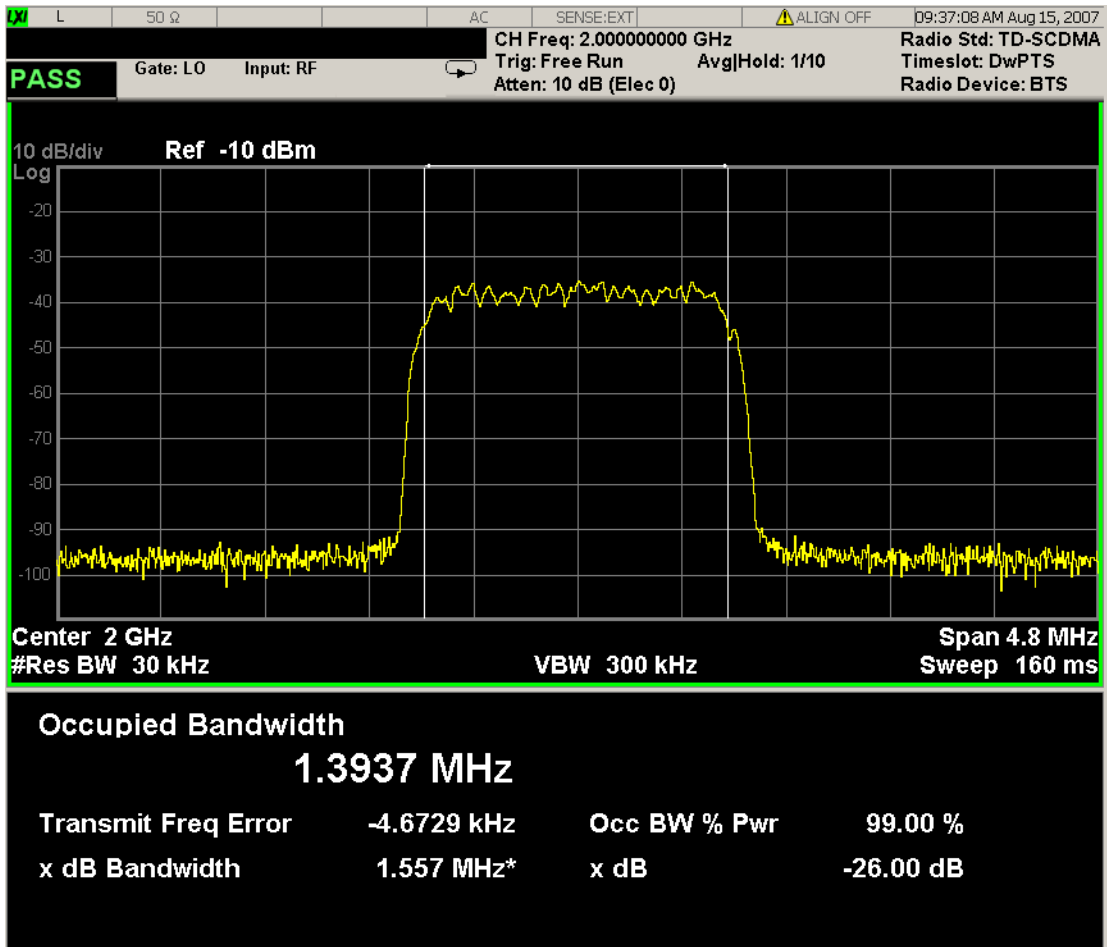

For Bluetooth mode only:

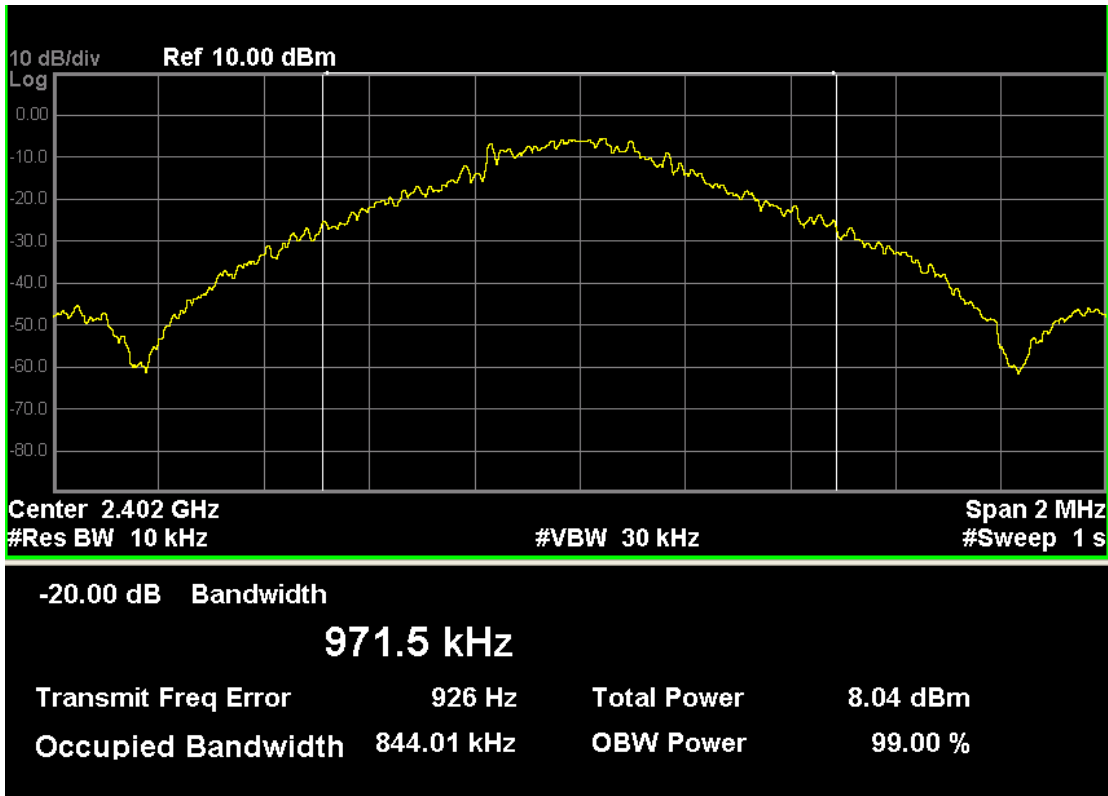

Key Path	Front-panel key
Initial S/W Revision	Prior to A.02.00

Display

The Display menu is common to most measurements, and is used for configuring items on the display. Some Display menu settings apply to all the measurements in a mode, and some only to the current measurement. Those under the System Display Settings key apply to all measurements in all modes.

Key Path	Display
Key Path	View/Display
Initial S/W Revision	Prior to A.02.00

Annotation

Turns on and off various parts of the display annotation. The annotation is divided up into four categories:

1. Meas Bar: This is the measurement bar at the top of the screen. It does not include the settings panel or the Active Function. Turning off the Meas Bar turns off the settings panel and the Active Function. When the Meas Bar is off, the graticule area expands to fill the area formerly occupied by the Meas Bar.

2. Screen Annotation: this is the annotation and annunciation around the graticule, including any annotation on lines (such as the display line, the threshold line, etc.) This does NOT include the marker number or the N dB result. When off, the graticule expands to fill the entire graticule area.
3. Trace annotation: these are the labels on the traces, showing their detector (or their math mode).
4. Active Function annotation: this is the active function display in the meas bar, and all of the active function values displayed on softkeys.

See the figure below. Each type of annotation can be turned on and off individually.

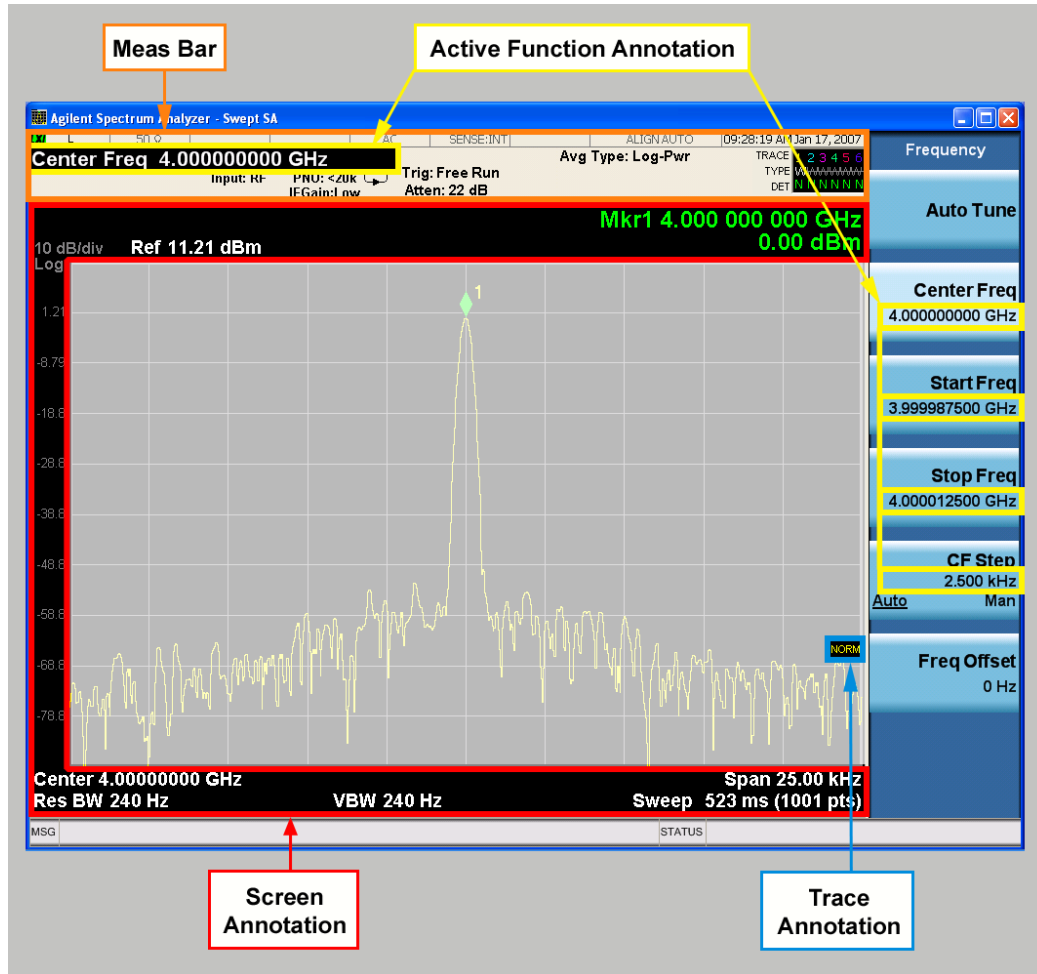

Key Path	View/Display, Display
Initial S/W Revision	Prior to A.02.00

Meas Bar On/Off

This function turns the Measurement Bar on and off, including the settings panel. When off, the graticule area expands to fill the area formerly occupied by the Measurement Bar.

Key Path	View/Display, Display, Annotation
Remote Command	:DISPlay:ANNotation:MBAR[:STATe] OFF ON 0 1 :DISPlay:ANNotation:MBAR[:STATe]?
Example	DISP:ANN:MBAR OFF
Dependencies	Grayed out and forced to OFF when System Display Settings, Annotation is set to Off.
Preset	On This should remain Off through a Preset when System DisplaySettings, Annotation is set to Off.
State Saved	Saved in instrument state.
Initial S/W Revision	Prior to A.02.00

Screen

This controls the display of the annunciation and annotation around the graticule, including any annotation on lines (such as the display line, the threshold line, etc.) and the y-axis annotation. This does NOT include marker annotation (or the N dB result). When off, the graticule expands to fill the entire graticule area, leaving only the 1.5% gap above the graticule as described in the Trace/Detector chapter.

Key Path	View/Display, Display, Annotation
Remote Command	:DISPlay:ANNotation:SCReen[:STATe] OFF ON 0 1 :DISPlay:ANNotation:SCReen[:STATe]?
Example	DISP:ANN:SCR OFF
Dependencies	Grayed-out and forced to OFF when System Display Settings, Annotation is set to Off.
Preset	On This should remain Off through a Preset when System DisplaySettings, Annotation is set to Off
State Saved	Saved in instrument state.
Initial S/W Revision	Prior to A.02.00

Active Function Values On/Off

Turns on and off the active function display in the Meas Bar, and all of the active function values displayed on the softkeys.

Note that all of the softkeys that have active functions have these numeric values blanked when this function is on. This is a security feature..

9 Occupied Bandwidth Measurement
View/Display

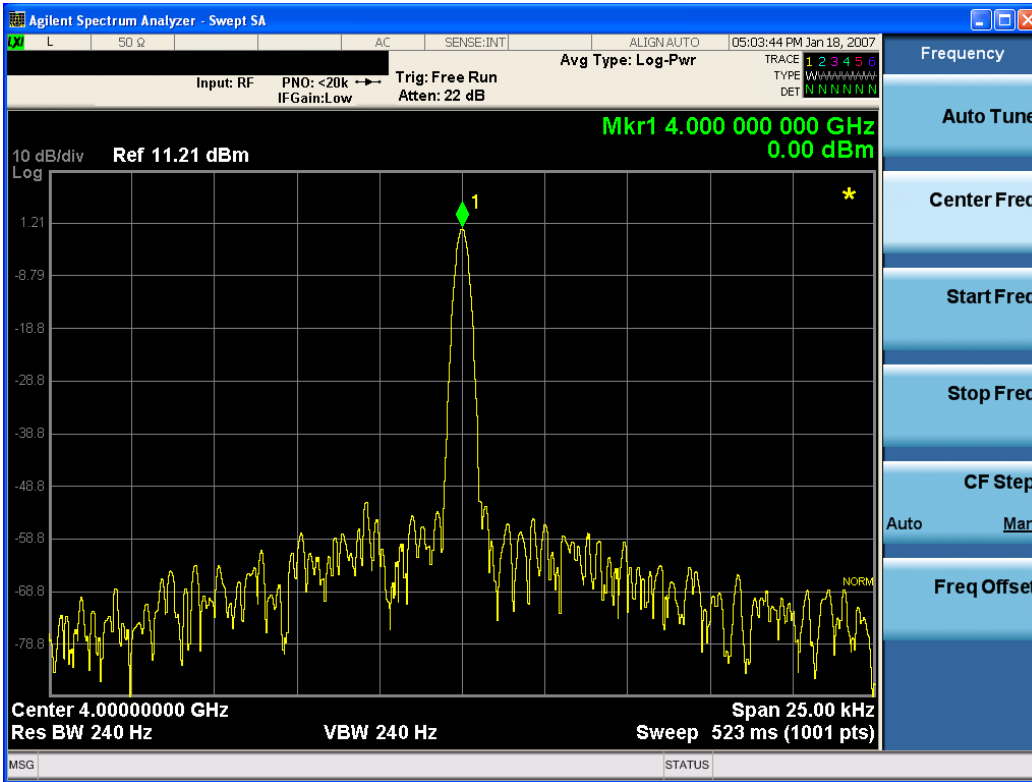

Key Path	View/Display, Display, Annotation
Remote Command	:DISPlay:ACTivefunc[:STATe] ON OFF 1 0 :DISPlay:ACTivefunc[:STATe]?
Example	DISP:ACT OFF
Dependencies	Grayed out and forced to OFF when System Display Settings, Annotation is set to Off.
Preset	On This should remain Off through a Preset when System DisplaySettings, Annotation is set to Off
State Saved	Saved in instrument state.
Initial S/W Revision	Prior to A.02.00

Title

Displays menu keys that enable you to change or clear a title on your display.

Key Path	View/Display, Display
Initial S/W Revision	Prior to A.02.00

Change Title

Writes a title into the "measurement name" field in the banner, for example, "Swept SA".

Press Change Title to enter a new title through the alpha editor. Press Enter or Return to complete the entry. Press ESC to cancel the entry and preserve your existing title.

The display title will replace the measurement name. It remains for this measurement until you press Change Title again, or you recall a state, or a Preset is performed. A title can also be cleared by pressing Title, Clear Title.

NOTE

Notice the inclusion of the <measurement> parameter in the command below. Because each measurement remembers the Display Title, the command must be qualified with the measurement name. For the Swept SA measurement this is not the case; no <measurement> parameter is used when changing the Display Title for the Swept SA measurement.

Key Path	View/Display, Display, Title
Mode	All
Remote Command	:DISPlay:<measurement>:ANNotation:TITLe:DATA <string> :DISPlay:<measurement>:ANNotation:TITLe:DATA?
Example	DISP:ANN:TITL:DATA "This Is My Title" This example is for the Swept SA measurement in the Spectrum Analyzer mode. The SANalyzer <measurement> name is not used. DISP:ACP:ANN:TITL:DATA "This Is My Title" This example is for Measurements other than Swept SA. Both set the title to: This Is My Title
Notes	Pressing this key cancels any active function. When a title is edited the previous title remains intact (it is not cleared) and the cursor goes at the end so that characters can be added or BKSP can be used to go back over previous characters.
Preset	No title (measurement name instead)
State Saved	Saved in instrument state.
Initial S/W Revision	Prior to A.02.00

Clear Title

Clears a title from the front-panel display. Once cleared, the title cannot be retrieved. After the title is cleared, the current Measurement Name replaces it in the title bar.

Key Path	View/Display, Display, Title
Example	The following commands clear the title and restore the measurement's original title: DISP:ANN:TITL:DATA "" This example is for the Swept SA measurement in the Spectrum Analyzer mode. The SANalyzer <measurement> name is not used. DISP:ACP:ANN:TITL:DATA "" This example is for ACP; in measurements other than Swept SA the measurement name is required.
Notes	Uses the :DISPlay:<measurement>:ANNotation:TITLe:DATA <string> command with an empty string (in the Swept SA, the <measurement> is omitted).
Preset	Performed on Preset.
Initial S/W Revision	Prior to A.02.00

Graticule

Pressing Graticule turns the display graticule On or Off. It also turns the graticule y-axis annotation on and off.

Key Path	View/Display, Display
Remote Command	:DISPlay:WINDow[1]:TRACe:GRATicule:GRID[:STATe] OFF ON 0 1 :DISPlay:WINDow[1]:TRACe:GRATicule:GRID[:STATe]?
Example	DISP:WIND:TRAC:GRAT:GRID OFF
Notes	The graticule is the set of horizontal and vertical lines that make up the grid/divisions for the x-axis and y-axis.
Preset	On
State Saved	Saved in instrument state
Initial S/W Revision	Prior to A.02.00

System Display Settings

These settings are "Mode Global" – they affect all modes and measurements and are reset only by Restore Misc Defaults or Restore System Defaults under System.

Key Path	View/Display, Display
Initial S/W Revision	Prior to A.02.00

Annotation Local Settings

This is a Mode Global override of the meas local annotation settings. When it is All Off, it forces ScreenAnnotation, Meas Bar, Trace, and Active Function Values settings to be OFF for all measurements in all modes. This provides the security based "annotation off" function of previous analyzers; hence it uses the legacy SCPI command.

When it is All Off, the Screen, Meas Bar, Trace, and Active Function Values keys under the Display, Annotation menu are grayed out and forced to Off. When Local Settings is selected, you are able to set the local annotation settings on a measurement by measurement basis.

Key Path	View/Display, Display, System Display Settings
Remote Command	:DISPlay:WINDow[1]:ANNotation[:ALL] OFF ON 0 1 :DISPlay:WINDow[1]:ANNotation[:ALL]?
Example	:DISP:WIND:ANN OFF
Preset	On (Set by Restore Misc Defaults)
State Saved	Not saved in instrument state.
Backwards Compatibility Notes	The WINDow parameter and optional subopcode is included for backwards compatibility but ignored – all windows are equally affected.
Initial S/W Revision	Prior to A.02.00

Themes

Accesses a menu of functions that enable you to choose the theme to be used when saving the screen image.

The **Themes** option is the same as the **Themes** option under the **Display** and **Page Setup** dialogs. It allows you to choose between themes to be used when saving the screen image.

Key Path	Save, Screen Image
Remote Command	:MMEMory:STORe:SCReen:THEMe TDColor TDMonochrome FCOLOR FMONochrome :MMEMory:STORe:SCReen:THEMe?
Example	:MMEM:STOR:SCR:THEM TDM
Preset	3D Color; Is not part of Preset, but is reset by Restore Misc Defaults or Restore System Defaults All and survives subsequent running of the modes.
Readback	3D Color 3D Mono Flat Color Flat Mono
Backwards Compatibility Notes	In ESA and PSA we offer the choice of "Reverse Bitmap" or "Reverse Metafile" when saving screen images. This is much like the "Flat Color" theme available in X-Series. Also, if you selected Reverse Bitmap AND a black & white screen image, that would be much like "Flat Monochrome". In other words, each of the X-Series themes has a similar screen image type in ESA/PSA. But they are not identical.
Initial S/W Revision	Prior to A.02.00

3D Color

Selects a standard color theme with each object filled, shaded and colored as designed.

Key Path	Save, Screen Image, Themes
Example	MMEM:STOR:SCR:THEM TDC
Readback	3D Color
Initial S/W Revision	Prior to A.02.00

3D Monochrome

Selects a format that is like 3D color but shades of gray are used instead of colors.

Key Path	Save, Screen Image, Themes
Example	MMEM:STOR:SCR:THEM TDM
Readback	3D Mono
Initial S/W Revision	Prior to A.02.00

Flat Color

Selects a format that is best when the screen is to be printed on an ink printer.

Key Path	Save, Screen Image, Themes
Example	MMEM:STOR:SCR:THEM FCOL
Readback	Flat Color
Initial S/W Revision	Prior to A.02.00

Flat Monochrome

Selects a format that is like Flat Color. But only black is used (no colors, not even gray), and no fill.

Key Path	Save, Screen Image, Themes
Example	MMEM:STOR:SCR:THEM FMON
Readback	Flat Mono
Initial S/W Revision	Prior to A.02.00

10 ACP Measurement

ACP is a measurement of the amount of interference, or power, in an adjacent frequency channel. The results are displayed as a bar graph or as spectrum data, with measurement data at specified offsets. For measurement results and views, see ["View/Display" on page 1242](#).

This topic contains the following sections:

["Measurement Commands for ACP" on page 934](#)

["Remote Command Results for ACP Measurement" on page 935](#)

Measurement Commands for ACP

The following commands are used to retrieve the measurement results:

```
:CONFigure:ACP  
:CONFigure:ACP:NDEFault  
:INITiate:ACP  
:FETCh:ACP[n]?  
:READ:ACP[n]?  
:MEASure:ACP[n]?
```

For more measurement related commands, see the SENSE subsystem, and the section "[Remote Measurement Functions](#)" on page 2355.

Remote Command Results for ACP Measurement

Condition	N	Results Returned
Mode = SA mode, Radio Std = None, Number of carriers = 1 and only offset A is on	Not specified or n = 1	Returns 3 comma-separated values that correspond to: Reference carrier power, lower-adjacent channel power (dBc), and upper-adjacent channel power (dBc).
Mode = DTMB (CTTB) or CMMB, Radio BW = 8 MHz, Number of carriers = 1 and Meas Type = Power spectral density reference	not specified or n = 1	Returns 32 comma-separated scalar results, in the following order. 1. 0.0 2. Total carrier power (dBm/Hz or dBm/MHz) 3. 0.0 4. Reference carrier power (dBm/Hz or dBm/MHz) 5. Lower offset A - relative power (dB) 6. Lower offset A - absolute power (dBm/Hz or dBm/MHz) 7. Upper offset A - relative power (dB) 8. Upper offset A - absolute power (dBm/Hz or dBm/MHz) 9. Lower offset B - relative power (dB) 10. Lower offset B - absolute power (dBm/Hz or dBm/MHz) 11. Upper offset B - relative power (dB) 12. Upper offset B - absolute power (dBm/Hz or dBm/MHz) ... 25. Lower offset F - relative power (dB) 26. Lower offset F - absolute power (dBm/Hz or dBm/MHz) 27. Upper offset F - relative power (dB) 28. Upper offset F - absolute power (dBm/Hz or dBm/MHz) 29. -999.0 30. -999.0 31. -999.0 32. -999.0 The last four (29, 30, 31 and 32) results always returned -999.0. If the results are not available, -999.0 is returned.
Meas Type = Total power reference	Not specified or n = 1	Returns 28 comma-separated scalar results, in the following order. 1. 0.0 2. Total carrier power (dBm) 3. 0.0 4. Reference carrier power (dBm) 5. Lower offset A - relative power (dB) 6. Lower offset A - absolute power (dBm)

Condition	N	Results Returned
		7. Upper offset A - relative power (dB) 8. Upper offset A - absolute power (dBm) 9. Lower offset B - relative power (dB) 10. Lower offset B - absolute power (dBm) 11. Upper offset B - relative power (dB) 12. Upper offset B - absolute power (dBm) ... 25. Lower offset F - relative power (dB) 26. Lower offset F - absolute power (dBm) 27. Upper offset F - relative power (dB) 28. Upper offset F - absolute power (dBm) If the results are not available, -999.0 is returned.
Meas Type = Power spectral density reference	not specified or n = 1	Returns 28 comma-separated scalar results, in the following order. 1. 0.0 2. Total carrier power (dBm/Hz or dBm/MHz) 3. 0.0 4. Reference carrier power (dBm/Hz or dBm/MHz) 5. Lower offset A - relative power (dB) 6. Lower offset A - absolute power (dBm/Hz or dBm/MHz) 7. Upper offset A - relative power (dB) 8. Upper offset A - absolute power (dBm/Hz or dBm/MHz) 9. Lower offset B - relative power (dB) 10. Lower offset B - absolute power (dBm/Hz or dBm/MHz) 11. Upper offset B - relative power (dB) 12. Upper offset B - absolute power (dBm/Hz or dBm/MHz) ... 25. Lower offset F - relative power (dB) 26. Lower offset F - absolute power (dBm/Hz or dBm/MHz) 27. Upper offset F - relative power (dB) 28. Upper offset F - absolute power (dBm/Hz or dBm/MHz) If the results are not available, -999.0 is returned.
Meas Method = FAST	not specified or n = 1	Returns 5 comma-separated results, in the following order: 1. Reference carrier - absolute power (dBm) 2. Lower offset A - absolute power (dBm) 3. Upper offset A - absolute power (dBm) 4. Lower offset B - absolute power (dBm) 5. Upper offset B - absolute power (dBm)

Condition	N	Results Returned
Meas Type = Total power reference	n = 2	Returns 48 scalar results, in the following order: 1. Channel (1) - relative power (dB) 2. Channel (1) - absolute power (dBm) 3. Channel (2) - relative power (dB) 4. Channel (2) - absolute power (dBm) ... 23. Channel (12) - relative power (dB) 24. Channel (12) - absolute power (dBm) 25. Lower offset A - relative power (dB) 26. Lower offset A - absolute power (dBm) 27. Upper offset A - relative power (dB) 28. Upper offset A - absolute power (dBm) 29. Lower offset B - relative power (dB) 30. Lower offset B - absolute power (dBm) 31. Upper offset B - relative power (dB) 32. Upper offset B - absolute power (dBm) ... 45. Lower offset F - relative power (dB) 46. Lower offset F - absolute power (dBm) 47. Upper offset F - relative power (dB) 48. Upper offset F - absolute power (dBm) If the results are not available, -999.0 is returned.
Meas Type = Power spectral density reference	n = 2	Returns 48 scalar results, in the following order: 1. Channel (1) - relative power (dB) 2. Channel (1) - absolute power (dBm/Hz or dBm/MHz) 3. Channel (2) - relative power (dB) 4. Channel (2) - absolute power (dBm/Hz or dBm/MHz) ... 23. Channel (12) - relative power (dB) 24. Channel (12) - absolute power (dBm/Hz or dBm/MHz) 25. Lower offset A - relative power (dB) 26. Lower offset A - absolute power (dBm/Hz or dBm/MHz) 27. Upper offset A - relative power (dB) 28. Upper offset A - absolute power (dBm/Hz or dBm/MHz) 29. Lower offset B - relative power (dB) 30. Lower offset B - absolute power (dBm/Hz or dBm/MHz) 31. Upper offset B - relative power (dB) 32. Upper offset B - absolute power (dBm/Hz or dBm/MHz)

Condition	N	Results Returned
		<p>...</p> <p>45. Lower offset F - relative power (dB)</p> <p>46. Lower offset F - absolute power (dBm/Hz or dBm/MHz)</p> <p>47. Upper offset F - relative power (dB)</p> <p>48. Upper offset F - absolute power (dBm/Hz or dBm/MHz)</p> <p>If the results are not available, -999.0 is returned.</p>
Meas Type = Total power reference	n = 3	<p>Returns 24 scalar values of the pass/fail (0 = passed, or 1 = failed) determined by testing the relative to the reference carrier and by testing the absolute power limit of the offset frequencies (measured as total power in dB):</p> <p>1. Lower offset A - relative limit result</p> <p>2. Lower offset A - absolute limit result</p> <p>3. Upper offset A - relative limit result</p> <p>4. Upper offset A - absolute limit result</p> <p>5. Lower offset B - relative limit result</p> <p>6. Lower offset B - absolute limit result</p> <p>7. Upper offset B - relative limit result</p> <p>8. Upper offset B - absolute limit result</p> <p>...</p> <p>21 Lower offset F - relative limit result</p> <p>22 Lower offset F - absolute limit result</p> <p>23 Upper offset F - relative limit result</p> <p>24 Upper offset F - absolute limit result</p>
Meas Type = Power spectral density reference	n = 3	<p>Returns 24 scalar values of the pass/fail (0 = passed, or 1 = failed) determined by testing the relative to the reference carrier and by testing the absolute power limit of the offset frequencies (measured as power spectral density in dB):</p> <p>1. Lower offset A - relative limit result</p> <p>2. Lower offset A - absolute limit result</p> <p>3. Upper offset A - relative limit result</p> <p>4. Upper offset A - absolute limit result</p> <p>5. Lower offset B - relative limit result</p> <p>6. Lower offset B - absolute limit result</p> <p>7. Upper offset B - relative limit result</p> <p>8. Upper offset B - absolute limit result</p> <p>...</p> <p>21 Lower offset F - relative limit result</p> <p>22 Lower offset F - absolute limit result</p> <p>23 Upper offset F - relative limit result</p> <p>24 Upper offset F - absolute limit result</p>

Condition	N	Results Returned
	n = 4	Returns <Num Pts> comma-separated scalar values representing the Y values in Trace 1
	n = 5	Returns <Num Pts> comma-separated scalar values representing the Y values in Trace 2
	n = 6	Returns <Num Pts> comma-separated scalar values representing the Y values in Trace 3
Meas Type = Total power reference	n = 7	<p>Returns (2 * Number of Carriers) scalar results, in the following order:</p> <p>The Number of Carriers is the value filled in Carriers under Carrier Setup menu. If license N9060A-5FP is enabled, max value of Number of Carriers is 18, otherwise, max value of Number of Carriers is 12. In MSR mode, max value of Number of Carriers is 100.</p> <ol style="list-style-type: none"> 1. Channel (1) - relative power (dB) 2. Channel (1) - absolute power (dBm) 3. Channel (2) - relative power (dB) 4. Channel (2) - absolute power (dBm) <p>...</p> <p>2 * Number of Carriers -1. Channel (Number of Carriers) - relative power (dB)</p> <p>2 * Number of Carriers. Channel (Number of Carriers) - absolute power (dBm)</p> <p>If the results are not available, 9.91E+37 is returned.</p>
Meas Type = Power spectral density reference	n = 7	<p>Returns (2 * Number of Carriers) scalar results, in the following order: The Number of Carriers is the value filled in Carriers under Carrier Setup menu.</p> <p>If license N9060A-5FP is enabled, max value of Number of Carriers is 18, otherwise, max value of Number of Carriers is 12. In MSR mode, max value of Number of Carriers is 100.</p> <ol style="list-style-type: none"> 1. Channel (1) - relative power (dB) 2. Channel (1) - absolute power (dBm/Hz or dBm/MHz) 3. Channel (2) - relative power (dB) 4. Channel (2) - absolute power (dBm/Hz or dBm/MHz) <p>...</p> <p>2 * Number of Carriers -1. Channel (Number of Carriers) - relative power (dB)</p> <p>2 * Number of Carriers. Channel (Number of Carriers) - absolute power (dBm/Hz or dBm/MHz)</p> <p>If the results are not available, 9.91E+37 is returned</p>
Key Path		Front-panel key
Initial S/W Revision		Prior to A.02.00
Modified at S/W Revision		A.13.00

AMPTD Y Scale

Accesses a menu of functions that enable you to set the vertical scale parameters. The parameter values are measurement independent, except all Attenuation values and the Internal Preamp selections, which are the same across all measurements.

Key Path	Front-panel key
Initial S/W Revision	Prior to A.02.00

Ref Value

Sets the value for the absolute power reference. However, since the Auto Scaling is defaulted to On, this value is automatically determined by the measurement result. When you set a value manually, Auto Scaling automatically changes to Off.

Key Path	AMPTD Y Scale
Mode	SA, WCDMA, C2K, WIMAX OFDMA, TD-SCDMA, 1xEVDO, DVB-T/H, DTMB (CTTB), ISDB-T, CMMB, LTE, LTE-TDD, Digital Cable TV
Remote Command	:DISPlay:ACPower:VIEW[1]:WINDow[1]:TRACe:Y[:SCALe]:RLEVel <real> :DISPlay:ACPower:VIEW[1]:WINDow[1]:TRACe:Y[:SCALe]:RLEVel?
Example	DISP:ACP:VIEW:WIND:TRAC:Y:RLEV 100 DISP:ACP:VIEW:WIND:TRAC:Y:RLEV?
Notes	You must be in the mode that includes ACP measurements to use this command. Use :INSTrument:SElect to set the mode.
Couplings	When the Auto Scaling is On, this value is automatically determined by the measurement result. When you set a value manually, Auto Scaling automatically changes to Off.
Preset	10dBm
State Saved	Saved in instrument state.
Min	-250.00 dBm
Max	250.00 dBm
Initial S/W Revision	Prior to A.02.00
Modified at S/W Revision	A.02.00, A.03.00

Range

The Range menu allows setting amplitude controls of the instrument.

Key Path	AMPTD Y Scale
Scope	Meas Global
Initial S/W Revision	A.12.50

Range

Represents the amplitude of the largest sinusoidal signal that could be present within the IF without being clipped by the ADC. For signals with high peak-to-average ratios, the range may need to exceed the rms signal power by a fair amount to avoid clipping.

Key Path	Range
Mode	BASIC
Remote Command	<code>[:SENSe] :POWer [:RF] :RANGe <real></code> <code>[:SENSe] :POWer [:RF] :RANGe?</code>
Example	<code>:POW:RANG 10.0</code> <code>:POW:RANG?</code>
Notes	The MIN and MAX values are affected by the External Gain parameters, and by the Center Frequency. (The hardware compensates for frequency response and alters the Range setting.)
Preset	0
State Saved	Saved in instrument state.
Min	-100
Max	100
Initial S/W Revision	A.12.50

Adjust Range For Min Clip

Sets the combination of attenuation and gain based on the current measured signal level so that clipping will be at a minimum.

This is an "immediate action" function, that is, it executes once, when the key is pressed.

This key is grayed out in measurements that do not support this functionality.

Key Path	AMPTD Y Scale, Attenuation
Remote Command	<code>[:SENSe] :POWer [:RF] :RANGe:OPTimize IMMEDIATE</code>
Initial S/W Revision	Prior to A.02.00
Modified at S/W Revision	A.03.00

Pre-Adjust for Min Clip

If this function is on, it does the adjustment described under Adjust Range For Min Clip each time a measurement restarts. Therefore, in Continuous measurement mode, it only executes before the first measurement.

Key Path	AMPTD Y Scale, Attenuation
Remote Command	<code>[:SENSe] :POWer [:RF] :RANGe:OPTimize:ATTenuation OFF ON ELEctrical COMBined</code>

	<code>[:SENSe] :POWer [:RF] :RANGe:OPTimize:ATTenuation?</code>
Notes	This parameter is shared with old XA platform which uses AutoAtten. To keep the backward compatibility, ELECTrical and COMBined still can be used. Then, upon receiving ELECTrical and COMBined, these enums will be interpreted as aliases of ON. Then, when queried, ON will be returned.
Preset	OFF for Swept SA measurement; ON for all other measurements that support Pre-Adjust for Min Clip
State Saved	Saved in instrument state
Initial S/W Revision	Prior to A.02.00
Modified at S/W Revision	A.03.00

Peak to Average

The Peak to Average Ratio is used with the Range setting to optimize the level control in the instrument. The value is the ratio, in dB, of the peak power to the average power of the signal to be measured. A ratio of 0 should be used for sinusoidal signals; for 802.11g OFDM signals use 9 dB.

All Applications (Modes) will show the current value of Peak to Average ratio on the softkey. However, some applications will not permit changing the value. In these situations the softkey will be grayed-out.

Key Path	AMPTD Y Scale, Range
Remote Command	<code>[:SENSe] :POWer [:RF] :RANGe:PARatio <real></code> <code>[:SENSe] :POWer [:RF] :RANGe:PARatio?</code>
Example	POW:RANG:PAR 12 dB
Notes	In some Applications (Modes) this parameter will be read-only; meaning the value will appear on the softkey and query via SCPI, but not changeable. In such applications the softkey will be grayed-out. Attempting to change the value via SCPI will be ignored and no error message will be generated.
Preset	10 dB
State Saved	Saved in instrument state
Min	0 dB
Max	20 dB
Initial S/W Revision	A.13.00

Mixer Level Offset

Mixer level offset is an advanced setting to adjust target Range at the input mixer which in turn affects the signal level in the instrument's IF. This setting can be used when additional optimization is needed after setting Peak to Average ratio. Positive values of offset optimize noise performance over distortion, negative values optimize distortion performance over noise.

Key Path	AMPTD Y Scale, Range
Remote Command	<code>[:SENSe] :POWer [:RF] :RANGe:MIXer:OFFSet <real></code>

	<code>[:SENSe] :POWer [:RF] :RANGe :MIXer :OFFSet ?</code>
Example	POW:RANG:MIX:OFFS -5 dB
Preset	0 dB
State Saved	Saved in instrument state
Min	-35 dB
Max	30 dB
Initial S/W Revision	A.13.00

Scale/Div

Sets the units-per-division of the vertical scale in the logarithmic display. However, since the Auto Scaling is defaulted to On, this value is automatically determined by the measurement result. When you set a value manually, Auto Scaling automatically changes to Off.

Key Path	AMPTD Y Scale
Mode	SA, WCDMA, C2K, WIMAX OFDMA, TD-SCDMA, 1xEVDO, DVB-T/H, DTMB (CTTB), ISDB-T, CMMB, LTE, LTETDD, Digital Cable TV
Remote Command	<code>:DISPlay:ACPower:VIEW[1]:WINDow[1]:TRACe:Y[:SCALe]:PDIVision <rel_ampl></code> <code>:DISPlay:ACPower:VIEW[1]:WINDow[1]:TRACe:Y[:SCALe]:PDIVision?</code>
Example	DISP:ACP:VIEW:WIND:TRAC:Y:PDIV 5 DISP:ACP:VIEW:WIND:TRAC:Y:PDIV?
Notes	You must be in the mode that includes ACP measurements to use this command. Use <code>:INSTrument:SElect</code> to set the mode.
Couplings	When the Auto Scaling is On, this value is automatically determined by the measurement result. When you set a value manually, Auto Scaling automatically changes to Off.
Preset	10.00 dB
State Saved	Saved in instrument state.
Min	0.10 dB
Max	20.00 dB
Initial S/W Revision	Prior to A.02.00
Modified at S/W Revision	A.02.00, A.03.00

Ref Position

Positions the reference level at the top, center, or bottom of the Y- scale display. Changing the reference position does not change the reference level value.

Key Path	AMPTD Y Scale
Mode	SA, WCDMA, C2K, WIMAX OFDMA, TD-SCDMA, 1xEVDO, DVB-T/H, DTMB (CTTB), ISDB-T, CMMB, LTE, LTETDD, Digital Cable TV

Remote Command	:DISPlay:ACPower:VIEW[1]:WINDow[1]:TRACe:Y[:SCALe]:RPOSition TOP CENTer BOTTom :DISPlay:ACPower:VIEW[1]:WINDow[1]:TRACe:Y[:SCALe]:RPOSition?
Example	DISP:ACP:VIEW:WIND:TRAC:Y:RPOS CENT DISP:ACP:VIEW:WIND:TRAC:Y:RPOS?
Notes	You must be in the mode that includes ACP measurements to use this command. Use :INSTrument:SElect to set the mode.
Preset	TOP
State Saved	Saved in instrument state.
Range	Top Ctr Bot
Initial S/W Revision	Prior to A.02.00
Modified at S/W Revision	A.02.00, A.03.00

Auto Scaling

Toggles the Auto Scaling function between On and Off.

Key Path	AMPTD Y Scale
Mode	SA, WCDMA, C2K, WIMAX OFDMA, TD-SCDMA, 1xEVDO, DVB-T/H, DTMB (CTTB), ISDB-T, CMMB, LTE, LTETDD
Remote Command	:DISPlay:ACPower:VIEW[1]:WINDow[1]:TRACe:Y[:SCALe]:COUPle 0 1 OFF ON :DISPlay:ACPower:VIEW[1]:WINDow[1]:TRACe:Y[:SCALe]:COUPle?
Example	DISP:ACP:VIEW:WIND:TRAC:Y:COUP ON DISP:ACP:VIEW:WIND:TRAC:Y:COUP?
Notes	You must be in the mode that includes ACP measurements to use this command. Use :INSTrument:SElect to set the mode.
Couplings	When Auto Scaling is On and the Restart front-panel key is pressed, this function automatically determines the scale per division and reference values based on the measurement results. When you set a value to either Scale/Div or Ref Value manually, Auto Scaling automatically changes to Off.
Preset	ON
State Saved	Saved in instrument state.
Range	On Off
Initial S/W Revision	Prior to A.02.00
Modified at S/W Revision	A.02.00, A.03.00

Auto Couple

The Auto Couple feature provides a quick and convenient way to automatically couple multiple instrument settings. This helps ensure accurate measurements and optimum dynamic range. When the Auto Couple feature is activated, either from the front panel or remotely, all parameters of the current measurement that have an Auto/Manual mode are set to Auto mode and all measurement settings dependent on (or coupled to) the Auto/Man parameters are automatically adjusted for optimal performance.

However, the Auto Couple key actions are confined to the current measurement only. It does not affect other measurements in the mode, and it does not affect markers, marker functions, or trace or display attributes.

See "[More Information](#)" on page 945

Key Path	Front-panel key
Remote Command	:COUPle ALL NONE
Example	:COUP ALL
Notes	:COUPle ALL puts all Auto/Man parameters in Auto mode (equivalent to pressing the Auto Couple key). :COUPLE NONE puts all Auto/Man parameters in manual mode. It decouples all the coupled instrument parameters and is not recommended for making measurements.
Initial S/W Revision	Prior to A.02.00

More Information

There are two types of functions that have Auto/Manual modes.

Auto/Man Active Function keys

An Auto/Man toggle key controls the binary state associated with an instrument parameter by toggling between Auto (where the parameter is automatically coupled to the other parameters it is dependent upon) and Man (where the parameter is controlled independent of the other parameters), as well as making the parameter the active function. The current mode is indicated on the softkey with either Auto or Man underlined as illustrated below.



Auto/Man 1-of-N keys

An Auto/Man 1-of-N key allows you to manually pick from a list of parameter values, or place the function in Auto, in which case the value is automatically selected (and indicated) as shown below. If in Auto, Auto is underlined on the calling key. If in manual operation, manual is indicated on the calling key. But the calling key does not actually toggle the function, it simply opens the menu.

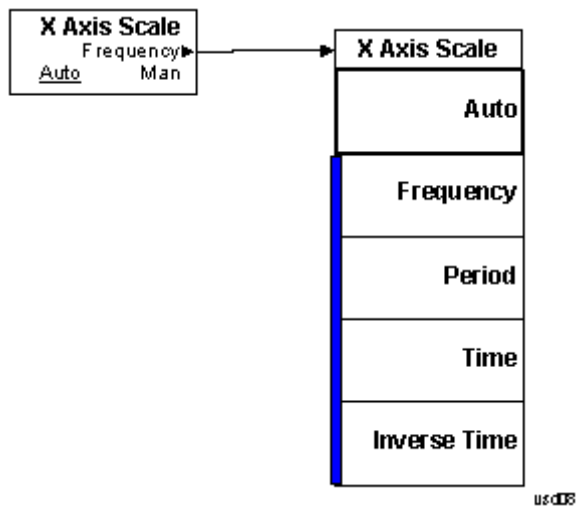

BW

Accesses a menu of functions that enable you to specify and control the video and resolution bandwidths. You can also select the type of filter for the measurement and set the filter bandwidth.

Key Path	Front-panel key
Initial S/W Revision	Prior to A.02.00

Res BW

Sets the value of the resolution bandwidth. If an unavailable bandwidth is entered with the numeric keypad, the closest available bandwidth is selected.

Key Path	BW
Mode	SA, WCDMA, C2K, WIMAX OFDMA, TD-SCDMA, 1xEVDO, DVB-T/H, DTMB (CTTB), ISDB-T, CMMB, LTE, LTE-TDD
Remote Command	<pre>[:SENSe]:ACPower:BANDwidth[:RESolution] <freq> [:SENSe]:ACPower:BANDwidth[:RESolution]? [:SENSe]:ACPower:BANDwidth[:RESolution]:AUTO ON OFF 1 0 [:SENSe]:ACPower:BANDwidth[:RESolution]:AUTO?</pre>
Example	<pre>ACP:BAND 25kHz ACP:BAND? ACP:BAND:AUTO ON ACP:BAND:AUTO?</pre>
Notes	<p>This key is available only in IBW mode.</p> <p>This parameter is preset by the Meas Method selection. Preset values are as follows: IBW: 100 kHz IBWR: 27 kHz FAST (WCDMA): 390 kHz</p> <p>You must be in the mode that includes ACP measurements to use this command. Use :INSTrument:SElect to set the mode.</p>
Dependencies	When Meas Method is RBW or FAST, this key is grayed out and disabled. If the key is pressed, an advisory message is generated. If the equivalent remote command is sent, a "Setting conflict" warning is generated.
Couplings	The resolution bandwidth is coupled to the video bandwidth based on the video to resolution bandwidth ratio setting if AUTO is selected.
Preset	<pre>SA: 220 kHz WCDMA: 100 kHz WIMAX OFDMA: 100 kHz C2K: 15 kHz TD-SCDMA: 30 kHz 1xEVDO: 30 kHz</pre>

	DVB-T/H: 39 kHz DTMB (CTTB): 39 kHz ISDB-T: 39 kHz CMMB: 39 kHz LTE: 100 kHz LTETDD: 100 kHz Digital Cable TV: 39 kHz MSR: 100 kHz 0
State Saved	Saved in instrument state.
Min	1 Hz
Max	8 MHz
Backwards Compatibility SCPI	[:SENSe] :ACPpower:BWIDth [:RESolution] [:SENSe] :ACP:SWEep:BAWdwidth BWIDth [:RESolution] (PSA W-CDMA, PSA cdma2000)
Initial S/W Revision	Prior to A.02.00
Modified at S/W Revision	A.02.00, A.03.00

Video BW

Changes the analyzer post-detection filter (VBW).

Key Path	BW
Mode	SA, WCDMA, C2K, WIMAX OFDMA, TD-SCDMA, 1xEVDO, DVB-T/H, DTMB (CTTB), ISDB-T, CMMB, LTE, LTETDD
Remote Command	[:SENSe] :ACPpower:BAWdwidth:VIDeo <freq> [:SENSe] :ACPpower:BAWdwidth:VIDeo? [:SENSe] :ACPpower:BAWdwidth:VIDeo:AUTO OFF ON 0 1 [:SENSe] :ACPpower:BAWdwidth:VIDeo:AUTO?
Example	ACP:BAWd:VID 1kHz ACP:BAWd:VID? ACP:BAWd:VID:AUTO ON ACP:BAWd:VID:AUTO?
Notes	The values shown in this table reflect the conditions after a Mode Preset.
Dependencies	When Meas Method is RBW or FAST, this key is grayed out and disabled. If the key is pressed, an advisory message is generated. If the equivalent remote command is sent, a "Setting conflict" warning is generated.
Preset	SA: 22 kHz WCDMA, WIMAX OFDMA: 1 MHz C2K:

Method RBW: grayed out (1.2 MHz)

Method IBW: 150 kHz

TD-SCDMA: 300 kHz

1xEVDO: 300 kHz

DVB-T/H: 390 kHz

DTMB (CTTB): 390 kHz

ISDB-T: 390 kHz

CMMB: 390 kHz

LTE, LTETDD: Auto

LTETDD: 1 MHz

SA: ON

WCDMA: OFF

WIMAX OFDMA: OFF

TD-SCDMA: OFF

DVB-T/H: OFF

DTMB (CTTB): OFF

CDMA1xEVDO: OFF

ISDB-T: OFF

CMMB: OFF

LTE, MSR: ON

LTETDD: ON

State Saved	Saved in instrument state.
-------------	----------------------------

Min	1 Hz
-----	------

Max	50 MHz
-----	--------

Backwards Compatibility SCPI	[:SENSe] :ACPower :BWIDth :VIDeo
-------------------------------------	------------------------------------

Initial S/W Revision	Prior to A.02.00
----------------------	------------------

Modified at S/W Revision	A.02.00, A.03.00
--------------------------	------------------

RBW Control

Accesses a menu that enables you to select the filter bandwidth and type.

Key Path	BW
----------	----

Initial S/W Revision	Prior to A.02.00
----------------------	------------------

Filter Type

Selects the type of bandwidth filter that is used. The choices are Gaussian or Flat top.

Key Path	BW, RBW Control
Mode	SA, WCDMA, C2K, WIMAX OFDMA, TD-SCDMA, 1xEVDO, DVB-T/H, DTMB (CTTB), ISDB-T, CMMB, LTE, LTETDD
Remote Command	[:SENSe] :ACPower :BANDwidth :SHAPE GAUSSian FLATtop [:SENSe] :ACPower :BANDwidth :SHAPE ?
Example	ACP:BAND:SHAP GAUS ACP:BAND:SHAP?
Dependencies	When Meas Method is FAST, this key is grayed out and disabled. If the key is pressed, an advisory message is generated. If the equivalent remote command is sent, a "Setting conflict" warning is generated.
Preset	GAUSSian C2K: FLATtop
State Saved	Saved in instrument state.
Range	Gaussian (Normal) Flattop
Backwards Compatibility SCPI	[:SENSe] :ACPower :BWIDth :SHAPE
Initial S/W Revision	Prior to A.02.00
Modified at S/W Revision	A.02.00, A.03.00

Filter BW

Selects a Gaussian filter based on its -3 dB (Normal) bandwidth or its -6 dB bandwidth.

Key Path	BW, RBW Control
Mode	SA, WCDMA, C2K, WIMAX OFDMA, TD-SCDMA, 1xEVDO, DVB-T/H, DTMB (CTTB), ISDB-T, CMMB, LTE, LTETDD
Remote Command	[:SENSe] :ACPower :BANDwidth :TYPE DB3 DB6 [:SENSe] :ACPower :BANDwidth :TYPE ?
Example	ACP:BAND:TYPE DB3 ACP:BAND:TYPE?
Dependencies	When Filter Type is Flattop or Meas Method is RBW or FAST, this key is grayed out and disabled. If the key is pressed, an advisory message is generated. If the equivalent remote command is sent, a "Setting conflict" warning is generated.
Preset	DB3
State Saved	Saved in instrument state.
Range	-3 dB (Normal) -6 dB
Backwards Compatibility SCPI	[:SENSe] :ACPower :BWIDth :TYPE
Initial S/W Revision	Prior to A.02.00
Modified at S/W Revision	A.02.00, A.03.00

Cont (Continuous Measurement/Sweep)

Sets the analyzer for Continuous measurement operation. The single/continuous state is Meas Global so the setting will affect all measurements. If you are Paused, pressing Cont does a Resume.

Key Path	Front-panel key
Remote Command	:INITiate:CONTinuous OFF ON 0 1 :INITiate:CONTinuous?
Example	:INIT:CONT 0 puts analyzer in Single measurement operation. :INIT:CONT 1 puts analyzer in Continuous measurement operation
Preset	ON (Note that SYST:PRESet sets INIT:CONT to ON but *RST sets INIT:CONT to OFF)
State Saved	Saved in instrument state
Backwards Compatibility Notes	For Spectrum Analysis mode in ESA and PSA, there is no Cont hardkey, instead there is a Sweep Single/Cont key. In these analyzers, switching the Sweep Single/Cont key from Single to Cont restarts averages (displayed average count reset to 1), but does not restart Max Hold and Min Hold. The X-Series has Single and Cont keys in place of the SweepSingleCont key. In the X-Series, if in single measurement, the Cont key (and INIT:CONT ON) switches to continuous measurement, but never restarts a measurement and never resets a sweep.
Initial S/W Revision	Prior to A.02.00

In Swept SA Measurement (Spectrum Analysis Mode):

The analyzer takes repetitive sweeps, averages, measurements, etc., when in Continuous mode. When the average count reaches the Average/Hold Number the count stops incrementing, but the analyzer keeps sweeping. See the Trace/Detector section for the averaging formula used both before and after the Average/Hold Number is reached. The trigger condition must be met prior to each sweep. The type of trace processing for multiple sweeps, is set under the Trace/Detector key, with choices of Trace Average, Max Hold, or Min Hold.

In Other Measurements/Modes:

With Avg/Hold Num (in the Meas Setup menu) set to Off or set to On with a value of 1, a sweep is taken after the trigger condition is met; and the analyzer continues to take new sweeps after the current sweep has completed and the trigger condition is again met. However, with Avg/Hold Num set to On with a value >1, multiple sweeps (data acquisitions) are taken for the measurement. The trigger condition must be met prior to each sweep. The sweep is not stopped when the average count k equals the number N set for Avg/Hold Num is reached, but the number k stops incrementing. A measurement average usually applies to all traces, marker results, and numeric results. But sometimes it only applies to the numeric results.

If the analyzer is in Single measurement, pressing the Cont key does not change k and does not cause the sweep to be reset; the only action is to put the analyzer into Continuous measurement operation.

If it is already in continuous sweep:

the INIT:CONT 1 command has no effect

the INIT:CONT 0 command will place the analyzer in Single Sweep but will have no effect on the current sequence until $k = N$, at which point the current sequence will stop and the instrument will go to the idle state.

10 ACP Measurement
File

File

See "File" on page 266

FREQ Channel

Accesses a menu of keys that allow you to control the Frequency and Channel parameters of the instrument.

Some features in the Frequency menu are the same for all measurements - they do not change as you change measurements. Settings like these are called "Meas Global" and are unaffected by Meas Preset. For example, the Center Freq setting is the same for all measurements - it does not change as you change measurements.

Key Path	Front Panel Key
Mode	LTETDD, LTEAFDD
Initial S/W Revision	A.14.00

Carrier Ref Freq

Sets carrier reference frequency. The center frequencies of carriers are defined as offset frequency from this value.

If the following conditions are satisfied at the same time:

- the Number of Component Carrier equals to 1
- the Center Freq Offset equals to 0 Hz
- the mode of the Center Freq is Auto

the Center Freq is equivalent to Carrier Ref Freq.

When the Center Freq changes in such conditions, the mode of the Center Freq keeps as Auto and the Carrier Ref Freq will be changed to same value. The major purpose of this coupling is to keep BWCC with legacy LTE/LTE TDD, in which :SENSe:FREQuency:CENTer is used to set up the Frequency of the measurement.

Key Path	FREQ Channel Mode Setup, Component Carrier Setup
Mode	LTEATDD, LTEAFDD
Measurement	All
Remote Command	<code>[:SENSe] :CCARrier:REFeRence <freq></code> <code>[:SENSe] :CCARrier:REFeRence?</code>
Example	CCAR:REF 2GHz CCAR:REF?
Notes	In order to easily configure component carriers, the key is also placed in the Mode Setup.
Preset	1GHz
State Saved	Saved in instrument state
Min	Depends on instrument minimum center frequency. Same as Center Freq
Max	Depends on instrument maximum center frequency. Same as Center Freq

10 ACP Measurement
FREQ Channel

Initial S/W Revision	A.14.00
Modified at S/W Revision	A.14.50

Input/Output

See "Input/Output" on page 182

Marker

Accesses a menu that enables you to select, set up and control the markers for the current measurement. Note that this hard key and all sub keys are unavailable when "Meas Method" on page 1013 is set to RBW.

Key Path	Front-panel key
Initial S/W Revision	Prior to A.02.00

Select Marker

Displays 12 markers available for selection. Note that this key is unavailable when "Meas Method" on page 1013 is set to RBW.

Key Path	Marker
Initial S/W Revision	Prior to A.02.00

Marker Type

Sets the marker control mode to Normal, Delta, Fixed or Off. All interactions and dependencies detailed under the key description are enforced when the remote command is sent. If the selected marker is Off, pressing Marker sets it to Normal and places it at the center of the screen on the trace determined by the Marker Trace rules. At the same time, Marker X Axis Value appears on the Active Function area.

The default active function is the active function for the currently selected marker control mode. If the current control mode is Off, there is no active function and the active function is turned off.

Key Path	Marker
Mode	SA, WCDMA, C2K, WIMAX OFDMA, TD-SCDMA, 1xEVDO, DVB-T/H, DTMB (CTTB), ISDB-T, CMMB, LTE, LTE-TDD
Remote Command	:CALCulate:ACPower:MARKer[1] 2 ... 12:MODE POSition DELTa OFF :CALCulate:ACPower:MARKer[1] 2 ... 12:MODE?
Example	CALC:ACP:MARK2:MODE DELT CALC:ACP:MARK2:MODE?
Notes	<p>If the selected marker is Off, pressing Marker sets it to Normal and places it at the center of the screen on the trace determined by the Marker Trace rules. At the same time, Marker X Axis Value appears on the Active Function area.</p> <p>Default Active Function: the active function for the selected marker's current control mode. If the current control mode is Off, there is no active function and the active function is turned off.</p> <p>Active Function Display: the marker X axis value entered in the active function area will display the marker value to its full entered precision.</p> <p>You must be in the mode that includes ACP measurements to use this command. Use :INSTrument:SElect to set the mode.</p>
Dependencies	This key is unavailable when "Meas Method" on page 1013 is set to RBW.

Preset	OFF OFF OFF OFF OFF OFF OFF OFF OFF OFF OFF OFF OFF
State Saved	Saved in instrument state.
Range	Normal Delta Off
Initial S/W Revision	Prior to A.02.00
Modified at S/W Revision	A.02.00, A.03.00

Properties

Accesses the marker properties menu. Note that this key is unavailable when "Meas Method" on page 1013 is set to RBW.

Key Path	Marker
Initial S/W Revision	Prior to A.02.00

Select Marker

Displays 12 markers available for selection. Note that this key is unavailable when "Meas Method" on page 1013 is set to RBW.

Key Path	Marker
Initial S/W Revision	Prior to A.02.00

Relative To

Selects the desired marker. The selected marker will be relative to its reference marker.

Key Path	Marker, Properties
Mode	SA, WCDMA, C2K, WIMAX OFDMA, TD-SCDMA, 1xEVDO, DVB-T/H, DTMB (CTTB), ISDB-T, CMMB, LTE, LTE-TDD
Remote Command	:CALCulate:ACPower:MARKer[1] 2 ... 12:REFerence <integer> :CALCulate:ACPower:MARKer[1] 2 ... 12:REFerence?
Example	CALC:ACP:MARK2:REF 6 CALC:ACP:MARK2:REF?
Notes	A marker cannot be relative to itself so that choice is grayed out, and if sent from a remote command, generates error -221: "Settings conflict; marker cannot be relative to itself." When queried a single value will be returned (the specified marker numbers relative marker). You must be in the mode that includes ACP measurements to use this command. Use :INSTrument:SElect to set the mode.
Dependencies	This key is unavailable when "Meas Method" on page 1013 is set to RBW.

Preset	2 3 4 5 6 7 8 9 10 11 12 1
State Saved	Saved in instrument state.
Min	1
Max	12
Initial S/W Revision	Prior to A.02.00
Modified at S/W Revision	A.02.00, A.03.00

Marker Trace

Selects the trace that you want your marker to be placed on. A marker is associated with one and only one trace. This trace is used to determine the placement, result, and X Axis Scale of the marker. All markers have an associated trace, even Fixed markers; it is from that trace that they determine their attributes and behaviors, and it is to that trace that they go when they become Normal or Delta markers.

Key Path	Marker, Properties
Mode	SA, WCDMA, C2K, WIMAX OFDMA, TD-SCDMA, 1xEVDO, DVB-T/H, DTMB (CTTB), ISDB-T, CMMB, LTE, LTETDD
Remote Command	:CALCulate:ACPower:MARKer[1] 2 ... 12:TRACe 1 2 3 :CALCulate:ACPower:MARKer[1] 2 ... 12:TRACe?
Example	CALC:ACP:MARK2:TRAC 2 CALC:ACP:MARK2:TRAC?
Notes	If the selected marker is Off, pressing Marker sets it to Normal and places it at the center of the screen on the trace determined by the Marker Trace rules. At the same time, Marker X Axis Value appears on the Active Function area. Default Active Function: the active function for the selected marker's current control mode. If the current control mode is Off, there is no active function and the active function is turned off. Active Function Display: the marker X axis value entered in the active function area will display the marker value to its full entered precision.
Dependencies	This key is unavailable when " Meas Method " on page 1013 is set to RBW.
Couplings	This is not affected by Auto Coupling. Sending the remote command causes the addressed marker to become selected.
Preset	All Markers Off
State Saved	Saved in instrument state.
Range	1 2 3
Initial S/W Revision	Prior to A.02.00
Modified at S/W Revision	A.02.00, A.03.00

Couple Markers

When this function is On, moving any marker causes an equal X axis movement of every other marker which is not Off. By “equal X axis movement” we mean that we preserve the difference between each marker’s X axis value (in the fundamental x-axis units of the trace that marker is on) and the X axis value of the marker being moved (in the same fundamental x-axis units).

Key Path	Marker
Mode	SA, WCDMA, C2K, WIMAX OFDMA, TD-SCDMA, 1xEVDO, DVB-T/H, DTMB (CTTB), ISDB-T, CMMB, LTE, LTE-TDD
Remote Command	:CALCulate:ACPower:MARKer:COUPle[:STATe] ON OFF 1 0 :CALCulate:ACPower:MARKer:COUPle[:STATe]?
Example	CALC:ACP:MARK:COUP ON
Dependencies	This key is unavailable when " Meas Method " on page 1013 is set to RBW.
Preset	OFF
State Saved	Saved in instrument state.
Range	On Off
Initial S/W Revision	Prior to A.02.00
Modified at S/W Revision	A.02.00, A.03.00

Marker All Off

Turns all active markers off.

Key Path	Marker
Mode	SA, WCDMA, C2K, WIMAX OFDMA, TD-SCDMA, 1xEVDO, DVB-T/H, DTMB (CTTB), ISDB-T, CMMB, LTE, LTE-TDD
Remote Command	:CALCulate:ACPower:MARKer:AOff
Example	CALC:ACP:MARK:AOff
Dependencies	This key is unavailable when " Meas Method " on page 1013 is set to RBW.
Initial S/W Revision	Prior to A.02.00
Modified at S/W Revision	A.02.00, A.03.00

Marker X Axis Value (Remote Command only)

Sets the marker X axis value in the current marker X Axis Scale unit. This value has no effect if the control mode is Off, but is the SCPI equivalent of entering an X value if the control mode is Normal, Delta or Fixed.

Mode	SA, WCDMA, C2K, WIMAX OFDMA, TD-SCDMA, 1xEVDO, DVB-T/H, DTMB (CTTB), ISDB-T, CMMB, LTE, LTE-TDD
Remote Command	:CALCulate:ACPower:MARKer[1] 2 ... 12:X <freq> :CALCulate:ACPower:MARKer[1] 2 ... 12:X?

Example	CALC:ACP:MARK3:X 0 CALC:ACP:MARK3:X?
Notes	The query returns the marker's absolute X Axis value if the control mode is Normal, or the offset from the marker's reference marker if the control mode is Delta. If the marker is Off the response is not a number.
Dependencies	Unavailable when " Meas Method " on page 1013 is set to RBW.
Preset	After a preset, all Markers are turned OFF, so Marker X Axis Value query will return a not a number (NAN).
State Saved	No
Min	-9.9E+37
Max	9.9E+37
Initial S/W Revision	Prior to A.02.00
Modified at S/W Revision	A.02.00, A.03.00

Marker X Axis Position (Remote Command only)

Sets the marker X position in trace points. It has no effect if the control mode is Off, but is the SCPI equivalent of entering a value if the control mode is Normal, Delta or Fixed. The entered value is immediately translated into the current X Axis Scale units for setting the value of the marker.

Mode	SA, WCDMA, C2K, WIMAX OFDMA, TD-SCDMA, 1xEVDO, DVB-T/H, DTMB (CTTB), ISDB-T, CMMB, LTE, LTE-TDD
Remote Command	:CALCulate:ACPower:MARKer[1] 2 ... 12:X:POSition <real> :CALCulate:ACPower:MARKer[1] 2 ... 12:X:POSition?
Example	CALC:ACP:MARK10:X:POS 0 CALC:ACP:MARK10:X:POS?
Notes	The query returns the marker's absolute X Axis value in trace points if the control mode is Normal, or the offset from the marker's reference marker in trace points if the control mode is Delta. The value is returned as a real number, not an integer, corresponding to the translation from X Axis Scale units to trace points (see "Fractional Trace Points"). If the marker is Off the response is not a number. When a Marker is turned on, it is placed center of the screen on the trace. Therefore the default value depends on instrument condition, although the Preset/Default is defined as 500 (this value might be expected value when all offset is on).
Dependencies	Unavailable when " Meas Method " on page 1013 is set to RBW.
Preset	After a preset, all Markers are turned OFF, so Marker X Axis Value query will return a not a number (NAN).
State Saved	No
Min	-9.9E+37
Max	9.9E+37
Initial S/W Revision	Prior to A.02.00
Modified at S/W Revision	A.02.00, A.03.00

Marker Y Axis Value (Remote Command only)

Returns the marker Y axis value in the current marker Y axis unit.

Mode	SA, WCDMA, C2K, WIMAX OFDMA, TD-SCDMA, 1xEVDO, DVB-T/H, DTMB (CTTB), ISDB-T, CMMB, LTE, LTE-TDD
Remote Command	:CALCulate:ACPower:MARKer [1] 2 ... 12 : Y ?
Example	CALC:ACP:MARK11:Y?
Notes	Since the result value is always calculated from acquisition data, the default value is arbitrary. Although the Preset/Default values are defined.
Dependencies	Unavailable when " Meas Method " on page 1013 is set to RBW.
Preset	Result dependent on markers setup and signal source.
State Saved	No
Backwards Compatibility SCPI	:CALCulate:ACPower:MARKer [1] 2 ... 12 : FUNCTION:RESULT?
Initial S/W Revision	Prior to A.02.00
Modified at S/W Revision	A.02.00, A.03.00

Backward Compatibility Remote Commands

Sets or queries the state of a marker. Setting a marker which is off to the on state or 1 puts it in Normal mode and places it at the center of the screen.

Mode	SA, WCDMA, WIMAX OFDMA, CDMA2K, TDSCDMA, CDMA1XEV, DVB, DTMB, ISDBT, CMMB, LTE, LTE-TDD
Remote Command	:CALCulate:ACPower:MARKer [1] 2 ... 12 : STATE OFF ON 0 1 :CALCulate:ACPower:MARKer [1] 2 ... 12 : STATE ?
Example	CALC:ACP:MARK2:STAT ON CALC:ACP:MARK2:STAT?
Notes	This parameter is also accessed from Marker, Properties, 1 You must be in the mode that includes ACP measurements to use this command. Use :INSTRument:SElect to set the mode.
Preset	OFF OFF OFF OFF OFF OFF OFF OFF OFF OFF OFF OFF
State Saved	Saved in instrument state.
Range	On Off
Initial S/W Revision	Prior to A.02.00
Modified at S/W Revision	A.02.00, A.03.00

Marker Function

There are no Marker Functions supported in the ACP measurement. The front-panel key will display a blank key menu when pressed.

Key Path	Front-panel key
Initial S/W Revision	Prior to A.02.00

Marker To

There is no Marker To functionality supported in ACP. The front-panel key will display a blank key menu when pressed.

Key Path	Front-panel key
Initial S/W Revision	Prior to A.02.00

Meas

The information in this section is common to all measurements. For key and remote command information for a specific measurement, refer to the section that describes the measurement of interest.

Measurements available under the Meas key are specific to the current Mode.

When viewing Help for measurements, note the following:

NOTE

Operation for some keys differs between measurements. The information displayed in Help pertains to the current measurement. To see how a key operates in a different measurement, exit Help (press the Cancel Esc key), select the measurement, then reenter Help (press the Help key) and press that key.

Key Path	Front-panel key
Initial S/W Revision	Prior to A.02.00

Remote Measurement Functions

This section contains the following topics:

["Measurement Group of Commands" on page 2356](#)

["Current Measurement Query \(Remote Command Only\)" on page 2358](#)

["Limit Test Current Results \(Remote Command Only\)" on page 2358](#)

["Data Query \(Remote Command Only\)" on page 2358](#)

["Calculate/Compress Trace Data Query \(Remote Command Only\)" on page 2359](#)

["Calculate Peaks of Trace Data \(Remote Command Only\)" on page 2364](#)

["Hardware-Accelerated Fast Power Measurement \(Remote Command Only\)" on page 2365](#)

["Format Data: Numeric Data \(Remote Command Only\)" on page 2379](#)

["Format Data: Byte Order \(Remote Command Only\)" on page 2380](#)

Initial S/W Revision	Prior to A.02.00
----------------------	------------------

Measurement Group of Commands

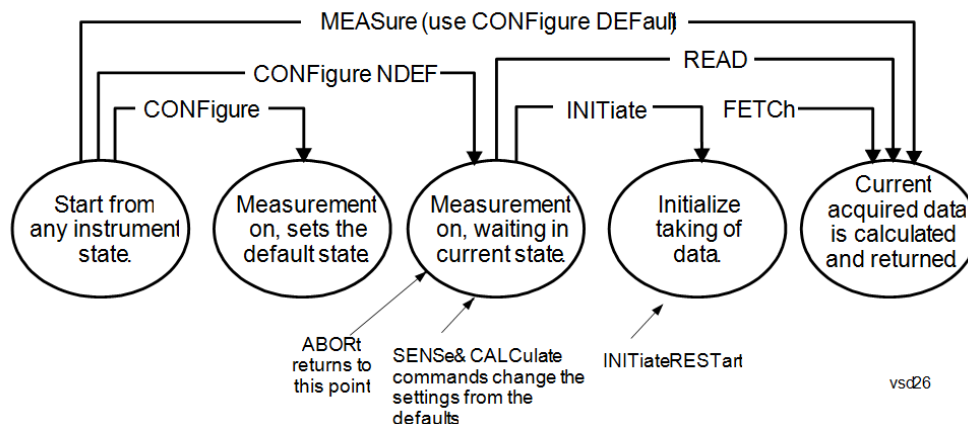

Measure Commands:

:MEASure:<measurement>[n]?

This is a fast single-command way to make a measurement using the factory default instrument settings. These are the settings and units that conform to the Mode Setup settings (e.g. radio standard) that you have currently selected.

- Stops the current measurement (if any) and sets up the instrument for the specified measurement using the factory defaults
- Initiates the data acquisition for the measurement
- Blocks other SCPI communication, waiting until the measurement is complete before returning results.
- If the function does averaging, it is turned on and the number of averages is set to 10.
- After the data is valid it returns the scalar results, or the trace data, for the specified measurement. The type of data returned may be defined by an [n] value that is sent with the command.
- The scalar measurement results will be returned if the optional [n] value is not included, or is set to 1. If the [n] value is set to a value other than 1, the selected trace data results will be returned. See each command for details of what types of scalar results or trace data results are available.
- ASCII is the default format for the data output. (Older versions of Spectrum Analysis and Phase Noise mode measurements only use ASCII.) The binary data formats should be used for handling large blocks of data since they are smaller and faster than the ASCII format. Refer to the FORMat:DATA command for more information.

If you need to change some of the measurement parameters from the factory default settings you can set up the measurement with the CONFigure command. Use the commands in the SENSe:<measurement> and CALCulate:<measurement> subsystems to change the settings. Then you can use the READ? command to initiate the measurement and query the results.

If you need to repeatedly make a given measurement with settings other than the factory defaults, you can use the commands in the SENSe:<measurement> and CALCulate:<measurement> subsystems to set up the measurement. Then use the READ? command to initiate the measurement and query results.

Measurement settings persist if you initiate a different measurement and then return to a previous one. Use READ:<measurement>? if you want to use those persistent settings. If you want to go back to the default settings, use MEASure:<measurement>?.

Configure Commands:

:CONFigure:<measurement>

This command stops the current measurement (if any) and sets up the instrument for the specified measurement using

the factory default instrument settings. It does not initiate the taking of measurement data unless INIT:CONTinuous is ON. If you change any measurement settings after using the CONFigure command, the READ command can be used to initiate a measurement without changing the settings back to their defaults.

In the Swept SA measurement in Spectrum Analyzer mode the CONFigure command also turns the averaging function on and sets the number of averages to 10 for all measurements.

:CONFigure: <measurement>: NDEFault stops the current measurement and changes to the specified measurement. It does not change the settings to the defaults. It does not initiate the taking of measurement data unless INIT:CONTinuous is ON.

The CONFigure? query returns the current measurement name.

The CONFigure:CATalog? query returns a quoted string of all licensed measurement names in the current mode. For example, "SAN, CHP, OBW, ACP, PST, TXP, SPUR, SEM, LIST".

Fetch Commands:

:FETCh:<measurement>[n]?

This command puts selected data from the most recent measurement into the output buffer. Use FETCh if you have already made a good measurement and you want to return several types of data (different [n] values, for example, both scalars and trace data) from a single measurement. FETCh saves you the time of re-making the measurement. You can only FETCh results from the measurement that is currently active, it will not change to a different measurement. An error message is reported if a measurement other than the current one is specified.

If you need to get new measurement data, use the READ command, which is equivalent to an INITiate followed by a FETCh.

The scalar measurement results will be returned if the optional [n] value is not included, or is set to 1. If the [n] value is set to a value other than 1, the selected trace data results will be returned. See each command for details of what types of scalar results or trace data results are available. The binary data formats should be used for handling large blocks of data since they are smaller and transfer faster than the ASCII format. (FORMat:DATA)

FETCh may be used to return results other than those specified with the original READ or MEASure command that you sent.

INITiate Commands:

:INITiate:<measurement>

This command is not available for measurements in all the instrument modes:

- Initiates a trigger cycle for the specified measurement, but does not output any data. You must then use the FETCh<meas> command to return data. If a measurement other than the current one is specified, the instrument will switch to that measurement and then initiate it.
 - For example, suppose you have previously initiated the ACP measurement, but now you are running the channel power measurement. If you send INIT:ACP? it will change from channel power to ACP and will initiate an ACP measurement.
 - Does not change any of the measurement settings. For example, if you have previously started the ACP measurement and you send INIT:ACP? it will initiate a new ACP measurement using the same instrument settings as the last time ACP was run.
 - If your selected measurement is currently active (in the idle state) it triggers the measurement, assuming the trigger conditions are met. Then it completes one trigger cycle. Depending upon the measurement and the number of averages, there may be multiple data acquisitions, with multiple trigger events, for one full trigger cycle. It also holds off additional commands on GPIB until the acquisition is complete.
-

READ Commands:

:READ:<measurement>[n]?

- Does not preset the measurement to the factory default settings. For example, if you have previously initiated the ACP
-

measurement and you send READ:ACP? it will initiate a new measurement using the same instrument settings.

- Initiates the measurement and puts valid data into the output buffer. If a measurement other than the current one is specified, the instrument will switch to that measurement before it initiates the measurement and returns results.
 - For example, suppose you have previously initiated the ACP measurement, but now you are running the channel power measurement. Then you send READ:ACP? It will change from channel power back to ACP and, using the previous ACP settings, will initiate the measurement and return results.
 - Blocks other SCPI communication, waiting until the measurement is complete before returning the results
 - If the optional [n] value is not included, or is set to 1, the scalar measurement results will be returned. If the [n] value is set to a value other than 1, the selected trace data results will be returned. See each command for details of what types of scalar results or trace data results are available. The binary data formats should be used when handling large blocks of data since they are smaller and faster than the ASCII format. (FORMat:DATA)
-

Initial S/W Revision	Prior to A.02.00
----------------------	------------------

Current Measurement Query (Remote Command Only)

This command returns the name of the measurement that is currently running.

Remote Command	:CONFigure?
-----------------------	-------------

Example	CONF?
----------------	-------

Initial S/W Revision	Prior to A.02.00
----------------------	------------------

Limit Test Current Results (Remote Command Only)

Queries the status of the current measurement limit testing. It returns a 0 if the measured results pass when compared with the current limits. It returns a 1 if the measured results fail any limit tests.

Remote Command	:CALCulate:CLIMits:FAIL?
-----------------------	--------------------------

Example	CALC:CLIM:FAIL? queries the current measurement to see if it fails the defined limits. Returns a 0 or 1: 0 it passes, 1 it fails.
----------------	--

Initial S/W Revision	Prior to A.02.00
----------------------	------------------

Data Query (Remote Command Only)

Returns the designated measurement data for the currently selected measurement and subopcode.

n = any valid subopcode for the current measurement. See the measurement command results table for your current measurement, for information about what data is returned for the subopcodes.

This command uses the data setting specified by the FORMat:BORDER and FORMat:DATA commands and can return real or ASCII data. (See the format command descriptions under Input/Output in the Analyzer Setup section.)

Remote Command	:CALCulate:DATA[n]?
Notes	The return trace depends on the measurement. In CALCulate:<meas>:DATA[n], n is any valid subopcode for the current measurement. It returns the same data as the FETCH:<measurement>? query where <measurement> is the current measurement.
Initial S/W Revision	Prior to A.02.00

Calculate/Compress Trace Data Query (Remote Command Only)

Returns compressed data for the currently selected measurement and sub-opcode [n].

n = any valid sub-opcode for that measurement. See the MEASure:<measurement>? command description of your specific measurement for information on the data that can be returned.

The data is returned in the current Y Axis Unit of the analyzer. The command is used with a sub-opcode <n> (default=1) to specify the trace. With trace queries, it is best if the analyzer is not sweeping during the query. Therefore, it is generally advisable to be in Single Sweep, or Update=Off.

This command is used to compress or decimate a long trace to extract and return only the desired data. A typical example would be to acquire N frames of GSM data and return the mean power of the first burst in each frame. The command can also be used to identify the best curve fit for the data.

Remote Command	:CALCulate:DATA<n>:COMPRESS? BLOCK CFIT MAXimum MINimum MEAN DMEan RMS RMSCubed SAMPLE SDEVIation PPHase [,<soffset> [,<length>[,<roffset>[,<rlimit>]]]]
Example	To query the mean power of a set of GSM bursts: Supply a signal that is a set of GSM bursts. Select the IQ Waveform measurement (in IQ Analyzer Mode). Set the sweep time to acquire at least one burst. Set the triggers such that acquisition happens at a known position relative to a burst. Then query the mean burst levels using, CALC:DATA2:COMP? MEAN, 24e-6, 526e-6 (These parameter values correspond to GSM signals, where 526e-6 is the length of the burst in the slot and you just want 1 burst.)
Notes	The command supports 5 parameters. Note that the last 4 (<soffset>, <length>, <roffset>, <rlimit>) are optional. But these optional parameters must be entered in the specified order. For example, if you want to specify <length>, then you must also specify <soffset>. See details below for a definition of each of these parameters. This command uses the data in the format specified by FORMat:DATA, returning either binary or ASCII data.
Initial S/W Revision	Prior to A.02.00

- BLOCK or block data - returns all the data points from the region of the trace data that you specify. For example, it could be used to return the data points of an input signal over several timeslots, excluding the portions of the trace data that you do not want. (This is x,y pairs for trace data and I,Q pairs for complex data.)

- CFIT or curve fit - applies curve fitting routines to the data. <soffset> and <length> are required to define the data that you want. <roffset> is an optional parameter for the desired order of the curve equation. The query will return the following values: the x-offset (in seconds) and the curve coefficients ((order + 1) values).

MIN, MAX, MEAN, DME, RMS, RMSC, SAMP, SDEV and PPH return one data value for each specified region (or <length>) of trace data, for as many regions as possible until you run out of trace data (using <roffset> to specify regions). Or they return the number of regions you specify (using <rlimit>) ignoring any data beyond that.

- MINimum - returns the minimum data point (y value) for the specified region(s) of trace data. For I/Q trace data, the minimum magnitude of the I/Q pairs is returned.
- MAXimum - returns the maximum data point (y value) for the specified region(s) of trace data. For I/Q trace data, the maximum magnitude of the I/Q pairs is returned.
- MEAN - returns a single value that is the arithmetic mean of the data point values (in dB/ dBm) for the specified region(s) of trace data. For I/Q trace data, the mean of the magnitudes of the I/Q pairs is returned. See the following equations.

-

NOTE

If the original trace data is in dB, this function returns the arithmetic mean of those log values, not log of the mean power which is a more useful value. The mean of the log is the better measurement technique when measuring CW signals in the presence of noise. The mean of the power, expressed in dB, is useful in power measurements such as Channel Power. To achieve the mean of the power, use the RMS option.

Equation 1

Mean Value of Data Points for Specified Region(s)

$$\text{MEAN} = \frac{1}{n} \sum_{X_i \in \text{region}(s)} X_i$$

where X_i is a data point value, and n is the number of data points in the specified region(s).

Equation 2

Mean Value of I/Q Data Pairs for Specified Region(s)

$$\text{MEAN} = \frac{1}{n} \sum_{X_i \in \text{region}(s)} |X_i|$$

where $|X_i|$ is the magnitude of an I/Q pair, and n is the number of I/Q pairs in the specified region(s).

- DMEan - returns a single value that is the mean power (in dB/ dBm) of the data point values for the specified region(s) of trace data. See the following equation:

Equation 3

DMEan Value of Data Points for Specified Region(s)

$$\text{DME} = 10 \times \log_{10} \left(\frac{1}{n} \sum_{X_i \in \text{region}(s)} 10^{\frac{X_i}{10}} \right)$$

- RMS - returns a single value that is the average power on a root-mean-squared voltage scale (arithmetic rms) of the data point values for the specified region(s) of trace data. See the following equation.

NOTE

For I/Q trace data, the rms of the magnitudes of the I/Q pairs is returned. See the following equation. This function is very useful for I/Q trace data. However, if the original trace data is in dB, this function returns the rms of the log values which is not usually needed.

Equation 4

RMS Value of Data Points for Specified Region(s)

$$\text{RMS} = \sqrt{\frac{1}{n} \sum_{X_i \in \text{region}(s)} X_i^2}$$

where X_i is a data point value, and n is the number of data points in the specified region(s).

Equation 5

RMS Value of I/Q Data Pairs for Specified Region(s)

$$\text{RMS} = \sqrt{\frac{1}{n} \sum_{X_i \in \text{region}(s)} X_i X_i^*}$$

where X_i is the complex value representation of an I/Q pair, X_i^* its conjugate complex number, and n is the number of I/Q pairs in the specified region(s).

Once you have the rms value for a region of trace data (linear or I/Q), you may want to calculate the mean power. You must convert this rms value (peak volts) to power in dBm:

$$10 \times \log[10 \times (\text{rms value})^2]$$

- SAMPLe - returns the first data value (x,y pair) for the specified region(s) of trace data. For I/Q trace data, the first I/Q pair is returned.
- SDEViation - returns a single value that is the arithmetic standard deviation for the data point values for the specified region(s) of trace data. See the following equation.
- For I/Q trace data, the standard deviation of the magnitudes of the I/Q pairs is returned. See the following equation.

Equation 6

Standard Deviation of Data Point Values for Specified Region(s)

$$\text{SDEV} = \sqrt{\frac{1}{n} \sum_{X_i \in \text{region}(s)} (X_i - \bar{X})^2}$$

where X_i is a data point value, \bar{X} is the arithmetic mean of the data point values for the specified region (s), and n is the number of data points in the specified region(s).

$$\text{SDEV} = \sqrt{\frac{1}{n} \sum_{X_i \in \text{region}(s)} (|X_i| - \bar{X})^2}$$

where $|X_i|$ is the magnitude of an I/Q pair, \bar{X} is the mean of the magnitudes for the specified region(s), and n is the number of data points in the specified region(s).

- PPHase - returns the x,y pairs of both rms power (dBm) and arithmetic mean phase (radian) for every specified region and frequency offset (Hz). The number of pairs is defined by the specified number of regions. This parameter can be used for I/Q vector ($n=0$) in Waveform (time domain) measurement and all parameters are specified by data point in PPHase.

The rms power of the specified region may be expressed as:

$$\text{Power} = 10 \times \log [10 \times (\text{RMS I/Q value})] + 10.$$

The RMS I/Q value (peak volts) is:

$$\sqrt{\frac{1}{n} \sum_{X_i \in \text{region}} X_i X_i^*}$$

where X_i is the complex value representation of an I/Q pair, X_i^* its conjugate complex number, and n is the number of I/Q pairs in the specified region.

The arithmetic mean phase of the specified region may be expressed as:

$$\frac{1}{n} \sum_{Y_i \in \text{region}} Y_i$$

where Y_i is the unwrapped phase of I/Q pair with applying frequency correction and n is the number of I/Q pairs in the specified region.

The frequency correction is made by the frequency offset calculated by the arithmetic mean of every specified region's frequency offset. Each frequency offset is calculated by the least square method against the unwrapped phase of I/Q pair.

Sample Trace Data - Constant Envelope

(See below for explanation of variables.)

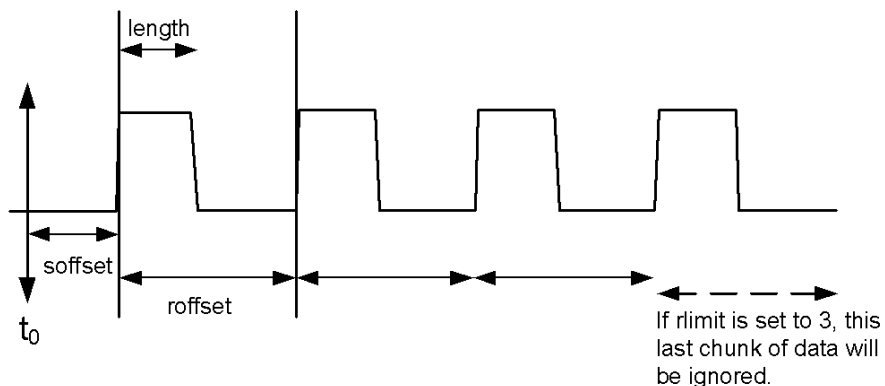

Sample Trace Data - Not Constant Envelope

(See below for explanation of variables.)

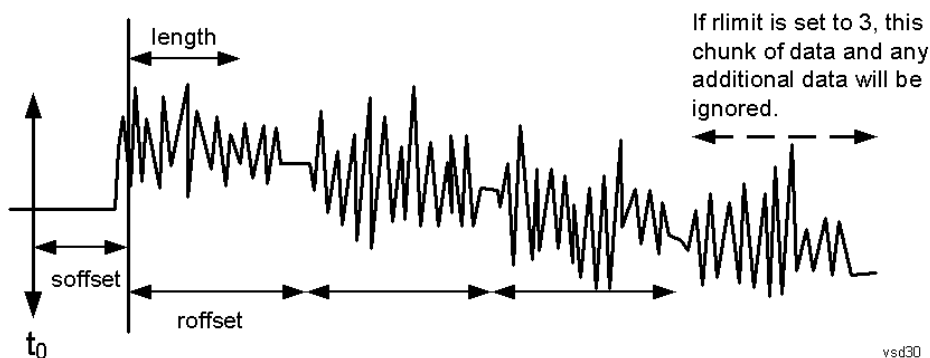

<soffset> - start offset is an optional real number. (It is in seconds for time-domain traces, and is a dimensionless index 0 to Npoints - 1, for frequency-domain traces). It specifies the amount of data at the beginning of the trace that will be ignored before the decimation process starts. It is the time or frequency change from the start of the trace to the point where you want to start using the data. The default value is zero.

<length> - is an optional real number. (It is in seconds for time-domain traces, and is a dimensionless index 0 to Npoints - 1, for frequency-domain traces). It defines how much data will be compressed into one value. This parameter has a default value equal to the current trace length.

<roffset> - repeat offset is an optional real number. (It is in seconds for time-domain traces, and is a dimensionless index 0 to Npoints - 1, for frequency-domain traces). It defines the beginning of the next field of trace elements to be compressed. This is relative to the beginning of the previous field. This parameter has a default value equal to the <length> variable. Note that this parameter is used for a completely different purpose when curve fitting (see CFIT above).

<rlimit> - repeat limit is an optional integer. It specifies the number of data items that you want returned. It will ignore any additional items beyond that number. You can use the Start offset and the Repeat limit to pick out exactly what part of the data you want to use. The default value is all the data.

Calculate Peaks of Trace Data (Remote Command Only)

Returns a list of all the peaks for the currently selected measurement and sub-opcode [n]. The peaks must meet the requirements of the peak threshold and excursion values.

n = any valid sub-opcode for the current measurement. See the MEASure:<measurement> command description of your specific measurement for information on the data that can be returned.

The command can only be used with specific sub-opcodes with measurement results that are trace data. Both real and complex traces can be searched, but complex traces are converted to magnitude in dBm. In many measurements the sub-opcode n=0, is the raw trace data which cannot be searched for peaks. And Sub-opcode n=1, is often calculated results values which also cannot be searched for peaks.

This command uses the data setting specified by the FORMat:BORDER and FORMat:DATA commands and can return real or ASCII data. If the format is set to INT,32, it returns REAL,32 data.

The command has four types of parameters:

- Threshold (in dBm)
- Excursion (in dB)
- Sorting order (amplitude, frequency, time)
- Optional in some measurements: Display line use (all, > display line, < display line)

Remote Command	<p>For Swept SA measurement:</p> <pre>:CALCulate:DATA[1] 2 ... 6:PEAKs? <threshold>,<excursion>[,AMPLitude FREQuency TIME[,ALL GTDLline LTDLine]]</pre> <p>For most other measurements:</p> <pre>:CALCulate:DATA[1] 2 ... 6:PEAKs? <threshold>,<excursion>[,AMPLitude FREQuency TIME]</pre>
-----------------------	---

Example	<p>Example for Swept SA measurement in Spectrum Analyzer Mode:</p> <p>CALC:DATA4:PEAK? -40, 10, FREQ, GTDL This will identify the peaks of trace 4 that are above -40 dBm, with excursions of at least 10 dB. The peaks are returned in order of increasing frequency, starting with the lowest frequency. Only the peaks that are above the display line are returned.</p> <p>Query Results 1:</p> <p>With FORMat:DATA REAL, 32 selected, it returns a list of floating-point numbers. The first value in the list is the number of peak points that are in the following list. A peak point consists of two values: a peak amplitude followed by its corresponding frequency (or time).</p> <p>If no peaks are found the peak list will consist of only the number of peaks, (0).</p>
----------------	---

Notes	<p><n> - is the trace that will be used</p> <p><threshold> - is the level below which trace data peaks are ignored. Note that the threshold value is required and is always used as a peak criterion. To effectively disable the threshold criterion for this command, provide a substantially low threshold value such as -200 dBm. Also note that the threshold value used in this command is independent of and has no effect on the threshold value stored under the Peak Criteria menu.</p> <p><excursion> - is the minimum amplitude variation (rise and fall) required for a signal to be identified as peak. Note that the excursion value is required and is always used as a peak criterion. To effectively disable the excursion criterion for this command, provide the minimum value of 0.0 dB. Also note that the excursion value used in this command is independent of and has no effect on the</p>
--------------	---

excursion value stored under the Peak Criteria menu.

Values must be provided for threshold and excursion. The sorting and display line parameters are optional (defaults are AMPLitude and ALL).

Note that there is always a Y-axis value for the display line, regardless of whether the display line state is on or off. It is the current Y-axis value of the display line which is used by this command to determine whether a peak should be reported
Sorting order:

AMPLitude - lists the peaks in order of descending amplitude, with the highest peak first (default if optional parameter not sent)

FREQuency - lists the peaks in order of occurrence, left to right across the x-axis.

TIME - lists the peaks in order of occurrence, left to right across the x-axis.

Peaks vs. Display Line:

ALL - lists all of the peaks found (default if optional parameter not sent).

GTDLine (greater than display line) - lists all of the peaks found above the display line.

LTDLine (less than display line) - lists all of the peaks found below the display line.

Initial S/W Revision	Prior to A.02.00
----------------------	------------------

Hardware-Accelerated Fast Power Measurement (Remote Command Only)

The Fast Power option (FP2) enables very fast channel power measurements for instruments with the prerequisite hardware (DP2 and/or B40). It accomplishes this by performing real-time overlapped FFTs at the hardware layer, using software for basic post-processing before returning the result to the user. The upshot of this approach is improved throughput for user applications that require many sequential power measurements.

The analysis bandwidth of FP2 is limited by the licenses in the instrument, but its maximum overall analysis bandwidth per acquisition is 40 MHz.

FP2 is remote-only, which means the instrument does not switch to any particular mode or measurement. FP2 commands can be sent while another application is in use on the front panel.

Each Fast Power measurement can be predefined using an array index, and up to 1,000 measurements can be stored. In the following documentation, instances of [1,2,...,999] can be substituted with a particular measurement index, e.g. CALC:FPOW:POW1?, CALC:FPOW:POW2?, CALC:FPOW:POW134?. In this way, power measurements can be defined one time in a batch, and then executed multiple times without having to redefine them, similar to “list mode” on other measurements.

In addition to basic channel power measurements, there are a number of other measurement “functions” for each channel, including peak power, peak frequency, and power spectral density. See the Function parameter for more information.

Reset Fast Power Measurement (Remote Command Only)

Resets the measurement configuration to the defaults.

Mode	All
Remote Command	:CALCulate:FPOWer:POWer [1, 2, ..., 999] :RESet
Example	:CALC:FPOW:POW1:RES

Notes	Option FP2 is required.
Initial S/W Revision	A.14.00

Define Fast Power Measurement (Remote Command Only)

Fast Power acquisitions are configured using the DEFine command. This command accepts a comma-delimited string of configuration parameters and their appropriate values, which are all specified in the subsection below.

Mode	All
Remote Command	:CALCulate:FPOWer:POWer[1,2,...,999]:DEFine "configuration string"
Example	:CALC:FPOW:POW1:DEF "CenterFrequency=2e9, AcquisitionTime=0.005"
Notes	See below for a list of measurement variables that can be defined in the configuration string.
Initial S/W Revision	A.14.00

Acquisition Time

Example	CALC:FPOW:POW1:DEF "AcquisitionTime=0.002"
Notes	The acquisition time parameter sets the time in which the entire spectrum is measured. An increase in the acquisition time yields an improvement in measurement repeatability.
Preset	0.001 s
Range	0 s to 1 s
Default Unit	Time (s)
Initial S/W Revision	A.14.00

Center Frequency

Example	CALC:FPOW:POW1:DEF "CenterFrequency=2e9"
Notes	The center frequency parameter sets the frequency in which the measurement is centered around. The OffsetFrequency parameter is calculated relative to the center frequency.
Preset	1 GHz
Range	0 Hz to maximum instrument frequency
Default Unit	Frequency (Hz)
Initial S/W Revision	A.14.00

DC Coupled

Example	CALC:FPOW:POW1:DEF "DCCoupled=True"
Notes	The DC coupled parameter allows the user to specify whether the DC blocking capacitor is utilized. Set parameter to true when measuring frequencies below 10 MHz.
Preset	False
Range	True (DC Coupled) or False (AC Coupled)
Default Unit	Boolean
Initial S/W Revision	A.14.00

DetectorType

Example	CALC:FPOW:POW1:DEF "DetectorType=Peak"
Notes	Option FP2 is required. The detector type parameter allows the user to choose whether a RMS average or peak value is used during the measurement.
Preset	RmsAverage
Range	RmsAverage, Peak
Initial S/W Revision	A.14.00

Do Noise Correction

Example	CALC:FPOW:POW1:DEF "DoNoiseCorrection=True"
Notes	When noise correction is enabled, the linear noise power contributed by the analyzer is subtracted from all measurements. This effectively lowers the noise floor of the analyzer. When noise correction is enabled, the first measurement for a given set of input parameters will take extra time. This is because the analyzer takes an extra acquisition with the RF input disconnected from the analyzer's front end to measure the noise of just the analyzer. The measured noise floor is stored in a cache so the noise acquisition will occur only once for the same state settings. In other words, if noise correction was turned on and the analyzer made an acquisition at frequency A, then frequency B, and back again to frequency A, the hidden initial noise floor acquisition would only occur for the first acquisition at frequency A and the cached noise floor would be used the second time frequency A was measured.
Preset	False
Range	True (enable noise correction) or False (disable noise correction)
Default Unit	Boolean
Initial S/W Revision	A.14.00

Do Spur Suppression

Example	CALC:FPOW:POW1:DEF "DoSpurSuppression=True"
Notes	<p>When measuring very low level signals, or when large out-of-band inputs are input into the analyzer, sometimes unwanted spurs and residuals can appear in the measured spectrum. Spur suppression is a method to help minimize the levels of these internally generated spurs and residuals.</p> <p>When spur suppression is enabled, the analyzer will automatically take two acquisitions using two different internal analog LO frequencies. The FFT spectrums from both acquisitions are combined by taking the minimum power between both traces on a per FFT bin basis. External signals will have the same amplitude for both traces and therefore will return the expected amplitudes. However, low level spurs and residuals generated internally to the analyzer tend to move to different FFT bins depending on the internal analog LO frequency used, and therefore tend to be suppressed using this spur suppression method.</p> <p>Because two acquisitions, rather than a single acquisition, are made when spur suppression is enabled, the measurement time will always be slower when spur suppression is enabled.</p>
Preset	False
Range	True (enable spur suppression) or False (disable spur suppression)
Default Unit	Boolean
Initial S/W Revision	A.14.00

Electronic Attenuator Bypass

Example	CALC:FPOW:POW1:DEF "ElecAttBypass =False"
Notes	The electronic attenuation bypass parameter allows the user to either utilize or bypass the electronic attenuator. The electronic attenuator is only available for frequencies up to 3.6 GHz. Set parameter to true when using frequencies above 3.6 GHz and set the parameter to false when using the preamp.
Preset	True
Range	True (bypass electronic attenuator) or False (use electronic attenuator)
Default Unit	Boolean
Initial S/W Revision	A.14.00

Electronic Attenuation

Example	CALC:FPOW:POW1:DEF "ElecAttenuation=10"
Notes	<p>Option EA3 is required.</p> <p>The electronic attenuation value parameter sets the amount of electrical attenuation from 0 to 24 dB (1 dB steps).</p> <p>Set "ElecAttBypass=False" to make sure the electronic attenuator path is enabled.</p>
Preset	0 dB
Range	0 - 24 dB (1 dB steps)

Default Unit	dB
Initial S/W Revision	A.14.00

IF Gain

Example	CALC:FPOW:POW1:DEF "IFGain=10"
Notes	The IF gain parameter allows the user to specify the gain at the IF stage anywhere from -6 to 16 dB (1 dB steps). This is an advanced feature, and for most cases this should remain at its default value of 0 dB.
Preset	0 dB
Range	-6 - 16 dB (1 dB steps)
Default Unit	dB
Initial S/W Revision	A.14.00

IF Type

Example	CALC:FPOW:POW1:DEF "IFType=B25M"
Notes	The IF type parameter allows the user to select between different IF paths. For example, if the signal is less than 25 MHz wide, then the user can select the B25M path to take advantage of additional filtering on this analog IF path.
Preset	B40M
Range	B10M, B25M, B40M
Initial S/W Revision	A.14.00

Include Power Spectrum

Example	CALC:FPOW:POW1:DEF "IncludePowerSpectrum=True"
Notes	The power spectrum parameter allows the user to read data on the entire spectrum for diagnostic purposes. It is not recommended for production use. See CALC:FPOW:POW[n]:READ2? for details on the binary format of the response.
Preset	False
Range	True (return both channel power and full power spectrum) or False (returns only channel power)
Default Unit	Boolean
Initial S/W Revision	A.14.00

Mechanical Attenuation

Example	CALC:FPOW:POW1:DEF "MechAttenuation=10"
Notes	The mechanical attenuation value parameter sets the amount of mechanical attenuation anywhere from 0 to 70 dB (2 dB steps).
Preset	0 dB
Range	0 – 70 dB (2 dB steps)
Default Unit	dB
Initial S/W Revision	A.14.00

Preamp Mode

Example	CALC:FPOW:POW1:DEF "PreAmpMode=Low"
Notes	The license for the appropriate preamp is required. The preamp mode parameter specifies whether the preamps are being utilized. Low allows any preamps up to 3.6 GHz, and Full allows all licensed preamps. Set "ElecAttBypass=True" in order to utilize any preamps.
Preset	Off
Range	Off, Low, Full
Initial S/W Revision	A.14.00

Resolution Bandwidth Mode

Example	CALC:FPOW:POW1:DEF "PreAmpMode=Low"
Notes	The resolution bandwidth mode parameter allows the user to choose whether the RBW filter is automatically or manually set. The BestSpeed value minimizes measurement time, while the Narrowest value minimizes RBW size (minimum of two FFT bins per RBW). To manually specify an RBW, set this parameter to Explicit, and set the ResolutionBW parameter to the desired value.
Preset	BestSpeed
Range	BestSpeed, Narrowest, Explicit
Initial S/W Revision	A.14.00

Resolution Bandwidth

Example	CALC:FPOW:POW1:DEF "ResolutionBW=25e3"
Notes	The resolution bandwidth parameter sets the 3-dB bandwidth of the RBW filter. The ResolutionBWMode parameter must be set to Explicit in order to manually set the RBW.

Preset	0 Hz
Default Unit	Hz
Initial S/W Revision	A.14.00

Trigger Delay

Example	CALC:FPOW:POW1:DEF "TriggerDelay=0.025"
Notes	The trigger delay parameter sets the time after an external trigger is detected until the measurement is performed.
Preset	0 s
Range	0 - 1 s
Default Unit	Seconds
Initial S/W Revision	A.14.00

Trigger Level

Example	CALC:FPOW:POW1:DEF "TriggerLevel=2"
Notes	The trigger level parameter sets the voltage value at which an external trigger is detected.
Preset	1.2 V
Range	-5 to 5 V
Default Unit	Volts
Initial S/W Revision	A.14.00

Trigger Slope

Example	CALC:FPOW:POW1:DEF "TriggerSlope=Negative"
Notes	The trigger slope parameter indicates the direction of the edge trigger voltage for detection.
Preset	Positive
Range	Positive, Negative
Initial S/W Revision	A.14.00

Trigger Source

Example	CALC:FPOW:POW1:DEF "TriggerSource=Ext1"
Notes	The trigger source parameter allows the user to choose between measurement's triggering freely or controlled by an external input. Ext1 and Ext2 correspond to Trigger 1 In and Trigger 2 In, respectively.
Preset	Free
Range	Free, Ext1, Ext2
Initial S/W Revision	A.14.00

Trigger Timeout

Example	CALC:FPOW:POW1:DEF "TriggerTimeout=0.1"
Notes	The trigger timeout parameter sets the time in which the analyzer will wait for a trigger before automatically performing the measurement.
Preset	1 s
Range	0 – 1 s
Default Unit	Seconds
Initial S/W Revision	A.14.00

Signal Input

Example	CALC:FPOW:POW1:DEF "SignalInput=Fp50MHzCW"
Notes	The signal input parameter allows the user to select between using the main RF input or the internal analyzer reference CW signal of 50 MHz.
Preset	FpMainRf
Range	FpMainRf, Fp50MHzCW
Initial S/W Revision	A.14.00

Use Preselector

Example	CALC:FPOW:POW1:DEF "UsePreSelector=True"
Notes	The preselector parameter allows the user to either utilize or bypass the front end tunable filter at frequencies above 3.6 GHz. For frequencies below 3.6 GHz, the preselector is automatically bypassed, so you do not need to set this parameter to False in those cases.
Preset	False
Range	True (use preselector above 3.6 GHz), or False (preselector bypassed)

Default Unit	Boolean
Initial S/W Revision	A.14.00

Channel Bandwidth Array

Example	CALC:FPOW:POW1:DEF "Bandwidth=[3.84e6, 5e6, 3.84e6]"
Notes	The bandwidth parameter array defines the bandwidth of each channel that will be measured. All array parameters should have the same number of elements. Alternatively, if all the elements are the same value, a single number with no square brackets can be used to define the parameter.
Preset	[1e6]
Range	0 to 40 MHz
Default Unit	Hz
Initial S/W Revision	A.14.00

Channel Filter Type Array

Example	CALC:FPOW:POW1:DEF "FilterType=[RRC, IBW, RRC]"
Notes	The filter type parameter allows the user to choose between an integration bandwidth (IBW) filter or a root-raised-cosine (RRC) filter. The integration bandwidth filter weighs all frequencies within the bandwidth equally. The root-raised-cosine filter has an associated shape parameter, defined by the FilterAlpha parameter. All array parameters should have the same number of elements. Alternatively, if all the elements are the same value, a single value with no square brackets can be used to define the parameter.
Preset	[IBW]
Range	IBW, RRC
Initial S/W Revision	A.14.00

Channel Filter Alpha Array

Example	CALC:FPOW:POW1:DEF "FilterAlpha=[0.5, 0.0, 0.5]"
Notes	The filter alpha parameter allows the user to adjust the alpha value associated with the root-raised-cosine (RRC) filter type. Set FilterType to RRC in order to utilize this parameter. All array parameters should have the same number of elements. Alternatively, if all the elements are the same value, a single number with no square brackets can be used to define the parameter.
Preset	[0.22]
Range	0.0 – 1.0
Initial S/W Revision	A.14.00

Channel Measurement Function Array

Example	CALC:FPOW:POW1:DEF "Function=[BandPower, PeakPower, BandPower]"
Notes	<p>This parameter array defines what measurement is being made for each individually-specified channel:</p> <p>BandPower: Total power within the specified bandwidth of the channel (dBm)</p> <p>BandDensity: Total power density within the specified bandwidth of the channel (dBm/Hz)</p> <p>PeakPower: The peak power value within the specified bandwidth of the channel (dBm)</p> <p>PeakFrequency: The frequency which corresponds to the peak power value within the specified bandwidth of the channel. This frequency is relative to the center frequency (Hz)</p> <p>XdBBandwidth: The half power (-3.01 dB) bandwidth of the highest amplitude signal that resides within the channel (Hz), dB is configurable using XdBBandwidth parameter</p> <p>OccupiedBandwidth: The bandwidth at which 99% of the total power resides within the channel (Hz), percentage configurable using OccupiedBandwidthPercent parameter</p> <p>All array parameters should have the same number of elements. Alternatively, if all the elements are the same value, a single value with no square brackets can be used to define the parameter.</p>
Preset	[BandPower]
Range	BandPower, BandDensity, PeakPower, PeakFrequency, XdBBandwidth, OccupiedBandwidth
Initial S/W Revision	A.14.00

Channel Offset Frequency Array

Example	CALC:FPOW:POW1:DEF "OffsetFrequency=[-5e6, 0, 5e6]"
Notes	<p>The offset frequency parameter array defines the difference between the center frequency to the center frequency of each channel.</p> <p>All array parameters should have the same number of elements.</p>
Preset	[0]
Range	0 to 20 MHz
Default Unit	Hz
Initial S/W Revision	A.14.00

Channel Occupied Bandwidth Percent Array

Example	CALC:FPOW:POW1:DEF "OccupiedBandwidthPercent =[0.95, 0.95, 0.95]"
Notes	<p>This parameter only applies for channels whose Function is set to OccupiedBandwidth. The occupied bandwidth percent parameter specifies the percent of total power in these channels. The valid range for this parameter is 0.0 to 1.0, where 1.0 represents 100%. The default for this parameter is 0.99, which will return the bandwidth that contains 99% of the total channel power.</p>

Preset	[0.99]
Range	0 - 1.0
Initial S/W Revision	A.14.00

Channel x-dB Bandwidth Array

Example	CALC:FPOW:POW1:DEF " XdBBandwidth =[-6.02, -3.01, -1.0]"
Notes	This parameter only applies for channels whose Function is set to XdBBandwidth. The X dB bandwidth parameter is used to specify the power relative to the peak channel power over which the bandwidth is calculated. The parameter value must be a negative number.
Preset	[-3.01]
Range	-200 to 0 dB
Default Unit	dB
Initial S/W Revision	A.14.00

Define Fast Power Measurement Query (Remote Command Only)

The DEFine? command is used to retrieve a list of all defined parameters in an ASCII string format

M	All
o	
d	
e	
R	:CALCulate:FPOWer:POWer[1,2,...,999]:DEFine?
e	
m	
o	
t	
e	
C	
o	
m	
m	
a	
n	
d	
E	:CALC:FPOW:POW1:DEF?
x	
a	
m	

p
l
e

N This command query is used to retrieve a list of all defined parameters in an ASCII format.

O The following is an example of the returned results:

S "DCCoupled=False,ElecAttBypass=True,ElecAttenuation=0,IFGain=0,MechAttenuation=0,PreAmpMode=Off,PreSelectorOffset=0,UsePreSelector=False,ExternalReferenceFrequency=1000000,FrequencyReferenceSource=AutoExternalFrequencyReference,IFType=B40M,LOMode=SLW,SignalInput=FpMainRf,AcquisitionTime=0.001,CenterFrequency=100000000,ResolutionBW=0,ResolutionBWMode=BestSpeed,DetectorType=RmsAverage,Bandwidth=[1000000],OffsetFrequency=[0],Function=[BandPower],FilterType=[IBW],FilterAlpha=[0.22],OccupiedBandwidthPercent=[0.99],XdBBandwidth=[-3.01],DoNoiseCorrection=False,DoSpurSuppression=False,MeasurementMethod=HardwareFFT,IncludePowerSpectrum=False,TriggerDelay=0,TriggerLevel=1.2,TriggerSlope=Positive,TriggerSource=Free,TriggerTimeout=1"

I A.14.00

n
i
t
i
a
lS
/
WR
e
v
i
s
i
o
n

Configure Fast Power Measurement (Remote Command Only)

The configure command begins hardware setup and returns immediately, with no acquisition made. This can be used in parallel with other hardware operations to effectively hide the hardware setup time.

Mode	All
Remote Command	:CALCulate:FPOWER:POWER[1,2,...,999]:CONFigure
Example	:CALC:FPOW:POW1:CONF
Notes	Option FP2 is required.
Initial S/W Revision	A.14.00

Initiate Fast Power Measurement (Remote Command Only)

The INITiate command begins an acquisition and returns immediately. The results of the measurement can be retrieved using FETCh.

Mode	All
Remote Command	:CALCulate:FPOWer:POWer[1,2,...,999]:INITiate
Example	:CALC:FPOW:POW1:INIT
Notes	Option FP2 is required.
Initial S/W Revision	A.14.00

Fetch Fast Power Measurement (Remote Command Only)

The FETCh command query is used to retrieve the results of an acquisition initiated by the INIT command. The returned results are in ASCII string format. The string begins and ends with quotation marks.

Mode	All
Remote Command	:CALCulate:FPOWer:POWer[1,2,...,999]:FETCh?
Example	:CALC:FPOW:POW1:FETC?
Notes	Option FP2 is required. Returns m comma-separated ASCII values, where m corresponds to the number of bandwidths defined. 1. Declared function return in the 1st specified channel 2. Declared function return in the 2nd specified channel ... m. Declared function return in the last specified channel The INIT and FETC? command sequence performs the same functionality of a single CALC:FPOW:POW[n]? query. Units of the returned values are dependent on the Function parameter for each channel.
Initial S/W Revision	A.14.00

Execute Fast Power Measurement (Remote Command Only)

This command query is used as shorthand for an INIT command immediately followed by a FETC? command. The returned results are in ASCII string format. The string begins and ends with quotation marks.

Mode	All
Remote Command	:CALCulate:FPOWer:POWer[1,2,...,999]?
Example	:CALC:FPOW:POW1?
Notes	Option FP2 is required. See notes for Fast Power Fetch for return format.
Initial S/W Revision	A.14.00

Binary Read Fast Power Measurement (Remote Command Only)

This command query is used as shorthand for an INIT command immediately followed by a FETC? command. The returned results are in a binary format.

Mode	All
Remote Command	:CALCulate:FPOWER:POWER[1,2,...,999]:READ? :CALCulate:FPOWER:POWER[1,2,...,999]:READ1?
Example	:CALC:FPOW:POW1:READ? :CALC:FPOW:POW1:READ1?
Notes	Option FP2 is required. Returns m 4 byte floating point binary values (Little-Endian), where m corresponds to the number of bandwidths defined.
Initial S/W Revision	A.14.00

Diagnostic Binary Read Fast Power Measurement (Remote Command Only)

This command query is used as shorthand for an INIT command immediately followed by a FETC? command. The returned results are in a binary format. This command is used primarily for diagnostic purposes to test for ADC overloads and to visibly inspect the spectrum.

Mode	All
Remote Command	:CALCulate:FPOWER:POWER[1,2,...,999]:READ2?
Example	:CALC:FPOW:POW1:READ2?
Notes	Option FP2 is required. Note: Spectrum data is only returned if the IncludePowerSpectrum parameter is set to True. If IncludePowerSpectrum is False, the number of spectrum points will be zero (0). Units of the returned values are dependent on the Function parameter per channel (e.g. dBm for BandPower, Hz for PeakFrequency). Returns binary data (Little-Endian) that contains information on m amount of channels, along with ADC over range and full spectrum data. The following is the binary format of the response. Bandwidth Return Value 1. Number of channels specified, m [4 byte int] 2. Declared function result for the 1st specified channel [4 byte float] 3. Declared function result for the 2nd specified channel [4 byte float] ... (m + 1). Declared function result for the last (mth) specified channel [4 byte float] ADC Over Range 1. ADC over-range occurred (1: true, 0: false) [2 byte short]

	<p>Spectrum Data</p> <ol style="list-style-type: none"> 1. Number of points in the spectrum data, k [4 byte int] 2. Start frequency of spectrum data (Hz) [8 byte double] 3. Step frequency of spectrum data (Hz) [8 byte double] 4. FFT bin at 1st point (dBm) [4 byte float] 5. FFT bin at 2nd point (dBm) [4 byte float] ... (k + 3). FFT bin at last (kth) point (dBm) [4 byte float]
Initial S/W Revision	A.14.00

Format Data: Numeric Data (Remote Command Only)

This command specifies the format of the trace data input and output. It specifies the formats used for trace data during data transfer across any remote port. It affects only the data format for setting and querying trace data for the :TRACe[:DATA], TRACe[:DATA]?, :CALCulate:DATA[n]? and FETCh:SANalyzer[n]? commands and queries.

Remote Command	<pre>:FORMat [:TRACe] [:DATA] ASCii INTeger, 32 REAL, 32 REAL, 64 :FORMat [:TRACe] [:DATA] ?</pre>
Notes	<p>The query response is:</p> <p>ASCii: ASC,8 REAL,32: REAL,32 REAL,64: REAL,64 INTeger,32: INT,32</p> <p>When the numeric data format is REAL or ASCii, data is output in the current Y Axis unit. When the data format is INTeger, data is output in units of m dBm (.001 dBm).</p> <p>The INT,32 format returns binary 32-bit integer values in internal units (m dBm), in a definite length block.</p>
Dependencies	<p>Sending a data format spec with an invalid number (for example, INT,48) generates no error. The analyzer simply uses the default (8 for ASCii, 32 for INTeger, 32 for REAL).</p> <p>Sending data to the analyzer which does not conform to the current FORMat specified, results in an error. Sending ASCII data when a definite block is expected generates message -161 "Invalid Block Data" and sending a definite block when ASCII data is expected generates message -121 "Invalid Character in Number".</p>
Preset	ASCii
Backwards Compatibility Notes	Note that the INT,32 format is only applicable to the command, TRACe:DATA. This preserves backwards compatibility for the Swept SA measurement. For all other commands/queries which honor FORMat:DATA, if INT,32 is sent the analyzer will behave as though it were set to REAL,32.
Initial S/W Revision	Prior to A.02.00

The specs for each output type follow:

AScii - Amplitude values are in ASCII, in the current Y Axis Unit, one ASCII character per digit, values separated by commas, each value in the form:

SX.YYYYYEsZZ

Where:

S = sign (+ or -)

X = one digit to left of decimal point

Y = 5 digits to right of decimal point

E = E, exponent header

s = sign of exponent (+ or -)

ZZ = two digit exponent

REAL,32 - Binary 32-bit real values in the current Y Axis Unit, in a definite length block.

REAL,64 - Binary 64-bit real values in the current Y Axis Unit, in a definite length block.

Format Data: Byte Order (Remote Command Only)

This command selects the binary data byte order for data transfer and other queries. It controls whether binary data is transferred in normal or swapped mode. This command affects only the byte order for setting and querying trace data for the :TRACe[:DATA], TRACe[:DATA]? , :CALCulate:DATA[n]? and FETCh:SANalyzer[n]? commands and queries.

By definition any command that says it uses FORMat:DATA uses any format supported by FORMat:DATA.

The NORMal order is a byte sequence that begins with the most significant byte (MSB) first, and ends with the least significant byte (LSB) last in the sequence: 1|2|3|4. SWAPped order is when the byte sequence begins with the LSB first, and ends with the MSB last in the sequence: 4|3|2|1.

Remote Command	:FORMat:BORDER NORMal SWAPped :FORMat:BORDER?
Preset	NORMal
Initial S/W Revision	Prior to A.02.00

Meas Setup

Displays the setup menu for the currently selected measurement. The functions included in the measurement setup menu include setting the parameters for the carriers, offsets, bandwidths, measurement methods and types. This menu also allows you to turn noise correction on and off.

Key Path	Front-panel key
Initial S/W Revision	Prior to A.02.00

Average/Hold Number

Specifies the number of measurement averages used to calculate the measurement result. The average will be displayed at the end of each sweep. After the specified number of average counts, the average mode (termination control) setting determines the average action.

Key Path	Meas Setup
Mode	SA, WCDMA, C2K, WIMAX OFDMA, TD-SCDMA, 1xEVDO, DVB-T/H, DTMB (CTTB), ISDB-T, CMMB, LTE, LTETDD
Remote Command	[:SENSe]:ACPower:AVERage:COUNT <integer> [:SENSe]:ACPower:AVERage:COUNT? [:SENSe]:ACPower:AVERage[:STATe] OFF ON 0 1 [:SENSe]:ACPower:AVERage[:STATe]?
Example	ACP:AVER:COUN 250 ACP:AVER:COUN? ACP:AVER OFF ACP:AVER?
Notes	You must be in the mode that includes ACP measurements to use this command. Use :INSTrument:SElect to set the mode.
Preset	10 ON
State Saved	Saved in instrument state.
Min	1
Max	1000
Backwards Compatibility SCPI	[:SENSe]:ACPR:AVERage:COUNT [:SENSe]:MCPower:AVERage:COUNT (PSA Power Suite, PSA W-CDMA, PSA cdma2000)
Initial S/W Revision	Prior to A.02.00
Modified at S/W Revision	A.02.00, A.03.00

Avg Mode

Enables you to set the averaging mode. This determines the averaging action after the specified number of data acquisitions (average count) is reached.

When set to Exponential (Exp) the measurement averaging continues using the specified number of averages to compute each averaged value. The average will be displayed at the end of each sweep.

When set to Repeat, the measurement resets the average counter each time the specified number of averages is reached.

Key Path	Meas Setup
Mode	SA, WCDMA, C2K, WIMAX OFDMA, TD-SCDMA, 1xEVDO, DVB-T/H, DTMB (CTTB), ISDB-T, CMMB, LTE, LTETDD
Remote Command	[:SENSe] :ACPower:AVERage:TCONtrol EXPonential REPeat [:SENSe] :ACPower:AVERage:TCONtrol?
Example	ACP:AVER:TCON EXP ACP:AVER:TCON?
Notes	You must be in the mode that includes ACP measurements to use this command. Use :INSTrument:SElect to set the mode.
Preset	EXPonential
State Saved	Saved in instrument state.
Range	Exp Repeat
Backwards Compatibility SCPI	[:SENSe] :ACPR:AVERage:TCONtrol
Initial S/W Revision	Prior to A.02.00
Modified at S/W Revision	A.02.00, A.03.00

Offset/Limits

Accesses a menu of functions that contains Offset, Offset Freq/Offset To Edge, Offset Integ BW, Upper Offset Limit and Lower Offset parameters.

Key Path	Meas Setup
Initial S/W Revision	Prior to A.02.00
Modified at S/W Revision	A.13.00

Select Offset

Selects the offset to configure.

Key Path	Meas Setup, Offset/Limits, Limits
Mode	SA, WCDMA, C2K, WIMAX OFDMA, TD-SCDMA, 1xEVDO, DVB-T/H, DTMB (CTTB), ISDB-T, CMMB, LTE, LTETDD
Preset	A
State Saved	Saved in instrument state.
Range	Offset A Offset B Offset C Offset D Offset E Offset F
Initial S/W Revision	Prior to A.02.00
Modified at S/W Revision	A.02.00, A.03.00, A.13.00

Offset Freq

This parameter determines the frequency difference between the center of the main channel and the center of the carrier.

Each Offset Freq state value is entered individually by selecting the desired carrier on the carrier menu key using the up down arrows, RPG or numeric keypad. Then enter the Offset Freq State using the Offset Frequency key.

The list contains up to six (6) entries, depending on the mode selected, for offset frequencies. Each offset frequency in the list corresponds to a reference bandwidth in the bandwidth list.

An offset frequency of zero turns the display of the measurement for that offset off, but the measurement is still made and reported. You can turn off (not use) specific offsets with the [:SENSe]:ACP:OFFSet:LIST:STATe command.

Turning the offset off has the same effect as setting the frequency of the offset to 0 Hz and will cause it to be removed from the results screen.

Key Path	Meas Setup, Offset/Limits
Mode	SA, WCDMA, C2K, WIMAX OFDMA, TD-SCDMA, 1xEVDO, DVB-T/H, DTMB (CTTB), ISDB-T, CMMB, LTE, LTETDD
Remote Command	<pre>[:SENSe]:ACP:OFFSet [1] 2[:OUTer]:LIST[:FREQuency] <freq>, <freq>, <freq>, <freq>, <freq>, <freq> [:SENSe]:ACP:OFFSet [1] 2[:OUTer]:LIST[:FREQuency]? [:SENSe]:ACP:OFFSet [1] 2[:OUTer]:LIST:STATe OFF ON 0 1, OFF ON 0 1, OFF ON 0 1, OFF ON 0 1, OFF ON 0 1, OFF ON 0 1 [:SENSe]:ACP:OFFSet [1] 2[:OUTer]:LIST:STATe?</pre>
Example	<pre>ACP:OFFS1:LIST 0,0,0,0,0,0 ACP:OFFS1:LIST? ACP:OFFS2:LIST:STAT 1,1,0,0,0,0 ACP:OFFS2:LIST:STAT?</pre>
Notes	The label for this menu key will change depending on the currently selected radio standard or mode. For cdma2000 the label for the menu key will be Offset to Edge. For all other supported standards the label will be Offset Freq.

	<p>When setting these values remotely, the position in the list sent corresponds to the offset. Missing values are not permitted, unless the number of values sent is greater than the number of carriers, then subsequent values will be ignored.</p> <p>Offset sub op code. 1 for BTS, 2 for MS. Default is BTS.</p> <p>Note that Offset sub op code 2 is supported only in Non-SA modes.</p> <p>In the SA mode, Offset sub op code 1 is used for both BTS and MS.</p> <p>You must be in the mode that includes ACP measurements to use this command. Use :INSTrument:SElect to set the mode.</p>
Couplings	Changing Offset Frequency might affect the Span. See the Span key section for details.
Preset	<p>SA: 3 MHz, 0 Hz, 0 Hz, 0 Hz, 0 Hz, 0 Hz 3 MHz, 0 Hz, 0 Hz, 0 Hz, 0 Hz, 0 Hz</p> <p>WCDMA: 5.0 MHz, 10.0 MHz, 0 Hz, 0 Hz, 0 Hz, 0 Hz 5.0 MHz, 10.0 MHz, 0 Hz, 0 Hz, 0 Hz, 0 Hz</p> <p>WIMAX OFDMA: 10 MHz, 20 MHz, 0 Hz, 0 Hz, 0 Hz, 0 Hz 10 MHz, 20 MHz, 0 Hz, 0 Hz, 0 Hz, 0 Hz</p> <p>C2K:750KHz, 1.980 MHz, 0 Hz, 0 Hz, 0 Hz, 0 Hz 885 kHz, 1.980 MHz, 0 Hz, 0 Hz, 0 Hz, 0 Hz</p> <p>TD-SCDMA: 1.6 MHz, 3.2 MHz, 0 Hz, 0 Hz, 0 Hz, 0 Hz 1.6 MHz, 3.2 MHz, 0 Hz, 0 Hz, 0 Hz, 0 Hz</p> <p>1xEVDO: 750KHz, 1.98MHz, 3.125MHz, 4.000MHz, 7.500MHz, 7.500MHz 885KHz, 1.98MHz, 3.125MHz, 4.000MHz, 7.500MHz, 7.500MHz</p> <p>DVB-T/H: 8 MHz, 16 MHz, 0 Hz, 0 Hz, 0 Hz, 0 Hz 8 MHz, 16 MHz, 0 Hz, 0 Hz, 0 Hz, 0 Hz</p> <p>DTMB (CTTB): 8 MHz, 16 MHz, 24 MHz, 32 MHz, 0 Hz, 0 Hz 8 MHz, 16 MHz, 24 MHz, 32 MHz, 0 Hz, 0 Hz</p> <p>ISDB-T: 6 MHz, 12 MHz, 0 Hz, 0 Hz, 0 Hz, 0 Hz 6 MHz, 12 MHz, 0 Hz, 0 Hz, 0 Hz, 0 Hz</p> <p>CMMB: 8 MHz, 16 MHz, 24 MHz, 32 MHz, 0 Hz, 0 Hz 8 MHz, 16 MHz, 24 MHz, 32 MHz, 0 Hz, 0 Hz</p> <p>LTE, LTE-TDD: 5 MHz, 10 MHz, 0, 0, 0, 0 5 MHz, 10 MHz, 0, 0, 0, 0</p> <p>Digital Cable TV: 8 MHz, 16 MHz, 0 Hz, 0 Hz, 0 Hz, 0 Hz 8 MHz, 16 MHz, 0 Hz, 0 Hz, 0 Hz, 0 Hz</p> <p>SA: ON, OFF, OFF, OFF, OFF, OFF ON, OFF, OFF, OFF, OFF, OFF</p> <p>WCDMA: ON, ON, OFF, OFF, OFF, OFF ON, ON, OFF, OFF, OFF, OFF</p> <p>WIMAX OFDMA: ON, ON, OFF, OFF, OFF, OFF ON, ON, OFF, OFF, OFF, OFF</p> <p>TD-SCDMA: ON, ON, OFF, OFF, OFF, OFF ON, ON, OFF, OFF, OFF, OFF</p> <p>DVB-T/H: ON, ON, OFF, OFF, OFF, OFF ON, ON, OFF, OFF, OFF, OFF</p> <p>DTMB (CTTB): ON, ON, OFF, OFF, OFF, OFF ON, ON, OFF, OFF, OFF, OFF</p> <p>CDMA1xEVDO: ON, ON, OFF, OFF, OFF, OFF ON, ON, OFF, OFF, OFF, OFF</p> <p>ISDB-T: ON, ON, OFF, OFF, OFF, OFF ON, ON, OFF, OFF, OFF, OFF</p> <p>CMMB: ON, ON, ON, ON, OFF, OFF ON, ON, ON, ON, OFF, OFF</p> <p>LTE, LTE-TDD: ON, ON, OFF, OFF, OFF, OFF ON, OFF, OFF, OFF, OFF, OFF</p> <p>Digital Cable TV: ON, ON, OFF, OFF, OFF, OFF ON, ON, OFF, OFF, OFF, OFF</p>
State Saved	Saved in instrument state.
Min	0 Hz
Max	500 MHz
Backwards Compatibility SCPI	[:SENSe] :MCPower:OFFSet [1] 2 :LIST [:FREQuency] (PSA Power Suite)
Initial S/W Revision	Prior to A.02.00
Modified at S/W Revision	A.02.00, A.03.00, A.13.00

Integ BW

Sets the Integration Bandwidth for the offsets. Each resolution bandwidth in the list corresponds to an offset frequency in the list defined by [:SENSE]:ACP:OFFSet[n][:OUTer]:LIST[:FREQUency].

Enter each value individually by selecting the desired offset on the offset menu key using the up down arrows, the knob, or the numeric keypad, then enter the Offset Integration Bandwidth using the Offset Integration Bandwidth menu key.

You can turn off (not use) specific offsets with the [:SENSE]:ACP:OFFSet[n][:OUTer]:LIST:STATe command.

Key Path	Meas Setup, Offset/Limits
Mode	SA, WCDMA, C2K, WIMAX OFDMA, TD-SCDMA, 1xEVDO, DVB-T/H, DTMB (CTTB), ISDB-T, CMMB, LTE, LTETDD
Remote Command	[:SENSE]:ACP:OFFSet [1] 2 [:OUTer]:LIST:BANDwidth[:INTegration] <freq>, <freq>, <freq>, <freq>, <freq>, <freq> [:SENSE]:ACP:OFFSet [1] 2 [:OUTer]:LIST:BANDwidth[:INTegration]?
Example	ACP:OFFS2:LIST:BAND 2MHz, 2MHz, 2MHz, 2MHz, 2MHz, 2MHz ACP:OFFS2:LIST:BAND?
Notes	<p>When setting these values remotely, the position in the list sent corresponds to the offset. Missing values are not permitted i.e. if you want to change the second value, you must send all values up to it. Subsequent values will remain unchanged, unless the number of values sent is greater than the number of carriers, then subsequent values will be ignored.</p> <p>Offset sub op code. 1 for BTS, 2 for MS. Default is BTS.</p> <p>Note that Offset sub op code 2 is supported only in Non-SA modes.</p> <p>In the SA mode, Offset sub op code 1 is used for both BTS and MS.</p> <p>You must be in the mode that includes ACP measurements to use this command. Use :INSTrument:SElect to set the mode.</p>
Couplings	Changing Integ BW might affect the Span. See Span section for details.
Preset	<p>SA: 2 MHz, 2 MHz, 2 MHz, 2 MHz, 2 MHz, 2 MHz 2 MHz, 2 MHz, 2 MHz, 2 MHz, 2 MHz, 2 MHz</p> <p>WCDMA: 3.84 MHz, 3.84 MHz, 3.84 MHz, 3.84 MHz, 3.84 MHz, 3.84 MHz 3.84 MHz, 3.84 MHz, 3.84 MHz, 3.84 MHz</p> <p>WIMAX OFDMA: 10 MHz, 10 MHz, 10 MHz, 10 MHz, 10 MHz, 10 MHz 10 MHz, 10 MHz, 10 MHz, 10 MHz, 10 MHz, 10 MHz</p> <p>C2K: 30 kHz, 30 kHz, 30 kHz, 30 kHz, 30 kHz, 30 kHz 30 kHz, 30 kHz, 30 kHz, 30 kHz, 30 kHz, 30 kHz</p> <p>TD-SCDMA: 1.28 MHz, 1.28 MHz, 1.28 MHz, 1.28 MHz, 1.28 MHz, 1.28 MHz</p> <p>1xEVDO: C2K: 30 kHz, 30 kHz, 30 kHz, 30 kHz, 30 kHz, 30 kHz 30 kHz, 30 kHz, 30 kHz, 30 kHz, 30 kHz, 30 kHz</p> <p>DVB-T/H: 7.61 MHz, 7.61 MHz, 7.61 MHz, 7.61 MHz, 7.61 MHz, 7.61 MHz 7.61 MHz, 7.61 MHz, 7.61 MHz, 7.61 MHz, 7.61 MHz, 7.61 MHz</p> <p>DTMB (CTTB): 7.56 MHz, 7.56 MHz, 7.56 MHz, 7.56 MHz, 7.56 MHz, 7.56 MHz 7.56 MHz, 7.56 MHz, 7.56 MHz, 7.56 MHz, 7.56 MHz, 7.56 MHz</p>

	ISDB-T: 5.6 MHz, 5.6 MHz, 5.6 MHz, 5.6 MHz, 5.6 MHz, 5.6 MHz 5.6 MHz, 5.6 MHz, 5.6 MHz, 5.6 MHz, 5.6 MHz, 5.6 MHz CMMB: 7.512 MHz, 7.512 MHz, 7.512 MHz, 7.512 MHz, 7.512 MHz, 7.512 MHz 7.512 MHz, 7.512 MHz, 7.512 MHz, 7.512 MHz, 7.512 MHz LTE, LTE-TDD: 4.515 MHz, 4.515 MHz, 4.515 MHz, 4.515 MHz, 4.515 MHz, 4.515 MHz 4.5 MHz, 4.5 MHz, 4.5 MHz, 4.5 MHz, 4.5 MHz Digital Cable TV: 8.0 MHz, 8.0 MHz, 8.0 MHz, 8.0 MHz, 8.0 MHz, 8.0 MHz 8.0 MHz, 8.0 MHz, 8.0 MHz, 8.0 MHz, 8.0 MHz, 8.0 MHz
State Saved	Saved in instrument state.
Min	10 Hz
Max	1 GHz
Backwards Compatibility SCPI	<code>[[:SENSe]:ACPower:OFFSet[1] 2:LIST:BWIDth[:INTEgration]</code> <code>[[:SENSe]:ACPR:OFFSet[1] 2:LIST:BANDwidth</code> <code>[[:SENSe]:ACPR:OFFSet[1] 2:LIST:BWIDth</code> <code>[[:SENSe]:MCPower:OFFSet[1] 2:LIST:BANDwidth[:INTEgration]</code> (PSA Power Suite) <code>[[:SENSe]:MCPower:OFFSet[1] 2:LIST:BWIDth[:INTEgration]</code> (PSA Power Suite)
Initial S/W Revision	Prior to A.02.00
Modified at S/W Revision	A.02.00, A.03.00, A.13.00

Offset BW

Accesses the offset bandwidth menu.

Key Path	Meas Setup, Offset/Limits
Initial S/W Revision	Prior to A.02.00

Res BW

Sets the resolution bandwidth. If an unavailable bandwidth is entered with the numeric keypad, the closest available bandwidth is selected.

Key Path	Meas Setup, Offset/Limits
Mode	SA, WCDMA, C2K, WIMAX OFDMA, TD-SCDMA, 1xEVDO, DVB-T/H, DTMB (CTTB), ISDB-T, CMMB, LTE, LTE-TDD
Remote Command	<code>[[:SENSe]:ACPower:OFFSet[1] 2[:OUTer]:LIST:BANDwidth:RESolution <freq>, <freq>, <freq>, <freq>, <freq></code> <code>[[:SENSe]:ACPower:OFFSet[1] 2[:OUTer]:LIST:BANDwidth:RESolution?</code> <code>[[:SENSe]:ACPower:OFFSet[1] 2[:OUTer]:LIST:BANDwidth:RESolution:AUTO ON OFF 1 0, ON OFF 1 0, ON OFF 1 0, ON OFF 1 0, ON OFF 1 0, ON OFF 1 0</code>

	<code>[:SENSe] :ACPower:OFFSet [1] 2 [:OUTer] :LIST:BANDwidth:RESolution:AUTO?</code>
Example	<p>ACP:OFFS2:LIST:BAND:RES 220kHz, 220kHz, 220kHz, 220kHz, 220kHz, 220kHz</p> <p>ACP:OFFS2:LIST:BAND:RES?</p> <p>ACP:OFFS2:LIST:BAND:RES:AUTO 1,1,1,1,1,1</p> <p>ACP:OFFS2:LIST:BAND:RES:AUTO?</p>
Notes	<p>Offset sub op code. 1 for BTS, 2 for MS. Default is BTS.</p> <p>Note that Offset sub op code 2 is supported only in Non-SA modes.</p> <p>In the SA mode, Offset sub op code 1 is used for both BTS and MS.</p> <p>You must be in the mode that includes ACP measurements to use this command. Use <code>:INSTrument:SElect</code> to set the mode.</p>
Dependencies	When Meas Method is RBW or FAST, this key is grayed out and disabled. If the key is pressed, an advisory message is generated. If the equivalent remote command is sent, a "Setting conflict" warning is generated.
Couplings	When Res BW Mode is AUTO, this value is exactly same as Res BW under BW key. And when this value is changed by user, Res BW Mode is also changed to Man.
Preset	<p>SA: 220 kHz, 220 kHz, 220 kHz, 220 kHz, 220 kHz, 220 kHz</p> <p>WCDMA: 100 kHz, 100 kHz, 100 kHz, 100 kHz, 100 kHz, 100 kHz</p> <p>WIMAX OFDMA: 100 kHz, 100 kHz, 100 kHz, 100 kHz, 100 kHz, 100 kHz</p> <p>C2K:</p> <p>Method:RBW</p> <p>30 kHz</p> <p>Method: IBW</p> <p>C2K: 15 kHz, 15 kHz, 15 kHz, 15 kHz, 15 kHz, 15 kHz 15 kHz, 15 kHz, 15 kHz, 15 kHz, 15 kHz, 15 kHz</p> <p>TD-SCDMA: 30 kHz, 30 kHz, 30 kHz, 30 kHz, 30 kHz, 30 kHz</p> <p>1xEVDO: 30kHz, 30kHz, 30kHz, 30kHz, 30kHz, 30kHz 30kHz, 30kHz, 30kHz, 30kHz, 30kHz, 30kHz</p> <p>DVB-T/H: 39 kHz, 39 kHz, 39 kHz, 39 kHz, 39 kHz, 39 kHz 39 kHz, 39 kHz, 39 kHz, 39 kHz, 39 kHz, 39 kHz</p> <p>DTMB (CTTB): 39 kHz, 39 kHz, 39 kHz, 39 kHz, 39 kHz, 39 kHz 39 kHz, 39 kHz, 39 kHz, 39 kHz, 39 kHz, 39 kHz</p> <p>ISDB-T: 39 kHz, 39 kHz, 39 kHz, 39 kHz, 39 kHz, 39 kHz 39 kHz, 39 kHz, 39 kHz, 39 kHz, 39 kHz, 39 kHz</p> <p>CMMB: 39 kHz, 39 kHz, 39 kHz, 39 kHz, 39 kHz, 39 kHz 39 kHz, 39 kHz, 39 kHz, 39 kHz, 39 kHz, 39 kHz</p> <p>LTE, LTE TDD: 100 kHz, 100 kHz, 100 kHz, 100 kHz, 100kHz, 100 kHz 100 kHz, 100 kHz, 100 kHz, 100 kHz, 100 kHz, 100 kHz</p> <p>Digital Cable TV: 39 kHz, 39 kHz, 39 kHz, 39 kHz, 39 kHz, 39 kHz 39 kHz, 39 kHz, 39 kHz, 39 kHz, 39 kHz, 39 kHz</p> <p>1, 1, 1, 1, 1, 1</p>
State Saved	Saved in instrument state.

Min	1 Hz
Max	8 MHz
Backwards Compatibility SCPI	<code>[[:SENSe]:ACPower:OFFSet[1] 2[:LIST:BWIDth:RESolution</code>
Initial S/W Revision	Prior to A.02.00
Modified at S/W Revision	A.02.00, A.03.00, A.13.00

Video BW

Enables you to change the analyzer post-detection filter (VBW).

Key Path	Meas Setup, Offset/Limits, Offset BW
Mode	SA, WCDMA, C2K, WIMAX OFDMA, TD-SCDMA, 1xEVDO, DVB-T/H, DTMB (CTTB), ISDB-T, CMMB, LTE, LTE-TDD
Remote Command	<pre>[[:SENSe]:ACPower:OFFSet[1] 2[:OUTer]:LIST:BANDwidth:VIDeo <freq>, <freq>, <freq>, <freq>, <freq> [:SENSe]:ACPower:OFFSet[1] 2[:OUTer]:LIST:BANDwidth:VIDeo? [:SENSe]:ACPower:OFFSet[1] 2[:OUTer]:LIST:BANDwidth:VIDeo:AUTO OFF ON 0 1, OFF ON 0 1, OFF ON 0 1, OFF ON 0 1, OFF ON 0 1, OFF ON 0 1 [:SENSe]:ACPower:OFFSet[1] 2[:OUTer]:LIST:BANDwidth:VIDeo:AUTO?</pre>
Example	<pre>ACP:OFFS2:LIST:BAND:VID 5MHz, 5MHz, 5MHz, 5MHz, 5MHz, 5MHz ACP:OFFS2:LIST:BAND:VID? ACP:OFFS2:LIST:BAND:VID:AUTO 0,0,0,0,1,1 ACP:OFFS2:LIST:BAND:VID:AUTO?</pre>
Notes	<p>The values shown in this table reflect the conditions after a Mode Preset.</p> <p>Offset sub op code. 1 for BTS, 2 for MS. Default is BTS.</p> <p>Note that Offset sub op code 2 is supported only in Non-SA modes.</p> <p>In the SA mode, Offset sub op code 1 is used for both BTS and MS.</p> <p>You must be in the mode that includes ACP measurements to use this command. Use <code>:INSTrument:SElect</code> to set the mode.</p> <p>.</p>
Dependencies	When Meas Method is RBW or FAST, this key is grayed out and disabled. If the key is pressed, an advisory message is generated. If the equivalent remote command is sent, a "Setting conflict" warning is generated.
Preset	<pre>SA: 22 kHz, 22 kHz, 22 kHz, 22 kHz, 22 kHz, 22 kHz WCDMA, WIMAX OFDMA: 1 MHz, 1 MHz, 1 MHz, 1 MHz, 1 MHz, 1 MHz C2K: 150 kHz, 150 kHz, 150 kHz, 150 kHz, 150 kHz, 150 kHz 150 kHz, 150 kHz, 150 kHz, 1150 kHz, 1150 kHz, 150 kHz TD-SCDMA: 300 kHz, 300 kHz, 300 kHz, 300 kHz, 300 kHz, 300 kHz 1xEVDO: 300KHz, 300KHz, 300KHz, 300KHz, 300KHz, 300KHz 300KHz, 300KHz, 300KHz, 300KHz, 300KHz, 300KHz</pre>

	DVB-T/H: 390 kHz, 390 kHz, 390 kHz, 390 kHz, 390 kHz, 390 kHz 390 kHz, 390 kHz, 390 kHz, 390 kHz, 390 kHz, 390 kHz
	DTMB (CTTB): 390 kHz, 390 kHz, 390 kHz, 390 kHz, 390 kHz, 390 kHz 390 kHz, 390 kHz, 390 kHz, 390 kHz, 390 kHz, 390 kHz
	ISDB-T: 390 kHz, 390 kHz, 390 kHz, 390 kHz, 390 kHz, 390 kHz 390 kHz, 390 kHz, 390 kHz, 390 kHz, 390 kHz, 390 kHz
	CMMB: 390 kHz, 390 kHz, 390 kHz, 390 kHz, 390 kHz, 390 kHz 390 kHz, 390 kHz, 390 kHz, 390 kHz, 390 kHz, 390 kHz
	LTE, LTETDD: 1 MHz, 1 MHz, 1 MHz, 1 MHz, 1 MHz, 1 MHz
	Digital Cable TV: 390 kHz, 390 kHz, 390 kHz, 390 kHz, 390 kHz, 390 kHz 390 kHz, 390 kHz, 390 kHz, 390 kHz, 390 kHz, 390 kHz
	ON, ON, ON, ON, ON, ON
State Saved	Saved in instrument state.
Min	1 Hz
Max	50 MHz
Backwards Compatibility SCPI	[:SENSe] :ACPower:OFFSet [1] 2 :LIST:BWIDth:VIDeo
Initial S/W Revision	Prior to A.02.00
Modified at S/W Revision	A.02.00, A.03.00, A.13.00

RBW Control

Accesses the resolution bandwidth control menu.

Key Path	Meas Setup, Offset/Limits, Offset BW
Initial S/W Revision	Prior to A.02.00

Filter Type

Selects the type of bandwidth filter that is used.

Key Path	Meas Setup, Offset/Limits, Offset BW, RBW Control
Mode	SA, WCDMA, C2K, WIMAX OFDMA, TD-SCDMA, 1xEVDO, DVB-T/H, DTMB (CTTB), ISDB-T, CMMB, LTE, LTETDD
Remote Command	[:SENSe] :ACPower:OFFSet [1] 2 [:OUTer] :LIST:BWIDth:SHAPe GAUSSian FLATtop, GAUSSian FLATtop, GAUSSian FLATtop, GAUSSian FLATtop, GAUSSian FLATtop, GAUSSian FLATtop [:SENSe] :ACPower:OFFSet [1] 2 [:OUTer] :LIST:BWIDth:SHAPe?
Example	ACP:OFFS2:LIST:BAND:SHAP FLAT, GAUS, GAUS, GAUS, GAUS, GAUS ACP:OFFS2:LIST:BAND:SHAP?
Notes	Offset sub op code. 1 for BTS, 2 for MS. Default is BTS. Note that Offset sub op code 2 is supported only in Non-SA modes.

	In the SA mode, Offset sub op code 1 is used for both BTS and MS. You must be in the mode that includes ACP measurements to use this command. Use :INSTrument:SElect to set the mode.
Dependencies	When Res BW Mode for the offset is Auto, this key is grayed out and disabled. Since Res BW Mode for the offset is preset to Auto on changing Meas Method to RBW or FAST, this key is grayed out and disabled too. If the key is pressed, an advisory message is generated. If the equivalent remote command is sent, a "Setting conflict" warning is generated.
Couplings	See the description above
Preset	GAUSSian, GAUSSian, GAUSSian, GAUSSian, GAUSSian, GAUSSian
State Saved	Saved in instrument state.
Range	GAUSSian FLATtop
Backwards Compatibility SCPI	[:SENSe] :ACPpower:OFFSet [1] 2 :LIST:BWIDth:SHApe
Initial S/W Revision	Prior to A.02.00
Modified at S/W Revision	A.02.00, A.03.00, A.13.00

Filter BW

Selects a Gaussian filter based on its –3 dB (Normal) bandwidth or its –6 dB bandwidth.

Key Path	Meas Setup, Offset/Limits, Offset BW, RBW Control
Mode	SA, WCDMA, C2K, WIMAX OFDMA, TD-SCDMA, 1xEVDO, DVB-T/H, DTMB (CTTB), ISDB-T, CMMB, LTE, LTE-TDD
Remote Command	[:SENSe] :ACPpower:OFFSet [1] 2 [:OUTer] :LIST:BWIDth:TYPE DB3 DB6, DB3 DB6, DB3 DB6, DB3 DB6, DB3 DB6 [:SENSe] :ACPpower:OFFSet [1] 2 [:OUTer] :LIST:BWIDth:TYPE?
Example	ACP:OFFS2:LIST:BWIDth:TYPE DB3, DB3, DB3, DB3, DB3, DB3 ACP:OFFS2:LIST:BWIDth:TYPE?
Notes	Offset sub op code. 1 for BTS, 2 for MS. Default is BTS. Note that Offset sub op code 2 is supported only in Non-SA modes. In the SA mode, Offset sub op code 1 is used for both BTS and MS. You must be in the mode that includes ACP measurements to use this command. Use :INSTrument:SElect to set the mode.
Dependencies	When Filter Type is Flattop or Res BW Mode for the offset is Auto, this key is grayed out and disabled. Since Res BW Mode for the offset is preset to Auto on changing Meas Method to RBW or FAST, this key is grayed out and disabled too. If the key is pressed, an advisory message is generated. If the equivalent remote command is sent, a "Setting conflict" warning is generated.
Preset	DB3, DB3, DB3, DB3, DB3, DB3
State Saved	Saved in instrument state.
Range	–3 dB (Normal) –6 dB
Backwards Compatibility SCPI	[:SENSe] :ACPpower:OFFSet [1] 2 :LIST:BWIDth:TYPE

Initial S/W Revision	Prior to A.02.00
Modified at S/W Revision	A.02.00, A.03.00, A.13.00

Limits

Limits key accesses a menu of functions that contains Select Offset, Abs Limit, Rel Limit and Fail Mask parameters.

Key Path	Meas Setup, Offset/Limits
Initial S/W Revision	A.03.00

Select Offset

Selects the offset to configure.

Key Path	Meas Setup, Offset/Limits, Limits
Mode	SA, WCDMA, C2K, WIMAX OFDMA, TD-SCDMA, 1xEVDO, DVB-T/H, DTMB (CTTB), ISDB-T, CMMB, LTE, LTETDD
Preset	A
State Saved	Saved in instrument state.
Range	Offset A Offset B Offset C Offset D Offset E Offset F
Initial S/W Revision	Prior to A.02.00
Modified at S/W Revision	A.02.00, A.03.00, A.13.00

Abs Limit

Enters an absolute limit value, which sets the absolute amplitude levels to test against for each of the custom offsets. The list must contain six (6) entries. If there is more than one offset, the offset closest to the carrier channel is the first one in the list. [:SENSe]:ACP:OFFSet[n][:OUTer]:LIST:TEST selects the type of testing to be done at each offset.

You can turn off (not use) specific offsets with the [:SENSe]:ACP:OFFSet[n][:OUTer]:LIST:STATe command.

The query returns the six (6) sets of real numbers that are the current absolute amplitude test limits.

Key Path	Meas Setup, Offset/Limits, Limits
Mode	SA, WCDMA, C2K, WIMAX OFDMA, TD-SCDMA, 1xEVDO, DVB-T/H, DTMB (CTTB), ISDB-T, CMMB, LTE, LTETDD
Remote Command	[:SENSe]:ACP:OFFSet[1] 2[:OUTer]:LIST:ABSolute <real>, <real>, <real>, <real>, <real>, <real> [:SENSe]:ACP:OFFSet[1] 2[:OUTer]:LIST:ABSolute?
Example	ACP:OFFS2:LIST:ABS -10, -10, -10, -10, -10, -10

	ACP:OFFS2:LIST:ABS?
Notes	Offset sub op code. 1 for BTS, 2 for MS. Default is BTS. Note that Offset sub op code 2 is supported only in Non-SA modes. In the SA mode, Offset sub op code 1 is used for both BTS and MS. You must be in the mode that includes ACP measurements to use this command. Use :INSTrument:SElect to set the mode.
Couplings	None If current mode is DTMB (CTTB) or CMMB and current device type is Transmitter, the value from position 2 to position 4 are coupled, changing any one will change the others.
Preset	SA: 0dBm, 0 dBm, 0 dBm, 0 dBm, 0 dBm, 0 dBm 0dBm, 0 dBm, 0 dBm, 0 dBm, 0 dBm, 0 dBm WCDMA: 50 dBm, 50 dBm, 50 dBm, 50 dBm, 50 dBm, 50 dBm 50 dBm, 50 dBm, 50 dBm, 50 dBm, 50 dBm, 50 dBm C2K: 50 dBm, 50 dBm, 50 dBm, 50 dBm, 50 dBm, 50 dBm 50 dBm, 50 dBm, 50 dBm, 50 dBm, 50 dBm, 50 dBm WIMAX OFDMA: 50,50,50,50,50,50 TD-SCDMA: 50 dBm, 50 dBm, 50 dBm, 50 dBm, 50 dBm, 50 dBm 50 dBm, 50 dBm, 50 dBm, 50 dBm, 50 dBm, 50 dBm 1xEVDO: -27dBm, -27dBm, -13dBm, -13dBm, -13dBm, -13dBm -27dBm, -27dBm, -13dBm, -13dBm, -13dBm, -13dBm DVB-T/H: 50 dBm, 50 dBm, 50 dBm, 50 dBm, 50 dBm, 50 dBm 50 dBm, 50 dBm, 50 dBm, 50 dBm, 50 dBm, 50 dBm DTMB (CTTB): 11.14 dBm, 11.14dBm, 11.14 dBm, 11.14 dBm, 50 dBm, 50 dBm 11.14 dBm, 11.14 dBm, 11.14 dBm, 11.14 dBm, 50 dBm, 50 dBm ISDB-T: 50 dBm, 50 dBm, 50 dBm, 50 dBm, 50 dBm, 50 dBm 50 dBm, 50 dBm, 50 dBm, 50 dBm, 50 dBm, 50 dBm CMMB: 11.14 dBm, 11.14dBm, 11.14 dBm, 11.14 dBm, 50 dBm, 50 dBm 11.14 dBm, 11.14 dBm, 11.14 dBm, 11.14 dBm, 50 dBm, 50 dBm LTE, LTE-TDD: -8.45, -8.45, -8.45, -8.45, -8.45, -8.45 -50.0, -50.0, -50.0, -50.0, -50.0, -50.0 Digital Cable TV: 50 dBm, 50 dBm, 50 dBm, 50 dBm, 50 dBm, 50 dBm 50 dBm, 50 dBm, 50 dBm, 50 dBm, 50 dBm, 50 dBm
State Saved	Saved in instrument state.
Min	-200.0 dBm
Max	50.0 dBm
Backwards Compatibility SCPI	[:SENSe] :ACPR:OFFSet [1] 2 :LIST:ABSolute (PSA W-CDMA, PSA cdma2000) [:SENSe] :MCPower:OFFSet [1] 2 :LIST:ABSolute (PSA W-CDMA)
Initial S/W Revision	Prior to A.02.00
Modified at S/W Revision	A.02.00, A.03.00, A.13.00

Rel Lim (Car)

Enters a relative limit value for the carrier level. This sets the amplitude levels to test against for the specified offsets.

The amplitude level is relative to the carrier amplitude. If multiple offsets are available, the list contains six (6) entries. The offset closest to the carrier channel is the first one in the list.

[[:SENSE]:ACP:OFFSet[n]:OUTer]:LIST:TEST selects the type of testing to be done at each offset.

You can turn off (not use) specific offsets with the [[:SENSE]:ACP:OFFSet[n]:OUTer]:LIST:STATe command.

The query returns the six (6) sets of real numbers that are the current amplitude test limits, relative to the carrier, for each offset.

Offset[n] n = 1 is base station and n = 2 is mobiles. The default is base station (1).

Key Path	Meas Setup, Offset/Limits, Limits,
Mode	SA, WCDMA, C2K, WIMAX OFDMA, TD-SCDMA, 1xEVDO, DVB-T/H, DTMB (CTTB), ISDB-T, CMMB, LTE, LTETDD
Remote Command	[[:SENSE]:ACP:OFFSet[1] 2[:OUTer]:LIST:RCARrier <real>, <real>, <real>, <real>, <real>, <real> [[:SENSE]:ACP:OFFSet[1] 2[:OUTer]:LIST:RCARrier?
Example	ACP:OFFS2:LIST:RCAR 0,0,0,0,0,0 ACP:OFFS2:LIST:RCAR?
Notes	Offset sub op code. 1 for BTS, 2 for MS. Default is BTS. Note that Offset sub op code 2 is supported only in Non-SA modes. In the SA mode, Offset sub op code 1 is used for both BTS and MS. You must be in the mode that includes ACP measurements to use this command. Use :INSTrument:SElect to set the mode.
Couplings	None If current mode is DTMB (CTTB) or CMMB and current device type is Transmitter, the value from position 2 to position 4 are coupled, changing any one will change the others.
Preset	SA: -45, -60, 0, 0, 0, 0 -45, -60, 0, 0, 0, 0 WCDMA: -44.2, -49.2, -49.2, -49.2, -49.2, -49.2 -32.2, -42.2, -42.2, -42.2, -42.2, -42.2 C2K: 0, 0, 0, 0, 0, 0 0, 0, 0, 0, 0, 0 WIMAX OFDMA: -50,-60,0,0,0,0 TD-SCDMA: -40, -45, -45, -45, -45, -45 -33, -43, -43, -43, -43, -43 1xEVDO: -45, -55, -55, -55, -55, -55 -45, -55, -55, -55, -55, -55 DVB-T/H: -60, -60, 0, 0, 0, 0 -60, -60, 0, 0, 0, 0 DTMB (CTTB): -45, -60, -60, -60, 50, 50 -45, -60, -60, -60, 50, 50 ISDB-T: -60, -60, 0, 0, 0, 0 -60, -60, 0, 0, 0, 0 CMMB: -45, -60, -60, -60, 50, 50 -45, -60, -60, -60, 50, 50 LTE, LTETDD: -44.2, -44.2, -44.2, -44.2, -44.2, -44.2 -29.2, -29.2, -29.2, -29.2, -29.2, -29.2 Digital Cable TV: -58, -62, -65, -73, -73, -73 -58, -62, -65, -73, -73, -73
State Saved	Saved in instrument state.
Min	-150
Max	50.0
Backwards	[[:SENSE]:MCPower:OFFSet[1] 2:LIST:RCARrier (PSA WCDMA)

Compatibility SCPI

Initial S/W Revision	Prior to A.02.00
Modified at S/W Revision	A.02.00, A.03.00, A.04.00, A.13.00

Positive Offset Limit (SCPI only)

Enables you to set the upper limit for the upper segment of the specified offset pair.

Mode	SA, WCDMA, CDMA2K, WIMAXOFDMA, TDSCDMA, CDMA1XEV, DVB, DTMB, LTE, LTETDD
Remote Command	:CALCulate:ACPower:OFFSet[:OUTer]:LIST:LIMit:POSitive[:UPPer]:DATA <real>, <real>, <real>, <real>, <real>, <real> :CALCulate:ACPower:OFFSet[:OUTer]:LIST:LIMit:POSitive[:UPPer]:DATA?
Example	CALC:ACP:OFFS:LIST:LIM:POS:DATA 0, 0, 0, 0, 0, 0 CALC:ACP:OFFS:LIST:LIM:POS:DATA?
Notes	SCPI only command
Preset	SA: -45, -60, 0, 0, 0, 0 -45, -60, 0, 0, 0, 0 WCDMA: -44.2, -49.2, -49.2, -49.2, -49.2, -49.2 -32.2, -42.2, -42.2, -42.2, -42.2, -42.2 C2K: 0, 0, 0, 0, 0, 0 0, 0, 0, 0, 0, 0 WIMAX OFDMA: -50, -60, 0, 0, 0, 0 TD-SCDMA: -40, -45, -45, -45, -45, -45 -33, -43, -43, -43, -43, -43 1xEVDO: -45, -55, -55, -55, -55, -55 -45, -55, -55, -55, -55, -55 DVB-T/H: -60, -60, 0, 0, 0, 0 -60, -60, 0, 0, 0, 0 DTMB (CTTB): -45, -60, -60, -60, 0, 0 -45, -60, -60, -60, 0, 0 Digital Cable TV: -58, -62, -65, -73, -73, -73 -58, -62, -65, -73, -73, -73 LTE, LTETDD: -44.2, -44.2, -44.2, -44.2, -44.2, -44.2 -29.2, -29.2, -29.2, -29.2, -29.2, -29.2
State Saved	Saved in instrument state.
Min	-150.0
Max	50.0
Backwards Compatibility SCPI	:CALCulate:MCPower:OFFSet:LIST:LIMit:POSitive[:UPPer]:DATA (PSA Power Suite)
Initial S/W Revision	A.04.00
Modified at S/W Revision	A.13.00

Negative Offset Limit

Enables you to set the upper limit for the lower segment of the specified offset pair.

Mode	SA, WCDMA, CDMA2K, WIMAXOFDMA, TDSCDMA, CDMA1XEV, DVB, DTMB, LTE, LTETDD
Remote Command	:CALCulate:ACPower:OFFSet[:OUTer]:LIST:LIMit:NEGative[:UPPer]:DATA <real>, <real>, <real>, <real>, <real>, <real> :CALCulate:ACPower:OFFSet[:OUTer]:LIST:LIMit:NEGative[:UPPer]:DATA?

Example	CALC:ACP:OFFS:LIST:LIM:NEG:DATA 0, 0, 0, 0, 0, 0 CALC:ACP:OFFS:LIST:LIM:NEG:DATA?
Notes	SCPI only command
Preset	SA: -45, -60, 0, 0, 0, 0 -45, -60, 0, 0, 0, 0 WCDMA: -44.2, -49.2, -49.2, -49.2, -49.2, -49.2 -32.2, -42.2, -42.2, -42.2, -42.2, -42.2 C2K: 0, 0, 0, 0, 0, 0 0, 0, 0, 0, 0, 0 WIMAX OFDMA: -50, -60, 0, 0, 0, 0 TD-SCDMA: -40, -45, -45, -45, -45, -45 -33, -43, -43, -43, -43, -43 1xEVDO: -45, -55, -55, -55, -55, -55 -45, -55, -55, -55, -55, -55 DVB-T/H: -60, -60, 0, 0, 0, 0 -60, -60, 0, 0, 0, 0 DTMB (CTTB): -45, -60, -60, -60, 0, 0 -45, -60, -60, -60, 0, 0 Digital Cable TV: -58, -62, -65, -73, -73, -73 -58, -62, -65, -73, -73, -73 LTE, LTE TDD: -44.2, -44.2, -44.2, -44.2, -44.2, -44.2 -29.2, -29.2, -29.2, -29.2, -29.2, -29.2
State Saved	Saved in instrument state.
Min	-150.0
Max	50.0
Backwards Compatibility SCPI	:CALCulate:MCPower:OFFSet:LIST:LIMit:NEGative[:UPPer]:DATA (PSA Power Suite)
Initial S/W Revision	A.04.00
Modified at S/W Revision	A.13.00

Rel Limit (PSD)

Enters a relative limit value for the level of the power spectral density. This sets the amplitude levels to test against for any custom offsets. The amplitude level is relative to the power spectral density. If multiple offsets are available, the list contains six (6) entries. The offset closest to the carrier channel is the first one in the list.

[[:SENSe]:ACP:OFFSet[n]::OUTer]:LIST:TEST selects the type of testing to be done at each offset.

You can turn off (not use) specific offsets with the [[:SENSe]:ACP:OFFSet[n]::OUTer]:LIST:STATe command.

The query returns the six (6) sets of real numbers that are the current amplitude test limits, relative to the power spectral density, for each offset.

Offset[n] n = 1 is base station and n = 2 is mobiles. The default is base station (1).

Key Path	Meas Setup, Offset/Limits, Limits
Mode	SA, WCDMA, C2K, WIMAX OFDMA, TD-SCDMA, 1xEVDO, DVB-T/H, DTMB (CTTB), ISDB-T, CMMB, LTE, LTE TDD
Remote Command	[[:SENSe]:ACPower:OFFSet [1] 2[:OUTer]:LIST:RPSDensity <rel_ampl>, <rel_ampl>, <rel_ampl>, <rel_ampl>, <rel_ampl>, <rel_ampl> [:SENSe]:ACPower:OFFSet [1] 2[:OUTer]:LIST:RPSDensity?

Example	ACP:OFFS2:LIST:RPSD 10,10,10,10,10,10 ACP:OFFS2:LIST:RPSD?
Notes	Offset sub op code. 1 for BTS, 2 for MS. Default is BTS. Note that Offset sub op code 2 is supported only in Non-SA modes. In the SA mode, Offset sub op code 1 is used for both BTS and MS. You must be in the mode that includes ACP measurements to use this command. Use :INSTrument:SElect to set the mode.
Preset	SA: -28.87 dB, -43.87 dB, 0 dB, 0 dB, 0 dB, 0 dB -28.87 dB, -43.87 dB, 0 dB, 0 dB, 0 dB, 0 dB WCDMA: -44.2 dB, -49.2 dB, -49.2 dB, -49.2 dB, -49.2 dB, -49.2 dB -32.2 dB, -42.2 dB, -42.2 dB, -42.2 dB, -42.2 dB, -42.2 dB C2K: 0 dB, 0 dB, 0 dB, 0 dB, 0 dB, 0 dB 0 dB, 0 dB, 0 dB, 0 dB, 0 dB, 0 dB WIMAX OFDMA: -25,-35,0,0,0,0 TD-SCDMA: -40 dB, -45 dB, -45 dB, -45 dB, -45 dB, -45 dB -33 dB, -43 dB, -43 dB, -43 dB, -43 dB, -43 dB 1xEVDO: -45, -55, -55, -55, -55, -55 -45, -55, -55, -55, -55, -55 DVB-T/H: -60 dB, -60 dB, 0 dB, 0 dB, 0 dB, 0 dB -60 dB, -60 dB, 0 dB, 0 dB, 0 dB, 0 dB DTMB (CTTB): 50 dB, 50 dB, 50 dB, 50 dB, 50 dB, 50 dB 50 dB, 50 dB, 50 dB, 50 dB, 50 dB, 50 dB ISDB-T: -60 dB, -60 dB, 0 dB, 0 dB, 0 dB, 0 dB -60 dB, -60 dB, 0 dB, 0 dB, 0 dB, 0 dB CMMB: 50 dB, 50 dB, 50 dB, 50 dB, 50 dB, 50 dB 50 dB, 50 dB, 50 dB, 50 dB, 50 dB, 50 dB LTE, LTETDD: 0, 0, 0, 0, 0, 0 0, 0, 0, 0, 0, 0 Digital Cable TV: 50 dB, 50 dB, 50 dB, 50 dB, 50 dB, 50 dB 50 dB, 50dB, 50 dB, 50 dB, 50 dB, 50 dB
State Saved	Saved in instrument state.
Min	-150.0 dB
Max	50.0 dB
Initial S/W Revision	Prior to A.02.00
Modified at S/W Revision	A.02.00, A.03.00, A.13.00

Fail Mask

Accesses a menu that enables you to select one of the logic keys for the fail conditions between the measurement results and the test limits. The setting defines the type of testing to be done at any custom offset frequencies. The measured powers are tested against the absolute values defined with [:SENSE]:ACP:OFFSet[n][:OUTer]:LIST:ABSolute, or the relative values defined with [:SENSE]:ACP:OFFSet[n][:OUTer]:LIST:RPSDensity and [:SENSE]:ACP:OFFSet[n][:OUTer]:LIST:RCARrier.

You can turn off (not use) specific offsets with the [:SENSE]:ACP:OFFSet[n][:OUTer]:LIST:STATe command.

- Absolute – Fail is shown if one of the absolute ACP measurement results is larger than the limit for Abs Limit.
- Relative – Fail is shown if one of the relative ACP measurement results is larger than the limit for Rel Lim (Car) or Rel Lim (PSD).

- Abs AND Rel – Fail is shown if one of the absolute ACP measurement results is larger than the limit for Abs Limit AND one of the relative ACP measurement results is larger than the limit for Rel Lim (Car) or Rel Lim (PSD).
- Abs OR Rel– Fail is shown if one of the absolute ACP measurement results is larger than the limit for Abs Limit OR one of the relative ACP measurement results is larger than the limit for Rel Lim (Car) or Rel Lim (PSD).

Key Path	Meas Setup, Offset/Limits, Limits
Mode	SA, WCDMA, C2K, WIMAX OFDMA, TD-SCDMA, 1xEVDO, DVB-T/H, DTMB (CTTB), ISDB-T, CMMB, LTE, LTETDD
Remote Command	[:SENSe]:ACPpower:OFFSet [1] 2[:OUTer]:LIST:TEST ABSolute AND OR RELative, ABSolute AND OR RELative, ABSolute AND OR RELative, ABSolute AND OR RELative, ABSolute AND OR RELative [:SENSe]:ACPpower:OFFSet [1] 2[:OUTer]:LIST:TEST?
Example	ACP:OFFS2:LIST:TEST ABS, ABS, ABS, ABS, ABS, ABS ACP:OFFS2:LIST:TEST?
Notes	Offset sub op code. 1 for BTS, 2 for MS. Default is BTS. Note that Offset sub op code 2 is supported only in Non-SA modes. In the SA mode, Offset sub op code 1 is used for both BTS and MS. You must be in the mode that includes ACP measurements to use this command. Use :INSTrument:SElect to set the mode.
Couplings	None If current mode is DTMB (CTTB) or CMMB and current device type is Transmitter, the value from position 2 to position 4 are coupled, changing any one will change the others.
Preset	SA, WCDMA, C2K, TD-SCDMA: REL, REL, REL, REL, REL, REL REL, REL, REL, REL, REL, REL WIMAX OFDMA: REL, REL, REL, REL, REL, REL DVB-T/H: REL, REL, REL, REL, REL, REL DTMB (CTTB): OR,AND, AND,AND, REL, REL CDMA1xEVDO: REL, REL, ABS, REL, REL, REL REL, REL, ABS, REL, REL, REL ISDB-T : REL, REL, REL, REL, REL, REL CMMB : OR,AND, AND,AND, REL, REL LTE, LTETDD: AND, AND, AND, AND, AND, AND AND, AND, AND, AND, AND, AND Digital Cable TV: REL, REL, REL, REL, REL, REL
State Saved	Saved in instrument state.
Range	Absolute Relative Abs AND Rel (fail if both fail) Abs OR Rel (fail if either fails)
Backwards Compatibility SCPI	[:SENSe]:MCPower:OFFSet [1] 2:LIST:TEST
Initial S/W Revision	Prior to A.02.00
Modified at S/W Revision	A.02.00, A.03.00, A.04.00, A13.00

Offset Side

Enables you to turn off (not use) specific offsets with `[[:SENSe]:ACPower:OFFSet[1]|2[:OUTer]:LIST:SIDE`.

- NEGative - Negative (lower) sideband only
- BOTH - Both of the negative (lower) and positive (upper) sidebands
- POSitive - Positive (upper) sideband only

Key Path	Meas Setup, Offset/Limits
Mode	SA, WCDMA, C2K, WIMAX OFDMA, TD-SCDMA, 1xEVDO, DTMB (CTTB), DVB-T/H, LTE, LTETDD
Remote Command	<code>[[:SENSe]:ACPower:OFFSet[1] 2[:OUTer]:LIST:SIDE NEGative BOTH POSitive,NEGative BOTH POSitive,NEGative BOTH POSitive,NEGative BOTH POSitive,NEGative BOTH POSitive</code> <code>[[:SENSe]:ACPower:OFFSet[1] 2[:OUTer]:LIST:SIDE?</code>
Example	ACP:OFFS:LIST:SIDE BOTH ACP:OFFS:LIST:SIDE?
Notes	OFFSet1 is for BTS, 2 for MS. Default is BTS. You must be in the Spectrum Analysis mode, W-CDMA mode, cdma2000 mode, TD-SCDMA mode, DTMB (CTTB) mode, DVB-T/H mode, ISDB-T mode, CMMB mode, Digital Cable TV mode, 1xEVDO mode, WIMAX OFDMA mode, LTE mode, or LTETDD mode to use this command. Use <code>:INSTrument:SElect</code> to set the mode. If you set POS or NEG in an offset, result of the inactive side will return -999.
Preset	BOTH, BOTH, BOTH, BOTH, BOTH, BOTH BOTH, BOTH, BOTH, BOTH, BOTH, BOTH
State Saved	Saved in instrument state.
Range	Neg Both Pos
Initial S/W Revision	A.03.00
Modified at S/W Revision	A.13.00

Method for Offset

This key allows you to turn RRC filtering of each offset on or off. The value (roll off) for the filter will be set to the value of the Filter Alpha parameter.

Key Path	Meas Setup, Offset/Limits
Mode	SA, WCDMA, WIMAX OFDMA, TD-SCDMA, DVB-T/H, DTMB (CTTB), ISDB-T, CMMB, LTE, LTETDD
Remote Command	<code>[[:SENSe]:ACPower:OFFSet[1] 2[:OUTer]:LIST:FILTer[:RRC][:STATe] ON OFF 1 0, ON OFF 1 0, ON OFF 1 0, ON OFF 1 0, ON OFF 1 0, ON OFF 1 0, ON OFF 1 0</code> <code>[[:SENSe]:ACPower:OFFSet[1] 2[:OUTer]:LIST:FILTer[:RRC][:STATe]?</code>
Example	ACP:OFFS:LIST:FILT 1,0,0 ACP:OFFS:LIST:FILT?
Notes	1 ON = RRC Weighted, 0 OFF = Integ BW This parameter is not available for cdma2000 and 1xEVDO.

	You must be in the mode that includes ACP measurements to use this command. Use :INSTRument:SElect to set the mode.
Preset	SA: 0, 0, 0, 0, 0, 0 0, 0, 0, 0, 0, 0 WCDMA:1, 1, 1, 1, 1, 1 1, 1, 1, 1, 1, 1 C2K: NO WIMAX OFDMA: 0, 0, 0, 0, 0, 0 0, 0, 0, 0, 0, 0 TD-SCDMA: 1, 1, 1, 1, 1, 1 1, 1, 1, 1, 1, 1 DVB-T/H: 0, 0, 0, 0, 0, 0 0, 0, 0, 0, 0, 0 DTMB (CTTB): 1, 1, 1, 1, 1, 1 1, 1, 1, 1, 1, 1 ISDB-T: 0, 0, 0, 0, 0, 0 0, 0, 0, 0, 0, 0 CMMB: 1, 1, 1, 1, 1, 1 1, 1, 1, 1, 1, 1 LTE: 0, 0, 0, 0, 0, 0 0, 0, 0, 0, 0, 0 LTETDD: 0, 0, 0, 0, 0, 0 0, 0, 0, 0, 0, 0
State Saved	Saved in instrument state.
Range	Integ BW RRC Weighted
Initial S/W Revision	A.03.00
Modified at S/W Revision	A.13.00

Method for Offset

This key allows you to turn RRC filtering of each offset on or off. The value (roll off) for the filter will be set to the value of the Filter Alpha parameter.

Key Path	Meas Setup, Offset/Limits
Mode	SA, WCDMA, WIMAX OFDMA, TD-SCDMA, DVB-T/H, DTMB (CTTB), ISDB-T, CMMB, LTE, LTETDD
Remote Command	[:SENSe] :ACPpower:OFFSet [1] 2 [:OUTer] :LIST:FiLTer [:RRC] [:STATe] ON OFF 1 0, ON OFF 1 0, ON OFF 1 0, ON OFF 1 0, ON OFF 1 0, ON OFF 1 0 [:SENSe] :ACPpower:OFFSet [1] 2 [:OUTer] :LIST:FiLTer [:RRC] [:STATe] ?
Example	ACP:OFFS:LIST:FILT 1,0,0 ACP:OFFS:LIST:FILT?
Notes	1 ON = RRC Weighted, 0 OFF = Integ BW This parameter is not available for cdma2000 and 1xEVDO. You must be in the mode that includes ACP measurements to use this command. Use :INSTRument:SElect to set the mode.
Preset	SA: 0, 0, 0, 0, 0, 0 0, 0, 0, 0, 0, 0 WCDMA:1, 1, 1, 1, 1, 1 1, 1, 1, 1, 1, 1 C2K: NO WIMAX OFDMA: 0, 0, 0, 0, 0, 0 0, 0, 0, 0, 0, 0 TD-SCDMA: 1, 1, 1, 1, 1, 1 1, 1, 1, 1, 1, 1 DVB-T/H: 0, 0, 0, 0, 0, 0 0, 0, 0, 0, 0, 0

	DTMB (CTTB): 1, 1, 1, 1, 1, 1 1, 1, 1, 1, 1, 1 ISDB-T: 0, 0, 0, 0, 0, 0 0, 0, 0, 0, 0, 0 CMMB: 1, 1, 1, 1, 1, 1 1, 1, 1, 1, 1, 1 LTE: 0, 0, 0, 0, 0, 0 0, 0, 0, 0, 0, 0 LTETDD: 0, 0, 0, 0, 0, 0 0, 0, 0, 0, 0, 0
State Saved	Saved in instrument state.
Range	Integ BW RRC Weighted
Initial S/W Revision	A.03.00
Modified at S/W Revision	A.13.00

Filter Alpha for Offset

Sets the alpha value for the RRC Filter for each offset.

Key Path	Meas Setup, Offset/Limits, Method, RRC Weighted
Mode	SA, WCDMA, WIMAX OFDMA, TD-SCDMA, DVB-T/H, DTMB (CTTB), ISDB-T, CMMB, LTE, LTETDD
Remote Command	[[:SENSE]:ACPower:OFFSet[1] 2[:OUTer]:LIST:FILTer:ALPHa <real>, <real>, <real>, <real>, <real> [:SENSe]:ACPower:OFFSet[1] 2[:OUTer]:LIST:FILTer:ALPHa?
Example	ACP:OFFS:LIST:FILT:ALPH 0.5, 0.5, 0.5, 0.5, 0.5, 0.5 ACP:OFFS:LIST:FILT:ALPH?
Notes	This parameter is not available for cdma2000 and 1xEVDO. You must be in the mode that includes ACP measurements to use this command. Use :INSTrument:SElect to set the mode.
Preset	SA: 0.22, 0.22, 0.22, 0.22, 0.22, 0.22 0.22, 0.22, 0.22, 0.22, 0.22, 0.22 WCDMA: 0.22, 0.22, 0.22, 0.22, 0.22, 0.22 0.22, 0.22, 0.22, 0.22, 0.22, 0.22 WIMAX OFDMA: 0.22, 0.22, 0.22, 0.22, 0.22, 0.22 0.22, 0.22, 0.22, 0.22, 0.22, 0.22 C2K: NO TD-SCDMA: 0.22, 0.22, 0.22, 0.22, 0.22, 0.22 0.22, 0.22, 0.22, 0.22, 0.22, 0.22 DVB-T/H: 0.22, 0.22, 0.22, 0.22, 0.22, 0.22 0.22, 0.22, 0.22, 0.22, 0.22, 0.22 DTMB (CTTB): 0.05, 0.05, 0.05, 0.05, 0.05, 0.05 0.05, 0.05, 0.05, 0.05, 0.05, 0.05 ISDB-T: 0.22, 0.22, 0.22, 0.22, 0.22, 0.22 0.22, 0.22, 0.22, 0.22, 0.22, 0.22 CMMB: 0.22, 0.22, 0.22, 0.22, 0.22, 0.22 0.22, 0.22, 0.22, 0.22, 0.22, 0.22 LTE: 0.22, 0.22, 0.22, 0.22, 0.22, 0.22 0.22, 0.22, 0.22, 0.22, 0.22, 0.22 LTETDD: 0.22, 0.22, 0.22, 0.22, 0.22, 0.22 0.22, 0.22, 0.22, 0.22, 0.22, 0.22
State Saved	Saved in instrument state.
Min	0.01
Max	1.00
Initial S/W Revision	A.03.00
Modified at S/W Revision	A.13.00

Offset Frequency Define

This key allows you to select “Offset” definition. Each standard defines each “Offset” from Carrier.

3GPP2 requires the “From Carrier Center to MeasBW Closer Edge” definition. LTE conformance test requires “From Carrier Edge to MeasBW Center” and/or “From Carrier Edge to MeasBW Closer Edge” definition.

- CTOCenter – From the center of the carrier closest to the adjacent channel to the center of the adjacent channel Offset Integ BW
- CTOEdge – From the center of the carrier closest to the adjacent channel to the edge of the closest adjacent channel Offset Integ BW
- ETOCenter – From Center Frequency - Carrier Spacing / 2 (for lower offset), Center Frequency + Carrier Spacing / 2 (for upper offset) of the carrier closest to the adjacent channel's to the center of the adjacent channel Offset Integ BW
- ETOEdge – From Center Frequency - Carrier Spacing / 2 (for lower offset), Center Frequency + Carrier Spacing / 2 (for upper offset) of the carrier closest to the adjacent channel's to the edge of the closest adjacent channel Offset Integ BW

Key Path	Meas Setup, Offset/Limits
Mode	SA, WCDMA, C2K, WIMAX OFDMA, TD-SCDMA, 1xEVDO, DVB-T/H, DTMB (CTTB), ISDB-T, CMMB, LTE, LTETDD
Remote Command	[:SENSe] :ACPower:OFFSet [1] 2 [:OUTer] :TYPE CTOCenter CTOEdge ETOCenter ETOEdge [:SENSe] :ACPower:OFFSet [1] 2 [:OUTer] :TYPE?
Example	ACP:OFFS:TYPE ETOC ACP:OFFS:TYPE?
Notes	You must be in the mode that includes ACP measurements to use this command. Use :INSTrument:SElect to set the mode.
Preset	All Except C2K and 1xEVDO: CTOCenter C2K and 1xEVDO: CTOEdge
State Saved	Saved in instrument state.
Range	Carrier Center To Meas BW Center Carrier Center To Meas BW Edge Carrier Edge To Meas BW Center Carrier Edge To Meas BW Edge
Initial S/W Revision	A.03.00
Modified at S/W Revision	A.13.00

Carrier Result

Allows you to view and scroll through the carrier power results.

Key Path	Meas Setup
----------	------------

Mode	SA, WCDMA, C2K, WIMAX OFDMA, TD-SCDMA, 1xEVDO, DVB-T/H, DTMB (CTTB), ISDB-T, CMMB, LTE, LTETDD
Couplings	This key will be grayed out if there is only one carrier.
Preset	1
State Saved	No
Min	1
Max	Number of carriers.
Initial S/W Revision	Prior to A.02.00
Modified at S/W Revision	A.02.00, A.03.00

Meas Method

Sets the desired method to measure ACP.

Integration BW – one sweep of the trace is taken, and the band power for each offset is computed. Depending on the status of the Meas Type parameter (Total Power Reference or PSD Reference), results are displayed relative to the total power or the power spectral density. The display reflects either the current trace or a bar graph view.

Filtered IBW (max dynamic range) – the ACP Path is used to compute ACP when an ACP path is available. This method increases dynamic range, but increases measurement time as it limits the resolution bandwidth. This method is useful for improving dynamic range on a W-CDMA signal because a sharp cutoff bandpass filter is used. The accuracy of the adjacent channel power ratio is not degraded by this method, but the absolute accuracy of both adjacent channel power and carrier power are degraded by up to about 0.5 dB.

RBW – the algorithm uses zero-span and an appropriate RBW setting to capture all of the power in the carrier channel and the offsets. The zero-span algorithm (RBW method) is slower than the IBW method, but greatly improves repeatability.

Fast (in WCDMA mode or SA mode with 3GPP WCDMA radio standard selected) – this provides the same method as the Integration BW method, but is optimized for speed to measure a W-CDMA signal.

Fast (in CDMA2K mode or SA mode with CDMA2K radio standard selected) – this provides faster measurement using the FFT method with a limited parameter flexibility. When this is selected, CDMA2K preset offsets are given and control of the following are grayed out:

BW menu, Sweep/Control menu except Pause/Resume, Trace/Detector menu, Carrier Setup, Offset Limit, RRC Weighting, Filter Alpha, and Noise Correction softkeys in Meas Setup menu.

Key Path	Meas Setup
Mode	SA, WCDMA, C2K, WIMAX OFDMA, 1xEVDO, DVB-T/H, DTMB (CTTB), ISDB-T, CMMB, LTE, LTETDD
Remote Command	[:SENSe] :ACPower:METhod IBW IBWRange FAST RBW [:SENSe] :ACPower:METhod?
Example	ACP:METh IBW ACP:METh?

Notes	<p>FAST mode is only supported for WCDMA and C2K signal. You must be in the WCDMA or C2K mode or SA mode with 3GPP WCDMA or CDMA2K radio standard. Otherwise a setting conflict error message will be reported.</p> <p>In the TDSCDMA mode, only the IBW method is available to use. Therefore, the measure method key is not displayed in the TD-SCDMA mode.</p> <p>CDMA1xEVDO mode only supports RBW and Integration BW method.</p> <p>C2K mode only supports RBW, Integration BW and FAST method.</p> <p>LTETDD mode only supports Integration BW and Filtered IBW method.</p> <p>You must be in the mode that includes ACP measurements to use this command. Use :INSTrument:SElect to set the mode.</p>
Dependencies	<p>When RBW or FAST is selected, Gate function is not available. If you try to turn Gate On while Meas Method is RBW or FAST, an error is generated.</p> <p>When Gate function is ON, RBW and FAST method is not available. If you try to change Meas Method to RBW or FAST, an error is generated.</p>
Couplings	<p>IBW (Range) restricts the Res BW available for making this measurement to 30 kHz. When selected, the Res BW is clipped to this value if required and an error number displayed.</p>
Preset	<p>SA, LTE, LTETDD: IBW</p> <p>WCDMA: IBW</p> <p>C2K: RBW</p> <p>WIMAX OFDMA: IBW</p> <p>1xEVDO: IBW</p> <p>DVB-T/H: IBW</p> <p>DTMB (CTTB): IBW</p> <p>ISDB-T: IBW</p> <p>CMMB: IBW</p> <p>Digital Cable TV: IBW</p>
State Saved	<p>Saved in instrument state.</p>
Range	<p>Integration BW Filtered IBW (max dynamic range) RBW Fast</p>
Readback Text	<p>IBW Filtered IBW RBW Fast</p>
Backwards Compatibility SCPI	<p>[:SENSe] :ACPR :SWEep :TYPE</p> <p>[:SENSe] :MCPower :METHod (PSA Power Suite)</p>
Initial S/W Revision	<p>Prior to A.02.00</p>
Modified at S/W Revision	<p>A.02.00, A.03.00</p>

Meas Type

Changes the reference used for the measurement. This allows you to make absolute and relative power measurements of either total power or the power normalized to the measurement bandwidth.

Total Pwr Ref (TPR) sets the reference to the total carrier power. PSD Ref (PSDR) sets the reference to the power spectral density of the carrier.

Key Path	Meas Setup
Mode	SA, WCDMA, C2K, WIMAX OFDMA, TD-SCDMA, 1xEVDO, DVB-T/H, DTMB (CTTB), ISDB-T, CMMB, LTE, LTE-TDD
Remote Command	<code>[:SENSe] :ACPower:TYPE TPreRef PSDRef</code> <code>[:SENSe] :ACPower:TYPE?</code>
Example	ACP:TYPE PSDR ACP:TYPE?
Notes	You must be in the mode that includes ACP measurements to use this command. Use <code>:INSTrument:SElect</code> to set the mode.
Preset	TPRef
State Saved	Saved in instrument state.
Range	Total Power Ref PSD Ref
Initial S/W Revision	Prior to A.02.00
Modified at S/W Revision	A.02.00, A.03.00

PSD Ref

Sets the unit bandwidth for Power Spectral Density. The available units are dBm/Hz and dBm/MHz.

Key Path	Meas Setup
Mode	A, WCDMA, C2K, WIMAX OFDMA, TD-SCDMA, 1xEVDO, DVB-T/H, DTMB (CTTB), ISDB-T, CMMB, LTE, LTE-TDD
Remote Command	<code>:UNIT:ACPower:POWer:PSD DBMHZ DBMMHZ</code> <code>:UNIT:ACPower:POWer:PSD?</code>
Example	UNIT:ACP:POW:PSD DBMMHZ UNIT:ACP:POW:PSD?
Couplings	When the PSD unit is changed, the PSD reference result of the “MEAS READ FETCH:ACP[n]?” is also changed by the PSD unit basis (in either dBm/Hz or dBm/MHz).
Preset	DBMHZ
State Saved	Saved in instrument state.
Range	dBm/Hz dBm/MHz
Initial S/W Revision	Prior to A.02.00
Modified at S/W Revision	A.02.00, A.03.00

Limit Test

Turns limit checking for each offset On or Off. The limits may be specified within the Offset menu, for each offset, both sides of the carrier. For results that fail the limit, a red F is appended. In the Combined view, the bar turns red.

Key Path	Meas Setup
Mode	SA, WCDMA, C2K, WIMAX OFDMA, TD-SCDMA, 1xEVDO, DVB-T/H, DTMB (CTTB), ISDB-T, CMMB, LTE, LTETDD
Remote Command	:CALCulate:ACPower:LIMit:STATe OFF ON 0 1 :CALCulate:ACPower:LIMit:STATe?
Example	CALC:ACP:LIM:STAT OFF CALC:ACP:LIM:STAT?
Notes	You must be in the mode that includes ACP measurements to use this command. Use :INSTrument:SElect to set the mode.
Preset	SA: OFF WCDMA: ON C2K: ON WIMAX OFDMA: OFF TD-SCDMA: ON 1xEVDO: ON DVB-T/H: OFF DTMB (CTTB): ON ISDB-T: OFF CMMB: ON LTE, LTETDD: ON
State Saved	Saved in instrument state.
Range	On Off
Backwards Compatibility SCPI	[:SENSe] :MCPower:LIMit [:STATe] [:SENSe] :ACPower:LIMit [:STATe]
Initial S/W Revision	Prior to A.02.00
Modified at S/W Revision	A.02.00, A.03.00

Meas Preset

Restores all the measurement parameters to their default values.

Key Path	Meas Setup
Mode	SA, WCDMA, C2K, WIMAX OFDMA, TD-SCDMA, 1xEVDO, DVB-T/H, DTMB (CTTB), ISDB-T, CMMB, LTE, LTETDD
Remote Command	:CONFigure:ACPower
Example	CONF:ACP
Notes	You must be in the mode that includes ACP measurements to use this command. Use :INSTrument:SElect to set the mode.
Couplings	Selecting Meas Preset will restore all measurement parameters to their default values.
Initial S/W Revision	Prior to A.02.00
Modified at S/W Revision	A.02.00, A.03.00

Offset RRC Weighting (Backward Compatibility SCPI)

Mode	SA, WCDMA, TD-SCDMA, WIMAX OFDMA, DVB-T/H, DTMB (CTTB), ISDB-T, CMMB, LTE, LTETDD
Remote Command	[:SENSe] :ACPower:FILTer [:RRC] [:STATe] OFF ON 0 1 [:SENSe] :ACPower:FILTer [:RRC] [:STATe] ?
Example	ACP:FILT OFF ACP:FILT?
Notes	This parameter is not available for cdma2000 and 1xEVDO The backwards Compatibility SCPI command, [:SENSe] :ACPR:FILTer [:RRC] [:STATe], is provided to support same functionality as [:SENSe] :ACPr:FILTer [:RRC] [:STATe] (PSA W-CDMA, PSA cdma2000 and PSA 1xEVDO) due to ACPr node conflicts with ACPower node. You must be in the mode that includes ACP measurements to use this command. Use :INSTrument:SElect to set the mode.
Couplings	This command is an alias to [:SENSe] :ACPower:OFFSet[1]2:LIST:FILTer [:RRC] [:STATe] Sending the commands to set values of all offsets for BS and MS, however, sending the query always return a value of BS Offset A.
Preset	SA, WIMAX OFDMA, LTE, LTETDD: OFF WCDMA: ON C2K: NO TD-SCDMA: ON
State Saved	Saved in instrument state.
Backwards Compatibility SCPI	[:SENSe] :ACPR:FILTer [:RRC] [:STATe] [:SENSe] :MCPower:FILTer [:RRC] [:STATe]
Initial S/W Revision	Prior to A.02.00
Modified at S/W Revision	A.03.00

Offset Filter Alpha (Backward Compatibility SCPI)

Mode	SA, WCDMA, WIMAX OFDMA, TD-SCDMA, DVB-T/H, DTMB (CTTB), ISDB-T, CMMB, LTE, LTETDD
Remote Command	[:SENSe] :ACPower:FILTer [:RRC] :ALPHa <real> [:SENSe] :ACPower:FILTer [:RRC] :ALPHa ?
Example	ACP:FILT:ALPH 0.5 ACP:FILT:ALPH?
Notes	This parameter is not available for cdma2000 and 1xEVDO The backwards Compatibility SCPI command, [:SENSe] :ACPR:FILTer [:RRC] :ALPHa, is provided to support same functionality as [:SENSe] :ACPr:FILTer [:RRC] :ALPHa (PSA W-CDMA, PSA cdma2000 and PSA 1xEVDO) due to ACPr node conflicts with ACPower node. You must be in the mode that includes ACP measurements to use this command. Use

	:INSTrument:SElect to set the mode.
Couplings	This command is an alias to [:SENSe]:ACPpower:OFFSet[1]2:LIST:FILTer:ALPha Sending the commands to set values of all offsets for BS and MS, however, sending the query always return a value of BS Offset A.
Preset	SA, WCDMA, WIMAX OFDMA, TD-SCDMA, LTE, LTETDD: 0.22 C2K: NO
State Saved	Saved in instrument state.
Min	0.01
Max	1.00
Backwards Compatibility SCPI	[:SENSe]:ACPR:FILTer[:RRC]:ALPha [:SENSe]:MCPower:FILTer[:RRC]:ALPha
Initial S/W Revision	Prior to A.02.00
Modified at S/W Revision	A.03.00

Method for Carrier (Backward Compatibility SCPI)

Mode	SA, WCDMA, WIMAX OFDMA, TD-SCDMA, LTE, LTETDD
Remote Command	[:SENSe]:ACPpower:CARRier[1]2:LIST:METhod IBW RRC, ... [:SENSe]:ACPpower:CARRier[1]2:LIST:METhod?
Example	ACP:CARR2:LIST:METh RRC ACP:CARR2:LIST:METh?
Notes	You must be in the mode that includes ACP measurements to use this command. Use :INSTrument:SElect to set the mode. Maximum of Array length depends on the number of carriers.
Couplings	This command is an alias to [:SENSe]:ACPpower:CARRier[1]2:LIST:FILTer[:RRC]:[STATe] The enum value translates as follows: RRC Weighted = 1 ON Integ BW = 0 OFF Maximum of Array length depends on the number of carriers.
Preset	SA: IBW WCDMA: RRC WIMAX OFDMA: IBW TD-SCDMA: RRC DVB-T/H: IBW DTMB (CTTB): RRC ISDB-T: IBW CMMB: IBW

	LTE, MSR: IBW LTETDD: IBW Digital Cable TV: RRC
State Saved	Saved in instrument state.
Initial S/W Revision	Prior to A.02.00
Modified at S/W Revision	A.03.00

10 ACP Measurement
Mode

Mode

See "[Mode](#)" on page 222

Mode Preset

Returns the active mode to a known state.

Mode Preset does the following for the currently active mode:

- Aborts the currently running measurement.
- Brings up the default menu for the mode, with no active function.
- Sets measurement Global settings to their preset values for the active mode only.
- Activates the default measurement.
- Brings up the default menu for the mode.
- Clears the input and output buffers.
- Sets Status Byte to 0.

Mode Preset does not:

- Cause a mode switch
- Affect mode persistent settings
- Affect system settings
- See "[How-To Preset](#)" on page 1022 for more information.

Key Path	Front-panel key
Remote Command	:SYSTem:PRESet
Example	:SYST:PRES
Notes	*RST is preferred over :SYST:PRES for remote operation. *RST does a Mode Preset, as done by the :SYST:PRES command, and it sets the measurement mode to Single measurement rather than Continuous for optimal remote control throughput. Clears all pending OPC bits. The Status Byte is set to 0.
Couplings	A Mode Preset aborts the currently running measurement, activates the default measurement, and gets the mode to a consistent state with all of the default couplings set.
Backwards Compatibility Notes	In the X-Series, the legacy "Factory Preset" has been replaced with Mode Preset, which only presets the currently active mode, not the entire instrument. In the X-Series, the way to preset the entire instrument is by using System, Restore System Defaults All, which behaves essentially the same way as restore System Defaults does on ESA and PSA. There is also no "Preset Type" as there is on the PSA. There is a green Mode Preset front-panel key that does a Mode Preset and a white-with-green-letters User Preset front-panel key that does a User Preset. The old PRESet:TYPE command is ignored (without generating an error), and SYST:PRES without a parameter does a Mode Preset, which should cover most backward code compatibility issues. The settings and correction data under the Input/Output front-panel key (examples: Input Z Corr, Ext Amp Gain, etc.) are no longer part of any Mode, so they will not be preset by a Mode Preset. They are preset using Restore Input/Output Defaults, Restore System Defaults All. Note that because User Preset does a Recall State, and all of these settings are saved in State, they ARE recalled when using

	User Preset.
Initial S/W Revision	Prior to A.02.00

How-To Preset

The table below shows all possible presets, their corresponding SCPI commands and front-panel access (key paths). Instrument settings depend on the current measurement context. Some settings are local to the current measurement, some are global (common) across all the measurements in the current mode, and some are global to all the available modes. In a similar way, restoring the settings to their preset state can be done within the different contexts.

Auto Couple - is a measurement local key. It sets all Auto/Man parameter couplings in the measurement to Auto. Any Auto/Man selection that is local to other measurements in the mode will not be affected.

Meas Preset - is a measurement local key. Meas Preset resets all the variables local to the current measurement except the persistent ones.

Mode Preset - resets all the current mode's measurement local and measurement global variables except the persistent ones.

Restore Mode Defaults - resets ALL the Mode variables (and all the Meas global and Meas local variables), including the persistent ones.

Type Of Preset	SCPI Command	Front Panel Access
Auto Couple	:COUPle ALL	Auto Couple front-panel key
Meas Preset	:CONFigure:<Measurement>	Meas Setup Menu
Mode Preset	:SYSTem:PRESet	Mode Preset (green key)
Restore Mode Defaults	:INSTrument:DEFault	Mode Setup Menu
Restore All Mode Defaults	:SYSTem:DEFault MODes	System Menu; Restore System Default Menu
*RST	*RST	not possible (Mode Preset with Single)
Restore Input/Output Defaults	:SYSTem:DEFault INPUt	System Menu; Restore System Default Menu
Restore Power On Defaults	:SYSTem:DEFault PON	System Menu; Restore System Default Menu
Restore Alignment Defaults	:SYSTem:DEFault ALIGN	System Menu; Restore System Default Menu
Restore Miscellaneous Defaults	:SYSTem:DEFault MISC	System Menu; Restore System Default Menu
Restore All System Defaults	:SYSTem:DEFault [ALL] :SYSTem:PRESet:PERsistent	System Menu; Restore System Default Menu
User Preset	:SYSTem:PRESet:USER	User Preset Menu
User Preset All Modes	:SYSTem:PRESet:USER:ALL	User Preset Menu

Power On Mode Preset	:SYSTem:PON:TYPE MODE	System Menu
Power On User Preset	:SYSTem:PON:TYPE USER	System Menu
Power On Last State	:SYSTem:PON:TYPE LAST	System Menu

Mode Setup

See "[Mode Setup](#)" on page 242

Peak Search

Places the selected marker on the trace point with the maximum y-axis value.

Key Path	Peak Search
Mode	SA, WCDMA, C2K, WIMAX OFDMA, TD-SCDMA, 1xEVDO, DVB-T/H, DTMB (CTTB), ISDB-T, CMMB, LTE, LTETDD
Remote Command	:CALCulate:ACPower:MARKer[1] 2 ... 12:MAXimum
Example	CALC:ACP:MARK2:MAX
Initial S/W Revision	Prior to A.02.00
Modified at S/W Revision	A.02.00, A.03.00

Next Peak

Moves the selected marker to the peak that has the next highest amplitude.

Key Path	Peak Search
Mode	SA, WCDMA, C2K, WIMAX OFDMA, TD-SCDMA, 1xEVDO, DVB-T/H, DTMB (CTTB), ISDB-T, CMMB, LTE, LTETDD
Remote Command	:CALCulate:ACPower:MARKer[1] 2 ... 12:MAXimum:NEXT
Example	CALC:ACP:MARK2:MAX:NEXT
Initial S/W Revision	Prior to A.02.00
Modified at S/W Revision	A.02.00, A.03.00

Next Pk Right

Moves the selected marker to the nearest peak to the right of the current marker that meets all enabled peak criteria.

Key Path	Peak Search
Mode	SA, WCDMA, C2K, WIMAX OFDMA, TD-SCDMA, 1xEVDO, DVB-T/H, DTMB (CTTB), ISDB-T, CMMB, LTE, LTETDD
Remote Command	:CALCulate:ACPower:MARKer[1] 2 ... 12:MAXimum:RIGHT
Example	CALC:ACP:MARK2:MAX:RIGH
Initial S/W Revision	Prior to A.02.00
Modified at S/W Revision	A.02.00, A.03.00

Next Pk Left

Moves the selected marker to the nearest peak to the left of the current marker that meets all enabled peak criteria.

Key Path	Peak Search
Mode	SA, WCDMA, C2K, WIMAX OFDMA, TD-SCDMA, 1xEVDO, DVB-T/H, DTMB (CTTB), ISDB-T, CMMB, LTE, LTETDD
Remote Command	:CALCulate:ACPower:MARKer[1] 2 ... 12:MAXimum:LEFT
Example	CALC:ACP:MARK2:MAX:LEFT
Initial S/W Revision	Prior to A.02.00
Modified at S/W Revision	A.02.00, A.03.00

Marker Delta

Sets the control mode for the selected marker to Delta mode.

See Marker Delta in the "Marker Functions" section for more information.

Key Path	Peak Search
Initial S/W Revision	Prior to A.02.00

Pk-Pk Search

Finds and displays the amplitude and frequency (or time, if in zero span) differences between the highest and lowest y-axis value.

Key Path	Peak Search
Mode	SA, WCDMA, C2K, WIMAX OFDMA, TD-SCDMA, 1xEVDO, DVB-T/H, DTMB (CTTB), ISDB-T, CMMB, LTE, LTETDD
Remote Command	:CALCulate:ACPower:MARKer[1] 2 ... 12:PTPeak
Example	CALC:ACP:MARK:PTP
Notes	Turns on the Marker Δ active function.
Couplings	This key is not available (key is grayed out) when Coupled Markers is on.
Initial S/W Revision	Prior to A.02.00
Modified at S/W Revision	A.02.00, A.03.00

Min Search

Moves the selected marker to the minimum y-axis value on the current trace.

Key Path	Peak Search
Mode	SA, WCDMA, C2K, WIMAX OFDMA, TD-SCDMA, 1xEVDO, DVB-T/H, DTMB (CTTB), ISDB-T, CMMB, LTE, LTE-TDD
Remote Command	:CALCulate:ACPower:MARKer [1] 2 . . . 12:MINimum
Example	CALC:ACP:MARK:MIN
Initial S/W Revision	Prior to A.02.00
Modified at S/W Revision	A.02.00, A.03.00

10 ACP Measurement
Print

Print

See "Print" on page 271

Quick Save

The Quick Save front-panel key repeats the most recent save that was performed from the Save menu, with the following exceptions:

- Register saves are not remembered as Saves for the purpose of the Quick Save function
- If the current measurement does not support the last non-register save that was performed, an informational message is generated, “File type not supported for this measurement”

Quick Save repeats the last type of qualified save (that is, a save qualified by the above criteria) in the last save directory by creating a unique filename using the Auto File Naming algorithm described below.

If Quick Save is pressed after startup and before any qualified Save has been performed, the Quick Save function performs a Screen Image save using the current settings for Screen Image saves (current theme, current directory), which then becomes the “last save” for the purpose of subsequent Quick Saves.

The Auto File Naming feature automatically generates a file name for use when saving a file. The filename consists of a prefix and suffix separated by a dot, as is standard for the Windows® file system. A default prefix exists for each of the available file types:

Type	Default Prefix	Menu
State	State_	(Save/Recall)
Trace + State	State_	(Save/Recall)
Screen	Screen_	(Save/Recall)
Amplitude Corrections	Ampcor_	(Import/Export)
Traces	Trace_	(Import/Export)
Limit Lines	LLine_	(Import/Export)
Measurement Result	MeasR_	(Import/Export)
Capture Buffer	CapBuf_	(Import/Export)

A four digit number is appended to the prefix to create a unique file name. The numbering sequence starts at 0000 within each Mode for each file type and updates incrementally to 9999, then wraps to 0000 again. It remembers where it was through a Mode Preset and when leaving and returning to the Mode. It is reset by Restore Misc Defaults and Restore System Defaults and subsequent running of the instrument application. So, for example, the first auto file name generated for State files is State_0000.state. The next is State_0001, and so forth.

One of the key features of Auto File Name is that we guarantee that the Auto File Name will never conflict with an existing file. The algorithm looks for the next available number. If it gets to 9999, then it looks for holes. If it find no holes, that is no more numbers are available, it gives an error.

For example, if when we get to State_0010.state there is already a State_0010.state file in the current directory, it advances the counter to State_0011.state to ensure that no conflict will exist (and then it verifies that State_0011.state also does not exist in the current directory and advances again if it does, and so forth).

If you enter a file name for a given file type, then the prefix becomes the filename you entered instead of the default prefix, followed by an underscore. The last four letters (the suffix) are the 4-digit number.

For example, if you save a measurement results file as “fred.csv”, then the next auto file name chosen for a measurement results save will be fred_0000.csv.

NOTE

Although 0000 is used in the example above, the number that is used is actually the current number in the Meas Results sequence, that is, the number that would have been used if you had not entered your own file name.

NOTE

If the filename you entered ends with _dddd, where d=any number, making it look just like an auto file name, then the next auto file name picks up where you left off with the suffix being dddd + 1.

Key Path	Front-panel key
Notes	No remote command for this key specifically.
Initial S/W Revision	Prior to A.02.00

Recall

In the LTE-Advanced TDD/FDD modes, two types of recall functions are available under the Data menu: “Parameter Configuration per Component Carrier” and “Limit Mask”. Limit Mask enables setting a preset limit mask for Power Suite-based measurements, and currently it is available for the SEM, ACP and SPUR measurements in LTE-Advanced TDD/FDD modes.

Recalling the complicated RB settings specified in the test models of the standards and the LTE state file. And it can also recalls the parameters which have been set and saved for “Signal Studio Setup” or “89600 Vector Signal Analyzer” on the external platform .

Key Path	Front Panel Key
Mode	LTEATDD, LTEAFDD
Initial S/W Revision	A.14.00

State

The Recall State menu lets you choose a register or file from which to recall the state.

The content of a state file includes all of the settings and data required to return the analyzer as closely as possible to the Mode it was in, with the exact settings that were in place, when the save occurred. The Mode settings in each state file include the settings that are affected by Mode Preset, as well as the additional settings affected by Restore Mode Defaults; all of the Mode’s settings. In addition, all of the settings of the Input/Output system are included, even though they are outside of the Mode’s state, because they are needed to restore the complete setup. Persistent System settings (for example, GPIB address) are not affected by either a Mode Preset or Restore Mode Defaults, nor are they included in a saved State file.

Since each state file is only for one Mode, the settings for other Modes are unaffected when it is loaded. Recall State will cause a mode switch if the state being recalled is not from the current active mode.

After the recall completes, the message "File <filename> recalled" or “Recalled State Register <register number>” is displayed.

For rapid recalls, the State menu lists 16 registers that you can choose from to recall. Pressing a Register key initiates the recall. You can also select a file from which to recall.

The default path for all State Files is:

My Documents\<>mode name>\state

where <mode name> is the parameter used to select the mode with the INST:SEL command (for example, SA for the Spectrum Analyzer).

See "[More Information](#)" on page 1032.

Key Path	Recall
Mode	All
Remote Command	:MMEMory:LOAD:STATe <filename>

Example	:MMEM:LOAD:STAT "myState.state" This recalls the file myState.state on the default path
Example	MMEM:LOAD:STAT "MyStateFile.state" This loads the state file data (on the default file directory path) into the instrument state.
Notes	<p>When you pick a file to recall, the analyzer first verifies that the file is recallable in the current instrument by checking the software version and model number of the instrument. If everything matches, a full recall proceeds by aborting the currently running measurement, clearing any pending operations, and then loading the State from the saved state file. You can open state files from any mode, so recalling a State file switches to the mode that was active when the save occurred. After switching to the mode of the saved state file, mode settings and data (if any for the mode) are loaded with values from the saved file. The saved measurement of the mode becomes the newly active measurement and the data relevant to the measurement (if there is any) is recalled.</p> <ul style="list-style-type: none"> • If there is a mismatch between file version or model number or instrument version or model number, the recall function tries to recall as much as possible and returns a warning message. It may limit settings that differ based on model number, licensing or version number. <p>After recalling the state, the Recall State function does the following:</p> <ul style="list-style-type: none"> • Makes the saved measurement for the mode the active measurement. • Clears the input and output buffers. • Status Byte is set to 0. • Executes a *CLS <p>If the file specified is empty an error is generated. If the specified file does not exist, another error is generated. If there is a mismatch between the file and the proper file type, an error is generated. If there is a mismatch between file version or model number or instrument version or model number, a warning is displayed. Then it returns to the State menu and File Open dialog goes away.</p> <p>After the Recall, the analyzer exits the Recall menu and returns to the previous menu.</p>
Backwards Compatibility SCPI	:MMEMory:LOAD:STATe 1,<filename> For backwards compatibility, the above syntax is supported. The "1" is simply ignored.
Initial S/W Revision	Prior to A.02.00

More Information

In measurements that support saving Traces, for example, Swept SA, the Trace data is saved along with the State in the State file. When recalling the State, the Trace data is recalled as well. Traces are recalled exactly as they were stored, including the writing mode and update and display modes. If a Trace was updating and visible when the State was saved, it will come back updating and visible, and its data will be rewritten right away. When you use State to save and recall traces, any trace whose data must be preserved should be placed in View or Blank mode before saving.

The following table describes the Trace Save and Recall possibilities:

You want to recall state and one trace's data, leaving other traces unaffected.	Save Trace+State from 1 trace. Make sure that no other traces are updating (they should all be in View or Blank mode) when the save is performed.	On Recall, specify the trace you want to load the one trace's data into. This trace will load in View. All other traces' data will be unaffected, although their trace
---	---	--

You want to recall all traces	Save Trace+State from ALL traces.	mode will be as it was when the state save was performed. On Recall, all traces will come back in View (or Blank if they were in Blank or Background when saved)
You want all traces to load exactly as they were when saved.	Save State	On recall, all traces' mode and data will be exactly as they were when saved. Any traces that were updating will have their data immediately overwritten.

From File...

When you press “From File”, the analyzer brings up a Windows dialog and a menu entitled “File Open.” This menu allows you to navigate to the various fields in the Windows dialog without using a keyboard or mouse. The Tab and Arrow keys can also be used for dialog navigation.

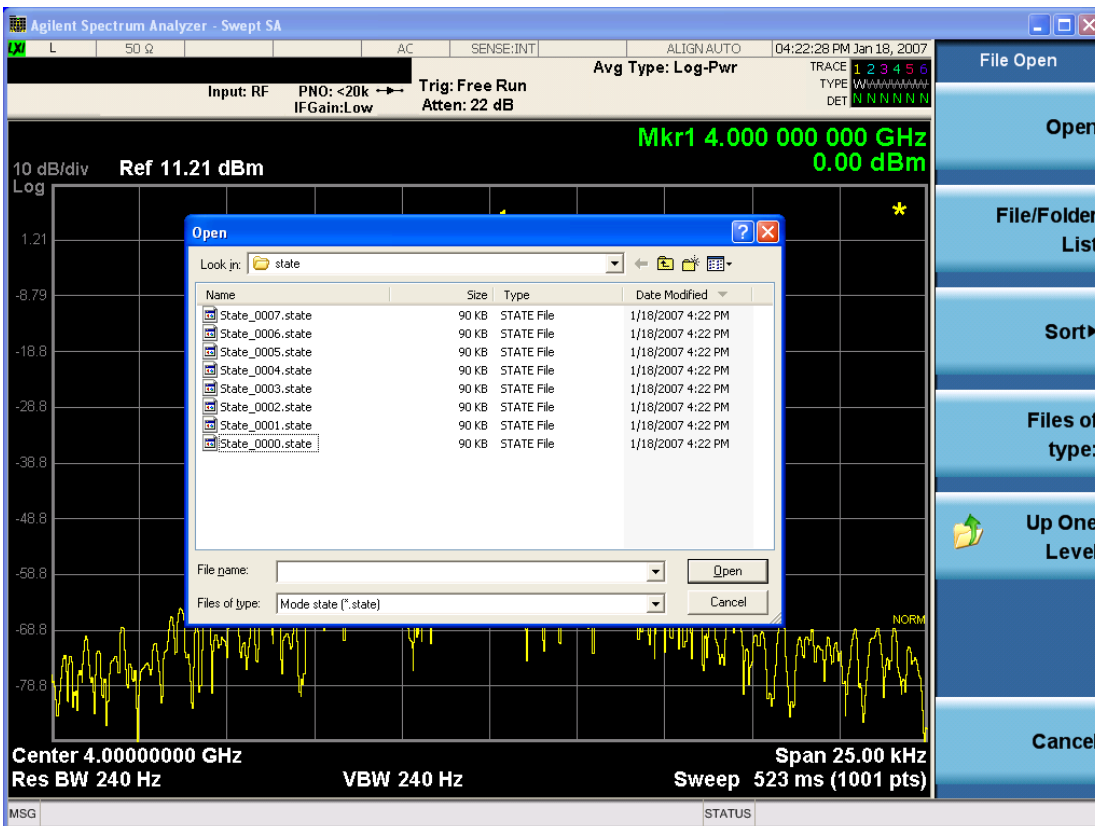

Listed below are the functions of the various fields in the dialog, and the corresponding softkeys:

Open

Performs the recall of the specified file. While the recall is being performed, the floppy icon appears briefly in the Meas bar.

File/Folder List

Enables you to navigate to the center of the dialog that contains the list of files and folders. Once here you can get information about the file and use the tab keys to navigate to the other fields in the dialog, such as Look In.

Look In

The Look In field shows the path from which the file will be recalled and allows you to change the path using the up and down arrow keys to navigate to other paths; the Enter key to open a directory; and the Backspace key to go back one directory. The **Look In field** first uses the last path from the Save As dialog **Save In:** path for that same file type. There is no softkey for directly navigating to the Look In field, but you can use the left tab to get here from the File/Folder List.

User specified paths are remembered when you leave and return to a Mode and are reset back to the default using Restore Mode Defaults.

Sort

Accesses a menu that enables you to sort the files within the File Open dialog. Only one sorting type can be selected at a time and the sorting happens immediately. The sorting types are By Date, By Name, By extension, and By Size.

Files of Type

This field shows the file suffix for the type of file you have selected to recall. For example, if you navigated here while recalling State, "Mode state (*.state)" is in the field. If you navigated here while recalling Trace, ""Mode state (*.trace)" is in the field. If you navigated here while importing a trace data file, "Trace Data (*.csv)" is in the field. For some file types, there is more than one choice in the dropdown menu, which you can select by using the up and down arrow keys and Enter.

Up One Level

This key corresponds to the icon of a folder with the up arrow that is in the tool bar of the dialog. When pressed, it causes the file and folder list to navigate up one level in the directory structure. The Backspace key does the same thing.

Cancel

This key corresponds to the Cancel selection in the dialog. It causes the current **Open** request to be cancelled. The ESC key does the same thing.

Key Path	Recall, State
Notes	Brings up the Open dialog for recalling a State Save Type
Initial S/W Revision	Prior to A.02.00

Edit Register Names

You may enter a custom name on any of the Register keys, to help you remember what you are using that state to save. To do this, press the Edit Register Names key, choose the register whose name you wish to edit, and then enter the desired label using the Alpha Editor or an external PC keyboard.

The maximum number of characters that can be added is 30. In most cases, 30 characters will fit on two lines of the key.

For more information and the SCPI command, see Edit Register Names under the Save, State function.

Key Path	Recall, State
Mode	All
Dependencies	N9060A-7FP or N9060B-2FP license required to edit the register names. When the feature is not licensed, sending the SCPI command generates an error, -221, "Settings conflict;Option not available"
Initial S/W Revision	A.11.00

Register 1 thru Register 16

Selecting any one of these register keys causes the State of the mode from the specified Register to be recalled. Each of the register keys annotates whether it is empty or at what date and time it was last modified. In addition, you can use the Edit Register Names key under Save, State to enter custom names for each register.

NOTE

In products that run multiple instances of the X-Series Application, recalling the same register name on each instance is a way to share setups between the instances.

Registers are shared by all modes, so recalling from any one of the registers will cause a mode switch to the mode that was active when the save to the Register occurred.

Although these 16 registers are the only registers available from the front panel, there are 128 state registers available in the instrument. Registers 17-128 are only available from the SCPI interface, using the *RCL command.

After the recall completes, the message "Register <register number> recalled" appears in the message bar. If you are in the Spectrum Analyzer Mode, and you are recalling a register that was saved in the Spectrum Analyzer Mode, then after the recall, you will still be in the Recall Register menu. If the Recall causes you to switch modes, then after the Recall, you will be in the Frequency menu.

If a requested register is empty an error is generated.

Key Path	Recall, State
Example	*RCL 1
Range	1-16 from front panel, 1-128 from SCPI
Readback	Date and time with seconds resolution are displayed on the key OR A custom name of up to 30 characters entered using the Save, State,Edit Register Names key

	OR “(empty)” if no prior save operation has been performed to this register.
Initial S/W Revision	Prior to A.02.00
Modified at S/W Revision	Prior to A.11.00

Register 1 thru Register 16

Selecting any one of these register keys causes the State of the mode from the specified Register to be recalled. Each of the register keys annotates whether it is empty or at what date and time it was last modified. In addition, you can use the Edit Register Names key under Save, State to enter custom names for each register.

NOTE

In products that run multiple instances of the X-Series Application, recalling the same register name on each instance is a way to share setups between the instances.

Registers are shared by all modes, so recalling from any one of the registers will cause a mode switch to the mode that was active when the save to the Register occurred.

Although these 16 registers are the only registers available from the front panel, there are 128 state registers available in the instrument. Registers 17–128 are only available from the SCPI interface, using the *RCL command.

After the recall completes, the message "Register <register number> recalled" appears in the message bar. If you are in the Spectrum Analyzer Mode, and you are recalling a register that was saved in the Spectrum Analyzer Mode, then after the recall, you will still be in the Recall Register menu. If the Recall causes you to switch modes, then after the Recall, you will be in the Frequency menu.

If a requested register is empty an error is generated.

Key Path	Recall, State
Example	*RCL 1
Range	1–16 from front panel, 1–128 from SCPI
Readback	Date and time with seconds resolution are displayed on the key OR A custom name of up to 30 characters entered using the Save, State, Edit Register Names key OR “(empty)” if no prior save operation has been performed to this register.
Initial S/W Revision	Prior to A.02.00
Modified at S/W Revision	Prior to A.11.00

Sequences

These keys allow you to import a Tab separated or .txt file that will automatically setup all the parameters required for building a Sequence. The parameters will automatically be loaded into the Stated Sequencer.

Once selected, in order to import the selected Sequence Type you must select the Open key in the Source Sequence menu.

Key Path	Recall, Sequences
Mode	All
Remote Command	:MMEMory:LOAD:SEQ:Sequences: SLIS ALIS SAALIS "MySequence.txt"
Example	:MMEM:LOAD:SEQ:SLIS "MySequence.txt"
Notes	Available file types are: –CSV (Comma delimited) (*.csv) –Text (Tab delimited) (*.txt)
Initial S/W Revision	A.05.00

Source Sequence

The list of parameters, that configure steps, that makes up a sequence for the Source.

The Source sequence is a sequence of flexible configurable steps that can be set anywhere in the instruments frequency range.

Key Path	Recall, Sequences
Example	:MMEM:LOAD:SEQ:SLIS "MySequence.txt"
Dependencies	Only available in XOBT
Initial S/W Revision	A.05.00

Open...

When you press "Open", the analyzer brings up a Windows dialog and a menu entitled "File Open." This menu allows you to navigate to the various fields in the Windows dialog without using a keyboard or mouse. The Tab and Arrow keys can also be used for dialog navigation.

See "[From File...](#)" on page 2401 in Recall, State, for a full description of this dialog and menu.

Key Path	Recall, Data
Notes	The key location is mode-dependent and will vary. Brings up Open dialog for recalling a <mode specific> Save Type
Initial S/W Revision	Prior to A.02.00

Data (Import)

Importing a data file loads data that was previously saved from the current measurement or from other measurements and/or modes that produce compatible data files. The Import Menu only contains Data Types that are supported by the current measurement.

Since the commonly exported data files are in .csv format, the data can be edited by the user prior to importing. This allows you to export a data file, manipulate the data in Excel (the most common PC Application for manipulating .csv files) and then import it.

Importing Data loads measurement data from the specified file into the specified or default destination, depending on the data type selected. Selecting an Import Data menu key will not actually cause the importing to occur, since the analyzer still needs to know from where to get the data. Pressing the Open key in this menu brings up the Open dialog and Open menu that provides you with the options from where to recall the data. Once a filename has been selected or entered in the Open menu, the recall occurs as soon as the Open button is pressed.

Key Path	Recall
Mode	All
Notes	The menu is built from whatever data types are available for the mode. Some keys will be missing completely, so the key locations in the sub-menu will vary. No SCPI command directly controls the Data Type that this key controls. The Data Type is included in the MMEM:LOAD commands.
Dependencies	If a file type is not used by a certain measurement, it is grayed out for that measurement. The key for a file type will not show at all if there are no measurements in the Mode that support it.
Preset	Is not affected by Preset or shutdown, but is reset during Restore Mode Defaults
Readback	The data type that is currently selected
Initial S/W Revision	Prior to A.02.00

Component Carrier Setup

Enables you to import LTE-A setup files for all Component Carriers or the specified Component Carrier. Selecting this key displays a menu that enables you to select what the Component Carrier setup files to be imported. After making this selection, depress Open... and use the file dialog to select the file you wish to recall. The Key is valid for Conformance EVM measurements only.

It supports to the following import file formats

- LTE app state files (*.state)
- EVM Setup Files (*.evms)
- 89601 VSA Setup Files (*.set, *.setx)
- Signal Studio Setup Files (*.scp)

App State Files

Extension: state

The parameters of the LTE Modulation Analysis measurement can be imported to LTE-Advanced EVM and CEVM measurements from the LTE .state file. It depends on the parameter of the Component Carrier Setup to decide which component carriers' measurement parameters are affected.

Pressing OPEN under the Import Data menu will open the above directory from which you can select an LTE app state file.

EVM Setup Files

Extension: evms

It will recall LTE test model parameters specified in the standards to LTE-Advanced FDD/TDD EVM and CEVM measurements. It depends on the parameter of the Component Carrier Setup to decide which component carriers 'measurement parameters are affected.

The default path is My Documents\LTEATDD\LTEAFDD\data\evmsetup. Note that "My Documents" is an alias to a directory and its place differs depending on which user is logged in. At XSA start up, XSA will overwrite all of the EVM Setup files to the current user's "My Documents\LTEATDD\LTEAFDD\data\evmsetup" each time.

Pressing OPEN under the Import Data menu will open the above directory from which you can select an EVM Setup file.

You cannot read the contents of the provided EVM Setup file since it is a binary file.

89601 VSA Setup Files

Extension: set, setx

The 89600 Vector Signal Analyzer Setup file created using the 89600 Vector Signal Analyzer Option BHD (LTETDD|LTEFDD) can be imported as LTE-Advanced TDD/FDD EVM and CEVM parameter sets.

The 89600 Vector Signal Analyzer Setup file created using the 89600 Vector Signal Analyzer Option BHD (LTEATDD|LTEAFDD) can be imported as LTE-Advanced TDD/FDD EVM and CEVM parameter sets.

Which component carriers 'measurement parameters are affected depends on depends on the parameter of the Component Carrier Setup.

If the setup file is not loaded successfully, an error message, -230 "Data corrupt or stale", is issued with the specified file name.

Signal Studio Setup Files

Extension: scp

The Keysight Signal Studio setup file created using Signal Studio (N7624B/N7625B) can be imported as LTE-Advanced TDD/FDD parameter set.

Supported component carrier types are listed in the table below:

<i>Signal Studio</i>	<i>Carrier Type</i>
N7624B Signal Studio for 3GPP LTE	Advanced LTE FDD Downlink (2009-03)
	Advanced LTE FDD Downlink (2009-12)
	Advanced LTE FDD Downlink (2010-06)
	Advanced LTE FDD Uplink (2009-12)
	Advanced LTE FDD Uplink (2010-06)
	Basic LTE FDD Downlink (2009-03)
	Basic LTE FDD Downlink (2009-12)
	Basic LTE FDD Downlink (2010-06)
	Basic LTE FDD Uplink (2009-03)

	Basic LTE FDD Uplink (2009-12)
	Basic LTE FDD Uplink (2010-06)
	Basic LTE-A FDD Downlink (2010-12)
	Basic LTE-A FDD Uplink (2010-12)
	Basic LTE FDD R9 Downlink
	Basic LTE FDD R9 Uplink
	Advanced LTE FDD R9 Downlink
	Advanced LTE FDD R9 Uplink
	Basic LTE-A FDD R10 Downlink
	Basic LTE-A FDD R10 Uplink
N7625B Signal Studio for 3GPP LTE TDD	Advanced LTE TDD (2009-03)
	Advanced LTE TDD (2009-12)
	Basic LTE TDD (2009-03)
	Basic LTE TDD (2009-12)
	Basic LTE-A TDD (2010-01)
	Basic LTE-A TDD R10 (2010-12)

If the setup file is not loaded successfully, an error message, -230 "Data corrupt or stale", is issued with the specified file name.

Key Path	Recall, Data
Mode	LTEATDD, LTEAFDD
Remote Command	MME ^M o ^R y:LOAD:SE ^T up ALL CC0 CC1 CC2 CC3 CC4,<string>
Example	MME:LOAD:SE ^T up CC0,"LTE-A TDD.set"
Notes	The options CC1~CC4 can be enabled with 9080B/9082B-2FP license.
Notes	"ALL" is primarily used to LTE-A setup file for each component carrier including the number of component carriers. "CC*" is used to import LTE-A setup file for the specified component carrier.
Backwards Compatibility SCPI	MME ^M o ^R y:LOAD:SS ^S etup <string> MME ^M o ^R y:LOAD:VS ^S A ^S etup <string> MME ^M o ^R y:LOAD:EV ^M S ^S etup <string>
Initial S/W Revision	A.14.00
Modified at S/W Revision	A.14.50

Masks

This key enables you to recall a preset mask file which contains Offset and Limit settings. Parameters except them will not be overwritten. You cannot change or create preset mask files since they are binary files. This key is valid for the Spectrum Emission Mask, ACP and Spurious Emissions measurements.

Default path: “My Documents\LTEATDD\LTEAFDD\data\masks”

Note that “**My Documents**” is an alias to a directory and its location depends on which user is logged in. At XSA start up, all of the limit mask files in the current user’s “My Documents\LTEATDD\LTEAFDD\data\masks” directory are overwritten.

File type: Binary

Filename: The filename follows the rule below with the words connected using underscores.

<Measurement>_<Condition>.mask

Where

<Measurement> Measurement the limit mask file is applied to: SEM, ACP or SPUR

<Condition> Condition. It depends on the measurement.

File extension: .mask

File Dialog Filter: Preset Mask Files (*.mask)

Selecting OPEN... under the Import Data menu opens the above directory enabling you to select a mask file.

Details of the masks are provided in the default folder of masks with the PDF extension.

Key Path	Recall, Data
Mode	LTEATDD, LTEAFDD
Remote Command	MMEemory:LOAD:MASK <string>
Example	MME:LOAD:MASK “ACP_BS\ACP_BS_3MHz_pairE-UTRA_CatA.mask”
Notes	Parameters related to Limit and Offset are overwritten by the contents of the preset mask file.
Initial S/W Revision	A.14.00

Open...

When you press “Open”, the analyzer brings up a Windows dialog and a menu entitled “**File Open.**” This menu allows you to navigate to the various fields in the Windows dialog without using a keyboard or mouse. The Tab and Arrow keys can also be used for dialog navigation.

See "[From File...](#)" on page 2401 in Recall, State, for a full description of this dialog and menu.

Key Path	Recall, Data
Notes	The key location is mode-dependent and will vary. Brings up Open dialog for recalling a <mode specific> Save Type
Initial S/W Revision	Prior to A.02.00

Restart

The Restart function restarts the current sweep, or measurement, or set of averaged/held sweeps or measurements. If you are Paused, pressing Restart does a Resume.

The Restart function is accessed in several ways:

- Pressing the Restart key
- Sending the remote command INIT:IMMEDIATE
- Sending the remote command INIT:RESTART

See "[More Information](#)" on page 1042

Key Path	Front-panel key
Remote Command	:INITiate[:IMMEDIATE] :INITiate:RESTART
Example	:INIT:IMM :INIT:REST
Notes	:INITiate:RESTART and :INITiate:IMMEDIATE perform exactly the same function.
Couplings	Resets average/hold count k. For the first sweep overwrites all active (update=on) traces with new current data. For application modes, it resets other parameters as required by the measurement.
Status Bits/OPC dependencies	This is an Overlapped command. The STATus:OPERation register bits 0 through 8 are cleared. The STATus:QUESTionable register bit 9 (INTEgrity sum) is cleared. The SWEEPING bit is set. The MEASURING bit is set.
Backwards Compatibility Notes	For Spectrum Analysis mode in ESA and PSA, the Restart hardkey and the INITiate:RESTART command restart trace averages (displayed average count reset to 1) for a trace in Clear Write, but did not restart Max Hold and Min Hold. In the X-Series, the Restart hardkey and the INITiate:RESTART command restart not only Trace Average, but MaxHold and MinHold traces as well. For wireless comms modes in ESA and PSA, the Restart hardkey and the INITiate:RESTART command restart every measurement, which includes all traces and numeric results. There is no change to this operation.
Initial S/W Revision	Prior to A.02.00

More Information

The **Restart** function first aborts the current sweep/measurement as quickly as possible. It then resets the sweep and trigger systems, sets up the measurement and initiates a new data measurement sequence with a new data acquisition (sweep) taken once the trigger condition is met.

If the analyzer is in the process of aligning when **Restart** is executed, the alignment finishes before the restart function is performed.

Even when set for Single operation, multiple sweeps may be taken when Restart is pressed (for example, when averaging/holding is on). Thus when we say that **Restart** "restarts a measurement," we may mean:

- It restarts the current sweep
- It restarts the current measurement
- It restarts the current set of sweeps if any trace is in Trace Average, Max Hold or Min Hold
- It restarts the current set of measurements if Averaging, or Max Hold, or Min Hold is on for the measurement
- depending on the current settings.

With **Average/Hold Number** (in **Meas Setup** menu) set to 1, or Averaging off, or no trace in Trace Average or Hold, a single sweep is equivalent to a single measurement. A single sweep is taken after the trigger condition is met; and the analyzer stops sweeping once that sweep has completed. However, with **Average/Hold Number** >1 and at least one trace set to **Trace Average, Max Hold, or Min Hold (SA Measurement)** or **Averaging on (most other measurements)**, multiple sweeps/data acquisitions are taken for a single measurement. The trigger condition must be met prior to each sweep. The sweep is stopped when the average count k equals the number N set for **Average/Hold Number**. A measurement average usually applies to all traces, marker results, and numeric results; but sometimes it only applies to the numeric results.

Once the full set of sweeps has been taken, the analyzer will go to idle state. To take one more sweep without resetting the average count, increment the average count by 1, by pressing the step up key while **Average/Hold Number** is the active function, or sending the remote command `CALC:AVER:TCON UP`.

Save

The Save menu lets you choose what you want to save and where you want to save it. Among the types of files you can save are **States**, **Traces**, and **Screen Images**. In addition, an Export (Data) option lets you save a number of data types as CSV files for easy import into Excel and other spreadsheet programs.

Key Path	Front-panel key
Mode	All
Notes	No remote command for this key specifically, but the :MMEM:STORe command is available for specific file types. An example is :MMEM:STOR:STATe <filename>.
Initial S/W Revision	Prior to A.02.00

State

The Save State menu lets you choose a register or file for saving the state.

NOTE In products that run multiple instances of the X-Series Application, all instances share the same register and file location where you want to save the state.

The content of a state file includes all of the settings and data required to return the analyzer as closely as possible to the Mode it was in, with the exact settings which were in place, when the save occurred. The Mode settings in each state file include the settings that are affected by Mode Preset, as well as the additional settings affected by Restore Mode Defaults; all of the Mode's settings. In addition, all of the settings of the Input/Output system are included, even though they are outside of the Mode's state, because they are needed to restore the complete setup. Persistent System settings (for example, Verbose SCPI) are not affected by either Mode Preset or Restore Mode Defaults, nor are they included in a saved State file.

After the save completes, the message "File <filename> saved" or "State Register <register number> saved" is displayed.

For rapid saving, the State menu lists 16 registers to save to. Pressing a Register key initiates the save. You can also select a file to save to.

The default path for all State Files is:

My Documents\<<mode name>\state

where <mode name> is the parameter used to select the mode with the INST:SEL command (for example, SA for the Spectrum Analyzer).

Key Path	Save
Mode	All
Remote Command	:MMEMory:STORe:STATe <filename>
Example	MMEM:STOR:STATe "MyStateFile.state" This stores the current instrument state data in the file MyStateFile.state in the default directory.
Notes	Both single and double quotes are supported for any filename parameter over remote.

After saving to a register, that register's menu key is updated with the date the time, unless a custom label has been entered for that key.

After saving to a register, you remain in the Save State menu, so that you can see the Register key update. After saving to a file, the analyzer automatically returns to the previous menu and any Save As dialog goes away.

Backwards Compatibility SCPI :MMEMory:STORe:STATe 1,<filename>

For backwards compatibility, the above syntax is supported. The "1" is simply ignored. The command is sequential.

Initial S/W Revision Prior to A.02.00

To File . . .

When you press "To File", the analyzer brings up a Windows dialog and a menu entitled "Save As." This menu allows you to navigate to the various fields in the Windows dialog without using a keyboard or mouse. The Tab and Arrow keys can also be used for dialog navigation.

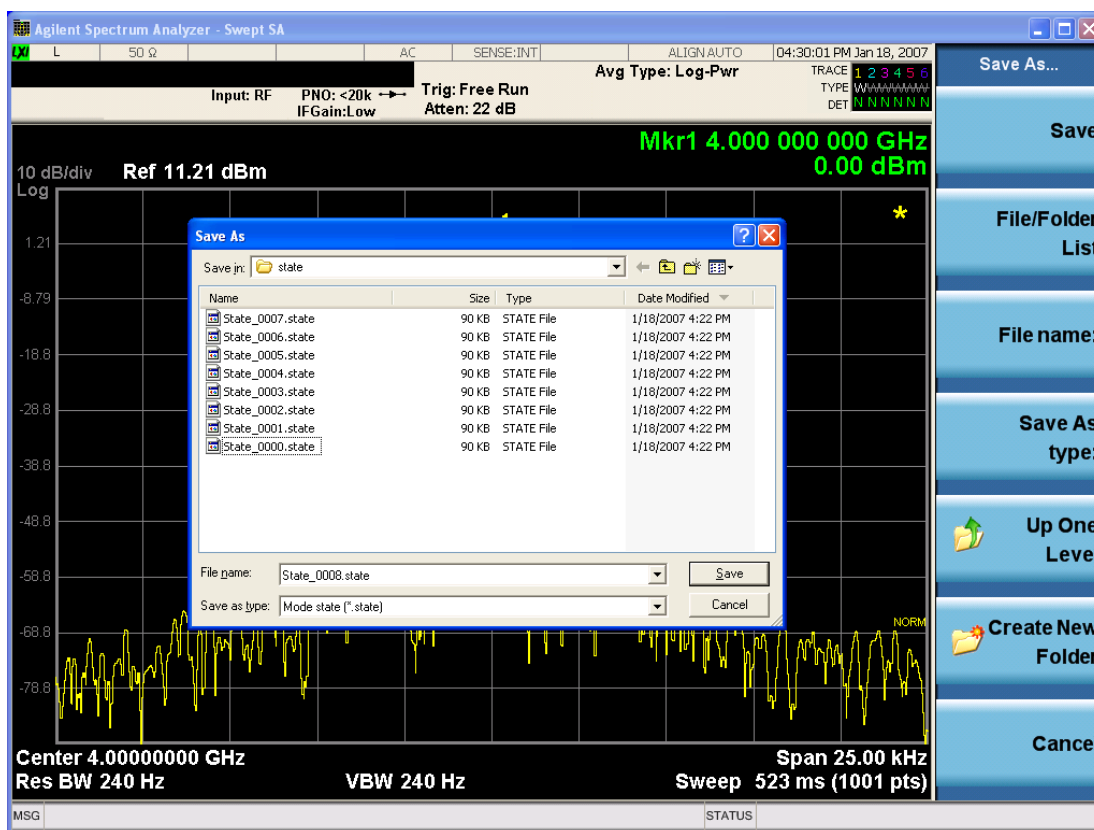

The Listed below

are the functions of the various fields in the dialog, and the corresponding softkeys:

Save

Performs the save to the specified file of the selected type. If the file already exists, a dialog will appear that allows you to replace the existing file by selecting OK, or you can Cancel the request. If you select OK,

the file will be overwritten. Using the C: drive is strongly discouraged, since it runs the risk of being overwritten during an instrument software upgrade.

While the save is being performed, the floppy icon appears briefly in the Meas bar.

File/Folder List

Enables you to navigate to the center of the dialog that contains the list of files and folders. Once here you can get information about the file and use the tab keys to navigate to the other fields in the dialog, such as Save In.

Save In

The Save In field shows the path to which the file will be saved and allows you to change the path using the up and down arrow keys to navigate to other paths; the Enter key to open a directory; and the Backspace key to go back one directory. The **Save In field** defaults to the default path for this type of file and remembers the last path you used to save this type of file. There is no softkey for directly navigating to the Save In field but you can use left tab to get here from the File/Folder List.

User specified paths are remembered when you leave and return to a Mode and are reset back to the default using Restore Mode Defaults.

File Name

The File Name field is initially loaded with an automatically generated filename specific to the appropriate Save Type. The automatically generated filename is guaranteed not to conflict with any filename currently in the directory. You may replace or modify this filename using the File Name key. See the ["Quick Save " on page 2397](#) documentation for more on the automatic file naming algorithm.

When you press the File Name key the analyzer displays the Alpha Editor. Use the knob to choose the letter to add and the front-panel Enter key to add the letter to the file name. The BK character moves you back and the FW character moves you forward in the filename. The Select key on the front panel generates a space character. When you are done entering the filename press the Done softkey. This returns back to the **File Open** dialog and menu, but does not cause the save to occur.

Save As Type

This field shows the file suffix for the type of file you have selected to save. For example, if you navigated here while saving State, "Mode state (*.state)" is in the field. If you navigated here from saving Trace, ""Mode state (*.trace)" is in the field. If you navigated here while exporting a trace data file, "Trace Data (*.csv)" is in the field. For some file types, there is more than one choice in the dropdown, which you can select by using the up and down arrow keys and Enter.

Up One Level

This key corresponds to the icon of a folder with the up arrow that is in the tool bar of the dialog. When pressed, it causes the file and folder list to navigate up one level in the directory structure. The Backspace key does the same thing.

Create New Folder

This key corresponds to the icon of a folder with the "*" that is in the tool bar of the dialog. When pressed, a new folder is created in the current directory with the name **New Folder** and you can enter a new folder name using the Alpha Editor.

Cancel

This key corresponds to the Cancel selection in the dialog. It causes the current **Save As** request to be cancelled. The ESC key does the same thing.

Key Path	Save, State
Mode	All
Notes	Brings up Save As dialog for saving a State Save Type
Initial S/W Revision	Prior to A.02.00

Edit Register Names

You may enter a custom name on any of the Register keys, to help you remember what you are using that state to save. To do this, press the Edit Register Names key, choose the register whose name you wish to edit, and then enter the desired label using the Alpha Editor or an external PC keyboard.

The maximum number of characters that can be added is 30. In most cases, 30 characters will fit on two lines of the key.

See ["More Information" on page 1047](#)

Key Path	Save, State
Mode	All
Remote Command	:MMEMory:REGister:STATe:LABel <reg number>,"label" :MMEMory:REGister:STATe:LABel? <reg number>
Example	:MMEM:REG:STAT:LAB 1,"my label"
Notes	<reg number> is an integer from 1 to 16. If the SCPI specifies an invalid register number an error message is generated, -222,"Data out of range;Invalid register label number" "label" is a string from 0 to 30 characters in length. If a label exceeds 30 characters, an error message is generated, -150,"String data error;Label clipped to 30 characters" "label" of length 0 erases the custom label and restores the default (time and date) label. E.g.: :MMEM:REG:STAT:LAB 1,""
Dependencies	N9060A-7FP or N9060B-2FP license required to edit the register names. When the feature is not licensed, sending this command generates an error, -221,"Settings conflict;Option not available"
Preset	The names are unaffected by Preset or power cycle but are set to the default label (time and date) on a "Restore System Defaults->Misc"
Initial S/W Revision	A.11.00

More Information

When you edit one of the register names, the time and date field will be replaced by the custom name.

If you delete all the characters in the custom name, it restores the default (time and date).

The register names are stored within the state files, but they are not part of the instrument state; that is, once you have edited a register name, loading a new state will not change that register name. Another

consequence of this is that the names will be persistent through a power cycle. Also, if a named state file is transferred to another analyzer, it will bring its custom name along with it.

If you try to edit the name of an empty register, the analyzer will first save the state to have a file to put the name in. If you load a named state file into an analyzer with older firmware it will ignore the metadata.

The *SAV and *RCL commands will not be affected by the custom register names, nor will the MMEM commands.

Register 1 thru Register 16

Selecting any one of these register menu keys causes the State of the currently active mode to be saved to the specified Register. The registers are provided for rapid saving and recalling, since you do not need to specify a filename or navigate to a file. Each of the register menu keys annotates whether it is empty or at what date and time it was last modified. In addition, you can use the Edit Register Names key to enter custom names for each register.

NOTE

In products that run multiple instances of the X-Series Application, save with different register name if you do not want to overwrite the register of another running instance.

Although these 16 registers are the only registers available from the front panel, there are 128 state registers available in the instrument. Registers 17–128 are only available from the SCPI interface, using the *SAV command.

There is one set of 128 state registers in the instrument, not one set for each Mode. When a state is saved, the Mode it was saved from is saved with it; then when it is recalled, the instrument switches to that Mode.

After the save completes, the corresponding register menu key annotation is updated with the date and time and the message "Register <register number> saved" is displayed.

Key Path	Save, State
Mode	All
Example	*SAV 1
Range	1–16 from front panel, 1–128 from SCPI
Readback	Date and time with seconds resolution are displayed on the key OR A custom name of up to 30 characters entered using the Edit Register Names key OR “(empty)” if no prior save operation has been performed to this register.
Initial S/W Revision	Prior to A.02.00
Modified at S/W Revision	A.11.00

Register 1 thru Register 16

Selecting any one of these register menu keys causes the State of the currently active mode to be saved to the specified Register. The registers are provided for rapid saving and recalling, since you do not need to specify a filename or navigate to a file. Each of the register menu keys annotates whether it is empty or at

what date and time it was last modified. In addition, you can use the Edit Register Names key to enter custom names for each register.

NOTE

In products that run multiple instances of the X-Series Application, save with different register name if you do not want to overwrite the register of another running instance.

Although these 16 registers are the only registers available from the front panel, there are 128 state registers available in the instrument. Registers 17–128 are only available from the SCPI interface, using the *SAV command.

There is one set of 128 state registers in the instrument, not one set for each Mode. When a state is saved, the Mode it was saved from is saved with it; then when it is recalled, the instrument switches to that Mode.

After the save completes, the corresponding register menu key annotation is updated with the date and time and the message "Register <register number> saved" is displayed.

Key Path	Save, State
Mode	All
Example	*SAV 1
Range	1–16 from front panel, 1–128 from SCPI
Readback	Date and time with seconds resolution are displayed on the key OR A custom name of up to 30 characters entered using the Edit Register Names key OR “(empty)” if no prior save operation has been performed to this register.
Initial S/W Revision	Prior to A.02.00
Modified at S/W Revision	A.11.00

Mass Storage Catalog (Remote Command Only)

Key path	SCPI Only
Remote Command	:MMEMory:CATalog? [<directory_name>]
Notes	The string must be a valid logical path. Queries disk usage information (drive capacity, free space available) and obtains a list of files and directories in a specified directory in the following format: <numeric_value>,<numeric_value>,{<file_entry>} It returns two numeric parameters and as many strings as there are files and directories. The first parameter indicates the total amount of storage currently used in bytes. The second parameter indicates the total amount of storage available, also in bytes. The <file_entry> is a string. Each <file_entry> indicates the name, type, and size of one file in the directory list: <file_name>,<file_type>,<file_size> As the windows file system has an extension that indicates file type, <file_type> is always empty. <file_size> provides the size of the file in bytes. For directories, <file_entry> is surrounded by square brackets and both <file_type> and <file_size> are empty
Initial S/W Revision	Prior to A.02.00

Mass Storage Change Directory (Remote Command Only)

Key path	SCPI Only
Remote Command	:MMEMory:CDIRectory [<directory_name>] :MMEMory:CDIRectory?
Notes	The string must be a valid logical path. Changes the default directory for a mass memory file system. The <directory_name> parameter is a string. If no parameter is specified, the directory is set to the *RST value. At *RST, this value is set to the default user data storage area, that is defined as System.Environment.SpecialFolder.Personal. Query returns full path of the default directory.
Initial S/W Revision	Prior to A.02.00

Mass Storage Copy (Remote Command Only)

Key path	SCPI Only
Remote Command	:MMEMory:COPY <string>,<string>[,<string>,<string>]
Notes	The string must be a valid logical path. Copies an existing file to a new file or an existing directory to a new directory. Two forms of parameters are allowed. The first form has two parameters. In this form, the first parameter specifies the source, and the second parameter specifies the destination. The second form has four parameters. In this form, the first and third parameters specify the source. The second and fourth parameters specify the directories. The first pair of parameters specifies the source. The second pair specifies the destination. An error is generated if the source doesn't exist or the destination file already exists. This command will generate an "access denied" error if the destination is a restricted folder (e.g., C:\Windows) and the current user does not have Power User or Administrator privileges.

Mass Storage Device Copy (Remote Command Only)

This command transfers data to/from a file and a peripheral device.

Key path	SCPI Only
Remote Command	:MMEMory:COPY:DEvice <source_string>,<dest_string>
Notes	The strings must be a valid logical path or a valid device keyword. If the dest_string is a device keyword, the data is copied from the source file to the device. If the source_string is a device keyword, the data is copied to the source file from the device. Valid device keywords are: SNS (smart noise source) An error is generated if the file or device is not found.

Mass Storage Delete (Remote Command Only)

Key path	SCPI Only
Remote Command	:MMEMory:DELeTe <file_name>[,<directory_name>]
Notes	The string must be a valid logical path. Removes a file from the specified directory. The <file_name> parameter specifies the file name to be removed. This command will generate an “access denied” error if the file is in a restricted folder (e.g., C:\Windows) and the current user does not have Power User or Administrator privileges.
Initial S/W Revision	Prior to A.02.00

Mass Storage Data (Remote Command Only)

Creates a file containing the specified data OR queries the data from an existing file.

Key path	SCPI Only
Remote Command	:MMEMory:DATA <file_name>, <data> :MMEMory:DATA? <file_name>
Notes	The string must be a valid logical path. The command form is MMEMory:DATA <file_name>,<data>. It loads <data> into the file <file_name>. <data> is in 488.2 block format. <file_name> is string data. The query form is MMEMory:DATA? <file_name> with the response being the associated <data> in block format.
Initial S/W Revision	Prior to A.02.00

Mass Storage Make Directory (Remote Command Only)

Key path	SCPI Only
Remote Command	:MMEMory:MDIRectory <directory_name>
Notes	The string must be a valid logical path. Creates a new directory. The <directory_name> parameter specifies the name to be created. This command will generate an “access denied” error if the new directory would be in a restricted folder (e.g., C:\Windows) and the current user does not have Power User or Administrator privileges.
Initial S/W Revision	Prior to A.02.00

Mass Storage Move (Remote Command Only)

Key path	SCPI Only
Remote Command	:MMEMory:MOVE <string>,<string>[,<string>,<string>]
Notes	The string must be a valid logical path. Moves an existing file to a new file or an existing directory to a new directory.

	<p>Two forms of parameters are allowed. The first form has two parameters. In this form, the first parameter specifies the source, and the second parameter specifies the destination.</p> <p>The second form has four parameters. In this form, the first and third parameters specify the source. The second and fourth parameters specify the directories. The first pair of parameters specifies the source. The second pair specifies the destination. An error is generated if the source doesn't exist or the destination file already exists.</p> <p>This command will generate an "access denied" error if the destination is a restricted folder (e.g., C:\Windows) and the current user does not have Power User or Administrator privileges.</p>
Initial S/W Revision	Prior to A.02.00

Mass Storage Remove Directory (Remote Command Only)

Key path	SCPI Only
Remote Command	:MMEMory:RDIRECTory <directory_name>
Notes	<p>The string must be a valid logical path.</p> <p>Removes a directory. The <directory_name> parameter specifies the directory name to be removed. All files and directories under the specified directory shall also be removed.</p> <p>This command will generate an "access denied" error if the folder is a restricted folder (e.g., C:\Windows) or is in a restricted folder and the current user does not have Power User or Administrator privileges.</p>
Initial S/W Revision	Prior to A.02.00

Sequences

These keys allow you to save a Tab separated or CSV file of the setup parameters required to build a Sequence.

In order to save you must select the Save As button and choose a destination folder.

Key Path	Save, Sequences
Mode	All
Remote Command	:MMEM:STOR:SEQ:SLIST ALIST SAALIST SSTEP "MySequence.txt"
Example	:MMEM:STOR:SEQ:SLIST "MySequence.txt"
Notes	<p>Available file types are:</p> <ul style="list-style-type: none"> -CSV (Comma delimited) (*.csv) -Text (Tab delimited) (*.txt)
Initial S/W Revision	A.05.00

Source Sequence

The list of parameters, that configure steps, that makes up a sequence for the Source.

The Source sequence is a sequence of flexible configurable steps that can be set anywhere in the instruments frequency range.

Key Path	Save, Sequences
Example	:MMEM:STOR:SEQ:SLIS "MySequence.txt"
Dependencies	Only available in XOBT
Initial S/W Revision	A.05.00

Save As . . .

This menu lets you select the location where you can save the Sequence. This menu is a standard Windows® dialog with Save As menu keys. The "File Name" field in the Save As dialog is initially loaded with an automatically generated filename specific to the appropriate Save Type. The automatically generated filename is guaranteed not to conflict with any filename currently in the directory. You may replace or modify this filename using the File Name softkey. See the Quick Save key documentation for more on the automatic file naming algorithm.

The default path for all Sequence Files is:

My Documents\Sequences

Key Path	Save, Sequences
Mode	All
Notes	Brings up Save As dialog for saving a Sequence Save Type
Initial S/W Revision	A.05.00

Data (Export)

Exporting a data file stores data from the current measurement to mass storage files. The Export Menu only contains data types that are supported by the current measurement.

Since the commonly exported data files are in .csv format, the data can be edited by you prior to importing. This allows you to export a data file, manipulate the data in Excel (the most common PC Application for manipulating .csv files) and then import it.

Selecting an Export Data menu key will not actually cause the exporting to occur, since the analyzer still needs to know where you wish to save the data. Pressing the Save As key in this menu brings up the Save As dialog and Save As menu that allows you to specify the destination file and directory. Once a filename has been selected or entered in the Open menu, the export will occur as soon as the Save key is pressed.

Key Path	Save
Mode	All

Notes	The menu is built from whatever data types are available for the mode. So the key locations in the sub menu will vary. No SCPI command directly controls the Data Type that this key controls. The Data Type is included in the MMEM:STORe commands.
Dependencies	If a file type is not used by a certain measurement, that type is grayed out for that measurement. The key for a file type will not show at all if there are no measurements in the Mode that support it.
Preset	Is not affected by a Preset or shutdown, but is reset during Restore Mode Defaults
Readback	The data type that is currently selected
Initial S/W Revision	Prior to A.02.00

Export Trace Data

Enables you to export trace data with (optional) associated headers. Selecting this key displays a menu that enables you to choose which Trace to save (default is the selected Trace) and whether or not to save headers with the data. The header information is used by the VXA application when saved trace data is recalled, and enables it to be displayed with the same formatting and scaling that it had when saved. If headers are not saved, the scaling and format are set to default values when the trace is recalled. After making these selections, press Save As... and use the file dialog to choose a file name and format for the saved data.

Trace data can be exported in several different formats. Text and comma-separated variable (CSV) formats are useful for viewing the data or importing it to a spreadsheet program. The other formats are binary and thus more compact. Trace data files can be recalled for viewing into other VXA, LTE, LTETDD, iDEN, or 89601 measurements.

Key Path	Save, Data (Export)
Mode	VSA, LTE, LTETDD, IDEN
Remote Command	:MMEMory:STORe:TRACe:DATA TRACE1 TRACE2 TRACE3 TRACE4 TRACE5 TRACE6, "<filename>" [,CSV TXT SDF MAT4 MAT HDF5 BIN[,OFF ON 0 1]]
Example	:MMEM:STOR:TRAC:DATA TRACE1, "TRC1.TXT", TXT, ON
Notes	The Save As... dialog box has the following format options when you are saving trace data: <ul style="list-style-type: none"> • CSV (Comma delimited) (*.csv) • SDF (Fast) (*.sdf;*.dat) • Text (Tab delimited) (*.txt) File format saved depends on selection. The appropriate file extension is appended to the filename if it is not supplied by the user. If the SCPI command includes just a file name, the file format is determined by the filename extension, which must be one of the choices above. *.sdf or an unrecognized extension chooses the SDF fast format. If the optional file format enumerator is included in the command, then this determines the file format and the file extension is ignored. The optional binary parameter determines if file headers are saved. The default is ON. If file headers are not wanted, use the optional "OFF" parameter. The optional Boolean parameter determines whether headers are saved in the file. By default the

headers are saved.

If you are not licensed to save a particular file type, then error -203.9010 is returned. If an invalid file format is specified or the file cannot be saved successfully, then error -25x is returned. If the save is successful, then advisory 0.1500 is shown.

State Saved	No
Readback	(Trace 1 Trace 2 Trace 3 Trace 4 Trace 5 Trace 6)(with without) headers

Trace 1

Selects the Trace 1 register as the destination for the imported data.

Key Path	Save, Data (Export), Trace
Mode	VSA, LTE, LTETDD, IDEN

Trace 2

Selects the Trace 2 register as the destination for the imported data.

Key Path	Save, Data (Export), Trace
Mode	VSA, LTE, LTETDD, IDEN

Trace 3

Selects the Trace 3 register as the destination for the imported data.

Key Path	Save, Data (Export), Trace
Mode	VSA, LTE, LTETDD, IDEN

Trace 4

Selects the Trace 4 register as the destination for the imported data.

Key Path	Save, Data (Export), Trace
Mode	VSA, LTE, LTETDD, IDEN

Trace 5

Selects the Trace 5 register as the destination for the imported data.

Key Path	Save, Data (Export), Trace
Mode	VSA, LTE, LTETDD, IDEN

Trace 6

Selects the Trace 6 register as the destination for the imported data.

Key Path	Save, Data (Export), Trace
Mode	VSA, LTE, LTETDD, IDEN

Include Header

Enables you to select whether or not the saved trace data includes header information describing scaling, formatting, etc.

Key Path	Save, Data (Export), Trace
Mode	VSA, LTE, LTETDD, IDEN
State Saved	No

Measurement Results

Pressing this key selects Meas Results as the data type to be exported.

The Meas Results file contains information which describes the current state of the analyzer. It is detailed in Meas Result File Contents below.

Key Path	Save, Data
Remote Command	:MMEMory:STORe:RESults <string>
Example	:MMEM:STOR:RES "MeasR_0000.csv"
Notes	<p>If the save is initiated via SCPI and the file already exists, the file will be overwritten.</p> <p>The SCPI command exports ACP measurement results to the file specified as the parameter in the current path. The default path is My Documents\<current mode>\data\ACP\results.</p> <p>Using the C: drive is strongly discouraged, since it runs the risk of being overwritten during an instrument software upgrade.</p> <p>The SCPI parameter is a quoted string that specifies the filename. Both single and double quotes are supported for any filename parameter over SCPI.</p>
Dependencies	The current active measurement must be the ACP measurement to use this command.
Status Bits/OPC dependencies	Sequential – waits for the previous measurement to complete
Initial S/W Revision	Prior to A.02.00

Meas Results File Contents

A Meas Results File contains measurement results with the following information.

- File ID string, which is “MeasResult”

- Measurement ID following Mode ID, which is “SA:ACP” for example.
- Firmware rev and model number
- Option string
- Auto Scaling
- Auto Sweep Time Rules
- Automatic Trigger Time
- Automatic Trigger Time State
- Average Mode
- Average Number
- Average State
- Bar Graph
- Carrier Coupling
- Carrier Pwr Present
- Carrier Spacing
- Carriers
- Center Frequency
- Center Frequency Step
- Center Frequency Step State
- Detector Auto
- Detector Selection
- Electrical Atten
- Electrical Atten State
- External Array Trigger Delay
- External Array Trigger Delay State
- External Array Trigger Level
- External Array Trigger Slope
- Filter Alpha
- Filter BW
- Filter Type
- Internal Preamp
- Internal Preamp Band

- Limit Test
- Line Trigger Delay
- Line Trigger Delay State
- Line Trigger Slope
- Meas Method
- Meas Type
- Measurement Noise Bandwidth
- Mechanical Atten
- MechanicalAttenStepEnum
- Method
- Noise Correction
- Offset Abs Limit
- Offset Fail
- Offset Filter Alpha
- Offset Filter BW
- Offset Filter Type
- Offset Freq
- Offset Freq State
- Offset Integ BW
- Offset Method
- Offset Rel Lim (Car)
- Offset Rel Lim (PSD)
- Offset Res BW
- Offset Res BW Mode
- Offset Video BW
- Offset Video BW Mode
- Periodic Timer Period
- Periodic Timer Sync Source
- Periodic Timer Trigger Delay
- Periodic Timer Trigger Delay State
- Points

- Power Ref
- Power Ref State
- Preselector Adjust
- PSD Ref
- PSD Unit
- Ref Car Freq
- Ref Car Freq State
- Ref Carrier
- Ref Carrier Mode
- Ref Position
- Ref Value
- Res BW
- Res BW Mode
- RFBurst Trigger Delay
- RFBurst Trigger Delay State
- RFBurst Trigger Level Abs
- RFBurst Trigger Level Rel
- RFBurst Trigger Level Type
- RFBurst Trigger Slope
- Scale/Div
- Span
- Sweep Time
- Sweep Time Auto
- Trigger Holdoff
- Trigger Holdoff State
- Trigger Source
- Video BW
- Video BW Auto

The file contains these data followed by MeasResult1, MeasResult2, and MeasResult3 that flag the start of the measurement results. Each line of Measurement Results consists of three comma separated values, MeasResult1 value, MeasResult2 value, and MeasResult3 value. MeasResult1 contains the same result as MEAS/READ/FETCH:ACPower1; MeasResult2, MEAS/READ/FETCH:ACPower2; MeasResult3, MEAS/READ/FETCH:ACPower3.

Exported file is .csv file. The Meas Results file, when imported into Excel, will show the following data:

MeasResult												
SA:ACP												
A.10.53	N9030A											
526 ALV ATP	1											
B1X B1Y B25												
B40 BBA CR3												
CRP DCF DDA												
DP2 DRD EA3												
EDP EMC EP1												
ERC ESC ESP												
EXM FSA LFE												
LNP MAT MPB												
NFE NUL P26												
PFR PNC RTL												
RTS S40 SB1												
SEC SM1 TVT												
YAS YAV												
Auto Scaling	TRUE											
Auto Sweep Time Rules	Accy											
Automatic Trigger Time	0.1											
Automatic Trigger Time State	FALSE											
Average Mode	Exponential											
Average Number	10											
Average State	TRUE											
Bar Graph	TRUE											
Carrier Coupling	TRUE	TRUE	TRUE	TRUE	TRUE	TRUE	TRUE	TRUE	TRUE	TRUE	TRUE	TRUE
Carrier Pwr Present	Yes	Yes	Yes	Yes	Yes	Yes	Yes	Yes	Yes	Yes	Yes	Yes
Carrier Spacing	5000000	5000000	500000	500000	500000	500000	500000	500000	500000	500000	500000	500000
Carriers	1											
Center Frequency	1.33E+10											
Center Frequency Step	800000											

Center Frequency Step State	TRUE											
Detector Auto	TRUE											
Detector Selection	Average											
Electrical Atten	0											
Electrical Atten State	FALSE											
External Array Trigger Delay	1.00E-06	1.00E-06										
External Array Trigger Delay State	FALSE	FALSE										
External Array Trigger Level	1.2	1.2										
External Array Trigger Slope	Positive	Positive										
Filter Alpha	0.22	0.22	0.22	0.22	0.22	0.22	0.22	0.22	0.22	0.22	0.22	0.22
Filter BW	Minus3dB											
Filter Type	Gaussian											
Internal Preamp	FALSE											
Internal Preamp Band	Low											
Limit Test	FALSE											
Line Trigger Delay	1.00E-06											
Line Trigger Delay State	FALSE											
Line Trigger Slope	Positive											
Meas Method	lbwSpeed											
Meas Type	TPRef											
Measurement Noise Bandwidth	2000000	2000000	200000	200000	200000	200000	200000	200000	200000	200000	200000	200000
Mechanical Atten	10											
MechanicalAtt	S2dB											

enStepEnum												
Method	IBW	IBW	IBW	IBW	IBW	IBW	IBW	IBW	IBW	IBW	IBW	IBW
Noise Correction	FALSE											
Offset Abs Limit	0	0	0	0	0	0						
Offset Fail	Relative	Relative	Relative	Relative	Relative	Relative						
Offset Filter Alpha	0.22											
Offset Filter BW	Minus3dB	Minus3dB	Minus3dB	Minus3dB	Minus3dB	Minus3dB						
Offset Filter Type	Gaussian	Gaussian	Gaussian	Gaussian	Gaussian	Gaussian						
Offset Freq	3000000	0	0	0	0	0						
Offset Freq State	TRUE	FALSE	FALSE	FALSE	FALSE	FALSE						
Offset Integ BW	2000000	2000000	2000000	2000000	2000000	2000000						
Offset Method	FALSE											
Offset Rel Lim (Car)	-45	-60	0	0	0	0						
Offset Rel Lim (PSD)	-28.87	-43.87	0	0	0	0						
Offset Res BW	220000	220000	220000	220000	220000	220000						
Offset Res BW Mode	TRUE	TRUE	TRUE	TRUE	TRUE	TRUE						
Offset Video BW	22000	22000	22000	22000	22000	22000						
Offset Video BW Mode	TRUE	TRUE	TRUE	TRUE	TRUE	TRUE						
Periodic Timer Period	0.02											
Periodic Timer Sync Source	None											
Periodic Timer Trigger Delay	1.00E-06											
Periodic Timer Trigger Delay	FALSE											

State	
Points	1001
Power Ref	-76.81 dBm
Power Ref State	On
Preselector Adjust	0
PSD Ref	-139.82 dBm/Hz
PSD Unit	DbmHz
Ref Car Freq	13.25500 0000 GHz
Ref Car Freq State	On
Ref Carrier	1
Ref Carrier Mode	On
Ref Position	Top
Ref Value	-30
Res BW	220000
Res BW Mode	FALSE
RFBurst Trigger Delay	1.00E-06
RFBurst Trigger Delay State	FALSE
RFBurst Trigger Level Abs	-20
RFBurst Trigger Level Rel	-6
RFBurst Trigger Level Type	Absolute
RFBurst Trigger Slope	Positive
Scale/Div	10
Span	8000000
Sweep Time	0.02
Sweep Time	TRUE

Auto		
Trigger Holdoff	0.1	
Trigger Holdoff State	FALSE	
Trigger Source	Free	
Video BW	22000	
Video BW Auto	TRUE	
MeasResult1	MeasResult 2	Meas Result 3
- 76.80585177 44559	0	1
0.084790019 950006	- 76.80585 17744559	0
0.028392912 8313787	-999	1
	-999	0
	-999	1

Save As . . .

When you press “Save As”, the analyzer brings up a Windows dialog and a menu entitled “**Save As.**” This menu allows you to navigate to the various fields in the Windows dialog without using a keyboard or mouse. The Tab and Arrow keys can also be used for dialog navigation.

See "[To File . . .](#)" on page 2413 in Save, State for a full description of this dialog and menu.

The default path for saving files is:

For all of the Trace Data Files:

My Documents\`<mode name>`\data\traces

For all of the Limit Data Files:

My Documents\`<mode name>`\data\limits

For all of the Measurement Results Data Files:

My Documents\`<mode name>`\data\`<measurement name>`\results

For all of the Capture Buffer Data Files:

My Documents\`<mode name>`\data\captureBuffer

Key Path	Save, Data
Mode	All
Notes	The key location is mode-dependent and will vary. Brings up the Save As dialog for saving a <mode specific> Save Type. The save is performed immediately and does not wait until the measurement is complete.
Initial S/W Revision	Prior to A.02.00

Screen Image

Pressing Screen Image accesses a menu of functions that enable you to specify a format and location for the saved screen image. It brings up a menu that allows you to specify the color scheme of the Screen Image (Themes) or navigate to the Save As dialog to perform the actual save.

Screen Image files contain an exact representation of the analyzer display. They cannot be loaded back onto the analyzer, but they can be loaded into your PC for use in many popular applications.

The image to be saved is actually captured when the Save front panel key is pressed, and kept in temporary storage to be used if you ask for a Screen Image save. When the Screen Image key is pressed, a "thumbnail" of the captured image is displayed, as shown below:

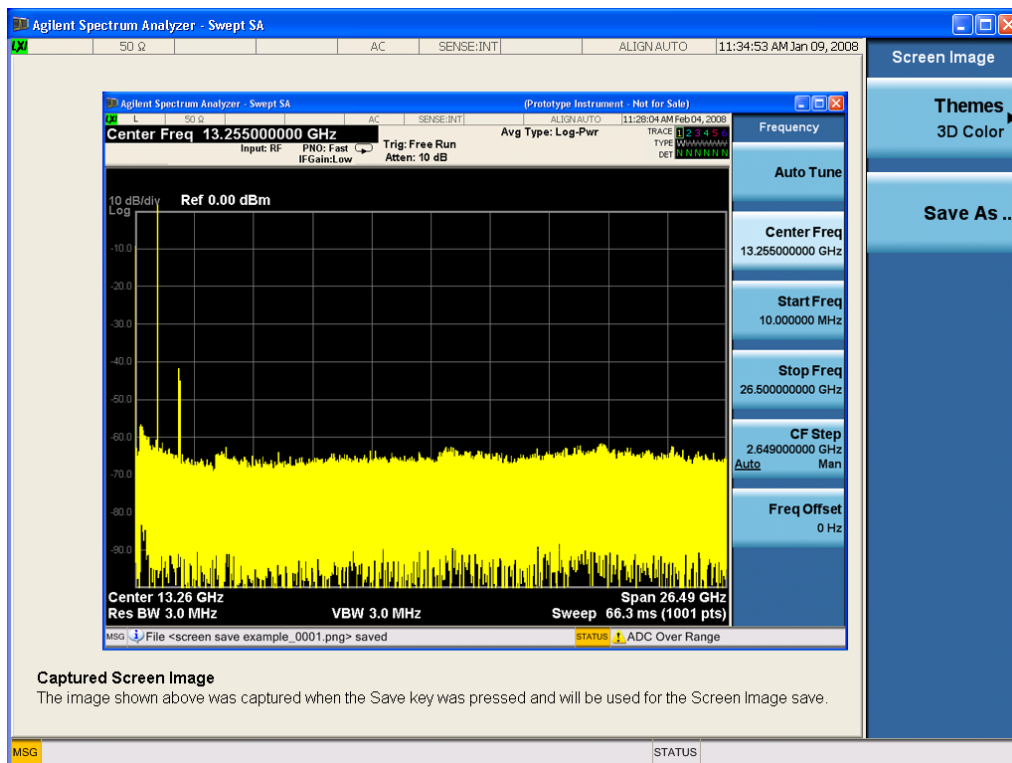

When you continue on into the Save As menu and complete the Screen Image save, the image depicted in the thumbnail is the one that gets saved, showing the menus that were on the screen before going into the Save menus. The save is performed immediately and does not wait until the measurement is complete.

After you have completed the save, the Quick Save front-panel key lets you quickly repeat the last save performed, using an auto-named file, with the current screen data.

NOTE

For versions previous to A.01.55, if you initiate a screen image save by navigating through the Save menus, the image that is saved will contain the Save menu softkeys, not the menus and the active function that were on the screen when you first pressed the Save front panel key.

Key Path	Save
Mode	All
Remote Command	:MMEMory:STORe:SCReen <filename>
Example	:MMEM:STOR:SCR "myScreen.png" This stores the current screen image in the file MyScreenFile.png in the default directory.
Initial S/W Revision	Prior to A.02.00

Themes

Accesses a menu of functions that enable you to choose the theme to be used when saving the screen image.

The **Themes** option is the same as the **Themes** option under the **Display** and **Page Setup** dialogs. It allows you to choose between themes to be used when saving the screen image.

Key Path	Save, Screen Image
Remote Command	:MMEMory:STORe:SCReen:THEMe TDColor TDMonochrome FCOLor FMONochrome :MMEMory:STORe:SCReen:THEMe?
Example	:MMEM:STOR:SCR:THEM TDM
Preset	3D Color; Is not part of Preset, but is reset by Restore Misc Defaults or Restore System Defaults All and survives subsequent running of the modes.
Readback	3D Color 3D Mono Flat Color Flat Mono
Backwards Compatibility Notes	In ESA and PSA we offer the choice of "Reverse Bitmap" or "Reverse Metafile" when saving screen images. This is much like the "Flat Color" theme available in X-Series. Also, if you selected Reverse Bitmap AND a black & white screen image, that would be much like "Flat Monochrome". In other words, each of the X-Series themes has a similar screen image type in ESA/PSA. But they are not identical.
Initial S/W Revision	Prior to A.02.00

3D Color

Selects a standard color theme with each object filled, shaded and colored as designed.

Key Path	Save, Screen Image, Themes
Example	MMEM:STOR:SCR:THEM TDC

Readback	3D Color
Initial S/W Revision	Prior to A.02.00

3D Monochrome

Selects a format that is like 3D color but shades of gray are used instead of colors.

Key Path	Save, Screen Image, Themes
Example	MMEM:STOR:SCR:THEM TDM
Readback	3D Mono
Initial S/W Revision	Prior to A.02.00

Flat Color

Selects a format that is best when the screen is to be printed on an ink printer.

Key Path	Save, Screen Image, Themes
Example	MMEM:STOR:SCR:THEM FCOL
Readback	Flat Color
Initial S/W Revision	Prior to A.02.00

Flat Monochrome

Selects a format that is like Flat Color. But only black is used (no colors, not even gray), and no fill.

Key Path	Save, Screen Image, Themes
Example	MMEM:STOR:SCR:THEM FMON
Readback	Flat Mono
Initial S/W Revision	Prior to A.02.00

Save As...

When you press "Save As", the analyzer brings up a Windows dialog and a menu entitled "**Save As.**" This menu allows you to navigate to the various fields in the Windows dialog without using a keyboard or mouse. The Tab and Arrow keys can also be used for dialog navigation.

See "[To File . . .](#)" on page 2413 in Save, State for a full description of this dialog and menu.

The default path for Screen Images is

My Documents\`<mode name>`\screen.

where <mode name> is the parameter used to select the mode with the INST:SEL command (for example, SA for the Spectrum Analyzer).

Key Path	Save, Screen Image
Notes	Brings up Save As dialog for saving a Screen Image Save Type
Initial S/W Revision	Prior to A.02.00

Single (Single Measurement/Sweep)

Sets the analyzer for Single measurement operation. The single/continuous state is Meas Global, so the setting will affect all the measurements. If you are Paused, pressing Single does a Resume.

See ["More Information" on page 1069](#)

Key Path	Front-panel key
Example	:INIT:CONT OFF
Notes	See Cont key description.
Backwards Compatibility Notes	<p>For Spectrum Analysis mode in ESA and PSA, the Single hardkey and the INITiate:IMM switched from continuous measurement to single measurement and restarted sweeps and averages (displayed average count reset to 1), but did not restart Max Hold and Min Hold. In the X-Series, the Single hardkey and the INITiate:IMM command initiate a sweep/ measurement/ average sequence/hold sequence including MaxHold and MinHold.</p> <p>For Spectrum Analysis mode in ESA and PSA, the Single hardkey restarted the sweep regardless of whether or not you were in an active sweep or sweep sequence. In the X-Series, Restart does this but Single only restarts the sweep or sweep sequence if you are in the idle state.</p> <p>INIT[:IMM] in ESA & PSA Spectrum Analysis Mode does an implied ABORT. In some other PSA Modes, INIT[:IMM] is ignored if not in the idle state. . The X-Series follows the ESA/PSA SA Mode model, which may cause some Modes to have compatibility problems.</p>
Initial S/W Revision	Prior to A.02.00

More Information

See ["Restart" on page 2410](#) for details on the INIT:IMMEDIATE (Restart) function.

If you are already in single sweep, the INIT:CONT OFF command has no effect.

If you are already in Single Sweep, then pressing the Single key in the middle of a sweep does not restart the sweep or sequence. Similarly, pressing the Single key does not restart the sweep or sequence if the sweep is not in the idle state (for example, if you are taking a very slow sweep, or the analyzer is waiting for a trigger). Instead, it results in a message. "Already in Single, press Restart to initiate a new sweep or sequence". Even though pressing the Single key in the middle of a sweep does not restart the sweep, sending INIT:IMMEDIATE does reset it.

To take one more sweep without resetting the average count, increment the average count by 1, by pressing the step up key while **Average/Hold Number** is the active function, or sending the remote command CALC:AVER:TCON UP.

Source

Opens a menu of keys that access various source configuration menus and settings. In the test set, pressing this key also causes the central view area to change and display the Source Control Main view.

Key Path	Front-panel key
----------	-----------------

RF Output

This parameter sets the source RF power output state.

Key Path	Source
Remote Command	:OUTPut[:EXTErnal][:STATe] ON OFF 1 0 :OUTPut[:EXTErnal][:STATe]?
Example	OUTP OFF OUTP?
Notes	<p>The EXTErnal node is shown in RD text so the SCPI remains the same between internal and external source control. However, for EXT we do not wish to document this node to the customer since we are controlling the internal source rather than the external source.</p> <p>This setting is for the independent mode and has no effect on the "List Sequencer" on page 2520. If the "Sequencer" on page 2521 is set to ON, the list sequencer controls the source output and this key will be grayed-out. And this setting will be none-forceful grey out on front panel to indicate out-of-scope. Non-forceful means user still can change this setting by SCPI but cannot change on front panel. When set to OFF will make source leave list sequencer and this setting will be black out and take effect immediately.</p> <p>When the RF Output is ON, an "RF" annunciator is displayed in the system settings panel. When the RF Output is turned Off, the RF annunciator is cleared. If the "Sequencer" on page 2521 is set to ON, the "RF" annunciator will be replaced by "SEQ" in the system settings panel, indicating that the output is controlled by the list sequencer.</p>
Preset	Off
Range	On Off
Initial S/W Revision	A.05.00

Amplitude

Allows you to access the Amplitude sub-menu.

Key Path	Source
Notes	<p>The sub-menu under this button is for independent mode and has no effect on "List Sequencer" on page 2520. If the "Sequencer" on page 2521 is set to ON, the list sequencer controls the source output and this key will be grayed-out on front panel to indicate out-of-scope. When you set "Sequencer" on page 2521 to Off will make source leave list sequencer and this button will be black out.</p>
Initial S/W Revision	A.05.00

RF Power

Allows you to adjust the power level of the source using the numeric keypad, step keys, or RPG. Pressing any digit, 0 through 9, on the numeric keypad brings up the unit terminator.

Please refer to the "RF Power Range " on page 1072 table below for the valid ranges.

Key Path	Source, Amplitude
Remote Command	:SOURce:POWer[:LEVel][:IMMediate][:AMPLitude] <ampl> :SOURce:POWer[:LEVel][:IMMediate][:AMPLitude]?
Example	:SOUR:POW -100 dBm
Notes	<p>Amplitude corrections can be specified for use with the source. In the event of amplitude corrections being applied, the valid ranges for the RF power do not change dependant on the current amplitude correction setting. If the combination of RF power + amplitude correction is higher or lower than the source output range, the Source Unleveled bit is set and the "Source Unleveled" indicator will appear on status panel to indicate that the source cannot maintain the output power that has been requested.</p> <p>When signal generator is unable to maintain the requested output level, the "Source Unleveled" indicator will appear on status panel. When the source output setting is restored to the normal range, the "Source Unleveled" is removed from status panel.</p> <p>Internal source has list sequence mode, which comprises of several steps which contain separate output power, frequency and waveform etc. When the source list sequence playing is complete, the last step keeps playing, and user can use this command to change the list sequence last step's output power.</p> <p>The multiport adapter RFIO TX ports and GPS ports cannot ensure power accuracy when power setting is lower than -130dBm, this power setting value is defined by the sum of RF Power setting and related amplitude correction value. But user settable value could be lower than this limit. When application detected there exists power setting lower than -130dBm on MPA RFIO TX ports, then popup warning message . When application detected there exists power setting lower than -130dBm on MPA GPS ports, then popup warning message . This is only warning message, and check is performed when RF is ON.</p>
Notes	The Min and Max value here defined UI settable amplitude range. This range is larger than actual amplitude range with level accuracy defined in spec.
Dependencies	The RF power is dependent on the RF output port and frequency, such that the current frequency and selected output port determine the valid range of power values.
Preset	-100 dBm
Min	The range of values depends on the current frequency and selected RF output port. Please refer to the "RF Power Range " on page 1072 table below for the valid ranges.
Max	The range of values depends on the current frequency and selected RF output port. Please refer to the "RF Power Range " on page 1072 table below for the valid ranges.
Initial S/W Revision	A.05.00

RF Power Range

RF Output Port	Frequency Range	Min Output Power	Max Output Power
High Power RF Out	10 MHz ≤ f ≤ 6 GHz	-150 dBm	20 dBm
RFIO 1 & RFIO 2	10 MHz ≤ f ≤ 6 GHz	-150 dBm	0 dBm
GPS (Note2)	10 MHz ≤ f ≤ 6 GHz	-150 dBm	0 dBm

Note: This is the UI power range, it's larger than actual spec.

Note2: GPS port is on the multiport adapter, or E6607C which has embedded MPA.

Set Reference Power

This key allows you to set the power reference. Pressing this key turns the power reference state to ON, sets the reference power value to the current RF output power, maintains this power at the RF output, and sets the displayed power to 0.00 dB. All subsequent RF power values entered under Source>Amplitude>RF Power are interpreted as being relative to this reference power.

When you use a power reference, the signal generator outputs an RF power that is set relative to the reference power by the value entered under Source>Amplitude>RF Power as follows:

Output power = reference power – entered power

Where:

reference power equals the original RF Power entered under Source>Amplitude>RF Power and set as the reference power

entered power equals a new value entered under Source>Amplitude>Amptd Offset

In addition, the displayed power value is the same as a new value entered under Source>Amplitude>RF Power.

NOTE

If Power Ref is set to ON with a reference value set, entering a value under Source>Amplitude>RF Power and pressing Set Reference Power will add that value to the existing Power Ref value.

If you wish to change the reference power value to a new value entered under Source>Amplitude>RF Power, first you must set Power Ref to OFF and then press Set Reference Power.

Key Path	Source, Amplitude
Dependencies	This key is unavailable, and is grayed out when the "List Sequencer" on page 2520 is turned ON.
Initial S/W Revision	A.05.00

Power Ref

This key allows you to toggle the state of the power reference.

When you use a power reference, the signal generator outputs an RF power that is set relative to the reference power by the value entered under Source>Amplitude>RF Power as follows:

Output power = reference power + entered power

Where:

reference power equals the original RF Power entered under Source>Amplitude>RF Power and set as the reference power

entered power equals a new value entered under Source>Amplitude>Amptd Offset

For more information on Reference Frequency refer to ["Set Reference Power " on page 2443](#)

Key Path	Source, Amplitude
Remote Command	:SOURce:POWer:REFeRence <ampl> :SOURce:POWer:REFeRence? :SOURce:POWer:REFeRence:STATe OFF ON 0 1 :SOURce:POWer:REFeRence:STATe?
Example	:SOUR:POW:REF 0.00 dBm :SOUR:POW:REF:STATe ON
Dependencies	This setting is unavailable and is grayed out when the "List Sequencer" on page 2520 is turned ON.
Couplings	This value is coupled to the "Set Reference Power " on page 2443 key such that pressing the Set Reference Power key updates the reference power with the current output power.
Preset	0.00 dBm OFF
Min	-125.00 dBm
Max	10.00 dBm
Initial S/W Revision	A.05.00

Amptd Offset

Allows you to specify the RF output power offset value.

When the amplitude offset is set to zero (0) and you set a new offset value (positive or negative), the displayed amplitude value will change as follows and the RF output power will not change:

Displayed value = output power + offset value

Where:

output power equals the original RF Power entered under Source>Amplitude>RF Power

offset value equals the value entered under Source>Amplitude>Amptd Offset

When the amplitude offset is set to a value other than zero (0) and you enter a new RF power value under Source>Amplitude>RF Power, the displayed power will be the same as the value entered and the RF output power will be equal to the value entered minus the offset value as follows:

Output power = entered power – offset power

Displayed Power = output power + offset power

Displayed power = entered power

Where:

entered power equals the amplitude entered under Source>Amplitude>RF Power

offset power equals the value previously entered and set under Source>Amplitude>Amptd Offset

Key Path	Source, Amplitude
Remote Command	:SOURce:POWer[:LEVel][:IMMediate]:OFFSet <rel_ampl> :SOURce:POWer[:LEVel][:IMMediate]:OFFSet?
Example	:SOUR:POW:OFFS 0.00 dB
Dependencies	This setting is unavailable, and is grayed out when the List Sequencer is turned ON.
Preset	0.00 dB
Min	-200.00 dB
Max	200.00 dB
Initial S/W Revision	A.05.00

Modulation

Allows you to toggle the state of the modulation.

Key Path	Source
Remote Command	:OUTPut:MODulation[:STATe] ON OFF 1 0 :OUTPut:MODulation[:STATe]?
Example	:OUTP:MOD OFF
Notes	This setting is for independent mode and has no effect on " List Sequencer " on page 2520. If the " Sequencer " on page 2521 is set to ON, the list sequencer controls the source output and this key will be grayed-out. And this setting will be none-forceful grey out on front panel to indicate out-of-scope. Non-forceful means user still can change this setting by SCPI but cannot change manually on front panel. When set to Off will make source leave list sequencer and this setting will be black out and take effect immediately. When the Modulation is ON, the "MOD" annunciator is displayed in the system settings panel. When the Modulation is turned Off, the "MOD" annunciator is cleared. If the " Sequencer " on page 2521 is set to ON, the "MOD" annunciator will be replaced by "SEQ" in the system settings panel indicating that the output is controlled by list sequencer.
Preset	Off
Range	On Off
Initial S/W Revision	A.05.00

Frequency

Allows you to access the Frequency sub-menu.

Key Path	Source
Notes	The sub-menu under this button is for independent mode and has no effect on " List Sequencer " on

[page 2520](#). If the ["Sequencer" on page 2521](#) is set to ON, the list sequencer controls the source output and this key will be grayed-out. And this button will be grey out on front panel to indicate out-of-scope. When set to Off will make source leave list sequencer and this button will be black out.

Initial S/W Revision A.05.00

Frequency

Allows you to set the RF Output Frequency. You can adjust the frequency of the source using the numeric keypad, step keys, or RPG. Pressing any digit, 0 through 9, on the numeric keypad brings up the unit terminator.

Key Path	Source, Frequency
Remote Command	:SOURce:FREQuency[:CW] <freq> :SOURce:FREQuency[:CW]?
Example	:SOUR:FREQ 1.00 GHz
Notes	Internal source has list sequence mode, which comprises of several steps which contain separate output power, frequency and waveform etc. When the source list sequence playing is complete, the last step keeps playing, and user can use this command to change the list sequence last step's output frequency.
Couplings	The frequency value is coupled to the current channel band and number, such that updates to the band and number will update the frequency value to the corresponding absolute frequency.
Preset	1.00 GHz If license F1A or 5WC is present, the default Center Frequency should be 2.412GHz.
Min	10.00 MHz
Max	Hardware Dependant: Option 503 = 3.6 GHz Option 504 = 3.8 GHz Option 506 = 6.00 GHz For E6640A, if license 5WC is present, the frequency range should be limited to: 1.1GHz-1.7GHz, 2.4GHz-2.5GHz, 4.8GHz-6.0GHz. If the user-defined frequency is outside of range, UI will report an error message called "Settings conflict; Frequency is outside available range".
Initial S/W Revision	A.05.00

Channel

The frequency of the source can be specified by a channel number of a given frequency band. This key allows you to specify the current channel number. For the appropriate range of channel numbers for a given frequency band, refer to the following tables: ["GSM/EDGE Channel Number Ranges" on page 1076](#), ["W-CDMA Channel Number Ranges" on page 1077](#), ["CDMA 2000 / 1xEVDO Channel Number Ranges" on page 1078](#), and ["LTE FDD Channel Number Ranges" on page 1080](#).

Key Path	Source, Frequency
Remote Command	:SOURCE:FREQUENCY:CHANNELS:NUMBER <int> :SOURCE:FREQUENCY:CHANNELS:NUMBER?
Example	:SOUR:FREQ:CHAN:NUMB 1
Notes	This key is grayed out when the "Radio Standard" on page 2455 is set to NONE. This key is grayed out on E6630A.
Dependencies	This key is grayed out when the "Radio Standard" on page 2455 is set to NONE. This key is grayed out on E6630A.
Couplings	The channel number is coupled to the frequency value when the "Radio Standard" on page 2455 is not set to NONE. When the frequency value is changed, the channel number will increase or decrease to match the new frequency. If the frequency is not at an exact match for a channel number, the nearest channel number is displayed along with a greater than or less than sign to indicate the frequency is above or below the channel number.
Preset	1
Min	Please refer to the tables below for the valid ranges.
Max	Please refer to the tables below for the valid ranges.
Initial S/W Revision	A.05.00

GSM/EDGE Channel Number Ranges

Band	Link (Device)	Range	Frequency (MHz)
P-GSM	Uplink (MS)	$1 \leq n \leq 124$	$890.0 + 0.2*n$
	Downlink (BS)	$1 \leq n \leq 124$	$935.0 + 0.2*n$
E-GSM	Uplink (MS)	$0 \leq n \leq 124$	$890.0 + 0.2*n$
		$975 \leq n \leq 1023$	$890.0 + 0.2*(n-1024)$
	Downlink (BS)	$0 \leq n \leq 124$	$935.0 + 0.2*n$
		$975 \leq n \leq 1023$	$935.0 + 0.2*(n-1024)$
DCS 1800	Uplink (MS)	$512 \leq n \leq 885$	$1710.200 + 0.20*(n-512)$
	Downlink (BS)	$512 \leq n \leq 885$	$1805.200 + 0.20*(n-512)$
PCS 1900	Uplink (MS)	$512 \leq n \leq 810$	$1850.200 + 0.2*(n-512)$
	Downlink (BS)	$512 \leq n \leq 810$	$1930.200 + 0.2*(n-512)$
R-GSM	Uplink (MS)	$0 \leq n \leq 124$	$890.0 + 0.2*n$
		$955 \leq n \leq 1023$	$890.0 + 0.2*(n-1024)$
	Downlink (BS)	$0 \leq n \leq 124$	$935.0 + 0.2*n$
		$955 \leq n \leq 1023$	$935.0 + 0.2*(n-1024)$
GSM 450	Uplink (MS)	$256 \leq n \leq 293$	$450.6 + 0.2*(n-259)$
	Downlink (BS)	$256 \leq n \leq 293$	$460.6 + 0.2*(n-259)$
GSM 480	Uplink (MS)	$306 \leq n \leq 340$	$479.000 + 0.20*(n-306)$

Band	Link (Device)	Range	Frequency (MHz)
GSM 850	Downlink (BS)	$306 \leq n \leq 340$	$489.000 + 0.20*(n-306)$
	Uplink (MS)	$128 \leq n \leq 251$	$824.200 + 0.20*(n-128)$
GSM 700	Downlink (BS)	$128 \leq n \leq 251$	$869.200 + 0.20*(n-128)$
	Uplink (MS)	$438 \leq n \leq 516$	$777.200 + 0.20*(n-438)$
T-GSM810	Downlink (BS)	$438 \leq n \leq 516$	$747.200 + 0.20*(n-438)$
	Uplink (MS)	$350 \leq n \leq 425$	$806.0 + 0.20*(n-350)$
	Downlink (BS)	$350 \leq n \leq 425$	$851.0 + 0.20*(n-350)$

W-CDMA Channel Number Ranges

Band	Link (Device)	Range	Frequency (MHz)
Band I	Downlink	$10562 \leq n \leq 10838$	$n \div 5$
	Uplink	$9612 \leq n \leq 9888$	$n \div 5$
Band II	Downlink	$412 \leq n \leq 687$	$n \div 5 + 1850.1$
		$9662 \leq n \leq 9938$	$n \div 5$
	Uplink	$12 \leq n \leq 287$	$n \div 5 + 1850.1$
Band III	Downlink	$350 \leq n \leq 425$	$n \div 5$
	Downlink	$1162 \leq n \leq 1513$	$n \div 5 + 1575$
Band IV	Uplink	$937 \leq n \leq 1288$	$n \div 5 + 1525$
	Downlink	$537 \leq n \leq 1738$	$n \div 5 + 1805$
Band V	Downlink	$1887 \leq n \leq 2087$	$n \div 5 + 1735.1$
		Uplink	$1312 \leq n \leq 1513$
	Downlink	$1662 \leq n \leq 1862$	$n \div 5 + 1380.1$
Band VI	Downlink	$1007 \leq n \leq 1087$	$n \div 5 + 670.1$
		$4357 \leq n \leq 4458$	$n \div 5$
	Uplink	$782 \leq n \leq 862$	$n \div 5 + 670.1$
Band VII	Downlink	$4132 \leq n \leq 4233$	$n \div 5$
		Downlink	$1037 \leq n \leq 1062$
	Uplink	$4387 \leq n \leq 4413$	$n \div 5$
Band VIII	Downlink	$812 \leq n \leq 837$	$n \div 5 + 670.1$
		$4162 \leq n \leq 4188$	$n \div 5$
	Downlink	$2237 \leq n \leq 2563$	$n \div 5 + 2175$
Band IX	Downlink	$2587 \leq n \leq 2912$	$n \div 5 + 2105.1$
		Uplink	$2012 \leq n \leq 2338$
	Downlink	$2362 \leq n \leq 2687$	$n \div 5 + 2030.1$
Band X	Downlink	$2937 \leq n \leq 3088$	$n \div 5 + 340$
	Uplink	$2712 \leq n \leq 2863$	$n \div 5 + 340$

Band	Link (Device)	Range	Frequency (MHz)
Band IX	Downlink	$9237 \leq n \leq 9387$	$n \div 5$
	Uplink	$8762 \leq n \leq 8912$	$n \div 5$
Band X	Downlink	$3112 \leq n \leq 3388$	$n \div 5 + 1490$
		$3412 \leq n \leq 3687$	$n \div 5 + 1430.1$
	Uplink	$2887 \leq n \leq 3163$	$n \div 5 + 1135$
		$3187 \leq n \leq 3462$	$n \div 5 + 1075.1$
Band XI	Downlink	$3712 \leq n \leq 3812$	$n \div 5 + 736$
	Uplink	$3487 \leq n \leq 3587$	$n \div 5 + 733$
Band XII	Downlink	$3837 \leq n \leq 3903$	$n \div 5 - 37$
		$3927 \leq n \leq 3992$	$n \div 5 - 54.9$
	Uplink	$3612 \leq n \leq 3678$	$n \div 5 - 22$
		$3702 \leq n \leq 3767$	$n \div 5 - 39.9$
Band XIII	Downlink	$4017 \leq n \leq 4043$	$n \div 5 - 55$
		$4067 \leq n \leq 4092$	$n \div 5 - 64.9$
	Uplink	$3792 \leq n \leq 3818$	$n \div 5 + 21$
		$3702 \leq n \leq 3767$	$n \div 5 - 39.9$
Band XIV	Downlink	$4117 \leq n \leq 4143$	$n \div 5 - 63$
		$4167 \leq n \leq 4192$	$n \div 5 - 72.9$
	Uplink	$3892 \leq n \leq 3918$	$n \div 5 + 12$
		$3942 \leq n \leq 3967$	$n \div 5 + 2.1$
Band XIX	Downlink	$712 \leq n \leq 763$	$n \div 5 + 735$
		$787 \leq n \leq 837$	$n \div 5 + 720.1$
	Uplink	$312 \leq n \leq 363$	$n \div 5 + 770$
		$387 \leq n \leq 437$	$n \div 5 + 755.1$

CDMA 2000 / 1xEVDO Channel Number Ranges

Band	Link (Device)	Range	Frequency (MHz)
US Cellular	Uplink (MS, reverse link)	$1 \leq N \leq 799$	$0.030 \times N + 825.000$
		$991 \leq N \leq 1023$	$0.030 \times (N - 1023) + 825.000$
		$1024 \leq N \leq 1323$	$0.030 \times (N - 1024) + 815.040$
	Downlink (BS, forward link)	$1 \leq N \leq 799$	$0.030 \times N + 870.000$
		$991 \leq N \leq 1023$	$0.030 \times (N - 1023) + 870.000$
		$1024 \leq N \leq 1323$	$0.030 \times (N - 1024) + 860.040$
US PCS	Uplink (MS, reverse link)	$0 \leq N \leq 1199$	$1850.000 + 0.050 \times N$
	Downlink (BS, forward link)	$0 \leq N \leq 1199$	$1930.000 + 0.050 \times N$

Band	Link (Device)	Range	Frequency (MHz)
Japan Cellular Band	Uplink (MS, reverse link)	$1 \leq N \leq 799$	$0.0125 \times (N + 915.000)$
		$801 \leq N \leq 1039$	$0.0125 \times (N - 800) + 898.000$
		$1041 \leq N \leq 1199$	$0.0125 \times (N - 1040) + 887.000$
		$1201 \leq N \leq 1600$	$0.0125 \times (N - 1200) + 893.000$
	Downlink (BS, forward link)	$1 \leq N \leq 799$	$0.0125 \times (N + 860.000)$
		$801 \leq N \leq 1039$	$0.0125 \times (N - 800) + 843.000$
		$1041 \leq N \leq 1199$	$0.0125 \times (N - 1040) + 832.000$
		$1201 \leq N \leq 1600$	$0.0125 \times (N - 1200) + 838.000$
Korean PCS Band	Uplink (MS, reverse link)	$0 \leq N \leq 599$	$0.050 \times N + 1750.000$
	Downlink (BS, forward link)	$0 \leq N \leq 599$	$0.050 \times N + 1840.000$
NMT-450 Band	Uplink (MS, reverse link)	$1 \leq N \leq 400$	$0.025 \times (N - 1) + 450.000$
		$472 \leq N \leq 871$	$0.025 \times (N - 472) + 410.000$
		$1039 \leq N \leq 1473$	$0.020 \times (N - 1024) + 451.010$
		$1536 \leq N \leq 1715$	$0.025 \times (N - 1536) + 479.000$
	Downlink (BS, forward link)	$1 \leq N \leq 400$	$0.025 \times (N - 1) + 460.000$
		$472 \leq N \leq 871$	$0.025 \times (N - 472) + 420.000$
		$1039 \leq N \leq 1473$	$0.020 \times (N - 1024) + 461.010$
		$1536 \leq N \leq 1715$	$0.025 \times (N - 1536) + 489.000$
IMT-2000 Band	Uplink (MS, reverse link)	$0 \leq N \leq 1199$	$1920.000 + 0.050 \times N$
	Downlink (BS, forward link)	$0 \leq N \leq 1199$	$2100.000 + 0.050 \times N$
Upper 700 MHz Band	Uplink (MS, reverse link)	$0 \leq N \leq 240$	$776.000 + 0.050 \times N$
	Downlink (BS, forward link)	$0 \leq N \leq 240$	$746.000 + 0.050 \times N$
Secondary 800 MHz Band	Uplink (MS, reverse link)	$0 \leq N \leq 719$	$0.025 \times N + 806.000$
		$720 \leq N \leq 919$	$0.025 \times (N - 720) + 896.000$
	Downlink (BS, forward link)	$0 \leq N \leq 719$	$0.025 \times N + 851.000$
		$720 \leq N \leq 919$	$0.025 \times (N - 720) + 935.000$
2.5 GHz IMT Extension	Uplink (MS, reverse link)	$0 \leq N \leq 1399$	$2500.000 + 0.050 \times N$
	Downlink (BS, forward link)	$0 \leq N \leq 1399$	$2620.000 + 0.050 \times N$
US PCS 1.9 GHz	Uplink (MS, reverse link)	$0 \leq N \leq 1299$	$1850.000 + 0.050 \times N$

Band	Link (Device)	Range	Frequency (MHz)
AWS	Downlink (BS, forward link)	$0 \leq N \leq 1299$	$1930.000 + 0.050 \times N$
	Uplink (MS, reverse link)	$0 \leq N \leq 899$	$1710.000 + 0.050 \times N$
US 2.5 GHz	Downlink (BS, forward link)	$0 \leq N \leq 899$	$2100.000 + 0.050 \times N$
	Uplink (MS, reverse link)	$140 \leq N \leq 1459$	$2495.000 + 0.050 \times N$
700 Public Safety	Downlink (BS, forward link)	$140 \leq N \leq 1459$	$2617.000 + 0.050 \times N$
	Uplink (MS, reverse link)	$0 \leq N \leq 240$	$787.000 + 0.050 \times N$
C2K Lower 700	Downlink (BS, forward link)	$0 \leq N \leq 240$	$757.000 + 0.050 \times N$
	Uplink (MS, reverse link)	$0 \leq N \leq 360$	$698.000 + 0.050 \times N$
400 Euro PAMR	Downlink (BS, forward link)	$0 \leq N \leq 360$	$728.000 + 0.050 \times N$
	Uplink (MS, reverse link)	$1 \leq N \leq 400$	$0.025 \times (N-1) + 450.000$
	Uplink (MS, reverse link)	$472 \leq N \leq 871$	$0.025 \times (N-472) + 410.000$
	Uplink (MS, reverse link)	$1536 \leq N \leq 1715$	$0.025 \times (N-1536) + 479.000$
	Downlink (BS, forward link)	$1 \leq N \leq 400$	$0.025 \times (N-1) + 460.000$
	Downlink (BS, forward link)	$472 \leq N \leq 871$	$0.025 \times (N-472) + 420.000$
	Downlink (BS, forward link)	$1536 \leq N \leq 1715$	$0.025 \times (N-1536) + 489.000$
	Downlink (BS, forward link)		
800 PAMR	Uplink (MS, reverse link)	$0 \leq N \leq 239$	$870.0125 + 0.025 \times N$
	Downlink (BS, forward link)	$0 \leq N \leq 239$	$915.0125 + 0.025 \times N$

LTE FDD Channel Number Ranges

The carrier frequency in the uplink and downlink is designated by the E-UTRA Absolute Radio Frequency Channel Number (EARFCN) in the range 0 – 65535. The relation between EARFCN and the carrier frequency in MHz for the downlink is given by the following equation, where FDL_low and NOFFS-DL are given in table 5.4.4–1 and ND L is the downlink EARFCN.

$$FDL = FDL_low + 0.1(NDL - NOFFS-DL)$$

The relation between EARFCN and the carrier frequency in MHz for the uplink is given by the following equation where FUL_low and NOffs-UL are given in table 5.4.4-1 and NUL is the uplink EARFCN.

$$FUL = FUL_low + 0.1(NUL - NOffs-UL)$$

Band	Downlink		Uplink			
	FDL_low (MHz)	NOffs-DL	Range of ND L	FUL_low (MHz)	NOffs-UL	Range of NUL
1		2110	0	0 - 599	1920	18000 - 18599
2		1930	600	600 - 1199	1850	18600 - 19199
3		1805	1200	1200 - 1949	1710	19200 - 19949
4		2110	1950	1950 - 2399	1710	19950 - 20399
5		869	2400	2400 - 2649	824	20400 - 20649
6		875	2650	2650 - 2749	830	20650 - 20749
7		2620	2750	2750 - 3449	2500	20750 - 20449
8		925	3450	3450 - 3799	880	21450 - 21799
9		1844.9	3800	3800 - 4149	1749.9	21800 - 22149
10		2110	4150	4150 - 4749	1710	22150 - 22749
11		1475.9	4750	4750 - 4949	1427.9	22750 - 22949
12		729	5010	5010 - 5179	699	23010 - 23179
13		746	5180	5180 - 5279	777	23180 - 23279
14		758	5280	5280 - 5379	788	23280 - 23379
...						
17		734	5730	5730 - 5849	704	23730 - 23849
18		860	5850	5850 - 5999	815	23850 - 23999
19		875	6000	6000 - 6149	830	24000 - 24149
20		791	6150	6150 - 6449	832	24150 - 24449
21		1495.9	6450	6450 - 6599	1447.9	24450 - 24599
...						
24		1525	7700	7700 - 8039	1626.5	25700 - 26039
25		1930	8040	8040 - 8689	1850	26040 - 26689
26		859	8690	8690 - 9039	814	26690 - 27039
...						

Note: The channel numbers that designate carrier frequencies so close to the operating band edges that the carrier extends beyond the operating band edge shall not be used. This implies that the first 7, 15, 25, 50, 75 and 100 channel numbers at the lower operating band edge and the last 6, 14, 24, 49, 74 and 99 channel numbers at the upper operating band edge shall not be used for channel bandwidths of 1.4, 3, 5, 10, 15 and 20 MHz respectively.

LTE TDD Channel Number Ranges

The carrier frequency in the uplink and downlink is designated by the E-UTRA Absolute Radio Frequency Channel Number (EARFCN) in the range 0 – 65535. The relation between EARFCN and the carrier frequency in MHz for the downlink is given by the following equation, where FDL_low and NOffs-DL are given in table 5.4.4–1 and NDL is the downlink EARFCN.

$$FDL = FDL_low + 0.1(NDL - NOffs-DL)$$

The relation between EARFCN and the carrier frequency in MHz for the uplink is given by the following equation where FUL_low and NOffs-UL are given in table 5.4.4–1 and NUL is the uplink EARFCN.

$$FUL = FUL_low + 0.1(NUL - NOffs-UL)$$

Band	Downlink		Uplink			
	FDL_low (MHz)	NOffs-DL	Range of NDL	FUL_low (MHz)	NOffs-UL	Range of NUL
33		1900	36000	36000 – 36199	1900	36000 – 36199
34		2010	36200	36200 – 36349	2010	36200 – 36349
35		1850	36350	36350 – 36949	1850	36350 – 36949
36		1930	36950	36950 – 37549	1930	36950 – 37549
37		1910	37550	37550 – 37749	1910	37550 – 37749
38		2570	37750	37750 – 38249	2570	37750 – 38249
39		1880	38250	38250 – 38649	1880	38250 – 38649
40		2300	38650	38650 – 39649	2300	38650 – 39649
41		2496	39650	39650 – 41589	2496	39650 – 41589
42		3400	41590	41590 – 43589	3400	41590 – 43589
43		3600	43590	43590 – 45589	3600	43590 – 45589

Note: The channel numbers that designate carrier frequencies so close to the operating band edges that the carrier extends beyond the operating band edge shall not be used. This implies that the first 7, 15, 25, 50, 75 and 100 channel numbers at the lower operating band edge and the last 6, 14, 24, 49, 74 and 99 channel numbers at the upper operating band edge shall not be used for channel bandwidths of 1.4, 3, 5, 10, 15 and 20 MHz respectively.

TDSCDMA Channel Number Ranges

1.28 Mcps TDD Option

No TX-RX frequency separation is required as Time Division Duplex (TDD) is employed. Each subframe consists of 7 main timeslots where all main timeslots (at least the first one) before the single switching point are allocated DL and all main timeslots (at least the last one) after the single switching point are allocated UL.

The nominal channel spacing is 1.6 MHz, but this can be adjusted to optimise performance in a particular deployment scenario.

The carrier frequency is designated by the UTRA absolute radio frequency channel number (UARFCN). The value of the UARFCN in the IMT2000 band is defined in the general case as follows:

$$N_t = 5 * F \quad 0.0 \text{ MHz} \leq F \leq 3276.6 \text{ MHz}$$

where F is the carrier frequency in MHz

Additional channels applicable to operation in the frequency band defined in sub-clause 5.2(d) are defined via the following UARFCN definition:

$$N_t = 5 * (F - 2150.1 \text{ MHz}) \quad 2572.5 \text{ MHz} \leq F \leq 2617.5 \text{ MHz}$$

UARFCN

1.28 Mcps TDD Option

The following UARFCN range shall be supported for each band:

Table: UTRA Absolute Radio Frequency Channel Number 1.28 Mcps TDD Option		
Frequency Band	Frequency Range	UARFCN Uplink and Downlink transmission
For operation in frequency band as defined in subclause 5.2 (a)	1900–1920 MHz	9504 to 9596
	2010–2025 MHz	10054 to 10121
For operation in frequency band as defined in subclause 5.2 (b)	1850–1910 MHz	9254 to 9546
	1930–1990 MHz	9654 to 9946
For operation in frequency band as defined in subclause 5.2 (c)	1910–1930 MHz	9554 to 9646
For operation in frequency band as defined in subclause 5.2 (d)	2570–2620 MHz	12854 to 13096
For operation in frequency band as defined in subclause 5.2 (e)	2300–2400 MHz	11504 to 11996
For operation in frequency band as defined in subclause 5.2 (f)	1880–1920 MHz	9404 to 9596

Radio Setup

Allows access to the sub-menus for selecting the radio standard and associated radio band. You can also set a frequency reference and offset.

This menu is greyed out when on E6630A. Radio band settings for GSM, cdma2000, and so on -- most of which are not actually supported in E6630A, which has three narrow frequency bands. So band settings are grayed out.

Key Path	Source, Frequency
Initial S/W Revision	A.05.00

Radio Standard

Allows access to the channel band sub-menus to select the desired radio standard. When you have selected the radio standard, you can then set an active channel band. The radio standard and the active channel band allow you to use channel numbers to set frequency automatically.

Key Path	Source, Frequency, Radio Setup
Remote Command	:SOURce:FREQuency:CHANnels:BAND NONE PGSM EGSM RGSM DCS1800 PCS1900 TGSM810 GSM450 GSM480 GSM700 GSM850 BANDI BANDII BANDIII BANDIV BANDV BANDVI BANDVII BANDVIII BANDIX BANDX BANDXI BANDXII BANDXIII BANDXIV BANDXIX USCELL USPCS JAPAN KOREAN NMT IMT2K UPPER SECOND PAMR400 PAMR800 IMTEXT PCS1DOT9G AWS US2DOT5G PUBLIC LOWER BAND1 BAND2 BAND3 BAND4 BAND5 BAND6 BAND7 BAND8 BAND10 BAND11 BAND12 BAND13 BAND14 BAND17 BAND18 BAND19 BAND20 BAND21 BAND24 BAND25 BAND26 BAND27 BAND28 BAND31 BAND33 BAND34 BAND35 BAND36 BAND37 BAND38 BAND39 BAND40 BAND41 BAND42 BAND43 BAND44 BANDA BANDB BANDC BANDD BANDE BANDF :SOURce:FREQuency:CHANnels:BAND?
Example	:SOUR:FREQ:CHAN:BAND PGSM
Notes	Set this setting to "NONE" will grey out "Channel" on page 2446 Channel
Initial S/W Revision	A.05.00

None

Selects no radio standard for use. When you have selected the radio standard to NONE, you cannot use channel numbers to set frequency automatically. You will need to set the frequency manually.

Key Path	Source, Frequency, Radio Setup, Radio Standard
Initial S/W Revision	A.05.00

GSM/EDGE

Sets GSM/EDGE as the radio standard for use and accesses the GSM/EDGE specific channel band sub-menus.

Key Path	Source, Frequency, Radio Setup, Radio Standard
Initial S/W Revision	A.05.00

P-GSM

Selects P-GSM as the active channel band.

Key Path	Source, Frequency, Radio Setup, Radio Standard, GSM/EDGE
Example	:SOUR:FREQ:CHAN:BAND PGSM
Initial S/W Revision	A.05.00

E-GSM

Selects E-GSM as the active channel band.

Key Path	Source, Frequency, Radio Setup, Radio Standard, GSM/EDGE
Example	:SOUR:FREQ:CHAN:BAND EGSM
Initial S/W Revision	A.05.00

R-GSM

Selects R-GSM as the active channel band.

Key Path	Source, Frequency, Radio Setup, Radio Standard, GSM/EDGE
Example	:SOUR:FREQ:CHAN:BAND RGSM
Initial S/W Revision	A.05.00

DCS 1800

Selects DCS 1800 as the active channel band.

Key Path	Source, Frequency, Radio Setup, Radio Standard, GSM/EDGE
Example	:SOUR:FREQ:CHAN:BAND DCS1800
Initial S/W Revision	A.05.00

PCS 1900

Selects PCS 1900 as the active channel band.

Key Path	Source, Frequency, Radio Setup, Radio Standard, GSM/EDGE
Example	:SOUR:FREQ:CHAN:BAND PCS1900
Initial S/W Revision	A.05.00

GSM 450

Selects GSM 450 as the active channel band.

Key Path	Source, Frequency, Radio Setup, Radio Standard, GSM/EDGE
Example	:SOUR:FREQ:CHAN:BAND GSM450
Initial S/W Revision	A.05.00

GSM 480

Selects GSM 480 as the active channel band.

Key Path	Source, Frequency, Radio Setup, Radio Standard, GSM/EDGE
Example	:SOUR:FREQ:CHAN:BAND GSM480
Initial S/W Revision	A.05.00

GSM 850

Selects GSM 850 as the active channel band.

Key Path	Source, Frequency, Radio Setup, Radio Standard, GSM/EDGE
Example	:SOUR:FREQ:CHAN:BAND GSM850
Initial S/W Revision	A.05.00

GSM 700

Selects GSM 700 as the active channel band.

Key Path	Source, Frequency, Radio Setup, Radio Standard, GSM/EDGE
Example	:SOUR:FREQ:CHAN:BAND GSM700
Initial S/W Revision	A.05.00

T-GSM 810

Selects T-GSM 810 as the active channel band.

Key Path	Source, Frequency, Radio Setup, Radio Standard, GSM/EDGE
Example	:SOUR:FREQ:CHAN:BAND T-GSM810
Initial S/W Revision	A.05.00

WCDMA

Sets WCDMA as the radio standard for use and accesses the W-CDMA specific channel band sub-menus.

Key Path	Source, Frequency, Radio Setup, Radio Standard
Initial S/W Revision	A.05.00

Band I

Selects Band I as the active channel band.

Key Path	Source, Frequency, Radio Setup, Radio Standard, WCDMA
Example	:SOUR:FREQ:CHAN:BAND BANDI
Initial S/W Revision	A.05.00

Band II

Selects Band II as the active channel band.

Key Path	Source, Frequency, Radio Setup, Radio Standard, WCDMA
Example	:SOUR:FREQ:CHAN:BAND BANDII
Initial S/W Revision	A.05.00

Band III

Selects Band III as the active channel band.

Key Path	Source, Frequency, Radio Setup, Radio Standard, WCDMA
Example	:SOUR:FREQ:CHAN:BAND BANDIII
Initial S/W Revision	A.05.00

Band IV

Selects Band IV as the active channel band.

Key Path	Source, Frequency, Radio Setup, Radio Standard, WCDMA
Example	:SOUR:FREQ:CHAN:BAND BANDIV
Initial S/W Revision	A.05.00

Band V

Selects Band V as the active channel band.

Key Path	Source, Frequency, Radio Setup, Radio Standard, WCDMA
Example	:SOUR:FREQ:CHAN:BAND BANDV
Initial S/W Revision	A.05.00

Band VI

Selects Band VI as the active channel band.

Key Path	Source, Frequency, Radio Setup, Radio Standard, WCDMA
Example	:SOUR:FREQ:CHAN:BAND BANDVI
Initial S/W Revision	A.05.00

Band VII

Selects Band VII as the active channel band.

Key Path	Source, Frequency, Radio Setup, Radio Standard, WCDMA
Example	:SOUR:FREQ:CHAN:BAND BANDVII
Initial S/W Revision	A.05.00

Band VIII

Selects Band VIII as the active channel band.

Key Path	Source, Frequency, Radio Setup, Radio Standard, WCDMA
Example	:SOUR:FREQ:CHAN:BAND BANDVIII
Initial S/W Revision	A.05.00

Band IX

Selects Band IX as the active channel band.

Key Path	Source, Frequency, Radio Setup, Radio Standard, WCDMA
Example	:SOUR:FREQ:CHAN:BAND BANDIX
Initial S/W Revision	A.05.00

Band X

Selects Band X as the active channel band.

Key Path	Source, Frequency, Radio Setup, Radio Standard, WCDMA
Example	:SOUR:FREQ:CHAN:BAND BANDX
Initial S/W Revision	A.05.00

Band XI

Selects Band XI as the active channel band.

Key Path	Source, Frequency, Radio Setup, Radio Standard, WCDMA
Example	:SOUR:FREQ:CHAN:BAND BANDXI
Initial S/W Revision	A.05.00

Band XII

Selects Band XII as the active channel band.

Key Path	Source, Frequency, Radio Setup, Radio Standard, WCDMA
Example	:SOUR:FREQ:CHAN:BAND BANDXII
Initial S/W Revision	A.05.00

Band XIII

Selects band XIII as the active channel band.

Key Path	Source, Frequency, Radio Setup, Radio Standard, WCDMA
Example	:SOUR:FREQ:CHAN:BAND BANDXIII
Initial S/W Revision	A.05.00

Band XIV

Selects Band XIV as the active channel band.

Key Path	Source, Frequency, Radio Setup, Radio Standard, WCDMA
Example	:SOUR:FREQ:CHAN:BAND BANDXIV
Initial S/W Revision	A.05.00

Band XIX

Selects Band XIX as the active channel band.

Key Path	Source, Frequency, Radio Setup, Radio Standard, WCDMA
Example	:SOUR:FREQ:CHAN:BAND BANDXIX
Initial S/W Revision	A.14.50

CDMA 2000 / 1xEVDO

Sets CDMA 2000 / 1XEVDO as the radio standard for use and accesses the CDMA 2000/1xEVDO specific channel band sub-menus.

Key Path	Source, Frequency, Radio Setup, Radio Standard
Initial S/W Revision	A.05.00

US CELL

Selects US Cell as the active channel band.

Key Path	Source, Frequency, Radio Setup, Radio Standard, CDMA 2000 / 1xEVDO
Example	:SOUR:FREQ:CHAN:BAND USCELL
Initial S/W Revision	A.05.00

US PCS

Selects US PCS as the active channel band.

Key Path	Source, Frequency, Radio Setup, Radio Standard, CDMA 2000 / 1xEVDO
Example	:SOUR:FREQ:CHAN:BAND PCS
Initial S/W Revision	A.05.00

Japan Cell

Selects Japan Cell as the active channel band.

Key Path	Source, Frequency, Radio Setup, Radio Standard, CDMA 2000 / 1xEVDO
Example	:SOUR:FREQ:CHAN:BAND JAPAN
Initial S/W Revision	A.05.00

Korean PCS

Selects Korean PCS as the active channel band.

Key Path	Source, Frequency, Radio Setup, Radio Standard, CDMA 2000 / 1xEVDO
Example	:SOUR:FREQ:CHAN:BAND KOREAN
Initial S/W Revision	A.05.00

NMT 450

Selects NMT 450 as the active channel band.

Key Path	Source, Frequency, Radio Setup, Radio Standard, CDMA 2000 / 1xEVDO
----------	--

Example	:SOUR:FREQ:CHAN:BAND NMT
Initial S/W Revision	A.05.00

IMT 2000

Selects IMT 2000 as the active channel band.

Key Path	Source, Frequency, Radio Setup, Radio Standard, CDMA 2000 / 1xEVDO
Example	:SOUR:FREQ:CHAN:BAND IMT2K
Initial S/W Revision	A.05.00

Upper 700

Selects Upper 700 as the active channel band.

Key Path	Source, Frequency, Radio Setup, Radio Standard, CDMA 2000 / 1xEVDO
Example	:SOUR:FREQ:CHAN:BAND UPPER
Initial S/W Revision	A.05.00

Secondary 800

Selects Secondary 800 as the active channel band.

Key Path	Source, Frequency, Radio Setup, Radio Standard, CDMA 2000 / 1xEVDO
Example	:SOUR:FREQ:CHAN:BAND SECOND
Initial S/W Revision	A.05.00

400 Euro PAMR

Selects 400 Euro PAMR as the active channel band.

Key Path	Source, Frequency, Radio Setup, Radio Standard, CDMA 2000 / 1xEVDO
Example	:SOUR:FREQ:CHAN:BAND PAMR400
Initial S/W Revision	A.05.00

800 PAMR

Selects 800 PAMR as the active channel band.

Key Path	Source, Frequency, Radio Setup, Radio Standard, CDMA 2000 / 1xEVDO
----------	--

Example	:SOUR:FREQ:CHAN:BAND PAMR800
Initial S/W Revision	A.05.00

2.5GHz IMT EXT

Selects 2.5 GHz IMT EXT as the active channel band.

Key Path	Source, Frequency, Radio Setup, Radio Standard, CDMA 2000 / 1xEVDO
Example	:SOUR:FREQ:CHAN:BAND IMTEXT
Initial S/W Revision	A.05.00

US PCS 1.9GHz

Selects US PCS 1.9 GHz as the active channel band.

Key Path	Source, Frequency, Radio Setup, Radio Standard, CDMA 2000 / 1xEVDO
Example	:SOUR:FREQ:CHAN:BAND PCS1DOT9G
Initial S/W Revision	A.05.00

AWS

Selects AWS as the active channel band.

Key Path	Source, Frequency, Radio Setup, Radio Standard, CDMA 2000 / 1xEVDO
Example	:SOUR:FREQ:CHAN:BAND AWS
Initial S/W Revision	A.05.00

US 2.5GHz

Selects US 2.5 GHz as the active channel band.

Key Path	Source, Frequency, Radio Setup, Radio Standard, CDMA 2000 / 1xEVDO
Example	:SOUR:FREQ:CHAN:BAND US2DOT5G
Initial S/W Revision	A.05.00

700 Public Safety

Selects 700 Public Safety as the active channel band.

Key Path	Source, Frequency, Radio Setup, Radio Standard, CDMA 2000 / 1xEVDO
----------	--

Example	:SOUR:FREQ:CHAN:BAND PUBLIC
Initial S/W Revision	A.05.00

C2K Lower 700

Selects C2K Lower 700 as the active channel band.

Key Path	Source, Frequency, Radio Setup, Radio Standard, CDMA 2000 / 1xEVDO
Example	:SOUR:FREQ:CHAN:BAND LOWER
Initial S/W Revision	A.05.00

LTE

Sets LTE FDD as the radio standard for use and accesses the LTE FDD specific channel band sub-menus..

Key Path	Source, Frequency, Radio Setup, Radio Standard
Initial S/W Revision	A.09.50

BAND 1

Selects BAND 1 as the band for the current step.

Key Path	Source, Frequency, Radio Setup, Radio Standard, LTE
Example	:SOUR:FREQ:CHAN:BAND BAND1
Initial S/W Revision	A.09.50

BAND 2

Selects BAND 2 as the band for the current step.

Key Path	Source, Frequency, Radio Setup, Radio Standard, LTE
Example	:SOUR:FREQ:CHAN:BAND BAND2
Initial S/W Revision	A.09.50

BAND 3

Selects BAND 3 as the band for the current step.

Key Path	Source, Frequency, Radio Setup, Radio Standard, LTE
Example	:SOUR:FREQ:CHAN:BAND BAND3
Initial S/W Revision	A.09.50

BAND 4

Selects BAND 4 as the band for the current step.

Key Path	Source, Frequency, Radio Setup, Radio Standard, LTE
Example	:SOUR:FREQ:CHAN:BAND BAND4
Initial S/W Revision	A.09.50

BAND 5

Selects BAND 5 as the band for the current step.

Key Path	Source, Frequency, Radio Setup, Radio Standard, LTE
Example	:SOUR:FREQ:CHAN:BAND BAND5
Initial S/W Revision	A.09.50

BAND 6

Selects BAND 6 as the band for the current step.

Key Path	Source, Frequency, Radio Setup, Radio Standard, LTE
Example	:SOUR:FREQ:CHAN:BAND BAND6
Initial S/W Revision	A.09.50

BAND 7

Selects BAND 7 as the band for the current step.

Key Path	Source, Frequency, Radio Setup, Radio Standard, LTE
Example	:SOUR:FREQ:CHAN:BAND BAND7
Initial S/W Revision	A.09.50

BAND 8

Selects BAND 8 as the band for the current step.

Key Path	Source, Frequency, Radio Setup, Radio Standard, LTE
Example	:SOUR:FREQ:CHAN:BAND BAND8
Initial S/W Revision	A.09.50

BAND 9

Selects BAND 9 as the band for the current step.

Key Path	Source, Frequency, Radio Setup, Radio Standard, LTE
Example	:SOUR:FREQ:CHAN:BAND BAND9
Initial S/W Revision	A.09.50

BAND 10

Selects BAND 10 as the band for the current step.

Key Path	Source, Frequency, Radio Setup, Radio Standard, LTE
Example	:SOUR:FREQ:CHAN:BAND BAND10
Initial S/W Revision	A.09.50

BAND 11

Selects BAND 11 as the band for the current step.

Key Path	Source, Frequency, Radio Setup, Radio Standard, LTE
Example	:SOUR:FREQ:CHAN:BAND BAND11
Initial S/W Revision	A.09.50

BAND 12

Selects BAND 12 as the band for the current step.

Key Path	Source, Frequency, Radio Setup, Radio Standard, LTE
Example	:SOUR:FREQ:CHAN:BAND BAND12
Initial S/W Revision	A.09.50

BAND 13

Selects BAND 13 as the band for the current step.

Key Path	Source, Frequency, Radio Setup, Radio Standard, LTE
Example	:SOUR:FREQ:CHAN:BAND BAND13
Initial S/W Revision	A.09.50

BAND 14

Selects BAND 14 as the band for the current step.

Key Path	Source, Frequency, Radio Setup, Radio Standard, LTE
Example	:SOUR:FREQ:CHAN:BAND BAND14
Initial S/W Revision	A.09.50

BAND 17

Selects BAND 17 as the band for the current step.

Key Path	Source, Frequency, Radio Setup, Radio Standard, LTE
Example	:SOUR:FREQ:CHAN:BAND BAND17
Initial S/W Revision	A.09.50

BAND 18

Selects BAND 18 as the band for the current step.

Key Path	Source, Frequency, Radio Setup, Radio Standard, LTE
Example	:SOUR:FREQ:CHAN:BAND BAND18
Initial S/W Revision	A.09.50

BAND 19

Selects BAND 19 as the band for the current step.

Key Path	Source, Frequency, Radio Setup, Radio Standard, LTE
Example	:SOUR:FREQ:CHAN:BAND BAND19
Initial S/W Revision	A.09.50

BAND 20

Selects BAND 20 as the band for the current step.

Key Path	Source, Frequency, Radio Setup, Radio Standard, LTE
Example	:SOUR:FREQ:CHAN:BAND BAND20
Initial S/W Revision	A.09.50

BAND 21

Selects BAND 21 as the band for the current step.

Key Path	Source, Frequency, Radio Setup, Radio Standard, LTE
Example	:SOUR:FREQ:CHAN:BAND BAND21
Initial S/W Revision	A.09.50

BAND 24

Selects BAND 24 as the band for the current step.

Key Path	Source, Frequency, Radio Setup, Radio Standard, LTE
Example	:SOUR:FREQ:CHAN:BAND BAND24
Initial S/W Revision	A.09.50

BAND 25

Selects BAND 25 as the band for the current step.

Key Path	Source, Frequency, Radio Setup, Radio Standard, LTE
Example	:SOUR:FREQ:CHAN:BAND BAND25
Initial S/W Revision	A.09.50

BAND 26

Selects BAND 26 as the band for the current step.

Key Path	Source, Frequency, Radio Setup, Radio Standard, LTE
Example	:SOUR:FREQ:CHAN:BAND BAND26
Initial S/W Revision	A.12.53

BAND 27

Selects BAND 27 as the band for the current step.

Key Path	Source, Frequency, Radio Setup, Radio Standard, LTE
Example	:SOUR:FREQ:CHAN:BAND BAND27
Initial S/W Revision	A.14.00

BAND 28

Selects BAND 28 as the band for the current step.

Key Path	Source, Frequency, Radio Setup, Radio Standard, LTE
Example	:SOUR:FREQ:CHAN:BAND BAND28
Initial S/W Revision	A.14.00

BAND 31

Selects BAND 31 as the band for the current step.

Key Path	Source, Frequency, Radio Setup, Radio Standard, LTE
Example	:SOUR:FREQ:CHAN:BAND BAND31
Initial S/W Revision	A.14.00

LTE TDD

Sets LTE TDD as the radio standard for use and accesses the LTE TDD specific channel band sub-menus..

Key Path	Source, Frequency, Radio Setup, Radio Standard
Initial S/W Revision	A.11.50

BAND 33

Selects BAND 33 as the band for the current step.

Key Path	Source, Frequency, Radio Setup, Radio Standard, LTE TDD
Example	:SOUR:FREQ:CHAN:BAND BAND33
Initial S/W Revision	A.11.50

BAND 34

Selects BAND 34 as the band for the current step.

Key Path	Source, Frequency, Radio Setup, Radio Standard, LTE TDD
Example	:SOUR:FREQ:CHAN:BAND BAND34
Initial S/W Revision	A.11.50

BAND 35

Selects BAND 35 as the band for the current step.

Key Path	Source, Frequency, Radio Setup, Radio Standard, LTE TDD
Example	:SOUR:FREQ:CHAN:BAND BAND35
Initial S/W Revision	A.11.50

BAND 36

Selects BAND 36 as the band for the current step.

Key Path	Source, Frequency, Radio Setup, Radio Standard, LTE TDD
Example	:SOUR:FREQ:CHAN:BAND BAND36
Initial S/W Revision	A.11.50

BAND 37

Selects BAND 37 as the band for the current step.

Key Path	Source, Frequency, Radio Setup, Radio Standard, LTE TDD
Example	:SOUR:FREQ:CHAN:BAND BAND37
Initial S/W Revision	A.11.50

BAND 38

Selects BAND 38 as the band for the current step.

Key Path	Source, Frequency, Radio Setup, Radio Standard, LTE TDD
Example	:SOUR:FREQ:CHAN:BAND BAND38
Initial S/W Revision	A.11.50

BAND 39

Selects BAND 39 as the band for the current step.

Key Path	Source, Frequency, Radio Setup, Radio Standard, LTE TDD
Example	:SOUR:FREQ:CHAN:BAND BAND39
Initial S/W Revision	A.11.50

BAND 40

Selects BAND 40 as the band for the current step.

Key Path	Source, Frequency, Radio Setup, Radio Standard, LTE TDD
Example	:SOUR:FREQ:CHAN:BAND BAND40
Initial S/W Revision	A.11.50

BAND 41

Selects BAND 41 as the band for the current step.

Key Path	Source, Frequency, Radio Setup, Radio Standard, LTE TDD
Example	:SOUR:FREQ:CHAN:BAND BAND41
Initial S/W Revision	A.11.50

BAND 42

Selects BAND 42 as the band for the current step.

Key Path	Source, Frequency, Radio Setup, Radio Standard, LTE TDD
Example	:SOUR:FREQ:CHAN:BAND BAND42
Initial S/W Revision	A.11.50

BAND 43

Selects BAND 43 as the band for the current step.

Key Path	Source, Frequency, Radio Setup, Radio Standard, LTE TDD
Example	:SOUR:FREQ:CHAN:BAND BAND43
Initial S/W Revision	A.11.50

BAND 44

Selects BAND 44 as the band for the current step.

Key Path	Source, Frequency, Radio Setup, Radio Standard, LTE TDD
Example	:SOUR:FREQ:CHAN:BAND BAND44
Initial S/W Revision	A.14.00

TDSCDMA

Sets TDSCDMA as the radio standard for use and accesses the TDSCDMA specific channel band sub-menus..

Key Path	Source, Frequency, Radio Setup, Radio Standard
Initial S/W Revision	A.11.50

BAND A

Selects BAND A as the band for the current step.

Key Path	Source, Frequency, Radio Setup, Radio Standard, TDSCDMA
Example	:SOUR:FREQ:CHAN:BAND BANDA
Initial S/W Revision	A.11.50

BAND B

Selects BAND B as the band for the current step.

Key Path	Source, Frequency, Radio Setup, Radio Standard, TDSCDMA
Example	:SOUR:FREQ:CHAN:BAND BANDB
Initial S/W Revision	A.11.50

BAND C

Selects BAND C as the band for the current step.

Key Path	Source, Frequency, Radio Setup, Radio Standard, TDSCDMA
Example	:SOUR:FREQ:CHAN:BAND BANDC
Initial S/W Revision	A.11.50

BAND D

Selects BAND D as the band for the current step.

Key Path	Source, Frequency, Radio Setup, Radio Standard, TDSCDMA
Example	:SOUR:FREQ:CHAN:BAND BANDD
Initial S/W Revision	A.11.50

BAND E

Selects BAND E as the band for the current step.

Key Path	Source, Frequency, Radio Setup, Radio Standard, TDSCDMA
----------	---

Example	:SOUR:FREQ:CHAN:BAND BANDE
Initial S/W Revision	A.11.50

BAND F

Selects BAND F as the band for the current step.

Key Path	Source, Frequency, Radio Setup, Radio Standard, TDSCDMA
Example	:SOUR:FREQ:CHAN:BAND BANDF
Initial S/W Revision	A.11.50

Radio Band Link

Allows you to specify the channel band type as either uplink or downlink link direction. This value is used in conjunction with the channel band and channel number to determine the absolute frequency output by the source. When set to “Uplink”, the source will calculate the uplink frequency using an uplink formula together with the selected channel band and channel number . When set to “Downlink”, the source will calculate the downlink frequency using a downlink formula together with the selected channel band and channel number.

Key Path	Source, Frequency, Radio Setup
Remote Command	:SOURce:RADio:BAND:LINK DOWN UP :SOURce:RADio:BAND:LINK?
Example	:SOUR:RAD:BAND:LINK UP
Preset	DOWN
Range	DOWN UP
Backwards Compatibility SCPI	:SOURce:RADio:DEVIce BTS MS :SOURce:RADio:DEVIce?
Backwards Compatibility Notes	BTS maps to the Downlink frequency MS maps to the Uplink frequency
Initial S/W Revision	A.05.00

Set Reference Frequency

This key allows you to set the frequency reference. Pressing this key turns the frequency reference state to ON, sets the reference frequency value to the current frequency, maintains this frequency at the RF output, and sets the displayed frequency to 0.00 Hz. All subsequent frequencies entered under Source>Frequency>Frequency are interpreted as being relative to this reference frequency.

When you use a frequency reference, the signal generator outputs a frequency that is set relative to the reference frequency by the value entered under Source>Frequency>Frequency as follows:

$$\text{Output frequency} = \text{reference frequency} - \text{entered frequency}$$

Where:

reference frequency equals the original RF frequency entered under Source>Frequency>Frequency and set as the reference frequency

entered frequency equals a new value entered under Source>Frequency>Frequency

In addition, the displayed frequency value will be the same as the value entered under Source>Frequency>Frequency.

NOTE

If Freq Reference is set to ON with a reference value set, entering a value under Source>Frequency>Frequency and pressing Set Frequency Reference will add that value to the existing Freq Reference value.

If you wish to change the reference frequency value to the new value entered under Source>Frequency>Frequency, first you must set Freq Reference to OFF and then press Set Frequency Reference.

Key Path	Source, Frequency
Remote Command	:SOURce:FREQuency:REFeRence:SET
Example	:SOUR:FREQ:REF:SET
Dependencies	This setting is unavailable, and is grayed out when the List Sequencer is turned ON.
Initial S/W Revision	A.05.00

Freq Reference

This key allows you to toggle the state of the frequency reference. When the frequency reference state is ON, an annunciator is displayed on the main source view to indicate this state to the user.

When you use a frequency reference, the signal generator outputs a frequency that is set relative to the reference frequency by the value entered under Source>Frequency>Frequency as follows:

Output frequency = reference frequency + entered frequency

Where:

reference frequency equals the original RF frequency entered under Source>Frequency>Frequency and set as the reference frequency

entered frequency equals a new value entered under Source>Frequency>Frequency

For more information on Reference Frequency refer to ["Set Reference Frequency" on page 2473](#)

Key Path	Source, Frequency
Remote Command	:SOURce:FREQuency:REFeRence <freq> :SOURce:FREQuency:REFeRence? :SOURce:FREQuency:REFeRence:STATe OFF ON 0 1 :SOURce:FREQuency:REFeRence:STATe?
Example	:SOUR:FREQ:REF 0.00 Hz

	:SOUR:FREQ:REF:STATe ON
Dependencies	This setting is unavailable, and is grayed out when the List Sequencer is turned ON.
Couplings	The frequency reference state is coupled to the frequency reference set immediate action. When the reference set immediate action key is pressed, or the SCPI command issued, it turns the frequency reference state ON.
Preset	0.00 Hz OFF
Min	0.00 Hz
Max	Hardware Dependant: Option 503 = 3.6 GHz Option 504 = 3.8 GHz Option 506 = 6.00 GHz
Initial S/W Revision	A.05.00

Freq Offset

Allows you to specify the frequency offset value. When the frequency offset state is ON, an annunciator is displayed on the main source view to indicate this state to the user.

When the frequency offset is set to zero (0) and you set a new offset value, the displayed frequency value will change as follows and the RF output frequency will not change:

Displayed value = output frequency + offset value

Where:

output frequency equals the original frequency entered under Source>Frequency>Frequency

offset value equals the value entered under Source>Frequency>Freq Offset

When the frequency offset is set to a value other than zero (0) and you enter a new frequency value under Source>Frequency>Frequency, the displayed frequency will be the same as the value entered and the RF output frequency will be equal to the value entered minus the offset value as follows:

Output frequency = entered frequency – offset frequency

Displayed frequency = output frequency + offset frequency

Displayed frequency = entered frequency

Where:

entered frequency equals the frequency entered under Source>Frequency>Frequency

offset frequency equals the value previously entered and set under Source>Frequency>Freq Offset

Key Path	Source, Frequency
Remote Command	:SOURce:FREQuency:OFFSet <freq>

	:SOURce:FREQuency:OFFSet?
Example	:SOUR:FREQ:OFFS 0 Hz
Dependencies	This setting is unavailable, and is grayed out when the List Sequencer is turned ON.
Preset	0 Hz
Min	-100.00 GHz
Max	100.00 GHz
Initial S/W Revision	A.05.00

Modulation Setup

Allows access to the menus for setting up the available modulation types: "ARB" on page 2476, "AM" on page 2517, "FM" on page 2518, and "PM" on page 2519.

Key Path	Source
Initial S/W Revision	A.05.00

ARB

Allows you access to the ARB sub-menus.

Key Path	Source, Modulation Setup
Initial S/W Revision	A.05.00

ARB

Allows you to toggle the state of the ARB function. When the ARB is On, a "MOD" annunciator is displayed in the system settings panel. When the ARB is turned Off, the MOD annunciator is cleared

Key Path	Source, Modulation Setup, ARB
Remote Command	:SOURce:RADio:ARB[:STATe] ON OFF 1 0 :SOURce:RADio:ARB[:STATe]?
Example	:SOUR:RAD:ARB OFF :SOUR:RAD:ARB?
Notes	If the ARB is ON, a user then loads or deletes another file to ARB memory, the playing waveform segment may not keep phase continuity during the ARB memory operation. The waveform will be replayed after the ARB operation is finished.
Dependencies	This setting is for independent mode and has no effect on 3.3.8 list sequencer mode. Setting "Sequencer" on page 2521 Sequencer to On will put source enter list sequencer mode, and even if ARB state is On, the ARB file will not be played. Setting "Sequencer" on page 2521 Sequencer to Off will make source leave list sequencer mode, and this setting will take effect immediately.

The ARB can only be turned on when there is a waveform file selected for playback. On the GUI if no waveform is selected, this key is grayed out. If you send the SCPI command to turn the ARB on with no waveform selected for playback, the ARB state remains OFF and an error is generated. “-

When you try to recall a certain set of states in which the selected waveform is not in ARB memory and the ARB state is On, errors are reported

Preset	Off
Range	On Off
Initial S/W Revision	A.05.00

Select Waveform

Allows you to access to the waveform selection sub-menus.

Pressing this key changes the central view area to show the Waveform File Selection view.

Key Path	Source, Modulation Setup, ARB
Initial S/W Revision	A.05.00

Select Waveform

Allows you to select a waveform sequence or segment for the dual ARB to play.

NOTE: Selecting a waveform file does not result in automatic adjustments to burst timing (to compensate for the presence or absence of a Multiport Adapter); that adjustment occurs only when a waveform is loaded to ARB memory. See "Load Segment to ARB Memory" for more information about this adjustment.

Key Path	Source, Modulation Setup, ARB, Select Waveform
Remote Command	:SOURce:RADio:ARB:WAVeform <string> :SOURce:RADio:ARB:WAVeform?

Example :SOUR:RAD:ARB:WAV "test_waveform.bin"

Notes

If intended waveform is not in the memory yet, then issuing this command by SCPI will invoke ARB loading operation first, which involves a delay of unpredictable length. So this command should be followed by the query *OPC?, which holds off subsequent commands until the loading operating is complete.

<string> - specifies the name of the waveform segment or waveform sequence to be played by the ARB.

When in Sequence Analyzer mode, and Include Source is Yes, if the you attempt to play a waveform sequence but not all the required waveform segments are in the ARB playback memory, the application will reject the loading operation with an error is generated .

When Include Source is No, if you attempt to play a waveform sequence but not all the required waveform segments are contained in the ARB playback memory, the application will attempt to load the required segments from either the default directory of the current directory. If the ARB memory does not have enough space for all the waveform segments to be loaded, an error is generated and

none of the waveform segments is loaded.

If the ARB is ON, and you attempt to play a waveform sequence but not all the waveform segments within the sequence could be found to be loaded into ARB memory, an error is generated. The selected waveform keeps the previous value and ARB state remains On.

If you specify a waveform segment over SCPI but the waveform segment is not present within ARB playback memory and cannot be found for auto loading within the current directory or the default directory, an error is generated and the file selection remains unchanged.

If you select a waveform for playback and the waveform requires a license that is not installed on the instrument, an error is generated.

If the ARB is ON and you load a file to ARB memory or delete a file from ARB memory, the playing waveform segment may not keep phase continuity during the ARB memory operation. The waveform will be replayed after the ARB operation is finished.

Initial S/W Revision	A.05.00
----------------------	---------

Segments on Hard Disk

Allows you access to the sub-menus for loading waveform segments from the hard disk into ARB memory. The default directory is: D: varb.

Pressing this key changes the current view to the Waveform Management View.

Key Path	Source, Modulation Setup, ARB, Select Waveform
----------	--

Initial S/W Revision	A.05.00
----------------------	---------

Load Segment To ARB Memory

Allows you to load the selected file into ARB memory. On the front panel you select the file for loading to the ARB memory by highlighting the desired file in the list. Using the SCPI command, you specify the file name on the HDD.

“NVWFM” (non-volatile storage) MSUS (Mass Storage Unit Specifier) is supported in the memory subsystem because the ARB memory cannot be accessed directly. Therefore, files must be downloaded to the instrument hard disk and then loaded into the ARB memory. “NVWFM” MSUS will be mapped to the default directory D: VARB. The SCPI command supports using either “NVWFM” MSUS or specifying a full path. For more information, see [Memory Subsystem \(Remote Command Only\)](#).

If a file of the same name already exists within ARB memory, it is overwritten. If you wish to load two segments of the same name, you must rename one of the segments before loading it into ARB memory. To rename a segment, you can either use Windows File Explorer, or the :MMEMory:COPY command.

NOTE: When a waveform file is loaded to ARB memory, burst timing adjustments are made automatically, based on whether or not a Multiport Adapter is connected to the test set and powered on. If the connection/power status of the Multiport Adapter is changed after a waveform file has been loaded, it needs to be loaded again.

Key Path	Source, Modulation Setup, ARB, Select Waveform, Segments on Hard Disk
----------	---

Remote Command	:SOURce:RADio:ARB:LOAD <string>
Example	:SOUR:RAD:ARB:LOAD "D: VARB\testwaveform.bin" or :SOUR:RAD:ARB:LOAD "NVWFM:testwaveform.bin"
Notes	<p>Because loading the file involves a delay of unpredictable length, this command should be followed by the query *OPC?, which holds off subsequent commands until the loading operating is complete.</p> <p><string> – specifies the path name of the file to load from the HDD into ARB memory. It could be a <full path + filename>, or <"NVWFM" MSUS + colon + filename>.</p> <p>When in Sequence Analyzer mode, and Include Source is Yes, an attempt to load a file to ARB memory will be rejected with an error.</p> <p>When Include Source is No and if there is insufficient free ARB memory to load the selected waveform, an error is generated. .</p> <p>If you specify a file over SCPI, but the file is not at the specified location, an error is generated.</p> <p>If you try to load a waveform file but the file contains less than 500 IQ samples, an error is generated.</p> <p>If you try to load a Signal Studio waveform "*.wfm" which contains invalid waveform header, an error is generated.</p> <p>If the ARB is ON when you load a file to ARB memory or delete a file from ARB memory, the playing waveform segment may not keep phase continuity during the ARB memory operation. The waveform will be replayed after the ARB operation is finished.</p> <p>ARB can be loaded into ARB memory even required licenses do not present on the instrument. In this case, a GUI only warning message –800, "Operation complete; Loaded <filename> successfully, but no license <required licenses> installed". User can install required licenses according to <required licenses> string to license it, or multi-pack license it.</p>
Initial S/W Revision	A.05.00

Load All To ARB Memory

Allows you to load all the segment files within the currently selected directory into ARB memory. If a file of the same name already exists within ARB memory, it is overwritten. If you wish to load two segments of the same name, you must rename one of the segments before loading it into ARB memory. To rename a segment, you can either use Windows File Explorer, or the :MEMory:COPY command.

NOTE: When a waveform file is loaded to ARB memory, burst timing adjustments are made automatically, based on whether or not a Multiport Adapter is connected to the test set and powered on. If the connection/power status of the Multiport Adapter is changed after a waveform file has been loaded, it needs to be loaded again.

Key Path	Source, Modulation Setup, ARB, Select Waveform, Segments on Hard Disk
Remote Command	:SOURce:RADio:ARB:LOAD:ALL <string>
Example	:SOUR:RAD:ARB:LOAD:ALL "D: varb"
Notes	<p><string> - specifies the directory on the HDD to load the files into ARB memory from.</p> <p>When in Sequence Analyzer mode, and Include Source is Yes, an attempt to load all files from a directory to ARB memory is rejected with an error.</p> <p>When Include Source is No and there is insufficient free ARB memory to load all the waveforms,</p>

when the ARB memory is full, the copy ceases, and an error is generated.
 If you specify a directory over SCPI, but the directory does not exist, an error is generated.
 If the ARB is ON, a user then loads or deletes file to ARB memory, the playing waveform segment may not keep phase continuity during the ARB memory operation. The waveform will be replayed after the ARB operation is finished.

Initial S/W Revision	A.05.00
----------------------	---------

Change Directory...

Allows you to change the currently selected directory on the hard disk. Pressing this key opens a standard windows change directory dialog allowing you to select the new directory of interest.

The current directory is used for manually loading waveform segments into ARB memory for playback, and as a search location for waveform segments that are required to be loaded into ARB memory for playback of a waveform sequence or a list sequence.

Key Path	Source, Modulation Setup, ARB, Select Waveform, Segments on Hard Disk
Notes	No remote command, SCPI front panel only.
Initial S/W Revision	A.05.00

Default Directory...

Allows you to change the default directory. It is used as a search location for waveform segments that are required to be loaded into ARB memory for playback of a waveform sequence, and as a search location for selecting waveforms using SCPI.

Key Path	Source, Modulation Setup, ARB, Select Waveform, Segments on Hard Disk
Remote Command	:SOURce:RADio:ARB:DEFault:DIRectory <string> :SOURce:RADio:ARB: DEFault:DIRectory?
Example	:SOUR:RAD:ARB:DEF:DIR "D:\ArbFiles" :SOUR:RAD:ARB:DEF:DIR?
State Saved	Persistent, survives a power cycle and a preset but not saved in the instrument state
Initial S/W Revision	A.05.00

Segments in ARB Memory

Allows you access to the sub-menus for managing the files within ARB memory.

Key Path	Source, Modulation Setup, ARB, Select Waveform
Initial S/W Revision	A.05.00

Delete Segment From ARB Mem

Allows you to remove a segment from ARB playback memory.

Key Path	Source, Modulation Setup, ARB, Select Waveform, Segments in ARB Memory
Remote Command	:SOURce:RADio:ARB:DELeTe <string>
Example	:SOUR:RAD:ARB:DEL "testwaveform.bin"
Notes	<p><string> - specifies the waveform to be deleted from the ARB playback memory.</p> <p>When in Sequence Analyzer mode and Include Source is Yes, an attempt to delete a file from ARB memory is rejected with an error.</p> <p>When Include Source is No and you specify a file that does not exist within ARB memory, an error is generated.</p> <p>It is possible to delete files from within the ARB memory when the ARB is ON. However, if you attempt to delete the file that is currently playing an error is generated.</p> <p>It is possible to delete a file from within the ARB memory when the sequencer state is ON and the file is not being used by the List Sequencer. If you attempt to delete a file which is being used by the list sequencer, an error is generated.</p> <p>When sequencer state is On, even if ARB state is On, the selected waveform will not be played. In this case, if the selected waveform is not used in List Sequence, it can be deleted and the ARB state is turned Off.</p> <p>If the ARB is ON and you load a file to ARB memory or delete a file from ARB memory, the playing waveform segment may not keep phase continuity during the ARB memory operation. The waveform will be replayed after the ARB operation is finished.</p>
Initial S/W Revision	A.05.00

Delete All From ARB Memory

Allows you to remove all segments from ARB playback memory.

Key Path	Source, Modulation Setup, ARB, Select Waveform, Segments in ARB Memory
Remote Command	:SOURce:RADio:ARB:DELeTe:ALL
Example	:SOUR:RAD:ARB:DELeTe:ALL
Notes	<p>When in Sequence Analyzer mode and Include Source is Yes, an attempt to delete all files from ARB memory is rejected with an error.</p> <p>When Include Source is No and you attempt to delete all files from ARB memory when the ARB is currently playing a file, all files except the one playing are deleted and an error is generated.</p> <p>If you attempt to delete all files from ARB memory when there are waveform files used in "List Sequencer" on page 2520 and "Sequencer" on page 2521 state is ON, all files except the files currently being used in list sequencer are deleted, and an error is generated.</p> <p>If the ARB is ON and you load a file to ARB memory or delete a file from ARB memory, the playing waveform segment may not keep phase continuity during the ARB memory operation. The waveform will be replayed after the ARB operation is finished.</p>
Initial S/W Revision	A.05.00

Query ARB Memory File List (Remote Command Only)

Queries the test set for the list of waveform segments in the ARB memory.

NOTE

This command returns a string for waveform segment names in ARB memory. If you want a string list of waveform segments in the ARB memory, use "[Query ARB Memory Full File List \(Remote Command Only\)](#)" on page 2482.

Remote Command	:SOURce:RADio:ARB:CATalog?
Example	:SOUR:RAD:ARB:CATalog?
Notes	The return data is in the following format: <integer> - memory used <integer> - memory free <string> ... - comma separated list of waveform segments within ARB memory
Initial S/W Revision	A.05.00

Query ARB Memory Full File List (Remote Command Only)

Queries the test set for the string list of waveform segments in the ARB memory. It returns a string list for waveform segment names in the ARB memory.

Remote Command	:SOURce:RADio:ARB:FCATalog?
Example	:SOUR:RAD:ARB:FCATalog?
Notes	The return data is in the following format: <integer> - memory used <integer> - memory free <integer> - file count in ARB memory <string>,<string>, ... <string> - comma separated string list of waveform segments within ARB memory Example: SOUR:RAD:ARB:FCAT? EXT returns: 27499,2069653,3,"c2k.wfm","gsm.wfm","wcdma.wfm"
Initial S/W Revision	A.09.00

ARB Setup

Allows access to the ARB setup sub-menus.

Key Path	Source, Modulation Setup, ARB
Initial S/W Revision	A.05.00

Sample Rate

Allows you to set the ARB waveform playback sample rate.

Key Path	Source, Modulation Setup, ARB, ARB Setup
Remote Command	:SOURce:RADio:ARB:SCLock:RATE <freq> :SOURce:RADio:ARB:SCLock:RATE?
Example	:SOUR:RAD:ARB:SCL:RATE 48.00 MHz
Notes	If there is a sample rate specified in the header of the waveform file, changing that sample rate is not recommended, as it may cause problems with burst timing.
Dependencies	When a new waveform is selected for playback the settings contained within the associated waveform header file are applied to the ARB. The sample rate is one of the values stored within the header file. If the newly selected waveform file has an associated header file, the sample rate is updated with the value from the header file. The sample rate will remain unchanged if the newly selected waveform does not have an associated header file.
Preset	125.00 MHz
Min	1.00 kHz
Max	125.00 MHz
Initial S/W Revision	A.05.00

Run-Time Scaling

Allows you to adjust the run-time scaling value. The run-time scaling value is applied in real-time while the waveform is playing.

Key Path	Source, Modulation Setup, ARB, ARB Setup
Remote Command	:SOURce:RADio:ARB:RSCaling <real> :SOURce:RADio:ARB:RSCaling?
Example	:SOUR:RAD:ARB:RSC 100.00
Notes	This setting cannot be set in E6640A. Grey out on menu and the value is fixed at 70.00%.
Dependencies	When a new waveform is selected for playback the settings contained within the associated waveform header file are applied to the ARB. The run-time scaling is one of the values stored within the header file. If the newly selected waveform file has an associated header file, the run-time scaling is updated with the value from the header file. The run-time scaling will remain unchanged if the newly selected waveform does not have an associated header file.
Preset	70.00 %
Min	1.00 %
Max	100.00 %
Initial S/W Revision	A.05.00

Baseband Freq Offset

Allows you to adjust the value by which the baseband frequency is offset relative to the carrier.

Key Path	Source, Modulation Setup, ARB, ARB Setup
Remote Command	:SOURce:RADio:ARB:BASEband:FREQuency:OFFSet <freq> :SOURce:RADio:ARB:BASEband:FREQuency:OFFSet?
Example	:SOUR:RAD:ARB:BAS:FREQ:OFFS 0.00 Hz
Dependencies	When a new waveform is selected for playback the settings contained within the associated waveform header file are applied to the ARB. The baseband frequency offset is one of the values stored within the header file. If the newly selected waveform has an associated header file, the baseband frequency offset is updated with the value from the header file. The baseband frequency offset will remain unchanged if the newly selected waveform does not have an associated header file.
Preset	0.00 Hz
Min	-50.00 MHz
Max	50.00 MHz
Initial S/W Revision	A.05.00

Trigger Type

Allows access to the trigger type sub-menus. The setting for trigger type determines the behavior of the waveform when it plays.

Key Path	Source, Modulation Setup, ARB
Remote Command	:SOURce:RADio:ARB:TRIGger:TYPE CONTInuous SINGLE SADVance GATE :SOURce:RADio:ARB:TRIGger:TYPE?
Example	:SOUR:RAD:ARB:TRIG:TYPE CONT :SOUR:RAD:ARB:TRIG:TYPE?
Notes	Gated trigger type will be implemented at a later release
Preset	CONTInuous
Range	Continuous Single Seg Adv Gated
Initial S/W Revision	A.05.00

Continuous

Sets the active trigger type to Continuous. If Continuous is already selected as the active trigger type, pressing this key allows access to the continuous trigger type setup menu. In Continuous trigger mode, the waveform repeats continuously.

Key Path	Source, Modulation Setup, ARB, Trigger Type
Remote Command	:SOURce:RADio:ARB:TRIGger:TYPE:CONTInuous[:TYPE] FREE TRIGger RESet :SOURce:RADio:ARB:TRIGger:TYPE:CONTInuous[:TYPE]?
Example	:SOUR:RAD:ARB:TRIG:TYPE:CONT FREE
Preset	FREE

Range	Free Run Trigger + Run Reset + Run
Initial S/W Revision	A.05.00

Free Run

Selects Free Run as the trigger response for the continuous trigger type. Free Run sets the waveform generator to play a waveform sequence or segment continuously, without waiting for a trigger. In this mode, the waveform generator does not respond to triggers.

Key Path	Source, Modulation Setup, ARB, Trigger Type, Continuous
Example	:SOUR:RAD:ARB:TRIG:TYPE:CONT FREE
Initial S/W Revision	A.05.00

Trigger + Run

Sets Trigger and Run as the trigger response for the continuous trigger type. Trigger and Run sets the waveform generator to play a waveform sequence or segment continuously when the first trigger is received, and to ignore any subsequent triggers.

Key Path	Source, Modulation Setup, ARB, Trigger Type, Continuous
Example	:SOUR:RAD:ARB:TRIG:TYPE:CONT TRIG
Initial S/W Revision	A.05.00

Reset + Run

Sets Reset and Run as the trigger response for the continuous trigger type. Reset and Run sets the waveform generator to play a waveform sequence or segment continuously when the first trigger is received. Subsequent triggers reset the waveform sequence or segment to the start, and then play it continuously.

Key Path	Source, Modulation Setup, ARB, Trigger Type, Continuous
Example	:SOUR:RAD:ARB:TRIG:TYPE:CONT RES
Initial S/W Revision	A.05.00

Single

Sets the active trigger type to Single. If Single is already selected as the active trigger type, pressing this key allows access to the single trigger type setup menu. In Single trigger mode, the waveform plays once.

Key Path	Source, Modulation Setup, ARB, Trigger Type
Remote Command	:SOURce:RADio:ARB:RETRigger ON OFF IMMediate

	:SOURce:RADio:ARB:RETRigger?
Example	:SOUR:RAD:ARB:RETR OFF
Notes	ON: Buffered Trigger OFF: No Retrigger Immediate: Restart on Trigger This is defined as an enumerated SCPI command, with ON OFF being considered as enumerated types rather than Boolean. This means the query will return OFF instead of 0, and ON instead of 1.
Preset	ON
Range	No Retrigger Buffered Trigger Restart on Trigger
Initial S/W Revision	A.05.00

No Retrigger

Selects No Retrigger as the trigger response for single trigger type. No Retrigger sets the waveform generator to play a waveform sequence or segment once when a trigger is received. Any triggers then received during playback are ignored.

Key Path	Source, Modulation Setup, ARB, Trigger Type, Single
Example	:SOUR:RAD:ARB:RETR OFF
Initial S/W Revision	A.05.00

Buffered Trigger

Selects Buffered Trigger as the trigger response for single trigger type. Buffered Trigger sets the waveform generator to play a waveform sequence or segment once when a trigger is received. If a trigger is received during playback, the waveform generator plays the sequence or segment to the end, then plays the sequence or segment once more.

Key Path	Source, Modulation Setup, ARB, Trigger Type, Single
Example	:SOUR:RAD:ARB:RETR ON
Initial S/W Revision	A.05.00

Restart on Trigger

Selects Restart on Trigger as the trigger response for single trigger type. Restart on Trigger sets the waveform generator to play a waveform sequence or segment once when a trigger is received. If a trigger is received during playback, the waveform generator resets and plays the sequence or segment from the start.

Key Path	Source, Modulation Setup, ARB, Trigger Type, Single
Example	:SOUR:RAD:ARB:RETR IMM
Initial S/W Revision	A.05.00

Segment Advance

Sets the active trigger type to Segment Advance. If Segment Advance is already selected as the active trigger type, pressing this key allows access to the segment advance trigger type setup menu.

Segment Advance triggering allows you to control the playback of waveform segments within a waveform sequence. When a trigger is received the ARB advances to the next waveform segment within the waveform sequence. This type of triggering ignores the repetition count for the waveform segment within the waveform sequence. For example, if a waveform segment has a repetition count of 10 and you select single segment advance triggering mode, the waveform segment will only play once.

Segment Advance triggering can also be used for waveform segments only. In this situation the same waveform segment is played again when a trigger is received.

Key Path	Source, Modulation Setup, ARB, Trigger Type
Remote Command	:SOURce:RADio:ARB:TRIGger:TYPE:SADVance[:TYPE] SINGLE CONTInuous :SOURce:RADio:ARB:TRIGger:TYPE:SADVance[:TYPE]?
Example	:SOUR:RAD:ARB:TRIG:TYPE:SADV SING
Preset	CONTInuous
Range	Single Continuous
Initial S/W Revision	A.05.00

Single

Selects Single as the trigger response for Segment Advance trigger type. With single selected, once a trigger is received a segment is played once. If a trigger is received during playback of a segment, the segment plays to completion and the next segment is played once.

Key Path	Source, Modulation Setup, ARB, Trigger Type, Segment Advance
Example	:SOUR:RAD:ARB:TRIG:TYPE:SADV SING
Initial S/W Revision	A.05.00

Continuous

Selects Continuous as the trigger response for Segment Advance trigger type. With continuous selected, once a trigger is received a segment is played continuously. When subsequent triggers are received, the currently playing segment plays to completion and then the next segment is played continuously.

Key Path	Source, Modulation Setup, ARB, Trigger Type, Segment Advance
Example	:SOUR:RAD:ARB:TRIG:TYPE:SADV CONT
Initial S/W Revision	A.05.00

Trigger Source

Allows access to the trigger source sub-menus. The trigger source setting determines how the source receives the trigger that starts the waveform playing. Therefore, this key is grayed out if the trigger type is free run, since free run triggers immediately with no trigger source required.

Key Path	Source, Modulation Setup, ARB
Remote Command	:SOURce:RADio:ARB:TRIGger[:SOURce] KEY BUS EXTernal2 :SOURce:RADio:ARB:TRIGger[:SOURce]?
Example	:SOUR:RAD:ARB:TRIGger KEY
Dependencies	This key is grayed out if the current trigger type is Continuous, Free Run.
Preset	EXTernal2
Range	Trigger Key Bus External 2
Initial S/W Revision	A.05.00

Trigger Key

Sets the current trigger source to the front panel Trigger key. When Trigger Key is selected, the waveform is triggered when you press the front panel Trigger key.

Key Path	Source, Modulation Setup, ARB, Trigger Source
Example	:SOUR:RAD:ARB:TRIGger KEY
Initial S/W Revision	A.05.00

Bus

Sets the current trigger source to Bus. Selecting Bus trigger source enables triggering over GPIB, LAN, or USB using the :SOURce:RADio:ARB:TRIGger:INITiate command.

Key Path	Source, Modulation Setup, ARB, Trigger Source
Example	:SOUR:RAD:ARB:TRIGger BUS
Initial S/W Revision	A.05.00

External 2

Sets the current trigger source to External 2. Selecting External 2 enables triggering a waveform by an externally applied signal.

Key Path	Source, Modulation Setup, ARB, Trigger Source
Example	:SOUR:RAD:ARB:TRIGger EXT2
Notes	Note: When on E6640A, trigger 2 is a bi-directional trigger port. So when trigger 2 has been configured as OUTPUT type, choosing External 2 as the input trigger for the current step will generate error.
Initial S/W Revision	A.05.00

Trigger Initiate

Used to initiate an immediate trigger event if the trigger source is set to Trigger Key.

Key Path	Source, Modulation Setup, ARB
Notes	No remote command, SCPI front panel only.
Initial S/W Revision	A.05.00

Waveform Sequences

Allows access to the waveform sequence sub-menus. Pressing this key changes the central view area to display the Waveform Sequence List view.

Key Path	Source, Modulation Setup, ARB
Notes	No remote command, SCPI front panel only.
Initial S/W Revision	A.05.00

Build New Sequence

Allows access to the sub-menus for creating a new waveform sequence. Pressing this key changes the central view area to display the Waveform Sequence Creation and Editing view.

Key Path	Source, Modulation Setup, ARB, Waveform Sequences
Notes	No remote command, SCPI front panel only.
Initial S/W Revision	A.05.00

Current Segment

Specifies the selected sequence segment that will be affected by the menu functions.

Key Path	Source, Modulation Setup, ARB, Waveform Sequences, Build New Sequence
Notes	No remote command, SCPI front panel only. This key is grayed out and unavailable if the sequence is currently empty.
Initial S/W Revision	A.05.00

Insert New Waveform

Allows you access to the sub-menu for inserting a new waveform segment or sequence. Pressing this key also changes the central display to show the Waveform File Selection View.

Key Path	Source, Modulation Setup, ARB, Waveform Sequences, Build New Sequence
Notes	No remote command, SCPIfront panel only. Waveform segment name string length upper limit is 128 chars. Please do NOT insert waveform which name string exceeds 128 chars.
Initial S/W Revision	A.05.00

Insert Waveform

Inserts the currently highlighted waveform to the end of the waveform sequence. Pressing this key also returns you to the menus for creating or editing a sequence, and returns the central view to the sequence creation view.

Key Path	Source, Modulation Setup, ARB, Waveform Sequences, Build New Sequence, Insert New Waveform
Notes	No remote command, SCPIfront panel only. Waveform segment name string length upper limit is 128 chars. Please do NOT insert waveform which name string exceeds 128 chars.
Initial S/W Revision	A.05.00

Segments on Hard Disk

Allows you access to the sub-menus for loading waveform segments from the hard disk into ARB memory. The default directory is: D: varb.

Pressing this key changes the current view to the Waveform Management View.

Key Path	Source, Modulation Setup, ARB, Select Waveform
Initial S/W Revision	A.05.00

Load Segment To ARB Memory

Allows you to load the selected file into ARB memory. On the front panel you select the file for loading to the ARB memory by highlighting the desired file in the list. Using the SCPI command, you specify the file name on the HDD.

“NVWFM” (none-volatile storage) MSUS (Mass Storage Unit Specifier) is supported in the memory subsystem because the ARB memory cannot be accessed directly. Therefore, files must be downloaded to the instrument hard disk and then loaded into the ARB memory. “NVWFM” MSUS will be mapped to the default directory D: VARB. The SCPI command supports using either “NVWFM” MSUS or specifying a full path. For more information, see [Memory Subsystem \(Remote Command Only\)](#).

If a file of the same name already exists within ARB memory, it is overwritten. If you wish to load two segments of the same name, you must rename one of the segments before loading it into ARB memory. To rename a segment, you can either use Windows File Explorer, or the :MMEMORY:COPY command.

NOTE: When a waveform file is loaded to ARB memory, burst timing adjustments are made automatically, based on whether or not a Multiport Adapter is connected to the test set and powered on. If the connection/power status of the Multiport Adapter is changed after a waveform file has been loaded, it needs to be loaded again.

Key Path	Source, Modulation Setup, ARB, Select Waveform, Segments on Hard Disk
Remote Command	:SOURce:RADio:ARB:LOAD <string>
Example	:SOUR:RAD:ARB:LOAD "D: VARB\testwaveform.bin" or :SOUR:RAD:ARB:LOAD "NVWFM:testwaveform.bin"
Notes	<p>Because loading the file involves a delay of unpredictable length, this command should be followed by the query *OPC?, which holds off subsequent commands until the loading operating is complete.</p> <p><string> – specifies the path name of the file to load from the HDD into ARB memory. It could be a <full path + filename>, or <"NVWFM" MSUS + colon + filename>.</p> <p>When in Sequence Analyzer mode, and Include Source is Yes, an attempt to load a file to ARB memory will be rejected with an error.</p> <p>When Include Source is No and if there is insufficient free ARB memory to load the selected waveform, an error is generated. .</p> <p>If you specify a file over SCPI, but the file is not at the specified location, an error is generated.</p> <p>If you try to load a waveform file but the file contains less than 500 IQ samples, an error is generated.</p> <p>If you try to load a Signal Studio waveform "*.wfm" which contains invalid waveform header, an error is generated.</p> <p>If the ARB is ON when you load a file to ARB memory or delete a file from ARB memory, the playing waveform segment may not keep phase continuity during the ARB memory operation. The waveform will be replayed after the ARB operation is finished.</p> <p>ARB can be loaded into ARB memory even required licenses do not present on the instrument. In this case, a GUI only warning message –800, "Operation complete; Loaded <filename> successfully, but no license <required licenses> installed". User can install required licenses according to <required licenses> string to license it, or multi-pack license it.</p>
Initial S/W Revision	A.05.00

Load All To ARB Memory

Allows you to load all the segment files within the currently selected directory into ARB memory. If a file of the same name already exists within ARB memory, it is overwritten. If you wish to load two segments of the same name, you must rename one of the segments before loading it into ARB memory. To rename a segment, you can either use Windows File Explorer, or the :MEMory:COpy command.

NOTE: When a waveform file is loaded to ARB memory, burst timing adjustments are made automatically, based on whether or not a Multiport Adapter is connected to the test set and powered on. If the connection/power status of the Multiport Adapter is changed after a waveform file has been loaded, it needs to be loaded again.

Key Path	Source, Modulation Setup, ARB, Select Waveform, Segments on Hard Disk
Remote Command	:SOURce:RADio:ARB:LOAD:ALL <string>

Example	:SOUR:RAD:ARB:LOAD:ALL "D: varb"
Notes	<p><string> - specifies the directory on the HDD to load the files into ARB memory from.</p> <p>When in Sequence Analyzer mode, and Include Source is Yes, an attempt to load all files from a directory to ARB memory is rejected with an error.</p> <p>When Include Source is No and there is insufficient free ARB memory to load all the waveforms, when the ARB memory is full, the copy ceases, and an error is generated.</p> <p>If you specify a directory over SCPI, but the directory does not exist, an error is generated.</p> <p>If the ARB is ON, a user then loads or deletes file to ARB memory, the playing waveform segment may not keep phase continuity during the ARB memory operation. The waveform will be replayed after the ARB operation is finished.</p>
Initial S/W Revision	A.05.00

Change Directory...

Allows you to change the currently selected directory on the hard disk. Pressing this key opens a standard windows change directory dialog allowing you to select the new directory of interest.

The current directory is used for manually loading waveform segments into ARB memory for playback, and as a search location for waveform segments that are required to be loaded into ARB memory for playback of a waveform sequence or a list sequence.

Key Path	Source, Modulation Setup, ARB, Select Waveform, Segments on Hard Disk
Notes	No remote command, SCPIfront panel only.
Initial S/W Revision	A.05.00

Default Directory...

Allows you to change the default directory. It is used as a search location for waveform segments that are required to be loaded into ARB memory for playback of a waveform sequence, and as a search location for selecting waveforms using SCPI.

Key Path	Source, Modulation Setup, ARB, Select Waveform, Segments on Hard Disk
Remote Command	:SOURce:RADio:ARB:DEFault:DIRectory <string> :SOURce:RADio:ARB: DEFault:DIRectory?
Example	:SOUR:RAD:ARB:DEF:DIR "D:\ArbFiles" :SOUR:RAD:ARB:DEF:DIR?
State Saved	Persistent, survives a power cycle and a preset but not saved in the instrument state
Initial S/W Revision	A.05.00

Segments in ARB Memory

Allows you access to the sub-menus for managing the files within ARB memory.

Key Path	Source, Modulation Setup, ARB, Select Waveform
Initial S/W Revision	A.05.00

Delete Segment From ARB Mem

Allows you to remove a segment from ARB playback memory.

Key Path	Source, Modulation Setup, ARB, Select Waveform, Segments in ARB Memory
Remote Command	:SOURce:RADio:ARB:DELeTe <string>
Example	:SOUR:RAD:ARB:DEL "testwaveform.bin"
Notes	<p><string> - specifies the waveform to be deleted from the ARB playback memory.</p> <p>When in Sequence Analyzer mode and Include Source is Yes, an attempt to delete a file from ARB memory is rejected with an error.</p> <p>When Include Source is No and you specify a file that does not exist within ARB memory, an error is generated.</p> <p>It is possible to delete files from within the ARB memory when the ARB is ON. However, if you attempt to delete the file that is currently playing an error is generated.</p> <p>It is possible to delete a file from within the ARB memory when the sequencer state is ON and the file is not being used by the List Sequencer. If you attempt to delete a file which is being used by the list sequencer, an error is generated.</p> <p>When sequencer state is On, even if ARB state is On, the selected waveform will not be played. In this case, if the selected waveform is not used in List Sequence, it can be deleted and the ARB state is turned Off.</p> <p>If the ARB is ON and you load a file to ARB memory or delete a file from ARB memory, the playing waveform segment may not keep phase continuity during the ARB memory operation. The waveform will be replayed after the ARB operation is finished.</p>
Initial S/W Revision	A.05.00

Delete All From ARB Memory

Allows you to remove all segments from ARB playback memory.

Key Path	Source, Modulation Setup, ARB, Select Waveform, Segments in ARB Memory
Remote Command	:SOURce:RADio:ARB:DELeTe:ALL
Example	:SOUR:RAD:ARB:DELeTe:ALL
Notes	<p>When in Sequence Analyzer mode and Include Source is Yes, an attempt to delete all files from ARB memory is rejected with an error.</p> <p>When Include Source is No and you attempt to delete all files from ARB memory when the ARB is currently playing a file, all files except the one playing are deleted and an error is generated.</p> <p>If you attempt to delete all files from ARB memory when there are waveform files used in "List Sequencer" on page 2520 and "Sequencer" on page 2521 state is ON, all files except the files currently being used in list sequencer are deleted, and an error is generated.</p>

If the ARB is ON and you load a file to ARB memory or delete a file from ARB memory, the playing waveform segment may not keep phase continuity during the ARB memory operation. The waveform will be replayed after the ARB operation is finished.

Initial S/W Revision	A.05.00
----------------------	---------

Segments on Hard Disk

This key functions the same as "[Segments on Hard Disk](#)" on page 2547.

Key Path	Source, Modulation Setup, ARB, Waveform Sequences, Build New Sequence, Insert New Waveform
----------	--

Initial S/W Revision	Prior to A.09.00
----------------------	------------------

Load Segment To ARB Memory

This key functions the same as "[Load Segment To ARB Memory](#)" on page 2547.

Key Path	Source, Modulation Setup, ARB, Waveform Sequences, Build New Sequence, Insert New Waveform, Segment on Hard Drive
----------	---

Initial S/W Revision	Prior to A.09.00
----------------------	------------------

Load All To ARB Memory

This key functions the same as "[Load All To ARB Memory](#)" on page 2548.

Key Path	Source, Modulation Setup, ARB, Waveform Sequences, Build New Sequence, Insert New Waveform, Segment on Hard Drive
----------	---

Initial S/W Revision	Prior to A.09.00
----------------------	------------------

Change Directory ...

This key functions the same as "[Change Directory...](#)" on page 2549.

Key Path	Source, Modulation Setup, ARB, Waveform Sequences, Build New Sequence, Insert New Waveform, Segment on Hard Drive
----------	---

Initial S/W Revision	Prior to A.09.00
----------------------	------------------

Default Directory ...

This key functions the same as "[Default Directory...](#)" on page 2549

Key Path	Source, Modulation Setup, ARB, Waveform Sequences, Build New Sequence, Insert New Waveform, Segment on Hard Drive
----------	---

Initial S/W Revision	Prior to A.09.00
----------------------	------------------

Segments in ARB Memory

This key functions the same as ["Segments in ARB Memory" on page 2549](#).

Key Path	Source, Modulation Setup, ARB, Waveform Sequences, Build New Sequence, Insert New Waveform
Initial S/W Revision	Prior to A.09.00

Delete Segment From ARB Memory

This key functions the same as ["Delete Segment From ARB Mem" on page 2549](#).

Key Path	Source, Modulation Setup, ARB, Waveform Sequences, Build New Sequence, Insert New Waveform, Segment in ARB Memory
Initial S/W Revision	Prior to A.09.00

Delete All From ARB Memory

This key functions the same as ["Delete All From ARB Memory" on page 2550](#).

Key Path	Source, Modulation Setup, ARB, Waveform Sequences, Build New Sequence, Insert New Waveform, Segment in ARB Memory
Initial S/W Revision	Prior to A.09.00

Query ARB Memory File List (Remote Command Only)

This command functions the same as ["Query ARB Memory File List \(Remote Command Only\)" on page 2482](#).

Initial S/W Revision	Prior to A.09.00
----------------------	------------------

Edit Selected Waveform

Allows access to the sub-menus for editing the details of the currently selected waveform segment.

Key Path	Source, Modulation Setup, ARB, Waveform Sequences, Build New Sequence
Notes	No remote command, front panel only.
Initial S/W Revision	A.05.00

Repetitions

Allows you to specify the number of times the currently selected waveform is played within the sequence.

Key Path	Source, Modulation Setup, ARB, Waveform Sequences, Build New Sequence, Edit Selected Waveform
Notes	No remote command, SCPI front panel only.
Preset	1
Min	1
Max	65535
Initial S/W Revision	A.05.00

Marker 1

Allows you to enable or disable marker 1 for the currently selected waveform. For a waveform sequence, you can enable and disable markers on a per-segment basis, allowing you to output markers from some waveform segments within the sequence, but not for others.

Key Path	Source, Modulation Setup, ARB, Waveform Sequences, Build New Sequence, Edit Selected Waveform
Notes	No remote command, front panel only.
Preset	Enabled
Range	Enabled Disabled
Initial S/W Revision	A.05.00

Marker 2

Allows you to enable or disable marker 2 for the currently selected waveform. For a waveform sequence, you can enable and disable markers on a per-segment basis, allowing you to output markers from some waveform segments within the sequence, but not for others.

Key Path	Source, Modulation Setup, ARB, Waveform Sequences, Build New Sequence, Edit Selected Waveform
Notes	No remote command, front panel only.
Preset	Enabled
Range	Enabled Disabled
Initial S/W Revision	A.05.00

Marker 3

Allows you to enable or disable marker 3 for the currently selected waveform. For a waveform sequence, you can enable and disable markers on a per-segment basis, allowing you to output markers from some waveform segments within the sequence, but not for others.

Key Path	Source, Modulation Setup, ARB, Waveform Sequences, Build New Sequence, Edit Selected
----------	--

	Waveform
Notes	No remote command, front panel only.
Preset	Enabled
Range	Enabled Disabled
Initial S/W Revision	A.05.00

Marker 4

Allows you to enable or disable marker 4 for the currently selected waveform. For a waveform sequence, you can enable and disable markers on a per-segment basis, allowing you to output markers from some waveform segments within the sequence, but not for others.

Key Path	Source, Modulation Setup, ARB, Waveform Sequences, Build New Sequence, Edit Selected Waveform
Notes	No remote command, front panel only.
Preset	Enabled
Range	Enabled Disabled
Initial S/W Revision	A.05.00

Delete Segment

Allows you to delete the selected segment from the waveform sequence.

Key Path	Source, Modulation Setup, ARB, Waveform Sequences, Build New Sequence
Notes	No remote command, front panel only.
Initial S/W Revision	A.05.00

Save Sequence...

Pressing this key displays the “Save As” dialog. The sequence name is passed to the save as dialog to use as the filename for saving, and the directory the save as dialog will open into is the default waveform directory.

Key Path	Source, Modulation Setup, ARB, Waveform Sequences, Build New Sequence
Initial S/W Revision	A.05.00

Build New Sequence (Remote Command Only)

This command is the SCPI equivalent of the waveform sequence creation features described in ["Build New Sequence" on page 2489](#).

This command writes a waveform sequence file to the hard disk. You must specify the waveform sequence file path and filename which will be saved on the hard disk, and the waveform segment file path and name which will be nested into the waveform sequence file. You can utilize mass storage unit specifier (MSUS) “NVWFM” or use a real full path representation. See the example below. MSUS “NVWFM” is mapped to D:VARB directory on test set hard disk.

Any number of segments, up to a segment count limit of 64, can be used to create a sequence. Repeated segments are included in the count limit.

Each waveform segment name string length upper limit is 128 chars. Please do NOT insert waveform which name string exceeds 128 chars.

The internal source does not support nesting one waveform sequence file into another waveform sequence file.

Remote Command :SOURce:RADio:ARB:SEQuence[:MWAVeform] <filename>, <waveform1>, <reps>, NONE | M1 | M2 | M3 | M4 | M1M2 | M1M3 | M1M4 | M2M3 | M2M4 | M3M4 | M1M2M3 | M1M2M4 | M1M3M4 | M2M3M4 | M1M2M3M4 | ALL, {<waveform2>, <reps>, NONE | M1 | M2 | M3 | M4 | M1M2 | M1M3 | M1M4 | M2M3 | M2M4 | M3M4 | M1M2M3 | M1M2M4 | M1M3M4 | M2M3M4 | M1M2M3M4 | ALL, } ...

(For additional description of each item, see Notes below ["For Setup SCPI" on page 1127](#) "For Setup SCPI".)

:SOURce:RADio:ARB:SEQuence[:MWAVeform]? <filename>

(For additional description of each item, see Notes ["For Query SCPI" on page 1128](#) below.)

Example For setup:

```
>:SOUR:RAD:ARB:SEQ "NVWFM:testSeq1.seq", "NVWFM:wfmSegment1.wfm", 10, M2M3M4, "NVWFM:wfmSegment2.wfm", 20, M1M3
```

Or

```
>:SOUR:RAD:ARB:SEQ "D: VARB\testSeq1.seq", " D: VARB\wfmSegment1.wfm", 10, M2M3M4, " D: VARB\wfmSegment2.wfm", 20, M1M3
```

For query, must specify which waveform sequence file to query.

```
>:SOUR:RAD:ARB:SEQ? "NVWFM:testSeq1.seq"
```

Or

```
>:SOUR:RAD:ARB:SEQ? "D: VARB\testSeq1.seq",
```

Notes

For Setup SCPI

For the Setup SCPI command, the parameters are:

<filename> - String Type

This variable specifies the path and name for the waveform sequence file. The path supports MSUS (NVWFM) or a real full path representation. See example.

<waveform1> - String Type

This variable specifies the path and name of the first existing waveform segment. The path supports MSUS (NVWFM) or a real full path representation. See example.

The segment file must reside within ARB playback memory before it can be played by the ARB player.

<reps> - Integer Type

This variable specifies the number of times a segment or sequence plays before moving on to the next segment or sequence.

<marker> - Enum Type

NONE - This choice disables all four markers for the waveform. Disabling markers means that the waveform sequence ignores the segments or sequence marker settings.

M1, M2, M3, M4 - these choices, either individually or a combination of them, enable the markers for the waveform segment or sequence. Markers not specified are ignored for that segment or sequence.

ALL - This choice enables all four markers in the waveform segment or sequence.

<waveform2> - String type.

This variable specifies the name of a second existing waveform segment. The path supports MSUS (NVWFM) and real full path representation both. See example.

The segment file must reside within ARB playback memory before it can be played by the ARB player.

<reps> same as above, for the 2nd waveform segment.

<marker> same as above, for the 2nd waveform segment.

You can insert several waveform segments into a waveform sequence file. Just repeat inserting waveform segments as described above.

Error Checks for Setup SCPI command:

If you do not specify a filename, or you use an unsupported MSUS (that is, not NVWFM), or have an error in the waveform sequence file path, an error is generated.

Notes

Error Checks for Query SCPI command: (Continued)

If the specified waveform sequence file name suffix is not ".seq", error is generated.

If you use an unsupported MSUS (that is, not NVWFM), or have an error in the waveform segment file path, an error is generated.

If the first specified waveform file cannot be found, an error is generated.

If you nest one waveform sequence file into another waveform sequence file, an error is generated.

If the specified repetition value is larger than 65535 or smaller than 1, an error is generated.

If the specified marker type is unrecognized, an error is generated.

For Query SCPI

For the Query the parameters are:

<filename> - String type.

This variable specifies the path and name of the waveform sequence file being queried. The path supports MSUS (NVWFM) or a real full path representation. See example.

The return value is a <string>, which includes each waveform segment file name, repetitions, and marker type. For example:

>:SOUR:RAD:ARB:SEQ? "NVWFM:testSeq1.seq",

<"wfmSegment1.wfm, 10, ALL, wfmSegment2.wfm, 20, M1M3",

Error Checks for Query SCPI command:

If you do not specify a filename, an error is generated.

If the waveform sequence file name is empty, an error is generated.

If the specified waveform sequence file cannot be found, an error is generated.

Initial S/W Revision

A.05.00

Edit Selected Sequence

Allows access to the sub-menus for editing the sequence currently selected within the Waveform Sequence List view. Pressing this key changes the central view area to display the Waveform Sequence Creation and Editing view.

Key Path	Source, Modulation Setup, ARB, Waveform Sequences
Notes	No remote command, front panel only.
Initial S/W Revision	A.05.00

Current Directory...

Allows you to change the currently selected directory on the hard disk. Pressing this key opens a standard windows change directory dialog and allows you to select the new directory of interest.

Key Path	Source, Modulation Setup, ARB, Waveform Sequences
Notes	No remote command, front panel only.
Initial S/W Revision	A.05.00

Waveform Utilities

Allows you access to the waveform utilities sub-menus.

Key Path	Source, Modulation Setup, ARB
Initial S/W Revision	A.05.00

Multi-Pack Licenses

Allows you access to the Multi - Pack License sub-menus. Pressing this key also changes the central view area to display the Multi -Pack License Management view.

On modular instrument like E6630A or E6640A, multi-pack license operations are only allowed on the default module, i.e. "Left" module for E6630A or "TRX1" module for E6640A.

Key Path	Source, Modulation Setup, ARB, Waveform Utilities
Notes	If access multi-pack license sub-menu from modules other than "TRX1", an advisory message like "Please goto "TRX1" to operate multi-pack license" will display.
Dependencies	This key is only available if there is at least one Multi-pack license installed on the instrument.
Initial S/W Revision	A.05.00

Add Waveform

Pressing this key accesses the Add Waveform sub-menu. It also changes the central display area to display the Multi-Pack License Waveform Add view.

Key Path	Source, Modulation Setup, ARB, Waveform Utilities, Multi-Pack Licenses
Dependencies	This key is only available if there is at least one slot available within at least one multi-pack license.
Initial S/W Revision	A.05.00

Add Waveform

Allows you to add the currently selected waveform segment to a multi-pack license. The new waveform is added to the next available slot regardless of which slot was selected on the Multi-Pack License Management view.

Key Path	Source, Modulation Setup, ARB, Waveform Utilities, Multi-Pack Licenses, Add Waveform
Remote Command	:SYSTem:LKEY:WAVeform:ADD <string> or :SYSTem:LIcense[:FPACK]:WAVeform:ADD <string>
Example	SYST:LKEY:WAV:ADD "mywaveform.wfm" or SYST:LIC:WAV:ADD "mywaveform.wfm"
Notes	The second SCPI :SYSTem:LIcense[:FPACK]:WAVeform:ADD is provided to be consistent with the style of Agilent signal sources. You can use either one of them. Since adding a waveform segment to a Multi-Pack license causes the license slot to enter the trial period of only 48 hours, pressing this key causes a confirmation dialog to be displayed to ensure you do want to add the waveform segment to the Multi-Pack. If you attempt to license a waveform that is already licensed using another slot an error is generated. . If current module is not "TRX1" module, the key will grey out, and error message is generated "-221 Setting conflict; Not allowed on current module. Goto "TRX1" to operate multi-pack license" when invoking SCPI.
Dependencies	This key is only available if the currently selected file is a secure waveform requiring a license, and there is at least one slot available within at least one multi-pack license. If the waveform highlighted is a secure waveform, but is already licensed, this key will be unavailable.
Initial S/W Revision	A.05.00

Segments on Hard Disk

Allows you access to the sub-menus for loading waveform segments from the hard disk into ARB memory. The default directory is: D: varb.

Pressing this key changes the current view to the Waveform Management View.

Key Path	Source, Modulation Setup, ARB, Select Waveform
Initial S/W Revision	A.05.00

Load Segment To ARB Memory

Allows you to load the selected file into ARB memory. On the front panel you select the file for loading to the ARB memory by highlighting the desired file in the list. Using the SCPI command, you specify the file name on the HDD.

“NVWFM” (none-volatile storage) MSUS (Mass Storage Unit Specifier) is supported in the memory subsystem because the ARB memory cannot be accessed directly. Therefore, files must be downloaded to the instrument hard disk and then loaded into the ARB memory. “NVWFM” MSUS will be mapped to the default directory D: VARB. The SCPI command supports using either “NVWFM” MSUS or specifying a full path. For more information, see [Memory Subsystem \(Remote Command Only\)](#).

If a file of the same name already exists within ARB memory, it is overwritten. If you wish to load two segments of the same name, you must rename one of the segments before loading it into ARB memory. To rename a segment, you can either use Windows File Explorer, or the :MMEMory:COPI command.

NOTE: When a waveform file is loaded to ARB memory, burst timing adjustments are made automatically, based on whether or not a Multiport Adapter is connected to the test set and powered on. If the connection/power status of the Multiport Adapter is changed after a waveform file has been loaded, it needs to be loaded again.

Key Path	Source, Modulation Setup, ARB, Select Waveform, Segments on Hard Disk
Remote Command	:SOURce:RADio:ARB:LOAD <string>
Example	:SOUR:RAD:ARB:LOAD "D: VARB\testwaveform.bin" or :SOUR:RAD:ARB:LOAD "NVWFM:testwaveform.bin"
Notes	<p>Because loading the file involves a delay of unpredictable length, this command should be followed by the query *OPC?, which holds off subsequent commands until the loading operating is complete.</p> <p><string> – specifies the path name of the file to load from the HDD into ARB memory. It could be a <full path + filename>, or <“NVWFM” MSUS + colon + filename>.</p> <p>When in Sequence Analyzer mode, and Include Source is Yes, an attempt to load a file to ARB memory will be rejected with an error.</p> <p>When Include Source is No and if there is insufficient free ARB memory to load the selected waveform, an error is generated. .</p> <p>If you specify a file over SCPI, but the file is not at the specified location, an error is generated.</p> <p>If you try to load a waveform file but the file contains less than 500 IQ samples, an error is generated.</p> <p>If you try to load a Signal Studio waveform “*.wfm” which contains invalid waveform header, an error is generated.</p> <p>If the ARB is ON when you load a file to ARB memory or delete a file from ARB memory, the playing waveform segment may not keep phase continuity during the ARB memory operation. The waveform will be replayed after the ARB operation is finished.</p> <p>ARB can be loaded into ARB memory even required licenses do not present on the instrument. In this</p>

	case, a GUI only warning message -800, "Operation complete; Loaded <filename> successfully, but no license <required licenses> installed". User can install required licenses according to <required licenses> string to license it, or multi-pack license it.
Initial S/W Revision	A.05.00

Load All To ARB Memory

Allows you to load all the segment files within the currently selected directory into ARB memory. If a file of the same name already exists within ARB memory, it is overwritten. If you wish to load two segments of the same name, you must rename one of the segments before loading it into ARB memory. To rename a segment, you can either use Windows File Explorer, or the :MEMory:COPY command.

NOTE: When a waveform file is loaded to ARB memory, burst timing adjustments are made automatically, based on whether or not a Multiport Adapter is connected to the test set and powered on. If the connection/power status of the Multiport Adapter is changed after a waveform file has been loaded, it needs to be loaded again.

Key Path	Source, Modulation Setup, ARB, Select Waveform, Segments on Hard Disk
Remote Command	:SOURce:RADio:ARB:LOAD:ALL <string>
Example	:SOUR:RAD:ARB:LOAD:ALL "D: varb"
Notes	<p><string> - specifies the directory on the HDD to load the files into ARB memory from.</p> <p>When in Sequence Analyzer mode, and Include Source is Yes, an attempt to load all files from a directory to ARB memory is rejected with an error.</p> <p>When Include Source is No and there is insufficient free ARB memory to load all the waveforms, when the ARB memory is full, the copy ceases, and an error is generated.</p> <p>If you specify a directory over SCPI, but the directory does not exist, an error is generated.</p> <p>If the ARB is ON, a user then loads or deletes file to ARB memory, the playing waveform segment may not keep phase continuity during the ARB memory operation. The waveform will be replayed after the ARB operation is finished.</p>
Initial S/W Revision	A.05.00

Change Directory...

Allows you to change the currently selected directory on the hard disk. Pressing this key opens a standard windows change directory dialog allowing you to select the new directory of interest.

The current directory is used for manually loading waveform segments into ARB memory for playback, and as a search location for waveform segments that are required to be loaded into ARB memory for playback of a waveform sequence or a list sequence.

Key Path	Source, Modulation Setup, ARB, Select Waveform, Segments on Hard Disk
Notes	No remote command, SCPIfront panel only.
Initial S/W Revision	A.05.00

Default Directory...

Allows you to change the default directory. It is used as a search location for waveform segments that are required to be loaded into ARB memory for playback of a waveform sequence, and as a search location for selecting waveforms using SCPI.

Key Path	Source, Modulation Setup, ARB, Select Waveform, Segments on Hard Disk
Remote Command	:SOURce:RADio:ARB:DEFault:DIRectory <string> :SOURce:RADio:ARB: DEFault:DIRectory?
Example	:SOUR:RAD:ARB:DEF:DIR "D:\ArbFiles" :SOUR:RAD:ARB:DEF:DIR?
State Saved	Persistent, survives a power cycle and a preset but not saved in the instrument state
Initial S/W Revision	A.05.00

Segments on Hard Disk

This key functions the same as ["Segments on Hard Disk" on page 2547](#).

Key Path	Source, Modulation Setup, ARB, Waveform Utilities, Multi-Pack Licenses, Add Waveform
Initial S/W Revision	Prior to A.09.00

Load Segment To ARB Memory

This key functions the same as ["Load Segment To ARB Memory" on page 2547](#).

Key Path	Source, Modulation Setup, ARB, Waveform Utilities, Multi-Pack Licenses, Add Waveform, Segment on Hard Drive
Initial S/W Revision	Prior to A.09.00

Load All To ARB Memory

This key functions the same as ["Load All To ARB Memory" on page 2548](#).

Key Path	Source, Modulation Setup, ARB, Waveform Utilities, Multi-Pack Licenses, Add Waveform, Segment on Hard Drive
Initial S/W Revision	Prior to A.09.00

Change Directory ...

This key functions the same as ["Change Directory..." on page 2549](#).

Key Path	Source, Modulation Setup, ARB, Waveform Utilities, Multi-Pack Licenses, Add Waveform, Segment on Hard Drive
Initial S/W Revision	Prior to A.09.00

Default Directory ...

This key functions the same as ["Default Directory..." on page 2549](#)

Key Path	Source, Modulation Setup, ARB, Waveform Utilities, Multi-Pack Licenses, Add Waveform, Segment on Hard Drive
Initial S/W Revision	Prior to A.09.00

Replace Waveform

Pressing this key accesses the Replace Waveform submenu. It also changes the central display area to display the Multi-Pack License Waveform Add view.

Key Path	Source, Modulation Setup, ARB, Waveform Utilities, Multi-Pack Licenses
Dependencies	This key is only available if the currently selected slot is in the trial state.
Initial S/W Revision	A.05.00

Replace Waveform

Allows you to replace the waveform in the currently selected slot with the waveform currently selected in the Multi-Pack License Waveform Add view.

Key Path	Source, Modulation Setup, ARB, Waveform Utilities, Multi-Pack Licenses, Replace Waveform
Remote Command	:SYSTem:LKEY:WAVeform:REPLace <int>, <string> or :SYSTem:LICense[:FPACK]:WAVeform:REPLace <int>, <string>
Example	SYST:LKEY:WAV:REPL 1, "myotherwaveform.wfm" or :SYST:LIC:WAV:REPL 1, "myotherwaveform.wfm"
Notes	The second SCPI :SYSTem:LICense[:FPACK]:WAVeform:REPLace is provided to be consistent with the style of Agilent signal sources. You can use either one of them. If you attempt to license a waveform that is already licensed using another slot an error is generated. Waveform slot number <int> is positive. If you attempt to input a slot number less than or equals 0, an error is generated. If current module is not "TRX1" module, the key will grey out, and error message is generated "-221 Setting conflict; Not allowed on current module. Goto "TRX1" to operate multi-pack license" when invoking SCPI.
Initial S/W Revision	A.05.00

Segments on Hard Disk

This key functions the same as ["Segments on Hard Disk" on page 2547](#).

Key Path	Source, Modulation Setup, ARB, Waveform Utilities, Multi-Pack Licenses, Replace Waveform
Initial S/W Revision	Prior to A.09.00

Load Segment To ARB Memory

This key functions the same as ["Load Segment To ARB Memory" on page 2547](#).

Key Path	Source, Modulation Setup, ARB, Waveform Utilities, Multi-Pack Licenses, Replace Waveform, Segment on Hard Drive
Initial S/W Revision	Prior to A.09.00

Load All To ARB Memory

This key functions the same as ["Load All To ARB Memory" on page 2548](#).

Key Path	Source, Modulation Setup, ARB, Waveform Utilities, Multi-Pack Licenses, Replace Waveform, Segment on Hard Drive
Initial S/W Revision	Prior to A.09.00

Change Directory ...

This key functions the same as ["Change Directory..." on page 2549](#).

Key Path	Source, Modulation Setup, ARB, Waveform Utilities, Multi-Pack Licenses, Replace Waveform, Segment on Hard Drive
Initial S/W Revision	Prior to A.09.00

Default Directory ...

This key functions the same as ["Default Directory..." on page 2549](#)

Key Path	Source, Modulation Setup, ARB, Waveform Utilities, Multi-Pack Licenses, Replace Waveform, Segment on Hard Drive
Initial S/W Revision	Prior to A.09.00

Clear Waveform from Slot

Allows you to clear the waveform from the selected slot.

Key Path	Source, Modulation Setup, ARB, Waveform Utilities, Multi-Pack Licenses
Remote Command	:SYSTem:LKEY:WAVeform:CLEar <int> or :SYSTem:LICense[:FPACK]:WAVeform:CLEar <int>
Example	SYST:LKEY:WAV:CLE 1 or :SYST:LIC:WAV:CLE 1
Notes	The second SCPI :SYSTem:LICense[:FPACK]:WAVeform:CLEar is provided to be consistent with the style of Agilent signal sources. You can use either one of them. Waveform slot number <int> is positive. If you attempt to input a slot number less than or equals 0, an error is generated. If current module is not "TRX1" module, the key will grey out, and error message is generated "-221 Setting conflict; Not allowed on current module. Goto "TRX1" to operate multi-pack license" when invoking SCPI.
Dependencies	This key is only available if the currently selected slot is in the trial state.
Initial S/W Revision	A.05.00

Lock Waveform in Slot

If the selected slot is in the trial state or the lock required state, the waveform that occupies the slot is locked and permanently licensed.

Key Path	Source, Modulation Setup, ARB, Waveform Utilities, Multi-Pack Licenses
Remote Command	:SYSTem:LKEY:WAVeform:LOCK <int> or :SYSTem:LICense[:FPACK]:WAVeform:LOCK <int>
Example	SYST:LKEY:WAV:LOCK 1 or SYST:LIC:WAV:LOCK 1
Notes	The second SCPI :SYSTem:LICense[:FPACK]:WAVeform:LOCK is provided to be consistent with the style of Agilent signal sources. You can use either one of them. Waveform slot number <int> is positive. If you attempt to input a slot number less than or equals 0, an error is generated. If current module is not "TRX1" module, the key will grey out, and error message is generated "-221 Setting conflict; Not allowed on current module. Goto "TRX1" to operate multi-pack license" when invoking SCPI.
Dependencies	This key is only available if the currently selected slot is in the trial state or the lock required state.
Initial S/W Revision	A.05.00

Slot Status Query (Remote Command Only)

Returns the status of the specified slot.

Remote Command	:SYSTem:LKEY:WAVeform:STATus? <int> or :SYSTem:LICense[:FPACK]:WAVeform:STATus? <int>
Example	:SYST:LKEY:WAV:STAT? 1 <"Locked" or :SYST:LIC:WAV:STAT? 1 <"Locked"
Notes	The second SCPI :SYSTem:LICense[:FPACK]:WAVeform:STATus is provided to be consistent with the style of Agilent signal sources. You can use either one of them. Waveform slot number <int> is positive. If you attempt to input a slot number less than or equals 0, an error is generated. Result type is string. If input slot number exceeds total available slot number, "Nonexistent" is returned.
Range	"Locked" "Available" "Trail" "LockRequired" "Nonexistent"
Initial S/W Revision	A.05.00

Slots Free Query (Remote Command Only)

Returns the number of license slots free.

Remote Command	:SYSTem:LKEY:WAVeform:FREE? or :SYSTem:LICense[:FPACK]:WAVeform:FREE?
Example	:SYST:LKEY:WAV:FREE? or :SYST:LIC:WAV:FREE?
Notes	The second SCPI :SYSTem:LICense[:FPACK]:WAVeform:FREE is provided to be consistent with the style of Agilent signal sources. You can use either one of them.
Initial S/W Revision	A.05.00

Slot Used Query (Remote Command Only)

Returns the number of license slots used.

Remote Command	:SYSTem:LKEY:WAVeform:USED? or :SYSTem:LICense[:FPACK]:WAVeform:USED?
Example	:SYST:LKEY:WAV:USED?

	or :SYST:LIC:WAV:USED?
Notes	The second SCPI :SYSTem:LIcense[:FPACK]:WAVeform:USED is provided to be consistent with the style of Agilent signal sources. You can use either one of them.
Initial S/W Revision	A.05.00

Slot Waveform Name Query (Remote Command Only)

Returns the waveform name of the specified slot

Remote Command	:SYSTem:LKEY:WAVeform:NAME? <int> or :SYSTem:LIcense[:FPACK]:WAVeform:NAME? <int>
Example	:SYST:LKEY:WAV:NAME? 1 <"CDMA2K_22.wfm" or :SYST:LIC:WAV:NAME? 1 <"CDMA2K_22.wfm"
Notes	Waveform slot number <int> is positive. If you attempt to input a slot number less than or equals 0, an error is generated. Result type is string. If input slot number exceeds total available slot number, "Nonexistent" is returned. If no waveform stored in the specified slot, then empty string is returned.
Initial S/W Revision	A.12.00

Slot Waveform Unique ID Query (Remote Command Only)

Returns the waveform unique ID of the specified slot

Remote Command	:SYSTem:LKEY:WAVeform:UID? <int> or :SYSTem:LIcense[:FPACK]:WAVeform:UID? <int>
Example	:SYST:LKEY:WAV:UID? 2 <"1346752140" or :SYST:LIC:WAV:UID? 2 <"1346752140"
Notes	Waveform slot number <int> is positive. If you attempt to input a slot number less than or equals 0, an error is generated. Result type is string. If input slot number exceeds total available slot number, "Nonexistent" is returned.

If no waveform stored in the specified slot, then "0" is returned

Initial S/W Revision A.12.00

Locked Waveform Name List Query (Remote Command Only)

Returns the waveform name list of locked.

Remote Command :SOURce:RADio:ARB:MPLicensed:NAME:LOCKed?

Example SOUR:RAD:ARB:MPL:NAME:LOCKed?
 <"CDMA2K_27.wfm", "GSM_MCS1.WFM", "c2kWfm.wfm"

Initial S/W Revision A.11.00

Locked Waveform Unique ID List Query (Remote Command Only)

Returns the waveform unique id list of locked.

Remote Command :SOURce:RADio:ARB:MPLicensed:UID:LOCKed?

Example SOUR:RAD:ARB:MPL:UID:LOCKed?
 <"2996927136", "3812603511", "3710986266"

Notes Each Signal Studio waveform has a unique id recorded in header. So if the unique ids are same, that means they are same one waveform. So besides SCPI to query locked waveform name list, also provide a SCPI to query locked waveform unique id list

Initial S/W Revision A.11.00

Marker Utilities

Allows access to the marker utilities sub-menus.

Key Path Source, Modulation Setup, ARB

Initial S/W Revision A.05.00

Marker Polarity

Allows access to the marker polarity sub-menu, which allows you to specify the polarity for the four markers. For a positive polarity, the marker signal is high during the marker points. For a negative marker polarity, the marker signal is high during the period of no marker points.

Key Path Source, Modulation Setup, ARB, Marker Utilities

Initial S/W Revision A.05.00

Mkr 1 Polarity

Allows you to set the polarity of marker 1.

Key Path	Source, Modulation Setup, ARB, Marker Utilities, Marker Polarity
Remote Command	:SOURce:RADio:ARB:MPOLarity:MARKer1 POSitive NEGative :SOURce:RADio:ARB:MPOLarity:MARKer1?
Example	:SOUR:RAD:ARB:MPOL:MARK1 NEG
Dependencies	When a new waveform is selected for playback the settings contained within the associated waveform header file are applied to the ARB. The marker polarity is one of the values stored within the header file. If the newly selected waveform file has an associated header file, the marker polarity is updated with the value from the header file. The marker polarity will remain unchanged if the newly selected waveform does not have an associated header file.
Preset	Pos
Range	Neg Pos
Initial S/W Revision	A.05.00

Mkr 2 Polarity

Allows you to set the polarity of marker 2.

Key Path	Source, Modulation Setup, ARB, Marker Utilities, Marker Polarity
Remote Command	:SOURce:RADio:ARB:MPOLarity:MARKer2 POSitive NEGative :SOURce:RADio:ARB:MPOLarity:MARKer2?
Example	:SOUR:RAD:ARB:MPOL:MARK2 NEG
Dependencies	When a new waveform is selected for playback the settings contained within the associated waveform header file are applied to the ARB. The marker polarity is one of the values stored within the header file. If the newly selected waveform file has an associated header file, the marker polarity is updated with the value from the header file. The marker polarity will remain unchanged if the newly selected waveform does not have an associated header file.
Preset	Pos
Range	Neg Pos
Initial S/W Revision	A.05.00

Mkr 3 Polarity

Allows you to set the polarity of marker 3.

Key Path	Source, Modulation Setup, ARB, Marker Utilities, Marker Polarity
Remote Command	:SOURce:RADio:ARB:MPOLarity:MARKer3 POSitive NEGative :SOURce:RADio:ARB:MPOLarity:MARKer3?
Example	:SOUR:RAD:ARB:MPOL:MARK3 NEG
Dependencies	When a new waveform is selected for playback the settings contained within the associated

waveform header file are applied to the ARB. The marker polarity is one of the values stored within the header file. If the newly selected waveform file has an associated header file, the marker polarity is updated with the value from the header file. The marker polarity will remain unchanged if the newly selected waveform does not have an associated header file.

Preset	Pos
--------	-----

Range	Neg Pos
-------	-----------

Initial S/W Revision	A.05.00
----------------------	---------

Mkr 4 Polarity

Allows you to set the polarity of marker 4.

Key Path	Source, Modulation Setup, ARB, Marker Utilities, Marker Polarity
----------	--

Remote Command	:SOURce:RADio:ARB:MPOLarity:MARKer4 POSitive NEGative :SOURce:RADio:ARB:MPOLarity:MARKer4?
-----------------------	---

Example	:SOUR:RAD:ARB:MPOL:MARK4 NEG
----------------	------------------------------

Dependencies	When a new waveform is selected for playback the settings contained within the associated waveform header file are applied to the ARB. The marker polarity is one of the values stored within the header file. If the newly selected waveform file has an associated header file, the marker polarity is updated with the value from the header file. The marker polarity will remain unchanged if the newly selected waveform does not have an associated header file.
--------------	---

Preset	Pos
--------	-----

Range	Neg Pos
-------	-----------

Initial S/W Revision	A.05.00
----------------------	---------

Marker Routing

Allows access to the marker routing sub-menus, which allow you to specify where the marker events are routed. It should be noted that the markers can also be routed to Trigger 1 Out and Trigger 2 Out, however this must be set up using the menus accessed by pressing the "Trigger" hard key.

Key Path	Source, Modulation Setup, ARB, Marker Utilities
----------	---

Initial S/W Revision	A.05.00
----------------------	---------

Pulse/RF Blank

Allows you to select which marker is used for the pulse/RF blanking function. The pulse/RF blanking function blanks the RF when the marker signal goes low. The marker polarity determines when the marker signal is high. For a positive polarity, this is during the marker points. For a negative polarity, this is when there are no marker points.

Marker points should be set before using this function. Enabling this function without setting maker points may create a continuous low or high signal, dependant on the marker polarity. This causes either no RF output, or a continuous RF output.

Key Path	Source, Modulation Setup, ARB, Marker Utilities, Marker Routing
Remote Command	:SOURce:RADio:ARB:MDEStination:PULSe NONE M1 M2 M3 M4 :SOURce:RADio:ARB:MDEStination:PULSe?
Example	:SOUR:RAD:ARB:MDES:PULS NONE
Dependencies	When a new waveform is selected for playback the settings contained within the associated waveform header file are applied to the ARB. The pulse/RF blanking setting is one of the values stored within the header file. If the newly selected waveform file has an associated header file, the pulse/RF blanking setting is updated with the value from the header file. The pulse/RF blanking setting will remain unchanged if the newly selected waveform does not have an associated header file.
Range	None M1 M2 M3 M4
Initial S/W Revision	A.05.00

None

Sets no marker to be used for the pulse/RF blanking function, essentially turning the RF blanking function off.

Key Path	Source, Modulation Setup, ARB, Marker Utilities, Marker Routing, Pulse/RF Blank
Example	:SOUR:RAD:ARB:MDES:PULS NONE
Initial S/W Revision	A.05.00

Marker 1

Sets marker 1 to be used for the pulse/RF blanking function.

Key Path	Source, Modulation Setup, ARB, Marker Utilities, Marker Routing, Pulse/RF Blank
Example	:SOUR:RAD:ARB:MDES:PULS M1
Initial S/W Revision	A.05.00

Marker 2

Sets marker 2 to be used for the pulse/RF blanking function.

Key Path	Source, Modulation Setup, ARB, Marker Utilities, Marker Routing, Pulse/RF Blank
Example	:SOUR:RAD:ARB:MDES:PULS M2
Initial S/W Revision	A.05.00

Marker 3

Sets marker 3 to be used for the pulse/RF blanking function.

Key Path	Source, Modulation Setup, ARB, Marker Utilities, Marker Routing, Pulse/RF Blank
Example	:SOUR:RAD:ARB:MDES:PULS M3
Initial S/W Revision	A.05.00

Marker 4

Sets marker 4 to be used for the pulse/RF blanking function.

Key Path	Source, Modulation Setup, ARB, Marker Utilities, Marker Routing, Pulse/RF Blank
Example	:SOUR:RAD:ARB:MDES:PULS M4
Initial S/W Revision	A.05.00

ALC Hold

Allows you to specify which marker is routed for use within the ALC hold function. The ALC hold marker function holds the ALC circuitry at the average value of the sample points set by the marker.

The ALC hold function operates during the low periods of the marker signal. The marker polarity determines when the marker signal is high. For positive polarity, this is during the marker points. For a negative polarity, this is when there are no marker points.

Key Path	Source, Modulation Setup, ARB, Marker Utilities, Marker Routing
Remote Command	:SOURce:RADio:ARB:MDEStination:ALCHold NONE M1 M2 M3 M4 :SOURce:RADio:ARB:MDEStination:ALCHold?
Example	:SOUR:RAD:ARB:MDES:ALCH NONE
Dependencies	When a new waveform is selected for playback the settings contained within the associated waveform header file are applied to the ARB. The ALC hold setting is one of the values stored within the header file. If the newly selected waveform file has an associated header file, the ALC hold setting is updated with the value from the header file. The ALC hold setting will remain unchanged if the newly selected waveform does not have an associated header file.
Range	None M1 M2 M3 M4
Initial S/W Revision	A.05.00

None

Sets no marker to be used for the ALC hold function, essentially turning the ALC hold function off.

Key Path	Source, Modulation Setup, ARB, Marker Utilities, Marker Routing, ALC Hold
Example	:SOUR:RAD:ARB:MDES:PULS NONE
Initial S/W Revision	A.05.00

Marker 1

Sets marker 1 to be used for the ALC hold function.

Key Path	Source, Modulation Setup, ARB, Marker Utilities, Marker Routing, ALC Hold
Example	:SOUR:RAD:ARB:MDES:PULS M1
Initial S/W Revision	A.05.00

Marker 2

Sets marker 2 to be used for the ALC hold function.

Key Path	Source, Modulation Setup, ARB, Marker Utilities, Marker Routing, ALC Hold
Example	:SOUR:RAD:ARB:MDES:PULS M2
Initial S/W Revision	A.05.00

Marker 3

Sets marker 3 to be used for the ALC hold function.

Key Path	Source, Modulation Setup, ARB, Marker Utilities, Marker Routing, ALC Hold
Example	:SOUR:RAD:ARB:MDES:PULS M3
Initial S/W Revision	A.05.00

Marker 4

Sets marker 4 to be used for the ALC hold function.

Key Path	Source, Modulation Setup, ARB, Marker Utilities, Marker Routing, ALC Hold
Example	:SOUR:RAD:ARB:MDES:PULS M4
Initial S/W Revision	A.05.00

Header Utilities

Allows access to the header utilities sub-menu. Pressing this key also causes the central display area to change to display the File Header Information view.

Key Path	Source, Modulation Setup, ARB
Dependencies	This key is only available if there is currently a waveform selected for playback. If no waveform is selected, the key is grayed out.
Initial S/W Revision	A.05.00

Clear Header

Allows you to clear the header information from the file header associated with the currently selected waveform.

Key Path	Source, Modulation Setup, ARB, Header Utilities
Remote Command	:SOURce:RADio:ARB:HEADer:CLEar
Example	:SOUR:RAD:ARB:HEAD:CLE
Notes	Attempting to clear the header details via SCPI when no waveform was selected for playback will generate an error.
Initial S/W Revision	A.05.00

Save Setup To Header

Allows you to save new file header information details to the file.

Key Path	Source, Modulation Setup, ARB, Header Utilities
Remote Command	:SOURce:RADio:ARB:HEADer:SAVE
Example	:SOUR:RAD:ARB:HEAD:SAVE
Notes	Attempting to save the header details via SCPI when no waveform was selected for playback will generate an error.
Initial S/W Revision	A.05.00

Query Waveform Unique ID (Remote Command Only)

Each Signal Studio waveform contains a unique waveform ID, which recorded in the header. This command allows you to query the unique waveform ID from the header. This is a SCPI only command. User can also check [Error! Reference source not found.](#) for waveform unique ID display.

Remote Command	:MMEMory:HEADer:ID? "<file name>"
Example	:MMEM:HEAD:ID? "test.wfm" (query the waveform already loaded into the ARB memory) :MMEM:HEAD:ID? "D: VARB\test.wfm" (query the waveform on the hard disk by absolute path) :MMEM:HEAD:ID? "NVWFM:test.wfm" (query the waveform on the hard disk by MSUS)
Notes	SCPI query only. The queried waveform file can be in ARB memory, or on hard disk. If want to query ARB in ARB memory, then give out the file name directly. If want to query ARB on the hard disk, then absolute file path or MSUS should be given along with the file name. The valid MSUS is "NVWFM" which is mapped to D: VARB on hard disk. If the file cannot be found in ARB memory or on hard disk, an error is generated and value -1 is returned
Initial S/W Revision	A.09.00

Bus Trigger Command (Remote Command Only)

Used to initiate an immediate trigger event if the trigger source is set to Bus.

Remote Command	:SOURce:RADio:ARB:TRIGger:INITiate
Example	:SOUR:RAD:ARB:TRIG:INIT
Initial S/W Revision	A.05.00

AM

Allows access to the menu for configuring the Amplitude Modulation.

Key Path	Source, Modulation Setup
Initial S/W Revision	A.05.00

AM

Enables or disables the amplitude modulation.

Turning AM on when another modulation format is already on results in the previous modulation format being turned off and the generation of an error.

Key Path	Source, Modulation Setup, AM
Remote Command	:SOURce:AM:STATe :SOURce:AM:STATe?
Example	:SOUR:AM:STAT OFF
Preset	Off
Range	On Off
Initial S/W Revision	A.05.00

AM Depth

Allows you to set the amplitude modulation depth in percent.

Key Path	Source, Modulation Setup, AM
Remote Command	:SOURce:AM[:DEPTh] [:LINear] :SOURce:AM[:DEPTh] [:LINear]?
Example	:SOUR:AM 0.1
Preset	0.1 %
Min	0.1 %
Max	95.0 %
Initial S/W Revision	A.05.00

AM Rate

Allows you to set the internal amplitude modulation rate.

Key Path	Source, Modulation Setup, AM
Remote Command	:SOURce:AM:INTernal:FREQuency :SOURce:AM:INTernal:FREQuency?
Example	:SOUR:AM:INT:FREQ 40.0 Hz
Preset	400.0 Hz
Min	10 Hz
Max	40 kHz
Initial S/W Revision	A.05.00

FM

Allows access to the menu for configuring the frequency modulation.

Key Path	Source, Modulation Setup
Initial S/W Revision	A.05.00

FM

Enables or disables the frequency modulation.

Turning FM on when another modulation format is already on results in the previous modulation format being turned off and the generation of an error.

Key Path	Source, Modulation Setup, FM
Remote Command	:SOURce:FM:STATe :SOURce:FM:STATe?
Example	:SOUR:FM:STAT OFF
Preset	Off
Range	On Off
Initial S/W Revision	A.05.00

FM Deviation

Allows you to set the frequency modulation deviation.

Key Path	Source, Modulation Setup, FM
----------	------------------------------

Remote Command	:SOURce:FM[:DEVIation] :SOURce:FM[:DEVIation]?
Example	:SOUR:FM 1.00 kHz
Preset	1.00 Hz
Min	1.00 Hz
Max	100.00 kHz
Initial S/W Revision	A.05.00

FM Rate

Allows you to set the internal frequency modulation rate.

Key Path	Source, Modulation Setup, FM
Remote Command	:SOURce:FM:INTernal:FREQuency :SOURce:FM:INTernal:FREQuency?
Example	:SOUR:FM:INT:FREQ 40.0 Hz
Preset	400.0 Hz
Min	10 Hz
Max	40 kHz
Initial S/W Revision	A.05.00

PM

Allows access to the menu for configuring the phase modulation.

Key Path	Source, Modulation Setup
Initial S/W Revision	A.05.00

PM

Enables or disables the phase modulation.

Turning PM on when another modulation format is already on results in the previous modulation format being turned off and the generation of an error.

Key Path	Source, Modulation Setup, PM
Remote Command	:SOURce:PM:STATe :SOURce:PM:STATe?
Example	:SOUR:PM:STAT OFF

Preset	Off
Range	On Off
Initial S/W Revision	A.05.00

PM Deviation

Allows you to set the phase modulation deviation.

Key Path	Source, Modulation Setup, PM
Remote Command	:SOURce:PM[:DEVIation] :SOURce:PM[:DEVIation]?
Example	:SOUR:PM 1.00 rad
Preset	0.1 rad
Min	0.1 rad
Max	20.0 rad
Initial S/W Revision	A.05.00

PM Rate

Allows you to set the internal phase modulation rate.

Key Path	Source, Modulation Setup, PM
Remote Command	:SOURce:PM:INTernal:FREQuency :SOURce:PM:INTernal:FREQuency?
Example	:SOUR:PM:INT:FREQ 40.0 Hz
Preset	400.0 Hz
Min	10 Hz
Max	40 kHz
Initial S/W Revision	A.05.00

List Sequencer

Allows you access to the sub-menus for configuring the list sequencer.

List sequences allows you to enter frequencies and amplitudes at unequal intervals in nonlinear ascending, descending or random order. Each step within the list can also include its own waveform file for playback, step duration, trigger event and trigger output.

The complexities involved in configuring the list sequencer do not lend itself to manual configuration; hence the manual configuration for this feature is limited. For easier configuration of the list sequencer, it is recommended that you use either SCPI or load a tab delimited file containing the setup parameters in a

tabular form. The details of the SCPI for configuring the list sequencer can be found in "[Step Configuration \(Remote Command Only\)](#)" on page 2554.

Once the List Sequencer has been configured using the front panel, SCPI, or loading in a tab delimited file, the sequence must be initiated using the front panel Initiate Sequence key or the corresponding SCPI command.

Key Path	Source
Initial S/W Revision	A.05.00

Sequencer

Allows you to set the state of the list sequencer. When the list sequencer is on, the source is outputting the sequence defined by the sequencer. When the list sequencer is off, the source outputs a single waveform segment or sequence (independent mode) at a single frequency and amplitude.

Key Path	Source, List Sequencer
Remote Command	:SOURce:LIST[:STATe] ON OFF 1 0 :SOURce:LIST[:STATe] ?
Example	:SOUR:LIST OFF
Notes	When the sequencer is set to ON, the list sequencer controls the output of the source.
Couplings	When in Sequence Analyzer mode and the list sequencer state is Off, Include Source is forced to No, and the Include Source key is grayed out. When in Sequence Analyzer mode and the list sequencer state is On, Include Source is available to set. And, an ARB memory related operation, like load or delete will be rejected.
Preset	Off
Range	On Off
Initial S/W Revision	A.05.00

Initiate Sequence

Pressing this key arms the sequence for single execution. Once the sequence is armed the source begins the sequence as soon as the trigger is received. If the trigger is set to Free Run, the sequence starts immediately.

Key Path	Source, List Sequencer
Remote Command	:SOURce:LIST:TRIGger[:IMMediate]
Example	:SOUR:LIST:TRIG
Notes	When in Sequence Analyzer mode and Include Source is Yes, the Initiate list sequencer operation is rejected, and the key is grayed out, since source list sequence request is sent to physics via Parallel batch by sequence analyzer. If the file needed by the sequencer is not already in ARB memory, the sequence cannot be initiated

and an error will be generated.

There is a blocking SCPI query which can be used to query if source list sequence being initiated successfully or not. (see "[Query List Sequence Initiation Armed Status \(Remote Command Only\)](#)" on [page 2565](#) Query Source List Sequence Armed Status)

Dependencies	Under the Sequence Analyzer Mode, if Meas Setup->Include Source is set to YES, Source->List Sequencer->Initiate Sequence is disabled.
--------------	---

Initial S/W Revision	A.05.00
----------------------	---------

List Sequencer Setup

Allows you access to the list sequencer setup menus.

Key Path	Source, List Sequencer
----------	------------------------

Number of Steps

Allows you to specify the number of steps within the list sequence.

Key Path	Source, List Sequencer, List Sequencer Setup
----------	--

Remote Command	:SOURce:LIST:NUMBer:STEPs <integer>
-----------------------	-------------------------------------

	:SOURce:LIST:NUMBer:STEPs?
--	----------------------------

Example	:SOUR:LIST:NUMB:STEP 1
----------------	------------------------

Notes	Increasing the number of steps creates additional steps at the end of the list, with all the settings within the steps set to their default values. Decreasing the number of steps removes steps from the end of the list. The settings within the removed steps are not reset. This means that increasing the number of steps again would allow you to retrieve these steps.
-------	--

Dependencies	The Step Count parameter is increased or decreased when you insert or delete a point from within the GUI interface to the sequencer.
--------------	--

Preset	1
--------	---

Min	1
-----	---

Max	1000
-----	------

Initial S/W Revision	A.05.00
----------------------	---------

Current Step

Allows you to select the step number you wish to view or edit.

Key Path	Source, List Sequencer, List Sequencer Setup
----------	--

Notes	No remote command, front panel only.
Preset	1
Min	1
Max	Step Count
Initial S/W Revision	A.05.00

Insert Step Before

Allows you to insert a new step, containing default values, before the currently selected step. Inserting a step will automatically increase the Step Count parameter by 1. If sequence already reaches upper limit of 1000 steps, then insert more step will be rejected and popup error -221, "Setting Conflict; Cannot insert more steps, maximum number of steps reached"

Key Path	Source, List Sequencer, List Sequencer Setup
Notes	No remote command, front panel only. If the list already contains the maximum limit of 1000 steps, no operation will be made after pressing this key.
Initial S/W Revision	A.05.00

Delete Step

Allows you to delete the current step. Deleting a step will automatically decrease the Step Count parameter by 1. If sequence only has one step left, delete step will be rejected and popup error -221, "Setting conflict; Cannot delete current step, minimum number of steps reached"

Key Path	Source, List Sequencer, List Sequencer Setup
Notes	No remote command, Front Panel key only. If the list already contains the minimum limit of 1 step, no operation will be made after pressing this key
Initial S/W Revision	A.05.00

Clear List

Allows you to clear the list. Clearing the list sets the number of steps to the default value of 1 and sets the parameters for the only step to their default values.

Key Path	Source, List Sequencer, List Sequencer Setup
Initial S/W Revision	A.05.00

Step Trigger

Allows access to the sub-menu for selecting the trigger input for the current step.

Key Path	Source, List Sequencer, List Sequencer Setup
Remote Command	:SOURce:LIST:STEP[1] 2 3...1000:SETup:INPut:TRIGger IMMEDIATE INTernal EXTernal2 KEY BUS EXTernal4 :SOURce:LIST:STEP[1] 2 3...1000:SETup:INPut:TRIGger?
Example	:SOUR:LIST:STEP2:SET:INP:TRIG BUS :SOUR:LIST:STEP2:SET:INP:TRIG?
Notes	SCPI is supported after A.09.40
Preset	Free Run
Range	Free Run Internal Manual (Trigger Key) Bus External 2 EXTernal4
Initial S/W Revision	A.05.00

Free Run

Sets the trigger input for the current step to Free Run.

Key Path	Source, List Sequencer, List Sequencer Setup, Step Trigger
Example	:SOUR:LIST:STEP2:SET:INP:TRIG IMM
Notes	SCPI is supported after A.09.40
Initial S/W Revision	A.05.00

Internal

Sets the trigger input for the current step to Internal.

Key Path	Source, List Sequencer, List Sequencer Setup, Step Trigger
Example	:SOUR:LIST:STEP2:SET:INP:TRIG INT
Notes	SCPI is supported after A.09.40
Initial S/W Revision	A.05.00

Manual (Trigger Key)

Sets the trigger input for the current step to Manual (Trigger Key). Any step in the sequence set to Manual will cause the sequence execution to stop until the manual trigger key is pressed. Sending the Bus Trigger SCPI command will have no effect. At any point in the sequence where the list sequencer is paused waiting for a software trigger, a pop up dialog is displayed until the trigger event occurs.

Key Path	Source, List Sequencer, List Sequencer Setup, Step Trigger
Example	:SOUR:LIST:STEP2:SET:INP:TRIG KEY
Notes	SCPI is supported after A.09.40
Initial S/W Revision	A.05.00

Bus

Sets the trigger input for the current step to Bus. Any step in the sequence set to Bus will cause the sequence execution to stop until the Bus Trigger SCPI command is sent. Pressing the manual trigger key has no effect. At any point in the sequence where the list sequencer is paused waiting for a software trigger, a pop up dialog is displayed until the trigger event occurs.

Key Path	Source, List Sequencer, List Sequencer Setup, Step Trigger
Example	:SOUR:LIST:STEP2:SET:INP:TRIG BUS
Notes	SCPI is supported after A.09.40
Initial S/W Revision	A.05.00

External 2

Sets the trigger input for the current step to External 2.

Key Path	Source, List Sequencer, List Sequencer Setup, Step Trigger
Example	:SOUR:LIST:STEP2:SET:INP:TRIG EXT2
Notes	SCPI is supported after A.09.40
Notes	Note: When on E6640A, trigger 2 is a bi-directional trigger port. So when trigger 2 has been configured as OUTPUT type, choosing External 2 as the input trigger for the current step will generate error.
Initial S/W Revision	A.05.00

Transition Time

Allows you to specify the transition time for the current step.

The transition time is the amount of time allowed for the source to settle at the current frequency or amplitude value.

Transition Time should not be taken as additional time before or inside the Step Duration. You can set a value for the settling time to allow the source output frequency or amplitude to become stable. Make sure that during this period of time, you do not use the source output signal.

The following table lists recommended values for appropriate settling times to allow for changes within the source.

Value Changed	Recommended Transition Time
Frequency	500 μ s
Amplitude	100 μ s to within 0.1 dB 20 μ s to within 1.0 dB

If the Transition Time value is shorter than the time necessary for the hardware to settle and a List Sequence is initiated, a **warning** is generated.

If the Transition Time value is longer than the Step Duration, an error is generated when initiating a source list sequence. For source list sequence, transition time is included in the step duration length. If the Transition Time value is longer than the Step Duration Time, the real step duration length is extended to equal the transition time and cause a timing shift.

Key Path	Source, List Sequencer, List Sequencer Setup
Remote Command	:SOURce:LIST:STEP[1] 2 3...1000:SETup:TRANSition:TIME <time> :SOURce:LIST:STEP[1] 2 3...1000:SETup:TRANSition:TIME?
Example	:SOUR:LIST:STEP2:SET:TRAN:TIME 1ms :SOUR:LIST:STEP2:SET:TRAN:TIME?
Notes	SCPI is supported after A.09.40
Preset	1.0 ms
Min	0.0 ms
Max	4.0 ks
Initial S/W Revision	A.05.00

Radio Setup

Allows you access to the sub-menus for setting up the radio standard, band, and radio band link direction for the current step.

Key Path	Source, List Sequencer, List Sequencer Setup
Notes	No remote command, front panel only.
Initial S/W Revision	A.05.00

Radio Standard

Allows access to the sub-menus for selecting the radio standard and the associated radio band for use in the current step.

Key Path	Source, List Sequencer, List Sequencer Setup, Radio Setup
Remote Command	:SOURce:LIST:STEP[1] 2 3...1000:SETup:RADio:BAND NONE PGSM EGSM RGSM DCS1800 PCS1900 TGSM810 GSM450 GSM480 GSM700 GSM850 BANDI BANDII BANDIII BANDIV BANDV BANDVI BANDVII BANDVIII BANDIX BANDX BANDXI BANDXII BANDXIII BANDXIV BANDXIX USCELL USPCS JAPAN KOREAN NMT IMT2K UPPER SECOND PAMR400 PAMR800 IMTEXT PCS1DOT9G AWS US2DOT5G PUBLIC LOWER NONE BAND1 BAND2 BAND3 BAND4 BAND5 BAND6 BAND7 BAND8 BAND10 BAND11 BAND12 BAND13 BAND14 BAND17 BAND18 BAND19 BAND20 BAND21 BAND24 BAND25 BAND26 BAND27 BAND28 BAND31 BAND33 BAND34 BAND35 BAND36 BAND37 BAND38

	BAND39 BAND40 BAND41 BAND42 BAND43 BAND44 BANDA BANDB BANDC BANDD BANDE BANDF :SOURce:LIST:STEP[1] 2 3...1000:SETup: RADio:BAND?
Example	:SOUR:LIST:STEP2:SET:RAD:BAND PGSM :SOUR:LIST:STEP2:SET:RAD:BAND?
Notes	SCPI is supported after A.09.40
Initial S/W Revision	A.05.00

None

Selects no radio standard for use on the current step.

Key Path	Source, List Sequencer, List Sequencer Setup, Radio Setup, Radio Standard
Example	:SOUR:LIST:STEP2:SET:RAD:BAND NONE
Notes	SCPI is supported after A.09.40
Initial S/W Revision	A.05.00

GSM/EDGE

Pressing this key once selects GSM/EDGE as the radio standard and the current GSM/EDGE band as the active channel band. Pressing this key again allows access to the sub-menus for selecting a different GSM/EDGE band.

Key Path	Source, List Sequencer, List Sequencer Setup, Radio Setup, Radio Standard
Initial S/W Revision	A.05.00

P-GSM

Selects P-GSM as the band for the current step.

Key Path	Source, List Sequencer, List Sequencer Setup, Radio Setup, Radio Standard, GSM/EDGE
Initial S/W Revision	A.05.00

E-GSM

Selects E-GSM as the band for the current step.

Key Path	Source, List Sequencer, List Sequencer Setup, Radio Setup, Radio Standard, GSM/EDGE
Initial S/W Revision	A.05.00

R-GSM

Selects R-GSM as the band for the current step.

Key Path	Source, List Sequencer, List Sequencer Setup, Radio Setup, Radio Standard, GSM/EDGE
Initial S/W Revision	A.05.00

DCS 1800

Selects DCS 1800 as the band for the current step.

Key Path	Source, List Sequencer, List Sequencer Setup, Radio Setup, Radio Standard, GSM/EDGE
Initial S/W Revision	A.05.00

PCS 1900

Selects PCS 1900 as the band for the current step.

Key Path	Source, List Sequencer, List Sequencer Setup, Radio Setup, Radio Standard, GSM/EDGE
Initial S/W Revision	A.05.00

GSM 450

Selects GSM 450 as the band for the current step.

Key Path	Source, List Sequencer, List Sequencer Setup, Radio Setup, Radio Standard, GSM/EDGE
Initial S/W Revision	A.05.00

GSM 480

Selects GSM 480 as the band for the current step.

Key Path	Source, List Sequencer, List Sequencer Setup, Radio Setup, Radio Standard, GSM/EDGE
Initial S/W Revision	A.05.00

GSM 850

Selects GSM 850 as the band for the current step.

Key Path	Source, List Sequencer, List Sequencer Setup, Radio Setup, Radio Standard, GSM/EDGE
Initial S/W Revision	A.05.00

GSM 700

Selects GSM 700 as the band for the current step.

Key Path	Source, List Sequencer, List Sequencer Setup, Radio Setup, Radio Standard, GSM/EDGE
Initial S/W Revision	A.05.00

T-GSM 810

Selects T-GSM 810 as the band for the current step.

Key Path	Source, List Sequencer, List Sequencer Setup, Radio Setup, Radio Standard, GSM/EDGE
Initial S/W Revision	A.05.00

WCDMA

Pressing this key once selects WCDMA as the radio standard and the current WCDMA band as the active channel band. Pressing this key again allows access to the sub-menus for selecting a different WCDMA band.

Key Path	Source, List Sequencer, List Sequencer Setup, Radio Setup, Radio Standard
Initial S/W Revision	A.05.00

Band I

Selects Band I as the band for the current step.

Key Path	Source, List Sequencer, List Sequencer Setup, Radio Setup, Radio Standard, WCDMA
Initial S/W Revision	A.05.00

Band II

Selects Band II as the band for the current step.

Key Path	Source, List Sequencer, List Sequencer Setup, Radio Setup, Radio Standard, WCDMA
Initial S/W Revision	A.05.00

Band III

Selects Band III as the band for the current step.

Key Path	Source, List Sequencer, List Sequencer Setup, Radio Setup, Radio Standard, WCDMA
Initial S/W Revision	A.05.00

Band IV

Selects Band IV as the band for the current step.

Key Path	Source, List Sequencer, List Sequencer Setup, Radio Setup, Radio Standard, WCDMA
Initial S/W Revision	A.05.00

Band V

Selects Band V as the band for the current step.

Key Path	Source, List Sequencer, List Sequencer Setup, Radio Setup, Radio Standard, WCDMA
Initial S/W Revision	A.05.00

Band VI

Selects Band VI as the band for the current step.

Key Path	Source, List Sequencer, List Sequencer Setup, Radio Setup, Radio Standard, WCDMA
Initial S/W Revision	A.05.00

Band VII

Selects Band VII as the band for the current step.

Key Path	Source, List Sequencer, List Sequencer Setup, Radio Setup, Radio Standard, WCDMA
Initial S/W Revision	A.05.00

Band VIII

Selects Band VIII as the band for the current step.

Key Path	Source, List Sequencer, List Sequencer Setup, Radio Setup, Radio Standard, WCDMA
Initial S/W Revision	A.05.00

Band IX

Selects Band IX as the band for the current step.

Key Path	Source, List Sequencer, List Sequencer Setup, Radio Setup, Radio Standard, WCDMA
Initial S/W Revision	A.05.00

Band X

Selects Band X as the band for the current step.

Key Path	Source, List Sequencer, List Sequencer Setup, Radio Setup, Radio Standard, WCDMA
Initial S/W Revision	A.05.00

Band XI

Selects Band XI as the band for the current step.

Key Path	Source, List Sequencer, List Sequencer Setup, Radio Setup, Radio Standard, WCDMA
Initial S/W Revision	A.05.00

Band XII

Selects Band XII as the band for the current step.

Key Path	Source, List Sequencer, List Sequencer Setup, Radio Setup, Radio Standard, WCDMA
Initial S/W Revision	A.05.00

Band XIII

Selects Band XIII as the band for the current step.

Key Path	Source, List Sequencer, List Sequencer Setup, Radio Setup, Radio Standard, WCDMA
Initial S/W Revision	A.05.00

Band XIV

Selects Band XIV as the band for the current step.

Key Path	Source, List Sequencer, List Sequencer Setup, Radio Setup, Radio Standard, WCDMA
Initial S/W Revision	A.05.00

Band XIX

Selects Band XIX as the band for the current step.

Key Path	Source, List Sequencer, List Sequencer Setup, Radio Setup, Radio Standard, WCDMA
Initial S/W Revision	A.14.50

CDMA 2000 / 1xEVDO

Pressing this key once selects CDMA 2000/1xEVDO as the radio standard and the current CDMA 2000/1xEVDO band as the active channel band. Pressing this key again allows access to the sub-menus for selecting a different CDMA 2000/1xEVDO band.

Key Path	Source, List Sequencer, List Sequencer Setup, Radio Setup, Radio Standard
Initial S/W Revision	A.05.00

US CELL

Selects US Cell as the band for the current step.

Key Path	Source, List Sequencer, List Sequencer Setup, Radio Setup, Radio Standard, CDMA 2000 / 1xEVDO
Initial S/W Revision	A.05.00

US PCS

Selects US PCS as the band for the current step.

Key Path	Source, List Sequencer, List Sequencer Setup, Radio Setup, Radio Standard, CDMA 2000 / 1xEVDO
Initial S/W Revision	A.05.00

Japan Cell

Selects Japan Cell as the band for the current step.

Key Path	Source, List Sequencer, List Sequencer Setup, Radio Setup, Radio Standard, CDMA 2000 / 1xEVDO
Initial S/W Revision	A.05.00

Korean PCS

Selects Korean PCS as the band for the current step.

Key Path	Source, List Sequencer, List Sequencer Setup, Radio Setup, Radio Standard, CDMA 2000 / 1xEVDO
Initial S/W Revision	A.05.00

NMT 450

Selects NMT 450 as the band for the current step.

Key Path	Source, List Sequencer, List Sequencer Setup, Radio Setup, Radio Standard, CDMA 2000 / 1xEVDO
Initial S/W Revision	A.05.00

IMT 2000

Selects IMT 2000 as the band for the current step.

Key Path	Source, List Sequencer, List Sequencer Setup, Radio Setup, Radio Standard, CDMA 2000 / 1xEVDO
Initial S/W Revision	A.05.00

Upper 700

Selects Upper 700 as the band for the current step.

Key Path	Source, List Sequencer, List Sequencer Setup, Radio Setup, Radio Standard, CDMA 2000 / 1xEVDO
Initial S/W Revision	A.05.00

Secondary 800

Selects Secondary 800 as the band for the current step.

Key Path	Source, List Sequencer, List Sequencer Setup, Radio Setup, Radio Standard, CDMA 2000 / 1xEVDO
Initial S/W Revision	A.05.00

400 Euro PAMR

Selects 400 Euro PAMR as the band for the current step.

Key Path	Source, List Sequencer, List Sequencer Setup, Radio Setup, Radio Standard, CDMA 2000 / 1xEVDO
Initial S/W Revision	A.05.00

800 PAMR

Selects 800 PAMR as the band for the current step.

Key Path	Source, List Sequencer, List Sequencer Setup, Radio Setup, Radio Standard, CDMA 2000 / 1xEVDO
Initial S/W Revision	A.05.00

2.5GHz IMT EXT

Selects 2.5 GHz IMT EXT as the band for the current step.

Key Path	Source, List Sequencer, List Sequencer Setup, Radio Setup, Radio Standard, CDMA 2000 / 1xEVDO
Initial S/W Revision	A.05.00

US PCS 1.9GHz

Selects US PCS 1.9 GHz as the band for the current step.

Key Path	Source, List Sequencer, List Sequencer Setup, Radio Setup, Radio Standard, CDMA 2000 / 1xEVDO
Initial S/W Revision	A.05.00

AWS

Selects AWS as the band for the current step.

Key Path	Source, List Sequencer, List Sequencer Setup, Radio Setup, Radio Standard, CDMA 2000 / 1xEVDO
Initial S/W Revision	A.05.00

US 2.5GHz

Selects US 2.5 GHz as the band for the current step.

Key Path	Source, List Sequencer, List Sequencer Setup, Radio Setup, Radio Standard, CDMA 2000 / 1xEVDO
Initial S/W Revision	A.05.00

700 Public Safety

Selects 700 Public Safety as the band for the current step.

Key Path	Source, List Sequencer, List Sequencer Setup, Radio Setup, Radio Standard, CDMA 2000 / 1xEVDO
Initial S/W Revision	A.05.00

C2K Lower 700

Selects C2K Lower 700 as the band for the current step.

Key Path	Source, List Sequencer, List Sequencer Setup, Radio Setup, Radio Standard, CDMA 2000 / 1xEVDO
Initial S/W Revision	A.05.00

LTE

Pressing this key once selects LTE FDD as the radio standard and the current LTE FDD band as the active channel band. Pressing this key again allows access to the sub-menus for selecting a different LTE FDD band.

Key Path	Source, List Sequencer, List Sequencer Setup, Radio Setup, Radio Standard
Initial S/W Revision	A.09.50

BAND 1

Selects BAND 1 as the band for the current step.

Key Path	Source, List Sequencer, List Sequencer Setup, Radio Setup, Radio Standard, LTE
Initial S/W Revision	A.09.50

BAND 2

Selects BAND 2 as the band for the current step.

Key Path	Source, List Sequencer, List Sequencer Setup, Radio Setup, Radio Standard, LTE
Initial S/W Revision	A.09.50

BAND 3

Selects BAND 3 as the band for the current step.

Key Path	Source, List Sequencer, List Sequencer Setup, Radio Setup, Radio Standard, LTE
Initial S/W Revision	A.09.50

BAND 4

Selects BAND 4 as the band for the current step.

Key Path	Source, List Sequencer, List Sequencer Setup, Radio Setup, Radio Standard, LTE
Initial S/W Revision	A.09.50

BAND 5

Selects BAND 5 as the band for the current step.

Key Path	Source, List Sequencer, List Sequencer Setup, Radio Setup, Radio Standard, LTE
Initial S/W Revision	A.09.50

BAND 6

Selects BAND 6 as the band for the current step.

Key Path	Source, List Sequencer, List Sequencer Setup, Radio Setup, Radio Standard, LTE
Initial S/W Revision	A.09.50

BAND 7

Selects BAND 7 as the band for the current step.

Key Path	Source, List Sequencer, List Sequencer Setup, Radio Setup, Radio Standard, LTE
Initial S/W Revision	A.09.50

BAND 8

Selects BAND 8 as the band for the current step.

Key Path	Source, List Sequencer, List Sequencer Setup, Radio Setup, Radio Standard, LTE
Initial S/W Revision	A.09.50

BAND 9

Selects BAND 9 as the band for the current step.

Key Path	Source, List Sequencer, List Sequencer Setup, Radio Setup, Radio Standard, LTE
Initial S/W Revision	A.09.50

BAND 10

Selects BAND 10 as the band for the current step.

Key Path	Source, List Sequencer, List Sequencer Setup, Radio Setup, Radio Standard, LTE
Initial S/W Revision	A.09.50

BAND 11

Selects BAND 11 as the band for the current step.

Key Path	Source, List Sequencer, List Sequencer Setup, Radio Setup, Radio Standard, LTE
Initial S/W Revision	A.09.50

BAND 12

Selects BAND 12 as the band for the current step.

Key Path	Source, List Sequencer, List Sequencer Setup, Radio Setup, Radio Standard, LTE
Initial S/W Revision	A.09.50

BAND 13

Selects BAND 13 as the band for the current step.

Key Path	Source, List Sequencer, List Sequencer Setup, Radio Setup, Radio Standard, LTE
Initial S/W Revision	A.09.50

BAND 14

Selects BAND 14 as the band for the current step.

Key Path	Source, List Sequencer, List Sequencer Setup, Radio Setup, Radio Standard, LTE
Initial S/W Revision	A.09.50

BAND 17

Selects BAND 17 as the band for the current step.

Key Path	Source, List Sequencer, List Sequencer Setup, Radio Setup, Radio Standard, LTE
Initial S/W Revision	A.09.50

BAND 18

Selects BAND 18 as the band for the current step.

Key Path	Source, List Sequencer, List Sequencer Setup, Radio Setup, Radio Standard, LTE
Initial S/W Revision	A.09.50

BAND 19

Selects BAND 19 as the band for the current step.

Key Path	Source, List Sequencer, List Sequencer Setup, Radio Setup, Radio Standard, LTE
Initial S/W Revision	A.09.50

BAND 20

Selects BAND 20 as the band for the current step.

Key Path	Source, List Sequencer, List Sequencer Setup, Radio Setup, Radio Standard, LTE
Initial S/W Revision	A.09.50

BAND 21

Selects BAND 21 as the band for the current step.

Key Path	Source, List Sequencer, List Sequencer Setup, Radio Setup, Radio Standard, LTE
Initial S/W Revision	A.09.50

BAND 24

Selects BAND 24 as the band for the current step.

Key Path	Source, List Sequencer, List Sequencer Setup, Radio Setup, Radio Standard, LTE
Initial S/W Revision	A.09.50

BAND 25

Selects BAND 25 as the band for the current step.

Key Path	Source, List Sequencer, List Sequencer Setup, Radio Setup, Radio Standard, LTE
Initial S/W Revision	A.09.50

BAND 26

Selects BAND 26 as the band for the current step.

Key Path	Source, List Sequencer, List Sequencer Setup, Radio Setup, Radio Standard, LTE
Initial S/W Revision	A.12.53

BAND 27

Selects BAND 27 as the band for the current step.

Key Path	Source, List Sequencer, List Sequencer Setup, Radio Setup, Radio Standard, LTE
Initial S/W Revision	A.14.00

BAND 28

Selects BAND 28 as the band for the current step.

Key Path	Source, List Sequencer, List Sequencer Setup, Radio Setup, Radio Standard, LTE
Initial S/W Revision	A.14.00

BAND 31

Selects BAND 31 as the band for the current step.

Key Path	Source, List Sequencer, List Sequencer Setup, Radio Setup, Radio Standard, LTE
Initial S/W Revision	A.14.00

LTE TDD

Sets LTE TDD as the radio standard for use and accesses the LTE TDD specific channel band sub-menus..

Key Path	Source, Frequency, Radio Setup, Radio Standard
Initial S/W Revision	A.11.50

BAND 33

Selects BAND 33 as the band for the current step.

Key Path	Source, Frequency, Radio Setup, Radio Standard, LTE TDD
Example	:SOUR:FREQ:CHAN:BAND BAND33
Initial S/W Revision	A.11.50

BAND 34

Selects BAND 34 as the band for the current step.

Key Path	Source, Frequency, Radio Setup, Radio Standard, LTE TDD
Example	:SOUR:FREQ:CHAN:BAND BAND34
Initial S/W Revision	A.11.50

BAND 35

Selects BAND 35 as the band for the current step.

Key Path	Source, Frequency, Radio Setup, Radio Standard, LTE TDD
Example	:SOUR:FREQ:CHAN:BAND BAND35
Initial S/W Revision	A.11.50

BAND 36

Selects BAND 36 as the band for the current step.

Key Path	Source, Frequency, Radio Setup, Radio Standard, LTE TDD
Example	:SOUR:FREQ:CHAN:BAND BAND36
Initial S/W Revision	A.11.50

BAND 37

Selects BAND 37 as the band for the current step.

Key Path	Source, Frequency, Radio Setup, Radio Standard, LTE TDD
Example	:SOUR:FREQ:CHAN:BAND BAND37
Initial S/W Revision	A.11.50

BAND 38

Selects BAND 38 as the band for the current step.

Key Path	Source, Frequency, Radio Setup, Radio Standard, LTE TDD
Example	:SOUR:FREQ:CHAN:BAND BAND38
Initial S/W Revision	A.11.50

BAND 39

Selects BAND 39 as the band for the current step.

Key Path	Source, Frequency, Radio Setup, Radio Standard, LTE TDD
Example	:SOUR:FREQ:CHAN:BAND BAND39
Initial S/W Revision	A.11.50

BAND 40

Selects BAND 40 as the band for the current step.

Key Path	Source, Frequency, Radio Setup, Radio Standard, LTE TDD
Example	:SOUR:FREQ:CHAN:BAND BAND40
Initial S/W Revision	A.11.50

BAND 41

Selects BAND 41 as the band for the current step.

Key Path	Source, Frequency, Radio Setup, Radio Standard, LTE TDD
Example	:SOUR:FREQ:CHAN:BAND BAND41
Initial S/W Revision	A.11.50

BAND 42

Selects BAND 42 as the band for the current step.

Key Path	Source, Frequency, Radio Setup, Radio Standard, LTE TDD
Example	:SOUR:FREQ:CHAN:BAND BAND42
Initial S/W Revision	A.11.50

BAND 43

Selects BAND 43 as the band for the current step.

Key Path	Source, Frequency, Radio Setup, Radio Standard, LTE TDD
Example	:SOUR:FREQ:CHAN:BAND BAND43
Initial S/W Revision	A.11.50

BAND 44

Selects BAND 44 as the band for the current step.

Key Path	Source, List Sequencer, List Sequencer Setup, Radio Setup, Radio Standard, LTE TDD
Initial S/W Revision	A.14.00

TDSCDMA

Sets TDSCDMA as the radio standard for use and accesses the TDSCDMA specific channel band sub-menus..

Key Path	Source, Frequency, Radio Setup, Radio Standard
Initial S/W Revision	A.11.50

BAND A

Selects BAND A as the band for the current step.

Key Path	Source, Frequency, Radio Setup, Radio Standard, TDSCDMA
Example	:SOUR:FREQ:CHAN:BAND BANDA
Initial S/W Revision	A.11.50

BAND B

Selects BAND B as the band for the current step.

Key Path	Source, Frequency, Radio Setup, Radio Standard, TDSCDMA
Example	:SOUR:FREQ:CHAN:BAND BANDB
Initial S/W Revision	A.11.50

BAND C

Selects BAND C as the band for the current step.

Key Path	Source, Frequency, Radio Setup, Radio Standard, TDSCDMA
Example	:SOUR:FREQ:CHAN:BAND BANDC
Initial S/W Revision	A.11.50

BAND D

Selects BAND D as the band for the current step.

Key Path	Source, Frequency, Radio Setup, Radio Standard, TDSCDMA
Example	:SOUR:FREQ:CHAN:BAND BANDD
Initial S/W Revision	A.11.50

BAND E

Selects BAND E as the band for the current step.

Key Path	Source, Frequency, Radio Setup, Radio Standard, TDSCDMA
----------	---

Example	:SOUR:FREQ:CHAN:BAND BANDE
Initial S/W Revision	A.11.50

BAND F

Selects BAND F as the band for the current step.

Key Path	Source, Frequency, Radio Setup, Radio Standard, TDSCDMA
Example	:SOUR:FREQ:CHAN:BAND BANDF
Initial S/W Revision	A.11.50

Radio Band Link

Allows you to specify the radio band link direction for the steps within the list sequence. The link is used in conjunction with the channel band and channel number to determine the output frequency.

When set to “Uplink”, the source will calculate the uplink frequency according to an uplink formula together with selected channel band and channel number. When set to “Downlink”, the source will calculate the downlink frequency according to a downlink formula together with selected channel band and channel number.

Key Path	Source, List Sequencer, List Sequencer Setup, Radio Setup
Remote Command	:SOURce:LIST:STEP [1] 2 3...1000:SETup:RADio:BAND:LINK DOWN UP :SOURce:LIST:STEP [1] 2 3...1000:SETup:RADio:BAND:LINK?
Example	:SOUR:LIST:STEP2:SET:RAD:BAND:LINK UP :SOUR:LIST:STEP2:SET:RAD:BAND:LINK?
Notes	SCPI is supported after A.09.40
Preset	DOWN
Range	DOWN UP
Initial S/W Revision	A.05.00

Channel

Allows you to specify the frequency of the current step via a channel number.

Key Path	Source, List Sequencer, List Sequencer Setup
Remote Command	:SOURce:LIST:STEP [1] 2 3...1000:SETup:CNFRequency <double> :SOURce:LIST:STEP [1] 2 3...1000:SETup:CNFRequency?
Example	:SOUR:LIST:STEP2:SET:CNFR 124 :SOUR:LIST:STEP2:SET:CNFR?
Notes	SCPI is supported after A.09.40.

	This SCPI is used to setup channel number or frequency setting, according to current Radio Band setting. If Radio Band is "NONE", then it's frequency. If Radio Band is not "NONE", then it's channel number.
Couplings	The channel number is coupled to the step frequency value. When the step frequency value is changed, the channel number will increase or decrease to match the new step frequency. If the step frequency is not at an exact match for a channel number, the nearest channel number is displayed, along with a greater than, or less than sign to indicate the frequency is above or below the channel number.
Preset	1
Min	0 (Please refer to for valid ranges.)
Max	10838 (Please refer to for valid ranges.)
Initial S/W Revision	A.05.00

Frequency

Allows you to specify a frequency value for the current step.

Key Path	Source, List Sequencer, List Sequencer Setup
Remote Command	:SOURce:LIST:STEP[1] 2 3...1000:SETup:CNFRfrequency <double> :SOURce:LIST:STEP[1] 2 3...1000:SETup:CNFRfrequency?
Example	:SOUR:LIST:STEP2:SET:CNFR 1GHz :SOUR:LIST:STEP2:SET:CNFR?
Notes	SCPI is supported after A.09.40. This SCPI is used to setup channel number or frequency setting, according to current Radio Band setting. If Radio Band is "NONE", then it's frequency. If Radio Band is not "NONE", then it's channel number.
Couplings	The frequency value is coupled to the channel band and number for the step, such that updates to the radio band and channel number will update the frequency value to the corresponding absolute frequency. The reverse is also true, changing the frequency value causes the value of the channel number to be updated.
Preset	1.00 GHz
Min	10.00 MHz
Max	Hardware Dependant: Option 503 = 3.6 GHz Option 504 = 3.9 GHz Option 506 = 6.00 GHz
Initial S/W Revision	A.05.00

Power

Allows you to specify a power value for the current step.

Key Path	Source, List Sequencer, List Sequencer Setup
Remote Command	:SOURce:LIST:STEP[1] 2 3...1000:SETup:AMPLitude <double> :SOURce:LIST:STEP[1] 2 3...1000:SETup:AMPLitude?
Example	:SOUR:LIST:STEP2:SET:AMPL -50dBm :SOUR:LIST:STEP2:SET:AMPL?
Notes	SCPI is supported after A.09.40
Notes	<p>Amplitude corrections can be specified for use with the source. In the event of amplitude corrections being applied, the valid ranges for the RF power do not change dependant on the current amplitude correction setting. Instead, if the combination of RF power + amplitude correction is higher or lower than the source output range, the Source Unleveled bit is set and the “Source Unleveled” indicator will appear on status panel to indicate that the source cannot maintain the output power that has been requested.</p> <p>The multiport adapter RFIO TX ports and GPS ports cannot ensure power accuracy when power setting is lower than -130dBm, this power setting value is defined by the sum of RF Power setting and related amplitude correction value. But user settable value could be lower than this limit. When application detected there exists power setting lower than -130dBm on MPA RFIO TX ports, then popup warning message . When application detected there exists power setting lower than -130dBm on MPA GPS ports, then popup warning message . These are only warning messages, and check is performed when RF is ON.</p>
Notes	The Min and Max value here defined UI settable amplitude range. This range is larger than actual amplitude range with level accuracy defined in spec.
Dependencies	The RF power is dependent on the RF output port and frequency, such that the current frequency and selected output port determine the valid range of power values.
Preset	-100 dBm
Min	The range of values depends on the current frequency and selected RF output port. Please refer to "RF Power" on page 2442 and the table RF Power Range for the valid ranges.
Max	The range of values depends on the current frequency and selected RF output port. Please refer to "RF Power" on page 2442 and the table RF Power Range for the valid ranges.
Initial S/W Revision	A.05.00

Waveform

Allows you access to the sub-menus for selecting the waveform to be played back during the current step. Pressing this key also changes the central display area to show the Waveform File Selection view.

Key Path	Source, List Sequencer, List Sequencer Setup
Remote Command	:SOURce:LIST:STEP[1] 2 3...1000:SETup:WAVeform <string> :SOURce:LIST:STEP[1] 2 3...1000:SETup:WAVeform?
Example	:SOUR:LIST:STEP2:SET:WAV "CW" :SOUR:LIST:STEP2:SET:WAV?
Notes	SCPI is supported after A.09.40
Remote Command Notes	String type, takes "Off" "CW" "Cont" "waveform name"

Preset	CW
Range	Waveform Continue Previous CW Off
Initial S/W Revision	A.05.00

CW

Sets the current step to output a CW tone.

Key Path	Source, List Sequencer, List Sequencer Setup, Waveform
Example	:SOUR:LIST:STEP2:SET:WAV "CW"
Notes	SCPI is supported after A.09.40
Initial S/W Revision	A.05.00

Selected Waveform

Inserts the currently selected waveform in the waveform selection view as the waveform for playback during the current step.

Key Path	Source, List Sequencer, List Sequencer Setup, Waveform
Example	:SOUR:LIST:STEP2:SET:WAV "waveform name"
Notes	SCPI is supported after A.09.40 If the selected waveform contains header (which contains ARB play parameters), source list sequence will automatically apply header settings of the selected waveform in that step.
Initial S/W Revision	A.05.00

Continue Previous

Sets the current step to continue with playback of the waveform from the previous step. When continuing the previous waveform, the ARB playback will not pause while the source retunes to the new frequency or amplitude that may be defined for the new step.

Key Path	Source, List Sequencer, List Sequencer Setup, Waveform
Example	:SOUR:LIST:STEP2:SET:WAV "Cont"
Notes	SCPI is supported after A.09.40
Initial S/W Revision	A.05.00

Off

Disable RF output of the current step.

Key Path	Source, List Sequencer, List Sequencer Setup, Waveform
Example	:SOUR:LIST:STEP2:SET:WAV "Off"
Notes	SCPI is supported after A.09.40
Initial S/W Revision	A.05.00

Segments on Hard Disk

Allows you access to the sub-menus for loading waveform segments from the hard disk into ARB memory. The default directory is: D: varb.

Pressing this key changes the current view to the Waveform Management View.

Key Path	Source, Modulation Setup, ARB, Select Waveform
Initial S/W Revision	A.05.00

Load Segment To ARB Memory

Allows you to load the selected file into ARB memory. On the front panel you select the file for loading to the ARB memory by highlighting the desired file in the list. Using the SCPI command, you specify the file name on the HDD.

“NVWFM” (none-volatile storage) MSUS (Mass Storage Unit Specifier) is supported in the memory subsystem because the ARB memory cannot be accessed directly. Therefore, files must be downloaded to the instrument hard disk and then loaded into the ARB memory. “NVWFM” MSUS will be mapped to the default directory D: VARB. The SCPI command supports using either “NVWFM” MSUS or specifying a full path. For more information, see [Memory Subsystem \(Remote Command Only\)](#).

If a file of the same name already exists within ARB memory, it is overwritten. If you wish to load two segments of the same name, you must rename one of the segments before loading it into ARB memory. To rename a segment, you can either use Windows File Explorer, or the :MMEMORY:COPY command.

NOTE: When a waveform file is loaded to ARB memory, burst timing adjustments are made automatically, based on whether or not a Multiport Adapter is connected to the test set and powered on. If the connection/power status of the Multiport Adapter is changed after a waveform file has been loaded, it needs to be loaded again.

Key Path	Source, Modulation Setup, ARB, Select Waveform, Segments on Hard Disk
Remote Command	:SOURce:RADio:ARB:LOAD <string>
Example	:SOUR:RAD:ARB:LOAD "D: VARB\testwaveform.bin" or :SOUR:RAD:ARB:LOAD "NVWFM:testwaveform.bin"
Notes	Because loading the file involves a delay of unpredictable length, this command should be followed by the query *OPC?, which holds off subsequent commands until the loading operating is complete. <string> – specifies the path name of the file to load from the HDD into ARB memory. It could be a <full path + filename>, or <"NVWFM" MSUS + colon + filename>.

When in Sequence Analyzer mode, and Include Source is Yes, an attempt to load a file to ARB memory will be rejected with an error.

When Include Source is No and if there is insufficient free ARB memory to load the selected waveform, an error is generated. .

If you specify a file over SCPI, but the file is not at the specified location, an error is generated.

If you try to load a waveform file but the file contains less than 500 IQ samples, an error is generated.

If you try to load a Signal Studio waveform “*.wfm” which contains invalid waveform header, an error is generated.

If the ARB is ON when you load a file to ARB memory or delete a file from ARB memory, the playing waveform segment may not keep phase continuity during the ARB memory operation. The waveform will be replayed after the ARB operation is finished.

ARB can be loaded into ARB memory even required licenses do not present on the instrument. In this case, a GUI only warning message -800, “Operation complete; Loaded <filename> successfully, but no license <required licenses> installed”. User can install required licenses according to <required licenses> string to license it, or multi-pack license it.

Initial S/W Revision	A.05.00
----------------------	---------

Load All To ARB Memory

Allows you to load all the segment files within the currently selected directory into ARB memory. If a file of the same name already exists within ARB memory, it is overwritten. If you wish to load two segments of the same name, you must rename one of the segments before loading it into ARB memory. To rename a segment, you can either use Windows File Explorer, or the :MEMORY:COPY command.

NOTE: When a waveform file is loaded to ARB memory, burst timing adjustments are made automatically, based on whether or not a Multiport Adapter is connected to the test set and powered on. If the connection/power status of the Multiport Adapter is changed after a waveform file has been loaded, it needs to be loaded again.

Key Path	Source, Modulation Setup, ARB, Select Waveform, Segments on Hard Disk
----------	---

Remote Command	:SOURce:RADio:ARB:LOAD:ALL <string>
----------------	-------------------------------------

Example	:SOUR:RAD:ARB:LOAD:ALL “D: varb”
---------	----------------------------------

Notes	<p><string> - specifies the directory on the HDD to load the files into ARB memory from.</p> <p>When in Sequence Analyzer mode, and Include Source is Yes, an attempt to load all files from a directory to ARB memory is rejected with an error.</p> <p>When Include Source is No and there is insufficient free ARB memory to load all the waveforms, when the ARB memory is full, the copy ceases, and an error is generated.</p> <p>If you specify a directory over SCPI, but the directory does not exist, an error is generated.</p> <p>If the ARB is ON, a user then loads or deletes file to ARB memory, the playing waveform segment may not keep phase continuity during the ARB memory operation. The waveform will be replayed after the ARB operation is finished.</p>
-------	---

Initial S/W Revision	A.05.00
----------------------	---------

Change Directory...

Allows you to change the currently selected directory on the hard disk. Pressing this key opens a standard windows change directory dialog allowing you to select the new directory of interest.

The current directory is used for manually loading waveform segments into ARB memory for playback, and as a search location for waveform segments that are required to be loaded into ARB memory for playback of a waveform sequence or a list sequence.

Key Path	Source, Modulation Setup, ARB, Select Waveform, Segments on Hard Disk
Notes	No remote command, SCPIfront panel only.
Initial S/W Revision	A.05.00

Default Directory...

Allows you to change the default directory. It is used as a search location for waveform segments that are required to be loaded into ARB memory for playback of a waveform sequence, and as a search location for selecting waveforms using SCPI.

Key Path	Source, Modulation Setup, ARB, Select Waveform, Segments on Hard Disk
Remote Command	:SOURce:RADio:ARB:DEFault:DIRectory <string> :SOURce:RADio:ARB: DEFault:DIRectory?
Example	:SOUR:RAD:ARB:DEF:DIR "D:\ArbFiles" :SOUR:RAD:ARB:DEF:DIR?
State Saved	Persistent, survives a power cycle and a preset but not saved in the instrument state
Initial S/W Revision	A.05.00

Segments in ARB Memory

Allows you access to the sub-menus for managing the files within ARB memory.

Key Path	Source, Modulation Setup, ARB, Select Waveform
Initial S/W Revision	A.05.00

Delete Segment From ARB Mem

Allows you to remove a segment from ARB playback memory.

Key Path	Source, Modulation Setup, ARB, Select Waveform, Segments in ARB Memory
Remote Command	:SOURce:RADio:ARB:DELeTe <string>
Example	:SOUR:RAD:ARB:DEL "testwaveform.bin"
Notes	<string> - specifies the waveform to be deleted from the ARB playback memory. When in Sequence Analyzer mode and Include Source is Yes, an attempt to delete a file from ARB

memory is rejected with an error.

When Include Source is No and you specify a file that does not exist within ARB memory, an error is generated.

It is possible to delete files from within the ARB memory when the ARB is ON. However, if you attempt to delete the file that is currently playing an error is generated.

It is possible to delete a file from within the ARB memory when the sequencer state is ON and the file is not being used by the List Sequencer. If you attempt to delete a file which is being used by the list sequencer, an error is generated.

When sequencer state is On, even if ARB state is On, the selected waveform will not be played. In this case, if the selected waveform is not used in List Sequence, it can be deleted and the ARB state is turned Off.

If the ARB is ON and you load a file to ARB memory or delete a file from ARB memory, the playing waveform segment may not keep phase continuity during the ARB memory operation. The waveform will be replayed after the ARB operation is finished.

Initial S/W Revision	A.05.00
----------------------	---------

Delete All From ARB Memory

Allows you to remove all segments from ARB playback memory.

Key Path	Source, Modulation Setup, ARB, Select Waveform, Segments in ARB Memory
Remote Command	:SOURce:RADio:ARB:DELeTe:ALL
Example	:SOUR:RAD:ARB:DELeTe:ALL
Notes	<p>When in Sequence Analyzer mode and Include Source is Yes, an attempt to delete all files from ARB memory is rejected with an error.</p> <p>When Include Source is No and you attempt to delete all files from ARB memory when the ARB is currently playing a file, all files except the one playing are deleted and an error is generated.</p> <p>If you attempt to delete all files from ARB memory when there are waveform files used in "List Sequencer" on page 2520 and "Sequencer" on page 2521 state is ON, all files except the files currently being used in list sequencer are deleted, and an error is generated.</p> <p>If the ARB is ON and you load a file to ARB memory or delete a file from ARB memory, the playing waveform segment may not keep phase continuity during the ARB memory operation. The waveform will be replayed after the ARB operation is finished.</p>
Initial S/W Revision	A.05.00

Segments on Hard Disk

This key functions the same as "[Segments on Hard Disk](#)" on page 2547.

Key Path	Source, List Sequencer, List Sequencer Setup, Waveform
Initial S/W Revision	Prior to A.09.00

Load Segment To ARB Memory

This key functions the same as "[Load Segment To ARB Memory](#)" on page 2547.

Key Path	Source, List Sequencer, List Sequencer Setup, Waveform, Segment on Hard Drive
Initial S/W Revision	Prior to A.09.00

Load All To ARB Memory

This key functions the same as "[Load All To ARB Memory](#)" on page 2548.

Key Path	Source, List Sequencer, List Sequencer Setup, Waveform, Segment on Hard Drive
Initial S/W Revision	Prior to A.09.00

Change Directory ...

This key functions the same as "[Change Directory...](#)" on page 2549.

Key Path	Source, List Sequencer, List Sequencer Setup, Waveform, Segment on Hard Drive
Initial S/W Revision	Prior to A.09.00

Default Directory ...

This key functions the same as "[Default Directory...](#)" on page 2549

Key Path	Source, List Sequencer, List Sequencer Setup, Waveform, Segment on Hard Drive
Initial S/W Revision	Prior to A.09.00

Segments in ARB Memory

This key functions the same as "[Segments in ARB Memory](#)" on page 2549.

Key Path	Source, List Sequencer, List Sequencer Setup, Waveform, Segments in ARB Memory
Initial S/W Revision	Prior to A.09.00

Delete Segment From ARB Memory

This key functions the same as "[Delete Segment From ARB Mem](#)" on page 2549.

Key Path	Source, List Sequencer, List Sequencer Setup, Waveform, Segments in ARB Memory, Segment in ARB Memory
Initial S/W Revision	Prior to A.09.00

Delete All From ARB Memory

This key functions the same as "Delete All From ARB Memory" on page 2550.

Key Path	Source, List Sequencer, List Sequencer Setup, Waveform, Segments in ARB Memory, Segment in ARB Memory
Initial S/W Revision	Prior to A.09.00

Step Duration

Allows access to the sub-menus for setting up the duration of play for the current step.

The duration can be set to be either the number of times for the ARB file associated with the sequence to play, or a specific time value, or continuous. If the step is set to play a CW tone, the step duration cannot be set to a play count.

Key Path	Source, List Sequencer, List Sequencer Setup
Remote Command	:SOURce:LIST:STEP[1] 2 3...1000:SETup:DURation:TYPE TIME COUNT CONTInuous CABort :SOURce:LIST:STEP[1] 2 3...1000:SETup:DURation:TYPE?
Example	:SOUR:LIST:STEP2:SET:DUR:TYPE TIME :SOUR:LIST:STEP2:SET:DUR:TYPE?
Notes	SCPI is supported after A.09.40
Notes	If "Step Duration" is set to "Time" or "Play Count" for the last step, the last step of ARB keeps playing as if set to "Continuous", until the set "Time" has expired or until the "Play Count" setting is reached. However, you can query Error! Reference source not found. Source Sweeping Condition Message to find out if the current list sequence is complete or not.
Range	Time Play Count Continuous Continuous Abort
Initial S/W Revision	A.05.00

Time

Sets the duration of the current step to be a time value for the length of time the step will play. Pressing this key again opens another menu which allows you to set the time value for the step duration.

Key Path	Source, List Sequencer, List Sequencer Setup, Step Duration
Example	:SOUR:LIST:STEP2:SET:DUR:TYPE TIME
Notes	SCPI is supported after A.09.40
Initial S/W Revision	A.05.00

Duration Time

Allows you to specify the length of time the current step will play.

When Step Duration is **Continuous Abort** this parameter specifies the maximum duration that the waveform will continue to play after a step trigger is received before the transition to the next waveform will occur. Duration is limited to a maximum of 20 seconds.

If the Transition Time value is longer than the Step Duration Time, an error is generated when initiating a source list sequence. For source list sequence, transition time is included in the step duration length (not occupy additional time). If the Transition Time value is longer than the Step Duration Time, the real step duration length is extended to equal the transition time and cause a timing shift. This check is also described in section **Error! Reference source not found**. List Sequence Step Validation.

Key Path	Source, List Sequencer, List Sequencer Setup, Step Duration, Time
Remote Command	:SOURce:LIST:STEP[1] 2 3...1000:SETup:DURation:TCOut <double> :SOURce:LIST:STEP[1] 2 3...1000:SETup:DURation:TCOut?
Example	:SOUR:LIST:STEP2:SET:DUR:TCO 1s :SOUR:LIST:STEP2:SET:DUR:TCO?
Notes	SCPI is supported after A.09.40 This SCPI is reused by "Play Count", "Duration Time" and "Continuous Abort" according to current Duration Type setting is "Play Count" or "Duration Time" or "Continuous Abort". If current "Duration Type" is "Continuous", then popup error -221, "Settings conflict; Cannot accept time or count input when step duration type is Continuous on step #"
Notes	If "Duration Time" is set for the last step, the last step of ARB keeps playing as if set to "Continuous" after set time expires. However, you can query Source Sweeping Condition Message (:STAT:OPER:COND?) to find out if the current list sequence is complete or not.
Preset	1.00 ms
Min	100 µs
Max	1800 s
Initial S/W Revision	A.05.00

Play Count

Sets the duration of the current step to be an integer value for the number of times (play count) the ARB file is selected for playback during this step. For example, a 5 second ARB will be set to play 5 times during the step.

Key Path	Source, List Sequencer, List Sequencer Setup, Step Duration
Example	:SOUR:LIST:STEP2:SET:DUR:TYPE COUN
Notes	SCPI is supported after A.09.40 This key is unavailable and is grayed out if the current step is configured to CW tone rather than an ARB waveform.
Initial S/W Revision	A.05.00

Header Utilities

Allows access to the header utilities sub-menu. Pressing this key also causes the central display area to change to display the File Header Information view.

Key Path	Source, Modulation Setup, ARB
Dependencies	This key is only available if there is currently a waveform selected for playback. If no waveform is selected, the key is grayed out.
Initial S/W Revision	A.05.00

Continuous

Sets the current step to be played continuously until the next step starts. The waveform will always play completely before transitioning to the next step.

Key Path	Source, List Sequencer, List Sequencer Setup, Step Duration
Example	:SOUR:LIST:STEP2:SET:DUR:TYPE CONT
Notes	SCPI is supported after A.09.40
Initial S/W Revision	A.05.00

Output Trigger

Allows you to specify the trigger output for the current step. The trigger output signal is sent at the start of the step.

When select “On”, trigger event will occur on both Internal and External2 paths. Select “Off” will turn off trigger output.

Key Path	Source, List Sequencer, List Sequencer Setup
Remote Command	:SOURce:LIST:STEP[1] 2 3...1000:SETup:OUTPut:TRIGger ON OFF 1 0 :SOURce:LIST:STEP[1] 2 3...1000:SETup:OUTPut:TRIGger
Example	:SOUR:LIST:STEP2:SET:OUTP:TRIG ON :SOUR:LIST:STEP2:SET:OUTP:TRIG?
Notes	SCPI is supported after A.09.40
Preset	Off
Range	On Off
Initial S/W Revision	A.05.00

Step Configuration (Remote Command Only)

This SCPI command is used to configure the List Sequencer and is detailed in the table below. The command is defined such that you send one command per step, with the step number being specified as a subopcode of the SCPI command. Each command includes all the parameter settings for the step. As a step is setup, the values entered are run through several levels of validation.

Remote Command	:SOURce:LIST:STEP[1] 2 ... 4..1000:SETup IMMEDIATE INTERNAL KEY
-----------------------	---

```
BUS | EXTERNAL2, <time>, NONE | PGSM | EGSM | RGSM | DCS1800 | PCS1900
| TGSM810 | GSM450 | GSM480 | GSM700 | GSM850 | BANDI | BANDII |
BANDIII | BANDIV | BANDV | BANDVI | BANDVII | BANDVIII | BANDIX | BANDX
| BANDXI | BANDXII | BANDXIII | BANDXIV | BANDXIX | USCELL | USPCS |
JAPAN | KOREAN | NMT | IMT2K | UPPER | SECOND | PAMR400 | PAMR800 |
IMTEXT | PCS1DOT9G | AWS | US2DOT5G | PUBLIC | LOWER | NONE | BAND1 |
BAND2 | BAND3 | BAND4 | BAND5 | BAND6 | BAND7 | BAND8 | BAND10 | BAND11
| BAND12 | BAND13 | BAND14 | BAND17 | BAND18 | BAND19 | BAND20 | BAND21
| BAND24 | BAND25 | BAND26 | BAND33 | BAND34 | BAND35 | BAND36 | BAND37
| BAND38 | BAND39 | BAND40 | BAND41 | BAND42 | BAND43 | BANDA | BANDB |
BANDC | BANDD | BANDE | BANDE, DOWN | UP, <freq>, <ampl>, <string>,
TIME | COUNT | CONTINUOUS, <time>, ON | OFF | 1 | 0, [<int>],
:SOURce:LIST:STEP[1]|2|...|4..1000:SETup?
```

Example :SOUR:LIST:STEP1:SET INT, 1ms, PGSM, DOWN, 10, -25 dBm, "GSM_Test1.bin", TIME, 10ms, OFF, 255

Notes The parameters are:
(There is a total of 11 items in each step, the following is a list of the items in the order they must appear in the remote command.)

1. Step Trigger **<enum>** – specifies the input trigger for the step. For details of the valid types of step trigger see ["Step Trigger" on page 2523](#).
2. Transition Time **<time>** – specifies the transition time for the step in seconds. For details of the valid ranges for the transition time see ["Transition Time" on page 2525](#).
3. Radio Band **<enum>** – specifies the radio band for the step. For details of the valid radio bands see ["Radio Setup" on page 2526](#).
4. Radio Band Link **<enum>** – specifies the radio band link direction for the step. For details of the valid link types, see ["Radio Band Link" on page 2543](#).
5. Frequency/Channel Number **<freq>/<chan num>** – specifies the frequency in Hz or the channel number for the step. The channel number and frequency are combined as one parameter that represents the frequency or channel number depending on the radio band setting. If the radio band is set to NONE, this value is interpreted as a frequency value in Hz. If the radio band is set to a valid band, this value is interpreted as a channel number. For details of the valid ranges for frequency and channel numbers, see ["Channel" on page 2543](#) and ["Frequency" on page 2544](#).
6. Power **<ampl>** – specifies the output power for the step in dBm. For details of the valid ranges see ["Power" on page 2544](#).
7. Waveform **<string>** – specifies the waveform for playback during the step. The step can output either a new ARB waveform, continue playback of the previous waveform, or output a CW tone. The options for specifying these are:
<filename> - plays the specified waveform from the start. The filename value is the name of the file within ARB playback memory, it does not include the windows path to the file on the HDD. If you enter a filename for a waveform that does not reside within ARB playback memory, an error is generated.
CONT – continues playback of the ARB file from the previous step
CW – outputs a CW tone
OFF – disable RF output
8. Step Duration **<enum>** – specifies the duration of the step. The duration can be specified to be either time, or play count of the ARB file associated with the step, or continuous. If Waveform is set to "CW", this value cannot be set to Play Count and an error will be generated. If continuous is selected, the following Time or Count value is ignored. For further details of this setting, see ["Step](#)

[Duration" on page 2552.](#)

9. Time or Count <time/int> – specifies time duration in seconds or play count of the ARB file associated with the step. For further details of this setting, including the valid ranges for the time or play count setting, ["Time" on page 2552](#) and ["Play Count" on page 2553](#).

10. Output Trigger <Boolean> – specifies the output trigger for the step. For details of the ranges for this setting see ["Output Trigger" on page 2554](#).

Dependencies	The range of subopcode values is 1 to 1000 and the value you enter is determined by the number of steps you have configured. For details see "Number of Steps" on page 2522 . If you attempt to remotely set or query a subopcode that is out of range, an error is generated.
Initial S/W Revision	A.05.00

Step Configuration of Step Trigger parameter list (Remote Command Only)

This SCPI command is to configure “Step Trigger” parameter array of the whole List Sequencer at one time. The number of array is same as step number defined in ["Number of Steps" on page 2522](#) Number of Steps. As a step is setup, the value entered run through several levels of validation.

Remote Command	:SOURce:LIST:SETup:INPut:TRIGger <enum>, <enum>, <enum>, ... :SOURce:LIST:SETup:INPut:TRIGger?
Example	:SOUR:LIST:SET:INP:TRIG IMM,INT,EXT2 :SOUR:LIST:SET:INP:TRIG?
Notes	The command is to setup below parameter array of whole list sequence. Step Trigger <enum> – specifies the input trigger for the step. For details of the valid types of step trigger see "Step Trigger" on page 2523 . If input parameter number exceeds the step number defined by "Number of Steps" on page 2522 Number of Steps then generate error ", and only those parametes whose index number falls in number of steps will be updated.
Remote Command Notes	IMMediate INTerna KEY BUS EXTerna2
Dependencies	The range is 1 to 1000 which is determined by the number of steps you have configured. For details see "Number of Steps" on page 2522 .
Initial S/W Revision	A.09.40

Step Configuration of Transition Time parameter list (Remote Command Only)

This SCPI command is to configure “Transition Time” parameter array of the whole List Sequencer at one time. The number of array is same as step number defined in ["Number of Steps" on page 2522](#) Number of Steps. As a step is setup, the value entered run through several levels of validation.

Remote Command	:SOURce:LIST:SETup:TRANSition:TIME <time>, <time>, <time>, ... :SOURce:LIST:SETup:TRANSition:TIME?
Example	:SOUR:LIST:SET:TRAN:TIME 1ms,1ms,1ms

	:SOUR:LIST:SET:TRAN:TIME?
Notes	<p>The command is to setup below parameter array of whole list sequence.</p> <p>Transition Time <time> – specifies the transition time for the step in seconds. For details of the valid ranges for the transition time see "Transition Time" on page 2525</p> <p>If input parameter number exceeds the step number defined by "Number of Steps" on page 2522 Number of Steps then generate error ", and only those parameters whose index number falls in number of steps will be updated.</p>
Dependencies	The range is 1 to 1000 which is determined by the number of steps you have configured. For details see "Number of Steps" on page 2522 .
Initial S/W Revision	A.09.40

Step Configuration of Radio Band parameter list (Remote Command Only)

This SCPI command is to configure "Radio Band" parameter array of the whole List Sequencer at one time. The number of array is same as step number defined in ["Number of Steps" on page 2522](#) Number of Steps. As a step is setup, the value entered run through several levels of validation.

R :SOURce:LIST:SETup:RADio:BAND <enum>, <enum>, <enum>, ...

e :SOURce:LIST:SETup:RADio:BAND?

m
o
t
e

C
o
m
m
a
n
d

E :SOUR:LIST:SET:RAD:BAND PGSM, EGSM, RGSM

x :SOUR:LIST:SET:RAD:BAND?

a
m
p
l
e

N The command is to setup below parameter array of whole list sequence.

o Radio Band <enum> – specifies the radio band for the step. For details of the valid radio bands see ["Radio Setup" on page 2526](#).

t If input parameter number exceeds the step number defined by ["Number of Steps" on page 2522](#) Number of Steps then generate error ", and only those parameters whose index number falls in number of steps will be updated.

e NONE|PGSM|EGSM|RGSM|DCS1800|PCS1900|TGSM810|GSM450|GSM480|GSM700|GSM850|BANDI|BANDII|BANDIII|BANDIV|BANDV|BANDVI|BANDVII|BANDVIII|BANDIX|BANDX|BANDXI|BANDXII|BANDXIII|BANDXIV|BANDXIX|USCELL|USPCS|JAPAN|KOREAN|NMT|IMT2K|UPPER|SECOND|PAMR400|PAMR800|IMTEXT|PCS1 DOT9G|AWS|US2DOT5G|PUBLIC|LOWER|NONE|BAND1|BAND2|BAND3|BAND4|BAND5|BAND6|BAND7|BAND8|BAND10|BAND11|BAND12|BAND13|BAND14|BAND17|BAND18|BAND1

o 9|BAND20|BAND21|BAND24|BAND25|BAND26|BAND33|BAND34|BAND35|BAND36|BAND37|BAND38|BAND39|BAND40|BAN
t D41|BAND42|BAND43|BANDA|BANDB|BANDC|BANDD|BANDE|BANDF
e

C
o
m
m
a
n
d

N
o
t
e
s

D The range is 1 to 1000 which is determined by the number of steps you have configured. For details see "[Number of Steps](#)" on
e [page 2522](#).

p
e
n
d
e
n
c
i
e
s

I A.09.40

n
i
t
i
a
l

S
/
W

R
e
v
i
s
i
o
n

Step Configuration of Radio Band Link parameter list (Remote Command Only)

This SCPI command is to configure “Radio Band Link” parameter array of the whole List Sequencer at one time. The number of array is same as step number defined in ["Number of Steps" on page 2522](#) Number of Steps. As a step is setup, the value entered run through several levels of validation.

Remote Command	:SOURce:LIST:SETup:RADio:BAND:LINK <enum>, <enum>, <enum>, ... :SOURce:LIST:SETup:RADio:BAND:LINK?
Example	:SOUR:LIST:SET:RAD:BAND:LINK DOWN,UP,UP :SOUR:LIST:SET:RAD:BAND:LINK?
Notes	The command is to setup below parameter array of whole list sequence. Radio Band Link <enum> – specifies the radio band link direction for the step. For details of the valid link types, see "Radio Band Link" on page 2543 . If input parameter number exceeds the step number defined by "Number of Steps" on page 2522 Number of Steps then generate error ", and only those parametes whose index number falls in number of steps will be updated.
Remote Command Notes	DOWN UP
Dependencies	The range is 1 to 1000 which is determined by the number of steps you have configured. For details see "Number of Steps" on page 2522 .
Initial S/W Revision	A.09.40

Step Configuration of Frequency/Channel Number parameter list (Remote Command Only)

This SCPI command is to configure “Frequency” or “Channel Number” parameter array of the whole List Sequencer at one time. The number of array is same as step number defined in ["Number of Steps" on page 2522](#) Number of Steps. As a step is setup, the value entered run through several levels of validation.

Remote Command	:SOURce:LIST:SETup:CNFRrequency <double>, <double>, <double>, ... :SOURce:LIST:SETup:CNFRrequency?
Example	:SOUR:LIST:SET:CNFR 1GHz,100MHz,100MHz :SOUR:LIST:SET:CNFR? SOUR:LIST:SET:CNFR 124,124,124 :SOUR:LIST:SET:CNFR?
Notes	The command is to setup below parameter array of whole list sequence. Frequency/Channel Number <freq>/<chan num> – specifies the frequency in Hz or the channel number for the step. The channel number and frequency are combined as one parameter that represents the frequency or channel number depending on the radio band setting. If the radio band is set to NONE, this value is interpreted as a frequency value in Hz. If the radio band is set to a valid band, this value is interpreted as a channel number. For details of the valid ranges for frequency and channel numbers, see "Channel" on page 2543 and "Frequency" on page 2544 This SCPI is used to setup/query channel number or frequency setting, according to current Radio Band setting of that step. If Radio Band is “NONE”, then it’s frequency. If Radio Band is not “NONE”, then it’s channel number If input parameter number exceeds the step number defined by "Number of Steps" on page 2522 Number of Steps then generate error ", and only those parametes whose index number falls in

	legal step number will be updated.
Dependencies	The range is 1 to 1000 which is determined by the number of steps you have configured. For details see "Number of Steps" on page 2522 .
Initial S/W Revision	A.09.40

Step Configuration of Power parameter list (Remote Command Only)

This SCPI command is to configure “Power” parameter array of the whole List Sequencer at one time. The number of array is same as step number defined in ["Number of Steps" on page 2522](#) Number of Steps. As a step is setup, the value entered run through several levels of validation.

Remote Command	:SOURce:LIST:SETup:AMPLitude <ampl>, <ampl>, <ampl>, ... :SOURce:LIST:SETup:AMPLitude?
Example	:SOUR:LIST:SET:AMPL -50dBm,-40dBm,-30dBm :SOUR:LIST:SET:AMPL?
Notes	The command is to setup below parameter array of whole list sequence. Power <ampl> – specifies the output power for the step in dBm. For details of the valid ranges see "Power" on page 2544 . If input parameter number exceeds the step number defined by "Number of Steps" on page 2522 Number of Steps then generate error ", and only those parametes whose index number falls in legal step number will be updated.
Dependencies	The range is 1 to 1000 which is determined by the number of steps you have configured. For details see "Number of Steps" on page 2522 .
Initial S/W Revision	A.09.40

Step Configuration of Waveform parameter list (Remote Command Only)

This SCPI command is to configure “Waveform” parameter array of the whole List Sequencer at one time. The number of array is same as step number defined in ["Number of Steps" on page 2522](#) Number of Steps. As a step is setup, the value entered run through several levels of validation.

Remote Command	:SOURce:LIST:SETup:WAVEform <string>, <string>, <string>, ... :SOURce:LIST:SETup:WAVEform?
Example	:SOUR:LIST:SET:WAV "CW","Off","CONT" :SOUR:LIST:SET:WAV?
Notes	The command is to setup below parameter array of whole list sequence. Waveform <string> – specifies the waveform for playback during the step. The step can output either a new ARB waveform, continue playback of the previous waveform, or output a CW tone. The options for specifying these are: <filename> – plays the specified waveform from the start. The filename value is the name of the file within ARB playback memory, it is does not include the windows path to the file on the HDD. If you enter a filename for a waveform that does not reside within ARB playback memory, an error is generated.

	<p>CONT – continues playback of the ARB file from the previous step</p> <p>CW – outputs a CW tone</p> <p>OFF – disable RF output</p> <p>If input parameter number exceeds the step number defined by "Number of Steps" on page 2522 Number of Steps then generate error ", and only those parametes whose index number falls in number of steps will be updated.</p>
Dependencies	The range is 1 to 1000 which is determined by the number of steps you have configured. For details see "Number of Steps" on page 2522.
Range	"filename" "CW" "Off" "CONT"
Initial S/W Revision	A.09.40

Step Configuration of Step Duration parameter list (Remote Command Only)

This SCPI command is to configure "Step Duration" parameter array of the whole List Sequencer at one time. The number of array is same as step number defined in "Number of Steps" on page 2522 Number of Steps. As a step is setup, the value entered run through several levels of validation.

Remote Command	<pre>:SOURce:LIST:SETup:DURation:TYPE <enum>, <enum>, <enum>, ... :SOURce:LIST:SETup:DURation:TYPE?</pre>
Example	<pre>:SOUR:LIST:SET:DUR:TYPE COUN,TIME,CONT :SOUR:LIST:SET:DUR:TYPE?</pre>
Notes	<p>The command is to setup below parameter array of whole list sequence.</p> <p>Step Duration <enum> – specifies the duration of the step. The duration can be specified to be either time, or play count of the ARB file associated with the step, or continuous. If Waveform is set to "CW", this value cannot be set to Play Count and an error will be generated. If continuous is selected, the following Time or Count value is ignored. For further details of this setting, see "Step Duration" on page 2552.</p> <p>If input parameter number exceeds the step number defined by "Number of Steps" on page 2522 Number of Steps then generate error ", and only those parametes whose index number falls in number of steps will be updated.</p>
Remote Command Notes	TIME COUNT CONTinuous
Dependencies	The range is 1 to 1000 which is determined by the number of steps you have configured. For details see "Number of Steps" on page 2522.
Initial S/W Revision	A.09.40

Step Configuration of Duration Time or Play Count parameter list (Remote Command Only)

This SCPI command is to configure "Duration Time" or "Play Count" parameter array of the whole List Sequencer at one time. The number of array is same as step number defined in "Number of Steps" on page 2522 Number of Steps. As a step is setup, the value entered run through several levels of validation.

Remote Command	<pre>:SOURce:LIST:SETup:TOCount <time/int>, <time/int>, <time/int>, ... :SOURce:LIST:SETup:TOCount?</pre>
-----------------------	---

Example	:SOUR:LIST:SET:TOC 1s,2s,3s :SOUR:LIST:SET:TOC? :SOUR:LIST:SET:TOC 5,6,7 :SOUR:LIST:SET:TOC?
Notes	The command is to setup below parameter array of whole list sequence. Time or Count <time/int> – specifies time duration in seconds or play count of the ARB file associated with the step. For further details of this setting, including the valid ranges for the time or play count setting, " Time " on page 2552 and " Play Count " on page 2553. If input parameter number exceeds the step number defined by " Number of Steps " on page 2522 Number of Steps then generate error ", and only those parametes whose index number falls in number of steps will be updated. If current " Step Duration " on page 2552 is "Continuous", then generate error -221,"Settings conflict;Cannot accept time or count input when step duration type is Continuous on step #"
Dependencies	The range is 1 to 1000 which is determined by the number of steps you have configured. For details see " Number of Steps " on page 2522.
Initial S/W Revision	A.09.40

Step Configuration of Output Trigger parameter list (Remote Command Only)

This SCPI command is to configure "Output Trigger" parameter array of the whole List Sequencer at one time. The number of array is same as step number defined in "[Number of Steps](#)" on page 2522 Number of Steps. As a step is setup, the value entered run through several levels of validation.

Remote Command	:SOURce:LIST:SETup:OUTPut:TRIGger <bool>, <bool>, <bool>, ... :SOURce:LIST:SETup:OUTPut:TRIGger ?
Example	:SOUR:LIST:SET:OUTP:TRIG ON,OFF,ON :SOUR:LIST:SET:OUTP:TRIG?
Notes	The command is to setup below parameter array of whole list sequence. Output Trigger <Boolean> – specifies the output trigger for the step. For details of the ranges for this setting see " Output Trigger " on page 2554. If input parameter number exceeds the step number defined by " Number of Steps " on page 2522 Number of Steps then generate error ", and only those parametes whose index number falls in legal step number will be updated.
Remote Command Notes	ON OFF 1 0
Dependencies	The range is 1 to 1000 which is determined by the number of steps you have configured. For details see " Number of Steps " on page 2522.
Initial S/W Revision	A.09.40

Clear List (Remote Command Only)

This command is the SCPI equivalent of the Clear List UI featuredescribed in.

Remote Command	:SOURce:LIST:SETup:CLEar
Example	:SOUR:LIST:SETup:CLE
Initial S/W Revision	A.05.00

Trigger Type

Allows access to the sub-menu for selecting the output trigger type for the list sequencer globally. It cannot be changed between different sequence steps.

Key Path	Source, List Sequencer
Remote Command	:SOURce:LIST:TRIGgerout:TYPE BEGinningofstep DATamarker
Example	:SOUR:LIST:TRIG:TYP BEG :SOUR:LIST:TRIG:TYP?
Notes	SCPI is supported after A.14.00
Preset	BEGinningofstep
Range	BEGinningofstep DATamarker
Initial S/W Revision	A.14.00

BeginningOfStep

Sets the output trigger type as BeginningOfStep for the whole source sequence.

Key Path	Source, List Sequencer, Trigger Type
Example	:SOUR:LIST:TRIG:TYP BEG
Notes	SCPI is supported after A.14.00
Initial S/W Revision	A.14.00

DataMarker

Sets the output trigger type as DataMarker for the whole source sequence. When DataMarker is selected, which marker to route is also needed to be set.

Key Path	Source, List Sequencer, Trigger Type
Example	:SOUR:LIST:TRIG:TYP DAT
Notes	SCPI is supported after A.14.00
Initial S/W Revision	A.14.00

Marker 1

Sets the output trigger maker routing to Marker 1 for DataMarker in the whole source sequence.

Key Path	Source, List Sequencer, Trigger Type, DataMarker
Example	:SOUR:LIST:TRIG:TYPE:MARK M1
Notes	SCPI is supported after A.14.00
Initial S/W Revision	A.14.00

Marker 2

Sets the output trigger maker routing to Marker 2 for DataMarker in the whole source sequence.

Key Path	Source, List Sequencer, Trigger Type, DataMarker
Example	:SOUR:LIST:TRIG:TYPE:MARK M2
Notes	SCPI is supported after A.14.00
Initial S/W Revision	A.14.00

Marker 3

Sets the output trigger maker routing to Marker 3 for DataMarker in the whole source sequence.

Key Path	Source, List Sequencer, Trigger Type, DataMarker
Example	:SOUR:LIST:TRIG:TYPE:MARK M3
Notes	SCPI is supported after A.14.00
Initial S/W Revision	A.14.00

Marker 4

Sets the output trigger maker routing to Marker 4 for DataMarker in the whole source sequence.

Key Path	Source, List Sequencer, Trigger Type, DataMarker
Example	:SOUR:LIST:TRIG:TYPE:MARK M4
Notes	SCPI is supported after A.14.00
Initial S/W Revision	A.14.00

Manual Trigger Now

Pressing this key provides a software trigger event to the list sequencer. During execution of sequence, if the sequencer is halted on any step that has been configured with a “Manual” step trigger, then this key press will cause the sequencer to continue and execute the step.

Key Path	Source, List Sequencer
Remote Command	No remote command, front panel only.
Initial S/W Revision	A.05.00

Remote Software Trigger (Remote command Only)

During execution of a list sequence, the sequence will halt and wait at any step that has Step Trigger set to "Bus". Sending this command will trigger the step and continue the sequence.

Remote Command	:SOURce:LIST:TRIGger:INITiate[:IMMediate]
Example	:SOUR:LIST:TRIG:INIT
Initial S/W Revision	A.05.00

Query List Sequence Initiation Armed Status (Remote Command Only)

This is a blocking SCPI query to determine if source list sequence being initiated successfully or not.

Remote Command	:SOURce:LIST:INITiation:ARMed?
Example	:SOUR:LIST:INIT:ARMed?
Notes	The return data is in the following format: Integer
Notes	Query only SCPI. Returning "1" if list sequence has been initiated successfully, returning "0" if not. Once get "0", you can use :SYST:ERR? to query what error happened. Just like "*OPC?", this command can be blocked until event/status "IsSourceSweeping" happens, and then returns. Doing so can help user's script query armed status only once during the time interval of the initiation. As an ancillary SCPI of existing SCPI ":SOUR:LIST:TRIGger[:IMMediate]" (see "Initiate Sequence" on page 2521 Initiate Sequence), the right usage of this command is to use it after ":SOUR:LIST:TRIG". If not, this command will return "1" immediately.
Notes	There is an alias SCPI ":SOURce:LIST:TRIGger:INITiation:ARMed?".
Initial S/W Revision	A.09.40

Source Preset

Allows you to preset the source settings to their default values.

Key Path	Source
Remote Command	:SOURce:PRESet
Example	:SOUR:PRES

SPAN X Scale

Accesses a menu of functions that enable you set the horizontal scale parameters.

Key Path	Front-panel key
Initial S/W Revision	Prior to A.02.00

Span

Changes the frequency range symmetrically about the center frequency.

The default (and minimum) span is calculated using the number of carriers and the carrier width where;

$$\text{Span} = (\text{Upper Carrier Freq} + (\text{max offset IBW} * (1 + \alpha)) / 2) - (\text{Lower Carrier Freq} - (\text{max offset IBW} * (1 + \alpha)) / 2)$$

The span is increased by a factor of 1 + Filter Alpha if the RRC Filter is on.

Key Path	SPAN X Scale
Mode	SA, WCDMA, C2K, WIMAX OFDMA, TD-SCDMA, 1xEVDO, DVB-T/H, DTMB (CTTB), ISDB-T, CMMB, LTE, LTE-TDD
Remote Command	[:SENSe] :ACPpower:FREQuency:SPAN <freq> [:SENSe] :ACPpower:FREQuency:SPAN?
Example	ACP:FREQ:SPAN 25MHz ACP:FREQ:SPAN?
Notes	You must be in the mode that includes ACP measurements to use this command. Use :INSTrument:SElect to set the mode.
Couplings	The span value is clipped when the carrier settings and/or the offset settings are changed. The value is changed to satisfy following formula: $\text{Span} = (\text{Upper Carrier Freq} + (\text{max offset IBW} * (1 + \alpha)) / 2) - (\text{Lower Carrier Freq} - (\text{max offset IBW} * (1 + \alpha)) / 2)$
Preset	SA: 8 MHz WCDMA: 24.6848 MHz WIMAX OFDMA: 50 MHz C2K: 4.5 MHz TD-SCDMA: 8 MHz 1xEVDO: 4.05 MHz LTE, LTE-TDD: 25 MHz
State Saved	Saved in instrument state.
Min	10 Hz
Max	Hardware Dependent: Option 503 = 3.7 GHz Option 507 = 7.1 GHz

	Option 508 = 8.5 GHz Option 513 = 13.8 GHz Option 526 = 27.0 GHz
Initial S/W Revision	Prior to A.02.00
Modified at S/W Revision	A.02.00, A.03.00

Last Span

Changes the span to the previous span setting. If no previous span value exists, then the span will remain unchanged.

Key Path	SPAN X Scale
Mode	SA, WCDMA, C2K, WIMAX OFDMA, TD-SCDMA, 1xEVDO, DVB-T/H, DTMB (CTTB), ISDB-T, CMMB, LTE, LTETDD
Remote Command	[:SENSe] :ACPowEr:FREQuency:SPAN:PREVious
Example	ACP:FREQ:SPAN:PREV
Notes	You must be in the mode that includes ACP measurements to use this command. Use :INSTrument:SElect to set the mode.
Initial S/W Revision	Prior to A.02.00
Modified at S/W Revision	A.02.00, A.03.00

Sweep/Control

Accesses a menu of functions that enable you to set up and control the acquisition time, and source.

See Key and Command Descriptions – Sweep/Control for more information.

Key Path	Front-panel key
Initial S/W Revision	Prior to A.02.00

Acq Time

Sets the acquisition time; acquisition time can be set manually or put in auto mode. The time value is the acquisition time for an individual FFT segment, not the cumulated time for all FFT segments in the measurement.

Key Path	Sweep/Control
Mode	SA, WCDMA, C2K, WIMAX OFDMA, TD-SCDMA, 1xEVDO, DVB-T/H, DTMB (CTTB), ISDB-T, CMMB, LTE, LTETDD
Remote Command	[:SENSe]:ACPower:SWEep:TIME <time> [:SENSe]:ACPower:SWEep:TIME? [:SENSe]:ACPower:SWEep:TIME:AUTO OFF ON 0 1 [:SENSe]:ACPower:SWEep:TIME:AUTO?
Example	ACP:SWE:TIME 50ms ACP:SWE:TIME? ACP:SWE:TIME:AUTO OFF ACP:SWE:TIME:AUTO?
Notes	This parameter is preset by Meas Method selection. Preset values are as follows: IBW: 29 ms IBWR: 108 ms FAST (WCDMA): 7.5 ms
Preset	SA, LTE, LTETDD: Automatically calculated WCDMA: 29 ms WIMAX OFDMA: Automatically calculated C2K: Automatically calculated TD-SCDMA: Automatically calculated 1xEVDO: Automatically calculated SA, LTE, LTETDD: ON WCDMA: OFF C2K: OFF (mehtod IBW) WIMAX OFDMA: ON TD-SCDMA: ON

State Saved	Saved in instrument state.
Min	100 ns
Max	4000 s
Initial S/W Revision	Prior to A.02.00
Modified at S/W Revision	A.02.00, A.03.00

Sweep Setup

Accesses the sweep setup menu.

Key Path	Sweep/Control
Initial S/W Revision	Prior to A.02.00

Auto Sweep Time Rules

Switches the analyzer between normal and accuracy sweep states.

Key Path	Sweep/Control, Sweep Setup
Mode	SA, WCDMA, C2K, WIMAX OFDMA, TD-SCDMA, 1xEVDO, DVB-T/H, DTMB (CTTB), ISDB-T, CMMB, LTE, LTETDD
Remote Command	[:SENSe] :ACPoweR:SWEep:TIME:AUTO:RULEs NORMAl ACCuracy [:SENSe] :ACPoweR:SWEep:TIME:AUTO:RULEs?
Example	ACP:SWE:TIME:AUTO:RUL NORM ACP:SWE:TIME:AUTO:RUL?
Notes	Set to Norm when Auto Couple is pressed or sent remotely.
Preset	SA, WCDMA, C2K, TD-SCDMA, 1xEVDO, LTE, LTETDD: ACCuracy WIMAX OFDMA: NORMAl
State Saved	Saved in instrument state.
Range	Norm Accy
Initial S/W Revision	Prior to A.02.00
Modified at S/W Revision	A.02.00, A.03.00

Pause

Pauses a measurement after the current data acquisition is complete. When Paused, the label on the key changes to Resume. Pressing the Resume key resumes the measurement at the point where it was paused. When Paused, pressing Restart, Single, or Cont does a Resume

See "[Pause/Resume](#)" on page 1865 for more details.

Key Path	Sweep/Control
Initial S/W Revision	Prior to A.02.00

Gate

Accesses a menu that enables you to control the gating function. The Gate functionality is used to view signals best viewed by qualifying them with other events.

Gate setup parameters are the same for all measurements – they do not change as you change measurements. Settings like these are called “Meas Global” and are unaffected by Meas Preset.

Key Path	Sweep/Control
Scope	Meas Global
Readback	The state and method of Gate, as [Off, FFT] or [On, FFT]. Note that for measurements that only support gated FFT, the method is nonetheless read back, but always as FFT.
Initial S/W Revision	Prior to A.02.00

Gate On/Off

Turns the gate function on and off.

When the Gate Function is on, the selected Gate Method is used along with the gate settings and the signal at the gate source to control the sweep system with the gate signal. Not all measurements allow every type of Gate Methods.

When Gate is on, the annunciation in the measurement bar reflects that it is on and what method is used, as seen in the following "Gate: FFT" annunciator graphic.

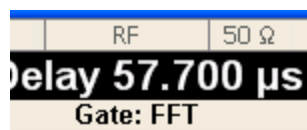

Key Path	Sweep/Control, Gate
Remote Command	[:SENSe] :SWEep:EGATe [:STATe] OFF ON 0 1 [:SENSe] :SWEep:EGATe [:STATe] ?
Example	SWE:EGAT ON SWE:EGAT?
Dependencies	When in the ACP measurement: <ul style="list-style-type: none"> • When Meas Method is RBW or FAST, this function is unavailable and the key is grayed out.

	<ul style="list-style-type: none"> • Whenever Gate is on, Meas Method, RBW or FAST is unavailable and keys for those are grayed out. • When Gate is on, Offset Res BW and Offset Video BW are ignored (if you set these values) and the measurement works as if all Offset Res BW and all Offset Video BW are coupled with the Res BW and the Video BW under the BW menu. When Gate is on, the Offset BW key in the Offset/Limit menu is grayed out.
Preset	Off LTETDD: On
State Saved	Saved in instrument state
Range	On Off
Backwards Compatibility SCPI	[:SENSe]:SWEep:TIME:GATE[:STATe] ESA compatibility
Backwards Compatibility Notes	In ESA, Trig Delay (On) and Gate (On) could not be active at the same time.. This dependency does not exist in PSA or in the X-Series.
Initial S/W Revision	Prior to A.02.00

Gate View On/Off

Turning on Gate View in the Swept SA measurement provides a single-window gate view display..

Turning on Gate View in other measurements shows the split-screen Gate View. In these measurements, when the Gate View is on, the regular view of the current measurement traces and results are reduced vertically to about 70% of the regular height. The Zero Span window, showing the positions of the Gate, is shown between the Measurement Bar and the reduced measurement window. By reducing the height of the measurement window, some of the annotation on the Data Display may not fit and is not shown.

Key Path	Sweep/Control, Gate
Remote Command	[:SENSe]:SWEep:EGATe:VIEW ON OFF 1 0 [:SENSe]:SWEep:EGATe:VIEW?
Example	SWE:EGAT:VIEW ON turns on the gate view.
Dependencies	<p>In the Swept SA measurement:</p> <p>In Gate View, the regular Acq Time key is grayed out . When pressed, the grayed out key puts up the informational message "Use Gate View Sweep Time in the Gate menu."</p> <p>In the other measurements:</p> <p>When you turn Gate View on, the lower window takes on the current state of the instrument. Upon leaving Gate View, the instrument takes on the state of the lower window.</p> <p>When you turn Gate View on, the upper window Acquisition Time is set to the gate view acquisition time.</p>
Couplings	<p>These couplings apply to the Swept SA measurement:</p> <ul style="list-style-type: none"> • When Gate View is turned on, the instrument is set to Zero Span. • Gate View automatically turns off whenever a Span other than Zero is selected. • Gate View automatically turns off if you press the Last Span key while in Gate View, and the instrument returns to the Span it was in before entering Gate View (even if that is Zero Span).

- When Gate View is turned on, the sweep time used is the gate view sweep time. This is set according to the rules in section "Gate View Setup " on page 1553
- When Gate View is turned off, Sweep Time is set to the normal Swept SA measurement sweep time.
- If Gate View is on and Gate is off, then turning on Gate turns off Gate View.

Preset	OFF
State Saved	Saved in instrument state
Range	On Off
Initial S/W Revision	Prior to A.02.00

A sample of the Gate View screen in the Swept SA measurement is shown in the following graphic :

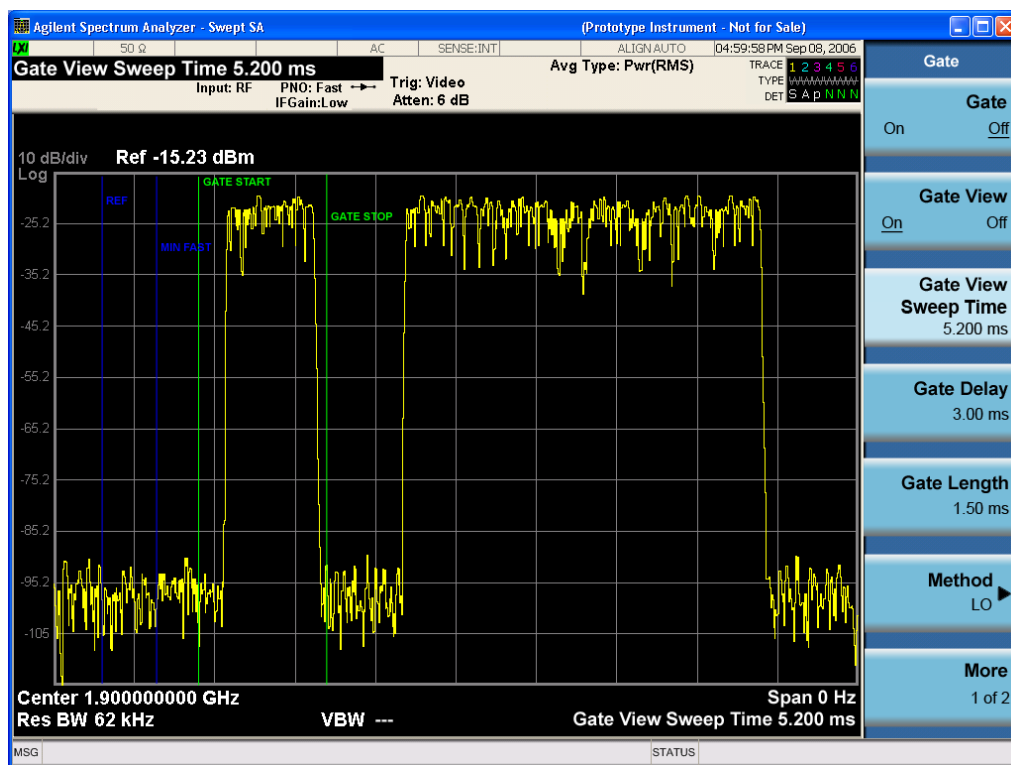

A sample of the Gate View screen in other measurements is shown in the following graphic . This example is for the ACP measurement:

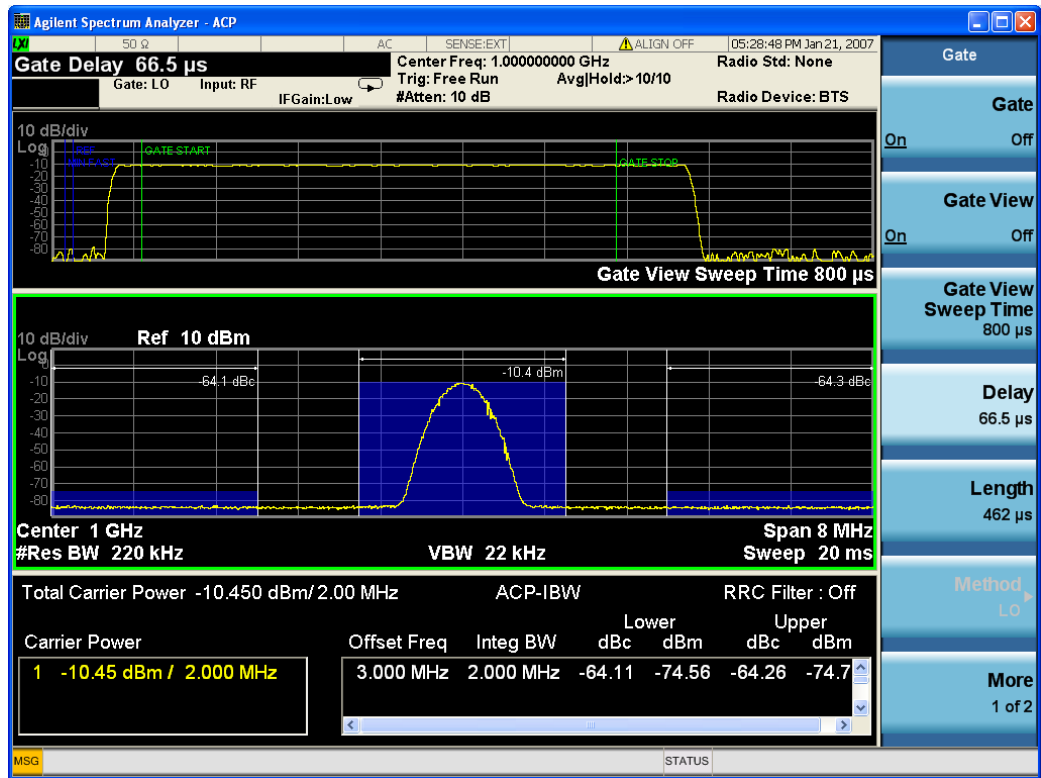

Turning Gate View off returns the analyzer to the Normal measurement view.

In the Swept SA, the normal measurement view is the single-window Swept SA view. When returning to this view, the Swept SA measurement returns to the Span it was in before entering **Gate View** (even if that is Zero Span).

The **Gate View** window is triggered from the Gate Source, with zero trigger delay. Also, when updating the **Gate View** window, the Gate itself must not operate. So it is internally shut off while the gate view window is being updated. For the Swept SA measurement, this means that the Gate is internally shut off whenever the gate view window is displayed. The measurement bar and softkeys continue to show the Trigger source for the main sweep window and give no indication that the Gate is shut off or that the Gate View window is triggered from the Gate Source.

When in **Gate View**, vertical lines are displayed in the Gate View window as follows:

- Green lines are displayed at the gate edges as follows: in Edge Gate, a line is shown for Delay and one for the end of the Gate period, defined by Length. You can adjust the position of the green lines by adjusting the gate length and the gate delay. These lines update in the Gate View window as the active function changes, even if the window is not being updated. In Gated FFT, their location is relative to the left edge of the screen.
- A blue line is displayed showing the delay reference, that is, the reference point for the Gate Delay within the Zero Span window. The blue line represents where (in time) the effective location of the gate start would be if the gate were programmed to zero delay.
-

Gate View Setup

Accesses a menu that enables you to setup parameters relevant to the Gate View

Key Path	Sweep/Control, Gate
Scope	Meas Global
Initial S/W Revision	A.10.00

Gate View Acquisition Time

Controls the acquisition time in the Gate View window. To provide an optimal view of the gate signal, the analyzer initializes Gate View Acq Time based on the current settings of Gate Delay and Gate Length.

Key Path	Sweep/Control, Gate, Gate View Setup
Remote Command	[:SENSe] :SWEep:EGATe:TIME <time> [:SENSe] :SWEep:EGATe:TIME?
Example	SWE:EGAT:TIME 500 ms
Dependencies	Gate View Acquisition Time is initialized: <ul style="list-style-type: none"> • On Preset (after initializing delay and length). • Every time the Gate Method is set/changed. <ol style="list-style-type: none"> 1. Compute the location of the "gate stop" line, which you know is at time $t = t_{min} + GateDelay + GateLength$.
Preset	519.3 μ s WiMAX OFDMA: 5 ms GSM/EDGE: 1 ms
State Saved	Saved in instrument state
Min	100 ns
Max	6000 s
Initial S/W Revision	Prior to A.02.00

Gate View Start Time

Controls the time at the left edge of the Gate View.

Key Path	Sweep/Control, Gate, Gate View Setup
Remote Command	[:SENSe] :SWEep:EGATe:VIEW:STARt <time> [:SENSe] :SWEep:EGATe:VIEW:STARt?
Example	SWE:EGAT:VIEW:STAR 10ms
Notes	Units of time are required or no units; otherwise an invalid suffix error message will be generated. See error -131.

Preset	0 ms
State Saved	Saved in instrument state
Min	0
Max	500 ms
Initial S/W Revision	A.10.00

Gate Delay

Controls the length of time from the time the gate condition goes True until the gate is turned on.

Key Path	Sweep/Control, Gate
Remote Command	[:SENSe] :SWEep:EGATe:DELay <time> [:SENSe] :SWEep:EGATe:DELay?
Example	SWE:EGAT:DELay 500ms SWE:EGAT:DELay?
Notes	Units of time are required or no units; otherwise an invalid suffix error message will be generated.
Preset	57.7 us WiMAX OFDMA: 71 us GSM/EDGE: 600 us WLAN: 500 us WLAN: 36 us
State Saved	Saved in instrument state
Min	0.0 us
Max	100 s
Backwards Compatibility SCPI	[:SENSe] :SWEep:TIME:GATE:DELay ESA compatibility
Initial S/W Revision	Prior to A.02.00

Gate Length

Controls the length of time that the gate is on after it opens.

Key Path	Sweep/Control, Gate
Remote Command	[:SENSe] :SWEep:EGATe:LENGth <time> [:SENSe] :SWEep:EGATe:LENGth?
Example	SWE:EGAT:LENG 1 SWE:EGAT:LENG?

Notes	Units of time are required or no units; otherwise an invalid suffix error message will be generated.
Preset	461.6 us WiMAX OFDMA: 50 us GSM/EDGE: 200 us WLAN: 1.54 ms WLAN: 32 us
State Saved	Saved in instrument state
Min	100 ns
Max	5 s
Backwards Compatibility SCPI	[:SENSe]:SWEep:TIME:GATE:LENGth ESA compatibility
Initial S/W Revision	Prior to A.02.00

Gate Source

The menus under the Gate Source key are the same as those under the Trigger key, with the exception that neither Free Run nor Video are available as Gate Source selections. However, a different SCPI command is used to select the Gate Source (see table below) because you may independently set the Gate Source and the Trigger Source.

Any changes to the settings in the setup menus under each Gate Source selection key (for example: Trigger Level, Trigger Delay, etc.) also affect the corresponding settings under the Trigger menu keys. The SCPI commands used for these are the same for Trigger and Gate, since there is only one setting which affects both Gate and Trigger. Example: to set the Trigger Level for External 1 you use the command :TRIG:EXT1:LEV regardless of whether you are using External 1 as a Trigger Source or a Gate Source.

Key Path	Sweep/Control, Gate
Remote Command	[:SENSe]:SWEep:EGATe:SOURce EXTernal1 EXTernal2 LINE FRAME RFBurst [:SENSe]:SWEep:EGATe:SOURce?
Dependencies	In some models, there is no second External input. In these models, the External 2 key is blanked and the EXTernal2 parameter will generate a "Hardware missing; Not available for this model number" error.
Preset	EXTernal 1 GSM/EDGE, MSR: FRAME LTETDD: EXTernal 1When Direction is Downlink, FRAME when Direction is Uplink.
Initial S/W Revision	Prior to A.02.00
Modified at S/W Revision	A.03.00, A.14.00

Video (IF Envelope)

Pressing this key, when it is not selected, selects the video signal as the trigger. The Video trigger condition is met when the video signal (the filtered and detected version of the input signal, including both RBW and VBW filtering) crosses the video trigger level.

NOTE

When the detector selected for all active traces is the average detector, the video signal for triggering does not include any VBW filtering.

The video trigger level is shown as a labeled line on the display. The line is displayed as long as video is the selected trigger source.

Pressing this key, when it is already selected, accesses the video trigger setup functions.

Key Path	Trigger
Example	TRIG:SOUR VID Swept SA measurement TRIG:<meas>:SOUR VID Measurements other than Swept SA
Notes	Log Plot and Spot Frequency measurements do not support Video Trigger
Dependencies	Video trigger is allowed in average detector mode.
State Saved	Saved in instrument state
Status Bits/OPC dependencies	The Status Operation Register bit 5 "Waiting for Trigger" is set at the same time as the Sweeping or Measuring bit is set. It is cleared when the trigger actually occurs (that is, after the trigger event occurs and all the applicable trigger criteria have been met). A corresponding pop-up message ("Waiting for trigger") is generated if no trigger signal appears after approximately 2 sec. This message goes away when a trigger signal appears.
Backwards Compatibility Notes	In the past, the Average detector was not available when Video triggering was on, and consequently, functions that set the detector to average (such as Marker Noise or Band/Intvl Power) were not available when the video trigger was on. Similarly, Video triggering was not available when the detector was Average. In the X-Series, these restrictions are removed.
Initial S/W Revision	Prior to A.02.00

Trigger Level

Sets a level for the video signal trigger. When the video signal crosses this level, with the chosen slope, the trigger occurs. This level is displayed with a horizontal line only if **Video** is the selected trigger source.

Key Path	Trigger, Video
Remote Command	:TRIGger[:SEquence]:VIDeo:LEVel <ampl> :TRIGger[:SEquence]:VIDeo:LEVel?
Example	TRIG:VID:LEV -40 dBm
Notes	When sweep type = FFT, the video trigger uses the amplitude envelope in a bandwidth wider than the FFT width as a trigger source. This might often be useful, but does not have the same relationship between the displayed trace and the trigger level as in swept triggering. Amplitude Corrections are not taken into account by the Video Trig Level. For example, if you have given yourself effective gain with an amplitude correction factor, the Video Trigger will not fire until

you have dropped the trigger line that far below the displayed signal level, rather than simply dropping it down to the displayed signal level.

Note that other corrections, specifically External Gain and Ref Level Offset, modify the actual trace data as it is taken and therefore ARE taken into account by Trig Level.

Couplings	This same level is used for the Video trigger source in the Trigger menu and for the Video selection in the Gate Source menu.
Preset	Set the Video Trigger Level -25 dBm on Preset. When the Video Trigger Level becomes the active function, if the value is off screen, set it to either the top or bottom of screen, depending on which direction off screen it was.
State Saved	Saved in instrument state
Min	-170 dBm
Max	+30 dBm
Default Unit	Depends on the current selected Y axis unit
Backwards Compatibility SCPI	:TRIGger[:SEQuence]:IF:LEVel :TRIGger[:SEQuence]:IF:LEVel?
Backwards Compatibility Notes	This alias is provided for backward compatibility with VSA/PSA comms apps.
Initial S/W Revision	Prior to A.02.00

Trig Slope

Controls the trigger polarity. It is set positive to trigger on a rising edge and negative to trigger on a falling edge.

Key Path	Trigger, Video
Remote Command	:TRIGger[:SEQuence]:VIDeo:SLOPe POSitive NEGative :TRIGger[:SEQuence]:VIDeo:SLOPe?
Example	TRIG:VID:SLOP NEG
Preset	POSitive
State Saved	Saved in instrument state
Backwards Compatibility SCPI	:TRIGger[:SEQuence]:IF:SLOPe NEGative POSitive :TRIGger[:SEQuence]:IF:SLOPe? For backward compatibility with VSA/PSA comms apps
Backwards Compatibility Notes	The legacy :TRIGger[:SEQuence]:SLOPe command affects the slopes for the VID, LINE, EXT1, EXT2, and RFB triggers.
Initial S/W Revision	Prior to A.02.00
Remote Command	:TRIGger[:SEQuence]:SLOPe POSitive NEGative

	:TRIGger[:SEquence]:SLOPe?
Example	TRIG:SLOP NEG
Preset	POSitive
State Saved	Saved in instrument state
Backwards Compatibility Notes	In ESA/PSA, the Trigger Slope was global to all triggers. In the X-Series, the slope can be set individually for each Trigger Source. For backward compatibility, the global SLOPe command updates all instances of trigger slope (VID, LINE, EXT1, EXT2, TV, RFB). The query returns the trigger slope setting of the currently selected trigger source.
Initial S/W Revision	Prior to A.02.00

External 1

Pressing this key, when it is not selected, selects an external input signal as the trigger. A new sweep/measurement will start when the external trigger condition is met using the external 1 input connector on the rear panel.

Pressing this key, when it is already selected, accesses the external 1 trigger setup menu.

Key Path	Trigger
Example	TRIG:SOUR EXT1 Swept SA measurement TRIG:<meas>:SOUR EXT1 Measurements other than Swept SA
Dependencies	Grayed out if in use by Point Trigger in the Source Setup menu. Forced to Free Run if already selected and Point Trigger is set to External 1.
State Saved	Saved in instrument state
Status Bits/OPC dependencies	The Status Operation Register bit 5 "Waiting for Trigger" is set at the same time as the Sweeping or Measuring bit is set. It is cleared when the trigger actually occurs (that is, after the trigger event occurs and all the applicable trigger criteria have been met). A corresponding pop-up message ("Waiting for trigger") is generated if no trigger signal appears after approximately 2 sec. This message goes away when a trigger signal appears.
Initial S/W Revision	Prior to A.02.00

Trigger Level

Sets the value where the external 1 trigger input will trigger a new sweep/measurement.

Key Path	Trigger, External 1
Remote Command	:TRIGger[:SEquence]:EXTernal1:LEVel <level> :TRIGger[:SEquence]:EXTernal1:LEVel?
Example	TRIG:EXT1:LEV 0.4 V
Couplings	This same level is used for the Ext1 trigger source in the Trigger menu, for the Ext1 selection in the Periodic Timer sync source (in the Trigger menu and in the Gate Source menu), and also for the Ext1

	selection in the Gate Source menu.
Preset	1.2 V
State Saved	Saved in instrument state
Min	-5 V
Max	5 V
Default Unit	V
Backwards Compatibility SCPI	:TRIGger[:SEquence]:EXTernal:LEVel
	For backward compatibility, the parameter EXTernal is mapped to EXTernal1
Backwards Compatibility SCPI	:TRIGger[:SEquence]:FRAMe:EXTernal1:LEVel
Initial S/W Revision	Prior to A.02.00

Trig Slope

Controls the trigger polarity. It is set positive to trigger on a rising edge and negative to trigger on a falling edge.

Key Path	Trigger, External 1
Remote Command	:TRIGger[:SEquence]:EXTernal1:SLOPe POSitive NEGative :TRIGger[:SEquence]:EXTernal1:SLOPe?
Example	TRIG:EXT1:SLOP NEG
Couplings	This same slope is used in the Ext1 selection for the trigger source in the Trigger menu and for the period timer sync source (in the Trigger menu and in the Gate Source menu).
Preset	POSitive
State Saved	Saved in instrument state
Backwards Compatibility SCPI	:TRIGger[:SEquence]:EXTernal:SLOPe
	For backward compatibility, the parameter EXTernal is mapped to EXTernal1
Backwards Compatibility SCPI	:TRIGger[:SEquence]:FRAMe:EXTernal1:SLOPe
Backwards Compatibility Notes	The legacy :TRIGger[:SEquence]:SLOPe command affects the slopes for the VID, LINE, EXT1, EXT2, and RFB triggers.
Initial S/W Revision	Prior to A.02.00

Zero Span Delay Comp On/Off

In zero span, there is a natural delay in the signal path, which comes from the RBW filter. This is usually desirable, as it allows you to trigger on events and also see those events, because the signal is delayed from the trigger event. However, in some cases it is desirable to eliminate this delay, so that trigger events line up exactly with the zero time point in zero span. You can use the Zero Span Delay Comp On/Off feature to enable or disable zero span delay compensation.

Key Path	Trigger, External 1
Remote Command	:TRIGger[:SEquence]:EXTErnal1:DELay:COMPensation OFF ON 0 1 :TRIGger[:SEquence]:EXTErnal1:DELay:COMPensation?
Example	TRIG:EXT1:DEL:COMP ON
Dependencies	No effect except in zero-span, but not locked out in nonzero spans. Blanked in modes that do not support zero-span measurements. If the SCPI command is sent when the key is blanked, an error is returned: -221, "Settings conflict; Feature not supported for this measurement" In analyzers shipping N9060A, this feature requires N9060A-7FP.
Preset	OFF
State Saved	Saved in instrument state
Initial S/W Revision	A.11.00

External 2

Pressing this key, when it is not selected, selects an external input signal as the trigger. A new sweep/measurement will start when the external trigger condition is met using the external 2 input connector. The external trigger 2 input connector is on the rear panel.

Pressing this key, when it is already selected, accesses the external 2 trigger setup menu.

Key Path	Trigger
Example	TRIG:SOUR EXT2 Swept SA measurement TRIG:<meas>:SOUR EXT2 Measurements other than Swept SA
Dependencies	In some models, there is no second External input. In these models, the External 2 key is blanked and the EXTErnal2 parameter will generate a "Hardware missing; Not available for this model number" message. Grayed out if in use by Point Trigger in the Source Setup menu. Forced to Free Run if already selected and Point Trigger is set to External 2.
State Saved	Saved in instrument state
Status Bits/OPC dependencies	The Status Operation Register bit 5 "Waiting for Trigger" is set at the same time as the Sweeping or Measuring bit is set. It is cleared when the trigger actually occurs (that is, after the trigger event occurs and all the applicable trigger criteria have been met). A corresponding pop-up message ("Waiting for trigger") is generated if no trigger signal appears after approximately 2 sec. This message goes away when a trigger signal appears.
Initial S/W Revision	Prior to A.02.00
Modified at S/W Revision	A.03.00

Trigger Level

Sets the value where the external 2 trigger input will trigger a new sweep/measurement.

Key Path	Trigger, External 2
Remote Command	:TRIGger[:SEquence]:EXTernal2:LEVel :TRIGger[:SEquence]:EXTernal2:LEVel?
Example	TRIG:EXT2:LEV 1.1 V
Couplings	This same level is used for the Ext2 trigger source in the Trigger menu, for the Ext2 selection in the Periodic Timer sync source (in the Trigger menu and in the Gate Source menu), and also for the Ext2 selection in the Gate Source menu.
Preset	1.2 V
State Saved	Saved in instrument state
Min	-5 V
Max	5 V
Default Unit	V
Backwards Compatibility SCPI	:TRIGger[:SEquence]:FRAMe:EXTernal2:LEVel
Initial S/W Revision	Prior to A.02.00

Trig Slope

Controls the trigger polarity. It is set positive to trigger on a rising edge and negative to trigger on a falling edge.

Key Path	Trigger, External 2
Remote Command	:TRIGger[:SEquence]:EXTernal2:SLOPe POSitive NEGative :TRIGger[:SEquence]:EXTernal2:SLOPe?
Example	TRIG:EXT2:SLOP NEG
Couplings	This same slope is used in the Ext2 selection for the trigger source in the Trigger menu and for the period timer sync source (in the Trigger menu and in the Gate Source menu).
Preset	POSitive
State Saved	Saved in instrument state
Backwards Compatibility SCPI	:TRIGger[:SEquence]:FRAMe:EXTernal2:SLOPe
Backwards Compatibility Notes	The legacy :TRIGger[:SEquence]:SLOPe command affects the slopes for the VID, LINE, EXT1, EXT2, and RFB triggers.
Initial S/W Revision	Prior to A.02.00

Zero Span Delay Comp On/Off

In zero span, there is a natural delay in the signal path, which comes from the RBW filter. This is usually desirable, as it allows you to trigger on events and also see those events, because the signal is delayed from the trigger event. However, in some cases it is desirable to eliminate this delay, so that trigger

events line up exactly with the zero time point in zero span. You can use the Zero Span Delay Comp On/Off feature to enable or disable zero span delay compensation.

Key Path	Trigger, External 2
Remote Command	:TRIGger[:SEquence]:EXTernal2:DELay:COMPensation OFF ON 0 1 :TRIGger[:SEquence]:EXTernal2:DELay:COMPensation?
Example	TRIG:EXT2:DEL:COMP ON
Dependencies	No effect except in zero-span, but not locked out in nonzero spans. Blanked in modes that do not support zero-span measurements. If the SCPI command is sent when the key is blanked, an error is returned: -221, "Settings conflict; Feature not supported for this measurement" In analyzers shipping N9060A, this feature requires N9060A-7FP.
Preset	OFF
State Saved	Saved in instrument state
Initial S/W Revision	A.11.00

RF Burst

Pressing this key, when it is not selected, selects the RF Burst as the trigger. A new sweep/measurement will start when an RF burst envelope signal is identified from the signal at the RF Input connector. Pressing this key, when it is already selected, accesses the RF Burst trigger setup menu.

In some models, a variety of burst trigger circuitry is available, resulting in various available burst trigger bandwidths. The analyzer automatically chooses the appropriate trigger path based on the hardware configuration and other settings of the analyzer.

Key Path	Trigger
Example	TRIG:SOUR RFB Swept SA measurement TRIG:<meas>:SOUR RFB Measurements other than Swept SA
State Saved	Saved in instrument state
Status Bits/OPC dependencies	The Status Operation Register bit 5 "Waiting for Trigger" is set at the same time as the Sweeping or Measuring bit is set. It is cleared when the trigger actually occurs (that is, after the trigger event occurs and all the applicable trigger criteria have been met). A corresponding pop-up message ("Waiting for trigger") is generated if no trigger signal appears after approximately 2 sec. This message goes away when a trigger signal appears.
Backwards Compatibility Notes	The legacy command: :TRIGger[:SEquence]:RFBurst:FSElectivity[:STATe] OFF ON 0 1 is not supported in the X-Series, as the hardware to do Frequency Selective burst triggers does not exist in X-Series.
Initial S/W Revision	Prior to A.02.00
Modified at S/W Revision	A.04.00

Absolute Trigger Level

Sets the absolute trigger level for the RF burst envelope.

When using the External Mixing path, the Absolute Trigger Level is uncalibrated because the factory default was set to accommodate the expected IF levels for the RF path.

Key Path	Trigger, RF Burst
Scope	Meas Global
Remote Command	<code>:TRIGger[:SEquence]:RFBurst:LEVel:ABSolute <ampl></code> <code>:TRIGger[:SEquence]:RFBurst:LEVel:ABSolute?</code>
Example	TRIG:RFB:LEV:ABS 10 dBm sets the trigger level of the RF burst envelope signal to the absolute level of 10 dBm
Notes	Sending this command does not switch the setting from relative to absolute; to switch it you need to send the <code>:TRIGger[:SEquence]:RFBurst:LEVel:TYPE</code> command, below. Amplitude Corrections are not taken into account by the Absolute Trigger Level. For example, if you have given yourself effective gain with an amplitude correction factor, the Absolute Trigger will not fire until you have set the trigger level that far below the displayed signal level, rather than simply to the displayed signal level. This is only true for Amplitude Corrections, not External Gain or Ref Level Offset functions. If mode is Bluetooth, the default value is -50 dBm.
Couplings	This same level is used for the RF Burst trigger source in the Trigger menu, for the RF Burst selection in the Periodic Timer sync source (in the Trigger menu and in the Gate Source menu), and also for the RF Burst selection in the Gate Source menu
Preset	-20 dBm
State Saved	Saved in instrument state
Min	-200 dBm
Max	100 dBm
Default Unit	depends on the current selected Y-Axis unit
Backwards Compatibility SCPI	<code>:TRIGger[:SEquence]:FRAME:RFBurst:LEVel:ABSolute</code>
Initial S/W Revision	Prior to A.02.00
Modified at S/W Revision	A.04.00

Key Path	Trigger, RF Burst
Remote Command	<code>:TRIGger[:SEquence]:RFBurst:LEVel:TYPE ABSolute RELative</code> <code>:TRIGger[:SEquence]:RFBurst:LEVel:TYPE?</code>
Example	TRIG:RFB:LEV:TYPE REL sets the trigger level type of the RF burst trigger to Relative.
Preset	ABSolute
State Saved	Saved in instrument state
Initial S/W Revision	Prior to A.02.00
Modified at S/W Revision	A.04.00

Relative Trigger Level

Sets the relative trigger level for the RF burst envelope.

In some models, the relative burst trigger function is implemented in hardware. In other models, without the advanced triggering hardware required, the relative burst trigger function is implemented in software in some measurements, and is unavailable in other measurements.

When implemented in software, the relative RF Burst trigger function is implemented as follows:

1. The measurement starts with the absolute RF Burst trigger setting. If it cannot get a trigger with that level, auto trigger fires and the acquisition starts anyway. After the acquisition, the measurement searches for the peak in the acquired waveform and saves it.
2. Now, in the next cycle of the measurement, the measurement determines a new absolute RF Burst level based on the peak value from the first measurement and the Relative RF Burst Trigger Level (always 0 or negative dB) set by the user. The following formula is used:
3. absolute RF Burst level = peak level of the previous acquisition + relative RF Burst level
4. If the new absolute RF Burst level differs from the previous by more than 0.5 dB, the new level is sent to the hardware; otherwise it is not updated (to avoid slowing down the acquisition)

Steps 2 and 3 repeat for subsequent measurements.

Key Path	Trigger, RF Burst
Scope	Meas Global
Remote Command	:TRIGger[:SEquence]:RFBurst:LEVel:RELative <rel_ampl> :TRIGger[:SEquence]:RFBurst:LEVel:RELative?
Example	TRIG:RFB:LEV:REL -10 dB sets the trigger level of the RF burst envelope signal to the relative level of -10 dB
Notes	Sending this command does not switch the setting from absolute to relative; to switch it you need to send the :TRIGger[:SEquence]:RFBurst:LEVel:TYPE command, above. The relative trigger level is not available in some measurements. In those measurements the RELative parameter, and the :TRIGger[:SEquence]:RFBurst:LEVel:TYPE command (above), will generate an error if sent.
Dependencies	This key is grayed out and Absolute Trigger Level selected if the required hardware is not present in your analyzer and the current measurement does not support Relative triggering.
Preset	-6 dB GSM: -25 dB
State Saved	Saved in instrument state
Min	-45 dB
Max	0 dB
Default Unit	dB or dBc
Backwards Compatibility SCPI	:TRIGger[:SEquence]:RFBurst:LEVel This legacy command is aliased to :TRIGger[:SEquence]:RFBurst:LEVel:RELative because the PSA

	had ONLY relative burst triggering
Initial S/W Revision	Prior to A.02.00
Modified at S/W Revision	A.04.00

Trigger Slope

It is set positive to trigger on a rising edge and negative to trigger on a falling edge.

Key Path	Trigger, RF Burst
Remote Command	:TRIGger[:SEquence]:RFBurst:SLOPe POSitive NEGative :TRIGger[:SEquence]:RFBurst:SLOPe?
Example	TRIG:RFB:SLOP NEG
Couplings	This same slope is used in the RF Burst selection for the trigger source in the Trigger menu and for the period timer sync source (in the Trigger menu and in the Gate Source menu).
Preset	POSitive
State Saved	Saved in instrument state
Backwards Compatibility SCPI	:TRIGger[:SEquence]:FRAME:RFBurst:SLOPe
Backwards Compatibility Notes	The legacy :TRIGger[:SEquence]:SLOPe command affects the slopes for the VID, LINE, EXT1, EXT2, and RFB triggers.
Initial S/W Revision	Prior to A.02.00

Periodic Timer (Frame Trigger)

Pressing this key, when it is not selected, selects the internal periodic timer signal as the trigger. Triggering occurrences are set by the **Period** parameter, which is modified by the **Sync Source** and **Offset**. Pressing this key, when it is already selected, accesses the periodic timer trigger setup functions.

If you do not have a sync source selected (it is Off), then the internal timer will not be synchronized with any external timing events.

Key Path	Trigger
Example	TRIG:SOUR FRAM Swept SA measurement TRIG:<meas>:SOUR FRAM Measurements other than Swept SA
State Saved	Saved in instrument state
Readback	[Sync: <value of Sync Source>], for example, [Sync: External 1]
Status Bits/OPC dependencies	The Status Operation Register bit 5 "Waiting for Trigger" is set at the same time as the Sweeping or Measuring bit is set. It is cleared when the trigger actually occurs (that is, after the trigger event occurs and all the applicable trigger criteria have been met). A corresponding pop-up message ("Waiting for trigger") is generated if no trigger signal appears after approximately 2 sec. This message goes away when a trigger signal appears.
Initial S/W Revision	Prior to A.02.00

Periodic Timer Triggering:

This feature selects the internal periodic timer signal as the trigger. Trigger occurrences are set by the **Periodic Timer** parameter, which is modified by the **Sync Source** and **Offset**.

The figure below shows the action of the periodic timer trigger. Before reviewing the figure, we'll explain some uses for the periodic trigger.

A common application is measuring periodic burst RF signals for which a trigger signal is not easily available. For example, we might be measuring a TDMA radio which bursts every 20 ms. Let's assume that the 20 ms period is very consistent. Let's also assume that we do not have an external trigger source available that is synchronized with the period, and that the signal-to-noise ratio of the signal is not high enough to provide a clean RF burst trigger at all of the analysis frequencies. For example, we might want to measure spurious transmissions at an offset from the carrier that is larger than the bandwidth of the RF burst trigger. In this application, we can set the Periodic Timer to a 20.00 ms period and adjust the offset from that timer to position our trigger just where we want it. If we find that the 20.00 ms is not exactly right, we can adjust the period slightly to minimize the drift between the period timer and the signal to be measured.

A second way to use this feature would be to use **Sync Source** temporarily, instead of **Offset**. In this case, we might tune to the signal in a narrow span and use the RF Burst trigger to synchronize the periodic timer. Then we would turn the sync source off so that it would not miss-trigger. Miss-triggering can occur when we are tuned so far away from the RF burst trigger that it is no longer reliable.

A third example would be to synchronize to a signal that has a reference time element of much longer period than the period of interest. In some CDMA applications, it is useful to look at signals with a short periodicity, by synchronizing that periodicity to the "even-second clock" edge that happens every two seconds. Thus, we could connect the even-second clock trigger to Ext1 and use then Ext1 as the sync source for the periodic timer.

The figure below illustrates this third example. The top trace represents the even-second clock. It causes the periodic timer to synchronize with the leading edge shown. The analyzer trigger occurs at a time delayed by the accumulated offset from the period trigger event. The periodic timer continues to run, and triggers continue to occur, with a periodicity determined by the analyzer time base. The timer output (labeled "late event") will drift away from its ideal time due to imperfect matching between the time base of the signal being measured and the time base of the analyzer, and also because of imperfect setting of the period parameter. But the synchronization is restored on the next even-second clock event. ("Accumulated offset" is described in the in the **Offset** function section.)

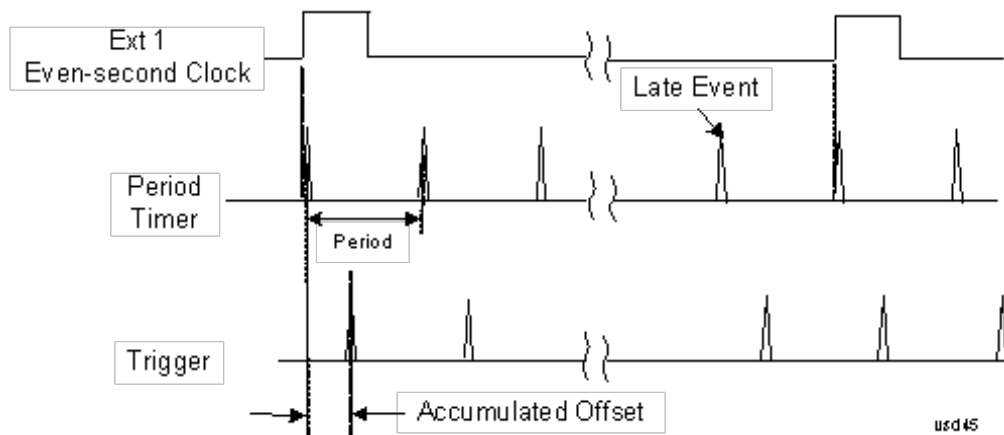

Period

Sets the period of the internal periodic timer clock. For digital communications signals, this is usually set to the frame period of your current input signal. In the case that sync source is not set to OFF, and the external sync source rate is changed for some reason, the periodic timer is synchronized at the every external synchronization pulse by resetting the internal state of the timer circuit.

Key Path	Trigger, Periodic Timer
Remote Command	:TRIGger[:SEquence]:FRAMe:PERiod <time> :TRIGger[:SEquence]:FRAMe:PERiod?
Example	TRIG:FRAM:PER 100 ms
Dependencies	The invalid data indicator turns on when the period is changed, until the next sweep/measurement completes.
Couplings	The same period is used in the Gate Source selection of the period timer.
Preset	20 ms GSM: 4.615383
State Saved	Saved in instrument state
Min	100.000 ns
Max	559.0000 ms
Default Unit	S
Initial S/W Revision	Prior to A.02.00

Offset

Adjusts the accumulated offset between the periodic timer events and the trigger event. Adjusting the accumulated offset is different than setting an offset, and requires explanation.

The periodic timer is usually not synchronized with any external events, so the timing of its output events has no absolute meaning. Since the timing relative to external events (RF signals) is important, you need to be able to adjust (offset) it. However, you have no direct way to see when the periodic timer events occur. All that you can see is the trigger timing. When you want to adjust the trigger timing, you will be changing the internal offset between the periodic timer events and the trigger event. Because the absolute value of

that internal offset is unknown, we will just call that the accumulated offset. Whenever the Offset parameter is changed, you are changing that accumulated offset. You can reset the displayed offset using Reset Offset Display. Changing the display does not change the value of the accumulated offset, and you can still make additional changes to accumulated offset.

To avoid ambiguity, we define that an increase in the "offset" parameter, either from the knob or the SCPI adjust command, serves to delay the timing of the trigger event.

Key Path	Trigger, Periodic Timer
Remote Command	:TRIGger[:SEquence]:FRAMe:OFFSet <time> :TRIGger[:SEquence]:FRAMe:OFFSet?
Example	TRIG:FRAM:OFFS 1.2 ms
Notes	<p>The front panel interface (for example, the knob), and this command, adjust the accumulated offset, which is shown on the active function display. However, the actual amount sent to the hardware each time the offset is updated is the delta value, that is, the current accumulated offset value minus the previous accumulated offset value. Note that the accumulated offset value is essentially arbitrary; it represents the accumulated offset from the last time the offset was zeroed (with the Reset Offset Display key).</p> <p>Note that this command does not change the period of the trigger waveform. Note also that Offset is used only when the sync source is set to OFF, otherwise delay is used, see section "Trig Delay" on page 359.</p> <p>An increase in the "offset" parameter, either from the knob or the SCPI adjust command, serves to delay the timing of the trigger event.</p>
Notes	<p>When the SCPI command is sent the value shown on the key (and the Active Function, if this happens to be the active function) is updated with the new value. However, the actual amount sent to the hardware is the delta value, that is, the current accumulated offset value minus the previous accumulated offset value.</p> <p>The SCPI query simply returns the value currently showing on the key.</p>
Dependencies	The invalid data indicator turns on when the offset is changed, until the next sweep/measurement completes.
Couplings	The same offset is used in the Gate Source selection of the period timer.
Preset	0 s
State Saved	Saved in instrument state
Min	-10.000 s
Max	10.000 s
Default Unit	S
Initial S/W Revision	Prior to A.02.00

Offset Adjust (Remote Command Only)

This remote command does not work at all like the related front panel keys. This command lets you advance the phase of the frame trigger by the amount you specify.

It does not change the period of the trigger waveform. If the command is sent multiple times, it advances the phase of the frame trigger an additional amount each time it is sent. Negative numbers are permitted.

Remote Command	:TRIGger[:SEquence]:FRAMe:ADJust <time>
Example	TRIG:FRAM:ADJ 1.2 ms
Notes	Note also that Offset is used only when the sync source is set to OFF, otherwise delay is used, see section "Trig Delay" on page 359 An increase in the "offset" parameter, either from the knob or the SCPI adjust command, serves to delay the timing of the trigger event.
Notes	The front panel interface (for example, the knob) and the :TRIG:FRAM:OFFS command adjust the accumulated offset, which is shown on the active function display. However, the actual amount sent to the hardware is the delta value, that is, the current offset value minus the previous offset value. When the SCPI command is sent the value shown on the key (and the Active Function, if this happens to be the active function) is updated by increasing it (or decreasing it if the value sent is negative) by the amount specified in the SCPI command. This is a "command only" SCPI command, with no query.
Dependencies	The invalid data indicator turns on when the offset is changed, until the next sweep/measurement completes.
Couplings	The same offset is used in the Gate Source selection of the period timer.
Preset	0 s
State Saved	Saved in instrument state
Min	-10.000 s
Max	10.000 s
Default Unit	S
Initial S/W Revision	Prior to A.02.00

Reset Offset Display

Resets the value of the periodic trigger offset display setting to 0.0 seconds. The current displayed trigger location may include an offset value defined with the Offset key. Pressing this key redefines the currently displayed trigger location as the new trigger point that is 0.0 s offset. The Offset key can then be used to add offset relative to this new timing.

Key Path	Trigger, Periodic Timer
Remote Command	:TRIGger[:SEquence]:FRAMe:OFFSet:DISPlay:RESet
Example	TRIG:FRAM:OFFS:DISP:RES
Initial S/W Revision	Prior to A.02.00

Sync Source

Selects a signal source for you to synchronize your periodic timer trigger to, otherwise you are triggering at some arbitrary location in the frame. Synchronization reduces the precision requirements on the setting of the period.

For convenience you may adjust the level and slope of the selected sync source in a conditional branch setup menu accessed from the Sync Source menu. Note that these settings match those in the **Trigger** and **Gate Source** menus; that is, each trigger source has only one value of level and slope, regardless of which menu it is accessed from.

Key Path	Trigger, Periodic Timer
Remote Command	:TRIGger[:SEquence]:FRAMe:SYNC EXTernal1 EXTernal2 RFBurst OFF :TRIGger[:SEquence]:FRAMe:SYNC?
Example	TRIG:FRAM:SYNC EXT2
Dependencies	In some models, there is no second External input. In these models, the External 2 key is blanked and the EXTernal2 parameter will generate a “Hardware missing; Not available for this model number” message.
Preset	Off GSM/EDGE, MSR,LTE,LTETDD: RFBurst
State Saved	Saved in instrument state
Readback	The current setting is read back to this key and it is also Readback to the previous Periodic Timer trigger key.
Backwards Compatibility SCPI	:TRIGger[:SEquence]:FRAMe:SYNC EXTernal For backward compatibility, the parameter EXTernal is mapped to EXTernal1
Initial S/W Revision	Prior to A.02.00
Modified at S/W Revision	A.03.00, A.14.00

Off

Turns off the sync source for your periodic trigger. With the sync source off, the timing will drift unless the signal source frequency is locked to the analyzer frequency reference.

Key Path	Trigger, Periodic Timer, Sync Source
Example	TRIG:FRAM:SYNC OFF
Readback	Off
Initial S/W Revision	Prior to A.02.00

External 1

Pressing this key, when it is not selected, selects an external input signal as the trigger. A new sweep/measurement will start when the external trigger condition is met using the external 1 input connector on the rear panel.

Pressing this key, when it is already selected, accesses the external 1 trigger setup menu.

Key Path	Trigger
Example	TRIG:SOUR EXT1 Swept SA measurement

	TRIG:<meas>:SOUR EXT1 Measurements other than Swept SA
Dependencies	Grayed out if in use by Point Trigger in the Source Setup menu. Forced to Free Run if already selected and Point Trigger is set to External 1.
State Saved	Saved in instrument state
Status Bits/OPC dependencies	The Status Operation Register bit 5 "Waiting for Trigger" is set at the same time as the Sweeping or Measuring bit is set. It is cleared when the trigger actually occurs (that is, after the trigger event occurs and all the applicable trigger criteria have been met). A corresponding pop-up message ("Waiting for trigger") is generated if no trigger signal appears after approximately 2 sec. This message goes away when a trigger signal appears.
Initial S/W Revision	Prior to A.02.00

Trigger Level

Sets the value where the external 1 trigger input will trigger a new sweep/measurement.

Key Path	Trigger, External 1
Remote Command	:TRIGger[:SEquence]:EXTernal1:LEVel <level> :TRIGger[:SEquence]:EXTernal1:LEVel?
Example	TRIG:EXT1:LEV 0.4 V
Couplings	This same level is used for the Ext1 trigger source in the Trigger menu, for the Ext1 selection in the Periodic Timer sync source (in the Trigger menu and in the Gate Source menu), and also for the Ext1 selection in the Gate Source menu.
Preset	1.2 V
State Saved	Saved in instrument state
Min	-5 V
Max	5 V
Default Unit	V
Backwards Compatibility SCPI	:TRIGger[:SEquence]:EXTernal:LEVel For backward compatibility, the parameter EXTernal is mapped to EXTernal1
Backwards Compatibility SCPI	:TRIGger[:SEquence]:FRAMe:EXTernal1:LEVel
Initial S/W Revision	Prior to A.02.00

Trig Slope

Controls the trigger polarity. It is set positive to trigger on a rising edge and negative to trigger on a falling edge.

Key Path	Trigger, External 1
Remote Command	:TRIGger[:SEquence]:EXTernal1:SLOPe POSitive NEGative

	:TRIGger[:SEquence]:EXTernal1:SLOPe?
Example	TRIG:EXT1:SLOP NEG
Couplings	This same slope is used in the Ext1 selection for the trigger source in the Trigger menu and for the period timer sync source (in the Trigger menu and in the Gate Source menu).
Preset	POSitive
State Saved	Saved in instrument state
Backwards Compatibility SCPI	:TRIGger[:SEquence]:EXTernal:SLOPe For backward compatibility, the parameter EXTernal is mapped to EXTernal1
Backwards Compatibility SCPI	:TRIGger[:SEquence]:FRAMe:EXTernal1:SLOPe
Backwards Compatibility Notes	The legacy :TRIGger[:SEquence]:SLOPe command affects the slopes for the VID, LINE, EXT1, EXT2, and RFB triggers.
Initial S/W Revision	Prior to A.02.00

External 2

Pressing this key, when it is not selected, selects an external input signal as the trigger. A new sweep/measurement will start when the external trigger condition is met using the external 2 input connector. The external trigger 2 input connector is on the rear panel.

Pressing this key, when it is already selected, accesses the external 2 trigger setup menu.

Key Path	Trigger
Example	TRIG:SOUR EXT2 Swept SA measurement TRIG:<meas>:SOUR EXT2 Measurements other than Swept SA
Dependencies	In some models, there is no second External input. In these models, the External 2 key is blanked and the EXTernal2 parameter will generate a "Hardware missing; Not available for this model number" message. Grayed out if in use by Point Trigger in the Source Setup menu. Forced to Free Run if already selected and Point Trigger is set to External 2.
State Saved	Saved in instrument state
Status Bits/OPC dependencies	The Status Operation Register bit 5 "Waiting for Trigger" is set at the same time as the Sweeping or Measuring bit is set. It is cleared when the trigger actually occurs (that is, after the trigger event occurs and all the applicable trigger criteria have been met). A corresponding pop-up message ("Waiting for trigger") is generated if no trigger signal appears after approximately 2 sec. This message goes away when a trigger signal appears.
Initial S/W Revision	Prior to A.02.00
Modified at S/W Revision	A.03.00

Trigger Level

Sets the value where the external 2 trigger input will trigger a new sweep/measurement.

Key Path	Trigger, External 2
Remote Command	:TRIGger[:SEquence]:EXTernal2:LEVel :TRIGger[:SEquence]:EXTernal2:LEVel?
Example	TRIG:EXT2:LEV 1.1 V
Couplings	This same level is used for the Ext2 trigger source in the Trigger menu, for the Ext2 selection in the Periodic Timer sync source (in the Trigger menu and in the Gate Source menu), and also for the Ext2 selection in the Gate Source menu.
Preset	1.2 V
State Saved	Saved in instrument state
Min	-5 V
Max	5 V
Default Unit	V
Backwards Compatibility SCPI	:TRIGger[:SEquence]:FRAMe:EXTernal2:LEVel
Initial S/W Revision	Prior to A.02.00

Trig Slope

Controls the trigger polarity. It is set positive to trigger on a rising edge and negative to trigger on a falling edge.

Key Path	Trigger, External 2
Remote Command	:TRIGger[:SEquence]:EXTernal2:SLOPe POSitive NEGative :TRIGger[:SEquence]:EXTernal2:SLOPe?
Example	TRIG:EXT2:SLOP NEG
Couplings	This same slope is used in the Ext2 selection for the trigger source in the Trigger menu and for the period timer sync source (in the Trigger menu and in the Gate Source menu).
Preset	POSitive
State Saved	Saved in instrument state
Backwards Compatibility SCPI	:TRIGger[:SEquence]:FRAMe:EXTernal2:SLOPe
Backwards Compatibility Notes	The legacy :TRIGger[:SEquence]:SLOPe command affects the slopes for the VID, LINE, EXT1, EXT2, and RFB triggers.
Initial S/W Revision	Prior to A.02.00

RF Burst

Pressing this key, when it is not selected, selects the RF Burst as the trigger. A new sweep/measurement will start when an RF burst envelope signal is identified from the signal at the RF Input connector. Pressing this key, when it is already selected, accesses the RF Burst trigger setup menu.

In some models, a variety of burst trigger circuitry is available, resulting in various available burst trigger bandwidths. The analyzer automatically chooses the appropriate trigger path based on the hardware configuration and other settings of the analyzer.

Key Path	Trigger
Example	TRIG:SOUR RFB Swept SA measurement TRIG:<meas>:SOUR RFB Measurements other than Swept SA
State Saved	Saved in instrument state
Status Bits/OPC dependencies	The Status Operation Register bit 5 "Waiting for Trigger" is set at the same time as the Sweeping or Measuring bit is set. It is cleared when the trigger actually occurs (that is, after the trigger event occurs and all the applicable trigger criteria have been met). A corresponding pop-up message ("Waiting for trigger") is generated if no trigger signal appears after approximately 2 sec. This message goes away when a trigger signal appears.
Backwards Compatibility Notes	The legacy command: :TRIGger[:SEquence]:RFBurst:FSElectivity[:STATe] OFF ON 0 1 is not supported in the X-Series, as the hardware to do Frequency Selective burst triggers does not exist in X-Series.
Initial S/W Revision	Prior to A.02.00
Modified at S/W Revision	A.04.00

Absolute Trigger Level

Sets the absolute trigger level for the RF burst envelope.

When using the External Mixing path, the Absolute Trigger Level is uncalibrated because the factory default was set to accommodate the expected IF levels for the RF path.

Key Path	Trigger, RF Burst
Scope	Meas Global
Remote Command	:TRIGger[:SEquence]:RFBurst:LEVel:ABSolute <ampl> :TRIGger[:SEquence]:RFBurst:LEVel:ABSolute?
Example	TRIG:RFB:LEV:ABS 10 dBm sets the trigger level of the RF burst envelope signal to the absolute level of 10 dBm
Notes	Sending this command does not switch the setting from relative to absolute; to switch it you need to send the :TRIGger[:SEquence]:RFBurst:LEVel:TYPE command, below. Amplitude Corrections are not taken into account by the Absolute Trigger Level. For example, if you have given yourself effective gain with an amplitude correction factor, the Absolute Trigger will not fire until you have set the trigger level that far below the displayed signal level, rather than simply to the displayed signal level. This is only true for Amplitude Corrections, not External Gain or Ref Level Offset functions. If mode is Bluetooth, the default value is -50 dBm.
Couplings	This same level is used for the RF Burst trigger source in the Trigger menu, for the RF Burst selection in the Periodic Timer sync source (in the Trigger menu and in the Gate Source menu), and also for the

	RF Burst selection in the Gate Source menu
Preset	-20 dBm
State Saved	Saved in instrument state
Min	-200 dBm
Max	100 dBm
Default Unit	depends on the current selected Y-Axis unit
Backwards Compatibility SCPI	:TRIGger[:SEquence]:FRAMe:RFBurst:LEVel:ABSolute
Initial S/W Revision	Prior to A.02.00
Modified at S/W Revision	A.04.00

Key Path	Trigger, RF Burst
Remote Command	:TRIGger[:SEquence]:RFBurst:LEVel:TYPE ABSolute RELative :TRIGger[:SEquence]:RFBurst:LEVel:TYPE?
Example	TRIG:RFB:LEV:TYPE REL sets the trigger level type of the RF burst trigger to Relative.
Preset	ABSolute
State Saved	Saved in instrument state
Initial S/W Revision	Prior to A.02.00
Modified at S/W Revision	A.04.00

Trigger Slope

It is set positive to trigger on a rising edge and negative to trigger on a falling edge.

Key Path	Trigger, RF Burst
Remote Command	:TRIGger[:SEquence]:RFBurst:SLOPe POSitive NEGative :TRIGger[:SEquence]:RFBurst:SLOPe?
Example	TRIG:RFB:SLOP NEG
Couplings	This same slope is used in the RF Burst selection for the trigger source in the Trigger menu and for the period timer sync source (in the Trigger menu and in the Gate Source menu).
Preset	POSitive
State Saved	Saved in instrument state
Backwards Compatibility SCPI	:TRIGger[:SEquence]:FRAMe:RFBurst:SLOPe
Backwards Compatibility Notes	The legacy :TRIGger[:SEquence]:SLOPe command affects the slopes for the VID, LINE, EXT1, EXT2, and RFB triggers.
Initial S/W Revision	Prior to A.02.00

Sync Holdoff

Sync Holdoff specifies the duration that the sync source signal must be kept false before the transition to true to be recognized as the sync timing. The periodic timer phase is aligned when the sync source signal becomes true, after the Holdoff time is satisfied.

A holdoff of 2 ms will work with most WiMAX signals, but there may be cases where the burst off duration is less than 1 ms and this value will need to be changed.

Key Path	Trigger, Periodic Timer
Remote Command	:TRIGger[:SEquence]:FRAMe:SYNC:HOLDoff <time> :TRIGger[:SEquence]:FRAMe:SYNC:HOLDoff? :TRIGger[:SEquence]:FRAMe:SYNC:HOLDoff:STATe OFF ON 0 1 :TRIGger[:SEquence]:FRAMe:SYNC:HOLDoff:STATe?
Preset	On, 1.000 ms
State Saved	Saved in instrument state
Min	0 ms
Max	+500 ms
Default Unit	s
Initial S/W Revision	Prior to A.02.00

Auto/Holdoff

Opens up a menu that lets you adjust Auto Trigger and Trigger Holdoff parameters

Key Path	Trigger
Readback line	Displays a summary of the Auto Trig and Holdoff settings, in square brackets First line: Auto Off or Auto On Second Line: "Hldf" followed by: <ul style="list-style-type: none"> • If Holdoff is Off, readback Off • If Holdoff On and Type = Normal, readback value • If Holdoff On and Type = Above, readback value followed by AL • If Holdoff On and Type = Below, readback value followed by BL • If Holdoff Type selection is not supported by the current measurement, Holdoff Type is always Normal
Initial S/W Revision	A.02.00

Auto Trig

Sets the time that the analyzer will wait for the trigger conditions to be met. If they are not met after that much time, then the analyzer is triggered anyway.

Key Path	Trigger, Auto/Holdoff
Remote Command	:TRIGger[:SEquence]:ATRigger <time> :TRIGger[:SEquence]:ATRigger? :TRIGger[:SEquence]:ATRigger:STATe OFF ON 0 1 :TRIGger[:SEquence]:ATRigger:STATe?
Example	TRIG:ATR:STAT ON TRIG:ATR 100 ms
Notes	The "time that the analyzer will wait" starts when the analyzer is ready for a trigger, which may be hundreds of ms after the data acquisition for a sweep is done. The "time" ends when the trigger condition is satisfied, not when the delay ends.
Preset	Off, 100 ms
State Saved	Saved in instrument state
Min	1 ms
Max	100 s
Default Unit	s
Initial S/W Revision	Prior to A.02.00

Trig Holdoff

Sets the holdoff time between triggers. When the trigger condition is satisfied, the trigger occurs, the delay begins, and the holdoff time begins. New trigger conditions will be ignored until the holdoff time expires. For a free-running trigger, the holdoff value is the minimum time between triggers.

Key Path	Trigger, Auto/Holdoff
Remote Command	:TRIGger[:SEquence]:HOLDoff <time> :TRIGger[:SEquence]:HOLDoff? :TRIGger[:SEquence]:HOLDoff:STATe OFF ON 0 1 :TRIGger[:SEquence]:HOLDoff:STATe?
Example	TRIG:HOLD:STAT ON TRIG:HOLD 100 ms
Dependencies	Unavailable if the selected Input is BBIQ. If this is the case, the key is grayed out if it is pressed the informational message "Feature not supported for this Input" is displayed. If the SCPI command is sent, the error "Settings conflict; Feature not supported for this Input" is generated.
Preset	Off, 100 ms
State Saved	Saved in instrument state
Min	0 s
Max	0.5 s
Default Unit	s
Initial S/W Revision	Prior to A.02.00

Gate Preset (Remote Command Only)

Presets the time-gated spectrum analysis capability.

This command sets gate parameter values to the ESA preset values, as follows:

Gate trigger type = edge

Gate polarity = positive

Gate delay = 1 us

Gate length = 1 us

Remote Command	<code>[[:SENSe]:SWEep:TIME:GATE:PRESet</code> ESA Compatibility
Initial S/W Revision	Prior to A.02.00

Gate Level (Remote Command Only)

Sets the gate input transition point level for the external TRIGGER inputs on the front and rear panel. This is a legacy command for PSA compatibility. It is simply an alias to the equivalent trigger level command.

Remote Command	<code>[[:SENSe]:SWEep:EGATE:EXTernal [1] 2:LEVel <voltage></code> <code>[[:SENSe]:SWEep:EGATE:EXTernal [1] 2:LEVel?</code>
Notes	This command is simply an alias to <code>:TRIGger[:SEQuence]:EXTernal[1]2:LEVel</code> For details refer
Initial S/W Revision	Prior to A.02.00

Gate Polarity (Remote Command Only)

Sets the polarity for the gate signal. This setup is now done using the gate trigger's slope setting.

When Positive (Pos) is selected, a positive-going edge (Edge) or a high voltage (Level) will satisfy the gate condition, after the delay set with the Gate Delay key. When Negative (Neg) is selected, a negative-going edge (Edge) or a low voltage (Level) will satisfy the gate condition after the delay.

Remote Command	<code>[[:SENSe]:SWEep:EGATE:POLarity</code> NEGative POSitive <code>[[:SENSe]:SWEep:EGATE:POLarity?</code>
Example	<code>SWE:EGAT:POL NEG</code> <code>SWE:EGAT:POL?</code>
Preset	POSitive
State Saved	Saved in instrument state
Backwards Compatibility SCPI	<code>[[:SENSe]:SWEep:TIME:GATE:POLarity</code> ESA compatibility
Initial S/W Revision	Prior to A.02.00

Remote Command	[:SENSe] :SWEep:TIME:GATE:LEVel HIGH LOW [:SENSe] :SWEep:TIME:GATE:LEVel? ESA compatibility
Preset	HIGH
Initial S/W Revision	Prior to A.02.00

Points

Sets the number of points per sweep, from 1 to 20001. The acquisition time resolution setting will depend on the number of points selected.

Key Path	Sweep/Control
Mode	SA, WCDMA, C2K, WIMAX OFDMA, TD-SCDMA, 1xEVDO, DVB-T/H, DTMB (CTTB), ISDB-T, CMMB, LTE, LTE-TDD
Remote Command	[:SENSe] :ACPoweR:SWEep:POINts <integer> [:SENSe] :ACPoweR:SWEep:POINts?
Example	ACP:SWE:POIN 500 ACP:SWE:POIN?
Notes	Whenever the number of sweep points changes: <ul style="list-style-type: none"> • All trace data is erased • Any traces with Update Off will also go to Display Off (like going from View to Blank in the older analyzers) • Acquisition time is re-quantized • Any limit lines that are on will be updated • If averaging/hold is on, averaging/hold starts over
Couplings	Whenever the number of sweep points changes, the acquisition time is re-quantized.
Preset	Others: 1001 DVB-T/H:2001 DTMB (CTTB): 2001 ISDB-T: 2001 CMMB: 2001 Digital Cable TV: 2001
State Saved	Saved in instrument state.
Min	1
Max	20001
Initial S/W Revision	Prior to A.02.00
Modified at S/W Revision	A.02.00, A.03.00

10 ACP Measurement
System

System

See "[System](#)" on page 272

Trace/Detector

Accesses a menu of functions that enable you to control the detectors for the current measurement.

Key Path	Front-panel key
Initial S/W Revision	Prior to A.02.00

Select Trace (Front-panel Only)

This key selects which trace the other parameters under the Trace/Detector menu will apply to.

Key Path	Trace/Detector
Notes	Front-panel only.
Couplings	When Meas Method is RBW or FAST, Select Trace is disabled.
Preset	1
State Saved	Saved in instrument state.
Range	1 2 3
Initial S/W Revision	Prior to A.02.00

Trace Type

Allows you to select the type of trace for the current measurement. The first page of this menu contains a selection of the trace type (Clear Write, Trace Average, Max Hold, Min Hold) for the selected trace.

Key Path	Trace/Detector
Mode	SA, WCDMA, C2K, WIMAX OFDMA, TD-SCDMA, 1xEVDO, DVB-T/H, DTMB (CTTB), ISDB-T, CMMB, LTE, LTE-TDD
Remote Command	:TRACe [1] 2 3 :ACPoweR:TYPE WRITe AVERAge MAXHold MINHold :TRACe [1] 2 3 :ACPoweR:TYPE?
Example	TRAC:ACP:TYPE MINH TRAC:ACP:TYPE?
Notes	WRITe = Clear Write AVERAge = Average MAXHold = Maximum Hold MINHold = Minimum Hold
Couplings	When Detector setting is "Auto" ([:SENSe]:ACPoweR:DETEctor:AUTO?), Detector is set to what the Radio Standard defaults states (see detector section below) for all conditions of Trace Type and for all traces. When set to Manual, all Traces use the same detector type. When Average State = Off then Trace Types AVERAge, MaxHold and MinHold will not function, since Averaging is required to be 'on' for them to operate.

	When Meas Method is RBW or FAST, Trace Type is disabled.
Preset	AVERage
State Saved	Saved in instrument state.
Initial S/W Revision	Prior to A.02.00
Modified at S/W Revision	A.02.00, A.03.00

View/Blank

Enables you to select how to view the displayed trace.

Key Path	Trace/Detector
Mode	SA,WCDMA, C2K, WIMAX OFDMA, TD-SCDMA, 1xEVDO, DVB-T/H, DTMB (CTTB), ISDB-T, CMMB, LTE, LTETDD
Notes	No remote control. Front panel only.
Couplings	The four states of this 1-of-N actually set two variables, Update and Display, to their four possible combinations. Trace On: Update and Display both On View: Update Off and Display On (Not implemented) Blank: Update Off and Display Off Background: Update On, Display Off (Not implemented) See tables below for detail on remote commands to control these two variables. Selecting a trace type (Clear Write, Trace Average, Max Hold, Min Hold) for a trace (pressing the key or sending the equivalent remote command) puts the trace in 'Trace On' state (Update On and Display On), even if that trace type was already selected. When Meas Method is RBW or FAST, this key is grayed out.
Preset	Trace On
State Saved	Saved in instrument state.
Range	Trace On Blank
Initial S/W Revision	Prior to A.02.00
Modified at S/W Revision	A.03.00

Key Path	Trace/Detector
Mode	WCDMA, C2K, WIMAX OFDMA, TD-SCDMA, 1xEVDO, DVB-T/H, DTMB (CTTB), ISDB-T, CMMB, LTE, LTETDD
Remote Command	:TRACe [1] 2 3 :ACPoweR:UPDate [:STATe] ON OFF 0 1 :TRACe [1] 2 3 :ACPoweR:UPDate [:STATe] ?
Example	TRAC:ACP:UPD ON TRAC:ACP:UPD?
Couplings	Whenever you set Update to On for any trace, the Display is set to On for that trace. When Meas Method is RBW or FAST, Trace Update is disabled.
Preset	1 0 0 (On for Trace 1; Off for 2 & 3)

State Saved	Saved in instrument state.
Range	0 1
Initial S/W Revision	Prior to A.02.00
Modified at S/W Revision	A.03.00
<hr/>	
Key Path	Trace/Detector
Mode	WCDMA, C2K, WIMAX OFDMA, TD-SCDMA, 1xEVDO, DVB-T/H, DTMB (CTTB), ISDB-T, CMMB, LTE, LTETDD
Remote Command	:TRACe[1] 2 3:ACPoweR:DISPlay[:STATe] ON OFF 0 1 :TRACe[1] 2 3:ACPoweR:DISPlay[:STATe]?
Example	TRAC:ACP:DISP ON TRAC:ACP:DISP?
Couplings	Whenever you set Update to On for any trace, the Display is set to On for that trace. When Meas Method is RBW or FAST, Trace Display is disabled.
Preset	1 0 0 (On for Trace 1; Off for 2 &3)
State Saved	Saved in instrument state.
Range	0 1
Initial S/W Revision	Prior to A.02.00
Modified at S/W Revision	A.03.00

Detector

Accesses a menu of functions that enables you to control the detectors for the current measurement. Allows up to three (3) traces, but each use the same detector type choice. The following choices are available:

- Auto– the detector selected is set to AVERage, unless the Radio Standard defaults state otherwise e.g. it is set to Peak for Radio Standard = PDC when Device = both MS and BTS, and when Radio Standard = NADC and Device = MS.
- Normal–the detector determines the peak of the CW-like signals, and it yields alternating maximums and minimums of noise-like signals. This is also referred to as Rosenfell detection.
- Average–the detector determines the average of the signal within the sweep points. The averaging method is Power (RMS).
- Peak–the detector determines the maximum of the signal within the sweep points.
- Sample–the detector indicates the instantaneous level of the signal at the center of the sweep points represented by each display point.
- Negative Peak–the detector determines the minimum of the signal within the sweep points.

In swept analysis, the time interval of the data collection for the display sweep points also represents a frequency interval. In FFT analysis, the sweep points represents just a frequency interval. The detector

determines the relationship between the spectrum computed by the FFT and the single data point displayed for the sweep points.

Key Path	Trace/Detector
Initial S/W Revision	Prior to A.02.00

Auto

Sets the detector for the currently selected trace to auto.

Key Path	Trace/Detector
Mode	SA, WCDMA, C2K, WIMAX OFDMA, TD-SCDMA, 1xEVDO, DVB-T/H, DTMB (CTTB), ISDB-T, CMMB, LTE, LTETDD
Remote Command	<code>[:SENSe] :ACPower:DETECTOR:AUTO ON OFF 1 0</code> <code>[:SENSe] :ACPower:DETECTOR:AUTO?</code>
Example	ACP:DET:AUTO 1 ACP:DET?
Couplings	When Detector setting is “Auto” (<code>[:SENSe] :ACPower:DETECTOR:AUTO?</code>), Detector is set to what the Radio Standard defaults states (see detector section) for all conditions of Trace Type and for all traces. When set to Manual, all Traces use the same detector type. When Average State = Off then Trace Types AVERage, MaxHold and MinHold will not function, since Averaging is required to be ‘on’ for them to operate.
Preset	ON
State Saved	Saved in instrument state.
Range	ON OFF
Initial S/W Revision	Prior to A.02.00
Modified at S/W Revision	A.02.00, A.03.00

Detector Selection

Selects a detector to be used by the analyzer for the current measurement. All traces will use the same detector type, similar to Monitor Spectrum measurement

Key Path	Trace/Detector
Mode	SA, WCDMA, C2K, WIMAX OFDMA, TD-SCDMA, 1xEVDO, DVB-T/H, DTMB (CTTB), ISDB-T, CMMB, LTE, LTETDD
Remote Command	<code>[:SENSe] :ACPower:DETECTOR[:FUNCTION] AVERage NEGative NORMal POSitive SAMPlE</code> <code>[:SENSe] :ACPower:DETECTOR[:FUNCTION] ?</code>
Example	ACP:DET NORM ACP:DET?
Notes	When you manually select a detector (instead of selecting Auto), that detector is used regardless of

other analyzer settings.

The detector choices are:

- The Normal detector determines the peak of CW-like signals, and it yields alternating maximums and minimums of noise-like signals. This is also referred to as Rosenfell detection.
- The Average detector determines the average of the signal within the data range. The averaging method is Power (RMS).
- The Peak detector determines the maximum of the signal within the data range.
- The Sample detector indicates the instantaneous level of the signal at the center of the data represented by each display point.
- The Negative Peak detector determines the minimum of the signal within the data range.

Because they may not find a spectral component's true peak, neither average nor sample detectors measure amplitudes of CW signals as accurately as peak or normal, but they do measure noise without the biases of peak detection.

When a detector selection is made, the menu returns to the previous menu.

Couplings	When Detector setting is "Auto" (:SENSe]:ACPower:DETECTOR:AUTO?), Detector is set to what the Radio Standard defaults states (see detector section) for all conditions of Trace Type and for all traces. When set to Manual, all Traces use the same detector type. When Average State = Off then Trace Types AVERage, MaxHold and MinHold will not function, since Averaging is required to be 'on' for them to operate. Only one detector type for all 3 traces is allowed. When Meas Method is RBW or FAST, Detector is disabled.
Preset	AVERage
State Saved	Saved in instrument state.
Range	Normal Average Peak Sample Negative Peak
Backwards Compatibility SCPI	[:SENSe] :ACPR :SWEep :DETECTOR [:FUNction]
Initial S/W Revision	Prior to A.02.00
Modified at S/W Revision	A.02.00, A.03.00

Trigger

See ["Trigger" on page 328](#)

Free Run

See ["Free Run " on page 335](#)

Video

See ["Video \(IF Envelope\) " on page 1556](#)

Trigger Level

See ["Trigger Level " on page 1557](#)

Trig Slope

See ["Trig Slope " on page 1558](#)

Trig Delay

See ["Trig Delay " on page 338](#)

External 1

See ["External 1 " on page 1571](#)

Trigger Level

See ["Trigger Level " on page 1571](#)

Trig Slope

See ["Trig Slope " on page 1572](#)

Trig Delay

See ["Trig Delay " on page 341](#)

Zero Span Delay Comp

See ["Zero Span Delay Comp On/Off" on page 1560](#)

External 2

See ["External 2 " on page 1572](#)

Trigger Level

See ["Trigger Level " on page 1573](#)

Trig Slope

See ["Trig Slope " on page 1574](#)

Trig Delay

See "Trig Delay " on page 344

Zero Span Delay Comp

See "Zero Span Delay Comp On/Off" on page 1562

RF Burst

See "RF Burst " on page 1574

Absolute Trigger

See "Absolute Trigger Level" on page 1575

Relative Trigger

See "Relative Trigger Level" on page 1564

Trig Slope

See "Trigger Slope " on page 1576

Trig Delay

See "Trig Delay " on page 348

Periodic Timer

See "Periodic Timer (Frame Trigger) " on page 1566

Period

See "Period " on page 1567

Offset

See "Offset " on page 1568

Reset Offset Display

See "Reset Offset Display " on page 1570

Sync Source

See "Sync Source " on page 1570

Off

See "Off " on page 1571

External 1

See "External 1 " on page 1571

10 ACP Measurement
Trigger

Trigger Level

See ["Trigger Level "](#) on page 1571

Trig Slope

See ["Trig Slope "](#) on page 1572

External 2

See ["External 2 "](#) on page 1572

Trigger Level

See ["Trigger Level "](#) on page 1573

Trig Slope

See ["Trig Slope "](#) on page 1574

RF Burst

See ["RF Burst "](#) on page 1574

Absolute Trigger

See ["Absolute Trigger Level"](#) on page 1575

Trig Slope

See ["Trigger Slope "](#) on page 1576

Trig Delay

See ["Trig Delay"](#) on page 359

Auto/Holdoff

See ["Auto/Holdoff "](#) on page 1577

Auto Trig

See ["Auto Trig "](#) on page 1577

Trig Holdoff

See ["Trig Holdoff "](#) on page 1578

Holdoff Type

See ["Holdoff Type"](#) on page 361

User Preset

Accesses a menu that gives you the following three choices:

- User Preset – recalls a state previously saved using the Save User Preset function.
- User Preset All Modes – presets all of the modes in the analyzer
- Save User Preset– saves the current state for the current mode

NOTE

In products that run multiple instances of the X-Series Application, all instances use the same location to save User Preset state. So Save User Preset of one instance will overwrite the Save User Preset of another instance.

Key Path	Front-panel key
Backwards Compatibility Notes	<p>User Preset is actually loading a state, and in legacy analyzers, it was possible to load a state without affecting the trace data, limit lines or correction data. Similarly it was possible to do a User Preset without affecting the trace data, limit lines or correction data.</p> <p>In the X-Series, “state” always includes all of this data; so whenever state is loaded, or User Preset is executed, all of the traces, limit lines and corrections are affected. Although this differs from previous behavior, it is desirable behavior, and should not cause adverse issues for users.</p> <p>On ESA and PSA, User Preset affected the entire instrument’s state. In the X-Series, User Preset only recalls the state for the active mode. There is a User Preset file for each mode. User Preset can never cause a mode switch as it can in legacy analyzers. If you want to recall all modes to their user preset file state, you will need to do a User Preset after mode switching into each mode.</p> <p>User Preset recalls mode state which can now include data like traces; whereas on ESA and PSA, User Preset did not affect data.</p>
Initial S/W Revision	Prior to A.02.00

User Preset

User Preset sets the state of the currently active mode back to the state that was previously saved for this mode using the Save User Preset menu key or the SCPI command, SYST:PRES:USER:SAV. It not only recalls the Mode Preset settings, but it also recalls all of the mode persistent settings, and the Input/Output system setting that existed at the time Save User Preset was executed.

If a Save User Preset has not been done at any time, User Preset recalls the default user preset file for the currently active mode. The default user preset files are created if, at power-on, a mode detects there is no user preset file. There will never be a scenario when there is no user preset file to restore. For each mode, the default user preset state is the same state that would be saved if a Save User Preset is performed in each mode right after doing a Restore Mode Default and after a Restore Input/Output Defaults.

The User Preset function does the following:

- Aborts the currently running measurement.
- Sets the mode State to the values defined by Save User Preset.
- Makes the saved measurement for the currently running mode the active measurement.
- Brings up the saved menu for the power-on mode.

- Clears the input and output buffers.
- Sets the Status Byte to 0.

Key Path	User Preset
Remote Command	:SYSTem:PRESet:USER
Example	:SYST:PRES:USER:SAVE:SYST:PRES:USER
Notes	:SYST:PRES:USER:SAVE is used to save the current state as the user preset state. Clears all pending OPC bits. The Status Byte is set to 0. Pressing the User Preset front-panel key while already in the User Preset menu will cause the User Preset to get executed
Couplings	A user preset will cause the currently running measurement to be aborted and cause the saved measurement to be active. Recalling a User Preset file has the same issues that recalling a Save State file has. Some settings may need to be limited and therefore re-coupled, since the capabilities of the mode may have changes when the User Preset file was last saved.
Initial S/W Revision	Prior to A.02.00

User Preset All Modes

Recalls all of the User Preset files for each mode, switches to the power-on mode, and activates the saved measurement from the power-on mode User Preset file.

NOTE

When the instrument is secured, all of the user preset files are converted back to their default user preset files.

The User Preset function does the following:

- Aborts the currently running measurement.
- Switches the Mode to the power-on mode.
- Restores the User Preset files for each mode.
- Makes the saved measurement for the power-on mode the active measurement.
- Brings up the saved menu for the power-on mode.
- Clears the input and output buffers.
- Sets the Status Byte to 0.

Key Path	User Preset
Remote Command	:SYSTem:PRESet:USER:ALL
Example	:SYST:PRES:USER:SAVE:SYST:PRES:USER:ALL
Notes	Clears all pending OPC bits. The Status Byte is set to 0. :SYST:PRES:USER:SAVE is used to save the current state as the user preset state.
Couplings	A user preset will cause the currently running measurement to be aborted, cause a mode switch to the power-on mode, and cause the saved measurement to be active in the power-on mode.

Recalling a User Preset file has the same issues that recalling a Save State file has. Some settings may need to be limited and therefore re-coupled, since the capabilities of the mode may have changes when the User Preset file was last saved.

Initial S/W Revision Prior to A.02.00

Save User Preset

Saves the currently active mode and its State. You can recall this User Preset file by pressing the User Preset menu key or sending the SYST:PRES:USER remote command. This same state is also saved by the Save State function.

Key Path	User Preset
Remote Command	:SYSTem:PRESet:USER:SAVE
Example	:SYST:PRES:USER:SAVE
Notes	:SYST:PRES:SAVE creates the same file as if the user requested a *SAV or a MMEM:STOR:STAT, except User Preset Save does not allow the user to specify the filename or the location of the file.
Initial S/W Revision	Prior to A.02.00

View/Display

Accesses a menu of functions that enable you to control the instrument display as well as turn the bar graph On and Off.

If current mode is NOT MSR mode, the front panel views only contain one view: Spectrum View.

The results of the measurement can be displayed as a single spectrum trace view or displayed with a Bar Graph trace on the spectrum trace.

The display consists of the following two windows:

"Spectrum Window" on page 1244

"Results Window" on page 1244



The following two views are only for DTMB (CTTB) and CMMB:

DTMB and CMMB Transmitter:

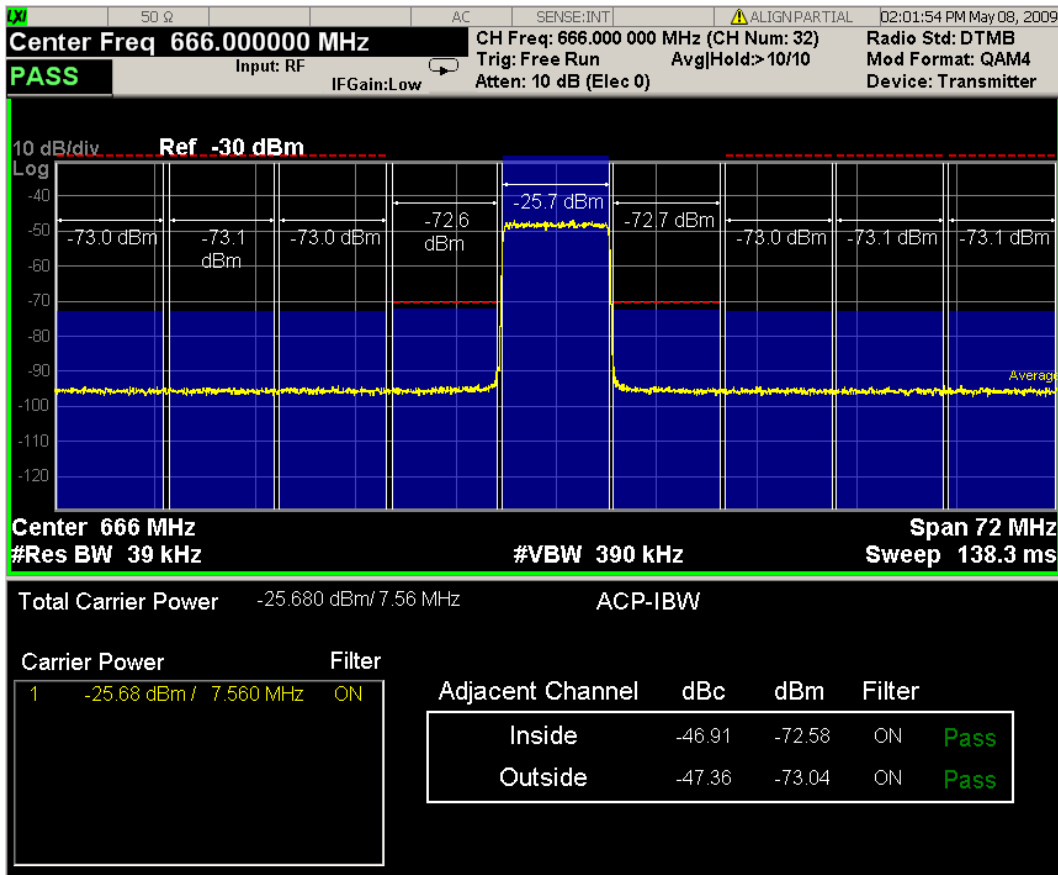

DTMB and CMMB Exciter:

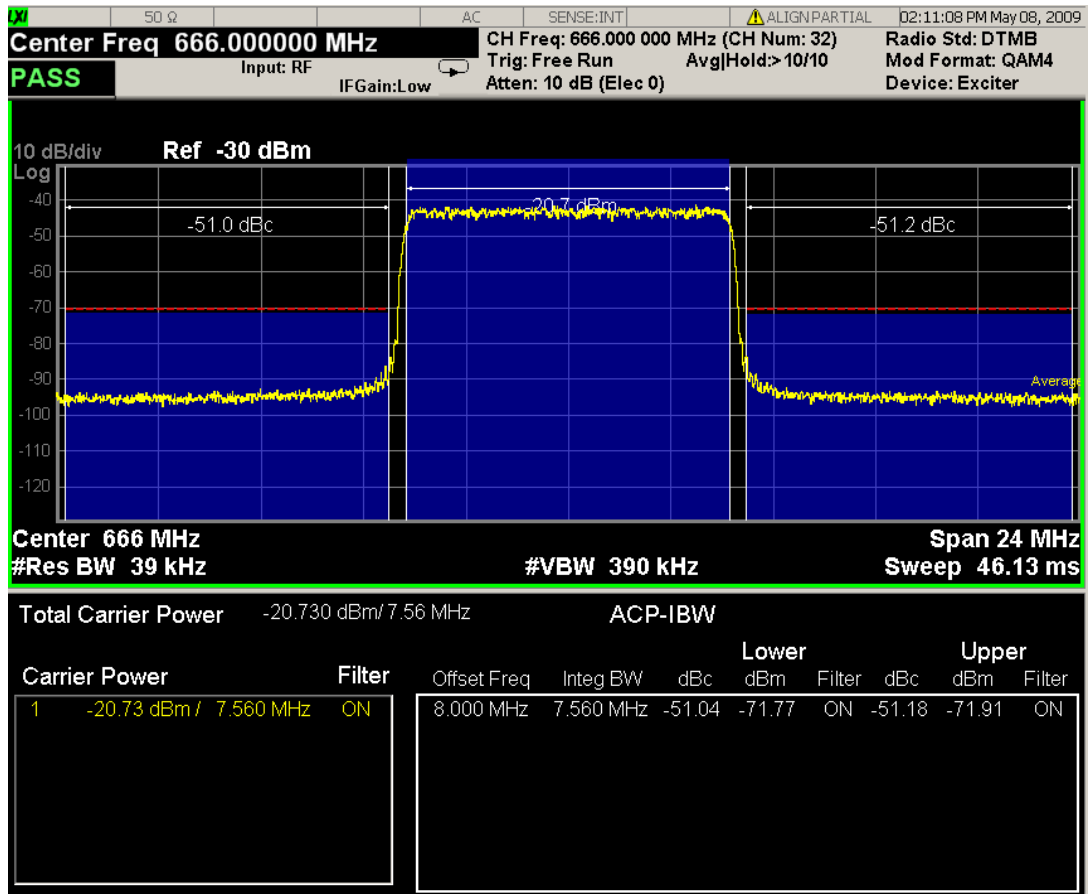

Spectrum Window

When the Bar Graph is On and Limit Test is On, the color of each bar graph reflects the limit test result. When the limit test fails, the bar color is red, and when limit test passes, the bar color is blue.

When RBW is selected as the measurement method, the spectrum trace is not displayed, only the bar graph is displayed. In addition, the Bar Graph key (under the View/Display front-panel key) is set to ON and is grayed out.

The RRC Filter display item is only displayed when RRC filter is on.

Results Window

The text window displays the following results:

Total Carrier Power

This is the total power of all the carriers with carrier power present set to yes. The power is calculated by integrating across the bandwidth declared by the Carrier Integ Bw parameter for each carrier and then totaling the sums. The total integration bandwidth is shown as part of the result. This will be the total of the Carrier Integ Bw of the carriers used in calculating the total carrier power. If the RRC Filter is on, then the integration bandwidth used is $(1 + \alpha)/T$ where $T = 1/(\text{Carrier Integ Bw})$ multiplied by the number of carriers with carrier power present set to yes.

Ref Carrier Power

This is the power in the reference carrier. The power is calculated by integrating across the bandwidth declared by the Carrier Integ Bw parameter for that carrier. The integration bandwidth is shown as part of the result. This is the value of the Carrier Integ Bw for that carrier unless the RRC Filter is on, then the integration bandwidth used is the displayed value, which is $(1 + \alpha)/T$ where $T = 1/(\text{Carrier Integ Bw})$.

Carrier Power

This is the power in all the currently defined carriers. If the carrier has carrier power present, the power will be absolute. If the carrier is defined as not having power present, the power will be relative to the reference carrier. The power is calculated by integrating across the bandwidth declared by the Carrier Integ Bw parameter. The integration bandwidth is shown as part of the result. This is the value of the Carrier Integ Bw for the carrier unless the RRC Filter is on, then the integration bandwidth used is the displayed value, which is $(1 + \alpha)/T$ where $T = 1/(\text{Carrier Integ Bw})$.

As there are potentially more results than can be easily viewed on the display, a scrollable list is used to display all results. The Carrier Results menu key is used to index the carrier amplitude results. This key is grayed out unless the measurement is in single mode (as in continual measurement mode). The display is continuously updating and will not need to be accessed. The currently selected Carrier Result is displayed on the last line of the carrier power result list unless:

- The selected Carrier Result is 4 or less in normal multi carrier power results view. In this case the first 4 carrier power results will be displayed.
- The selected Carrier Result is 9 or greater in normal multi carrier power results view. In this case the last 4 carrier power results will be displayed.
- The zoom mode is selected. In this case all carrier power ranges can be displayed.

Offset Relative Power

This is the power in the offsets relative to the reference carrier. The power is calculated by integrating across the bandwidth declared by the Offset Integ Bw parameter. The offset integration bandwidth is shown as part of the result. This is the value on the Offset Integ Bw menu key unless the RRC Filter is on, then the integration bandwidth used is the displayed value, which is $(1 + \alpha)/T$ where $T = 1/(\text{Offset Integ Bw})$.

Offset Absolute Power

This is the absolute power in the offsets. The power is calculated by integrating across the bandwidth declared by the Offset Integ Bw parameter. The offset integration bandwidth is shown as part of the result. This is the value on the Offset Integ Bw menu key unless the RRC Filter is on, then the integration bandwidth used is the displayed value, which is $(1 + \alpha)/T$ where $T = 1/(\text{Offset Integ Bw})$.

Inside Adjacent Channel Power (DTMB (CTTB) and CMMB only)

This result is only valid for DTMB (CTTB) transmitter and CMMB transmitter. It contains two parts: Relative Power and Absolute Power. The power is calculated by integrating across the bandwidth (Integ Bw) at the frequency Offset A.

Inside Absolute Power = $\text{MAX}(P_{\text{Lower Offset A}}, P_{\text{Upper Offset A}})$;

Inside Relative Power = Inside Absolute Power – Carrier Power;

Outside Adjacent Channel Absolute Power (DTMB (CTTB) and CMMB only)

This result is only valid for DTMB (CTTB) transmitter and CMMB transmitter. It contains two parts: Relative Power and Absolute Power. The power is the Root-Mean-Square of the power calculated by integrating across the bandwidth (Integ Bw) at frequency Offset B, C and D.

$$\text{Outside Absolute Power} = \sqrt{\frac{P_{\text{Lower OffsetB}}^2 + P_{\text{Upper OffsetB}}^2 + P_{\text{Lower OffsetC}}^2 + P_{\text{Upper OffsetC}}^2 + P_{\text{Lower OffsetD}}^2 + P_{\text{Upper OffsetD}}^2}{6}}$$

Outside Relative Power = Outside Absolute Power – Carrier Power;

Key Path	Front-panel key
Initial S/W Revision	Prior to A.02.00

Display

The Display menu is common to most measurements, and is used for configuring items on the display. Some Display menu settings apply to all the measurements in a mode, and some only to the current measurement. Those under the System Display Settings key apply to all measurements in all modes.

Key Path	Display
Key Path	View/Display
Initial S/W Revision	Prior to A.02.00

Annotation

Turns on and off various parts of the display annotation. The annotation is divided up into four categories:

1. Meas Bar: This is the measurement bar at the top of the screen. It does not include the settings panel or the Active Function. Turning off the Meas Bar turns off the settings panel and the Active Function. When the Meas Bar is off, the graticule area expands to fill the area formerly occupied by the Meas Bar.
2. Screen Annotation: this is the annotation and annunciation around the graticule, including any annotation on lines (such as the display line, the threshold line, etc.) This does NOT include the marker number or the N dB result. When off, the graticule expands to fill the entire graticule area.
3. Trace annotation: these are the labels on the traces, showing their detector (or their math mode).
4. Active Function annotation: this is the active function display in the meas bar, and all of the active function values displayed on softkeys.

See the figure below. Each type of annotation can be turned on and off individually.

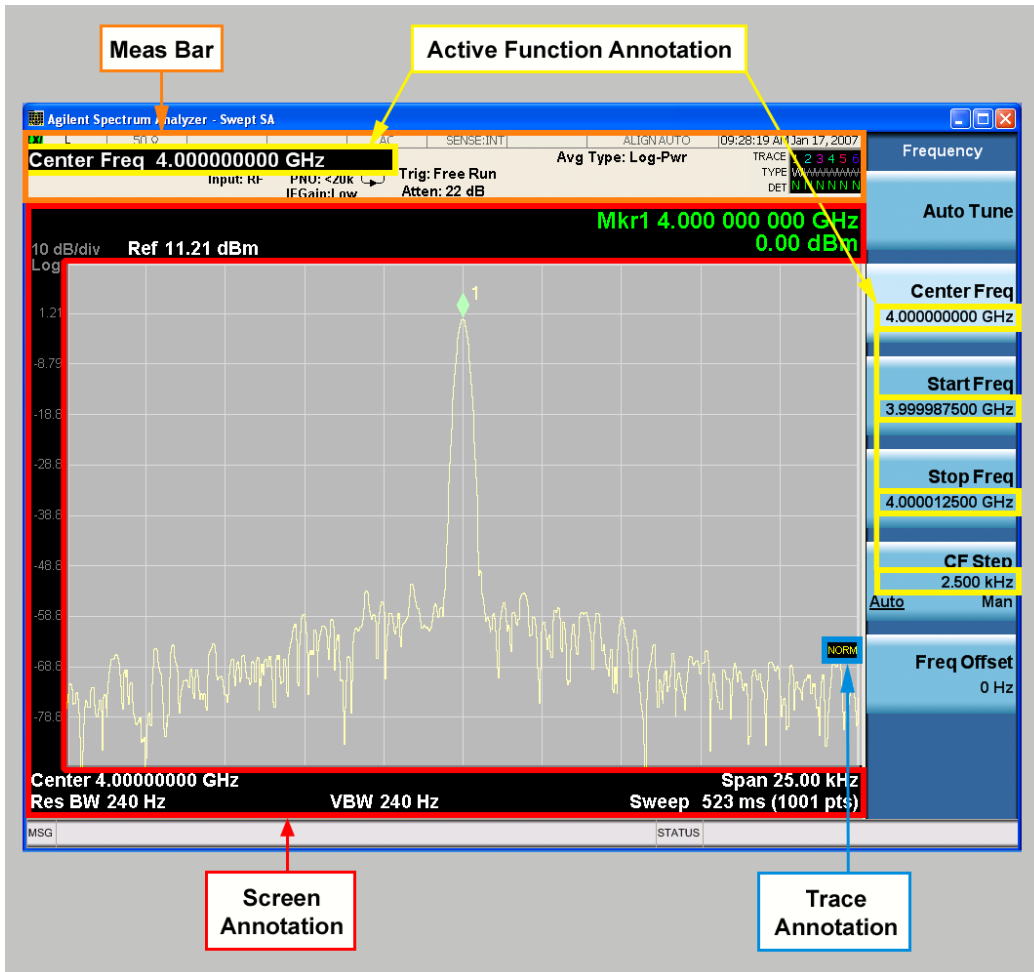

Key Path	View/Display, Display
Initial S/W Revision	Prior to A.02.00

Meas Bar On/Off

This function turns the Measurement Bar on and off, including the settings panel. When off, the graticule area expands to fill the area formerly occupied by the Measurement Bar.

Key Path	View/Display, Display, Annotation
Remote Command	:DISPlay:ANNotation:MBAR[:STATE] OFF ON 0 1 :DISPlay:ANNotation:MBAR[:STATE]?
Example	DISP:ANN:MBAR OFF
Dependencies	Grayed out and forced to OFF when System Display Settings, Annotation is set to Off.
Preset	On This should remain Off through a Preset when System DisplaySettings, Annotation is set to Off.
State Saved	Saved in instrument state.
Initial S/W Revision	Prior to A.02.00

Screen

This controls the display of the annunciation and annotation around the graticule, including any annotation on lines (such as the display line, the threshold line, etc.) and the y-axis annotation. This does NOT include marker annotation (or the N dB result). When off, the graticule expands to fill the entire graticule area, leaving only the 1.5% gap above the graticule as described in the Trace/Detector chapter.

Key Path	View/Display, Display, Annotation
Remote Command	:DISPlay:ANNotation:SCReen[:STATe] OFF ON 0 1 :DISPlay:ANNotation:SCReen[:STATe]?
Example	DISP:ANN:SCR OFF
Dependencies	Grayed-out and forced to OFF when System Display Settings, Annotation is set to Off.
Preset	On This should remain Off through a Preset when System DisplaySettings, Annotation is set to Off
State Saved	Saved in instrument state.
Initial S/W Revision	Prior to A.02.00

Active Function Values On/Off

Turns on and off the active function display in the Meas Bar, and all of the active function values displayed on the softkeys.

Note that all of the softkeys that have active functions have these numeric values blanked when this function is on. This is a security feature..

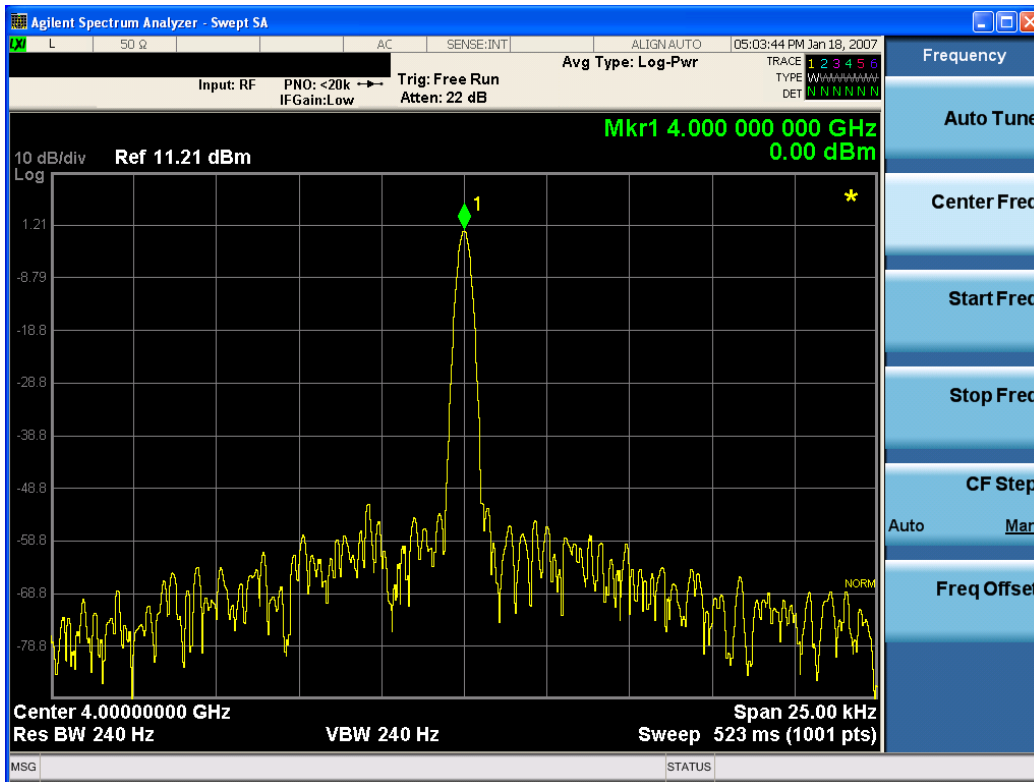

Key Path	View/Display, Display, Annotation
Remote Command	:DISPlay:ACTivefunc[:STATe] ON OFF 1 0 :DISPlay:ACTivefunc[:STATe]?
Example	DISP:ACT OFF
Dependencies	Grayed out and forced to OFF when System Display Settings, Annotation is set to Off.
Preset	On This should remain Off through a Preset when System DisplaySettings, Annotation is set to Off
State Saved	Saved in instrument state.
Initial S/W Revision	Prior to A.02.00

Title

Displays menu keys that enable you to change or clear a title on your display.

Key Path	View/Display, Display
Initial S/W Revision	Prior to A.02.00

Change Title

Writes a title into the "measurement name" field in the banner, for example, "Swept SA".

Press Change Title to enter a new title through the alpha editor. Press Enter or Return to complete the entry. Press ESC to cancel the entry and preserve your existing title.

The display title will replace the measurement name. It remains for this measurement until you press Change Title again, or you recall a state, or a Preset is performed. A title can also be cleared by pressing Title, Clear Title.

NOTE

Notice the inclusion of the <measurement> parameter in the command below. Because each measurement remembers the Display Title, the command must be qualified with the measurement name. For the Swept SA measurement this is not the case; no <measurement> parameter is used when changing the Display Title for the Swept SA measurement.

Key Path	View/Display, Display, Title
Mode	All
Remote Command	:DISPlay:<measurement>:ANNotation:TITLe:DATA <string> :DISPlay:<measurement>:ANNotation:TITLe:DATA?
Example	DISP:ANN:TITL:DATA "This Is My Title" This example is for the Swept SA measurement in the Spectrum Analyzer mode. The SANalyzer <measurement> name is not used. DISP:ACP:ANN:TITL:DATA "This Is My Title" This example is for Measurements other than Swept SA. Both set the title to: This Is My Title
Notes	Pressing this key cancels any active function. When a title is edited the previous title remains intact (it is not cleared) and the cursor goes at the end so that characters can be added or BKSP can be used to go back over previous characters.
Preset	No title (measurement name instead)
State Saved	Saved in instrument state.
Initial S/W Revision	Prior to A.02.00

Clear Title

Clears a title from the front-panel display. Once cleared, the title cannot be retrieved. After the title is cleared, the current Measurement Name replaces it in the title bar.

Key Path	View/Display, Display, Title
Example	The following commands clear the title and restore the measurement's original title: DISP:ANN:TITL:DATA "" This example is for the Swept SA measurement in the Spectrum Analyzer mode. The SANalyzer <measurement> name is not used. DISP:ACP:ANN:TITL:DATA "" This example is for ACP; in measurements other than Swept SA the measurement name is required.
Notes	Uses the :DISPlay:<measurement>:ANNotation:TITLe:DATA <string> command with an empty string (in the Swept SA, the <measurement> is omitted).
Preset	Performed on Preset.
Initial S/W Revision	Prior to A.02.00

Graticule

Pressing Graticule turns the display graticule On or Off. It also turns the graticule y-axis annotation on and off.

Key Path	View/Display, Display
Remote Command	:DISPlay:WINDow[1]:TRACe:GRATicule:GRID[:STATe] OFF ON 0 1 :DISPlay:WINDow[1]:TRACe:GRATicule:GRID[:STATe]?
Example	DISP:WIND:TRAC:GRAT:GRID OFF
Notes	The graticule is the set of horizontal and vertical lines that make up the grid/divisions for the x-axis and y-axis.
Preset	On
State Saved	Saved in instrument state
Initial S/W Revision	Prior to A.02.00

System Display Settings

These settings are "Mode Global" – they affect all modes and measurements and are reset only by Restore Misc Defaults or Restore System Defaults under System.

Key Path	View/Display, Display
Initial S/W Revision	Prior to A.02.00

Annotation Local Settings

This is a Mode Global override of the meas local annotation settings. When it is All Off, it forces ScreenAnnotation, Meas Bar, Trace, and Active Function Values settings to be OFF for all measurements in all modes. This provides the security based "annotation off" function of previous analyzers; hence it uses the legacy SCPI command.

When it is All Off, the Screen, Meas Bar, Trace, and Active Function Values keys under the Display, Annotation menu are grayed out and forced to Off. When Local Settings is selected, you are able to set the local annotation settings on a measurement by measurement basis.

Key Path	View/Display, Display, System Display Settings
Remote Command	:DISPlay:WINDow[1]:ANNotation[:ALL] OFF ON 0 1 :DISPlay:WINDow[1]:ANNotation[:ALL]?
Example	:DISP:WIND:ANN OFF
Preset	On (Set by Restore Misc Defaults)
State Saved	Not saved in instrument state.
Backwards Compatibility Notes	The WINDow parameter and optional subopcode is included for backwards compatibility but ignored – all windows are equally affected.
Initial S/W Revision	Prior to A.02.00

Themes

Accesses a menu of functions that enable you to choose the theme to be used when saving the screen image.

The **Themes** option is the same as the **Themes** option under the **Display** and **Page Setup** dialogs. It allows you to choose between themes to be used when saving the screen image.

Key Path	Save, Screen Image
Remote Command	:MMEMory:STORe:SCReem:THEMe TDColor TDMonochrome FCOLor FMONochrome :MMEMory:STORe:SCReem:THEMe?
Example	:MMEM:STOR:SCR:THEM TDM
Preset	3D Color; Is not part of Preset, but is reset by Restore Misc Defaults or Restore System Defaults All and survives subsequent running of the modes.
Readback	3D Color 3D Mono Flat Color Flat Mono
Backwards Compatibility Notes	In ESA and PSA we offer the choice of "Reverse Bitmap" or "Reverse Metafile" when saving screen images. This is much like the "Flat Color" theme available in X-Series. Also, if you selected Reverse Bitmap AND a black & white screen image, that would be much like "Flat Monochrome". In other words, each of the X-Series themes has a similar screen image type in ESA/PSA. But they are not identical.
Initial S/W Revision	Prior to A.02.00

3D Color

Selects a standard color theme with each object filled, shaded and colored as designed.

Key Path	Save, Screen Image, Themes
Example	MMEM:STOR:SCR:THEM TDC
Readback	3D Color
Initial S/W Revision	Prior to A.02.00

3D Monochrome

Selects a format that is like 3D color but shades of gray are used instead of colors.

Key Path	Save, Screen Image, Themes
Example	MMEM:STOR:SCR:THEM TDM
Readback	3D Mono
Initial S/W Revision	Prior to A.02.00

Flat Color

Selects a format that is best when the screen is to be printed on an ink printer.

Key Path	Save, Screen Image, Themes
Example	MMEM:STOR:SCR:THEM FCOL
Readback	Flat Color
Initial S/W Revision	Prior to A.02.00

Flat Monochrome

Selects a format that is like Flat Color. But only black is used (no colors, not even gray), and no fill.

Key Path	Save, Screen Image, Themes
Example	MMEM:STOR:SCR:THEM FMON
Readback	Flat Mono
Initial S/W Revision	Prior to A.02.00

Bar Graph

Turns the Bar Graph On and Off.

Key Path	View/Display
Mode	SA, WCDMA, C2K, WIMAX OFDMA, TD-SCDMA, 1xEVDO, DVB-T/H, DTMB (CTTB), ISDB-T, CMMB, LTE, LTE-TDD
Remote Command	:DISPlay:ACPowEr:VIEW[1]:WINDow[1]:BGRaph OFF ON 0 1 :DISPlay:ACPowEr:VIEW[1]:WINDow[1]:BGRaph?
Example	DISP:ACP:VIEW:WIND:BGR OFF DISP:ACP:VIEW:WIND:BGR?
Notes	You must be in the mode that includes ACP measurements to use this command. Use :INSTrument:SElect to set the mode.
Dependencies	When the method is RBW, this key is always set to On and grayed out.
Preset	ON
State Saved	Saved in instrument state.
Range	On Off
Initial S/W Revision	Prior to A.02.00
Modified at S/W Revision	A.02.00, A.03.00

11 Spectrum Emission Mask Measurement

The spectrum emission mask measures spurious signal levels in up to six pairs of offset frequencies and relates them to the carrier power. For measurement results and views, see ["View/Display" on page 1591](#).

This topic contains the following sections:

["Measurement Commands for Spectrum Emission Mask" on page 1256](#)

["Remote Command Results for Spectrum Emission Mask Measurement" on page 1257](#)

["Number of Offsets" on page 1272](#)

Measurement Commands for Spectrum Emission Mask

Offsets that are turned off (inactive) return -999.0 when their results are queried via SCPI.

```
:CONFigure:SEMask  
:CONFigure:SEMask:NDEFault  
:INITiate:SEMask  
:FETCh:SEMask[n]?  
:MEASure:SEMask[n]?  
:READ:SEMask[n]?
```

For more measurement related commands, see the SENSE subsystem, and the section "[Remote Measurement Functions](#)" on page 2355.

Remote Command Results for Spectrum Emission Mask Measurement

The following table describes the results returned by the FETCh, MEASure, and READ queries listed above, according to the index value n:

Modes	n	Return Value
All except MSR, WLAN, LTEAFDD, LTEATDD	1	<p>Meas Type: Total Power Reference</p> <p>Returns 82 comma-separated scalar results, in the following order:</p> <ol style="list-style-type: none"> 1. Reserved for the future use, returns -999.0 2. Absolute power at the center frequency (reference) area (dBm) 3. Reserved for the future use, returns -999.0 4. Reserved for the future use, returns -999.0 5. Peak frequency in the center frequency (reference) area (Hz) 6. Reserved for the future use, returns -999.0 7. Reserved for the future use, returns -999.0 8. Reserved for the future use, returns -999.0 9. Reserved for the future use, returns -999.0 10. Reserved for the future use, returns -999.0 11. Relative integrated power on the negative offset A (dBc) 12. Absolute integrated power on the negative offset A (dBm) 13. Relative peak power on the negative offset A (dBc) 14. Absolute peak power on the negative offset A (dBm) 15. Peak power offset frequency from the center or carrier edge frequency in the negative offset A, depending on Offset Frequency Define settings (Hz) 16. Relative integrated power on the positive offset A (dBc) 17. Absolute integrated power on the positive offset A (dBm) 18. Relative peak power on the positive offset A (dBc) 19. Absolute peak power on the positive offset A (dBm) 20. Peak power offset frequency from the center or carrier edge frequency in the positive offset A, depending on Offset Frequency Define settings (Hz) 21. Relative integrated power on the negative offset B (dBc) --- 69. Absolute peak power on the positive offset F (dBm) 70. Peak power offset frequency from the center or carrier edge frequency in the positive offset F, depending on Offset Frequency Define settings (Hz) 71. Minimum margin from limit line on the negative offset A (dB) 72. Minimum margin from limit line on the positive offset A (dB) 73. Minimum margin from limit line on the negative offset B (dB) 74. Minimum margin from limit line on the positive offset B (dB) 75. Minimum margin from limit line on the negative offset C (dB) 76. Minimum margin from limit line on the positive offset C (dB)

Modes	n	Return Value
		77. Minimum margin from limit line on the negative offset D (dB) 78. Minimum margin from limit line on the positive offset D (dB) 79. Minimum margin from limit line on the negative offset E (dB) 80. Minimum margin from limit line on the positive offset E (dB) 81. Minimum margin from limit line on the negative offset F (dB) 82. Minimum margin from limit line on the positive offset F (dB)
All except MSR, WLAN, LTEAFDD, LTEATDD	1	Meas Type: Power Spectral Density Reference Returns 82 comma-separated scalar results, in the following order: 1. Reserved for the future use, returns -999.0 2. Absolute power at the center frequency (reference) area (dBm/Hz) 3. Reserved for the future use, returns -999.0 4. Reserved for the future use, returns -999.0 5. Peak frequency in the center frequency (reference) area (Hz) 6. Reserved for the future use, returns -999.0 7. Reserved for the future use, returns -999.0 8. Reserved for the future use, returns -999.0 9. Reserved for the future use, returns -999.0 10. Reserved for the future use, returns -999.0 11. Relative integrated power on the negative offset A (dB) 12. Absolute integrated power on the negative offset A (dBm/Hz) 13. Relative peak power on the negative offset A (dB) 14. Absolute peak power on the negative offset A (dBm/Hz) 15. Peak power offset frequency from the center or carrier edge frequency in the negative offset A, depending on Offset Frequency Define settings (Hz) 16. Relative integrated power on the positive offset A (dB) 17. Absolute integrated power on the positive offset A (dBm/Hz) 18. Relative peak power on the positive offset A (dB) 19. Absolute peak power on the positive offset A (dBm/Hz) 20. Peak power offset frequency from the center or carrier edge frequency in the positive offset A, depending on Offset Frequency Define settings (Hz) 21. Relative integrated power on the negative offset B (dB) --- 69. Absolute peak power on the positive offset F (dBm/Hz) 70. Peak power offset frequency from the center or carrier edge frequency in the positive offset F, depending on Offset Frequency Define settings (Hz) 71. Minimum margin from limit line on the negative offset A (dB) 72. Minimum margin from limit line on the positive offset A (dB) 73. Minimum margin from limit line on the negative offset B (dB) 74. Minimum margin from limit line on the positive offset B (dB)

Modes	n	Return Value
		75. Minimum margin from limit line on the negative offset C (dB) 76. Minimum margin from limit line on the positive offset C (dB) 77. Minimum margin from limit line on the negative offset D (dB) 78. Minimum margin from limit line on the positive offset D (dB) 79. Minimum margin from limit line on the negative offset E (dB) 80. Minimum margin from limit line on the positive offset E (dB) 81. Minimum margin from limit line on the negative offset F (dB) 82. Minimum margin from limit line on the positive offset F (dB)
All except MSR, WLAN, LTEAFDD, LTEATDD	1	Meas Type: Spectrum Peak Reference Returns 82 comma-separated scalar results, in the following order: <ol style="list-style-type: none"> 1. Reserved for the future use, returns -999.0 2. Peak power at the center frequency (reference) area (dBm) 3. Reserved for the future use, returns -999.0 4. Reserved for the future use, returns -999.0 5. Peak frequency in the center frequency (reference) area (Hz) 6. Reserved for the future use, returns -999.0 7. Reserved for the future use, returns -999.0 8. Reserved for the future use, returns -999.0 9. Reserved for the future use, returns -999.0 10. Reserved for the future use, returns -999.0 11. Reserved for the future use, returns -999.0 12. Reserved for the future use, returns -999.0 13. Relative peak power on the negative offset A (dB) 14. Absolute peak power on the negative offset A (dBm) 15. Peak power offset frequency from the center or carrier edge frequency in the negative offset A, depending on Offset Frequency Define settings (Hz) 16. Reserved for the future use, returns -999.0 17. Reserved for the future use, returns -999.0 18. Relative peak power on the positive offset A (dB) 19. Absolute peak power on the positive offset A (dBm) 20. Peak power offset frequency from the center or carrier edge frequency in the positive offset A, depending on Offset Frequency Define settings (Hz) 21. Reserved for the future use, returns -999.0 --- 69. Absolute peak power on the positive offset F (dBm) 70. Peak power offset frequency from the center or carrier edge frequency in the positive offset F, depending on Offset Frequency Define settings (Hz) 71. Minimum margin from limit line on the negative offset A (dB) 72. Minimum margin from limit line on the positive offset A (dB)

Modes	n	Return Value
		73. Minimum margin from limit line on the negative offset B (dB)
		74. Minimum margin from limit line on the positive offset B (dB)
		75. Minimum margin from limit line on the negative offset C (dB)
		76. Minimum margin from limit line on the positive offset C (dB)
		77. Minimum margin from limit line on the negative offset D (dB)
		78. Minimum margin from limit line on the positive offset D (dB)
		79. Minimum margin from limit line on the negative offset E (dB)
		80. Minimum margin from limit line on the positive offset E (dB)
		81. Minimum margin from limit line on the negative offset F (dB)
		82. Minimum margin from limit line on the positive offset F (dB)
WLAN, with radio standard 802.11 ac (80 MHz + 80 MHz)	1	<p>Meas Type: Total Power Reference Returns 82 comma-separated scalar results, in the following order:</p> <ol style="list-style-type: none"> 1. Reserved for the future use, returns -999.0 2. Absolute reference power (dBm) 3. Absolute power of the carrier of which the frequency is indicated by Freq Segment 1 (dBm) 4. Absolute power of the carrier of which the frequency is indicated by Freq Segment 2 (dBm) 5. Peak frequency in the center frequency (reference) area (Hz) 6. Reserved for the future use, returns -999.0 7. Reserved for the future use, returns -999.0 8. Reserved for the future use, returns -999.0 9. Reserved for the future use, returns -999.0 10. Reserved for the future use, returns -999.0 11. Relative integrated power on the negative offset A (dBc) 12. Absolute integrated power on the negative offset A (dBm) 13. Relative peak power on the negative offset A (dBc) 14. Absolute peak power on the negative offset A (dBm) 15. Peak power offset frequency from the center or carrier edge frequency in the negative offset A, depending on Offset Frequency Define settings (Hz) 16. Relative integrated power on the positive offset A (dBc) 17. Absolute integrated power on the positive offset A (dBm) 18. Relative peak power on the positive offset A (dBc) 19. Absolute peak power on the positive offset A (dBm) 20. Peak power offset frequency from the center or carrier edge frequency in the positive offset A, depending on Offset Frequency Define settings (Hz) 21. Relative integrated power on the negative offset B (dBc) <p>---</p>

Modes	n	Return Value
		69. Absolute peak power on the positive offset F (dBm) 70. Peak power offset frequency from the center or carrier edge frequency in the positive offset F, depending on Offset Frequency Define settings (Hz) 71. Minimum margin from limit line on the negative offset A (dB) 72. Minimum margin from limit line on the positive offset A (dB) 73. Minimum margin from limit line on the negative offset B (dB) 74. Minimum margin from limit line on the positive offset B (dB) 75. Minimum margin from limit line on the negative offset C (dB) 76. Minimum margin from limit line on the positive offset C (dB) 77. Minimum margin from limit line on the negative offset D (dB) 78. Minimum margin from limit line on the positive offset D (dB) 79. Minimum margin from limit line on the negative offset E (dB) 80. Minimum margin from limit line on the positive offset E (dB) 81. Minimum margin from limit line on the negative offset F (dB) 82. Minimum margin from limit line on the positive offset F (dB)
WLAN, with radio standard 802.11 ac (80 MHz + 80 MHz)	1	Meas Type: Power Spectral Density Reference Returns 82 comma-separated scalar results, in the following order: 1. Reserved for the future use, returns -999.0 2. Absolute reference power (dBm/Hz) 3. Absolute power of the carrier of which the frequency is indicated by Freq Segment 1 (dBm/Hz) 4. Absolute power of the carrier of which the frequency is indicated by Freq Segment 2 (dBm/Hz) 5. Peak frequency in the center frequency (reference) area (Hz) 6. Reserved for the future use, returns -999.0 7. Reserved for the future use, returns -999.0 8. Reserved for the future use, returns -999.0 9. Reserved for the future use, returns -999.0 10. Reserved for the future use, returns -999.0 11. Relative integrated power on the negative offset A (dB) 12. Absolute integrated power on the negative offset A (dBm/Hz) 13. Relative peak power on the negative offset A (dB) 14. Absolute peak power on the negative offset A (dBm/Hz) 15. Peak power offset frequency from the center or carrier edge frequency in the negative offset A, depending on Offset Frequency Define settings (Hz) 16. Relative integrated power on the positive offset A (dB) 17. Absolute integrated power on the positive offset A (dBm/Hz) 18. Relative peak power on the positive offset A (dB) 19. Absolute peak power on the positive offset A (dBm/Hz) 20. Peak power offset frequency from the center or carrier edge frequency in the positive offset A, depending on Offset Frequency Define settings (Hz)

Modes	n	Return Value
		21. Relative integrated power on the negative offset B (dB) --- 69. Absolute peak power on the positive offset F (dBm/Hz) 70. Peak power offset frequency from the center or carrier edge frequency in the positive offset F, depending on Offset Frequency Define settings (Hz) 71. Minimum margin from limit line on the negative offset A (dB) 72. Minimum margin from limit line on the positive offset A (dB) 73. Minimum margin from limit line on the negative offset B (dB) 74. Minimum margin from limit line on the positive offset B (dB) 75. Minimum margin from limit line on the negative offset C (dB) 76. Minimum margin from limit line on the positive offset C (dB) 77. Minimum margin from limit line on the negative offset D (dB) 78. Minimum margin from limit line on the positive offset D (dB) 79. Minimum margin from limit line on the negative offset E (dB) 80. Minimum margin from limit line on the positive offset E (dB) 81. Minimum margin from limit line on the negative offset F (dB) 82. Minimum margin from limit line on the positive offset F (dB)
All	2	Returns the displayed frequency domain spectrum trace data separated by comma. The number of data points is 2001.
All	3	Returns the displayed frequency domain absolute limit trace data separated by comma. The number of data points is 2001.
All	4	Returns the displayed frequency domain relative limit trace data separated by comma. The number of data points is 2001.
All (see details)	5	<p>Meas Type: Total Power Reference Returns comma-separated scalar values (in dBm) of the absolute integrated power of the segment frequencies. The length of the result depends on the number of available offset (See "Number of Offsets" on page 1272).</p> <p>1. Total power reference (dBm) 2. Reserved for the future use, returns -999.0 3. Absolute integrated power at negative offset frequency (A) 4. Absolute integrated power at positive offset frequency (A) --- 25. Absolute integrated power at negative offset frequency (L) 26. Absolute integrated power at positive offset frequency (L)</p> <p>In MSR and LTE-Advanced FDD/TDD mode. Returns outer offset results when Non-Contiguous Meas Region is set to Outer, and returns inner offset results when it is set to Inner, in the following order.</p> <p>1. Ref carrier power. Left ref carrier power if Power Ref type is "Left & Right Carriers." Ref carrier power of the left sub-block if Power Ref type is "Max Power Carrier in Sub-block." (dBm) 2. Right ref carrier power if Ref channel type is "Left & Right Carriers." Ref carrier power of the</p>

Modes	n	Return Value
		<p>right sub-block if Power Ref type is "Max Power Carrier in Sub-block." Otherwise -999.0 is returned. (dBm)</p> <p>3. Absolute integrated power at negative offset frequency (A)</p> <p>4. Absolute integrated power at positive offset frequency (A)</p> <p>---</p> <p>25. Absolute integrated power at negative offset frequency (L)</p> <p>26. Absolute integrated power at positive offset frequency (L)</p> <p>In WLAN mode.</p> <p>Returns 26 comma-separated scalar values (in dBm) of the absolute integrated power of the segment frequencies:</p> <p>1. Ref carrier power (dBm)</p> <p>2. Reserved for the future use, returns -999.0</p> <p>3. Absolute integrated power at negative offset frequency (A)</p> <p>4. Absolute integrated power at positive offset frequency (A)</p> <p>---</p> <p>25. Absolute integrated power at negative offset frequency (L)</p> <p>26. Absolute integrated power at positive offset frequency (L)</p> <p>If the result is not available, -999.0 is returned.</p> <p>The number of values returned is subject to change in future releases.</p>
All (see details)	5	<p>Meas Type: Power Spectral Density Reference</p> <p>Returns comma-separated scalar values (in dBm/Hz) of the absolute integrated power of the segment frequencies. The length of the result depends on the number of available offset (See "Number of Offsets" on page 1272).</p> <p>1. Power spectral density reference (dBm/Hz)</p> <p>2. Reserved for the future use, returns -999.0</p> <p>3. Absolute integrated power at negative offset frequency (A)</p> <p>4. Absolute integrated power at positive offset frequency (A)</p> <p>---</p> <p>25. Absolute integrated power at negative offset frequency (L)</p> <p>26. Absolute integrated power at positive offset frequency (L)</p> <p>In MSR and LTE-Advanced FDD/TDD mode.</p> <p>Returns outer offset results when Non-Contiguous Meas Region is set to Outer, and returns inner offset results when it is set to Inner, in the following order.</p> <p>1. Ref carrier power. Left ref carrier power if Power Ref type is "Left & Right Carriers" Ref carrier power of the left sub-block if Power Ref type is "Max Power Carrier in Sub-block." (dBm/Hz)</p> <p>2. Right ref carrier power if Power Ref type is "Left & Right Carriers." Ref carrier power of the right sub-block if Power Ref type is "Max Power Carrier in Sub-block." Otherwise -999.0 is returned. (dBm/Hz)</p> <p>3. Absolute integrated power at negative offset frequency (A)</p> <p>4. Absolute integrated power at positive offset frequency (A)</p>

Modes	n	Return Value
		<p>---</p> <p>25. Absolute integrated power at negative offset frequency (L)</p> <p>26. Absolute integrated power at positive offset frequency (L)</p> <p>In WLAN mode.</p> <p>Returns 26 comma-separated scalar values (in dBm/Hz) of the absolute integrated power of the segment frequencies:</p> <ol style="list-style-type: none"> 1. Ref carrier power (dBm/Hz) 2. Reserved for the future use, returns -999.0 3. Absolute integrated power at negative offset frequency (A) 4. Absolute integrated power at positive offset frequency (A) <p>---</p> <p>25. Absolute integrated power at negative offset frequency (L)</p> <p>26. Absolute integrated power at positive offset frequency (L)</p> <p>If the result is not available, -999.0 is returned.</p> <p>The number of values returned is subject to change in future releases.</p>
All (see details)	5	<p>Meas Type: Spectrum Peak Reference</p> <p>Returns comma-separated scalar values (in dBm) of the absolute peak power of the segment frequencies. The length of the result depends on the number of available offset (See "Number of Offsets" on page 1272).</p> <ol style="list-style-type: none"> 1. Spectrum Peak Power reference (dBm) 2. Reserved for the future use, returns -999.0 3. Absolute peak power at negative offset frequency (A) 4. Absolute peak power at positive offset frequency (A) <p>---</p> <p>25. Absolute peak power at negative offset frequency (L)</p> <p>26. Absolute peak power at positive offset frequency (L)</p> <p>In MSR and LTE-Advanced FDD/TDD mode.</p> <p>Returns outer offset results when Non-Contiguous Meas Region is set to Outer, and returns inner offset results when it is set to Inner, in the following order.</p> <ol style="list-style-type: none"> 1. Spectrum Peak Power reference of ref carrier. Spectrum Peak Power reference of left ref carrier if Power Ref type is "Left & Right Carriers." Spectrum Peak Power reference of the left sub-block if Power Ref type is "Max Power Carrier in Sub-block." (dBm) 2. Spectrum Peak Power reference of right ref carrier power if Power Ref type is "Left & Right carriers." Spectrum Peak Power reference of the right sub-block if Power Ref type is "Max Power Carrier in Sub-block." Otherwise -999.0 is returned. (dBm) 3. Absolute peak power at negative offset frequency (A) 4. Absolute peak power at positive offset frequency (A) <p>---</p> <p>25. Absolute peak power at negative offset frequency (L)</p> <p>26. Absolute peak power at positive offset frequency (L)</p>

Modes	n	Return Value
		<p>If the result is not available, -999.0 is returned.</p> <p>The number of values returned is subject to change in future releases.</p>
All	6	<p>Meas Type: Total Power Reference Returns comma-separated scalar values (in dBc) of the integrated power relative to the carrier at the segment frequencies. The length of the result depends on the number of available offset (See "Number of Offsets" on page 1272).</p> <p>When in the MSR and LTE-Advanced FDD/TDD mode, returns outer offset results when Non-Contiguous Meas Region is set to Outer, and returns inner offset results when it is set to Inner, in the following order.</p> <ol style="list-style-type: none"> 1. Reserved for the future use, returns -999.0 2. Reserved for the future use, returns -999.0 3. Relative integrated power at negative offset frequency (A) 4. Relative integrated power at positive offset frequency (A) --- 25. Relative integrated power at negative offset frequency (L) 26. Relative integrated power at positive offset frequency (L) <p>If the result is not available, -999.0 is returned.</p> <p>The number of values returned is subject to change in future releases.</p>
All	6	<p>Meas Type: Power Spectral Density Reference Returns comma-separated scalar values (in dBc/Hz) of the integrated power relative to the carrier at the segment frequencies. The length of the result depends on the number of available offset (See "Number of Offsets" on page 1272).</p> <p>When in the MSR and LTE-Advanced FDD/TDD mode, returns outer offset results when Non-Contiguous Meas Region is set to Outer, and returns inner offset results when it is set to Inner, in the following order.</p> <p>Returns -999.0 for the offsets if in WLAN:</p> <ol style="list-style-type: none"> 1. Reserved for the future use, returns -999.0 2. Reserved for the future use, returns -999.0 3. Relative integrated power at negative offset frequency (A) 4. Relative integrated power at positive offset frequency (A) --- 25. Relative integrated power at negative offset frequency (L) 26. Relative integrated power at positive offset frequency (L) <p>If the result is not available, -999.0 is returned.</p> <p>The number of values returned is subject to change in future releases.</p>
All	6	<p>Meas Type: Spectrum Peak Reference Returns comma-separated scalar values (in dB) of the integrated power relative to the carrier at the segment frequencies. The length of the result depends on the number of available offset (See "Number of Offsets" on page 1272).</p>

Modes	n	Return Value
		<p>When in the MSR and LTE-Advanced FDD/TDD mode, returns outer offset results when Non-Contiguous Meas Region is set to Outer, and returns inner offset results when it is set to Inner, in the following order.</p> <ol style="list-style-type: none"> 1. Reserved for the future use, returns -999.0 2. Reserved for the future use, returns -999.0 3. Relative peak power at negative offset frequency (A) 4. Relative peak power at positive offset frequency (A) --- 25. Relative peak power at negative offset frequency (L) 26. Relative peak power at positive offset frequency (L) <p>If the result is not available, -999.0 is returned.</p> <p>The number of values returned is subject to change in future releases.</p>
All	7	<p>Returns comma-separated pass/fail test results (0=passed, or 1=failed) determined by testing the minimum margin point from the limit line that is determined each offset's Limits setting. The length of the result depends on the number of available offset (See "Number of Offsets" on page 1272).</p> <p>When in the MSR and LTE-Advanced FDD/TDD mode, returns outer offset results when Non-Contiguous Meas Region is set to Outer, and returns inner offset results when it is set to Inner, in the following order.</p> <ol style="list-style-type: none"> 1. Reserved for the future use, returns -999.0 2. Reserved for the future use, returns -999.0 3. At negative offset frequency (A) 4. At positive offset frequency (A) --- 25. At negative offset frequency (L) 26. At positive offset frequency (L) <p>The number of values returned is subject to change in future releases.</p>
All	8	<p>Offset Pass/Fail.</p> <p>Returns comma-separated pass/fail test results (0=passed, or 1=failed) determined by testing the minimum margin point from the limit line that is determined each offset's Limits setting. The length of the result depends on the number of available offset (See "Number of Offsets" on page 1272).</p> <p>When in the MSR and LTE-Advanced FDD/TDD mode, returns outer offset results when Non-Contiguous Meas Region is set to Outer, and returns inner offset results when it is set to Inner, in the following order.</p> <p>Note: These results (n=8) are the same as n=7 result.</p> <ol style="list-style-type: none"> 1. Reserved for the future use, returns -999.0 2. Reserved for the future use, returns -999.0 3. At negative offset frequency (A) 4. At positive offset frequency (A) ---

Modes	n	Return Value
		<p>25. At negative offset frequency (L)</p> <p>26. At positive offset frequency (L)</p> <p>The number of values returned is subject to change in future releases.</p>
All	9	<p>Offset Peak Power Freq.</p> <p>Returns comma-separated scalar values of frequency (in Hz) that have peak power from center or carrier edge frequency in each offset, depending on Offset Frequency Define settings. The length of the result depends on the number of available offset (See "Number of Offsets" on page 1272).</p> <p>When in the MSR and LTE-Advanced FDD/TDD mode, returns outer offset results when Non-Contiguous Meas Region is set to Outer, and returns inner offset results when it is set to Inner, in the following order.</p> <ol style="list-style-type: none"> 1. Reserved for the future use, returns -999.0 2. Reserved for the future use, returns -999.0 3. Negative offset frequency (A) 4. Positive offset frequency (A) <p>---</p> <p>25. Negative offset frequency (L)</p> <p>26. Positive offset frequency (L)</p> <p>If the result is not available, -999.0 is returned.</p> <p>The number of values returned is subject to change in future releases.</p>
All	10	<p>Offset Abs Peak Power.</p> <p>Returns comma-separated scalar values (in dBm) of the absolute peak power of the segment frequencies. The length of the result depends on the number of available offset (See "Number of Offsets" on page 1272).</p> <p>When in the MSR and LTE-Advanced FDD/TDD mode, returns outer offset results when Non-Contiguous Meas Region is set to Outer, and returns inner offset results when it is set to Inner, in the following order.</p> <ol style="list-style-type: none"> 1. Reserved for the future use, returns -999.0 2. Reserved for the future use, returns -999.0 3. At negative offset frequency (A) 4. At positive offset frequency (A) <p>---</p> <p>25. At negative offset frequency (L)</p> <p>26. At positive offset frequency (L)</p> <p>If the result is not available, -999.0 is returned.</p> <p>The number of values returned is subject to change in future releases.</p>
All	11	<p>Offset Rel Peak Power.</p> <p>Returns comma-separated scalar values in dBc (dB if MeasType = PSD) of the peak power relative to the carrier at the segment frequencies. The length of the result depends on the number of available offset (See "Number of Offsets" on page 1272).</p> <p>When in the MSR and LTE-Advanced FDD/TDD mode, returns outer offset results when Non-Contiguous Meas Region is set to Outer, and returns inner offset results when it is set to Inner, in the following order.</p>

Modes	n	Return Value
		1. Reserved for the future use, returns -999.0 2. Reserved for the future use, returns -999.0 3. At negative offset frequency (A) 4. At positive offset frequency (A) --- 25. At negative offset frequency (L) 26. At positive offset frequency (L) If the result is not available, -999.0 is returned. The number of values returned is subject to change in future releases.
All	12	Returns the power result (the peak power of the signal in the ref channel) when Meas Type is Spectrum Peak reference. Otherwise, the value returned will be -999.0. When in the MSR and LTE-Advanced FDD/TDD mode, returns outer offset results when Non-Contiguous Meas Region is set to Outer, and returns inner offset results when it is set to Inner, in the following order.
All	14	Meas Type: Total Power Reference Returns comma-separated scalar results, in the following order: When in the MSR and LTE-Advanced FDD/TDD mode, returns outer offset results when Non-Contiguous Meas Region is set to Outer, and returns inner offset results when it is set to Inner, in the following order. <ol style="list-style-type: none"> 1. Relative integrated power on the negative offset A (dBc) 2. Absolute integrated power on the negative offset A (dBm) 3. Relative peak power on the negative offset A (dBc) 4. Absolute peak power on the negative offset A (dBm) 5. Peak power offset frequency from the center or carrier edge frequency in the negative offset A, depending on Offset Frequency Define settings (Hz) 6. Relative integrated power on the positive offset A (dBc) 7. Absolute integrated power on the positive offset A (dBm) 8. Relative peak power on the positive offset A (dBc) 9. Absolute peak power on the positive offset A (dBm) 10. Peak power offset frequency from the center or carrier edge frequency in the positive offset A, depending on Offset Frequency Define settings (Hz) 11. Relative integrated power on the negative offset B (dBc) --- 119. Absolute peak power on the positive offset L (dBm) 120. Peak power offset frequency from the center or carrier edge frequency in the positive offset L, depending on Offset Frequency Define settings (Hz)

Modes	n	Return Value
All	14	<p>If the result is not available, NaN (9.91E+37) is returned.</p> <p>The length of the result depends on the number of available offset (See "Number of Offsets" on page 1272).</p> <p>The number of values returned is subject to change in future releases.</p>
All	14	<p>Meas Type: Power Spectral Density Reference</p> <p>Returns comma-separated scalar results, in the following order:</p> <p>When in the MSR and LTE-Advanced FDD/TDD mode, returns outer offset results when Non-Contiguous Meas Region is set to Outer, and returns inner offset results when it is set to Inner, in the following order.</p> <ol style="list-style-type: none"> 1. Relative integrated power on the negative offset A (dB) 2. Absolute integrated power on the negative offset A (dBm/Hz) 3. Relative peak power on the negative offset A (dB) 4. Absolute peak power on the negative offset A (dBm/Hz) 5. Peak power offset frequency from the center or carrier edge frequency in the negative offset A, depending on Offset Frequency Define settings (Hz) 6. Relative integrated power on the positive offset A (dB) 7. Absolute integrated power on the positive offset A (dBm/Hz) 8. Relative peak power on the positive offset A (dB) 9. Absolute peak power on the positive offset A (dBm/Hz) 10. Peak power offset frequency from the center or carrier edge frequency in the positive offset A, depending on Offset Frequency Define settings (Hz) 11. Relative integrated power on the negative offset B (dB) <p>---</p> <ol style="list-style-type: none"> 119. Absolute peak power on the positive offset L (dBm/Hz) 120. Peak power offset frequency from the center or carrier edge frequency in the positive offset L, depending on Offset Frequency Define settings (Hz) <p>If the result is not available, NaN (9.91E+37) is returned.</p> <p>The length of the result depends on the number of available offset (See "Number of Offsets" on page 1272).</p> <p>The number of values returned is subject to change in future releases.</p>
All	14	<p>Meas Type: Spectrum Peak Reference</p> <p>Returns comma-separated scalar results, in the following order:</p> <p>When in the MSR and LTE-Advanced FDD/TDD mode, returns outer offset results when Non-Contiguous Meas Region is set to Outer, and returns inner offset results when it is set to Inner, in the following order.</p> <ol style="list-style-type: none"> 1. Reserved for the future use, returns NaN (9.91E+37) 2. Reserved for the future use, returns NaN (9.91E+37) 3. Relative peak power on the negative offset A (dB) 4. Absolute peak power on the negative offset A (dBm)

Modes	n	Return Value
		<p>5. Peak power offset frequency from the center or carrier edge frequency in the negative offset A, depending on Offset Frequency Define settings (Hz)</p> <p>6. Reserved for the future use, returns NaN (9.91E+37)</p> <p>7. Reserved for the future use, returns NaN (9.91E+37)</p> <p>8. Relative peak power on the positive offset A (dB)</p> <p>9. Absolute peak power on the positive offset A (dBm)</p> <p>10. Peak power offset frequency from the center or carrier edge frequency in the positive offset A, depending on Offset Frequency Define settings (Hz)</p> <p>11. Relative integrated power on the negative offset B (dB)</p> <p>---</p> <p>119. Absolute peak power on the positive offset L (dBm)</p> <p>120. Peak power offset frequency from the center or carrier edge frequency in the positive offset L, depending on Offset Frequency Define settings (Hz)</p> <p>If the result is not available, NaN (9.91E+37) is returned.</p> <p>The length of the result depends on the number of available offset (See "Number of Offsets" on page 1272).</p> <p>The number of values returned is subject to change in future releases.</p>
All	15	<p>Meas Type: Total Power Reference</p> <p>Returns comma-separated scalar results, in the following order:</p> <p>When in the MSR and LTE-Advanced FDD/TDD mode, returns outer offset results when Non-Contiguous Meas Region is set to Outer, and returns inner offset results when it is set to Inner, in the following order.</p> <ol style="list-style-type: none"> 1. Minimum margin from limit line on the negative offset A (dB) 2. Minimum margin from limit line on the positive offset A (dB) 3. Minimum margin from limit line on the negative offset B (dB) 4. Minimum margin from limit line on the positive offset B (dB) <p>---</p> <ol style="list-style-type: none"> 23. Minimum margin from limit line on the negative offset L (dB) 24. Minimum margin from limit line on the positive offset L (dB) <p>If the result is not available, NaN (9.91E+37) is returned.</p> <p>The length of the result depends on the number of available offset (See "Number of Offsets" on page 1272).</p> <p>The number of values returned is subject to change in future releases.</p>
WLAN only	16	<p>Returns two carriers comma-separated scalar results when the radio standard is 802.11 ac 80+80 MHz. And returns NaN otherwise.</p> <ol style="list-style-type: none"> 1. Absolute power of carrier segment 1 (dBm) 2. Absolute power of carrier segment 2 (dBm)

Number of Offsets

The number of available offsets varies depending on the mode and option as below.

Mode	The number of available offsets
WLAN	12 (Offset A to L)
Other modes with option N9060A-7FP	12 (Offset A to L)
Other modes without option N9060A-7FP	6 (Offset A to F)

Key Path	Meas
Initial S/W Revision	Prior to A.02.00
Modified at S/W Revision	A.11.00, A.14.00

AMPTD Y Scale

Accesses a menu of functions that enable you to set the vertical scale parameters. The parameter values are measurement independent except all Attenuation values and Internal Preamp selections that are measurement global.

Key Path	Front-panel key
Initial S/W Revision	Prior to A.02.00

Ref Value

Sets the value for the absolute power reference. However, since Auto Scaling defaults to On, this value is automatically determined by the measurement result. When you set a value manually, Auto Scaling automatically changes to Off.

Key Path	AMPTD Y Scale
Mode	SA, WCDMA, C2K, WIMAX OFDMA, TD-SCDMA, 1xEVDO, DTMB (CTTB), DVB-T/H, ISDB-T, CMMB, LTE, LTE-TDD, Digital Cable TV, WLAN, MSR, LTEAFDD, LTEATDD
Remote Command	:DISPlay:SEMask:VIEW[1]:WINDow[1]:TRACe:Y[:SCALE]:RLEVel <real> :DISPlay:SEMask:VIEW[1]:WINDow[1]:TRACe:Y[:SCALE]:RLEVel?
Example	DISP:SEM:VIEW:WIND:TRAC:Y:RLEV 100 DISP:SEM:VIEW:WIND:TRAC:Y:RLEV?
Notes	You must be in the mode that includes SEM measurement to use this command. Use :INSTrument:SElect to set the mode.
Couplings	When the Auto Scaling is On, this value is automatically determined by the measurement result. When you set a value manually, Auto Scaling automatically changed to Off.
Preset	10.0 dBm
State Saved	Saved in instrument state.
Min	-250 dBm
Max	250 dBm
Initial S/W Revision	Prior to A.02.00
Modified at S/W Revision	A.02.00, A.03.00

Range

The Range menu allows setting amplitude controls of the instrument.

Key Path	AMPTD Y Scale
Scope	Meas Global
Initial S/W Revision	A.12.50

Range

Represents the amplitude of the largest sinusoidal signal that could be present within the IF without being clipped by the ADC. For signals with high peak-to-average ratios, the range may need to exceed the rms signal power by a fair amount to avoid clipping.

Key Path	Range
Mode	BASIC
Remote Command	<code>[:SENSe] :POWer [:RF] :RANGe <real></code> <code>[:SENSe] :POWer [:RF] :RANGe?</code>
Example	<code>:POW:RANG 10.0</code> <code>:POW:RANG?</code>
Notes	The MIN and MAX values are affected by the External Gain parameters, and by the Center Frequency. (The hardware compensates for frequency response and alters the Range setting.)
Preset	0
State Saved	Saved in instrument state.
Min	-100
Max	100
Initial S/W Revision	A.12.50

Adjust Range For Min Clip

Sets the combination of attenuation and gain based on the current measured signal level so that clipping will be at a minimum.

This is an "immediate action" function, that is, it executes once, when the key is pressed.

This key is grayed out in measurements that do not support this functionality.

Key Path	AMPTD Y Scale, Attenuation
Remote Command	<code>[:SENSe] :POWer [:RF] :RANGe:OPTimize IMMEDIATE</code>
Initial S/W Revision	Prior to A.02.00
Modified at S/W Revision	A.03.00

Pre-Adjust for Min Clip

If this function is on, it does the adjustment described under Adjust Range For Min Clip each time a measurement restarts. Therefore, in Continuous measurement mode, it only executes before the first measurement.

Key Path	AMPTD Y Scale, Attenuation
Remote Command	<code>[:SENSe] :POWer [:RF] :RANGe:OPTimize:ATTenuation OFF ON ELEctrical COMBined</code>

	<code>[:SENSe] :POWeR [:RF] :RANGe :OPTimize :ATTenuation ?</code>
Notes	This parameter is shared with old XA platform which uses AutoAtten. To keep the backward compatibility, ELECTRical and COMBined still can be used. Then, upon receiving ELECTRical and COMBined, these enums will be interpreted as aliases of ON. Then, when queried, ON will be returned.
Preset	OFF for Swept SA measurement; ON for all other measurements that support Pre-Adjust for Min Clip
State Saved	Saved in instrument state
Initial S/W Revision	Prior to A.02.00
Modified at S/W Revision	A.03.00

Peak to Average

The Peak to Average Ratio is used with the Range setting to optimize the level control in the instrument. The value is the ratio, in dB, of the peak power to the average power of the signal to be measured. A ratio of 0 should be used for sinusoidal signals; for 802.11g OFDM signals use 9 dB.

All Applications (Modes) will show the current value of Peak to Average ratio on the softkey. However, some applications will not permit changing the value. In these situations the softkey will be grayed-out.

Key Path	AMPTD Y Scale, Range
Remote Command	<code>[:SENSe] :POWeR [:RF] :RANGe :PARatio <real></code> <code>[:SENSe] :POWeR [:RF] :RANGe :PARatio ?</code>
Example	POW:RANG:PAR 12 dB
Notes	In some Applications (Modes) this parameter will be read-only; meaning the value will appear on the softkey and query via SCPI, but not changeable. In such applications the softkey will be grayed-out. Attempting to change the value via SCPI will be ignored and no error message will be generated.
Preset	10 dB
State Saved	Saved in instrument state
Min	0 dB
Max	20 dB
Initial S/W Revision	A.13.00

Mixer Level Offset

Mixer level offset is an advanced setting to adjust target Range at the input mixer which in turn affects the signal level in the instrument's IF. This setting can be used when additional optimization is needed after setting Peak to Average ratio. Positive values of offset optimize noise performance over distortion, negative values optimize distortion performance over noise.

Key Path	AMPTD Y Scale, Range
Remote Command	<code>[:SENSe] :POWeR [:RF] :RANGe :MIXer :OFFSet <real></code>

	<code>[:SENSe] :POWer [:RF] :RANGe :MIXer :OFFSet ?</code>
Example	POW:RANG:MIX:OFFS -5 dB
Preset	0 dB
State Saved	Saved in instrument state
Min	-35 dB
Max	30 dB
Initial S/W Revision	A.13.00

Scale/Div

Sets the units-per-division of the vertical scale in the logarithmic display. When Auto Scaling is On, the scale per division value is automatically determined by the measurement result. When you set a value manually, Auto Scaling automatically changes to Off.

Key Path	AMPTD Y Scale
Mode	SA, WCDMA, C2K, WIMAX OFDMA, TD-SCDMA, 1xEVDO, DTMB (CTTB), DVB-T/H, ISDB-T, CMMB, LTE, LTE-TDD, Digital Cable TV, WLAN, MSR, LTEAFDD, LTEATDD
Remote Command	<code>:DISPlay:SEMask:VIEW[1]:WINDow[1]:TRACe:Y[:SCALE]:PDIVision <rel_ampl></code> <code>:DISPlay:SEMask:VIEW[1]:WINDow[1]:TRACe:Y[:SCALE]:PDIVision?</code>
Example	DISP:SEM:VIEW:WIND:TRAC:Y:PDIV 15dB DISP:SEM:VIEW:WIND:TRAC:Y:PDIV?
Notes	You must be in the mode that includes SEM measurement to use this command. Use <code>:INSTrument:SElect</code> to set the mode.
Couplings	When the Auto Scaling is On, this value is automatically determined by the measurement result. When you set a value manually, Auto Scaling automatically changes to Off.
Preset	10 dB
State Saved	Saved in instrument state
Min	0.10 dB
Max	20.00 dB
Initial S/W Revision	Prior to A.02.00
Modified at S/W Revision	A.02.00, A.03.00

Ref Position

Positions the reference level at the top, center or bottom of the Y scale display. Changing the reference position does not affect the reference level value.

Key Path	AMPTD Y Scale
Mode	SA, WCDMA, C2K, WIMAX OFDMA, TD-SCDMA, 1xEVDO, DTMB (CTTB), DVB-T/H, ISDB-T, CMMB, LTE, LTE-TDD, Digital Cable TV, WLAN, MSR, LTEAFDD, LTEATDD

Remote Command	:DISPlay:SEMask:VIEW[1]:WINDow[1]:TRACe:Y[:SCALe]:RPOSition TOP CENTER BOTTom :DISPlay:SEMask:VIEW[1]:WINDow[1]:TRACe:Y[:SCALe]:RPOSition?
Example	DISP:SEM:VIEW:WIND:TRAC:Y:RPOS BOTT DISP:SEM:VIEW:WIND:TRAC:Y:RPOS?
Notes	You must be in the mode that includes SEM measurement to use this command. Use :INSTrument:SElect to set the mode.
Preset	TOP
State Saved	Saved in instrument state
Range	Top Ctr Bot
Initial S/W Revision	Prior to A.02.00
Modified at S/W Revision	A.02.00, A.03.00

Auto Scaling

Toggles the Auto Scaling function between On and Off.

When Auto Scaling is On and the Restart front-panel key is pressed, the analyzer automatically determines the scale per division and reference values based on the measurement results. When you set a value to either Scale/Div or Ref Value manually, Auto Scaling automatically changes to Off.

Key Path	AMPTD Y Scale
Mode	SA, WCDMA, C2K, WIMAX OFDMA, TD-SCDMA, 1xEVDO, DTMB (CTTB), DVB-T/H, ISDB-T, CMMB, LTE, LTE-TDD, Digital Cable TV, WLAN, MSR, LTEAFDD, LTEATDD
Remote Command	:DISPlay:SEMask:VIEW[1]:WINDow[1]:TRACe:Y[:SCALe]:COUPle 0 1 ON OFF :DISPlay:SEMask:VIEW[1]:WINDow[1]:TRACe:Y[:SCALe]:COUPle?
Example	DISP:SEM:VIEW:WIND:TRAC:Y:COUP OFF DISP:SEM:VIEW:WIND:TRAC:Y:COUP?
Notes	You must be in the mode that includes SEM measurement to use this command. Use :INSTrument:SElect to set the mode.
Couplings	When Auto Scaling is On, upon pressing the Restart front-panel key, this function automatically determines the scale per division and reference values based on the measurement results. When you set a value to either Scale/Div or Ref Value manually, Auto Scaling automatically changes to Off.
Preset	ON
State Saved	Saved in instrument state
Range	On Off
Initial S/W Revision	Prior to A.02.00
Modified at S/W Revision	A.02.00, A.03.00

Auto Couple

The Auto Couple feature provides a quick and convenient way to automatically couple multiple instrument settings. This helps ensure accurate measurements and optimum dynamic range. When the Auto Couple feature is activated, either from the front panel or remotely, all parameters of the current measurement that have an Auto/Manual mode are set to Auto mode and all measurement settings dependent on (or coupled to) the Auto/Man parameters are automatically adjusted for optimal performance.

However, the Auto Couple key actions are confined to the current measurement only. It does not affect other measurements in the mode, and it does not affect markers, marker functions, or trace or display attributes.

See "[More Information](#)" on page 1278

Key Path	Front-panel key
Remote Command	:COUPle ALL NONE
Example	:COUP ALL
Notes	:COUPle ALL puts all Auto/Man parameters in Auto mode (equivalent to pressing the Auto Couple key). :COUPLE NONE puts all Auto/Man parameters in manual mode. It decouples all the coupled instrument parameters and is not recommended for making measurements.
Initial S/W Revision	Prior to A.02.00

More Information

There are two types of functions that have Auto/Manual modes.

Auto/Man Active Function keys

An Auto/Man toggle key controls the binary state associated with an instrument parameter by toggling between Auto (where the parameter is automatically coupled to the other parameters it is dependent upon) and Man (where the parameter is controlled independent of the other parameters), as well as making the parameter the active function. The current mode is indicated on the softkey with either Auto or Man underlined as illustrated below.



Auto/Man 1-of-N keys

An Auto/Man 1-of-N key allows you to manually pick from a list of parameter values, or place the function in Auto, in which case the value is automatically selected (and indicated) as shown below. If in Auto, Auto is underlined on the calling key. If in manual operation, manual is indicated on the calling key. But the calling key does not actually toggle the function, it simply opens the menu.

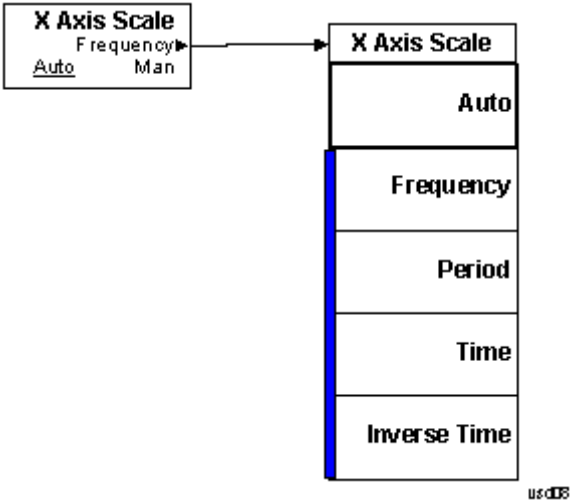

BW

Accesses a menu of functions that enable you to select the type of filter for the measurement.

Key Path	Front-panel key
Initial S/W Revision	Prior to A.02.00
Modified at S/W Revision	A.03.00

Filter Type

Selects the type of bandwidth filter that is used in Carrier and Offsets.

When Gaussian or Flattop is selected, selected filter is applied to carriers and all offsets.

When Auto Sense is selected, filter type is automatically selected for each carriers and offsets, so that measurement speed and accuracy is optimized.

Key Path	BW
Mode	SA, WCDMA, C2K, WIMAX OFDMA, TD-SCDMA, 1xEVDO, DVB-T/H, DTMB (CTTB), ISDB-T, CMMB, LTE, LTE-TDD, Digital Cable TV, WLAN, MSR, LTEAFDD, LTEATDD
Remote Command	[:SENSe] :SEMAsk :BANDwidth :SHAPE ASENse GAUSSian FLATtop [:SENSe] :SEMAsk :BANDwidth :SHAPE ?
Example	SEM:BAND:SHAP GAUS SEM:BAND:SHAP ?
Couplings	See the description above
Preset	ASENse
State Saved	Saved in instrument state
Range	Auto Sense (each offset and carrier) Gaussian (all offsets and carriers) Flattop (all offsets and carriers)
Initial S/W Revision	A.03.00

Cont (Continuous Measurement/Sweep)

Sets the analyzer for Continuous measurement operation. The single/continuous state is Meas Global so the setting will affect all measurements. If you are Paused, pressing Cont does a Resume.

Key Path	Front-panel key
Remote Command	:INITiate:CONTinuous OFF ON 0 1 :INITiate:CONTinuous?
Example	:INIT:CONT 0 puts analyzer in Single measurement operation. :INIT:CONT 1 puts analyzer in Continuous measurement operation
Preset	ON (Note that SYST:PRESet sets INIT:CONT to ON but *RST sets INIT:CONT to OFF)
State Saved	Saved in instrument state
Backwards Compatibility Notes	For Spectrum Analysis mode in ESA and PSA, there is no Cont hardkey, instead there is a Sweep Single/Cont key. In these analyzers, switching the Sweep Single/Cont key from Single to Cont restarts averages (displayed average count reset to 1), but does not restart Max Hold and Min Hold. The X-Series has Single and Cont keys in place of the SweepSingleCont key. In the X-Series, if in single measurement, the Cont key (and INIT:CONT ON) switches to continuous measurement, but never restarts a measurement and never resets a sweep.
Initial S/W Revision	Prior to A.02.00

In Swept SA Measurement (Spectrum Analysis Mode):

The analyzer takes repetitive sweeps, averages, measurements, etc., when in Continuous mode. When the average count reaches the Average/Hold Number the count stops incrementing, but the analyzer keeps sweeping. See the Trace/Detector section for the averaging formula used both before and after the Average/Hold Number is reached. The trigger condition must be met prior to each sweep. The type of trace processing for multiple sweeps, is set under the Trace/Detector key, with choices of Trace Average, Max Hold, or Min Hold.

In Other Measurements/Modes:

With Avg/Hold Num (in the Meas Setup menu) set to Off or set to On with a value of 1, a sweep is taken after the trigger condition is met; and the analyzer continues to take new sweeps after the current sweep has completed and the trigger condition is again met. However, with Avg/Hold Num set to On with a value >1, multiple sweeps (data acquisitions) are taken for the measurement. The trigger condition must be met prior to each sweep. The sweep is not stopped when the average count k equals the number N set for Avg/Hold Num is reached, but the number k stops incrementing. A measurement average usually applies to all traces, marker results, and numeric results. But sometimes it only applies to the numeric results.

If the analyzer is in Single measurement, pressing the Cont key does not change k and does not cause the sweep to be reset; the only action is to put the analyzer into Continuous measurement operation.

If it is already in continuous sweep:

the INIT:CONT 1 command has no effect

11 Spectrum Emission Mask Measurement Cont (Continuous Measurement/Sweep)

the INIT:CONT 0 command will place the analyzer in Single Sweep but will have no effect on the current sequence until $k = N$, at which point the current sequence will stop and the instrument will go to the idle state.

File

See "File" on page 266

FREQ Channel

Accesses a menu of keys that allow you to control the Frequency and Channel parameters of the instrument.

Some features in the Frequency menu are the same for all measurements - they do not change as you change measurements. Settings like these are called "Meas Global" and are unaffected by Meas Preset. For example, the Center Freq setting is the same for all measurements - it does not change as you change measurements.

Key Path	Front Panel Key
Mode	LTETDD, LTEAFDD
Initial S/W Revision	A.14.00

Carrier Ref Freq

Sets carrier reference frequency. The center frequencies of carriers are defined as offset frequency from this value.

If the following conditions are satisfied at the same time:

- the Number of Component Carrier equals to 1
- the Center Freq Offset equals to 0 Hz
- the mode of the Center Freq is Auto

the Center Freq is equivalent to Carrier Ref Freq.

When the Center Freq changes in such conditions, the mode of the Center Freq keeps as Auto and the Carrier Ref Freq will be changed to same value. The major purpose of this coupling is to keep BWCC with legacy LTE/LTE TDD, in which :SENSe:FREQuency:CENTer is used to set up the Frequency of the measurement.

Key Path	FREQ Channel Mode Setup, Component Carrier Setup
Mode	LTEATDD, LTEAFDD
Measurement	All
Remote Command	[:SENSe] :CCARrier:REFerence <freq> [:SENSe] :CCARrier:REFerence?
Example	CCAR:REF 2GHz CCAR:REF?
Notes	In order to easily configure component carriers, the key is also placed in the Mode Setup.
Preset	1GHz
State Saved	Saved in instrument state
Min	Depends on instrument minimum center frequency. Same as Center Freq
Max	Depends on instrument maximum center frequency. Same as Center Freq

Initial S/W Revision	A.14.00
Modified at S/W Revision	A.14.50

11 Spectrum Emission Mask Measurement
Input/Output

Input/Output

See "[Input/Output](#)" on page 182

Marker

Accesses a menu that enables you to select, set up and control the markers for the current measurement. If there are no active markers, Marker selects marker 1, sets it to Normal and places it at the center of the display. You can turn on and control up to 12 markers.

Key Path	Front-panel key
Initial S/W Revision	Prior to A.02.00

Select Marker

Displays 12 markers available for selection.

Key Path	Marker
Initial S/W Revision	Prior to A.02.00

Marker Type

Sets the marker control mode to Normal and Off. If the selected marker is Off, pressing Marker sets it to Normal and places it at the center of the screen on the trace determined by the Marker Trace rules. At the same time, Marker X Axis Value appears on the Active Function area. The marker X axis value entered in the active function area will display the marker value to its full entered precision. If the current control mode for the measurement is Off, there is no active function and the active function is turned off.

Key Path	Marker
Mode	SA, WCDMA, C2K, WIMAX OFDMA, TD-SCDMA, 1xEVDO, DTMB (CTTB), DVB-T/H, ISDB-T, CMMB, LTE, LTE-TDD, Digital Cable TV, WLAN, MSR, LTEAFDD, LTEATDD
Remote Command	:CALCulate:SEMask:MARKer[1] 2 ... 12:MODE POSition OFF :CALCulate:SEMask:MARKer[1] 2 ... 12:MODE?
Example	CALC:SEM:MARK:MODE POS CALC:SEM:MARK:MODE?
Notes	If the selected marker is Off, pressing Marker sets it to Normal and places it at the center of the screen on the trace determined by the Marker Trace rules. At the same time, Marker X Axis Value appears on the Active Function area. Default Active Function: the active function for the selected marker's current control mode. Note that if the current control mode is Off, there is no active function and the active function is turned off. Active Function Display: the marker X axis value entered in the active function area will display the marker value to its full entered precision.
Preset	OFF OFF OFF OFF OFF OFF OFF OFF OFF OFF OFF OFF
State Saved	Saved in instrument state
Range	Normal Off
Initial S/W Revision	Prior to A.02.00
Modified at S/W Revision	A.02.00, A.03.00

Couple Markers

When this function is true, moving any marker causes an equal X Axis movement of every other marker that is not Off. By “equal X Axis movement” we mean that we preserve the difference between each marker’s X Axis value (in the fundamental x-axis units of the trace that marker is on) and the X Axis value of the marker being moved (in the same fundamental x-axis units).

Key Path	Marker
Mode	SA, WCDMA, C2K, WIMAX OFDMA, TD-SCDMA, 1xEVDO, DTMB (CTTB), DVB-T/H, ISDB-T, CMMB, LTE, LTETDD, Digital Cable TV, WLAN, MSR, LTEAFDD, LTEATDD
Remote Command	:CALCulate:SEMask:MARKer:COUPle[:STATe] ON OFF 1 0 :CALCulate:SEMask:MARKer:COUPle[:STATe]?
Example	CALC:SEM:MARK:COUP ON CALC:SEM:MARK:COUP?
Preset	OFF
State Saved	Saved in instrument state
Range	On Off
Initial S/W Revision	Prior to A.02.00
Modified at S/W Revision	A.02.00, A.03.00

All Markers Off

Turns all active markers off in all views.

Key Path	Marker
Mode	SA, WCDMA, C2K, WIMAX OFDMA, TD-SCDMA, 1xEVDO, DTMB (CTTB), DVB-T/H, ISDB-T, CMMB, LTE, LTETDD, Digital Cable TV, WLAN, MSR, LTEAFDD, LTEATDD
Remote Command	:CALCulate:SEMask:MARKer:AOFF
Example	CALC:SEM:MARK:AOFF
Initial S/W Revision	Prior to A.02.00
Modified at S/W Revision	A.02.00, A.03.00

Marker X Axis Value (Remote Command Only)

Sets the marker X Axis value in the current marker X Axis Scale unit. It has no effect if the control mode is Off, but is the SCPI equivalent of entering an X value if the control mode is Normal.

Mode	SA, WCDMA, C2K, WIMAX OFDMA, TD-SCDMA, 1xEVDO, DTMB (CTTB), DVB-T/H ISDB-T, CMMB, LTE, LTETDD, Digital Cable TV, WLAN, MSR, LTEAFDD, LTEATDD
Remote Command	:CALCulate:SEMask:MARKer[1] 2 ... 12:X <freq>

	:CALCulate:SEMask:MARKer[1] 2 ... 12:X?
Example	CALC:SEM:MARK3:X 1.0 GHz CALC:SEM:MARK3:X?
Notes	If no suffix is sent it will use the fundamental units for the current marker X Axis Scale. If a suffix is sent that does not match the current marker X Axis Scale unit, an error "Invalid suffix" will be generated. The query returns the marker's absolute X Axis value if the control mode is Normal. The query is returned in the fundamental units for the current marker X Axis scale. If the marker is Off the response is not a number. When a Marker is turned on, it is placed center of the screen on the trace. Therefore the default value depends on instrument condition, although the Preset/Default is defined as 1.5 GHz.
Preset	After a preset, all Markers are turned OFF, so a Marker X Axis Value query will return a not a number (NAN).
State Saved	No
Min	-9.9E+37
Max	9.9E+37
Initial S/W Revision	Prior to A.02.00
Modified at S/W Revision	A.02.00, A.03.00

Marker X Axis Position (Remote Command Only)

Sets the marker X position in trace points. It has no effect if the control mode is Off, but is the SCPI equivalent of entering a value if the control mode is Normal, except in trace points rather than X Axis Scale units. The entered value is immediately translated into the current X Axis Scale units for setting the value of the marker.

Mode	SA, WCDMA, C2K, WIMAX OFDMA, TD-SCDMA, 1xEVDO, DTMB (CTTB), DVB-T/H, ISDB-T, CMMB, LTE, LTE-TDD, Digital Cable TV, WLAN, MSR, LTEAFDD, LTEATDD
Remote Command	:CALCulate:SEMask:MARKer[1] 2 ... 12:X:POsition <real> :CALCulate:SEMask:MARKer[1] 2 ... 12:X:POsition?
Example	CALC:SEM:MARK10:X:POS 1001 CALC:SEM:MARK10:X:POS?
Notes	The query returns the marker's absolute X Axis value in trace points if the control mode is Normal. The value is returned as a real number, not an integer, corresponding to the translation from X Axis Scale units to trace points. If the marker is Off the response is not a number. When a Marker is turned on, it is placed center of the screen on the trace. Therefore the default value depends on the instrument condition although the Preset/Default is defined as 6507 (this value might be the expected value when all the offsets are on).
Preset	After a preset, all Markers are turned OFF, so a Marker X Axis Value query will return a not a number (NAN).
State Saved	No

Min	-9.9E+37
Max	9.9E+37
Initial S/W Revision	Prior to A.02.00
Modified at S/W Revision	A.02.00, A.03.00

Marker Y Axis Value (Remote Command Only)

Returns the marker Y Axis value in the current marker Y Axis unit.

Mode	SA, WCDMA, C2K, WIMAX OFDMA, TD-SCDMA, 1xEVDO, DTMB (CTTB), DVB-T/H, ISDB-T, CMMB, LTE, LTE-TDD, Digital Cable TV, WLAN, MSR, LTEAFDD, LTEATDD
Remote Command	:CALCulate:SEMask:MARKer[1] 2 ... 12:Y?
Example	CALC:SEM:MARK11:Y 10 dBm CALC:SEM:MARK11:Y?
Notes	Since the result value is always calculated from acquisition data, the default value is arbitrary, although the Preset/Default values is defined.
Preset	Result dependent on markers setup and signal source
State Saved	No
Backwards Compatibility SCPI	:CALCulate:SEMask:MARKer[1] 2 ... 12:FUNction:RESult?
Initial S/W Revision	Prior to A.02.00
Modified at S/W Revision	A.02.00, A.03.00

Marker Function

There are no 'Marker Functions' supported in Spectrum Emission Mask so this front-panel key displays a blank menu when pressed.

Key Path	Front-panel key
Initial S/W Revision	Prior to A.02.00

Marker To

There is no 'Marker To' functionality supported in Spectrum Emission Mask so this front-panel key displays a blank menu when pressed.

Key Path	Front-panel key
Initial S/W Revision	Prior to A.02.00

Meas

The information in this section is common to all measurements. For key and remote command information for a specific measurement, refer to the section that describes the measurement of interest.

Measurements available under the Meas key are specific to the current Mode.

When viewing Help for measurements, note the following:

NOTE

Operation for some keys differs between measurements. The information displayed in Help pertains to the current measurement. To see how a key operates in a different measurement, exit Help (press the Cancel Esc key), select the measurement, then reenter Help (press the Help key) and press that key.

Key Path	Front-panel key
Initial S/W Revision	Prior to A.02.00

Remote Measurement Functions

This section contains the following topics:

"Measurement Group of Commands" on page 2356

"Current Measurement Query (Remote Command Only)" on page 2358

"Limit Test Current Results (Remote Command Only)" on page 2358

"Data Query (Remote Command Only)" on page 2358

"Calculate/Compress Trace Data Query (Remote Command Only)" on page 2359

"Calculate Peaks of Trace Data (Remote Command Only)" on page 2364

"Hardware-Accelerated Fast Power Measurement (Remote Command Only)" on page 2365

"Format Data: Numeric Data (Remote Command Only)" on page 2379

"Format Data: Byte Order (Remote Command Only)" on page 2380

Initial S/W Revision	Prior to A.02.00
----------------------	------------------

Measurement Group of Commands

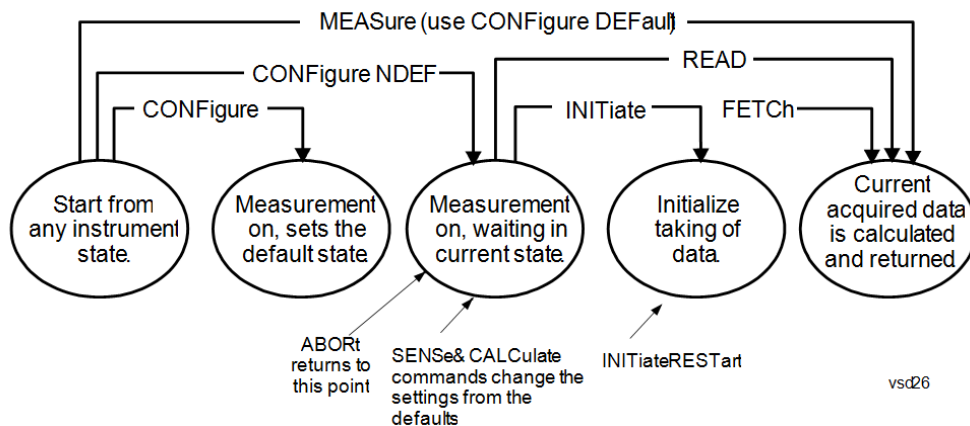

Measure Commands:

:MEASure:<measurement>[n]?

This is a fast single-command way to make a measurement using the factory default instrument settings. These are the settings and units that conform to the Mode Setup settings (e.g. radio standard) that you have currently selected.

- Stops the current measurement (if any) and sets up the instrument for the specified measurement using the factory defaults
- Initiates the data acquisition for the measurement
- Blocks other SCPI communication, waiting until the measurement is complete before returning results.
- If the function does averaging, it is turned on and the number of averages is set to 10.
- After the data is valid it returns the scalar results, or the trace data, for the specified measurement. The type of data returned may be defined by an [n] value that is sent with the command.
- The scalar measurement results will be returned if the optional [n] value is not included, or is set to 1. If the [n] value is set to a value other than 1, the selected trace data results will be returned. See each command for details of what types of scalar results or trace data results are available.
- ASCII is the default format for the data output. (Older versions of Spectrum Analysis and Phase Noise mode measurements only use ASCII.) The binary data formats should be used for handling large blocks of data since they are smaller and faster than the ASCII format. Refer to the FORMat:DATA command for more information.

If you need to change some of the measurement parameters from the factory default settings you can set up the measurement with the CONFigure command. Use the commands in the SENSe:<measurement> and CALCulate:<measurement> subsystems to change the settings. Then you can use the READ? command to initiate the measurement and query the results.

If you need to repeatedly make a given measurement with settings other than the factory defaults, you can use the commands in the SENSe:<measurement> and CALCulate:<measurement> subsystems to set up the measurement. Then use the READ? command to initiate the measurement and query results.

Measurement settings persist if you initiate a different measurement and then return to a previous one. Use READ:<measurement>? if you want to use those persistent settings. If you want to go back to the default settings, use MEASure:<measurement>?.

Configure Commands:

:CONFigure:<measurement>

This command stops the current measurement (if any) and sets up the instrument for the specified measurement using

the factory default instrument settings. It does not initiate the taking of measurement data unless INIT:CONTInuous is ON. If you change any measurement settings after using the CONFigure command, the READ command can be used to initiate a measurement without changing the settings back to their defaults.

In the Swept SA measurement in Spectrum Analyzer mode the CONFigure command also turns the averaging function on and sets the number of averages to 10 for all measurements.

:CONFigure: <measurement>: NDEFault stops the current measurement and changes to the specified measurement. It does not change the settings to the defaults. It does not initiate the taking of measurement data unless INIT:CONTInuous is ON.

The CONFigure? query returns the current measurement name.

The CONFigure:CATalog? query returns a quoted string of all licensed measurement names in the current mode. For example, "SAN, CHP, OBW, ACP, PST, TXP, SPUR, SEM, LIST".

Fetch Commands:

:FETCh:<measurement>[n]?

This command puts selected data from the most recent measurement into the output buffer. Use FETCh if you have already made a good measurement and you want to return several types of data (different [n] values, for example, both scalars and trace data) from a single measurement. FETCh saves you the time of re-making the measurement. You can only FETCh results from the measurement that is currently active, it will not change to a different measurement. An error message is reported if a measurement other than the current one is specified.

If you need to get new measurement data, use the READ command, which is equivalent to an INITiate followed by a FETCh.

The scalar measurement results will be returned if the optional [n] value is not included, or is set to 1. If the [n] value is set to a value other than 1, the selected trace data results will be returned. See each command for details of what types of scalar results or trace data results are available. The binary data formats should be used for handling large blocks of data since they are smaller and transfer faster than the ASCII format. (FORMat:DATA)

FETCh may be used to return results other than those specified with the original READ or MEASure command that you sent.

INITiate Commands:

:INITiate:<measurement>

This command is not available for measurements in all the instrument modes:

- Initiates a trigger cycle for the specified measurement, but does not output any data. You must then use the FETCh<meas> command to return data. If a measurement other than the current one is specified, the instrument will switch to that measurement and then initiate it.
 - For example, suppose you have previously initiated the ACP measurement, but now you are running the channel power measurement. If you send INIT:ACP? it will change from channel power to ACP and will initiate an ACP measurement.
 - Does not change any of the measurement settings. For example, if you have previously started the ACP measurement and you send INIT:ACP? it will initiate a new ACP measurement using the same instrument settings as the last time ACP was run.
 - If your selected measurement is currently active (in the idle state) it triggers the measurement, assuming the trigger conditions are met. Then it completes one trigger cycle. Depending upon the measurement and the number of averages, there may be multiple data acquisitions, with multiple trigger events, for one full trigger cycle. It also holds off additional commands on GPIB until the acquisition is complete.
-

READ Commands:

:READ:<measurement>[n]?

- Does not preset the measurement to the factory default settings. For example, if you have previously initiated the ACP
-

measurement and you send READ:ACP? it will initiate a new measurement using the same instrument settings.

- Initiates the measurement and puts valid data into the output buffer. If a measurement other than the current one is specified, the instrument will switch to that measurement before it initiates the measurement and returns results.
 - For example, suppose you have previously initiated the ACP measurement, but now you are running the channel power measurement. Then you send READ:ACP? It will change from channel power back to ACP and, using the previous ACP settings, will initiate the measurement and return results.
 - Blocks other SCPI communication, waiting until the measurement is complete before returning the results
 - If the optional [n] value is not included, or is set to 1, the scalar measurement results will be returned. If the [n] value is set to a value other than 1, the selected trace data results will be returned. See each command for details of what types of scalar results or trace data results are available. The binary data formats should be used when handling large blocks of data since they are smaller and faster than the ASCII format. (FORMat:DATA)
-

Initial S/W Revision	Prior to A.02.00
----------------------	------------------

Current Measurement Query (Remote Command Only)

This command returns the name of the measurement that is currently running.

Remote Command	:CONFigure?
-----------------------	-------------

Example	CONF?
----------------	-------

Initial S/W Revision	Prior to A.02.00
----------------------	------------------

Limit Test Current Results (Remote Command Only)

Queries the status of the current measurement limit testing. It returns a 0 if the measured results pass when compared with the current limits. It returns a 1 if the measured results fail any limit tests.

Remote Command	:CALCulate:CLIMits:FAIL?
-----------------------	--------------------------

Example	CALC:CLIM:FAIL? queries the current measurement to see if it fails the defined limits. Returns a 0 or 1: 0 it passes, 1 it fails.
----------------	--

Initial S/W Revision	Prior to A.02.00
----------------------	------------------

Data Query (Remote Command Only)

Returns the designated measurement data for the currently selected measurement and subopcode.

n = any valid subopcode for the current measurement. See the measurement command results table for your current measurement, for information about what data is returned for the subopcodes.

This command uses the data setting specified by the FORMat:BORDER and FORMat:DATA commands and can return real or ASCII data. (See the format command descriptions under Input/Output in the Analyzer Setup section.)

Remote Command	:CALCulate:DATA[n]?
Notes	The return trace depends on the measurement. In CALCulate:<meas>:DATA[n], n is any valid subopcode for the current measurement. It returns the same data as the FETCH:<measurement>? query where <measurement> is the current measurement.
Initial S/W Revision	Prior to A.02.00

Calculate/Compress Trace Data Query (Remote Command Only)

Returns compressed data for the currently selected measurement and sub-opcode [n].

n = any valid sub-opcode for that measurement. See the MEASure:<measurement>? command description of your specific measurement for information on the data that can be returned.

The data is returned in the current Y Axis Unit of the analyzer. The command is used with a sub-opcode <n> (default=1) to specify the trace. With trace queries, it is best if the analyzer is not sweeping during the query. Therefore, it is generally advisable to be in Single Sweep, or Update=Off.

This command is used to compress or decimate a long trace to extract and return only the desired data. A typical example would be to acquire N frames of GSM data and return the mean power of the first burst in each frame. The command can also be used to identify the best curve fit for the data.

Remote Command	:CALCulate:DATA<n>:COMPRESS? BLOCK CFIT MAXimum MINimum MEAN DMEan RMS RMSCubed SAMPLE SDEVIation PPHase [,<soffset> [,<length>[,<roffset>[,<rlimit>]]]]
Example	To query the mean power of a set of GSM bursts: Supply a signal that is a set of GSM bursts. Select the IQ Waveform measurement (in IQ Analyzer Mode). Set the sweep time to acquire at least one burst. Set the triggers such that acquisition happens at a known position relative to a burst. Then query the mean burst levels using, CALC:DATA2:COMP? MEAN, 24e-6, 526e-6 (These parameter values correspond to GSM signals, where 526e-6 is the length of the burst in the slot and you just want 1 burst.)
Notes	The command supports 5 parameters. Note that the last 4 (<soffset>, <length>, <roffset>, <rlimit>) are optional. But these optional parameters must be entered in the specified order. For example, if you want to specify <length>, then you must also specify <soffset>. See details below for a definition of each of these parameters. This command uses the data in the format specified by FORMat:DATA, returning either binary or ASCII data.
Initial S/W Revision	Prior to A.02.00

- BLOCK or block data - returns all the data points from the region of the trace data that you specify. For example, it could be used to return the data points of an input signal over several timeslots, excluding the portions of the trace data that you do not want. (This is x,y pairs for trace data and I,Q pairs for complex data.)

- CFIT or curve fit - applies curve fitting routines to the data. <soffset> and <length> are required to define the data that you want. <roffset> is an optional parameter for the desired order of the curve equation. The query will return the following values: the x-offset (in seconds) and the curve coefficients ((order + 1) values).

MIN, MAX, MEAN, DME, RMS, RMSC, SAMP, SDEV and PPH return one data value for each specified region (or <length>) of trace data, for as many regions as possible until you run out of trace data (using <roffset> to specify regions). Or they return the number of regions you specify (using <rlimit>) ignoring any data beyond that.

- MINimum - returns the minimum data point (y value) for the specified region(s) of trace data. For I/Q trace data, the minimum magnitude of the I/Q pairs is returned.
- MAXimum - returns the maximum data point (y value) for the specified region(s) of trace data. For I/Q trace data, the maximum magnitude of the I/Q pairs is returned.
- MEAN - returns a single value that is the arithmetic mean of the data point values (in dB/ dBm) for the specified region(s) of trace data. For I/Q trace data, the mean of the magnitudes of the I/Q pairs is returned. See the following equations.

NOTE If the original trace data is in dB, this function returns the arithmetic mean of those log values, not log of the mean power which is a more useful value. The mean of the log is the better measurement technique when measuring CW signals in the presence of noise. The mean of the power, expressed in dB, is useful in power measurements such as Channel Power. To achieve the mean of the power, use the RMS option.

Equation 1

Mean Value of Data Points for Specified Region(s)

$$MEAN = \frac{1}{n} \sum_{X_i \in \text{region}(s)} X_i$$

where X_i is a data point value, and n is the number of data points in the specified region(s).

Equation 2

Mean Value of I/Q Data Pairs for Specified Region(s)

$$MEAN = \frac{1}{n} \sum_{X_i \in \text{region}(s)} |X_i|$$

where $|X_i|$ is the magnitude of an I/Q pair, and n is the number of I/Q pairs in the specified region(s).

- DMEan - returns a single value that is the mean power (in dB/ dBm) of the data point values for the specified region(s) of trace data. See the following equation:

Equation 3

DMEan Value of Data Points for Specified Region(s)

$$\text{DME} = 10 \times \log_{10} \left(\frac{1}{n} \sum_{X_i \in \text{region}(s)} 10^{\frac{X_i}{10}} \right)$$

- RMS - returns a single value that is the average power on a root-mean-squared voltage scale (arithmetic rms) of the data point values for the specified region(s) of trace data. See the following equation.

NOTE

For I/Q trace data, the rms of the magnitudes of the I/Q pairs is returned. See the following equation. This function is very useful for I/Q trace data. However, if the original trace data is in dB, this function returns the rms of the log values which is not usually needed.

Equation 4

RMS Value of Data Points for Specified Region(s)

$$\text{RMS} = \sqrt{\frac{1}{n} \sum_{X_i \in \text{region}(s)} X_i^2}$$

where X_i is a data point value, and n is the number of data points in the specified region(s).

Equation 5

RMS Value of I/Q Data Pairs for Specified Region(s)

$$\text{RMS} = \sqrt{\frac{1}{n} \sum_{X_i \in \text{region}(s)} X_i X_i^*}$$

where X_i is the complex value representation of an I/Q pair, X_i^* its conjugate complex number, and n is the number of I/Q pairs in the specified region(s).

Once you have the rms value for a region of trace data (linear or I/Q), you may want to calculate the mean power. You must convert this rms value (peak volts) to power in dBm:

$$10 \times \log[10 \times (\text{rms value})^2]$$

- SAMPLe - returns the first data value (x,y pair) for the specified region(s) of trace data. For I/Q trace data, the first I/Q pair is returned.
- SDEViation - returns a single value that is the arithmetic standard deviation for the data point values for the specified region(s) of trace data. See the following equation.
- For I/Q trace data, the standard deviation of the magnitudes of the I/Q pairs is returned. See the following equation.

Equation 6

Standard Deviation of Data Point Values for Specified Region(s)

$$\text{SDEV} = \sqrt{\frac{1}{n} \sum_{X_i \in \text{region}(s)} (X_i - \bar{X})^2}$$

where X_i is a data point value, \bar{X} is the arithmetic mean of the data point values for the specified region (s), and n is the number of data points in the specified region(s).

$$\text{SDEV} = \sqrt{\frac{1}{n} \sum_{X_i \in \text{region}(s)} (|X_i| - \bar{X})^2}$$

where $|X_i|$ is the magnitude of an I/Q pair, \bar{X} is the mean of the magnitudes for the specified region(s), and n is the number of data points in the specified region(s).

- PPHase - returns the x,y pairs of both rms power (dBm) and arithmetic mean phase (radian) for every specified region and frequency offset (Hz). The number of pairs is defined by the specified number of regions. This parameter can be used for I/Q vector ($n=0$) in Waveform (time domain) measurement and all parameters are specified by data point in PPHase.

The rms power of the specified region may be expressed as:

$$\text{Power} = 10 \times \log [10 \times (\text{RMS I/Q value})] + 10.$$

The RMS I/Q value (peak volts) is:

$$\sqrt{\frac{1}{n} \sum_{X_i \in \text{region}} X_i X_i^*}$$

where X_i is the complex value representation of an I/Q pair, X_i^* its conjugate complex number, and n is the number of I/Q pairs in the specified region.

The arithmetic mean phase of the specified region may be expressed as:

$$\frac{1}{n} \sum_{Y_i \in \text{region}} Y_i$$

where Y_i is the unwrapped phase of I/Q pair with applying frequency correction and n is the number of I/Q pairs in the specified region.

The frequency correction is made by the frequency offset calculated by the arithmetic mean of every specified region's frequency offset. Each frequency offset is calculated by the least square method against the unwrapped phase of I/Q pair.

Sample Trace Data - Constant Envelope

(See below for explanation of variables.)

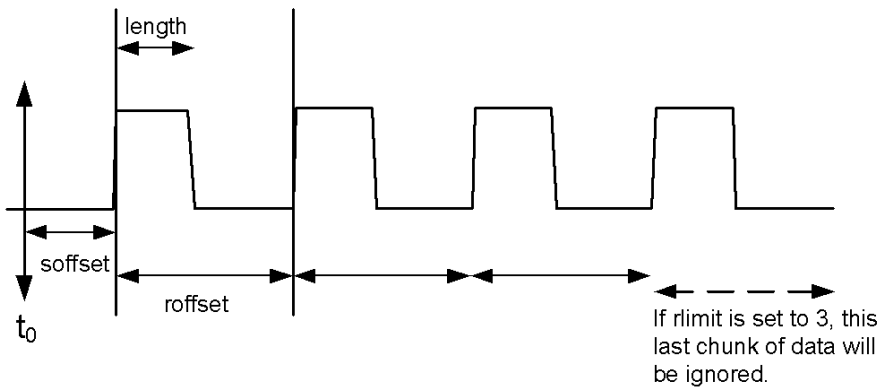

Sample Trace Data - Not Constant Envelope

(See below for explanation of variables.)

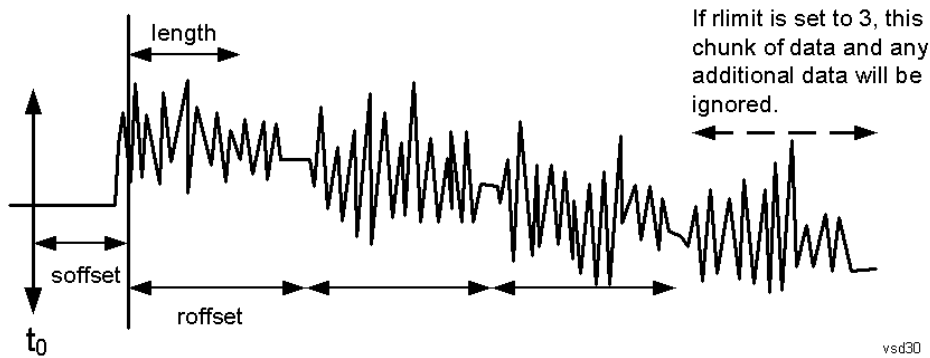

<soffset> - start offset is an optional real number. (It is in seconds for time-domain traces, and is a dimensionless index 0 to Npoints - 1, for frequency-domain traces). It specifies the amount of data at the beginning of the trace that will be ignored before the decimation process starts. It is the time or frequency change from the start of the trace to the point where you want to start using the data. The default value is zero.

<length> - is an optional real number. (It is in seconds for time-domain traces, and is a dimensionless index 0 to Npoints - 1, for frequency-domain traces). It defines how much data will be compressed into one value. This parameter has a default value equal to the current trace length.

<roffset> - repeat offset is an optional real number. (It is in seconds for time-domain traces, and is a dimensionless index 0 to Npoints - 1, for frequency-domain traces). It defines the beginning of the next field of trace elements to be compressed. This is relative to the beginning of the previous field. This parameter has a default value equal to the <length> variable. Note that this parameter is used for a completely different purpose when curve fitting (see CFIT above).

<rlimit> - repeat limit is an optional integer. It specifies the number of data items that you want returned. It will ignore any additional items beyond that number. You can use the Start offset and the Repeat limit to pick out exactly what part of the data you want to use. The default value is all the data.

Calculate Peaks of Trace Data (Remote Command Only)

Returns a list of all the peaks for the currently selected measurement and sub-opcode [n]. The peaks must meet the requirements of the peak threshold and excursion values.

n = any valid sub-opcode for the current measurement. See the MEASure:<measurement> command description of your specific measurement for information on the data that can be returned.

The command can only be used with specific sub-opcodes with measurement results that are trace data. Both real and complex traces can be searched, but complex traces are converted to magnitude in dBm. In many measurements the sub-opcode n=0, is the raw trace data which cannot be searched for peaks. And Sub-opcode n=1, is often calculated results values which also cannot be searched for peaks.

This command uses the data setting specified by the FORMat:BORDER and FORMat:DATA commands and can return real or ASCII data. If the format is set to INT,32, it returns REAL,32 data.

The command has four types of parameters:

- Threshold (in dBm)
- Excursion (in dB)
- Sorting order (amplitude, frequency, time)
- Optional in some measurements: Display line use (all, > display line, < display line)

Remote Command	<p>For Swept SA measurement:</p> <pre>:CALCulate:DATA[1] 2 ... 6:PEAKs? <threshold>,<excursion>[,AMPLitude FREQuency TIME[,ALL GTDLine LTDLine]]</pre> <p>For most other measurements:</p> <pre>:CALCulate:DATA[1] 2 ... 6:PEAKs? <threshold>,<excursion>[,AMPLitude FREQuency TIME]</pre>
-----------------------	--

Example	<p>Example for Swept SA measurement in Spectrum Analyzer Mode:</p> <p>CALC:DATA4:PEAK? -40, 10, FREQ, GTDL This will identify the peaks of trace 4 that are above -40 dBm, with excursions of at least 10 dB. The peaks are returned in order of increasing frequency, starting with the lowest frequency. Only the peaks that are above the display line are returned.</p> <p>Query Results 1:</p> <p>With FORMat:DATA REAL, 32 selected, it returns a list of floating-point numbers. The first value in the list is the number of peak points that are in the following list. A peak point consists of two values: a peak amplitude followed by its corresponding frequency (or time).</p> <p>If no peaks are found the peak list will consist of only the number of peaks, (0).</p>
----------------	---

Notes	<p><n> - is the trace that will be used</p> <p><threshold> - is the level below which trace data peaks are ignored. Note that the threshold value is required and is always used as a peak criterion. To effectively disable the threshold criterion for this command, provide a substantially low threshold value such as -200 dBm. Also note that the threshold value used in this command is independent of and has no effect on the threshold value stored under the Peak Criteria menu.</p> <p><excursion> - is the minimum amplitude variation (rise and fall) required for a signal to be identified as peak. Note that the excursion value is required and is always used as a peak criterion. To effectively disable the excursion criterion for this command, provide the minimum value of 0.0 dB. Also note that the excursion value used in this command is independent of and has no effect on the</p>
--------------	---

excursion value stored under the Peak Criteria menu.

Values must be provided for threshold and excursion. The sorting and display line parameters are optional (defaults are AMPLitude and ALL).

Note that there is always a Y-axis value for the display line, regardless of whether the display line state is on or off. It is the current Y-axis value of the display line which is used by this command to determine whether a peak should be reported

Sorting order:

AMPLitude - lists the peaks in order of descending amplitude, with the highest peak first (default if optional parameter not sent)

FREQUency - lists the peaks in order of occurrence, left to right across the x-axis.

TIME - lists the peaks in order of occurrence, left to right across the x-axis.

Peaks vs. Display Line:

ALL - lists all of the peaks found (default if optional parameter not sent).

GTDLine (greater than display line) - lists all of the peaks found above the display line.

LTDLine (less than display line) - lists all of the peaks found below the display line.

Initial S/W Revision	Prior to A.02.00
----------------------	------------------

Hardware-Accelerated Fast Power Measurement (Remote Command Only)

The Fast Power option (FP2) enables very fast channel power measurements for instruments with the prerequisite hardware (DP2 and/or B40). It accomplishes this by performing real-time overlapped FFTs at the hardware layer, using software for basic post-processing before returning the result to the user. The upshot of this approach is improved throughput for user applications that require many sequential power measurements.

The analysis bandwidth of FP2 is limited by the licenses in the instrument, but its maximum overall analysis bandwidth per acquisition is 40 MHz.

FP2 is remote-only, which means the instrument does not switch to any particular mode or measurement. FP2 commands can be sent while another application is in use on the front panel.

Each Fast Power measurement can be predefined using an array index, and up to 1,000 measurements can be stored. In the following documentation, instances of [1,2,...,999] can be substituted with a particular measurement index, e.g. CALC:FPOW:POW1?, CALC:FPOW:POW2?, CALC:FPOW:POW134?. In this way, power measurements can be defined one time in a batch, and then executed multiple times without having to redefine them, similar to “list mode” on other measurements.

In addition to basic channel power measurements, there are a number of other measurement “functions” for each channel, including peak power, peak frequency, and power spectral density. See the Function parameter for more information.

Reset Fast Power Measurement (Remote Command Only)

Resets the measurement configuration to the defaults.

Mode	All
Remote Command	:CALCulate:FPOWer:POWer[1,2,...,999]:RESet
Example	:CALC:FPOW:POW1:RES

Notes	Option FP2 is required.
Initial S/W Revision	A.14.00

Define Fast Power Measurement (Remote Command Only)

Fast Power acquisitions are configured using the DEFine command. This command accepts a comma-delimited string of configuration parameters and their appropriate values, which are all specified in the subsection below.

Mode	All
Remote Command	:CALCulate:FPOWER:POWer[1,2,...,999]:DEFine "configuration string"
Example	:CALC:FPOW:POW1:DEF "CenterFrequency=2e9, AcquisitionTime=0.005"
Notes	See below for a list of measurement variables that can be defined in the configuration string.
Initial S/W Revision	A.14.00

Acquisition Time

Example	CALC:FPOW:POW1:DEF "AcquisitionTime=0.002"
Notes	The acquisition time parameter sets the time in which the entire spectrum is measured. An increase in the acquisition time yields an improvement in measurement repeatability.
Preset	0.001 s
Range	0 s to 1 s
Default Unit	Time (s)
Initial S/W Revision	A.14.00

Center Frequency

Example	CALC:FPOW:POW1:DEF "CenterFrequency=2e9"
Notes	The center frequency parameter sets the frequency in which the measurement is centered around. The OffsetFrequency parameter is calculated relative to the center frequency.
Preset	1 GHz
Range	0 Hz to maximum instrument frequency
Default Unit	Frequency (Hz)
Initial S/W Revision	A.14.00

DC Coupled

Example	CALC:FPOW:POW1:DEF "DCCoupled=True"
Notes	The DC coupled parameter allows the user to specify whether the DC blocking capacitor is utilized. Set parameter to true when measuring frequencies below 10 MHz.
Preset	False
Range	True (DC Coupled) or False (AC Coupled)
Default Unit	Boolean
Initial S/W Revision	A.14.00

DetectorType

Example	CALC:FPOW:POW1:DEF "DetectorType=Peak"
Notes	Option FP2 is required. The detector type parameter allows the user to choose whether a RMS average or peak value is used during the measurement.
Preset	RmsAverage
Range	RmsAverage, Peak
Initial S/W Revision	A.14.00

Do Noise Correction

Example	CALC:FPOW:POW1:DEF "DoNoiseCorrection=True"
Notes	When noise correction is enabled, the linear noise power contributed by the analyzer is subtracted from all measurements. This effectively lowers the noise floor of the analyzer. When noise correction is enabled, the first measurement for a given set of input parameters will take extra time. This is because the analyzer takes an extra acquisition with the RF input disconnected from the analyzer's front end to measure the noise of just the analyzer. The measured noise floor is stored in a cache so the noise acquisition will occur only once for the same state settings. In other words, if noise correction was turned on and the analyzer made an acquisition at frequency A, then frequency B, and back again to frequency A, the hidden initial noise floor acquisition would only occur for the first acquisition at frequency A and the cached noise floor would be used the second time frequency A was measured.
Preset	False
Range	True (enable noise correction) or False (disable noise correction)
Default Unit	Boolean
Initial S/W Revision	A.14.00

Do Spur Suppression

Example	CALC:FPOW:POW1:DEF "DoSpurSuppression=True"
Notes	<p>When measuring very low level signals, or when large out-of-band inputs are input into the analyzer, sometimes unwanted spurs and residuals can appear in the measured spectrum. Spur suppression is a method to help minimize the levels of these internally generated spurs and residuals.</p> <p>When spur suppression is enabled, the analyzer will automatically take two acquisitions using two different internal analog LO frequencies. The FFT spectrums from both acquisitions are combined by taking the minimum power between both traces on a per FFT bin basis. External signals will have the same amplitude for both traces and therefore will return the expected amplitudes. However, low level spurs and residuals generated internally to the analyzer tend to move to different FFT bins depending on the internal analog LO frequency used, and therefore tend to be suppressed using this spur suppression method.</p> <p>Because two acquisitions, rather than a single acquisition, are made when spur suppression is enabled, the measurement time will always be slower when spur suppression is enabled.</p>
Preset	False
Range	True (enable spur suppression) or False (disable spur suppression)
Default Unit	Boolean
Initial S/W Revision	A.14.00

Electronic Attenuator Bypass

Example	CALC:FPOW:POW1:DEF "ElecAttBypass =False"
Notes	The electronic attenuation bypass parameter allows the user to either utilize or bypass the electronic attenuator. The electronic attenuator is only available for frequencies up to 3.6 GHz. Set parameter to true when using frequencies above 3.6 GHz and set the parameter to false when using the preamp.
Preset	True
Range	True (bypass electronic attenuator) or False (use electronic attenuator)
Default Unit	Boolean
Initial S/W Revision	A.14.00

Electronic Attenuation

Example	CALC:FPOW:POW1:DEF "ElecAttenuation=10"
Notes	<p>Option EA3 is required.</p> <p>The electronic attenuation value parameter sets the amount of electrical attenuation from 0 to 24 dB (1 dB steps).</p> <p>Set "ElecAttBypass=False" to make sure the electronic attenuator path is enabled.</p>
Preset	0 dB
Range	0 – 24 dB (1 dB steps)

Default Unit	dB
Initial S/W Revision	A.14.00

IF Gain

Example	CALC:FPOW:POW1:DEF "IFGain=10"
Notes	The IF gain parameter allows the user to specify the gain at the IF stage anywhere from -6 to 16 dB (1 dB steps). This is an advanced feature, and for most cases this should remain at its default value of 0 dB.
Preset	0 dB
Range	-6 - 16 dB (1 dB steps)
Default Unit	dB
Initial S/W Revision	A.14.00

IF Type

Example	CALC:FPOW:POW1:DEF "IFType=B25M"
Notes	The IF type parameter allows the user to select between different IF paths. For example, if the signal is less than 25 MHz wide, then the user can select the B25M path to take advantage of additional filtering on this analog IF path.
Preset	B40M
Range	B10M, B25M, B40M
Initial S/W Revision	A.14.00

Include Power Spectrum

Example	CALC:FPOW:POW1:DEF "IncludePowerSpectrum=True"
Notes	The power spectrum parameter allows the user to read data on the entire spectrum for diagnostic purposes. It is not recommended for production use. See CALC:FPOW:POW[n]:READ2? for details on the binary format of the response.
Preset	False
Range	True (return both channel power and full power spectrum) or False (returns only channel power)
Default Unit	Boolean
Initial S/W Revision	A.14.00

Mechanical Attenuation

Example	CALC:FPOW:POW1:DEF "MechAttenuation=10"
Notes	The mechanical attenuation value parameter sets the amount of mechanical attenuation anywhere from 0 to 70 dB (2 dB steps).
Preset	0 dB
Range	0 – 70 dB (2 dB steps)
Default Unit	dB
Initial S/W Revision	A.14.00

Preamp Mode

Example	CALC:FPOW:POW1:DEF "PreAmpMode=Low"
Notes	The license for the appropriate preamp is required. The preamp mode parameter specifies whether the preamps are being utilized. Low allows any preamps up to 3.6 GHz, and Full allows all licensed preamps. Set "ElecAttBypass=True" in order to utilize any preamps.
Preset	Off
Range	Off, Low, Full
Initial S/W Revision	A.14.00

Resolution Bandwidth Mode

Example	CALC:FPOW:POW1:DEF "PreAmpMode=Low"
Notes	The resolution bandwidth mode parameter allows the user to choose whether the RBW filter is automatically or manually set. The BestSpeed value minimizes measurement time, while the Narrowest value minimizes RBW size (minimum of two FFT bins per RBW). To manually specify an RBW, set this parameter to Explicit, and set the ResolutionBW parameter to the desired value.
Preset	BestSpeed
Range	BestSpeed, Narrowest, Explicit
Initial S/W Revision	A.14.00

Resolution Bandwidth

Example	CALC:FPOW:POW1:DEF "ResolutionBW=25e3"
Notes	The resolution bandwidth parameter sets the 3-dB bandwidth of the RBW filter. The ResolutionBWMode parameter must be set to Explicit in order to manually set the RBW.

Preset	0 Hz
Default Unit	Hz
Initial S/W Revision	A.14.00

Trigger Delay

Example	CALC:FPOW:POW1:DEF "TriggerDelay=0.025"
Notes	The trigger delay parameter sets the time after an external trigger is detected until the measurement is performed.
Preset	0 s
Range	0 – 1 s
Default Unit	Seconds
Initial S/W Revision	A.14.00

Trigger Level

Example	CALC:FPOW:POW1:DEF "TriggerLevel=2"
Notes	The trigger level parameter sets the voltage value at which an external trigger is detected.
Preset	1.2 V
Range	-5 to 5 V
Default Unit	Volts
Initial S/W Revision	A.14.00

Trigger Slope

Example	CALC:FPOW:POW1:DEF "TriggerSlope=Negative"
Notes	The trigger slope parameter indicates the direction of the edge trigger voltage for detection.
Preset	Positive
Range	Positive, Negative
Initial S/W Revision	A.14.00

Trigger Source

Example	CALC:FPOW:POW1:DEF "TriggerSource=Ext1"
Notes	The trigger source parameter allows the user to choose between measurement's triggering freely or controlled by an external input. Ext1 and Ext2 correspond to Trigger 1 In and Trigger 2 In, respectively.
Preset	Free
Range	Free, Ext1, Ext2
Initial S/W Revision	A.14.00

Trigger Timeout

Example	CALC:FPOW:POW1:DEF "TriggerTimeout=0.1"
Notes	The trigger timeout parameter sets the time in which the analyzer will wait for a trigger before automatically performing the measurement.
Preset	1 s
Range	0 - 1 s
Default Unit	Seconds
Initial S/W Revision	A.14.00

Signal Input

Example	CALC:FPOW:POW1:DEF "SignalInput=Fp50MHzCW"
Notes	The signal input parameter allows the user to select between using the main RF input or the internal analyzer reference CW signal of 50 MHz.
Preset	FpMainRf
Range	FpMainRf, Fp50MHzCW
Initial S/W Revision	A.14.00

Use Preselector

Example	CALC:FPOW:POW1:DEF "UsePreSelector=True"
Notes	The preselector parameter allows the user to either utilize or bypass the front end tunable filter at frequencies above 3.6 GHz. For frequencies below 3.6 GHz, the preselector is automatically bypassed, so you do not need to set this parameter to False in those cases.
Preset	False
Range	True (use preselector above 3.6 GHz), or False (preselector bypassed)

Default Unit	Boolean
Initial S/W Revision	A.14.00

Channel Bandwidth Array

Example	CALC:FPOW:POW1:DEF "Bandwidth=[3.84e6, 5e6, 3.84e6]"
Notes	The bandwidth parameter array defines the bandwidth of each channel that will be measured. All array parameters should have the same number of elements. Alternatively, if all the elements are the same value, a single number with no square brackets can be used to define the parameter.
Preset	[1 e6]
Range	0 to 40 MHz
Default Unit	Hz
Initial S/W Revision	A.14.00

Channel Filter Type Array

Example	CALC:FPOW:POW1:DEF "FilterType=[RRC, IBW, RRC]"
Notes	The filter type parameter allows the user to choose between an integration bandwidth (IBW) filter or a root-raised-cosine (RRC) filter. The integration bandwidth filter weighs all frequencies within the bandwidth equally. The root-raised-cosine filter has an associated shape parameter, defined by the FilterAlpha parameter. All array parameters should have the same number of elements. Alternatively, if all the elements are the same value, a single value with no square brackets can be used to define the parameter.
Preset	[IBW]
Range	IBW, RRC
Initial S/W Revision	A.14.00

Channel Filter Alpha Array

Example	CALC:FPOW:POW1:DEF "FilterAlpha=[0.5, 0.0, 0.5]"
Notes	The filter alpha parameter allows the user to adjust the alpha value associated with the root-raised-cosine (RRC) filter type. Set FilterType to RRC in order to utilize this parameter. All array parameters should have the same number of elements. Alternatively, if all the elements are the same value, a single number with no square brackets can be used to define the parameter.
Preset	[0.22]
Range	0.0 – 1.0
Initial S/W Revision	A.14.00

Channel Measurement Function Array

Example	CALC:FPOW:POW1:DEF "Function=[BandPower, PeakPower, BandPower]"
Notes	<p>This parameter array defines what measurement is being made for each individually-specified channel:</p> <p>BandPower: Total power within the specified bandwidth of the channel (dBm)</p> <p>BandDensity: Total power density within the specified bandwidth of the channel (dBm/Hz)</p> <p>PeakPower: The peak power value within the specified bandwidth of the channel (dBm)</p> <p>PeakFrequency: The frequency which corresponds to the peak power value within the specified bandwidth of the channel. This frequency is relative to the center frequency (Hz)</p> <p>XdBBandwidth: The half power (-3.01 dB) bandwidth of the highest amplitude signal that resides within the channel (Hz), dB is configurable using XdBBandwidth parameter</p> <p>OccupiedBandwidth: The bandwidth at which 99% of the total power resides within the channel (Hz), percentage configurable using OccupiedBandwidthPercent parameter</p> <p>All array parameters should have the same number of elements. Alternatively, if all the elements are the same value, a single value with no square brackets can be used to define the parameter.</p>
Preset	[BandPower]
Range	BandPower, BandDensity, PeakPower, PeakFrequency, XdBBandwidth, OccupiedBandwidth
Initial S/W Revision	A.14.00

Channel Offset Frequency Array

Example	CALC:FPOW:POW1:DEF "OffsetFrequency=[-5e6, 0, 5e6]"
Notes	<p>The offset frequency parameter array defines the difference between the center frequency to the center frequency of each channel.</p> <p>All array parameters should have the same number of elements.</p>
Preset	[0]
Range	0 to 20 MHz
Default Unit	Hz
Initial S/W Revision	A.14.00

Channel Occupied Bandwidth Percent Array

Example	CALC:FPOW:POW1:DEF "OccupiedBandwidthPercent =[0.95, 0.95, 0.95]"
Notes	<p>This parameter only applies for channels whose Function is set to OccupiedBandwidth. The occupied bandwidth percent parameter specifies the percent of total power in these channels. The valid range for this parameter is 0.0 to 1.0, where 1.0 represents 100%. The default for this parameter is 0.99, which will return the bandwidth that contains 99% of the total channel power.</p>

Preset	[0.99]
Range	0 – 1.0
Initial S/W Revision	A.14.00

Channel x-dB Bandwidth Array

Example	CALC:FPOW:POW1:DEF " XdBBandwidth =[-6.02, -3.01, -1.0]"
Notes	This parameter only applies for channels whose Function is set to XdBBandwidth. The X dB bandwidth parameter is used to specify the power relative to the peak channel power over which the bandwidth is calculated. The parameter value must be a negative number.
Preset	[-3.01]
Range	-200 to 0 dB
Default Unit	dB
Initial S/W Revision	A.14.00

Define Fast Power Measurement Query (Remote Command Only)

The DEFine? command is used to retrieve a list of all defined parameters in an ASCII string format

M o d e	All
R e m o t e	:CALCulate:FPOWER:POWER [1,2,...,999]:DEFine?
C o m m a n d	
E x a m	:CALC:FPOW:POW1:DEF?

```

p
l
e
N This command query is used to retrieve a list of all defined parameters in an ASCII format.
o The following is an example of the returned results:
t "DCCoupled=False,ElecAttBypass=True,ElecAttenuation=0,IFGain=0,MechAttenuation=0,PreAmpMode=Off,PreSelectorOffset
e =0,UsePreSelector=False,ExternalReferenceFrequency=10000000,FrequencyReferenceSource=AutoExternalFrequencyRefer
s ence,IFType=B40M,LOMode=SLW,SignalInput=FpMainRf,AcquisitionTime=0.001,CenterFrequency=1000000000,Resolution
BW=0,ResolutionBWMode=BestSpeed,DetectorType=RmsAverage,Bandwidth=[1000000],OffsetFrequency=[0],Function=
[BandPower],FilterType=[IBW],FilterAlpha=[0.22],OccupiedBandwidthPercent=[0.99],XdBBandwidth=[-
3.01],DoNoiseCorrection=False,DoSpurSuppression=False,MeasurementMethod=HardwareFFT,IncludePowerSpectrum=False
e,TriggerDelay=0,TriggerLevel=1.2,TriggerSlope=Positive,TriggerSource=Free,TriggerTimeout=1"
I A.14.00
n
i
t
i
a
l
S
/
W
R
e
v
i
s
i
o
n

```

Configure Fast Power Measurement (Remote Command Only)

The configure command begins hardware setup and returns immediately, with no acquisition made. This can be used in parallel with other hardware operations to effectively hide the hardware setup time.

Mode	All
Remote Command	:CALCulate:FPOWER:POWER[1,2,...,999]:CONFigure
Example	:CALC:FPOW:POW1:CONF
Notes	Option FP2 is required.
Initial S/W Revision	A.14.00

Initiate Fast Power Measurement (Remote Command Only)

The INITiate command begins an acquisition and returns immediately. The results of the measurement can be retrieved using FETCh.

Mode	All
Remote Command	:CALCulate:FPOWER:POWER[1,2,...,999]:INITiate
Example	:CALC:FPOW:POW1:INIT
Notes	Option FP2 is required.
Initial S/W Revision	A.14.00

Fetch Fast Power Measurement (Remote Command Only)

The FETCh command query is used to retrieve the results of an acquisition initiated by the INIT command. The returned results are in ASCII string format. The string begins and ends with quotation marks.

Mode	All
Remote Command	:CALCulate:FPOWER:POWER[1,2,...,999]:FETCh?
Example	:CALC:FPOW:POW1:FETC?
Notes	Option FP2 is required. Returns m comma-separated ASCII values, where m corresponds to the number of bandwidths defined. 1. Declared function return in the 1st specified channel 2. Declared function return in the 2nd specified channel ... m. Declared function return in the last specified channel The INIT and FETC? command sequence performs the same functionality of a single CALC:FPOW:POW[n]? query. Units of the returned values are dependent on the Function parameter for each channel.
Initial S/W Revision	A.14.00

Execute Fast Power Measurement (Remote Command Only)

This command query is used as shorthand for an INIT command immediately followed by a FETC? command. The returned results are in ASCII string format. The string begins and ends with quotation marks.

Mode	All
Remote Command	:CALCulate:FPOWER:POWER[1,2,...,999]?
Example	:CALC:FPOW:POW1?
Notes	Option FP2 is required. See notes for Fast Power Fetch for return format.
Initial S/W Revision	A.14.00

Binary Read Fast Power Measurement (Remote Command Only)

This command query is used as shorthand for an INIT command immediately followed by a FETC? command. The returned results are in a binary format.

Mode	All
Remote Command	:CALCulate:FPOWER:POWER[1,2,...,999]:READ? :CALCulate:FPOWER:POWER[1,2,...,999]:READ1?
Example	:CALC:FPOW:POW1:READ? :CALC:FPOW:POW1:READ1?
Notes	Option FP2 is required. Returns m 4 byte floating point binary values (Little-Endian), where m corresponds to the number of bandwidths defined.
Initial S/W Revision	A.14.00

Diagnostic Binary Read Fast Power Measurement (Remote Command Only)

This command query is used as shorthand for an INIT command immediately followed by a FETC? command. The returned results are in a binary format. This command is used primarily for diagnostic purposes to test for ADC overloads and to visibly inspect the spectrum.

Mode	All
Remote Command	:CALCulate:FPOWER:POWER[1,2,...,999]:READ2?
Example	:CALC:FPOW:POW1:READ2?
Notes	Option FP2 is required. Note: Spectrum data is only returned if the IncludePowerSpectrum parameter is set to True. If IncludePowerSpectrum is False, the number of spectrum points will be zero (0). Units of the returned values are dependent on the Function parameter per channel (e.g. dBm for BandPower, Hz for PeakFrequency). Returns binary data (Little-Endian) that contains information on m amount of channels, along with ADC over range and full spectrum data. The following is the binary format of the response. Bandwidth Return Value 1. Number of channels specified, m [4 byte int] 2. Declared function result for the 1st specified channel [4 byte float] 3. Declared function result for the 2nd specified channel [4 byte float] ... (m + 1). Declared function result for the last (mth) specified channel [4 byte float] ADC Over Range 1. ADC over-range occurred (1: true, 0: false) [2 byte short]

	<p>Spectrum Data</p> <ol style="list-style-type: none"> 1. Number of points in the spectrum data, k [4 byte int] 2. Start frequency of spectrum data (Hz) [8 byte double] 3. Step frequency of spectrum data (Hz) [8 byte double] 4. FFT bin at 1st point (dBm) [4 byte float] 5. FFT bin at 2nd point (dBm) [4 byte float] <p>...</p> <p>(k + 3). FFT bin at last (kth) point (dBm) [4 byte float]</p>
Initial S/W Revision	A.14.00

Format Data: Numeric Data (Remote Command Only)

This command specifies the format of the trace data input and output. It specifies the formats used for trace data during data transfer across any remote port. It affects only the data format for setting and querying trace data for the :TRACe[:DATA], TRACe[:DATA]?, :CALCulate:DATA[n]? and FETCh:SANalyzer[n]? commands and queries.

Remote Command	<pre>:FORMat[:TRACe][:DATA] ASCii INTeger,32 REAL,32 REAL,64 :FORMat[:TRACe][:DATA]?</pre>
Notes	<p>The query response is:</p> <pre>ASCii: ASC,8 REAL,32: REAL,32 REAL,64: REAL,64 INTeger,32: INT,32</pre> <p>When the numeric data format is REAL or ASCii, data is output in the current Y Axis unit. When the data format is INTeger, data is output in units of m dBm (.001 dBm).</p> <p>The INT,32 format returns binary 32-bit integer values in internal units (m dBm), in a definite length block.</p>
Dependencies	<p>Sending a data format spec with an invalid number (for example, INT,48) generates no error. The analyzer simply uses the default (8 for ASCii, 32 for INTeger, 32 for REAL).</p> <p>Sending data to the analyzer which does not conform to the current FORMat specified, results in an error. Sending ASCII data when a definite block is expected generates message -161 "Invalid Block Data" and sending a definite block when ASCII data is expected generates message -121 "Invalid Character in Number".</p>
Preset	ASCii
Backwards Compatibility Notes	Note that the INT,32 format is only applicable to the command, TRACe:DATA. This preserves backwards compatibility for the Swept SA measurement. For all other commands/queries which honor FORMat:DATA, if INT,32 is sent the analyzer will behave as though it were set to REAL,32.
Initial S/W Revision	Prior to A.02.00

The specs for each output type follow:

AScii - Amplitude values are in ASCII, in the current Y Axis Unit, one ASCII character per digit, values separated by commas, each value in the form:

SX.YYYYYEsZZ

Where:

S = sign (+ or -)

X = one digit to left of decimal point

Y = 5 digits to right of decimal point

E = E, exponent header

s = sign of exponent (+ or -)

ZZ = two digit exponent

REAL,32 - Binary 32-bit real values in the current Y Axis Unit, in a definite length block.

REAL,64 - Binary 64-bit real values in the current Y Axis Unit, in a definite length block.

Format Data: Byte Order (Remote Command Only)

This command selects the binary data byte order for data transfer and other queries. It controls whether binary data is transferred in normal or swapped mode. This command affects only the byte order for setting and querying trace data for the :TRACe[:DATA], TRACe[:DATA]? , :CALCulate:DATA[n]? and FETCh:SANalyzer[n]? commands and queries.

By definition any command that says it uses FORMat:DATA uses any format supported by FORMat:DATA.

The NORMal order is a byte sequence that begins with the most significant byte (MSB) first, and ends with the least significant byte (LSB) last in the sequence: 1|2|3|4. SWAPped order is when the byte sequence begins with the LSB first, and ends with the MSB last in the sequence: 4|3|2|1.

Remote Command	:FORMat:BORDER NORMAL SWAPped :FORMat:BORDER?
Preset	NORMal
Initial S/W Revision	Prior to A.02.00

Meas Setup

Displays the setup menu for the currently selected measurement.

Key Path	Front-panel key
Initial S/W Revision	Prior to A.02.00

Avg/Hold Num

Toggles averaging On or Off in addition to enabling you to set the number of measurement averages used to calculate the measurement result. The average is displayed at the end of each sweep. After the specified number of average counts, the average mode (termination control) setting determines the average action.

In the remote mode, use the Average State command to turn averaging on or off.

Key Path	Meas Setup
Mode	SA, WCDMA, C2K, WIMAX OFDMA, TD-SCDMA, 1xEVDO, DTMB (CTTB), DVB-T/H, ISDB-T, CMMB, LTE, LTE-TDD, Digital Cable TV, WLAN, MSR, LTEAFDD, LTEATDD
Remote Command	[:SENSe]:SEMask:AVERage:COUNT <integer> [:SENSe]:SEMask:AVERage:COUNT? [:SENSe]:SEMask:AVERage[:STATe] ON OFF 1 0 [:SENSe]:SEMask:AVERage[:STATe]?
Example	SEM:AVER:COUN 100 SEM:AVER:COUN? SEM:AVER ON SEM:AVER?
Notes	You must be in the mode that includes SEM measurement to use this command. Use :INSTrument:SElect to set the mode.
Preset	10 OFF
State Saved	Saved in instrument state.
Min	1
Max	10000
Initial S/W Revision	Prior to A.02.00
Modified at S/W Revision	A.02.00, A.03.00

Meas Type

Accesses a menu that enables you to select one of the following measurement reference types:

- Total Pwr Ref – Sets the reference to the total carrier power and the measured data is shown in dBc and dBm.
- PSD Ref – Sets the reference to the mean power spectral density of the carrier and the measured data is shown in dB and dBm/Hz.
- Spectrum Peak Ref – Sets the reference to the spectrum peak power of the carrier and the measured data is shown in dB and dBm.

Key Path	Meas Setup
Mode	SA, WCDMA, C2K, WIMAX OFDMA, TD-SCDMA, 1xEVDO, DTMB (CTTB), DVB-T/H, ISDB-T, CMMB, LTE, LTETDD, Digital Cable TV, WLAN, MSR, LTEAFDD, LTEATDD
Remote Command	[:SENSE] :SEMAsk:TYPE PSDRef TPreRef SPRef [:SENSE] :SEMAsk:TYPE?
Example	SEM:TYPE PSDR SEM:TYPE?
Notes	You must be in the mode that includes SEM measurement to use this command. Use :INSTRument:SElect to set the mode.
Preset	SA, WCDMA, C2K, TD-SCDMA, 1xEVDO, DTMB (CTTB), DVB-T/H, ISDB-T, CMMB, LTE, LTETDD, Digital Cable TV, MSR, LTEAFDD, LTEATDD: TPreRef WIMAX OFDMA, WLAN: SPRef
State Saved	Saved in instrument state.
Range	Total Pwr Ref PSD Ref Spectrum Peak Ref
Initial S/W Revision	Prior to A.02.00
Modified at S/W Revision	A.02.00, A.03.00

Ref Channel

Accesses a menu that enables you to set up the measurement parameters used to calculate the power in the reference channel.

Key Path	Meas Setup
Initial S/W Revision	Prior to A.02.00

Acq Time

Sets the acquisition time used to calculate the power in the reference channel. Acquisition Time can be set manually or put in auto mode. The time value is the acquisition time for an individual FFT segment, not the cumulated time for all FFT segments in the channel.

Key Path	Meas Setup, Ref Channel
Mode	SA, WCDMA, C2K, WIMAX OFDMA, TD-SCDMA, 1xEVDO, DTMB (CTTB), DVB-T/H, ISDB-T, CMMB, LTE, LTETDD, Digital Cable TV, WLAN, MSR, LTEAFDD, LTEATDD

Remote Command	<pre>[:SENSe] :SEMask :SWEep [1] 2 :TIME <time> [:SENSe] :SEMask :SWEep [1] 2 :TIME ? [:SENSe] :SEMask :SWEep [1] 2 :TIME :AUTO OFF 0 ON 1 [:SENSe] :SEMask :SWEep [1] 2 :TIME :AUTO ?</pre>
Example	<pre>SEM:SWE:TIME 9ms SEM:SWE:TIME? SEM:SWE:TIME:AUTO OFF SEM:SWE:TIME:AUTO?</pre>
Notes	<p>Sub op code, 1 is for BTS, 2 for MS. Default is BTS.</p> <p>You must be in the mode that includes SEM measurement to use this command. Use :INSTrument:SElect to set the mode.</p>
Couplings	<p>When the time is set manually, Auto is set to OFF.</p> <p>Value is coupled with Channel Detector selection, Channel Resolution BW, Channel Video BW if the state is Auto.</p> <p>When set to Auto, the Acquisition Time is automatically calculated</p>
Preset	<p>Automatically calculated</p> <p>ON</p>
State Saved	<p>Saved in instrument state.</p>
Min	<p>TBD</p>
Max	<p>4000 s</p>
Initial S/W Revision	<p>Prior to A.02.00</p>
Modified at S/W Revision	<p>A.02.00, A.03.00</p>

Res BW

Sets the resolution bandwidth used to calculate the power in the reference channel. The Channel Resolution BW can be set manually or put in to auto mode.

LTE	1.4 MHz	13
	3 MHz	27
	5 MHz	47
	10 MHz	91
	15 MHz	150
	20 MHz	180
W-CDMA		75
GSM		30

In LTE-Advanced FDD/TDD, the resolution bandwidth is predefined based on the corresponding bandwidth of the single LTE carrier, which is listed above. When ResBW mode is Auto, the narrowest RBW is selected.

Key Path	Meas Setup, Ref Channel
Mode	SA, WCDMA, C2K, WIMAX OFDMA, TD-SCDMA, 1xEVDO, DTMB (CTTB), DVB-T/H, ISDB-T, CMMB, LTE, LTE-TDD, Digital Cable TV, WLAN, MSR, LTEAFDD, LTEATDD
Remote Command	<pre>[:SENSe] :SEMAsk :BANDwidth [1] 2 [:RESolution] <bandwidth> [:SENSe] :SEMAsk :BANDwidth [1] 2 [:RESolution] ? [:SENSe] :SEMAsk :BANDwidth [1] 2 [:RESolution] :AUTO OFF ON 1 0 [:SENSe] :SEMAsk :BANDwidth [1] 2 [:RESolution] :AUTO?</pre>
Example	<pre>SEM:BAND 100 kHz SEM:BAND? SEM:BAND:AUTO ON SEM:BAND:AUTO?</pre>
Notes	<p>Bandwidth sub op code, 1 is for BTS, 2 for MS. Default is BTS.</p> <p>You must be in the mode that includes SEM measurement to use this command. Use :INSTrument:SElect to set the mode.</p>
Couplings	<p>When Res BW is set manually, Channel Resolution BW Mode is set to Manual.</p> <p>Value is coupled with Channel Detector selection, Channel Acquisition Time, Channel Video BW.</p> <p>When set to Auto, the resolution bandwidth is automatically calculated.</p>
Preset	<pre>SA: 100 kHz WCDMA: 75 kHz C2K: 24 kHz WIMAX OFDMA: 100 kHz TD-SCDMA: 30 kHz 1xEVDO: 30.0 KHz DTMB (CTTB): 3.9 kHz DVB-T/H: 3.9 kHz ISDB-T: 10 kHz CMMB: 3.9 kHz LTE, LTE-TDD, MSR, LTEAFDD, LTEATDD:Auto (47 kHz) Digital Cable TV: 3.9 kHz WLAN: 100 kHz ON</pre>
State Saved	Saved in instrument state.
Min	1 Hz
Max	8 MHz
Backwards Compatibility SCPI	[:SENSe] :SEMAsk :BWIDth [1] 2 [:RESolution]
Initial S/W Revision	Prior to A.02.00
Modified at S/W Revision	A.02.00, A.03.00

Video BW

Sets the video bandwidth used to calculate the power in the reference channel. The Channel Video BW can be set manually or put in to auto mode.

Key Path	Meas Setup, Ref Channel
Mode	SA, WCDMA, C2K, WIMAX OFDMA, TD-SCDMA, 1xEVDO, DTMB (CTTB), DVB-T/H, ISDB-T, CMMB, LTE, LTE-TDD, Digital Cable TV, WLAN, MSR, LTEAFDD, LTEATDD
Remote Command	[:SENSe]:SEMask:BANDwidth[1] 2:VIDeo <bandwidth> [:SENSe]:SEMask:BANDwidth[1] 2:VIDeo? [:SENSe]:SEMask:BANDwidth[1] 2:VIDeo:AUTO OFF ON 1 0 [:SENSe]:SEMask:BANDwidth[1] 2:VIDeo:AUTO?
Example	SEM:BAND:VID 100 kHz SEM:BAND:VID? SEM:BAND:VID:AUTO ON SEM:BAND:VID:AUTO?
Notes	Bandwidth sub op code, 1 is for BTS, 2 for MS. Default is BTS. You must be in the mode that includes SEM measurement to use this command. Use :INSTrument:SElect to set the mode.
Couplings	When Video BW is set manually, Channel Video BW Mode is set to MANual Value is coupled with Channel Detector selection, Channel Acquisition Time, Channel Resolution BW. When set to Auto, the video bandwidth is automatically calculated.
Preset	SA: 100 kHz WCDMA: 75 kHz C2K: 24 kHz WIMAX OFDMA: 30 kHz TD-SCDMA: 300 kHz 1xEVDO: 300.0 kHz DTMB (CTTB): 39 kHz DVB-T/H: 39 kHz ISDB-T: 1 kHz CMMB: 39 kHz LTE, MSR, LTEAFDD, LTEATDD: Auto LTE-TDD: Auto Digital Cable TV: 39 kHz WLAN: Auto ON
State Saved	Saved in instrument state.
Min	1 Hz
Max	50 MHz

Backwards Compatibility SCPI	<code>[:SENSe] :SEMAsk:BWIDth [1] 2 :VIDeo</code>
Initial S/W Revision	Prior to A.02.00
Modified at S/W Revision	A.02.00, A.03.00

VBW/RBW

Sets the Video BW/Resolution BW Ratio to calculate the Channel Resolution BW and Channel Video BW. The VBW/RBW Ratio can be set manually or put in to auto mode.

Key Path	Meas Setup, Ref Channel
Mode	SA, WCDMA, C2K, WIMAX OFDMA, TD-SCDMA mode, 1xEVDO, DTMB (CTTB), DVB-T/H, ISDB-T, CMMB, LTE, LTE4DD, Digital Cable TV, WLAN, MSR, LTEAFDD, LTEATDD
Remote Command	<pre>[:SENSe] :SEMAsk:BA NDwidth [1] 2 :VIDeo:RATio <real> [:SENSe] :SEMAsk:BA NDwidth [1] 2 :VIDeo:RATio [:SENSe] :SEMAsk:BA NDwidth [1] 2 :VIDeo:RATio:AUTO OFF ON 1 0 [:SENSe] :SEMAsk:BA NDwidth [1] 2 :VIDeo:RATio:AUTO?</pre>
Example	<pre>SEM:BA ND:VID:RAT 0.1 SEM:BA ND:VID:RAT? SEM:BA ND:VID:RAT:AUTO ON SEM:BA ND:VID:RAT:AUTO?</pre>
Notes	<p>Bandwidth sub op code, 1 is for BTS, 2 for MS. Default is BTS.</p> <p>You must be in the mode that includes SEM measurement to use this command. Use <code>:INSTrument:SElect</code> to set the mode.</p>
Couplings	<p>When Video BW/Res BW is set manually, Channel VBW/RBW Ratio Mode is set to MANual</p> <p>When set to Auto, the VBW/RBW Ratio is automatically calculated.</p>
Preset	<pre>SA, WCDMA, C2K: 1.0 WIMAX OFDMA: 0.3 TD-SCDMA: 10 1xEVDO: 10.0 DTMB (CTTB): 10 DVB-T/H: 10 ISDB-T: 0.1 CMMB: 10 LTE, MSR: Auto LTEAFDD,LTEATDD:Auto LTE4DD: Auto Digital Cable TV: 10 WLAN: Auto ON</pre>

State Saved	Saved in instrument state.
Min	0.00001
Max	3000000
Backwards Compatibility SCPI	<code>[:SENSe] :SEMask:BWIDth[1] 2:VIDeo:RATio</code>
Initial S/W Revision	Prior to A.02.00
Modified at S/W Revision	A.02.00, A.03.00

Power Ref (Only for MSR and LTE-Advanced FDD/TDD)

Selects the power reference type.

- Left & Right Carriers – Powers of leftmost and rightmost carriers with Measure Carrier On in a sub-block are the references of left and right sides respectively. Only the frequency ranges of leftmost and rightmost carriers are swept and measured, and other frequency ranges in the RFBW are not measured. Left and right carriers are determined based on the carrier center frequencies. If Measure Carriers of all the carriers in a sub-block are off, the reference power in a sub-block and all the relative power results are NaN. Relative limits are not evaluated.
- Max Power Carrier – Maximum carrier power is the reference of measurement. All the configured carriers are measured. If Measure Carriers of all the carriers are off, the reference power and all the relative power results are NaN. Relative limits are not evaluated.
- Carrier Index – Power of the specified carrier is the reference of measurement. Only the frequency range of the specified carrier is swept and measured, and other frequency ranges in the RFBW are not measured. If Measure Carriers of this carrier index is off, the reference power and all the relative power results are NaN. Relative limits are not evaluated.
- Manual – Power or PSD specified by the user is the reference of measurement. No carriers are measured and the manually specified value is used as reference.
- Max Power Carrier in Sub-block – Maximum carrier power among the sub-block carriers with Measure Carrier On is the reference of measurement. All the configured carriers are measured. If Measure Carriers of all the carriers in a sub-block are off, the reference power of the sub-block and all the relative power results referring to this sub-block are NaN, and these relative limits are not evaluated.
- RF Bandwidth – Power or PSD of total of the RF bandwidth is the reference of measurement. Power not only in the carrier bands but also carrier gaps is integrated into the reference power. Measure Carrier On/Off doesn't affect this selection because RF bandwidth is determined by the carrier configuration.

Key Path	Meas Setup, Ref Channel
Mode	MSR, LTEAFDD, LTEATDD
Remote Command	<code>[:SENSe] :SEMask:CARRier:PREFERENCE:TYPE LRCarriers MPCarrier CINDEX MANual MPCSubblock RFBandwidth</code> <code>[:SENSe] :SEMask:CARRier:PREFERENCE:TYPE?</code>
Example	<code>SEM:CARR:PREF:TYPE CIND</code> <code>SEM:CARR:PREF:TYPE?</code>

Notes	You must be in the MSR and LTE-Advanced FDD/TDD mode to use this command. Use :INSTRument:SElect to set the mode.								
Preset	MPCarrier								
State Saved	Saved in instrument state								
Range	Left & Right Carriers Max Power Carriers Carrier Index Manual Max Power Carrier in Sub-block RF Bandwidth								
Readback	Indirect readback as below: <table border="1" style="margin-left: auto; margin-right: auto;"> <tr> <td>Power Ref [Left & Right▶ Carriers]</td> <td>Power Ref [Max Power▶ Carrier]</td> <td>Power Ref [Carrier Index▶ 1]</td> <td>Power Ref [Manual Power▶ -10 dBm]</td> </tr> <tr> <td>Power Ref [Manual PSD▶ -10 dBm/Hz]</td> <td>Power Ref [Manual Spec Pk▶ -10 dBm]</td> <td>Power Ref [Max Power▶ Carrier in SB]</td> <td>Power Ref [RF Bandwidth▶]</td> </tr> </table>	Power Ref [Left & Right▶ Carriers]	Power Ref [Max Power▶ Carrier]	Power Ref [Carrier Index▶ 1]	Power Ref [Manual Power▶ -10 dBm]	Power Ref [Manual PSD▶ -10 dBm/Hz]	Power Ref [Manual Spec Pk▶ -10 dBm]	Power Ref [Max Power▶ Carrier in SB]	Power Ref [RF Bandwidth▶]
Power Ref [Left & Right▶ Carriers]	Power Ref [Max Power▶ Carrier]	Power Ref [Carrier Index▶ 1]	Power Ref [Manual Power▶ -10 dBm]						
Power Ref [Manual PSD▶ -10 dBm/Hz]	Power Ref [Manual Spec Pk▶ -10 dBm]	Power Ref [Max Power▶ Carrier in SB]	Power Ref [RF Bandwidth▶]						
Initial S/W Revision	A.10.00								

Carrier Index (Only for MSR and LTE-Advanced FDD/TDD)

Sets carrier index of the reference power. The power of the carrier selected by this index becomes reference power when Power Ref is Carrier Index.

Key Path	Meas Setup, Ref Channel, Power Ref
Mode	MSR, LTEAFDD, LTEATDD
Remote Command	[:SENSe] :SEMAsk:CARRier:INDex <integer> [:SENSe] :SEMAsk:CARRier:INDex?
Example	SEM:CARR:IND 1 SEM:CARR:IND?
Notes	You must be in the MSR and LTE-Advanced FDD/TDD mode to use this command. Use :INSTRument:SElect to set the mode.
Preset	1
State Saved	Saved in instrument state
Min	1
Max	MSR:100 LTEAFDD,LTEATDD:5
Initial S/W Revision	A.10.00

Manual (Only for MSR and LTE-Advanced FDD/TDD)

Accesses a menu that sets the manual reference power that is used to compute the relative values for the offsets.

Key Path	Meas Setup, Power Ref
Initial S/W Revision	A.10.00

Total Power

Sets manual total power reference. This is used when Power Ref is Manual and Meas Type is Total Power. See [Total Power](#) for more information.

Key Path	Meas Setup, Ref Channel, Power Ref, Manual
Initial S/W Revision	A.10.00

PSD

Sets manual PSD reference. This is used when Power Ref is Manual and Meas Type is PSD. See [PSD](#) for more information.

Key Path	Meas Setup, Ref Channel, Power Ref, Manual
Initial S/W Revision	A.10.00

Spectrum Peak

Sets manual Spectrum Peak reference. This is used when Power Ref is Manual and Meas Type is Spectrum Peak. See [Spectrum Peak](#) for more information.

Key Path	Meas Setup, Ref Channel, Power Ref, Manual
Initial S/W Revision	A.10.00

Offset/Limits

Accesses a menu that enables you to set up the measurement parameters for offset pairs. For example, you can assign the start and stop frequencies, select the resolution bandwidth, and set the acquisition time. When in the MSR and LTE-Advanced FDD/TDD mode, the softkey label changes to Outer Offset/Limits.

Key Path	Meas Setup
Initial S/W Revision	Prior to A.02.00
Modified at S/W Revision	A.14.00

Select Offset

Selects the offset (upper and lower) and displays the memory selection menu that enables you to store a set of parameter values for the offset, such as Start Freq, Stop Freq, Acq Time, Res BW, Meas BW, Abs Start, and Abs Stop. Only one selection at a time is shown on this menu key label.

Key Path	Meas Setup, Offset/Limits
Mode	SA, WCDMA, C2K, WIMAX OFDMA, TD-SCDMA, 1xEVDO, DTMB (CTTB), DVB-T/H, ISDB-T, CMMB, LTE, LTE-TDD, Digital Cable TV, WLAN, MSR, LTEAFDD, LTEATDD
Preset	A
Range	MSR, LTEATDD, LTEAFDD, WLAN: A B C D E F G H J K L Other modes without option N9060A-7FP: A B C D E F Other modes with option N9060A-7FP: A B C D E F G H J K L
Initial S/W Revision	Prior to A.02.00
Modified at S/W Revision	A.02.00, A.03.00, A.10.00, A.11.00, A.14.00

Start Freq

Specifies the start frequency for the currently selected offset. Also enables you to toggle that offset between On and Off.

Missing values are not permitted; that is, if you want to change values 2 and 6, you must send all values up to 6. Subsequent values will remain as they were. The query for this parameter always returns 12 values.

Key Path	Meas Setup, Offset/Limits
Mode	SA, WCDMA, C2K, WIMAX OFDMA, TD-SCDMA, 1xEVDO, DTMB (CTTB), DVB-T/H, ISDB-T, CMMB, LTE, LTE-TDD, Digital Cable TV, WLAN, MSR, LTEAFDD, LTEATDD
Remote Command	[:SENSe] :SEMAsk:OFFSet [1] 2 [:OUTer] :LIST:FREQuency:STARt <freq>, ... [:SENSe] :SEMAsk:OFFSet [1] 2 [:OUTer] :LIST:FREQuency:STARt? [:SENSe] :SEMAsk:OFFSet [1] 2 [:OUTer] :LIST:STATe ON OFF 1 0, ... [:SENSe] :SEMAsk:OFFSet [1] 2 [:OUTer] :LIST:STATe?
Example	SEM:OFFS2:LIST:FREQ:STAR 2.515 MHz, 2.715 MHz, 3.515 MHz, 4.00 MHz, 8.00 MHz, 12.50 MHz SEM:OFFS2:LIST:FREQ:STAR? SEM:OFFS:LIST:STAT ON, ON, ON, OFF, OFF, OFF SEM:OFFS:LIST:STAT?
Notes	Comma separated list of values. OFFSet1 is for BTS, 2 for MS. Default is BTS. You must be in the mode that includes SEM measurement to use this command. Use :INSTrument:SElect to set the mode.

Couplings	<p>Coupled to Stop Freq. When the start freq goes above the stop freq, the stop freq is automatically adjusted to the start freq plus 100 Hz.</p> <p>If the current mode is DVB-T/H, this value will be modified automatically according to the limit type and the output power of the transmitter which is less or more than 25 W.</p> <p>If the current mode is ISDB-T, this value will be modified automatically according to the limit type.</p>
Preset	<p>For modes (except MSR, LTEAFDD, LTEATDD and WLAN) without option N9060A-7FP, the preset value is as follows.</p> <p>SA: 2.515 MHz, 2.715 MHz, 3.515 MHz, 4.00 MHz, 8.00 MHz, 12.50 MHz</p> <p>WCDMA: 2.515 MHz, 2.715 MHz, 3.515 MHz, 4.000 MHz, 8.000 MHz, 12.50 MHz 2.515MHz, 4.000 MHz, 7.500 MHz, 8.500 MHz, 12.5 MHz, 15 MHz</p> <p>C2K: 750.0 kHz, 780.0 kHz, 1.980 MHz, 3.25 MHz, 7.0 MHz, 7.0 MHz 885 kHz, 1.980 MHz, 2.250 MHz, 8.0 MHz, 12.0 MHz, 12.0 MHz</p> <p>WIMAX OFDMA: 4.75 MHz, 5.45 MHz, 9.75 MHz, 14.75 MHz, 19.75 MHz, 24.75 MHz 4.75 MHz, 5.45 MHz, 9.75 MHz, 14.75 MHz, 19.75 MHz, 24.75 MHz</p> <p>TD-SCDMA:</p> <p>81 5kHz, 1015 kHz, 1815 kHz, 2.3 MHz, , 2.3 MHz, , 2.3 MHz 815 kHz, 1.8 MHz, 2.9 MHz, 2.9 MHz, 2.9 MHz, 2.9 MHz</p> <p>1xEVDO: 750.0 kHz, 780.0 kHz, 1.98 MHz, 3.25 MHz, 7 MHz, 7 MHz 885.0 kHz, 1.98 MHz, 1.98 MHz, 1.98 MHz, 1.98 MHz, 1.98 MHz</p> <p>LTE, LTEATDD: 50 kHz, 5.05 MHz, 10.5 MHz, 15.00 MHz, 30 MHz, 40 MHz 15.00 kHz, 1.5 MHz, 5.5 MHz, 6.5 MHz, 10 MHz, 20MHz</p> <p>When option N9060A-7FP is installed in these modes, the preset value of Offset G ~ L is the same as the Offset F value.</p> <p>-----</p> <p>WLAN:</p> <p>if Radio Std is 802.11a/g(OFDM/DSSS-OFDM)/802.11n(20MHz): 9 MHz, 11 MHz, 20 MHz, 30 MHz, 50 MHz, 216 MHz, 216 MHz, 216 MHz, 216 MHz, 216 MHz, 216 MHz, 216 MHz</p> <p>if Radio Std is 802.11b/g(DSSS/CCK/PBCC): 11 MHz, 22 MHz, 50 MHz, 70 MHz, 90 MHz, 100 MHz, 100 MHz, 100 MHz, 100 MHz, 100 MHz, 100 MHz</p> <p>if Radio Std is 802.11n(20MHz): 9 MHz, 11 MHz, 20 MHz, 30 MHz, 50 MHz, 100 MHz, 100 MHz, 100 MHz, 100 MHz, 100 MHz, 100 MHz</p> <p>if Radio Std is 802.11n(40MHz): 19 MHz, 21 MHz, 40 MHz, 60 MHz, 100 MHz, 200 MHz, 200 MHz, 200 MHz, 200 MHz, 200 MHz, 200 MHz</p> <p>if Radio Std is 802.11ac(20MHz): 9 MHz, 11 MHz, 20 MHz, 30 MHz, 30 MHz, 30 MHz, 30 MHz, 30 MHz, 30 MHz, 30 MHz, 30 MHz</p> <p>if Radio Std is 802.11ac(40MHz): 19 MHz, 21 MHz, 40 MHz, 60 MHz, 60 MHz, 60 MHz, 60 MHz, 60 MHz, 60 MHz, 60 MHz, 60 MHz</p> <p>if Radio Std is 802.11ac(80MHz): 39 MHz, 41 MHz, 80 MHz, 120 MHz, 120 MHz, 120 MHz, 120 MHz, 120 MHz, 120 MHz, 120 MHz, 120 MHz</p> <p>if Radio Std is 802.11ac(160MHz): 79 MHz, 81 MHz, 160 MHz, 240 MHz, 240 MHz, 240 MHz, 240 MHz, 240 MHz, 240 MHz, 240 MHz, 240 MHz</p> <p>if Radio Std is 802.11ac(80 MHz + 80MHz): 0 MHz, 40 MHz, 79 MHz, 159 MHz, 161 MHz, 200 MHz, 240 MHz, 240 MHz, 240 MHz, 240 MHz, 240 MHz, 240 MHz</p> <p>For modes (except MSR, LTEAFDD, LTEATDD and WLAN) without option N9060A-7FP, the preset value is as follows.</p>

SA: ON, ON, ON, ON, ON, OFF
WCDMA: ON, ON, ON, ON, ON, OFF|ON, ON, ON, ON, OFF, OFF
C2K: ON, ON, ON, OFF, OFF, OFF|ON, ON, OFF, OFF, OFF, OFF
WIMAX OFDMA: ON, ON, ON, OFF, OFF, OFF|ON, ON, ON, OFF, OFF, OFF
TD-SCDMA: ON, ON, ON, ON, OFF, OFF|ON, ON, ON, OFF, OFF, OFF
1xEVDO: ON, ON, ON, OFF, OFF, OFF|ON, ON, OFF, OFF, OFF, OFF
LTE, LTE-TDD: ON, ON, ON, OFF, OFF, OFF|ON, ON, ON, ON, OFF, OFF
When option N9060A-7FP is installed in these modes, the preset value of Offset G ~ L is the same as the Offset F value.

WLAN:
if Radio Std is 802.11b/g(DSSS/CCK/PBCC): ON, ON, OFF, OFF, OFF, OFF, OFF, OFF, OFF, OFF, OFF, OFF
if Radio Std is 802.11a/g(OFDM/DSSS-OFDM)/802.11n(20MHz/40MHz): ON, ON, ON, OFF, OFF, OFF, OFF, OFF, OFF, OFF, OFF, OFF
if Radio Std is 802.11ac (20 MHz/ 40 MHz/ 80 MHz/ 160 MHz): ON, ON, ON, OFF, OFF, OFF, OFF, OFF, OFF, OFF, OFF, OFF
if Radio Std is 802.11ac (80 MHz + 80 MHz): ON, ON, ON, OFF, ON, ON, ON, OFF, OFF, OFF, OFF, OFF, OFF

State Saved	Saved in instrument state.
Min	0 Hz
Max	499.9999 MHz
Initial S/W Revision	Prior to A.02.00
Modified at S/W Revision	A.02.00, A.03.00, A.10.00, A.11.00, A.14.00

Stop Freq

Specifies the stop frequency for the currently selected offset.

Missing values are not permitted; that is, if you want to change values 2 and 6, you must send all values up to 6. Subsequent values will remain as they were. The query for this parameter always returns 12 values.

Key Path	Meas Setup, Offset/Limits
Mode	SA, WCDMA, C2K, WIMAX OFDMA, TD-SCDMA, 1xEVDO, DTMB (CTTB), DVB-T/H, ISDB-T, CMMB, LTE, LTE-TDD, Digital Cable TV, WLAN, MSR, LTEAFDD, LTEATDD
Remote Command	[:SENSe] :SEMAsk:OFFSet [1] 2 [:OUTer] :LIST:FREQuency:STOP <freq>, ... [:SENSe] :SEMAsk:OFFSet [1] 2 [:OUTer] :LIST:FREQuency:STOP?
Example	SEM:OFFS:LIST:FREQ:STOP 2.715 MHz, 3.515 MHz, 4.00 MHz, 8.00 MHz, 12.50 MHz, 15.0 MHz SEM:OFFS:LIST:FREQ:STOP?
Notes	Comma separated list of values. OFFSet1 is for BTS, 2 for MS. Default is BTS.

	<p>You must be in the mode that includes SEM measurement to use this command. Use :INSTRument:SElect to set the mode.</p>
Couplings	<p>Coupled to Start Freq. When the stop freq goes below the start freq, the start freq is automatically adjusted to the stop freq minus 100 Hz.</p> <p>If the current mode is DVB-T/H, this value will be modified automatically according to the limit type and the output power of the transmitter which is less or more than 25 W.</p> <p>If the current mode is ISDB-T, this value will be modified automatically according to the limit type.</p>
Preset	<p>For modes (except MSR, LTEAFDD, LTEATDD and WLAN) without option N9060A-7FP, the preset value is as follows.</p> <p>SA: 2.715 MHz, 3.515 MHz, 4.00 MHz, 8.00 MHz, 12.50 MHz, 15.0 MHz</p> <p>WCDMA: 2.715 MHz, 3.515 MHz, 4.000 MHz, 8.000 MHz, 12.50 MHz, 15.0 MHz 3.485 MHz, 7.500 MHz, 8.500 MHz, 12.00 MHz, 15.00 MHz, 18.0 MHz</p> <p>C2K: 780.0 kHz, 1.980 MHz, 4.0 MHz, 4.0 MHz, 12.0 MHz, 12.0 MHz 1.980 MHz, 4.0 MHz, 4.0 MHz, 11.5 MHz, 14.5 MHz, 14.5 MHz</p> <p>WIMAX OFDMA: 5.45 MHz, 9.75 MHz, 14.75 MHz, 19.75 MHz, 24.75 MHz, 29.75 MHz 5.45 MHz, 9.75 MHz, 14.75 MHz, 19.75 MHz, 24.75 MHz, 29.75 MHz</p> <p>TD-SCDMA:</p> <p>1015 kHz, 1815 kHz, 2.3 MHz, 4 MHz, 4 MHz, 4 MHz 1.8 MHz, 2385 kHz, 3.5 MHz, 3.5 MHz, 3.5 MHz, 3.5 MHz</p> <p>1xEVDO: 780.0 kHz, 1.98 MHz, 4.0 MHz, 4.0 MHz, 12 MHz, 12 MHz 1.98 MHz, 4.0 MHz, 4.0 MHz, 4.0 MHz, 4.0 MHz, 4.0 MHz</p> <p>When option N9060A-7FP is installed in these modes, the preset value of Offset G ~ L is the same as the Offset F value.</p> <p>-----</p> <p>WLAN:</p> <p>if Radio Std is 802.11a/g(OFDM/DSSS-OFDM)/802.11n(20MHz): 11 MHz, 20 MHz, 30 MHz, 50 MHz, 100 MHz, 250 MHz, 250 MHz, 250 MHz, 250 MHz, 250 MHz, 250 MHz, 250 MHz</p> <p>if Radio Std is 802.11b/g(DSSS/CCK/PBCC): 22 MHz, 50 MHz, 70 MHz, 90 MHz, 100 MHz, 120 MHz, 120 MHz, 120 MHz, 120 MHz, 120 MHz, 120 MHz, 120 MHz</p> <p>if Radio Std is 802.11n(20MHz): 11 MHz, 20 MHz, 30 MHz, 50 MHz, 100 MHz, 200 MHz, 200 MHz, 200 MHz, 200 MHz, 200 MHz, 200 MHz, 200 MHz</p> <p>if Radio Std is 802.11n(40MHz): 21 MHz, 40 MHz, 60 MHz, 100 MHz, 200 MHz, 300 MHz, 300 MHz, 300 MHz, 300 MHz, 300 MHz, 300 MHz, 300 MHz</p> <p>if Radio Std is 802.11ac(20MHz): 11 MHz, 20 MHz, 30 MHz, 50 MHz, 50 MHz, 50 MHz, 50 MHz, 50 MHz, 50 MHz, 50 MHz, 50 MHz, 50 MHz</p> <p>if Radio Std is 802.11ac(40MHz): 21 MHz, 40 MHz, 60 MHz, 100 MHz, 100 MHz, 100 MHz, 100 MHz, 100 MHz, 100 MHz, 100 MHz, 100 MHz, 100 MHz</p> <p>if Radio Std is 802.11ac(80MHz): 41 MHz, 80 MHz, 120 MHz, 200 MHz, 200 MHz, 200 MHz, 200 MHz, 200 MHz, 200 MHz, 200 MHz, 200 MHz, 200 MHz</p> <p>if Radio Std is 802.11ac(160MHz): 81 MHz, 160 MHz, 240 MHz, 400 MHz, 400 MHz, 400 MHz, 400 MHz, 400 MHz, 400 MHz, 400 MHz, 400 MHz, 400 MHz</p> <p>if Radio Std is 802.11ac(80 MHz + 80MHz): 40 MHz, 79 MHz, 81 MHz, 161 MHz, 200 MHz, 240 MHz, 260 MHz, 260 MHz, 260 MHz, 260 MHz, 260 MHz, 260 MHz</p>
State Saved	<p>Saved in instrument state.</p>

Min	100 Hz
Max	500 MHz
Initial S/W Revision	Prior to A.02.00
Modified at S/W Revision	A.02.00, A.03.00, A.10.00, A.11.00, A.14.00

Acq Time

Specifies the acquisition time for the currently selected offset and enables you to toggle the Acq Time mode between Auto and Man.

Missing values are not permitted; that is, if you want to change values 2 and 6, you must send all values up to 6. Subsequent values will remain as they were. The query for this parameter always returns 12 values.

Key Path	Meas Setup, Offset/Limits
Mode	SA, WCDMA, C2K, WIMAX OFDMA, TD-SCDMA, 1xEVDO, DTMB (CTTB), DVB-T/H, ISDB-T, CMMB, LTE, LTEFDD, Digital Cable TV, WLAN, MSR, LTEAFDD, LTEATDD
Remote Command	<pre>[:SENSE] :SEMAsk:OFFSet [1] 2 [:OUTer] :LIST:SWEep:TIME <time>, ... [:SENSE] :SEMAsk:OFFSet [1] 2 [:OUTer] :LIST:SWEep:TIME? [:SENSE] :SEMAsk:OFFSet [1] 2 [:OUTer] :LIST:SWEep:TIME:AUTO ON OFF 1 0, ... [:SENSE] :SEMAsk:OFFSet [1] 2 [:OUTer] :LIST:SWEep:TIME:AUTO?</pre>
Example	<pre>SEM:OFFS2:LIST:SWE:TIME 1.0 ms, 3.4 ms, 2.08 ms, 1.0 ms, 1.0 ms, 1.0 ms SEM:OFFS2:LIST:SWE:TIME? SEM:OFFS2:LIST:SWE:TIME:AUTO ON, ON, ON, ON, OFF, OFF SEM:OFFS2:LIST:SWE:TIME:AUTO?</pre>
Notes	<p>Comma separated list of values.</p> <p>OFFSet1 is for BTS, 2 for MS. Default is BTS.</p> <p>You must be in the mode that includes SEM measurement to use this command. Use :INSTrument:SElect to set the mode.</p>
Couplings	<p>When the acquisition time is set manually, Acq Time Mode is set to MANUAL.</p> <p>If the current mode is DVB-T/H, this value will be modified automatically according to the output power of the transmitter which is less or more than 25W.</p> <p>If the current mode is ISDB-T, this value will be modified automatically according to the limit type.</p>
Preset	<p>Automatically calculated</p> <p>Modes (except MSR, LTEAFDD, LTEATDD and WLAN) without option N9060A-7FP: ON, ON, ON, ON, ON, ON, ON</p> <p>Modes (except MSR, LTEAFDD, LTEATDD and WLAN) with option N9060A-7FP: ON, ON, ON, ON, ON, ON, ON, ON, ON, ON, ON, ON</p> <p>WLAN: ON, ON, ON, ON, ON, ON, ON, ON, ON, ON, ON, ON</p>
State Saved	Saved in instrument state.

Min	TBD
Max	4000 s
Backwards Compatibility SCPI	[:SENSe] :SEMAsk:OFFSet [1] 2 :LIST:SWEep [:TIME]
Initial S/W Revision	Prior to A.02.00
Modified at S/W Revision	A.02.00, A.03.00, A.10.00, A.11.00, A.14.00

Offset Side

Specifies which offset side to measure.

You can turn off (not use) specific offsets with [:SENSe]:SEMAsk:OFFSet[n][:OUTer]:LIST:STATe.

- BOTH – Both of the negative (lower) and positive (upper) sidebands
- NEGative – Negative (lower) sideband only
- POSitive – Positive (upper) sideband only

Missing values are not permitted; that is, if you want to change values 2 and 6, you must send all values up to 6. Subsequent values will remain as they were. The query for this parameter always returns 12 values.

The figure below shows the relation between the negative/positive offset side setups and the upper/lower results in the MSR and LTE-Advanced FDD/TDD.

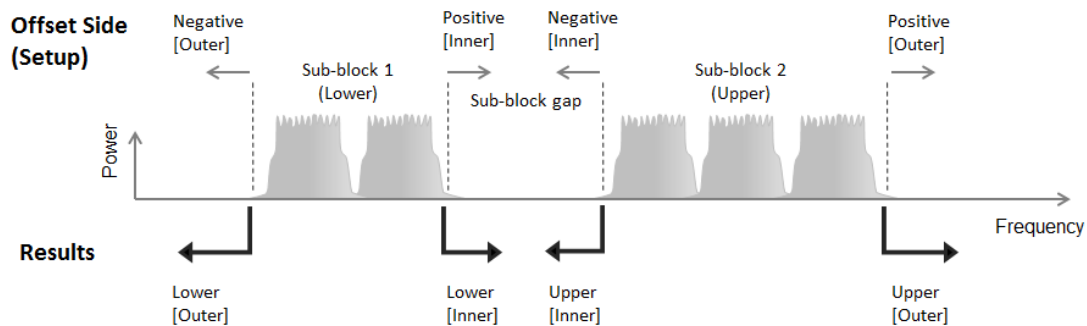

Key Path	Meas Setup, Offset/Limits
Mode	SA, WCDMA, C2K, WIMAX OFDMA, TD-SCDMA, 1xEVDO, DTMB (CTTB), DVB-T/H, ISDB-T, CMMB, LTE, LTE-TDD, Digital Cable TV, WLAN, MSR, LTEAFDD, LTEATDD
Remote Command	[:SENSe] :SEMAsk:OFFSet [1] 2 [:OUTer] :LIST:SIDE BOTH NEGative POSitive, ... [:SENSe] :SEMAsk:OFFSet [1] 2 [:OUTer] :LIST:SIDE?
Example	SEM:OFFS:LIST:SIDE BOTH, NEG, NEG, POS, POS, POS SEM:OFFS:LIST:SIDE?
Notes	Comma separated list of values. OFFSet1 is for BTS, 2 for MS. Default is BTS.

	You must be in the mode that includes SEM measurement to use this command. Use :INSTrument:SElect to set the mode.
Preset	Modes (except MSR, LTEAFDD, LTEATDD and WLAN) without option N9060A-7FP: BOTH, BOTH, BOTH, BOTH, BOTH, BOTH Modes (except MSR, LTEAFDD, LTEATDD and WLAN) with option N9060A-7FP: BOTH, BOTH, BOTH, BOTH, BOTH, BOTH, BOTH, BOTH, BOTH, BOTH, BOTH WLAN: BOTH, BOTH, BOTH, BOTH, BOTH, BOTH, BOTH, BOTH, BOTH, BOTH, BOTH, BOTH
State Saved	Saved in instrument state.
Range	Neg Both Pos
Initial S/W Revision	Prior to A.02.00
Modified at S/W Revision	A.02.00, A.03.00, A.10.00, A.11.00, A.14.00

Res BW

Specifies which Resolution BW filter to use when measuring the currently selected offset.

Offset Res BW Mode allows the instrument to determine the optimum Resolution BW filter to use when measuring the currently selected offset.. When changing the Meas BW parameter, if the Res BW needs to be changed to adhere to the rule

$(N \times \text{Res BW}) \leq (\text{Stop freq of the offset} - \text{Start freq of the offset})$,

where N is the multiplier, this setting will automatically be changed to manual.

Missing values are not permitted; that is, if you want to change values 2 and 6, you must send all values up to 6. Subsequent values will remain as they were. The query for this parameter always returns 12 values.

Key Path	Meas Setup, Offset/Limits
Mode	SA, WCDMA, C2K, WIMAX OFDMA, TD-SCDMA, 1xEVDO mode, DTMB (CTTB), DVB-T/H, ISDB-T, CMMB, LTE, LTEFDD, Digital Cable TV, WLAN, MSR, LTEAFDD, LTEATDD
Remote Command	[:SENSe] :SEMAsk:OFFSet [1] 2 [:OUTer] :LIST:BA NDwidth [:RESolution] <bandwidth>, ... [:SENSe] :SEMAsk:OFFSet [1] 2 [:OUTer] :LIST:BA NDwidth [:RESolution] ? [:SENSe] :SEMAsk:OFFSet [1] 2 [:OUTer] :LIST:BA NDwidth [:RESolution] :AUTO OFF ON 1 0, ... [:SENSe] :SEMAsk:OFFSet [1] 2 [:OUTer] :LIST:BA NDwidth [:RESolution] :AUTO?
Example	SEM:OFFS2:LIST:BA ND 30.0 kHz, 30.0 kHz, 30.0 kHz, 1.00 MHz, 1.00 MHz, 1.00 MHz SEM:OFFS2:LIST:BA ND? SEM:OFFS:LIST:BA ND:AUTO 1,1,1,1,1,1 SEM:OFFS:LIST:BA ND:AUTO?
Notes	Comma separated list of values. OFFSet1 is for BTS, 2 for MS. Default is BTS. You must be in the mode that includes SEM measurement to use this command. Use :INSTrument:SElect to set the mode.

Couplings	<p>Coupled to Start and Stop offset and Meas BW multiplier. This parameter must adhere to the rule (N x Res BW) <= (Stop freq of the offset - Start freq of the offset), where N is the multiplier. If the multiplier is changed, the Res BW will be changed to ensure this. When set manually, Res BW Coupling is set to manual.</p> <p>The resolution bandwidth is coupled to the offset width determined by the start frequency and stop frequency.</p>
Preset	<p>For modes (except MSR, LTEAFDD, LTEATDD and WLAN) without option N9060A-7FP, the preset value is as follows.</p> <p>SA: 30.0 kHz, 30.0 kHz, 30.0 kHz, 1.00 MHz, 1.00 MHz, 1.00 MHz</p> <p>WCDMA: 30.00 kHz, 30.00 kHz, 30.00 kHz, 100.00 kHz, 1.000 MHz, 1.00 MHz 30.00 kHz, 1.000 MHz, 1.000 MHz, 1.000 MHz, 1.000 MHz, 1.00 MHz</p> <p>C2K: 3.00 kHz, 30.00 kHz, 30.00 kHz, 6.2 kHz, 1.000 MHz, 1.00 MHz 30.00 kHz, 30.00 kHz, 6.2 kHz, 1.000 MHz, 1.000 MHz, 1.00 MHz</p> <p>WIMAX OFDMA: 100 KHz, 100 KHz, 100 KHz, 100 KHz, 100 KHz, 100 KHz 100 KHz, 100 KHz, 100 KHz, 100 KHz, 100 KHz, 100 KHz</p> <p>TD-SCDMA: 30 kHz, 30 kHz, 30 kHz, 50 kHz, 1 MHz, 1 MHz 30 kHz, 30 kHz, 50 kHz, 1 MHz, 1 MHz, 1 MHz</p> <p>1xEVDO: 30.00 kHz, 30.00 kHz, 30.00 kHz, 6.2 kHz, 1.000 MHz, 1.000 MHz 30.00 kHz, 30.00 kHz, 30.00 kHz, 30.00 kHz, 30.00 kHz, 30.00 kHz</p> <p>LTE, LTEFDD, LTEATDD: 51 kHz, 100 kHz, 1.0 MHz, 1.0 MHz, 1.0 MHz, 1.0 MHz 15.0 kHz, 510 kHz, 1.0 MHz, 1.0 MHz, 1.0 MHz, 1.0 MHz</p> <p>When option N9060A-7FP is installed in these modes, the preset value of Offset G ~ L is the same as the Offset F value.</p> <p>-----</p> <p>WLAN: 100 KHz, 100 KHz, 100 KHz, 100 KHz, 100 KHz, 100 KHz, 100 KHz, 100 KHz, 100 KHz, 100 KHz, 100 KHz, 100 KHz</p> <p>Modes (except MSR, LTEAFDD, LTEATDD and WLAN) without option N9060A-7FP: OFF, OFF, OFF, OFF, OFF, OFF, OFF OFF, OFF, OFF, OFF, OFF, OFF</p> <p>Modes (except MSR, LTEAFDD, LTEATDD and WLAN) with option N9060A-7FP: OFF, OFF, OFF, OFF, OFF, OFF, OFF, OFF, OFF, OFF, OFF, OFF OFF, OFF, OFF, OFF, OFF, OFF, OFF, OFF, OFF, OFF, OFF, OFF</p> <p>WLAN: OFF, OFF, OFF, OFF, OFF, OFF, OFF, OFF, OFF, OFF, OFF, OFF OFF, OFF, OFF, OFF, OFF, OFF, OFF, OFF, OFF, OFF, OFF, OFF</p>
State Saved	Saved in instrument state.
Min	1 Hz
Max	8 MHz
Backwards Compatibility SCPI	[:SENSe] :SEMask:OFFSet [1] 2 :LIST:BWIDth [:RESolution]
Initial S/W Revision	Prior to A.02.00
Modified at S/W Revision	A.02.00, A.03.00, A.10.00, A.11.00, A.14.00

Meas BW

Allows you to specify a multiplier of Res BW for the measurement integration bandwidth.

Meas BW is multiplier integer number. It shows a ratio between Integration BW and Resolution BW of the measurement result.

$$\text{Integ BW} = \text{Meas BW} * \text{Resolution BW}$$

Integration BW is desired resolution bandwidth and Resolution BW is actual bandwidth for sweep. Measurement sweeps with Resolution BW and Meas BW compensates sweep resolution bandwidth to Integration BW.

If you set this parameter greater than 1, you can set Resolution BW narrower to avoid carrier power leakage effect to the offset power integration.

Missing values are not permitted; that is, if you want to change values 2 and 6, you must send all values up to 6. Subsequent values will remain as they were. The query for this parameter always returns 12 values.

Key Path	Meas Setup, Offset/Limits
Mode	SA, WCDMA, C2K, WIMAX OFDMA, TD-SCDMA, 1xEVDO, DTMB (CTTB), DVB-T/HISDB-T, CMMB, LTE, LTETDD, Digital Cable TV, WLAN
Remote Command	<code>[:SENSe] :SEMAsk:OFFSet [1] 2 [:OUTer] :LIST:BAWdth:IMULti <integer>, ...</code> <code>[:SENSe] :SEMAsk:OFFSet [1] 2 [:OUTer] :LIST:BAWdth:IMULti?</code>
Example	SEM:OFFS2:LIST:BAND:IMUL 1,1,1,1,1 SEM:OFFS2:LIST:BAND:IMUL?
Notes	Comma separated list of values. OFFSet1 is for BTS, 2 for MS. Default is BTS. You must be in the mode that includes SEM measurement to use this command. Use :INSTRument:SElect to set the mode.
Couplings	This parameter must adhere to the rule $(N \times \text{Res BW}) \leq (\text{Stop freq of the offset} - \text{Start freq of the offset})$, where N is the multiplier. If the Res Bw is changed, the multiplier will be changed to ensure this.
Preset	For modes (except MSR, LTEAFDD, LTEATDD and WLAN) without option N9060A-7FP, the preset value is as follows. SA: 1, 1, 1, 1, 1, 1 WCDMA: 1, 1, 1, 10, 1, 1 1, 1, 1, 1, 1, 1 C2K: 10, 1, 1, 1, 1, 1 1, 1, 1, 1, 1, 1 WIMAX OFDMA, 1xEVDO: 1, 1, 1, 1, 1, 1 1, 1, 1, 1, 1, 1 TD-SCDMA:1, 1, 1, 20, 1, 1 1, 1, 20, 1, 1, 1 LTE, LTETDD: 2, 1, 1, 1, 1, 1 2, 2, 1, 1, 1, 1 When option N9060A-7FP is installed in these modes, the preset value of Offset G ~ L is the same as the Offset F value. ----- WLAN: 1, 1, 1, 1, 1, 1, 1, 1, 1, 1, 1, 1
State Saved	Saved in instrument state.
Min	1
Max	1000
Backwards Compatibility SCPI	<code>[:SENSe] :SEMAsk:OFFSet [1] 2 :LIST:BWIDth:IMULti</code>

Initial S/W Revision	Prior to A.02.00
Modified at S/W Revision	A.02.00, A.03.00, A.10.00, A.11.00, A.14.00

Video BW

Changes the analyzer post-detection filter.

Missing values are not permitted; that is, if you want to change values 2 and 6, you must send all values up to 6. Subsequent values will remain as they were. The query for this parameter always returns 12 values.

Key Path	Meas Setup, Offset/Limits
Mode	SA, WCDMA, C2K, WIMAXOFDMA, TD-SCDMA, 1xEVDO, DTMB (CTTB), DVB-T/H, ISDB-T, CMMB, LTE, LTEFDD, Digital Cable TV, WLAN, MSR, LTEAFDD, LTEATDD
Remote Command	[:SENSe]:SEMask:OFFSet [1] 2 [:OUTer]:LIST:BANDwidth:VIDeo <freq>, ... [:SENSe]:SEMask:OFFSet [1] 2 [:OUTer]:LIST:BANDwidth:VIDeo? [:SENSe]:SEMask:OFFSet [1] 2 [:OUTer]:LIST:BANDwidth:VIDeo:AUTO OFF ON 0 1, ... [:SENSe]:SEMask:OFFSet [1] 2 [:OUTer]:LIST:BANDwidth:VIDeo:AUTO?
Example	SEM:OFFS2:LIST:BAND:VID 3.00 kHz, 3.00 kHz, 3.00 kHz, 100.0 kHz, 100.0 kHz, 100.0 kHz SEM:OFFS2:LIST:BAND:VID? SEM:OFFS2:LIST:BAND:VID:AUTO ON, ON, ON, ON, ON, ON SEM:OFFS2:LIST:BAND:VID:AUTO?
Notes	Comma separated list of values. OFFSet1 is for BTS, 2 for MS. Default is BTS. You must be in the mode that includes SEM measurement to use this command. Use :INSTrument:SElect to set the mode.
Preset	ISDB-T: 1.0kHz, 1.0kHz, 1.0kHz, 1.0kHz, 1.0kHz, 1.0kHz Other than ISDB-T: Automatically Calculated Modes (except MSR, LTEAFDD, LTEATDD, WLAN, ISDB-T) without option N9060A-7FP: ON, ON, ON, ON, ON, ON ON, ON, ON, ON, ON, ON Modes (except MSR, LTEAFDD, LTEATDD, WLAN, ISDB-T) with option N9060A-7FP:ON, ON, ON, ON, ON, ON, ON, ON, ON, ON, ON, ON ON, ON, ON, ON, ON, ON, ON, ON, ON, ON, ON, ON ----- WLAN: ON, ON, ON, ON, ON, ON, ON, ON, ON, ON, ON, ON ON, ON, ON, ON, ON, ON, ON, ON, ON, ON, ON, ON
State Saved	Saved in instrument state.
Min	1 Hz
Max	50 MHz
Backwards Compatibility SCPI	[:SENSe]:SEMask:OFFSet [1] 2 :LIST:BWIDth:VIDeo
Initial S/W Revision	Prior to A.02.00
Modified at S/W Revision	A.02.00, A.03.00, A.10.00, A.11.00, A.14.00

VBW/RBW

Selects the ratio between the video and resolution bandwidths.

Missing values are not permitted; that is, if you want to change values 2 and 6, you must send all values up to 6. Subsequent values will remain as they were. The query for this parameter always returns 12 values.

Key Path	Meas Setup, Offset/Limits
Mode	SA, WCDMA, C2K, WIMAX OFDMA, TD-SCDMA, 1xEVDO, DTMB (CTTB), DVB-T/H, ISDB-T, CMMB, LTE, LTE-TDD, Digital Cable TV, WLAN, MSR, LTEAFDD, LTEATDD
Remote Command	[:SENSe]:SEMAsk:OFFSet[1] 2[:OUTer]:LIST:BANDwidth:VIDeo:RATio <real>, ... [:SENSe]:SEMAsk:OFFSet[1] 2[:OUTer]:LIST:BANDwidth:VIDeo:RATio? [:SENSe]:SEMAsk:OFFSet[1] 2[:OUTer]:LIST:BANDwidth:VIDeo:RATio:AUTO OFF ON 0 1, ... [:SENSe]:SEMAsk:OFFSet[1] 2[:OUTer]:LIST:BANDwidth:VIDeo:RATio:AUTO?
Example	SEM:OFFS2:LIST:BAND:VID:RAT 0.1, 0.1, 0.1, 0.1, 0.1, 0.1 SEM:OFFS2:LIST:BAND:VID:RAT? SEM:OFFS2:LIST:BAND:VID:RAT:AUTO ON, ON, ON, ON, ON, ON SEM:OFFS2:LIST:BAND:VID:RAT:AUTO?
Notes	Comma separated list of values. OFFSet1 is for BTS, 2 for MS. Default is BTS. You must be in the mode that includes SEM measurement to use this command. Use :INSTrument:SElect to set the mode.
Preset	For modes (except MSR, LTEAFDD, LTEATDD and WLAN) without option N9060A-7FP, the preset value is as follows. SA, WCDMA, C2K, LTE, LTE-TDD: 0.01, 0.01, 0.01, 0.01, 0.01, 0.01 0.01, 0.01, 0.01, 0.01, 0.01, 0.01 WIMAX OFDMA: 0.3, 0.3, 0.3, 0.3, 0.3, 0.3 TD-SCDMA: 10, 10, 10, 10, 1, 1 10, 10, 10, 1, 1, 1 1xEVDO: 10, 10, 10, 10, 10, 10 10, 10, 10, 10, 10, 10 When option N9060A-7FP is installed in these modes, the preset value of Offset G ~ L is the same as the Offset F value. ----- WLAN: 0.3, 0.3, 0.3, 0.3, 0.3, 0.3, 0.3, 0.3, 0.3, 0.3, 0.3, 0.3 Modes (except MSR, LTEAFDD, LTEATDD and WLAN) without option N9060A-7FP: OFF, OFF, OFF, OFF, OFF, OFF OFF, OFF, OFF, OFF, OFF, OFF Modes (except MSR, LTEAFDD, LTEATDD and WLAN) with option N9060A-7FP: OFF, OFF, OFF, OFF, OFF, OFF, OFF, OFF, OFF, OFF OFF, OFF, OFF, OFF, OFF, OFF, OFF, OFF, OFF, OFF, OFF, OFF WLAN: OFF, OFF, OFF, OFF, OFF, OFF, OFF, OFF, OFF, OFF OFF, OFF, OFF, OFF, OFF, OFF, OFF, OFF
State Saved	Saved in instrument state.

Min	0.00001
Max	3000000
Initial S/W Revision	Prior to A.02.00
Modified at S/W Revision	A.02.00, A.03.00, A.10.00, A.11.00, A.14.00

Limits

Accesses a menu that enables you to set the power limits for start and stop frequencies of the selected offsets.

Key Path	Meas Setup
Initial S/W Revision	Prior to A.02.00

Select Offset

Selects the offset (upper and lower) and displays the memory selection menu that enables you to store a set of parameter values for the offset, such as Start Freq, Stop Freq, Acq Time, Res BW, Meas BW, Abs Start, and Abs Stop. Only one selection at a time is shown on this menu key label.

Key Path	Meas Setup, Offset/Limits
Mode	SA, WCDMA, C2K, WIMAX OFDMA, TD-SCDMA, 1xEVDO, DTMB (CTTB), DVB-T/H, ISDB-T, CMMB, LTE, LTE-TDD, Digital Cable TV, WLAN, MSR, LTEAFDD, LTEATDD
Preset	A
Range	MSR, LTEATDD, LTEAFDD, WLAN: A B C D E F G H J K L Other modes without option N9060A-7FP: A B C D E F Other modes with option N9060A-7FP: A B C D E F G H J K L
Initial S/W Revision	Prior to A.02.00
Modified at S/W Revision	A.02.00, A.03.00, A.10.00, A.11.00, A.14.00

Abs Start

Sets the absolute power level limit at the start frequency for the selected offset. The absolute power level limit ranges from -200 to +50 dBm.

The fail condition for each offset channel is set remotely by [:SENSe]:SEMAsk:OFFSet[n]
[:OUTer]:LIST:TEST.

You can turn off (not use) specific offset channels remotely with [:SENSe]:SEMAsk:OFFSet[n]
[:OUTer]:LIST:STATe.

The SCPI query returns values currently set to the absolute power test limits.

Missing values are not permitted; that is, if you want to change values 2 and 6, you must send all values up to 6. Subsequent values will remain as they were. The query for this parameter always returns 12 values.

Key Path	Meas Setup, Offset/Limit, Limits
Mode	SA, WCDMA, C2K, WIMAX OFDMA, TD-SCDMA, 1xEVDO, DTMB (CTTB), DVB-T/H, ISDB-T, CMMB, LTE, LTE-TDD, Digital Cable TV, WLAN, MSR, LTEAFDD, LTEATDD
Remote Command	[:SENSe] :SEMAsk:OFFSet [1] 2 [:OUTer] :LIST:STARt:ABSolute <real>, ... [:SENSe] :SEMAsk:OFFSet [1] 2 [:OUTer] :LIST:STARt:ABSolute?
Example	SEM:OFFS2:LIST:STAR:ABS -12.50 dBm, -12.50 dBm, -24.50 dBm, -11.50 dBm, -11.50 dBm, -11.50 dBm SEM:OFFS2:LIST:STAR:ABS?
Notes	Comma separated list of values. OFFSet1 is for BTS, 2 for MS. Default is BTS. You must be in the mode that includes SEM measurement to use this command. Use :INSTrument:SElect to set the mode.
Couplings	If the current mode is DVB-T/H, this value will be modified automatically according to the limit type and the output power of the transmitter which is less or more than 25W. If the current mode is ISDB-T, this value will be modified automatically according to the limit type.
Preset	For modes (except MSR, LTEAFDD, LTEATDD and WLAN) without option N9060A-7FP, the preset value is as follows. SA, WIMAX OFDMA: -14.00 dBm , -14.00 dBm , -26.00 dBm , -13.00 dBm , -13.00 dBm, -13.00 dBm WCDMA: -12.50 dBm, -12.50 dBm, -24.50 dBm, -11.50 dBm, -11.50 dBm, -11.50 dBm -69.6 dBm, -54.3 dBm, -54.3 dBm, -54.3 dBm, -54.3 dBm, -54.3 dBm C2K: -27.00 dBm, -27.00 dBm, -27.00 dBm, -46.00 dBm, -13.00 dBm, -13.00 dBm -70.13 dBm, -70.13 dBm, -35.00 dBm, -13.00 dBm, -13.00 dBm, -13.00 dBm TD-SCDMA: -28 dBm, -28 dBm, -36 dBm, -21 dBm, -21 dBm, -21 dBm -71.3 dBm, -71.3 dBm, -56.07 dBm, -56.07 dBm, -56.07 dBm, -56.07 dBm 1xEVDO: -27.0dBm, -27.00 dBm, -27.00 dBm, -46.00 dBm, -13.00 dBm, -13.00 dBm -70.13 dBm, -70.13 dBm, -70.13 dBm, -70.13 dBm, -70.13 dBm, -70.13 dBm LTE, LTE-TDD: -5.5 dBm, -12.5 dBm, -15.0 dBm, -15.0 dBm, -15.0 dBm, -15.0 dBm -13.5 dBm, -8.5 dBm, -11.5 dBm, -23.5 dBm, -23.5 dBm, -23.5 dBm When option N9060A-7FP is installed in these modes, the preset value of Offset G ~ L is the same as the Offset F value. ----- WLAN: if Radio Std is 802.11a/g(OFDM/DSSS-OFDM): 16.00 dBm, -4.00 dBm, -12.00 dBm, -24.00 dBm, -24.00 dBm, -24.00 dBm, -24.00 dBm, -24.00 dBm, -24.00 dBm, -24.00 dBm, -24.00 dBm, -24.00 dBm if Radio Std is 802.11b/g(DSSS/CCK/PBCC): -10 dBm, -30 dBm, -30 dBm, -30 dBm, -30 dBm, -30 dBm, -30 dBm, -30 dBm, -30 dBm, -30 dBm, -30 dBm, -30 dBm if Radio Std is 802.11n(20MHz) or 802.11ac(20MHz): 16.00 dBm, -4.00 dBm, -12.00 dBm, -63.00 dBm, -63.00 dBm, -63.00 dBm, -63.00 dBm, -63.00 dBm, -63.00 dBm, -63.00 dBm, -63.00 dBm, -63.00 dBm

	<p>if Radio Std is 802.11n(40MHz) or 802.11ac(40MHz): 16.00 dBm, -4.00 dBm, -12.00 dBm, -66.00 dBm, -66.00 dBm, -66.00 dBm, -66.00 dBm, -66.00 dBm, -66.00 dBm, -66.00 dBm, -66.00 dBm, -66.00 dBm, -66.00 dBm, -66.00 dBm</p> <p>if Radio Std is 802.11ac(80MHz/160MHz): 16.00 dBm, -4.00 dBm, -12.00 dBm, -69.00 dBm, -69.00 dBm, -69.00 dBm, -69.00 dBm, -69.00 dBm, -69.00 dBm, -69.00 dBm, -69.00 dBm, -69.00 dBm, -69.00 dBm, -69.00 dBm, -69.00 dBm</p> <p>if Radio Std is 802.11ac (80 MHz + 80 MHz): -69.00 dBm, -69.00 dBm, -69.00 dBm, -69.00 dBm, -69.00 dBm, -69.00 dBm, -69.00 dBm, -69.00 dBm, -69.00 dBm, -69.00 dBm, -69.00 dBm, -69.00 dBm, -69.00 dBm, -69.00 dBm, -69.00 dBm</p>
State Saved	Saved in instrument state.
Min	-200 dBm
Max	50 dBm
Initial S/W Revision	Prior to A.02.00
Modified at S/W Revision	A.02.00, A.03.00, A.10.00, A.11.00, A.14.00

Abs Stop

Sets the absolute power level limit at the stop frequency for the selected offset. The absolute power level limit ranges from -200 to +50 dBm. You can also toggle this function between couple and manual. If set to Couple, the Abs Stop power level limit is coupled to Abs Start to result in a flat limit line. If set to Man, Abs Start and Abs Stop take different values to result in a sloped limit line.

The SCPI query returns values currently set to the offset stop absolute power limits.

Missing values are not permitted; that is, if you want to change values 2 and 6, you must send all values up to 6. Subsequent values will remain as they were. The query for this parameter always returns 12 values.

Key Path	Meas Setup, Offset/Limits, Limits
Mode	SA, WCDMA, C2K, WIMAX OFDMA, TD-SCDMA, 1xEVDO, DTMB (CTTB), DVB-T/H, ISDB-T, CMMB, LTE, LTE-TDD, Digital Cable TV, WLAN, MSR, LTEAFDD, LTEATDD
Remote Command	<pre>[:SENSe] :SEMAsk:OFFSet [1] 2 [:OUTer] :LIST:STOP:ABSolute <real>, ... [:SENSe] :SEMAsk:OFFSet [1] 2 [:OUTer] :LIST:STOP:ABSolute? [:SENSe] :SEMAsk:OFFSet [1] 2 [:OUTer] :LIST:STOP:ABSolute:COUPle ON OFF 1 0, ... [:SENSe] :SEMAsk:OFFSet [1] 2 [:OUTer] :LIST:STOP:ABSolute:COUPle?</pre>
Example	<pre>SEM:OFFS:LIST:STOP:ABS -12.50 dBm, -24.50 dBm, -24.50 dBm, -11.50 dBm, -11.50 dBm, - 11.50 dBm SEM:OFFS1:LIST:STOP:ABS? SEM:OFFS:LIST:STOP:ABS:COUP ON, OFF, ON, ON, ON, ON SEM:OFFS:LIST:STOP:ABS:COUP?</pre>
Notes	<p>Comma separated list of values.</p> <p>OFFSet1 is for BTS, 2 for MS. Default is BTS.</p>

	<p>You must be in the mode that includes SEM measurement to use this command. Use :INSTrument:SElect to set the mode.</p>
Couplings	<p>Coupled to Abs Start if “Auto” is selected, that is, the Stop value is equal to the Start value.</p> <p>If the current mode is DVB-T/H, this value will be modified automatically according to the limit type and the output power of the transmitter which is less or more than 25W.</p> <p>If the current mode is ISDB-T, this value will be modified automatically according to the limit type.</p>
Preset	<p>For modes (except MSR, LTEAFDD, LTEATDD and WLAN) without option N9060A-7FP, the preset value is as follows.</p> <p>SA, WIMAX OFDMA: -14.00 dBm, -26.00 dBm, -26.00 dBm, -13.00 dBm, -13.00 dBm, -13.00 dBm</p> <p>WCDMA: -12.50 dBm, -24.50 dBm, -24.50 dBm, -11.50 dBm, -11.50 dBm, -11.50 dBm -69.6 dBm, -54.3 dBm, -54.3 dBm, -54.3 dBm, -54.3 dBm, -54.3 dBm</p> <p>C2K: -27.00 dBm, -27.00 dBm, -27.00 dBm, -46.00 dBm, -13.00 dBm, -13.00 dBm -70.13 dBm, -70.13 dBm, -35.00 dBm, -13.00 dBm, -13.00 dBm, -13.00 dBm</p> <p>TD-SCDMA: -28 dBm, -36 dBm, -36 dBm, -21 dBm, -21 dBm, -21 dBm -71.3 dBm, -71.3 dBm, -56.07 dBm, -56.07 dBm, -56.07 dBm, -56.07 dBm</p> <p>1xEVDO: -27dBm, -27.00 dBm, -27.00 dBm, -46.00 dBm, -13.00 dBm, -13.00 dBm -70.13 dBm, -70.13 dBm, -70.13 dBm, -70.13 dBm, -70.13 dBm, -70.13 dBm</p> <p>LTE, LTEATDD: -12.5 dBm, -12.5 dBm, -15.0 dBm, -15.0 dBm, -15.0 dBm, -15.0 dBm -13.5 dBm, -8.5 dBm, -11.5 dBm, -23.5 dBm, -23.5 dBm, -23.5 dBm</p> <p>When option N9060A-7FP is installed in these modes, the preset value of Offset G ~ L is the same as the Offset F value.</p> <p>-----</p> <p>WLAN:</p> <p>if Radio Std is 802.11a/g(OFDM/DSSS-OFDM): -4.00 dBm, -12.00 dBm, -24.00 dBm, -24.00 dBm, -24.00 dBm, -24.00 dBm, -24.00 dBm, -24.00 dBm, -24.00 dBm, -24.00 dBm, -24.00 dBm, -24.00 dBm, -24.00 dBm, -24.00 dBm</p> <p>if Radio Std is 802.11b/g(DSSS/CCK/PBCC): -10 dBm, -30 dBm, -30 dBm, -30 dBm, -30 dBm, -30 dBm, -30 dBm, -30 dBm, -30 dBm, -30 dBm, -30 dBm, -30 dBm, -30 dBm, -30 dBm, -30 dBm</p> <p>if Radio Std is 802.11n(20MHz) or 802.11ac(20MHz): -4.00 dBm, -12.00 dBm, -24.00 dBm, -63.00 dBm, -63.00 dBm, -63.00 dBm, -63.00 dBm, -63.00 dBm, -63.00 dBm, -63.00 dBm, -63.00 dBm, -63.00 dBm, -63.00 dBm, -63.00 dBm, -63.00 dBm</p> <p>if Radio Std is 802.11n(40MHz) or 802.11ac(40MHz): -4.00 dBm, -12.00 dBm, -24.00 dBm, -66.00 dBm, -66.00 dBm, -66.00 dBm, -66.00 dBm, -66.00 dBm, -66.00 dBm, -66.00 dBm, -66.00 dBm, -66.00 dBm, -66.00 dBm, -66.00 dBm, -66.00 dBm</p> <p>if Radio Std is 802.11ac(80MHz/160MHz): -4.00 dBm, -12.00 dBm, -24.00 dBm, -69.00 dBm, -69.00 dBm, -69.00 dBm, -69.00 dBm, -69.00 dBm, -69.00 dBm, -69.00 dBm, -69.00 dBm, -69.00 dBm, -69.00 dBm, -69.00 dBm, -69.00 dBm</p> <p>if Radio Std is 802.11ac (80 + 80 MHz): -69.00 dBm, -69.00 dBm, -69.00 dBm, -69.00 dBm, -69.00 dBm, -69.00 dBm, -69.00 dBm, -69.00 dBm, -69.00 dBm, -69.00 dBm, -69.00 dBm, -69.00 dBm, -69.00 dBm, -69.00 dBm, -69.00 dBm</p> <p>For modes (except MSR, LTEAFDD, LTEATDD and WLAN) without option N9060A-7FP, the preset value is as follows.</p> <p>SA,WIMAX OFDMA: ON, OFF, ON, ON, ON, ON</p> <p>WCDMA: ON, OFF, ON, ON, ON, ON ON, ON, ON, ON, ON, ON</p>

C2K: ON, ON, ON, ON, ON, OFF|ON, ON, ON, ON, ON, OFF
 TD-SCDMA: ON, OFF, ON, ON, ON, ON|ON, ON, ON, ON, ON, ON
 1xEVDO: ON, ON, ON, ON, ON, OFF|ON, ON, ON, ON, ON, OFF
 LTE, LTE-TDD: OFF, ON, ON, ON, ON, ON|ON, ON, ON, ON, ON, ON
 When option N9060A-7FP is installed in these modes, the preset value of Offset G ~ L is the same as the Offset F value.

 WLAN:

if Radio Std is 802.11a/g(OFDM/DSSS-OFDM)/802.11n(20MHz/40MHz)/802.11 ac
 (20MHz/40MHz/80MHz/160MHz): OFF, OFF, OFF, ON, ON, ON, ON, ON, ON, ON, ON, ON
 if Radio Std is 802.11 ac(80+80 MHz): ON, ON, ON, ON, ON, ON, ON, ON, ON, ON, ON, ON
 if Radio Std is 802.11b/g(DSSS/CCK/PBCC): ON, ON, ON, ON, ON, ON, ON, ON, ON, ON, ON, ON

State Saved	Saved in instrument state.
Min	-200 dBm
Max	50 dBm
Initial S/W Revision	Prior to A.02.00
Modified at S/W Revision	A.02.00, A.03.00, A.10.00, A.11.00, A.14.00

Rel Start

Sets a relative power level limit at the start frequency for the selected offset. The relative power level limit ranges from -200 to +50 dBc.

The fail condition is set remotely by [:SENSe]:SEMAsk:OFFSet[n][:OUTer]:LIST:TEST for each offset channel test.

You can turn off (not use) specific offset channels remotely with [:SENSe]:SEMAsk:OFFSet[n][:OUTer]:LIST:STATe.

The SCPI query returns values currently set to the relative power test limits.

Missing values are not permitted; that is, if you want to change values 2 and 6, you must send all values up to 6. Subsequent values will remain as they were. The query for this parameter always returns 12 values.

Key Path	Meas Setup, Offset/Limits, Limits
Mode	SA, WCDMA, C2K, WIMAX OFDMA, TD-SCDMA, 1xEVDO, DTMB (CTTB), DVB-T/H, ISDB-T, CMMB, LTE, LTE-TDD, Digital Cable TV, WLAN, MSR, LTEAFDD, LTEATDD
Remote Command	[:SENSe]:SEMAsk:OFFSet[1] 2[:OUTer]:LIST:STARt:RCARrier <rel_ampl>, ... [:SENSe]:SEMAsk:OFFSet[1] 2[:OUTer]:LIST:STARt:RCARrier?
Example	SEM:OFFS:LIST:STAR:RCAR -30, -30, -30, -30, -30, -30 SEM:OFFS:LIST:STAR:RCAR?
Notes	Comma separated list of values. OFFSet1 is for BTS, 2 for MS. Default is BTS.

	<p>You must be in the mode that includes SEM measurement to use this command. Use :INSTrument:SElect to set the mode.</p>
Couplings	<p>If the current mode is DVB-T/H, this value will be modified automatically according to the limit type the output power of the transmitter which is less or more than 25W.</p> <p>If the current mode is ISDB-T, this value will be modified automatically according to the limit type.</p> <p>If the current mode is WLAN and radio std is 802.11n, Rel Start limits will be set to following values when frequency changed to above 5GHz: 0 dB, -20.00 dB, -28.00 dB, -40.00 dB, -40.00 dB, -40.00 dB, -40.00 dB, -40.00 dB, -40.00 dB, -40.00 dB, -40.00 dB, -40.00 dB</p>
Preset	<p>For modes (except MSR, LTEAFDD, LTEATDD and WLAN) without option N9060A-7FP, the preset value is as follows.</p> <p>SA: -30.00 dB, -30.00 dB, -30.00 dB, -30.00 dB, -30.00 dB, -30.00 dB</p> <p>WCDMA: -30.00 dB, -30.00 dB, -30.00 dB, -30.00 dB, -30.00 dB, -30.00 dB -33.73 dB, -34.00 dB, -37.50 dB, -47.50 dB, -47.50 dB, -47.50 dB</p> <p>C2K: -45.00 dB, -45.00 dB, -55.00 dB, -55.00 dB, -55.00 dB, -55.00 dB -42.00 dB, -54.00 dB, -54.00 dB, -54.00 dB, -54.00 dB</p> <p>WIMAX OFDMA: 0 dB, -25 dB, -32 dB, -50 dB, -50 dB, -50 dB</p> <p>TD-SCDMA: -54.00 dB, -54.00 dB, -62.00 dB, -47.00 dB, -47.00 dB, -47.00 dB -35.21 dB, -49.00 dB, -44.00 dB, -44.00 dB, -44.00 dB, -44.00 dB</p> <p>1xEVDO: -45dBc, -45.00 dB, -55.00 dB, -55.00 dB, -55.00 dB, -55.00 dB -42dBc, -54.00 dB, -54.00 dB, -54.00 dB, -54.00 dB</p> <p>LTE, LTE TDD: 0 dB, 0 dB, 0 dB, 0 dB, 0 dB, 0 dB 0 dB, 0 dB, 0 dB, 0 dB, 0 dB, 0 dB</p> <p>Digital Cable TV: 0 dB, 0 dB, 0 dB, 0 dB, 0 dB, 0 dB 0 dB, 0 dB, 0 dB, 0 dB, 0 dB, 0 dB</p> <p>When option N9060A-7FP is installed in these modes, the preset value of Offset G ~ L is the same as the Offset F value.</p> <p>-----</p> <p>WLAN:</p> <p>if Radio Std is 802.11a/g(OFDM/DSSS-OFDM): 0 dB, -20.00 dB, -28.00 dB, -40.00 dB, -40.00 dB, -47.00 dB, -47.00 dB, -47.00 dB, -47.00 dB, -47.00 dB, -47.00 dB, -47.00 dB</p> <p>if Radio Std is 802.11b/g(DSSS/CCK/PBCC): -30 dB, -50 dB, -50 dB, -50 dB, -50 dB, -50 dB, -50 dB, -50 dB, -50 dB, -50 dB, -50 dB, -50 dB</p> <p>if Radio Std is 802.11n(20MHz/40MHz): 0 dB, -20.00 dB, -28.00 dB, -45.00 dB, -45.00 dB, -45.00 dB, -45.00 dB, -45.00 dB, -45.00 dB, -45.00 dB, -45.00 dB</p> <p>if Radio Std is 802.11ac (20 MHz/ 40 MHz/ 80 MHz/ 160 MHz): 0 dB, -20.00 dB, -28.00 dB, -40.00 dB, -40.00 dB, -40.00 dB, -40.00 dB, -40.00 dB, -40.00 dB, -40.00 dB, -40.00 dB, -40.00 dB</p> <p>if Radio Std is 802.11ac(80 MHz + 80MHz): -40.00 dB, -28.00 dB, -20 dB, 0 dB, - 20 dB, -28 dB, -40 dB, -40 dB, -40.00 dB, -40.00 dB, -40.00 dB, -40.00 dB</p>
State Saved	Saved in instrument state.
Min	-200 dB
Max	50 dB

Initial S/W Revision	Prior to A.02.00
Modified at S/W Revision	A.02.00, A.03.00, A.10.00, A.11.00, A.14.00

Rel Stop

Sets a relative power level limit at the stop frequency for the selected offset. The relative power level limit ranges from -200 to +50 dBc.

The fail condition is set remotely by [:SENSe]:SEMask:OFFSet[n][:OUTer]:LIST:TEST for each offset channel.

You can turn off (not use) specific offset channels remotely with [:SENSe]:SEMask:OFFSet[n][:OUTer]:LIST:STATe.

The SCPI query returns values currently set to the offset stop relative power limits.

Missing values are not permitted; that is, if you want to change values 2 and 6, you must send all values up to 6. Subsequent values will remain as they were. The query for this parameter always returns 12 values.

Key Path	Meas Setup, Offset/Limits, Limits
Mode	SA, WCDMA, C2K, WIMAX OFDMA, TD-SCDMA, 1xEVDO, DTMB (CTTB), DVB-T/H, ISDB-T, CMMB, LTE, LTE-TDD, Digital Cable TV, WLAN, MSR, LTEAFDD, LTEATDD
Remote Command	<pre>[:SENSe]:SEMask:OFFSet[1] 2[:OUTer]:LIST:STOP:RCARrier <rel_ampl>, ... [:SENSe]:SEMask:OFFSet[1] 2[:OUTer]:LIST:STOP:RCARrier? [:SENSe]:SEMask:OFFSet[1] 2[:OUTer]:LIST:STOP:RCARrier:COUPle ON OFF 1 0, ... [:SENSe]:SEMask:OFFSet[1] 2[:OUTer]:LIST:STOP:RCARrier:COUPle?</pre>
Example	<pre>SEM:OFFS:LIST:STOP:RCAR -30, -30, -30, -30, -30, -30 SEM:OFFS:LIST:STOP:RCAR? SEM:OFFS:LIST:STOP:RCAR:COUP ON, ON, ON, ON, ON, ON SEM:OFFS:LIST:STOP:RCAR:COUP?</pre>
Notes	<p>Comma separated list of values. OFFSet1 is for BTS, 2 for MS. Default is BTS. You must be in the mode that includes SEM measurement to use this command. Use :INSTrument:SElect to set the mode.</p>
Couplings	<p>Coupled to Rel Start if "Auto" is selected, that is, Start is made the same as Stop. If the current mode is DVB-T/H, this value will be modified automatically according to the limit type and the output power of the transmitter which is less or more than 25W. If the current mode is ISDB-T, this value will be modified automatically according to the limit type. If the current mode is WLAN and radio std is 802.11n, Rel Stop limits will be set to following values when frequency changed to above 5GHz: -20.00 dB, -28.00 dB, -40.00 dB, -40.00 dB, -40.00 dB, -40.00 dB, -40.00 dB, -40.00 dB, -40.00 dB, -40.00 dB, -40.00 dB, -40.00 dB</p>

Preset	<p>For modes (except MSR, LTEAFDD, LTEATDD and WLAN) without option N9060A-7FP, the preset value is as follows.</p> <p>SA: -30.00 dB, -30.00 dB, -30.00 dB, -30.00 dB, -30.00 dB, -30.00 dB</p> <p>WCDMA: -30.00 dB, -30.00 dB, -30.00 dB, -30.00 dB, -30.00 dB, -30.00 dB -48.28 dB, -37.50 dB, -47.50 dB, -47.50 dB, -47.50 dB, -47.50 dB</p> <p>C2K: -45.00 dB, -45.00 dB, -55.00 dB, -55.00 dB, -55.00 dB, -55.00 dB -42.00 dB, -54.00 dB, -54.00 dB, -54.00 dB, -54.00 dB</p> <p>WIMAX OFDMA: -25 dB, -32 dB, -50 dB, -50 dB, -50 dB, -50 dB</p> <p>TD-SCDMA: -54.00 dB, -62.00 dB, -62.00 dB, -47.00 dB, -47.00 dB, -47.00 dB -49.00 dB, -58.945 dB, -44.00 dB, -44.00 dB, -44.00 dB, -44.00 dB</p> <p>1xEVDO: -45dB, -45.00 dB, -55.00 dB, -55.00 dB, -55.00 dB, -55.00 dB -42dB, -54.00 dB, -54.00 dB, -54.00 dB, -54.00 dB</p> <p>LTE, LTEATDD: 0 dB, 0 dB, 0 dB, 0 dB, 0 dB, 0 dB</p> <p>Digital Cable TV: 0 dB, 0 dB, 0 dB, 0 dB, 0 dB, 0 dB 0 dB, 0 dB, 0 dB, 0 dB, 0 dB, 0 dB</p> <p>When option N9060A-7FP is installed in these modes, the preset value of Offset G ~ L is the same as the Offset F value.</p> <p>-----</p> <p>WLAN:</p> <p>if Radio Std is 802.11a/g(OFDM/DSSS-OFDM): -20.00 dB, -28.00 dB, -40.00 dB, -40.00 dB, -47.00 dB, -47.00 dB, -47.00 dB, -47.00 dB, -47.00 dB, -47.00 dB, -47.00 dB, -47.00 dB</p> <p>if Radio Std is 802.11b/g(DSSS/CCK/PBCC): -30 dB, -50 dB, -50 dB, -50 dB, -50 dB, -50 dB, -50 dB, -50 dB, -50 dB, -50 dB, -50 dB, -50 dB</p> <p>if Radio Std is 802.11n(20MHz/40MHz): -20.00 dB, -28.00 dB, -45.00 dB, -45.00 dB, -45.00 dB, -45.00 dB, -45.00 dB, -45.00 dB, -45.00 dB, -45.00 dB, -45.00 dB, -45.00 dB</p> <p>if Radio Std is 802.11ac (20 MHz/ 40 MHz/ 80 MHz/ 160 MHz): -20.00 dB, -28.00 dB, -40.00 dB, -40.00 dB, -40.00 dB, -40.00 dB, -40.00 dB, -40.00 dB, -40.00 dB, -40.00 dB, -40.00 dB, -40.00 dB, -40.00 dB</p> <p>if Radio Std is 802.11ac(80 MHz + 80MHz): -28.00 dB, -20.00 dB, 0 dB, -20.00 dB, -28.00 dB, -40.00 dB, -40.00 dB, -40.00 dB, -40.00 dB, -40.00 dB, -40.00 dB, -40.00 dB, -40.00 dB</p> <p>For modes (except MSR, LTEAFDD, LTEATDD and WLAN) without option N9060A-7FP, the preset value is as follows.</p> <p>For modes (except MSR, LTEAFDD, LTEATDD and WLAN) with option N9060A-7FP, the preset value of Offset G ~ L is the same as the Offset F value.</p> <p>SA: ON, ON, ON, ON, ON, ON, ON</p> <p>WCDMA: ON, ON, ON, ON, ON, ON OFF, OFF, OFF, ON, ON, ON</p> <p>C2K: ON, ON, ON, ON, ON, OFF ON, ON, ON, ON, ON, OFF</p> <p>WIMAX OFDMA: OFF, OFF, OFF, ON, ON, ON OFF, OFF, OFF, ON, ON, ON</p> <p>TD-SCDMA: ON, OFF, ON, ON, ON, ON OFF, OFF, ON, ON, ON, ON</p> <p>1xEVDO: ON, ON, ON, ON, ON, OFF ON, ON, ON, ON, ON, OFF</p> <p>LTE, LTEATDD: ON, ON, ON, ON, ON, ON</p> <p>Digital Cable TV: OFF, OFF, OFF, OFF, OFF, OFF</p> <p>-----</p>
--------	--

	<p>WLAN:</p> <p>if Radio Std is 802.11a/g(OFDM/DSSS-OFDM)/802.11n(20MHz/40MHz): OFF, OFF, OFF, ON, ON, ON, ON, ON, ON, ON, ON, ON</p> <p>if Radio Std is 802.11b/g(DSSS/CCK/PBCC): ON, ON, ON, ON, ON, ON, ON, ON, ON, ON, ON, ON, ON</p> <p>if Radio Std is 802.11ac (20 MHz/ 40 MHz/ 80 MHz/ 160 MHz): OFF, OFF, OFF, ON, ON, ON, ON, ON, ON, ON, ON, ON, ON</p> <p>if Radio Std is 802.11ac(80 MHz + 80MHz): OFF, OFF, OFF, OFF, OFF, OFF, OFF, OFF, OFF, OFF, OFF, OFF, OFF, OFF, OFF</p>
State Saved	Saved in instrument state.
Min	-200 dB
Max	50 dB
Initial S/W Revision	Prior to A.02.00
Modified at S/W Revision	A.02.00, A.03.00, A.10.00, A.11.00, A.14.00

Fail Mask

Selects one of the logic keys for fail conditions between the measurement results and the test limits:

- Absolute and Relative both check the results against the respective limit.
- OR checks against both limits, failing if either of the limits is broken.
- AND will only display a fail if both of the limits are broken.

The absolute or relative power limit value for each offset channel can be set remotely with `[:SENSE]:SEMASK:OFFSet[n][:OUTer]:LIST:ABSolute` or `[:SENSE]:SEMASK:OFFSet[n][:OUTer]:LIST:RCARrier`.

You can turn off (not use) specific offset channels remotely with `[:SENSE]:SEMASK:OFFSet[n][:OUTer]:LIST:STATe`.

Missing values are not permitted; that is, if you want to change values 2 and 6, you must send all values up to 6. Subsequent values will remain as they were. The query for this parameter always returns 12 values.

Key Path	Meas Setup, Offset/Limits, Limits
Mode	SA, WCDMA, C2K, WIMAX OFDMA, TD-SCDMA, 1xEVDO, DTMB (CTTB), DVB-T/H, ISDB-T, CMMB, LTE, LTE-TDD, Digital Cable TV, WLAN, MSR, LTEAFDD, LTEATDD
Remote Command	<pre>[:SENSE]:SEMASK:OFFSet[1] 2[:OUTer]:LIST:TEST ABSolute AND OR RELative, ... [:SENSE]:SEMASK:OFFSet[1] 2[:OUTer]:LIST:TEST?</pre>
Example	<pre>SEM:OFFS:LIST:TEST ABS, ABS, ABS, ABS, ABS, ABS SEM:OFFS:LIST:TEST?</pre>
Notes	<p>Comma separated list of values.</p> <p>You must be in the mode that includes SEM measurement to use this command. Use <code>:INSTrument:SElect</code> to set the mode.</p>

Couplings	None If the current mode is DVB-T/H, this value will be modified automatically according to the limit type and the output power of the transmitter which is less or more than 25W.
Preset	For modes (except MSR, LTEAFDD, LTEATDD and WLAN) without option N9060A-7FP, the preset value is as follows. SA: ABS, ABS, ABS, ABS, ABS, ABS WCDMA: ABS, ABS, ABS, ABS, ABS, ABS AND, AND, AND, AND, AND, AND C2K: REL, REL, REL, ABS, REL, REL AND, AND, ABS, REL, REL, REL WIMAX OFDMA: REL, REL, REL, REL, REL, REL REL, REL, REL, REL, REL, REL TD-SCDMA: ABS, ABS, ABS, ABS, ABS, ABS AND, AND, AND, AND, AND, AND 1xEVDO: REL, REL, REL, ABS, REL, REL AND, AND, AND, OR, AND, AND LTE, LTDTDD: ABS, ABS, ABS, ABS, ABS, ABS Digital Cable TV: REL, REL, REL, REL, REL, REL REL, REL, REL, REL, REL, REL When option N9060A-7FP is installed in these modes, the preset value of Offset G ~ L is the same as the Offset F value. ----- WLAN: if Radio Std is 802.11a/g(OFDM/DSSS-OFDM) or 802.11b/g(DSSS/CCK/PBCC): REL, REL, REL, REL, REL, REL, REL, REL, REL, REL if Radio Std is 802.11n(20MHz/40MHz): REL, REL, REL, AND, AND, AND, AND, AND, AND, AND, AND, AND if Radio Std is 802.11ac (20 MHz/ 40 MHz/ 80 MHz/ 160 MHz): REL, REL, REL, AND, AND, AND, AND, AND, AND, AND, AND, AND if Radio Std is 802.11ac (80 MHz + 80MHz): REL, REL, REL, REL, REL, REL, AND, AND, AND, AND, AND, AND
State Saved	Saved in instrument state.
Range	Absolute Relative Abs AND Rel Abs OR Rel
Initial S/W Revision	Prior to A.02.00
Modified at S/W Revision	A.02.00, A.03.00, A.10.00, A.11.00, A.14.00

Offset Freq Define

This key enables you to select “Offset” definition. Each standard defines each “Offset” from Carrier.

Meas BW Edge means the edge of resolution band width that is represented by Meas BW and Res BW settings. Actual center frequency of Meas BW and the limit line have ½ Meas BW offset when the Meas BW Edge is selected.

3GPP2 requires the “Carrier Center to Meas BW Edge” definition, and LTE conformance test requires “Carrier Edge to Meas BW Center” and/or “Carrier Edge to Meas BW Edge” definition. MSR standard requires “RFBW Edge to Meas BW Center” and/or “RFBW Edge to Meas Edge” definition.

- **CTOC** – From the lowermost carrier frequency (for lower offset), the uppermost carrier frequency (for upper offset) to the center of offset measuring filter*

- **CTOE** – From the lowermost carrier frequency (for lower offset), the uppermost carrier frequency (for upper offset) to the nominal –3 dB point of the offset measuring filter* closer to the carrier
- **ETOC** – From the lowermost carrier frequency - spacing of this carrier /2 (for lower offset), the uppermost carrier frequency + spacing of this carrier /2 (for upper offset) to the center of offset measuring filter*
- **ETOE** – From the lowermost carrier frequency - spacing of this carrier /2 (for lower offset), the uppermost carrier frequency + spacing of this carrier /2 (for upper offset) to the nominal –3 dB point of the offset measuring filter* closer to the carrier
- **STOC** – From either the lower or upper sub-block edges to the center of offset measuring filter*
- **STOE** – From either the lower or upper sub-block edges to the nominal –3 dB point of the offset measuring filter* closer to the carrier

*Measuring filter = Meas BW (N) x Res BW

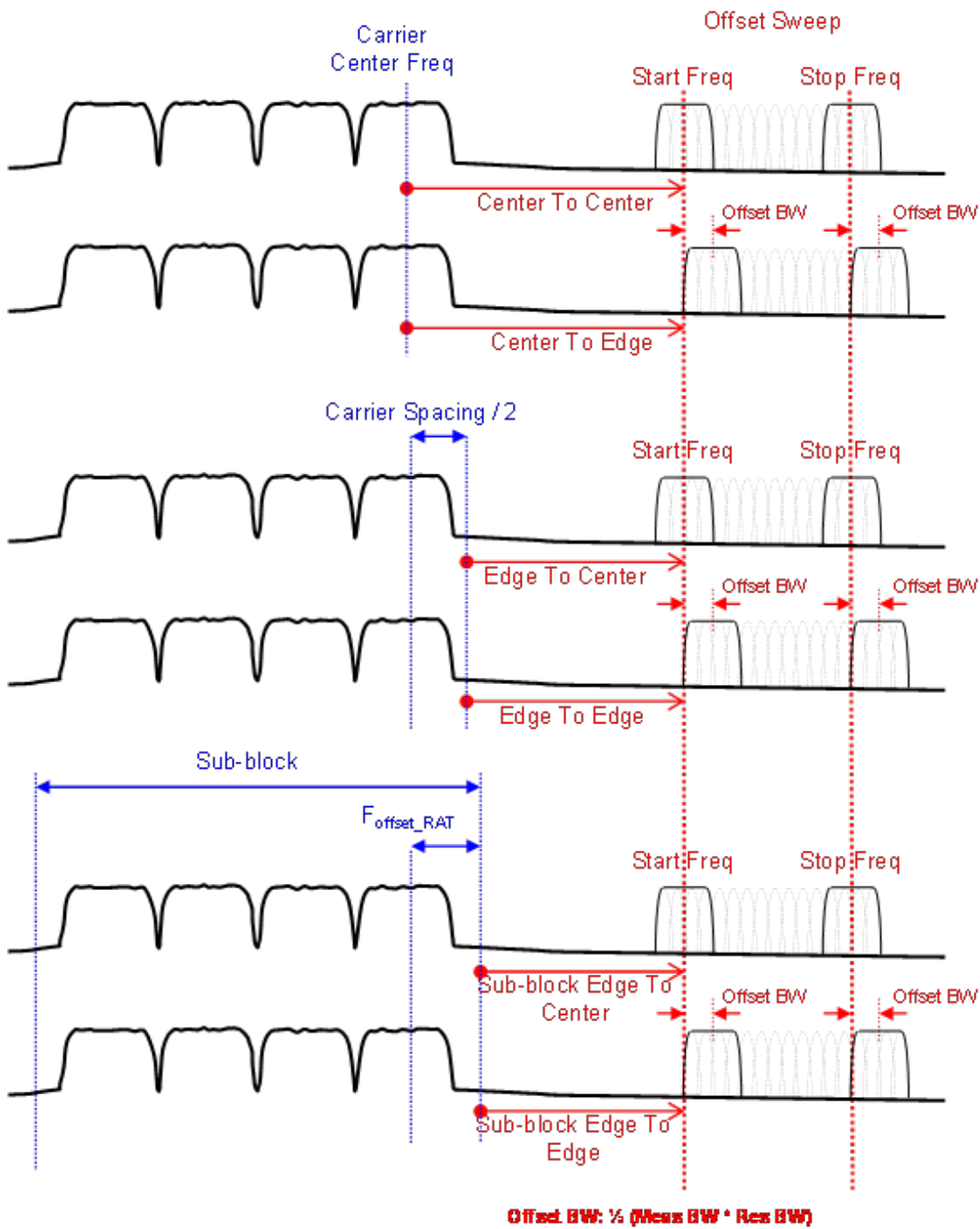

Offset Freq Definition in SEM Measurement

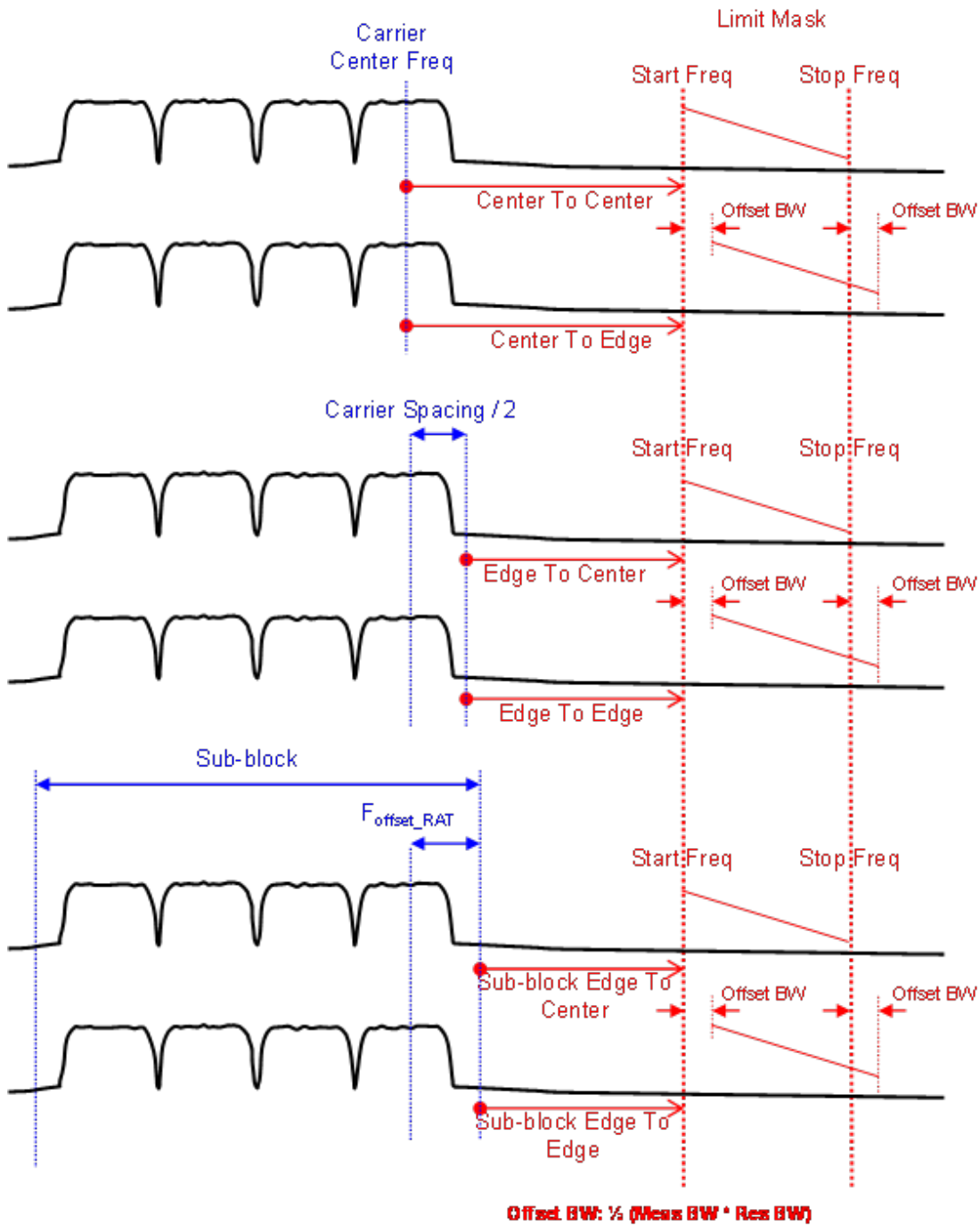

Offset Freq Definition (Limit Mask) in SEM measurement

Key Path	Meas Setup, Inner Offset/Limits
Mode	MSR, LTEAFDD, LTEATDD
Remote Command	[[:SENSe]:SEMAsk:OFFSet[1] 2:INNER:TYPE CTOC CTOE ETOC ETOE STOC STOE [:SENSe]:SEMAsk:OFFSet[1] 2:INNER:TYPE?

Example	SEM:OFFS:INN:TYPE ETOC SEM:OFFS:INN:TYPE?
Notes	You must be in the MSR and LTE-Advanced FDD/TDD modes to use this command. Use :INSTrument:SElect to set the mode.
Preset	STOC
State Saved	Saved in instrument state.
Range	Carrier Center To Meas BW Center Carrier Center To Meas BW Edge Carrier Edge To Meas BW Center Carrier Edge To Meas BW Edge Sub-block Edge To Meas BW Center Sub-block Edge To Meas BW Edge
Readback	Center to Center Center to Edge Edge to Center Edge to Edge S Edge to Center S Edge to Edge
Initial S/W Revision	A.14.00

Inner Offset/Limits (Only for MSR and LTE-Advanced FDD/TDD)

Accesses a menu that enables you to set up the measurement parameters for offset pairs. For example, you can assign the start and stop frequencies, select the resolution bandwidth, and set the acquisition time.

Until now, the latest LTE-Advanced FDD/TDD standards give the test specification requirements for BS intra-band contiguous aggregation and intra-band non-contiguous aggregation modes. However for UE, they just define the requirements of intra-band contiguous aggregation modes. So the standards don't support to do the measurement in UE intra-band non-contiguous aggregation mode for LTE-Advanced FDD/TDD, then the preset values of Inner Offset/Limits are temporarily set as those of Outer Offset/Limits for UE.

Limits for Inner Offsets

Since inner offsets are defined from the sub-block edges to the gap, limits from two sub-blocks overlap each other. Therefore the limit used for inner offsets are the cumulative sum of limits from the both sub-blocks. Offsets can have different RBWs, which must be compensated when accumulated.

For example, when offset A and D overlap, the limit of offset A is calculated as follows.

$$\text{Cumulated Limit of Offset A} = 10^{\frac{[\text{Offset A Limit in dBm}]}{10}} + \frac{\text{Offset A RBW}}{\text{Offset D RBW}} 10^{\frac{[\text{Offset D Limit in dBm}]}{10}}$$

Key Path	Meas Setup
Initial S/W Revision	A.14.00

Select Offset

Selects the offset (upper and lower) and displays the memory selection menu that enables you to store a set of parameter values for the offset, such as Start Freq, Stop Freq, Acq Time, Res BW, Meas BW, Abs Start, and Abs Stop. Only one selection at a time is shown on this menu key label.

Key Path	Meas Setup, Inner Offset/Limits
Mode	MSR, LTEAFDD, LTEATDD
Preset	A
Range	A B C D E F G H J K L
Initial S/W Revision	A.14.00

Start Freq

Specifies the start frequency for the currently selected offset. Also, enables you to toggle that offset between On and Off. Missing values are not permitted; that is, if you want to change values 2 and 6, you must send all values up to 6. Subsequent values will remain as they were. The query for this parameter always returns 12 values.

Key Path	Meas Setup, Inner Offset/Limits
Mode	MSR, LTEAFDD, LTEATDD
Remote Command	<pre>[:SENSe] :SEMask:OFFSet [1] 2 :INNeR:LIST:FREQuency:STARt <freq>, ... [:SENSe] :SEMask:OFFSet [1] 2 :INNeR:LIST:FREQuency:STARt? [:SENSe] :SEMask:OFFSet [1] 2 :INNeR:LIST:STATe ON OFF 1 0, ... [:SENSe] :SEMask:OFFSet [1] 2 :INNeR:LIST:STATe?</pre>
Example	<pre>SEM:OFFS2:INN:LIST:FREQ:STAR 2.515 MHz, 2.715 MHz, 3.515 MHz, 4.00 MHz, 8.00 MHz, 12.50 MHz SEM:OFFS2:INN:LIST:FREQ:STAR? SEM:OFFS:INN:LIST:STAT ON, ON, ON, OFF, OFF, OFF SEM:OFFS:INN:LIST:STAT?</pre>
Notes	<p>Comma separated list of values.</p> <p>OFFSet1 is for BTS, 2 for MS. Default is BTS.</p> <p>You must be in the MSR and LTE-Advanced FDD/TDD modes to use this command. Use :INSTrument:SElect to set the mode.</p>
Couplings	Coupled to Stop Freq. When the start freq goes above the stop freq, the stop freq is automatically adjusted to the start freq plus 100Hz.
Preset	<pre>MSR:15 kHz, 215 kHz, 1.015 MHz, 1.5 MHz, 10.5 MHz, 15.00 MHz, 30 MHz, 30 MHz, 30 MHz, 30 MHz, 30 MHz, 30 MHz 15 kHz, 215 kHz, 1.015 MHz, 1.5 MHz, 10.5 MHz, 15.00 MHz, 30 MHz, 30 MHz, 30 MHz, 30 MHz, 30 MHz, 30 MHz LTEAFDD, LTEATDD: 50 kHz, 5.05 MHz, 10.5 MHz, 15.00 MHz, 30 MHz, 40 MHz, 40 MHz, 40 MHz, 40 MHz, 40 MHz, 40 MHz, 40 MHz 15.00 kHz, 1.5 MHz, 5.5 MHz, 6.5 MHz, 10 MHz, 20MHz, 20MHz, 20MHz, 20MHz, 20MHz, 20MHz, 20MHz MSR:ON, ON, ON, ON, ON, OFF, OFF, OFF, OFF, OFF, OFF, OFF ON, ON, ON, ON, ON, OFF, OFF, OFF, OFF, OFF, OFF, OFF LTEAFDD, LTEATDD: ON, ON, ON, OFF, OFF, OFF, OFF, OFF, OFF, OFF, OFF ON, ON, ON, ON, OFF, OFF, OFF, OFF, OFF, OFF, OFF</pre>
State Saved	Saved in instrument state.

Min	0 Hz
Max	499.9999 MHz
Initial S/W Revision	A.14.00

Stop Freq

Specifies the stop frequency for the currently selected offset.

Missing values are not permitted; that is, if you want to change values 2 and 6 you must send all values up to 6. Subsequent values will remain as they were. The query for this parameter always returns 12 values.

Key Path	Meas Setup, Inner Offset/Limits
Mode	MSR, LTEAFDD, LTEATDD
Remote Command	<code>[:SENSe] :SEMAsk:OFFSet [1] 2 :INNeR:LIST:FREQuency:STOP <freq>, ...</code> <code>[:SENSe] :SEMAsk:OFFSet [1] 2 :INNeR:LIST:FREQuency:STOP?</code>
Example	SEM:OFFS:INN:LIST:FREQ:STOP 2.715 MHz, 3.515 MHz, 4.00 MHz, 8.00 MHz, 12.50 MHz, 15.0 MHz SEM:OFFS:INN:LIST:FREQ:STOP?
Notes	Comma separated list of values. OFFSet1 is for BTS, 2 for MS. Default is BTS. You must be in the MSR and LTE-Advanced FDD/TDD mode to use this command. Use :INSTrument:SElect to set the mode.
Couplings	Coupled to Start Freq. When the stop freq goes below the start freq, the start freq is automatically adjusted to the stop freq minus 100 Hz.
Preset	MSR:215 kHz, 1.015 MHz, 1.5 MHz, 10.5 MHz, 50 MHz, 50 MHz, 50 MHz, 50 MHz, 50 MHz, 50 MHz, 50 MHz, 50 MHz LTEAFDD, LTEATDD: 5.05 MHz, 10.05 MHz, 15 MHz, 30 MHz, 40 MHz, 50 MHz, 50 MHz, 50 MHz, 50 MHz, 50 MHz 985.0 kHz, 4.50 MHz, 5.5001 MHz, 9.50 MHz, 20 MHz, 40 MHz, 40 MHz, 40 MHz, 40 MHz, 40 MHz, 40 MHz, 40 MHz
State Saved	Saved in instrument state.
Min	100 Hz
Max	500 MHz
Initial S/W Revision	A.14.00

Acq Time

Specifies the acquisition time for the currently selected offset and enables you to toggle the Acq Time mode between Auto and Man.

Missing values are not permitted; that is, if you want to change values 2 and 6, you must send all values up to 6. Subsequent values will remain as they were. The query for this parameter always returns 12 values.

Key Path	Meas Setup, Inner Offset/Limits
Mode	MSR, LTEAFDD, LTEATDD
Remote Command	<pre>[:SENSe] :SEMAsk:OFFSet [1] 2 :INNer:LIST:SWEep:TIME <time>, ... [:SENSe] :SEMAsk:OFFSet [1] 2 :INNer:LIST:SWEep:TIME? [:SENSe] :SEMAsk:OFFSet [1] 2 :INNer:LIST:SWEep:TIME:AUTO ON OFF 1 0, ... [:SENSe] :SEMAsk:OFFSet [1] 2 :INNer:LIST:SWEep:TIME:AUTO?</pre>
Example	<pre>SEM:OFFS2:INN:LIST:SWE:TIME 1.0 ms, 3.4 ms, 2.08 ms, 1.0 ms, 1.0 ms, 1.0 ms SEM:OFFS2:INN:LIST:SWE:TIME? SEM:OFFS2:INN:LIST:SWE:TIME:AUTO ON, ON, ON, ON, OFF, OFF SEM:OFFS2:INN:LIST:SWE:TIME:AUTO?</pre>
Notes	<p>OFFSet1 is for BTS, 2 for MS. Default is BTS.</p> <p>You must be in the MSR and LTE-Advanced FDD/TDD modes to use this command. Use :INSTrument:SElect to set the mode.</p>
Couplings	When the acquisition time is set manually, Acq Time Mode is set to MANual.
Preset	<p>Automatically calculated</p> <pre>MSR:ON,ON,ON,ON,ON,ON,ON,ON,ON,ON,ON,ON,ON,ON,ON LTEAFDD, LTEATDD: ON, ON, ON, ON, ON, ON, ON, ON, ON, ON, ON, ON ON, ON, ON, ON, ON, ON, ON, ON, ON, ON, ON, ON</pre>
State Saved	Saved in instrument state.
Min	TBD
Max	10 s
Initial S/W Revision	A.14.00

Offset Side

Specifies which offset side to measure.

You can turn off (not use) specific offsets with [:SENSe]:SEMAsk:OFFSet[n]:INNer:LIST:STATe.

- BOTH – Both sides in the sub-block gap are enabled.
- NEGative – The upper side in the sub-block gap only (i.e. negative sideband of the upper sub-block) is enabled
- POSitive – The lower side in the sub-block gap only (i.e. positive sideband of the lower sub-block) is enabled.

Missing values are not permitted; that is, if you want to change values 2 and 6, you must send all values up to 6. Subsequent values will remain as they were. The query for this parameter always returns 12 values.

The figure below shows the relation between the negative/positive offset side setups and the upper/lower results in the MSR and LTE-Advanced FDD/TDD.

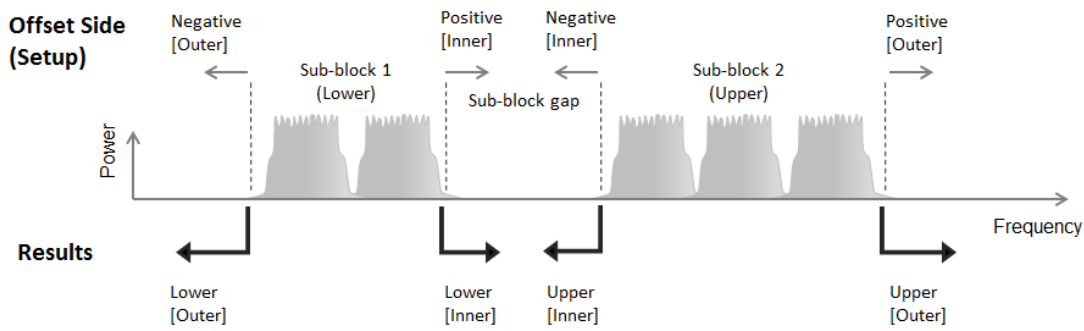

Key Path	Meas Setup, Inner Offset/Limits
Mode	MSR, LTEAFDD, LTEATDD
Remote Command	[[:SENSE]:SEMask:OFFSet[1] 2:INNer:LIST:SIDE BOTH NEGative POSitive, ... [:SENSE]:SEMask:OFFSet[1] 2:INNer:LIST:SIDE?
Example	SEM:OFFS:INN:LIST:SIDE BOTH, NEG, NEG, POS, POS, POS SEM:OFFS:INN:LIST:SIDE?
Notes	Comma separated list of values. OFFSet1 is for BTS, 2 for MS. Default is BTS. You must be in the MSR and LTE-Advanced FDD/TDD modes to use this command. Use :INSTRUMENT:SElect to set the mode.
Preset	MSR: BOTH, BOTH, BOTH, BOTH, BOTH, BOTH, BOTH, BOTH, BOTH, BOTH, BOTH, BOTH LTEAFDD, LTEATDD: BOTH, BOTH, BOTH, BOTH, BOTH, BOTH, BOTH, BOTH, BOTH, BOTH, BOTH, BOTH, BOTH BOTH, BOTH, BOTH, BOTH, BOTH, BOTH, BOTH, BOTH, BOTH, BOTH, BOTH, BOTH
State Saved	Saved in instrument state.
Range	Neg Both Pos
Initial S/W Revision	A.14.00

Res BW

Specifies which Resolution BW filter to use when measuring the currently selected offset.

Offset Res BW Mode allows the instrument to determine the optimum Resolution BW filter to use when measuring the currently selected offset. using front panel and all the offsets using SCPI. When changing the Meas BW parameter, if the Res BW needs to be changed to adhere to the rule

$$(N \times \text{Res BW}) \leq (\text{Stop freq of the offset} - \text{Start freq of the offset}),$$

where N is the multiplier, this setting will automatically be changed to manual.

Missing values are not permitted; that is, if you want to change values 2 and 6, you must send all values up to 6. Subsequent values will remain as they were. The query for this parameter always returns 12 values.

Key Path	Meas Setup, Inner Offset/Limits
----------	---------------------------------

Mode	MSR, LTEAFDD, LTEATDD
Remote Command	<pre>[:SENSe] :SEMask:OFFSet [1] 2 :INNeR:LIST:BAWdwidth[:RESolution] <bandwidth>, ... [:SENSe] :SEMask:OFFSet [1] 2 :INNeR:LIST:BAWdwidth[:RESolution]? [:SENSe] :SEMask:OFFSet [1] 2 :INNeR:LIST:BAWdwidth[:RESolution]:AUTO OFF ON 1 0, ... [:SENSe] :SEMask:OFFSet [1] 2 :INNeR:LIST:BAWdwidth[:RESolution]:AUTO?</pre>
Example	<pre>SEM:OFFS2:INN:LIST:BAND 30.0 kHz, 30.0 kHz, 30.0 kHz, 1.00 MHz, 1.00 MHz, 1.00 MHz SEM:OFFS2:INN:LIST:BAND? SEM:OFFS:INN:LIST:BAND:AUTO 1,1,1,1,1,1 SEM:OFFS:INN:LIST:BAND:AUTO?</pre>
Notes	<p>Comma separated list of values.</p> <p>OFFSet1 is for BTS, 2 for MS. Default is BTS.</p> <p>You must be in the MSR and LTE-Advanced FDD/TDD modes to use this command. Use :INSTrument:SElect to set the mode.</p>
Couplings	<p>Coupled to Start and Stop offset and Meas BW multiplier. This parameter must adhere to the rule (N x Res BW) <= (Stop freq of the offset - Start freq of the offset), where N is the multiplier. If the multiplier is changed, the Res BW will be changed to ensure this. When set manually, Res BW Coupling is set to manual.</p> <p>The resolution bandwidth is coupled to the offset width determined by the start frequency and stop frequency.</p>
Preset	<pre>MSR:30 kHz, 30 kHz, 30 kHz, 1.0 MHz, 1.0 MHz, 1.0 MHz, 1.0 MHz, 1.0 MHz, 1.0 MHz, 1.0 MHz, 1.0 MHz, 1.0 MHz 30 kHz, 30 kHz, 30 kHz, 1.0 MHz, 1.0 MHz, 1.0 MHz, 1.0 MHz, 1.0 MHz, 1.0 MHz, 1.0 MHz, 1.0 MHz, 1.0 MHz LTEAFDD, LTEATDD: 51 kHz, 100 kHz, 1.0 MHz, 1.0 MHz, 1.0 MHz, 1.0 MHz, 1.0 MHz, 1.0 MHz, 1.0 MHz, 1.0 MHz, 1.0 MHz, 1.0 MHz 15.0 kHz, 510 kHz, 1.0 MHz, 1.0 MHz, 1.0 MHz, 1.0 MHz , 1.0 MHz, 1.0 MHz, 1.0 MHz, 1.0 MHz, 1.0 MHz, 1.0 MHz OFF, OFF, OFF, OFF, OFF, OFF, OFF, OFF, OFF, OFF, OFF, OFF OFF, OFF, OFF, OFF, OFF, OFF, OFF, OFF, OFF, OFF, OFF, OFF</pre>
State Saved	Saved in instrument state.
Min	1 Hz
Max	8 MHz
Initial S/W Revision	A.14.00

Meas BW

Allows you to specify a multiplier of Res BW for the measurement integration bandwidth.

Meas BW is multiplier integer number. It shows a ratio between Integration BW and Resolution BW of the measurement result.

Integ BW = Meas BW * Resolution BW

Integration BW is desired resolution bandwidth and Resolution BW is actual bandwidth for sweep. Measurement sweeps with Resolution BW and Meas BW compensates sweep resolution bandwidth to Integration BW.

If you set this parameter greater than 1, you can set Resolution BW narrower to avoid carrier power leakage effect to the offset power integration.

Missing values are not permitted; that is, if you want to change values 2 and 6, you must send all values up to 6. Subsequent values will remain as they were. The query for this parameter always returns 12 values.

Key Path	Meas Setup, Inner Offset/Limits
Mode	MSR, LTEAFDD, LTEATDD
Remote Command	[:SENSE] :SEMAsk:OFFSet [1] 2 :INNer:LIST:BA NDwidth:IMULti <integer>, ... [:SENSE] :SEMAsk:OFFSet [1] 2 :INNer:LIST:BA NDwidth:IMULti?
Example	SEM:OFFS2:INN:LIST:BA ND:IMUL 1,1,1,1,1,1 SEM:OFFS2:INN:LIST:BA ND:IMUL?
Notes	Comma separated list of values. OFFSet1 is for BTS, 2 for MS. Default is BTS. You must be in the MSR and LTE-Advanced FDD/TDD modes to use this command. Use :INSTrument:SElect to set the mode.
Couplings	This parameter must adhere to the rule (N x Res BW) <= (Stop freq of the offset - Start freq of the offset), where N is the multiplier. If the Res Bw is changed, the multiplier will be changed to ensure this.
Preset	MSR:1, 1, 1, 1, 1, 1, 1, 1, 1, 1, 1, 1 1, 1, 1, 1, 1, 1, 1, 1, 1, 1, 1, 1 LTEAFDD, LTEATDD: 2, 1, 1, 1, 1, 1, 1, 1, 1, 1, 1 2, 2, 1, 1, 1, 1, 1, 1, 1, 1, 1, 1
State Saved	Saved in instrument state.
Min	1
Max	1000
Initial S/W Revision	A.14.00

Video BW

Changes the analyzer post-detection filter.

Missing values are not permitted; that is, if you want to change values 2 and 6, you must send all values up to 6. Subsequent values will remain as they were. The query for this parameter always returns 12 values.

Key Path	Meas Setup, Inner Offset/Limits
Mode	MSR, LTEAFDD, LTEATDD
Remote Command	[:SENSE] :SEMAsk:OFFSet [1] 2 :INNer:LIST:BA NDwidth:VIDeo <freq>, ... [:SENSE] :SEMAsk:OFFSet [1] 2 :INNer:LIST:BA NDwidth:VIDeo? [:SENSE] :SEMAsk:OFFSet [1] 2 :INNer:LIST:BA NDwidth:VIDeo:AUTO OFF ON 0 1, ... [:SENSE] :SEMAsk:OFFSet [1] 2 :INNer:LIST:BA NDwidth:VIDeo:AUTO?

Example	SEM:OFFS2:INN:LIST:BAND:VID 3.00 kHz, 3.00 kHz, 3.00 kHz, 100.0 kHz, 100.0 kHz, 100.0 kHz SEM:OFFS2:INN:LIST:BAND:VID? SEM:OFFS2:INN:LIST:BAND:VID:AUTO ON, ON, ON, ON, ON, ON SEM:OFFS2:INN:LIST:BAND:VID:AUTO?
Notes	Comma separated list of values. OFFSet1 is for BTS, 2 for MS. Default is BTS. You must be in the MSR and LTE-Advanced FDD/TDD modes to use this command. Use :INSTrument:SElect to set the mode.
Couplings	This parameter is basically coupled with other parameters like Spectrum Analyzer. When the Auto State is ON, Video BW is basically coupled with other parameters like Spectrum Analyzer.
Preset	Automatically Calculated ON, ON, ON, ON, ON, ON, ON, ON, ON, ON, ON, ON, ON ON, ON, ON, ON, ON, ON, ON, ON, ON, ON, ON, ON, ON, ON, ON
State Saved	Saved in instrument state.
Min	1 Hz
Max	50 MHz
Initial S/W Revision	A.14.00

VBW/RBW

Selects the ratio between the video and resolution bandwidths.

Missing values are not permitted; that is, if you want to change values 2 and 6, you must send all values up to 6. Subsequent values will remain as they were. The query for this parameter always returns 12 values.

Key Path	Meas Setup, Inner Offset/Limits
Mode	MSR, LTEAFDD, LTEATDD
Remote Command	[:SENSE] :SEMAsk:OFFSet [1] 2 :INNEr:LIST:BANDwidth:VIDeo:RATio <real>, ... [:SENSE] :SEMAsk:OFFSet [1] 2 :INNEr:LIST:BANDwidth:VIDeo:RATio? [:SENSE] :SEMAsk:OFFSet [1] 2 :INNEr:LIST:BANDwidth:VIDeo:RATio:AUTO OFF ON 0 1, ... [:SENSE] :SEMAsk:OFFSet [1] 2 :INNEr:LIST:BANDwidth:VIDeo:RATio:AUTO?
Example	SEM:OFFS2:INN:LIST:BAND:VID:RAT 0.1, 0.1, 0.1, 0.1, 0.1, 0.1 SEM:OFFS2:INN:LIST:BAND:VID:RAT? SEM:OFFS:INN:LIST:BAND:VID:RAT:AUTO ON, ON, ON, ON, ON, ON SEM:OFFS:INN:LIST:BAND:VID:RAT:AUTO?
Notes	Comma separated list of values. OFFSet1 is for BTS, 2 for MS. Default is BTS. You must be in the MSR and LTE-Advanced FDD/TDD modes to use this command. Use :INSTrument:SElect to set the mode.

Couplings	This parameter is basically coupled with other parameters like Spectrum Analyzer. When the Auto State is ON, the VBW/RBW is basically coupled with other parameters like Spectrum Analyzer.
Preset	0.01, 0.01, 0.01, 0.01, 0.01, 0.01, 0.01, 0.01, 0.01, 0.01, 0.01, 0.01 0.01, 0.01, 0.01, 0.01, 0.01, 0.01, 0.01, 0.01, 0.01, 0.01, 0.01, 0.01 OFF, OFF, OFF, OFF, OFF, OFF, OFF, OFF, OFF, OFF, OFF, OFF OFF, OFF, OFF, OFF, OFF, OFF, OFF, OFF, OFF, OFF, OFF, OFF
State Saved	Saved in instrument state.
Min	0.00001
Max	3000000
Initial S/W Revision	A.14.00

Limits

Accesses a menu that enables you to set the power limits for start and stop frequencies of the selected offsets.

Key Path	Meas Setup
Initial S/W Revision	A.14.00

Select Offset

Selects the offset (upper and lower) and displays the memory selection menu that enables you to store a set of parameter values for the offset, such as Start Freq, Stop Freq, Acq Time, Res BW, Meas BW, Abs Start, and Abs Stop. Only one selection at a time is shown on this menu key label.

Key Path	Meas Setup, Inner Offset/Limits
Mode	MSR, LTEAFDD, LTEATDD
Preset	A
Range	A B C D E F G H J K L
Initial S/W Revision	A.14.00

Abs Start

Sets the absolute power level limit at the start frequency for the selected offset. The absolute power level limit ranges from -200 to +50 dBm.

The fail condition for each offset channel is set remotely by [:SENSe]:SEMAsk:OFFSet[n]:INNeR:LIST:TEST.

You can turn off (not use) specific offset channels remotely with [:SENSe]:SEMAsk:OFFSet [n]:INNeR:LIST:STATe.

The SCPI query returns values currently set to the absolute power test limits.

Missing values are not permitted; that is, if you want to change values 2 and 6, you must send all values up to 6. Subsequent values will remain as they were. The query for this parameter always returns 12 values.

Key Path	Meas Setup, Inner Offset/Limits, Limits
Mode	MSR, LTEAFDD, LTEATDD
Remote Command	<code>[:SENSe] :SEMask:OFFSet [1] 2 :INNer:LIST:STARt:ABSolute <real>, ...</code> <code>[:SENSe] :SEMask:OFFSet [1] 2 :INNer:LIST:STARt:ABSolute?</code>
Example	SEM:OFFS2:INN:LIST:STAR:ABS -12.50 dBm, -12.50 dBm, -24.50 dBm, -11.50 dBm, -11.50 dBm, -11.50 dBm SEM:OFFS2:INN:LIST:STAR:ABS?
Notes	Comma separated list of values. OFFSet1 is for BTS, 2 for MS. Default is BTS. You must be in the MSR and LTE-Advanced FDD/TDD modes to use this command. Use :INSTRument:SElect to set the mode.
Preset	MSR:-12.5 dBm, -12.5 dBm, -24.5 dBm, -11.5 dBm, -15.0 dBm, -15.0 dBm, -15.0 dBm, -15.0 dBm, -15.0 dBm, -15.0 dBm, -15.0 dBm, -15.0 dBm -12.5 dBm, -12.5 dBm, -24.5 dBm, -11.5 dBm, -15.0 dBm, -15.0 dBm, -15.0 dBm, -15.0 dBm, -15.0 dBm, -15.0 dBm, -15.0 dBm, -15.0 dBm, -15.0 dBm, -15.0 dBm, -15.0 dBm, -15.0 dBm, -15.0 dBm, -15.0 dBm LTEAFDD, LTEATDD: -5.5 dBm, -12.5 dBm, -15.0 dBm, -15.0 dBm, -15.0 dBm, -15.0 dBm, -15.0 dBm, -15.0 dBm, -15.0 dBm, -15.0 dBm, -15.0 dBm, -15.0 dBm -13.5 dBm, -8.5 dBm, -11.5 dBm, -23.5 dBm, -23.5 dBm, -23.5 dBm, -23.5 dBm, -23.5 dBm, -23.5 dBm, -23.5 dBm, -23.5 dBm, -23.5 dBm, -23.5 dBm, -23.5 dBm, -23.5 dBm, -23.5 dBm, -23.5 dBm
State Saved	Saved in instrument state.
Min	-200 dBm
Max	50 dBm
Initial S/W Revision	A.14.00

Abs Stop

Allows you to enter an absolute level limit at Stop Freq ranging from -200 to +50 dBm, and to toggle this function between Couple and Man. If set to Couple, this is coupled to Abs Start to make a flat limit line. If set to Man, Abs Start and Abs Stop can take different values to make a sloped limit line.

Sets the absolute power level limit at the stop frequency for the selected offset. The absolute power level limit ranges from -200 to +50 dBm. You can also toggle this function between couple and manual. If set to Couple, the Abs Stop power level limit is coupled to Abs Start to result in a flat limit line. If set to Man, Abs Start and Abs Stop take different values to result in a sloped limit line.

The SCPI query returns values currently set to the offset stop absolute power limits.

Missing values are not permitted; that is, if you want to change values 2 and 6, you must send all values up to 6. Subsequent values will remain as they were. The query for this parameter always returns 12 values.

Key Path	Meas Setup, Inner Offset/Limits, Limits
Mode	MSR, LTEAFDD, LTEATDD

Remote Command	<pre>[:SENSe]:SEMask:OFFSet[1] 2:INNeR:LIST:STOP:ABSolute <real>, ... [:SENSe]:SEMask:OFFSet[1] 2:INNeR:LIST:STOP:ABSolute? [:SENSe]:SEMask:OFFSet[1] 2:INNeR:LIST:STOP:ABSolute:COUPle ON OFF 1 0, ... [:SENSe]:SEMask:OFFSet[1] 2:INNeR:LIST:STOP:ABSolute:COUPle?</pre>
Example	<pre>SEM:OFFS:INN:LIST:STOP:ABS -12.50 dBm, -24.50 dBm, -24.50 dBm, -11.50 dBm, -11.50 dBm, -11.50 dBm SEM:OFFS1:INN:LIST:STOP:ABS? SEM:OFFS:INN:LIST:STOP:ABS:COUP ON, OFF, ON, ON, ON, ON SEM:OFFS:INN:LIST:STOP:ABS:COUP?</pre>
Notes	<p>Comma separated list of values. OFFSet1 is for BTS, 2 for MS. Default is BTS. You must be in the MSR and LTE-Advanced FDD/TDD modes to use this command. Use :INSTrument:SElect to set the mode.</p>
Couplings	Coupled to Abs Start if “Auto” is selected, that is, the Stop value is equal to the Start value.
Preset	<pre>MSR:-12.5 dBm, -24.5 dBm, -11.5 dBm, -15.0 dBm, -15.0 dBm, -15.0 dBm, -15.0 dBm, -15.0 dBm, -15.0 dBm, -15.0 dBm, -15.0 dBm, -15.0 dBm -12.5 dBm, -24.5 dBm, -11.5 dBm, -15.0 dBm, -15.0 dBm, -15.0 dBm, -15.0 dBm, -15.0 dBm, -15.0 dBm, -15.0 dBm, -15.0 dBm, -15.0 dBm LTEAFDD, LTEATDD:-12.5 dBm, -12.5 dBm, -15.0 dBm, -15.0 dBm, -15.0 dBm, -15.0 dBm, - 15.0 dBm, -15.0 dBm, -15.0 dBm, -15.0 dBm, -15.0 dBm -13.5 dBm, -8.5 dBm, - 11.5 dBm, -23.5 dBm, -23.5 dBm, -23.5 dBm -23.5 dBm, -23.5 dBm, -23.5 dBm, -23.5 dBm, - 23.5 dBm, -23.5 dBm MSR:ON, OFF, OFF, OFF, ON, OFF, OFF, OFF, OFF, OFF, OFF, OFF ON, OFF, OFF, OFF, ON, OFF, OFF, OFF, OFF, OFF, OFF, OFF LTEAFDD, LTEATDD: OFF, ON, ON, ON, ON, ON, ON, ON, ON, ON, ON ON, ON, ON, ON, ON, ON, ON, ON, ON, ON, ON, ON</pre>
State Saved	Saved in instrument state.
Min	-200 dBm
Max	50 dBm
Initial S/W Revision	A.14.00

Rel Start

Allows you to enter a relative level limit at Start Freq ranging from -200 to +50 dBc.

Sets a relative power level limit at the start frequency for the selected offset. The relative power level limit ranges from -200 to +50 dBc.

The fail condition is set remotely by [:SENSe]:SEMask:OFFSet[n]:INNeR:LIST:TEST for each offset channel test.

You can turn off (not use) specific offset channels remotely with [:SENSe]:SEMask:OFFSet [n]:INNeR:LIST:STATe.

The SCPI query returns values currently set to the relative power test limits.

Missing values are not permitted; that is, if you want to change values 2 and 6, you must send all values up to 6. Subsequent values will remain as they were. The query for this parameter always returns 12 values.

Key Path	Meas Setup, Inner Offset/Limits, Limits
Mode	MSR, LTEAFDD, LTEATDD
Remote Command	<code>[:SENSE] :SEMAsk:OFFSet [1] 2 :INNer:LIST:STARt:RCARrier <rel_ampl>, ...</code> <code>[:SENSE] :SEMAsk:OFFSet [1] 2 :INNer:LIST:STARt:RCARrier?</code>
Example	SEM:OFFS:INN:LIST:STAR:RCAR -30, -30, -30, -30, -30, -30 SEM:OFFS:INN:LIST:STAR:RCAR?
Notes	Comma separated list of values. OFFSet1 is for BTS, 2 for MS. Default is BTS. You must be in the MSR and LTE-Advanced FDD/TDD modes to use this command. Use :INSTrument:SElect to set the mode.
Preset	0 dB, 0 dB, 0 dB, 0 dB, 0 dB, 0 dB, 0 dB, 0 dB, 0 dB, 0 dB, 0 dB 0 dB, 0 dB, 0 dB, 0 dB, 0 dB, 0 dB, 0 dB, 0 dB, 0 dB, 0 dB, 0 dB
State Saved	Saved in instrument state.
Min	-200 dB
Max	50 dB
Initial S/W Revision	A.14.00

Rel Stop

Sets a relative power level limit at the stop frequency for the selected offset. The relative power level limit ranges from -200 to +50 dBc.

The fail condition is set remotely by `[:SENSE] :SEMAsk:OFFSet [n] :INNer:LIST:TEST` for each offset channel.

You can turn off (not use) specific offset channels remotely with `[:SENSE] :SEMAsk:OFFSet [n] :INNer:LIST:STATe`.

The SCPI query returns values currently set to the offset stop relative power limits.

Missing values are not permitted; that is, if you want to change values 2 and 6, you must send all values up to 6. Subsequent values will remain as they were. The query for this parameter always returns 12 values.

Key Path	Meas Setup, Inner Offset/Limits, Limits
Mode	MSR, LTEAFDD, LTEATDD
Remote Command	<code>[:SENSE] :SEMAsk:OFFSet [1] 2 :INNer:LIST:STOP:RCARrier <rel_ampl>, ...</code> <code>[:SENSE] :SEMAsk:OFFSet [1] 2 :INNer:LIST:STOP:RCARrier?</code> <code>[:SENSE] :SEMAsk:OFFSet [1] 2 :INNer:LIST:STOP:RCARrier:COUPle ON OFF 1 0, ...</code> <code>[:SENSE] :SEMAsk:OFFSet [1] 2 :INNer:LIST:STOP:RCARrier:COUPle?</code>
Example	SEM:OFFS:INN:LIST:STOP:RCAR -30, -30, -30, -30, -30, -30

	SEM:OFFS:INN:LIST:STOP:RCAR? SEM:OFFS:INN:LIST:STOP:RCAR:COUP ON, ON, ON, ON, ON, ON SEM:OFFS:INN:LIST:STOP:RCAR:COUP?
Notes	Comma separated list of values. OFFSet1 is for BTS, 2 for MS. Default is BTS. You must be in the MSR and LTE-Advanced FDD/TDD modes to use this command. Use :INSTRument:SElect to set the mode.
Couplings	Coupled to Rel Start if “Auto” is selected, that is, Start is made the same as Stop.
Preset	0 dB, 0 dB, 0 dB, 0 dB, 0 dB, 0 dB, 0 dB, 0 dB, 0 dB, 0 dB, 0 dB, 0 dB 0 dB, 0 dB, 0 dB, 0 dB, 0 dB, 0 dB, 0 dB, 0 dB, 0 dB, 0 dB, 0 dB, 0 dB ON, ON, ON, ON, ON, ON, ON, ON, ON, ON, ON, ON ON, ON, ON, ON, ON, ON, ON, ON, ON, ON, ON, ON, ON, ON
State Saved	Saved in instrument state.
Min	-200 dB
Max	50 dB
Initial S/W Revision	A.14.00

Fail Mask

Selects one of the logic keys for fail conditions between the measurement results and the test limits:

- Absolute and Relative both check the results against the respective limit.
- OR checks against both limits, failing if either of the limits is broken.
- AND will only display a fail if both of the limits are broken.

The absolute or relative power limit value for each offset channel can be set remotely with [:SENSe]:SEMask:OFFSet[n]:INNer:LIST:ABSolute or [:SENSe]:SEMask:OFFSet[n]:INNer:LIST:RCARrier.

You can turn off (not use) specific offset channels remotely with [:SENSe]:SEMask:OFFSet[n]:INNer:LIST:STATe.

Missing values are not permitted; that is, if you want to change values 2 and 6, you must send all values up to 6. Subsequent values will remain as they were. The query for this parameter always returns 12 values.

Key Path	Meas Setup, Inner Offset/Limits, Limits
Mode	MSR, LTEAFDD, LTEATDD
Remote Command	[:SENSe]:SEMask:OFFSet[1] 2:INNer:LIST:TEST ABSolute AND OR RELative, ... [:SENSe]:SEMask:OFFSet[1] 2:INNer:LIST:TEST?
Example	SEM:OFFS:INN:LIST:TEST ABS, ABS, ABS, ABS, ABS, ABS SEM:OFFS:INN:LIST:TEST?
Notes	Comma separated list of values. You must be in the MSR and LTE-Advanced FDD/TDD modes to use this command. Use

	:INSTRument:SElect to set the mode.
Preset	ABS, ABS, ABS, ABS, ABS, ABS, ABS, ABS, ABS, ABS, ABS, ABS
State Saved	Saved in instrument state.
Range	Absolute Relative Abs AND Rel Abs OR Rel
Initial S/W Revision	A.14.00

Offset Freq Define

This key enables you to select “Offset” definition. Each standard defines each “Offset” from Carrier.

Meas BW Edge means the edge of resolution band width that is represented by Meas BW and Res BW settings. Actual center frequency of Meas BW and the limit line have $\frac{1}{2}$ Meas BW offset when the Meas BW Edge is selected.

3GPP2 requires the “Carrier Center to Meas BW Edge” definition, and LTE conformance test requires “Carrier Edge to Meas BW Center” and/or “Carrier Edge to Meas BW Edge” definition. MSR standard requires “RFBW Edge to Meas BW Center” and/or “RFBW Edge to Meas Edge” definition.

- **CTOC** – From the lowermost carrier frequency (for lower offset), the uppermost carrier frequency (for upper offset) to the center of offset measuring filter*
- **CTOE** – From the lowermost carrier frequency (for lower offset), the uppermost carrier frequency (for upper offset) to the nominal -3 dB point of the offset measuring filter* closer to the carrier
- **ETOC** – From the lowermost carrier frequency - spacing of this carrier $/2$ (for lower offset), the uppermost carrier frequency + spacing of this carrier $/2$ (for upper offset) to the center of offset measuring filter*
- **ETOE** – From the lowermost carrier frequency - spacing of this carrier $/2$ (for lower offset), the uppermost carrier frequency + spacing of this carrier $/2$ (for upper offset) to the nominal -3 dB point of the offset measuring filter* closer to the carrier
- **STOC** – From either the lower or upper sub-block edges to the center of offset measuring filter*
- **STOE** – From either the lower or upper sub-block edges to the nominal -3 dB point of the offset measuring filter* closer to the carrier

*Measuring filter = Meas BW (N) x Res BW

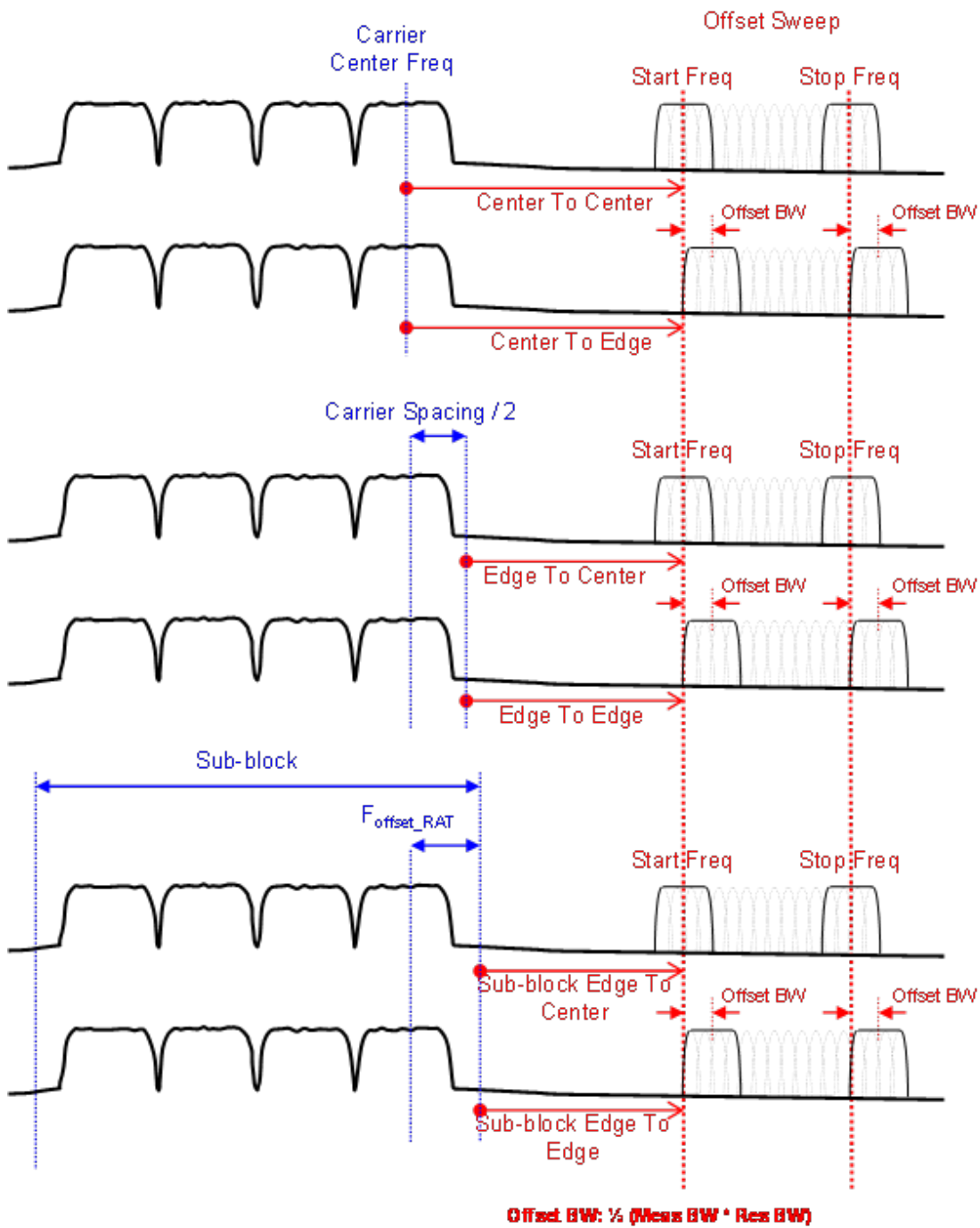

Offset Freq Definition in SEM Measurement

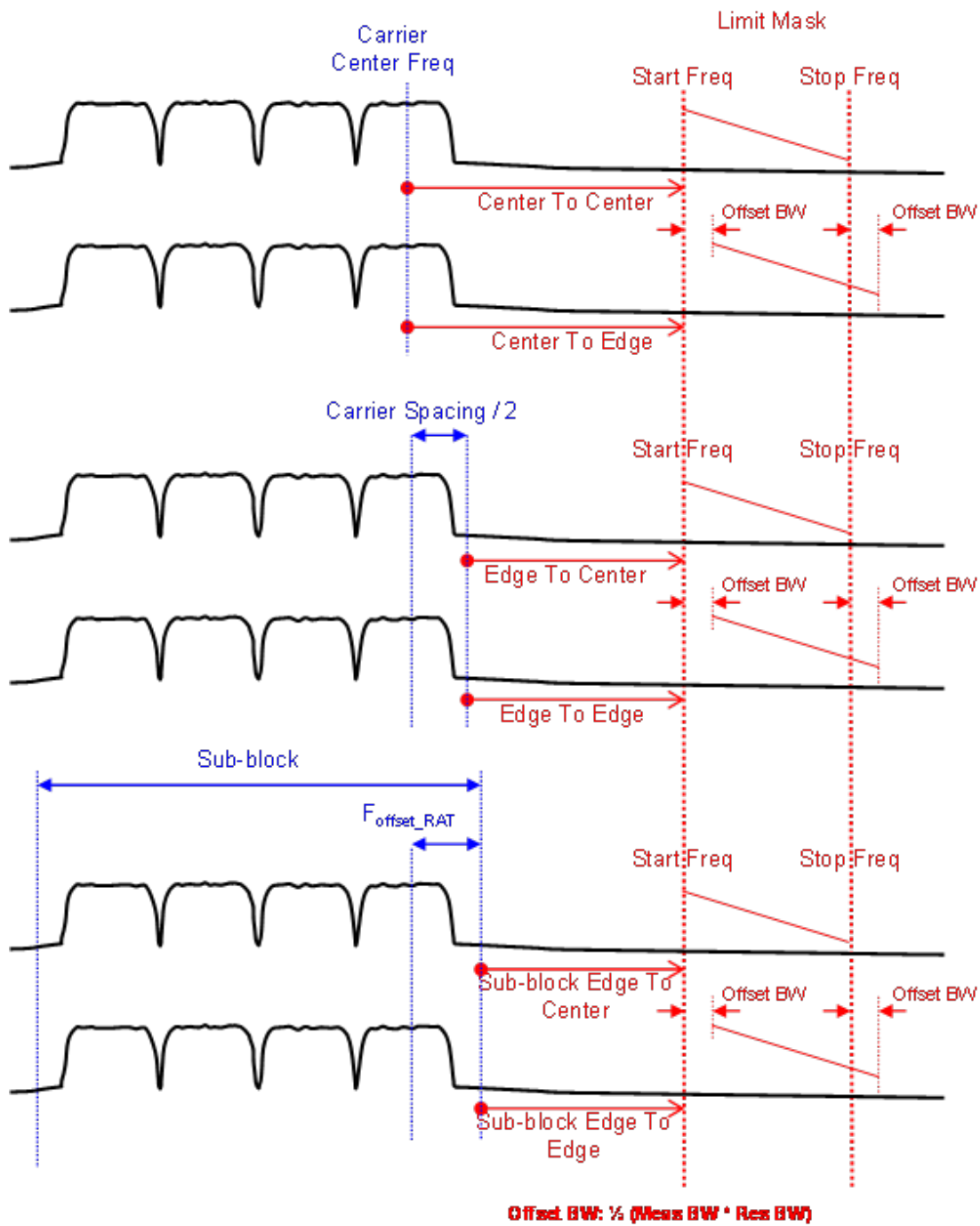

Offset Freq Definition (Limit Mask) in SEM measurement

Key Path	Meas Setup, Inner Offset/Limits
Mode	MSR, LTEAFDD, LTEATDD
Remote Command	[[:SENSe]:SEMAsk:OFFSet[1] 2:INNER:TYPE CTOC CTOE ETOC ETOE STOC STOE [:SENSe]:SEMAsk:OFFSet[1] 2:INNER:TYPE?

Example	SEM:OFFS:INN:TYPE ETOC SEM:OFFS:INN:TYPE?
Notes	You must be in the MSR and LTE-Advanced FDD/TDD modes to use this command. Use :INSTrument:SElect to set the mode.
Preset	STOC
State Saved	Saved in instrument state.
Range	Carrier Center To Meas BW Center Carrier Center To Meas BW Edge Carrier Edge To Meas BW Center Carrier Edge To Meas BW Edge Sub-block Edge To Meas BW Center Sub-block Edge To Meas BW Edge
Readback	Center to Center Center to Edge Edge to Center Edge to Edge S Edge to Center S Edge to Edge
Initial S/W Revision	A.14.00

Cumulate Mask

Selects whether inner offset limit masks are cumulated or not.

Key Path	Meas Setup, Inner Offset/Limits
Mode	MSR, LTEAFDD, LTEATDD
Remote Command	[:SENSe] :SEMAsk:OFFSet [1] 2 :INNer:CMASk [:STATe] ON OFF 0 1 [:SENSe] :SEMAsk:OFFSet [1] 2 :INNer:CMASk [:STATe] ?
Example	SEM:OFFS:INN:CMAS 0 SEM:OFFS:INN:CMAS?
Notes	OFFSet1 is for BTS, 2 for MS. Default is BTS. You must be in the MSR and LTE-Advanced FDD/TDD modes to use this command. Use :INSTrument:SElect to set the mode.
Preset	1
State Saved	Saved in instrument state.
Range	ON OFF
Initial S/W Revision	A.14.00

Cumulate Mask Stop Frequency

Specifies stop frequency of summing limit masks. For outside of the stop frequency, the limit masks are not cumulated.

Key Path	Meas Setup, Inner Offset/Limits
Mode	MSR, LTEAFDD, LTEATDD
Remote Command	[:SENSe] :SEMAsk:OFFSet [1] 2 :INNer:CMASk:FREQuency:STOP <freq> [:SENSe] :SEMAsk:OFFSet [1] 2 :INNer:CMASk:FREQuency:STOP?
Example	SEM:OFFS:INN:CMAS:FREQ:STOP 500E6

	SEM:OFFS:INN:CMAS:FREQ:STOP?
Notes	OFFSet1 is for BTS, 2 for MS. Default is BTS. You must be in the MSR and LTE-Advanced FDD/TDD modes to use this command. Use :INSTrument:SElect to set the mode.
Dependencies	This parameter is valid only when Cumulate Mask is On.
Preset	10.5 MHz
State Saved	Saved in instrument state.
Min	0 Hz
Max	500 MHz
Initial S/W Revision	A.14.00

Non-Contiguous Meas Region

Selects the region to measure for the non-contiguous frequency allocation from either inner or outer.

Key Path	Meas Setup
Mode	MSR, LTEAFDD, LTEATDD
Remote Command	[:SENSe] :SEMAsk:NCONtiguous:REGion INNer OUTer [:SENSe] :SEMAsk:NCONtiguous:REGion?
Example	SEM:NCON:REG INN SEM:NCON:REG?
Notes	You must be in the MSR and LTE-Advanced FDD/TDD modes to use this command. Use :INSTrument:SElect to set the mode.
Preset	INNer
State Saved	Saved in instrument state.
Range	Inner Outer
Initial S/W Revision	A.14.00

Method

Sets the measurement method:

- **Integ BW**—enables you to set the channel integration bandwidth.
- **RRC Weight**—selects Root Raised Cosine (RRC) filtering of the carriers. The α value (rolloff) for the filter is set to the value of the Filter Alpha parameter.

Key Path	Meas Setup
Mode	SA, WCDMA, WIMAX OFDMA, TD-SCDMA, DTMB (CTTB), DVB-T/H, ISDB-T, CMMB, LTE, LTETDD, Digital Cable TV, WLAN, MSR, LTEAFDD, LTEATDD
Remote Command	[:SENSe] :SEMAsk:FILTer [:RRC] [:STATe] OFF ON 0 1

	<code>[:SENSe] :SEMAsk:FILTEr [:RRC] [:STATe] ?</code>
Example	SEM:FILT ON SEM:FILT?
Notes	For the C2K and 1xEVDO mode, this key is not available. 1 ON = RRC Weight, 0 OFF = IntegBW You must be in the mode that includes SEM measurement to use this command. Use :INSTrument:SElect to set the mode.
Dependencies	WLAN: RRC Weight is not supported when the radio standard is WLAN 802.11ac (80+80MHz).
Preset	SA, WIMAX OFDMA, DVB-T/H, ISDB-T, CMMB, LTE, LTETDD, WLAN, MSR, LTEAFDD, LTEATDD: OFF WCDMA, TD-SCDMA, DTMB (CTTB), Digital Cable TV: ON
State Saved	Saved in instrument state.
Range	RRCWeight IntegBW
Initial S/W Revision	Prior to A.02.00
Modified at S/W Revision	A.02.00, A.03.00

Filter Alpha

Sets the alpha value for the RRC Filter.

Key Path	Meas Setup
Mode	SA, WCDMA, WIMAX OFDMA, TD-SCDMA, DTMB (CTTB), DVB-T/H, ISDB-T, CMMB, LTE, LTETDD, Digital Cable TV, MSR, LTEAFDD, LTEATDD
Remote Command	<code>[:SENSe] :SEMAsk:FILTEr [:RRC] :ALPHa <real></code> <code>[:SENSe] :SEMAsk:FILTEr [:RRC] :ALPHa?</code>
Example	SEM:FILT:ALPH 0.3 SEM:FILT:ALPH?
Notes	For the C2K and 1xEVDO mode, this key is not available. You must be in the mode that includes SEM measurement to use this command. Use :INSTrument:SElect to set the mode.
Preset	0.22 DTMB (CTTB): 0.05 Digital Cable TV: 0.15
State Saved	Saved in instrument state.
Min	0.01
Max	1.0
Initial S/W Revision	Prior to A.02.00
Modified at S/W Revision	A.02.00, A.03.00

Meas Preset

Restores all the measurement parameters to their default values.

Key Path	Meas Setup
Mode	SA, WCDMA, C2K, WIMAX OFDMA, TD-SCDMA, 1xEVDO, DTMB (CTTB), DVB-T/H, ISDB-T, CMMB, LTE, LTE-TDD, Digital Cable TV, WLAN, MSR, LTEAFDD, LTEATDD
Remote Command	:CONFigure:SEMask
Example	CONF:SEM
Notes	You must be in the mode that includes SEM measurement to use this command. Use :INSTrument:SElect to set the mode.
Couplings	Selecting Meas Preset will restore all measurement parameters to their default values.
Initial S/W Revision	Prior to A.02.00
Modified at S/W Revision	A.02.00, A.03.00

11 Spectrum Emission Mask Measurement
Mode

Mode

See "[Mode](#)" on page 222

Mode Preset

Returns the active mode to a known state.

Mode Preset does the following for the currently active mode:

- Aborts the currently running measurement.
- Brings up the default menu for the mode, with no active function.
- Sets measurement Global settings to their preset values for the active mode only.
- Activates the default measurement.
- Brings up the default menu for the mode.
- Clears the input and output buffers.
- Sets Status Byte to 0.

Mode Preset does not:

- Cause a mode switch
- Affect mode persistent settings
- Affect system settings
- See "[How-To Preset](#)" on page 1374 for more information.

Key Path	Front-panel key
Remote Command	:SYSTem:PRESet
Example	:SYST:PRES
Notes	*RST is preferred over :SYST:PRES for remote operation. *RST does a Mode Preset, as done by the :SYST:PRES command, and it sets the measurement mode to Single measurement rather than Continuous for optimal remote control throughput. Clears all pending OPC bits. The Status Byte is set to 0.
Couplings	A Mode Preset aborts the currently running measurement, activates the default measurement, and gets the mode to a consistent state with all of the default couplings set.
Backwards Compatibility Notes	In the X-Series, the legacy "Factory Preset" has been replaced with Mode Preset, which only presets the currently active mode, not the entire instrument. In the X-Series, the way to preset the entire instrument is by using System, Restore System Defaults All, which behaves essentially the same way as restore System Defaults does on ESA and PSA. There is also no "Preset Type" as there is on the PSA. There is a green Mode Preset front-panel key that does a Mode Preset and a white-with-green-letters User Preset front-panel key that does a User Preset. The old PRESet:TYPE command is ignored (without generating an error), and SYST:PRES without a parameter does a Mode Preset, which should cover most backward code compatibility issues. The settings and correction data under the Input/Output front-panel key (examples: Input Z Corr, Ext Amp Gain, etc.) are no longer part of any Mode, so they will not be preset by a Mode Preset. They are preset using Restore Input/Output Defaults, Restore System Defaults All. Note that because User Preset does a Recall State, and all of these settings are saved in State, they ARE recalled when using

	User Preset.
Initial S/W Revision	Prior to A.02.00

How-To Preset

The table below shows all possible presets, their corresponding SCPI commands and front-panel access (key paths). Instrument settings depend on the current measurement context. Some settings are local to the current measurement, some are global (common) across all the measurements in the current mode, and some are global to all the available modes. In a similar way, restoring the settings to their preset state can be done within the different contexts.

Auto Couple - is a measurement local key. It sets all Auto/Man parameter couplings in the measurement to Auto. Any Auto/Man selection that is local to other measurements in the mode will not be affected.

Meas Preset - is a measurement local key. Meas Preset resets all the variables local to the current measurement except the persistent ones.

Mode Preset - resets all the current mode's measurement local and measurement global variables except the persistent ones.

Restore Mode Defaults - resets ALL the Mode variables (and all the Meas global and Meas local variables), including the persistent ones.

Type Of Preset	SCPI Command	Front Panel Access
Auto Couple	:COUPle ALL	Auto Couple front-panel key
Meas Preset	:CONFigure:<Measurement>	Meas Setup Menu
Mode Preset	:SYSTem:PRESet	Mode Preset (green key)
Restore Mode Defaults	:INSTrument:DEFault	Mode Setup Menu
Restore All Mode Defaults	:SYSTem:DEFault MODes	System Menu; Restore System Default Menu
*RST	*RST	not possible (Mode Preset with Single)
Restore Input/Output Defaults	:SYSTem:DEFault INPUt	System Menu; Restore System Default Menu
Restore Power On Defaults	:SYSTem:DEFault PON	System Menu; Restore System Default Menu
Restore Alignment Defaults	:SYSTem:DEFault ALIGN	System Menu; Restore System Default Menu
Restore Miscellaneous Defaults	:SYSTem:DEFault MISC	System Menu; Restore System Default Menu
Restore All System Defaults	:SYSTem:DEFault [ALL] :SYSTem:PRESet:PERsistent	System Menu; Restore System Default Menu
User Preset	:SYSTem:PRESet:USER	User Preset Menu
User Preset All Modes	:SYSTem:PRESet:USER:ALL	User Preset Menu

Power On Mode Preset	:SYSTem:PON:TYPE MODE	System Menu
Power On User Preset	:SYSTem:PON:TYPE USER	System Menu
Power On Last State	:SYSTem:PON:TYPE LAST	System Menu

Mode Setup

See "[Mode Setup](#)" on page 242

Peak Search

There is no 'Peak Search' supported in Spectrum Emission Mask so this front-panel key displays a blank menu when pressed.

Key Path	Front-panel key
Initial S/W Revision	Prior to A.02.00

11 Spectrum Emission Mask Measurement
Print

Print

See "Print" on page 271

Quick Save

The Quick Save front-panel key repeats the most recent save that was performed from the Save menu, with the following exceptions:

- Register saves are not remembered as Saves for the purpose of the Quick Save function
- If the current measurement does not support the last non-register save that was performed, an informational message is generated, “File type not supported for this measurement”

Quick Save repeats the last type of qualified save (that is, a save qualified by the above criteria) in the last save directory by creating a unique filename using the Auto File Naming algorithm described below.

If Quick Save is pressed after startup and before any qualified Save has been performed, the Quick Save function performs a Screen Image save using the current settings for Screen Image saves (current theme, current directory), which then becomes the “last save” for the purpose of subsequent Quick Saves.

The Auto File Naming feature automatically generates a file name for use when saving a file. The filename consists of a prefix and suffix separated by a dot, as is standard for the Windows® file system. A default prefix exists for each of the available file types:

Type	Default Prefix	Menu
State	State_	(Save/Recall)
Trace + State	State_	(Save/Recall)
Screen	Screen_	(Save/Recall)
Amplitude Corrections	Ampcor_	(Import/Export)
Traces	Trace_	(Import/Export)
Limit Lines	LLine_	(Import/Export)
Measurement Result	MeasR_	(Import/Export)
Capture Buffer	CapBuf_	(Import/Export)

A four digit number is appended to the prefix to create a unique file name. The numbering sequence starts at 0000 within each Mode for each file type and updates incrementally to 9999, then wraps to 0000 again. It remembers where it was through a Mode Preset and when leaving and returning to the Mode. It is reset by Restore Misc Defaults and Restore System Defaults and subsequent running of the instrument application. So, for example, the first auto file name generated for State files is State_0000.state. The next is State_0001, and so forth.

One of the key features of Auto File Name is that we guarantee that the Auto File Name will never conflict with an existing file. The algorithm looks for the next available number. If it gets to 9999, then it looks for holes. If it find no holes, that is no more numbers are available, it gives an error.

For example, if when we get to State_0010.state there is already a State_0010.state file in the current directory, it advances the counter to State_0011.state to ensure that no conflict will exist (and then it verifies that State_0011.state also does not exist in the current directory and advances again if it does, and so forth).

If you enter a file name for a given file type, then the prefix becomes the filename you entered instead of the default prefix, followed by an underscore. The last four letters (the suffix) are the 4-digit number.

For example, if you save a measurement results file as “fred.csv”, then the next auto file name chosen for a measurement results save will be fred_0000.csv.

NOTE

Although 0000 is used in the example above, the number that is used is actually the current number in the Meas Results sequence, that is, the number that would have been used if you had not entered your own file name.

NOTE

If the filename you entered ends with _dddd, where d=any number, making it look just like an auto file name, then the next auto file name picks up where you left off with the suffix being dddd + 1.

Key Path	Front-panel key
Notes	No remote command for this key specifically.
Initial S/W Revision	Prior to A.02.00

Recall

In the LTE-Advanced TDD/FDD modes, two types of recall functions are available under the Data menu: “Parameter Configuration per Component Carrier” and “Limit Mask”. Limit Mask enables setting a preset limit mask for Power Suite-based measurements, and currently it is available for the SEM, ACP and SPUR measurements in LTE-Advanced TDD/FDD modes.

Recalling the complicated RB settings specified in the test models of the standards and the LTE state file. And it can also recalls the parameters which have been set and saved for “Signal Studio Setup” or “89600 Vector Signal Analyzer” on the external platform .

Key Path	Front Panel Key
Mode	LTEATDD, LTEAFDD
Initial S/W Revision	A.14.00

State

The Recall State menu lets you choose a register or file from which to recall the state.

The content of a state file includes all of the settings and data required to return the analyzer as closely as possible to the Mode it was in, with the exact settings that were in place, when the save occurred. The Mode settings in each state file include the settings that are affected by Mode Preset, as well as the additional settings affected by Restore Mode Defaults; all of the Mode’s settings. In addition, all of the settings of the Input/Output system are included, even though they are outside of the Mode’s state, because they are needed to restore the complete setup. Persistent System settings (for example, GPIB address) are not affected by either a Mode Preset or Restore Mode Defaults, nor are they included in a saved State file.

Since each state file is only for one Mode, the settings for other Modes are unaffected when it is loaded. Recall State will cause a mode switch if the state being recalled is not from the current active mode.

After the recall completes, the message "File <filename> recalled" or “Recalled State Register <register number>” is displayed.

For rapid recalls, the State menu lists 16 registers that you can choose from to recall. Pressing a Register key initiates the recall. You can also select a file from which to recall.

The default path for all State Files is:

My Documents\<>mode name>\state

where <mode name> is the parameter used to select the mode with the INST:SEL command (for example, SA for the Spectrum Analyzer).

See "[More Information](#)" on page 1382.

Key Path	Recall
Mode	All
Remote Command	:MMEMory:LOAD:STATe <filename>

Example	:MMEM:LOAD:STAT "myState.state" This recalls the file myState.state on the default path
Example	MMEM:LOAD:STAT "MyStateFile.state" This loads the state file data (on the default file directory path) into the instrument state.
Notes	<p>When you pick a file to recall, the analyzer first verifies that the file is recallable in the current instrument by checking the software version and model number of the instrument. If everything matches, a full recall proceeds by aborting the currently running measurement, clearing any pending operations, and then loading the State from the saved state file. You can open state files from any mode, so recalling a State file switches to the mode that was active when the save occurred. After switching to the mode of the saved state file, mode settings and data (if any for the mode) are loaded with values from the saved file. The saved measurement of the mode becomes the newly active measurement and the data relevant to the measurement (if there is any) is recalled.</p> <ul style="list-style-type: none"> • If there is a mismatch between file version or model number or instrument version or model number, the recall function tries to recall as much as possible and returns a warning message. It may limit settings that differ based on model number, licensing or version number. <p>After recalling the state, the Recall State function does the following:</p> <ul style="list-style-type: none"> • Makes the saved measurement for the mode the active measurement. • Clears the input and output buffers. • Status Byte is set to 0. • Executes a *CLS <p>If the file specified is empty an error is generated. If the specified file does not exist, another error is generated. If there is a mismatch between the file and the proper file type, an error is generated. If there is a mismatch between file version or model number or instrument version or model number, a warning is displayed. Then it returns to the State menu and File Open dialog goes away.</p> <p>After the Recall, the analyzer exits the Recall menu and returns to the previous menu.</p>
Backwards Compatibility SCPI	:MMEMory:LOAD:STATe 1,<filename> For backwards compatibility, the above syntax is supported. The "1" is simply ignored.
Initial S/W Revision	Prior to A.02.00

More Information

In measurements that support saving Traces, for example, Swept SA, the Trace data is saved along with the State in the State file. When recalling the State, the Trace data is recalled as well. Traces are recalled exactly as they were stored, including the writing mode and update and display modes. If a Trace was updating and visible when the State was saved, it will come back updating and visible, and its data will be rewritten right away. When you use State to save and recall traces, any trace whose data must be preserved should be placed in View or Blank mode before saving.

The following table describes the Trace Save and Recall possibilities:

You want to recall state and one trace's data, leaving other traces unaffected.	Save Trace+State from 1 trace. Make sure that no other traces are updating (they should all be in View or Blank mode) when the save is performed.	On Recall, specify the trace you want to load the one trace's data into. This trace will load in View. All other traces' data will be unaffected, although their trace
---	---	--

You want to recall all traces	Save Trace+State from ALL traces.	mode will be as it was when the state save was performed. On Recall, all traces will come back in View (or Blank if they were in Blank or Background when saved)
You want all traces to load exactly as they were when saved.	Save State	On recall, all traces' mode and data will be exactly as they were when saved. Any traces that were updating will have their data immediately overwritten.

From File...

When you press “From File”, the analyzer brings up a Windows dialog and a menu entitled “File Open.” This menu allows you to navigate to the various fields in the Windows dialog without using a keyboard or mouse. The Tab and Arrow keys can also be used for dialog navigation.

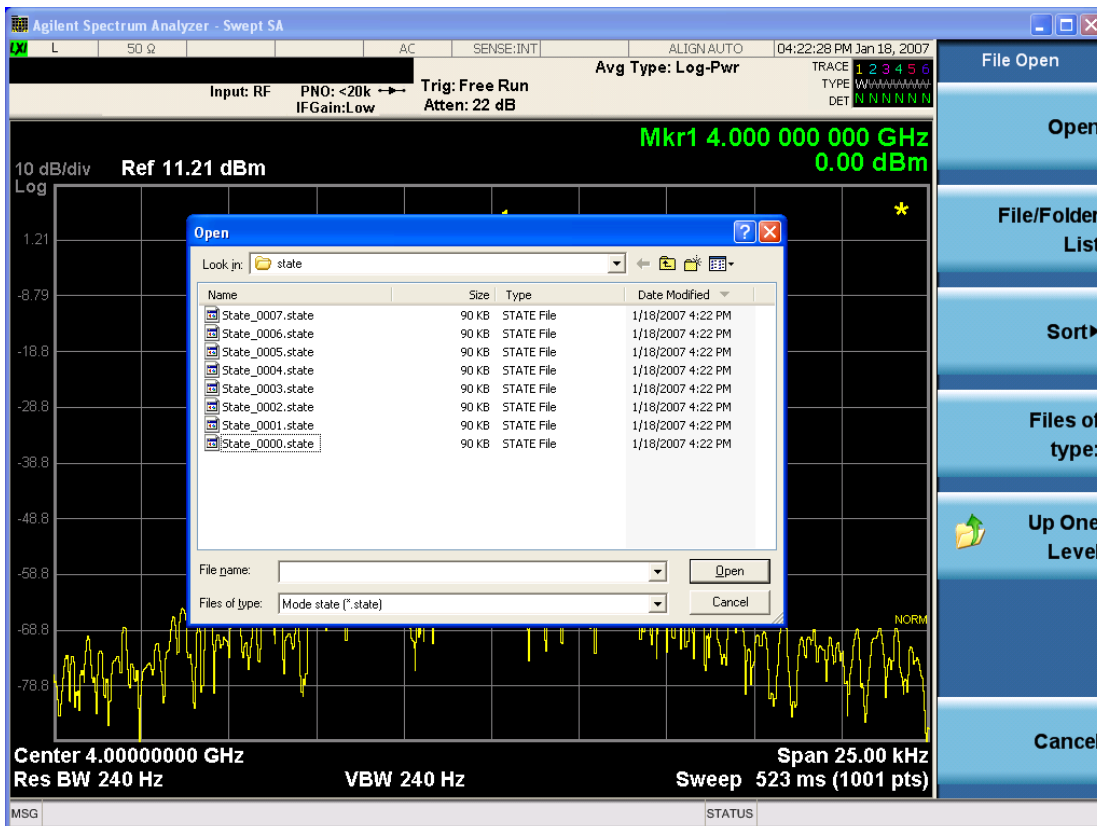

Listed below are the functions of the various fields in the dialog, and the corresponding softkeys:

Open

Performs the recall of the specified file. While the recall is being performed, the floppy icon appears briefly in the Meas bar.

File/Folder List

Enables you to navigate to the center of the dialog that contains the list of files and folders. Once here you can get information about the file and use the tab keys to navigate to the other fields in the dialog, such as Look In.

Look In

The Look In field shows the path from which the file will be recalled and allows you to change the path using the up and down arrow keys to navigate to other paths; the Enter key to open a directory; and the Backspace key to go back one directory. The **Look In field** first uses the last path from the Save As dialog **Save In:** path for that same file type. There is no softkey for directly navigating to the Look In field, but you can use the left tab to get here from the File/Folder List.

User specified paths are remembered when you leave and return to a Mode and are reset back to the default using Restore Mode Defaults.

Sort

Accesses a menu that enables you to sort the files within the File Open dialog. Only one sorting type can be selected at a time and the sorting happens immediately. The sorting types are By Date, By Name, By extension, and By Size.

Files of Type

This field shows the file suffix for the type of file you have selected to recall. For example, if you navigated here while recalling State, "Mode state (*.state)" is in the field. If you navigated here while recalling Trace, ""Mode state (*.trace)" is in the field. If you navigated here while importing a trace data file, "Trace Data (*.csv)" is in the field. For some file types, there is more than one choice in the dropdown menu, which you can select by using the up and down arrow keys and Enter.

Up One Level

This key corresponds to the icon of a folder with the up arrow that is in the tool bar of the dialog. When pressed, it causes the file and folder list to navigate up one level in the directory structure. The Backspace key does the same thing.

Cancel

This key corresponds to the Cancel selection in the dialog. It causes the current **Open** request to be cancelled. The ESC key does the same thing.

Key Path	Recall, State
Notes	Brings up the Open dialog for recalling a State Save Type
Initial S/W Revision	Prior to A.02.00

Edit Register Names

You may enter a custom name on any of the Register keys, to help you remember what you are using that state to save. To do this, press the Edit Register Names key, choose the register whose name you wish to edit, and then enter the desired label using the Alpha Editor or an external PC keyboard.

The maximum number of characters that can be added is 30. In most cases, 30 characters will fit on two lines of the key.

For more information and the SCPI command, see Edit Register Names under the Save, State function.

Key Path	Recall, State
Mode	All
Dependencies	N9060A-7FP or N9060B-2FP license required to edit the register names. When the feature is not licensed, sending the SCPI command generates an error, -221, "Settings conflict;Option not available"
Initial S/W Revision	A.11.00

Register 1 thru Register 16

Selecting any one of these register keys causes the State of the mode from the specified Register to be recalled. Each of the register keys annotates whether it is empty or at what date and time it was last modified. In addition, you can use the Edit Register Names key under Save, State to enter custom names for each register.

NOTE

In products that run multiple instances of the X-Series Application, recalling the same register name on each instance is a way to share setups between the instances.

Registers are shared by all modes, so recalling from any one of the registers will cause a mode switch to the mode that was active when the save to the Register occurred.

Although these 16 registers are the only registers available from the front panel, there are 128 state registers available in the instrument. Registers 17–128 are only available from the SCPI interface, using the *RCL command.

After the recall completes, the message "Register <register number> recalled" appears in the message bar. If you are in the Spectrum Analyzer Mode, and you are recalling a register that was saved in the Spectrum Analyzer Mode, then after the recall, you will still be in the Recall Register menu. If the Recall causes you to switch modes, then after the Recall, you will be in the Frequency menu.

If a requested register is empty an error is generated.

Key Path	Recall, State
Example	*RCL 1
Range	1–16 from front panel, 1–128 from SCPI
Readback	Date and time with seconds resolution are displayed on the key OR A custom name of up to 30 characters entered using the Save, State,Edit Register Names key

	OR “(empty)” if no prior save operation has been performed to this register.
Initial S/W Revision	Prior to A.02.00
Modified at S/W Revision	Prior to A.11.00

Register 1 thru Register 16

Selecting any one of these register keys causes the State of the mode from the specified Register to be recalled. Each of the register keys annotates whether it is empty or at what date and time it was last modified. In addition, you can use the Edit Register Names key under Save, State to enter custom names for each register.

NOTE

In products that run multiple instances of the X-Series Application, recalling the same register name on each instance is a way to share setups between the instances.

Registers are shared by all modes, so recalling from any one of the registers will cause a mode switch to the mode that was active when the save to the Register occurred.

Although these 16 registers are the only registers available from the front panel, there are 128 state registers available in the instrument. Registers 17–128 are only available from the SCPI interface, using the *RCL command.

After the recall completes, the message "Register <register number> recalled" appears in the message bar. If you are in the Spectrum Analyzer Mode, and you are recalling a register that was saved in the Spectrum Analyzer Mode, then after the recall, you will still be in the Recall Register menu. If the Recall causes you to switch modes, then after the Recall, you will be in the Frequency menu.

If a requested register is empty an error is generated.

Key Path	Recall, State
Example	*RCL 1
Range	1–16 from front panel, 1–128 from SCPI
Readback	Date and time with seconds resolution are displayed on the key OR A custom name of up to 30 characters entered using the Save, State, Edit Register Names key OR “(empty)” if no prior save operation has been performed to this register.
Initial S/W Revision	Prior to A.02.00
Modified at S/W Revision	Prior to A.11.00

Sequences

These keys allow you to import a Tab separated or .txt file that will automatically setup all the parameters required for building a Sequence. The parameters will automatically be loaded into the Stated Sequencer.

Once selected, in order to import the selected Sequence Type you must select the Open key in the Source Sequence menu.

Key Path	Recall, Sequences
Mode	All
Remote Command	:MMEMory:LOAD:SEQ:ences: SLIS ALIS SAALIS "MySequence.txt"
Example	:MMEM:LOAD:SEQ:SLIS "MySequence.txt"
Notes	Available file types are: –CSV (Comma delimited) (*.csv) –Text (Tab delimited) (*.txt)
Initial S/W Revision	A.05.00

Source Sequence

The list of parameters, that configure steps, that makes up a sequence for the Source.

The Source sequence is a sequence of flexible configurable steps that can be set anywhere in the instruments frequency range.

Key Path	Recall, Sequences
Example	:MMEM:LOAD:SEQ:SLIS "MySequence.txt"
Dependencies	Only available in XOBT
Initial S/W Revision	A.05.00

Open...

When you press “Open”, the analyzer brings up a Windows dialog and a menu entitled “**File Open.**” This menu allows you to navigate to the various fields in the Windows dialog without using a keyboard or mouse. The Tab and Arrow keys can also be used for dialog navigation.

See "[From File...](#)" on page 2401 in Recall, State, for a full description of this dialog and menu.

Key Path	Recall, Data
Notes	The key location is mode-dependent and will vary. Brings up Open dialog for recalling a <mode specific> Save Type
Initial S/W Revision	Prior to A.02.00

Data (Import)

Importing a data file loads data that was previously saved from the current measurement or from other measurements and/or modes that produce compatible data files. The Import Menu only contains Data Types that are supported by the current measurement.

Since the commonly exported data files are in .csv format, the data can be edited by the user prior to importing. This allows you to export a data file, manipulate the data in Excel (the most common PC Application for manipulating .csv files) and then import it.

Importing Data loads measurement data from the specified file into the specified or default destination, depending on the data type selected. Selecting an Import Data menu key will not actually cause the importing to occur, since the analyzer still needs to know from where to get the data. Pressing the Open key in this menu brings up the Open dialog and Open menu that provides you with the options from where to recall the data. Once a filename has been selected or entered in the Open menu, the recall occurs as soon as the Open button is pressed.

Key Path	Recall
Mode	All
Notes	The menu is built from whatever data types are available for the mode. Some keys will be missing completely, so the key locations in the sub-menu will vary. No SCPI command directly controls the Data Type that this key controls. The Data Type is included in the MMEM:LOAD commands.
Dependencies	If a file type is not used by a certain measurement, it is grayed out for that measurement. The key for a file type will not show at all if there are no measurements in the Mode that support it.
Preset	Is not affected by Preset or shutdown, but is reset during Restore Mode Defaults
Readback	The data type that is currently selected
Initial S/W Revision	Prior to A.02.00

Component Carrier Setup

Enables you to import LTE-A setup files for all Component Carriers or the specified Component Carrier. Selecting this key displays a menu that enables you to select what the Component Carrier setup files to be imported. After making this selection, depress Open... and use the file dialog to select the file you wish to recall. The Key is valid for Conformance EVM measurements only.

It supports to the following import file formats

- LTE app state files (*.state)
- EVM Setup Files (*.evms)
- 89601 VSA Setup Files (*.set, *.setx)
- Signal Studio Setup Files (*.scp)

App State Files

Extension: state

The parameters of the LTE Modulation Analysis measurement can be imported to LTE-Advanced EVM and CEVM measurements from the LTE .state file. It depends on the parameter of the Component Carrier Setup to decide which component carriers' measurement parameters are affected.

Pressing OPEN under the Import Data menu will open the above directory from which you can select an LTE app state file.

EVM Setup Files

Extension: evms

It will recall LTE test model parameters specified in the standards to LTE-Advanced FDD/TDD EVM and CEVM measurements. It depends on the parameter of the Component Carrier Setup to decide which component carriers 'measurement parameters are affected.

The default path is My Documents\LTEATDD\LTEAFDD\data\evmsetup. Note that "My Documents" is an alias to a directory and its place differs depending on which user is logged in. At XSA start up, XSA will overwrite all of the EVM Setup files to the current user's "My Documents\LTEATDD\LTEAFDD\data\evmsetup" each time.

Pressing OPEN under the Import Data menu will open the above directory from which you can select an EVM Setup file.

You cannot read the contents of the provided EVM Setup file since it is a binary file.

89601 VSA Setup Files

Extension: set, setx

The 89600 Vector Signal Analyzer Setup file created using the 89600 Vector Signal Analyzer Option BHD (LTETDD|LTEFDD) can be imported as LTE-Advanced TDD/FDD EVM and CEVM parameter sets.

The 89600 Vector Signal Analyzer Setup file created using the 89600 Vector Signal Analyzer Option BHD (LTEATDD|LTEAFDD) can be imported as LTE-Advanced TDD/FDD EVM and CEVM parameter sets.

Which component carriers 'measurement parameters are affected depends on depends on the parameter of the Component Carrier Setup.

If the setup file is not loaded successfully, an error message, -230 "Data corrupt or stale", is issued with the specified file name.

Signal Studio Setup Files

Extension: scp

The Keysight Signal Studio setup file created using Signal Studio (N7624B/N7625B) can be imported as LTE-Advanced TDD/FDD parameter set.

Supported component carrier types are listed in the table below:

<i>Signal Studio</i>	<i>Carrier Type</i>
N7624B Signal Studio for 3GPP LTE	Advanced LTE FDD Downlink (2009-03)
	Advanced LTE FDD Downlink (2009-12)
	Advanced LTE FDD Downlink (2010-06)
	Advanced LTE FDD Uplink (2009-12)
	Advanced LTE FDD Uplink (2010-06)
	Basic LTE FDD Downlink (2009-03)
	Basic LTE FDD Downlink (2009-12)
	Basic LTE FDD Downlink (2010-06)
	Basic LTE FDD Uplink (2009-03)

	Basic LTE FDD Uplink (2009-12)
	Basic LTE FDD Uplink (2010-06)
	Basic LTE-A FDD Downlink (2010-12)
	Basic LTE-A FDD Uplink (2010-12)
	Basic LTE FDD R9 Downlink
	Basic LTE FDD R9 Uplink
	Advanced LTE FDD R9 Downlink
	Advanced LTE FDD R9 Uplink
	Basic LTE-A FDD R10 Downlink
	Basic LTE-A FDD R10 Uplink
N7625B Signal Studio for 3GPP LTE TDD	Advanced LTE TDD (2009-03)
	Advanced LTE TDD (2009-12)
	Basic LTE TDD (2009-03)
	Basic LTE TDD (2009-12)
	Basic LTE-A TDD (2010-01)
	Basic LTE-A TDD R10 (2010-12)

If the setup file is not loaded successfully, an error message, -230 "Data corrupt or stale", is issued with the specified file name.

Key Path	Recall, Data
Mode	LTEATDD, LTEAFDD
Remote Command	MME ^M emory:LOAD:SETup ALL CC0 CC1 CC2 CC3 CC4,<string>
Example	MME ^M :LOAD:SETup CC0,"LTE-A TDD.set"
Notes	The options CC1~CC4 can be enabled with 9080B/9082B-2FP license.
Notes	"ALL" is primarily used to LTE-A setup file for each component carrier including the number of component carriers. "CC*" is used to import LTE-A setup file for the specified component carrier.
Backwards Compatibility SCPI	MME ^M emory:LOAD:SSSetup <string> MME ^M emory:LOAD:VSASetup <string> MME ^M emory:LOAD:EVMSSetup <string>
Initial S/W Revision	A.14.00
Modified at S/W Revision	A.14.50

Masks

This key enables you to recall a preset mask file which contains Offset and Limit settings. Parameters except them will not be overwritten. You cannot change or create preset mask files since they are binary files. This key is valid for the Spectrum Emission Mask, ACP and Spurious Emissions measurements.

Default path: “My Documents\LTEATDD\LTEAFDD\data.masks”

Note that “**My Documents**” is an alias to a directory and its location depends on which user is logged in. At XSA start up, all of the limit mask files in the current user’s “My Documents\LTEATDD\LTEAFDD\data.masks” directory are overwritten.

File type: Binary

Filename: The filename follows the rule below with the words connected using underscores.

<Measurement>_<Condition>.mask

Where

<Measurement> Measurement the limit mask file is applied to: SEM, ACP or SPUR

<Condition> Condition. It depends on the measurement.

File extension: .mask

File Dialog Filter: Preset Mask Files (*.mask)

Selecting OPEN... under the Import Data menu opens the above directory enabling you to select a mask file.

Details of the masks are provided in the default folder of masks with the PDF extension.

Key Path	Recall, Data
Mode	LTEATDD, LTEAFDD
Remote Command	MMEemory:LOAD:MASK <string>
Example	MME:LOAD:MASK “ACP_BS\ACP_BS_3MHz_pairE-UTRA_CatA.mask”
Notes	Parameters related to Limit and Offset are overwritten by the contents of the preset mask file.
Initial S/W Revision	A.14.00

Open...

When you press “Open”, the analyzer brings up a Windows dialog and a menu entitled “**File Open.**” This menu allows you to navigate to the various fields in the Windows dialog without using a keyboard or mouse. The Tab and Arrow keys can also be used for dialog navigation.

See "[From File...](#)" on page 2401 in Recall, State, for a full description of this dialog and menu.

Key Path	Recall, Data
Notes	The key location is mode-dependent and will vary. Brings up Open dialog for recalling a <mode specific> Save Type
Initial S/W Revision	Prior to A.02.00

Restart

The Restart function restarts the current sweep, or measurement, or set of averaged/held sweeps or measurements. If you are Paused, pressing Restart does a Resume.

The Restart function is accessed in several ways:

- Pressing the Restart key
- Sending the remote command INIT:IMMEDIATE
- Sending the remote command INIT:RESTART

See "[More Information](#)" on page 1392

Key Path	Front-panel key
Remote Command	:INITiate[:IMMEDIATE] :INITiate:RESTART
Example	:INIT:IMM :INIT:REST
Notes	:INITiate:RESTART and :INITiate:IMMEDIATE perform exactly the same function.
Couplings	Resets average/hold count k. For the first sweep overwrites all active (update=on) traces with new current data. For application modes, it resets other parameters as required by the measurement.
Status Bits/OPC dependencies	This is an Overlapped command. The STATUS:OPERation register bits 0 through 8 are cleared. The STATUS:QUESTionable register bit 9 (INTEGRITY sum) is cleared. The SWEEPING bit is set. The MEASURING bit is set.
Backwards Compatibility Notes	For Spectrum Analysis mode in ESA and PSA, the Restart hardkey and the INITiate:RESTART command restart trace averages (displayed average count reset to 1) for a trace in Clear Write, but did not restart Max Hold and Min Hold. In the X-Series, the Restart hardkey and the INITiate:RESTART command restart not only Trace Average, but MaxHold and MinHold traces as well. For wireless comms modes in ESA and PSA, the Restart hardkey and the INITiate:RESTART command restart every measurement, which includes all traces and numeric results. There is no change to this operation.
Initial S/W Revision	Prior to A.02.00

More Information

The **Restart** function first aborts the current sweep/measurement as quickly as possible. It then resets the sweep and trigger systems, sets up the measurement and initiates a new data measurement sequence with a new data acquisition (sweep) taken once the trigger condition is met.

If the analyzer is in the process of aligning when **Restart** is executed, the alignment finishes before the restart function is performed.

Even when set for Single operation, multiple sweeps may be taken when Restart is pressed (for example, when averaging/holding is on). Thus when we say that **Restart** "restarts a measurement," we may mean:

- It restarts the current sweep
- It restarts the current measurement
- It restarts the current set of sweeps if any trace is in Trace Average, Max Hold or Min Hold
- It restarts the current set of measurements if Averaging, or Max Hold, or Min Hold is on for the measurement
- depending on the current settings.

With **Average/Hold Number** (in **Meas Setup** menu) set to 1, or Averaging off, or no trace in Trace Average or Hold, a single sweep is equivalent to a single measurement. A single sweep is taken after the trigger condition is met; and the analyzer stops sweeping once that sweep has completed. However, with **Average/Hold Number** >1 and at least one trace set to **Trace Average, Max Hold, or Min Hold (SA Measurement)** or **Averaging on (most other measurements)**, multiple sweeps/data acquisitions are taken for a single measurement. The trigger condition must be met prior to each sweep. The sweep is stopped when the average count k equals the number N set for **Average/Hold Number**. A measurement average usually applies to all traces, marker results, and numeric results; but sometimes it only applies to the numeric results.

Once the full set of sweeps has been taken, the analyzer will go to idle state. To take one more sweep without resetting the average count, increment the average count by 1, by pressing the step up key while **Average/Hold Number** is the active function, or sending the remote command `CALC:AVER:TCON UP`.

Save

The Save menu lets you choose what you want to save and where you want to save it. Among the types of files you can save are **States**, **Traces**, and **Screen Images**. In addition, an Export (Data) option lets you save a number of data types as CSV files for easy import into Excel and other spreadsheet programs.

Key Path	Front-panel key
Mode	All
Notes	No remote command for this key specifically, but the :MMEM:STORe command is available for specific file types. An example is :MMEM:STOR:STATe <filename>.
Initial S/W Revision	Prior to A.02.00

State

The Save State menu lets you choose a register or file for saving the state.

NOTE In products that run multiple instances of the X-Series Application, all instances share the same register and file location where you want to save the state.

The content of a state file includes all of the settings and data required to return the analyzer as closely as possible to the Mode it was in, with the exact settings which were in place, when the save occurred. The Mode settings in each state file include the settings that are affected by Mode Preset, as well as the additional settings affected by Restore Mode Defaults; all of the Mode's settings. In addition, all of the settings of the Input/Output system are included, even though they are outside of the Mode's state, because they are needed to restore the complete setup. Persistent System settings (for example, Verbose SCPI) are not affected by either Mode Preset or Restore Mode Defaults, nor are they included in a saved State file.

After the save completes, the message "File <filename> saved" or "State Register <register number> saved" is displayed.

For rapid saving, the State menu lists 16 registers to save to. Pressing a Register key initiates the save. You can also select a file to save to.

The default path for all State Files is:

My Documents\<<mode name>\state

where <mode name> is the parameter used to select the mode with the INST:SEL command (for example, SA for the Spectrum Analyzer).

Key Path	Save
Mode	All
Remote Command	:MMEMory:STORe:STATe <filename>
Example	MMEM:STOR:STATe "MyStateFile.state" This stores the current instrument state data in the file MyStateFile.state in the default directory.
Notes	Both single and double quotes are supported for any filename parameter over remote.

After saving to a register, that register's menu key is updated with the date the time, unless a custom label has been entered for that key.

After saving to a register, you remain in the Save State menu, so that you can see the Register key update. After saving to a file, the analyzer automatically returns to the previous menu and any Save As dialog goes away.

Backwards Compatibility SCPI :MMEMory:STORe:STATe 1,<filename>

For backwards compatibility, the above syntax is supported. The "1" is simply ignored. The command is sequential.

Initial S/W Revision Prior to A.02.00

To File . . .

When you press "To File", the analyzer brings up a Windows dialog and a menu entitled "Save As." This menu allows you to navigate to the various fields in the Windows dialog without using a keyboard or mouse. The Tab and Arrow keys can also be used for dialog navigation.

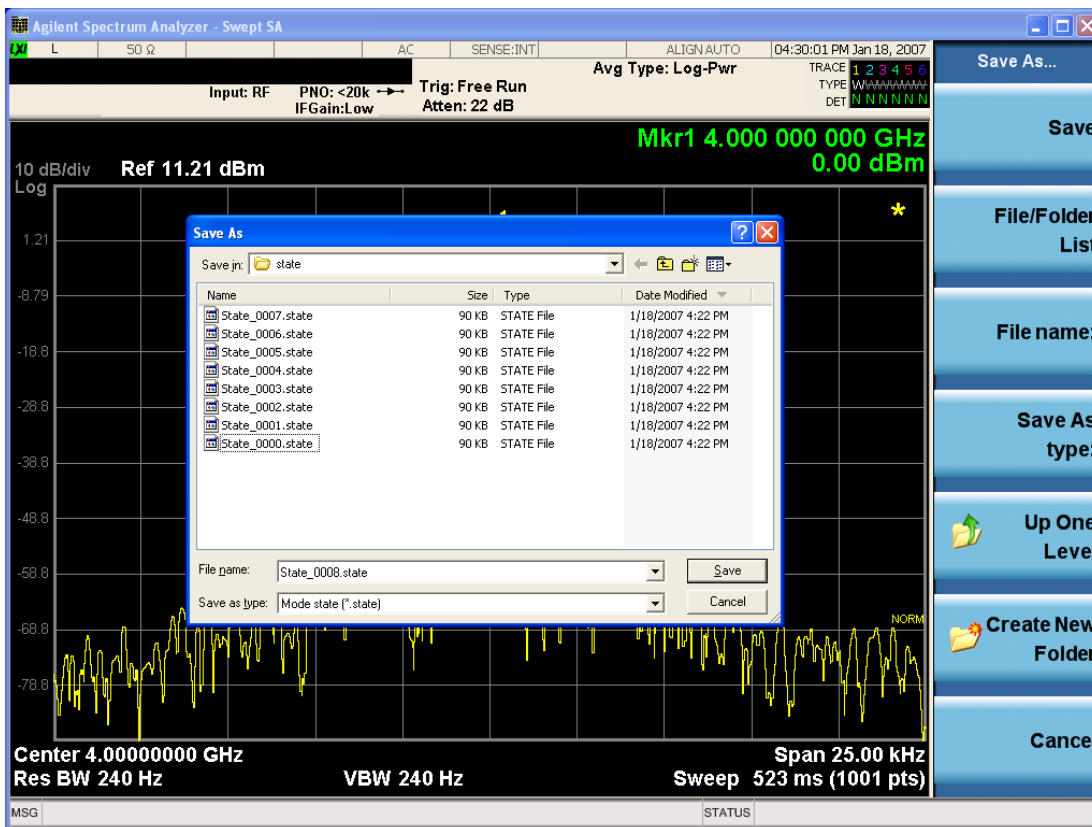

The Listed below

are the functions of the various fields in the dialog, and the corresponding softkeys:

Save

Performs the save to the specified file of the selected type. If the file already exists, a dialog will appear that allows you to replace the existing file by selecting OK, or you can Cancel the request. If you select OK,

the file will be overwritten. Using the C: drive is strongly discouraged, since it runs the risk of being overwritten during an instrument software upgrade.

While the save is being performed, the floppy icon appears briefly in the Meas bar.

File/Folder List

Enables you to navigate to the center of the dialog that contains the list of files and folders. Once here you can get information about the file and use the tab keys to navigate to the other fields in the dialog, such as Save In.

Save In

The Save In field shows the path to which the file will be saved and allows you to change the path using the up and down arrow keys to navigate to other paths; the Enter key to open a directory; and the Backspace key to go back one directory. The **Save In field** defaults to the default path for this type of file and remembers the last path you used to save this type of file. There is no softkey for directly navigating to the Save In field but you can use left tab to get here from the File/Folder List.

User specified paths are remembered when you leave and return to a Mode and are reset back to the default using Restore Mode Defaults.

File Name

The File Name field is initially loaded with an automatically generated filename specific to the appropriate Save Type. The automatically generated filename is guaranteed not to conflict with any filename currently in the directory. You may replace or modify this filename using the File Name key. See the ["Quick Save " on page 2397](#) documentation for more on the automatic file naming algorithm.

When you press the File Name key the analyzer displays the Alpha Editor. Use the knob to choose the letter to add and the front-panel Enter key to add the letter to the file name. The BK character moves you back and the FW character moves you forward in the filename. The Select key on the front panel generates a space character. When you are done entering the filename press the Done softkey. This returns back to the **File Open** dialog and menu, but does not cause the save to occur.

Save As Type

This field shows the file suffix for the type of file you have selected to save. For example, if you navigated here while saving State, "Mode state (*.state)" is in the field. If you navigated here from saving Trace, ""Mode state (*.trace)" is in the field. If you navigated here while exporting a trace data file, "Trace Data (*.csv)" is in the field. For some file types, there is more than one choice in the dropdown, which you can select by using the up and down arrow keys and Enter.

Up One Level

This key corresponds to the icon of a folder with the up arrow that is in the tool bar of the dialog. When pressed, it causes the file and folder list to navigate up one level in the directory structure. The Backspace key does the same thing.

Create New Folder

This key corresponds to the icon of a folder with the "*" that is in the tool bar of the dialog. When pressed, a new folder is created in the current directory with the name **New Folder** and you can enter a new folder name using the Alpha Editor.

Cancel

This key corresponds to the Cancel selection in the dialog. It causes the current **Save As** request to be cancelled. The ESC key does the same thing.

Key Path	Save, State
Mode	All
Notes	Brings up Save As dialog for saving a State Save Type
Initial S/W Revision	Prior to A.02.00

Edit Register Names

You may enter a custom name on any of the Register keys, to help you remember what you are using that state to save. To do this, press the Edit Register Names key, choose the register whose name you wish to edit, and then enter the desired label using the Alpha Editor or an external PC keyboard.

The maximum number of characters that can be added is 30. In most cases, 30 characters will fit on two lines of the key.

See ["More Information" on page 1397](#)

Key Path	Save, State
Mode	All
Remote Command	:MMEMory:REGister:STATe:LABel <reg number>,"label" :MMEMory:REGister:STATe:LABel? <reg number>
Example	:MMEM:REG:STAT:LAB 1,"my label"
Notes	<reg number> is an integer from 1 to 16. If the SCPI specifies an invalid register number an error message is generated, -222,"Data out of range;Invalid register label number" "label" is a string from 0 to 30 characters in length. If a label exceeds 30 characters, an error message is generated, -150,"String data error;Label clipped to 30 characters" "label" of length 0 erases the custom label and restores the default (time and date) label. E.g.: :MMEM:REG:STAT:LAB 1,""
Dependencies	N9060A-7FP or N9060B-2FP license required to edit the register names. When the feature is not licensed, sending this command generates an error, -221,"Settings conflict;Option not available"
Preset	The names are unaffected by Preset or power cycle but are set to the default label (time and date) on a "Restore System Defaults->Misc"
Initial S/W Revision	A.11.00

More Information

When you edit one of the register names, the time and date field will be replaced by the custom name.

If you delete all the characters in the custom name, it restores the default (time and date).

The register names are stored within the state files, but they are not part of the instrument state; that is, once you have edited a register name, loading a new state will not change that register name. Another

consequence of this is that the names will be persistent through a power cycle. Also, if a named state file is transferred to another analyzer, it will bring its custom name along with it.

If you try to edit the name of an empty register, the analyzer will first save the state to have a file to put the name in. If you load a named state file into an analyzer with older firmware it will ignore the metadata.

The *SAV and *RCL commands will not be affected by the custom register names, nor will the MMEM commands.

Register 1 thru Register 16

Selecting any one of these register menu keys causes the State of the currently active mode to be saved to the specified Register. The registers are provided for rapid saving and recalling, since you do not need to specify a filename or navigate to a file. Each of the register menu keys annotates whether it is empty or at what date and time it was last modified. In addition, you can use the Edit Register Names key to enter custom names for each register.

NOTE

In products that run multiple instances of the X-Series Application, save with different register name if you do not want to overwrite the register of another running instance.

Although these 16 registers are the only registers available from the front panel, there are 128 state registers available in the instrument. Registers 17–128 are only available from the SCPI interface, using the *SAV command.

There is one set of 128 state registers in the instrument, not one set for each Mode. When a state is saved, the Mode it was saved from is saved with it; then when it is recalled, the instrument switches to that Mode.

After the save completes, the corresponding register menu key annotation is updated with the date and time and the message "Register <register number> saved" is displayed.

Key Path	Save, State
Mode	All
Example	*SAV 1
Range	1–16 from front panel, 1–128 from SCPI
Readback	Date and time with seconds resolution are displayed on the key OR A custom name of up to 30 characters entered using the Edit Register Names key OR “(empty)” if no prior save operation has been performed to this register.
Initial S/W Revision	Prior to A.02.00
Modified at S/W Revision	A.11.00

Register 1 thru Register 16

Selecting any one of these register menu keys causes the State of the currently active mode to be saved to the specified Register. The registers are provided for rapid saving and recalling, since you do not need to specify a filename or navigate to a file. Each of the register menu keys annotates whether it is empty or at

what date and time it was last modified. In addition, you can use the Edit Register Names key to enter custom names for each register.

NOTE In products that run multiple instances of the X-Series Application, save with different register name if you do not want to overwrite the register of another running instance.

Although these 16 registers are the only registers available from the front panel, there are 128 state registers available in the instrument. Registers 17–128 are only available from the SCPI interface, using the *SAV command.

There is one set of 128 state registers in the instrument, not one set for each Mode. When a state is saved, the Mode it was saved from is saved with it; then when it is recalled, the instrument switches to that Mode.

After the save completes, the corresponding register menu key annotation is updated with the date and time and the message "Register <register number> saved" is displayed.

Key Path	Save, State
Mode	All
Example	*SAV 1
Range	1–16 from front panel, 1–128 from SCPI
Readback	Date and time with seconds resolution are displayed on the key OR A custom name of up to 30 characters entered using the Edit Register Names key OR “(empty)” if no prior save operation has been performed to this register.
Initial S/W Revision	Prior to A.02.00
Modified at S/W Revision	A.11.00

Mass Storage Catalog (Remote Command Only)

Key path	SCPI Only
Remote Command	:MMEMory:CATalog? [<directory_name>]
Notes	The string must be a valid logical path. Queries disk usage information (drive capacity, free space available) and obtains a list of files and directories in a specified directory in the following format: <numeric_value>,<numeric_value>,{<file_entry>} It returns two numeric parameters and as many strings as there are files and directories. The first parameter indicates the total amount of storage currently used in bytes. The second parameter indicates the total amount of storage available, also in bytes. The <file_entry> is a string. Each <file_entry> indicates the name, type, and size of one file in the directory list: <file_name>,<file_type>,<file_size> As the windows file system has an extension that indicates file type, <file_type> is always empty. <file_size> provides the size of the file in bytes. For directories, <file_entry> is surrounded by square brackets and both <file_type> and <file_size> are empty
Initial S/W Revision	Prior to A.02.00

Mass Storage Change Directory (Remote Command Only)

Key path	SCPI Only
Remote Command	:MMEMory:CDIRectory [<directory_name>] :MMEMory:CDIRectory?
Notes	The string must be a valid logical path. Changes the default directory for a mass memory file system. The <directory_name> parameter is a string. If no parameter is specified, the directory is set to the *RST value. At *RST, this value is set to the default user data storage area, that is defined as System.Environment.SpecialFolder.Personal. Query returns full path of the default directory.
Initial S/W Revision	Prior to A.02.00

Mass Storage Copy (Remote Command Only)

Key path	SCPI Only
Remote Command	:MMEMory:COPY <string>,<string>[,<string>,<string>]
Notes	The string must be a valid logical path. Copies an existing file to a new file or an existing directory to a new directory. Two forms of parameters are allowed. The first form has two parameters. In this form, the first parameter specifies the source, and the second parameter specifies the destination. The second form has four parameters. In this form, the first and third parameters specify the source. The second and fourth parameters specify the directories. The first pair of parameters specifies the source. The second pair specifies the destination. An error is generated if the source doesn't exist or the destination file already exists. This command will generate an "access denied" error if the destination is a restricted folder (e.g., C:\Windows) and the current user does not have Power User or Administrator privileges.

Mass Storage Device Copy (Remote Command Only)

This command transfers data to/from a file and a peripheral device.

Key path	SCPI Only
Remote Command	:MMEMory:COPY:DEvice <source_string>,<dest_string>
Notes	The strings must be a valid logical path or a valid device keyword. If the dest_string is a device keyword, the data is copied from the source file to the device. If the source_string is a device keyword, the data is copied to the source file from the device. Valid device keywords are: SNS (smart noise source) An error is generated if the file or device is not found.

Mass Storage Delete (Remote Command Only)

Key path	SCPI Only
Remote Command	:MMEMory:DELeTe <file_name>[,<directory_name>]
Notes	The string must be a valid logical path. Removes a file from the specified directory. The <file_name> parameter specifies the file name to be removed. This command will generate an “access denied” error if the file is in a restricted folder (e.g., C:\Windows) and the current user does not have Power User or Administrator privileges.
Initial S/W Revision	Prior to A.02.00

Mass Storage Data (Remote Command Only)

Creates a file containing the specified data OR queries the data from an existing file.

Key path	SCPI Only
Remote Command	:MMEMory:DATA <file_name>, <data> :MMEMory:DATA? <file_name>
Notes	The string must be a valid logical path. The command form is MMEMory:DATA <file_name>,<data>. It loads <data> into the file <file_name>. <data> is in 488.2 block format. <file_name> is string data. The query form is MMEMory:DATA? <file_name> with the response being the associated <data> in block format.
Initial S/W Revision	Prior to A.02.00

Mass Storage Make Directory (Remote Command Only)

Key path	SCPI Only
Remote Command	:MMEMory:MDIRectory <directory_name>
Notes	The string must be a valid logical path. Creates a new directory. The <directory_name> parameter specifies the name to be created. This command will generate an “access denied” error if the new directory would be in a restricted folder (e.g., C:\Windows) and the current user does not have Power User or Administrator privileges.
Initial S/W Revision	Prior to A.02.00

Mass Storage Move (Remote Command Only)

Key path	SCPI Only
Remote Command	:MMEMory:MOVE <string>,<string>[,<string>,<string>]
Notes	The string must be a valid logical path. Moves an existing file to a new file or an existing directory to a new directory.

Two forms of parameters are allowed. The first form has two parameters. In this form, the first parameter specifies the source, and the second parameter specifies the destination.

The second form has four parameters. In this form, the first and third parameters specify the source. The second and fourth parameters specify the directories. The first pair of parameters specifies the source. The second pair specifies the destination. An error is generated if the source doesn't exist or the destination file already exists.

This command will generate an "access denied" error if the destination is a restricted folder (e.g., C:\Windows) and the current user does not have Power User or Administrator privileges.

Initial S/W Revision	Prior to A.02.00
----------------------	------------------

Mass Storage Remove Directory (Remote Command Only)

Key path	SCPI Only
Remote Command	:MMEMory:RDIRECTory <directory_name>
Notes	<p>The string must be a valid logical path.</p> <p>Removes a directory. The <directory_name> parameter specifies the directory name to be removed. All files and directories under the specified directory shall also be removed.</p> <p>This command will generate an "access denied" error if the folder is a restricted folder (e.g., C:\Windows) or is in a restricted folder and the current user does not have Power User or Administrator privileges.</p>

Initial S/W Revision	Prior to A.02.00
----------------------	------------------

Sequences

These keys allow you to save a Tab separated or CSV file of the setup parameters required to build a Sequence.

In order to save you must select the Save As button and choose a destination folder.

Key Path	Save, Sequences
Mode	All
Remote Command	:MMEM:STOR:SEQ:ences: SLIST ALIST SAAList SSTep "MySequence.txt"
Example	:MMEM:STOR:SEQ:SLIST "MySequence.txt"
Notes	<p>Available file types are:</p> <ul style="list-style-type: none"> -CSV (Comma delimited) (*.csv) -Text (Tab delimited) (*.txt)

Initial S/W Revision	A.05.00
----------------------	---------

Source Sequence

The list of parameters, that configure steps, that makes up a sequence for the Source.

The Source sequence is a sequence of flexible configurable steps that can be set anywhere in the instruments frequency range.

Key Path	Save, Sequences
Example	:MMEM:STOR:SEQ:SLIS "MySequence.txt"
Dependencies	Only available in XOBT
Initial S/W Revision	A.05.00

Save As . . .

This menu lets you select the location where you can save the Sequence. This menu is a standard Windows® dialog with Save As menu keys. The "File Name" field in the Save As dialog is initially loaded with an automatically generated filename specific to the appropriate Save Type. The automatically generated filename is guaranteed not to conflict with any filename currently in the directory. You may replace or modify this filename using the File Name softkey. See the Quick Save key documentation for more on the automatic file naming algorithm.

The default path for all Sequence Files is:

My Documents\Sequences

Key Path	Save, Sequences
Mode	All
Notes	Brings up Save As dialog for saving a Sequence Save Type
Initial S/W Revision	A.05.00

Data (Export)

Exporting a data file stores data from the current measurement to mass storage files. The Export Menu only contains data types that are supported by the current measurement.

Since the commonly exported data files are in .csv format, the data can be edited by you prior to importing. This allows you to export a data file, manipulate the data in Excel (the most common PC Application for manipulating .csv files) and then import it.

Selecting an Export Data menu key will not actually cause the exporting to occur, since the analyzer still needs to know where you wish to save the data. Pressing the Save As key in this menu brings up the Save As dialog and Save As menu that allows you to specify the destination file and directory. Once a filename has been selected or entered in the Open menu, the export will occur as soon as the Save key is pressed.

Key Path	Save
Mode	All

Notes	The menu is built from whatever data types are available for the mode. So the key locations in the sub menu will vary. No SCPI command directly controls the Data Type that this key controls. The Data Type is included in the MMEM:STORe commands.
Dependencies	If a file type is not used by a certain measurement, that type is grayed out for that measurement. The key for a file type will not show at all if there are no measurements in the Mode that support it.
Preset	Is not affected by a Preset or shutdown, but is reset during Restore Mode Defaults
Readback	The data type that is currently selected
Initial S/W Revision	Prior to A.02.00

Export Trace Data

Enables you to export trace data with (optional) associated headers. Selecting this key displays a menu that enables you to choose which Trace to save (default is the selected Trace) and whether or not to save headers with the data. The header information is used by the VXA application when saved trace data is recalled, and enables it to be displayed with the same formatting and scaling that it had when saved. If headers are not saved, the scaling and format are set to default values when the trace is recalled. After making these selections, press Save As... and use the file dialog to choose a file name and format for the saved data.

Trace data can be exported in several different formats. Text and comma-separated variable (CSV) formats are useful for viewing the data or importing it to a spreadsheet program. The other formats are binary and thus more compact. Trace data files can be recalled for viewing into other VXA, LTE, LTETDD, iDEN, or 89601 measurements.

Key Path	Save, Data (Export)
Mode	VSA, LTE, LTETDD, IDEN
Remote Command	:MMEMory:STORe:TRACe:DATA TRACE1 TRACE2 TRACE3 TRACE4 TRACE5 TRACE6, "<filename>" [,CSV TXT SDF MAT4 MAT HDF5 BIN[,OFF ON 0 1]]
Example	:MMEM:STOR:TRAC:DATA TRACE1, "TRC1.TXT", TXT, ON
Notes	The Save As... dialog box has the following format options when you are saving trace data: <ul style="list-style-type: none"> • CSV (Comma delimited) (*.csv) • SDF (Fast) (*.sdf;*.dat) • Text (Tab delimited) (*.txt) File format saved depends on selection. The appropriate file extension is appended to the filename if it is not supplied by the user. If the SCPI command includes just a file name, the file format is determined by the filename extension, which must be one of the choices above. *.sdf or an unrecognized extension chooses the SDF fast format. If the optional file format enumerator is included in the command, then this determines the file format and the file extension is ignored. The optional binary parameter determines if file headers are saved. The default is ON. If file headers are not wanted, use the optional "OFF" parameter. The optional Boolean parameter determines whether headers are saved in the file. By default the

headers are saved.

If you are not licensed to save a particular file type, then error -203.9010 is returned. If an invalid file format is specified or the file cannot be saved successfully, then error -25x is returned. If the save is successful, then advisory 0.1500 is shown.

State Saved	No
Readback	(Trace 1 Trace 2 Trace 3 Trace 4 Trace 5 Trace 6)(with without) headers

Trace 1

Selects the Trace 1 register as the destination for the imported data.

Key Path	Save, Data (Export), Trace
Mode	VSA, LTE, LTETDD, IDEN

Trace 2

Selects the Trace 2 register as the destination for the imported data.

Key Path	Save, Data (Export), Trace
Mode	VSA, LTE, LTETDD, IDEN

Trace 3

Selects the Trace 3 register as the destination for the imported data.

Key Path	Save, Data (Export), Trace
Mode	VSA, LTE, LTETDD, IDEN

Trace 4

Selects the Trace 4 register as the destination for the imported data.

Key Path	Save, Data (Export), Trace
Mode	VSA, LTE, LTETDD, IDEN

Trace 5

Selects the Trace 5 register as the destination for the imported data.

Key Path	Save, Data (Export), Trace
Mode	VSA, LTE, LTETDD, IDEN

Trace 6

Selects the Trace 6 register as the destination for the imported data.

Key Path	Save, Data (Export), Trace
Mode	VSA, LTE, LTETDD, IDEN

Include Header

Enables you to select whether or not the saved trace data includes header information describing scaling, formatting, etc.

Key Path	Save, Data (Export), Trace
Mode	VSA, LTE, LTETDD, IDEN
State Saved	No

Measurement Results

Pressing this key selects Meas Results as the data type to be exported.

The Meas Results file contains information that describes the current state of the analyzer. It is detailed in "[Meas Results File Contents](#)" on page 1407 below.

Key Path	Save, Data
Remote Command	:MMEMory:STORe:RESults <string>
Example	:MMEM:STOR:RES "MeasR_0000.csv"
Notes	<p>If the save is initiated via SCPI and the file already exists, the file will be overwritten.</p> <p>The SCPI command exports Spectrum Emission Mask measurement results to the file specified as the parameter in the current path. The default path is My Documents\<current mode>\data\sem\results.<="" p=""> <p>Using the C: drive is strongly discouraged, since it runs the risk of being overwritten during an instrument software upgrade.</p> <p>The SCPI parameter is a quoted string that specifies the filename. Both single and double quotes are supported for any filename parameter over SCPI.</p> </current></p>
Dependencies	The current active measurement must be the Spectrum Emission Mask measurement to use this command.
Status Bits/OPC dependencies	Sequential – waits for the previous measurement to complete
Initial S/W Revision	Prior to A.02.00

Meas Results File Contents

A Meas Results File contains measurement results with the following information.

- File ID string, which is “MeasResult”
- Measurement ID following Mode ID, which is “SA:SEM” for example.
- Firmware rev and model number
- Option string
- Automatic Trigger Time
- Automatic Trigger Time State
- Center Frequency
- ChanIntegBW
- ChannelDetector
- ChannelDetectorState
- ChanPwrRefAuto
- ChanResBW
- ChanResBWAuto
- ChanSpan
- ChanSweepTime
- ChanSweepTimeAuto
- ChanVbwRbwRatio
- ChanVbwRbwRatioAuto
- ChanVideoBW
- ChanVideoBWAuto
- Electrical Atten
- Electrical Atten Bypass
- Electrical Atten State
- External1 Trigger Delay
- External1 Trigger Delay State
- External1 Trigger Level
- External1 Trigger Slope
- External2 Trigger Delay
- External2 Trigger Delay State

- External2 Trigger Level
- External2 Trigger Slope
- FilterAlpha
- Internal Preamp
- Internal Preamp Band
- Line Trigger Delay
- Line Trigger Delay State
- Line Trigger Slope
- Mechanical Atten
- Mechanical Atten Auto
- OffsetDetector
- OffsetDetectorState
- OffsetLimitAbsStartBTS
- OffsetLimitAbsStartMS
- OffsetLimitAbsStopBTS
- OffsetLimitAbsStopMS
- OffsetLimitFailMaskBTS
- OffsetLimitFailMaskMS
- OffsetLimitRelStartBTS
- OffsetLimitRelStartMS
- OffsetLimitRelStopBTS
- OffsetLimitRelStopMS
- OffsetMeasBWMS
- OffsetMeasBWMS
- OffsetResolutionBWAUTOBTS
- OffsetResolutionBWAUTOMS
- OffsetResolutionBWMS
- OffsetResolutionBWMS
- OffsetSideBTS
- OffsetSideMS
- OffsetStartFrequencyBTS

- OffsetStartFrequencyMS
- OffsetStateBTS
- OffsetStateMS
- OffsetStopFrequencyBTS
- OffsetStopFrequencyMS
- OffsetSweepTimeAutoBTS
- OffsetSweepTimeAutoMS
- OffsetSweepTimeBTS
- OffsetSweepTimeMS
- OffsetVbwRbwRatioAutoBTS
- OffsetVbwRbwRatioAutoMS
- OffsetVbwRbwRatioBTS
- OffsetVbwRbwRatioMS
- OffsetVideoBWAutoBTS
- OffsetVideoBWAutoMS
- OffsetVideoBWBTS
- OffsetVideoBWMS
- PeakReference
- Periodic Timer Period
- Periodic Timer Sync Source
- Periodic Timer Trigger Delay
- Periodic Timer Trigger Delay State
- PowerReference
- PSDReference
- Radio Device
- RFBurst Trigger Delay
- RFBurst Trigger Delay State
- RFBurst Trigger Level Abs
- RFBurst Trigger Level Rel
- RFBurst Trigger Level Type
- RFBurst Trigger Slope

- RrcFilter
- SemAverageNumber
- SemAverageState
- TotalAtten
- Trigger Holdoff
- Trigger Holdoff State
- TriggerSource
- Video Trigger Delay
- Video Trigger Delay State
- Video Trigger Level
- Video Trigger Slope
- ViewSelection

The file contains these data followed by MeasResult1 to MeasResult12 that flag the start of the measurement results. Each line of Measurement Results consists of twelve comma separated values from MeasResult1 value to MeasResult12 value. MeasResult1 contains the same results as MEAS/READ/FETCh:SEMAsk1; MeasResult2, MEAS/READ/FETCh:SEMAsk2; MeasResult3, MEAS/READ/FETCh:SEMAsk3;... (continues in the same manner)

The exported file is in CSV format, with a.csv extension. The Meas Results file, when imported into Excel, shows the following data:

MeasResult	
SA:SEM	
A.10.53	N90 30A
526 ALV ATP	1
B1X B1Y B25	
B40 BBA CR3	
CRP DCF DDA	
DP2 DRD EA3	
EDP EMC EP1	
ERC ESC ESP	
EXM FSA LFE	
LNP MAT	
MPB NFE	
NUL P26 PFR	
PNC RTL RTS	
S40 SB1 SEC	
SM1 TVT YAS	
YAV	
Automatic	0.1
Trigger Time	

Automatic Trigger Time State	FALS E	
Center Frequency	1.33 E+10	
ChanIntegBW	384 000 0	384 000 0
ChannelDetector	Average	
ChannelDetectorState	TRUE	
ChanPwrRefAuto	TRUE	
ChanResBW	100 000	100 000
ChanResBWAuto	FALS E	FALS E
ChanSpan	500 000 0	500 000 0
ChanSweepTime	0.00 250 7	0.00 250 7
ChanSweepTimeAuto	TRUE	TRUE
ChanVbwRbwRatio	1	1
ChanVbwRbwRatioAuto	FALS E	FALS E
ChanVideoBW	100 000	100 000
ChanVideoBWAuto	TRUE	TRUE
Electrical Atten	0	
Electrical Atten Bypass	TRUE	
Electrical Atten State	FALS E	
External1 Trigger Delay	1.00 E-06	
External1 Trigger Delay	FALS E	

State						
External1 Trigger Level	1.2					
External1 Trigger Slope	Positive					
External2 Trigger Delay	1.00 E-06					
External2 Trigger Delay State	FALSE					
External2 Trigger Level	1.2					
External2 Trigger Slope	Positive					
FilterAlpha	0.22					
Internal Preamp	FALSE					
Internal Preamp Band	Low					
Line Trigger Delay	1.00 E-06					
Line Trigger Delay State	FALSE					
Line Trigger Slope	Positive					
Mechanical Atten	10					
Mechanical Atten Auto	TRUE					
OffsetDetector	Peak					
OffsetDetectorState	TRUE					
OffsetLimitAbsStartBTS	-14	-14	-26	-13	-13	-13
OffsetLimitAbsStartMS	-14	-14	-26	-13	-13	-13
OffsetLimitAbsStopBTS	-14	-26	-26	-13	-13	-13
OffsetLimitAbsStopMS	-14	-26	-26	-13	-13	-13
OffsetLimitFailMaskBTS	ABSolute	ABSolute	ABSolute	ABSolute	ABSolute	ABSolute

OffsetLimitFairMaskMS	ABSolute	ABSolute	ABSolute	ABSolute	ABSolute	ABSolute
OffsetLimitRelStartBTS	-30	-30	-30	-30	-30	-30
OffsetLimitRelStartMS	-30	-30	-30	-30	-30	-30
OffsetLimitRelStopBTS	-30	-30	-30	-30	-30	-30
OffsetLimitRelStopMS	-30	-30	-30	-30	-30	-30
OffsetMeasBWBTS	1	1	1	1	1	1
OffsetMeasBWMS	1	1	1	1	1	1
OffsetResolutionBWAutoBTS	FALSE	FALSE	FALSE	FALSE	FALSE	FALSE
OffsetResolutionBWAutoMS	FALSE	FALSE	FALSE	FALSE	FALSE	FALSE
OffsetResolutionBW BTS	30000	30000	30000	1000000	100000	100000
OffsetResolutionBWMS	30000	30000	30000	1000000	100000	100000
OffsetSideBTS	Both	Both	Both	Both	Both	Both
OffsetSideMS	Both	Both	Both	Both	Both	Both
OffsetStartFrequencyBTS	25150000	27150000	35150000	4000000	800000	125000
OffsetStartFrequencyMS	25150000	27150000	35150000	4000000	800000	125000
OffsetStateBTS	TRUE	TRUE	TRUE	TRUE	TRUE	FALSE
OffsetStateMS	TRUE	TRUE	TRUE	TRUE	TRUE	FALSE
OffsetStopFrequencyBTS	27150000	35150000	4000000	8000000	125000	150000
OffsetStopFrequencyMS	27150000	35150000	4000000	8000000	125000	150000
OffsetSweepT	TRUE	TRUE	TRUE	TRUE	TRUE	TRUE

imeAutoBTS						
OffsetSweepTimeAutoMS	TRUE	TRUE	TRUE	TRUE	TRUE	TRUE
OffsetSweepTimeBTS	0.01 733 3	0.06 932	0.04 202 7	0.002053	0.00 225 3	0.00 125 3
OffsetSweepTimeMS	0.01 733 3	0.06 932	0.04 202 7	0.002053	0.00 225 3	0.00 125 3
OffsetVbwRbwRatioAutoBTS	FALSE	FALSE	FALSE	FALSE	FALSE	FALSE
OffsetVbwRbwRatioAutoMS	FALSE	FALSE	FALSE	FALSE	FALSE	FALSE
OffsetVbwRbwRatioBTS	0.01	0.01	0.01	0.01	0.01	0.01
OffsetVbwRbwRatioMS	0.01	0.01	0.01	0.01	0.01	0.01
OffsetVideoBWAutoBTS	TRUE	TRUE	TRUE	TRUE	TRUE	TRUE
OffsetVideoBWAutoMS	TRUE	TRUE	TRUE	TRUE	TRUE	TRUE
OffsetVideoBWAutoBTS	300	300	300	10000	100 00	100 00
OffsetVideoBWAutoMS	300	300	300	10000	100 00	100 00
PeakReference	- 82.9 957					
Periodic Timer Period	0.02					
Periodic Timer Sync Source	None					
Periodic Timer Trigger Delay	1.00 E-06					
Periodic Timer Trigger Delay State	FALSE					
PowerReference	- 73.6 966					

PSDReference	- 139. 54
Radio Device	Bts
RFBurst Trigger Delay	1.00 E-06
RFBurst Trigger Delay State	FALS E
RFBurst Trigger Level Abs	-20
RFBurst Trigger Level Rel	-6
RFBurst Trigger Level Type	Absol ute
RFBurst Trigger Slope	Posit ive
RrcFilter	FALS E
SemAverageN umber	10
SemAverageS tate	FALS E
TotalAtten	10
Trigger Holdoff	0.1
Trigger Holdoff State	FALS E
TriggerSource	Free
Video Trigger Delay	1.00 E-06
Video Trigger Delay State	FALS E
Video Trigger Level	-25
Video Trigger Slope	Posit ive
Video Selection	AbsP wrFr eq

MeasResult1	Meas Resul t2	Meas Resul t3	Meas Resul t4	MeasResu lt5	Meas Resul t6	Meas Resul t7	Meas Resul t8	Meas Resul t9	Meas Result 10	Meas Result 11	Meas Result 12
-999	- 78.8 935 9	-13	999	- 73.6966 3340998 79	-999	-999	-999	-999	-999	-999	-999
- 73.6966334 099879	- 78.9 523 5	-13	999	-999	-999	-999	-999	-999	-999	-999	-999

Save As . . .

When you press “Save As”, the analyzer brings up a Windows dialog and a menu entitled “**Save As.**” This menu allows you to navigate to the various fields in the Windows dialog without using a keyboard or mouse. The Tab and Arrow keys can also be used for dialog navigation.

See ["To File . . ." on page 2413](#) in Save, State for a full description of this dialog and menu.

The default path for saving files is:

For all of the Trace Data Files:

My Documents\<<mode name>\data\traces

For all of the Limit Data Files:

My Documents\<<mode name>\data\limits

For all of the Measurement Results Data Files:

My Documents\<<mode name>\data\<<measurement name>\results

For all of the Capture Buffer Data Files:

My Documents\<<mode name>\data\captureBuffer

Key Path	Save, Data
Mode	All
Notes	The key location is mode-dependent and will vary. Brings up the Save As dialog for saving a <mode specific> Save Type. The save is performed immediately and does not wait until the measurement is complete.
Initial S/W Revision	Prior to A.02.00

Screen Image

Pressing Screen Image accesses a menu of functions that enable you to specify a format and location for the saved screen image. It brings up a menu that allows you to specify the color scheme of the Screen

Image (Themes) or navigate to the Save As dialog to perform the actual save.

Screen Image files contain an exact representation of the analyzer display. They cannot be loaded back onto the analyzer, but they can be loaded into your PC for use in many popular applications.

The image to be saved is actually captured when the Save front panel key is pressed, and kept in temporary storage to be used if you ask for a Screen Image save. When the Screen Image key is pressed, a "thumbnail" of the captured image is displayed, as shown below:

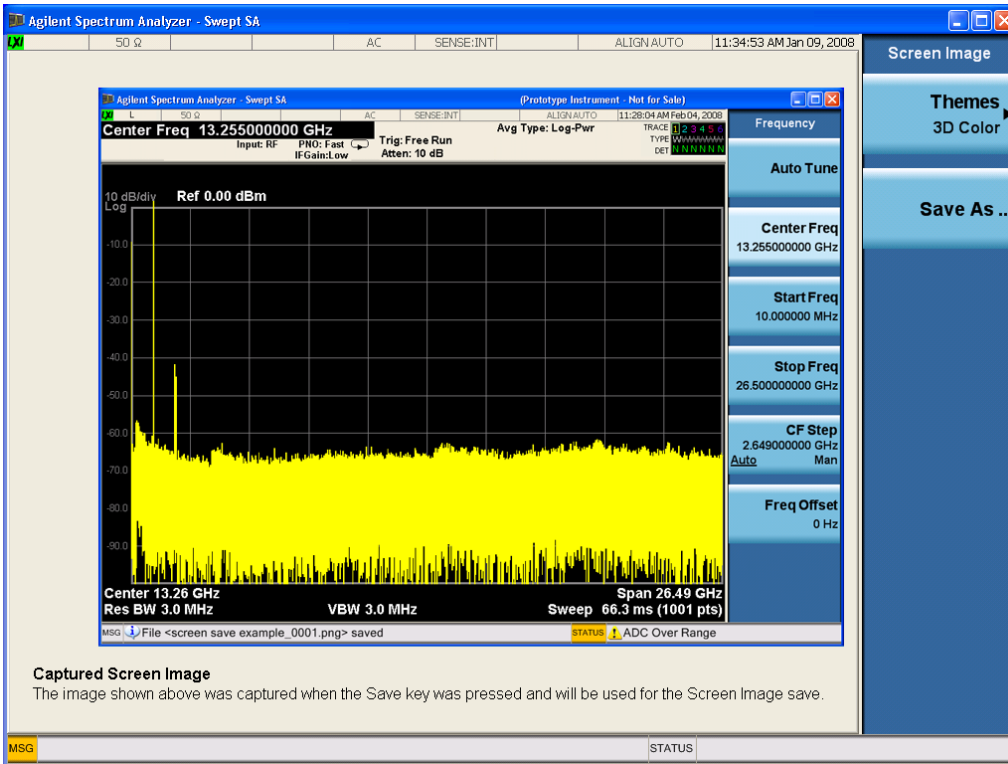

When you continue on into the Save As menu and complete the Screen Image save, the image depicted in the thumbnail is the one that gets saved, showing the menus that were on the screen before going into the Save menus. The save is performed immediately and does not wait until the measurement is complete.

After you have completed the save, the Quick Save front-panel key lets you quickly repeat the last save performed, using an auto-named file, with the current screen data.

NOTE

For versions previous to A.01.55, if you initiate a screen image save by navigating through the Save menus, the image that is saved will contain the Save menu softkeys, not the menus and the active function that were on the screen when you first pressed the Save front panel key.

Key Path	Save
Mode	All
Remote Command	:MMEMory:STORe:SCReen <filename>
Example	:MMEM:STOR:SCR "myScreen.png" This stores the current screen image in the file MyScreenFile.png in the default directory.
Initial S/W Revision	Prior to A.02.00

Themes

Accesses a menu of functions that enable you to choose the theme to be used when saving the screen image.

The **Themes** option is the same as the **Themes** option under the **Display** and **Page Setup** dialogs. It allows you to choose between themes to be used when saving the screen image.

Key Path	Save, Screen Image
Remote Command	:MMEMory:STORe:SCReen:THEMe TDColor TDMonochrome FCOLor FMONochrome :MMEMory:STORe:SCReen:THEMe?
Example	:MMEM:STOR:SCR:THEM TDM
Preset	3D Color; Is not part of Preset, but is reset by Restore Misc Defaults or Restore System Defaults All and survives subsequent running of the modes.
Readback	3D Color 3D Mono Flat Color Flat Mono
Backwards Compatibility Notes	In ESA and PSA we offer the choice of "Reverse Bitmap" or "Reverse Metafile" when saving screen images. This is much like the "Flat Color" theme available in X-Series. Also, if you selected Reverse Bitmap AND a black & white screen image, that would be much like "Flat Monochrome". In other words, each of the X-Series themes has a similar screen image type in ESA/PSA. But they are not identical.
Initial S/W Revision	Prior to A.02.00

3D Color

Selects a standard color theme with each object filled, shaded and colored as designed.

Key Path	Save, Screen Image, Themes
Example	MMEM:STOR:SCR:THEM TDC
Readback	3D Color
Initial S/W Revision	Prior to A.02.00

3D Monochrome

Selects a format that is like 3D color but shades of gray are used instead of colors.

Key Path	Save, Screen Image, Themes
Example	MMEM:STOR:SCR:THEM TDM
Readback	3D Mono
Initial S/W Revision	Prior to A.02.00

Flat Color

Selects a format that is best when the screen is to be printed on an ink printer.

Key Path	Save, Screen Image, Themes
Example	MMEM:STOR:SCR:THEM FCOL
Readback	Flat Color
Initial S/W Revision	Prior to A.02.00

Flat Monochrome

Selects a format that is like Flat Color. But only black is used (no colors, not even gray), and no fill.

Key Path	Save, Screen Image, Themes
Example	MMEM:STOR:SCR:THEM FMON
Readback	Flat Mono
Initial S/W Revision	Prior to A.02.00

Save As...

When you press “Save As”, the analyzer brings up a Windows dialog and a menu entitled “**Save As.**” This menu allows you to navigate to the various fields in the Windows dialog without using a keyboard or mouse. The Tab and Arrow keys can also be used for dialog navigation.

See "[To File ...](#)" on page 2413 in Save, State for a full description of this dialog and menu.

The default path for Screen Images is

My Documents\`<mode name>`\screen.

where `<mode name>` is the parameter used to select the mode with the INST:SEL command (for example, SA for the Spectrum Analyzer).

Key Path	Save, Screen Image
Notes	Brings up Save As dialog for saving a Screen Image Save Type
Initial S/W Revision	Prior to A.02.00

Single (Single Measurement/Sweep)

Sets the analyzer for Single measurement operation. The single/continuous state is Meas Global, so the setting will affect all the measurements. If you are Paused, pressing Single does a Resume.

See "[More Information](#)" on page 1420

Key Path	Front-panel key
Example	:INIT:CONT OFF
Notes	See Cont key description.
Backwards Compatibility Notes	<p>For Spectrum Analysis mode in ESA and PSA, the Single hardkey and the INITiate:IMM switched from continuous measurement to single measurement and restarted sweeps and averages (displayed average count reset to 1), but did not restart Max Hold and Min Hold. In the X-Series, the Single hardkey and the INITiate:IMM command initiate a sweep/ measurement/ average sequence/hold sequence including MaxHold and MinHold.</p> <p>For Spectrum Analysis mode in ESA and PSA, the Single hardkey restarted the sweep regardless of whether or not you were in an active sweep or sweep sequence. In the X-Series, Restart does this but Single only restarts the sweep or sweep sequence if you are in the idle state.</p> <p>INIT[:IMM] in ESA & PSA Spectrum Analysis Mode does an implied ABORT. In some other PSA Modes, INIT[:IMM] is ignored if not in the idle state. . The X-Series follows the ESA/PSA SA Mode model, which may cause some Modes to have compatibility problems.</p>
Initial S/W Revision	Prior to A.02.00

More Information

See "[Restart](#)" on page 2410 for details on the INIT:IMMEDIATE (Restart) function.

If you are already in single sweep, the INIT:CONT OFF command has no effect.

If you are already in Single Sweep, then pressing the Single key in the middle of a sweep does not restart the sweep or sequence. Similarly, pressing the Single key does not restart the sweep or sequence if the sweep is not in the idle state (for example, if you are taking a very slow sweep, or the analyzer is waiting for a trigger). Instead, it results in a message. "Already in Single, press Restart to initiate a new sweep or sequence". Even though pressing the Single key in the middle of a sweep does not restart the sweep, sending INIT:IMMEDIATE does reset it.

To take one more sweep without resetting the average count, increment the average count by 1, by pressing the step up key while **Average/Hold Number** is the active function, or sending the remote command CALC:AVER:TCON UP.

Source

Opens a menu of keys that access various source configuration menus and settings. In the test set, pressing this key also causes the central view area to change and display the Source Control Main view.

Key Path	Front-panel key
----------	-----------------

RF Output

This parameter sets the source RF power output state.

Key Path	Source
Remote Command	:OUTPut[:EXTernal][:STATe] ON OFF 1 0 :OUTPut[:EXTernal][:STATe]?
Example	OUTP OFF OUTP?
Notes	<p>The EXTERNAL node is shown in RD text so the SCPI remains the same between internal and external source control. However, for EXT we do not wish to document this node to the customer since we are controlling the internal source rather than the external source.</p> <p>This setting is for the independent mode and has no effect on the "List Sequencer" on page 2520. If the "Sequencer" on page 2521 is set to ON, the list sequencer controls the source output and this key will be grayed-out. And this setting will be none-forceful grey out on front panel to indicate out-of-scope. Non-forceful means user still can change this setting by SCPI but cannot change on front panel. When set to OFF will make source leave list sequencer and this setting will be black out and take effect immediately.</p> <p>When the RF Output is ON, an "RF" annunciator is displayed in the system settings panel. When the RF Output is turned Off, the RF annunciator is cleared. If the "Sequencer" on page 2521 is set to ON, the "RF" annunciator will be replaced by "SEQ" in the system settings panel, indicating that the output is controlled by the list sequencer.</p>
Preset	Off
Range	On Off
Initial S/W Revision	A.05.00

Amplitude

Allows you to access the Amplitude sub-menu.

Key Path	Source
Notes	<p>The sub-menu under this button is for independent mode and has no effect on "List Sequencer" on page 2520. If the "Sequencer" on page 2521 is set to ON, the list sequencer controls the source output and this key will be grayed-out on front panel to indicate out-of-scope. When you set "Sequencer" on page 2521 to Off will make source leave list sequencer and this button will be black out.</p>
Initial S/W Revision	A.05.00

RF Power

Allows you to adjust the power level of the source using the numeric keypad, step keys, or RPG. Pressing any digit, 0 through 9, on the numeric keypad brings up the unit terminator.

Please refer to the ["RF Power Range " on page 1423](#) table below for the valid ranges.

Key Path	Source, Amplitude
Remote Command	:SOURce:POWer[:LEVel][:IMMediate][:AMPLitude] <ampl> :SOURce:POWer[:LEVel][:IMMediate][:AMPLitude]?
Example	:SOUR:POW -100 dBm
Notes	<p>Amplitude corrections can be specified for use with the source. In the event of amplitude corrections being applied, the valid ranges for the RF power do not change dependant on the current amplitude correction setting. If the combination of RF power + amplitude correction is higher or lower than the source output range, the Source Unleveled bit is set and the "Source Unleveled" indicator will appear on status panel to indicate that the source cannot maintain the output power that has been requested.</p> <p>When signal generator is unable to maintain the requested output level, the "Source Unleveled" indicator will appear on status panel. When the source output setting is restored to the normal range, the "Source Unleveled" is removed from status panel.</p> <p>Internal source has list sequence mode, which comprises of several steps which contain separate output power, frequency and waveform etc. When the source list sequence playing is complete, the last step keeps playing, and user can use this command to change the list sequence last step's output power.</p> <p>The multiport adapter RFIO TX ports and GPS ports cannot ensure power accuracy when power setting is lower than -130dBm, this power setting value is defined by the sum of RF Power setting and related amplitude correction value. But user settable value could be lower than this limit. When application detected there exists power setting lower than -130dBm on MPA RFIO TX ports, then popup warning message . When application detected there exists power setting lower than -130dBm on MPA GPS ports, then popup warning message . This is only warning message, and check is performed when RF is ON.</p>
Notes	The Min and Max value here defined UI settable amplitude range. This range is larger than actual amplitude range with level accuracy defined in spec.
Dependencies	The RF power is dependent on the RF output port and frequency, such that the current frequency and selected output port determine the valid range of power values.
Preset	-100 dBm
Min	The range of values depends on the current frequency and selected RF output port. Please refer to the "RF Power Range " on page 1423 table below for the valid ranges.
Max	The range of values depends on the current frequency and selected RF output port. Please refer to the "RF Power Range " on page 1423 table below for the valid ranges.
Initial S/W Revision	A.05.00

RF Power Range

RF Output Port	Frequency Range	Min Output Power	Max Output Power
High Power RF Out	10 MHz ≤ f ≤ 6 GHz	-150 dBm	20 dBm
RFIO 1 & RFIO 2	10 MHz ≤ f ≤ 6 GHz	-150 dBm	0 dBm
GPS (Note2)	10 MHz ≤ f ≤ 6 GHz	-150 dBm	0 dBm

Note: This is the UI power range, it's larger than actual spec.

Note2: GPS port is on the multiport adapter, or E6607C which has embedded MPA.

Set Reference Power

This key allows you to set the power reference. Pressing this key turns the power reference state to ON, sets the reference power value to the current RF output power, maintains this power at the RF output, and sets the displayed power to 0.00 dB. All subsequent RF power values entered under Source>Amplitude>RF Power are interpreted as being relative to this reference power.

When you use a power reference, the signal generator outputs an RF power that is set relative to the reference power by the value entered under Source>Amplitude>RF Power as follows:

Output power = reference power – entered power

Where:

reference power equals the original RF Power entered under Source>Amplitude>RF Power and set as the reference power

entered power equals a new value entered under Source>Amplitude>Amptd Offset

In addition, the displayed power value is the same as a new value entered under Source>Amplitude>RF Power.

NOTE

If Power Ref is set to ON with a reference value set, entering a value under Source>Amplitude>RF Power and pressing Set Reference Power will add that value to the existing Power Ref value.

If you wish to change the reference power value to a new value entered under Source>Amplitude>RF Power, first you must set Power Ref to OFF and then press Set Reference Power.

Key Path	Source, Amplitude
Dependencies	This key is unavailable, and is grayed out when the " List Sequencer " on page 2520 is turned ON.
Initial S/W Revision	A.05.00

Power Ref

This key allows you to toggle the state of the power reference.

When you use a power reference, the signal generator outputs an RF power that is set relative to the reference power by the value entered under Source>Amplitude>RF Power as follows:

Output power = reference power + entered power

Where:

reference power equals the original RF Power entered under Source>Amplitude>RF Power and set as the reference power

entered power equals a new value entered under Source>Amplitude>Amptd Offset

For more information on Reference Frequency refer to ["Set Reference Power " on page 2443](#)

Key Path	Source, Amplitude
Remote Command	:SOURce:POWer:REFeRence <ampl> :SOURce:POWer:REFeRence? :SOURce:POWer:REFeRence:STATe OFF ON 0 1 :SOURce:POWer:REFeRence:STATe?
Example	:SOUR:POW:REF 0.00 dBm :SOUR:POW:REF:STATe ON
Dependencies	This setting is unavailable and is grayed out when the "List Sequencer" on page 2520 is turned ON.
Couplings	This value is coupled to the "Set Reference Power " on page 2443 key such that pressing the Set Reference Power key updates the reference power with the current output power.
Preset	0.00 dBm OFF
Min	-125.00 dBm
Max	10.00 dBm
Initial S/W Revision	A.05.00

Amptd Offset

Allows you to specify the RF output power offset value.

When the amplitude offset is set to zero (0) and you set a new offset value (positive or negative), the displayed amplitude value will change as follows and the RF output power will not change:

Displayed value = output power + offset value

Where:

output power equals the original RF Power entered under Source>Amplitude>RF Power

offset value equals the value entered under Source>Amplitude>Amptd Offset

When the amplitude offset is set to a value other than zero (0) and you enter a new RF power value under Source>Amplitude>RF Power, the displayed power will be the same as the value entered and the RF output power will be equal to the value entered minus the offset value as follows:

Output power = entered power – offset power

Displayed Power = output power + offset power

Displayed power = entered power

Where:

entered power equals the amplitude entered under Source>Amplitude>RF Power

offset power equals the value previously entered and set under Source>Amplitude>Amptd Offset

Key Path	Source, Amplitude
Remote Command	:SOURce:POWer[:LEVel][:IMMediate]:OFFSet <rel_ampl> :SOURce:POWer[:LEVel][:IMMediate]:OFFSet?
Example	:SOUR:POW:OFFS 0.00 dB
Dependencies	This setting is unavailable, and is grayed out when the List Sequencer is turned ON.
Preset	0.00 dB
Min	-200.00 dB
Max	200.00 dB
Initial S/W Revision	A.05.00

Modulation

Allows you to toggle the state of the modulation.

Key Path	Source
Remote Command	:OUTPut:MODulation[:STATe] ON OFF 1 0 :OUTPut:MODulation[:STATe]?
Example	:OUTP:MOD OFF
Notes	This setting is for independent mode and has no effect on " List Sequencer " on page 2520. If the " Sequencer " on page 2521 is set to ON, the list sequencer controls the source output and this key will be grayed-out. And this setting will be none-forceful grey out on front panel to indicate out-of-scope. Non-forceful means user still can change this setting by SCPI but cannot change manually on front panel. When set to Off will make source leave list sequencer and this setting will be black out and take effect immediately. When the Modulation is ON, the "MOD" annunciator is displayed in the system settings panel. When the Modulation is turned Off, the "MOD" annunciator is cleared. If the " Sequencer " on page 2521 is set to ON, the "MOD" annunciator will be replaced by "SEQ" in the system settings panel indicating that the output is controlled by list sequencer.
Preset	Off
Range	On Off
Initial S/W Revision	A.05.00

Frequency

Allows you to access the Frequency sub-menu.

Key Path	Source
Notes	The sub-menu under this button is for independent mode and has no effect on " List Sequencer " on

[page 2520](#). If the "[Sequencer](#)" on [page 2521](#) is set to ON, the list sequencer controls the source output and this key will be grayed-out. And this button will be grey out on front panel to indicate out-of-scope. When set to Off will make source leave list sequencer and this button will be black out.

Initial S/W Revision A.05.00

Frequency

Allows you to set the RF Output Frequency. You can adjust the frequency of the source using the numeric keypad, step keys, or RPG. Pressing any digit, 0 through 9, on the numeric keypad brings up the unit terminator.

Key Path	Source, Frequency
Remote Command	:SOURce:FREQuency[:CW] <freq> :SOURce:FREQuency[:CW]?
Example	:SOUR:FREQ 1.00 GHz
Notes	Internal source has list sequence mode, which comprises of several steps which contain separate output power, frequency and waveform etc. When the source list sequence playing is complete, the last step keeps playing, and user can use this command to change the list sequence last step's output frequency.
Couplings	The frequency value is coupled to the current channel band and number, such that updates to the band and number will update the frequency value to the corresponding absolute frequency.
Preset	1.00 GHz If license F1A or 5WC is present, the default Center Frequency should be 2.412GHz.
Min	10.00 MHz
Max	Hardware Dependant: Option 503 = 3.6 GHz Option 504 = 3.8 GHz Option 506 = 6.00 GHz For E6640A, if license 5WC is present, the frequency range should be limited to: 1.1GHz–1.7GHz, 2.4GHz–2.5GHz, 4.8GHz–6.0GHz. If the user-defined frequency is outside of range, UI will report an error message called "Settings conflict; Frequency is outside available range".
Initial S/W Revision	A.05.00

Channel

The frequency of the source can be specified by a channel number of a given frequency band. This key allows you to specify the current channel number. For the appropriate range of channel numbers for a given frequency band, refer to the following tables: "[GSM/EDGE Channel Number Ranges](#)" on [page 1427](#), "[W-CDMA Channel Number Ranges](#)" on [page 1428](#), "[CDMA 2000 / 1xEVDO Channel Number Ranges](#)" on [page 1429](#), and "[LTE FDD Channel Number Ranges](#)" on [page 1431](#).

Key Path	Source, Frequency
Remote Command	:SOURce:FREQuency:CHANnels:NUMBer <int> :SOURce:FREQuency:CHANnels:NUMBer?
Example	:SOUR:FREQ:CHAN:NUMB 1
Notes	This key is grayed out when the "Radio Standard" on page 2455 is set to NONE. This key is grayed out on E6630A.
Dependencies	This key is grayed out when the "Radio Standard" on page 2455 is set to NONE. This key is grayed out on E6630A.
Couplings	The channel number is coupled to the frequency value when the "Radio Standard" on page 2455 is not set to NONE. When the frequency value is changed, the channel number will increase or decrease to match the new frequency. If the frequency is not at an exact match for a channel number, the nearest channel number is displayed along with a greater than or less than sign to indicate the frequency is above or below the channel number.
Preset	1
Min	Please refer to the tables below for the valid ranges.
Max	Please refer to the tables below for the valid ranges.
Initial S/W Revision	A.05.00

GSM/EDGE Channel Number Ranges

Band	Link (Device)	Range	Frequency (MHz)
P-GSM	Uplink (MS)	$1 \leq n \leq 124$	$890.0 + 0.2*n$
	Downlink (BS)	$1 \leq n \leq 124$	$935.0 + 0.2*n$
E-GSM	Uplink (MS)	$0 \leq n \leq 124$	$890.0 + 0.2*n$
		$975 \leq n \leq 1023$	$890.0 + 0.2*(n-1024)$
	Downlink (BS)	$0 \leq n \leq 124$	$935.0 + 0.2*n$
		$975 \leq n \leq 1023$	$935.0 + 0.2*(n-1024)$
DCS 1800	Uplink (MS)	$512 \leq n \leq 885$	$1710.200 + 0.20*(n-512)$
	Downlink (BS)	$512 \leq n \leq 885$	$1805.200 + 0.20*(n-512)$
PCS 1900	Uplink (MS)	$512 \leq n \leq 810$	$1850.200 + 0.2*(n-512)$
	Downlink (BS)	$512 \leq n \leq 810$	$1930.200 + 0.2*(n-512)$
R-GSM	Uplink (MS)	$0 \leq n \leq 124$	$890.0 + 0.2*n$
		$955 \leq n \leq 1023$	$890.0 + 0.2*(n-1024)$
	Downlink (BS)	$0 \leq n \leq 124$	$935.0 + 0.2*n$
		$955 \leq n \leq 1023$	$935.0 + 0.2*(n-1024)$
GSM 450	Uplink (MS)	$256 \leq n \leq 293$	$450.6 + 0.2*(n-259)$
	Downlink (BS)	$256 \leq n \leq 293$	$460.6 + 0.2*(n-259)$
GSM 480	Uplink (MS)	$306 \leq n \leq 340$	$479.000 + 0.20*(n-306)$

Band	Link (Device)	Range	Frequency (MHz)
GSM 850	Downlink (BS)	$306 \leq n \leq 340$	$489.000 + 0.20*(n-306)$
	Uplink (MS)	$128 \leq n \leq 251$	$824.200 + 0.20*(n-128)$
GSM 700	Downlink (BS)	$128 \leq n \leq 251$	$869.200 + 0.20*(n-128)$
	Uplink (MS)	$438 \leq n \leq 516$	$777.200 + 0.20*(n-438)$
T-GSM810	Downlink (BS)	$438 \leq n \leq 516$	$747.200 + 0.20*(n-438)$
	Uplink (MS)	$350 \leq n \leq 425$	$806.0 + 0.20*(n-350)$
	Downlink (BS)	$350 \leq n \leq 425$	$851.0 + 0.20*(n-350)$

W-CDMA Channel Number Ranges

Band	Link (Device)	Range	Frequency (MHz)
Band I	Downlink	$10562 \leq n \leq 10838$	$n \div 5$
	Uplink	$9612 \leq n \leq 9888$	$n \div 5$
Band II	Downlink	$412 \leq n \leq 687$	$n \div 5 + 1850.1$
		$9662 \leq n \leq 9938$	$n \div 5$
	Uplink	$12 \leq n \leq 287$	$n \div 5 + 1850.1$
Band III	Downlink	$350 \leq n \leq 425$	$n \div 5$
	Downlink	$1162 \leq n \leq 1513$	$n \div 5 + 1575$
Band IV	Uplink	$937 \leq n \leq 1288$	$n \div 5 + 1525$
	Downlink	$537 \leq n \leq 1738$	$n \div 5 + 1805$
Band V	Downlink	$1887 \leq n \leq 2087$	$n \div 5 + 1735.1$
		Uplink	$1312 \leq n \leq 1513$
	Downlink	$1662 \leq n \leq 1862$	$n \div 5 + 1380.1$
Band VI	Downlink	$1007 \leq n \leq 1087$	$n \div 5 + 670.1$
		$4357 \leq n \leq 4458$	$n \div 5$
	Uplink	$782 \leq n \leq 862$	$n \div 5 + 670.1$
Band VII	Downlink	$4132 \leq n \leq 4233$	$n \div 5$
		Downlink	$1037 \leq n \leq 1062$
	Uplink	$4387 \leq n \leq 4413$	$n \div 5$
Band VIII	Downlink	$812 \leq n \leq 837$	$n \div 5 + 670.1$
		$4162 \leq n \leq 4188$	$n \div 5$
	Downlink	$2237 \leq n \leq 2563$	$n \div 5 + 2175$
Band IX	Downlink	$2587 \leq n \leq 2912$	$n \div 5 + 2105.1$
		Uplink	$2012 \leq n \leq 2338$
Band X	Downlink	$2362 \leq n \leq 2687$	$n \div 5 + 2030.1$
		Downlink	$2937 \leq n \leq 3088$
	Uplink	$2712 \leq n \leq 2863$	$n \div 5 + 340$

Band	Link (Device)	Range	Frequency (MHz)
Band IX	Downlink	$9237 \leq n \leq 9387$	$n \div 5$
	Uplink	$8762 \leq n \leq 8912$	$n \div 5$
Band X	Downlink	$3112 \leq n \leq 3388$	$n \div 5 + 1490$
		$3412 \leq n \leq 3687$	$n \div 5 + 1430.1$
	Uplink	$2887 \leq n \leq 3163$	$n \div 5 + 1135$
		$3187 \leq n \leq 3462$	$n \div 5 + 1075.1$
Band XI	Downlink	$3712 \leq n \leq 3812$	$n \div 5 + 736$
	Uplink	$3487 \leq n \leq 3587$	$n \div 5 + 733$
Band XII	Downlink	$3837 \leq n \leq 3903$	$n \div 5 - 37$
		$3927 \leq n \leq 3992$	$n \div 5 - 54.9$
	Uplink	$3612 \leq n \leq 3678$	$n \div 5 - 22$
		$3702 \leq n \leq 3767$	$n \div 5 - 39.9$
Band XIII	Downlink	$4017 \leq n \leq 4043$	$n \div 5 - 55$
		$4067 \leq n \leq 4092$	$n \div 5 - 64.9$
	Uplink	$3792 \leq n \leq 3818$	$n \div 5 + 21$
		$3702 \leq n \leq 3767$	$n \div 5 - 39.9$
Band XIV	Downlink	$4117 \leq n \leq 4143$	$n \div 5 - 63$
		$4167 \leq n \leq 4192$	$n \div 5 - 72.9$
	Uplink	$3892 \leq n \leq 3918$	$n \div 5 + 12$
		$3942 \leq n \leq 3967$	$n \div 5 + 2.1$
Band XIX	Downlink	$712 \leq n \leq 763$	$n \div 5 + 735$
		$787 \leq n \leq 837$	$n \div 5 + 720.1$
	Uplink	$312 \leq n \leq 363$	$n \div 5 + 770$
		$387 \leq n \leq 437$	$n \div 5 + 755.1$

CDMA 2000 / 1xEVDO Channel Number Ranges

Band	Link (Device)	Range	Frequency (MHz)
US Cellular	Uplink (MS, reverse link)	$1 \leq N \leq 799$	$0.030 \times N + 825.000$
		$991 \leq N \leq 1023$	$0.030 \times (N - 1023) + 825.000$
		$1024 \leq N \leq 1323$	$0.030 \times (N - 1024) + 815.040$
	Downlink (BS, forward link)	$1 \leq N \leq 799$	$0.030 \times N + 870.000$
		$991 \leq N \leq 1023$	$0.030 \times (N - 1023) + 870.000$
		$1024 \leq N \leq 1323$	$0.030 \times (N - 1024) + 860.040$
US PCS	Uplink (MS, reverse link)	$0 \leq N \leq 1199$	$1850.000 + 0.050 \times N$
	Downlink (BS, forward link)	$0 \leq N \leq 1199$	$1930.000 + 0.050 \times N$

Band	Link (Device)	Range	Frequency (MHz)
Japan Cellular Band	Uplink (MS, reverse link)	$1 \leq N \leq 799$	$0.0125 \times (N + 915.000)$
		$801 \leq N \leq 1039$	$0.0125 \times (N - 800) + 898.000$
		$1041 \leq N \leq 1199$	$0.0125 \times (N - 1040) + 887.000$
		$1201 \leq N \leq 1600$	$0.0125 \times (N - 1200) + 893.000$
	Downlink (BS, forward link)	$1 \leq N \leq 799$	$0.0125 \times (N + 860.000)$
		$801 \leq N \leq 1039$	$0.0125 \times (N - 800) + 843.000$
		$1041 \leq N \leq 1199$	$0.0125 \times (N - 1040) + 832.000$
		$1201 \leq N \leq 1600$	$0.0125 \times (N - 1200) + 838.000$
Korean PCS Band	Uplink (MS, reverse link)	$0 \leq N \leq 599$	$0.050 \times N + 1750.000$
	Downlink (BS, forward link)	$0 \leq N \leq 599$	$0.050 \times N + 1840.000$
NMT-450 Band	Uplink (MS, reverse link)	$1 \leq N \leq 400$	$0.025 \times (N - 1) + 450.000$
		$472 \leq N \leq 871$	$0.025 \times (N - 472) + 410.000$
		$1039 \leq N \leq 1473$	$0.020 \times (N - 1024) + 451.010$
		$1536 \leq N \leq 1715$	$0.025 \times (N - 1536) + 479.000$
		$1792 \leq N \leq 2016$	$0.020 \times (N - 1792) + 479.000$
	Downlink (BS, forward link)	$1 \leq N \leq 400$	$0.025 \times (N - 1) + 460.000$
		$472 \leq N \leq 871$	$0.025 \times (N - 472) + 420.000$
		$1039 \leq N \leq 1473$	$0.020 \times (N - 1024) + 461.010$
IMT-2000 Band	Uplink (MS, reverse link)	$0 \leq N \leq 1199$	$1920.000 + 0.050 \times N$
	Downlink (BS, forward link)	$0 \leq N \leq 1199$	$2100.000 + 0.050 \times N$
Upper 700 MHz Band	Uplink (MS, reverse link)	$0 \leq N \leq 240$	$776.000 + 0.050 \times N$
	Downlink (BS, forward link)	$0 \leq N \leq 240$	$746.000 + 0.050 \times N$
Secondary 800 MHz Band	Uplink (MS, reverse link)	$0 \leq N \leq 719$	$0.025 \times N + 806.000$
		$720 \leq N \leq 919$	$0.025 \times (N - 720) + 896.000$
	Downlink (BS, forward link)	$0 \leq N \leq 719$	$0.025 \times N + 851.000$
2.5 GHz IMT Extension	Uplink (MS, reverse link)	$0 \leq N \leq 1399$	$2500.000 + 0.050 \times N$
	Downlink (BS, forward link)	$0 \leq N \leq 1399$	$2620.000 + 0.050 \times N$
US PCS 1.9 GHz	Uplink (MS, reverse link)	$0 \leq N \leq 1299$	$1850.000 + 0.050 \times N$

Band	Link (Device)	Range	Frequency (MHz)
AWS	Downlink (BS, forward link)	$0 \leq N \leq 1299$	$1930.000 + 0.050 \times N$
	Uplink (MS, reverse link)	$0 \leq N \leq 899$	$1710.000 + 0.050 \times N$
US 2.5 GHz	Downlink (BS, forward link)	$0 \leq N \leq 899$	$2100.000 + 0.050 \times N$
	Uplink (MS, reverse link)	$140 \leq N \leq 1459$	$2495.000 + 0.050 \times N$
700 Public Safety	Downlink (BS, forward link)	$140 \leq N \leq 1459$	$2617.000 + 0.050 \times N$
	Uplink (MS, reverse link)	$0 \leq N \leq 240$	$787.000 + 0.050 \times N$
C2K Lower 700	Downlink (BS, forward link)	$0 \leq N \leq 240$	$757.000 + 0.050 \times N$
	Uplink (MS, reverse link)	$0 \leq N \leq 360$	$698.000 + 0.050 \times N$
400 Euro PAMR	Downlink (BS, forward link)	$0 \leq N \leq 360$	$728.000 + 0.050 \times N$
	Uplink (MS, reverse link)	$1 \leq N \leq 400$	$0.025 \times (N-1) + 450.000$
	Uplink (MS, reverse link)	$472 \leq N \leq 871$	$0.025 \times (N-472) + 410.000$
	Uplink (MS, reverse link)	$1536 \leq N \leq 1715$	$0.025 \times (N-1536) + 479.000$
	Downlink (BS, forward link)	$1 \leq N \leq 400$	$0.025 \times (N-1) + 460.000$
	Downlink (BS, forward link)	$472 \leq N \leq 871$	$0.025 \times (N-472) + 420.000$
	Downlink (BS, forward link)	$1536 \leq N \leq 1715$	$0.025 \times (N-1536) + 489.000$
	Downlink (BS, forward link)		
800 PAMR	Uplink (MS, reverse link)	$0 \leq N \leq 239$	$870.0125 + 0.025 \times N$
	Downlink (BS, forward link)	$0 \leq N \leq 239$	$915.0125 + 0.025 \times N$

LTE FDD Channel Number Ranges

The carrier frequency in the uplink and downlink is designated by the E-UTRA Absolute Radio Frequency Channel Number (EARFCN) in the range 0 – 65535. The relation between EARFCN and the carrier frequency in MHz for the downlink is given by the following equation, where FDL_low and NOffs-DL are given in table 5.4.4-1 and NDL is the downlink EARFCN.

$$FDL = FDL_low + 0.1(NDL - NOffs-DL)$$

The relation between EARFCN and the carrier frequency in MHz for the uplink is given by the following equation where FUL_low and NOffs-UL are given in table 5.4.4-1 and NUL is the uplink EARFCN.

$$FUL = FUL_low + 0.1(NUL - NOffs-UL)$$

Band	Downlink	Uplink				
FDL_low (MHz)	NOffs-DL	Range of NDL	FUL_low (MHz)	NOffs-UL	Range of NUL	
1	2110	0	0 - 599	1920	18000	18000 - 18599
2	1930	600	600 - 1199	1850	18600	18600 - 19199
3	1805	1200	1200 - 1949	1710	19200	19200 - 19949
4	2110	1950	1950 - 2399	1710	19950	19950 - 20399
5	869	2400	2400 - 2649	824	20400	20400 - 20649
6	875	2650	2650 - 2749	830	20650	20650 - 20749
7	2620	2750	2750 - 3449	2500	20750	20750 - 20449
8	925	3450	3450 - 3799	880	21450	21450 - 21799
9	1844.9	3800	3800 - 4149	1749.9	21800	21800 - 22149
10	2110	4150	4150 - 4749	1710	22150	22150 - 22749
11	1475.9	4750	4750 - 4949	1427.9	22750	22750 - 22949
12	729	5010	5010 - 5179	699	23010	23010 - 23179
13	746	5180	5180 - 5279	777	23180	23180 - 23279
14	758	5280	5280 - 5379	788	23280	23280 - 23379
...						
17	734	5730	5730 - 5849	704	23730	23730 - 23849
18	860	5850	5850 - 5999	815	23850	23850 - 23999
19	875	6000	6000 - 6149	830	24000	24000 - 24149
20	791	6150	6150 - 6449	832	24150	24150 - 24449
21	1495.9	6450	6450 - 6599	1447.9	24450	24450 - 24599
...						
24	1525	7700	7700 - 8039	1626.5	25700	25700 - 26039
25	1930	8040	8040 - 8689	1850	26040	26040 - 26689
26	859	8690	8690 - 9039	814	26690	26690 - 27039
...						

Note: The channel numbers that designate carrier frequencies so close to the operating band edges that the carrier extends beyond the operating band edge shall not be used. This implies that the first 7, 15, 25, 50, 75 and 100 channel numbers at the lower operating band edge and the last 6, 14, 24, 49, 74 and 99 channel numbers at the upper operating band edge shall not be used for channel bandwidths of 1.4, 3, 5, 10, 15 and 20 MHz respectively.

LTE TDD Channel Number Ranges

The carrier frequency in the uplink and downlink is designated by the E-UTRA Absolute Radio Frequency Channel Number (EARFCN) in the range 0 – 65535. The relation between EARFCN and the carrier frequency in MHz for the downlink is given by the following equation, where FDL_low and NOffs-DL are given in table 5.4.4-1 and NDL is the downlink EARFCN.

$$FDL = FDL_low + 0.1(NDL - NOffs-DL)$$

The relation between EARFCN and the carrier frequency in MHz for the uplink is given by the following equation where FUL_low and NOffs-UL are given in table 5.4.4-1 and NUL is the uplink EARFCN.

$$FUL = FUL_low + 0.1(NUL - NOffs-UL)$$

Band	Downlink		Uplink			
	FDL_low (MHz)	NOffs-DL	Range of NDL	FUL_low (MHz)	NOffs-UL	Range of NUL
33		1900	36000	36000 - 36199	1900	36000 - 36199
34		2010	36200	36200 - 36349	2010	36200 - 36349
35		1850	36350	36350 - 36949	1850	36350 - 36949
36		1930	36950	36950 - 37549	1930	36950 - 37549
37		1910	37550	37550 - 37749	1910	37550 - 37749
38		2570	37750	37750 - 38249	2570	37750 - 38249
39		1880	38250	38250 - 38649	1880	38250 - 38649
40		2300	38650	38650 - 39649	2300	38650 - 39649
41		2496	39650	39650 - 41589	2496	39650 - 41589
42		3400	41590	41590 - 43589	3400	41590 - 43589
43		3600	43590	43590 - 45589	3600	43590 - 45589

Note: The channel numbers that designate carrier frequencies so close to the operating band edges that the carrier extends beyond the operating band edge shall not be used. This implies that the first 7, 15, 25, 50, 75 and 100 channel numbers at the lower operating band edge and the last 6, 14, 24, 49, 74 and 99 channel numbers at the upper operating band edge shall not be used for channel bandwidths of 1.4, 3, 5, 10, 15 and 20 MHz respectively.

TDSCDMA Channel Number Ranges

1.28 Mcps TDD Option

No TX-RX frequency separation is required as Time Division Duplex (TDD) is employed. Each subframe consists of 7 main timeslots where all main timeslots (at least the first one) before the single switching point are allocated DL and all main timeslots (at least the last one) after the single switching point are allocated UL.

The nominal channel spacing is 1.6 MHz, but this can be adjusted to optimise performance in a particular deployment scenario.

The carrier frequency is designated by the UTRA absolute radio frequency channel number (UARFCN). The value of the UARFCN in the IMT2000 band is defined in the general case as follows:

$$N_t = 5 * F \quad 0.0 \text{ MHz} \leq F \leq 3276.6 \text{ MHz}$$

where F is the carrier frequency in MHz

Additional channels applicable to operation in the frequency band defined in sub-clause 5.2(d) are defined via the following UARFCN definition:

$$N_t = 5 * (F - 2150.1 \text{ MHz}) \quad 2572.5 \text{ MHz} \leq F \leq 2617.5 \text{ MHz}$$

UARFCN

1.28 Mcps TDD Option

The following UARFCN range shall be supported for each band:

**Table: UTRA Absolute Radio
Frequency Channel Number 1.28
Mcps TDD Option**

Frequency Band	Frequency Range	UARFCN Uplink and Downlink transmission
For operation in frequency band as defined in subclause 5.2 (a)	1900–1920 MHz	9504 to 9596
	2010–2025 MHz	10054 to 10121
For operation in frequency band as defined in subclause 5.2 (b)	1850–1910 MHz	9254 to 9546
	1930–1990 MHz	9654 to 9946
For operation in frequency band as defined in subclause 5.2 (c)	1910–1930 MHz	9554 to 9646
For operation in frequency band as defined in subclause 5.2 (d)	2570–2620 MHz	12854 to 13096
For operation in frequency band as defined in subclause 5.2 (e)	2300–2400 MHz	11504 to 11996
For operation in frequency band as defined in subclause 5.2 (f)	1880–1920 MHz	9404 to 9596

Radio Setup

Allows access to the sub-menus for selecting the radio standard and associated radio band. You can also set a frequency reference and offset.

This menu is greyed out when on E6630A. Radio band settings for GSM, cdma2000, and so on -- most of which are not actually supported in E6630A, which has three narrow frequency bands. So band settings are grayed out.

Key Path	Source, Frequency
Initial S/W Revision	A.05.00

Radio Standard

Allows access to the channel band sub-menus to select the desired radio standard. When you have selected the radio standard, you can then set an active channel band. The radio standard and the active channel band allow you to use channel numbers to set frequency automatically.

Key Path	Source, Frequency, Radio Setup
Remote Command	:SOURce:FREQuency:CHANnels:BAND NONE PGSM EGSM RGSM DCS1800 PCS1900 TGSM810 GSM450 GSM480 GSM700 GSM850 BANDI BANDII BANDIII BANDIV BANDV BANDVI BANDVII BANDVIII BANDIX BANDX BANDXI BANDXII BANDXIII BANDXIV BANDXIX USCELL USPCS JAPAN KOREAN NMT IMT2K UPPER SECOND PAMR400 PAMR800 IMTEXT PCS1DOT9G AWS US2DOT5G PUBLIC LOWER BAND1 BAND2 BAND3 BAND4 BAND5 BAND6 BAND7 BAND8 BAND10 BAND11 BAND12 BAND13 BAND14 BAND17 BAND18 BAND19 BAND20 BAND21 BAND24 BAND25 BAND26 BAND27 BAND28 BAND31 BAND33 BAND34 BAND35 BAND36 BAND37 BAND38 BAND39 BAND40 BAND41 BAND42 BAND43 BAND44 BANDA BANDB BANDC BANDD BANDE BANDF :SOURce:FREQuency:CHANnels:BAND?
Example	:SOUR:FREQ:CHAN:BAND PGSM
Notes	Set this setting to "NONE" will grey out "Channel" on page 2446 Channel
Initial S/W Revision	A.05.00

None

Selects no radio standard for use. When you have selected the radio standard to NONE, you cannot use channel numbers to set frequency automatically. You will need to set the frequency manually.

Key Path	Source, Frequency, Radio Setup, Radio Standard
Initial S/W Revision	A.05.00

GSM/EDGE

Sets GSM/EDGE as the radio standard for use and accesses the GSM/EDGE specific channel band sub-menus.

Key Path	Source, Frequency, Radio Setup, Radio Standard
Initial S/W Revision	A.05.00

P-GSM

Selects P-GSM as the active channel band.

Key Path	Source, Frequency, Radio Setup, Radio Standard, GSM/EDGE
Example	:SOUR:FREQ:CHAN:BAND PGSM
Initial S/W Revision	A.05.00

E-GSM

Selects E-GSM as the active channel band.

Key Path	Source, Frequency, Radio Setup, Radio Standard, GSM/EDGE
Example	:SOUR:FREQ:CHAN:BAND EGSM
Initial S/W Revision	A.05.00

R-GSM

Selects R-GSM as the active channel band.

Key Path	Source, Frequency, Radio Setup, Radio Standard, GSM/EDGE
Example	:SOUR:FREQ:CHAN:BAND RGSM
Initial S/W Revision	A.05.00

DCS 1800

Selects DCS 1800 as the active channel band.

Key Path	Source, Frequency, Radio Setup, Radio Standard, GSM/EDGE
Example	:SOUR:FREQ:CHAN:BAND DCS1800
Initial S/W Revision	A.05.00

PCS 1900

Selects PCS 1900 as the active channel band.

Key Path	Source, Frequency, Radio Setup, Radio Standard, GSM/EDGE
Example	:SOUR:FREQ:CHAN:BAND PCS1900
Initial S/W Revision	A.05.00

GSM 450

Selects GSM 450 as the active channel band.

Key Path	Source, Frequency, Radio Setup, Radio Standard, GSM/EDGE
Example	:SOUR:FREQ:CHAN:BAND GSM450
Initial S/W Revision	A.05.00

GSM 480

Selects GSM 480 as the active channel band.

Key Path	Source, Frequency, Radio Setup, Radio Standard, GSM/EDGE
Example	:SOUR:FREQ:CHAN:BAND GSM480
Initial S/W Revision	A.05.00

GSM 850

Selects GSM 850 as the active channel band.

Key Path	Source, Frequency, Radio Setup, Radio Standard, GSM/EDGE
Example	:SOUR:FREQ:CHAN:BAND GSM850
Initial S/W Revision	A.05.00

GSM 700

Selects GSM 700 as the active channel band.

Key Path	Source, Frequency, Radio Setup, Radio Standard, GSM/EDGE
Example	:SOUR:FREQ:CHAN:BAND GSM700
Initial S/W Revision	A.05.00

T-GSM 810

Selects T-GSM 810 as the active channel band.

Key Path	Source, Frequency, Radio Setup, Radio Standard, GSM/EDGE
Example	:SOUR:FREQ:CHAN:BAND T-GSM810
Initial S/W Revision	A.05.00

WCDMA

Sets WCDMA as the radio standard for use and accesses the W-CDMA specific channel band sub-menus.

Key Path	Source, Frequency, Radio Setup, Radio Standard
Initial S/W Revision	A.05.00

Band I

Selects Band I as the active channel band.

Key Path	Source, Frequency, Radio Setup, Radio Standard, WCDMA
Example	:SOUR:FREQ:CHAN:BAND BANDI
Initial S/W Revision	A.05.00

Band II

Selects Band II as the active channel band.

Key Path	Source, Frequency, Radio Setup, Radio Standard, WCDMA
Example	:SOUR:FREQ:CHAN:BAND BANDII
Initial S/W Revision	A.05.00

Band III

Selects Band III as the active channel band.

Key Path	Source, Frequency, Radio Setup, Radio Standard, WCDMA
Example	:SOUR:FREQ:CHAN:BAND BANDIII
Initial S/W Revision	A.05.00

Band IV

Selects Band IV as the active channel band.

Key Path	Source, Frequency, Radio Setup, Radio Standard, WCDMA
Example	:SOUR:FREQ:CHAN:BAND BANDIV
Initial S/W Revision	A.05.00

Band V

Selects Band V as the active channel band.

Key Path	Source, Frequency, Radio Setup, Radio Standard, WCDMA
Example	:SOUR:FREQ:CHAN:BAND BANDV
Initial S/W Revision	A.05.00

Band VI

Selects Band VI as the active channel band.

Key Path	Source, Frequency, Radio Setup, Radio Standard, WCDMA
Example	:SOUR:FREQ:CHAN:BAND BANDVI
Initial S/W Revision	A.05.00

Band VII

Selects Band VII as the active channel band.

Key Path	Source, Frequency, Radio Setup, Radio Standard, WCDMA
Example	:SOUR:FREQ:CHAN:BAND BANDVII
Initial S/W Revision	A.05.00

Band VIII

Selects Band VIII as the active channel band.

Key Path	Source, Frequency, Radio Setup, Radio Standard, WCDMA
Example	:SOUR:FREQ:CHAN:BAND BANDVIII
Initial S/W Revision	A.05.00

Band IX

Selects Band IX as the active channel band.

Key Path	Source, Frequency, Radio Setup, Radio Standard, WCDMA
Example	:SOUR:FREQ:CHAN:BAND BANDIX
Initial S/W Revision	A.05.00

Band X

Selects Band X as the active channel band.

Key Path	Source, Frequency, Radio Setup, Radio Standard, WCDMA
Example	:SOUR:FREQ:CHAN:BAND BANDX
Initial S/W Revision	A.05.00

Band XI

Selects Band XI as the active channel band.

Key Path	Source, Frequency, Radio Setup, Radio Standard, WCDMA
Example	:SOUR:FREQ:CHAN:BAND BANDXI
Initial S/W Revision	A.05.00

Band XII

Selects Band XII as the active channel band.

Key Path	Source, Frequency, Radio Setup, Radio Standard, WCDMA
Example	:SOUR:FREQ:CHAN:BAND BANDXII
Initial S/W Revision	A.05.00

Band XIII

Selects band XIII as the active channel band.

Key Path	Source, Frequency, Radio Setup, Radio Standard, WCDMA
Example	:SOUR:FREQ:CHAN:BAND BANDXIII
Initial S/W Revision	A.05.00

Band XIV

Selects Band XIV as the active channel band.

Key Path	Source, Frequency, Radio Setup, Radio Standard, WCDMA
Example	:SOUR:FREQ:CHAN:BAND BANDXIV
Initial S/W Revision	A.05.00

Band XIX

Selects Band XIX as the active channel band.

Key Path	Source, Frequency, Radio Setup, Radio Standard, WCDMA
Example	:SOUR:FREQ:CHAN:BAND BANDXIX
Initial S/W Revision	A.14.50

CDMA 2000 / 1xEVDO

Sets CDMA 2000 / 1xEVDO as the radio standard for use and accesses the CDMA 2000/1xEVDO specific channel band sub-menus.

Key Path	Source, Frequency, Radio Setup, Radio Standard
Initial S/W Revision	A.05.00

US CELL

Selects US Cell as the active channel band.

Key Path	Source, Frequency, Radio Setup, Radio Standard, CDMA 2000 / 1xEVDO
Example	:SOUR:FREQ:CHAN:BAND USCELL
Initial S/W Revision	A.05.00

US PCS

Selects US PCS as the active channel band.

Key Path	Source, Frequency, Radio Setup, Radio Standard, CDMA 2000 / 1xEVDO
Example	:SOUR:FREQ:CHAN:BAND PCS
Initial S/W Revision	A.05.00

Japan Cell

Selects Japan Cell as the active channel band.

Key Path	Source, Frequency, Radio Setup, Radio Standard, CDMA 2000 / 1xEVDO
Example	:SOUR:FREQ:CHAN:BAND JAPAN
Initial S/W Revision	A.05.00

Korean PCS

Selects Korean PCS as the active channel band.

Key Path	Source, Frequency, Radio Setup, Radio Standard, CDMA 2000 / 1xEVDO
Example	:SOUR:FREQ:CHAN:BAND KOREAN
Initial S/W Revision	A.05.00

NMT 450

Selects NMT 450 as the active channel band.

Key Path	Source, Frequency, Radio Setup, Radio Standard, CDMA 2000 / 1xEVDO
----------	--

Example	:SOUR:FREQ:CHAN:BAND NMT
Initial S/W Revision	A.05.00

IMT 2000

Selects IMT 2000 as the active channel band.

Key Path	Source, Frequency, Radio Setup, Radio Standard, CDMA 2000 / 1xEVDO
Example	:SOUR:FREQ:CHAN:BAND IMT2K
Initial S/W Revision	A.05.00

Upper 700

Selects Upper 700 as the active channel band.

Key Path	Source, Frequency, Radio Setup, Radio Standard, CDMA 2000 / 1xEVDO
Example	:SOUR:FREQ:CHAN:BAND UPPER
Initial S/W Revision	A.05.00

Secondary 800

Selects Secondary 800 as the active channel band.

Key Path	Source, Frequency, Radio Setup, Radio Standard, CDMA 2000 / 1xEVDO
Example	:SOUR:FREQ:CHAN:BAND SECOND
Initial S/W Revision	A.05.00

400 Euro PAMR

Selects 400 Euro PAMR as the active channel band.

Key Path	Source, Frequency, Radio Setup, Radio Standard, CDMA 2000 / 1xEVDO
Example	:SOUR:FREQ:CHAN:BAND PAMR400
Initial S/W Revision	A.05.00

800 PAMR

Selects 800 PAMR as the active channel band.

Key Path	Source, Frequency, Radio Setup, Radio Standard, CDMA 2000 / 1xEVDO
----------	--

Example	:SOUR:FREQ:CHAN:BAND PAMR800
Initial S/W Revision	A.05.00

2.5GHz IMT EXT

Selects 2.5 GHz IMT EXT as the active channel band.

Key Path	Source, Frequency, Radio Setup, Radio Standard, CDMA 2000 / 1xEVDO
Example	:SOUR:FREQ:CHAN:BAND IMTEXT
Initial S/W Revision	A.05.00

US PCS 1.9GHz

Selects US PCS 1.9 GHz as the active channel band.

Key Path	Source, Frequency, Radio Setup, Radio Standard, CDMA 2000 / 1xEVDO
Example	:SOUR:FREQ:CHAN:BAND PCS1DOT9G
Initial S/W Revision	A.05.00

AWS

Selects AWS as the active channel band.

Key Path	Source, Frequency, Radio Setup, Radio Standard, CDMA 2000 / 1xEVDO
Example	:SOUR:FREQ:CHAN:BAND AWS
Initial S/W Revision	A.05.00

US 2.5GHz

Selects US 2.5 GHz as the active channel band.

Key Path	Source, Frequency, Radio Setup, Radio Standard, CDMA 2000 / 1xEVDO
Example	:SOUR:FREQ:CHAN:BAND US2DOT5G
Initial S/W Revision	A.05.00

700 Public Safety

Selects 700 Public Safety as the active channel band.

Key Path	Source, Frequency, Radio Setup, Radio Standard, CDMA 2000 / 1xEVDO
----------	--

Example	:SOUR:FREQ:CHAN:BAND PUBLIC
Initial S/W Revision	A.05.00

C2K Lower 700

Selects C2K Lower 700 as the active channel band.

Key Path	Source, Frequency, Radio Setup, Radio Standard, CDMA 2000 / 1xEVDO
Example	:SOUR:FREQ:CHAN:BAND LOWER
Initial S/W Revision	A.05.00

LTE

Sets LTE FDD as the radio standard for use and accesses the LTE FDD specific channel band sub-menus..

Key Path	Source, Frequency, Radio Setup, Radio Standard
Initial S/W Revision	A.09.50

BAND 1

Selects BAND 1 as the band for the current step.

Key Path	Source, Frequency, Radio Setup, Radio Standard, LTE
Example	:SOUR:FREQ:CHAN:BAND BAND1
Initial S/W Revision	A.09.50

BAND 2

Selects BAND 2 as the band for the current step.

Key Path	Source, Frequency, Radio Setup, Radio Standard, LTE
Example	:SOUR:FREQ:CHAN:BAND BAND2
Initial S/W Revision	A.09.50

BAND 3

Selects BAND 3 as the band for the current step.

Key Path	Source, Frequency, Radio Setup, Radio Standard, LTE
Example	:SOUR:FREQ:CHAN:BAND BAND3
Initial S/W Revision	A.09.50

BAND 4

Selects BAND 4 as the band for the current step.

Key Path	Source, Frequency, Radio Setup, Radio Standard, LTE
Example	:SOUR:FREQ:CHAN:BAND BAND4
Initial S/W Revision	A.09.50

BAND 5

Selects BAND 5 as the band for the current step.

Key Path	Source, Frequency, Radio Setup, Radio Standard, LTE
Example	:SOUR:FREQ:CHAN:BAND BAND5
Initial S/W Revision	A.09.50

BAND 6

Selects BAND 6 as the band for the current step.

Key Path	Source, Frequency, Radio Setup, Radio Standard, LTE
Example	:SOUR:FREQ:CHAN:BAND BAND6
Initial S/W Revision	A.09.50

BAND 7

Selects BAND 7 as the band for the current step.

Key Path	Source, Frequency, Radio Setup, Radio Standard, LTE
Example	:SOUR:FREQ:CHAN:BAND BAND7
Initial S/W Revision	A.09.50

BAND 8

Selects BAND 8 as the band for the current step.

Key Path	Source, Frequency, Radio Setup, Radio Standard, LTE
Example	:SOUR:FREQ:CHAN:BAND BAND8
Initial S/W Revision	A.09.50

BAND 9

Selects BAND 9 as the band for the current step.

Key Path	Source, Frequency, Radio Setup, Radio Standard, LTE
Example	:SOUR:FREQ:CHAN:BAND BAND9
Initial S/W Revision	A.09.50

BAND 10

Selects BAND 10 as the band for the current step.

Key Path	Source, Frequency, Radio Setup, Radio Standard, LTE
Example	:SOUR:FREQ:CHAN:BAND BAND10
Initial S/W Revision	A.09.50

BAND 11

Selects BAND 11 as the band for the current step.

Key Path	Source, Frequency, Radio Setup, Radio Standard, LTE
Example	:SOUR:FREQ:CHAN:BAND BAND11
Initial S/W Revision	A.09.50

BAND 12

Selects BAND 12 as the band for the current step.

Key Path	Source, Frequency, Radio Setup, Radio Standard, LTE
Example	:SOUR:FREQ:CHAN:BAND BAND12
Initial S/W Revision	A.09.50

BAND 13

Selects BAND 13 as the band for the current step.

Key Path	Source, Frequency, Radio Setup, Radio Standard, LTE
Example	:SOUR:FREQ:CHAN:BAND BAND13
Initial S/W Revision	A.09.50

BAND 14

Selects BAND 14 as the band for the current step.

Key Path	Source, Frequency, Radio Setup, Radio Standard, LTE
Example	:SOUR:FREQ:CHAN:BAND BAND14
Initial S/W Revision	A.09.50

BAND 17

Selects BAND 17 as the band for the current step.

Key Path	Source, Frequency, Radio Setup, Radio Standard, LTE
Example	:SOUR:FREQ:CHAN:BAND BAND17
Initial S/W Revision	A.09.50

BAND 18

Selects BAND 18 as the band for the current step.

Key Path	Source, Frequency, Radio Setup, Radio Standard, LTE
Example	:SOUR:FREQ:CHAN:BAND BAND18
Initial S/W Revision	A.09.50

BAND 19

Selects BAND 19 as the band for the current step.

Key Path	Source, Frequency, Radio Setup, Radio Standard, LTE
Example	:SOUR:FREQ:CHAN:BAND BAND19
Initial S/W Revision	A.09.50

BAND 20

Selects BAND 20 as the band for the current step.

Key Path	Source, Frequency, Radio Setup, Radio Standard, LTE
Example	:SOUR:FREQ:CHAN:BAND BAND20
Initial S/W Revision	A.09.50

BAND 21

Selects BAND 21 as the band for the current step.

Key Path	Source, Frequency, Radio Setup, Radio Standard, LTE
Example	:SOUR:FREQ:CHAN:BAND BAND21
Initial S/W Revision	A.09.50

BAND 24

Selects BAND 24 as the band for the current step.

Key Path	Source, Frequency, Radio Setup, Radio Standard, LTE
Example	:SOUR:FREQ:CHAN:BAND BAND24
Initial S/W Revision	A.09.50

BAND 25

Selects BAND 25 as the band for the current step.

Key Path	Source, Frequency, Radio Setup, Radio Standard, LTE
Example	:SOUR:FREQ:CHAN:BAND BAND25
Initial S/W Revision	A.09.50

BAND 26

Selects BAND 26 as the band for the current step.

Key Path	Source, Frequency, Radio Setup, Radio Standard, LTE
Example	:SOUR:FREQ:CHAN:BAND BAND26
Initial S/W Revision	A.12.53

BAND 27

Selects BAND 27 as the band for the current step.

Key Path	Source, Frequency, Radio Setup, Radio Standard, LTE
Example	:SOUR:FREQ:CHAN:BAND BAND27
Initial S/W Revision	A.14.00

BAND 28

Selects BAND 28 as the band for the current step.

Key Path	Source, Frequency, Radio Setup, Radio Standard, LTE
Example	:SOUR:FREQ:CHAN:BAND BAND28
Initial S/W Revision	A.14.00

BAND 31

Selects BAND 31 as the band for the current step.

Key Path	Source, Frequency, Radio Setup, Radio Standard, LTE
Example	:SOUR:FREQ:CHAN:BAND BAND31
Initial S/W Revision	A.14.00

LTE TDD

Sets LTE TDD as the radio standard for use and accesses the LTE TDD specific channel band sub-menus..

Key Path	Source, Frequency, Radio Setup, Radio Standard
Initial S/W Revision	A.11.50

BAND 33

Selects BAND 33 as the band for the current step.

Key Path	Source, Frequency, Radio Setup, Radio Standard, LTE TDD
Example	:SOUR:FREQ:CHAN:BAND BAND33
Initial S/W Revision	A.11.50

BAND 34

Selects BAND 34 as the band for the current step.

Key Path	Source, Frequency, Radio Setup, Radio Standard, LTE TDD
Example	:SOUR:FREQ:CHAN:BAND BAND34
Initial S/W Revision	A.11.50

BAND 35

Selects BAND 35 as the band for the current step.

Key Path	Source, Frequency, Radio Setup, Radio Standard, LTE TDD
Example	:SOUR:FREQ:CHAN:BAND BAND35
Initial S/W Revision	A.11.50

BAND 36

Selects BAND 36 as the band for the current step.

Key Path	Source, Frequency, Radio Setup, Radio Standard, LTE TDD
Example	:SOUR:FREQ:CHAN:BAND BAND36
Initial S/W Revision	A.11.50

BAND 37

Selects BAND 37 as the band for the current step.

Key Path	Source, Frequency, Radio Setup, Radio Standard, LTE TDD
Example	:SOUR:FREQ:CHAN:BAND BAND37
Initial S/W Revision	A.11.50

BAND 38

Selects BAND 38 as the band for the current step.

Key Path	Source, Frequency, Radio Setup, Radio Standard, LTE TDD
Example	:SOUR:FREQ:CHAN:BAND BAND38
Initial S/W Revision	A.11.50

BAND 39

Selects BAND 39 as the band for the current step.

Key Path	Source, Frequency, Radio Setup, Radio Standard, LTE TDD
Example	:SOUR:FREQ:CHAN:BAND BAND39
Initial S/W Revision	A.11.50

BAND 40

Selects BAND 40 as the band for the current step.

Key Path	Source, Frequency, Radio Setup, Radio Standard, LTE TDD
Example	:SOUR:FREQ:CHAN:BAND BAND40
Initial S/W Revision	A.11.50

BAND 41

Selects BAND 41 as the band for the current step.

Key Path	Source, Frequency, Radio Setup, Radio Standard, LTE TDD
Example	:SOUR:FREQ:CHAN:BAND BAND41
Initial S/W Revision	A.11.50

BAND 42

Selects BAND 42 as the band for the current step.

Key Path	Source, Frequency, Radio Setup, Radio Standard, LTE TDD
Example	:SOUR:FREQ:CHAN:BAND BAND42
Initial S/W Revision	A.11.50

BAND 43

Selects BAND 43 as the band for the current step.

Key Path	Source, Frequency, Radio Setup, Radio Standard, LTE TDD
Example	:SOUR:FREQ:CHAN:BAND BAND43
Initial S/W Revision	A.11.50

BAND 44

Selects BAND 44 as the band for the current step.

Key Path	Source, Frequency, Radio Setup, Radio Standard, LTE TDD
Example	:SOUR:FREQ:CHAN:BAND BAND44
Initial S/W Revision	A.14.00

TDSCDMA

Sets TDSCDMA as the radio standard for use and accesses the TDSCDMA specific channel band sub-menus..

Key Path	Source, Frequency, Radio Setup, Radio Standard
Initial S/W Revision	A.11.50

BAND A

Selects BAND A as the band for the current step.

Key Path	Source, Frequency, Radio Setup, Radio Standard, TDSCDMA
Example	:SOUR:FREQ:CHAN:BAND BANDA
Initial S/W Revision	A.11.50

BAND B

Selects BAND B as the band for the current step.

Key Path	Source, Frequency, Radio Setup, Radio Standard, TDSCDMA
Example	:SOUR:FREQ:CHAN:BAND BANDB
Initial S/W Revision	A.11.50

BAND C

Selects BAND C as the band for the current step.

Key Path	Source, Frequency, Radio Setup, Radio Standard, TDSCDMA
Example	:SOUR:FREQ:CHAN:BAND BANDC
Initial S/W Revision	A.11.50

BAND D

Selects BAND D as the band for the current step.

Key Path	Source, Frequency, Radio Setup, Radio Standard, TDSCDMA
Example	:SOUR:FREQ:CHAN:BAND BANDD
Initial S/W Revision	A.11.50

BAND E

Selects BAND E as the band for the current step.

Key Path	Source, Frequency, Radio Setup, Radio Standard, TDSCDMA
----------	---

Example	:SOUR:FREQ:CHAN:BAND BANDE
Initial S/W Revision	A.11.50

BAND F

Selects BAND F as the band for the current step.

Key Path	Source, Frequency, Radio Setup, Radio Standard, TDSCDMA
Example	:SOUR:FREQ:CHAN:BAND BANDF
Initial S/W Revision	A.11.50

Radio Band Link

Allows you to specify the channel band type as either uplink or downlink link direction. This value is used in conjunction with the channel band and channel number to determine the absolute frequency output by the source. When set to “Uplink”, the source will calculate the uplink frequency using an uplink formula together with the selected channel band and channel number . When set to “Downlink”, the source will calculate the downlink frequency using a downlink formula together with the selected channel band and channel number.

Key Path	Source, Frequency, Radio Setup
Remote Command	:SOURce:RADio:BAND:LINK DOWN UP :SOURce:RADio:BAND:LINK?
Example	:SOUR:RAD:BAND:LINK UP
Preset	DOWN
Range	DOWN UP
Backwards Compatibility SCPI	:SOURce:RADio:DEVice BTS MS :SOURce:RADio:DEVice?
Backwards Compatibility Notes	BTS maps to the Downlink frequency MS maps to the Uplink frequency
Initial S/W Revision	A.05.00

Set Reference Frequency

This key allows you to set the frequency reference. Pressing this key turns the frequency reference state to ON, sets the reference frequency value to the current frequency, maintains this frequency at the RF output, and sets the displayed frequency to 0.00 Hz. All subsequent frequencies entered under Source>Frequency>Frequency are interpreted as being relative to this reference frequency.

When you use a frequency reference, the signal generator outputs a frequency that is set relative to the reference frequency by the value entered under Source>Frequency>Frequency as follows:

Output frequency = reference frequency - entered frequency

Where:

reference frequency equals the original RF frequency entered under Source>Frequency>Frequency and set as the reference frequency

entered frequency equals a new value entered under Source>Frequency>Frequency

In addition, the displayed frequency value will be the same as the value entered under Source>Frequency>Frequency.

NOTE

If Freq Reference is set to ON with a reference value set, entering a value under Source>Frequency>Frequency and pressing Set Frequency Reference will add that value to the existing Freq Reference value.

If you wish to change the reference frequency value to the new value entered under Source>Frequency>Frequency, first you must set Freq Reference to OFF and then press Set Frequency Reference.

Key Path	Source, Frequency
Remote Command	:SOURce:FREQuency:REFerence:SET
Example	:SOUR:FREQ:REF:SET
Dependencies	This setting is unavailable, and is grayed out when the List Sequencer is turned ON.
Initial S/W Revision	A.05.00

Freq Reference

This key allows you to toggle the state of the frequency reference. When the frequency reference state is ON, an annunciator is displayed on the main source view to indicate this state to the user.

When you use a frequency reference, the signal generator outputs a frequency that is set relative to the reference frequency by the value entered under Source>Frequency>Frequency as follows:

$$\text{Output frequency} = \text{reference frequency} + \text{entered frequency}$$

Where:

reference frequency equals the original RF frequency entered under Source>Frequency>Frequency and set as the reference frequency

entered frequency equals a new value entered under Source>Frequency>Frequency

For more information on Reference Frequency refer to ["Set Reference Frequency" on page 2473](#)

Key Path	Source, Frequency
Remote Command	:SOURce:FREQuency:REFerence <freq> :SOURce:FREQuency:REFerence? :SOURce:FREQuency:REFerence:STATe OFF ON 0 1 :SOURce:FREQuency:REFerence:STATe?
Example	:SOUR:FREQ:REF 0.00 Hz

	:SOUR:FREQ:REF:STATe ON
Dependencies	This setting is unavailable, and is grayed out when the List Sequencer is turned ON.
Couplings	The frequency reference state is coupled to the frequency reference set immediate action. When the reference set immediate action key is pressed, or the SCPI command issued, it turns the frequency reference state ON.
Preset	0.00 Hz OFF
Min	0.00 Hz
Max	Hardware Dependant: Option 503 = 3.6 GHz Option 504 = 3.8 GHz Option 506 = 6.00 GHz
Initial S/W Revision	A.05.00

Freq Offset

Allows you to specify the frequency offset value. When the frequency offset state is ON, an annunciator is displayed on the main source view to indicate this state to the user.

When the frequency offset is set to zero (0) and you set a new offset value, the displayed frequency value will change as follows and the RF output frequency will not change:

Displayed value = output frequency + offset value

Where:

output frequency equals the original frequency entered under Source>Frequency>Frequency

offset value equals the value entered under Source>Frequency>Freq Offset

When the frequency offset is set to a value other than zero (0) and you enter a new frequency value under Source>Frequency>Frequency, the displayed frequency will be the same as the value entered and the RF output frequency will be equal to the value entered minus the offset value as follows:

Output frequency = entered frequency – offset frequency

Displayed frequency = output frequency + offset frequency

Displayed frequency = entered frequency

Where:

entered frequency equals the frequency entered under Source>Frequency>Frequency

offset frequency equals the value previously entered and set under Source>Frequency>Freq Offset

Key Path	Source, Frequency
Remote Command	:SOURce:FREQuency:OFFSet <freq>

	:SOURce:FREQuency:OFFSet?
Example	:SOUR:FREQ:OFFS 0 Hz
Dependencies	This setting is unavailable, and is grayed out when the List Sequencer is turned ON.
Preset	0 Hz
Min	-100.00 GHz
Max	100.00 GHz
Initial S/W Revision	A.05.00

Modulation Setup

Allows access to the menus for setting up the available modulation types: "ARB" on page 2476, "AM" on page 2517, "FM" on page 2518, and "PM" on page 2519.

Key Path	Source
Initial S/W Revision	A.05.00

ARB

Allows you access to the ARB sub-menus.

Key Path	Source, Modulation Setup
Initial S/W Revision	A.05.00

ARB

Allows you to toggle the state of the ARB function. When the ARB is On, a "MOD" annunciator is displayed in the system settings panel. When the ARB is turned Off, the MOD annunciator is cleared

Key Path	Source, Modulation Setup, ARB
Remote Command	:SOURce:RADio:ARB[:STATe] ON OFF 1 0 :SOURce:RADio:ARB[:STATe]?
Example	:SOUR:RAD:ARB OFF :SOUR:RAD:ARB?
Notes	If the ARB is ON, a user then loads or deletes another file to ARB memory, the playing waveform segment may not keep phase continuity during the ARB memory operation. The waveform will be replayed after the ARB operation is finished.
Dependencies	This setting is for independent mode and has no effect on 3.3.8 list sequencer mode. Setting "Sequencer" on page 2521 Sequencer to On will put source enter list sequencer mode, and even if ARB state is On, the ARB file will not be played. Setting "Sequencer" on page 2521 Sequencer to Off will make source leave list sequencer mode, and this setting will take effect immediately.

The ARB can only be turned on when there is a waveform file selected for playback. On the GUI If no waveform is selected, this key is grayed out. If you send the SCPI command to turn the ARB on with no waveform selected for playback, the ARB state remains OFF and an error is generated. "-

When you try to recall a certain set of states in which the selected waveform is not in ARB memory and the ARB state is On, errors are reported

Preset	Off
Range	On Off
Initial S/W Revision	A.05.00

Select Waveform

Allows you to access to the waveform selection sub-menus.

Pressing this key changes the central view area to show the Waveform File Selection view.

Key Path	Source, Modulation Setup, ARB
Initial S/W Revision	A.05.00

Select Waveform

Allows you to select a waveform sequence or segment for the dual ARB to play.

NOTE: Selecting a waveform file does not result in automatic adjustments to burst timing (to compensate for the presence or absence of a Multiport Adapter); that adjustment occurs only when a waveform is loaded to ARB memory. See "Load Segment to ARB Memory" for more information about this adjustment.

Key Path	Source, Modulation Setup, ARB, Select Waveform
Remote Command	:SOURce:RADio:ARB:WAVeform <string> :SOURce:RADio:ARB:WAVeform?
Example	:SOUR:RAD:ARB:WAV "test_waveform.bin"
Notes	<p>If intended waveform is not in the memory yet, then issuing this command by SCPI will invoke ARB loading operation first, which involves a delay of unpredictable length. So this command should be followed by the query *OPC?, which holds off subsequent commands until the loading operating is complete.</p> <p><string> - specifies the name of the waveform segment or waveform sequence to be played by the ARB.</p> <p>When in Sequence Analyzer mode, and Include Source is Yes, if the you attempt to play a waveform sequence but not all the required waveform segments are in the ARB playback memory, the application will reject the loading operation with an error is generated .</p> <p>When Include Source is No, if you attempt to play a waveform sequence but not all the required waveform segments are contained in the ARB playback memory, the application will attempt to load the required segments from either the default directory of the current directory. If the ARB memory does not have enough space for all the waveform segments to be loaded, an error is generated and</p>

none of the waveform segments is loaded.

If the ARB is ON, and you attempt to play a waveform sequence but not all the waveform segments within the sequence could be found to be loaded into ARB memory, an error is generated. The selected waveform keeps the previous value and ARB state remains On.

If you specify a waveform segment over SCPI but the waveform segment is not present within ARB playback memory and cannot be found for auto loading within the current directory or the default directory, an error is generated and the file selection remains unchanged.

If you select a waveform for playback and the waveform requires a license that is not installed on the instrument, an error is generated.

If the ARB is ON and you load a file to ARB memory or delete a file from ARB memory, the playing waveform segment may not keep phase continuity during the ARB memory operation. The waveform will be replayed after the ARB operation is finished.

Initial S/W Revision	A.05.00
----------------------	---------

Segments on Hard Disk

Allows you access to the sub-menus for loading waveform segments from the hard disk into ARB memory. The default directory is: D: varb.

Pressing this key changes the current view to the Waveform Management View.

Key Path	Source, Modulation Setup, ARB, Select Waveform
----------	--

Initial S/W Revision	A.05.00
----------------------	---------

Load Segment To ARB Memory

Allows you to load the selected file into ARB memory. On the front panel you select the file for loading to the ARB memory by highlighting the desired file in the list. Using the SCPI command, you specify the file name on the HDD.

“NVWFM” (non-volatile storage) MSUS (Mass Storage Unit Specifier) is supported in the memory subsystem because the ARB memory cannot be accessed directly. Therefore, files must be downloaded to the instrument hard disk and then loaded into the ARB memory. “NVWFM” MSUS will be mapped to the default directory D: VARB. The SCPI command supports using either “NVWFM” MSUS or specifying a full path. For more information, see [Memory Subsystem \(Remote Command Only\)](#).

If a file of the same name already exists within ARB memory, it is overwritten. If you wish to load two segments of the same name, you must rename one of the segments before loading it into ARB memory. To rename a segment, you can either use Windows File Explorer, or the :MMEMory:COPY command.

NOTE: When a waveform file is loaded to ARB memory, burst timing adjustments are made automatically, based on whether or not a Multiport Adapter is connected to the test set and powered on. If the connection/power status of the Multiport Adapter is changed after a waveform file has been loaded, it needs to be loaded again.

Key Path	Source, Modulation Setup, ARB, Select Waveform, Segments on Hard Disk
----------	---

Remote Command	:SOURce:RADio:ARB:LOAD <string>
Example	:SOUR:RAD:ARB:LOAD "D: VARB\testwaveform.bin" or :SOUR:RAD:ARB:LOAD "NVWFM:testwaveform.bin"
Notes	<p>Because loading the file involves a delay of unpredictable length, this command should be followed by the query *OPC?, which holds off subsequent commands until the loading operating is complete.</p> <p><string> - specifies the path name of the file to load from the HDD into ARB memory. It could be a <full path + filename>, or <"NVWFM" MSUS + colon + filename>.</p> <p>When in Sequence Analyzer mode, and Include Source is Yes, an attempt to load a file to ARB memory will be rejected with an error.</p> <p>When Include Source is No and if there is insufficient free ARB memory to load the selected waveform, an error is generated. .</p> <p>If you specify a file over SCPI, but the file is not at the specified location, an error is generated.</p> <p>If you try to load a waveform file but the file contains less than 500 IQ samples, an error is generated.</p> <p>If you try to load a Signal Studio waveform "*.wfm" which contains invalid waveform header, an error is generated.</p> <p>If the ARB is ON when you load a file to ARB memory or delete a file from ARB memory, the playing waveform segment may not keep phase continuity during the ARB memory operation. The waveform will be replayed after the ARB operation is finished.</p> <p>ARB can be loaded into ARB memory even required licenses do not present on the instrument. In this case, a GUI only warning message -800, "Operation complete; Loaded <filename> successfully, but no license <required licenses> installed". User can install required licenses according to <required licenses> string to license it, or multi-pack license it.</p>
Initial S/W Revision	A.05.00

Load All To ARB Memory

Allows you to load all the segment files within the currently selected directory into ARB memory. If a file of the same name already exists within ARB memory, it is overwritten. If you wish to load two segments of the same name, you must rename one of the segments before loading it into ARB memory. To rename a segment, you can either use Windows File Explorer, or the :MEMory:COPI command.

NOTE: When a waveform file is loaded to ARB memory, burst timing adjustments are made automatically, based on whether or not a Multiport Adapter is connected to the test set and powered on. If the connection/power status of the Multiport Adapter is changed after a waveform file has been loaded, it needs to be loaded again.

Key Path	Source, Modulation Setup, ARB, Select Waveform, Segments on Hard Disk
Remote Command	:SOURce:RADio:ARB:LOAD:ALL <string>
Example	:SOUR:RAD:ARB:LOAD:ALL "D: varb"
Notes	<p><string> - specifies the directory on the HDD to load the files into ARB memory from.</p> <p>When in Sequence Analyzer mode, and Include Source is Yes, an attempt to load all files from a directory to ARB memory is rejected with an error.</p> <p>When Include Source is No and there is insufficient free ARB memory to load all the waveforms,</p>

when the ARB memory is full, the copy ceases, and an error is generated.
 If you specify a directory over SCPI, but the directory does not exist, an error is generated.
 If the ARB is ON, a user then loads or deletes file to ARB memory, the playing waveform segment may not keep phase continuity during the ARB memory operation. The waveform will be replayed after the ARB operation is finished.

Initial S/W Revision A.05.00

Change Directory...

Allows you to change the currently selected directory on the hard disk. Pressing this key opens a standard windows change directory dialog allowing you to select the new directory of interest.

The current directory is used for manually loading waveform segments into ARB memory for playback, and as a search location for waveform segments that are required to be loaded into ARB memory for playback of a waveform sequence or a list sequence.

Key Path Source, Modulation Setup, ARB, Select Waveform, Segments on Hard Disk

Notes No remote command, SCPI front panel only.

Initial S/W Revision A.05.00

Default Directory...

Allows you to change the default directory. It is used as a search location for waveform segments that are required to be loaded into ARB memory for playback of a waveform sequence, and as a search location for selecting waveforms using SCPI.

Key Path Source, Modulation Setup, ARB, Select Waveform, Segments on Hard Disk

Remote Command :SOURce:RADio:ARB:DEFault:DIRectory <string>
 :SOURce:RADio:ARB: DEFault:DIRectory?

Example :SOUR:RAD:ARB:DEF:DIR "D:\ArbFiles"
 :SOUR:RAD:ARB:DEF:DIR?

State Saved Persistent, survives a power cycle and a preset but not saved in the instrument state

Initial S/W Revision A.05.00

Segments in ARB Memory

Allows you access to the sub-menus for managing the files within ARB memory.

Key Path Source, Modulation Setup, ARB, Select Waveform

Initial S/W Revision A.05.00

Delete Segment From ARB Mem

Allows you to remove a segment from ARB playback memory.

Key Path	Source, Modulation Setup, ARB, Select Waveform, Segments in ARB Memory
Remote Command	:SOURce:RADio:ARB:DELeTe <string>
Example	:SOUR:RAD:ARB:DEL "testwaveform.bin"
Notes	<p><string> - specifies the waveform to be deleted from the ARB playback memory.</p> <p>When in Sequence Analyzer mode and Include Source is Yes, an attempt to delete a file from ARB memory is rejected with an error.</p> <p>When Include Source is No and you specify a file that does not exist within ARB memory, an error is generated.</p> <p>It is possible to delete files from within the ARB memory when the ARB is ON. However, if you attempt to delete the file that is currently playing an error is generated.</p> <p>It is possible to delete a file from within the ARB memory when the sequencer state is ON and the file is not being used by the List Sequencer. If you attempt to delete a file which is being used by the list sequencer, an error is generated.</p> <p>When sequencer state is On, even if ARB state is On, the selected waveform will not be played. In this case, if the selected waveform is not used in List Sequence, it can be deleted and the ARB state is turned Off.</p> <p>If the ARB is ON and you load a file to ARB memory or delete a file from ARB memory, the playing waveform segment may not keep phase continuity during the ARB memory operation. The waveform will be replayed after the ARB operation is finished.</p>
Initial S/W Revision	A.05.00

Delete All From ARB Memory

Allows you to remove all segments from ARB playback memory.

Key Path	Source, Modulation Setup, ARB, Select Waveform, Segments in ARB Memory
Remote Command	:SOURce:RADio:ARB:DELeTe:ALL
Example	:SOUR:RAD:ARB:DELeTe:ALL
Notes	<p>When in Sequence Analyzer mode and Include Source is Yes, an attempt to delete all files from ARB memory is rejected with an error.</p> <p>When Include Source is No and you attempt to delete all files from ARB memory when the ARB is currently playing a file, all files except the one playing are deleted and an error is generated.</p> <p>If you attempt to delete all files from ARB memory when there are waveform files used in "List Sequencer" on page 2520 and "Sequencer" on page 2521 state is ON, all files except the files currently being used in list sequencer are deleted, and an error is generated.</p> <p>If the ARB is ON and you load a file to ARB memory or delete a file from ARB memory, the playing waveform segment may not keep phase continuity during the ARB memory operation. The waveform will be replayed after the ARB operation is finished.</p>
Initial S/W Revision	A.05.00

Query ARB Memory File List (Remote Command Only)

Queries the test set for the list of waveform segments in the ARB memory.

NOTE

This command returns a string for waveform segment names in ARB memory. If you want a string list of waveform segments in the ARB memory, use ["Query ARB Memory Full File List \(Remote Command Only\)" on page 2482](#).

Remote Command	:SOURce:RADio:ARB:CATalog?
Example	:SOUR:RAD:ARB:CATalog?
Notes	The return data is in the following format: <integer> - memory used <integer> - memory free <string> ... - comma separated list of waveform segments within ARB memory
Initial S/W Revision	A.05.00

Query ARB Memory Full File List (Remote Command Only)

Queries the test set for the string list of waveform segments in the ARB memory. It returns a string list for waveform segment names in the ARB memory.

Remote Command	:SOURce:RADio:ARB:FCATalog?
Example	:SOUR:RAD:ARB:FCATalog?
Notes	The return data is in the following format: <integer> - memory used <integer> - memory free <integer> - file count in ARB memory <string>,<string>, ... <string> - comma separated string list of waveform segments within ARB memory Example: SOUR:RAD:ARB:FCAT? EXT returns: 27499,2069653,3,"c2k.wfm","gsm.wfm","wcdma.wfm"
Initial S/W Revision	A.09.00

ARB Setup

Allows access to the ARB setup sub-menus.

Key Path	Source, Modulation Setup, ARB
Initial S/W Revision	A.05.00

Sample Rate

Allows you to set the ARB waveform playback sample rate.

Key Path	Source, Modulation Setup, ARB, ARB Setup
Remote Command	:SOURce:RADio:ARB:SCLock:RATE <freq> :SOURce:RADio:ARB:SCLock:RATE?
Example	:SOUR:RAD:ARB:SCL:RATE 48.00 MHz
Notes	If there is a sample rate specified in the header of the waveform file, changing that sample rate is not recommended, as it may cause problems with burst timing.
Dependencies	When a new waveform is selected for playback the settings contained within the associated waveform header file are applied to the ARB. The sample rate is one of the values stored within the header file. If the newly selected waveform file has an associated header file, the sample rate is updated with the value from the header file. The sample rate will remain unchanged if the newly selected waveform does not have an associated header file.
Preset	125.00 MHz
Min	1.00 kHz
Max	125.00 MHz
Initial S/W Revision	A.05.00

Run-Time Scaling

Allows you to adjust the run-time scaling value. The run-time scaling value is applied in real-time while the waveform is playing.

Key Path	Source, Modulation Setup, ARB, ARB Setup
Remote Command	:SOURce:RADio:ARB:RSCaling <real> :SOURce:RADio:ARB:RSCaling?
Example	:SOUR:RAD:ARB:RSC 100.00
Notes	This setting cannot be set in E6640A. Grey out on menu and the value is fixed at 70.00%.
Dependencies	When a new waveform is selected for playback the settings contained within the associated waveform header file are applied to the ARB. The run-time scaling is one of the values stored within the header file. If the newly selected waveform file has an associated header file, the run-time scaling is updated with the value from the header file. The run-time scaling will remain unchanged if the newly selected waveform does not have an associated header file.
Preset	70.00 %
Min	1.00 %
Max	100.00 %
Initial S/W Revision	A.05.00

Baseband Freq Offset

Allows you to adjust the value by which the baseband frequency is offset relative to the carrier.

Key Path	Source, Modulation Setup, ARB, ARB Setup
Remote Command	:SOURce:RADio:ARB:BASEband:FREQuency:OFFSet <freq> :SOURce:RADio:ARB:BASEband:FREQuency:OFFSet?
Example	:SOUR:RAD:ARB:BAS:FREQ:OFFS 0.00 Hz
Dependencies	When a new waveform is selected for playback the settings contained within the associated waveform header file are applied to the ARB. The baseband frequency offset is one of the values stored within the header file. If the newly selected waveform file has an associated header file, the baseband frequency offset is updated with the value from the header file. The baseband frequency offset will remain unchanged if the newly selected waveform does not have an associated header file.
Preset	0.00 Hz
Min	-50.00 MHz
Max	50.00 MHz
Initial S/W Revision	A.05.00

Trigger Type

Allows access to the trigger type sub-menus. The setting for trigger type determines the behavior of the waveform when it plays.

Key Path	Source, Modulation Setup, ARB
Remote Command	:SOURce:RADio:ARB:TRIGger:TYPE CONTInuous SINGLE SADVance GATE :SOURce:RADio:ARB:TRIGger:TYPE?
Example	:SOUR:RAD:ARB:TRIG:TYPE CONT :SOUR:RAD:ARB:TRIG:TYPE?
Notes	Gated trigger type will be implemented at a later release
Preset	CONTInuous
Range	Continuous Single Seg Adv Gated
Initial S/W Revision	A.05.00

Continuous

Sets the active trigger type to Continuous. If Continuous is already selected as the active trigger type, pressing this key allows access to the continuous trigger type setup menu. In Continuous trigger mode, the waveform repeats continuously.

Key Path	Source, Modulation Setup, ARB, Trigger Type
Remote Command	:SOURce:RADio:ARB:TRIGger:TYPE:CONTInuous[:TYPE] FREE TRIGger RESet :SOURce:RADio:ARB:TRIGger:TYPE:CONTInuous[:TYPE]?
Example	:SOUR:RAD:ARB:TRIG:TYPE:CONT FREE
Preset	FREE

Range	Free Run Trigger + Run Reset + Run
Initial S/W Revision	A.05.00

Free Run

Selects Free Run as the trigger response for the continuous trigger type. Free Run sets the waveform generator to play a waveform sequence or segment continuously, without waiting for a trigger. In this mode, the waveform generator does not respond to triggers.

Key Path	Source, Modulation Setup, ARB, Trigger Type, Continuous
Example	:SOUR:RAD:ARB:TRIG:TYPE:CONT FREE
Initial S/W Revision	A.05.00

Trigger + Run

Sets Trigger and Run as the trigger response for the continuous trigger type. Trigger and Run sets the waveform generator to play a waveform sequence or segment continuously when the first trigger is received, and to ignore any subsequent triggers.

Key Path	Source, Modulation Setup, ARB, Trigger Type, Continuous
Example	:SOUR:RAD:ARB:TRIG:TYPE:CONT TRIG
Initial S/W Revision	A.05.00

Reset + Run

Sets Reset and Run as the trigger response for the continuous trigger type. Reset and Run sets the waveform generator to play a waveform sequence or segment continuously when the first trigger is received. Subsequent triggers reset the waveform sequence or segment to the start, and then play it continuously.

Key Path	Source, Modulation Setup, ARB, Trigger Type, Continuous
Example	:SOUR:RAD:ARB:TRIG:TYPE:CONT RES
Initial S/W Revision	A.05.00

Single

Sets the active trigger type to Single. If Single is already selected as the active trigger type, pressing this key allows access to the single trigger type setup menu. In Single trigger mode, the waveform plays once.

Key Path	Source, Modulation Setup, ARB, Trigger Type
Remote Command	:SOURce:RADio:ARB:RETRigger ON OFF IMMediate

	:SOURce:RADio:ARB:RETRigger?
Example	:SOUR:RAD:ARB:RETR OFF
Notes	ON: Buffered Trigger OFF: No Retrigger Immediate: Restart on Trigger This is defined as an enumerated SCPI command, with ON OFF being considered as enumerated types rather than Boolean. This means the query will return OFF instead of 0, and ON instead of 1.
Preset	ON
Range	No Retrigger Buffered Trigger Restart on Trigger
Initial S/W Revision	A.05.00

No Retrigger

Selects No Retrigger as the trigger response for single trigger type. No Retrigger sets the waveform generator to play a waveform sequence or segment once when a trigger is received. Any triggers then received during playback are ignored.

Key Path	Source, Modulation Setup, ARB, Trigger Type, Single
Example	:SOUR:RAD:ARB:RETR OFF
Initial S/W Revision	A.05.00

Buffered Trigger

Selects Buffered Trigger as the trigger response for single trigger type. Buffered Trigger sets the waveform generator to play a waveform sequence or segment once when a trigger is received. If a trigger is received during playback, the waveform generator plays the sequence or segment to the end, then plays the sequence or segment once more.

Key Path	Source, Modulation Setup, ARB, Trigger Type, Single
Example	:SOUR:RAD:ARB:RETR ON
Initial S/W Revision	A.05.00

Restart on Trigger

Selects Restart on Trigger as the trigger response for single trigger type. Restart on Trigger sets the waveform generator to play a waveform sequence or segment once when a trigger is received. If a trigger is received during playback, the waveform generator resets and plays the sequence or segment from the start.

Key Path	Source, Modulation Setup, ARB, Trigger Type, Single
Example	:SOUR:RAD:ARB:RETR IMM
Initial S/W Revision	A.05.00

Segment Advance

Sets the active trigger type to Segment Advance. If Segment Advance is already selected as the active trigger type, pressing this key allows access to the segment advance trigger type setup menu.

Segment Advance triggering allows you to control the playback of waveform segments within a waveform sequence. When a trigger is received the ARB advances to the next waveform segment within the waveform sequence. This type of triggering ignores the repetition count for the waveform segment within the waveform sequence. For example, if a waveform segment has a repetition count of 10 and you select single segment advance triggering mode, the waveform segment will only play once.

Segment Advance triggering can also be used for waveform segments only. In this situation the same waveform segment is played again when a trigger is received.

Key Path	Source, Modulation Setup, ARB, Trigger Type
Remote Command	:SOURce:RADio:ARB:TRIGger:TYPE:SADVance[:TYPE] Single CONTInuous :SOURce:RADio:ARB:TRIGger:TYPE:SADVance[:TYPE]?
Example	:SOUR:RAD:ARB:TRIG:TYPE:SADV SING
Preset	CONTInuous
Range	Single Continuous
Initial S/W Revision	A.05.00

Single

Selects Single as the trigger response for Segment Advance trigger type. With single selected, once a trigger is received a segment is played once. If a trigger is received during playback of a segment, the segment plays to completion and the next segment is played once.

Key Path	Source, Modulation Setup, ARB, Trigger Type, Segment Advance
Example	:SOUR:RAD:ARB:TRIG:TYPE:SADV SING
Initial S/W Revision	A.05.00

Continuous

Selects Continuous as the trigger response for Segment Advance trigger type. With continuous selected, once a trigger is received a segment is played continuously. When subsequent triggers are received, the currently playing segment plays to completion and then the next segment is played continuously.

Key Path	Source, Modulation Setup, ARB, Trigger Type, Segment Advance
Example	:SOUR:RAD:ARB:TRIG:TYPE:SADV CONT
Initial S/W Revision	A.05.00

Trigger Source

Allows access to the trigger source sub-menus. The trigger source setting determines how the source receives the trigger that starts the waveform playing. Therefore, this key is grayed out if the trigger type is free run, since free run triggers immediately with no trigger source required.

Key Path	Source, Modulation Setup, ARB
Remote Command	:SOURce:RADio:ARB:TRIGger[:SOURce] KEY BUS EXTernal2 :SOURce:RADio:ARB:TRIGger[:SOURce]?
Example	:SOUR:RAD:ARB:TRIGger KEY
Dependencies	This key is grayed out if the current trigger type is Continuous, Free Run.
Preset	EXTernal2
Range	Trigger Key Bus External 2
Initial S/W Revision	A.05.00

Trigger Key

Sets the current trigger source to the front panel Trigger key. When Trigger Key is selected, the waveform is triggered when you press the front panel Trigger key.

Key Path	Source, Modulation Setup, ARB, Trigger Source
Example	:SOUR:RAD:ARB:TRIGger KEY
Initial S/W Revision	A.05.00

Bus

Sets the current trigger source to Bus. Selecting Bus trigger source enables triggering over GPIB, LAN, or USB using the :SOURce:RADio:ARB:TRIGger:INITiate command.

Key Path	Source, Modulation Setup, ARB, Trigger Source
Example	:SOUR:RAD:ARB:TRIGger BUS
Initial S/W Revision	A.05.00

External 2

Sets the current trigger source to External 2. Selecting External 2 enables triggering a waveform by an externally applied signal.

Key Path	Source, Modulation Setup, ARB, Trigger Source
Example	:SOUR:RAD:ARB:TRIGger EXT2
Notes	Note: When on E6640A, trigger 2 is a bi-directional trigger port. So when trigger 2 has been configured as OUTPUT type, choosing External 2 as the input trigger for the current step will generate error.
Initial S/W Revision	A.05.00

Trigger Initiate

Used to initiate an immediate trigger event if the trigger source is set to Trigger Key.

Key Path	Source, Modulation Setup, ARB
Notes	No remote command, SCPI front panel only.
Initial S/W Revision	A.05.00

Waveform Sequences

Allows access to the waveform sequence sub-menus. Pressing this key changes the central view area to display the Waveform Sequence List view.

Key Path	Source, Modulation Setup, ARB
Notes	No remote command, SCPI front panel only.
Initial S/W Revision	A.05.00

Build New Sequence

Allows access to the sub-menus for creating a new waveform sequence. Pressing this key changes the central view area to display the Waveform Sequence Creation and Editing view.

Key Path	Source, Modulation Setup, ARB, Waveform Sequences
Notes	No remote command, SCPI front panel only.
Initial S/W Revision	A.05.00

Current Segment

Specifies the selected sequence segment that will be affected by the menu functions.

Key Path	Source, Modulation Setup, ARB, Waveform Sequences, Build New Sequence
Notes	No remote command, SCPI front panel only. This key is grayed out and unavailable if the sequence is currently empty.
Initial S/W Revision	A.05.00

Insert New Waveform

Allows you access to the sub-menu for inserting a new waveform segment or sequence. Pressing this key also changes the central display to show the Waveform File Selection View.

Key Path	Source, Modulation Setup, ARB, Waveform Sequences, Build New Sequence
Notes	No remote command, SCPI front panel only. Waveform segment name string length upper limit is 128 chars. Please do NOT insert waveform which name string exceeds 128 chars.
Initial S/W Revision	A.05.00

Insert Waveform

Inserts the currently highlighted waveform to the end of the waveform sequence. Pressing this key also returns you to the menus for creating or editing a sequence, and returns the central view to the sequence creation view.

Key Path	Source, Modulation Setup, ARB, Waveform Sequences, Build New Sequence, Insert New Waveform
Notes	No remote command, SCPI front panel only. Waveform segment name string length upper limit is 128 chars. Please do NOT insert waveform which name string exceeds 128 chars.
Initial S/W Revision	A.05.00

Segments on Hard Disk

Allows you access to the sub-menus for loading waveform segments from the hard disk into ARB memory. The default directory is: D: varb.

Pressing this key changes the current view to the Waveform Management View.

Key Path	Source, Modulation Setup, ARB, Select Waveform
Initial S/W Revision	A.05.00

Load Segment To ARB Memory

Allows you to load the selected file into ARB memory. On the front panel you select the file for loading to the ARB memory by highlighting the desired file in the list. Using the SCPI command, you specify the file name on the HDD.

“NVWFM” (none-volatile storage) MSUS (Mass Storage Unit Specifier) is supported in the memory subsystem because the ARB memory cannot be accessed directly. Therefore, files must be downloaded to the instrument hard disk and then loaded into the ARB memory. “NVWFM” MSUS will be mapped to the default directory D: VARB. The SCPI command supports using either “NVWFM” MSUS or specifying a full path. For more information, see [Memory Subsystem \(Remote Command Only\)](#).

If a file of the same name already exists within ARB memory, it is overwritten. If you wish to load two segments of the same name, you must rename one of the segments before loading it into ARB memory. To rename a segment, you can either use Windows File Explorer, or the :MMEMory:COPY command.

NOTE: When a waveform file is loaded to ARB memory, burst timing adjustments are made automatically, based on whether or not a Multiport Adapter is connected to the test set and powered on. If the connection/power status of the Multiport Adapter is changed after a waveform file has been loaded, it needs to be loaded again.

Key Path	Source, Modulation Setup, ARB, Select Waveform, Segments on Hard Disk
Remote Command	:SOURce:RADio:ARB:LOAD <string>
Example	:SOUR:RAD:ARB:LOAD "D: VARB\testwaveform.bin" or :SOUR:RAD:ARB:LOAD "NVWFM:testwaveform.bin"
Notes	<p>Because loading the file involves a delay of unpredictable length, this command should be followed by the query *OPC?, which holds off subsequent commands until the loading operating is complete.</p> <p><string> – specifies the path name of the file to load from the HDD into ARB memory. It could be a <full path + filename>, or <"NVWFM" MSUS + colon + filename>.</p> <p>When in Sequence Analyzer mode, and Include Source is Yes, an attempt to load a file to ARB memory will be rejected with an error.</p> <p>When Include Source is No and if there is insufficient free ARB memory to load the selected waveform, an error is generated. .</p> <p>If you specify a file over SCPI, but the file is not at the specified location, an error is generated.</p> <p>If you try to load a waveform file but the file contains less than 500 IQ samples, an error is generated.</p> <p>If you try to load a Signal Studio waveform "*.wfm" which contains invalid waveform header, an error is generated.</p> <p>If the ARB is ON when you load a file to ARB memory or delete a file from ARB memory, the playing waveform segment may not keep phase continuity during the ARB memory operation. The waveform will be replayed after the ARB operation is finished.</p> <p>ARB can be loaded into ARB memory even required licenses do not present on the instrument. In this case, a GUI only warning message –800, "Operation complete; Loaded <filename> successfully, but no license <required licenses> installed". User can install required licenses according to <required licenses> string to license it, or multi-pack license it.</p>
Initial S/W Revision	A.05.00

Load All To ARB Memory

Allows you to load all the segment files within the currently selected directory into ARB memory. If a file of the same name already exists within ARB memory, it is overwritten. If you wish to load two segments of the same name, you must rename one of the segments before loading it into ARB memory. To rename a segment, you can either use Windows File Explorer, or the :MEMory:COPI command.

NOTE: When a waveform file is loaded to ARB memory, burst timing adjustments are made automatically, based on whether or not a Multiport Adapter is connected to the test set and powered on. If the connection/power status of the Multiport Adapter is changed after a waveform file has been loaded, it needs to be loaded again.

Key Path	Source, Modulation Setup, ARB, Select Waveform, Segments on Hard Disk
Remote Command	:SOURce:RADio:ARB:LOAD:ALL <string>

Example	:SOUR:RAD:ARB:LOAD:ALL "D: varb"
Notes	<p><string> - specifies the directory on the HDD to load the files into ARB memory from.</p> <p>When in Sequence Analyzer mode, and Include Source is Yes, an attempt to load all files from a directory to ARB memory is rejected with an error.</p> <p>When Include Source is No and there is insufficient free ARB memory to load all the waveforms, when the ARB memory is full, the copy ceases, and an error is generated.</p> <p>If you specify a directory over SCPI, but the directory does not exist, an error is generated.</p> <p>If the ARB is ON, a user then loads or deletes file to ARB memory, the playing waveform segment may not keep phase continuity during the ARB memory operation. The waveform will be replayed after the ARB operation is finished.</p>
Initial S/W Revision	A.05.00

Change Directory...

Allows you to change the currently selected directory on the hard disk. Pressing this key opens a standard windows change directory dialog allowing you to select the new directory of interest.

The current directory is used for manually loading waveform segments into ARB memory for playback, and as a search location for waveform segments that are required to be loaded into ARB memory for playback of a waveform sequence or a list sequence.

Key Path	Source, Modulation Setup, ARB, Select Waveform, Segments on Hard Disk
Notes	No remote command, SCPIfront panel only.
Initial S/W Revision	A.05.00

Default Directory...

Allows you to change the default directory. It is used as a search location for waveform segments that are required to be loaded into ARB memory for playback of a waveform sequence, and as a search location for selecting waveforms using SCPI.

Key Path	Source, Modulation Setup, ARB, Select Waveform, Segments on Hard Disk
Remote Command	:SOURce:RADio:ARB:DEFault:DIRectory <string> :SOURce:RADio:ARB: DEFault:DIRectory?
Example	:SOUR:RAD:ARB:DEF:DIR "D:\ArbFiles" :SOUR:RAD:ARB:DEF:DIR?
State Saved	Persistent, survives a power cycle and a preset but not saved in the instrument state
Initial S/W Revision	A.05.00

Segments in ARB Memory

Allows you access to the sub-menus for managing the files within ARB memory.

Key Path	Source, Modulation Setup, ARB, Select Waveform
Initial S/W Revision	A.05.00

Delete Segment From ARB Mem

Allows you to remove a segment from ARB playback memory.

Key Path	Source, Modulation Setup, ARB, Select Waveform, Segments in ARB Memory
Remote Command	:SOURce:RADio:ARB:DELeTe <string>
Example	:SOUR:RAD:ARB:DEL "testwaveform.bin"
Notes	<p><string> - specifies the waveform to be deleted from the ARB playback memory.</p> <p>When in Sequence Analyzer mode and Include Source is Yes, an attempt to delete a file from ARB memory is rejected with an error.</p> <p>When Include Source is No and you specify a file that does not exist within ARB memory, an error is generated.</p> <p>It is possible to delete files from within the ARB memory when the ARB is ON. However, if you attempt to delete the file that is currently playing an error is generated.</p> <p>It is possible to delete a file from within the ARB memory when the sequencer state is ON and the file is not being used by the List Sequencer. If you attempt to delete a file which is being used by the list sequencer, an error is generated.</p> <p>When sequencer state is On, even if ARB state is On, the selected waveform will not be played. In this case, if the selected waveform is not used in List Sequence, it can be deleted and the ARB state is turned Off.</p> <p>If the ARB is ON and you load a file to ARB memory or delete a file from ARB memory, the playing waveform segment may not keep phase continuity during the ARB memory operation. The waveform will be replayed after the ARB operation is finished.</p>
Initial S/W Revision	A.05.00

Delete All From ARB Memory

Allows you to remove all segments from ARB playback memory.

Key Path	Source, Modulation Setup, ARB, Select Waveform, Segments in ARB Memory
Remote Command	:SOURce:RADio:ARB:DELeTe:ALL
Example	:SOUR:RAD:ARB:DELeTe:ALL
Notes	<p>When in Sequence Analyzer mode and Include Source is Yes, an attempt to delete all files from ARB memory is rejected with an error.</p> <p>When Include Source is No and you attempt to delete all files from ARB memory when the ARB is currently playing a file, all files except the one playing are deleted and an error is generated.</p> <p>If you attempt to delete all files from ARB memory when there are waveform files used in "List Sequencer" on page 2520 and "Sequencer" on page 2521 state is ON, all files except the files currently being used in list sequencer are deleted, and an error is generated.</p>

If the ARB is ON and you load a file to ARB memory or delete a file from ARB memory, the playing waveform segment may not keep phase continuity during the ARB memory operation. The waveform will be replayed after the ARB operation is finished.

Initial S/W Revision A.05.00

Segments on Hard Disk

This key functions the same as ["Segments on Hard Disk" on page 2547](#).

Key Path Source, Modulation Setup, ARB, Waveform Sequences, Build New Sequence, Insert New Waveform

Initial S/W Revision Prior to A.09.00

Load Segment To ARB Memory

This key functions the same as ["Load Segment To ARB Memory" on page 2547](#).

Key Path Source, Modulation Setup, ARB, Waveform Sequences, Build New Sequence, Insert New Waveform, Segment on Hard Drive

Initial S/W Revision Prior to A.09.00

Load All To ARB Memory

This key functions the same as ["Load All To ARB Memory" on page 2548](#).

Key Path Source, Modulation Setup, ARB, Waveform Sequences, Build New Sequence, Insert New Waveform, Segment on Hard Drive

Initial S/W Revision Prior to A.09.00

Change Directory ...

This key functions the same as ["Change Directory..." on page 2549](#).

Key Path Source, Modulation Setup, ARB, Waveform Sequences, Build New Sequence, Insert New Waveform, Segment on Hard Drive

Initial S/W Revision Prior to A.09.00

Default Directory ...

This key functions the same as ["Default Directory..." on page 2549](#)

Key Path Source, Modulation Setup, ARB, Waveform Sequences, Build New Sequence, Insert New Waveform, Segment on Hard Drive

Initial S/W Revision Prior to A.09.00

Segments in ARB Memory

This key functions the same as ["Segments in ARB Memory" on page 2549](#).

Key Path	Source, Modulation Setup, ARB, Waveform Sequences, Build New Sequence, Insert New Waveform
Initial S/W Revision	Prior to A.09.00

Delete Segment From ARB Memory

This key functions the same as ["Delete Segment From ARB Mem" on page 2549](#).

Key Path	Source, Modulation Setup, ARB, Waveform Sequences, Build New Sequence, Insert New Waveform, Segment in ARB Memory
Initial S/W Revision	Prior to A.09.00

Delete All From ARB Memory

This key functions the same as ["Delete All From ARB Memory" on page 2550](#).

Key Path	Source, Modulation Setup, ARB, Waveform Sequences, Build New Sequence, Insert New Waveform, Segment in ARB Memory
Initial S/W Revision	Prior to A.09.00

Query ARB Memory File List (Remote Command Only)

This command functions the same as ["Query ARB Memory File List \(Remote Command Only\)" on page 2482](#).

Initial S/W Revision	Prior to A.09.00
----------------------	------------------

Edit Selected Waveform

Allows access to the sub-menus for editing the details of the currently selected waveform segment.

Key Path	Source, Modulation Setup, ARB, Waveform Sequences, Build New Sequence
Notes	No remote command, front panel only.
Initial S/W Revision	A.05.00

Repetitions

Allows you to specify the number of times the currently selected waveform is played within the sequence.

Key Path	Source, Modulation Setup, ARB, Waveform Sequences, Build New Sequence, Edit Selected Waveform
Notes	No remote command, SCPI front panel only.
Preset	1
Min	1
Max	65535
Initial S/W Revision	A.05.00

Marker 1

Allows you to enable or disable marker 1 for the currently selected waveform. For a waveform sequence, you can enable and disable markers on a per-segment basis, allowing you to output markers from some waveform segments within the sequence, but not for others.

Key Path	Source, Modulation Setup, ARB, Waveform Sequences, Build New Sequence, Edit Selected Waveform
Notes	No remote command, front panel only.
Preset	Enabled
Range	Enabled Disabled
Initial S/W Revision	A.05.00

Marker 2

Allows you to enable or disable marker 2 for the currently selected waveform. For a waveform sequence, you can enable and disable markers on a per-segment basis, allowing you to output markers from some waveform segments within the sequence, but not for others.

Key Path	Source, Modulation Setup, ARB, Waveform Sequences, Build New Sequence, Edit Selected Waveform
Notes	No remote command, front panel only.
Preset	Enabled
Range	Enabled Disabled
Initial S/W Revision	A.05.00

Marker 3

Allows you to enable or disable marker 3 for the currently selected waveform. For a waveform sequence, you can enable and disable markers on a per-segment basis, allowing you to output markers from some waveform segments within the sequence, but not for others.

Key Path	Source, Modulation Setup, ARB, Waveform Sequences, Build New Sequence, Edit Selected
----------	--

	Waveform
Notes	No remote command, front panel only.
Preset	Enabled
Range	Enabled Disabled
Initial S/W Revision	A.05.00

Marker 4

Allows you to enable or disable marker 4 for the currently selected waveform. For a waveform sequence, you can enable and disable markers on a per-segment basis, allowing you to output markers from some waveform segments within the sequence, but not for others.

Key Path	Source, Modulation Setup, ARB, Waveform Sequences, Build New Sequence, Edit Selected Waveform
Notes	No remote command, front panel only.
Preset	Enabled
Range	Enabled Disabled
Initial S/W Revision	A.05.00

Delete Segment

Allows you to delete the selected segment from the waveform sequence.

Key Path	Source, Modulation Setup, ARB, Waveform Sequences, Build New Sequence
Notes	No remote command, front panel only.
Initial S/W Revision	A.05.00

Save Sequence...

Pressing this key displays the “Save As” dialog. The sequence name is passed to the save as dialog to use as the filename for saving, and the directory the save as dialog will open into is the default waveform directory.

Key Path	Source, Modulation Setup, ARB, Waveform Sequences, Build New Sequence
Initial S/W Revision	A.05.00

Build New Sequence (Remote Command Only)

This command is the SCPI equivalent of the waveform sequence creation features described in ["Build New Sequence" on page 2489](#).

This command writes a waveform sequence file to the hard disk. You must specify the waveform sequence file path and filename which will be saved on the hard disk, and the waveform segment file path and name which will be nested into the waveform sequence file. You can utilize mass storage unit specifier (MSUS) “NVWFM” or use a real full path representation. See the example below. MSUS “NVWFM” is mapped to D:\VARB directory on test set hard disk.

Any number of segments, up to a segment count limit of 64, can be used to create a sequence. Repeated segments are included in the count limit.

Each waveform segment name string length upper limit is 128 chars. Please do NOT insert waveform which name string exceeds 128 chars.

The internal source does not support nesting one waveform sequence file into another waveform sequence file.

Remote Command :SOURce:RADio:ARB:SEquence[:MWAVeform] <filename>, <waveform1>, <reps>, NONE | M1 | M2 | M3 | M4 | M1M2 | M1M3 | M1M4 | M2M3 | M2M4 | M3M4 | M1M2M3 | M1M2M4 | M1M3M4 | M2M3M4 | M1M2M3M4 | ALL, {<waveform2>, <reps>, NONE | M1 | M2 | M3 | M4 | M1M2 | M1M3 | M1M4 | M2M3 | M2M4 | M3M4 | M1M2M3 | M1M2M4 | M1M3M4 | M2M3M4 | M1M2M3M4 | ALL, } ...

(For additional description of each item, see Notes below ["For Setup SCPI" on page 1478](#) "For Setup SCPI".)

:SOURce:RADio:ARB:SEquence[:MWAVeform]? <filename>

(For additional description of each item, see Notes ["For Query SCPI" on page 1479](#) below.)

Example For setup:

```
>:SOUR:RAD:ARB:SEQ "NVWFM:testSeq1.seq", "NVWFM:wfmSegment1.wfm", 10, M2M3M4, "NVWFM:wfmSegment2.wfm", 20, M1 M3
```

Or

```
>:SOUR:RAD:ARB:SEQ "D: VARB\testSeq1.seq", "D: VARB\wfmSegment1.wfm", 10, M2M3M4, "D: VARB\wfmSegment2.wfm", 20, M1 M3
```

For query, must specify which waveform sequence file to query.

```
>:SOUR:RAD:ARB:SEQ? "NVWFM:testSeq1.seq"
```

Or

```
>:SOUR:RAD:ARB:SEQ? "D: VARB\testSeq1.seq",
```

Notes For Setup SCPI

For the Setup SCPI command, the parameters are:

<filename> - String Type

This variable specifies the path and name for the waveform sequence file. The path supports MSUS (NVWFM) or a real full path representation. See example.

<waveform1> - String Type

This variable specifies the path and name of the first existing waveform segment. The path supports MSUS (NVWFM) or a real full path representation. See example.

The segment file must reside within ARB playback memory before it can be played by the ARB player.

<reps> - Integer Type

This variable specifies the number of times a segment or sequence plays before moving on to the next segment or sequence.

<marker> - Enum Type

NONE – This choice disables all four markers for the waveform. Disabling markers means that the waveform sequence ignores the segments or sequence marker settings.

M1, M2, M3, M4 – these choices, either individually or a combination of them, enable the markers for the waveform segment or sequence. Markers not specified are ignored for that segment or sequence.

ALL – This choice enables all four markers in the waveform segment or sequence.

<waveform2> - String type.

This variable specifies the name of a second existing waveform segment. The path supports MSUS (NVWFM) and real full path representation both. See example.

The segment file must reside within ARB playback memory before it can be played by the ARB player.

<reps> same as above, for the 2nd waveform segment.

<marker> same as above, for the 2nd waveform segment.

You can insert several waveform segments into a waveform sequence file. Just repeat inserting waveform segments as described above.

Error Checks for Setup SCPI command:

If you do not specify a filename, or you use an unsupported MSUS (that is, not NVWFM), or have an error in the waveform sequence file path, an error is generated.

Notes

Error Checks for Query SCPI command: (Continued)

If the specified waveform sequence file name suffix is not “.seq”, error is generated.

If you use an unsupported MSUS (that is, not NVWFM), or have an error in the waveform segment file path, an error is generated.

If the first specified waveform file cannot be found, an error is generated.

If you nest one waveform sequence file into another waveform sequence file, an error is generated.

If the specified repetition value is larger than 65535 or smaller than 1, an error is generated.

If the specified marker type is unrecognized, an error is generated.

For Query SCPI

For the Query the parameters are:

<filename> - String type.

This variable specifies the path and name of the waveform sequence file being queried. The path supports MSUS (NVWFM) or a real full path representation. See example.

The return value is a <string>, which includes each waveform segment file name, repetitions, and marker type. For example:

>:SOUR:RAD:ARB:SEQ? “NVWFM:testSeq1.seq”,

<“wfmSegment1. wfm, 10, ALL, wfmSegment2.wfm, 20, M1M3”,

Error Checks for Query SCPI command:

If you do not specify a filename, an error is generated.

If the waveform sequence file name is empty, an error is generated.

If the specified waveform sequence file cannot be found, an error is generated.

Initial S/W Revision

A.05.00

Edit Selected Sequence

Allows access to the sub-menus for editing the sequence currently selected within the Waveform Sequence List view. Pressing this key changes the central view area to display the Waveform Sequence Creation and Editing view.

Key Path	Source, Modulation Setup, ARB, Waveform Sequences
Notes	No remote command, front panel only.
Initial S/W Revision	A.05.00

Current Directory...

Allows you to change the currently selected directory on the hard disk. Pressing this key opens a standard windows change directory dialog and allows you to select the new directory of interest.

Key Path	Source, Modulation Setup, ARB, Waveform Sequences
Notes	No remote command, front panel only.
Initial S/W Revision	A.05.00

Waveform Utilities

Allows you access to the waveform utilities sub-menus.

Key Path	Source, Modulation Setup, ARB
Initial S/W Revision	A.05.00

Multi-Pack Licenses

Allows you access to the Multi - Pack License sub-menus. Pressing this key also changes the central view area to display the Multi -Pack License Management view.

On modular instrument like E6630A or E6640A, multi-pack license operations are only allowed on the default module, i.e. "Left" module for E6630A or "TRX1" module for E6640A.

Key Path	Source, Modulation Setup, ARB, Waveform Utilities
Notes	If access multi-pack license sub-menu from modules other than "TRX1", an advisory message like "Please goto "TRX1" to operate multi-pack license" will display.
Dependencies	This key is only available if there is at least one Multi-pack license installed on the instrument.
Initial S/W Revision	A.05.00

Add Waveform

Pressing this key accesses the Add Waveform sub-menu. It also changes the central display area to display the Multi-Pack License Waveform Add view.

Key Path	Source, Modulation Setup, ARB, Waveform Utilities, Multi-Pack Licenses
Dependencies	This key is only available if there is at least one slot available within at least one multi-pack license.
Initial S/W Revision	A.05.00

Add Waveform

Allows you to add the currently selected waveform segment to a multi-pack license. The new waveform is added to the next available slot regardless of which slot was selected on the Multi-Pack License Management view.

Key Path	Source, Modulation Setup, ARB, Waveform Utilities, Multi-Pack Licenses, Add Waveform
Remote Command	:SYSTem:LKEY:WAVeform:ADD <string> or :SYSTem:LIcense[:FPACK]:WAVeform:ADD <string>
Example	SYST:LKEY:WAV:ADD "mywaveform.wfm" or SYST:LIC:WAV:ADD "mywaveform.wfm"
Notes	The second SCPI :SYSTem:LIcense[:FPACK]:WAVeform:ADD is provided to be consistent with the style of Agilent signal sources. You can use either one of them. Since adding a waveform segment to a Multi-Pack license causes the license slot to enter the trial period of only 48 hours, pressing this key causes a confirmation dialog to be displayed to ensure you do want to add the waveform segment to the Multi-Pack. If you attempt to license a waveform that is already licensed using another slot an error is generated. . If current module is not "TRX1" module, the key will grey out, and error message is generated "-221 Setting conflict; Not allowed on current module. Goto "TRX1" to operate multi-pack license" when invoking SCPI.
Dependencies	This key is only available if the currently selected file is a secure waveform requiring a license, and there is at least one slot available within at least one multi-pack license. If the waveform highlighted is a secure waveform, but is already licensed, this key will be unavailable.
Initial S/W Revision	A.05.00

Segments on Hard Disk

Allows you access to the sub-menus for loading waveform segments from the hard disk into ARB memory. The default directory is: D: varb.

Pressing this key changes the current view to the Waveform Management View.

Key Path	Source, Modulation Setup, ARB, Select Waveform
Initial S/W Revision	A.05.00

Load Segment To ARB Memory

Allows you to load the selected file into ARB memory. On the front panel you select the file for loading to the ARB memory by highlighting the desired file in the list. Using the SCPI command, you specify the file name on the HDD.

“NVWFM” (none-volatile storage) MSUS (Mass Storage Unit Specifier) is supported in the memory subsystem because the ARB memory cannot be accessed directly. Therefore, files must be downloaded to the instrument hard disk and then loaded into the ARB memory. “NVWFM” MSUS will be mapped to the default directory D: VARB. The SCPI command supports using either “NVWFM” MSUS or specifying a full path. For more information, see [Memory Subsystem \(Remote Command Only\)](#).

If a file of the same name already exists within ARB memory, it is overwritten. If you wish to load two segments of the same name, you must rename one of the segments before loading it into ARB memory. To rename a segment, you can either use Windows File Explorer, or the :MMEMory:COpy command.

NOTE: When a waveform file is loaded to ARB memory, burst timing adjustments are made automatically, based on whether or not a Multiport Adapter is connected to the test set and powered on. If the connection/power status of the Multiport Adapter is changed after a waveform file has been loaded, it needs to be loaded again.

Key Path	Source, Modulation Setup, ARB, Select Waveform, Segments on Hard Disk
Remote Command	:SOURce:RADio:ARB:LOAD <string>
Example	:SOUR:RAD:ARB:LOAD "D: VARB\testwaveform.bin" or :SOUR:RAD:ARB:LOAD "NVWFM:testwaveform.bin"
Notes	<p>Because loading the file involves a delay of unpredictable length, this command should be followed by the query *OPC?, which holds off subsequent commands until the loading operating is complete.</p> <p><string> – specifies the path name of the file to load from the HDD into ARB memory. It could be a <full path + filename>, or <“NVWFM” MSUS + colon + filename>.</p> <p>When in Sequence Analyzer mode, and Include Source is Yes, an attempt to load a file to ARB memory will be rejected with an error.</p> <p>When Include Source is No and if there is insufficient free ARB memory to load the selected waveform, an error is generated. .</p> <p>If you specify a file over SCPI, but the file is not at the specified location, an error is generated.</p> <p>If you try to load a waveform file but the file contains less than 500 IQ samples, an error is generated.</p> <p>If you try to load a Signal Studio waveform “*.wfm” which contains invalid waveform header, an error is generated.</p> <p>If the ARB is ON when you load a file to ARB memory or delete a file from ARB memory, the playing waveform segment may not keep phase continuity during the ARB memory operation. The waveform will be replayed after the ARB operation is finished.</p> <p>ARB can be loaded into ARB memory even required licenses do not present on the instrument. In this</p>

case, a GUI only warning message -800, "Operation complete; Loaded <filename> successfully, but no license <required licenses> installed". User can install required licenses according to <required licenses> string to license it, or multi-pack license it.

Initial S/W Revision	A.05.00
----------------------	---------

Load All To ARB Memory

Allows you to load all the segment files within the currently selected directory into ARB memory. If a file of the same name already exists within ARB memory, it is overwritten. If you wish to load two segments of the same name, you must rename one of the segments before loading it into ARB memory. To rename a segment, you can either use Windows File Explorer, or the :MEMory:COpy command.

NOTE: When a waveform file is loaded to ARB memory, burst timing adjustments are made automatically, based on whether or not a Multiport Adapter is connected to the test set and powered on. If the connection/power status of the Multiport Adapter is changed after a waveform file has been loaded, it needs to be loaded again.

Key Path	Source, Modulation Setup, ARB, Select Waveform, Segments on Hard Disk
Remote Command	:SOURce:RADio:ARB:LOAD:ALL <string>
Example	:SOUR:RAD:ARB:LOAD:ALL "D: varb"
Notes	<p><string> - specifies the directory on the HDD to load the files into ARB memory from.</p> <p>When in Sequence Analyzer mode, and Include Source is Yes, an attempt to load all files from a directory to ARB memory is rejected with an error.</p> <p>When Include Source is No and there is insufficient free ARB memory to load all the waveforms, when the ARB memory is full, the copy ceases, and an error is generated.</p> <p>If you specify a directory over SCPI, but the directory does not exist, an error is generated.</p> <p>If the ARB is ON, a user then loads or deletes file to ARB memory, the playing waveform segment may not keep phase continuity during the ARB memory operation. The waveform will be replayed after the ARB operation is finished.</p>
Initial S/W Revision	A.05.00

Change Directory...

Allows you to change the currently selected directory on the hard disk. Pressing this key opens a standard windows change directory dialog allowing you to select the new directory of interest.

The current directory is used for manually loading waveform segments into ARB memory for playback, and as a search location for waveform segments that are required to be loaded into ARB memory for playback of a waveform sequence or a list sequence.

Key Path	Source, Modulation Setup, ARB, Select Waveform, Segments on Hard Disk
Notes	No remote command, SCPIfront panel only.
Initial S/W Revision	A.05.00

Default Directory...

Allows you to change the default directory. It is used as a search location for waveform segments that are required to be loaded into ARB memory for playback of a waveform sequence, and as a search location for selecting waveforms using SCPI.

Key Path	Source, Modulation Setup, ARB, Select Waveform, Segments on Hard Disk
Remote Command	:SOURce:RADio:ARB:DEFault:DIRectory <string> :SOURce:RADio:ARB: DEFault:DIRectory?
Example	:SOUR:RAD:ARB:DEF:DIR "D:\ArbFiles" :SOUR:RAD:ARB:DEF:DIR?
State Saved	Persistent, survives a power cycle and a preset but not saved in the instrument state
Initial S/W Revision	A.05.00

Segments on Hard Disk

This key functions the same as ["Segments on Hard Disk" on page 2547](#).

Key Path	Source, Modulation Setup, ARB, Waveform Utilities, Multi-Pack Licenses, Add Waveform
Initial S/W Revision	Prior to A.09.00

Load Segment To ARB Memory

This key functions the same as ["Load Segment To ARB Memory" on page 2547](#).

Key Path	Source, Modulation Setup, ARB, Waveform Utilities, Multi-Pack Licenses, Add Waveform, Segment on Hard Drive
Initial S/W Revision	Prior to A.09.00

Load All To ARB Memory

This key functions the same as ["Load All To ARB Memory" on page 2548](#).

Key Path	Source, Modulation Setup, ARB, Waveform Utilities, Multi-Pack Licenses, Add Waveform, Segment on Hard Drive
Initial S/W Revision	Prior to A.09.00

Change Directory ...

This key functions the same as ["Change Directory..." on page 2549](#).

Key Path	Source, Modulation Setup, ARB, Waveform Utilities, Multi-Pack Licenses, Add Waveform, Segment on Hard Drive
Initial S/W Revision	Prior to A.09.00

Default Directory ...

This key functions the same as ["Default Directory..." on page 2549](#)

Key Path	Source, Modulation Setup, ARB, Waveform Utilities, Multi-Pack Licenses, Add Waveform, Segment on Hard Drive
Initial S/W Revision	Prior to A.09.00

Replace Waveform

Pressing this key accesses the Replace Waveform submenu. It also changes the central display area to display the Multi-Pack License Waveform Add view.

Key Path	Source, Modulation Setup, ARB, Waveform Utilities, Multi-Pack Licenses
Dependencies	This key is only available if the currently selected slot is in the trial state.
Initial S/W Revision	A.05.00

Replace Waveform

Allows you to replace the waveform in the currently selected slot with the waveform currently selected in the Multi-Pack License Waveform Add view.

Key Path	Source, Modulation Setup, ARB, Waveform Utilities, Multi-Pack Licenses, Replace Waveform
Remote Command	:SYSTem:LKEY:WAVeform:REPLace <int>, <string> or :SYSTem:LIcense[:FPACK]:WAVeform:REPLace <int>, <string>
Example	SYST:LKEY:WAV:REPL 1, "myotherwaveform.wfm" or :SYST:LIC:WAV:REPL 1, "myotherwaveform.wfm"
Notes	The second SCPI :SYSTem:LIcense[:FPACK]:WAVeform:REPLace is provided to be consistent with the style of Agilent signal sources. You can use either one of them. If you attempt to license a waveform that is already licensed using another slot an error is generated. Waveform slot number <int> is positive. If you attempt to input a slot number less than or equals 0, an error is generated. If current module is not "TRX1" module, the key will grey out, and error message is generated "-221 Setting conflict; Not allowed on current module. Goto "TRX1" to operate multi-pack license" when invoking SCPI.
Initial S/W Revision	A.05.00

Segments on Hard Disk

This key functions the same as ["Segments on Hard Disk" on page 2547](#).

Key Path	Source, Modulation Setup, ARB, Waveform Utilities, Multi-Pack Licenses, Replace Waveform
Initial S/W Revision	Prior to A.09.00

Load Segment To ARB Memory

This key functions the same as ["Load Segment To ARB Memory" on page 2547](#).

Key Path	Source, Modulation Setup, ARB, Waveform Utilities, Multi-Pack Licenses, Replace Waveform, Segment on Hard Drive
Initial S/W Revision	Prior to A.09.00

Load All To ARB Memory

This key functions the same as ["Load All To ARB Memory" on page 2548](#).

Key Path	Source, Modulation Setup, ARB, Waveform Utilities, Multi-Pack Licenses, Replace Waveform, Segment on Hard Drive
Initial S/W Revision	Prior to A.09.00

Change Directory ...

This key functions the same as ["Change Directory..." on page 2549](#).

Key Path	Source, Modulation Setup, ARB, Waveform Utilities, Multi-Pack Licenses, Replace Waveform, Segment on Hard Drive
Initial S/W Revision	Prior to A.09.00

Default Directory ...

This key functions the same as ["Default Directory..." on page 2549](#)

Key Path	Source, Modulation Setup, ARB, Waveform Utilities, Multi-Pack Licenses, Replace Waveform, Segment on Hard Drive
Initial S/W Revision	Prior to A.09.00

Clear Waveform from Slot

Allows you to clear the waveform from the selected slot.

Key Path	Source, Modulation Setup, ARB, Waveform Utilities, Multi-Pack Licenses
Remote Command	:SYSTem:LKEY:WAVeform:CLEar <int> or :SYSTem:LICense[:FPACK]:WAVeform:CLEar <int>
Example	SYST:LKEY:WAV:CLE 1 or :SYST:LIC:WAV:CLE 1
Notes	The second SCPI :SYSTem:LICense[:FPACK]:WAVeform:CLEar is provided to be consistent with the style of Agilent signal sources. You can use either one of them. Waveform slot number <int> is positive. If you attempt to input a slot number less than or equals 0, an error is generated. If current module is not "TRX1" module, the key will grey out, and error message is generated "-221 Setting conflict; Not allowed on current module. Goto "TRX1" to operate multi-pack license" when invoking SCPI.
Dependencies	This key is only available if the currently selected slot is in the trial state.
Initial S/W Revision	A.05.00

Lock Waveform in Slot

If the selected slot is in the trial state or the lock required state, the waveform that occupies the slot is locked and permanently licensed.

Key Path	Source, Modulation Setup, ARB, Waveform Utilities, Multi-Pack Licenses
Remote Command	:SYSTem:LKEY:WAVeform:LOCK <int> or :SYSTem:LICense[:FPACK]:WAVeform:LOCK <int>
Example	SYST:LKEY:WAV:LOCK 1 or SYST:LIC:WAV:LOCK 1
Notes	The second SCPI :SYSTem:LICense[:FPACK]:WAVeform:LOCK is provided to be consistent with the style of Agilent signal sources. You can use either one of them. Waveform slot number <int> is positive. If you attempt to input a slot number less than or equals 0, an error is generated. If current module is not "TRX1" module, the key will grey out, and error message is generated "-221 Setting conflict; Not allowed on current module. Goto "TRX1" to operate multi-pack license" when invoking SCPI.
Dependencies	This key is only available if the currently selected slot is in the trial state or the lock required state.
Initial S/W Revision	A.05.00

Slot Status Query (Remote Command Only)

Returns the status of the specified slot.

Remote Command	:SYSTem:LKEY:WAVeform:STATus? <int> or :SYSTem:LICense[:FPACK]:WAVeform:STATus? <int>
Example	:SYST:LKEY:WAV:STAT? 1 <"Locked" or :SYST:LIC:WAV:STAT? 1 <"Locked"
Notes	The second SCPI :SYSTem:LICense[:FPACK]:WAVeform:STATus is provided to be consistent with the style of Agilent signal sources. You can use either one of them. Waveform slot number <int> is positive. If you attempt to input a slot number less than or equals 0, an error is generated. Result type is string. If input slot number exceeds total available slot number, "Nonexistent" is returned.
Range	"Locked" "Available" "Trail" "LockRequired" "Nonexistent"
Initial S/W Revision	A.05.00

Slots Free Query (Remote Command Only)

Returns the number of license slots free.

Remote Command	:SYSTem:LKEY:WAVeform:FREE? or :SYSTem:LICense[:FPACK]:WAVeform:FREE?
Example	:SYST:LKEY:WAV:FREE? or :SYST:LIC:WAV:FREE?
Notes	The second SCPI :SYSTem:LICense[:FPACK]:WAVeform:FREE is provided to be consistent with the style of Agilent signal sources. You can use either one of them.
Initial S/W Revision	A.05.00

Slot Used Query (Remote Command Only)

Returns the number of license slots used.

Remote Command	:SYSTem:LKEY:WAVeform:USED? or :SYSTem:LICense[:FPACK]:WAVeform:USED?
Example	:SYST:LKEY:WAV:USED?

	or :SYSTem:LiC:WAV:USED?
Notes	The second SCPI :SYSTem:LiCense[:FPACK]:WAVeform:USED is provided to be consistent with the style of Agilent signal sources. You can use either one of them.
Initial S/W Revision	A.05.00

Slot Waveform Name Query (Remote Command Only)

Returns the waveform name of the specified slot

Remote Command	:SYSTem:LKEY:WAVeform:NAME? <int> or :SYSTem:LiCense[:FPACK]:WAVeform:NAME? <int>
Example	:SYST:LKEY:WAV:NAME? 1 <"CDMA2K_22.wfm" or :SYST:LiC:WAV:NAME? 1 <"CDMA2K_22.wfm"
Notes	Waveform slot number <int> is positive. If you attempt to input a slot number less than or equals 0, an error is generated. Result type is string. If input slot number exceeds total available slot number, "Nonexistent" is returned. If no waveform stored in the specified slot, then empty string is returned.
Initial S/W Revision	A.12.00

Slot Waveform Unique ID Query (Remote Command Only)

Returns the waveform unique ID of the specified slot

Remote Command	:SYSTem:LKEY:WAVeform:UID? <int> or :SYSTem:LiCense[:FPACK]:WAVeform:UID? <int>
Example	:SYST:LKEY:WAV:UID? 2 <"1346752140" or :SYST:LiC:WAV:UID? 2 <"1346752140"
Notes	Waveform slot number <int> is positive. If you attempt to input a slot number less than or equals 0, an error is generated. Result type is string. If input slot number exceeds total available slot number, "Nonexistent" is returned.

	If no waveform stored in the specified slot, then "0" is returned
Initial S/W Revision	A.12.00

Locked Waveform Name List Query (Remote Command Only)

Returns the waveform name list of locked.

Remote Command	:SOURce:RADio:ARB:MPLicensed:NAME:LOCKed?
Example	SOUR:RAD:ARB:MPL:NAME:LOCKed? <"CDMA2K_27.wfm", "GSM_MCS1.WFM", "c2kWfm.wfm"
Initial S/W Revision	A.11.00

Locked Waveform Unique ID List Query (Remote Command Only)

Returns the waveform unique id list of locked.

Remote Command	:SOURce:RADio:ARB:MPLicensed:UID:LOCKed?
Example	SOUR:RAD:ARB:MPL:UID:LOCKed? <"2996927136", "3812603511", "3710986266"
Notes	Each Signal Studio waveform has a unique id recorded in header. So if the unique ids are same, that means they are same one waveform. So besides SCPI to query locked waveform name list, also provide a SCPI to query locked waveform unique id list
Initial S/W Revision	A.11.00

Marker Utilities

Allows access to the marker utilities sub-menus.

Key Path	Source, Modulation Setup, ARB
Initial S/W Revision	A.05.00

Marker Polarity

Allows access to the marker polarity sub-menu, which allows you to specify the polarity for the four markers. For a positive polarity, the marker signal is high during the marker points. For a negative marker polarity, the marker signal is high during the period of no marker points.

Key Path	Source, Modulation Setup, ARB, Marker Utilities
Initial S/W Revision	A.05.00

Mkr 1 Polarity

Allows you to set the polarity of marker 1.

Key Path	Source, Modulation Setup, ARB, Marker Utilities, Marker Polarity
Remote Command	:SOURce:RADio:ARB:MPOLarity:MARKer1 POSitive NEGative :SOURce:RADio:ARB:MPOLarity:MARKer1?
Example	:SOUR:RAD:ARB:MPOL:MARK1 NEG
Dependencies	When a new waveform is selected for playback the settings contained within the associated waveform header file are applied to the ARB. The marker polarity is one of the values stored within the header file. If the newly selected waveform file has an associated header file, the marker polarity is updated with the value from the header file. The marker polarity will remain unchanged if the newly selected waveform does not have an associated header file.
Preset	Pos
Range	Neg Pos
Initial S/W Revision	A.05.00

Mkr 2 Polarity

Allows you to set the polarity of marker 2.

Key Path	Source, Modulation Setup, ARB, Marker Utilities, Marker Polarity
Remote Command	:SOURce:RADio:ARB:MPOLarity:MARKer2 POSitive NEGative :SOURce:RADio:ARB:MPOLarity:MARKer2?
Example	:SOUR:RAD:ARB:MPOL:MARK2 NEG
Dependencies	When a new waveform is selected for playback the settings contained within the associated waveform header file are applied to the ARB. The marker polarity is one of the values stored within the header file. If the newly selected waveform file has an associated header file, the marker polarity is updated with the value from the header file. The marker polarity will remain unchanged if the newly selected waveform does not have an associated header file.
Preset	Pos
Range	Neg Pos
Initial S/W Revision	A.05.00

Mkr 3 Polarity

Allows you to set the polarity of marker 3.

Key Path	Source, Modulation Setup, ARB, Marker Utilities, Marker Polarity
Remote Command	:SOURce:RADio:ARB:MPOLarity:MARKer3 POSitive NEGative :SOURce:RADio:ARB:MPOLarity:MARKer3?
Example	:SOUR:RAD:ARB:MPOL:MARK3 NEG
Dependencies	When a new waveform is selected for playback the settings contained within the associated

	waveform header file are applied to the ARB. The marker polarity is one of the values stored within the header file. If the newly selected waveform file has an associated header file, the marker polarity is updated with the value from the header file. The marker polarity will remain unchanged if the newly selected waveform does not have an associated header file.
Preset	Pos
Range	Neg Pos
Initial S/W Revision	A.05.00

Mkr 4 Polarity

Allows you to set the polarity of marker 4.

Key Path	Source, Modulation Setup, ARB, Marker Utilities, Marker Polarity
Remote Command	:SOURce:RADio:ARB:MPOLarity:MARKer4 POSitive NEGative :SOURce:RADio:ARB:MPOLarity:MARKer4?
Example	:SOUR:RAD:ARB:MPOL:MARK4 NEG
Dependencies	When a new waveform is selected for playback the settings contained within the associated waveform header file are applied to the ARB. The marker polarity is one of the values stored within the header file. If the newly selected waveform file has an associated header file, the marker polarity is updated with the value from the header file. The marker polarity will remain unchanged if the newly selected waveform does not have an associated header file.
Preset	Pos
Range	Neg Pos
Initial S/W Revision	A.05.00

Marker Routing

Allows access to the marker routing sub-menus, which allow you to specify where the marker events are routed. It should be noted that the markers can also be routed to Trigger 1 Out and Trigger 2 Out, however this must be set up using the menus accessed by pressing the “Trigger” hard key.

Key Path	Source, Modulation Setup, ARB, Marker Utilities
Initial S/W Revision	A.05.00

Pulse/RF Blank

Allows you to select which marker is used for the pulse/RF blanking function. The pulse/RF blanking function blanks the RF when the marker signal goes low. The marker polarity determines when the marker signal is high. For a positive polarity, this is during the marker points. For a negative polarity, this is when there are no marker points.

Marker points should be set before using this function. Enabling this function without setting maker points may create a continuous low or high signal, dependant on the marker polarity. This causes either no RF output, or a continuous RF output.

Key Path	Source, Modulation Setup, ARB, Marker Utilities, Marker Routing
Remote Command	:SOURce:RADio:ARB:MDESTination:PULSe NONE M1 M2 M3 M4 :SOURce:RADio:ARB:MDESTination:PULSe?
Example	:SOUR:RAD:ARB:MDES:PULS NONE
Dependencies	When a new waveform is selected for playback the settings contained within the associated waveform header file are applied to the ARB. The pulse/RF blanking setting is one of the values stored within the header file. If the newly selected waveform file has an associated header file, the pulse/RF blanking setting is updated with the value from the header file. The pulse/RF blanking setting will remain unchanged if the newly selected waveform does not have an associated header file.
Range	None M1 M2 M3 M4
Initial S/W Revision	A.05.00

None

Sets no marker to be used for the pulse/RF blanking function, essentially turning the RF blanking function off.

Key Path	Source, Modulation Setup, ARB, Marker Utilities, Marker Routing, Pulse/RF Blank
Example	:SOUR:RAD:ARB:MDES:PULS NONE
Initial S/W Revision	A.05.00

Marker 1

Sets marker 1 to be used for the pulse/RF blanking function.

Key Path	Source, Modulation Setup, ARB, Marker Utilities, Marker Routing, Pulse/RF Blank
Example	:SOUR:RAD:ARB:MDES:PULS M1
Initial S/W Revision	A.05.00

Marker 2

Sets marker 2 to be used for the pulse/RF blanking function.

Key Path	Source, Modulation Setup, ARB, Marker Utilities, Marker Routing, Pulse/RF Blank
Example	:SOUR:RAD:ARB:MDES:PULS M2
Initial S/W Revision	A.05.00

Marker 3

Sets marker 3 to be used for the pulse/RF blanking function.

Key Path	Source, Modulation Setup, ARB, Marker Utilities, Marker Routing, Pulse/RF Blank
Example	:SOUR:RAD:ARB:MDES:PULS M3
Initial S/W Revision	A.05.00

Marker 4

Sets marker 4 to be used for the pulse/RF blanking function.

Key Path	Source, Modulation Setup, ARB, Marker Utilities, Marker Routing, Pulse/RF Blank
Example	:SOUR:RAD:ARB:MDES:PULS M4
Initial S/W Revision	A.05.00

ALC Hold

Allows you to specify which marker is routed for use within the ALC hold function. The ALC hold marker function holds the ALC circuitry at the average value of the sample points set by the marker.

The ALC hold function operates during the low periods of the marker signal. The marker polarity determines when the marker signal is high. For positive polarity, this is during the marker points. For a negative polarity, this is when there are no marker points.

Key Path	Source, Modulation Setup, ARB, Marker Utilities, Marker Routing
Remote Command	:SOURce:RADio:ARB:MDEStination:ALCHold NONE M1 M2 M3 M4 :SOURce:RADio:ARB:MDEStination:ALCHold?
Example	:SOUR:RAD:ARB:MDES:ALCH NONE
Dependencies	When a new waveform is selected for playback the settings contained within the associated waveform header file are applied to the ARB. The ALC hold setting is one of the values stored within the header file. If the newly selected waveform file has an associated header file, the ALC hold setting is updated with the value from the header file. The ALC hold setting will remain unchanged if the newly selected waveform does not have an associated header file.
Range	None M1 M2 M3 M4
Initial S/W Revision	A.05.00

None

Sets no marker to be used for the ALC hold function, essentially turning the ALC hold function off.

Key Path	Source, Modulation Setup, ARB, Marker Utilities, Marker Routing, ALC Hold
Example	:SOUR:RAD:ARB:MDES:PULS NONE
Initial S/W Revision	A.05.00

Marker 1

Sets marker 1 to be used for the ALC hold function.

Key Path	Source, Modulation Setup, ARB, Marker Utilities, Marker Routing, ALC Hold
Example	:SOUR:RAD:ARB:MDES:PULS M1
Initial S/W Revision	A.05.00

Marker 2

Sets marker 2 to be used for the ALC hold function.

Key Path	Source, Modulation Setup, ARB, Marker Utilities, Marker Routing, ALC Hold
Example	:SOUR:RAD:ARB:MDES:PULS M2
Initial S/W Revision	A.05.00

Marker 3

Sets marker 3 to be used for the ALC hold function.

Key Path	Source, Modulation Setup, ARB, Marker Utilities, Marker Routing, ALC Hold
Example	:SOUR:RAD:ARB:MDES:PULS M3
Initial S/W Revision	A.05.00

Marker 4

Sets marker 4 to be used for the ALC hold function.

Key Path	Source, Modulation Setup, ARB, Marker Utilities, Marker Routing, ALC Hold
Example	:SOUR:RAD:ARB:MDES:PULS M4
Initial S/W Revision	A.05.00

Header Utilities

Allows access to the header utilities sub-menu. Pressing this key also causes the central display area to change to display the File Header Information view.

Key Path	Source, Modulation Setup, ARB
Dependencies	This key is only available if there is currently a waveform selected for playback. If no waveform is selected, the key is grayed out.
Initial S/W Revision	A.05.00

Clear Header

Allows you to clear the header information from the file header associated with the currently selected waveform.

Key Path	Source, Modulation Setup, ARB, Header Utilities
Remote Command	:SOURce:RADio:ARB:HEADer:CLEar
Example	:SOUR:RAD:ARB:HEAD:CLE
Notes	Attempting to clear the header details via SCPI when no waveform was selected for playback will generate an error.
Initial S/W Revision	A.05.00

Save Setup To Header

Allows you to save new file header information details to the file.

Key Path	Source, Modulation Setup, ARB, Header Utilities
Remote Command	:SOURce:RADio:ARB:HEADer:SAVE
Example	:SOUR:RAD:ARB:HEAD:SAVE
Notes	Attempting to save the header details via SCPI when no waveform was selected for playback will generate an error.
Initial S/W Revision	A.05.00

Query Waveform Unique ID (Remote Command Only)

Each Signal Studio waveform contains a unique waveform ID, which recorded in the header. This command allows you to query the unique waveform ID from the header. This is a SCPI only command. User can also check [Error! Reference source not found.](#) for waveform unique ID display.

Remote Command	:MMEMory:HEADer:ID? "<file name>"
Example	:MMEM:HEAD:ID? "test.wfm" (query the waveform already loaded into the ARB memory) :MMEM:HEAD:ID? "D: VARB\test.wfm" (query the waveform on the hard disk by absolute path) :MMEM:HEAD:ID? "NVWFM:test.wfm" (query the waveform on the hard disk by MSUS)
Notes	SCPI query only. The queried waveform file can be in ARB memory, or on hard disk. If want to query ARB in ARB memory, then give out the file name directly. If want to query ARB on the hard disk, then absolute file path or MSUS should be given along with the file name. The valid MSUS is "NVWFM" which is mapped to D: VARB on hard disk. If the file cannot be found in ARB memory or on hard disk, an error is generated and value -1 is returned
Initial S/W Revision	A.09.00

Bus Trigger Command (Remote Command Only)

Used to initiate an immediate trigger event if the trigger source is set to Bus.

Remote Command	:SOURce:RADio:ARB:TRIGger:INITiate
Example	:SOUR:RAD:ARB:TRIG:INIT
Initial S/W Revision	A.05.00

AM

Allows access to the menu for configuring the Amplitude Modulation.

Key Path	Source, Modulation Setup
Initial S/W Revision	A.05.00

AM

Enables or disables the amplitude modulation.

Turning AM on when another modulation format is already on results in the previous modulation format being turned off and the generation of an error.

Key Path	Source, Modulation Setup, AM
Remote Command	:SOURce:AM:STATe :SOURce:AM:STATe?
Example	:SOUR:AM:STAT OFF
Preset	Off
Range	On Off
Initial S/W Revision	A.05.00

AM Depth

Allows you to set the amplitude modulation depth in percent.

Key Path	Source, Modulation Setup, AM
Remote Command	:SOURce:AM[:DEPTh] [:LINear] :SOURce:AM[:DEPTh] [:LINear]?
Example	:SOUR:AM 0.1
Preset	0.1 %
Min	0.1 %
Max	95.0 %
Initial S/W Revision	A.05.00

AM Rate

Allows you to set the internal amplitude modulation rate.

Key Path	Source, Modulation Setup, AM
Remote Command	:SOURce:AM:INTernal:FREQuency :SOURce:AM:INTernal:FREQuency?
Example	:SOUR:AM:INT:FREQ 40.0 Hz
Preset	400.0 Hz
Min	10 Hz
Max	40 kHz
Initial S/W Revision	A.05.00

FM

Allows access to the menu for configuring the frequency modulation.

Key Path	Source, Modulation Setup
Initial S/W Revision	A.05.00

FM

Enables or disables the frequency modulation.

Turning FM on when another modulation format is already on results in the previous modulation format being turned off and the generation of an error.

Key Path	Source, Modulation Setup, FM
Remote Command	:SOURce:FM:STATe :SOURce:FM:STATe?
Example	:SOUR:FM:STAT OFF
Preset	Off
Range	On Off
Initial S/W Revision	A.05.00

FM Deviation

Allows you to set the frequency modulation deviation.

Key Path	Source, Modulation Setup, FM
----------	------------------------------

Remote Command	:SOURce:FM[:DEVIation] :SOURce:FM[:DEVIation]?
Example	:SOUR:FM 1.00 kHz
Preset	1.00 Hz
Min	1.00 Hz
Max	100.00 kHz
Initial S/W Revision	A.05.00

FM Rate

Allows you to set the internal frequency modulation rate.

Key Path	Source, Modulation Setup, FM
Remote Command	:SOURce:FM:INTernal:FREQuency :SOURce:FM:INTernal:FREQuency?
Example	:SOUR:FM:INT:FREQ 40.0 Hz
Preset	400.0 Hz
Min	10 Hz
Max	40 kHz
Initial S/W Revision	A.05.00

PM

Allows access to the menu for configuring the phase modulation.

Key Path	Source, Modulation Setup
Initial S/W Revision	A.05.00

PM

Enables or disables the phase modulation.

Turning PM on when another modulation format is already on results in the previous modulation format being turned off and the generation of an error.

Key Path	Source, Modulation Setup, PM
Remote Command	:SOURce:PM:STATe :SOURce:PM:STATe?
Example	:SOUR:PM:STAT OFF

Preset	Off
Range	On Off
Initial S/W Revision	A.05.00

PM Deviation

Allows you to set the phase modulation deviation.

Key Path	Source, Modulation Setup, PM
Remote Command	:SOURce:PM[:DEVIation] :SOURce:PM[:DEVIation]?
Example	:SOUR:PM 1.00 rad
Preset	0.1 rad
Min	0.1 rad
Max	20.0 rad
Initial S/W Revision	A.05.00

PM Rate

Allows you to set the internal phase modulation rate.

Key Path	Source, Modulation Setup, PM
Remote Command	:SOURce:PM:INTernal:FREQuency :SOURce:PM:INTernal:FREQuency?
Example	:SOUR:PM:INT:FREQ 40.0 Hz
Preset	400.0 Hz
Min	10 Hz
Max	40 kHz
Initial S/W Revision	A.05.00

List Sequencer

Allows you access to the sub-menus for configuring the list sequencer.

List sequences allows you to enter frequencies and amplitudes at unequal intervals in nonlinear ascending, descending or random order. Each step within the list can also include its own waveform file for playback, step duration, trigger event and trigger output.

The complexities involved in configuring the list sequencer do not lend itself to manual configuration; hence the manual configuration for this feature is limited. For easier configuration of the list sequencer, it is recommended that you use either SCPI or load a tab delimited file containing the setup parameters in a

tabular form. The details of the SCPI for configuring the list sequencer can be found in "[Step Configuration \(Remote Command Only\)](#)" on page 2554.

Once the List Sequencer has been configured using the front panel, SCPI, or loading in a tab delimited file, the sequence must be initiated using the front panel Initiate Sequence key or the corresponding SCPI command.

Key Path	Source
Initial S/W Revision	A.05.00

Sequencer

Allows you to set the state of the list sequencer. When the list sequencer is on, the source is outputting the sequence defined by the sequencer. When the list sequencer is off, the source outputs a single waveform segment or sequence (independent mode) at a single frequency and amplitude.

Key Path	Source, List Sequencer
Remote Command	:SOURce:LIST[:STATe] ON OFF 1 0 :SOURce:LIST[:STATe]?
Example	:SOUR:LIST OFF
Notes	When the sequencer is set to ON, the list sequencer controls the output of the source.
Couplings	When in Sequence Analyzer mode and the list sequencer state is Off, Include Source is forced to No, and the Include Source key is grayed out. When in Sequence Analyzer mode and the list sequencer state is On, Include Source is available to set. And, an ARB memory related operation, like load or delete will be rejected.
Preset	Off
Range	On Off
Initial S/W Revision	A.05.00

Initiate Sequence

Pressing this key arms the sequence for single execution. Once the sequence is armed the source begins the sequence as soon as the trigger is received. If the trigger is set to Free Run, the sequence starts immediately.

Key Path	Source, List Sequencer
Remote Command	:SOURce:LIST:TRIGger[:IMMediate]
Example	:SOUR:LIST:TRIG
Notes	When in Sequence Analyzer mode and Include Source is Yes, the Initiate list sequencer operation is rejected, and the key is grayed out, since source list sequence request is sent to physics via Parallel batch by sequence analyzer. If the file needed by the sequencer is not already in ARB memory, the sequence cannot be initiated

	and an error will be generated. There is a blocking SCPI query which can be used to query if source list sequence being initiated successfully or not. (see " Query List Sequence Initiation Armed Status (Remote Command Only) " on page 2565 Query Source List Sequence Armed Status)
Dependencies	Under the Sequence Analyzer Mode, if Meas Setup->Include Source is set to YES, Source->List Sequencer->Initiate Sequence is disabled.
Initial S/W Revision	A.05.00

List Sequencer Setup

Allows you access to the list sequencer setup menus.

Key Path	Source, List Sequencer
----------	------------------------

Number of Steps

Allows you to specify the number of steps within the list sequence.

Key Path	Source, List Sequencer, List Sequencer Setup
Remote Command	:SOURce:LIST:NUMBer:STEPs <integer> :SOURce:LIST:NUMBer:STEPs?
Example	:SOUR:LIST:NUMB:STEP 1
Notes	Increasing the number of steps creates additional steps at the end of the list, with all the settings within the steps set to their default values. Decreasing the number of steps removes steps from the end of the list. The settings within the removed steps are not reset. This means that increasing the number of steps again would allow you to retrieve these steps.
Dependencies	The Step Count parameter is increased or decreased when you insert or delete a point from within the GUI interface to the sequencer.
Preset	1
Min	1
Max	1000
Initial S/W Revision	A.05.00

Current Step

Allows you to select the step number you wish to view or edit.

Key Path	Source, List Sequencer, List Sequencer Setup
----------	--

Notes	No remote command, front panel only.
Preset	1
Min	1
Max	Step Count
Initial S/W Revision	A.05.00

Insert Step Before

Allows you to insert a new step, containing default values, before the currently selected step. Inserting a step will automatically increase the Step Count parameter by 1. If sequence already reaches upper limit of 1000 steps, then insert more step will be rejected and popup error –221, “Setting Conflict; Cannot insert more steps, maximum number of steps reached”

Key Path	Source, List Sequencer, List Sequencer Setup
Notes	No remote command, front panel only. If the list already contains the maximum limit of 1000 steps, no operation will be made after pressing this key.
Initial S/W Revision	A.05.00

Delete Step

Allows you to delete the current step. Deleting a step will automatically decrease the Step Count parameter by 1. If sequence only has one step left, delete step will be rejected and popup error –221, “Setting conflict; Cannot delete current step, minimum number of steps reached”

Key Path	Source, List Sequencer, List Sequencer Setup
Notes	No remote command, Front Panel key only. If the list already contains the minimum limit of 1 step, no operation will be made after pressing this key
Initial S/W Revision	A.05.00

Clear List

Allows you to clear the list. Clearing the list sets the number of steps to the default value of 1 and sets the parameters for the only step to their default values.

Key Path	Source, List Sequencer, List Sequencer Setup
Initial S/W Revision	A.05.00

Step Trigger

Allows access to the sub-menu for selecting the trigger input for the current step.

Key Path	Source, List Sequencer, List Sequencer Setup
Remote Command	:SOURce:LIST:STEP[1] 2 3...1000:SETup:INPut:TRIGger IMMEDIATE INTERNAL EXTERNAL2 KEY BUS EXTERNAL4 :SOURce:LIST:STEP[1] 2 3...1000:SETup:INPut:TRIGger?
Example	:SOUR:LIST:STEP2:SET:INP:TRIG BUS :SOUR:LIST:STEP2:SET:INP:TRIG?
Notes	SCPI is supported after A.09.40
Preset	Free Run
Range	Free Run Internal Manual (Trigger Key) Bus External 2 EXTERNAL4
Initial S/W Revision	A.05.00

Free Run

Sets the trigger input for the current step to Free Run.

Key Path	Source, List Sequencer, List Sequencer Setup, Step Trigger
Example	:SOUR:LIST:STEP2:SET:INP:TRIG IMM
Notes	SCPI is supported after A.09.40
Initial S/W Revision	A.05.00

Internal

Sets the trigger input for the current step to Internal.

Key Path	Source, List Sequencer, List Sequencer Setup, Step Trigger
Example	:SOUR:LIST:STEP2:SET:INP:TRIG INT
Notes	SCPI is supported after A.09.40
Initial S/W Revision	A.05.00

Manual (Trigger Key)

Sets the trigger input for the current step to Manual (Trigger Key). Any step in the sequence set to Manual will cause the sequence execution to stop until the manual trigger key is pressed. Sending the Bus Trigger SCPI command will have no effect. At any point in the sequence where the list sequencer is paused waiting for a software trigger, a pop up dialog is displayed until the trigger event occurs.

Key Path	Source, List Sequencer, List Sequencer Setup, Step Trigger
Example	:SOUR:LIST:STEP2:SET:INP:TRIG KEY
Notes	SCPI is supported after A.09.40
Initial S/W Revision	A.05.00

Bus

Sets the trigger input for the current step to Bus. Any step in the sequence set to Bus will cause the sequence execution to stop until the Bus Trigger SCPI command is sent. Pressing the manual trigger key has no effect. At any point in the sequence where the list sequencer is paused waiting for a software trigger, a pop up dialog is displayed until the trigger event occurs.

Key Path	Source, List Sequencer, List Sequencer Setup, Step Trigger
Example	:SOUR:LIST:STEP2:SET:INP:TRIG BUS
Notes	SCPI is supported after A.09.40
Initial S/W Revision	A.05.00

External 2

Sets the trigger input for the current step to External 2.

Key Path	Source, List Sequencer, List Sequencer Setup, Step Trigger
Example	:SOUR:LIST:STEP2:SET:INP:TRIG EXT2
Notes	SCPI is supported after A.09.40
Notes	Note: When on E6640A, trigger 2 is a bi-directional trigger port. So when trigger 2 has been configured as OUTPUT type, choosing External 2 as the input trigger for the current step will generate error.
Initial S/W Revision	A.05.00

Transition Time

Allows you to specify the transition time for the current step.

The transition time is the amount of time allowed for the source to settle at the current frequency or amplitude value.

Transition Time should not be taken as additional time before or inside the Step Duration. You can set a value for the settling time to allow the source output frequency or amplitude to become stable. Make sure that during this period of time, you do not use the source output signal.

The following table lists recommended values for appropriate settling times to allow for changes within the source.

Value Changed	Recommended Transition Time
Frequency	500 μ s
Amplitude	100 μ s to within 0.1 dB 20 μ s to within 1.0 dB

If the Transition Time value is shorter than the time necessary for the hardware to settle and a List Sequence is initiated, a **warning** is generated.

If the Transition Time value is longer than the Step Duration, an error is generated when initiating a source list sequence. For source list sequence, transition time is included in the step duration length. If the Transition Time value is longer than the Step Duration Time, the real step duration length is extended to equal the transition time and cause a timing shift.

Key Path	Source, List Sequencer, List Sequencer Setup
Remote Command	:SOURce:LIST:STEP[1] 2 3...1000:SETup:TRANsition:TIME <time> :SOURce:LIST:STEP[1] 2 3...1000:SETup:TRANsition:TIME?
Example	:SOUR:LIST:STEP2:SET:TRAN:TIME 1ms :SOUR:LIST:STEP2:SET:TRAN:TIME?
Notes	SCPI is supported after A.09.40
Preset	1.0 ms
Min	0.0 ms
Max	4.0 ks
Initial S/W Revision	A.05.00

Radio Setup

Allows you access to the sub-menus for setting up the radio standard, band, and radio band link direction for the current step.

Key Path	Source, List Sequencer, List Sequencer Setup
Notes	No remote command, front panel only.
Initial S/W Revision	A.05.00

Radio Standard

Allows access to the sub-menus for selecting the radio standard and the associated radio band for use in the current step.

Key Path	Source, List Sequencer, List Sequencer Setup, Radio Setup
Remote Command	:SOURce:LIST:STEP[1] 2 3...1000:SETup:RADio:BAND NONE PGSM EGSM RGSM DCS1800 PCS1900 TGSM810 GSM450 GSM480 GSM700 GSM850 BANDI BANDII BANDIII BANDIV BANDV BANDVI BANDVII BANDVIII BANDIX BANDX BANDXI BANDXII BANDXIII BANDXIV BANDXIX USCELL USPCS JAPAN KOREAN NMT IMT2K UPPER SECOND PAMR400 PAMR800 IMTEXT PCS1DOT9G AWS US2DOT5G PUBLIC LOWER NONE BAND1 BAND2 BAND3 BAND4 BAND5 BAND6 BAND7 BAND8 BAND10 BAND11 BAND12 BAND13 BAND14 BAND17 BAND18 BAND19 BAND20 BAND21 BAND24 BAND25 BAND26 BAND27 BAND28 BAND31 BAND33 BAND34 BAND35 BAND36 BAND37 BAND38

	BAND39 BAND40 BAND41 BAND42 BAND43 BAND44 BANDA BANDB BANDC BANDD BANDE BANDF :SOURce:LIST:STEP[1] 2 3...1000:SETup: RADio:BAND?
Example	:SOUR:LIST:STEP2:SET:RAD:BAND PGSM :SOUR:LIST:STEP2:SET:RAD:BAND?
Notes	SCPI is supported after A.09.40
Initial S/W Revision	A.05.00

None

Selects no radio standard for use on the current step.

Key Path	Source, List Sequencer, List Sequencer Setup, Radio Setup, Radio Standard
Example	:SOUR:LIST:STEP2:SET:RAD:BAND NONE
Notes	SCPI is supported after A.09.40
Initial S/W Revision	A.05.00

GSM/EDGE

Pressing this key once selects GSM/EDGE as the radio standard and the current GSM/EDGE band as the active channel band. Pressing this key again allows access to the sub-menus for selecting a different GSM/EDGE band.

Key Path	Source, List Sequencer, List Sequencer Setup, Radio Setup, Radio Standard
Initial S/W Revision	A.05.00

P-GSM

Selects P-GSM as the band for the current step.

Key Path	Source, List Sequencer, List Sequencer Setup, Radio Setup, Radio Standard, GSM/EDGE
Initial S/W Revision	A.05.00

E-GSM

Selects E-GSM as the band for the current step.

Key Path	Source, List Sequencer, List Sequencer Setup, Radio Setup, Radio Standard, GSM/EDGE
Initial S/W Revision	A.05.00

R-GSM

Selects R-GSM as the band for the current step.

Key Path	Source, List Sequencer, List Sequencer Setup, Radio Setup, Radio Standard, GSM/EDGE
Initial S/W Revision	A.05.00

DCS 1800

Selects DCS 1800 as the band for the current step.

Key Path	Source, List Sequencer, List Sequencer Setup, Radio Setup, Radio Standard, GSM/EDGE
Initial S/W Revision	A.05.00

PCS 1900

Selects PCS 1900 as the band for the current step.

Key Path	Source, List Sequencer, List Sequencer Setup, Radio Setup, Radio Standard, GSM/EDGE
Initial S/W Revision	A.05.00

GSM 450

Selects GSM 450 as the band for the current step.

Key Path	Source, List Sequencer, List Sequencer Setup, Radio Setup, Radio Standard, GSM/EDGE
Initial S/W Revision	A.05.00

GSM 480

Selects GSM 480 as the band for the current step.

Key Path	Source, List Sequencer, List Sequencer Setup, Radio Setup, Radio Standard, GSM/EDGE
Initial S/W Revision	A.05.00

GSM 850

Selects GSM 850 as the band for the current step.

Key Path	Source, List Sequencer, List Sequencer Setup, Radio Setup, Radio Standard, GSM/EDGE
Initial S/W Revision	A.05.00

GSM 700

Selects GSM 700 as the band for the current step.

Key Path	Source, List Sequencer, List Sequencer Setup, Radio Setup, Radio Standard, GSM/EDGE
Initial S/W Revision	A.05.00

T-GSM 810

Selects T-GSM 810 as the band for the current step.

Key Path	Source, List Sequencer, List Sequencer Setup, Radio Setup, Radio Standard, GSM/EDGE
Initial S/W Revision	A.05.00

WCDMA

Pressing this key once selects WCDMA as the radio standard and the current WCDMA band as the active channel band. Pressing this key again allows access to the sub-menus for selecting a different WCDMA band.

Key Path	Source, List Sequencer, List Sequencer Setup, Radio Setup, Radio Standard
Initial S/W Revision	A.05.00

Band I

Selects Band I as the band for the current step.

Key Path	Source, List Sequencer, List Sequencer Setup, Radio Setup, Radio Standard, WCDMA
Initial S/W Revision	A.05.00

Band II

Selects Band II as the band for the current step.

Key Path	Source, List Sequencer, List Sequencer Setup, Radio Setup, Radio Standard, WCDMA
Initial S/W Revision	A.05.00

Band III

Selects Band III as the band for the current step.

Key Path	Source, List Sequencer, List Sequencer Setup, Radio Setup, Radio Standard, WCDMA
Initial S/W Revision	A.05.00

Band IV

Selects Band IV as the band for the current step.

Key Path	Source, List Sequencer, List Sequencer Setup, Radio Setup, Radio Standard, WCDMA
Initial S/W Revision	A.05.00

Band V

Selects Band V as the band for the current step.

Key Path	Source, List Sequencer, List Sequencer Setup, Radio Setup, Radio Standard, WCDMA
Initial S/W Revision	A.05.00

Band VI

Selects Band VI as the band for the current step.

Key Path	Source, List Sequencer, List Sequencer Setup, Radio Setup, Radio Standard, WCDMA
Initial S/W Revision	A.05.00

Band VII

Selects Band VII as the band for the current step.

Key Path	Source, List Sequencer, List Sequencer Setup, Radio Setup, Radio Standard, WCDMA
Initial S/W Revision	A.05.00

Band VIII

Selects Band VIII as the band for the current step.

Key Path	Source, List Sequencer, List Sequencer Setup, Radio Setup, Radio Standard, WCDMA
Initial S/W Revision	A.05.00

Band IX

Selects Band IX as the band for the current step.

Key Path	Source, List Sequencer, List Sequencer Setup, Radio Setup, Radio Standard, WCDMA
Initial S/W Revision	A.05.00

Band X

Selects Band X as the band for the current step.

Key Path	Source, List Sequencer, List Sequencer Setup, Radio Setup, Radio Standard, WCDMA
Initial S/W Revision	A.05.00

Band XI

Selects Band XI as the band for the current step.

Key Path	Source, List Sequencer, List Sequencer Setup, Radio Setup, Radio Standard, WCDMA
Initial S/W Revision	A.05.00

Band XII

Selects Band XII as the band for the current step.

Key Path	Source, List Sequencer, List Sequencer Setup, Radio Setup, Radio Standard, WCDMA
Initial S/W Revision	A.05.00

Band XIII

Selects Band XIII as the band for the current step.

Key Path	Source, List Sequencer, List Sequencer Setup, Radio Setup, Radio Standard, WCDMA
Initial S/W Revision	A.05.00

Band XIV

Selects Band XIV as the band for the current step.

Key Path	Source, List Sequencer, List Sequencer Setup, Radio Setup, Radio Standard, WCDMA
Initial S/W Revision	A.05.00

Band XIX

Selects Band XIX as the band for the current step.

Key Path	Source, List Sequencer, List Sequencer Setup, Radio Setup, Radio Standard, WCDMA
Initial S/W Revision	A.14.50

CDMA 2000 / 1xEVDO

Pressing this key once selects CDMA 2000/1xEVDO as the radio standard and the current CDMA 2000/1xEVDO band as the active channel band. Pressing this key again allows access to the sub-menus for selecting a different CDMA 2000/1xEVDO band.

Key Path	Source, List Sequencer, List Sequencer Setup, Radio Setup, Radio Standard
Initial S/W Revision	A.05.00

US CELL

Selects US Cell as the band for the current step.

Key Path	Source, List Sequencer, List Sequencer Setup, Radio Setup, Radio Standard, CDMA 2000 / 1xEVDO
Initial S/W Revision	A.05.00

US PCS

Selects US PCS as the band for the current step.

Key Path	Source, List Sequencer, List Sequencer Setup, Radio Setup, Radio Standard, CDMA 2000 / 1xEVDO
Initial S/W Revision	A.05.00

Japan Cell

Selects Japan Cell as the band for the current step.

Key Path	Source, List Sequencer, List Sequencer Setup, Radio Setup, Radio Standard, CDMA 2000 / 1xEVDO
Initial S/W Revision	A.05.00

Korean PCS

Selects Korean PCS as the band for the current step.

Key Path	Source, List Sequencer, List Sequencer Setup, Radio Setup, Radio Standard, CDMA 2000 / 1xEVDO
Initial S/W Revision	A.05.00

NMT 450

Selects NMT 450 as the band for the current step.

Key Path	Source, List Sequencer, List Sequencer Setup, Radio Setup, Radio Standard, CDMA 2000 / 1xEVDO
Initial S/W Revision	A.05.00

IMT 2000

Selects IMT 2000 as the band for the current step.

Key Path	Source, List Sequencer, List Sequencer Setup, Radio Setup, Radio Standard, CDMA 2000 / 1xEVDO
Initial S/W Revision	A.05.00

Upper 700

Selects Upper 700 as the band for the current step.

Key Path	Source, List Sequencer, List Sequencer Setup, Radio Setup, Radio Standard, CDMA 2000 / 1xEVDO
Initial S/W Revision	A.05.00

Secondary 800

Selects Secondary 800 as the band for the current step.

Key Path	Source, List Sequencer, List Sequencer Setup, Radio Setup, Radio Standard, CDMA 2000 / 1xEVDO
Initial S/W Revision	A.05.00

400 Euro PAMR

Selects 400 Euro PAMR as the band for the current step.

Key Path	Source, List Sequencer, List Sequencer Setup, Radio Setup, Radio Standard, CDMA 2000 / 1xEVDO
Initial S/W Revision	A.05.00

800 PAMR

Selects 800 PAMR as the band for the current step.

Key Path	Source, List Sequencer, List Sequencer Setup, Radio Setup, Radio Standard, CDMA 2000 / 1xEVDO
Initial S/W Revision	A.05.00

2.5GHz IMT EXT

Selects 2.5 GHz IMT EXT as the band for the current step.

Key Path	Source, List Sequencer, List Sequencer Setup, Radio Setup, Radio Standard, CDMA 2000 / 1xEVDO
Initial S/W Revision	A.05.00

US PCS 1.9GHz

Selects US PCS 1.9 GHz as the band for the current step.

Key Path	Source, List Sequencer, List Sequencer Setup, Radio Setup, Radio Standard, CDMA 2000 / 1xEVDO
Initial S/W Revision	A.05.00

AWS

Selects AWS as the band for the current step.

Key Path	Source, List Sequencer, List Sequencer Setup, Radio Setup, Radio Standard, CDMA 2000 / 1xEVDO
Initial S/W Revision	A.05.00

US 2.5GHz

Selects US 2.5 GHz as the band for the current step.

Key Path	Source, List Sequencer, List Sequencer Setup, Radio Setup, Radio Standard, CDMA 2000 / 1xEVDO
Initial S/W Revision	A.05.00

700 Public Safety

Selects 700 Public Safety as the band for the current step.

Key Path	Source, List Sequencer, List Sequencer Setup, Radio Setup, Radio Standard, CDMA 2000 / 1xEVDO
Initial S/W Revision	A.05.00

C2K Lower 700

Selects C2K Lower 700 as the band for the current step.

Key Path	Source, List Sequencer, List Sequencer Setup, Radio Setup, Radio Standard, CDMA 2000 / 1xEVDO
Initial S/W Revision	A.05.00

LTE

Pressing this key once selects LTE FDD as the radio standard and the current LTE FDD band as the active channel band. Pressing this key again allows access to the sub-menus for selecting a different LTE FDD band.

Key Path	Source, List Sequencer, List Sequencer Setup, Radio Setup, Radio Standard
Initial S/W Revision	A.09.50

BAND 1

Selects BAND 1 as the band for the current step.

Key Path	Source, List Sequencer, List Sequencer Setup, Radio Setup, Radio Standard, LTE
Initial S/W Revision	A.09.50

BAND 2

Selects BAND 2 as the band for the current step.

Key Path	Source, List Sequencer, List Sequencer Setup, Radio Setup, Radio Standard, LTE
Initial S/W Revision	A.09.50

BAND 3

Selects BAND 3 as the band for the current step.

Key Path	Source, List Sequencer, List Sequencer Setup, Radio Setup, Radio Standard, LTE
Initial S/W Revision	A.09.50

BAND 4

Selects BAND 4 as the band for the current step.

Key Path	Source, List Sequencer, List Sequencer Setup, Radio Setup, Radio Standard, LTE
Initial S/W Revision	A.09.50

BAND 5

Selects BAND 5 as the band for the current step.

Key Path	Source, List Sequencer, List Sequencer Setup, Radio Setup, Radio Standard, LTE
Initial S/W Revision	A.09.50

BAND 6

Selects BAND 6 as the band for the current step.

Key Path	Source, List Sequencer, List Sequencer Setup, Radio Setup, Radio Standard, LTE
Initial S/W Revision	A.09.50

BAND 7

Selects BAND 7 as the band for the current step.

Key Path	Source, List Sequencer, List Sequencer Setup, Radio Setup, Radio Standard, LTE
Initial S/W Revision	A.09.50

BAND 8

Selects BAND 8 as the band for the current step.

Key Path	Source, List Sequencer, List Sequencer Setup, Radio Setup, Radio Standard, LTE
Initial S/W Revision	A.09.50

BAND 9

Selects BAND 9 as the band for the current step.

Key Path	Source, List Sequencer, List Sequencer Setup, Radio Setup, Radio Standard, LTE
Initial S/W Revision	A.09.50

BAND 10

Selects BAND 10 as the band for the current step.

Key Path	Source, List Sequencer, List Sequencer Setup, Radio Setup, Radio Standard, LTE
Initial S/W Revision	A.09.50

BAND 11

Selects BAND 11 as the band for the current step.

Key Path	Source, List Sequencer, List Sequencer Setup, Radio Setup, Radio Standard, LTE
Initial S/W Revision	A.09.50

BAND 12

Selects BAND 12 as the band for the current step.

Key Path	Source, List Sequencer, List Sequencer Setup, Radio Setup, Radio Standard, LTE
Initial S/W Revision	A.09.50

BAND 13

Selects BAND 13 as the band for the current step.

Key Path	Source, List Sequencer, List Sequencer Setup, Radio Setup, Radio Standard, LTE
Initial S/W Revision	A.09.50

BAND 14

Selects BAND 14 as the band for the current step.

Key Path	Source, List Sequencer, List Sequencer Setup, Radio Setup, Radio Standard, LTE
Initial S/W Revision	A.09.50

BAND 17

Selects BAND 17 as the band for the current step.

Key Path	Source, List Sequencer, List Sequencer Setup, Radio Setup, Radio Standard, LTE
Initial S/W Revision	A.09.50

BAND 18

Selects BAND 18 as the band for the current step.

Key Path	Source, List Sequencer, List Sequencer Setup, Radio Setup, Radio Standard, LTE
Initial S/W Revision	A.09.50

BAND 19

Selects BAND 19 as the band for the current step.

Key Path	Source, List Sequencer, List Sequencer Setup, Radio Setup, Radio Standard, LTE
Initial S/W Revision	A.09.50

BAND 20

Selects BAND 20 as the band for the current step.

Key Path	Source, List Sequencer, List Sequencer Setup, Radio Setup, Radio Standard, LTE
Initial S/W Revision	A.09.50

BAND 21

Selects BAND 21 as the band for the current step.

Key Path	Source, List Sequencer, List Sequencer Setup, Radio Setup, Radio Standard, LTE
Initial S/W Revision	A.09.50

BAND 24

Selects BAND 24 as the band for the current step.

Key Path	Source, List Sequencer, List Sequencer Setup, Radio Setup, Radio Standard, LTE
Initial S/W Revision	A.09.50

BAND 25

Selects BAND 25 as the band for the current step.

Key Path	Source, List Sequencer, List Sequencer Setup, Radio Setup, Radio Standard, LTE
Initial S/W Revision	A.09.50

BAND 26

Selects BAND 26 as the band for the current step.

Key Path	Source, List Sequencer, List Sequencer Setup, Radio Setup, Radio Standard, LTE
Initial S/W Revision	A.12.53

BAND 27

Selects BAND 27 as the band for the current step.

Key Path	Source, List Sequencer, List Sequencer Setup, Radio Setup, Radio Standard, LTE
Initial S/W Revision	A.14.00

BAND 28

Selects BAND 28 as the band for the current step.

Key Path	Source, List Sequencer, List Sequencer Setup, Radio Setup, Radio Standard, LTE
Initial S/W Revision	A.14.00

BAND 31

Selects BAND 31 as the band for the current step.

Key Path	Source, List Sequencer, List Sequencer Setup, Radio Setup, Radio Standard, LTE
Initial S/W Revision	A.14.00

LTE TDD

Sets LTE TDD as the radio standard for use and accesses the LTE TDD specific channel band sub-menus..

Key Path	Source, Frequency, Radio Setup, Radio Standard
Initial S/W Revision	A.11.50

BAND 33

Selects BAND 33 as the band for the current step.

Key Path	Source, Frequency, Radio Setup, Radio Standard, LTE TDD
Example	:SOUR:FREQ:CHAN:BAND BAND33
Initial S/W Revision	A.11.50

BAND 34

Selects BAND 34 as the band for the current step.

Key Path	Source, Frequency, Radio Setup, Radio Standard, LTE TDD
Example	:SOUR:FREQ:CHAN:BAND BAND34
Initial S/W Revision	A.11.50

BAND 35

Selects BAND 35 as the band for the current step.

Key Path	Source, Frequency, Radio Setup, Radio Standard, LTE TDD
Example	:SOUR:FREQ:CHAN:BAND BAND35
Initial S/W Revision	A.11.50

BAND 36

Selects BAND 36 as the band for the current step.

Key Path	Source, Frequency, Radio Setup, Radio Standard, LTE TDD
Example	:SOUR:FREQ:CHAN:BAND BAND36
Initial S/W Revision	A.11.50

BAND 37

Selects BAND 37 as the band for the current step.

Key Path	Source, Frequency, Radio Setup, Radio Standard, LTE TDD
Example	:SOUR:FREQ:CHAN:BAND BAND37
Initial S/W Revision	A.11.50

BAND 38

Selects BAND 38 as the band for the current step.

Key Path	Source, Frequency, Radio Setup, Radio Standard, LTE TDD
Example	:SOUR:FREQ:CHAN:BAND BAND38
Initial S/W Revision	A.11.50

BAND 39

Selects BAND 39 as the band for the current step.

Key Path	Source, Frequency, Radio Setup, Radio Standard, LTE TDD
Example	:SOUR:FREQ:CHAN:BAND BAND39
Initial S/W Revision	A.11.50

BAND 40

Selects BAND 40 as the band for the current step.

Key Path	Source, Frequency, Radio Setup, Radio Standard, LTE TDD
Example	:SOUR:FREQ:CHAN:BAND BAND40
Initial S/W Revision	A.11.50

BAND 41

Selects BAND 41 as the band for the current step.

Key Path	Source, Frequency, Radio Setup, Radio Standard, LTE TDD
Example	:SOUR:FREQ:CHAN:BAND BAND41
Initial S/W Revision	A.11.50

BAND 42

Selects BAND 42 as the band for the current step.

Key Path	Source, Frequency, Radio Setup, Radio Standard, LTE TDD
Example	:SOUR:FREQ:CHAN:BAND BAND42
Initial S/W Revision	A.11.50

BAND 43

Selects BAND 43 as the band for the current step.

Key Path	Source, Frequency, Radio Setup, Radio Standard, LTE TDD
Example	:SOUR:FREQ:CHAN:BAND BAND43
Initial S/W Revision	A.11.50

BAND 44

Selects BAND 44 as the band for the current step.

Key Path	Source, List Sequencer, List Sequencer Setup, Radio Setup, Radio Standard, LTE TDD
Initial S/W Revision	A.14.00

TDSCDMA

Sets TDSCDMA as the radio standard for use and accesses the TDSCDMA specific channel band sub-menus..

Key Path	Source, Frequency, Radio Setup, Radio Standard
Initial S/W Revision	A.11.50

BAND A

Selects BAND A as the band for the current step.

Key Path	Source, Frequency, Radio Setup, Radio Standard, TDSCDMA
Example	:SOUR:FREQ:CHAN:BAND BANDA
Initial S/W Revision	A.11.50

BAND B

Selects BAND B as the band for the current step.

Key Path	Source, Frequency, Radio Setup, Radio Standard, TDSCDMA
Example	:SOUR:FREQ:CHAN:BAND BANDB
Initial S/W Revision	A.11.50

BAND C

Selects BAND C as the band for the current step.

Key Path	Source, Frequency, Radio Setup, Radio Standard, TDSCDMA
Example	:SOUR:FREQ:CHAN:BAND BANDC
Initial S/W Revision	A.11.50

BAND D

Selects BAND D as the band for the current step.

Key Path	Source, Frequency, Radio Setup, Radio Standard, TDSCDMA
Example	:SOUR:FREQ:CHAN:BAND BANDD
Initial S/W Revision	A.11.50

BAND E

Selects BAND E as the band for the current step.

Key Path	Source, Frequency, Radio Setup, Radio Standard, TDSCDMA
----------	---

Example	:SOUR:FREQ:CHAN:BAND BANDE
Initial S/W Revision	A.11.50

BAND F

Selects BAND F as the band for the current step.

Key Path	Source, Frequency, Radio Setup, Radio Standard, TDSCDMA
Example	:SOUR:FREQ:CHAN:BAND BANDF
Initial S/W Revision	A.11.50

Radio Band Link

Allows you to specify the radio band link direction for the steps within the list sequence. The link is used in conjunction with the channel band and channel number to determine the output frequency.

When set to “Uplink”, the source will calculate the uplink frequency according to an uplink formula together with selected channel band and channel number. When set to “Downlink”, the source will calculate the downlink frequency according to a downlink formula together with selected channel band and channel number.

Key Path	Source, List Sequencer, List Sequencer Setup, Radio Setup
Remote Command	:SOURce:LIST:STEP [1] 2 3...1000:SETup:RADio:BAND:LINK DOWN UP :SOURce:LIST:STEP [1] 2 3...1000:SETup:RADio:BAND:LINK?
Example	:SOUR:LIST:STEP2:SET:RAD:BAND:LINK UP :SOUR:LIST:STEP2:SET:RAD:BAND:LINK?
Notes	SCPI is supported after A.09.40
Preset	DOWN
Range	DOWN UP
Initial S/W Revision	A.05.00

Channel

Allows you to specify the frequency of the current step via a channel number.

Key Path	Source, List Sequencer, List Sequencer Setup
Remote Command	:SOURce:LIST:STEP [1] 2 3...1000:SETup:CNFRrequency <double> :SOURce:LIST:STEP [1] 2 3...1000:SETup:CNFRrequency?
Example	:SOUR:LIST:STEP2:SET:CNFR 124 :SOUR:LIST:STEP2:SET:CNFR?
Notes	SCPI is supported after A.09.40.

	This SCPI is used to setup channel number or frequency setting, according to current Radio Band setting. If Radio Band is "NONE", then it's frequency. If Radio Band is not "NONE", then it's channel number.
Couplings	The channel number is coupled to the step frequency value. When the step frequency value is changed, the channel number will increase or decrease to match the new step frequency. If the step frequency is not at an exact match for a channel number, the nearest channel number is displayed, along with a greater than, or less than sign to indicate the frequency is above or below the channel number.
Preset	1
Min	0 (Please refer to for valid ranges.)
Max	10838 (Please refer to for valid ranges.)
Initial S/W Revision	A.05.00

Frequency

Allows you to specify a frequency value for the current step.

Key Path	Source, List Sequencer, List Sequencer Setup
Remote Command	:SOURce:LIST:STEP[1] 2 3...1000:SETup:CNFRfrequency <double> :SOURce:LIST:STEP[1] 2 3...1000:SETup:CNFRfrequency?
Example	:SOUR:LIST:STEP2:SET:CNFR 1GHz :SOUR:LIST:STEP2:SET:CNFR?
Notes	SCPI is supported after A.09.40. This SCPI is used to setup channel number or frequency setting, according to current Radio Band setting. If Radio Band is "NONE", then it's frequency. If Radio Band is not "NONE", then it's channel number.
Couplings	The frequency value is coupled to the channel band and number for the step, such that updates to the radio band and channel number will update the frequency value to the corresponding absolute frequency. The reverse is also true, changing the frequency value causes the value of the channel number to be updated.
Preset	1.00 GHz
Min	10.00 MHz
Max	Hardware Dependant: Option 503 = 3.6 GHz Option 504 = 3.9 GHz Option 506 = 6.00 GHz
Initial S/W Revision	A.05.00

Power

Allows you to specify a power value for the current step.

Key Path	Source, List Sequencer, List Sequencer Setup
Remote Command	:SOURce:LIST:STEP[1] 2 3...1000:SETup:AMPLitude <double> :SOURce:LIST:STEP[1] 2 3...1000:SETup:AMPLitude?
Example	:SOUR:LIST:STEP2:SET:AMPL -50dBm :SOUR:LIST:STEP2:SET:AMPL?
Notes	SCPI is supported after A.09.40
Notes	Amplitude corrections can be specified for use with the source. In the event of amplitude corrections being applied, the valid ranges for the RF power do not change dependant on the current amplitude correction setting. Instead, if the combination of RF power + amplitude correction is higher or lower than the source output range, the Source Unleveled bit is set and the “Source Unleveled” indicator will appear on status panel to indicate that the source cannot maintain the output power that has been requested. The multiport adapter RFIO TX ports and GPS ports cannot ensure power accuracy when power setting is lower than -130dBm, this power setting value is defined by the sum of RF Power setting and related amplitude correction value. But user settable value could be lower than this limit. When application detected there exists power setting lower than -130dBm on MPA RFIO TX ports, then popup warning message . When application detected there exists power setting lower than -130dBm on MPA GPS ports, then popup warning message . These are only warning messages, and check is performed when RF is ON.
Notes	The Min and Max value here defined UI settable amplitude range. This range is larger than actual amplitude range with level accuracy defined in spec.
Dependencies	The RF power is dependent on the RF output port and frequency, such that the current frequency and selected output port determine the valid range of power values.
Preset	-100 dBm
Min	The range of values depends on the current frequency and selected RF output port. Please refer to "RF Power" on page 2442 and the table RF Power Range for the valid ranges.
Max	The range of values depends on the current frequency and selected RF output port. Please refer to "RF Power" on page 2442 and the table RF Power Range for the valid ranges.
Initial S/W Revision	A.05.00

Waveform

Allows you access to the sub-menus for selecting the waveform to be played back during the current step. Pressing this key also changes the central display area to show the Waveform File Selection view.

Key Path	Source, List Sequencer, List Sequencer Setup
Remote Command	:SOURce:LIST:STEP[1] 2 3...1000:SETup:WAVEform <string> :SOURce:LIST:STEP[1] 2 3...1000:SETup:WAVEform?
Example	:SOUR:LIST:STEP2:SET:WAV "CW" :SOUR:LIST:STEP2:SET:WAV?
Notes	SCPI is supported after A.09.40
Remote Command Notes	String type, takes “Off” “CW” “Cont” “waveform name”

Preset	CW
Range	Waveform Continue Previous CW Off
Initial S/W Revision	A.05.00

CW

Sets the current step to output a CW tone.

Key Path	Source, List Sequencer, List Sequencer Setup, Waveform
Example	:SOUR:LIST:STEP2:SET:WAV "CW"
Notes	SCPI is supported after A.09.40
Initial S/W Revision	A.05.00

Selected Waveform

Inserts the currently selected waveform in the waveform selection view as the waveform for playback during the current step.

Key Path	Source, List Sequencer, List Sequencer Setup, Waveform
Example	:SOUR:LIST:STEP2:SET:WAV "waveform name"
Notes	SCPI is supported after A.09.40 If the selected waveform contains header (which contains ARB play parameters), source list sequence will automatically apply header settings of the selected waveform in that step.
Initial S/W Revision	A.05.00

Continue Previous

Sets the current step to continue with playback of the waveform from the previous step. When continuing the previous waveform, the ARB playback will not pause while the source retunes to the new frequency or amplitude that may be defined for the new step.

Key Path	Source, List Sequencer, List Sequencer Setup, Waveform
Example	:SOUR:LIST:STEP2:SET:WAV "Cont"
Notes	SCPI is supported after A.09.40
Initial S/W Revision	A.05.00

Off

Disable RF output of the current step.

Key Path	Source, List Sequencer, List Sequencer Setup, Waveform
Example	:SOUR:LIST:STEP2:SET:WAV "Off"
Notes	SCPI is supported after A.09.40
Initial S/W Revision	A.05.00

Segments on Hard Disk

Allows you access to the sub-menus for loading waveform segments from the hard disk into ARB memory. The default directory is: D: varb.

Pressing this key changes the current view to the Waveform Management View.

Key Path	Source, Modulation Setup, ARB, Select Waveform
Initial S/W Revision	A.05.00

Load Segment To ARB Memory

Allows you to load the selected file into ARB memory. On the front panel you select the file for loading to the ARB memory by highlighting the desired file in the list. Using the SCPI command, you specify the file name on the HDD.

“NVWFM” (none-volatile storage) MSUS (Mass Storage Unit Specifier) is supported in the memory subsystem because the ARB memory cannot be accessed directly. Therefore, files must be downloaded to the instrument hard disk and then loaded into the ARB memory. “NVWFM” MSUS will be mapped to the default directory D: VARB. The SCPI command supports using either “NVWFM” MSUS or specifying a full path. For more information, see [Memory Subsystem \(Remote Command Only\)](#).

If a file of the same name already exists within ARB memory, it is overwritten. If you wish to load two segments of the same name, you must rename one of the segments before loading it into ARB memory. To rename a segment, you can either use Windows File Explorer, or the :MMEMory:COPY command.

NOTE: When a waveform file is loaded to ARB memory, burst timing adjustments are made automatically, based on whether or not a Multiport Adapter is connected to the test set and powered on. If the connection/power status of the Multiport Adapter is changed after a waveform file has been loaded, it needs to be loaded again.

Key Path	Source, Modulation Setup, ARB, Select Waveform, Segments on Hard Disk
Remote Command	:SOURce:RADio:ARB:LOAD <string>
Example	:SOUR:RAD:ARB:LOAD "D: VARB\testwaveform.bin" or :SOUR:RAD:ARB:LOAD "NVWFM:testwaveform.bin"
Notes	Because loading the file involves a delay of unpredictable length, this command should be followed by the query *OPC?, which holds off subsequent commands until the loading operating is complete. <string> – specifies the path name of the file to load from the HDD into ARB memory. It could be a <full path + filename>, or <"NVWFM" MSUS + colon + filename>.

When in Sequence Analyzer mode, and Include Source is Yes, an attempt to load a file to ARB memory will be rejected with an error.

When Include Source is No and if there is insufficient free ARB memory to load the selected waveform, an error is generated. .

If you specify a file over SCPI, but the file is not at the specified location, an error is generated.

If you try to load a waveform file but the file contains less than 500 IQ samples, an error is generated.

If you try to load a Signal Studio waveform “*.wfm” which contains invalid waveform header, an error is generated.

If the ARB is ON when you load a file to ARB memory or delete a file from ARB memory, the playing waveform segment may not keep phase continuity during the ARB memory operation. The waveform will be replayed after the ARB operation is finished.

ARB can be loaded into ARB memory even required licenses do not present on the instrument. In this case, a GUI only warning message -800, “Operation complete; Loaded <filename> successfully, but no license <required licenses> installed”. User can install required licenses according to <required licenses> string to license it, or multi-pack license it.

Initial S/W Revision A.05.00

Load All To ARB Memory

Allows you to load all the segment files within the currently selected directory into ARB memory. If a file of the same name already exists within ARB memory, it is overwritten. If you wish to load two segments of the same name, you must rename one of the segments before loading it into ARB memory. To rename a segment, you can either use Windows File Explorer, or the :MEMory:COpy command.

NOTE: When a waveform file is loaded to ARB memory, burst timing adjustments are made automatically, based on whether or not a Multiport Adapter is connected to the test set and powered on. If the connection/power status of the Multiport Adapter is changed after a waveform file has been loaded, it needs to be loaded again.

Key Path	Source, Modulation Setup, ARB, Select Waveform, Segments on Hard Disk
Remote Command	:SOURce:RADio:ARB:LOAD:ALL <string>
Example	:SOUR:RAD:ARB:LOAD:ALL “D: varb”
Notes	<p><string> - specifies the directory on the HDD to load the files into ARB memory from.</p> <p>When in Sequence Analyzer mode, and Include Source is Yes, an attempt to load all files from a directory to ARB memory is rejected with an error.</p> <p>When Include Source is No and there is insufficient free ARB memory to load all the waveforms, when the ARB memory is full, the copy ceases, and an error is generated.</p> <p>If you specify a directory over SCPI, but the directory does not exist, an error is generated.</p> <p>If the ARB is ON, a user then loads or deletes file to ARB memory, the playing waveform segment may not keep phase continuity during the ARB memory operation. The waveform will be replayed after the ARB operation is finished.</p>
Initial S/W Revision	A.05.00

Change Directory...

Allows you to change the currently selected directory on the hard disk. Pressing this key opens a standard windows change directory dialog allowing you to select the new directory of interest.

The current directory is used for manually loading waveform segments into ARB memory for playback, and as a search location for waveform segments that are required to be loaded into ARB memory for playback of a waveform sequence or a list sequence.

Key Path	Source, Modulation Setup, ARB, Select Waveform, Segments on Hard Disk
Notes	No remote command, SCPIfront panel only.
Initial S/W Revision	A.05.00

Default Directory...

Allows you to change the default directory. It is used as a search location for waveform segments that are required to be loaded into ARB memory for playback of a waveform sequence, and as a search location for selecting waveforms using SCPI.

Key Path	Source, Modulation Setup, ARB, Select Waveform, Segments on Hard Disk
Remote Command	:SOURce:RADio:ARB:DEFault:DIRectory <string> :SOURce:RADio:ARB: DEFault:DIRectory?
Example	:SOUR:RAD:ARB:DEF:DIR "D:\ArbFiles" :SOUR:RAD:ARB:DEF:DIR?
State Saved	Persistent, survives a power cycle and a preset but not saved in the instrument state
Initial S/W Revision	A.05.00

Segments in ARB Memory

Allows you access to the sub-menus for managing the files within ARB memory.

Key Path	Source, Modulation Setup, ARB, Select Waveform
Initial S/W Revision	A.05.00

Delete Segment From ARB Mem

Allows you to remove a segment from ARB playback memory.

Key Path	Source, Modulation Setup, ARB, Select Waveform, Segments in ARB Memory
Remote Command	:SOURce:RADio:ARB:DELeTe <string>
Example	:SOUR:RAD:ARB:DEL "testwaveform.bin"
Notes	<string> - specifies the waveform to be deleted from the ARB playback memory. When in Sequence Analyzer mode and Include Source is Yes, an attempt to delete a file from ARB

memory is rejected with an error.

When Include Source is No and you specify a file that does not exist within ARB memory, an error is generated.

It is possible to delete files from within the ARB memory when the ARB is ON. However, if you attempt to delete the file that is currently playing an error is generated.

It is possible to delete a file from within the ARB memory when the sequencer state is ON and the file is not being used by the List Sequencer. If you attempt to delete a file which is being used by the list sequencer, an error is generated.

When sequencer state is On, even if ARB state is On, the selected waveform will not be played. In this case, if the selected waveform is not used in List Sequence, it can be deleted and the ARB state is turned Off.

If the ARB is ON and you load a file to ARB memory or delete a file from ARB memory, the playing waveform segment may not keep phase continuity during the ARB memory operation. The waveform will be replayed after the ARB operation is finished.

Initial S/W Revision	A.05.00
----------------------	---------

Delete All From ARB Memory

Allows you to remove all segments from ARB playback memory.

Key Path	Source, Modulation Setup, ARB, Select Waveform, Segments in ARB Memory
Remote Command	:SOURce:RADio:ARB:DELeTe:ALL
Example	:SOUR:RAD:ARB:DELeTe:ALL
Notes	<p>When in Sequence Analyzer mode and Include Source is Yes, an attempt to delete all files from ARB memory is rejected with an error.</p> <p>When Include Source is No and you attempt to delete all files from ARB memory when the ARB is currently playing a file, all files except the one playing are deleted and an error is generated.</p> <p>If you attempt to delete all files from ARB memory when there are waveform files used in "List Sequencer" on page 2520 and "Sequencer" on page 2521 state is ON, all files except the files currently being used in list sequencer are deleted, and an error is generated.</p> <p>If the ARB is ON and you load a file to ARB memory or delete a file from ARB memory, the playing waveform segment may not keep phase continuity during the ARB memory operation. The waveform will be replayed after the ARB operation is finished.</p>

Initial S/W Revision	A.05.00
----------------------	---------

Segments on Hard Disk

This key functions the same as "[Segments on Hard Disk](#)" on page 2547.

Key Path	Source, List Sequencer, List Sequencer Setup, Waveform
Initial S/W Revision	Prior to A.09.00

Load Segment To ARB Memory

This key functions the same as ["Load Segment To ARB Memory" on page 2547](#).

Key Path	Source, List Sequencer, List Sequencer Setup, Waveform, Segment on Hard Drive
Initial S/W Revision	Prior to A.09.00

Load All To ARB Memory

This key functions the same as ["Load All To ARB Memory" on page 2548](#).

Key Path	Source, List Sequencer, List Sequencer Setup, Waveform, Segment on Hard Drive
Initial S/W Revision	Prior to A.09.00

Change Directory ...

This key functions the same as ["Change Directory..." on page 2549](#).

Key Path	Source, List Sequencer, List Sequencer Setup, Waveform, Segment on Hard Drive
Initial S/W Revision	Prior to A.09.00

Default Directory ...

This key functions the same as ["Default Directory..." on page 2549](#)

Key Path	Source, List Sequencer, List Sequencer Setup, Waveform, Segment on Hard Drive
Initial S/W Revision	Prior to A.09.00

Segments in ARB Memory

This key functions the same as ["Segments in ARB Memory" on page 2549](#).

Key Path	Source, List Sequencer, List Sequencer Setup, Waveform, Segments in ARB Memory
Initial S/W Revision	Prior to A.09.00

Delete Segment From ARB Memory

This key functions the same as ["Delete Segment From ARB Mem" on page 2549](#).

Key Path	Source, List Sequencer, List Sequencer Setup, Waveform, Segments in ARB Memory, Segment in ARB Memory
Initial S/W Revision	Prior to A.09.00

Delete All From ARB Memory

This key functions the same as "Delete All From ARB Memory" on page 2550.

Key Path	Source, List Sequencer, List Sequencer Setup, Waveform, Segments in ARB Memory, Segment in ARB Memory
Initial S/W Revision	Prior to A.09.00

Step Duration

Allows access to the sub-menus for setting up the duration of play for the current step.

The duration can be set to be either the number of times for the ARB file associated with the sequence to play, or a specific time value, or continuous. If the step is set to play a CW tone, the step duration cannot be set to a play count.

Key Path	Source, List Sequencer, List Sequencer Setup
Remote Command	:SOURce:LIST:STEP[1] 2 3...1000:SETup:DURation:TYPE TIME COUNT CONTInuous CABort :SOURce:LIST:STEP[1] 2 3...1000:SETup:DURation:TYPE?
Example	:SOUR:LIST:STEP2:SET:DUR:TYPE TIME :SOUR:LIST:STEP2:SET:DUR:TYPE?
Notes	SCPI is supported after A.09.40
Notes	If "Step Duration" is set to "Time" or "Play Count" for the last step, the last step of ARB keeps playing as if set to "Continuous", until the set "Time" has expired or until the "Play Count" setting is reached. However, you can query Error! Reference source not found. Source Sweeping Condition Message to find out if the current list sequence is complete or not.
Range	Time Play Count Continuous Continuous Abort
Initial S/W Revision	A.05.00

Time

Sets the duration of the current step to be a time value for the length of time the step will play. Pressing this key again opens another menu which allows you to set the time value for the step duration.

Key Path	Source, List Sequencer, List Sequencer Setup, Step Duration
Example	:SOUR:LIST:STEP2:SET:DUR:TYPE TIME
Notes	SCPI is supported after A.09.40
Initial S/W Revision	A.05.00

Duration Time

Allows you to specify the length of time the current step will play.

When Step Duration is **Continuous Abort** this parameter specifies the maximum duration that the waveform will continue to play after a step trigger is received before the transition to the next waveform will occur. Duration is limited to a maximum of 20 seconds.

If the Transition Time value is longer than the Step Duration Time, an error is generated when initiating a source list sequence. For source list sequence, transition time is included in the step duration length (not occupy additional time). If the Transition Time value is longer than the Step Duration Time, the real step duration length is extended to equal the transition time and cause a timing shift. This check is also described in section **Error! Reference source not found**. List Sequence Step Validation.

Key Path	Source, List Sequencer, List Sequencer Setup, Step Duration, Time
Remote Command	:SOURce:LIST:STEP[1] 2 3...1000:SETup:DURation:TCOUNT <double> :SOURce:LIST:STEP[1] 2 3...1000:SETup:DURation:TCOUNT?
Example	:SOUR:LIST:STEP2:SET:DUR:TCO 1s :SOUR:LIST:STEP2:SET:DUR:TCO?
Notes	SCPI is supported after A.09.40 This SCPI is reused by "Play Count", "Duration Time" and "Continuous Abort" according to current Duration Type setting is "Play Count" or "Duration Time" or "Continuous Abort". If current "Duration Type" is "Continuous", then popup error -221, "Settings conflict; Cannot accept time or count input when step duration type is Continuous on step #"
Notes	If "Duration Time" is set for the last step, the last step of ARB keeps playing as if set to "Continuous" after set time expires. However, you can query Source Sweeping Condition Message (:STAT:OPER:COND?) to find out if the current list sequence is complete or not.
Preset	1.00 ms
Min	100 μ s
Max	1800 s
Initial S/W Revision	A.05.00

Play Count

Sets the duration of the current step to be an integer value for the number of times (play count) the ARB file is selected for playback during this step. For example, a 5 second ARB will be set to play 5 times during the step.

Key Path	Source, List Sequencer, List Sequencer Setup, Step Duration
Example	:SOUR:LIST:STEP2:SET:DUR:TYPE COUN
Notes	SCPI is supported after A.09.40 This key is unavailable and is grayed out if the current step is configured to CW tone rather than an ARB waveform.
Initial S/W Revision	A.05.00

Header Utilities

Allows access to the header utilities sub-menu. Pressing this key also causes the central display area to change to display the File Header Information view.

Key Path	Source, Modulation Setup, ARB
Dependencies	This key is only available if there is currently a waveform selected for playback. If no waveform is selected, the key is grayed out.
Initial S/W Revision	A.05.00

Continuous

Sets the current step to be played continuously until the next step starts. The waveform will always play completely before transitioning to the next step.

Key Path	Source, List Sequencer, List Sequencer Setup, Step Duration
Example	:SOUR:LIST:STEP2:SET:DUR:TYPE CONT
Notes	SCPI is supported after A.09.40
Initial S/W Revision	A.05.00

Output Trigger

Allows you to specify the trigger output for the current step. The trigger output signal is sent at the start of the step.

When select “On”, trigger event will occur on both Internal and External2 paths. Select “Off” will turn off trigger output.

Key Path	Source, List Sequencer, List Sequencer Setup
Remote Command	:SOURce:LIST:STEP[1] 2 3...1000:SETup:OUTPut:TRIGger ON OFF 1 0 :SOURce:LIST:STEP[1] 2 3...1000:SETup:OUTPut:TRIGger
Example	:SOUR:LIST:STEP2:SET:OUTP:TRIG ON :SOUR:LIST:STEP2:SET:OUTP:TRIG?
Notes	SCPI is supported after A.09.40
Preset	Off
Range	On Off
Initial S/W Revision	A.05.00

Step Configuration (Remote Command Only)

This SCPI command is used to configure the List Sequencer and is detailed in the table below. The command is defined such that you send one command per step, with the step number being specified as a subopcode of the SCPI command. Each command includes all the parameter settings for the step. As a step is setup, the values entered are run through several levels of validation.

Remote Command	:SOURce:LIST:STEP[1] 2 ... 4..1000:SETup IMMEDIATE INTernal KEY
-----------------------	---

```

BUS | EXTernal2, <time>, NONE | PGSM | EGSM | RGSM | DCS1800 | PCS1900
| TGSM810 | GSM450 | GSM480 | GSM700 | GSM850 | BANDI | BANDII |
BANDIII | BANDIV | BANDV | BANDVI | BANDVII | BANDVIII | BANDIX | BANDX
| BANDXI | BANDXII | BANDXIII | BANDXIV | BANDXIX | USCELL | USPCS |
JAPAN | KOREAN | NMT | IMT2K | UPPER | SECOND | PAMR400 | PAMR800 |
IMTEXT | PCS1DOT9G | AWS | US2DOT5G | PUBLIC | LOWER | NONE | BAND1 |
BAND2 | BAND3 | BAND4 | BAND5 | BAND6 | BAND7 | BAND8 | BAND10 | BAND11
| BAND12 | BAND13 | BAND14 | BAND17 | BAND18 | BAND19 | BAND20 | BAND21
| BAND24 | BAND25 | BAND26 | BAND33 | BAND34 | BAND35 | BAND36 | BAND37
| BAND38 | BAND39 | BAND40 | BAND41 | BAND42 | BAND43 | BANDA | BANDB |
BANDC | BANDD | BANDE | BANDF, DOWN | UP, <freq>, <ampl>, <string>,
TIME | COUNT | CONTinuous, <time>, ON | OFF | 1 | 0, [<int>],

:SOURce:LIST:STEP[1]|2|...|4..1000:SETup?

```

Example :SOUR:LIST:STEP1:SET INT, 1ms, PGSM, DOWN, 10, -25 dBm, "GSM_Test1.bin", TIME, 10ms, OFF, 255

Notes The parameters are:
(There is a total of 11 items in each step, the following is a list of the items in the order they must appear in the remote command.)

1. Step Trigger **<enum>** – specifies the input trigger for the step. For details of the valid types of step trigger see ["Step Trigger" on page 2523](#).
2. Transition Time **<time>** – specifies the transition time for the step in seconds. For details of the valid ranges for the transition time see ["Transition Time" on page 2525](#).
3. Radio Band **<enum>** – specifies the radio band for the step. For details of the valid radio bands see ["Radio Setup" on page 2526](#).
4. Radio Band Link **<enum>** – specifies the radio band link direction for the step. For details of the valid link types, see ["Radio Band Link" on page 2543](#).
5. Frequency/Channel Number **<freq>/<chan num>** – specifies the frequency in Hz or the channel number for the step. The channel number and frequency are combined as one parameter that represents the frequency or channel number depending on the radio band setting. If the radio band is set to NONE, this value is interpreted as a frequency value in Hz. If the radio band is set to a valid band, this value is interpreted as a channel number. For details of the valid ranges for frequency and channel numbers, see ["Channel" on page 2543](#) and ["Frequency" on page 2544](#).
6. Power **<ampl>** – specifies the output power for the step in dBm. For details of the valid ranges see ["Power" on page 2544](#).
7. Waveform **<string>** – specifies the waveform for playback during the step. The step can output either a new ARB waveform, continue playback of the previous waveform, or output a CW tone. The options for specifying these are:
 - <filename> - plays the specified waveform from the start. The filename value is the name of the file within ARB playback memory, it does not include the windows path to the file on the HDD. If you enter a filename for a waveform that does not reside within ARB playback memory, an error is generated.
 - CONT – continues playback of the ARB file from the previous step
 - CW – outputs a CW tone
 - OFF – disable RF output
8. Step Duration **<enum>** – specifies the duration of the step. The duration can be specified to be either time, or play count of the ARB file associated with the step, or continuous. If Waveform is set to "CW", this value cannot be set to Play Count and an error will be generated. If continuous is selected, the following Time or Count value is ignored. For further details of this setting, see ["Step](#)

	<p>Duration" on page 2552.</p> <p>9. Time or Count <time/int> – specifies time duration in seconds or play count of the ARB file associated with the step. For further details of this setting, including the valid ranges for the time or play count setting, "Time" on page 2552 and "Play Count" on page 2553.</p> <p>10. Output Trigger <Boolean> – specifies the output trigger for the step. For details of the ranges for this setting see "Output Trigger" on page 2554.</p>
Dependencies	<p>The range of subopcode values is 1 to 1000 and the value you enter is determined by the number of steps you have configured. For details see "Number of Steps" on page 2522.</p> <p>If you attempt to remotely set or query a subopcode that is out of range, an error is generated.</p>
Initial S/W Revision	A.05.00

Step Configuration of Step Trigger parameter list (Remote Command Only)

This SCPI command is to configure “Step Trigger” parameter array of the whole List Sequencer at one time. The number of array is same as step number defined in "**Number of Steps" on page 2522** Number of Steps. As a step is setup, the value entered run through several levels of validation.

Remote Command	<pre>:SOURce:LIST:SETup:INPut:TRIGger <enum>, <enum>, <enum>, ... :SOURce:LIST:SETup:INPut:TRIGger?</pre>
Example	<pre>:SOUR:LIST:SET:INP:TRIG IMM,INT,EXT2 :SOUR:LIST:SET:INP:TRIG?</pre>
Notes	<p>The command is to setup below parameter array of whole list sequence.</p> <p>Step Trigger <enum> – specifies the input trigger for the step. For details of the valid types of step trigger see "Step Trigger" on page 2523.</p> <p>If input parameter number exceeds the step number defined by "Number of Steps" on page 2522Number of Steps then generate error ", and only those parametes whose index number falls in number of steps will be updated.</p>
Remote Command Notes	IMMEDIATE INTERNAL KEY BUS EXTERNAL2
Dependencies	<p>The range is 1 to 1000 which is determined by the number of steps you have configured. For details see "Number of Steps" on page 2522.</p>
Initial S/W Revision	A.09.40

Step Configuration of Transition Time parameter list (Remote Command Only)

This SCPI command is to configure “Transition Time” parameter array of the whole List Sequencer at one time. The number of array is same as step number defined in "**Number of Steps" on page 2522** Number of Steps. As a step is setup, the value entered run through several levels of validation.

Remote Command	<pre>:SOURce:LIST:SETup:TRANSition:TIME <time>, <time>, <time>, ... :SOURce:LIST:SETup:TRANSition:TIME?</pre>
Example	<pre>:SOUR:LIST:SET:TRAN:TIME 1ms,1ms,1ms</pre>

	:SOUR:LIST:SET:TRAN:TIME?
Notes	<p>The command is to setup below parameter array of whole list sequence.</p> <p>Transition Time <time> – specifies the transition time for the step in seconds. For details of the valid ranges for the transition time see "Transition Time" on page 2525</p> <p>If input parameter number exceeds the step number defined by "Number of Steps" on page 2522 Number of Steps then generate error ", and only those parameters whose index number falls in number of steps will be updated.</p>
Dependencies	The range is 1 to 1000 which is determined by the number of steps you have configured. For details see "Number of Steps" on page 2522 .
Initial S/W Revision	A.09.40

Step Configuration of Radio Band parameter list (Remote Command Only)

This SCPI command is to configure “Radio Band” parameter array of the whole List Sequencer at one time. The number of array is same as step number defined in ["Number of Steps" on page 2522](#) Number of Steps. As a step is setup, the value entered run through several levels of validation.

R	:SOURce:LIST:SETup:RADio:BAND <enum>, <enum>, <enum>, ...
e	:SOURce:LIST:SETup:RADio:BAND?
m	
o	
t	
e	
C	
o	
m	
m	
a	
n	
d	
E	:SOUR:LIST:SET:RAD:BAND PGSM, EGSM, RGSM
X	:SOUR:LIST:SET:RAD:BAND?
a	
m	
p	
l	
e	
N	The command is to setup below parameter array of whole list sequence.
O	Radio Band <enum> – specifies the radio band for the step. For details of the valid radio bands see "Radio Setup" on page 2526 .
t	If input parameter number exceeds the step number defined by "Number of Steps" on page 2522 Number of Steps then
e	generate error ", and only those parameters whose index number falls in number of steps will be updated.
s	
R	NONE PGSM EGSM RGSM DCS1800 PCS1900 TGSM810 GSM450 GSM480 GSM700 GSM850 BANDI BANDII BANDIII BANDI
e	V BANDV BANDVI BANDVII BANDVIII BANDIX BANDX BANDXI BANDXII BANDXIII BANDXIV BANDXIX USCELL USPCS JAPAN KO
m	REAN NMT IMT2K UPPER SECOND PAMR400 PAMR800 IMTEXT PCS1 DOT9G AWS US2DOT5G PUBLIC LOWER NONE BAND1
	BAND2 BAND3 BAND4 BAND5 BAND6 BAND7 BAND8 BAND10 BAND11 BAND12 BAND13 BAND14 BAND17 BAND18 BAND1

o 9|BAND20|BAND21|BAND24|BAND25|BAND26|BAND33|BAND34|BAND35|BAND36|BAND37|BAND38|BAND39|BAND40|BAN
t D41|BAND42|BAND43|BANDA|BANDB|BANDC|BANDD|BANDE|BANDF
e

C
o
m
m
a
n
d

N
o
t
e
s

D The range is 1 to 1000 which is determined by the number of steps you have configured. For details see "[Number of Steps](#)" on
e [page 2522](#).

p
e
n
d
e
n
c
i
e
s

I A.09.40

n
i
t
i
a
l

S
/
W

R
e
v
i
s
i
o
n

Step Configuration of Radio Band Link parameter list (Remote Command Only)

This SCPI command is to configure “Radio Band Link” parameter array of the whole List Sequencer at one time. The number of array is same as step number defined in ["Number of Steps" on page 2522](#) Number of Steps. As a step is setup, the value entered run through several levels of validation.

Remote Command	:SOURce:LIST:SETup:RADio:BAND:LINK <enum>, <enum>, <enum>, ... :SOURce:LIST:SETup:RADio:BAND:LINK?
Example	:SOUR:LIST:SET:RAD:BAND:LINK DOWN,UP,UP :SOUR:LIST:SET:RAD:BAND:LINK?
Notes	The command is to setup below parameter array of whole list sequence. Radio Band Link <enum> – specifies the radio band link direction for the step. For details of the valid link types, see "Radio Band Link" on page 2543 . If input parameter number exceeds the step number defined by "Number of Steps" on page 2522 Number of Steps then generate error ", and only those parametes whose index number falls in number of steps will be updated.
Remote Command Notes	DOWN UP
Dependencies	The range is 1 to 1000 which is determined by the number of steps you have configured. For details see "Number of Steps" on page 2522 .
Initial S/W Revision	A.09.40

Step Configuration of Frequency/Channel Number parameter list (Remote Command Only)

This SCPI command is to configure “Frequency” or “Channel Number” parameter array of the whole List Sequencer at one time. The number of array is same as step number defined in ["Number of Steps" on page 2522](#) Number of Steps. As a step is setup, the value entered run through several levels of validation.

Remote Command	:SOURce:LIST:SETup:CNFRequency <double>, <double>, <double>, ... :SOURce:LIST:SETup:CNFRequency?
Example	:SOUR:LIST:SET:CNFR 1GHz,100MHz,100MHz :SOUR:LIST:SET:CNFR? SOUR:LIST:SET:CNFR 124,124,124 :SOUR:LIST:SET:CNFR?
Notes	The command is to setup below parameter array of whole list sequence. Frequency/Channel Number <freq>/<chan num> – specifies the frequency in Hz or the channel number for the step. The channel number and frequency are combined as one parameter that represents the frequency or channel number depending on the radio band setting. If the radio band is set to NONE, this value is interpreted as a frequency value in Hz. If the radio band is set to a valid band, this value is interpreted as a channel number. For details of the valid ranges for frequency and channel numbers, see "Channel" on page 2543 and "Frequency" on page 2544 . This SCPI is used to setup/query channel number or frequency setting, according to current Radio Band setting of that step. If Radio Band is “NONE”, then it’s frequency. If Radio Band is not “NONE”, then it’s channel number If input parameter number exceeds the step number defined by "Number of Steps" on page 2522 Number of Steps then generate error ", and only those parametes whose index number falls in

	legal step number will be updated.
Dependencies	The range is 1 to 1000 which is determined by the number of steps you have configured. For details see "Number of Steps" on page 2522 .
Initial S/W Revision	A.09.40

Step Configuration of Power parameter list (Remote Command Only)

This SCPI command is to configure “Power” parameter array of the whole List Sequencer at one time. The number of array is same as step number defined in ["Number of Steps" on page 2522](#) Number of Steps. As a step is setup, the value entered run through several levels of validation.

Remote Command	:SOURce:LIST:SETup:AMPLitude <ampl>, <ampl>, <ampl>, ... :SOURce:LIST:SETup:AMPLitude?
Example	:SOUR:LIST:SET:AMPL -50dBm,-40dBm,-30dBm :SOUR:LIST:SET:AMPL?
Notes	The command is to setup below parameter array of whole list sequence. Power <ampl> – specifies the output power for the step in dBm. For details of the valid ranges see "Power" on page 2544 . If input parameter number exceeds the step number defined by "Number of Steps" on page 2522 Number of Steps then generate error ", and only those parametes whose index number falls in legal step number will be updated.
Dependencies	The range is 1 to 1000 which is determined by the number of steps you have configured. For details see "Number of Steps" on page 2522 .
Initial S/W Revision	A.09.40

Step Configuration of Waveform parameter list (Remote Command Only)

This SCPI command is to configure “Waveform” parameter array of the whole List Sequencer at one time. The number of array is same as step number defined in ["Number of Steps" on page 2522](#) Number of Steps. As a step is setup, the value entered run through several levels of validation.

Remote Command	:SOURce:LIST:SETup:WAVeform <string>, <string>, <string>, ... :SOURce:LIST:SETup:WAVeform?
Example	:SOUR:LIST:SET:WAV "CW","Off","CONT" :SOUR:LIST:SET:WAV?
Notes	The command is to setup below parameter array of whole list sequence. Waveform <string> – specifies the waveform for playback during the step. The step can output either a new ARB waveform, continue playback of the previous waveform, or output a CW tone. The options for specifying these are: <filename> - plays the specified waveform from the start. The filename value is the name of the file within ARB playback memory, it is does not include the windows path to the file on the HDD. If you enter a filename for a waveform that does not reside within ARB playback memory, an error is generated.

	<p>CONT – continues playback of the ARB file from the previous step</p> <p>CW – outputs a CW tone</p> <p>OFF – disable RF output</p> <p>If input parameter number exceeds the step number defined by "Number of Steps" on page 2522 Number of Steps then generate error ", and only those parametes whose index number falls in number of steps will be updated.</p>
Dependencies	The range is 1 to 1000 which is determined by the number of steps you have configured. For details see " Number of Steps " on page 2522.
Range	"filename" "CW" "Off" "CONT"
Initial S/W Revision	A.09.40

Step Configuration of Step Duration parameter list (Remote Command Only)

This SCPI command is to configure "Step Duration" parameter array of the whole List Sequencer at one time. The number of array is same as step number defined in "[Number of Steps](#)" on page 2522 Number of Steps. As a step is setup, the value entered run through several levels of validation.

Remote Command	<pre>:SOURce:LIST:SETup:DURation:TYPE <enum>, <enum>, <enum>, ... :SOURce:LIST:SETup:DURation:TYPE?</pre>
Example	<pre>:SOUR:LIST:SET:DUR:TYPE COUN,TIME,CONT :SOUR:LIST:SET:DUR:TYPE?</pre>
Notes	<p>The command is to setup below parameter array of whole list sequence.</p> <p>Step Duration <enum> – specifies the duration of the step. The duration can be specified to be either time, or play count of the ARB file associated with the step, or continuous. If Waveform is set to "CW", this value cannot be set to Play Count and an error will be generated. If continuous is selected, the following Time or Count value is ignored. For further details of this setting, see "Step Duration" on page 2552.</p> <p>If input parameter number exceeds the step number defined by "Number of Steps" on page 2522 Number of Steps then generate error ", and only those parametes whose index number falls in number of steps will be updated.</p>
Remote Command Notes	TIME COUNT CONTinuous
Dependencies	The range is 1 to 1000 which is determined by the number of steps you have configured. For details see " Number of Steps " on page 2522.
Initial S/W Revision	A.09.40

Step Configuration of Duration Time or Play Count parameter list (Remote Command Only)

This SCPI command is to configure "Duration Time" or "Play Count" parameter array of the whole List Sequencer at one time. The number of array is same as step number defined in "[Number of Steps](#)" on page 2522 Number of Steps. As a step is setup, the value entered run through several levels of validation.

Remote Command	<pre>:SOURce:LIST:SETup:TOCount <time/int>, <time/int>, <time/int>, ... :SOURce:LIST:SETup:TOCount?</pre>
-----------------------	---

Example	:SOUR:LIST:SET:TOC 1s,2s,3s :SOUR:LIST:SET:TOC? :SOUR:LIST:SET:TOC 5,6,7 :SOUR:LIST:SET:TOC?
Notes	The command is to setup below parameter array of whole list sequence. Time or Count <time/int> – specifies time duration in seconds or play count of the ARB file associated with the step. For further details of this setting, including the valid ranges for the time or play count setting, " Time " on page 2552 and " Play Count " on page 2553. If input parameter number exceeds the step number defined by " Number of Steps " on page 2522 Number of Steps then generate error ", and only those parametes whose index number falls in number of steps will be updated. If current " Step Duration " on page 2552 is "Continuous", then generate error -221,"Settings conflict;Cannot accept time or count input when step duration type is Continuous on step #"
Dependencies	The range is 1 to 1000 which is determined by the number of steps you have configured. For details see " Number of Steps " on page 2522.
Initial S/W Revision	A.09.40

Step Configuration of Output Trigger parameter list (Remote Command Only)

This SCPI command is to configure "Output Trigger" parameter array of the whole List Sequencer at one time. The number of array is same as step number defined in "[Number of Steps](#)" on page 2522 Number of Steps. As a step is setup, the value entered run through several levels of validation.

Remote Command	:SOURce:LIST:SETup:OUTPut:TRIGger <bool>, <bool>, <bool>, ... :SOURce:LIST:SETup:OUTPut:TRIGger ?
Example	:SOUR:LIST:SET:OUTP:TRIG ON,OFF,ON :SOUR:LIST:SET:OUTP:TRIG?
Notes	The command is to setup below parameter array of whole list sequence. Output Trigger <Boolean> – specifies the output trigger for the step. For details of the ranges for this setting see " Output Trigger " on page 2554. If input parameter number exceeds the step number defined by " Number of Steps " on page 2522 Number of Steps then generate error ", and only those parametes whose index number falls in legal step number will be updated.
Remote Command Notes	ON OFF 1 0
Dependencies	The range is 1 to 1000 which is determined by the number of steps you have configured. For details see " Number of Steps " on page 2522.
Initial S/W Revision	A.09.40

Clear List (Remote Command Only)

This command is the SCPI equivalent of the Clear List UI feature described in.

Remote Command	:SOURce:LIST:SETup:CLEar
Example	:SOUR:LIST:SETup:CLE
Initial S/W Revision	A.05.00

Trigger Type

Allows access to the sub-menu for selecting the output trigger type for the list sequencer globally. It cannot be changed between different sequence steps.

Key Path	Source, List Sequencer
Remote Command	:SOURce:LIST:TRIGgerout:TYPe BEGinningofstep DATamarker
Example	:SOUR:LIST:TRIG:TYP BEG :SOUR:LIST:TRIG:TYP?
Notes	SCPI is supported after A.14.00
Preset	BEGinningofstep
Range	BEGinningofstep DATamarker
Initial S/W Revision	A.14.00

BeginningOfStep

Sets the output trigger type as BeginningOfStep for the whole source sequence.

Key Path	Source, List Sequencer, Trigger Type
Example	:SOUR:LIST:TRIG:TYP BEG
Notes	SCPI is supported after A.14.00
Initial S/W Revision	A.14.00

DataMarker

Sets the output trigger type as DataMarker for the whole source sequence. When DataMarker is selected, which marker to route is also needed to be set.

Key Path	Source, List Sequencer, Trigger Type
Example	:SOUR:LIST:TRIG:TYP DAT
Notes	SCPI is supported after A.14.00
Initial S/W Revision	A.14.00

Marker 1

Sets the output trigger maker routing to Marker 1 for DataMarker in the whole source sequence.

Key Path	Source, List Sequencer, Trigger Type, DataMarker
Example	:SOUR:LIST:TRIG:TYPE:MARK M1
Notes	SCPI is supported after A.14.00
Initial S/W Revision	A.14.00

Marker 2

Sets the output trigger maker routing to Marker 2 for DataMarker in the whole source sequence.

Key Path	Source, List Sequencer, Trigger Type, DataMarker
Example	:SOUR:LIST:TRIG:TYPE:MARK M2
Notes	SCPI is supported after A.14.00
Initial S/W Revision	A.14.00

Marker 3

Sets the output trigger maker routing to Marker 3 for DataMarker in the whole source sequence.

Key Path	Source, List Sequencer, Trigger Type, DataMarker
Example	:SOUR:LIST:TRIG:TYPE:MARK M3
Notes	SCPI is supported after A.14.00
Initial S/W Revision	A.14.00

Marker 4

Sets the output trigger maker routing to Marker 4 for DataMarker in the whole source sequence.

Key Path	Source, List Sequencer, Trigger Type, DataMarker
Example	:SOUR:LIST:TRIG:TYPE:MARK M4
Notes	SCPI is supported after A.14.00
Initial S/W Revision	A.14.00

Manual Trigger Now

Pressing this key provides a software trigger event to the list sequencer. During execution of sequence, if the sequencer is halted on any step that has been configured with a “Manual” step trigger, then this key press will cause the sequencer to continue and execute the step.

Key Path	Source, List Sequencer
Remote Command	No remote command, front panel only.
Initial S/W Revision	A.05.00

Remote Software Trigger (Remote command Only)

During execution of a list sequence, the sequence will halt and wait at any step that has Step Trigger set to “Bus”. Sending this command will trigger the step and continue the sequence.

Remote Command	:SOURce:LIST:TRIGger:INITiate[:IMMediate]
Example	:SOUR:LIST:TRIG:INIT
Initial S/W Revision	A.05.00

Query List Sequence Initiation Armed Status (Remote Command Only)

This is a blocking SCPI query to determine if source list sequence being initiated successfully or not.

Remote Command	:SOURce:LIST:INITiation:ARMed?
Example	:SOUR:LIST:INIT:ARMed?
Notes	The return data is in the following format: Integer
Notes	Query only SCPI. Returning “1” if list sequence has been initiated successfully, returning “0” if not. Once get “0”, you can use :SYST:ERR? to query what error happened. Just like “*OPC?”, this command can be blocked until event/status “IsSourceSweeping” happens, and then returns. Doing so can help user’s script query armed status only once during the time interval of the initiation. As an ancillary SCPI of existing SCPI “:SOUR:LIST:TRIGger[:IMMediate]” (see "Initiate Sequence" on page 2521 Initiate Sequence), the right usage of this command is to use it after “:SOUR:LIST:TRIG”. If not, this command will return “1” immediately.
Notes	There is an alias SCPI “:SOURce:LIST:TRIGger:INITiation:ARMed?”.
Initial S/W Revision	A.09.40

Source Preset

Allows you to preset the source settings to their default values.

Key Path	Source
Remote Command	:SOURce:PRESet
Example	:SOUR:PRES

Span X Scale

Accesses a menu of functions that enable you to set the horizontal scale parameters.

Key Path	Front-panel key
Initial S/W Revision	A.11.00

Ref Value

Sets the X reference value.

Key Path	SPAN X Scale
Mode	BASIC, PNOISE, WCDMA, C2K, GSM, WIMAXOFDMA, TDSCDMA, 1XEVDO, DVB, DTMB, ISDBT, CMMB, LTE, LTETDD, DCTV, WLAN, MSR, LTEAFDD, LTEATDD
Remote Command	:DISPlay:SEMask:VIEW[1]:WINDow[1]:TRACe:X[:SCALe]:RLEVel <freq> :DISPlay:SEMask:VIEW[1]:WINDow[1]:TRACe:X[:SCALe]:RLEVel?
Example	DISP:SEM:VIEW:WIND:TRAC:X:RLEV 10 DISP:SEM:VIEW:WIND:TRAC:X:RLEV?
Notes	You must be in the mode that includes SEM measurement to use this command. Use :INSTrument:SElect to set the mode.
Couplings	If Auto Scaling is set to On, this value is automatically determined by the measurement result. When you set this value manually, Auto Scaling automatically changes to Off.
Preset	1.0 GHz
State Saved	Saved in instrument state.
Min	-1000 GHz
Max	1000 GHz
Default Unit	Hz
Initial S/W Revision	A.11.00

Scale/Div

Sets the horizontal scale.

Key Path	SPAN X Scale
Mode	BASIC, PNOISE, WCDMA, C2K, GSM, WIMAXOFDMA, TDSCDMA, 1XEVDO, DVB, DTMB, ISDBT, CMMB, LTE, LTETDD, DCTV, WLAN, MSR, LTEAFDD, LTEATDD
Remote Command	:DISPlay:SEMask:VIEW[1]:WINDow[1]:TRACe:X[:SCALe]:PDIVision <freq> :DISPlay:SEMask:VIEW[1]:WINDow[1]:TRACe:X[:SCALe]:PDIVision ?
Example	DISP:SEM:VIEW:WIND:TRAC:X:PDIV 500 DISP:SEM:VIEW:WIND:TRAC:X:PDIV?

Notes	You must be in a mode that includes the SEM measurement to use this command. Use INSTRUMENT:SElect to set the mode.
Couplings	If Auto Scaling is set to On, this value is automatically determined by the measurement result. When you set this value manually, Auto Scaling automatically changes to Off.
Preset	Automatically Calculated
State Saved	Yes Saved in instrument state.
Min	1 Hz
Max	10.0 GHz
Initial S/W Revision	A.11.00

Ref Position

Sets the reference position for the X axis to Left, Center or Right.

Key Path	SPAN X Scale
Mode	BASIC, PNOISE, WCDMA, C2K, GSM, WIMAXOFDMA, TDSCDMA, 1XEVD0, DVB, DTMB, ISDBT, CMMB, LTE, LTETDD, DCTV, WLAN, MSR, LTEAFDD, LTEATDD
Remote Command	:DISPlay:SEMask:VIEW[1]:WINDow[1]:TRACe:X[:SCALE]:RPOsition LEFT CENTER RIGHT :DISPlay:SEMask:VIEW[1]:WINDow[1]:TRACe:X[:SCALE]:RPOsition?
Example	DISP:SEM:VIEW:WIND:TRAC:X:RPOS LEFT DISP:SEM:VIEW:WIND:TRAC:X:RPOS?
Notes	You must be in a mode that includes the SEM measurement to use this command. Use INSTRUMENT:SElect to set the mode.
Preset	CENTER
State Saved	Yes Saved in instrument state.
Range	Left Ctr Right
Initial S/W Revision	A.11.00

Auto Scaling

Toggles the scale coupling function between On and Off.

Key Path	SPAN X Scale
Mode	BASIC, PNOISE, WCDMA, C2K, GSM, WIMAXOFDMA, TDSCDMA, 1XEVD0, DVB, DTMB, ISDBT, CMMB, LTE, LTETDD, DCTV, WLAN, MSR, LTEAFDD, LTEATDD
Remote Command	:DISPlay:SEMask:VIEW[1]:WINDow[1]:TRACe:X[:SCALE]:COUPle 0 1 OFF ON :DISPlay:SEMask:VIEW[1]:WINDow[1]:TRACe:X[:SCALE]:COUPle?
Example	DISP:SEM:VIEW:WIND:TRAC:X:COUP ON

DISP:SEM:VIEW:WIND:TRAC:X:COUP?	
Notes	You must be in a mode that includes the SEM measurement to use this command. Use INSTRUMENT:SElect to set the mode.
Couplings	When Auto Scaling is On and the Restart front-panel key is pressed, this function automatically determines the scale per division and reference values based on the measurement results. When you set a value to either Scale/Div or Ref Value manually, Auto Scaling automatically changes to Off.
Preset	1
State Saved	Yes Saved in instrument state.
Range	On Off
Initial S/W Revision	A.11.00

Sweep/Control

Displays a menu that enables you to set up and control the acquisition time, gate method, and source of the current measurement. See Sweep/Control for more information.

Key Path	Front-panel key
Initial S/W Revision	Prior to A.02.00

Pause

Pauses a measurement after the current data acquisition is complete. When Paused, the label on the key changes to Resume. Pressing the Resume key resumes the measurement at the point it was at when paused. See ["Pause/Resume" on page 1865](#) for more details.

Key Path	Sweep/Control
Initial S/W Revision	Prior to A.02.00

Gate

Accesses a menu that enables you to control the gating function. The Gate functionality is used to view signals best viewed by qualifying them with other events.

Gate setup parameters are the same for all measurements – they do not change as you change measurements. Settings like these are called “Meas Global” and are unaffected by Meas Preset.

Key Path	Sweep/Control
Scope	Meas Global
Readback	The state and method of Gate, as [Off, FFT] or [On, FFT]. Note that for measurements that only support gated FFT, the method is nonetheless read back, but always as FFT.
Initial S/W Revision	Prior to A.02.00

Gate On/Off

Turns the gate function on and off.

When the Gate Function is on, the selected Gate Method is used along with the gate settings and the signal at the gate source to control the sweep system with the gate signal. Not all measurements allow every type of Gate Methods.

When Gate is on, the annunciation in the measurement bar reflects that it is on and what method is used, as seen in the following "Gate: FFT" annunciator graphic.



Key Path	Sweep/Control, Gate
Remote Command	[:SENSe] :SWEep:EGATe [:STATe] OFF ON 0 1 [:SENSe] :SWEep:EGATe [:STATe] ?
Example	SWE:EGAT ON SWE:EGAT?
Dependencies	<p>When in the ACP measurement:</p> <ul style="list-style-type: none"> • When Meas Method is RBW or FAST, this function is unavailable and the key is grayed out. • Whenever Gate is on, Meas Method, RBW or FAST is unavailable and keys for those are grayed out. • When Gate is on, Offset Res BW and Offset Video BW are ignored (if you set these values) and the measurement works as if all Offset Res BW and all Offset Video BW are coupled with the Res BW and the Video BW under the BW menu. When Gate is on, the Offset BW key in the Offset/Limit menu is grayed out.
Preset	Off LTETDD: On
State Saved	Saved in instrument state
Range	On Off
Backwards Compatibility SCPI	[:SENSe] :SWEep:TIME:GATE [:STATe] ESA compatibility
Backwards Compatibility Notes	In ESA, Trig Delay (On) and Gate (On) could not be active at the same time.. This dependency does not exist in PSA or in the X-Series.
Initial S/W Revision	Prior to A.02.00

Gate View On/Off

Turning on Gate View in the Swept SA measurement provides a single-window gate view display..

Turning on Gate View in other measurements shows the split-screen Gate View. In these measurements, when the Gate View is on, the regular view of the current measurement traces and results are reduced vertically to about 70% of the regular height. The Zero Span window, showing the positions of the Gate, is shown between the Measurement Bar and the reduced measurement window. By reducing the height of the measurement window, some of the annotation on the Data Display may not fit and is not shown.

Key Path	Sweep/Control, Gate
Remote Command	[:SENSe] :SWEep:EGATe:VIEW ON OFF 1 0 [:SENSe] :SWEep:EGATe:VIEW?
Example	SWE:EGAT:VIEW ON turns on the gate view.

Dependencies	<p>In the Swept SA measurement:</p> <p>In Gate View, the regular Acq Time key is grayed out . When pressed, the grayed out key puts up the informational message "Use Gate View Sweep Time in the Gate menu."</p> <p>In the other measurements:</p> <p>When you turn Gate View on, the lower window takes on the current state of the instrument. Upon leaving Gate View, the instrument takes on the state of the lower window.</p> <p>When you turn Gate View on, the upper window Acquisition Time is set to the gate view acquisition time.</p>
Couplings	<p>These couplings apply to the Swept SA measurement:</p> <ul style="list-style-type: none"> • When Gate View is turned on, the instrument is set to Zero Span. • Gate View automatically turns off whenever a Span other than Zero is selected. • Gate View automatically turns off if you press the Last Span key while in Gate View, and the instrument returns to the Span it was in before entering Gate View (even if that is Zero Span). • When Gate View is turned on, the sweep time used is the gate view sweep time. This is set according to the rules in section "Gate View Setup" on page 1553 • When Gate View is turned off, Sweep Time is set to the normal Swept SA measurement sweep time. • If Gate View is on and Gate is off, then turning on Gate turns off Gate View.
Preset	OFF
State Saved	Saved in instrument state
Range	On Off
Initial S/W Revision	Prior to A.02.00

A sample of the Gate View screen in the Swept SA measurement is shown in the following graphic :

11 Spectrum Emission Mask Measurement Sweep/Control

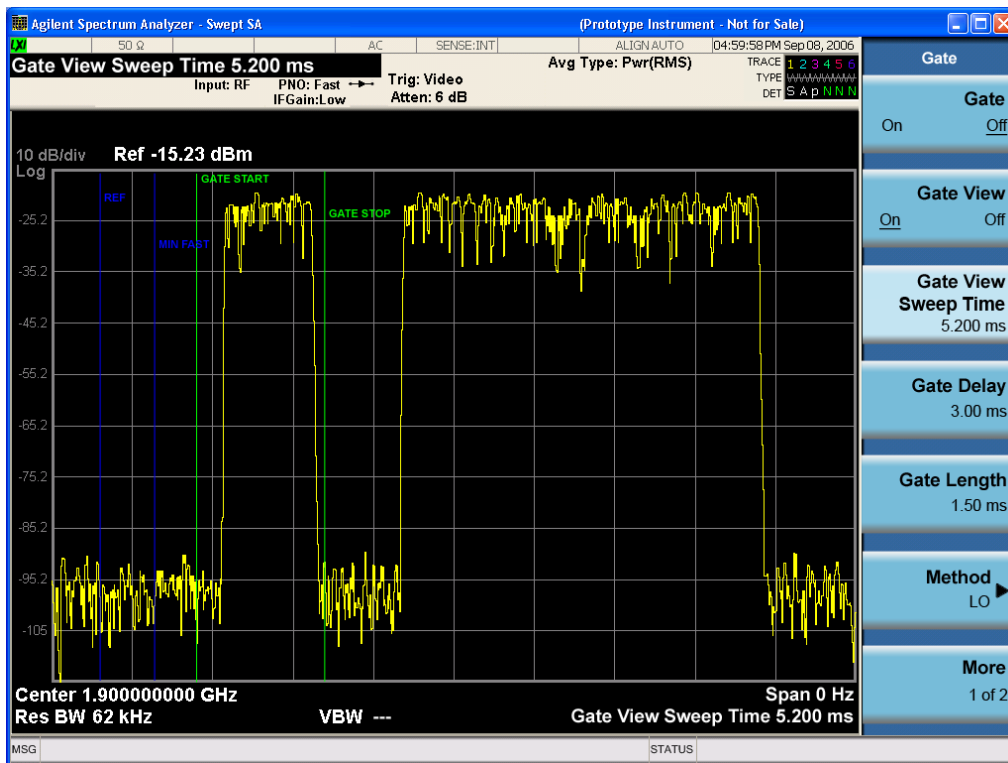

A sample of the Gate View screen in other measurements is shown in the following graphic. This example is for the ACP measurement:

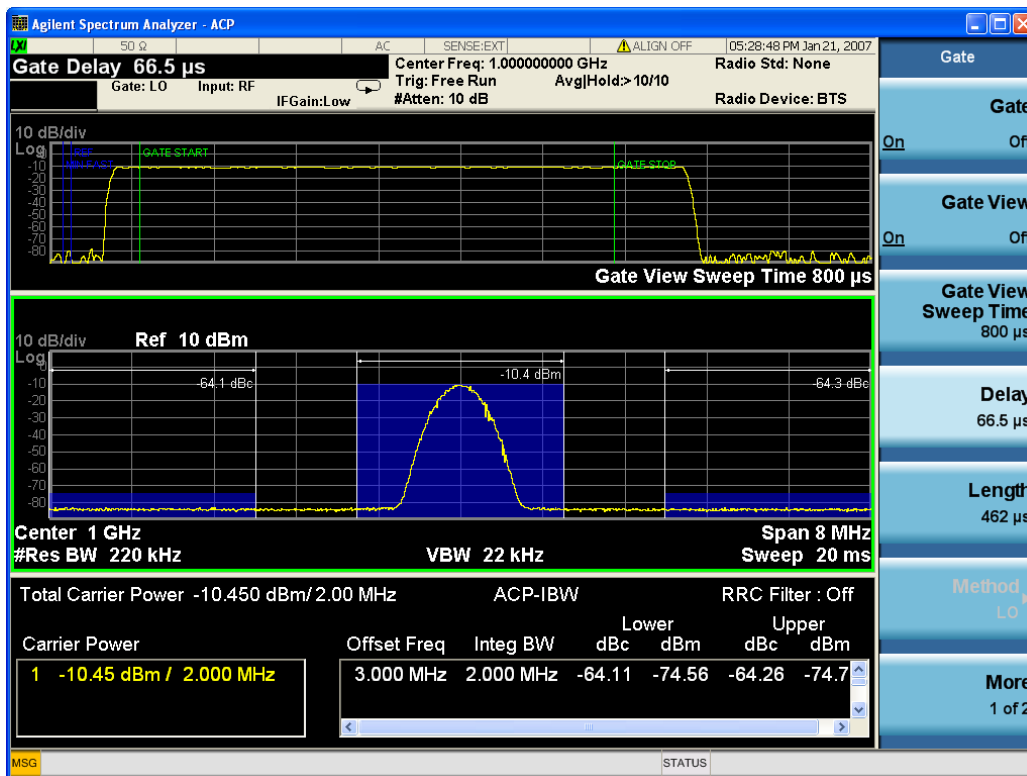

Turning Gate View off returns the analyzer to the Normal measurement view.

In the Swept SA, the normal measurement view is the single-window Swept SA view. When returning to this view, the Swept SA measurement returns to the Span it was in before entering **Gate View** (even if that is Zero Span).

The **Gate View** window is triggered from the Gate Source, with zero trigger delay. Also, when updating the **Gate View** window, the Gate itself must not operate. So it is internally shut off while the gate view window is being updated. For the Swept SA measurement, this means that the Gate is internally shut off whenever the gate view window is displayed. The measurement bar and softkeys continue to show the Trigger source for the main sweep window and give no indication that the Gate is shut off or that the Gate View window is triggered from the Gate Source.

When in **Gate View**, vertical lines are displayed in the Gate View window as follows:

- Green lines are displayed at the gate edges as follows: in Edge Gate, a line is shown for Delay and one for the end of the Gate period, defined by Length. You can adjust the position of the green lines by adjusting the gate length and the gate delay. These lines update in the Gate View window as the active function changes, even if the window is not being updated. In Gated FFT, their location is relative to the left edge of the screen.
- A blue line is displayed showing the delay reference, that is, the reference point for the Gate Delay within the Zero Span window. The blue line represents where (in time) the effective location of the gate start would be if the gate were programmed to zero delay.

-

Gate View Setup

Accesses a menu that enables you to setup parameters relevant to the Gate View

Key Path	Sweep/Control, Gate
Scope	Meas Global
Initial S/W Revision	A.10.00

Gate View Acquisition Time

Controls the acquisition time in the Gate View window. To provide an optimal view of the gate signal, the analyzer initializes Gate View Acq Time based on the current settings of Gate Delay and Gate Length.

Key Path	Sweep/Control, Gate, Gate View Setup
Remote Command	[:SENSe] :SWEep:EGATe:TIME <time> [:SENSe] :SWEep:EGATe:TIME?
Example	SWE:EGAT:TIME 500 ms
Dependencies	Gate View Acquisition Time is initialized: <ul style="list-style-type: none"> • On Preset (after initializing delay and length). • Every time the Gate Method is set/changed. 1. Compute the location of the "gate stop" line, which you know is at time $t = t_{min} + GateDelay +$

GateLength.	
Preset	519.3 μ s WiMAX OFDMA: 5 ms GSM/EDGE: 1 ms
State Saved	Saved in instrument state
Min	100 ns
Max	6000 s
Initial S/W Revision	Prior to A.02.00

Gate View Start Time

Controls the time at the left edge of the Gate View.

Key Path	Sweep/Control, Gate, Gate View Setup
Remote Command	[:SENSe] :SWEep:EGATe:VIEW:STARt <time> [:SENSe] :SWEep:EGATe:VIEW:STARt?
Example	SWE:EGAT:VIEW:STAR 10ms
Notes	Units of time are required or no units; otherwise an invalid suffix error message will be generated. See error -131.
Preset	0 ms
State Saved	Saved in instrument state
Min	0
Max	500 ms
Initial S/W Revision	A.10.00

Gate Delay

Controls the length of time from the time the gate condition goes True until the gate is turned on.

Key Path	Sweep/Control, Gate
Remote Command	[:SENSe] :SWEep:EGATe:DELay <time> [:SENSe] :SWEep:EGATe:DELay?
Example	SWE:EGAT:DELay 500ms SWE:EGAT:DELay?
Notes	Units of time are required or no units; otherwise an invalid suffix error message will be generated.
Preset	57.7 μ s WiMAX OFDMA: 71 μ s GSM/EDGE: 600 μ s

	WLAN: 500 us WLAN: 36 us
State Saved	Saved in instrument state
Min	0.0 us
Max	100 s
Backwards Compatibility SCPI	[:SENSe]:SWEep:TIME:GATE:DELay ESA compatibility
Initial S/W Revision	Prior to A.02.00

Gate Length

Controls the length of time that the gate is on after it opens.

Key Path	Sweep/Control, Gate
Remote Command	[:SENSe]:SWEep:EGATe:LENGth <time> [:SENSe]:SWEep:EGATe:LENGth?
Example	SWE:EGAT:LENG 1 SWE:EGAT:LENG?
Notes	Units of time are required or no units; otherwise an invalid suffix error message will be generated.
Preset	461.6 us WiMAX OFDMA: 50 us GSM/EDGE: 200 us WLAN: 1.54 ms WLAN: 32 us
State Saved	Saved in instrument state
Min	100 ns
Max	5 s
Backwards Compatibility SCPI	[:SENSe]:SWEep:TIME:GATE:LENGth ESA compatibility
Initial S/W Revision	Prior to A.02.00

Gate Source

The menus under the Gate Source key are the same as those under the Trigger key, with the exception that neither Free Run nor Video are available as Gate Source selections. However, a different SCPI command is used to select the Gate Source (see table below) because you may independently set the Gate Source and the Trigger Source.

Any changes to the settings in the setup menus under each Gate Source selection key (for example: Trigger Level, Trigger Delay, etc.) also affect the corresponding settings under the Trigger menu keys. The SCPI commands used for these are the same for Trigger and Gate, since there is only one setting which affects both Gate and Trigger. Example: to set the Trigger Level for External 1 you use the command :TRIG:EXT1:LEV regardless of whether you are using External 1 as a Trigger Source or a Gate Source.

Key Path	Sweep/Control, Gate
Remote Command	[:SENSe] :SWEep:EGATe:SOURce EXTernal1 EXTernal2 LINE FRAME RFBurst [:SENSe] :SWEep:EGATe:SOURce?
Dependencies	In some models, there is no second External input. In these models, the External 2 key is blanked and the EXTernal2 parameter will generate a "Hardware missing; Not available for this model number" error.
Preset	EXTernal 1 GSM/EDGE, MSR: FRAME LTETDD: EXTernal 1When Direction is Downlink, FRAME when Direction is Uplink.
Initial S/W Revision	Prior to A.02.00
Modified at S/W Revision	A.03.00, A.14.00

Video (IF Envelope)

Pressing this key, when it is not selected, selects the video signal as the trigger. The Video trigger condition is met when the video signal (the filtered and detected version of the input signal, including both RBW and VBW filtering) crosses the video trigger level.

NOTE

When the detector selected for all active traces is the average detector, the video signal for triggering does not include any VBW filtering.

The video trigger level is shown as a labeled line on the display. The line is displayed as long as video is the selected trigger source.

Pressing this key, when it is already selected, accesses the video trigger setup functions.

Key Path	Trigger
Example	TRIG:SOUR VID Swept SA measurement TRIG:< meas > :SOUR VID Measurements other than Swept SA
Notes	Log Plot and Spot Frequency measurements do not support Video Trigger
Dependencies	Video trigger is allowed in average detector mode.
State Saved	Saved in instrument state
Status Bits/OPC dependencies	The Status Operation Register bit 5 "Waiting for Trigger" is set at the same time as the Sweeping or Measuring bit is set. It is cleared when the trigger actually occurs (that is, after the trigger event occurs and all the applicable trigger criteria have been met). A corresponding pop-up message ("Waiting for trigger") is generated if no trigger signal appears after approximately 2 sec. This message goes away when a trigger signal appears.

Backwards Compatibility Notes	In the past, the Average detector was not available when Video triggering was on, and consequently, functions that set the detector to average (such as Marker Noise or Band/Intvl Power) were not available when the video trigger was on. Similarly, Video triggering was not available when the detector was Average. In the X-Series, these restrictions are removed.
Initial S/W Revision	Prior to A.02.00

Trigger Level

Sets a level for the video signal trigger. When the video signal crosses this level, with the chosen slope, the trigger occurs. This level is displayed with a horizontal line only if **Video** is the selected trigger source.

Key Path	Trigger, Video
Remote Command	:TRIGger[:SEquence]:VIDeo:LEVel <ampl> :TRIGger[:SEquence]:VIDeo:LEVel?
Example	TRIG:VID:LEV -40 dBm
Notes	<p>When sweep type = FFT, the video trigger uses the amplitude envelope in a bandwidth wider than the FFT width as a trigger source. This might often be useful, but does not have the same relationship between the displayed trace and the trigger level as in swept triggering.</p> <p>Amplitude Corrections are not taken into account by the Video Trig Level. For example, if you have given yourself effective gain with an amplitude correction factor, the Video Trigger will not fire until you have dropped the trigger line that far below the displayed signal level, rather than simply dropping it down to the displayed signal level.</p> <p>Note that other corrections, specifically External Gain and Ref Level Offset, modify the actual trace data as it is taken and therefore ARE taken into account by Trig Level.</p>
Couplings	This same level is used for the Video trigger source in the Trigger menu and for the Video selection in the Gate Source menu.
Preset	Set the Video Trigger Level -25 dBm on Preset. When the Video Trigger Level becomes the active function, if the value is off screen, set it to either the top or bottom of screen, depending on which direction off screen it was.
State Saved	Saved in instrument state
Min	-170 dBm
Max	+30 dBm
Default Unit	Depends on the current selected Y axis unit
Backwards Compatibility SCPI	:TRIGger[:SEquence]:IF:LEVel :TRIGger[:SEquence]:IF:LEVel?
Backwards Compatibility Notes	This alias is provided for backward compatibility with VSA/PSA comms apps.
Initial S/W Revision	Prior to A.02.00

Trig Slope

Controls the trigger polarity. It is set positive to trigger on a rising edge and negative to trigger on a falling edge.

Key Path	Trigger, Video
Remote Command	:TRIGger[:SEquence]:VIDeo:SLOPe POSitive NEGative :TRIGger[:SEquence]:VIDeo:SLOPe?
Example	TRIG:VID:SLOP NEG
Preset	POSitive
State Saved	Saved in instrument state
Backwards Compatibility SCPI	:TRIGger[:SEquence]:IF:SLOPe NEGative POSitive :TRIGger[:SEquence]:IF:SLOPe? For backward compatibility with VSA/PSA comms apps
Backwards Compatibility Notes	The legacy :TRIGger[:SEquence]:SLOPe command affects the slopes for the VID, LINE, EXT1, EXT2, and RFB triggers.
Initial S/W Revision	Prior to A.02.00

Remote Command	:TRIGger[:SEquence]:SLOPe POSitive NEGative :TRIGger[:SEquence]:SLOPe?
Example	TRIG:SLOP NEG
Preset	POSitive
State Saved	Saved in instrument state
Backwards Compatibility Notes	In ESA/PSA, the Trigger Slope was global to all triggers. In the X-Series, the slope can be set individually for each Trigger Source. For backward compatibility, the global SLOPe command updates all instances of trigger slope (VID, LINE, EXT1, EXT2, TV, RFB). The query returns the trigger slope setting of the currently selected trigger source.
Initial S/W Revision	Prior to A.02.00

External 1

Pressing this key, when it is not selected, selects an external input signal as the trigger. A new sweep/measurement will start when the external trigger condition is met using the external 1 input connector on the rear panel.

Pressing this key, when it is already selected, accesses the external 1 trigger setup menu.

Key Path	Trigger
Example	TRIG:SOUR EXT1 Swept SA measurement TRIG:<meas>:SOUR EXT1 Measurements other than Swept SA
Dependencies	Grayed out if in use by Point Trigger in the Source Setup menu. Forced to Free Run if already selected and Point Trigger is set to External 1.

State Saved	Saved in instrument state
Status Bits/OPC dependencies	The Status Operation Register bit 5 "Waiting for Trigger" is set at the same time as the Sweeping or Measuring bit is set. It is cleared when the trigger actually occurs (that is, after the trigger event occurs and all the applicable trigger criteria have been met). A corresponding pop-up message ("Waiting for trigger") is generated if no trigger signal appears after approximately 2 sec. This message goes away when a trigger signal appears.
Initial S/W Revision	Prior to A.02.00

Trigger Level

Sets the value where the external 1 trigger input will trigger a new sweep/measurement.

Key Path	Trigger, External 1
Remote Command	:TRIGger[:SEquence]:EXTernal1:LEVel <level> :TRIGger[:SEquence]:EXTernal1:LEVel?
Example	TRIG:EXT1:LEV 0.4 V
Couplings	This same level is used for the Ext1 trigger source in the Trigger menu, for the Ext1 selection in the Periodic Timer sync source (in the Trigger menu and in the Gate Source menu), and also for the Ext1 selection in the Gate Source menu.
Preset	1.2 V
State Saved	Saved in instrument state
Min	-5 V
Max	5 V
Default Unit	V
Backwards Compatibility SCPI	:TRIGger[:SEquence]:EXTernal:LEVel For backward compatibility, the parameter EXTernal is mapped to EXTernal1
Backwards Compatibility SCPI	:TRIGger[:SEquence]:FRAMe:EXTernal1:LEVel
Initial S/W Revision	Prior to A.02.00

Trig Slope

Controls the trigger polarity. It is set positive to trigger on a rising edge and negative to trigger on a falling edge.

Key Path	Trigger, External 1
Remote Command	:TRIGger[:SEquence]:EXTernal1:SLOPe POSitive NEGative :TRIGger[:SEquence]:EXTernal1:SLOPe?
Example	TRIG:EXT1:SLOP NEG
Couplings	This same slope is used in the Ext1 selection for the trigger source in the Trigger menu and for the

	period timer sync source (in the Trigger menu and in the Gate Source menu).
Preset	POSitive
State Saved	Saved in instrument state
Backwards Compatibility SCPI	:TRIGger[:SEQuence]:EXTernal:SLOPe
Backwards Compatibility SCPI	For backward compatibility, the parameter EXTernal is mapped to EXTernal1
Backwards Compatibility SCPI	:TRIGger[:SEQuence]:FRAMe:EXTernal1:SLOPe
Backwards Compatibility Notes	The legacy :TRIGger[:SEQuence]:SLOPe command affects the slopes for the VID, LINE, EXT1, EXT2, and RFB triggers.
Initial S/W Revision	Prior to A.02.00

Zero Span Delay Comp On/Off

In zero span, there is a natural delay in the signal path, which comes from the RBW filter. This is usually desirable, as it allows you to trigger on events and also see those events, because the signal is delayed from the trigger event. However, in some cases it is desirable to eliminate this delay, so that trigger events line up exactly with the zero time point in zero span. You can use the Zero Span Delay Comp On/Off feature to enable or disable zero span delay compensation.

Key Path	Trigger, External 1
Remote Command	:TRIGger[:SEQuence]:EXTernal1:DELay:COMPensation OFF ON 0 1 :TRIGger[:SEQuence]:EXTernal1:DELay:COMPensation?
Example	TRIG:EXT1:DEL:COMP ON
Dependencies	No effect except in zero-span, but not locked out in nonzero spans. Blanked in modes that do not support zero-span measurements. If the SCPI command is sent when the key is blanked, an error is returned: -221, "Settings conflict; Feature not supported for this measurement" In analyzers shipping N9060A, this feature requires N9060A-7FP.
Preset	OFF
State Saved	Saved in instrument state
Initial S/W Revision	A.11.00

External 2

Pressing this key, when it is not selected, selects an external input signal as the trigger. A new sweep/measurement will start when the external trigger condition is met using the external 2 input connector. The external trigger 2 input connector is on the rear panel.

Pressing this key, when it is already selected, accesses the external 2 trigger setup menu.

Key Path	Trigger
Example	TRIG:SOUR EXT2 Swept SA measurement

	TRIG:<meas>:SOUR EXT2 Measurements other than Swept SA
Dependencies	In some models, there is no second External input. In these models, the External 2 key is blanked and the EXTernal2 parameter will generate a "Hardware missing; Not available for this model number" message. Grayed out if in use by Point Trigger in the Source Setup menu. Forced to Free Run if already selected and Point Trigger is set to External 2.
State Saved	Saved in instrument state
Status Bits/OPC dependencies	The Status Operation Register bit 5 "Waiting for Trigger" is set at the same time as the Sweeping or Measuring bit is set. It is cleared when the trigger actually occurs (that is, after the trigger event occurs and all the applicable trigger criteria have been met). A corresponding pop-up message ("Waiting for trigger") is generated if no trigger signal appears after approximately 2 sec. This message goes away when a trigger signal appears.
Initial S/W Revision	Prior to A.02.00
Modified at S/W Revision	A.03.00

Trigger Level

Sets the value where the external 2 trigger input will trigger a new sweep/measurement.

Key Path	Trigger, External 2
Remote Command	:TRIGger[:SEquence]:EXTernal2:LEVel :TRIGger[:SEquence]:EXTernal2:LEVel?
Example	TRIG:EXT2:LEV 1.1 V
Couplings	This same level is used for the Ext2 trigger source in the Trigger menu, for the Ext2 selection in the Periodic Timer sync source (in the Trigger menu and in the Gate Source menu), and also for the Ext2 selection in the Gate Source menu.
Preset	1.2 V
State Saved	Saved in instrument state
Min	-5 V
Max	5 V
Default Unit	V
Backwards Compatibility SCPI	:TRIGger[:SEquence]:FRAMe:EXTernal2:LEVel
Initial S/W Revision	Prior to A.02.00

Trig Slope

Controls the trigger polarity. It is set positive to trigger on a rising edge and negative to trigger on a falling edge.

Key Path	Trigger, External 2
Remote Command	:TRIGger[:SEquence]:EXTernal2:SLOPe POSitive NEGative :TRIGger[:SEquence]:EXTernal2:SLOPe?
Example	TRIG:EXT2:SLOP NEG
Couplings	This same slope is used in the Ext2 selection for the trigger source in the Trigger menu and for the period timer sync source (in the Trigger menu and in the Gate Source menu).
Preset	POSitive
State Saved	Saved in instrument state
Backwards Compatibility SCPI	:TRIGger[:SEquence]:FRAME:EXTernal2:SLOPe
Backwards Compatibility Notes	The legacy :TRIGger[:SEquence]:SLOPe command affects the slopes for the VID, LINE, EXT1, EXT2, and RFB triggers.
Initial S/W Revision	Prior to A.02.00

Zero Span Delay Comp On/Off

In zero span, there is a natural delay in the signal path, which comes from the RBW filter. This is usually desirable, as it allows you to trigger on events and also see those events, because the signal is delayed from the trigger event. However, in some cases it is desirable to eliminate this delay, so that trigger events line up exactly with the zero time point in zero span. You can use the Zero Span Delay Comp On/Off feature to enable or disable zero span delay compensation.

Key Path	Trigger, External 2
Remote Command	:TRIGger[:SEquence]:EXTernal2:DELAy:COMPensation OFF ON 0 1 :TRIGger[:SEquence]:EXTernal2:DELAy:COMPensation?
Example	TRIG:EXT2:DEL:COMP ON
Dependencies	No effect except in zero-span, but not locked out in nonzero spans. Blanked in modes that do not support zero-span measurements. If the SCPI command is sent when the key is blanked, an error is returned: -221, "Settings conflict; Feature not supported for this measurement" In analyzers shipping N9060A, this feature requires N9060A-7FP.
Preset	OFF
State Saved	Saved in instrument state
Initial S/W Revision	A.11.00

RF Burst

Pressing this key, when it is not selected, selects the RF Burst as the trigger. A new sweep/measurement will start when an RF burst envelope signal is identified from the signal at the RF Input connector. Pressing this key, when it is already selected, accesses the RF Burst trigger setup menu.

In some models, a variety of burst trigger circuitry is available, resulting in various available burst trigger bandwidths. The analyzer automatically chooses the appropriate trigger path based on the hardware configuration and other settings of the analyzer.

Key Path	Trigger
Example	TRIG:SOUR RFB Swept SA measurement TRIG:<meas>:SOUR RFB Measurements other than Swept SA
State Saved	Saved in instrument state
Status Bits/OPC dependencies	The Status Operation Register bit 5 "Waiting for Trigger" is set at the same time as the Sweeping or Measuring bit is set. It is cleared when the trigger actually occurs (that is, after the trigger event occurs and all the applicable trigger criteria have been met). A corresponding pop-up message ("Waiting for trigger") is generated if no trigger signal appears after approximately 2 sec. This message goes away when a trigger signal appears.
Backwards Compatibility Notes	The legacy command: :TRIGger[:SEquence]:RFBurst:FSElectivity[:STATe] OFF ON 0 1 is not supported in the X-Series, as the hardware to do Frequency Selective burst triggers does not exist in X-Series.
Initial S/W Revision	Prior to A.02.00
Modified at S/W Revision	A.04.00

Absolute Trigger Level

Sets the absolute trigger level for the RF burst envelope.

When using the External Mixing path, the Absolute Trigger Level is uncalibrated because the factory default was set to accommodate the expected IF levels for the RF path.

Key Path	Trigger, RF Burst
Scope	Meas Global
Remote Command	:TRIGger[:SEquence]:RFBurst:LEVel:ABSolute <ampl> :TRIGger[:SEquence]:RFBurst:LEVel:ABSolute?
Example	TRIG:RFB:LEV:ABS 10 dBm sets the trigger level of the RF burst envelope signal to the absolute level of 10 dBm
Notes	Sending this command does not switch the setting from relative to absolute; to switch it you need to send the :TRIGger[:SEquence]:RFBurst:LEVel:TYPE command, below. Amplitude Corrections are not taken into account by the Absolute Trigger Level. For example, if you have given yourself effective gain with an amplitude correction factor, the Absolute Trigger will not fire until you have set the trigger level that far below the displayed signal level, rather than simply to the displayed signal level. This is only true for Amplitude Corrections, not External Gain or Ref Level Offset functions. If mode is Bluetooth, the default value is -50 dBm.
Couplings	This same level is used for the RF Burst trigger source in the Trigger menu, for the RF Burst selection in the Periodic Timer sync source (in the Trigger menu and in the Gate Source menu), and also for the

	RF Burst selection in the Gate Source menu
Preset	-20 dBm
State Saved	Saved in instrument state
Min	-200 dBm
Max	100 dBm
Default Unit	depends on the current selected Y-Axis unit
Backwards Compatibility SCPI	:TRIGger[:SEquence]:FRAMe:RFBurst:LEVel:ABSolute
Initial S/W Revision	Prior to A.02.00
Modified at S/W Revision	A.04.00

Key Path	Trigger, RF Burst
Remote Command	:TRIGger[:SEquence]:RFBurst:LEVel:TYPE ABSolute RELative :TRIGger[:SEquence]:RFBurst:LEVel:TYPE?
Example	TRIG:RFB:LEV:TYPE REL sets the trigger level type of the RF burst trigger to Relative.
Preset	ABSolute
State Saved	Saved in instrument state
Initial S/W Revision	Prior to A.02.00
Modified at S/W Revision	A.04.00

Relative Trigger Level

Sets the relative trigger level for the RF burst envelope.

In some models, the relative burst trigger function is implemented in hardware. In other models, without the advanced triggering hardware required, the relative burst trigger function is implemented in software in some measurements, and is unavailable in other measurements.

When implemented in software, the relative RF Burst trigger function is implemented as follows:

1. The measurement starts with the absolute RF Burst trigger setting. If it cannot get a trigger with that level, auto trigger fires and the acquisition starts anyway. After the acquisition, the measurement searches for the peak in the acquired waveform and saves it.
2. Now, in the next cycle of the measurement, the measurement determines a new absolute RF Burst level based on the peak value from the first measurement and the Relative RF Burst Trigger Level (always 0 or negative dB) set by the user. The following formula is used:
3. absolute RF Burst level = peak level of the previous acquisition + relative RF Burst level
4. If the new absolute RF Burst level differs from the previous by more than 0.5 dB, the new level is sent to the hardware; otherwise it is not updated (to avoid slowing down the acquisition)

Steps 2 and 3 repeat for subsequent measurements.

Key Path	Trigger, RF Burst
Scope	Meas Global
Remote Command	:TRIGger[:SEquence]:RFBurst:LEVel:RELative <rel_ampl> :TRIGger[:SEquence]:RFBurst:LEVel:RELative?
Example	TRIG:RFB:LEV:REL -10 dB sets the trigger level of the RF burst envelope signal to the relative level of -10 dB
Notes	Sending this command does not switch the setting from absolute to relative; to switch it you need to send the :TRIGger[:SEquence]:RFBurst:LEVel:TYPE command, above. The relative trigger level is not available in some measurements. In those measurements the RELative parameter, and the :TRIGger[:SEquence]:RFBurst:LEVel:TYPE command (above), will generate an error if sent.
Dependencies	This key is grayed out and Absolute Trigger Level selected if the required hardware is not present in your analyzer and the current measurement does not support Relative triggering.
Preset	-6 dB GSM: -25 dB
State Saved	Saved in instrument state
Min	-45 dB
Max	0 dB
Default Unit	dB or dBc
Backwards Compatibility SCPI	:TRIGger[:SEquence]:RFBurst:LEVel This legacy command is aliased to :TRIGger[:SEquence]:RFBurst:LEVel:RELative because the PSA had ONLY relative burst triggering
Initial S/W Revision	Prior to A.02.00
Modified at S/W Revision	A.04.00

Trigger Slope

It is set positive to trigger on a rising edge and negative to trigger on a falling edge.

Key Path	Trigger, RF Burst
Remote Command	:TRIGger[:SEquence]:RFBurst:SLOPe POSitive NEGative :TRIGger[:SEquence]:RFBurst:SLOPe?
Example	TRIG:RFB:SLOP NEG
Couplings	This same slope is used in the RF Burst selection for the trigger source in the Trigger menu and for the period timer sync source (in the Trigger menu and in the Gate Source menu).
Preset	POSitive
State Saved	Saved in instrument state
Backwards Compatibility SCPI	:TRIGger[:SEquence]:FRAMe:RFBurst:SLOPe

Backwards Compatibility Notes	The legacy :TRIGger[:SEQUence]:SLOPe command affects the slopes for the VID, LINE, EXT1, EXT2, and RFB triggers.
Initial S/W Revision	Prior to A.02.00

Periodic Timer (Frame Trigger)

Pressing this key, when it is not selected, selects the internal periodic timer signal as the trigger. Triggering occurrences are set by the **Period** parameter, which is modified by the **Sync Source** and **Offset**. Pressing this key, when it is already selected, accesses the periodic timer trigger setup functions.

If you do not have a sync source selected (it is Off), then the internal timer will not be synchronized with any external timing events.

Key Path	Trigger
Example	TRIG:SOUR FRAM Swept SA measurement TRIG:<meas>:SOUR FRAM Measurements other than Swept SA
State Saved	Saved in instrument state
Readback	[Sync: <value of Sync Source>], for example, [Sync: External 1]
Status Bits/OPC dependencies	The Status Operation Register bit 5 "Waiting for Trigger" is set at the same time as the Sweeping or Measuring bit is set. It is cleared when the trigger actually occurs (that is, after the trigger event occurs and all the applicable trigger criteria have been met). A corresponding pop-up message ("Waiting for trigger") is generated if no trigger signal appears after approximately 2 sec. This message goes away when a trigger signal appears.
Initial S/W Revision	Prior to A.02.00

Periodic Timer Triggering:

This feature selects the internal periodic timer signal as the trigger. Trigger occurrences are set by the **Periodic Timer** parameter, which is modified by the **Sync Source** and **Offset**.

The figure below shows the action of the periodic timer trigger. Before reviewing the figure, we'll explain some uses for the periodic trigger.

A common application is measuring periodic burst RF signals for which a trigger signal is not easily available. For example, we might be measuring a TDMA radio which bursts every 20 ms. Let's assume that the 20 ms period is very consistent. Let's also assume that we do not have an external trigger source available that is synchronized with the period, and that the signal-to-noise ratio of the signal is not high enough to provide a clean RF burst trigger at all of the analysis frequencies. For example, we might want to measure spurious transmissions at an offset from the carrier that is larger than the bandwidth of the RF burst trigger. In this application, we can set the Periodic Timer to a 20.00 ms period and adjust the offset from that timer to position our trigger just where we want it. If we find that the 20.00 ms is not exactly right, we can adjust the period slightly to minimize the drift between the period timer and the signal to be measured.

A second way to use this feature would be to use **Sync Source** temporarily, instead of **Offset**. In this case, we might tune to the signal in a narrow span and use the RF Burst trigger to synchronize the periodic timer. Then we would turn the sync source off so that it would not miss-trigger. Miss-triggering can occur when we are tuned so far away from the RF burst trigger that it is no longer reliable.

A third example would be to synchronize to a signal that has a reference time element of much longer period than the period of interest. In some CDMA applications, it is useful to look at signals with a short periodicity, by synchronizing that periodicity to the "even-second clock" edge that happens every two seconds. Thus, we could connect the even-second clock trigger to Ext1 and use then Ext1 as the sync source for the periodic timer.

The figure below illustrates this third example. The top trace represents the even-second clock. It causes the periodic timer to synchronize with the leading edge shown. The analyzer trigger occurs at a time delayed by the accumulated offset from the period trigger event. The periodic timer continues to run, and triggers continue to occur, with a periodicity determined by the analyzer time base. The timer output (labeled "late event") will drift away from its ideal time due to imperfect matching between the time base of the signal being measured and the time base of the analyzer, and also because of imperfect setting of the period parameter. But the synchronization is restored on the next even-second clock event. ("Accumulated offset" is described in the **Offset** function section.)

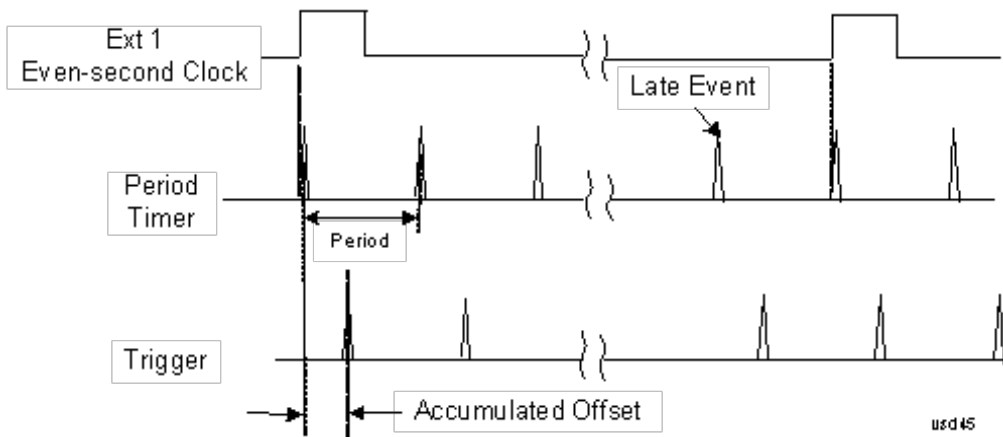

Period

Sets the period of the internal periodic timer clock. For digital communications signals, this is usually set to the frame period of your current input signal. In the case that sync source is not set to OFF, and the external sync source rate is changed for some reason, the periodic timer is synchronized at the every external synchronization pulse by resetting the internal state of the timer circuit.

Key Path	Trigger, Periodic Timer
Remote Command	:TRIGger[:SEquence]:FRAMe:PERiod <time> :TRIGger[:SEquence]:FRAMe:PERiod?
Example	TRIG:FRAM:PER 100 ms
Dependencies	The invalid data indicator turns on when the period is changed, until the next sweep/measurement completes.
Couplings	The same period is used in the Gate Source selection of the period timer.
Preset	20 ms

	GSM: 4.615383
State Saved	Saved in instrument state
Min	100.000 ns
Max	559.0000 ms
Default Unit	S
Initial S/W Revision	Prior to A.02.00

Offset

Adjusts the accumulated offset between the periodic timer events and the trigger event. Adjusting the accumulated offset is different than setting an offset, and requires explanation.

The periodic timer is usually not synchronized with any external events, so the timing of its output events has no absolute meaning. Since the timing relative to external events (RF signals) is important, you need to be able to adjust (offset) it. However, you have no direct way to see when the periodic timer events occur. All that you can see is the trigger timing. When you want to adjust the trigger timing, you will be changing the internal offset between the periodic timer events and the trigger event. Because the absolute value of that internal offset is unknown, we will just call that the accumulated offset. Whenever the Offset parameter is changed, you are changing that accumulated offset. You can reset the displayed offset using Reset Offset Display. Changing the display does not change the value of the accumulated offset, and you can still make additional changes to accumulated offset.

To avoid ambiguity, we define that an increase in the "offset" parameter, either from the knob or the SCPI adjust command, serves to delay the timing of the trigger event.

Key Path	Trigger, Periodic Timer
Remote Command	:TRIGger[:SEquence]:FRAMe:OFFSet <time> :TRIGger[:SEquence]:FRAMe:OFFSet?
Example	TRIG:FRAM:OFFS 1.2 ms
Notes	<p>The front panel interface (for example, the knob), and this command, adjust the accumulated offset, which is shown on the active function display. However, the actual amount sent to the hardware each time the offset is updated is the delta value, that is, the current accumulated offset value minus the previous accumulated offset value. Note that the accumulated offset value is essentially arbitrary; it represents the accumulated offset from the last time the offset was zeroed (with the Reset Offset Display key).</p> <p>Note that this command does not change the period of the trigger waveform. Note also that Offset is used only when the sync source is set to OFF, otherwise delay is used, see section "Trig Delay" on page 359.</p> <p>An increase in the "offset" parameter, either from the knob or the SCPI adjust command, serves to delay the timing of the trigger event.</p>
Notes	<p>When the SCPI command is sent the value shown on the key (and the Active Function, if this happens to be the active function) is updated with the new value. However, the actual amount sent to the hardware is the delta value, that is, the current accumulated offset value minus the previous accumulated offset value.</p> <p>The SCPI query simply returns the value currently showing on the key.</p>

Dependencies	The invalid data indicator turns on when the offset is changed, until the next sweep/measurement completes.
Couplings	The same offset is used in the Gate Source selection of the period timer.
Preset	0 s
State Saved	Saved in instrument state
Min	-10.000 s
Max	10.000 s
Default Unit	S
Initial S/W Revision	Prior to A.02.00

Offset Adjust (Remote Command Only)

This remote command does not work at all like the related front panel keys. This command lets you advance the phase of the frame trigger by the amount you specify.

It does not change the period of the trigger waveform. If the command is sent multiple times, it advances the phase of the frame trigger an additional amount each time it is sent. Negative numbers are permitted.

Remote Command	:TRIGger[:SEquence]:FRAMe:ADJust <time>
Example	TRIG:FRAM:ADJ 1.2 ms
Notes	Note also that Offset is used only when the sync source is set to OFF, otherwise delay is used, see section "Trig Delay" on page 359 An increase in the "offset" parameter, either from the knob or the SCPI adjust command, serves to delay the timing of the trigger event.
Notes	The front panel interface (for example, the knob) and the :TRIG:FRAM:OFFS command adjust the accumulated offset, which is shown on the active function display. However, the actual amount sent to the hardware is the delta value, that is, the current offset value minus the previous offset value. When the SCPI command is sent the value shown on the key (and the Active Function, if this happens to be the active function) is updated by increasing it (or decreasing it if the value sent is negative) by the amount specified in the SCPI command. This is a "command only" SCPI command, with no query.
Dependencies	The invalid data indicator turns on when the offset is changed, until the next sweep/measurement completes.
Couplings	The same offset is used in the Gate Source selection of the period timer.
Preset	0 s
State Saved	Saved in instrument state
Min	-10.000 s
Max	10.000 s
Default Unit	S
Initial S/W Revision	Prior to A.02.00

Reset Offset Display

Resets the value of the periodic trigger offset display setting to 0.0 seconds. The current displayed trigger location may include an offset value defined with the Offset key. Pressing this key redefines the currently displayed trigger location as the new trigger point that is 0.0 s offset. The Offset key can then be used to add offset relative to this new timing.

Key Path	Trigger, Periodic Timer
Remote Command	:TRIGger[:SEquence]:FRAMe:OFFSet:DISPlay:RESet
Example	TRIG:FRAM:OFFS:DISP:RES
Initial S/W Revision	Prior to A.02.00

Sync Source

Selects a signal source for you to synchronize your periodic timer trigger to, otherwise you are triggering at some arbitrary location in the frame. Synchronization reduces the precision requirements on the setting of the period.

For convenience you may adjust the level and slope of the selected sync source in a conditional branch setup menu accessed from the Sync Source menu. Note that these settings match those in the **Trigger** and **Gate Source** menus; that is, each trigger source has only one value of level and slope, regardless of which menu it is accessed from.

Key Path	Trigger, Periodic Timer
Remote Command	:TRIGger[:SEquence]:FRAMe:SYNC EXTernal1 EXTernal2 RFBurst OFF :TRIGger[:SEquence]:FRAMe:SYNC?
Example	TRIG:FRAM:SYNC EXT2
Dependencies	In some models, there is no second External input. In these models, the External 2 key is blanked and the EXTernal2 parameter will generate a "Hardware missing; Not available for this model number" message.
Preset	Off GSM/EDGE, MSR,LTE,LTETDD: RFBurst
State Saved	Saved in instrument state
Readback	The current setting is read back to this key and it is also Readback to the previous Periodic Timer trigger key.
Backwards Compatibility SCPI	:TRIGger[:SEquence]:FRAMe:SYNC EXTernal For backward compatibility, the parameter EXTernal is mapped to EXTernal1
Initial S/W Revision	Prior to A.02.00
Modified at S/W Revision	A.03.00, A.14.00

Off

Turns off the sync source for your periodic trigger. With the sync source off, the timing will drift unless the signal source frequency is locked to the analyzer frequency reference.

Key Path	Trigger, Periodic Timer, Sync Source
Example	TRIG:FRAM:SYNC OFF
Readback	Off
Initial S/W Revision	Prior to A.02.00

External 1

Pressing this key, when it is not selected, selects an external input signal as the trigger. A new sweep/measurement will start when the external trigger condition is met using the external 1 input connector on the rear panel.

Pressing this key, when it is already selected, accesses the external 1 trigger setup menu.

Key Path	Trigger
Example	TRIG:SOUR EXT1 Swept SA measurement TRIG:<meas>:SOUR EXT1 Measurements other than Swept SA
Dependencies	Grayed out if in use by Point Trigger in the Source Setup menu. Forced to Free Run if already selected and Point Trigger is set to External 1.
State Saved	Saved in instrument state
Status Bits/OPC dependencies	The Status Operation Register bit 5 "Waiting for Trigger" is set at the same time as the Sweeping or Measuring bit is set. It is cleared when the trigger actually occurs (that is, after the trigger event occurs and all the applicable trigger criteria have been met). A corresponding pop-up message ("Waiting for trigger") is generated if no trigger signal appears after approximately 2 sec. This message goes away when a trigger signal appears.
Initial S/W Revision	Prior to A.02.00

Trigger Level

Sets the value where the external 1 trigger input will trigger a new sweep/measurement.

Key Path	Trigger, External 1
Remote Command	:TRIGger[:SEquence]:EXTernal1:LEVel <level> :TRIGger[:SEquence]:EXTernal1:LEVel?
Example	TRIG:EXT1:LEV 0.4 V
Couplings	This same level is used for the Ext1 trigger source in the Trigger menu, for the Ext1 selection in the Periodic Timer sync source (in the Trigger menu and in the Gate Source menu), and also for the Ext1 selection in the Gate Source menu.

Preset	1.2 V
State Saved	Saved in instrument state
Min	-5 V
Max	5 V
Default Unit	V
Backwards Compatibility SCPI	:TRIGger[:SEquence]:EXTernal:LEVel
Backwards Compatibility SCPI	For backward compatibility, the parameter EXTernal is mapped to EXTernal1
Backwards Compatibility SCPI	:TRIGger[:SEquence]:FRAMe:EXTernal1:LEVel
Initial S/W Revision	Prior to A.02.00

Trig Slope

Controls the trigger polarity. It is set positive to trigger on a rising edge and negative to trigger on a falling edge.

Key Path	Trigger, External 1
Remote Command	:TRIGger[:SEquence]:EXTernal1:SLOPe POSitive NEGative :TRIGger[:SEquence]:EXTernal1:SLOPe?
Example	TRIG:EXT1:SLOP NEG
Couplings	This same slope is used in the Ext1 selection for the trigger source in the Trigger menu and for the period timer sync source (in the Trigger menu and in the Gate Source menu).
Preset	POSitive
State Saved	Saved in instrument state
Backwards Compatibility SCPI	:TRIGger[:SEquence]:EXTernal:SLOPe
Backwards Compatibility SCPI	For backward compatibility, the parameter EXTernal is mapped to EXTernal1
Backwards Compatibility SCPI	:TRIGger[:SEquence]:FRAMe:EXTernal1:SLOPe
Backwards Compatibility Notes	The legacy :TRIGger[:SEquence]:SLOPe command affects the slopes for the VID, LINE, EXT1, EXT2, and RFB triggers.
Initial S/W Revision	Prior to A.02.00

External 2

Pressing this key, when it is not selected, selects an external input signal as the trigger. A new sweep/measurement will start when the external trigger condition is met using the external 2 input connector. The external trigger 2 input connector is on the rear panel.

Pressing this key, when it is already selected, accesses the external 2 trigger setup menu.

Key Path	Trigger
Example	TRIG:SOUR EXT2 Swept SA measurement TRIG:<meas>:SOUR EXT2 Measurements other than Swept SA
Dependencies	In some models, there is no second External input. In these models, the External 2 key is blanked and the EXTernal2 parameter will generate a "Hardware missing; Not available for this model number" message. Grayed out if in use by Point Trigger in the Source Setup menu. Forced to Free Run if already selected and Point Trigger is set to External 2.
State Saved	Saved in instrument state
Status Bits/OPC dependencies	The Status Operation Register bit 5 "Waiting for Trigger" is set at the same time as the Sweeping or Measuring bit is set. It is cleared when the trigger actually occurs (that is, after the trigger event occurs and all the applicable trigger criteria have been met). A corresponding pop-up message ("Waiting for trigger") is generated if no trigger signal appears after approximately 2 sec. This message goes away when a trigger signal appears.
Initial S/W Revision	Prior to A.02.00
Modified at S/W Revision	A.03.00

Trigger Level

Sets the value where the external 2 trigger input will trigger a new sweep/measurement.

Key Path	Trigger, External 2
Remote Command	:TRIGger[:SEquence]:EXTernal2:LEVel :TRIGger[:SEquence]:EXTernal2:LEVel?
Example	TRIG:EXT2:LEV 1.1 V
Couplings	This same level is used for the Ext2 trigger source in the Trigger menu, for the Ext2 selection in the Periodic Timer sync source (in the Trigger menu and in the Gate Source menu), and also for the Ext2 selection in the Gate Source menu.
Preset	1.2 V
State Saved	Saved in instrument state
Min	-5 V
Max	5 V
Default Unit	V
Backwards Compatibility SCPI	:TRIGger[:SEquence]:FRAMe:EXTernal2:LEVel
Initial S/W Revision	Prior to A.02.00

Trig Slope

Controls the trigger polarity. It is set positive to trigger on a rising edge and negative to trigger on a falling edge.

Key Path	Trigger, External 2
Remote Command	:TRIGger[:SEquence]:EXternal2:SLOPe POSitive NEGative :TRIGger[:SEquence]:EXternal2:SLOPe?
Example	TRIG:EXT2:SLOP NEG
Couplings	This same slope is used in the Ext2 selection for the trigger source in the Trigger menu and for the period timer sync source (in the Trigger menu and in the Gate Source menu).
Preset	POSitive
State Saved	Saved in instrument state
Backwards Compatibility SCPI	:TRIGger[:SEquence]:FRAMe:EXternal2:SLOPe
Backwards Compatibility Notes	The legacy :TRIGger[:SEquence]:SLOPe command affects the slopes for the VID, LINE, EXT1, EXT2, and RFB triggers.
Initial S/W Revision	Prior to A.02.00

RF Burst

Pressing this key, when it is not selected, selects the RF Burst as the trigger. A new sweep/measurement will start when an RF burst envelope signal is identified from the signal at the RF Input connector. Pressing this key, when it is already selected, accesses the RF Burst trigger setup menu.

In some models, a variety of burst trigger circuitry is available, resulting in various available burst trigger bandwidths. The analyzer automatically chooses the appropriate trigger path based on the hardware configuration and other settings of the analyzer.

Key Path	Trigger
Example	TRIG:SOUR RFB Swept SA measurement TRIG:< meas>:SOUR RFB Measurements other than Swept SA
State Saved	Saved in instrument state
Status Bits/OPC dependencies	The Status Operation Register bit 5 "Waiting for Trigger" is set at the same time as the Sweeping or Measuring bit is set. It is cleared when the trigger actually occurs (that is, after the trigger event occurs and all the applicable trigger criteria have been met). A corresponding pop-up message ("Waiting for trigger") is generated if no trigger signal appears after approximately 2 sec. This message goes away when a trigger signal appears.
Backwards Compatibility Notes	The legacy command: :TRIGger[:SEquence]:RFBurst:FSElectivity[:STATe] OFF ON 0 1 is not supported in the X-Series, as the hardware to do Frequency Selective burst triggers does not exist in X-Series.
Initial S/W Revision	Prior to A.02.00
Modified at S/W Revision	A.04.00

Absolute Trigger Level

Sets the absolute trigger level for the RF burst envelope.

When using the External Mixing path, the Absolute Trigger Level is uncalibrated because the factory default was set to accommodate the expected IF levels for the RF path.

Key Path	Trigger, RF Burst
Scope	Meas Global
Remote Command	<code>:TRIGger[:SEquence]:RFBurst:LEVel:ABSolute <ampl></code> <code>:TRIGger[:SEquence]:RFBurst:LEVel:ABSolute?</code>
Example	TRIG:RFB:LEV:ABS 10 dBm sets the trigger level of the RF burst envelope signal to the absolute level of 10 dBm
Notes	Sending this command does not switch the setting from relative to absolute; to switch it you need to send the <code>:TRIGger[:SEquence]:RFBurst:LEVel:TYPE</code> command, below. Amplitude Corrections are not taken into account by the Absolute Trigger Level. For example, if you have given yourself effective gain with an amplitude correction factor, the Absolute Trigger will not fire until you have set the trigger level that far below the displayed signal level, rather than simply to the displayed signal level. This is only true for Amplitude Corrections, not External Gain or Ref Level Offset functions. If mode is Bluetooth, the default value is -50 dBm.
Couplings	This same level is used for the RF Burst trigger source in the Trigger menu, for the RF Burst selection in the Periodic Timer sync source (in the Trigger menu and in the Gate Source menu), and also for the RF Burst selection in the Gate Source menu
Preset	-20 dBm
State Saved	Saved in instrument state
Min	-200 dBm
Max	100 dBm
Default Unit	depends on the current selected Y-Axis unit
Backwards Compatibility SCPI	<code>:TRIGger[:SEquence]:FRAMe:RFBurst:LEVel:ABSolute</code>
Initial S/W Revision	Prior to A.02.00
Modified at S/W Revision	A.04.00

Key Path	Trigger, RF Burst
Remote Command	<code>:TRIGger[:SEquence]:RFBurst:LEVel:TYPE ABSolute RELative</code> <code>:TRIGger[:SEquence]:RFBurst:LEVel:TYPE?</code>
Example	TRIG:RFB:LEV:TYPE REL sets the trigger level type of the RF burst trigger to Relative.
Preset	ABSolute

State Saved	Saved in instrument state
Initial S/W Revision	Prior to A.02.00
Modified at S/W Revision	A.04.00

Trigger Slope

It is set positive to trigger on a rising edge and negative to trigger on a falling edge.

Key Path	Trigger, RF Burst
Remote Command	:TRIGger[:SEquence]:RFBurst:SLOPe POSitive NEGative :TRIGger[:SEquence]:RFBurst:SLOPe?
Example	TRIG:RFB:SLOP NEG
Couplings	This same slope is used in the RF Burst selection for the trigger source in the Trigger menu and for the period timer sync source (in the Trigger menu and in the Gate Source menu).
Preset	POSitive
State Saved	Saved in instrument state
Backwards Compatibility SCPI	:TRIGger[:SEquence]:FRAME:RFBurst:SLOPe
Backwards Compatibility Notes	The legacy :TRIGger[:SEquence]:SLOPe command affects the slopes for the VID, LINE, EXT1, EXT2, and RFB triggers.
Initial S/W Revision	Prior to A.02.00

Sync Holdoff

Sync Holdoff specifies the duration that the sync source signal must be kept false before the transition to true to be recognized as the sync timing. The periodic timer phase is aligned when the sync source signal becomes true, after the Holdoff time is satisfied.

A holdoff of 2 ms will work with most WiMAX signals, but there may be cases where the burst off duration is less than 1 ms and this value will need to be changed.

Key Path	Trigger, Periodic Timer
Remote Command	:TRIGger[:SEquence]:FRAME:SYNC:HOLDoff <time> :TRIGger[:SEquence]:FRAME:SYNC:HOLDoff? :TRIGger[:SEquence]:FRAME:SYNC:HOLDoff:STATE OFF ON 0 1 :TRIGger[:SEquence]:FRAME:SYNC:HOLDoff:STATE?
Preset	On, 1.000 ms
State Saved	Saved in instrument state
Min	0 ms
Max	+500 ms
Default Unit	s
Initial S/W Revision	Prior to A.02.00

Auto/Holdoff

Opens up a menu that lets you adjust Auto Trigger and Trigger Holdoff parameters

Key Path	Trigger
Readback line	<p>Displays a summary of the Auto Trig and Holdoff settings, in square brackets</p> <p>First line: Auto Off or Auto On</p> <p>Second Line: "Hld" followed by:</p> <ul style="list-style-type: none"> • If Holdoff is Off, readback Off • If Holdoff On and Type = Normal, readback value • If Holdoff On and Type = Above, readback value followed by AL • If Holdoff On and Type = Below, readback value followed by BL • If Holdoff Type selection is not supported by the current measurement, Holdoff Type is always Normal
Initial S/W Revision	A.02.00

Auto Trig

Sets the time that the analyzer will wait for the trigger conditions to be met. If they are not met after that much time, then the analyzer is triggered anyway.

Key Path	Trigger, Auto/Holdoff
Remote Command	<pre>:TRIGger[:SEquence]:ATRigger <time> :TRIGger[:SEquence]:ATRigger? :TRIGger[:SEquence]:ATRigger:STATE OFF ON 0 1 :TRIGger[:SEquence]:ATRigger:STATE?</pre>
Example	<pre>TRIG:ATR:STAT ON TRIG:ATR 100 ms</pre>
Notes	The "time that the analyzer will wait" starts when the analyzer is ready for a trigger, which may be hundreds of ms after the data acquisition for a sweep is done. The "time" ends when the trigger condition is satisfied, not when the delay ends.
Preset	Off, 100 ms
State Saved	Saved in instrument state
Min	1 ms
Max	100 s
Default Unit	s
Initial S/W Revision	Prior to A.02.00

Trig Holdoff

Sets the holdoff time between triggers. When the trigger condition is satisfied, the trigger occurs, the delay begins, and the holdoff time begins. New trigger conditions will be ignored until the holdoff time expires. For a free-running trigger, the holdoff value is the minimum time between triggers.

Key Path	Trigger, Auto/Holdoff
Remote Command	:TRIGger[:SEquence]:HOLDoff <time> :TRIGger[:SEquence]:HOLDoff? :TRIGger[:SEquence]:HOLDoff:STATe OFF ON 0 1 :TRIGger[:SEquence]:HOLDoff:STATe?
Example	TRIG:HOLD:STAT ON TRIG:HOLD 100 ms
Dependencies	Unavailable if the selected Input is BBIQ. If this is the case, the key is grayed out if it is pressed the informational message "Feature not supported for this Input" is displayed. If the SCPI command is sent, the error "Settings conflict; Feature not supported for this Input" is generated.
Preset	Off, 100 ms
State Saved	Saved in instrument state
Min	0 s
Max	0.5 s
Default Unit	s
Initial S/W Revision	Prior to A.02.00

Gate Preset (Remote Command Only)

Presets the time-gated spectrum analysis capability.

This command sets gate parameter values to the ESA preset values, as follows:

Gate trigger type = edge

Gate polarity = positive

Gate delay = 1 us

Gate length = 1 us

Remote Command	[:SENSe]:SWEep:TIME:GATE:PRESet ESA Compatibility
Initial S/W Revision	Prior to A.02.00

Gate Level (Remote Command Only)

Sets the gate input transition point level for the external TRIGGER inputs on the front and rear panel. This is a legacy command for PSA compatibility. It is simply an alias to the equivalent trigger level command.

Remote Command	<code>[:SENSe] :SWEep:EGATe:EXTeRnal [1] 2:LEVe1 <voltage></code> <code>[:SENSe] :SWEep:EGATe:EXTeRnal [1] 2:LEVe1?</code>
Notes	This command is simply an alias to <code>:TRIGger[:SEQuence]:EXTeRnal[1]2:LEVe1</code> For details refer
Initial S/W Revision	Prior to A.02.00

Gate Polarity (Remote Command Only)

Sets the polarity for the gate signal. This setup is now done using the gate trigger's slope setting.

When Positive (Pos) is selected, a positive-going edge (Edge) or a high voltage (Level) will satisfy the gate condition, after the delay set with the Gate Delay key. When Negative (Neg) is selected, a negative-going edge (Edge) or a low voltage (Level) will satisfy the gate condition after the delay.

Remote Command	<code>[:SENSe] :SWEep:EGATe:POLarity NEGative POSitive</code> <code>[:SENSe] :SWEep:EGATe:POLarity?</code>
Example	<code>SWE:EGAT:POL NEG</code> <code>SWE:EGAT:POL?</code>
Preset	POSitive
State Saved	Saved in instrument state
Backwards Compatibility SCPI	<code>[:SENSe] :SWEep:TIME:GATE:POLarity</code> ESA compatibility
Initial S/W Revision	Prior to A.02.00

Remote Command	<code>[:SENSe] :SWEep:TIME:GATE:LEVe1 HIGH LOW</code> <code>[:SENSe] :SWEep:TIME:GATE:LEVe1?</code> ESA compatibility
Preset	HIGH
Initial S/W Revision	Prior to A.02.00

System

See "[System](#)" on page 272

Trace/Detector

Accesses a menu of functions that enable you to control trace and detector for the current measurement.

Key Path	Front-panel key
Initial S/W Revision	Prior to A.02.00

Trace Type

Allows you to select the type of trace for the current measurement. The menu contains a 1-of-N selection of the trace type (Clear Write, Average, Max Hold, Min Hold).

Key Path	Trace/Detector
Mode	SA, WCDMA, C2K, WIMAX OFDMA, TD-SCDMA, 1xEVDO, DTMB (CTTB), DVB-T/H, ISDB-T, CMMB, LTE, LTE-TDD, Digital Cable TV, WLAN, MSR, LTEAFDD, LTEATDD
Remote Command	:TRACe:SEMAsk:TYPE WRITe AVERAge MAXHold MINHold :TRACe:SEMAsk:TYPE?
Example	TRAC:SEM:TYPE MINH TRAC:SEM:TYPE?
Notes	WRITe = Clear Write AVERAge = Average MAXHold = Maximum Hold MINHold = Minimum Hold
Couplings	When Detector setting is "Auto" ([:SENSe]:SEMAsk:DETECTOR:AUTO?), Detector ([:SENSe]:SEMAsk:DETECTOR[:FUNCTION]?) switches aligning with the switch of this parameter: "NORMal" with WRITe (Clear Write), "AVERAge" with AVERAge, "POSitive (peak)" with MAXHold, and "NEGative (peak)" with MINHold.
Preset	AVERAge
State Saved	Saved in instrument state.
Range	WRITe AVERAge MAXHold MINHold
Initial S/W Revision	Prior to A.02.00
Modified at S/W Revision	A.02.00, A.03.00

Chan Detector

Accesses a menu of functions that enable you to control the detectors for reference channel. The following choices are available:

- Auto—the detector selected depends on marker functions, trace functions, average type, and the trace averaging function.
- Normal—the detector determines the peak of the CW-like signals, and it yields alternating maximums and minimums of noise-like signals. This is also referred to as Rosenfell detection.

- Average—the detector determines the average of the signal within the sweep points. The averaging method depends upon the Average Type selection (voltage, power or log scales).
- Peak—the detector determines the maximum of the signal within the sweep points.
- Sample—the detector indicates the instantaneous level of the signal at the center of the sweep points represented by each display point.
- Negative Peak—the detector determines the minimum of the signal within the sweep points.

Key Path	Trace/Detector
Initial S/W Revision	Prior to A.02.00

Chan Detector Auto

Sets the detector to the default detection mode for the reference channel. This mode is dependent upon the current reference channel conditions.

Key Path	Trace/Detector
Mode	SA, WCDMA, C2K, WIMAX OFDMA, TD-SCDMA, 1xEVDO, DTMB (CTTB), DVB-T/H, ISDB-T, CMMB, LTE, LTETDD, Digital Cable TV, WLAN, MSR, LTEAFDD, LTEATDD
Remote Command	<code>[:SENSe] :SEMAsk:DETEctor:CARRier:AUTO ON OFF 1 0</code> <code>[:SENSe] :SEMAsk:DETEctor:CARRier:AUTO?</code>
Example	<code>SEM:DET:CARR:AUTO OFF</code> <code>SEM:DET:CARR:AUTO?</code>
Notes	See Couplings in the Trace Type section. You must be in the mode that includes SEM measurement to use this command. Use <code>:INSTRument:SElect</code> to set the mode.
Preset	ON
State Saved	Saved in instrument state
Range	On Off
Initial S/W Revision	Prior to A.02.00
Modified at S/W Revision	A.02.00, A.03.00

Chan Detector Selection

Selects the detector mode for the reference channel.

Key Path	Trace/Detector
Mode	SA, WCDMA, C2K, WIMAX OFDMA, TD-SCDMA, 1xEVDO, DTMB (CTTB), DVB-T/H, ISDB-T, CMMB, LTE, LTETDD, Digital Cable TV, WLAN, MSR, LTEAFDD, LTEATDD
Remote Command	<code>[:SENSe] :SEMAsk:DETEctor:CARRier[:FUNCTion] AVERAge NEGAtive NORMAl POSitive SAMPlE</code> <code>[:SENSe] :SEMAsk:DETEctor:CARRier[:FUNCTion]?</code>

Example	SEM:DET:CARR NEG SEM:DET:CARR?
Notes	When you manually select a detector (instead of selecting Auto), that detector is used regardless of other analyzer settings. Note: This detector setting affects the reference channel. There is not a per trace detector. You must be in the mode that includes SEM measurement to use this command. Use :INSTrument:SElect to set the mode.
Couplings	See Couplings in the Trace Type section.
Preset	AVERage
State Saved	Saved in instrument state.
Range	Normal Average Peak Sample Negative Peak
Initial S/W Revision	Prior to A.02.00
Modified at S/W Revision	A.02.00, A.03.00

Offset Detector

Accesses a menu of functions that enable you to control the detector for offsets. The following choices are available.

- Auto– the detector selected depends on marker functions, trace functions, average type, and the trace averaging function.
- Normal–the detector determines the peak of the CW-like signals, and it yields alternating maximums and minimums of noise-like signals. This is also referred to as Rosenfell detection.
- Average–the detector determines the average of the signal within the sweep points. The averaging method depends upon the Average Type selection (voltage, power or log scales).
- Peak–the detector determines the maximum of the signal within the sweep points.
- Sample–the detector indicates the instantaneous level of the signal at the center of the sweep points represented by each display point.
- Negative Peak–the detector determines the minimum of the signal within the sweep points.

Key Path	Trace/Detector
Initial S/W Revision	Prior to A.02.00

Offset Detector Auto

Sets the detector to the default detection mode for the offsets. This mode is dependent upon the current signal conditions of the offsets.

Key Path	Trace/Detector
Mode	SA, WCDMA, C2K, WIMAX OFDMA, TD-SCDMA, 1xEVDO, DTMB (CTTB), DVB-T/H, ISDB-T, CMMB,

	LTE, LTE-TDD, Digital Cable TV, WLAN, MSR, LTE-AFDD, LTE-TDD
Remote Command	<code>[:SENSe] :SEMAsk :DETEctor :OFFSet :AUTO ON OFF 1 0</code> <code>[:SENSe] :SEMAsk :DETEctor :OFFSet :AUTO ?</code>
Example	SEM:DET:OFFS:AUTO OFF SEM:DET:OFFS:AUTO?
Notes	See Couplings in the Trace Type section. You must be in the mode that includes SEM measurement to use this command. Use :INSTRument:SElect to set the mode.
Preset	ON
State Saved	Saved in instrument state.
Range	On Off
Initial S/W Revision	Prior to A.02.00
Modified at S/W Revision	A.02.00, A.03.00

Offset Detector Selection

Selects the detector mode for the offsets.

Key Path	Trace/Detector
Mode	SA, WCDMA, C2K, WIMAX OFDMA, TD-SCDMA, 1xEVDO, DTMB (CTTB), DVB-T/H, ISDB-T, CMMB, LTE, LTE-TDD, Digital Cable TV, WLAN, MSR, LTE-AFDD, LTE-TDD
Remote Command	<code>[:SENSe] :SEMAsk :DETEctor :OFFSet [:FUNction] AVERAge NEGAtive NORMAl POSitive SAMPlE</code> <code>[:SENSe] :SEMAsk :DETEctor :OFFSet [:FUNction] ?</code>
Example	SEM:DET:OFFS AVER SEM:DET:OFFS?
Notes	When you manually select a detector (instead of selecting Auto), that detector is used regardless of other analyzer settings. Note: This detector setting has effects all offsets. There is not a per trace detector. You must be in the mode that includes SEM measurement to use this command. Use :INSTRument:SElect to set the mode.
Couplings	See Couplings in the Trace Type section.
Preset	POSitive
State Saved	Saved in instrument state.
Range	Normal Average Peak Sample Negative Peak
Initial S/W Revision	Prior to A.02.00
Modified at S/W Revision	A.02.00, A.03.00

Trigger

See ["Trigger" on page 328](#)

Free Run

See ["Free Run " on page 335](#)

Video

See ["Video \(IF Envelope\) " on page 1556](#)

Trigger Level

See ["Trigger Level " on page 1557](#)

Trig Slope

See ["Trig Slope " on page 1558](#)

Trig Delay

See ["Trig Delay " on page 338](#)

External 1

See ["External 1 " on page 1571](#)

Trigger Level

See ["Trigger Level " on page 1571](#)

Trig Slope

See ["Trig Slope " on page 1572](#)

Trig Delay

See ["Trig Delay " on page 341](#)

Zero Span Delay Comp

See ["Zero Span Delay Comp On/Off" on page 1560](#)

External 2

See ["External 2 " on page 1572](#)

Trigger Level

See ["Trigger Level " on page 1573](#)

Trig Slope

See ["Trig Slope " on page 1574](#)

Trig Delay

See "[Trig Delay](#) " on page 344

Zero Span Delay Comp

See "[Zero Span Delay Comp On/Off](#)" on page 1562

RF Burst

See "[RF Burst](#) " on page 1574

Absolute Trigger

See "[Absolute Trigger Level](#)" on page 1575

Relative Trigger

See "[Relative Trigger Level](#)" on page 1564

Trig Slope

See "[Trigger Slope](#) " on page 1576

Trig Delay

See "[Trig Delay](#) " on page 348

Periodic Timer

See "[Periodic Timer \(Frame Trigger\)](#) " on page 1566

Period

See "[Period](#) " on page 1567

Offset

See "[Offset](#) " on page 1568

Reset Offset Display

See "[Reset Offset Display](#) " on page 1570

Sync Source

See "[Sync Source](#) " on page 1570

Off

See "[Off](#) " on page 1571

External 1

See "[External 1](#) " on page 1571

Trigger Level

See ["Trigger Level "](#) on page 1571

Trig Slope

See ["Trig Slope "](#) on page 1572

External 2

See ["External 2 "](#) on page 1572

Trigger Level

See ["Trigger Level "](#) on page 1573

Trig Slope

See ["Trig Slope "](#) on page 1574

RF Burst

See ["RF Burst "](#) on page 1574

Absolute Trigger

See ["Absolute Trigger Level"](#) on page 1575

Trig Slope

See ["Trigger Slope "](#) on page 1576

Trig Delay

See ["Trig Delay"](#) on page 359

Auto/Holdoff

See ["Auto/Holdoff "](#) on page 1577

Auto Trig

See ["Auto Trig "](#) on page 1577

Trig Holdoff

See ["Trig Holdoff "](#) on page 1578

Holdoff Type

See ["Holdoff Type"](#) on page 361

User Preset

Accesses a menu that gives you the following three choices:

- User Preset – recalls a state previously saved using the Save User Preset function.
- User Preset All Modes – presets all of the modes in the analyzer
- Save User Preset– saves the current state for the current mode

NOTE

In products that run multiple instances of the X-Series Application, all instances use the same location to save User Preset state. So Save User Preset of one instance will overwrite the Save User Preset of another instance.

Key Path	Front-panel key
Backwards Compatibility Notes	<p>User Preset is actually loading a state, and in legacy analyzers, it was possible to load a state without affecting the trace data, limit lines or correction data. Similarly it was possible to do a User Preset without affecting the trace data, limit lines or correction data.</p> <p>In the X-Series, “state” always includes all of this data; so whenever state is loaded, or User Preset is executed, all of the traces, limit lines and corrections are affected. Although this differs from previous behavior, it is desirable behavior, and should not cause adverse issues for users.</p> <p>On ESA and PSA, User Preset affected the entire instrument’s state. In the X-Series, User Preset only recalls the state for the active mode. There is a User Preset file for each mode. User Preset can never cause a mode switch as it can in legacy analyzers. If you want to recall all modes to their user preset file state, you will need to do a User Preset after mode switching into each mode.</p> <p>User Preset recalls mode state which can now include data like traces; whereas on ESA and PSA, User Preset did not affect data.</p>
Initial S/W Revision	Prior to A.02.00

User Preset

User Preset sets the state of the currently active mode back to the state that was previously saved for this mode using the Save User Preset menu key or the SCPI command, SYST:PRES:USER:SAV. It not only recalls the Mode Preset settings, but it also recalls all of the mode persistent settings, and the Input/Output system setting that existed at the time Save User Preset was executed.

If a Save User Preset has not been done at any time, User Preset recalls the default user preset file for the currently active mode. The default user preset files are created if, at power-on, a mode detects there is no user preset file. There will never be a scenario when there is no user preset file to restore. For each mode, the default user preset state is the same state that would be saved if a Save User Preset is performed in each mode right after doing a Restore Mode Default and after a Restore Input/Output Defaults.

The User Preset function does the following:

- Aborts the currently running measurement.
- Sets the mode State to the values defined by Save User Preset.
- Makes the saved measurement for the currently running mode the active measurement.
- Brings up the saved menu for the power-on mode.

- Clears the input and output buffers.
- Sets the Status Byte to 0.

Key Path	User Preset
Remote Command	:SYSTem:PRESet:USER
Example	:SYST:PRES:USER:SAVE:SYST:PRES:USER
Notes	:SYST:PRES:USER:SAVE is used to save the current state as the user preset state. Clears all pending OPC bits. The Status Byte is set to 0. Pressing the User Preset front-panel key while already in the User Preset menu will cause the User Preset to get executed
Couplings	A user preset will cause the currently running measurement to be aborted and cause the saved measurement to be active. Recalling a User Preset file has the same issues that recalling a Save State file has. Some settings may need to be limited and therefore re-coupled, since the capabilities of the mode may have changes when the User Preset file was last saved.
Initial S/W Revision	Prior to A.02.00

User Preset All Modes

Recalls all of the User Preset files for each mode, switches to the power-on mode, and activates the saved measurement from the power-on mode User Preset file.

NOTE

When the instrument is secured, all of the user preset files are converted back to their default user preset files.

The User Preset function does the following:

- Aborts the currently running measurement.
- Switches the Mode to the power-on mode.
- Restores the User Preset files for each mode.
- Makes the saved measurement for the power-on mode the active measurement.
- Brings up the saved menu for the power-on mode.
- Clears the input and output buffers.
- Sets the Status Byte to 0.

Key Path	User Preset
Remote Command	:SYSTem:PRESet:USER:ALL
Example	:SYST:PRES:USER:SAVE:SYST:PRES:USER:ALL
Notes	Clears all pending OPC bits. The Status Byte is set to 0. :SYST:PRES:USER:SAVE is used to save the current state as the user preset state.
Couplings	A user preset will cause the currently running measurement to be aborted, cause a mode switch to the power-on mode, and cause the saved measurement to be active in the power-on mode.

Recalling a User Preset file has the same issues that recalling a Save State file has. Some settings may need to be limited and therefore re-coupled, since the capabilities of the mode may have changes when the User Preset file was last saved.

Initial S/W Revision Prior to A.02.00

Save User Preset

Saves the currently active mode and its State. You can recall this User Preset file by pressing the User Preset menu key or sending the SYST:PRES:USER remote command. This same state is also saved by the Save State function.

Key Path User Preset

Remote Command :SYSTem:PRESet:USER:SAVE

Example :SYST:PRES:USER:SAVE

Notes :SYST:PRES:SAVE creates the same file as if the user requested a *SAV or a MMEM:STOR:STAT, except User Preset Save does not allow the user to specify the filename or the location of the file.

Initial S/W Revision Prior to A.02.00

View/Display

Accesses a menu of functions that enable you to control the instrument display.

The following keys select how the results are displayed:

- **Abs Pwr Freq**—displays the absolute power levels in dBm and the corresponding frequencies in the text window.
- **Rel Pwr Freq**—displays the relative power levels in dBc and the corresponding frequencies in the text window.
- **Integrated Power**—displays the absolute and relative power levels integrated throughout the bandwidths between the start and stop frequencies in the text window.
- **Carrier Info** —displays the carrier configuration information with measure powers. (Only available in MSR and LTE-Advanced FDD/TDD)

["View Selection by Name \(Remote Command Only\)" on page 1591](#)

["Views Selection by Number \(Remote Command only\)" on page 1591](#)

View Selection by Name (Remote Command Only)

Key Path	View/Display
Mode	SA, WCDMA, C2K, WIMAX OFDMA, TD-SCDMA, 1xEVDO, DTMB (CTTB), DVB-T/H, ISDB-T, CMMB, LTE, LTETDD, Digital Cable TV, WLAN, MSR, LTEAFDD, LTEATDD
Remote Command	:DISPlay:SEMask:VIEW[:SElect] APFReq RPFReq IPOWer CINformation :DISPlay:SEMask:VIEW[:SElect]?
Example	DISP:SEM:VIEW IPOW DISP:SEM:VIEW?
Notes	You must be in the mode that includes SEM measurement to use this command. Use :INSTrument:SElect to set the mode.
Preset	SA, WCDMA, C2K, TD-SCDMA, 1xEVDO, DTMB (CTTB), DVB-T/H, ISDB-T, CMMB, LTE, LTETDD, Digital Cable TV, MSR, LTEAFDD, LTEATDD: APFReq WIMAX OFDMA, WLAN: RPFReq
State Saved	Saved in instrument state.
Range	Abs Pwr & Freq Rel Pwr & Freq Integrated Power Carrier Info
Initial S/W Revision	Prior to A.02.00
Modified at S/W Revision	A.02.00, A.03.00, A.10.00

Views Selection by Number (Remote Command only)

The following numerical selections determine how the results are displayed:

1. displays the absolute power levels in dBm and the corresponding frequencies in the text window.
2. displays the relative power levels in dBc and the corresponding frequencies in the text window.

3. displays the absolute and relative power levels integrated throughout the bandwidths between the start and stop frequencies in the text window.

4.

Mode	SA, WCDMA, C2K, WIMAX OFDMA, TD-SCDMA, 1xEVDO, DTMB (CTTB), DVB-T/H, ISDB-T, CMMB, LTE, LTETDD, Digital Cable TV, WLAN, MSR, LTEAFDD, LTEATDD
Remote Command	:DISPlay:SEMask:VIEW:NSElect <integer> :DISPlay:SEMask:VIEW:NSElect?
Example	DISP:SEM:VIEW:NSEL 2 DISP:SEM:VIEW:NSEL?
Notes	You must be in the mode that includes SEM measurement to use this command. Use :INSTrument:SElect to set the mode.
Preset	SA, WCDMA, C2K, TD-SCDMA, 1xEVDO, DTMB (CTTB), DVB-T/H, ISDB-T, CMMB, LTE, LTETDD, Digital Cable TV, MSR, LTEAFDD, LTEATDD: 1 WIMAX OFDMA, WLAN: 2
State Saved	Saved in instrument state.
Min	1
Max	MSR, LTEAFDD, LTEATDD: 4 Other modes: 3
Initial S/W Revision	Prior to A.02.00
Modified at S/W Revision	A.02.00, A.03.00, A.10.00

Key Path	Front-panel key
Initial S/W Revision	Prior to A.02.00

Display

The Display menu is common to most measurements, and is used for configuring items on the display. Some Display menu settings apply to all the measurements in a mode, and some only to the current measurement. Those under the System Display Settings key apply to all measurements in all modes.

Key Path	Display
Key Path	View/Display
Initial S/W Revision	Prior to A.02.00

Annotation

Turns on and off various parts of the display annotation. The annotation is divided up into four categories:

1. Meas Bar: This is the measurement bar at the top of the screen. It does not include the settings panel or the Active Function. Turning off the Meas Bar turns off the settings panel and the Active Function. When the Meas Bar is off, the graticule area expands to fill the area formerly occupied by the Meas Bar.
2. Screen Annotation: this is the annotation and annunciation around the graticule, including any annotation on lines (such as the display line, the threshold line, etc.) This does NOT include the marker number or the N dB result. When off, the graticule expands to fill the entire graticule area.
3. Trace annotation: these are the labels on the traces, showing their detector (or their math mode).
4. Active Function annotation: this is the active function display in the meas bar, and all of the active function values displayed on softkeys.

See the figure below. Each type of annotation can be turned on and off individually.

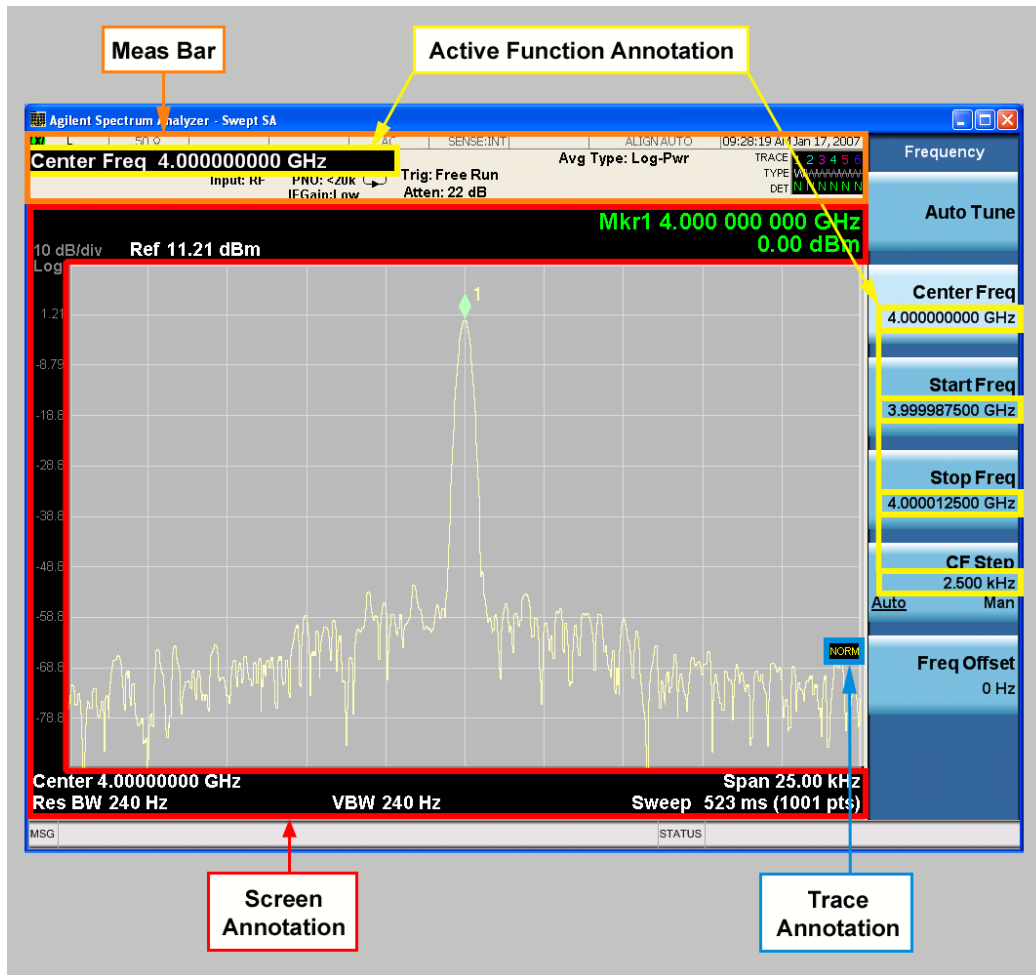

Key Path	View/Display, Display
Initial S/W Revision	Prior to A.02.00

Meas Bar On/Off

This function turns the Measurement Bar on and off, including the settings panel. When off, the graticule area expands to fill the area formerly occupied by the Measurement Bar.

Key Path	View/Display, Display, Annotation
Remote Command	:DISPlay:ANNotation:MBAR[:STATe] OFF ON 0 1 :DISPlay:ANNotation:MBAR[:STATe]?
Example	DISP:ANN:MBAR OFF
Dependencies	Grayed out and forced to OFF when System Display Settings, Annotation is set to Off.
Preset	On This should remain Off through a Preset when System DisplaySettings, Annotation is set to Off.
State Saved	Saved in instrument state.
Initial S/W Revision	Prior to A.02.00

Screen

This controls the display of the annunciation and annotation around the graticule, including any annotation on lines (such as the display line, the threshold line, etc.) and the y-axis annotation. This does NOT include marker annotation (or the N dB result). When off, the graticule expands to fill the entire graticule area, leaving only the 1.5% gap above the graticule as described in the Trace/Detector chapter.

Key Path	View/Display, Display, Annotation
Remote Command	:DISPlay:ANNotation:SCReen[:STATe] OFF ON 0 1 :DISPlay:ANNotation:SCReen[:STATe]?
Example	DISP:ANN:SCR OFF
Dependencies	Grayed-out and forced to OFF when System Display Settings, Annotation is set to Off.
Preset	On This should remain Off through a Preset when System DisplaySettings, Annotation is set to Off
State Saved	Saved in instrument state.
Initial S/W Revision	Prior to A.02.00

Active Function Values On/Off

Turns on and off the active function display in the Meas Bar, and all of the active function values displayed on the softkeys.

Note that all of the softkeys that have active functions have these numeric values blanked when this function is on. This is a security feature..

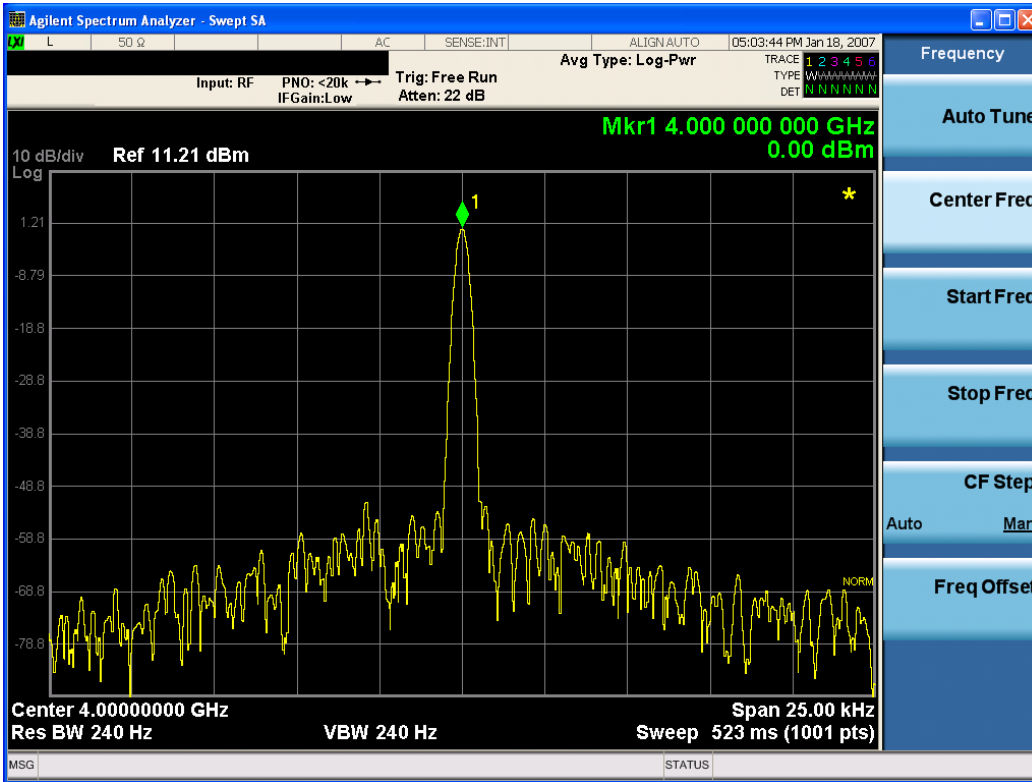

Key Path	View/Display, Display, Annotation
Remote Command	:DISPlay:ACTivefunc[:STATE] ON OFF 1 0 :DISPlay:ACTivefunc[:STATE]?
Example	DISP:ACT OFF
Dependencies	Grayed out and forced to OFF when System Display Settings, Annotation is set to Off.
Preset	On This should remain Off through a Preset when System DisplaySettings, Annotation is set to Off
State Saved	Saved in instrument state.
Initial S/W Revision	Prior to A.02.00

Title

Displays menu keys that enable you to change or clear a title on your display.

Key Path	View/Display, Display
Initial S/W Revision	Prior to A.02.00

Change Title

Writes a title into the "measurement name" field in the banner, for example, "Swept SA".

Press Change Title to enter a new title through the alpha editor. Press Enter or Return to complete the entry. Press ESC to cancel the entry and preserve your existing title.

The display title will replace the measurement name. It remains for this measurement until you press Change Title again, or you recall a state, or a Preset is performed. A title can also be cleared by pressing Title, Clear Title.

NOTE

Notice the inclusion of the <measurement> parameter in the command below. Because each measurement remembers the Display Title, the command must be qualified with the measurement name. For the Swept SA measurement this is not the case; no <measurement> parameter is used when changing the Display Title for the Swept SA measurement.

Key Path	View/Display, Display, Title
Mode	All
Remote Command	:DISPlay:<measurement>:ANNotation:TITLe:DATA <string> :DISPlay:<measurement>:ANNotation:TITLe:DATA?
Example	DISP:ANN:TITL:DATA "This Is My Title" This example is for the Swept SA measurement in the Spectrum Analyzer mode. The SANalyzer <measurement> name is not used. DISP:ACP:ANN:TITL:DATA "This Is My Title" This example is for Measurements other than Swept SA. Both set the title to: This Is My Title
Notes	Pressing this key cancels any active function. When a title is edited the previous title remains intact (it is not cleared) and the cursor goes at the end so that characters can be added or BKSP can be used to go back over previous characters.
Preset	No title (measurement name instead)
State Saved	Saved in instrument state.
Initial S/W Revision	Prior to A.02.00

Clear Title

Clears a title from the front-panel display. Once cleared, the title cannot be retrieved. After the title is cleared, the current Measurement Name replaces it in the title bar.

Key Path	View/Display, Display, Title
Example	The following commands clear the title and restore the measurement's original title: DISP:ANN:TITL:DATA "" This example is for the Swept SA measurement in the Spectrum Analyzer mode. The SANalyzer <measurement> name is not used. DISP:ACP:ANN:TITL:DATA "" This example is for ACP; in measurements other than Swept SA the measurement name is required.
Notes	Uses the :DISPlay:<measurement>:ANNotation:TITLe:DATA <string> command with an empty string (in the Swept SA, the <measurement> is omitted).
Preset	Performed on Preset.
Initial S/W Revision	Prior to A.02.00

Graticule

Pressing Graticule turns the display graticule On or Off. It also turns the graticule y-axis annotation on and off.

Key Path	View/Display, Display
Remote Command	:DISPlay:WINDow[1]:TRACe:GRATicule:GRID[:STATe] OFF ON 0 1 :DISPlay:WINDow[1]:TRACe:GRATicule:GRID[:STATe]?
Example	DISP:WIND:TRAC:GRAT:GRID OFF
Notes	The graticule is the set of horizontal and vertical lines that make up the grid/divisions for the x-axis and y-axis.
Preset	On
State Saved	Saved in instrument state
Initial S/W Revision	Prior to A.02.00

System Display Settings

These settings are "Mode Global" – they affect all modes and measurements and are reset only by Restore Misc Defaults or Restore System Defaults under System.

Key Path	View/Display, Display
Initial S/W Revision	Prior to A.02.00

Annotation Local Settings

This is a Mode Global override of the meas local annotation settings. When it is All Off, it forces ScreenAnnotation, Meas Bar, Trace, and Active Function Values settings to be OFF for all measurements in all modes. This provides the security based "annotation off" function of previous analyzers; hence it uses the legacy SCPI command.

When it is All Off, the Screen, Meas Bar, Trace, and Active Function Values keys under the Display, Annotation menu are grayed out and forced to Off. When Local Settings is selected, you are able to set the local annotation settings on a measurement by measurement basis.

Key Path	View/Display, Display, System Display Settings
Remote Command	:DISPlay:WINDow[1]:ANNotation[:ALL] OFF ON 0 1 :DISPlay:WINDow[1]:ANNotation[:ALL]?
Example	:DISP:WIND:ANN OFF
Preset	On (Set by Restore Misc Defaults)
State Saved	Not saved in instrument state.
Backwards Compatibility Notes	The WINDow parameter and optional subopcode is included for backwards compatibility but ignored – all windows are equally affected.
Initial S/W Revision	Prior to A.02.00

Themes

Accesses a menu of functions that enable you to choose the theme to be used when saving the screen image.

The **Themes** option is the same as the **Themes** option under the **Display** and **Page Setup** dialogs. It allows you to choose between themes to be used when saving the screen image.

Key Path	Save, Screen Image
Remote Command	:MMEMory:STORe:SCReen:THEMe TDColor TDMonochrome FCOLor FMONochrome :MMEMory:STORe:SCReen:THEMe?
Example	:MMEM:STOR:SCR:THEM TDM
Preset	3D Color; Is not part of Preset, but is reset by Restore Misc Defaults or Restore System Defaults All and survives subsequent running of the modes.
Readback	3D Color 3D Mono Flat Color Flat Mono
Backwards Compatibility Notes	In ESA and PSA we offer the choice of "Reverse Bitmap" or "Reverse Metafile" when saving screen images. This is much like the "Flat Color" theme available in X-Series. Also, if you selected Reverse Bitmap AND a black & white screen image, that would be much like "Flat Monochrome". In other words, each of the X-Series themes has a similar screen image type in ESA/PSA. But they are not identical.
Initial S/W Revision	Prior to A.02.00

3D Color

Selects a standard color theme with each object filled, shaded and colored as designed.

Key Path	Save, Screen Image, Themes
Example	MMEM:STOR:SCR:THEM TDC
Readback	3D Color
Initial S/W Revision	Prior to A.02.00

3D Monochrome

Selects a format that is like 3D color but shades of gray are used instead of colors.

Key Path	Save, Screen Image, Themes
Example	MMEM:STOR:SCR:THEM TDM
Readback	3D Mono
Initial S/W Revision	Prior to A.02.00

Flat Color

Selects a format that is best when the screen is to be printed on an ink printer.

Key Path	Save, Screen Image, Themes
Example	MMEM:STOR:SCR:THEM FCOL
Readback	Flat Color
Initial S/W Revision	Prior to A.02.00

Flat Monochrome

Selects a format that is like Flat Color. But only black is used (no colors, not even gray), and no fill.

Key Path	Save, Screen Image, Themes
Example	MMEM:STOR:SCR:THEM FMON
Readback	Flat Mono
Initial S/W Revision	Prior to A.02.00

Abs Pwr Freq

Sets the display to the Absolute Peak Power and Frequency view. The views differ depending on the setting of the measurement type (Meas Type) under the Measurement Setup menu.

"Abs Peak Pwr & Freq (Total Pwr Ref)" on page 1599

"Abs Peak Pwr & Freq (PSD Ref)" on page 1601

"Abs Peak Pwr & Freq (Spectrum Pk Ref)" on page 1602

Abs Peak Pwr & Freq (Total Pwr Ref)

This view consists of the following two windows:

"Trace Window" on page 1600

"Results Window " on page 1600

11 Spectrum Emission Mask Measurement
View/Display

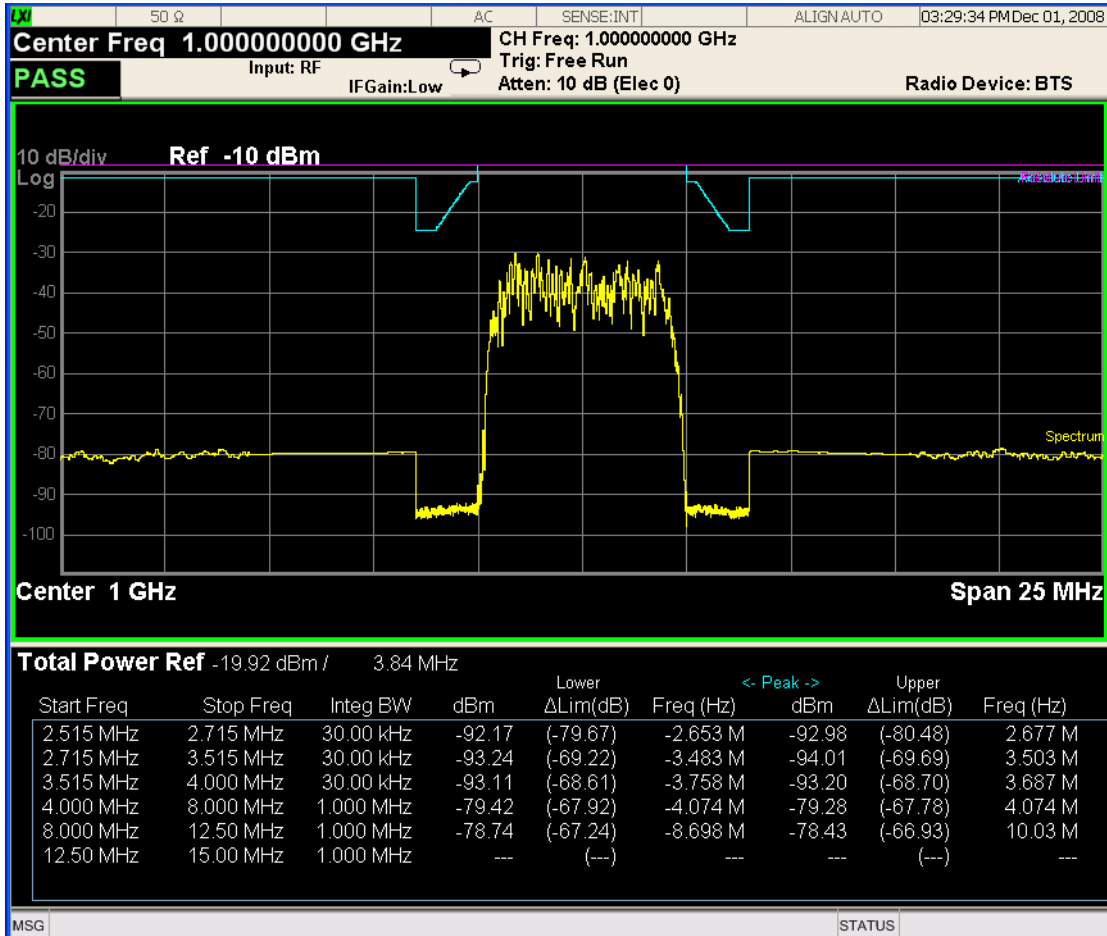

Trace Window

Corresponding Trace	yellow - Combined trace from carrier and each offset
---------------------	--

Results Window

Name	Corresponding Results
Total Pwr Ref	n=1 2nd element Absolute power at the reference area.
	Channel Integration Bandwidth
Start (Hz)	Start frequency for offset
Stop (Hz)	Stop frequency for offset
Meas BW (Hz)	Measurement bandwidth for offset
Lower Peak (dBm)	Absolute peak power on minimum margin point of the negative offset
Lower Δlim (dB)	Minimum margin from limit line which is decided by Fail Mask setting on the negative offset

Name	Corresponding Results
Lower Freq (Hz)	Frequency on minimum margin point of the negative offset
Upper Peak (dBm)	Absolute peak power on minimum margin point of the positive offset
Upper Δlim (dB)	Minimum margin from limit line which is decided by Fail Mask setting on the positive offset
Upper Freq (Hz)	Frequency on minimum margin point of the positive offset

Abs Peak Pwr & Freq (PSD Ref)

This view consists of the following two windows:

"Trace Window" on page 1601

"Results Window" on page 1602

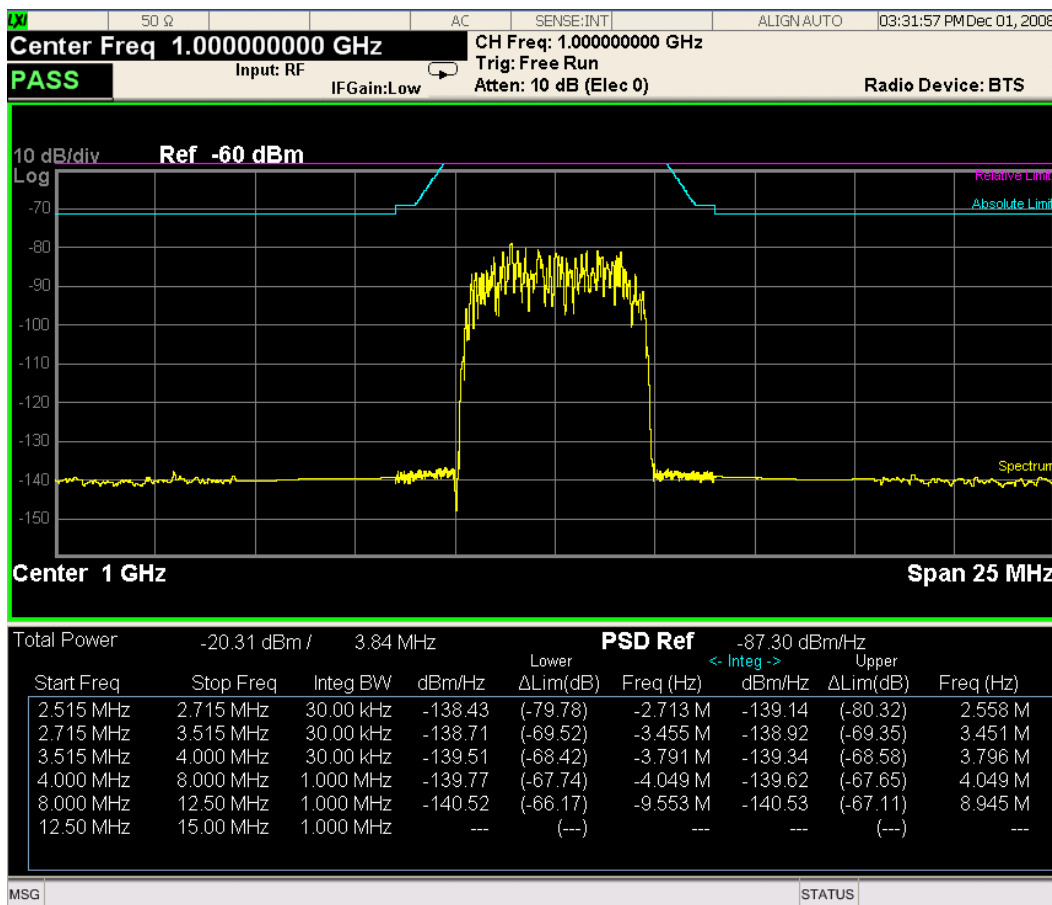

Trace Window

Corresponding Trace	yellow - Combined trace from carrier and each offset
---------------------	--

Results Window

Name	Corresponding Results
Total Pwr	n=1 2nd element Absolute power at the reference area.
	Channel Integration Bandwidth
PSD Ref	n=5 1st element Power spectral density reference at the reference area
Start (Hz)	Start frequency for offset
Stop (Hz)	Stop frequency for offset
Meas BW (Hz)	Measurement bandwidth for offset
Lower (dBm/Hz)	Absolute power spectrum density of the negative offset
Lower Δ lim (dB)	Minimum margin from limit line which is decided by Fail Mask setting on the negative offset
Lower Freq (Hz)	Frequency on minimum margin point of the negative offset
Upper (dBm/Hz)	Absolute power spectrum density of the positive offset
Upper Δ lim (dB)	Minimum margin from limit line which is decided by Fail Mask setting on the positive offset
Upper Freq (Hz)	Frequency on minimum margin point of the positive offset

Abs Peak Pwr & Freq (Spectrum Pk Ref)

This view consists of the following two windows:

"Trace Window" on page 1601

"Results Window " on page 1602

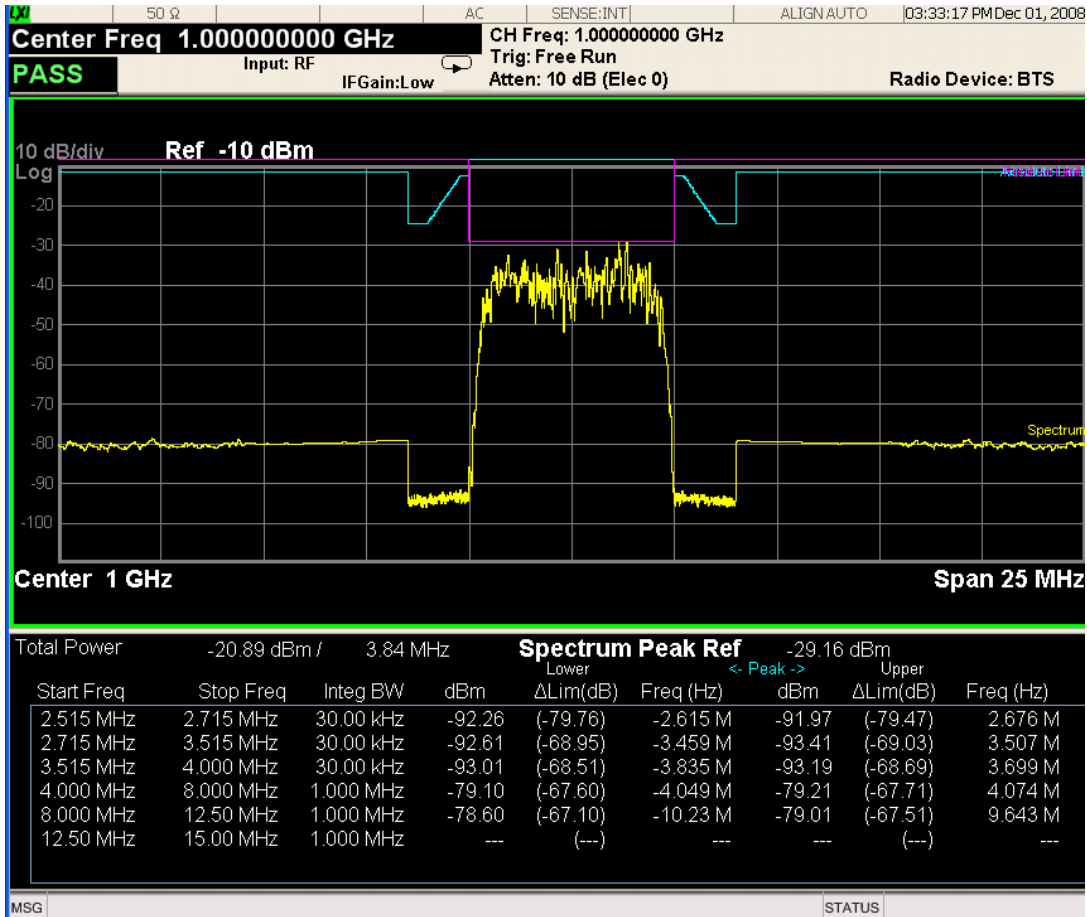

Trace Window

Corresponding Trace	yellow - Combined trace from carrier and each offset
---------------------	--

Results Window

Name	Corresponding Results
Total Pwr	Absolute power at the reference area.
	Channel Integration Bandwidth
Spectrum Peak Ref	n=5 1st element Spectrum peak power reference at the reference area
Start (Hz)	Start frequency for offset
Stop (Hz)	Stop frequency for offset
Meas BW (Hz)	Measurement bandwidth for offset
Lower(dBm)	Absolute peak power on minimum margin point of the negative offset
Lower Δlim (dB)	Minimum margin from limit line which is decided by Fail Mask setting on the negative offset

Name	Corresponding Results
Lower Freq (Hz)	Frequency on minimum margin point of the negative offset
Upper (dBm)	Absolute peak power on minimum margin point of the positive offset
Upper Δ lim (dB)	Minimum margin from limit line which is decided by Fail Mask setting on the positive offset
Upper Freq (Hz)	Frequency on minimum margin point of the positive offset

Key Path	View/Display
Initial S/W Revision	Prior to A.02.00

Rel Pwr Freq

Sets the display to the Relative Peak Power and Frequency view. The views differ depending on the setting of the measurement type (Meas Type) under the Measurement Setup menu.

["Rel Peak Pwr & Freq \(Total Pwr Ref\)" on page 1604](#)

["Rel Peak Pwr & Freq \(PSD Ref\)" on page 1606](#)

["Rel Peak Pwr & Freq \(Spectrum Pk Ref\)" on page 1607](#)

Rel Peak Pwr & Freq (Total Pwr Ref)

This view consists of the following two windows:

["Trace Window" on page 1605](#)

["Results Window" on page 1605](#)

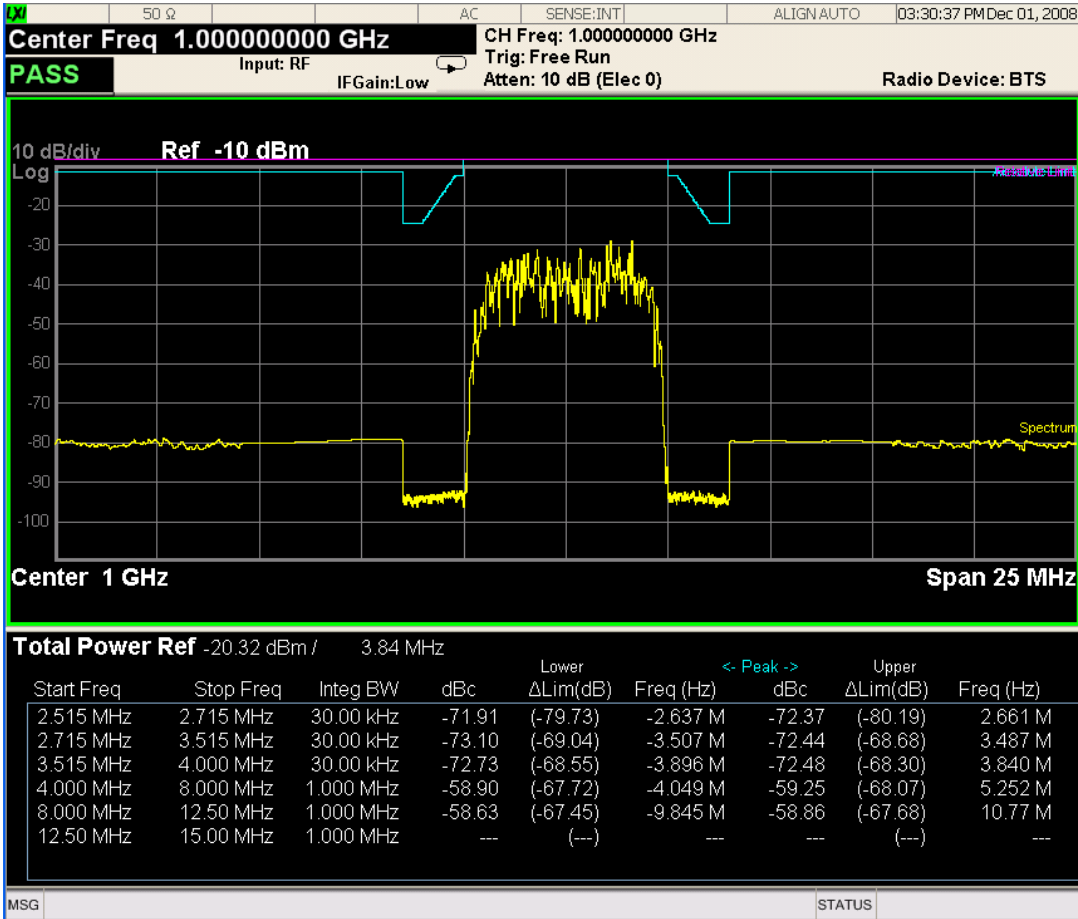

Trace Window

Corresponding Trace yellow - Combined trace from carrier and each offset

Results Window

Name	Corresponding Results
Total Pwr Ref	n=1 2nd element Absolute power at the reference area.
	Channel Integration Bandwidth
Start (Hz)	Start frequency for offset
Stop (Hz)	Stop frequency for offset
Meas BW (Hz)	Measurement bandwidth for offset
Lower Peak (dBc)	Relative peak power on minimum margin point of the negative offset
Lower ΔLim (dB)	Minimum margin from limit line which is decided by Fail Mask setting on the negative offset

Name	Corresponding Results
Lower Freq (Hz)	Frequency on minimum margin point of the negative offset
Upper Peak (dBc)	Relative peak power on minimum margin point of the positive offset
Upper ΔLim (dB)	Minimum margin from limit line which is decided by Fail Mask setting on the positive offset
Upper Freq (Hz)	Frequency on minimum margin point of the positive offset

Rel Peak Pwr & Freq (PSD Ref)

This view consists of the following two windows:

"Trace Window" on page 1606

"Results Window" on page 1607

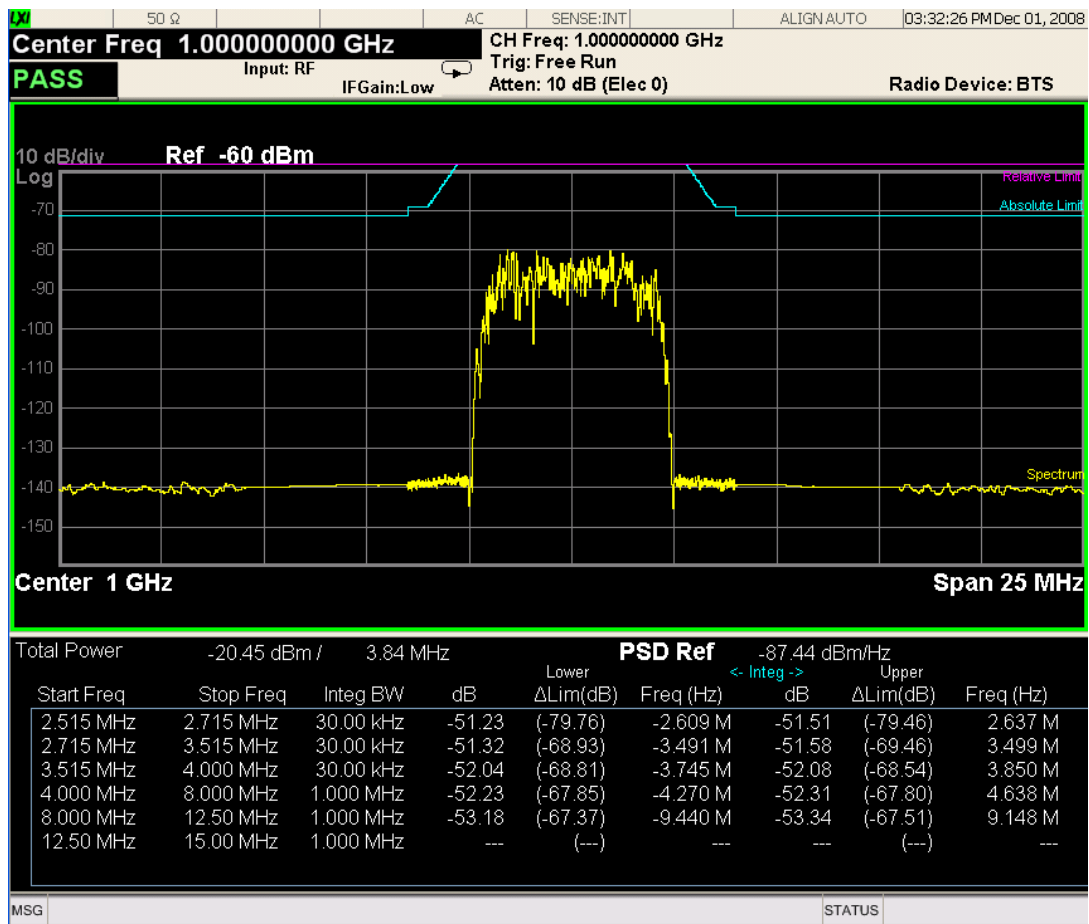

Trace Window

Corresponding Trace yellow - Combined trace from carrier and each offset

Results Window

Name	Corresponding Results
Total Pwr	n=1 2nd element Absolute power at the reference area.
	Channel Integration Bandwidth
PSD Ref	n=5 1st element Power spectral density reference at the reference area
Start (Hz)	Start frequency for offset
Stop (Hz)	Stop frequency for offset
Meas BW (Hz)	Measurement bandwidth for offset
Lower (dB)	Relative power spectrum density of the negative offset
Lower ΔLim (dB)	Minimum margin from limit line which is decided by Fail Mask setting on the negative offset
Lower Freq (Hz)	Frequency on minimum margin point of the negative offset
Upper (dB)	Relative power spectrum density of the positive offset
Upper ΔLim (dB)	Minimum margin from limit line which is decided by Fail Mask setting on the positive offset
Upper Freq (Hz)	Frequency on minimum margin point of the positive offset

Rel Peak Pwr & Freq (Spectrum Pk Ref)

This view consists of the following two windows:

"Trace Window" on page 1605

"Results Window" on page 1605

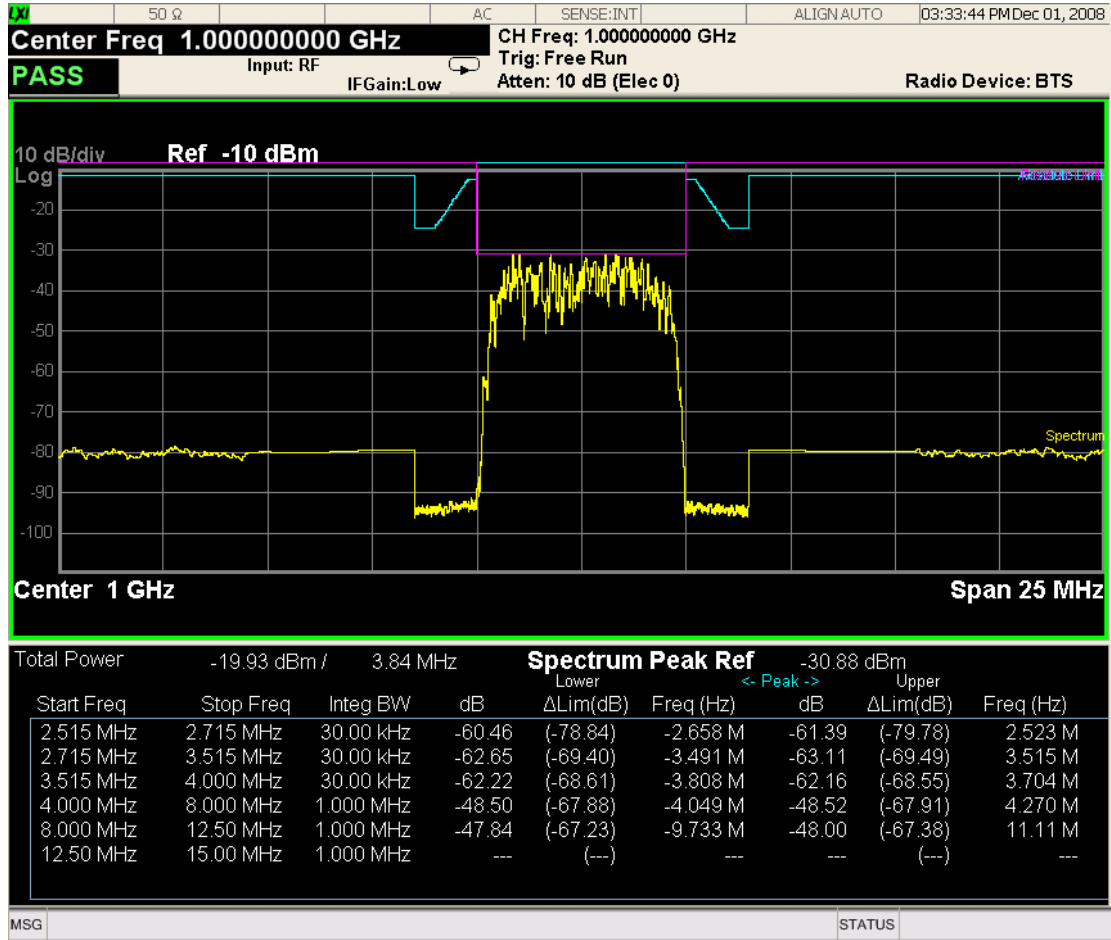

Trace Window

Corresponding Trace	yellow - Combined trace from carrier and each offset
---------------------	--

Results Window

Name	Corresponding Results
Total Pwr	Absolute power at the reference area.
	Channel Integration Bandwidth
Spectrum Peak Ref	n=5 1st element Spectrum peak power reference at the reference area
Start (Hz)	Start frequency for offset
Stop (Hz)	Stop frequency for offset
Meas BW (Hz)	Measurement bandwidth for offset
Lower Peak (dB)	Relative peak power on minimum margin point of the negative offset
Lower ΔLim (dB)	Minimum margin from limit line which is decided by Fail Mask setting

Name	Corresponding Results
	on the negative offset
Lower Freq (Hz)	Frequency on minimum margin point of the negative offset
Upper Peak (dB)	Relative peak power on minimum margin point of the positive offset
Upper Δ Lim (dB)	Minimum margin from limit line which is decided by Fail Mask setting on the positive offset
Upper Freq (Hz)	Frequency on minimum margin point of the positive offset

Key Path	View/Display
Initial S/W Revision	Prior to A.02.00

Integrated Power

Sets the display to the Integrated Power view. The views differ depending on the setting of the measurement type (Meas Type) under the Measurement Setup menu.

"Integrated Power (Total Pwr Ref)" on page 1609

"Integrated Power (PSD Ref)" on page 1612

"Integrated Power (Spectrum Pk Ref)" on page 1614

Integrated Power (Total Pwr Ref)

"Trace Window" on page 1611

"Results Window" on page 1611

11 Spectrum Emission Mask Measurement
View/Display

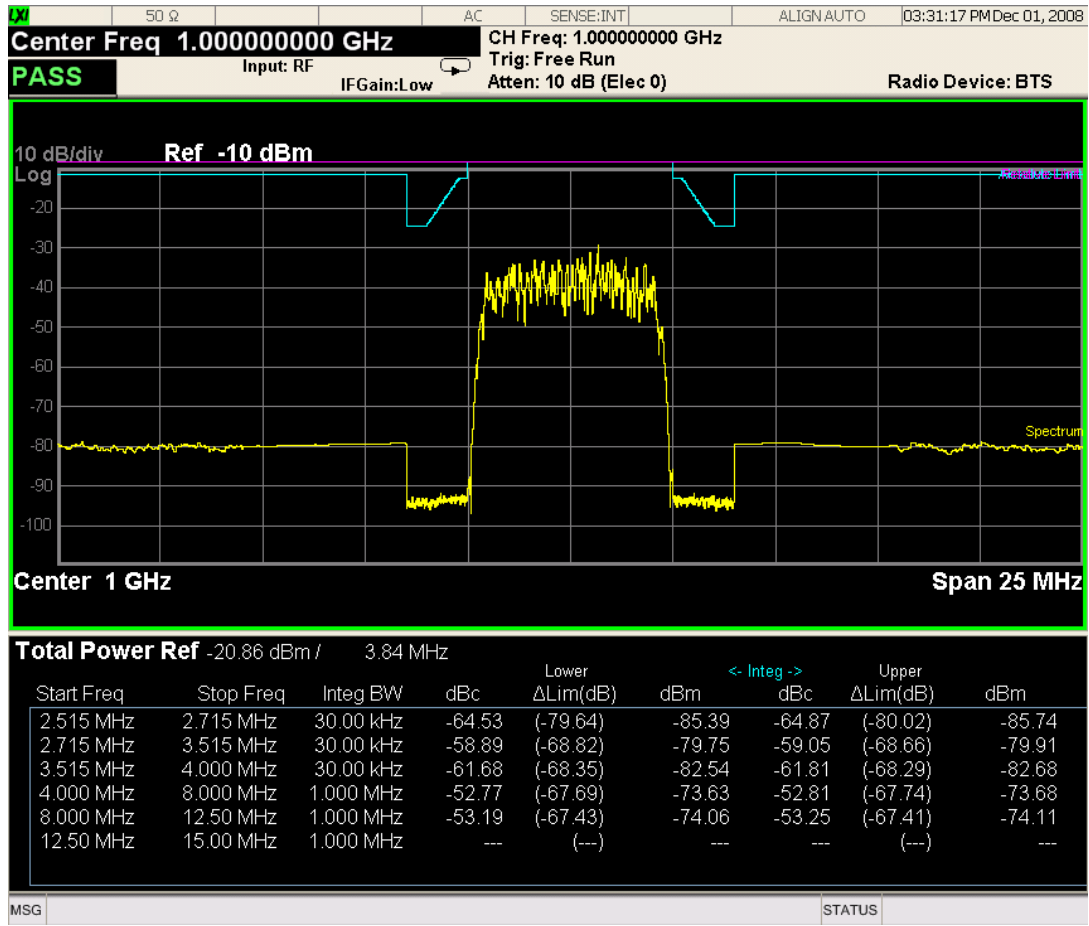

For WLAN 802.11ac (80 + 80 MHz), power readouts of both of the carriers are displayed in the lower result window.

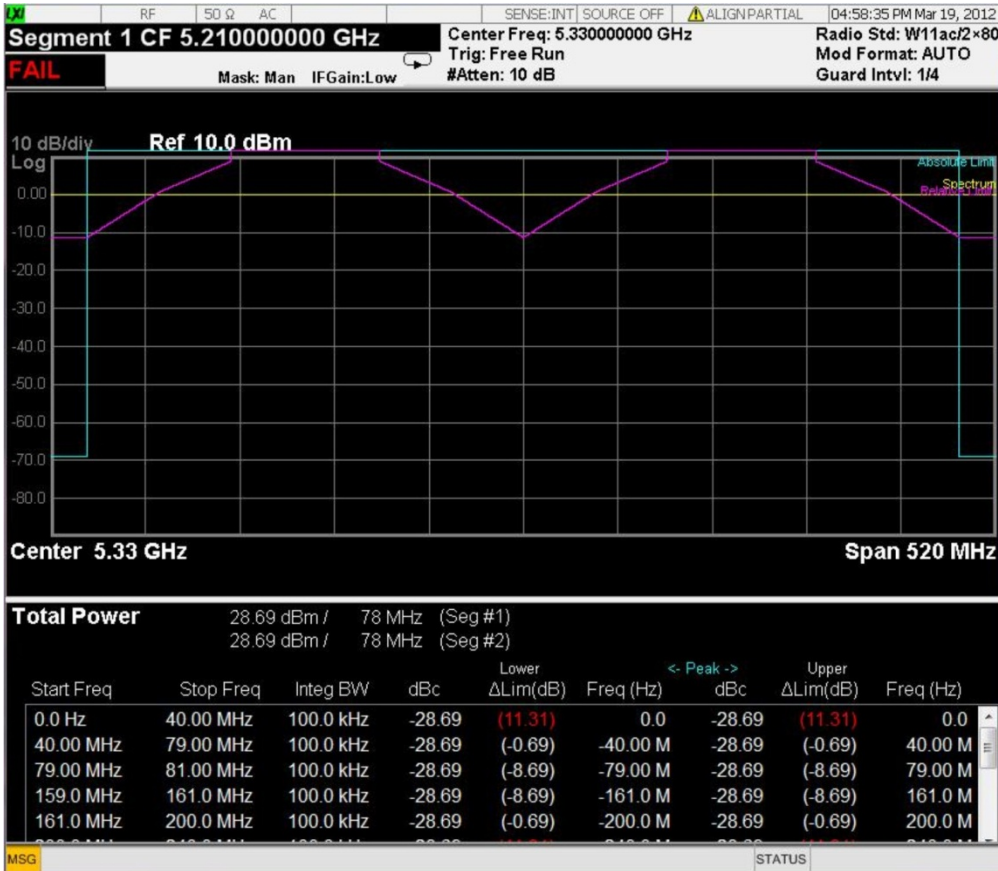

Trace Window

Corresponding Trace yellow - Combined trace from carrier and each offset

Results Window

Name	Corresponding Results
Total Pwr Ref	n=1 2nd element Absolute power at the reference area.
	Channel Integration Bandwidth
Start (Hz)	Start frequency for offset
Stop (Hz)	Stop frequency for offset
Meas BW (Hz)	Measurement bandwidth for offset
Lower Integ (dBc)	Relative integrated power on the negative offset
Lower ΔLim (dB)	Minimum margin from limit line which is decided by Fail Mask setting on the negative offset
Lower Integ (dBm)	Absolute integrated power on the negative offset

Name	Corresponding Results
Upper Integ (dBc)	Relative integrated power on the positive offset
Upper ΔLim (dB)	Minimum margin from limit line which is decided by Fail Mask setting on the positive offset
Upper Integ (dBm)	Absolute integrated power on the positive offset

Integrated Power (PSD Ref)

"Trace Window" on page 1613

"Results Window" on page 1613

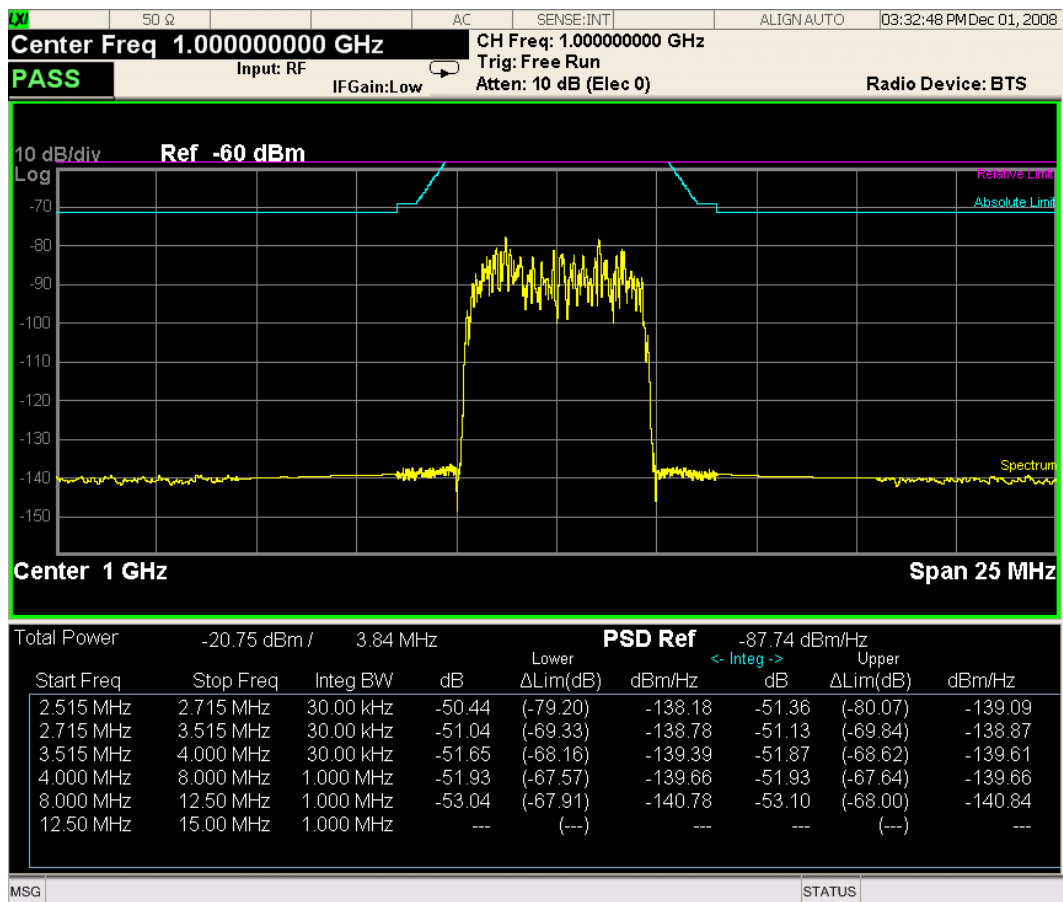

For WLAN 802.11ac (80 + 80 MHz), power readouts of both of the carriers are displayed in the lower result window.

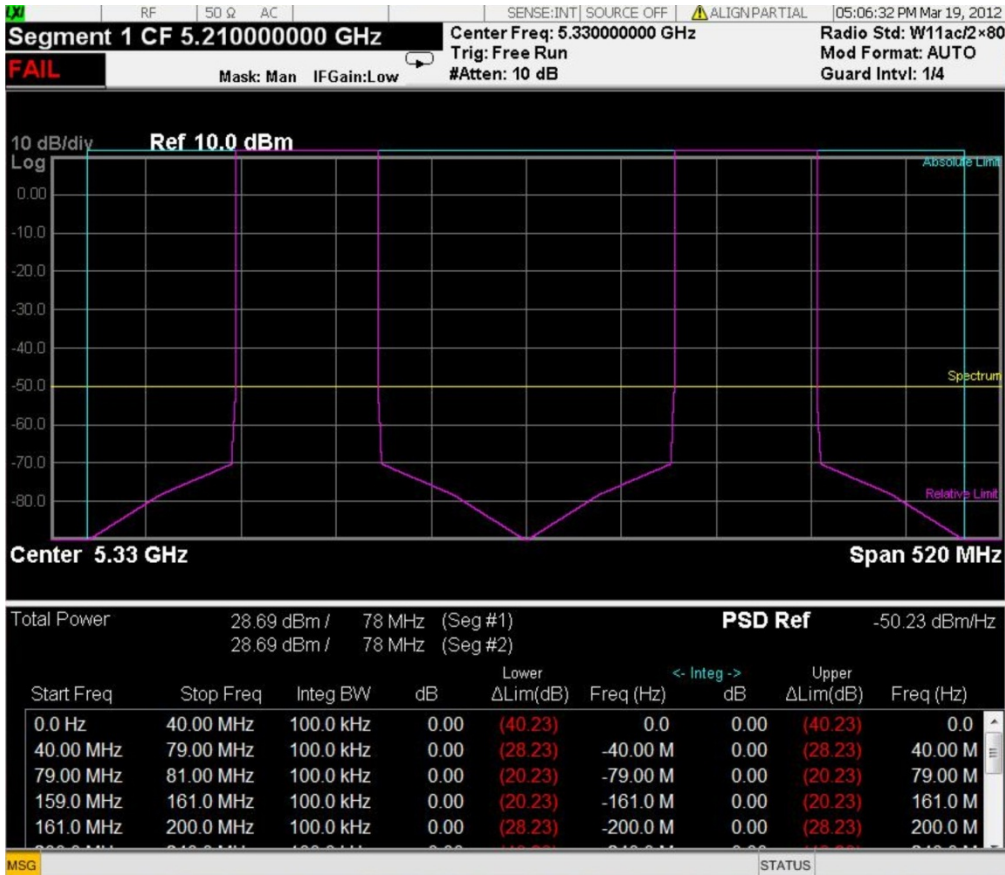

Trace Window

Corresponding Trace yellow - Combined trace from carrier and each offset

Results Window

Name	Corresponding Results
Total Pwr	n=1 2nd element Absolute power at the reference area.
PSD Ref	n=5 1st element Power spectral density reference at the reference area
Start (Hz)	Start frequency for offset
Stop (Hz)	Stop frequency for offset
Meas BW (Hz)	Measurement bandwidth for offset
Lower (dB)	Relative power spectrum density of the negative offset
Lower ΔLim (dB)	Minimum margin from limit line which is decided by Fail Mask setting on the negative offset

Name	Corresponding Results
Lower (dBm/Hz)	Absolute power spectrum density of the negative offset
Upper (dB)	Relative power spectrum density of the positive offset
Upper ΔLim (dB)	Minimum margin from limit line which is decided by Fail Mask setting on the positive offset
Upper (dBm/Hz)	Absolute power spectrum density of the negative offset

Integrated Power (Spectrum Pk Ref)

"Trace Window" on page 1611

"Results Window" on page 1611

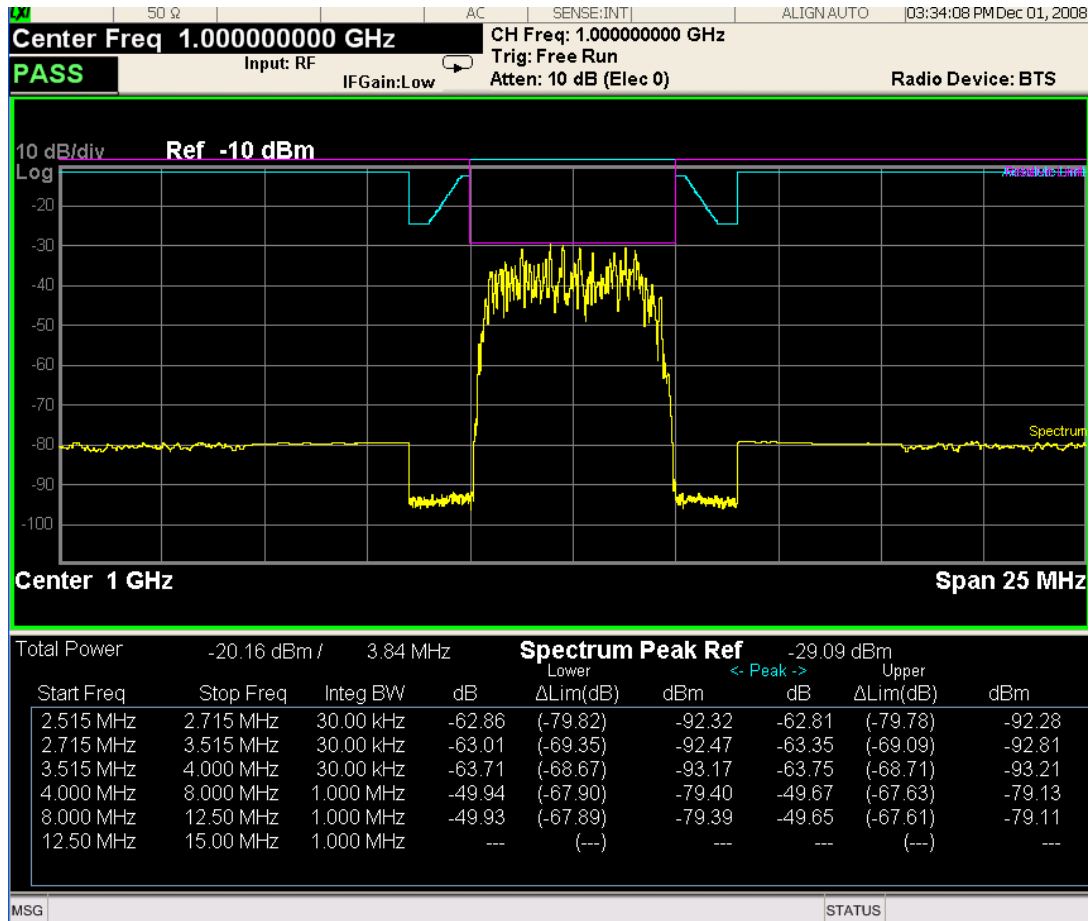

For WLAN 802.11ac (80 + 80 MHz), power readouts of both of the carriers are displayed in the lower result window.

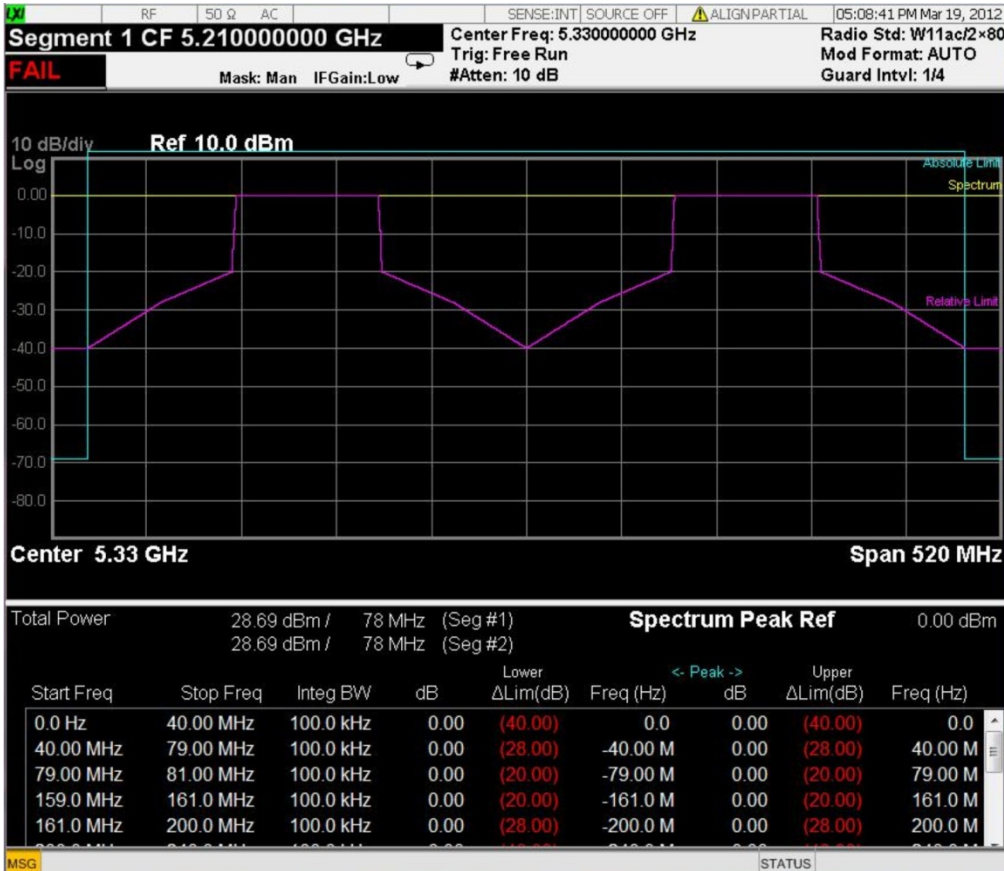

Trace Window

Corresponding Trace yellow - Combined trace from carrier and each offset

Results Window

Name	Corresponding Results
Total Pwr	Absolute power at the reference area. Channel Integration Bandwidth
Spectrum Peak Ref	n=5 1st element Peak power at the reference area
Start (Hz)	Start frequency for offset
Stop (Hz)	Stop frequency for offset
Meas BW (Hz)	Measurement bandwidth for offset
Lower Peak (dB)	Relative peak power on minimum margin point of the negative offset
Lower Δlim (dB)	Minimum margin from limit line which is decided by Fail Mask setting on the negative offset

Name	Corresponding Results
Lower Peak (dBm)	Absolute peak power on minimum margin point of the negative offset
Upper Peak (dB)	Relative peak power on minimum margin point of the positive offset
Upper Δlim (dB)	Minimum margin from limit line which is decided by Fail Mask setting on the positive offset
Upper Peak (dBm)	Absolute peak power on minimum margin point of the positive offset

Key Path	View/Display
Initial S/W Revision	Prior to A.02.00

Carrier Info (MSR and LTE-AdvancedFDD/TDD Only)

Sets the display to the Carrier Info view. The lower window is the carrier info table in this view.

Carrier center frequency can be displayed in either offset or absolute frequency depending on Carrier Freq. The table can be scrolled by Carrier Result on Meas Setup menu or by Select Carrier on Config Carriers menu. The highlighted row changes as either Carrier Result or Select Carrier is changed. The highlighted row and these keys are not coupled.

LTE-Advanced FDD/TDD has the different carrier info table from that in MSR in this view, which displays with measured component carrier powers and its power spectral density in the order of component carrier index in one of the view windows.

Carrier Info Table View (Total Power)

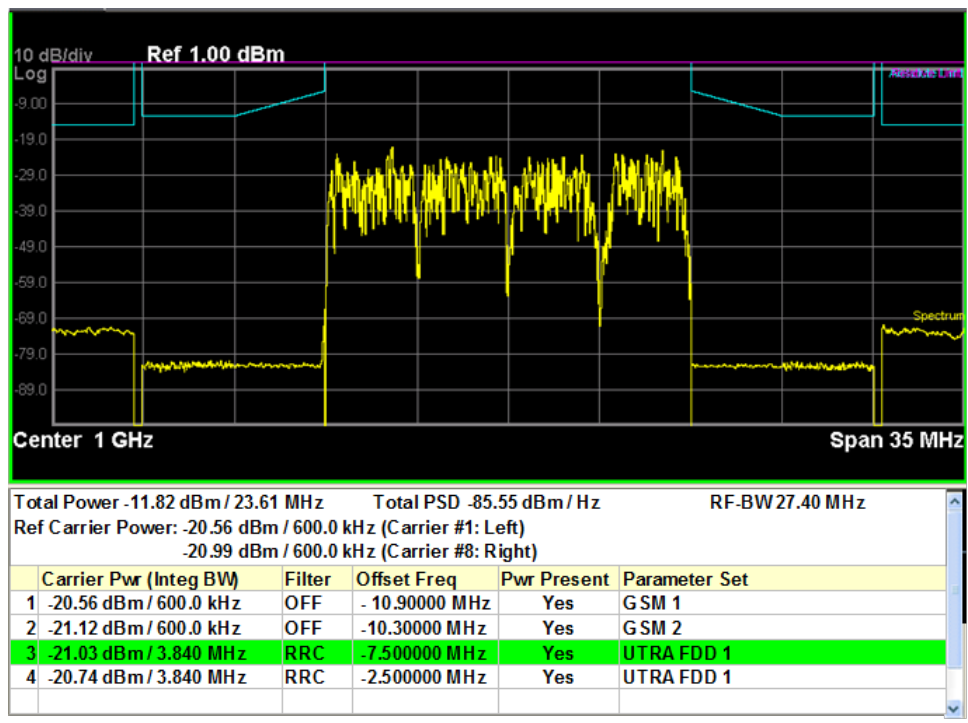

Carrier Info Table (PSD)

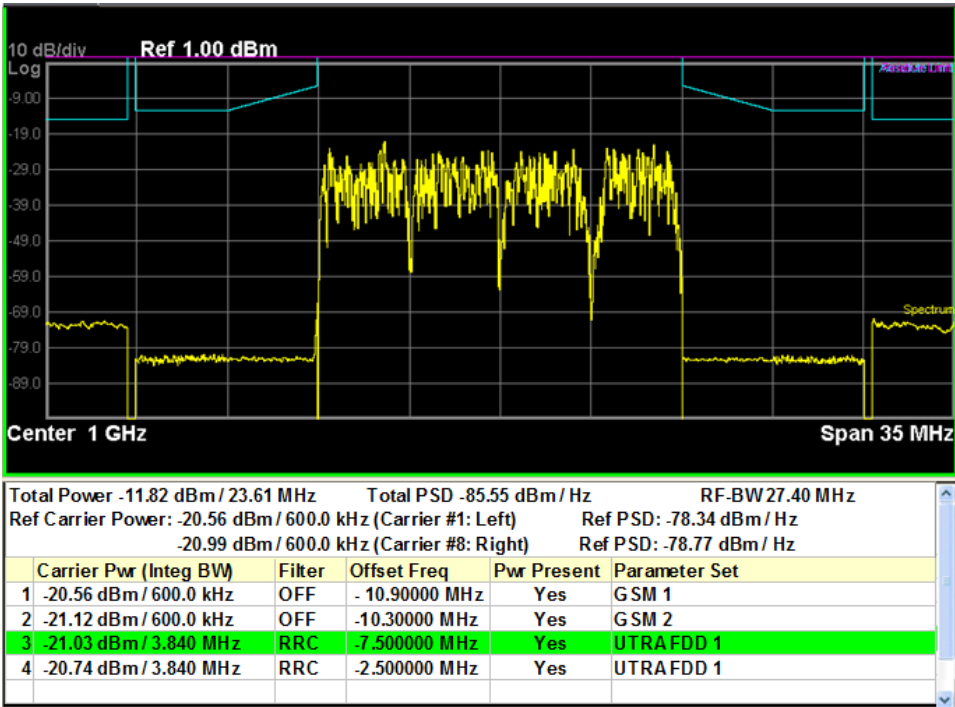

Carrier Info Table (Spectrum Pk)

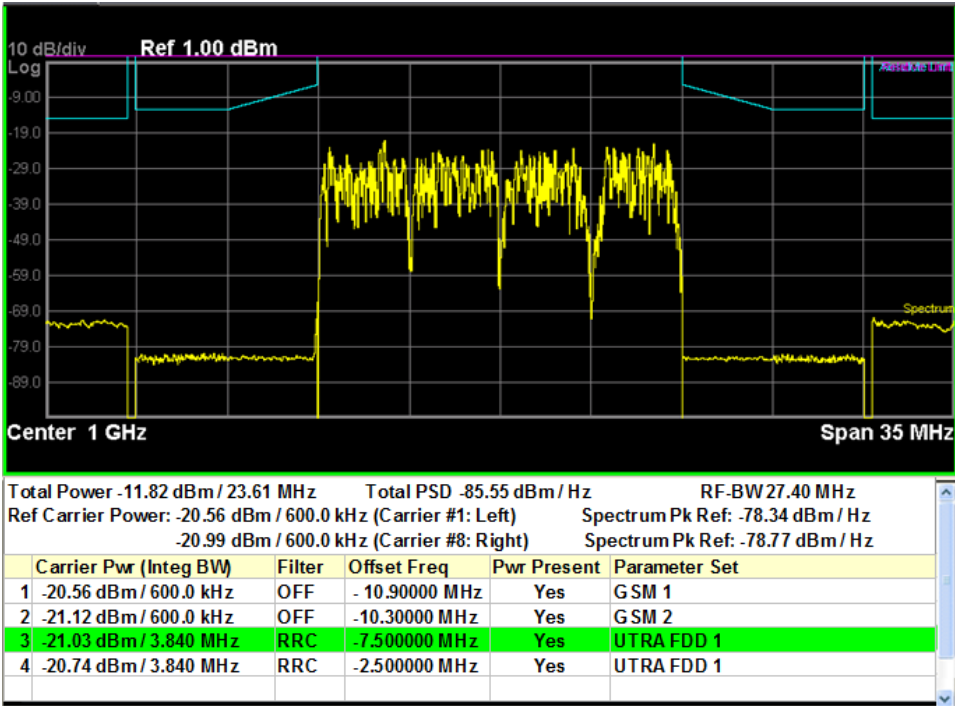

Key Path	View/Display
Initial S/W Revision	A.10.00

Carrier Freq (MSR and LTE-Advanced FDD/TDD Only)

Sets the carrier frequency display type.

- Offset – The carrier center frequencies are displayed as offset from Carrier Ref Freq.
- Absolute – The carrier center frequencies are displayed as absolute frequency.

Key Path	View/Display, Carrier Info
Mode	MSR, LTEAFDD, LTEATDD
Remote Command	:DISPlay:SEMask:VIEW[1]:WINDow[1]:CINFormation:FREQuency OFFSet ABSolute :DISPlay:SEMask:VIEW[1]:WINDow[1]:CINFormation:FREQuency?
Example	DISP:SEM:VIEW:WIND:CINF:FREQ ABS DISP:SEM:VIEW:WIND:CINF:FREQ?
Preset	OFFSet
State Saved	Saved in instrument state
Range	Offset Absolute
Initial S/W Revision	A.10.00

Limit Lines

Toggles the limit lines display function for the spectrum emission mask measurements On and Off.

Key Path	View/Display
Mode	SA, WCDMA, C2K, WIMAX OFDMA, TD-SCDMA, 1xEVDO, DTMB (CTTB), DVB-T/H, ISDB-T, CMMA, LTE, LTE-TDD, Digital Cable TV, WLAN, MSR, LTEAFDD, LTEATDD
Remote Command	:CALCulate:SEMask:LLINe:STATe ON OFF 1 0 :CALCulate:SEMask:LLINe:STATe?
Example	CALC:SEM:LLIN:STAT OFF CALC:SEM:LLIN:STAT?
Notes	You must be in the mode that includes SEM measurement to use this command. Use :INSTrument:SElect to set the mode.
Preset	ON
State Saved	Saved in instrument state.
Range	On Off
Initial S/W Revision	Prior to A.02.00
Modified at S/W Revision	A.02.00, A.03.00

12 Transmit On/Off Power Measurement Functions

This measurement is designed for testing Transmit On/Off power for the E-UTRA TDD BS, E-UTRA TDD UE and E-UTRA FDD UE. You must be in the LTE or LTETDD mode to use these commands.

For the measurement results and views, see ["View/Display" on page 1876](#).

This topic contains the following sections.

["Remote Commands for Transmit On/Off power" on page 1620](#)

["Measurement Results for Transmit On/Off power Measurement" on page 1621](#)

Remote Commands for Transmit On/Off power

The following commands are used to retrieve the measurement results:

`:CONFigure:PVTime`

`:CONFigure:PVTime:NDEFault`

`:INITiate:PVTime`

`:FETCh:PVTime[n]?`

`:READ:PVTime[n]?`

`:MEASure:PVTime[n]?`

For more measurement related commands, see the SENSE subsystem, and the section "[Remote Measurement Functions](#)" on page 2355.

Measurement Results for Transmit On/Off power Measurement

For each result, the following heading is used to represent its format and precision.

#.Result Name (type of number) [unit] <explanation>

Type of number includes double, float and integer.

Index n	Results Returned
0	Returns unprocessed I/Q trace data as a series of comma-separated trace point values, in volts. The I values are listed first in each pair, using 0 through the even-indexed values. The Q values are odd-indexed values.
n=1 (or not specified)	<p>Returns the following comma-separated scalar results:</p> <ol style="list-style-type: none"> 1. Sample time is a floating point number representing the time between samples of displayed trace which you can get by using the trace queries (n=2, 3, ...). 2. Number of samples is the number of data points in the displayed trace. This number is useful when performing a query on the signal (i.e. when n=2, 3, ...). 3. On Power/ Mean Power of First SRS Symbol is the mean power (in dBm) of the active part in the range specified by Analysis Time Slot and Measured Time Slots in the most recently acquired data, or in the last data acquired at the end of a set of averages. For LTETDD, When Direction is Uplink and Measure Dual SRS is selected, this result will be the mean power of the first SRS symbol. 4. Burst width is the width of the first set of continuous active slots in the range specified by Analysis Time slot and Measured Time Slots. 5. Trigger Diff is the time difference between the position of the trigger line and the start point of the start slot specified by Analysis Time Slot. 6. Ramp up time is the time difference between 10% and 90% voltage points (relative to peak) on the positive slope of the burst, here burst has the same meaning in Burst width. 7. Ramp down time is the time difference between 90% and 10% voltage points (relative to peak) on the negative slope of the burst, here burst has the same meaning in Burst width. 8. Off power/Off power before is the mean power measured during the transmitter OFF period, When Direction is Uplink, this result is the OFF power during the sub-frame prior to the active subframe. 9. Maximum power is the maximum peak level in the range specified by Analysis Time Slot and Measured Time Slots (in dBm). 10. Minimum power is the minimum peak level in the range specified by Analysis Time Slot and Measured Time Slots (in dBm). 11. Actual sample time is the a floating point number representing the time between samples of uncompressed I/Q trace data, which could be get by using trace query(n=0). 12. Actual number of samples is the number of data points in the uncompressed I/Q trace data, which could be get by using trace query(n=0). 13. Off power after This result is Uplink only. It is the OFF power during the sub-frame following the active subframe. When Direction is not Uplink, the value will be NaN (9.91 E 37). 14. Mean Power of Second SRS Symbol. For LTETDD, When Direction is Uplink and Measure Dual SRS is selected, this result will be the mean power of the second SRS symbol. When Direction is not Uplink and Meas DualSRS is not selected, the value will be NaN (9.91 E 37).
2	<p>Measured Trace data</p> <p>This returns comma-separated floating point numbers representing the Measured Trace data (in dBm).</p>
3	Measured Max Hold Trace data

Index n	Results Returned
	This returns comma-separated floating point numbers representing the Measured Max Hold Trace data (in dBm).
4	<p>Measured Min Hold Trace data</p> <p>This returns comma-separated floating point numbers representing the Measured Min Hold Trace data (in dBm).</p>
5	<p>Averaged absolute power of the slots</p> <p>This returns at most 20 comma-separated float values representing the averaged absolute power of each time slot (in dBm). For the inactive slot, the value will be NaN (9.91 E 37)..</p> <ol style="list-style-type: none"> 1. Averaged absolute power of TS0 2. Averaged absolute power of TS1 3. Averaged absolute power of DwPTS 4. Averaged absolute power of UpPTS 5. Averaged absolute power of TS4 6. Averaged absolute power of TS5 7. Averaged absolute power of TS6 8. Averaged absolute power of TS7 9. Averaged absolute power of TS8 10. Averaged absolute power of TS9 11. Averaged absolute power of TS10 12. Averaged absolute power of TS11 13. Averaged absolute power of TS12 (if the Uplink-downlink configuration indicates it is 5ms periodicity, it is 2nd DwPTS) 14. Averaged absolute power of TS13(if the Uplink-downlink configuration indicates it is 5ms periodicity, it is 2nd UpPTS) 15. Averaged absolute power of TS14 16. Averaged absolute power of TS15 17. Averaged absolute power of TS16 18. Averaged absolute power of TS17 19. Averaged absolute power of TS18 20. Averaged absolute power of TS19
6	<p>Width of the slots</p> <p>This returns 20 comma-separated float values representing the width of each time slot (in us). For the inactive slot, the value will be NaN(9.91E37).</p> <ol style="list-style-type: none"> 1. Active signal width of TS0 2. Active signal width of TS1 3. Active signal width of DwPTS 4. Active signal width of UpPTS 5. Active signal width of TS4 6. Active signal width of TS5

Index n	Results Returned
	<ul style="list-style-type: none"> 7. Active signal width of TS6 8. Active signal width of TS7 9. Active signal width of TS8 10. Active signal width of TS9 11. Active signal width of TS10 12. Active signal width of TS11 13. Active signal width of TS12 (if the Uplink-downlink configuration indicates it is 5ms periodicity, it is 2nd DwPTS) 14. Active signal width of TS13(if the Uplink-downlink configuration indicates it is 5ms periodicity, it is 2nd UpPTS) 15. Active signal width of TS14 16. Active signal width of TS15 17. Active signal width of TS16 18. Active signal width of TS17 19. Active signal width of TS18 20. Active signal width of TS19
7	<p data-bbox="329 957 748 984">Averaged absolute power of the subframes</p> <p data-bbox="329 999 1377 1150">This returns 10 comma-separated float values, for active subframe, it represents mean power (in dBm) of each subframe excluding any transient time, for inactive subframe, it represents the OFF power. For subframes not included in the specified measure interval, the value will be NaN(9.91E37). For special subframes in LTETDD, when Direction is Downlink,it will be the mean power in DwPTS, when Direction is Uplink, it will be the mean power of UpPTS.</p> <ul style="list-style-type: none"> 1. Averaged absolute power of Subframe 0 2. Averaged absolute power of Subframe 1 3. Averaged absolute power of Subframe 2 4. Averaged absolute power of Subframe 3 5. Averaged absolute power of Subframe 4 6. Averaged absolute power of Subframe 5 7. Averaged absolute power of Subframe 6 8. Averaged absolute power of Subframe 7 9. Averaged absolute power of Subframe 8 10. Averaged absolute power of Subframe 9
8	<p data-bbox="329 1608 659 1635">Averaged Width of the subframes</p> <p data-bbox="329 1650 1393 1738">This returns 10 comma-separated float values representing burst width (in us) of each subframe. For special subframes in LTETDD, when Direction is Downlink,it will be the burst width of DwPTS, when Direction is Uplink, it will be the burst width of UpPTS.</p> <p data-bbox="329 1753 906 1780">For the inactive subframe, the value will be NaN(9.91E37)</p> <ul style="list-style-type: none"> 1. Active signal width of Subframe 0 2. Active signal width of Subframe 1

Index n	Results Returned
	3. Active signal width of Subframe 2
	4. Active signal width of Subframe 3
	5. Active signal width of Subframe 4
	6. Active signal width of Subframe 5
	7. Active signal width of Subframe 6
	8. Active signal width of Subframe 7
	9. Active signal width of Subframe 8
	10. Active signal width of Subframe 9

Key Path	Front-panel key
Initial S/W Revision	A.03.00

Amplitude (AMPTD) Y Scale

The AMPLITUDE Y Scale key accesses the menu to set the desired vertical scale and associated settings.

Key Path	Front-panel key
Initial S/W Revision	A.03.00

Range

The Range menu allows setting amplitude controls of the instrument.

Key Path	AMPTD Y Scale
Scope	Meas Global
Initial S/W Revision	A.12.50

Range

Represents the amplitude of the largest sinusoidal signal that could be present within the IF without being clipped by the ADC. For signals with high peak-to-average ratios, the range may need to exceed the rms signal power by a fair amount to avoid clipping.

Key Path	Range
Mode	BASIC
Remote Command	<code>[:SENSe] :POWer [:RF] :RANGe <real></code> <code>[:SENSe] :POWer [:RF] :RANGe?</code>
Example	<code>:POW:RANG 10.0</code> <code>:POW:RANG?</code>
Notes	The MIN and MAX values are affected by the External Gain parameters, and by the Center Frequency. (The hardware compensates for frequency response and alters the Range setting.)
Preset	0
State Saved	Saved in instrument state.
Min	-100
Max	100
Initial S/W Revision	A.12.50

Adjust Range For Min Clip

Sets the combination of attenuation and gain based on the current measured signal level so that clipping will be at a minimum.

This is an "immediate action" function, that is, it executes once, when the key is pressed.

This key is grayed out in measurements that do not support this functionality.

Key Path	AMPTD Y Scale, Attenuation
Remote Command	[:SENSe] :POWer [:RF] :RANGe:OPTimize IMMEDIATE
Initial S/W Revision	Prior to A.02.00
Modified at S/W Revision	A.03.00

Pre-Adjust for Min Clip

If this function is on, it does the adjustment described under Adjust Range For Min Clip each time a measurement restarts. Therefore, in Continuous measurement mode, it only executes before the first measurement.

Key Path	AMPTD Y Scale, Attenuation
Remote Command	[:SENSe] :POWer [:RF] :RANGe:OPTimize:ATTenuation OFF ON ELECTrical COMBined [:SENSe] :POWer [:RF] :RANGe:OPTimize:ATTenuation?
Notes	This parameter is shared with old XA platform which uses AutoAtten. To keep the backward compatibility, ELECTrical and COMBined still can be used. Then, upon receiving ELECTrical and COMBined, these enums will be interpreted as aliases of ON. Then, when queried, ON will be returned.
Preset	OFF for Swept SA measurement; ON for all other measurements that support Pre-Adjust for Min Clip
State Saved	Saved in instrument state
Initial S/W Revision	Prior to A.02.00
Modified at S/W Revision	A.03.00

Peak to Average

The Peak to Average Ratio is used with the Range setting to optimize the level control in the instrument. The value is the ratio, in dB, of the peak power to the average power of the signal to be measured. A ratio of 0 should be used for sinusoidal signals; for 802.11g OFDM signals use 9 dB.

All Applications (Modes) will show the current value of Peak to Average ratio on the softkey. However, some applications will not permit changing the value. In these situations the softkey will be grayed-out.

Key Path	AMPTD Y Scale, Range
Remote Command	[:SENSe] :POWer [:RF] :RANGe:PARatio <real> [:SENSe] :POWer [:RF] :RANGe:PARatio?
Example	POW:RANG:PAR 12 dB
Notes	In some Applications (Modes) this parameter will be read-only; meaning the value will appear on the softkey and query via SCPI, but not changeable. In such applications the softkey will be grayed-out. Attempting to change the value via SCPI will be ignored and no error message will be generated.

Preset	10 dB
State Saved	Saved in instrument state
Min	0 dB
Max	20 dB
Initial S/W Revision	A.13.00

Mixer Level Offset

Mixer level offset is an advanced setting to adjust target Range at the input mixer which in turn affects the signal level in the instrument's IF. This setting can be used when additional optimization is needed after setting Peak to Average ratio. Positive values of offset optimize noise performance over distortion, negative values optimize distortion performance over noise.

Key Path	AMPTD Y Scale, Range
Remote Command	<code>[:SENSe] :POWer [:RF] :RANGe :MIXer :OFFSet <real></code> <code>[:SENSe] :POWer [:RF] :RANGe :MIXer :OFFSet?</code>
Example	POW:RANG:MIX:OFFS -5 dB
Preset	0 dB
State Saved	Saved in instrument state
Min	-35 dB
Max	30 dB
Initial S/W Revision	A.13.00

Ref Value

Sets the power reference.

Key Path	AMPTD Y Scale
----------	---------------

Ref Value (Burst View)

Sets the absolute power reference.

Key Path	AMPTD Y Scale
Mode	LTETDD, LTE
Remote Command	<code>:DISPlay:PVTime:VIEW[1]:WINDow[1]:TRACe:Y[:SCALe]:RLEVel <real></code> <code>:DISPlay:PVTime:VIEW[1]:WINDow[1]:TRACe:Y[:SCALe]:RLEVel?</code>
Example	DISP:PVT:VIEW:WIND:TRAC:Y:SCAL:RLEV 5dbm DISP:PVT:VIEW:WIND:TRAC:Y:SCAL:RLEV?

Couplings	When Y Auto Scale is set to On, this value is automatically determined by the measurement result. When you set this value manually, Y Auto Scale is automatically set to Off.
Preset	10.00
State Saved	Saved in instrument state.
Min	-250.0
Max	250.0
Initial S/W Revision	A.03.00

Ref Value (Rise & Fall view)

Allows you to set the absolute power reference.

Key Path	AMPTD Y Scale
Mode	LTETDD, LTE
Remote Command	:DISPlay:PVTime:VIEW2:WINDow[1] 2:TRACe:Y[:SCALe]:RLEVel <real> :DISPlay:PVTime:VIEW2:WINDow[1] 2:TRACe:Y[:SCALe]:RLEVel?
Example	DISP:PVT:VIEW:WIND:TRAC:Y:SCAL:RLEV 5 DISP:PVT:VIEW:WIND:TRAC:Y:SCAL:RLEV?
Couplings	When Y Auto Scaling is On, this value is automatically determined by the measurement result. When the user sets this value manually, Y Auto Scaling automatically changes to Off.
Preset	0.00 dBm
State Saved	Saved in instrument state.
Min	-250.0
Max	250.0
Initial S/W Revision	A.03.00

Scale/Div

Allows you to enter a numeric value to change the vertical display sensitivity.

Key Path	AMPTD Y Scale
----------	---------------

Scale/Div(Burst View)

Allows you to enter a numeric value to change the vertical display sensitivity.

Key Path	AMPTD Y Scale
Mode	LTETDD, LTE
Remote Command	:DISPlay:PVTime:VIEW[1]:WINDow[1]:TRACe:Y[:SCALe]:PDIVision <rel_ampl>

	:DISPlay:PVTime:VIEW[1]:WINDow[1]:TRACe:Y[:SCALe]:PDIVision?
Example	DISP:PVT:VIEW:WIND:TRAC:Y:PDIV 5 dB DISP:PVT:VIEW:WIND:TRAC:Y:PDIV?
Couplings	When the Auto Scale is On, this value is automatically determined by the measurement result. When you set a value manually, Auto Scale automatically changes to Off.
Preset	10.00 dB
State Saved	Saved in instrument state.
Min	0.10 dB
Max	20.00 dB
Initial S/W Revision	A.03.00

Scale/Div (Rise & Fall view)

Allows you to enter a numeric value to change the vertical display sensitivity.

Parameter Name	Y Scale/Div
Key Path	AMPTD Y Scale
Parameter Type	Float32 A6
Mode	LTETDD, LTE
Remote Command	:DISPlay:PVTime:VIEW2:WINDow[1] 2:TRACe:Y[:SCALe]:PDIVision <rel_amp1> :DISPlay:PVTime:VIEW2:WINDow[1] 2:TRACe:Y[:SCALe]:PDIVision?
Example	DISP:PVT:VIEW:WIND:TRAC:Y:PDIV 10 DISP:PVT:VIEW:WIND:TRAC:Y:PDIV?
Couplings	When Y Auto Scaling is On, this value is automatically determined by the measurement result. When the user sets this value manually, Y Auto Scaling automatically changes to Off.
Preset	10.00
Force Restart	No
State Saved	Saved in instrument state.
Min	0.1
Max	20.0
Test MIN/MAX/DEF	Yes
Resolution	0.1
Knob Increment	0.1 dB
Test UP/DOWN	1, 2, 5, 10 ...
Unit Terminator Key	dB
Annotation	<value> dB/ left upper of graph
Initial S/W Revision	A.03.00
Softkey Label	Scale/Div

Ref Position

Sets the display reference position to the top, center, or bottom of the display.

Key Path	AMPTD Y Scale
----------	---------------

Ref Position(Burst View)

Allows you to set the display reference position to the top, center, or bottom of the display.

Key Path	AMPTD Y Scale, More
Mode	LTETDD, LTE
Remote Command	:DISPlay:PVTime:VIEW[1]:WINDow[1]:TRACe:Y[:SCALe]:RPOSition TOP CENTer BOTTom :DISPlay:PVTime:VIEW[1]:WINDow[1]:TRACe:Y[:SCALe]:RPOSition?
Example	:DISP:PVT:VIEW:WIND:TRAC:Y:SCAL:RPOS CENT :DISP:PVT:VIEW:WIND:TRAC:Y:SCAL:RPOS?
Preset	TOP
State Saved	Saved in instrument state.
Range	Top Ctr Bot
Initial S/W Revision	A.03.00

Ref Position (Rise & Fall view)

Allows you to set the display reference position to Top, Center, or Bottom.

Key Path	AMPTD Y Scale
Mode	LTETDD, LTE
Remote Command	:DISPlay:PVTime:VIEW2:WINDow[1] 2:TRACe:Y[:SCALe]:RPOSition TOP CENTer BOTTom :DISPlay:PVTime:VIEW2:WINDow[1] 2:TRACe:Y[:SCALe]:RPOSition?
Example	DISP:PVT:VIEW:WIND:TRAC:Y:RPOS CENT DISP:PVT:VIEW:WIND:TRAC:Y:RPOS?
Preset	TOP
State Saved	Saved in instrument state.
Range	Top Ctr Bot
Initial S/W Revision	A.03.00

Auto Scale

Allows you to toggle the Y axis Auto Scale function between On and Off.

Key Path	AMPTD Y Scale
----------	---------------

Auto Scale(Burst View)

Allows you to toggle the Y axis Auto Scale function between On and Off.

Key Path	AMPTD Y Scale, More
Mode	LTETDD, LTE
Remote Command	:DISPlay:PVTime:VIEW[1]:WINDow[1]:TRACe:Y[:SCALe]:COUPle 0 1 OFF ON :DISPlay:PVTime:VIEW[1]:WINDow[1]:TRACe:Y[:SCALe]:COUPle?
Example	:DISP:PVT:VIEW:WIND:TRAC:Y:COUP ON :DISP:PVT:VIEW:WIND:TRAC:Y:COUP?
Couplings	When Auto Scale is On, and you press the Restart front-panel key, this function automatically determines the scale per division and reference values based on the measurement results. When you manually set a value for the Y Rel Value or Y Scale/Div, this parameter is automatically set to Off.
Preset	ON
State Saved	Saved in instrument state.
Range	On Off
Initial S/W Revision	A.03.00

Auto Scale (Rise & Fall view)

Allows you to toggle the Y-axis auto scaling function between On and Off.

Key Path	AMPTD Y Scale
Mode	LTETDD, LTE
Remote Command	:DISPlay:PVTime:VIEW2:WINDow[1] 2:TRACe:Y[:SCALe]:COUPle 0 1 OFF ON :DISPlay:PVTime:VIEW2:WINDow[1] 2:TRACe:Y[:SCALe]:COUPle?
Example	DISP:PVT:VIEW:WIND:TRAC:Y:COUP 0 DISP:PVT:VIEW:WIND:TRAC:Y:COUP?
Couplings	When Auto Scale is On, and you press the Restart front-panel key, this function automatically determines the scale per division and reference values based on the measurement results. When you manually set a value for the Y Rel Value or Y Scale/Div, this parameter is automatically set to Off.
Preset	ON
State Saved	Saved in instrument state.
Range	On Off
Initial S/W Revision	A.03.00

Auto Couple

The Auto Couple feature provides a quick and convenient way to automatically couple multiple instrument settings. This helps ensure accurate measurements and optimum dynamic range. When the Auto Couple feature is activated, either from the front panel or remotely, all parameters of the current measurement that have an Auto/Manual mode are set to Auto mode and all measurement settings dependent on (or coupled to) the Auto/Man parameters are automatically adjusted for optimal performance.

However, the Auto Couple key actions are confined to the current measurement only. It does not affect other measurements in the mode, and it does not affect markers, marker functions, or trace or display attributes.

See "[More Information](#)" on page 1633

Key Path	Front-panel key
Remote Command	:COUPle ALL NONE
Example	:COUP ALL
Notes	:COUPle ALL puts all Auto/Man parameters in Auto mode (equivalent to pressing the Auto Couple key). :COUPLE NONE puts all Auto/Man parameters in manual mode. It decouples all the coupled instrument parameters and is not recommended for making measurements.
Initial S/W Revision	Prior to A.02.00

More Information

There are two types of functions that have Auto/Manual modes.

Auto/Man Active Function keys

An Auto/Man toggle key controls the binary state associated with an instrument parameter by toggling between Auto (where the parameter is automatically coupled to the other parameters it is dependent upon) and Man (where the parameter is controlled independent of the other parameters), as well as making the parameter the active function. The current mode is indicated on the softkey with either Auto or Man underlined as illustrated below.



Auto/Man 1-of-N keys

An Auto/Man 1-of-N key allows you to manually pick from a list of parameter values, or place the function in Auto, in which case the value is automatically selected (and indicated) as shown below. If in Auto, Auto is underlined on the calling key. If in manual operation, manual is indicated on the calling key. But the calling key does not actually toggle the function, it simply opens the menu.

12 Transmit On/Off Power Measurement Functions
Auto Couple

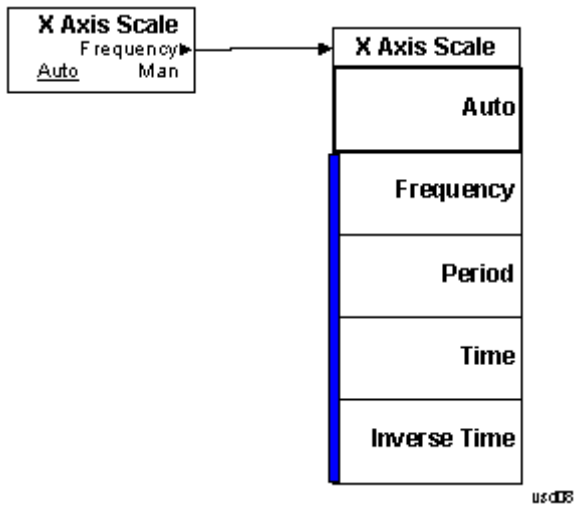

BW

This key allows you to set the Bandwidth of the signal being measured.

Preset To Standard	Info BW	Notes
1.4 MHz (6 RB)	1.5 MHz	
3.0 MHz (15 RB)	3.0 MHz	
5.0 MHz (25 RB)	5.0 MHz	
10.0 MHz (50 RB)	10.0 MHz	Need B25 opt
15.0 MHz (75 RB)	25.0 MHz	Need B25 opt
20.0 MHz (100 RB)	25.0 MHz	Need B25 opt

Bandwidth	Info BW	Notes
1.4 MHz (6 RB)	1.08 MHz	Need B40 or wider
3.0 MHz (15 RB)	2.7 MHz	Need B40 or wider
5.0 MHz (25 RB)	4.5 MHz	Need B40 or wider
10.0 MHz (50 RB)	9.0 MHz	Need B40 or wider
15.0 MHz (75 RB)	13.5 MHz	Need B40 or wider
20.0 MHz (100 RB)	18.0 MHz	Need B40 or wider

Key Path	BW
Mode	LTETDD, LTE
Remote Command	[:SENSe] :PVTime:BAWdwidth <freq> [:SENSe] :PVTime:BAWdwidth?
Example	PVT:BAW 6.0 MHz PVT:BAW?
Couplings	This parameter is coupled with Preset to Standard in Mode Setup Menu. The relationship is in the table above.
Preset	5.0 MHz
State Saved	Saved in instrument state.
Min	10 Hz
Max	Hardware Dependent: No Option = 10 MHz Option B25 = 25 MHz Option B40 = 40 MHz Option B85 = 85 MHz Option B1A = 125 MHz

12 Transmit On/Off Power Measurement Functions
BW

	Option B1X = 140 MHz
	Option B1Y = 160 MHz
Initial S/W Revision	A.03.00
Modified at S/W Revision	A.13.00

Cont (Continuous Measurement/Sweep)

Sets the analyzer for Continuous measurement operation. The single/continuous state is Meas Global so the setting will affect all measurements. If you are Paused, pressing Cont does a Resume.

Key Path	Front-panel key
Remote Command	:INITiate:CONTinuous OFF ON 0 1 :INITiate:CONTinuous?
Example	:INIT:CONT 0 puts analyzer in Single measurement operation. :INIT:CONT 1 puts analyzer in Continuous measurement operation
Preset	ON (Note that SYST:PRESet sets INIT:CONT to ON but *RST sets INIT:CONT to OFF)
State Saved	Saved in instrument state
Backwards Compatibility Notes	For Spectrum Analysis mode in ESA and PSA, there is no Cont hardkey, instead there is a Sweep Single/Cont key. In these analyzers, switching the Sweep Single/Cont key from Single to Cont restarts averages (displayed average count reset to 1), but does not restart Max Hold and Min Hold. The X-Series has Single and Cont keys in place of the SweepSingleCont key. In the X-Series, if in single measurement, the Cont key (and INIT:CONT ON) switches to continuous measurement, but never restarts a measurement and never resets a sweep.
Initial S/W Revision	Prior to A.02.00

In Swept SA Measurement (Spectrum Analysis Mode):

The analyzer takes repetitive sweeps, averages, measurements, etc., when in Continuous mode. When the average count reaches the Average/Hold Number the count stops incrementing, but the analyzer keeps sweeping. See the Trace/Detector section for the averaging formula used both before and after the Average/Hold Number is reached. The trigger condition must be met prior to each sweep. The type of trace processing for multiple sweeps, is set under the Trace/Detector key, with choices of Trace Average, Max Hold, or Min Hold.

In Other Measurements/Modes:

With Avg/Hold Num (in the Meas Setup menu) set to Off or set to On with a value of 1, a sweep is taken after the trigger condition is met; and the analyzer continues to take new sweeps after the current sweep has completed and the trigger condition is again met. However, with Avg/Hold Num set to On with a value >1, multiple sweeps (data acquisitions) are taken for the measurement. The trigger condition must be met prior to each sweep. The sweep is not stopped when the average count k equals the number N set for Avg/Hold Num is reached, but the number k stops incrementing. A measurement average usually applies to all traces, marker results, and numeric results. But sometimes it only applies to the numeric results.

If the analyzer is in Single measurement, pressing the Cont key does not change k and does not cause the sweep to be reset; the only action is to put the analyzer into Continuous measurement operation.

If it is already in continuous sweep:

the INIT:CONT 1 command has no effect

12 Transmit On/Off Power Measurement Functions Cont (Continuous Measurement/Sweep)

the INIT:CONT 0 command will place the analyzer in Single Sweep but will have no effect on the current sequence until $k = N$, at which point the current sequence will stop and the instrument will go to the idle state.

File

See "File" on page 266

FREQ Channel

Accesses a menu of keys that allow you to control the Frequency and Channel parameters of the instrument.

Some features in the Frequency menu are the same for all measurements - they do not change as you change measurements. Settings like these are called "Meas Global" and are unaffected by Meas Preset. For example, the Center Freq setting is the same for all measurements - it does not change as you change measurements.

Key Path	Front Panel Key
Mode	LTETDD, LTEAFDD
Initial S/W Revision	A.14.00

Carrier Ref Freq

Sets carrier reference frequency. The center frequencies of carriers are defined as offset frequency from this value.

If the following conditions are satisfied at the same time:

- the Number of Component Carrier equals to 1
- the Center Freq Offset equals to 0 Hz
- the mode of the Center Freq is Auto

the Center Freq is equivalent to Carrier Ref Freq.

When the Center Freq changes in such conditions, the mode of the Center Freq keeps as Auto and the Carrier Ref Freq will be changed to same value. The major purpose of this coupling is to keep BWCC with legacy LTE/LTE TDD, in which :SENSE:FREQUENCY:CENTER is used to set up the Frequency of the measurement.

Key Path	FREQ Channel Mode Setup, Component Carrier Setup
Mode	LTEATDD, LTEAFDD
Measurement	All
Remote Command	[:SENSE] :CCARrier:REFerence <freq> [:SENSE] :CCARrier:REFerence?
Example	CCAR:REF 2GHz CCAR:REF?
Notes	In order to easily configure component carriers, the key is also placed in the Mode Setup.
Preset	1GHz
State Saved	Saved in instrument state
Min	Depends on instrument minimum center frequency. Same as Center Freq
Max	Depends on instrument maximum center frequency. Same as Center Freq

Initial S/W Revision	A.14.00
Modified at S/W Revision	A.14.50

Input/Output

See "[Input/Output](#)" on page 182

Marker

Accesses the menu that allows you to select, set up, and control the markers for the current measurement. Sets the marker control mode as described under Normal, Delta, and Off, below. All interactions and dependencies detailed under the softkey description are enforced when the remote command is sent.

See Marker in the "Common Measurement Functions" for more information.

Key Path	Front-panel key
Initial S/W Revision	A.03.00

Select Marker

Accesses menus that allows you to select one or more markers

Key Path	Marker, Properties
Initial S/W Revision	A.03.00

Marker Type

Sets the marker control mode. If the selected marker is Off, pressing Marker sets it to Normal and places it at the center of the screen on the trace determined by the Marker Trace rules. At the same time, the reference value of the selected marker appears on the Active Function area.

Active Function Display: Marker X-axis value

Default Active Function: the active function for the selected marker's current control mode. If the current control mode is Off, there is no active function and the active function is turned off.

The marker X axis value entered in the active function area will display the marker value to its full entered precision.

Key Path	Marker
Mode	LTETDD, LTE
Remote Command	:CALCulate:PVTime:MARKer[1] 2 ...12:MODE POSition DELTA OFF :CALCulate:PVTime:MARKer[1] 2 ...12:MODE?
Example	:CALC:PVT:MARK:MODE OFF :CALC:PVT:MARK:MODE?
Notes	If the selected marker is Off, pressing Marker sets it to Normal and places it at the center of the screen on the trace determined by the Marker Trace rules. At the same time, Marker X Axis Value appears in the Active Function area. Default Active Function: the active function for the selected marker's current control mode. Note that if the current control mode is Off, there is no active function and the active function is turned off. Active Function Display: the marker X axis value entered in the active function area will display the

	marker value to its fully entered precision.
Preset	OFF
State Saved	Saved in instrument state.
Range	Normal Delta Off
Initial S/W Revision	A.03.00

Properties

Accesses a menu that allows you to set marker properties and to access the marker trace menu.

Key Path	Marker
Initial S/W Revision	A.03.00

Select Marker

Accesses menus that allows you to select one or more markers

Key Path	Marker, Properties
Initial S/W Revision	A.03.00

Relative To

Selects the marker that the selected marker will be relative to, which is referred to as its “reference marker”.

Key Path	Marker, Properties
Mode	LTETDD, LTE
Remote Command	:CALCulate:PVTTime:MARKer[1] 2 ...12:REFerence <integer> :CALCulate:PVTTime:MARKer[1] 2 ...12:REFerence?
Example	:CALC:PVT:MARK5:REF 1 :CALC:PVT:MARK5:REF?
Notes	When queried, a single value will be returned - the specified marker number's relative marker.
Preset	2 3 4 5 6 7 8 9 10 11 12 1
State Saved	Saved in instrument state.
Min	1
Max	12
Initial S/W Revision	A.03.00

Marker Trace

Assigns the specified marker to the designated trace.

Key Path	Marker, Properties
Mode	LTETDD, LTE
Remote Command	:CALCulate:PVTime:MARKer[1] 2 ...12:TRACe RFENvelope MAXHold MINHold :CALCulate:PVTime:MARKer[1] 2 ...12:TRACe?
Example	:CALC:PVT:MARK:TRAC MINH :CALC:PVT:MARK:TRAC?
Preset	RFENvelope
State Saved	Saved in instrument state.
Range	RF Envelope Max Hold RF Envelope Min Hold RF Envelope
Initial S/W Revision	A.03.00

Couple Marker

When this function is invoked, moving any marker causes an “equal X Axis movement” of every other marker which is active. By “equal X Axis movement” we mean that the difference between each marker’s X Axis value (in the fundamental x-axis units of the trace that marker is on) is preserved, as is the X Axis value of the marker being moved (in the same fundamental X-axis units).

NOTE This may result in markers going off screen.

Key Path	Marker, More
Mode	LTETDD, LTE
Remote Command	:CALCulate:PVTime:MARKer:COUPle[:STATe] ON OFF 1 0 :CALCulate:PVTime:MARKer:COUPle[:STATe]?
Example	CALC:PVT:MARK:COUP ON CALC:PVT:MARK:COUP?
Preset	OFF
State Saved	Saved in instrument state.
Range	On Off
Initial S/W Revision	A.03.00

All Markers Off

Turns all markers Off.

Key Path	Marker, More
----------	--------------

Mode	LTETDD, LTE
Remote Command	:CALCulate:PVTTime:MARKer:AOff
Example	:CALC:PVT:MARK:AOff
Initial S/W Revision	A.03.00

Marker X Axis Value (Remote Command Only)

Sets the marker X Axis value in the current marker X Axis Scale unit. It has no effect if the control mode is Off, but is the SCPI equivalent of entering an X value, if the control mode is Normal or Delta.

Mode	LTETDD, LTE
Remote Command	:CALCulate:PVTTime:MARKer[1] 2 ...12:X <real> :CALCulate:PVTTime:MARKer[1] 2 ...12:X?
Example	:CALC:PVT:MARK3:X 0 :CALC:PVT:MARK3:X?
Notes	If no suffix is sent, it will use the fundamental units for the current marker X Axis Scale. If a suffix is sent that does not match the current marker X Axis Scale unit, an "Invalid suffix" error will be generated. The query returns the marker's absolute X Axis value if the control mode is Normal, or the offset from the marker's reference marker, if the control mode is Delta. The query is returned in the fundamental units for the current marker X Axis scale: seconds. If the marker is off the response is not a number (NAN).
Couplings	Max value would be changed by Meas Interval in 6.3.2 in epsg1129241.
Preset	After a preset, all markers are turned OFF, so a Marker X Axis Value query will return a not a number (NAN).
State Saved	No
Min	-9.9E+37
Max	9.9E+37
Initial S/W Revision	A.03.00

Marker X Axis Position (Remote Command only)

Sets the marker X position in trace points. This allows you to enter a value in trace points rather than in X Axis Scale units. The entered value is immediately converted into the current X Axis Scale unit for setting the value of the marker. It has no effect if the control mode is Off, but is the SCPI equivalent of entering an X value, if the control mode is Normal or Delta.

Mode	LTETDD, LTE
Remote Command	:CALCulate:PVTTime:MARKer[1] 2 ...12:X:POsition <real> :CALCulate:PVTTime:MARKer[1] 2 ...12:X:POsition?
Example	:CALC:PVT:MARK10:X:POS 500

	:CALC:PVT:MARK10:X:POS?
Notes	A query returns the marker's absolute X Axis value in trace points, if the control mode is Normal, or the offset from the marker's reference marker in trace points, if the control mode is Delta. If the marker is Off the response is not a number (NAN).
Preset	After a preset, all markers are turned Off, so a Marker X Axis Value query will return a not a number (NAN).
State Saved	No
Min	-9.9E+37
Max	9.9E+37
Initial S/W Revision	A.03.00

Marker Y Axis Value (Remote Command only)

Returns the marker Y Axis value in the current marker Y Axis unit.

The “result” of a marker is the value that is displayed on the second line of the Marker Result block. To properly interpret the returned value, you must also know how the analyzer's Y-Axis Unit is set, as described below.

A marker can have up to two results, only one of which is displayed or returned in a query, as follows:

- Absolute result: every marker has an absolute result. For Normal and Delta markers, the Y-axis value of the trace point the marker is currently On. The absolute result is displayed in the result block or returned as a query, unless the marker control mode is Delta.
- Relative result: if a marker's control mode is Delta, the relative result is displayed in the result block or returned in a query. This is the ratio of the Absolute Result of a delta marker to the Absolute Result of its reference marker. The ratio is expressed in dB.

Mode	LTETDD, LTE
Remote Command	:CALCulate:PVTime:MARKer[1] 2 ...12:Y?
Example	:CALC:PVT:MARK11:Y 0 :CALC:PVT:MARK11:Y?
Notes	The query returns the marker Y-axis result. If the marker is Off the response is not a number (NAN).
Preset	0
State Saved	No
Initial S/W Revision	A.03.00

Maker State (Remote Command Only)

Sets or queries the state of a marker. Setting a marker which is Off to state On, or 1, puts it in Normal mode and places it at the center of the screen.

12 Transmit On/Off Power Measurement Functions
Marker

Mode	LTETDD, LTE
Remote Command	:CALCulate:PVTTime:MARKer[1] 2 ...12:STATe OFF ON 0 1 :CALCulate:PVTTime:MARKer[1] 2 ...12:STATe?
Example	:CALC:PVT:MARK3:STATE ON :CALC:PVT:MARK3:STATE?
Preset	OFF
State Saved	Saved in instrument state.
Range	On Off
Initial S/W Revision	A.03.00

Marker Fctn

There are no 'Marker Functions' supported in transmit On/Off Power measurement. Pressing this key will display a blank menu.

Key Path	Front-panel key
Initial S/W Revision	A.03.00

Marker To

There is no 'Marker To' functionality supported in Transmit On/Off Power measurement so this front-panel key will display a blank menu when pressed

Key Path	Front-panel key
Initial S/W Revision	A.03.00

Meas

The information in this section is common to all measurements. For key and remote command information for a specific measurement, refer to the section that describes the measurement of interest.

Measurements available under the Meas key are specific to the current Mode.

When viewing Help for measurements, note the following:

NOTE

Operation for some keys differs between measurements. The information displayed in Help pertains to the current measurement. To see how a key operates in a different measurement, exit Help (press the Cancel Esc key), select the measurement, then reenter Help (press the Help key) and press that key.

Key Path	Front-panel key
Initial S/W Revision	Prior to A.02.00

Remote Measurement Functions

This section contains the following topics:

"Measurement Group of Commands" on page 2356

"Current Measurement Query (Remote Command Only)" on page 2358

"Limit Test Current Results (Remote Command Only)" on page 2358

"Data Query (Remote Command Only)" on page 2358

"Calculate/Compress Trace Data Query (Remote Command Only)" on page 2359

"Calculate Peaks of Trace Data (Remote Command Only)" on page 2364

"Hardware-Accelerated Fast Power Measurement (Remote Command Only)" on page 2365

"Format Data: Numeric Data (Remote Command Only)" on page 2379

"Format Data: Byte Order (Remote Command Only)" on page 2380

Initial S/W Revision	Prior to A.02.00
----------------------	------------------

Measurement Group of Commands

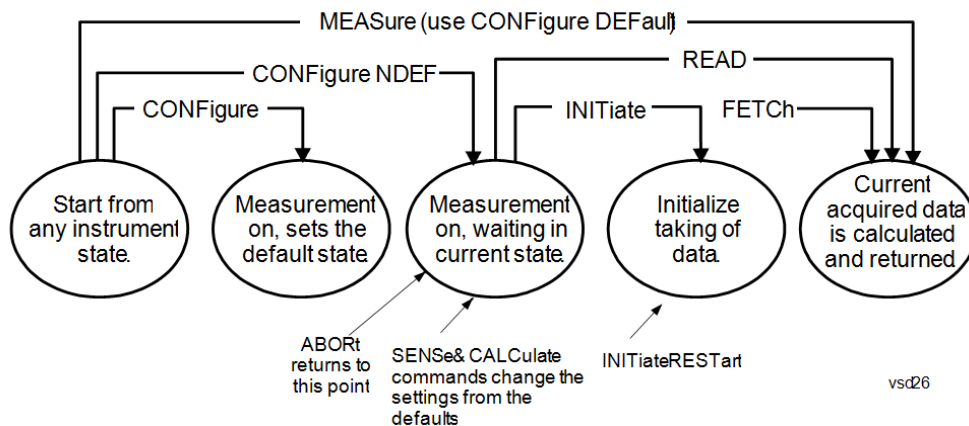

Measure Commands:

:MEASure:<measurement>[n]?

This is a fast single-command way to make a measurement using the factory default instrument settings. These are the settings and units that conform to the Mode Setup settings (e.g. radio standard) that you have currently selected.

- Stops the current measurement (if any) and sets up the instrument for the specified measurement using the factory defaults
- Initiates the data acquisition for the measurement
- Blocks other SCPI communication, waiting until the measurement is complete before returning results.
- If the function does averaging, it is turned on and the number of averages is set to 10.
- After the data is valid it returns the scalar results, or the trace data, for the specified measurement. The type of data returned may be defined by an [n] value that is sent with the command.
- The scalar measurement results will be returned if the optional [n] value is not included, or is set to 1. If the [n] value is set to a value other than 1, the selected trace data results will be returned. See each command for details of what types of scalar results or trace data results are available.
- ASCII is the default format for the data output. (Older versions of Spectrum Analysis and Phase Noise mode measurements only use ASCII.) The binary data formats should be used for handling large blocks of data since they are smaller and faster than the ASCII format. Refer to the FORMat:DATA command for more information.

If you need to change some of the measurement parameters from the factory default settings you can set up the measurement with the CONFigure command. Use the commands in the SENSe:<measurement> and CALCulate:<measurement> subsystems to change the settings. Then you can use the READ? command to initiate the measurement and query the results.

If you need to repeatedly make a given measurement with settings other than the factory defaults, you can use the commands in the SENSe:<measurement> and CALCulate:<measurement> subsystems to set up the measurement. Then use the READ? command to initiate the measurement and query results.

Measurement settings persist if you initiate a different measurement and then return to a previous one. Use READ:<measurement>? if you want to use those persistent settings. If you want to go back to the default settings, use MEASure:<measurement>?.

Configure Commands:

:CONFigure:<measurement>

This command stops the current measurement (if any) and sets up the instrument for the specified measurement using

the factory default instrument settings. It does not initiate the taking of measurement data unless INIT:CONTinuous is ON. If you change any measurement settings after using the CONFigure command, the READ command can be used to initiate a measurement without changing the settings back to their defaults.

In the Swept SA measurement in Spectrum Analyzer mode the CONFigure command also turns the averaging function on and sets the number of averages to 10 for all measurements.

:CONFigure: <measurement>: NDEFault stops the current measurement and changes to the specified measurement. It does not change the settings to the defaults. It does not initiate the taking of measurement data unless INIT:CONTinuous is ON.

The CONFigure? query returns the current measurement name.

The CONFigure:CATalog? query returns a quoted string of all licensed measurement names in the current mode. For example, "SAN, CHP, OBW, ACP, PST, TXP, SPUR, SEM, LIST".

Fetch Commands:

:FETCh:<measurement>[n]?

This command puts selected data from the most recent measurement into the output buffer. Use FETCh if you have already made a good measurement and you want to return several types of data (different [n] values, for example, both scalars and trace data) from a single measurement. FETCh saves you the time of re-making the measurement. You can only FETCh results from the measurement that is currently active, it will not change to a different measurement. An error message is reported if a measurement other than the current one is specified.

If you need to get new measurement data, use the READ command, which is equivalent to an INITiate followed by a FETCh.

The scalar measurement results will be returned if the optional [n] value is not included, or is set to 1. If the [n] value is set to a value other than 1, the selected trace data results will be returned. See each command for details of what types of scalar results or trace data results are available. The binary data formats should be used for handling large blocks of data since they are smaller and transfer faster than the ASCII format. (FORMat:DATA)

FETCh may be used to return results other than those specified with the original READ or MEASure command that you sent.

INITiate Commands:

:INITiate:<measurement>

This command is not available for measurements in all the instrument modes:

- Initiates a trigger cycle for the specified measurement, but does not output any data. You must then use the FETCh<meas> command to return data. If a measurement other than the current one is specified, the instrument will switch to that measurement and then initiate it.
- For example, suppose you have previously initiated the ACP measurement, but now you are running the channel power measurement. If you send INIT:ACP? it will change from channel power to ACP and will initiate an ACP measurement.
- Does not change any of the measurement settings. For example, if you have previously started the ACP measurement and you send INIT:ACP? it will initiate a new ACP measurement using the same instrument settings as the last time ACP was run.
- If your selected measurement is currently active (in the idle state) it triggers the measurement, assuming the trigger conditions are met. Then it completes one trigger cycle. Depending upon the measurement and the number of averages, there may be multiple data acquisitions, with multiple trigger events, for one full trigger cycle. It also holds off additional commands on GPIB until the acquisition is complete.

READ Commands:

:READ:<measurement>[n]?

- Does not preset the measurement to the factory default settings. For example, if you have previously initiated the ACP
-

measurement and you send READ:ACP? it will initiate a new measurement using the same instrument settings.

- Initiates the measurement and puts valid data into the output buffer. If a measurement other than the current one is specified, the instrument will switch to that measurement before it initiates the measurement and returns results.
 - For example, suppose you have previously initiated the ACP measurement, but now you are running the channel power measurement. Then you send READ:ACP? It will change from channel power back to ACP and, using the previous ACP settings, will initiate the measurement and return results.
 - Blocks other SCPI communication, waiting until the measurement is complete before returning the results
 - If the optional [n] value is not included, or is set to 1, the scalar measurement results will be returned. If the [n] value is set to a value other than 1, the selected trace data results will be returned. See each command for details of what types of scalar results or trace data results are available. The binary data formats should be used when handling large blocks of data since they are smaller and faster than the ASCII format. (FORMat:DATA)
-

Initial S/W Revision	Prior to A.02.00
----------------------	------------------

Current Measurement Query (Remote Command Only)

This command returns the name of the measurement that is currently running.

Remote Command	:CONFigure?
-----------------------	-------------

Example	CONF?
----------------	-------

Initial S/W Revision	Prior to A.02.00
----------------------	------------------

Limit Test Current Results (Remote Command Only)

Queries the status of the current measurement limit testing. It returns a 0 if the measured results pass when compared with the current limits. It returns a 1 if the measured results fail any limit tests.

Remote Command	:CALCulate:CLIMits:FAIL?
-----------------------	--------------------------

Example	CALC:CLIM:FAIL? queries the current measurement to see if it fails the defined limits. Returns a 0 or 1: 0 it passes, 1 it fails.
----------------	--

Initial S/W Revision	Prior to A.02.00
----------------------	------------------

Data Query (Remote Command Only)

Returns the designated measurement data for the currently selected measurement and subopcode.

n = any valid subopcode for the current measurement. See the measurement command results table for your current measurement, for information about what data is returned for the subopcodes.

This command uses the data setting specified by the FORMat:BORDER and FORMat:DATA commands and can return real or ASCII data. (See the format command descriptions under Input/Output in the Analyzer Setup section.)

Remote Command	:CALCulate:DATA[n]?
Notes	The return trace depends on the measurement. In CALCulate:<meas>:DATA[n], n is any valid subopcode for the current measurement. It returns the same data as the FETCH:<measurement>? query where <measurement> is the current measurement.
Initial S/W Revision	Prior to A.02.00

Calculate/Compress Trace Data Query (Remote Command Only)

Returns compressed data for the currently selected measurement and sub-opcode [n].

n = any valid sub-opcode for that measurement. See the MEASure:<measurement>? command description of your specific measurement for information on the data that can be returned.

The data is returned in the current Y Axis Unit of the analyzer. The command is used with a sub-opcode <n> (default=1) to specify the trace. With trace queries, it is best if the analyzer is not sweeping during the query. Therefore, it is generally advisable to be in Single Sweep, or Update=Off.

This command is used to compress or decimate a long trace to extract and return only the desired data. A typical example would be to acquire N frames of GSM data and return the mean power of the first burst in each frame. The command can also be used to identify the best curve fit for the data.

Remote Command	:CALCulate:DATA<n>:COMPRESS? BLOCK CFIT MAXimum MINimum MEAN DMEan RMS RMSCubed SAMPLE SDEVIation PPHase [,<soffset> [,<length>[,<roffset>[,<rlimit>]]]]
Example	To query the mean power of a set of GSM bursts: Supply a signal that is a set of GSM bursts. Select the IQ Waveform measurement (in IQ Analyzer Mode). Set the sweep time to acquire at least one burst. Set the triggers such that acquisition happens at a known position relative to a burst. Then query the mean burst levels using, CALC:DATA2:COMP? MEAN, 24e-6, 526e-6 (These parameter values correspond to GSM signals, where 526e-6 is the length of the burst in the slot and you just want 1 burst.)
Notes	The command supports 5 parameters. Note that the last 4 (<soffset>, <length>, <roffset>, <rlimit>) are optional. But these optional parameters must be entered in the specified order. For example, if you want to specify <length>, then you must also specify <soffset>. See details below for a definition of each of these parameters. This command uses the data in the format specified by FORMat:DATA, returning either binary or ASCII data.
Initial S/W Revision	Prior to A.02.00

- BLOCK or block data - returns all the data points from the region of the trace data that you specify. For example, it could be used to return the data points of an input signal over several timeslots, excluding the portions of the trace data that you do not want. (This is x,y pairs for trace data and I,Q pairs for complex data.)

- CFIT or curve fit - applies curve fitting routines to the data. <soffset> and <length> are required to define the data that you want. <roffset> is an optional parameter for the desired order of the curve equation. The query will return the following values: the x-offset (in seconds) and the curve coefficients ((order + 1) values).

MIN, MAX, MEAN, DME, RMS, RMSC, SAMP, SDEV and PPH return one data value for each specified region (or <length>) of trace data, for as many regions as possible until you run out of trace data (using <roffset> to specify regions). Or they return the number of regions you specify (using <rlimit>) ignoring any data beyond that.

- MINimum - returns the minimum data point (y value) for the specified region(s) of trace data. For I/Q trace data, the minimum magnitude of the I/Q pairs is returned.
- MAXimum - returns the maximum data point (y value) for the specified region(s) of trace data. For I/Q trace data, the maximum magnitude of the I/Q pairs is returned.
- MEAN - returns a single value that is the arithmetic mean of the data point values (in dB/ dBm) for the specified region(s) of trace data. For I/Q trace data, the mean of the magnitudes of the I/Q pairs is returned. See the following equations.

•

NOTE If the original trace data is in dB, this function returns the arithmetic mean of those log values, not log of the mean power which is a more useful value. The mean of the log is the better measurement technique when measuring CW signals in the presence of noise. The mean of the power, expressed in dB, is useful in power measurements such as Channel Power. To achieve the mean of the power, use the RMS option.

Equation 1

Mean Value of Data Points for Specified Region(s)

$$\text{MEAN} = \frac{1}{n} \sum_{X_i \in \text{region}(s)} X_i$$

where X_i is a data point value, and n is the number of data points in the specified region(s).

Equation 2

Mean Value of I/Q Data Pairs for Specified Region(s)

$$\text{MEAN} = \frac{1}{n} \sum_{X_i \in \text{region}(s)} |X_i|$$

where $|X_i|$ is the magnitude of an I/Q pair, and n is the number of I/Q pairs in the specified region(s).

- DMEan - returns a single value that is the mean power (in dB/ dBm) of the data point values for the specified region(s) of trace data. See the following equation:

Equation 3

DMEan Value of Data Points for Specified Region(s)

$$\text{DME} = 10 \times \log_{10} \left(\frac{1}{n} \sum_{X_i \in \text{region}(s)} 10^{\frac{X_i}{10}} \right)$$

- RMS - returns a single value that is the average power on a root-mean-squared voltage scale (arithmetic rms) of the data point values for the specified region(s) of trace data. See the following equation.

NOTE

For I/Q trace data, the rms of the magnitudes of the I/Q pairs is returned. See the following equation. This function is very useful for I/Q trace data. However, if the original trace data is in dB, this function returns the rms of the log values which is not usually needed.

Equation 4

RMS Value of Data Points for Specified Region(s)

$$\text{RMS} = \sqrt{\frac{1}{n} \sum_{X_i \in \text{region}(s)} X_i^2}$$

where X_i is a data point value, and n is the number of data points in the specified region(s).

Equation 5

RMS Value of I/Q Data Pairs for Specified Region(s)

$$\text{RMS} = \sqrt{\frac{1}{n} \sum_{X_i \in \text{region}(s)} X_i X_i^*}$$

where X_i is the complex value representation of an I/Q pair, X_i^* its conjugate complex number, and n is the number of I/Q pairs in the specified region(s).

Once you have the rms value for a region of trace data (linear or I/Q), you may want to calculate the mean power. You must convert this rms value (peak volts) to power in dBm:

$$10 \times \log[10 \times (\text{rms value})^2]$$

- SAMPLe - returns the first data value (x,y pair) for the specified region(s) of trace data. For I/Q trace data, the first I/Q pair is returned.
- SDEViation - returns a single value that is the arithmetic standard deviation for the data point values for the specified region(s) of trace data. See the following equation.
- For I/Q trace data, the standard deviation of the magnitudes of the I/Q pairs is returned. See the following equation.

Equation 6

Standard Deviation of Data Point Values for Specified Region(s)

$$\text{SDEV} = \sqrt{\frac{1}{n} \sum_{X_i \in \text{region}(s)} (X_i - \bar{X})^2}$$

where X_i is a data point value, \bar{X} is the arithmetic mean of the data point values for the specified region (s), and n is the number of data points in the specified region(s).

$$\text{SDEV} = \sqrt{\frac{1}{n} \sum_{X_i \in \text{region}(s)} (|X_i| - \bar{X})^2}$$

where $|X_i|$ is the magnitude of an I/Q pair, \bar{X} is the mean of the magnitudes for the specified region(s), and n is the number of data points in the specified region(s).

- PPHase - returns the x,y pairs of both rms power (dBm) and arithmetic mean phase (radian) for every specified region and frequency offset (Hz). The number of pairs is defined by the specified number of regions. This parameter can be used for I/Q vector ($n=0$) in Waveform (time domain) measurement and all parameters are specified by data point in PPHase.

The rms power of the specified region may be expressed as:

$$\text{Power} = 10 \times \log [10 \times (\text{RMS I/Q value})] + 10.$$

The RMS I/Q value (peak volts) is:

$$\sqrt{\frac{1}{n} \sum_{X_i \in \text{region}} X_i X_i^*}$$

where X_i is the complex value representation of an I/Q pair, X_i^* its conjugate complex number, and n is the number of I/Q pairs in the specified region.

The arithmetic mean phase of the specified region may be expressed as:

$$\frac{1}{n} \sum_{Y_i \in \text{region}} Y_i$$

where Y_i is the unwrapped phase of I/Q pair with applying frequency correction and n is the number of I/Q pairs in the specified region.

The frequency correction is made by the frequency offset calculated by the arithmetic mean of every specified region's frequency offset. Each frequency offset is calculated by the least square method against the unwrapped phase of I/Q pair.

Sample Trace Data - Constant Envelope

(See below for explanation of variables.)

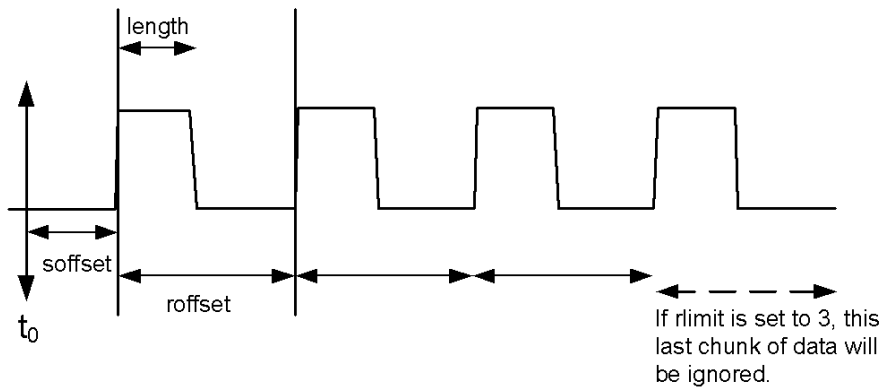

Sample Trace Data - Not Constant Envelope

(See below for explanation of variables.)

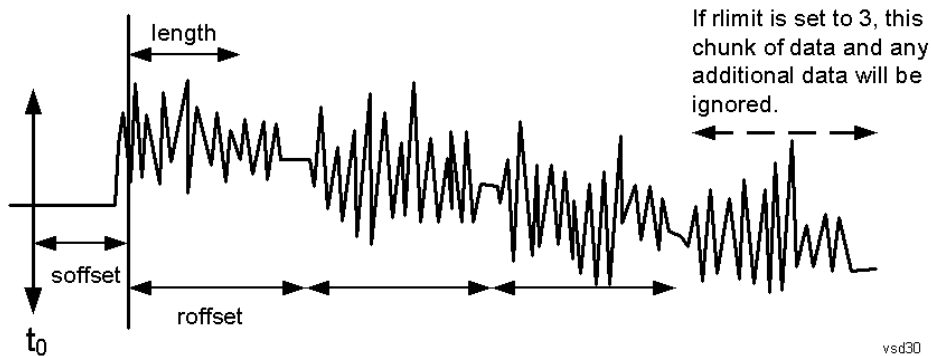

<soffset> - start offset is an optional real number. (It is in seconds for time-domain traces, and is a dimensionless index 0 to Npoints - 1, for frequency-domain traces). It specifies the amount of data at the beginning of the trace that will be ignored before the decimation process starts. It is the time or frequency change from the start of the trace to the point where you want to start using the data. The default value is zero.

<length> - is an optional real number. (It is in seconds for time-domain traces, and is a dimensionless index 0 to Npoints - 1, for frequency-domain traces). It defines how much data will be compressed into one value. This parameter has a default value equal to the current trace length.

<roffset> - repeat offset is an optional real number. (It is in seconds for time-domain traces, and is a dimensionless index 0 to Npoints - 1, for frequency-domain traces). It defines the beginning of the next field of trace elements to be compressed. This is relative to the beginning of the previous field. This parameter has a default value equal to the <length> variable. Note that this parameter is used for a completely different purpose when curve fitting (see CFIT above).

<rlimit> - repeat limit is an optional integer. It specifies the number of data items that you want returned. It will ignore any additional items beyond that number. You can use the Start offset and the Repeat limit to pick out exactly what part of the data you want to use. The default value is all the data.

Calculate Peaks of Trace Data (Remote Command Only)

Returns a list of all the peaks for the currently selected measurement and sub-opcode [n]. The peaks must meet the requirements of the peak threshold and excursion values.

n = any valid sub-opcode for the current measurement. See the MEASure:<measurement> command description of your specific measurement for information on the data that can be returned.

The command can only be used with specific sub-opcodes with measurement results that are trace data. Both real and complex traces can be searched, but complex traces are converted to magnitude in dBm. In many measurements the sub-opcode n=0, is the raw trace data which cannot be searched for peaks. And Sub-opcode n=1, is often calculated results values which also cannot be searched for peaks.

This command uses the data setting specified by the FORMat:BORDER and FORMat:DATA commands and can return real or ASCII data. If the format is set to INT,32, it returns REAL,32 data.

The command has four types of parameters:

- Threshold (in dBm)
- Excursion (in dB)
- Sorting order (amplitude, frequency, time)
- Optional in some measurements: Display line use (all, > display line, < display line)

Remote Command	<p>For Swept SA measurement:</p> <pre>:CALCulate:DATA[1] 2 ... 6:PEAKs? <threshold>,<excursion>[,AMPLitude FREQuency TIME[,ALL GTDLLine LTDLine]]</pre> <p>For most other measurements:</p> <pre>:CALCulate:DATA[1] 2 ... 6:PEAKs? <threshold>,<excursion>[,AMPLitude FREQuency TIME]</pre>
-----------------------	---

Example	<p>Example for Swept SA measurement in Spectrum Analyzer Mode:</p> <p>CALC:DATA4:PEAK? -40, 10, FREQ, GTDL This will identify the peaks of trace 4 that are above -40 dBm, with excursions of at least 10 dB. The peaks are returned in order of increasing frequency, starting with the lowest frequency. Only the peaks that are above the display line are returned.</p> <p>Query Results 1:</p> <p>With FORMat:DATA REAL, 32 selected, it returns a list of floating-point numbers. The first value in the list is the number of peak points that are in the following list. A peak point consists of two values: a peak amplitude followed by its corresponding frequency (or time).</p> <p>If no peaks are found the peak list will consist of only the number of peaks, (0).</p>
----------------	---

Notes	<p><n> - is the trace that will be used</p> <p><threshold> - is the level below which trace data peaks are ignored. Note that the threshold value is required and is always used as a peak criterion. To effectively disable the threshold criterion for this command, provide a substantially low threshold value such as -200 dBm. Also note that the threshold value used in this command is independent of and has no effect on the threshold value stored under the Peak Criteria menu.</p> <p><excursion> - is the minimum amplitude variation (rise and fall) required for a signal to be identified as peak. Note that the excursion value is required and is always used as a peak criterion. To effectively disable the excursion criterion for this command, provide the minimum value of 0.0 dB. Also note that the excursion value used in this command is independent of and has no effect on the</p>
--------------	---

excursion value stored under the Peak Criteria menu.

Values must be provided for threshold and excursion. The sorting and display line parameters are optional (defaults are AMPLitude and ALL).

Note that there is always a Y-axis value for the display line, regardless of whether the display line state is on or off. It is the current Y-axis value of the display line which is used by this command to determine whether a peak should be reported

Sorting order:

AMPLitude - lists the peaks in order of descending amplitude, with the highest peak first (default if optional parameter not sent)

FREQUency - lists the peaks in order of occurrence, left to right across the x-axis.

TIME - lists the peaks in order of occurrence, left to right across the x-axis.

Peaks vs. Display Line:

ALL - lists all of the peaks found (default if optional parameter not sent).

GTDLine (greater than display line) - lists all of the peaks found above the display line.

LTDLine (less than display line) - lists all of the peaks found below the display line.

Initial S/W Revision	Prior to A.02.00
----------------------	------------------

Hardware-Accelerated Fast Power Measurement (Remote Command Only)

The Fast Power option (FP2) enables very fast channel power measurements for instruments with the prerequisite hardware (DP2 and/or B40). It accomplishes this by performing real-time overlapped FFTs at the hardware layer, using software for basic post-processing before returning the result to the user. The upshot of this approach is improved throughput for user applications that require many sequential power measurements.

The analysis bandwidth of FP2 is limited by the licenses in the instrument, but its maximum overall analysis bandwidth per acquisition is 40 MHz.

FP2 is remote-only, which means the instrument does not switch to any particular mode or measurement. FP2 commands can be sent while another application is in use on the front panel.

Each Fast Power measurement can be predefined using an array index, and up to 1,000 measurements can be stored. In the following documentation, instances of [1,2,...,999] can be substituted with a particular measurement index, e.g. CALC:FPOW:POW1?, CALC:FPOW:POW2?, CALC:FPOW:POW134?. In this way, power measurements can be defined one time in a batch, and then executed multiple times without having to redefine them, similar to “list mode” on other measurements.

In addition to basic channel power measurements, there are a number of other measurement “functions” for each channel, including peak power, peak frequency, and power spectral density. See the Function parameter for more information.

Reset Fast Power Measurement (Remote Command Only)

Resets the measurement configuration to the defaults.

Mode	All
Remote Command	:CALCulate:FPOWer:POWer[1,2,...,999]:RESet
Example	:CALC:FPOW:POW1:RES

Notes	Option FP2 is required.
Initial S/W Revision	A.14.00

Define Fast Power Measurement (Remote Command Only)

Fast Power acquisitions are configured using the DEFine command. This command accepts a comma-delimited string of configuration parameters and their appropriate values, which are all specified in the subsection below.

Mode	All
Remote Command	:CALCulate:FPOWER:POWer[1,2,...,999]:DEFine "configuration string"
Example	:CALC:FPOW:POW1:DEF "CenterFrequency=2e9, AcquisitionTime=0.005"
Notes	See below for a list of measurement variables that can be defined in the configuration string.
Initial S/W Revision	A.14.00

Acquisition Time

Example	CALC:FPOW:POW1:DEF "AcquisitionTime=0.002"
Notes	The acquisition time parameter sets the time in which the entire spectrum is measured. An increase in the acquisition time yields an improvement in measurement repeatability.
Preset	0.001 s
Range	0 s to 1 s
Default Unit	Time (s)
Initial S/W Revision	A.14.00

Center Frequency

Example	CALC:FPOW:POW1:DEF "CenterFrequency=2e9"
Notes	The center frequency parameter sets the frequency in which the measurement is centered around. The OffsetFrequency parameter is calculated relative to the center frequency.
Preset	1 GHz
Range	0 Hz to maximum instrument frequency
Default Unit	Frequency (Hz)
Initial S/W Revision	A.14.00

DC Coupled

Example	CALC:FPOW:POW1:DEF "DCCoupled=True"
Notes	The DC coupled parameter allows the user to specify whether the DC blocking capacitor is utilized. Set parameter to true when measuring frequencies below 10 MHz.
Preset	False
Range	True (DC Coupled) or False (AC Coupled)
Default Unit	Boolean
Initial S/W Revision	A.14.00

DetectorType

Example	CALC:FPOW:POW1:DEF "DetectorType=Peak"
Notes	Option FP2 is required. The detector type parameter allows the user to choose whether a RMS average or peak value is used during the measurement.
Preset	RmsAverage
Range	RmsAverage, Peak
Initial S/W Revision	A.14.00

Do Noise Correction

Example	CALC:FPOW:POW1:DEF "DoNoiseCorrection=True"
Notes	When noise correction is enabled, the linear noise power contributed by the analyzer is subtracted from all measurements. This effectively lowers the noise floor of the analyzer. When noise correction is enabled, the first measurement for a given set of input parameters will take extra time. This is because the analyzer takes an extra acquisition with the RF input disconnected from the analyzer's front end to measure the noise of just the analyzer. The measured noise floor is stored in a cache so the noise acquisition will occur only once for the same state settings. In other words, if noise correction was turned on and the analyzer made an acquisition at frequency A, then frequency B, and back again to frequency A, the hidden initial noise floor acquisition would only occur for the first acquisition at frequency A and the cached noise floor would be used the second time frequency A was measured.
Preset	False
Range	True (enable noise correction) or False (disable noise correction)
Default Unit	Boolean
Initial S/W Revision	A.14.00

Do Spur Suppression

Example	CALC:FPOW:POW1:DEF "DoSpurSuppression=True"
Notes	<p>When measuring very low level signals, or when large out-of-band inputs are input into the analyzer, sometimes unwanted spurs and residuals can appear in the measured spectrum. Spur suppression is a method to help minimize the levels of these internally generated spurs and residuals.</p> <p>When spur suppression is enabled, the analyzer will automatically take two acquisitions using two different internal analog LO frequencies. The FFT spectrums from both acquisitions are combined by taking the minimum power between both traces on a per FFT bin basis. External signals will have the same amplitude for both traces and therefore will return the expected amplitudes. However, low level spurs and residuals generated internally to the analyzer tend to move to different FFT bins depending on the internal analog LO frequency used, and therefore tend to be suppressed using this spur suppression method.</p> <p>Because two acquisitions, rather than a single acquisition, are made when spur suppression is enabled, the measurement time will always be slower when spur suppression is enabled.</p>
Preset	False
Range	True (enable spur suppression) or False (disable spur suppression)
Default Unit	Boolean
Initial S/W Revision	A.14.00

Electronic Attenuator Bypass

Example	CALC:FPOW:POW1:DEF "ElecAttBypass =False"
Notes	The electronic attenuation bypass parameter allows the user to either utilize or bypass the electronic attenuator. The electronic attenuator is only available for frequencies up to 3.6 GHz. Set parameter to true when using frequencies above 3.6 GHz and set the parameter to false when using the preamp.
Preset	True
Range	True (bypass electronic attenuator) or False (use electronic attenuator)
Default Unit	Boolean
Initial S/W Revision	A.14.00

Electronic Attenuation

Example	CALC:FPOW:POW1:DEF "ElecAttenuation=10"
Notes	<p>Option EA3 is required.</p> <p>The electronic attenuation value parameter sets the amount of electrical attenuation from 0 to 24 dB (1 dB steps).</p> <p>Set "ElecAttBypass=False" to make sure the electronic attenuator path is enabled.</p>
Preset	0 dB
Range	0 – 24 dB (1 dB steps)

Default Unit	dB
Initial S/W Revision	A.14.00

IF Gain

Example	CALC:FPOW:POW1:DEF "IFGain=10"
Notes	The IF gain parameter allows the user to specify the gain at the IF stage anywhere from -6 to 16 dB (1 dB steps). This is an advanced feature, and for most cases this should remain at its default value of 0 dB.
Preset	0 dB
Range	-6 - 16 dB (1 dB steps)
Default Unit	dB
Initial S/W Revision	A.14.00

IF Type

Example	CALC:FPOW:POW1:DEF "IFType=B25M"
Notes	The IF type parameter allows the user to select between different IF paths. For example, if the signal is less than 25 MHz wide, then the user can select the B25M path to take advantage of additional filtering on this analog IF path.
Preset	B40M
Range	B10M, B25M, B40M
Initial S/W Revision	A.14.00

Include Power Spectrum

Example	CALC:FPOW:POW1:DEF "IncludePowerSpectrum=True"
Notes	The power spectrum parameter allows the user to read data on the entire spectrum for diagnostic purposes. It is not recommended for production use. See CALC:FPOW:POW[n]:READ2? for details on the binary format of the response.
Preset	False
Range	True (return both channel power and full power spectrum) or False (returns only channel power)
Default Unit	Boolean
Initial S/W Revision	A.14.00

Mechanical Attenuation

Example	CALC:FPOW:POW1:DEF "MechAttenuation=10"
Notes	The mechanical attenuation value parameter sets the amount of mechanical attenuation anywhere from 0 to 70 dB (2 dB steps).
Preset	0 dB
Range	0 – 70 dB (2 dB steps)
Default Unit	dB
Initial S/W Revision	A.14.00

Preamp Mode

Example	CALC:FPOW:POW1:DEF "PreAmpMode=Low"
Notes	The license for the appropriate preamp is required. The preamp mode parameter specifies whether the preamps are being utilized. Low allows any preamps up to 3.6 GHz, and Full allows all licensed preamps. Set "ElecAttBypass=True" in order to utilize any preamps.
Preset	Off
Range	Off, Low, Full
Initial S/W Revision	A.14.00

Resolution Bandwidth Mode

Example	CALC:FPOW:POW1:DEF "PreAmpMode=Low"
Notes	The resolution bandwidth mode parameter allows the user to choose whether the RBW filter is automatically or manually set. The BestSpeed value minimizes measurement time, while the Narrowest value minimizes RBW size (minimum of two FFT bins per RBW). To manually specify an RBW, set this parameter to Explicit, and set the ResolutionBW parameter to the desired value.
Preset	BestSpeed
Range	BestSpeed, Narrowest, Explicit
Initial S/W Revision	A.14.00

Resolution Bandwidth

Example	CALC:FPOW:POW1:DEF "ResolutionBW=25e3"
Notes	The resolution bandwidth parameter sets the 3-dB bandwidth of the RBW filter. The ResolutionBWMode parameter must be set to Explicit in order to manually set the RBW.

Preset	0 Hz
Default Unit	Hz
Initial S/W Revision	A.14.00

Trigger Delay

Example	CALC:FPOW:POW1:DEF "TriggerDelay=0.025"
Notes	The trigger delay parameter sets the time after an external trigger is detected until the measurement is performed.
Preset	0 s
Range	0 – 1 s
Default Unit	Seconds
Initial S/W Revision	A.14.00

Trigger Level

Example	CALC:FPOW:POW1:DEF "TriggerLevel=2"
Notes	The trigger level parameter sets the voltage value at which an external trigger is detected.
Preset	1.2 V
Range	-5 to 5 V
Default Unit	Volts
Initial S/W Revision	A.14.00

Trigger Slope

Example	CALC:FPOW:POW1:DEF "TriggerSlope=Negative"
Notes	The trigger slope parameter indicates the direction of the edge trigger voltage for detection.
Preset	Positive
Range	Positive, Negative
Initial S/W Revision	A.14.00

Trigger Source

Example	CALC:FPOW:POW1:DEF "TriggerSource=Ext1"
Notes	The trigger source parameter allows the user to choose between measurement's triggering freely or controlled by an external input. Ext1 and Ext2 correspond to Trigger 1 In and Trigger 2 In, respectively.
Preset	Free
Range	Free, Ext1, Ext2
Initial S/W Revision	A.14.00

Trigger Timeout

Example	CALC:FPOW:POW1:DEF "TriggerTimeout=0.1"
Notes	The trigger timeout parameter sets the time in which the analyzer will wait for a trigger before automatically performing the measurement.
Preset	1 s
Range	0 - 1 s
Default Unit	Seconds
Initial S/W Revision	A.14.00

Signal Input

Example	CALC:FPOW:POW1:DEF "SignalInput=Fp50MHzCW"
Notes	The signal input parameter allows the user to select between using the main RF input or the internal analyzer reference CW signal of 50 MHz.
Preset	FpMainRf
Range	FpMainRf, Fp50MHzCW
Initial S/W Revision	A.14.00

Use Preselector

Example	CALC:FPOW:POW1:DEF "UsePreSelector=True"
Notes	The preselector parameter allows the user to either utilize or bypass the front end tunable filter at frequencies above 3.6 GHz. For frequencies below 3.6 GHz, the preselector is automatically bypassed, so you do not need to set this parameter to False in those cases.
Preset	False
Range	True (use preselector above 3.6 GHz), or False (preselector bypassed)

Default Unit	Boolean
Initial S/W Revision	A.14.00

Channel Bandwidth Array

Example	CALC:FPOW:POW1:DEF "Bandwidth=[3.84e6, 5e6, 3.84e6]"
Notes	The bandwidth parameter array defines the bandwidth of each channel that will be measured. All array parameters should have the same number of elements. Alternatively, if all the elements are the same value, a single number with no square brackets can be used to define the parameter.
Preset	[1 e6]
Range	0 to 40 MHz
Default Unit	Hz
Initial S/W Revision	A.14.00

Channel Filter Type Array

Example	CALC:FPOW:POW1:DEF "FilterType=[RRC, IBW, RRC]"
Notes	The filter type parameter allows the user to choose between an integration bandwidth (IBW) filter or a root-raised-cosine (RRC) filter. The integration bandwidth filter weighs all frequencies within the bandwidth equally. The root-raised-cosine filter has an associated shape parameter, defined by the FilterAlpha parameter. All array parameters should have the same number of elements. Alternatively, if all the elements are the same value, a single value with no square brackets can be used to define the parameter.
Preset	[IBW]
Range	IBW, RRC
Initial S/W Revision	A.14.00

Channel Filter Alpha Array

Example	CALC:FPOW:POW1:DEF "FilterAlpha=[0.5, 0.0, 0.5]"
Notes	The filter alpha parameter allows the user to adjust the alpha value associated with the root-raised-cosine (RRC) filter type. Set FilterType to RRC in order to utilize this parameter. All array parameters should have the same number of elements. Alternatively, if all the elements are the same value, a single number with no square brackets can be used to define the parameter.
Preset	[0.22]
Range	0.0 – 1.0
Initial S/W Revision	A.14.00

Channel Measurement Function Array

Example	CALC:FPOW:POW1:DEF "Function=[BandPower, PeakPower, BandPower]"
Notes	<p>This parameter array defines what measurement is being made for each individually-specified channel:</p> <p>BandPower: Total power within the specified bandwidth of the channel (dBm)</p> <p>BandDensity: Total power density within the specified bandwidth of the channel (dBm/Hz)</p> <p>PeakPower: The peak power value within the specified bandwidth of the channel (dBm)</p> <p>PeakFrequency: The frequency which corresponds to the peak power value within the specified bandwidth of the channel. This frequency is relative to the center frequency (Hz)</p> <p>XdBBandwidth: The half power (-3.01 dB) bandwidth of the highest amplitude signal that resides within the channel (Hz), dB is configurable using XdBBandwidth parameter</p> <p>OccupiedBandwidth: The bandwidth at which 99% of the total power resides within the channel (Hz), percentage configurable using OccupiedBandwidthPercent parameter</p> <p>All array parameters should have the same number of elements. Alternatively, if all the elements are the same value, a single value with no square brackets can be used to define the parameter.</p>
Preset	[BandPower]
Range	BandPower, BandDensity, PeakPower, PeakFrequency, XdBBandwidth, OccupiedBandwidth
Initial S/W Revision	A.14.00

Channel Offset Frequency Array

Example	CALC:FPOW:POW1:DEF "OffsetFrequency=[-5e6, 0, 5e6]"
Notes	<p>The offset frequency parameter array defines the difference between the center frequency to the center frequency of each channel.</p> <p>All array parameters should have the same number of elements.</p>
Preset	[0]
Range	0 to 20 MHz
Default Unit	Hz
Initial S/W Revision	A.14.00

Channel Occupied Bandwidth Percent Array

Example	CALC:FPOW:POW1:DEF "OccupiedBandwidthPercent =[0.95, 0.95, 0.95]"
Notes	<p>This parameter only applies for channels whose Function is set to OccupiedBandwidth. The occupied bandwidth percent parameter specifies the percent of total power in these channels. The valid range for this parameter is 0.0 to 1.0, where 1.0 represents 100%. The default for this parameter is 0.99, which will return the bandwidth that contains 99% of the total channel power.</p>

Preset	[0.99]
Range	0 – 1.0
Initial S/W Revision	A.14.00

Channel x-dB Bandwidth Array

Example	CALC:FPOW:POW1:DEF " XdBBandwidth =[-6.02, -3.01, -1.0]"
Notes	This parameter only applies for channels whose Function is set to XdBBandwidth. The X dB bandwidth parameter is used to specify the power relative to the peak channel power over which the bandwidth is calculated. The parameter value must be a negative number.
Preset	[-3.01]
Range	-200 to 0 dB
Default Unit	dB
Initial S/W Revision	A.14.00

Define Fast Power Measurement Query (Remote Command Only)

The DEFine? command is used to retrieve a list of all defined parameters in an ASCII string format

M o d e	All
R e m o t e	:CALCulate:FPOWER:POWER[1,2,...,999]:DEFine?
C o m m a n d	
E x a m	:CALC:FPOW:POW1:DEF?

```

p
l
e
-----
N This command query is used to retrieve a list of all defined parameters in an ASCII format.
o The following is an example of the returned results:
t "DCCoupled=False,ElecAttBypass=True,ElecAttenuation=0,IFGain=0,MechAttenuation=0,PreAmpMode=Off,PreSelectorOffset
e =0,UsePreSelector=False,ExternalReferenceFrequency=10000000,FrequencyReferenceSource=AutoExternalFrequencyRefer
s ence,IFType=B40M,LOMode=SLW,SignalInput=FpMainRf,AcquisitionTime=0.001,CenterFrequency=1000000000,Resolution
BW=0,ResolutionBWMode=BestSpeed,DetectorType=RmsAverage,Bandwidth=[1000000],OffsetFrequency=[0],Function=
[BandPower],FilterType=[IBW],FilterAlpha=[0.22],OccupiedBandwidthPercent=[0.99],XdBBandwidth=[-
3.01],DoNoiseCorrection=False,DoSpurSuppression=False,MeasurementMethod=HardwareFFT,IncludePowerSpectrum=False
e,TriggerDelay=0,TriggerLevel=1.2,TriggerSlope=Positive,TriggerSource=Free,TriggerTimeout=1"
-----
I A.14.00
n
i
t
i
a
l

S
/
W

R
e
v
i
s
i
o
n

```

Configure Fast Power Measurement (Remote Command Only)

The configure command begins hardware setup and returns immediately, with no acquisition made. This can be used in parallel with other hardware operations to effectively hide the hardware setup time.

Mode	All
Remote Command	:CALCulate:FPOWer:POWer[1,2,...,999]:CONFigure
Example	:CALC:FPOW:POW1:CONF
Notes	Option FP2 is required.
Initial S/W Revision	A.14.00

Initiate Fast Power Measurement (Remote Command Only)

The INITiate command begins an acquisition and returns immediately. The results of the measurement can be retrieved using FETCh.

Mode	All
Remote Command	:CALCulate:FPOWer:POWer[1,2,...,999]:INITiate
Example	:CALC:FPOW:POW1:INIT
Notes	Option FP2 is required.
Initial S/W Revision	A.14.00

Fetch Fast Power Measurement (Remote Command Only)

The FETCh command query is used to retrieve the results of an acquisition initiated by the INIT command. The returned results are in ASCII string format. The string begins and ends with quotation marks.

Mode	All
Remote Command	:CALCulate:FPOWer:POWer[1,2,...,999]:FETCh?
Example	:CALC:FPOW:POW1:FETC?
Notes	Option FP2 is required. Returns m comma-separated ASCII values, where m corresponds to the number of bandwidths defined. 1. Declared function return in the 1st specified channel 2. Declared function return in the 2nd specified channel ... m. Declared function return in the last specified channel The INIT and FETC? command sequence performs the same functionality of a single CALC:FPOW:POW[n]? query. Units of the returned values are dependent on the Function parameter for each channel.
Initial S/W Revision	A.14.00

Execute Fast Power Measurement (Remote Command Only)

This command query is used as shorthand for an INIT command immediately followed by a FETC? command. The returned results are in ASCII string format. The string begins and ends with quotation marks.

Mode	All
Remote Command	:CALCulate:FPOWer:POWer[1,2,...,999]?
Example	:CALC:FPOW:POW1?
Notes	Option FP2 is required. See notes for Fast Power Fetch for return format.
Initial S/W Revision	A.14.00

Binary Read Fast Power Measurement (Remote Command Only)

This command query is used as shorthand for an INIT command immediately followed by a FETC? command. The returned results are in a binary format.

Mode	All
Remote Command	:CALCulate:FPOWER:POWER[1,2,...,999]:READ? :CALCulate:FPOWER:POWER[1,2,...,999]:READ1?
Example	:CALC:FPOW:POW1:READ? :CALC:FPOW:POW1:READ1?
Notes	Option FP2 is required. Returns m 4 byte floating point binary values (Little-Endian), where m corresponds to the number of bandwidths defined.
Initial S/W Revision	A.14.00

Diagnostic Binary Read Fast Power Measurement (Remote Command Only)

This command query is used as shorthand for an INIT command immediately followed by a FETC? command. The returned results are in a binary format. This command is used primarily for diagnostic purposes to test for ADC overloads and to visibly inspect the spectrum.

Mode	All
Remote Command	:CALCulate:FPOWER:POWER[1,2,...,999]:READ2?
Example	:CALC:FPOW:POW1:READ2?
Notes	Option FP2 is required. Note: Spectrum data is only returned if the IncludePowerSpectrum parameter is set to True. If IncludePowerSpectrum is False, the number of spectrum points will be zero (0). Units of the returned values are dependent on the Function parameter per channel (e.g. dBm for BandPower, Hz for PeakFrequency). Returns binary data (Little-Endian) that contains information on m amount of channels, along with ADC over range and full spectrum data. The following is the binary format of the response. Bandwidth Return Value 1. Number of channels specified, m [4 byte int] 2. Declared function result for the 1st specified channel [4 byte float] 3. Declared function result for the 2nd specified channel [4 byte float] ... (m + 1). Declared function result for the last (mth) specified channel [4 byte float] ADC Over Range 1. ADC over-range occurred (1: true, 0: false) [2 byte short]

	<p>Spectrum Data</p> <ol style="list-style-type: none"> 1. Number of points in the spectrum data, k [4 byte int] 2. Start frequency of spectrum data (Hz) [8 byte double] 3. Step frequency of spectrum data (Hz) [8 byte double] 4. FFT bin at 1st point (dBm) [4 byte float] 5. FFT bin at 2nd point (dBm) [4 byte float] <p>...</p> <p>(k + 3). FFT bin at last (kth) point (dBm) [4 byte float]</p>
Initial S/W Revision	A.14.00

Format Data: Numeric Data (Remote Command Only)

This command specifies the format of the trace data input and output. It specifies the formats used for trace data during data transfer across any remote port. It affects only the data format for setting and querying trace data for the :TRACe[:DATA], TRACe[:DATA]?, :CALCulate:DATA[n]? and FETCh:SANalyzer[n]? commands and queries.

Remote Command	<pre>:FORMat[:TRACe][:DATA] ASCii INTeger,32 REAL,32 REAL,64 :FORMat[:TRACe][:DATA]?</pre>
Notes	<p>The query response is:</p> <pre>ASCii: ASC,8 REAL,32: REAL,32 REAL,64: REAL,64 INTeger,32: INT,32</pre> <p>When the numeric data format is REAL or ASCii, data is output in the current Y Axis unit. When the data format is INTeger, data is output in units of m dBm (.001 dBm).</p> <p>The INT,32 format returns binary 32-bit integer values in internal units (m dBm), in a definite length block.</p>
Dependencies	<p>Sending a data format spec with an invalid number (for example, INT,48) generates no error. The analyzer simply uses the default (8 for ASCii, 32 for INTeger, 32 for REAL).</p> <p>Sending data to the analyzer which does not conform to the current FORMat specified, results in an error. Sending ASCII data when a definite block is expected generates message -161 "Invalid Block Data" and sending a definite block when ASCII data is expected generates message -121 "Invalid Character in Number".</p>
Preset	ASCii
Backwards Compatibility Notes	Note that the INT,32 format is only applicable to the command, TRACe:DATA. This preserves backwards compatibility for the Swept SA measurement. For all other commands/queries which honor FORMat:DATA, if INT,32 is sent the analyzer will behave as though it were set to REAL,32.
Initial S/W Revision	Prior to A.02.00

The specs for each output type follow:

AScii - Amplitude values are in ASCII, in the current Y Axis Unit, one ASCII character per digit, values separated by commas, each value in the form:

SX.YYYYYEsZZ

Where:

S = sign (+ or -)

X = one digit to left of decimal point

Y = 5 digits to right of decimal point

E = E, exponent header

s = sign of exponent (+ or -)

ZZ = two digit exponent

REAL,32 - Binary 32-bit real values in the current Y Axis Unit, in a definite length block.

REAL,64 - Binary 64-bit real values in the current Y Axis Unit, in a definite length block.

Format Data: Byte Order (Remote Command Only)

This command selects the binary data byte order for data transfer and other queries. It controls whether binary data is transferred in normal or swapped mode. This command affects only the byte order for setting and querying trace data for the :TRACe[:DATA], TRACe[:DATA]? , :CALCulate:DATA[n]? and FETCh:SANalyzer[n]? commands and queries.

By definition any command that says it uses FORMat:DATA uses any format supported by FORMat:DATA.

The NORMal order is a byte sequence that begins with the most significant byte (MSB) first, and ends with the least significant byte (LSB) last in the sequence: 1|2|3|4. SWAPped order is when the byte sequence begins with the LSB first, and ends with the MSB last in the sequence: 4|3|2|1.

Remote Command	:FORMat:BORDER NORMAL SWAPped :FORMat:BORDER?
Preset	NORMal
Initial S/W Revision	Prior to A.02.00

Meas Setup

Accesses the measurement setup menu for the current measurement.

Key Path	Front-panel key
Initial S/W Revision	A.03.00

Avg/Hold Num

Used to specify the number of data acquisitions that will be averaged. After the specified number of average counts, the averaging mode (termination control) setting determines the averaging action.

- On - Sets measurement averaging on.
- Off - Sets measurement averaging off.

Key Path	Meas Setup
Mode	LTETDD, LTE
Remote Command	[:SENSe]:PVT:AVER:COUNT <integer> [:SENSe]:PVT:AVER:COUNT? [:SENSe]:PVT:AVER:STAT OFF ON 0 1 [:SENSe]:PVT:AVER:STAT?
Example	:SENS:PVT:AVER:COUN 10 :SENS:PVT:AVER:COUN? :SENS:PVT:AVER:STAT OFF :SENS:PVT:AVER:STAT?
Preset	10 OFF
State Saved	Saved in instrument state.
Min	1
Max	10000
Initial S/W Revision	A.03.00

Avg Mode

Selects the type of termination control used for the averaging function. This determines the averaging action after the specified number of data acquisitions (average count) is reached.

KEY:Exponential SCPI:EXPonential	After the average count is reached, each successive data acquisition is exponentially weighted and combined with the existing average.
KEY:Repeat SCPI:REPeat	After reaching the average count, the averaging is reset and a new average is started. The default value is Exp.

Key Path	Meas Setup
Mode	LTETDD, LTE
Remote Command	[:SENSe] :PVTime :AVERage :TCONtrol EXPonential REPeat [:SENSe] :PVTime :AVERage :TCONtrol ?
Example	:SENS:PVT:AVER:TCON REP :SENS:PVT:AVER:TCON?
Preset	REPeat
State Saved	Saved in instrument state.
Range	Exp Repeat
Initial S/W Revision	A.03.00

Avg Type

Specifies the type of trace and result averaging to use.

KEY:Pwr Avg (RMS) SCPI:RMS POWer	True power averaging that is equivalent to taking the RMS value of the voltage. It is the most accurate type of averaging.
KEY:Log-Pwr Avg (Video) SCPI:LOG LPOWer	Simulates the traditional spectrum analyzer type of averaging by averaging the log of the power.

Key Path	Meas Setup
Mode	LTETDD, LTE
Remote Command	[:SENSe] :PVTime :AVERage :TYPE LOG LPOWer RMS POWer [:SENSe] :PVTime :AVERage :TYPE ?
Example	:SENS:PVT:AVER:TYPE RMS :SENS:PVT:AVER:TYPE?
Preset	RMS
State Saved	Saved in instrument state.
Range	Pwr Avg (RMS) Log-Pwr Avg(Video)
Initial S/W Revision	A.03.00

Ramp Time Length

This parameter indicates the searching window length from which the ramp on and down is searched. If it is set shorter than actual ramp time, the ramp may be lost.

Key Path	Meas Setup
----------	------------

Mode	LTETDD, LTE
Remote Command	[:SENSe] :PVTime :RAMP :SEARch :LENGth <time> [:SENSe] :PVTime :RAMP :SEARch :LENGth?
Example	PVT:RAMP:SEAR:LENG 1.0 PVT:RAMP:SEAR:LENG?
Preset	17.0 us
State Saved	Saved in instrument state.
Min	1.0 us
Max	100.0 us
Initial S/W Revision	A.07.00

Limits

Accesses the setup menu for the measurement ramp up, ramp down time and threshold for off power.

Please note, whether the pass/fail shown in measurement bar (at upper-left corner of screen) will be pass or fail is just determined by the threshold listed in Limits menu, they are Max Ramp Up Time, Max Ramp Down Time, Downlink Off Power and Uplink Off Power. If and only if ramp up time, ramp down time and off power (downlink or uplink) measured are all less than Max Ramp Up Time, Max Ramp Down Time and Off Power

(downlink or uplink) separately, the Pass/Fail flag is set to pass(green), otherwise Pass/Fail flag is set to fail(red). The limit mask shown on screen is just to indicate which part is active burst and which part is inactive burst, the mask is nothing to do with the Pass/Fail criteria.

Key Path	Meas Setup
Initial S/W Revision	A.03.00

Max Ramp Down Time

It used as threshold which can judge whether the real measured ramp down time can be passed or not. If real measured ramp down time exceeds Max Ramp Down Time, then ramp down time measurement fails, otherwise, it passes.

Key Path	Meas Setup, More, Limits
Mode	LTETDD, LTE
Remote Command	[:SENSe] :PVTime :LIMit :RAMP :DRTime <time> [:SENSe] :PVTime :LIMit :RAMP :DRTime? [:SENSe] :PVTime :LIMit :RAMP :DRTime?
Example	PVT:LIM:RAMP:DRT 17.0e-6 PVT:LIM:RAMP:DRT?
Couplings	While Downlink is selected, the default value is 17us, and while Uplink is selected, the default value is 20.0us.

Preset	17.0 us
State Saved	No
Min	1.0 us
Max	100.0 us
Initial S/W Revision	A.03.00

Max Ramp Up Time

It used as threshold which can judge whether the real measured ramp up time can be passed or not. If real measured ramp up time exceeds Max Ramp Up Time, then ramp up time measurement fails, otherwise, it passes.

Key Path	Meas Setup, More, Limits
Mode	LTETDD, LTE
Remote Command	<code>[:SENSe] :PVTime:LIMit:RAMP:URTime <time></code> <code>[:SENSe] :PVTime:LIMit:RAMP:URTime?</code>
Example	PVT:LIM:RAMP:URT 17.0e-6 PVT:LIM:RAMP:URT?
Couplings	While Downlink is selected, the default value is 17us, and while Uplink is selected, the default value is 20.0us.
Preset	17.0 us
State Saved	No
Min	1.0 us
Max	100.0 us
Initial S/W Revision	A.03.00

Downlink Off Power

It is used as threshold in downlink which can judge whether the real measured off power can be passed or not. If real measured off power exceeds Downlink Off Power, then off power measurement fails, otherwise, it passes. Please note, the unit of this parameter is dBm/MHz.

Key Path	Meas Setup, More, Limits
Mode	LTETDD, LTE
Remote Command	<code>[:SENSe] :PVTime:LIMit:POFF:DLINK <real></code> <code>[:SENSe] :PVTime:LIMit:POFF:DLINK? [:SENSe] :PVTime:LIMit:POFF:DLINK?</code>
Example	PVT:LIM:POFF:DLIN -89.0 PVT:LIM:POFF:DLIN?
Preset	-85.00

State Saved	Saved in instrument state.
Min	-150.00
Max	0.00
Initial S/W Revision	A.04.00

Uplink Off Power

It is used as threshold in uplink which can judge whether the real measured off power can be passed or not. If real measured off power exceeds Uplink Off Power, then off power measurement fails, otherwise, it passes. Please note, the unit of this parameter is dBm.

Key Path	Meas Setup, More, Limits
Mode	LTETDD, LTE
Remote Command	[:SENSe] :PVTime:LIMit:POFF:ULINK <real> [:SENSe] :PVTime:LIMit:POFF:ULINK?
Example	PVT:LIM:POFF:ULIN -50.0 PVT:LIM:POFF:ULIN?
Preset	-50.00
State Saved	Saved in instrument state.
Min	-150.00 dBm
Max	0.00 dBm
Initial S/W Revision	A.04.00

Threshold

Accesses the setup menu to set the thresholds used to find ramp up and ramp down part in burst signal.

Key Path	Meas Setup
Initial S/W Revision	A.03.00

Ramp Up Start Level

It specifies the relative power level to active slots average power level at which the ramp-up starts.

Key Path	Meas Setup, More, Threshold
Mode	LTETDD, LTE
Remote Command	[:SENSe] :PVTime:THReshold:UP:STARt <rel_ampl> [:SENSe] :PVTime:THReshold:UP:STARt?
Example	PVT:THR:UP:STAR -50.0

	PVT:THR:UP:STAR?
Preset	-20.000 dB
State Saved	Saved in instrument state.
Min	-120.000 dB
Max	0.000 dB
Initial S/W Revision	A.03.00

Ramp Up End Level

It specifies the relative power level to active slots average power level at which the ramp-up ends.

Key Path	Meas Setup, More, Threshold
Mode	LTETDD, LTE
Remote Command	[:SENSe] :PVTime:THReshold:UP:END <rel_ampl> [:SENSe] :PVTime:THReshold:UP:END?
Example	PVT:THR:UP:END -50.0 PVT:THR:UP:END?
Preset	-0.915 dB
State Saved	Saved in instrument state.
Min	-120.000 dB
Max	0.000 dB
Initial S/W Revision	A.03.00

Ramp Down Start Level

It specifies the relative power level to active slots average power level at which the ramp-down starts.

Key Path	Meas Setup, More, Threshold
Mode	LTETDD, LTE
Remote Command	[:SENSe] :PVTime:THReshold:DOWN:STARt <rel_ampl> [:SENSe] :PVTime:THReshold:DOWN:STARt?
Example	PVT:THR:DOWN:STAR -50.0 PVT:THR:DOWN:STAR?
Preset	-0.915 dB
State Saved	Saved in instrument state.
Min	-120.000 dB
Max	0.000 dB
Initial S/W Revision	A.03.00

Ramp Down End Level

It specifies the relative power level to active slots average power level at which the ramp-down ends.

Key Path	Meas Setup, More, Threshold
Mode	LTETDD, LTE
Remote Command	[:SENSe] :PVTime:THReshold:DOWN:END <rel_ampl> [:SENSe] :PVTime:THReshold:DOWN:END?
Example	PVT:THR:DOWN:END -50.0 PVT:THR:DOWN:END?
Preset	-20.000 dB
State Saved	Saved in instrument state.
Min	-120.000 dB
Max	0.000 dB
Initial S/W Revision	A.03.00

Meas Preset

Returns parameters for the current measurement to those set by the factory.

Key Path	Meas Setup, More
Mode	LTETDD, LTE
Remote Command	:CONFigure:PVTime
Example	:CONF:PVT
Initial S/W Revision	A.03.00

12 Transmit On/Off Power Measurement Functions
Mode

Mode

See "[Mode](#)" on page 222

Mode Preset

Returns the active mode to a known state.

Mode Preset does the following for the currently active mode:

- Aborts the currently running measurement.
- Brings up the default menu for the mode, with no active function.
- Sets measurement Global settings to their preset values for the active mode only.
- Activates the default measurement.
- Brings up the default menu for the mode.
- Clears the input and output buffers.
- Sets Status Byte to 0.

Mode Preset does not:

- Cause a mode switch
- Affect mode persistent settings
- Affect system settings
- See "[How-To Preset](#)" on page 1686 for more information.

Key Path	Front-panel key
Remote Command	:SYSTem:PRESet
Example	:SYST:PRES
Notes	*RST is preferred over :SYST:PRES for remote operation. *RST does a Mode Preset, as done by the :SYST:PRES command, and it sets the measurement mode to Single measurement rather than Continuous for optimal remote control throughput. Clears all pending OPC bits. The Status Byte is set to 0.
Couplings	A Mode Preset aborts the currently running measurement, activates the default measurement, and gets the mode to a consistent state with all of the default couplings set.
Backwards Compatibility Notes	In the X-Series, the legacy "Factory Preset" has been replaced with Mode Preset, which only presets the currently active mode, not the entire instrument. In the X-Series, the way to preset the entire instrument is by using System, Restore System Defaults All, which behaves essentially the same way as restore System Defaults does on ESA and PSA. There is also no "Preset Type" as there is on the PSA. There is a green Mode Preset front-panel key that does a Mode Preset and a white-with-green-letters User Preset front-panel key that does a User Preset. The old PRESet:TYPE command is ignored (without generating an error), and SYST:PRES without a parameter does a Mode Preset, which should cover most backward code compatibility issues. The settings and correction data under the Input/Output front-panel key (examples: Input Z Corr, Ext Amp Gain, etc.) are no longer part of any Mode, so they will not be preset by a Mode Preset. They are preset using Restore Input/Output Defaults, Restore System Defaults All. Note that because User Preset does a Recall State, and all of these settings are saved in State, they ARE recalled when using

	User Preset.
Initial S/W Revision	Prior to A.02.00

How-To Preset

The table below shows all possible presets, their corresponding SCPI commands and front-panel access (key paths). Instrument settings depend on the current measurement context. Some settings are local to the current measurement, some are global (common) across all the measurements in the current mode, and some are global to all the available modes. In a similar way, restoring the settings to their preset state can be done within the different contexts.

Auto Couple - is a measurement local key. It sets all Auto/Man parameter couplings in the measurement to Auto. Any Auto/Man selection that is local to other measurements in the mode will not be affected.

Meas Preset - is a measurement local key. Meas Preset resets all the variables local to the current measurement except the persistent ones.

Mode Preset - resets all the current mode's measurement local and measurement global variables except the persistent ones.

Restore Mode Defaults - resets ALL the Mode variables (and all the Meas global and Meas local variables), including the persistent ones.

Type Of Preset	SCPI Command	Front Panel Access
Auto Couple	:COUPle ALL	Auto Couple front-panel key
Meas Preset	:CONFigure:<Measurement>	Meas Setup Menu
Mode Preset	:SYSTem:PRESet	Mode Preset (green key)
Restore Mode Defaults	:INSTrument:DEFault	Mode Setup Menu
Restore All Mode Defaults	:SYSTem:DEFault MODes	System Menu; Restore System Default Menu
*RST	*RST	not possible (Mode Preset with Single)
Restore Input/Output Defaults	:SYSTem:DEFault INPUt	System Menu; Restore System Default Menu
Restore Power On Defaults	:SYSTem:DEFault PON	System Menu; Restore System Default Menu
Restore Alignment Defaults	:SYSTem:DEFault ALIGN	System Menu; Restore System Default Menu
Restore Miscellaneous Defaults	:SYSTem:DEFault MISC	System Menu; Restore System Default Menu
Restore All System Defaults	:SYSTem:DEFault [ALL] :SYSTem:PRESet:PERsistent	System Menu; Restore System Default Menu
User Preset	:SYSTem:PRESet:USER	User Preset Menu
User Preset All Modes	:SYSTem:PRESet:USER:ALL	User Preset Menu

Power On Mode Preset	:SYSTem:PON:TYPE MODE	System Menu
Power On User Preset	:SYSTem:PON:TYPE USER	System Menu
Power On Last State	:SYSTem:PON:TYPE LAST	System Menu

Mode Setup

See "[Mode Setup](#)" on page 242

Peak Search

Places the selected marker on the trace point with the maximum y-axis value for that marker's trace. Pressing Peak Search with the selected marker off causes the selected marker to be set to Normal, then a peak search is immediately performed.

Key Path	Front-panel key
Mode	LTETDD, LTE,
Remote Command	:CALCulate:PVTtime:MARKer[1] 2 ...12:MAXimum
Example	CALC:PVT:MARK2:MAX
Initial S/W Revision	A.03.00

12 Transmit On/Off Power Measurement Functions
Print

Print

See ["Print" on page 271](#)

Quick Save

The Quick Save front-panel key repeats the most recent save that was performed from the Save menu, with the following exceptions:

- Register saves are not remembered as Saves for the purpose of the Quick Save function
- If the current measurement does not support the last non-register save that was performed, an informational message is generated, “File type not supported for this measurement”

Quick Save repeats the last type of qualified save (that is, a save qualified by the above criteria) in the last save directory by creating a unique filename using the Auto File Naming algorithm described below.

If Quick Save is pressed after startup and before any qualified Save has been performed, the Quick Save function performs a Screen Image save using the current settings for Screen Image saves (current theme, current directory), which then becomes the “last save” for the purpose of subsequent Quick Saves.

The Auto File Naming feature automatically generates a file name for use when saving a file. The filename consists of a prefix and suffix separated by a dot, as is standard for the Windows® file system. A default prefix exists for each of the available file types:

Type	Default Prefix	Menu
State	State_	(Save/Recall)
Trace + State	State_	(Save/Recall)
Screen	Screen_	(Save/Recall)
Amplitude Corrections	Ampcor_	(Import/Export)
Traces	Trace_	(Import/Export)
Limit Lines	LLine_	(Import/Export)
Measurement Result	MeasR_	(Import/Export)
Capture Buffer	CapBuf_	(Import/Export)

A four digit number is appended to the prefix to create a unique file name. The numbering sequence starts at 0000 within each Mode for each file type and updates incrementally to 9999, then wraps to 0000 again. It remembers where it was through a Mode Preset and when leaving and returning to the Mode. It is reset by Restore Misc Defaults and Restore System Defaults and subsequent running of the instrument application. So, for example, the first auto file name generated for State files is State_0000.state. The next is State_0001, and so forth.

One of the key features of Auto File Name is that we guarantee that the Auto File Name will never conflict with an existing file. The algorithm looks for the next available number. If it gets to 9999, then it looks for holes. If it find no holes, that is no more numbers are available, it gives an error.

For example, if when we get to State_0010.state there is already a State_0010.state file in the current directory, it advances the counter to State_0011.state to ensure that no conflict will exist (and then it verifies that State_0011.state also does not exist in the current directory and advances again if it does, and so forth).

If you enter a file name for a given file type, then the prefix becomes the filename you entered instead of the default prefix, followed by an underscore. The last four letters (the suffix) are the 4-digit number.

For example, if you save a measurement results file as “fred.csv”, then the next auto file name chosen for a measurement results save will be fred_0000.csv.

NOTE

Although 0000 is used in the example above, the number that is used is actually the current number in the Meas Results sequence, that is, the number that would have been used if you had not entered your own file name.

NOTE

If the filename you entered ends with _dddd, where d=any number, making it look just like an auto file name, then the next auto file name picks up where you left off with the suffix being dddd + 1.

Key Path	Front-panel key
Notes	No remote command for this key specifically.
Initial S/W Revision	Prior to A.02.00

Recall

In the LTE-Advanced TDD/FDD modes, two types of recall functions are available under the Data menu: “Parameter Configuration per Component Carrier” and “Limit Mask”. Limit Mask enables setting a preset limit mask for Power Suite-based measurements, and currently it is available for the SEM, ACP and SPUR measurements in LTE-Advanced TDD/FDD modes.

Recalling the complicated RB settings specified in the test models of the standards and the LTE state file. And it can also recalls the parameters which have been set and saved for “Signal Studio Setup” or “89600 Vector Signal Analyzer” on the external platform .

Key Path	Front Panel Key
Mode	LTEATDD, LTEAFDD
Initial S/W Revision	A.14.00

State

The Recall State menu lets you choose a register or file from which to recall the state.

The content of a state file includes all of the settings and data required to return the analyzer as closely as possible to the Mode it was in, with the exact settings that were in place, when the save occurred. The Mode settings in each state file include the settings that are affected by Mode Preset, as well as the additional settings affected by Restore Mode Defaults; all of the Mode’s settings. In addition, all of the settings of the Input/Output system are included, even though they are outside of the Mode’s state, because they are needed to restore the complete setup. Persistent System settings (for example, GPIB address) are not affected by either a Mode Preset or Restore Mode Defaults, nor are they included in a saved State file.

Since each state file is only for one Mode, the settings for other Modes are unaffected when it is loaded. Recall State will cause a mode switch if the state being recalled is not from the current active mode.

After the recall completes, the message "File <filename> recalled" or “Recalled State Register <register number>” is displayed.

For rapid recalls, the State menu lists 16 registers that you can choose from to recall. Pressing a Register key initiates the recall. You can also select a file from which to recall.

The default path for all State Files is:

My Documents\<<mode name>\state

where <mode name> is the parameter used to select the mode with the INST:SEL command (for example, SA for the Spectrum Analyzer).

See "[More Information](#)" on page 1694.

Key Path	Recall
Mode	All
Remote Command	:MMEMory:LOAD:STATe <filename>

Example	<code>:MMEM:LOAD:STAT "myState.state"</code> This recalls the file myState.state on the default path
Example	<code>MMEM:LOAD:STAT "MyStateFile.state"</code> This loads the state file data (on the default file directory path) into the instrument state.
Notes	<p>When you pick a file to recall, the analyzer first verifies that the file is recallable in the current instrument by checking the software version and model number of the instrument. If everything matches, a full recall proceeds by aborting the currently running measurement, clearing any pending operations, and then loading the State from the saved state file. You can open state files from any mode, so recalling a State file switches to the mode that was active when the save occurred. After switching to the mode of the saved state file, mode settings and data (if any for the mode) are loaded with values from the saved file. The saved measurement of the mode becomes the newly active measurement and the data relevant to the measurement (if there is any) is recalled.</p> <ul style="list-style-type: none"> • If there is a mismatch between file version or model number or instrument version or model number, the recall function tries to recall as much as possible and returns a warning message. It may limit settings that differ based on model number, licensing or version number. <p>After recalling the state, the Recall State function does the following:</p> <ul style="list-style-type: none"> • Makes the saved measurement for the mode the active measurement. • Clears the input and output buffers. • Status Byte is set to 0. • Executes a *CLS <p>If the file specified is empty an error is generated. If the specified file does not exist, another error is generated. If there is a mismatch between the file and the proper file type, an error is generated. If there is a mismatch between file version or model number or instrument version or model number, a warning is displayed. Then it returns to the State menu and File Open dialog goes away.</p> <p>After the Recall, the analyzer exits the Recall menu and returns to the previous menu.</p>
Backwards Compatibility SCPI	<code>:MMEMory:LOAD:STATe 1,<filename></code> For backwards compatibility, the above syntax is supported. The "1" is simply ignored.
Initial S/W Revision	Prior to A.02.00

More Information

In measurements that support saving Traces, for example, Swept SA, the Trace data is saved along with the State in the State file. When recalling the State, the Trace data is recalled as well. Traces are recalled exactly as they were stored, including the writing mode and update and display modes. If a Trace was updating and visible when the State was saved, it will come back updating and visible, and its data will be rewritten right away. When you use State to save and recall traces, any trace whose data must be preserved should be placed in View or Blank mode before saving.

The following table describes the Trace Save and Recall possibilities:

You want to recall state and one trace's data, leaving other traces unaffected.	Save Trace+State from 1 trace. Make sure that no other traces are updating (they should all be in View or Blank mode) when the save is performed.	On Recall, specify the trace you want to load the one trace's data into. This trace will load in View. All other traces' data will be unaffected, although their trace
---	---	--

You want to recall all traces	Save Trace+State from ALL traces.	mode will be as it was when the state save was performed. On Recall, all traces will come back in View (or Blank if they were in Blank or Background when saved)
You want all traces to load exactly as they were when saved.	Save State	On recall, all traces' mode and data will be exactly as they were when saved. Any traces that were updating will have their data immediately overwritten.

From File...

When you press “From File”, the analyzer brings up a Windows dialog and a menu entitled “File Open.” This menu allows you to navigate to the various fields in the Windows dialog without using a keyboard or mouse. The Tab and Arrow keys can also be used for dialog navigation.

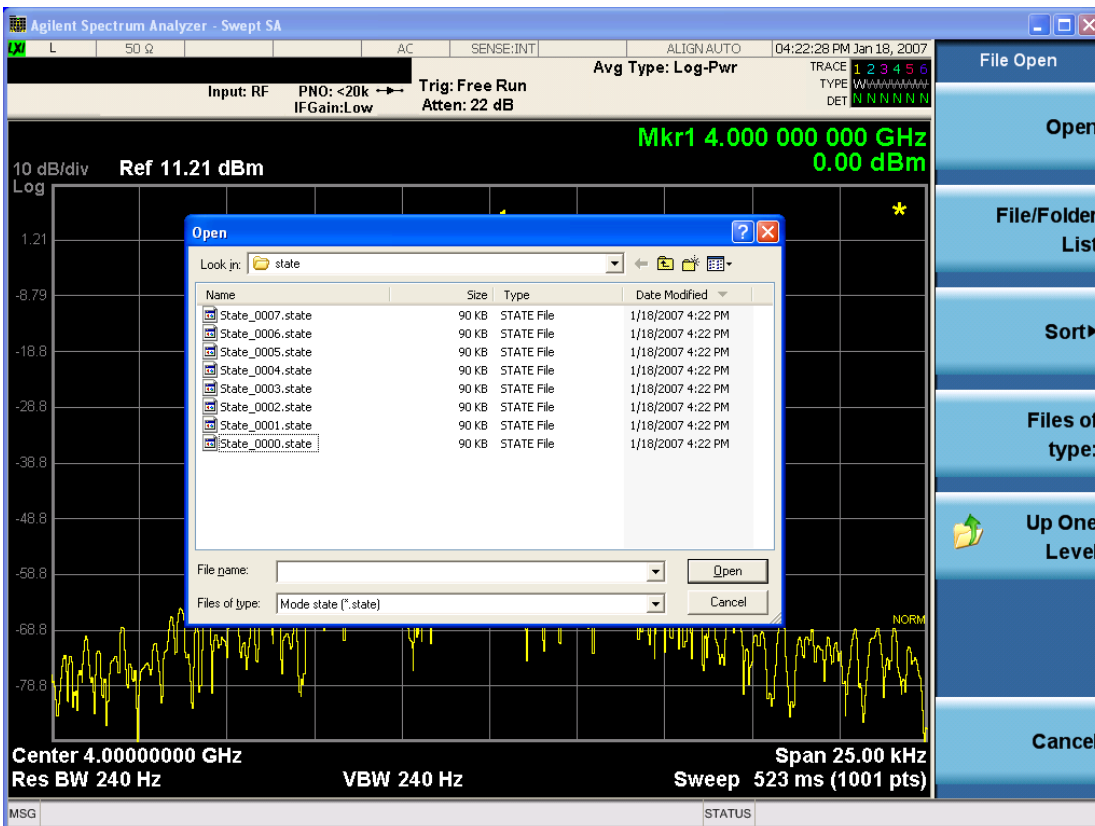

Listed below are the functions of the various fields in the dialog, and the corresponding softkeys:

Open

Performs the recall of the specified file. While the recall is being performed, the floppy icon appears briefly in the Meas bar.

File/Folder List

Enables you to navigate to the center of the dialog that contains the list of files and folders. Once here you can get information about the file and use the tab keys to navigate to the other fields in the dialog, such as Look In.

Look In

The Look In field shows the path from which the file will be recalled and allows you to change the path using the up and down arrow keys to navigate to other paths; the Enter key to open a directory; and the Backspace key to go back one directory. The **Look In field** first uses the last path from the Save As dialog **Save In:** path for that same file type. There is no softkey for directly navigating to the Look In field, but you can use the left tab to get here from the File/Folder List.

User specified paths are remembered when you leave and return to a Mode and are reset back to the default using Restore Mode Defaults.

Sort

Accesses a menu that enables you to sort the files within the File Open dialog. Only one sorting type can be selected at a time and the sorting happens immediately. The sorting types are By Date, By Name, By extension, and By Size.

Files of Type

This field shows the file suffix for the type of file you have selected to recall. For example, if you navigated here while recalling State, "Mode state (*.state)" is in the field. If you navigated here while recalling Trace, ""Mode state (*.trace)" is in the field. If you navigated here while importing a trace data file, "Trace Data (*.csv)" is in the field. For some file types, there is more than one choice in the dropdown menu, which you can select by using the up and down arrow keys and Enter.

Up One Level

This key corresponds to the icon of a folder with the up arrow that is in the tool bar of the dialog. When pressed, it causes the file and folder list to navigate up one level in the directory structure. The Backspace key does the same thing.

Cancel

This key corresponds to the Cancel selection in the dialog. It causes the current **Open** request to be cancelled. The ESC key does the same thing.

Key Path	Recall, State
Notes	Brings up the Open dialog for recalling a State Save Type
Initial S/W Revision	Prior to A.02.00

Edit Register Names

You may enter a custom name on any of the Register keys, to help you remember what you are using that state to save. To do this, press the Edit Register Names key, choose the register whose name you wish to edit, and then enter the desired label using the Alpha Editor or an external PC keyboard.

The maximum number of characters that can be added is 30. In most cases, 30 characters will fit on two lines of the key.

For more information and the SCPI command, see Edit Register Names under the Save, State function.

Key Path	Recall, State
Mode	All
Dependencies	N9060A-7FP or N9060B-2FP license required to edit the register names. When the feature is not licensed, sending the SCPI command generates an error, -221, "Settings conflict;Option not available"
Initial S/W Revision	A.11.00

Register 1 thru Register 16

Selecting any one of these register keys causes the State of the mode from the specified Register to be recalled. Each of the register keys annotates whether it is empty or at what date and time it was last modified. In addition, you can use the Edit Register Names key under Save, State to enter custom names for each register.

NOTE

In products that run multiple instances of the X-Series Application, recalling the same register name on each instance is a way to share setups between the instances.

Registers are shared by all modes, so recalling from any one of the registers will cause a mode switch to the mode that was active when the save to the Register occurred.

Although these 16 registers are the only registers available from the front panel, there are 128 state registers available in the instrument. Registers 17-128 are only available from the SCPI interface, using the *RCL command.

After the recall completes, the message "Register <register number> recalled" appears in the message bar. If you are in the Spectrum Analyzer Mode, and you are recalling a register that was saved in the Spectrum Analyzer Mode, then after the recall, you will still be in the Recall Register menu. If the Recall causes you to switch modes, then after the Recall, you will be in the Frequency menu.

If a requested register is empty an error is generated.

Key Path	Recall, State
Example	*RCL 1
Range	1-16 from front panel, 1-128 from SCPI
Readback	Date and time with seconds resolution are displayed on the key OR A custom name of up to 30 characters entered using the Save, State,Edit Register Names key

	OR “(empty)” if no prior save operation has been performed to this register.
Initial S/W Revision	Prior to A.02.00
Modified at S/W Revision	Prior to A.11.00

Register 1 thru Register 16

Selecting any one of these register keys causes the State of the mode from the specified Register to be recalled. Each of the register keys annotates whether it is empty or at what date and time it was last modified. In addition, you can use the Edit Register Names key under Save, State to enter custom names for each register.

NOTE In products that run multiple instances of the X-Series Application, recalling the same register name on each instance is a way to share setups between the instances.

Registers are shared by all modes, so recalling from any one of the registers will cause a mode switch to the mode that was active when the save to the Register occurred.

Although these 16 registers are the only registers available from the front panel, there are 128 state registers available in the instrument. Registers 17–128 are only available from the SCPI interface, using the *RCL command.

After the recall completes, the message "Register <register number> recalled" appears in the message bar. If you are in the Spectrum Analyzer Mode, and you are recalling a register that was saved in the Spectrum Analyzer Mode, then after the recall, you will still be in the Recall Register menu. If the Recall causes you to switch modes, then after the Recall, you will be in the Frequency menu.

If a requested register is empty an error is generated.

Key Path	Recall, State
Example	*RCL 1
Range	1–16 from front panel, 1–128 from SCPI
Readback	Date and time with seconds resolution are displayed on the key OR A custom name of up to 30 characters entered using the Save, State, Edit Register Names key OR “(empty)” if no prior save operation has been performed to this register.
Initial S/W Revision	Prior to A.02.00
Modified at S/W Revision	Prior to A.11.00

Sequences

These keys allow you to import a Tab separated or .txt file that will automatically setup all the parameters required for building a Sequence. The parameters will automatically be loaded into the Stated Sequencer.

Once selected, in order to import the selected Sequence Type you must select the Open key in the Source Sequence menu.

Key Path	Recall, Sequences
Mode	All
Remote Command	:MMEMory:LOAD:SEQ:Sequences: SLIS ALIS SAALIS "MySequence.txt"
Example	:MMEM:LOAD:SEQ:SLIS "MySequence.txt"
Notes	Available file types are: –CSV (Comma delimited) (*.csv) –Text (Tab delimited) (*.txt)
Initial S/W Revision	A.05.00

Source Sequence

The list of parameters, that configure steps, that makes up a sequence for the Source.

The Source sequence is a sequence of flexible configurable steps that can be set anywhere in the instruments frequency range.

Key Path	Recall, Sequences
Example	:MMEM:LOAD:SEQ:SLIS "MySequence.txt"
Dependencies	Only available in XOBT
Initial S/W Revision	A.05.00

Open...

When you press “Open”, the analyzer brings up a Windows dialog and a menu entitled “**File Open.**” This menu allows you to navigate to the various fields in the Windows dialog without using a keyboard or mouse. The Tab and Arrow keys can also be used for dialog navigation.

See "[From File...](#)" on page 2401 in Recall, State, for a full description of this dialog and menu.

Key Path	Recall, Data
Notes	The key location is mode-dependent and will vary. Brings up Open dialog for recalling a <mode specific> Save Type
Initial S/W Revision	Prior to A.02.00

Data (Import)

Importing a data file loads data that was previously saved from the current measurement or from other measurements and/or modes that produce compatible data files. The Import Menu only contains Data Types that are supported by the current measurement.

Since the commonly exported data files are in .csv format, the data can be edited by the user prior to importing. This allows you to export a data file, manipulate the data in Excel (the most common PC Application for manipulating .csv files) and then import it.

Importing Data loads measurement data from the specified file into the specified or default destination, depending on the data type selected. Selecting an Import Data menu key will not actually cause the importing to occur, since the analyzer still needs to know from where to get the data. Pressing the Open key in this menu brings up the Open dialog and Open menu that provides you with the options from where to recall the data. Once a filename has been selected or entered in the Open menu, the recall occurs as soon as the Open button is pressed.

Key Path	Recall
Mode	All
Notes	The menu is built from whatever data types are available for the mode. Some keys will be missing completely, so the key locations in the sub-menu will vary. No SCPI command directly controls the Data Type that this key controls. The Data Type is included in the MMEM:LOAD commands.
Dependencies	If a file type is not used by a certain measurement, it is grayed out for that measurement. The key for a file type will not show at all if there are no measurements in the Mode that support it.
Preset	Is not affected by Preset or shutdown, but is reset during Restore Mode Defaults
Readback	The data type that is currently selected
Initial S/W Revision	Prior to A.02.00

Component Carrier Setup

Enables you to import LTE-A setup files for all Component Carriers or the specified Component Carrier. Selecting this key displays a menu that enables you to select what the Component Carrier setup files to be imported. After making this selection, depress Open... and use the file dialog to select the file you wish to recall. The Key is valid for Conformance EVM measurements only.

It supports to the following import file formats

- LTE app state files (*.state)
- EVM Setup Files (*.evms)
- 89601 VSA Setup Files (*.set, *.setx)
- Signal Studio Setup Files (*.scp)

App State Files

Extension: state

The parameters of the LTE Modulation Analysis measurement can be imported to LTE-Advanced EVM and CEVM measurements from the LTE .state file. It depends on the parameter of the Component Carrier Setup to decide which component carriers' measurement parameters are affected.

Pressing OPEN under the Import Data menu will open the above directory from which you can select an LTE app state file.

EVM Setup Files

Extension: evms

It will recall LTE test model parameters specified in the standards to LTE-Advanced FDD/TDD EVM and CEVM measurements. It depends on the parameter of the Component Carrier Setup to decide which component carriers 'measurement parameters are affected.

The default path is My Documents\LTEATDD\LTEAFDD\data\evmsetup. Note that "My Documents" is an alias to a directory and its place differs depending on which user is logged in. At XSA start up, XSA will overwrite all of the EVM Setup files to the current user's "My Documents\LTEATDD\LTEAFDD\data\evmsetup" each time.

Pressing OPEN under the Import Data menu will open the above directory from which you can select an EVM Setup file.

You cannot read the contents of the provided EVM Setup file since it is a binary file.

89601 VSA Setup Files

Extension: set, setx

The 89600 Vector Signal Analyzer Setup file created using the 89600 Vector Signal Analyzer Option BHD (LTETDD|LTEFDD) can be imported as LTE-Advanced TDD/FDD EVM and CEVM parameter sets.

The 89600 Vector Signal Analyzer Setup file created using the 89600 Vector Signal Analyzer Option BHD (LTEATDD|LTEAFDD) can be imported as LTE-Advanced TDD/FDD EVM and CEVM parameter sets.

Which component carriers 'measurement parameters are affected depends on depends on the parameter of the Component Carrier Setup.

If the setup file is not loaded successfully, an error message, -230 "Data corrupt or stale", is issued with the specified file name.

Signal Studio Setup Files

Extension: scp

The Keysight Signal Studio setup file created using Signal Studio (N7624B/N7625B) can be imported as LTE-Advanced TDD/FDD parameter set.

Supported component carrier types are listed in the table below:

<i>Signal Studio</i>	<i>Carrier Type</i>
N7624B Signal Studio for 3GPP LTE	Advanced LTE FDD Downlink (2009-03)
	Advanced LTE FDD Downlink (2009-12)
	Advanced LTE FDD Downlink (2010-06)
	Advanced LTE FDD Uplink (2009-12)
	Advanced LTE FDD Uplink (2010-06)
	Basic LTE FDD Downlink (2009-03)
	Basic LTE FDD Downlink (2009-12)
	Basic LTE FDD Downlink (2010-06)
	Basic LTE FDD Uplink (2009-03)

	Basic LTE FDD Uplink (2009-12)
	Basic LTE FDD Uplink (2010-06)
	Basic LTE-A FDD Downlink (2010-12)
	Basic LTE-A FDD Uplink (2010-12)
	Basic LTE FDD R9 Downlink
	Basic LTE FDD R9 Uplink
	Advanced LTE FDD R9 Downlink
	Advanced LTE FDD R9 Uplink
	Basic LTE-A FDD R10 Downlink
	Basic LTE-A FDD R10 Uplink
N7625B Signal Studio for 3GPP LTE TDD	Advanced LTE TDD (2009-03)
	Advanced LTE TDD (2009-12)
	Basic LTE TDD (2009-03)
	Basic LTE TDD (2009-12)
	Basic LTE-A TDD (2010-01)
	Basic LTE-A TDD R10 (2010-12)

If the setup file is not loaded successfully, an error message, -230 "Data corrupt or stale", is issued with the specified file name.

Key Path	Recall, Data
Mode	LTEATDD, LTEAFDD
Remote Command	MME ^M emory:LOAD:SETup ALL CC0 CC1 CC2 CC3 CC4,<string>
Example	MME ^M :LOAD:SETup CC0,"LTE-A TDD.set"
Notes	The options CC1~CC4 can be enabled with 9080B/9082B-2FP license.
Notes	"ALL" is primarily used to LTE-A setup file for each component carrier including the number of component carriers. "CC*" is used to import LTE-A setup file for the specified component carrier.
Backwards Compatibility SCPI	MME ^M emory:LOAD:SSSetup <string> MME ^M emory:LOAD:VSASetup <string> MME ^M emory:LOAD:EVMSSetup <string>
Initial S/W Revision	A.14.00
Modified at S/W Revision	A.14.50

Masks

This key enables you to recall a preset mask file which contains Offset and Limit settings. Parameters except them will not be overwritten. You cannot change or create preset mask files since they are binary files. This key is valid for the Spectrum Emission Mask, ACP and Spurious Emissions measurements.

Default path: “My Documents\LTEATDD\LTEAFDD\data\masks”

Note that “**My Documents**” is an alias to a directory and its location depends on which user is logged in. At XSA start up, all of the limit mask files in the current user’s “My Documents\LTEATDD\LTEAFDD\data\masks” directory are overwritten.

File type: Binary

Filename: The filename follows the rule below with the words connected using underscores.

<Measurement>_<Condition>.mask

Where

<Measurement> Measurement the limit mask file is applied to: SEM, ACP or SPUR

<Condition> Condition. It depends on the measurement.

File extension: .mask

File Dialog Filter: Preset Mask Files (*.mask)

Selecting OPEN... under the Import Data menu opens the above directory enabling you to select a mask file.

Details of the masks are provided in the default folder of masks with the PDF extension.

Key Path	Recall, Data
Mode	LTEATDD, LTEAFDD
Remote Command	MMEemory:LOAD:MASK <string>
Example	MME:LOAD:MASK “ACP_BS\ACP_BS_3MHz_pairE-UTRA_CatA.mask”
Notes	Parameters related to Limit and Offset are overwritten by the contents of the preset mask file.
Initial S/W Revision	A.14.00

Open...

When you press “Open”, the analyzer brings up a Windows dialog and a menu entitled “**File Open.**” This menu allows you to navigate to the various fields in the Windows dialog without using a keyboard or mouse. The Tab and Arrow keys can also be used for dialog navigation.

See "[From File...](#)" on page 2401 in Recall, State, for a full description of this dialog and menu.

Key Path	Recall, Data
Notes	The key location is mode-dependent and will vary. Brings up Open dialog for recalling a <mode specific> Save Type
Initial S/W Revision	Prior to A.02.00

Restart

The Restart function restarts the current sweep, or measurement, or set of averaged/held sweeps or measurements. If you are Paused, pressing Restart does a Resume.

The Restart function is accessed in several ways:

- Pressing the Restart key
- Sending the remote command INIT:IMMEDIATE
- Sending the remote command INIT:RESTART

See "[More Information](#)" on page 1704

Key Path	Front-panel key
Remote Command	:INITiate[:IMMEDIATE] :INITiate:RESTART
Example	:INIT:IMM :INIT:REST
Notes	:INITiate:RESTART and :INITiate:IMMEDIATE perform exactly the same function.
Couplings	Resets average/hold count k. For the first sweep overwrites all active (update=on) traces with new current data. For application modes, it resets other parameters as required by the measurement.
Status Bits/OPC dependencies	This is an Overlapped command. The STATUS:OPERation register bits 0 through 8 are cleared. The STATUS:QUESTionable register bit 9 (INTEGRITY sum) is cleared. The SWEEPING bit is set. The MEASURING bit is set.
Backwards Compatibility Notes	For Spectrum Analysis mode in ESA and PSA, the Restart hardkey and the INITiate:RESTART command restart trace averages (displayed average count reset to 1) for a trace in Clear Write, but did not restart Max Hold and Min Hold. In the X-Series, the Restart hardkey and the INITiate:RESTART command restart not only Trace Average, but MaxHold and MinHold traces as well. For wireless comms modes in ESA and PSA, the Restart hardkey and the INITiate:RESTART command restart every measurement, which includes all traces and numeric results. There is no change to this operation.
Initial S/W Revision	Prior to A.02.00

More Information

The **Restart** function first aborts the current sweep/measurement as quickly as possible. It then resets the sweep and trigger systems, sets up the measurement and initiates a new data measurement sequence with a new data acquisition (sweep) taken once the trigger condition is met.

If the analyzer is in the process of aligning when **Restart** is executed, the alignment finishes before the restart function is performed.

Even when set for Single operation, multiple sweeps may be taken when Restart is pressed (for example, when averaging/holding is on). Thus when we say that **Restart** "restarts a measurement," we may mean:

- It restarts the current sweep
- It restarts the current measurement
- It restarts the current set of sweeps if any trace is in Trace Average, Max Hold or Min Hold
- It restarts the current set of measurements if Averaging, or Max Hold, or Min Hold is on for the measurement
- depending on the current settings.

With **Average/Hold Number** (in **Meas Setup** menu) set to 1, or Averaging off, or no trace in Trace Average or Hold, a single sweep is equivalent to a single measurement. A single sweep is taken after the trigger condition is met; and the analyzer stops sweeping once that sweep has completed. However, with **Average/Hold Number** >1 and at least one trace set to **Trace Average, Max Hold, or Min Hold (SA Measurement)** or **Averaging on (most other measurements)**, multiple sweeps/data acquisitions are taken for a single measurement. The trigger condition must be met prior to each sweep. The sweep is stopped when the average count k equals the number N set for **Average/Hold Number**. A measurement average usually applies to all traces, marker results, and numeric results; but sometimes it only applies to the numeric results.

Once the full set of sweeps has been taken, the analyzer will go to idle state. To take one more sweep without resetting the average count, increment the average count by 1, by pressing the step up key while **Average/Hold Number** is the active function, or sending the remote command `CALC:AVER:TCON UP`.

Save

The Save menu lets you choose what you want to save and where you want to save it. Among the types of files you can save are **States**, **Traces**, and **Screen Images**. In addition, an Export (Data) option lets you save a number of data types as CSV files for easy import into Excel and other spreadsheet programs.

Key Path	Front-panel key
Mode	All
Notes	No remote command for this key specifically, but the :MMEM:STORe command is available for specific file types. An example is :MMEM:STOR:STATe <filename>.
Initial S/W Revision	Prior to A.02.00

State

The Save State menu lets you choose a register or file for saving the state.

NOTE In products that run multiple instances of the X-Series Application, all instances share the same register and file location where you want to save the state.

The content of a state file includes all of the settings and data required to return the analyzer as closely as possible to the Mode it was in, with the exact settings which were in place, when the save occurred. The Mode settings in each state file include the settings that are affected by Mode Preset, as well as the additional settings affected by Restore Mode Defaults; all of the Mode's settings. In addition, all of the settings of the Input/Output system are included, even though they are outside of the Mode's state, because they are needed to restore the complete setup. Persistent System settings (for example, Verbose SCPI) are not affected by either Mode Preset or Restore Mode Defaults, nor are they included in a saved State file.

After the save completes, the message "File <filename> saved" or "State Register <register number> saved" is displayed.

For rapid saving, the State menu lists 16 registers to save to. Pressing a Register key initiates the save. You can also select a file to save to.

The default path for all State Files is:

My Documents\<<mode name>\state

where <mode name> is the parameter used to select the mode with the INST:SEL command (for example, SA for the Spectrum Analyzer).

Key Path	Save
Mode	All
Remote Command	:MMEMory:STORe:STATe <filename>
Example	MMEM:STOR:STATe "MyStateFile.state" This stores the current instrument state data in the file MyStateFile.state in the default directory.
Notes	Both single and double quotes are supported for any filename parameter over remote.

After saving to a register, that register's menu key is updated with the date the time, unless a custom label has been entered for that key.

After saving to a register, you remain in the Save State menu, so that you can see the Register key update. After saving to a file, the analyzer automatically returns to the previous menu and any Save As dialog goes away.

Backwards Compatibility SCPI :MMEMory:STORe:STATe 1,<filename>

For backwards compatibility, the above syntax is supported. The "1" is simply ignored. The command is sequential.

Initial S/W Revision Prior to A.02.00

To File . . .

When you press "To File", the analyzer brings up a Windows dialog and a menu entitled "Save As." This menu allows you to navigate to the various fields in the Windows dialog without using a keyboard or mouse. The Tab and Arrow keys can also be used for dialog navigation.

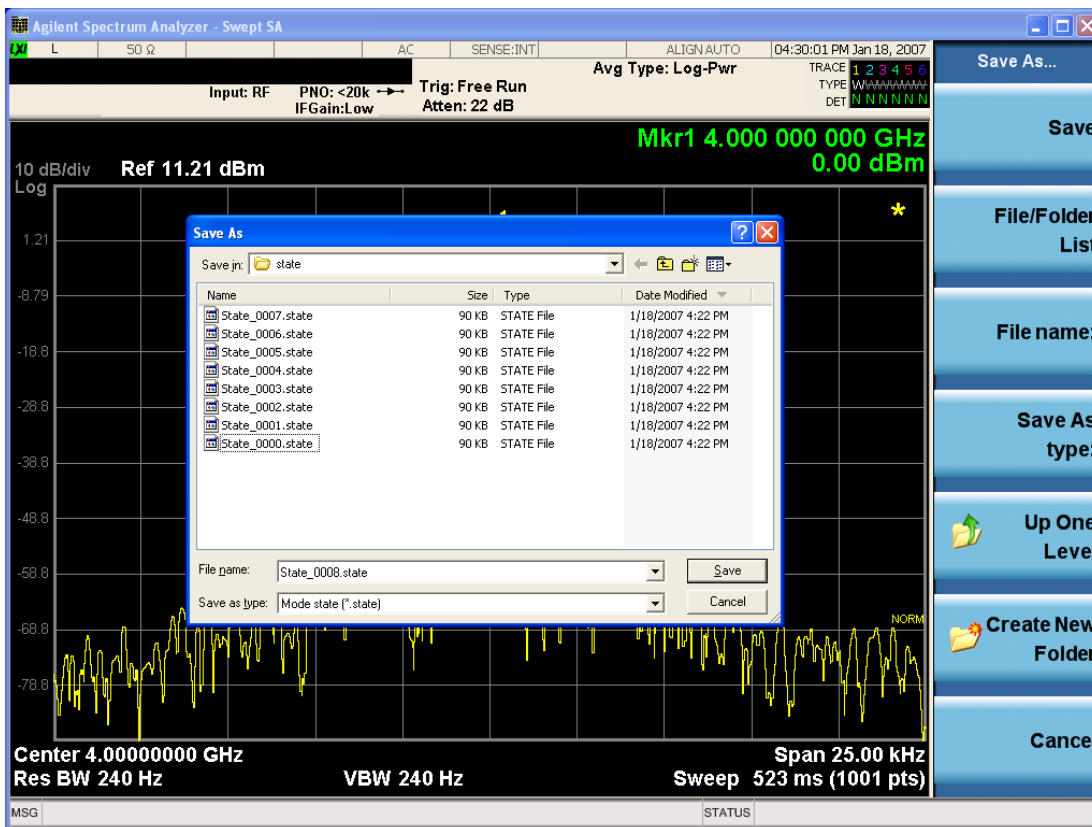

The Listed below

are the functions of the various fields in the dialog, and the corresponding softkeys:

Save

Performs the save to the specified file of the selected type. If the file already exists, a dialog will appear that allows you to replace the existing file by selecting OK, or you can Cancel the request. If you select OK,

the file will be overwritten. Using the C: drive is strongly discouraged, since it runs the risk of being overwritten during an instrument software upgrade.

While the save is being performed, the floppy icon appears briefly in the Meas bar.

File/Folder List

Enables you to navigate to the center of the dialog that contains the list of files and folders. Once here you can get information about the file and use the tab keys to navigate to the other fields in the dialog, such as Save In.

Save In

The Save In field shows the path to which the file will be saved and allows you to change the path using the up and down arrow keys to navigate to other paths; the Enter key to open a directory; and the Backspace key to go back one directory. The **Save In field** defaults to the default path for this type of file and remembers the last path you used to save this type of file. There is no softkey for directly navigating to the Save In field but you can use left tab to get here from the File/Folder List.

User specified paths are remembered when you leave and return to a Mode and are reset back to the default using Restore Mode Defaults.

File Name

The File Name field is initially loaded with an automatically generated filename specific to the appropriate Save Type. The automatically generated filename is guaranteed not to conflict with any filename currently in the directory. You may replace or modify this filename using the File Name key. See the ["Quick Save " on page 2397](#) documentation for more on the automatic file naming algorithm.

When you press the File Name key the analyzer displays the Alpha Editor. Use the knob to choose the letter to add and the front-panel Enter key to add the letter to the file name. The BK character moves you back and the FW character moves you forward in the filename. The Select key on the front panel generates a space character. When you are done entering the filename press the Done softkey. This returns back to the **File Open** dialog and menu, but does not cause the save to occur.

Save As Type

This field shows the file suffix for the type of file you have selected to save. For example, if you navigated here while saving State, "Mode state (*.state)" is in the field. If you navigated here from saving Trace, ""Mode state (*.trace)" is in the field. If you navigated here while exporting a trace data file, "Trace Data (*.csv)" is in the field. For some file types, there is more than one choice in the dropdown, which you can select by using the up and down arrow keys and Enter.

Up One Level

This key corresponds to the icon of a folder with the up arrow that is in the tool bar of the dialog. When pressed, it causes the file and folder list to navigate up one level in the directory structure. The Backspace key does the same thing.

Create New Folder

This key corresponds to the icon of a folder with the "*" that is in the tool bar of the dialog. When pressed, a new folder is created in the current directory with the name **New Folder** and you can enter a new folder name using the Alpha Editor.

Cancel

This key corresponds to the Cancel selection in the dialog. It causes the current **Save As** request to be cancelled. The ESC key does the same thing.

Key Path	Save, State
Mode	All
Notes	Brings up Save As dialog for saving a State Save Type
Initial S/W Revision	Prior to A.02.00

Edit Register Names

You may enter a custom name on any of the Register keys, to help you remember what you are using that state to save. To do this, press the Edit Register Names key, choose the register whose name you wish to edit, and then enter the desired label using the Alpha Editor or an external PC keyboard.

The maximum number of characters that can be added is 30. In most cases, 30 characters will fit on two lines of the key.

See ["More Information" on page 1709](#)

Key Path	Save, State
Mode	All
Remote Command	:MMEMory:REGister:STATe:LABel <reg number>,"label" :MMEMory:REGister:STATe:LABel? <reg number>
Example	:MMEM:REG:STAT:LAB 1,"my label"
Notes	<reg number> is an integer from 1 to 16. If the SCPI specifies an invalid register number an error message is generated, -222,"Data out of range;Invalid register label number" "label" is a string from 0 to 30 characters in length. If a label exceeds 30 characters, an error message is generated, -150,"String data error;Label clipped to 30 characters" "label" of length 0 erases the custom label and restores the default (time and date) label. E.g.: :MMEM:REG:STAT:LAB 1,""
Dependencies	N9060A-7FP or N9060B-2FP license required to edit the register names. When the feature is not licensed, sending this command generates an error, -221,"Settings conflict;Option not available"
Preset	The names are unaffected by Preset or power cycle but are set to the default label (time and date) on a "Restore System Defaults->Misc"
Initial S/W Revision	A.11.00

More Information

When you edit one of the register names, the time and date field will be replaced by the custom name.

If you delete all the characters in the custom name, it restores the default (time and date).

The register names are stored within the state files, but they are not part of the instrument state; that is, once you have edited a register name, loading a new state will not change that register name. Another

consequence of this is that the names will be persistent through a power cycle. Also, if a named state file is transferred to another analyzer, it will bring its custom name along with it.

If you try to edit the name of an empty register, the analyzer will first save the state to have a file to put the name in. If you load a named state file into an analyzer with older firmware it will ignore the metadata.

The *SAV and *RCL commands will not be affected by the custom register names, nor will the MMEM commands.

Register 1 thru Register 16

Selecting any one of these register menu keys causes the State of the currently active mode to be saved to the specified Register. The registers are provided for rapid saving and recalling, since you do not need to specify a filename or navigate to a file. Each of the register menu keys annotates whether it is empty or at what date and time it was last modified. In addition, you can use the Edit Register Names key to enter custom names for each register.

NOTE

In products that run multiple instances of the X-Series Application, save with different register name if you do not want to overwrite the register of another running instance.

Although these 16 registers are the only registers available from the front panel, there are 128 state registers available in the instrument. Registers 17–128 are only available from the SCPI interface, using the *SAV command.

There is one set of 128 state registers in the instrument, not one set for each Mode. When a state is saved, the Mode it was saved from is saved with it; then when it is recalled, the instrument switches to that Mode.

After the save completes, the corresponding register menu key annotation is updated with the date and time and the message "Register <register number> saved" is displayed.

Key Path	Save, State
Mode	All
Example	*SAV 1
Range	1–16 from front panel, 1–128 from SCPI
Readback	Date and time with seconds resolution are displayed on the key OR A custom name of up to 30 characters entered using the Edit Register Names key OR “(empty)” if no prior save operation has been performed to this register.
Initial S/W Revision	Prior to A.02.00
Modified at S/W Revision	A.11.00

Register 1 thru Register 16

Selecting any one of these register menu keys causes the State of the currently active mode to be saved to the specified Register. The registers are provided for rapid saving and recalling, since you do not need to specify a filename or navigate to a file. Each of the register menu keys annotates whether it is empty or at

what date and time it was last modified. In addition, you can use the Edit Register Names key to enter custom names for each register.

NOTE In products that run multiple instances of the X-Series Application, save with different register name if you do not want to overwrite the register of another running instance.

Although these 16 registers are the only registers available from the front panel, there are 128 state registers available in the instrument. Registers 17–128 are only available from the SCPI interface, using the *SAV command.

There is one set of 128 state registers in the instrument, not one set for each Mode. When a state is saved, the Mode it was saved from is saved with it; then when it is recalled, the instrument switches to that Mode.

After the save completes, the corresponding register menu key annotation is updated with the date and time and the message "Register <register number> saved" is displayed.

Key Path	Save, State
Mode	All
Example	*SAV 1
Range	1–16 from front panel, 1–128 from SCPI
Readback	Date and time with seconds resolution are displayed on the key OR A custom name of up to 30 characters entered using the Edit Register Names key OR “(empty)” if no prior save operation has been performed to this register.
Initial S/W Revision	Prior to A.02.00
Modified at S/W Revision	A.11.00

Mass Storage Catalog (Remote Command Only)

Key path	SCPI Only
Remote Command	:MMEMory:CATalog? [<directory_name>]
Notes	The string must be a valid logical path. Queries disk usage information (drive capacity, free space available) and obtains a list of files and directories in a specified directory in the following format: <numeric_value>,<numeric_value>,{<file_entry>} It returns two numeric parameters and as many strings as there are files and directories. The first parameter indicates the total amount of storage currently used in bytes. The second parameter indicates the total amount of storage available, also in bytes. The <file_entry> is a string. Each <file_entry> indicates the name, type, and size of one file in the directory list: <file_name>,<file_type>,<file_size> As the windows file system has an extension that indicates file type, <file_type> is always empty. <file_size> provides the size of the file in bytes. For directories, <file_entry> is surrounded by square brackets and both <file_type> and <file_size> are empty
Initial S/W Revision	Prior to A.02.00

Mass Storage Change Directory (Remote Command Only)

Key path	SCPI Only
Remote Command	:MMEMory:CDIRectory [<directory_name>] :MMEMory:CDIRectory?
Notes	The string must be a valid logical path. Changes the default directory for a mass memory file system. The <directory_name> parameter is a string. If no parameter is specified, the directory is set to the *RST value. At *RST, this value is set to the default user data storage area, that is defined as System.Environment.SpecialFolder.Personal. Query returns full path of the default directory.
Initial S/W Revision	Prior to A.02.00

Mass Storage Copy (Remote Command Only)

Key path	SCPI Only
Remote Command	:MMEMory:COPY <string>,<string>[,<string>,<string>]
Notes	The string must be a valid logical path. Copies an existing file to a new file or an existing directory to a new directory. Two forms of parameters are allowed. The first form has two parameters. In this form, the first parameter specifies the source, and the second parameter specifies the destination. The second form has four parameters. In this form, the first and third parameters specify the source. The second and fourth parameters specify the directories. The first pair of parameters specifies the source. The second pair specifies the destination. An error is generated if the source doesn't exist or the destination file already exists. This command will generate an "access denied" error if the destination is a restricted folder (e.g., C:\Windows) and the current user does not have Power User or Administrator privileges.

Mass Storage Device Copy (Remote Command Only)

This command transfers data to/from a file and a peripheral device.

Key path	SCPI Only
Remote Command	:MMEMory:COPY:DEvice <source_string>,<dest_string>
Notes	The strings must be a valid logical path or a valid device keyword. If the dest_string is a device keyword, the data is copied from the source file to the device. If the source_string is a device keyword, the data is copied to the source file from the device. Valid device keywords are: SNS (smart noise source) An error is generated if the file or device is not found.

Mass Storage Delete (Remote Command Only)

Key path	SCPI Only
Remote Command	:MMEMory:DELeTe <file_name>[,<directory_name>]
Notes	The string must be a valid logical path. Removes a file from the specified directory. The <file_name> parameter specifies the file name to be removed. This command will generate an “access denied” error if the file is in a restricted folder (e.g., C:\Windows) and the current user does not have Power User or Administrator privileges.
Initial S/W Revision	Prior to A.02.00

Mass Storage Data (Remote Command Only)

Creates a file containing the specified data OR queries the data from an existing file.

Key path	SCPI Only
Remote Command	:MMEMory:DATA <file_name>, <data> :MMEMory:DATA? <file_name>
Notes	The string must be a valid logical path. The command form is MMEMory:DATA <file_name>,<data>. It loads <data> into the file <file_name>. <data> is in 488.2 block format. <file_name> is string data. The query form is MMEMory:DATA? <file_name> with the response being the associated <data> in block format.
Initial S/W Revision	Prior to A.02.00

Mass Storage Make Directory (Remote Command Only)

Key path	SCPI Only
Remote Command	:MMEMory:MDIRectory <directory_name>
Notes	The string must be a valid logical path. Creates a new directory. The <directory_name> parameter specifies the name to be created. This command will generate an “access denied” error if the new directory would be in a restricted folder (e.g., C:\Windows) and the current user does not have Power User or Administrator privileges.
Initial S/W Revision	Prior to A.02.00

Mass Storage Move (Remote Command Only)

Key path	SCPI Only
Remote Command	:MMEMory:MOVE <string>,<string>[,<string>,<string>]
Notes	The string must be a valid logical path. Moves an existing file to a new file or an existing directory to a new directory.

Two forms of parameters are allowed. The first form has two parameters. In this form, the first parameter specifies the source, and the second parameter specifies the destination.

The second form has four parameters. In this form, the first and third parameters specify the source. The second and fourth parameters specify the directories. The first pair of parameters specifies the source. The second pair specifies the destination. An error is generated if the source doesn't exist or the destination file already exists.

This command will generate an "access denied" error if the destination is a restricted folder (e.g., C:\Windows) and the current user does not have Power User or Administrator privileges.

Initial S/W Revision	Prior to A.02.00
----------------------	------------------

Mass Storage Remove Directory (Remote Command Only)

Key path	SCPI Only
Remote Command	:MMEMory:RDIRECTory <directory_name>
Notes	<p>The string must be a valid logical path.</p> <p>Removes a directory. The <directory_name> parameter specifies the directory name to be removed. All files and directories under the specified directory shall also be removed.</p> <p>This command will generate an "access denied" error if the folder is a restricted folder (e.g., C:\Windows) or is in a restricted folder and the current user does not have Power User or Administrator privileges.</p>

Initial S/W Revision	Prior to A.02.00
----------------------	------------------

Sequences

These keys allow you to save a Tab separated or CSV file of the setup parameters required to build a Sequence.

In order to save you must select the Save As button and choose a destination folder.

Key Path	Save, Sequences
Mode	All
Remote Command	:MMEM:STOR:SEQ:ences: SLIST ALIST SAAList SSTep "MySequence.txt"
Example	:MMEM:STOR:SEQ:SLIST "MySequence.txt"
Notes	<p>Available file types are:</p> <ul style="list-style-type: none"> -CSV (Comma delimited) (*.csv) -Text (Tab delimited) (*.txt)

Initial S/W Revision	A.05.00
----------------------	---------

Source Sequence

The list of parameters, that configure steps, that makes up a sequence for the Source.

The Source sequence is a sequence of flexible configurable steps that can be set anywhere in the instruments frequency range.

Key Path	Save, Sequences
Example	:MMEM:STOR:SEQ:SLIS "MySequence.txt"
Dependencies	Only available in XOBT
Initial S/W Revision	A.05.00

Save As . . .

This menu lets you select the location where you can save the Sequence. This menu is a standard Windows® dialog with Save As menu keys. The "File Name" field in the Save As dialog is initially loaded with an automatically generated filename specific to the appropriate Save Type. The automatically generated filename is guaranteed not to conflict with any filename currently in the directory. You may replace or modify this filename using the File Name softkey. See the Quick Save key documentation for more on the automatic file naming algorithm.

The default path for all Sequence Files is:

My Documents\Sequences

Key Path	Save, Sequences
Mode	All
Notes	Brings up Save As dialog for saving a Sequence Save Type
Initial S/W Revision	A.05.00

Data (Export)

Exporting a data file stores data from the current measurement to mass storage files. The Export Menu only contains data types that are supported by the current measurement.

Since the commonly exported data files are in .csv format, the data can be edited by you prior to importing. This allows you to export a data file, manipulate the data in Excel (the most common PC Application for manipulating .csv files) and then import it.

Selecting an Export Data menu key will not actually cause the exporting to occur, since the analyzer still needs to know where you wish to save the data. Pressing the Save As key in this menu brings up the Save As dialog and Save As menu that allows you to specify the destination file and directory. Once a filename has been selected or entered in the Open menu, the export will occur as soon as the Save key is pressed.

Key Path	Save
Mode	All

Notes	The menu is built from whatever data types are available for the mode. So the key locations in the sub menu will vary. No SCPI command directly controls the Data Type that this key controls. The Data Type is included in the MMEM:STORe commands.
Dependencies	If a file type is not used by a certain measurement, that type is grayed out for that measurement. The key for a file type will not show at all if there are no measurements in the Mode that support it.
Preset	Is not affected by a Preset or shutdown, but is reset during Restore Mode Defaults
Readback	The data type that is currently selected
Initial S/W Revision	Prior to A.02.00

Export Trace Data

Enables you to export trace data with (optional) associated headers. Selecting this key displays a menu that enables you to choose which Trace to save (default is the selected Trace) and whether or not to save headers with the data. The header information is used by the VXA application when saved trace data is recalled, and enables it to be displayed with the same formatting and scaling that it had when saved. If headers are not saved, the scaling and format are set to default values when the trace is recalled. After making these selections, press Save As... and use the file dialog to choose a file name and format for the saved data.

Trace data can be exported in several different formats. Text and comma-separated variable (CSV) formats are useful for viewing the data or importing it to a spreadsheet program. The other formats are binary and thus more compact. Trace data files can be recalled for viewing into other VXA, LTE, LTETDD, iDEN, or 89601 measurements.

Key Path	Save, Data (Export)
Mode	VSA, LTE, LTETDD, IDEN
Remote Command	:MMEMory:STORe:TRACe:DATA TRACE1 TRACE2 TRACE3 TRACE4 TRACE5 TRACE6, "<filename>" [,CSV TXT SDF MAT4 MAT HDF5 BIN[,OFF ON 0 1]]
Example	:MMEM:STOR:TRAC:DATA TRACE1, "TRC1.TXT", TXT, ON
Notes	The Save As... dialog box has the following format options when you are saving trace data: <ul style="list-style-type: none"> • CSV (Comma delimited) (*.csv) • SDF (Fast) (*.sdf;*.dat) • Text (Tab delimited) (*.txt) File format saved depends on selection. The appropriate file extension is appended to the filename if it is not supplied by the user. If the SCPI command includes just a file name, the file format is determined by the filename extension, which must be one of the choices above. *.sdf or an unrecognized extension chooses the SDF fast format. If the optional file format enumerator is included in the command, then this determines the file format and the file extension is ignored. The optional binary parameter determines if file headers are saved. The default is ON. If file headers are not wanted, use the optional "OFF" parameter. The optional Boolean parameter determines whether headers are saved in the file. By default the

headers are saved.

If you are not licensed to save a particular file type, then error -203.9010 is returned. If an invalid file format is specified or the file cannot be saved successfully, then error -25x is returned. If the save is successful, then advisory 0.1500 is shown.

State Saved	No
Readback	(Trace 1 Trace 2 Trace 3 Trace 4 Trace 5 Trace 6)(with without) headers

Trace 1

Selects the Trace 1 register as the destination for the imported data.

Key Path	Save, Data (Export), Trace
Mode	VSA, LTE, LTETDD, IDEN

Trace 2

Selects the Trace 2 register as the destination for the imported data.

Key Path	Save, Data (Export), Trace
Mode	VSA, LTE, LTETDD, IDEN

Trace 3

Selects the Trace 3 register as the destination for the imported data.

Key Path	Save, Data (Export), Trace
Mode	VSA, LTE, LTETDD, IDEN

Trace 4

Selects the Trace 4 register as the destination for the imported data.

Key Path	Save, Data (Export), Trace
Mode	VSA, LTE, LTETDD, IDEN

Trace 5

Selects the Trace 5 register as the destination for the imported data.

Key Path	Save, Data (Export), Trace
Mode	VSA, LTE, LTETDD, IDEN

Trace 6

Selects the Trace 6 register as the destination for the imported data.

Key Path	Save, Data (Export), Trace
Mode	VSA, LTE, LTETDD, IDEN

Include Header

Enables you to select whether or not the saved trace data includes header information describing scaling, formatting, etc.

Key Path	Save, Data (Export), Trace
Mode	VSA, LTE, LTETDD, IDEN
State Saved	No

Measurement Results

Pressing this key selects Meas Results as the data type to be exported. Pressing the key a second time brings up the Meas Results menu, which allows you to select which **Meas Result** to save. In the Swept SA measurement, there are three types of Measurement Results files: Peak Table, Marker Table and Spectrogram.

See "[Meas Results File Contents](#)" on page 1719.

See "[Marker Table](#)" on page 1719.

See "[Peak Table](#)" on page 1722.

See Spectrogram

Remote Command	:MMEMory:STORe:RESults:MTABle PTABle SPEctrogram <filename>
Example	:MMEM:STOR:RES:MTAB "myResults.csv" Saves the results from the current marker table to the file myResults.csv in the current path. :MMEM:STOR:RES:PTAB "myResults.csv" Saves the results from the current peak table to the file myResults.csv in the current path. :MMEM:STOR:RES:SPEC "myResults.csv" Saves the results from the current Spectrogram display to the file myResults.csv in the current path. The default path is My Documents\SA\data\SAN\results
Notes	If the save is initiated via SCPI, and the file already exists, the file will be overwritten. Using the C: drive is strongly discouraged, since it runs the risk of being overwritten during an instrument software upgrade. Both single and double quotes are supported for any filename parameter over SCPI.
Dependencies	If a save of Marker Table results is requested and the Marker Table is not on, no file is saved and a

message is generated

If a save of Peak Table results is requested and the Peak Table is not on, no file is saved and a message is generated

If a save of Spectrogram results is requested and the Spectrogram is not on, no file is saved and a message is generated.

The Spectrogram choice only appears if option EDP is licensed.

Preset	Not part of Preset, but is reset to Peak Table by Restore Mode Defaults. Survives a shutdown.
Initial S/W Revision	Prior to A.02.00

Meas Results File Contents

All files are .csv files. The following section details the data in each file type.

Marker Table

This section discusses the Marker Table Meas Results file format.

Imagine that, at the point where a Marker Table Meas Result is requested, the following screen is showing:

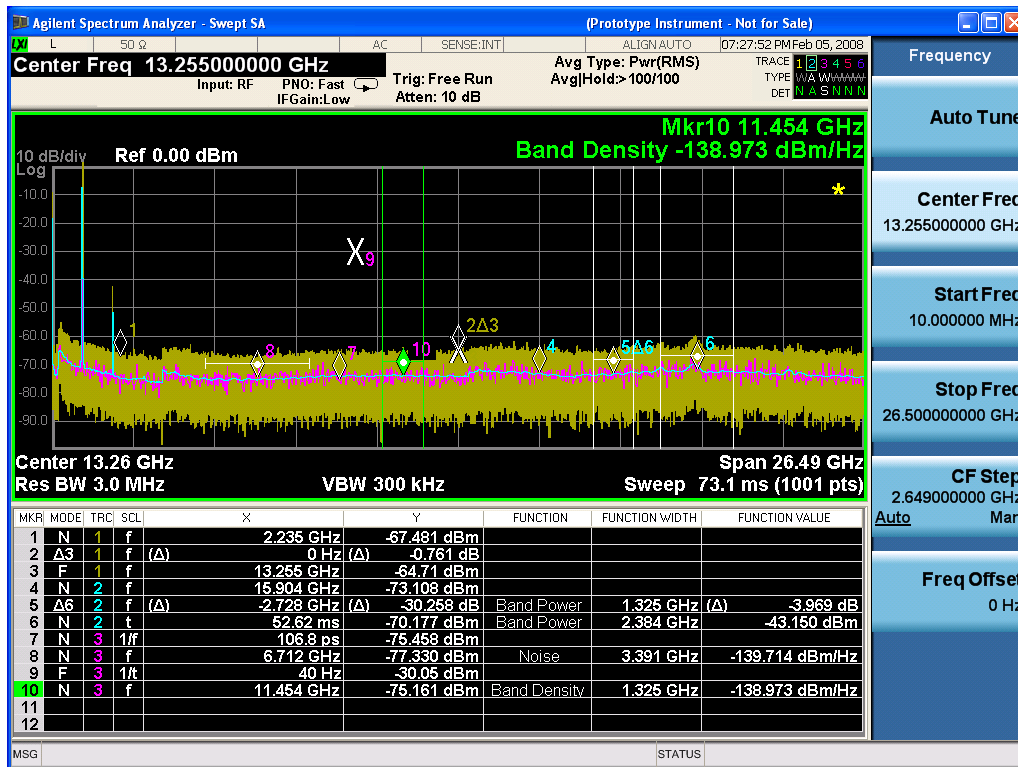

Then the Meas Results file, when opened, would show the following data:

MeasurementR
esult

Swept SA	
A.01.40_R0017	N9020A
526 B25 PFR P26 EA3	1
Result Type	Marker Table
Ref Level	0
Number of Points	1001
Sweep Time	0.0662666 67
Start Frequency	10000000
Stop Frequency	26500000 000
Average Count	0
Average Type	LogPower (Video)
RBW	3000000
RBW Filter	Gaussian
RBW Filter BW	3dB
VBW	3000000
Sweep Type	Swept
X Axis Scale	Lin
PreAmp State	Off
PreAmp Band	Low
Trigger Source	Free
Trigger Level	1.2
Trigger Slope	Positive
Trigger Delay	1.00E-06
Phase Noise Optimization	Fast
Swept If Gain	Low
FFT If Gain	Autorange
RF Coupling	AC
FFT Width	411900
Ext Ref	10000000
Input	RF
RF Calibrator	Off

Attenuation	10								
Ref Level Offset	0								
External Gain	0								
X Axis Units	Hz								
Y Axis Units	dBm								
DATA									
MKR	MODE	TR C	SCL	X	Y	FUNCTI ON	FUNCTIO N WIDTH	FUNCTI ON VALUE	FUNCTI ON UNIT
1	Normal	1	Freque ncy	2.2350E+ 09	- 67.4 81	Off	0.0000E+ 00	0	None
2	Delta3	1	Freque ncy	0.0000E+ 00	- 0.76 1	Off	0.0000E+ 00	0	None
3	Fixed	1	Freque ncy	1.3255E+ 10	- 64.7 1	Off	0.0000E+ 00	0	None
4	Normal	2	Freque ncy	1.5904E+ 10	- 73.1 08	Off	0.0000E+ 00	0	None
5	Delta7	2	Freque ncy	- 2.7280E+ 09	- 30.2 58	Band Power	1.3250E+ 06	-3.969	dB
6	Normal	2	Time	5.2620E- 02	- 70.1 77	Band Power	2.3840E+ 06	-43.15	dBm
7	Normal	3	Period	1.0680E- 10	- 75.4 58	Off	0.0000E+ 00	0	None
8	Normal	3	Freque ncy	6.7120E+ 09	- 77.3 3	Noise	3.3910E+ 06	- 139.71 4	dBm/Hz
9	Fixed	3	Inverse Time	4.0000E+ 01	- 30.0 5	Off	0.0000E+ 00	0	None
10	Normal	3	Freque ncy	1.1454E+ 10	- 75.1 61	Band Density	1.3250E+ 06	- 138.97 3	dBm/Hz
11	Off	1	Freque ncy	0.0000E+ 00	0	Off	0.0000E+ 00	0	None
12	Off	1	Freque ncy	0.0000E+ 00	0	Off	0.0000E+ 00	0	None

The numbers appear in the file exactly as they appear onscreen. If it says 11.454 GHz onscreen, then in the file it is 11.454E+09.

The metadata header is very similar to the metadata used in the trace data .csv files. See Trace File Contents. The only new information concerns the 1-of-N fields in the marker table itself.

Peak Table

This section discusses the Peak Table Meas Results file format.

Imagine that, at the point where a Marker Table Meas Result is requested, the following screen is showing:

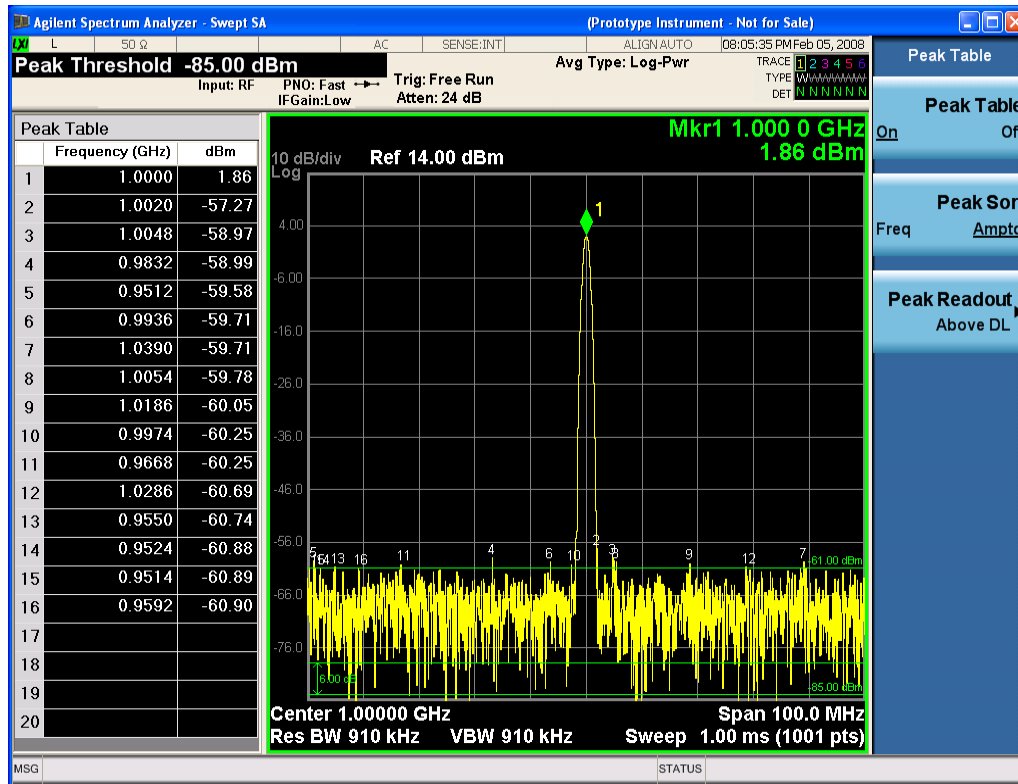

Then the Meas Results file, when opened, would show the header data (the same as for the Marker Table except that the Result Type is Peak Table) ending with a few fields of specific interest to Peak Table users:

- Peak Threshold
- Peak Threshold State (On|Off)
- Peak Excursion
- Peak Excursion State (On|Off)
- Display Line
- Peak Readout (All|AboveDL|BelowDL)
- Peak Sort (Freq|Amptd)

These fields are then followed by the data for the Peak Table itself.

Note that the label for the Frequency column changes to Time in 0 span.

Here is what the table for the above display looks like:

MeasurementResult	
Swept SA	
A.01.40_R0017	N9020A
526 B25 PFR P26 EA3	1
Result Type	Peak Table
Ref Level	0
Number of Points	1001
Sweep Time	0.066266667
Start Frequency	10000000
Stop Frequency	26500000000
Average Count	0
Average Type	LogPower(Video)
RBW	3000000
RBW Filter	Gaussian
RBW Filter BW	3dB
VBW	3000000
Sweep Type	Swept
X Axis Scale	Lin
PreAmp State	Off
PreAmp Band	Low
Trigger Source	Free
Trigger Level	1.2
Trigger Slope	Positive
Trigger Delay	1.00E-06
Phase Noise Optimization	Fast
Swept If Gain	Low
FFT If Gain	Autorange
RF Coupling	AC
FFT Width	411900
Ext Ref	10000000
Input	RF
RF Calibrator	Off
Attenuation	10
Ref Level Offset	0
External Gain	0

X Axis Units	Hz	
Y Axis Units	dBm	
Peak Threshold	-85	
Peak Threshold State	On	
Peak Excursion	6	
Peak Excursion State	On	
Display Line	-61	
Peak Readout	AboveDL	
Peak Sort	Amptd	
DATA		
Peak	Frequency	Amplitude
1	1.0000E+06	1.86
2	1.0020E+06	-57.27
3	1.0048E+06	-58.97
4	9.8320E+05	-58.99
5	9.5120E+05	-59.58
6	9.9360E+05	-59.71
7	1.0390E+06	-59.71
8	1.0054E+06	-59.78
9	1.1086E+06	-60.05
10	9.9740E+05	-60.25
11	9.6680E+05	-60.25
12	1.0286E+06	-60.69
13	9.5500E+05	-60.74
14	9.5240E+05	-60.88
15	9.5140E+05	-60.89
16	9.5920E+05	-60.90
17		
18		
19		
20		

Spectrogram

This section discusses the Spectrogram Results file format. The Spectrogram choice only appears if option EDP is licensed.

The Spectrogram results are the same as a Trace data export, except that instead of having just one trace's data, all 300 traces appear one after the other.

Each trace has its own data mark; the data for Spectrogram Trace 0 follows the row marked DATA, the data for Spectrogram Trace 1 follows the row marked DATA1, for Spectrogram Trace 2 follows the row marked DATA2, and so on.

Each DATA row has a timestamp in the second column (as of firmware revision A.11.01). So, for example, if Trace 0 had a relative start time of 1729.523 sec, then the first DATA row would look like this:

```
DATA,1729.523
```

And if Trace 13 had a relative start time of 100.45 sec, then the fourteenth data row would look like:

```
DATA13,100.453
```

To find the absolute time for the relative timestamps of each trace, the last row before the first DATA row gives the absolute start time of the Spectrogram, in the form YYYYMMDDHHMMSS

So, for example, if the absolute start time is 13:23:45:678 on January 30, 2012, this row would look like:

```
Start Time,20120130132345678
```

NOTE:

NOTE

The resolution of the absolute time stored is 1 ms, which matches up with the fact that the fastest sweep time is also 1 ms. However, there is no specification for the absolute accuracy of the clock in the analyzer, nor is there any facility provided to allow the user to set this time to any particular degree of accuracy.

Traces that have not yet been filled in the Spectrogram display are empty; there is no DATA header for them. The file ends after the last non-empty trace.

Imagine that, at the point where a Spectrogram Meas Result is requested, the following screen is showing:

12 Transmit On/Off Power Measurement Functions
 Save

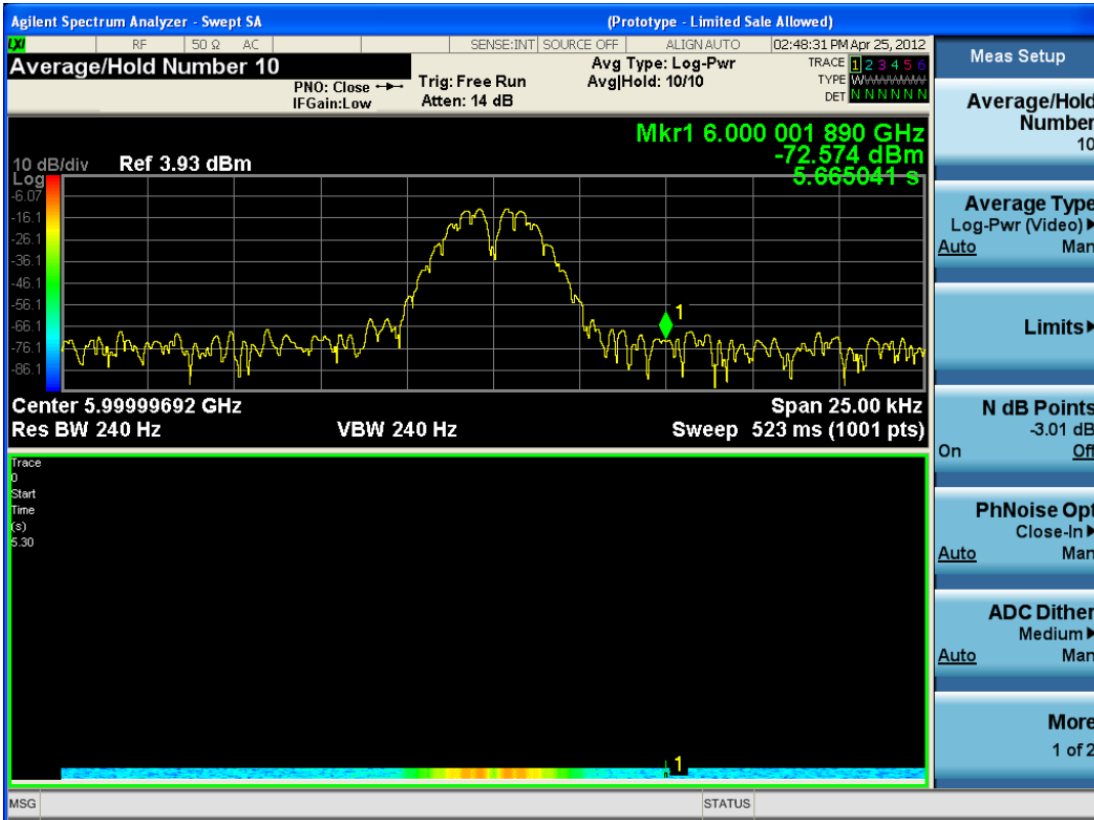

For the purpose of this example, we have set the Average/Hold Number to 10, thus we have only traces 0 thru 10. The Spectrogram was started at 02:28:08:700 pm on April 25, 2012 (that is, 700 ms after 2:28:08 pm), although the screen dump itself shows a different time, as it was taken ten minutes after the Spectrogram data. Trace 0 is showing a start time of 5.30 seconds, meaning 5.3 seconds after the Spectrogram started (trace 10 has a start time of 0, as it was the first trace taken but has now rolled up into the tenth trace slot).

The Meas Results file, when opened, shows the header data and ten traces of trace data. Below is an extract from the result file for the above display. Note the start time of 20120425142808700 showing in the last row before the first DATA row, and the relative time of 5.299231048 showing in the first DATA row:

Result Type	Spectrogram
MeasResult	
Swept SA	
A.11.00.01	N9020A
503 508 513 526 ALL ALV B1C B1X B25 B2X B40 BAB BBA CR3 CRP DP2 DRD EA3 EDP EMC EP1 ERC ESC ESP EXM FSA HBA K03 LFE MPB P03 P08 P13 P26 PFR RTL RTS S40 SB1 SEC SM1 UK6 YAS YAV	1
Segment	0

Result Type	Spectrogram
Number of Points	1001
Sweep Time	0.523333333
Start Frequency	5999984415
Stop Frequency	6000009415
Average Count	0
Average Type	LogPower(Video)
RBW	240
RBW Filter	Gaussian
RBW Filter BW	3dB
VBW	240
Sweep Type	Swept
X Axis Scale	Lin
PreAmp State	Off
PreAmp Band	Low
Trigger Source	Free
Trigger Level	1.2
Trigger Slope	Positive
Trigger Delay	0
Phase Noise Optimization	Wide
Swept If Gain	Low
FFT If Gain	Autorange
RF Coupling	AC
FFT Width	411900
Ext Ref	10000000
Input	RF
RF Calibrator	Off
Attenuation	14
Ref Level Offset	0
External Gain	0
Trace Type	Clearwrite
Detector	Normal
Trace Math	Off
Trace Math Oper1	Trace5
Trace Math Oper2	Trace6
Trace Math Offset	0
Trace Name	Trace1

Result Type	Spectrogram
X Axis Units	Hz
Y Axis Units	dBm
Start Time	20120425142808700
DATA	5.299231048
5999984415	-76.34749519
5999984440	-77.28097006
5999984465	-75.32317869
5999984490	-73.64417681
5999984515	-72.67154604

○
○
○

6000009315	-77.94423277
6000009340	-79.51829697
6000009365	-78.46108961
6000009390	-78.46108957
6000009415	-76.59570596
DATA2	4.708697055
5999984415	-80.98197882
5999984440	-80.98197879
5999984465	-75.83142132
5999984490	-74.02712079
5999984515	-73.57213005

○
○
○

6000009315	-75.9183103
6000009340	-79.53787488
6000009365	-78.82602191
6000009390	-78.82602188
6000009415	-76.37486709

DATA10	0
5999984415	-75.56751112
5999984440	-75.76485645
5999984465	-76.67718717
5999984490	-78.79238489
5999984515	-83.72680212

0
0
0

6000009315	-71.3942461
6000009340	-72.28308332
6000009365	-73.92684489
6000009390	-75.45548832
6000009415	-75.17904815

Save As . . .

When you press “Save As”, the analyzer brings up a Windows dialog and a menu entitled “**Save As.**” This menu allows you to navigate to the various fields in the Windows dialog without using a keyboard or mouse. The Tab and Arrow keys can also be used for dialog navigation.

See "[To File . . .](#)" on page 2413 in Save, State for a full description of this dialog and menu.

The default path for saving files is:

For all of the Trace Data Files:

My Documents\`<mode name>`\data\traces

For all of the Limit Data Files:

My Documents\`<mode name>`\data\limits

For all of the Measurement Results Data Files:

My Documents\`<mode name>`\data\`<measurement name>`\results

For all of the Capture Buffer Data Files:

My Documents\`<mode name>`\data\captureBuffer

Key Path	Save, Data
Mode	All

Notes	<p>The key location is mode-dependent and will vary.</p> <p>Brings up the Save As dialog for saving a <mode specific> Save Type. The save is performed immediately and does not wait until the measurement is complete.</p>
Initial S/W Revision	Prior to A.02.00

Screen Image

Pressing Screen Image accesses a menu of functions that enable you to specify a format and location for the saved screen image. It brings up a menu that allows you to specify the color scheme of the Screen Image (Themes) or navigate to the Save As dialog to perform the actual save.

Screen Image files contain an exact representation of the analyzer display. They cannot be loaded back onto the analyzer, but they can be loaded into your PC for use in many popular applications.

The image to be saved is actually captured when the Save front panel key is pressed, and kept in temporary storage to be used if you ask for a Screen Image save. When the Screen Image key is pressed, a "thumbnail" of the captured image is displayed, as shown below:

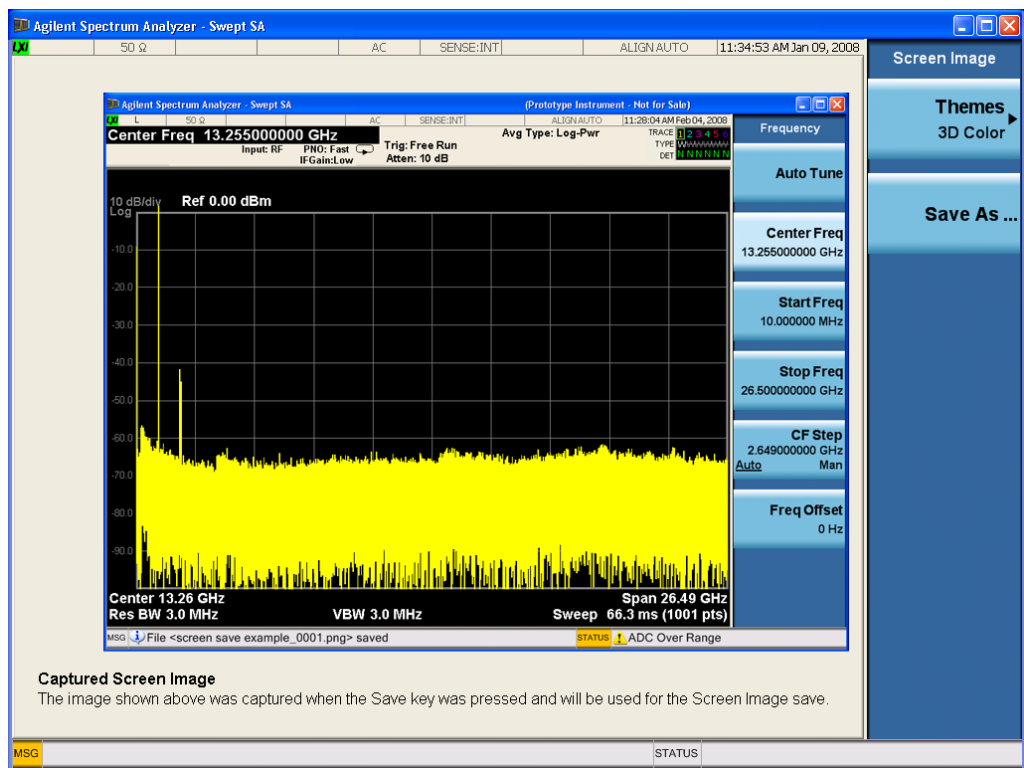

When you continue on into the Save As menu and complete the Screen Image save, the image depicted in the thumbnail is the one that gets saved, showing the menus that were on the screen before going into the Save menus. The save is performed immediately and does not wait until the measurement is complete.

After you have completed the save, the Quick Save front-panel key lets you quickly repeat the last save performed, using an auto-named file, with the current screen data.

NOTE

For versions previous to A.01.55, if you initiate a screen image save by navigating through the Save menus, the image that is saved will contain the Save menu softkeys, not the menus and the active function that were on the screen when you first pressed the Save front panel key.

Key Path	Save
Mode	All
Remote Command	:MMEMory:STORe:SCReen <filename>
Example	:MMEM:STOR:SCR "myScreen.png" This stores the current screen image in the file MyScreenFile.png in the default directory.
Initial S/W Revision	Prior to A.02.00

Themes

Accesses a menu of functions that enable you to choose the theme to be used when saving the screen image.

The **Themes** option is the same as the **Themes** option under the **Display** and **Page Setup** dialogs. It allows you to choose between themes to be used when saving the screen image.

Key Path	Save, Screen Image
Remote Command	:MMEMory:STORe:SCReen:THEMe TDColor TDMonochrome FColor FMONochrome :MMEMory:STORe:SCReen:THEMe?
Example	:MMEM:STOR:SCR:THEM TDM
Preset	3D Color; Is not part of Preset, but is reset by Restore Misc Defaults or Restore System Defaults All and survives subsequent running of the modes.
Readback	3D Color 3D Mono Flat Color Flat Mono
Backwards Compatibility Notes	In ESA and PSA we offer the choice of "Reverse Bitmap" or "Reverse Metafile" when saving screen images. This is much like the "Flat Color" theme available in X-Series. Also, if you selected Reverse Bitmap AND a black & white screen image, that would be much like "Flat Monochrome". In other words, each of the X-Series themes has a similar screen image type in ESA/PSA. But they are not identical.
Initial S/W Revision	Prior to A.02.00

3D Color

Selects a standard color theme with each object filled, shaded and colored as designed.

Key Path	Save, Screen Image, Themes
Example	MMEM:STOR:SCR:THEM TDC
Readback	3D Color
Initial S/W Revision	Prior to A.02.00

3D Monochrome

Selects a format that is like 3D color but shades of gray are used instead of colors.

Key Path	Save, Screen Image, Themes
Example	MMEM:STOR:SCR:THEM TDM
Readback	3D Mono
Initial S/W Revision	Prior to A.02.00

Flat Color

Selects a format that is best when the screen is to be printed on an ink printer.

Key Path	Save, Screen Image, Themes
Example	MMEM:STOR:SCR:THEM FCOL
Readback	Flat Color
Initial S/W Revision	Prior to A.02.00

Flat Monochrome

Selects a format that is like Flat Color. But only black is used (no colors, not even gray), and no fill.

Key Path	Save, Screen Image, Themes
Example	MMEM:STOR:SCR:THEM FMON
Readback	Flat Mono
Initial S/W Revision	Prior to A.02.00

Save As...

When you press "Save As", the analyzer brings up a Windows dialog and a menu entitled "**Save As.**" This menu allows you to navigate to the various fields in the Windows dialog without using a keyboard or mouse. The Tab and Arrow keys can also be used for dialog navigation.

See "[To File . . .](#)" on page 2413 in Save, State for a full description of this dialog and menu.

The default path for Screen Images is

My Documents\`<mode name>`\screen.

where `<mode name>` is the parameter used to select the mode with the INST:SEL command (for example, SA for the Spectrum Analyzer).

Key Path	Save, Screen Image
Notes	Brings up Save As dialog for saving a Screen Image Save Type
Initial S/W Revision	Prior to A.02.00

Single (Single Measurement/Sweep)

Sets the analyzer for Single measurement operation. The single/continuous state is Meas Global, so the setting will affect all the measurements. If you are Paused, pressing Single does a Resume.

See ["More Information" on page 1734](#)

Key Path	Front-panel key
Example	:INIT:CONT OFF
Notes	See Cont key description.
Backwards Compatibility Notes	<p>For Spectrum Analysis mode in ESA and PSA, the Single hardkey and the INITiate:IMM switched from continuous measurement to single measurement and restarted sweeps and averages (displayed average count reset to 1), but did not restart Max Hold and Min Hold. In the X-Series, the Single hardkey and the INITiate:IMM command initiate a sweep/ measurement/ average sequence/hold sequence including MaxHold and MinHold.</p> <p>For Spectrum Analysis mode in ESA and PSA, the Single hardkey restarted the sweep regardless of whether or not you were in an active sweep or sweep sequence. In the X-Series, Restart does this but Single only restarts the sweep or sweep sequence if you are in the idle state.</p> <p>INIT[:IMM] in ESA & PSA Spectrum Analysis Mode does an implied ABORT. In some other PSA Modes, INIT[:IMM] is ignored if not in the idle state. . The X-Series follows the ESA/PSA SA Mode model, which may cause some Modes to have compatibility problems.</p>
Initial S/W Revision	Prior to A.02.00

More Information

See ["Restart" on page 2410](#) for details on the INIT:IMMEDIATE (Restart) function.

If you are already in single sweep, the INIT:CONT OFF command has no effect.

If you are already in Single Sweep, then pressing the Single key in the middle of a sweep does not restart the sweep or sequence. Similarly, pressing the Single key does not restart the sweep or sequence if the sweep is not in the idle state (for example, if you are taking a very slow sweep, or the analyzer is waiting for a trigger). Instead, it results in a message. "Already in Single, press Restart to initiate a new sweep or sequence". Even though pressing the Single key in the middle of a sweep does not restart the sweep, sending INIT:IMMEDIATE does reset it.

To take one more sweep without resetting the average count, increment the average count by 1, by pressing the step up key while **Average/Hold Number** is the active function, or sending the remote command CALC:AVER:TCON UP.

Source

Opens a menu of keys that access various source configuration menus and settings. In the test set, pressing this key also causes the central view area to change and display the Source Control Main view.

Key Path	Front-panel key
----------	-----------------

RF Output

This parameter sets the source RF power output state.

Key Path	Source
Remote Command	:OUTPut[:EXTernal][:STATe] ON OFF 1 0 :OUTPut[:EXTernal][:STATe]?
Example	OUTP OFF OUTP?
Notes	<p>The EXTERNAL node is shown in RD text so the SCPI remains the same between internal and external source control. However, for EXT we do not wish to document this node to the customer since we are controlling the internal source rather than the external source.</p> <p>This setting is for the independent mode and has no effect on the "List Sequencer" on page 2520. If the "Sequencer" on page 2521 is set to ON, the list sequencer controls the source output and this key will be grayed-out. And this setting will be none-forceful grey out on front panel to indicate out-of-scope. Non-forceful means user still can change this setting by SCPI but cannot change on front panel. When set to OFF will make source leave list sequencer and this setting will be black out and take effect immediately.</p> <p>When the RF Output is ON, an "RF" annunciator is displayed in the system settings panel. When the RF Output is turned Off, the RF annunciator is cleared. If the "Sequencer" on page 2521 is set to ON, the "RF" annunciator will be replaced by "SEQ" in the system settings panel, indicating that the output is controlled by the list sequencer.</p>
Preset	Off
Range	On Off
Initial S/W Revision	A.05.00

Amplitude

Allows you to access the Amplitude sub-menu.

Key Path	Source
Notes	<p>The sub-menu under this button is for independent mode and has no effect on "List Sequencer" on page 2520. If the "Sequencer" on page 2521 is set to ON, the list sequencer controls the source output and this key will be grayed-out on front panel to indicate out-of-scope. When you set "Sequencer" on page 2521 to Off will make source leave list sequencer and this button will be black out.</p>
Initial S/W Revision	A.05.00

RF Power

Allows you to adjust the power level of the source using the numeric keypad, step keys, or RPG. Pressing any digit, 0 through 9, on the numeric keypad brings up the unit terminator.

Please refer to the ["RF Power Range " on page 1737](#) table below for the valid ranges.

Key Path	Source, Amplitude
Remote Command	:SOURce:POWer[:LEVel][:IMMediate][:AMPLitude] <ampl> :SOURce:POWer[:LEVel][:IMMediate][:AMPLitude]?
Example	:SOUR:POW -100 dBm
Notes	<p>Amplitude corrections can be specified for use with the source. In the event of amplitude corrections being applied, the valid ranges for the RF power do not change dependant on the current amplitude correction setting. If the combination of RF power + amplitude correction is higher or lower than the source output range, the Source Unleveled bit is set and the "Source Unleveled" indicator will appear on status panel to indicate that the source cannot maintain the output power that has been requested.</p> <p>When signal generator is unable to maintain the requested output level, the "Source Unleveled" indicator will appear on status panel. When the source output setting is restored to the normal range, the "Source Unleveled" is removed from status panel.</p> <p>Internal source has list sequence mode, which comprises of several steps which contain separate output power, frequency and waveform etc. When the source list sequence playing is complete, the last step keeps playing, and user can use this command to change the list sequence last step's output power.</p> <p>The multiport adapter RFIO TX ports and GPS ports cannot ensure power accuracy when power setting is lower than -130dBm, this power setting value is defined by the sum of RF Power setting and related amplitude correction value. But user settable value could be lower than this limit. When application detected there exists power setting lower than -130dBm on MPA RFIO TX ports, then popup warning message . When application detected there exists power setting lower than -130dBm on MPA GPS ports, then popup warning message . This is only warning message, and check is performed when RF is ON.</p>
Notes	The Min and Max value here defined UI settable amplitude range. This range is larger than actual amplitude range with level accuracy defined in spec.
Dependencies	The RF power is dependent on the RF output port and frequency, such that the current frequency and selected output port determine the valid range of power values.
Preset	-100 dBm
Min	The range of values depends on the current frequency and selected RF output port. Please refer to the "RF Power Range " on page 1737 table below for the valid ranges.
Max	The range of values depends on the current frequency and selected RF output port. Please refer to the "RF Power Range " on page 1737 table below for the valid ranges.
Initial S/W Revision	A.05.00

RF Power Range

RF Output Port	Frequency Range	Min Output Power	Max Output Power
High Power RF Out	10 MHz ≤ f ≤ 6 GHz	-150 dBm	20 dBm
RFIO 1 & RFIO 2	10 MHz ≤ f ≤ 6 GHz	-150 dBm	0 dBm
GPS (Note2)	10 MHz ≤ f ≤ 6 GHz	-150 dBm	0 dBm

Note: This is the UI power range, it's larger than actual spec.

Note2: GPS port is on the multiport adapter, or E6607C which has embedded MPA.

Set Reference Power

This key allows you to set the power reference. Pressing this key turns the power reference state to ON, sets the reference power value to the current RF output power, maintains this power at the RF output, and sets the displayed power to 0.00 dB. All subsequent RF power values entered under Source>Amplitude>RF Power are interpreted as being relative to this reference power.

When you use a power reference, the signal generator outputs an RF power that is set relative to the reference power by the value entered under Source>Amplitude>RF Power as follows:

Output power = reference power – entered power

Where:

reference power equals the original RF Power entered under Source>Amplitude>RF Power and set as the reference power

entered power equals a new value entered under Source>Amplitude>Amptd Offset

In addition, the displayed power value is the same as a new value entered under Source>Amplitude>RF Power.

NOTE

If Power Ref is set to ON with a reference value set, entering a value under Source>Amplitude>RF Power and pressing Set Reference Power will add that value to the existing Power Ref value.

If you wish to change the reference power value to a new value entered under Source>Amplitude>RF Power, first you must set Power Ref to OFF and then press Set Reference Power.

Key Path	Source, Amplitude
Dependencies	This key is unavailable, and is grayed out when the " List Sequencer " on page 2520 is turned ON.
Initial S/W Revision	A.05.00

Power Ref

This key allows you to toggle the state of the power reference.

When you use a power reference, the signal generator outputs an RF power that is set relative to the reference power by the value entered under Source>Amplitude>RF Power as follows:

Output power = reference power + entered power

Where:

reference power equals the original RF Power entered under Source>Amplitude>RF Power and set as the reference power

entered power equals a new value entered under Source>Amplitude>Amptd Offset

For more information on Reference Frequency refer to ["Set Reference Power " on page 2443](#)

Key Path	Source, Amplitude
Remote Command	:SOURce:POWer:REFeRence <ampl> :SOURce:POWer:REFeRence? :SOURce:POWer:REFeRence:STATe OFF ON 0 1 :SOURce:POWer:REFeRence:STATe?
Example	:SOUR:POW:REF 0.00 dBm :SOUR:POW:REF:STATe ON
Dependencies	This setting is unavailable and is grayed out when the "List Sequencer" on page 2520 is turned ON.
Couplings	This value is coupled to the "Set Reference Power " on page 2443 key such that pressing the Set Reference Power key updates the reference power with the current output power.
Preset	0.00 dBm OFF
Min	-125.00 dBm
Max	10.00 dBm
Initial S/W Revision	A.05.00

Amptd Offset

Allows you to specify the RF output power offset value.

When the amplitude offset is set to zero (0) and you set a new offset value (positive or negative), the displayed amplitude value will change as follows and the RF output power will not change:

Displayed value = output power + offset value

Where:

output power equals the original RF Power entered under Source>Amplitude>RF Power

offset value equals the value entered under Source>Amplitude>Amptd Offset

When the amplitude offset is set to a value other than zero (0) and you enter a new RF power value under Source>Amplitude>RF Power, the displayed power will be the same as the value entered and the RF output power will be equal to the value entered minus the offset value as follows:

Output power = entered power – offset power

Displayed Power = output power + offset power

Displayed power = entered power

Where:

entered power equals the amplitude entered under Source>Amplitude>RF Power

offset power equals the value previously entered and set under Source>Amplitude>Amptd Offset

Key Path	Source, Amplitude
Remote Command	:SOURce:POWer[:LEVel][:IMMediate]:OFFSet <rel_ampl> :SOURce:POWer[:LEVel][:IMMediate]:OFFSet?
Example	:SOUR:POW:OFFS 0.00 dB
Dependencies	This setting is unavailable, and is grayed out when the List Sequencer is turned ON.
Preset	0.00 dB
Min	-200.00 dB
Max	200.00 dB
Initial S/W Revision	A.05.00

Modulation

Allows you to toggle the state of the modulation.

Key Path	Source
Remote Command	:OUTPut:MODulation[:STATe] ON OFF 1 0 :OUTPut:MODulation[:STATe]?
Example	:OUTP:MOD OFF
Notes	This setting is for independent mode and has no effect on " List Sequencer " on page 2520. If the " Sequencer " on page 2521 is set to ON, the list sequencer controls the source output and this key will be grayed-out. And this setting will be none-forceful grey out on front panel to indicate out-of-scope. Non-forceful means user still can change this setting by SCPI but cannot change manually on front panel. When set to Off will make source leave list sequencer and this setting will be black out and take effect immediately. When the Modulation is ON, the "MOD" annunciator is displayed in the system settings panel. When the Modulation is turned Off, the "MOD" annunciator is cleared. If the " Sequencer " on page 2521 is set to ON, the "MOD" annunciator will be replaced by "SEQ" in the system settings panel indicating that the output is controlled by list sequencer.
Preset	Off
Range	On Off
Initial S/W Revision	A.05.00

Frequency

Allows you to access the Frequency sub-menu.

Key Path	Source
Notes	The sub-menu under this button is for independent mode and has no effect on " List Sequencer " on

[page 2520](#). If the **"Sequencer"** on [page 2521](#) is set to ON, the list sequencer controls the source output and this key will be grayed-out. And this button will be grey out on front panel to indicate out-of-scope. When set to Off will make source leave list sequencer and this button will be black out.

Initial S/W Revision A.05.00

Frequency

Allows you to set the RF Output Frequency. You can adjust the frequency of the source using the numeric keypad, step keys, or RPG. Pressing any digit, 0 through 9, on the numeric keypad brings up the unit terminator.

Key Path	Source, Frequency
Remote Command	:SOURce:FREQuency[:CW] <freq> :SOURce:FREQuency[:CW]?
Example	:SOUR:FREQ 1.00 GHz
Notes	Internal source has list sequence mode, which comprises of several steps which contain separate output power, frequency and waveform etc. When the source list sequence playing is complete, the last step keeps playing, and user can use this command to change the list sequence last step's output frequency.
Couplings	The frequency value is coupled to the current channel band and number, such that updates to the band and number will update the frequency value to the corresponding absolute frequency.
Preset	1.00 GHz If license F1A or 5WC is present, the default Center Frequency should be 2.412GHz.
Min	10.00 MHz
Max	Hardware Dependant: Option 503 = 3.6 GHz Option 504 = 3.8 GHz Option 506 = 6.00 GHz For E6640A, if license 5WC is present, the frequency range should be limited to: 1.1GHz–1.7GHz, 2.4GHz–2.5GHz, 4.8GHz–6.0GHz. If the user-defined frequency is outside of range, UI will report an error message called "Settings conflict; Frequency is outside available range".
Initial S/W Revision	A.05.00

Channel

The frequency of the source can be specified by a channel number of a given frequency band. This key allows you to specify the current channel number. For the appropriate range of channel numbers for a given frequency band, refer to the following tables: ["GSM/EDGE Channel Number Ranges" on page 1741](#), ["W-CDMA Channel Number Ranges" on page 1742](#), ["CDMA 2000 / 1xEVDO Channel Number Ranges" on page 1743](#), and ["LTE FDD Channel Number Ranges" on page 1745](#).

Key Path	Source, Frequency
Remote Command	:SOURce:FREQuency:CHANnels:NUMBer <int> :SOURce:FREQuency:CHANnels:NUMBer?
Example	:SOUR:FREQ:CHAN:NUMB 1
Notes	This key is grayed out when the "Radio Standard" on page 2455 is set to NONE. This key is grayed out on E6630A.
Dependencies	This key is grayed out when the "Radio Standard" on page 2455 is set to NONE. This key is grayed out on E6630A.
Couplings	The channel number is coupled to the frequency value when the "Radio Standard" on page 2455 is not set to NONE. When the frequency value is changed, the channel number will increase or decrease to match the new frequency. If the frequency is not at an exact match for a channel number, the nearest channel number is displayed along with a greater than or less than sign to indicate the frequency is above or below the channel number.
Preset	1
Min	Please refer to the tables below for the valid ranges.
Max	Please refer to the tables below for the valid ranges.
Initial S/W Revision	A.05.00

GSM/EDGE Channel Number Ranges

Band	Link (Device)	Range	Frequency (MHz)
P-GSM	Uplink (MS)	$1 \leq n \leq 124$	$890.0 + 0.2*n$
	Downlink (BS)	$1 \leq n \leq 124$	$935.0 + 0.2*n$
E-GSM	Uplink (MS)	$0 \leq n \leq 124$	$890.0 + 0.2*n$
		$975 \leq n \leq 1023$	$890.0 + 0.2*(n-1024)$
	Downlink (BS)	$0 \leq n \leq 124$	$935.0 + 0.2*n$
		$975 \leq n \leq 1023$	$935.0 + 0.2*(n-1024)$
DCS 1800	Uplink (MS)	$512 \leq n \leq 885$	$1710.200 + 0.20*(n-512)$
	Downlink (BS)	$512 \leq n \leq 885$	$1805.200 + 0.20*(n-512)$
PCS 1900	Uplink (MS)	$512 \leq n \leq 810$	$1850.200 + 0.2*(n-512)$
	Downlink (BS)	$512 \leq n \leq 810$	$1930.200 + 0.2*(n-512)$
R-GSM	Uplink (MS)	$0 \leq n \leq 124$	$890.0 + 0.2*n$
		$955 \leq n \leq 1023$	$890.0 + 0.2*(n-1024)$
	Downlink (BS)	$0 \leq n \leq 124$	$935.0 + 0.2*n$
		$955 \leq n \leq 1023$	$935.0 + 0.2*(n-1024)$
GSM 450	Uplink (MS)	$256 \leq n \leq 293$	$450.6 + 0.2*(n-259)$
	Downlink (BS)	$256 \leq n \leq 293$	$460.6 + 0.2*(n-259)$
GSM 480	Uplink (MS)	$306 \leq n \leq 340$	$479.000 + 0.20*(n-306)$

Band	Link (Device)	Range	Frequency (MHz)
GSM 850	Downlink (BS)	$306 \leq n \leq 340$	$489.000 + 0.20*(n-306)$
	Uplink (MS)	$128 \leq n \leq 251$	$824.200 + 0.20*(n-128)$
GSM 700	Downlink (BS)	$128 \leq n \leq 251$	$869.200 + 0.20*(n-128)$
	Uplink (MS)	$438 \leq n \leq 516$	$777.200 + 0.20*(n-438)$
T-GSM810	Downlink (BS)	$438 \leq n \leq 516$	$747.200 + 0.20*(n-438)$
	Uplink (MS)	$350 \leq n \leq 425$	$806.0 + 0.20*(n-350)$
	Downlink (BS)	$350 \leq n \leq 425$	$851.0 + 0.20*(n-350)$

W-CDMA Channel Number Ranges

Band	Link (Device)	Range	Frequency (MHz)
Band I	Downlink	$10562 \leq n \leq 10838$	$n \div 5$
	Uplink	$9612 \leq n \leq 9888$	$n \div 5$
Band II	Downlink	$412 \leq n \leq 687$	$n \div 5 + 1850.1$
		$9662 \leq n \leq 9938$	$n \div 5$
	Uplink	$12 \leq n \leq 287$	$n \div 5 + 1850.1$
Band III	Downlink	$350 \leq n \leq 425$	$n \div 5$
	Downlink	$1162 \leq n \leq 1513$	$n \div 5 + 1575$
Band IV	Uplink	$937 \leq n \leq 1288$	$n \div 5 + 1525$
	Downlink	$537 \leq n \leq 1738$	$n \div 5 + 1805$
Band V	Downlink	$1887 \leq n \leq 2087$	$n \div 5 + 1735.1$
		Uplink	$1312 \leq n \leq 1513$
	Downlink	$1662 \leq n \leq 1862$	$n \div 5 + 1380.1$
Band VI	Downlink	$1007 \leq n \leq 1087$	$n \div 5 + 670.1$
		$4357 \leq n \leq 4458$	$n \div 5$
	Uplink	$782 \leq n \leq 862$	$n \div 5 + 670.1$
Band VII	Downlink	$4132 \leq n \leq 4233$	$n \div 5$
		Downlink	$1037 \leq n \leq 1062$
	Uplink	$4387 \leq n \leq 4413$	$n \div 5$
Band VIII	Downlink	$812 \leq n \leq 837$	$n \div 5 + 670.1$
		$4162 \leq n \leq 4188$	$n \div 5$
	Downlink	$2237 \leq n \leq 2563$	$n \div 5 + 2175$
Band IX	Downlink	$2587 \leq n \leq 2912$	$n \div 5 + 2105.1$
		Uplink	$2012 \leq n \leq 2338$
Band X	Downlink	$2362 \leq n \leq 2687$	$n \div 5 + 2030.1$
		Downlink	$2937 \leq n \leq 3088$
	Uplink	$2712 \leq n \leq 2863$	$n \div 5 + 340$

Band	Link (Device)	Range	Frequency (MHz)
Band IX	Downlink	$9237 \leq n \leq 9387$	$n \div 5$
	Uplink	$8762 \leq n \leq 8912$	$n \div 5$
Band X	Downlink	$3112 \leq n \leq 3388$	$n \div 5 + 1490$
		$3412 \leq n \leq 3687$	$n \div 5 + 1430.1$
	Uplink	$2887 \leq n \leq 3163$	$n \div 5 + 1135$
		$3187 \leq n \leq 3462$	$n \div 5 + 1075.1$
Band XI	Downlink	$3712 \leq n \leq 3812$	$n \div 5 + 736$
	Uplink	$3487 \leq n \leq 3587$	$n \div 5 + 733$
Band XII	Downlink	$3837 \leq n \leq 3903$	$n \div 5 - 37$
		$3927 \leq n \leq 3992$	$n \div 5 - 54.9$
	Uplink	$3612 \leq n \leq 3678$	$n \div 5 - 22$
		$3702 \leq n \leq 3767$	$n \div 5 - 39.9$
Band XIII	Downlink	$4017 \leq n \leq 4043$	$n \div 5 - 55$
		$4067 \leq n \leq 4092$	$n \div 5 - 64.9$
	Uplink	$3792 \leq n \leq 3818$	$n \div 5 + 21$
		$3702 \leq n \leq 3767$	$n \div 5 - 39.9$
Band XIV	Downlink	$4117 \leq n \leq 4143$	$n \div 5 - 63$
		$4167 \leq n \leq 4192$	$n \div 5 - 72.9$
	Uplink	$3892 \leq n \leq 3918$	$n \div 5 + 12$
		$3942 \leq n \leq 3967$	$n \div 5 + 2.1$
Band XIX	Downlink	$712 \leq n \leq 763$	$n \div 5 + 735$
		$787 \leq n \leq 837$	$n \div 5 + 720.1$
	Uplink	$312 \leq n \leq 363$	$n \div 5 + 770$
		$387 \leq n \leq 437$	$n \div 5 + 755.1$

CDMA 2000 / 1xEVDO Channel Number Ranges

Band	Link (Device)	Range	Frequency (MHz)
US Cellular	Uplink (MS, reverse link)	$1 \leq N \leq 799$	$0.030 \times N + 825.000$
		$991 \leq N \leq 1023$	$0.030 \times (N - 1023) + 825.000$
		$1024 \leq N \leq 1323$	$0.030 \times (N - 1024) + 815.040$
	Downlink (BS, forward link)	$1 \leq N \leq 799$	$0.030 \times N + 870.000$
		$991 \leq N \leq 1023$	$0.030 \times (N - 1023) + 870.000$
		$1024 \leq N \leq 1323$	$0.030 \times (N - 1024) + 860.040$
US PCS	Uplink (MS, reverse link)	$0 \leq N \leq 1199$	$1850.000 + 0.050 \times N$
	Downlink (BS, forward link)	$0 \leq N \leq 1199$	$1930.000 + 0.050 \times N$

Band	Link (Device)	Range	Frequency (MHz)
Japan Cellular Band	Uplink (MS, reverse link)	$1 \leq N \leq 799$	$0.0125 \times (N + 915.000)$
		$801 \leq N \leq 1039$	$0.0125 \times (N - 800) + 898.000$
		$1041 \leq N \leq 1199$	$0.0125 \times (N - 1040) + 887.000$
		$1201 \leq N \leq 1600$	$0.0125 \times (N - 1200) + 893.000$
	Downlink (BS, forward link)	$1 \leq N \leq 799$	$0.0125 \times (N + 860.000)$
		$801 \leq N \leq 1039$	$0.0125 \times (N - 800) + 843.000$
		$1041 \leq N \leq 1199$	$0.0125 \times (N - 1040) + 832.000$
		$1201 \leq N \leq 1600$	$0.0125 \times (N - 1200) + 838.000$
Korean PCS Band	Uplink (MS, reverse link)	$0 \leq N \leq 599$	$0.050 \times N + 1750.000$
	Downlink (BS, forward link)	$0 \leq N \leq 599$	$0.050 \times N + 1840.000$
NMT-450 Band	Uplink (MS, reverse link)	$1 \leq N \leq 400$	$0.025 \times (N - 1) + 450.000$
		$472 \leq N \leq 871$	$0.025 \times (N - 472) + 410.000$
		$1039 \leq N \leq 1473$	$0.020 \times (N - 1024) + 451.010$
		$1536 \leq N \leq 1715$	$0.025 \times (N - 1536) + 479.000$
		$1792 \leq N \leq 2016$	$0.020 \times (N - 1792) + 479.000$
	Downlink (BS, forward link)	$1 \leq N \leq 400$	$0.025 \times (N - 1) + 460.000$
		$472 \leq N \leq 871$	$0.025 \times (N - 472) + 420.000$
		$1039 \leq N \leq 1473$	$0.020 \times (N - 1024) + 461.010$
IMT-2000 Band	Uplink (MS, reverse link)	$0 \leq N \leq 1199$	$1920.000 + 0.050 \times N$
	Downlink (BS, forward link)	$0 \leq N \leq 1199$	$2100.000 + 0.050 \times N$
Upper 700 MHz Band	Uplink (MS, reverse link)	$0 \leq N \leq 240$	$776.000 + 0.050 \times N$
	Downlink (BS, forward link)	$0 \leq N \leq 240$	$746.000 + 0.050 \times N$
Secondary 800 MHz Band	Uplink (MS, reverse link)	$0 \leq N \leq 719$	$0.025 \times N + 806.000$
		$720 \leq N \leq 919$	$0.025 \times (N - 720) + 896.000$
	Downlink (BS, forward link)	$0 \leq N \leq 719$	$0.025 \times N + 851.000$
		$720 \leq N \leq 919$	$0.025 \times (N - 720) + 935.000$
2.5 GHz IMT Extension	Uplink (MS, reverse link)	$0 \leq N \leq 1399$	$2500.000 + 0.050 \times N$
	Downlink (BS, forward link)	$0 \leq N \leq 1399$	$2620.000 + 0.050 \times N$
US PCS 1.9 GHz	Uplink (MS, reverse link)	$0 \leq N \leq 1299$	$1850.000 + 0.050 \times N$

Band	Link (Device)	Range	Frequency (MHz)
AWS	Downlink (BS, forward link)	$0 \leq N \leq 1299$	$1930.000 + 0.050 \times N$
	Uplink (MS, reverse link)	$0 \leq N \leq 899$	$1710.000 + 0.050 \times N$
US 2.5 GHz	Downlink (BS, forward link)	$0 \leq N \leq 899$	$2100.000 + 0.050 \times N$
	Uplink (MS, reverse link)	$140 \leq N \leq 1459$	$2495.000 + 0.050 \times N$
700 Public Safety	Downlink (BS, forward link)	$140 \leq N \leq 1459$	$2617.000 + 0.050 \times N$
	Uplink (MS, reverse link)	$0 \leq N \leq 240$	$787.000 + 0.050 \times N$
C2K Lower 700	Downlink (BS, forward link)	$0 \leq N \leq 240$	$757.000 + 0.050 \times N$
	Uplink (MS, reverse link)	$0 \leq N \leq 360$	$698.000 + 0.050 \times N$
400 Euro PAMR	Downlink (BS, forward link)	$0 \leq N \leq 360$	$728.000 + 0.050 \times N$
	Uplink (MS, reverse link)	$1 \leq N \leq 400$	$0.025 \times (N-1) + 450.000$
	Uplink (MS, reverse link)	$472 \leq N \leq 871$	$0.025 \times (N-472) + 410.000$
	Uplink (MS, reverse link)	$1536 \leq N \leq 1715$	$0.025 \times (N-1536) + 479.000$
	Downlink (BS, forward link)	$1 \leq N \leq 400$	$0.025 \times (N-1) + 460.000$
	Downlink (BS, forward link)	$472 \leq N \leq 871$	$0.025 \times (N-472) + 420.000$
	Downlink (BS, forward link)	$1536 \leq N \leq 1715$	$0.025 \times (N-1536) + 489.000$
	Downlink (BS, forward link)		
800 PAMR	Uplink (MS, reverse link)	$0 \leq N \leq 239$	$870.0125 + 0.025 \times N$
	Downlink (BS, forward link)	$0 \leq N \leq 239$	$915.0125 + 0.025 \times N$

LTE FDD Channel Number Ranges

The carrier frequency in the uplink and downlink is designated by the E-UTRA Absolute Radio Frequency Channel Number (EARFCN) in the range 0 – 65535. The relation between EARFCN and the carrier frequency in MHz for the downlink is given by the following equation, where FDL_low and NOffs-DL are given in table 5.4.4-1 and NDL is the downlink EARFCN.

$$FDL = FDL_low + 0.1(NDL - NOffs-DL)$$

The relation between EARFCN and the carrier frequency in MHz for the uplink is given by the following equation where FUL_low and NOffs-UL are given in table 5.4.4-1 and NUL is the uplink EARFCN.

$$FUL = FUL_low + 0.1(NUL - NOffs-UL)$$

Band	Downlink		Uplink			
	FDL_low (MHz)	NOffs-DL	Range of NDL	FUL_low (MHz)	NOffs-UL	Range of NUL
1		2110	0	0 - 599	1920	18000 - 18599
2		1930	600	600 - 1199	1850	18600 - 19199
3		1805	1200	1200 - 1949	1710	19200 - 19949
4		2110	1950	1950 - 2399	1710	19950 - 20399
5		869	2400	2400 - 2649	824	20400 - 20649
6		875	2650	2650 - 2749	830	20650 - 20749
7		2620	2750	2750 - 3449	2500	20750 - 20449
8		925	3450	3450 - 3799	880	21450 - 21799
9		1844.9	3800	3800 - 4149	1749.9	21800 - 22149
10		2110	4150	4150 - 4749	1710	22150 - 22749
11		1475.9	4750	4750 - 4949	1427.9	22750 - 22949
12		729	5010	5010 - 5179	699	23010 - 23179
13		746	5180	5180 - 5279	777	23180 - 23279
14		758	5280	5280 - 5379	788	23280 - 23379
...						
17		734	5730	5730 - 5849	704	23730 - 23849
18		860	5850	5850 - 5999	815	23850 - 23999
19		875	6000	6000 - 6149	830	24000 - 24149
20		791	6150	6150 - 6449	832	24150 - 24449
21		1495.9	6450	6450 - 6599	1447.9	24450 - 24599
...						
24		1525	7700	7700 - 8039	1626.5	25700 - 26039
25		1930	8040	8040 - 8689	1850	26040 - 26689
26		859	8690	8690 - 9039	814	26690 - 27039
...						

Note: The channel numbers that designate carrier frequencies so close to the operating band edges that the carrier extends beyond the operating band edge shall not be used. This implies that the first 7, 15, 25, 50, 75 and 100 channel numbers at the lower operating band edge and the last 6, 14, 24, 49, 74 and 99 channel numbers at the upper operating band edge shall not be used for channel bandwidths of 1.4, 3, 5, 10, 15 and 20 MHz respectively.

LTE TDD Channel Number Ranges

The carrier frequency in the uplink and downlink is designated by the E-UTRA Absolute Radio Frequency Channel Number (EARFCN) in the range 0 – 65535. The relation between EARFCN and the carrier frequency in MHz for the downlink is given by the following equation, where FDL_low and NOffs-DL are given in table 5.4.4-1 and NDL is the downlink EARFCN.

$$FDL = FDL_low + 0.1(NDL - NOffs-DL)$$

The relation between EARFCN and the carrier frequency in MHz for the uplink is given by the following equation where FUL_low and NOffs-UL are given in table 5.4.4-1 and NUL is the uplink EARFCN.

$$FUL = FUL_low + 0.1(NUL - NOffs-UL)$$

Band	Downlink	Uplink			
FDL_low (MHz)	NOffs-DL	Range of NDL	FUL_low (MHz)	NOffs-UL	Range of NUL
33	1900	36000	36000 – 36199	1900	36000 – 36199
34	2010	36200	36200 – 36349	2010	36200 – 36349
35	1850	36350	36350 – 36949	1850	36350 – 36949
36	1930	36950	36950 – 37549	1930	36950 – 37549
37	1910	37550	37550 – 37749	1910	37550 – 37749
38	2570	37750	37750 – 38249	2570	37750 – 38249
39	1880	38250	38250 – 38649	1880	38250 – 38649
40	2300	38650	38650 – 39649	2300	38650 – 39649
41	2496	39650	39650 – 41589	2496	39650 – 41589
42	3400	41590	41590 – 43589	3400	41590 – 43589
43	3600	43590	43590 – 45589	3600	43590 – 45589

Note: The channel numbers that designate carrier frequencies so close to the operating band edges that the carrier extends beyond the operating band edge shall not be used. This implies that the first 7, 15, 25, 50, 75 and 100 channel numbers at the lower operating band edge and the last 6, 14, 24, 49, 74 and 99 channel numbers at the upper operating band edge shall not be used for channel bandwidths of 1.4, 3, 5, 10, 15 and 20 MHz respectively.

TDSCDMA Channel Number Ranges

1.28 Mcps TDD Option

No TX-RX frequency separation is required as Time Division Duplex (TDD) is employed. Each subframe consists of 7 main timeslots where all main timeslots (at least the first one) before the single switching point are allocated DL and all main timeslots (at least the last one) after the single switching point are allocated UL.

The nominal channel spacing is 1.6 MHz, but this can be adjusted to optimise performance in a particular deployment scenario.

The carrier frequency is designated by the UTRA absolute radio frequency channel number (UARFCN). The value of the UARFCN in the IMT2000 band is defined in the general case as follows:

$$N_t = 5 * F \quad 0.0 \text{ MHz} \leq F \leq 3276.6 \text{ MHz}$$

where F is the carrier frequency in MHz

Additional channels applicable to operation in the frequency band defined in sub-clause 5.2(d) are defined via the following UARFCN definition:

$$N_t = 5 * (F - 2150.1 \text{ MHz}) \quad 2572.5 \text{ MHz} \leq F \leq 2617.5 \text{ MHz}$$

UARFCN

1.28 Mcps TDD Option

The following UARFCN range shall be supported for each band:

**Table: UTRA Absolute Radio
Frequency Channel Number 1.28
Mcps TDD Option**

Frequency Band	Frequency Range	UARFCN Uplink and Downlink transmission
For operation in frequency band as defined in subclause 5.2 (a)	1900–1920 MHz	9504 to 9596
	2010–2025 MHz	10054 to 10121
For operation in frequency band as defined in subclause 5.2 (b)	1850–1910 MHz	9254 to 9546
	1930–1990 MHz	9654 to 9946
For operation in frequency band as defined in subclause 5.2 (c)	1910–1930 MHz	9554 to 9646
For operation in frequency band as defined in subclause 5.2 (d)	2570–2620 MHz	12854 to 13096
For operation in frequency band as defined in subclause 5.2 (e)	2300–2400 MHz	11504 to 11996
For operation in frequency band as defined in subclause 5.2 (f)	1880–1920 MHz	9404 to 9596

Radio Setup

Allows access to the sub-menus for selecting the radio standard and associated radio band. You can also set a frequency reference and offset.

This menu is greyed out when on E6630A. Radio band settings for GSM, cdma2000, and so on -- most of which are not actually supported in E6630A, which has three narrow frequency bands. So band settings are grayed out.

Key Path	Source, Frequency
Initial S/W Revision	A.05.00

Radio Standard

Allows access to the channel band sub-menus to select the desired radio standard. When you have selected the radio standard, you can then set an active channel band. The radio standard and the active channel band allow you to use channel numbers to set frequency automatically.

Key Path	Source, Frequency, Radio Setup
Remote Command	:SOURce:FREQuency:CHANnels:BAND NONE PGSM EGSM RGSM DCS1800 PCS1900 TGSM810 GSM450 GSM480 GSM700 GSM850 BANDI BANDII BANDIII BANDIV BANDV BANDVI BANDVII BANDVIII BANDIX BANDX BANDXI BANDXII BANDXIII BANDXIV BANDXIX USCELL USPCS JAPAN KOREAN NMT IMT2K UPPER SECOND PAMR400 PAMR800 IMTEXT PCS1DOT9G AWS US2DOT5G PUBLIC LOWER BAND1 BAND2 BAND3 BAND4 BAND5 BAND6 BAND7 BAND8 BAND10 BAND11 BAND12 BAND13 BAND14 BAND17 BAND18 BAND19 BAND20 BAND21 BAND24 BAND25 BAND26 BAND27 BAND28 BAND31 BAND33 BAND34 BAND35 BAND36 BAND37 BAND38 BAND39 BAND40 BAND41 BAND42 BAND43 BAND44 BANDA BANDB BANDC BANDD BANDE BANDF :SOURce:FREQuency:CHANnels:BAND?
Example	:SOUR:FREQ:CHAN:BAND PGSM
Notes	Set this setting to "NONE" will grey out "Channel" on page 2446 Channel
Initial S/W Revision	A.05.00

None

Selects no radio standard for use. When you have selected the radio standard to NONE, you cannot use channel numbers to set frequency automatically. You will need to set the frequency manually.

Key Path	Source, Frequency, Radio Setup, Radio Standard
Initial S/W Revision	A.05.00

GSM/EDGE

Sets GSM/EDGE as the radio standard for use and accesses the GSM/EDGE specific channel band sub-menus.

Key Path	Source, Frequency, Radio Setup, Radio Standard
Initial S/W Revision	A.05.00

P-GSM

Selects P-GSM as the active channel band.

Key Path	Source, Frequency, Radio Setup, Radio Standard, GSM/EDGE
Example	:SOUR:FREQ:CHAN:BAND PGSM
Initial S/W Revision	A.05.00

E-GSM

Selects E-GSM as the active channel band.

Key Path	Source, Frequency, Radio Setup, Radio Standard, GSM/EDGE
Example	:SOUR:FREQ:CHAN:BAND EGSM
Initial S/W Revision	A.05.00

R-GSM

Selects R-GSM as the active channel band.

Key Path	Source, Frequency, Radio Setup, Radio Standard, GSM/EDGE
Example	:SOUR:FREQ:CHAN:BAND RGSM
Initial S/W Revision	A.05.00

DCS 1800

Selects DCS 1800 as the active channel band.

Key Path	Source, Frequency, Radio Setup, Radio Standard, GSM/EDGE
Example	:SOUR:FREQ:CHAN:BAND DCS1800
Initial S/W Revision	A.05.00

PCS 1900

Selects PCS 1900 as the active channel band.

Key Path	Source, Frequency, Radio Setup, Radio Standard, GSM/EDGE
Example	:SOUR:FREQ:CHAN:BAND PCS1900
Initial S/W Revision	A.05.00

GSM 450

Selects GSM 450 as the active channel band.

Key Path	Source, Frequency, Radio Setup, Radio Standard, GSM/EDGE
Example	:SOUR:FREQ:CHAN:BAND GSM450
Initial S/W Revision	A.05.00

GSM 480

Selects GSM 480 as the active channel band.

Key Path	Source, Frequency, Radio Setup, Radio Standard, GSM/EDGE
Example	:SOUR:FREQ:CHAN:BAND GSM480
Initial S/W Revision	A.05.00

GSM 850

Selects GSM 850 as the active channel band.

Key Path	Source, Frequency, Radio Setup, Radio Standard, GSM/EDGE
Example	:SOUR:FREQ:CHAN:BAND GSM850
Initial S/W Revision	A.05.00

GSM 700

Selects GSM 700 as the active channel band.

Key Path	Source, Frequency, Radio Setup, Radio Standard, GSM/EDGE
Example	:SOUR:FREQ:CHAN:BAND GSM700
Initial S/W Revision	A.05.00

T-GSM 810

Selects T-GSM 810 as the active channel band.

Key Path	Source, Frequency, Radio Setup, Radio Standard, GSM/EDGE
Example	:SOUR:FREQ:CHAN:BAND T-GSM810
Initial S/W Revision	A.05.00

WCDMA

Sets WCDMA as the radio standard for use and accesses the W-CDMA specific channel band sub-menus.

Key Path	Source, Frequency, Radio Setup, Radio Standard
Initial S/W Revision	A.05.00

Band I

Selects Band I as the active channel band.

Key Path	Source, Frequency, Radio Setup, Radio Standard, WCDMA
Example	:SOUR:FREQ:CHAN:BAND BANDI
Initial S/W Revision	A.05.00

Band II

Selects Band II as the active channel band.

Key Path	Source, Frequency, Radio Setup, Radio Standard, WCDMA
Example	:SOUR:FREQ:CHAN:BAND BANDII
Initial S/W Revision	A.05.00

Band III

Selects Band III as the active channel band.

Key Path	Source, Frequency, Radio Setup, Radio Standard, WCDMA
Example	:SOUR:FREQ:CHAN:BAND BANDIII
Initial S/W Revision	A.05.00

Band IV

Selects Band IV as the active channel band.

Key Path	Source, Frequency, Radio Setup, Radio Standard, WCDMA
Example	:SOUR:FREQ:CHAN:BAND BANDIV
Initial S/W Revision	A.05.00

Band V

Selects Band V as the active channel band.

Key Path	Source, Frequency, Radio Setup, Radio Standard, WCDMA
Example	:SOUR:FREQ:CHAN:BAND BANDV
Initial S/W Revision	A.05.00

Band VI

Selects Band VI as the active channel band.

Key Path	Source, Frequency, Radio Setup, Radio Standard, WCDMA
Example	:SOUR:FREQ:CHAN:BAND BANDVI
Initial S/W Revision	A.05.00

Band VII

Selects Band VII as the active channel band.

Key Path	Source, Frequency, Radio Setup, Radio Standard, WCDMA
Example	:SOUR:FREQ:CHAN:BAND BANDVII
Initial S/W Revision	A.05.00

Band VIII

Selects Band VIII as the active channel band.

Key Path	Source, Frequency, Radio Setup, Radio Standard, WCDMA
Example	:SOUR:FREQ:CHAN:BAND BANDVIII
Initial S/W Revision	A.05.00

Band IX

Selects Band IX as the active channel band.

Key Path	Source, Frequency, Radio Setup, Radio Standard, WCDMA
Example	:SOUR:FREQ:CHAN:BAND BANDIX
Initial S/W Revision	A.05.00

Band X

Selects Band X as the active channel band.

Key Path	Source, Frequency, Radio Setup, Radio Standard, WCDMA
Example	:SOUR:FREQ:CHAN:BAND BANDX
Initial S/W Revision	A.05.00

Band XI

Selects Band XI as the active channel band.

Key Path	Source, Frequency, Radio Setup, Radio Standard, WCDMA
Example	:SOUR:FREQ:CHAN:BAND BANDXI
Initial S/W Revision	A.05.00

Band XII

Selects Band XII as the active channel band.

Key Path	Source, Frequency, Radio Setup, Radio Standard, WCDMA
Example	:SOUR:FREQ:CHAN:BAND BANDXII
Initial S/W Revision	A.05.00

Band XIII

Selects band XIII as the active channel band.

Key Path	Source, Frequency, Radio Setup, Radio Standard, WCDMA
Example	:SOUR:FREQ:CHAN:BAND BANDXIII
Initial S/W Revision	A.05.00

Band XIV

Selects Band XIV as the active channel band.

Key Path	Source, Frequency, Radio Setup, Radio Standard, WCDMA
Example	:SOUR:FREQ:CHAN:BAND BANDXIV
Initial S/W Revision	A.05.00

Band XIX

Selects Band XIX as the active channel band.

Key Path	Source, Frequency, Radio Setup, Radio Standard, WCDMA
Example	:SOUR:FREQ:CHAN:BAND BANDXIX
Initial S/W Revision	A.14.50

CDMA 2000 / 1xEVDO

Sets CDMA 2000 / 1xEVDO as the radio standard for use and accesses the CDMA 2000/1xEVDO specific channel band sub-menus.

Key Path	Source, Frequency, Radio Setup, Radio Standard
Initial S/W Revision	A.05.00

US CELL

Selects US Cell as the active channel band.

Key Path	Source, Frequency, Radio Setup, Radio Standard, CDMA 2000 / 1xEVDO
Example	:SOUR:FREQ:CHAN:BAND USCELL
Initial S/W Revision	A.05.00

US PCS

Selects US PCS as the active channel band.

Key Path	Source, Frequency, Radio Setup, Radio Standard, CDMA 2000 / 1xEVDO
Example	:SOUR:FREQ:CHAN:BAND PCS
Initial S/W Revision	A.05.00

Japan Cell

Selects Japan Cell as the active channel band.

Key Path	Source, Frequency, Radio Setup, Radio Standard, CDMA 2000 / 1xEVDO
Example	:SOUR:FREQ:CHAN:BAND JAPAN
Initial S/W Revision	A.05.00

Korean PCS

Selects Korean PCS as the active channel band.

Key Path	Source, Frequency, Radio Setup, Radio Standard, CDMA 2000 / 1xEVDO
Example	:SOUR:FREQ:CHAN:BAND KOREAN
Initial S/W Revision	A.05.00

NMT 450

Selects NMT 450 as the active channel band.

Key Path	Source, Frequency, Radio Setup, Radio Standard, CDMA 2000 / 1xEVDO
----------	--

Example	:SOUR:FREQ:CHAN:BAND NMT
Initial S/W Revision	A.05.00

IMT 2000

Selects IMT 2000 as the active channel band.

Key Path	Source, Frequency, Radio Setup, Radio Standard, CDMA 2000 / 1xEVDO
Example	:SOUR:FREQ:CHAN:BAND IMT2K
Initial S/W Revision	A.05.00

Upper 700

Selects Upper 700 as the active channel band.

Key Path	Source, Frequency, Radio Setup, Radio Standard, CDMA 2000 / 1xEVDO
Example	:SOUR:FREQ:CHAN:BAND UPPER
Initial S/W Revision	A.05.00

Secondary 800

Selects Secondary 800 as the active channel band.

Key Path	Source, Frequency, Radio Setup, Radio Standard, CDMA 2000 / 1xEVDO
Example	:SOUR:FREQ:CHAN:BAND SECOND
Initial S/W Revision	A.05.00

400 Euro PAMR

Selects 400 Euro PAMR as the active channel band.

Key Path	Source, Frequency, Radio Setup, Radio Standard, CDMA 2000 / 1xEVDO
Example	:SOUR:FREQ:CHAN:BAND PAMR400
Initial S/W Revision	A.05.00

800 PAMR

Selects 800 PAMR as the active channel band.

Key Path	Source, Frequency, Radio Setup, Radio Standard, CDMA 2000 / 1xEVDO
----------	--

Example	:SOUR:FREQ:CHAN:BAND PAMR800
Initial S/W Revision	A.05.00

2.5GHz IMT EXT

Selects 2.5 GHz IMT EXT as the active channel band.

Key Path	Source, Frequency, Radio Setup, Radio Standard, CDMA 2000 / 1xEVDO
Example	:SOUR:FREQ:CHAN:BAND IMTEXT
Initial S/W Revision	A.05.00

US PCS 1.9GHz

Selects US PCS 1.9 GHz as the active channel band.

Key Path	Source, Frequency, Radio Setup, Radio Standard, CDMA 2000 / 1xEVDO
Example	:SOUR:FREQ:CHAN:BAND PCS1DOT9G
Initial S/W Revision	A.05.00

AWS

Selects AWS as the active channel band.

Key Path	Source, Frequency, Radio Setup, Radio Standard, CDMA 2000 / 1xEVDO
Example	:SOUR:FREQ:CHAN:BAND AWS
Initial S/W Revision	A.05.00

US 2.5GHz

Selects US 2.5 GHz as the active channel band.

Key Path	Source, Frequency, Radio Setup, Radio Standard, CDMA 2000 / 1xEVDO
Example	:SOUR:FREQ:CHAN:BAND US2DOT5G
Initial S/W Revision	A.05.00

700 Public Safety

Selects 700 Public Safety as the active channel band.

Key Path	Source, Frequency, Radio Setup, Radio Standard, CDMA 2000 / 1xEVDO
----------	--

Example	:SOUR:FREQ:CHAN:BAND PUBLIC
Initial S/W Revision	A.05.00

C2K Lower 700

Selects C2K Lower 700 as the active channel band.

Key Path	Source, Frequency, Radio Setup, Radio Standard, CDMA 2000 / 1xEVDO
Example	:SOUR:FREQ:CHAN:BAND LOWER
Initial S/W Revision	A.05.00

LTE

Sets LTE FDD as the radio standard for use and accesses the LTE FDD specific channel band sub-menus..

Key Path	Source, Frequency, Radio Setup, Radio Standard
Initial S/W Revision	A.09.50

BAND 1

Selects BAND 1 as the band for the current step.

Key Path	Source, Frequency, Radio Setup, Radio Standard, LTE
Example	:SOUR:FREQ:CHAN:BAND BAND1
Initial S/W Revision	A.09.50

BAND 2

Selects BAND 2 as the band for the current step.

Key Path	Source, Frequency, Radio Setup, Radio Standard, LTE
Example	:SOUR:FREQ:CHAN:BAND BAND2
Initial S/W Revision	A.09.50

BAND 3

Selects BAND 3 as the band for the current step.

Key Path	Source, Frequency, Radio Setup, Radio Standard, LTE
Example	:SOUR:FREQ:CHAN:BAND BAND3
Initial S/W Revision	A.09.50

BAND 4

Selects BAND 4 as the band for the current step.

Key Path	Source, Frequency, Radio Setup, Radio Standard, LTE
Example	:SOUR:FREQ:CHAN:BAND BAND4
Initial S/W Revision	A.09.50

BAND 5

Selects BAND 5 as the band for the current step.

Key Path	Source, Frequency, Radio Setup, Radio Standard, LTE
Example	:SOUR:FREQ:CHAN:BAND BAND5
Initial S/W Revision	A.09.50

BAND 6

Selects BAND 6 as the band for the current step.

Key Path	Source, Frequency, Radio Setup, Radio Standard, LTE
Example	:SOUR:FREQ:CHAN:BAND BAND6
Initial S/W Revision	A.09.50

BAND 7

Selects BAND 7 as the band for the current step.

Key Path	Source, Frequency, Radio Setup, Radio Standard, LTE
Example	:SOUR:FREQ:CHAN:BAND BAND7
Initial S/W Revision	A.09.50

BAND 8

Selects BAND 8 as the band for the current step.

Key Path	Source, Frequency, Radio Setup, Radio Standard, LTE
Example	:SOUR:FREQ:CHAN:BAND BAND8
Initial S/W Revision	A.09.50

BAND 9

Selects BAND 9 as the band for the current step.

Key Path	Source, Frequency, Radio Setup, Radio Standard, LTE
Example	:SOUR:FREQ:CHAN:BAND BAND9
Initial S/W Revision	A.09.50

BAND 10

Selects BAND 10 as the band for the current step.

Key Path	Source, Frequency, Radio Setup, Radio Standard, LTE
Example	:SOUR:FREQ:CHAN:BAND BAND10
Initial S/W Revision	A.09.50

BAND 11

Selects BAND 11 as the band for the current step.

Key Path	Source, Frequency, Radio Setup, Radio Standard, LTE
Example	:SOUR:FREQ:CHAN:BAND BAND11
Initial S/W Revision	A.09.50

BAND 12

Selects BAND 12 as the band for the current step.

Key Path	Source, Frequency, Radio Setup, Radio Standard, LTE
Example	:SOUR:FREQ:CHAN:BAND BAND12
Initial S/W Revision	A.09.50

BAND 13

Selects BAND 13 as the band for the current step.

Key Path	Source, Frequency, Radio Setup, Radio Standard, LTE
Example	:SOUR:FREQ:CHAN:BAND BAND13
Initial S/W Revision	A.09.50

BAND 14

Selects BAND 14 as the band for the current step.

Key Path	Source, Frequency, Radio Setup, Radio Standard, LTE
Example	:SOUR:FREQ:CHAN:BAND BAND14
Initial S/W Revision	A.09.50

BAND 17

Selects BAND 17 as the band for the current step.

Key Path	Source, Frequency, Radio Setup, Radio Standard, LTE
Example	:SOUR:FREQ:CHAN:BAND BAND17
Initial S/W Revision	A.09.50

BAND 18

Selects BAND 18 as the band for the current step.

Key Path	Source, Frequency, Radio Setup, Radio Standard, LTE
Example	:SOUR:FREQ:CHAN:BAND BAND18
Initial S/W Revision	A.09.50

BAND 19

Selects BAND 19 as the band for the current step.

Key Path	Source, Frequency, Radio Setup, Radio Standard, LTE
Example	:SOUR:FREQ:CHAN:BAND BAND19
Initial S/W Revision	A.09.50

BAND 20

Selects BAND 20 as the band for the current step.

Key Path	Source, Frequency, Radio Setup, Radio Standard, LTE
Example	:SOUR:FREQ:CHAN:BAND BAND20
Initial S/W Revision	A.09.50

BAND 21

Selects BAND 21 as the band for the current step.

Key Path	Source, Frequency, Radio Setup, Radio Standard, LTE
Example	:SOUR:FREQ:CHAN:BAND BAND21
Initial S/W Revision	A.09.50

BAND 24

Selects BAND 24 as the band for the current step.

Key Path	Source, Frequency, Radio Setup, Radio Standard, LTE
Example	:SOUR:FREQ:CHAN:BAND BAND24
Initial S/W Revision	A.09.50

BAND 25

Selects BAND 25 as the band for the current step.

Key Path	Source, Frequency, Radio Setup, Radio Standard, LTE
Example	:SOUR:FREQ:CHAN:BAND BAND25
Initial S/W Revision	A.09.50

BAND 26

Selects BAND 26 as the band for the current step.

Key Path	Source, Frequency, Radio Setup, Radio Standard, LTE
Example	:SOUR:FREQ:CHAN:BAND BAND26
Initial S/W Revision	A.12.53

BAND 27

Selects BAND 27 as the band for the current step.

Key Path	Source, Frequency, Radio Setup, Radio Standard, LTE
Example	:SOUR:FREQ:CHAN:BAND BAND27
Initial S/W Revision	A.14.00

BAND 28

Selects BAND 28 as the band for the current step.

Key Path	Source, Frequency, Radio Setup, Radio Standard, LTE
Example	:SOUR:FREQ:CHAN:BAND BAND28
Initial S/W Revision	A.14.00

BAND 31

Selects BAND 31 as the band for the current step.

Key Path	Source, Frequency, Radio Setup, Radio Standard, LTE
Example	:SOUR:FREQ:CHAN:BAND BAND31
Initial S/W Revision	A.14.00

LTE TDD

Sets LTE TDD as the radio standard for use and accesses the LTE TDD specific channel band sub-menus..

Key Path	Source, Frequency, Radio Setup, Radio Standard
Initial S/W Revision	A.11.50

BAND 33

Selects BAND 33 as the band for the current step.

Key Path	Source, Frequency, Radio Setup, Radio Standard, LTE TDD
Example	:SOUR:FREQ:CHAN:BAND BAND33
Initial S/W Revision	A.11.50

BAND 34

Selects BAND 34 as the band for the current step.

Key Path	Source, Frequency, Radio Setup, Radio Standard, LTE TDD
Example	:SOUR:FREQ:CHAN:BAND BAND34
Initial S/W Revision	A.11.50

BAND 35

Selects BAND 35 as the band for the current step.

Key Path	Source, Frequency, Radio Setup, Radio Standard, LTE TDD
Example	:SOUR:FREQ:CHAN:BAND BAND35
Initial S/W Revision	A.11.50

BAND 36

Selects BAND 36 as the band for the current step.

Key Path	Source, Frequency, Radio Setup, Radio Standard, LTE TDD
Example	:SOUR:FREQ:CHAN:BAND BAND36
Initial S/W Revision	A.11.50

BAND 37

Selects BAND 37 as the band for the current step.

Key Path	Source, Frequency, Radio Setup, Radio Standard, LTE TDD
Example	:SOUR:FREQ:CHAN:BAND BAND37
Initial S/W Revision	A.11.50

BAND 38

Selects BAND 38 as the band for the current step.

Key Path	Source, Frequency, Radio Setup, Radio Standard, LTE TDD
Example	:SOUR:FREQ:CHAN:BAND BAND38
Initial S/W Revision	A.11.50

BAND 39

Selects BAND 39 as the band for the current step.

Key Path	Source, Frequency, Radio Setup, Radio Standard, LTE TDD
Example	:SOUR:FREQ:CHAN:BAND BAND39
Initial S/W Revision	A.11.50

BAND 40

Selects BAND 40 as the band for the current step.

Key Path	Source, Frequency, Radio Setup, Radio Standard, LTE TDD
Example	:SOUR:FREQ:CHAN:BAND BAND40
Initial S/W Revision	A.11.50

BAND 41

Selects BAND 41 as the band for the current step.

Key Path	Source, Frequency, Radio Setup, Radio Standard, LTE TDD
Example	:SOUR:FREQ:CHAN:BAND BAND41
Initial S/W Revision	A.11.50

BAND 42

Selects BAND 42 as the band for the current step.

Key Path	Source, Frequency, Radio Setup, Radio Standard, LTE TDD
Example	:SOUR:FREQ:CHAN:BAND BAND42
Initial S/W Revision	A.11.50

BAND 43

Selects BAND 43 as the band for the current step.

Key Path	Source, Frequency, Radio Setup, Radio Standard, LTE TDD
Example	:SOUR:FREQ:CHAN:BAND BAND43
Initial S/W Revision	A.11.50

BAND 44

Selects BAND 44 as the band for the current step.

Key Path	Source, Frequency, Radio Setup, Radio Standard, LTE TDD
Example	:SOUR:FREQ:CHAN:BAND BAND44
Initial S/W Revision	A.14.00

TDSCDMA

Sets TDSCDMA as the radio standard for use and accesses the TDSCDMA specific channel band sub-menus..

Key Path	Source, Frequency, Radio Setup, Radio Standard
Initial S/W Revision	A.11.50

BAND A

Selects BAND A as the band for the current step.

Key Path	Source, Frequency, Radio Setup, Radio Standard, TDSCDMA
Example	:SOUR:FREQ:CHAN:BAND BANDA
Initial S/W Revision	A.11.50

BAND B

Selects BAND B as the band for the current step.

Key Path	Source, Frequency, Radio Setup, Radio Standard, TDSCDMA
Example	:SOUR:FREQ:CHAN:BAND BANDB
Initial S/W Revision	A.11.50

BAND C

Selects BAND C as the band for the current step.

Key Path	Source, Frequency, Radio Setup, Radio Standard, TDSCDMA
Example	:SOUR:FREQ:CHAN:BAND BANDC
Initial S/W Revision	A.11.50

BAND D

Selects BAND D as the band for the current step.

Key Path	Source, Frequency, Radio Setup, Radio Standard, TDSCDMA
Example	:SOUR:FREQ:CHAN:BAND BANDD
Initial S/W Revision	A.11.50

BAND E

Selects BAND E as the band for the current step.

Key Path	Source, Frequency, Radio Setup, Radio Standard, TDSCDMA
----------	---

Example	:SOUR:FREQ:CHAN:BAND BANDE
Initial S/W Revision	A.11.50

BAND F

Selects BAND F as the band for the current step.

Key Path	Source, Frequency, Radio Setup, Radio Standard, TDSCDMA
Example	:SOUR:FREQ:CHAN:BAND BANDF
Initial S/W Revision	A.11.50

Radio Band Link

Allows you to specify the channel band type as either uplink or downlink link direction. This value is used in conjunction with the channel band and channel number to determine the absolute frequency output by the source. When set to “Uplink”, the source will calculate the uplink frequency using an uplink formula together with the selected channel band and channel number . When set to “Downlink”, the source will calculate the downlink frequency using a downlink formula together with the selected channel band and channel number.

Key Path	Source, Frequency, Radio Setup
Remote Command	:SOURce:RADio:BAND:LINK DOWN UP :SOURce:RADio:BAND:LINK?
Example	:SOUR:RAD:BAND:LINK UP
Preset	DOWN
Range	DOWN UP
Backwards Compatibility SCPI	:SOURce:RADio:DEVice BTS MS :SOURce:RADio:DEVice?
Backwards Compatibility Notes	BTS maps to the Downlink frequency MS maps to the Uplink frequency
Initial S/W Revision	A.05.00

Set Reference Frequency

This key allows you to set the frequency reference. Pressing this key turns the frequency reference state to ON, sets the reference frequency value to the current frequency, maintains this frequency at the RF output, and sets the displayed frequency to 0.00 Hz. All subsequent frequencies entered under Source>Frequency>Frequency are interpreted as being relative to this reference frequency.

When you use a frequency reference, the signal generator outputs a frequency that is set relative to the reference frequency by the value entered under Source>Frequency>Frequency as follows:

Output frequency = reference frequency - entered frequency

Where:

reference frequency equals the original RF frequency entered under Source>Frequency>Frequency and set as the reference frequency

entered frequency equals a new value entered under Source>Frequency>Frequency

In addition, the displayed frequency value will be the same as the value entered under Source>Frequency>Frequency.

NOTE

If Freq Reference is set to ON with a reference value set, entering a value under Source>Frequency>Frequency and pressing Set Frequency Reference will add that value to the existing Freq Reference value.

If you wish to change the reference frequency value to the new value entered under Source>Frequency>Frequency, first you must set Freq Reference to OFF and then press Set Frequency Reference.

Key Path	Source, Frequency
Remote Command	:SOURce:FREQuency:REFerence:SET
Example	:SOUR:FREQ:REF:SET
Dependencies	This setting is unavailable, and is grayed out when the List Sequencer is turned ON.
Initial S/W Revision	A.05.00

Freq Reference

This key allows you to toggle the state of the frequency reference. When the frequency reference state is ON, an annunciator is displayed on the main source view to indicate this state to the user.

When you use a frequency reference, the signal generator outputs a frequency that is set relative to the reference frequency by the value entered under Source>Frequency>Frequency as follows:

$$\text{Output frequency} = \text{reference frequency} + \text{entered frequency}$$

Where:

reference frequency equals the original RF frequency entered under Source>Frequency>Frequency and set as the reference frequency

entered frequency equals a new value entered under Source>Frequency>Frequency

For more information on Reference Frequency refer to ["Set Reference Frequency" on page 2473](#)

Key Path	Source, Frequency
Remote Command	:SOURce:FREQuency:REFerence <freq> :SOURce:FREQuency:REFerence? :SOURce:FREQuency:REFerence:STATe OFF ON 0 1 :SOURce:FREQuency:REFerence:STATe?
Example	:SOUR:FREQ:REF 0.00 Hz

	:SOUR:FREQ:REF:STATe ON
Dependencies	This setting is unavailable, and is grayed out when the List Sequencer is turned ON.
Couplings	The frequency reference state is coupled to the frequency reference set immediate action. When the reference set immediate action key is pressed, or the SCPI command issued, it turns the frequency reference state ON.
Preset	0.00 Hz OFF
Min	0.00 Hz
Max	Hardware Dependant: Option 503 = 3.6 GHz Option 504 = 3.8 GHz Option 506 = 6.00 GHz
Initial S/W Revision	A.05.00

Freq Offset

Allows you to specify the frequency offset value. When the frequency offset state is ON, an annunciator is displayed on the main source view to indicate this state to the user.

When the frequency offset is set to zero (0) and you set a new offset value, the displayed frequency value will change as follows and the RF output frequency will not change:

Displayed value = output frequency + offset value

Where:

output frequency equals the original frequency entered under Source>Frequency>Frequency

offset value equals the value entered under Source>Frequency>Freq Offset

When the frequency offset is set to a value other than zero (0) and you enter a new frequency value under Source>Frequency>Frequency, the displayed frequency will be the same as the value entered and the RF output frequency will be equal to the value entered minus the offset value as follows:

Output frequency = entered frequency – offset frequency

Displayed frequency = output frequency + offset frequency

Displayed frequency = entered frequency

Where:

entered frequency equals the frequency entered under Source>Frequency>Frequency

offset frequency equals the value previously entered and set under Source>Frequency>Freq Offset

Key Path	Source, Frequency
Remote Command	:SOURce:FREQuency:OFFSet <freq>

	:SOURce:FREQuency:OFFSet?
Example	:SOUR:FREQ:OFFS 0 Hz
Dependencies	This setting is unavailable, and is grayed out when the List Sequencer is turned ON.
Preset	0 Hz
Min	-100.00 GHz
Max	100.00 GHz
Initial S/W Revision	A.05.00

Modulation Setup

Allows access to the menus for setting up the available modulation types: "ARB" on page 2476, "AM" on page 2517, "FM" on page 2518, and "PM" on page 2519.

Key Path	Source
Initial S/W Revision	A.05.00

ARB

Allows you access to the ARB sub-menus.

Key Path	Source, Modulation Setup
Initial S/W Revision	A.05.00

ARB

Allows you to toggle the state of the ARB function. When the ARB is On, a "MOD" annunciator is displayed in the system settings panel. When the ARB is turned Off, the MOD annunciator is cleared

Key Path	Source, Modulation Setup, ARB
Remote Command	:SOURce:RADio:ARB[:STATe] ON OFF 1 0 :SOURce:RADio:ARB[:STATe]?
Example	:SOUR:RAD:ARB OFF :SOUR:RAD:ARB?
Notes	If the ARB is ON, a user then loads or deletes another file to ARB memory, the playing waveform segment may not keep phase continuity during the ARB memory operation. The waveform will be replayed after the ARB operation is finished.
Dependencies	This setting is for independent mode and has no effect on 3.3.8 list sequencer mode. Setting "Sequencer" on page 2521 Sequencer to On will put source enter list sequencer mode, and even if ARB state is On, the ARB file will not be played. Setting "Sequencer" on page 2521 Sequencer to Off will make source leave list sequencer mode, and this setting will take effect immediately.

The ARB can only be turned on when there is a waveform file selected for playback. On the GUI If no waveform is selected, this key is grayed out. If you send the SCPI command to turn the ARB on with no waveform selected for playback, the ARB state remains OFF and an error is generated. "-
When you try to recall a certain set of states in which the selected waveform is not in ARB memory and the ARB state is On, errors are reported

Preset	Off
Range	On Off
Initial S/W Revision	A.05.00

Select Waveform

Allows you to access to the waveform selection sub-menus.

Pressing this key changes the central view area to show the Waveform File Selection view.

Key Path	Source, Modulation Setup, ARB
Initial S/W Revision	A.05.00

Select Waveform

Allows you to select a waveform sequence or segment for the dual ARB to play.

NOTE: Selecting a waveform file does not result in automatic adjustments to burst timing (to compensate for the presence or absence of a Multiport Adapter); that adjustment occurs only when a waveform is loaded to ARB memory. See "Load Segment to ARB Memory" for more information about this adjustment.

Key Path	Source, Modulation Setup, ARB, Select Waveform
Remote Command	:SOURce:RADio:ARB:WAVeform <string> :SOURce:RADio:ARB:WAVeform?
Example	:SOUR:RAD:ARB:WAV "test_waveform.bin"
Notes	<p>If intended waveform is not in the memory yet, then issuing this command by SCPI will invoke ARB loading operation first, which involves a delay of unpredictable length. So this command should be followed by the query *OPC?, which holds off subsequent commands until the loading operating is complete.</p> <p><string> - specifies the name of the waveform segment or waveform sequence to be played by the ARB.</p> <p>When in Sequence Analyzer mode, and Include Source is Yes, if the you attempt to play a waveform sequence but not all the required waveform segments are in the ARB playback memory, the application will reject the loading operation with an error is generated .</p> <p>When Include Source is No, if you attempt to play a waveform sequence but not all the required waveform segments are contained in the ARB playback memory, the application will attempt to load the required segments from either the default directory of the current directory. If the ARB memory does not have enough space for all the waveform segments to be loaded, an error is generated and</p>

none of the waveform segments is loaded.

If the ARB is ON, and you attempt to play a waveform sequence but not all the waveform segments within the sequence could be found to be loaded into ARB memory, an error is generated. The selected waveform keeps the previous value and ARB state remains On.

If you specify a waveform segment over SCPI but the waveform segment is not present within ARB playback memory and cannot be found for auto loading within the current directory or the default directory, an error is generated and the file selection remains unchanged.

If you select a waveform for playback and the waveform requires a license that is not installed on the instrument, an error is generated.

If the ARB is ON and you load a file to ARB memory or delete a file from ARB memory, the playing waveform segment may not keep phase continuity during the ARB memory operation. The waveform will be replayed after the ARB operation is finished.

Initial S/W Revision	A.05.00
----------------------	---------

Segments on Hard Disk

Allows you access to the sub-menus for loading waveform segments from the hard disk into ARB memory. The default directory is: D: varb.

Pressing this key changes the current view to the Waveform Management View.

Key Path	Source, Modulation Setup, ARB, Select Waveform
----------	--

Initial S/W Revision	A.05.00
----------------------	---------

Load Segment To ARB Memory

Allows you to load the selected file into ARB memory. On the front panel you select the file for loading to the ARB memory by highlighting the desired file in the list. Using the SCPI command, you specify the file name on the HDD.

“NVWFM” (non-volatile storage) MSUS (Mass Storage Unit Specifier) is supported in the memory subsystem because the ARB memory cannot be accessed directly. Therefore, files must be downloaded to the instrument hard disk and then loaded into the ARB memory. “NVWFM” MSUS will be mapped to the default directory D: VARB. The SCPI command supports using either “NVWFM” MSUS or specifying a full path. For more information, see [Memory Subsystem \(Remote Command Only\)](#).

If a file of the same name already exists within ARB memory, it is overwritten. If you wish to load two segments of the same name, you must rename one of the segments before loading it into ARB memory. To rename a segment, you can either use Windows File Explorer, or the :MMEMory:COPY command.

NOTE: When a waveform file is loaded to ARB memory, burst timing adjustments are made automatically, based on whether or not a Multiport Adapter is connected to the test set and powered on. If the connection/power status of the Multiport Adapter is changed after a waveform file has been loaded, it needs to be loaded again.

Key Path	Source, Modulation Setup, ARB, Select Waveform, Segments on Hard Disk
----------	---

Remote Command	:SOURce:RADio:ARB:LOAD <string>
Example	:SOUR:RAD:ARB:LOAD "D: VARB\testwaveform.bin" or :SOUR:RAD:ARB:LOAD "NVWFM:testwaveform.bin"
Notes	<p>Because loading the file involves a delay of unpredictable length, this command should be followed by the query *OPC?, which holds off subsequent commands until the loading operating is complete.</p> <p><string> - specifies the path name of the file to load from the HDD into ARB memory. It could be a <full path + filename>, or <"NVWFM" MSUS + colon + filename>.</p> <p>When in Sequence Analyzer mode, and Include Source is Yes, an attempt to load a file to ARB memory will be rejected with an error.</p> <p>When Include Source is No and if there is insufficient free ARB memory to load the selected waveform, an error is generated. .</p> <p>If you specify a file over SCPI, but the file is not at the specified location, an error is generated.</p> <p>If you try to load a waveform file but the file contains less than 500 IQ samples, an error is generated.</p> <p>If you try to load a Signal Studio waveform "*.wfm" which contains invalid waveform header, an error is generated.</p> <p>If the ARB is ON when you load a file to ARB memory or delete a file from ARB memory, the playing waveform segment may not keep phase continuity during the ARB memory operation. The waveform will be replayed after the ARB operation is finished.</p> <p>ARB can be loaded into ARB memory even required licenses do not present on the instrument. In this case, a GUI only warning message -800, "Operation complete; Loaded <filename> successfully, but no license <required licenses> installed". User can install required licenses according to <required licenses> string to license it, or multi-pack license it.</p>
Initial S/W Revision	A.05.00

Load All To ARB Memory

Allows you to load all the segment files within the currently selected directory into ARB memory. If a file of the same name already exists within ARB memory, it is overwritten. If you wish to load two segments of the same name, you must rename one of the segments before loading it into ARB memory. To rename a segment, you can either use Windows File Explorer, or the :MEMory:COPI command.

NOTE: When a waveform file is loaded to ARB memory, burst timing adjustments are made automatically, based on whether or not a Multiport Adapter is connected to the test set and powered on. If the connection/power status of the Multiport Adapter is changed after a waveform file has been loaded, it needs to be loaded again.

Key Path	Source, Modulation Setup, ARB, Select Waveform, Segments on Hard Disk
Remote Command	:SOURce:RADio:ARB:LOAD:ALL <string>
Example	:SOUR:RAD:ARB:LOAD:ALL "D: varb"
Notes	<p><string> - specifies the directory on the HDD to load the files into ARB memory from.</p> <p>When in Sequence Analyzer mode, and Include Source is Yes, an attempt to load all files from a directory to ARB memory is rejected with an error.</p> <p>When Include Source is No and there is insufficient free ARB memory to load all the waveforms,</p>

when the ARB memory is full, the copy ceases, and an error is generated.
 If you specify a directory over SCPI, but the directory does not exist, an error is generated.
 If the ARB is ON, a user then loads or deletes file to ARB memory, the playing waveform segment may not keep phase continuity during the ARB memory operation. The waveform will be replayed after the ARB operation is finished.

Initial S/W Revision A.05.00

Change Directory...

Allows you to change the currently selected directory on the hard disk. Pressing this key opens a standard windows change directory dialog allowing you to select the new directory of interest.

The current directory is used for manually loading waveform segments into ARB memory for playback, and as a search location for waveform segments that are required to be loaded into ARB memory for playback of a waveform sequence or a list sequence.

Key Path Source, Modulation Setup, ARB, Select Waveform, Segments on Hard Disk

Notes No remote command, SCPI front panel only.

Initial S/W Revision A.05.00

Default Directory...

Allows you to change the default directory. It is used as a search location for waveform segments that are required to be loaded into ARB memory for playback of a waveform sequence, and as a search location for selecting waveforms using SCPI.

Key Path Source, Modulation Setup, ARB, Select Waveform, Segments on Hard Disk

Remote Command :SOURce:RADio:ARB:DEFault:DIRectory <string>
 :SOURce:RADio:ARB: DEFault:DIRectory?

Example :SOUR:RAD:ARB:DEF:DIR "D:\ArbFiles"
 :SOUR:RAD:ARB:DEF:DIR?

State Saved Persistent, survives a power cycle and a preset but not saved in the instrument state

Initial S/W Revision A.05.00

Segments in ARB Memory

Allows you access to the sub-menus for managing the files within ARB memory.

Key Path Source, Modulation Setup, ARB, Select Waveform

Initial S/W Revision A.05.00

Delete Segment From ARB Mem

Allows you to remove a segment from ARB playback memory.

Key Path	Source, Modulation Setup, ARB, Select Waveform, Segments in ARB Memory
Remote Command	:SOURce:RADio:ARB:DELeTe <string>
Example	:SOUR:RAD:ARB:DEL "testwaveform.bin"
Notes	<p><string> - specifies the waveform to be deleted from the ARB playback memory.</p> <p>When in Sequence Analyzer mode and Include Source is Yes, an attempt to delete a file from ARB memory is rejected with an error.</p> <p>When Include Source is No and you specify a file that does not exist within ARB memory, an error is generated.</p> <p>It is possible to delete files from within the ARB memory when the ARB is ON. However, if you attempt to delete the file that is currently playing an error is generated.</p> <p>It is possible to delete a file from within the ARB memory when the sequencer state is ON and the file is not being used by the List Sequencer. If you attempt to delete a file which is being used by the list sequencer, an error is generated.</p> <p>When sequencer state is On, even if ARB state is On, the selected waveform will not be played. In this case, if the selected waveform is not used in List Sequence, it can be deleted and the ARB state is turned Off.</p> <p>If the ARB is ON and you load a file to ARB memory or delete a file from ARB memory, the playing waveform segment may not keep phase continuity during the ARB memory operation. The waveform will be replayed after the ARB operation is finished.</p>
Initial S/W Revision	A.05.00

Delete All From ARB Memory

Allows you to remove all segments from ARB playback memory.

Key Path	Source, Modulation Setup, ARB, Select Waveform, Segments in ARB Memory
Remote Command	:SOURce:RADio:ARB:DELeTe:ALL
Example	:SOUR:RAD:ARB:DELeTe:ALL
Notes	<p>When in Sequence Analyzer mode and Include Source is Yes, an attempt to delete all files from ARB memory is rejected with an error.</p> <p>When Include Source is No and you attempt to delete all files from ARB memory when the ARB is currently playing a file, all files except the one playing are deleted and an error is generated.</p> <p>If you attempt to delete all files from ARB memory when there are waveform files used in "List Sequencer" on page 2520 and "Sequencer" on page 2521 state is ON, all files except the files currently being used in list sequencer are deleted, and an error is generated.</p> <p>If the ARB is ON and you load a file to ARB memory or delete a file from ARB memory, the playing waveform segment may not keep phase continuity during the ARB memory operation. The waveform will be replayed after the ARB operation is finished.</p>
Initial S/W Revision	A.05.00

Query ARB Memory File List (Remote Command Only)

Queries the test set for the list of waveform segments in the ARB memory.

NOTE

This command returns a string for waveform segment names in ARB memory. If you want a string list of waveform segments in the ARB memory, use ["Query ARB Memory Full File List \(Remote Command Only\)"](#) on page 2482.

Remote Command	:SOURce:RADio:ARB:CATalog?
Example	:SOUR:RAD:ARB:CATalog?
Notes	The return data is in the following format: <integer> - memory used <integer> - memory free <string> ... - comma separated list of waveform segments within ARB memory
Initial S/W Revision	A.05.00

Query ARB Memory Full File List (Remote Command Only)

Queries the test set for the string list of waveform segments in the ARB memory. It returns a string list for waveform segment names in the ARB memory.

Remote Command	:SOURce:RADio:ARB:FCATalog?
Example	:SOUR:RAD:ARB:FCATalog?
Notes	The return data is in the following format: <integer> - memory used <integer> - memory free <integer> - file count in ARB memory <string>,<string>, ... <string> - comma separated string list of waveform segments within ARB memory Example: SOUR:RAD:ARB:FCAT? EXT returns: 27499,2069653,3,"c2k.wfm","gsm.wfm","wcdma.wfm"
Initial S/W Revision	A.09.00

ARB Setup

Allows access to the ARB setup sub-menus.

Key Path	Source, Modulation Setup, ARB
Initial S/W Revision	A.05.00

Sample Rate

Allows you to set the ARB waveform playback sample rate.

Key Path	Source, Modulation Setup, ARB, ARB Setup
Remote Command	:SOURce:RADio:ARB:SCLock:RATE <freq> :SOURce:RADio:ARB:SCLock:RATE?
Example	:SOUR:RAD:ARB:SCL:RATE 48.00 MHz
Notes	If there is a sample rate specified in the header of the waveform file, changing that sample rate is not recommended, as it may cause problems with burst timing.
Dependencies	When a new waveform is selected for playback the settings contained within the associated waveform header file are applied to the ARB. The sample rate is one of the values stored within the header file. If the newly selected waveform file has an associated header file, the sample rate is updated with the value from the header file. The sample rate will remain unchanged if the newly selected waveform does not have an associated header file.
Preset	125.00 MHz
Min	1.00 kHz
Max	125.00 MHz
Initial S/W Revision	A.05.00

Run-Time Scaling

Allows you to adjust the run-time scaling value. The run-time scaling value is applied in real-time while the waveform is playing.

Key Path	Source, Modulation Setup, ARB, ARB Setup
Remote Command	:SOURce:RADio:ARB:RSCaling <real> :SOURce:RADio:ARB:RSCaling?
Example	:SOUR:RAD:ARB:RSC 100.00
Notes	This setting cannot be set in E6640A. Grey out on menu and the value is fixed at 70.00%.
Dependencies	When a new waveform is selected for playback the settings contained within the associated waveform header file are applied to the ARB. The run-time scaling is one of the values stored within the header file. If the newly selected waveform file has an associated header file, the run-time scaling is updated with the value from the header file. The run-time scaling will remain unchanged if the newly selected waveform does not have an associated header file.
Preset	70.00 %
Min	1.00 %
Max	100.00 %
Initial S/W Revision	A.05.00

Baseband Freq Offset

Allows you to adjust the value by which the baseband frequency is offset relative to the carrier.

Key Path	Source, Modulation Setup, ARB, ARB Setup
Remote Command	:SOURce:RADio:ARB:BASEband:FREQuency:OFFSet <freq> :SOURce:RADio:ARB:BASEband:FREQuency:OFFSet?
Example	:SOUR:RAD:ARB:BAS:FREQ:OFFS 0.00 Hz
Dependencies	When a new waveform is selected for playback the settings contained within the associated waveform header file are applied to the ARB. The baseband frequency offset is one of the values stored within the header file. If the newly selected waveform file has an associated header file, the baseband frequency offset is updated with the value from the header file. The baseband frequency offset will remain unchanged if the newly selected waveform does not have an associated header file.
Preset	0.00 Hz
Min	-50.00 MHz
Max	50.00 MHz
Initial S/W Revision	A.05.00

Trigger Type

Allows access to the trigger type sub-menus. The setting for trigger type determines the behavior of the waveform when it plays.

Key Path	Source, Modulation Setup, ARB
Remote Command	:SOURce:RADio:ARB:TRIGger:TYPE CONTInuous SINGLE SADVance GATE :SOURce:RADio:ARB:TRIGger:TYPE?
Example	:SOUR:RAD:ARB:TRIG:TYPE CONT :SOUR:RAD:ARB:TRIG:TYPE?
Notes	Gated trigger type will be implemented at a later release
Preset	CONTInuous
Range	Continuous Single Seg Adv Gated
Initial S/W Revision	A.05.00

Continuous

Sets the active trigger type to Continuous. If Continuous is already selected as the active trigger type, pressing this key allows access to the continuous trigger type setup menu. In Continuous trigger mode, the waveform repeats continuously.

Key Path	Source, Modulation Setup, ARB, Trigger Type
Remote Command	:SOURce:RADio:ARB:TRIGger:TYPE:CONTInuous[:TYPE] FREE TRIGger RESet :SOURce:RADio:ARB:TRIGger:TYPE:CONTInuous[:TYPE]?
Example	:SOUR:RAD:ARB:TRIG:TYPE:CONT FREE
Preset	FREE

Range	Free Run Trigger + Run Reset + Run
Initial S/W Revision	A.05.00

Free Run

Selects Free Run as the trigger response for the continuous trigger type. Free Run sets the waveform generator to play a waveform sequence or segment continuously, without waiting for a trigger. In this mode, the waveform generator does not respond to triggers.

Key Path	Source, Modulation Setup, ARB, Trigger Type, Continuous
Example	:SOUR:RAD:ARB:TRIG:TYPE:CONT FREE
Initial S/W Revision	A.05.00

Trigger + Run

Sets Trigger and Run as the trigger response for the continuous trigger type. Trigger and Run sets the waveform generator to play a waveform sequence or segment continuously when the first trigger is received, and to ignore any subsequent triggers.

Key Path	Source, Modulation Setup, ARB, Trigger Type, Continuous
Example	:SOUR:RAD:ARB:TRIG:TYPE:CONT TRIG
Initial S/W Revision	A.05.00

Reset + Run

Sets Reset and Run as the trigger response for the continuous trigger type. Reset and Run sets the waveform generator to play a waveform sequence or segment continuously when the first trigger is received. Subsequent triggers reset the waveform sequence or segment to the start, and then play it continuously.

Key Path	Source, Modulation Setup, ARB, Trigger Type, Continuous
Example	:SOUR:RAD:ARB:TRIG:TYPE:CONT RES
Initial S/W Revision	A.05.00

Single

Sets the active trigger type to Single. If Single is already selected as the active trigger type, pressing this key allows access to the single trigger type setup menu. In Single trigger mode, the waveform plays once.

Key Path	Source, Modulation Setup, ARB, Trigger Type
Remote Command	:SOURce:RADio:ARB:RETRigger ON OFF IMMediate

	:SOURce:RADio:ARB:RETRigger?
Example	:SOUR:RAD:ARB:RETR OFF
Notes	ON: Buffered Trigger OFF: No Retrigger Immediate: Restart on Trigger This is defined as an enumerated SCPI command, with ON OFF being considered as enumerated types rather than Boolean. This means the query will return OFF instead of 0, and ON instead of 1.
Preset	ON
Range	No Retrigger Buffered Trigger Restart on Trigger
Initial S/W Revision	A.05.00

No Retrigger

Selects No Retrigger as the trigger response for single trigger type. No Retrigger sets the waveform generator to play a waveform sequence or segment once when a trigger is received. Any triggers then received during playback are ignored.

Key Path	Source, Modulation Setup, ARB, Trigger Type, Single
Example	:SOUR:RAD:ARB:RETR OFF
Initial S/W Revision	A.05.00

Buffered Trigger

Selects Buffered Trigger as the trigger response for single trigger type. Buffered Trigger sets the waveform generator to play a waveform sequence or segment once when a trigger is received. If a trigger is received during playback, the waveform generator plays the sequence or segment to the end, then plays the sequence or segment once more.

Key Path	Source, Modulation Setup, ARB, Trigger Type, Single
Example	:SOUR:RAD:ARB:RETR ON
Initial S/W Revision	A.05.00

Restart on Trigger

Selects Restart on Trigger as the trigger response for single trigger type. Restart on Trigger sets the waveform generator to play a waveform sequence or segment once when a trigger is received. If a trigger is received during playback, the waveform generator resets and plays the sequence or segment from the start.

Key Path	Source, Modulation Setup, ARB, Trigger Type, Single
Example	:SOUR:RAD:ARB:RETR IMM
Initial S/W Revision	A.05.00

Segment Advance

Sets the active trigger type to Segment Advance. If Segment Advance is already selected as the active trigger type, pressing this key allows access to the segment advance trigger type setup menu.

Segment Advance triggering allows you to control the playback of waveform segments within a waveform sequence. When a trigger is received the ARB advances to the next waveform segment within the waveform sequence. This type of triggering ignores the repetition count for the waveform segment within the waveform sequence. For example, if a waveform segment has a repetition count of 10 and you select single segment advance triggering mode, the waveform segment will only play once.

Segment Advance triggering can also be used for waveform segments only. In this situation the same waveform segment is played again when a trigger is received.

Key Path	Source, Modulation Setup, ARB, Trigger Type
Remote Command	:SOURce:RADio:ARB:TRIGger:TYPE:SADVance[:TYPE] Single CONTInuous :SOURce:RADio:ARB:TRIGger:TYPE:SADVance[:TYPE]?
Example	:SOUR:RAD:ARB:TRIG:TYPE:SADV SING
Preset	CONTInuous
Range	Single Continuous
Initial S/W Revision	A.05.00

Single

Selects Single as the trigger response for Segment Advance trigger type. With single selected, once a trigger is received a segment is played once. If a trigger is received during playback of a segment, the segment plays to completion and the next segment is played once.

Key Path	Source, Modulation Setup, ARB, Trigger Type, Segment Advance
Example	:SOUR:RAD:ARB:TRIG:TYPE:SADV SING
Initial S/W Revision	A.05.00

Continuous

Selects Continuous as the trigger response for Segment Advance trigger type. With continuous selected, once a trigger is received a segment is played continuously. When subsequent triggers are received, the currently playing segment plays to completion and then the next segment is played continuously.

Key Path	Source, Modulation Setup, ARB, Trigger Type, Segment Advance
Example	:SOUR:RAD:ARB:TRIG:TYPE:SADV CONT
Initial S/W Revision	A.05.00

Trigger Source

Allows access to the trigger source sub-menus. The trigger source setting determines how the source receives the trigger that starts the waveform playing. Therefore, this key is grayed out if the trigger type is free run, since free run triggers immediately with no trigger source required.

Key Path	Source, Modulation Setup, ARB
Remote Command	:SOURce:RADio:ARB:TRIGger[:SOURce] KEY BUS EXTernal2 :SOURce:RADio:ARB:TRIGger[:SOURce]?
Example	:SOUR:RAD:ARB:TRIGger KEY
Dependencies	This key is grayed out if the current trigger type is Continuous, Free Run.
Preset	EXTernal2
Range	Trigger Key Bus External 2
Initial S/W Revision	A.05.00

Trigger Key

Sets the current trigger source to the front panel Trigger key. When Trigger Key is selected, the waveform is triggered when you press the front panel Trigger key.

Key Path	Source, Modulation Setup, ARB, Trigger Source
Example	:SOUR:RAD:ARB:TRIGger KEY
Initial S/W Revision	A.05.00

Bus

Sets the current trigger source to Bus. Selecting Bus trigger source enables triggering over GPIB, LAN, or USB using the :SOURce:RADio:ARB:TRIGger:INITiate command.

Key Path	Source, Modulation Setup, ARB, Trigger Source
Example	:SOUR:RAD:ARB:TRIGger BUS
Initial S/W Revision	A.05.00

External 2

Sets the current trigger source to External 2. Selecting External 2 enables triggering a waveform by an externally applied signal.

Key Path	Source, Modulation Setup, ARB, Trigger Source
Example	:SOUR:RAD:ARB:TRIGger EXT2
Notes	Note: When on E6640A, trigger 2 is a bi-directional trigger port. So when trigger 2 has been configured as OUTPUT type, choosing External 2 as the input trigger for the current step will generate error.
Initial S/W Revision	A.05.00

Trigger Initiate

Used to initiate an immediate trigger event if the trigger source is set to Trigger Key.

Key Path	Source, Modulation Setup, ARB
Notes	No remote command, SCPI front panel only.
Initial S/W Revision	A.05.00

Waveform Sequences

Allows access to the waveform sequence sub-menus. Pressing this key changes the central view area to display the Waveform Sequence List view.

Key Path	Source, Modulation Setup, ARB
Notes	No remote command, SCPI front panel only.
Initial S/W Revision	A.05.00

Build New Sequence

Allows access to the sub-menus for creating a new waveform sequence. Pressing this key changes the central view area to display the Waveform Sequence Creation and Editing view.

Key Path	Source, Modulation Setup, ARB, Waveform Sequences
Notes	No remote command, SCPI front panel only.
Initial S/W Revision	A.05.00

Current Segment

Specifies the selected sequence segment that will be affected by the menu functions.

Key Path	Source, Modulation Setup, ARB, Waveform Sequences, Build New Sequence
Notes	No remote command, SCPI front panel only. This key is grayed out and unavailable if the sequence is currently empty.
Initial S/W Revision	A.05.00

Insert New Waveform

Allows you access to the sub-menu for inserting a new waveform segment or sequence. Pressing this key also changes the central display to show the Waveform File Selection View.

Key Path	Source, Modulation Setup, ARB, Waveform Sequences, Build New Sequence
Notes	No remote command, SCPI front panel only. Waveform segment name string length upper limit is 128 chars. Please do NOT insert waveform which name string exceeds 128 chars.
Initial S/W Revision	A.05.00

Insert Waveform

Inserts the currently highlighted waveform to the end of the waveform sequence. Pressing this key also returns you to the menus for creating or editing a sequence, and returns the central view to the sequence creation view.

Key Path	Source, Modulation Setup, ARB, Waveform Sequences, Build New Sequence, Insert New Waveform
Notes	No remote command, SCPI front panel only. Waveform segment name string length upper limit is 128 chars. Please do NOT insert waveform which name string exceeds 128 chars.
Initial S/W Revision	A.05.00

Segments on Hard Disk

Allows you access to the sub-menus for loading waveform segments from the hard disk into ARB memory. The default directory is: D: varb.

Pressing this key changes the current view to the Waveform Management View.

Key Path	Source, Modulation Setup, ARB, Select Waveform
Initial S/W Revision	A.05.00

Load Segment To ARB Memory

Allows you to load the selected file into ARB memory. On the front panel you select the file for loading to the ARB memory by highlighting the desired file in the list. Using the SCPI command, you specify the file name on the HDD.

“NVWFM” (none-volatile storage) MSUS (Mass Storage Unit Specifier) is supported in the memory subsystem because the ARB memory cannot be accessed directly. Therefore, files must be downloaded to the instrument hard disk and then loaded into the ARB memory. “NVWFM” MSUS will be mapped to the default directory D: VARB. The SCPI command supports using either “NVWFM” MSUS or specifying a full path. For more information, see [Memory Subsystem \(Remote Command Only\)](#).

If a file of the same name already exists within ARB memory, it is overwritten. If you wish to load two segments of the same name, you must rename one of the segments before loading it into ARB memory. To rename a segment, you can either use Windows File Explorer, or the :MMEMory:COPY command.

NOTE: When a waveform file is loaded to ARB memory, burst timing adjustments are made automatically, based on whether or not a Multiport Adapter is connected to the test set and powered on. If the connection/power status of the Multiport Adapter is changed after a waveform file has been loaded, it needs to be loaded again.

Key Path	Source, Modulation Setup, ARB, Select Waveform, Segments on Hard Disk
Remote Command	:SOURce:RADio:ARB:LOAD <string>
Example	:SOUR:RAD:ARB:LOAD "D: VARB\testwaveform.bin" or :SOUR:RAD:ARB:LOAD "NVWFM:testwaveform.bin"
Notes	<p>Because loading the file involves a delay of unpredictable length, this command should be followed by the query *OPC?, which holds off subsequent commands until the loading operation is complete.</p> <p><string> – specifies the path name of the file to load from the HDD into ARB memory. It could be a <full path + filename>, or <"NVWFM" MSUS + colon + filename>.</p> <p>When in Sequence Analyzer mode, and Include Source is Yes, an attempt to load a file to ARB memory will be rejected with an error.</p> <p>When Include Source is No and if there is insufficient free ARB memory to load the selected waveform, an error is generated. .</p> <p>If you specify a file over SCPI, but the file is not at the specified location, an error is generated.</p> <p>If you try to load a waveform file but the file contains less than 500 IQ samples, an error is generated.</p> <p>If you try to load a Signal Studio waveform "*.wfm" which contains invalid waveform header, an error is generated.</p> <p>If the ARB is ON when you load a file to ARB memory or delete a file from ARB memory, the playing waveform segment may not keep phase continuity during the ARB memory operation. The waveform will be replayed after the ARB operation is finished.</p> <p>ARB can be loaded into ARB memory even if required licenses do not present on the instrument. In this case, a GUI only warning message –800, "Operation complete; Loaded <filename> successfully, but no license <required licenses> installed". User can install required licenses according to <required licenses> string to license it, or multi-pack license it.</p>
Initial S/W Revision	A.05.00

Load All To ARB Memory

Allows you to load all the segment files within the currently selected directory into ARB memory. If a file of the same name already exists within ARB memory, it is overwritten. If you wish to load two segments of the same name, you must rename one of the segments before loading it into ARB memory. To rename a segment, you can either use Windows File Explorer, or the :MEMory:COPY command.

NOTE: When a waveform file is loaded to ARB memory, burst timing adjustments are made automatically, based on whether or not a Multiport Adapter is connected to the test set and powered on. If the connection/power status of the Multiport Adapter is changed after a waveform file has been loaded, it needs to be loaded again.

Key Path	Source, Modulation Setup, ARB, Select Waveform, Segments on Hard Disk
Remote Command	:SOURce:RADio:ARB:LOAD:ALL <string>

Example	:SOUR:RAD:ARB:LOAD:ALL "D: varb"
Notes	<p><string> - specifies the directory on the HDD to load the files into ARB memory from.</p> <p>When in Sequence Analyzer mode, and Include Source is Yes, an attempt to load all files from a directory to ARB memory is rejected with an error.</p> <p>When Include Source is No and there is insufficient free ARB memory to load all the waveforms, when the ARB memory is full, the copy ceases, and an error is generated.</p> <p>If you specify a directory over SCPI, but the directory does not exist, an error is generated.</p> <p>If the ARB is ON, a user then loads or deletes file to ARB memory, the playing waveform segment may not keep phase continuity during the ARB memory operation. The waveform will be replayed after the ARB operation is finished.</p>
Initial S/W Revision	A.05.00

Change Directory...

Allows you to change the currently selected directory on the hard disk. Pressing this key opens a standard windows change directory dialog allowing you to select the new directory of interest.

The current directory is used for manually loading waveform segments into ARB memory for playback, and as a search location for waveform segments that are required to be loaded into ARB memory for playback of a waveform sequence or a list sequence.

Key Path	Source, Modulation Setup, ARB, Select Waveform, Segments on Hard Disk
Notes	No remote command, SCPIfront panel only.
Initial S/W Revision	A.05.00

Default Directory...

Allows you to change the default directory. It is used as a search location for waveform segments that are required to be loaded into ARB memory for playback of a waveform sequence, and as a search location for selecting waveforms using SCPI.

Key Path	Source, Modulation Setup, ARB, Select Waveform, Segments on Hard Disk
Remote Command	:SOURce:RADio:ARB:DEFault:DIRectory <string> :SOURce:RADio:ARB: DEFault:DIRectory?
Example	:SOUR:RAD:ARB:DEF:DIR "D:\ArbFiles" :SOUR:RAD:ARB:DEF:DIR?
State Saved	Persistent, survives a power cycle and a preset but not saved in the instrument state
Initial S/W Revision	A.05.00

Segments in ARB Memory

Allows you access to the sub-menus for managing the files within ARB memory.

Key Path	Source, Modulation Setup, ARB, Select Waveform
Initial S/W Revision	A.05.00

Delete Segment From ARB Mem

Allows you to remove a segment from ARB playback memory.

Key Path	Source, Modulation Setup, ARB, Select Waveform, Segments in ARB Memory
Remote Command	:SOURce:RADio:ARB:DELeTe <string>
Example	:SOUR:RAD:ARB:DEL "testwaveform.bin"
Notes	<p><string> - specifies the waveform to be deleted from the ARB playback memory.</p> <p>When in Sequence Analyzer mode and Include Source is Yes, an attempt to delete a file from ARB memory is rejected with an error.</p> <p>When Include Source is No and you specify a file that does not exist within ARB memory, an error is generated.</p> <p>It is possible to delete files from within the ARB memory when the ARB is ON. However, if you attempt to delete the file that is currently playing an error is generated.</p> <p>It is possible to delete a file from within the ARB memory when the sequencer state is ON and the file is not being used by the List Sequencer. If you attempt to delete a file which is being used by the list sequencer, an error is generated.</p> <p>When sequencer state is On, even if ARB state is On, the selected waveform will not be played. In this case, if the selected waveform is not used in List Sequence, it can be deleted and the ARB state is turned Off.</p> <p>If the ARB is ON and you load a file to ARB memory or delete a file from ARB memory, the playing waveform segment may not keep phase continuity during the ARB memory operation. The waveform will be replayed after the ARB operation is finished.</p>
Initial S/W Revision	A.05.00

Delete All From ARB Memory

Allows you to remove all segments from ARB playback memory.

Key Path	Source, Modulation Setup, ARB, Select Waveform, Segments in ARB Memory
Remote Command	:SOURce:RADio:ARB:DELeTe:ALL
Example	:SOUR:RAD:ARB:DELeTe:ALL
Notes	<p>When in Sequence Analyzer mode and Include Source is Yes, an attempt to delete all files from ARB memory is rejected with an error.</p> <p>When Include Source is No and you attempt to delete all files from ARB memory when the ARB is currently playing a file, all files except the one playing are deleted and an error is generated.</p> <p>If you attempt to delete all files from ARB memory when there are waveform files used in "List Sequencer" on page 2520 and "Sequencer" on page 2521 state is ON, all files except the files currently being used in list sequencer are deleted, and an error is generated.</p>

If the ARB is ON and you load a file to ARB memory or delete a file from ARB memory, the playing waveform segment may not keep phase continuity during the ARB memory operation. The waveform will be replayed after the ARB operation is finished.

Initial S/W Revision	A.05.00
----------------------	---------

Segments on Hard Disk

This key functions the same as ["Segments on Hard Disk" on page 2547](#).

Key Path	Source, Modulation Setup, ARB, Waveform Sequences, Build New Sequence, Insert New Waveform
----------	--

Initial S/W Revision	Prior to A.09.00
----------------------	------------------

Load Segment To ARB Memory

This key functions the same as ["Load Segment To ARB Memory" on page 2547](#).

Key Path	Source, Modulation Setup, ARB, Waveform Sequences, Build New Sequence, Insert New Waveform, Segment on Hard Drive
----------	---

Initial S/W Revision	Prior to A.09.00
----------------------	------------------

Load All To ARB Memory

This key functions the same as ["Load All To ARB Memory" on page 2548](#).

Key Path	Source, Modulation Setup, ARB, Waveform Sequences, Build New Sequence, Insert New Waveform, Segment on Hard Drive
----------	---

Initial S/W Revision	Prior to A.09.00
----------------------	------------------

Change Directory ...

This key functions the same as ["Change Directory..." on page 2549](#).

Key Path	Source, Modulation Setup, ARB, Waveform Sequences, Build New Sequence, Insert New Waveform, Segment on Hard Drive
----------	---

Initial S/W Revision	Prior to A.09.00
----------------------	------------------

Default Directory ...

This key functions the same as ["Default Directory..." on page 2549](#)

Key Path	Source, Modulation Setup, ARB, Waveform Sequences, Build New Sequence, Insert New Waveform, Segment on Hard Drive
----------	---

Initial S/W Revision	Prior to A.09.00
----------------------	------------------

Segments in ARB Memory

This key functions the same as ["Segments in ARB Memory" on page 2549](#).

Key Path	Source, Modulation Setup, ARB, Waveform Sequences, Build New Sequence, Insert New Waveform
Initial S/W Revision	Prior to A.09.00

Delete Segment From ARB Memory

This key functions the same as ["Delete Segment From ARB Mem" on page 2549](#).

Key Path	Source, Modulation Setup, ARB, Waveform Sequences, Build New Sequence, Insert New Waveform, Segment in ARB Memory
Initial S/W Revision	Prior to A.09.00

Delete All From ARB Memory

This key functions the same as ["Delete All From ARB Memory" on page 2550](#).

Key Path	Source, Modulation Setup, ARB, Waveform Sequences, Build New Sequence, Insert New Waveform, Segment in ARB Memory
Initial S/W Revision	Prior to A.09.00

Query ARB Memory File List (Remote Command Only)

This command functions the same as ["Query ARB Memory File List \(Remote Command Only\)" on page 2482](#).

Initial S/W Revision	Prior to A.09.00
----------------------	------------------

Edit Selected Waveform

Allows access to the sub-menus for editing the details of the currently selected waveform segment.

Key Path	Source, Modulation Setup, ARB, Waveform Sequences, Build New Sequence
Notes	No remote command, front panel only.
Initial S/W Revision	A.05.00

Repetitions

Allows you to specify the number of times the currently selected waveform is played within the sequence.

Key Path	Source, Modulation Setup, ARB, Waveform Sequences, Build New Sequence, Edit Selected Waveform
Notes	No remote command, SCPI front panel only.
Preset	1
Min	1
Max	65535
Initial S/W Revision	A.05.00

Marker 1

Allows you to enable or disable marker 1 for the currently selected waveform. For a waveform sequence, you can enable and disable markers on a per-segment basis, allowing you to output markers from some waveform segments within the sequence, but not for others.

Key Path	Source, Modulation Setup, ARB, Waveform Sequences, Build New Sequence, Edit Selected Waveform
Notes	No remote command, front panel only.
Preset	Enabled
Range	Enabled Disabled
Initial S/W Revision	A.05.00

Marker 2

Allows you to enable or disable marker 2 for the currently selected waveform. For a waveform sequence, you can enable and disable markers on a per-segment basis, allowing you to output markers from some waveform segments within the sequence, but not for others.

Key Path	Source, Modulation Setup, ARB, Waveform Sequences, Build New Sequence, Edit Selected Waveform
Notes	No remote command, front panel only.
Preset	Enabled
Range	Enabled Disabled
Initial S/W Revision	A.05.00

Marker 3

Allows you to enable or disable marker 3 for the currently selected waveform. For a waveform sequence, you can enable and disable markers on a per-segment basis, allowing you to output markers from some waveform segments within the sequence, but not for others.

Key Path	Source, Modulation Setup, ARB, Waveform Sequences, Build New Sequence, Edit Selected
----------	--

	Waveform
Notes	No remote command, front panel only.
Preset	Enabled
Range	Enabled Disabled
Initial S/W Revision	A.05.00

Marker 4

Allows you to enable or disable marker 4 for the currently selected waveform. For a waveform sequence, you can enable and disable markers on a per-segment basis, allowing you to output markers from some waveform segments within the sequence, but not for others.

Key Path	Source, Modulation Setup, ARB, Waveform Sequences, Build New Sequence, Edit Selected Waveform
Notes	No remote command, front panel only.
Preset	Enabled
Range	Enabled Disabled
Initial S/W Revision	A.05.00

Delete Segment

Allows you to delete the selected segment from the waveform sequence.

Key Path	Source, Modulation Setup, ARB, Waveform Sequences, Build New Sequence
Notes	No remote command, front panel only.
Initial S/W Revision	A.05.00

Save Sequence...

Pressing this key displays the “Save As” dialog. The sequence name is passed to the save as dialog to use as the filename for saving, and the directory the save as dialog will open into is the default waveform directory.

Key Path	Source, Modulation Setup, ARB, Waveform Sequences, Build New Sequence
Initial S/W Revision	A.05.00

Build New Sequence (Remote Command Only)

This command is the SCPI equivalent of the waveform sequence creation features described in ["Build New Sequence" on page 2489](#).

This command writes a waveform sequence file to the hard disk. You must specify the waveform sequence file path and filename which will be saved on the hard disk, and the waveform segment file path and name which will be nested into the waveform sequence file. You can utilize mass storage unit specifier (MSUS) “NVWFM” or use a real full path representation. See the example below. MSUS “NVWFM” is mapped to D:\VARB directory on test set hard disk.

Any number of segments, up to a segment count limit of 64, can be used to create a sequence. Repeated segments are included in the count limit.

Each waveform segment name string length upper limit is 128 chars. Please do NOT insert waveform which name string exceeds 128 chars.

The internal source does not support nesting one waveform sequence file into another waveform sequence file.

Remote Command :SOURce:RADio:ARB:SEQuence[:MWAveform] <filename>, <waveform1>, <reps>,
NONE | M1 | M2 | M3 | M4 | M1M2 | M1M3 | M1M4 | M2M3 | M2M4 | M3M4 |
M1M2M3 | M1M2M4 | M1M3M4 | M2M3M4 | M1M2M3M4 | ALL, {<waveform2>,
<reps>, NONE | M1 | M2 | M3 | M4 | M1M2 | M1M3 | M1M4 | M2M3 | M2M4 |
M3M4 | M1M2M3 | M1M2M4 | M1M3M4 | M2M3M4 | M1M2M3M4 | ALL, } ...

(For additional description of each item, see Notes below ["For Setup SCPI" on page 1792](#) "For Setup SCPI".)

:SOURce:RADio:ARB:SEQuence[:MWAveform]? <filename>

(For additional description of each item, see Notes ["For Query SCPI" on page 1793](#) below.)

Example For setup:

```
>:SOUR:RAD:ARB:SEQ "NVWFM:testSeq1.seq", "NVWFM:wfmSegment1.wfm", 10, M2M3M4,  
"NVWFM:wfmSegment2.wfm", 20, M1 M3
```

Or

```
>:SOUR:RAD:ARB:SEQ "D: VARB\testSeq1.seq", "D: VARB\wfmSegment1.wfm", 10, M2M3M4, "D:  
VARB\wfmSegment2.wfm", 20, M1 M3
```

For query, must specify which waveform sequence file to query.

```
>:SOUR:RAD:ARB:SEQ? "NVWFM:testSeq1.seq"
```

Or

```
>:SOUR:RAD:ARB:SEQ? "D: VARB\testSeq1.seq",
```

Notes

For Setup SCPI

For the Setup SCPI command, the parameters are:

<filename> - String Type

This variable specifies the path and name for the waveform sequence file. The path supports MSUS (NVWFM) or a real full path representation. See example.

<waveform1> - String Type

This variable specifies the path and name of the first existing waveform segment. The path supports MSUS (NVWFM) or a real full path representation. See example.

The segment file must reside within ARB playback memory before it can be played by the ARB player.

<reps> - Integer Type

This variable specifies the number of times a segment or sequence plays before moving on to the next segment or sequence.

<marker> - Enum Type

NONE – This choice disables all four markers for the waveform. Disabling markers means that the waveform sequence ignores the segments or sequence marker settings.

M1, M2, M3, M4 – these choices, either individually or a combination of them, enable the markers for the waveform segment or sequence. Markers not specified are ignored for that segment or sequence.

ALL – This choice enables all four markers in the waveform segment or sequence.

<waveform2> - String type.

This variable specifies the name of a second existing waveform segment. The path supports MSUS (NVWFM) and real full path representation both. See example.

The segment file must reside within ARB playback memory before it can be played by the ARB player.

<reps> same as above, for the 2nd waveform segment.

<marker> same as above, for the 2nd waveform segment.

You can insert several waveform segments into a waveform sequence file. Just repeat inserting waveform segments as described above.

Error Checks for Setup SCPI command:

If you do not specify a filename, or you use an unsupported MSUS (that is, not NVWFM), or have an error in the waveform sequence file path, an error is generated.

Notes

Error Checks for Query SCPI command: (Continued)

If the specified waveform sequence file name suffix is not “.seq”, error is generated.

If you use an unsupported MSUS (that is, not NVWFM), or have an error in the waveform segment file path, an error is generated.

If the first specified waveform file cannot be found, an error is generated.

If you nest one waveform sequence file into another waveform sequence file, an error is generated.

If the specified repetition value is larger than 65535 or smaller than 1, an error is generated.

If the specified marker type is unrecognized, an error is generated.

For Query SCPI

For the Query the parameters are:

<filename> - String type.

This variable specifies the path and name of the waveform sequence file being queried. The path supports MSUS (NVWFM) or a real full path representation. See example.

The return value is a <string>, which includes each waveform segment file name, repetitions, and marker type. For example:

```
>:SOUR:RAD:ARB:SEQ? "NVWFM:testSeq1.seq",
```

```
<"wfmSegment1.wfm, 10, ALL, wfmSegment2.wfm, 20, M1M3",
```

Error Checks for Query SCPI command:

If you do not specify a filename, an error is generated.

If the waveform sequence file name is empty, an error is generated.

If the specified waveform sequence file cannot be found, an error is generated.

Initial S/W Revision

A.05.00

Edit Selected Sequence

Allows access to the sub-menus for editing the sequence currently selected within the Waveform Sequence List view. Pressing this key changes the central view area to display the Waveform Sequence Creation and Editing view.

Key Path	Source, Modulation Setup, ARB, Waveform Sequences
Notes	No remote command, front panel only.
Initial S/W Revision	A.05.00

Current Directory...

Allows you to change the currently selected directory on the hard disk. Pressing this key opens a standard windows change directory dialog and allows you to select the new directory of interest.

Key Path	Source, Modulation Setup, ARB, Waveform Sequences
Notes	No remote command, front panel only.
Initial S/W Revision	A.05.00

Waveform Utilities

Allows you access to the waveform utilities sub-menus.

Key Path	Source, Modulation Setup, ARB
Initial S/W Revision	A.05.00

Multi-Pack Licenses

Allows you access to the Multi - Pack License sub-menus. Pressing this key also changes the central view area to display the Multi -Pack License Management view.

On modular instrument like E6630A or E6640A, multi-pack license operations are only allowed on the default module, i.e. "Left" module for E6630A or "TRX1" module for E6640A.

Key Path	Source, Modulation Setup, ARB, Waveform Utilities
Notes	If access multi-pack license sub-menu from modules other than "TRX1", an advisory message like "Please goto "TRX1" to operate multi-pack license" will display.
Dependencies	This key is only available if there is at least one Multi-pack license installed on the instrument.
Initial S/W Revision	A.05.00

Add Waveform

Pressing this key accesses the Add Waveform sub-menu. It also changes the central display area to display the Multi-Pack License Waveform Add view.

Key Path	Source, Modulation Setup, ARB, Waveform Utilities, Multi-Pack Licenses
Dependencies	This key is only available if there is at least one slot available within at least one multi-pack license.
Initial S/W Revision	A.05.00

Add Waveform

Allows you to add the currently selected waveform segment to a multi-pack license. The new waveform is added to the next available slot regardless of which slot was selected on the Multi-Pack License Management view.

Key Path	Source, Modulation Setup, ARB, Waveform Utilities, Multi-Pack Licenses, Add Waveform
Remote Command	:SYSTem:LKEY:WAVeform:ADD <string> or :SYSTem:LIcense[:FPACK]:WAVeform:ADD <string>
Example	SYST:LKEY:WAV:ADD "mywaveform.wfm" or SYST:LIC:WAV:ADD "mywaveform.wfm"
Notes	The second SCPI :SYSTem:LIcense[:FPACK]:WAVeform:ADD is provided to be consistent with the style of Agilent signal sources. You can use either one of them. Since adding a waveform segment to a Multi-Pack license causes the license slot to enter the trial period of only 48 hours, pressing this key causes a confirmation dialog to be displayed to ensure you do want to add the waveform segment to the Multi-Pack. If you attempt to license a waveform that is already licensed using another slot an error is generated. . If current module is not "TRX1" module, the key will grey out, and error message is generated "-221 Setting conflict; Not allowed on current module. Goto "TRX1" to operate multi-pack license" when invoking SCPI.
Dependencies	This key is only available if the currently selected file is a secure waveform requiring a license, and there is at least one slot available within at least one multi-pack license. If the waveform highlighted is a secure waveform, but is already licensed, this key will be unavailable.
Initial S/W Revision	A.05.00

Segments on Hard Disk

Allows you access to the sub-menus for loading waveform segments from the hard disk into ARB memory. The default directory is: D: varb.

Pressing this key changes the current view to the Waveform Management View.

Key Path	Source, Modulation Setup, ARB, Select Waveform
Initial S/W Revision	A.05.00

Load Segment To ARB Memory

Allows you to load the selected file into ARB memory. On the front panel you select the file for loading to the ARB memory by highlighting the desired file in the list. Using the SCPI command, you specify the file name on the HDD.

“NVWFM” (none-volatile storage) MSUS (Mass Storage Unit Specifier) is supported in the memory subsystem because the ARB memory cannot be accessed directly. Therefore, files must be downloaded to the instrument hard disk and then loaded into the ARB memory. “NVWFM” MSUS will be mapped to the default directory D: VARB. The SCPI command supports using either “NVWFM” MSUS or specifying a full path. For more information, see [Memory Subsystem \(Remote Command Only\)](#).

If a file of the same name already exists within ARB memory, it is overwritten. If you wish to load two segments of the same name, you must rename one of the segments before loading it into ARB memory. To rename a segment, you can either use Windows File Explorer, or the :MMEMory:COpy command.

NOTE: When a waveform file is loaded to ARB memory, burst timing adjustments are made automatically, based on whether or not a Multiport Adapter is connected to the test set and powered on. If the connection/power status of the Multiport Adapter is changed after a waveform file has been loaded, it needs to be loaded again.

Key Path	Source, Modulation Setup, ARB, Select Waveform, Segments on Hard Disk
Remote Command	:SOURce:RADio:ARB:LOAD <string>
Example	:SOUR:RAD:ARB:LOAD "D: VARB\testwaveform.bin" or :SOUR:RAD:ARB:LOAD "NVWFM:testwaveform.bin"
Notes	<p>Because loading the file involves a delay of unpredictable length, this command should be followed by the query *OPC?, which holds off subsequent commands until the loading operating is complete.</p> <p><string> – specifies the path name of the file to load from the HDD into ARB memory. It could be a <full path + filename>, or <"NVWFM" MSUS + colon + filename>.</p> <p>When in Sequence Analyzer mode, and Include Source is Yes, an attempt to load a file to ARB memory will be rejected with an error.</p> <p>When Include Source is No and if there is insufficient free ARB memory to load the selected waveform, an error is generated. .</p> <p>If you specify a file over SCPI, but the file is not at the specified location, an error is generated.</p> <p>If you try to load a waveform file but the file contains less than 500 IQ samples, an error is generated.</p> <p>If you try to load a Signal Studio waveform "*.wfm" which contains invalid waveform header, an error is generated.</p> <p>If the ARB is ON when you load a file to ARB memory or delete a file from ARB memory, the playing waveform segment may not keep phase continuity during the ARB memory operation. The waveform will be replayed after the ARB operation is finished.</p> <p>ARB can be loaded into ARB memory even required licenses do not present on the instrument. In this</p>

case, a GUI only warning message -800, "Operation complete; Loaded <filename> successfully, but no license <required licenses> installed". User can install required licenses according to <required licenses> string to license it, or multi-pack license it.

Initial S/W Revision A.05.00

Load All To ARB Memory

Allows you to load all the segment files within the currently selected directory into ARB memory. If a file of the same name already exists within ARB memory, it is overwritten. If you wish to load two segments of the same name, you must rename one of the segments before loading it into ARB memory. To rename a segment, you can either use Windows File Explorer, or the :MEMory:COpy command.

NOTE: When a waveform file is loaded to ARB memory, burst timing adjustments are made automatically, based on whether or not a Multiport Adapter is connected to the test set and powered on. If the connection/power status of the Multiport Adapter is changed after a waveform file has been loaded, it needs to be loaded again.

Key Path Source, Modulation Setup, ARB, Select Waveform, Segments on Hard Disk

Remote Command :SOURce:RADio:ARB:LOAD:ALL <string>

Example :SOUR:RAD:ARB:LOAD:ALL "D: varb"

Notes

- <string> - specifies the directory on the HDD to load the files into ARB memory from.
- When in Sequence Analyzer mode, and Include Source is Yes, an attempt to load all files from a directory to ARB memory is rejected with an error.
- When Include Source is No and there is insufficient free ARB memory to load all the waveforms, when the ARB memory is full, the copy ceases, and an error is generated.
- If you specify a directory over SCPI, but the directory does not exist, an error is generated.
- If the ARB is ON, a user then loads or deletes file to ARB memory, the playing waveform segment may not keep phase continuity during the ARB memory operation. The waveform will be replayed after the ARB operation is finished.

Initial S/W Revision A.05.00

Change Directory...

Allows you to change the currently selected directory on the hard disk. Pressing this key opens a standard windows change directory dialog allowing you to select the new directory of interest.

The current directory is used for manually loading waveform segments into ARB memory for playback, and as a search location for waveform segments that are required to be loaded into ARB memory for playback of a waveform sequence or a list sequence.

Key Path Source, Modulation Setup, ARB, Select Waveform, Segments on Hard Disk

Notes No remote command, SCPIfront panel only.

Initial S/W Revision A.05.00

Default Directory...

Allows you to change the default directory. It is used as a search location for waveform segments that are required to be loaded into ARB memory for playback of a waveform sequence, and as a search location for selecting waveforms using SCPI.

Key Path	Source, Modulation Setup, ARB, Select Waveform, Segments on Hard Disk
Remote Command	:SOURce:RADio:ARB:DEFault:DIRectory <string> :SOURce:RADio:ARB: DEFault:DIRectory?
Example	:SOUR:RAD:ARB:DEF:DIR "D:\ArbFiles" :SOUR:RAD:ARB:DEF:DIR?
State Saved	Persistent, survives a power cycle and a preset but not saved in the instrument state
Initial S/W Revision	A.05.00

Segments on Hard Disk

This key functions the same as ["Segments on Hard Disk" on page 2547](#).

Key Path	Source, Modulation Setup, ARB, Waveform Utilities, Multi-Pack Licenses, Add Waveform
Initial S/W Revision	Prior to A.09.00

Load Segment To ARB Memory

This key functions the same as ["Load Segment To ARB Memory" on page 2547](#).

Key Path	Source, Modulation Setup, ARB, Waveform Utilities, Multi-Pack Licenses, Add Waveform, Segment on Hard Drive
Initial S/W Revision	Prior to A.09.00

Load All To ARB Memory

This key functions the same as ["Load All To ARB Memory" on page 2548](#).

Key Path	Source, Modulation Setup, ARB, Waveform Utilities, Multi-Pack Licenses, Add Waveform, Segment on Hard Drive
Initial S/W Revision	Prior to A.09.00

Change Directory ...

This key functions the same as ["Change Directory..." on page 2549](#).

Key Path	Source, Modulation Setup, ARB, Waveform Utilities, Multi-Pack Licenses, Add Waveform, Segment on Hard Drive
Initial S/W Revision	Prior to A.09.00

Default Directory ...

This key functions the same as ["Default Directory..." on page 2549](#)

Key Path	Source, Modulation Setup, ARB, Waveform Utilities, Multi-Pack Licenses, Add Waveform, Segment on Hard Drive
Initial S/W Revision	Prior to A.09.00

Replace Waveform

Pressing this key accesses the Replace Waveform submenu. It also changes the central display area to display the Multi-Pack License Waveform Add view.

Key Path	Source, Modulation Setup, ARB, Waveform Utilities, Multi-Pack Licenses
Dependencies	This key is only available if the currently selected slot is in the trial state.
Initial S/W Revision	A.05.00

Replace Waveform

Allows you to replace the waveform in the currently selected slot with the waveform currently selected in the Multi-Pack License Waveform Add view.

Key Path	Source, Modulation Setup, ARB, Waveform Utilities, Multi-Pack Licenses, Replace Waveform
Remote Command	:SYSTem:LKEY:WAVeform:REPLace <int>, <string> or :SYSTem:LIcense[:FPACK]:WAVeform:REPLace <int>, <string>
Example	SYST:LKEY:WAV:REPL 1, "myotherwaveform.wfm" or :SYST:LIC:WAV:REPL 1, "myotherwaveform.wfm"
Notes	The second SCPI :SYSTem:LIcense[:FPACK]:WAVeform:REPLace is provided to be consistent with the style of Agilent signal sources. You can use either one of them. If you attempt to license a waveform that is already licensed using another slot an error is generated. Waveform slot number <int> is positive. If you attempt to input a slot number less than or equals 0, an error is generated. If current module is not "TRX1" module, the key will grey out, and error message is generated "-221 Setting conflict; Not allowed on current module. Goto "TRX1" to operate multi-pack license" when invoking SCPI.
Initial S/W Revision	A.05.00

Segments on Hard Disk

This key functions the same as ["Segments on Hard Disk" on page 2547](#).

Key Path	Source, Modulation Setup, ARB, Waveform Utilities, Multi-Pack Licenses, Replace Waveform
Initial S/W Revision	Prior to A.09.00

Load Segment To ARB Memory

This key functions the same as ["Load Segment To ARB Memory" on page 2547](#).

Key Path	Source, Modulation Setup, ARB, Waveform Utilities, Multi-Pack Licenses, Replace Waveform, Segment on Hard Drive
Initial S/W Revision	Prior to A.09.00

Load All To ARB Memory

This key functions the same as ["Load All To ARB Memory" on page 2548](#).

Key Path	Source, Modulation Setup, ARB, Waveform Utilities, Multi-Pack Licenses, Replace Waveform, Segment on Hard Drive
Initial S/W Revision	Prior to A.09.00

Change Directory ...

This key functions the same as ["Change Directory..." on page 2549](#).

Key Path	Source, Modulation Setup, ARB, Waveform Utilities, Multi-Pack Licenses, Replace Waveform, Segment on Hard Drive
Initial S/W Revision	Prior to A.09.00

Default Directory ...

This key functions the same as ["Default Directory..." on page 2549](#)

Key Path	Source, Modulation Setup, ARB, Waveform Utilities, Multi-Pack Licenses, Replace Waveform, Segment on Hard Drive
Initial S/W Revision	Prior to A.09.00

Clear Waveform from Slot

Allows you to clear the waveform from the selected slot.

Key Path	Source, Modulation Setup, ARB, Waveform Utilities, Multi-Pack Licenses
Remote Command	:SYSTem:LKEY:WAVeform:CLEar <int> or :SYSTem:LICense[:FPACK]:WAVeform:CLEar <int>
Example	SYST:LKEY:WAV:CLE 1 or :SYST:LIC:WAV:CLE 1
Notes	The second SCPI :SYSTem:LICense[:FPACK]:WAVeform:CLEar is provided to be consistent with the style of Agilent signal sources. You can use either one of them. Waveform slot number <int> is positive. If you attempt to input a slot number less than or equals 0, an error is generated. If current module is not "TRX1" module, the key will grey out, and error message is generated "-221 Setting conflict; Not allowed on current module. Goto "TRX1" to operate multi-pack license" when invoking SCPI.
Dependencies	This key is only available if the currently selected slot is in the trial state.
Initial S/W Revision	A.05.00

Lock Waveform in Slot

If the selected slot is in the trial state or the lock required state, the waveform that occupies the slot is locked and permanently licensed.

Key Path	Source, Modulation Setup, ARB, Waveform Utilities, Multi-Pack Licenses
Remote Command	:SYSTem:LKEY:WAVeform:LOCK <int> or :SYSTem:LICense[:FPACK]:WAVeform:LOCK <int>
Example	SYST:LKEY:WAV:LOCK 1 or SYST:LIC:WAV:LOCK 1
Notes	The second SCPI :SYSTem:LICense[:FPACK]:WAVeform:LOCK is provided to be consistent with the style of Agilent signal sources. You can use either one of them. Waveform slot number <int> is positive. If you attempt to input a slot number less than or equals 0, an error is generated. If current module is not "TRX1" module, the key will grey out, and error message is generated "-221 Setting conflict; Not allowed on current module. Goto "TRX1" to operate multi-pack license" when invoking SCPI.
Dependencies	This key is only available if the currently selected slot is in the trial state or the lock required state.
Initial S/W Revision	A.05.00

Slot Status Query (Remote Command Only)

Returns the status of the specified slot.

Remote Command	:SYSTem:LKEY:WAVeform:STATus? <int> or :SYSTem:LICense[:FPACK]:WAVeform:STATus? <int>
Example	:SYST:LKEY:WAV:STAT? 1 <"Locked" or :SYST:LIC:WAV:STAT? 1 <"Locked"
Notes	The second SCPI :SYSTem:LICense[:FPACK]:WAVeform:STATus is provided to be consistent with the style of Agilent signal sources. You can use either one of them. Waveform slot number <int> is positive. If you attempt to input a slot number less than or equals 0, an error is generated. Result type is string. If input slot number exceeds total available slot number, "Nonexistent" is returned.
Range	"Locked" "Available" "Trail" "LockRequired" "Nonexistent"
Initial S/W Revision	A.05.00

Slots Free Query (Remote Command Only)

Returns the number of license slots free.

Remote Command	:SYSTem:LKEY:WAVeform:FREE? or :SYSTem:LICense[:FPACK]:WAVeform:FREE?
Example	:SYST:LKEY:WAV:FREE? or :SYST:LIC:WAV:FREE?
Notes	The second SCPI :SYSTem:LICense[:FPACK]:WAVeform:FREE is provided to be consistent with the style of Agilent signal sources. You can use either one of them.
Initial S/W Revision	A.05.00

Slot Used Query (Remote Command Only)

Returns the number of license slots used.

Remote Command	:SYSTem:LKEY:WAVeform:USED? or :SYSTem:LICense[:FPACK]:WAVeform:USED?
Example	:SYST:LKEY:WAV:USED?

	or :SYST:LIC:WAV:USED?
Notes	The second SCPI :SYSTem:LIcense[:FPACK]:WAVeform:USED is provided to be consistent with the style of Agilent signal sources. You can use either one of them.
Initial S/W Revision	A.05.00

Slot Waveform Name Query (Remote Command Only)

Returns the waveform name of the specified slot

Remote Command	:SYSTem:LKEY:WAVeform:NAME? <int> or :SYSTem:LIcense[:FPACK]:WAVeform:NAME? <int>
Example	:SYST:LKEY:WAV:NAME? 1 <"CDMA2K_22.wfm" or :SYST:LIC:WAV:NAME? 1 <"CDMA2K_22.wfm"
Notes	Waveform slot number <int> is positive. If you attempt to input a slot number less than or equals 0, an error is generated. Result type is string. If input slot number exceeds total available slot number, "Nonexistent" is returned. If no waveform stored in the specified slot, then empty string is returned.
Initial S/W Revision	A.12.00

Slot Waveform Unique ID Query (Remote Command Only)

Returns the waveform unique ID of the specified slot

Remote Command	:SYSTem:LKEY:WAVeform:UID? <int> or :SYSTem:LIcense[:FPACK]:WAVeform:UID? <int>
Example	:SYST:LKEY:WAV:UID? 2 <"1346752140" or :SYST:LIC:WAV:UID? 2 <"1346752140"
Notes	Waveform slot number <int> is positive. If you attempt to input a slot number less than or equals 0, an error is generated. Result type is string. If input slot number exceeds total available slot number, "Nonexistent" is returned.

	If no waveform stored in the specified slot, then "0" is returned
Initial S/W Revision	A.12.00

Locked Waveform Name List Query (Remote Command Only)

Returns the waveform name list of locked.

Remote Command	:SOURce:RADio:ARB:MPLicensed:NAME:LOCKed?
Example	SOUR:RAD:ARB:MPL:NAME:LOCKed? <"CDMA2K_27.wfm", "GSM_MCS1.WFM", "c2kWfm.wfm"
Initial S/W Revision	A.11.00

Locked Waveform Unique ID List Query (Remote Command Only)

Returns the waveform unique id list of locked.

Remote Command	:SOURce:RADio:ARB:MPLicensed:UID:LOCKed?
Example	SOUR:RAD:ARB:MPL:UID:LOCKed? <"2996927136", "3812603511", "3710986266"
Notes	Each Signal Studio waveform has a unique id recorded in header. So if the unique ids are same, that means they are same one waveform. So besides SCPI to query locked waveform name list, also provide a SCPI to query locked waveform unique id list
Initial S/W Revision	A.11.00

Marker Utilities

Allows access to the marker utilities sub-menus.

Key Path	Source, Modulation Setup, ARB
Initial S/W Revision	A.05.00

Marker Polarity

Allows access to the marker polarity sub-menu, which allows you to specify the polarity for the four markers. For a positive polarity, the marker signal is high during the marker points. For a negative marker polarity, the marker signal is high during the period of no marker points.

Key Path	Source, Modulation Setup, ARB, Marker Utilities
Initial S/W Revision	A.05.00

Mkr 1 Polarity

Allows you to set the polarity of marker 1.

Key Path	Source, Modulation Setup, ARB, Marker Utilities, Marker Polarity
Remote Command	:SOURce:RADio:ARB:MPOLarity:MARKer1 POSitive NEGative :SOURce:RADio:ARB:MPOLarity:MARKer1?
Example	:SOUR:RAD:ARB:MPOL:MARK1 NEG
Dependencies	When a new waveform is selected for playback the settings contained within the associated waveform header file are applied to the ARB. The marker polarity is one of the values stored within the header file. If the newly selected waveform file has an associated header file, the marker polarity is updated with the value from the header file. The marker polarity will remain unchanged if the newly selected waveform does not have an associated header file.
Preset	Pos
Range	Neg Pos
Initial S/W Revision	A.05.00

Mkr 2 Polarity

Allows you to set the polarity of marker 2.

Key Path	Source, Modulation Setup, ARB, Marker Utilities, Marker Polarity
Remote Command	:SOURce:RADio:ARB:MPOLarity:MARKer2 POSitive NEGative :SOURce:RADio:ARB:MPOLarity:MARKer2?
Example	:SOUR:RAD:ARB:MPOL:MARK2 NEG
Dependencies	When a new waveform is selected for playback the settings contained within the associated waveform header file are applied to the ARB. The marker polarity is one of the values stored within the header file. If the newly selected waveform file has an associated header file, the marker polarity is updated with the value from the header file. The marker polarity will remain unchanged if the newly selected waveform does not have an associated header file.
Preset	Pos
Range	Neg Pos
Initial S/W Revision	A.05.00

Mkr 3 Polarity

Allows you to set the polarity of marker 3.

Key Path	Source, Modulation Setup, ARB, Marker Utilities, Marker Polarity
Remote Command	:SOURce:RADio:ARB:MPOLarity:MARKer3 POSitive NEGative :SOURce:RADio:ARB:MPOLarity:MARKer3?
Example	:SOUR:RAD:ARB:MPOL:MARK3 NEG
Dependencies	When a new waveform is selected for playback the settings contained within the associated

	waveform header file are applied to the ARB. The marker polarity is one of the values stored within the header file. If the newly selected waveform file has an associated header file, the marker polarity is updated with the value from the header file. The marker polarity will remain unchanged if the newly selected waveform does not have an associated header file.
Preset	Pos
Range	Neg Pos
Initial S/W Revision	A.05.00

Mkr 4 Polarity

Allows you to set the polarity of marker 4.

Key Path	Source, Modulation Setup, ARB, Marker Utilities, Marker Polarity
Remote Command	:SOURce:RADio:ARB:MPOLarity:MARKer4 POSitive NEGative :SOURce:RADio:ARB:MPOLarity:MARKer4?
Example	:SOUR:RAD:ARB:MPOL:MARK4 NEG
Dependencies	When a new waveform is selected for playback the settings contained within the associated waveform header file are applied to the ARB. The marker polarity is one of the values stored within the header file. If the newly selected waveform file has an associated header file, the marker polarity is updated with the value from the header file. The marker polarity will remain unchanged if the newly selected waveform does not have an associated header file.
Preset	Pos
Range	Neg Pos
Initial S/W Revision	A.05.00

Marker Routing

Allows access to the marker routing sub-menus, which allow you to specify where the marker events are routed. It should be noted that the markers can also be routed to Trigger 1 Out and Trigger 2 Out, however this must be set up using the menus accessed by pressing the “Trigger” hard key.

Key Path	Source, Modulation Setup, ARB, Marker Utilities
Initial S/W Revision	A.05.00

Pulse/RF Blank

Allows you to select which marker is used for the pulse/RF blanking function. The pulse/RF blanking function blanks the RF when the marker signal goes low. The marker polarity determines when the marker signal is high. For a positive polarity, this is during the marker points. For a negative polarity, this is when there are no marker points.

Marker points should be set before using this function. Enabling this function without setting marker points may create a continuous low or high signal, dependant on the marker polarity. This causes either no RF output, or a continuous RF output.

Key Path	Source, Modulation Setup, ARB, Marker Utilities, Marker Routing
Remote Command	:SOURce:RADio:ARB:MDEStination:PULSe NONE M1 M2 M3 M4 :SOURce:RADio:ARB:MDEStination:PULSe?
Example	:SOUR:RAD:ARB:MDES:PULS NONE
Dependencies	When a new waveform is selected for playback the settings contained within the associated waveform header file are applied to the ARB. The pulse/RF blanking setting is one of the values stored within the header file. If the newly selected waveform file has an associated header file, the pulse/RF blanking setting is updated with the value from the header file. The pulse/RF blanking setting will remain unchanged if the newly selected waveform does not have an associated header file.
Range	None M1 M2 M3 M4
Initial S/W Revision	A.05.00

None

Sets no marker to be used for the pulse/RF blanking function, essentially turning the RF blanking function off.

Key Path	Source, Modulation Setup, ARB, Marker Utilities, Marker Routing, Pulse/RF Blank
Example	:SOUR:RAD:ARB:MDES:PULS NONE
Initial S/W Revision	A.05.00

Marker 1

Sets marker 1 to be used for the pulse/RF blanking function.

Key Path	Source, Modulation Setup, ARB, Marker Utilities, Marker Routing, Pulse/RF Blank
Example	:SOUR:RAD:ARB:MDES:PULS M1
Initial S/W Revision	A.05.00

Marker 2

Sets marker 2 to be used for the pulse/RF blanking function.

Key Path	Source, Modulation Setup, ARB, Marker Utilities, Marker Routing, Pulse/RF Blank
Example	:SOUR:RAD:ARB:MDES:PULS M2
Initial S/W Revision	A.05.00

Marker 3

Sets marker 3 to be used for the pulse/RF blanking function.

Key Path	Source, Modulation Setup, ARB, Marker Utilities, Marker Routing, Pulse/RF Blank
Example	:SOUR:RAD:ARB:MDES:PULS M3
Initial S/W Revision	A.05.00

Marker 4

Sets marker 4 to be used for the pulse/RF blanking function.

Key Path	Source, Modulation Setup, ARB, Marker Utilities, Marker Routing, Pulse/RF Blank
Example	:SOUR:RAD:ARB:MDES:PULS M4
Initial S/W Revision	A.05.00

ALC Hold

Allows you to specify which marker is routed for use within the ALC hold function. The ALC hold marker function holds the ALC circuitry at the average value of the sample points set by the marker.

The ALC hold function operates during the low periods of the marker signal. The marker polarity determines when the marker signal is high. For positive polarity, this is during the marker points. For a negative polarity, this is when there are no marker points.

Key Path	Source, Modulation Setup, ARB, Marker Utilities, Marker Routing
Remote Command	:SOURce:RADio:ARB:MDEStination:ALCHold NONE M1 M2 M3 M4 :SOURce:RADio:ARB:MDEStination:ALCHold?
Example	:SOUR:RAD:ARB:MDES:ALCH NONE
Dependencies	When a new waveform is selected for playback the settings contained within the associated waveform header file are applied to the ARB. The ALC hold setting is one of the values stored within the header file. If the newly selected waveform file has an associated header file, the ALC hold setting is updated with the value from the header file. The ALC hold setting will remain unchanged if the newly selected waveform does not have an associated header file.
Range	None M1 M2 M3 M4
Initial S/W Revision	A.05.00

None

Sets no marker to be used for the ALC hold function, essentially turning the ALC hold function off.

Key Path	Source, Modulation Setup, ARB, Marker Utilities, Marker Routing, ALC Hold
Example	:SOUR:RAD:ARB:MDES:PULS NONE
Initial S/W Revision	A.05.00

Marker 1

Sets marker 1 to be used for the ALC hold function.

Key Path	Source, Modulation Setup, ARB, Marker Utilities, Marker Routing, ALC Hold
Example	:SOUR:RAD:ARB:MDES:PULS M1
Initial S/W Revision	A.05.00

Marker 2

Sets marker 2 to be used for the ALC hold function.

Key Path	Source, Modulation Setup, ARB, Marker Utilities, Marker Routing, ALC Hold
Example	:SOUR:RAD:ARB:MDES:PULS M2
Initial S/W Revision	A.05.00

Marker 3

Sets marker 3 to be used for the ALC hold function.

Key Path	Source, Modulation Setup, ARB, Marker Utilities, Marker Routing, ALC Hold
Example	:SOUR:RAD:ARB:MDES:PULS M3
Initial S/W Revision	A.05.00

Marker 4

Sets marker 4 to be used for the ALC hold function.

Key Path	Source, Modulation Setup, ARB, Marker Utilities, Marker Routing, ALC Hold
Example	:SOUR:RAD:ARB:MDES:PULS M4
Initial S/W Revision	A.05.00

Header Utilities

Allows access to the header utilities sub-menu. Pressing this key also causes the central display area to change to display the File Header Information view.

Key Path	Source, Modulation Setup, ARB
Dependencies	This key is only available if there is currently a waveform selected for playback. If no waveform is selected, the key is grayed out.
Initial S/W Revision	A.05.00

Clear Header

Allows you to clear the header information from the file header associated with the currently selected waveform.

Key Path	Source, Modulation Setup, ARB, Header Utilities
Remote Command	:SOURce:RADio:ARB:HEADer:CLEar
Example	:SOUR:RAD:ARB:HEAD:CLE
Notes	Attempting to clear the header details via SCPI when no waveform was selected for playback will generate an error.
Initial S/W Revision	A.05.00

Save Setup To Header

Allows you to save new file header information details to the file.

Key Path	Source, Modulation Setup, ARB, Header Utilities
Remote Command	:SOURce:RADio:ARB:HEADer:SAVE
Example	:SOUR:RAD:ARB:HEAD:SAVE
Notes	Attempting to save the header details via SCPI when no waveform was selected for playback will generate an error.
Initial S/W Revision	A.05.00

Query Waveform Unique ID (Remote Command Only)

Each Signal Studio waveform contains a unique waveform ID, which recorded in the header. This command allows you to query the unique waveform ID from the header. This is a SCPI only command. User can also check [Error! Reference source not found.](#) for waveform unique ID display.

Remote Command	:MMEMory:HEADer:ID? "<file name>"
Example	:MMEM:HEAD:ID? "test.wfm" (query the waveform already loaded into the ARB memory) :MMEM:HEAD:ID? "D: VARB\test.wfm" (query the waveform on the hard disk by absolute path) :MMEM:HEAD:ID? "NVWFM:test.wfm" (query the waveform on the hard disk by MSUS)
Notes	SCPI query only. The queried waveform file can be in ARB memory, or on hard disk. If want to query ARB in ARB memory, then give out the file name directly. If want to query ARB on the hard disk, then absolute file path or MSUS should be given along with the file name. The valid MSUS is "NVWFM" which is mapped to D: VARB on hard disk. If the file cannot be found in ARB memory or on hard disk, an error is generated and value -1 is returned
Initial S/W Revision	A.09.00

Bus Trigger Command (Remote Command Only)

Used to initiate an immediate trigger event if the trigger source is set to Bus.

Remote Command	:SOURce:RADio:ARB:TRIGger:INITiate
Example	:SOUR:RAD:ARB:TRIG:INIT
Initial S/W Revision	A.05.00

AM

Allows access to the menu for configuring the Amplitude Modulation.

Key Path	Source, Modulation Setup
Initial S/W Revision	A.05.00

AM

Enables or disables the amplitude modulation.

Turning AM on when another modulation format is already on results in the previous modulation format being turned off and the generation of an error.

Key Path	Source, Modulation Setup, AM
Remote Command	:SOURce:AM:STATe :SOURce:AM:STATe?
Example	:SOUR:AM:STAT OFF
Preset	Off
Range	On Off
Initial S/W Revision	A.05.00

AM Depth

Allows you to set the amplitude modulation depth in percent.

Key Path	Source, Modulation Setup, AM
Remote Command	:SOURce:AM[:DEPTh] [:LINear] :SOURce:AM[:DEPTh] [:LINear]?
Example	:SOUR:AM 0.1
Preset	0.1 %
Min	0.1 %
Max	95.0 %
Initial S/W Revision	A.05.00

AM Rate

Allows you to set the internal amplitude modulation rate.

Key Path	Source, Modulation Setup, AM
Remote Command	:SOURce:AM:INTernal:FREQuency :SOURce:AM:INTernal:FREQuency?
Example	:SOUR:AM:INT:FREQ 40.0 Hz
Preset	400.0 Hz
Min	10 Hz
Max	40 kHz
Initial S/W Revision	A.05.00

FM

Allows access to the menu for configuring the frequency modulation.

Key Path	Source, Modulation Setup
Initial S/W Revision	A.05.00

FM

Enables or disables the frequency modulation.

Turning FM on when another modulation format is already on results in the previous modulation format being turned off and the generation of an error.

Key Path	Source, Modulation Setup, FM
Remote Command	:SOURce:FM:STATe :SOURce:FM:STATe?
Example	:SOUR:FM:STAT OFF
Preset	Off
Range	On Off
Initial S/W Revision	A.05.00

FM Deviation

Allows you to set the frequency modulation deviation.

Key Path	Source, Modulation Setup, FM
----------	------------------------------

Remote Command	:SOURce:FM[:DEVIation] :SOURce:FM[:DEVIation]?
Example	:SOUR:FM 1.00 kHz
Preset	1.00 Hz
Min	1.00 Hz
Max	100.00 kHz
Initial S/W Revision	A.05.00

FM Rate

Allows you to set the internal frequency modulation rate.

Key Path	Source, Modulation Setup, FM
Remote Command	:SOURce:FM:INTernal:FREQuency :SOURce:FM:INTernal:FREQuency?
Example	:SOUR:FM:INT:FREQ 40.0 Hz
Preset	400.0 Hz
Min	10 Hz
Max	40 kHz
Initial S/W Revision	A.05.00

PM

Allows access to the menu for configuring the phase modulation.

Key Path	Source, Modulation Setup
Initial S/W Revision	A.05.00

PM

Enables or disables the phase modulation.

Turning PM on when another modulation format is already on results in the previous modulation format being turned off and the generation of an error.

Key Path	Source, Modulation Setup, PM
Remote Command	:SOURce:PM:STATe :SOURce:PM:STATe?
Example	:SOUR:PM:STAT OFF

Preset	Off
Range	On Off
Initial S/W Revision	A.05.00

PM Deviation

Allows you to set the phase modulation deviation.

Key Path	Source, Modulation Setup, PM
Remote Command	:SOURce:PM[:DEVIation] :SOURce:PM[:DEVIation]?
Example	:SOUR:PM 1.00 rad
Preset	0.1 rad
Min	0.1 rad
Max	20.0 rad
Initial S/W Revision	A.05.00

PM Rate

Allows you to set the internal phase modulation rate.

Key Path	Source, Modulation Setup, PM
Remote Command	:SOURce:PM:INTernal:FREQuency :SOURce:PM:INTernal:FREQuency?
Example	:SOUR:PM:INT:FREQ 40.0 Hz
Preset	400.0 Hz
Min	10 Hz
Max	40 kHz
Initial S/W Revision	A.05.00

List Sequencer

Allows you access to the sub-menus for configuring the list sequencer.

List sequences allows you to enter frequencies and amplitudes at unequal intervals in nonlinear ascending, descending or random order. Each step within the list can also include its own waveform file for playback, step duration, trigger event and trigger output.

The complexities involved in configuring the list sequencer do not lend itself to manual configuration; hence the manual configuration for this feature is limited. For easier configuration of the list sequencer, it is recommended that you use either SCPI or load a tab delimited file containing the setup parameters in a

tabular form. The details of the SCPI for configuring the list sequencer can be found in "[Step Configuration \(Remote Command Only\)](#)" on page 2554.

Once the List Sequencer has been configured using the front panel, SCPI, or loading in a tab delimited file, the sequence must be initiated using the front panel Initiate Sequence key or the corresponding SCPI command.

Key Path	Source
Initial S/W Revision	A.05.00

Sequencer

Allows you to set the state of the list sequencer. When the list sequencer is on, the source is outputting the sequence defined by the sequencer. When the list sequencer is off, the source outputs a single waveform segment or sequence (independent mode) at a single frequency and amplitude.

Key Path	Source, List Sequencer
Remote Command	:SOURce:LIST[:STATe] ON OFF 1 0 :SOURce:LIST[:STATe]?
Example	:SOUR:LIST OFF
Notes	When the sequencer is set to ON, the list sequencer controls the output of the source.
Couplings	When in Sequence Analyzer mode and the list sequencer state is Off, Include Source is forced to No, and the Include Source key is grayed out. When in Sequence Analyzer mode and the list sequencer state is On, Include Source is available to set. And, an ARB memory related operation, like load or delete will be rejected.
Preset	Off
Range	On Off
Initial S/W Revision	A.05.00

Initiate Sequence

Pressing this key arms the sequence for single execution. Once the sequence is armed the source begins the sequence as soon as the trigger is received. If the trigger is set to Free Run, the sequence starts immediately.

Key Path	Source, List Sequencer
Remote Command	:SOURce:LIST:TRIGger[:IMMediate]
Example	:SOUR:LIST:TRIG
Notes	When in Sequence Analyzer mode and Include Source is Yes, the Initiate list sequencer operation is rejected, and the key is grayed out, since source list sequence request is sent to physics via Parallel batch by sequence analyzer. If the file needed by the sequencer is not already in ARB memory, the sequence cannot be initiated

	and an error will be generated. There is a blocking SCPI query which can be used to query if source list sequence being initiated successfully or not. (see " Query List Sequence Initiation Armed Status (Remote Command Only) " on page 2565 Query Source List Sequence Armed Status)
Dependencies	Under the Sequence Analyzer Mode, if Meas Setup->Include Source is set to YES, Source->List Sequencer->Initiate Sequence is disabled.
Initial S/W Revision	A.05.00

List Sequencer Setup

Allows you access to the list sequencer setup menus.

Key Path	Source, List Sequencer
----------	------------------------

Number of Steps

Allows you to specify the number of steps within the list sequence.

Key Path	Source, List Sequencer, List Sequencer Setup
Remote Command	:SOURce:LIST:NUMBer:STEPs <integer> :SOURce:LIST:NUMBer:STEPs?
Example	:SOUR:LIST:NUMB:STEP 1
Notes	Increasing the number of steps creates additional steps at the end of the list, with all the settings within the steps set to their default values. Decreasing the number of steps removes steps from the end of the list. The settings within the removed steps are not reset. This means that increasing the number of steps again would allow you to retrieve these steps.
Dependencies	The Step Count parameter is increased or decreased when you insert or delete a point from within the GUI interface to the sequencer.
Preset	1
Min	1
Max	1000
Initial S/W Revision	A.05.00

Current Step

Allows you to select the step number you wish to view or edit.

Key Path	Source, List Sequencer, List Sequencer Setup
----------	--

Notes	No remote command, front panel only.
Preset	1
Min	1
Max	Step Count
Initial S/W Revision	A.05.00

Insert Step Before

Allows you to insert a new step, containing default values, before the currently selected step. Inserting a step will automatically increase the Step Count parameter by 1. If sequence already reaches upper limit of 1000 steps, then insert more step will be rejected and popup error –221, “Setting Conflict; Cannot insert more steps, maximum number of steps reached”

Key Path	Source, List Sequencer, List Sequencer Setup
Notes	No remote command, front panel only. If the list already contains the maximum limit of 1000 steps, no operation will be made after pressing this key.
Initial S/W Revision	A.05.00

Delete Step

Allows you to delete the current step. Deleting a step will automatically decrease the Step Count parameter by 1. If sequence only has one step left, delete step will be rejected and popup error –221, “Setting conflict; Cannot delete current step, minimum number of steps reached”

Key Path	Source, List Sequencer, List Sequencer Setup
Notes	No remote command, Front Panel key only. If the list already contains the minimum limit of 1 step, no operation will be made after pressing this key
Initial S/W Revision	A.05.00

Clear List

Allows you to clear the list. Clearing the list sets the number of steps to the default value of 1 and sets the parameters for the only step to their default values.

Key Path	Source, List Sequencer, List Sequencer Setup
Initial S/W Revision	A.05.00

Step Trigger

Allows access to the sub-menu for selecting the trigger input for the current step.

Key Path	Source, List Sequencer, List Sequencer Setup
Remote Command	:SOURce:LIST:STEP[1] 2 3...1000:SETup:INPut:TRIGger IMMEDIATE INTERNAL EXTERNAL2 KEY BUS EXTERNAL4 :SOURce:LIST:STEP[1] 2 3...1000:SETup:INPut:TRIGger?
Example	:SOUR:LIST:STEP2:SET:INP:TRIG BUS :SOUR:LIST:STEP2:SET:INP:TRIG?
Notes	SCPI is supported after A.09.40
Preset	Free Run
Range	Free Run Internal Manual (Trigger Key) Bus External 2 EXTERNAL4
Initial S/W Revision	A.05.00

Free Run

Sets the trigger input for the current step to Free Run.

Key Path	Source, List Sequencer, List Sequencer Setup, Step Trigger
Example	:SOUR:LIST:STEP2:SET:INP:TRIG IMM
Notes	SCPI is supported after A.09.40
Initial S/W Revision	A.05.00

Internal

Sets the trigger input for the current step to Internal.

Key Path	Source, List Sequencer, List Sequencer Setup, Step Trigger
Example	:SOUR:LIST:STEP2:SET:INP:TRIG INT
Notes	SCPI is supported after A.09.40
Initial S/W Revision	A.05.00

Manual (Trigger Key)

Sets the trigger input for the current step to Manual (Trigger Key). Any step in the sequence set to Manual will cause the sequence execution to stop until the manual trigger key is pressed. Sending the Bus Trigger SCPI command will have no effect. At any point in the sequence where the list sequencer is paused waiting for a software trigger, a pop up dialog is displayed until the trigger event occurs.

Key Path	Source, List Sequencer, List Sequencer Setup, Step Trigger
Example	:SOUR:LIST:STEP2:SET:INP:TRIG KEY
Notes	SCPI is supported after A.09.40
Initial S/W Revision	A.05.00

Bus

Sets the trigger input for the current step to Bus. Any step in the sequence set to Bus will cause the sequence execution to stop until the Bus Trigger SCPI command is sent. Pressing the manual trigger key has no effect. At any point in the sequence where the list sequencer is paused waiting for a software trigger, a pop up dialog is displayed until the trigger event occurs.

Key Path	Source, List Sequencer, List Sequencer Setup, Step Trigger
Example	:SOUR:LIST:STEP2:SET:INP:TRIG BUS
Notes	SCPI is supported after A.09.40
Initial S/W Revision	A.05.00

External 2

Sets the trigger input for the current step to External 2.

Key Path	Source, List Sequencer, List Sequencer Setup, Step Trigger
Example	:SOUR:LIST:STEP2:SET:INP:TRIG EXT2
Notes	SCPI is supported after A.09.40
Notes	Note: When on E6640A, trigger 2 is a bi-directional trigger port. So when trigger 2 has been configured as OUTPUT type, choosing External 2 as the input trigger for the current step will generate error.
Initial S/W Revision	A.05.00

Transition Time

Allows you to specify the transition time for the current step.

The transition time is the amount of time allowed for the source to settle at the current frequency or amplitude value.

Transition Time should not be taken as additional time before or inside the Step Duration. You can set a value for the settling time to allow the source output frequency or amplitude to become stable. Make sure that during this period of time, you do not use the source output signal.

The following table lists recommended values for appropriate settling times to allow for changes within the source.

Value Changed	Recommended Transition Time
Frequency	500 μ s
Amplitude	100 μ s to within 0.1 dB 20 μ s to within 1.0 dB

If the Transition Time value is shorter than the time necessary for the hardware to settle and a List Sequence is initiated, a **warning** is generated.

If the Transition Time value is longer than the Step Duration, an error is generated when initiating a source list sequence. For source list sequence, transition time is included in the step duration length. If the Transition Time value is longer than the Step Duration Time, the real step duration length is extended to equal the transition time and cause a timing shift.

Key Path	Source, List Sequencer, List Sequencer Setup
Remote Command	:SOURce:LIST:STEP[1] 2 3...1000:SETup:TRANSition:TIME <time> :SOURce:LIST:STEP[1] 2 3...1000:SETup:TRANSition:TIME?
Example	:SOUR:LIST:STEP2:SET:TRAN:TIME 1ms :SOUR:LIST:STEP2:SET:TRAN:TIME?
Notes	SCPI is supported after A.09.40
Preset	1.0 ms
Min	0.0 ms
Max	4.0 ks
Initial S/W Revision	A.05.00

Radio Setup

Allows you access to the sub-menus for setting up the radio standard, band, and radio band link direction for the current step.

Key Path	Source, List Sequencer, List Sequencer Setup
Notes	No remote command, front panel only.
Initial S/W Revision	A.05.00

Radio Standard

Allows access to the sub-menus for selecting the radio standard and the associated radio band for use in the current step.

Key Path	Source, List Sequencer, List Sequencer Setup, Radio Setup
Remote Command	:SOURce:LIST:STEP[1] 2 3...1000:SETup:RADio:BAND NONE PGSM EGSM RGSM DCS1800 PCS1900 TGSM810 GSM450 GSM480 GSM700 GSM850 BANDI BANDII BANDIII BANDIV BANDV BANDVI BANDVII BANDVIII BANDIX BANDX BANDXI BANDXII BANDXIII BANDXIV BANDXIX USCELL USPCS JAPAN KOREAN NMT IMT2K UPPER SECOND PAMR400 PAMR800 IMTEXT PCS1DOT9G AWS US2DOT5G PUBLIC LOWER NONE BAND1 BAND2 BAND3 BAND4 BAND5 BAND6 BAND7 BAND8 BAND10 BAND11 BAND12 BAND13 BAND14 BAND17 BAND18 BAND19 BAND20 BAND21 BAND24 BAND25 BAND26 BAND27 BAND28 BAND31 BAND33 BAND34 BAND35 BAND36 BAND37 BAND38

	BAND39 BAND40 BAND41 BAND42 BAND43 BAND44 BANDA BANDB BANDC BANDD BANDE BANDF :SOURce:LIST:STEP[1] 2 3...1000:SETup: RADio:BAND?
Example	:SOUR:LIST:STEP2:SET:RAD:BAND PGSM :SOUR:LIST:STEP2:SET:RAD:BAND?
Notes	SCPI is supported after A.09.40
Initial S/W Revision	A.05.00

None

Selects no radio standard for use on the current step.

Key Path	Source, List Sequencer, List Sequencer Setup, Radio Setup, Radio Standard
Example	:SOUR:LIST:STEP2:SET:RAD:BAND NONE
Notes	SCPI is supported after A.09.40
Initial S/W Revision	A.05.00

GSM/EDGE

Pressing this key once selects GSM/EDGE as the radio standard and the current GSM/EDGE band as the active channel band. Pressing this key again allows access to the sub-menus for selecting a different GSM/EDGE band.

Key Path	Source, List Sequencer, List Sequencer Setup, Radio Setup, Radio Standard
Initial S/W Revision	A.05.00

P-GSM

Selects P-GSM as the band for the current step.

Key Path	Source, List Sequencer, List Sequencer Setup, Radio Setup, Radio Standard, GSM/EDGE
Initial S/W Revision	A.05.00

E-GSM

Selects E-GSM as the band for the current step.

Key Path	Source, List Sequencer, List Sequencer Setup, Radio Setup, Radio Standard, GSM/EDGE
Initial S/W Revision	A.05.00

R-GSM

Selects R-GSM as the band for the current step.

Key Path	Source, List Sequencer, List Sequencer Setup, Radio Setup, Radio Standard, GSM/EDGE
Initial S/W Revision	A.05.00

DCS 1800

Selects DCS 1800 as the band for the current step.

Key Path	Source, List Sequencer, List Sequencer Setup, Radio Setup, Radio Standard, GSM/EDGE
Initial S/W Revision	A.05.00

PCS 1900

Selects PCS 1900 as the band for the current step.

Key Path	Source, List Sequencer, List Sequencer Setup, Radio Setup, Radio Standard, GSM/EDGE
Initial S/W Revision	A.05.00

GSM 450

Selects GSM 450 as the band for the current step.

Key Path	Source, List Sequencer, List Sequencer Setup, Radio Setup, Radio Standard, GSM/EDGE
Initial S/W Revision	A.05.00

GSM 480

Selects GSM 480 as the band for the current step.

Key Path	Source, List Sequencer, List Sequencer Setup, Radio Setup, Radio Standard, GSM/EDGE
Initial S/W Revision	A.05.00

GSM 850

Selects GSM 850 as the band for the current step.

Key Path	Source, List Sequencer, List Sequencer Setup, Radio Setup, Radio Standard, GSM/EDGE
Initial S/W Revision	A.05.00

GSM 700

Selects GSM 700 as the band for the current step.

Key Path	Source, List Sequencer, List Sequencer Setup, Radio Setup, Radio Standard, GSM/EDGE
Initial S/W Revision	A.05.00

T-GSM 810

Selects T-GSM 810 as the band for the current step.

Key Path	Source, List Sequencer, List Sequencer Setup, Radio Setup, Radio Standard, GSM/EDGE
Initial S/W Revision	A.05.00

WCDMA

Pressing this key once selects WCDMA as the radio standard and the current WCDMA band as the active channel band. Pressing this key again allows access to the sub-menus for selecting a different WCDMA band.

Key Path	Source, List Sequencer, List Sequencer Setup, Radio Setup, Radio Standard
Initial S/W Revision	A.05.00

Band I

Selects Band I as the band for the current step.

Key Path	Source, List Sequencer, List Sequencer Setup, Radio Setup, Radio Standard, WCDMA
Initial S/W Revision	A.05.00

Band II

Selects Band II as the band for the current step.

Key Path	Source, List Sequencer, List Sequencer Setup, Radio Setup, Radio Standard, WCDMA
Initial S/W Revision	A.05.00

Band III

Selects Band III as the band for the current step.

Key Path	Source, List Sequencer, List Sequencer Setup, Radio Setup, Radio Standard, WCDMA
Initial S/W Revision	A.05.00

Band IV

Selects Band IV as the band for the current step.

Key Path	Source, List Sequencer, List Sequencer Setup, Radio Setup, Radio Standard, WCDMA
Initial S/W Revision	A.05.00

Band V

Selects Band V as the band for the current step.

Key Path	Source, List Sequencer, List Sequencer Setup, Radio Setup, Radio Standard, WCDMA
Initial S/W Revision	A.05.00

Band VI

Selects Band VI as the band for the current step.

Key Path	Source, List Sequencer, List Sequencer Setup, Radio Setup, Radio Standard, WCDMA
Initial S/W Revision	A.05.00

Band VII

Selects Band VII as the band for the current step.

Key Path	Source, List Sequencer, List Sequencer Setup, Radio Setup, Radio Standard, WCDMA
Initial S/W Revision	A.05.00

Band VIII

Selects Band VIII as the band for the current step.

Key Path	Source, List Sequencer, List Sequencer Setup, Radio Setup, Radio Standard, WCDMA
Initial S/W Revision	A.05.00

Band IX

Selects Band IX as the band for the current step.

Key Path	Source, List Sequencer, List Sequencer Setup, Radio Setup, Radio Standard, WCDMA
Initial S/W Revision	A.05.00

Band X

Selects Band X as the band for the current step.

Key Path	Source, List Sequencer, List Sequencer Setup, Radio Setup, Radio Standard, WCDMA
Initial S/W Revision	A.05.00

Band XI

Selects Band XI as the band for the current step.

Key Path	Source, List Sequencer, List Sequencer Setup, Radio Setup, Radio Standard, WCDMA
Initial S/W Revision	A.05.00

Band XII

Selects Band XII as the band for the current step.

Key Path	Source, List Sequencer, List Sequencer Setup, Radio Setup, Radio Standard, WCDMA
Initial S/W Revision	A.05.00

Band XIII

Selects Band XIII as the band for the current step.

Key Path	Source, List Sequencer, List Sequencer Setup, Radio Setup, Radio Standard, WCDMA
Initial S/W Revision	A.05.00

Band XIV

Selects Band XIV as the band for the current step.

Key Path	Source, List Sequencer, List Sequencer Setup, Radio Setup, Radio Standard, WCDMA
Initial S/W Revision	A.05.00

Band XIX

Selects Band XIX as the band for the current step.

Key Path	Source, List Sequencer, List Sequencer Setup, Radio Setup, Radio Standard, WCDMA
Initial S/W Revision	A.14.50

CDMA 2000 / 1xEVDO

Pressing this key once selects CDMA 2000/1xEVDO as the radio standard and the current CDMA 2000/1xEVDO band as the active channel band. Pressing this key again allows access to the sub-menus for selecting a different CDMA 2000/1xEVDO band.

Key Path	Source, List Sequencer, List Sequencer Setup, Radio Setup, Radio Standard
Initial S/W Revision	A.05.00

US CELL

Selects US Cell as the band for the current step.

Key Path	Source, List Sequencer, List Sequencer Setup, Radio Setup, Radio Standard, CDMA 2000 / 1xEVDO
Initial S/W Revision	A.05.00

US PCS

Selects US PCS as the band for the current step.

Key Path	Source, List Sequencer, List Sequencer Setup, Radio Setup, Radio Standard, CDMA 2000 / 1xEVDO
Initial S/W Revision	A.05.00

Japan Cell

Selects Japan Cell as the band for the current step.

Key Path	Source, List Sequencer, List Sequencer Setup, Radio Setup, Radio Standard, CDMA 2000 / 1xEVDO
Initial S/W Revision	A.05.00

Korean PCS

Selects Korean PCS as the band for the current step.

Key Path	Source, List Sequencer, List Sequencer Setup, Radio Setup, Radio Standard, CDMA 2000 / 1xEVDO
Initial S/W Revision	A.05.00

NMT 450

Selects NMT 450 as the band for the current step.

Key Path	Source, List Sequencer, List Sequencer Setup, Radio Setup, Radio Standard, CDMA 2000 / 1xEVDO
Initial S/W Revision	A.05.00

IMT 2000

Selects IMT 2000 as the band for the current step.

Key Path	Source, List Sequencer, List Sequencer Setup, Radio Setup, Radio Standard, CDMA 2000 / 1xEVDO
Initial S/W Revision	A.05.00

Upper 700

Selects Upper 700 as the band for the current step.

Key Path	Source, List Sequencer, List Sequencer Setup, Radio Setup, Radio Standard, CDMA 2000 / 1xEVDO
Initial S/W Revision	A.05.00

Secondary 800

Selects Secondary 800 as the band for the current step.

Key Path	Source, List Sequencer, List Sequencer Setup, Radio Setup, Radio Standard, CDMA 2000 / 1xEVDO
Initial S/W Revision	A.05.00

400 Euro PAMR

Selects 400 Euro PAMR as the band for the current step.

Key Path	Source, List Sequencer, List Sequencer Setup, Radio Setup, Radio Standard, CDMA 2000 / 1xEVDO
Initial S/W Revision	A.05.00

800 PAMR

Selects 800 PAMR as the band for the current step.

Key Path	Source, List Sequencer, List Sequencer Setup, Radio Setup, Radio Standard, CDMA 2000 / 1xEVDO
Initial S/W Revision	A.05.00

2.5GHz IMT EXT

Selects 2.5 GHz IMT EXT as the band for the current step.

Key Path	Source, List Sequencer, List Sequencer Setup, Radio Setup, Radio Standard, CDMA 2000 / 1xEVDO
Initial S/W Revision	A.05.00

US PCS 1.9GHz

Selects US PCS 1.9 GHz as the band for the current step.

Key Path	Source, List Sequencer, List Sequencer Setup, Radio Setup, Radio Standard, CDMA 2000 / 1xEVDO
Initial S/W Revision	A.05.00

AWS

Selects AWS as the band for the current step.

Key Path	Source, List Sequencer, List Sequencer Setup, Radio Setup, Radio Standard, CDMA 2000 / 1xEVDO
Initial S/W Revision	A.05.00

US 2.5GHz

Selects US 2.5 GHz as the band for the current step.

Key Path	Source, List Sequencer, List Sequencer Setup, Radio Setup, Radio Standard, CDMA 2000 / 1xEVDO
Initial S/W Revision	A.05.00

700 Public Safety

Selects 700 Public Safety as the band for the current step.

Key Path	Source, List Sequencer, List Sequencer Setup, Radio Setup, Radio Standard, CDMA 2000 / 1xEVDO
Initial S/W Revision	A.05.00

C2K Lower 700

Selects C2K Lower 700 as the band for the current step.

Key Path	Source, List Sequencer, List Sequencer Setup, Radio Setup, Radio Standard, CDMA 2000 / 1xEVDO
Initial S/W Revision	A.05.00

LTE

Pressing this key once selects LTE FDD as the radio standard and the current LTE FDD band as the active channel band. Pressing this key again allows access to the sub-menus for selecting a different LTE FDD band.

Key Path	Source, List Sequencer, List Sequencer Setup, Radio Setup, Radio Standard
Initial S/W Revision	A.09.50

BAND 1

Selects BAND 1 as the band for the current step.

Key Path	Source, List Sequencer, List Sequencer Setup, Radio Setup, Radio Standard, LTE
Initial S/W Revision	A.09.50

BAND 2

Selects BAND 2 as the band for the current step.

Key Path	Source, List Sequencer, List Sequencer Setup, Radio Setup, Radio Standard, LTE
Initial S/W Revision	A.09.50

BAND 3

Selects BAND 3 as the band for the current step.

Key Path	Source, List Sequencer, List Sequencer Setup, Radio Setup, Radio Standard, LTE
Initial S/W Revision	A.09.50

BAND 4

Selects BAND 4 as the band for the current step.

Key Path	Source, List Sequencer, List Sequencer Setup, Radio Setup, Radio Standard, LTE
Initial S/W Revision	A.09.50

BAND 5

Selects BAND 5 as the band for the current step.

Key Path	Source, List Sequencer, List Sequencer Setup, Radio Setup, Radio Standard, LTE
Initial S/W Revision	A.09.50

BAND 6

Selects BAND 6 as the band for the current step.

Key Path	Source, List Sequencer, List Sequencer Setup, Radio Setup, Radio Standard, LTE
Initial S/W Revision	A.09.50

BAND 7

Selects BAND 7 as the band for the current step.

Key Path	Source, List Sequencer, List Sequencer Setup, Radio Setup, Radio Standard, LTE
Initial S/W Revision	A.09.50

BAND 8

Selects BAND 8 as the band for the current step.

Key Path	Source, List Sequencer, List Sequencer Setup, Radio Setup, Radio Standard, LTE
Initial S/W Revision	A.09.50

BAND 9

Selects BAND 9 as the band for the current step.

Key Path	Source, List Sequencer, List Sequencer Setup, Radio Setup, Radio Standard, LTE
Initial S/W Revision	A.09.50

BAND 10

Selects BAND 10 as the band for the current step.

Key Path	Source, List Sequencer, List Sequencer Setup, Radio Setup, Radio Standard, LTE
Initial S/W Revision	A.09.50

BAND 11

Selects BAND 11 as the band for the current step.

Key Path	Source, List Sequencer, List Sequencer Setup, Radio Setup, Radio Standard, LTE
Initial S/W Revision	A.09.50

BAND 12

Selects BAND 12 as the band for the current step.

Key Path	Source, List Sequencer, List Sequencer Setup, Radio Setup, Radio Standard, LTE
Initial S/W Revision	A.09.50

BAND 13

Selects BAND 13 as the band for the current step.

Key Path	Source, List Sequencer, List Sequencer Setup, Radio Setup, Radio Standard, LTE
Initial S/W Revision	A.09.50

BAND 14

Selects BAND 14 as the band for the current step.

Key Path	Source, List Sequencer, List Sequencer Setup, Radio Setup, Radio Standard, LTE
Initial S/W Revision	A.09.50

BAND 17

Selects BAND 17 as the band for the current step.

Key Path	Source, List Sequencer, List Sequencer Setup, Radio Setup, Radio Standard, LTE
Initial S/W Revision	A.09.50

BAND 18

Selects BAND 18 as the band for the current step.

Key Path	Source, List Sequencer, List Sequencer Setup, Radio Setup, Radio Standard, LTE
Initial S/W Revision	A.09.50

BAND 19

Selects BAND 19 as the band for the current step.

Key Path	Source, List Sequencer, List Sequencer Setup, Radio Setup, Radio Standard, LTE
Initial S/W Revision	A.09.50

BAND 20

Selects BAND 20 as the band for the current step.

Key Path	Source, List Sequencer, List Sequencer Setup, Radio Setup, Radio Standard, LTE
Initial S/W Revision	A.09.50

BAND 21

Selects BAND 21 as the band for the current step.

Key Path	Source, List Sequencer, List Sequencer Setup, Radio Setup, Radio Standard, LTE
Initial S/W Revision	A.09.50

BAND 24

Selects BAND 24 as the band for the current step.

Key Path	Source, List Sequencer, List Sequencer Setup, Radio Setup, Radio Standard, LTE
Initial S/W Revision	A.09.50

BAND 25

Selects BAND 25 as the band for the current step.

Key Path	Source, List Sequencer, List Sequencer Setup, Radio Setup, Radio Standard, LTE
Initial S/W Revision	A.09.50

BAND 26

Selects BAND 26 as the band for the current step.

Key Path	Source, List Sequencer, List Sequencer Setup, Radio Setup, Radio Standard, LTE
Initial S/W Revision	A.12.53

BAND 27

Selects BAND 27 as the band for the current step.

Key Path	Source, List Sequencer, List Sequencer Setup, Radio Setup, Radio Standard, LTE
Initial S/W Revision	A.14.00

BAND 28

Selects BAND 28 as the band for the current step.

Key Path	Source, List Sequencer, List Sequencer Setup, Radio Setup, Radio Standard, LTE
Initial S/W Revision	A.14.00

BAND 31

Selects BAND 31 as the band for the current step.

Key Path	Source, List Sequencer, List Sequencer Setup, Radio Setup, Radio Standard, LTE
Initial S/W Revision	A.14.00

LTE TDD

Sets LTE TDD as the radio standard for use and accesses the LTE TDD specific channel band sub-menus..

Key Path	Source, Frequency, Radio Setup, Radio Standard
Initial S/W Revision	A.11.50

BAND 33

Selects BAND 33 as the band for the current step.

Key Path	Source, Frequency, Radio Setup, Radio Standard, LTE TDD
Example	:SOUR:FREQ:CHAN:BAND BAND33
Initial S/W Revision	A.11.50

BAND 34

Selects BAND 34 as the band for the current step.

Key Path	Source, Frequency, Radio Setup, Radio Standard, LTE TDD
Example	:SOUR:FREQ:CHAN:BAND BAND34
Initial S/W Revision	A.11.50

BAND 35

Selects BAND 35 as the band for the current step.

Key Path	Source, Frequency, Radio Setup, Radio Standard, LTE TDD
Example	:SOUR:FREQ:CHAN:BAND BAND35
Initial S/W Revision	A.11.50

BAND 36

Selects BAND 36 as the band for the current step.

Key Path	Source, Frequency, Radio Setup, Radio Standard, LTE TDD
Example	:SOUR:FREQ:CHAN:BAND BAND36
Initial S/W Revision	A.11.50

BAND 37

Selects BAND 37 as the band for the current step.

Key Path	Source, Frequency, Radio Setup, Radio Standard, LTE TDD
Example	:SOUR:FREQ:CHAN:BAND BAND37
Initial S/W Revision	A.11.50

BAND 38

Selects BAND 38 as the band for the current step.

Key Path	Source, Frequency, Radio Setup, Radio Standard, LTE TDD
Example	:SOUR:FREQ:CHAN:BAND BAND38
Initial S/W Revision	A.11.50

BAND 39

Selects BAND 39 as the band for the current step.

Key Path	Source, Frequency, Radio Setup, Radio Standard, LTE TDD
Example	:SOUR:FREQ:CHAN:BAND BAND39
Initial S/W Revision	A.11.50

BAND 40

Selects BAND 40 as the band for the current step.

Key Path	Source, Frequency, Radio Setup, Radio Standard, LTE TDD
Example	:SOUR:FREQ:CHAN:BAND BAND40
Initial S/W Revision	A.11.50

BAND 41

Selects BAND 41 as the band for the current step.

Key Path	Source, Frequency, Radio Setup, Radio Standard, LTE TDD
Example	:SOUR:FREQ:CHAN:BAND BAND41
Initial S/W Revision	A.11.50

BAND 42

Selects BAND 42 as the band for the current step.

Key Path	Source, Frequency, Radio Setup, Radio Standard, LTE TDD
Example	:SOUR:FREQ:CHAN:BAND BAND42
Initial S/W Revision	A.11.50

BAND 43

Selects BAND 43 as the band for the current step.

Key Path	Source, Frequency, Radio Setup, Radio Standard, LTE TDD
Example	:SOUR:FREQ:CHAN:BAND BAND43
Initial S/W Revision	A.11.50

BAND 44

Selects BAND 44 as the band for the current step.

Key Path	Source, List Sequencer, List Sequencer Setup, Radio Setup, Radio Standard, LTE TDD
Initial S/W Revision	A.14.00

TDSCDMA

Sets TDSCDMA as the radio standard for use and accesses the TDSCDMA specific channel band sub-menus..

Key Path	Source, Frequency, Radio Setup, Radio Standard
Initial S/W Revision	A.11.50

BAND A

Selects BAND A as the band for the current step.

Key Path	Source, Frequency, Radio Setup, Radio Standard, TDSCDMA
Example	:SOUR:FREQ:CHAN:BAND BANDA
Initial S/W Revision	A.11.50

BAND B

Selects BAND B as the band for the current step.

Key Path	Source, Frequency, Radio Setup, Radio Standard, TDSCDMA
Example	:SOUR:FREQ:CHAN:BAND BANDB
Initial S/W Revision	A.11.50

BAND C

Selects BAND C as the band for the current step.

Key Path	Source, Frequency, Radio Setup, Radio Standard, TDSCDMA
Example	:SOUR:FREQ:CHAN:BAND BANDC
Initial S/W Revision	A.11.50

BAND D

Selects BAND D as the band for the current step.

Key Path	Source, Frequency, Radio Setup, Radio Standard, TDSCDMA
Example	:SOUR:FREQ:CHAN:BAND BANDD
Initial S/W Revision	A.11.50

BAND E

Selects BAND E as the band for the current step.

Key Path	Source, Frequency, Radio Setup, Radio Standard, TDSCDMA
----------	---

Example	:SOUR:FREQ:CHAN:BAND BANDE
Initial S/W Revision	A.11.50

BAND F

Selects BAND F as the band for the current step.

Key Path	Source, Frequency, Radio Setup, Radio Standard, TDSCDMA
Example	:SOUR:FREQ:CHAN:BAND BANDF
Initial S/W Revision	A.11.50

Radio Band Link

Allows you to specify the radio band link direction for the steps within the list sequence. The link is used in conjunction with the channel band and channel number to determine the output frequency.

When set to “Uplink”, the source will calculate the uplink frequency according to an uplink formula together with selected channel band and channel number. When set to “Downlink”, the source will calculate the downlink frequency according to a downlink formula together with selected channel band and channel number.

Key Path	Source, List Sequencer, List Sequencer Setup, Radio Setup
Remote Command	:SOURce:LIST:STEP [1] 2 3...1000:SETup:RADio:BAND:LINK DOWN UP :SOURce:LIST:STEP [1] 2 3...1000:SETup:RADio:BAND:LINK?
Example	:SOUR:LIST:STEP2:SET:RAD:BAND:LINK UP :SOUR:LIST:STEP2:SET:RAD:BAND:LINK?
Notes	SCPI is supported after A.09.40
Preset	DOWN
Range	DOWN UP
Initial S/W Revision	A.05.00

Channel

Allows you to specify the frequency of the current step via a channel number.

Key Path	Source, List Sequencer, List Sequencer Setup
Remote Command	:SOURce:LIST:STEP [1] 2 3...1000:SETup:CNFRrequency <double> :SOURce:LIST:STEP [1] 2 3...1000:SETup:CNFRrequency?
Example	:SOUR:LIST:STEP2:SET:CNFR 124 :SOUR:LIST:STEP2:SET:CNFR?
Notes	SCPI is supported after A.09.40.

	This SCPI is used to setup channel number or frequency setting, according to current Radio Band setting. If Radio Band is "NONE", then it's frequency. If Radio Band is not "NONE", then it's channel number.
Couplings	The channel number is coupled to the step frequency value. When the step frequency value is changed, the channel number will increase or decrease to match the new step frequency. If the step frequency is not at an exact match for a channel number, the nearest channel number is displayed, along with a greater than, or less than sign to indicate the frequency is above or below the channel number.
Preset	1
Min	0 (Please refer to for valid ranges.)
Max	10838 (Please refer to for valid ranges.)
Initial S/W Revision	A.05.00

Frequency

Allows you to specify a frequency value for the current step.

Key Path	Source, List Sequencer, List Sequencer Setup
Remote Command	:SOURce:LIST:STEP[1] 2 3...1000:SETup:CNFRfrequency <double> :SOURce:LIST:STEP[1] 2 3...1000:SETup:CNFRfrequency?
Example	:SOUR:LIST:STEP2:SET:CNFR 1GHz :SOUR:LIST:STEP2:SET:CNFR?
Notes	SCPI is supported after A.09.40. This SCPI is used to setup channel number or frequency setting, according to current Radio Band setting. If Radio Band is "NONE", then it's frequency. If Radio Band is not "NONE", then it's channel number.
Couplings	The frequency value is coupled to the channel band and number for the step, such that updates to the radio band and channel number will update the frequency value to the corresponding absolute frequency. The reverse is also true, changing the frequency value causes the value of the channel number to be updated.
Preset	1.00 GHz
Min	10.00 MHz
Max	Hardware Dependant: Option 503 = 3.6 GHz Option 504 = 3.9 GHz Option 506 = 6.00 GHz
Initial S/W Revision	A.05.00

Power

Allows you to specify a power value for the current step.

Key Path	Source, List Sequencer, List Sequencer Setup
Remote Command	:SOURce:LIST:STEP[1] 2 3...1000:SETup:AMPLitude <double> :SOURce:LIST:STEP[1] 2 3...1000:SETup:AMPLitude?
Example	:SOUR:LIST:STEP2:SET:AMPL -50dBm :SOUR:LIST:STEP2:SET:AMPL?
Notes	SCPI is supported after A.09.40
Notes	Amplitude corrections can be specified for use with the source. In the event of amplitude corrections being applied, the valid ranges for the RF power do not change dependant on the current amplitude correction setting. Instead, if the combination of RF power + amplitude correction is higher or lower than the source output range, the Source Unleveled bit is set and the “Source Unleveled” indicator will appear on status panel to indicate that the source cannot maintain the output power that has been requested. The multiport adapter RFIO TX ports and GPS ports cannot ensure power accuracy when power setting is lower than -130dBm, this power setting value is defined by the sum of RF Power setting and related amplitude correction value. But user settable value could be lower than this limit. When application detected there exists power setting lower than -130dBm on MPA RFIO TX ports, then popup warning message . When application detected there exists power setting lower than -130dBm on MPA GPS ports, then popup warning message . These are only warning messages, and check is performed when RF is ON.
Notes	The Min and Max value here defined UI settable amplitude range. This range is larger than actual amplitude range with level accuracy defined in spec.
Dependencies	The RF power is dependent on the RF output port and frequency, such that the current frequency and selected output port determine the valid range of power values.
Preset	-100 dBm
Min	The range of values depends on the current frequency and selected RF output port. Please refer to "RF Power" on page 2442 and the table RF Power Range for the valid ranges.
Max	The range of values depends on the current frequency and selected RF output port. Please refer to "RF Power" on page 2442 and the table RF Power Range for the valid ranges.
Initial S/W Revision	A.05.00

Waveform

Allows you access to the sub-menus for selecting the waveform to be played back during the current step. Pressing this key also changes the central display area to show the Waveform File Selection view.

Key Path	Source, List Sequencer, List Sequencer Setup
Remote Command	:SOURce:LIST:STEP[1] 2 3...1000:SETup:WAVEform <string> :SOURce:LIST:STEP[1] 2 3...1000:SETup:WAVEform?
Example	:SOUR:LIST:STEP2:SET:WAV "CW" :SOUR:LIST:STEP2:SET:WAV?
Notes	SCPI is supported after A.09.40
Remote Command Notes	String type, takes “Off” “CW” “Cont” “waveform name”

Preset	CW
Range	Waveform Continue Previous CW Off
Initial S/W Revision	A.05.00

CW

Sets the current step to output a CW tone.

Key Path	Source, List Sequencer, List Sequencer Setup, Waveform
Example	:SOUR:LIST:STEP2:SET:WAV "CW"
Notes	SCPI is supported after A.09.40
Initial S/W Revision	A.05.00

Selected Waveform

Inserts the currently selected waveform in the waveform selection view as the waveform for playback during the current step.

Key Path	Source, List Sequencer, List Sequencer Setup, Waveform
Example	:SOUR:LIST:STEP2:SET:WAV "waveform name"
Notes	SCPI is supported after A.09.40 If the selected waveform contains header (which contains ARB play parameters), source list sequence will automatically apply header settings of the selected waveform in that step.
Initial S/W Revision	A.05.00

Continue Previous

Sets the current step to continue with playback of the waveform from the previous step. When continuing the previous waveform, the ARB playback will not pause while the source retunes to the new frequency or amplitude that may be defined for the new step.

Key Path	Source, List Sequencer, List Sequencer Setup, Waveform
Example	:SOUR:LIST:STEP2:SET:WAV "Cont"
Notes	SCPI is supported after A.09.40
Initial S/W Revision	A.05.00

Off

Disable RF output of the current step.

Key Path	Source, List Sequencer, List Sequencer Setup, Waveform
Example	:SOUR:LIST:STEP2:SET:WAV "Off"
Notes	SCPI is supported after A.09.40
Initial S/W Revision	A.05.00

Segments on Hard Disk

Allows you access to the sub-menus for loading waveform segments from the hard disk into ARB memory. The default directory is: D: varb.

Pressing this key changes the current view to the Waveform Management View.

Key Path	Source, Modulation Setup, ARB, Select Waveform
Initial S/W Revision	A.05.00

Load Segment To ARB Memory

Allows you to load the selected file into ARB memory. On the front panel you select the file for loading to the ARB memory by highlighting the desired file in the list. Using the SCPI command, you specify the file name on the HDD.

“NVWFM” (none-volatile storage) MSUS (Mass Storage Unit Specifier) is supported in the memory subsystem because the ARB memory cannot be accessed directly. Therefore, files must be downloaded to the instrument hard disk and then loaded into the ARB memory. “NVWFM” MSUS will be mapped to the default directory D: VARB. The SCPI command supports using either “NVWFM” MSUS or specifying a full path. For more information, see [Memory Subsystem \(Remote Command Only\)](#).

If a file of the same name already exists within ARB memory, it is overwritten. If you wish to load two segments of the same name, you must rename one of the segments before loading it into ARB memory. To rename a segment, you can either use Windows File Explorer, or the :MMEMory:COPY command.

NOTE: When a waveform file is loaded to ARB memory, burst timing adjustments are made automatically, based on whether or not a Multiport Adapter is connected to the test set and powered on. If the connection/power status of the Multiport Adapter is changed after a waveform file has been loaded, it needs to be loaded again.

Key Path	Source, Modulation Setup, ARB, Select Waveform, Segments on Hard Disk
Remote Command	:SOURce:RADio:ARB:LOAD <string>
Example	:SOUR:RAD:ARB:LOAD "D: VARB\testwaveform.bin" or :SOUR:RAD:ARB:LOAD "NVWFM:testwaveform.bin"
Notes	Because loading the file involves a delay of unpredictable length, this command should be followed by the query *OPC?, which holds off subsequent commands until the loading operating is complete. <string> – specifies the path name of the file to load from the HDD into ARB memory. It could be a <full path + filename>, or <"NVWFM" MSUS + colon + filename>.

When in Sequence Analyzer mode, and Include Source is Yes, an attempt to load a file to ARB memory will be rejected with an error.

When Include Source is No and if there is insufficient free ARB memory to load the selected waveform, an error is generated. .

If you specify a file over SCPI, but the file is not at the specified location, an error is generated.

If you try to load a waveform file but the file contains less than 500 IQ samples, an error is generated.

If you try to load a Signal Studio waveform “*.wfm” which contains invalid waveform header, an error is generated.

If the ARB is ON when you load a file to ARB memory or delete a file from ARB memory, the playing waveform segment may not keep phase continuity during the ARB memory operation. The waveform will be replayed after the ARB operation is finished.

ARB can be loaded into ARB memory even required licenses do not present on the instrument. In this case, a GUI only warning message -800, “Operation complete; Loaded <filename> successfully, but no license <required licenses> installed”. User can install required licenses according to <required licenses> string to license it, or multi-pack license it.

Initial S/W Revision A.05.00

Load All To ARB Memory

Allows you to load all the segment files within the currently selected directory into ARB memory. If a file of the same name already exists within ARB memory, it is overwritten. If you wish to load two segments of the same name, you must rename one of the segments before loading it into ARB memory. To rename a segment, you can either use Windows File Explorer, or the :MEMory:COpy command.

NOTE: When a waveform file is loaded to ARB memory, burst timing adjustments are made automatically, based on whether or not a Multiport Adapter is connected to the test set and powered on. If the connection/power status of the Multiport Adapter is changed after a waveform file has been loaded, it needs to be loaded again.

Key Path	Source, Modulation Setup, ARB, Select Waveform, Segments on Hard Disk
Remote Command	:SOURce:RADio:ARB:LOAD:ALL <string>
Example	:SOUR:RAD:ARB:LOAD:ALL “D: varb”
Notes	<p><string> - specifies the directory on the HDD to load the files into ARB memory from.</p> <p>When in Sequence Analyzer mode, and Include Source is Yes, an attempt to load all files from a directory to ARB memory is rejected with an error.</p> <p>When Include Source is No and there is insufficient free ARB memory to load all the waveforms, when the ARB memory is full, the copy ceases, and an error is generated.</p> <p>If you specify a directory over SCPI, but the directory does not exist, an error is generated.</p> <p>If the ARB is ON, a user then loads or deletes file to ARB memory, the playing waveform segment may not keep phase continuity during the ARB memory operation. The waveform will be replayed after the ARB operation is finished.</p>

Initial S/W Revision A.05.00

Change Directory...

Allows you to change the currently selected directory on the hard disk. Pressing this key opens a standard windows change directory dialog allowing you to select the new directory of interest.

The current directory is used for manually loading waveform segments into ARB memory for playback, and as a search location for waveform segments that are required to be loaded into ARB memory for playback of a waveform sequence or a list sequence.

Key Path	Source, Modulation Setup, ARB, Select Waveform, Segments on Hard Disk
Notes	No remote command, SCPI front panel only.
Initial S/W Revision	A.05.00

Default Directory...

Allows you to change the default directory. It is used as a search location for waveform segments that are required to be loaded into ARB memory for playback of a waveform sequence, and as a search location for selecting waveforms using SCPI.

Key Path	Source, Modulation Setup, ARB, Select Waveform, Segments on Hard Disk
Remote Command	:SOURce:RADio:ARB:DEFault:DIRectory <string> :SOURce:RADio:ARB: DEFault:DIRectory?
Example	:SOUR:RAD:ARB:DEF:DIR "D:\ArbFiles" :SOUR:RAD:ARB:DEF:DIR?
State Saved	Persistent, survives a power cycle and a preset but not saved in the instrument state
Initial S/W Revision	A.05.00

Segments in ARB Memory

Allows you access to the sub-menus for managing the files within ARB memory.

Key Path	Source, Modulation Setup, ARB, Select Waveform
Initial S/W Revision	A.05.00

Delete Segment From ARB Mem

Allows you to remove a segment from ARB playback memory.

Key Path	Source, Modulation Setup, ARB, Select Waveform, Segments in ARB Memory
Remote Command	:SOURce:RADio:ARB:DELeTe <string>
Example	:SOUR:RAD:ARB:DEL "testwaveform.bin"
Notes	<string> - specifies the waveform to be deleted from the ARB playback memory. When in Sequence Analyzer mode and Include Source is Yes, an attempt to delete a file from ARB

memory is rejected with an error. When Include Source is No and you specify a file that does not exist within ARB memory, an error is generated. It is possible to delete files from within the ARB memory when the ARB is ON. However, if you attempt to delete the file that is currently playing an error is generated. It is possible to delete a file from within the ARB memory when the sequencer state is ON and the file is not being used by the List Sequencer. If you attempt to delete a file which is being used by the list sequencer, an error is generated. When sequencer state is On, even if ARB state is On, the selected waveform will not be played. In this case, if the selected waveform is not used in List Sequence, it can be deleted and the ARB state is turned Off. If the ARB is ON and you load a file to ARB memory or delete a file from ARB memory, the playing waveform segment may not keep phase continuity during the ARB memory operation. The waveform will be replayed after the ARB operation is finished.
Initial S/W Revision A.05.00

Delete All From ARB Memory

Allows you to remove all segments from ARB playback memory.

Key Path	Source, Modulation Setup, ARB, Select Waveform, Segments in ARB Memory
Remote Command	:SOURce:RADio:ARB:DELeTe:ALL
Example	:SOUR:RAD:ARB:DELeTe:ALL
Notes	When in Sequence Analyzer mode and Include Source is Yes, an attempt to delete all files from ARB memory is rejected with an error. When Include Source is No and you attempt to delete all files from ARB memory when the ARB is currently playing a file, all files except the one playing are deleted and an error is generated. If you attempt to delete all files from ARB memory when there are waveform files used in " List Sequencer " on page 2520 and " Sequencer " on page 2521 state is ON, all files except the files currently being used in list sequencer are deleted, and an error is generated. If the ARB is ON and you load a file to ARB memory or delete a file from ARB memory, the playing waveform segment may not keep phase continuity during the ARB memory operation. The waveform will be replayed after the ARB operation is finished.
Initial S/W Revision A.05.00	

Segments on Hard Disk

This key functions the same as "[Segments on Hard Disk](#)" on page 2547.

Key Path	Source, List Sequencer, List Sequencer Setup, Waveform
Initial S/W Revision Prior to A.09.00	

Load Segment To ARB Memory

This key functions the same as ["Load Segment To ARB Memory" on page 2547](#).

Key Path	Source, List Sequencer, List Sequencer Setup, Waveform, Segment on Hard Drive
Initial S/W Revision	Prior to A.09.00

Load All To ARB Memory

This key functions the same as ["Load All To ARB Memory" on page 2548](#).

Key Path	Source, List Sequencer, List Sequencer Setup, Waveform, Segment on Hard Drive
Initial S/W Revision	Prior to A.09.00

Change Directory ...

This key functions the same as ["Change Directory..." on page 2549](#).

Key Path	Source, List Sequencer, List Sequencer Setup, Waveform, Segment on Hard Drive
Initial S/W Revision	Prior to A.09.00

Default Directory ...

This key functions the same as ["Default Directory..." on page 2549](#)

Key Path	Source, List Sequencer, List Sequencer Setup, Waveform, Segment on Hard Drive
Initial S/W Revision	Prior to A.09.00

Segments in ARB Memory

This key functions the same as ["Segments in ARB Memory" on page 2549](#).

Key Path	Source, List Sequencer, List Sequencer Setup, Waveform, Segments in ARB Memory
Initial S/W Revision	Prior to A.09.00

Delete Segment From ARB Memory

This key functions the same as ["Delete Segment From ARB Mem" on page 2549](#).

Key Path	Source, List Sequencer, List Sequencer Setup, Waveform, Segments in ARB Memory, Segment in ARB Memory
Initial S/W Revision	Prior to A.09.00

Delete All From ARB Memory

This key functions the same as ["Delete All From ARB Memory" on page 2550](#).

Key Path	Source, List Sequencer, List Sequencer Setup, Waveform, Segments in ARB Memory, Segment in ARB Memory
Initial S/W Revision	Prior to A.09.00

Step Duration

Allows access to the sub-menus for setting up the duration of play for the current step.

The duration can be set to be either the number of times for the ARB file associated with the sequence to play, or a specific time value, or continuous. If the step is set to play a CW tone, the step duration cannot be set to a play count.

Key Path	Source, List Sequencer, List Sequencer Setup
Remote Command	:SOURce:LIST:STEP[1] 2 3...1000:SETup:DURation:TYPE TIME COUNT CONTInuous CABort :SOURce:LIST:STEP[1] 2 3...1000:SETup:DURation:TYPE?
Example	:SOUR:LIST:STEP2:SET:DUR:TYPE TIME :SOUR:LIST:STEP2:SET:DUR:TYPE?
Notes	SCPI is supported after A.09.40
Notes	If "Step Duration" is set to "Time" or "Play Count" for the last step, the last step of ARB keeps playing as if set to "Continuous", until the set "Time" has expired or until the "Play Count" setting is reached. However, you can query Error! Reference source not found. Source Sweeping Condition Message to find out if the current list sequence is complete or not.
Range	Time Play Count Continuous Continuous Abort
Initial S/W Revision	A.05.00

Time

Sets the duration of the current step to be a time value for the length of time the step will play. Pressing this key again opens another menu which allows you to set the time value for the step duration.

Key Path	Source, List Sequencer, List Sequencer Setup, Step Duration
Example	:SOUR:LIST:STEP2:SET:DUR:TYPE TIME
Notes	SCPI is supported after A.09.40
Initial S/W Revision	A.05.00

Duration Time

Allows you to specify the length of time the current step will play.

When Step Duration is **Continuous Abort** this parameter specifies the maximum duration that the waveform will continue to play after a step trigger is received before the transition to the next waveform will occur. Duration is limited to a maximum of 20 seconds.

If the Transition Time value is longer than the Step Duration Time, an error is generated when initiating a source list sequence. For source list sequence, transition time is included in the step duration length (not occupy additional time). If the Transition Time value is longer than the Step Duration Time, the real step duration length is extended to equal the transition time and cause a timing shift. This check is also described in section **Error! Reference source not found**. List Sequence Step Validation.

Key Path	Source, List Sequencer, List Sequencer Setup, Step Duration, Time
Remote Command	:SOURce:LIST:STEP[1] 2 3...1000:SETup:DURation:TCOUNT <double> :SOURce:LIST:STEP[1] 2 3...1000:SETup:DURation:TCOUNT?
Example	:SOUR:LIST:STEP2:SET:DUR:TCO 1s :SOUR:LIST:STEP2:SET:DUR:TCO?
Notes	SCPI is supported after A.09.40 This SCPI is reused by "Play Count", "Duration Time" and "Continuous Abort" according to current Duration Type setting is "Play Count" or "Duration Time" or "Continuous Abort". If current "Duration Type" is "Continuous", then popup error -221, "Settings conflict; Cannot accept time or count input when step duration type is Continuous on step #"
Notes	If "Duration Time" is set for the last step, the last step of ARB keeps playing as if set to "Continuous" after set time expires. However, you can query Source Sweeping Condition Message (:STAT:OPER:COND?) to find out if the current list sequence is complete or not.
Preset	1.00 ms
Min	100 μs
Max	1800 s
Initial S/W Revision	A.05.00

Play Count

Sets the duration of the current step to be an integer value for the number of times (play count) the ARB file is selected for playback during this step. For example, a 5 second ARB will be set to play 5 times during the step.

Key Path	Source, List Sequencer, List Sequencer Setup, Step Duration
Example	:SOUR:LIST:STEP2:SET:DUR:TYPE COUN
Notes	SCPI is supported after A.09.40 This key is unavailable and is grayed out if the current step is configured to CW tone rather than an ARB waveform.
Initial S/W Revision	A.05.00

Header Utilities

Allows access to the header utilities sub-menu. Pressing this key also causes the central display area to change to display the File Header Information view.

Key Path	Source, Modulation Setup, ARB
Dependencies	This key is only available if there is currently a waveform selected for playback. If no waveform is selected, the key is grayed out.
Initial S/W Revision	A.05.00

Continuous

Sets the current step to be played continuously until the next step starts. The waveform will always play completely before transitioning to the next step.

Key Path	Source, List Sequencer, List Sequencer Setup, Step Duration
Example	:SOUR:LIST:STEP2:SET:DUR:TYPE CONT
Notes	SCPI is supported after A.09.40
Initial S/W Revision	A.05.00

Output Trigger

Allows you to specify the trigger output for the current step. The trigger output signal is sent at the start of the step.

When select “On”, trigger event will occur on both Internal and External2 paths. Select “Off” will turn off trigger output.

Key Path	Source, List Sequencer, List Sequencer Setup
Remote Command	:SOURce:LIST:STEP[1] 2 3...1000:SETup:OUTPut:TRIGger ON OFF 1 0 :SOURce:LIST:STEP[1] 2 3...1000:SETup:OUTPut:TRIGger
Example	:SOUR:LIST:STEP2:SET:OUTP:TRIG ON :SOUR:LIST:STEP2:SET:OUTP:TRIG?
Notes	SCPI is supported after A.09.40
Preset	Off
Range	On Off
Initial S/W Revision	A.05.00

Step Configuration (Remote Command Only)

This SCPI command is used to configure the List Sequencer and is detailed in the table below. The command is defined such that you send one command per step, with the step number being specified as a subopcode of the SCPI command. Each command includes all the parameter settings for the step. As a step is setup, the values entered are run through several levels of validation.

Remote Command	:SOURce:LIST:STEP[1] 2 ... 4..1000:SETup IMMEDIATE INTernal KEY
-----------------------	---

```
BUS | EXTERNAL2, <time>, NONE | PGSM | EGSM | RGSM | DCS1800 | PCS1900
| TGSM810 | GSM450 | GSM480 | GSM700 | GSM850 | BANDI | BANDII |
BANDIII | BANDIV | BANDV | BANDVI | BANDVII | BANDVIII | BANDIX | BANDX
| BANDXI | BANDXII | BANDXIII | BANDXIV | BANDXIX | USCELL | USPCS |
JAPAN | KOREAN | NMT | IMT2K | UPPER | SECOND | PAMR400 | PAMR800 |
IMTEXT | PCS1DOT9G | AWS | US2DOT5G | PUBLIC | LOWER | NONE | BAND1 |
BAND2 | BAND3 | BAND4 | BAND5 | BAND6 | BAND7 | BAND8 | BAND10 | BAND11
| BAND12 | BAND13 | BAND14 | BAND17 | BAND18 | BAND19 | BAND20 | BAND21
| BAND24 | BAND25 | BAND26 | BAND33 | BAND34 | BAND35 | BAND36 | BAND37
| BAND38 | BAND39 | BAND40 | BAND41 | BAND42 | BAND43 | BANDA | BANDB |
BANDC | BANDD | BANDE | BANDF, DOWN | UP, <freq>, <ampl>, <string>,
TIME | COUNT | CONTinuous, <time>, ON | OFF | 1 | 0, [<int>],
:SOURce:LIST:STEP[1]|2|...|4..1000:SETup?
```

Example :SOUR:LIST:STEP1:SET INT, 1ms, PGSM, DOWN, 10, -25 dBm, "GSM_Test1.bin", TIME, 10ms, OFF, 255

Notes

The parameters are:

(There is a total of 11 items in each step, the following is a list of the items in the order they must appear in the remote command.)

1. Step Trigger <enum> – specifies the input trigger for the step. For details of the valid types of step trigger see ["Step Trigger" on page 2523](#).
 2. Transition Time <time> – specifies the transition time for the step in seconds. For details of the valid ranges for the transition time see ["Transition Time" on page 2525](#).
 3. Radio Band <enum> – specifies the radio band for the step. For details of the valid radio bands see ["Radio Setup" on page 2526](#).
 4. Radio Band Link <enum> – specifies the radio band link direction for the step. For details of the valid link types, see ["Radio Band Link" on page 2543](#).
 5. Frequency/Channel Number <freq>/<chan num> – specifies the frequency in Hz or the channel number for the step. The channel number and frequency are combined as one parameter that represents the frequency or channel number depending on the radio band setting. If the radio band is set to NONE, this value is interpreted as a frequency value in Hz. If the radio band is set to a valid band, this value is interpreted as a channel number. For details of the valid ranges for frequency and channel numbers, see ["Channel" on page 2543](#) and ["Frequency" on page 2544](#).
 6. Power <ampl> – specifies the output power for the step in dBm. For details of the valid ranges see ["Power" on page 2544](#).
 7. Waveform <string> – specifies the waveform for playback during the step. The step can output either a new ARB waveform, continue playback of the previous waveform, or output a CW tone. The options for specifying these are:
 - <filename> - plays the specified waveform from the start. The filename value is the name of the file within ARB playback memory, it does not include the windows path to the file on the HDD. If you enter a filename for a waveform that does not reside within ARB playback memory, an error is generated.
 - CONT – continues playback of the ARB file from the previous step
 - CW – outputs a CW tone
 - OFF – disable RF output
 8. Step Duration <enum> – specifies the duration of the step. The duration can be specified to be either time, or play count of the ARB file associated with the step, or continuous. If Waveform is set to "CW", this value cannot be set to Play Count and an error will be generated. If continuous is selected, the following Time or Count value is ignored. For further details of this setting, see ["Step](#)
-

	<p>Duration" on page 2552.</p> <p>9. Time or Count <time/int> – specifies time duration in seconds or play count of the ARB file associated with the step. For further details of this setting, including the valid ranges for the time or play count setting, "Time" on page 2552 and "Play Count" on page 2553.</p> <p>10. Output Trigger <Boolean> – specifies the output trigger for the step. For details of the ranges for this setting see "Output Trigger" on page 2554.</p>
Dependencies	<p>The range of subopcode values is 1 to 1000 and the value you enter is determined by the number of steps you have configured. For details see "Number of Steps" on page 2522.</p> <p>If you attempt to remotely set or query a subopcode that is out of range, an error is generated.</p>
Initial S/W Revision	A.05.00

Step Configuration of Step Trigger parameter list (Remote Command Only)

This SCPI command is to configure “Step Trigger” parameter array of the whole List Sequencer at one time. The number of array is same as step number defined in "**Number of Steps" on page 2522** Number of Steps. As a step is setup, the value entered run through several levels of validation.

Remote Command	<pre>:SOURce:LIST:SETup:INPut:TRIGger <enum>, <enum>, <enum>, ... :SOURce:LIST:SETup:INPut:TRIGger?</pre>
Example	<pre>:SOUR:LIST:SET:INP:TRIG IMM,INT,EXT2 :SOUR:LIST:SET:INP:TRIG?</pre>
Notes	<p>The command is to setup below parameter array of whole list sequence.</p> <p>Step Trigger <enum> – specifies the input trigger for the step. For details of the valid types of step trigger see "Step Trigger" on page 2523.</p> <p>If input parameter number exceeds the step number defined by "Number of Steps" on page 2522Number of Steps then generate error ", and only those parametes whose index number falls in number of steps will be updated.</p>
Remote Command Notes	IMMEDIATE INTERNAL KEY BUS EXTERNAL2
Dependencies	The range is 1 to 1000 which is determined by the number of steps you have configured. For details see " Number of Steps" on page 2522.
Initial S/W Revision	A.09.40

Step Configuration of Transition Time parameter list (Remote Command Only)

This SCPI command is to configure “Transition Time” parameter array of the whole List Sequencer at one time. The number of array is same as step number defined in "**Number of Steps" on page 2522** Number of Steps. As a step is setup, the value entered run through several levels of validation.

Remote Command	<pre>:SOURce:LIST:SETup:TRANSition:TIME <time>, <time>, <time>, ... :SOURce:LIST:SETup:TRANSition:TIME?</pre>
Example	<pre>:SOUR:LIST:SET:TRAN:TIME 1ms,1ms,1ms</pre>

	:SOUR:LIST:SET:TRAN:TIME?
Notes	The command is to setup below parameter array of whole list sequence. Transition Time <time> – specifies the transition time for the step in seconds. For details of the valid ranges for the transition time see "Transition Time" on page 2525 If input parameter number exceeds the step number defined by "Number of Steps" on page 2522 Number of Steps then generate error ", and only those parameters whose index number falls in number of steps will be updated.
Dependencies	The range is 1 to 1000 which is determined by the number of steps you have configured. For details see "Number of Steps" on page 2522 .
Initial S/W Revision	A.09.40

Step Configuration of Radio Band parameter list (Remote Command Only)

This SCPI command is to configure “Radio Band” parameter array of the whole List Sequencer at one time. The number of array is same as step number defined in ["Number of Steps" on page 2522](#) Number of Steps. As a step is setup, the value entered run through several levels of validation.

R	:SOURce:LIST:SETup:RADio:BAND <enum>, <enum>, <enum>, ...
e	:SOURce:LIST:SETup:RADio:BAND?
m	
o	
t	
e	
C	
o	
m	
m	
a	
n	
d	
E	:SOUR:LIST:SET:RAD:BAND PGSM, EGSM, RGSM
X	:SOUR:LIST:SET:RAD:BAND?
a	
m	
p	
l	
e	
N	The command is to setup below parameter array of whole list sequence.
O	Radio Band <enum> – specifies the radio band for the step. For details of the valid radio bands see "Radio Setup" on page 2526 .
t	If input parameter number exceeds the step number defined by "Number of Steps" on page 2522 Number of Steps then
e	generate error ", and only those parameters whose index number falls in number of steps will be updated.
s	
R	NONE PGSM EGSM RGSM DCS1800 PCS1900 TGSM810 GSM450 GSM480 GSM700 GSM850 BANDI BANDII BANDIII BANDI
e	V BANDV BANDVI BANDVII BANDVIII BANDIX BANDX BANDXI BANDXII BANDXIII BANDXIV BANDXIX USCELL USPCS JAPAN KO
m	REAN NMT IMT2K UPPER SECOND PAMR400 PAMR800 IMTEXT PCS1 DOT9G AWS US2DOT5G PUBLIC LOWER NONE BAND1
	BAND2 BAND3 BAND4 BAND5 BAND6 BAND7 BAND8 BAND10 BAND11 BAND12 BAND13 BAND14 BAND17 BAND18 BAND1

o 9|BAND20|BAND21|BAND24|BAND25|BAND26|BAND33|BAND34|BAND35|BAND36|BAND37|BAND38|BAND39|BAND40|BAN
t D41|BAND42|BAND43|BANDA|BANDB|BANDC|BANDD|BANDE|BANDF
e

C
o
m
m
a
n
d

N
o
t
e
s

D The range is 1 to 1000 which is determined by the number of steps you have configured. For details see "[Number of Steps](#)" on
e [page 2522](#).

p
e
n
d
e
n
c
i
e
s

I A.09.40

n
i
t
i
a
l

S
/
W

R
e
v
i
s
i
o
n

Step Configuration of Radio Band Link parameter list (Remote Command Only)

This SCPI command is to configure “Radio Band Link” parameter array of the whole List Sequencer at one time. The number of array is same as step number defined in ["Number of Steps" on page 2522](#) Number of Steps. As a step is setup, the value entered run through several levels of validation.

Remote Command	:SOURce:LIST:SETup:RADio:BAND:LINK <enum>, <enum>, <enum>, ... :SOURce:LIST:SETup:RADio:BAND:LINK?
Example	:SOUR:LIST:SET:RAD:BAND:LINK DOWN,UP,UP :SOUR:LIST:SET:RAD:BAND:LINK?
Notes	The command is to setup below parameter array of whole list sequence. Radio Band Link <enum> – specifies the radio band link direction for the step. For details of the valid link types, see "Radio Band Link" on page 2543 . If input parameter number exceeds the step number defined by "Number of Steps" on page 2522 Number of Steps then generate error ", and only those parametes whose index number falls in number of steps will be updated.
Remote Command Notes	DOWN UP
Dependencies	The range is 1 to 1000 which is determined by the number of steps you have configured. For details see "Number of Steps" on page 2522 .
Initial S/W Revision	A.09.40

Step Configuration of Frequency/Channel Number parameter list (Remote Command Only)

This SCPI command is to configure “Frequency” or “Channel Number” parameter array of the whole List Sequencer at one time. The number of array is same as step number defined in ["Number of Steps" on page 2522](#) Number of Steps. As a step is setup, the value entered run through several levels of validation.

Remote Command	:SOURce:LIST:SETup:CNFRequency <double>, <double>, <double>, ... :SOURce:LIST:SETup:CNFRequency?
Example	:SOUR:LIST:SET:CNFR 1GHz,100MHz,100MHz :SOUR:LIST:SET:CNFR? SOUR:LIST:SET:CNFR 124,124,124 :SOUR:LIST:SET:CNFR?
Notes	The command is to setup below parameter array of whole list sequence. Frequency/Channel Number <freq>/<chan num> – specifies the frequency in Hz or the channel number for the step. The channel number and frequency are combined as one parameter that represents the frequency or channel number depending on the radio band setting. If the radio band is set to NONE, this value is interpreted as a frequency value in Hz. If the radio band is set to a valid band, this value is interpreted as a channel number. For details of the valid ranges for frequency and channel numbers, see "Channel" on page 2543 and "Frequency" on page 2544 . This SCPI is used to setup/query channel number or frequency setting, according to current Radio Band setting of that step. If Radio Band is “NONE”, then it’s frequency. If Radio Band is not “NONE”, then it’s channel number If input parameter number exceeds the step number defined by "Number of Steps" on page 2522 Number of Steps then generate error ", and only those parametes whose index number falls in

	legal step number will be updated.
Dependencies	The range is 1 to 1000 which is determined by the number of steps you have configured. For details see "Number of Steps" on page 2522 .
Initial S/W Revision	A.09.40

Step Configuration of Power parameter list (Remote Command Only)

This SCPI command is to configure “Power” parameter array of the whole List Sequencer at one time. The number of array is same as step number defined in ["Number of Steps" on page 2522](#) Number of Steps. As a step is setup, the value entered run through several levels of validation.

Remote Command	:SOURce:LIST:SETup:AMPLitude <ampl>, <ampl>, <ampl>, ... :SOURce:LIST:SETup:AMPLitude?
Example	:SOUR:LIST:SET:AMPL -50dBm,-40dBm,-30dBm :SOUR:LIST:SET:AMPL?
Notes	The command is to setup below parameter array of whole list sequence. Power <ampl> – specifies the output power for the step in dBm. For details of the valid ranges see "Power" on page 2544 . If input parameter number exceeds the step number defined by "Number of Steps" on page 2522 Number of Steps then generate error ", and only those parametes whose index number falls in legal step number will be updated.
Dependencies	The range is 1 to 1000 which is determined by the number of steps you have configured. For details see "Number of Steps" on page 2522 .
Initial S/W Revision	A.09.40

Step Configuration of Waveform parameter list (Remote Command Only)

This SCPI command is to configure “Waveform” parameter array of the whole List Sequencer at one time. The number of array is same as step number defined in ["Number of Steps" on page 2522](#) Number of Steps. As a step is setup, the value entered run through several levels of validation.

Remote Command	:SOURce:LIST:SETup:WAVeform <string>, <string>, <string>, ... :SOURce:LIST:SETup:WAVeform?
Example	:SOUR:LIST:SET:WAV "CW","Off","CONT" :SOUR:LIST:SET:WAV?
Notes	The command is to setup below parameter array of whole list sequence. Waveform <string> – specifies the waveform for playback during the step. The step can output either a new ARB waveform, continue playback of the previous waveform, or output a CW tone. The options for specifying these are: <filename> - plays the specified waveform from the start. The filename value is the name of the file within ARB playback memory, it is does not include the windows path to the file on the HDD. If you enter a filename for a waveform that does not reside within ARB playback memory, an error is generated.

	<p>CONT – continues playback of the ARB file from the previous step</p> <p>CW – outputs a CW tone</p> <p>OFF – disable RF output</p> <p>If input parameter number exceeds the step number defined by "Number of Steps" on page 2522 Number of Steps then generate error ", and only those parametes whose index number falls in number of steps will be updated.</p>
Dependencies	The range is 1 to 1000 which is determined by the number of steps you have configured. For details see " Number of Steps " on page 2522.
Range	"filename" "CW" "Off" "CONT"
Initial S/W Revision	A.09.40

Step Configuration of Step Duration parameter list (Remote Command Only)

This SCPI command is to configure "Step Duration" parameter array of the whole List Sequencer at one time. The number of array is same as step number defined in "[Number of Steps](#)" on page 2522 Number of Steps. As a step is setup, the value entered run through several levels of validation.

Remote Command	<pre>:SOURce:LIST:SETup:DURation:TYPE <enum>, <enum>, <enum>, ... :SOURce:LIST:SETup:DURation:TYPE?</pre>
Example	<pre>:SOUR:LIST:SET:DUR:TYPE COUN,TIME,CONT :SOUR:LIST:SET:DUR:TYPE?</pre>
Notes	<p>The command is to setup below parameter array of whole list sequence.</p> <p>Step Duration <enum> – specifies the duration of the step. The duration can be specified to be either time, or play count of the ARB file associated with the step, or continuous. If Waveform is set to "CW", this value cannot be set to Play Count and an error will be generated. If continuous is selected, the following Time or Count value is ignored. For further details of this setting, see "Step Duration" on page 2552.</p> <p>If input parameter number exceeds the step number defined by "Number of Steps" on page 2522 Number of Steps then generate error ", and only those parametes whose index number falls in number of steps will be updated.</p>
Remote Command Notes	TIME COUNT CONTinuous
Dependencies	The range is 1 to 1000 which is determined by the number of steps you have configured. For details see " Number of Steps " on page 2522.
Initial S/W Revision	A.09.40

Step Configuration of Duration Time or Play Count parameter list (Remote Command Only)

This SCPI command is to configure "Duration Time" or "Play Count" parameter array of the whole List Sequencer at one time. The number of array is same as step number defined in "[Number of Steps](#)" on page 2522 Number of Steps. As a step is setup, the value entered run through several levels of validation.

Remote Command	<pre>:SOURce:LIST:SETup:TOCount <time/int>, <time/int>, <time/int>, ... :SOURce:LIST:SETup:TOCount?</pre>
-----------------------	---

Example	:SOUR:LIST:SET:TOC 1s,2s,3s :SOUR:LIST:SET:TOC? :SOUR:LIST:SET:TOC 5,6,7 :SOUR:LIST:SET:TOC?
Notes	The command is to setup below parameter array of whole list sequence. Time or Count <time/int> – specifies time duration in seconds or play count of the ARB file associated with the step. For further details of this setting, including the valid ranges for the time or play count setting, "Time" on page 2552 and "Play Count" on page 2553 . If input parameter number exceeds the step number defined by "Number of Steps" on page 2522 Number of Steps then generate error ", and only those parametes whose index number falls in number of steps will be updated. If current "Step Duration" on page 2552 is "Continuous", then generate error -221,"Settings conflict;Cannot accept time or count input when step duration type is Continuous on step #"
Dependencies	The range is 1 to 1000 which is determined by the number of steps you have configured. For details see "Number of Steps" on page 2522 .
Initial S/W Revision	A.09.40

Step Configuration of Output Trigger parameter list (Remote Command Only)

This SCPI command is to configure "Output Trigger" parameter array of the whole List Sequencer at one time. The number of array is same as step number defined in ["Number of Steps" on page 2522](#) Number of Steps. As a step is setup, the value entered run through several levels of validation.

Remote Command	:SOURce:LIST:SETup:OUTPut:TRIGger <bool>, <bool>, <bool>, ... :SOURce:LIST:SETup:OUTPut:TRIGger ?
Example	:SOUR:LIST:SET:OUTP:TRIG ON,OFF,ON :SOUR:LIST:SET:OUTP:TRIG?
Notes	The command is to setup below parameter array of whole list sequence. Output Trigger <Boolean> – specifies the output trigger for the step. For details of the ranges for this setting see "Output Trigger" on page 2554 . If input parameter number exceeds the step number defined by "Number of Steps" on page 2522 Number of Steps then generate error ", and only those parametes whose index number falls in legal step number will be updated.
Remote Command Notes	ON OFF 1 0
Dependencies	The range is 1 to 1000 which is determined by the number of steps you have configured. For details see "Number of Steps" on page 2522 .
Initial S/W Revision	A.09.40

Clear List (Remote Command Only)

This command is the SCPI equivalent of the Clear List UI feature described in.

Remote Command	:SOURce:LIST:SETup:CLEar
Example	:SOUR:LIST:SETup:CLE
Initial S/W Revision	A.05.00

Trigger Type

Allows access to the sub-menu for selecting the output trigger type for the list sequencer globally. It cannot be changed between different sequence steps.

Key Path	Source, List Sequencer
Remote Command	:SOURce:LIST:TRIGgerout:TYPe BEGinningofstep DATamarker
Example	:SOUR:LIST:TRIG:TYP BEG :SOUR:LIST:TRIG:TYP?
Notes	SCPI is supported after A.14.00
Preset	BEGinningofstep
Range	BEGinningofstep DATamarker
Initial S/W Revision	A.14.00

BeginningOfStep

Sets the output trigger type as BeginningOfStep for the whole source sequence.

Key Path	Source, List Sequencer, Trigger Type
Example	:SOUR:LIST:TRIG:TYP BEG
Notes	SCPI is supported after A.14.00
Initial S/W Revision	A.14.00

DataMarker

Sets the output trigger type as DataMarker for the whole source sequence. When DataMarker is selected, which marker to route is also needed to be set.

Key Path	Source, List Sequencer, Trigger Type
Example	:SOUR:LIST:TRIG:TYP DAT
Notes	SCPI is supported after A.14.00
Initial S/W Revision	A.14.00

Marker 1

Sets the output trigger maker routing to Marker 1 for DataMarker in the whole source sequence.

Key Path	Source, List Sequencer, Trigger Type, DataMarker
Example	:SOUR:LIST:TRIG:TYPE:MARK M1
Notes	SCPI is supported after A.14.00
Initial S/W Revision	A.14.00

Marker 2

Sets the output trigger maker routing to Marker 2 for DataMarker in the whole source sequence.

Key Path	Source, List Sequencer, Trigger Type, DataMarker
Example	:SOUR:LIST:TRIG:TYPE:MARK M2
Notes	SCPI is supported after A.14.00
Initial S/W Revision	A.14.00

Marker 3

Sets the output trigger maker routing to Marker 3 for DataMarker in the whole source sequence.

Key Path	Source, List Sequencer, Trigger Type, DataMarker
Example	:SOUR:LIST:TRIG:TYPE:MARK M3
Notes	SCPI is supported after A.14.00
Initial S/W Revision	A.14.00

Marker 4

Sets the output trigger maker routing to Marker 4 for DataMarker in the whole source sequence.

Key Path	Source, List Sequencer, Trigger Type, DataMarker
Example	:SOUR:LIST:TRIG:TYPE:MARK M4
Notes	SCPI is supported after A.14.00
Initial S/W Revision	A.14.00

Manual Trigger Now

Pressing this key provides a software trigger event to the list sequencer. During execution of sequence, if the sequencer is halted on any step that has been configured with a “Manual” step trigger, then this key press will cause the sequencer to continue and execute the step.

Key Path	Source, List Sequencer
Remote Command	No remote command, front panel only.
Initial S/W Revision	A.05.00

Remote Software Trigger (Remote command Only)

During execution of a list sequence, the sequence will halt and wait at any step that has Step Trigger set to “Bus”. Sending this command will trigger the step and continue the sequence.

Remote Command	:SOURce:LIST:TRIGger:INITiate[:IMMediate]
Example	:SOUR:LIST:TRIG:INIT
Initial S/W Revision	A.05.00

Query List Sequence Initiation Armed Status (Remote Command Only)

This is a blocking SCPI query to determine if source list sequence being initiated successfully or not.

Remote Command	:SOURce:LIST:INITiation:ARMed?
Example	:SOUR:LIST:INIT:ARMed?
Notes	The return data is in the following format: Integer
Notes	Query only SCPI. Returning “1” if list sequence has been initiated successfully, returning “0” if not. Once get “0”, you can use :SYST:ERR? to query what error happened. Just like “*OPC?”, this command can be blocked until event/status “IsSourceSweeping” happens, and then returns. Doing so can help user’s script query armed status only once during the time interval of the initiation. As an ancillary SCPI of existing SCPI “:SOUR:LIST:TRIGger[:IMMediate]” (see "Initiate Sequence" on page 2521 Initiate Sequence), the right usage of this command is to use it after “:SOUR:LIST:TRIG”. If not, this command will return “1” immediately.
Notes	There is an alias SCPI “:SOURce:LIST:TRIGger:INITiation:ARMed?”.
Initial S/W Revision	A.09.40

Source Preset

Allows you to preset the source settings to their default values.

Key Path	Source
Remote Command	:SOURce:PRESet
Example	:SOUR:PRES

SPAN X Scale

Accesses a menu of functions that enable you set the horizontal scale parameters.

Key Path	Front-panel key
Initial S/W Revision	A.03.00

Ref Value

Allows you to set the display X reference value.

Key Path	SPAN X Scale
----------	--------------

Ref Value(Burst View)

Allows you to set the display X reference value.

Key Path	SPAN X Scale
Mode	LTETDD, LTE
Remote Command	:DISPlay:PVTime:VIEW[1]:WINDow[1]:TRACe:X[:SCALe]:RLEVel <time> :DISPlay:PVTime:VIEW[1]:WINDow[1]:TRACe:X[:SCALe]:RLEVel?
Example	DISP:PVT:VIEW:WIND:TRACE:X:RLEV 1s DISP:PVT:VIEW:WIND:TRACE:X:RLEV?
Notes	If X Auto Scale is On, this value is automatically determined by the measurement result. When a value is set manually, X Auto Scale is automatically set to Off.
Couplings	See Notes
Preset	0 s
State Saved	Saved in instrument state.
Min	-10.0 s
Max	10.00 s
Initial S/W Revision	A.03.00

Ref Value(Rise & Fall view)

Allows you to set the display X reference value.

Key Path	SPAN X Scale
Mode	LTETDD, LTE
Remote Command	:DISPlay:PVTime:VIEW2:WINDow[1] 2:TRACe:X[:SCALe]:RLEVel <time> :DISPlay:PVTime:VIEW2:WINDow[1] 2:TRACe:X[:SCALe]:RLEVel?

Example	DISP:PVT:VIEW2:WIND2:TRAC:X:RLEV 1 DISP:PVT:VIEW2:WIND2:TRAC:X:RLEV?
Notes	If X Auto Scale is On, this value is automatically determined by the measurement result. When a value is set manually, X Auto Scale is automatically set to Off.
Couplings	See Notes
Preset	0 s
State Saved	Saved in instrument state.
Min	-10.0 s
Max	10.00 s
Initial S/W Revision	A.03.00

Scale/Div

Allows you to set the display X scale/division value.

Key Path	SPAN X Scale
----------	--------------

Scale/Div(Burst View)

Allows you to set the display X scale/division value.

Key Path	SPAN X Scale
Mode	LTETDD, LTE
Remote Command	:DISPlay:PVTime:VIEW[1]:WINDow[1]:TRACe:X[:SCALe]:PDIVision <time> :DISPlay:PVTime:VIEW[1]:WINDow[1]:TRACe:X[:SCALe]:PDIVision?
Example	:DISP:PVT:VIEW:WIND:TRACE:X:PDIV 1ms :DISP:PVT:VIEW:WIND:TRACE:X:PDIV?
Notes	If X Auto Scale is set to On, this value is automatically determined by the measurement result. When a value is set manually, X Auto Scale is automatically set to Off.
Couplings	See Notes
Preset	1.0 ms
State Saved	Saved in instrument state.
Min	1.00 ns
Max	1.00 s
Initial S/W Revision	A.03.00
MIN/MAX/DEF Support	Yes

Scale/Div(Rise & Fall View)

Allows you to set the display X scale/division value.

Key Path	SPAN X Scale
Mode	LTETDD, LTE
Remote Command	:DISPlay:PVTime:VIEW2:WINDow[1] 2:TRACe:X[:SCALe]:PDIVision <time> :DISPlay:PVTime:VIEW2:WINDow[1] 2:TRACe:X[:SCALe]:PDIVision?
Example	DISP:PVT:VIEW2:WIND2:TRAC:X:PDIV 1ms DISP:PVT:VIEW2:WIND2:TRAC:X:PDIV?
Notes	If X Auto Scale is set to On, this value is automatically determined by the measurement result. When a value is set manually, X Auto Scale is automatically set to Off.
Couplings	See Notes
Preset	4.0 us
State Saved	Saved in instrument state.
Min	1.00 ns
Max	1.00 s
Initial S/W Revision	A.03.00
MIN/MAX/DEF Support	Yes

Ref Position

Allows you to set the X reference position to the left, center, or right of the display.

Key Path	SPAN X Scale
----------	--------------

Ref Position(Burst View)

Allows you to set the X reference position to the left, center, or right of the display.

Key Path	SPAN X Scale
Mode	LTETDD, LTE
Remote Command	:DISPlay:PVTime:VIEW[1]:WINDow[1]:TRACe:X[:SCALe]:RPOSition LEFT CENTer RIGHT :DISPlay:PVTime:VIEW[1]:WINDow[1]:TRACe:X[:SCALe]:RPOSition?
Example	:DISP:PVT:VIEW:WIND:TRACE:X:RPOS LEFT :DISP:PVT:VIEW:WIND:TRACE:X:RPOS?
Preset	LEFT
State Saved	Saved in instrument state.
Range	Left Ctr Right
Initial S/W Revision	A.03.00

Ref Position(Rise & Fall View)

Allows you to set the X reference position to the left, center, or right of the display.

Key Path	SPAN X Scale
Mode	LTETDD, LTE
Remote Command	:DISPlay:PVTime:VIEW2:WINDow[1] 2:TRACe:X[:SCALe]:RPOStion LEFT CENTER RIGHT :DISPlay:PVTime:VIEW2:WINDow[1] 2:TRACe:X[:SCALe]:RPOStion?
Example	DISP:PVT:VIEW2:WIND2:TRAC:X:RPOS LEFT DISP:PVT:VIEW2:WIND2:TRAC:X:RPOS?
Preset	CENTer
State Saved	Saved in instrument state.
Range	Left Ctr Right
Initial S/W Revision	A.03.00

Auto Scale

Allows you to toggle the X Auto Scale function between On and Off.

Key Path	SPAN X Scale
----------	--------------

Auto Scale(Burst View)

Allows you to toggle the X Auto Scale function between On and Off.

Key Path	SPAN X Scale
Mode	LTETDD, LTE
Remote Command	:DISPlay:PVTime:VIEW[1]:WINDow[1]:TRACe:X[:SCALe]:COUPle 0 1 OFF ON :DISPlay:PVTime:VIEW[1]:WINDow[1]:TRACe:X[:SCALe]:COUPle?
Example	:DISP:PVT:VIEW:WIND:TRAC:X:COUP OFF :DISP:PVT:VIEW:WIND:TRAC:X:COUP?
Notes	Upon pressing the Restart front-panel key, the scale coupling function automatically determines the scale per division and reference values, based on the measurement results, if this parameter is set to On. When you manually set a value to either X Rel Value or X Scale/Div, X Auto Scale is automatically set to Off.
Couplings	See Notes
Preset	ON
State Saved	Saved in instrument state.

Range	On Off
Initial S/W Revision	A.03.00

Auto Scale(Rise & Fall View)

Allows you to toggle the X Auto Scale function between On and Off.

Key Path	SPAN X Scale
Mode	LTETDD, LTE
Remote Command	:DISPlay:PVTime:VIEW2:WINDow[1] 2:TRACe:X[:SCALe]:COUPle 0 1 OFF ON :DISPlay:PVTime:VIEW2:WINDow[1] 2:TRACe:X[:SCALe]:COUPle?
Example	DISP:PVT:VIEW2:WIND2:TRAC:X:COUP OFF DISP:PVT:VIEW2:WIND2:TRAC:X:COUP?
Notes	Upon pressing the Restart front-panel key, the scale coupling function automatically determines the scale per division and reference values, based on the measurement results, if this parameter is set to On. When you manually set a value to either X Rel Value or X Scale/Div, X Auto Scale is automatically set to Off.
Couplings	See Notes
Preset	ON
State Saved	Saved in instrument state.
Range	On Off
Initial S/W Revision	A.03.00

Sweep/Control

Operation of this key is identical across several measurements. For details about this key, see Sweep / Control in the "Common Measurement Functions".

NOTE

Gate function is not supported in Transmit On/Off Power measurement.

Key Path	Sweep/Control
Mode	LTETDD, LTE

Pause/Resume

Pauses a measurement after the current data acquisition is complete.

When Paused, the label on the key changes to Resume. Pressing Resume un-pauses the measurement. When you are Paused, pressing Restart, Single or Cont does a Resume.

Key Path	Sweep/Control
Remote Command	:INITiate:PAUSE
Dependencies	Grayed out in Measurements that do not support Pausing. Blanked in Modes that do not support Pausing.
Initial S/W Revision	Prior to A.02.00

Key Path	Sweep/Control
Remote Command	:INITiate:RESume
Dependencies	Grayed out in Measurements that do not support Pausing. Blanked in Modes that do not support Pausing.
Initial S/W Revision	Prior to A.02.00

Abort (Remote Command Only)

This command is used to stop the current measurement. It aborts the current measurement as quickly as possible, resets the sweep and trigger systems, and puts the measurement into an "idle" state. If the analyzer is in the process of aligning when ABORT is sent, the alignment finishes before the abort function is performed. So ABORT does not abort an alignment.

If the analyzer is set for Continuous measurement, it sets up the measurement and initiates a new data measurement sequence with a new data acquisition (sweep) taken once the trigger condition is met.

If the analyzer is set for Single measurement, it remains in the "idle" state until an :INIT:IMM command is received.

Parameter Name	Abort Measurement
Key Type	No equivalent front-panel key.
Remote Command	:ABORt
Example	:ABOR
Notes	<p>If :INITiate:CONTInuous is ON, then a new continuous measurement will start immediately, with sweep (data acquisition) occurring once the trigger condition has been met.</p> <p>If :INITiate:CONTInuous is OFF, then :INITiate:IMMediate is used to start a single measurement; with sweep (data acquisition) occurring once the trigger condition has been met.</p>
Dependencies	<p>For continuous measurement, ABORt is equivalent to the Restart key.</p> <p>Not all measurements support the abort command.</p>
Status Bits/OPC dependencies	<p>The STATus:OPERation register bits 0 through 8 are cleared.</p> <p>The STATus:QUEStionable register bit 9 (INTEgrity sum) is cleared.</p> <p>Since all the bits that feed into OPC are cleared by the ABORt, the ABORt will cause the *OPC query to return true.</p>
Initial S/W Revision	Prior to A.02.00

System

See "System" on page 272

Trace/Detector

Accesses a menu that allows you to control trace settings.

NOTE Max/Min Hold Traces will be held during the averaging cycle.

Key Path	Front-panel key
Initial S/W Revision	A.03.00

Max Hold Trace

This key allows you to make the Max Hold Trace visible or invisible in the display..

Key Path	Trace/Detector
Mode	LTETDD, LTE
Remote Command	:DISPlay:PVTime:VIEW[1]:WINDow[1]:TRACe:MAXHold[:STATe] ON OFF 1 0 :DISPlay:PVTime:VIEW[1]:WINDow[1]:TRACe:MAXHold[:STATe]?
Example	:DISP:PVT:VIEW:WIND:TRAC:MAXH ON :DISP:PVT:VIEW:WIND:TRAC:MAXH?
Couplings	While Rise & Fall view is selected, this key will be grayed out. Rise & Fall view will not support trace max/min hold.
Preset	OFF
State Saved	Saved in instrument state.
Range	On Off
Initial S/W Revision	A.03.00

Min Hold Trace

This key allows you to make the Min Hold Trace visible or invisible in the display.

Key Path	Trace/Detector
Mode	LTETDD, LTE
Remote Command	:DISPlay:PVTime:VIEW[1]:WINDow[1]:TRACe:MINHold[:STATe] ON OFF 1 0 :DISPlay:PVTime:VIEW[1]:WINDow[1]:TRACe:MINHold[:STATe]?
Example	:DISP:PVT:VIEW:WIND:TRAC:MINH ON :DISP:PVT:VIEW:WIND:TRAC:MINH?
Couplings	While Rise & Fall view is selected, this key will be grayed out. Rise & Fall view will not support trace max/min hold.
Preset	OFF

State Saved	Saved in instrument state.
Range	On Off
Initial S/W Revision	A.03.00

Trigger

See ["Trigger" on page 328](#)

Free Run

See ["Free Run " on page 335](#)

Video

See ["Video \(IF Envelope\) " on page 1556](#)

Trigger Level

See ["Trigger Level " on page 1557](#)

Trig Slope

See ["Trig Slope " on page 1558](#)

Trig Delay

See ["Trig Delay " on page 338](#)

External 1

See ["External 1 " on page 1571](#)

Trigger Level

See ["Trigger Level " on page 1571](#)

Trig Slope

See ["Trig Slope " on page 1572](#)

Trig Delay

See ["Trig Delay " on page 341](#)

Zero Span Delay Comp

See ["Zero Span Delay Comp On/Off" on page 1560](#)

External 2

See ["External 2 " on page 1572](#)

Trigger Level

See ["Trigger Level " on page 1573](#)

Trig Slope

See ["Trig Slope " on page 1574](#)

Trig Delay

See ["Trig Delay "](#) on page 344

Zero Span Delay Comp

See ["Zero Span Delay Comp On/Off"](#) on page 1562

RF Burst

See ["RF Burst "](#) on page 1574

Absolute Trigger

See ["Absolute Trigger Level"](#) on page 1575

Relative Trigger

See ["Relative Trigger Level"](#) on page 1564

Trig Slope

See ["Trigger Slope "](#) on page 1576

Trig Delay

See ["Trig Delay "](#) on page 348

Periodic Timer

See ["Periodic Timer \(Frame Trigger\) "](#) on page 1566

Period

See ["Period "](#) on page 1567

Offset

See ["Offset "](#) on page 1568

Offset Adjust (Remote Command Only)

See ["Offset Adjust \(Remote Command Only\)"](#) on page 1569

Reset Offset Display

See ["Reset Offset Display "](#) on page 1570

Sync Source

See ["Sync Source "](#) on page 1570

Off

See ["Off "](#) on page 1571

External 1

See "[External 1](#) " on page 1571

Trigger Level

See "[Trigger Level](#) " on page 1571

Trig Slope

See "[Trig Slope](#) " on page 1572

External 2

See "[External 2](#) " on page 1572

Trigger Level

See "[Trigger Level](#) " on page 1573

Trig Slope

See "[Trig Slope](#) " on page 1574

RF Burst

See "[RF Burst](#) " on page 1574

Absolute Trigger

See "[Absolute Trigger Level](#)" on page 1575

Trig Slope

See "[Trigger Slope](#) " on page 1576

Trig Delay

See "[Trig Delay](#)" on page 359

Auto/Holdoff

See "[Auto/Holdoff](#) " on page 1577

Auto Trig

See "[Auto Trig](#) " on page 1577

Trig Holdoff

See "[Trig Holdoff](#) " on page 1578

Holdoff Type

See "[Holdoff Type](#)" on page 361

User Preset

Accesses a menu that gives you the following three choices:

- User Preset – recalls a state previously saved using the Save User Preset function.
- User Preset All Modes – presets all of the modes in the analyzer
- Save User Preset– saves the current state for the current mode

NOTE

In products that run multiple instances of the X-Series Application, all instances use the same location to save User Preset state. So Save User Preset of one instance will overwrite the Save User Preset of another instance.

Key Path	Front-panel key
Backwards Compatibility Notes	<p>User Preset is actually loading a state, and in legacy analyzers, it was possible to load a state without affecting the trace data, limit lines or correction data. Similarly it was possible to do a User Preset without affecting the trace data, limit lines or correction data.</p> <p>In the X-Series, “state” always includes all of this data; so whenever state is loaded, or User Preset is executed, all of the traces, limit lines and corrections are affected. Although this differs from previous behavior, it is desirable behavior, and should not cause adverse issues for users.</p> <p>On ESA and PSA, User Preset affected the entire instrument’s state. In the X-Series, User Preset only recalls the state for the active mode. There is a User Preset file for each mode. User Preset can never cause a mode switch as it can in legacy analyzers. If you want to recall all modes to their user preset file state, you will need to do a User Preset after mode switching into each mode.</p> <p>User Preset recalls mode state which can now include data like traces; whereas on ESA and PSA, User Preset did not affect data.</p>
Initial S/W Revision	Prior to A.02.00

User Preset

User Preset sets the state of the currently active mode back to the state that was previously saved for this mode using the Save User Preset menu key or the SCPI command, SYST:PRES:USER:SAV. It not only recalls the Mode Preset settings, but it also recalls all of the mode persistent settings, and the Input/Output system setting that existed at the time Save User Preset was executed.

If a Save User Preset has not been done at any time, User Preset recalls the default user preset file for the currently active mode. The default user preset files are created if, at power-on, a mode detects there is no user preset file. There will never be a scenario when there is no user preset file to restore. For each mode, the default user preset state is the same state that would be saved if a Save User Preset is performed in each mode right after doing a Restore Mode Default and after a Restore Input/Output Defaults.

The User Preset function does the following:

- Aborts the currently running measurement.
- Sets the mode State to the values defined by Save User Preset.
- Makes the saved measurement for the currently running mode the active measurement.
- Brings up the saved menu for the power-on mode.

- Clears the input and output buffers.
- Sets the Status Byte to 0.

Key Path	User Preset
Remote Command	:SYSTem:PRESet:USER
Example	:SYST:PRES:USER:SAVE:SYST:PRES:USER
Notes	:SYST:PRES:USER:SAVE is used to save the current state as the user preset state. Clears all pending OPC bits. The Status Byte is set to 0. Pressing the User Preset front-panel key while already in the User Preset menu will cause the User Preset to get executed
Couplings	A user preset will cause the currently running measurement to be aborted and cause the saved measurement to be active. Recalling a User Preset file has the same issues that recalling a Save State file has. Some settings may need to be limited and therefore re-coupled, since the capabilities of the mode may have changes when the User Preset file was last saved.
Initial S/W Revision	Prior to A.02.00

User Preset All Modes

Recalls all of the User Preset files for each mode, switches to the power-on mode, and activates the saved measurement from the power-on mode User Preset file.

NOTE

When the instrument is secured, all of the user preset files are converted back to their default user preset files.

The User Preset function does the following:

- Aborts the currently running measurement.
- Switches the Mode to the power-on mode.
- Restores the User Preset files for each mode.
- Makes the saved measurement for the power-on mode the active measurement.
- Brings up the saved menu for the power-on mode.
- Clears the input and output buffers.
- Sets the Status Byte to 0.

Key Path	User Preset
Remote Command	:SYSTem:PRESet:USER:ALL
Example	:SYST:PRES:USER:SAVE:SYST:PRES:USER:ALL
Notes	Clears all pending OPC bits. The Status Byte is set to 0. :SYST:PRES:USER:SAVE is used to save the current state as the user preset state.
Couplings	A user preset will cause the currently running measurement to be aborted, cause a mode switch to the power-on mode, and cause the saved measurement to be active in the power-on mode.

Recalling a User Preset file has the same issues that recalling a Save State file has. Some settings may need to be limited and therefore re-coupled, since the capabilities of the mode may have changes when the User Preset file was last saved.

Initial S/W Revision Prior to A.02.00

Save User Preset

Saves the currently active mode and its State. You can recall this User Preset file by pressing the User Preset menu key or sending the SYST:PRES:USER remote command. This same state is also saved by the Save State function.

Key Path	User Preset
Remote Command	:SYSTem:PRESet:USER:SAVE
Example	:SYST:PRES:USER:SAVE
Notes	:SYST:PRES:SAVE creates the same file as if the user requested a *SAV or a MMEM: STOR:STAT, except User Preset Save does not allow the user to specify the filename or the location of the file.
Initial S/W Revision	Prior to A.02.00

View/Display

Opens the View menu for the current measurement. The available views are specific to the current measurement selected under the Meas key.

All Soft Keys in the “View/Display” menu work regardless of which result window currently has the focus.

For example, the scroll function works on the lower numeric result window even if the upper RF Envelope window currently has the focus.

The View/Display menu includes two View Selection keys as shown below, which allow you to select the desired view of the measurement.

View	Name	Description
1	Burst (SCPI: ALL)	View Burst envelope, the length of burst can be determined by slot number in mode setup.
2	Rise & Fall (SCPI: BOTH)	Zooms in on the rising and falling portions of the burst being tested.

View Selection by name

Key Path	View/Display
Mode	LTETDD, LTE
Remote Command	:DISPlay:PVTime:VIEW[:SElect] ALL BOTH :DISPlay:PVTime:VIEW[:SElect]?
Example	DISP:PVT:VIEW:SEL ALL DISP:PVT:VIEW:SEL?
Preset	ALL
State Saved	Saved in instrument state.
Range	Burst Rise & Fall
Initial S/W Revision	A.03.00

Mode	LTETDD, LTE
Remote Command	:DISPlay:PVTime:VIEW:NSElect <integer> :DISPlay:PVTime:VIEW:NSElect?
Example	DISP:PVT:VIEW:NSEL 2 DISP:PVT:VIEW:NSEL?
Notes	1: Burst 2: Rise & Fall You must be in the LTETDD or LTE or LTE-Advanced FDD/TDD mode to use this command. Use INSTRument:SElect to set the mode.
Preset	1
State Saved	Saved in instrument state.

Min	1
Max	2
Initial S/W Revision	A.03.00

Display

The Display menu is common to most measurements, and is used for configuring items on the display. Some Display menu settings apply to all the measurements in a mode, and some only to the current measurement. Those under the System Display Settings key apply to all measurements in all modes.

Key Path	Display
Key Path	View/Display
Initial S/W Revision	Prior to A.02.00

Annotation

Turns on and off various parts of the display annotation. The annotation is divided up into four categories:

1. Meas Bar: This is the measurement bar at the top of the screen. It does not include the settings panel or the Active Function. Turning off the Meas Bar turns off the settings panel and the Active Function. When the Meas Bar is off, the graticule area expands to fill the area formerly occupied by the Meas Bar.
2. Screen Annotation: this is the annotation and annunciation around the graticule, including any annotation on lines (such as the display line, the threshold line, etc.) This does NOT include the marker number or the N dB result. When off, the graticule expands to fill the entire graticule area.
3. Trace annotation: these are the labels on the traces, showing their detector (or their math mode).
4. Active Function annotation: this is the active function display in the meas bar, and all of the active function values displayed on softkeys.

See the figure below. Each type of annotation can be turned on and off individually.

12 Transmit On/Off Power Measurement Functions
View/Display

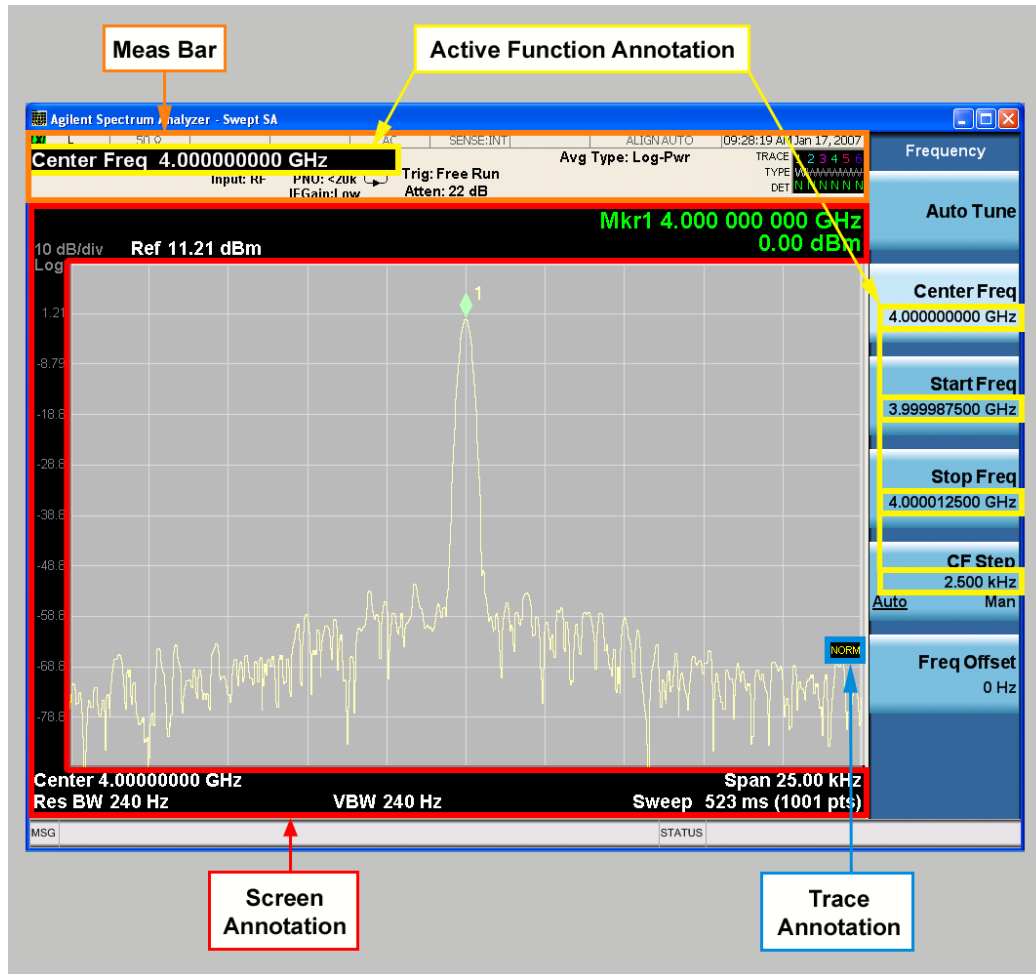

Key Path	View/Display, Display
Initial S/W Revision	Prior to A.02.00

Meas Bar On/Off

This function turns the Measurement Bar on and off, including the settings panel. When off, the graticule area expands to fill the area formerly occupied by the Measurement Bar.

Key Path	View/Display, Display, Annotation
Remote Command	:DISPlay:ANNOtation:MBAR[:STATe] OFF ON 0 1 :DISPlay:ANNOtation:MBAR[:STATe]?
Example	DISP:ANN:MBAR OFF
Dependencies	Grayed out and forced to OFF when System Display Settings, Annotation is set to Off.
Preset	On This should remain Off through a Preset when System DisplaySettings, Annotation is set to Off.
State Saved	Saved in instrument state.
Initial S/W Revision	Prior to A.02.00

Screen

This controls the display of the annunciation and annotation around the graticule, including any annotation on lines (such as the display line, the threshold line, etc.) and the y-axis annotation. This does NOT include marker annotation (or the N dB result). When off, the graticule expands to fill the entire graticule area, leaving only the 1.5% gap above the graticule as described in the Trace/Detector chapter.

Key Path	View/Display, Display, Annotation
Remote Command	:DISPlay:ANNotation:SCReen[:STATe] OFF ON 0 1 :DISPlay:ANNotation:SCReen[:STATe]?
Example	DISP:ANN:SCR OFF
Dependencies	Grayed-out and forced to OFF when System Display Settings, Annotation is set to Off.
Preset	On This should remain Off through a Preset when System DisplaySettings, Annotation is set to Off
State Saved	Saved in instrument state.
Initial S/W Revision	Prior to A.02.00

Active Function Values On/Off

Turns on and off the active function display in the Meas Bar, and all of the active function values displayed on the softkeys.

Note that all of the softkeys that have active functions have these numeric values blanked when this function is on. This is a security feature..

12 Transmit On/Off Power Measurement Functions
View/Display

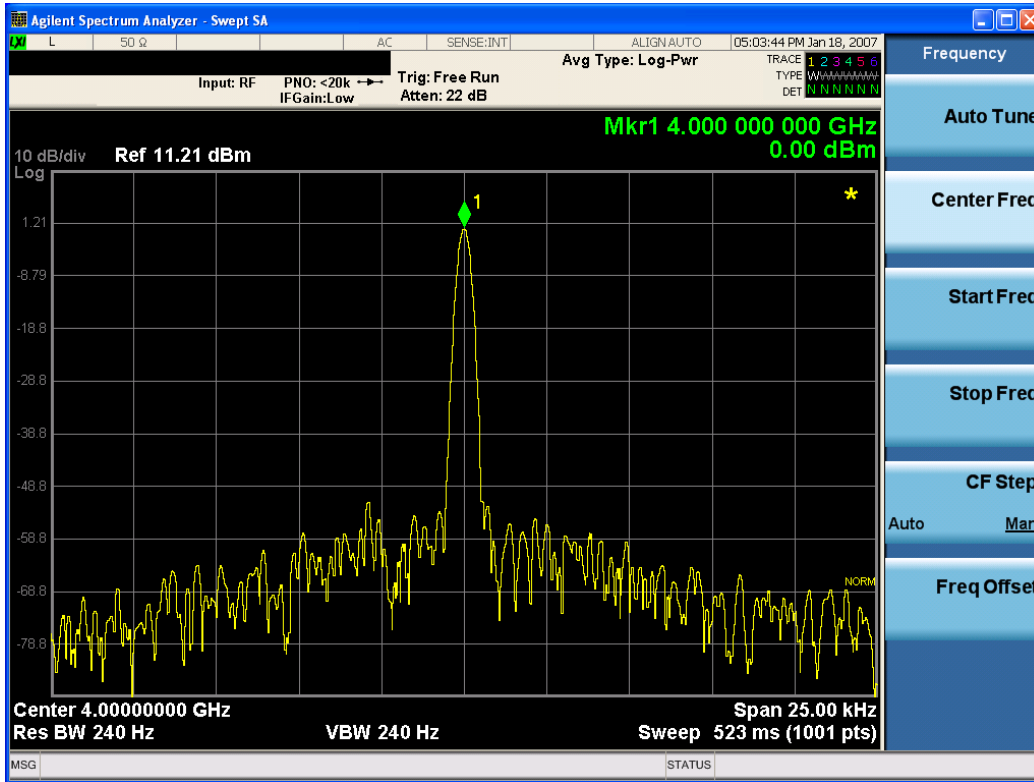

Key Path	View/Display, Display, Annotation
Remote Command	:DISPlay:ACTivefunc[:STATe] ON OFF 1 0 :DISPlay:ACTivefunc[:STATe]?
Example	DISP:ACT OFF
Dependencies	Grayed out and forced to OFF when System Display Settings, Annotation is set to Off.
Preset	On This should remain Off through a Preset when System DisplaySettings, Annotation is set to Off
State Saved	Saved in instrument state.
Initial S/W Revision	Prior to A.02.00

Title

Displays menu keys that enable you to change or clear a title on your display.

Key Path	View/Display, Display
Initial S/W Revision	Prior to A.02.00

Change Title

Writes a title into the "measurement name" field in the banner, for example, "Swept SA".

Press Change Title to enter a new title through the alpha editor. Press Enter or Return to complete the entry. Press ESC to cancel the entry and preserve your existing title.

The display title will replace the measurement name. It remains for this measurement until you press Change Title again, or you recall a state, or a Preset is performed. A title can also be cleared by pressing Title, Clear Title.

NOTE

Notice the inclusion of the <measurement> parameter in the command below. Because each measurement remembers the Display Title, the command must be qualified with the measurement name. For the Swept SA measurement this is not the case; no <measurement> parameter is used when changing the Display Title for the Swept SA measurement.

Key Path	View/Display, Display, Title
Mode	All
Remote Command	:DISPlay:<measurement>:ANNotation:TITLe:DATA <string> :DISPlay:<measurement>:ANNotation:TITLe:DATA?
Example	DISP:ANN:TITL:DATA "This Is My Title" This example is for the Swept SA measurement in the Spectrum Analyzer mode. The SANalyzer <measurement> name is not used. DISP:ACP:ANN:TITL:DATA "This Is My Title" This example is for Measurements other than Swept SA. Both set the title to: This Is My Title
Notes	Pressing this key cancels any active function. When a title is edited the previous title remains intact (it is not cleared) and the cursor goes at the end so that characters can be added or BKSP can be used to go back over previous characters.
Preset	No title (measurement name instead)
State Saved	Saved in instrument state.
Initial S/W Revision	Prior to A.02.00

Clear Title

Clears a title from the front-panel display. Once cleared, the title cannot be retrieved. After the title is cleared, the current Measurement Name replaces it in the title bar.

Key Path	View/Display, Display, Title
Example	The following commands clear the title and restore the measurement's original title: DISP:ANN:TITL:DATA "" This example is for the Swept SA measurement in the Spectrum Analyzer mode. The SANalyzer <measurement> name is not used. DISP:ACP:ANN:TITL:DATA "" This example is for ACP; in measurements other than Swept SA the measurement name is required.
Notes	Uses the :DISPlay:<measurement>:ANNotation:TITLe:DATA <string> command with an empty string (in the Swept SA, the <measurement> is omitted).
Preset	Performed on Preset.
Initial S/W Revision	Prior to A.02.00

Graticule

Pressing Graticule turns the display graticule On or Off. It also turns the graticule y-axis annotation on and off.

Key Path	View/Display, Display
Remote Command	:DISPlay:WINDow[1]:TRACe:GRATicule:GRID[:STATe] OFF ON 0 1 :DISPlay:WINDow[1]:TRACe:GRATicule:GRID[:STATe]?
Example	DISP:WIND:TRAC:GRAT:GRID OFF
Notes	The graticule is the set of horizontal and vertical lines that make up the grid/divisions for the x-axis and y-axis.
Preset	On
State Saved	Saved in instrument state
Initial S/W Revision	Prior to A.02.00

System Display Settings

These settings are "Mode Global" – they affect all modes and measurements and are reset only by Restore Misc Defaults or Restore System Defaults under System.

Key Path	View/Display, Display
Initial S/W Revision	Prior to A.02.00

Annotation Local Settings

This is a Mode Global override of the meas local annotation settings. When it is All Off, it forces ScreenAnnotation, Meas Bar, Trace, and Active Function Values settings to be OFF for all measurements in all modes. This provides the security based "annotation off" function of previous analyzers; hence it uses the legacy SCPI command.

When it is All Off, the Screen, Meas Bar, Trace, and Active Function Values keys under the Display, Annotation menu are grayed out and forced to Off. When Local Settings is selected, you are able to set the local annotation settings on a measurement by measurement basis.

Key Path	View/Display, Display, System Display Settings
Remote Command	:DISPlay:WINDow[1]:ANNotation[:ALL] OFF ON 0 1 :DISPlay:WINDow[1]:ANNotation[:ALL]?
Example	:DISP:WIND:ANN OFF
Preset	On (Set by Restore Misc Defaults)
State Saved	Not saved in instrument state.
Backwards Compatibility Notes	The WINDow parameter and optional subopcode is included for backwards compatibility but ignored – all windows are equally affected.
Initial S/W Revision	Prior to A.02.00

Themes

Accesses a menu of functions that enable you to choose the theme to be used when saving the screen image.

The **Themes** option is the same as the **Themes** option under the **Display** and **Page Setup** dialogs. It allows you to choose between themes to be used when saving the screen image.

Key Path	Save, Screen Image
Remote Command	:MMEMory:STORe:SCReem:THEMe TDColor TDMonochrome FCOLor FMONochrome :MMEMory:STORe:SCReem:THEMe?
Example	:MMEM:STOR:SCR:THEM TDM
Preset	3D Color; Is not part of Preset, but is reset by Restore Misc Defaults or Restore System Defaults All and survives subsequent running of the modes.
Readback	3D Color 3D Mono Flat Color Flat Mono
Backwards Compatibility Notes	In ESA and PSA we offer the choice of "Reverse Bitmap" or "Reverse Metafile" when saving screen images. This is much like the "Flat Color" theme available in X-Series. Also, if you selected Reverse Bitmap AND a black & white screen image, that would be much like "Flat Monochrome". In other words, each of the X-Series themes has a similar screen image type in ESA/PSA. But they are not identical.
Initial S/W Revision	Prior to A.02.00

3D Color

Selects a standard color theme with each object filled, shaded and colored as designed.

Key Path	Save, Screen Image, Themes
Example	MMEM:STOR:SCR:THEM TDC
Readback	3D Color
Initial S/W Revision	Prior to A.02.00

3D Monochrome

Selects a format that is like 3D color but shades of gray are used instead of colors.

Key Path	Save, Screen Image, Themes
Example	MMEM:STOR:SCR:THEM TDM
Readback	3D Mono
Initial S/W Revision	Prior to A.02.00

Flat Color

Selects a format that is best when the screen is to be printed on an ink printer.

Key Path	Save, Screen Image, Themes
Example	MMEM:STOR:SCR:THEM FCOL
Readback	Flat Color
Initial S/W Revision	Prior to A.02.00

Flat Monochrome

Selects a format that is like Flat Color. But only black is used (no colors, not even gray), and no fill.

Key Path	Save, Screen Image, Themes
Example	MMEM:STOR:SCR:THEM FMON
Readback	Flat Mono
Initial S/W Revision	Prior to A.02.00

Burst View

This view shows power vs. time and mask result for a LTE-modulated burst. The view has two windows:

- "RF Envelope window" on page 1885 (upper)
- "Result Metrics window" on page 1885 (lower)

For the associated Remote Commands, see the subtopics under "View/Display" on page 1876.

The figure below shows an example of the Burst View.

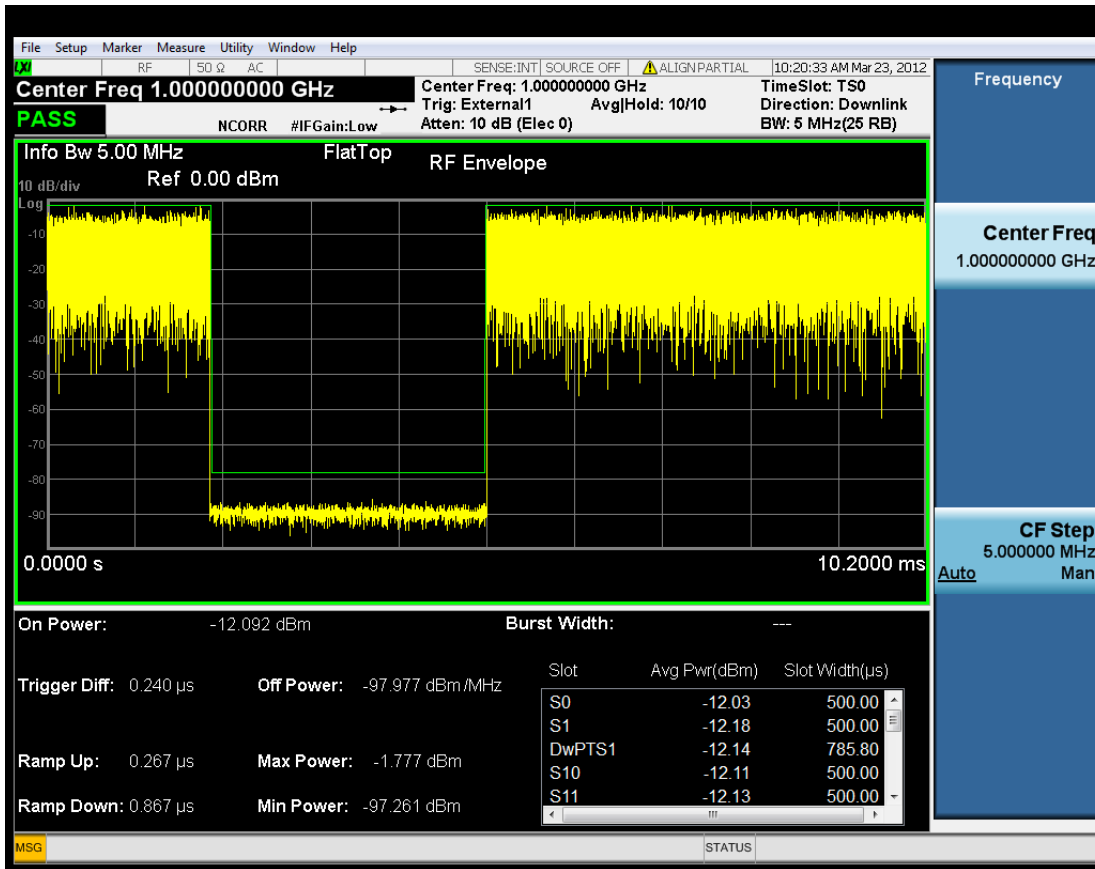

Figure 0-1 Burst view for Transmit On/Off Power Measurement

RF Envelope window

This table illustrates the details of RF envelope window:

Marker Operation	Yes
Corresponding Trace	Yellow: Signal wave form, n=2, 3, 4 White: Trigger line Red: Burst lines Blue: Ramp up/down lines Green: Limit Mask Line

Result Metrics window

This table illustrates the details of metrics window when Direction is Downlink:

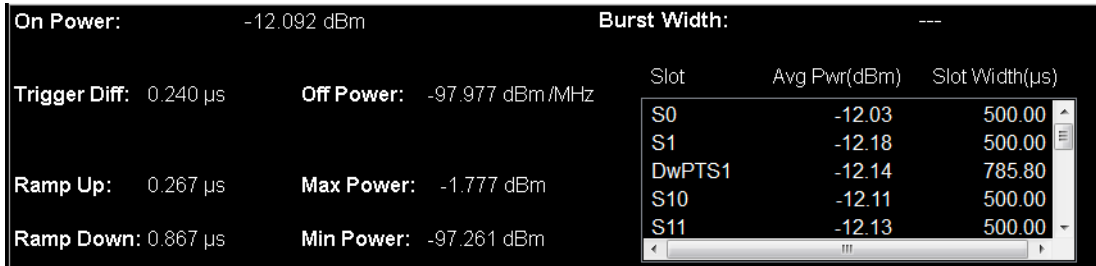

Name	Corresponding Results	Display Format
On Power	n=1 3rd	99.999 dBm
Burst Width	n=1 4th	99.999 ms
Trigger Diff	n=1 5th	99.999 us
Ramp Up	n=1 6th	99.999 us
Ramp Down	n=1 7th	99.999 us
Off Power	n=1 8th	99.999 dBm
Max Power	n=1 9th	99.999 dBm
Min Power	n=1 10th	99.999 dBm
Slot	N/A	AAA
Avg Pwr	n=7	99.99 dBm
Slot width	n=8	99.99 us

NOTE Slot/AvgPwr/SlotWidth section only displays measure results for active slot within display range.

This table illustrates the details of metrics window when Direction is Uplink and Meas DualSRS is not selected

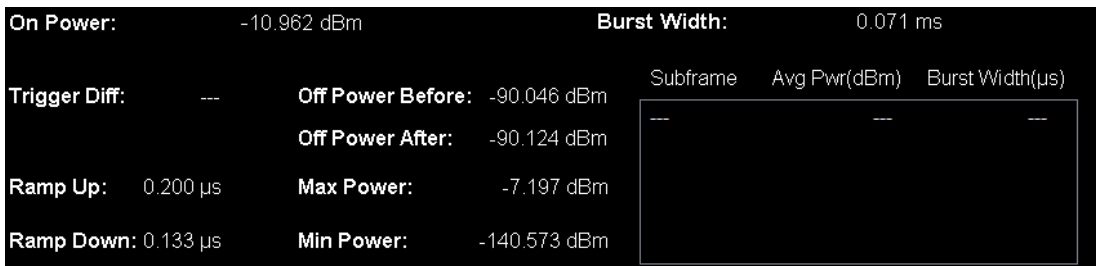

Name	Corresponding Results	Display Format
On Power	n=1 3rd	99.999 dBm
Burst Width	n=1 4th	99.999 ms
Trigger Diff	n=1 5th	99.999 us
Ramp Up	n=1 6th	99.999 us
Ramp Down	n=1 7th	99.999 us

Off Power Before	n=1 8th	99.999 dBm
Off Power After	n=1 13th	99.999 dBm
Max Power	n=1 9th	99.999 dBm
Min Power	n=1 10th	99.999 dBm
Subframe	N/A	AAA
Avg Pwr	n=7	99.99 dBm
Burst width	n=8	99.99 us

NOTE

Subframe/AvgPwr/SlotWidth section displays measure results for all subframes within display range.

When Direction is Uplink and Meas DualSRS is selected, the mean power for SRS1 and SRS2 are listed separately:

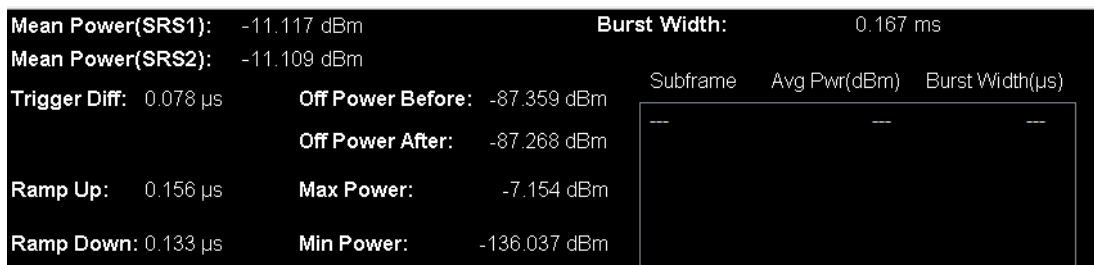

Name	Corresponding Results	Display Format
Mean Power for SRS1	n=1 3rd	99.999 dBm
Mean Power for SRS2	n=1 14th	99.999 dBm
Burst Width	n=1 4th	99.999 ms
Trigger Diff	n=1 5th	99.999 us
Ramp Up	n=1 6th	99.999 us
Ramp Down	n=1 7th	99.999 us
Off Power Before	n=1 8th	99.999 dBm
Off Power After	n=1 13th	99.999 dBm
Max Power	n=1 9th	99.999 dBm
Min Power	n=1 10th	99.999 dBm
Subframe	N/A	AAA
Avg Pwr	n=7	99.99 dBm
Burst width	n=8	99.99 us

NOTE

Subframe/AvgPwr/SlotWidth section displays measure results for all subframes within display range.

Key Path	Front-panel key
Initial S/W Revision	A.03.00

Trigger Lines

Turns the trigger lines On or Off. Please note, Trigger Lines are just supported in RF Envelop window of Burst view.

Key Path	View/Display,Burst
Mode	LTETDD, LTE
Remote Command	:DISPlay:PVTime:VIEW[1]:WINDow[1]:TRIGger[:STATe] ON OFF 1 0 :DISPlay:PVTime:VIEW[1]:WINDow[1]:TRIGger[:STATe]?
Example	:DISP:PVT:VIEW:WIND:TRIG ON :DISP:PVT:VIEW:WIND:TRIG?
Preset	OFF
State Saved	Saved in instrument state.
Range	On Off
Initial S/W Revision	A.03.00

Burst Lines

Turns the burst lines On or Off. The burst line will indicate where is the detected burst start and burst end. Please note, Burst Lines are just supported in RF Envelop window of Burst view.

Key Path	View/Display
Mode	LTETDD, LTE
Remote Command	:DISPlay:PVTime:VIEW[1]:WINDow[1]:BLINes[:STATe] ON OFF 1 0 :DISPlay:PVTime:VIEW[1]:WINDow[1]:BLINes[:STATe]?
Example	:DISP:PVT:VIEW:WIND:BLIN ON :DISP:PVT:VIEW:WIND:BLIN?
Preset	OFF
State Saved	Saved in instrument state.
Range	On Off
Initial S/W Revision	A.03.00

Limit Mask

Turns the limit mask On or Off. Please note, Trigger Lines are just supported in RF Envelop window of Burst view.

The limit mask shown on screen is just to indicate which part of signal is active burst and which part is inactive burst, the mask is nothing to do with the Pass/Fail (shown at the upper-left corner of screen) criteria. Regarding the Pass/Fail criteria, please refer to Limits section "[Limits](#)" on page 1679.

Key Path	View/Display, Burst
Mode	LTETDD, LTE
Remote Command	:DISPlay:PVTime:VIEW[1]:WINDow[1]:LIMit:MASK OFF ON 0 1 :DISPlay:PVTime:VIEW[1]:WINDow[1]:LIMit:MASK?
Example	DISP:PVT:VIEW:WIND:LIM:MASK 1 DISP:PVT:VIEW:WIND:LIM:MASK?
Notes	This parameter only hides or shows the limit mask line on the display.
Preset	ON
State Saved	Saved in instrument state.
Range	On Off
Initial S/W Revision	A.03.00

Rise & Fall View

This view has three windows:

Rising RF Envelope Window.	The parameters of this window are identical to those of the RF Window in the " Burst View " on page 1884.
Falling RF Envelope Window.	The parameters of this window are identical to those of the RF Window in the " Burst View " on page 1884.
Numeric Results Window.	The parameters of this window are identical to those of the Numeric Results Window in the " Burst View " on page 1884.

The figure below shows an example of the Rise & Fall View.

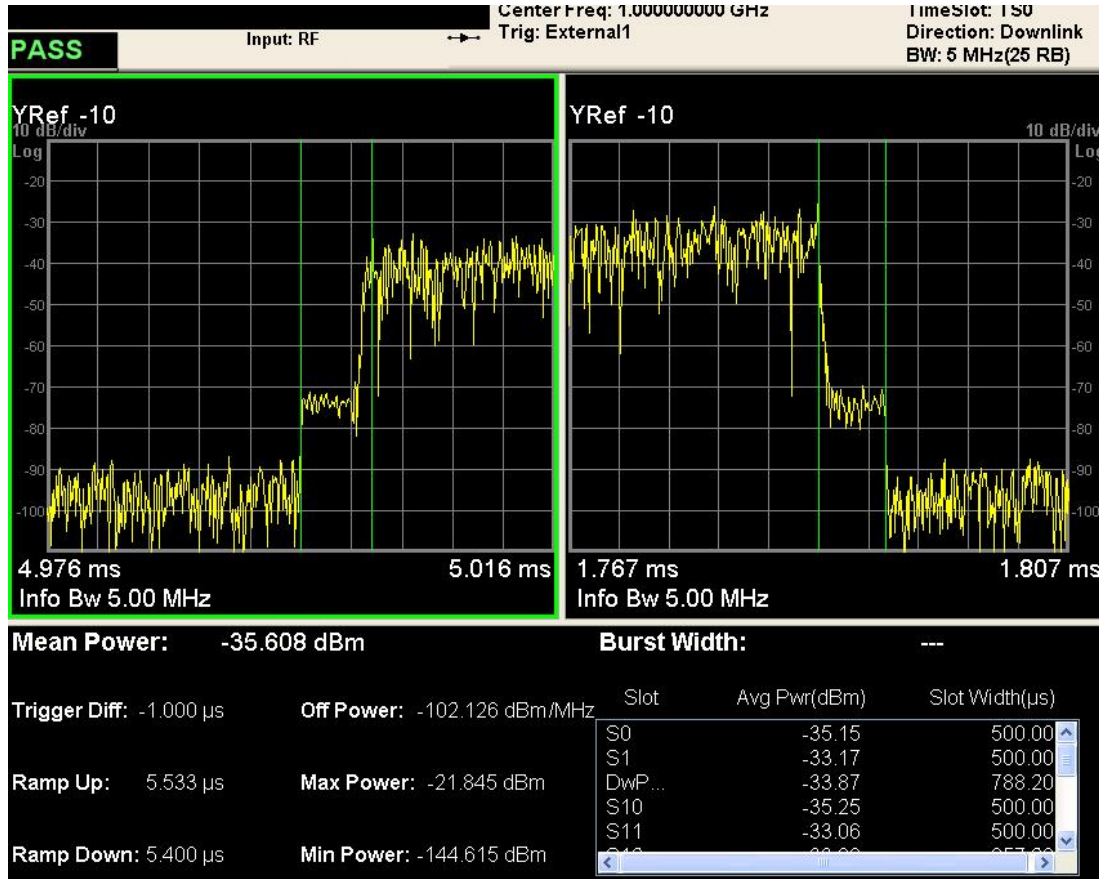

Figure 4-13 Rise & Fall View for LTE Power vs. Time Measurement

Key Path	View/Display
Mode	LTETDD, LTE
Initial S/W Revision	Prior to A.02.00

Ramp Lines

Turns the ramp lines On or Off.

Key Path	View/Display
Mode	LTETDD, LTE
Remote Command	:DISPlay:PVTime:RAMP[:STATE] OFF ON 0 1 :DISPlay:PVTime:RAMP[:STATE]?
Example	:DISP:PVT:RAMP ON :DISP:PVT:RAMP?

Preset	OFF
State Saved	Saved in instrument state.
Range	On Off
Initial S/W Revision	A.03.00

Scroll

Accesses the Scroll menu, which contains features that enable you to navigate the display.

Key Path	View/Display
Initial S/W Revision	A.03.00

Prev Page

Moves the display one page back to the previous page of the result metrics window.

Key Path	View/Display, Scroll
Mode	LTETDD, LTE
Initial S/W Revision	A.03.00

Next Page

Moves the display one page forward to the next page of the result metrics window.

Key Path	View/Display, Scroll
Mode	LTETDD, LTE
Initial S/W Revision	A.03.00

Scroll Up

Moves one line upward from the current line of the result metrics window.

Pressing the up arrow hard key has the same effect as this function, if no active function is shown. If an active function is shown, the up arrow hard key controls the active function, but has no effect on line movement.

Scroll up soft key and up arrow hard key will only effective when Metrics window is focused.

Key Path	View/Display, Scroll
Mode	LTETDD, LTE
Initial S/W Revision	A.03.00

Scroll Down

Moves one line downward from the current line of the result metrics window.

Pressing the down arrow hard key has the same effect as this function, if no active function is shown. If an active function is shown, the up arrow hard key controls the active function, but has no effect on line movement, as the Scroll Down function does.

The scroll down soft key and down arrow hard key are only effective when the Metrics window is focused.

Key Path	View/Display, Scroll
Mode	LTETDD, LTE
Initial S/W Revision	A.03.00

First Page

Moves the display to the first page of the result metrics window.

Key Path	View/Display, Scroll
Mode	LTETDD, LTE
Initial S/W Revision	A.03.00

Last Page

Moves the display to the last page of the result metrics window.

Key Path	View/Display, Scroll
Mode	LTETDD, LTE
Initial S/W Revision	A.03.00

Display

Invokes the Display menu. All measurements have the same Display menu and the same functionality for each key under the Display menu. Refer to ["Display" on page 2576](#) in the "Common Measurement Functions" for more information.

13 LTE-Advanced Modulation Analysis Measurement

This section contains the following topics:

["Description" on page 1894](#)

["Remote Commands" on page 1895](#)

["Remote SCPI Results" on page 1896](#)

Description

LTE-Advanced aggregates multiple LTE carriers (up to 5) to obtain a collective transmission bandwidth of up to 100 MHz. Every component carrier can be configured independently either from GUI or by send SCPI command with correct CC node, for example, by sending following two commands the Sync Type can be set to PSS for CC0 and CC1:

```
EVM:CCAR0:DLINK:SYNC:TYPE PSS
```

```
EVM:CCAR1:DLINK:SYNC:TYPE PSS
```

Once you have configured the measurement you can use these commands to initiate the measurement and retrieve the measurement results.

All of the scalar results for this measurement are contained in two tables: the Error Summary and Frame Summary; and each has an equivalent subopcode that is used to obtain the remote results. You can obtain the measurement results by either visually inspecting the corresponding summary trace on the display, or by using CALC:DATA queries that return descriptions of the corresponding summary trace.

Remote Commands

```
:CONFigure:EVM  
:FETCh:EVM[n]?  
:INITiate:EVM  
:MEASure:EVM[n]?  
:READ:EVM[n]?  
:CALCulate:EVM:DATA<n>:TABLe:STRing?  
:CALCulate:EVM:DATA<n>:TABLe:NAMes?  
:CALCulate:EVM:DATA<n>:TABLe:UNIT?  
:CALC:EVM:DATA4:TABL:STR? "FreqErr"
```

See ["Remote SCPI Commands and Data Queries" on page 2587](#) for more measurement SCPI commands.

Also see [Trace/Detector, Data](#) for more measurement SCPI commands.

Remote SCPI Results

These standard remote results are also available thru the CALC:DATA<n> set of queries, where <n> is a reference to the trace number. The results assigned to each trace vary depending on which tests are enabled. As an example, with the default trace layout, the results in the Error Summary results are returned by CALC:EVM: DATA4:TABL:STR?

See the following section: "[Remote SCPI Commands and Data Queries](#)" on page 2587.

The following table denotes the LTE-Advanced Modulation Analysis specific results returned from the (FETCh|MEASure|READ):EVM commands, indexed by subopcode. MEASure:EVM<n> performs the equivalent of CONF:EVM;INIT:IMM:FETCh:EVM<n>. This gets you the default measurement, which is a 5 MHz downlink with auto detection of allocations.

Some table results are string data, rather than numeric. As FETCh|MEASure|READ can only return numeric data, NaN is returned as a placeholder for string data. To get the full table data, including string results (with numbers in ASCII format) use the CALC:EVM:DATA<n>:TABL:STR? query. Use the associated CALC:EVM:DATA<n>:TABL queries to get information about names and units for the table data.

Remote Command SCPI Results

For queries listed in section, the results returned depend on the value of n, as follows.

N	Results Returned
Not specified or n=1	<p>Returns measurement results for every active Component Carrier. The total number of Component Carriers is specified by Num Component Carriers in Component Carriers Setup. The total result length is variable. Each Component Carrier can be specified as active or inactive by setting the Measure Carrier in Component Carriers Setup to ON or OFF. The results of each Component Carrier vary depending on the Link Direction and the enable/disable setting of the result values (Downlink/Uplink Result Output Selection).</p> <p>For example, if the Num Component Carriers is 3 and every result is enabled so there are 30 results for each Component Carrier, if all 3 Component Carriers are active, total number of return value is 90, first 30 results are for Component Carrier 0, and last 30 results are for Component Carrier 2. if Component Carrier 0 is specified as inactive by setting the Measure Carrier of CCO to OFF, then the total number of return value is 60, first 30 results are for Component Carrier 1, and last 30 results are for Component Carrier 2.</p> <p>All the return values are floating points.</p> <p>LTE-Advanced Downlink Results for each Component Carrier</p> <p>The result contents are customizable. See LTEA Result Output Selection (SCPI only) section for details. If no result is available, NaN (9.91 E+37) is returned.</p> <ol style="list-style-type: none"> 1. EVM (%) 2. EVM Symbol Time Adjust 3. 1: Window Start 4. 2: Window End 5. 3: Center 6. 4: Custom 7. EVM Pk (%) 8. EVM Pk Index 9. EVM Peak Sub Car Index 10. Data EVM (%) – Not available when Detection is Manual and no User is added. 11. 3GPP-defined QPSK EVM (%) 12. 3GPP-defined 16QAM EVM (%) 13. 3GPP-defined 64QAM EVM (%) 14. RS EVM (%) 15. RS Tx. Power (dBm) 16. OFDM Symbol Tx. Power (dBm) 17. Frequency Error (Hz) 18. Sync Correlation (%) 19. Sync Type 20. 1: P-SS 21. 20: Ant Port 0 RS 22. 21: Ant Port 1 RS 23. 22: Ant Port 2 RS 24. 23: Ant Port 3 RS

N	Results Returned
	25. Common Tracking Error (%)
	26. Symbol Clock Error (ppm)
	27. Time Offset (s)
	28. IQ Offset (dB)
	29. IQ Gain Imbalance (dB)
	30. IQ Quad Error (deg)
	31. IQ Timing Skew (s)
	32. CP Length Mode
	33. 1: Normal
	34. 2: Extended
	35. Cell ID
	36. Cell ID Group/Sector
	37. Integer part: Cell ID Group, After the decimal point: Cell ID Sector
	38. RS-OS/PRS
	39. 1: 3GPP
	40. 4: Custom
	41. Reference Signal Rx Power (dBm)
	42. Reference Signal Rx Quality (dB)
	43. Received Signal Strength Indicator (dBm)
	44. Channel Power(dBm)
	LTE-Advanced Uplink Results for each Component Carrier
	The result contents are customizable. See for details. If no result is available, NaN (9.91E+37) is returned.
	1. EVM (%)
	2. EVM Symbol Time Adjust
	3. 1: Window Start
	4. 2: Window End
	5. 3: Center
	6. 4: Custom
	7. EVM Pk (%)
	8. EVM Pk Index
	9. EVM Peak Sub Car Index
	10. Data EVM (%) – Not available when Detection is Manual and no User is added.
	11. 3GPP-defined QPSK EVM (%)
	12. 3GPP-defined 16QAM EVM (%)
	13. 3GPP-defined 64QAM EVM (%)
	14. RS EVM (%)
	15. NaN (9.91E+37) returned.
	16. NaN (9.91E+37) returned.
	17. Frequency Error (Hz)
	18. Sync Correlation (%)

N	Results Returned												
	19. Sync Type 20. 2: PUSCH-DMRS 21. 3: PUCCH-DMRS 22. 4: SRS 23. 5: PRACH 24. Common Tracking Error (%) 25. Symbol Clock Error (ppm) 26. Time Offset (s) 27. IQ Offset (dB) 28. IQ Gain Imbalance (dB) 29. IQ Quad Error (deg) 30. IQ Timing Skew (s) 31. CP Length Mode 32. 1: Normal 33. 2: Extended 34. Channel Power (dBm) 35. In-band Emissions Result 0: PASS 1: FAIL 36. In-band Emissions worst Margin (dB) 37. In-band Emissions worst Slot 38. In-band Emissions worst RB 39. Spectral Flatness Result 0: PASS 1: FAIL 40. Spectral Flatness worst Margin (dB) 41. Spectral Flatness worst Slot 42. Spectral Flatness worst Subcarrier												
2	Returns the results of the Frame Summary table of CCO in numeric format, with NaN in place of string results. Since this table changes depending on the Channel Profile Setup, the data names and units must be determined at run time by using CALC:EVM:DATA<k>:TABL queries												
3	Error Information of each Component Carrier Returns total error information of each Component Carrier . The values are bitwise OR operated on the Error Information as follows: <table border="1" data-bbox="370 1640 1446 1808"> <tbody> <tr> <td data-bbox="370 1650 456 1677">No Error</td> <td data-bbox="967 1650 984 1677">0</td> <td data-bbox="1101 1650 1240 1677">0x00000000</td> </tr> <tr> <td data-bbox="370 1692 643 1719">Parameter Setting Conflict</td> <td data-bbox="967 1692 984 1719">1</td> <td data-bbox="1101 1692 1240 1719">0x00000001</td> </tr> <tr> <td data-bbox="370 1734 532 1761">ADC OverRange</td> <td data-bbox="967 1734 984 1761">2</td> <td data-bbox="1101 1734 1240 1761">0x00000010</td> </tr> <tr> <td data-bbox="370 1776 480 1803">Sync Error</td> <td data-bbox="967 1776 984 1803">4</td> <td data-bbox="1101 1776 1240 1803">0x00000100</td> </tr> </tbody> </table>	No Error	0	0x00000000	Parameter Setting Conflict	1	0x00000001	ADC OverRange	2	0x00000010	Sync Error	4	0x00000100
No Error	0	0x00000000											
Parameter Setting Conflict	1	0x00000001											
ADC OverRange	2	0x00000010											
Sync Error	4	0x00000100											

N	Results Returned	
	Demod Error	8 0x00001000
	Burst Not Found	16 0x00010000

For example, if ADC Over Range and Sync Error occurred, the value is 6.

The total result length is variable. The returned contents vary depending on the total number of Component Carriers, which is specified by Num Component Carriers in Component Carriers Setup.

Returns the following scalar results:

1.Total Error Information of CC0.

2.Total Error Information of CC1.

3. ...

nCarr. Total Error Information of the last carrier.

Where nCarr is the number of carriers to be measured.

For more results defined for READ and FETCh, see the following section: "[Remote SCPI Commands and Data Queries](#)" on page 2587.

Because the results of MEASure, READ, or FETCh queries are statically defined, you should use the following query:

CALCulate:EVM:DATA<n>:TABLe:STRing?

as this provides both string and numeric results (numeric formatted as ASCII), and the queries

CALCulate:EVM:DATA<n>:TABLe:NAMes?

CALCulate:EVM:DATA<n>:TABLe:UNIT?

to obtain lists of descriptive data names and associated units. For table results that can change dynamically, such as the Frame Summary, these provide the only possible way to interpret remote table data, since static tabulations such as those above will not suffice.

As an example of the above commands, if you have performed CONF:EVM;INIT:IMM;FORM ASCII, then the following commands will return results similar to those shown in the columns below. The FORM ASCII command dictates that the FETC results will be returned as ASCII in a comma-separated list. The CALC:EVM:DATA<n>:TABL query responses are a comma-separated list enclosed in quotes (i.e., they are a single string).

FETC:EVM1	CALC:EVM:DATA4 :TABL:STR?	CALC:EVM:DATA4 :TABL:UNIT?	CALC:EVM:DATA4 :TABL:NAM?
9.2223893260E+01	92.22389326	%rms	EVM
9.9100000000E+37	EVM Window End		EVMSymTimeAdj
4.2397593130E+02	423.9759313	%rms	EVMPeak
6.0000000000E+00	6	sym	EVMPeakIdx
2.1000000000E+01	21	subcar	EVMPeakSubcarIdx

8.6673950980E+01	86.67395098	%rms	DataEVM
7.6970986550E+01	76.97098655	%rms	RSEVM
6.6970986550E+01	66.97098655	%rms	3GPPEVMQPSK
9.6673950980E+01	96.67395098	%rms	3GPPEVM16QAM
2.8573950980E+01	28.57395098	%rms	3GPPEVM64QAM
3.9100000000E+01	3.91	dBm/subcar	RSTP
-20.4500000000E+01	-20.45	dBm	OSTP
8.4413310460E+02	844.1331046	Hz	FreqErr
1.0699478450E-01	0.106994784	%	SyncCorr
9.9100000000E+37	P-SS		SyncType
1.6618317400E+01	16.6183174	%rms	CTE
4.2218131000E+02	422.18131	ppm	SymClkErr
3.4869991450E-03	0.003486999	sec	TimeOffset
-2.2683995020E+01	-22.68399502	dB	IQOffset
-1.1367356920E-01	-0.113673569	dB	IQGainImb
-3.6632873820E-01	-0.366328738	deg	IQQuadErr
-2.6630113160E-09	-2.66E-09	sec	IQTimingSkew
9.9100000000E+37	Normal(auto)		CpLengthMode
9.9100000000E+37	503 (auto)		CellId
9.9100000000E+37	167/2 (auto)		CellIdGroupSector
9.9100000000E+37	Custom		RSPRS
1.003800000000E+01	-10.038	dBm	RSRP
-6.4700000000E+00	-6.47	dB	RSRQ
-2.0050000000E+01	-20.05	dBm	RSSI
-3.613801427E+00	-3.61380142693588	dBm	ChannelPower
9.9100000000E+37	PASS		InbandEmissions
3.38484E+01	33.848	dB	InbandEmissionsWorstMargin
2	2		InbandEmissionsWorstSlot
18	18		InbandEmissionsWorstRB
9.9100000000E+37	FAIL		SpectralFlatness
-3.915E+00	-3.915	dB	SpectralFlatnessWorstMargin
2	2		SpectralFlatnessWorstSlot
-8	-8		SpectralFlatnessWorstSubcarrier

In addition, if just the “FreqErr” result is desired, you can obtain it using the command:

```
CALC:EVM:TABL:STR? “FreqErr”
```

For the example data above, the response will be:

```
“844.1331046”
```

Key Path	Meas
Mode	LTEAFDD LTEATDD
Initial S/W Revision	A.14.0

AMPTD (Amplitude) Y Scale

Key Path	Front-panel key
Mode	LTEAFDD, LTEATDD
Initial S/W Revision	A.14.00

Y Auto Scale

Changes the Y reference value and Scale per Division so the full trace is displayed without clipping.

Key Path	AMPTD Y Scale
Mode	VSA, LTE, LTETDD, IDEN, LTEAFDD, LTEATDD
Measurement	<meas>:=VECTor ADEMod DDEMod W11A W11B EVM IPOWER IDEMod MOTotalk
Remote Command	:DISPlay:<meas>:TRACe [1] 2 . . . 4 : Y [: SCALE] : AUTO : ONCE
Example	:DISP:VECT:TRAC1:Y:AUTO:ONCE
Initial S/W Revision	Prior to A.02.00
Modified at S/W Revision	A.02.00

Range

The Range menu allows setting amplitude controls of the instrument.

Key Path	AMPTD Y Scale
Scope	Meas Global
Initial S/W Revision	A.12.50

Range

Represents the amplitude of the largest sinusoidal signal that could be present within the IF without being clipped by the ADC. For signals with high peak-to-average ratios, the range may need to exceed the rms signal power by a fair amount to avoid clipping.

Key Path	Range
Mode	BASIC
Remote Command	[: SENSE] : POWER [: RF] : RANGE <real> [: SENSE] : POWER [: RF] : RANGE ?
Example	:POW:RANG 10.0 :POW:RANG ?
Notes	The MIN and MAX values are affected by the External Gain parameters, and by the Center Frequency. (The hardware compensates for frequency response and alters the Range setting.)

Preset	0
State Saved	Saved in instrument state.
Min	-100
Max	100
Initial S/W Revision	A.12.50

Adjust Range For Min Clip

Sets the combination of attenuation and gain based on the current measured signal level so that clipping will be at a minimum.

This is an "immediate action" function, that is, it executes once, when the key is pressed.

This key is grayed out in measurements that do not support this functionality.

Key Path	AMPTD Y Scale, Attenuation
Remote Command	<code>[:SENSe] :POWer [:RF] :RANGe:OPTimize IMMEDIATE</code>
Initial S/W Revision	Prior to A.02.00
Modified at S/W Revision	A.03.00

Pre-Adjust for Min Clip

If this function is on, it does the adjustment described under Adjust Range For Min Clip each time a measurement restarts. Therefore, in Continuous measurement mode, it only executes before the first measurement.

Key Path	AMPTD Y Scale, Attenuation
Remote Command	<code>[:SENSe] :POWer [:RF] :RANGe:OPTimize:ATTenuation OFF ON ELECTRICAL COMBined</code> <code>[:SENSe] :POWer [:RF] :RANGe:OPTimize:ATTenuation?</code>
Notes	This parameter is shared with old XA platform which uses AutoAtten. To keep the backward compatibility, ELECTRICAL and COMBined still can be used. Then, upon receiving ELECTRICAL and COMBined, these enums will be interpreted as aliases of ON. Then, when queried, ON will be returned.
Preset	OFF for Swept SA measurement; ON for all other measurements that support Pre-Adjust for Min Clip
State Saved	Saved in instrument state
Initial S/W Revision	Prior to A.02.00
Modified at S/W Revision	A.03.00

Peak to Average

The Peak to Average Ratio is used with the Range setting to optimize the level control in the instrument. The value is the ratio, in dB, of the peak power to the average power of the signal to be measured. A ratio of 0 should be used for sinusoidal signals; for 802.11g OFDM signals use 9 dB.

All Applications (Modes) will show the current value of Peak to Average ratio on the softkey. However, some applications will not permit changing the value. In these situations the softkey will be grayed-out.

Key Path	AMPTD Y Scale, Range
Remote Command	[:SENSe] :POWer [:RF] :RANGe :PARatio <real> [:SENSe] :POWer [:RF] :RANGe :PARatio?
Example	POW:RANG:PAR 12 dB
Notes	In some Applications (Modes) this parameter will be read-only; meaning the value will appear on the softkey and query via SCPI, but not changeable. In such applications the softkey will be grayed-out. Attempting to change the value via SCPI will be ignored and no error message will be generated.
Preset	10 dB
State Saved	Saved in instrument state
Min	0 dB
Max	20 dB
Initial S/W Revision	A.13.00

Mixer Level Offset

Mixer level offset is an advanced setting to adjust target Range at the input mixer which in turn affects the signal level in the instrument's IF. This setting can be used when additional optimization is needed after setting Peak to Average ratio. Positive values of offset optimize noise performance over distortion, negative values optimize distortion performance over noise.

Key Path	AMPTD Y Scale, Range
Remote Command	[:SENSe] :POWer [:RF] :RANGe :MIXer :OFFSet <real> [:SENSe] :POWer [:RF] :RANGe :MIXer :OFFSet?
Example	POW:RANG:MIX:OFFS -5 dB
Preset	0 dB
State Saved	Saved in instrument state
Min	-35 dB
Max	30 dB
Initial S/W Revision	A.13.00

Select Trace

Displays a menu that enables you to select the trace that is to receive the action of all successive trace-specific commands like scaling, assignment of trace data, and so on. The selected trace is outlined in green and is always visible. While the Select Trace menu is showing, each visible trace is annotated in the middle with its own trace number, as shown in the following figure. The trace number annotations disappear when any other menu is showing.

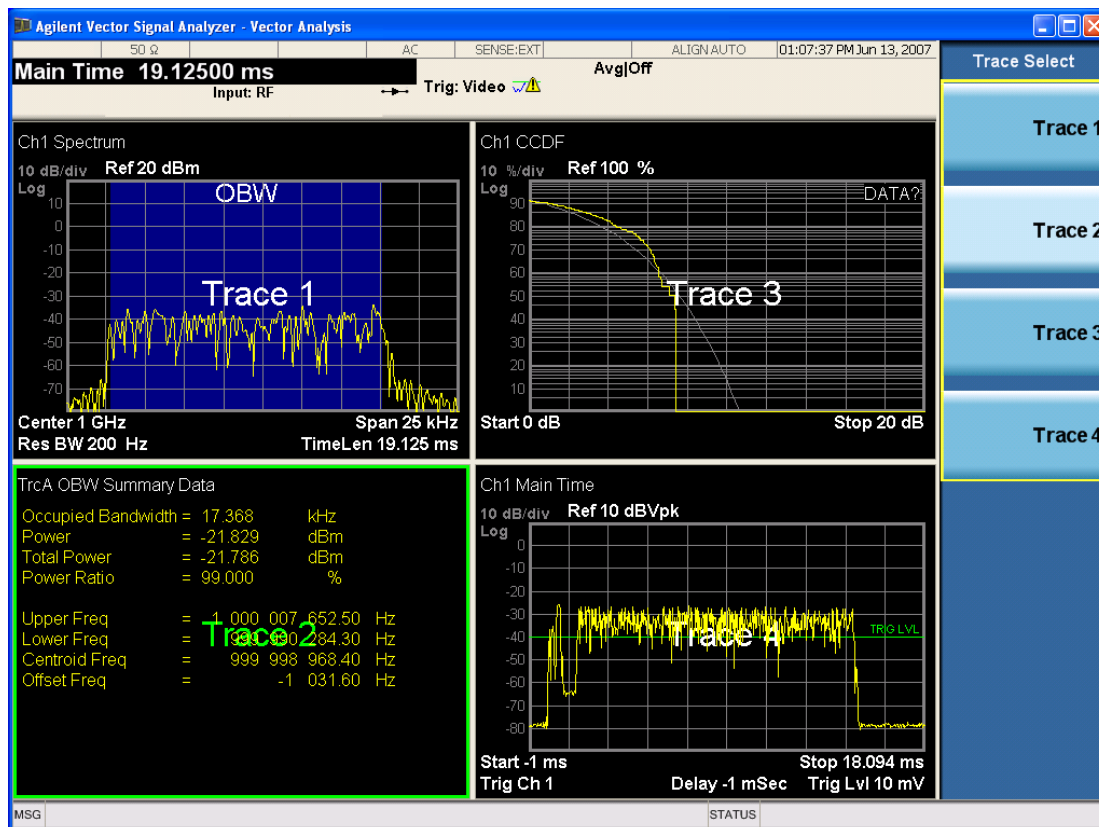

Grid 2x2 layout showing trace annotations when Trace Select dialog is active

This softkey also appears in the X and Y scaling menus. There is only one selected trace at any time. If you change which trace is selected, that change is reflected in this softkey/menu wherever it appears. Other ways to select a trace include use of the Next Window key, clicking within a trace window with a mouse cursor, and issuing a trace-specific SCPI command.

There is no SCPI command associated with this function. Instead, SCPI commands that are trace-specific have an index on the TRACe node that determines the selected trace. Using such a command has the side effect that the trace addressed by the SCPI command becomes the selected trace for any front panel interaction.

Key Path	Trace/Detector or Span X Scale or AMPTD Y Scale
Mode	VSA, LTE, LTETDD, IDEN, LTEAFDD, LTEATDD
Notes	No SCPI. Front panel only.

Couplings	Affects any trace-specific commands
Range	Trace 1 Trace 2 Trace 3 Trace 4 Trace 5 Trace 6
Readback Text	Trace <n>
Initial S/W Revision	Prior to A.02.00
Modified at S/W Revision	A.02.00

Couple Ref to Range

When Couple Ref to Range is on, Y scaling is adjusted when the Range changes. For example, on traces with Y units of dBm, the reference value changes by the same amount in dB as the Range does. On a trace with Y units of Volts, the Per Division setting changes by a factor of approximately 1.25 when the Range changes by 2 dB. This function can be turned on or off for each individual trace.

Key Path	AMPTD Y Scale
Mode	VSA, LTE, LTETDD, IDEN, LTEAFDD, LTEATDD
Measurement	<meas>:=VECTor ADEMod DDEMod W11A W11B EVM IPOWER IDEMod MOTotalk
Remote Command	:DISPlay:<meas>:TRACe [1] 2 ... 4:Y[:SCALE]:RLEVel:AUTO OFF ON 0 1 :DISPlay:<meas>:TRACe [1] 2 ... 4:Y[:SCALE]:RLEVel:AUTO?
Example	DISP:VECT:TRAC1:Y:RLEV:AUTO ON DISP:VECT:TRAC1:Y:RLEV:AUTO?
Notes	Range coupling is not available for Phase and Group delay traces.
Preset	1
State Saved	Saved in instrument state.
Range	On Off
Initial S/W Revision	Prior to A.02.00
Modified at S/W Revision	A.02.00

Y Reference Value

Controls the Y value of the selected trace at the Reference Position. It has no effect on hardware input settings.

See "[Y Reference: Position](#)" on page 1908 for more details.

Key Path	AMPTD Y Scale
Mode	VSA, LTE, LTETDD, IDEN, LTEAFDD, LTEATDD
Measurement	<meas>:=VECTor ADEMod DDEMod W11A W11B EVM IPOWER IDEMod MOTotalk
Remote Command	:DISPlay:<meas>:TRACe [1] 2 ... 4:Y[:SCALE]:RLEVel <real> :DISPlay:<meas>:TRACe [1] 2 ... 4:Y[:SCALE]:RLEVel?
Example	DISP:VECT:TRAC:Y:RLEV 20

	DISP:VECT:TRAC:Y:RLEV?
Couplings	None. This does not affect any hardware input settings.
Preset	Depends on trace
State Saved	Saved in instrument state.
Min	-9.9E+37
Max	9.9E+37
Initial S/W Revision	Prior to A.02.00
Modified at S/W Revision	A.02.00

Y Scale Per Division

Controls the Y scale per division of the selected trace.

Key Path	AMPTD Y Scale
Mode	VSA, LTE, LTETDD, IDEN, LTEAFDD, LTEATDD
Measurement	<meas>:=VECTor ADEMod DDEMod W11A W11B EVM IPOWER IDEMod MOTotalk
Remote Command	:DISPlay:<meas>:TRACe[1] 2 ... 4:Y[:SCALE]:PDIVision <real> :DISPlay:<meas>:TRACe[1] 2 ... 4:Y[:SCALE]:PDIVision?
Example	DISP:VECT:TRAC:Y:PDIV 10 DISP:VECT:TRAC:Y:PDIV?
Couplings	None.
Preset	Depends on trace
State Saved	Saved in instrument state.
Min	-9.9E+37
Max	9.9E+37
Initial S/W Revision	Prior to A.02.00
Modified at S/W Revision	A.02.00

Y Reference: Position

Sets the position of the reference line for Y scaling for the selected trace. It can be set to the top, bottom, or center of the grid.

Key Path	AMPTD Y Scale
Mode	VSA, LTE, LTETDD, IDEN, LTEAFDD, LTEATDD
Measurement	<meas>:=VECTor ADEMod DDEMod W11A W11B EVM IPOWER IDEMod MOTotalk
Remote Command	:DISPlay:<meas>:TRACe[1] 2 ... 4:Y[:SCALE]:RPOSITION TOP CENTER BOTTom :DISPlay:<meas>:TRACe[1] 2 ... 4:Y[:SCALE]:RPOSITION?

Example	DISP:VECT:TRAC1:Y:RPOS TOP DISP:VECT:TRAC1:Y:RPOS?
Couplings	Changing trace format or data can affect this. Each format "remembers" its reference position.
Preset	Depends on trace format and trace data. Top for LogMag or most LinearMag traces, middle for Real, Imaginary, Vector displays, Eye diagrams, Phase, Delay, Bottom for Linear Mag EVM.
State Saved	Saved in instrument state.
Range	Top Ctr Bottom
Initial S/W Revision	Prior to A.02.00
Modified at S/W Revision	A.02.00

Reference Line

Controls whether the Y reference line is visible or not.

Key Path	AMPTD Y Scale
Mode	VSA, LTE, LTETDD, IDEN, LTEAFDD, LTEATDD
Measurement	<meas>:=VECTor ADEMod DDEMod W11A W11B EVM IPOWER IDEMod MOTotalk
Remote Command	:DISPlay:<meas>:TRACe [1] 2 ... 4:RLINe OFF ON 0 1 :DISPlay:<meas>:TRACe [1] 2 ... 4:RLINe?
Example	DISP:VECT:TRAC1:RLIN ON DISP:VECT:TRAC1:RLIN?
Preset	OFF
State Saved	Saved in instrument state.
Initial S/W Revision	Prior to A.02.00
Modified at S/W Revision	A.02.00

Y Unit Preference

Displays a menu that enables you to set the preferred Y unit for the selected trace. You can select Peak, RMS, Power units, or an automatic selection. The automatic selection uses Power units for frequency domain data and Peak units for time domain data.

Key Path	AMPTD Y Scale
Mode	VSA, LTE, LTETDD, IDEN, LTEAFDD, LTEATDD
Measurement	<meas>:=VECTor ADEMod DDEMod W11A W11B EVM IPOWER IDEMod MOTotalk
Remote Command	:DISPlay:<meas>:TRACe [1] 2 ... 4:Y:UNIT:PREFeRence AUTO PEAK RMS POWER MRMS :DISPlay:<meas>:TRACe [1] 2 ... 4:Y:UNIT:PREFeRence?
Example	DISP:VECT:TRAC1:Y:UNIT:PREF PEAK DISP:VECT:TRAC1:Y:UNIT:PREF?

Preset	AUTO
State Saved	Saved in instrument state.
Range	AUTO PEAK RMS POW MRMS
Readback Text	Auto Peak RMS Power mRMS
Initial S/W Revision	Prior to A.02.00
Modified at S/W Revision	A.02.00

The following SCPI only command can be used to determine exactly which Y unit was chosen based on the setting of the above:

Key Path	AMPTD Y Scale
Mode	VSA, LTE, LTETDD, IDEN
Measurement	<meas>:=VECTor ADEMod DDEMod W11A W11B EVM IPOWER IDEMod MOTotalk
Remote Command	:DISPlay:<meas>:TRACe[1] 2 ... 4:Y:UNIT?
Example	DISP:VECT:TRAC1:Y:UNIT?
Initial S/W Revision	Prior to A.02.00
Modified at S/W Revision	A.02.00

Y Log Ratio

Enabled if the Trace Format is set to LogMag (Linear Unit). In this format type, you set the Y Log Ratio instead of Y Scale Per Division to determine Y scaling. It sets the ratio of the top of the Y axis to the bottom.

Key Path	AMPTD Y Scale
Mode	VSA, LTE, LTETDD, IDEN, LTEAFDD, LTEATDD
Measurement	<meas>:=VECTor ADEMod DDEMod W11A W11B EVM IPOWER IDEMod MOTotalk
Remote Command	:DISPlay:<meas>:TRACe[1] 2 ... 4:Y:LRATio <real> :DISPlay:<meas>:TRACe[1] 2 ... 4:Y:LRATio?
Example	DISP:VECT:TRAC1:Y:LRAT 10000 DISP:VECT:TRAC1:Y:LRAT?
Notes	This is grayed out if the trace format is not Log Mag (linear unit).
Preset	100000
State Saved	Saved in instrument state.
Min	1.001
Max	100e6
Initial S/W Revision	Prior to A.02.00
Modified at S/W Revision	A.02.00

Vector Horiz Center

Sets the position of the origin for Vector trace formats such as I-Q and Constellation. When using one of these formats, you set the vertical (imaginary) axis scaling with the Y Reference Value, Y Reference Position, and Y Scale Per Division properties. The scaling of the horizontal axis is set to maintain an aspect ratio of 1:1.

Key Path	AMPTD Y Scale
Mode	VSA, LTE, LTETDD, IDEN, LTEAFDD, LTEATDD
Measurement	<meas>:=VECTor ADEMod DDEMod W11A W11B EVM IPOWER IDEMod MOTotalk
Remote Command	:DISPlay:<meas>:TRACe[1] 2 ... 4:VHCenter <real> :DISPlay:<meas>:TRACe[1] 2 ... 4:VHCenter?
Example	DISP:DDEM:TRAC1:VHC 0.2 DISP:DDEM:TRAC1:VHC?
Preset	0
State Saved	Saved in instrument state.
Min	-9.9e37
Max	9.9e37
Initial S/W Revision	Prior to A.02.00
Modified at S/W Revision	A.02.00

Copy Y Scale

Copies the following Y scaling information from the selected trace to another:

- Y reference Position
- Y Reference Value
- Y Unit Preference
- Vector Horiz Center
- Couple Ref to Range
- Y Log Ratio
- Y Reference Line

This is a front-panel only function.

Key Path	AMPTD Y Scale, Y Axis Scaling
Mode	VSA, LTE, LTETDD, IDEN, LTEAFDD, LTEATDD
Initial S/W Revision	Prior to A.02.00
Modified at S/W Revision	A.02.00

Y Auto Scale

See "[Y Auto Scale](#)" on page 1903 for more information.

Attenuation

See AMPTD Y Scale, Attenuation@3003 for details.

Select Trace

See "[Select Trace](#)" on page 2272 for more information.

Couple Ref to Range

See "[Couple Ref to Range](#)" on page 1907 for more information.

Y Reference Value

See "[Y Reference Value](#)" on page 1907 for more information.

Y Scale Per Division

See "[Y Scale Per Division](#)" on page 1908 for more information.

Y Reference: Position

See "[Y Reference: Position](#)" on page 1908 for more information.

Reference Line

See "[Reference Line](#)" on page 1909 for more information.

Y Unit Preference

See "[Y Unit Preference](#)" on page 1909 for more information.

Y Log Ratio

See "[Y Log Ratio](#)" on page 1910 for more information.

Vector Horiz Center

See "[Vector Horiz Center](#)" on page 1911 for more information.

Copy Y Scale

See "[Vector Horiz Center](#)" on page 1911 for more information.

Auto Couple

The Auto Couple feature provides a quick and convenient way to automatically couple multiple instrument settings. This helps ensure accurate measurements and optimum dynamic range. When the Auto Couple feature is activated, either from the front panel or remotely, all parameters of the current measurement that have an Auto/Manual mode are set to Auto mode and all measurement settings dependent on (or coupled to) the Auto/Man parameters are automatically adjusted for optimal performance.

However, the Auto Couple key actions are confined to the current measurement only. It does not affect other measurements in the mode, and it does not affect markers, marker functions, or trace or display attributes.

See ["More Information" on page 1913](#)

Key Path	Front-panel key
Remote Command	:COUPle ALL NONE
Example	:COUP ALL
Notes	:COUPle ALL puts all Auto/Man parameters in Auto mode (equivalent to pressing the Auto Couple key). :COUPLE NONE puts all Auto/Man parameters in manual mode. It decouples all the coupled instrument parameters and is not recommended for making measurements.
Initial S/W Revision	Prior to A.02.00

More Information

There are two types of functions that have Auto/Manual modes.

Auto/Man Active Function keys

An Auto/Man toggle key controls the binary state associated with an instrument parameter by toggling between Auto (where the parameter is automatically coupled to the other parameters it is dependent upon) and Man (where the parameter is controlled independent of the other parameters), as well as making the parameter the active function. The current mode is indicated on the softkey with either Auto or Man underlined as illustrated below.



Auto/Man 1-of-N keys

An Auto/Man 1-of-N key allows you to manually pick from a list of parameter values, or place the function in Auto, in which case the value is automatically selected (and indicated) as shown below. If in Auto, Auto is underlined on the calling key. If in manual operation, manual is indicated on the calling key. But the calling key does not actually toggle the function, it simply opens the menu.

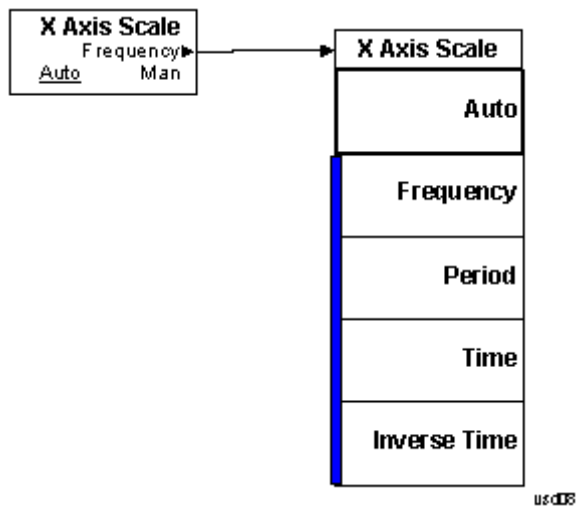

BW

There is no BW functionality in this measurement. When pressed, blank menu appears.

Key Path	Front-panel key
Initial S/W Revision	A.14.00

Cont (Continuous Measurement/Sweep)

Sets the analyzer for Continuous measurement operation. The single/continuous state is Meas Global so the setting will affect all measurements. If you are Paused, pressing Cont does a Resume.

Key Path	Front-panel key
Remote Command	:INITiate:CONTinuous OFF ON 0 1 :INITiate:CONTinuous?
Example	:INIT:CONT 0 puts analyzer in Single measurement operation. :INIT:CONT 1 puts analyzer in Continuous measurement operation
Preset	ON (Note that SYST:PRESet sets INIT:CONT to ON but *RST sets INIT:CONT to OFF)
State Saved	Saved in instrument state
Backwards Compatibility Notes	For Spectrum Analysis mode in ESA and PSA, there is no Cont hardkey, instead there is a Sweep Single/Cont key. In these analyzers, switching the Sweep Single/Cont key from Single to Cont restarts averages (displayed average count reset to 1), but does not restart Max Hold and Min Hold. The X-Series has Single and Cont keys in place of the SweepSingleCont key. In the X-Series, if in single measurement, the Cont key (and INIT:CONT ON) switches to continuous measurement, but never restarts a measurement and never resets a sweep.
Initial S/W Revision	Prior to A.02.00

In Swept SA Measurement (Spectrum Analysis Mode):

The analyzer takes repetitive sweeps, averages, measurements, etc., when in Continuous mode. When the average count reaches the Average/Hold Number the count stops incrementing, but the analyzer keeps sweeping. See the Trace/Detector section for the averaging formula used both before and after the Average/Hold Number is reached. The trigger condition must be met prior to each sweep. The type of trace processing for multiple sweeps, is set under the Trace/Detector key, with choices of Trace Average, Max Hold, or Min Hold.

In Other Measurements/Modes:

With Avg/Hold Num (in the Meas Setup menu) set to Off or set to On with a value of 1, a sweep is taken after the trigger condition is met; and the analyzer continues to take new sweeps after the current sweep has completed and the trigger condition is again met. However, with Avg/Hold Num set to On with a value >1, multiple sweeps (data acquisitions) are taken for the measurement. The trigger condition must be met prior to each sweep. The sweep is not stopped when the average count k equals the number N set for Avg/Hold Num is reached, but the number k stops incrementing. A measurement average usually applies to all traces, marker results, and numeric results. But sometimes it only applies to the numeric results.

If the analyzer is in Single measurement, pressing the Cont key does not change k and does not cause the sweep to be reset; the only action is to put the analyzer into Continuous measurement operation.

If it is already in continuous sweep:

the INIT:CONT 1 command has no effect

the INIT:CONT 0 command will place the analyzer in Single Sweep but will have no effect on the current sequence until $k = N$, at which point the current sequence will stop and the instrument will go to the idle state.

File

See "File" on page 266

FREQ Channel

Accesses a menu of keys that allow you to control the Frequency and Channel parameters of the instrument.

Some features in the Frequency menu are the same for all measurements - they do not change as you change measurements. Settings like these are called "Meas Global" and are unaffected by Meas Preset. For example, the Center Freq setting is the same for all measurements - it does not change as you change measurements.

Key Path	Front Panel Key
Mode	LTETDD, LTEAFDD
Initial S/W Revision	A.14.00

Carrier Ref Freq

Sets carrier reference frequency. The center frequencies of carriers are defined as offset frequency from this value.

If the following conditions are satisfied at the same time:

- the Number of Component Carrier equals to 1
- the Center Freq Offset equals to 0 Hz
- the mode of the Center Freq is Auto

the Center Freq is equivalent to Carrier Ref Freq.

When the Center Freq changes in such conditions, the mode of the Center Freq keeps as Auto and the Carrier Ref Freq will be changed to same value. The major purpose of this coupling is to keep BWCC with legacy LTE/LTE TDD, in which :SENSe:FREQUENCY:CENTER is used to set up the Frequency of the measurement.

Key Path	FREQ Channel Mode Setup, Component Carrier Setup
Mode	LTEATDD, LTEAFDD
Measurement	All
Remote Command	<code>[:SENSe] :CCARrier:REFeRence <freq></code> <code>[:SENSe] :CCARrier:REFeRence?</code>
Example	CCAR:REF 2GHz CCAR:REF?
Notes	In order to easily configure component carriers, the key is also placed in the Mode Setup.
Preset	1GHz
State Saved	Saved in instrument state
Min	Depends on instrument minimum center frequency. Same as Center Freq
Max	Depends on instrument maximum center frequency. Same as Center Freq

Initial S/W Revision	A.14.00
Modified at S/W Revision	A.14.50

Input/Output

See "Input/Output" on page 182

Marker

Displays the Marker menu. A marker can be placed on a trace to precisely determine the value of the trace data at the marker position. Markers can also be used in pairs to read the difference (or delta) between two data points. They can also be used to make power calculations over a band of frequencies or a time interval. See "[Marker Function](#)" on page 1940 for more details.

The functions in this menu include a 1-of-N selection of the control mode **Normal**, **Delta**, **Fixed**, or **Off** for the selected marker. The control mode is described below.

Pressing **Marker** always makes the selected maker's X position the active function.

If the currently selected marker is **Off**, pressing **Marker** sets it to **Normal** mode and places it at the center of the screen on the currently selected trace.

As a convenience, if there are no markers displayed on the current trace, pressing the marker hardkey (whenever the marker menu is already showing) selects the lowest numbered marker that is currently off and turns it on in normal mode on the selected trace. In other words, pressing the Marker hardkey twice always turns on a marker on the selected trace if none was turned on before.

Key Path	Front Panel
Mode	VSA, LTE, LTETDD, IDEN,LTEAFDD,LTEATDD
Initial S/W Revision	Prior to A.02.00
Modified at S/W Revision	A.02.00

Select Marker

Specifies the selected marker. The selected marker is the one that is affected by the marker position and properties settings, peak search, and other marker functions. Several menus have a Select Marker key for convenience. Marker selection using any one of these is reflected in all others, in other words, there is only one selected marker for the whole measurement. If all markers are off, then marker 1 becomes the selected marker.

As a convenience, if no markers are displayed on the selected trace, selecting a marker that is off automatically turns it on in normal mode on the selected trace.

There is no SCPI function for selecting a marker. Instead, SCPI functions can explicitly include the index of the marker for which they are to apply. (Most SCPI marker functions that affect the state of a marker also make it the selected marker for front panel commands.)

Key Path	Marker or Marker> or Marker Function or Peak Search
Mode	VSA, LTE, LTETDD, IDEN,LTEAFDD,LTEATDD
State Saved	No
Range	1 2 3 4 5 6 7 8 9 10 11 12
Initial S/W Revision	Prior to A.02.00
Modified at S/W Revision	A.02.00

Control Mode

Pressing **Normal**, **Delta**, **Fixed**, or **Off** sets the control mode of the selected marker. The current control mode is shown by highlighting the appropriate key.

The SCPI command in the table below selects the marker and sets the marker control mode as described under "**Normal (Position)**" on page 1933, "**Delta**" on page 1934, "**Fixed**" on page 1935 and "**Off**" on page 1935. All interactions and dependencies detailed under the key description are enforced when the remote command is sent.

Key Path	Marker
Mode	VSA, LTE, LTETDD, IDEN,LTEAFDD,LTEATDD
Measurement	<meas>:=VECTor ADEMod DDEMod W11A W11B EVM IPOWER IDEMod MOTotalk
Remote Command	:CALCulate:<meas>:MARKer[1] 2 ... 12:MODE POSition DELTa FIXed =OFF :CALCulate:<meas>:MARKer[1] 2 ... 12:MODE?
Example	CALC:VECT:MARK1:MODE POS CALC:VECT:MARK1:MODE?
Couplings	When Delta mode is selected or when the mode is changed from Delta to Off, the marker relative to the selected marker can be affected as described in the text descriptions below.
Preset	=OFF
State Saved	Saved in instrument state.
Range	Normal Delta Fixed Off
Initial S/W Revision	Prior to A.02.00
Modified at S/W Revision	A.02.00

Marker Properties

Accesses a menu of common marker properties.

Key Path	Marker
Mode	VSA, LTE, LTETDD, IDEN,LTEAFDD,LTEATDD
Initial S/W Revision	Prior to A.02.00

Select Marker

Specifies the selected marker. The selected marker is the one that is affected by the marker position and properties settings, peak search, and other marker functions. Several menus have a Select Marker key for convenience. Marker selection using any one of these is reflected in all others, in other words, there is only one selected marker for the whole measurement. If all markers are off, then marker 1 becomes the selected marker.

As a convenience, if no markers are displayed on the selected trace, selecting a marker that is off automatically turns it on in normal mode on the selected trace.

There is no SCPI function for selecting a marker. Instead, SCPI functions can explicitly include the index of the marker for which they are to apply. (Most SCPI marker functions that affect the state of a marker also make it the selected marker for front panel commands.)

Key Path	Marker or Marker> or Marker Function or Peak Search
Mode	VSA, LTE, LTETDD, IDEN,LTEAFDD,LTEATDD
State Saved	No
Range	1 2 3 4 5 6 7 8 9 10 11 12
Initial S/W Revision	Prior to A.02.00
Modified at S/W Revision	A.02.00

Relative To

Enables you to specify which marker is used as a reference for the selected marker when the selected marker's control mode is set to Delta. By default, the reference marker is numerically one higher than the selected marker, that is, marker 1 is relative to marker 2, marker 2 to marker 3, and so on. Marker 12 by default is relative to marker 1. This key enables you to change the reference marker from the default. Note that a marker cannot be made relative to itself.

Key Path	Marker, Properties
Mode	VSA, LTE, LTETDD, IDEN,LTEAFDD,LTEATDD
Measurement	<meas>:=VECTor ADEMod DDEMod W11A W11B EVM IPOWER IDEMod MOTotalk
Remote Command	:CALCulate:<meas>:MARKer[1] 2 ... 12:REFerence <integer> :CALCulate:<meas>:MARKer[1] 2 ... 12:REFerence?
Example	CALC:VECT:MARK2:REF 4 CALC:VECT:MARK2:REF?
Notes	The reference marker cannot be the same value as the selected marker, that is, a marker cannot be relative to itself. The currently selected marker is not an available choice in the relative to selection (i.e., the selected marker appears grayed out). When queried, a single value is returned (the specified marker numbers relative marker).
Couplings	See " Coupling of Delta and Reference Markers " on page 1935. The old reference remains as it was.
Preset	2 3 4 5 6 7 8 9 10 11 12 1
State Saved	Saved in instrument state.
Range	1 2 3 4 5 6 7 8 9 10 11 12
Initial S/W Revision	Prior to A.02.00
Modified at S/W Revision	A.02.00

Complex Format

Determines the format for the readout when a marker is placed on a complex display (vector or constellation). The choices are to read out in rectangular or polar coordinates. The readout format applies

to the marker display and marker table only; there is no SCPI for reading out the marker value in polar form.

Key Path	Marker, Properties
Mode	VSA, LTE, LTETDD, IDEN,LTEAFDD,LTEATDD
Measurement	<meas>:=VECTor ADEMod DDEMod W11A W11B EVM IPOWER IDEMod MOTotalk
Remote Command	:CALCulate:<meas>:MARKer[1] 2 ... 12:CFORmat RECTangular POLar :CALCulate:<meas>:MARKer[1] 2 ... 12:CFORmat?
Example	CALC:VECT:MARK1:CFOR RECT CALC:VECT:MARK1:CFOR?
Preset	RECT
State Saved	Saved in instrument state.
Range	Rect Polar
Initial S/W Revision	Prior to A.02.00
Modified at S/W Revision	A.02.00

Marker Trace

Enables you to determine the trace to which a marker is assigned. By default, when a marker is turned on it is assigned to the currently selected trace. You can change that assignment using this control.

Key Path	Marker, Properties
Mode	VSA, LTE, LTETDD, IDEN,LTEAFDD,LTEATDD
Measurement	<meas>:=VECTor ADEMod DDEMod W11A W11B EVM IPOWER IDEMod MOTotalk
Remote Command	:CALCulate:<meas>:MARKer[1] 2 ... 12:TRACe <integer> :CALCulate:<meas>:MARKer[1] 2 ... 12:TRACe?
Example	CALC:VECT:MARK3:TRAC 2 CALC:VECT:MARK3:TRAC?
Couplings	See " Coupling of Delta and Reference Markers " on page 1935.
Preset	Marker is assigned to currently selected trace when turned on.
State Saved	Saved in instrument state.
Range	Trace 1 Trace2 Trace 3 Trace 4
Min	1
Max	4
Initial S/W Revision	Prior to A.02.00
Modified at S/W Revision	A.02.00

Marker Count

Enables the frequency counter algorithm on the selected marker. This algorithm can more precisely determine the frequency of a peak. The marker must be on a frequency domain trace, with data coming from hardware. Place the marker on a peak and enable the frequency counter. The marker readout then shows the calculated frequency rather than the marker X position. Only one marker can be counted at any time. Turning on marker count for any marker turns it off for all other markers.

Key Path	Marker, Properties
Mode	VSA, IDEN,LTEAFDD,LTEATDD
Measurement	<meas>:=VECTor ADEMod DDEMod W11A W11B EVM IPOWER IDEMod MOTotalk
Remote Command	:CALCulate:<meas>:MARKer [1] 2 ... 12:FCOunt[:STATE] OFF ON 0 1 :CALCulate:<meas>:MARKer [1] 2 ... 12:FCOunt[:STATE] ?
Example	CALC:VECT:MARK:FCO ON CALC:VECT:MARK:FCO?
Notes	Marker must be on a frequency-domain trace and data must be live, not recorded or simulated.
Preset	OFF
State Saved	Saved in instrument state.
Range	Off On
Initial S/W Revision	Prior to A.02.00
Modified at S/W Revision	A.02.00

The frequency counter result must be read back with the following SCPI command. The Marker X query command only gets the marker's data point position, which is not as accurate as the frequency counter result.

Mode	VSA, IDEN,LTEAFDD,LTEATDD
Measurement	<meas>:=VECTor ADEMod DDEMod W11A W11B EVM IPOWER IDEMod MOTotalk
Remote Command	:CALCulate:<meas>:MARKer [1] 2 ... 12:FCOunt:X?
Example	CALC:VECT:MARK:FCO:X?
Notes	Query only. If the marker counter result is unavailable, NaN is returned.
Initial S/W Revision	Prior to A.02.00
Modified at S/W Revision	A.02.00

Marker Table

Displays the marker data display window below the measurement window. For each marker that is on, information is displayed in the data display window, which includes the marker number, control mode, trace number, X axis scale, X axis value, and the Y-axis result. Additional information is shown for markers that have marker functions turned on.

Key Path	Marker
Mode	VSA, LTE, LTETDD, IDEN,LTEAFDD,LTEATDD
Measurement	<meas>:=VECTor ADEMod DDEMod W11A W11B EVM IPOWER IDEMod MOTotalk
Remote Command	:CALCulate:<meas>:MARKer:TABLE[:STATE] OFF ON 0 1 :CALCulate:<meas>:MARKer:TABLE[:STATE]?
Example	CALC:VECT:MARK:TABL ON CALC:VECT:MARK:TABL?
Preset	OFF
State Saved	No
Range	Off On
Initial S/W Revision	Prior to A.02.00
Modified at S/W Revision	A.02.00

Marker Position

Selects which data point in a trace to read out with the marker (or where to locate a fixed marker). The marker position is primarily set in terms of the domain units, not trace points (although it can be set in terms of points via SCPI). The default active function when you press a marker hard key is the X position for the currently selected marker. The exception to this is when the selected marker is fixed. In that case there is no default active function (to prevent inadvertently changing a fixed marker's location).

Marker position is not defined when a marker's control mode is Off. When a marker is turned on in Normal or Delta mode, its X (and Z) values are set to the center of the trace data. If a marker is turned on in Fixed mode, its position is set so that it appears in the middle of the trace grid.

The Marker Position key branches to the Marker Position menu, which enables you to set any position variable relevant to the selected marker's control mode and trace format.

For Normal and Delta markers, usually only Marker X is available. Marker Z is available for trace data with 2-dimensional domain. For Fixed markers, Y can also be set. If the trace format is Vector or Constellation, **Marker Y** controls the real (horizontal axis) value and **Marker Y Imag** controls the imaginary (vertical axis) value. The key (or the keys below it) is grayed out if the selected marker is off.

Key Path	Marker
Mode	VSA, LTE, LTETDD, IDEN,LTEAFDD,LTEATDD
Initial S/W Revision	Prior to A.02.00
Modified at S/W Revision	A.02.00

Marker X

Sets the selected marker's X Axis value position in the current X Axis Scale unit. If the control mode is Off, the SCPI command has no affect other than to cause the marker to become selected. Note that the X value can change if the marker is moved to a trace with a different domain.

The Marker X position is absolute if the marker control mode is Normal or Fixed. If the control mode is Delta, then the X position is relative to the reference marker. The valid X positions are the actual data points in the trace; the marker cannot be located between points. If a SCPI command attempts to place the marker between two points, the X value snaps to the closest point.

Note that for Vector or Constellation format, the X axis is perpendicular to the screen (because the screen axes are used to show the real and imaginary parts of the Y value), so adjusting the X value in this case only causes the marker to move horizontally if the real Y value changes. For Fixed markers on a trace with one of these formats, adjusting the X value does not cause horizontal motion of the marker at all. Instead, use the Marker X and Marker Y (imag) controls to move the marker horizontally and vertically.

Key Path	Marker, Marker Position
Mode	VSA, LTE, LTETDD, IDEN, LTEAFDD, LTEATDD
Measurement	<meas>:=VECTor ADEMod DDEMod W11A W11B EVM IPOWER IDEMod MOTotalk
Remote Command	:CALCulate:<meas>:MARKer[1] 2 ... 12:X <real> :CALCulate:<meas>:MARKer[1] 2 ... 12:X?
Example	CALC:VECT:MARK:X 0.325 CALC:VECT:MARK:X?
Notes	Marker X does not go outside the bounds of the data unless it is Fixed. If you attempt to set it to a value outside the bounds, it is clipped at the closest limit and error -222 Data Out of Range is generated. If suffix is sent, it must match the X units for the trace the marker is on. Otherwise, error -138, "Suffix not allowed" is generated. If you try to read or set the position of a Delta marker, remember that the position is in relative units.
Couplings	See "Coupling of Delta and Reference Markers" on page 1935 . See also: "Couple Markers" on page 1932
Preset	None until marker is turned on.
State Saved	Saved in instrument state.
Min	Depends on trace data
Max	Depends on trace data
Initial S/W Revision	Prior to A.02.00
Modified at S/W Revision	A.02.00

SCPI only X position commands

Via SCPI, the marker position can also be set or queried in trace points. In this case, the position setting or reading is absolute regardless of control mode.

NOTE

The entered value in Trace Points is immediately translated into the current domain units for setting the value of the marker. The marker's value in domain units, NOT trace points, is preserved if a change is made to the X Axis scale settings. Thus, if you use this command to place a marker on point 500, which happens at that time to correspond to 13 GHz, and then you change the Start Frequency so that point 500 is no longer 13 GHz, the marker stays at 13 GHz, NOT at point 500.

If the trace the marker is on has a 2-dimensional domain, then the points are numbered in the following way:

Starting at the minimum X and Z position, this point is numbered 0. Each time you increment the point number, increment the X value to the next available value. When X reaches the maximum X position, then reset X to the minimum and increment the Z value. Then continue incrementing the X position in the same manner as before.

Note that for symbol tables, which have no axes, incrementing the X position in points moves the marker consecutively through all table entries.

Mode	VSA, LTE, LTETDD, IDEN,LTEAFDD,LTEATDD
Measurement	<meas>:=VECTor ADEMod DDEMod W11A W11B EVM IPOWER IDEMod MOTotalk
Remote Command	:CALCulate:<meas>:MARKer[1] 2 ... 12[:X]:POSition <real> :CALCulate:<meas>:MARKer[1] 2 ... 12[:X]:POSition?
Example	CALC:VECT:MARK:POS 25 CALC:VECT:MARK:POS?
Notes	When a marker control mode is changed from off to any other mode, the X position is set to mid-screen.
Couplings	See "Coupling of Delta and Reference Markers" on page 1935 . See also: "Couple Markers" on page 1932
Preset	None until marker is turned on.
State Saved	Saved in instrument state.
Min	Depends on trace data
Max	Depends on trace data
Initial S/W Revision	Prior to A.02.00
Modified at S/W Revision	A.02.00

Marker X Unit can be queried via SCPI

Mode	VSA, LTE, LTETDD, IDEN,LTEAFDD,LTEATDD
Measurement	<meas>:=VECTor ADEMod DDEMod W11A W11B EVM IPOWER IDEMod MOTotalk
Remote Command	:CALCulate:<meas>:MARKer[1] 2 ... 12:X:UNIT?
Example	CALC:VECT:MARK:X:UNIT?
Notes	Query Only
Initial S/W Revision	Prior to A.02.00
Modified at S/W Revision	A.02.00

Marker Z

Sets the selected markers Z Axis value in the current Z Axis Scale unit for markers on traces with a 2-dimensional domain. In each case the marker that is addressed becomes the selected marker. It has no

affect (other than to cause the marker to become selected) if the control mode is **Off** or if the trace has no Z domain. Note that the Z value can change or become irrelevant if the marker is moved to a trace with a different Z domain or no Z domain.

Note that this Z value is affected if the SCPI command to set marker point position is used.

Key Path	Marker, Marker Position
Mode	VSA, LTE, LTETDD, IDEN, LTEAFDD, LTEATDD
Measurement	<meas>:=VECTor ADEMod DDEMod W11A W11B EVM IPOWER IDEMod MOTotalk
Remote Command	:CALCulate:<meas>:MARKer[1] 2 ... 12:Z <real> :CALCulate:<meas>:MARKer[1] 2 ... 12:Z?
Example	CALC:OFDM:MARK:Z 12 CALC:OFDM:MARK:Z?
Notes	Marker Z does not go outside the bounds of the data unless it is Fixed. If you attempt to set it to a value outside the bounds it is clipped at the closest limit, and error -222 Data Out of Range is generated. If suffix is sent, it must match the Z units for the trace the marker is on. Otherwise, error -138, "Suffix not allowed" is generated.
Couplings	See "Coupling of Delta and Reference Markers" on page 1935 . See also: "Couple Markers" on page 1932
Preset	None until marker is turned on.
State Saved	Saved in instrument state.
Min	Depends on trace data
Max	Depends on trace data
Initial S/W Revision	Prior to A.02.00
Modified at S/W Revision	A.02.00

Marker Z Unit can be queried via SCPI.

Mode	VSA, LTE, LTETDD, IDEN, LTEAFDD, LTEATDD
Measurement	<meas>:=VECTor ADEMod DDEMod W11A W11B EVM IPOWER IDEMod MOTotalk
Remote Command	:CALCulate:<meas>:MARKer[1] 2 ... 12:Z:UNIT?
Example	CALC:OFDM:MARK:Z:UNIT?
Notes	Query Only
Initial S/W Revision	Prior to A.02.00
Modified at S/W Revision	A.02.00

Marker Y

Enables you to set or read back the selected marker's Y Axis value in the current Y Axis Scale unit. Setting the Y value has no affect (other than to cause the marker to become selected) if the control mode is other

than fixed. The query form generates an error if the control mode is Off. Note that the Y value can change if the Y-axis units change, either from a change in format of the trace the marker is on or if the marker is moved to a different trace.

If the selected marker is on a trace that is displayed with Vector or Constellation format, this function controls only the real part of the Y value (i.e., the horizontal axis value). Use the **Marker Y (imag)** control to change the imaginary (vertical) value. Marker Y and Marker Y Imag always set or get the rectangular form of Y, regardless of whether the marker readout is polar or rectangular.

Key Path	Marker, Marker Position
Mode	VSA, LTE, LTETDD, IDEN,LTEAFDD,LTEATDD
Measurement	<meas>:=VECTor ADEMod DDEMod W11A W11B EVM IPOWER IDEMod MOTotalk
Remote Command	:CALCulate:<meas>:MARKer[1] 2 ... 12:Y[:REAL] <real> :CALCulate:<meas>:MARKer[1] 2 ... 12:Y[:REAL]?
Example	CALC:VECT:MARK2:Y 0.325 CALC:VECT:MARK2:Y?
Notes	You cannot set Y unless the marker type is fixed. If the marker becomes fixed after a marker function is turned on, it is set to whatever the Y value was when the marker became fixed. If suffix is sent, it must match the Y units for the trace the marker is on. Otherwise, error -138, "Suffix not allowed" is generated.
Couplings	Changes if marker is relative to a Delta marker that is turned on or re-zeroed (see "Coupling of Delta and Reference Markers" on page 1935).
Preset	None until marker is turned on.
State Saved	Saved in instrument state.
Min	-9.9E+37
Max	9.9E+37
Initial S/W Revision	Prior to A.02.00
Modified at S/W Revision	A.02.00

Marker Y Unit can be queried via SCPI.

Mode	VSA, LTE, LTETDD, IDEN,LTEAFDD,LTEATDD
Measurement	<meas>:=VECTor ADEMod DDEMod W11A W11B EVM IPOWER IDEMod MOTotalk
Remote Command	:CALCulate:<meas>:MARKer[1] 2 ... 12:Y:UNIT?
Example	CALC:VECT:MARK:Y:UNIT?
Notes	Query Only
Initial S/W Revision	Prior to A.02.00
Modified at S/W Revision	A.02.00

Marker Y Imag (Imaginary)

Enables you to set or read back the selected marker's quadrature (imaginary) Y value in the current Y Axis Scale unit. It has no affect (other than to cause the marker to become selected) if the control mode is other than fixed or if the current trace format is not complex (Vector or Constellation). The query form generates an error if it is used for a marker that is not on a complex trace. Marker Y Imag is not affected by whether the marker readout is polar or rectangular.

Key Path	Marker, Marker Position
Mode	VSA, LTE, LTETDD, IDEN, LTEAFDD, LTEATDD
Measurement	<meas>:=VECTor ADEMod DDEMod W11A W11B EVM IPOWER IDEMod MOTotalk
Remote Command	:CALCulate:<meas>:MARKer[1] 2 ... 12:Y:IMAGinary <real> :CALCulate:<meas>:MARKer[1] 2 ... 12:Y:IMAGinary?
Example	CALC:DDEM:MARK1:Y:IMAG 0.435 CALC:DDEM:MARK1:Y:IMAG?
Notes	Grayed out unless the marker is fixed and on a vector display. If suffix is sent, it must match the Y units for the trace the marker is on. Otherwise, an Invalid Suffix error is generated. Otherwise, error -138, "Suffix not allowed" is generated. If query is sent while the marker is on a trace whose format is not vector or constellation, NaN (9.91E+37) is returned.
Preset	None until marker is turned on.
State Saved	Saved in instrument state.
Min	Depends on trace format
Max	Depends on trace format
Initial S/W Revision	Prior to A.02.00
Modified at S/W Revision	A.02.00

Couple Markers

Affects all currently displayed markers. In general, when coupling is turned on then all Normal or Delta markers with the same (or equivalent) domain as the selected marker move in the same manner as the selected marker. Coupling is relative between markers on the same trace (so that their relative positions in the domain are maintained). Coupling can be absolute between markers on different traces that have equivalent domains. That is, they have the same position in the domain, if possible. (As an example of equivalent domains, demodulated symbol positions can be derived from time by using the current symbol rate). When you move the selected marker, then others on related traces track it. This enables you to correlate different measurement results. For example, you can place a marker at a particular symbol time on an error vector magnitude display, have tracking markers on the symbol table and pre-demod time trace showing you the symbol value, and the actual time-varying signal value at the same point in time.

Absolute coupling is performed only for the lowest numbered Normal or Delta marker on each trace. All other markers on a trace couple relatively. When you turn on marker coupling, the subset of markers that have the same domain as the selected marker track it and all other markers remain at their current location. The absolutely coupled markers within this subset is moved at this time to match the domain setting of the selected marker, with the relatively coupled markers following accordingly to maintain offsets within their respective traces. Those markers with different domains remain at their current

location. When you select a marker with a different domain than the previously selected marker, then the subset of markers with that domain go through the same procedure.

Any marker that coupling would move outside its range of X values, remains at the closest limiting value. If the coupled markers are on data that do not have the same domain resolution, then they are positioned as close to each other as possible.

If markers change mode or trace, or trace data is changed below them, the coupling rules are immediately applied to the new set.

Key Path	Marker
Mode	VSA, LTE, LTETDD, IDEN,LTEAFDD,LTEATDD
Measurement	<meas>:=VECTor ADEMod DDEMod W11A W11B EVM IPOWER IDEMod MOTotalk
Remote Command	:CALCulate:<meas>:MARKer:COUple[:STATe] OFF ON 0 1 :CALCulate:<meas>:MARKer:COUple[:STATe]?
Example	CALC:VECT:MARK:COUP ON CALC:VECT:MARK:COUP?
Preset	OFF
State Saved	Saved in instrument state.
Range	Off On
Initial S/W Revision	Prior to A.02.00
Modified at S/W Revision	A.02.00

All Markers Off

Turns all markers off and sets the selected marker to 1.

Key Path	Marker
Mode	VSA, LTE, LTETDD, IDEN,LTEAFDD,LTEATDD
Measurement	<meas>:=VECTor ADEMod DDEMod W11A W11B EVM IPOWER IDEMod MOTotalk
Remote Command	:CALCulate:<meas>:MARKer:AOFF
Example	CALC:VECT:MARK:AOFF:
Initial S/W Revision	Prior to A.02.00
Modified at S/W Revision	A.02.00

Normal (Position)

Reports the trace data value (Y value) at a particular point on a trace. The marker's absolute X (and Z) position is specified by you in displayed units. The marker symbol appears on the trace at the specified position and tracks the absolute Y value at that position as it changes from scan to scan. The absolute Y value is displayed in the marker readout area. In older instruments this was called Position mode, and the designation can still be used for backward compatibility.

For Control Mode SCPI command information see: ["Control Mode" on page 1923](#)

Key Path	Marker
Mode	VSA, LTE, LTETDD, IDEN,LTEAFDD,LTEATDD
Initial S/W Revision	Prior to A.02.00
Modified at S/W Revision	A.02.00

Delta

Reports the difference between Y values at two points. A delta marker is relative to an associated reference marker on the same trace. (The reference marker can be set on the Marker, Properties, Relative To menu). The reference marker is usually fixed, but can also be normal or delta. The X (and Z) position of a delta marker is specified as an offset from the reference marker position. The delta marker symbol tracks the absolute Y value just like a normal marker, but the marker readout displays the difference between the absolute Y values of the delta marker and its reference marker (absolute units are used even if the reference is itself a delta marker). Usually this is a straight difference in the current displayed units. For example, if the trace format is LogMag (dBm), the delta marker displays the difference in dB, thus showing a power ratio. But if the trace format is Real, then the delta marker shows a voltage difference, not a ratio. Exceptions for this are:

- When the trace format is **Linear Mag** or **Log Mag (linear unit)** the delta marker displays a voltage ratio or (if the Y Axis unit is Power) a power ratio, rather than a difference.
- When either the marker or its reference has a marker function turned on, the delta marker always displays a ratio or its decibel equivalent. See ["Marker Function" on page 1940](#) for more details on how delta markers work with marker functions. The type of ratio calculated (power or voltage) depends on the delta marker units; the reference marker value is converted as needed so it has compatible units.
- When the trace format is **Wrap Phase**, the delta marker readout is constrained to the wrapped phase display range, which is usually $(-180, +180]$ degrees. For example, if the absolute phase at marker 1 is 170 deg and its reference has phase of -170 deg, the delta does not show 340 deg, but -20 deg. Note that the Wrap Phase display range can be changed (see ["Phase/Trellis Offset" on page 2306](#)).

There is no current support for calculating deltas across traces (and this cannot be done at all unless the traces have the same domain and ranges).

By default, the reference marker for marker 1 is marker 2; for marker 2 is 3 and so on, but the reference marker can be changed. See ["Relative To" on page 1924](#).

For coupling rules, see ["Coupling of Delta and Reference Markers" on page 1935](#).

For Control Mode SCPI command information see: ["Control Mode" on page 1923](#)

Key Path	Marker
Mode	VSA, LTE, LTETDD, IDEN,LTEAFDD,LTEATDD
Initial S/W Revision	Prior to A.02.00
Modified at S/W Revision	A.02.00

Fixed

Mainly used as reference markers for Delta markers. A fixed marker's X and Y Axis values can be directly or indirectly specified by you, and they remain fixed once specified, in other words, they do not follow the trace data value. These markers are represented on the display by an "X" rather than a diamond. If a marker is changed from off to fixed, the X and Y (and Z) values are chosen to put it in the center of the display. If the marker is changed from some other type to fixed, the current X and Z values of the marker remain unchanged. The Y value is taken from the current trace data value and must be changed manually thereafter.

For Control Mode SCPI command information see: ["Control Mode" on page 1923](#)

Key Path	Marker
Mode	VSA, LTE, LTETDD, IDEN,LTEAFDD,LTEATDD
Initial S/W Revision	Prior to A.02.00
Modified at S/W Revision	A.02.00

Off

Turning a marker off makes it invisible, and also its annotation.

Turning a marker on (i.e., changing its control mode from Off to any other control mode) assigns the marker to the currently selected trace.

For Control Mode SCPI command information see: ["Control Mode" on page 1923](#)

Key Path	Marker
Mode	VSA, LTE, LTETDD, IDEN,LTEAFDD,LTEATDD
Initial S/W Revision	Prior to A.02.00
Modified at S/W Revision	A.02.00

Coupling of Delta and Reference Markers

The following coupling rules apply from the front panel and also if the equivalent SCPI commands are sent.

Pressing the Delta key causes the selected marker to become a delta marker if it is not already. Also, the selected marker's reference is affected as follows:

- If the reference marker was off, it is turned on as a fixed marker.
- The reference marker is moved to the trace of the selected marker and set to the same position as the selected marker.
- If the delta marker has a marker function turned on, the reference marker takes on the same function (with the same band limits).

Exception: Pressing Delta when the selected marker's mode is not yet Delta does not move or change a reference marker that is already turned on (Normal, Delta, or Fixed) and on the same trace as the selected

marker. It merely changes the selected marker's mode to Delta and shows the current offset between it and the reference. If you press Delta again (when the selected marker is already in Delta mode) then the reference is moved and modified as described above.

When a delta marker is changed to any other control mode, if its reference marker is fixed then the reference marker is also turned off.

If you move a delta marker to a different trace, it is forced to Normal mode and if its reference is fixed, the reference is turned off.

A delta marker is forced to Normal mode if you turn its reference off or if you move its reference to another trace. (In the latter case the reference is not turned off even if it is fixed.)

If you change the selected marker's reference (using the Marker, Properties, Relative To), the selected marker is forced to Delta mode. This change of the selected marker to Delta mode causes its new reference's control mode and position to change as described above.

Marker -> (Marker To)

Provides access to some convenient functions for copying the marker position to a number of frequency and Y-axis scaling parameters. These functions are available from the front panel only. No SCPI is provided, because you can already read the marker position via SCPI and then set any frequency or scaling parameter accordingly, with full accuracy.

Pressing the Marker -> hardkey always makes the selected marker's X position the active function.

If the selected marker is off, pressing the Marker -> hardkey turns on the selected marker in normal mode on the currently selected trace.

Key Path	Front Panel
Mode	VSA, LTE, LTETDD, IDEN,LTEAFDD,LTEATDD
Initial S/W Revision	Prior to A.02.00
Modified at S/W Revision	A.02.00

Mkr -> CF (Center Frequency)

Sets the center frequency equal to the selected marker's absolute frequency. The marker must be on a frequency-domain trace. The absolute marker frequency is used regardless of whether its control mode is Normal, Delta, or Fixed.

If the currently selected marker is not on when this key is pressed, it is turned on at the center of the screen as a normal type marker.

Key Path	Marker To
Mode	VSA, LTE, LTETDD, IDEN,LTEAFDD,LTEATDD
Initial S/W Revision	Prior to A.02.00
Modified at S/W Revision	A.02.00

Mkr -> CF Step

Sets the center frequency step size equal to the selected marker's frequency. The marker must be on a frequency-domain trace. The absolute marker frequency is used regardless of whether its control mode is Normal, Delta, or Fixed.

If the currently selected marker is not on when this key is pressed, it is turned on at the center of the screen as a normal type marker.

Key Path	Marker To
Mode	VSA, LTE, LTETDD, IDEN,LTEAFDD,LTEATDD
Initial S/W Revision	Prior to A.02.00
Modified at S/W Revision	A.02.00

Mkr -> Start

Sets the start frequency equal to the selected marker's frequency. The marker must be on a frequency-domain trace. The absolute marker frequency is used regardless of whether its control mode is Normal, Delta, or Fixed.

If the currently selected marker is not on when this key is pressed, it is turned on at the center of the screen as a normal type marker.

Key Path	Marker To
Mode	VSA, LTE, LTETDD, IDEN,LTEAFDD,LTEATDD
Initial S/W Revision	Prior to A.02.00
Modified at S/W Revision	A.02.00

Mkr -> Stop

Sets the stop frequency equal to the selected marker's frequency. The marker must be on a frequency-domain trace. The absolute marker frequency is used regardless of whether its control mode is Normal, Delta, or Fixed.

If the currently selected marker is not on when this key is pressed, it is turned on at the center of the screen as a normal type marker.

Key Path	Marker To
Mode	VSA, LTE, LTETDD, IDEN,LTEAFDD,LTEATDD
Initial S/W Revision	Prior to A.02.00
Modified at S/W Revision	A.02.00

Mkr Delta -> Span

Sets the start and stop frequencies equal to the selected marker's frequency and that of its reference. That is, the measurement span is "zoomed in" so that the selected marker and its associated reference appear on the extreme left and right of the display. The marker must be on a frequency-domain trace and its control mode must be Delta.

Key Path	Marker To
Mode	VSA, LTE, LTETDD, IDEN,LTEAFDD,LTEATDD
Initial S/W Revision	Prior to A.02.00
Modified at S/W Revision	A.02.00

Mkr -> Ref Lvl

Sets the Y axis reference value equal to the selected marker's Y value. For example, if the reference position is at the top of the screen, the whole trace is moved up so that the marker appears at the top of

the screen. Note that this is a display scaling function only. The input range remains the same.

Key Path	Marker To
Mode	VSA, LTE, LTETDD, IDEN,LTEAFDD,LTEATDD
Initial S/W Revision	Prior to A.02.00
Modified at S/W Revision	A.02.00

Counter -> CF (Center Frequency)

Sets the frequency of the marker counter to the center frequency. The marker counter function must be on.

Key Path	Marker To
Mode	VSA, IDEN,LTEAFDD,LTEATDD
Initial S/W Revision	Prior to A.02.00
Modified at S/W Revision	A.02.00

Mkr Delta -> CF (Center Frequency)

Sets the center frequency equal to the difference in frequency between the selected Delta marker and its reference. The marker must be on a frequency-domain trace and the selected marker's control mode must be Delta.

Key Path	Marker To
Mode	VSA, LTE, LTETDD, IDEN,LTEAFDD,LTEATDD
Initial S/W Revision	Prior to A.02.00
Modified at S/W Revision	A.02.00

Marker Function

Accesses a menu of selectable marker functions for VSA based measurements.

Marker Functions perform post-processing operations on marker data. Band Functions are Marker Functions that enable you to define a band of frequencies around the marker. The band defines the region of data used for the numerical calculations. These marker functions also enable you to perform mathematical calculations on trace and marker data and report the results of these calculations in place of the normal marker result.

Unlike regular markers, marker function markers are not placed directly on the trace. They are placed at a location that is relative to the result of the function calculation.

The Marker Function menu provides access to power calculations in bands of frequencies or time intervals centered on a marker. It also enables you to make calculations like carrier to noise by combining delta markers with marker functions. Marker functions are generally available for time and frequency domain traces, and not for others. If the marker function calculation is undefined for particular trace data, then "---" is shown in place of a number in the result display and marker table, and CALC:<meas>:MARK[n]:Y? returns 9.91E+37 (NaN).

Pressing Marker Function always makes the selected marker's X position the active function.

If the selected marker is off, pressing the Marker Function hardkey turns on the selected marker in normal mode on the currently selected trace.

Key Path	Front Panel
Mode	VSA, LTE, LTETDD, IDEN,LTEAFDD,LTEATDD
Measurement	<meas>:=VECTor ADEMod DDEMod W11A W11B EVM IPOWER IDEMod MOTotalk
Remote Command	:CALCulate:<meas>:MARKer[1] 2 ... 12:FUNction BPOwer BDENsity =OFF :CALCulate:<meas>:MARKer[1] 2 ... 12:FUNction?
Example	CALC:VECT:MARK1:FUNC BPOW CALC:VECT:MARK1:FUNC?
Notes	:CALC:<meas>:MARK1:FUNC? returns the current function type for marker 1. To return the result, use :CALC:<meas>:MARK1:Y?
Preset	=OFF
State Saved	Saved in instrument state.
Range	Band Power Band Density Off
Initial S/W Revision	Prior to A.02.00
Modified at S/W Revision	A.02.00

Select Marker

Specifies the selected marker. The selected marker is the one that is affected by the marker position and properties settings, peak search, and other marker functions. Several menus have a Select Marker key for convenience. Marker selection using any one of these is reflected in all others, in other words, there is only

one selected marker for the whole measurement. If all markers are off, then marker 1 becomes the selected marker.

As a convenience, if no markers are displayed on the selected trace, selecting a marker that is off automatically turns it on in normal mode on the selected trace.

There is no SCPI function for selecting a marker. Instead, SCPI functions can explicitly include the index of the marker for which they are to apply. (Most SCPI marker functions that affect the state of a marker also make it the selected marker for front panel commands.)

Key Path	Marker or Marker> or Marker Function or Peak Search
Mode	VSA, LTE, LTETDD, IDEN,LTEAFDD,LTEATDD
State Saved	No
Range	1 2 3 4 5 6 7 8 9 10 11 12
Initial S/W Revision	Prior to A.02.00
Modified at S/W Revision	A.02.00

Band/Interval Power

Turns on the Band/Interval Power function for the selected marker. This function calculates the power within the band centered on the marker. The function works generally with frequency spectra, PSD, and time traces. On traces where band power is undefined, the result display shows "---" and CALC:<meas>:MARK[n]:Y? returns 9.91E+37 (NaN), although the band interval can still be defined.

Frequency-domain data

If the marker is on a frequency-domain trace, the result is total power within the band. This is true whether the underlying trace data is a power spectrum or power spectral density.

Time-domain data

If the marker is on a time-domain trace, the result is average power within the time interval, that is, the power at each time sample in the time interval is calculated, the powers are summed and the total divided by the number of samples.

Key Path	Marker Function
Mode	VSA, LTE, LTETDD, IDEN,LTEAFDD,LTEATDD
Initial S/W Revision	Prior to A.02.00
Modified at S/W Revision	A.02.00

Band Power Calculation

Shows results in dBm, dBVrms, Watts, Volts RMS Squared or Volts RMS. The table below shows the choice of display units if **Band Power Calculation** is set to **Mean**, depending on the current format and Y units of the trace the marker is on.

Trace data type	Trace Format	Y Unit	Result format
Spectrum, PSD, Time record	LogMag (dB)	Auto, Power	dBm
		Peak, RMS	dBVrms
		mRMS	dBmVrms
	Linear Mag, Real, Imag, Log Mag (lin)	Auto, Peak, RMS, mRMS	Vrms^2
	Linear Mag, Real, Imag, Log Mag(lin)	Power	W
	Wrap Phase, Unwrap Phase, Delay	Any	Vrms^2
	Vector, Constellation, Eye, Trellis	Any	blanked
Dimensionless (e.g., Frequency response, Impulse response, various Demodulation error types)	LogMag (dB)	Any	dBrms
	Linear Mag, Real, Imag, Wrap Phase, Unwrap Phase, Delay, Log Mag (lin)	Any	rms^2
General dimensions(e.g., Hz, %)	LogMag (dB)	Any	dB<unit>rms
	Linear Mag, Real, Imag, Wrap Phase, Unwrap Phase, Delay, Log Mag (lin)	Any	<unit>rms^2

If the **Band Power Calculation** is set to **RMS**, then the readout unit does not depend on trace format or Y unit. For Spectrums, PS, and Time record traces, the displayed unit is "Vrms". For general units, the unit abbreviation is shown followed by "rms".

The Band Power Calculation only controls the readout format for Normal and Fixed markers. For Delta markers, see "[Band Power and Delta Markers](#)" on page 1946.

Key Path	Marker Function, Band/Interval Power
Mode	VSA, LTE, LTETDD, IDEN, LTEAFDD, LTEATDD
Measurement	<meas>:=VECTor ADEMod DDEMod W11A W11B EVM IPOWER IDEMod MOTotalk
Remote Command	:CALCulate:<meas>:MARKer[1] 2 ... 12:FUNction:BPOwer:CTYPe MEAN RMS :CALCulate:<meas>:MARKer[1] 2 ... 12:FUNction:BPOwer:CTYPe?
Example	CALC:VECT:MARK1:FUNC:BPOW:CTYP MEAN CALC:VECT:MARK1:FUNC:BPOW:CTYP?
Preset	MEAN
State Saved	Saved in instrument state.
Range	Mean RMS
Initial S/W Revision	Prior to A.02.00
Modified at S/W Revision	A.02.00

Band/Interval Density

Calculates the average power density within the band centered on the marker. The function works generally with frequency spectra, PSD, and time traces. On traces where band power cannot reasonably be defined, the result display shows "---" and CALC:<meas>:MARK[n]:Y? returns NaN (9.91E+37), although the band interval can still be defined.

Frequency-domain data

If the marker is on a frequency-domain trace, the result is the band power (as computed above) divided by the bandwidth over which it is measured. This is true whether the underlying trace data is a power spectrum or power spectral density.

Time-domain data

If the marker is on a time-domain trace, the result is average power within the time interval (as computed above) divided by the equivalent noise bandwidth of the span.

Key Path	Marker Function
Mode	VSA, LTE, LTETDD, IDEN,LTEAFDD,LTEATDD
Initial S/W Revision	Prior to A.02.00
Modified at S/W Revision	A.02.00

Band Density Calculation

Turns on the Band/Interval Density function for the selected marker. If the selected marker is off, it is turned on in **Normal** marker mode and is located at the center of the screen.

If **Band/Interval Density** is selected while in the **Marker Function Off** state, the **Band Span** or **Interval Span** is initialized to 5% of the screen width.

If the detector mode for the detector on the marker's trace is set to Auto, the average detector is selected. If the Average type is set to Auto, Power Averaging is selected. Other choices for the detector or Average type usually cause measurement inaccuracy.

A band/interval density calculation result can be shown in dBm/Hz, Volts RMS Squared, or Volts RMS. The following table shows the choice of display units if **Band Density Calculation** is set to **Mean**, depending on the current format of the trace the marker is on.

Trace data type	Trace Format	Result format
Spectrum, PSD, Time record	LogMag (dB)	dBm/Hz
	Linear Mag, Real, Imag, Wrap Phase, Unwrap Phase, Delay, Log Mag (lin)	Vrms^2/Hz
Dimensionless (e.g., Frequency response, Impulse response, various Demodulation error types)	LogMag (dB)	dBrms/Hz
	Linear Mag, Real, Imag, Wrap Phase, Unwrap Phase, Delay, Log Mag (lin)	rms^2/Hz

General dimensions (e.g., Hz, %)	LogMag (dB)	dB<unit>rms/Hz
	Linear Mag, Real, Imag, Wrap Phase, Unwrap Phase, Delay, Log Mag (lin)	<unit>rms^2/Hz

If the **Band Density Calculation** is set to **RMS**, then the readout unit does not depend on trace format. For Spectrum, PSD, and Time record traces, the displayed unit is "Vrms/rtHz". For general units, the unit abbreviation is shown followed by "rms/rtHz".

The Band Density Calculation only controls the readout format for Normal and Fixed markers. For Delta markers, see "[Band Power and Delta Markers](#)" on page 1946.

Key Path	Marker Function, Band/Interval Power
Mode	VSA, LTE, LTETDD, IDEN,LTEAFDD,LTEATDD
Measurement	<meas>:=VECTor ADEMod DDEMod W11A W11B EVM IPOWER IDEMod MOTotalk
Remote Command	:CALCulate:<meas>:MARKer[1] 2 ... 12:FUNction:BDENsity:CTYPe MEAN RMS :CALCulate:<meas>:MARKer[1] 2 ... 12:FUNction:BDENsity:CTYPe?
Example	CALC:VECT:MARK1:FUNC:BDEN:CTYP RMS CALC:VECT:MARK1:FUNC:BDEN:CTYP?
Preset	MEAN
State Saved	Saved in instrument state.
Range	Mean RMS
Initial S/W Revision	Prior to A.02.00
Modified at S/W Revision	A.02.00

Band Adjust

Enables you to define the bandwidth around the marker. The band is always centered on the marker position. Entering the menu always sets Band/Interval Span as the active function.

Key Path	Marker Function
Mode	VSA, LTE, LTETDD, IDEN,LTEAFDD,LTEATDD
Initial S/W Revision	Prior to A.02.00
Modified at S/W Revision	A.02.00

Band/Interval Center

Enables you to define the center of the band. That is, it enables you to adjust the marker position in absolute units (regardless of whether the marker mode is Normal or Delta).

Key Path	Marker Function, Band Adjust
----------	------------------------------

Mode	VSA, LTE, LTETDD, IDEN,LTEAFDD,LTEATDD
Measurement	<meas>:=VECTor ADEMod DDEMod W11A W11B EVM IPOWER IDEMod MOTotalk
Remote Command	:CALCulate:<meas>:MARKer[1] 2 ... 12:FUNCtion:BAND:CENTer <real> :CALCulate:<meas>:MARKer[1] 2 ... 12:FUNCtion:BAND:CENTer?
Example	CALC:VECT:MARK2:FUNC:BAND:CENT 1.23E+09 CALC:VECT:MARK2:FUNC:BAND:CENT?
Preset	Center of screen
State Saved	Saved in instrument state.
Min	-9.9E+37
Max	9.9E+37
Initial S/W Revision	Prior to A.02.00
Modified at S/W Revision	A.02.00

Band/Interval Span

Sets the width of the span for the selected marker. This function defines the span of frequencies or time. The marker position does not change when you adjust the span.

Key Path	Marker Function, Band Adjust
Mode	VSA, LTE, LTETDD, IDEN,LTEAFDD,LTEATDD
Measurement	<meas>:=VECTor ADEMod DDEMod W11A W11B EVM IPOWER IDEMod MOTotalk
Remote Command	:CALCulate:<meas>:MARKer[1] 2 ... 12:FUNCtion:BAND:SPAN <real> :CALCulate:<meas>:MARKer[1] 2 ... 12:FUNCtion:BAND:SPAN?
Example	CALC:VECT:MARK2:FUNC:BAND:SPAN 1.23E+06 CALC:VECT:MARK2:FUNC:BAND:SPAN?
Preset	When marker turned on, 1/20th of current span or displayed time length.
State Saved	Saved in instrument state.
Min	-9.9E+37
Max	9.9E+37
Initial S/W Revision	Prior to A.02.00
Modified at S/W Revision	A.02.00

Band/Interval Left

Enables you to adjust the left side of the band. In order to remain centered in the band, the marker position must also change as you change the left edge. The right edge is unaffected.

Key Path	Marker Function, Band Adjust
----------	------------------------------

Mode	VSA, LTE, LTETDD, IDEN, LTEAFDD, LTEATDD
Measurement	<meas>:=VECTor ADEMod DDEMod W11A W11B EVM IPOWER IDEMod MOTotalk
Remote Command	:CALCulate:<meas>:MARKer[1] 2 ... 12:FUNction:BAND:LEFT <real> :CALCulate:<meas>:MARKer[1] 2 ... 12:FUNction:BAND:LEFT?
Example	CALC:VECT:MARK2:FUNC:BAND:LEFT 1.23E+06 CALC:VECT:MARK2:FUNC:BAND:LEFT?
Couplings	Changes marker X to keep the marker centered in the band.
Preset	When marker turned on, 1/40th of current span or displayed time length left of the marker position.
State Saved	Saved in instrument state.
Min	-9.9E+37
Max	9.9E+37
Initial S/W Revision	Prior to A.02.00
Modified at S/W Revision	A.02.00

Band/Interval Right

Enables you to adjust the right side of the band. In order to remain centered in the band, the marker position must also change as you change the right edge. The left edge is unaffected.

Key Path	Marker Function, Band Adjust
Mode	VSA, LTE, LTETDD, IDEN, LTEAFDD, LTEATDD
Measurement	<meas>:=VECTor ADEMod DDEMod W11A W11B EVM IPOWER IDEMod MOTotalk
Remote Command	:CALCulate:<meas>:MARKer[1] 2 ... 12:FUNction:BAND:RIGHT <real> :CALCulate:<meas>:MARKer[1] 2 ... 12:FUNction:BAND:RIGHT?
Example	CALC:VECT:MARK2:FUNC:BAND:RIGHT 1.23E+06 CALC:VECT:MARK2:FUNC:BAND:RIGHT?
Couplings	Changes marker X to keep the marker centered in the band.
Preset	When marker turned on, 1/40th of current span or displayed time length right of the marker position.
State Saved	Saved in instrument state.
Min	-9.9E+37
Max	9.9E+37
Initial S/W Revision	Prior to A.02.00
Modified at S/W Revision	A.02.00

Band Power and Delta Markers

When either a Delta marker or its reference has a band power function turned on, the Delta marker readout always shows a ratio calculation. This enables you to perform common calculations like carrier to noise ratio or adjacent channel power ratio. The form of the ratio depends on the main marker function

calculation type (Mean or RMS). If the main marker function calculation type is Mean, then when you change the marker to Delta the result is a power ratio. If the main marker function calculation type is RMS, then the Delta marker result is a voltage ratio. (If the main marker band power function is off, then the form of the ratio depends on the reference marker calculation type: If it is Mean you get a power ratio and if it is RMS you get a voltage ratio.)

For example, if the main marker function is Band/Interval Power with a calculation type of Mean and the reference marker function is Band/Interval Power with a calculation type of RMS, then the Delta marker shows the ratio of the main marker “Band/Interval Power Mean” value to the reference marker “Band/Interval Power Mean” (not RMS) value.

A dimensionless ratio (for example, Volt/Volt or Watt/Watt) is shown with units of "x". The marker function calculation type indicates whether the ratio is voltage or power (see above). A dimensionless power ratio is shown with units of dB if the trace format is Log Mag (dB).

If the reference marker function is Band/Interval Density and the main marker is either Band/Interval Power or its function is turned off, then the ratio is not dimensionless, but has units of Hz (or dB-Hz) for power calculations or rtHz for voltage calculations. When the main marker function is Band/Interval Density and the reference is either Band/interval Power or its function is off, the units are /Hz (or dB/Hz) for power calculations or /rtHz for voltage calculations.

Key Path	Marker Function
Mode	VSA, LTE, LTETDD, IDEN,LTEAFDD,LTEATDD
Initial S/W Revision	Prior to A.02.00
Modified at S/W Revision	A.02.00

Meas

The information in this section is common to all measurements. For key and remote command information for a specific measurement, refer to the section that describes the measurement of interest.

Measurements available under the Meas key are specific to the current Mode.

When viewing Help for measurements, note the following:

NOTE

Operation for some keys differs between measurements. The information displayed in Help pertains to the current measurement. To see how a key operates in a different measurement, exit Help (press the Cancel Esc key), select the measurement, then reenter Help (press the Help key) and press that key.

Key Path	Front-panel key
Initial S/W Revision	Prior to A.02.00

Remote Measurement Functions

This section contains the following topics:

["Measurement Group of Commands" on page 2356](#)

["Current Measurement Query \(Remote Command Only\)" on page 2358](#)

["Limit Test Current Results \(Remote Command Only\)" on page 2358](#)

["Data Query \(Remote Command Only\)" on page 2358](#)

["Calculate/Compress Trace Data Query \(Remote Command Only\)" on page 2359](#)

["Calculate Peaks of Trace Data \(Remote Command Only\)" on page 2364](#)

["Hardware-Accelerated Fast Power Measurement \(Remote Command Only\)" on page 2365](#)

["Format Data: Numeric Data \(Remote Command Only\)" on page 2379](#)

["Format Data: Byte Order \(Remote Command Only\)" on page 2380](#)

Initial S/W Revision	Prior to A.02.00
----------------------	------------------

Measurement Group of Commands

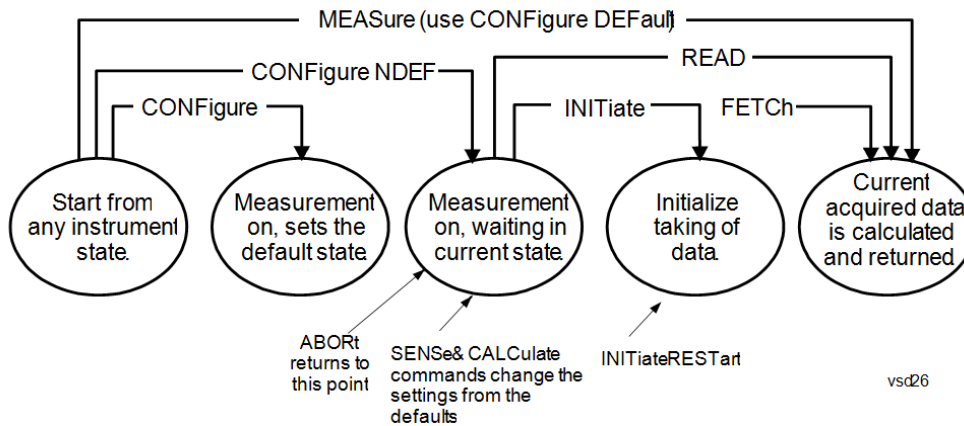

Measure Commands:

:MEASure:<measurement>[n]?

This is a fast single-command way to make a measurement using the factory default instrument settings. These are the settings and units that conform to the Mode Setup settings (e.g. radio standard) that you have currently selected.

- Stops the current measurement (if any) and sets up the instrument for the specified measurement using the factory defaults
- Initiates the data acquisition for the measurement
- Blocks other SCPI communication, waiting until the measurement is complete before returning results.
- If the function does averaging, it is turned on and the number of averages is set to 10.
- After the data is valid it returns the scalar results, or the trace data, for the specified measurement. The type of data returned may be defined by an [n] value that is sent with the command.
- The scalar measurement results will be returned if the optional [n] value is not included, or is set to 1. If the [n] value is set to a value other than 1, the selected trace data results will be returned. See each command for details of what types of scalar results or trace data results are available.
- ASCII is the default format for the data output. (Older versions of Spectrum Analysis and Phase Noise mode measurements only use ASCII.) The binary data formats should be used for handling large blocks of data since they are smaller and faster than the ASCII format. Refer to the FORMat:DATA command for more information.

If you need to change some of the measurement parameters from the factory default settings you can set up the measurement with the CONFIgure command. Use the commands in the SENSE:<measurement> and CALCulate:<measurement> subsystems to change the settings. Then you can use the READ? command to initiate the measurement and query the results.

If you need to repeatedly make a given measurement with settings other than the factory defaults, you can use the commands in the SENSE:<measurement> and CALCulate:<measurement> subsystems to set up the measurement. Then use the READ? command to initiate the measurement and query results.

Measurement settings persist if you initiate a different measurement and then return to a previous one. Use READ:<measurement>? if you want to use those persistent settings. If you want to go back to the default settings, use MEASure:<measurement>?.

Configure Commands:

:CONFIgure:<measurement>

This command stops the current measurement (if any) and sets up the instrument for the specified measurement using

the factory default instrument settings. It does not initiate the taking of measurement data unless INIT:CONTinuous is ON. If you change any measurement settings after using the CONFigure command, the READ command can be used to initiate a measurement without changing the settings back to their defaults.

In the Swept SA measurement in Spectrum Analyzer mode the CONFigure command also turns the averaging function on and sets the number of averages to 10 for all measurements.

:CONFigure: <measurement>: NDEFault stops the current measurement and changes to the specified measurement. It does not change the settings to the defaults. It does not initiate the taking of measurement data unless INIT:CONTinuous is ON.

The CONFigure? query returns the current measurement name.

The CONFigure:CATalog? query returns a quoted string of all licensed measurement names in the current mode. For example, "SAN, CHP, OBW, ACP, PST, TXP, SPUR, SEM, LIST".

Fetch Commands:

:FETCh:<measurement>[n]?

This command puts selected data from the most recent measurement into the output buffer. Use FETCh if you have already made a good measurement and you want to return several types of data (different [n] values, for example, both scalars and trace data) from a single measurement. FETCh saves you the time of re-making the measurement. You can only FETCh results from the measurement that is currently active, it will not change to a different measurement. An error message is reported if a measurement other than the current one is specified.

If you need to get new measurement data, use the READ command, which is equivalent to an INITiate followed by a FETCh.

The scalar measurement results will be returned if the optional [n] value is not included, or is set to 1. If the [n] value is set to a value other than 1, the selected trace data results will be returned. See each command for details of what types of scalar results or trace data results are available. The binary data formats should be used for handling large blocks of data since they are smaller and transfer faster than the ASCII format. (FORMat:DATA)

FETCh may be used to return results other than those specified with the original READ or MEASure command that you sent.

INITiate Commands:

:INITiate:<measurement>

This command is not available for measurements in all the instrument modes:

- Initiates a trigger cycle for the specified measurement, but does not output any data. You must then use the FETCh<meas> command to return data. If a measurement other than the current one is specified, the instrument will switch to that measurement and then initiate it.
 - For example, suppose you have previously initiated the ACP measurement, but now you are running the channel power measurement. If you send INIT:ACP? it will change from channel power to ACP and will initiate an ACP measurement.
 - Does not change any of the measurement settings. For example, if you have previously started the ACP measurement and you send INIT:ACP? it will initiate a new ACP measurement using the same instrument settings as the last time ACP was run.
 - If your selected measurement is currently active (in the idle state) it triggers the measurement, assuming the trigger conditions are met. Then it completes one trigger cycle. Depending upon the measurement and the number of averages, there may be multiple data acquisitions, with multiple trigger events, for one full trigger cycle. It also holds off additional commands on GPIB until the acquisition is complete.
-

READ Commands:

:READ:<measurement>[n]?

- Does not preset the measurement to the factory default settings. For example, if you have previously initiated the ACP
-

measurement and you send READ:ACP? it will initiate a new measurement using the same instrument settings.

- Initiates the measurement and puts valid data into the output buffer. If a measurement other than the current one is specified, the instrument will switch to that measurement before it initiates the measurement and returns results.
 - For example, suppose you have previously initiated the ACP measurement, but now you are running the channel power measurement. Then you send READ:ACP? It will change from channel power back to ACP and, using the previous ACP settings, will initiate the measurement and return results.
 - Blocks other SCPI communication, waiting until the measurement is complete before returning the results
 - If the optional [n] value is not included, or is set to 1, the scalar measurement results will be returned. If the [n] value is set to a value other than 1, the selected trace data results will be returned. See each command for details of what types of scalar results or trace data results are available. The binary data formats should be used when handling large blocks of data since they are smaller and faster than the ASCII format. (FORMat:DATA)
-

Initial S/W Revision	Prior to A.02.00
----------------------	------------------

Current Measurement Query (Remote Command Only)

This command returns the name of the measurement that is currently running.

Remote Command	:CONFigure?
-----------------------	-------------

Example	CONF?
----------------	-------

Initial S/W Revision	Prior to A.02.00
----------------------	------------------

Limit Test Current Results (Remote Command Only)

Queries the status of the current measurement limit testing. It returns a 0 if the measured results pass when compared with the current limits. It returns a 1 if the measured results fail any limit tests.

Remote Command	:CALCulate:CLIMits:FAIL?
-----------------------	--------------------------

Example	CALC:CLIM:FAIL? queries the current measurement to see if it fails the defined limits. Returns a 0 or 1: 0 it passes, 1 it fails.
----------------	--

Initial S/W Revision	Prior to A.02.00
----------------------	------------------

Data Query (Remote Command Only)

Returns the designated measurement data for the currently selected measurement and subopcode.

n = any valid subopcode for the current measurement. See the measurement command results table for your current measurement, for information about what data is returned for the subopcodes.

This command uses the data setting specified by the FORMat:BORDER and FORMat:DATA commands and can return real or ASCII data. (See the format command descriptions under Input/Output in the Analyzer Setup section.)

Remote Command	:CALCulate:DATA[n]?
Notes	The return trace depends on the measurement. In CALCulate:<meas>:DATA[n], n is any valid subopcode for the current measurement. It returns the same data as the FETCH:<measurement>? query where <measurement> is the current measurement.
Initial S/W Revision	Prior to A.02.00

Calculate/Compress Trace Data Query (Remote Command Only)

Returns compressed data for the currently selected measurement and sub-opcode [n].

n = any valid sub-opcode for that measurement. See the MEASure:<measurement>? command description of your specific measurement for information on the data that can be returned.

The data is returned in the current Y Axis Unit of the analyzer. The command is used with a sub-opcode <n> (default=1) to specify the trace. With trace queries, it is best if the analyzer is not sweeping during the query. Therefore, it is generally advisable to be in Single Sweep, or Update=Off.

This command is used to compress or decimate a long trace to extract and return only the desired data. A typical example would be to acquire N frames of GSM data and return the mean power of the first burst in each frame. The command can also be used to identify the best curve fit for the data.

Remote Command	:CALCulate:DATA<n>:COMPRESS? BLOCK CFIT MAXimum MINimum MEAN DMEan RMS RMSCubed SAMPLE SDEVIation PPHase [,<soffset> [,<length>[,<roffset>[,<rlimit>]]]]
Example	To query the mean power of a set of GSM bursts: Supply a signal that is a set of GSM bursts. Select the IQ Waveform measurement (in IQ Analyzer Mode). Set the sweep time to acquire at least one burst. Set the triggers such that acquisition happens at a known position relative to a burst. Then query the mean burst levels using, CALC:DATA2:COMP? MEAN, 24e-6, 526e-6 (These parameter values correspond to GSM signals, where 526e-6 is the length of the burst in the slot and you just want 1 burst.)
Notes	The command supports 5 parameters. Note that the last 4 (<soffset>, <length>, <roffset>, <rlimit>) are optional. But these optional parameters must be entered in the specified order. For example, if you want to specify <length>, then you must also specify <soffset>. See details below for a definition of each of these parameters. This command uses the data in the format specified by FORMat:DATA, returning either binary or ASCII data.
Initial S/W Revision	Prior to A.02.00

- BLOCK or block data - returns all the data points from the region of the trace data that you specify. For example, it could be used to return the data points of an input signal over several timeslots, excluding the portions of the trace data that you do not want. (This is x,y pairs for trace data and I,Q pairs for complex data.)

- CFIT or curve fit - applies curve fitting routines to the data. <soffset> and <length> are required to define the data that you want. <roffset> is an optional parameter for the desired order of the curve equation. The query will return the following values: the x-offset (in seconds) and the curve coefficients ((order + 1) values).

MIN, MAX, MEAN, DME, RMS, RMSC, SAMP, SDEV and PPH return one data value for each specified region (or <length>) of trace data, for as many regions as possible until you run out of trace data (using <roffset> to specify regions). Or they return the number of regions you specify (using <rlimit>) ignoring any data beyond that.

- MINimum - returns the minimum data point (y value) for the specified region(s) of trace data. For I/Q trace data, the minimum magnitude of the I/Q pairs is returned.
- MAXimum - returns the maximum data point (y value) for the specified region(s) of trace data. For I/Q trace data, the maximum magnitude of the I/Q pairs is returned.
- MEAN - returns a single value that is the arithmetic mean of the data point values (in dB/ dBm) for the specified region(s) of trace data. For I/Q trace data, the mean of the magnitudes of the I/Q pairs is returned. See the following equations.

-

NOTE

If the original trace data is in dB, this function returns the arithmetic mean of those log values, not log of the mean power which is a more useful value. The mean of the log is the better measurement technique when measuring CW signals in the presence of noise. The mean of the power, expressed in dB, is useful in power measurements such as Channel Power. To achieve the mean of the power, use the RMS option.

Equation 1

Mean Value of Data Points for Specified Region(s)

$$\text{MEAN} = \frac{1}{n} \sum_{X_i \in \text{region}(s)} X_i$$

where X_i is a data point value, and n is the number of data points in the specified region(s).

Equation 2

Mean Value of I/Q Data Pairs for Specified Region(s)

$$\text{MEAN} = \frac{1}{n} \sum_{X_i \in \text{region}(s)} |X_i|$$

where $|X_i|$ is the magnitude of an I/Q pair, and n is the number of I/Q pairs in the specified region(s).

- DMEan - returns a single value that is the mean power (in dB/ dBm) of the data point values for the specified region(s) of trace data. See the following equation:

Equation 3

DMEan Value of Data Points for Specified Region(s)

$$\text{DME} = 10 \times \log_{10} \left(\frac{1}{n} \sum_{X_i \in \text{region}(s)} 10^{\frac{X_i}{10}} \right)$$

- RMS - returns a single value that is the average power on a root-mean-squared voltage scale (arithmetic rms) of the data point values for the specified region(s) of trace data. See the following equation.

NOTE For I/Q trace data, the rms of the magnitudes of the I/Q pairs is returned. See the following equation. This function is very useful for I/Q trace data. However, if the original trace data is in dB, this function returns the rms of the log values which is not usually needed.

Equation 4

RMS Value of Data Points for Specified Region(s)

$$\text{RMS} = \sqrt{\frac{1}{n} \sum_{X_i \in \text{region}(s)} X_i^2}$$

where X_i is a data point value, and n is the number of data points in the specified region(s).

Equation 5

RMS Value of I/Q Data Pairs for Specified Region(s)

$$\text{RMS} = \sqrt{\frac{1}{n} \sum_{X_i \in \text{region}(s)} X_i X_i^*}$$

where X_i is the complex value representation of an I/Q pair, X_i^* its conjugate complex number, and n is the number of I/Q pairs in the specified region(s).

Once you have the rms value for a region of trace data (linear or I/Q), you may want to calculate the mean power. You must convert this rms value (peak volts) to power in dBm:

$$10 \times \log[10 \times (\text{rms value})^2]$$

- SAMPlE - returns the first data value (x,y pair) for the specified region(s) of trace data. For I/Q trace data, the first I/Q pair is returned.
- SDEViation - returns a single value that is the arithmetic standard deviation for the data point values for the specified region(s) of trace data. See the following equation.
- For I/Q trace data, the standard deviation of the magnitudes of the I/Q pairs is returned. See the following equation.

Equation 6

Standard Deviation of Data Point Values for Specified Region(s)

$$\text{SDEV} = \sqrt{\frac{1}{n} \sum_{X_i \in \text{region}(s)} (X_i - \bar{X})^2}$$

where X_i is a data point value, \bar{X} is the arithmetic mean of the data point values for the specified region (s), and n is the number of data points in the specified region(s).

$$\text{SDEV} = \sqrt{\frac{1}{n} \sum_{X_i \in \text{region}(s)} (|X_i| - \bar{X})^2}$$

where $|X_i|$ is the magnitude of an I/Q pair, \bar{X} is the mean of the magnitudes for the specified region(s), and n is the number of data points in the specified region(s).

- PPHase - returns the x,y pairs of both rms power (dBm) and arithmetic mean phase (radian) for every specified region and frequency offset (Hz). The number of pairs is defined by the specified number of regions. This parameter can be used for I/Q vector (n=0) in Waveform (time domain) measurement and all parameters are specified by data point in PPHase.

The rms power of the specified region may be expressed as:

$$\text{Power} = 10 \times \log [10 \times (\text{RMS I/Q value})] + 10.$$

The RMS I/Q value (peak volts) is:

$$\sqrt{\frac{1}{n} \sum_{X_i \in \text{region}} X_i X_i^*}$$

where X_i is the complex value representation of an I/Q pair, X_i^* its conjugate complex number, and n is the number of I/Q pairs in the specified region.

The arithmetic mean phase of the specified region may be expressed as:

$$\frac{1}{n} \sum_{Y_i \in \text{region}} Y_i$$

where Y_i is the unwrapped phase of I/Q pair with applying frequency correction and n is the number of I/Q pairs in the specified region.

The frequency correction is made by the frequency offset calculated by the arithmetic mean of every specified region's frequency offset. Each frequency offset is calculated by the least square method against the unwrapped phase of I/Q pair.

Sample Trace Data - Constant Envelope

(See below for explanation of variables.)

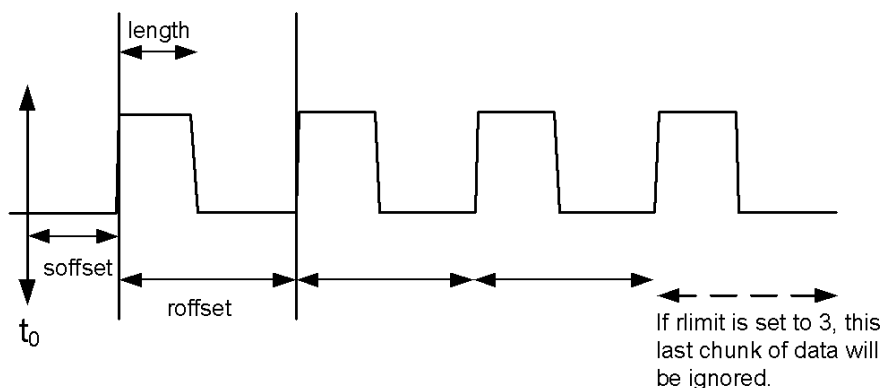

Sample Trace Data - Not Constant Envelope

(See below for explanation of variables.)

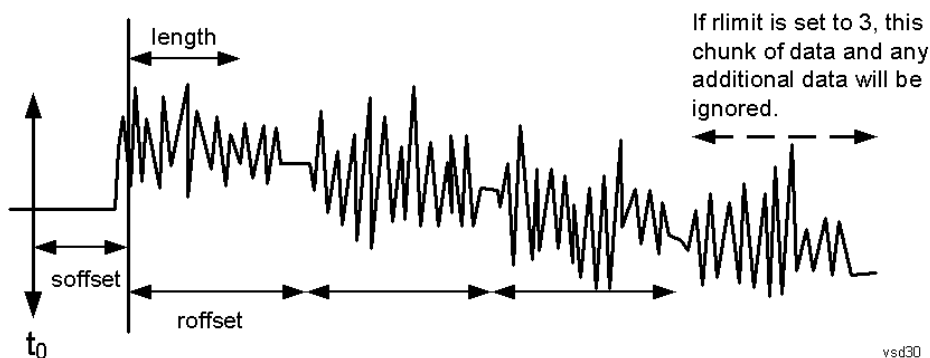

<soffset> - start offset is an optional real number. (It is in seconds for time-domain traces, and is a dimensionless index 0 to Npoints - 1, for frequency-domain traces). It specifies the amount of data at the beginning of the trace that will be ignored before the decimation process starts. It is the time or frequency change from the start of the trace to the point where you want to start using the data. The default value is zero.

<length> - is an optional real number. (It is in seconds for time-domain traces, and is a dimensionless index 0 to Npoints - 1, for frequency-domain traces). It defines how much data will be compressed into one value. This parameter has a default value equal to the current trace length.

<roffset> - repeat offset is an optional real number. (It is in seconds for time-domain traces, and is a dimensionless index 0 to Npoints - 1, for frequency-domain traces). It defines the beginning of the next field of trace elements to be compressed. This is relative to the beginning of the previous field. This parameter has a default value equal to the <length> variable. Note that this parameter is used for a completely different purpose when curve fitting (see CFIT above).

<rlimit> - repeat limit is an optional integer. It specifies the number of data items that you want returned. It will ignore any additional items beyond that number. You can use the Start offset and the Repeat limit to pick out exactly what part of the data you want to use. The default value is all the data.

Calculate Peaks of Trace Data (Remote Command Only)

Returns a list of all the peaks for the currently selected measurement and sub-opcode [n]. The peaks must meet the requirements of the peak threshold and excursion values.

n = any valid sub-opcode for the current measurement. See the MEASure:<measurement> command description of your specific measurement for information on the data that can be returned.

The command can only be used with specific sub-opcodes with measurement results that are trace data. Both real and complex traces can be searched, but complex traces are converted to magnitude in dBm. In many measurements the sub-opcode n=0, is the raw trace data which cannot be searched for peaks. And Sub-opcode n=1, is often calculated results values which also cannot be searched for peaks.

This command uses the data setting specified by the FORMat:BORDER and FORMat:DATA commands and can return real or ASCII data. If the format is set to INT,32, it returns REAL,32 data.

The command has four types of parameters:

- Threshold (in dBm)
- Excursion (in dB)
- Sorting order (amplitude, frequency, time)
- Optional in some measurements: Display line use (all, > display line, < display line)

Remote Command	<p>For Swept SA measurement:</p> <pre>:CALCulate:DATA[1] 2 ... 6:PEAKs? <threshold>,<excursion>[,AMPLitude FREQuency TIME[,ALL GTDLline LTDLine]]</pre> <p>For most other measurements:</p> <pre>:CALCulate:DATA[1] 2 ... 6:PEAKs? <threshold>,<excursion>[,AMPLitude FREQuency TIME]</pre>
-----------------------	---

Example	<p>Example for Swept SA measurement in Spectrum Analyzer Mode:</p> <p>CALC:DATA4:PEAK? -40, 10, FREQ, GTDL This will identify the peaks of trace 4 that are above -40 dBm, with excursions of at least 10 dB. The peaks are returned in order of increasing frequency, starting with the lowest frequency. Only the peaks that are above the display line are returned.</p> <p>Query Results 1:</p> <p>With FORMat:DATA REAL, 32 selected, it returns a list of floating-point numbers. The first value in the list is the number of peak points that are in the following list. A peak point consists of two values: a peak amplitude followed by its corresponding frequency (or time).</p> <p>If no peaks are found the peak list will consist of only the number of peaks, (0).</p>
----------------	---

Notes	<p><n> - is the trace that will be used</p> <p><threshold> - is the level below which trace data peaks are ignored. Note that the threshold value is required and is always used as a peak criterion. To effectively disable the threshold criterion for this command, provide a substantially low threshold value such as -200 dBm. Also note that the threshold value used in this command is independent of and has no effect on the threshold value stored under the Peak Criteria menu.</p> <p><excursion> - is the minimum amplitude variation (rise and fall) required for a signal to be identified as peak. Note that the excursion value is required and is always used as a peak criterion. To effectively disable the excursion criterion for this command, provide the minimum value of 0.0 dB. Also note that the excursion value used in this command is independent of and has no effect on the</p>
--------------	---

excursion value stored under the Peak Criteria menu.

Values must be provided for threshold and excursion. The sorting and display line parameters are optional (defaults are AMPLitude and ALL).

Note that there is always a Y-axis value for the display line, regardless of whether the display line state is on or off. It is the current Y-axis value of the display line which is used by this command to determine whether a peak should be reported

Sorting order:

AMPLitude - lists the peaks in order of descending amplitude, with the highest peak first (default if optional parameter not sent)

FREQuency - lists the peaks in order of occurrence, left to right across the x-axis.

TIME - lists the peaks in order of occurrence, left to right across the x-axis.

Peaks vs. Display Line:

ALL - lists all of the peaks found (default if optional parameter not sent).

GTDLine (greater than display line) - lists all of the peaks found above the display line.

LTDLine (less than display line) - lists all of the peaks found below the display line.

Initial S/W Revision	Prior to A.02.00
----------------------	------------------

Hardware-Accelerated Fast Power Measurement (Remote Command Only)

The Fast Power option (FP2) enables very fast channel power measurements for instruments with the prerequisite hardware (DP2 and/or B40). It accomplishes this by performing real-time overlapped FFTs at the hardware layer, using software for basic post-processing before returning the result to the user. The upshot of this approach is improved throughput for user applications that require many sequential power measurements.

The analysis bandwidth of FP2 is limited by the licenses in the instrument, but its maximum overall analysis bandwidth per acquisition is 40 MHz.

FP2 is remote-only, which means the instrument does not switch to any particular mode or measurement. FP2 commands can be sent while another application is in use on the front panel.

Each Fast Power measurement can be predefined using an array index, and up to 1,000 measurements can be stored. In the following documentation, instances of [1,2,...,999] can be substituted with a particular measurement index, e.g. CALC:FPOW:POW1?, CALC:FPOW:POW2?, CALC:FPOW:POW134?. In this way, power measurements can be defined one time in a batch, and then executed multiple times without having to redefine them, similar to “list mode” on other measurements.

In addition to basic channel power measurements, there are a number of other measurement “functions” for each channel, including peak power, peak frequency, and power spectral density. See the Function parameter for more information.

Reset Fast Power Measurement (Remote Command Only)

Resets the measurement configuration to the defaults.

Mode	All
Remote Command	:CALCulate:FPOWer:POWer [1, 2, ..., 999] :RESet
Example	:CALC:FPOW:POW1:RES

Notes	Option FP2 is required.
Initial S/W Revision	A.14.00

Define Fast Power Measurement (Remote Command Only)

Fast Power acquisitions are configured using the DEFine command. This command accepts a comma-delimited string of configuration parameters and their appropriate values, which are all specified in the subsection below.

Mode	All
Remote Command	:CALCulate:FPOWer:POWer[1,2,...,999]:DEFine "configuration string"
Example	:CALC:FPOW:POW1:DEF "CenterFrequency=2e9, AcquisitionTime=0.005"
Notes	See below for a list of measurement variables that can be defined in the configuration string.
Initial S/W Revision	A.14.00

Acquisition Time

Example	CALC:FPOW:POW1:DEF "AcquisitionTime=0.002"
Notes	The acquisition time parameter sets the time in which the entire spectrum is measured. An increase in the acquisition time yields an improvement in measurement repeatability.
Preset	0.001 s
Range	0 s to 1 s
Default Unit	Time (s)
Initial S/W Revision	A.14.00

Center Frequency

Example	CALC:FPOW:POW1:DEF "CenterFrequency=2e9"
Notes	The center frequency parameter sets the frequency in which the measurement is centered around. The OffsetFrequency parameter is calculated relative to the center frequency.
Preset	1 GHz
Range	0 Hz to maximum instrument frequency
Default Unit	Frequency (Hz)
Initial S/W Revision	A.14.00

DC Coupled

Example	CALC:FPOW:POW1:DEF "DCCoupled=True"
Notes	The DC coupled parameter allows the user to specify whether the DC blocking capacitor is utilized. Set parameter to true when measuring frequencies below 10 MHz.
Preset	False
Range	True (DC Coupled) or False (AC Coupled)
Default Unit	Boolean
Initial S/W Revision	A.14.00

DetectorType

Example	CALC:FPOW:POW1:DEF "DetectorType=Peak"
Notes	Option FP2 is required. The detector type parameter allows the user to choose whether a RMS average or peak value is used during the measurement.
Preset	RmsAverage
Range	RmsAverage, Peak
Initial S/W Revision	A.14.00

Do Noise Correction

Example	CALC:FPOW:POW1:DEF "DoNoiseCorrection=True"
Notes	When noise correction is enabled, the linear noise power contributed by the analyzer is subtracted from all measurements. This effectively lowers the noise floor of the analyzer. When noise correction is enabled, the first measurement for a given set of input parameters will take extra time. This is because the analyzer takes an extra acquisition with the RF input disconnected from the analyzer's front end to measure the noise of just the analyzer. The measured noise floor is stored in a cache so the noise acquisition will occur only once for the same state settings. In other words, if noise correction was turned on and the analyzer made an acquisition at frequency A, then frequency B, and back again to frequency A, the hidden initial noise floor acquisition would only occur for the first acquisition at frequency A and the cached noise floor would be used the second time frequency A was measured.
Preset	False
Range	True (enable noise correction) or False (disable noise correction)
Default Unit	Boolean
Initial S/W Revision	A.14.00

Do Spur Suppression

Example	CALC:FPOW:POW1:DEF "DoSpurSuppression=True"
Notes	<p>When measuring very low level signals, or when large out-of-band inputs are input into the analyzer, sometimes unwanted spurs and residuals can appear in the measured spectrum. Spur suppression is a method to help minimize the levels of these internally generated spurs and residuals.</p> <p>When spur suppression is enabled, the analyzer will automatically take two acquisitions using two different internal analog LO frequencies. The FFT spectrums from both acquisitions are combined by taking the minimum power between both traces on a per FFT bin basis. External signals will have the same amplitude for both traces and therefore will return the expected amplitudes. However, low level spurs and residuals generated internally to the analyzer tend to move to different FFT bins depending on the internal analog LO frequency used, and therefore tend to be suppressed using this spur suppression method.</p> <p>Because two acquisitions, rather than a single acquisition, are made when spur suppression is enabled, the measurement time will always be slower when spur suppression is enabled.</p>
Preset	False
Range	True (enable spur suppression) or False (disable spur suppression)
Default Unit	Boolean
Initial S/W Revision	A.14.00

Electronic Attenuator Bypass

Example	CALC:FPOW:POW1:DEF "ElecAttBypass =False"
Notes	The electronic attenuation bypass parameter allows the user to either utilize or bypass the electronic attenuator. The electronic attenuator is only available for frequencies up to 3.6 GHz. Set parameter to true when using frequencies above 3.6 GHz and set the parameter to false when using the preamp.
Preset	True
Range	True (bypass electronic attenuator) or False (use electronic attenuator)
Default Unit	Boolean
Initial S/W Revision	A.14.00

Electronic Attenuation

Example	CALC:FPOW:POW1:DEF "ElecAttenuation=10"
Notes	<p>Option EA3 is required.</p> <p>The electronic attenuation value parameter sets the amount of electrical attenuation from 0 to 24 dB (1 dB steps).</p> <p>Set "ElecAttBypass=False" to make sure the electronic attenuator path is enabled.</p>
Preset	0 dB
Range	0 - 24 dB (1 dB steps)

Default Unit	dB
Initial S/W Revision	A.14.00

IF Gain

Example	CALC:FPOW:POW1:DEF "IFGain=10"
Notes	The IF gain parameter allows the user to specify the gain at the IF stage anywhere from -6 to 16 dB (1 dB steps). This is an advanced feature, and for most cases this should remain at its default value of 0 dB.
Preset	0 dB
Range	-6 - 16 dB (1 dB steps)
Default Unit	dB
Initial S/W Revision	A.14.00

IF Type

Example	CALC:FPOW:POW1:DEF "IFType=B25M"
Notes	The IF type parameter allows the user to select between different IF paths. For example, if the signal is less than 25 MHz wide, then the user can select the B25M path to take advantage of additional filtering on this analog IF path.
Preset	B40M
Range	B10M, B25M, B40M
Initial S/W Revision	A.14.00

Include Power Spectrum

Example	CALC:FPOW:POW1:DEF "IncludePowerSpectrum=True"
Notes	The power spectrum parameter allows the user to read data on the entire spectrum for diagnostic purposes. It is not recommended for production use. See CALC:FPOW:POW[n]:READ2? for details on the binary format of the response.
Preset	False
Range	True (return both channel power and full power spectrum) or False (returns only channel power)
Default Unit	Boolean
Initial S/W Revision	A.14.00

Mechanical Attenuation

Example	CALC:FPOW:POW1:DEF "MechAttenuation=10"
Notes	The mechanical attenuation value parameter sets the amount of mechanical attenuation anywhere from 0 to 70 dB (2 dB steps).
Preset	0 dB
Range	0 – 70 dB (2 dB steps)
Default Unit	dB
Initial S/W Revision	A.14.00

Preamp Mode

Example	CALC:FPOW:POW1:DEF "PreAmpMode=Low"
Notes	The license for the appropriate preamp is required. The preamp mode parameter specifies whether the preamps are being utilized. Low allows any preamps up to 3.6 GHz, and Full allows all licensed preamps. Set "ElecAttBypass=True" in order to utilize any preamps.
Preset	Off
Range	Off, Low, Full
Initial S/W Revision	A.14.00

Resolution Bandwidth Mode

Example	CALC:FPOW:POW1:DEF "PreAmpMode=Low"
Notes	The resolution bandwidth mode parameter allows the user to choose whether the RBW filter is automatically or manually set. The BestSpeed value minimizes measurement time, while the Narrowest value minimizes RBW size (minimum of two FFT bins per RBW). To manually specify an RBW, set this parameter to Explicit, and set the ResolutionBW parameter to the desired value.
Preset	BestSpeed
Range	BestSpeed, Narrowest, Explicit
Initial S/W Revision	A.14.00

Resolution Bandwidth

Example	CALC:FPOW:POW1:DEF "ResolutionBW=25e3"
Notes	The resolution bandwidth parameter sets the 3-dB bandwidth of the RBW filter. The ResolutionBWMode parameter must be set to Explicit in order to manually set the RBW.

Preset	0 Hz
Default Unit	Hz
Initial S/W Revision	A.14.00

Trigger Delay

Example	CALC:FPOW:POW1:DEF "TriggerDelay=0.025"
Notes	The trigger delay parameter sets the time after an external trigger is detected until the measurement is performed.
Preset	0 s
Range	0 - 1 s
Default Unit	Seconds
Initial S/W Revision	A.14.00

Trigger Level

Example	CALC:FPOW:POW1:DEF "TriggerLevel=2"
Notes	The trigger level parameter sets the voltage value at which an external trigger is detected.
Preset	1.2 V
Range	-5 to 5 V
Default Unit	Volts
Initial S/W Revision	A.14.00

Trigger Slope

Example	CALC:FPOW:POW1:DEF "TriggerSlope=Negative"
Notes	The trigger slope parameter indicates the direction of the edge trigger voltage for detection.
Preset	Positive
Range	Positive, Negative
Initial S/W Revision	A.14.00

Trigger Source

Example	CALC:FPOW:POW1:DEF "TriggerSource=Ext1"
Notes	The trigger source parameter allows the user to choose between measurement's triggering freely or controlled by an external input. Ext1 and Ext2 correspond to Trigger 1 In and Trigger 2 In, respectively.
Preset	Free
Range	Free, Ext1, Ext2
Initial S/W Revision	A.14.00

Trigger Timeout

Example	CALC:FPOW:POW1:DEF "TriggerTimeout=0.1"
Notes	The trigger timeout parameter sets the time in which the analyzer will wait for a trigger before automatically performing the measurement.
Preset	1 s
Range	0 – 1 s
Default Unit	Seconds
Initial S/W Revision	A.14.00

Signal Input

Example	CALC:FPOW:POW1:DEF "SignalInput=Fp50MHzCW"
Notes	The signal input parameter allows the user to select between using the main RF input or the internal analyzer reference CW signal of 50 MHz.
Preset	FpMainRf
Range	FpMainRf, Fp50MHzCW
Initial S/W Revision	A.14.00

Use Preselector

Example	CALC:FPOW:POW1:DEF "UsePreSelector=True"
Notes	The preselector parameter allows the user to either utilize or bypass the front end tunable filter at frequencies above 3.6 GHz. For frequencies below 3.6 GHz, the preselector is automatically bypassed, so you do not need to set this parameter to False in those cases.
Preset	False
Range	True (use preselector above 3.6 GHz), or False (preselector bypassed)

Default Unit	Boolean
Initial S/W Revision	A.14.00

Channel Bandwidth Array

Example	CALC:FPOW:POW1:DEF "Bandwidth=[3.84e6, 5e6, 3.84e6]"
Notes	The bandwidth parameter array defines the bandwidth of each channel that will be measured. All array parameters should have the same number of elements. Alternatively, if all the elements are the same value, a single number with no square brackets can be used to define the parameter.
Preset	[1e6]
Range	0 to 40 MHz
Default Unit	Hz
Initial S/W Revision	A.14.00

Channel Filter Type Array

Example	CALC:FPOW:POW1:DEF "FilterType=[RRC, IBW, RRC]"
Notes	The filter type parameter allows the user to choose between an integration bandwidth (IBW) filter or a root-raised-cosine (RRC) filter. The integration bandwidth filter weighs all frequencies within the bandwidth equally. The root-raised-cosine filter has an associated shape parameter, defined by the FilterAlpha parameter. All array parameters should have the same number of elements. Alternatively, if all the elements are the same value, a single value with no square brackets can be used to define the parameter.
Preset	[IBW]
Range	IBW, RRC
Initial S/W Revision	A.14.00

Channel Filter Alpha Array

Example	CALC:FPOW:POW1:DEF "FilterAlpha=[0.5, 0.0, 0.5]"
Notes	The filter alpha parameter allows the user to adjust the alpha value associated with the root-raised-cosine (RRC) filter type. Set FilterType to RRC in order to utilize this parameter. All array parameters should have the same number of elements. Alternatively, if all the elements are the same value, a single number with no square brackets can be used to define the parameter.
Preset	[0.22]
Range	0.0 – 1.0
Initial S/W Revision	A.14.00

Channel Measurement Function Array

Example	CALC:FPOW:POW1:DEF "Function=[BandPower, PeakPower, BandPower]"
Notes	<p>This parameter array defines what measurement is being made for each individually-specified channel:</p> <p>BandPower: Total power within the specified bandwidth of the channel (dBm)</p> <p>BandDensity: Total power density within the specified bandwidth of the channel (dBm/Hz)</p> <p>PeakPower: The peak power value within the specified bandwidth of the channel (dBm)</p> <p>PeakFrequency: The frequency which corresponds to the peak power value within the specified bandwidth of the channel. This frequency is relative to the center frequency (Hz)</p> <p>XdBBandwidth: The half power (-3.01 dB) bandwidth of the highest amplitude signal that resides within the channel (Hz), dB is configurable using XdBBandwidth parameter</p> <p>OccupiedBandwidth: The bandwidth at which 99% of the total power resides within the channel (Hz), percentage configurable using OccupiedBandwidthPercent parameter</p> <p>All array parameters should have the same number of elements. Alternatively, if all the elements are the same value, a single value with no square brackets can be used to define the parameter.</p>
Preset	[BandPower]
Range	BandPower, BandDensity, PeakPower, PeakFrequency, XdBBandwidth, OccupiedBandwidth
Initial S/W Revision	A.14.00

Channel Offset Frequency Array

Example	CALC:FPOW:POW1:DEF "OffsetFrequency=[-5e6, 0, 5e6]"
Notes	<p>The offset frequency parameter array defines the difference between the center frequency to the center frequency of each channel.</p> <p>All array parameters should have the same number of elements.</p>
Preset	[0]
Range	0 to 20 MHz
Default Unit	Hz
Initial S/W Revision	A.14.00

Channel Occupied Bandwidth Percent Array

Example	CALC:FPOW:POW1:DEF "OccupiedBandwidthPercent =[0.95, 0.95, 0.95]"
Notes	<p>This parameter only applies for channels whose Function is set to OccupiedBandwidth. The occupied bandwidth percent parameter specifies the percent of total power in these channels. The valid range for this parameter is 0.0 to 1.0, where 1.0 represents 100%. The default for this parameter is 0.99, which will return the bandwidth that contains 99% of the total channel power.</p>

Preset	[0.99]
Range	0 - 1.0
Initial S/W Revision	A.14.00

Channel x-dB Bandwidth Array

Example	CALC:FPOW:POW1:DEF " XdBBandwidth =[-6.02, -3.01, -1.0]"
Notes	This parameter only applies for channels whose Function is set to XdBBandwidth. The X dB bandwidth parameter is used to specify the power relative to the peak channel power over which the bandwidth is calculated. The parameter value must be a negative number.
Preset	[-3.01]
Range	-200 to 0 dB
Default Unit	dB
Initial S/W Revision	A.14.00

Define Fast Power Measurement Query (Remote Command Only)

The DEFine? command is used to retrieve a list of all defined parameters in an ASCII string format

M	All
o	
d	
e	
R	:CALCulate:FPOWer:POWer[1,2,...,999]:DEFine?
e	
m	
o	
t	
e	
C	
o	
m	
m	
a	
n	
d	
E	:CALC:FPOW:POW1:DEF?
x	
a	
m	

p
l
e

N This command query is used to retrieve a list of all defined parameters in an ASCII format.

O The following is an example of the returned results:

S "DCCoupled=False,ElecAttBypass=True,ElecAttenuation=0,IFGain=0,MechAttenuation=0,PreAmpMode=Off,PreSelectorOffset=0,UsePreSelector=False,ExternalReferenceFrequency=1000000,FrequencyReferenceSource=AutoExternalFrequencyReference,IFType=B40M,LOMode=SLW,SignalInput=FpMainRf,AcquisitionTime=0.001,CenterFrequency=100000000,ResolutionBW=0,ResolutionBWMode=BestSpeed,DetectorType=RmsAverage,Bandwidth=[1000000],OffsetFrequency=[0],Function=[BandPower],FilterType=[IBW],FilterAlpha=[0.22],OccupiedBandwidthPercent=[0.99],XdBBandwidth=[-3.01],DoNoiseCorrection=False,DoSpurSuppression=False,MeasurementMethod=HardwareFFT,IncludePowerSpectrum=False,TriggerDelay=0,TriggerLevel=1.2,TriggerSlope=Positive,TriggerSource=Free,TriggerTimeout=1"

I A.14.00

n
i
t
i
a
l

S
/
W

R
e
v
i
s
i
o
n

Configure Fast Power Measurement (Remote Command Only)

The configure command begins hardware setup and returns immediately, with no acquisition made. This can be used in parallel with other hardware operations to effectively hide the hardware setup time.

Mode	All
Remote Command	:CALCulate:FPOWER:POWER[1,2,...,999]:CONFigure
Example	:CALC:FPOW:POW1:CONF
Notes	Option FP2 is required.
Initial S/W Revision	A.14.00

Initiate Fast Power Measurement (Remote Command Only)

The INITiate command begins an acquisition and returns immediately. The results of the measurement can be retrieved using FETCh.

Mode	All
Remote Command	:CALCulate:FPOWer:POWer[1,2,...,999]:INITiate
Example	:CALC:FPOW:POW1:INIT
Notes	Option FP2 is required.
Initial S/W Revision	A.14.00

Fetch Fast Power Measurement (Remote Command Only)

The FETCh command query is used to retrieve the results of an acquisition initiated by the INIT command. The returned results are in ASCII string format. The string begins and ends with quotation marks.

Mode	All
Remote Command	:CALCulate:FPOWer:POWer[1,2,...,999]:FETCh?
Example	:CALC:FPOW:POW1:FETC?
Notes	Option FP2 is required. Returns m comma-separated ASCII values, where m corresponds to the number of bandwidths defined. 1. Declared function return in the 1st specified channel 2. Declared function return in the 2nd specified channel ... m. Declared function return in the last specified channel The INIT and FETC? command sequence performs the same functionality of a single CALC:FPOW:POW[n]? query. Units of the returned values are dependent on the Function parameter for each channel.
Initial S/W Revision	A.14.00

Execute Fast Power Measurement (Remote Command Only)

This command query is used as shorthand for an INIT command immediately followed by a FETC? command. The returned results are in ASCII string format. The string begins and ends with quotation marks.

Mode	All
Remote Command	:CALCulate:FPOWer:POWer[1,2,...,999]?
Example	:CALC:FPOW:POW1?
Notes	Option FP2 is required. See notes for Fast Power Fetch for return format.
Initial S/W Revision	A.14.00

Binary Read Fast Power Measurement (Remote Command Only)

This command query is used as shorthand for an INIT command immediately followed by a FETC? command. The returned results are in a binary format.

Mode	All
Remote Command	:CALCulate:FPOWER:POWER[1,2,...,999]:READ? :CALCulate:FPOWER:POWER[1,2,...,999]:READ1?
Example	:CALC:FPOW:POW1:READ? :CALC:FPOW:POW1:READ1?
Notes	Option FP2 is required. Returns m 4 byte floating point binary values (Little-Endian), where m corresponds to the number of bandwidths defined.
Initial S/W Revision	A.14.00

Diagnostic Binary Read Fast Power Measurement (Remote Command Only)

This command query is used as shorthand for an INIT command immediately followed by a FETC? command. The returned results are in a binary format. This command is used primarily for diagnostic purposes to test for ADC overloads and to visibly inspect the spectrum.

Mode	All
Remote Command	:CALCulate:FPOWER:POWER[1,2,...,999]:READ2?
Example	:CALC:FPOW:POW1:READ2?
Notes	Option FP2 is required. Note: Spectrum data is only returned if the IncludePowerSpectrum parameter is set to True. If IncludePowerSpectrum is False, the number of spectrum points will be zero (0). Units of the returned values are dependent on the Function parameter per channel (e.g. dBm for BandPower, Hz for PeakFrequency). Returns binary data (Little-Endian) that contains information on m amount of channels, along with ADC over range and full spectrum data. The following is the binary format of the response. Bandwidth Return Value 1. Number of channels specified, m [4 byte int] 2. Declared function result for the 1st specified channel [4 byte float] 3. Declared function result for the 2nd specified channel [4 byte float] ... (m + 1). Declared function result for the last (mth) specified channel [4 byte float] ADC Over Range 1. ADC over-range occurred (1: true, 0: false) [2 byte short]

	<p>Spectrum Data</p> <ol style="list-style-type: none"> 1. Number of points in the spectrum data, k [4 byte int] 2. Start frequency of spectrum data (Hz) [8 byte double] 3. Step frequency of spectrum data (Hz) [8 byte double] 4. FFT bin at 1st point (dBm) [4 byte float] 5. FFT bin at 2nd point (dBm) [4 byte float] ... (k + 3). FFT bin at last (kth) point (dBm) [4 byte float]
Initial S/W Revision	A.14.00

Format Data: Numeric Data (Remote Command Only)

This command specifies the format of the trace data input and output. It specifies the formats used for trace data during data transfer across any remote port. It affects only the data format for setting and querying trace data for the :TRACe[:DATA], TRACe[:DATA]?, :CALCulate:DATA[n]? and FETCh:SANalyzer[n]? commands and queries.

Remote Command	<pre>:FORMat [:TRACe] [:DATA] ASCii INTeger, 32 REAL, 32 REAL, 64 :FORMat [:TRACe] [:DATA] ?</pre>
Notes	<p>The query response is:</p> <p>ASCii: ASC,8 REAL,32: REAL,32 REAL,64: REAL,64 INTeger,32: INT,32</p> <p>When the numeric data format is REAL or ASCii, data is output in the current Y Axis unit. When the data format is INTeger, data is output in units of m dBm (.001 dBm).</p> <p>The INT,32 format returns binary 32-bit integer values in internal units (m dBm), in a definite length block.</p>
Dependencies	<p>Sending a data format spec with an invalid number (for example, INT,48) generates no error. The analyzer simply uses the default (8 for ASCii, 32 for INTeger, 32 for REAL).</p> <p>Sending data to the analyzer which does not conform to the current FORMat specified, results in an error. Sending ASCII data when a definite block is expected generates message -161 "Invalid Block Data" and sending a definite block when ASCII data is expected generates message -121 "Invalid Character in Number".</p>
Preset	ASCii
Backwards Compatibility Notes	Note that the INT,32 format is only applicable to the command, TRACe:DATA. This preserves backwards compatibility for the Swept SA measurement. For all other commands/queries which honor FORMat:DATA, if INT,32 is sent the analyzer will behave as though it were set to REAL,32.
Initial S/W Revision	Prior to A.02.00

The specs for each output type follow:

AScii - Amplitude values are in ASCII, in the current Y Axis Unit, one ASCII character per digit, values separated by commas, each value in the form:

SX.YYYYYEsZZ

Where:

S = sign (+ or -)

X = one digit to left of decimal point

Y = 5 digits to right of decimal point

E = E, exponent header

s = sign of exponent (+ or -)

ZZ = two digit exponent

REAL,32 - Binary 32-bit real values in the current Y Axis Unit, in a definite length block.

REAL,64 - Binary 64-bit real values in the current Y Axis Unit, in a definite length block.

Format Data: Byte Order (Remote Command Only)

This command selects the binary data byte order for data transfer and other queries. It controls whether binary data is transferred in normal or swapped mode. This command affects only the byte order for setting and querying trace data for the :TRACe[:DATA], TRACe[:DATA]? , :CALCulate:DATA[n]? and FETCh:SANalyzer[n]? commands and queries.

By definition any command that says it uses FORMat:DATA uses any format supported by FORMat:DATA.

The NORMal order is a byte sequence that begins with the most significant byte (MSB) first, and ends with the least significant byte (LSB) last in the sequence: 1|2|3|4. SWAPped order is when the byte sequence begins with the LSB first, and ends with the MSB last in the sequence: 4|3|2|1.

Remote Command	:FORMat:BORDER NORMal SWAPped :FORMat:BORDER?
Preset	NORMal
Initial S/W Revision	Prior to A.02.00

Meas Setup

Accesses a menu of keys that select measurement functions for VSA based measurements.

Key Path	Front Panel
Mode	VSA, LTE, LTETDD, IDEN, LTEAFDD, LTEATDD
Initial S/W Revision	Prior to A.02.00
Modified at S/W Revision	A.02.00

Component Carrier

This parameter specifies which component carrier's configuration menu is displayed. This parameter decides which Component Carrier is the target CC when one parameter is changed through front panel. For example, when CC0 is selected, Sync Type is changed to PSS from front panel, and then measurement will know the Sync Type for CC0 is PSS, which is equivalent to send following SCPI command:

```
EVM:CCAR0:DLINK:SYNC:TYPE PSS
```

This parameter also identifies the trace views of which component carrier are to preset and displayed on the screen. For example, when number of Component Carrier is 2, if you select CC1, then after you press Preset View Basic key, then following 4 traces are displayed for CC1.

- IQ Meas
- Spectrum
- Error Vector Spectrum
- Error Summary

Key Path	Meas Setup View/Display
Mode	LTEAFDD, LTEATDD
Remote Command	[:SENSe] :EVM:SElected CC0 CC1 CC2 CC3 CC4 [:SENSe] :EVM:SElected?
Example	EVM:SEL CC0 EVM:SEL?
Notes	In order to clearly identify it, it is called "Component Carrier" under Meas Setup and "CC For Preset View" under View/Display. The options CC1~CC4 can be enabled with 9080B/9082B-2FP license.
Dependencies	Component Carrier is coupled to Number of Component Carriers. For example, Component Carrier list will include CC0~CC1 if the number Component Carriers is 2.
Preset	CC0
State Saved	Saved in instrument state
Range	CC0 CC1 CC2 CC3 CC4
Readback	CC0 CC1 CC2 CC3 CC4

Initial S/W Revision	A.14.00
Modified at S/W Revision	A.14.50

Sync/Format Setup (Downlink)

Displays a menu of commonly used sync/format setup parameters when Direction is set to Downlink.

Key Path	Meas Setup
Mode	LTEAFDD, LTEATDD
Initial S/W Revision	A.14.00
Modified at S/W Revision	A.14.00

Sync Type

Selects the Sync Type.

- PSS – Selects Primary Sync Signal for Sync Type
- C-RS – Selects Cell-specific reference signal for Sync Type

Sync Type sets the channel or signal to be used for synchronization.

The LTE demodulator can be set to use either the Primary Sync signal (P-SS) or the Cell-specific reference signal (C-RS) to synchronize the downlink signal.

This synchronization is performed at the frame level. For smaller scale adjustments (such as at the symbol or slot level), see the EVM Minimization parameter.

P-SS is normally used for downlink synchronization. However, when P-SS is impaired in some way (for example, P-SS has a different Cell ID from RS), C-RS can be used for synchronization so that the signal can be demodulated.

NOTE

S-SS must be present in the time capture (Raw Main Time) for demodulation to occur, since finding S-SS is the only way to distinguish between the beginning and the middle of a frame.

When Sync Type is set to C-RS:

The Error Summary data result SyncCorr shows which C-RS antenna port's reference signal was used for synchronization to the right of the correlation value.

Auto detection of Cell ID and Custom RS-PRS are not supported.

The reference C-RS port must be specified, since the demodulator does not automatically search the input signal for all C-RS antenna ports when Sync Type is set to C-RS.

Key Path	Meas Setup, Sync/Format Setup
Mode	LTEAFDD, LTEATDD
Remote Command	[:SENSe] :EVM:CCARrier0 1 2 3 4:DLINK:SYNC:TYPE PSS RS [:SENSe] :EVM:CCARrier0 1 2 3 4:DLINK:SYNC:TYPE?

Example	EVM:CCAR0:DLIN:SYNC:TYPE PSS EVM:CCAR0:DLIN:SYNC:TYPE?
Dependencies	When Sync Type is set to C-RS, auto detection of Cell ID and Custom RS-PRS are not supported.
Preset	PSS
State Saved	Saved in instrument state.
Range	P-SS C-RS
Backwards Compatibility SCPI	[:SENSe] :EVM:DLINK:SYNC:TYPE
Initial S/W Revision	A.14.00
Modified at S/W Revision	A.14.50

P-SS

Selects P-SS Sync Type.

P-SS is the Primary Synchronization signal for an LTE downlink frame. The center 72 subcarriers (6 RB wide) are allocated to P-SS, but only the center 62 subcarriers are used. The unused subcarriers (the outer five on each side) are set to zero power during P-SS transmission. P-SS is not present in an uplink frame.

For FDD frame type 1, P-SS is present in the last symbol of slots 0 and 11 in every frame.

For TDD frame type 2, P-SS is present in the third symbol of slots 2 and 12 in every frame.

NOTE See ["Edit Control Channels" on page 2011](#) for information on setting P-SS Power Boost.

P-SS is transmitted as a Zadoff-Chu sequence and thus appears as irregularly spaced points on a circle in the IQ Meas constellation diagram.

Key Path	Meas Setup, Sync/Format Setup, Sync Type
Mode	LTEAFDD, LTEATDD
Initial S/W Revision	A.14.00

C-RS

Selects C-RS (Cell-specific Ref Signal Sync Type).

C-RS is the downlink Cell-specific Reference Signal and is used for ["EVM Minimization" on page 2065](#) and Equalizer Training, and it can be used for synchronization. The reference signal is also used as the power level reference for the rest of the signal. See ["Edit Control Channels" on page 2011](#) for more information.

The modulation type of C-RS is QPSK.

Key Path	Meas Setup, Sync/Format Setup, Sync Type
Mode	LTEAFDD, LTEATDD
Initial S/W Revision	A.14.00

RS-PRS

Sets the RS-PRS.

- 3GPP – The demodulator will expect the RS pseudorandom sequence to follow the formula given in the LTE standard in Section 6.10.1.1 of 3GPP TS 36.211.
- CUSTom – The demodulator will autodetect the RS sequence (including non-standard sequences). Since the RS points can only be in certain positions, the demodulator will assume that the point closest to the measured point is the desired reference signal point and will calculate the EVM and other metrics using the assumed reference signal constellation point.

RS-PRS specifies whether or not the demodulator should expect the reference signal sequence to adhere to the standard.

NOTE

When Sync Type is set to RS, autodetecting of a Custom RS-PRS is not supported since the demodulator needs to know the RS-PRS to be able to synchronize the signal using RS.

When RS-PRS is set to Custom and any of the antenna port signals are phase delayed by more than 45 degrees, the demodulator will autodetect a different RS-PRS. This will cause equalization to be incorrect and demodulation will fail. To ensure correct demodulation of signals containing an antenna port transmission with a phase rotation of more than 45 degrees, set RS-PRS to 3GPP to enable RS-PRS to be determined by Cell ID according to the standard.

Key Path	Meas Setup, Sync/Format Setup
Mode	LTEAFDD, LTEATDD
Remote Command	[:SENSe] :EVM:CCARrier0 1 2 3 4:DLINk:SYNC:RSPRs GPP CUSTom [:SENSe] :EVM:CCARrier0 1 2 3 4:DLINk:SYNC:RSPRs?
Example	EVM:CCAR0:DLIN:SYNC:RSPR CUSTom EVM:CCAR0:DLIN:SYNC:RSPR?
Dependencies	When Sync Type for Downlink is set to RS, the Custom selection is disabled and the softkey is grayed out.
Preset	GPP
State Saved	Saved in instrument state.
Range	3GPP Custom
Backwards Compatibility SCPI	[:SENSe] :EVM:DLINk:SYNC: RSPR
Initial S/W Revision	A.14.00
Modified at S/W Revision	A.14.50

Cell ID

Autodetects the Cell ID from the SSCH content or to manually select the Cell ID.

Cell ID sets the physical (PHY) layer Cell Identity. This PHY-layer Cell ID determines the Cell ID Group and Cell ID Sector. There are 168 possible Cell ID groups and 3 possible Cell ID sectors; therefore, there are 3*

168 = 504 possible PHY-layer Cell IDs. When Cell ID is set to Auto, the analyzer will automatically detect the Cell ID. When Cell ID is set to Manual, the PHY-layer Cell ID must be specified for successful demodulation.

The physical layer Cell ID can be calculated from the following formula:

$$\text{PHY-layer Cell ID} = 3 * (\text{Cell ID Group}) + \text{Cell ID Sector}$$

When Sync Type is set to RS, the Cell ID Auto selection will be disabled, and Cell ID must be specified manually. This is because the demodulator needs to know the values of the RS sequence to use for synchronization and because Cell ID determines these values. See "RS-PRS" on page 1977 for more information.

NOTE

Cell ID Sector and Group information can be found on the Error Summary trace.
Only cell-specific reference signals are supported by the LTE demod (MBSFN and UE-specific reference signals are not supported).

Cell ID Sector determines the Zadoff-Chu Root Index used to generate the Primary Synchronization Signal (P-SS):

- Cell ID sector 0 = ZC Root Index 25
- Cell ID sector 1 = ZC Root Index 29
- Cell ID sector 2 = ZC Root Index 34

Normally, the same sequence used to generate P-SS is used to generate RS, but a custom RS can be used by setting RS-PRS to Custom.

Key Path	Meas Setup, Sync/Format Setup
Mode	LTEAFDD, LTEATDD
Remote Command	[:SENSe] :EVM:CCARrier0 1 2 3 4:DLINK:SYNC:CID <integer> [:SENSe] :EVM:CCARrier0 1 2 3 4:DLINK:SYNC:CID? [:SENSe] :EVM:CCARrier0 1 2 3 4:DLINK:SYNC:CID:AUTO OFF ON 0 1 [:SENSe] :EVM:CCARrier0 1 2 3 4:DLINK:SYNC:CID:AUTO?
Example	EVM:CCAR0:DLIN:SYNC:CID 0 EVM:CCAR0:DLIN:SYNC:CID? EVM:CCAR0:DLIN:SYNC:CID:AUTO ON
Dependencies	When Sync Type for Downlink is set to RS, the Cell ID Auto selection is disabled and Cell ID must be specified manually.
Preset	0 ON
State Saved	Saved in instrument state.
Min	0
Max	503
Backwards Compatibility SCPI	[:SENSe] :EVM:DLINK:SYNC:CID [:SENSe] :EVM:DLINK:SYNC:CID:AUTO
Initial S/W Revision	A.14.00
Modified at S/W Revision	A.14.50

Tx Antenna

Displays a menu of Tx Antenna parameters.

Key Path	Meas Setup
Mode	LTEAFDD, LTEATDD
Initial S/W Revision	A.14.00

Number of C-RS Ports

Selects the number of C-RS Ports.

- ANT1 – 1 Port
- ANT2 – 2 Ports
- ANT4 – 4 Ports

Number of C-RS Ports specifies the number of C-RS (Cell-specific RS) antenna ports there are for the current LTE signal, and thus determines how many C-RS antenna port signals the demodulator searches for.

NOTE

When RS-PRS is set to Custom and any of the C-RS antenna port signals are phase delayed by more than 45 degrees, the demodulator will autodetect a different RS-PRS. This will cause equalization to be incorrect and demodulation will fail. To ensure correct demodulation of signals containing an antenna port transmission with a phase rotation of more than 45 degrees, set RS-PRS to 3GPP to enable RS-PRS to be determined by Cell ID according to the standard.

Key Path	Meas Setup, Sync/Format Setup
Mode	LTEAFDD, LTEATDD
Remote Command	<code>[:SENSe] :EVM:CCARrier0 1 2 3 4 :DLINk:SYNC:ANTenna:NUMBER ANT1 ANT2 ANT4</code> <code>[:SENSe] :EVM:CCARrier0 1 2 3 4 :DLINk:SYNC:ANTenna:NUMBER?</code>
Example	<code>EVM:CCAR0:DLIN:SYNC:ANT:NUMB ANT1</code>
Dependencies	When Sync Type for Downlink is set to C-RS, the Custom selection is disabled and the softkey is grayed out.
Preset	ANT1
State Saved	Saved in instrument state.
Range	1 Port 2 Ports 4 Ports
Backwards Compatibility SCPI	<code>[:SENSe] :EVM:DLINk:SYNC:ANTenna:NUMBER</code>
Initial S/W Revision	A.14.00
Modified at S/W Revision	A.14.50

1 Port

Selects one C-RS Port.

Key Path	Meas Setup, Sync/Format Setup, TX Antenna, Num of C-RS Ports
Mode	LTEAFDD, LTEATDD
Initial S/W Revision	A.14.00

2 Ports

Selects two C-RS Ports.

Key Path	Meas Setup, Sync/Format Setup, TX Antenna, Num of C-RS Ports
Mode	LTEAFDD, LTEATDD
Initial S/W Revision	A.14.00

4 Ports

Selects four C-RS Ports.

Key Path	Meas Setup, Sync/Format Setup, TX Antenna, Num of C-RS Ports
Mode	LTEAFDD, LTEATDD
Initial S/W Revision	A.14.00

Reference C-RS Port

Selects which Reference C-RS Port to use.

- P0 – C-RS Port 0
- P1 – C-RS Port 1
- P2 – C-RS Port 2
- P3 – C-RS Port 3

Reference C-RS Port determines which C-RS path to use for synchronization and initial equalization and to show on certain non-MIMO traces (listed below). This parameter determines the transmitted Cell-specific RS antenna port.

Auto/Man selection enables you to specify whether the analyzer uses auto-detection or manual mode to determine the reference C-RS antenna port.

- Auto – The demodulator searches for the strongest C-RS antenna port signal and uses that C-RS port as the reference.
- Man – Selected C-RS port is used as the reference.

C-RS metrics for other C-RS/Rx paths are expressed relative to the C-RS metrics for the reference C-RS/Rx path. For example, when C-RS port 0 and Rx0 (Measurement Channel 1) are selected, the C-RS0/Rx0 section of the MIMO Info Table will show 0 dB for RSPwr and the other C-RS/Rx paths' RSPwr will be expressed in dB relative to this 0 dB point.

NOTE In the absence of cross-channel paths (when connecting directory to the transmitter), make sure that the specified C-RS path is present; otherwise, the signal will not be demodulated.
The **Sync Type** parameter affects how the reference C-RS path must be specified.

NOTE • Sync Type = P-SS (note: Input Signal must contain P-SS)

NOTE -Ref C-RS Port is Man: the demodulator will use the specified reference C-RS antenna port (which must be present on the Input Signal).
-Ref C-RS Port is Auto: the demodulator will automatically detect the strongest C-RS port signal to sue for the reference C-RS port.

NOTE • **Sync Type = RS:** reference path auto detection is not supported and the reference C-RS path must be specified manually.

This parameter also determines which C-RS path results are shown on the following traces:

- Eq Chan Freq Resp
- Eq Chan Freq Resp Diff
- Eq Impulse Response
- Common Tracking Error
- Inst Eq Chan Freq Resp
- Inst Eq Chan Freq Resp Diff
- Freq Err per Slot

To view show information for all detected antenna port signals, use the MIMO traces (Trace > Data > MIMO).

NOTE P-SS and S-SS must be present in the time capture (Raw Main Time) for successful demodulation to occur. For example, for two-channel transmit diversity signal that has P-SS and S-SS transmitted only on antenna 2, the demodulator can analyze antenna 2 without antenna 1 connected, but not vice versa.

Key Path	Meas Setup, Sync/Format Setup, Tx Antenna
Mode	LTEAFDD, LTEATDD
Remote Command	[:SENSe]:EVM:CCARrier0 1 2 3 4:DLINk:SYNC:ANTenna:PORT P0 P1 P2 P3 [:SENSe]:EVM:CCARrier0 1 2 3 4:DLINk:SYNC:ANTenna:PORT? [:SENSe]:EVM:CCARrier0 1 2 3 4:DLINk:SYNC:ANTenna:PORT:AUTO OFF ON 0 1 [:SENSe]:EVM:CCARrier0 1 2 3 4:DLINk:SYNC:ANTenna:PORT:AUTO?
Example	EVM:CCAR0:DLIN:SYNC:ANT:PORT P0

	EVM:CCAR0:DLIN:SYNC:ANT:PORT?
Dependencies	When Number of C-RS Ports is 1 Port, only Port 0 is enabled and the others are disabled. When Number of C-RS Ports is 2 Ports, Port 0 and Port 1 are enabled and the others are disabled. When Number of C-RS Ports is 4 Ports, all Ports are enabled.
Preset	P0 ON
State Saved	Saved in instrument state.
Range	Port 0 Port 1 Port 2 Port 3
Backwards Compatibility SCPI	[:SENSe] :EVM:DLINK:SYNC:ANTenna:PORT [:SENSe] :EVM:DLINK:SYNC:ANTenna:PORT:AUTO
Initial S/W Revision	A.14.00
Modified at S/W Revision	A.14.50

Port 0

Selects Port 0 for the Reference C-RS Port.

Key Path	Meas Setup, Sync/Format Setup, TX Antenna, Reference C-RS Port
Mode	LTEAFDD, LTEATDD
Initial S/W Revision	A.14.00

Port 1

Selects Port 1 for the Reference C-RS Port.

Key Path	Meas Setup, Sync/Format Setup, TX Antenna, Reference C-RS Port
Mode	LTEAFDD, LTEATDD
Initial S/W Revision	A.14.00

Port 2

Selects Port 2 for the Reference C-RS Port.

Key Path	Meas Setup, Sync/Format Setup, TX Antenna, Reference C-RS Port
Mode	LTEAFDD, LTEATDD
Initial S/W Revision	A.14.00

Port 3

Selects Port 3 for the Reference C-RS Port.

Key Path	Meas Setup, Sync/Format Setup, TX Antenna, Reference C-RS Port
Mode	LTEAFDD, LTEATDD
Initial S/W Revision	A.14.00

Antenna Detect Threshold

Sets the Antenna Detection Threshold.

Antenna Detection Threshold sets the threshold for transmit antenna port signal detection. The average RS power from a Tx antenna port has to be above the Antenna Detection Threshold to be detected by the demodulator. The threshold is specified relative to the average RS subcarrier power level of the reference antenna path selected.

For example, a combination of the transmissions from Ports 0–3 are being received, Antenna Detection Threshold is set to –10 dB, Reference Tx Antenna Port is set to Port 1. The demodulator will set the detection threshold 10 dB below the average RS power level of the reference antenna path (Tx1). Any other antenna port transmission paths with an average RS power level that is at or below this threshold will not be detected nor included in demodulation results. However, any undetected transmissions will affect EVM since they will not be equalized and will act as noise.

NOTE

Include Inactive Antenna Paths can be used to show information about all Tx paths on the MIMO trace.

Key Path	Meas Setup, Sync/Format Setup, Tx Antenna,
Mode	LTEAFDD, LTEATDD
Remote Command	<code>[:SENSe] :EVM:CCARrier0 1 2 3 4 :DLINk:SYNC:ANTenna:DETECT:THReshold <rel_amp1></code> <code>[:SENSe] :EVM:CCARrier0 1 2 3 4 :DLINk:SYNC:ANTenna:DETECT:THReshold?</code>
Example	<code>EVM:CCAR0:DLIN:SYNC:ANT:DET:THR -10</code> <code>EVM:CCAR0:DLIN:SYNC:ANT:DET:THR?</code>
Dependencies	This parameter is disabled when Number of C-RS Ports is 1 Port.
Preset	-10
State Saved	Saved in instrument state.
Min	-100 dB
Max	100 dB
Backwards Compatibility SCPI	<code>[:SENSe] :EVM:DLINk:SYNC:ANTenna:DETECT:THReshold</code>
Initial S/W Revision	A.14.00
Modified at S/W Revision	A.14.50

P-SS/S-SS Antenna Port

Selects the Antenna Port that is transmitting P-SS/S-SS when the Number of C-RS Ports is set to 2 Ports or 4 Ports.

When All Ports is selected, the Power Boost value for P-SS and S-SS entered in Downlink Control Channel Properties is assumed to be split equally among the transmit antennas.

For example, when P-SS Power Boost = 0.6 dB and P-SS/S-SS Antenna Port is set to All Ports for a four antenna port signal, the demodulator will expect P-SS power on each antenna port to be 0.6 dB – 6.02 dB = –5.38 dB.

Otherwise, when Port 0, Port 1, Port 2, or Port 3 is selected, the entire power specified by the P-SS and S-SS Power Boost parameter is assumed to be transmitted on the selected antenna port.

- PORT0 – Port 0
- PORT1 – Port 1
- PORT2 – Port 2
- PORT3 – Port 3
- APORts – All Ports

Key Path	Meas Setup, Sync/Format Setup, Tx Antenna
Mode	LTEAFDD, LTEATDD
Remote Command	[:SENSe] :EVM:CCARrier0 1 2 3 4:DLINK:SYNC:SS:ANTenna:PORT P0 P1 P2 P3 APORts [:SENSe] :EVM:CCARrier0 1 2 3 4:DLINK:SYNC:SS:ANTenna:PORT?
Example	EVM:CCAR0:DLIN:SYNC:SS:ANT:PORT P0 EVM:CCAR0:DLIN:SYNC:SS:ANT:PORT?
Dependencies	Disabled when Number of C-RS Ports is 1 Port.
Preset	P0
State Saved	Saved in instrument state.
Range	Port 0 Port 1 Port 2 Port 3 All Ports
Backwards Compatibility SCPI	[:SENSe] :EVM:DLINK:SYNC:SS:ANTenna:PORT
Initial S/W Revision	A.14.00
Modified at S/W Revision	A.14.50

Port 0

Selects Port 0.

Key Path	Meas Setup, Sync/Format Setup, Tx Antenna, P-SS/S-SS Ant
Mode	LTEAFDD, LTEATDD
Initial S/W Revision	A.14.00

Port 1

Selects Port 1.

Key Path	Meas Setup, Sync/Format Setup, Tx Antenna, P-SS/S-SS Ant
Mode	LTEAFDD, LTEATDD
Initial S/W Revision	A.14.00

Port 2

Selects Port 2.

Key Path	Meas Setup, Sync/Format Setup, Tx Antenna, P-SS/S-SS Ant
Mode	LTEAFDD, LTEATDD
Dependencies	Disabled when Number of C-RS Ports is 2 Ports.
Initial S/W Revision	A.14.00

Port 3

Selects Port 3.

Key Path	Meas Setup, Sync/Format Setup, Tx Antenna, P-SS/S-SS Ant
Mode	LTEAFDD, LTEATDD
Dependencies	Disabled when Number of C-RS Ports is 2 Ports.
Initial S/W Revision	A.14.00

All Ports

Selects All Ports.

Key Path	Meas Setup, Sync/Format Setup, Tx Antenna, P-SS/S-SS Ant
Mode	LTEAFDD, LTEATDD
Initial S/W Revision	A.14.00

Include Inactive Antenna Paths

Selects whether or not inactive antenna paths are included in the result.

- Include - All Tx/Rx antenna paths are shown on the MIMO traces whether or not the path is present.
- Exclude - Only Tx/Rx antenna paths that have an average RS power above the antenna detection threshold will be shown on the MIMO traces.

Key Path	Meas Setup, Sync/Format Setup, Tx Antenna
Mode	LTEAFDD, LTEATDD

Remote Command	<code>[:SENSe] :EVM:CCARrier0 1 2 3 4 :DLINK:SYNC:ANTenna:INACtive:PATHs INCLude EXCLude</code> <code>[:SENSe] :EVM:CCARrier0 1 2 3 4 :DLINK:SYNC:ANTenna:INACtive:PATHs?</code>
Example	<code>EVM:CCAR0:DLIN:SYNC:ANT:INAC:PATH INCL</code> <code>EVM:CCAR0:DLIN:SYNC:ANT:INAC:PATH?</code>
Preset	<code>EXCLude</code>
State Saved	Saved in instrument state.
Range	<code>INCLude EXCLude</code>
Backwards Compatibility SCPI	<code>[:SENSe] :EVM:DLINK:SYNC:ANTenna:INACtive:PATHs</code>
Initial S/W Revision	A.14.00
Modified at S/W Revision	A.14.50

MIMO Decoding

Determines the MIMO decoding method.

- NONE – No decoding
- GPPMimo – Selects 3GPP MIMO decoding

MIMO Decoding determines how much of the transmit chain is decoded by the demodulator. The selection of this parameter directly affects what values are shown on the IQ Meas trace and all other traces that depend on the IQ Meas data (error vector traces).

MIMO Decoding applies to multi-antenna signals only.

3GPP MIMO Decoding

When 3GPP MIMO Decoding is selected, the data points shown on the IQ Meas trace are equivalent to the data points before precoding was applied in the transmit chain. In other words, the demodulator will undo MIMO precoding and show the results on IQ Meas. Although the data points are mapped onto "subcarriers" when being shown on the layer traces, the data points do not have a one-to-one correspondence to the subcarrier that they are mapped onto. For instance, when there is a frequency null that affects a subcarrier, there will be several (depending on the precoding) data points in IQ Meas that are affected. Another way of looking at this is that each subcarrier contains information from multiple data points after precoding is performed (this does not apply to RS, P-SS, and S-SS which do not undergo precoding).

For channels that undergo transmit diversity, the demodulator will undo transmit diversity precoding, undo codeword-to-layer mapping, and show the resulting codeword data points in their respective resource elements, copied on all layer traces. That is, constellation points on layer traces for transmit diversity-precoded channels will be the same for all layer traces.

When a signal uses Tx Diversity, the amount of data transmitted is not increased, but the reliability of the signal is increased by transmitting multiple copies of the data.

In two Tx Antenna mode, each antenna port transmission carries enough information to determine all the data.

In four Tx Antenna mode, each antenna port transmission only carries enough information to determine half the data. Any data that cannot be determined from the detected antenna ports will be considered part of Non-Alloc signals and shown as blanks on the Symbol Table (unless the Non-Alloc parameter is selected; then the data will be shown as gray zeros).

For channels that undergo spatial multiplexing, the demodulator will only undo Spatial Multiplexing precoding and show the layer data points in their respective resource elements on the appropriate layer traces.

For precoded channels, subcarrier points on the layer traces do not have a one-to-one correspondence to on-air subcarriers. Rather, each subcarrier point is actually the demodulated value of a codeword data point that was present prior to the codeword-to-layer mapping at the transmitter.

NOTE For LTE signals that contain more than one layer, the P-SS and S-SS subcarriers from the P-SS/S-SS Antenna Port are copied to all layer traces. RS subcarriers from all Tx antenna ports are copied to their respective subcarrier/symbol locations in all layer traces.

No Decoding

When No Decoding is selected, no decoding or cross-channel equalization will be performed on the measured IQ data. This means that, for LTE signals that have been precoded (multi-antenna signals), subcarrier points shown on measured IQ traces (IQ Meas and IQ MEas Time) will actually be an addition of multiple modulation points, resulting in non-standard constellations.

For example, in a two antenna port signal, there will be subcarrier points that are an addition of two QPSK points. The resulting diagram will be a 9QAM constellation. These are effectively the points that were transmitted on the OFDM subcarriers.

Reference antenna path equalization will still be performed when Equalizer Training is enabled (set to RS or RS+Data).

The No Decoding selection is useful for the case that you have four antenna signals, and you want to isolate channel effects from transmit chain effects (filters, mixers, etc.). You could connect each transmit port directly to your measurement instrument with identical cables. That way, any observed anomalies will come primarily from the RF transmit chain.

NOTE When No Decoding is selected, EVM results will not be relevant since the ideal symbol points (shown on the IQ Ref and IQ Ref Time), which are used to compute EVM, will still be standard constellation points and hence may not match the non-standard constellation points of IQ Meas arising due to No Decoding.

Key Path	Meas Setup, Sync/Format Setup
Mode	LTEAFDD, LTEATDD
Remote Command	[:SENSe] :EVM:CCARrier0 1 2 3 4:DLINk:SYNC:MIMO:DECoding NONE GPPMimo [:SENSe] :EVM:CCARrier0 1 2 3 4:DLINk:SYNC:MIMO:DECoding?
Example	EVM:CCAR0:DLIN:SYNC:MIMO:DEC NONE EVM:CCAR0:DLIN:SYNC:MIMO:DEC?
Notes	The selection “JEQualizer” is removed at A.14.00. For backward compatibility, when it is sent, this parameter is set to GPPM, the Preset value.
Preset	3GPP MIMO

State Saved	Saved in instrument state.
Range	None 3GPP MIMO
Backwards Compatibility SCPI	[:SENSe] :EVM:DLINK:SYNC:MIMO:DECoding
Initial S/W Revision	A.14.00
Modified at S/W Revision	A.14.50

PDSCH Cell Specific Ratio

Determines PDSCH cell-specific ratio ρ_B/ρ_A or cell-specific parameter PB. (3GPP TS 36.213 V8.5.0 5.2) PDSCH cell-specific ratio specifies the power ratio between PDSCH resource elements and cell-specific reference signal elements.

- R1 – Cell-specific ratio ρ_B/ρ_A = always 1 (0 dB)
- PB0 – Cell-specific parameter PB = 0
- PB1 – Cell-specific parameter PB = 1
- PB2 – Cell-specific Parameter PB = 2
- PB3 – Cell-specific parameter PB = 3

When PB(x) is selected, the LTE parameter PB will be set to (x), and the ratio ρ_B/ρ_A will be determined from Table 5.2–2 in 3GPP TS.36.213.

When R1 is selected, the cell-specific ratio ρ_B/ρ_A will be set to 1.

Key Path	Meas Setup, Sync/Format Setup
Mode	LTEAFDD, LTEATDD
Remote Command	[:SENSe] :EVM:CCARrier0 1 2 3 4:DLINK:PDSCh:CSRatio R1 PB0 PB1 PB2 PB3 [:SENSe] :EVM:CCARrier0 1 2 3 4:DLINK:PDSCh:CSRatio?
Example	EVM:CCAR0:DLIN:PDSC:CSR R1 EVM:CCAR0:DLIN:PDSC:CSR?
Preset	$\rho_B/\rho_A = 1$
State Saved	Saved in instrument state.
Range	$\rho_B/\rho_A = 1$ PB = 0 PB = 1 PB = 2 PB = 3
Backwards Compatibility SCPI	[:SENSe] :EVM:DLINK:PDSCh:CSRatio
Initial S/W Revision	A.14.00
Modified at S/W Revision	A.14.50

Meas Time Setup

Displays a menu of commonly used measurement time setup parameters.

Key Path	Meas Setup
Mode	LTEAFDD, LTEATDD
Initial S/W Revision	A.14.00

Result Length

Sets the maximum result length for analysis.

Result Length determines how many slots will be available for demodulation for each component carrier. This parameter is common to all component carriers, which means any change made to one component carrier will be applied to all component carriers. Measurement Interval and Measurement Offset specify what part of the result length is demodulated.

The result data starts where the analysis boundary is found and ends after the amount of data specified by Result Length.

The length of the time capture (contained in Search Time) is longer than the result length by approximately the length of the Analysis Start Boundary (frame = 10 ms, slot = 0.5 ms, etc.) to enable for location of the analysis boundary within the time capture.

NOTE

For downlink, an entire slot containing S-SS must be present in the time capture (Raw Main Time) for demodulation to occur.

For LTEATDD, the maximum Result Length is 40 slots when Direction is set to Downlink, for Uplink, the maximum Result Length is 20 slots.

Key Path	Meas Setup, Meas Time Setup
Mode	LTEAFDD, LTEATDD
Remote Command	<code>[:SENSe] :EVM:CCARrier0 1 2 3 4:TIME:RESult:LENGth <integer></code> <code>[:SENSe] :EVM:CCARrier0 1 2 3 4:TIME:RESult:LENGth?</code>
Example	<code>EVM:CCAR0:TIME:RES:LENG 20</code> <code>EVM:CCAR0:TIME:RES:LENG?</code>
Preset	20 slots
State Saved	Saved in instrument state.
Min	1 slot
Max	LTEAFDD: 20 slots LTEATDD: 40 slots for Downlink, 20 slots for Uplink
Backwards Compatibility SCPI	<code>[:SENSe] :EVM:TIME:RESult:LENGth</code>
Initial S/W Revision	A.14.00
Modified at S/W Revision	A.14.50

Meas Offset Slot

Sets the Meas Offset Slot.

Measurement Offset Slot specifies the offset from the Analysis Start Boundary to the beginning of the Measurement Interval (the data sent to the demodulator), and can be specified in slots + symbols-times.

Key Path	Meas Setup, Meas Time Setup
Mode	LTEAFDD, LTEATDD
Remote Command	[:SENSe] :EVM:CCARrier0 1 2 3 4:TIME:OFFSet:SLOT <integer> [:SENSe] :EVM:CCARrier0 1 2 3 4:TIME:OFFSet:SLOT?
Example	EVM:CCAR0:TIME:OFFS:SLOT 0 EVM:CCAR0:TIME:OFFS:SLOT?
Couplings	Max value determined by Result Length (refer to "Result Length" on page 1989)
Preset	0 slots
State Saved	Saved in instrument state.
Min	0 slots
Max	Determined by Result Length (refer to "Result Length" on page 1989)
Max	Determined by Result Length (refer to "Result Length" on page 1989)
Backwards Compatibility SCPI	[:SENSe] :EVM:TIME:OFFSet:SLOT
Initial S/W Revision	A.14.00
Modified at S/W Revision	A.14.50

Meas Offset Symbol

Sets the Meas Offset Symbol.

Measurement Offset Symbol specifies the offset from the Analysis Start Boundary to the beginning of the Measurement Interval (the data sent to the demodulator), and can be specified in slots + symbols-times.

Key Path	Meas Setup, Meas Time Setup
Mode	LTEAFDD, LTEATDD
Remote Command	[:SENSe] :EVM:CCARrier0 1 2 3 4:TIME:OFFSet:SYMBol <integer> [:SENSe] :EVM:CCARrier0 1 2 3 4:TIME:OFFSet:SYMBol?
Example	EVM:CCAR0:TIME:OFFS:SYMB 0 EVM:CCAR0:TIME:OFFS:SYMB?
Preset	0 symbols
State Saved	Saved in instrument state.
Min	0 symbols
Max	6 symbols
Backwards	[:SENSe] :EVM:TIME:OFFSet:SYMBol

Compatibility SCPI	
Initial S/W Revision	A.14.00
Modified at S/W Revision	A.14.50

Meas Interval Slot

Sets the Meas Interval Slot.

Measurement Interval determines how much data is sent to the demodulator, and can be specified in slots + symbols-times. The beginning of the measurement interval is specified as an offset from the Analysis Start Boundary. The offset is specified by the Measurement Offset parameter.

NOTE The Time Offset data result in the Error Summary trace shows the distance from the beginning of the Search Time trace to the beginning of the measurement interval.

Key Path	Meas Setup, Meas Time Setup
Mode	LTEAFDD, LTEATDD
Remote Command	<code>[:SENSe] :EVM:CCARrier0 1 2 3 4:TIME:INTerval:SLOT <integer></code> <code>[:SENSe] :EVM:CCARrier0 1 2 3 4:TIME:INTerval:SLOT?</code>
Example	EVM:CCAR0:TIME:INT:SLOT 1 EVM:CCAR0:TIME:INT:SLOT?
Couplings	Max value determined by Result Length (refer to "Result Length" on page 1989)
Preset	LTEAFDD: 6 slots LTEATDD: 6 slots
State Saved	Saved in instrument state.
Min	0 slots
Max	Determined by Result Length (refer to "Result Length" on page 1989)
Max	Determined by Result Length (refer to "Result Length" on page 1989)
Backwards Compatibility SCPI	<code>[:SENSe] :EVM:TIME:INTerval:SLOT</code>
Initial S/W Revision	A.14.00
Modified at S/W Revision	A.14.50

Meas Interval Symbol

Sets the Meas Interval Symbol.

Measurement Interval determines how much data after the measurement offset is sent to the demodulator, and can be specified in slots + symbols-times.

Key Path	Meas Setup, Meas Time Setup
----------	-----------------------------

Mode	LTEAFDD, LTEATDD
Remote Command	[:SENSe] :EVM:CCARrier0 1 2 3 4:TIME:INTerval:SYMBOL <integer> [:SENSe] :EVM:CCARrier0 1 2 3 4:TIME:INTerval:SYMBOL?
Example	EVM:CCAR0:TIME:INT:SYMB 0 EVM:CCAR0:TIME:INT:SYMB?
Preset	0 symbols
State Saved	Saved in instrument state.
Min	0 symbols
Max	6 symbols
Backwards Compatibility SCPI	[:SENSe] :EVM:TIME:INTerval:SYMBOL
Initial S/W Revision	A.14.00
Modified at S/W Revision	A.14.50

Analysis Start Boundary

Sets the Analysis Start Boundary. Analysis Start Boundary specifies the alignment boundary of the Result Length time data. To ensure that this alignment can be achieved, the total amount of data acquired by the analyzer is equal to the Result Length plus the length of the alignment boundary specified by Analysis Start Boundary. For example, if Analysis Start Boundary were set to Half-Frame, the total acquisition will be equal to ResultLength + 10 slots (and the Measurement Interval will start at a Half-Frame boundary).

Once the Result Length is located within the time capture, Measurement Offset and Measurement Interval determine the data that is to be analyzed. This data is also displayed on the Time trace.

This parameter cannot be set to Slot for downlink signals since MIMO Decoding must be applied beginning at a subframe boundary. This parameter is common to all component carriers, which means any change made to one component carrier will be applied to all component carriers.

NOTE

Since uplink signals do not contain a separate synchronization channel, the demodulator cannot determine the frame boundary exactly unless there is a unique slot in a user mapping and that unique slot is present within the Search Time data.

Key Path	Meas Setup, Meas Time Setup
Mode	LTEAFDD, LTEATDD
Remote Command	[:SENSe] :EVM:CCARrier0 1 2 3 4:TIME:ASBoundary FRAME HALF SUB SLOT [:SENSe] :EVM:CCARrier0 1 2 3 4:TIME:ASBoundary?
Example	EVM:CCAR0:TIME:ASB FRAM EVM:CCAR0:TIME:ASB?
Dependencies	When Direction is set to Downlink, SLOT cannot be selected and the softkey is grayed out. When Direction is changed to Downlink from Uplink, this parameter is set to FRAME.

Preset	FRAMe
State Saved	Saved in instrument state.
Range	Frame Half-Frame SubFrame Slot
Backwards Compatibility SCPI	[:SENSE] :EVM:TIME:ASBoundary
Initial S/W Revision	A.14.00
Modified at S/W Revision	A.14.50

Frame

Selects Frame as Analysis Start Boundary.

Key Path	Meas Setup, Meas Time Setup, Analysis Start Boundary
Mode	LTEAFDD, LTEATDD
Initial S/W Revision	A.14.00

Half-Frame

Selects Half-Frame as Analysis Start Boundary.

Key Path	Meas Setup, Meas Time Setup, Analysis Start Boundary
Mode	LTEAFDD, LTEATDD
Initial S/W Revision	A.14.00

SubFrame

Selects SubFrame as Analysis Start Boundary.

Key Path	Meas Setup, Meas Time Setup, Analysis Start Boundary
Mode	LTEAFDD, LTEATDD
Initial S/W Revision	A.14.00

Slot

Selects Slot as Analysis Start Boundary. This selection is available when Direction is Uplink.

Key Path	Meas Setup, Meas Time Setup, Analysis Start Boundary
Mode	LTEAFDD, LTEATDD
Initial S/W Revision	A.14.00

Chan Profile Setup (Downlink)

Displays a menu of commonly used channel profile setup parameters when Direction is Downlink.

Key Path	Meas Setup
Mode	LTE, LTETDD
Initial S/W Revision	Prior to A.02.00
Modified at S/W Revision	A.03.00

Detection

Determines whether or not the user allocations will be autodetected.

Downlink:

When enabled, the demodulator can perform power based auto detection or can auto detect allocations by decoding PDCCH. See the ["RB Auto Detect Mode" on page 1995](#) for more information.

Uplink:

When enabled, PUSCH, PUCCH, SRS, and PRACH allocations can be autodetected when the necessary parameters are defined.

NOTE

The LTE demodulator can perform sync slot auto detection or user-assigned auto detection for uplink signals.

To configure automatic sync slot detection, select the Auto Sync parameter on the User Mapping Editor.

To configure user-assigned auto detection, set the Auto Sync to OFF for a channel and define a sync slot with associated Per-slot Parameters (in the User Mapping Editor) to be used for initial synchronization.

User-assigned auto detection results in faster measurements than automatic sync slot detection.

Key Path	Meas Setup, Chan Profile Setup
Mode	LTE, LTETDD
Remote Command	<code>[:SENSe] :EVM:PROFile:AUTO[:DETeCt] OFF ON 0 1</code> <code>[:SENSe] :EVM:PROFile:AUTO[:DETeCt] ?</code>
Example	EVM:PROF:AUTO ON EVM:PROF:AUTO?
Couplings	This parameter is the same for Downlink and Uplink When Direction is Downlink, this parameter is coupled to the Include User (Downlink) menu. This menu is context sensitive and when Auto Include is on the user can include QPSK, 16QAM or 64QAM channels. When Off the user can include any of the user defined PDSCH channels. When direction is Uplink, this parameter is coupled to the Include User (Uplink) menu. This menu is context sensitive and when Auto Include is On the user can include channels from the Auto Detected User. When Off the user can include channels from ONE of the user defined Users.
Preset	ON
State Saved	Saved in instrument state.
Initial S/W Revision	Prior to A.02.00
Modified at S/W Revision	A.03.00

RB Auto Detect Mode

Sets the level of auto detection that the LTE demodulator uses. There are two levels of auto detection, described as follows:

- **POWER** - Power Based, User allocations are detected using codeword power levels and MIMO parameters. Detected allocations are grouped according to modulation type (QPSK, 16QAM, or 64QAM). The codeword powers (needed for EVM calculations) and Precoding type are not autodetected and need to be specified. When SpMux is selected as the precoding type, No. Layers, No. Codewords, CDD, and Codebook Idx must also be specified, and these parameters are assumed to apply to all autodetected PDSCH channels.
- **DECODE** - Decoded PDCCH, User allocations are determined by decoding PDCCH.

NOTE

The demodulator can be configured to autodetect 3GPP-defined codeword power levels when Auto Detect Power Levels is On. When codeword power levels are not autodetected, they must be specified using the CW0/1 Power parameters in the User Mapping Editor for each expected user allocation. The number of expected user allocations is set by Number of Expected DL Users and by selecting the individual users.

Key Path	Meas Setup, Chan Profile Setup
Mode	LTE, LTETDD
Remote Command	[:SENSe] :EVM:DLINk:PROFile:AUTO[:DETECT]:MODE Power DECODEd [:SENSe] :EVM:DLINk:PROFile:AUTO[:DETECT]:MODE?
Example	EVM:DLIN:PROF:AUTO:MODE POW EVM:DLIN:PROF:AUTO:MODE?
Dependencies	Available when Detection is Auto.
Preset	POWER
State Saved	Saved in instrument state.
Range	Power Based Decoded PDCCH
Initial S/W Revision	A.06.00

Auto Detect Power Levels In Power Mode

Selects whether or not power levels are autodetected when Detection is Auto and RB Auto Detect Mode is Power-based.

- **ON** - Detected allocations are grouped according to modulation type (QPSK, 16QAM, or 64QAM).
- The codeword power levels are detected also.
- **OFF** - The codeword power levels for each user allocation need to be specified for EVM calculations to be correct.

The power levels are detected as one of the levels specified by the standard in 3GPP TS 36.331, section 6.3.2 under the PDSCH-Config parameter.

These power levels are -6 dB, -4.77 dB, -3 dB, -1.77 dB, 0 dB, 1 dB, 2 dB, and 3 dB.

Key Path	Meas Setup, Chan Profile Setup, RB Auto Detect Mode, Power Based
Mode	LTEAFDD, LTEATDD
Remote Command	[:SENSe] :EVM:CCARrier0 1 2 3 4:DLINK:PROFile:AUTO[:DETect]:POWer:PMODE OFF ON 0 1 [:SENSe] :EVM:CCARrier0 1 2 3 4:DLINK:PROFile:AUTO[:DETect]:POWer:PMODE?
Example	EVM:CCAR0:DLIN:PROF:AUTO:POW:PMOD ON EVM:CCAR0:DLIN:PROF:AUTO:POW:PMOD?
Notes	When you enter the Edit User Mapping form, the RB Auto Detect Mode selection that you set before entering the form appears. You can switch the mode between Decoded PDCCH and Power Based on the Editor, however, the Auto Detect Power Levels state on the form and its softkey are still for the mode you set before entering the form and do not change even if you change the mode.
Dependencies	Available when Detection is Auto and RB Auto Detect Mode is Power based.
Preset	ON
State Saved	Saved in instrument state.
Range	On Off
Backwards Compatibility SCPI	[:SENSe] :EVM:DLINK:PROFile:AUTO[:DETect]:POWer:PMODE
Initial S/W Revision	A.14.00
Modified at S/W Revision	A.14.50

Auto Detect Power Levels

Selects whether or not power levels are autodetected.

- ON - Detects the relative PDSCH power level for each user allocation (PA). RB Auto Detect Mode must be set to Decoded PDCCH for power levels to be autodetected.
- OFF - The codeword power levels for each user allocation need to be specified for EVM calculations to be correct. The Expected Num. of Users parameter determines the number of users listed in the LTE Allocation Editor for which the power levels can be defined.

The power levels are detected as one of the levels specified by the standard in 3GPP TS 36.331, section 6.3.2 under the PDSCH-Config parameter.

These power levels are -6 dB, -4.77 dB, -3 dB, -1.77 dB, 0 dB, 1 dB, 2 dB, and 3 dB.

The autodetected power levels (P_A(n)) can be viewed on the DL Decode Info trace.

Key Path	Meas Setup, Chan Profile Setup, RB Auto Detect Mode, Decoded PDCCH
Mode	LTE, LTETDD
Remote Command	[:SENSe] :EVM:DLINK:PROFile:AUTO[:DETect]:POWer OFF ON 0 1 [:SENSe] :EVM:DLINK:PROFile:AUTO[:DETect]:POWer?
Example	EVM:DLIN:PROF:AUTO:POW ON

	EVM:DLIN:PROF:AUTO:POW?
Notes	When you enter the Edit User Mapping form, the RB Auto Detect Mode selection that you set before entering the form appears. You can switch the mode between Decoded PDCCH and Power Based on the Editor, however, the Auto Detect Power Levels state on the form and its softkey are still for the mode you set before entering the form and do not change even if you change the mode.
Dependencies	Available when Detection is Auto and RB Auto Detect Mode is Decoded PDCCH.
Preset	ON
State Saved	Saved in instrument state.
Range	On Off
Initial S/W Revision	A.06.00

Auto Detect Power Levels

Selects whether or not power levels are autodetected.

- ON - Detects the relative PDSCH power level for each user allocation (PA). RB Auto Detect Mode must be set to Decode PDCCH for power levels to be autodetected.
- OFF - The codeword power levels for each user allocation need to be specified for EVM calculations to be correct. The **Expected Num. of Users** parameter determines the number of users listed in the LTE Allocation Editor for which the power levels can be defined.

The power levels are detected as one of the levels specified by the standard in 3GPP TS 36.331, section 6.3.2 under the PDSCH-Config parameter.

These power levels are -6 dB, -4.77 dB, -3 dB, -1.77 dB, 0 dB, 1 dB, 2 dB, and 3 dB.

The autodetected power levels (P_A(n)) can be viewed on the DL Decode Info trace.

Key Path	Meas Setup, Chan Profile Setup, RB Auto Detect Mode, Decoded PDCCH
Mode	LTEAFDD, LTEATDD
Remote Command	[:SENSe] :EVM:CCARrier0 1 2 3 4:DLINK:PROFile:AUTO[:DETect]:POWer OFF ON 0 1 [:SENSe] :EVM:CCARrier0 1 2 3 4:DLINK:PROFile:AUTO[:DETect]:POWer?
Example	EVM:CCAR0:DLIN:PROF:AUTO:POW ON EVM:CCAR0:DLIN:PROF:AUTO:POW?
Notes	When you enter the Edit User Mapping form, the RB Auto Detect Mode selection that you set before entering the form appears. You can switch the mode between Decoded PDCCH and Power Based on the Editor, however, the Auto Detect Power Levels state on the form and its softkey are still for the mode you set before entering the form and do not change even if you change the mode.
Dependencies	Available Detection is Auto and RB Auto Detect Mode is Decoded PDCCH.
Preset	ON
State Saved	Saved in instrument state.
Range	On Off

Backwards Compatibility SCPI	<code>[:SENSe] :EVM:DLINk:PROFile:AUTO [:DETeCt] :POWeR</code>
Initial S/W Revision	A.14.00
Modified at S/W Revision	A.14.50

Auto Detect Power Levels In Power Mode

Selects whether or not power levels are autodetected when Detection is Auto and RB Auto Detect Mode is Power-based.

- ON - Detected allocations are grouped according to modulation type (QPSK, 16QAM, or 64QAM).
- The codeword power levels are detected also.
- OFF - The codeword power levels for each user allocation need to be specified for EVM calculations to be correct.

The power levels are detected as one of the levels specified by the standard in 3GPP TS 36.331, section 6.3.2 under the PDSCH-Config parameter.

These power levels are -6 dB, -4.77 dB, -3 dB, -1.77 dB, 0 dB, 1 dB, 2 dB, and 3 dB.

Key Path	Meas Setup, Chan Profile Setup, RB Auto Detect Mode, Power Based
Mode	LTE, LTETDD
Remote Command	<code>[:SENSe] :EVM:DLINk:PROFile:AUTO [:DETeCt] :POWeR:PMODE OFF ON 0 1</code> <code>[:SENSe] :EVM:DLINk:PROFile:AUTO [:DETeCt] :POWeR:PMODE?</code>
Example	<code>EVM:DLIN:PROF:AUTO:POW:PMOD ON</code> <code>EVM:DLIN:PROF:AUTO:POW:PMOD?</code>
Notes	When you enter the Edit User Mapping form, the RB Auto Detect Mode selection that you set before entering the form appears. You can switch the mode between Decoded PDCCH and Power Based on the Editor, however, the Auto Detect Power Levels state on the form and its softkey are still for the mode you set before entering the form and do not change even if you change the mode.
Dependencies	Available when Detection is Auto and RB Auto Detect Mode is Power based.
Preset	ON
State Saved	Saved in instrument state.
Range	On Off
Initial S/W Revision	A.14.00

Round to Standard Values

Determines whether the measured, relative power levels for PDSCH allocations are detected as one of the standard values or assumed to be equal to the measured power level.

When on, the power levels are detected as the closest standard power level. Standard power levels are specified in 3GPP TS 36.331, section 6.3.2 under the PDSCH-Config parameter. These power levels are -6

dB, -4.77 dB, -3 dB, -1.77 dB, 0 dB, 1 dB, 2 dB, and 3 dB. When off, the measured power levels are used as the actual power levels.

Key Path	Meas Setup, Chan Profile Setup
Mode	LTEAFDD, LTEATDD
Remote Command	<code>[:SENSe] :EVM:CCARrier0 1 2 3 4:DLINk:PROFile:AUTO[:DETECT]:POWer:ROUNd OFF ON 0 1</code> <code>[:SENSe] :EVM:CCARrier0 1 2 3 4:DLINk:PROFile:AUTO[:DETECT]:POWer:ROUNd?</code>
Example	EVM:CCAR0:DLIN:PROF:AUTO:POW:ROUN ON EVM:CCAR0:DLIN:PROF:AUTO:POW:ROUN?
Dependencies	Available when the following conditions are met. Direction: Downlink Detection: Auto RB Auto Detect Mode: Decoded PDCCH Auto Detect Power Levels: On.
Preset	ON
State Saved	Saved in instrument state.
Range	On Off
Backwards Compatibility SCPI	<code>[:SENSe] :EVM:DLINk:PROFile:AUTO[:DETECT]:POWer:ROUNd</code>
Initial S/W Revision	A.14.00
Modified at S/W Revision	A.14.50

Number of Expected DL Users

Specifies the number of user allocations from 1 to 50 when RB Auto Detect Mode is set to Decoded PDCCH.

Other user allocations detected from PDCCH will be shown on traces and included in calculations, but only the number of users specified with this key will be included in the Composite Include menu where they can be excluded from traces and calculations.

When Auto Detect Power levels is set to OFF, PDSCH Decoded User Power Boost must be specified. This parameter limits the number of PDSCH user allocations for which codeword power levels can be manually defined. When there are more user allocations found in the signal than are specified by this parameter, any additional user allocation will be assumed to have a PDSCH power level of 0 dB.

Key Path	Meas Setup, Chan Profile Setup
Mode	LTEAFDD, LTEATDD
Remote Command	<code>[:SENSe] :EVM:CCARrier0 1 2 3 4:DLINk:PROFile:EUSers:COUNT <integer></code> <code>[:SENSe] :EVM:CCARrier0 1 2 3 4:DLINk:PROFile:EUSers:COUNT?</code>
Example	EVM:CCAR0:DLIN:PROF:EUS:COUN 1 EVM:CCAR0:DLIN:PROF:EUS:COUN?

Dependencies	Available when Detection is Auto and RB Auto Detect Mode is Decoded PDCCH.
Preset	3
State Saved	Saved in instrument state.
Min	0
Max	50
Backwards Compatibility SCPI	[:SENSe] :EVM:DLINK:PROFile:EUSers:COUNT
Initial S/W Revision	A.14.00
Modified at S/W Revision	A.14.50

Composite Include

Displays a menu that enables the inclusion or exclusion of all channels.

Key Path	Meas Setup, Chan Profile Setup
Mode	LTEAFDD, LTEATDD
Initial S/W Revision	A.14.00

Include All

Turns On all Downlink channels.

Key Path	Meas Setup, Chan Profile Setup, Composite Include
Mode	LTEAFDD, LTEATDD
Remote Command	[:SENSe] :EVM:CCARrier0 1 2 3 4:DLINK:PROFile:INCLude:ALL
Example	EVM:CCAR0:DLIN:PROFile:INCL:ALL
Couplings	Turns On the following parameters <ul style="list-style-type: none"> • Include P-SCH • Include S-SCH • Include PBCH • Include PCFICH • Include PHICH • Include RS • Include PDCCH • All Users under the Include Users (Downlink) Menu
Backwards Compatibility SCPI	[:SENSe] :EVM:DLINK:PROFile:INCLude:ALL
Initial S/W Revision	A.14.00
Modified at S/W Revision	A.14.50

Exclude All

Turns Off all Downlink channels.

Key Path	Meas Setup, Chan Profile Setup, Composite Include
Mode	LTEAFDD, LTEATDD
Remote Command	[:SENSe] :EVM:CCARrier0 1 2 3 4:DLINk:PROFile:EXCLude:ALL
Example	EVM:CCAR0:DLIN:PROF:EXCL:ALL
Couplings	Turns Off the following parameters <ul style="list-style-type: none"> • Include P-SCH • Include S-SCH • Include PBCH • Include PCFICH • Include PHICH • Include RS • Include PDCCH • Include Non Allocation • All Users under the Include Users (Downlink) Menu
Backwards Compatibility SCPI	[:SENSe] :EVM:DLINk:PROFile:EXCLude:ALL
Initial S/W Revision	A.14.00
Modified at S/W Revision	A.14.50

Include Channels

Displays a menu that enables you to determine which channels should be included in the results.

Key Path	Meas Setup, Chan Profile Setup
Mode	LTEAFDD, LTEATDD
Initial S/W Revision	A.14.00

Include P-SS

Includes the Primary Synchronization Channel in the results.

Key Path	Meas Setup, Chan Profile Setup, Include Channels
Mode	LTEAFDD, LTEATDD
Remote Command	[:SENSe] :EVM:CCARrier0 1 2 3 4:DLINk:PROFile:PSS INCLude EXCLude [:SENSe] :EVM:CCARrier0 1 2 3 4:DLINk:PROFile:PSS?
Example	EVM:CCAR0:DLIN:PROF:PSS INCL EVM:CCAR0:DLIN:PROF:PSS?

Couplings	This parameter is set to Include when Downlink Include All is selected and set to Exclude when Downlink Exclude All is selected.
Preset	INCLude
State Saved	Saved in instrument state.
Range	Include Exclude
Backwards Compatibility SCPI	[:SENSe] :EVM:DLINK:PROFile:PSS
Initial S/W Revision	A.14.00
Modified at S/W Revision	A.14.50

Include S-SS

Includes the Secondary Synchronization Channel in the results.

Key Path	Meas Setup, Chan Profile Setup, Include Channels
Mode	LTEAFDD, LTEATDD
Remote Command	[:SENSe] :EVM:CCARrier0 1 2 3 4:DLINK:PROFile:SSS INCLude EXCLude [:SENSe] :EVM:CCARrier0 1 2 3 4:DLINK:PROFile:SSS?
Example	EVM:CCAR0:DLIN:PROF:SSS INCL EVM:CCAR0:DLIN:PROF:SSS?
Couplings	This parameter is set to Include when Downlink Include All is selected and set to Exclude when Downlink Exclude All is selected.
Preset	INCLude
State Saved	Saved in instrument state.
Range	Include Exclude
Backwards Compatibility SCPI	[:SENSe] :EVM:DLINK:PROFile:SSS
Initial S/W Revision	A.14.00
Modified at S/W Revision	A.14.50

Include PBCH

Includes PBCH in the results.

Key Path	Meas Setup, Chan Profile Setup, Include Channels
Mode	LTEAFDD, LTEATDD
Remote Command	[:SENSe] :EVM:CCARrier0 1 2 3 4:DLINK:PROFile:PBCH INCLude EXCLude [:SENSe] :EVM:CCARrier0 1 2 3 4:DLINK:PROFile:PBCH?
Example	EVM:CCAR0:DLIN:PROF:PBCH INCL

	EVM:CCAR0:DLIN:PROF:PBCH?
Couplings	This parameter is set to Include when Downlink Include All is selected and set to Exclude when Downlink Exclude All is selected.
Preset	INCLude
State Saved	Saved in instrument state.
Range	Include Exclude
Backwards Compatibility SCPI	[:SENSe] :EVM:DLINk:PROFile:PBCH
Initial S/W Revision	A.14.00
Modified at S/W Revision	A.14.50

Include PCFICH

Includes PCFICH in the results.

Key Path	Meas Setup, Chan Profile Setup, Include Channels
Mode	LTEAFDD, LTEATDD
Remote Command	[:SENSe] :EVM:CCARrier0 1 2 3 4:DLINk:PROFile:PCFich INCLude EXCLude [:SENSe] :EVM:CCARrier0 1 2 3 4:DLINk:PROFile:PCFich?
Example	EVM:CCAR0:DLIN:PROF:PCF INCL EVM:CCAR0:DLIN:PROF:PCF?
Couplings	This parameter is set to Include when Downlink Include All is selected and set to Exclude when Downlink Exclude All is selected.
Preset	INCLude
State Saved	Saved in instrument state.
Range	Include Exclude
Backwards Compatibility SCPI	[:SENSe] :EVM:DLINk:PROFile:PCFich
Initial S/W Revision	A.14.00
Modified at S/W Revision	A.14.50

Include PHICH

Includes PHICH in the results.

Key Path	Meas Setup, Chan Profile Setup, Include Channels
Mode	LTEAFDD, LTEATDD
Remote Command	[:SENSe] :EVM:CCARrier0 1 2 3 4:DLINk:PROFile:PHIch INCLude EXCLude [:SENSe] :EVM:CCARrier0 1 2 3 4:DLINk:PROFile:PHIch?

Example	EVM:CCAR0:DLIN:PROF:PHIC INCL EVM:CCAR0:DLIN:PROF:PHIC?
Couplings	This parameter is set to Include when Downlink Include All is selected and set to Exclude when Downlink Exclude All is selected.
Preset	INCLude
State Saved	Saved in instrument state.
Range	Include Exclude
Backwards Compatibility SCPI	[:SENSe] :EVM:DLINK:PROFile:PHICh
Initial S/W Revision	A.14.00
Modified at S/W Revision	A.14.50

Include C-RS

Includes RS in the results.

Key Path	Meas Setup, Chan Profile Setup, Include Channels
Mode	LTEAFDD, LTEATDD
Remote Command	[:SENSe] :EVM:CCARrier0 1 2 3 4:DLINK:PROFile:RS INCLude EXCLude [:SENSe] :EVM:CCARrier0 1 2 3 4:DLINK:PROFile:RS?
Example	EVM:CCAR0:DLIN:PROF:RS INCL EVM:CCAR0:DLIN:PROF:RS?
Couplings	This parameter is set to Include when Downlink Include All is selected and set to Exclude when Downlink Exclude All is selected.
Preset	INCLude
State Saved	Saved in instrument state.
Range	Include Exclude
Backwards Compatibility SCPI	[:SENSe] :EVM:DLINK:PROFile:RS
Initial S/W Revision	A.14.00
Modified at S/W Revision	A.14.50

Include PDCCH

Includes PDCCH in the results.

Key Path	Meas Setup, Chan Profile Setup, Include Channels
Mode	LTEAFDD, LTEATDD
Remote Command	[:SENSe] :EVM:CCARrier0 1 2 3 4:DLINK:PROFile:PDCCh INCLude EXCLude

	<code>[:SENSe] :EVM:CCARrier0 1 2 3 4:DLINk:PROFile:PDCC?</code>
Example	EVM:CCAR0:DLIN:PROF:PDCC INCL EVM:CCAR0:DLIN:PROF:PDCC?
Couplings	This parameter is set to Include when Downlink Include All is selected and set to Exclude when Downlink Exclude All is selected.
Preset	INCLude
State Saved	Saved in instrument state.
Range	Include Exclude
Backwards Compatibility SCPI	<code>[:SENSe] :EVM:DLINk:PROFile:PDCC</code>
Initial S/W Revision	A.14.00
Modified at S/W Revision	A.14.50

Include P-RS

Includes the Position Reference Channel in the results.

Key Path	Meas Setup, Chan Profile Setup, Include Channels
Mode	LTEAFDD, LTEATDD
Remote Command	<code>[:SENSe] :EVM:CCARrier0 1 2 3 4:DLINk:PROFile:PRS INCLude EXCLude</code> <code>[:SENSe] :EVM:CCARrier0 1 2 3 4:DLINk:PROFile:PRS?</code>
Example	EVM:CCAR0:DLIN:PROF:PRS INCL EVM:CCAR0:DLIN:PROF:PRS?
Dependencies	Available when P-RS Active is On. Otherwise, this key is grayed out.
Couplings	This parameter is set to Include when Downlink Include All is selected and set to Exclude when Downlink Exclude All is selected.
Preset	EXCLude
State Saved	Saved in instrument state.
Range	Include Exclude
Backwards Compatibility SCPI	<code>[:SENSe] :EVM:DLINk:PROFile:PRS</code>
Initial S/W Revision	A.14.00
Modified at S/W Revision	A.14.50

Include MBSFN-RS

Includes the MBSFN-RS channel in the results.

Key Path	Meas Setup, Chan Profile Setup, Include Channels
----------	--

Mode	LTEAFDD, LTEATDD
Remote Command	[:SENSe] :EVM:CCARrier0 1 2 3 4:DLINK:PROFile:MBSFn INCLude EXCLude [:SENSe] :EVM:CCARrier0 1 2 3 4:DLINK:PROFile:MBSFn?
Example	EVM:CCAR0:DLIN:PROF:MBSF INCL EVM:CCAR0:DLIN:PROF:MBSF?
Dependencies	Available when MBSFN Active is On. Otherwise, this key is grayed out.
Couplings	This parameter is set to Include when Downlink Include All is selected and set to Exclude when Downlink Exclude All is selected.
Preset	EXCLude
State Saved	Saved in instrument state.
Range	Include Exclude
Backwards Compatibility SCPI	[:SENSe] :EVM:DLINK:PROFile:MBSFn
Initial S/W Revision	A.14.00
Modified at S/W Revision	A.14.50

Include PMCH

Includes the PMCH channel in the results.

Key Path	Meas Setup, Chan Profile Setup, Include Channels
Mode	LTEAFDD, LTEATDD
Remote Command	[:SENSe] :EVM:CCARrier0 1 2 3 4:DLINK:PROFile:PMCH INCLude EXCLude [:SENSe] :EVM:CCARrier0 1 2 3 4:DLINK:PROFile:PMCH?
Example	EVM:CCAR0:DLIN:PROF:PMCH INCL EVM:CCAR0:DLIN:PROF:PMCH?
Dependencies	Available when MBSFN Active is On. Otherwise, this key is grayed out.
Couplings	This parameter is set to Include when Downlink Include All is selected and set to Exclude when Downlink Exclude All is selected.
Preset	EXCLude
State Saved	Saved in instrument state.
Range	Include Exclude
Backwards Compatibility SCPI	[:SENSe] :EVM:DLINK:PROFile:PMCH
Initial S/W Revision	A.14.00
Modified at S/W Revision	A.14.50

Include CSI-RS

Includes the CSI-RS in the results.

Key Path	Meas Setup, Chan Profile Setup, Include Channels
Mode	LTEAFDD, LTEATDD
Remote Command	[[:SENSe]:EVM:CCARrier0 1 2 3 4:DLINK:PROFile:CSIRs INCLude EXCLude [:SENSe]:EVM:CCARrier0 1 2 3 4:DLINK:PROFile:CSIRs?
Example	EVM:CCAR0:DLIN:PROF:CSIR INCL EVM:CCAR0:DLIN:PROF:CSIR?
Notes	The parameter can be enabled with 9080B/9082B-2FP license
Dependencies	Available when CSI-RS Active is On. Otherwise, this key is grayed out.
Couplings	This parameter is set to Include when Downlink Include All is selected and set to Exclude when Downlink Exclude All is selected.
Preset	EXCLude
State Saved	Saved in instrument state.
Range	Include Exclude
Backwards Compatibility SCPI	[[:SENSe]:EVM:DLINK:PROFile:CSIRs
Initial S/W Revision	A.14.00
Modified at S/W Revision	A.14.50

Include Non Allocation

Includes the inactive signals in the results.

Key Path	Meas Setup, Chan Profile Setup, Include Channels
Mode	LTEAFDD, LTEATDD
Remote Command	[[:SENSe]:EVM:CCARrier0 1 2 3 4:PROFile:NALLocation INCLude EXCLude [:SENSe]:EVM:CCARrier0 1 2 3 4:PROFile:NALLocation?
Example	EVM:CCAR0:PROF:NALL EXCL EVM:CCAR0:PROF:NALL?
Couplings	This parameter is same for Downlink and Uplink When either Downlink Exclude All or Uplink Exclude All is selected, this parameter is set to Exclude.
Preset	EXCLude
State Saved	Saved in instrument state.
Range	Include Exclude
Backwards Compatibility SCPI	[[:SENSe]:EVM:PROFile:NALLocation
Initial S/W Revision	A.14.00
Modified at S/W Revision	A.14.50

Include Users (Downlink)

Displays a menu that enables you to determine which PDSCH channels should be included in the results.

When set to Include, the corresponding user mapping is displayed on appropriate traces. When set to Exclude, only the Frame Summary trace will display the user mapping.

Key Path	Meas Setup, Chan Profile Setup
Mode	LTEAFDD, LTEATDD
Initial S/W Revision	A.14.00

User

Indexes the currently defined Users.

Key Path	Meas Setup, Chan Profile Setup, Include Users
Mode	LTEAFDD, LTEATDD
Dependencies	Available when Detection is Manual. You need to set allocations to the user in advance. Otherwise, this key is grayed out.
Couplings	Max value determined by the number of Users the user has configured
Preset	0
State Saved	Saved in instrument state.
Min	1
Max	Determined by the number of Users the user has configured
Initial S/W Revision	A.14.00

Include PDSCH

Includes the user defined channel PDSCH in the results.

Key Path	Meas Setup, Chan Profile Setup, Include Users
Mode	LTEAFDD, LTEATDD
Remote Command	<code>[:SENSe] :EVM:CCARrier0 1 2 3 4:DLINK:PROFile:USER<n>:PDSCh INCLude EXCLude</code> <code>[:SENSe] :EVM:CCARrier0 1 2 3 4:DLINK:PROFile:USER<n>:PDSCh?</code>
Example	<code>EVM:CCAR0:DLIN:PROF:USER1:PDSC EXCL</code> <code>EVM:CCAR0:DLIN:PROF:USER1:PDSC?</code>
Dependencies	The range of sub op code <n> values is determined by the number of Users the user has configured. If the user attempts to remotely set or query a sub op code that is out of range, this will result in an error message. Available when Detection is Manual. You need to set allocations to the user in advance. Otherwise, this key is grayed out.

Couplings	This parameter is set to Include when Downlink Include All is selected and set to Exclude when Downlink Exclude All is selected.
Preset	EXCLude
State Saved	Saved in instrument state.
Range	Include Exclude
Backwards Compatibility SCPI	[:SENSe] :EVM:DLINk:PROFile:USER<n>:PDSCh
Initial S/W Revision	A.14.00
Modified at S/W Revision	A.14.50

Include Decoded PDSCH

Includes the user defined channel Decoded PDSCH in the results.

Key Path	Meas Setup, Chan Profile Setup, Include Users
Mode	LTEAFDD, LTEATDD
Remote Command	[:SENSe] :EVM:CCARrier0 1 2 3 4:DLINk:PROFile:USER<n>:DECoded:PDSCh INCLude EXCLude [:SENSe] :EVM:CCARrier0 1 2 3 4:DLINk:PROFile:USER<n>:DECoded:PDSCh?
Example	EVM:CCAR0:DLIN:PROF:USER1:DEC:PDSC EXCL EVM:CCAR0:DLIN:PROF:USER1:DEC:PDSC?
Dependencies	The range of sub op code <n> values is determined by the Number of Expected DL Users the user has configured. If the user attempts to remotely set or query a sub op code that is out of range, this will result in an error message. Available When Detection is Auto, RB Auto Detect Mode is Decoded PDCCH, User and Decoded PDSCH are available.
Couplings	This parameter is set to Include when Downlink Include All is selected, and set to Exclude when Downlink Exclude All is selected.
Preset	INCLude
State Saved	Saved in instrument state.
Range	Include Exclude
Backwards Compatibility SCPI	[:SENSe] :EVM:DLINk:PROFile:USER<n>:DECoded:PDSCh
Initial S/W Revision	A.14.00
Modified at S/W Revision	A.14.50

Include QPSK

Includes channels using QPSK Mod Type in the results.

Key Path	Meas Setup, Chan Profile Setup, Include Users
Mode	LTEAFDD, LTEATDD
Remote Command	[:SENSe] :EVM:CCARrier0 1 2 3 4:DLINK:PROFile:QPSK INCLude EXCLude [:SENSe] :EVM:CCARrier0 1 2 3 4:DLINK:PROFile:QPSK?
Example	EVM:CCAR0:DLIN:PROF:QPSK INCL EVM:CCAR0:DLIN:PROF:QPSK?
Dependencies	Enabled when PDSCH Detection is Auto.
Couplings	This parameter is set to Include when Downlink Include All is selected and set to Exclude when Downlink Exclude All is selected.
Preset	INCLude
State Saved	Saved in instrument state.
Range	Include Exclude
Backwards Compatibility SCPI	[:SENSe] :EVM:DLINK:PROFile:QPSK
Initial S/W Revision	A.14.00
Modified at S/W Revision	A.14.50

Include 16QAM

Includes channels using 16QAM Mod Type in the results.

Key Path	Meas Setup, Chan Profile Setup, Include Users
Mode	LTEAFDD, LTEATDD
Remote Command	[:SENSe] :EVM:CCARrier0 1 2 3 4:DLINK:PROFile:QAM16 INCLude EXCLude [:SENSe] :EVM:CCARrier0 1 2 3 4:DLINK:PROFile:QAM16?
Example	EVM:CCAR0:DLIN:PROF:QAM16 INCL EVM:CCAR0:DLIN:PROF:QAM16?
Dependencies	Enabled when PDSCH Detection is Auto.
Couplings	This parameter is set to Include when Downlink Include All is selected and set to Exclude when Downlink Exclude All is selected.
Preset	INCLude
State Saved	Saved in instrument state.
Range	Include Exclude
Backwards Compatibility SCPI	[:SENSe] :EVM:DLINK:PROFile:QAM16
Initial S/W Revision	A.14.00
Modified at S/W Revision	A.14.50

Include 64QAM

Includes channels using 64QAM Mod Type in the results.

Key Path	Meas Setup, Chan Profile Setup, Include Users
Mode	LTEAFDD, LTEATDD
Remote Command	[:SENSe] :EVM:CCARrier0 1 2 3 4:DLINk:PROFile:QAM64 INCLude EXCLude [:SENSe] :EVM:CCARrier0 1 2 3 4:DLINk:PROFile:QAM64?
Example	EVM:CCAR0:DLIN:PROF:QAM64 INCL EVM:CCAR0:DLIN:PROF:QAM64?
Dependencies	Enabled when Downlink Detection is Auto.
Couplings	This parameter is set to Include when Downlink Include All is selected and set to Exclude when Downlink Exclude All is selected.
Preset	INCLUDE
State Saved	Saved in instrument state.
Range	Include Exclude
Backwards Compatibility SCPI	[:SENSe] :EVM:DLINk:PROFile:QAM64
Initial S/W Revision	A.14.00
Modified at S/W Revision	A.14.50

Edit Control Channels

Displays a dialog that enables you to edit the Downlink Control Channel parameters. When a parameter is selected, the corresponding softkeys will appear.

You can set the Power Boost parameter for P-SS, S-SS, PBCH, PCFICH, RS, PDCCH, and PHICH. There are also several other PDCCH and PHICH parameters.

Power Boost (for all physical channels except PHICH) specifies the expected average subcarrier power of a channel. When there are multiple antenna ports, the Power Boost value is split equally over all antenna ports.

For example, PBCH Power Boost is set to 0 dB. For a single-antenna signal, the expected average subcarrier power of PBCH would be 0 dB, but for a two-antenna signal, the expected average subcarrier power of PBCH per antenna port would be -3 dB.

This is done so that specifying a channel's Power Boost parameter is like specifying the average power of the channel being transmitted from the base station regardless of the number of transmit antennas.

NOTE

When P-SS/S-SS Antenna Port is set to Port 0-3, the P-SS/S-SS Power Boost parameter specifies the expected average subcarrier power of P-SS/S-SS on the specified antenna port (in other words, the value is not split across all antenna ports). However, when P-SS/S-SS Antenna Port is set to All Port, then the Power Boost value is split across all antenna ports like the other channels.

Other power boost parameters are expressed relative to the 0 dB level set by RS Power Boost. A value of 2.5 dB for RS Power Boost specifies that the 0 dB level is set to be 2.5 dB below the measured RS power level.

For example, setting PBCH Power Boost to 0.5 dB for a single-antenna signal when RS Power Boost is set to 2.5 dB tells the demodulator to expect the PBCH power level to be 0.5 dB above the 0 dB level (which is 2.0 dB below the measured RS power level).

- Use Tab key to select a parameter field to edit. The rotary knob can be also used to select a parameter field as it has two functions: value adjustment (default) and field navigation. Use Enter key to toggle the function.
- In order to apply or discard changes, select OK button or Cancel button on the editor to show the corresponding softkeys and press either of them. These softkeys also appear by pressing Cancel (Esc) key when the active function is disabled.

NOTE If Help is open when you select this key, the dialog and menu does not appear. Close Help by pressing **Cancel (Esc)**, then select this key. After the menu has changed, press the green **Help** key to see Help for the dialog and keys. Close Help when you are ready to edit the parameters.

Key Path	Meas Setup, Chan Profile Setup, More
Mode	LTEAFDD, LTEATDD
Initial S/W Revision	A.14.00

Edit User Mapping (Downlink)

Displays the LTE Allocation Editor that enables you to edit the Downlink channel parameters. When a parameter is selected, the corresponding softkeys will appear.

- Use Tab key to select a parameter field to edit. The rotary knob can be also used to select a parameter field as it has two functions: value adjustment (default) and field navigation. Use Enter key to toggle the function.
- In order to apply or discard changes, select OK button or Cancel button on the editor to show the corresponding softkeys and press either of them. These softkeys also appear by pressing Cancel (Esc) key when the active function is disabled.

NOTE If Help is open when you select this key, the dialog and menu does not appear. Close Help by pressing **Cancel (Esc)**, then select this key. After the menu has changed, press the green **Help** key to see Help for the dialog and keys. Close Help when you are ready to edit the parameters.

Key Path	Meas Setup, Chan Profile Setup
Mode	LTEAFDD, LTEATDD
Initial S/W Revision	A.14.00

This table lists all the parameters available to set up downlink PDSCH user allocations.

Parameter	Description
Detection	When Auto, the demodulator will autodetect PDSCH user allocations. The only parameter needed is Power Boost (for EVM calculations). RB Autodetect groups resource blocks that contain the same modulation type into a user so that there are three possible users: QPSK, QAM16, and QAM64.
RB Auto Detect Mode	Specifies how the LTE demodulator detects user allocations when Detection is Auto.
Auto Detect Power Levels	Selects whether or not power levels are autodetected. Enabled only when RB Auto Detect is On and RB Auto Detect Mode is Decoded PDCCH.
Use Per Antenna EPRE	Determines whether the EPRE is interpreted as energy per antenna port or the sum total of energies contributed by all antenna ports involved. When it is On, EPRE is interpreted as energy per antenna port.
Multi-Frame Analysis	When On, the demodulator enables user to setup PDSCH allocations for two continuous frames. This parameter needs to be set to On when the signal under analysis is complied with E-UTRA TDD Test Models defined in 3GPP TS36.141 6.1.1 V8.2.0.
Show Mapping	Specifies which frame's allocation will be shown in RB Mapping diagram when Multi-Frame Analysis is On.
Include	When this check box is selected, the corresponding user mapping is displayed on appropriate traces. When cleared, only the Frame Summary trace will display the user mapping.
Add	Adds a user mapping.
Delete	Deletes the selected user mapping.
RNTI	Sets the radio network temporary identifier for the user. Enabled only when Detection is manual. (TDD only)
UE-RS Active	Selects whether the UE-specific reference signal is present in the signal under test. Enabled only when Detection is manual. (TDD only)
UE-RS Include	Selects whether the UE-specific reference signal is included in the analysis results. Enabled only when UE-RS Active is On and Detection is manual. (TDD only)
UE-RS Power	Specifies the power boost for the UE-specific reference signal. Enabled only when Detection is manual. (TDD only)
UE-RS Port	Specifies on which logical antenna port UE-RS is transmitted for the selected PDSCH user allocation. (TDD only)
UE-RS nSCID	Specifies downlink user's scrambling identity value nSCID(TDD only)
Precoding Parameters	
Precoding	Specifies the type of shared channel precoding method that the demodulator should expect.
Number of layers	Specifies the number of layers. It's less than or equal to the number of antenna ports used for transmission of the physical channel.
Number of codewords	Specifies the number of codewords.
CDD	Specifies whether precoding will be done with or without CDD (cyclic delay diversity) for spatial multiplexing.
Codebook Index	Specifies the Codebook index for spatial multiplexing precoding.

PDSCH Per-allocation Parameters	
Couple	Certain parameters can be coupled across all RB allocation groups for a user or can be set independently for each RB allocation group. Selecting the checkbox next to a parameter will couple that parameter across all RB allocation groups.
RB Start	Specifies the RB start boundary of the current allocation group for the current user.
RB End	Specifies the RB end boundary of the current allocation group for the current user.
Slot Start	Specifies the slot start boundary of the current allocation group for the current user.
Slot End	Specifies the slot end boundary of the current allocation group for the current user.
Allocation EPRE	Sets the EPRE value for the selected Allocation.
Codeword 0 Mod Type	Modulation type for codeword 0: QPSK, QAM16, or QAM64.
Codeword 1 Mod Type	Modulation type for codeword 1: QPSK, QAM16, or QAM64.
Codeword 0 Power Boost	The power of the subcarriers relative to the 0 dB level determined by the RS power level for codeword 0. See Chan Profile Setup (Downlink) for more information.
Codeword 1 Power Boost	The power of the subcarriers relative to the 0 dB level determined by the RS power level for codeword 1. See Chan Profile Setup (Downlink) for more information.
Frame Index	<i>Specifies which frame of the current allocation for the current user belongs to.</i>
Add	Adds an allocation to the selected user.
Delete	Deletes the selected allocation.

OK/Cancel

Displays a menu that enables the changes to the parameters on the dialog to be applied or cancelled.

Mode	LTEAFDD, LTEATDD
Initial S/W Revision	A.14.00

OK

Applies all changes made to the parameters on the dialog then exits the dialog.

Mode	LTEAFDD, LTEATDD
Initial S/W Revision	A.14.00

Cancel

Cancels all changes made to the parameters on the dialog then exits the dialog.

Mode	LTEAFDD, LTEATDD
Initial S/W Revision	A.14.00

Count Number of Users (Downlink)

SCPI Only. This command returns the number of added users.

Mode	LTEAFDD, LTEATDD
Remote Command	[:SENSe] :EVM:CCARrier0 1 2 3 4:DLINK:PROFile:COUNT?
Example	EVM:CCAR0:DLIN:PROF:COUN?
Backwards Compatibility SCPI	[:SENSe] :EVM:DLINK:PROFile:COUNT
Initial S/W Revision	A.14.00
Modified at S/W Revision	A.14.50

Count Number of PDSCH Allocations (Downlink)

SCPI Only. This command returns the number of added PDSCH allocations.

Mode	LTEAFDD, LTEATDD
Remote Command	[:SENSe] :EVM:CCARrier0 1 2 3 4:DLINK:PROFile:USER<n>:PDSCh:COUNT?
Example	EVM:CCAR0:DLIN:PROF:USER2:PDSC:COUN?
Dependencies	The range of sub op code <n> values is determined by the number of Users the user has configured. If the user attempts to remotely set or query a sub op code that is out of range, this will result in an error message.
Backwards Compatibility SCPI	[:SENSe] :EVM:DLINK:PROFile:USER<n>:PDSCh:COUNT
Initial S/W Revision	A.14.00
Modified at S/W Revision	A.14.50

Copy Auto -> Manual

Copies all autodetected allocations into the Resource Block Editor.

For downlink, when Copy Auto -> Manual is pressed, each autodetected modulation group will be assigned to a user. When RB Auto Detect Mode is set to Power Based, User_01 will contain resource blocks with QPSK; User_02 will contain resource blocks with 16QAM; and User_03 will contain resource blocks with 64QAM.

When RB Auto Detect Mode is set to Decode PDCCH, the user allocations will be copied into the LTE Allocation Editor as manual allocations.

For uplink, when Copy Auto -> Manual is pressed, User_01, which contains all autodetected channels, will be copied into the LTE Allocation Editor.

This key is useful when you have two signals with identical allocations, where one has a fairly good SNR, but the other has a low SNR. In this case, RB Auto Detect may detect the allocations for the noisy signal incorrectly. To work around this, you can recall the clean signal, autodetect allocations, and press Copy Auto -> Manual. Then you can recall the noisy signal and don't need to rely on auto detection.

Note that existing manual user mappings will be overwritten when you press this button.

Key Path	Meas Setup, Chan Profile Setup
Mode	LTEAFDD, LTEATDD
Remote Command	[:SENSe] :EVM:CCARrier0 1 2 3 4:PROFile:COPIY[:IMMediate]
Example	EVM:CCAR0:PROF:COPIY
Notes	Available when Detection is Auto.
Backwards Compatibility SCPI	[:SENSe] :EVM:PROFile:COPIY[:IMMediate]
Initial S/W Revision	A.14.00
Modified at S/W Revision	A.14.50

Copy CC To

This parameter provides parameter copy function of selected Component Carrier to another Component Carrier or all Component Carrier.

NOTE

This parameter copies LTE-Advanced demodulation parameters from one Component Carrier to other Component Carrier or all Component Carriers.

Key Path	Meas Setup
Mode	LTEAFDD, LTEATDD
Remote Command	[:SENSe] :EVM:COPIY CC0 CC1 CC2 CC3 CC4 All
Example	EVM:COPIY All
Notes	The options CC0~CC4 can be enabled with 9080B/9082B-2FP license.
Couplings	Copy the parameters settings of selected Component Carrier to the target Component Carrier.
Preset	All
State Saved	Saved in instrument state.
Range	CC0 CC1 CC2 CC3 CC4 All
Initial S/W Revision	A.14.00

Decode

Displays a menu that enables you to configure RA-RNTI and TPC-RNTI search ranges and what level of decoding to perform on PBCH, PCFICH, PDCCH, PDSCH, and PUSCH.

Key Path	Meas Setup
Initial S/W Revision	A.14.00

Decode Type

Displays a menu that enables you to select the decoding type of each channel. The decoded symbols will be displayed in the Decoded Symbol Table.

Key Path	Meas Setup, Decode
Initial S/W Revision	A.14.00

PBCH Decoding

Selects the decoding type of the PBCH. It specifies how much coding to undo before showing the Master Information Block (MIB) bits from PBCH on the Decoded Symbol Table. See 3GPP TS 36.212, Section 5.3.1 for a diagram of the coding operations performed on PBCH.

The following is a list of the available PBCH decoding type selections and the resulting bits:

- NONE – None, no bits for this channel will be shown on the Decoded Symbol Table.
- DESCrambled – Descrambled, 480 (Normal CP) or 432 (Extended CP) descrambled (rate-matched) bits for each subframe 0 in a frame
- DRMatched – DeRateMatched, 120 deratematched (channel coded) bits for each subframe 0 in a frame
- DECOded – 40 (information bits + CRC) bits for each subframe 0 in a frame

NOTE The PBCH decoder is On when PBCH Decoding is not set to None or when PHICH Duration or PHICH Allocation (Ng) are set to Auto Detect.

Parameter Name	PBCH Decoding
Key Path	Meas Setup, Decode, Decode Type
Parameter Type	EnumParameter
Mode	LTEAFDD, LTEATDD
Remote Command	[:SENSe]:EVM:CCARrier0 1 2 3 4:DLINk:DECode:PBCH NONE DESCrambled DRMatched DECOded [:SENSe]:EVM:CCARrier0 1 2 3 4:DLINk:DECode:PBCH?
Example	EVM:CCAR0:DLIN:DEC:PBCH NONE EVM:CCAR0:DLIN:DEC:PBCH?
Notes	Available when Direction is Downlink.
Force Restart	Yes
State Saved	Saved in instrument state.

Range	None Descrambled DeRateMatched Decoded
Softkey Label	PBCH
Backwards Compatibility SCPI	[:SENSe] :EVM:DLINK:DECode:PBCH
Initial S/W Revision	A.14.00
Modified at S/W Revision	A.14.50

PCFICH Decoding

Selects the decoding type of the PCFICH. It specifies how much coding to undo before showing the bits from PCFICH on the Decoded Symbol Table. See 3GPP TS 36.212, Section 5.3.4 for a diagram of the coding operations performed to PCFICH.

The following is a list of the available PCFICH decoding type selections and the resulting bits:

- NONE – None, no bits for this channel will be shown on the Decoded Symbol Table.
- DESCrambled – Descrambled, 32 descrambled (channel coded) bits per subframe
- DECodeD – Decoded, 2 decoded bits (CFI) per subframe

NOTE

The PCFICH decoder is On when PCFICH Decoding is not set to None or when PDCCH Allocation Auto Detect is set to On.

Parameter Name	PCFICH Decoding
Key Path	Meas Setup, Decode, Decode Type
Parameter Type	EnumParameter
Mode	LTEAFDD, LTEATDD
Remote Command	[:SENSe] :EVM:CCARrier0 1 2 3 4:DLINK:DECode:PCFich NONE DESCrambled DECodeD [:SENSe] :EVM:CCARrier0 1 2 3 4:DLINK:DECode:PCFich?
Example	EVM:CCAR0:DLIN:DEC:PCF NONE EVM:CCAR0:DLIN:DEC:PCF?
Notes	Available when Direction is Downlink.
Force Restart	Yes
State Saved	Saved in instrument state.
Range	None Descrambled Decoded
Softkey Label	PCFICH
Backwards Compatibility SCPI	[:SENSe] :EVM:DLINK:DECode:PCFich
Initial S/W Revision	A.14.00
Modified at S/W Revision	A.14.50

PDCCH Decoding

Selects the decoding type of the PDCCH. It specifies how much coding to undo before showing the bits from PDCCH on the Decoded Symbol Table. See 3GPP TS 36.212, Section 5.3.1 for a diagram of the coding operations performed on PDCCH.

The following is a list of the available PDCCH decoding type selections and the resulting bits. NREG is the number of resource element groups not allocated for PHICH or PCFICH in a subframe.

- NONE – None, no PDCCH bits will be shown in the Decoded Symbol Table.
- DEMapped – Demapped, NREG*8 demapped (interleaved) DCI format bits for each subframe
- DINTErleaved – Deinterleaved, NREG*8 deinterleaved (scrambled) DCI format bits for each subframe
- DESCrambled – Descrambled, NREG*8 descrambled (rate-matched) bits for each subframe
- DRMatched – DeRateMatched, $\Sigma (8 + LEN_i)$ bits for each subframe
- Each set of bits for an active PDCCH transmission consists of an 8-bit length field (LEN_i) followed by the deratematched (channel coded) bits.
- LEN_i indicates the number of deratematched bits for the i th PDCCH transmission in a subframe and can be used to determine where a PDCCH ends and the next PDCCH begins in the Decoded Symbol Table.
- $LEN_i = 3 * (\text{DCI Payload Length} + \text{CRC Length})$
- DECoded – Decoded, $\Sigma (8 + LEN_i)$ bits for each subframe
- Each set of bits for an active PDCCH transmission consists of an 8-bit length field (LEN_i), the decoded (DCI payload + CRC) bits, and the 16-bit CRC.
- LEN_i indicates the number of decoded bits (including CRC) for the i th PDCCH transmission in a subframe and can be used to determine where a PDCCH ends and the next PDCCH begins in the Decoded Symbol Table.
- $LEN_i = \text{DCI Payload Length} + \text{CRC Length}$

NOTE

For both Deratematched and Decoded PDCCH bits, the analyzer auto-detects the number of active PDCCH transmitted within each subframe, nPDCCH.

The PDCCH decoder is On when RB Auto Detect Mode is set to Decode PDCCH or when PDCCH Decoding is not set to None.

Parameter Name	PDCCH Decoding
Key Path	Meas Setup, Decode, Decode Type
Parameter Type	EnumParameter
Mode	LTEAFDD, LTEATDD
Remote Command	[:SENSe] :EVM:CCARrier0 1 2 3 4 :DLINk:DECode:PDCC NONE DEMapped DINTErleaved DESCrambled DRMatched DECoded [:SENSe] :EVM:CCARrier0 1 2 3 4 :DLINk:DECode:PDCC?
Example	EVM:CCAR0:DLIN:DEC:PDCC NONE EVM:CCAR0:DLIN:DEC:PDCC?

Notes	Available when Direction is Downlink.
Force Restart	Yes
State Saved	Saved in instrument state.
Range	None Demapped Deinterleaved Descrambled DeRateMatched Decoded
Softkey Label	PDCCH
Backwards Compatibility SCPI	[:SENSe] :EVM:DLINk:DECode:PDCCh
Initial S/W Revision	A.14.00
Modified at S/W Revision	A.14.50

PDSCH Decoding

Selects the decoding type of the PDSCH. It specifies how much coding to undo before showing the bits from PDSCH on the Decoded Symbol Table. See 3GPP TS 36.212, Section 5.3.2 for a diagram of the coding operations performed on PDSCH. The following is a list of the available PDSCH decoding type selections and the resulting bits:

- NONE - None, no bits for this channel will be shown on the Decoded Symbol Table.
- DESCrambled - Descrambled, descrambled (rate-matched) bits for each subframe
- DRMatched – DeRateMatched, $\Sigma (16 + LEN_i)$ bits per subframe
- Each set of bits for a PDSCH transmission consists of a 16-bit length field (LEN_i) followed by the deratematched (channel coded) bits.
- LEN_i indicates the number of deratematched bits for the i th PDSCH allocation in a subframe and can be used to determine where one set of deratematched bits ends and the next set begins in the Decoded Symbol Table.
- $LEN_i = 3 * (\text{Codeblock Length} + \text{CRC Length} + \text{Trellis Termination Bit Length})$ where Trellis Termination Bit Length = 4.
- DCBLoCk – Decoded CB, $\Sigma (16 + LEN_i)$ bits per subframe
- Each set of bits for a PDSCH codeblock consists of a 16-bit length field (LEN_i), the decoded codeblock bits, and a 24-bit CRC. When codeblock segmentation is not performed (Transport Block Size (TBS(n)) is less than 6144), the codeblock + CRC bits shown are the same as the transport block + CRC bits.
- LEN_i indicates the number of decoded bits (including CRC) for the i th PDSCH codeblock in a subframe and can be used to determine where a set of codeblock bits ends and the next set begins in the Decoded Symbol Table.
- DTBLoCk – Decoded TB, $\Sigma (\text{Transport Block Sizes} + 24)$ decoded transport block bits (including CRCs) per subframe
- Each set of bits consists of the decoded transport block bits followed by a 24-bit CRC. There is no LEN field for decoded transport block bits since the Transport Block Size for each PDSCH allocation is shown on the DL Decode Info table in the TBS(n) data result.

NOTE

The PDSCH decoder is On when PDSCH Decoding is not set to None.

Parameter Name	PDSCH Decoding
Key Path	Meas Setup, Decode, Decode Type
Parameter Type	EnumParameter
Mode	LTEAFDD, LTEATDD
Remote Command	[:SENSe] :EVM:CCARrier0 1 2 3 4:DLINK:DECode:PDSCh NONE DESCrambled DRMatched DCBLock DTBLock [:SENSe] :EVM:CCARrier0 1 2 3 4:DLINK:DECode:PDSCh?
Example	EVM:CCAR0:DLIN:DEC:PDSC NONE EVM:CCAR0:DLIN:DEC:PDSC?
Dependencies	Available when Direction is Downlink. Available when Detection is Auto and RB Auto Detect Mode is Decoded PDCCH.
Force Restart	Yes
State Saved	Saved in instrument state.
Range	None DESCrambled DeRateMatched Decoded Code Block Decoded Tx Port Block
Softkey Label	PDSCH
Backwards Compatibility SCPI	[:SENSe] :EVM:DLINK:DECode:PDSCh
Initial S/W Revision	A.14.00
Modified at S/W Revision	A.14.50

PUSCH Decoding

Selects the decoding type of the PUSCH. It determines the level of decoding for PUSCH bits shown in the Decoded Symbol Table.

- NONE - None, no decoding is performed on PUCCH bits. Mapped bits are shown in the Symbol Table.
- DESCrambled – Descrambled, descrambled (rate-matched) bits for each subframe are shown in the Decoded Symbol Table.
- DRMatched – DeRateMatched, $\Sigma (16 + LEN_i)$ bits per subframe.
- Each set of bits for a PUSCH transmission consists of a 16-bit length field (LEN_i) followed by the deratematched (channel coded) bits for each codeblock.
- LEN_i indicates the number of deratematched bits for the i th codeblock in a subframe and can be used to determine where one set of deratematched codeblock bits ends and the next set begins in the Decoded Symbol Table.
- $LEN = 3 * (\text{Codeblock Length} + \text{CRC Length} + \text{Trellis Termination Bit Length})$ bits, where Codeblock Length is transmission dependent, CRC Length = 24 bits, and Trellis Termination Bit Length = 4 bits.
- DCBLock – Decoded CB, $\Sigma (16 + LEN_i)$ bits per subframe.

- Each set of bits for a PUSCH codeblock consists of a 16-bit length field (LEN), the decoded codeblock bits, and a 24-bit CRC. When codeblock segmentation is not performed (Transport Block Size (TBS(n)) is less than 6144), the codeblock + CRC bits shown are the same as the transport block + CRC bits.
- LEN_i indicates the number of decoded bits (including CRC) for the ith codeblock in a subframe and can be used to determine where a set of codeblock bits ends and the next set begins in the Decoded Symbol Table. LEN_i = Codeblock Length + CRC Length, where Codeblock Length is transmission dependent, and CRC Length = 24 bits.
- DTB_{lock} – Decoded TB, (Transport Block Size + 24) decoded transport block bits (including CRCs) per subframe.
- The number of bits shown on the Decoded Symbol Table for a PUSCH channel allocation when PUSCH Bits is set to Decoded is equal to the sum of the Size metrics (HARQ Size, CQI/PMI Size, SR Size, etc.) plus the Transport Block Size (TBS) for the corresponding decoded PUSCH allocation listed in the UL Decode Info trace.

NOTE

RNTI needs to be specified for a user allocation for PUSCH descrambling to be performed.

Parameter Name	PUSCH Decoding
Key Path	Meas Setup, Decode, Decode Type
Parameter Type	EnumParameter
Mode	LTEAFDD, LTEATDD
Remote Command	[:SENSe] :EVM:CCARrier0 1 2 3 4:ULINk:DECode:PUSCh NONE DESCrambled DRMatched DCBLock DTBLock [:SENSe] :EVM:CCARrier0 1 2 3 4:ULINk:DECode:PUSCh?
Example	EVM:CCAR0:ULIN:DEC:PUSC NONE EVM:CCAR0:ULIN:DEC:PUSC?
Notes	Available when Direction is Uplink. RNTI needs to be specified for a user allocation in the LTE Allocation Editor for PUSCH descrambling to be performed.
Force Restart	Yes
State Saved	Saved in instrument state.
Range	None Descrambled DeRatematched Decoded Code Block Decoded Tx Port Block
Softkey Label	PUSCH
Backwards Compatibility SCPI	[:SENSe] :EVM:ULINk:DECode:PUSCh
Initial S/W Revision	A.14.00
Modified at S/W Revision	A.14.50

PUCCH Decoding

Selects the decoding type of the PUCCH. It determines how much coding to undo before showing the bits from PUCCH on the Decoded Symbol Table. See 3GPP TS 36.212, Section 5.2.3 for a diagram of the coding operations performed on PUCCH.

- NONE - None, raw PUCCH bits are mapped to resource element locations and shown in the Symbol Table. No PUCCH bits are shown in the Decoded Symbol Table.
- DESCrambled –Descrambled, descrambled (channel coded) bits for each subframe are shown on the Decoded Symbol Table.
- DECOded – Decoded, decoded bits for each subframe are shown in the Decoded Symbol Table.

NOTE

For PUCCH Format 2/2a/2b, where both CQI/PMI and HARQ-ACK bits are jointly encoded, CQI/PMI information bits are listed first in a set of PUCCH bits, followed by HARQ-ACK information bits.

Parameter Name	PUCCH Decoding
Key Path	Meas Setup, Decode, Decode Type
Parameter Type	EnumParameter
Mode	LTEAFDD, LTEATDD
Remote Command	[:SENSe] :EVM:CCARrier0 1 2 3 4:ULINk:DECOde:PUCCh NONE DESCrambled DECOded [:SENSe] :EVM:CCARrier0 1 2 3 4:ULINk:DECOde:PUCCh?
Example	EVM:CCAR0:ULIN:DEC:PUCCh NONE EVM:CCAR0:ULIN:DEC:PUCCh?
Notes	Available when Direction is Uplink.
Force Restart	Yes
State Saved	Saved in instrument state.
Range	None DESCrambled DECOded
Softkey Label	PUCCH
Backwards Compatibility SCPI	[:SENSe] :EVM:ULINk:DECOde:PUCCh
Initial S/W Revision	A.14.00
Modified at S/W Revision	A.14.50

DCI Format Detection Include

Configures how the demodulator detects DCI formats 1, 1B, and 1D.

The analyzer uses the number of the PDCCH message payload bits to determine the DCI format used in a PDCCH. DCI formats 1B and 1D always have equal lengths. In some cases, message payload length for DCI format 1 can be the same length as 1B and 1D. To specify which DCI formats to look for, the analyzer provides the following settings for the DCI Formats 1, 1B, 1D Detection Include parameter.

- F1F1B - Formats 1 and 1B, the analyzer assumes format 1D is not present. When frame configuration enables format 1 to have the same length as format 1B, all DCI message payloads of this length are decoded as format 1. Otherwise, formats 1 and 1B are decoded separately.
- F1FD - Formats 1 and 1D, the analyzer assumes format 1B is not present. When frame configuration enables format 1 to have the same length as format 1D, all DCI message payloads of this length are decoded as format 1. Otherwise, formats 1 and 1D are decoded separately.

- F1 - Format 1 only, the analyzer assumes that formats 1B and 1D are not present. Format 1B or 1D message payloads are decoded as format 1 when possible format 1 message payload lengths include the format 1B/1D payload length. Otherwise, format 1B or 1D message payloads are ignored.
- F1B - Format 1B only, the analyzer assumes that formats 1 and 1D are not present. Any message payloads with the length of a format 1B payload are decoded as format 1B.
- F1D - Format 1D only, the analyzer assumes that formats 1 and 1B are not present. Any message payloads with the length of a format 1D payload are decoded as format 1D.

Parameter Name	DCI Formats Detection Include
Key Path	Meas Setup, Decode
Parameter Type	EnumParameter
Mode	LTEAFDD, LTEATDD
Remote Command	[:SENSe] :EVM:CCARrier0 1 2 3 4:DLINK:DECode:DFINclude F1F1B F1F1D F1 F1B F1D [:SENSe] :EVM:CCARrier0 1 2 3 4:DLINK:DECode:DFINclude?
Example	EVM:CCAR0:DLIN:DEC:DFIN F1F1B EVM:CCAR0:DLIN:DEC:DFIN?
Dependencies	Available when Direction is Downlink.
Preset	F1F1B
Force Restart	Yes
State Saved	Saved in instrument state.
Range	Formats1 and 1B Formats1 and 1D Format1 only Format1B only Format1D only
Softkey Label	DCI Format Include
Readback Text	1 and 1B 1 and 1D 1 only 1B only 1D only
Backwards Compatibility SCPI	[:SENSe] :EVM:DLINK:DECode:DFINclude
Initial S/W Revision	A.14.00
Modified at S/W Revision	A.14.50

RNTI Range

Specifies the range of RNTI values for PDCCH transmissions that will be used as Random Access RNTIs (=RA-RNTI) or Transmit Power Control RNTIs (=TPC-RNTI) for decoding purposes. This parameter is available when Direction is Downlink.

Key Path	Meas Setup, Decode
Initial S/W Revision	A.14.00

RA-RNTI Range Min Value

Sets the minimum value of the RA-RNTI range.

RA-RNTI Range specifies the range of RNTI values that are assumed to be RA-RNTIs when decoding PDCCH transmissions. This parameter is needed to unambiguously decode the contents of DCI Format 1A.

NOTE

Zero is not a valid RA-RNTI value, but is used to indicate that there are no RA-RNTI contained in the LTE signal when both the Min and Max values are set to 0.

Any PDCCH whose CRC is scrambled with an RNTI that is not contained in either the RA-RNTI or TPC-RNTI ranges and cannot be determined to be a SI-RNTI or P-RNTI will be demodulated as a C-RNTI PDCCH.

Parameter Name	RA-RNTI Range Min Value
Key Path	Meas Setup, Decode, RNTI Range
Parameter Type	IntParameter
Mode	LTEAFDD, LTEATDD
Remote Command	[:SENSe] :EVM:CCARrier0 1 2 3 4:DLINk:DECode:RNTI:MINimum:RA <integer> [:SENSe] :EVM:CCARrier0 1 2 3 4:DLINk:DECode:RNTI:MINimum:RA?
Example	EVM:CCAR0:DLIN:DEC:RNTI:MIN:RA 0 EVM:CCAR0:DLIN:DEC:RNTI:MIN:RA?
Notes	The value should be less than or equal to RA-RNTI Range Max Value.
Dependencies	Available when Direction is Downlink.
Preset	0
Force Restart	Yes
State Saved	Saved in instrument state.
Min	0
Max	60
Test MIN/MAX/DEF	Yes
Resolution	1
Test UP/DOWN	Yes
Softkey Label	RA-RNTI Min
Backwards Compatibility SCPI	[:SENSe] :EVM:DLINk:DECode:RNTI:MINimum:RA
Initial S/W Revision	A.14.00
Modified at S/W Revision	A.14.50

RA-RNTI Range Max Value

Sets the maximum value of the RA-RNTI range.

RA-RNTI Range specifies the range of RNTI values that are assumed to be RA-RNTIs when decoding PDCCH transmissions. This parameter is needed to unambiguously decode the contents of DCI Format 1A.

NOTE

Zero is not a valid RA-RNTI value, but is used to indicate that there are no RA-RNTI contained in the LTE signal when both the Min and Max values are set to 0.

Any PDCCH whose CRC is scrambled with an RNTI that is not contained in either the RA-RNTI or TPC-RNTI ranges and cannot be determined to be a SI-RNTI or P-RNTI will be demodulated as a C-RNTI PDCCH.

Parameter Name	RA-RNTI Range Max Value
Key Path	Meas Setup, Decode, RNTI Range
Parameter Type	IntParameter
Mode	LTEAFDD, LTEATDD
Remote Command	[:SENSe] :EVM:CCARrier0 1 2 3 4 :DLINk:DECode:RNTI:MAXimum:RA <integer> [:SENSe] :EVM:CCARrier0 1 2 3 4 :DLINk:DECode:RNTI:MAXimum:RA?
Example	EVM:CCAR0:DLIN:DEC:RNTI:MAX:RA 0 EVM:CCAR0:DLIN:DEC:RNTI:MAX:RA?
Notes	The value should be greater than or equal to the RA-RNTI Range Min Value.
Dependencies	Available only when Direction is Downlink.
Preset	0
Force Restart	Yes
State Saved	Saved in instrument state.
Min	0
Max	60
Test MIN/MAX/DEF	Yes
Resolution	1
Test UP/DOWN	Yes
Softkey Label	RA-RNTI Max
Backwards Compatibility SCPI	[:SENSe] :EVM:DLINk:DECode:RNTI:MAXimum:RA
Initial S/W Revision	A.14.00
Modified at S/W Revision	A.14.50

TPC-RNTI Range Min Value

Sets the minimum value of the TPC-RNTI range.

TPC-RNTI Range specifies the range of RNTI values that are assumed to be TPC-RNTIs when decoding PDCCH transmissions.

DCI Formats 3 and 3A have the same message payload size as DCI Formats 0 and 1A. Any PDCCHs with a RNTI falling within the specified TPC-RNTI Range will be decoded as DCI Format 3/3A transmit power control commands.

NOTE

Any PDCCH whose CRC is scrambled with an RNTI that is not contained in either the RA-RNTI or TPC-RNTI ranges and cannot be determined to be a SI-RNTI or P-RNTI will be demodulated as a C-RNTI PDCCH.

Parameter Name	TCP-RNTI Range Min Value
Key Path	Meas Setup, Decode, RNTI Range
Parameter Type	IntParameter
Mode	LTEAFDD, LTEATDD
Remote Command	[:SENSe] :EVM:CCARrier0 1 2 3 4:DLINk:DECode:RNTI:MINimum:TPC <integer> [:SENSe] :EVM:CCARrier0 1 2 3 4:DLINk:DECode:RNTI:MINimum:TPC?
Example	EVM:CCAR0:DLIN:DEC:RNTI:MIN:TPC 0 EVM:CCAR0:DLIN:DEC:RNTI:MIN:TPC?
Notes	The value should be less than or equal to TPC-RNTI Range Max Value.
Dependencies	Available only when Direction is Downlink.
Preset	0
Force Restart	Yes
State Saved	Saved in instrument state.
Min	0
Max	65523
Test MIN/MAX/DEF	Yes
Resolution	1
Test UP/DOWN	Yes
Softkey Label	TPC-RNT1 Min
Backwards Compatibility SCPI	[:SENSe] :EVM:DLINk:DECode:RNTI:MINimum:TPC
Initial S/W Revision	A.14.00
Modified at S/W Revision	A.14.50

TPC-RNTI Range Max Value

Sets the maximum value of the TPC-RNTI range.

TPC-RNTI Range specifies the range of RNTI values that are assumed to be TPC-RNTIs when decoding PDCCH transmissions.

DCI Formats 3 and 3A have the same message payload size as DCI Formats 0 and 1A. Any PDCCHs with a RNTI falling within the specified TPC-RNTI Range will be decoded as DCI Format 3/3A transmit power control commands.

NOTE

Any PDCCH whose CRC is scrambled with an RNTI that is not contained in either the RA-RNTI or TPC-RNTI ranges and cannot be determined to be a SI-RNTI or P-RNTI will be demodulated as a C-RNTI PDCCH.

Parameter Name	TCP-RNTI Range Min Value
Key Path	Meas Setup, Decode, RNTI Range
Parameter Type	IntParameter
Mode	LTEAFDD, LTEATDD
Remote Command	[:SENSe] :EVM:CCARrier0 1 2 3 4 :DLINK:DECode:RNTI:MAXimum:TPC <integer> [:SENSe] :EVM:CCARrier0 1 2 3 4 :DLINK:DECode:RNTI:MAXimum:TPC?
Example	EVM:CCAR0:DLIN:DEC:RNTI:MAX:TPC 0 EVM:CCAR0:DLIN:DEC:RNTI:MAX:TPC?
Notes	The value should be greater than or equal to the TPC-RNTI Range Min Value.
Dependencies	Available only when Direction is Downlink.
Preset	0
Force Restart	Yes
State Saved	Saved in instrument state.
Min	0
Max	65523
Test MIN/MAX/DEF	Yes
Resolution	1
Test UP/DOWN	Yes
Softkey Label	TPC-RNTI Max
Backwards Compatibility SCPI	[:SENSe] :EVM:DLINK:DECode:RNTI:MAXimum:TPC
Initial S/W Revision	A.14.00
Modified at S/W Revision	A.14.50

DCI Format 2 PMI Config

Displays a menu that enables you to specify the latest Precoding Matrix Indicator(s) (PMI) reported by the UE. The latest PMI report can be specified for PDSCH allocations using 1, 2, 3, or 4 layers. Valid PMI reports are shown in the table below:

Num. of Layers	2 Tx Antenna Ports	4 Tx Antenna Ports
1	0-3	0-15
2	0-1	0-15
3	n/a	0-15
4	n/a	0-15

When Format 2 DCI is used to specify PDSCH RB allocations for a user, the eNodeB can explicitly specify the precoding that was applied to the PDSCH allocations, or can indicate that the last PMI report from the UE was used. In the latter case, the LTE demodulator needs to know what PMI that the UE reported to be able to completely decode the contents of the DCI payload as well as decode the corresponding PDSCH user allocation.

More information about DCI Format 2 can be found in 3GPP TS 36.211, Section 5.3.3.1.5.

Key Path	Meas Setup, Decode,
Mode	LTEAFDD, LTEATDD
Initial S/W Revision	A.14.00

Latest PMI Report on PUSCH using 1 Layer

Specifies the latest Precoding Matrix Indicator(s) (PMI) reported by the UE.

Parameter Name	Latest PMI Report on PUSCH using 1 Layer
Key Path	Meas Setup, Decode, DCI Format 2 PMI Config
Parameter Type	IntParameter
Mode	LTEAFDD, LTEATDD
Remote Command	[:SENSe] :EVM:CCARrier0 1 2 3 4 :DLINk:DECode:DFTWo:PRONe <integer> [:SENSe] :EVM:CCARrier0 1 2 3 4 :DLINk:DECode:DFTWo:PRONe?
Example	EVM:CCAR0:DLIN:DEC:DFTW:PRON 1 EVM:CCAR0:DLIN:DEC:DFTW:PRON?
Dependencies	Available when Direction is Downlink and Number of C-RS Ports is set to 2 or 4 Ports. The number of valid PMI reports differs depending on the Number of C-RS Ports. 2 Ports : 0-3 4 Ports: 0-15
Preset	0
Force Restart	Yes
State Saved	Saved in instrument state.
Min	0
Max	Depends on the Number of C-RS Ports. 2 Ports: 3 4 Ports: 15
Test MIN/MAX/DEF	No
Resolution	1
Test UP/DOWN	No
Softkey Label	Latest PMI Report 1 Layer
Backwards Compatibility SCPI	[:SENSe] :EVM:DLINk:DECode:DFTWo:PRONe

Initial S/W Revision	A.14.00
Modified at S/W Revision	A.14.50

Latest PMI Report on PUSCH using 2 Layers

Specifies the latest Precoding Matrix Indicator(s) (PMI) reported by the UE.

Parameter Name	Latest PMI Report on PUSCH using 2 Layers
Key Path	Meas Setup, Decode, DCI Format 2 PMI Config
Parameter Type	IntParameter
Mode	LTEAFDD, LTEATDD
Remote Command	[:SENSe] :EVM:CCARrier0 1 2 3 4 :DLINK:DECode:DFTWo:PRTWo <integer> [:SENSe] :EVM:CCARrier0 1 2 3 4 :DLINK:DECode:DFTWo:PRTWo?
Example	EVM:CCAR0:DLIN:DEC:DFTW:PRTW 1 EVM:CCAR0:DLIN:DEC:DFTW:PRTW?
Dependencies	Available when Direction is Downlink and Number of C-RS Ports is set to 2 or 4 Ports. The number of valid PMI reports differs depending on Number of C-RS Ports. 2 Ports: 0-1 4 Ports: 0-15
Preset	0
Force Restart	Yes
State Saved	Saved in instrument state.
Min	0
Max	Depends on the Number of C-RS Ports. 2 Ports: 1 4 Ports: 15
Test MIN/MAX/DEF	No
Resolution	1
Test UP/DOWN	No
Softkey Label	Latest PMI Report 2 Layers
Backwards Compatibility SCPI	[:SENSe] :EVM:DLINK:DECode:DFTWo:PRTWo
Initial S/W Revision	A.14.00
Modified at S/W Revision	A.14.50

Latest PMI Report on PUSCH using 3 Layers

Specifies the latest Precoding Matrix Indicator(s) (PMI) reported by the UE.

Parameter Name	Latest PMI Report on PUSCH using 3 Layer
Key Path	Meas Setup, Decode, DCI Format 2 PMI Config
Parameter Type	IntParameter
Mode	LTEAFDD, LTEATDD
Remote Command	[:SENSe] :EVM:CCARrier0 1 2 3 4:DLINk:DECode:DFTWo:PRTHree <integer> [:SENSe] :EVM:CCARrier0 1 2 3 4:DLINk:DECode:DFTWo:PRTHree?
Example	EVM:CCAR0:DLIN:DEC:DFTW:PRTH 1 EVM:CCAR0:DLIN:DEC:DFTW:PRTH?
Dependencies	Available when Direction is Downlink and Number of C-RS Ports is set to 4 Ports. The number of valid PMI reports differs depending on Number of C-RS Ports.
Preset	0
Force Restart	Yes
State Saved	Saved in instrument state.
Min	0
Max	15
Test MIN/MAX/DEF	No
Resolution	1
Test UP/DOWN	No
Softkey Label	Latest PMI Report 3 Layers
Backwards Compatibility SCPI	[:SENSe] :EVM:DLINk:DECode:DFTWo:PRTHree
Initial S/W Revision	A.14.00
Modified at S/W Revision	A.14.50

Latest PMI Report on PUSCH using 4 Layers

Specifies the latest Precoding Matrix Indicator(s) (PMI) reported by the UE.

Parameter Name	Latest PMI Report on PUSCH using 4 Layers
Key Path	Meas Setup, Decode, DCI Format 2 PMI Config
Parameter Type	IntParameter
Mode	LTEAFDD, LTEATDD
Remote Command	[:SENSe] :EVM:CCARrier0 1 2 3 4:DLINk:DECode:DFTWo:PRFour <integer> [:SENSe] :EVM:CCARrier0 1 2 3 4:DLINk:DECode:DFTWo:PRFour?
Example	EVM:CCAR0:DLIN:DEC:DFTW:PRF 1 EVM:CCAR0:DLIN:DEC:DFTW:PRF?
Dependencies	Available when Direction is Downlink and Number of C-RS Ports is set to 4 Ports.
Preset	0

Force Restart	Yes
State Saved	Saved in instrument state.
Min	0
Max	15
Test MIN/MAX/DEF	No
Resolution	1
Test UP/DOWN	No
Softkey Label	Latest PMI Report 4 Layers
Backwards Compatibility SCPI	[:SENSe] :EVM:DLINk:DECode:DFTwo:PRFour
Initial S/W Revision	A.14.00
Modified at S/W Revision	A.14.50

PUSCH Decode Parameters

Displays a menu that enables you to configure decoding of HARQ-ACK, RI, and CQI/PMI information bits.

Available when Direction is Uplink.

Info Size parameter

Specifies the number of bits for all PUSCH transmissions for the selected uplink user allocation.

When AutoDet is selected for HARQ-ACK, RI, or CQI/PMI, the corresponding information bit size will be auto detected as far as possible.

The possible range of information bits is listed as follows:

- HARQ-ACK bits range: 0–11 bits
- RI bits range: 0–2 bits
- CQI-PMI bits range: 0–128 bits

TIP: For best demodulation performance, specify Info Size manually.

Offset Index parameter

Specifies the value of loffset for HARQ-ACK, RI, and CQI in the tables listed in 3GPP TS 36.213, Section 8.6.3.

The possible range of Offset Index values are as follows:

- HARQ-ACK bits range: 0–14 bits
- RI bits range: 0–12 bits
- CQI-PMI bits range: 2–15 bits

Key Path	Meas Setup, Decode
Mode	LTEAFDD, LTEATDD
Initial S/W Revision	A.14.00

PUSCH HARQ-ACK

Displays a menu that enables you to set the information size and offset index of PUSCH HARQ ACK/NACK.

Key Path	Meas Setup, Decode, PUSCH Decode Parameters
Mode	LTEAFDD, LTEATDD
Initial S/W Revision	A.14.00

PUSCH HARQ-ACK Info Size

Specifies the HARQ-ACK informatin size in bits.

When AutoDet is selected, information size will be auto detected as far as possible.

TIP: For the best demodulation performance, specify Info Size manually.

Parameter Name	PUSCH HARQ-ACK Info Size
Key Path	Meas Setup, Decode, PUSCH Decode Parameters, HARQ-ACK
Parameter Type	IntParameter
Mode	LTEAFDD, LTEATDD
Remote Command	<pre>[:SENSe]:EVM:CCARrier0 1 2 3 4:ULINk:DECode:PUSCh:HARQ:ISIZe <integer> [:SENSe]:EVM:CCARrier0 1 2 3 4:ULINk:DECode:PUSCh:HARQ:ISIZe? [:SENSe]:EVM:CCARrier0 1 2 3 4:ULINk:DECode:PUSCh:HARQ:ISIZe:AUTO OFF ON 0 1 [:SENSe]:EVM:CCARrier0 1 2 3 4:ULINk:DECode:PUSCh:HARQ:ISIZe:AUTO?</pre>
Example	<pre>EVM:CCAR0:ULIN:DEC:PUSC:HARQ:ISIZ 0 EVM:CCAR0:ULIN:DEC:PUSC:HARQ:ISIZ? EVM:CCAR0:ULIN:DEC:PUSC:HARQ:ISIZ:AUTO 0 EVM:CCAR0:ULIN:DEC:PUSC:HARQ:ISIZ:AUTO?</pre>
Dependencies	Available when Direction is Uplink and PUSCH HARQ-ACK Info Size Auto Detect is OFF.
Preset	0 ON
Force Restart	Yes
State Saved	Saved in instrument state.
Min	0
Max	11

Test MIN/MAX/DEF	No
Knob Increment	1
Step Increment	1
Softkey Label	Info Size
Backwards Compatibility SCPI	[:SENSe] :EVM:ULINk:DECode:PUSCh:HARQ:ISIZe
	[:SENSe] :EVM:ULINk:DECode:PUSCh:HARQ:ISIZe:AUTO
BAF Parameter Name	PUSCH HARQ-ACK Info Size Auto Detect
BAF SCPI Command	[:SENSe]:EVM:CCARrier0 1 2 3 4:ULINk:DECode:PUSCh:HARQ:ISIZe:AUTO OFF ON 0 1 [:SENSe]:EVM:CCARrier0 1 2 3 4:ULINk:DECode:PUSCh:HARQ:ISIZe:AUTO?
BAF SCPI Example	EVM:CCAR0:ULIN:DEC:PUSC:HARQ:ISIZ:AUTO 0 EVM:CCAR0:ULIN:DEC:PUSC:HARQ:ISIZ:AUTO?
BAF Preset	ON
BAF State Saved	Yes
Initial S/W Revision	A.14.00
Modified at S/W Revision	A.14.50

PUSCH HARQ-ACK Offset Index

Specifies the value of loffset for HARQ-ACK in the tables listed in 3GPP TS 36.213, Section 8.6.3.

Parameter Name	PUSCH HARQ-ACK Offset Index
Key Path	Meas Setup, Decode, PUSCH Decode Parameters, HARQ-ACK
Parameter Type	IntParameter
Mode	LTEAFDD, LTEATDD
Remote Command	[:SENSe] :EVM:CCARrier0 1 2 3 4:ULINk:DECode:PUSCh:HARQ:OFFSet <integer> [:SENSe] :EVM:CCARrier0 1 2 3 4:ULINk:DECode:PUSCh:HARQ:OFFSet?
Example	EVM:CCAR0:ULIN:DEC:PUSC:HARQ:OFFS 0 EVM:CCAR0:ULIN:DEC:PUSC:HARQ:OFFS?
Dependencies	Available when Direction is Uplink.
Preset	0
Force Restart	Yes
State Saved	Saved in instrument state.
Min	0
Max	14
Test MIN/MAX/DEF	No
Knob Increment	1
Step Increment	1
Softkey Label	Offset Index

Backwards Compatibility SCPI	<code>[:SENSe] :EVM:ULINK:DECode:PUSCh:HARQ:OFFSet</code>
Initial S/W Revision	A.14.00
Modified at S/W Revision	A.14.50

PUSCH RI

Displays a menu that enables you to set the information size and offset index of PUSCH Rank Indicator.

Key Path	Meas Setup, Decode, PUSCH Decode Parameters
Mode	LTEAFDD, LTEATDD
Initial S/W Revision	A.14.00

PUSCH RI Info Size

Specifies the RI informatin size in bits.

When AutoDet is selected, information size will be auto detected as far as possible.

TIP: For the best demodulation performance, specify Info Size manually.

Parameter Name	PUSCH RI Info Size
Key Path	Meas Setup, Decode, PUSCH Decode Parameters, RI
Parameter Type	IntParameter
Mode	LTEAFDD, LTEATDD
Remote Command	<pre>[:SENSe] :EVM:CCARrier0 1 2 3 4:ULINK:DECode:PUSCh:RI:ISIZe <integer> [:SENSe] :EVM:CCARrier0 1 2 3 4:ULINK:DECode:PUSCh:RI:ISIZe? [:SENSe] :EVM:CCARrier0 1 2 3 4:ULINK:DECode:PUSCh:RI:ISIZe:AUTO OFF ON 0 1 [:SENSe] :EVM:CCARrier0 1 2 3 4:ULINK:DECode:PUSCh:RI:ISIZe:AUTO?</pre>
Example	<pre>EVM:CCAR0:ULIN:DEC:PUSC:RI:ISIZ 0 EVM:CCAR0:ULIN:DEC:PUSC:RI:ISIZ? EVM:CCAR0:ULIN:DEC:PUSC:RI:ISIZ:AUTO 1 EVM:CCAR0:ULIN:DEC:PUSC:RI:ISIZ:AUTO?</pre>
Dependencies	Available when Direction is Uplink and PUSCH RI Info Size Auto Detect is Off.
Preset	0 ON
Force Restart	Yes
State Saved	Saved in instrument state.
Min	0

Max	2
Test MIN/MAX/DEF	No
Knob Increment	1
Step Increment	1
Softkey Label	Info Size
Backwards Compatibility SCPI	<code>[:SENSe] :EVM:ULINk:DECode:PUSCh:RI:ISIZe</code>
BAF Parameter Name	PUSCH RI Info Size Auto Detect
BAF SCPI Command	<code>[:SENSe] :EVM:CCARrier0 1 2 3 4:ULINk:DECode:PUSCh:RI:ISIZe:AUTO OFF ON 0 1</code> <code>[:SENSe] :EVM:CCARrier0 1 2 3 4:ULINk:DECode:PUSCh:RI:ISIZe:AUTO?</code>
BAF SCPI Example	<code>EVM:CCAR0:ULIN:DEC:PUSC:RI:ISIZ:AUTO 1</code> <code>EVM:CCAR0:ULIN:DEC:PUSC:RI:ISIZ:AUTO?</code>
BAF Preset	ON
BAF State Saved	Yes
Initial S/W Revision	A.14.00
Modified at S/W Revision	A.14.50

PUSCH RI Offset Index

Specifies the value of loffset for RI in the tables listed in 3GPP TS 36.213, Section 8.6.3.

Parameter Name	PUSCH RI Offset Index
Key Path	Meas Setup, Decode, PUSCH Decode Parameters, RI
Parameter Type	IntParameter
Mode	LTEAFDD, LTEATDD
Remote Command	<code>[:SENSe] :EVM:CCARrier0 1 2 3 4:ULINk:DECode:PUSCh:RI:OFFSet <integer></code> <code>[:SENSe] :EVM:CCARrier0 1 2 3 4:ULINk:DECode:PUSCh:RI:OFFSet?</code>
Example	<code>EVM:CCAR0:ULIN:DEC:PUSC:RI:OFFS 1</code> <code>EVM:CCAR0:ULIN:DEC:PUSC:RI:OFFS?</code>
Dependencies	Available when Direction is Uplink.
Preset	0
Force Restart	Yes
State Saved	Saved in instrument state.
Min	0
Max	12
Test MIN/MAX/DEF	No
Knob Increment	1
Step Increment	1

Softkey Label	Offset Index
Backwards Compatibility SCPI	[:SENSe] :EVM:ULINk:DECode:PUSCh:RI:OFFSet
Initial S/W Revision	A.14.00
Modified at S/W Revision	A.14.50

PUSCH CQI/PMI

Displays a menu that enables you to set the information size and offset index of PUSCH Channel Quality & Precoding Matrix Indicator.

Key Path	Meas Setup, Decode, PUSCH Decode Parameters
Mode	LTEAFDD, LTEATDD
Initial S/W Revision	A.14.00

PUSCH CQI/PMI Info Size

Specifies the CQI/PMI information size in bits.

When AutoDet is selected, information size will be auto detected as far as possible.

TIP: For the best demodulation performance, specify Info Size manually.

Parameter Name	PUSCH CQI/PMI Info Size
Key Path	Meas Setup, Decode, PUSCH Decode Parameters, CQI/PMI
Parameter Type	IntParameter
Mode	LTEAFDD, LTEATDD
Remote Command	[:SENSe] :EVM:CCARrier0 1 2 3 4:ULINk:DECode:PUSCh:CQI:ISIZe <integer> [:SENSe] :EVM:CCARrier0 1 2 3 4:ULINk:DECode:PUSCh:CQI:ISIZe? [:SENSe] :EVM:CCARrier0 1 2 3 4:ULINk:DECode:PUSCh:CQI:ISIZe:AUTO OFF ON 0 1 [:SENSe] :EVM:CCARrier0 1 2 3 4:ULINk:DECode:PUSCh:CQI:ISIZe:AUTO?
Example	EVM:CCAR0:ULIN:DEC:PUSC:CQI:ISIZ 1 EVM:CCAR0:ULIN:DEC:PUSC:CQI:ISIZ? EVM:CCAR0:ULIN:DEC:PUSC:CQI:ISIZ:AUTO OFF EVM:CCAR0:ULIN:DEC:PUSC:CQI:ISIZ:AUTO?
Dependencies	Available when Direction is Uplink and PUSCH CQI/RI Info Size Auto Detect is Off.
Preset	0 ON
Force Restart	Yes
State Saved	Saved in instrument state.

Min	0
Max	128
Test MIN/MAX/DEF	No
Knob Increment	1
Step Increment	1
Softkey Label	Info Size
Backwards Compatibility SCPI	[:SENSe] :EVM:ULINK:DECode:PUSCh:CQI:ISIZe
	[:SENSe] :EVM:ULINK:DECode:PUSCh:CQI:ISIZe:AUTO
BAF Parameter Name	PUSCH HARQ-ACK Info Size Auto Detect
BAF SCPI Command	[:SENSe] :EVM:CCARrier0 1 2 3 4:ULINK:DECode:PUSCh:CQI:ISIZe:AUTO OFF ON 0 1 [:SENSe] :EVM:CCARrier0 1 2 3 4:ULINK:DECode:PUSCh:CQI:ISIZe:AUTO?
BAF SCPI Example	EVM:CCAR0:ULIN:DEC:PUSC:CQI:ISIZ:AUTO OFF EVM:CCAR0:ULIN:DEC:PUSC:CQI:ISIZ:AUTO?
BAF Preset	ON
BAF State Saved	Yes
Initial S/W Revision	A.14.00
Modified at S/W Revision	A.14.50

PUSCH CQI/PMI Offset Index

Specifies the value of loffset for CQI/PMI in the tables listed in 3GPP TS 36.213, Section 8.6.3.

Parameter Name	PUSCH CQI/PMI Offset Index
Key Path	Meas Setup, Decode, PUSCH Decode Parameters, CQI/PMI
Parameter Type	IntParameter
Mode	LTEAFDD, LTEATDD
Remote Command	[:SENSe] :EVM:CCARrier0 1 2 3 4:ULINK:DECode:PUSCh:CQI:OFFSet <integer> [:SENSe] :EVM:CCARrier0 1 2 3 4:ULINK:DECode:PUSCh:CQI:OFFSet?
Example	EVM:CCAR0:ULIN:DEC:PUSC:CQI:OFFS 2 EVM:CCAR0:ULIN:DEC:PUSC:CQI:OFFS?
Preset	2
Force Restart	Yes
State Saved	Saved in instrument state.
Min	2
Max	15
Test MIN/MAX/DEF	No
Knob Increment	1
Step Increment	1

Softkey Label	Offset Index
Backwards Compatibility SCPI	[:SENSe] :EVM:ULINk:DECode:PUSCh:CQI:OFFSet
Initial S/W Revision	A.14.00
Modified at S/W Revision	A.14.50

PUCCH Decode Parameters

Displays a menu that enables you to configure decoding of HARQ-ACK and CQI/PMI information bits. The Info Size parameter specifies the number of bits for all PUCCH transmissions for the selected uplink user allocation.

Available when Direction is Uplink.

Info Size parameter

Specifies the number of bits for all PUCCH transmissions for the selected uplink user allocation.

When AutoDet is selected for HARQ-ACK or CQI/PMI, the corresponding information bit size will be auto detected as far as possible.

The possible range of information bits is listed as follows:

- HARQ-ACK bits range: 0–2 bits
- CQI-PMI bits range: 0–11 bits

TIP: For best demodulation performance, specify Info Size manually.

Key Path	Meas Setup, Decode
Mode	LTEAFDD, LTEATDD
Initial S/W Revision	A.14.00

PUCCH HARQ-ACK

Displays a menu that enables you to set the of PUCCH HARQ ACK/NACK information size in bits.

Key Path	Meas Setup, Decode, PUCCH Decode Parameters
Mode	LTEAFDD, LTEATDD
Initial S/W Revision	A.14.00

PUCCH HARQ-ACK Info Size

Specifies the HARQ-ACK information size in bits.

When AutoDet is selected, information size will be auto detected as far as possible.

TIP: For the best demodulation performance, specify Info Size manually.

Parameter Name	PUCCH HARQ-ACK Info Size
Key Path	Meas Setup, Decode, PUCCH Decode Parameters, HARQ-ACK
Parameter Type	IntParameter
Mode	LTEAFDD, LTEATDD
Remote Command	<pre>[:SENSe]:EVM:CCARrier0 1 2 3 4:ULINK:DECode:PUCCh:HARQ:ISIZe <integer> [:SENSe]:EVM:CCARrier0 1 2 3 4:ULINK:DECode:PUCCh:HARQ:ISIZe? [:SENSe]:EVM:CCARrier0 1 2 3 4:ULINK:DECode:PUCCh:HARQ:ISIZe:AUTO OFF ON 0 1 [:SENSe]:EVM:CCARrier0 1 2 3 4:ULINK:DECode:PUCCh:HARQ:ISIZe:AUTO?</pre>
Example	<pre>EVM:CCAR0:ULIN:DEC:PUCCh:HARQ:ISIZ 0 EVM:CCAR0:ULIN:DEC:PUCCh:HARQ:ISIZ? EVM:CCAR0:ULIN:DEC:PUCCh:HARQ:ISIZ:AUTO 0 EVM:CCAR0:ULIN:DEC:PUCCh:HARQ:ISIZ:AUTO?</pre>
Dependencies	Available when Direction is Uplink and PUCCH HARQ-ACK Info Size Auto Detect is Off.
Preset	0 ON
Force Restart	Yes
State Saved	Saved in instrument state.
Min	0
Max	2
Test MIN/MAX/DEF	No
Knob Increment	1
Step Increment	1
Softkey Label	Info Size
Backwards Compatibility SCPI	<pre>[:SENSe]:EVM:ULINK:DECode:PUCCh:HARQ:ISIZe [:SENSe]:EVM:ULINK:DECode:PUCCh:HARQ:ISIZe:AUTO</pre>
BAF Parameter Name	PUCCH HARQ-ACK Info Size Auto Detect
BAF SCPI Command	<pre>[:SENSe]:EVM:CCARrier0 1 2 3 4:ULINK:DECode:PUCCh:HARQ:ISIZe:AUTO OFF ON 0 1 [:SENSe]:EVM:CCARrier0 1 2 3 4:ULINK:DECode:PUCCh:HARQ:ISIZe:AUTO?</pre>
BAF SCPI Example	<pre>EVM:CCAR0:ULIN:DEC:PUCCh:HARQ:ISIZ:AUTO 0 EVM:CCAR0:ULIN:DEC:PUCCh:HARQ:ISIZ:AUTO?</pre>
BAF Preset	ON
BAF State Saved	Yes
Initial S/W Revision	A.14.00
Modified at S/W Revision	A.14.50

PUCCH CQI/PMI

Displays a menu that enables you to set the Channel Quality & Precoding Matrix Indicator information size in bits.

Key Path	Meas Setup, Decode, PUCCH Decode Parameters
Mode	LTEAFDD, LTEATDD
Initial S/W Revision	A.14.00

PUCCH CQI/PMI Info Size

Specifies the CQI/PMI information size in bits.

When AutoDet is selected, information size will be auto detected as far as possible.

TIP: For the best demodulation performance, specify Info Size manually.

Parameter Name	PUCCH CQI/PMI Info Size
Key Path	Meas Setup, Decode, PUCCH Decode Parameters, CQI/PMI
Parameter Type	IntParameter
Mode	LTEAFDD, LTEATDD
Remote Command	[:SENSe]:EVM:CCARrier0 1 2 3 4:ULINk:DECode:PUCCh:CQI:ISIZe <integer> [:SENSe]:EVM:CCARrier0 1 2 3 4:ULINk:DECode:PUCCh:CQI:ISIZe? [:SENSe]:EVM:CCARrier0 1 2 3 4:ULINk:DECode:PUCCh:CQI:ISIZe:AUTO OFF ON 0 1 [:SENSe]:EVM:CCARrier0 1 2 3 4:ULINk:DECode:PUCCh:CQI:ISIZe:AUTO?
Example	EVM:CCAR0:ULIN:DEC:PUCC:CQI:ISIZ 0 EVM:CCAR0:ULIN:DEC:PUCC:CQI:ISIZ? EVM:CCAR0:ULIN:DEC:PUCC:CQI:ISIZ:AUTO 0 EVM:CCAR0:ULIN:DEC:PUCC:CQI:ISIZ:AUTO?
Dependencies	Available when Direction is Uplink and PUCCH HARQ-ACK Info Size Auto Detect is Off.
Preset	0 ON
Force Restart	Yes
State Saved	Saved in instrument state.
Min	0
Max	11
Test MIN/MAX/DEF	No
Knob Increment	1
Step Increment	1
Softkey Label	Info Size
Backwards	[:SENSe]:EVM:ULINk:DECode:PUCCh:CQI:ISIZe

Compatibility SCPI	[:SENSe] :EVM:ULINK:DECode:PUCCh:CQI:ISIZe:AUTO
BAF Parameter Name	PUCCH CQI/PMI Info Size Auto Detect
BAF SCPI Command	[:SENSe] :EVM:CCARrier0 1 2 3 4:ULINK:DECode:PUCCh:CQI:ISIZe:AUTO OFF ON 0 1 [:SENSe] :EVM:CCARrier0 1 2 3 4:ULINK:DECode:PUCCh:CQI:ISIZe:AUTO?
BAF SCPI Example	EVM:CCAR0:ULIN:DEC:PUCc:CQI:ISIZ:AUTO 0 EVM:CCAR0:ULIN:DEC:PUCc:CQI:ISIZ:AUTO?
BAF Preset	ON
BAF State Saved	Yes
Initial S/W Revision	A.14.00
Modified at S/W Revision	A.14.50

ACK/NACK Feedback Mode

Specifies whether the current HARQ ACK/NACK feedback mode is ACK/NACK multiplexing or ACK/NACK bundling. See 3GPP TS 36.212, Section 5.2.2.6 and 3GPP TS 36.213, Section 7.3 for more information.

Parameter Name	ACK/NACK Feedback Mode
Key Path	Meas Setup, Decode
Parameter Type	EnumParameter
Mode	LTETDD
Remote Command	[:SENSe] :EVM:CCARrier0 1 2 3 4:ULINK:DECode:ANFMode MULTiplexing BUNDling [:SENSe] :EVM:CCARrier0 1 2 3 4:ULINK:DECode:ANFMode?
Example	EVM:CCAR0:ULIN:DEC:ANFM MULT EVM:CCAR0:ULIN:DEC:ANFM?
Dependencies	Available when Direction is Uplink.
Preset	MULTiplexing
Force Restart	Yes
State Saved	Saved in instrument state.
Range	BUNDling MULTiplexing
Softkey Label	ACK/NACK Feedback
Backwards Compatibility SCPI	[:SENSe] :EVM:ULINK:DECode:ANFMode
Initial S/W Revision	A.14.00
Modified at S/W Revision	A.14.50

ACK/NACK Feedback Mode

Specifies whether the current HARQ ACK/NACK feedback mode is ACK/NACK multiplexing or ACK/NACK bundling. See 3GPP TS 36.212, Section 5.2.2.6 and 3GPP TS 36.213, Section 7.3 for more information.

Key Path	Meas Setup, Decode
Mode	LTETDD
Remote Command	[:SENSe] :EVM:ULINk:DECode:ANFMode MULTiplexing BUNDling [:SENSe] :EVM:ULINk:DECode:ANFMode?
Example	EVM:ULIN:DEC:ANFM MULT EVM:ULIN:DEC:ANFM?
Dependencies	Available when Direction is Uplink.
Preset	MULTiplexing
State Saved	Saved in instrument state.
Range	BUNDling MULTiplexing
Initial S/W Revision	A.10.00

Advanced

Displays a menu that enables you to select lesser used demodulation parameters for the current measurement. These settings are for advanced users and do not normally require adjustment for most common measurements.

Key Path	Meas Setup, More
Mode	LTEAFDD, LTEATDD
Initial S/W Revision	A.14.00

Cyclic Prefix Length (Downlink)

Selects whether to automatically detect the Cyclic Prefix Length or specify the cyclic prefix length for Downlink.

- AUTO – Auto detect the Cyclic Prefix Length
- NORMAl – Specify Cyclic Prefix Length as Normal (7.03125% the length of the symbol)
- EXTended – Specify Cyclic Prefix Length as Extended (25% the length of the symbol)

Cyclic Prefix Length specifies the cyclic prefix mode. The current Cyclic Prefix Length mode is displayed in the **"Error Summary" on page 2284** trace.

The Cyclic Prefix is added by the transmitter to each OFDM symbol by taking the last 7% (or 25% for extended Cyclic Prefix) of the OFDM symbol and appending it to the front. The addition of the Cyclic Prefix enables time for all the paths in a multipath environment to arrive at the receiver before the symbol is demodulated.

See **"Symbol Timing Adjust" on page 2053** for information about setting the location of the symbol FFT.

Parameter Name	Cyclic Prefix Length (Downlink)
Key Path	Meas Setup, Advanced
Parameter Type	EnumParameter
Mode	LTEAFDD, LTEATDD
Remote Command	[:SENSe]:EVM:CCARrier0 1 2 3 4:DLINK:SYNC:CPLength AUTO NORMal EXTended [:SENSe]:EVM:CCARrier0 1 2 3 4:DLINK:SYNC:CPLength? [:SENSe]:EVM:CCARrier0 1 2 3 4:DLINK:SYNC:CPLength:AUTO OFF ON 0 1 [:SENSe]:EVM:CCARrier0 1 2 3 4:DLINK:SYNC:CPLength:AUTO?
Example	EVM:CCAR0:DLIN:SYNC:CPL NORM EVM:CCAR0:DLIN:SYNC:CPL? EVM:CCAR0:DLIN:SYNC:CPL:AUTO 1 EVM:CCAR0:DLIN:SYNC:CPL:AUTO?
Couplings	Coupled with Cyclic Prefix Length (Uplink).
Preset	AUTO ON
Force Restart	Yes
State Saved	Saved in instrument state.
Range	Normal Extended
Active Function Text	Cyclic Prefix Length
Softkey Label	Cyclic Prefix Length
Backwards Compatibility SCPI	[:SENSe]:EVM:DLINK:SYNC:CPLength
History	Moved from Sync/Format setup menu at A.14.00.
BAF Parameter Name	Cyclic Prefix Length State (Downlink)
BAF SCPI Command	[:SENSe]:EVM:CCARrier0 1 2 3 4:DLINK:SYNC:CPLength:AUTO OFF ON 0 1 [:SENSe]:EVM:CCARrier0 1 2 3 4:DLINK:SYNC:CPLength:AUTO?
BAF SCPI Example	EVM:CCAR0:DLIN:SYNC:CPL:AUTO 1 EVM:CCAR0:DLIN:SYNC:CPL:AUTO?
BAF Preset	ON
BAF State Saved	Yes
Initial S/W Revision	A.14.00
Modified at S/W Revision	A.14.50

Auto

Selects Cyclic Prefix Length automatically.

Key Path	Meas Setup, Advanced, Cyclic Prefix Length
Mode	LTEAFDD, LTEATDD
Initial S/W Revision	A.14.00

Normal

Selects Normal Cyclic Prefix Length.

Key Path	Meas Setup, Advanced, Cyclic Prefix Length
Mode	LTEAFDD, LTEATDD
Initial S/W Revision	A.14.00

Extended

Selects Extended Cyclic Prefix Length.

Key Path	Meas Setup, Advanced, Cyclic Prefix Length
Mode	LTEAFDD, LTEATDD
Initial S/W Revision	A.14.00

Cyclic Prefix Length (Uplink)

Selects whether to automatically detect the Cyclic Prefix Length or specify the cyclic prefix length for Uplink.

- AUTO – Auto detect the Cyclic Prefix Length
- NORMAl – Specify Cyclic Prefix Length as Normal (7.03125% the length of the symbol)
- EXTended – Specify Cyclic Prefix Length as Extended (25% the length of the symbol)

Cyclic Prefix Length specifies the cyclic prefix mode. The current Cyclic Prefix Length mode is displayed in the ["Error Summary" on page 2284](#) trace.

The Cyclic Prefix is added by the transmitter to each OFDM symbol by taking the last 7% (or 25% for extended Cyclic Prefix) of the OFDM symbol and appending it to the front. The addition of the Cyclic Prefix enables time for all the paths in a multipath environment to arrive at the receiver before the symbol is demodulated.

See ["Symbol Timing Adjust" on page 2053](#) for information about setting the location of the symbol FFT.

Parameter Name	Cyclic Prefix Length (Uplink)
Key Path	Meas Setup, Advanced
Parameter Type	EnumParameter

Mode	LTEAFDD, LTEATDD
Remote Command	[:SENSe] :EVM:CCARrier0 1 2 3 4:ULINK:SYNC:CPLength AUTO NORMal EXTended [:SENSe] :EVM:CCARrier0 1 2 3 4:ULINK:SYNC:CPLength? [:SENSe] :EVM:CCARrier0 1 2 3 4:ULINK:SYNC:CPLength:AUTO OFF ON 0 1 [:SENSe] :EVM:CCARrier0 1 2 3 4:ULINK:SYNC:CPLength:AUTO?
Example	EVM:CCAR0:ULIN:SYNC:CPL AUTO EVM:CCAR0:ULIN:SYNC:CPL? EVM:CCAR0:ULIN:SYNC:CPL:AUTO 1 EVM:CCAR0:ULIN:SYNC:CPL:AUTO?
Dependencies	When Sync Type is set to PRACH, Auto softkey is grayed out.
Couplings	Coupled with Cyclic Prefix Length (Downlink).
Preset	AUTO ON
Force Restart	Yes
State Saved	Saved in instrument state.
Range	Normal Extended
Active Function Text	Cyclic Prefix Length
Softkey Label	Cyclic Prefix Length
Backwards Compatibility SCPI	[:SENSe] :EVM:ULINK:SYNC:CPLength [:SENSe] :EVM:ULINK:SYNC:CPLength:AUTO
History	Moved from Sync/Format setup menu at A.14.00
BAF Parameter Name	Cyclic Prefix Length State (Uplink)
BAF SCPI Command	[:SENSe] :EVM:CCARrier0 1 2 3 4:ULINK:SYNC:CPLength:AUTO OFF ON 0 1 [:SENSe] :EVM:CCARrier0 1 2 3 4:ULINK:SYNC:CPLength:AUTO?
BAF SCPI Example	EVM:CCAR0:ULIN:SYNC:CPL:AUTO 1 EVM:CCAR0:ULIN:SYNC:CPL:AUTO?
BAF Preset	ON
BAF State Saved	Yes
Initial S/W Revision	A.14.00
Modified at S/W Revision	A.14.50

Auto

Selects Cyclic Prefix Length automatically.

Key Path	Meas Setup, Advanced, Cyclic Prefix Length
Mode	LTEAFDD, LTEATDD
Initial S/W Revision	A.14.00

Normal

Selects Normal Cyclic Prefix Length.

Key Path	Meas Setup, Advanced, Cyclic Prefix Length
Mode	LTEAFDD, LTEATDD
Initial S/W Revision	A.14.00

Extended

Selects Extended Cyclic Prefix Length.

Key Path	Meas Setup, Advanced, Cyclic Prefix Length
Mode	LTEAFDD, LTEATDD
Initial S/W Revision	A.14.00

Extended Freq Lock Range

Provides the ability to reduce the frequency lock range. When this parameter is on, the frequency lock range is two and a half times the subcarrier spacing or 37.5 kHz. When this parameter is off, it is reduced to one half the subcarrier spacing, or 7.5kHz, which enables faster processing time.

Parameter Name	Extended Freq Lock Range
Key Path	Meas Setup, Advanced
Parameter Type	BooleanParameter
Mode	LTEAFDD, LTEATDD
Remote Command	<code>[:SENSe] :EVM:CCARrier0 1 2 3 4 :EXTended:FREQuency:LOCK:RANGe OFF ON 0 1</code> <code>[:SENSe] :EVM:CCARrier0 1 2 3 4 :EXTended:FREQuency:LOCK:RANGe?</code>
Example	<code>EVM:CCAR0:EXT:FREQ:LOCK:RANG OFF</code> <code>EVM:CCAR0:EXT:FREQ:LOCK:RANG?</code>
Preset	OFF
Force Restart	Yes
State Saved	Saved in instrument state.
Softkey Label	Extended Freq Lock Range
Backwards Compatibility SCPI	<code>[:SENSe] :EVM:EXTended:FREQuency:LOCK:RANGe</code>
Initial S/W Revision	A.14.00
Modified at S/W Revision	A.14.50

Equalizer Training

Displays a menu that enables you to set whether or not to equalize the signal.

Channel equalization only applies to phase and amplitude. For information about signal-level timing correction, see ["Sync Type" on page 1975](#).

NOTE

Small-scale deviations (slot-by-slot or symbol-by-symbol) from the equalization channel frequency response are compensated by EVM Minimization.

Downlink:

The channel frequency response is computed over the entire Result Length, and the resulting coefficients are shown in the Eq Chan Freq Resp trace.

- OFF - When Off is selected, no equalization will be applied to the signal.
- RS - When RS is selected, equalization will be performed using the frequency response calculated from the reference signal for the reference antenna path. The channel frequency response for subcarriers between reference signals will be linearly interpolated.
- For downlink, the standard only specifies using the reference signal for equalization. However, the LTE demodulator can apply a RS+Data equalization for single-channel downlink signals.
- RSD - When RS+Data is selected, equalization will be performed using the frequency response calculated using the reference signal and the data subcarriers. RS+Data equalization is not supported for multi-antenna downlink signals (when number of input channels is greater than 1).

When including data (PDSCH) subcarriers in equalizer calculations:

4. The demodulator equalizes the signal using the reference signal and demodulates the data subcarrier values.
5. Using the demodulated signal, the demodulator calculates a reference LTE signal (shown in IQ Ref)
6. Then the demodulator calculates another equalizer channel frequency response by comparing all the measured PDSCH and RS subcarrier values with the corresponding reference subcarrier values
7. Finally, the channel frequency response including PDSCH is applied to the signal, the signal is demodulated, and the results of the demodulation are shown on the traces

A moving average can be applied to the RS subcarriers in frequency. For more information, see ["Moving Average Filter" on page 2050](#).

NOTE

To see the measured channel frequency response for the current Tx/Rx path, use the Eq Chan Freq Resp trace.

To see the measured channel frequency responses for all Tx/Rx paths, use the MIMO Eq Chan Freq Resp trace.

The **Equalizer Training** setting determines what subcarriers are used when the Tracking method of EVM Minimization is selected. See the ["EVM Minimization" on page 2065](#) for more information.

Uplink:

Channel frequency responses are computed and equalization is applied on a slot-by-slot basis. These per-slot channel frequency responses are shown in the ["Eq Ch Freq Resp Per Slot" on page 2295](#) trace. The ["Eq Ch Frequency Response" on page 2294](#) trace however shows a single set of channel frequency response

coefficients computed from the time data in the Search Time trace (capture length defined by "Result Length" on page 1989).

- OFF - When Off is selected, the channel frequency response will still be calculated from the DM-RS subcarriers but will not be applied to the signal.
- RS - When RS is selected, the signal will be equalized using the channel frequency response calculated using the DM-RS subcarriers in the signal.
- RSD - When RS+Data is selected, the LTE demodulator calculates the equalizer channel frequency response according to the standard using the DM-RS subcarriers and the DFT-spread (SC-FDMA) subcarriers (PUSCH). The LTE standard specifies that an RS+Data equalization should be performed for uplink signals.

NOTE

PRACH equalization is done differently from the other uplink channels' equalization. First, the channel frequency response is calculated for a PRACH transmission by comparing the received preamble sequence to the reference preamble sequence. Then, the channel frequency response is averaged to a single correction value and this correction is applied to all subcarriers in the PRACH preamble. Each PRACH transmission is equalized separately from the other PRACH transmissions.

PRACH equalization is done this way because if each PRACH subcarrier were corrected individually, the equalization will simply remove the error from the PRACH transmission (resulting in near zero EVM) since the channel frequency response will be calculated from the same subcarriers that were being equalized.

Parameter Name	Equalizer Training
Key Path	Meas Setup, Advanced
Parameter Type	EnumParameter
Mode	LTEAFDD, LTEATDD
Remote Command	<code>[:SENSe] :EVM:CCARrier0 1 2 3 4:EQUalizer:TRaining OFF RS RSD</code> <code>[:SENSe] :EVM:CCARrier0 1 2 3 4:EQUalizer:TRaining?</code>
Example	<code>EVM:CCAR0:EQU:TRA RS</code> <code>EVM:CCAR0:EQU:TRA?</code>
Preset	RS
Force Restart	Yes
State Saved	Saved in instrument state.
Range	None RS RS + Data
Softkey Label	Equalizer Training
Backwards Compatibility SCPI	<code>[:SENSe] :EVM:EQUalizer:TRaining</code>
History	RS+Data is added at A.14.00
Initial S/W Revision	A.14.00
Modified at S/W Revision	A.14.50

Off

Selects no Equalizer Training.

Key Path	Meas Setup, Advanced, Equalizer Training
Mode	LTEAFDD, LTEATDD
Initial S/W Revision	A.14.00

RS

Selects RS Equalizer Training.

Key Path	Meas Setup, Advanced, Equalizer Training
Mode	LTEAFDD, LTEATDD
Initial S/W Revision	A.14.00

RS + Data

Selects RS + Data Equalizer Training.

Key Path	Meas Setup, Advanced, Equalizer Training
Mode	LTEAFDD, LTEATDD
Initial S/W Revision	A.14.00

Moving Average Filter

Sets the value and state of the Moving Avg Filter.

Moving Avg Filter specifies whether or not to perform a moving average (frequency smoothing) on the reference signals during equalization, as well as the number of RS subcarriers to use in each average.

When Equalizer Training is set to **RS**, a value of 5 RS means the value of an RS subcarrier is calculated as the average of the value of that subcarrier and the values of the next two and previous two RS subcarriers in frequency.

When Equalizer Training is set to **RS+Data**, data subcarriers (PDSCH) in between the RS subcarriers are included in the average. For example, a setting of 3 RS means that the value of an RS subcarrier will be taken as the average of the next and previous RS subcarrier in frequency and all data subcarriers that are in between the next and previous RS subcarriers.

For RS subcarrier locations that do not have enough RS subcarriers to one side or the other (those near the edge of the frequency spectrum), the average is taken over available reference signal subcarriers.

Parameter Name	Moving Average Filter
Key Path	Meas Setup, Sync/Format Setup
Parameter Type	IntParameter
Mode	LTEAFDD, LTEATDD

Remote Command	[:SENSe]:EVM:CCARrier0 1 2 3 4:EQUalizer:TRaining:MAFilter:LENGth <integer> [:SENSe]:EVM:CCARrier0 1 2 3 4:EQUalizer:TRaining:MAFilter:LENGth? [:SENSe]:EVM:CCARrier0 1 2 3 4:EQUalizer:TRaining:MAFilter OFF ON 0 1 [:SENSe]:EVM:CCARrier0 1 2 3 4:EQUalizer:TRaining:MAFilter?
Example	EVM:CCAR0:EQU:TRA:MAF:LENG 19 EVM:CCAR0:EQU:TRA:MAF:LENG? EVM:CCAR0:EQU:TRA:MAF ON EVM:CCAR0:EQU:TRA:MAF?
Notes	This parameter will always clip to an odd number. Available when Direction is Downlink.
Preset	19 ON
Force Restart	Yes
State Saved	Saved in instrument state.
Min	1
Max	399
Test MIN/MAX/DEF	No
Resolution	2
Knob Increment	2
Step Increment	2
Unit Terminator Key	RS
Softkey Label	Moving Avg Filt
Backwards Compatibility SCPI	[:SENSe]:EVM:EQUalizer:TRaining:MAFilter:LENGth
BAF Parameter Name	Moving Average Filter State
BAF SCPI Command	[:SENSe]:EVM:CCARrier0 1 2 3 4:EQUalizer:TRaining:MAFilter OFF ON 0 1 [:SENSe]:EVM:CCARrier0 1 2 3 4:EQUalizer:TRaining:MAFilter?
BAF SCPI Example	EVM:CCAR0:EQU:TRA:MAF ON EVM:CCAR0:EQU:TRA:MAF?
BAF Preset	ON
BAF State Saved	Yes
BAF Range	On Off
Initial S/W Revision	A.14.00
Modified at S/W Revision	A.14.50

MIMO Channel Frequency Normalize

Selects normalized or non-normalized MIMO Ch Frequency Response trace data. Normalized trace data is scaled to show each MIMO channel antenna path frequency response trace centered around 0 db. For normalized traces, all MIMO Channel paths are individually normalized for magnitude, phase, and time offset. For non-normalized trace data, the trace data is not scaled or modified.

Parameter Name	Normalize MIMO Channel Frequency
Key Path	Meas Setup, Advanced, Equalizer Training
Parameter Type	BooleanParameter
Mode	LTEAFDD, LTEATDD
Remote Command	<code>[:SENSe] :EVM:CCARrier0 1 2 3 4:EQUalizer:TRAIning:MCFNormalIze OFF ON 0 1</code> <code>[:SENSe] :EVM:CCARrier0 1 2 3 4:EQUalizer:TRAIning:MCFNormalIze?</code>
Example	<code>EVM:CCAR0:EQU:TRA:MCFN OFF</code> <code>EVM:CCAR0:EQU:TRA:MCFN?</code>
Dependencies	Available only when Direction is Downlink.
Preset	ON
Force Restart	Yes
State Saved	Saved in instrument state.
Range	On Off
Backwards Compatibility SCPI	<code>[:SENSe] :EVM:EQUalizer:TRAIning:MCFNormalIze</code>
Initial S/W Revision	A.14.00
Modified at S/W Revision	A.14.50

Equalizer Training Mode

Selects the equalization method. This key is available only when Direction is set to Uplink.

- ZFORcing – Use Zero-Forcing equalizer
- LSQuares – Use Least Squares equalizer

Parameter Name	Equalizer Training Mode
Key Path	Meas Setup, Advanced
Parameter Type	EnumParameter
Mode	LTEAFDD, LTEATDD
Remote Command	<code>[:SENSe] :EVM:CCARrier0 1 2 3 4:EQUalizer:TRAIning:MODE ZFORcing LSQuares</code> <code>[:SENSe] :EVM:CCARrier0 1 2 3 4:EQUalizer:TRAIning:MODE?</code>
Example	<code>EVM:CCAR0:EQU:TRA:MODE ZFOR</code> <code>EVM:CCAR0:EQU:TRA:MODE?</code>

Dependencies	Available only when Direction is Uplink. Disabled when Sync Type is PRACH.
Preset	ZFORcing
Force Restart	Yes
State Saved	Saved in instrument state.
Range	Zero Forcing Least Squares
Softkey Label	Equalizer Tng Mode
Backwards Compatibility SCPI	[:SENSe] :EVM:EQUalizer:TRAIning:MODE
Initial S/W Revision	A.14.00
Modified at S/W Revision	A.14.50

Equalizer Training Mode

Selects the equalization method. This key is available only when Direction is set to Uplink.

- ZFORcing – Use Zero-Forcing equalizer
- LSQuares – Use Least Squares equalizer

Key Path	Meas Setup, Advanced
Mode	LTE, LTEFDD
Remote Command	[:SENSe] :EVM:EQUalizer:TRAIning:MODE ZFORcing LSQuares [:SENSe] :EVM:EQUalizer:TRAIning:MODE?
Example	EVM:EQU:TRA:MODE ZFOR EVM:EQU:TRA:MODE?
Dependencies	Available only when Direction is Uplink. Disabled when Sync Type is PRACH.
Preset	ZFORcing
State Saved	Saved in instrument state.
Range	Zero Forcing Least Squares
Initial S/W Revision	A.06.00

Symbol Timing Adjust

Sets the demodulator to equalize the signal (i.e., whether or not to compensate for measured channel frequency response).

Parameter Name	Symbol Timing Adjust
Key Path	Meas Setup, Advanced
Parameter Type	EnumParameter
Mode	LTEAFDD, LTEATDD

Remote Command	<code>[:SENSe] :EVM:CCARrier0 1 2 3 4:SYMBOL:TIMing:ADJust MAX MIN START END CENTer FFTSize</code> <code>[:SENSe] :EVM:CCARrier0 1 2 3 4:SYMBOL:TIMing:ADJust?</code>
Example	<code>EVM:CCAR0:SYMB:TIM:ADJ MAX</code> <code>EVM:CCAR0:SYMB:TIM:ADJ?</code>
Preset	MAX
Force Restart	Yes
State Saved	Saved in instrument state.
Range	Max of EVM Win Start/End Min of EVM Win Start/End EVM Window Start EVM Window End EVM Window Center %FFT Size
Softkey Label	Symbol Timing Adjust
Backwards Compatibility SCPI	<code>[:SENSe] :EVM:SYMBOL:TIMing:ADJust</code>
Initial S/W Revision	A.14.00
Modified at S/W Revision	A.14.50

Max of EVM Window Start/End

Selects Max of EVM Window Start/End for Symbol Timing Adjust . When Max of EVM Window Start / End selected, the EVM for each subcarrier comes from the data set determined in the following manner: For each OFDM symbol, two FFTs are taken to determine the values of the subcarriers. The first FFT is taken starting at the beginning of the EVM Window. The second is taken starting at the end of the EVM Window. Two sets of EVMs are calculated for the subcarriers, one from each FFT. Then an RMS average is taken over each set. The set with the highest RMS average EVM is then chosen as the set to use in EVM and demodulation results.

Key Path	Meas Setup, Advanced, Symbol Timing Adjust
Mode	LTEAFDD, LTEATDD
Initial S/W Revision	A.14.00

Min of EVM in Start/End

Selects Min of EVM Window Start/End for Symbol Timing Adjust. When Min of EVM Window Start / End is selected, the EVM for each subcarrier comes from the data set determined in the following manner: For each OFDM symbol, two FFTs are taken to determine the values of the subcarriers. The first FFT is taken starting at the beginning of the EVM Window. The second is taken starting at the end of the EVM Window. Two sets of EVMs are calculated for the subcarriers, one from each FFT. Then an RMS average is taken over each set. The set with the highest RMS average EVM is then chosen as the set to use in EVM and demodulation results.

Key Path	Meas Setup, Advanced, Symbol Timing Adjust
Mode	LTEAFDD, LTEATDD
Initial S/W Revision	A.14.00

EVM Window Start

Selects EVM Window Start for Symbol Timing Adjust .

Key Path	Meas Setup, Advanced, Symbol Timing Adjust
Mode	LTEAFDD, LTEATDD
Initial S/W Revision	A.14.00

EVM Window End

Selects EVM Window Stop for Symbol Timing Adjust.

Key Path	Meas Setup, Advanced, Symbol Timing Adjust
Mode	LTEAFDD, LTEATDD
Initial S/W Revision	A.14.00

EVM Window Center

Selects EVM Window Center for Symbol Timing Adjust.

Key Path	Meas Setup, Advanced, Symbol Timing Adjust
Mode	LTEAFDD, LTEATDD
Initial S/W Revision	A.14.00

% FFT Size

Selects %FFT Size for Symbol Timing Adjust which enables you to enter the value. When % of FFT Size is selected, the symbol FFT used for EVM and demodulation results begins at the specified location. A maximum value of 0% begins the FFT at the end of the CP (beginning of the Symbol). The minimum value of -7.125% (or -25% for extended CP Length) begins the FFT at the beginning of the cyclic prefix. Setting the value to 0% will provide the maximum amount of time for all the paths in a multipath environment to arrive at the receiver before the symbol FFT is taken.

Parameter Name	% FFT Size
Key Path	Meas Setup, Advanced, Symbol Timing Adjust
Parameter Type	DoubleParameter
Mode	LTEAFDD, LTEATDD
Remote Command	[:SENSe] :EVM:CCARrier0 1 2 3 4 :SYMBol:TIMing:ADJust:USER <percent> [:SENSe] :EVM:CCARrier0 1 2 3 4 :SYMBol:TIMing:ADJust:USER?
Example	EVM:CCAR:SYMB:TIM:ADJ:USER -3.125

	EVM:CCAR:SYMB:TIM:ADJ:USER?
Preset	-3.125 %
Force Restart	Yes
State Saved	Saved in instrument state.
Active Function Text	Sym Time Adjust
Min	-25 %
Max	0 %
Test MIN/MAX/DEF	No
Resolution	0.001 %
Knob Increment	0.001 %
Step Increment	0.01 %
Unit Terminator Key	%
Softkey Label	% FFT Size
Backwards Compatibility SCPI	[:SENSe] :EVM:SYMBol:TIMing:ADJust:USER
Initial S/W Revision	A.14.00
Modified at S/W Revision	A.14.50

EVM Window Length

Selects the EVM Window Length.

EVM Window Length specifies the length of the window used for EVM calculations. The EVM window is centered in the cyclic prefix.

A value of 3GPP will set EVM Window Length according to the LTE standard for EVM measurements. A Custom EVM window length can also be specified in the range of 1–512 samples. A value of 512 samples corresponds to the entire CP length for Extended CP on a 20 MHz signal.

The standard states that the EVM for an LTE signal's subcarriers should be taken from the higher of the two EVM RMS averages calculated from the FFTs taken from the start and from the end of the EVM window. For example, an EVM Window Length of 3 samples means that two FFTs will be taken, one on either sample adjacent to the center sample of the CP. The EVMs for the subcarriers will come from the FFT with the higher EVM RMS average. However, the location of the symbol FFT used for EVM calculations can be set specifically using the Symbol Timing Adjust parameter.

NOTE

A value of 1 sample will cause the EVM to be measured from an FFT taken from the center of the cyclic prefix, since any other FFTs will just be taken over the same sample points.

EVM Window Length does not apply when Symbol Timing Adjust is set to % of FFT Size or EVM Window Center since these settings cause only one FFT to be taken starting from the specified location within the cyclic prefix regardless of the EVM Window Length setting.

Parameter Name	EVM Window Length
----------------	-------------------

Key Path	Meas Setup, Advanced
Parameter Type	EnumParameter
Mode	LTEAFDD, LTEATDD
Remote Command	[:SENSe] :EVM:CCARrier0 1 2 3 4:WINDow:LENGth GPP CUSTom [:SENSe] :EVM:CCARrier0 1 2 3 4:WINDow:LENGth?
Example	EVM:CCAR0:WIND:LENG GPP EVM:CCAR0:WIND:LENG?
Preset	GPP
Force Restart	Yes
State Saved	Saved in instrument state.
Range	RS None
Softkey Label	EVM Window Length
Backwards Compatibility SCPI	[:SENSe] :EVM:WINDow:LENGth
Initial S/W Revision	A.14.00
Modified at S/W Revision	A.14.50

3GPP

Selects 3GPP for EVM Window Length.

Key Path	Meas Setup, Advanced, EVM Window Length
Mode	LTEAFDD, LTEATDD
Initial S/W Revision	A.14.00

EVM Window Length Custom

Sets the EVM Window Length. This key is available only when EVM Window Length is set to Custom.

Parameter Name	EVM Window Length Custom
Key Path	Meas Setup, Advanced, EVM Window Length, Custom
Parameter Type	IntParameter
Mode	LTEAFDD, LTEATDD
Remote Command	[:SENSe] :EVM:CCARrier0 1 2 3 4:WINDow:LENGth:CUSTom <int> [:SENSe] :EVM:CCARrier0 1 2 3 4:WINDow:LENGth:CUSTom?
Example	EVM:CCAR0:WIND:LENG:CUST 1 EVM:CCAR0:WIND:LENG:CUST?
Preset	32

Force Restart	Yes
State Saved	Saved in instrument state.
Active Function Text	EVM Window Length
Min	1
Max	The max value differs depending on the Sync Type (Uplink) and BW the user selected. When Sync Type (Uplink) is set to PRACH; 1.4 MHz -> 1314 3 MHz -> 2628 5 MHz -> 5256 10 MHz -> 10512 15 MHz -> 15768 20 MHz -> 21024 When Sync Type (Uplink) is set to other than PRACH; 1.4 MHz -> 32 3 MHz -> 64 5 MHz -> 128 10 MHz -> 256 15 MHz -> 384 20 MHz -> 512
Test MIN/MAX/DEF	No
Resolution	1
Knob Increment	1
Step Increment	1
Unit Terminator Key	Samples
Softkey Label	Custom
Backwards Compatibility SCPI	[:SENSe] :EVM:ULINK:WINDow:LENGth:CUSTom
Initial S/W Revision	A.14.00

Result Format

Displays a menu of keys that enables you to set the result format.

Key Path	Meas Setup, Advanced
Mode	LTE, LTETDD
Initial S/W Revision	A.06.00

Report EVM in dB

Switches the unit of EVM reporting between percentage and dB.

When set to ON, EVM is reported in dB on all traces.

When set to Off, EVM is reported in %rms according to the LTE standard.

The reference for EVM calculation in both cases is the ideal IQ points that are displayed on the IQ Ref and IQ Ref Time traces.

Parameter Name	Report EVM in dB
Key Path	Meas Setup, Advanced, Result Format
Parameter Type	BooleanParameter
Mode	LTEAFDD, LTEATDD
Remote Command	[:SENSe] :EVM:CCARrier0 1 2 3 4:REPort:DB OFF ON 0 1 [:SENSe] :EVM:CCARrier0 1 2 3 4:REPort:DB?
Example	EVM:CCAR0:REP:DB OFF EVM:CCAR0:REP:DB?
Preset	OFF
Force Restart	Yes
State Saved	Saved in instrument state.
Softkey Label	Report EVM in dB
Backwards Compatibility SCPI	[:SENSe] :EVM:REPort:DB
Initial S/W Revision	A.14.00
Modified at S/W Revision	A.14.50

Report Relative Power Levels

Switches the unit of Power reporting between in Absolute (dBm) and relative (dB).

The following traces are affected by this parameter:

- Error Vector Spectrum
- Error Vector Time
- IQ Freq Meas
- IQ Freq Ref
- IQ Meas
- IQ Meas Time
- IQ Ref
- IQ Ref Time
- RB Error Mag Spectrum
- RB Error Mag Time

- RB Power Spectrum
- RB Power Time
- RMS Error Vector Spectrum
- RMS Error Vector Time

The only summary table affected by this parameter is the Frame Summary table. The channel power will be reported in dB when this parameter is selected and in dBm when this parameter is cleared. The power values reported on Error Summary and MIMO Info Table are not affected by this parameter.

Parameter Name	Report Relative Power Levels
Key Path	Meas Setup, Advanced, Result Format
Parameter Type	BooleanParameter
Mode	LTEAFDD, LTEATDD
Remote Command	[:SENSe] :EVM:CCARrier0 1 2 3 4:REPort:POWer:RELative OFF ON 0 1 [:SENSe] :EVM:CCARrier0 1 2 3 4:REPort:POWer:RELative?
Example	EVM:CCAR0:REP:POW:REL OFF EVM:CCAR0:REP:POW:REL?
Preset	ON
Force Restart	Yes
State Saved	Saved in instrument state.
Softkey Label	Report Relative Power Levels
Backwards Compatibility SCPI	[:SENSe] :EVM:REPort:POWer:RELative
Initial S/W Revision	A.14.00
Modified at S/W Revision	A.14.50

Power Boost Normalize

Determines if Power Boost Normalize is used.

When Power Boost Normalize is enabled, results displayed on IQ traces will be normalized by the power level (set for each channel in the LTE Allocation Editor) or power boost (in Downlink Control Channel Properties) settings of the corresponding channels so that each channel's average power is 0 dB.

Parameter Name	Power Boost Normalize
Key Path	Meas Setup, Advanced, Result Format
Parameter Type	BooleanParameter
Mode	LTEAFDD, LTEATDD
Remote Command	[:SENSe] :EVM:CCARrier0 1 2 3 4:POWer:BOOSt:NORMalize OFF ON 0 1 [:SENSe] :EVM:CCARrier0 1 2 3 4:POWer:BOOSt:NORMalize?
Example	EVM:CCAR0:POW:BOOS:NORM OFF

	EVM:CCAR0:POW:BOOS:NORM?
Preset	ON
Force Restart	Yes
State Saved	Saved in instrument state.
Softkey Label	Power Boost Normalize
Backwards Compatibility SCPI	[:SENSe] :EVM:POWer:BOOSt:NORMAlize
Initial S/W Revision	A.14.00
Modified at S/W Revision	A.14.50

UE-RS Weights

Displays a menu that enables you to set UE-RS Weights parameters.

Key Path	Meas Setup, Advanced, Result Format
Mode	LTEAFDD, LTEATDD
Initial S/W Revision	A.14.00

Compensate Chan Freq Resp

Determines whether the UE-RS weights are compensated for the channel calculated from the Reference Signal.

- On: the UE-RS weights are compensated for the channel frequency response which is shown in the Eq Chan Freq trace.
- Off: the UE-RS weights are not compensated for the channel frequency response.

Parameter Name	Compensate Chan Freq Resp
Key Path	Meas Setup, Advanced, Result Format, UE-RS Weights
Parameter Type	BooleanParameter
Mode	LTEAFDD, LTEATDD
Remote Command	[:SENSe] :EVM:CCARrier0 1 2 3 4:DLINk:UERS:CFRCCompen OFF ON 0 1 [:SENSe] :EVM:CCARrier0 1 2 3 4:DLINk:UERS:CFRCCompen?
Example	EVM:CCAR0:DLIN:UERS:CFRC ON EVM:CCAR0:DLIN:UERS:CFRC?
Notes	Available when Direction is Downlink.
Preset	ON
Force Restart	Yes
State Saved	Saved in instrument state.

Range	On Off
Softkey Label	Compensate Chan Freq Resp
Backwards Compatibility SCPI	[:SENSe] :EVM:DLINK:UERS:CFRCompen
Initial S/W Revision	A.14.00
Modified at S/W Revision	A.14.50

Display Weights in Real/Imaginary Format

Determines whether the values of complex UE-RS weights are shown as real/imaginary pairs or as magnitude/phase pairs on the UE-Specific RS Weights summary table.

Parameter Name	Display Weights in Real/Imaginary Format
Key Path	Meas Setup, Advanced, Result Format, UE-RS Weights
Parameter Type	BooleanParameter
Mode	LTEAFDD, LTEATDD
Remote Command	[:SENSe] :EVM:CCARrier0 1 2 3 4:DLINK:UERS:WEIGhts:RIFormat OFF ON 0 1 [:SENSe] :EVM:CCARrier0 1 2 3 4:DLINK:UERS:WEIGhts:RIFormat?
Example	EVM:CCAR0:DLIN:UERS:WEIG:RIF ON EVM:CCAR0:DLIN:UERS:WEIG:RIF?
Notes	Available when Direction is Downlink.
Preset	OFF
Force Restart	Yes
State Saved	Saved in instrument state.
Range	On Off
Softkey Label	Display Weights in Real/Imag
Backwards Compatibility SCPI	[:SENSe] :EVM:DLINK:UERS:WEIGhts:RIFormat
Initial S/W Revision	A.14.00
Modified at S/W Revision	A.14.50

Weights Display Mode

Determines how the UE-RS weights are shown in the UE-specific Weights summary table.

- PSUBcarrier - Per Subcarrier: the UE-RS weights are shown for each UE-RS subcarrier. UE-RS subcarrier weights are averaged over all subframes in the Measurement Interval. Weights Display Mode can be set to Per Subcarrier only by SCPI command, it is not accessible from front panel.

- PRB - Per RB: the UE-RS weights are shown for each resource block in frequency. A UE-RS weight for a resource block is averaged over the subcarriers in the resource block as well as all subframes in the Measurement Interval.
- PUSer - Per User: UE-RS subcarrier weights are averaged over all UE-RS resource elements in the Measurement Interval for a user allocation and the averaged UE-RS is shown for each user.

Parameter Name	Weights Display Mode
Key Path	Meas Setup, Advanced, Result Format, UE-RS Weights
Parameter Type	EnumParameter
Mode	LTEAFDD, LTEATDD
Remote Command	[:SENSe] :EVM:CCARrier0 1 2 3 4:DLINk:UERS:WEIGhts:DISPlay PSUBcarrier PRB PUSer [:SENSe] :EVM:CCARrier0 1 2 3 4:DLINk:UERS:WEIGhts:DISPlay?
Example	EVM:CCAR0:DLIN:UERS:WEIG:DISP PUSer EVM:CCAR0:DLIN:UERS:WEIG:DISP?
Notes	Available when Direction is Downlink.
Preset	PUSer
Force Restart	Yes
State Saved	Saved in instrument state.
Range	PRB PUSer
Softkey Label	Weights Display Mode
Backwards Compatibility SCPI	[:SENSe] :EVM:DLINk:UERS:WEIGhts:DISPlay
Initial S/W Revision	A.14.00
Modified at S/W Revision	A.14.50

Weights Display Mode

Determines how the UE-RS weights are shown in the UE-specific Weights summary table.

- PSUBcarrier - Per Subcarrier: the UE-RS weights are shown for each UE-RS subcarrier. UE-RS subcarrier weights are averaged over all subframes in the Measurement Interval. Weights Display Mode can be set to Per Subcarrier only by SCPI command, it is not accessible from front panel.
- PRB - Per RB: the UE-RS weights are shown for each resource block in frequency. A UE-RS weight for a resource block is averaged over the subcarriers in the resource block as well as all subframes in the Measurement Interval.
- PUSer - Per User: UE-RS subcarrier weights are averaged over all UE-RS resource elements in the Measurement Interval for a user allocation and the averaged UE-RS is shown for each user.

Key Path	Meas Setup, Advanced, Result Format, UE-RS Weights
Mode	LTE, LTE TDD
Remote Command	[:SENSe] :EVM:DLINk:UERS:WEIGhts:DISPlay PSUBcarrier PRB PUSer

	[:SENSe] :EVM:DLINK:UERS:WEIGhts:DISPlay?
Example	EVM:DLIN:UERS:WEIG:DISP PUSer EVM:DLIN:UERS:WEIG:DISP?
Notes	Available when Direction is Downlink.
Preset	PUSer
State Saved	Saved in instrument state.
Range	PRB PUSer
Initial S/W Revision	A.10.00
Modified at S/W Revision	A.12.00, , A.13.00

Time Scale Factor

Sets Time Scale Factor.

Time Scale Factor sets the value by which to scale the bandwidth and time lengths of the measured signal. This setting can be used to compensate for mistuned crystals or to enable demodulation of signals at a lower rate, such as half rate or 1/10 rate.

Parameter Name	Time Scale Factor
Key Path	Meas Setup, Advanced, More
Parameter Type	DoubleParameter
Remote Command	[:SENSe] :EVM:CCARrier0 1 2 3 4:TIME:SCALE:FACTor <value> [:SENSe] :EVM:CCARrier0 1 2 3 4:TIME:SCALE:FACTor?
Example	EVM:CCAR0:TIME:SCAL:FACT 1 EVM:CCAR0:TIME:SCAL:FACT?
Preset	1
Force Restart	Yes
State Saved	Saved in instrument state.
Active Function Text	Time Factor
Min	0.0625
Max	16
Test MIN/MAX/DEF	No
Resolution	0.0001
Knob Increment	0.0001
Step Increment	0.001
Softkey Label	Time Scale Factor
Backwards Compatibility SCPI	[:SENSe] :EVM:TIME:SCALE:FACTor
Initial S/W Revision	A.14.00
Modified at S/W Revision	A.14.00, A14.50

Multi Carrier Filter

Specifies whether or not to apply a filter to the received component carrier to filter out adjacent carriers.

When other carriers are expected to be adjacent to the component carrier of interest, this multi-carrier filter can be used to filter out the unwanted carrier and minimize leakage into the component carrier of interest.

Parameter Name	Multi Carrier Filter
Key Path	Meas Setup, Advanced
Key Type	BooleanParameter
Mode	LTEAFDD, LTEATDD
Remote Command	[:SENSe] :EVM:CCARrier0 1 2 3 4:MCFilter:STATe OFF ON 0 1 [:SENSe] :EVM:CCARrier0 1 2 3 4:MCFilter:STATe?
Example	EVM:CCAR0:MCF:STAT ON EVM:CCAR0:MCF:STAT?
Dependencies	Multi-Carrier Filter is coupled to Number of Component Carriers. If the number of Component Carriers is 1, the state of multi-carrier filter is OFF; If the number of Component Carriers is greater than 1, the state of multi-carrier filter per CC is ON.
Preset	OFF ON ON ON ON
Force Restart	Yes
State Saved	Saved in instrument state.
Range	On Off
Softkey Label	Multi Carrier Filter
Backwards Compatibility SCPI	[:SENSe] :EVM:MCFilter:STATe OFF ON 0 1
Initial S/W Revision	A.14.00
Modified at S/W Revision	A.14.50

EVM Minimization

Selects whether or not EVM Minimization algorithm will be applied. EVM Minimization uses the reference signal to correct the signal.

- OFF - Disable EVM Minimization
- GPP – 3GPP EVM minimization, the demodulator calculates timing, frequency/phase and IQ offset corrections using the reference signal and the data subcarriers as defined in Section F.3.1 of 36.141 for DL and Section E.3.1 of 36.521 for UL. For downlink, the data subcarriers are from PDSCH, and for uplink the data subcarriers are from PUSCH and PUCCH.
- The demodulator applies the corrections on a slot-by-slot basis for uplink, or on a subframe-by-subframe basis for downlink, as defined by the LTE standard.

- **TRACking** – Tracking, the demodulator applies corrections on a symbol-by-symbol basis and the Equalizer Training parameter determines whether or not data subcarriers are included in calculating corrections. When Equalizer Training is set to RS+Data, EVM Minimization Tracking is performed using the reference signal and the PDSCH data subcarriers. When Equalizer Training is set to RS or Off, EVM Minimization Tracking is performed using only the reference signal.

Reference signal subcarriers are transmitted periodically in time and frequency. The demodulator compares the reference signals with the expected data sequence and computes an error, or correction value, that can be used to track phase, amplitude, and timing at the symbol level when Tracking is selected and at the slot or subframe level when 3GPP is selected. For subcarriers that do not have a corresponding reference subcarrier to compare to, the correction value is calculated by linearly interpolating between RS (and PDSCH, when Equalizer Training is set to RS+Data) subcarrier corrections.

When corrections are averaged and applied to a slot or subframe, the same correction is applied to each symbol in the slot or subframe.

There are four corrections that can be applied to the signal to minimize the EVM: Amplitude, Frequency/Phase, Timing, and IQ Offset (IQ Offset is only for Uplink). See ["EVM Minimization Items" on page 2066](#) for more details.

Parameter Name	EVM Minimization
Key Path	Meas Setup, Advanced
Parameter Type	EnumParameter
Mode	LTEAFDD, LTEATDD
Remote Command	[:SENSe] :EVM:CCARrier0 1 2 3 4:EVMMinimize OFF GPP TRACking [:SENSe] :EVM:CCARrier0 1 2 3 4:EVMMinimize?
Example	EVM:CCAR0:EVMM OFF EVM:CCAR0:EVMM?
Dependencies	3GPP is available only when Number of C-RS Ports is set to 1 Port.
Preset	3GPP
Force Restart	Yes
State Saved	Saved in instrument state.
Range	Off 3GPP Tracking
Softkey Label	EVM Minimization
Backwards Compatibility SCPI	[:SENSe] :EVM:EVMMinimize
Initial S/W Revision	A.14.00
Modified at S/W Revision	A.14.50

EVM Minimization Items

Four types of corrections are available. They are calculated by comparing the measured reference signal to the ideal reference signal:

- Amplitude - When selected, the average reference signal amplitude error will be used to correct the amplitudes of the subcarriers.
- Frequency/Phase - When selected, the average reference signal phase difference will be used to adjust subcarrier phase.
- Timing - When selected, the average slope (average rate of change) of the RS phase in the frequency domain is used to correct the timing.
- IQ Offset (uplink, 3GPP only) - When selected, any IQ offset is compensated for on a slot-by-slot basis. This type of EVM minimization is only available when 3GPP is selected and the direction is uplink.
- IQ Imbalance - When selected, IQ gain, Quadrature error and Timing Skew are compensated. EVM result is minimized to exclude those IQ errors.

For uplink, both equalization and 3GPP EVM Minimization occur on a slot-by-slot basis, while for downlink, equalization occurs over the entire Measurement Interval and 3GPP EVM Minimization occurs on a subframe-by-subframe basis.

Parameter Name	EVM Minimization Items
Key Path	Meas Setup, Advanced
Mode	LTEAFDD, LTEATDD
Initial S/W Revision	A.14.00
Modified at S/W Revision	A.14.00

EVM Minimization by Timing

Selects whether or not Timing will be used for EVM minimization algorithm.

Parameter Name	EVM Minimization by Timing
Key Path	Meas Setup, Advanced, EVM Minimization Items
Parameter Type	BooleanParameter
Mode	LTEAFDD, LTEATDD
Remote Command	[:SENSe] :EVM:CCARrier0 1 2 3 4:EVMMinimize:TIMing OFF ON 0 1 [:SENSe] :EVM:CCARrier0 1 2 3 4:EVMMinimize:TIMing?
Example	EVM:CCAR0:EVMM:TIM OFF EVM:CCAR0:EVMM:TIM?
Dependencies	Enabled when EVM minimization is set to ON.
Preset	ON
Force Restart	Yes
State Saved	Saved in instrument state.
Softkey Label	Timing
Backwards Compatibility SCPI	[:SENSe] :EVM:CCARrier0 1 2 3 4:PILot:TRACk:TIMing [:SENSe] :EVM:EVMMinimize:TIMing

	<code>[:SENSe] :EVM:PILot:TRACk:TIMing</code>
Initial S/W Revision	A.14.00
Modified at S/W Revision	A.14.00, A.14.50

EVM Minimization by Frequency/Phase

Selects whether or not Frequency/Phase will be used for EVM minimization algorithm.

Parameter Name	EVM Minimization by Frequency/Phase
Key Path	Meas Setup, Advanced, EVM Minimization Items
Parameter Type	BooleanParameter
Mode	LTEAFDD, LTEATDD
Remote Command	<code>[:SENSe] :EVM:CCARrier0 1 2 3 4:EVMMinimize:FREQuency OFF ON 0 1</code> <code>[:SENSe] :EVM:CCARrier0 1 2 3 4:EVMMinimize:FREQuency?</code>
Example	<code>EVM:CCAR0:EVMM:FREQ OFF</code> <code>EVM:CCAR0:EVMM:FREQ?</code>
Dependencies	Enabled when EVM minimization is set to ON
Preset	ON
Force Restart	Yes
State Saved	Saved in instrument state.
Softkey Label	Frequency/Phase
Backwards Compatibility SCPI	<code>[:SENSe] :EVM:CCARrier0 1 2 3 4:PILot:TRACk:PHASe</code> <code>[:SENSe] :EVM:EVMMinimize:FREQuency</code> <code>[:SENSe] :EVM:PILot:TRACk:PHASe</code>
Initial S/W Revision	A.14.00
Modified at S/W Revision	A.14.50

EVM Minimization by Amplitude

Selects whether or not Amplitude will be used for EVM minimization algorithm.

Parameter Name	EVM Minimization by Amplitude
Key Path	Meas Setup, Advanced, EVM Minimization Items
Parameter Type	BooleanParameter
Mode	LTEAFDD, LTEATDD
Remote Command	<code>[:SENSe] :EVM:CCARrier0 1 2 3 4:EVMMinimize:AMPLitude OFF ON 0 1</code> <code>[:SENSe] :EVM:CCARrier0 1 2 3 4:EVMMinimize:AMPLitude?</code>
Example	<code>EVM:CCAR0:EVMM:AMPL OFF</code> <code>EVM:CCAR0:EVMM:AMPL?</code>

Dependencies	Enabled when EVM minimization is set to ON
Preset	ON
Force Restart	Yes
State Saved	Saved in instrument state.
Softkey Label	Amplitude
Backwards Compatibility SCPI	[:SENSe] :EVM:CCARrier0 1 2 3 4 :PILot:TRACk:AMPLitude [:SENSe] :EVM:EVMMinimize:AMPLitude [:SENSe] :EVM:PILot:TRACk:AMPLitude
Initial S/W Revision	A.14.00
Modified at S/W Revision	A.14.50

EVM Minimization by IQ Offset

Selects whether or not IQ Offset will be used for EVM minimization algorithm.

Parameter Name	EVM Minimization by IQ Offset
Key Path	Meas Setup, Advanced, EVM Minimization Items
Parameter Type	BooleanParameter
Mode	LTEAFDD, LTEATDD
Remote Command	[:SENSe] :EVM:CCARrier0 1 2 3 4 :EVMMinimize:IQOffset OFF ON 0 1 [:SENSe] :EVM:CCARrier0 1 2 3 4 :EVMMinimize:IQOffset?
Example	EVM:CCAR0:EVMM:IQOF OFF EVM:CCAR0:EVMM:IQOF?
Dependencies	Enabled when EVM minimization is set to ON and Direction is Uplink.
Preset	ON
Force Restart	Yes
State Saved	Saved in instrument state.
Softkey Label	IQ Offset
Backwards Compatibility SCPI	[:SENSe] :EVM:CCARrier0 1 2 3 4 :ULINk:SYNC:IQOComp [:SENSe] :EVM:EVMMinimize:IQOffset
Initial S/W Revision	A.14.00
Modified at S/W Revision	A.14.50

EVM Minimization by IQ Imbalance

Selects whether or not IQ Imbalance will be used for EVM minimization algorithm.

Parameter Name	EVM Minimization by IQ Imbalance
----------------	----------------------------------

Key Path	Meas Setup, Advanced, EVM Minimization Items
Parameter Type	BooleanParameter
Mode	LTEAFDD, LTEATDD
Remote Command	[:SENSe]:EVM:CCARrier0 1 2 3 4:EVMMinimize:IQIMbalance OFF ON 0 1 [:SENSe]:EVM:CCARrier0 1 2 3 4:EVMMinimize:IQIMbalance?
Example	EVM:CCAR0:EVMM:IQIM OFF EVM:CCAR0:EVMM:IQIM?
Dependencies	Enabled when EVM minimization is not OFF.
Preset	OFF
Force Restart	Yes
State Saved	Saved in instrument state.
Softkey Label	IQ Imbalance
Backwards Compatibility SCPI	[:SENSe]:EVM:EVMMinimize:IQIMbalance
Initial S/W Revision	A.14.50
Modified at S/W Revision	A.14.50

Exclude EVM Transient Time

Excludes the EVM results calculated from part of OFDM symbols during a PUSCH allocation change as specified by the standard.

Parameter Name	Exclude EVM Transient Time
Key Path	Meas Setup, Advanced
Key Type	BooleanParameter
Mode	LTEAFDD, LTEATDD
Remote Command	[:SENSe]:EVM:CCARrier0 1 2 3 4:EETTime OFF ON 0 1 [:SENSe]:EVM:CCARrier0 1 2 3 4:EETTime?
Example	EVM:CCAR0:EETT ON EVM:CCAR0:EETT?
Notes	Available when Direction is Uplink.
Preset	OFF
Force Restart	Yes
State Saved	Saved in instrument state.
Range	On Off
Softkey Label	Exclude EVM Transient Time
Backwards Compatibility SCPI	[:SENSe]:EVM:EETTime
Initial S/W Revision	A.14.00
Modified at S/W Revision	A.14.50

Opposite Direction Active

Specifies whether or not the signal for opposite direction is present in the signal under test. For example, when downlink signal is under test, if there is also uplink signal present in uplink subframe, set the Opposite Direction Active to On will make the measurement more accurate with the knowledge of possible interference from uplink subframes.

Parameter Name	Opposite Direction Active
Key Path	Meas Setup, Advanced
Key Type	BooleanParameter
Mode	LTETDD
Remote Command	[:SENSe] :EVM:CCARrier0 1 2 3 4:ODActive OFF ON 0 1 [:SENSe] :EVM:CCARrier0 1 2 3 4:ODActive?
Example	EVM:CCAR0:ODAC ON EVM:CCAR0:ODAC?
Preset	OFF
Force Restart	Yes
State Saved	Saved in instrument state.
Range	On Off
Softkey Label	Opposite Direction Active
Backwards Compatibility SCPI	[:SENSe] :EVM:ODActive
Initial S/W Revision	A.14.00
Modified at S/W Revision	A.14.50

Antenna Element Spacing

Specifies the distance between the antennas in a linear antenna array. This parameter is used only for calculating the Antenna Beam Pattern trace, which shows the beam patterns applied to PDSCH user allocations.

This parameter is specified in units of wavelengths of the Center Frequency.

NOTE

NOTE The LTE demodulator only supports vertical linear antenna arrays with uniform spacing.

Parameter Name	Antenna Element Spacing
Key Path	Meas Setup, Advanced
Parameter Type	DoubleParameter
Mode	LTEAFDD, LTEATDD
Remote Command	[:SENSe] :EVM:CCARrier0 1 2 3 4:DLINK:AESpacing <double>

	<code>[:SENSe] :EVM:CCARrier0 1 2 3 4:DLINK:AESpacing?</code>
Example	EVM:CCAR0:DLIN:AESP 0 EVM:CCAR0:DLIN:AESP?
Dependencies	Available when Direction is Downlink.
Preset	0.5
Force Restart	Yes
State Saved	Saved in instrument state.
Active Function Text	Antenna Element Spacing
Min	0
Max	100
Test MIN/MAX/DEF	No
Resolution	0.001
Test UP/DOWN	No
Softkey Label	Ant Element Spacing
Backwards Compatibility SCPI	<code>[:SENSe] :EVM:DLINK:AESpacing</code>
Initial S/W Revision	A.14.00
Modified at S/W Revision	A.14.50

Number of Antenna Elements

Sets the number of antenna elements per antenna group.

Parameter Name	Number of Antenna Elements
Key Path	Meas Setup, Advanced
Parameter Type	IntParameter
Mode	LTEAFDD, LTEATDD
Remote Command	<code>[:SENSe] :EVM:CCARrier0 1 2 3 4:DLINK:AENumber <integer></code> <code>[:SENSe] :EVM:CCARrier0 1 2 3 4:DLINK:AENumber?</code>
Example	EVM:CCAR0:DLIN:AEN 3 EVM:CCAR0:DLIN:AEN?
Dependencies	Available when Direction is Downlink.
Preset	2
Force Restart	Yes
State Saved	Saved in instrument state.
Min	2
Max	8
Test MIN/MAX/DEF	Yes

Resolution	1
Test UP/DOWN	Yes
Softkey Label	Number of Ant Elements
Backwards Compatibility SCPI	[:SENSe] :EVM:DLINK:AENumber
Initial S/W Revision	A.14.00
Modified at S/W Revision	A.14.50

Limits

Accesses a menu that enables you to set parameters required to calculate the limit for Per Slot Freq Resp trace. This key is available only when Direction is Uplink.

Key Path	Meas Setup, Advanced
Initial S/W Revision	A.14.00

Spectrum Flatness Mask

Four parameters are required to calculate the limit for Per Slot Freq Resp trace, which can be used to perform the EVM equalizer spectrum flatness test defined in TS36–521 6.5.2.4

- Channel Condition – Specify under what environmental condition the test is performed. There two temperature conditions defined in TS36.101 Annex E, which are normal condition(+15°C to +35°C) and extreme condition(–10°C to +55°C).
- F_UL_Center – Specify the carrier frequency of the signal under test.
- F_UL_Low – Specify the lower frequency of the E-UTRA operating band defined in TS36–521–1 Table 5.2.1
- F_UL_High – Specify the upper frequency of the E-UTRA operating band defined in TS36–521–1 Table 5.2.1

This key is available only when Direction is Uplink.

Parameter Name	Spectrum Flatness Mask
Key Path	Meas Setup, Advanced, Limit
Mode	LTEAFDD, LTEATDD
Initial S/W Revision	A.14.00

Channel Condition

Specifies under what condition the test is performed. This parameter will determine the minimum requirements for EVM equalizer spectrum flatness test.

Parameter Name	Channel Condition
Key Path	Meas Setup, Advanced, Limit, Spectrum Flatness Mask
Parameter Type	EnumParameter
Mode	LTEAFDD, LTEATDD
Remote Command	[:SENSe] :EVM:CCARrier0 1 2 3 4 :ULINK:FLATness:CHANnel:CONDition NORMal EXTReMe [:SENSe] :EVM:CCARrier0 1 2 3 4 :ULINK:FLATness:CHANnel:CONDition?
Example	EVM:CCAR0:ULIN:FLAT:CHAN:COND NORM EVM:CCAR0:ULIN:FLAT:CHAN:COND?
Dependencies	Available when Direction is uplink.
Preset	NORMal
Force Restart	Yes
State Saved	Saved in instrument state.
Range	NORMal EXTReMe
Softkey Label	Channel Condition
Backwards Compatibility SCPI	[:SENSe] :EVM:ULINK:FLATness:CHANnel:CONDition
Initial S/W Revision	A.14.00
Modified at S/W Revision	A.14.50

F_UL_Center

Specifies the carrier frequency of signal under test.

Parameter Name	F_UL_Center
Key Path	Meas Setup, Advanced, Limit, Spectrum Flatness Mask
Key Type	Active Function
Parameter Type	FrequencyParameter
Remote Command	[:SENSe] :EVM:CCARrier0 1 2 3 4 :ULINK:FREQuency:CENTer <freq> [:SENSe] :EVM:CCARrier0 1 2 3 4 :ULINK:FREQuency:CENTer?
Example	EVM:CCAR0:ULIN:FREQ:CENT 1.95 GHz EVM:CCAR0:ULIN:FREQ:CENT?
Couplings	The value is clipped to F_UL_Low or F_UL_High. If the value entered is greater than F_UL_High, it is set to the value of F_UL_High. If the value entered is lower than F_UL_Low, it is set to the value of F_UL_Low.
Preset	1.95GHz
State Saved	Saved in instrument state
Active Function Text	F_UL_Center <value>

Min	Depends on F_UL_Low
Max	Depends on F_UL_High
Test MIN/MAX/DEF	Yes
Step Increment	the CF Step value
Unit Terminator Key	GHz, MHz, kHz, Hz
Default Unit	Hz
Softkey Label	F_UL_Center
Backwards Compatibility SCPI	[:SENSe] :EVM:ULINk:FREQuency:CENTer
Initial S/W Revision	A.14.00
Modified at S/W Revision	A.14.50

F_UL_Low

Specifies the lower frequency of the E-UTRA operating band defined in TS36-521-1 Table 5.2.1.

Parameter Name	F_UL_Low
Key Path	Meas Setup, Advanced, Limit, Spectrum Flatness Mask
Key Type	Active Function
Parameter Type	FrequencyParameter
Remote Command	[:SENSe] :EVM:CCARrier0 1 2 3 4:ULINk:FREQuency:LOW <freq>START [:SENSe] :EVM:CCARrier0 1 2 3 4:ULINk:FREQuency:LOW?
Example	EVM:CCAR0:ULIN:FREQ:LOW 1.92 GHz EVM:CCAR0:ULIN:FREQ:LOW?
Couplings	If the value entered is greater than F_UL_High, F_UL_High is set to the value of F_UL_Low.
Preset	1.92GHz
State Saved	Saved in instrument state
Active Function Text	F_UL_Low <value>
Min	0Hz
Max	Depends on F_UL_High
Test MIN/MAX/DEF	Yes
Step Increment	the CF Step value
Unit Terminator Key	GHz, MHz, kHz, Hz
Default Unit	Hz
Softkey Label	F_UL_Low
Backwards Compatibility SCPI	[:SENSe] :EVM:ULINk:FREQuency:LOW
Initial S/W Revision	A.14.00
Modified at S/W Revision	A.14.50

F_UL_High

Specifies the upper frequency of the E-UTRA operating band defined in TS36-521-1 Table 5.2.1

Parameter Name	F_UL_High
Key Path	Meas Setup, Advanced, Limit, Spectrum Flatness Mask
Key Type	Active Function
Parameter Type	FrequencyParameter
Remote Command	[:SENSe] :EVM:CCARrier0 1 2 3 4 :ULINk:FREQuency:HIGH <freq> [:SENSe] :EVM:CCARrier0 1 2 3 4 :ULINk:FREQuency:HIGH?
Example	EVM:CCAR0:ULIN:FREQ:HIGH 1.98 GHz EVM:CCAR0:ULIN:FREQ:HIGH?
Couplings	The value entered is lower than F_UL_Low, it is set to the F_UL_Low.
Preset	1.98GHz
State Saved	Saved in instrument state
Active Function Text	F_UL_High <value>
Min	Depends on F_UL_Low
Max	5GHz
Test MIN/MAX/DEF	Yes
Step Increment	the CF Step value
Unit Terminator Key	GHz, MHz, kHz, Hz
Default Unit	Hz
Softkey Label	F_UL_High
Backwards Compatibility SCPI	[:SENSe] :EVM:ULINk:FREQuency:HIGH
Initial S/W Revision	A.14.00
Modified at S/W Revision	A.14.50

Avg Number

Enables you to turn averaging on or off, and set the number of scans (time records) whose measurement results are averaged. Averaging can be done over spectrum results (RMS) or over time records (Time). A third kind of pseudo averaging displays the maximum value seen at each spectral line over the specified number of scans. See [Average Type](#) for a more detailed description of how measurement results are averaged. For RMS or Time averaging, the process is similar. Each time an averaged result is displayed, it is the sum of the individual results taken since measurement restart, divided by the number of scans. (For Max averaging, there is no actual summation or division.) The Measurement Bar shows the number of scans and the Avg number setting. For example, if 4 scans have been taken and the Avg Number is 10, the Meas Bar shows "4/10". The measurement continues to take new scans until the number of scans is equal to the Avg Number setting, at which time the measurement stops if Sweep control is in Single Mode.

Otherwise, the measurement continues, and the Average Mode setting determines how successive scans are added to the averaged result. See [Average Mode](#) for details.

Key Path	Meas Setup, More
Mode	VSA, LTE, LTETDD, IDEN, LTEAFDD, LTEATDD
Measurement	<meas>:=VECTor ADEMod DDEMod W11A W11B EVM IPOWER IDEMod MOTotalk
Remote Command	[:SENSe] :<meas>:AVERage:COUNT <integer> [:SENSe] :<meas>:AVERage:COUNT? [:SENSe] :<meas>:AVERage [:STATe] OFF ON 0 1 [:SENSe] :<meas>:AVERage [:STATe] ?
Example	VECT:AVER:COUN 20 VECT:AVER:COUN? VECT:AVER ON VECT:AVER?
Notes	If an averaged measurement is idle because the scan count is equal to the Avg Number and the Avg Number is increased, the measurement resumes until the new number of averages is satisfied.
Preset	10 OFF IPOW: ON
State Saved	Saved in instrument state.
Min	1
Max	2147483647
Initial S/W Revision	Prior to A.02.00
Modified at S/W Revision	A.02.00

Average Setup

Accesses a menu enabling you to set Averaging parameters for all VSA based measurements.

Key Path	Meas Setup
Mode	VSA, LTE, LTETDD, IDEN, LTEAFDD, LTEATDD
Initial S/W Revision	Prior to A.02.00
Modified at S/W Revision	A.02.00

Average Type

Enables you to select the type of averaging. The following table shows what measurement results are averaged for each average type. This applies in the Vector Measurement.

Average Type	Measurement result averaged.
---------------------	------------------------------

RMS	Spectrum, PSD: Power is averaged for each spectral line (i.e., this is a mean-square average of voltage). For the Spectrum result only, if the display transform is linear or real, the RMS result is displayed.
Max	Spectrum, PSD: Not strictly an average. For each spectral line, power from the current measurement is compared to the average buffer value and the maximum is kept in the average buffer.

They average continuously until the next measurement restart.

Key Path	Meas Setup, Average Setup
Mode	LTE, LTETDD, LTEAFDD, LTEATDD
Remote Command	[:SENSe] : <meas> : AVERAge : TYPE RMS MAXimum [:SENSe] : <meas> : AVERAge : TYPE?
Example	AVER:TYPE RMS AVER:TYPE?
Notes	The Time option is not used in the measurement. It only appears in the SCPI command for back-compatibility. The option doesn't affect the current average type.
Preset	RMS
State Saved	Saved in instrument state.
Range	RMS Max
Backwards Compatibility SCPI	[:SENSe] : <meas> : AVERAge : TYPE RMS TIME MAXimum
Initial S/W Revision	A.14.50

Fast Average

Controls the display of average data. If fast averaging is off, then the display is updated after each time record is processed. If fast averaging is on, then the display is only updated after every M records, where M is the Update Rate (see ["Update Rate" on page 2079](#)). For example, if the fast average count is 10, then the running average is only displayed every 10th time record.

Key Path	Meas Setup, Average Setup
Mode	VSA, LTE, LTETDD, IDEN, LTEAFDD, LTEATDD
Measurement	<meas> := VECTor ADEMod DDEMod W11A W11B EVM IPOWer IDEMod MOTotalk
Remote Command	[:SENSe] : <meas> : AVERAge : FAST OFF ON 0 1 [:SENSe] : <meas> : AVERAge : FAST?
Example	VECT: AVER: FAST ON VECT: AVER: FAST?
Preset	OFF
State Saved	Saved in instrument state.

Range	On Off
Initial S/W Revision	Prior to A.02.00
Modified at S/W Revision	A.02.00

Update Rate

Controls how often the display updates when fast averaging is turned on. If the Fast Averaging State is MAX then the display is updated only after the full Average Count is reached. Otherwise, the display is updated whenever the average count is a multiple of the Update Rate.

Key Path	Meas Setup, More, Average Setup
Mode	VSA, LTE, LTETDD, IDEN, LTEAFDD, LTEATDD
Measurement	<meas>:=VECTor ADEMod DDEMod W11A W11B EVM IPOWER IDEMod MOTotalk
Remote Command	[:SENSe] :<meas>:AVERage:FAST:URATe <integer> [:SENSe] :<meas>:AVERage:FAST:URATe? [:SENSe] :<meas>:AVERage:FAST:URATe:AUTO OFF ON 0 1 [:SENSe] :<meas>:AVERage:FAST:URATe:AUTO?
Example	VECT:AVER:FAST:URAT 20 VECT:AVER:FAST:URAT? VECT:AVER:FAST:URAT:AUTO ON VECT:AVER:FAST:URAT:AUTO?
Preset	10 ON
State Saved	Saved in instrument state.
Min	1
Max	2147483647
Initial S/W Revision	Prior to A.02.00
Modified at S/W Revision	A.02.00

Adjust Attenuation for each CC

This parameter specifies how to adjust the attenuation when multiple Component Carriers are under test. For example, when CC0 is selected, the attenuation will be set based on the peak power of CC0. When All is selected, the attenuation will be adjusted for each CC.

Key Path	Meas Setup
Mode	LTEAFDD, LTEATDD
Remote Command	[:SENSe] :EVM:RANGe:OPTimize CC0 CC1 CC2 CC3 CC4 All [:SENSe] :EVM:RANGe:OPTimize?

Example	EVM:RANG:OPT CC0 EVM:RANG:OPT?
Notes	The options CC1~CC4 can be enabled with 9080B/9082B-2FP license
Dependencies	Component Carrier is coupled to Number of Component Carriers. For example, Component Carrier list will include CC0 to CC1 if the number Component Carriers is 2.
Preset	CC0
State Saved	Saved in instrument state
Range	CC0 CC1 CC2 CC3 CC4 All
Readback	CC0 CC1 CC2 CC3 CC4 All
Initial S/W Revision	A.14.50

Meas Preset

Immediately sets all measurement parameters to their Preset values. For more information, see "[Mode Preset](#)" on page 2391.

Parameter Name	Meas Preset
Key Path	Meas Setup, More
Mode	LTEAFDD, LTEATDD
Initial S/W Revision	A.14.00

Mode

See "Mode" on page 222

Mode Preset

Returns the active mode to a known state.

Mode Preset does the following for the currently active mode:

- Aborts the currently running measurement.
- Brings up the default menu for the mode, with no active function.
- Sets measurement Global settings to their preset values for the active mode only.
- Activates the default measurement.
- Brings up the default menu for the mode.
- Clears the input and output buffers.
- Sets Status Byte to 0.

Mode Preset does not:

- Cause a mode switch
- Affect mode persistent settings
- Affect system settings
- See "[How-To Preset](#)" on page 2083 for more information.

Key Path	Front-panel key
Remote Command	:SYSTem:PRESet
Example	:SYST:PRES
Notes	*RST is preferred over :SYST:PRES for remote operation. *RST does a Mode Preset, as done by the :SYST:PRES command, and it sets the measurement mode to Single measurement rather than Continuous for optimal remote control throughput. Clears all pending OPC bits. The Status Byte is set to 0.
Couplings	A Mode Preset aborts the currently running measurement, activates the default measurement, and gets the mode to a consistent state with all of the default couplings set.
Backwards Compatibility Notes	In the X-Series, the legacy "Factory Preset" has been replaced with Mode Preset, which only presets the currently active mode, not the entire instrument. In the X-Series, the way to preset the entire instrument is by using System, Restore System Defaults All, which behaves essentially the same way as restore System Defaults does on ESA and PSA. There is also no "Preset Type" as there is on the PSA. There is a green Mode Preset front-panel key that does a Mode Preset and a white-with-green-letters User Preset front-panel key that does a User Preset. The old PRESet:TYPE command is ignored (without generating an error), and SYST:PRES without a parameter does a Mode Preset, which should cover most backward code compatibility issues. The settings and correction data under the Input/Output front-panel key (examples: Input Z Corr, Ext Amp Gain, etc.) are no longer part of any Mode, so they will not be preset by a Mode Preset. They are preset using Restore Input/Output Defaults, Restore System Defaults All. Note that because User Preset does a Recall State, and all of these settings are saved in State, they ARE recalled when using

	User Preset.
Initial S/W Revision	Prior to A.02.00

How-To Preset

The table below shows all possible presets, their corresponding SCPI commands and front-panel access (key paths). Instrument settings depend on the current measurement context. Some settings are local to the current measurement, some are global (common) across all the measurements in the current mode, and some are global to all the available modes. In a similar way, restoring the settings to their preset state can be done within the different contexts.

Auto Couple - is a measurement local key. It sets all Auto/Man parameter couplings in the measurement to Auto. Any Auto/Man selection that is local to other measurements in the mode will not be affected.

Meas Preset - is a measurement local key. Meas Preset resets all the variables local to the current measurement except the persistent ones.

Mode Preset - resets all the current mode's measurement local and measurement global variables except the persistent ones.

Restore Mode Defaults - resets ALL the Mode variables (and all the Meas global and Meas local variables), including the persistent ones.

Type Of Preset	SCPI Command	Front Panel Access
Auto Couple	:COUPlE ALL	Auto Couple front-panel key
Meas Preset	:CONFIgure:<Measurement>	Meas Setup Menu
Mode Preset	:SYSTem:PRESet	Mode Preset (green key)
Restore Mode Defaults	:INSTRument:DEFault	Mode Setup Menu
Restore All Mode Defaults	:SYSTem:DEFault MODEs	System Menu; Restore System Default Menu
*RST	*RST	not possible (Mode Preset with Single)
Restore Input/Output Defaults	:SYSTem:DEFault INPut	System Menu; Restore System Default Menu
Restore Power On Defaults	:SYSTem:DEFault PON	System Menu; Restore System Default Menu
Restore Alignment Defaults	:SYSTem:DEFault ALIGN	System Menu; Restore System Default Menu
Restore Miscellaneous Defaults	:SYSTem:DEFault MISC	System Menu; Restore System Default Menu
Restore All System Defaults	:SYSTem:DEFault [ALL] :SYSTem:PRESet:PERSistent	System Menu; Restore System Default Menu
User Preset	:SYSTem:PRESet:USER	User Preset Menu
User Preset All Modes	:SYSTem:PRESet:USER:ALL	User Preset Menu

13 LTE-Advanced Modulation Analysis Measurement
Mode Preset

Power On Mode Preset	:SYSTem:PON:TYPE MODE	System Menu
Power On User Preset	:SYSTem:PON:TYPE USER	System Menu
Power On Last State	:SYSTem:PON:TYPE LAST	System Menu

Mode Setup

See ["Mode Setup" on page 242](#)

Peak Search

Displays a menu that enables markers to be easily moved among peaks on a trace and also performs the peak search function. Pressing Peak Search also makes the selected marker's X position the active function.

The peak search function causes the marker to move to the highest point in the trace. The highest point is the point with the largest y-axis value in the current trace format. If the format is complex (vector or constellation) then the point with the highest magnitude is chosen.

Pressing the Peak Search hard key always performs a Peak Search, with one exception: if the Peak Search menu is not showing but the selected marker is on (Normal, Delta, or Fixed), then pressing the Peak Search hardkey only displays the Peak Search menu. This enables you to select one of the other peak search functions without disturbing the selected marker's position. If you want to perform a peak search in this case, press the Peak Search hardkey again.

If the selected marker is Off, then pressing the Peak Search hardkey once not only shows the menu, but it turns on the selected marker in Normal mode, assigns it to the selected trace, and performs a peak search.

If any peak search SCPI command is invoked on a marker that is Off, the marker is first turned on in Normal mode and assigned to the selected trace. Then the peak search is performed.

Key Path	Front Panel
Mode	VSA, LTE, LTETDD, IDEN
Measurement	<meas>:=VECTor ADEMod DDEMod W11A W11B EVM IPOWER IDEMod MOTotalk
Remote Command	:CALCulate:<meas>:MARKer[1] 2 ... 12:MAXimum
Example	CALC:VECT:MARK2:MAX
Notes	There is no softkey for this function. Instead, you press the Peak Search hardkey twice. (Pressing it once is sufficient if the Peak Search menu is showing, but twice guarantees that the function is invoked) If peak search function is not invoked (because the response to pressing the hardkey was only to show the menu) then the following message is shown: "Press Peak Search again to perform a Peak Search."
Initial S/W Revision	Prior to A.02.00
Modified at S/W Revision	A.02.00

Select Marker

Specifies the selected marker. The selected marker is the one that is affected by the marker position and properties settings, peak search, and other marker functions. Several menus have a Select Marker key for convenience. Marker selection using any one of these is reflected in all others, in other words, there is only one selected marker for the whole measurement. If all markers are off, then marker 1 becomes the selected marker.

As a convenience, if no markers are displayed on the selected trace, selecting a marker that is off automatically turns it on in normal mode on the selected trace.

There is no SCPI function for selecting a marker. Instead, SCPI functions can explicitly include the index of the marker for which they are to apply. (Most SCPI marker functions that affect the state of a marker also make it the selected marker for front panel commands.)

Key Path	Marker or Marker> or Marker Function or Peak Search
Mode	VSA, LTE, LTETDD, IDEN,LTEAFDD,LTEATDD
State Saved	No
Range	1 2 3 4 5 6 7 8 9 10 11 12
Initial S/W Revision	Prior to A.02.00
Modified at S/W Revision	A.02.00

Next Peak (Next Lower Amptd)

Moves the marker to the peak next lower in Y value than the peak it is currently on. If the format is complex (vector or constellation) then the marker moves to the closest point that has a lower magnitude than the marker's current position. If this function is invoked via SCPI on a marker that is off, the result is the same as if you sent a Peak Search command.

Key Path	Peak Search
Mode	VSA, LTE, LTETDD, IDEN
Measurement	<meas>:=VECTor ADEMod DDEMod W11A W11B EVM IPOWER IDEMod MOTotalk
Remote Command	:CALCulate:<meas>:MARKer[1] 2 ... 12:MAXimum:NEXT
Example	CALC:VECT:MARK2:MAX:NEXT
Initial S/W Revision	Prior to A.02.00
Modified at S/W Revision	A.02.00

Next Higher Amptd

Moves the marker to the peak next higher in Y value than the peak it is currently on. If the format is complex (vector or constellation) then the marker moves to the closest point that has a higher magnitude than the marker's current position. If this function is invoked via SCPI on a marker that is off, the result is the same as if you sent a Peak Search command.

Key Path	Peak Search
Mode	VSA, LTE, LTETDD, IDEN
Measurement	<meas>:=VECTor ADEMod DDEMod W11A W11B EVM IPOWER IDEMod MOTotalk
Remote Command	:CALCulate:<meas>:MARKer[1] 2 ... 12:MAXimum:PREVIOUS
Example	CALC:VECT:MARK2:MAX:PREV
Initial S/W Revision	Prior to A.02.00
Modified at S/W Revision	A.02.00

Next Right

Moves the marker to the next peak to the right of its current position. If the format is complex (vector or constellation) then the marker moves forward in time to the next peak. If this function is invoked via SCPI on a marker that is off, the result is the same as if you sent a Peak Search command.

A valid peak is one for which the displayed Y-axis values drop monotonically on both sides of the local maximum at least 4% of the distance between the top and bottom of the display grid before the values begin to rise again.

Key Path	Peak Search
Mode	VSA, LTE, LTETDD, IDEN
Measurement	<meas>:=VECTor ADEMod DDEMod W11A W11B EVM IPOWER IDEMod MOTotalk
Remote Command	:CALCulate:<meas>:MARKer [1] 2 ... 12:MAXimum:RIGHT
Example	CALC:VECT:MARK2:MAX:RIGH
Initial S/W Revision	Prior to A.02.00
Modified at S/W Revision	A.02.00

Next Left

Moves the marker to the next peak to the left of its current position. If the format is complex (vector or constellation) then the marker moves back in time to the next peak. If this function is invoked via SCPI on a marker that is off, the result is the same as if you sent a Peak Search command.

A valid peak is one for which the displayed Y-axis values drop monotonically on both sides of the local maximum at least 4% of the distance between the top and bottom of the display grid before the values begin to rise again.

Key Path	Peak Search
Mode	VSA, LTE, LTETDD, IDEN
Measurement	<meas>:=VECTor ADEMod DDEMod W11A W11B EVM IPOWER IDEMod MOTotalk
Remote Command	:CALCulate:<meas>:MARKer [1] 2 ... 12:MAXimum:LEFT
Example	CALC:VECT:MARK2:MAX:LEFT
Initial S/W Revision	Prior to A.02.00
Modified at S/W Revision	A.02.00

Mkr -> CF (Center Frequency)

Sets the center frequency equal to the selected marker's absolute frequency. The marker must be on a frequency-domain trace. The absolute marker frequency is used regardless of whether its control mode is Normal, Delta, or Fixed.

If the currently selected marker is not on when this key is pressed, it is turned on at the center of the screen as a normal type marker.

Key Path	Marker To
Mode	VSA, LTE, LTETDD, IDEN, LTEAFDD, LTEATDD
Initial S/W Revision	Prior to A.02.00
Modified at S/W Revision	A.02.00

Continuous Peak Search

Turns on Continuous Peak Search for the selected marker. This function can be turned on for any marker independently of any other marker. This function moves the marker to the highest point on the trace each time the trace is updated. If the SCPI command refers to a marker that is off, it is turned on in Normal mode.

It is possible to have Couple Markers and Continuous Peak Search both on. If this is the case, it is recommended that Continuous Peak search be turned on for only one marker in any tracking set (that is, any set of markers with the same or equivalent domain). Otherwise, conflicts over marker position can arise that cause erratic marker movement.

Key Path	Peak Search
Mode	VSA, LTE, LTETDD, IDEN
Measurement	<meas>:=VECTor ADEMod DDEMod W11A W11B EVM IPOWER IDEMod MOTotalk
Remote Command	:CALCulate:<meas>:MARKer[1] 2 ... 12:CPSearch[:STATe] ON OFF 1 0 :CALCulate:<meas>:MARKer[1] 2 ... 12:CPSearch[:STATe]?
Example	CALC:VECT:MARK1:CPS ON
Couplings	The Continuous Peak Search key is grayed out when the selected marker is a Fixed marker. Also, if Continuous Peak Search is on and the selected marker becomes a fixed marker, then Continuous Peak Search is turned off and the key grayed out. Continuous Peak Search is turned off when the selected marker is turned off.
Preset	OFF
State Saved	Saved in instrument state.
Range	Off On
Initial S/W Revision	Prior to A.02.00
Modified at S/W Revision	A.02.00

Min Search

Moves the marker to the lowest Y value on the trace. If the format is complex (vector or constellation) then the marker moves to the lowest value in magnitude. If the SCPI command refers to a marker that is off, it is first turned on in Normal mode and then set on the minimum point.

Key Path	Peak Search
Mode	VSA, LTE, LTETDD, IDEN

Measurement	<meas>:=VECTor ADEMod DDEMod W11A W11B EVM IPOWER IDEMod MOTotalk
Remote Command	:CALCulate:<meas>:MARKer [1] 2 ... 12:MINimum
Example	CALC:VECT:MARK2:MIN
Initial S/W Revision	Prior to A.02.00
Modified at S/W Revision	A.02.00

Mkr -> Ref Lvl (Reference Level)

Sets the Y axis reference value equal to the selected marker's Y value. For example, if the reference position is at the top of the screen, the whole trace is moved up so that the marker appears at the top of the screen. Note that this is a display scaling function only. The input range remains the same.

Key Path	Peak Search
Mode	VSA, LTE, LTETDD, IDEN
Initial S/W Revision	Prior to A.02.00
Modified at S/W Revision	A.02.00

Print

See "Print" on page 271

Quick Save

The Quick Save front-panel key repeats the most recent save that was performed from the Save menu, with the following exceptions:

- Register saves are not remembered as Saves for the purpose of the Quick Save function
- If the current measurement does not support the last non-register save that was performed, an informational message is generated, “File type not supported for this measurement”

Quick Save repeats the last type of qualified save (that is, a save qualified by the above criteria) in the last save directory by creating a unique filename using the Auto File Naming algorithm described below.

If Quick Save is pressed after startup and before any qualified Save has been performed, the Quick Save function performs a Screen Image save using the current settings for Screen Image saves (current theme, current directory), which then becomes the “last save” for the purpose of subsequent Quick Saves.

The Auto File Naming feature automatically generates a file name for use when saving a file. The filename consists of a prefix and suffix separated by a dot, as is standard for the Windows® file system. A default prefix exists for each of the available file types:

Type	Default Prefix	Menu
State	State_	(Save/Recall)
Trace + State	State_	(Save/Recall)
Screen	Screen_	(Save/Recall)
Amplitude Corrections	Ampcor_	(Import/Export)
Traces	Trace_	(Import/Export)
Limit Lines	LLine_	(Import/Export)
Measurement Result	MeasR_	(Import/Export)
Capture Buffer	CapBuf_	(Import/Export)

A four digit number is appended to the prefix to create a unique file name. The numbering sequence starts at 0000 within each Mode for each file type and updates incrementally to 9999, then wraps to 0000 again. It remembers where it was through a Mode Preset and when leaving and returning to the Mode. It is reset by Restore Misc Defaults and Restore System Defaults and subsequent running of the instrument application. So, for example, the first auto file name generated for State files is State_0000.state. The next is State_0001, and so forth.

One of the key features of Auto File Name is that we guarantee that the Auto File Name will never conflict with an existing file. The algorithm looks for the next available number. If it gets to 9999, then it looks for holes. If it find no holes, that is no more numbers are available, it gives an error.

For example, if when we get to State_0010.state there is already a State_0010.state file in the current directory, it advances the counter to State_0011.state to ensure that no conflict will exist (and then it verifies that State_0011.state also does not exist in the current directory and advances again if it does, and so forth).

If you enter a file name for a given file type, then the prefix becomes the filename you entered instead of the default prefix, followed by an underscore. The last four letters (the suffix) are the 4-digit number.

For example, if you save a measurement results file as “fred.csv”, then the next auto file name chosen for a measurement results save will be fred_0000.csv.

NOTE Although 0000 is used in the example above, the number that is used is actually the current number in the Meas Results sequence, that is, the number that would have been used if you had not entered your own file name.

NOTE If the filename you entered ends with _dddd, where d=any number, making it look just like an auto file name, then the next auto file name picks up where you left off with the suffix being dddd + 1.

Key Path	Front-panel key
Notes	No remote command for this key specifically.
Initial S/W Revision	Prior to A.02.00

Recall

In the LTE-Advanced TDD/FDD modes, two types of recall functions are available under the Data menu: “Parameter Configuration per Component Carrier” and “Limit Mask”. Limit Mask enables setting a preset limit mask for Power Suite-based measurements, and currently it is available for the SEM, ACP and SPUR measurements in LTE-Advanced TDD/FDD modes.

Recalling the complicated RB settings specified in the test models of the standards and the LTE state file. And it can also recalls the parameters which have been set and saved for “Signal Studio Setup” or “89600 Vector Signal Analyzer” on the external platform .

Key Path	Front Panel Key
Mode	LTEATDD, LTEAFDD
Initial S/W Revision	A.14.00

State

The Recall State menu lets you choose a register or file from which to recall the state.

The content of a state file includes all of the settings and data required to return the analyzer as closely as possible to the Mode it was in, with the exact settings that were in place, when the save occurred. The Mode settings in each state file include the settings that are affected by Mode Preset, as well as the additional settings affected by Restore Mode Defaults; all of the Mode’s settings. In addition, all of the settings of the Input/Output system are included, even though they are outside of the Mode’s state, because they are needed to restore the complete setup. Persistent System settings (for example, GPIB address) are not affected by either a Mode Preset or Restore Mode Defaults, nor are they included in a saved State file.

Since each state file is only for one Mode, the settings for other Modes are unaffected when it is loaded. Recall State will cause a mode switch if the state being recalled is not from the current active mode.

After the recall completes, the message "File <filename> recalled" or “Recalled State Register <register number>” is displayed.

For rapid recalls, the State menu lists 16 registers that you can choose from to recall. Pressing a Register key initiates the recall. You can also select a file from which to recall.

The default path for all State Files is:

My Documents\<mode name>\state

where <mode name> is the parameter used to select the mode with the INST:SEL command (for example, SA for the Spectrum Analyzer).

See "[More Information](#)" on page 2095.

Key Path	Recall
Mode	All
Remote Command	:MMEMory:LOAD:STATe <filename>

Example	:MMEM:LOAD:STAT "myState.state" This recalls the file myState.state on the default path
Example	MMEM:LOAD:STAT "MyStateFile.state" This loads the state file data (on the default file directory path) into the instrument state.
Notes	<p>When you pick a file to recall, the analyzer first verifies that the file is recallable in the current instrument by checking the software version and model number of the instrument. If everything matches, a full recall proceeds by aborting the currently running measurement, clearing any pending operations, and then loading the State from the saved state file. You can open state files from any mode, so recalling a State file switches to the mode that was active when the save occurred. After switching to the mode of the saved state file, mode settings and data (if any for the mode) are loaded with values from the saved file. The saved measurement of the mode becomes the newly active measurement and the data relevant to the measurement (if there is any) is recalled.</p> <ul style="list-style-type: none"> • If there is a mismatch between file version or model number or instrument version or model number, the recall function tries to recall as much as possible and returns a warning message. It may limit settings that differ based on model number, licensing or version number. <p>After recalling the state, the Recall State function does the following:</p> <ul style="list-style-type: none"> • Makes the saved measurement for the mode the active measurement. • Clears the input and output buffers. • Status Byte is set to 0. • Executes a *CLS <p>If the file specified is empty an error is generated. If the specified file does not exist, another error is generated. If there is a mismatch between the file and the proper file type, an error is generated. If there is a mismatch between file version or model number or instrument version or model number, a warning is displayed. Then it returns to the State menu and File Open dialog goes away.</p> <p>After the Recall, the analyzer exits the Recall menu and returns to the previous menu.</p>
Backwards Compatibility SCPI	:MMEMory:LOAD:STATe 1,<filename> For backwards compatibility, the above syntax is supported. The "1" is simply ignored.
Initial S/W Revision	Prior to A.02.00

More Information

In measurements that support saving Traces, for example, Swept SA, the Trace data is saved along with the State in the State file. When recalling the State, the Trace data is recalled as well. Traces are recalled exactly as they were stored, including the writing mode and update and display modes. If a Trace was updating and visible when the State was saved, it will come back updating and visible, and its data will be rewritten right away. When you use State to save and recall traces, any trace whose data must be preserved should be placed in View or Blank mode before saving.

The following table describes the Trace Save and Recall possibilities:

You want to recall state and one trace's data, leaving other traces unaffected.	Save Trace+State from 1 trace. Make sure that no other traces are updating (they should all be in View or Blank mode) when the save is performed.	On Recall, specify the trace you want to load the one trace's data into. This trace will load in View. All other traces' data will be unaffected, although their trace
---	---	--

		mode will be as it was when the state save was performed.
You want to recall all traces	Save Trace+State from ALL traces.	On Recall, all traces will come back in View (or Blank if they were in Blank or Background when saved)
You want all traces to load exactly as they were when saved.	Save State	On recall, all traces' mode and data will be exactly as they were when saved. Any traces that were updating will have their data immediately overwritten.

From File...

When you press “From File”, the analyzer brings up a Windows dialog and a menu entitled “File Open.” This menu allows you to navigate to the various fields in the Windows dialog without using a keyboard or mouse. The Tab and Arrow keys can also be used for dialog navigation.

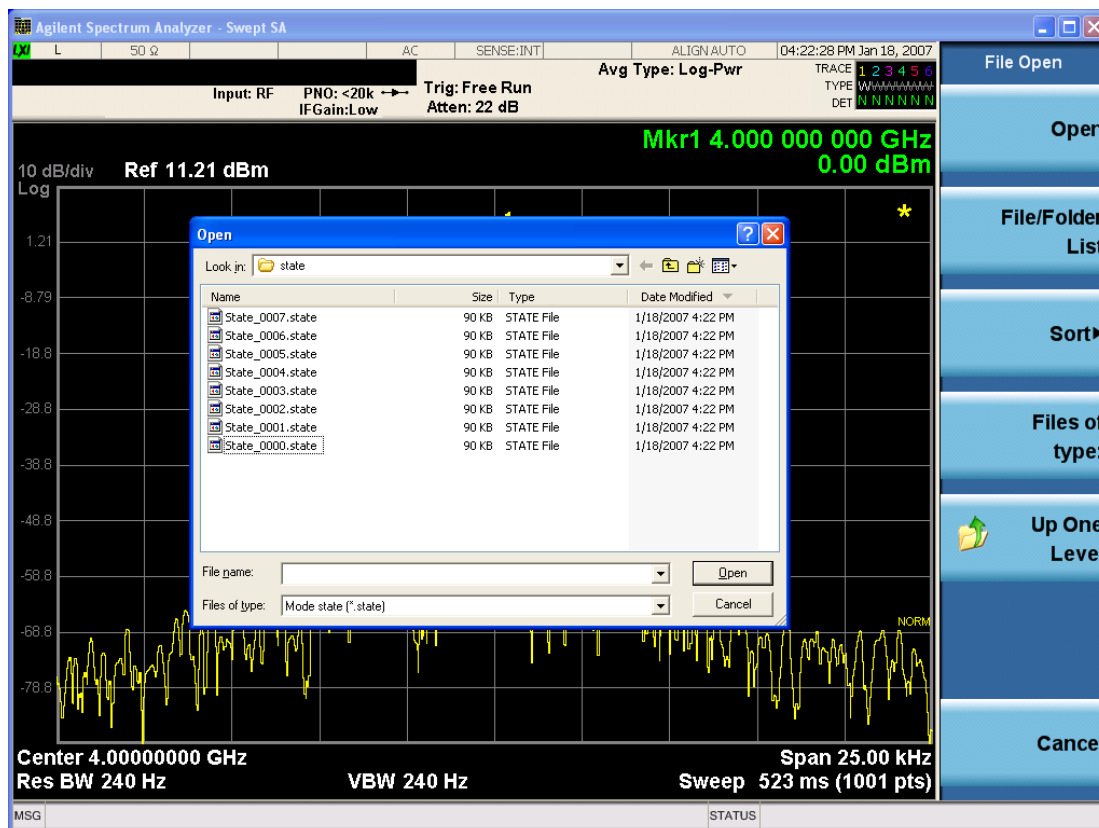

Listed below are the functions of the various fields in the dialog, and the corresponding softkeys:

Open

Performs the recall of the specified file. While the recall is being performed, the floppy icon appears briefly in the Meas bar.

File/Folder List

Enables you to navigate to the center of the dialog that contains the list of files and folders. Once here you can get information about the file and use the tab keys to navigate to the other fields in the dialog, such as Look In.

Look In

The Look In field shows the path from which the file will be recalled and allows you to change the path using the up and down arrow keys to navigate to other paths; the Enter key to open a directory; and the Backspace key to go back one directory. The **Look In field** first uses the last path from the Save As dialog **Save In:** path for that same file type. There is no softkey for directly navigating to the Look In field, but you can use the left tab to get here from the File/Folder List.

User specified paths are remembered when you leave and return to a Mode and are reset back to the default using Restore Mode Defaults.

Sort

Accesses a menu that enables you to sort the files within the File Open dialog. Only one sorting type can be selected at a time and the sorting happens immediately. The sorting types are By Date, By Name, By extension, and By Size.

Files of Type

This field shows the file suffix for the type of file you have selected to recall. For example, if you navigated here while recalling State, "Mode state (*.state)" is in the field. If you navigated here while recalling Trace, ""Mode state (*.trace)" is in the field. If you navigated here while importing a trace data file, "Trace Data (*.csv)" is in the field. For some file types, there is more than one choice in the dropdown menu, which you can select by using the up and down arrow keys and Enter.

Up One Level

This key corresponds to the icon of a folder with the up arrow that is in the tool bar of the dialog. When pressed, it causes the file and folder list to navigate up one level in the directory structure. The Backspace key does the same thing.

Cancel

This key corresponds to the Cancel selection in the dialog. It causes the current **Open** request to be cancelled. The ESC key does the same thing.

Key Path	Recall, State
Notes	Brings up the Open dialog for recalling a State Save Type
Initial S/W Revision	Prior to A.02.00

Edit Register Names

You may enter a custom name on any of the Register keys, to help you remember what you are using that state to save. To do this, press the Edit Register Names key, choose the register whose name you wish to edit, and then enter the desired label using the Alpha Editor or an external PC keyboard.

The maximum number of characters that can be added is 30. In most cases, 30 characters will fit on two lines of the key.

For more information and the SCPI command, see Edit Register Names under the Save, State function.

Key Path	Recall, State
Mode	All
Dependencies	N9060A-7FP or N9060B-2FP license required to edit the register names. When the feature is not licensed, sending the SCPI command generates an error, -221, "Settings conflict;Option not available"
Initial S/W Revision	A.11.00

Register 1 thru Register 16

Selecting any one of these register keys causes the State of the mode from the specified Register to be recalled. Each of the register keys annotates whether it is empty or at what date and time it was last modified. In addition, you can use the Edit Register Names key under Save, State to enter custom names for each register.

NOTE

In products that run multiple instances of the X-Series Application, recalling the same register name on each instance is a way to share setups between the instances.

Registers are shared by all modes, so recalling from any one of the registers will cause a mode switch to the mode that was active when the save to the Register occurred.

Although these 16 registers are the only registers available from the front panel, there are 128 state registers available in the instrument. Registers 17-128 are only available from the SCPI interface, using the *RCL command.

After the recall completes, the message "Register <register number> recalled" appears in the message bar. If you are in the Spectrum Analyzer Mode, and you are recalling a register that was saved in the Spectrum Analyzer Mode, then after the recall, you will still be in the Recall Register menu. If the Recall causes you to switch modes, then after the Recall, you will be in the Frequency menu.

If a requested register is empty an error is generated.

Key Path	Recall, State
Example	*RCL 1
Range	1-16 from front panel, 1-128 from SCPI
Readback	Date and time with seconds resolution are displayed on the key OR A custom name of up to 30 characters entered using the Save, State,Edit Register Names key

	OR “(empty)” if no prior save operation has been performed to this register.
Initial S/W Revision	Prior to A.02.00
Modified at S/W Revision	Prior to A.11.00

Register 1 thru Register 16

Selecting any one of these register keys causes the State of the mode from the specified Register to be recalled. Each of the register keys annotates whether it is empty or at what date and time it was last modified. In addition, you can use the Edit Register Names key under Save, State to enter custom names for each register.

NOTE In products that run multiple instances of the X-Series Application, recalling the same register name on each instance is a way to share setups between the instances.

Registers are shared by all modes, so recalling from any one of the registers will cause a mode switch to the mode that was active when the save to the Register occurred.

Although these 16 registers are the only registers available from the front panel, there are 128 state registers available in the instrument. Registers 17–128 are only available from the SCPI interface, using the *RCL command.

After the recall completes, the message "Register <register number> recalled" appears in the message bar. If you are in the Spectrum Analyzer Mode, and you are recalling a register that was saved in the Spectrum Analyzer Mode, then after the recall, you will still be in the Recall Register menu. If the Recall causes you to switch modes, then after the Recall, you will be in the Frequency menu.

If a requested register is empty an error is generated.

Key Path	Recall, State
Example	*RCL 1
Range	1–16 from front panel, 1–128 from SCPI
Readback	Date and time with seconds resolution are displayed on the key OR A custom name of up to 30 characters entered using the Save, State, Edit Register Names key OR “(empty)” if no prior save operation has been performed to this register.
Initial S/W Revision	Prior to A.02.00
Modified at S/W Revision	Prior to A.11.00

Sequences

These keys allow you to import a Tab separated or .txt file that will automatically setup all the parameters required for building a Sequence. The parameters will automatically be loaded into the Stated Sequencer.

Once selected, in order to import the selected Sequence Type you must select the Open key in the Source Sequence menu.

Key Path	Recall, Sequences
Mode	All
Remote Command	:MMEMory:LOAD:SEQuences: SLIS ALIS SAALIS "MySequence.txt"
Example	:MMEM:LOAD:SEQ:SLIS "MySequence.txt"
Notes	Available file types are: –CSV (Comma delimited) (*.csv) –Text (Tab delimited) (*.txt)
Initial S/W Revision	A.05.00

Source Sequence

The list of parameters, that configure steps, that makes up a sequence for the Source.

The Source sequence is a sequence of flexible configurable steps that can be set anywhere in the instruments frequency range.

Key Path	Recall,Sequences
Example	:MMEM:LOAD:SEQ:SLIS "MySequence.txt"
Dependencies	Only available in XOBT
Initial S/W Revision	A.05.00

Open...

When you press “Open”, the analyzer brings up a Windows dialog and a menu entitled “File Open.” This menu allows you to navigate to the various fields in the Windows dialog without using a keyboard or mouse. The Tab and Arrow keys can also be used for dialog navigation.

See "[From File...](#)" on page 2401 in Recall, State, for a full description of this dialog and menu.

Key Path	Recall, Data
Notes	The key location is mode-dependent and will vary. Brings up Open dialog for recalling a <mode specific> Save Type
Initial S/W Revision	Prior to A.02.00

Data (Import)

Importing a data file loads data that was previously saved from the current measurement or from other measurements and/or modes that produce compatible data files. The Import Menu only contains Data Types that are supported by the current measurement.

Since the commonly exported data files are in .csv format, the data can be edited by the user prior to importing. This allows you to export a data file, manipulate the data in Excel (the most common PC Application for manipulating .csv files) and then import it.

Importing Data loads measurement data from the specified file into the specified or default destination, depending on the data type selected. Selecting an Import Data menu key will not actually cause the importing to occur, since the analyzer still needs to know from where to get the data. Pressing the Open key in this menu brings up the Open dialog and Open menu that provides you with the options from where to recall the data. Once a filename has been selected or entered in the Open menu, the recall occurs as soon as the Open button is pressed.

Key Path	Recall
Mode	All
Notes	The menu is built from whatever data types are available for the mode. Some keys will be missing completely, so the key locations in the sub-menu will vary. No SCPI command directly controls the Data Type that this key controls. The Data Type is included in the MMEM:LOAD commands.
Dependencies	If a file type is not used by a certain measurement, it is grayed out for that measurement. The key for a file type will not show at all if there are no measurements in the Mode that support it.
Preset	Is not affected by Preset or shutdown, but is reset during Restore Mode Defaults
Readback	The data type that is currently selected
Initial S/W Revision	Prior to A.02.00

Component Carrier Setup

Enables you to import LTE-A setup files for all Component Carriers or the specified Component Carrier. Selecting this key displays a menu that enables you to select what the Component Carrier setup files to be imported. After making this selection, depress Open... and use the file dialog to select the file you wish to recall. The Key is valid for Conformance EVM measurements only.

It supports to the following import file formats

- LTE app state files (*.state)
- EVM Setup Files (*.evms)
- 89601 VSA Setup Files (*.set, *.setx)
- Signal Studio Setup Files (*.scp)

App State Files

Extension: state

The parameters of the LTE Modulation Analysis measurement can be imported to LTE-Advanced EVM and CEVM measurements from the LTE .state file. It depends on the parameter of the Component Carrier Setup to decide which component carriers' measurement parameters are affected.

Pressing OPEN under the Import Data menu will open the above directory from which you can select an LTE app state file.

EVM Setup Files

Extension: evms

It will recall LTE test model parameters specified in the standards to LTE-Advanced FDD/TDD EVM and CEVM measurements. It depends on the parameter of the Component Carrier Setup to decide which component carriers 'measurement parameters are affected.

The default path is My Documents\LTEATDD\LTEAFDD\data\evmsetup. Note that "My Documents" is an alias to a directory and its place differs depending on which user is logged in. At XSA start up, XSA will overwrite all of the EVM Setup files to the current user's "My Documents\LTEATDD\LTEAFDD\data\evmsetup" each time.

Pressing OPEN under the Import Data menu will open the above directory from which you can select an EVM Setup file.

You cannot read the contents of the provided EVM Setup file since it is a binary file.

89601 VSA Setup Files

Extension: set, setx

The 89600 Vector Signal Analyzer Setup file created using the 89600 Vector Signal Analyzer Option BHD (LTETDD\LTEFDD) can be imported as LTE-Advanced TDD/FDD EVM and CEVM parameter sets.

The 89600 Vector Signal Analyzer Setup file created using the 89600 Vector Signal Analyzer Option BHD (LTEATDD\LTEAFDD) can be imported as LTE-Advanced TDD/FDD EVM and CEVM parameter sets.

Which component carriers 'measurement parameters are affected depends on depends on the parameter of the Component Carrier Setup.

If the setup file is not loaded successfully, an error message, -230 "Data corrupt or stale", is issued with the specified file name.

Signal Studio Setup Files

Extension: scp

The Keysight Signal Studio setup file created using Signal Studio (N7624B/N7625B) can be imported as LTE-Advanced TDD/FDD parameter set.

Supported component carrier types are listed in the table below:

<i>Signal Studio</i>	<i>Carrier Type</i>
N7624B Signal Studio for 3GPP LTE	Advanced LTE FDD Downlink (2009-03)
	Advanced LTE FDD Downlink (2009-12)
	Advanced LTE FDD Downlink (2010-06)
	Advanced LTE FDD Uplink (2009-12)
	Advanced LTE FDD Uplink (2010-06)
	Basic LTE FDD Downlink (2009-03)
	Basic LTE FDD Downlink (2009-12)
	Basic LTE FDD Downlink (2010-06)
	Basic LTE FDD Uplink (2009-03)

	Basic LTE FDD Uplink (2009-12)
	Basic LTE FDD Uplink (2010-06)
	Basic LTE-A FDD Downlink (2010-12)
	Basic LTE-A FDD Uplink (2010-12)
	Basic LTE FDD R9 Downlink
	Basic LTE FDD R9 Uplink
	Advanced LTE FDD R9 Downlink
	Advanced LTE FDD R9 Uplink
	Basic LTE-A FDD R10 Downlink
	Basic LTE-A FDD R10 Uplink
N7625B Signal Studio for 3GPP LTE TDD	Advanced LTE TDD (2009-03)
	Advanced LTE TDD (2009-12)
	Basic LTE TDD (2009-03)
	Basic LTE TDD (2009-12)
	Basic LTE-A TDD (2010-01)
	Basic LTE-A TDD R10 (2010-12)

If the setup file is not loaded successfully, an error message, -230 “Data corrupt or stale”, is issued with the specified file name.

Key Path	Recall, Data
Mode	LTEATDD, LTEAFDD
Remote Command	MMEMemory:LOAD:SETup ALL CC0 CC1 CC2 CC3 CC4,<string>
Example	MMEMemory:LOAD:SETup CC0,"LTE-A TDD.set"
Notes	The options CC1~CC4 can be enabled with 9080B/9082B-2FP license.
Notes	“ALL” is primarily used to LTE-A setup file for each component carrier including the number of component carriers. “CC*” is used to import LTE-A setup file for the specified component carrier.
Backwards Compatibility SCPI	MMEMemory:LOAD:SSSetup <string> MMEMemory:LOAD:VSASetup <string> MMEMemory:LOAD:EVMSSetup <string>
Initial S/W Revision	A.14.00
Modified at S/W Revision	A.14.50

Import Trace Data

Enables you to import previously saved trace data into a Data Register and optionally display it. Selecting this key displays a menu that enables you to select the destination data register, and also enables you to

choose whether or not to display the recalled data in the currently selected trace. After making these selections, select Open... and use the file dialog to select the file you want to recall.

Recalling trace data into an already used Data Register overwrites the previous data. If the data register is displayed on any trace, the display is updated to reflect the new data.

The SCPI command

```
:MMEM:LOAD:TRAC:DATA D1|D2|D3|D4|D5|D6,<filename>
```

recalls data into a specified register, but does not display it in the selected trace. Use the command

```
:DISP:<meas>:TRAC<n>:FEED D1|D2|D3|D4|D5|D6
```

to display the register in the desired trace.

It is possible to recall trace data saved by other VX A measurements, or measurements made using the LTE, LTETDD, iDEN, or 89601 applications.

Key Path	Recall, Data (Import)
Mode	VSA, LTE, LTETDD, IDEN
Remote Command	:MMEMory:LOAD:TRACe:DATA D1 D2 D3 D4 D5 D6,<filename>[,CSV TXT SDF MAT4 MAT HDF5 BIN]
Example	:MMEM:LOAD:TRAC:DATA D1,"Trc1.txt",TXT
Notes	<p>The Open: dialog box has the following filter options when you are recalling trace data::</p> <ul style="list-style-type: none"> • CSV (Comma delimited) (*.csv) • SDF (Fast) (*.sdf;*.dat) • Text (Tab delimited) (*.txt) <p>The file must have the same format as that created by the Export Recorded Data command.</p> <p>The SCPI command has an optional file format parameter. If you do not include this parameter in the SCPI command, the file format is determined by the file name extension. If no file extension is recognized, the file is scanned to determine the format.</p> <p>If you are not licensed to recall a particular file type, then error -203.9010 is returned. If the file format cannot be determined or the file cannot be recalled successfully, then error -250.5290 is returned. If the recall is successful, then advisory 0.1600 is shown.</p>
State Saved	No
Readback	Data 1 Data 2 Data 3 Data 4 Data 5 Data 6

Data 1

Selects the Data 1 register as the destination for the imported data.

Key Path	Recall, Data (Import), Trace (to)
Mode	VSA, LTE, LTETDD, IDEN

Data 2

Selects the Data 2 register as the destination for the imported data.

Key Path	Recall, Data (Import), Trace (to)
Mode	VSA, LTE, LTETDD, IDEN

Data 3

Selects the Data 3 register as the destination for the imported data.

Key Path	Recall, Data (Import), Trace (to)
Mode	VSA, LTE, LTETDD, IDEN

Data 4

Selects the Data 4 register as the destination for the imported data.

Key Path	Recall, Data (Import), Trace (to)
Mode	VSA, LTE, LTETDD, IDEN

Data 5

Selects the Data 5 register as the destination for the imported data..

Key Path	Recall, Data (Import), Trace (to)
Mode	VSA, LTE, LTETDD, IDEN

Data 6

Selects the Data 6 register as the destination for the imported data.

Key Path	Recall, Data (Import), Trace (to)
Mode	VSA, LTE, LTETDD, IDEN

Display in Selected Trace

Enables you to select whether the recalled trace data is displayed in the current Trace.

Key Path	Recall, Data (Import), Trace (to)
Mode	VSA, LTE, LTETDD, IDEN
State Saved	No

Masks

This key enables you to recall a preset mask file which contains Offset and Limit settings. Parameters except them will not be overwritten. You cannot change or create preset mask files since they are binary files. This key is valid for the Spectrum Emission Mask, ACP and Spurious Emissions measurements.

Default path: “My Documents\LTEATDD\LTEAFDD\data\masks”

Note that “My Documents” is an alias to a directory and its location depends on which user is logged in. At XSA start up, all of the limit mask files in the current user’s “My Documents\LTEATDD\LTEAFDD\data\masks” directory are overwritten.

File type: Binary

Filename: The filename follows the rule below with the words connected using underscores.

<Measurement>_<Condition>.mask

Where

<Measurement> Measurement the limit mask file is applied to: SEM, ACP or SPUR

<Condition> Condition. It depends on the measurement.

File extension: .mask

File Dialog Filter: Preset Mask Files (*.mask)

Selecting OPEN... under the Import Data menu opens the above directory enabling you to select a mask file.

Details of the masks are provided in the default folder of masks with the PDF extension.

Key Path	Recall, Data
Mode	LTEATDD, LTEAFDD
Remote Command	MMEMory:LOAD:MASK <string>
Example	MMEM:LOAD:MASK “ACP_BS\ACP_BS_3MHz_pairE-UTRA_CatA.mask”
Notes	Parameters related to Limit and Offset are overwritten by the contents of the preset mask file.
Initial S/W Revision	A.14.00

Open...

When you press “Open”, the analyzer brings up a Windows dialog and a menu entitled “File Open.” This menu allows you to navigate to the various fields in the Windows dialog without using a keyboard or mouse. The Tab and Arrow keys can also be used for dialog navigation.

See ["From File..." on page 2401](#) in Recall, State, for a full description of this dialog and menu.

Key Path	Recall, Data
Notes	The key location is mode-dependent and will vary. Brings up Open dialog for recalling a <mode specific> Save Type
Initial S/W Revision	Prior to A.02.00

Restart

The Restart function restarts the current sweep, or measurement, or set of averaged/held sweeps or measurements. If you are Paused, pressing Restart does a Resume.

The Restart function is accessed in several ways:

- Pressing the Restart key
- Sending the remote command INIT:IMMEDIATE
- Sending the remote command INIT:RESTART

See "[More Information](#)" on page 2108

Key Path	Front-panel key
Remote Command	:INITiate[:IMMEDIATE] :INITiate:RESTART
Example	:INIT:IMM :INIT:REST
Notes	:INITiate:RESTART and :INITiate:IMMEDIATE perform exactly the same function.
Couplings	Resets average/hold count k. For the first sweep overwrites all active (update=on) traces with new current data. For application modes, it resets other parameters as required by the measurement.
Status Bits/OPC dependencies	This is an Overlapped command. The STATus:OPERation register bits 0 through 8 are cleared. The STATus:QUESTionable register bit 9 (INTegrity sum) is cleared. The SWEEPING bit is set. The MEASURING bit is set.
Backwards Compatibility Notes	For Spectrum Analysis mode in ESA and PSA, the Restart hardkey and the INITiate:RESTART command restart trace averages (displayed average count reset to 1) for a trace in Clear Write, but did not restart Max Hold and Min Hold. In the X-Series, the Restart hardkey and the INITiate:RESTART command restart not only Trace Average, but MaxHold and MinHold traces as well. For wireless comms modes in ESA and PSA, the Restart hardkey and the INITiate:RESTART command restart every measurement, which includes all traces and numeric results. There is no change to this operation.
Initial S/W Revision	Prior to A.02.00

More Information

The **Restart** function first aborts the current sweep/measurement as quickly as possible. It then resets the sweep and trigger systems, sets up the measurement and initiates a new data measurement sequence with a new data acquisition (sweep) taken once the trigger condition is met.

If the analyzer is in the process of aligning when **Restart** is executed, the alignment finishes before the restart function is performed.

Even when set for Single operation, multiple sweeps may be taken when Restart is pressed (for example, when averaging/holding is on). Thus when we say that **Restart** "restarts a measurement," we may mean:

- It restarts the current sweep
- It restarts the current measurement
- It restarts the current set of sweeps if any trace is in Trace Average, Max Hold or Min Hold
- It restarts the current set of measurements if Averaging, or Max Hold, or Min Hold is on for the measurement
- depending on the current settings.

With **Average/Hold Number** (in **Meas Setup** menu) set to 1, or Averaging off, or no trace in Trace Average or Hold, a single sweep is equivalent to a single measurement. A single sweep is taken after the trigger condition is met; and the analyzer stops sweeping once that sweep has completed. However, with **Average/Hold Number** >1 and at least one trace set to **Trace Average, Max Hold, or Min Hold (SA Measurement)** or **Averaging on (most other measurements)**, multiple sweeps/data acquisitions are taken for a single measurement. The trigger condition must be met prior to each sweep. The sweep is stopped when the average count k equals the number N set for **Average/Hold Number**. A measurement average usually applies to all traces, marker results, and numeric results; but sometimes it only applies to the numeric results.

Once the full set of sweeps has been taken, the analyzer will go to idle state. To take one more sweep without resetting the average count, increment the average count by 1, by pressing the step up key while **Average/Hold Number** is the active function, or sending the remote command `CALC:AVER:TCON UP`.

Save

The Save menu lets you choose what you want to save and where you want to save it. Among the types of files you can save are **States**, **Traces**, and **Screen Images**. In addition, an Export (Data) option lets you save a number of data types as CSV files for easy import into Excel and other spreadsheet programs.

Key Path	Front-panel key
Mode	All
Notes	No remote command for this key specifically, but the :MMEM:STORe command is available for specific file types. An example is :MMEM:STOR:STATe <filename>.
Initial S/W Revision	Prior to A.02.00

State

The Save State menu lets you choose a register or file for saving the state.

NOTE In products that run multiple instances of the X-Series Application, all instances share the same register and file location where you want to save the state.

The content of a state file includes all of the settings and data required to return the analyzer as closely as possible to the Mode it was in, with the exact settings which were in place, when the save occurred. The Mode settings in each state file include the settings that are affected by Mode Preset, as well as the additional settings affected by Restore Mode Defaults; all of the Mode's settings. In addition, all of the settings of the Input/Output system are included, even though they are outside of the Mode's state, because they are needed to restore the complete setup. Persistent System settings (for example, Verbose SCPI) are not affected by either Mode Preset or Restore Mode Defaults, nor are they included in a saved State file.

After the save completes, the message "File <filename> saved" or "State Register <register number> saved" is displayed.

For rapid saving, the State menu lists 16 registers to save to. Pressing a Register key initiates the save. You can also select a file to save to.

The default path for all State Files is:

My Documents\<<mode name>\state

where <mode name> is the parameter used to select the mode with the INST:SEL command (for example, SA for the Spectrum Analyzer).

Key Path	Save
Mode	All
Remote Command	:MMEMory:STORe:STATe <filename>
Example	MMEM:STOR:STATe "MyStateFile.state" This stores the current instrument state data in the file MyStateFile.state in the default directory.
Notes	Both single and double quotes are supported for any filename parameter over remote.

After saving to a register, that register's menu key is updated with the date the time, unless a custom label has been entered for that key.

After saving to a register, you remain in the Save State menu, so that you can see the Register key update. After saving to a file, the analyzer automatically returns to the previous menu and any Save As dialog goes away.

Backwards Compatibility SCPI :MMEMory:STORe:STATe 1,<filename>

For backwards compatibility, the above syntax is supported. The "1" is simply ignored. The command is sequential.

Initial S/W Revision Prior to A.02.00

To File . . .

When you press "To File", the analyzer brings up a Windows dialog and a menu entitled "Save As." This menu allows you to navigate to the various fields in the Windows dialog without using a keyboard or mouse. The Tab and Arrow keys can also be used for dialog navigation.

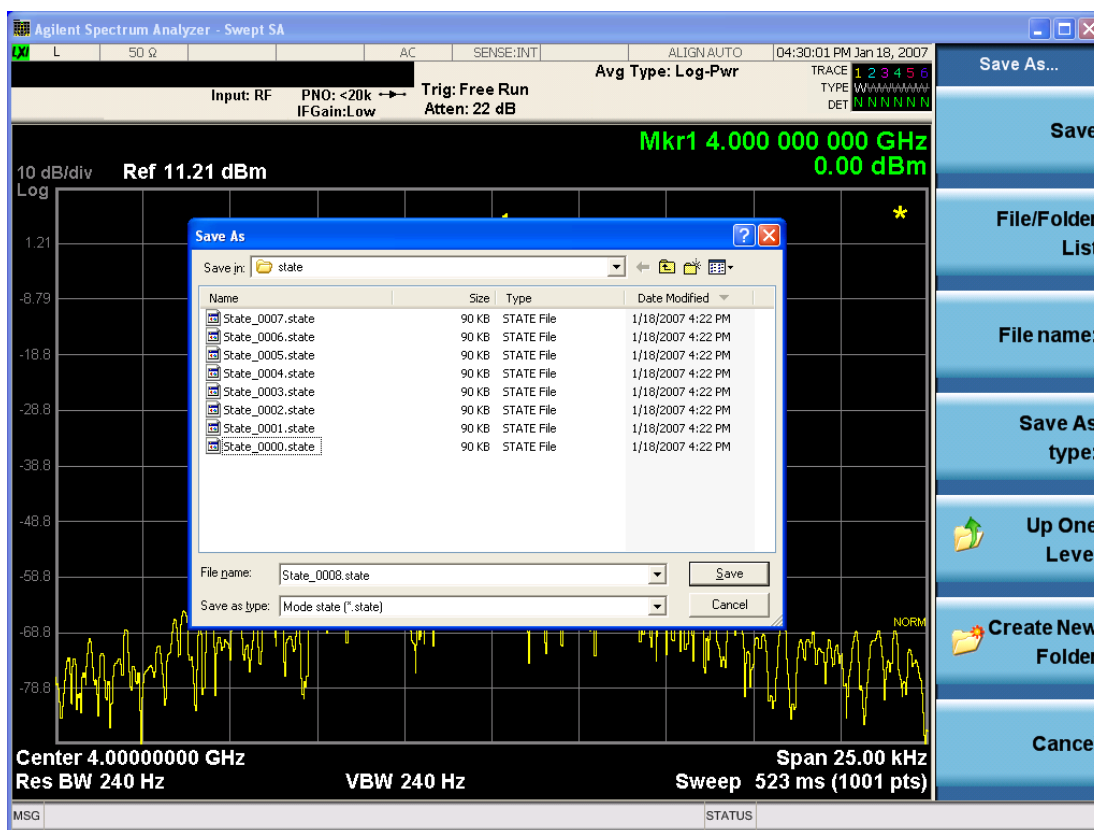

The Listed below

are the functions of the various fields in the dialog, and the corresponding softkeys:

Save

Performs the save to the specified file of the selected type. If the file already exists, a dialog will appear that allows you to replace the existing file by selecting OK, or you can Cancel the request. If you select OK,

the file will be overwritten. Using the C: drive is strongly discouraged, since it runs the risk of being overwritten during an instrument software upgrade.

While the save is being performed, the floppy icon appears briefly in the Meas bar.

File/Folder List

Enables you to navigate to the center of the dialog that contains the list of files and folders. Once here you can get information about the file and use the tab keys to navigate to the other fields in the dialog, such as Save In.

Save In

The Save In field shows the path to which the file will be saved and allows you to change the path using the up and down arrow keys to navigate to other paths; the Enter key to open a directory; and the Backspace key to go back one directory. The **Save In field** defaults to the default path for this type of file and remembers the last path you used to save this type of file. There is no softkey for directly navigating to the Save In field but you can use left tab to get here from the File/Folder List.

User specified paths are remembered when you leave and return to a Mode and are reset back to the default using Restore Mode Defaults.

File Name

The File Name field is initially loaded with an automatically generated filename specific to the appropriate Save Type. The automatically generated filename is guaranteed not to conflict with any filename currently in the directory. You may replace or modify this filename using the File Name key. See the ["Quick Save " on page 2397](#) documentation for more on the automatic file naming algorithm.

When you press the File Name key the analyzer displays the Alpha Editor. Use the knob to choose the letter to add and the front-panel Enter key to add the letter to the file name. The BK character moves you back and the FW character moves you forward in the filename. The Select key on the front panel generates a space character. When you are done entering the filename press the Done softkey. This returns back to the **File Open** dialog and menu, but does not cause the save to occur.

Save As Type

This field shows the file suffix for the type of file you have selected to save. For example, if you navigated here while saving State, "Mode state (*.state)" is in the field. If you navigated here from saving Trace, ""Mode state (*.trace)" is in the field. If you navigated here while exporting a trace data file, "Trace Data (*.csv)" is in the field. For some file types, there is more than one choice in the dropdown, which you can select by using the up and down arrow keys and Enter.

Up One Level

This key corresponds to the icon of a folder with the up arrow that is in the tool bar of the dialog. When pressed, it causes the file and folder list to navigate up one level in the directory structure. The Backspace key does the same thing.

Create New Folder

This key corresponds to the icon of a folder with the "*" that is in the tool bar of the dialog. When pressed, a new folder is created in the current directory with the name **New Folder** and you can enter a new folder name using the Alpha Editor.

Cancel

This key corresponds to the Cancel selection in the dialog. It causes the current **Save As** request to be cancelled. The ESC key does the same thing.

Key Path	Save, State
Mode	All
Notes	Brings up Save As dialog for saving a State Save Type
Initial S/W Revision	Prior to A.02.00

Edit Register Names

You may enter a custom name on any of the Register keys, to help you remember what you are using that state to save. To do this, press the Edit Register Names key, choose the register whose name you wish to edit, and then enter the desired label using the Alpha Editor or an external PC keyboard.

The maximum number of characters that can be added is 30. In most cases, 30 characters will fit on two lines of the key.

See ["More Information" on page 2113](#)

Key Path	Save, State
Mode	All
Remote Command	:MMEMory:REGister:STATe:LABel <reg number>,"label" :MMEMory:REGister:STATe:LABel? <reg number>
Example	:MMEM:REG:STAT:LAB 1,"my label"
Notes	<reg number> is an integer from 1 to 16. If the SCPI specifies an invalid register number an error message is generated, -222,"Data out of range;Invalid register label number" "label" is a string from 0 to 30 characters in length. If a label exceeds 30 characters, an error message is generated, -150,"String data error;Label clipped to 30 characters" "label" of length 0 erases the custom label and restores the default (time and date) label. E.g.: :MMEM:REG:STAT:LAB 1,""
Dependencies	N9060A-7FP or N9060B-2FP license required to edit the register names. When the feature is not licensed, sending this command generates an error, -221,"Settings conflict;Option not available"
Preset	The names are unaffected by Preset or power cycle but are set to the default label (time and date) on a "Restore System Defaults->Misc"
Initial S/W Revision	A.11.00

More Information

When you edit one of the register names, the time and date field will be replaced by the custom name.

If you delete all the characters in the custom name, it restores the default (time and date).

The register names are stored within the state files, but they are not part of the instrument state; that is, once you have edited a register name, loading a new state will not change that register name. Another

consequence of this is that the names will be persistent through a power cycle. Also, if a named state file is transferred to another analyzer, it will bring its custom name along with it.

If you try to edit the name of an empty register, the analyzer will first save the state to have a file to put the name in. If you load a named state file into an analyzer with older firmware it will ignore the metadata.

The *SAV and *RCL commands will not be affected by the custom register names, nor will the MMEM commands.

Register 1 thru Register 16

Selecting any one of these register menu keys causes the State of the currently active mode to be saved to the specified Register. The registers are provided for rapid saving and recalling, since you do not need to specify a filename or navigate to a file. Each of the register menu keys annotates whether it is empty or at what date and time it was last modified. In addition, you can use the Edit Register Names key to enter custom names for each register.

NOTE In products that run multiple instances of the X-Series Application, save with different register name if you do not want to overwrite the register of another running instance.

Although these 16 registers are the only registers available from the front panel, there are 128 state registers available in the instrument. Registers 17–128 are only available from the SCPI interface, using the *SAV command.

There is one set of 128 state registers in the instrument, not one set for each Mode. When a state is saved, the Mode it was saved from is saved with it; then when it is recalled, the instrument switches to that Mode.

After the save completes, the corresponding register menu key annotation is updated with the date and time and the message "Register <register number> saved" is displayed.

Key Path	Save, State
Mode	All
Example	*SAV 1
Range	1–16 from front panel, 1–128 from SCPI
Readback	Date and time with seconds resolution are displayed on the key OR A custom name of up to 30 characters entered using the Edit Register Names key OR “(empty)” if no prior save operation has been performed to this register.
Initial S/W Revision	Prior to A.02.00
Modified at S/W Revision	A.11.00

Register 1 thru Register 16

Selecting any one of these register menu keys causes the State of the currently active mode to be saved to the specified Register. The registers are provided for rapid saving and recalling, since you do not need to specify a filename or navigate to a file. Each of the register menu keys annotates whether it is empty or at

what date and time it was last modified. In addition, you can use the Edit Register Names key to enter custom names for each register.

NOTE In products that run multiple instances of the X-Series Application, save with different register name if you do not want to overwrite the register of another running instance.

Although these 16 registers are the only registers available from the front panel, there are 128 state registers available in the instrument. Registers 17–128 are only available from the SCPI interface, using the *SAV command.

There is one set of 128 state registers in the instrument, not one set for each Mode. When a state is saved, the Mode it was saved from is saved with it; then when it is recalled, the instrument switches to that Mode.

After the save completes, the corresponding register menu key annotation is updated with the date and time and the message "Register <register number> saved" is displayed.

Key Path	Save, State
Mode	All
Example	*SAV 1
Range	1–16 from front panel, 1–128 from SCPI
Readback	Date and time with seconds resolution are displayed on the key OR A custom name of up to 30 characters entered using the Edit Register Names key OR “(empty)” if no prior save operation has been performed to this register.
Initial S/W Revision	Prior to A.02.00
Modified at S/W Revision	A.11.00

Mass Storage Catalog (Remote Command Only)

Key path	SCPI Only
Remote Command	:MMEMory:CATalog? [<directory_name>]
Notes	The string must be a valid logical path. Queries disk usage information (drive capacity, free space available) and obtains a list of files and directories in a specified directory in the following format: <numeric_value>,<numeric_value>,{<file_entry>} It returns two numeric parameters and as many strings as there are files and directories. The first parameter indicates the total amount of storage currently used in bytes. The second parameter indicates the total amount of storage available, also in bytes. The <file_entry> is a string. Each <file_entry> indicates the name, type, and size of one file in the directory list: <file_name>,<file_type>,<file_size> As the windows file system has an extension that indicates file type, <file_type> is always empty. <file_size> provides the size of the file in bytes. For directories, <file_entry> is surrounded by square brackets and both <file_type> and <file_size> are empty
Initial S/W Revision	Prior to A.02.00

Mass Storage Change Directory (Remote Command Only)

Key path	SCPI Only
Remote Command	:MMEMory:CDIRectory [<directory_name>] :MMEMory:CDIRectory?
Notes	The string must be a valid logical path. Changes the default directory for a mass memory file system. The <directory_name> parameter is a string. If no parameter is specified, the directory is set to the *RST value. At *RST, this value is set to the default user data storage area, that is defined as System.Environment.SpecialFolder.Personal. Query returns full path of the default directory.
Initial S/W Revision	Prior to A.02.00

Mass Storage Copy (Remote Command Only)

Key path	SCPI Only
Remote Command	:MMEMory:COPY <string>,<string>[,<string>,<string>]
Notes	The string must be a valid logical path. Copies an existing file to a new file or an existing directory to a new directory. Two forms of parameters are allowed. The first form has two parameters. In this form, the first parameter specifies the source, and the second parameter specifies the destination. The second form has four parameters. In this form, the first and third parameters specify the source. The second and fourth parameters specify the directories. The first pair of parameters specifies the source. The second pair specifies the destination. An error is generated if the source doesn't exist or the destination file already exists. This command will generate an "access denied" error if the destination is a restricted folder (e.g., C:\Windows) and the current user does not have Power User or Administrator privileges.

Mass Storage Device Copy (Remote Command Only)

This command transfers data to/from a file and a peripheral device.

Key path	SCPI Only
Remote Command	:MMEMory:COPY:DEvice <source_string>,<dest_string>
Notes	The strings must be a valid logical path or a valid device keyword. If the dest_string is a device keyword, the data is copied from the source file to the device. If the source_string is a device keyword, the data is copied to the source file from the device. Valid device keywords are: SNS (smart noise source) An error is generated if the file or device is not found.

Mass Storage Delete (Remote Command Only)

Key path	SCPI Only
Remote Command	:MMEMory:DELeTe <file_name>[,<directory_name>]
Notes	The string must be a valid logical path. Removes a file from the specified directory. The <file_name> parameter specifies the file name to be removed. This command will generate an “access denied” error if the file is in a restricted folder (e.g., C:\Windows) and the current user does not have Power User or Administrator privileges.
Initial S/W Revision	Prior to A.02.00

Mass Storage Data (Remote Command Only)

Creates a file containing the specified data OR queries the data from an existing file.

Key path	SCPI Only
Remote Command	:MMEMory:DATA <file_name>, <data> :MMEMory:DATA? <file_name>
Notes	The string must be a valid logical path. The command form is MMEMory:DATA <file_name>,<data>. It loads <data> into the file <file_name>. <data> is in 488.2 block format. <file_name> is string data. The query form is MMEMory:DATA? <file_name> with the response being the associated <data> in block format.
Initial S/W Revision	Prior to A.02.00

Mass Storage Make Directory (Remote Command Only)

Key path	SCPI Only
Remote Command	:MMEMory:MDIRectory <directory_name>
Notes	The string must be a valid logical path. Creates a new directory. The <directory_name> parameter specifies the name to be created. This command will generate an “access denied” error if the new directory would be in a restricted folder (e.g., C:\Windows) and the current user does not have Power User or Administrator privileges.
Initial S/W Revision	Prior to A.02.00

Mass Storage Move (Remote Command Only)

Key path	SCPI Only
Remote Command	:MMEMory:MOVE <string>,<string>[,<string>,<string>]
Notes	The string must be a valid logical path. Moves an existing file to a new file or an existing directory to a new directory.

	<p>Two forms of parameters are allowed. The first form has two parameters. In this form, the first parameter specifies the source, and the second parameter specifies the destination.</p> <p>The second form has four parameters. In this form, the first and third parameters specify the source. The second and fourth parameters specify the directories. The first pair of parameters specifies the source. The second pair specifies the destination. An error is generated if the source doesn't exist or the destination file already exists.</p> <p>This command will generate an "access denied" error if the destination is a restricted folder (e.g., C:\Windows) and the current user does not have Power User or Administrator privileges.</p>
Initial S/W Revision	Prior to A.02.00

Mass Storage Remove Directory (Remote Command Only)

Key path	SCPI Only
Remote Command	:MMEMory:RDIRECTory <directory_name>
Notes	<p>The string must be a valid logical path.</p> <p>Removes a directory. The <directory_name> parameter specifies the directory name to be removed. All files and directories under the specified directory shall also be removed.</p> <p>This command will generate an "access denied" error if the folder is a restricted folder (e.g., C:\Windows) or is in a restricted folder and the current user does not have Power User or Administrator privileges.</p>
Initial S/W Revision	Prior to A.02.00

Sequences

These keys allow you to save a Tab separated or CSV file of the setup parameters required to build a Sequence.

In order to save you must select the Save As button and choose a destination folder.

Key Path	Save, Sequences
Mode	All
Remote Command	:MMEM:STOR:SEQ:SLIST ALIST SAALIST SSTep "MySequence.txt"
Example	:MMEM:STOR:SEQ:SLIST "MySequence.txt"
Notes	<p>Available file types are:</p> <ul style="list-style-type: none"> -CSV (Comma delimited) (*.csv) -Text (Tab delimited) (*.txt)
Initial S/W Revision	A.05.00

Source Sequence

The list of parameters, that configure steps, that makes up a sequence for the Source.

The Source sequence is a sequence of flexible configurable steps that can be set anywhere in the instruments frequency range.

Key Path	Save, Sequences
Example	:MMEM:STOR:SEQ:SLIS "MySequence.txt"
Dependencies	Only available in XOBT
Initial S/W Revision	A.05.00

Save As . . .

This menu lets you select the location where you can save the Sequence. This menu is a standard Windows® dialog with Save As menu keys. The "File Name" field in the Save As dialog is initially loaded with an automatically generated filename specific to the appropriate Save Type. The automatically generated filename is guaranteed not to conflict with any filename currently in the directory. You may replace or modify this filename using the File Name softkey. See the Quick Save key documentation for more on the automatic file naming algorithm.

The default path for all Sequence Files is:

My Documents\Sequences

Key Path	Save, Sequences
Mode	All
Notes	Brings up Save As dialog for saving a Sequence Save Type
Initial S/W Revision	A.05.00

Data (Export)

Exporting a data file stores data from the current measurement to mass storage files. The Export Menu only contains data types that are supported by the current measurement.

Since the commonly exported data files are in .csv format, the data can be edited by you prior to importing. This allows you to export a data file, manipulate the data in Excel (the most common PC Application for manipulating .csv files) and then import it.

Selecting an Export Data menu key will not actually cause the exporting to occur, since the analyzer still needs to know where you wish to save the data. Pressing the Save As key in this menu brings up the Save As dialog and Save As menu that allows you to specify the destination file and directory. Once a filename has been selected or entered in the Open menu, the export will occur as soon as the Save key is pressed.

Key Path	Save
Mode	All

Notes	The menu is built from whatever data types are available for the mode. So the key locations in the sub menu will vary. No SCPI command directly controls the Data Type that this key controls. The Data Type is included in the MMEM:STORe commands.
Dependencies	If a file type is not used by a certain measurement, that type is grayed out for that measurement. The key for a file type will not show at all if there are no measurements in the Mode that support it.
Preset	Is not affected by a Preset or shutdown, but is reset during Restore Mode Defaults
Readback	The data type that is currently selected
Initial S/W Revision	Prior to A.02.00

Export Trace Data

Enables you to export trace data with (optional) associated headers. Selecting this key displays a menu that enables you to choose which Trace to save (default is the selected Trace) and whether or not to save headers with the data. The header information is used by the VXA application when saved trace data is recalled, and enables it to be displayed with the same formatting and scaling that it had when saved. If headers are not saved, the scaling and format are set to default values when the trace is recalled. After making these selections, press Save As... and use the file dialog to choose a file name and format for the saved data.

Trace data can be exported in several different formats. Text and comma-separated variable (CSV) formats are useful for viewing the data or importing it to a spreadsheet program. The other formats are binary and thus more compact. Trace data files can be recalled for viewing into other VXA, LTE, LTETDD, iDEN, or 89601 measurements.

Key Path	Save, Data (Export)
Mode	VSA, LTE, LTETDD, IDEN
Remote Command	:MMEMory:STORe:TRACe:DATA TRACE1 TRACE2 TRACE3 TRACE4 TRACE5 TRACE6, "<filename>" [,CSV TXT SDF MAT4 MAT HDF5 BIN[,OFF ON 0 1]]
Example	:MMEM:STOR:TRAC:DATA TRACE1, "TRC1.TXT", TXT, ON
Notes	The Save As... dialog box has the following format options when you are saving trace data: <ul style="list-style-type: none"> • CSV (Comma delimited) (*.csv) • SDF (Fast) (*.sdf;*.dat) • Text (Tab delimited) (*.txt) File format saved depends on selection. The appropriate file extension is appended to the filename if it is not supplied by the user. If the SCPI command includes just a file name, the file format is determined by the filename extension, which must be one of the choices above. *.sdf or an unrecognized extension chooses the SDF fast format. If the optional file format enumerator is included in the command, then this determines the file format and the file extension is ignored. The optional binary parameter determines if file headers are saved. The default is ON. If file headers are not wanted, use the optional "OFF" parameter. The optional Boolean parameter determines whether headers are saved in the file. By default the

headers are saved.

If you are not licensed to save a particular file type, then error -203.9010 is returned. If an invalid file format is specified or the file cannot be saved successfully, then error -25x is returned. If the save is successful, then advisory 0.1500 is shown.

State Saved	No
Readback	(Trace 1 Trace 2 Trace 3 Trace 4 Trace 5 Trace 6)(with without) headers

Trace 1

Selects the Trace 1 register as the destination for the imported data.

Key Path	Save, Data (Export), Trace
Mode	VSA, LTE, LTETDD, IDEN

Trace 2

Selects the Trace 2 register as the destination for the imported data.

Key Path	Save, Data (Export), Trace
Mode	VSA, LTE, LTETDD, IDEN

Trace 3

Selects the Trace 3 register as the destination for the imported data.

Key Path	Save, Data (Export), Trace
Mode	VSA, LTE, LTETDD, IDEN

Trace 4

Selects the Trace 4 register as the destination for the imported data.

Key Path	Save, Data (Export), Trace
Mode	VSA, LTE, LTETDD, IDEN

Trace 5

Selects the Trace 5 register as the destination for the imported data.

Key Path	Save, Data (Export), Trace
Mode	VSA, LTE, LTETDD, IDEN

Trace 6

Selects the Trace 6 register as the destination for the imported data.

Key Path	Save, Data (Export), Trace
Mode	VSA, LTE, LTETDD, IDEN

Include Header

Enables you to select whether or not the saved trace data includes header information describing scaling, formatting, etc.

Key Path	Save, Data (Export), Trace
Mode	VSA, LTE, LTETDD, IDEN
State Saved	No

Measurement Results

Pressing this key selects Meas Results as the data type to be exported. Pressing the key a second time brings up the Meas Results menu, which allows you to select which **Meas Result** to save. In the Swept SA measurement, there are three types of Measurement Results files: Peak Table, Marker Table and Spectrogram.

See "[Meas Results File Contents](#)" on page 2123.

See "[Marker Table](#)" on page 2123.

See "[Peak Table](#)" on page 2126.

See Spectrogram

Remote Command	:MMEMory:STORe:RESults:MTABle PTABle SPEctrogram <filename>
Example	:MMEM:STOR:RES:MTAB "myResults.csv" Saves the results from the current marker table to the file myResults.csv in the current path. :MMEM:STOR:RES:PTAB "myResults.csv" Saves the results from the current peak table to the file myResults.csv in the current path. :MMEM:STOR:RES:SPEC "myResults.csv" Saves the results from the current Spectrogram display to the file myResults.csv in the current path. The default path is My Documents\SA\data\SAN\results
Notes	If the save is initiated via SCPI, and the file already exists, the file will be overwritten. Using the C: drive is strongly discouraged, since it runs the risk of being overwritten during an instrument software upgrade. Both single and double quotes are supported for any filename parameter over SCPI.
Dependencies	If a save of Marker Table results is requested and the Marker Table is not on, no file is saved and a

message is generated

If a save of Peak Table results is requested and the Peak Table is not on, no file is saved and a message is generated

If a save of Spectrogram results is requested and the Spectrogram is not on, no file is saved and a message is generated.

The Spectrogram choice only appears if option EDP is licensed.

Preset	Not part of Preset, but is reset to Peak Table by Restore Mode Defaults. Survives a shutdown.
Initial S/W Revision	Prior to A.02.00

Meas Results File Contents

All files are .csv files. The following section details the data in each file type.

Marker Table

This section discusses the Marker Table Meas Results file format.

Imagine that, at the point where a Marker Table Meas Result is requested, the following screen is showing:

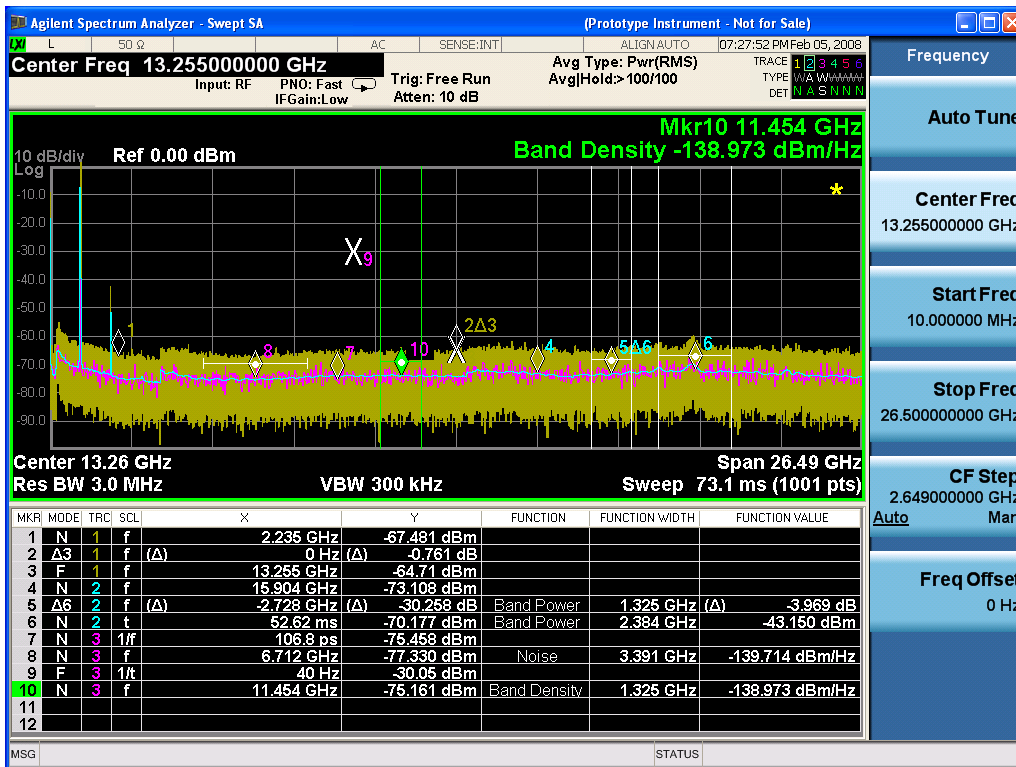

Then the Meas Results file, when opened, would show the following data:

MeasurementR
esult

Swept SA	
A.01.40_R0017	N9020A
526 B25 PFR P26 EA3	1
Result Type	Marker Table
Ref Level	0
Number of Points	1001
Sweep Time	0.0662666 67
Start Frequency	10000000
Stop Frequency	26500000 000
Average Count	0
Average Type	LogPower (Video)
RBW	3000000
RBW Filter	Gaussian
RBW Filter BW	3dB
VBW	3000000
Sweep Type	Swept
X Axis Scale	Lin
PreAmp State	Off
PreAmp Band	Low
Trigger Source	Free
Trigger Level	1.2
Trigger Slope	Positive
Trigger Delay	1.00E-06
Phase Noise Optimization	Fast
Swept If Gain	Low
FFT If Gain	Autorange
RF Coupling	AC
FFT Width	411900
Ext Ref	10000000
Input	RF
RF Calibrator	Off

Attenuation	10								
Ref Level Offset	0								
External Gain	0								
X Axis Units	Hz								
Y Axis Units	dBm								
DATA									
MKR	MODE	TR C	SCL	X	Y	FUNCTI ON	FUNCTIO N WIDTH	FUNCTI ON VALUE	FUNCTI ON UNIT
1	Normal	1	Freque ncy	2.2350E+09	- 67.481	Off	0.0000E+00	0	None
2	Delta3	1	Freque ncy	0.0000E+00	- 0.761	Off	0.0000E+00	0	None
3	Fixed	1	Freque ncy	1.3255E+10	- 64.71	Off	0.0000E+00	0	None
4	Normal	2	Freque ncy	1.5904E+10	- 73.108	Off	0.0000E+00	0	None
5	Delta7	2	Freque ncy	- 2.7280E+09	- 30.258	Band Power	1.3250E+06	-3.969	dB
6	Normal	2	Time	5.2620E-02	- 70.177	Band Power	2.3840E+06	-43.15	dBm
7	Normal	3	Period	1.0680E-10	- 75.458	Off	0.0000E+00	0	None
8	Normal	3	Freque ncy	6.7120E+09	- 77.33	Noise	3.3910E+06	- 139.714	dBm/Hz
9	Fixed	3	Inverse Time	4.0000E+01	- 30.05	Off	0.0000E+00	0	None
10	Normal	3	Freque ncy	1.1454E+10	- 75.161	Band Density	1.3250E+06	- 138.973	dBm/Hz
11	Off	1	Freque ncy	0.0000E+00	0	Off	0.0000E+00	0	None
12	Off	1	Freque ncy	0.0000E+00	0	Off	0.0000E+00	0	None

The numbers appear in the file exactly as they appear onscreen. If it says 11.454 GHz onscreen, then in the file it is 11.454E+09.

The metadata header is very similar to the metadata used in the trace data .csv files. See Trace File Contents. The only new information concerns the 1-of-N fields in the marker table itself.

Peak Table

This section discusses the Peak Table Meas Results file format.

Imagine that, at the point where a Marker Table Meas Result is requested, the following screen is showing:

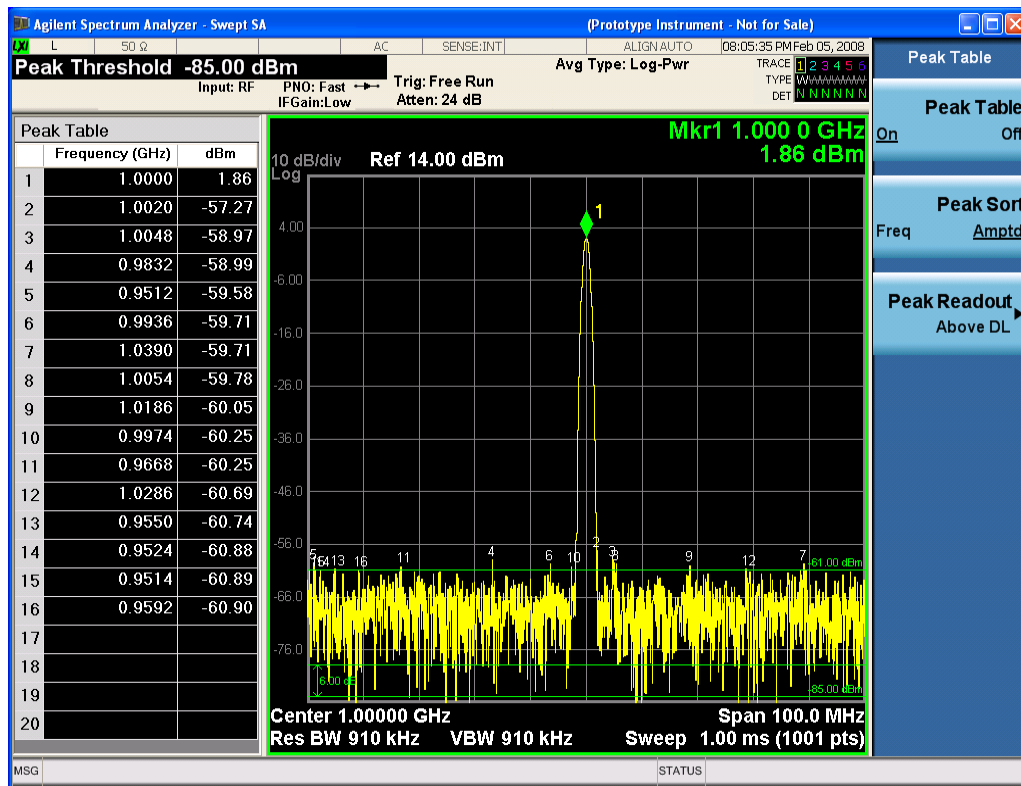

Then the Meas Results file, when opened, would show the header data (the same as for the Marker Table except that the Result Type is Peak Table) ending with a few fields of specific interest to Peak Table users:

- Peak Threshold
- Peak Threshold State (On|Off)
- Peak Excursion
- Peak Excursion State (On|Off)
- Display Line
- Peak Readout (All|AboveDL|BelowDL)
- Peak Sort (Freq|Amptd)

These fields are then followed by the data for the Peak Table itself.

Note that the label for the Frequency column changes to Time in 0 span.

Here is what the table for the above display looks like:

MeasurementResult	
Swept SA	
A.01.40_R0017	N9020A
526 B25 PFR P26 EA3	1
Result Type	Peak Table
Ref Level	0
Number of Points	1001
Sweep Time	0.066266667
Start Frequency	10000000
Stop Frequency	26500000000
Average Count	0
Average Type	LogPower(Video)
RBW	3000000
RBW Filter	Gaussian
RBW Filter BW	3dB
VBW	3000000
Sweep Type	Swept
X Axis Scale	Lin
PreAmp State	Off
PreAmp Band	Low
Trigger Source	Free
Trigger Level	1.2
Trigger Slope	Positive
Trigger Delay	1.00E-06
Phase Noise Optimization	Fast
Swept If Gain	Low
FFT If Gain	Autorange
RF Coupling	AC
FFT Width	411900
Ext Ref	10000000
Input	RF
RF Calibrator	Off
Attenuation	10
Ref Level Offset	0
External Gain	0

X Axis Units	Hz	
Y Axis Units	dBm	
Peak Threshold	-85	
Peak Threshold State	On	
Peak Excursion	6	
Peak Excursion State	On	
Display Line	-61	
Peak Readout	AboveDL	
Peak Sort	Amptd	
DATA		
Peak	Frequency	Amplitude
1	1.0000E+06	1.86
2	1.0020E+06	-57.27
3	1.0048E+06	-58.97
4	9.8320E+05	-58.99
5	9.5120E+05	-59.58
6	9.9360E+05	-59.71
7	1.0390E+06	-59.71
8	1.0054E+06	-59.78
9	1.1086E+06	-60.05
10	9.9740E+05	-60.25
11	9.6680E+05	-60.25
12	1.0286E+06	-60.69
13	9.5500E+05	-60.74
14	9.5240E+05	-60.88
15	9.5140E+05	-60.89
16	9.5920E+05	-60.90
17		
18		
19		
20		

Spectrogram

This section discusses the Spectrogram Results file format. The Spectrogram choice only appears if option EDP is licensed.

The Spectrogram results are the same as a Trace data export, except that instead of having just one trace's data, all 300 traces appear one after the other.

Each trace has its own data mark; the data for Spectrogram Trace 0 follows the row marked DATA, the data for Spectrogram Trace 1 follows the row marked DATA1, for Spectrogram Trace 2 follows the row marked DATA2, and so on.

Each DATA row has a timestamp in the second column (as of firmware revision A.11.01). So, for example, if Trace 0 had a relative start time of 1729.523 sec, then the first DATA row would look like this:

```
DATA,1729.523
```

And if Trace 13 had a relative start time of 100.45 sec, then the fourteenth data row would look like:

```
DATA13,100.453
```

To find the absolute time for the relative timestamps of each trace, the last row before the first DATA row gives the absolute start time of the Spectrogram, in the form YYYYMMDDHHMMSS

So, for example, if the absolute start time is 13:23:45:678 on January 30, 2012, this row would look like:

```
Start Time,20120130132345678
```

NOTE:

NOTE

The resolution of the absolute time stored is 1 ms, which matches up with the fact that the fastest sweep time is also 1 ms. However, there is no specification for the absolute accuracy of the clock in the analyzer, nor is there any facility provided to allow the user to set this time to any particular degree of accuracy.

Traces that have not yet been filled in the Spectrogram display are empty; there is no DATA header for them. The file ends after the last non-empty trace.

Imagine that, at the point where a Spectrogram Meas Result is requested, the following screen is showing:

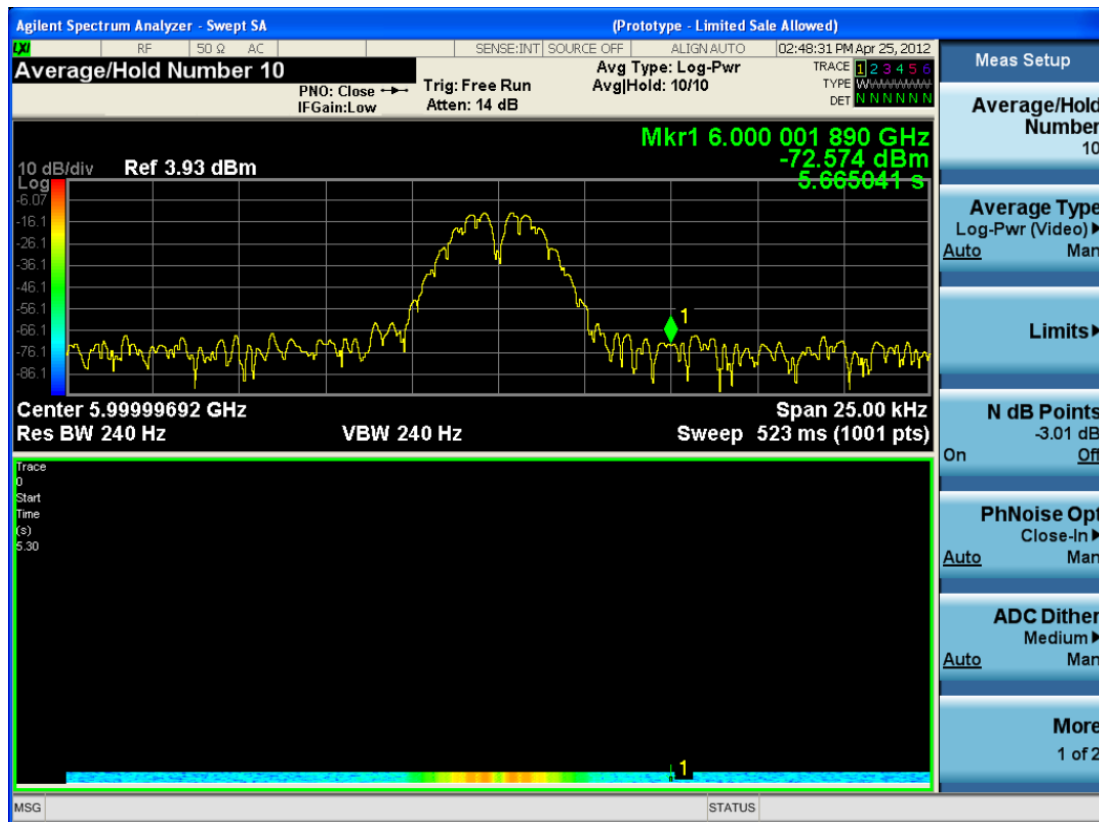

For the purpose of this example, we have set the Average/Hold Number to 10, thus we have only traces 0 thru 10. The Spectrogram was started at 02:28:08:700 pm on April 25, 2012 (that is, 700 ms after 2:28:08 pm), although the screen dump itself shows a different time, as it was taken ten minutes after the Spectrogram data. Trace 0 is showing a start time of 5.30 seconds, meaning 5.3 seconds after the Spectrogram started (trace 10 has a start time of 0, as it was the first trace taken but has now rolled up into the tenth trace slot).

The Meas Results file, when opened, shows the header data and ten traces of trace data. Below is an extract from the result file for the above display. Note the start time of 20120425142808700 showing in the last row before the first DATA row, and the relative time of 5.299231048 showing in the first DATA row:

Result Type	Spectrogram
MeasResult	
Swept SA	
A.11.00.01	N9020A
503 508 513 526 ALL ALV B1C B1X B25 B2X B40 BAB BBA CR3 CRP DP2 DRD EA3 EDP EMC EP1 ERC ESC ESP EXM FSA HBA K03 LFE MPB P03 P08 P13 P26 PFR RTL RTS S40 SB1 SEC SM1 UK6 YAS YAV	1
Segment	0

Result Type	Spectrogram
Number of Points	1001
Sweep Time	0.523333333
Start Frequency	5999984415
Stop Frequency	6000009415
Average Count	0
Average Type	LogPower(Video)
RBW	240
RBW Filter	Gaussian
RBW Filter BW	3dB
VBW	240
Sweep Type	Swept
X Axis Scale	Lin
PreAmp State	Off
PreAmp Band	Low
Trigger Source	Free
Trigger Level	1.2
Trigger Slope	Positive
Trigger Delay	0
Phase Noise Optimization	Wide
Swept If Gain	Low
FFT If Gain	Autorange
RF Coupling	AC
FFT Width	411900
Ext Ref	10000000
Input	RF
RF Calibrator	Off
Attenuation	14
Ref Level Offset	0
External Gain	0
Trace Type	Clearwrite
Detector	Normal
Trace Math	Off
Trace Math Oper1	Trace5
Trace Math Oper2	Trace6
Trace Math Offset	0
Trace Name	Trace1

Result Type	Spectrogram
X Axis Units	Hz
Y Axis Units	dBm
Start Time	20120425142808700
DATA	5.299231048
5999984415	-76.34749519
5999984440	-77.28097006
5999984465	-75.32317869
5999984490	-73.64417681
5999984515	-72.67154604

o
o
o

6000009315	-77.94423277
6000009340	-79.51829697
6000009365	-78.46108961
6000009390	-78.46108957
6000009415	-76.59570596
DATA2	4.708697055
5999984415	-80.98197882
5999984440	-80.98197879
5999984465	-75.83142132
5999984490	-74.02712079
5999984515	-73.57213005

o
o
o

6000009315	-75.9183103
6000009340	-79.53787488
6000009365	-78.82602191
6000009390	-78.82602188
6000009415	-76.37486709

DATA10	0
5999984415	-75.56751112
5999984440	-75.76485645
5999984465	-76.67718717
5999984490	-78.79238489
5999984515	-83.72680212

o
o
o

6000009315	-71.3942461
6000009340	-72.28308332
6000009365	-73.92684489
6000009390	-75.45548832
6000009415	-75.17904815

Save As . . .

When you press “Save As”, the analyzer brings up a Windows dialog and a menu entitled “**Save As.**” This menu allows you to navigate to the various fields in the Windows dialog without using a keyboard or mouse. The Tab and Arrow keys can also be used for dialog navigation.

See "[To File . . .](#)" on page 2413 in Save, State for a full description of this dialog and menu.

The default path for saving files is:

For all of the Trace Data Files:

My Documents\`<mode name>`\data\traces

For all of the Limit Data Files:

My Documents\`<mode name>`\data\limits

For all of the Measurement Results Data Files:

My Documents\`<mode name>`\data\`<measurement name>`\results

For all of the Capture Buffer Data Files:

My Documents\`<mode name>`\data\captureBuffer

Key Path	Save, Data
Mode	All

Notes	The key location is mode-dependent and will vary. Brings up the Save As dialog for saving a <mode specific> Save Type. The save is performed immediately and does not wait until the measurement is complete.
Initial S/W Revision	Prior to A.02.00

Screen Image

Pressing Screen Image accesses a menu of functions that enable you to specify a format and location for the saved screen image. It brings up a menu that allows you to specify the color scheme of the Screen Image (Themes) or navigate to the Save As dialog to perform the actual save.

Screen Image files contain an exact representation of the analyzer display. They cannot be loaded back onto the analyzer, but they can be loaded into your PC for use in many popular applications.

The image to be saved is actually captured when the Save front panel key is pressed, and kept in temporary storage to be used if you ask for a Screen Image save. When the Screen Image key is pressed, a "thumbnail" of the captured image is displayed, as shown below:

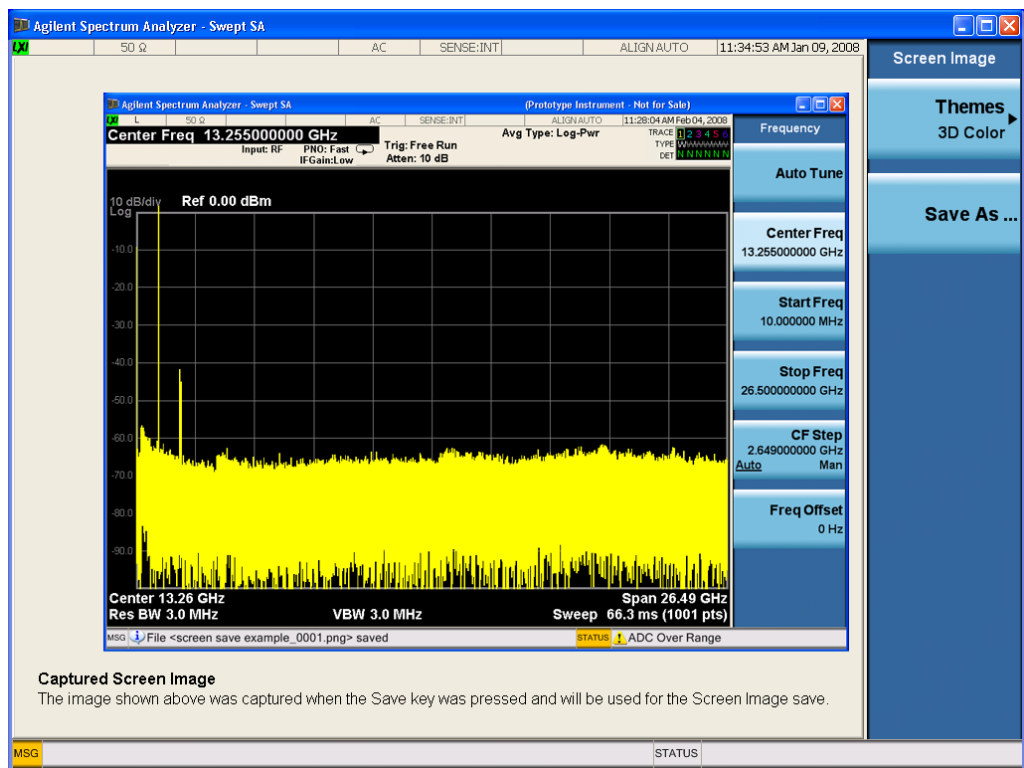

When you continue on into the Save As menu and complete the Screen Image save, the image depicted in the thumbnail is the one that gets saved, showing the menus that were on the screen before going into the Save menus. The save is performed immediately and does not wait until the measurement is complete.

After you have completed the save, the Quick Save front-panel key lets you quickly repeat the last save performed, using an auto-named file, with the current screen data.

NOTE

For versions previous to A.01.55, if you initiate a screen image save by navigating through the Save menus, the image that is saved will contain the Save menu softkeys, not the menus and the active function that were on the screen when you first pressed the Save front panel key.

Key Path	Save
Mode	All
Remote Command	:MMEMory:STORe:SCReen <filename>
Example	:MMEM:STOR:SCR "myScreen.png" This stores the current screen image in the file MyScreenFile.png in the default directory.
Initial S/W Revision	Prior to A.02.00

Themes

Accesses a menu of functions that enable you to choose the theme to be used when saving the screen image.

The **Themes** option is the same as the **Themes** option under the **Display** and **Page Setup** dialogs. It allows you to choose between themes to be used when saving the screen image.

Key Path	Save, Screen Image
Remote Command	:MMEMory:STORe:SCReen:THEMe TDColor TDMonochrome FColor FMONochrome :MMEMory:STORe:SCReen:THEMe?
Example	:MMEM:STOR:SCR:THEM TDM
Preset	3D Color; Is not part of Preset, but is reset by Restore Misc Defaults or Restore System Defaults All and survives subsequent running of the modes.
Readback	3D Color 3D Mono Flat Color Flat Mono
Backwards Compatibility Notes	In ESA and PSA we offer the choice of "Reverse Bitmap" or "Reverse Metafile" when saving screen images. This is much like the "Flat Color" theme available in X-Series. Also, if you selected Reverse Bitmap AND a black & white screen image, that would be much like "Flat Monochrome". In other words, each of the X-Series themes has a similar screen image type in ESA/PSA. But they are not identical.
Initial S/W Revision	Prior to A.02.00

3D Color

Selects a standard color theme with each object filled, shaded and colored as designed.

Key Path	Save, Screen Image, Themes
Example	MMEM:STOR:SCR:THEM TDC
Readback	3D Color
Initial S/W Revision	Prior to A.02.00

3D Monochrome

Selects a format that is like 3D color but shades of gray are used instead of colors.

Key Path	Save, Screen Image, Themes
Example	MMEM:STOR:SCR:THEM TDM
Readback	3D Mono
Initial S/W Revision	Prior to A.02.00

Flat Color

Selects a format that is best when the screen is to be printed on an ink printer.

Key Path	Save, Screen Image, Themes
Example	MMEM:STOR:SCR:THEM FCOL
Readback	Flat Color
Initial S/W Revision	Prior to A.02.00

Flat Monochrome

Selects a format that is like Flat Color. But only black is used (no colors, not even gray), and no fill.

Key Path	Save, Screen Image, Themes
Example	MMEM:STOR:SCR:THEM FMON
Readback	Flat Mono
Initial S/W Revision	Prior to A.02.00

Save As...

When you press "Save As", the analyzer brings up a Windows dialog and a menu entitled "**Save As.**" This menu allows you to navigate to the various fields in the Windows dialog without using a keyboard or mouse. The Tab and Arrow keys can also be used for dialog navigation.

See "[To File . . .](#)" on page 2413 in Save, State for a full description of this dialog and menu.

The default path for Screen Images is

My Documents\`<mode name>`\screen.

where `<mode name>` is the parameter used to select the mode with the INST:SEL command (for example, SA for the Spectrum Analyzer).

Key Path	Save, Screen Image
Notes	Brings up Save As dialog for saving a Screen Image Save Type
Initial S/W Revision	Prior to A.02.00

Single (Single Measurement/Sweep)

Sets the analyzer for Single measurement operation. The single/continuous state is Meas Global, so the setting will affect all the measurements. If you are Paused, pressing Single does a Resume.

See "[More Information](#)" on page 2138

Key Path	Front-panel key
Example	:INIT:CONT OFF
Notes	See Cont key description.
Backwards Compatibility Notes	<p>For Spectrum Analysis mode in ESA and PSA, the Single hardkey and the INITiate:IMM switched from continuous measurement to single measurement and restarted sweeps and averages (displayed average count reset to 1), but did not restart Max Hold and Min Hold. In the X-Series, the Single hardkey and the INITiate:IMM command initiate a sweep/ measurement/ average sequence/hold sequence including MaxHold and MinHold.</p> <p>For Spectrum Analysis mode in ESA and PSA, the Single hardkey restarted the sweep regardless of whether or not you were in an active sweep or sweep sequence. In the X-Series, Restart does this but Single only restarts the sweep or sweep sequence if you are in the idle state.</p> <p>INIT[:IMM] in ESA & PSA Spectrum Analysis Mode does an implied ABORT. In some other PSA Modes, INIT[:IMM] is ignored if not in the idle state. . The X-Series follows the ESA/PSA SA Mode model, which may cause some Modes to have compatibility problems.</p>
Initial S/W Revision	Prior to A.02.00

More Information

See "[Restart](#)" on page 2410 for details on the INIT:IMMEDIATE (Restart) function.

If you are already in single sweep, the INIT:CONT OFF command has no effect.

If you are already in Single Sweep, then pressing the Single key in the middle of a sweep does not restart the sweep or sequence. Similarly, pressing the Single key does not restart the sweep or sequence if the sweep is not in the idle state (for example, if you are taking a very slow sweep, or the analyzer is waiting for a trigger). Instead, it results in a message. "Already in Single, press Restart to initiate a new sweep or sequence". Even though pressing the Single key in the middle of a sweep does not restart the sweep, sending INIT:IMMEDIATE does reset it.

To take one more sweep without resetting the average count, increment the average count by 1, by pressing the step up key while **Average/Hold Number** is the active function, or sending the remote command CALC:AVER:TCON UP.

Source

Opens a menu of keys that access various source configuration menus and settings. In the test set, pressing this key also causes the central view area to change and display the Source Control Main view.

Key Path	Front-panel key
----------	-----------------

RF Output

This parameter sets the source RF power output state.

Key Path	Source
Remote Command	:OUTPut[:EXTernal][:STATe] ON OFF 1 0 :OUTPut[:EXTernal][:STATe]?
Example	OUTP OFF OUTP?
Notes	<p>The EXTERNAL node is shown in RD text so the SCPI remains the same between internal and external source control. However, for EXT we do not wish to document this node to the customer since we are controlling the internal source rather than the external source.</p> <p>This setting is for the independent mode and has no effect on the "List Sequencer" on page 2520. If the "Sequencer" on page 2521 is set to ON, the list sequencer controls the source output and this key will be grayed-out. And this setting will be none-forceful grey out on front panel to indicate out-of-scope. Non-forceful means user still can change this setting by SCPI but cannot change on front panel. When set to OFF will make source leave list sequencer and this setting will be black out and take effect immediately.</p> <p>When the RF Output is ON, an "RF" annunciator is displayed in the system settings panel. When the RF Output is turned Off, the RF annunciator is cleared. If the "Sequencer" on page 2521 is set to ON, the "RF" annunciator will be replaced by "SEQ" in the system settings panel, indicating that the output is controlled by the list sequencer.</p>
Preset	Off
Range	On Off
Initial S/W Revision	A.05.00

Amplitude

Allows you to access the Amplitude sub-menu.

Key Path	Source
Notes	<p>The sub-menu under this button is for independent mode and has no effect on "List Sequencer" on page 2520. If the "Sequencer" on page 2521 is set to ON, the list sequencer controls the source output and this key will be grayed-out on front panel to indicate out-of-scope. When you set "Sequencer" on page 2521 to Off will make source leave list sequencer and this button will be black out.</p>
Initial S/W Revision	A.05.00

RF Power

Allows you to adjust the power level of the source using the numeric keypad, step keys, or RPG. Pressing any digit, 0 through 9, on the numeric keypad brings up the unit terminator.

Please refer to the ["RF Power Range " on page 2141](#) table below for the valid ranges.

Key Path	Source, Amplitude
Remote Command	:SOURce:POWer[:LEVel][:IMMediate][:AMPLitude] <ampl> :SOURce:POWer[:LEVel][:IMMediate][:AMPLitude]?
Example	:SOUR:POW -100 dBm
Notes	<p>Amplitude corrections can be specified for use with the source. In the event of amplitude corrections being applied, the valid ranges for the RF power do not change dependant on the current amplitude correction setting. If the combination of RF power + amplitude correction is higher or lower than the source output range, the Source Unleveled bit is set and the "Source Unleveled" indicator will appear on status panel to indicate that the source cannot maintain the output power that has been requested.</p> <p>When signal generator is unable to maintain the requested output level, the "Source Unleveled" indicator will appear on status panel. When the source output setting is restored to the normal range, the "Source Unleveled" is removed from status panel.</p> <p>Internal source has list sequence mode, which comprises of several steps which contain separate output power, frequency and waveform etc. When the source list sequence playing is complete, the last step keeps playing, and user can use this command to change the list sequence last step's output power.</p> <p>The multiport adapter RFIO TX ports and GPS ports cannot ensure power accuracy when power setting is lower than -130dBm, this power setting value is defined by the sum of RF Power setting and related amplitude correction value. But user settable value could be lower than this limit. When application detected there exists power setting lower than -130dBm on MPA RFIO TX ports, then popup warning message . When application detected there exists power setting lower than -130dBm on MPA GPS ports, then popup warning message . This is only warning message, and check is performed when RF is ON.</p>
Notes	The Min and Max value here defined UI settable amplitude range. This range is larger than actual amplitude range with level accuracy defined in spec.
Dependencies	The RF power is dependent on the RF output port and frequency, such that the current frequency and selected output port determine the valid range of power values.
Preset	-100 dBm
Min	The range of values depends on the current frequency and selected RF output port. Please refer to the "RF Power Range " on page 2141 table below for the valid ranges.
Max	The range of values depends on the current frequency and selected RF output port. Please refer to the "RF Power Range " on page 2141 table below for the valid ranges.
Initial S/W Revision	A.05.00

RF Power Range

RF Output Port	Frequency Range	Min Output Power	Max Output Power
High Power RF Out	10 MHz ≤ f ≤ 6 GHz	-150 dBm	20 dBm
RFIO 1 & RFIO 2	10 MHz ≤ f ≤ 6 GHz	-150 dBm	0 dBm
GPS (Note2)	10 MHz ≤ f ≤ 6 GHz	-150 dBm	0 dBm

Note: This is the UI power range, it's larger than actual spec.

Note2: GPS port is on the multiport adapter, or E6607C which has embedded MPA.

Set Reference Power

This key allows you to set the power reference. Pressing this key turns the power reference state to ON, sets the reference power value to the current RF output power, maintains this power at the RF output, and sets the displayed power to 0.00 dB. All subsequent RF power values entered under Source>Amplitude>RF Power are interpreted as being relative to this reference power.

When you use a power reference, the signal generator outputs an RF power that is set relative to the reference power by the value entered under Source>Amplitude>RF Power as follows:

Output power = reference power – entered power

Where:

reference power equals the original RF Power entered under Source>Amplitude>RF Power and set as the reference power

entered power equals a new value entered under Source>Amplitude>Amptd Offset

In addition, the displayed power value is the same as a new value entered under Source>Amplitude>RF Power.

NOTE

If Power Ref is set to ON with a reference value set, entering a value under Source>Amplitude>RF Power and pressing Set Reference Power will add that value to the existing Power Ref value.

If you wish to change the reference power value to a new value entered under Source>Amplitude>RF Power, first you must set Power Ref to OFF and then press Set Reference Power.

Key Path	Source, Amplitude
Dependencies	This key is unavailable, and is grayed out when the " List Sequencer " on page 2520 is turned ON.
Initial S/W Revision	A.05.00

Power Ref

This key allows you to toggle the state of the power reference.

When you use a power reference, the signal generator outputs an RF power that is set relative to the reference power by the value entered under Source>Amplitude>RF Power as follows:

Output power = reference power + entered power

Where:

reference power equals the original RF Power entered under Source>Amplitude>RF Power and set as the reference power

entered power equals a new value entered under Source>Amplitude>Amptd Offset

For more information on Reference Frequency refer to ["Set Reference Power " on page 2443](#)

Key Path	Source, Amplitude
Remote Command	:SOURce:POWer:REFeRence <ampl> :SOURce:POWer:REFeRence? :SOURce:POWer:REFeRence:STATe OFF ON 0 1 :SOURce:POWer:REFeRence:STATe?
Example	:SOUR:POW:REF 0.00 dBm :SOUR:POW:REF:STATe ON
Dependencies	This setting is unavailable and is grayed out when the "List Sequencer" on page 2520 is turned ON.
Couplings	This value is coupled to the "Set Reference Power " on page 2443 key such that pressing the Set Reference Power key updates the reference power with the current output power.
Preset	0.00 dBm OFF
Min	-125.00 dBm
Max	10.00 dBm
Initial S/W Revision	A.05.00

Amptd Offset

Allows you to specify the RF output power offset value.

When the amplitude offset is set to zero (0) and you set a new offset value (positive or negative), the displayed amplitude value will change as follows and the RF output power will not change:

Displayed value = output power + offset value

Where:

output power equals the original RF Power entered under Source>Amplitude>RF Power

offset value equals the value entered under Source>Amplitude>Amptd Offset

When the amplitude offset is set to a value other than zero (0) and you enter a new RF power value under Source>Amplitude>RF Power, the displayed power will be the same as the value entered and the RF output power will be equal to the value entered minus the offset value as follows:

Output power = entered power – offset power

Displayed Power = output power + offset power

Displayed power = entered power

Where:

entered power equals the amplitude entered under Source>Amplitude>RF Power

offset power equals the value previously entered and set under Source>Amplitude>Amptd Offset

Key Path	Source, Amplitude
Remote Command	:SOURce:POWer[:LEVel][:IMMediate]:OFFSet <rel_ampl> :SOURce:POWer[:LEVel][:IMMediate]:OFFSet?
Example	:SOUR:POW:OFFS 0.00 dB
Dependencies	This setting is unavailable, and is grayed out when the List Sequencer is turned ON.
Preset	0.00 dB
Min	-200.00 dB
Max	200.00 dB
Initial S/W Revision	A.05.00

Modulation

Allows you to toggle the state of the modulation.

Key Path	Source
Remote Command	:OUTPut:MODulation[:STATe] ON OFF 1 0 :OUTPut:MODulation[:STATe]?
Example	:OUTP:MOD OFF
Notes	This setting is for independent mode and has no effect on " List Sequencer " on page 2520. If the " Sequencer " on page 2521 is set to ON, the list sequencer controls the source output and this key will be grayed-out. And this setting will be none-forceful grey out on front panel to indicate out-of-scope. Non-forceful means user still can change this setting by SCPI but cannot change manually on front panel. When set to Off will make source leave list sequencer and this setting will be black out and take effect immediately When the Modulation is ON, the "MOD" annunciator is displayed in the system settings panel. When the Modulation is turned Off, the "MOD" annunciator is cleared. If the " Sequencer " on page 2521 is set to ON, the "MOD" annunciator will be replaced by "SEQ" in the system settings panel indicating that the output is controlled by list sequencer.
Preset	Off
Range	On Off
Initial S/W Revision	A.05.00

Frequency

Allows you to access the Frequency sub-menu.

Key Path	Source
Notes	The sub-menu under this button is for independent mode and has no effect on " List Sequencer " on

[page 2520](#). If the "[Sequencer](#)" on [page 2521](#) is set to ON, the list sequencer controls the source output and this key will be grayed-out. And this button will be grey out on front panel to indicate out-of-scope. When set to Off will make source leave list sequencer and this button will be black out.

Initial S/W Revision A.05.00

Frequency

Allows you to set the RF Output Frequency. You can adjust the frequency of the source using the numeric keypad, step keys, or RPG. Pressing any digit, 0 through 9, on the numeric keypad brings up the unit terminator.

Key Path	Source, Frequency
Remote Command	:SOURce:FREQuency[:CW] <freq> :SOURce:FREQuency[:CW]?
Example	:SOUR:FREQ 1.00 GHz
Notes	Internal source has list sequence mode, which comprises of several steps which contain separate output power, frequency and waveform etc. When the source list sequence playing is complete, the last step keeps playing, and user can use this command to change the list sequence last step's output frequency.
Couplings	The frequency value is coupled to the current channel band and number, such that updates to the band and number will update the frequency value to the corresponding absolute frequency.
Preset	1.00 GHz If license F1A or 5WC is present, the default Center Frequency should be 2.412GHz.
Min	10.00 MHz
Max	Hardware Dependant: Option 503 = 3.6 GHz Option 504 = 3.8 GHz Option 506 = 6.00 GHz For E6640A, if license 5WC is present, the frequency range should be limited to: 1.1GHz–1.7GHz, 2.4GHz–2.5GHz, 4.8GHz–6.0GHz. If the user-defined frequency is outside of range, UI will report an error message called "Settings conflict; Frequency is outside available range".
Initial S/W Revision	A.05.00

Channel

The frequency of the source can be specified by a channel number of a given frequency band. This key allows you to specify the current channel number. For the appropriate range of channel numbers for a given frequency band, refer to the following tables: "[GSM/EDGE Channel Number Ranges](#)" on [page 2145](#), "[W-CDMA Channel Number Ranges](#)" on [page 2146](#), "[CDMA 2000 / 1xEVDO Channel Number Ranges](#)" on [page 2147](#), and "[LTE FDD Channel Number Ranges](#)" on [page 2149](#).

Key Path	Source, Frequency
Remote Command	:SOURce:FREQuency:CHANnels:NUMBer <int> :SOURce:FREQuency:CHANnels:NUMBer?
Example	:SOUR:FREQ:CHAN:NUMB 1
Notes	This key is grayed out when the "Radio Standard" on page 2455 is set to NONE. This key is grayed out on E6630A.
Dependencies	This key is grayed out when the "Radio Standard" on page 2455 is set to NONE. This key is grayed out on E6630A.
Couplings	The channel number is coupled to the frequency value when the "Radio Standard" on page 2455 is not set to NONE. When the frequency value is changed, the channel number will increase or decrease to match the new frequency. If the frequency is not at an exact match for a channel number, the nearest channel number is displayed along with a greater than or less than sign to indicate the frequency is above or below the channel number.
Preset	1
Min	Please refer to the tables below for the valid ranges.
Max	Please refer to the tables below for the valid ranges.
Initial S/W Revision	A.05.00

GSM/EDGE Channel Number Ranges

Band	Link (Device)	Range	Frequency (MHz)
P-GSM	Uplink (MS)	$1 \leq n \leq 124$	$890.0 + 0.2*n$
	Downlink (BS)	$1 \leq n \leq 124$	$935.0 + 0.2*n$
E-GSM	Uplink (MS)	$0 \leq n \leq 124$	$890.0 + 0.2*n$
		$975 \leq n \leq 1023$	$890.0 + 0.2*(n-1024)$
	Downlink (BS)	$0 \leq n \leq 124$	$935.0 + 0.2*n$
		$975 \leq n \leq 1023$	$935.0 + 0.2*(n-1024)$
DCS 1800	Uplink (MS)	$512 \leq n \leq 885$	$1710.200 + 0.20*(n-512)$
	Downlink (BS)	$512 \leq n \leq 885$	$1805.200 + 0.20*(n-512)$
PCS 1900	Uplink (MS)	$512 \leq n \leq 810$	$1850.200 + 0.2*(n-512)$
	Downlink (BS)	$512 \leq n \leq 810$	$1930.200 + 0.2*(n-512)$
R-GSM	Uplink (MS)	$0 \leq n \leq 124$	$890.0 + 0.2*n$
		$955 \leq n \leq 1023$	$890.0 + 0.2*(n-1024)$
	Downlink (BS)	$0 \leq n \leq 124$	$935.0 + 0.2*n$
		$955 \leq n \leq 1023$	$935.0 + 0.2*(n-1024)$
GSM 450	Uplink (MS)	$256 \leq n \leq 293$	$450.6 + 0.2*(n-259)$
	Downlink (BS)	$256 \leq n \leq 293$	$460.6 + 0.2*(n-259)$
GSM 480	Uplink (MS)	$306 \leq n \leq 340$	$479.000 + 0.20*(n-306)$

Band	Link (Device)	Range	Frequency (MHz)
GSM 850	Downlink (BS)	$306 \leq n \leq 340$	$489.000 + 0.20*(n-306)$
	Uplink (MS)	$128 \leq n \leq 251$	$824.200 + 0.20*(n-128)$
GSM 700	Downlink (BS)	$128 \leq n \leq 251$	$869.200 + 0.20*(n-128)$
	Uplink (MS)	$438 \leq n \leq 516$	$777.200 + 0.20*(n-438)$
T-GSM810	Downlink (BS)	$438 \leq n \leq 516$	$747.200 + 0.20*(n-438)$
	Uplink (MS)	$350 \leq n \leq 425$	$806.0 + 0.20*(n-350)$
	Downlink (BS)	$350 \leq n \leq 425$	$851.0 + 0.20*(n-350)$

W-CDMA Channel Number Ranges

Band	Link (Device)	Range	Frequency (MHz)
Band I	Downlink	$10562 \leq n \leq 10838$	$n \div 5$
	Uplink	$9612 \leq n \leq 9888$	$n \div 5$
Band II	Downlink	$412 \leq n \leq 687$	$n \div 5 + 1850.1$
		$9662 \leq n \leq 9938$	$n \div 5$
	Uplink	$12 \leq n \leq 287$	$n \div 5 + 1850.1$
Band III	Downlink	$350 \leq n \leq 425$	$n \div 5$
	Uplink	$1162 \leq n \leq 1513$	$n \div 5 + 1575$
Band IV	Downlink	$937 \leq n \leq 1288$	$n \div 5 + 1525$
		$537 \leq n \leq 1738$	$n \div 5 + 1805$
	Uplink	$1887 \leq n \leq 2087$	$n \div 5 + 1735.1$
Band V	Downlink	$1312 \leq n \leq 1513$	$n \div 5 + 1450$
		$1662 \leq n \leq 1862$	$n \div 5 + 1380.1$
	Uplink	$1007 \leq n \leq 1087$	$n \div 5 + 670.1$
Band VI	Downlink	$4357 \leq n \leq 4458$	$n \div 5$
		$782 \leq n \leq 862$	$n \div 5 + 670.1$
	Uplink	$4132 \leq n \leq 4233$	$n \div 5$
Band VII	Downlink	$1037 \leq n \leq 1062$	$n \div 5 + 670.1$
		$4387 \leq n \leq 4413$	$n \div 5$
	Uplink	$812 \leq n \leq 837$	$n \div 5 + 670.1$
Band VIII	Downlink	$4162 \leq n \leq 4188$	$n \div 5$
		$2237 \leq n \leq 2563$	$n \div 5 + 2175$
	Uplink	$2587 \leq n \leq 2912$	$n \div 5 + 2105.1$
Band VIII	Downlink	$2012 \leq n \leq 2338$	$n \div 5 + 2100$
		$2362 \leq n \leq 2687$	$n \div 5 + 2030.1$
Band VIII	Downlink	$2937 \leq n \leq 3088$	$n \div 5 + 340$
	Uplink	$2712 \leq n \leq 2863$	$n \div 5 + 340$

Band	Link (Device)	Range	Frequency (MHz)
Band IX	Downlink	$9237 \leq n \leq 9387$	$n \div 5$
	Uplink	$8762 \leq n \leq 8912$	$n \div 5$
Band X	Downlink	$3112 \leq n \leq 3388$	$n \div 5 + 1490$
		$3412 \leq n \leq 3687$	$n \div 5 + 1430.1$
	Uplink	$2887 \leq n \leq 3163$	$n \div 5 + 1135$
		$3187 \leq n \leq 3462$	$n \div 5 + 1075.1$
Band XI	Downlink	$3712 \leq n \leq 3812$	$n \div 5 + 736$
	Uplink	$3487 \leq n \leq 3587$	$n \div 5 + 733$
Band XII	Downlink	$3837 \leq n \leq 3903$	$n \div 5 - 37$
		$3927 \leq n \leq 3992$	$n \div 5 - 54.9$
	Uplink	$3612 \leq n \leq 3678$	$n \div 5 - 22$
		$3702 \leq n \leq 3767$	$n \div 5 - 39.9$
Band XIII	Downlink	$4017 \leq n \leq 4043$	$n \div 5 - 55$
		$4067 \leq n \leq 4092$	$n \div 5 - 64.9$
	Uplink	$3792 \leq n \leq 3818$	$n \div 5 + 21$
		$3702 \leq n \leq 3767$	$n \div 5 - 39.9$
Band XIV	Downlink	$4117 \leq n \leq 4143$	$n \div 5 - 63$
		$4167 \leq n \leq 4192$	$n \div 5 - 72.9$
	Uplink	$3892 \leq n \leq 3918$	$n \div 5 + 12$
		$3942 \leq n \leq 3967$	$n \div 5 + 2.1$
Band XIX	Downlink	$712 \leq n \leq 763$	$n \div 5 + 735$
		$787 \leq n \leq 837$	$n \div 5 + 720.1$
	Uplink	$312 \leq n \leq 363$	$n \div 5 + 770$
		$387 \leq n \leq 437$	$n \div 5 + 755.1$

CDMA 2000 / 1xEVDO Channel Number Ranges

Band	Link (Device)	Range	Frequency (MHz)
US Cellular	Uplink (MS, reverse link)	$1 \leq N \leq 799$	$0.030 \times N + 825.000$
		$991 \leq N \leq 1023$	$0.030 \times (N - 1023) + 825.000$
		$1024 \leq N \leq 1323$	$0.030 \times (N - 1024) + 815.040$
	Downlink (BS, forward link)	$1 \leq N \leq 799$	$0.030 \times N + 870.000$
		$991 \leq N \leq 1023$	$0.030 \times (N - 1023) + 870.000$
		$1024 \leq N \leq 1323$	$0.030 \times (N - 1024) + 860.040$
US PCS	Uplink (MS, reverse link)	$0 \leq N \leq 1199$	$1850.000 + 0.050 \times N$
	Downlink (BS, forward link)	$0 \leq N \leq 1199$	$1930.000 + 0.050 \times N$

Band	Link (Device)	Range	Frequency (MHz)
Japan Cellular Band	Uplink (MS, reverse link)	$1 \leq N \leq 799$	$0.0125 \times (N + 915.000)$
		$801 \leq N \leq 1039$	$0.0125 \times (N - 800) + 898.000$
		$1041 \leq N \leq 1199$	$0.0125 \times (N - 1040) + 887.000$
		$1201 \leq N \leq 1600$	$0.0125 \times (N - 1200) + 893.000$
	Downlink (BS, forward link)	$1 \leq N \leq 799$	$0.0125 \times (N + 860.000)$
		$801 \leq N \leq 1039$	$0.0125 \times (N - 800) + 843.000$
		$1041 \leq N \leq 1199$	$0.0125 \times (N - 1040) + 832.000$
		$1201 \leq N \leq 1600$	$0.0125 \times (N - 1200) + 838.000$
Korean PCS Band	Uplink (MS, reverse link)	$0 \leq N \leq 599$	$0.050 \times N + 1750.000$
	Downlink (BS, forward link)	$0 \leq N \leq 599$	$0.050 \times N + 1840.000$
NMT-450 Band	Uplink (MS, reverse link)	$1 \leq N \leq 400$	$0.025 \times (N - 1) + 450.000$
		$472 \leq N \leq 871$	$0.025 \times (N - 472) + 410.000$
		$1039 \leq N \leq 1473$	$0.020 \times (N - 1024) + 451.010$
		$1536 \leq N \leq 1715$	$0.025 \times (N - 1536) + 479.000$
		$1792 \leq N \leq 2016$	$0.020 \times (N - 1792) + 479.000$
	Downlink (BS, forward link)	$1 \leq N \leq 400$	$0.025 \times (N - 1) + 460.000$
		$472 \leq N \leq 871$	$0.025 \times (N - 472) + 420.000$
		$1039 \leq N \leq 1473$	$0.020 \times (N - 1024) + 461.010$
IMT-2000 Band	Uplink (MS, reverse link)	$0 \leq N \leq 1199$	$1920.000 + 0.050 \times N$
	Downlink (BS, forward link)	$0 \leq N \leq 1199$	$2100.000 + 0.050 \times N$
Upper 700 MHz Band	Uplink (MS, reverse link)	$0 \leq N \leq 240$	$776.000 + 0.050 \times N$
	Downlink (BS, forward link)	$0 \leq N \leq 240$	$746.000 + 0.050 \times N$
Secondary 800 MHz Band	Uplink (MS, reverse link)	$0 \leq N \leq 719$	$0.025 \times N + 806.000$
		$720 \leq N \leq 919$	$0.025 \times (N - 720) + 896.000$
	Downlink (BS, forward link)	$0 \leq N \leq 719$	$0.025 \times N + 851.000$
		$720 \leq N \leq 919$	$0.025 \times (N - 720) + 935.000$
2.5 GHz IMT Extension	Uplink (MS, reverse link)	$0 \leq N \leq 1399$	$2500.000 + 0.050 \times N$
	Downlink (BS, forward link)	$0 \leq N \leq 1399$	$2620.000 + 0.050 \times N$
US PCS 1.9 GHz	Uplink (MS, reverse link)	$0 \leq N \leq 1299$	$1850.000 + 0.050 \times N$

Band	Link (Device)	Range	Frequency (MHz)
AWS	Downlink (BS, forward link)	$0 \leq N \leq 1299$	$1930.000 + 0.050 \times N$
	Uplink (MS, reverse link)	$0 \leq N \leq 899$	$1710.000 + 0.050 \times N$
US 2.5 GHz	Downlink (BS, forward link)	$0 \leq N \leq 899$	$2100.000 + 0.050 \times N$
	Uplink (MS, reverse link)	$140 \leq N \leq 1459$	$2495.000 + 0.050 \times N$
700 Public Safety	Downlink (BS, forward link)	$140 \leq N \leq 1459$	$2617.000 + 0.050 \times N$
	Uplink (MS, reverse link)	$0 \leq N \leq 240$	$787.000 + 0.050 \times N$
C2K Lower 700	Downlink (BS, forward link)	$0 \leq N \leq 240$	$757.000 + 0.050 \times N$
	Uplink (MS, reverse link)	$0 \leq N \leq 360$	$698.000 + 0.050 \times N$
400 Euro PAMR	Downlink (BS, forward link)	$0 \leq N \leq 360$	$728.000 + 0.050 \times N$
	Uplink (MS, reverse link)	$1 \leq N \leq 400$	$0.025 \times (N-1) + 450.000$
	Uplink (MS, reverse link)	$472 \leq N \leq 871$	$0.025 \times (N-472) + 410.000$
	Uplink (MS, reverse link)	$1536 \leq N \leq 1715$	$0.025 \times (N-1536) + 479.000$
	Downlink (BS, forward link)	$1 \leq N \leq 400$	$0.025 \times (N-1) + 460.000$
	Downlink (BS, forward link)	$472 \leq N \leq 871$	$0.025 \times (N-472) + 420.000$
	Downlink (BS, forward link)	$1536 \leq N \leq 1715$	$0.025 \times (N-1536) + 489.000$
	Downlink (BS, forward link)		
800 PAMR	Uplink (MS, reverse link)	$0 \leq N \leq 239$	$870.0125 + 0.025 \times N$
	Downlink (BS, forward link)	$0 \leq N \leq 239$	$915.0125 + 0.025 \times N$

LTE FDD Channel Number Ranges

The carrier frequency in the uplink and downlink is designated by the E-UTRA Absolute Radio Frequency Channel Number (EARFCN) in the range 0 – 65535. The relation between EARFCN and the carrier frequency in MHz for the downlink is given by the following equation, where FDL_low and NOffs-DL are given in table 5.4.4-1 and NDL is the downlink EARFCN.

$$FDL = FDL_low + 0.1(NDL - NOffs-DL)$$

The relation between EARFCN and the carrier frequency in MHz for the uplink is given by the following equation where FUL_low and NOffs-UL are given in table 5.4.4-1 and NUL is the uplink EARFCN.

$$FUL = FUL_low + 0.1(NUL - NOffs-UL)$$

Band	Downlink		Uplink			
	FDL_low (MHz)	NOffs-DL	Range of NDL	FUL_low (MHz)	NOffs-UL	Range of NUL
1		2110	0	0 - 599	1920	18000 - 18599
2		1930	600	600 - 1199	1850	18600 - 19199
3		1805	1200	1200 - 1949	1710	19200 - 19949
4		2110	1950	1950 - 2399	1710	19950 - 20399
5		869	2400	2400 - 2649	824	20400 - 20649
6		875	2650	2650 - 2749	830	20650 - 20749
7		2620	2750	2750 - 3449	2500	20750 - 20449
8		925	3450	3450 - 3799	880	21450 - 21799
9		1844.9	3800	3800 - 4149	1749.9	21800 - 22149
10		2110	4150	4150 - 4749	1710	22150 - 22749
11		1475.9	4750	4750 - 4949	1427.9	22750 - 22949
12		729	5010	5010 - 5179	699	23010 - 23179
13		746	5180	5180 - 5279	777	23180 - 23279
14		758	5280	5280 - 5379	788	23280 - 23379
...						
17		734	5730	5730 - 5849	704	23730 - 23849
18		860	5850	5850 - 5999	815	23850 - 23999
19		875	6000	6000 - 6149	830	24000 - 24149
20		791	6150	6150 - 6449	832	24150 - 24449
21		1495.9	6450	6450 - 6599	1447.9	24450 - 24599
...						
24		1525	7700	7700 - 8039	1626.5	25700 - 26039
25		1930	8040	8040 - 8689	1850	26040 - 26689
26		859	8690	8690 - 9039	814	26690 - 27039
...						

Note: The channel numbers that designate carrier frequencies so close to the operating band edges that the carrier extends beyond the operating band edge shall not be used. This implies that the first 7, 15, 25, 50, 75 and 100 channel numbers at the lower operating band edge and the last 6, 14, 24, 49, 74 and 99 channel numbers at the upper operating band edge shall not be used for channel bandwidths of 1.4, 3, 5, 10, 15 and 20 MHz respectively.

LTE TDD Channel Number Ranges

The carrier frequency in the uplink and downlink is designated by the E-UTRA Absolute Radio Frequency Channel Number (EARFCN) in the range 0 – 65535. The relation between EARFCN and the carrier frequency in MHz for the downlink is given by the following equation, where FDL_low and NOffs-DL are given in table 5.4.4-1 and NDL is the downlink EARFCN.

$$FDL = FDL_low + 0.1(NDL - NOffs-DL)$$

The relation between EARFCN and the carrier frequency in MHz for the uplink is given by the following equation where FUL_low and NOffs-UL are given in table 5.4.4-1 and NUL is the uplink EARFCN.

$$FUL = FUL_low + 0.1(NUL - NOffs-UL)$$

Band	Downlink		Uplink			
	FDL_low (MHz)	NOffs-DL	Range of NDL	FUL_low (MHz)	NOffs-UL	Range of NUL
33		1900	36000	36000 - 36199	1900	36000 - 36199
34		2010	36200	36200 - 36349	2010	36200 - 36349
35		1850	36350	36350 - 36949	1850	36350 - 36949
36		1930	36950	36950 - 37549	1930	36950 - 37549
37		1910	37550	37550 - 37749	1910	37550 - 37749
38		2570	37750	37750 - 38249	2570	37750 - 38249
39		1880	38250	38250 - 38649	1880	38250 - 38649
40		2300	38650	38650 - 39649	2300	38650 - 39649
41		2496	39650	39650 - 41589	2496	39650 - 41589
42		3400	41590	41590 - 43589	3400	41590 - 43589
43		3600	43590	43590 - 45589	3600	43590 - 45589

Note: The channel numbers that designate carrier frequencies so close to the operating band edges that the carrier extends beyond the operating band edge shall not be used. This implies that the first 7, 15, 25, 50, 75 and 100 channel numbers at the lower operating band edge and the last 6, 14, 24, 49, 74 and 99 channel numbers at the upper operating band edge shall not be used for channel bandwidths of 1.4, 3, 5, 10, 15 and 20 MHz respectively.

TDSCDMA Channel Number Ranges

1.28 Mcps TDD Option

No TX-RX frequency separation is required as Time Division Duplex (TDD) is employed. Each subframe consists of 7 main timeslots where all main timeslots (at least the first one) before the single switching point are allocated DL and all main timeslots (at least the last one) after the single switching point are allocated UL.

The nominal channel spacing is 1.6 MHz, but this can be adjusted to optimise performance in a particular deployment scenario.

The carrier frequency is designated by the UTRA absolute radio frequency channel number (UARFCN). The value of the UARFCN in the IMT2000 band is defined in the general case as follows:

$$N_t = 5 * F \quad 0.0 \text{ MHz} \leq F \leq 3276.6 \text{ MHz}$$

where F is the carrier frequency in MHz

Additional channels applicable to operation in the frequency band defined in sub-clause 5.2(d) are defined via the following UARFCN definition:

$$N_t = 5 * (F - 2150.1 \text{ MHz}) \quad 2572.5 \text{ MHz} \leq F \leq 2617.5 \text{ MHz}$$

UARFCN

1.28 Mcps TDD Option

The following UARFCN range shall be supported for each band:

**Table: UTRA Absolute Radio
Frequency Channel Number 1.28
Mcps TDD Option**

Frequency Band	Frequency Range	UARFCN Uplink and Downlink transmission
For operation in frequency band as defined in subclause 5.2 (a)	1900–1920 MHz	9504 to 9596
	2010–2025 MHz	10054 to 10121
For operation in frequency band as defined in subclause 5.2 (b)	1850–1910 MHz	9254 to 9546
	1930–1990 MHz	9654 to 9946
For operation in frequency band as defined in subclause 5.2 (c)	1910–1930 MHz	9554 to 9646
For operation in frequency band as defined in subclause 5.2 (d)	2570–2620 MHz	12854 to 13096
For operation in frequency band as defined in subclause 5.2 (e)	2300–2400 MHz	11504 to 11996
For operation in frequency band as defined in subclause 5.2 (f)	1880–1920 MHz	9404 to 9596

Radio Setup

Allows access to the sub-menus for selecting the radio standard and associated radio band. You can also set a frequency reference and offset.

This menu is greyed out when on E6630A. Radio band settings for GSM, cdma2000, and so on -- most of which are not actually supported in E6630A, which has three narrow frequency bands. So band settings are grayed out.

Key Path	Source, Frequency
Initial S/W Revision	A.05.00

Radio Standard

Allows access to the channel band sub-menus to select the desired radio standard. When you have selected the radio standard, you can then set an active channel band. The radio standard and the active channel band allow you to use channel numbers to set frequency automatically.

Key Path	Source, Frequency, Radio Setup
Remote Command	:SOURce:FREQuency:CHANnels:BAND NONE PGSM EGSM RGSM DCS1800 PCS1900 TGSM810 GSM450 GSM480 GSM700 GSM850 BANDI BANDII BANDIII BANDIV BANDV BANDVI BANDVII BANDVIII BANDIX BANDX BANDXI BANDXII BANDXIII BANDXIV BANDXIX USCELL USPCS JAPAN KOREAN NMT IMT2K UPPER SECOND PAMR400 PAMR800 IMTEXT PCS1DOT9G AWS US2DOT5G PUBLIC LOWER BAND1 BAND2 BAND3 BAND4 BAND5 BAND6 BAND7 BAND8 BAND10 BAND11 BAND12 BAND13 BAND14 BAND17 BAND18 BAND19 BAND20 BAND21 BAND24 BAND25 BAND26 BAND27 BAND28 BAND31 BAND33 BAND34 BAND35 BAND36 BAND37 BAND38 BAND39 BAND40 BAND41 BAND42 BAND43 BAND44 BANDA BANDB BANDC BANDD BANDE BANDF :SOURce:FREQuency:CHANnels:BAND?
Example	:SOUR:FREQ:CHAN:BAND PGSM
Notes	Set this setting to "NONE" will grey out "Channel" on page 2446 Channel
Initial S/W Revision	A.05.00

None

Selects no radio standard for use. When you have selected the radio standard to NONE, you cannot use channel numbers to set frequency automatically. You will need to set the frequency manually.

Key Path	Source, Frequency, Radio Setup, Radio Standard
Initial S/W Revision	A.05.00

GSM/EDGE

Sets GSM/EDGE as the radio standard for use and accesses the GSM/EDGE specific channel band sub-menus.

Key Path	Source, Frequency, Radio Setup, Radio Standard
Initial S/W Revision	A.05.00

P-GSM

Selects P-GSM as the active channel band.

Key Path	Source, Frequency, Radio Setup, Radio Standard, GSM/EDGE
Example	:SOUR:FREQ:CHAN:BAND PGSM
Initial S/W Revision	A.05.00

E-GSM

Selects E-GSM as the active channel band.

Key Path	Source, Frequency, Radio Setup, Radio Standard, GSM/EDGE
Example	:SOUR:FREQ:CHAN:BAND EGSM
Initial S/W Revision	A.05.00

R-GSM

Selects R-GSM as the active channel band.

Key Path	Source, Frequency, Radio Setup, Radio Standard, GSM/EDGE
Example	:SOUR:FREQ:CHAN:BAND RGSM
Initial S/W Revision	A.05.00

DCS 1800

Selects DCS 1800 as the active channel band.

Key Path	Source, Frequency, Radio Setup, Radio Standard, GSM/EDGE
Example	:SOUR:FREQ:CHAN:BAND DCS1800
Initial S/W Revision	A.05.00

PCS 1900

Selects PCS 1900 as the active channel band.

Key Path	Source, Frequency, Radio Setup, Radio Standard, GSM/EDGE
Example	:SOUR:FREQ:CHAN:BAND PCS1900
Initial S/W Revision	A.05.00

GSM 450

Selects GSM 450 as the active channel band.

Key Path	Source, Frequency, Radio Setup, Radio Standard, GSM/EDGE
Example	:SOUR:FREQ:CHAN:BAND GSM450
Initial S/W Revision	A.05.00

GSM 480

Selects GSM 480 as the active channel band.

Key Path	Source, Frequency, Radio Setup, Radio Standard, GSM/EDGE
Example	:SOUR:FREQ:CHAN:BAND GSM480
Initial S/W Revision	A.05.00

GSM 850

Selects GSM 850 as the active channel band.

Key Path	Source, Frequency, Radio Setup, Radio Standard, GSM/EDGE
Example	:SOUR:FREQ:CHAN:BAND GSM850
Initial S/W Revision	A.05.00

GSM 700

Selects GSM 700 as the active channel band.

Key Path	Source, Frequency, Radio Setup, Radio Standard, GSM/EDGE
Example	:SOUR:FREQ:CHAN:BAND GSM700
Initial S/W Revision	A.05.00

T-GSM 810

Selects T-GSM 810 as the active channel band.

Key Path	Source, Frequency, Radio Setup, Radio Standard, GSM/EDGE
Example	:SOUR:FREQ:CHAN:BAND T-GSM810
Initial S/W Revision	A.05.00

WCDMA

Sets WCDMA as the radio standard for use and accesses the W-CDMA specific channel band sub-menus.

Key Path	Source, Frequency, Radio Setup, Radio Standard
Initial S/W Revision	A.05.00

Band I

Selects Band I as the active channel band.

Key Path	Source, Frequency, Radio Setup, Radio Standard, WCDMA
Example	:SOUR:FREQ:CHAN:BAND BANDI
Initial S/W Revision	A.05.00

Band II

Selects Band II as the active channel band.

Key Path	Source, Frequency, Radio Setup, Radio Standard, WCDMA
Example	:SOUR:FREQ:CHAN:BAND BANDII
Initial S/W Revision	A.05.00

Band III

Selects Band III as the active channel band.

Key Path	Source, Frequency, Radio Setup, Radio Standard, WCDMA
Example	:SOUR:FREQ:CHAN:BAND BANDIII
Initial S/W Revision	A.05.00

Band IV

Selects Band IV as the active channel band.

Key Path	Source, Frequency, Radio Setup, Radio Standard, WCDMA
Example	:SOUR:FREQ:CHAN:BAND BANDIV
Initial S/W Revision	A.05.00

Band V

Selects Band V as the active channel band.

Key Path	Source, Frequency, Radio Setup, Radio Standard, WCDMA
Example	:SOUR:FREQ:CHAN:BAND BANDV
Initial S/W Revision	A.05.00

Band VI

Selects Band VI as the active channel band.

Key Path	Source, Frequency, Radio Setup, Radio Standard, WCDMA
Example	:SOUR:FREQ:CHAN:BAND BANDVI
Initial S/W Revision	A.05.00

Band VII

Selects Band VII as the active channel band.

Key Path	Source, Frequency, Radio Setup, Radio Standard, WCDMA
Example	:SOUR:FREQ:CHAN:BAND BANDVII
Initial S/W Revision	A.05.00

Band VIII

Selects Band VIII as the active channel band.

Key Path	Source, Frequency, Radio Setup, Radio Standard, WCDMA
Example	:SOUR:FREQ:CHAN:BAND BANDVIII
Initial S/W Revision	A.05.00

Band IX

Selects Band IX as the active channel band.

Key Path	Source, Frequency, Radio Setup, Radio Standard, WCDMA
Example	:SOUR:FREQ:CHAN:BAND BANDIX
Initial S/W Revision	A.05.00

Band X

Selects Band X as the active channel band.

Key Path	Source, Frequency, Radio Setup, Radio Standard, WCDMA
Example	:SOUR:FREQ:CHAN:BAND BANDX
Initial S/W Revision	A.05.00

Band XI

Selects Band XI as the active channel band.

Key Path	Source, Frequency, Radio Setup, Radio Standard, WCDMA
Example	:SOUR:FREQ:CHAN:BAND BANDXI
Initial S/W Revision	A.05.00

Band XII

Selects Band XII as the active channel band.

Key Path	Source, Frequency, Radio Setup, Radio Standard, WCDMA
Example	:SOUR:FREQ:CHAN:BAND BANDXII
Initial S/W Revision	A.05.00

Band XIII

Selects band XIII as the active channel band.

Key Path	Source, Frequency, Radio Setup, Radio Standard, WCDMA
Example	:SOUR:FREQ:CHAN:BAND BANDXIII
Initial S/W Revision	A.05.00

Band XIV

Selects Band XIV as the active channel band.

Key Path	Source, Frequency, Radio Setup, Radio Standard, WCDMA
Example	:SOUR:FREQ:CHAN:BAND BANDXIV
Initial S/W Revision	A.05.00

Band XIX

Selects Band XIX as the active channel band.

Key Path	Source, Frequency, Radio Setup, Radio Standard, WCDMA
Example	:SOUR:FREQ:CHAN:BAND BANDXIX
Initial S/W Revision	A.14.50

CDMA 2000 / 1xEVDO

Sets CDMA 2000 / 1xEVDO as the radio standard for use and accesses the CDMA 2000/1xEVDO specific channel band sub-menus.

Key Path	Source, Frequency, Radio Setup, Radio Standard
Initial S/W Revision	A.05.00

US CELL

Selects US Cell as the active channel band.

Key Path	Source, Frequency, Radio Setup, Radio Standard, CDMA 2000 / 1xEVDO
Example	:SOUR:FREQ:CHAN:BAND USCELL
Initial S/W Revision	A.05.00

US PCS

Selects US PCS as the active channel band.

Key Path	Source, Frequency, Radio Setup, Radio Standard, CDMA 2000 / 1xEVDO
Example	:SOUR:FREQ:CHAN:BAND PCS
Initial S/W Revision	A.05.00

Japan Cell

Selects Japan Cell as the active channel band.

Key Path	Source, Frequency, Radio Setup, Radio Standard, CDMA 2000 / 1xEVDO
Example	:SOUR:FREQ:CHAN:BAND JAPAN
Initial S/W Revision	A.05.00

Korean PCS

Selects Korean PCS as the active channel band.

Key Path	Source, Frequency, Radio Setup, Radio Standard, CDMA 2000 / 1xEVDO
Example	:SOUR:FREQ:CHAN:BAND KOREAN
Initial S/W Revision	A.05.00

NMT 450

Selects NMT 450 as the active channel band.

Key Path	Source, Frequency, Radio Setup, Radio Standard, CDMA 2000 / 1xEVDO
----------	--

Example	:SOUR:FREQ:CHAN:BAND NMT
Initial S/W Revision	A.05.00

IMT 2000

Selects IMT 2000 as the active channel band.

Key Path	Source, Frequency, Radio Setup, Radio Standard, CDMA 2000 / 1xEVDO
Example	:SOUR:FREQ:CHAN:BAND IMT2K
Initial S/W Revision	A.05.00

Upper 700

Selects Upper 700 as the active channel band.

Key Path	Source, Frequency, Radio Setup, Radio Standard, CDMA 2000 / 1xEVDO
Example	:SOUR:FREQ:CHAN:BAND UPPER
Initial S/W Revision	A.05.00

Secondary 800

Selects Secondary 800 as the active channel band.

Key Path	Source, Frequency, Radio Setup, Radio Standard, CDMA 2000 / 1xEVDO
Example	:SOUR:FREQ:CHAN:BAND SECOND
Initial S/W Revision	A.05.00

400 Euro PAMR

Selects 400 Euro PAMR as the active channel band.

Key Path	Source, Frequency, Radio Setup, Radio Standard, CDMA 2000 / 1xEVDO
Example	:SOUR:FREQ:CHAN:BAND PAMR400
Initial S/W Revision	A.05.00

800 PAMR

Selects 800 PAMR as the active channel band.

Key Path	Source, Frequency, Radio Setup, Radio Standard, CDMA 2000 / 1xEVDO
----------	--

Example	:SOUR:FREQ:CHAN:BAND PAMR800
Initial S/W Revision	A.05.00

2.5GHz IMT EXT

Selects 2.5 GHz IMT EXT as the active channel band.

Key Path	Source, Frequency, Radio Setup, Radio Standard, CDMA 2000 / 1xEVDO
Example	:SOUR:FREQ:CHAN:BAND IMTEXT
Initial S/W Revision	A.05.00

US PCS 1.9GHz

Selects US PCS 1.9 GHz as the active channel band.

Key Path	Source, Frequency, Radio Setup, Radio Standard, CDMA 2000 / 1xEVDO
Example	:SOUR:FREQ:CHAN:BAND PCS1DOT9G
Initial S/W Revision	A.05.00

AWS

Selects AWS as the active channel band.

Key Path	Source, Frequency, Radio Setup, Radio Standard, CDMA 2000 / 1xEVDO
Example	:SOUR:FREQ:CHAN:BAND AWS
Initial S/W Revision	A.05.00

US 2.5GHz

Selects US 2.5 GHz as the active channel band.

Key Path	Source, Frequency, Radio Setup, Radio Standard, CDMA 2000 / 1xEVDO
Example	:SOUR:FREQ:CHAN:BAND US2DOT5G
Initial S/W Revision	A.05.00

700 Public Safety

Selects 700 Public Safety as the active channel band.

Key Path	Source, Frequency, Radio Setup, Radio Standard, CDMA 2000 / 1xEVDO
----------	--

Example	:SOUR:FREQ:CHAN:BAND PUBLIC
Initial S/W Revision	A.05.00

C2K Lower 700

Selects C2K Lower 700 as the active channel band.

Key Path	Source, Frequency, Radio Setup, Radio Standard, CDMA 2000 / 1xEVDO
Example	:SOUR:FREQ:CHAN:BAND LOWER
Initial S/W Revision	A.05.00

LTE

Sets LTE FDD as the radio standard for use and accesses the LTE FDD specific channel band sub-menus..

Key Path	Source, Frequency, Radio Setup, Radio Standard
Initial S/W Revision	A.09.50

BAND 1

Selects BAND 1 as the band for the current step.

Key Path	Source, Frequency, Radio Setup, Radio Standard, LTE
Example	:SOUR:FREQ:CHAN:BAND BAND1
Initial S/W Revision	A.09.50

BAND 2

Selects BAND 2 as the band for the current step.

Key Path	Source, Frequency, Radio Setup, Radio Standard, LTE
Example	:SOUR:FREQ:CHAN:BAND BAND2
Initial S/W Revision	A.09.50

BAND 3

Selects BAND 3 as the band for the current step.

Key Path	Source, Frequency, Radio Setup, Radio Standard, LTE
Example	:SOUR:FREQ:CHAN:BAND BAND3
Initial S/W Revision	A.09.50

BAND 4

Selects BAND 4 as the band for the current step.

Key Path	Source, Frequency, Radio Setup, Radio Standard, LTE
Example	:SOUR:FREQ:CHAN:BAND BAND4
Initial S/W Revision	A.09.50

BAND 5

Selects BAND 5 as the band for the current step.

Key Path	Source, Frequency, Radio Setup, Radio Standard, LTE
Example	:SOUR:FREQ:CHAN:BAND BAND5
Initial S/W Revision	A.09.50

BAND 6

Selects BAND 6 as the band for the current step.

Key Path	Source, Frequency, Radio Setup, Radio Standard, LTE
Example	:SOUR:FREQ:CHAN:BAND BAND6
Initial S/W Revision	A.09.50

BAND 7

Selects BAND 7 as the band for the current step.

Key Path	Source, Frequency, Radio Setup, Radio Standard, LTE
Example	:SOUR:FREQ:CHAN:BAND BAND7
Initial S/W Revision	A.09.50

BAND 8

Selects BAND 8 as the band for the current step.

Key Path	Source, Frequency, Radio Setup, Radio Standard, LTE
Example	:SOUR:FREQ:CHAN:BAND BAND8
Initial S/W Revision	A.09.50

BAND 9

Selects BAND 9 as the band for the current step.

Key Path	Source, Frequency, Radio Setup, Radio Standard, LTE
Example	:SOUR:FREQ:CHAN:BAND BAND9
Initial S/W Revision	A.09.50

BAND 10

Selects BAND 10 as the band for the current step.

Key Path	Source, Frequency, Radio Setup, Radio Standard, LTE
Example	:SOUR:FREQ:CHAN:BAND BAND10
Initial S/W Revision	A.09.50

BAND 11

Selects BAND 11 as the band for the current step.

Key Path	Source, Frequency, Radio Setup, Radio Standard, LTE
Example	:SOUR:FREQ:CHAN:BAND BAND11
Initial S/W Revision	A.09.50

BAND 12

Selects BAND 12 as the band for the current step.

Key Path	Source, Frequency, Radio Setup, Radio Standard, LTE
Example	:SOUR:FREQ:CHAN:BAND BAND12
Initial S/W Revision	A.09.50

BAND 13

Selects BAND 13 as the band for the current step.

Key Path	Source, Frequency, Radio Setup, Radio Standard, LTE
Example	:SOUR:FREQ:CHAN:BAND BAND13
Initial S/W Revision	A.09.50

BAND 14

Selects BAND 14 as the band for the current step.

Key Path	Source, Frequency, Radio Setup, Radio Standard, LTE
Example	:SOUR:FREQ:CHAN:BAND BAND14
Initial S/W Revision	A.09.50

BAND 17

Selects BAND 17 as the band for the current step.

Key Path	Source, Frequency, Radio Setup, Radio Standard, LTE
Example	:SOUR:FREQ:CHAN:BAND BAND17
Initial S/W Revision	A.09.50

BAND 18

Selects BAND 18 as the band for the current step.

Key Path	Source, Frequency, Radio Setup, Radio Standard, LTE
Example	:SOUR:FREQ:CHAN:BAND BAND18
Initial S/W Revision	A.09.50

BAND 19

Selects BAND 19 as the band for the current step.

Key Path	Source, Frequency, Radio Setup, Radio Standard, LTE
Example	:SOUR:FREQ:CHAN:BAND BAND19
Initial S/W Revision	A.09.50

BAND 20

Selects BAND 20 as the band for the current step.

Key Path	Source, Frequency, Radio Setup, Radio Standard, LTE
Example	:SOUR:FREQ:CHAN:BAND BAND20
Initial S/W Revision	A.09.50

BAND 21

Selects BAND 21 as the band for the current step.

Key Path	Source, Frequency, Radio Setup, Radio Standard, LTE
Example	:SOUR:FREQ:CHAN:BAND BAND21
Initial S/W Revision	A.09.50

BAND 24

Selects BAND 24 as the band for the current step.

Key Path	Source, Frequency, Radio Setup, Radio Standard, LTE
Example	:SOUR:FREQ:CHAN:BAND BAND24
Initial S/W Revision	A.09.50

BAND 25

Selects BAND 25 as the band for the current step.

Key Path	Source, Frequency, Radio Setup, Radio Standard, LTE
Example	:SOUR:FREQ:CHAN:BAND BAND25
Initial S/W Revision	A.09.50

BAND 26

Selects BAND 26 as the band for the current step.

Key Path	Source, Frequency, Radio Setup, Radio Standard, LTE
Example	:SOUR:FREQ:CHAN:BAND BAND26
Initial S/W Revision	A.12.53

BAND 27

Selects BAND 27 as the band for the current step.

Key Path	Source, Frequency, Radio Setup, Radio Standard, LTE
Example	:SOUR:FREQ:CHAN:BAND BAND27
Initial S/W Revision	A.14.00

BAND 28

Selects BAND 28 as the band for the current step.

Key Path	Source, Frequency, Radio Setup, Radio Standard, LTE
Example	:SOUR:FREQ:CHAN:BAND BAND28
Initial S/W Revision	A.14.00

BAND 31

Selects BAND 31 as the band for the current step.

Key Path	Source, Frequency, Radio Setup, Radio Standard, LTE
Example	:SOUR:FREQ:CHAN:BAND BAND31
Initial S/W Revision	A.14.00

LTE TDD

Sets LTE TDD as the radio standard for use and accesses the LTE TDD specific channel band sub-menus..

Key Path	Source, Frequency, Radio Setup, Radio Standard
Initial S/W Revision	A.11.50

BAND 33

Selects BAND 33 as the band for the current step.

Key Path	Source, Frequency, Radio Setup, Radio Standard, LTE TDD
Example	:SOUR:FREQ:CHAN:BAND BAND33
Initial S/W Revision	A.11.50

BAND 34

Selects BAND 34 as the band for the current step.

Key Path	Source, Frequency, Radio Setup, Radio Standard, LTE TDD
Example	:SOUR:FREQ:CHAN:BAND BAND34
Initial S/W Revision	A.11.50

BAND 35

Selects BAND 35 as the band for the current step.

Key Path	Source, Frequency, Radio Setup, Radio Standard, LTE TDD
Example	:SOUR:FREQ:CHAN:BAND BAND35
Initial S/W Revision	A.11.50

BAND 36

Selects BAND 36 as the band for the current step.

Key Path	Source, Frequency, Radio Setup, Radio Standard, LTE TDD
Example	:SOUR:FREQ:CHAN:BAND BAND36
Initial S/W Revision	A.11.50

BAND 37

Selects BAND 37 as the band for the current step.

Key Path	Source, Frequency, Radio Setup, Radio Standard, LTE TDD
Example	:SOUR:FREQ:CHAN:BAND BAND37
Initial S/W Revision	A.11.50

BAND 38

Selects BAND 38 as the band for the current step.

Key Path	Source, Frequency, Radio Setup, Radio Standard, LTE TDD
Example	:SOUR:FREQ:CHAN:BAND BAND38
Initial S/W Revision	A.11.50

BAND 39

Selects BAND 39 as the band for the current step.

Key Path	Source, Frequency, Radio Setup, Radio Standard, LTE TDD
Example	:SOUR:FREQ:CHAN:BAND BAND39
Initial S/W Revision	A.11.50

BAND 40

Selects BAND 40 as the band for the current step.

Key Path	Source, Frequency, Radio Setup, Radio Standard, LTE TDD
Example	:SOUR:FREQ:CHAN:BAND BAND40
Initial S/W Revision	A.11.50

BAND 41

Selects BAND 41 as the band for the current step.

Key Path	Source, Frequency, Radio Setup, Radio Standard, LTE TDD
Example	:SOUR:FREQ:CHAN:BAND BAND41
Initial S/W Revision	A.11.50

BAND 42

Selects BAND 42 as the band for the current step.

Key Path	Source, Frequency, Radio Setup, Radio Standard, LTE TDD
Example	:SOUR:FREQ:CHAN:BAND BAND42
Initial S/W Revision	A.11.50

BAND 43

Selects BAND 43 as the band for the current step.

Key Path	Source, Frequency, Radio Setup, Radio Standard, LTE TDD
Example	:SOUR:FREQ:CHAN:BAND BAND43
Initial S/W Revision	A.11.50

BAND 44

Selects BAND 44 as the band for the current step.

Key Path	Source, Frequency, Radio Setup, Radio Standard, LTE TDD
Example	:SOUR:FREQ:CHAN:BAND BAND44
Initial S/W Revision	A.14.00

TDSCDMA

Sets TDSCDMA as the radio standard for use and accesses the TDSCDMA specific channel band sub-menus..

Key Path	Source, Frequency, Radio Setup, Radio Standard
Initial S/W Revision	A.11.50

BAND A

Selects BAND A as the band for the current step.

Key Path	Source, Frequency, Radio Setup, Radio Standard, TDSCDMA
Example	:SOUR:FREQ:CHAN:BAND BANDA
Initial S/W Revision	A.11.50

BAND B

Selects BAND B as the band for the current step.

Key Path	Source, Frequency, Radio Setup, Radio Standard, TDSCDMA
Example	:SOUR:FREQ:CHAN:BAND BANDB
Initial S/W Revision	A.11.50

BAND C

Selects BAND C as the band for the current step.

Key Path	Source, Frequency, Radio Setup, Radio Standard, TDSCDMA
Example	:SOUR:FREQ:CHAN:BAND BANDC
Initial S/W Revision	A.11.50

BAND D

Selects BAND D as the band for the current step.

Key Path	Source, Frequency, Radio Setup, Radio Standard, TDSCDMA
Example	:SOUR:FREQ:CHAN:BAND BANDD
Initial S/W Revision	A.11.50

BAND E

Selects BAND E as the band for the current step.

Key Path	Source, Frequency, Radio Setup, Radio Standard, TDSCDMA
----------	---

Example	:SOUR:FREQ:CHAN:BAND BANDE
Initial S/W Revision	A.11.50

BAND F

Selects BAND F as the band for the current step.

Key Path	Source, Frequency, Radio Setup, Radio Standard, TDSCDMA
Example	:SOUR:FREQ:CHAN:BAND BANDF
Initial S/W Revision	A.11.50

Radio Band Link

Allows you to specify the channel band type as either uplink or downlink link direction. This value is used in conjunction with the channel band and channel number to determine the absolute frequency output by the source. When set to “Uplink”, the source will calculate the uplink frequency using an uplink formula together with the selected channel band and channel number . When set to “Downlink”, the source will calculate the downlink frequency using a downlink formula together with the selected channel band and channel number.

Key Path	Source, Frequency, Radio Setup
Remote Command	:SOURce:RADio:BAND:LINK DOWN UP :SOURce:RADio:BAND:LINK?
Example	:SOUR:RAD:BAND:LINK UP
Preset	DOWN
Range	DOWN UP
Backwards Compatibility SCPI	:SOURce:RADio:DEVice BTS MS :SOURce:RADio:DEVice?
Backwards Compatibility Notes	BTS maps to the Downlink frequency MS maps to the Uplink frequency
Initial S/W Revision	A.05.00

Set Reference Frequency

This key allows you to set the frequency reference. Pressing this key turns the frequency reference state to ON, sets the reference frequency value to the current frequency, maintains this frequency at the RF output, and sets the displayed frequency to 0.00 Hz. All subsequent frequencies entered under Source>Frequency>Frequency are interpreted as being relative to this reference frequency.

When you use a frequency reference, the signal generator outputs a frequency that is set relative to the reference frequency by the value entered under Source>Frequency>Frequency as follows:

Output frequency = reference frequency - entered frequency

Where:

reference frequency equals the original RF frequency entered under Source>Frequency>Frequency and set as the reference frequency

entered frequency equals a new value entered under Source>Frequency>Frequency

In addition, the displayed frequency value will be the same as the value entered under Source>Frequency>Frequency.

NOTE

If Freq Reference is set to ON with a reference value set, entering a value under Source>Frequency>Frequency and pressing Set Frequency Reference will add that value to the existing Freq Reference value.

If you wish to change the reference frequency value to the new value entered under Source>Frequency>Frequency, first you must set Freq Reference to OFF and then press Set Frequency Reference.

Key Path	Source, Frequency
Remote Command	:SOURce:FREQuency:REFerence:SET
Example	:SOUR:FREQ:REF:SET
Dependencies	This setting is unavailable, and is grayed out when the List Sequencer is turned ON.
Initial S/W Revision	A.05.00

Freq Reference

This key allows you to toggle the state of the frequency reference. When the frequency reference state is ON, an annunciator is displayed on the main source view to indicate this state to the user.

When you use a frequency reference, the signal generator outputs a frequency that is set relative to the reference frequency by the value entered under Source>Frequency>Frequency as follows:

$$\text{Output frequency} = \text{reference frequency} + \text{entered frequency}$$

Where:

reference frequency equals the original RF frequency entered under Source>Frequency>Frequency and set as the reference frequency

entered frequency equals a new value entered under Source>Frequency>Frequency

For more information on Reference Frequency refer to ["Set Reference Frequency" on page 2473](#)

Key Path	Source, Frequency
Remote Command	:SOURce:FREQuency:REFerence <freq> :SOURce:FREQuency:REFerence? :SOURce:FREQuency:REFerence:STATe OFF ON 0 1 :SOURce:FREQuency:REFerence:STATe?
Example	:SOUR:FREQ:REF 0.00 Hz

	:SOUR:FREQ:REF:STATe ON
Dependencies	This setting is unavailable, and is grayed out when the List Sequencer is turned ON.
Couplings	The frequency reference state is coupled to the frequency reference set immediate action. When the reference set immediate action key is pressed, or the SCPI command issued, it turns the frequency reference state ON.
Preset	0.00 Hz OFF
Min	0.00 Hz
Max	Hardware Dependant: Option 503 = 3.6 GHz Option 504 = 3.8 GHz Option 506 = 6.00 GHz
Initial S/W Revision	A.05.00

Freq Offset

Allows you to specify the frequency offset value. When the frequency offset state is ON, an annunciator is displayed on the main source view to indicate this state to the user.

When the frequency offset is set to zero (0) and you set a new offset value, the displayed frequency value will change as follows and the RF output frequency will not change:

Displayed value = output frequency + offset value

Where:

output frequency equals the original frequency entered under Source>Frequency>Frequency

offset value equals the value entered under Source>Frequency>Freq Offset

When the frequency offset is set to a value other than zero (0) and you enter a new frequency value under Source>Frequency>Frequency, the displayed frequency will be the same as the value entered and the RF output frequency will be equal to the value entered minus the offset value as follows:

Output frequency = entered frequency – offset frequency

Displayed frequency = output frequency + offset frequency

Displayed frequency = entered frequency

Where:

entered frequency equals the frequency entered under Source>Frequency>Frequency

offset frequency equals the value previously entered and set under Source>Frequency>Freq Offset

Key Path	Source, Frequency
Remote Command	:SOURce:FREQuency:OFFSet <freq>

	:SOURce:FREQuency:OFFSet?
Example	:SOUR:FREQ:OFFS 0 Hz
Dependencies	This setting is unavailable, and is grayed out when the List Sequencer is turned ON.
Preset	0 Hz
Min	-100.00 GHz
Max	100.00 GHz
Initial S/W Revision	A.05.00

Modulation Setup

Allows access to the menus for setting up the available modulation types: "ARB" on page 2476, "AM" on page 2517, "FM" on page 2518, and "PM" on page 2519.

Key Path	Source
Initial S/W Revision	A.05.00

ARB

Allows you access to the ARB sub-menus.

Key Path	Source, Modulation Setup
Initial S/W Revision	A.05.00

ARB

Allows you to toggle the state of the ARB function. When the ARB is On, a "MOD" annunciator is displayed in the system settings panel. When the ARB is turned Off, the MOD annunciator is cleared

Key Path	Source, Modulation Setup, ARB
Remote Command	:SOURce:RADio:ARB[:STATe] ON OFF 1 0 :SOURce:RADio:ARB[:STATe]?
Example	:SOUR:RAD:ARB OFF :SOUR:RAD:ARB?
Notes	If the ARB is ON, a user then loads or deletes another file to ARB memory, the playing waveform segment may not keep phase continuity during the ARB memory operation. The waveform will be replayed after the ARB operation is finished.
Dependencies	This setting is for independent mode and has no effect on 3.3.8 list sequencer mode. Setting "Sequencer" on page 2521 Sequencer to On will put source enter list sequencer mode, and even if ARB state is On, the ARB file will not be played. Setting "Sequencer" on page 2521 Sequencer to Off will make source leave list sequencer mode, and this setting will take effect immediately.

The ARB can only be turned on when there is a waveform file selected for playback. On the GUI If no waveform is selected, this key is grayed out. If you send the SCPI command to turn the ARB on with no waveform selected for playback, the ARB state remains OFF and an error is generated. “-
When you try to recall a certain set of states in which the selected waveform is not in ARB memory and the ARB state is On, errors are reported

Preset	Off
Range	On Off
Initial S/W Revision	A.05.00

Select Waveform

Allows you to access to the waveform selection sub-menus.

Pressing this key changes the central view area to show the Waveform File Selection view.

Key Path	Source, Modulation Setup, ARB
Initial S/W Revision	A.05.00

Select Waveform

Allows you to select a waveform sequence or segment for the dual ARB to play.

NOTE: Selecting a waveform file does not result in automatic adjustments to burst timing (to compensate for the presence or absence of a Multiport Adapter); that adjustment occurs only when a waveform is loaded to ARB memory. See "Load Segment to ARB Memory" for more information about this adjustment.

Key Path	Source, Modulation Setup, ARB, Select Waveform
Remote Command	:SOURce:RADio:ARB:WAVeform <string> :SOURce:RADio:ARB:WAVeform?
Example	:SOUR:RAD:ARB:WAV "test_waveform.bin"
Notes	<p>If intended waveform is not in the memory yet, then issuing this command by SCPI will invoke ARB loading operation first, which involves a delay of unpredictable length. So this command should be followed by the query *OPC?, which holds off subsequent commands until the loading operating is complete.</p> <p><string> - specifies the name of the waveform segment or waveform sequence to be played by the ARB.</p> <p>When in Sequence Analyzer mode, and Include Source is Yes, if the you attempt to play a waveform sequence but not all the required waveform segments are in the ARB playback memory, the application will reject the loading operation with an error is generated .</p> <p>When Include Source is No, if you attempt to play a waveform sequence but not all the required waveform segments are contained in the ARB playback memory, the application will attempt to load the required segments from either the default directory of the current directory. If the ARB memory does not have enough space for all the waveform segments to be loaded, an error is generated and</p>

none of the waveform segments is loaded.

If the ARB is ON, and you attempt to play a waveform sequence but not all the waveform segments within the sequence could be found to be loaded into ARB memory, an error is generated. The selected waveform keeps the previous value and ARB state remains On.

If you specify a waveform segment over SCPI but the waveform segment is not present within ARB playback memory and cannot be found for auto loading within the current directory or the default directory, an error is generated and the file selection remains unchanged.

If you select a waveform for playback and the waveform requires a license that is not installed on the instrument, an error is generated.

If the ARB is ON and you load a file to ARB memory or delete a file from ARB memory, the playing waveform segment may not keep phase continuity during the ARB memory operation. The waveform will be replayed after the ARB operation is finished.

Initial S/W Revision	A.05.00
----------------------	---------

Segments on Hard Disk

Allows you access to the sub-menus for loading waveform segments from the hard disk into ARB memory. The default directory is: D: varb.

Pressing this key changes the current view to the Waveform Management View.

Key Path	Source, Modulation Setup, ARB, Select Waveform
----------	--

Initial S/W Revision	A.05.00
----------------------	---------

Load Segment To ARB Memory

Allows you to load the selected file into ARB memory. On the front panel you select the file for loading to the ARB memory by highlighting the desired file in the list. Using the SCPI command, you specify the file name on the HDD.

“NVWFM” (non-volatile storage) MSUS (Mass Storage Unit Specifier) is supported in the memory subsystem because the ARB memory cannot be accessed directly. Therefore, files must be downloaded to the instrument hard disk and then loaded into the ARB memory. “NVWFM” MSUS will be mapped to the default directory D: VARB. The SCPI command supports using either “NVWFM” MSUS or specifying a full path. For more information, see [Memory Subsystem \(Remote Command Only\)](#).

If a file of the same name already exists within ARB memory, it is overwritten. If you wish to load two segments of the same name, you must rename one of the segments before loading it into ARB memory. To rename a segment, you can either use Windows File Explorer, or the :MMEMory:COPY command.

NOTE: When a waveform file is loaded to ARB memory, burst timing adjustments are made automatically, based on whether or not a Multiport Adapter is connected to the test set and powered on. If the connection/power status of the Multiport Adapter is changed after a waveform file has been loaded, it needs to be loaded again.

Key Path	Source, Modulation Setup, ARB, Select Waveform, Segments on Hard Disk
----------	---

Remote Command	:SOURce:RADio:ARB:LOAD <string>
Example	:SOUR:RAD:ARB:LOAD "D: VARB\testwaveform.bin" or :SOUR:RAD:ARB:LOAD "NVWFM:testwaveform.bin"
Notes	<p>Because loading the file involves a delay of unpredictable length, this command should be followed by the query *OPC?, which holds off subsequent commands until the loading operating is complete.</p> <p><string> - specifies the path name of the file to load from the HDD into ARB memory. It could be a <full path + filename>, or <"NVWFM" MSUS + colon + filename>.</p> <p>When in Sequence Analyzer mode, and Include Source is Yes, an attempt to load a file to ARB memory will be rejected with an error.</p> <p>When Include Source is No and if there is insufficient free ARB memory to load the selected waveform, an error is generated. .</p> <p>If you specify a file over SCPI, but the file is not at the specified location, an error is generated.</p> <p>If you try to load a waveform file but the file contains less than 500 IQ samples, an error is generated.</p> <p>If you try to load a Signal Studio waveform "*.wfm" which contains invalid waveform header, an error is generated.</p> <p>If the ARB is ON when you load a file to ARB memory or delete a file from ARB memory, the playing waveform segment may not keep phase continuity during the ARB memory operation. The waveform will be replayed after the ARB operation is finished.</p> <p>ARB can be loaded into ARB memory even required licenses do not present on the instrument. In this case, a GUI only warning message -800, "Operation complete; Loaded <filename> successfully, but no license <required licenses> installed". User can install required licenses according to <required licenses> string to license it, or multi-pack license it.</p>
Initial S/W Revision	A.05.00

Load All To ARB Memory

Allows you to load all the segment files within the currently selected directory into ARB memory. If a file of the same name already exists within ARB memory, it is overwritten. If you wish to load two segments of the same name, you must rename one of the segments before loading it into ARB memory. To rename a segment, you can either use Windows File Explorer, or the :MEMory:COPI command.

NOTE: When a waveform file is loaded to ARB memory, burst timing adjustments are made automatically, based on whether or not a Multiport Adapter is connected to the test set and powered on. If the connection/power status of the Multiport Adapter is changed after a waveform file has been loaded, it needs to be loaded again.

Key Path	Source, Modulation Setup, ARB, Select Waveform, Segments on Hard Disk
Remote Command	:SOURce:RADio:ARB:LOAD:ALL <string>
Example	:SOUR:RAD:ARB:LOAD:ALL "D: varb"
Notes	<p><string> - specifies the directory on the HDD to load the files into ARB memory from.</p> <p>When in Sequence Analyzer mode, and Include Source is Yes, an attempt to load all files from a directory to ARB memory is rejected with an error.</p> <p>When Include Source is No and there is insufficient free ARB memory to load all the waveforms,</p>

when the ARB memory is full, the copy ceases, and an error is generated.
 If you specify a directory over SCPI, but the directory does not exist, an error is generated.
 If the ARB is ON, a user then loads or deletes file to ARB memory, the playing waveform segment may not keep phase continuity during the ARB memory operation. The waveform will be replayed after the ARB operation is finished.

Initial S/W Revision A.05.00

Change Directory...

Allows you to change the currently selected directory on the hard disk. Pressing this key opens a standard windows change directory dialog allowing you to select the new directory of interest.

The current directory is used for manually loading waveform segments into ARB memory for playback, and as a search location for waveform segments that are required to be loaded into ARB memory for playback of a waveform sequence or a list sequence.

Key Path Source, Modulation Setup, ARB, Select Waveform, Segments on Hard Disk

Notes No remote command, SCPI front panel only.

Initial S/W Revision A.05.00

Default Directory...

Allows you to change the default directory. It is used as a search location for waveform segments that are required to be loaded into ARB memory for playback of a waveform sequence, and as a search location for selecting waveforms using SCPI.

Key Path Source, Modulation Setup, ARB, Select Waveform, Segments on Hard Disk

Remote Command :SOURce:RADio:ARB:DEFault:DIRectory <string>
 :SOURce:RADio:ARB: DEFault:DIRectory?

Example :SOUR:RAD:ARB:DEF:DIR "D:\ArbFiles"
 :SOUR:RAD:ARB:DEF:DIR?

State Saved Persistent, survives a power cycle and a preset but not saved in the instrument state

Initial S/W Revision A.05.00

Segments in ARB Memory

Allows you access to the sub-menus for managing the files within ARB memory.

Key Path Source, Modulation Setup, ARB, Select Waveform

Initial S/W Revision A.05.00

Delete Segment From ARB Mem

Allows you to remove a segment from ARB playback memory.

Key Path	Source, Modulation Setup, ARB, Select Waveform, Segments in ARB Memory
Remote Command	:SOURce:RADio:ARB:DELeTe <string>
Example	:SOUR:RAD:ARB:DEL "testwaveform.bin"
Notes	<p><string> - specifies the waveform to be deleted from the ARB playback memory.</p> <p>When in Sequence Analyzer mode and Include Source is Yes, an attempt to delete a file from ARB memory is rejected with an error.</p> <p>When Include Source is No and you specify a file that does not exist within ARB memory, an error is generated.</p> <p>It is possible to delete files from within the ARB memory when the ARB is ON. However, if you attempt to delete the file that is currently playing an error is generated.</p> <p>It is possible to delete a file from within the ARB memory when the sequencer state is ON and the file is not being used by the List Sequencer. If you attempt to delete a file which is being used by the list sequencer, an error is generated.</p> <p>When sequencer state is On, even if ARB state is On, the selected waveform will not be played. In this case, if the selected waveform is not used in List Sequence, it can be deleted and the ARB state is turned Off.</p> <p>If the ARB is ON and you load a file to ARB memory or delete a file from ARB memory, the playing waveform segment may not keep phase continuity during the ARB memory operation. The waveform will be replayed after the ARB operation is finished.</p>
Initial S/W Revision	A.05.00

Delete All From ARB Memory

Allows you to remove all segments from ARB playback memory.

Key Path	Source, Modulation Setup, ARB, Select Waveform, Segments in ARB Memory
Remote Command	:SOURce:RADio:ARB:DELeTe:ALL
Example	:SOUR:RAD:ARB:DELeTe:ALL
Notes	<p>When in Sequence Analyzer mode and Include Source is Yes, an attempt to delete all files from ARB memory is rejected with an error.</p> <p>When Include Source is No and you attempt to delete all files from ARB memory when the ARB is currently playing a file, all files except the one playing are deleted and an error is generated.</p> <p>If you attempt to delete all files from ARB memory when there are waveform files used in "List Sequencer" on page 2520 and "Sequencer" on page 2521 state is ON, all files except the files currently being used in list sequencer are deleted, and an error is generated.</p> <p>If the ARB is ON and you load a file to ARB memory or delete a file from ARB memory, the playing waveform segment may not keep phase continuity during the ARB memory operation. The waveform will be replayed after the ARB operation is finished.</p>
Initial S/W Revision	A.05.00

Query ARB Memory File List (Remote Command Only)

Queries the test set for the list of waveform segments in the ARB memory.

NOTE

This command returns a string for waveform segment names in ARB memory. If you want a string list of waveform segments in the ARB memory, use **"Query ARB Memory Full File List (Remote Command Only)"** on page 2482.

Remote Command	:SOURce:RADio:ARB:CATalog?
Example	:SOUR:RAD:ARB:CATalog?
Notes	The return data is in the following format: <integer> - memory used <integer> - memory free <string> ... - comma separated list of waveform segments within ARB memory
Initial S/W Revision	A.05.00

Query ARB Memory Full File List (Remote Command Only)

Queries the test set for the string list of waveform segments in the ARB memory. It returns a string list for waveform segment names in the ARB memory.

Remote Command	:SOURce:RADio:ARB:FCATalog?
Example	:SOUR:RAD:ARB:FCATalog?
Notes	The return data is in the following format: <integer> - memory used <integer> - memory free <integer> - file count in ARB memory <string>,<string>, ... <string> - comma separated string list of waveform segments within ARB memory Example: SOUR:RAD:ARB:FCAT? EXT returns: 27499,2069653,3,"c2k.wfm","gsm.wfm","wcdma.wfm"
Initial S/W Revision	A.09.00

ARB Setup

Allows access to the ARB setup sub-menus.

Key Path	Source, Modulation Setup, ARB
Initial S/W Revision	A.05.00

Sample Rate

Allows you to set the ARB waveform playback sample rate.

Key Path	Source, Modulation Setup, ARB, ARB Setup
Remote Command	:SOURce:RADio:ARB:SCLock:RATE <freq> :SOURce:RADio:ARB:SCLock:RATE?
Example	:SOUR:RAD:ARB:SCL:RATE 48.00 MHz
Notes	If there is a sample rate specified in the header of the waveform file, changing that sample rate is not recommended, as it may cause problems with burst timing.
Dependencies	When a new waveform is selected for playback the settings contained within the associated waveform header file are applied to the ARB. The sample rate is one of the values stored within the header file. If the newly selected waveform file has an associated header file, the sample rate is updated with the value from the header file. The sample rate will remain unchanged if the newly selected waveform does not have an associated header file.
Preset	125.00 MHz
Min	1.00 kHz
Max	125.00 MHz
Initial S/W Revision	A.05.00

Run-Time Scaling

Allows you to adjust the run-time scaling value. The run-time scaling value is applied in real-time while the waveform is playing.

Key Path	Source, Modulation Setup, ARB, ARB Setup
Remote Command	:SOURce:RADio:ARB:RSCaling <real> :SOURce:RADio:ARB:RSCaling?
Example	:SOUR:RAD:ARB:RSC 100.00
Notes	This setting cannot be set in E6640A. Grey out on menu and the value is fixed at 70.00%.
Dependencies	When a new waveform is selected for playback the settings contained within the associated waveform header file are applied to the ARB. The run-time scaling is one of the values stored within the header file. If the newly selected waveform file has an associated header file, the run-time scaling is updated with the value from the header file. The run-time scaling will remain unchanged if the newly selected waveform does not have an associated header file.
Preset	70.00 %
Min	1.00 %
Max	100.00 %
Initial S/W Revision	A.05.00

Baseband Freq Offset

Allows you to adjust the value by which the baseband frequency is offset relative to the carrier.

Key Path	Source, Modulation Setup, ARB, ARB Setup
Remote Command	:SOURce:RADio:ARB:BASEband:FREQuency:OFFSet <freq> :SOURce:RADio:ARB:BASEband:FREQuency:OFFSet?
Example	:SOUR:RAD:ARB:BAS:FREQ:OFFS 0.00 Hz
Dependencies	When a new waveform is selected for playback the settings contained within the associated waveform header file are applied to the ARB. The baseband frequency offset is one of the values stored within the header file. If the newly selected waveform file has an associated header file, the baseband frequency offset is updated with the value from the header file. The baseband frequency offset will remain unchanged if the newly selected waveform does not have an associated header file.
Preset	0.00 Hz
Min	-50.00 MHz
Max	50.00 MHz
Initial S/W Revision	A.05.00

Trigger Type

Allows access to the trigger type sub-menus. The setting for trigger type determines the behavior of the waveform when it plays.

Key Path	Source, Modulation Setup, ARB
Remote Command	:SOURce:RADio:ARB:TRIGger:TYPE CONTInuous SINGLE SADVance GATE :SOURce:RADio:ARB:TRIGger:TYPE?
Example	:SOUR:RAD:ARB:TRIG:TYPE CONT :SOUR:RAD:ARB:TRIG:TYPE?
Notes	Gated trigger type will be implemented at a later release
Preset	CONTInuous
Range	Continuous Single Seg Adv Gated
Initial S/W Revision	A.05.00

Continuous

Sets the active trigger type to Continuous. If Continuous is already selected as the active trigger type, pressing this key allows access to the continuous trigger type setup menu. In Continuous trigger mode, the waveform repeats continuously.

Key Path	Source, Modulation Setup, ARB, Trigger Type
Remote Command	:SOURce:RADio:ARB:TRIGger:TYPE:CONTInuous[:TYPE] FREE TRIGger RESet :SOURce:RADio:ARB:TRIGger:TYPE:CONTInuous[:TYPE]?
Example	:SOUR:RAD:ARB:TRIG:TYPE:CONT FREE
Preset	FREE

Range	Free Run Trigger + Run Reset + Run
Initial S/W Revision	A.05.00

Free Run

Selects Free Run as the trigger response for the continuous trigger type. Free Run sets the waveform generator to play a waveform sequence or segment continuously, without waiting for a trigger. In this mode, the waveform generator does not respond to triggers.

Key Path	Source, Modulation Setup, ARB, Trigger Type, Continuous
Example	:SOUR:RAD:ARB:TRIG:TYPE:CONT FREE
Initial S/W Revision	A.05.00

Trigger + Run

Sets Trigger and Run as the trigger response for the continuous trigger type. Trigger and Run sets the waveform generator to play a waveform sequence or segment continuously when the first trigger is received, and to ignore any subsequent triggers.

Key Path	Source, Modulation Setup, ARB, Trigger Type, Continuous
Example	:SOUR:RAD:ARB:TRIG:TYPE:CONT TRIG
Initial S/W Revision	A.05.00

Reset + Run

Sets Reset and Run as the trigger response for the continuous trigger type. Reset and Run sets the waveform generator to play a waveform sequence or segment continuously when the first trigger is received. Subsequent triggers reset the waveform sequence or segment to the start, and then play it continuously.

Key Path	Source, Modulation Setup, ARB, Trigger Type, Continuous
Example	:SOUR:RAD:ARB:TRIG:TYPE:CONT RES
Initial S/W Revision	A.05.00

Single

Sets the active trigger type to Single. If Single is already selected as the active trigger type, pressing this key allows access to the single trigger type setup menu. In Single trigger mode, the waveform plays once.

Key Path	Source, Modulation Setup, ARB, Trigger Type
Remote Command	:SOURce:RADio:ARB:RETRigger ON OFF IMMediate

	:SOURce:RADio:ARB:RETRigger?
Example	:SOUR:RAD:ARB:RETR OFF
Notes	ON: Buffered Trigger OFF: No Retrigger Immediate: Restart on Trigger This is defined as an enumerated SCPI command, with ON OFF being considered as enumerated types rather than Boolean. This means the query will return OFF instead of 0, and ON instead of 1.
Preset	ON
Range	No Retrigger Buffered Trigger Restart on Trigger
Initial S/W Revision	A.05.00

No Retrigger

Selects No Retrigger as the trigger response for single trigger type. No Retrigger sets the waveform generator to play a waveform sequence or segment once when a trigger is received. Any triggers then received during playback are ignored.

Key Path	Source, Modulation Setup, ARB, Trigger Type, Single
Example	:SOUR:RAD:ARB:RETR OFF
Initial S/W Revision	A.05.00

Buffered Trigger

Selects Buffered Trigger as the trigger response for single trigger type. Buffered Trigger sets the waveform generator to play a waveform sequence or segment once when a trigger is received. If a trigger is received during playback, the waveform generator plays the sequence or segment to the end, then plays the sequence or segment once more.

Key Path	Source, Modulation Setup, ARB, Trigger Type, Single
Example	:SOUR:RAD:ARB:RETR ON
Initial S/W Revision	A.05.00

Restart on Trigger

Selects Restart on Trigger as the trigger response for single trigger type. Restart on Trigger sets the waveform generator to play a waveform sequence or segment once when a trigger is received. If a trigger is received during playback, the waveform generator resets and plays the sequence or segment from the start.

Key Path	Source, Modulation Setup, ARB, Trigger Type, Single
Example	:SOUR:RAD:ARB:RETR IMM
Initial S/W Revision	A.05.00

Segment Advance

Sets the active trigger type to Segment Advance. If Segment Advance is already selected as the active trigger type, pressing this key allows access to the segment advance trigger type setup menu.

Segment Advance triggering allows you to control the playback of waveform segments within a waveform sequence. When a trigger is received the ARB advances to the next waveform segment within the waveform sequence. This type of triggering ignores the repetition count for the waveform segment within the waveform sequence. For example, if a waveform segment has a repetition count of 10 and you select single segment advance triggering mode, the waveform segment will only play once.

Segment Advance triggering can also be used for waveform segments only. In this situation the same waveform segment is played again when a trigger is received.

Key Path	Source, Modulation Setup, ARB, Trigger Type
Remote Command	:SOURce:RADio:ARB:TRIGger:TYPE:SADVance[:TYPE] Single CONTInuous :SOURce:RADio:ARB:TRIGger:TYPE:SADVance[:TYPE]?
Example	:SOUR:RAD:ARB:TRIG:TYPE:SADV SING
Preset	CONTInuous
Range	Single Continuous
Initial S/W Revision	A.05.00

Single

Selects Single as the trigger response for Segment Advance trigger type. With single selected, once a trigger is received a segment is played once. If a trigger is received during playback of a segment, the segment plays to completion and the next segment is played once.

Key Path	Source, Modulation Setup, ARB, Trigger Type, Segment Advance
Example	:SOUR:RAD:ARB:TRIG:TYPE:SADV SING
Initial S/W Revision	A.05.00

Continuous

Selects Continuous as the trigger response for Segment Advance trigger type. With continuous selected, once a trigger is received a segment is played continuously. When subsequent triggers are received, the currently playing segment plays to completion and then the next segment is played continuously.

Key Path	Source, Modulation Setup, ARB, Trigger Type, Segment Advance
Example	:SOUR:RAD:ARB:TRIG:TYPE:SADV CONT
Initial S/W Revision	A.05.00

Trigger Source

Allows access to the trigger source sub-menus. The trigger source setting determines how the source receives the trigger that starts the waveform playing. Therefore, this key is grayed out if the trigger type is free run, since free run triggers immediately with no trigger source required.

Key Path	Source, Modulation Setup, ARB
Remote Command	:SOURce:RADio:ARB:TRIGger[:SOURce] KEY BUS EXTernal2 :SOURce:RADio:ARB:TRIGger[:SOURce]?
Example	:SOUR:RAD:ARB:TRIGger KEY
Dependencies	This key is grayed out if the current trigger type is Continuous, Free Run.
Preset	EXTernal2
Range	Trigger Key Bus External 2
Initial S/W Revision	A.05.00

Trigger Key

Sets the current trigger source to the front panel Trigger key. When Trigger Key is selected, the waveform is triggered when you press the front panel Trigger key.

Key Path	Source, Modulation Setup, ARB, Trigger Source
Example	:SOUR:RAD:ARB:TRIGger KEY
Initial S/W Revision	A.05.00

Bus

Sets the current trigger source to Bus. Selecting Bus trigger source enables triggering over GPIB, LAN, or USB using the :SOURce:RADio:ARB:TRIGger:INITiate command.

Key Path	Source, Modulation Setup, ARB, Trigger Source
Example	:SOUR:RAD:ARB:TRIGger BUS
Initial S/W Revision	A.05.00

External 2

Sets the current trigger source to External 2. Selecting External 2 enables triggering a waveform by an externally applied signal.

Key Path	Source, Modulation Setup, ARB, Trigger Source
Example	:SOUR:RAD:ARB:TRIGger EXT2
Notes	Note: When on E6640A, trigger 2 is a bi-directional trigger port. So when trigger 2 has been configured as OUTPUT type, choosing External 2 as the input trigger for the current step will generate error.
Initial S/W Revision	A.05.00

Trigger Initiate

Used to initiate an immediate trigger event if the trigger source is set to Trigger Key.

Key Path	Source, Modulation Setup, ARB
Notes	No remote command, SCPI front panel only.
Initial S/W Revision	A.05.00

Waveform Sequences

Allows access to the waveform sequence sub-menus. Pressing this key changes the central view area to display the Waveform Sequence List view.

Key Path	Source, Modulation Setup, ARB
Notes	No remote command, SCPI front panel only.
Initial S/W Revision	A.05.00

Build New Sequence

Allows access to the sub-menus for creating a new waveform sequence. Pressing this key changes the central view area to display the Waveform Sequence Creation and Editing view.

Key Path	Source, Modulation Setup, ARB, Waveform Sequences
Notes	No remote command, SCPI front panel only.
Initial S/W Revision	A.05.00

Current Segment

Specifies the selected sequence segment that will be affected by the menu functions.

Key Path	Source, Modulation Setup, ARB, Waveform Sequences, Build New Sequence
Notes	No remote command, SCPI front panel only. This key is grayed out and unavailable if the sequence is currently empty.
Initial S/W Revision	A.05.00

Insert New Waveform

Allows you access to the sub-menu for inserting a new waveform segment or sequence. Pressing this key also changes the central display to show the Waveform File Selection View.

Key Path	Source, Modulation Setup, ARB, Waveform Sequences, Build New Sequence
Notes	No remote command, SCPI front panel only. Waveform segment name string length upper limit is 128 chars. Please do NOT insert waveform which name string exceeds 128 chars.
Initial S/W Revision	A.05.00

Insert Waveform

Inserts the currently highlighted waveform to the end of the waveform sequence. Pressing this key also returns you to the menus for creating or editing a sequence, and returns the central view to the sequence creation view.

Key Path	Source, Modulation Setup, ARB, Waveform Sequences, Build New Sequence, Insert New Waveform
Notes	No remote command, SCPI front panel only. Waveform segment name string length upper limit is 128 chars. Please do NOT insert waveform which name string exceeds 128 chars.
Initial S/W Revision	A.05.00

Segments on Hard Disk

Allows you access to the sub-menus for loading waveform segments from the hard disk into ARB memory. The default directory is: D: varb.

Pressing this key changes the current view to the Waveform Management View.

Key Path	Source, Modulation Setup, ARB, Select Waveform
Initial S/W Revision	A.05.00

Load Segment To ARB Memory

Allows you to load the selected file into ARB memory. On the front panel you select the file for loading to the ARB memory by highlighting the desired file in the list. Using the SCPI command, you specify the file name on the HDD.

“NVWFM” (non-volatile storage) MSUS (Mass Storage Unit Specifier) is supported in the memory subsystem because the ARB memory cannot be accessed directly. Therefore, files must be downloaded to the instrument hard disk and then loaded into the ARB memory. “NVWFM” MSUS will be mapped to the default directory D: VARB. The SCPI command supports using either “NVWFM” MSUS or specifying a full path. For more information, see [Memory Subsystem \(Remote Command Only\)](#).

If a file of the same name already exists within ARB memory, it is overwritten. If you wish to load two segments of the same name, you must rename one of the segments before loading it into ARB memory. To rename a segment, you can either use Windows File Explorer, or the :MMEMORY:COPY command.

NOTE: When a waveform file is loaded to ARB memory, burst timing adjustments are made automatically, based on whether or not a Multiport Adapter is connected to the test set and powered on. If the connection/power status of the Multiport Adapter is changed after a waveform file has been loaded, it needs to be loaded again.

Key Path	Source, Modulation Setup, ARB, Select Waveform, Segments on Hard Disk
Remote Command	:SOURce:RADio:ARB:LOAD <string>
Example	:SOUR:RAD:ARB:LOAD "D: VARB\testwaveform.bin" or :SOUR:RAD:ARB:LOAD "NVWFM:testwaveform.bin"
Notes	<p>Because loading the file involves a delay of unpredictable length, this command should be followed by the query *OPC?, which holds off subsequent commands until the loading operation is complete.</p> <p><string> – specifies the path name of the file to load from the HDD into ARB memory. It could be a <full path + filename>, or <"NVWFM" MSUS + colon + filename>.</p> <p>When in Sequence Analyzer mode, and Include Source is Yes, an attempt to load a file to ARB memory will be rejected with an error.</p> <p>When Include Source is No and if there is insufficient free ARB memory to load the selected waveform, an error is generated. .</p> <p>If you specify a file over SCPI, but the file is not at the specified location, an error is generated.</p> <p>If you try to load a waveform file but the file contains less than 500 IQ samples, an error is generated.</p> <p>If you try to load a Signal Studio waveform "*.wfm" which contains invalid waveform header, an error is generated.</p> <p>If the ARB is ON when you load a file to ARB memory or delete a file from ARB memory, the playing waveform segment may not keep phase continuity during the ARB memory operation. The waveform will be replayed after the ARB operation is finished.</p> <p>ARB can be loaded into ARB memory even if required licenses do not present on the instrument. In this case, a GUI only warning message –800, "Operation complete; Loaded <filename> successfully, but no license <required licenses> installed". User can install required licenses according to <required licenses> string to license it, or multi-pack license it.</p>
Initial S/W Revision	A.05.00

Load All To ARB Memory

Allows you to load all the segment files within the currently selected directory into ARB memory. If a file of the same name already exists within ARB memory, it is overwritten. If you wish to load two segments of the same name, you must rename one of the segments before loading it into ARB memory. To rename a segment, you can either use Windows File Explorer, or the :MEMORY:COPY command.

NOTE: When a waveform file is loaded to ARB memory, burst timing adjustments are made automatically, based on whether or not a Multiport Adapter is connected to the test set and powered on. If the connection/power status of the Multiport Adapter is changed after a waveform file has been loaded, it needs to be loaded again.

Key Path	Source, Modulation Setup, ARB, Select Waveform, Segments on Hard Disk
Remote Command	:SOURce:RADio:ARB:LOAD:ALL <string>

Example	:SOUR:RAD:ARB:LOAD:ALL "D: varb"
Notes	<p><string> - specifies the directory on the HDD to load the files into ARB memory from.</p> <p>When in Sequence Analyzer mode, and Include Source is Yes, an attempt to load all files from a directory to ARB memory is rejected with an error.</p> <p>When Include Source is No and there is insufficient free ARB memory to load all the waveforms, when the ARB memory is full, the copy ceases, and an error is generated.</p> <p>If you specify a directory over SCPI, but the directory does not exist, an error is generated.</p> <p>If the ARB is ON, a user then loads or deletes file to ARB memory, the playing waveform segment may not keep phase continuity during the ARB memory operation. The waveform will be replayed after the ARB operation is finished.</p>
Initial S/W Revision	A.05.00

Change Directory...

Allows you to change the currently selected directory on the hard disk. Pressing this key opens a standard windows change directory dialog allowing you to select the new directory of interest.

The current directory is used for manually loading waveform segments into ARB memory for playback, and as a search location for waveform segments that are required to be loaded into ARB memory for playback of a waveform sequence or a list sequence.

Key Path	Source, Modulation Setup, ARB, Select Waveform, Segments on Hard Disk
Notes	No remote command, SCPIfront panel only.
Initial S/W Revision	A.05.00

Default Directory...

Allows you to change the default directory. It is used as a search location for waveform segments that are required to be loaded into ARB memory for playback of a waveform sequence, and as a search location for selecting waveforms using SCPI.

Key Path	Source, Modulation Setup, ARB, Select Waveform, Segments on Hard Disk
Remote Command	:SOURce:RADio:ARB:DEFault:DIRectory <string> :SOURce:RADio:ARB: DEFault:DIRectory?
Example	:SOUR:RAD:ARB:DEF:DIR "D:\ArbFiles" :SOUR:RAD:ARB:DEF:DIR?
State Saved	Persistent, survives a power cycle and a preset but not saved in the instrument state
Initial S/W Revision	A.05.00

Segments in ARB Memory

Allows you access to the sub-menus for managing the files within ARB memory.

Key Path	Source, Modulation Setup, ARB, Select Waveform
Initial S/W Revision	A.05.00

Delete Segment From ARB Mem

Allows you to remove a segment from ARB playback memory.

Key Path	Source, Modulation Setup, ARB, Select Waveform, Segments in ARB Memory
Remote Command	:SOURce:RADio:ARB:DELeTe <string>
Example	:SOUR:RAD:ARB:DEL "testwaveform.bin"
Notes	<p><string> - specifies the waveform to be deleted from the ARB playback memory.</p> <p>When in Sequence Analyzer mode and Include Source is Yes, an attempt to delete a file from ARB memory is rejected with an error.</p> <p>When Include Source is No and you specify a file that does not exist within ARB memory, an error is generated.</p> <p>It is possible to delete files from within the ARB memory when the ARB is ON. However, if you attempt to delete the file that is currently playing an error is generated.</p> <p>It is possible to delete a file from within the ARB memory when the sequencer state is ON and the file is not being used by the List Sequencer. If you attempt to delete a file which is being used by the list sequencer, an error is generated.</p> <p>When sequencer state is On, even if ARB state is On, the selected waveform will not be played. In this case, if the selected waveform is not used in List Sequence, it can be deleted and the ARB state is turned Off.</p> <p>If the ARB is ON and you load a file to ARB memory or delete a file from ARB memory, the playing waveform segment may not keep phase continuity during the ARB memory operation. The waveform will be replayed after the ARB operation is finished.</p>
Initial S/W Revision	A.05.00

Delete All From ARB Memory

Allows you to remove all segments from ARB playback memory.

Key Path	Source, Modulation Setup, ARB, Select Waveform, Segments in ARB Memory
Remote Command	:SOURce:RADio:ARB:DELeTe:ALL
Example	:SOUR:RAD:ARB:DELeTe:ALL
Notes	<p>When in Sequence Analyzer mode and Include Source is Yes, an attempt to delete all files from ARB memory is rejected with an error.</p> <p>When Include Source is No and you attempt to delete all files from ARB memory when the ARB is currently playing a file, all files except the one playing are deleted and an error is generated.</p> <p>If you attempt to delete all files from ARB memory when there are waveform files used in "List Sequencer" on page 2520 and "Sequencer" on page 2521 state is ON, all files except the files currently being used in list sequencer are deleted, and an error is generated.</p>

If the ARB is ON and you load a file to ARB memory or delete a file from ARB memory, the playing waveform segment may not keep phase continuity during the ARB memory operation. The waveform will be replayed after the ARB operation is finished.

Initial S/W Revision	A.05.00
----------------------	---------

Segments on Hard Disk

This key functions the same as ["Segments on Hard Disk" on page 2547](#).

Key Path	Source, Modulation Setup, ARB, Waveform Sequences, Build New Sequence, Insert New Waveform
----------	--

Initial S/W Revision	Prior to A.09.00
----------------------	------------------

Load Segment To ARB Memory

This key functions the same as ["Load Segment To ARB Memory" on page 2547](#).

Key Path	Source, Modulation Setup, ARB, Waveform Sequences, Build New Sequence, Insert New Waveform, Segment on Hard Drive
----------	---

Initial S/W Revision	Prior to A.09.00
----------------------	------------------

Load All To ARB Memory

This key functions the same as ["Load All To ARB Memory" on page 2548](#).

Key Path	Source, Modulation Setup, ARB, Waveform Sequences, Build New Sequence, Insert New Waveform, Segment on Hard Drive
----------	---

Initial S/W Revision	Prior to A.09.00
----------------------	------------------

Change Directory ...

This key functions the same as ["Change Directory..." on page 2549](#).

Key Path	Source, Modulation Setup, ARB, Waveform Sequences, Build New Sequence, Insert New Waveform, Segment on Hard Drive
----------	---

Initial S/W Revision	Prior to A.09.00
----------------------	------------------

Default Directory ...

This key functions the same as ["Default Directory..." on page 2549](#)

Key Path	Source, Modulation Setup, ARB, Waveform Sequences, Build New Sequence, Insert New Waveform, Segment on Hard Drive
----------	---

Initial S/W Revision	Prior to A.09.00
----------------------	------------------

Segments in ARB Memory

This key functions the same as ["Segments in ARB Memory" on page 2549](#).

Key Path	Source, Modulation Setup, ARB, Waveform Sequences, Build New Sequence, Insert New Waveform
Initial S/W Revision	Prior to A.09.00

Delete Segment From ARB Memory

This key functions the same as ["Delete Segment From ARB Mem" on page 2549](#).

Key Path	Source, Modulation Setup, ARB, Waveform Sequences, Build New Sequence, Insert New Waveform, Segment in ARB Memory
Initial S/W Revision	Prior to A.09.00

Delete All From ARB Memory

This key functions the same as ["Delete All From ARB Memory" on page 2550](#).

Key Path	Source, Modulation Setup, ARB, Waveform Sequences, Build New Sequence, Insert New Waveform, Segment in ARB Memory
Initial S/W Revision	Prior to A.09.00

Query ARB Memory File List (Remote Command Only)

This command functions the same as ["Query ARB Memory File List \(Remote Command Only\)" on page 2482](#).

Initial S/W Revision	Prior to A.09.00
----------------------	------------------

Edit Selected Waveform

Allows access to the sub-menus for editing the details of the currently selected waveform segment.

Key Path	Source, Modulation Setup, ARB, Waveform Sequences, Build New Sequence
Notes	No remote command, front panel only.
Initial S/W Revision	A.05.00

Repetitions

Allows you to specify the number of times the currently selected waveform is played within the sequence.

Key Path	Source, Modulation Setup, ARB, Waveform Sequences, Build New Sequence, Edit Selected Waveform
Notes	No remote command, SCPI front panel only.
Preset	1
Min	1
Max	65535
Initial S/W Revision	A.05.00

Marker 1

Allows you to enable or disable marker 1 for the currently selected waveform. For a waveform sequence, you can enable and disable markers on a per-segment basis, allowing you to output markers from some waveform segments within the sequence, but not for others.

Key Path	Source, Modulation Setup, ARB, Waveform Sequences, Build New Sequence, Edit Selected Waveform
Notes	No remote command, front panel only.
Preset	Enabled
Range	Enabled Disabled
Initial S/W Revision	A.05.00

Marker 2

Allows you to enable or disable marker 2 for the currently selected waveform. For a waveform sequence, you can enable and disable markers on a per-segment basis, allowing you to output markers from some waveform segments within the sequence, but not for others.

Key Path	Source, Modulation Setup, ARB, Waveform Sequences, Build New Sequence, Edit Selected Waveform
Notes	No remote command, front panel only.
Preset	Enabled
Range	Enabled Disabled
Initial S/W Revision	A.05.00

Marker 3

Allows you to enable or disable marker 3 for the currently selected waveform. For a waveform sequence, you can enable and disable markers on a per-segment basis, allowing you to output markers from some waveform segments within the sequence, but not for others.

Key Path	Source, Modulation Setup, ARB, Waveform Sequences, Build New Sequence, Edit Selected
----------	--

	Waveform
Notes	No remote command, front panel only.
Preset	Enabled
Range	Enabled Disabled
Initial S/W Revision	A.05.00

Marker 4

Allows you to enable or disable marker 4 for the currently selected waveform. For a waveform sequence, you can enable and disable markers on a per-segment basis, allowing you to output markers from some waveform segments within the sequence, but not for others.

Key Path	Source, Modulation Setup, ARB, Waveform Sequences, Build New Sequence, Edit Selected Waveform
Notes	No remote command, front panel only.
Preset	Enabled
Range	Enabled Disabled
Initial S/W Revision	A.05.00

Delete Segment

Allows you to delete the selected segment from the waveform sequence.

Key Path	Source, Modulation Setup, ARB, Waveform Sequences, Build New Sequence
Notes	No remote command, front panel only.
Initial S/W Revision	A.05.00

Save Sequence...

Pressing this key displays the “Save As” dialog. The sequence name is passed to the save as dialog to use as the filename for saving, and the directory the save as dialog will open into is the default waveform directory.

Key Path	Source, Modulation Setup, ARB, Waveform Sequences, Build New Sequence
Initial S/W Revision	A.05.00

Build New Sequence (Remote Command Only)

This command is the SCPI equivalent of the waveform sequence creation features described in ["Build New Sequence" on page 2489](#).

This command writes a waveform sequence file to the hard disk. You must specify the waveform sequence file path and filename which will be saved on the hard disk, and the waveform segment file path and name which will be nested into the waveform sequence file. You can utilize mass storage unit specifier (MSUS) “NVWFM” or use a real full path representation. See the example below. MSUS “NVWFM” is mapped to D:\VARB directory on test set hard disk.

Any number of segments, up to a segment count limit of 64, can be used to create a sequence. Repeated segments are included in the count limit.

Each waveform segment name string length upper limit is 128 chars. Please do NOT insert waveform which name string exceeds 128 chars.

The internal source does not support nesting one waveform sequence file into another waveform sequence file.

Remote Command :SOURce:RADio:ARB:SEQuence[:MWAVeform] <filename>, <waveform1>, <reps>, NONE | M1 | M2 | M3 | M4 | M1M2 | M1M3 | M1M4 | M2M3 | M2M4 | M3M4 | M1M2M3 | M1M2M4 | M1M3M4 | M2M3M4 | M1M2M3M4 | ALL, {<waveform2>, <reps>, NONE | M1 | M2 | M3 | M4 | M1M2 | M1M3 | M1M4 | M2M3 | M2M4 | M3M4 | M1M2M3 | M1M2M4 | M1M3M4 | M2M3M4 | M1M2M3M4 | ALL, } ...

(For additional description of each item, see Notes below ["For Setup SCPI" on page 2196](#) "For Setup SCPI".)

:SOURce:RADio:ARB:SEQuence[:MWAVeform]? <filename>

(For additional description of each item, see Notes ["For Query SCPI" on page 2197](#) below.)

Example For setup:

>:SOUR:RAD:ARB:SEQ "NVWFM:testSeq1.seq", "NVWFM:wfmSegment1.wfm", 10, M2M3M4, "NVWFM:wfmSegment2.wfm", 20, M1 M3

Or

>:SOUR:RAD:ARB:SEQ "D: VARB\testSeq1.seq", "D: VARB\wfmSegment1.wfm", 10, M2M3M4, "D: VARB\wfmSegment2.wfm", 20, M1 M3

For query, must specify which waveform sequence file to query.

>:SOUR:RAD:ARB:SEQ? "NVWFM:testSeq1.seq"

Or

>:SOUR:RAD:ARB:SEQ? "D: VARB\testSeq1.seq",

Notes For Setup SCPI

For the Setup SCPI command, the parameters are:

<filename> - String Type

This variable specifies the path and name for the waveform sequence file. The path supports MSUS (NVWFM) or a real full path representation. See example.

<waveform1> - String Type

This variable specifies the path and name of the first existing waveform segment. The path supports MSUS (NVWFM) or a real full path representation. See example.

The segment file must reside within ARB playback memory before it can be played by the ARB player.

<reps> - Integer Type

This variable specifies the number of times a segment or sequence plays before moving on to the next segment or sequence.

<marker> - Enum Type

NONE – This choice disables all four markers for the waveform. Disabling markers means that the waveform sequence ignores the segments or sequence marker settings.

M1, M2, M3, M4 – these choices, either individually or a combination of them, enable the markers for the waveform segment or sequence. Markers not specified are ignored for that segment or sequence.

ALL – This choice enables all four markers in the waveform segment or sequence.

<waveform2> - String type.

This variable specifies the name of a second existing waveform segment. The path supports MSUS (NVWFM) and real full path representation both. See example.

The segment file must reside within ARB playback memory before it can be played by the ARB player.

<reps> same as above, for the 2nd waveform segment.

<marker> same as above, for the 2nd waveform segment.

You can insert several waveform segments into a waveform sequence file. Just repeat inserting waveform segments as described above.

Error Checks for Setup SCPI command:

If you do not specify a filename, or you use an unsupported MSUS (that is, not NVWFM), or have an error in the waveform sequence file path, an error is generated.

Notes

Error Checks for Query SCPI command: (Continued)

If the specified waveform sequence file name suffix is not “.seq”, error is generated.

If you use an unsupported MSUS (that is, not NVWFM), or have an error in the waveform segment file path, an error is generated.

If the first specified waveform file cannot be found, an error is generated.

If you nest one waveform sequence file into another waveform sequence file, an error is generated.

If the specified repetition value is larger than 65535 or smaller than 1, an error is generated.

If the specified marker type is unrecognized, an error is generated.

For Query SCPI

For the Query the parameters are:

<filename> - String type.

This variable specifies the path and name of the waveform sequence file being queried. The path supports MSUS (NVWFM) or a real full path representation. See example.

The return value is a <string>, which includes each waveform segment file name, repetitions, and marker type. For example:

>:SOUR:RAD:ARB:SEQ? “NVWFM:testSeq1.seq”,

<“wfmSegment1. wfm, 10, ALL, wfmSegment2.wfm, 20, M1M3”,

Error Checks for Query SCPI command:

If you do not specify a filename, an error is generated.

If the waveform sequence file name is empty, an error is generated.

If the specified waveform sequence file cannot be found, an error is generated.

Initial S/W Revision

A.05.00

Edit Selected Sequence

Allows access to the sub-menus for editing the sequence currently selected within the Waveform Sequence List view. Pressing this key changes the central view area to display the Waveform Sequence Creation and Editing view.

Key Path	Source, Modulation Setup, ARB, Waveform Sequences
Notes	No remote command, front panel only.
Initial S/W Revision	A.05.00

Current Directory...

Allows you to change the currently selected directory on the hard disk. Pressing this key opens a standard windows change directory dialog and allows you to select the new directory of interest.

Key Path	Source, Modulation Setup, ARB, Waveform Sequences
Notes	No remote command, front panel only.
Initial S/W Revision	A.05.00

Waveform Utilities

Allows you access to the waveform utilities sub-menus.

Key Path	Source, Modulation Setup, ARB
Initial S/W Revision	A.05.00

Multi-Pack Licenses

Allows you access to the Multi - Pack License sub-menus. Pressing this key also changes the central view area to display the Multi -Pack License Management view.

On modular instrument like E6630A or E6640A, multi-pack license operations are only allowed on the default module, i.e. "Left" module for E6630A or "TRX1" module for E6640A.

Key Path	Source, Modulation Setup, ARB, Waveform Utilities
Notes	If access multi-pack license sub-menu from modules other than "TRX1", an advisory message like "Please goto "TRX1" to operate multi-pack license" will display.
Dependencies	This key is only available if there is at least one Multi-pack license installed on the instrument.
Initial S/W Revision	A.05.00

Add Waveform

Pressing this key accesses the Add Waveform sub-menu. It also changes the central display area to display the Multi-Pack License Waveform Add view.

Key Path	Source, Modulation Setup, ARB, Waveform Utilities, Multi-Pack Licenses
Dependencies	This key is only available if there is at least one slot available within at least one multi-pack license.
Initial S/W Revision	A.05.00

Add Waveform

Allows you to add the currently selected waveform segment to a multi-pack license. The new waveform is added to the next available slot regardless of which slot was selected on the Multi-Pack License Management view.

Key Path	Source, Modulation Setup, ARB, Waveform Utilities, Multi-Pack Licenses, Add Waveform
Remote Command	:SYSTem:LKEY:WAVeform:ADD <string> or :SYSTem:LIcense[:FPACK]:WAVeform:ADD <string>
Example	SYST:LKEY:WAV:ADD "mywaveform.wfm" or SYST:LIC:WAV:ADD "mywaveform.wfm"
Notes	The second SCPI :SYSTem:LIcense[:FPACK]:WAVeform:ADD is provided to be consistent with the style of Agilent signal sources. You can use either one of them. Since adding a waveform segment to a Multi-Pack license causes the license slot to enter the trial period of only 48 hours, pressing this key causes a confirmation dialog to be displayed to ensure you do want to add the waveform segment to the Multi-Pack. If you attempt to license a waveform that is already licensed using another slot an error is generated. . If current module is not "TRX1" module, the key will grey out, and error message is generated "-221 Setting conflict; Not allowed on current module. Goto "TRX1" to operate multi-pack license" when invoking SCPI.
Dependencies	This key is only available if the currently selected file is a secure waveform requiring a license, and there is at least one slot available within at least one multi-pack license. If the waveform highlighted is a secure waveform, but is already licensed, this key will be unavailable.
Initial S/W Revision	A.05.00

Segments on Hard Disk

Allows you access to the sub-menus for loading waveform segments from the hard disk into ARB memory. The default directory is: D: varb.

Pressing this key changes the current view to the Waveform Management View.

Key Path	Source, Modulation Setup, ARB, Select Waveform
Initial S/W Revision	A.05.00

Load Segment To ARB Memory

Allows you to load the selected file into ARB memory. On the front panel you select the file for loading to the ARB memory by highlighting the desired file in the list. Using the SCPI command, you specify the file name on the HDD.

“NVWFM” (none-volatile storage) MSUS (Mass Storage Unit Specifier) is supported in the memory subsystem because the ARB memory cannot be accessed directly. Therefore, files must be downloaded to the instrument hard disk and then loaded into the ARB memory. “NVWFM” MSUS will be mapped to the default directory D: VARB. The SCPI command supports using either “NVWFM” MSUS or specifying a full path. For more information, see [Memory Subsystem \(Remote Command Only\)](#).

If a file of the same name already exists within ARB memory, it is overwritten. If you wish to load two segments of the same name, you must rename one of the segments before loading it into ARB memory. To rename a segment, you can either use Windows File Explorer, or the :MMEMory:COPI command.

NOTE: When a waveform file is loaded to ARB memory, burst timing adjustments are made automatically, based on whether or not a Multiport Adapter is connected to the test set and powered on. If the connection/power status of the Multiport Adapter is changed after a waveform file has been loaded, it needs to be loaded again.

Key Path	Source, Modulation Setup, ARB, Select Waveform, Segments on Hard Disk
Remote Command	:SOURce:RADio:ARB:LOAD <string>
Example	:SOUR:RAD:ARB:LOAD "D: VARB\testwaveform.bin" or :SOUR:RAD:ARB:LOAD "NVWFM:testwaveform.bin"
Notes	<p>Because loading the file involves a delay of unpredictable length, this command should be followed by the query *OPC?, which holds off subsequent commands until the loading operating is complete.</p> <p><string> – specifies the path name of the file to load from the HDD into ARB memory. It could be a <full path + filename>, or <"NVWFM" MSUS + colon + filename>.</p> <p>When in Sequence Analyzer mode, and Include Source is Yes, an attempt to load a file to ARB memory will be rejected with an error.</p> <p>When Include Source is No and if there is insufficient free ARB memory to load the selected waveform, an error is generated. .</p> <p>If you specify a file over SCPI, but the file is not at the specified location, an error is generated.</p> <p>If you try to load a waveform file but the file contains less than 500 IQ sampes, an error is generated.</p> <p>If you try to load a Signal Studio waveform "*.wfm" which contains invalid waveform header, an error is generated.</p> <p>If the ARB is ON when you load afile to ARB memory or delete a file from ARB memory, the playing waveform segment may not keep phase continuity during the ARB memory operation. The waveform will be replayed after the ARB operation is finished.</p> <p>ARB can be loaded into ARB memory even required licenses do not present on the instrument. In this</p>

case, a GUI only warning message -800, "Operation complete; Loaded <filename> successfully, but no license <required licenses> installed". User can install required licenses according to <required licenses> string to license it, or multi-pack license it.

Initial S/W Revision A.05.00

Load All To ARB Memory

Allows you to load all the segment files within the currently selected directory into ARB memory. If a file of the same name already exists within ARB memory, it is overwritten. If you wish to load two segments of the same name, you must rename one of the segments before loading it into ARB memory. To rename a segment, you can either use Windows File Explorer, or the :MEMory:COpy command.

NOTE: When a waveform file is loaded to ARB memory, burst timing adjustments are made automatically, based on whether or not a Multiport Adapter is connected to the test set and powered on. If the connection/power status of the Multiport Adapter is changed after a waveform file has been loaded, it needs to be loaded again.

Key Path	Source, Modulation Setup, ARB, Select Waveform, Segments on Hard Disk
Remote Command	:SOURce:RADio:ARB:LOAD:ALL <string>
Example	:SOUR:RAD:ARB:LOAD:ALL "D: varb"
Notes	<p><string> - specifies the directory on the HDD to load the files into ARB memory from.</p> <p>When in Sequence Analyzer mode, and Include Source is Yes, an attempt to load all files from a directory to ARB memory is rejected with an error.</p> <p>When Include Source is No and there is insufficient free ARB memory to load all the waveforms, when the ARB memory is full, the copy ceases, and an error is generated.</p> <p>If you specify a directory over SCPI, but the directory does not exist, an error is generated.</p> <p>If the ARB is ON, a user then loads or deletes file to ARB memory, the playing waveform segment may not keep phase continuity during the ARB memory operation. The waveform will be replayed after the ARB operation is finished.</p>
Initial S/W Revision	A.05.00

Change Directory...

Allows you to change the currently selected directory on the hard disk. Pressing this key opens a standard windows change directory dialog allowing you to select the new directory of interest.

The current directory is used for manually loading waveform segments into ARB memory for playback, and as a search location for waveform segments that are required to be loaded into ARB memory for playback of a waveform sequence or a list sequence.

Key Path	Source, Modulation Setup, ARB, Select Waveform, Segments on Hard Disk
Notes	No remote command, SCPIfront panel only.
Initial S/W Revision	A.05.00

Default Directory...

Allows you to change the default directory. It is used as a search location for waveform segments that are required to be loaded into ARB memory for playback of a waveform sequence, and as a search location for selecting waveforms using SCPI.

Key Path	Source, Modulation Setup, ARB, Select Waveform, Segments on Hard Disk
Remote Command	:SOURce:RADio:ARB:DEFault:DIRectory <string> :SOURce:RADio:ARB: DEFault:DIRectory?
Example	:SOUR:RAD:ARB:DEF:DIR "D:\ArbFiles" :SOUR:RAD:ARB:DEF:DIR?
State Saved	Persistent, survives a power cycle and a preset but not saved in the instrument state
Initial S/W Revision	A.05.00

Segments on Hard Disk

This key functions the same as ["Segments on Hard Disk" on page 2547](#).

Key Path	Source, Modulation Setup, ARB, Waveform Utilities, Multi-Pack Licenses, Add Waveform
Initial S/W Revision	Prior to A.09.00

Load Segment To ARB Memory

This key functions the same as ["Load Segment To ARB Memory" on page 2547](#).

Key Path	Source, Modulation Setup, ARB, Waveform Utilities, Multi-Pack Licenses, Add Waveform, Segment on Hard Drive
Initial S/W Revision	Prior to A.09.00

Load All To ARB Memory

This key functions the same as ["Load All To ARB Memory" on page 2548](#).

Key Path	Source, Modulation Setup, ARB, Waveform Utilities, Multi-Pack Licenses, Add Waveform, Segment on Hard Drive
Initial S/W Revision	Prior to A.09.00

Change Directory ...

This key functions the same as ["Change Directory..." on page 2549](#).

Key Path	Source, Modulation Setup, ARB, Waveform Utilities, Multi-Pack Licenses, Add Waveform, Segment on Hard Drive
Initial S/W Revision	Prior to A.09.00

Default Directory ...

This key functions the same as ["Default Directory..." on page 2549](#)

Key Path	Source, Modulation Setup, ARB, Waveform Utilities, Multi-Pack Licenses, Add Waveform, Segment on Hard Drive
Initial S/W Revision	Prior to A.09.00

Replace Waveform

Pressing this key accesses the Replace Waveform submenu. It also changes the central display area to display the Multi-Pack License Waveform Add view.

Key Path	Source, Modulation Setup, ARB, Waveform Utilities, Multi-Pack Licenses
Dependencies	This key is only available if the currently selected slot is in the trial state.
Initial S/W Revision	A.05.00

Replace Waveform

Allows you to replace the waveform in the currently selected slot with the waveform currently selected in the Multi-Pack License Waveform Add view.

Key Path	Source, Modulation Setup, ARB, Waveform Utilities, Multi-Pack Licenses, Replace Waveform
Remote Command	:SYSTem:LKEY:WAVeform:REPLace <int>, <string> or :SYSTem:LIcense[:FPACK]:WAVeform:REPLace <int>, <string>
Example	SYST:LKEY:WAV:REPL 1, "myotherwaveform.wfm" or :SYST:LIC:WAV:REPL 1, "myotherwaveform.wfm"
Notes	The second SCPI :SYSTem:LIcense[:FPACK]:WAVeform:REPLace is provided to be consistent with the style of Agilent signal sources. You can use either one of them. If you attempt to license a waveform that is already licensed using another slot an error is generated. Waveform slot number <int> is positive. If you attempt to input a slot number less than or equals 0, an error is generated. If current module is not "TRX1" module, the key will grey out, and error message is generated "-221 Setting conflict; Not allowed on current module. Goto "TRX1" to operate multi-pack license" when invoking SCPI.
Initial S/W Revision	A.05.00

Segments on Hard Disk

This key functions the same as ["Segments on Hard Disk" on page 2547](#).

Key Path	Source, Modulation Setup, ARB, Waveform Utilities, Multi-Pack Licenses, Replace Waveform
Initial S/W Revision	Prior to A.09.00

Load Segment To ARB Memory

This key functions the same as ["Load Segment To ARB Memory" on page 2547](#).

Key Path	Source, Modulation Setup, ARB, Waveform Utilities, Multi-Pack Licenses, Replace Waveform, Segment on Hard Drive
Initial S/W Revision	Prior to A.09.00

Load All To ARB Memory

This key functions the same as ["Load All To ARB Memory" on page 2548](#).

Key Path	Source, Modulation Setup, ARB, Waveform Utilities, Multi-Pack Licenses, Replace Waveform, Segment on Hard Drive
Initial S/W Revision	Prior to A.09.00

Change Directory ...

This key functions the same as ["Change Directory..." on page 2549](#).

Key Path	Source, Modulation Setup, ARB, Waveform Utilities, Multi-Pack Licenses, Replace Waveform, Segment on Hard Drive
Initial S/W Revision	Prior to A.09.00

Default Directory ...

This key functions the same as ["Default Directory..." on page 2549](#)

Key Path	Source, Modulation Setup, ARB, Waveform Utilities, Multi-Pack Licenses, Replace Waveform, Segment on Hard Drive
Initial S/W Revision	Prior to A.09.00

Clear Waveform from Slot

Allows you to clear the waveform from the selected slot.

Key Path	Source, Modulation Setup, ARB, Waveform Utilities, Multi-Pack Licenses
Remote Command	:SYSTem:LKEY:WAVeform:CLEar <int> or :SYSTem:LIcense[:FPACK]:WAVeform:CLEar <int>
Example	SYST:LKEY:WAV:CLE 1 or :SYST:LIC:WAV:CLE 1
Notes	The second SCPI :SYSTem:LIcense[:FPACK]:WAVeform:CLEar is provided to be consistent with the style of Agilent signal sources. You can use either one of them. Waveform slot number <int> is positive. If you attempt to input a slot number less than or equals 0, an error is generated. If current module is not "TRX1" module, the key will grey out, and error message is generated "-221 Setting conflict; Not allowed on current module. Goto "TRX1" to operate multi-pack license" when invoking SCPI.
Dependencies	This key is only available if the currently selected slot is in the trial state.
Initial S/W Revision	A.05.00

Lock Waveform in Slot

If the selected slot is in the trial state or the lock required state, the waveform that occupies the slot is locked and permanently licensed.

Key Path	Source, Modulation Setup, ARB, Waveform Utilities, Multi-Pack Licenses
Remote Command	:SYSTem:LKEY:WAVeform:LOCK <int> or :SYSTem:LIcense[:FPACK]:WAVeform:LOCK <int>
Example	SYST:LKEY:WAV:LOCK 1 or SYST:LIC:WAV:LOCK 1
Notes	The second SCPI :SYSTem:LIcense[:FPACK]:WAVeform:LOCK is provided to be consistent with the style of Agilent signal sources. You can use either one of them. Waveform slot number <int> is positive. If you attempt to input a slot number less than or equals 0, an error is generated. If current module is not "TRX1" module, the key will grey out, and error message is generated "-221 Setting conflict; Not allowed on current module. Goto "TRX1" to operate multi-pack license" when invoking SCPI.
Dependencies	This key is only available if the currently selected slot is in the trial state or the lock required state.
Initial S/W Revision	A.05.00

Slot Status Query (Remote Command Only)

Returns the status of the specified slot.

Remote Command	:SYSTem:LKEY:WAVeform:STATus? <int> or :SYSTem:LICense[:FPACK]:WAVeform:STATus? <int>
Example	:SYST:LKEY:WAV:STAT? 1 <"Locked" or :SYST:LIC:WAV:STAT? 1 <"Locked"
Notes	The second SCPI :SYSTem:LICense[:FPACK]:WAVeform:STATus is provided to be consistent with the style of Agilent signal sources. You can use either one of them. Waveform slot number <int> is positive. If you attempt to input a slot number less than or equals 0, an error is generated. Result type is string. If input slot number exceeds total available slot number, "Nonexistent" is returned.
Range	"Locked" "Available" "Trail" "LockRequired" "Nonexistent"
Initial S/W Revision	A.05.00

Slots Free Query (Remote Command Only)

Returns the number of license slots free.

Remote Command	:SYSTem:LKEY:WAVeform:FREE? or :SYSTem:LICense[:FPACK]:WAVeform:FREE?
Example	:SYST:LKEY:WAV:FREE? or :SYST:LIC:WAV:FREE?
Notes	The second SCPI :SYSTem:LICense[:FPACK]:WAVeform:FREE is provided to be consistent with the style of Agilent signal sources. You can use either one of them.
Initial S/W Revision	A.05.00

Slot Used Query (Remote Command Only)

Returns the number of license slots used.

Remote Command	:SYSTem:LKEY:WAVeform:USED? or :SYSTem:LICense[:FPACK]:WAVeform:USED?
Example	:SYST:LKEY:WAV:USED?

	or :SYST:LIC:WAV:USED?
Notes	The second SCPI :SYSTem:LIcense[:FPACK]:WAVeform:USED is provided to be consistent with the style of Agilent signal sources. You can use either one of them.
Initial S/W Revision	A.05.00

Slot Waveform Name Query (Remote Command Only)

Returns the waveform name of the specified slot

Remote Command	:SYSTem:LKEY:WAVeform:NAME? <int> or :SYSTem:LIcense[:FPACK]:WAVeform:NAME? <int>
Example	:SYST:LKEY:WAV:NAME? 1 <"CDMA2K_22.wfm" or :SYST:LIC:WAV:NAME? 1 <"CDMA2K_22.wfm"
Notes	Waveform slot number <int> is positive. If you attempt to input a slot number less than or equals 0, an error is generated. Result type is string. If input slot number exceeds total available slot number, "Nonexistent" is returned. If no waveform stored in the specified slot, then empty string is returned.
Initial S/W Revision	A.12.00

Slot Waveform Unique ID Query (Remote Command Only)

Returns the waveform unique ID of the specified slot

Remote Command	:SYSTem:LKEY:WAVeform:UID? <int> or :SYSTem:LIcense[:FPACK]:WAVeform:UID? <int>
Example	:SYST:LKEY:WAV:UID? 2 <"1346752140" or :SYST:LIC:WAV:UID? 2 <"1346752140"
Notes	Waveform slot number <int> is positive. If you attempt to input a slot number less than or equals 0, an error is generated. Result type is string. If input slot number exceeds total available slot number, "Nonexistent" is returned.

	If no waveform stored in the specified slot, then "0" is returned
Initial S/W Revision	A.12.00

Locked Waveform Name List Query (Remote Command Only)

Returns the waveform name list of locked.

Remote Command	:SOURce:RADio:ARB:MPLicensed:NAME:LOCKed?
Example	SOUR:RAD:ARB:MPL:NAME:LOCKed? <"CDMA2K_27.wfm", "GSM_MCS1.WFM", "c2kWfm.wfm"
Initial S/W Revision	A.11.00

Locked Waveform Unique ID List Query (Remote Command Only)

Returns the waveform unique id list of locked.

Remote Command	:SOURce:RADio:ARB:MPLicensed:UID:LOCKed?
Example	SOUR:RAD:ARB:MPL:UID:LOCKed? <"2996927136", "3812603511", "3710986266"
Notes	Each Signal Studio waveform has a unique id recorded in header. So if the unique ids are same, that means they are same one waveform. So besides SCPI to query locked waveform name list, also provide a SCPI to query locked waveform unique id list
Initial S/W Revision	A.11.00

Marker Utilities

Allows access to the marker utilities sub-menus.

Key Path	Source, Modulation Setup, ARB
Initial S/W Revision	A.05.00

Marker Polarity

Allows access to the marker polarity sub-menu, which allows you to specify the polarity for the four markers. For a positive polarity, the marker signal is high during the marker points. For a negative marker polarity, the marker signal is high during the period of no marker points.

Key Path	Source, Modulation Setup, ARB, Marker Utilities
Initial S/W Revision	A.05.00

Mkr 1 Polarity

Allows you to set the polarity of marker 1.

Key Path	Source, Modulation Setup, ARB, Marker Utilities, Marker Polarity
Remote Command	:SOURce:RADio:ARB:MPOLarity:MARKer1 POSitive NEGative :SOURce:RADio:ARB:MPOLarity:MARKer1?
Example	:SOUR:RAD:ARB:MPOL:MARK1 NEG
Dependencies	When a new waveform is selected for playback the settings contained within the associated waveform header file are applied to the ARB. The marker polarity is one of the values stored within the header file. If the newly selected waveform file has an associated header file, the marker polarity is updated with the value from the header file. The marker polarity will remain unchanged if the newly selected waveform does not have an associated header file.
Preset	Pos
Range	Neg Pos
Initial S/W Revision	A.05.00

Mkr 2 Polarity

Allows you to set the polarity of marker 2.

Key Path	Source, Modulation Setup, ARB, Marker Utilities, Marker Polarity
Remote Command	:SOURce:RADio:ARB:MPOLarity:MARKer2 POSitive NEGative :SOURce:RADio:ARB:MPOLarity:MARKer2?
Example	:SOUR:RAD:ARB:MPOL:MARK2 NEG
Dependencies	When a new waveform is selected for playback the settings contained within the associated waveform header file are applied to the ARB. The marker polarity is one of the values stored within the header file. If the newly selected waveform file has an associated header file, the marker polarity is updated with the value from the header file. The marker polarity will remain unchanged if the newly selected waveform does not have an associated header file.
Preset	Pos
Range	Neg Pos
Initial S/W Revision	A.05.00

Mkr 3 Polarity

Allows you to set the polarity of marker 3.

Key Path	Source, Modulation Setup, ARB, Marker Utilities, Marker Polarity
Remote Command	:SOURce:RADio:ARB:MPOLarity:MARKer3 POSitive NEGative :SOURce:RADio:ARB:MPOLarity:MARKer3?
Example	:SOUR:RAD:ARB:MPOL:MARK3 NEG
Dependencies	When a new waveform is selected for playback the settings contained within the associated

	waveform header file are applied to the ARB. The marker polarity is one of the values stored within the header file. If the newly selected waveform file has an associated header file, the marker polarity is updated with the value from the header file. The marker polarity will remain unchanged if the newly selected waveform does not have an associated header file.
Preset	Pos
Range	Neg Pos
Initial S/W Revision	A.05.00

Mkr 4 Polarity

Allows you to set the polarity of marker 4.

Key Path	Source, Modulation Setup, ARB, Marker Utilities, Marker Polarity
Remote Command	:SOURce:RADio:ARB:MPOLarity:MARKer4 POSitive NEGative :SOURce:RADio:ARB:MPOLarity:MARKer4?
Example	:SOUR:RAD:ARB:MPOL:MARK4 NEG
Dependencies	When a new waveform is selected for playback the settings contained within the associated waveform header file are applied to the ARB. The marker polarity is one of the values stored within the header file. If the newly selected waveform file has an associated header file, the marker polarity is updated with the value from the header file. The marker polarity will remain unchanged if the newly selected waveform does not have an associated header file.
Preset	Pos
Range	Neg Pos
Initial S/W Revision	A.05.00

Marker Routing

Allows access to the marker routing sub-menus, which allow you to specify where the marker events are routed. It should be noted that the markers can also be routed to Trigger 1 Out and Trigger 2 Out, however this must be set up using the menus accessed by pressing the “Trigger” hard key.

Key Path	Source, Modulation Setup, ARB, Marker Utilities
Initial S/W Revision	A.05.00

Pulse/RF Blank

Allows you to select which marker is used for the pulse/RF blanking function. The pulse/RF blanking function blanks the RF when the marker signal goes low. The marker polarity determines when the marker signal is high. For a positive polarity, this is during the marker points. For a negative polarity, this is when there are no marker points.

Marker points should be set before using this function. Enabling this function without setting maker points may create a continuous low or high signal, dependant on the marker polarity. This causes either no RF output, or a continuous RF output.

Key Path	Source, Modulation Setup, ARB, Marker Utilities, Marker Routing
Remote Command	:SOURce:RADio:ARB:MDEStination:PULSe NONE M1 M2 M3 M4 :SOURce:RADio:ARB:MDEStination:PULSe?
Example	:SOUR:RAD:ARB:MDES:PULS NONE
Dependencies	When a new waveform is selected for playback the settings contained within the associated waveform header file are applied to the ARB. The pulse/RF blanking setting is one of the values stored within the header file. If the newly selected waveform file has an associated header file, the pulse/RF blanking setting is updated with the value from the header file. The pulse/RF blanking setting will remain unchanged if the newly selected waveform does not have an associated header file.
Range	None M1 M2 M3 M4
Initial S/W Revision	A.05.00

None

Sets no marker to be used for the pulse/RF blanking function, essentially turning the RF blanking function off.

Key Path	Source, Modulation Setup, ARB, Marker Utilities, Marker Routing, Pulse/RF Blank
Example	:SOUR:RAD:ARB:MDES:PULS NONE
Initial S/W Revision	A.05.00

Marker 1

Sets marker 1 to be used for the pulse/RF blanking function.

Key Path	Source, Modulation Setup, ARB, Marker Utilities, Marker Routing, Pulse/RF Blank
Example	:SOUR:RAD:ARB:MDES:PULS M1
Initial S/W Revision	A.05.00

Marker 2

Sets marker 2 to be used for the pulse/RF blanking function.

Key Path	Source, Modulation Setup, ARB, Marker Utilities, Marker Routing, Pulse/RF Blank
Example	:SOUR:RAD:ARB:MDES:PULS M2
Initial S/W Revision	A.05.00

Marker 3

Sets marker 3 to be used for the pulse/RF blanking function.

Key Path	Source, Modulation Setup, ARB, Marker Utilities, Marker Routing, Pulse/RF Blank
Example	:SOUR:RAD:ARB:MDES:PULS M3
Initial S/W Revision	A.05.00

Marker 4

Sets marker 4 to be used for the pulse/RF blanking function.

Key Path	Source, Modulation Setup, ARB, Marker Utilities, Marker Routing, Pulse/RF Blank
Example	:SOUR:RAD:ARB:MDES:PULS M4
Initial S/W Revision	A.05.00

ALC Hold

Allows you to specify which marker is routed for use within the ALC hold function. The ALC hold marker function holds the ALC circuitry at the average value of the sample points set by the marker.

The ALC hold function operates during the low periods of the marker signal. The marker polarity determines when the marker signal is high. For positive polarity, this is during the marker points. For a negative polarity, this is when there are no marker points.

Key Path	Source, Modulation Setup, ARB, Marker Utilities, Marker Routing
Remote Command	:SOURce:RADio:ARB:MDEStination:ALCHold NONE M1 M2 M3 M4 :SOURce:RADio:ARB:MDEStination:ALCHold?
Example	:SOUR:RAD:ARB:MDES:ALCH NONE
Dependencies	When a new waveform is selected for playback the settings contained within the associated waveform header file are applied to the ARB. The ALC hold setting is one of the values stored within the header file. If the newly selected waveform file has an associated header file, the ALC hold setting is updated with the value from the header file. The ALC hold setting will remain unchanged if the newly selected waveform does not have an associated header file.
Range	None M1 M2 M3 M4
Initial S/W Revision	A.05.00

None

Sets no marker to be used for the ALC hold function, essentially turning the ALC hold function off.

Key Path	Source, Modulation Setup, ARB, Marker Utilities, Marker Routing, ALC Hold
Example	:SOUR:RAD:ARB:MDES:PULS NONE
Initial S/W Revision	A.05.00

Marker 1

Sets marker 1 to be used for the ALC hold function.

Key Path	Source, Modulation Setup, ARB, Marker Utilities, Marker Routing, ALC Hold
Example	:SOUR:RAD:ARB:MDES:PULS M1
Initial S/W Revision	A.05.00

Marker 2

Sets marker 2 to be used for the ALC hold function.

Key Path	Source, Modulation Setup, ARB, Marker Utilities, Marker Routing, ALC Hold
Example	:SOUR:RAD:ARB:MDES:PULS M2
Initial S/W Revision	A.05.00

Marker 3

Sets marker 3 to be used for the ALC hold function.

Key Path	Source, Modulation Setup, ARB, Marker Utilities, Marker Routing, ALC Hold
Example	:SOUR:RAD:ARB:MDES:PULS M3
Initial S/W Revision	A.05.00

Marker 4

Sets marker 4 to be used for the ALC hold function.

Key Path	Source, Modulation Setup, ARB, Marker Utilities, Marker Routing, ALC Hold
Example	:SOUR:RAD:ARB:MDES:PULS M4
Initial S/W Revision	A.05.00

Header Utilities

Allows access to the header utilities sub-menu. Pressing this key also causes the central display area to change to display the File Header Information view.

Key Path	Source, Modulation Setup, ARB
Dependencies	This key is only available if there is currently a waveform selected for playback. If no waveform is selected, the key is grayed out.
Initial S/W Revision	A.05.00

Clear Header

Allows you to clear the header information from the file header associated with the currently selected waveform.

Key Path	Source, Modulation Setup, ARB, Header Utilities
Remote Command	:SOURce:RADio:ARB:HEADer:CLEar
Example	:SOUR:RAD:ARB:HEAD:CLE
Notes	Attempting to clear the header details via SCPI when no waveform was selected for playback will generate an error.
Initial S/W Revision	A.05.00

Save Setup To Header

Allows you to save new file header information details to the file.

Key Path	Source, Modulation Setup, ARB, Header Utilities
Remote Command	:SOURce:RADio:ARB:HEADer:SAVE
Example	:SOUR:RAD:ARB:HEAD:SAVE
Notes	Attempting to save the header details via SCPI when no waveform was selected for playback will generate an error.
Initial S/W Revision	A.05.00

Query Waveform Unique ID (Remote Command Only)

Each Signal Studio waveform contains a unique waveform ID, which recorded in the header. This command allows you to query the unique waveform ID from the header. This is a SCPI only command. User can also check [Error! Reference source not found.](#) for waveform unique ID display.

Remote Command	:MMEMory:HEADer:ID? "<file name>"
Example	:MMEM:HEAD:ID? "test.wfm" (query the waveform already loaded into the ARB memory) :MMEM:HEAD:ID? "D: VARB\test.wfm" (query the waveform on the hard disk by absolute path) :MMEM:HEAD:ID? "NVWFM:test.wfm" (query the waveform on the hard disk by MSUS)
Notes	SCPI query only. The queried waveform file can be in ARB memory, or on hard disk. If want to query ARB in ARB memory, then give out the file name directly. If want to query ARB on the hard disk, then absolute file path or MSUS should be given along with the file name. The valid MSUS is "NVWFM" which is mapped to D: VARB on hard disk. If the file cannot be found in ARB memory or on hard disk, an error is generated and value -1 is returned
Initial S/W Revision	A.09.00

Bus Trigger Command (Remote Command Only)

Used to initiate an immediate trigger event if the trigger source is set to Bus.

Remote Command	:SOURce:RADio:ARB:TRIGger:INITiate
Example	:SOUR:RAD:ARB:TRIG:INIT
Initial S/W Revision	A.05.00

AM

Allows access to the menu for configuring the Amplitude Modulation.

Key Path	Source, Modulation Setup
Initial S/W Revision	A.05.00

AM

Enables or disables the amplitude modulation.

Turning AM on when another modulation format is already on results in the previous modulation format being turned off and the generation of an error.

Key Path	Source, Modulation Setup, AM
Remote Command	:SOURce:AM:STATe :SOURce:AM:STATe?
Example	:SOUR:AM:STAT OFF
Preset	Off
Range	On Off
Initial S/W Revision	A.05.00

AM Depth

Allows you to set the amplitude modulation depth in percent.

Key Path	Source, Modulation Setup, AM
Remote Command	:SOURce:AM[:DEPTh] [:LINear] :SOURce:AM[:DEPTh] [:LINear]?
Example	:SOUR:AM 0.1
Preset	0.1 %
Min	0.1 %
Max	95.0 %
Initial S/W Revision	A.05.00

AM Rate

Allows you to set the internal amplitude modulation rate.

Key Path	Source, Modulation Setup, AM
Remote Command	:SOURce:AM:INTernal:FREQuency :SOURce:AM:INTernal:FREQuency?
Example	:SOUR:AM:INT:FREQ 40.0 Hz
Preset	400.0 Hz
Min	10 Hz
Max	40 kHz
Initial S/W Revision	A.05.00

FM

Allows access to the menu for configuring the frequency modulation.

Key Path	Source, Modulation Setup
Initial S/W Revision	A.05.00

FM

Enables or disables the frequency modulation.

Turning FM on when another modulation format is already on results in the previous modulation format being turned off and the generation of an error.

Key Path	Source, Modulation Setup, FM
Remote Command	:SOURce:FM:STATe :SOURce:FM:STATe?
Example	:SOUR:FM:STAT OFF
Preset	Off
Range	On Off
Initial S/W Revision	A.05.00

FM Deviation

Allows you to set the frequency modulation deviation.

Key Path	Source, Modulation Setup, FM
----------	------------------------------

Remote Command	:SOURce:FM[:DEVIation] :SOURce:FM[:DEVIation]?
Example	:SOUR:FM 1.00 kHz
Preset	1.00 Hz
Min	1.00 Hz
Max	100.00 kHz
Initial S/W Revision	A.05.00

FM Rate

Allows you to set the internal frequency modulation rate.

Key Path	Source, Modulation Setup, FM
Remote Command	:SOURce:FM:INTernal:FREQuency :SOURce:FM:INTernal:FREQuency?
Example	:SOUR:FM:INT:FREQ 40.0 Hz
Preset	400.0 Hz
Min	10 Hz
Max	40 kHz
Initial S/W Revision	A.05.00

PM

Allows access to the menu for configuring the phase modulation.

Key Path	Source, Modulation Setup
Initial S/W Revision	A.05.00

PM

Enables or disables the phase modulation.

Turning PM on when another modulation format is already on results in the previous modulation format being turned off and the generation of an error.

Key Path	Source, Modulation Setup, PM
Remote Command	:SOURce:PM:STATe :SOURce:PM:STATe?
Example	:SOUR:PM:STAT OFF

Preset	Off
Range	On Off
Initial S/W Revision	A.05.00

PM Deviation

Allows you to set the phase modulation deviation.

Key Path	Source, Modulation Setup, PM
Remote Command	:SOURce:PM[:DEVIation] :SOURce:PM[:DEVIation]?
Example	:SOUR:PM 1.00 rad
Preset	0.1 rad
Min	0.1 rad
Max	20.0 rad
Initial S/W Revision	A.05.00

PM Rate

Allows you to set the internal phase modulation rate.

Key Path	Source, Modulation Setup, PM
Remote Command	:SOURce:PM:INTernal:FREQuency :SOURce:PM:INTernal:FREQuency?
Example	:SOUR:PM:INT:FREQ 40.0 Hz
Preset	400.0 Hz
Min	10 Hz
Max	40 kHz
Initial S/W Revision	A.05.00

List Sequencer

Allows you access to the sub-menus for configuring the list sequencer.

List sequences allows you to enter frequencies and amplitudes at unequal intervals in nonlinear ascending, descending or random order. Each step within the list can also include its own waveform file for playback, step duration, trigger event and trigger output.

The complexities involved in configuring the list sequencer do not lend itself to manual configuration; hence the manual configuration for this feature is limited. For easier configuration of the list sequencer, it is recommended that you use either SCPI or load a tab delimited file containing the setup parameters in a

tabular form. The details of the SCPI for configuring the list sequencer can be found in "[Step Configuration \(Remote Command Only\)](#)" on page 2554.

Once the List Sequencer has been configured using the front panel, SCPI, or loading in a tab delimited file, the sequence must be initiated using the front panel Initiate Sequence key or the corresponding SCPI command.

Key Path	Source
Initial S/W Revision	A.05.00

Sequencer

Allows you to set the state of the list sequencer. When the list sequencer is on, the source is outputting the sequence defined by the sequencer. When the list sequencer is off, the source outputs a single waveform segment or sequence (independent mode) at a single frequency and amplitude.

Key Path	Source, List Sequencer
Remote Command	:SOURce:LIST[:STATe] ON OFF 1 0 :SOURce:LIST[:STATe]?
Example	:SOUR:LIST OFF
Notes	When the sequencer is set to ON, the list sequencer controls the output of the source.
Couplings	When in Sequence Analyzer mode and the list sequencer state is Off, Include Source is forced to No, and the Include Source key is grayed out. When in Sequence Analyzer mode and the list sequencer state is On, Include Source is available to set. And, an ARB memory related operation, like load or delete will be rejected.
Preset	Off
Range	On Off
Initial S/W Revision	A.05.00

Initiate Sequence

Pressing this key arms the sequence for single execution. Once the sequence is armed the source begins the sequence as soon as the trigger is received. If the trigger is set to Free Run, the sequence starts immediately.

Key Path	Source, List Sequencer
Remote Command	:SOURce:LIST:TRIGger[:IMMediate]
Example	:SOUR:LIST:TRIG
Notes	When in Sequence Analyzer mode and Include Source is Yes, the Initiate list sequencer operation is rejected, and the key is grayed out, since source list sequence request is sent to physics via Parallel batch by sequence analyzer. If the file needed by the sequencer is not already in ARB memory, the sequence cannot be initiated

	and an error will be generated. There is a blocking SCPI query which can be used to query if source list sequence being initiated successfully or not. (see " Query List Sequence Initiation Armed Status (Remote Command Only) " on page 2565 Query Source List Sequence Armed Status)
Dependencies	Under the Sequence Analyzer Mode, if Meas Setup->Include Source is set to YES, Source->List Sequencer->Initiate Sequence is disabled.
Initial S/W Revision	A.05.00

List Sequencer Setup

Allows you access to the list sequencer setup menus.

Key Path	Source, List Sequencer
----------	------------------------

Number of Steps

Allows you to specify the number of steps within the list sequence.

Key Path	Source, List Sequencer, List Sequencer Setup
Remote Command	:SOURce:LIST:NUMBer:STEPs <integer> :SOURce:LIST:NUMBer:STEPs?
Example	:SOUR:LIST:NUMB:STEP 1
Notes	Increasing the number of steps creates additional steps at the end of the list, with all the settings within the steps set to their default values. Decreasing the number of steps removes steps from the end of the list. The settings within the removed steps are not reset. This means that increasing the number of steps again would allow you to retrieve these steps.
Dependencies	The Step Count parameter is increased or decreased when you insert or delete a point from within the GUI interface to the sequencer.
Preset	1
Min	1
Max	1000
Initial S/W Revision	A.05.00

Current Step

Allows you to select the step number you wish to view or edit.

Key Path	Source, List Sequencer, List Sequencer Setup
----------	--

Notes	No remote command, front panel only.
Preset	1
Min	1
Max	Step Count
Initial S/W Revision	A.05.00

Insert Step Before

Allows you to insert a new step, containing default values, before the currently selected step. Inserting a step will automatically increase the Step Count parameter by 1. If sequence already reaches upper limit of 1000 steps, then insert more step will be rejected and popup error –221, “Setting Conflict; Cannot insert more steps, maximum number of steps reached”

Key Path	Source, List Sequencer, List Sequencer Setup
Notes	No remote command, front panel only. If the list already contains the maximum limit of 1000 steps, no operation will be made after pressing this key.
Initial S/W Revision	A.05.00

Delete Step

Allows you to delete the current step. Deleting a step will automatically decrease the Step Count parameter by 1. If sequence only has one step left, delete step will be rejected and popup error –221, “Setting conflict; Cannot delete current step, minimum number of steps reached”

Key Path	Source, List Sequencer, List Sequencer Setup
Notes	No remote command, Front Panel key only. If the list already contains the minimum limit of 1 step, no operation will be made after pressing this key
Initial S/W Revision	A.05.00

Clear List

Allows you to clear the list. Clearing the list sets the number of steps to the default value of 1 and sets the parameters for the only step to their default values.

Key Path	Source, List Sequencer, List Sequencer Setup
Initial S/W Revision	A.05.00

Step Trigger

Allows access to the sub-menu for selecting the trigger input for the current step.

Key Path	Source, List Sequencer, List Sequencer Setup
Remote Command	:SOURCE:LIST:STEP[1] 2 3...1000:SETup:INPut:TRIGger IMMEDIATE INTERNAL EXTERNAL2 KEY BUS EXTERNAL4 :SOURCE:LIST:STEP[1] 2 3...1000:SETup:INPut:TRIGger?
Example	:SOUR:LIST:STEP2:SET:INP:TRIG BUS :SOUR:LIST:STEP2:SET:INP:TRIG?
Notes	SCPI is supported after A.09.40
Preset	Free Run
Range	Free Run Internal Manual (Trigger Key) Bus External 2 EXTERNAL4
Initial S/W Revision	A.05.00

Free Run

Sets the trigger input for the current step to Free Run.

Key Path	Source, List Sequencer, List Sequencer Setup, Step Trigger
Example	:SOUR:LIST:STEP2:SET:INP:TRIG IMM
Notes	SCPI is supported after A.09.40
Initial S/W Revision	A.05.00

Internal

Sets the trigger input for the current step to Internal.

Key Path	Source, List Sequencer, List Sequencer Setup, Step Trigger
Example	:SOUR:LIST:STEP2:SET:INP:TRIG INT
Notes	SCPI is supported after A.09.40
Initial S/W Revision	A.05.00

Manual (Trigger Key)

Sets the trigger input for the current step to Manual (Trigger Key). Any step in the sequence set to Manual will cause the sequence execution to stop until the manual trigger key is pressed. Sending the Bus Trigger SCPI command will have no effect. At any point in the sequence where the list sequencer is paused waiting for a software trigger, a pop up dialog is displayed until the trigger event occurs.

Key Path	Source, List Sequencer, List Sequencer Setup, Step Trigger
Example	:SOUR:LIST:STEP2:SET:INP:TRIG KEY
Notes	SCPI is supported after A.09.40
Initial S/W Revision	A.05.00

Bus

Sets the trigger input for the current step to Bus. Any step in the sequence set to Bus will cause the sequence execution to stop until the Bus Trigger SCPI command is sent. Pressing the manual trigger key has no effect. At any point in the sequence where the list sequencer is paused waiting for a software trigger, a pop up dialog is displayed until the trigger event occurs.

Key Path	Source, List Sequencer, List Sequencer Setup, Step Trigger
Example	:SOUR:LIST:STEP2:SET:INP:TRIG BUS
Notes	SCPI is supported after A.09.40
Initial S/W Revision	A.05.00

External 2

Sets the trigger input for the current step to External 2.

Key Path	Source, List Sequencer, List Sequencer Setup, Step Trigger
Example	:SOUR:LIST:STEP2:SET:INP:TRIG EXT2
Notes	SCPI is supported after A.09.40
Notes	Note: When on E6640A, trigger 2 is a bi-directional trigger port. So when trigger 2 has been configured as OUTPUT type, choosing External 2 as the input trigger for the current step will generate error.
Initial S/W Revision	A.05.00

Transition Time

Allows you to specify the transition time for the current step.

The transition time is the amount of time allowed for the source to settle at the current frequency or amplitude value.

Transition Time should not be taken as additional time before or inside the Step Duration. You can set a value for the settling time to allow the source output frequency or amplitude to become stable. Make sure that during this period of time, you do not use the source output signal.

The following table lists recommended values for appropriate settling times to allow for changes within the source.

Value Changed	Recommended Transition Time
Frequency	500 μ s
Amplitude	100 μ s to within 0.1 dB 20 μ s to within 1.0 dB

If the Transition Time value is shorter than the time necessary for the hardware to settle and a List Sequence is initiated, a **warning** is generated.

If the Transition Time value is longer than the Step Duration, an error is generated when initiating a source list sequence. For source list sequence, transition time is included in the step duration length. If the Transition Time value is longer than the Step Duration Time, the real step duration length is extended to equal the transition time and cause a timing shift.

Key Path	Source, List Sequencer, List Sequencer Setup
Remote Command	:SOURce:LIST:STEP[1] 2 3...1000:SETup:TRANSition:TIME <time> :SOURce:LIST:STEP[1] 2 3...1000:SETup:TRANSition:TIME?
Example	:SOUR:LIST:STEP2:SET:TRAN:TIME 1ms :SOUR:LIST:STEP2:SET:TRAN:TIME?
Notes	SCPI is supported after A.09.40
Preset	1.0 ms
Min	0.0 ms
Max	4.0 ks
Initial S/W Revision	A.05.00

Radio Setup

Allows you access to the sub-menus for setting up the radio standard, band, and radio band link direction for the current step.

Key Path	Source, List Sequencer, List Sequencer Setup
Notes	No remote command, front panel only.
Initial S/W Revision	A.05.00

Radio Standard

Allows access to the sub-menus for selecting the radio standard and the associated radio band for use in the current step.

Key Path	Source, List Sequencer, List Sequencer Setup, Radio Setup
Remote Command	:SOURce:LIST:STEP[1] 2 3...1000:SETup:RADio:BAND NONE PGSM EGSM RGSM DCS1800 PCS1900 TGSM810 GSM450 GSM480 GSM700 GSM850 BANDI BANDII BANDIII BANDIV BANDV BANDVI BANDVII BANDVIII BANDIX BANDX BANDXI BANDXII BANDXIII BANDXIV BANDXIX USCELL USPCS JAPAN KOREAN NMT IMT2K UPPER SECOND PAMR400 PAMR800 IMTEXT PCS1DOT9G AWS US2DOT5G PUBLIC LOWER NONE BAND1 BAND2 BAND3 BAND4 BAND5 BAND6 BAND7 BAND8 BAND10 BAND11 BAND12 BAND13 BAND14 BAND17 BAND18 BAND19 BAND20 BAND21 BAND24 BAND25 BAND26 BAND27 BAND28 BAND31 BAND33 BAND34 BAND35 BAND36 BAND37 BAND38

	BAND39 BAND40 BAND41 BAND42 BAND43 BAND44 BANDA BANDB BANDC BANDD BANDE BANDF :SOURce:LIST:STEP[1] 2 3...1000:SETup: RADio:BAND?
Example	:SOUR:LIST:STEP2:SET:RAD:BAND PGSM :SOUR:LIST:STEP2:SET:RAD:BAND?
Notes	SCPI is supported after A.09.40
Initial S/W Revision	A.05.00

None

Selects no radio standard for use on the current step.

Key Path	Source, List Sequencer, List Sequencer Setup, Radio Setup, Radio Standard
Example	:SOUR:LIST:STEP2:SET:RAD:BAND NONE
Notes	SCPI is supported after A.09.40
Initial S/W Revision	A.05.00

GSM/EDGE

Pressing this key once selects GSM/EDGE as the radio standard and the current GSM/EDGE band as the active channel band. Pressing this key again allows access to the sub-menus for selecting a different GSM/EDGE band.

Key Path	Source, List Sequencer, List Sequencer Setup, Radio Setup, Radio Standard
Initial S/W Revision	A.05.00

P-GSM

Selects P-GSM as the band for the current step.

Key Path	Source, List Sequencer, List Sequencer Setup, Radio Setup, Radio Standard, GSM/EDGE
Initial S/W Revision	A.05.00

E-GSM

Selects E-GSM as the band for the current step.

Key Path	Source, List Sequencer, List Sequencer Setup, Radio Setup, Radio Standard, GSM/EDGE
Initial S/W Revision	A.05.00

R-GSM

Selects R-GSM as the band for the current step.

Key Path	Source, List Sequencer, List Sequencer Setup, Radio Setup, Radio Standard, GSM/EDGE
Initial S/W Revision	A.05.00

DCS 1800

Selects DCS 1800 as the band for the current step.

Key Path	Source, List Sequencer, List Sequencer Setup, Radio Setup, Radio Standard, GSM/EDGE
Initial S/W Revision	A.05.00

PCS 1900

Selects PCS 1900 as the band for the current step.

Key Path	Source, List Sequencer, List Sequencer Setup, Radio Setup, Radio Standard, GSM/EDGE
Initial S/W Revision	A.05.00

GSM 450

Selects GSM 450 as the band for the current step.

Key Path	Source, List Sequencer, List Sequencer Setup, Radio Setup, Radio Standard, GSM/EDGE
Initial S/W Revision	A.05.00

GSM 480

Selects GSM 480 as the band for the current step.

Key Path	Source, List Sequencer, List Sequencer Setup, Radio Setup, Radio Standard, GSM/EDGE
Initial S/W Revision	A.05.00

GSM 850

Selects GSM 850 as the band for the current step.

Key Path	Source, List Sequencer, List Sequencer Setup, Radio Setup, Radio Standard, GSM/EDGE
Initial S/W Revision	A.05.00

GSM 700

Selects GSM 700 as the band for the current step.

Key Path	Source, List Sequencer, List Sequencer Setup, Radio Setup, Radio Standard, GSM/EDGE
Initial S/W Revision	A.05.00

T-GSM 810

Selects T-GSM 810 as the band for the current step.

Key Path	Source, List Sequencer, List Sequencer Setup, Radio Setup, Radio Standard, GSM/EDGE
Initial S/W Revision	A.05.00

WCDMA

Pressing this key once selects WCDMA as the radio standard and the current WCDMA band as the active channel band. Pressing this key again allows access to the sub-menus for selecting a different WCDMA band.

Key Path	Source, List Sequencer, List Sequencer Setup, Radio Setup, Radio Standard
Initial S/W Revision	A.05.00

Band I

Selects Band I as the band for the current step.

Key Path	Source, List Sequencer, List Sequencer Setup, Radio Setup, Radio Standard, WCDMA
Initial S/W Revision	A.05.00

Band II

Selects Band II as the band for the current step.

Key Path	Source, List Sequencer, List Sequencer Setup, Radio Setup, Radio Standard, WCDMA
Initial S/W Revision	A.05.00

Band III

Selects Band III as the band for the current step.

Key Path	Source, List Sequencer, List Sequencer Setup, Radio Setup, Radio Standard, WCDMA
Initial S/W Revision	A.05.00

Band IV

Selects Band IV as the band for the current step.

Key Path	Source, List Sequencer, List Sequencer Setup, Radio Setup, Radio Standard, WCDMA
Initial S/W Revision	A.05.00

Band V

Selects Band V as the band for the current step.

Key Path	Source, List Sequencer, List Sequencer Setup, Radio Setup, Radio Standard, WCDMA
Initial S/W Revision	A.05.00

Band VI

Selects Band VI as the band for the current step.

Key Path	Source, List Sequencer, List Sequencer Setup, Radio Setup, Radio Standard, WCDMA
Initial S/W Revision	A.05.00

Band VII

Selects Band VII as the band for the current step.

Key Path	Source, List Sequencer, List Sequencer Setup, Radio Setup, Radio Standard, WCDMA
Initial S/W Revision	A.05.00

Band VIII

Selects Band VIII as the band for the current step.

Key Path	Source, List Sequencer, List Sequencer Setup, Radio Setup, Radio Standard, WCDMA
Initial S/W Revision	A.05.00

Band IX

Selects Band IX as the band for the current step.

Key Path	Source, List Sequencer, List Sequencer Setup, Radio Setup, Radio Standard, WCDMA
Initial S/W Revision	A.05.00

Band X

Selects Band X as the band for the current step.

Key Path	Source, List Sequencer, List Sequencer Setup, Radio Setup, Radio Standard, WCDMA
Initial S/W Revision	A.05.00

Band XI

Selects Band XI as the band for the current step.

Key Path	Source, List Sequencer, List Sequencer Setup, Radio Setup, Radio Standard, WCDMA
Initial S/W Revision	A.05.00

Band XII

Selects Band XII as the band for the current step.

Key Path	Source, List Sequencer, List Sequencer Setup, Radio Setup, Radio Standard, WCDMA
Initial S/W Revision	A.05.00

Band XIII

Selects Band XIII as the band for the current step.

Key Path	Source, List Sequencer, List Sequencer Setup, Radio Setup, Radio Standard, WCDMA
Initial S/W Revision	A.05.00

Band XIV

Selects Band XIV as the band for the current step.

Key Path	Source, List Sequencer, List Sequencer Setup, Radio Setup, Radio Standard, WCDMA
Initial S/W Revision	A.05.00

Band XIX

Selects Band XIX as the band for the current step.

Key Path	Source, List Sequencer, List Sequencer Setup, Radio Setup, Radio Standard, WCDMA
Initial S/W Revision	A.14.50

CDMA 2000 / 1xEVDO

Pressing this key once selects CDMA 2000/1xEVDO as the radio standard and the current CDMA 2000/1xEVDO band as the active channel band. Pressing this key again allows access to the sub-menus for selecting a different CDMA 2000/1xEVDO band.

Key Path	Source, List Sequencer, List Sequencer Setup, Radio Setup, Radio Standard
Initial S/W Revision	A.05.00

US CELL

Selects US Cell as the band for the current step.

Key Path	Source, List Sequencer, List Sequencer Setup, Radio Setup, Radio Standard, CDMA 2000 / 1xEVDO
Initial S/W Revision	A.05.00

US PCS

Selects US PCS as the band for the current step.

Key Path	Source, List Sequencer, List Sequencer Setup, Radio Setup, Radio Standard, CDMA 2000 / 1xEVDO
Initial S/W Revision	A.05.00

Japan Cell

Selects Japan Cell as the band for the current step.

Key Path	Source, List Sequencer, List Sequencer Setup, Radio Setup, Radio Standard, CDMA 2000 / 1xEVDO
Initial S/W Revision	A.05.00

Korean PCS

Selects Korean PCS as the band for the current step.

Key Path	Source, List Sequencer, List Sequencer Setup, Radio Setup, Radio Standard, CDMA 2000 / 1xEVDO
Initial S/W Revision	A.05.00

NMT 450

Selects NMT 450 as the band for the current step.

Key Path	Source, List Sequencer, List Sequencer Setup, Radio Setup, Radio Standard, CDMA 2000 / 1xEVDO
Initial S/W Revision	A.05.00

IMT 2000

Selects IMT 2000 as the band for the current step.

Key Path	Source, List Sequencer, List Sequencer Setup, Radio Setup, Radio Standard, CDMA 2000 / 1xEVDO
Initial S/W Revision	A.05.00

Upper 700

Selects Upper 700 as the band for the current step.

Key Path	Source, List Sequencer, List Sequencer Setup, Radio Setup, Radio Standard, CDMA 2000 / 1xEVDO
Initial S/W Revision	A.05.00

Secondary 800

Selects Secondary 800 as the band for the current step.

Key Path	Source, List Sequencer, List Sequencer Setup, Radio Setup, Radio Standard, CDMA 2000 / 1xEVDO
Initial S/W Revision	A.05.00

400 Euro PAMR

Selects 400 Euro PAMR as the band for the current step.

Key Path	Source, List Sequencer, List Sequencer Setup, Radio Setup, Radio Standard, CDMA 2000 / 1xEVDO
Initial S/W Revision	A.05.00

800 PAMR

Selects 800 PAMR as the band for the current step.

Key Path	Source, List Sequencer, List Sequencer Setup, Radio Setup, Radio Standard, CDMA 2000 / 1xEVDO
Initial S/W Revision	A.05.00

2.5GHz IMT EXT

Selects 2.5 GHz IMT EXT as the band for the current step.

Key Path	Source, List Sequencer, List Sequencer Setup, Radio Setup, Radio Standard, CDMA 2000 / 1xEVDO
Initial S/W Revision	A.05.00

US PCS 1.9GHz

Selects US PCS 1.9 GHz as the band for the current step.

Key Path	Source, List Sequencer, List Sequencer Setup, Radio Setup, Radio Standard, CDMA 2000 / 1xEVDO
Initial S/W Revision	A.05.00

AWS

Selects AWS as the band for the current step.

Key Path	Source, List Sequencer, List Sequencer Setup, Radio Setup, Radio Standard, CDMA 2000 / 1xEVDO
Initial S/W Revision	A.05.00

US 2.5GHz

Selects US 2.5 GHz as the band for the current step.

Key Path	Source, List Sequencer, List Sequencer Setup, Radio Setup, Radio Standard, CDMA 2000 / 1xEVDO
Initial S/W Revision	A.05.00

700 Public Safety

Selects 700 Public Safety as the band for the current step.

Key Path	Source, List Sequencer, List Sequencer Setup, Radio Setup, Radio Standard, CDMA 2000 / 1xEVDO
Initial S/W Revision	A.05.00

C2K Lower 700

Selects C2K Lower 700 as the band for the current step.

Key Path	Source, List Sequencer, List Sequencer Setup, Radio Setup, Radio Standard, CDMA 2000 / 1xEVDO
Initial S/W Revision	A.05.00

LTE

Pressing this key once selects LTE FDD as the radio standard and the current LTE FDD band as the active channel band. Pressing this key again allows access to the sub-menus for selecting a different LTE FDD band.

Key Path	Source, List Sequencer, List Sequencer Setup, Radio Setup, Radio Standard
Initial S/W Revision	A.09.50

BAND 1

Selects BAND 1 as the band for the current step.

Key Path	Source, List Sequencer, List Sequencer Setup, Radio Setup, Radio Standard, LTE
Initial S/W Revision	A.09.50

BAND 2

Selects BAND 2 as the band for the current step.

Key Path	Source, List Sequencer, List Sequencer Setup, Radio Setup, Radio Standard, LTE
Initial S/W Revision	A.09.50

BAND 3

Selects BAND 3 as the band for the current step.

Key Path	Source, List Sequencer, List Sequencer Setup, Radio Setup, Radio Standard, LTE
Initial S/W Revision	A.09.50

BAND 4

Selects BAND 4 as the band for the current step.

Key Path	Source, List Sequencer, List Sequencer Setup, Radio Setup, Radio Standard, LTE
Initial S/W Revision	A.09.50

BAND 5

Selects BAND 5 as the band for the current step.

Key Path	Source, List Sequencer, List Sequencer Setup, Radio Setup, Radio Standard, LTE
Initial S/W Revision	A.09.50

BAND 6

Selects BAND 6 as the band for the current step.

Key Path	Source, List Sequencer, List Sequencer Setup, Radio Setup, Radio Standard, LTE
Initial S/W Revision	A.09.50

BAND 7

Selects BAND 7 as the band for the current step.

Key Path	Source, List Sequencer, List Sequencer Setup, Radio Setup, Radio Standard, LTE
Initial S/W Revision	A.09.50

BAND 8

Selects BAND 8 as the band for the current step.

Key Path	Source, List Sequencer, List Sequencer Setup, Radio Setup, Radio Standard, LTE
Initial S/W Revision	A.09.50

BAND 9

Selects BAND 9 as the band for the current step.

Key Path	Source, List Sequencer, List Sequencer Setup, Radio Setup, Radio Standard, LTE
Initial S/W Revision	A.09.50

BAND 10

Selects BAND 10 as the band for the current step.

Key Path	Source, List Sequencer, List Sequencer Setup, Radio Setup, Radio Standard, LTE
Initial S/W Revision	A.09.50

BAND 11

Selects BAND 11 as the band for the current step.

Key Path	Source, List Sequencer, List Sequencer Setup, Radio Setup, Radio Standard, LTE
Initial S/W Revision	A.09.50

BAND 12

Selects BAND 12 as the band for the current step.

Key Path	Source, List Sequencer, List Sequencer Setup, Radio Setup, Radio Standard, LTE
Initial S/W Revision	A.09.50

BAND 13

Selects BAND 13 as the band for the current step.

Key Path	Source, List Sequencer, List Sequencer Setup, Radio Setup, Radio Standard, LTE
Initial S/W Revision	A.09.50

BAND 14

Selects BAND 14 as the band for the current step.

Key Path	Source, List Sequencer, List Sequencer Setup, Radio Setup, Radio Standard, LTE
Initial S/W Revision	A.09.50

BAND 17

Selects BAND 17 as the band for the current step.

Key Path	Source, List Sequencer, List Sequencer Setup, Radio Setup, Radio Standard, LTE
Initial S/W Revision	A.09.50

BAND 18

Selects BAND 18 as the band for the current step.

Key Path	Source, List Sequencer, List Sequencer Setup, Radio Setup, Radio Standard, LTE
Initial S/W Revision	A.09.50

BAND 19

Selects BAND 19 as the band for the current step.

Key Path	Source, List Sequencer, List Sequencer Setup, Radio Setup, Radio Standard, LTE
Initial S/W Revision	A.09.50

BAND 20

Selects BAND 20 as the band for the current step.

Key Path	Source, List Sequencer, List Sequencer Setup, Radio Setup, Radio Standard, LTE
Initial S/W Revision	A.09.50

BAND 21

Selects BAND 21 as the band for the current step.

Key Path	Source, List Sequencer, List Sequencer Setup, Radio Setup, Radio Standard, LTE
Initial S/W Revision	A.09.50

BAND 24

Selects BAND 24 as the band for the current step.

Key Path	Source, List Sequencer, List Sequencer Setup, Radio Setup, Radio Standard, LTE
Initial S/W Revision	A.09.50

BAND 25

Selects BAND 25 as the band for the current step.

Key Path	Source, List Sequencer, List Sequencer Setup, Radio Setup, Radio Standard, LTE
Initial S/W Revision	A.09.50

BAND 26

Selects BAND 26 as the band for the current step.

Key Path	Source, List Sequencer, List Sequencer Setup, Radio Setup, Radio Standard, LTE
Initial S/W Revision	A.12.53

BAND 27

Selects BAND 27 as the band for the current step.

Key Path	Source, List Sequencer, List Sequencer Setup, Radio Setup, Radio Standard, LTE
Initial S/W Revision	A.14.00

BAND 28

Selects BAND 28 as the band for the current step.

Key Path	Source, List Sequencer, List Sequencer Setup, Radio Setup, Radio Standard, LTE
Initial S/W Revision	A.14.00

BAND 31

Selects BAND 31 as the band for the current step.

Key Path	Source, List Sequencer, List Sequencer Setup, Radio Setup, Radio Standard, LTE
Initial S/W Revision	A.14.00

LTE TDD

Sets LTE TDD as the radio standard for use and accesses the LTE TDD specific channel band sub-menus..

Key Path	Source, Frequency, Radio Setup, Radio Standard
Initial S/W Revision	A.11.50

BAND 33

Selects BAND 33 as the band for the current step.

Key Path	Source, Frequency, Radio Setup, Radio Standard, LTE TDD
Example	:SOUR:FREQ:CHAN:BAND BAND33
Initial S/W Revision	A.11.50

BAND 34

Selects BAND 34 as the band for the current step.

Key Path	Source, Frequency, Radio Setup, Radio Standard, LTE TDD
Example	:SOUR:FREQ:CHAN:BAND BAND34
Initial S/W Revision	A.11.50

BAND 35

Selects BAND 35 as the band for the current step.

Key Path	Source, Frequency, Radio Setup, Radio Standard, LTE TDD
Example	:SOUR:FREQ:CHAN:BAND BAND35
Initial S/W Revision	A.11.50

BAND 36

Selects BAND 36 as the band for the current step.

Key Path	Source, Frequency, Radio Setup, Radio Standard, LTE TDD
Example	:SOUR:FREQ:CHAN:BAND BAND36
Initial S/W Revision	A.11.50

BAND 37

Selects BAND 37 as the band for the current step.

Key Path	Source, Frequency, Radio Setup, Radio Standard, LTE TDD
Example	:SOUR:FREQ:CHAN:BAND BAND37
Initial S/W Revision	A.11.50

BAND 38

Selects BAND 38 as the band for the current step.

Key Path	Source, Frequency, Radio Setup, Radio Standard, LTE TDD
Example	:SOUR:FREQ:CHAN:BAND BAND38
Initial S/W Revision	A.11.50

BAND 39

Selects BAND 39 as the band for the current step.

Key Path	Source, Frequency, Radio Setup, Radio Standard, LTE TDD
Example	:SOUR:FREQ:CHAN:BAND BAND39
Initial S/W Revision	A.11.50

BAND 40

Selects BAND 40 as the band for the current step.

Key Path	Source, Frequency, Radio Setup, Radio Standard, LTE TDD
Example	:SOUR:FREQ:CHAN:BAND BAND40
Initial S/W Revision	A.11.50

BAND 41

Selects BAND 41 as the band for the current step.

Key Path	Source, Frequency, Radio Setup, Radio Standard, LTE TDD
Example	:SOUR:FREQ:CHAN:BAND BAND41
Initial S/W Revision	A.11.50

BAND 42

Selects BAND 42 as the band for the current step.

Key Path	Source, Frequency, Radio Setup, Radio Standard, LTE TDD
Example	:SOUR:FREQ:CHAN:BAND BAND42
Initial S/W Revision	A.11.50

BAND 43

Selects BAND 43 as the band for the current step.

Key Path	Source, Frequency, Radio Setup, Radio Standard, LTE TDD
Example	:SOUR:FREQ:CHAN:BAND BAND43
Initial S/W Revision	A.11.50

BAND 44

Selects BAND 44 as the band for the current step.

Key Path	Source, List Sequencer, List Sequencer Setup, Radio Setup, Radio Standard, LTE TDD
Initial S/W Revision	A.14.00

TDSCDMA

Sets TDSCDMA as the radio standard for use and accesses the TDSCDMA specific channel band sub-menus..

Key Path	Source, Frequency, Radio Setup, Radio Standard
Initial S/W Revision	A.11.50

BAND A

Selects BAND A as the band for the current step.

Key Path	Source, Frequency, Radio Setup, Radio Standard, TDSCDMA
Example	:SOUR:FREQ:CHAN:BAND BANDA
Initial S/W Revision	A.11.50

BAND B

Selects BAND B as the band for the current step.

Key Path	Source, Frequency, Radio Setup, Radio Standard, TDSCDMA
Example	:SOUR:FREQ:CHAN:BAND BANDB
Initial S/W Revision	A.11.50

BAND C

Selects BAND C as the band for the current step.

Key Path	Source, Frequency, Radio Setup, Radio Standard, TDSCDMA
Example	:SOUR:FREQ:CHAN:BAND BANDC
Initial S/W Revision	A.11.50

BAND D

Selects BAND D as the band for the current step.

Key Path	Source, Frequency, Radio Setup, Radio Standard, TDSCDMA
Example	:SOUR:FREQ:CHAN:BAND BANDD
Initial S/W Revision	A.11.50

BAND E

Selects BAND E as the band for the current step.

Key Path	Source, Frequency, Radio Setup, Radio Standard, TDSCDMA
----------	---

Example	:SOUR:FREQ:CHAN:BAND BANDE
Initial S/W Revision	A.11.50

BAND F

Selects BAND F as the band for the current step.

Key Path	Source, Frequency, Radio Setup, Radio Standard, TDSCDMA
Example	:SOUR:FREQ:CHAN:BAND BANDF
Initial S/W Revision	A.11.50

Radio Band Link

Allows you to specify the radio band link direction for the steps within the list sequence. The link is used in conjunction with the channel band and channel number to determine the output frequency.

When set to “Uplink”, the source will calculate the uplink frequency according to an uplink formula together with selected channel band and channel number. When set to “Downlink”, the source will calculate the downlink frequency according to a downlink formula together with selected channel band and channel number.

Key Path	Source, List Sequencer, List Sequencer Setup, Radio Setup
Remote Command	:SOURce:LIST:STEP [1] 2 3...1000:SETup:RADio:BAND:LINK DOWN UP :SOURce:LIST:STEP [1] 2 3...1000:SETup:RADio:BAND:LINK?
Example	:SOUR:LIST:STEP2:SET:RAD:BAND:LINK UP :SOUR:LIST:STEP2:SET:RAD:BAND:LINK?
Notes	SCPI is supported after A.09.40
Preset	DOWN
Range	DOWN UP
Initial S/W Revision	A.05.00

Channel

Allows you to specify the frequency of the current step via a channel number.

Key Path	Source, List Sequencer, List Sequencer Setup
Remote Command	:SOURce:LIST:STEP [1] 2 3...1000:SETup:CNFRequency <double> :SOURce:LIST:STEP [1] 2 3...1000:SETup:CNFRequency?
Example	:SOUR:LIST:STEP2:SET:CNFR 124 :SOUR:LIST:STEP2:SET:CNFR?
Notes	SCPI is supported after A.09.40.

	This SCPI is used to setup channel number or frequency setting, according to current Radio Band setting. If Radio Band is "NONE", then it's frequency. If Radio Band is not "NONE", then it's channel number.
Couplings	The channel number is coupled to the step frequency value. When the step frequency value is changed, the channel number will increase or decrease to match the new step frequency. If the step frequency is not at an exact match for a channel number, the nearest channel number is displayed, along with a greater than, or less than sign to indicate the frequency is above or below the channel number.
Preset	1
Min	0 (Please refer to for valid ranges.)
Max	10838 (Please refer to for valid ranges.)
Initial S/W Revision	A.05.00

Frequency

Allows you to specify a frequency value for the current step.

Key Path	Source, List Sequencer, List Sequencer Setup
Remote Command	:SOURce:LIST:STEP[1] 2 3...1000:SETup:CNFRfrequency <double> :SOURce:LIST:STEP[1] 2 3...1000:SETup:CNFRfrequency?
Example	:SOUR:LIST:STEP2:SET:CNFR 1GHz :SOUR:LIST:STEP2:SET:CNFR?
Notes	SCPI is supported after A.09.40. This SCPI is used to setup channel number or frequency setting, according to current Radio Band setting. If Radio Band is "NONE", then it's frequency. If Radio Band is not "NONE", then it's channel number.
Couplings	The frequency value is coupled to the channel band and number for the step, such that updates to the radio band and channel number will update the frequency value to the corresponding absolute frequency. The reverse is also true, changing the frequency value causes the value of the channel number to be updated.
Preset	1.00 GHz
Min	10.00 MHz
Max	Hardware Dependant: Option 503 = 3.6 GHz Option 504 = 3.9 GHz Option 506 = 6.00 GHz
Initial S/W Revision	A.05.00

Power

Allows you to specify a power value for the current step.

Key Path	Source, List Sequencer, List Sequencer Setup
Remote Command	:SOURce:LIST:STEP[1] 2 3...1000:SETup:AMPLitude <double> :SOURce:LIST:STEP[1] 2 3...1000:SETup:AMPLitude?
Example	:SOUR:LIST:STEP2:SET:AMPL -50dBm :SOUR:LIST:STEP2:SET:AMPL?
Notes	SCPI is supported after A.09.40
Notes	Amplitude corrections can be specified for use with the source. In the event of amplitude corrections being applied, the valid ranges for the RF power do not change dependant on the current amplitude correction setting. Instead, if the combination of RF power + amplitude correction is higher or lower than the source output range, the Source Unleveled bit is set and the “Source Unleveled” indicator will appear on status panel to indicate that the source cannot maintain the output power that has been requested. The multiport adapter RFIO TX ports and GPS ports cannot ensure power accuracy when power setting is lower than -130dBm, this power setting value is defined by the sum of RF Power setting and related amplitude correction value. But user settable value could be lower than this limit. When application detected there exists power setting lower than -130dBm on MPA RFIO TX ports, then popup warning message . When application detected there exists power setting lower than -130dBm on MPA GPS ports, then popup warning message . These are only warning messages, and check is performed when RF is ON.
Notes	The Min and Max value here defined UI settable amplitude range. This range is larger than actual amplitude range with level accuracy defined in spec.
Dependencies	The RF power is dependent on the RF output port and frequency, such that the current frequency and selected output port determine the valid range of power values.
Preset	-100 dBm
Min	The range of values depends on the current frequency and selected RF output port. Please refer to "RF Power" on page 2442 and the table RF Power Range for the valid ranges.
Max	The range of values depends on the current frequency and selected RF output port. Please refer to "RF Power" on page 2442 and the table RF Power Range for the valid ranges.
Initial S/W Revision	A.05.00

Waveform

Allows you access to the sub-menus for selecting the waveform to be played back during the current step. Pressing this key also changes the central display area to show the Waveform File Selection view.

Key Path	Source, List Sequencer, List Sequencer Setup
Remote Command	:SOURce:LIST:STEP[1] 2 3...1000:SETup:WAVEform <string> :SOURce:LIST:STEP[1] 2 3...1000:SETup:WAVEform?
Example	:SOUR:LIST:STEP2:SET:WAV "CW" :SOUR:LIST:STEP2:SET:WAV?
Notes	SCPI is supported after A.09.40
Remote Command Notes	String type, takes “Off” “CW” “Cont” “waveform name”

Preset	CW
Range	Waveform Continue Previous CW Off
Initial S/W Revision	A.05.00

CW

Sets the current step to output a CW tone.

Key Path	Source, List Sequencer, List Sequencer Setup, Waveform
Example	:SOUR:LIST:STEP2:SET:WAV "CW"
Notes	SCPI is supported after A.09.40
Initial S/W Revision	A.05.00

Selected Waveform

Inserts the currently selected waveform in the waveform selection view as the waveform for playback during the current step.

Key Path	Source, List Sequencer, List Sequencer Setup, Waveform
Example	:SOUR:LIST:STEP2:SET:WAV "waveform name"
Notes	SCPI is supported after A.09.40 If the selected waveform contains header (which contains ARB play parameters), source list sequence will automatically apply header settings of the selected waveform in that step.
Initial S/W Revision	A.05.00

Continue Previous

Sets the current step to continue with playback of the waveform from the previous step. When continuing the previous waveform, the ARB playback will not pause while the source retunes to the new frequency or amplitude that may be defined for the new step.

Key Path	Source, List Sequencer, List Sequencer Setup, Waveform
Example	:SOUR:LIST:STEP2:SET:WAV "Cont"
Notes	SCPI is supported after A.09.40
Initial S/W Revision	A.05.00

Off

Disable RF output of the current step.

Key Path	Source, List Sequencer, List Sequencer Setup, Waveform
Example	:SOUR:LIST:STEP2:SET:WAV "Off"
Notes	SCPI is supported after A.09.40
Initial S/W Revision	A.05.00

Segments on Hard Disk

Allows you access to the sub-menus for loading waveform segments from the hard disk into ARB memory. The default directory is: D: varb.

Pressing this key changes the current view to the Waveform Management View.

Key Path	Source, Modulation Setup, ARB, Select Waveform
Initial S/W Revision	A.05.00

Load Segment To ARB Memory

Allows you to load the selected file into ARB memory. On the front panel you select the file for loading to the ARB memory by highlighting the desired file in the list. Using the SCPI command, you specify the file name on the HDD.

“NVWFM” (none-volatile storage) MSUS (Mass Storage Unit Specifier) is supported in the memory subsystem because the ARB memory cannot be accessed directly. Therefore, files must be downloaded to the instrument hard disk and then loaded into the ARB memory. “NVWFM” MSUS will be mapped to the default directory D: VARB. The SCPI command supports using either “NVWFM” MSUS or specifying a full path. For more information, see [Memory Subsystem \(Remote Command Only\)](#).

If a file of the same name already exists within ARB memory, it is overwritten. If you wish to load two segments of the same name, you must rename one of the segments before loading it into ARB memory. To rename a segment, you can either use Windows File Explorer, or the :MMEMory:COPY command.

NOTE: When a waveform file is loaded to ARB memory, burst timing adjustments are made automatically, based on whether or not a Multiport Adapter is connected to the test set and powered on. If the connection/power status of the Multiport Adapter is changed after a waveform file has been loaded, it needs to be loaded again.

Key Path	Source, Modulation Setup, ARB, Select Waveform, Segments on Hard Disk
Remote Command	:SOURce:RADio:ARB:LOAD <string>
Example	:SOUR:RAD:ARB:LOAD "D: VARB\testwaveform.bin" or :SOUR:RAD:ARB:LOAD "NVWFM:testwaveform.bin"
Notes	Because loading the file involves a delay of unpredictable length, this command should be followed by the query *OPC?, which holds off subsequent commands until the loading operating is complete. <string> – specifies the path name of the file to load from the HDD into ARB memory. It could be a <full path + filename>, or <"NVWFM" MSUS + colon + filename>.

When in Sequence Analyzer mode, and Include Source is Yes, an attempt to load a file to ARB memory will be rejected with an error.

When Include Source is No and if there is insufficient free ARB memory to load the selected waveform, an error is generated. .

If you specify a file over SCPI, but the file is not at the specified location, an error is generated.

If you try to load a waveform file but the file contains less than 500 IQ samples, an error is generated.

If you try to load a Signal Studio waveform “*.wfm” which contains invalid waveform header, an error is generated.

If the ARB is ON when you load a file to ARB memory or delete a file from ARB memory, the playing waveform segment may not keep phase continuity during the ARB memory operation. The waveform will be replayed after the ARB operation is finished.

ARB can be loaded into ARB memory even required licenses do not present on the instrument. In this case, a GUI only warning message -800, “Operation complete; Loaded <filename> successfully, but no license <required licenses> installed”. User can install required licenses according to <required licenses> string to license it, or multi-pack license it.

Initial S/W Revision A.05.00

Load All To ARB Memory

Allows you to load all the segment files within the currently selected directory into ARB memory. If a file of the same name already exists within ARB memory, it is overwritten. If you wish to load two segments of the same name, you must rename one of the segments before loading it into ARB memory. To rename a segment, you can either use Windows File Explorer, or the :MEMory:COpy command.

NOTE: When a waveform file is loaded to ARB memory, burst timing adjustments are made automatically, based on whether or not a Multiport Adapter is connected to the test set and powered on. If the connection/power status of the Multiport Adapter is changed after a waveform file has been loaded, it needs to be loaded again.

Key Path	Source, Modulation Setup, ARB, Select Waveform, Segments on Hard Disk
Remote Command	:SOURce:RADio:ARB:LOAD:ALL <string>
Example	:SOUR:RAD:ARB:LOAD:ALL “D: varb”
Notes	<p><string> - specifies the directory on the HDD to load the files into ARB memory from.</p> <p>When in Sequence Analyzer mode, and Include Source is Yes, an attempt to load all files from a directory to ARB memory is rejected with an error.</p> <p>When Include Source is No and there is insufficient free ARB memory to load all the waveforms, when the ARB memory is full, the copy ceases, and an error is generated.</p> <p>If you specify a directory over SCPI, but the directory does not exist, an error is generated.</p> <p>If the ARB is ON, a user then loads or deletes file to ARB memory, the playing waveform segment may not keep phase continuity during the ARB memory operation. The waveform will be replayed after the ARB operation is finished.</p>

Initial S/W Revision A.05.00

Change Directory...

Allows you to change the currently selected directory on the hard disk. Pressing this key opens a standard windows change directory dialog allowing you to select the new directory of interest.

The current directory is used for manually loading waveform segments into ARB memory for playback, and as a search location for waveform segments that are required to be loaded into ARB memory for playback of a waveform sequence or a list sequence.

Key Path	Source, Modulation Setup, ARB, Select Waveform, Segments on Hard Disk
Notes	No remote command, SCPIfront panel only.
Initial S/W Revision	A.05.00

Default Directory...

Allows you to change the default directory. It is used as a search location for waveform segments that are required to be loaded into ARB memory for playback of a waveform sequence, and as a search location for selecting waveforms using SCPI.

Key Path	Source, Modulation Setup, ARB, Select Waveform, Segments on Hard Disk
Remote Command	:SOURce:RADio:ARB:DEFault:DIRectory <string> :SOURce:RADio:ARB: DEFault:DIRectory?
Example	:SOUR:RAD:ARB:DEF:DIR "D:\ArbFiles" :SOUR:RAD:ARB:DEF:DIR?
State Saved	Persistent, survives a power cycle and a preset but not saved in the instrument state
Initial S/W Revision	A.05.00

Segments in ARB Memory

Allows you access to the sub-menus for managing the files within ARB memory.

Key Path	Source, Modulation Setup, ARB, Select Waveform
Initial S/W Revision	A.05.00

Delete Segment From ARB Mem

Allows you to remove a segment from ARB playback memory.

Key Path	Source, Modulation Setup, ARB, Select Waveform, Segments in ARB Memory
Remote Command	:SOURce:RADio:ARB:DELeTe <string>
Example	:SOUR:RAD:ARB:DEL "testwaveform.bin"
Notes	<string> - specifies the waveform to be deleted from the ARB playback memory. When in Sequence Analyzer mode and Include Source is Yes, an attempt to delete a file from ARB

	<p>memory is rejected with an error.</p> <p>When Include Source is No and you specify a file that does not exist within ARB memory, an error is generated.</p> <p>It is possible to delete files from within the ARB memory when the ARB is ON. However, if you attempt to delete the file that is currently playing an error is generated.</p> <p>It is possible to delete a file from within the ARB memory when the sequencer state is ON and the file is not being used by the List Sequencer. If you attempt to delete a file which is being used by the list sequencer, an error is generated.</p> <p>When sequencer state is On, even if ARB state is On, the selected waveform will not be played. In this case, if the selected waveform is not used in List Sequence, it can be deleted and the ARB state is turned Off.</p> <p>If the ARB is ON and you load a file to ARB memory or delete a file from ARB memory, the playing waveform segment may not keep phase continuity during the ARB memory operation. The waveform will be replayed after the ARB operation is finished.</p>
Initial S/W Revision	A.05.00

Delete All From ARB Memory

Allows you to remove all segments from ARB playback memory.

Key Path	Source, Modulation Setup, ARB, Select Waveform, Segments in ARB Memory
Remote Command	:SOURce:RADio:ARB:DELeTe:ALL
Example	:SOUR:RAD:ARB:DELeTe:ALL
Notes	<p>When in Sequence Analyzer mode and Include Source is Yes, an attempt to delete all files from ARB memory is rejected with an error.</p> <p>When Include Source is No and you attempt to delete all files from ARB memory when the ARB is currently playing a file, all files except the one playing are deleted and an error is generated.</p> <p>If you attempt to delete all files from ARB memory when there are waveform files used in "List Sequencer" on page 2520 and "Sequencer" on page 2521 state is ON, all files except the files currently being used in list sequencer are deleted, and an error is generated.</p> <p>If the ARB is ON and you load a file to ARB memory or delete a file from ARB memory, the playing waveform segment may not keep phase continuity during the ARB memory operation. The waveform will be replayed after the ARB operation is finished.</p>
Initial S/W Revision	A.05.00

Segments on Hard Disk

This key functions the same as "[Segments on Hard Disk](#)" on page 2547.

Key Path	Source, List Sequencer, List Sequencer Setup, Waveform
Initial S/W Revision	Prior to A.09.00

Load Segment To ARB Memory

This key functions the same as ["Load Segment To ARB Memory" on page 2547](#).

Key Path	Source, List Sequencer, List Sequencer Setup, Waveform, Segment on Hard Drive
Initial S/W Revision	Prior to A.09.00

Load All To ARB Memory

This key functions the same as ["Load All To ARB Memory" on page 2548](#).

Key Path	Source, List Sequencer, List Sequencer Setup, Waveform, Segment on Hard Drive
Initial S/W Revision	Prior to A.09.00

Change Directory ...

This key functions the same as ["Change Directory..." on page 2549](#).

Key Path	Source, List Sequencer, List Sequencer Setup, Waveform, Segment on Hard Drive
Initial S/W Revision	Prior to A.09.00

Default Directory ...

This key functions the same as ["Default Directory..." on page 2549](#)

Key Path	Source, List Sequencer, List Sequencer Setup, Waveform, Segment on Hard Drive
Initial S/W Revision	Prior to A.09.00

Segments in ARB Memory

This key functions the same as ["Segments in ARB Memory" on page 2549](#).

Key Path	Source, List Sequencer, List Sequencer Setup, Waveform, Segments in ARB Memory
Initial S/W Revision	Prior to A.09.00

Delete Segment From ARB Memory

This key functions the same as ["Delete Segment From ARB Mem" on page 2549](#).

Key Path	Source, List Sequencer, List Sequencer Setup, Waveform, Segments in ARB Memory, Segment in ARB Memory
Initial S/W Revision	Prior to A.09.00

Delete All From ARB Memory

This key functions the same as ["Delete All From ARB Memory" on page 2550](#).

Key Path	Source, List Sequencer, List Sequencer Setup, Waveform, Segments in ARB Memory, Segment in ARB Memory
Initial S/W Revision	Prior to A.09.00

Step Duration

Allows access to the sub-menus for setting up the duration of play for the current step.

The duration can be set to be either the number of times for the ARB file associated with the sequence to play, or a specific time value, or continuous. If the step is set to play a CW tone, the step duration cannot be set to a play count.

Key Path	Source, List Sequencer, List Sequencer Setup
Remote Command	:SOURce:LIST:STEP[1] 2 3...1000:SETup:DURation:TYPE TIME COUNT CONTInuous CABort :SOURce:LIST:STEP[1] 2 3...1000:SETup:DURation:TYPE?
Example	:SOUR:LIST:STEP2:SET:DUR:TYPE TIME :SOUR:LIST:STEP2:SET:DUR:TYPE?
Notes	SCPI is supported after A.09.40
Notes	If "Step Duration" is set to "Time" or "Play Count" for the last step, the last step of ARB keeps playing as if set to "Continuous", until the set "Time" has expired or until the "Play Count" setting is reached. However, you can query Error! Reference source not found. Source Sweeping Condition Message to find out if the current list sequence is complete or not.
Range	Time Play Count Continuous Continuous Abort
Initial S/W Revision	A.05.00

Time

Sets the duration of the current step to be a time value for the length of time the step will play. Pressing this key again opens another menu which allows you to set the time value for the step duration.

Key Path	Source, List Sequencer, List Sequencer Setup, Step Duration
Example	:SOUR:LIST:STEP2:SET:DUR:TYPE TIME
Notes	SCPI is supported after A.09.40
Initial S/W Revision	A.05.00

Duration Time

Allows you to specify the length of time the current step will play.

When Step Duration is **Continuous Abort** this parameter specifies the maximum duration that the waveform will continue to play after a step trigger is received before the transition to the next waveform will occur. Duration is limited to a maximum of 20 seconds.

If the Transition Time value is longer than the Step Duration Time, an error is generated when initiating a source list sequence. For source list sequence, transition time is included in the step duration length (not occupy additional time). If the Transition Time value is longer than the Step Duration Time, the real step duration length is extended to equal the transition time and cause a timing shift. This check is also described in section **Error! Reference source not found**. List Sequence Step Validation.

Key Path	Source, List Sequencer, List Sequencer Setup, Step Duration, Time
Remote Command	:SOURce:LIST:STEP[1] 2 3...1000:SETup:DURation:TCOUNT <double> :SOURce:LIST:STEP[1] 2 3...1000:SETup:DURation:TCOUNT?
Example	:SOUR:LIST:STEP2:SET:DUR:TCO 1s :SOUR:LIST:STEP2:SET:DUR:TCO?
Notes	SCPI is supported after A.09.40 This SCPI is reused by "Play Count", "Duration Time" and "Continuous Abort" according to current Duration Type setting is "Play Count" or "Duration Time" or "Continuous Abort". If current "Duration Type" is "Continuous", then popup error -221, "Settings conflict; Cannot accept time or count input when step duration type is Continuous on step #"
Notes	If "Duration Time" is set for the last step, the last step of ARB keeps playing as if set to "Continuous" after set time expires. However, you can query Source Sweeping Condition Message (:STAT:OPER:COND?) to find out if the current list sequence is complete or not.
Preset	1.00 ms
Min	100 μs
Max	1800 s
Initial S/W Revision	A.05.00

Play Count

Sets the duration of the current step to be an integer value for the number of times (play count) the ARB file is selected for playback during this step. For example, a 5 second ARB will be set to play 5 times during the step.

Key Path	Source, List Sequencer, List Sequencer Setup, Step Duration
Example	:SOUR:LIST:STEP2:SET:DUR:TYPE COUN
Notes	SCPI is supported after A.09.40 This key is unavailable and is grayed out if the current step is configured to CW tone rather than an ARB waveform.
Initial S/W Revision	A.05.00

Header Utilities

Allows access to the header utilities sub-menu. Pressing this key also causes the central display area to change to display the File Header Information view.

Key Path	Source, Modulation Setup, ARB
Dependencies	This key is only available if there is currently a waveform selected for playback. If no waveform is selected, the key is grayed out.
Initial S/W Revision	A.05.00

Continuous

Sets the current step to be played continuously until the next step starts. The waveform will always play completely before transitioning to the next step.

Key Path	Source, List Sequencer, List Sequencer Setup, Step Duration
Example	:SOUR:LIST:STEP2:SET:DUR:TYPE CONT
Notes	SCPI is supported after A.09.40
Initial S/W Revision	A.05.00

Output Trigger

Allows you to specify the trigger output for the current step. The trigger output signal is sent at the start of the step.

When select “On”, trigger event will occur on both Internal and External2 paths. Select “Off” will turn off trigger output.

Key Path	Source, List Sequencer, List Sequencer Setup
Remote Command	:SOURce:LIST:STEP[1] 2 3...1000:SETup:OUTPut:TRIGger ON OFF 1 0 :SOURce:LIST:STEP[1] 2 3...1000:SETup:OUTPut:TRIGger
Example	:SOUR:LIST:STEP2:SET:OUTP:TRIG ON :SOUR:LIST:STEP2:SET:OUTP:TRIG?
Notes	SCPI is supported after A.09.40
Preset	Off
Range	On Off
Initial S/W Revision	A.05.00

Step Configuration (Remote Command Only)

This SCPI command is used to configure the List Sequencer and is detailed in the table below. The command is defined such that you send one command per step, with the step number being specified as a subopcode of the SCPI command. Each command includes all the parameter settings for the step. As a step is setup, the values entered are run through several levels of validation.

Remote Command	:SOURce:LIST:STEP[1] 2 ... 4..1000:SETup IMMEDIATE INTernal KEY
-----------------------	---

```

BUS | EXTernal2, <time>, NONE | PGSM | EGSM | RGSM | DCS1800 | PCS1900
| TGSM810 | GSM450 | GSM480 | GSM700 | GSM850 | BANDI | BANDII |
BANDIII | BANDIV | BANDV | BANDVI | BANDVII | BANDVIII | BANDIX | BANDX
| BANDXI | BANDXII | BANDXIII | BANDXIV | BANDXIX | USCELL | USPCS |
JAPAN | KOREAN | NMT | IMT2K | UPPER | SECOND | PAMR400 | PAMR800 |
IMTEXT | PCS1DOT9G | AWS | US2DOT5G | PUBLIC | LOWER | NONE | BAND1 |
BAND2 | BAND3 | BAND4 | BAND5 | BAND6 | BAND7 | BAND8 | BAND10 | BAND11
| BAND12 | BAND13 | BAND14 | BAND17 | BAND18 | BAND19 | BAND20 | BAND21
| BAND24 | BAND25 | BAND26 | BAND33 | BAND34 | BAND35 | BAND36 | BAND37
| BAND38 | BAND39 | BAND40 | BAND41 | BAND42 | BAND43 | BANDA | BANDB |
BANDC | BANDD | BANDE | BANDF, DOWN | UP, <freq>, <ampl>, <string>,
TIME | COUNT | CONTinuous, <time>, ON | OFF | 1 | 0, [<int>],

:SOURce:LIST:STEP[1]|2|...|4..1000:SETup?

```

Example :SOUR:LIST:STEP1:SET INT, 1ms, PGSM, DOWN, 10, -25 dBm, "GSM_Test1.bin", TIME, 10ms, OFF, 255

Notes

The parameters are:

(There is a total of 11 items in each step, the following is a list of the items in the order they must appear in the remote command.)

1. Step Trigger <enum> – specifies the input trigger for the step. For details of the valid types of step trigger see ["Step Trigger" on page 2523](#).
 2. Transition Time <time> – specifies the transition time for the step in seconds. For details of the valid ranges for the transition time see ["Transition Time" on page 2525](#).
 3. Radio Band <enum> – specifies the radio band for the step. For details of the valid radio bands see ["Radio Setup" on page 2526](#).
 4. Radio Band Link <enum> – specifies the radio band link direction for the step. For details of the valid link types, see ["Radio Band Link" on page 2543](#).
 5. Frequency/Channel Number <freq>/<chan num> – specifies the frequency in Hz or the channel number for the step. The channel number and frequency are combined as one parameter that represents the frequency or channel number depending on the radio band setting. If the radio band is set to NONE, this value is interpreted as a frequency value in Hz. If the radio band is set to a valid band, this value is interpreted as a channel number. For details of the valid ranges for frequency and channel numbers, see ["Channel" on page 2543](#) and ["Frequency" on page 2544](#).
 6. Power <ampl> – specifies the output power for the step in dBm. For details of the valid ranges see ["Power" on page 2544](#).
 7. Waveform <string> – specifies the waveform for playback during the step. The step can output either a new ARB waveform, continue playback of the previous waveform, or output a CW tone. The options for specifying these are:
 - <filename> - plays the specified waveform from the start. The filename value is the name of the file within ARB playback memory, it does not include the windows path to the file on the HDD. If you enter a filename for a waveform that does not reside within ARB playback memory, an error is generated.
 - CONT – continues playback of the ARB file from the previous step
 - CW – outputs a CW tone
 - OFF – disable RF output
 8. Step Duration <enum> – specifies the duration of the step. The duration can be specified to be either time, or play count of the ARB file associated with the step, or continuous. If Waveform is set to "CW", this value cannot be set to Play Count and an error will be generated. If continuous is selected, the following Time or Count value is ignored. For further details of this setting, see ["Step](#)
-

	<p>Duration" on page 2552.</p> <p>9. Time or Count <time/int> – specifies time duration in seconds or play count of the ARB file associated with the step. For further details of this setting, including the valid ranges for the time or play count setting, "Time" on page 2552 and "Play Count" on page 2553.</p> <p>10. Output Trigger <Boolean> – specifies the output trigger for the step. For details of the ranges for this setting see "Output Trigger" on page 2554.</p>
Dependencies	<p>The range of subopcode values is 1 to 1000 and the value you enter is determined by the number of steps you have configured. For details see "Number of Steps" on page 2522.</p> <p>If you attempt to remotely set or query a subopcode that is out of range, an error is generated.</p>
Initial S/W Revision	A.05.00

Step Configuration of Step Trigger parameter list (Remote Command Only)

This SCPI command is to configure “Step Trigger” parameter array of the whole List Sequencer at one time. The number of array is same as step number defined in "**Number of Steps" on page 2522** Number of Steps. As a step is setup, the value entered run through several levels of validation.

Remote Command	<pre>:SOURce:LIST:SETup:INPut:TRIGger <enum>, <enum>, <enum>, ... :SOURce:LIST:SETup:INPut:TRIGger?</pre>
Example	<pre>:SOUR:LIST:SET:INP:TRIG IMM,INT,EXT2 :SOUR:LIST:SET:INP:TRIG?</pre>
Notes	<p>The command is to setup below parameter array of whole list sequence.</p> <p>Step Trigger <enum> – specifies the input trigger for the step. For details of the valid types of step trigger see "Step Trigger" on page 2523.</p> <p>If input parameter number exceeds the step number defined by "Number of Steps" on page 2522Number of Steps then generate error ", and only those parametes whose index number falls in number of steps will be updated.</p>
Remote Command Notes	IMMEDIATE INTERNAL KEY BUS EXTERNAL2
Dependencies	<p>The range is 1 to 1000 which is determined by the number of steps you have configured. For details see "Number of Steps" on page 2522.</p>
Initial S/W Revision	A.09.40

Step Configuration of Transition Time parameter list (Remote Command Only)

This SCPI command is to configure “Transition Time” parameter array of the whole List Sequencer at one time. The number of array is same as step number defined in "**Number of Steps" on page 2522** Number of Steps. As a step is setup, the value entered run through several levels of validation.

Remote Command	<pre>:SOURce:LIST:SETup:TRANSition:TIME <time>, <time>, <time>, ... :SOURce:LIST:SETup:TRANSition:TIME?</pre>
Example	<pre>:SOUR:LIST:SET:TRAN:TIME 1ms,1ms,1ms</pre>

	:SOUR:LIST:SET:TRAN:TIME?
Notes	<p>The command is to setup below parameter array of whole list sequence.</p> <p>Transition Time <time> – specifies the transition time for the step in seconds. For details of the valid ranges for the transition time see "Transition Time" on page 2525</p> <p>If input parameter number exceeds the step number defined by "Number of Steps" on page 2522 Number of Steps then generate error ", and only those parameters whose index number falls in number of steps will be updated.</p>
Dependencies	The range is 1 to 1000 which is determined by the number of steps you have configured. For details see "Number of Steps" on page 2522 .
Initial S/W Revision	A.09.40

Step Configuration of Radio Band parameter list (Remote Command Only)

This SCPI command is to configure “Radio Band” parameter array of the whole List Sequencer at one time. The number of array is same as step number defined in ["Number of Steps" on page 2522](#) Number of Steps. As a step is setup, the value entered run through several levels of validation.

R	:SOURce:LIST:SETup:RADio:BAND <enum>, <enum>, <enum>, ...
e	:SOURce:LIST:SETup:RADio:BAND?
m	
o	
t	
e	
C	
o	
m	
m	
a	
n	
d	
E	:SOUR:LIST:SET:RAD:BAND PGSM, EGSM, RGSM
x	:SOUR:LIST:SET:RAD:BAND?
a	
m	
p	
l	
e	
N	The command is to setup below parameter array of whole list sequence.
O	Radio Band <enum> – specifies the radio band for the step. For details of the valid radio bands see "Radio Setup" on page 2526 .
t	If input parameter number exceeds the step number defined by "Number of Steps" on page 2522 Number of Steps then
e	generate error ", and only those parameters whose index number falls in number of steps will be updated.
s	
R	NONE PGSM EGSM RGSM DCS1800 PCS1900 TGSM810 GSM450 GSM480 GSM700 GSM850 BANDI BANDII BANDIII BANDI
e	V BANDV BANDVI BANDVII BANDVIII BANDIX BANDX BANDXI BANDXII BANDXIII BANDXIV BANDXIX USCELL USPCS JAPAN KO
m	REAN NMT IMT2K UPPER SECOND PAMR400 PAMR800 IMTEXT PCS1 DOT9G AWS US2DOT5G PUBLIC LOWER NONE BAND1
	BAND2 BAND3 BAND4 BAND5 BAND6 BAND7 BAND8 BAND10 BAND11 BAND12 BAND13 BAND14 BAND17 BAND18 BAND1

o 9|BAND20|BAND21|BAND24|BAND25|BAND26|BAND33|BAND34|BAND35|BAND36|BAND37|BAND38|BAND39|BAND40|BAN
t D41|BAND42|BAND43|BANDA|BANDB|BANDC|BANDD|BANDE|BANDF
e

C
o
m
m
a
n
d

N
o
t
e
s

D The range is 1 to 1000 which is determined by the number of steps you have configured. For details see "[Number of Steps](#)" on
e [page 2522](#).

p
e
n
d
e
n
c
i
e
s

I A.09.40

n
i
t
i
a
l

S
/
W

R
e
v
i
s
i
o
n

Step Configuration of Radio Band Link parameter list (Remote Command Only)

This SCPI command is to configure “Radio Band Link” parameter array of the whole List Sequencer at one time. The number of array is same as step number defined in ["Number of Steps" on page 2522](#) Number of Steps. As a step is setup, the value entered run through several levels of validation.

Remote Command	:SOURce:LIST:SETup:RADio:BAND:LINK <enum>, <enum>, <enum>, ... :SOURce:LIST:SETup:RADio:BAND:LINK?
Example	:SOUR:LIST:SET:RAD:BAND:LINK DOWN,UP,UP :SOUR:LIST:SET:RAD:BAND:LINK?
Notes	The command is to setup below parameter array of whole list sequence. Radio Band Link <enum> – specifies the radio band link direction for the step. For details of the valid link types, see "Radio Band Link" on page 2543 . If input parameter number exceeds the step number defined by "Number of Steps" on page 2522 Number of Steps then generate error ", and only those parametes whose index number falls in number of steps will be updated.
Remote Command Notes	DOWN UP
Dependencies	The range is 1 to 1000 which is determined by the number of steps you have configured. For details see "Number of Steps" on page 2522 .
Initial S/W Revision	A.09.40

Step Configuration of Frequency/Channel Number parameter list (Remote Command Only)

This SCPI command is to configure “Frequency” or “Channel Number” parameter array of the whole List Sequencer at one time. The number of array is same as step number defined in ["Number of Steps" on page 2522](#) Number of Steps. As a step is setup, the value entered run through several levels of validation.

Remote Command	:SOURce:LIST:SETup:CNFRequency <double>, <double>, <double>, ... :SOURce:LIST:SETup:CNFRequency?
Example	:SOUR:LIST:SET:CNFR 1GHz,100MHz,100MHz :SOUR:LIST:SET:CNFR? SOUR:LIST:SET:CNFR 124,124,124 :SOUR:LIST:SET:CNFR?
Notes	The command is to setup below parameter array of whole list sequence. Frequency/Channel Number <freq>/<chan num> – specifies the frequency in Hz or the channel number for the step. The channel number and frequency are combined as one parameter that represents the frequency or channel number depending on the radio band setting. If the radio band is set to NONE, this value is interpreted as a frequency value in Hz. If the radio band is set to a valid band, this value is interpreted as a channel number. For details of the valid ranges for frequency and channel numbers, see "Channel" on page 2543 and "Frequency" on page 2544 This SCPI is used to setup/query channel number or frequency setting, according to current Radio Band setting of that step. If Radio Band is “NONE”, then it’s frequency. If Radio Band is not “NONE”, then it’s channel number If input parameter number exceeds the step number defined by "Number of Steps" on page 2522 Number of Steps then generate error ", and only those parametes whose index number falls in

	legal step number will be updated.
Dependencies	The range is 1 to 1000 which is determined by the number of steps you have configured. For details see "Number of Steps" on page 2522 .
Initial S/W Revision	A.09.40

Step Configuration of Power parameter list (Remote Command Only)

This SCPI command is to configure “Power” parameter array of the whole List Sequencer at one time. The number of array is same as step number defined in ["Number of Steps" on page 2522](#) Number of Steps. As a step is setup, the value entered run through several levels of validation.

Remote Command	:SOURce:LIST:SETup:AMPLitude <ampl>, <ampl>, <ampl>, ... :SOURce:LIST:SETup:AMPLitude?
Example	:SOUR:LIST:SET:AMPL -50dBm,-40dBm,-30dBm :SOUR:LIST:SET:AMPL?
Notes	The command is to setup below parameter array of whole list sequence. Power <ampl> – specifies the output power for the step in dBm. For details of the valid ranges see "Power" on page 2544 . If input parameter number exceeds the step number defined by "Number of Steps" on page 2522 Number of Steps then generate error ", and only those parametes whose index number falls in legal step number will be updated.
Dependencies	The range is 1 to 1000 which is determined by the number of steps you have configured. For details see "Number of Steps" on page 2522 .
Initial S/W Revision	A.09.40

Step Configuration of Waveform parameter list (Remote Command Only)

This SCPI command is to configure “Waveform” parameter array of the whole List Sequencer at one time. The number of array is same as step number defined in ["Number of Steps" on page 2522](#) Number of Steps. As a step is setup, the value entered run through several levels of validation.

Remote Command	:SOURce:LIST:SETup:WAVeform <string>, <string>, <string>, ... :SOURce:LIST:SETup:WAVeform?
Example	:SOUR:LIST:SET:WAV "CW","Off","CONT" :SOUR:LIST:SET:WAV?
Notes	The command is to setup below parameter array of whole list sequence. Waveform <string> – specifies the waveform for playback during the step. The step can output either a new ARB waveform, continue playback of the previous waveform, or output a CW tone. The options for specifying these are: <filename> - plays the specified waveform from the start. The filename value is the name of the file within ARB playback memory, it is does not include the windows path to the file on the HDD. If you enter a filename for a waveform that does not reside within ARB playback memory, an error is generated.

	<p>CONT – continues playback of the ARB file from the previous step</p> <p>CW – outputs a CW tone</p> <p>OFF – disable RF output</p> <p>If input parameter number exceeds the step number defined by "Number of Steps" on page 2522 Number of Steps then generate error ", and only those parametes whose index number falls in number of steps will be updated.</p>
Dependencies	The range is 1 to 1000 which is determined by the number of steps you have configured. For details see " Number of Steps " on page 2522.
Range	"filename" "CW" "Off" "CONT"
Initial S/W Revision	A.09.40

Step Configuration of Step Duration parameter list (Remote Command Only)

This SCPI command is to configure "Step Duration" parameter array of the whole List Sequencer at one time. The number of array is same as step number defined in "[Number of Steps](#)" on page 2522 Number of Steps. As a step is setup, the value entered run through several levels of validation.

Remote Command	<pre>:SOURce:LIST:SETup:DURation:TYPE <enum>, <enum>, <enum>, ... :SOURce:LIST:SETup:DURation:TYPE?</pre>
Example	<pre>:SOUR:LIST:SET:DUR:TYPE COUN,TIME,CONT :SOUR:LIST:SET:DUR:TYPE?</pre>
Notes	<p>The command is to setup below parameter array of whole list sequence.</p> <p>Step Duration <enum> – specifies the duration of the step. The duration can be specified to be either time, or play count of the ARB file associated with the step, or continuous. If Waveform is set to "CW", this value cannot be set to Play Count and an error will be generated. If continuous is selected, the following Time or Count value is ignored. For further details of this setting, see "Step Duration" on page 2552.</p> <p>If input parameter number exceeds the step number defined by "Number of Steps" on page 2522 Number of Steps then generate error ", and only those parametes whose index number falls in number of steps will be updated.</p>
Remote Command Notes	TIME COUNT CONTinuous
Dependencies	The range is 1 to 1000 which is determined by the number of steps you have configured. For details see " Number of Steps " on page 2522.
Initial S/W Revision	A.09.40

Step Configuration of Duration Time or Play Count parameter list (Remote Command Only)

This SCPI command is to configure "Duration Time" or "Play Count" parameter array of the whole List Sequencer at one time. The number of array is same as step number defined in "[Number of Steps](#)" on page 2522 Number of Steps. As a step is setup, the value entered run through several levels of validation.

Remote Command	<pre>:SOURce:LIST:SETup:TOCount <time/int>, <time/int>, <time/int>, ... :SOURce:LIST:SETup:TOCount?</pre>
-----------------------	---

Example	:SOUR:LIST:SET:TOC 1s,2s,3s :SOUR:LIST:SET:TOC? :SOUR:LIST:SET:TOC 5,6,7 :SOUR:LIST:SET:TOC?
Notes	The command is to setup below parameter array of whole list sequence. Time or Count <time/int> – specifies time duration in seconds or play count of the ARB file associated with the step. For further details of this setting, including the valid ranges for the time or play count setting, " Time " on page 2552 and " Play Count " on page 2553. If input parameter number exceeds the step number defined by " Number of Steps " on page 2522 Number of Steps then generate error ", and only those parametes whose index number falls in number of steps will be updated. If current " Step Duration " on page 2552 is "Continuous", then generate error -221,"Settings conflict;Cannot accept time or count input when step duration type is Continuous on step #"
Dependencies	The range is 1 to 1000 which is determined by the number of steps you have configured. For details see " Number of Steps " on page 2522.
Initial S/W Revision	A.09.40

Step Configuration of Output Trigger parameter list (Remote Command Only)

This SCPI command is to configure "Output Trigger" parameter array of the whole List Sequencer at one time. The number of array is same as step number defined in "[Number of Steps](#)" on page 2522 Number of Steps. As a step is setup, the value entered run through several levels of validation.

Remote Command	:SOURce:LIST:SETup:OUTPut:TRIGger <bool>, <bool>, <bool>, ... :SOURce:LIST:SETup:OUTPut:TRIGger ?
Example	:SOUR:LIST:SET:OUTP:TRIG ON,OFF,ON :SOUR:LIST:SET:OUTP:TRIG?
Notes	The command is to setup below parameter array of whole list sequence. Output Trigger <Boolean> – specifies the output trigger for the step. For details of the ranges for this setting see " Output Trigger " on page 2554. If input parameter number exceeds the step number defined by " Number of Steps " on page 2522 Number of Steps then generate error ", and only those parametes whose index number falls in legal step number will be updated.
Remote Command Notes	ON OFF 1 0
Dependencies	The range is 1 to 1000 which is determined by the number of steps you have configured. For details see " Number of Steps " on page 2522.
Initial S/W Revision	A.09.40

Clear List (Remote Command Only)

This command is the SCPI equivalent of the Clear List UI featuredescribed in.

Remote Command	:SOURce:LIST:SETup:CLEar
Example	:SOUR:LIST:SETup:CLE
Initial S/W Revision	A.05.00

Trigger Type

Allows access to the sub-menu for selecting the output trigger type for the list sequencer globally. It cannot be changed between different sequence steps.

Key Path	Source, List Sequencer
Remote Command	:SOURce:LIST:TRIGgerout:TYPe BEGinningofstep DATamarker
Example	:SOUR:LIST:TRIG:TYP BEG :SOUR:LIST:TRIG:TYP?
Notes	SCPI is supported after A.14.00
Preset	BEGinningofstep
Range	BEGinningofstep DATamarker
Initial S/W Revision	A.14.00

BeginningOfStep

Sets the output trigger type as BeginningOfStep for the whole source sequence.

Key Path	Source, List Sequencer, Trigger Type
Example	:SOUR:LIST:TRIG:TYP BEG
Notes	SCPI is supported after A.14.00
Initial S/W Revision	A.14.00

DataMarker

Sets the output trigger type as DataMarker for the whole source sequence. When DataMarker is selected, which marker to route is also needed to be set.

Key Path	Source, List Sequencer, Trigger Type
Example	:SOUR:LIST:TRIG:TYP DAT
Notes	SCPI is supported after A.14.00
Initial S/W Revision	A.14.00

Marker 1

Sets the output trigger maker routing to Marker 1 for DataMarker in the whole source sequence.

Key Path	Source, List Sequencer, Trigger Type, DataMarker
Example	:SOUR:LIST:TRIG:TYPE:MARK M1
Notes	SCPI is supported after A.14.00
Initial S/W Revision	A.14.00

Marker 2

Sets the output trigger maker routing to Marker 2 for DataMarker in the whole source sequence.

Key Path	Source, List Sequencer, Trigger Type, DataMarker
Example	:SOUR:LIST:TRIG:TYPE:MARK M2
Notes	SCPI is supported after A.14.00
Initial S/W Revision	A.14.00

Marker 3

Sets the output trigger maker routing to Marker 3 for DataMarker in the whole source sequence.

Key Path	Source, List Sequencer, Trigger Type, DataMarker
Example	:SOUR:LIST:TRIG:TYPE:MARK M3
Notes	SCPI is supported after A.14.00
Initial S/W Revision	A.14.00

Marker 4

Sets the output trigger maker routing to Marker 4 for DataMarker in the whole source sequence.

Key Path	Source, List Sequencer, Trigger Type, DataMarker
Example	:SOUR:LIST:TRIG:TYPE:MARK M4
Notes	SCPI is supported after A.14.00
Initial S/W Revision	A.14.00

Manual Trigger Now

Pressing this key provides a software trigger event to the list sequencer. During execution of sequence, if the sequencer is halted on any step that has been configured with a “Manual” step trigger, then this key press will cause the sequencer to continue and execute the step.

Key Path	Source, List Sequencer
Remote Command	No remote command, front panel only.
Initial S/W Revision	A.05.00

Remote Software Trigger (Remote command Only)

During execution of a list sequence, the sequence will halt and wait at any step that has Step Trigger set to “Bus”. Sending this command will trigger the step and continue the sequence.

Remote Command	:SOURce:LIST:TRIGger:INITiate[:IMMediate]
Example	:SOUR:LIST:TRIG:INIT
Initial S/W Revision	A.05.00

Query List Sequence Initiation Armed Status (Remote Command Only)

This is a blocking SCPI query to determine if source list sequence being initiated successfully or not.

Remote Command	:SOURce:LIST:INITiation:ARMed?
Example	:SOUR:LIST:INIT:ARMed?
Notes	The return data is in the following format: Integer
Notes	Query only SCPI. Returning “1” if list sequence has been initiated successfully, returning “0” if not. Once get “0”, you can use :SYST:ERR? to query what error happened. Just like “*OPC?”, this command can be blocked until event/status “IsSourceSweeping” happens, and then returns. Doing so can help user’s script query armed status only once during the time interval of the initiation. As an ancillary SCPI of existing SCPI “:SOUR:LIST:TRIGger[:IMMediate]” (see "Initiate Sequence" on page 2521 Initiate Sequence), the right usage of this command is to use it after “:SOUR:LIST:TRIG”. If not, this command will return “1” immediately.
Notes	There is an alias SCPI “:SOURce:LIST:TRIGger:INITiation:ARMed?”.
Initial S/W Revision	A.09.40

Source Preset

Allows you to preset the source settings to their default values.

Key Path	Source
Remote Command	:SOURce:PRESet
Example	:SOUR:PRES

SPAN X Scale

Displays a menu for selecting measurement span and also for scaling of the X axis.

Key Path	Front Panel
Mode	VSA, LTE, LTETDD, IDEN, LTEAFDD,LTEATDD
Initial S/W Revision	Prior to A.02.00
Modified at S/W Revision	A.02.00

Select Trace

Displays a menu that enables you to select the trace that is to receive the action of all successive trace-specific commands like scaling, assignment of trace data, and so on. The selected trace is outlined in green and is always visible. While the Select Trace menu is showing, each visible trace is annotated in the middle with its own trace number, as shown in the following figure. The trace number annotations disappear when any other menu is showing.

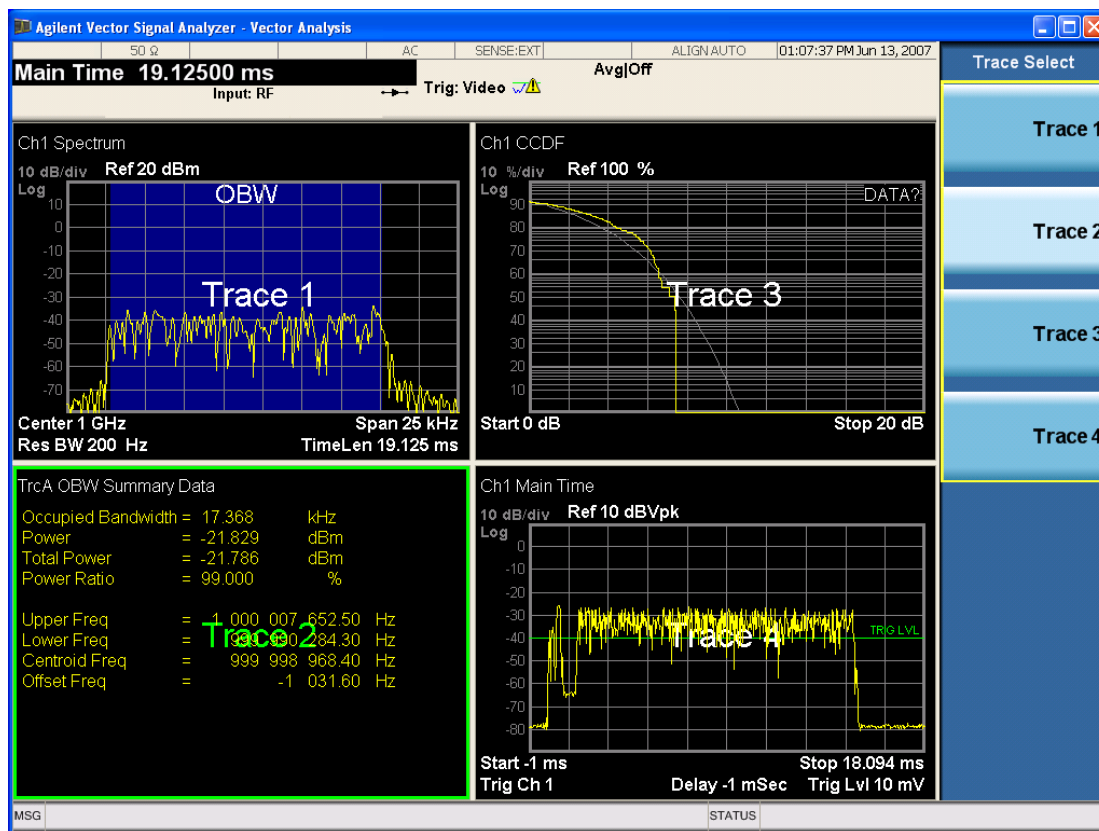

Grid 2x2 layout showing trace annotations when Trace Select dialog is active

This softkey also appears in the X and Y scaling menus. There is only one selected trace at any time. If you change which trace is selected, that change is reflected in this softkey/menu wherever it appears. Other

ways to select a trace include use of the Next Window key, clicking within a trace window with a mouse cursor, and issuing a trace-specific SCPI command.

There is no SCPI command associated with this function. Instead, SCPI commands that are trace-specific have an index on the TRACe node that determines the selected trace. Using such a command has the side effect that the trace addressed by the SCPI command becomes the selected trace for any front panel interaction.

Key Path	Trace/Detector or Span X Scale or AMPTD Y Scale
Mode	VSA, LTE, LTETDD, IDEN, LTEAFDD, LTEATDD
Notes	No SCPI. Front panel only.
Couplings	Affects any trace-specific commands
Range	Trace 1 Trace 2 Trace 3 Trace 4 Trace 5 Trace 6
Readback Text	Trace <n>
Initial S/W Revision	Prior to A.02.00
Modified at S/W Revision	A.02.00

X Scale

Causes the trace to display all available trace data when set to Auto. (Exception: the display of the outer edges of a spectrum that can contain aliases is governed by the All Frequency Points function setting – see below.) The annotation is updated as needed, but the X Reference Value and X Width keys are grayed out and not updated. When this function is set to Man, the X Reference Value and X Width softkey readbacks are updated with the current values.

Key Path	SPAN X Scale
Mode	VSA, LTE, LTETDD, IDEN, LTEAFDD, LTEATDD
Measurement	<meas>:=VECTor ADEMod DDEMod W11A W11B EVM IPOWER IDEMod MOTotalk
Remote Command	:DISPlay:<meas>:TRACe[1] 2 ... 4:X[:SCALE]:COUPle OFF ON 0 1 :DISPlay:<meas>:TRACe[1] 2 ... 4:X[:SCALE]:COUPle?
Example	:DISP:VECT:TRAC1:X:COUP ON DISP:VECT:TRAC1:X:COUP?
Couplings	Forced to Man if X Reference Value or X Width is set by user.
Preset	1
State Saved	Saved in instrument state.
Range	Auto Man
Initial S/W Revision	Prior to A.02.00
Modified at S/W Revision	A.02.00

X Reference Value

Controls the X value of the selected trace at the chosen X Reference Position (see below). It has no effect on hardware input settings.

Key Path	SPAN X Scale
Mode	VSA, LTE, LTETDD, IDEN, LTEAFDD,LTEATDD
Measurement	<meas>:=VECTor ADEMod DDEMod W11A W11B EVM IPOWER IDEMod MOTotalk
Remote Command	:DISPlay:<meas>:TRACe [1] 2 ... 4:X[:SCALE]:RLEVel <real> :DISPlay:<meas>:TRACe [1] 2 ... 4:X[:SCALE]:RLEVel?
Example	DISP:VECT:TRAC:X:RLEV 1e9 DISP:VECT:TRAC:X:RLEV?
Couplings	If X Scale is set to Auto, the X Reference Value is determined by the trace data and this key is grayed out.
Preset	Depends on trace
State Saved	Saved in instrument state.
Min	-9.9E+37
Max	9.9E+37
Initial S/W Revision	Prior to A.02.00
Modified at S/W Revision	A.02.00

X Width

Sets the width of the X axis that is displayed for the selected trace. The X width can be set less than the Span for frequency-domain traces, enabling you to zoom in on just a portion of the measured values. Likewise, it can be less than time span covered by time-domain data. This plus the X Reference Value and X Reference Position control the range of X values that can be displayed on a trace. For example, if the X Reference position is Center, the X Reference value is 1 GHz and the X Width is 20 MHz.

Key Path	SPAN X Scale
Mode	VSA, LTE, LTETDD, IDEN, LTEAFDD,LTEATDD
Measurement	<meas>:=VECTor ADEMod DDEMod W11A W11B EVM IPOWER IDEMod MOTotalk
Remote Command	:DISPlay:<meas>:TRACe [1] 2 ... 4:X[:SCALE]:SPAN <real> :DISPlay:<meas>:TRACe [1] 2 ... 4:X[:SCALE]:SPAN?
Example	DISP:VECT:TRAC:X:SPAN 10e6 DISP:VECT:TRAC:X:SPAN?
Couplings	If X Scale is set to Auto, the X Width is determined by the trace data and this key is grayed out.
Preset	Depends on trace
State Saved	Saved in instrument state.
Min	-9.9E+37

Max	9.9E+37
Initial S/W Revision	Prior to A.02.00
Modified at S/W Revision	A.02.00

X Reference Position

Determines the position from which the X scaling is calculated for the selected trace. It can be set to the left side, center, or right side of the grid.

Key Path	SPAN X Scale
Mode	VSA, LTE, LTETDD, IDEN, LTEAFDD, LTEATDD
Measurement	<meas>:=VECTor ADEMod DDEMod W11A W11B EVM IPOWER IDEMod MOTotalk
Remote Command	:DISPlay:<meas>:TRACe[1] 2 ... 4:X[:SCALE]:RPOSition LEFT CENTER RIGHT :DISPlay:<meas>:TRACe[1] 2 ... 4:X[:SCALE]:RPOSition?
Example	DISP:VECT:TRAC1:X:RPOS LEFT DISP:VECT:TRAC1:X:RPOS?
Couplings	If X Scale is set to Auto, the X Reference Position is determined by the trace data and this key is grayed out.
Preset	CENT
State Saved	Saved in instrument state.
Range	Left Ctr Right
Initial S/W Revision	Prior to A.02.00
Modified at S/W Revision	A.02.00

Freq Annotation

Controls how Spectrum and PSD traces are annotated when their X Scale is set to Auto. If Freq Annotation is set to Center/Span, the X-axes on windows containing frequency domain traces are labeled with the center frequency on the left and the span on the right. If the Freq Annotation is set to Start/Stop, then the start and stop frequencies appear in place of center and span. If the X Scale is manual, then this annotation style does not apply.

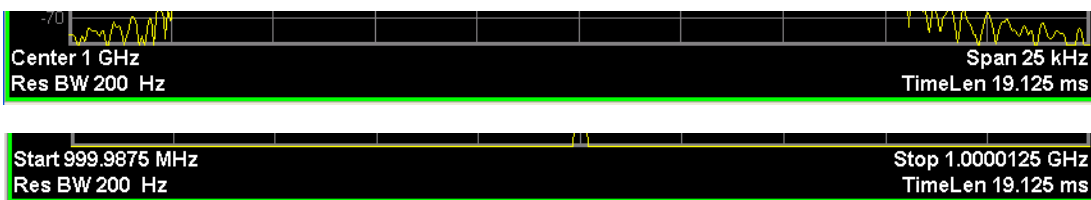

Key Path	SPAN X Scale
----------	--------------

Mode	VSA, LTE, LTETDD, IDEN, LTEAFDD,LTEATDD
Measurement	<meas>:=VECTor ADEMod DDEMod W11A W11B EVM IPOWer IDEMod MOTotalk
Remote Command	:DISPlay:<meas>:FANNotation CSPan SSTop :DISPlay:<meas>:FANNotation?
Example	DISP:VECT:FANN CSP DISP:VECT:FANN?
Preset	CSP
State Saved	Saved in instrument state.
Range	Center/Span Start/Stop
Initial S/W Revision	Prior to A.02.00
Modified at S/W Revision	A.02.00

All Frequency Points

Spectrum trace data (and PSD) are based on the FFT algorithm. By default, the outer edges of the spectrum are not displayed because they can show spurious results that are aliases of real signals that are not completely filtered out by the IF filter. For example, in the case of a 1024 point FFT only 801 points are displayed. If you want to view the additional FFT points at the edges of spectral displays, turn this function on. It is global to all traces, not specific to a single trace.

Key Path	SPAN X Scale
Mode	VSA, LTE, LTETDD, IDEN, LTEAFDD,LTEATDD
Measurement	<meas>:=VECTor ADEMod DDEMod W11A W11B EVM IPOWer IDEMod MOTotalk
Remote Command	:DISPlay:<meas>:AFPpoints OFF ON 0 1 :DISPlay:<meas>:AFPpoints?
Example	DISP:VECT:AFP ON DISP:VECT:AFP?
Notes	ac
Couplings	Only applies if trace is showing Spectrum or PSD results.
Preset	OFF
State Saved	Saved in instrument state.
Range	On Off
Initial S/W Revision	Prior to A.02.00
Modified at S/W Revision	A.02.00

Copy X Scale

Copies the following X scaling information from the selected trace to another:

- X reference Position

- X Reference Value
- X Width
- X Scale (Auto/Man)

This is a front-panel only function.

Key Path	SPAN X Scale, X Axis Scaling
Mode	VSA, LTE, LTETDD, IDEN, LTEAFDD,LTEATDD
Initial S/W Revision	Prior to A.02.00
Modified at S/W Revision	A.02.00

Sweep / Control

There is no BW functionality in this measurement. When pressed, blank menu appears.

Key Path	Front Panel
Mode	LTEAFDD, LTEATDD
Initial S/W Revision	A.14.00

System

See "System" on page 272

Trace/Detector

Accesses a menu enabling you to select various trace parameters for all VSA based measurements.

Key Path	Front Panel
Mode	VSA, LTE, LTETDD, IDEN, LTEAFDD, LTEATDD
Initial S/W Revision	Prior to A.02.00
Modified at S/W Revision	A.02.00

Select Trace

Displays a menu that enables you to select the trace that is to receive the action of all successive trace-specific commands like scaling, assignment of trace data, and so on. The selected trace is outlined in green and is always visible. While the Select Trace menu is showing, each visible trace is annotated in the middle with its own trace number, as shown in the following figure. The trace number annotations disappear when any other menu is showing.

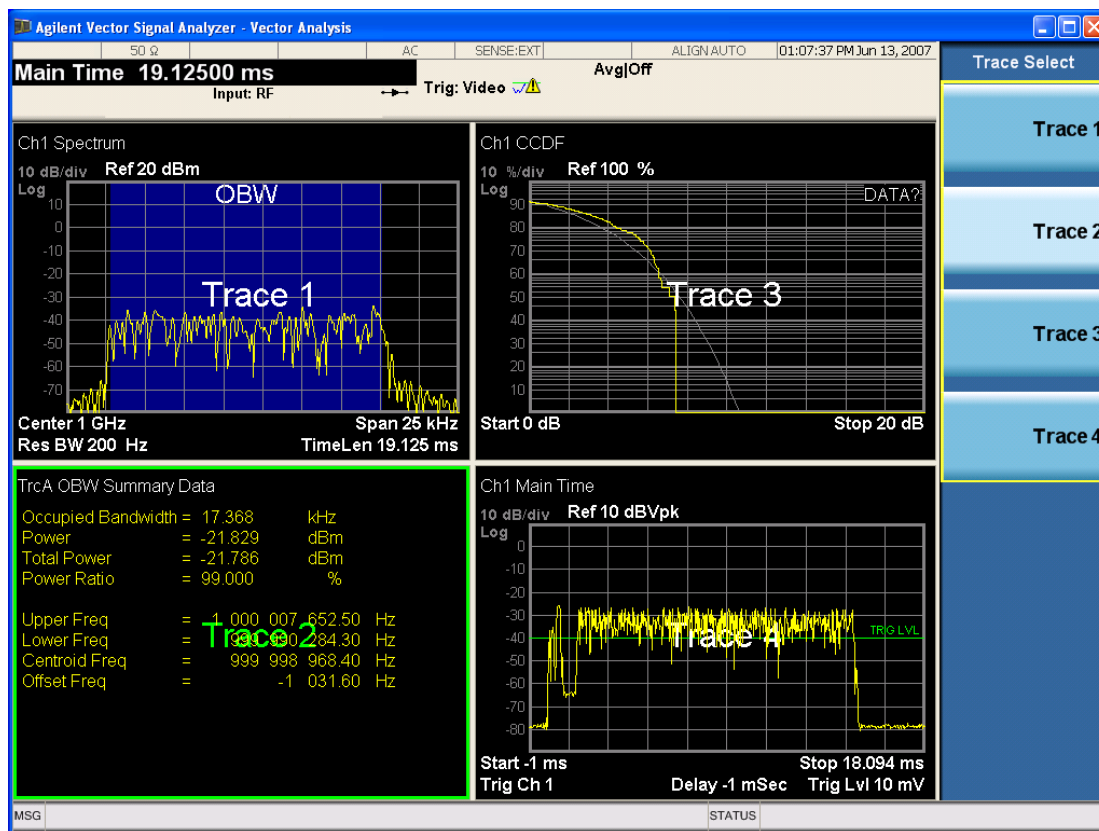

Grid 2x2 layout showing trace annotations when Trace Select dialog is active

This softkey also appears in the X and Y scaling menus. There is only one selected trace at any time. If you change which trace is selected, that change is reflected in this softkey/menu wherever it appears. Other

ways to select a trace include use of the Next Window key, clicking within a trace window with a mouse cursor, and issuing a trace-specific SCPI command.

There is no SCPI command associated with this function. Instead, SCPI commands that are trace-specific have an index on the TRACe node that determines the selected trace. Using such a command has the side effect that the trace addressed by the SCPI command becomes the selected trace for any front panel interaction.

Key Path	Trace/Detector or Span X Scale or AMPTD Y Scale
Mode	VSA, LTE, LTETDD, IDEN,LTEAFDD,LTEATDD
Notes	No SCPI. Front panel only.
Couplings	Affects any trace-specific commands
Range	Trace 1 Trace 2 Trace 3 Trace 4 Trace 5 Trace 6
Readback Text	Trace <n>
Initial S/W Revision	Prior to A.02.00
Modified at S/W Revision	A.02.00

CC For Selected Trace

This parameter specifies which component carrier measurement results are displayed in the selected Trace. This parameter decides which Component Carrier is the target CC when one specific Trace is selected under Data menu.

Key Path	Trace/Detector
Mode	LTEAFDD, LTEATDD
Remote Command	:DISPlay:EVM:TRACe1 2 3 4 5 6:SElected CC0 CC1 CC2 CC3 CC4 :DISPlay:EVM:TRACe1 2 3 4 5 6:SElected?
Example	:DISP:EVM:TRAC1:SEL CC0 :DISP:EVM:TRAC1:SEL?
Dependencies	CC For Selected Trace is not coupled to Number of Component Carriers. For example, Select CC list will include CC0~CC4 even if the number Component Carriers is 2, if the selected CC is not available, the “No Data” indicator will be shown in the upper right corner of the trace.
Preset	CC0
State Saved	Saved in instrument state
Range	CC0 CC1 CC2 CC3 CC4
Readback	CC0 CC1 CC2 CC3 CC4
Initial S/W Revision	A.14.50

Component Carrier

This parameter specifies which component carrier’s configuration menu is displayed. This parameter decides which Component Carrier is the target CC when one parameter is changed through front panel.

For example, when CC0 is selected, Sync Type is changed to PSS from front panel, and then measurement will know the Sync Type for CC0 is PSS, which is equivalent to send following SCPI command:

EVM:CCAR0:DLINK:SYNC:TYPE PSS

This parameter also identifies the trace views of which component carrier are to preset and displayed on the screen. For example, when number of Component Carrier is 2, if you select CC1, then after you press Preset View Basic key, then following 4 traces are displayed for CC1.

- IQ Meas
- Spectrum
- Error Vector Spectrum
- Error Summary

Key Path	Meas Setup View/Display
Mode	LTEAFDD, LTEATDD
Remote Command	[:SENSe] :EVM:SElected CC0 CC1 CC2 CC3 CC4 [:SENSe] :EVM:SElected?
Example	EVM:SEL CC0 EVM:SEL?
Notes	In order to clearly identify it, it is called “Component Carrier” under Meas Setup and “CC For Preset View” under View/Display. The options CC1~CC4 can be enabled with 9080B/9082B-2FP license.
Dependencies	Component Carrier is coupled to Number of Component Carriers. For example, Component Carrier list will include CC0~CC1 if the number Component Carriers is 2.
Preset	CC0
State Saved	Saved in instrument state
Range	CC0 CC1 CC2 CC3 CC4
Readback	CC0 CC1 CC2 CC3 CC4
Initial S/W Revision	A.14.00
Modified at S/W Revision	A.14.50

Data

Displays a menu of Trace data choices for the selected trace.

The following table shows available trace data types. The SCPI command “:DISPlay:EVM:TRACe[1] [2]3|4:FEED <string>” can be used to configure the trace data. For example, the following command sets the first trace to Spectrum.

:DISP:EVM:TRAC1:FEED “Spectrum1”

Pre Demod

Spectrum	"CC0 Spectrum1 "	
Inst Spectrum	"CC0 st Spectrum1 "	
Search Time	"CC0 Search Time1 "	
Time	"CC0 Time1 "	
Raw Main Time	"CC0 Raw Main Time1 "	
Demod	<Uplink>	<Downlink>
IQ Meas	"Demod CC0 IQ Meas1 "	"Layer CC0 IQ Meas1 "
IQ Ref	"Demod CC0 IQ Ref1 "	"Layer CC0 IQ Ref1 "
IQ Meas Time	"Demod CC0 IQ Meas Time1 "	"Layer CC0 IQ Meas Time1 "
IQ Ref Time	"Demod CC0 IQ Ref Time1 "	"Layer CC0 IQ Ref Time1 "
IQ Freq Meas	"Demod CC0 IQ Freq Meas1 "	"Layer CC0 IQ Freq Meas1 "
IQ Freq Ref	"Demod CC0 IQ Freq Ref1 "	"Layer CC0 IQ Freq Ref1 "
Detected Allocations	"Demod CC0 Detected Allocations Time1 "	"Layer CC0 Detected Allocations Time1 "
Antenna Beam Pattern	N/A	"Demod CC0 Antenna Beam Pattern 1 "
Demod Error	<Uplink>	<Downlink>
Error Vector Time	"Demod CC0 Error Vector Time1 "	"Layer CC0 Error Vector Time1 "
RMS Error Vector Time	"Demod CC0 RMS Error Vector Time1 "	"Layer CC0 RMS Error Vector Time1 "
Error Vector Spectrum	"Demod CC0 Error Vector Spectrum1 "	"Layer CC0 Error Vector Spectrum1 "
RMS Error Vector Spectrum	"Demod CC0 RMS Error Vector Spectrum1 "	"Layer CC0 RMS Error Vector Spectrum "
Common Tracking Error	"Demod CC0 Common Tracking Error1 "	
RB Error Mag Spectrum	"Demod CC0 RB Error Mag Spectrum1 "	"Layer RB Error Mag Spectrum1 "
RB Error Mag Time	"Demod CC0 RB Error Mag Time1 "	"Layer CC0 RB Error Mag Time1 "
RB Power Spectrum	"Demod CC0 RB Power Spectrum1 "	"Layer CC0 RB Power Spectrum1 "
RB Power Time	"Demod CC0 RB Power Time1 "	"Layer CC0 RB Power Time1 "
Freq Err Per Slot	"Demod CC0 Freq Err Per Slot1 "	
IQ Offset Per Slot	"Demod CC0 IQ Offset Per Slot1 "	
In-band Emissions.	"Demod CC0 In-band Emissions1 "	
Tables		
Error Summary	"Demod CC0 Error Summary1 "	
Frame Summary	"Demod CC0 Frame Summary1 "	
Symbols (Uplink)	"Demod CC0 Symbol Table1 "	
Symbols (Downlink)	"Layer CC0 Symbol Table1 "	
Decoded Symbol Table (Uplink)	"Demod CC0 Decoded Symbol Table1 "	
Decoded Symbol Table (Downlink)	"Demod CC0 CW0 Decoded Symbol Table1 "	
DL Decode Info	"Demod CC0 DL Decode Info1 "	
UL Decode Info	"Demod CC0 UL Decode Info1 "	
UE-RS Weights	"Demod CC0 UE-specific RS Weights1 "	

Response	
Eq Ch Freq Resp	"Demod CCO Eq Chan Freq Resp1 "
Inst Eq Ch Freq Resp	"Demod CCO Inst Eq Chan Freq Resp1 "
Eq Ch Freq Resp Diff	"Demod CCO Eq Chan Freq Resp Diff1 "
Inst Eq Ch Freq Resp Diff	"Demod CCO Inst Eq Chan Freq Resp Diff1 "
Eq Impulse Response	"Demod CCO Eq Impulse Response1 "
Eq Ch Freq Resp Per Slot	"Demod CCO Per Slot Eq Chan Freq Resp1 "
MIMO	
Info Table	"MIMO CCO Info Table1 "
Ch Freq Resp	"MIMO CCO Eq Chan Freq Resp1 "
Ch Freq Resp Diff	"MIMO CCO Eq Chan Freq Resp Diff1 "
Eq Impulse Resp	"MIMO CCO Eq Impulse Response1 "
Common Track Error	"MIMO CCO Common Tracking Error1 "

For further details, see [Trace/Detector, Data](#) and ["Remote SCPI Commands and Data Queries"](#) on page 2587 in the section "Common Measurement Functions 2."

Key Path	Trace/Detector
Mode	LTEAFDD, LTEATDD
Initial S/W Revision	A.14.00

Pre Demod

Displays the Trace Data choices that show pre-demodulation results. See ["Data"](#) on page 2274 for the corresponding SCPI command.

Key Path	Trace/Detector, Data
Mode	LTEAFDD, LTEATDD
Initial S/W Revision	A.14.00

Spectrum

Averaged FFT of the Time waveform for selected Component Carrier. See ["Data"](#) on page 2274 for the corresponding SCPI command.

Key Path	Trace/Detector, Data, Pre Demod
Mode	LTEAFDD, LTEATDD
Initial S/W Revision	A.14.00

Inst Spectrum

FFT of the time waveform for selected Component Carrier. “Inst” or Instantaneous refers to this result not being averaged like the Trace Data result. See ["Data" on page 2274](#) for the corresponding SCPI command.

Key Path	Trace/Detector, Data, Pre Demod
Mode	LTEAFDD, LTEATDD
Initial S/W Revision	A.14.00

Search Time

Search Length long time record acquired for the current measurement. See ["Data" on page 2274](#) for the corresponding SCPI command.

Key Path	Trace/Detector, Data, Pre Demod
Mode	LTEAFDD, LTEATDD
Initial S/W Revision	A.14.00

Time

Time data corresponding to the measurement interval used to compute demod results. See ["Data" on page 2274](#) for the corresponding SCPI command.

Key Path	Trace/Detector, Data, Pre Demod
Mode	LTEAFDD, LTEATDD
Initial S/W Revision	Prior to A.02.00

Raw Main Time

Raw time record acquired for the selected Component Carrier. This data is unprocessed and includes additional points acquired for settling of the filters involved in subsequent processing, such as the demodulation filtering. See ["Data" on page 2274](#) for the corresponding SCPI command.

Key Path	Trace/Detector, Data, Pre Demod
Mode	LTEAFDD, LTEATDD
Initial S/W Revision	A.14.00

Demod

Displays the Trace Data choices which show general demodulation results.

Key Path	Trace/Detector, Data
Mode	LTEAFDD, LTEATDD
Initial S/W Revision	A.14.00

IQ Meas

IQ Meas is the measured IQ symbol values of the subcarriers. There is one complex value for each subcarrier for each symbol in the burst.

Normally this trace data is displayed as a constellation. The constellation display shows both data and pilot subcarriers, the pilots and data values are shown in different colors.

See "[Data](#)" on page 2274 for the corresponding SCPI command.

Key Path	Trace/Detector, Data, Demod
Mode	LTEAFDD, LTEATDD
Initial S/W Revision	A.14.00

IQ Ref

IQ Ref is the reference (ideal) IQ values of the subcarriers. There is one complex value for each subcarrier for each symbol in the burst.

Normally this trace data is displayed as a constellation. The constellation shows both data and pilot subcarrier symbols, the pilots and data values are shown in different colors.

See "[Data](#)" on page 2274 for the corresponding SCPI command.

Key Path	Trace/Detector, Data, Demod
Mode	LTEAFDD, LTEATDD
Initial S/W Revision	A.14.00

IQ Meas Time

IQ Meas and IQ Ref traces show signal levels as a function of subcarriers or samples/subcarriers. Signals levels on different OFDM symbols are shown as different points on the same vertical line corresponding to a subcarrier or subcarrier/sample. There is also value in showing these traces as a function of symbols on the X-axis. For each symbol, different subcarriers or samples will be shown as different points on the same vertical line.

See "[Data](#)" on page 2274 for the corresponding SCPI command.

Key Path	Trace/Detector, Data, Demod
Mode	LTEAFDD, LTEATDD
Initial S/W Revision	A.14.00

IQ Ref Time

IQ Ref Time is similar to IQ Meas Time, except that the points plotted are the expected signal levels instead of the measured ones. See ["Data" on page 2274](#) for the corresponding SCPI command.

Key Path	Trace/Detector, Data, Demod
Mode	LTEAFDD, LTEATDD
Initial S/W Revision	A.14.00

IQ Freq Meas

IQ Freq Meas displays the measured IQ values (measured at the output of the FFT) of the subcarriers for each OFDM symbol point. This trace is identical to IQ Meas in downlink mode since IQ Meas also displays measured IQ values at the output of FFT. In uplink mode, while IQ Meas displays PUSCH values after despreading (IFFT), IQ Freq Meas continues to display PUSCH IQ values at the output of the FFT, which resembles a collection of random points concentrated around the origin. See ["Data" on page 2274](#) for the corresponding SCPI command.

NOTE

To view SC-FDMA (uplink PUSCH) signals in the time domain, use IQ Meas.

The data in IQ Freq Meas, which comes from the Time trace data as that data is passed through the demodulator, is a 2x2 matrix with frequency along one dimension and time along the other. In addition, each one of the points in the matrix is a complex value; therefore there are 4 total dimensions. The choice of trace format determines which two dimensions will be on the x-y plane, and which dimensions will be overlapped, averaged, or ignored. The relevant trace formats and their corresponding view of the data are described below.

Constellation, IQ - The I-Q plane is mapped to the x-y plane and each point contains both a subcarrier and a symbol-time reference. In other words, each point plotted on the complex plane came from a symbol transmitted on a specific subcarrier at a certain time.

LogMag, LinMag, Real, Imag, Wrapped Phase, Unwrapped Phase - Subcarriers are plotted along the x-axis. All the symbols that a subcarrier transmits have been plotted above the corresponding subcarrier tick on the x-axis, in the specified format (whether it be dB magnitude or the real value of the symbol point, etc.).

Key Path	Trace/Detector, Data, Demod
Mode	LTEAFDD, LTEATDD
Initial S/W Revision	A.14.00

IQ Freq Ref

IQ Freq Ref displays the reference (demodulated) IQ values of the subcarriers for each OFDM symbol point at the output of the FFT. This trace is identical to IQ Ref in downlink mode. In uplink mode, this trace always

displays OFDM reference IQ points (unlike IQ Ref, which displays reference PUSCH SC-FDMA IQ points after despreading (IFFT)). See ["Data" on page 2274](#) for the corresponding SCPI command.

NOTE To view SC-FDMA (uplink PUSCH) signals in the time domain, use IQ Meas.

Key Path	Trace/Detector, Data, Demod
Mode	LTEAFDD, LTEATDD
Initial S/W Revision	A.14.00

Detected Allocations

Detected Allocations displays the RB allocations detected by the measurement if “Auto Detect” is on, or the user-configured RB allocations if “Auto Detect” is off.

See ["Data" on page 2274](#) for the corresponding SCPI command.

Key Path	Trace/Detector, Data, Demod
Mode	LTEAFDD, LTEATDD
Initial S/W Revision	A.14.00

Demod Err (Error)

Displays the Trace Data Demod Error choices that show general demodulation results.

Key Path	Trace/Detector, Data
Mode	LTEAFDD, LTEATDD
Initial S/W Revision	A.14.00
Modified at S/W Revision	A.03.00

Error Vector Time

This trace shows each of the individual signal error vectors for each subcarrier and symbol vs. Time (symbol) and frequency (subcarrier). Each error vector is the vector difference, for that subcarrier at that symbol-time, between the corresponding IQ Meas value and the IQ Ref value.

On this trace, the individual error vectors are plotted vs Time (symbol). So at each valid symbol, there is a point plotted for each valid subcarrier (52 total, since subcarrier 0 is not used.) In addition, a white trace is drawn, where each point is the RMS average over the valid subcarriers, which is the same result as is plotted separately as RMS Error Vector Time.

See ["Data" on page 2274](#) for the corresponding SCPI command.

Key Path	Trace/Detector, Data, Demod Error
Mode	LTEAFDD, LTEATDD
Initial S/W Revision	A.14.00

RMS Error Vector Time

The difference between IQ Meas and IQ Ref is the error vector (which will have a complex value) at each subcarrier at each symbol-time. This trace is the RMS average of the error vector for each valid subcarrier at the plotted symbol, the same data shown as a white trace shown in Error Vector Time.

See ["Data" on page 2274](#) for the corresponding SCPI command.

Key Path	Trace/Detector, Data, Demod Error
Mode	LTEAFDD, LTEATDD
Initial S/W Revision	A.14.00

Error Vector Spectrum

This trace, like Error Vector Time shows each of the individual signal error vectors for each subcarrier and symbol vs. Time (symbol) and frequency (subcarrier). Each error vector is the vector difference, for that subcarrier at that symbol-time, between the corresponding IQ Meas value and the IQ Ref value.

On this trace, the individual error vectors are plotted vs frequency (subcarrier). So at each valid subcarrier, there is a point plotted for each valid symbol. Note that subcarrier 0 is not plotted since it is not used. In addition, a white trace is drawn, where each point is the RMS average over the valid symbols, which is the same result as is plotted separately as RMS Error Vector Spectrum.

See ["Data" on page 2274](#) for the corresponding SCPI command.

Key Path	Trace/Detector, Data, Demod Error
Mode	LTEAFDD, LTEATDD
Initial S/W Revision	A.14.00

RMS Error Vector Spectrum

This trace is the RMS average of the error vector for each valid symbol at the plotted subcarrier, the same data shown as a white trace shown in Error Vector Time. Note that subcarrier 0 is not plotted since it is not used.

See ["Data" on page 2274](#) for the corresponding SCPI command.

Key Path	Trace/Detector, Data, Demod Error
Mode	LTEAFDD, LTEATDD
Initial S/W Revision	A.14.00

Common Tracking Error

This trace shows the small scale deviations from the averaged channel response occurring from one symbol to another.

See ["Data" on page 2274](#) for the corresponding SCPI command.

Key Path	Trace/Detector, Data, Demod Error
Mode	LTEAFDD, LTEATDD
Initial S/W Revision	A.14.00

RB Error Mag Spectrum

This trace shows EVM (calculated as RMS average over one RB and one slot) and as functions of RBs on the X-axis and multiple slots for each RB. This is a frequency-domain trace coupled only to other frequency-domain traces (and not mixed-domain traces).

See ["Data" on page 2274](#) for the corresponding SCPI command.

Key Path	Trace/Detector, Data, Demod Error
Mode	LTEAFDD, LTEATDD
Initial S/W Revision	A.14.00

RB Error Mag Time

This trace shows EVM (calculated as RMS average over one RB and one slot) and as functions of RBs on the X-axis and multiple slots for each RB. This is a frequency-domain trace coupled only to other frequency-domain traces (and not mixed-domain traces).

See ["Data" on page 2274](#) for the corresponding SCPI command.

Key Path	Trace/Detector, Data, Demod Error, More
Mode	LTEAFDD, LTEATDD
Initial S/W Revision	A.14.00

RB Power Spectrum

This trace shows power levels (calculated as RMS average over one RB and one slot) as functions of RBs on the X-axis and multiple slots for each RB. This is a frequency-domain trace coupled only to other frequency-domain traces (and not mixed-domain traces).

See ["Data" on page 2274](#) for the corresponding SCPI command.

Key Path	Trace/Detector, Data, Demod Error, More
Mode	LTEAFDD, LTEATDD
Initial S/W Revision	A.14.00

RB Power vs Time

This trace shows power levels (calculated as RMS average over one RB and one slot) as functions of slots on the X-axis and multiple RBs for each slot. This is a frequency-domain trace coupled only to other frequency-domain traces (and not mixed-domain traces).

See ["Data" on page 2274](#) for the corresponding SCPI command.

Key Path	Trace/Detector, Data, Demod Error, More
Mode	LTEAFDD, LTEATDD
Initial S/W Revision	A.14.00

Freq Err Per Slot

This trace displays the average frequency error for each slot. The frequency error is expressed as an offset in Hz from the current center frequency setting.

See ["Data" on page 2274](#) for the corresponding SCPI command.

Key Path	Trace/Detector, Data, Demod Error, More
Mode	LTEAFDD, LTEATDD
Initial S/W Revision	A.14.00

IQ Offset Per Slot

IQ Offset Per Slot displays the average IQ Offset for each slot in the Measurement Interval. This trace is only available for uplink signals.

See ["Data" on page 2274](#) for the corresponding SCPI command.

Key Path	Trace/Detector, Data, Demod Error, More
Mode	LTEAFDD, LTEATDD
Initial S/W Revision	A.14.00

In-band Emissions

Shows the resource block power spectrum for the data specified by Measurement Interval and Measurement Offset.

This trace is identical to RB Power Spectrum except for two differences. The first difference is that In-band Emissions always includes Non-alloc signals, regardless of the Non-Alloc parameter selection. The second difference is that the RB Power levels are normalized such that the average active RB power is 0 dB.

See ["Data" on page 2274](#) for the corresponding SCPI command.

See Section 6.5.2.3 of 3GPP TS 36.521–1 for more information about in-band emissions measurements.
This trace is available only when Direction is Uplink.

Key Path	Trace/Detector, Data, Demod Error,
Mode	LTEAFDD, LTEATDD
Initial S/W Revision	A.14.00

Tables

Displays the Trace Data choices that are in tabular form, including demodulated symbols tables.

Key Path	Trace/Detector, Data
Mode	LTEAFDD, LTEATDD
Initial S/W Revision	A.14.00

Error Summary

The Error Summary table shows some metrics calculated from signal demod. The metrics are subject to averaging, unless indicated otherwise. See ["Data" on page 2274](#) for the corresponding SCPI command.

A scrollbar will appear when the contents are too long to be displayed in the window. You can scroll the window without a mouse with the following steps.

8. Press NextWindow key to select the window you want to scroll.
9. Press Esc key to turn off the active function
10. Then, press one of Arrow keys.

The following metrics are shown:

- EVM
- EVM Symbol TimeAdjust
- Peak EVM
- Peak EVM location symbol number
- Peak EVM subcarrier number
- Data EVM
- 3GPP-defined QPSK EVM (%rms)
- 3GPP-defined 16QAM EVM (%rms)
- 3GPP-defined 64QAM EVM (%rms)
- RS EVM
- RS Tx. Power (avg)

- OFDM Sym. Tx. Power
- Reference Signal Rx Power (Avg). Downlink only.
- Received Signal Strength Indicator
- Reference Signal Rx Quality. Downlink only.
- Freq Err
- Sync Corr
- Sync Type
- Common Tracking Error
- Sym Clk Err
- Time Offset (not averaged)
- IQ Offset
- IQ Gain Imb
- IQ Quad Err
- IQ Time Skew
- CP Length (not averaged)
- RS-OS/PRS (not averaged) (downlink only)
- Cell ID (not averaged) (downlink only)
- Cell ID Group/Sector (not averaged) (downlink only)
- Channel Power
- In-band Emissions Result (uplink only)
- In-band Emissions Worst Margin (uplink only)
- In-band Emissions Worst Slot (uplink only)
- In-band Emissions Worst RB (uplink only)
- Spectral Flatness Result (uplink only)
- Spectral Flatness Worst Margin (uplink only)
- Spectral Flatness Worst Slot (uplink only)
- Spectral Flatness Worst Subcarrier (uplink only)

Result name	Displayed Unit	Remote Name	Remote Unit
EVM	%rms*	EVM	%rms
EVM Symbol Timing Adjust	none	EVMSymTimeAdj	none

EVM Pk	%	EVMPeak	%
Peak EVM location symbol number	sym	EVMPeakIdx	sym
Peak EVM subcarrier number	subcar	EVMPeakSubcarIdx	subcar
Data EVM	%rms*	DataEVM	%rms
3GPP-defined QPSK EVM	%rms*	3GPPEVMQPSK	%rms
3GPP-defined 16QAM EVM	%rms*	3GPPEVM16QAM	%rms
3GPP-defined 64QAM EVM	%rms*	3GPPEVM64QAM	%rms
RS EVM	%rms*	RSEVM	%rms
RS Tx. Power (avg)	dBm/subcar	RSTP	dBm
OFDM Sym. Tx. Power	dBm	OSTP	dBm
Reference Signal Rx Power (Avg)	dBm	RSRP	dBm
Received Signal Strength Indicator	dBm	RSSI	dBm
Reference Signal Rx Quality	dB	RSRQ	dB
Frequency Error	Hz	FreqErr	Hz
Sync Corr	%	SyncCorr	%
Sync Type	None	SyncType	none
Common Tracking Error	%rms	CTE	%rms
Symbol Clock Err	ppm	SymClkErr	ppm
Time Offset	s	TimeOffset	sec
IQ Offset	dB	IQOffset	dB
IQ Gain Imbalance	dB	IQGainImb	dB
IQ Quadrature Error	deg	IQQuadErr	deg
IQ Timing Skew	s	IQTimingSkew	sec
CP Length Mode	None	CpLengthMode	None
Cell ID	None	CellId	None
Cell ID Group/Sector	None	CellIdGroupSector	None
RS PRS	None	RSPRS	None
Channel Power	dBm	ChannelPower	dBm
In-band Emissions Result	None	InbandEmissionsResult	None
In-band Emissions worst Margin	dB	InbandEmissionsMargin	dB
In-band Emissions worst Slot	None	InbandEmissionsMarginLocationSlot	None
In-band Emissions worst RB	None	InbandEmissionsMarginLocationWorstRB	None
Spectral Flatness Result	None	SpectralFlatnessResult	None
Spectral Flatness worst Margin	dB	SpectralFlatnessMargin	dB
Spectral Flatness worst Slot	None	SpectralFlatnessMarginLocationSlot	None
Spectral Flatness worst Subcarrier	None	SpectralFlatnessMarginLocationSC	None

* displayed in dB when Report EVM in dB parameter is On

The error summary values can be obtained using the CALC:EVM:DATA:TABL commands.

See also [":CALCulate:DATA" on page 2591](#) for more details.

Key Path	Trace/Detector, Data, CCO, Tables
Mode	LTEAFDD, LTEATDD
Initial S/W Revision	A.14.00

Frame Summary

This table shows certain characteristics of each of the logical channels. The list of channels shown is different for Downlink and Uplink. If auto-detection is selected, the list contains only PDSCH1-3, corresponding to the three modulation formats. If a channel is not found in the measurement interval under consideration, it is marked with a '...'. Each of the channels shown have the same color coding as used in the IQ demod traces.

See ["Data" on page 2274](#) for the corresponding SCPI command.

A scrollbar will appear when the contents are too long to be displayed in the window. You can scroll the window without a mouse with the following steps.

11. Press NextWindow key to select the window you want to scroll.
12. Press Esc key to turn off the active function
13. Then, press one of Arrow keys.

The following are the characteristics that are shown in the Frame Summary Table:

- Channel Name
- Error Vector Magnitude
- Relative Power Level
- Modulation Format
- Number of RBs occupied

When the link direction is downlink, the following channels are shown in the Frame Summary:

- P-SS
- S-SS
- PBCH
- PCFICH
- PHICH
- PDCCH

- RS
- P-RS
- MBSFN-RS
- PMCH
- PDSCH1 to PDSCHn
- Non-Alloc

Result name	Displayed Unit	Remote Name	Remote Unit
PSS EVM	%rms	PSSEVM	%rms
PSS Power	dB	PSSPower	dB
PSS Mod Format	none	PSSModFmt	none
PSS Num Rb	none	PSSNumRb	none
SSS EVM	%rms	SSSEVM	%rms
SSS Power	dB	SSSPower	dB
SSS Mod Format	none	SSSModFmt	none
SSS Num Rb	none	SSSNumRb	none
PBCH EVM	%rms	PBCH EVM	%rms
PBCH Power	dB	PBCHPower	dB
PBCH Mod Format	none	PBCHModFmt	none
PBCH Num Rb	none	PBCHNumRb	none
PCFICH EVM	%rms	PCFICHEVM	%rms
PCFICH Power	dB	PCFICHPower	dB
PCFICH Mod Format	none	PCFICHModFmt	none
PCFICH Num Rb	none	PCFICHNumRb	none
PHICH EVM	%rms	PHICHEVM	%rms
PHICH Power	dB	PHICHPower	dB
PHICH Mod Format	none	PHICHModFmt	none
PHICH Num Rb	none	PHICHNumRb	none
PDCCH EVM	%rms	PDCCHEVM	%rms
PDCCH Power	dB	PDCCHPower	dB
PDCCH Mod Format	none	PDCCHModFmt	none
PDCCH Num Rb	none	PDCCHNumRb	none
RS EVM	%rms	RSEVM	%rms
RS Power	dB	RSPower	dB
RS Mod Format	none	RSMoFmt	none
RS Num Rb	none	RSNumRb	none
P-RS EVM	%rms	PRSEVM	%rms

P-RS Power	dB	PRSPower	dB
P-RS Mod Format	none	PRSMoFmt	none
P-RS Num Rb	none	PRSNuRb	none
MBSFN-RS EVM	%rms	MBSFNREVM	%rms
MBSFN -RS Power	dB	MBSFNRSPower	dB
MBSFN -RS Mod Format	none	MBSFNRSMoFmt	none
MBSFN -RS Num Rb	none	MBSFNRSNuRb	none
PMCH EVM	%rms	PMCHEVM	%rms
PMCH Power	dB	PMCHPower	dB
PMCH Mod Format	none	PMCHMoFmt	none
PMCH Num Rb	none	PMCHNuRb	none
PDSCHn EVM	%rms	PDSCHnEVM	%rms
PDSCHn Power	dB	PDSCHnPower	dB
PDSCHn Mod Format	none	PDSCHnMoFmt	none
PDSCHn Num Rb	none	PDSCHnNuRb	none
Inactive EVM	%rms	InactiveEVM	%rms
Inactive Power	dB	InactivePower	dB
Inactive Mod Format	none	InactiveMoFmt	none
Inactive Num Rb	none	InactiveNuRb	none

When the link direction is uplink, the following are the channels that are shown in the Frame Summary:

- PUSCH DM-RS
- PUCCH
- PUSCH1 to PUSCHn
- PRACH
- S-RS
- Non-Alloc

Result name	Displayed Unit	Remote Name	Remote Unit
DMRS EVM	%rms	DMRSEVM	%rms
DMRS Power	dB	DMRSPower	dB
DMRS Mod Format	none	DMRSMoFmt	none
DMRS Num Rb	none	DMRSNuRb	none
PUCCH EVM	%rms	PUCCH EVM	%rms
PUCCH Power	dB	PUCCH Power	dB

PUCCH Mod Format	none	PUCCH ModFmt	none
PUCCH Num Rb	none	PUCCH NumRb	none
PUSCHn EVM	%rms	PUSCHn EVM	%rms
PUSCHn Power	dB	PUSCHn Power	dB
PUSCHn Mod Format	none	PUSCHn ModFmt	none
PUSCHn Num Rb	none	PUSCHn NumRb	none
PRACH EVM	%rms	PRACHEVM	%rms
PRACH Power	dB	PRACHPower	dB
PRACH Mod Format	none	PRACHModFmt	none
PRACH Num Rb	none	PRACHNumRb	none
SRS EVM	%rms	SRSEVM	%rms
SRS Power	dB	SRSPower	dB
SRS Mod Format	none	SRSModFmt	none
SRS Num Rb	none	SRSNumRb	none
Inactive EVM	%rms	InactiveEVM	%rms
Inactive Power	dB	InactivePower	dB
Inactive Mod Format	none	InactiveModFmt	none
Inactive Num Rb	none	InactiveNumRb	none

These values are never averaged; they always show the results of the current measurement. These results are valid only for the current measurement interval.

Non-Alloc signals consist of unused subcarriers in all shared and control channels. This includes unallocated user data subcarriers, the DC subcarrier, certain RS subcarriers in multi-antenna mode, and unused P-SS and S-SS subcarriers.

Non-Alloc signals include the following:

- Unallocated user data subcarriers
- The unused DC subcarrier
- Unused P-SS and S-SS subcarriers: these signals are 6 RBs (72 subcarriers) wide in the frequency domain, but only the center 62 subcarriers are actually used, and the remaining 10 are set to zero.
- Subcarriers reserved for RS in a multiple antenna port signal. For example, in a four Tx Antenna signal, the transmission from antenna port 0 will not transmit anything on the subcarriers that will be used for RS in the other three antenna port transmissions.

Manually defined and autodetected user allocations are always considered allocated whether or not they are enabled for display in **Composite Include** and are not included in Non-Alloc.

Non-alloc means only unallocated shared channel subcarriers (those that could be allocated for users but are not). The rest of the traces consider Non-alloc to be any unused subcarrier (whether in control or shared channels).

Any resource elements (subcarriers) contained by a user channel that is present in the Composite Include list are considered allocated, regardless of whether or not the user channel has been selected for analysis and display.

Non-Alloc signal's EVMs are normalized with respect to the signal's average power per subcarrier, since dividing by the reference vector's magnitude (0 in this case) will cause the result to be undefined.

Key Path	Trace/Detector, Data, Tables
Mode	LTEAFDD, LTEATDD
Initial S/W Revision	A.14.00

Cross-Carrier Summary

This table shows summary information about the Time Alignment Error (TAE) and Channel Power for each component carrier (CCx) relative to the selected Reference Component Carrier (Reference CC).

The TAE for the CCx is calculated by subtracting the Time Offset of the reference CC from the Time Offset of the CCx.

The relative Channel Power for the CCx is calculated by subtracting the Channel Power of the reference CC from the Channel Power of the CCx.

Key Path	Trace/Detector, Data, Tables
Mode	LTEAFDD, LTEATDD
Initial S/W Revision	A.14.50

Symbols

This table shows the demodulated symbols over the measurement interval. It displays one value per subcarrier for downlink and one value per sample/subcarrier for uplink. In uplink, this is a mixed-domain trace and coupled only to other mixed-domain traces (and not frequency domain traces).

See "[Data](#)" on page 2274 for the corresponding SCPI command.

A scrollbar will appear when the contents are too long to be displayed in the window. You can scroll the window without a mouse with the following steps.

14. Press NextWindow key to select the window you want to scroll.
15. Press Esc key to turn off the active function
16. Then, press one of Arrow keys.

Key Path	Trace/Detector, Data, CC0, Tables
Mode	LTEAFDD, LTEATDD
Initial S/W Revision	A.14.00

Decoded Symbol Table

When Direction is Downlink, this table shows the decoded values of the physical layer channels: PBCH, PDCCH, PCFICH, and PDSCH. The level of decoding is determined by each channel decoding selection (See "[Decode Type](#)" on page 2017 for details.)

When Direction is Uplink, this table shows descrambled PUSCH data when PUSCH Decoding is set to Descrambled. The default bit order for this trace is MSB-first.

See "[Data](#)" on page 2274 for the corresponding SCPI command.

A scrollbar will appear when the contents are too long to be displayed in the window. You can scroll the window without a mouse with the following steps.

17. Press NextWindow key to select the window you want to scroll.
18. Press Esc key to turn off the active function
19. Then, press one of Arrow keys.

Key Path	Trace/Detector, Data, Tables
Mode	LTEAFDD, LTEATDD
Initial S/W Revision	A.14.00

DL Decode Info

DL Decode Info contains the decoded information from PBCH, PDCCH, PCFICH and PDSCH.

The upper section shows the status of the PBCH, PDCCH, PCFICH, and PDSCH decoders (On or Off).

The lower part of the table shows the decoded information for each frame. The data is color coded to match the color of the corresponding channel in the Frame Summary trace.

See "[Data](#)" on page 2274 for the corresponding SCPI command.

A scrollbar will appear when the contents are too long to be displayed in the window. You can scroll the window without a mouse with the following steps.

20. Press NextWindow key to select the window you want to scroll.
21. Press Esc key to turn off the active function
22. Then, press one of Arrow keys.

Key Path	Trace/Detector, Data, Tables
Mode	LTEAFDD, LTEATDD
Initial S/W Revision	A.14.00

UL Decode Info

UL Decode Info contains the decoded information from PUCCH and PUSCH.

The upper section shows the status of the PUCCH and PUSCH decoders (On or Off).

The lower part of the table shows the decoded information for each frame.

See Data section for the corresponding SCPI command.

A scrollbar will appear when the contents are too long to be displayed in the window. You can scroll the window without a mouse with the following steps.

1. Press Next Window key to select the window you want to scroll.
2. Press Esc key to turn off the active function
3. Then, press one of Arrow keys.

Key Path	Trace/Detector, Data, Tables
Mode	LTEAFDD, LTEATDD
Initial S/W Revision	A.14.00

UE-RS Weights

This table shows the channel response for each subcarrier that is assigned to carry UE-specific reference signal.

See ["Data" on page 2274](#) for the corresponding SCPI command.

A scrollbar will appear when the contents are too long to be displayed in the window. You can scroll the window without a mouse with the following steps.

23. Press Next Window key to select the window you want to scroll.
24. Press Esc key to turn off the active function
25. Then, press one of Arrow keys.

Key Path	Trace/Detector, Data, Tables
Mode	LTETDD
Initial S/W Revision	A.14.00

Response

Displays the Trace Data choices that show equalizer response results.

Key Path	Trace/Detector, Data
Mode	LTEAFDD, LTEATDD
Initial S/W Revision	A.14.00

Eq Ch Frequency Response

This trace will show the frequency response of the channel derived from the equalizer coefficients, as a function of subcarriers. How the results are computed depends on the choice of Equalizer Training on the Advanced tab. Equalizer training off and that based on RS alone should yield the same trace, while that based on RS+Data should yield a different trace. This is a frequency domain trace coupled only to other frequency domain traces (and not mixed-domain traces).

See ["Data" on page 2274](#) for the corresponding SCPI command.

Key Path	Trace/Detector, Data, Response
Mode	LTEAFDD, LTEATDD
Initial S/W Revision	A.14.00

Inst Eq Ch Freq Resp

As Eq Ch Frequency Response, but this trace is not averaged.

See ["Data" on page 2274](#) for the corresponding SCPI command.

Key Path	Trace/Detector, Data, Response
Mode	LTEAFDD, LTEATDD
Initial S/W Revision	A.14.00

Eq Ch Freq Resp Diff

This is the adjacent difference of the channel frequency response. It shows the ratio of the magnitude of the channel response at adjacent subcarriers, expressed in dB so that an ideal response is flat at 0 dB. This trace is real valued. Because this is adjacent differences, the total number of points in the trace is one less than the number of subcarriers. This trace is averaged if averaging is turned on. This is a frequency domain trace coupled only to other frequency domain traces (and not mixed-domain traces).

See ["Data" on page 2274](#) for the corresponding SCPI command.

Key Path	Trace/Detector, Data, Response
Mode	LTEAFDD, LTEATDD
Initial S/W Revision	A.14.00

Inst Eq Ch Freq Resp Diff

As Eq Ch Resp Diff, but this trace is not averaged. See ["Data" on page 2274](#) for the corresponding SCPI command.

Key Path	Trace/Detector, Data, Response
Mode	LTEAFDD, LTEATDD
Initial S/W Revision	A.14.00

Eq Impulse Response

This shows the impulse response of the equalization filter. The equalizer impulse response is computed by taking the reciprocal of the channel equalizer frequency response, performing data filtering and computations that produce a result length of 4x the FFT length, and then converting to the time domain. The Eq Impulse Response is the computed channel impulse response used to compensate for signal channel response degradation.

See ["Data" on page 2274](#) for the corresponding SCPI command.

Key Path	Trace/Detector, Data, Response
Mode	LTEAFDD, LTEATDD
Initial S/W Revision	A.14.00

Eq Ch Freq Resp Per Slot

This shows the frequency response of the channel for each slot in the Measurement Interval.

Each slot's channel frequency response is plotted as a separate line with a different color. The colors have no correspondence to other traces or channels. The colors are only used to visually separate each slot's channel frequency response.

See ["Data" on page 2274](#) for the corresponding SCPI command.

NOTE

This trace can be used to measure Spectral Flatness as defined in Section 6.5.2.4 of 3GPP TS 36.521-1.

Key Path	Trace/Detector, Data, Response
Mode	LTEAFDD, LTEATDD
Initial S/W Revision	A.14.00

MIMO

Displays the Trace Data choices that show MIMO results.

Key Path	Trace/Detector, Data, More
Mode	LTEAFDD, LTEATDD
Initial S/W Revision	A.14.00

Info Table

The measurement automatically detects the presence of signals from all the antenna ports and measures certain metrics related to them only if the antenna port parameter ["Reference C-RS Port" on page 1980](#) is set to "auto". The results are reported in the form of the following table. The number of columns depends

on the number of transmit antennas selected. Antenna ports that have not contributed to the composite signal have their corresponding columns displayed simply as “---”.

See ["Data" on page 2274](#) for the corresponding SCPI command.

	Tx0/Rx0	Tx1/Rx0	Tx2/Rx0	Tx3/Rx0
RS Power				
RS EVM				
CPE				
Timing				
Phase				
Freq. Error				
Sym Clock Error				

Key Path	Trace/Detector, Data, MIMO
Mode	LTEAFDD, LTEATDD
Initial S/W Revision	A.14.00
Modified at S/W Revision	A.03.00

Ch Freq Resp

This trace shows the channel responses of the paths from all transmitter antenna ports that are auto-detected to exist in the signal. It comprises of up to 4 traces overlaid on top of each other, possibly with some color coding.

See ["Data" on page 2274](#) for the corresponding SCPI command.

Key Path	Trace/Detector, Data, MIMO
Mode	LTEAFDD, LTEATDD
Initial S/W Revision	A.14.00

Ch Freq Resp Diff

This trace shows the channel response differences of the paths from all transmitter antenna ports that are auto-detected to exist in the signal. It comprises of up to 4 traces overlaid on top of each other, possibly with some color coding.

See ["Data" on page 2274](#) for the corresponding SCPI command.

Key Path	Trace/Detector, Data, MIMO
Mode	LTEAFDD, LTEATDD
Initial S/W Revision	A.14.00

Eq Impulse Resp

This trace shows the Eq. impulse responses of the paths from all transmitter antenna ports that are auto-detected to exist in the signal. It comprises of up to 4 traces overlaid on top of each other, possibly with some color coding.

See ["Data" on page 2274](#) for the corresponding SCPI command.

Key Path	Trace/Detector, Data, MIMO
Mode	LTEAFDD, LTEATDD
Initial S/W Revision	A.14.00

MIMO Common Tracking Error

This trace shows the common pilot errors of the paths from all transmitter antenna ports that are auto-detected to exist in the signal. It comprises of up to 4 traces overlaid on top of each other, possibly with some color coding.

See ["Data" on page 2274](#) for the corresponding SCPI command.

Key Path	Trace/Detector, Data, MIMO
Mode	LTEAFDD, LTEATDD
Initial S/W Revision	A.14.00

No Data

Enables you to turn off trace computations. Measurement results are not computed unless assigned to a trace. No Data lets you increase measurement speed by turning off post-processing calculations that are not needed.

Key Path	Trace/Detector, Data
Mode	VSA, LTE, LTETDD, IDEN
Initial S/W Revision	Prior to A.02.00
Modified at S/W Revision	A.02.00

Format

Accesses a menu that enables you to choose the format of the selected trace. Any format can be assigned to any trace. For symbol tables and tabular data the format choice is ignored. If the data doesn't have defined symbol times, Constellation format is the same as I-Q, Eye formats are the same as Real or Imaginary, and Trellis format is the same as Unwrapped Phase.

The formats are:

Format name	Description
Log Mag (dB)	Data is converted to decibel units and shown on a linear Y axis
Linear Mag (Abs Value)	Magnitude of the data is shown on a linear Y axis
Real (I)	Real part of data is shown on a linear Y axis
Imaginary (Q)	Imaginary part of data is shown on linear Y axis
I-Q	Real part of data is shown on horizontal axis, imaginary part is shown on vertical axis, Independent variable (X axis) is normal to display
Constellation	Same as I-Q, but for data with symbols defined, only the symbol points are shown as dots with no connecting lines.
Wrap Phase	Phase of complex data, limited to ± 180 deg, is shown on Y axis
Unwrap Phase	Phase of complex data is shown "unwrapped", that is, without discontinuities. Not limited to ± 180 degrees.
I-Eye	Real part of data is shown with X axis segmented (generally into 2 symbol segments) and each segment is overlaid to show signal crossings at symbol boundaries
Q-Eye	Same as I-eye but imaginary part of data is shown
Trellis	Same as I-eye but uses unwrapped phase of data
Group Delay	Useful for frequency response displays. Shows the derivative of phase response with respect to frequency.
Log Mag (Linear Unit)	Displays data with a logarithmic Y axis, but marker read outs are in linear magnitude units.

Key Path	Trace/Detector, Format
Mode	VSA, LTE, LTETDD, IDEN
Measurement	<meas>:=VECTor ADEMod DDEMod W11A W11B EVM IPOWER IDEMod MOTotalk
Remote Command	:DISPlay:<meas>:TRACe[1] 2 ... 4:FORMat MLOG MLINear REAL IMAGinary VECTor CONS PHASE UPHase IEYE QEYE TRELLis GDElay MLGLinear :DISPlay:<meas>:TRACe[1] 2 ... 4:FORMat?
Example	DISP:DDEM:TRAC2:FORM MLIN DISP:DDEM:TRAC2:FORM?
Preset	Depends on trace and measurement
State Saved	Saved in instrument state.
Range	Log Mag (dB) Linear Mag (Abs Value) Real (I) (Lin) Imaginary (Q) (Lin) I-Q Constellation Wrap Phase Unwrap Phase I-Eye Q-Eye Trellis-Eye Group Delay Log Mag (Linear Unit)
Readback Text	Log Mag (dB) Linear Mag Real (I) Imaginary (Q) I-Q Constellation Wrap Phase Unwrap Phase I-Eye Q-Eye Trellis-Eye Group Delay Log Mag
Initial S/W Revision	Prior to A.02.00
Modified at S/W Revision	A.02.00

CC For All Traces

This parameter is very useful when you want to change all traces to display measurement results for specific Component Carrier. For example, when number of Component Carrier is 2, if you have 4 traces showing contents like below:

Trace 1	Demod CC0 Error Summary1
Trace 2	CC0 Spectrum1
Trace 3	Demod CC0 Frame Summary1
Trace 4	MIMO CC0 Info Table1

After you select CC1 for CC For All Traces, the contents of 4 traces will be changed to :

Trace 1	Demod CC1 Error Summary1
Trace 2	CC1 Spectrum1
Trace 3	Demod CC1 Frame Summary1
Trace 4	MIMO CC1 Info Table1

Key Path	Trace/Detector
Mode	LTEAFDD, LTEATDD
Remote Command	:DISPlay:EVM:TRACe:ALL:SElected CC0 CC1 CC2 CC3 CC4
Example	DISPLAY:EVM:TRAC:ALL:SEL CC0
Notes	The options CC1~CC4 can be enabled with 9080B/9082B-2FP license
Couplings	CC For All Traces is coupled to Number of Component Carriers. For example, CC For All Traces list will include CC0~CC1 if the number Component Carriers is 2.
Preset	CC0
State Saved	Saved in instrument state.
Range	CC0 CC1 CC2 CC3 CC4
Initial S/W Revision	A.14.50

Copy CC To

This parameter provides parameter copy function of selected Component Carrier to another Component Carrier or all Component Carrier.

NOTE

This parameter copies LTE-Advanced demodulation parameters from one Component Carrier to other Component Carrier or all Component Carriers.

Key Path	Meas Setup
Mode	LTEAFDD, LTEATDD

Remote Command	<code>[:SENSe] :EVM:COpy CC0 CC1 CC2 CC3 CC4 All</code>
Example	<code>EVM:COpy All</code>
Notes	The options CC0~CC4 can be enabled with 9080B/9082B-2FP license.
Couplings	Copy the parameters settings of selected Component Carrier to the target Component Carrier.
Preset	All
State Saved	Saved in instrument state.
Range	CC0 CC1 CC2 CC3 CC4 All
Initial S/W Revision	A.14.00

Digital Demod Trace Setup

Accesses a menu of settings that control certain elements of displays of digitally demodulated trace data.

Key Path	Trace/Detector
Mode	VSA, LTE, LTETDD, IDEN
Initial S/W Revision	Prior to A.02.00
Modified at S/W Revision	A.02.00

Symbol Shape

Enables you to display dots, bars, or nothing (none) at symbol locations (if the trace contains demodulated time-domain data) for all time-domain displays except IQ diagrams. This key enables you to select the symbol shape for the selected trace.

If you select bars, vertical lines (bars) are drawn from the baseline to the symbol location on the trace. The baseline is 0 for all traces that have coordinates other than log (dB). The baseline is the bottom of the trace box for traces that have log (dB) coordinates.

With IQ diagrams, displaying vertical bars is meaningless. Therefore, selecting bars displays dots in IQ diagrams.

With constellation diagrams, selecting none is the same as selecting bars – you cannot turn off the dots in a constellation diagram.

Key Path	Trace/Detector, Digital Demod Trace Setup
Mode	VSA, LTE, LTETDD, IDEN
Measurement	<code><meas>:=VECTor ADEMod DDEMod W11A W11B EVM IPOWER IDEMod MOTotalk</code>
Remote Command	<code>:DISPlay:<meas>:TRACe [1] 2 . . . 4 :DDEMod:SYMBol BARS DOTS OFF</code> <code>:DISPlay:<meas>:TRACe [1] 2 . . . 4 :DDEMod:SYMBol?</code>
Example	<code>DISP:DDEM:TRAC2:DDEM:SYMB DOTS</code> <code>DISP:DDEM:TRAC2:DDEM:SYMB?</code>

Preset	BARS
State Saved	Saved in instrument state.
Range	Bars Dots None
Initial S/W Revision	Prior to A.02.00
Modified at S/W Revision	A.02.00

Ideal State Shape

Enables you to choose between a cross, circle, or none to represent the ideal state on the selected trace. Digital Demodulation shows you the location of all ideal symbol states in an I-Q or constellation diagram.

Key Path	Trace/Detector, Digital Demod Trace Setup
Mode	VSA, LTE, LTETDD, IDEN
Measurement	<meas>:=VECTor ADEMod DDEMod W11A W11B EVM IPOWER IDEMod MOTotalk
Remote Command	:DISPlay:<meas>:TRACe [1] 2 . . . 4 :DDEMod:SYMBol:SHAPe CIRCle CROSS OFF :DISPlay:<meas>:TRACe [1] 2 . . . 4 :DDEMod:SYMBol:SHAPe?
Example	DISP:DDEM:TRAC2:DDEM:SYMB:SHAP CIRC DISP:DDEM:TRAC2:DDEM:SYMB:SHAP?
Preset	CIRC
State Saved	Saved in instrument state.
Range	Circle Cross None
Initial S/W Revision	Prior to A.02.00
Modified at S/W Revision	A.02.00

Ideal State Size

Determines the ideal state size, as a percentage of the maximum ideal state distance from the origin (the same way Error Vector Magnitude is defined). Ideal states are shown as circles or crosses in Vector and constellation diagrams, as determined by the Ideal State Shape setting.

The ideal state is where symbols occur if your signal is without error. Showing the ideal states gives a visual indication of the quality of your signal.

You can use this feature to determine if symbols have an EVM above a specified Value. For example, to see if any symbols have an EVM greater than 10%, set the state size to 10% and select Circle as the shape. Any symbols that fall outside of the circle (other than SYNC or PILOT symbols) have an EVM greater than 10%.

Key Path	Trace/Detector, Digital Demod Trace Setup
Mode	VSA, LTE, LTETDD, IDEN
Measurement	<meas>:=VECTor ADEMod DDEMod W11A W11B EVM IPOWER IDEMod MOTotalk

Remote Command	:DISPlay:<meas>:TRACe [1] 2 . . . 4 :DDEMod:SYMBol:SIZE <real> :DISPlay:<meas>:TRACe [1] 2 . . . 4 :DDEMod:SYMBol:SIZE?
Example	DISP:DDEM:TRAC2:DDEM:SYMB:SIZE 10 DISP:DDEM:TRAC2:DDEM:SYMB:SIZE?
Notes	Parameter is interpreted as a percent, e.g., if you want the ideal size to be 10% send 10, not 0.1
Preset	5
State Saved	Saved in instrument state.
Min	0.1
Max	50
Initial S/W Revision	Prior to A.02.00
Modified at S/W Revision	A.02.00

Symbol Table Format

Enables you to choose the format in which symbol table data is displayed, when the modulation format encodes 4 or more bits per symbol. You can choose binary or hexadecimal. Binary symbol data is padded with leading zeros to make a multiple of 4 bits before conversion to hexadecimal. For example, for 16 QAM format, each 4-bit symbol is displayed as 2 hex digits.

Binary Format: The symbol data bit format is binary and each character represents a binary digit. The number to the left of each row indicates the bit offset of the first bit in the row.

Hexadecimal Format: The symbol data bit format is hexadecimal and each character represents a hexadecimal digit. The number to the left of each row indicate the symbol offset of the first symbol in the row.

NOTE

There must be at least 4 bits/symbol to use the hexadecimal format, that is, symbols that have less than 4 bits/symbol are only displayed in binary format regardless of the Symbol Table Format setting.

This parameter is valid only when:

- The active trace is a symbol table, and
- The current demodulation format supports hexadecimal, the demodulation format's bits/symbol is equal to or greater than four.

Key Path	Trace/Detector, Digital Demod Trace Setup
Mode	VSA, LTE, LTETDD, IDEN
Measurement	<meas>:=VECTor ADEMod DDEMod W11A W11B EVM IPOWER IDEMod MOTotalk
Remote Command	:DISPlay:<meas>:TRACe [1] 2 . . . 4 :DDEMod:SYMBol:FORMat HEXadecimal BINary :DISPlay:<meas>:TRACe [1] 2 . . . 4 :DDEMod:SYMBol:FORMat?
Example	DISP:DDEM:TRAC2:DDEM:SYMB:FORM BIN DISP:DDEM:TRAC2:DDEM:SYMB:FORM?

Preset	HEX
Range	Hex Binary
Initial S/W Revision	Prior to A.02.00
Modified at S/W Revision	A.02.00

Time Unit

Enables you to select the time units that are applied to x-axis annotations and marker readouts for the selected trace, whenever it is assigned data with (demodulation) symbol information. The available measurement units are sym (symbols) or sec (seconds).

Key Path	Trace/Detector, Digital Demod Trace Setup
Mode	VSA, LTE, LTETDD, IDEN
Measurement	<meas>:=VECTor ADEMod DDEMod W11A W11B EVM IPOWER IDEMod MOTotalk
Remote Command	:DISPlay:<meas>:TRACe[1] 2 ... 4:DDEMod:UNIT:TIME SEC SYMBol :DISPlay:<meas>:TRACe[1] 2 ... 4:DDEMod:UNIT:TIME?
Example	DISP:VECT:TRAC2:DDEM:UNIT:TIME SYMB DISP:VECT:TRAC2:DDEM:UNIT:TIME?
Preset	SYMB
State Saved	Saved in instrument state.
Range	sym sec
Initial S/W Revision	Prior to A.02.00
Modified at S/W Revision	A.02.00

Freq Unit

Enables you to select the frequency units that are applied to x-axis annotations and marker readouts for the selected trace, whenever it is assigned data with (demodulation) carrier information. The available measurement units are carrier or Hz.

Key Path	Trace/Detector, Digital Demod Trace Setup
Mode	VSA, LTE, LTETDD, IDEN
Measurement	<meas>:=VECTor ADEMod DDEMod W11A W11B EVM IPOWER IDEMod MOTotalk
Remote Command	:DISPlay:<meas>:TRACe[1] 2 ... 4:DDEMod:UNIT:FREQuency CARRier HZ :DISPlay:<meas>:TRACe[1] 2 ... 4:DDEMod:UNIT:FREQuency?
Example	DISP:VECT:TRAC2:DDEM:UNIT:FREQ CARR DISP:VECT:TRAC2:DDEM:UNIT:FREQ?
Preset	CARR
State Saved	Saved in instrument state.

Range	carrier Hz
Initial S/W Revision	Prior to A.02.00
Modified at S/W Revision	A.02.00

Eye Length

Controls how wide (in symbol periods) the eye and trellis diagrams are, for the selected trace.

Key Path	Trace/Detector, Digital Demod Trace Setup
Mode	VSA, LTE, LTETDD, IDEN
Measurement	<meas>:=VECTor ADEMod DDEMod W11A W11B EVM IPOWER IDEMod MOTotalk
Remote Command	:DISPlay:<meas>:TRACe [1] 2 ... 4:DDEMod:EYE:COUNT <real> :DISPlay:<meas>:TRACe [1] 2 ... 4:DDEMod:EYE:COUNT?
Example	DISP:DDEM:TRAC2:DDEM:EYE:COUN 3 DISP:DDEM:TRAC2:DDEM:EYE:COUN?
Preset	2
State Saved	Saved in instrument state.
Min	0.1
Max	40
Initial S/W Revision	Prior to A.02.00
Modified at S/W Revision	A.02.00

Avg Line

Controls whether or not the average line is visible on certain demodulation analysis traces such as Error Vector Time and Error Vector Spectrum in Digital Demod measurements. These traces have 2-dimensional domains; typically subcarriers (frequency) and symbol times. Since the result can only be shown with one of these dimensions on the x-axis, the other dimension is placed on the z-axis. Since all the z-axis values are overlapped, an average is calculated for all z values at each x value and the average is normally displayed as a line in front of trace. The average line display can be turned on or off using this control.

Key Path	Trace/Detector, Digital Demod Trace Setup
Mode	VSA, LTE, LTETDD, IDEN
Measurement	<meas>:=VECTor ADEMod DDEMod W11A W11B EVM IPOWER IDEMod MOTotalk
Remote Command	:DISPlay:<meas>:TRACe [1] 2 ... 4:DDEMod:ALINE OFF ON 0 1 :DISPlay:<meas>:TRACe [1] 2 ... 4:DDEMod:ALIN?
Example	DISP:W11A:TRAC:DDEM:ALIN OFF
Preset	1
State Saved	Saved in instrument state.
Initial S/W Revision	A.03.00 or later

Copy to Data Register

Accesses a menu of immediate execute keys, each of which copies the selected trace to a particular data register. Data registers can be displayed in any trace. They are measurement global, so you can copy data to a register while in the Digital Demod measurement and view it later while in the Vector measurement. Data registers are cleared when the VSA Application is exited and reentered, but not when you change Modes and return.

Key Path	Trace/Detector
Mode	VSA, LTE, LTETDD, IDEN
Measurement	<meas>:=VECTor ADEMod DDEMod W11A W11B EVM IPOWER IDEMod MOTotalk
Remote Command	:DISPlay:<meas>:TRACe [1] 2 . . . 4 :COPY D1 D2 D3 D4 D5 D6
Example	DISP:VECT:TRAC:COPY D1
Readback Text	Last: <date_time> Empty
Initial S/W Revision	Prior to A.02.00
Modified at S/W Revision	A.02.00

The following SCPI provides means to determine if a Data Register is empty, and to erase the data from any or all Data Registers.

Mode	VSA, LTE, LTETDD, IDEN
Remote Command	:CALCulate:DATA:REGister [1] 2 . . . 6 :EMPTY?
Example	:CALC:DATA:REG2:EMPT?
Notes	Query only: returns 1 if a Data Register has no trace data assigned to it.
Initial S/W Revision	Prior to A.02.00
Modified at S/W Revision	A.02.00

Mode	VSA, LTE, LTETDD, IDEN
Remote Command	:CALCulate:DATA:REGister [1] 2 . . . 6 :REMOve
Example	:CALC:DATA:REG2:REM
Notes	Removes trace data assigned to specified Data Register.
Couplings	If Data Register is assigned to a trace, the trace data is changed to No Data
Initial S/W Revision	Prior to A.02.00
Modified at S/W Revision	A.02.00

Mode	VSA, LTE, LTETDD, IDEN
Remote Command	:CALCulate:DATA:REGister:ALL:REMOve

Example	:CALC:DATA:REG:ALL:REM
Notes	Removes trace data assigned to all Data Registers.
Couplings	If Data Register is assigned to a trace, the trace data is changed to No Data
Initial S/W Revision	Prior to A.02.00
Modified at S/W Revision	A.02.00

Phase/Delay Properties

Accesses a menu of properties that affect the selected trace when displayed using phase or delay formats.

Key Path	Trace/Detector
Mode	VSA, LTE, LTETDD, IDEN
Initial S/W Revision	Prior to A.02.00
Modified at S/W Revision	A.02.00

Phase/Trellis Offset

Only used if the trace format is Wrap Phase, Unwrap Phase, or Trellis. For Unwrap Phase or Trellis traces, the phase offset value is added to the existing phase at each point. For example, if you are viewing an Unwrapped Phase trace, setting the Phase/Trellis Offset to 5 degrees moves the entire trace up 5 degrees (and changes the value displayed by a marker by the same amount). For Wrap Phase traces the phase offset only affects the phase wrap point, not the underlying data. The point at which the phase wraps is 180 degrees plus the phase offset. For example, suppose you have a marker on a Wrap Phase trace whose phase offset is 0 and the marker is showing -3 degrees. The trace data is all confined within (-180, 180] degrees. If you then change the phase offset to 180 degrees, then the Wrap Phase trace shows values within the interval (0, 360] degrees and the marker value is displayed as 357 degrees, which is the wrapped equivalent of -3 degrees.

Key Path	Trace/Detector, Phase Delay Properties
Mode	VSA, LTE, LTETDD, IDEN
Measurement	<meas>:=VECTor ADEMod DDEMod W11A W11B EVM IPOWER IDEMod MOTotalk
Remote Command	:DISPlay:<meas>:TRACe[1] 2 ... 4:FORMat:PHASe:OFFSet <real> :DISPlay:<meas>:TRACe[1] 2 ... 4:FORMat:PHASe:OFFSet?
Example	DISP:DDEM:TRAC3:FORM:PHAS:OFFS 31 DISP:DDEM:TRAC3:FORM:PHAS:OFFS?
Preset	0
State Saved	Saved in instrument state.
Min	-1E+8
Max	1E+8
Initial S/W Revision	Prior to A.02.00
Modified at S/W Revision	A.02.00

Unwrap Phase Ref

Enables you to designate the point (x-axis) value about which phase values are to be unwrapped. That is, the phase at the designated reference is within -180 to 180 degrees, and phase varies smoothly without jumps around that point.

Key Path	Trace/Detector, Phase Delay Properties
Mode	VSA, LTE, LTETDD, IDEN
Measurement	<meas>:=VECTor ADEMod DDEMod W11A W11B EVM IPOWER IDEMod MOTotalk
Remote Command	:DISPlay:<meas>:TRACe[1] 2 ... 4:FORMat:PHASe:UNWRap:REFerence <real> :DISPlay:<meas>:TRACe[1] 2 ... 4:FORMat:PHASe:UNWRap:REFerence?
Example	DISP:DDEM:TRAC3:FORM:PHAS:UNWR:REF 24.5E6 DISP:DDEM:TRAC3:FORM:PHAS:UNWR:REF?
Preset	0
State Saved	Saved in instrument state.
Min	$-9.9e37$
Max	$9.9e37$
Initial S/W Revision	Prior to A.02.00
Modified at S/W Revision	A.02.00

Group Delay Aperture

Used when the trace format is Group Delay. The aperture is specified as a percentage of the current frequency span for frequency-domain data. It is specified as a percentage of the time-record length for time-domain data.

When group delay is calculated for a given point (which can be a time- or frequency-domain point), the aperture is centered at that point. Larger apertures decrease resolution, but they increase the smoothing of the group-delay trace.

The point plotted for group delay is located between the data points used to calculate it. For example, in the frequency domain, the group delay for 100 Hz can be calculated by measuring the change in phase between 90 and 110 Hz. If you had specified a start frequency of 90 Hz, 100 Hz would be the first point with group delay data. This results in a trace that does not extend to the edges of the screen (more noticeable as the delay aperture increases).

Note that the smallest aperture that you can select depends on the number of frequency points. If you select an invalid aperture, the analyzer automatically selects the smallest valid aperture.

Key Path	Trace/Detector, Phase Delay Properties
Mode	VSA, LTE, LTETDD, IDEN
Measurement	<meas>:=VECTor ADEMod DDEMod W11A W11B EVM IPOWER IDEMod MOTotalk
Remote Command	:DISPlay:<meas>:TRACe[1] 2 ... 4:FORMat:DELAy:APERture <real>

	:DISPlay:<meas>:TRACe [1] 2 . . . 4:FORMat:DELay:APERture?
Example	DISP:DDEM:TRAC3:FORM:DEL:APER 1 DISP:DDEM:TRAC3:FORM:DEL:APER?
Notes	Parameter is interpreted as a percent, e.g., if you want the group delay aperture to be 1% send 1, not 0.01
Preset	0.5
State Saved	Saved in instrument state.
Min	0.00390625
Max	16
Initial S/W Revision	Prior to A.02.00
Modified at S/W Revision	A.02.00

Trace Indicator Info

Enables you to get more information about why a trace indicator is showing. A trace indicator appears in the upper right corner of a trace display to announce exceptional conditions. When such an indicator is showing on the selected trace, pressing this key causes more information about the condition to appear in the message area. This is a front-panel only function. The SCPI commands for querying the Trace Indicator and the Trace Indicator Info for a particular trace are:

CALC:<meas>:DATA[1]|2|3|4:HEAD:STR? "TrcLedStr"

CALC:<meas>:DATA[1]|2|3|4:HEAD:STR? "TrcLedReason"

Key Path	Trace/Detector
Mode	VSA, LTE, LTETDD, IDEN
Initial S/W Revision	Prior to A.02.00
Modified at S/W Revision	A.02.00

Limit Test (SCPI Only)

Enables you to enable or disable the Limit Test function for each Trace when the Trace supports the Limit Test function.

When enabled, if the limit test fails on the trace, "FAIL" is shown on the Meas Bar. Otherwise, "PASS" is shown.

Available only for the EVM measurement.

Mode	VSA, LTE, LTETDD
Measurement	<meas>:=EVM
Remote Command	:CALCulate:<meas>:TRACe [1] 2 . . . 4:LIMit:VISible OFF ON 0 1 :CALCulate:<meas>:TRACe [1] 2 . . . 4:LIMit:VISible?

Example	CALC:EVM:TRAC1:LIM:VIS ON CALC:EVM:TRAC1:LIM:VIS?
Notes	On the LTE/LTETDD EVM measurement, the following trace data is supported: In-band Emissions Eq Ch Freq Resp Per Slot Limit data can be queried by :CALC:EVM:DATA[1]]2 3 4? LL UL command.
Preset	0
State Saved	Saved in instrument state.
Initial S/W Revision	A.08.00

Trigger

See ["Trigger" on page 328](#)

Free Run

See ["Free Run " on page 335](#)

Video

See ["Video \(IF Envelope\) " on page 1556](#)

Trigger Level

See ["Trigger Level " on page 1557](#)

Trig Slope

See ["Trig Slope " on page 1558](#)

Trig Delay

See ["Trig Delay " on page 338](#)

External 1

See ["External 1 " on page 1571](#)

Trigger Level

See ["Trigger Level " on page 1571](#)

Trig Slope

See ["Trig Slope " on page 1572](#)

Trig Delay

See ["Trig Delay " on page 341](#)

Zero Span Delay Comp

See ["Zero Span Delay Comp On/Off" on page 1560](#)

External 2

See ["External 2 " on page 1572](#)

Trigger Level

See ["Trigger Level " on page 1573](#)

Trig Slope

See ["Trig Slope " on page 1574](#)

Trig Delay

See "Trig Delay " on page 344

Zero Span Delay Comp

See "Zero Span Delay Comp On/Off" on page 1562

RF Burst

See "RF Burst " on page 1574

Absolute Trigger

See "Absolute Trigger Level" on page 1575

Relative Trigger

See "Relative Trigger Level" on page 1564

Trig Slope

See "Trigger Slope " on page 1576

Trig Delay

See "Trig Delay " on page 348

Periodic Timer

See "Periodic Timer (Frame Trigger) " on page 1566

Period

See "Period " on page 1567

Offset

See "Offset " on page 1568

Offset Adjust (Remote Command Only)

See "Offset Adjust (Remote Command Only)" on page 1569

Reset Offset Display

See "Reset Offset Display " on page 1570

Sync Source

See "Sync Source " on page 1570

Off

See "Off " on page 1571

External 1

See "[External 1](#) " on page 1571

Trigger Level

See "[Trigger Level](#) " on page 1571

Trig Slope

See "[Trig Slope](#) " on page 1572

External 2

See "[External 2](#) " on page 1572

Trigger Level

See "[Trigger Level](#) " on page 1573

Trig Slope

See "[Trig Slope](#) " on page 1574

RF Burst

See "[RF Burst](#) " on page 1574

Absolute Trigger

See "[Absolute Trigger Level](#)" on page 1575

Trig Slope

See "[Trigger Slope](#) " on page 1576

Trig Delay

See "[Trig Delay](#)" on page 359

Auto/Holdoff

See "[Auto/Holdoff](#) " on page 1577

Auto Trig

See "[Auto Trig](#) " on page 1577

Trig Holdoff

See "[Trig Holdoff](#) " on page 1578

Holdoff Type

See "[Holdoff Type](#)" on page 361

User Preset

Accesses a menu that gives you the following three choices:

- User Preset – recalls a state previously saved using the Save User Preset function.
- User Preset All Modes – presets all of the modes in the analyzer
- Save User Preset– saves the current state for the current mode

NOTE

In products that run multiple instances of the X-Series Application, all instances use the same location to save User Preset state. So Save User Preset of one instance will overwrite the Save User Preset of another instance.

Key Path	Front-panel key
Backwards Compatibility Notes	<p>User Preset is actually loading a state, and in legacy analyzers, it was possible to load a state without affecting the trace data, limit lines or correction data. Similarly it was possible to do a User Preset without affecting the trace data, limit lines or correction data.</p> <p>In the X-Series, “state” always includes all of this data; so whenever state is loaded, or User Preset is executed, all of the traces, limit lines and corrections are affected. Although this differs from previous behavior, it is desirable behavior, and should not cause adverse issues for users.</p> <p>On ESA and PSA, User Preset affected the entire instrument’s state. In the X-Series, User Preset only recalls the state for the active mode. There is a User Preset file for each mode. User Preset can never cause a mode switch as it can in legacy analyzers. If you want to recall all modes to their user preset file state, you will need to do a User Preset after mode switching into each mode.</p> <p>User Preset recalls mode state which can now include data like traces; whereas on ESA and PSA, User Preset did not affect data.</p>
Initial S/W Revision	Prior to A.02.00

User Preset

User Preset sets the state of the currently active mode back to the state that was previously saved for this mode using the Save User Preset menu key or the SCPI command, SYST:PRES:USER:SAV. It not only recalls the Mode Preset settings, but it also recalls all of the mode persistent settings, and the Input/Output system setting that existed at the time Save User Preset was executed.

If a Save User Preset has not been done at any time, User Preset recalls the default user preset file for the currently active mode. The default user preset files are created if, at power-on, a mode detects there is no user preset file. There will never be a scenario when there is no user preset file to restore. For each mode, the default user preset state is the same state that would be saved if a Save User Preset is performed in each mode right after doing a Restore Mode Default and after a Restore Input/Output Defaults.

The User Preset function does the following:

- Aborts the currently running measurement.
- Sets the mode State to the values defined by Save User Preset.
- Makes the saved measurement for the currently running mode the active measurement.
- Brings up the saved menu for the power-on mode.

- Clears the input and output buffers.
- Sets the Status Byte to 0.

Key Path	User Preset
Remote Command	:SYSTem:PRESet:USER
Example	:SYST:PRES:USER:SAVE:SYST:PRES:USER
Notes	:SYST:PRES:USER:SAVE is used to save the current state as the user preset state. Clears all pending OPC bits. The Status Byte is set to 0. Pressing the User Preset front-panel key while already in the User Preset menu will cause the User Preset to get executed
Couplings	A user preset will cause the currently running measurement to be aborted and cause the saved measurement to be active. Recalling a User Preset file has the same issues that recalling a Save State file has. Some settings may need to be limited and therefore re-coupled, since the capabilities of the mode may have changes when the User Preset file was last saved.
Initial S/W Revision	Prior to A.02.00

User Preset All Modes

Recalls all of the User Preset files for each mode, switches to the power-on mode, and activates the saved measurement from the power-on mode User Preset file.

NOTE

When the instrument is secured, all of the user preset files are converted back to their default user preset files.

The User Preset function does the following:

- Aborts the currently running measurement.
- Switches the Mode to the power-on mode.
- Restores the User Preset files for each mode.
- Makes the saved measurement for the power-on mode the active measurement.
- Brings up the saved menu for the power-on mode.
- Clears the input and output buffers.
- Sets the Status Byte to 0.

Key Path	User Preset
Remote Command	:SYSTem:PRESet:USER:ALL
Example	:SYST:PRES:USER:SAVE:SYST:PRES:USER:ALL
Notes	Clears all pending OPC bits. The Status Byte is set to 0. :SYST:PRES:USER:SAVE is used to save the current state as the user preset state.
Couplings	A user preset will cause the currently running measurement to be aborted, cause a mode switch to the power-on mode, and cause the saved measurement to be active in the power-on mode.

Recalling a User Preset file has the same issues that recalling a Save State file has. Some settings may need to be limited and therefore re-coupled, since the capabilities of the mode may have changes when the User Preset file was last saved.

Initial S/W Revision Prior to A.02.00

Save User Preset

Saves the currently active mode and its State. You can recall this User Preset file by pressing the User Preset menu key or sending the SYST:PRES:USER remote command. This same state is also saved by the Save State function.

Key Path	User Preset
Remote Command	:SYSTem:PRESet:USER:SAVE
Example	:SYST:PRES:USER:SAVE
Notes	:SYST:PRES:SAVE creates the same file as if the user requested a *SAV or a MMEM:STOR:STAT, except User Preset Save does not allow the user to specify the filename or the location of the file.
Initial S/W Revision	Prior to A.02.00

View/Display

Enables you to set many display properties. Many View Preset softkeys appear under this menu. These set up measurement-specific views, which are described in individual measurements. A view in this application is simply a preset; that is, a choice of layout, trace data assignment, and trace formatting and scaling. After a view preset is performed, the resulting arrangement can then be changed by any available trace manipulation functions or by changing the layout. All measurements have a default view that is used when they are first started, and the first listed preset view restores that arrangement without otherwise affecting the measurement.

This menu contains keys that enable control over the way data is displayed. The Layout key is described here. Other keys specific to measurements are described in their own descriptions.

Key Path	Front Panel
Mode	VSA, LTE, LTETDD, IDEN,LTEAFDD,LTEATDD
Initial S/W Revision	Prior to A.02.00
Modified at S/W Revision	A.02.00

Display

The Display menu is common to most measurements, and is used for configuring items on the display. Some Display menu settings apply to all the measurements in a mode, and some only to the current measurement. Those under the System Display Settings key apply to all measurements in all modes.

Key Path	Display
Key Path	View/Display
Initial S/W Revision	Prior to A.02.00

Annotation

Turns on and off various parts of the display annotation. The annotation is divided up into four categories:

1. Meas Bar: This is the measurement bar at the top of the screen. It does not include the settings panel or the Active Function. Turning off the Meas Bar turns off the settings panel and the Active Function. When the Meas Bar is off, the graticule area expands to fill the area formerly occupied by the Meas Bar.
2. Screen Annotation: this is the annotation and annunciation around the graticule, including any annotation on lines (such as the display line, the threshold line, etc.) This does NOT include the marker number or the N dB result. When off, the graticule expands to fill the entire graticule area.
3. Trace annotation: these are the labels on the traces, showing their detector (or their math mode).
4. Active Function annotation: this is the active function display in the meas bar, and all of the active function values displayed on softkeys.

See the figure below. Each type of annotation can be turned on and off individually.

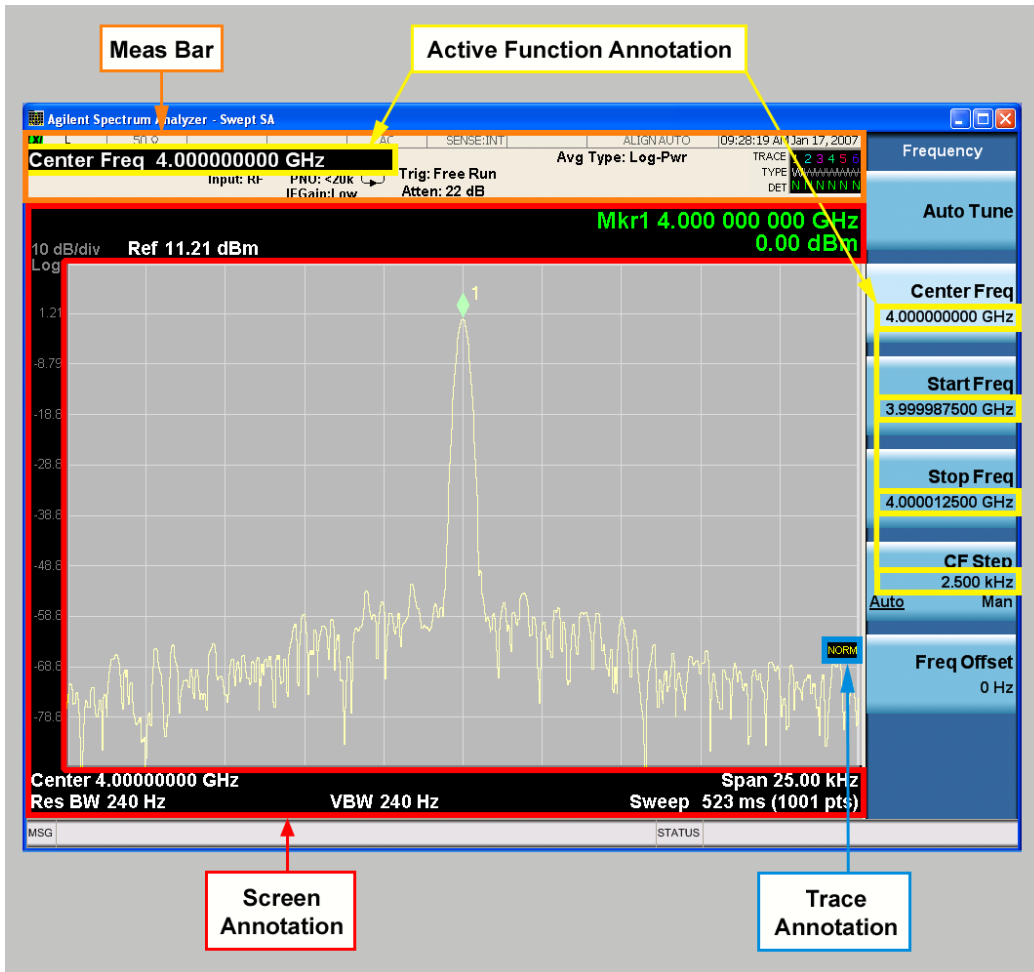

Key Path	View/Display, Display
Initial S/W Revision	Prior to A.02.00

Meas Bar On/Off

This function turns the Measurement Bar on and off, including the settings panel. When off, the graticule area expands to fill the area formerly occupied by the Measurement Bar.

Key Path	View/Display, Display, Annotation
Remote Command	:DISPlay:ANNotation:MBAR[:STATE] OFF ON 0 1 :DISPlay:ANNotation:MBAR[:STATE]?
Example	DISP:ANN:MBAR OFF
Dependencies	Grayed out and forced to OFF when System Display Settings, Annotation is set to Off.
Preset	On This should remain Off through a Preset when System DisplaySettings, Annotation is set to Off.
State Saved	Saved in instrument state.
Initial S/W Revision	Prior to A.02.00

Screen

This controls the display of the annunciation and annotation around the graticule, including any annotation on lines (such as the display line, the threshold line, etc.) and the y-axis annotation. This does NOT include marker annotation (or the N dB result). When off, the graticule expands to fill the entire graticule area, leaving only the 1.5% gap above the graticule as described in the Trace/Detector chapter.

Key Path	View/Display, Display, Annotation
Remote Command	:DISPlay:ANNotation:SCReen[:STATe] OFF ON 0 1 :DISPlay:ANNotation:SCReen[:STATe]?
Example	DISP:ANN:SCR OFF
Dependencies	Grayed-out and forced to OFF when System Display Settings, Annotation is set to Off.
Preset	On This should remain Off through a Preset when System DisplaySettings, Annotation is set to Off
State Saved	Saved in instrument state.
Initial S/W Revision	Prior to A.02.00

Active Function Values On/Off

Turns on and off the active function display in the Meas Bar, and all of the active function values displayed on the softkeys.

Note that all of the softkeys that have active functions have these numeric values blanked when this function is on. This is a security feature..

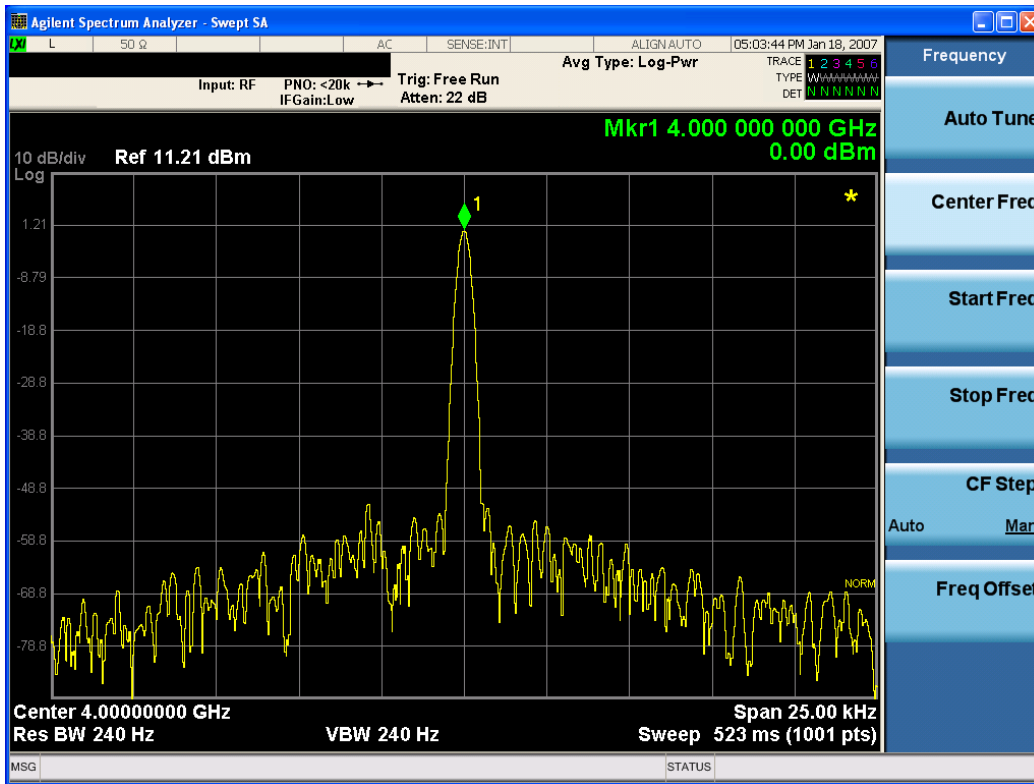

Key Path	View/Display, Display, Annotation
Remote Command	:DISPlay:ACTivefunc[:STATE] ON OFF 1 0 :DISPlay:ACTivefunc[:STATE]?
Example	DISP:ACT OFF
Dependencies	Grayed out and forced to OFF when System Display Settings, Annotation is set to Off.
Preset	On This should remain Off through a Preset when System DisplaySettings, Annotation is set to Off
State Saved	Saved in instrument state.
Initial S/W Revision	Prior to A.02.00

Title

Displays menu keys that enable you to change or clear a title on your display.

Key Path	View/Display, Display
Initial S/W Revision	Prior to A.02.00

Change Title

Writes a title into the "measurement name" field in the banner, for example, "Swept SA".

Press Change Title to enter a new title through the alpha editor. Press Enter or Return to complete the entry. Press ESC to cancel the entry and preserve your existing title.

The display title will replace the measurement name. It remains for this measurement until you press Change Title again, or you recall a state, or a Preset is performed. A title can also be cleared by pressing Title, Clear Title.

NOTE

Notice the inclusion of the <measurement> parameter in the command below. Because each measurement remembers the Display Title, the command must be qualified with the measurement name. For the Swept SA measurement this is not the case; no <measurement> parameter is used when changing the Display Title for the Swept SA measurement.

Key Path	View/Display, Display, Title
Mode	All
Remote Command	:DISPlay:<measurement>:ANNotation:TITLe:DATA <string> :DISPlay:<measurement>:ANNotation:TITLe:DATA?
Example	DISP:ANN:TITL:DATA "This Is My Title" This example is for the Swept SA measurement in the Spectrum Analyzer mode. The SANalyzer <measurement> name is not used. DISP:ACP:ANN:TITL:DATA "This Is My Title" This example is for Measurements other than Swept SA. Both set the title to: This Is My Title
Notes	Pressing this key cancels any active function. When a title is edited the previous title remains intact (it is not cleared) and the cursor goes at the end so that characters can be added or BKSP can be used to go back over previous characters.
Preset	No title (measurement name instead)
State Saved	Saved in instrument state.
Initial S/W Revision	Prior to A.02.00

Clear Title

Clears a title from the front-panel display. Once cleared, the title cannot be retrieved. After the title is cleared, the current Measurement Name replaces it in the title bar.

Key Path	View/Display, Display, Title
Example	The following commands clear the title and restore the measurement's original title: DISP:ANN:TITL:DATA "" This example is for the Swept SA measurement in the Spectrum Analyzer mode. The SANalyzer <measurement> name is not used. DISP:ACP:ANN:TITL:DATA "" This example is for ACP; in measurements other than Swept SA the measurement name is required.
Notes	Uses the :DISPlay:<measurement>:ANNotation:TITLe:DATA <string> command with an empty string (in the Swept SA, the <measurement> is omitted).
Preset	Performed on Preset.
Initial S/W Revision	Prior to A.02.00

Graticule

Pressing Graticule turns the display graticule On or Off. It also turns the graticule y-axis annotation on and off.

Key Path	View/Display, Display
Remote Command	:DISPlay:WINDow[1]:TRACe:GRATicule:GRID[:STATe] OFF ON 0 1 :DISPlay:WINDow[1]:TRACe:GRATicule:GRID[:STATe]?
Example	DISP:WIND:TRAC:GRAT:GRID OFF
Notes	The graticule is the set of horizontal and vertical lines that make up the grid/divisions for the x-axis and y-axis.
Preset	On
State Saved	Saved in instrument state
Initial S/W Revision	Prior to A.02.00

System Display Settings

These settings are "Mode Global" – they affect all modes and measurements and are reset only by Restore Misc Defaults or Restore System Defaults under System.

Key Path	View/Display, Display
Initial S/W Revision	Prior to A.02.00

Annotation Local Settings

This is a Mode Global override of the meas local annotation settings. When it is All Off, it forces ScreenAnnotation, Meas Bar, Trace, and Active Function Values settings to be OFF for all measurements in all modes. This provides the security based "annotation off" function of previous analyzers; hence it uses the legacy SCPI command.

When it is All Off, the Screen, Meas Bar, Trace, and Active Function Values keys under the Display, Annotation menu are grayed out and forced to Off. When Local Settings is selected, you are able to set the local annotation settings on a measurement by measurement basis.

Key Path	View/Display, Display, System Display Settings
Remote Command	:DISPlay:WINDow[1]:ANNOtation[:ALL] OFF ON 0 1 :DISPlay:WINDow[1]:ANNOtation[:ALL]?
Example	:DISP:WIND:ANN OFF
Preset	On (Set by Restore Misc Defaults)
State Saved	Not saved in instrument state.
Backwards Compatibility Notes	The WINDow parameter and optional subopcode is included for backwards compatibility but ignored – all windows are equally affected.
Initial S/W Revision	Prior to A.02.00

Themes

Accesses a menu of functions that enable you to choose the theme to be used when saving the screen image.

The **Themes** option is the same as the **Themes** option under the **Display** and **Page Setup** dialogs. It allows you to choose between themes to be used when saving the screen image.

Key Path	Save, Screen Image
Remote Command	:MMEMory:STORe:SCReen:THEMe TDColor TDMonochrome FCOLor FMONochrome :MMEMory:STORe:SCReen:THEMe?
Example	:MMEM:STOR:SCR:THEM TDM
Preset	3D Color; Is not part of Preset, but is reset by Restore Misc Defaults or Restore System Defaults All and survives subsequent running of the modes.
Readback	3D Color 3D Mono Flat Color Flat Mono
Backwards Compatibility Notes	In ESA and PSA we offer the choice of "Reverse Bitmap" or "Reverse Metafile" when saving screen images. This is much like the "Flat Color" theme available in X-Series. Also, if you selected Reverse Bitmap AND a black & white screen image, that would be much like "Flat Monochrome". In other words, each of the X-Series themes has a similar screen image type in ESA/PSA. But they are not identical.
Initial S/W Revision	Prior to A.02.00

3D Color

Selects a standard color theme with each object filled, shaded and colored as designed.

Key Path	Save, Screen Image, Themes
Example	MMEM:STOR:SCR:THEM TDC
Readback	3D Color
Initial S/W Revision	Prior to A.02.00

3D Monochrome

Selects a format that is like 3D color but shades of gray are used instead of colors.

Key Path	Save, Screen Image, Themes
Example	MMEM:STOR:SCR:THEM TDM
Readback	3D Mono
Initial S/W Revision	Prior to A.02.00

Flat Color

Selects a format that is best when the screen is to be printed on an ink printer.

Key Path	Save, Screen Image, Themes
Example	MMEM:STOR:SCR:THEM FCOL
Readback	Flat Color
Initial S/W Revision	Prior to A.02.00

Flat Monochrome

Selects a format that is like Flat Color. But only black is used (no colors, not even gray), and no fill.

Key Path	Save, Screen Image, Themes
Example	MMEM:STOR:SCR:THEM FMON
Readback	Flat Mono
Initial S/W Revision	Prior to A.02.00

Layout

Enables you to choose the number and position of windows on the screen. Each window contains one trace. The selected trace is always visible and its window outlined in green. The Window zoom key toggles between multiple windows and a single window mode without changing the setting for Layout.

Single layout has one window.

Stack 2 layout has two windows, one on top of the other, that display either traces 1 (top) and 2 (bottom) or traces 3 and 4. The pair that is showing always includes the selected trace.

Stack 3 layout has three windows that display, top to bottom, traces 1, 2, 3 or traces 2, 3, 4.

Grid 2x2 layout has 4 windows, arranged 2x2. They display (in order top to bottom, left to right) traces 1, 2, 3, and 4.

13 LTE-Advanced Modulation Analysis Measurement View/Display

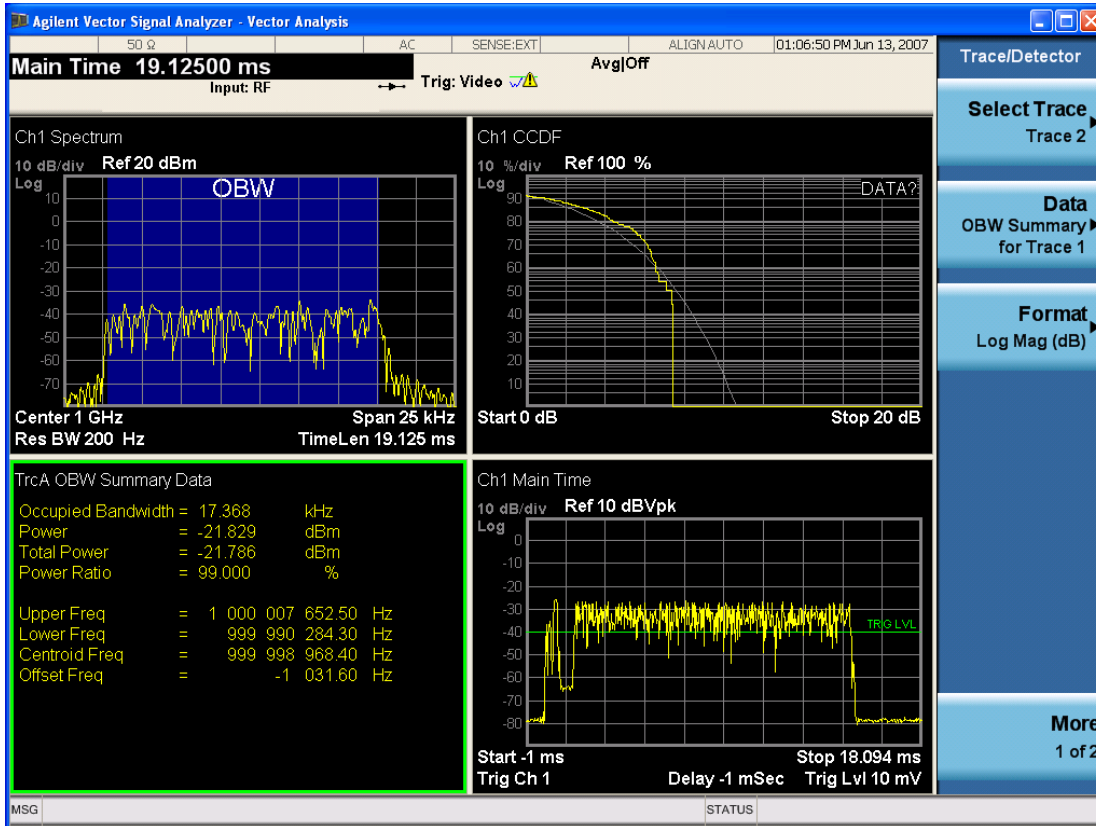

Grid 2x2 layout with Trace 2 selected

There are two other layouts that are available for iDEN Power, iDEN Demod, and MOTOTalk measurements since these enable 6 traces.

Grid 2x3 layout has 2 rows of 3 windows that display all 6 traces in order, top to bottom, then left to right.

Grid 3x2 layout has 3 rows of 2 windows that display all 6 traces in order, top to bottom, then left to right.

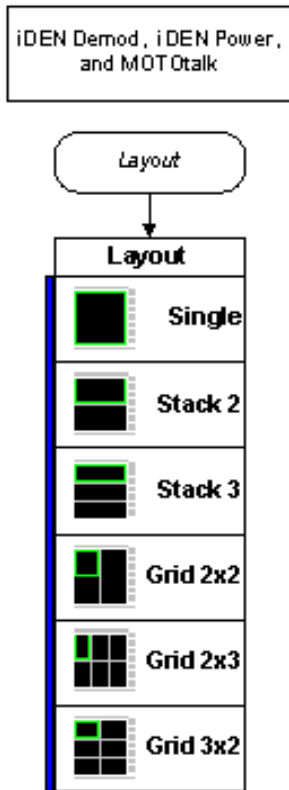

Key Path	View/Display
Mode	VSA, LTE, LTETDD, IDEN, LTEAFDD, LTEATDD
Measurement	<meas>:=VECTor ADEMod DDEMod W11A W11B EVM IPOWER IDEMod MOTotalk
Remote Command	:DISPlay:<meas>:WINDow:FORMat SINGLE TWO TRI QUAD :DISPlay:<meas>:WINDow:FORMat? For iDEN Power, iDEN Demod and MotoTalk measurements: :DISPlay:<meas>:WINDow:FORMat SINGLE TWO TRI QUAD GR2X3 GR3X2 :DISPlay:<meas>:WINDow:FORMat?
Example	DISP:VECT:WIND:FORM TWO DISP:IPOW:WIND:FORM GR2X3 DISP:VECT:WIND:FORM?
Couplings	If the window is currently zoomed, selecting a layout (even the current one) switches it to tiled mode.
Preset	TWO QUAD QUAD QUAD QUAD QUAD QUAD QUAD GR2X3 TRI
State Saved	Saved in instrument state.
Range	Single Stack 2 Stack 3 Grid 2x2 Grid 2x2 Grid 2x3 Stack 3
Initial S/W Revision	Prior to A.02.00
Modified at S/W Revision	A.02.00

Component Carrier

This parameter specifies which component carrier's configuration menu is displayed. This parameter decides which Component Carrier is the target CC when one parameter is changed through front panel. For example, when CC0 is selected, Sync Type is changed to PSS from front panel, and then measurement will know the Sync Type for CC0 is PSS, which is equivalent to send following SCPI command:

```
EVM:CCAR0:DLINK:SYNC:TYPE PSS
```

This parameter also identifies the trace views of which component carrier are to preset and displayed on the screen. For example, when number of Component Carrier is 2, if you select CC1, then after you press Preset View Basic key, then following 4 traces are displayed for CC1.

- IQ Meas
- Spectrum
- Error Vector Spectrum
- Error Summary

Key Path	Meas Setup View/Display
Mode	LTEAFDD, LTEATDD
Remote Command	[:SENSE] :EVM:SELected CC0 CC1 CC2 CC3 CC4 [:SENSE] :EVM:SELected?
Example	EVM:SEL CC0 EVM:SEL?
Notes	In order to clearly identify it, it is called "Component Carrier" under Meas Setup and "CC For Preset View" under View/Display. The options CC1~CC4 can be enabled with 9080B/9082B-2FP license.
Dependencies	Component Carrier is coupled to Number of Component Carriers. For example, Component Carrier list will include CC0~CC1 if the number Component Carriers is 2.
Preset	CC0
State Saved	Saved in instrument state
Range	CC0 CC1 CC2 CC3 CC4
Readback	CC0 CC1 CC2 CC3 CC4
Initial S/W Revision	A.14.00
Modified at S/W Revision	A.14.50

Preset View: Basic

This preset view consists of the following traces of the selected Component Carrier in a Grid 2x2 layout:

- IQ Meas
- Spectrum
- Error Vector Spectrum

- Error Summary

This layout is set by Meas Preset and is good for insuring that the signal is being demodulated correctly, as well as showing many basic demodulation setup problems.

The Preset View: Basic softkey performs the immediate action of changing the layout and view to this configuration. Preset View is an action, not a state.

Key Path	View/Display
Mode	LTEAFDD, LTEATDD
Remote Command	:DISPlay:EVM:VIEW:PRESet BASic
Example	DISP:EVM:VIEW:PRES BAS
Initial S/W Revision	A.14.00

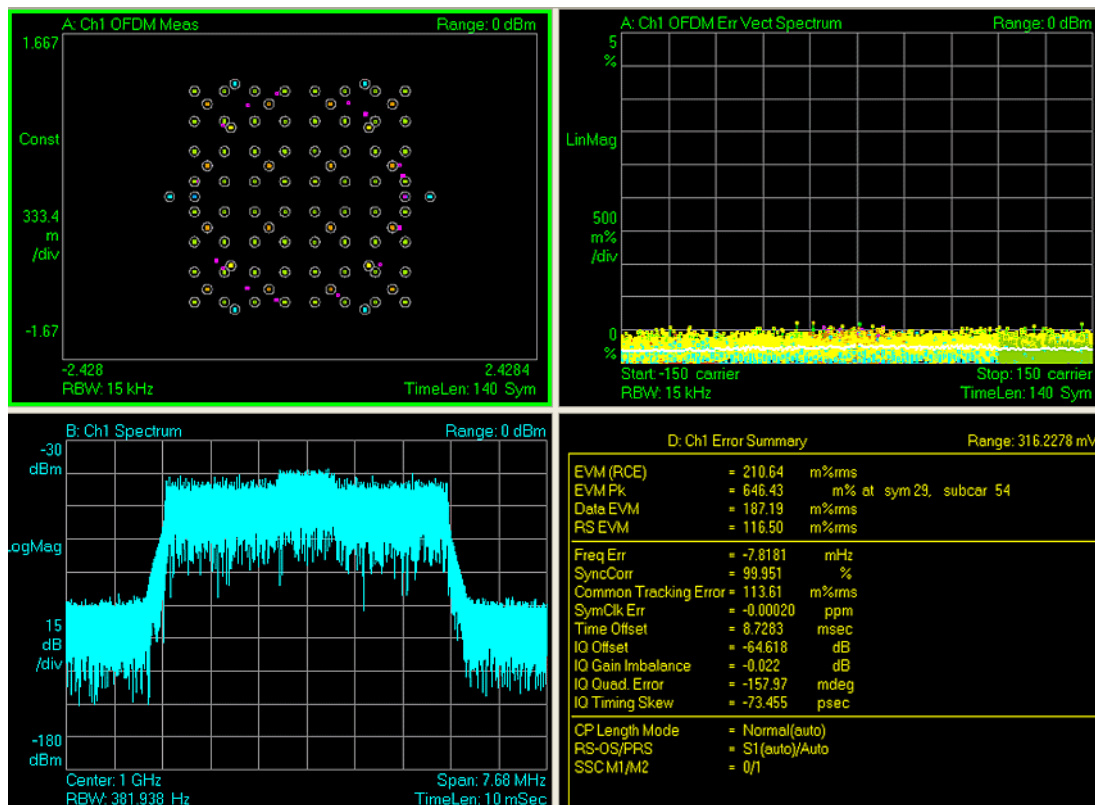

Preset View: Meas Summary

This preset view consists of the following traces of the selected Component Carrier in a Stacked layout:

- Error Summary
- Frame Summary

This layout provides the full list of the composite result metrics and characteristics of each of the logical channels.

The Preset View: Meas Summary softkey performs the immediate action of changing the layout and view to this configuration. Preset View is an action, not a state.

Key Path	View/Display
Mode	LTEAFDD, LTEATDD
Remote Command	:DISPlay:EVM:VIEW:PRESet SUMMary
Example	DISP:EVM:VIEW:PRES SUMM
Initial S/W Revision	A.14.00

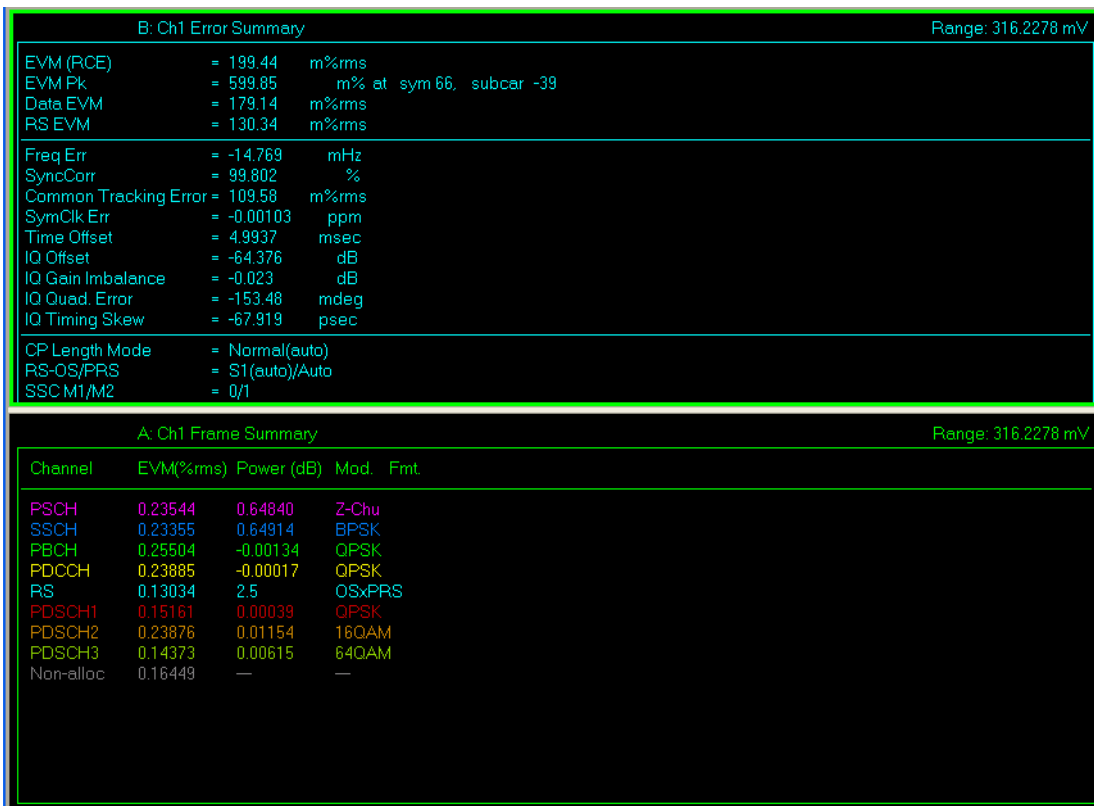

Preset View: RB Slot Meas

This preset view consists of the following traces of the selected Component Carrier in a Grid 2x2 layout:

- RB Power vs Spectrum
- RB Error Mag Spectrum
- RB Power vs Time
- RB Error Mag Time

This layout provides the details on the Resource Block.

The Preset View: RB Slot Meas softkey performs the immediate action of changing the layout and view to this configuration. Preset View is an action, not a state.

Key Path	View/Display
Mode	LTEAFDD, LTEATDD
Remote Command	:DISPlay:EVM:VIEW:PRESet RBSLot
Example	DISP:EVM:VIEW:PRES RBSL
Initial S/W Revision	A.14.00

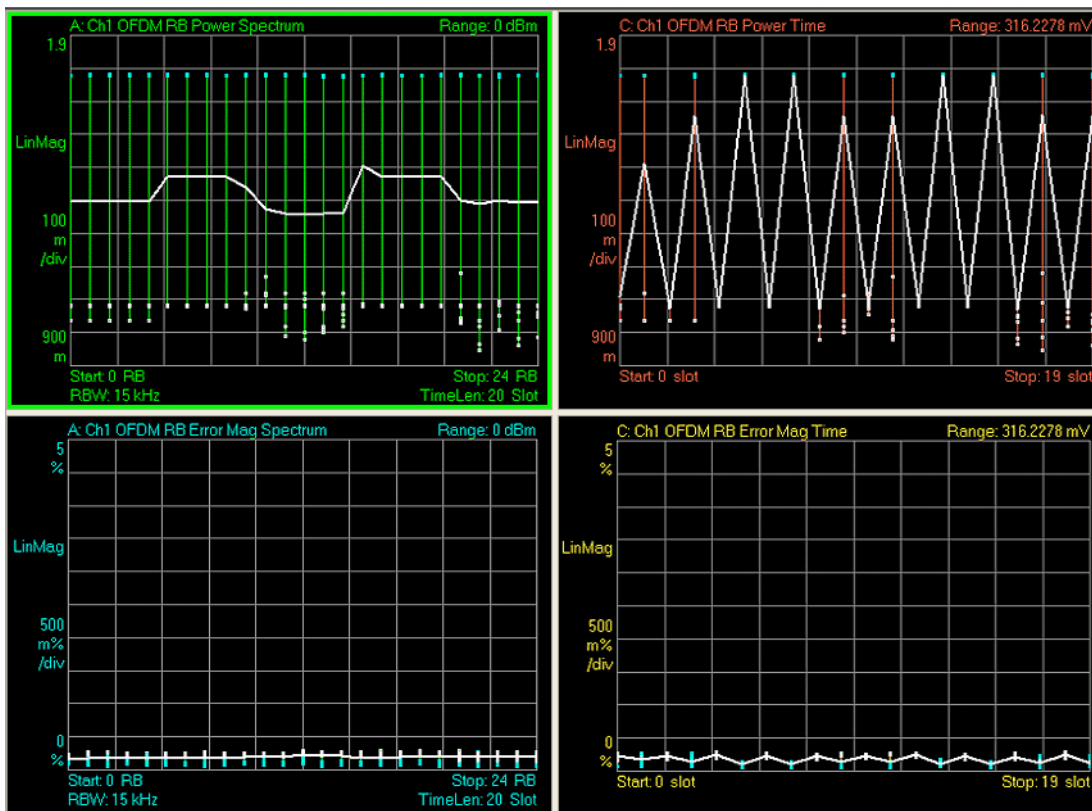

Preset View: Subcarrier Meas

This preset view consists of the following traces of the selected Component Carrier in a Grid 2x2 layout:

- Error Vector Spectrum
- IQ Meas (Log Mag)
- Error Vector Time
- IQ Meas Time (Log Mag)

This layout provides the details on the Power and EVM results.

The Preset View: Subcarrier Meas softkey performs the immediate action of changing the layout and view to this configuration. Preset View is an action, not a state.

Key Path	View/Display, More
Mode	LTEAFDD, LTEATDD
Remote Command	:DISPlay:EVM:VIEW:PRESet SUBCarrier
Example	DISP:EVM:VIEW:PRES SUBC
Initial S/W Revision	A.14.00

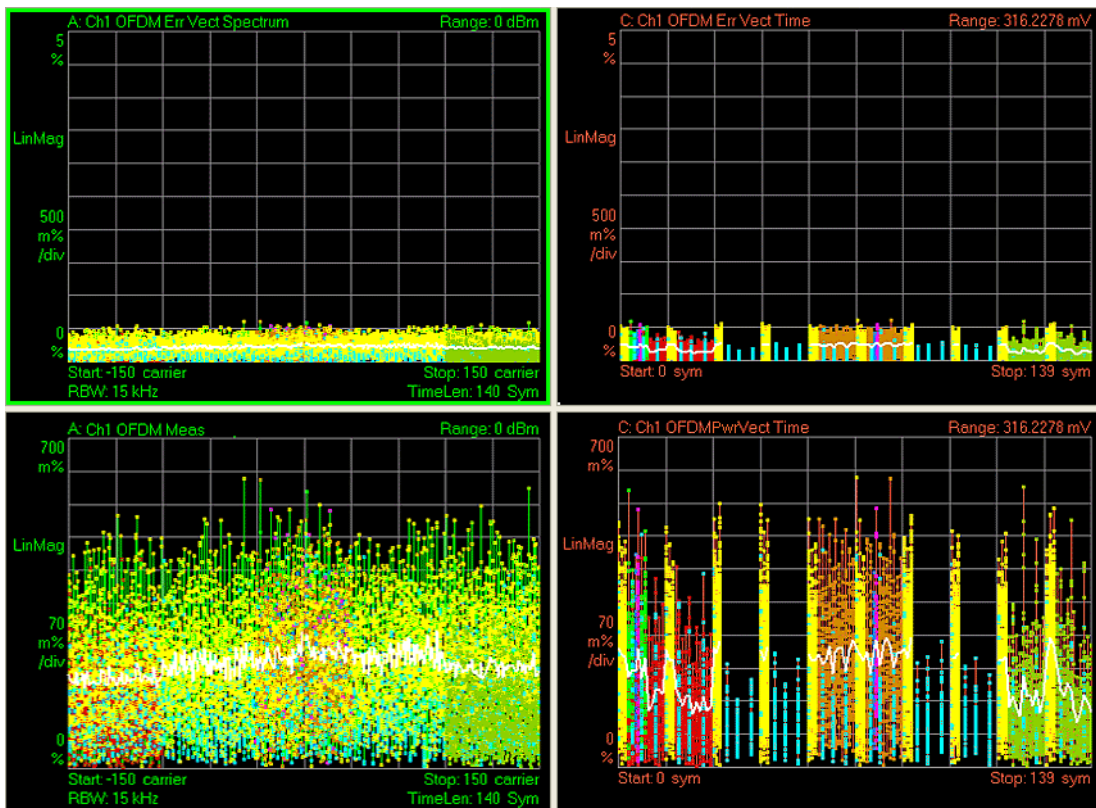

Preset View: MIMO Summary

This preset view consists of the following traces in a Stacked layout:

- MIMO Info Table
- Chan Freq Resp

This layout provides the details on the MIMO results.

The Preset View: MIMO Summary softkey performs the immediate action of changing the layout and view to this configuration. Preset View is an action, not a state.

Key Path	View/Display, More
----------	--------------------

Mode	LTEAFDD, LTEATDD
Remote Command	:DISPlay:EVM:VIEW:PRESet MIMO
Example	DISP:EVM:VIEW:PRES MIMO
Dependencies	Available only when Direction is Downlink.
Initial S/W Revision	A.14.00

Preset View: Cross-Carriers

The Layout is based on the number of component carrier, when Number of Component Carrier is 5, this preset view consists of the following traces in a 3x2 layout:

- Cross-Carriers Summary
- Error Summary (CC0)
- Error Summary (CC1)
- Error Summary (CC2)
- Error Summary (CC3)
- Error Summary (CC4)
- Error Summary (CC5)

This layout provides the details Error Summary of each Component Carrier and Cross-Carriers Summary information about the Time Alignment Error (TAE) and Channel Power for each component carrier (CCx) relative to the selected Reference Component Carrier (Reference CC).

The TAE for the CCx is calculated by subtracting the Time Offset of the reference CC from the Time Offset of the CCx.

The relative Channel Power for the CCx is calculated by subtracting the Channel Power of the reference CC from the Channel Power of the CCx.

Key Path	View/Display, More
Mode	LTEAFDD, LTEATDD
Remote Command	:DISPlay:EVM:VIEW:PRESet CROSS
Example	DISP:EVM:VIEW:PRES CROS
Initial S/W Revision	A.14.50

14 Conformance EVM

LTE-Advanced aggregates multiple LTE carriers (up to 5) to obtain a collective transmission bandwidth of up to 100 MHz. **The CEVM measurement allows you to measure LTE-Advanced signals according to 3GPP TS 36.211. The measurement supports aggregated carriers. Once you have configured the measurement, you can use these commands to initiate the measurement and retrieve the measurement results.**

["Measurement Commands for CEVM " on page 2334](#)

["Remote Command Results for CEVM Measurement" on page 2335](#)

Measurement Commands for CEVM

This section details remote commands and results. For the front-panel configuration and results, see [View/Display](#).

:CONFigure:CEVM

:CONFigure:CEVM:NDEFault

:FETCh:CEVM[n]?

:INITiate:CEVM

:MEASure:CEVM[n]?

:READ:CEVM[n]?

See "[Remote SCPI Commands and Data Queries](#)" on page 2587 and [Trace/Detector, Data](#) in Common Functions for more measurement SCPI commands.

Remote Command Results for CEVM Measurement

The following table denotes the Conformance EVM specific results returned from the (FETCh|MEASure|READ):CEVM commands, indexed by subopcode. MEASure:CEVM<n> is equivalent to CONF:CEVM;INIT:IMM:FETCh:CEVM<n>, which gets you the default measurement, that is, 5 MHz downlink with auto detection of allocations.

Remote Command SCPI Results

For queries listed in section, the results returned depend on the value of n, as follows.

N	Results Returned
Not specified or n=1	<p>Returns measurement results of every active Component Carriers. The total number of Component Carriers is specified by Num Component Carriers in Component Carrier Setup menu on LTE-Advanced mode. The total result length is variable. Each Component Carrier can be specified as active or inactive by setting the Measure Carrier in Component Carriers Setup to ON or OFF. The results of each Component Carrier vary depending on the Link Direction and result values enable/disable setting (Downlink/Uplink Result Output Selection).</p> <p>For example, If the Num Component Carriers is 3 and number of result for each Component Carrier is 21 (determined by Result Output Selection), if all 3 Component Carriers are active, total number of return value is 63, first 21 results are for Component Carrier 0, and last 21 results are for Component Carrier 2. if Component Carrier 0 is specified as inactive by setting the Measure Carrier of CC0 to OFF, then the total number of return value is 42, first 21 results are for Component Carrier 1, and last 21 results are for Component Carrier 2.</p> <p>All the return values are floating points.</p> <p>LTE-Advanced Downlink Results For Each Component Carrier</p> <p>The result contents are customizable. See Downlink Result Output Selection (SCPI only) section for details. If no result is available, NaN (9.91E+37) is returned.</p> <ol style="list-style-type: none"> 1. EVM (%) 2. EVM Symbol Time Adjust 3. 1: Window Start 4. 2: Window End 5. 3: Center 6. 4: Custom 7. EVM Pk (%) 8. EVM Pk Index 9. EVM Peak Sub Car Index 10. Data EVM (%) – Not available when Detection is Manual and no User is added. 11. 3GPP-defined QPSK EVM (%) 12. 3GPP-defined 16QAM EVM (%) 13. 3GPP-defined 64QAM EVM (%) 14. RS EVM (%) 15. RS Tx. Power (dBm) 16. OFDM Symbol Tx. Power (dBm) 17. Frequency Error (Hz) 18. Sync Correlation (%) 19. Sync Type 20. 1: P-SS 21. 20: Ant Port 0 RS 22. 21: Ant Port 1 RS 23. 22: Ant Port 2 RS

N	Results Returned
	24. 23: Ant Port 3 RS
	25. Common Tracking Error (%)
	26. Symbol Clock Error (ppm)
	27. Time Offset (s)
	28. IQ Offset (dB)
	29. IQ Gain Imbalance (dB)
	30. IQ Quad Error (deg)
	31. IQ Timing Skew (s)
	32. CP Length Mode
	33. 1: Normal
	34. 2: Extended
	35. Cell ID
	36. Cell ID Group/Sector
	37. Integer part: Cell ID Group, After the decimal point: Cell ID Sector
	38. RS-OS/PRS
	39. 1: 3GPP
	40. 4: Custom
	41. Reference Signal Rx Power (dBm)
	42. Reference Signal Rx Quality (dB)
	43. Received Signal Strength Indicator (dBm)
	44. Channel Power(dBm)
	LTE-Advanced Uplink Results For Each Component Carrier
	The result contents are customizable. See Uplink Result Output Selection for details. If no result is available, NaN (9.91E+37) is returned.
	1. EVM (%)
	2. EVM Symbol Time Adjust
	3. 1: Window Start
	4. 2: Window End
	5. 3: Center
	6. 4: Custom
	7. EVM Pk (%)
	8. EVM Pk Index
	9. EVM Peak Sub Car Index
	10. Data EVM (%) – Not available when Detection is Manual and no User is added.
	11. 3GPP-defined QPSK EVM (%)
	12. 3GPP-defined 16QAM EVM (%)
	13. 3GPP-defined 64QAM EVM (%)
	14. RS EVM (%)
	15. NaN (9.91E+37) returned.
	16. NaN (9.91E+37) returned.

N	Results Returned
	17. Frequency Error (Hz) 18. Sync Correlation (%) 19. Sync Type 20. 2: PUSCH-DMRS 21. 3: PUCCH-DMRS 22. 4: SRS 23. 5: PRACH 24. Common Tracking Error (%) 25. Symbol Clock Error (ppm) 26. Time Offset (s) 27. IQ Offset (dB) 28. IQ Gain Imbalance (dB) 29. IQ Quad Error (deg) 30. IQ Timing Skew (s) 31. CP Length Mode 32. 1: Normal 33. 2: Extended 34. Channel Power (dBm) 35. In-band Emissions Result 0: PASS 1: FAIL 36. In-band Emissions worst Margin (dB) 37. In-band Emissions worst Slot 38. In-band Emissions worst RB 39. Spectral Flatness Result 0: PASS 1: FAIL 40. Spectral Flatness worst Margin (dB) 41. Spectral Flatness worst Slot 42. Spectral Flatness worst Subcarrier
2	<p>Returns result of Equalizer Frequency Response Per Slot for CC0. The result length varies depending on the Bandwidth and Measurement Interval.</p> <p>For example, BW=5MHz and Result Length & Meas Interval Slot=20 slots, 12,000 points are returned. The first 600 points are 300 IQ pairs of EQ response of Slot 0 from the lowest to the highest frequency, and the second 600 points are those of Slot 1, and so on. Each slot (=EC(f)) is divided into EC_1(f) for Range1 and EC_2(f) for Range2, and then RP1, RP2, RP12 or RP21 is calculated in each region.</p>
3	<p>Error Information of each Component Carrier</p> <p>Returns total error information of each Component Carrier. The values are bitwise OR operated on the Error Information as follows:</p>

N	Results Returned		
	No Error	0	0x00000000
	Parameter Setting Conflict	1	0x00000001
	ADC OverRange	2	0x00000010
	Sync Error	4	0x00000100
	Demod Error	8	0x00001000
	Burst Not Found	16	0x00010000

For example, if ADC Over Range and Sync Error occurred, the value is 6.

The total result length is variable. The returned contents vary depending on the total number of Component Carriers, which is specified by Num Component Carriers in Component Carriers Setup.

Returns the following scalar results:

43.Total Error Information of CC0.

44.Total Error Information of CC1.

45. ...

nCarr. Total Error Information of the last carrier.

Where nCarr is the number of carriers to be measured.

Key Path	Meas
Mode	LTEAFDD, LTEATDD
Initial S/W Revision	A.14.00

AMPTD Y Scale

The Amplitude front-panel key activates the Amplitude menu and selects Reference Level or Reference Value (depending on the measurement) as the active function.

Some features in the Amplitude menu apply to multiple measurements; others apply only to specific measurements. Keys that only apply to some measurements are blanked or grayed out in measurements that are not supported.

Key Path	Front-panel key
Initial S/W Revision	Prior to A.02.00

Range

The Range menu allows setting amplitude controls of the instrument.

Key Path	AMPTD Y Scale
Scope	Meas Global
Initial S/W Revision	A.12.50

Range

Represents the amplitude of the largest sinusoidal signal that could be present within the IF without being clipped by the ADC. For signals with high peak-to-average ratios, the range may need to exceed the rms signal power by a fair amount to avoid clipping.

Key Path	Range
Mode	BASIC
Remote Command	<code>[:SENSe] :POWer [:RF] :RANGe <real></code> <code>[:SENSe] :POWer [:RF] :RANGe?</code>
Example	<code>:POW:RANG 10.0</code> <code>:POW:RANG?</code>
Notes	The MIN and MAX values are affected by the External Gain parameters, and by the Center Frequency. (The hardware compensates for frequency response and alters the Range setting.)
Preset	0
State Saved	Saved in instrument state.
Min	-100
Max	100
Initial S/W Revision	A.12.50

Adjust Range For Min Clip

Sets the combination of attenuation and gain based on the current measured signal level so that clipping will be at a minimum.

This is an "immediate action" function, that is, it executes once, when the key is pressed.

This key is grayed out in measurements that do not support this functionality.

Key Path	AMPTD Y Scale, Attenuation
Remote Command	<code>[:SENSe] :POWer [:RF] :RANGe :OPTimize IMMEDIATE</code>
Initial S/W Revision	Prior to A.02.00
Modified at S/W Revision	A.03.00

Pre-Adjust for Min Clip

If this function is on, it does the adjustment described under Adjust Range For Min Clip each time a measurement restarts. Therefore, in Continuous measurement mode, it only executes before the first measurement.

Key Path	AMPTD Y Scale, Attenuation
Remote Command	<code>[:SENSe] :POWer [:RF] :RANGe :OPTimize :ATTenuation OFF ON ELEctrical COMBined</code> <code>[:SENSe] :POWer [:RF] :RANGe :OPTimize :ATTenuation?</code>
Notes	This parameter is shared with old XA platform which uses AutoAtten. To keep the backward compatibility, ELEctrical and COMBined still can be used. Then, upon receiving ELEctrical and COMBined, these enums will be interpreted as aliases of ON. Then, when queried, ON will be returned.
Preset	OFF for Swept SA measurement; ON for all other measurements that support Pre-Adjust for Min Clip
State Saved	Saved in instrument state
Initial S/W Revision	Prior to A.02.00
Modified at S/W Revision	A.03.00

Peak to Average

The Peak to Average Ratio is used with the Range setting to optimize the level control in the instrument. The value is the ratio, in dB, of the peak power to the average power of the signal to be measured. A ratio of 0 should be used for sinusoidal signals; for 802.11g OFDM signals use 9 dB.

All Applications (Modes) will show the current value of Peak to Average ratio on the softkey. However, some applications will not permit changing the value. In these situations the softkey will be grayed-out.

Key Path	AMPTD Y Scale, Range
Remote Command	<code>[:SENSe] :POWer [:RF] :RANGe :PARatio <real></code>

	<code>[:SENSe] :POWeR [:RF] :RANGe :PARatio ?</code>
Example	POW:RANG:PAR 12 dB
Notes	In some Applications (Modes) this parameter will be read-only; meaning the value will appear on the softkey and query via SCPI, but not changeable. In such applications the softkey will be grayed-out. Attempting to change the value via SCPI will be ignored and no error message will be generated.
Preset	10 dB
State Saved	Saved in instrument state
Min	0 dB
Max	20 dB
Initial S/W Revision	A.13.00

Mixer Level Offset

Mixer level offset is an advanced setting to adjust target Range at the input mixer which in turn affects the signal level in the instrument's IF. This setting can be used when additional optimization is needed after setting Peak to Average ratio. Positive values of offset optimize noise performance over distortion, negative values optimize distortion performance over noise.

Key Path	AMPTD Y Scale, Range
Remote Command	<code>[:SENSe] :POWeR [:RF] :RANGe :MIXer :OFFSet <real></code> <code>[:SENSe] :POWeR [:RF] :RANGe :MIXer :OFFSet ?</code>
Example	POW:RANG:MIX:OFFS -5 dB
Preset	0 dB
State Saved	Saved in instrument state
Min	-35 dB
Max	30 dB
Initial S/W Revision	A.13.00

Auto Couple

The Auto Couple feature provides a quick and convenient way to automatically couple multiple instrument settings. This helps ensure accurate measurements and optimum dynamic range. When the Auto Couple feature is activated, either from the front panel or remotely, all parameters of the current measurement that have an Auto/Manual mode are set to Auto mode and all measurement settings dependent on (or coupled to) the Auto/Man parameters are automatically adjusted for optimal performance.

However, the Auto Couple key actions are confined to the current measurement only. It does not affect other measurements in the mode, and it does not affect markers, marker functions, or trace or display attributes.

See "[More Information](#)" on page 2343

Key Path	Front-panel key
Remote Command	:COUPle ALL NONE
Example	:COUP ALL
Notes	:COUPle ALL puts all Auto/Man parameters in Auto mode (equivalent to pressing the Auto Couple key). :COUPLE NONE puts all Auto/Man parameters in manual mode. It decouples all the coupled instrument parameters and is not recommended for making measurements.
Initial S/W Revision	Prior to A.02.00

More Information

There are two types of functions that have Auto/Manual modes.

Auto/Man Active Function keys

An Auto/Man toggle key controls the binary state associated with an instrument parameter by toggling between Auto (where the parameter is automatically coupled to the other parameters it is dependent upon) and Man (where the parameter is controlled independent of the other parameters), as well as making the parameter the active function. The current mode is indicated on the softkey with either Auto or Man underlined as illustrated below.



Auto/Man 1-of-N keys

An Auto/Man 1-of-N key allows you to manually pick from a list of parameter values, or place the function in Auto, in which case the value is automatically selected (and indicated) as shown below. If in Auto, Auto is underlined on the calling key. If in manual operation, manual is indicated on the calling key. But the calling key does not actually toggle the function, it simply opens the menu.

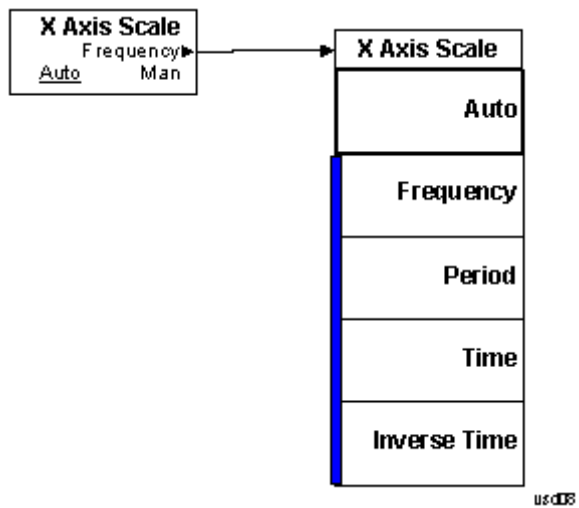

BW

The BW functionality is only available from SCPI only in this measurement. When pressed, blank menu appears.

Key Path	SCPI only
Mode	LTEAFDD, LTEATDD
Remote Command	[:SENSe] :CEVM:CCARrier0 1 2 3 4:IFBW <freq> [:SENSe] :CEVM:CCARrier0 1 2 3 4:IFBW?
Example	CEVM:CCAR0:IFBW 5MHZ CEVM:CCAR0:IFBW?
Notes	SCPI only. Some DIFs only have discrete IF BW settings. In that case, the closest wider BW the HW provides is selected as the Info BW. Info BW is optimized for the measurement speed. Although the user can change this, it could cause a measurement speed degradation especially in DIF cases with Opt.DP2.
Couplings	Info BW is automatically overwritten whenever Demod Bandwidth is changed. The following shows the relation between Demod Bandwidth in Mode Parameter and Info BW. Demod BandwidthInfo BW 1.4 MHz3.072 MHz 3 MHz6.144 MHz 5 MHz6.144 MHz 10 MHz12.288 MHz 15 MHz24.576 MHz 20 MHz24.576 MHz
Preset	6.144 MHz
State Saved	Saved in instrument state.
Min	1kHz
Max	Lower value of either Digital IF max value or 49.152MHz.
Backwards Compatibility SCPI	[:SENSe] :CEVM:IFBW
Initial S/W Revision	A.06.30
Modified at S/W Revision	A.14.50

Cont (Continuous Measurement/Sweep)

Sets the analyzer for Continuous measurement operation. The single/continuous state is Meas Global so the setting will affect all measurements. If you are Paused, pressing Cont does a Resume.

Key Path	Front-panel key
Remote Command	:INITiate:CONTinuous OFF ON 0 1 :INITiate:CONTinuous?
Example	:INIT:CONT 0 puts analyzer in Single measurement operation. :INIT:CONT 1 puts analyzer in Continuous measurement operation
Preset	ON (Note that SYST:PRESet sets INIT:CONT to ON but *RST sets INIT:CONT to OFF)
State Saved	Saved in instrument state
Backwards Compatibility Notes	For Spectrum Analysis mode in ESA and PSA, there is no Cont hardkey, instead there is a Sweep Single/Cont key. In these analyzers, switching the Sweep Single/Cont key from Single to Cont restarts averages (displayed average count reset to 1), but does not restart Max Hold and Min Hold. The X-Series has Single and Cont keys in place of the SweepSingleCont key. In the X-Series, if in single measurement, the Cont key (and INIT:CONT ON) switches to continuous measurement, but never restarts a measurement and never resets a sweep.
Initial S/W Revision	Prior to A.02.00

In Swept SA Measurement (Spectrum Analysis Mode):

The analyzer takes repetitive sweeps, averages, measurements, etc., when in Continuous mode. When the average count reaches the Average/Hold Number the count stops incrementing, but the analyzer keeps sweeping. See the Trace/Detector section for the averaging formula used both before and after the Average/Hold Number is reached. The trigger condition must be met prior to each sweep. The type of trace processing for multiple sweeps, is set under the Trace/Detector key, with choices of Trace Average, Max Hold, or Min Hold.

In Other Measurements/Modes:

With Avg/Hold Num (in the Meas Setup menu) set to Off or set to On with a value of 1, a sweep is taken after the trigger condition is met; and the analyzer continues to take new sweeps after the current sweep has completed and the trigger condition is again met. However, with Avg/Hold Num set to On with a value >1, multiple sweeps (data acquisitions) are taken for the measurement. The trigger condition must be met prior to each sweep. The sweep is not stopped when the average count k equals the number N set for Avg/Hold Num is reached, but the number k stops incrementing. A measurement average usually applies to all traces, marker results, and numeric results. But sometimes it only applies to the numeric results.

If the analyzer is in Single measurement, pressing the Cont key does not change k and does not cause the sweep to be reset; the only action is to put the analyzer into Continuous measurement operation.

If it is already in continuous sweep:

the INIT:CONT 1 command has no effect

the INIT:CONT 0 command will place the analyzer in Single Sweep but will have no effect on the current sequence until $k = N$, at which point the current sequence will stop and the instrument will go to the idle state.

14 Conformance EVM
File

File

See "File" on page 266

FREQ Channel

Accesses a menu of keys that allow you to control the Frequency and Channel parameters of the instrument.

Some features in the Frequency menu are the same for all measurements - they do not change as you change measurements. Settings like these are called "Meas Global" and are unaffected by Meas Preset. For example, the Center Freq setting is the same for all measurements - it does not change as you change measurements.

Key Path	Front Panel Key
Mode	LTETDD, LTEAFDD
Initial S/W Revision	A.14.00

Carrier Ref Freq

Sets carrier reference frequency. The center frequencies of carriers are defined as offset frequency from this value.

If the following conditions are satisfied at the same time:

- the Number of Component Carrier equals to 1
- the Center Freq Offset equals to 0 Hz
- the mode of the Center Freq is Auto

the Center Freq is equivalent to Carrier Ref Freq.

When the Center Freq changes in such conditions, the mode of the Center Freq keeps as Auto and the Carrier Ref Freq will be changed to same value. The major purpose of this coupling is to keep BWCC with legacy LTE/LTE TDD, in which :SENSe:FREQuency:CENTer is used to set up the Frequency of the measurement.

Key Path	FREQ Channel Mode Setup, Component Carrier Setup
Mode	LTEATDD, LTEAFDD
Measurement	All
Remote Command	<code>[:SENSe] :CCARrier:REFeRence <freq></code> <code>[:SENSe] :CCARrier:REFeRence?</code>
Example	CCAR:REF 2GHz CCAR:REF?
Notes	In order to easily configure component carriers, the key is also placed in the Mode Setup.
Preset	1GHz
State Saved	Saved in instrument state
Min	Depends on instrument minimum center frequency. Same as Center Freq
Max	Depends on instrument maximum center frequency. Same as Center Freq

Initial S/W Revision	A.14.00
Modified at S/W Revision	A.14.50

Input/Output

See "Input/Output" on page 182

Marker

There is no Marker functionality implemented in this measurement.

Key Path

Front-panel key

Marker > (Marker To)

There is no Marker To functionality implemented in this measurement.

Key Path	Front-panel key
----------	-----------------

Marker Fctn

There is no Marker functionality implemented in this measurement.

Key Path

Front-panel key

Meas

The information in this section is common to all measurements. For key and remote command information for a specific measurement, refer to the section that describes the measurement of interest.

Measurements available under the Meas key are specific to the current Mode.

When viewing Help for measurements, note the following:

NOTE

Operation for some keys differs between measurements. The information displayed in Help pertains to the current measurement. To see how a key operates in a different measurement, exit Help (press the Cancel Esc key), select the measurement, then reenter Help (press the Help key) and press that key.

Key Path	Front-panel key
Initial S/W Revision	Prior to A.02.00

Remote Measurement Functions

This section contains the following topics:

"Measurement Group of Commands" on page 2356

"Current Measurement Query (Remote Command Only)" on page 2358

"Limit Test Current Results (Remote Command Only)" on page 2358

"Data Query (Remote Command Only)" on page 2358

"Calculate/Compress Trace Data Query (Remote Command Only)" on page 2359

"Calculate Peaks of Trace Data (Remote Command Only)" on page 2364

"Hardware-Accelerated Fast Power Measurement (Remote Command Only)" on page 2365

"Format Data: Numeric Data (Remote Command Only)" on page 2379

"Format Data: Byte Order (Remote Command Only)" on page 2380

Initial S/W Revision	Prior to A.02.00
----------------------	------------------

Measurement Group of Commands

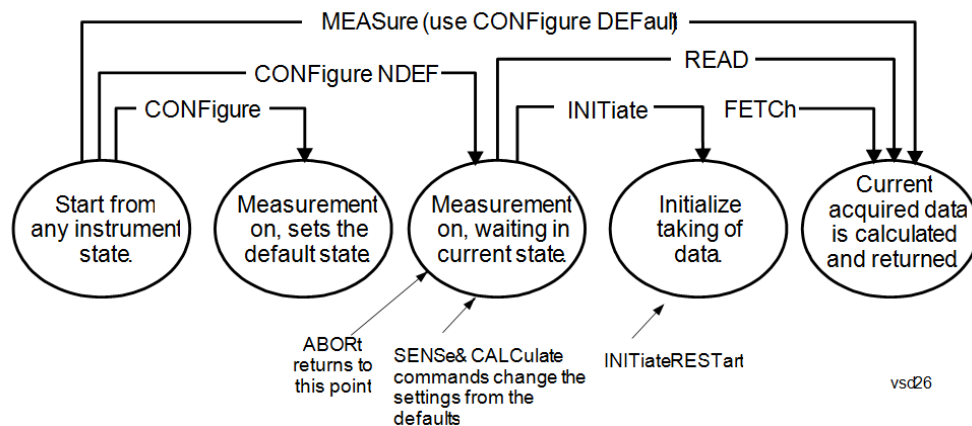

Measure Commands:

:MEASure:<measurement>[n]?

This is a fast single-command way to make a measurement using the factory default instrument settings. These are the settings and units that conform to the Mode Setup settings (e.g. radio standard) that you have currently selected.

- Stops the current measurement (if any) and sets up the instrument for the specified measurement using the factory defaults
- Initiates the data acquisition for the measurement
- Blocks other SCPI communication, waiting until the measurement is complete before returning results.
- If the function does averaging, it is turned on and the number of averages is set to 10.
- After the data is valid it returns the scalar results, or the trace data, for the specified measurement. The type of data returned may be defined by an [n] value that is sent with the command.
- The scalar measurement results will be returned if the optional [n] value is not included, or is set to 1. If the [n] value is set to a value other than 1, the selected trace data results will be returned. See each command for details of what types of scalar results or trace data results are available.
- ASCII is the default format for the data output. (Older versions of Spectrum Analysis and Phase Noise mode measurements only use ASCII.) The binary data formats should be used for handling large blocks of data since they are smaller and faster than the ASCII format. Refer to the FORMat:DATA command for more information.

If you need to change some of the measurement parameters from the factory default settings you can set up the measurement with the CONFigure command. Use the commands in the SENSe:<measurement> and CALCulate:<measurement> subsystems to change the settings. Then you can use the READ? command to initiate the measurement and query the results.

If you need to repeatedly make a given measurement with settings other than the factory defaults, you can use the commands in the SENSe:<measurement> and CALCulate:<measurement> subsystems to set up the measurement. Then use the READ? command to initiate the measurement and query results.

Measurement settings persist if you initiate a different measurement and then return to a previous one. Use READ:<measurement>? if you want to use those persistent settings. If you want to go back to the default settings, use MEASure:<measurement>?.

Configure Commands:

:CONFigure:<measurement>

This command stops the current measurement (if any) and sets up the instrument for the specified measurement using

the factory default instrument settings. It does not initiate the taking of measurement data unless INIT:CONTInuous is ON. If you change any measurement settings after using the CONFigure command, the READ command can be used to initiate a measurement without changing the settings back to their defaults.

In the Swept SA measurement in Spectrum Analyzer mode the CONFigure command also turns the averaging function on and sets the number of averages to 10 for all measurements.

:CONFigure: <measurement>: NDEFault stops the current measurement and changes to the specified measurement. It does not change the settings to the defaults. It does not initiate the taking of measurement data unless INIT:CONTInuous is ON.

The CONFigure? query returns the current measurement name.

The CONFigure:CATalog? query returns a quoted string of all licensed measurement names in the current mode. For example, "SAN, CHP, OBW, ACP, PST, TXP, SPUR, SEM, LIST".

Fetch Commands:

:FETCh:<measurement>[n]?

This command puts selected data from the most recent measurement into the output buffer. Use FETCh if you have already made a good measurement and you want to return several types of data (different [n] values, for example, both scalars and trace data) from a single measurement. FETCh saves you the time of re-making the measurement. You can only FETCh results from the measurement that is currently active, it will not change to a different measurement. An error message is reported if a measurement other than the current one is specified.

If you need to get new measurement data, use the READ command, which is equivalent to an INITiate followed by a FETCh.

The scalar measurement results will be returned if the optional [n] value is not included, or is set to 1. If the [n] value is set to a value other than 1, the selected trace data results will be returned. See each command for details of what types of scalar results or trace data results are available. The binary data formats should be used for handling large blocks of data since they are smaller and transfer faster than the ASCII format. (FORMat:DATA)

FETCh may be used to return results other than those specified with the original READ or MEASure command that you sent.

INITiate Commands:

:INITiate:<measurement>

This command is not available for measurements in all the instrument modes:

- Initiates a trigger cycle for the specified measurement, but does not output any data. You must then use the FETCh<meas> command to return data. If a measurement other than the current one is specified, the instrument will switch to that measurement and then initiate it.
- For example, suppose you have previously initiated the ACP measurement, but now you are running the channel power measurement. If you send INIT:ACP? it will change from channel power to ACP and will initiate an ACP measurement.
- Does not change any of the measurement settings. For example, if you have previously started the ACP measurement and you send INIT:ACP? it will initiate a new ACP measurement using the same instrument settings as the last time ACP was run.
- If your selected measurement is currently active (in the idle state) it triggers the measurement, assuming the trigger conditions are met. Then it completes one trigger cycle. Depending upon the measurement and the number of averages, there may be multiple data acquisitions, with multiple trigger events, for one full trigger cycle. It also holds off additional commands on GPIB until the acquisition is complete.

READ Commands:

:READ:<measurement>[n]?

- Does not preset the measurement to the factory default settings. For example, if you have previously initiated the ACP
-

measurement and you send READ:ACP? it will initiate a new measurement using the same instrument settings.

- Initiates the measurement and puts valid data into the output buffer. If a measurement other than the current one is specified, the instrument will switch to that measurement before it initiates the measurement and returns results.
 - For example, suppose you have previously initiated the ACP measurement, but now you are running the channel power measurement. Then you send READ:ACP? It will change from channel power back to ACP and, using the previous ACP settings, will initiate the measurement and return results.
 - Blocks other SCPI communication, waiting until the measurement is complete before returning the results
 - If the optional [n] value is not included, or is set to 1, the scalar measurement results will be returned. If the [n] value is set to a value other than 1, the selected trace data results will be returned. See each command for details of what types of scalar results or trace data results are available. The binary data formats should be used when handling large blocks of data since they are smaller and faster than the ASCII format. (FORMat:DATA)
-

Initial S/W Revision	Prior to A.02.00
----------------------	------------------

Current Measurement Query (Remote Command Only)

This command returns the name of the measurement that is currently running.

Remote Command	:CONFigure?
-----------------------	-------------

Example	CONF?
----------------	-------

Initial S/W Revision	Prior to A.02.00
----------------------	------------------

Limit Test Current Results (Remote Command Only)

Queries the status of the current measurement limit testing. It returns a 0 if the measured results pass when compared with the current limits. It returns a 1 if the measured results fail any limit tests.

Remote Command	:CALCulate:CLIMits:FAIL?
-----------------------	--------------------------

Example	CALC:CLIM:FAIL? queries the current measurement to see if it fails the defined limits. Returns a 0 or 1: 0 it passes, 1 it fails.
----------------	--

Initial S/W Revision	Prior to A.02.00
----------------------	------------------

Data Query (Remote Command Only)

Returns the designated measurement data for the currently selected measurement and subopcode.

n = any valid subopcode for the current measurement. See the measurement command results table for your current measurement, for information about what data is returned for the subopcodes.

This command uses the data setting specified by the FORMat:BORDER and FORMat:DATA commands and can return real or ASCII data. (See the format command descriptions under Input/Output in the Analyzer Setup section.)

Remote Command	:CALCulate:DATA[n]?
Notes	The return trace depends on the measurement. In CALCulate:<meas>:DATA[n], n is any valid subopcode for the current measurement. It returns the same data as the FETCH:<measurement>? query where <measurement> is the current measurement.
Initial S/W Revision	Prior to A.02.00

Calculate/Compress Trace Data Query (Remote Command Only)

Returns compressed data for the currently selected measurement and sub-opcode [n].

n = any valid sub-opcode for that measurement. See the MEASure:<measurement>? command description of your specific measurement for information on the data that can be returned.

The data is returned in the current Y Axis Unit of the analyzer. The command is used with a sub-opcode <n> (default=1) to specify the trace. With trace queries, it is best if the analyzer is not sweeping during the query. Therefore, it is generally advisable to be in Single Sweep, or Update=Off.

This command is used to compress or decimate a long trace to extract and return only the desired data. A typical example would be to acquire N frames of GSM data and return the mean power of the first burst in each frame. The command can also be used to identify the best curve fit for the data.

Remote Command	:CALCulate:DATA<n>:COMPRESS? BLOCK CFIT MAXimum MINimum MEAN DMEan RMS RMSCubed SAMPLE SDEVIation PPHase [,<soffset> [,<length>[,<roffset>[,<rlimit>]]]]
Example	To query the mean power of a set of GSM bursts: Supply a signal that is a set of GSM bursts. Select the IQ Waveform measurement (in IQ Analyzer Mode). Set the sweep time to acquire at least one burst. Set the triggers such that acquisition happens at a known position relative to a burst. Then query the mean burst levels using, CALC:DATA2:COMP? MEAN, 24e-6, 526e-6 (These parameter values correspond to GSM signals, where 526e-6 is the length of the burst in the slot and you just want 1 burst.)
Notes	The command supports 5 parameters. Note that the last 4 (<soffset>, <length>, <roffset>, <rlimit>) are optional. But these optional parameters must be entered in the specified order. For example, if you want to specify <length>, then you must also specify <soffset>. See details below for a definition of each of these parameters. This command uses the data in the format specified by FORMat:DATA, returning either binary or ASCII data.
Initial S/W Revision	Prior to A.02.00

- BLOCK or block data - returns all the data points from the region of the trace data that you specify. For example, it could be used to return the data points of an input signal over several timeslots, excluding the portions of the trace data that you do not want. (This is x,y pairs for trace data and I,Q pairs for complex data.)

- CFIT or curve fit - applies curve fitting routines to the data. <soffset> and <length> are required to define the data that you want. <roffset> is an optional parameter for the desired order of the curve equation. The query will return the following values: the x-offset (in seconds) and the curve coefficients ((order + 1) values).

MIN, MAX, MEAN, DME, RMS, RMSC, SAMP, SDEV and PPH return one data value for each specified region (or <length>) of trace data, for as many regions as possible until you run out of trace data (using <roffset> to specify regions). Or they return the number of regions you specify (using <rlimit>) ignoring any data beyond that.

- MINimum - returns the minimum data point (y value) for the specified region(s) of trace data. For I/Q trace data, the minimum magnitude of the I/Q pairs is returned.
- MAXimum - returns the maximum data point (y value) for the specified region(s) of trace data. For I/Q trace data, the maximum magnitude of the I/Q pairs is returned.
- MEAN - returns a single value that is the arithmetic mean of the data point values (in dB/ dBm) for the specified region(s) of trace data. For I/Q trace data, the mean of the magnitudes of the I/Q pairs is returned. See the following equations.

•

NOTE If the original trace data is in dB, this function returns the arithmetic mean of those log values, not log of the mean power which is a more useful value. The mean of the log is the better measurement technique when measuring CW signals in the presence of noise. The mean of the power, expressed in dB, is useful in power measurements such as Channel Power. To achieve the mean of the power, use the RMS option.

Equation 1

Mean Value of Data Points for Specified Region(s)

$$\text{MEAN} = \frac{1}{n} \sum_{X_i \in \text{region}(s)} X_i$$

where X_i is a data point value, and n is the number of data points in the specified region(s).

Equation 2

Mean Value of I/Q Data Pairs for Specified Region(s)

$$\text{MEAN} = \frac{1}{n} \sum_{X_i \in \text{region}(s)} |X_i|$$

where $|X_i|$ is the magnitude of an I/Q pair, and n is the number of I/Q pairs in the specified region(s).

- DMEan - returns a single value that is the mean power (in dB/ dBm) of the data point values for the specified region(s) of trace data. See the following equation:

Equation 3

DMEan Value of Data Points for Specified Region(s)

$$\text{DME} = 10 \times \log_{10} \left(\frac{1}{n} \sum_{X_i \in \text{region}(s)} 10^{\frac{X_i}{10}} \right)$$

- RMS - returns a single value that is the average power on a root-mean-squared voltage scale (arithmetic rms) of the data point values for the specified region(s) of trace data. See the following equation.

NOTE

For I/Q trace data, the rms of the magnitudes of the I/Q pairs is returned. See the following equation. This function is very useful for I/Q trace data. However, if the original trace data is in dB, this function returns the rms of the log values which is not usually needed.

Equation 4

RMS Value of Data Points for Specified Region(s)

$$\text{RMS} = \sqrt{\frac{1}{n} \sum_{X_i \in \text{region}(s)} X_i^2}$$

where X_i is a data point value, and n is the number of data points in the specified region(s).

Equation 5

RMS Value of I/Q Data Pairs for Specified Region(s)

$$\text{RMS} = \sqrt{\frac{1}{n} \sum_{X_i \in \text{region}(s)} X_i X_i^*}$$

where X_i is the complex value representation of an I/Q pair, X_i^* its conjugate complex number, and n is the number of I/Q pairs in the specified region(s).

Once you have the rms value for a region of trace data (linear or I/Q), you may want to calculate the mean power. You must convert this rms value (peak volts) to power in dBm:

$$10 \times \log[10 \times (\text{rms value})^2]$$

- SAMPLe - returns the first data value (x,y pair) for the specified region(s) of trace data. For I/Q trace data, the first I/Q pair is returned.
- SDEViation - returns a single value that is the arithmetic standard deviation for the data point values for the specified region(s) of trace data. See the following equation.
- For I/Q trace data, the standard deviation of the magnitudes of the I/Q pairs is returned. See the following equation.

Equation 6

Standard Deviation of Data Point Values for Specified Region(s)

$$\text{SDEV} = \sqrt{\frac{1}{n} \sum_{X_i \in \text{region}(s)} (X_i - \bar{X})^2}$$

where X_i is a data point value, \bar{X} is the arithmetic mean of the data point values for the specified region (s), and n is the number of data points in the specified region(s).

$$\text{SDEV} = \sqrt{\frac{1}{n} \sum_{X_i \in \text{region}(s)} (|X_i| - \bar{X})^2}$$

where $|X_i|$ is the magnitude of an I/Q pair, \bar{X} is the mean of the magnitudes for the specified region(s), and n is the number of data points in the specified region(s).

- PPHase - returns the x,y pairs of both rms power (dBm) and arithmetic mean phase (radian) for every specified region and frequency offset (Hz). The number of pairs is defined by the specified number of regions. This parameter can be used for I/Q vector ($n=0$) in Waveform (time domain) measurement and all parameters are specified by data point in PPHase.

The rms power of the specified region may be expressed as:

$$\text{Power} = 10 \times \log [10 \times (\text{RMS I/Q value})] + 10.$$

The RMS I/Q value (peak volts) is:

$$\sqrt{\frac{1}{n} \sum_{X_i \in \text{region}} X_i X_i^*}$$

where X_i is the complex value representation of an I/Q pair, X_i^* its conjugate complex number, and n is the number of I/Q pairs in the specified region.

The arithmetic mean phase of the specified region may be expressed as:

$$\frac{1}{n} \sum_{Y_i \in \text{region}} Y_i$$

where Y_i is the unwrapped phase of I/Q pair with applying frequency correction and n is the number of I/Q pairs in the specified region.

The frequency correction is made by the frequency offset calculated by the arithmetic mean of every specified region's frequency offset. Each frequency offset is calculated by the least square method against the unwrapped phase of I/Q pair.

Sample Trace Data - Constant Envelope

(See below for explanation of variables.)

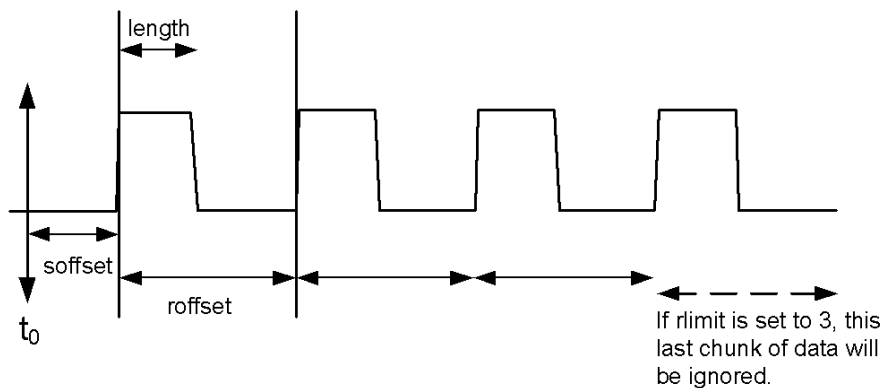

Sample Trace Data - Not Constant Envelope

(See below for explanation of variables.)

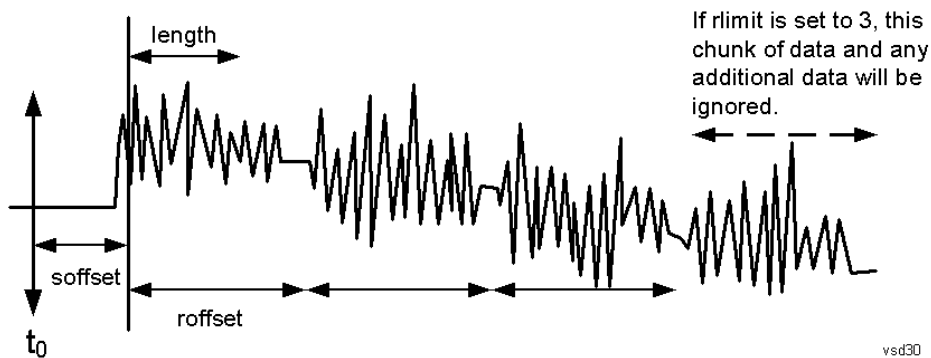

<soffset> - start offset is an optional real number. (It is in seconds for time-domain traces, and is a dimensionless index 0 to $N_{\text{points}} - 1$, for frequency-domain traces). It specifies the amount of data at the beginning of the trace that will be ignored before the decimation process starts. It is the time or frequency change from the start of the trace to the point where you want to start using the data. The default value is zero.

<length> - is an optional real number. (It is in seconds for time-domain traces, and is a dimensionless index 0 to $N_{\text{points}} - 1$, for frequency-domain traces). It defines how much data will be compressed into one value. This parameter has a default value equal to the current trace length.

<roffset> - repeat offset is an optional real number. (It is in seconds for time-domain traces, and is a dimensionless index 0 to $N_{\text{points}} - 1$, for frequency-domain traces). It defines the beginning of the next field of trace elements to be compressed. This is relative to the beginning of the previous field. This parameter has a default value equal to the <length> variable. Note that this parameter is used for a completely different purpose when curve fitting (see CFIT above).

<rlimit> - repeat limit is an optional integer. It specifies the number of data items that you want returned. It will ignore any additional items beyond that number. You can use the Start offset and the Repeat limit to pick out exactly what part of the data you want to use. The default value is all the data.

Calculate Peaks of Trace Data (Remote Command Only)

Returns a list of all the peaks for the currently selected measurement and sub-opcode [n]. The peaks must meet the requirements of the peak threshold and excursion values.

n = any valid sub-opcode for the current measurement. See the MEASure:<measurement> command description of your specific measurement for information on the data that can be returned.

The command can only be used with specific sub-opcodes with measurement results that are trace data. Both real and complex traces can be searched, but complex traces are converted to magnitude in dBm. In many measurements the sub-opcode n=0, is the raw trace data which cannot be searched for peaks. And Sub-opcode n=1, is often calculated results values which also cannot be searched for peaks.

This command uses the data setting specified by the FORMat:BORDER and FORMat:DATA commands and can return real or ASCII data. If the format is set to INT,32, it returns REAL,32 data.

The command has four types of parameters:

- Threshold (in dBm)
- Excursion (in dB)
- Sorting order (amplitude, frequency, time)
- Optional in some measurements: Display line use (all, > display line, < display line)

Remote Command	<p>For Swept SA measurement:</p> <pre>:CALCulate:DATA[1] 2 ... 6:PEAKs? <threshold>,<excursion>[,AMPLitude FREQuency TIME[,ALL GTDLine LTDLine]]</pre> <p>For most other measurements:</p> <pre>:CALCulate:DATA[1] 2 ... 6:PEAKs? <threshold>,<excursion>[,AMPLitude FREQuency TIME]</pre>
-----------------------	--

Example	<p>Example for Swept SA measurement in Spectrum Analyzer Mode:</p> <p>CALC:DATA4:PEAK? -40, 10, FREQ, GTDL This will identify the peaks of trace 4 that are above -40 dBm, with excursions of at least 10 dB. The peaks are returned in order of increasing frequency, starting with the lowest frequency. Only the peaks that are above the display line are returned.</p> <p>Query Results 1:</p> <p>With FORMat:DATA REAL, 32 selected, it returns a list of floating-point numbers. The first value in the list is the number of peak points that are in the following list. A peak point consists of two values: a peak amplitude followed by its corresponding frequency (or time).</p> <p>If no peaks are found the peak list will consist of only the number of peaks, (0).</p>
----------------	---

Notes	<p><n> - is the trace that will be used</p> <p><threshold> - is the level below which trace data peaks are ignored. Note that the threshold value is required and is always used as a peak criterion. To effectively disable the threshold criterion for this command, provide a substantially low threshold value such as -200 dBm. Also note that the threshold value used in this command is independent of and has no effect on the threshold value stored under the Peak Criteria menu.</p> <p><excursion> - is the minimum amplitude variation (rise and fall) required for a signal to be identified as peak. Note that the excursion value is required and is always used as a peak criterion. To effectively disable the excursion criterion for this command, provide the minimum value of 0.0 dB. Also note that the excursion value used in this command is independent of and has no effect on the</p>
--------------	---

excursion value stored under the Peak Criteria menu.

Values must be provided for threshold and excursion. The sorting and display line parameters are optional (defaults are AMPLitude and ALL).

Note that there is always a Y-axis value for the display line, regardless of whether the display line state is on or off. It is the current Y-axis value of the display line which is used by this command to determine whether a peak should be reported. Sorting order:

AMPLitude - lists the peaks in order of descending amplitude, with the highest peak first (default if optional parameter not sent)

FREQUENCY - lists the peaks in order of occurrence, left to right across the x-axis.

TIME - lists the peaks in order of occurrence, left to right across the x-axis.

Peaks vs. Display Line:

ALL - lists all of the peaks found (default if optional parameter not sent).

GTDLine (greater than display line) - lists all of the peaks found above the display line.

LTDLine (less than display line) - lists all of the peaks found below the display line.

Initial S/W Revision	Prior to A.02.00
----------------------	------------------

Hardware-Accelerated Fast Power Measurement (Remote Command Only)

The Fast Power option (FP2) enables very fast channel power measurements for instruments with the prerequisite hardware (DP2 and/or B40). It accomplishes this by performing real-time overlapped FFTs at the hardware layer, using software for basic post-processing before returning the result to the user. The upshot of this approach is improved throughput for user applications that require many sequential power measurements.

The analysis bandwidth of FP2 is limited by the licenses in the instrument, but its maximum overall analysis bandwidth per acquisition is 40 MHz.

FP2 is remote-only, which means the instrument does not switch to any particular mode or measurement. FP2 commands can be sent while another application is in use on the front panel.

Each Fast Power measurement can be predefined using an array index, and up to 1,000 measurements can be stored. In the following documentation, instances of [1,2,...,999] can be substituted with a particular measurement index, e.g. CALC:FPOW:POW1?, CALC:FPOW:POW2?, CALC:FPOW:POW134?. In this way, power measurements can be defined one time in a batch, and then executed multiple times without having to redefine them, similar to “list mode” on other measurements.

In addition to basic channel power measurements, there are a number of other measurement “functions” for each channel, including peak power, peak frequency, and power spectral density. See the Function parameter for more information.

Reset Fast Power Measurement (Remote Command Only)

Resets the measurement configuration to the defaults.

Mode	All
Remote Command	:CALCulate:FPOW:POW[1,2,...,999]:RESet
Example	:CALC:FPOW:POW1:RES

Notes	Option FP2 is required.
Initial S/W Revision	A.14.00

Define Fast Power Measurement (Remote Command Only)

Fast Power acquisitions are configured using the DEFine command. This command accepts a comma-delimited string of configuration parameters and their appropriate values, which are all specified in the subsection below.

Mode	All
Remote Command	:CALCulate:FPOWER:POWer[1,2,...,999]:DEFine "configuration string"
Example	:CALC:FPOW:POW1:DEF "CenterFrequency=2e9, AcquisitionTime=0.005"
Notes	See below for a list of measurement variables that can be defined in the configuration string.
Initial S/W Revision	A.14.00

Acquisition Time

Example	CALC:FPOW:POW1:DEF "AcquisitionTime=0.002"
Notes	The acquisition time parameter sets the time in which the entire spectrum is measured. An increase in the acquisition time yields an improvement in measurement repeatability.
Preset	0.001 s
Range	0 s to 1 s
Default Unit	Time (s)
Initial S/W Revision	A.14.00

Center Frequency

Example	CALC:FPOW:POW1:DEF "CenterFrequency=2e9"
Notes	The center frequency parameter sets the frequency in which the measurement is centered around. The OffsetFrequency parameter is calculated relative to the center frequency.
Preset	1 GHz
Range	0 Hz to maximum instrument frequency
Default Unit	Frequency (Hz)
Initial S/W Revision	A.14.00

DC Coupled

Example	CALC:FPOW:POW1:DEF "DCCoupled=True"
Notes	The DC coupled parameter allows the user to specify whether the DC blocking capacitor is utilized. Set parameter to true when measuring frequencies below 10 MHz.
Preset	False
Range	True (DC Coupled) or False (AC Coupled)
Default Unit	Boolean
Initial S/W Revision	A.14.00

DetectorType

Example	CALC:FPOW:POW1:DEF "DetectorType=Peak"
Notes	Option FP2 is required. The detector type parameter allows the user to choose whether a RMS average or peak value is used during the measurement.
Preset	RmsAverage
Range	RmsAverage, Peak
Initial S/W Revision	A.14.00

Do Noise Correction

Example	CALC:FPOW:POW1:DEF "DoNoiseCorrection=True"
Notes	When noise correction is enabled, the linear noise power contributed by the analyzer is subtracted from all measurements. This effectively lowers the noise floor of the analyzer. When noise correction is enabled, the first measurement for a given set of input parameters will take extra time. This is because the analyzer takes an extra acquisition with the RF input disconnected from the analyzer's front end to measure the noise of just the analyzer. The measured noise floor is stored in a cache so the noise acquisition will occur only once for the same state settings. In other words, if noise correction was turned on and the analyzer made an acquisition at frequency A, then frequency B, and back again to frequency A, the hidden initial noise floor acquisition would only occur for the first acquisition at frequency A and the cached noise floor would be used the second time frequency A was measured.
Preset	False
Range	True (enable noise correction) or False (disable noise correction)
Default Unit	Boolean
Initial S/W Revision	A.14.00

Do Spur Suppression

Example	CALC:FPOW:POW1:DEF "DoSpurSuppression=True"
Notes	<p>When measuring very low level signals, or when large out-of-band inputs are input into the analyzer, sometimes unwanted spurs and residuals can appear in the measured spectrum. Spur suppression is a method to help minimize the levels of these internally generated spurs and residuals.</p> <p>When spur suppression is enabled, the analyzer will automatically take two acquisitions using two different internal analog LO frequencies. The FFT spectrums from both acquisitions are combined by taking the minimum power between both traces on a per FFT bin basis. External signals will have the same amplitude for both traces and therefore will return the expected amplitudes. However, low level spurs and residuals generated internally to the analyzer tend to move to different FFT bins depending on the internal analog LO frequency used, and therefore tend to be suppressed using this spur suppression method.</p> <p>Because two acquisitions, rather than a single acquisition, are made when spur suppression is enabled, the measurement time will always be slower when spur suppression is enabled.</p>
Preset	False
Range	True (enable spur suppression) or False (disable spur suppression)
Default Unit	Boolean
Initial S/W Revision	A.14.00

Electronic Attenuator Bypass

Example	CALC:FPOW:POW1:DEF "ElecAttBypass =False"
Notes	The electronic attenuation bypass parameter allows the user to either utilize or bypass the electronic attenuator. The electronic attenuator is only available for frequencies up to 3.6 GHz. Set parameter to true when using frequencies above 3.6 GHz and set the parameter to false when using the preamp.
Preset	True
Range	True (bypass electronic attenuator) or False (use electronic attenuator)
Default Unit	Boolean
Initial S/W Revision	A.14.00

Electronic Attenuation

Example	CALC:FPOW:POW1:DEF "ElecAttenuation=10"
Notes	<p>Option EA3 is required.</p> <p>The electronic attenuation value parameter sets the amount of electrical attenuation from 0 to 24 dB (1 dB steps).</p> <p>Set "ElecAttBypass=False" to make sure the electronic attenuator path is enabled.</p>
Preset	0 dB
Range	0 – 24 dB (1 dB steps)

Default Unit	dB
Initial S/W Revision	A.14.00

IF Gain

Example	CALC:FPOW:POW1:DEF "IFGain=10"
Notes	The IF gain parameter allows the user to specify the gain at the IF stage anywhere from -6 to 16 dB (1 dB steps). This is an advanced feature, and for most cases this should remain at its default value of 0 dB.
Preset	0 dB
Range	-6 - 16 dB (1 dB steps)
Default Unit	dB
Initial S/W Revision	A.14.00

IF Type

Example	CALC:FPOW:POW1:DEF "IFType=B25M"
Notes	The IF type parameter allows the user to select between different IF paths. For example, if the signal is less than 25 MHz wide, then the user can select the B25M path to take advantage of additional filtering on this analog IF path.
Preset	B40M
Range	B10M, B25M, B40M
Initial S/W Revision	A.14.00

Include Power Spectrum

Example	CALC:FPOW:POW1:DEF "IncludePowerSpectrum=True"
Notes	The power spectrum parameter allows the user to read data on the entire spectrum for diagnostic purposes. It is not recommended for production use. See CALC:FPOW:POW[n]:READ2? for details on the binary format of the response.
Preset	False
Range	True (return both channel power and full power spectrum) or False (returns only channel power)
Default Unit	Boolean
Initial S/W Revision	A.14.00

Mechanical Attenuation

Example	CALC:FPOW:POW1:DEF "MechAttenuation=10"
Notes	The mechanical attenuation value parameter sets the amount of mechanical attenuation anywhere from 0 to 70 dB (2 dB steps).
Preset	0 dB
Range	0 – 70 dB (2 dB steps)
Default Unit	dB
Initial S/W Revision	A.14.00

Preamp Mode

Example	CALC:FPOW:POW1:DEF "PreAmpMode=Low"
Notes	The license for the appropriate preamp is required. The preamp mode parameter specifies whether the preamps are being utilized. Low allows any preamps up to 3.6 GHz, and Full allows all licensed preamps. Set "ElecAttBypass=True" in order to utilize any preamps.
Preset	Off
Range	Off, Low, Full
Initial S/W Revision	A.14.00

Resolution Bandwidth Mode

Example	CALC:FPOW:POW1:DEF "PreAmpMode=Low"
Notes	The resolution bandwidth mode parameter allows the user to choose whether the RBW filter is automatically or manually set. The BestSpeed value minimizes measurement time, while the Narrowest value minimizes RBW size (minimum of two FFT bins per RBW). To manually specify an RBW, set this parameter to Explicit, and set the ResolutionBW parameter to the desired value.
Preset	BestSpeed
Range	BestSpeed, Narrowest, Explicit
Initial S/W Revision	A.14.00

Resolution Bandwidth

Example	CALC:FPOW:POW1:DEF "ResolutionBW=25e3"
Notes	The resolution bandwidth parameter sets the 3-dB bandwidth of the RBW filter. The ResolutionBWMode parameter must be set to Explicit in order to manually set the RBW.

Preset	0 Hz
Default Unit	Hz
Initial S/W Revision	A.14.00

Trigger Delay

Example	CALC:FPOW:POW1:DEF "TriggerDelay=0.025"
Notes	The trigger delay parameter sets the time after an external trigger is detected until the measurement is performed.
Preset	0 s
Range	0 – 1 s
Default Unit	Seconds
Initial S/W Revision	A.14.00

Trigger Level

Example	CALC:FPOW:POW1:DEF "TriggerLevel=2"
Notes	The trigger level parameter sets the voltage value at which an external trigger is detected.
Preset	1.2 V
Range	-5 to 5 V
Default Unit	Volts
Initial S/W Revision	A.14.00

Trigger Slope

Example	CALC:FPOW:POW1:DEF "TriggerSlope=Negative"
Notes	The trigger slope parameter indicates the direction of the edge trigger voltage for detection.
Preset	Positive
Range	Positive, Negative
Initial S/W Revision	A.14.00

Trigger Source

Example	CALC:FPOW:POW1:DEF "TriggerSource=Ext1"
Notes	The trigger source parameter allows the user to choose between measurement's triggering freely or controlled by an external input. Ext1 and Ext2 correspond to Trigger 1 In and Trigger 2 In, respectively.
Preset	Free
Range	Free, Ext1, Ext2
Initial S/W Revision	A.14.00

Trigger Timeout

Example	CALC:FPOW:POW1:DEF "TriggerTimeout=0.1"
Notes	The trigger timeout parameter sets the time in which the analyzer will wait for a trigger before automatically performing the measurement.
Preset	1 s
Range	0 - 1 s
Default Unit	Seconds
Initial S/W Revision	A.14.00

Signal Input

Example	CALC:FPOW:POW1:DEF "SignalInput=Fp50MHzCW"
Notes	The signal input parameter allows the user to select between using the main RF input or the internal analyzer reference CW signal of 50 MHz.
Preset	FpMainRf
Range	FpMainRf, Fp50MHzCW
Initial S/W Revision	A.14.00

Use Preselector

Example	CALC:FPOW:POW1:DEF "UsePreSelector=True"
Notes	The preselector parameter allows the user to either utilize or bypass the front end tunable filter at frequencies above 3.6 GHz. For frequencies below 3.6 GHz, the preselector is automatically bypassed, so you do not need to set this parameter to False in those cases.
Preset	False
Range	True (use preselector above 3.6 GHz), or False (preselector bypassed)

Default Unit	Boolean
Initial S/W Revision	A.14.00

Channel Bandwidth Array

Example	CALC:FPOW:POW1:DEF "Bandwidth=[3.84e6, 5e6, 3.84e6]"
Notes	The bandwidth parameter array defines the bandwidth of each channel that will be measured. All array parameters should have the same number of elements. Alternatively, if all the elements are the same value, a single number with no square brackets can be used to define the parameter.
Preset	[1 e6]
Range	0 to 40 MHz
Default Unit	Hz
Initial S/W Revision	A.14.00

Channel Filter Type Array

Example	CALC:FPOW:POW1:DEF "FilterType=[RRC, IBW, RRC]"
Notes	The filter type parameter allows the user to choose between an integration bandwidth (IBW) filter or a root-raised-cosine (RRC) filter. The integration bandwidth filter weighs all frequencies within the bandwidth equally. The root-raised-cosine filter has an associated shape parameter, defined by the FilterAlpha parameter. All array parameters should have the same number of elements. Alternatively, if all the elements are the same value, a single value with no square brackets can be used to define the parameter.
Preset	[IBW]
Range	IBW, RRC
Initial S/W Revision	A.14.00

Channel Filter Alpha Array

Example	CALC:FPOW:POW1:DEF "FilterAlpha=[0.5, 0.0, 0.5]"
Notes	The filter alpha parameter allows the user to adjust the alpha value associated with the root-raised-cosine (RRC) filter type. Set FilterType to RRC in order to utilize this parameter. All array parameters should have the same number of elements. Alternatively, if all the elements are the same value, a single number with no square brackets can be used to define the parameter.
Preset	[0.22]
Range	0.0 – 1.0
Initial S/W Revision	A.14.00

Channel Measurement Function Array

Example	CALC:FPOW:POW1:DEF "Function=[BandPower, PeakPower, BandPower]"
Notes	<p>This parameter array defines what measurement is being made for each individually-specified channel:</p> <p>BandPower: Total power within the specified bandwidth of the channel (dBm)</p> <p>BandDensity: Total power density within the specified bandwidth of the channel (dBm/Hz)</p> <p>PeakPower: The peak power value within the specified bandwidth of the channel (dBm)</p> <p>PeakFrequency: The frequency which corresponds to the peak power value within the specified bandwidth of the channel. This frequency is relative to the center frequency (Hz)</p> <p>XdBBandwidth: The half power (-3.01 dB) bandwidth of the highest amplitude signal that resides within the channel (Hz), dB is configurable using XdBBandwidth parameter</p> <p>OccupiedBandwidth: The bandwidth at which 99% of the total power resides within the channel (Hz), percentage configurable using OccupiedBandwidthPercent parameter</p> <p>All array parameters should have the same number of elements. Alternatively, if all the elements are the same value, a single value with no square brackets can be used to define the parameter.</p>
Preset	[BandPower]
Range	BandPower, BandDensity, PeakPower, PeakFrequency, XdBBandwidth, OccupiedBandwidth
Initial S/W Revision	A.14.00

Channel Offset Frequency Array

Example	CALC:FPOW:POW1:DEF "OffsetFrequency=[-5e6, 0, 5e6]"
Notes	<p>The offset frequency parameter array defines the difference between the center frequency to the center frequency of each channel.</p> <p>All array parameters should have the same number of elements.</p>
Preset	[0]
Range	0 to 20 MHz
Default Unit	Hz
Initial S/W Revision	A.14.00

Channel Occupied Bandwidth Percent Array

Example	CALC:FPOW:POW1:DEF "OccupiedBandwidthPercent =[0.95, 0.95, 0.95]"
Notes	<p>This parameter only applies for channels whose Function is set to OccupiedBandwidth. The occupied bandwidth percent parameter specifies the percent of total power in these channels. The valid range for this parameter is 0.0 to 1.0, where 1.0 represents 100%. The default for this parameter is 0.99, which will return the bandwidth that contains 99% of the total channel power.</p>

Preset	[0.99]
Range	0 – 1.0
Initial S/W Revision	A.14.00

Channel x-dB Bandwidth Array

Example	CALC:FPOW:POW1:DEF " XdBBandwidth =[-6.02, -3.01, -1.0]"
Notes	This parameter only applies for channels whose Function is set to XdBBandwidth. The X dB bandwidth parameter is used to specify the power relative to the peak channel power over which the bandwidth is calculated. The parameter value must be a negative number.
Preset	[-3.01]
Range	-200 to 0 dB
Default Unit	dB
Initial S/W Revision	A.14.00

Define Fast Power Measurement Query (Remote Command Only)

The DEFine? command is used to retrieve a list of all defined parameters in an ASCII string format

M All
o
d
e

R :CALCulate:FPOWER:POWER[1,2,...,999]:DEFine?

e
m
o
t
e

C
o
m
m
a
n
d

E :CALC:FPOW:POW1:DEF?
x
a
m

```

p
l
e
N This command query is used to retrieve a list of all defined parameters in an ASCII format.
o The following is an example of the returned results:
t "DCCoupled=False,ElecAttBypass=True,ElecAttenuation=0,IFGain=0,MechAttenuation=0,PreAmpMode=Off,PreSelectorOffset
e =0,UsePreSelector=False,ExternalReferenceFrequency=10000000,FrequencyReferenceSource=AutoExternalFrequencyRefer
s ence,IFType=B40M,LOMode=SLW,SignalInput=FpMainRf,AcquisitionTime=0.001,CenterFrequency=1000000000,Resolution
BW=0,ResolutionBWMode=BestSpeed,DetectorType=RmsAverage,Bandwidth=[1000000],OffsetFrequency=[0],Function=
[BandPower],FilterType=[IBW],FilterAlpha=[0.22],OccupiedBandwidthPercent=[0.99],XdBBandwidth=[-
3.01],DoNoiseCorrection=False,DoSpurSuppression=False,MeasurementMethod=HardwareFFT,IncludePowerSpectrum=False,
e,TriggerDelay=0,TriggerLevel=1.2,TriggerSlope=Positive,TriggerSource=Free,TriggerTimeout=1"

I A.14.00
n
i
t
i
a
l

S
/
W

R
e
v
i
s
i
o
n

```

Configure Fast Power Measurement (Remote Command Only)

The configure command begins hardware setup and returns immediately, with no acquisition made. This can be used in parallel with other hardware operations to effectively hide the hardware setup time.

Mode	All
Remote Command	:CALCulate:FPOWer:POWer[1,2,...,999]:CONFigure
Example	:CALC:FPOW:POW1:CONF
Notes	Option FP2 is required.
Initial S/W Revision	A.14.00

Initiate Fast Power Measurement (Remote Command Only)

The INITiate command begins an acquisition and returns immediately. The results of the measurement can be retrieved using FETCh.

Mode	All
Remote Command	:CALCulate:FPOWER:POWER[1,2,...,999]:INITiate
Example	:CALC:FPOW:POW1:INIT
Notes	Option FP2 is required.
Initial S/W Revision	A.14.00

Fetch Fast Power Measurement (Remote Command Only)

The FETCh command query is used to retrieve the results of an acquisition initiated by the INIT command. The returned results are in ASCII string format. The string begins and ends with quotation marks.

Mode	All
Remote Command	:CALCulate:FPOWER:POWER[1,2,...,999]:FETCh?
Example	:CALC:FPOW:POW1:FETC?
Notes	Option FP2 is required. Returns m comma-separated ASCII values, where m corresponds to the number of bandwidths defined. 1. Declared function return in the 1st specified channel 2. Declared function return in the 2nd specified channel ... m. Declared function return in the last specified channel The INIT and FETC? command sequence performs the same functionality of a single CALC:FPOW:POW[n]? query. Units of the returned values are dependent on the Function parameter for each channel.
Initial S/W Revision	A.14.00

Execute Fast Power Measurement (Remote Command Only)

This command query is used as shorthand for an INIT command immediately followed by a FETC? command. The returned results are in ASCII string format. The string begins and ends with quotation marks.

Mode	All
Remote Command	:CALCulate:FPOWER:POWER[1,2,...,999]?
Example	:CALC:FPOW:POW1?
Notes	Option FP2 is required. See notes for Fast Power Fetch for return format.
Initial S/W Revision	A.14.00

Binary Read Fast Power Measurement (Remote Command Only)

This command query is used as shorthand for an INIT command immediately followed by a FETC? command. The returned results are in a binary format.

Mode	All
Remote Command	:CALCulate:FPOWER:POWER[1,2,...,999]:READ? :CALCulate:FPOWER:POWER[1,2,...,999]:READ1?
Example	:CALC:FPOW:POW1:READ? :CALC:FPOW:POW1:READ1?
Notes	Option FP2 is required. Returns m 4 byte floating point binary values (Little-Endian), where m corresponds to the number of bandwidths defined.
Initial S/W Revision	A.14.00

Diagnostic Binary Read Fast Power Measurement (Remote Command Only)

This command query is used as shorthand for an INIT command immediately followed by a FETC? command. The returned results are in a binary format. This command is used primarily for diagnostic purposes to test for ADC overloads and to visibly inspect the spectrum.

Mode	All
Remote Command	:CALCulate:FPOWER:POWER[1,2,...,999]:READ2?
Example	:CALC:FPOW:POW1:READ2?
Notes	Option FP2 is required. Note: Spectrum data is only returned if the IncludePowerSpectrum parameter is set to True. If IncludePowerSpectrum is False, the number of spectrum points will be zero (0). Units of the returned values are dependent on the Function parameter per channel (e.g. dBm for BandPower, Hz for PeakFrequency). Returns binary data (Little-Endian) that contains information on m amount of channels, along with ADC over range and full spectrum data. The following is the binary format of the response. Bandwidth Return Value 1. Number of channels specified, m [4 byte int] 2. Declared function result for the 1st specified channel [4 byte float] 3. Declared function result for the 2nd specified channel [4 byte float] ... (m + 1). Declared function result for the last (mth) specified channel [4 byte float] ADC Over Range 1. ADC over-range occurred (1: true, 0: false) [2 byte short]

	<p>Spectrum Data</p> <ol style="list-style-type: none"> 1. Number of points in the spectrum data, k [4 byte int] 2. Start frequency of spectrum data (Hz) [8 byte double] 3. Step frequency of spectrum data (Hz) [8 byte double] 4. FFT bin at 1st point (dBm) [4 byte float] 5. FFT bin at 2nd point (dBm) [4 byte float] <p>...</p> <p>(k + 3). FFT bin at last (kth) point (dBm) [4 byte float]</p>
Initial S/W Revision	A.14.00

Format Data: Numeric Data (Remote Command Only)

This command specifies the format of the trace data input and output. It specifies the formats used for trace data during data transfer across any remote port. It affects only the data format for setting and querying trace data for the :TRACe[:DATA], TRACe[:DATA]?, :CALCulate:DATA[n]? and FETCh:SANalyzer[n]? commands and queries.

Remote Command	<pre>:FORMat[:TRACe][:DATA] ASCii INTeger,32 REAL,32 REAL,64 :FORMat[:TRACe][:DATA]?</pre>
Notes	<p>The query response is:</p> <pre>ASCii: ASC,8 REAL,32: REAL,32 REAL,64: REAL,64 INTeger,32: INT,32</pre> <p>When the numeric data format is REAL or ASCii, data is output in the current Y Axis unit. When the data format is INTeger, data is output in units of m dBm (.001 dBm).</p> <p>The INT,32 format returns binary 32-bit integer values in internal units (m dBm), in a definite length block.</p>
Dependencies	<p>Sending a data format spec with an invalid number (for example, INT,48) generates no error. The analyzer simply uses the default (8 for ASCii, 32 for INTeger, 32 for REAL).</p> <p>Sending data to the analyzer which does not conform to the current FORMat specified, results in an error. Sending ASCII data when a definite block is expected generates message -161 "Invalid Block Data" and sending a definite block when ASCII data is expected generates message -121 "Invalid Character in Number".</p>
Preset	ASCii
Backwards Compatibility Notes	Note that the INT,32 format is only applicable to the command, TRACe:DATA. This preserves backwards compatibility for the Swept SA measurement. For all other commands/queries which honor FORMat:DATA, if INT,32 is sent the analyzer will behave as though it were set to REAL,32.
Initial S/W Revision	Prior to A.02.00

The specs for each output type follow:

AScii - Amplitude values are in ASCII, in the current Y Axis Unit, one ASCII character per digit, values separated by commas, each value in the form:

SX.YYYYYEsZZ

Where:

S = sign (+ or -)

X = one digit to left of decimal point

Y = 5 digits to right of decimal point

E = E, exponent header

s = sign of exponent (+ or -)

ZZ = two digit exponent

REAL,32 - Binary 32-bit real values in the current Y Axis Unit, in a definite length block.

REAL,64 - Binary 64-bit real values in the current Y Axis Unit, in a definite length block.

Format Data: Byte Order (Remote Command Only)

This command selects the binary data byte order for data transfer and other queries. It controls whether binary data is transferred in normal or swapped mode. This command affects only the byte order for setting and querying trace data for the :TRACe[:DATA], TRACe[:DATA]? , :CALCulate:DATA[n]? and FETCh:SANalyzer[n]? commands and queries.

By definition any command that says it uses FORMat:DATA uses any format supported by FORMat:DATA.

The NORMal order is a byte sequence that begins with the most significant byte (MSB) first, and ends with the least significant byte (LSB) last in the sequence: 1|2|3|4. SWAPped order is when the byte sequence begins with the LSB first, and ends with the MSB last in the sequence: 4|3|2|1.

Remote Command	:FORMat:BORDER NORMal SWAPped :FORMat:BORDER?
Preset	NORMal
Initial S/W Revision	Prior to A.02.00

Meas Setup

The other functions which are not available from Meas Setup are performed using Remote Commands documented in the following sections, or via setup tables, using the front-panel keys or a mouse and keyboard.

For more information on the measurement setup table screens, see:

Section [Measurement List view](#) and

Section [Parameter List view](#)

Key Path	Front-panel key
Initial S/W Revision	A.14.00

Average/Hold Number

Sets the number of data acquisitions that will be averaged for every Component Carrier, the average number is global for all Component Carriers.

Key Path	Meas Setup
Mode	LTEAFDD, LTEATDD
Remote Command	[:SENSe]:CEVM:AVERage:COUNT <integer> [:SENSe]:CEVM:AVERage:COUNT? [:SENSe]:CEVM:AVERage[:STATe] OFF ON 0 1 [:SENSe]:CEVM:AVERage[:STATe]?
Example	CEVM:AVER:COUN 3 CEVM:AVER:COUN? CEVM:AVER ON CEVM:AVER?
Preset	10 OFF
State Saved	Saved in instrument state.
Min	1
Max	10000
Initial S/W Revision	A.14.00

Meas Method (when 85 MHz or wider analysis bandwidth option is installed)

Selects the desired method for the CEVM measurement. This feature is available only when 85 MHz or wider analysis bandwidth option is installed.

NORMAL – Measurement speed is not optimized.

FAST – Measurement speed is optimized and faster than NORMAl. However, measurement settings are limited even in the valid combination of the parameter values. The limitations for Fast mode, See "[Fast Mode Limitation](#)" on page 2382.

Key Path	Meas Setup
Mode	LTE
Remote Command	[:SENSe] :CEVM:METhod NORMAl FAST [:SENSe] :CEVM:METhod?
Example	CEVM:METh FAST CEVM:METh?
Dependencies	This parameter is available only when the Wideband DIF (85 MHz or wider) hardware is installed in the instrument.
State Saved	Saved in instrument state.
Range	Normal Fast
Initial S/W Revision	A.10.01
Modified at S/W Revision	A.13.00

Fast Mode Limitation

- For downlink signals, Fast mode can be used only for E-UTRA test models, the setup files can be recalled by using Recall, Data, EVM Setup.
- For uplink signals, Fast mode only supports channel configuration for PUSCH, and other channels such as PUCCH are not supported. Multiple users are not supported in Fast mode. The auto function of the parameters must be OFF and see the table below for parameter values, others must be preset value.
- When Meas Method is FAST, EVM Minimization by IQ Imbalance is not valid and is always OFF to return the measurement results.

Name	SCPI	Fast Mode
RB Auto Detection	[:SENSe] :CEVM:PROFile:AUTO[:DETECT]	OFF
Analysis Boundary	[:SENSe] :CEVM:TIME:ASBoundary	FRAMe
Meas Interval/Offset	[:SENSe] :CEVM:TIME:INTerval:SLOT [:SENSe] :CEVM:TIME:INTerval:SYMBOL [:SENSe] :CEVM:TIME:OFFSet:SLOT [:SENSe] :CEVM:TIME:OFFSet:SYMBOL	Same as Normal Mode
Sync Type	[:SENSe] :CEVM:ULINK:SYNC:TYPE	RS
Cyclic Prefix Length	[:SENSe] :CEVM:ULINK:SYNC:CPLength	NORMAl
Add User	[:SENSe] :CEVM:ULINK:PROFile:ADD:USER	Only USER[1] is valid.

Include PUSCH	[:SENSe] :CEVM:ULINK:PROFile:USER:PUSCh	INCLude
PUSCH Active	[:SENSe] :CEVM:ULINK:PROFile:USER:PUSCh:ACTive	ON
Include PUSCH DMRS	[:SENSe] :CEVM:ULINK:PROFile:USER:PUSCh:DMRS	INCLude
PUSCH Auto Calc Params	[:SENSe] :CEVM:ULINK:PROFile:USER:PUSCh:DMRS:PARAmS	Same as Normal Mode
PUSCH n DMRS (1)	[:SENSe] :CEVM:ULINK:PROFile:USER:PUSCh:DMRS:ONE	Same as Normal Mode
PUSCH n DMRS (2)	[:SENSe] :CEVM:ULINK:PROFile:USER:PUSCh:DMRS:TWO	Same as Normal Mode
Delta SS	[:SENSe] :CEVM:ULINK:PROFile:USER:PUSCh:DSS	Same as Normal Mode
Add PUSCH Slot	[:SENSe] :CEVM:ULINK:PROFile:USER:PUSCh:ADD:SLOT	Same as Normal Mode
User PUSCH RB Start	[:SENSe] :CEVM:ULINK:PROFile:USER:PUSCh:RB:START	Same as Normal Mode
PUSCH Start RB Couple	[:SENSe] :CEVM:ULINK:PROFile:USER:PUSCh:RB:START:COUPlE	Same as Normal Mode
PUSCH Common RB End	[:SENSe] :CEVM:ULINK:PROFile:USER:PUSCh:RB:END	Same as Normal Mode
PUSCH End RB Couple	[:SENSe] :CEVM:ULINK:PROFile:USER:PUSCh:RB:END:COUPlE	Same as Normal Mode
PUSCH Sync Slot	[:SENSe] :CEVM:ULINK:PROFile:USER:PUSCh:SSLot	Same as Normal Mode
PUSCH Sync Slot Auto	[:SENSe] :CEVM:ULINK:PROFile:USER:PUSCh:SSLot:AUTO	OFF
PUSCH Common Mod Type	[:SENSe] :CEVM:ULINK:PROFile:USER1 50:PUSCh:MODulation:TYPE	Same as Normal Mode
Frequency Hopping	[:SENSe] :CEVM:ULINK:PROFile:USER:PUSCh:FHOPping	OFF
Group Hopping	[:SENSe] :CEVM:ULINK:PROFile:USER:HOPping:GROUp	Same as Normal Mode
Seq Hopping	[:SENSe] :CEVM:ULINK:PROFile:USER1 50:HOPping:SEQuence	Same as Normal Mode
Equalizer Training	[:SENSe] :CEVM:EQUalizer:TRaining	RSData

Copy from Mod Analysis Measurement

This immediate action key provides parameter copy function from Mod Analysis Measurement to CEVM.

NOTE This immediate action copies LTE-Advanced demodulation parameters from the Mod Analysis Measurement to Conformance EVM Measurement. Note that the other parameters such as Attenuation (Range), Trigger, averaging parameters, IFBW, etc. are NOT copied from Mod Analysis Measurement.

Key Path	Meas Setup
Mode	LTEAFDD, LTEATDD
Remote Command	[:SENSe] :CEVM:EVM:COPY [:IMMediate]
Example	CEVM:EVM:COPY
Initial S/W Revision	A.14.00

Meas Preset

This immediately sets all measurement parameters to their Preset values. For more information, see the Preset key in the System Functions section.

Key Path	Meas Setup
Mode	LTEAFDD, LTEATDD
Initial S/W Revision	A.14.00

EVM Minimization by IQ Imbalance

Selects whether or not IQ Imbalance will be used for EVM minimization algorithm for every component carrier.

Parameter Name	EVM Minimization by IQ Imbalance
Key Path	SCPI only
Parameter Type	BooleanParameter
Mode	LTEAFDD, LTEATDD
Remote Command	[:SENSe] :CEVM:CCARrier0 1 2 3 4:EVMMinimize:IQIMbalance OFF ON 0 1 [:SENSe] :CEVM:CCARrier0 1 2 3 4:EVMMinimize:IQIMbalance?
Example	CEVM:CCAR0:EVMM:IQIM OFF CEVM:CCAR0:EVMM:IQIM?
Dependencies	Enabled when EVM minimization is not OFF.
Preset	OFF
Force Restart	Yes

State Saved	Saved in instrument state.
Backwards Compatibility SCPI	[:SENSe] :CEVM :EVMMinimize : IQIMbalance
Initial S/W Revision	A.14.00
Modified at S/W Revision	A.14.50

IQ Imbalance Frequency Compensation

Toggles Frequency Compensation for IQ Imbalance measurement results (IQ Gain Imbalance, IQ Quadrature Error) for Receiver Device Under Test (DUT) between on and off. The Compensation is not valid for Transmitter DUT.

- ON: IQ Imbalance measurement results are compensated by taking account of Frequency Offset which is added before IQ Imbalance addition on DUT.
- OFF: IQ Imbalance measurement results are not compensated for the Frequency Offset.

Parameter Name	IQ Imbalance Frequency Compensation
Key Path	SCPI only
Parameter Type	BooleanParameter
Mode	LTE, LTE-TDD
Remote Command	[:SENSe] :CEVM :CCARrier0 1 2 3 4 :IQIMbalance :FCOMpen ON OFF [:SENSe] :CEVM :CCARrier0 1 2 3 4 :IQIMbalance :FCOMpen?
Example	CEVM :CCAR0 :IQIM :FCOM ON CEVM :CCAR0 :IQIM :FCOM ?
Preset	OFF
Force Restart	Yes
State Saved	Saved in instrument state.
Backwards Compatibility SCPI	[:SENSe] :CEVM :IQIMbalance :FCOMpen
Initial S/W Revision	A.14.00
Modified at S/W Revision	A.14.50

Result Values

In CEVM, the user can select results displayed in the Result Metrics View for every component carrier. These results are synchronized with the remote SCPI query results for index n=1.

Downlink Result Output Selection

The following table shows the mapping of the Array index and Result parameters.

Index	Result Parameter
1	EVM (%rms)
2	EVM Sym Time Adjust 1: Window Start, 2: Window End, 3: Center, 4: Custom
3	EVM Pk (%)
4	EVM Pk Index
5	EVM Peak Sub Car Index
6	Data EVM (%rms)
7	3GPP-defined QPSK EVM (%rms)
8	3GPP-defined 16QAM EVM (%rms)
9	3GPP-defined 64QAM EVM (%rms)
10	RS EVM (%rms)
11	RS Tx. Power (dBm)
12	OFDM Sym. Tx. Power (dBm)
13	Freq Error (Hz)
14	Sync Corr (%)
15	Sync Type 1: P-SS, 20: Ant Port 0 RS, 21: Ant Port 1 RS, 22:Ant Port 2 RS, 23: Ant Port 3 RS
16	Common Tracking Error (%rms)
17	Symbol Clock Error (ppm)
18	Time Offset (s)
19	IQ Offset (dB)
20	IQ Gain Imbalance (dB)
21	IQ Quad Error (deg)
22	IQ Timing Skew (s)
23	CP Length Mode 1: Normal, 2: Extended
24	Cell ID
25	Cell ID Group/Sector Integer part: Cell ID Group, After the decimal point: Cell ID Sector
26	RS-OS / PRS 1: 3GPP, 4: Custom
27	Reference Signal Rx Power (Avg)
28	Reference Signal Rx Quality (dB)
29	Received Signal Strength Indicator (dBm)
30	Channel Power (dBm)

Key Path	SCPI only
Mode	LTEAFDD, LTEATDD
Remote Command	[:SENSe] :CEVM:DLINK:RESult ON OFF 0 1, ... [:SENSe] :CEVM:DLINK:RESult?
Example	CEVM:DLIN:RES 0,1,0 CEVM:DLIN:RES?
Notes	Refer to the above table to see the mapping of the index and result parameter. The array length might be expanded for future enhancement.
Preset	1, 1
State Saved	Saved in instrument state.
Initial S/W Revision	A.14.00

Uplink Result Output Selection

The following table shows the mapping of the Array index and Result parameters.

Index	Result Parameter
1	EVM (%rms)
2	EVM Sym Time Adjust 1: Window Start, 2: Window End, 3: Center, 4: Custom
3	EVM Pk (%)
4	EVM Pk Index
5	EVM Peak Sub Car Index
6	Data EVM (%rms)
7	3GPP-defined QPSK EVM (%rms)
8	3GPP-defined 16QAM EVM (%rms)
9	3GPP-defined 64QAM EVM (%rms)
10	RS EVM (%rms)
11	RS Tx. Power (dBm) Always returns -999.0.
12	OFDM Sym. Tx. Power (dBm) Always returns -999.0.
13	Freq Error (Hz)
14	Sync Corr (%)
15	Sync Type 2: PUSCH-DMRS, 3: PUCCH-DMRS, 4: SRS, 5: PRACH
16	Common Tracking Error (%rms)
17	Symbol Clock Error (ppm)

Mode	LTE, LTETDD
Remote Command	[:SENSe] :CEVM:DLINk:RESult:ALL ON OFF 0 1
Example	CEVM:DLIN:RES:ALL 0
State Saved	No
Initial S/W Revision	A.14.50

Uplink Set All Results

This action command can set all of the “Uplink Result Output Selection” to 0 or 1 at once. It works whenever the command is sent, regardless of the current result status.

Key Path	SCPI only
Mode	LTE, LTETDD
Remote Command	[:SENSe] :CEVM:ULINk:RESult:ALL ON OFF 0 1
Example	CEVM:ULIN:RES:ALL 0
State Saved	No
Initial S/W Revision	A.14.50

Get Measurement Item List

Returns a comma-delimited string list of the current active measurement item on Result Metrics View.

Key Path	SCPI query only
Mode	LTE, LTETDD
Remote Command	CALCulate:CEVM:RESult:NAMes?
Example	CALC:CEVM:RES:NAM?
Notes	The result depends on Radio Standard Direction, “Downlink Result Output Selection” or “Uplink Result Output Selection.” This is a command of information on what the “READ:CEVM?” result stands for. The result strings may change in future releases.
State Saved	No
Initial S/W Revision	A.14.50

14 Conformance EVM
Mode

Mode

See "[Mode](#)" on page 222

Mode Preset

Returns the active mode to a known state.

Mode Preset does the following for the currently active mode:

- Aborts the currently running measurement.
- Brings up the default menu for the mode, with no active function.
- Sets measurement Global settings to their preset values for the active mode only.
- Activates the default measurement.
- Brings up the default menu for the mode.
- Clears the input and output buffers.
- Sets Status Byte to 0.

Mode Preset does not:

- Cause a mode switch
- Affect mode persistent settings
- Affect system settings
- See "[How-To Preset](#)" on page 2392 for more information.

Key Path	Front-panel key
Remote Command	:SYSTem:PRESet
Example	:SYST:PRES
Notes	*RST is preferred over :SYST:PRES for remote operation. *RST does a Mode Preset, as done by the :SYST:PRES command, and it sets the measurement mode to Single measurement rather than Continuous for optimal remote control throughput. Clears all pending OPC bits. The Status Byte is set to 0.
Couplings	A Mode Preset aborts the currently running measurement, activates the default measurement, and gets the mode to a consistent state with all of the default couplings set.
Backwards Compatibility Notes	In the X-Series, the legacy "Factory Preset" has been replaced with Mode Preset, which only presets the currently active mode, not the entire instrument. In the X-Series, the way to preset the entire instrument is by using System, Restore System Defaults All, which behaves essentially the same way as restore System Defaults does on ESA and PSA. There is also no "Preset Type" as there is on the PSA. There is a green Mode Preset front-panel key that does a Mode Preset and a white-with-green-letters User Preset front-panel key that does a User Preset. The old PRESet:TYPE command is ignored (without generating an error), and SYST:PRES without a parameter does a Mode Preset, which should cover most backward code compatibility issues. The settings and correction data under the Input/Output front-panel key (examples: Input Z Corr, Ext Amp Gain, etc.) are no longer part of any Mode, so they will not be preset by a Mode Preset. They are preset using Restore Input/Output Defaults, Restore System Defaults All. Note that because User Preset does a Recall State, and all of these settings are saved in State, they ARE recalled when using

	User Preset.
Initial S/W Revision	Prior to A.02.00

How-To Preset

The table below shows all possible presets, their corresponding SCPI commands and front-panel access (key paths). Instrument settings depend on the current measurement context. Some settings are local to the current measurement, some are global (common) across all the measurements in the current mode, and some are global to all the available modes. In a similar way, restoring the settings to their preset state can be done within the different contexts.

Auto Couple - is a measurement local key. It sets all Auto/Man parameter couplings in the measurement to Auto. Any Auto/Man selection that is local to other measurements in the mode will not be affected.

Meas Preset - is a measurement local key. Meas Preset resets all the variables local to the current measurement except the persistent ones.

Mode Preset - resets all the current mode's measurement local and measurement global variables except the persistent ones.

Restore Mode Defaults - resets ALL the Mode variables (and all the Meas global and Meas local variables), including the persistent ones.

Type Of Preset	SCPI Command	Front Panel Access
Auto Couple	:COUPle ALL	Auto Couple front-panel key
Meas Preset	:CONFigure:<Measurement>	Meas Setup Menu
Mode Preset	:SYSTem:PRESet	Mode Preset (green key)
Restore Mode Defaults	:INSTrument:DEFault	Mode Setup Menu
Restore All Mode Defaults	:SYSTem:DEFault MODes	System Menu; Restore System Default Menu
*RST	*RST	not possible (Mode Preset with Single)
Restore Input/Output Defaults	:SYSTem:DEFault INPUt	System Menu; Restore System Default Menu
Restore Power On Defaults	:SYSTem:DEFault PON	System Menu; Restore System Default Menu
Restore Alignment Defaults	:SYSTem:DEFault ALIGN	System Menu; Restore System Default Menu
Restore Miscellaneous Defaults	:SYSTem:DEFault MISC	System Menu; Restore System Default Menu
Restore All System Defaults	:SYSTem:DEFault [ALL] :SYSTem:PRESet:PERsistent	System Menu; Restore System Default Menu
User Preset	:SYSTem:PRESet:USER	User Preset Menu
User Preset All Modes	:SYSTem:PRESet:USER:ALL	User Preset Menu

Power On Mode Preset	:SYSTem:PON:TYPE MODE	System Menu
Power On User Preset	:SYSTem:PON:TYPE USER	System Menu
Power On Last State	:SYSTem:PON:TYPE LAST	System Menu

Mode Setup

See "[Mode Setup](#)" on page 242

Peak Search

There is no Peak Search functionality implemented in this measurement.

Key Path	Front-panel key
----------	-----------------

14 Conformance EVM
Print

Print

See "Print" on page 271

Quick Save

The Quick Save front-panel key repeats the most recent save that was performed from the Save menu, with the following exceptions:

- Register saves are not remembered as Saves for the purpose of the Quick Save function
- If the current measurement does not support the last non-register save that was performed, an informational message is generated, “File type not supported for this measurement”

Quick Save repeats the last type of qualified save (that is, a save qualified by the above criteria) in the last save directory by creating a unique filename using the Auto File Naming algorithm described below.

If Quick Save is pressed after startup and before any qualified Save has been performed, the Quick Save function performs a Screen Image save using the current settings for Screen Image saves (current theme, current directory), which then becomes the “last save” for the purpose of subsequent Quick Saves.

The Auto File Naming feature automatically generates a file name for use when saving a file. The filename consists of a prefix and suffix separated by a dot, as is standard for the Windows® file system. A default prefix exists for each of the available file types:

Type	Default Prefix	Menu
State	State_	(Save/Recall)
Trace + State	State_	(Save/Recall)
Screen	Screen_	(Save/Recall)
Amplitude Corrections	Ampcor_	(Import/Export)
Traces	Trace_	(Import/Export)
Limit Lines	LLine_	(Import/Export)
Measurement Result	MeasR_	(Import/Export)
Capture Buffer	CapBuf_	(Import/Export)

A four digit number is appended to the prefix to create a unique file name. The numbering sequence starts at 0000 within each Mode for each file type and updates incrementally to 9999, then wraps to 0000 again. It remembers where it was through a Mode Preset and when leaving and returning to the Mode. It is reset by Restore Misc Defaults and Restore System Defaults and subsequent running of the instrument application. So, for example, the first auto file name generated for State files is State_0000.state. The next is State_0001, and so forth.

One of the key features of Auto File Name is that we guarantee that the Auto File Name will never conflict with an existing file. The algorithm looks for the next available number. If it gets to 9999, then it looks for holes. If it find no holes, that is no more numbers are available, it gives an error.

For example, if when we get to State_0010.state there is already a State_0010.state file in the current directory, it advances the counter to State_0011.state to ensure that no conflict will exist (and then it verifies that State_0011.state also does not exist in the current directory and advances again if it does, and so forth).

If you enter a file name for a given file type, then the prefix becomes the filename you entered instead of the default prefix, followed by an underscore. The last four letters (the suffix) are the 4-digit number.

For example, if you save a measurement results file as “fred.csv”, then the next auto file name chosen for a measurement results save will be fred_0000.csv.

NOTE

Although 0000 is used in the example above, the number that is used is actually the current number in the Meas Results sequence, that is, the number that would have been used if you had not entered your own file name.

NOTE

If the filename you entered ends with _dddd, where d=any number, making it look just like an auto file name, then the next auto file name picks up where you left off with the suffix being dddd + 1.

Key Path	Front-panel key
Notes	No remote command for this key specifically.
Initial S/W Revision	Prior to A.02.00

Recall

In the LTE-Advanced TDD/FDD modes, two types of recall functions are available under the Data menu: “Parameter Configuration per Component Carrier” and “Limit Mask”. Limit Mask enables setting a preset limit mask for Power Suite-based measurements, and currently it is available for the SEM, ACP and SPUR measurements in LTE-Advanced TDD/FDD modes.

Recalling the complicated RB settings specified in the test models of the standards and the LTE state file. And it can also recalls the parameters which have been set and saved for “Signal Studio Setup” or “89600 Vector Signal Analyzer” on the external platform .

Key Path	Front Panel Key
Mode	LTEATDD, LTEAFDD
Initial S/W Revision	A.14.00

State

The Recall State menu lets you choose a register or file from which to recall the state.

The content of a state file includes all of the settings and data required to return the analyzer as closely as possible to the Mode it was in, with the exact settings that were in place, when the save occurred. The Mode settings in each state file include the settings that are affected by Mode Preset, as well as the additional settings affected by Restore Mode Defaults; all of the Mode’s settings. In addition, all of the settings of the Input/Output system are included, even though they are outside of the Mode’s state, because they are needed to restore the complete setup. Persistent System settings (for example, GPIB address) are not affected by either a Mode Preset or Restore Mode Defaults, nor are they included in a saved State file.

Since each state file is only for one Mode, the settings for other Modes are unaffected when it is loaded. Recall State will cause a mode switch if the state being recalled is not from the current active mode.

After the recall completes, the message "File <filename> recalled" or “Recalled State Register <register number>” is displayed.

For rapid recalls, the State menu lists 16 registers that you can choose from to recall. Pressing a Register key initiates the recall. You can also select a file from which to recall.

The default path for all State Files is:

My Documents\`<mode name>`\state

where `<mode name>` is the parameter used to select the mode with the INST:SEL command (for example, SA for the Spectrum Analyzer).

See "[More Information](#)" on page 2400.

Key Path	Recall
Mode	All
Remote Command	:MMEMory:LOAD:STATe <filename>

Example	:MMEM:LOAD:STAT "myState.state" This recalls the file myState.state on the default path
Example	MMEM:LOAD:STAT "MyStateFile.state" This loads the state file data (on the default file directory path) into the instrument state.
Notes	<p>When you pick a file to recall, the analyzer first verifies that the file is recallable in the current instrument by checking the software version and model number of the instrument. If everything matches, a full recall proceeds by aborting the currently running measurement, clearing any pending operations, and then loading the State from the saved state file. You can open state files from any mode, so recalling a State file switches to the mode that was active when the save occurred. After switching to the mode of the saved state file, mode settings and data (if any for the mode) are loaded with values from the saved file. The saved measurement of the mode becomes the newly active measurement and the data relevant to the measurement (if there is any) is recalled.</p> <ul style="list-style-type: none"> • If there is a mismatch between file version or model number or instrument version or model number, the recall function tries to recall as much as possible and returns a warning message. It may limit settings that differ based on model number, licensing or version number. <p>After recalling the state, the Recall State function does the following:</p> <ul style="list-style-type: none"> • Makes the saved measurement for the mode the active measurement. • Clears the input and output buffers. • Status Byte is set to 0. • Executes a *CLS <p>If the file specified is empty an error is generated. If the specified file does not exist, another error is generated. If there is a mismatch between the file and the proper file type, an error is generated. If there is a mismatch between file version or model number or instrument version or model number, a warning is displayed. Then it returns to the State menu and File Open dialog goes away.</p> <p>After the Recall, the analyzer exits the Recall menu and returns to the previous menu.</p>
Backwards Compatibility SCPI	:MMEMory:LOAD:STATe 1,<filename> For backwards compatibility, the above syntax is supported. The "1" is simply ignored.
Initial S/W Revision	Prior to A.02.00

More Information

In measurements that support saving Traces, for example, Swept SA, the Trace data is saved along with the State in the State file. When recalling the State, the Trace data is recalled as well. Traces are recalled exactly as they were stored, including the writing mode and update and display modes. If a Trace was updating and visible when the State was saved, it will come back updating and visible, and its data will be rewritten right away. When you use State to save and recall traces, any trace whose data must be preserved should be placed in View or Blank mode before saving.

The following table describes the Trace Save and Recall possibilities:

You want to recall state and one trace's data, leaving other traces unaffected.	Save Trace+State from 1 trace. Make sure that no other traces are updating (they should all be in View or Blank mode) when the save is performed.	On Recall, specify the trace you want to load the one trace's data into. This trace will load in View. All other traces' data will be unaffected, although their trace
---	---	--

		mode will be as it was when the state save was performed.
You want to recall all traces	Save Trace+State from ALL traces.	On Recall, all traces will come back in View (or Blank if they were in Blank or Background when saved)
You want all traces to load exactly as they were when saved.	Save State	On recall, all traces' mode and data will be exactly as they were when saved. Any traces that were updating will have their data immediately overwritten.

From File...

When you press “From File”, the analyzer brings up a Windows dialog and a menu entitled “File Open.” This menu allows you to navigate to the various fields in the Windows dialog without using a keyboard or mouse. The Tab and Arrow keys can also be used for dialog navigation.

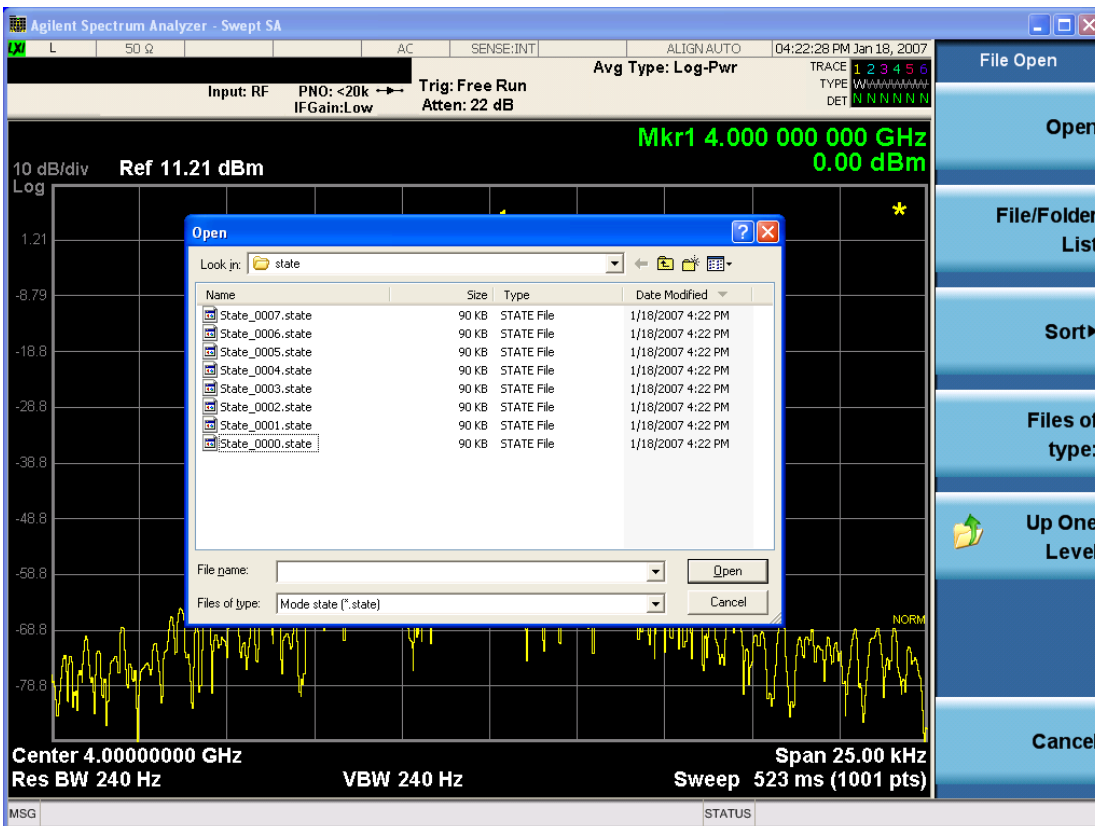

Listed below are the functions of the various fields in the dialog, and the corresponding softkeys:

Open

Performs the recall of the specified file. While the recall is being performed, the floppy icon appears briefly in the Meas bar.

File/Folder List

Enables you to navigate to the center of the dialog that contains the list of files and folders. Once here you can get information about the file and use the tab keys to navigate to the other fields in the dialog, such as Look In.

Look In

The Look In field shows the path from which the file will be recalled and allows you to change the path using the up and down arrow keys to navigate to other paths; the Enter key to open a directory; and the Backspace key to go back one directory. The **Look In field** first uses the last path from the Save As dialog **Save In:** path for that same file type. There is no softkey for directly navigating to the Look In field, but you can use the left tab to get here from the File/Folder List.

User specified paths are remembered when you leave and return to a Mode and are reset back to the default using Restore Mode Defaults.

Sort

Accesses a menu that enables you to sort the files within the File Open dialog. Only one sorting type can be selected at a time and the sorting happens immediately. The sorting types are By Date, By Name, By extension, and By Size.

Files of Type

This field shows the file suffix for the type of file you have selected to recall. For example, if you navigated here while recalling State, "Mode state (*.state)" is in the field. If you navigated here while recalling Trace, ""Mode state (*.trace)" is in the field. If you navigated here while importing a trace data file, "Trace Data (*.csv)" is in the field. For some file types, there is more than one choice in the dropdown menu, which you can select by using the up and down arrow keys and Enter.

Up One Level

This key corresponds to the icon of a folder with the up arrow that is in the tool bar of the dialog. When pressed, it causes the file and folder list to navigate up one level in the directory structure. The Backspace key does the same thing.

Cancel

This key corresponds to the Cancel selection in the dialog. It causes the current **Open** request to be cancelled. The ESC key does the same thing.

Key Path	Recall, State
Notes	Brings up the Open dialog for recalling a State Save Type
Initial S/W Revision	Prior to A.02.00

Edit Register Names

You may enter a custom name on any of the Register keys, to help you remember what you are using that state to save. To do this, press the Edit Register Names key, choose the register whose name you wish to edit, and then enter the desired label using the Alpha Editor or an external PC keyboard.

The maximum number of characters that can be added is 30. In most cases, 30 characters will fit on two lines of the key.

For more information and the SCPI command, see Edit Register Names under the Save, State function.

Key Path	Recall, State
Mode	All
Dependencies	N9060A-7FP or N9060B-2FP license required to edit the register names. When the feature is not licensed, sending the SCPI command generates an error, -221, "Settings conflict;Option not available"
Initial S/W Revision	A.11.00

Register 1 thru Register 16

Selecting any one of these register keys causes the State of the mode from the specified Register to be recalled. Each of the register keys annotates whether it is empty or at what date and time it was last modified. In addition, you can use the Edit Register Names key under Save, State to enter custom names for each register.

NOTE

In products that run multiple instances of the X-Series Application, recalling the same register name on each instance is a way to share setups between the instances.

Registers are shared by all modes, so recalling from any one of the registers will cause a mode switch to the mode that was active when the save to the Register occurred.

Although these 16 registers are the only registers available from the front panel, there are 128 state registers available in the instrument. Registers 17-128 are only available from the SCPI interface, using the *RCL command.

After the recall completes, the message "Register <register number> recalled" appears in the message bar. If you are in the Spectrum Analyzer Mode, and you are recalling a register that was saved in the Spectrum Analyzer Mode, then after the recall, you will still be in the Recall Register menu. If the Recall causes you to switch modes, then after the Recall, you will be in the Frequency menu.

If a requested register is empty an error is generated.

Key Path	Recall, State
Example	*RCL 1
Range	1-16 from front panel, 1-128 from SCPI
Readback	Date and time with seconds resolution are displayed on the key OR A custom name of up to 30 characters entered using the Save, State,Edit Register Names key

	OR “(empty)” if no prior save operation has been performed to this register.
Initial S/W Revision	Prior to A.02.00
Modified at S/W Revision	Prior to A.11.00

Register 1 thru Register 16

Selecting any one of these register keys causes the State of the mode from the specified Register to be recalled. Each of the register keys annotates whether it is empty or at what date and time it was last modified. In addition, you can use the Edit Register Names key under Save, State to enter custom names for each register.

NOTE

In products that run multiple instances of the X-Series Application, recalling the same register name on each instance is a way to share setups between the instances.

Registers are shared by all modes, so recalling from any one of the registers will cause a mode switch to the mode that was active when the save to the Register occurred.

Although these 16 registers are the only registers available from the front panel, there are 128 state registers available in the instrument. Registers 17–128 are only available from the SCPI interface, using the *RCL command.

After the recall completes, the message "Register <register number> recalled" appears in the message bar. If you are in the Spectrum Analyzer Mode, and you are recalling a register that was saved in the Spectrum Analyzer Mode, then after the recall, you will still be in the Recall Register menu. If the Recall causes you to switch modes, then after the Recall, you will be in the Frequency menu.

If a requested register is empty an error is generated.

Key Path	Recall, State
Example	*RCL 1
Range	1–16 from front panel, 1–128 from SCPI
Readback	Date and time with seconds resolution are displayed on the key OR A custom name of up to 30 characters entered using the Save, State, Edit Register Names key OR “(empty)” if no prior save operation has been performed to this register.
Initial S/W Revision	Prior to A.02.00
Modified at S/W Revision	Prior to A.11.00

Sequences

These keys allow you to import a Tab separated or .txt file that will automatically setup all the parameters required for building a Sequence. The parameters will automatically be loaded into the Stated Sequencer.

Once selected, in order to import the selected Sequence Type you must select the Open key in the Source Sequence menu.

Key Path	Recall, Sequences
Mode	All
Remote Command	:MMEMory:LOAD:SEQ:Sequences: SLIS ALIS SAALIS "MySequence.txt"
Example	:MMEM:LOAD:SEQ:SLIS "MySequence.txt"
Notes	Available file types are: –CSV (Comma delimited) (*.csv) –Text (Tab delimited) (*.txt)
Initial S/W Revision	A.05.00

Source Sequence

The list of parameters, that configure steps, that makes up a sequence for the Source.

The Source sequence is a sequence of flexible configurable steps that can be set anywhere in the instruments frequency range.

Key Path	Recall, Sequences
Example	:MMEM:LOAD:SEQ:SLIS "MySequence.txt"
Dependencies	Only available in XOBT
Initial S/W Revision	A.05.00

Open...

When you press “Open”, the analyzer brings up a Windows dialog and a menu entitled “**File Open.**” This menu allows you to navigate to the various fields in the Windows dialog without using a keyboard or mouse. The Tab and Arrow keys can also be used for dialog navigation.

See "[From File...](#)" on page 2401 in Recall, State, for a full description of this dialog and menu.

Key Path	Recall, Data
Notes	The key location is mode-dependent and will vary. Brings up Open dialog for recalling a <mode specific> Save Type
Initial S/W Revision	Prior to A.02.00

Data (Import)

Importing a data file loads data that was previously saved from the current measurement or from other measurements and/or modes that produce compatible data files. The Import Menu only contains Data Types that are supported by the current measurement.

Since the commonly exported data files are in .csv format, the data can be edited by the user prior to importing. This allows you to export a data file, manipulate the data in Excel (the most common PC Application for manipulating .csv files) and then import it.

Importing Data loads measurement data from the specified file into the specified or default destination, depending on the data type selected. Selecting an Import Data menu key will not actually cause the importing to occur, since the analyzer still needs to know from where to get the data. Pressing the Open key in this menu brings up the Open dialog and Open menu that provides you with the options from where to recall the data. Once a filename has been selected or entered in the Open menu, the recall occurs as soon as the Open button is pressed.

Key Path	Recall
Mode	All
Notes	The menu is built from whatever data types are available for the mode. Some keys will be missing completely, so the key locations in the sub-menu will vary. No SCPI command directly controls the Data Type that this key controls. The Data Type is included in the MMEM:LOAD commands.
Dependencies	If a file type is not used by a certain measurement, it is grayed out for that measurement. The key for a file type will not show at all if there are no measurements in the Mode that support it.
Preset	Is not affected by Preset or shutdown, but is reset during Restore Mode Defaults
Readback	The data type that is currently selected
Initial S/W Revision	Prior to A.02.00

Component Carrier Setup

Enables you to import LTE-A setup files for all Component Carriers or the specified Component Carrier. Selecting this key displays a menu that enables you to select what the Component Carrier setup files to be imported. After making this selection, depress Open... and use the file dialog to select the file you wish to recall. The Key is valid for Conformance EVM measurements only.

It supports to the following import file formats

- LTE app state files (*.state)
- EVM Setup Files (*.evms)
- 89601 VSA Setup Files (*.set, *.setx)
- Signal Studio Setup Files (*.scp)

App State Files

Extension: state

The parameters of the LTE Modulation Analysis measurement can be imported to LTE-Advanced EVM and CEVM measurements from the LTE .state file. It depends on the parameter of the Component Carrier Setup to decide which component carriers' measurement parameters are affected.

Pressing OPEN under the Import Data menu will open the above directory from which you can select an LTE app state file.

EVM Setup Files

Extension: evms

It will recall LTE test model parameters specified in the standards to LTE-Advanced FDD/TDD EVM and CEVM measurements. It depends on the parameter of the Component Carrier Setup to decide which component carriers 'measurement parameters are affected.

The default path is My Documents\LTEATDD\LTEAFDD\data\evmsetup. Note that "My Documents" is an alias to a directory and its place differs depending on which user is logged in. At XSA start up, XSA will overwrite all of the EVM Setup files to the current user's "My Documents\LTEATDD\LTEAFDD\data\evmsetup" each time.

Pressing OPEN under the Import Data menu will open the above directory from which you can select an EVM Setup file.

You cannot read the contents of the provided EVM Setup file since it is a binary file.

89601 VSA Setup Files

Extension: set, setx

The 89600 Vector Signal Analyzer Setup file created using the 89600 Vector Signal Analyzer Option BHD (LTETDD|LTEFDD) can be imported as LTE-Advanced TDD/FDD EVM and CEVM parameter sets.

The 89600 Vector Signal Analyzer Setup file created using the 89600 Vector Signal Analyzer Option BHD (LTEATDD|LTEAFDD) can be imported as LTE-Advanced TDD/FDD EVM and CEVM parameter sets.

Which component carriers 'measurement parameters are affected depends on depends on the parameter of the Component Carrier Setup.

If the setup file is not loaded successfully, an error message, -230 "Data corrupt or stale", is issued with the specified file name.

Signal Studio Setup Files

Extension: scp

The Keysight Signal Studio setup file created using Signal Studio (N7624B/N7625B) can be imported as LTE-Advanced TDD/FDD parameter set.

Supported component carrier types are listed in the table below:

<i>Signal Studio</i>	<i>Carrier Type</i>
N7624B Signal Studio for 3GPP LTE	Advanced LTE FDD Downlink (2009-03)
	Advanced LTE FDD Downlink (2009-12)
	Advanced LTE FDD Downlink (2010-06)
	Advanced LTE FDD Uplink (2009-12)
	Advanced LTE FDD Uplink (2010-06)
	Basic LTE FDD Downlink (2009-03)
	Basic LTE FDD Downlink (2009-12)
	Basic LTE FDD Downlink (2010-06)
	Basic LTE FDD Uplink (2009-03)

	Basic LTE FDD Uplink (2009-12)
	Basic LTE FDD Uplink (2010-06)
	Basic LTE-A FDD Downlink (2010-12)
	Basic LTE-A FDD Uplink (2010-12)
	Basic LTE FDD R9 Downlink
	Basic LTE FDD R9 Uplink
	Advanced LTE FDD R9 Downlink
	Advanced LTE FDD R9 Uplink
	Basic LTE-A FDD R10 Downlink
	Basic LTE-A FDD R10 Uplink
N7625B Signal Studio for 3GPP LTE TDD	Advanced LTE TDD (2009-03)
	Advanced LTE TDD (2009-12)
	Basic LTE TDD (2009-03)
	Basic LTE TDD (2009-12)
	Basic LTE-A TDD (2010-01)
	Basic LTE-A TDD R10 (2010-12)

If the setup file is not loaded successfully, an error message, -230 "Data corrupt or stale", is issued with the specified file name.

Key Path	Recall, Data
Mode	LTEATDD, LTEAFDD
Remote Command	MME ^M o ^R y:LOAD:SE ^T up ALL CC0 CC1 CC2 CC3 CC4,<string>
Example	MME:LOAD:SE ^T up CC0,"LTE-A TDD.set"
Notes	The options CC1~CC4 can be enabled with 9080B/9082B-2FP license.
Notes	"ALL" is primarily used to LTE-A setup file for each component carrier including the number of component carriers. "CC*" is used to import LTE-A setup file for the specified component carrier.
Backwards Compatibility SCPI	MME ^M o ^R y:LOAD:SS ^S etup <string> MME ^M o ^R y:LOAD:VS ^S A ^S etup <string> MME ^M o ^R y:LOAD:EV ^M S ^S etup <string>
Initial S/W Revision	A.14.00
Modified at S/W Revision	A.14.50

Masks

This key enables you to recall a preset mask file which contains Offset and Limit settings. Parameters except them will not be overwritten. You cannot change or create preset mask files since they are binary files. This key is valid for the Spectrum Emission Mask, ACP and Spurious Emissions measurements.

Default path: “My Documents\LTEATDD\LTEAFDD\data\masks”

Note that “**My Documents**” is an alias to a directory and its location depends on which user is logged in. At XSA start up, all of the limit mask files in the current user’s “My Documents\LTEATDD\LTEAFDD\data\masks” directory are overwritten.

File type: Binary

Filename: The filename follows the rule below with the words connected using underscores.

<Measurement>_<Condition>.mask

Where

<Measurement> Measurement the limit mask file is applied to: SEM, ACP or SPUR

<Condition> Condition. It depends on the measurement.

File extension: .mask

File Dialog Filter: Preset Mask Files (*.mask)

Selecting OPEN... under the Import Data menu opens the above directory enabling you to select a mask file.

Details of the masks are provided in the default folder of masks with the PDF extension.

Key Path	Recall, Data
Mode	LTEATDD, LTEAFDD
Remote Command	MMEemory:LOAD:MASK <string>
Example	MME:LOAD:MASK “ACP_BS\ACP_BS_3MHz_pairE-UTRA_CatA.mask”
Notes	Parameters related to Limit and Offset are overwritten by the contents of the preset mask file.
Initial S/W Revision	A.14.00

Open...

When you press “Open”, the analyzer brings up a Windows dialog and a menu entitled “**File Open.**” This menu allows you to navigate to the various fields in the Windows dialog without using a keyboard or mouse. The Tab and Arrow keys can also be used for dialog navigation.

See "[From File...](#)" on page 2401 in Recall, State, for a full description of this dialog and menu.

Key Path	Recall, Data
Notes	The key location is mode-dependent and will vary. Brings up Open dialog for recalling a <mode specific> Save Type
Initial S/W Revision	Prior to A.02.00

Restart

The Restart function restarts the current sweep, or measurement, or set of averaged/held sweeps or measurements. If you are Paused, pressing Restart does a Resume.

The Restart function is accessed in several ways:

- Pressing the Restart key
- Sending the remote command INIT:IMMEDIATE
- Sending the remote command INIT:RESTART

See "[More Information](#)" on page 2410

Key Path	Front-panel key
Remote Command	:INITiate[:IMMEDIATE] :INITiate:RESTART
Example	:INIT:IMM :INIT:REST
Notes	:INITiate:RESTART and :INITiate:IMMEDIATE perform exactly the same function.
Couplings	Resets average/hold count k. For the first sweep overwrites all active (update=on) traces with new current data. For application modes, it resets other parameters as required by the measurement.
Status Bits/OPC dependencies	This is an Overlapped command. The STATus:OPERation register bits 0 through 8 are cleared. The STATus:QUESTionable register bit 9 (INTegrity sum) is cleared. The SWEEPING bit is set. The MEASURING bit is set.
Backwards Compatibility Notes	For Spectrum Analysis mode in ESA and PSA, the Restart hardkey and the INITiate:RESTART command restart trace averages (displayed average count reset to 1) for a trace in Clear Write, but did not restart Max Hold and Min Hold. In the X-Series, the Restart hardkey and the INITiate:RESTART command restart not only Trace Average, but MaxHold and MinHold traces as well. For wireless comms modes in ESA and PSA, the Restart hardkey and the INITiate:RESTART command restart every measurement, which includes all traces and numeric results. There is no change to this operation.
Initial S/W Revision	Prior to A.02.00

More Information

The **Restart** function first aborts the current sweep/measurement as quickly as possible. It then resets the sweep and trigger systems, sets up the measurement and initiates a new data measurement sequence with a new data acquisition (sweep) taken once the trigger condition is met.

If the analyzer is in the process of aligning when **Restart** is executed, the alignment finishes before the restart function is performed.

Even when set for Single operation, multiple sweeps may be taken when Restart is pressed (for example, when averaging/holding is on). Thus when we say that **Restart** "restarts a measurement," we may mean:

- It restarts the current sweep
- It restarts the current measurement
- It restarts the current set of sweeps if any trace is in Trace Average, Max Hold or Min Hold
- It restarts the current set of measurements if Averaging, or Max Hold, or Min Hold is on for the measurement
- depending on the current settings.

With **Average/Hold Number** (in **Meas Setup** menu) set to 1, or Averaging off, or no trace in Trace Average or Hold, a single sweep is equivalent to a single measurement. A single sweep is taken after the trigger condition is met; and the analyzer stops sweeping once that sweep has completed. However, with **Average/Hold Number** >1 and at least one trace set to **Trace Average, Max Hold, or Min Hold (SA Measurement)** or **Averaging on (most other measurements)**, multiple sweeps/data acquisitions are taken for a single measurement. The trigger condition must be met prior to each sweep. The sweep is stopped when the average count k equals the number N set for **Average/Hold Number**. A measurement average usually applies to all traces, marker results, and numeric results; but sometimes it only applies to the numeric results.

Once the full set of sweeps has been taken, the analyzer will go to idle state. To take one more sweep without resetting the average count, increment the average count by 1, by pressing the step up key while **Average/Hold Number** is the active function, or sending the remote command `CALC:AVER:TCON UP`.

Save

The Save menu lets you choose what you want to save and where you want to save it. Among the types of files you can save are **States**, **Traces**, and **Screen Images**. In addition, an Export (Data) option lets you save a number of data types as CSV files for easy import into Excel and other spreadsheet programs.

Key Path	Front-panel key
Mode	All
Notes	No remote command for this key specifically, but the :MMEM:STORe command is available for specific file types. An example is :MMEM:STOR:STATe <filename>.
Initial S/W Revision	Prior to A.02.00

State

The Save State menu lets you choose a register or file for saving the state.

NOTE In products that run multiple instances of the X-Series Application, all instances share the same register and file location where you want to save the state.

The content of a state file includes all of the settings and data required to return the analyzer as closely as possible to the Mode it was in, with the exact settings which were in place, when the save occurred. The Mode settings in each state file include the settings that are affected by Mode Preset, as well as the additional settings affected by Restore Mode Defaults; all of the Mode's settings. In addition, all of the settings of the Input/Output system are included, even though they are outside of the Mode's state, because they are needed to restore the complete setup. Persistent System settings (for example, Verbose SCPI) are not affected by either Mode Preset or Restore Mode Defaults, nor are they included in a saved State file.

After the save completes, the message "File <filename> saved" or "State Register <register number> saved" is displayed.

For rapid saving, the State menu lists 16 registers to save to. Pressing a Register key initiates the save. You can also select a file to save to.

The default path for all State Files is:

My Documents\<<mode name>\state

where <mode name> is the parameter used to select the mode with the INST:SEL command (for example, SA for the Spectrum Analyzer).

Key Path	Save
Mode	All
Remote Command	:MMEMory:STORe:STATe <filename>
Example	MMEM:STOR:STATe "MyStateFile.state" This stores the current instrument state data in the file MyStateFile.state in the default directory.
Notes	Both single and double quotes are supported for any filename parameter over remote.

After saving to a register, that register's menu key is updated with the date the time, unless a custom label has been entered for that key.

After saving to a register, you remain in the Save State menu, so that you can see the Register key update. After saving to a file, the analyzer automatically returns to the previous menu and any Save As dialog goes away.

Backwards Compatibility SCPI :MMEMory:STORe:STATe 1,<filename>

For backwards compatibility, the above syntax is supported. The "1" is simply ignored. The command is sequential.

Initial S/W Revision Prior to A.02.00

To File . . .

When you press "To File", the analyzer brings up a Windows dialog and a menu entitled "Save As." This menu allows you to navigate to the various fields in the Windows dialog without using a keyboard or mouse. The Tab and Arrow keys can also be used for dialog navigation.

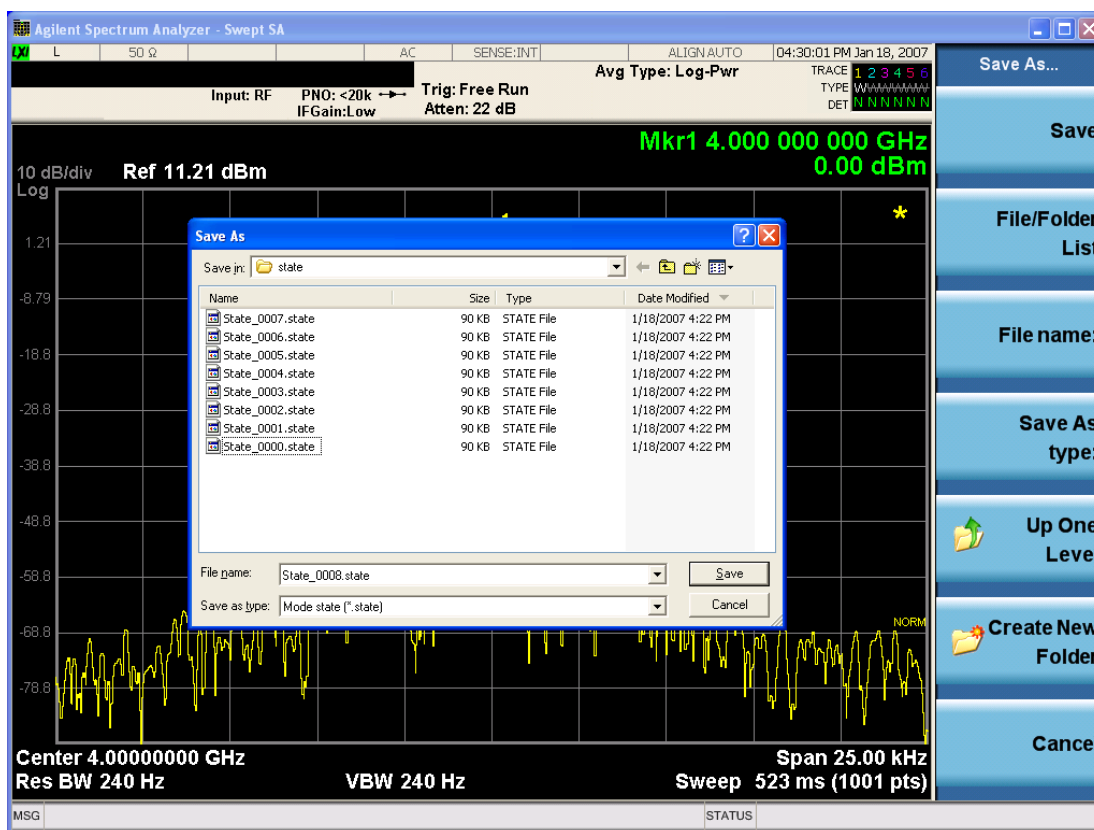

The Listed below

are the functions of the various fields in the dialog, and the corresponding softkeys:

Save

Performs the save to the specified file of the selected type. If the file already exists, a dialog will appear that allows you to replace the existing file by selecting OK, or you can Cancel the request. If you select OK,

the file will be overwritten. Using the C: drive is strongly discouraged, since it runs the risk of being overwritten during an instrument software upgrade.

While the save is being performed, the floppy icon appears briefly in the Meas bar.

File/Folder List

Enables you to navigate to the center of the dialog that contains the list of files and folders. Once here you can get information about the file and use the tab keys to navigate to the other fields in the dialog, such as Save In.

Save In

The Save In field shows the path to which the file will be saved and allows you to change the path using the up and down arrow keys to navigate to other paths; the Enter key to open a directory; and the Backspace key to go back one directory. The **Save In field** defaults to the default path for this type of file and remembers the last path you used to save this type of file. There is no softkey for directly navigating to the Save In field but you can use left tab to get here from the File/Folder List.

User specified paths are remembered when you leave and return to a Mode and are reset back to the default using Restore Mode Defaults.

File Name

The File Name field is initially loaded with an automatically generated filename specific to the appropriate Save Type. The automatically generated filename is guaranteed not to conflict with any filename currently in the directory. You may replace or modify this filename using the File Name key. See the ["Quick Save " on page 2397](#) documentation for more on the automatic file naming algorithm.

When you press the File Name key the analyzer displays the Alpha Editor. Use the knob to choose the letter to add and the front-panel Enter key to add the letter to the file name. The BK character moves you back and the FW character moves you forward in the filename. The Select key on the front panel generates a space character. When you are done entering the filename press the Done softkey. This returns back to the **File Open** dialog and menu, but does not cause the save to occur.

Save As Type

This field shows the file suffix for the type of file you have selected to save. For example, if you navigated here while saving State, "Mode state (*.state)" is in the field. If you navigated here from saving Trace, ""Mode state (*.trace)" is in the field. If you navigated here while exporting a trace data file, "Trace Data (*.csv)" is in the field. For some file types, there is more than one choice in the dropdown, which you can select by using the up and down arrow keys and Enter.

Up One Level

This key corresponds to the icon of a folder with the up arrow that is in the tool bar of the dialog. When pressed, it causes the file and folder list to navigate up one level in the directory structure. The Backspace key does the same thing.

Create New Folder

This key corresponds to the icon of a folder with the "*" that is in the tool bar of the dialog. When pressed, a new folder is created in the current directory with the name **New Folder** and you can enter a new folder name using the Alpha Editor.

Cancel

This key corresponds to the Cancel selection in the dialog. It causes the current **Save As** request to be cancelled. The ESC key does the same thing.

Key Path	Save, State
Mode	All
Notes	Brings up Save As dialog for saving a State Save Type
Initial S/W Revision	Prior to A.02.00

Edit Register Names

You may enter a custom name on any of the Register keys, to help you remember what you are using that state to save. To do this, press the Edit Register Names key, choose the register whose name you wish to edit, and then enter the desired label using the Alpha Editor or an external PC keyboard.

The maximum number of characters that can be added is 30. In most cases, 30 characters will fit on two lines of the key.

See ["More Information" on page 2415](#)

Key Path	Save, State
Mode	All
Remote Command	:MMEMory:REGister:STATe:LABel <reg number>,"label" :MMEMory:REGister:STATe:LABel? <reg number>
Example	:MMEM:REG:STAT:LAB 1,"my label"
Notes	<reg number> is an integer from 1 to 16. If the SCPI specifies an invalid register number an error message is generated, -222,"Data out of range;Invalid register label number" "label" is a string from 0 to 30 characters in length. If a label exceeds 30 characters, an error message is generated, -150,"String data error;Label clipped to 30 characters" "label" of length 0 erases the custom label and restores the default (time and date) label. E.g.: :MMEM:REG:STAT:LAB 1,""
Dependencies	N9060A-7FP or N9060B-2FP license required to edit the register names. When the feature is not licensed, sending this command generates an error, -221,"Settings conflict;Option not available"
Preset	The names are unaffected by Preset or power cycle but are set to the default label (time and date) on a "Restore System Defaults->Misc"
Initial S/W Revision	A.11.00

More Information

When you edit one of the register names, the time and date field will be replaced by the custom name.

If you delete all the characters in the custom name, it restores the default (time and date).

The register names are stored within the state files, but they are not part of the instrument state; that is, once you have edited a register name, loading a new state will not change that register name. Another

consequence of this is that the names will be persistent through a power cycle. Also, if a named state file is transferred to another analyzer, it will bring its custom name along with it.

If you try to edit the name of an empty register, the analyzer will first save the state to have a file to put the name in. If you load a named state file into an analyzer with older firmware it will ignore the metadata.

The *SAV and *RCL commands will not be affected by the custom register names, nor will the MMEM commands.

Register 1 thru Register 16

Selecting any one of these register menu keys causes the State of the currently active mode to be saved to the specified Register. The registers are provided for rapid saving and recalling, since you do not need to specify a filename or navigate to a file. Each of the register menu keys annotates whether it is empty or at what date and time it was last modified. In addition, you can use the Edit Register Names key to enter custom names for each register.

NOTE

In products that run multiple instances of the X-Series Application, save with different register name if you do not want to overwrite the register of another running instance.

Although these 16 registers are the only registers available from the front panel, there are 128 state registers available in the instrument. Registers 17–128 are only available from the SCPI interface, using the *SAV command.

There is one set of 128 state registers in the instrument, not one set for each Mode. When a state is saved, the Mode it was saved from is saved with it; then when it is recalled, the instrument switches to that Mode.

After the save completes, the corresponding register menu key annotation is updated with the date and time and the message "Register <register number> saved" is displayed.

Key Path	Save, State
Mode	All
Example	*SAV 1
Range	1–16 from front panel, 1–128 from SCPI
Readback	Date and time with seconds resolution are displayed on the key OR A custom name of up to 30 characters entered using the Edit Register Names key OR “(empty)” if no prior save operation has been performed to this register.
Initial S/W Revision	Prior to A.02.00
Modified at S/W Revision	A.11.00

Register 1 thru Register 16

Selecting any one of these register menu keys causes the State of the currently active mode to be saved to the specified Register. The registers are provided for rapid saving and recalling, since you do not need to specify a filename or navigate to a file. Each of the register menu keys annotates whether it is empty or at

what date and time it was last modified. In addition, you can use the Edit Register Names key to enter custom names for each register.

NOTE

In products that run multiple instances of the X-Series Application, save with different register name if you do not want to overwrite the register of another running instance.

Although these 16 registers are the only registers available from the front panel, there are 128 state registers available in the instrument. Registers 17–128 are only available from the SCPI interface, using the *SAV command.

There is one set of 128 state registers in the instrument, not one set for each Mode. When a state is saved, the Mode it was saved from is saved with it; then when it is recalled, the instrument switches to that Mode.

After the save completes, the corresponding register menu key annotation is updated with the date and time and the message "Register <register number> saved" is displayed.

Key Path	Save, State
Mode	All
Example	*SAV 1
Range	1–16 from front panel, 1–128 from SCPI
Readback	Date and time with seconds resolution are displayed on the key OR A custom name of up to 30 characters entered using the Edit Register Names key OR “(empty)” if no prior save operation has been performed to this register.
Initial S/W Revision	Prior to A.02.00
Modified at S/W Revision	A.11.00

Mass Storage Catalog (Remote Command Only)

Key path	SCPI Only
Remote Command	:MMEMory:CATalog? [<directory_name>]
Notes	The string must be a valid logical path. Queries disk usage information (drive capacity, free space available) and obtains a list of files and directories in a specified directory in the following format: <numeric_value>,<numeric_value>,{<file_entry>} It returns two numeric parameters and as many strings as there are files and directories. The first parameter indicates the total amount of storage currently used in bytes. The second parameter indicates the total amount of storage available, also in bytes. The <file_entry> is a string. Each <file_entry> indicates the name, type, and size of one file in the directory list: <file_name>,<file_type>,<file_size> As the windows file system has an extension that indicates file type, <file_type> is always empty. <file_size> provides the size of the file in bytes. For directories, <file_entry> is surrounded by square brackets and both <file_type> and <file_size> are empty
Initial S/W Revision	Prior to A.02.00

Mass Storage Change Directory (Remote Command Only)

Key path	SCPI Only
Remote Command	:MMEMory:CDIRectory [<directory_name>] :MMEMory:CDIRectory?
Notes	The string must be a valid logical path. Changes the default directory for a mass memory file system. The <directory_name> parameter is a string. If no parameter is specified, the directory is set to the *RST value. At *RST, this value is set to the default user data storage area, that is defined as System.Environment.SpecialFolder.Personal. Query returns full path of the default directory.
Initial S/W Revision	Prior to A.02.00

Mass Storage Copy (Remote Command Only)

Key path	SCPI Only
Remote Command	:MMEMory:COPY <string>,<string>[,<string>,<string>]
Notes	The string must be a valid logical path. Copies an existing file to a new file or an existing directory to a new directory. Two forms of parameters are allowed. The first form has two parameters. In this form, the first parameter specifies the source, and the second parameter specifies the destination. The second form has four parameters. In this form, the first and third parameters specify the source. The second and fourth parameters specify the directories. The first pair of parameters specifies the source. The second pair specifies the destination. An error is generated if the source doesn't exist or the destination file already exists. This command will generate an "access denied" error if the destination is a restricted folder (e.g., C:\Windows) and the current user does not have Power User or Administrator privileges.

Mass Storage Device Copy (Remote Command Only)

This command transfers data to/from a file and a peripheral device.

Key path	SCPI Only
Remote Command	:MMEMory:COPY:DEvice <source_string>,<dest_string>
Notes	The strings must be a valid logical path or a valid device keyword. If the dest_string is a device keyword, the data is copied from the source file to the device. If the source_string is a device keyword, the data is copied to the source file from the device. Valid device keywords are: SNS (smart noise source) An error is generated if the file or device is not found.

Mass Storage Delete (Remote Command Only)

Key path	SCPI Only
Remote Command	:MMEMory:DELeTe <file_name>[,<directory_name>]
Notes	The string must be a valid logical path. Removes a file from the specified directory. The <file_name> parameter specifies the file name to be removed. This command will generate an “access denied” error if the file is in a restricted folder (e.g., C:\Windows) and the current user does not have Power User or Administrator privileges.
Initial S/W Revision	Prior to A.02.00

Mass Storage Data (Remote Command Only)

Creates a file containing the specified data OR queries the data from an existing file.

Key path	SCPI Only
Remote Command	:MMEMory:DATA <file_name>, <data> :MMEMory:DATA? <file_name>
Notes	The string must be a valid logical path. The command form is MMEMory:DATA <file_name>,<data>. It loads <data> into the file <file_name>. <data> is in 488.2 block format. <file_name> is string data. The query form is MMEMory:DATA? <file_name> with the response being the associated <data> in block format.
Initial S/W Revision	Prior to A.02.00

Mass Storage Make Directory (Remote Command Only)

Key path	SCPI Only
Remote Command	:MMEMory:MDIRectory <directory_name>
Notes	The string must be a valid logical path. Creates a new directory. The <directory_name> parameter specifies the name to be created. This command will generate an “access denied” error if the new directory would be in a restricted folder (e.g., C:\Windows) and the current user does not have Power User or Administrator privileges.
Initial S/W Revision	Prior to A.02.00

Mass Storage Move (Remote Command Only)

Key path	SCPI Only
Remote Command	:MMEMory:MOVE <string>,<string>[,<string>,<string>]
Notes	The string must be a valid logical path. Moves an existing file to a new file or an existing directory to a new directory.

Two forms of parameters are allowed. The first form has two parameters. In this form, the first parameter specifies the source, and the second parameter specifies the destination.

The second form has four parameters. In this form, the first and third parameters specify the source. The second and fourth parameters specify the directories. The first pair of parameters specifies the source. The second pair specifies the destination. An error is generated if the source doesn't exist or the destination file already exists.

This command will generate an "access denied" error if the destination is a restricted folder (e.g., C:\Windows) and the current user does not have Power User or Administrator privileges.

Initial S/W Revision Prior to A.02.00

Mass Storage Remove Directory (Remote Command Only)

Key path SCPI Only

Remote Command :MMEMory:RDIRECTory <directory_name>

Notes

The string must be a valid logical path.

Removes a directory. The <directory_name> parameter specifies the directory name to be removed. All files and directories under the specified directory shall also be removed.

This command will generate an "access denied" error if the folder is a restricted folder (e.g., C:\Windows) or is in a restricted folder and the current user does not have Power User or Administrator privileges.

Initial S/W Revision Prior to A.02.00

Sequences

These keys allow you to save a Tab separated or CSV file of the setup parameters required to build a Sequence.

In order to save you must select the Save As button and choose a destination folder.

Key Path Save, Sequences

Mode All

Remote Command :MMEM:STOR:SEQ:ences: | SLIST | ALIST | SAAList | SSTep
"MySequence.txt"

Example :MMEM:STOR:SEQ:SLIST "MySequence.txt"

Notes

Available file types are:

- CSV (Comma delimited) (*.csv)
- Text (Tab delimited) (*.txt)

Initial S/W Revision A.05.00

Source Sequence

The list of parameters, that configure steps, that makes up a sequence for the Source.

The Source sequence is a sequence of flexible configurable steps that can be set anywhere in the instruments frequency range.

Key Path	Save, Sequences
Example	:MMEM:STOR:SEQ:SLIS "MySequence.txt"
Dependencies	Only available in XOBT
Initial S/W Revision	A.05.00

Save As . . .

This menu lets you select the location where you can save the Sequence. This menu is a standard Windows® dialog with Save As menu keys. The "File Name" field in the Save As dialog is initially loaded with an automatically generated filename specific to the appropriate Save Type. The automatically generated filename is guaranteed not to conflict with any filename currently in the directory. You may replace or modify this filename using the File Name softkey. See the Quick Save key documentation for more on the automatic file naming algorithm.

The default path for all Sequence Files is:

My Documents\Sequences

Key Path	Save, Sequences
Mode	All
Notes	Brings up Save As dialog for saving a Sequence Save Type
Initial S/W Revision	A.05.00

Data (Export)

Exporting a data file stores data from the current measurement to mass storage files. The Export Menu only contains data types that are supported by the current measurement.

Since the commonly exported data files are in .csv format, the data can be edited by you prior to importing. This allows you to export a data file, manipulate the data in Excel (the most common PC Application for manipulating .csv files) and then import it.

Selecting an Export Data menu key will not actually cause the exporting to occur, since the analyzer still needs to know where you wish to save the data. Pressing the Save As key in this menu brings up the Save As dialog and Save As menu that allows you to specify the destination file and directory. Once a filename has been selected or entered in the Open menu, the export will occur as soon as the Save key is pressed.

Key Path	Save
Mode	All

Notes	The menu is built from whatever data types are available for the mode. So the key locations in the sub menu will vary. No SCPI command directly controls the Data Type that this key controls. The Data Type is included in the MMEM:STORe commands.
Dependencies	If a file type is not used by a certain measurement, that type is grayed out for that measurement. The key for a file type will not show at all if there are no measurements in the Mode that support it.
Preset	Is not affected by a Preset or shutdown, but is reset during Restore Mode Defaults
Readback	The data type that is currently selected
Initial S/W Revision	Prior to A.02.00

Export Trace Data

Enables you to export trace data with (optional) associated headers. Selecting this key displays a menu that enables you to choose which Trace to save (default is the selected Trace) and whether or not to save headers with the data. The header information is used by the VXA application when saved trace data is recalled, and enables it to be displayed with the same formatting and scaling that it had when saved. If headers are not saved, the scaling and format are set to default values when the trace is recalled. After making these selections, press Save As... and use the file dialog to choose a file name and format for the saved data.

Trace data can be exported in several different formats. Text and comma-separated variable (CSV) formats are useful for viewing the data or importing it to a spreadsheet program. The other formats are binary and thus more compact. Trace data files can be recalled for viewing into other VXA, LTE, LTETDD, iDEN, or 89601 measurements.

Key Path	Save, Data (Export)
Mode	VSA, LTE, LTETDD, IDEN
Remote Command	:MMEMory:STORe:TRACe:DATA TRACE1 TRACE2 TRACE3 TRACE4 TRACE5 TRACE6, "<filename>" [,CSV TXT SDF MAT4 MAT HDF5 BIN[,OFF ON 0 1]]
Example	:MMEM:STOR:TRAC:DATA TRACE1, "TRC1.TXT", TXT, ON
Notes	The Save As... dialog box has the following format options when you are saving trace data: <ul style="list-style-type: none"> • CSV (Comma delimited) (*.csv) • SDF (Fast) (*.sdf;*.dat) • Text (Tab delimited) (*.txt) File format saved depends on selection. The appropriate file extension is appended to the filename if it is not supplied by the user. If the SCPI command includes just a file name, the file format is determined by the filename extension, which must be one of the choices above. *.sdf or an unrecognized extension chooses the SDF fast format. If the optional file format enumerator is included in the command, then this determines the file format and the file extension is ignored. The optional binary parameter determines if file headers are saved. The default is ON. If file headers are not wanted, use the optional "OFF" parameter. The optional Boolean parameter determines whether headers are saved in the file. By default the

headers are saved.

If you are not licensed to save a particular file type, then error -203.9010 is returned. If an invalid file format is specified or the file cannot be saved successfully, then error -25x is returned. If the save is successful, then advisory 0.1500 is shown.

State Saved	No
Readback	(Trace 1 Trace 2 Trace 3 Trace 4 Trace 5 Trace 6)(with without) headers

Trace 1

Selects the Trace 1 register as the destination for the imported data.

Key Path	Save, Data (Export), Trace
Mode	VSA, LTE, LTETDD, IDEN

Trace 2

Selects the Trace 2 register as the destination for the imported data.

Key Path	Save, Data (Export), Trace
Mode	VSA, LTE, LTETDD, IDEN

Trace 3

Selects the Trace 3 register as the destination for the imported data.

Key Path	Save, Data (Export), Trace
Mode	VSA, LTE, LTETDD, IDEN

Trace 4

Selects the Trace 4 register as the destination for the imported data.

Key Path	Save, Data (Export), Trace
Mode	VSA, LTE, LTETDD, IDEN

Trace 5

Selects the Trace 5 register as the destination for the imported data.

Key Path	Save, Data (Export), Trace
Mode	VSA, LTE, LTETDD, IDEN

Trace 6

Selects the Trace 6 register as the destination for the imported data.

Key Path	Save, Data (Export), Trace
Mode	VSA, LTE, LTETDD, IDEN

Include Header

Enables you to select whether or not the saved trace data includes header information describing scaling, formatting, etc.

Key Path	Save, Data (Export), Trace
Mode	VSA, LTE, LTETDD, IDEN
State Saved	No

Measurement Results

Pressing this key selects Meas Results as the data type to be exported. Pressing the key a second time brings up the Meas Results menu, which allows you to select which **Meas Result** to save. In the Swept SA measurement, there are three types of Measurement Results files: Peak Table, Marker Table and Spectrogram.

See "[Meas Results File Contents](#)" on page 2425.

See "[Marker Table](#)" on page 2425.

See "[Peak Table](#)" on page 2428.

See Spectrogram

Remote Command	:MMEMory:STORe:RESults:MTABle PTABle SPEctrogram <filename>
Example	:MMEM:STOR:RES:MTAB "myResults.csv" Saves the results from the current marker table to the file myResults.csv in the current path. :MMEM:STOR:RES:PTAB "myResults.csv" Saves the results from the current peak table to the file myResults.csv in the current path. :MMEM:STOR:RES:SPEC "myResults.csv" Saves the results from the current Spectrogram display to the file myResults.csv in the current path. The default path is My Documents\SA\data\SAN\results
Notes	If the save is initiated via SCPI, and the file already exists, the file will be overwritten. Using the C: drive is strongly discouraged, since it runs the risk of being overwritten during an instrument software upgrade. Both single and double quotes are supported for any filename parameter over SCPI.
Dependencies	If a save of Marker Table results is requested and the Marker Table is not on, no file is saved and a

message is generated

If a save of Peak Table results is requested and the Peak Table is not on, no file is saved and a message is generated

If a save of Spectrogram results is requested and the Spectrogram is not on, no file is saved and a message is generated.

The Spectrogram choice only appears if option EDP is licensed.

Preset	Not part of Preset, but is reset to Peak Table by Restore Mode Defaults. Survives a shutdown.
Initial S/W Revision	Prior to A.02.00

Meas Results File Contents

All files are .csv files. The following section details the data in each file type.

Marker Table

This section discusses the Marker Table Meas Results file format.

Imagine that, at the point where a Marker Table Meas Result is requested, the following screen is showing:

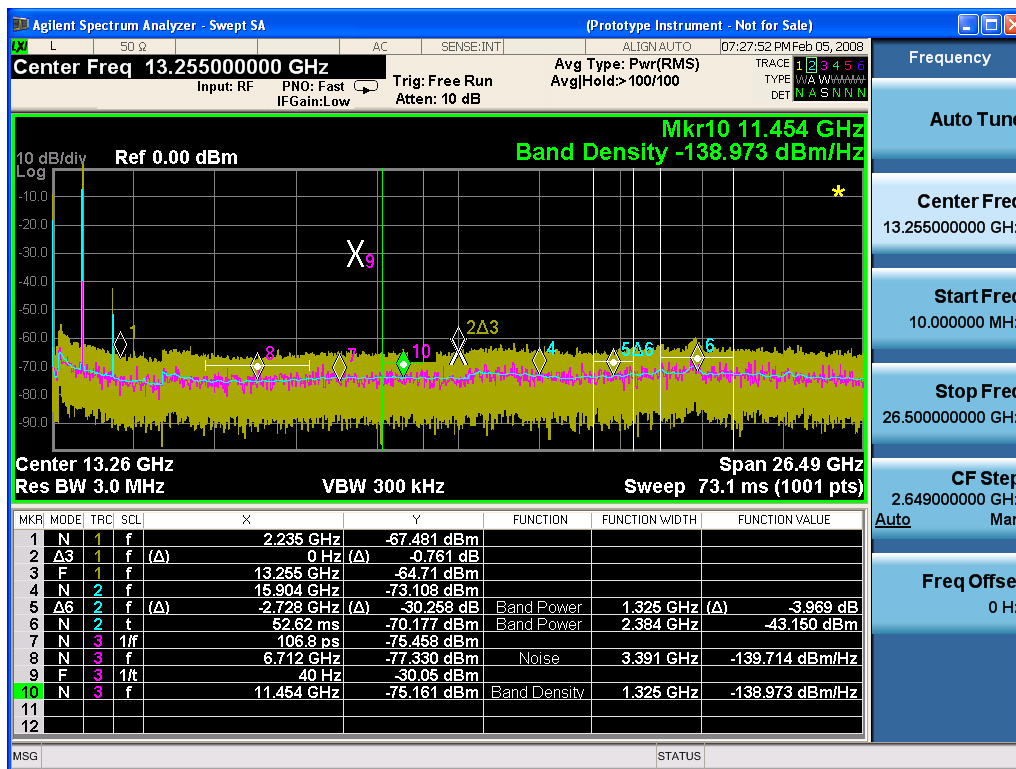

Then the Meas Results file, when opened, would show the following data:

MeasurementR
esult

Swept SA	
A.01.40_R0017	N9020A
526 B25 PFR P26 EA3	1
Result Type	Marker Table
Ref Level	0
Number of Points	1001
Sweep Time	0.0662666 67
Start Frequency	10000000
Stop Frequency	26500000 000
Average Count	0
Average Type	LogPower (Video)
RBW	3000000
RBW Filter	Gaussian
RBW Filter BW	3dB
VBW	3000000
Sweep Type	Swept
X Axis Scale	Lin
PreAmp State	Off
PreAmp Band	Low
Trigger Source	Free
Trigger Level	1.2
Trigger Slope	Positive
Trigger Delay	1.00E-06
Phase Noise Optimization	Fast
Swept If Gain	Low
FFT If Gain	Autorange
RF Coupling	AC
FFT Width	411900
Ext Ref	10000000
Input	RF
RF Calibrator	Off

Attenuation	10								
Ref Level Offset	0								
External Gain	0								
X Axis Units	Hz								
Y Axis Units	dBm								
DATA									
MKR	MODE	TR C	SCL	X	Y	FUNCTI ON	FUNCTIO N WIDTH	FUNCTI ON VALUE	FUNCTI ON UNIT
1	Normal	1	Freque ncy	2.2350E+ 09	- 67.4 81	Off	0.0000E+ 00	0	None
2	Delta3	1	Freque ncy	0.0000E+ 00	- 0.76 1	Off	0.0000E+ 00	0	None
3	Fixed	1	Freque ncy	1.3255E+ 10	- 64.7 1	Off	0.0000E+ 00	0	None
4	Normal	2	Freque ncy	1.5904E+ 10	- 73.1 08	Off	0.0000E+ 00	0	None
5	Delta7	2	Freque ncy	- 2.7280E+ 09	- 30.2 58	Band Power	1.3250E+ 06	-3.969	dB
6	Normal	2	Time	5.2620E- 02	- 70.1 77	Band Power	2.3840E+ 06	-43.15	dBm
7	Normal	3	Period	1.0680E- 10	- 75.4 58	Off	0.0000E+ 00	0	None
8	Normal	3	Freque ncy	6.7120E+ 09	- 77.3 3	Noise	3.3910E+ 06	- 139.71 4	dBm/Hz
9	Fixed	3	Inverse Time	4.0000E+ 01	- 30.0 5	Off	0.0000E+ 00	0	None
10	Normal	3	Freque ncy	1.1454E+ 10	- 75.1 61	Band Density	1.3250E+ 06	- 138.97 3	dBm/Hz
11	Off	1	Freque ncy	0.0000E+ 00	0	Off	0.0000E+ 00	0	None
12	Off	1	Freque ncy	0.0000E+ 00	0	Off	0.0000E+ 00	0	None

The numbers appear in the file exactly as they appear onscreen. If it says 11.454 GHz onscreen, then in the file it is 11.454E+09.

The metadata header is very similar to the metadata used in the trace data .csv files. See Trace File Contents. The only new information concerns the 1-of-N fields in the marker table itself.

Peak Table

This section discusses the Peak Table Meas Results file format.

Imagine that, at the point where a Marker Table Meas Result is requested, the following screen is showing:

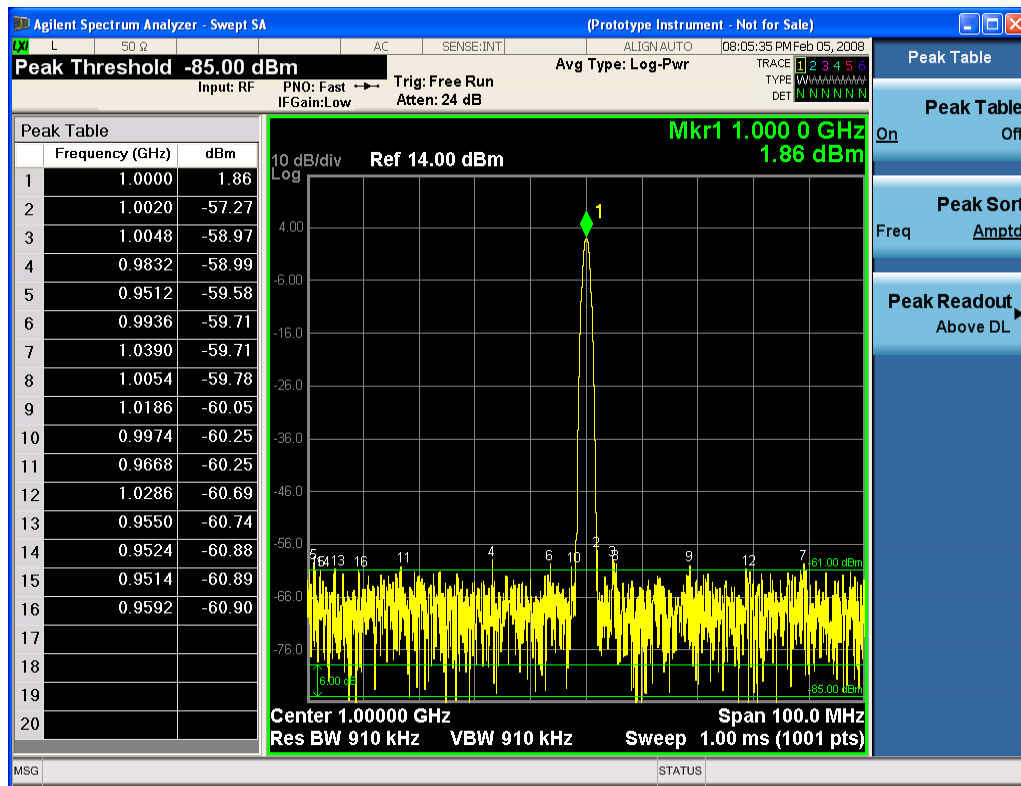

Then the Meas Results file, when opened, would show the header data (the same as for the Marker Table except that the Result Type is Peak Table) ending with a few fields of specific interest to Peak Table users:

- Peak Threshold
- Peak Threshold State (On|Off)
- Peak Excursion
- Peak Excursion State (On|Off)
- Display Line
- Peak Readout (All|AboveDL|BelowDL)
- Peak Sort (Freq|Amptd)

These fields are then followed by the data for the Peak Table itself.

Note that the label for the Frequency column changes to Time in 0 span.

Here is what the table for the above display looks like:

MeasurementResult	
Swept SA	
A.01.40_R0017	N9020A
526 B25 PFR P26 EA3	1
Result Type	Peak Table
Ref Level	0
Number of Points	1001
Sweep Time	0.066266667
Start Frequency	10000000
Stop Frequency	26500000000
Average Count	0
Average Type	LogPower(Video)
RBW	3000000
RBW Filter	Gaussian
RBW Filter BW	3dB
VBW	3000000
Sweep Type	Swept
X Axis Scale	Lin
PreAmp State	Off
PreAmp Band	Low
Trigger Source	Free
Trigger Level	1.2
Trigger Slope	Positive
Trigger Delay	1.00E-06
Phase Noise Optimization	Fast
Swept If Gain	Low
FFT If Gain	Autorange
RF Coupling	AC
FFT Width	411900
Ext Ref	10000000
Input	RF
RF Calibrator	Off
Attenuation	10
Ref Level Offset	0
External Gain	0

X Axis Units	Hz	
Y Axis Units	dBm	
Peak Threshold	-85	
Peak Threshold State	On	
Peak Excursion	6	
Peak Excursion State	On	
Display Line	-61	
Peak Readout	AboveDL	
Peak Sort	Amptd	
DATA		
Peak	Frequency	Amplitude
1	1.0000E+06	1.86
2	1.0020E+06	-57.27
3	1.0048E+06	-58.97
4	9.8320E+05	-58.99
5	9.5120E+05	-59.58
6	9.9360E+05	-59.71
7	1.0390E+06	-59.71
8	1.0054E+06	-59.78
9	1.1086E+06	-60.05
10	9.9740E+05	-60.25
11	9.6680E+05	-60.25
12	1.0286E+06	-60.69
13	9.5500E+05	-60.74
14	9.5240E+05	-60.88
15	9.5140E+05	-60.89
16	9.5920E+05	-60.90
17		
18		
19		
20		

Spectrogram

This section discusses the Spectrogram Results file format. The Spectrogram choice only appears if option EDP is licensed.

The Spectrogram results are the same as a Trace data export, except that instead of having just one trace's data, all 300 traces appear one after the other.

Each trace has its own data mark; the data for Spectrogram Trace 0 follows the row marked DATA, the data for Spectrogram Trace 1 follows the row marked DATA1, for Spectrogram Trace 2 follows the row marked DATA2, and so on.

Each DATA row has a timestamp in the second column (as of firmware revision A.11.01). So, for example, if Trace 0 had a relative start time of 1729.523 sec, then the first DATA row would look like this:

```
DATA,1729.523
```

And if Trace 13 had a relative start time of 100.45 sec, then the fourteenth data row would look like:

```
DATA13,100.453
```

To find the absolute time for the relative timestamps of each trace, the last row before the first DATA row gives the absolute start time of the Spectrogram, in the form YYYYMMDDHHMMSS

So, for example, if the absolute start time is 13:23:45:678 on January 30, 2012, this row would look like:

```
Start Time,20120130132345678
```

NOTE:

NOTE

The resolution of the absolute time stored is 1 ms, which matches up with the fact that the fastest sweep time is also 1 ms. However, there is no specification for the absolute accuracy of the clock in the analyzer, nor is there any facility provided to allow the user to set this time to any particular degree of accuracy.

Traces that have not yet been filled in the Spectrogram display are empty; there is no DATA header for them. The file ends after the last non-empty trace.

Imagine that, at the point where a Spectrogram Meas Result is requested, the following screen is showing:

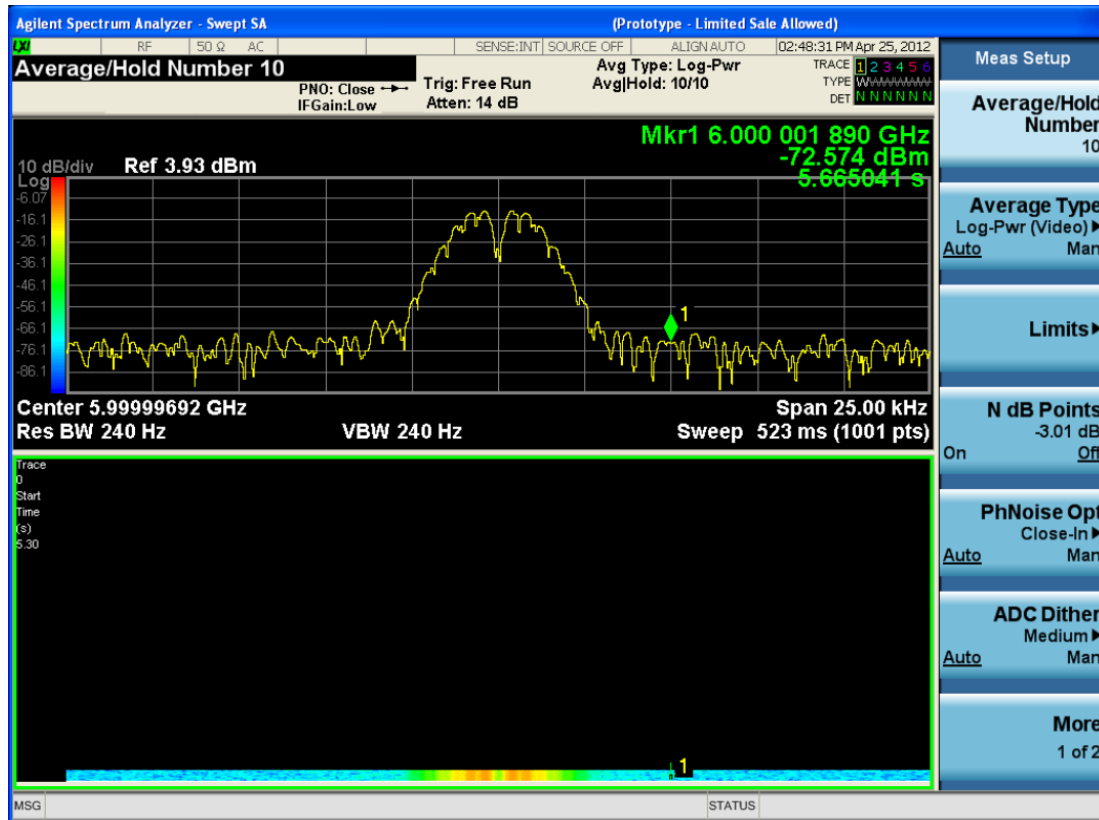

For the purpose of this example, we have set the Average/Hold Number to 10, thus we have only traces 0 thru 10. The Spectrogram was started at 02:28:08:700 pm on April 25, 2012 (that is, 700 ms after 2:28:08 pm), although the screen dump itself shows a different time, as it was taken ten minutes after the Spectrogram data. Trace 0 is showing a start time of 5.30 seconds, meaning 5.3 seconds after the Spectrogram started (trace 10 has a start time of 0, as it was the first trace taken but has now rolled up into the tenth trace slot).

The Meas Results file, when opened, shows the header data and ten traces of trace data. Below is an extract from the result file for the above display. Note the start time of 20120425142808700 showing in the last row before the first DATA row, and the relative time of 5.299231048 showing in the first DATA row:

Result Type	Spectrogram
MeasResult	
Swept SA	
A.11.00.01	N9020A
503 508 513 526 ALL ALV B1C B1X B25 B2X B40 BAB BBA CR3 CRP DP2 DRD EA3 EDP EMC EP1 ERC ESC ESP EXM FSA HBA K03 LFE MPB P03 P08 P13 P26 PFR RTL RTS S40 SB1 SEC SM1 UK6 YAS YAV	1
Segment	0

Result Type	Spectrogram
Number of Points	1001
Sweep Time	0.523333333
Start Frequency	5999984415
Stop Frequency	6000009415
Average Count	0
Average Type	LogPower(Video)
RBW	240
RBW Filter	Gaussian
RBW Filter BW	3dB
VBW	240
Sweep Type	Swept
X Axis Scale	Lin
PreAmp State	Off
PreAmp Band	Low
Trigger Source	Free
Trigger Level	1.2
Trigger Slope	Positive
Trigger Delay	0
Phase Noise Optimization	Wide
Swept If Gain	Low
FFT If Gain	Autorange
RF Coupling	AC
FFT Width	411900
Ext Ref	10000000
Input	RF
RF Calibrator	Off
Attenuation	14
Ref Level Offset	0
External Gain	0
Trace Type	Clearwrite
Detector	Normal
Trace Math	Off
Trace Math Oper1	Trace5
Trace Math Oper2	Trace6
Trace Math Offset	0
Trace Name	Trace1

Result Type	Spectrogram
X Axis Units	Hz
Y Axis Units	dBm
Start Time	20120425142808700
DATA	5.299231048
5999984415	-76.34749519
5999984440	-77.28097006
5999984465	-75.32317869
5999984490	-73.64417681
5999984515	-72.67154604

O
O
O

6000009315	-77.94423277
6000009340	-79.51829697
6000009365	-78.46108961
6000009390	-78.46108957
6000009415	-76.59570596
DATA2	4.708697055
5999984415	-80.98197882
5999984440	-80.98197879
5999984465	-75.83142132
5999984490	-74.02712079
5999984515	-73.57213005

O
O
O

6000009315	-75.9183103
6000009340	-79.53787488
6000009365	-78.82602191
6000009390	-78.82602188
6000009415	-76.37486709

DATA10	0
5999984415	-75.56751112
5999984440	-75.76485645
5999984465	-76.67718717
5999984490	-78.79238489
5999984515	-83.72680212

o
o
o

6000009315	-71.3942461
6000009340	-72.28308332
6000009365	-73.92684489
6000009390	-75.45548832
6000009415	-75.17904815

Save As . . .

When you press “Save As”, the analyzer brings up a Windows dialog and a menu entitled “**Save As.**” This menu allows you to navigate to the various fields in the Windows dialog without using a keyboard or mouse. The Tab and Arrow keys can also be used for dialog navigation.

See "[To File . . .](#)" on page 2413 in Save, State for a full description of this dialog and menu.

The default path for saving files is:

For all of the Trace Data Files:

My Documents\`<mode name>`\data\traces

For all of the Limit Data Files:

My Documents\`<mode name>`\data\limits

For all of the Measurement Results Data Files:

My Documents\`<mode name>`\data\`<measurement name>`\results

For all of the Capture Buffer Data Files:

My Documents\`<mode name>`\data\captureBuffer

Key Path	Save, Data
Mode	All

Notes	The key location is mode-dependent and will vary. Brings up the Save As dialog for saving a <mode specific> Save Type. The save is performed immediately and does not wait until the measurement is complete.
Initial S/W Revision	Prior to A.02.00

Screen Image

Pressing Screen Image accesses a menu of functions that enable you to specify a format and location for the saved screen image. It brings up a menu that allows you to specify the color scheme of the Screen Image (Themes) or navigate to the Save As dialog to perform the actual save.

Screen Image files contain an exact representation of the analyzer display. They cannot be loaded back onto the analyzer, but they can be loaded into your PC for use in many popular applications.

The image to be saved is actually captured when the Save front panel key is pressed, and kept in temporary storage to be used if you ask for a Screen Image save. When the Screen Image key is pressed, a "thumbnail" of the captured image is displayed, as shown below:

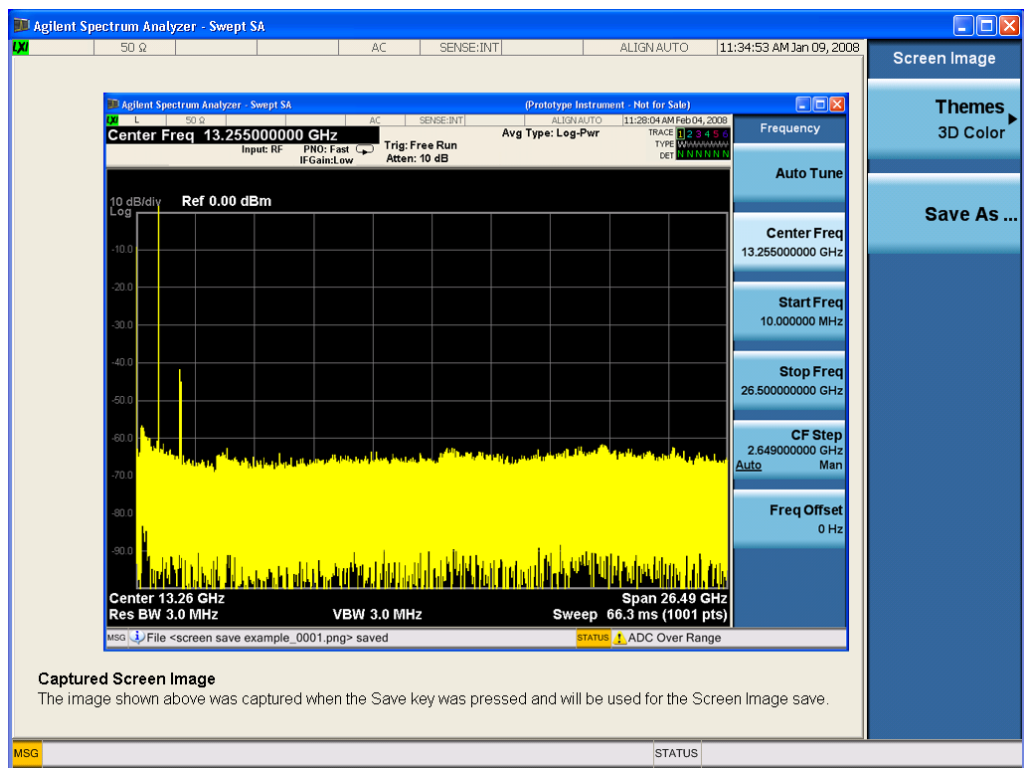

When you continue on into the Save As menu and complete the Screen Image save, the image depicted in the thumbnail is the one that gets saved, showing the menus that were on the screen before going into the Save menus. The save is performed immediately and does not wait until the measurement is complete.

After you have completed the save, the Quick Save front-panel key lets you quickly repeat the last save performed, using an auto-named file, with the current screen data.

NOTE

For versions previous to A.01.55, if you initiate a screen image save by navigating through the Save menus, the image that is saved will contain the Save menu softkeys, not the menus and the active function that were on the screen when you first pressed the Save front panel key.

Key Path	Save
Mode	All
Remote Command	:MMEMory:STORe:SCReen <filename>
Example	:MMEM:STOR:SCR "myScreen.png" This stores the current screen image in the file MyScreenFile.png in the default directory.
Initial S/W Revision	Prior to A.02.00

Themes

Accesses a menu of functions that enable you to choose the theme to be used when saving the screen image.

The **Themes** option is the same as the **Themes** option under the **Display** and **Page Setup** dialogs. It allows you to choose between themes to be used when saving the screen image.

Key Path	Save, Screen Image
Remote Command	:MMEMory:STORe:SCReen:THEMe TDColor TDMonochrome FColor FMONochrome :MMEMory:STORe:SCReen:THEMe?
Example	:MMEM:STOR:SCR:THEM TDM
Preset	3D Color; Is not part of Preset, but is reset by Restore Misc Defaults or Restore System Defaults All and survives subsequent running of the modes.
Readback	3D Color 3D Mono Flat Color Flat Mono
Backwards Compatibility Notes	In ESA and PSA we offer the choice of "Reverse Bitmap" or "Reverse Metafile" when saving screen images. This is much like the "Flat Color" theme available in X-Series. Also, if you selected Reverse Bitmap AND a black & white screen image, that would be much like "Flat Monochrome". In other words, each of the X-Series themes has a similar screen image type in ESA/PSA. But they are not identical.
Initial S/W Revision	Prior to A.02.00

3D Color

Selects a standard color theme with each object filled, shaded and colored as designed.

Key Path	Save, Screen Image, Themes
Example	MMEM:STOR:SCR:THEM TDC
Readback	3D Color
Initial S/W Revision	Prior to A.02.00

3D Monochrome

Selects a format that is like 3D color but shades of gray are used instead of colors.

Key Path	Save, Screen Image, Themes
Example	MMEM:STOR:SCR:THEM TDM
Readback	3D Mono
Initial S/W Revision	Prior to A.02.00

Flat Color

Selects a format that is best when the screen is to be printed on an ink printer.

Key Path	Save, Screen Image, Themes
Example	MMEM:STOR:SCR:THEM FCOL
Readback	Flat Color
Initial S/W Revision	Prior to A.02.00

Flat Monochrome

Selects a format that is like Flat Color. But only black is used (no colors, not even gray), and no fill.

Key Path	Save, Screen Image, Themes
Example	MMEM:STOR:SCR:THEM FMON
Readback	Flat Mono
Initial S/W Revision	Prior to A.02.00

Save As...

When you press "Save As", the analyzer brings up a Windows dialog and a menu entitled "**Save As.**" This menu allows you to navigate to the various fields in the Windows dialog without using a keyboard or mouse. The Tab and Arrow keys can also be used for dialog navigation.

See "[To File . . .](#)" on page 2413 in Save, State for a full description of this dialog and menu.

The default path for Screen Images is

My Documents\`<mode name>`\screen.

where `<mode name>` is the parameter used to select the mode with the INST:SEL command (for example, SA for the Spectrum Analyzer).

Key Path	Save, Screen Image
Notes	Brings up Save As dialog for saving a Screen Image Save Type
Initial S/W Revision	Prior to A.02.00

Single (Single Measurement/Sweep)

Sets the analyzer for Single measurement operation. The single/continuous state is Meas Global, so the setting will affect all the measurements. If you are Paused, pressing Single does a Resume.

See ["More Information" on page 2440](#)

Key Path	Front-panel key
Example	:INIT:CONT OFF
Notes	See Cont key description.
Backwards Compatibility Notes	<p>For Spectrum Analysis mode in ESA and PSA, the Single hardkey and the INITiate:IMM switched from continuous measurement to single measurement and restarted sweeps and averages (displayed average count reset to 1), but did not restart Max Hold and Min Hold. In the X-Series, the Single hardkey and the INITiate:IMM command initiate a sweep/ measurement/ average sequence/hold sequence including MaxHold and MinHold.</p> <p>For Spectrum Analysis mode in ESA and PSA, the Single hardkey restarted the sweep regardless of whether or not you were in an active sweep or sweep sequence. In the X-Series, Restart does this but Single only restarts the sweep or sweep sequence if you are in the idle state.</p> <p>INIT[:IMM] in ESA & PSA Spectrum Analysis Mode does an implied ABORT. In some other PSA Modes, INIT[:IMM] is ignored if not in the idle state. . The X-Series follows the ESA/PSA SA Mode model, which may cause some Modes to have compatibility problems.</p>
Initial S/W Revision	Prior to A.02.00

More Information

See ["Restart" on page 2410](#) for details on the INIT:IMMEDIATE (Restart) function.

If you are already in single sweep, the INIT:CONT OFF command has no effect.

If you are already in Single Sweep, then pressing the Single key in the middle of a sweep does not restart the sweep or sequence. Similarly, pressing the Single key does not restart the sweep or sequence if the sweep is not in the idle state (for example, if you are taking a very slow sweep, or the analyzer is waiting for a trigger). Instead, it results in a message. "Already in Single, press Restart to initiate a new sweep or sequence". Even though pressing the Single key in the middle of a sweep does not restart the sweep, sending INIT:IMMEDIATE does reset it.

To take one more sweep without resetting the average count, increment the average count by 1, by pressing the step up key while **Average/Hold Number** is the active function, or sending the remote command CALC:AVER:TCON UP.

Source

Opens a menu of keys that access various source configuration menus and settings. In the test set, pressing this key also causes the central view area to change and display the Source Control Main view.

Key Path	Front-panel key
----------	-----------------

RF Output

This parameter sets the source RF power output state.

Key Path	Source
Remote Command	:OUTPut[:EXTernal][:STATe] ON OFF 1 0 :OUTPut[:EXTernal][:STATe]?
Example	OUTP OFF OUTP?
Notes	<p>The EXTERNAL node is shown in RD text so the SCPI remains the same between internal and external source control. However, for EXT we do not wish to document this node to the customer since we are controlling the internal source rather than the external source.</p> <p>This setting is for the independent mode and has no effect on the "List Sequencer" on page 2520. If the "Sequencer" on page 2521 is set to ON, the list sequencer controls the source output and this key will be grayed-out. And this setting will be none-forceful grey out on front panel to indicate out-of-scope. Non-forceful means user still can change this setting by SCPI but cannot change on front panel. When set to OFF will make source leave list sequencer and this setting will be black out and take effect immediately.</p> <p>When the RF Output is ON, an "RF" annunciator is displayed in the system settings panel. When the RF Output is turned Off, the RF annunciator is cleared. If the "Sequencer" on page 2521 is set to ON, the "RF" annunciator will be replaced by "SEQ" in the system settings panel, indicating that the output is controlled by the list sequencer.</p>
Preset	Off
Range	On Off
Initial S/W Revision	A.05.00

Amplitude

Allows you to access the Amplitude sub-menu.

Key Path	Source
Notes	<p>The sub-menu under this button is for independent mode and has no effect on "List Sequencer" on page 2520. If the "Sequencer" on page 2521 is set to ON, the list sequencer controls the source output and this key will be grayed-out on front panel to indicate out-of-scope. When you set "Sequencer" on page 2521 to Off will make source leave list sequencer and this button will be black out.</p>
Initial S/W Revision	A.05.00

RF Power

Allows you to adjust the power level of the source using the numeric keypad, step keys, or RPG. Pressing any digit, 0 through 9, on the numeric keypad brings up the unit terminator.

Please refer to the "[RF Power Range](#) " on page 2443 table below for the valid ranges.

Key Path	Source, Amplitude
Remote Command	:SOURce:POWer[:LEVel][:IMMediate][:AMPLitude] <ampl> :SOURce:POWer[:LEVel][:IMMediate][:AMPLitude]?
Example	:SOUR:POW -100 dBm
Notes	<p>Amplitude corrections can be specified for use with the source. In the event of amplitude corrections being applied, the valid ranges for the RF power do not change dependant on the current amplitude correction setting. If the combination of RF power + amplitude correction is higher or lower than the source output range, the Source Unleveled bit is set and the "Source Unleveled" indicator will appear on status panel to indicate that the source cannot maintain the output power that has been requested.</p> <p>When signal generator is unable to maintain the requested output level, the "Source Unleveled" indicator will appear on status panel. When the source output setting is restored to the normal range, the "Source Unleveled" is removed from status panel.</p> <p>Internal source has list sequence mode, which comprises of several steps which contain separate output power, frequency and waveform etc. When the source list sequence playing is complete, the last step keeps playing, and user can use this command to change the list sequence last step's output power.</p> <p>The multiport adapter RFIO TX ports and GPS ports cannot ensure power accuracy when power setting is lower than -130dBm, this power setting value is defined by the sum of RF Power setting and related amplitude correction value. But user settable value could be lower than this limit. When application detected there exists power setting lower than -130dBm on MPA RFIO TX ports, then popup warning message . When application detected there exists power setting lower than -130dBm on MPA GPS ports, then popup warning message . This is only warning message, and check is performed when RF is ON.</p>
Notes	The Min and Max value here defined UI settable amplitude range. This range is larger than actual amplitude range with level accuracy defined in spec.
Dependencies	The RF power is dependent on the RF output port and frequency, such that the current frequency and selected output port determine the valid range of power values.
Preset	-100 dBm
Min	The range of values depends on the current frequency and selected RF output port. Please refer to the " RF Power Range " on page 2443 table below for the valid ranges.
Max	The range of values depends on the current frequency and selected RF output port. Please refer to the " RF Power Range " on page 2443 table below for the valid ranges.
Initial S/W Revision	A.05.00

RF Power Range

RF Output Port	Frequency Range	Min Output Power	Max Output Power
High Power RF Out	10 MHz ≤ f ≤ 6 GHz	-150 dBm	20 dBm
RFIO 1 & RFIO 2	10 MHz ≤ f ≤ 6 GHz	-150 dBm	0 dBm
GPS (Note2)	10 MHz ≤ f ≤ 6 GHz	-150 dBm	0 dBm

Note: This is the UI power range, it's larger than actual spec.

Note2: GPS port is on the multiport adapter, or E6607C which has embedded MPA.

Set Reference Power

This key allows you to set the power reference. Pressing this key turns the power reference state to ON, sets the reference power value to the current RF output power, maintains this power at the RF output, and sets the displayed power to 0.00 dB. All subsequent RF power values entered under Source>Amplitude>RF Power are interpreted as being relative to this reference power.

When you use a power reference, the signal generator outputs an RF power that is set relative to the reference power by the value entered under Source>Amplitude>RF Power as follows:

Output power = reference power – entered power

Where:

reference power equals the original RF Power entered under Source>Amplitude>RF Power and set as the reference power

entered power equals a new value entered under Source>Amplitude>Amptd Offset

In addition, the displayed power value is the same as a new value entered under Source>Amplitude>RF Power.

NOTE

If Power Ref is set to ON with a reference value set, entering a value under Source>Amplitude>RF Power and pressing Set Reference Power will add that value to the existing Power Ref value.

If you wish to change the reference power value to a new value entered under Source>Amplitude>RF Power, first you must set Power Ref to OFF and then press Set Reference Power.

Key Path	Source, Amplitude
Dependencies	This key is unavailable, and is grayed out when the " List Sequencer " on page 2520 is turned ON.
Initial S/W Revision	A.05.00

Power Ref

This key allows you to toggle the state of the power reference.

When you use a power reference, the signal generator outputs an RF power that is set relative to the reference power by the value entered under Source>Amplitude>RF Power as follows:

Output power = reference power + entered power

Where:

reference power equals the original RF Power entered under Source>Amplitude>RF Power and set as the reference power

entered power equals a new value entered under Source>Amplitude>Amptd Offset

For more information on Reference Frequency refer to ["Set Reference Power " on page 2443](#)

Key Path	Source, Amplitude
Remote Command	:SOURce:POWer:REFeRence <ampl> :SOURce:POWer:REFeRence? :SOURce:POWer:REFeRence:STATe OFF ON 0 1 :SOURce:POWer:REFeRence:STATe?
Example	:SOUR:POW:REF 0.00 dBm :SOUR:POW:REF:STATe ON
Dependencies	This setting is unavailable and is grayed out when the "List Sequencer" on page 2520 is turned ON.
Couplings	This value is coupled to the "Set Reference Power " on page 2443 key such that pressing the Set Reference Power key updates the reference power with the current output power.
Preset	0.00 dBm OFF
Min	-125.00 dBm
Max	10.00 dBm
Initial S/W Revision	A.05.00

Amptd Offset

Allows you to specify the RF output power offset value.

When the amplitude offset is set to zero (0) and you set a new offset value (positive or negative), the displayed amplitude value will change as follows and the RF output power will not change:

Displayed value = output power + offset value

Where:

output power equals the original RF Power entered under Source>Amplitude>RF Power

offset value equals the value entered under Source>Amplitude>Amptd Offset

When the amplitude offset is set to a value other than zero (0) and you enter a new RF power value under Source>Amplitude>RF Power, the displayed power will be the same as the value entered and the RF output power will be equal to the value entered minus the offset value as follows:

Output power = entered power – offset power

Displayed Power = output power + offset power

Displayed power = entered power

Where:

entered power equals the amplitude entered under Source>Amplitude>RF Power

offset power equals the value previously entered and set under Source>Amplitude>Amptd Offset

Key Path	Source, Amplitude
Remote Command	:SOURce:POWer[:LEVel][:IMMediate]:OFFSet <rel_ampl> :SOURce:POWer[:LEVel][:IMMediate]:OFFSet?
Example	:SOUR:POW:OFFS 0.00 dB
Dependencies	This setting is unavailable, and is grayed out when the List Sequencer is turned ON.
Preset	0.00 dB
Min	-200.00 dB
Max	200.00 dB
Initial S/W Revision	A.05.00

Modulation

Allows you to toggle the state of the modulation.

Key Path	Source
Remote Command	:OUTPut:MODulation[:STATe] ON OFF 1 0 :OUTPut:MODulation[:STATe]?
Example	:OUTP:MOD OFF
Notes	This setting is for independent mode and has no effect on " List Sequencer " on page 2520. If the " Sequencer " on page 2521 is set to ON, the list sequencer controls the source output and this key will be grayed-out. And this setting will be none-forceful grey out on front panel to indicate out-of-scope. Non-forceful means user still can change this setting by SCPI but cannot change manually on front panel. When set to Off will make source leave list sequencer and this setting will be black out and take effect immediately. When the Modulation is ON, the "MOD" annunciator is displayed in the system settings panel. When the Modulation is turned Off, the "MOD" annunciator is cleared. If the " Sequencer " on page 2521 is set to ON, the "MOD" annunciator will be replaced by "SEQ" in the system settings panel indicating that the output is controlled by list sequencer.
Preset	Off
Range	On Off
Initial S/W Revision	A.05.00

Frequency

Allows you to access the Frequency sub-menu.

Key Path	Source
Notes	The sub-menu under this button is for independent mode and has no effect on " List Sequencer " on

[page 2520](#). If the "[Sequencer](#)" on [page 2521](#) is set to ON, the list sequencer controls the source output and this key will be grayed-out. And this button will be grey out on front panel to indicate out-of-scope. When set to Off will make source leave list sequencer and this button will be black out.

Initial S/W Revision A.05.00

Frequency

Allows you to set the RF Output Frequency. You can adjust the frequency of the source using the numeric keypad, step keys, or RPG. Pressing any digit, 0 through 9, on the numeric keypad brings up the unit terminator.

Key Path	Source, Frequency
Remote Command	:SOURce:FREQuency[:CW] <freq> :SOURce:FREQuency[:CW]?
Example	:SOUR:FREQ 1.00 GHz
Notes	Internal source has list sequence mode, which comprises of several steps which contain separate output power, frequency and waveform etc. When the source list sequence playing is complete, the last step keeps playing, and user can use this command to change the list sequence last step's output frequency.
Couplings	The frequency value is coupled to the current channel band and number, such that updates to the band and number will update the frequency value to the corresponding absolute frequency.
Preset	1.00 GHz If license F1A or 5WC is present, the default Center Frequency should be 2.412GHz.
Min	10.00 MHz
Max	Hardware Dependant: Option 503 = 3.6 GHz Option 504 = 3.8 GHz Option 506 = 6.00 GHz For E6640A, if license 5WC is present, the frequency range should be limited to: 1.1GHz–1.7GHz, 2.4GHz–2.5GHz, 4.8GHz–6.0GHz. If the user-defined frequency is outside of range, UI will report an error message called "Settings conflict; Frequency is outside available range".
Initial S/W Revision	A.05.00

Channel

The frequency of the source can be specified by a channel number of a given frequency band. This key allows you to specify the current channel number. For the appropriate range of channel numbers for a given frequency band, refer to the following tables: "[GSM/EDGE Channel Number Ranges](#)" on [page 2447](#), "[W-CDMA Channel Number Ranges](#)" on [page 2448](#), "[CDMA 2000 / 1xEVDO Channel Number Ranges](#)" on [page 2449](#), and "[LTE FDD Channel Number Ranges](#)" on [page 2451](#).

Key Path	Source, Frequency
Remote Command	:SOURce:FREQuency:CHANnels:NUMBer <int> :SOURce:FREQuency:CHANnels:NUMBer?
Example	:SOUR:FREQ:CHAN:NUMB 1
Notes	This key is grayed out when the "Radio Standard" on page 2455 is set to NONE. This key is grayed out on E6630A.
Dependencies	This key is grayed out when the "Radio Standard" on page 2455 is set to NONE. This key is grayed out on E6630A.
Couplings	The channel number is coupled to the frequency value when the "Radio Standard" on page 2455 is not set to NONE. When the frequency value is changed, the channel number will increase or decrease to match the new frequency. If the frequency is not at an exact match for a channel number, the nearest channel number is displayed along with a greater than or less than sign to indicate the frequency is above or below the channel number.
Preset	1
Min	Please refer to the tables below for the valid ranges.
Max	Please refer to the tables below for the valid ranges.
Initial S/W Revision	A.05.00

GSM/EDGE Channel Number Ranges

Band	Link (Device)	Range	Frequency (MHz)
P-GSM	Uplink (MS)	$1 \leq n \leq 124$	$890.0 + 0.2*n$
	Downlink (BS)	$1 \leq n \leq 124$	$935.0 + 0.2*n$
E-GSM	Uplink (MS)	$0 \leq n \leq 124$	$890.0 + 0.2*n$
		$975 \leq n \leq 1023$	$890.0 + 0.2*(n-1024)$
	Downlink (BS)	$0 \leq n \leq 124$	$935.0 + 0.2*n$
		$975 \leq n \leq 1023$	$935.0 + 0.2*(n-1024)$
DCS 1800	Uplink (MS)	$512 \leq n \leq 885$	$1710.200 + 0.20*(n-512)$
	Downlink (BS)	$512 \leq n \leq 885$	$1805.200 + 0.20*(n-512)$
PCS 1900	Uplink (MS)	$512 \leq n \leq 810$	$1850.200 + 0.2*(n-512)$
	Downlink (BS)	$512 \leq n \leq 810$	$1930.200 + 0.2*(n-512)$
R-GSM	Uplink (MS)	$0 \leq n \leq 124$	$890.0 + 0.2*n$
		$955 \leq n \leq 1023$	$890.0 + 0.2*(n-1024)$
	Downlink (BS)	$0 \leq n \leq 124$	$935.0 + 0.2*n$
		$955 \leq n \leq 1023$	$935.0 + 0.2*(n-1024)$
GSM 450	Uplink (MS)	$256 \leq n \leq 293$	$450.6 + 0.2*(n-259)$
	Downlink (BS)	$256 \leq n \leq 293$	$460.6 + 0.2*(n-259)$
GSM 480	Uplink (MS)	$306 \leq n \leq 340$	$479.000 + 0.20*(n-306)$

Band	Link (Device)	Range	Frequency (MHz)
GSM 850	Downlink (BS)	$306 \leq n \leq 340$	$489.000 + 0.20*(n-306)$
	Uplink (MS)	$128 \leq n \leq 251$	$824.200 + 0.20*(n-128)$
GSM 700	Downlink (BS)	$128 \leq n \leq 251$	$869.200 + 0.20*(n-128)$
	Uplink (MS)	$438 \leq n \leq 516$	$777.200 + 0.20*(n-438)$
T-GSM810	Downlink (BS)	$438 \leq n \leq 516$	$747.200 + 0.20*(n-438)$
	Uplink (MS)	$350 \leq n \leq 425$	$806.0 + 0.20*(n-350)$
	Downlink (BS)	$350 \leq n \leq 425$	$851.0 + 0.20*(n-350)$

W-CDMA Channel Number Ranges

Band	Link (Device)	Range	Frequency (MHz)
Band I	Downlink	$10562 \leq n \leq 10838$	$n \div 5$
	Uplink	$9612 \leq n \leq 9888$	$n \div 5$
Band II	Downlink	$412 \leq n \leq 687$	$n \div 5 + 1850.1$
		$9662 \leq n \leq 9938$	$n \div 5$
	Uplink	$12 \leq n \leq 287$	$n \div 5 + 1850.1$
Band III	Downlink	$350 \leq n \leq 425$	$n \div 5$
	Uplink	$1162 \leq n \leq 1513$	$n \div 5 + 1575$
Band IV	Downlink	$937 \leq n \leq 1288$	$n \div 5 + 1525$
		$537 \leq n \leq 1738$	$n \div 5 + 1805$
	Uplink	$1887 \leq n \leq 2087$	$n \div 5 + 1735.1$
Band V	Downlink	$1312 \leq n \leq 1513$	$n \div 5 + 1450$
		$1662 \leq n \leq 1862$	$n \div 5 + 1380.1$
	Uplink	$1007 \leq n \leq 1087$	$n \div 5 + 670.1$
Band VI	Downlink	$4357 \leq n \leq 4458$	$n \div 5$
		$782 \leq n \leq 862$	$n \div 5 + 670.1$
	Uplink	$4132 \leq n \leq 4233$	$n \div 5$
Band VII	Downlink	$1037 \leq n \leq 1062$	$n \div 5 + 670.1$
		$4387 \leq n \leq 4413$	$n \div 5$
	Uplink	$812 \leq n \leq 837$	$n \div 5 + 670.1$
Band VIII	Downlink	$4162 \leq n \leq 4188$	$n \div 5$
		$2237 \leq n \leq 2563$	$n \div 5 + 2175$
	Uplink	$2587 \leq n \leq 2912$	$n \div 5 + 2105.1$
Band VIII	Downlink	$2012 \leq n \leq 2338$	$n \div 5 + 2100$
		$2362 \leq n \leq 2687$	$n \div 5 + 2030.1$
Band VIII	Downlink	$2937 \leq n \leq 3088$	$n \div 5 + 340$
	Uplink	$2712 \leq n \leq 2863$	$n \div 5 + 340$

Band	Link (Device)	Range	Frequency (MHz)
Band IX	Downlink	$9237 \leq n \leq 9387$	$n \div 5$
	Uplink	$8762 \leq n \leq 8912$	$n \div 5$
Band X	Downlink	$3112 \leq n \leq 3388$	$n \div 5 + 1490$
		$3412 \leq n \leq 3687$	$n \div 5 + 1430.1$
	Uplink	$2887 \leq n \leq 3163$	$n \div 5 + 1135$
		$3187 \leq n \leq 3462$	$n \div 5 + 1075.1$
Band XI	Downlink	$3712 \leq n \leq 3812$	$n \div 5 + 736$
	Uplink	$3487 \leq n \leq 3587$	$n \div 5 + 733$
Band XII	Downlink	$3837 \leq n \leq 3903$	$n \div 5 - 37$
		$3927 \leq n \leq 3992$	$n \div 5 - 54.9$
	Uplink	$3612 \leq n \leq 3678$	$n \div 5 - 22$
		$3702 \leq n \leq 3767$	$n \div 5 - 39.9$
Band XIII	Downlink	$4017 \leq n \leq 4043$	$n \div 5 - 55$
		$4067 \leq n \leq 4092$	$n \div 5 - 64.9$
	Uplink	$3792 \leq n \leq 3818$	$n \div 5 + 21$
		$3702 \leq n \leq 3767$	$n \div 5 - 39.9$
Band XIV	Downlink	$4117 \leq n \leq 4143$	$n \div 5 - 63$
		$4167 \leq n \leq 4192$	$n \div 5 - 72.9$
	Uplink	$3892 \leq n \leq 3918$	$n \div 5 + 12$
		$3942 \leq n \leq 3967$	$n \div 5 + 2.1$
Band XIX	Downlink	$712 \leq n \leq 763$	$n \div 5 + 735$
		$787 \leq n \leq 837$	$n \div 5 + 720.1$
	Uplink	$312 \leq n \leq 363$	$n \div 5 + 770$
		$387 \leq n \leq 437$	$n \div 5 + 755.1$

CDMA 2000 / 1xEVDO Channel Number Ranges

Band	Link (Device)	Range	Frequency (MHz)
US Cellular	Uplink (MS, reverse link)	$1 \leq N \leq 799$	$0.030 \times N + 825.000$
		$991 \leq N \leq 1023$	$0.030 \times (N - 1023) + 825.000$
		$1024 \leq N \leq 1323$	$0.030 \times (N - 1024) + 815.040$
	Downlink (BS, forward link)	$1 \leq N \leq 799$	$0.030 \times N + 870.000$
		$991 \leq N \leq 1023$	$0.030 \times (N - 1023) + 870.000$
		$1024 \leq N \leq 1323$	$0.030 \times (N - 1024) + 860.040$
US PCS	Uplink (MS, reverse link)	$0 \leq N \leq 1199$	$1850.000 + 0.050 \times N$
	Downlink (BS, forward link)	$0 \leq N \leq 1199$	$1930.000 + 0.050 \times N$

Band	Link (Device)	Range	Frequency (MHz)
Japan Cellular Band	Uplink (MS, reverse link)	$1 \leq N \leq 799$	$0.0125 \times (N + 915.000)$
		$801 \leq N \leq 1039$	$0.0125 \times (N - 800) + 898.000$
		$1041 \leq N \leq 1199$	$0.0125 \times (N - 1040) + 887.000$
		$1201 \leq N \leq 1600$	$0.0125 \times (N - 1200) + 893.000$
	Downlink (BS, forward link)	$1 \leq N \leq 799$	$0.0125 \times (N + 860.000)$
		$801 \leq N \leq 1039$	$0.0125 \times (N - 800) + 843.000$
		$1041 \leq N \leq 1199$	$0.0125 \times (N - 1040) + 832.000$
		$1201 \leq N \leq 1600$	$0.0125 \times (N - 1200) + 838.000$
Korean PCS Band	Uplink (MS, reverse link)	$0 \leq N \leq 599$	$0.050 \times N + 1750.000$
	Downlink (BS, forward link)	$0 \leq N \leq 599$	$0.050 \times N + 1840.000$
NMT-450 Band	Uplink (MS, reverse link)	$1 \leq N \leq 400$	$0.025 \times (N - 1) + 450.000$
		$472 \leq N \leq 871$	$0.025 \times (N - 472) + 410.000$
		$1039 \leq N \leq 1473$	$0.020 \times (N - 1024) + 451.010$
		$1536 \leq N \leq 1715$	$0.025 \times (N - 1536) + 479.000$
		$1792 \leq N \leq 2016$	$0.020 \times (N - 1792) + 479.000$
	Downlink (BS, forward link)	$1 \leq N \leq 400$	$0.025 \times (N - 1) + 460.000$
		$472 \leq N \leq 871$	$0.025 \times (N - 472) + 420.000$
		$1039 \leq N \leq 1473$	$0.020 \times (N - 1024) + 461.010$
IMT-2000 Band	Uplink (MS, reverse link)	$0 \leq N \leq 1199$	$1920.000 + 0.050 \times N$
	Downlink (BS, forward link)	$0 \leq N \leq 1199$	$2100.000 + 0.050 \times N$
Upper 700 MHz Band	Uplink (MS, reverse link)	$0 \leq N \leq 240$	$776.000 + 0.050 \times N$
	Downlink (BS, forward link)	$0 \leq N \leq 240$	$746.000 + 0.050 \times N$
Secondary 800 MHz Band	Uplink (MS, reverse link)	$0 \leq N \leq 719$	$0.025 \times N + 806.000$
		$720 \leq N \leq 919$	$0.025 \times (N - 720) + 896.000$
	Downlink (BS, forward link)	$0 \leq N \leq 719$	$0.025 \times N + 851.000$
		$720 \leq N \leq 919$	$0.025 \times (N - 720) + 935.000$
2.5 GHz IMT Extension	Uplink (MS, reverse link)	$0 \leq N \leq 1399$	$2500.000 + 0.050 \times N$
	Downlink (BS, forward link)	$0 \leq N \leq 1399$	$2620.000 + 0.050 \times N$
US PCS 1.9 GHz	Uplink (MS, reverse link)	$0 \leq N \leq 1299$	$1850.000 + 0.050 \times N$

Band	Link (Device)	Range	Frequency (MHz)
AWS	Downlink (BS, forward link)	$0 \leq N \leq 1299$	$1930.000 + 0.050 \times N$
	Uplink (MS, reverse link)	$0 \leq N \leq 899$	$1710.000 + 0.050 \times N$
US 2.5 GHz	Downlink (BS, forward link)	$0 \leq N \leq 899$	$2100.000 + 0.050 \times N$
	Uplink (MS, reverse link)	$140 \leq N \leq 1459$	$2495.000 + 0.050 \times N$
700 Public Safety	Downlink (BS, forward link)	$140 \leq N \leq 1459$	$2617.000 + 0.050 \times N$
	Uplink (MS, reverse link)	$0 \leq N \leq 240$	$787.000 + 0.050 \times N$
C2K Lower 700	Downlink (BS, forward link)	$0 \leq N \leq 240$	$757.000 + 0.050 \times N$
	Uplink (MS, reverse link)	$0 \leq N \leq 360$	$698.000 + 0.050 \times N$
400 Euro PAMR	Downlink (BS, forward link)	$0 \leq N \leq 360$	$728.000 + 0.050 \times N$
	Uplink (MS, reverse link)	$1 \leq N \leq 400$	$0.025 \times (N-1) + 450.000$
	Uplink (MS, reverse link)	$472 \leq N \leq 871$	$0.025 \times (N-472) + 410.000$
	Uplink (MS, reverse link)	$1536 \leq N \leq 1715$	$0.025 \times (N-1536) + 479.000$
	Downlink (BS, forward link)	$1 \leq N \leq 400$	$0.025 \times (N-1) + 460.000$
	Downlink (BS, forward link)	$472 \leq N \leq 871$	$0.025 \times (N-472) + 420.000$
	Downlink (BS, forward link)	$1536 \leq N \leq 1715$	$0.025 \times (N-1536) + 489.000$
	Downlink (BS, forward link)		
800 PAMR	Uplink (MS, reverse link)	$0 \leq N \leq 239$	$870.0125 + 0.025 \times N$
	Downlink (BS, forward link)	$0 \leq N \leq 239$	$915.0125 + 0.025 \times N$

LTE FDD Channel Number Ranges

The carrier frequency in the uplink and downlink is designated by the E-UTRA Absolute Radio Frequency Channel Number (EARFCN) in the range 0 – 65535. The relation between EARFCN and the carrier frequency in MHz for the downlink is given by the following equation, where FDL_low and NOffs-DL are given in table 5.4.4-1 and NDL is the downlink EARFCN.

$$FDL = FDL_low + 0.1(NDL - NOffs-DL)$$

The relation between EARFCN and the carrier frequency in MHz for the uplink is given by the following equation where FUL_low and NOffs-UL are given in table 5.4.4-1 and NUL is the uplink EARFCN.

$$FUL = FUL_low + 0.1(NUL - NOffs-UL)$$

Band	Downlink		Uplink			
	FDL_low (MHz)	NOffs-DL	Range of NDL	FUL_low (MHz)	NOffs-UL	Range of NUL
1	2110	0	0 - 599	1920	18000	18000 - 18599
2	1930	600	600 - 1199	1850	18600	18600 - 19199
3	1805	1200	1200 - 1949	1710	19200	19200 - 19949
4	2110	1950	1950 - 2399	1710	19950	19950 - 20399
5	869	2400	2400 - 2649	824	20400	20400 - 20649
6	875	2650	2650 - 2749	830	20650	20650 - 20749
7	2620	2750	2750 - 3449	2500	20750	20750 - 20449
8	925	3450	3450 - 3799	880	21450	21450 - 21799
9	1844.9	3800	3800 - 4149	1749.9	21800	21800 - 22149
10	2110	4150	4150 - 4749	1710	22150	22150 - 22749
11	1475.9	4750	4750 - 4949	1427.9	22750	22750 - 22949
12	729	5010	5010 - 5179	699	23010	23010 - 23179
13	746	5180	5180 - 5279	777	23180	23180 - 23279
14	758	5280	5280 - 5379	788	23280	23280 - 23379
...						
17	734	5730	5730 - 5849	704	23730	23730 - 23849
18	860	5850	5850 - 5999	815	23850	23850 - 23999
19	875	6000	6000 - 6149	830	24000	24000 - 24149
20	791	6150	6150 - 6449	832	24150	24150 - 24449
21	1495.9	6450	6450 - 6599	1447.9	24450	24450 - 24599
...						
24	1525	7700	7700 - 8039	1626.5	25700	25700 - 26039
25	1930	8040	8040 - 8689	1850	26040	26040 - 26689
26	859	8690	8690 - 9039	814	26690	26690 - 27039
...						

Note: The channel numbers that designate carrier frequencies so close to the operating band edges that the carrier extends beyond the operating band edge shall not be used. This implies that the first 7, 15, 25, 50, 75 and 100 channel numbers at the lower operating band edge and the last 6, 14, 24, 49, 74 and 99 channel numbers at the upper operating band edge shall not be used for channel bandwidths of 1.4, 3, 5, 10, 15 and 20 MHz respectively.

LTE TDD Channel Number Ranges

The carrier frequency in the uplink and downlink is designated by the E-UTRA Absolute Radio Frequency Channel Number (EARFCN) in the range 0 – 65535. The relation between EARFCN and the carrier frequency in MHz for the downlink is given by the following equation, where FDL_low and NOffs-DL are given in table 5.4.4-1 and NDL is the downlink EARFCN.

$$FDL = FDL_low + 0.1(NDL - NOffs-DL)$$

The relation between EARFCN and the carrier frequency in MHz for the uplink is given by the following equation where FUL_low and NOffs-UL are given in table 5.4.4-1 and NUL is the uplink EARFCN.

$$FUL = FUL_low + 0.1(NUL - NOffs-UL)$$

Band	Downlink		Uplink			
	FDL_low (MHz)	NOffs-DL	Range of NDL	FUL_low (MHz)	NOffs-UL	Range of NUL
33		1900	36000	36000 - 36199	1900	36000 - 36199
34		2010	36200	36200 - 36349	2010	36200 - 36349
35		1850	36350	36350 - 36949	1850	36350 - 36949
36		1930	36950	36950 - 37549	1930	36950 - 37549
37		1910	37550	37550 - 37749	1910	37550 - 37749
38		2570	37750	37750 - 38249	2570	37750 - 38249
39		1880	38250	38250 - 38649	1880	38250 - 38649
40		2300	38650	38650 - 39649	2300	38650 - 39649
41		2496	39650	39650 - 41589	2496	39650 - 41589
42		3400	41590	41590 - 43589	3400	41590 - 43589
43		3600	43590	43590 - 45589	3600	43590 - 45589

Note: The channel numbers that designate carrier frequencies so close to the operating band edges that the carrier extends beyond the operating band edge shall not be used. This implies that the first 7, 15, 25, 50, 75 and 100 channel numbers at the lower operating band edge and the last 6, 14, 24, 49, 74 and 99 channel numbers at the upper operating band edge shall not be used for channel bandwidths of 1.4, 3, 5, 10, 15 and 20 MHz respectively.

TDSCDMA Channel Number Ranges

1.28 Mcps TDD Option

No TX-RX frequency separation is required as Time Division Duplex (TDD) is employed. Each subframe consists of 7 main timeslots where all main timeslots (at least the first one) before the single switching point are allocated DL and all main timeslots (at least the last one) after the single switching point are allocated UL.

The nominal channel spacing is 1.6 MHz, but this can be adjusted to optimise performance in a particular deployment scenario.

The carrier frequency is designated by the UTRA absolute radio frequency channel number (UARFCN). The value of the UARFCN in the IMT2000 band is defined in the general case as follows:

$$N_t = 5 * F \quad 0.0 \text{ MHz} \leq F \leq 3276.6 \text{ MHz}$$

where F is the carrier frequency in MHz

Additional channels applicable to operation in the frequency band defined in sub-clause 5.2(d) are defined via the following UARFCN definition:

$$N_t = 5 * (F - 2150.1 \text{ MHz}) \quad 2572.5 \text{ MHz} \leq F \leq 2617.5 \text{ MHz}$$

UARFCN

1.28 Mcps TDD Option

The following UARFCN range shall be supported for each band:

**Table: UTRA Absolute Radio
Frequency Channel Number 1.28
Mcps TDD Option**

Frequency Band	Frequency Range	UARFCN Uplink and Downlink transmission
For operation in frequency band as defined in subclause 5.2 (a)	1900–1920 MHz	9504 to 9596
	2010–2025 MHz	10054 to 10121
For operation in frequency band as defined in subclause 5.2 (b)	1850–1910 MHz	9254 to 9546
	1930–1990 MHz	9654 to 9946
For operation in frequency band as defined in subclause 5.2 (c)	1910–1930 MHz	9554 to 9646
For operation in frequency band as defined in subclause 5.2 (d)	2570–2620 MHz	12854 to 13096
For operation in frequency band as defined in subclause 5.2 (e)	2300–2400 MHz	11504 to 11996
For operation in frequency band as defined in subclause 5.2 (f)	1880–1920 MHz	9404 to 9596

Radio Setup

Allows access to the sub-menus for selecting the radio standard and associated radio band. You can also set a frequency reference and offset.

This menu is greyed out when on E6630A. Radio band settings for GSM, cdma2000, and so on -- most of which are not actually supported in E6630A, which has three narrow frequency bands. So band settings are grayed out.

Key Path	Source, Frequency
Initial S/W Revision	A.05.00

Radio Standard

Allows access to the channel band sub-menus to select the desired radio standard. When you have selected the radio standard, you can then set an active channel band. The radio standard and the active channel band allow you to use channel numbers to set frequency automatically.

Key Path	Source, Frequency, Radio Setup
Remote Command	:SOURce:FREQuency:CHANnels:BAND NONE PGSM EGSM RGSM DCS1800 PCS1900 TGSM810 GSM450 GSM480 GSM700 GSM850 BANDI BANDII BANDIII BANDIV BANDV BANDVI BANDVII BANDVIII BANDIX BANDX BANDXI BANDXII BANDXIII BANDXIV BANDXIX USCELL USPCS JAPAN KOREAN NMT IMT2K UPPER SECOND PAMR400 PAMR800 IMTEXT PCS1DOT9G AWS US2DOT5G PUBLIC LOWER BAND1 BAND2 BAND3 BAND4 BAND5 BAND6 BAND7 BAND8 BAND10 BAND11 BAND12 BAND13 BAND14 BAND17 BAND18 BAND19 BAND20 BAND21 BAND24 BAND25 BAND26 BAND27 BAND28 BAND31 BAND33 BAND34 BAND35 BAND36 BAND37 BAND38 BAND39 BAND40 BAND41 BAND42 BAND43 BAND44 BANDA BANDB BANDC BANDD BANDE BANDF :SOURce:FREQuency:CHANnels:BAND?
Example	:SOUR:FREQ:CHAN:BAND PGSM
Notes	Set this setting to "NONE" will grey out "Channel" on page 2446 Channel
Initial S/W Revision	A.05.00

None

Selects no radio standard for use. When you have selected the radio standard to NONE, you cannot use channel numbers to set frequency automatically. You will need to set the frequency manually.

Key Path	Source, Frequency, Radio Setup, Radio Standard
Initial S/W Revision	A.05.00

GSM/EDGE

Sets GSM/EDGE as the radio standard for use and accesses the GSM/EDGE specific channel band sub-menus.

Key Path	Source, Frequency, Radio Setup, Radio Standard
Initial S/W Revision	A.05.00

P-GSM

Selects P-GSM as the active channel band.

Key Path	Source, Frequency, Radio Setup, Radio Standard, GSM/EDGE
Example	:SOUR:FREQ:CHAN:BAND PGSM
Initial S/W Revision	A.05.00

E-GSM

Selects E-GSM as the active channel band.

Key Path	Source, Frequency, Radio Setup, Radio Standard, GSM/EDGE
Example	:SOUR:FREQ:CHAN:BAND EGSM
Initial S/W Revision	A.05.00

R-GSM

Selects R-GSM as the active channel band.

Key Path	Source, Frequency, Radio Setup, Radio Standard, GSM/EDGE
Example	:SOUR:FREQ:CHAN:BAND RGSM
Initial S/W Revision	A.05.00

DCS 1800

Selects DCS 1800 as the active channel band.

Key Path	Source, Frequency, Radio Setup, Radio Standard, GSM/EDGE
Example	:SOUR:FREQ:CHAN:BAND DCS1800
Initial S/W Revision	A.05.00

PCS 1900

Selects PCS 1900 as the active channel band.

Key Path	Source, Frequency, Radio Setup, Radio Standard, GSM/EDGE
Example	:SOUR:FREQ:CHAN:BAND PCS1900
Initial S/W Revision	A.05.00

GSM 450

Selects GSM 450 as the active channel band.

Key Path	Source, Frequency, Radio Setup, Radio Standard, GSM/EDGE
Example	:SOUR:FREQ:CHAN:BAND GSM450
Initial S/W Revision	A.05.00

GSM 480

Selects GSM 480 as the active channel band.

Key Path	Source, Frequency, Radio Setup, Radio Standard, GSM/EDGE
Example	:SOUR:FREQ:CHAN:BAND GSM480
Initial S/W Revision	A.05.00

GSM 850

Selects GSM 850 as the active channel band.

Key Path	Source, Frequency, Radio Setup, Radio Standard, GSM/EDGE
Example	:SOUR:FREQ:CHAN:BAND GSM850
Initial S/W Revision	A.05.00

GSM 700

Selects GSM 700 as the active channel band.

Key Path	Source, Frequency, Radio Setup, Radio Standard, GSM/EDGE
Example	:SOUR:FREQ:CHAN:BAND GSM700
Initial S/W Revision	A.05.00

T-GSM 810

Selects T-GSM 810 as the active channel band.

Key Path	Source, Frequency, Radio Setup, Radio Standard, GSM/EDGE
Example	:SOUR:FREQ:CHAN:BAND T-GSM810
Initial S/W Revision	A.05.00

WCDMA

Sets WCDMA as the radio standard for use and accesses the W-CDMA specific channel band sub-menus.

Key Path	Source, Frequency, Radio Setup, Radio Standard
Initial S/W Revision	A.05.00

Band I

Selects Band I as the active channel band.

Key Path	Source, Frequency, Radio Setup, Radio Standard, WCDMA
Example	:SOUR:FREQ:CHAN:BAND BANDI
Initial S/W Revision	A.05.00

Band II

Selects Band II as the active channel band.

Key Path	Source, Frequency, Radio Setup, Radio Standard, WCDMA
Example	:SOUR:FREQ:CHAN:BAND BANDII
Initial S/W Revision	A.05.00

Band III

Selects Band III as the active channel band.

Key Path	Source, Frequency, Radio Setup, Radio Standard, WCDMA
Example	:SOUR:FREQ:CHAN:BAND BANDIII
Initial S/W Revision	A.05.00

Band IV

Selects Band IV as the active channel band.

Key Path	Source, Frequency, Radio Setup, Radio Standard, WCDMA
Example	:SOUR:FREQ:CHAN:BAND BANDIV
Initial S/W Revision	A.05.00

Band V

Selects Band V as the active channel band.

Key Path	Source, Frequency, Radio Setup, Radio Standard, WCDMA
Example	:SOUR:FREQ:CHAN:BAND BANDV
Initial S/W Revision	A.05.00

Band VI

Selects Band VI as the active channel band.

Key Path	Source, Frequency, Radio Setup, Radio Standard, WCDMA
Example	:SOUR:FREQ:CHAN:BAND BANDVI
Initial S/W Revision	A.05.00

Band VII

Selects Band VII as the active channel band.

Key Path	Source, Frequency, Radio Setup, Radio Standard, WCDMA
Example	:SOUR:FREQ:CHAN:BAND BANDVII
Initial S/W Revision	A.05.00

Band VIII

Selects Band VIII as the active channel band.

Key Path	Source, Frequency, Radio Setup, Radio Standard, WCDMA
Example	:SOUR:FREQ:CHAN:BAND BANDVIII
Initial S/W Revision	A.05.00

Band IX

Selects Band IX as the active channel band.

Key Path	Source, Frequency, Radio Setup, Radio Standard, WCDMA
Example	:SOUR:FREQ:CHAN:BAND BANDIX
Initial S/W Revision	A.05.00

Band X

Selects Band X as the active channel band.

Key Path	Source, Frequency, Radio Setup, Radio Standard, WCDMA
Example	:SOUR:FREQ:CHAN:BAND BANDX
Initial S/W Revision	A.05.00

Band XI

Selects Band XI as the active channel band.

Key Path	Source, Frequency, Radio Setup, Radio Standard, WCDMA
Example	:SOUR:FREQ:CHAN:BAND BANDXI
Initial S/W Revision	A.05.00

Band XII

Selects Band XII as the active channel band.

Key Path	Source, Frequency, Radio Setup, Radio Standard, WCDMA
Example	:SOUR:FREQ:CHAN:BAND BANDXII
Initial S/W Revision	A.05.00

Band XIII

Selects band XIII as the active channel band.

Key Path	Source, Frequency, Radio Setup, Radio Standard, WCDMA
Example	:SOUR:FREQ:CHAN:BAND BANDXIII
Initial S/W Revision	A.05.00

Band XIV

Selects Band XIV as the active channel band.

Key Path	Source, Frequency, Radio Setup, Radio Standard, WCDMA
Example	:SOUR:FREQ:CHAN:BAND BANDXIV
Initial S/W Revision	A.05.00

Band XIX

Selects Band XIX as the active channel band.

Key Path	Source, Frequency, Radio Setup, Radio Standard, WCDMA
Example	:SOUR:FREQ:CHAN:BAND BANDXIX
Initial S/W Revision	A.14.50

CDMA 2000 / 1xEVDO

Sets CDMA 2000 / 1xEVDO as the radio standard for use and accesses the CDMA 2000/1xEVDO specific channel band sub-menus.

Key Path	Source, Frequency, Radio Setup, Radio Standard
Initial S/W Revision	A.05.00

US CELL

Selects US Cell as the active channel band.

Key Path	Source, Frequency, Radio Setup, Radio Standard, CDMA 2000 / 1xEVDO
Example	:SOUR:FREQ:CHAN:BAND USCELL
Initial S/W Revision	A.05.00

US PCS

Selects US PCS as the active channel band.

Key Path	Source, Frequency, Radio Setup, Radio Standard, CDMA 2000 / 1xEVDO
Example	:SOUR:FREQ:CHAN:BAND PCS
Initial S/W Revision	A.05.00

Japan Cell

Selects Japan Cell as the active channel band.

Key Path	Source, Frequency, Radio Setup, Radio Standard, CDMA 2000 / 1xEVDO
Example	:SOUR:FREQ:CHAN:BAND JAPAN
Initial S/W Revision	A.05.00

Korean PCS

Selects Korean PCS as the active channel band.

Key Path	Source, Frequency, Radio Setup, Radio Standard, CDMA 2000 / 1xEVDO
Example	:SOUR:FREQ:CHAN:BAND KOREAN
Initial S/W Revision	A.05.00

NMT 450

Selects NMT 450 as the active channel band.

Key Path	Source, Frequency, Radio Setup, Radio Standard, CDMA 2000 / 1xEVDO
----------	--

Example	:SOUR:FREQ:CHAN:BAND NMT
Initial S/W Revision	A.05.00

IMT 2000

Selects IMT 2000 as the active channel band.

Key Path	Source, Frequency, Radio Setup, Radio Standard, CDMA 2000 / 1xEVDO
Example	:SOUR:FREQ:CHAN:BAND IMT2K
Initial S/W Revision	A.05.00

Upper 700

Selects Upper 700 as the active channel band.

Key Path	Source, Frequency, Radio Setup, Radio Standard, CDMA 2000 / 1xEVDO
Example	:SOUR:FREQ:CHAN:BAND UPPER
Initial S/W Revision	A.05.00

Secondary 800

Selects Secondary 800 as the active channel band.

Key Path	Source, Frequency, Radio Setup, Radio Standard, CDMA 2000 / 1xEVDO
Example	:SOUR:FREQ:CHAN:BAND SECOND
Initial S/W Revision	A.05.00

400 Euro PAMR

Selects 400 Euro PAMR as the active channel band.

Key Path	Source, Frequency, Radio Setup, Radio Standard, CDMA 2000 / 1xEVDO
Example	:SOUR:FREQ:CHAN:BAND PAMR400
Initial S/W Revision	A.05.00

800 PAMR

Selects 800 PAMR as the active channel band.

Key Path	Source, Frequency, Radio Setup, Radio Standard, CDMA 2000 / 1xEVDO
----------	--

Example	:SOUR:FREQ:CHAN:BAND PAMR800
Initial S/W Revision	A.05.00

2.5GHz IMT EXT

Selects 2.5 GHz IMT EXT as the active channel band.

Key Path	Source, Frequency, Radio Setup, Radio Standard, CDMA 2000 / 1xEVDO
Example	:SOUR:FREQ:CHAN:BAND IMTEXT
Initial S/W Revision	A.05.00

US PCS 1.9GHz

Selects US PCS 1.9 GHz as the active channel band.

Key Path	Source, Frequency, Radio Setup, Radio Standard, CDMA 2000 / 1xEVDO
Example	:SOUR:FREQ:CHAN:BAND PCS1DOT9G
Initial S/W Revision	A.05.00

AWS

Selects AWS as the active channel band.

Key Path	Source, Frequency, Radio Setup, Radio Standard, CDMA 2000 / 1xEVDO
Example	:SOUR:FREQ:CHAN:BAND AWS
Initial S/W Revision	A.05.00

US 2.5GHz

Selects US 2.5 GHz as the active channel band.

Key Path	Source, Frequency, Radio Setup, Radio Standard, CDMA 2000 / 1xEVDO
Example	:SOUR:FREQ:CHAN:BAND US2DOT5G
Initial S/W Revision	A.05.00

700 Public Safety

Selects 700 Public Safety as the active channel band.

Key Path	Source, Frequency, Radio Setup, Radio Standard, CDMA 2000 / 1xEVDO
----------	--

Example	:SOUR:FREQ:CHAN:BAND PUBLIC
Initial S/W Revision	A.05.00

C2K Lower 700

Selects C2K Lower 700 as the active channel band.

Key Path	Source, Frequency, Radio Setup, Radio Standard, CDMA 2000 / 1xEVDO
Example	:SOUR:FREQ:CHAN:BAND LOWER
Initial S/W Revision	A.05.00

LTE

Sets LTE FDD as the radio standard for use and accesses the LTE FDD specific channel band sub-menus..

Key Path	Source, Frequency, Radio Setup, Radio Standard
Initial S/W Revision	A.09.50

BAND 1

Selects BAND 1 as the band for the current step.

Key Path	Source, Frequency, Radio Setup, Radio Standard, LTE
Example	:SOUR:FREQ:CHAN:BAND BAND1
Initial S/W Revision	A.09.50

BAND 2

Selects BAND 2 as the band for the current step.

Key Path	Source, Frequency, Radio Setup, Radio Standard, LTE
Example	:SOUR:FREQ:CHAN:BAND BAND2
Initial S/W Revision	A.09.50

BAND 3

Selects BAND 3 as the band for the current step.

Key Path	Source, Frequency, Radio Setup, Radio Standard, LTE
Example	:SOUR:FREQ:CHAN:BAND BAND3
Initial S/W Revision	A.09.50

BAND 4

Selects BAND 4 as the band for the current step.

Key Path	Source, Frequency, Radio Setup, Radio Standard, LTE
Example	:SOUR:FREQ:CHAN:BAND BAND4
Initial S/W Revision	A.09.50

BAND 5

Selects BAND 5 as the band for the current step.

Key Path	Source, Frequency, Radio Setup, Radio Standard, LTE
Example	:SOUR:FREQ:CHAN:BAND BAND5
Initial S/W Revision	A.09.50

BAND 6

Selects BAND 6 as the band for the current step.

Key Path	Source, Frequency, Radio Setup, Radio Standard, LTE
Example	:SOUR:FREQ:CHAN:BAND BAND6
Initial S/W Revision	A.09.50

BAND 7

Selects BAND 7 as the band for the current step.

Key Path	Source, Frequency, Radio Setup, Radio Standard, LTE
Example	:SOUR:FREQ:CHAN:BAND BAND7
Initial S/W Revision	A.09.50

BAND 8

Selects BAND 8 as the band for the current step.

Key Path	Source, Frequency, Radio Setup, Radio Standard, LTE
Example	:SOUR:FREQ:CHAN:BAND BAND8
Initial S/W Revision	A.09.50

BAND 9

Selects BAND 9 as the band for the current step.

Key Path	Source, Frequency, Radio Setup, Radio Standard, LTE
Example	:SOUR:FREQ:CHAN:BAND BAND9
Initial S/W Revision	A.09.50

BAND 10

Selects BAND 10 as the band for the current step.

Key Path	Source, Frequency, Radio Setup, Radio Standard, LTE
Example	:SOUR:FREQ:CHAN:BAND BAND10
Initial S/W Revision	A.09.50

BAND 11

Selects BAND 11 as the band for the current step.

Key Path	Source, Frequency, Radio Setup, Radio Standard, LTE
Example	:SOUR:FREQ:CHAN:BAND BAND11
Initial S/W Revision	A.09.50

BAND 12

Selects BAND 12 as the band for the current step.

Key Path	Source, Frequency, Radio Setup, Radio Standard, LTE
Example	:SOUR:FREQ:CHAN:BAND BAND12
Initial S/W Revision	A.09.50

BAND 13

Selects BAND 13 as the band for the current step.

Key Path	Source, Frequency, Radio Setup, Radio Standard, LTE
Example	:SOUR:FREQ:CHAN:BAND BAND13
Initial S/W Revision	A.09.50

BAND 14

Selects BAND 14 as the band for the current step.

Key Path	Source, Frequency, Radio Setup, Radio Standard, LTE
Example	:SOUR:FREQ:CHAN:BAND BAND14
Initial S/W Revision	A.09.50

BAND 17

Selects BAND 17 as the band for the current step.

Key Path	Source, Frequency, Radio Setup, Radio Standard, LTE
Example	:SOUR:FREQ:CHAN:BAND BAND17
Initial S/W Revision	A.09.50

BAND 18

Selects BAND 18 as the band for the current step.

Key Path	Source, Frequency, Radio Setup, Radio Standard, LTE
Example	:SOUR:FREQ:CHAN:BAND BAND18
Initial S/W Revision	A.09.50

BAND 19

Selects BAND 19 as the band for the current step.

Key Path	Source, Frequency, Radio Setup, Radio Standard, LTE
Example	:SOUR:FREQ:CHAN:BAND BAND19
Initial S/W Revision	A.09.50

BAND 20

Selects BAND 20 as the band for the current step.

Key Path	Source, Frequency, Radio Setup, Radio Standard, LTE
Example	:SOUR:FREQ:CHAN:BAND BAND20
Initial S/W Revision	A.09.50

BAND 21

Selects BAND 21 as the band for the current step.

Key Path	Source, Frequency, Radio Setup, Radio Standard, LTE
Example	:SOUR:FREQ:CHAN:BAND BAND21
Initial S/W Revision	A.09.50

BAND 24

Selects BAND 24 as the band for the current step.

Key Path	Source, Frequency, Radio Setup, Radio Standard, LTE
Example	:SOUR:FREQ:CHAN:BAND BAND24
Initial S/W Revision	A.09.50

BAND 25

Selects BAND 25 as the band for the current step.

Key Path	Source, Frequency, Radio Setup, Radio Standard, LTE
Example	:SOUR:FREQ:CHAN:BAND BAND25
Initial S/W Revision	A.09.50

BAND 26

Selects BAND 26 as the band for the current step.

Key Path	Source, Frequency, Radio Setup, Radio Standard, LTE
Example	:SOUR:FREQ:CHAN:BAND BAND26
Initial S/W Revision	A.12.53

BAND 27

Selects BAND 27 as the band for the current step.

Key Path	Source, Frequency, Radio Setup, Radio Standard, LTE
Example	:SOUR:FREQ:CHAN:BAND BAND27
Initial S/W Revision	A.14.00

BAND 28

Selects BAND 28 as the band for the current step.

Key Path	Source, Frequency, Radio Setup, Radio Standard, LTE
Example	:SOUR:FREQ:CHAN:BAND BAND28
Initial S/W Revision	A.14.00

BAND 31

Selects BAND 31 as the band for the current step.

Key Path	Source, Frequency, Radio Setup, Radio Standard, LTE
Example	:SOUR:FREQ:CHAN:BAND BAND31
Initial S/W Revision	A.14.00

LTE TDD

Sets LTE TDD as the radio standard for use and accesses the LTE TDD specific channel band sub-menus..

Key Path	Source, Frequency, Radio Setup, Radio Standard
Initial S/W Revision	A.11.50

BAND 33

Selects BAND 33 as the band for the current step.

Key Path	Source, Frequency, Radio Setup, Radio Standard, LTE TDD
Example	:SOUR:FREQ:CHAN:BAND BAND33
Initial S/W Revision	A.11.50

BAND 34

Selects BAND 34 as the band for the current step.

Key Path	Source, Frequency, Radio Setup, Radio Standard, LTE TDD
Example	:SOUR:FREQ:CHAN:BAND BAND34
Initial S/W Revision	A.11.50

BAND 35

Selects BAND 35 as the band for the current step.

Key Path	Source, Frequency, Radio Setup, Radio Standard, LTE TDD
Example	:SOUR:FREQ:CHAN:BAND BAND35
Initial S/W Revision	A.11.50

BAND 36

Selects BAND 36 as the band for the current step.

Key Path	Source, Frequency, Radio Setup, Radio Standard, LTE TDD
Example	:SOUR:FREQ:CHAN:BAND BAND36
Initial S/W Revision	A.11.50

BAND 37

Selects BAND 37 as the band for the current step.

Key Path	Source, Frequency, Radio Setup, Radio Standard, LTE TDD
Example	:SOUR:FREQ:CHAN:BAND BAND37
Initial S/W Revision	A.11.50

BAND 38

Selects BAND 38 as the band for the current step.

Key Path	Source, Frequency, Radio Setup, Radio Standard, LTE TDD
Example	:SOUR:FREQ:CHAN:BAND BAND38
Initial S/W Revision	A.11.50

BAND 39

Selects BAND 39 as the band for the current step.

Key Path	Source, Frequency, Radio Setup, Radio Standard, LTE TDD
Example	:SOUR:FREQ:CHAN:BAND BAND39
Initial S/W Revision	A.11.50

BAND 40

Selects BAND 40 as the band for the current step.

Key Path	Source, Frequency, Radio Setup, Radio Standard, LTE TDD
Example	:SOUR:FREQ:CHAN:BAND BAND40
Initial S/W Revision	A.11.50

BAND 41

Selects BAND 41 as the band for the current step.

Key Path	Source, Frequency, Radio Setup, Radio Standard, LTE TDD
Example	:SOUR:FREQ:CHAN:BAND BAND41
Initial S/W Revision	A.11.50

BAND 42

Selects BAND 42 as the band for the current step.

Key Path	Source, Frequency, Radio Setup, Radio Standard, LTE TDD
Example	:SOUR:FREQ:CHAN:BAND BAND42
Initial S/W Revision	A.11.50

BAND 43

Selects BAND 43 as the band for the current step.

Key Path	Source, Frequency, Radio Setup, Radio Standard, LTE TDD
Example	:SOUR:FREQ:CHAN:BAND BAND43
Initial S/W Revision	A.11.50

BAND 44

Selects BAND 44 as the band for the current step.

Key Path	Source, Frequency, Radio Setup, Radio Standard, LTE TDD
Example	:SOUR:FREQ:CHAN:BAND BAND44
Initial S/W Revision	A.14.00

TDSCDMA

Sets TDSCDMA as the radio standard for use and accesses the TDSCDMA specific channel band sub-menus..

Key Path	Source, Frequency, Radio Setup, Radio Standard
Initial S/W Revision	A.11.50

BAND A

Selects BAND A as the band for the current step.

Key Path	Source, Frequency, Radio Setup, Radio Standard, TDSCDMA
Example	:SOUR:FREQ:CHAN:BAND BANDA
Initial S/W Revision	A.11.50

BAND B

Selects BAND B as the band for the current step.

Key Path	Source, Frequency, Radio Setup, Radio Standard, TDSCDMA
Example	:SOUR:FREQ:CHAN:BAND BANDB
Initial S/W Revision	A.11.50

BAND C

Selects BAND C as the band for the current step.

Key Path	Source, Frequency, Radio Setup, Radio Standard, TDSCDMA
Example	:SOUR:FREQ:CHAN:BAND BANDC
Initial S/W Revision	A.11.50

BAND D

Selects BAND D as the band for the current step.

Key Path	Source, Frequency, Radio Setup, Radio Standard, TDSCDMA
Example	:SOUR:FREQ:CHAN:BAND BANDD
Initial S/W Revision	A.11.50

BAND E

Selects BAND E as the band for the current step.

Key Path	Source, Frequency, Radio Setup, Radio Standard, TDSCDMA
----------	---

Example	:SOUR:FREQ:CHAN:BAND BANDE
Initial S/W Revision	A.11.50

BAND F

Selects BAND F as the band for the current step.

Key Path	Source, Frequency, Radio Setup, Radio Standard, TDSCDMA
Example	:SOUR:FREQ:CHAN:BAND BANDF
Initial S/W Revision	A.11.50

Radio Band Link

Allows you to specify the channel band type as either uplink or downlink link direction. This value is used in conjunction with the channel band and channel number to determine the absolute frequency output by the source. When set to “Uplink”, the source will calculate the uplink frequency using an uplink formula together with the selected channel band and channel number . When set to “Downlink”, the source will calculate the downlink frequency using a downlink formula together with the selected channel band and channel number.

Key Path	Source, Frequency, Radio Setup
Remote Command	:SOURce:RADio:BAND:LINK DOWN UP :SOURce:RADio:BAND:LINK?
Example	:SOUR:RAD:BAND:LINK UP
Preset	DOWN
Range	DOWN UP
Backwards Compatibility SCPI	:SOURce:RADio:DEVice BTS MS :SOURce:RADio:DEVice?
Backwards Compatibility Notes	BTS maps to the Downlink frequency MS maps to the Uplink frequency
Initial S/W Revision	A.05.00

Set Reference Frequency

This key allows you to set the frequency reference. Pressing this key turns the frequency reference state to ON, sets the reference frequency value to the current frequency, maintains this frequency at the RF output, and sets the displayed frequency to 0.00 Hz. All subsequent frequencies entered under Source>Frequency>Frequency are interpreted as being relative to this reference frequency.

When you use a frequency reference, the signal generator outputs a frequency that is set relative to the reference frequency by the value entered under Source>Frequency>Frequency as follows:

Output frequency = reference frequency - entered frequency

Where:

reference frequency equals the original RF frequency entered under Source>Frequency>Frequency and set as the reference frequency

entered frequency equals a new value entered under Source>Frequency>Frequency

In addition, the displayed frequency value will be the same as the value entered under Source>Frequency>Frequency.

NOTE

If Freq Reference is set to ON with a reference value set, entering a value under Source>Frequency>Frequency and pressing Set Frequency Reference will add that value to the existing Freq Reference value.

If you wish to change the reference frequency value to the new value entered under Source>Frequency>Frequency, first you must set Freq Reference to OFF and then press Set Frequency Reference.

Key Path	Source, Frequency
Remote Command	:SOURce:FREQuency:REFerence:SET
Example	:SOUR:FREQ:REF:SET
Dependencies	This setting is unavailable, and is grayed out when the List Sequencer is turned ON.
Initial S/W Revision	A.05.00

Freq Reference

This key allows you to toggle the state of the frequency reference. When the frequency reference state is ON, an annunciator is displayed on the main source view to indicate this state to the user.

When you use a frequency reference, the signal generator outputs a frequency that is set relative to the reference frequency by the value entered under Source>Frequency>Frequency as follows:

$$\text{Output frequency} = \text{reference frequency} + \text{entered frequency}$$

Where:

reference frequency equals the original RF frequency entered under Source>Frequency>Frequency and set as the reference frequency

entered frequency equals a new value entered under Source>Frequency>Frequency

For more information on Reference Frequency refer to ["Set Reference Frequency" on page 2473](#)

Key Path	Source, Frequency
Remote Command	:SOURce:FREQuency:REFerence <freq> :SOURce:FREQuency:REFerence? :SOURce:FREQuency:REFerence:STATe OFF ON 0 1 :SOURce:FREQuency:REFerence:STATe?
Example	:SOUR:FREQ:REF 0.00 Hz

	:SOUR:FREQ:REF:STATe ON
Dependencies	This setting is unavailable, and is grayed out when the List Sequencer is turned ON.
Couplings	The frequency reference state is coupled to the frequency reference set immediate action. When the reference set immediate action key is pressed, or the SCPI command issued, it turns the frequency reference state ON.
Preset	0.00 Hz OFF
Min	0.00 Hz
Max	Hardware Dependant: Option 503 = 3.6 GHz Option 504 = 3.8 GHz Option 506 = 6.00 GHz
Initial S/W Revision	A.05.00

Freq Offset

Allows you to specify the frequency offset value. When the frequency offset state is ON, an annunciator is displayed on the main source view to indicate this state to the user.

When the frequency offset is set to zero (0) and you set a new offset value, the displayed frequency value will change as follows and the RF output frequency will not change:

Displayed value = output frequency + offset value

Where:

output frequency equals the original frequency entered under Source>Frequency>Frequency

offset value equals the value entered under Source>Frequency>Freq Offset

When the frequency offset is set to a value other than zero (0) and you enter a new frequency value under Source>Frequency>Frequency, the displayed frequency will be the same as the value entered and the RF output frequency will be equal to the value entered minus the offset value as follows:

Output frequency = entered frequency – offset frequency

Displayed frequency = output frequency + offset frequency

Displayed frequency = entered frequency

Where:

entered frequency equals the frequency entered under Source>Frequency>Frequency

offset frequency equals the value previously entered and set under Source>Frequency>Freq Offset

Key Path	Source, Frequency
Remote Command	:SOURce:FREQuency:OFFSet <freq>

	:SOURce:FREQuency:OFFSet?
Example	:SOUR:FREQ:OFFS 0 Hz
Dependencies	This setting is unavailable, and is grayed out when the List Sequencer is turned ON.
Preset	0 Hz
Min	-100.00 GHz
Max	100.00 GHz
Initial S/W Revision	A.05.00

Modulation Setup

Allows access to the menus for setting up the available modulation types: "ARB" on page 2476, "AM" on page 2517, "FM" on page 2518, and "PM" on page 2519.

Key Path	Source
Initial S/W Revision	A.05.00

ARB

Allows you access to the ARB sub-menus.

Key Path	Source, Modulation Setup
Initial S/W Revision	A.05.00

ARB

Allows you to toggle the state of the ARB function. When the ARB is On, a "MOD" annunciator is displayed in the system settings panel. When the ARB is turned Off, the MOD annunciator is cleared

Key Path	Source, Modulation Setup, ARB
Remote Command	:SOURce:RADio:ARB[:STATe] ON OFF 1 0 :SOURce:RADio:ARB[:STATe]?
Example	:SOUR:RAD:ARB OFF :SOUR:RAD:ARB?
Notes	If the ARB is ON, a user then loads or deletes another file to ARB memory, the playing waveform segment may not keep phase continuity during the ARB memory operation. The waveform will be replayed after the ARB operation is finished.
Dependencies	This setting is for independent mode and has no effect on 3.3.8 list sequencer mode. Setting "Sequencer" on page 2521 Sequencer to On will put source enter list sequencer mode, and even if ARB state is On, the ARB file will not be played. Setting "Sequencer" on page 2521 Sequencer to Off will make source leave list sequencer mode, and this setting will take effect immediately.

The ARB can only be turned on when there is a waveform file selected for playback. On the GUI If no waveform is selected, this key is grayed out. If you send the SCPI command to turn the ARB on with no waveform selected for playback, the ARB state remains OFF and an error is generated. “-
When you try to recall a certain set of states in which the selected waveform is not in ARB memory and the ARB state is On, errors are reported

Preset	Off
Range	On Off
Initial S/W Revision	A.05.00

Select Waveform

Allows you to access to the waveform selection sub-menus.

Pressing this key changes the central view area to show the Waveform File Selection view.

Key Path	Source, Modulation Setup, ARB
Initial S/W Revision	A.05.00

Select Waveform

Allows you to select a waveform sequence or segment for the dual ARB to play.

NOTE: Selecting a waveform file does not result in automatic adjustments to burst timing (to compensate for the presence or absence of a Multiport Adapter); that adjustment occurs only when a waveform is loaded to ARB memory. See "Load Segment to ARB Memory" for more information about this adjustment.

Key Path	Source, Modulation Setup, ARB, Select Waveform
Remote Command	:SOURce:RADio:ARB:WAVeform <string> :SOURce:RADio:ARB:WAVeform?
Example	:SOUR:RAD:ARB:WAV "test_waveform.bin"
Notes	<p>If intended waveform is not in the memory yet, then issuing this command by SCPI will invoke ARB loading operation first, which involves a delay of unpredictable length. So this command should be followed by the query *OPC?, which holds off subsequent commands until the loading operating is complete.</p> <p><string> - specifies the name of the waveform segment or waveform sequence to be played by the ARB.</p> <p>When in Sequence Analyzer mode, and Include Source is Yes, if the you attempt to play a waveform sequence but not all the required waveform segments are in the ARB playback memory, the application will reject the loading operation with an error is generated .</p> <p>When Include Source is No, if you attempt to play a waveform sequence but not all the required waveform segments are contained in the ARB playback memory, the application will attempt to load the required segments from either the default directory of the current directory. If the ARB memory does not have enough space for all the waveform segments to be loaded, an error is generated and</p>

none of the waveform segments is loaded.

If the ARB is ON, and you attempt to play a waveform sequence but not all the waveform segments within the sequence could be found to be loaded into ARB memory, an error is generated. The selected waveform keeps the previous value and ARB state remains On.

If you specify a waveform segment over SCPI but the waveform segment is not present within ARB playback memory and cannot be found for auto loading within the current directory or the default directory, an error is generated and the file selection remains unchanged.

If you select a waveform for playback and the waveform requires a license that is not installed on the instrument, an error is generated.

If the ARB is ON and you load a file to ARB memory or delete a file from ARB memory, the playing waveform segment may not keep phase continuity during the ARB memory operation. The waveform will be replayed after the ARB operation is finished.

Initial S/W Revision	A.05.00
----------------------	---------

Segments on Hard Disk

Allows you access to the sub-menus for loading waveform segments from the hard disk into ARB memory. The default directory is: D: varb.

Pressing this key changes the current view to the Waveform Management View.

Key Path	Source, Modulation Setup, ARB, Select Waveform
----------	--

Initial S/W Revision	A.05.00
----------------------	---------

Load Segment To ARB Memory

Allows you to load the selected file into ARB memory. On the front panel you select the file for loading to the ARB memory by highlighting the desired file in the list. Using the SCPI command, you specify the file name on the HDD.

“NVWFM” (non-volatile storage) MSUS (Mass Storage Unit Specifier) is supported in the memory subsystem because the ARB memory cannot be accessed directly. Therefore, files must be downloaded to the instrument hard disk and then loaded into the ARB memory. “NVWFM” MSUS will be mapped to the default directory D: VARB. The SCPI command supports using either “NVWFM” MSUS or specifying a full path. For more information, see [Memory Subsystem \(Remote Command Only\)](#).

If a file of the same name already exists within ARB memory, it is overwritten. If you wish to load two segments of the same name, you must rename one of the segments before loading it into ARB memory. To rename a segment, you can either use Windows File Explorer, or the :MMEMory:COPY command.

NOTE: When a waveform file is loaded to ARB memory, burst timing adjustments are made automatically, based on whether or not a Multiport Adapter is connected to the test set and powered on. If the connection/power status of the Multiport Adapter is changed after a waveform file has been loaded, it needs to be loaded again.

Key Path	Source, Modulation Setup, ARB, Select Waveform, Segments on Hard Disk
----------	---

Remote Command	:SOURce:RADio:ARB:LOAD <string>
Example	:SOUR:RAD:ARB:LOAD "D: VARB\testwaveform.bin" or :SOUR:RAD:ARB:LOAD "NVWFM:testwaveform.bin"
Notes	<p>Because loading the file involves a delay of unpredictable length, this command should be followed by the query *OPC?, which holds off subsequent commands until the loading operating is complete.</p> <p><string> - specifies the path name of the file to load from the HDD into ARB memory. It could be a <full path + filename>, or <"NVWFM" MSUS + colon + filename>.</p> <p>When in Sequence Analyzer mode, and Include Source is Yes, an attempt to load a file to ARB memory will be rejected with an error.</p> <p>When Include Source is No and if there is insufficient free ARB memory to load the selected waveform, an error is generated. .</p> <p>If you specify a file over SCPI, but the file is not at the specified location, an error is generated.</p> <p>If you try to load a waveform file but the file contains less than 500 IQ samples, an error is generated.</p> <p>If you try to load a Signal Studio waveform (*.wfm) which contains invalid waveform header, an error is generated.</p> <p>If the ARB is ON when you load a file to ARB memory or delete a file from ARB memory, the playing waveform segment may not keep phase continuity during the ARB memory operation. The waveform will be replayed after the ARB operation is finished.</p> <p>ARB can be loaded into ARB memory even required licenses do not present on the instrument. In this case, a GUI only warning message -800, "Operation complete; Loaded <filename> successfully, but no license <required licenses> installed". User can install required licenses according to <required licenses> string to license it, or multi-pack license it.</p>
Initial S/W Revision	A.05.00

Load All To ARB Memory

Allows you to load all the segment files within the currently selected directory into ARB memory. If a file of the same name already exists within ARB memory, it is overwritten. If you wish to load two segments of the same name, you must rename one of the segments before loading it into ARB memory. To rename a segment, you can either use Windows File Explorer, or the :MEMory:COPI command.

NOTE: When a waveform file is loaded to ARB memory, burst timing adjustments are made automatically, based on whether or not a Multiport Adapter is connected to the test set and powered on. If the connection/power status of the Multiport Adapter is changed after a waveform file has been loaded, it needs to be loaded again.

Key Path	Source, Modulation Setup, ARB, Select Waveform, Segments on Hard Disk
Remote Command	:SOURce:RADio:ARB:LOAD:ALL <string>
Example	:SOUR:RAD:ARB:LOAD:ALL "D: varb"
Notes	<p><string> - specifies the directory on the HDD to load the files into ARB memory from.</p> <p>When in Sequence Analyzer mode, and Include Source is Yes, an attempt to load all files from a directory to ARB memory is rejected with an error.</p> <p>When Include Source is No and there is insufficient free ARB memory to load all the waveforms,</p>

when the ARB memory is full, the copy ceases, and an error is generated.
 If you specify a directory over SCPI, but the directory does not exist, an error is generated.
 If the ARB is ON, a user then loads or deletes file to ARB memory, the playing waveform segment may not keep phase continuity during the ARB memory operation. The waveform will be replayed after the ARB operation is finished.

Initial S/W Revision A.05.00

Change Directory...

Allows you to change the currently selected directory on the hard disk. Pressing this key opens a standard windows change directory dialog allowing you to select the new directory of interest.

The current directory is used for manually loading waveform segments into ARB memory for playback, and as a search location for waveform segments that are required to be loaded into ARB memory for playback of a waveform sequence or a list sequence.

Key Path Source, Modulation Setup, ARB, Select Waveform, Segments on Hard Disk

Notes No remote command, SCPI front panel only.

Initial S/W Revision A.05.00

Default Directory...

Allows you to change the default directory. It is used as a search location for waveform segments that are required to be loaded into ARB memory for playback of a waveform sequence, and as a search location for selecting waveforms using SCPI.

Key Path Source, Modulation Setup, ARB, Select Waveform, Segments on Hard Disk

Remote Command :SOURce:RADio:ARB:DEFault:DIRectory <string>
 :SOURce:RADio:ARB: DEFault:DIRectory?

Example :SOUR:RAD:ARB:DEF:DIR "D:\ArbFiles"
 :SOUR:RAD:ARB:DEF:DIR?

State Saved Persistent, survives a power cycle and a preset but not saved in the instrument state

Initial S/W Revision A.05.00

Segments in ARB Memory

Allows you access to the sub-menus for managing the files within ARB memory.

Key Path Source, Modulation Setup, ARB, Select Waveform

Initial S/W Revision A.05.00

Delete Segment From ARB Mem

Allows you to remove a segment from ARB playback memory.

Key Path	Source, Modulation Setup, ARB, Select Waveform, Segments in ARB Memory
Remote Command	:SOURce:RADio:ARB:DELeTe <string>
Example	:SOUR:RAD:ARB:DEL "testwaveform.bin"
Notes	<p><string> - specifies the waveform to be deleted from the ARB playback memory.</p> <p>When in Sequence Analyzer mode and Include Source is Yes, an attempt to delete a file from ARB memory is rejected with an error.</p> <p>When Include Source is No and you specify a file that does not exist within ARB memory, an error is generated.</p> <p>It is possible to delete files from within the ARB memory when the ARB is ON. However, if you attempt to delete the file that is currently playing an error is generated.</p> <p>It is possible to delete a file from within the ARB memory when the sequencer state is ON and the file is not being used by the List Sequencer. If you attempt to delete a file which is being used by the list sequencer, an error is generated.</p> <p>When sequencer state is On, even if ARB state is On, the selected waveform will not be played. In this case, if the selected waveform is not used in List Sequence, it can be deleted and the ARB state is turned Off.</p> <p>If the ARB is ON and you load a file to ARB memory or delete a file from ARB memory, the playing waveform segment may not keep phase continuity during the ARB memory operation. The waveform will be replayed after the ARB operation is finished.</p>
Initial S/W Revision	A.05.00

Delete All From ARB Memory

Allows you to remove all segments from ARB playback memory.

Key Path	Source, Modulation Setup, ARB, Select Waveform, Segments in ARB Memory
Remote Command	:SOURce:RADio:ARB:DELeTe:ALL
Example	:SOUR:RAD:ARB:DELeTe:ALL
Notes	<p>When in Sequence Analyzer mode and Include Source is Yes, an attempt to delete all files from ARB memory is rejected with an error.</p> <p>When Include Source is No and you attempt to delete all files from ARB memory when the ARB is currently playing a file, all files except the one playing are deleted and an error is generated.</p> <p>If you attempt to delete all files from ARB memory when there are waveform files used in "List Sequencer" on page 2520 and "Sequencer" on page 2521 state is ON, all files except the files currently being used in list sequencer are deleted, and an error is generated.</p> <p>If the ARB is ON and you load a file to ARB memory or delete a file from ARB memory, the playing waveform segment may not keep phase continuity during the ARB memory operation. The waveform will be replayed after the ARB operation is finished.</p>
Initial S/W Revision	A.05.00

Query ARB Memory File List (Remote Command Only)

Queries the test set for the list of waveform segments in the ARB memory.

NOTE

This command returns a string for waveform segment names in ARB memory. If you want a string list of waveform segments in the ARB memory, use **"Query ARB Memory Full File List (Remote Command Only)"** on page 2482.

Remote Command	:SOURce:RADio:ARB:CATalog?
Example	:SOUR:RAD:ARB:CATalog?
Notes	The return data is in the following format: <integer> - memory used <integer> - memory free <string> ... - comma separated list of waveform segments within ARB memory
Initial S/W Revision	A.05.00

Query ARB Memory Full File List (Remote Command Only)

Queries the test set for the string list of waveform segments in the ARB memory. It returns a string list for waveform segment names in the ARB memory.

Remote Command	:SOURce:RADio:ARB:FCATalog?
Example	:SOUR:RAD:ARB:FCATalog?
Notes	The return data is in the following format: <integer> - memory used <integer> - memory free <integer> - file count in ARB memory <string>,<string>, ... <string> - comma separated string list of waveform segments within ARB memory Example: SOUR:RAD:ARB:FCAT? EXT returns: 27499,2069653,3,"c2k.wfm","gsm.wfm","wcdma.wfm"
Initial S/W Revision	A.09.00

ARB Setup

Allows access to the ARB setup sub-menus.

Key Path	Source, Modulation Setup, ARB
Initial S/W Revision	A.05.00

Sample Rate

Allows you to set the ARB waveform playback sample rate.

Key Path	Source, Modulation Setup, ARB, ARB Setup
Remote Command	:SOURce:RADio:ARB:SCLock:RATE <freq> :SOURce:RADio:ARB:SCLock:RATE?
Example	:SOUR:RAD:ARB:SCL:RATE 48.00 MHz
Notes	If there is a sample rate specified in the header of the waveform file, changing that sample rate is not recommended, as it may cause problems with burst timing.
Dependencies	When a new waveform is selected for playback the settings contained within the associated waveform header file are applied to the ARB. The sample rate is one of the values stored within the header file. If the newly selected waveform file has an associated header file, the sample rate is updated with the value from the header file. The sample rate will remain unchanged if the newly selected waveform does not have an associated header file.
Preset	125.00 MHz
Min	1.00 kHz
Max	125.00 MHz
Initial S/W Revision	A.05.00

Run-Time Scaling

Allows you to adjust the run-time scaling value. The run-time scaling value is applied in real-time while the waveform is playing.

Key Path	Source, Modulation Setup, ARB, ARB Setup
Remote Command	:SOURce:RADio:ARB:RSCaling <real> :SOURce:RADio:ARB:RSCaling?
Example	:SOUR:RAD:ARB:RSC 100.00
Notes	This setting cannot be set in E6640A. Grey out on menu and the value is fixed at 70.00%.
Dependencies	When a new waveform is selected for playback the settings contained within the associated waveform header file are applied to the ARB. The run-time scaling is one of the values stored within the header file. If the newly selected waveform file has an associated header file, the run-time scaling is updated with the value from the header file. The run-time scaling will remain unchanged if the newly selected waveform does not have an associated header file.
Preset	70.00 %
Min	1.00 %
Max	100.00 %
Initial S/W Revision	A.05.00

Baseband Freq Offset

Allows you to adjust the value by which the baseband frequency is offset relative to the carrier.

Key Path	Source, Modulation Setup, ARB, ARB Setup
Remote Command	:SOURce:RADio:ARB:BASEband:FREQuency:OFFSet <freq> :SOURce:RADio:ARB:BASEband:FREQuency:OFFSet?
Example	:SOUR:RAD:ARB:BAS:FREQ:OFFS 0.00 Hz
Dependencies	When a new waveform is selected for playback the settings contained within the associated waveform header file are applied to the ARB. The baseband frequency offset is one of the values stored within the header file. If the newly selected waveform file has an associated header file, the baseband frequency offset is updated with the value from the header file. The baseband frequency offset will remain unchanged if the newly selected waveform does not have an associated header file.
Preset	0.00 Hz
Min	-50.00 MHz
Max	50.00 MHz
Initial S/W Revision	A.05.00

Trigger Type

Allows access to the trigger type sub-menus. The setting for trigger type determines the behavior of the waveform when it plays.

Key Path	Source, Modulation Setup, ARB
Remote Command	:SOURce:RADio:ARB:TRIGger:TYPE CONTInuous SINGLE SADVance GATE :SOURce:RADio:ARB:TRIGger:TYPE?
Example	:SOUR:RAD:ARB:TRIG:TYPE CONT :SOUR:RAD:ARB:TRIG:TYPE?
Notes	Gated trigger type will be implemented at a later release
Preset	CONTInuous
Range	Continuous Single Seg Adv Gated
Initial S/W Revision	A.05.00

Continuous

Sets the active trigger type to Continuous. If Continuous is already selected as the active trigger type, pressing this key allows access to the continuous trigger type setup menu. In Continuous trigger mode, the waveform repeats continuously.

Key Path	Source, Modulation Setup, ARB, Trigger Type
Remote Command	:SOURce:RADio:ARB:TRIGger:TYPE:CONTInuous[:TYPE] FREE TRIGger RESet :SOURce:RADio:ARB:TRIGger:TYPE:CONTInuous[:TYPE]?
Example	:SOUR:RAD:ARB:TRIG:TYPE:CONT FREE
Preset	FREE

Range	Free Run Trigger + Run Reset + Run
Initial S/W Revision	A.05.00

Free Run

Selects Free Run as the trigger response for the continuous trigger type. Free Run sets the waveform generator to play a waveform sequence or segment continuously, without waiting for a trigger. In this mode, the waveform generator does not respond to triggers.

Key Path	Source, Modulation Setup, ARB, Trigger Type, Continuous
Example	:SOUR:RAD:ARB:TRIG:TYPE:CONT FREE
Initial S/W Revision	A.05.00

Trigger + Run

Sets Trigger and Run as the trigger response for the continuous trigger type. Trigger and Run sets the waveform generator to play a waveform sequence or segment continuously when the first trigger is received, and to ignore any subsequent triggers.

Key Path	Source, Modulation Setup, ARB, Trigger Type, Continuous
Example	:SOUR:RAD:ARB:TRIG:TYPE:CONT TRIG
Initial S/W Revision	A.05.00

Reset + Run

Sets Reset and Run as the trigger response for the continuous trigger type. Reset and Run sets the waveform generator to play a waveform sequence or segment continuously when the first trigger is received. Subsequent triggers reset the waveform sequence or segment to the start, and then play it continuously.

Key Path	Source, Modulation Setup, ARB, Trigger Type, Continuous
Example	:SOUR:RAD:ARB:TRIG:TYPE:CONT RES
Initial S/W Revision	A.05.00

Single

Sets the active trigger type to Single. If Single is already selected as the active trigger type, pressing this key allows access to the single trigger type setup menu. In Single trigger mode, the waveform plays once.

Key Path	Source, Modulation Setup, ARB, Trigger Type
Remote Command	:SOURce:RADio:ARB:RETRigger ON OFF IMMediate

	:SOURce:RADio:ARB:RETRigger?
Example	:SOUR:RAD:ARB:RETR OFF
Notes	ON: Buffered Trigger OFF: No Retrigger Immediate: Restart on Trigger This is defined as an enumerated SCPI command, with ON OFF being considered as enumerated types rather than Boolean. This means the query will return OFF instead of 0, and ON instead of 1.
Preset	ON
Range	No Retrigger Buffered Trigger Restart on Trigger
Initial S/W Revision	A.05.00

No Retrigger

Selects No Retrigger as the trigger response for single trigger type. No Retrigger sets the waveform generator to play a waveform sequence or segment once when a trigger is received. Any triggers then received during playback are ignored.

Key Path	Source, Modulation Setup, ARB, Trigger Type, Single
Example	:SOUR:RAD:ARB:RETR OFF
Initial S/W Revision	A.05.00

Buffered Trigger

Selects Buffered Trigger as the trigger response for single trigger type. Buffered Trigger sets the waveform generator to play a waveform sequence or segment once when a trigger is received. If a trigger is received during playback, the waveform generator plays the sequence or segment to the end, then plays the sequence or segment once more.

Key Path	Source, Modulation Setup, ARB, Trigger Type, Single
Example	:SOUR:RAD:ARB:RETR ON
Initial S/W Revision	A.05.00

Restart on Trigger

Selects Restart on Trigger as the trigger response for single trigger type. Restart on Trigger sets the waveform generator to play a waveform sequence or segment once when a trigger is received. If a trigger is received during playback, the waveform generator resets and plays the sequence or segment from the start.

Key Path	Source, Modulation Setup, ARB, Trigger Type, Single
Example	:SOUR:RAD:ARB:RETR IMM
Initial S/W Revision	A.05.00

Segment Advance

Sets the active trigger type to Segment Advance. If Segment Advance is already selected as the active trigger type, pressing this key allows access to the segment advance trigger type setup menu.

Segment Advance triggering allows you to control the playback of waveform segments within a waveform sequence. When a trigger is received the ARB advances to the next waveform segment within the waveform sequence. This type of triggering ignores the repetition count for the waveform segment within the waveform sequence. For example, if a waveform segment has a repetition count of 10 and you select single segment advance triggering mode, the waveform segment will only play once.

Segment Advance triggering can also be used for waveform segments only. In this situation the same waveform segment is played again when a trigger is received.

Key Path	Source, Modulation Setup, ARB, Trigger Type
Remote Command	:SOURce:RADio:ARB:TRIGger:TYPE:SADVance[:TYPE] Single CONTInuous :SOURce:RADio:ARB:TRIGger:TYPE:SADVance[:TYPE]?
Example	:SOUR:RAD:ARB:TRIG:TYPE:SADV SING
Preset	CONTInuous
Range	Single Continuous
Initial S/W Revision	A.05.00

Single

Selects Single as the trigger response for Segment Advance trigger type. With single selected, once a trigger is received a segment is played once. If a trigger is received during playback of a segment, the segment plays to completion and the next segment is played once.

Key Path	Source, Modulation Setup, ARB, Trigger Type, Segment Advance
Example	:SOUR:RAD:ARB:TRIG:TYPE:SADV SING
Initial S/W Revision	A.05.00

Continuous

Selects Continuous as the trigger response for Segment Advance trigger type. With continuous selected, once a trigger is received a segment is played continuously. When subsequent triggers are received, the currently playing segment plays to completion and then the next segment is played continuously.

Key Path	Source, Modulation Setup, ARB, Trigger Type, Segment Advance
Example	:SOUR:RAD:ARB:TRIG:TYPE:SADV CONT
Initial S/W Revision	A.05.00

Trigger Source

Allows access to the trigger source sub-menus. The trigger source setting determines how the source receives the trigger that starts the waveform playing. Therefore, this key is grayed out if the trigger type is free run, since free run triggers immediately with no trigger source required.

Key Path	Source, Modulation Setup, ARB
Remote Command	:SOURce:RADio:ARB:TRIGger[:SOURce] KEY BUS EXTernal2 :SOURce:RADio:ARB:TRIGger[:SOURce]?
Example	:SOUR:RAD:ARB:TRIGger KEY
Dependencies	This key is grayed out if the current trigger type is Continuous, Free Run.
Preset	EXTernal2
Range	Trigger Key Bus External 2
Initial S/W Revision	A.05.00

Trigger Key

Sets the current trigger source to the front panel Trigger key. When Trigger Key is selected, the waveform is triggered when you press the front panel Trigger key.

Key Path	Source, Modulation Setup, ARB, Trigger Source
Example	:SOUR:RAD:ARB:TRIGger KEY
Initial S/W Revision	A.05.00

Bus

Sets the current trigger source to Bus. Selecting Bus trigger source enables triggering over GPIB, LAN, or USB using the :SOURce:RADio:ARB:TRIGger:INITiate command.

Key Path	Source, Modulation Setup, ARB, Trigger Source
Example	:SOUR:RAD:ARB:TRIGger BUS
Initial S/W Revision	A.05.00

External 2

Sets the current trigger source to External 2. Selecting External 2 enables triggering a waveform by an externally applied signal.

Key Path	Source, Modulation Setup, ARB, Trigger Source
Example	:SOUR:RAD:ARB:TRIGger EXT2
Notes	Note: When on E6640A, trigger 2 is a bi-directional trigger port. So when trigger 2 has been configured as OUTPUT type, choosing External 2 as the input trigger for the current step will generate error.
Initial S/W Revision	A.05.00

Trigger Initiate

Used to initiate an immediate trigger event if the trigger source is set to Trigger Key.

Key Path	Source, Modulation Setup, ARB
Notes	No remote command, SCPI front panel only.
Initial S/W Revision	A.05.00

Waveform Sequences

Allows access to the waveform sequence sub-menus. Pressing this key changes the central view area to display the Waveform Sequence List view.

Key Path	Source, Modulation Setup, ARB
Notes	No remote command, SCPI front panel only.
Initial S/W Revision	A.05.00

Build New Sequence

Allows access to the sub-menus for creating a new waveform sequence. Pressing this key changes the central view area to display the Waveform Sequence Creation and Editing view.

Key Path	Source, Modulation Setup, ARB, Waveform Sequences
Notes	No remote command, SCPI front panel only.
Initial S/W Revision	A.05.00

Current Segment

Specifies the selected sequence segment that will be affected by the menu functions.

Key Path	Source, Modulation Setup, ARB, Waveform Sequences, Build New Sequence
Notes	No remote command, SCPI front panel only. This key is grayed out and unavailable if the sequence is currently empty.
Initial S/W Revision	A.05.00

Insert New Waveform

Allows you access to the sub-menu for inserting a new waveform segment or sequence. Pressing this key also changes the central display to show the Waveform File Selection View.

Key Path	Source, Modulation Setup, ARB, Waveform Sequences, Build New Sequence
Notes	No remote command, SCPIfront panel only. Waveform segment name string length upper limit is 128 chars. Please do NOT insert waveform which name string exceeds 128 chars.
Initial S/W Revision	A.05.00

Insert Waveform

Inserts the currently highlighted waveform to the end of the waveform sequence. Pressing this key also returns you to the menus for creating or editing a sequence, and returns the central view to the sequence creation view.

Key Path	Source, Modulation Setup, ARB, Waveform Sequences, Build New Sequence, Insert New Waveform
Notes	No remote command, SCPIfront panel only. Waveform segment name string length upper limit is 128 chars. Please do NOT insert waveform which name string exceeds 128 chars.
Initial S/W Revision	A.05.00

Segments on Hard Disk

Allows you access to the sub-menus for loading waveform segments from the hard disk into ARB memory. The default directory is: D: varb.

Pressing this key changes the current view to the Waveform Management View.

Key Path	Source, Modulation Setup, ARB, Select Waveform
Initial S/W Revision	A.05.00

Load Segment To ARB Memory

Allows you to load the selected file into ARB memory. On the front panel you select the file for loading to the ARB memory by highlighting the desired file in the list. Using the SCPI command, you specify the file name on the HDD.

“NVWFM” (none-volatile storage) MSUS (Mass Storage Unit Specifier) is supported in the memory subsystem because the ARB memory cannot be accessed directly. Therefore, files must be downloaded to the instrument hard disk and then loaded into the ARB memory. “NVWFM” MSUS will be mapped to the default directory D: VARB. The SCPI command supports using either “NVWFM” MSUS or specifying a full path. For more information, see [Memory Subsystem \(Remote Command Only\)](#).

If a file of the same name already exists within ARB memory, it is overwritten. If you wish to load two segments of the same name, you must rename one of the segments before loading it into ARB memory. To rename a segment, you can either use Windows File Explorer, or the :MMEMory:COPY command.

NOTE: When a waveform file is loaded to ARB memory, burst timing adjustments are made automatically, based on whether or not a Multiport Adapter is connected to the test set and powered on. If the connection/power status of the Multiport Adapter is changed after a waveform file has been loaded, it needs to be loaded again.

Key Path	Source, Modulation Setup, ARB, Select Waveform, Segments on Hard Disk
Remote Command	:SOURce:RADio:ARB:LOAD <string>
Example	:SOUR:RAD:ARB:LOAD "D: VARB\testwaveform.bin" or :SOUR:RAD:ARB:LOAD "NVWFM:testwaveform.bin"
Notes	<p>Because loading the file involves a delay of unpredictable length, this command should be followed by the query *OPC?, which holds off subsequent commands until the loading operation is complete.</p> <p><string> – specifies the path name of the file to load from the HDD into ARB memory. It could be a <full path + filename>, or <"NVWFM" MSUS + colon + filename>.</p> <p>When in Sequence Analyzer mode, and Include Source is Yes, an attempt to load a file to ARB memory will be rejected with an error.</p> <p>When Include Source is No and if there is insufficient free ARB memory to load the selected waveform, an error is generated. .</p> <p>If you specify a file over SCPI, but the file is not at the specified location, an error is generated.</p> <p>If you try to load a waveform file but the file contains less than 500 IQ samples, an error is generated.</p> <p>If you try to load a Signal Studio waveform "*.wfm" which contains invalid waveform header, an error is generated.</p> <p>If the ARB is ON when you load a file to ARB memory or delete a file from ARB memory, the playing waveform segment may not keep phase continuity during the ARB memory operation. The waveform will be replayed after the ARB operation is finished.</p> <p>ARB can be loaded into ARB memory even if required licenses do not present on the instrument. In this case, a GUI only warning message –800, "Operation complete; Loaded <filename> successfully, but no license <required licenses> installed". User can install required licenses according to <required licenses> string to license it, or multi-pack license it.</p>
Initial S/W Revision	A.05.00

Load All To ARB Memory

Allows you to load all the segment files within the currently selected directory into ARB memory. If a file of the same name already exists within ARB memory, it is overwritten. If you wish to load two segments of the same name, you must rename one of the segments before loading it into ARB memory. To rename a segment, you can either use Windows File Explorer, or the :MEMORY:COPY command.

NOTE: When a waveform file is loaded to ARB memory, burst timing adjustments are made automatically, based on whether or not a Multiport Adapter is connected to the test set and powered on. If the connection/power status of the Multiport Adapter is changed after a waveform file has been loaded, it needs to be loaded again.

Key Path	Source, Modulation Setup, ARB, Select Waveform, Segments on Hard Disk
Remote Command	:SOURce:RADio:ARB:LOAD:ALL <string>

Example	:SOUR:RAD:ARB:LOAD:ALL "D: varb"
Notes	<p><string> - specifies the directory on the HDD to load the files into ARB memory from.</p> <p>When in Sequence Analyzer mode, and Include Source is Yes, an attempt to load all files from a directory to ARB memory is rejected with an error.</p> <p>When Include Source is No and there is insufficient free ARB memory to load all the waveforms, when the ARB memory is full, the copy ceases, and an error is generated.</p> <p>If you specify a directory over SCPI, but the directory does not exist, an error is generated.</p> <p>If the ARB is ON, a user then loads or deletes file to ARB memory, the playing waveform segment may not keep phase continuity during the ARB memory operation. The waveform will be replayed after the ARB operation is finished.</p>
Initial S/W Revision	A.05.00

Change Directory...

Allows you to change the currently selected directory on the hard disk. Pressing this key opens a standard windows change directory dialog allowing you to select the new directory of interest.

The current directory is used for manually loading waveform segments into ARB memory for playback, and as a search location for waveform segments that are required to be loaded into ARB memory for playback of a waveform sequence or a list sequence.

Key Path	Source, Modulation Setup, ARB, Select Waveform, Segments on Hard Disk
Notes	No remote command, SCPIfront panel only.
Initial S/W Revision	A.05.00

Default Directory...

Allows you to change the default directory. It is used as a search location for waveform segments that are required to be loaded into ARB memory for playback of a waveform sequence, and as a search location for selecting waveforms using SCPI.

Key Path	Source, Modulation Setup, ARB, Select Waveform, Segments on Hard Disk
Remote Command	:SOURce:RADio:ARB:DEFault:DIRectory <string> :SOURce:RADio:ARB: DEFault:DIRectory?
Example	:SOUR:RAD:ARB:DEF:DIR "D:\ArbFiles" :SOUR:RAD:ARB:DEF:DIR?
State Saved	Persistent, survives a power cycle and a preset but not saved in the instrument state
Initial S/W Revision	A.05.00

Segments in ARB Memory

Allows you access to the sub-menus for managing the files within ARB memory.

Key Path	Source, Modulation Setup, ARB, Select Waveform
Initial S/W Revision	A.05.00

Delete Segment From ARB Mem

Allows you to remove a segment from ARB playback memory.

Key Path	Source, Modulation Setup, ARB, Select Waveform, Segments in ARB Memory
Remote Command	:SOURce:RADio:ARB:DELeTe <string>
Example	:SOUR:RAD:ARB:DEL "testwaveform.bin"
Notes	<p><string> - specifies the waveform to be deleted from the ARB playback memory.</p> <p>When in Sequence Analyzer mode and Include Source is Yes, an attempt to delete a file from ARB memory is rejected with an error.</p> <p>When Include Source is No and you specify a file that does not exist within ARB memory, an error is generated.</p> <p>It is possible to delete files from within the ARB memory when the ARB is ON. However, if you attempt to delete the file that is currently playing an error is generated.</p> <p>It is possible to delete a file from within the ARB memory when the sequencer state is ON and the file is not being used by the List Sequencer. If you attempt to delete a file which is being used by the list sequencer, an error is generated.</p> <p>When sequencer state is On, even if ARB state is On, the selected waveform will not be played. In this case, if the selected waveform is not used in List Sequence, it can be deleted and the ARB state is turned Off.</p> <p>If the ARB is ON and you load a file to ARB memory or delete a file from ARB memory, the playing waveform segment may not keep phase continuity during the ARB memory operation. The waveform will be replayed after the ARB operation is finished.</p>
Initial S/W Revision	A.05.00

Delete All From ARB Memory

Allows you to remove all segments from ARB playback memory.

Key Path	Source, Modulation Setup, ARB, Select Waveform, Segments in ARB Memory
Remote Command	:SOURce:RADio:ARB:DELeTe:ALL
Example	:SOUR:RAD:ARB:DELeTe:ALL
Notes	<p>When in Sequence Analyzer mode and Include Source is Yes, an attempt to delete all files from ARB memory is rejected with an error.</p> <p>When Include Source is No and you attempt to delete all files from ARB memory when the ARB is currently playing a file, all files except the one playing are deleted and an error is generated.</p> <p>If you attempt to delete all files from ARB memory when there are waveform files used in "List Sequencer" on page 2520 and "Sequencer" on page 2521 state is ON, all files except the files currently being used in list sequencer are deleted, and an error is generated.</p>

If the ARB is ON and you load a file to ARB memory or delete a file from ARB memory, the playing waveform segment may not keep phase continuity during the ARB memory operation. The waveform will be replayed after the ARB operation is finished.

Initial S/W Revision	A.05.00
----------------------	---------

Segments on Hard Disk

This key functions the same as ["Segments on Hard Disk" on page 2547](#).

Key Path	Source, Modulation Setup, ARB, Waveform Sequences, Build New Sequence, Insert New Waveform
----------	--

Initial S/W Revision	Prior to A.09.00
----------------------	------------------

Load Segment To ARB Memory

This key functions the same as ["Load Segment To ARB Memory" on page 2547](#).

Key Path	Source, Modulation Setup, ARB, Waveform Sequences, Build New Sequence, Insert New Waveform, Segment on Hard Drive
----------	---

Initial S/W Revision	Prior to A.09.00
----------------------	------------------

Load All To ARB Memory

This key functions the same as ["Load All To ARB Memory" on page 2548](#).

Key Path	Source, Modulation Setup, ARB, Waveform Sequences, Build New Sequence, Insert New Waveform, Segment on Hard Drive
----------	---

Initial S/W Revision	Prior to A.09.00
----------------------	------------------

Change Directory ...

This key functions the same as ["Change Directory..." on page 2549](#).

Key Path	Source, Modulation Setup, ARB, Waveform Sequences, Build New Sequence, Insert New Waveform, Segment on Hard Drive
----------	---

Initial S/W Revision	Prior to A.09.00
----------------------	------------------

Default Directory ...

This key functions the same as ["Default Directory..." on page 2549](#)

Key Path	Source, Modulation Setup, ARB, Waveform Sequences, Build New Sequence, Insert New Waveform, Segment on Hard Drive
----------	---

Initial S/W Revision	Prior to A.09.00
----------------------	------------------

Segments in ARB Memory

This key functions the same as ["Segments in ARB Memory" on page 2549](#).

Key Path	Source, Modulation Setup, ARB, Waveform Sequences, Build New Sequence, Insert New Waveform
Initial S/W Revision	Prior to A.09.00

Delete Segment From ARB Memory

This key functions the same as ["Delete Segment From ARB Mem" on page 2549](#).

Key Path	Source, Modulation Setup, ARB, Waveform Sequences, Build New Sequence, Insert New Waveform, Segment in ARB Memory
Initial S/W Revision	Prior to A.09.00

Delete All From ARB Memory

This key functions the same as ["Delete All From ARB Memory" on page 2550](#).

Key Path	Source, Modulation Setup, ARB, Waveform Sequences, Build New Sequence, Insert New Waveform, Segment in ARB Memory
Initial S/W Revision	Prior to A.09.00

Query ARB Memory File List (Remote Command Only)

This command functions the same as ["Query ARB Memory File List \(Remote Command Only\)" on page 2482](#).

Initial S/W Revision	Prior to A.09.00
----------------------	------------------

Edit Selected Waveform

Allows access to the sub-menus for editing the details of the currently selected waveform segment.

Key Path	Source, Modulation Setup, ARB, Waveform Sequences, Build New Sequence
Notes	No remote command, front panel only.
Initial S/W Revision	A.05.00

Repetitions

Allows you to specify the number of times the currently selected waveform is played within the sequence.

Key Path	Source, Modulation Setup, ARB, Waveform Sequences, Build New Sequence, Edit Selected Waveform
Notes	No remote command, SCPI front panel only.
Preset	1
Min	1
Max	65535
Initial S/W Revision	A.05.00

Marker 1

Allows you to enable or disable marker 1 for the currently selected waveform. For a waveform sequence, you can enable and disable markers on a per-segment basis, allowing you to output markers from some waveform segments within the sequence, but not for others.

Key Path	Source, Modulation Setup, ARB, Waveform Sequences, Build New Sequence, Edit Selected Waveform
Notes	No remote command, front panel only.
Preset	Enabled
Range	Enabled Disabled
Initial S/W Revision	A.05.00

Marker 2

Allows you to enable or disable marker 2 for the currently selected waveform. For a waveform sequence, you can enable and disable markers on a per-segment basis, allowing you to output markers from some waveform segments within the sequence, but not for others.

Key Path	Source, Modulation Setup, ARB, Waveform Sequences, Build New Sequence, Edit Selected Waveform
Notes	No remote command, front panel only.
Preset	Enabled
Range	Enabled Disabled
Initial S/W Revision	A.05.00

Marker 3

Allows you to enable or disable marker 3 for the currently selected waveform. For a waveform sequence, you can enable and disable markers on a per-segment basis, allowing you to output markers from some waveform segments within the sequence, but not for others.

Key Path	Source, Modulation Setup, ARB, Waveform Sequences, Build New Sequence, Edit Selected
----------	--

	Waveform
Notes	No remote command, front panel only.
Preset	Enabled
Range	Enabled Disabled
Initial S/W Revision	A.05.00

Marker 4

Allows you to enable or disable marker 4 for the currently selected waveform. For a waveform sequence, you can enable and disable markers on a per-segment basis, allowing you to output markers from some waveform segments within the sequence, but not for others.

Key Path	Source, Modulation Setup, ARB, Waveform Sequences, Build New Sequence, Edit Selected Waveform
Notes	No remote command, front panel only.
Preset	Enabled
Range	Enabled Disabled
Initial S/W Revision	A.05.00

Delete Segment

Allows you to delete the selected segment from the waveform sequence.

Key Path	Source, Modulation Setup, ARB, Waveform Sequences, Build New Sequence
Notes	No remote command, front panel only.
Initial S/W Revision	A.05.00

Save Sequence...

Pressing this key displays the “Save As” dialog. The sequence name is passed to the save as dialog to use as the filename for saving, and the directory the save as dialog will open into is the default waveform directory.

Key Path	Source, Modulation Setup, ARB, Waveform Sequences, Build New Sequence
Initial S/W Revision	A.05.00

Build New Sequence (Remote Command Only)

This command is the SCPI equivalent of the waveform sequence creation features described in ["Build New Sequence" on page 2489](#).

This command writes a waveform sequence file to the hard disk. You must specify the waveform sequence file path and filename which will be saved on the hard disk, and the waveform segment file path and name which will be nested into the waveform sequence file. You can utilize mass storage unit specifier (MSUS) “NVWFM” or use a real full path representation. See the example below. MSUS “NVWFM” is mapped to D:\VARB directory on test set hard disk.

Any number of segments, up to a segment count limit of 64, can be used to create a sequence. Repeated segments are included in the count limit.

Each waveform segment name string length upper limit is 128 chars. Please do NOT insert waveform which name string exceeds 128 chars.

The internal source does not support nesting one waveform sequence file into another waveform sequence file.

Remote Command :SOURce:RADio:ARB:SEQuence[:MWAveform] <filename>, <waveform1>, <reps>, NONE | M1 | M2 | M3 | M4 | M1M2 | M1M3 | M1M4 | M2M3 | M2M4 | M3M4 | M1M2M3 | M1M2M4 | M1M3M4 | M2M3M4 | M1M2M3M4 | ALL, {<waveform2>, <reps>, NONE | M1 | M2 | M3 | M4 | M1M2 | M1M3 | M1M4 | M2M3 | M2M4 | M3M4 | M1M2M3 | M1M2M4 | M1M3M4 | M2M3M4 | M1M2M3M4 | ALL, } ...

(For additional description of each item, see Notes below ["For Setup SCPI" on page 2498](#) "For Setup SCPI".)

:SOURce:RADio:ARB:SEQuence[:MWAveform]? <filename>

(For additional description of each item, see Notes ["For Query SCPI" on page 2499](#) below.)

Example For setup:

```
>:SOUR:RAD:ARB:SEQ "NVWFM:testSeq1.seq", "NVWFM:wfmSegment1.wfm", 10, M2M3M4, "NVWFM:wfmSegment2.wfm", 20, M1 M3
```

Or

```
>:SOUR:RAD:ARB:SEQ "D: VARB\testSeq1.seq", "D: VARB\wfmSegment1.wfm", 10, M2M3M4, "D: VARB\wfmSegment2.wfm", 20, M1 M3
```

For query, must specify which waveform sequence file to query.

```
>:SOUR:RAD:ARB:SEQ? "NVWFM:testSeq1.seq"
```

Or

```
>:SOUR:RAD:ARB:SEQ? "D: VARB\testSeq1.seq",
```

Notes

For Setup SCPI

For the Setup SCPI command, the parameters are:

<filename> - String Type

This variable specifies the path and name for the waveform sequence file. The path supports MSUS (NVWFM) or a real full path representation. See example.

<waveform1> - String Type

This variable specifies the path and name of the first existing waveform segment. The path supports MSUS (NVWFM) or a real full path representation. See example.

The segment file must reside within ARB playback memory before it can be played by the ARB player.

<reps> - Integer Type

This variable specifies the number of times a segment or sequence plays before moving on to the next segment or sequence.

<marker> - Enum Type

NONE – This choice disables all four markers for the waveform. Disabling markers means that the waveform sequence ignores the segments or sequence marker settings.

M1, M2, M3, M4 – these choices, either individually or a combination of them, enable the markers for the waveform segment or sequence. Markers not specified are ignored for that segment or sequence.

ALL – This choice enables all four markers in the waveform segment or sequence.

<waveform2> - String type.

This variable specifies the name of a second existing waveform segment. The path supports MSUS (NVWFM) and real full path representation both. See example.

The segment file must reside within ARB playback memory before it can be played by the ARB player.

<reps> same as above, for the 2nd waveform segment.

<marker> same as above, for the 2nd waveform segment.

You can insert several waveform segments into a waveform sequence file. Just repeat inserting waveform segments as described above.

Error Checks for Setup SCPI command:

If you do not specify a filename, or you use an unsupported MSUS (that is, not NVWFM), or have an error in the waveform sequence file path, an error is generated.

Notes

Error Checks for Query SCPI command: (Continued)

If the specified waveform sequence file name suffix is not “.seq”, error is generated.

If you use an unsupported MSUS (that is, not NVWFM), or have an error in the waveform segment file path, an error is generated.

If the first specified waveform file cannot be found, an error is generated.

If you nest one waveform sequence file into another waveform sequence file, an error is generated.

If the specified repetition value is larger than 65535 or smaller than 1, an error is generated.

If the specified marker type is unrecognized, an error is generated.

For Query SCPI

For the Query the parameters are:

<filename> - String type.

This variable specifies the path and name of the waveform sequence file being queried. The path supports MSUS (NVWFM) or a real full path representation. See example.

The return value is a <string>, which includes each waveform segment file name, repetitions, and marker type. For example:

```
>:SOUR:RAD:ARB:SEQ? "NVWFM:testSeq1.seq",
```

```
<"wfmSegment1. wfm, 10, ALL, wfmSegment2.wfm, 20, M1M3",
```

Error Checks for Query SCPI command:

If you do not specify a filename, an error is generated.

If the waveform sequence file name is empty, an error is generated.

If the specified waveform sequence file cannot be found, an error is generated.

Initial S/W Revision

A.05.00

Edit Selected Sequence

Allows access to the sub-menus for editing the sequence currently selected within the Waveform Sequence List view. Pressing this key changes the central view area to display the Waveform Sequence Creation and Editing view.

Key Path	Source, Modulation Setup, ARB, Waveform Sequences
Notes	No remote command, front panel only.
Initial S/W Revision	A.05.00

Current Directory...

Allows you to change the currently selected directory on the hard disk. Pressing this key opens a standard windows change directory dialog and allows you to select the new directory of interest.

Key Path	Source, Modulation Setup, ARB, Waveform Sequences
Notes	No remote command, front panel only.
Initial S/W Revision	A.05.00

Waveform Utilities

Allows you access to the waveform utilities sub-menus.

Key Path	Source, Modulation Setup, ARB
Initial S/W Revision	A.05.00

Multi-Pack Licenses

Allows you access to the Multi - Pack License sub-menus. Pressing this key also changes the central view area to display the Multi -Pack License Management view.

On modular instrument like E6630A or E6640A, multi-pack license operations are only allowed on the default module, i.e. "Left" module for E6630A or "TRX1" module for E6640A.

Key Path	Source, Modulation Setup, ARB, Waveform Utilities
Notes	If access multi-pack license sub-menu from modules other than "TRX1", an advisory message like "Please goto "TRX1" to operate multi-pack license" will display.
Dependencies	This key is only available if there is at least one Multi-pack license installed on the instrument.
Initial S/W Revision	A.05.00

Add Waveform

Pressing this key accesses the Add Waveform sub-menu. It also changes the central display area to display the Multi-Pack License Waveform Add view.

Key Path	Source, Modulation Setup, ARB, Waveform Utilities, Multi-Pack Licenses
Dependencies	This key is only available if there is at least one slot available within at least one multi-pack license.
Initial S/W Revision	A.05.00

Add Waveform

Allows you to add the currently selected waveform segment to a multi-pack license. The new waveform is added to the next available slot regardless of which slot was selected on the Multi-Pack License Management view.

Key Path	Source, Modulation Setup, ARB, Waveform Utilities, Multi-Pack Licenses, Add Waveform
Remote Command	:SYSTem:LKEY:WAVeform:ADD <string> or :SYSTem:LIcense[:FPACK]:WAVeform:ADD <string>
Example	SYST:LKEY:WAV:ADD "mywaveform.wfm" or SYST:LIC:WAV:ADD "mywaveform.wfm"
Notes	The second SCPI :SYSTem:LIcense[:FPACK]:WAVeform:ADD is provided to be consistent with the style of Agilent signal sources. You can use either one of them. Since adding a waveform segment to a Multi-Pack license causes the license slot to enter the trial period of only 48 hours, pressing this key causes a confirmation dialog to be displayed to ensure you do want to add the waveform segment to the Multi-Pack. If you attempt to license a waveform that is already licensed using another slot an error is generated. . If current module is not "TRX1" module, the key will grey out, and error message is generated "-221 Setting conflict; Not allowed on current module. Goto "TRX1" to operate multi-pack license" when invoking SCPI.
Dependencies	This key is only available if the currently selected file is a secure waveform requiring a license, and there is at least one slot available within at least one multi-pack license. If the waveform highlighted is a secure waveform, but is already licensed, this key will be unavailable.
Initial S/W Revision	A.05.00

Segments on Hard Disk

Allows you access to the sub-menus for loading waveform segments from the hard disk into ARB memory. The default directory is: D: varb.

Pressing this key changes the current view to the Waveform Management View.

Key Path	Source, Modulation Setup, ARB, Select Waveform
Initial S/W Revision	A.05.00

Load Segment To ARB Memory

Allows you to load the selected file into ARB memory. On the front panel you select the file for loading to the ARB memory by highlighting the desired file in the list. Using the SCPI command, you specify the file name on the HDD.

“NVWFM” (none-volatile storage) MSUS (Mass Storage Unit Specifier) is supported in the memory subsystem because the ARB memory cannot be accessed directly. Therefore, files must be downloaded to the instrument hard disk and then loaded into the ARB memory. “NVWFM” MSUS will be mapped to the default directory D: VARB. The SCPI command supports using either “NVWFM” MSUS or specifying a full path. For more information, see [Memory Subsystem \(Remote Command Only\)](#).

If a file of the same name already exists within ARB memory, it is overwritten. If you wish to load two segments of the same name, you must rename one of the segments before loading it into ARB memory. To rename a segment, you can either use Windows File Explorer, or the :MMEMory:COpy command.

NOTE: When a waveform file is loaded to ARB memory, burst timing adjustments are made automatically, based on whether or not a Multiport Adapter is connected to the test set and powered on. If the connection/power status of the Multiport Adapter is changed after a waveform file has been loaded, it needs to be loaded again.

Key Path	Source, Modulation Setup, ARB, Select Waveform, Segments on Hard Disk
Remote Command	:SOURce:RADio:ARB:LOAD <string>
Example	:SOUR:RAD:ARB:LOAD "D: VARB\testwaveform.bin" or :SOUR:RAD:ARB:LOAD "NVWFM:testwaveform.bin"
Notes	<p>Because loading the file involves a delay of unpredictable length, this command should be followed by the query *OPC?, which holds off subsequent commands until the loading operating is complete.</p> <p><string> – specifies the path name of the file to load from the HDD into ARB memory. It could be a <full path + filename>, or <“NVWFM” MSUS + colon + filename>.</p> <p>When in Sequence Analyzer mode, and Include Source is Yes, an attempt to load a file to ARB memory will be rejected with an error.</p> <p>When Include Source is No and if there is insufficient free ARB memory to load the selected waveform, an error is generated. .</p> <p>If you specify a file over SCPI, but the file is not at the specified location, an error is generated.</p> <p>If you try to load a waveform file but the file contains less than 500 IQ samples, an error is generated.</p> <p>If you try to load a Signal Studio waveform “*.wfm” which contains invalid waveform header, an error is generated.</p> <p>If the ARB is ON when you load a file to ARB memory or delete a file from ARB memory, the playing waveform segment may not keep phase continuity during the ARB memory operation. The waveform will be replayed after the ARB operation is finished.</p> <p>ARB can be loaded into ARB memory even required licenses do not present on the instrument. In this</p>

case, a GUI only warning message -800, "Operation complete; Loaded <filename> successfully, but no license <required licenses> installed". User can install required licenses according to <required licenses> string to license it, or multi-pack license it.

Initial S/W Revision A.05.00

Load All To ARB Memory

Allows you to load all the segment files within the currently selected directory into ARB memory. If a file of the same name already exists within ARB memory, it is overwritten. If you wish to load two segments of the same name, you must rename one of the segments before loading it into ARB memory. To rename a segment, you can either use Windows File Explorer, or the :MEMory:COpy command.

NOTE: When a waveform file is loaded to ARB memory, burst timing adjustments are made automatically, based on whether or not a Multiport Adapter is connected to the test set and powered on. If the connection/power status of the Multiport Adapter is changed after a waveform file has been loaded, it needs to be loaded again.

Key Path Source, Modulation Setup, ARB, Select Waveform, Segments on Hard Disk

Remote Command :SOURce:RADio:ARB:LOAD:ALL <string>

Example :SOUR:RAD:ARB:LOAD:ALL "D: varb"

Notes <string> - specifies the directory on the HDD to load the files into ARB memory from.

When in Sequence Analyzer mode, and Include Source is Yes, an attempt to load all files from a directory to ARB memory is rejected with an error.

When Include Source is No and there is insufficient free ARB memory to load all the waveforms, when the ARB memory is full, the copy ceases, and an error is generated.

If you specify a directory over SCPI, but the directory does not exist, an error is generated.

If the ARB is ON, a user then loads or deletes file to ARB memory, the playing waveform segment may not keep phase continuity during the ARB memory operation. The waveform will be replayed after the ARB operation is finished.

Initial S/W Revision A.05.00

Change Directory...

Allows you to change the currently selected directory on the hard disk. Pressing this key opens a standard windows change directory dialog allowing you to select the new directory of interest.

The current directory is used for manually loading waveform segments into ARB memory for playback, and as a search location for waveform segments that are required to be loaded into ARB memory for playback of a waveform sequence or a list sequence.

Key Path Source, Modulation Setup, ARB, Select Waveform, Segments on Hard Disk

Notes No remote command, SCPIfront panel only.

Initial S/W Revision A.05.00

Default Directory...

Allows you to change the default directory. It is used as a search location for waveform segments that are required to be loaded into ARB memory for playback of a waveform sequence, and as a search location for selecting waveforms using SCPI.

Key Path	Source, Modulation Setup, ARB, Select Waveform, Segments on Hard Disk
Remote Command	:SOURce:RADio:ARB:DEFault:DIRectory <string> :SOURce:RADio:ARB: DEFault:DIRectory?
Example	:SOUR:RAD:ARB:DEF:DIR "D:\ArbFiles" :SOUR:RAD:ARB:DEF:DIR?
State Saved	Persistent, survives a power cycle and a preset but not saved in the instrument state
Initial S/W Revision	A.05.00

Segments on Hard Disk

This key functions the same as ["Segments on Hard Disk" on page 2547](#).

Key Path	Source, Modulation Setup, ARB, Waveform Utilities, Multi-Pack Licenses, Add Waveform
Initial S/W Revision	Prior to A.09.00

Load Segment To ARB Memory

This key functions the same as ["Load Segment To ARB Memory" on page 2547](#).

Key Path	Source, Modulation Setup, ARB, Waveform Utilities, Multi-Pack Licenses, Add Waveform, Segment on Hard Drive
Initial S/W Revision	Prior to A.09.00

Load All To ARB Memory

This key functions the same as ["Load All To ARB Memory" on page 2548](#).

Key Path	Source, Modulation Setup, ARB, Waveform Utilities, Multi-Pack Licenses, Add Waveform, Segment on Hard Drive
Initial S/W Revision	Prior to A.09.00

Change Directory ...

This key functions the same as ["Change Directory..." on page 2549](#).

Key Path	Source, Modulation Setup, ARB, Waveform Utilities, Multi-Pack Licenses, Add Waveform, Segment on Hard Drive
Initial S/W Revision	Prior to A.09.00

Default Directory ...

This key functions the same as ["Default Directory..." on page 2549](#)

Key Path	Source, Modulation Setup, ARB, Waveform Utilities, Multi-Pack Licenses, Add Waveform, Segment on Hard Drive
Initial S/W Revision	Prior to A.09.00

Replace Waveform

Pressing this key accesses the Replace Waveform submenu. It also changes the central display area to display the Multi-Pack License Waveform Add view.

Key Path	Source, Modulation Setup, ARB, Waveform Utilities, Multi-Pack Licenses
Dependencies	This key is only available if the currently selected slot is in the trial state.
Initial S/W Revision	A.05.00

Replace Waveform

Allows you to replace the waveform in the currently selected slot with the waveform currently selected in the Multi-Pack License Waveform Add view.

Key Path	Source, Modulation Setup, ARB, Waveform Utilities, Multi-Pack Licenses, Replace Waveform
Remote Command	:SYSTem:LKEY:WAVeform:REPLace <int>, <string> or :SYSTem:LIcense[:FPACK]:WAVeform:REPLace <int>, <string>
Example	SYST:LKEY:WAV:REPL 1, "myotherwaveform.wfm" or :SYST:LIC:WAV:REPL 1, "myotherwaveform.wfm"
Notes	The second SCPI :SYSTem:LIcense[:FPACK]:WAVeform:REPLace is provided to be consistent with the style of Agilent signal sources. You can use either one of them. If you attempt to license a waveform that is already licensed using another slot an error is generated. Waveform slot number <int> is positive. If you attempt to input a slot number less than or equals 0, an error is generated. If current module is not "TRX1" module, the key will grey out, and error message is generated "-221 Setting conflict; Not allowed on current module. Goto "TRX1" to operate multi-pack license" when invoking SCPI.
Initial S/W Revision	A.05.00

Segments on Hard Disk

This key functions the same as ["Segments on Hard Disk" on page 2547](#).

Key Path	Source, Modulation Setup, ARB, Waveform Utilities, Multi-Pack Licenses, Replace Waveform
Initial S/W Revision	Prior to A.09.00

Load Segment To ARB Memory

This key functions the same as ["Load Segment To ARB Memory" on page 2547](#).

Key Path	Source, Modulation Setup, ARB, Waveform Utilities, Multi-Pack Licenses, Replace Waveform, Segment on Hard Drive
Initial S/W Revision	Prior to A.09.00

Load All To ARB Memory

This key functions the same as ["Load All To ARB Memory" on page 2548](#).

Key Path	Source, Modulation Setup, ARB, Waveform Utilities, Multi-Pack Licenses, Replace Waveform, Segment on Hard Drive
Initial S/W Revision	Prior to A.09.00

Change Directory ...

This key functions the same as ["Change Directory..." on page 2549](#).

Key Path	Source, Modulation Setup, ARB, Waveform Utilities, Multi-Pack Licenses, Replace Waveform, Segment on Hard Drive
Initial S/W Revision	Prior to A.09.00

Default Directory ...

This key functions the same as ["Default Directory..." on page 2549](#)

Key Path	Source, Modulation Setup, ARB, Waveform Utilities, Multi-Pack Licenses, Replace Waveform, Segment on Hard Drive
Initial S/W Revision	Prior to A.09.00

Clear Waveform from Slot

Allows you to clear the waveform from the selected slot.

Key Path	Source, Modulation Setup, ARB, Waveform Utilities, Multi-Pack Licenses
Remote Command	:SYSTem:LKEY:WAVeform:CLEar <int> or :SYSTem:LICense[:FPACK]:WAVeform:CLEar <int>
Example	SYST:LKEY:WAV:CLE 1 or :SYST:LIC:WAV:CLE 1
Notes	The second SCPI :SYSTem:LICense[:FPACK]:WAVeform:CLEar is provided to be consistent with the style of Agilent signal sources. You can use either one of them. Waveform slot number <int> is positive. If you attempt to input a slot number less than or equals 0, an error is generated. If current module is not "TRX1" module, the key will grey out, and error message is generated "-221 Setting conflict; Not allowed on current module. Goto "TRX1" to operate multi-pack license" when invoking SCPI.
Dependencies	This key is only available if the currently selected slot is in the trial state.
Initial S/W Revision	A.05.00

Lock Waveform in Slot

If the selected slot is in the trial state or the lock required state, the waveform that occupies the slot is locked and permanently licensed.

Key Path	Source, Modulation Setup, ARB, Waveform Utilities, Multi-Pack Licenses
Remote Command	:SYSTem:LKEY:WAVeform:LOCK <int> or :SYSTem:LICense[:FPACK]:WAVeform:LOCK <int>
Example	SYST:LKEY:WAV:LOCK 1 or SYST:LIC:WAV:LOCK 1
Notes	The second SCPI :SYSTem:LICense[:FPACK]:WAVeform:LOCK is provided to be consistent with the style of Agilent signal sources. You can use either one of them. Waveform slot number <int> is positive. If you attempt to input a slot number less than or equals 0, an error is generated. If current module is not "TRX1" module, the key will grey out, and error message is generated "-221 Setting conflict; Not allowed on current module. Goto "TRX1" to operate multi-pack license" when invoking SCPI.
Dependencies	This key is only available if the currently selected slot is in the trial state or the lock required state.
Initial S/W Revision	A.05.00

Slot Status Query (Remote Command Only)

Returns the status of the specified slot.

Remote Command	:SYSTem:LKEY:WAVeform:STATus? <int> or :SYSTem:LICense[:FPACK]:WAVeform:STATus? <int>
Example	:SYST:LKEY:WAV:STAT? 1 <"Locked" or :SYST:LIC:WAV:STAT? 1 <"Locked"
Notes	The second SCPI :SYSTem:LICense[:FPACK]:WAVeform:STATus is provided to be consistent with the style of Agilent signal sources. You can use either one of them. Waveform slot number <int> is positive. If you attempt to input a slot number less than or equals 0, an error is generated. Result type is string. If input slot number exceeds total available slot number, "Nonexistent" is returned.
Range	"Locked" "Available" "Trail" "LockRequired" "Nonexistent"
Initial S/W Revision	A.05.00

Slots Free Query (Remote Command Only)

Returns the number of license slots free.

Remote Command	:SYSTem:LKEY:WAVeform:FREE? or :SYSTem:LICense[:FPACK]:WAVeform:FREE?
Example	:SYST:LKEY:WAV:FREE? or :SYST:LIC:WAV:FREE?
Notes	The second SCPI :SYSTem:LICense[:FPACK]:WAVeform:FREE is provided to be consistent with the style of Agilent signal sources. You can use either one of them.
Initial S/W Revision	A.05.00

Slot Used Query (Remote Command Only)

Returns the number of license slots used.

Remote Command	:SYSTem:LKEY:WAVeform:USED? or :SYSTem:LICense[:FPACK]:WAVeform:USED?
Example	:SYST:LKEY:WAV:USED?

	or :SYST:LIC:WAV:USED?
Notes	The second SCPI :SYSTem:LIcense[:FPACK]:WAVeform:USED is provided to be consistent with the style of Agilent signal sources. You can use either one of them.
Initial S/W Revision	A.05.00

Slot Waveform Name Query (Remote Command Only)

Returns the waveform name of the specified slot

Remote Command	:SYSTem:LKEY:WAVeform:NAME? <int> or :SYSTem:LIcense[:FPACK]:WAVeform:NAME? <int>
Example	:SYST:LKEY:WAV:NAME? 1 <"CDMA2K_22.wfm" or :SYST:LIC:WAV:NAME? 1 <"CDMA2K_22.wfm"
Notes	Waveform slot number <int> is positive. If you attempt to input a slot number less than or equals 0, an error is generated. Result type is string. If input slot number exceeds total available slot number, "Nonexistent" is returned. If no waveform stored in the specified slot, then empty string is returned.
Initial S/W Revision	A.12.00

Slot Waveform Unique ID Query (Remote Command Only)

Returns the waveform unique ID of the specified slot

Remote Command	:SYSTem:LKEY:WAVeform:UID? <int> or :SYSTem:LIcense[:FPACK]:WAVeform:UID? <int>
Example	:SYST:LKEY:WAV:UID? 2 <"1346752140" or :SYST:LIC:WAV:UID? 2 <"1346752140"
Notes	Waveform slot number <int> is positive. If you attempt to input a slot number less than or equals 0, an error is generated. Result type is string. If input slot number exceeds total available slot number, "Nonexistent" is returned.

	If no waveform stored in the specified slot, then "0" is returned
Initial S/W Revision	A.12.00

Locked Waveform Name List Query (Remote Command Only)

Returns the waveform name list of locked.

Remote Command	:SOURce:RADio:ARB:MPLicensed:NAME:LOCKed?
Example	SOUR:RAD:ARB:MPL:NAME:LOCKed? <"CDMA2K_27.wfm", "GSM_MCS1.WFM", "c2kWfm.wfm"
Initial S/W Revision	A.11.00

Locked Waveform Unique ID List Query (Remote Command Only)

Returns the waveform unique id list of locked.

Remote Command	:SOURce:RADio:ARB:MPLicensed:UID:LOCKed?
Example	SOUR:RAD:ARB:MPL:UID:LOCKed? <"2996927136", "3812603511", "3710986266"
Notes	Each Signal Studio waveform has a unique id recorded in header. So if the unique ids are same, that means they are same one waveform. So besides SCPI to query locked waveform name list, also provide a SCPI to query locked waveform unique id list
Initial S/W Revision	A.11.00

Marker Utilities

Allows access to the marker utilities sub-menus.

Key Path	Source, Modulation Setup, ARB
Initial S/W Revision	A.05.00

Marker Polarity

Allows access to the marker polarity sub-menu, which allows you to specify the polarity for the four markers. For a positive polarity, the marker signal is high during the marker points. For a negative marker polarity, the marker signal is high during the period of no marker points.

Key Path	Source, Modulation Setup, ARB, Marker Utilities
Initial S/W Revision	A.05.00

Mkr 1 Polarity

Allows you to set the polarity of marker 1.

Key Path	Source, Modulation Setup, ARB, Marker Utilities, Marker Polarity
Remote Command	:SOURce:RADio:ARB:MPOLarity:MARKer1 POSitive NEGative :SOURce:RADio:ARB:MPOLarity:MARKer1?
Example	:SOUR:RAD:ARB:MPOL:MARK1 NEG
Dependencies	When a new waveform is selected for playback the settings contained within the associated waveform header file are applied to the ARB. The marker polarity is one of the values stored within the header file. If the newly selected waveform file has an associated header file, the marker polarity is updated with the value from the header file. The marker polarity will remain unchanged if the newly selected waveform does not have an associated header file.
Preset	Pos
Range	Neg Pos
Initial S/W Revision	A.05.00

Mkr 2 Polarity

Allows you to set the polarity of marker 2.

Key Path	Source, Modulation Setup, ARB, Marker Utilities, Marker Polarity
Remote Command	:SOURce:RADio:ARB:MPOLarity:MARKer2 POSitive NEGative :SOURce:RADio:ARB:MPOLarity:MARKer2?
Example	:SOUR:RAD:ARB:MPOL:MARK2 NEG
Dependencies	When a new waveform is selected for playback the settings contained within the associated waveform header file are applied to the ARB. The marker polarity is one of the values stored within the header file. If the newly selected waveform file has an associated header file, the marker polarity is updated with the value from the header file. The marker polarity will remain unchanged if the newly selected waveform does not have an associated header file.
Preset	Pos
Range	Neg Pos
Initial S/W Revision	A.05.00

Mkr 3 Polarity

Allows you to set the polarity of marker 3.

Key Path	Source, Modulation Setup, ARB, Marker Utilities, Marker Polarity
Remote Command	:SOURce:RADio:ARB:MPOLarity:MARKer3 POSitive NEGative :SOURce:RADio:ARB:MPOLarity:MARKer3?
Example	:SOUR:RAD:ARB:MPOL:MARK3 NEG
Dependencies	When a new waveform is selected for playback the settings contained within the associated

	waveform header file are applied to the ARB. The marker polarity is one of the values stored within the header file. If the newly selected waveform file has an associated header file, the marker polarity is updated with the value from the header file. The marker polarity will remain unchanged if the newly selected waveform does not have an associated header file.
Preset	Pos
Range	Neg Pos
Initial S/W Revision	A.05.00

Mkr 4 Polarity

Allows you to set the polarity of marker 4.

Key Path	Source, Modulation Setup, ARB, Marker Utilities, Marker Polarity
Remote Command	:SOURce:RADio:ARB:MPOLarity:MARKer4 POSitive NEGative :SOURce:RADio:ARB:MPOLarity:MARKer4?
Example	:SOUR:RAD:ARB:MPOL:MARK4 NEG
Dependencies	When a new waveform is selected for playback the settings contained within the associated waveform header file are applied to the ARB. The marker polarity is one of the values stored within the header file. If the newly selected waveform file has an associated header file, the marker polarity is updated with the value from the header file. The marker polarity will remain unchanged if the newly selected waveform does not have an associated header file.
Preset	Pos
Range	Neg Pos
Initial S/W Revision	A.05.00

Marker Routing

Allows access to the marker routing sub-menus, which allow you to specify where the marker events are routed. It should be noted that the markers can also be routed to Trigger 1 Out and Trigger 2 Out, however this must be set up using the menus accessed by pressing the “Trigger” hard key.

Key Path	Source, Modulation Setup, ARB, Marker Utilities
Initial S/W Revision	A.05.00

Pulse/RF Blank

Allows you to select which marker is used for the pulse/RF blanking function. The pulse/RF blanking function blanks the RF when the marker signal goes low. The marker polarity determines when the marker signal is high. For a positive polarity, this is during the marker points. For a negative polarity, this is when there are no marker points.

Marker points should be set before using this function. Enabling this function without setting maker points may create a continuous low or high signal, dependant on the marker polarity. This causes either no RF output, or a continuous RF output.

Key Path	Source, Modulation Setup, ARB, Marker Utilities, Marker Routing
Remote Command	:SOURce:RADio:ARB:MDEStination:PULSe NONE M1 M2 M3 M4 :SOURce:RADio:ARB:MDEStination:PULSe?
Example	:SOUR:RAD:ARB:MDES:PULS NONE
Dependencies	When a new waveform is selected for playback the settings contained within the associated waveform header file are applied to the ARB. The pulse/RF blanking setting is one of the values stored within the header file. If the newly selected waveform file has an associated header file, the pulse/RF blanking setting is updated with the value from the header file. The pulse/RF blanking setting will remain unchanged if the newly selected waveform does not have an associated header file.
Range	None M1 M2 M3 M4
Initial S/W Revision	A.05.00

None

Sets no marker to be used for the pulse/RF blanking function, essentially turning the RF blanking function off.

Key Path	Source, Modulation Setup, ARB, Marker Utilities, Marker Routing, Pulse/RF Blank
Example	:SOUR:RAD:ARB:MDES:PULS NONE
Initial S/W Revision	A.05.00

Marker 1

Sets marker 1 to be used for the pulse/RF blanking function.

Key Path	Source, Modulation Setup, ARB, Marker Utilities, Marker Routing, Pulse/RF Blank
Example	:SOUR:RAD:ARB:MDES:PULS M1
Initial S/W Revision	A.05.00

Marker 2

Sets marker 2 to be used for the pulse/RF blanking function.

Key Path	Source, Modulation Setup, ARB, Marker Utilities, Marker Routing, Pulse/RF Blank
Example	:SOUR:RAD:ARB:MDES:PULS M2
Initial S/W Revision	A.05.00

Marker 3

Sets marker 3 to be used for the pulse/RF blanking function.

Key Path	Source, Modulation Setup, ARB, Marker Utilities, Marker Routing, Pulse/RF Blank
Example	:SOUR:RAD:ARB:MDES:PULS M3
Initial S/W Revision	A.05.00

Marker 4

Sets marker 4 to be used for the pulse/RF blanking function.

Key Path	Source, Modulation Setup, ARB, Marker Utilities, Marker Routing, Pulse/RF Blank
Example	:SOUR:RAD:ARB:MDES:PULS M4
Initial S/W Revision	A.05.00

ALC Hold

Allows you to specify which marker is routed for use within the ALC hold function. The ALC hold marker function holds the ALC circuitry at the average value of the sample points set by the marker.

The ALC hold function operates during the low periods of the marker signal. The marker polarity determines when the marker signal is high. For positive polarity, this is during the marker points. For a negative polarity, this is when there are no marker points.

Key Path	Source, Modulation Setup, ARB, Marker Utilities, Marker Routing
Remote Command	:SOURce:RADio:ARB:MDEStination:ALCHold NONE M1 M2 M3 M4 :SOURce:RADio:ARB:MDEStination:ALCHold?
Example	:SOUR:RAD:ARB:MDES:ALCH NONE
Dependencies	When a new waveform is selected for playback the settings contained within the associated waveform header file are applied to the ARB. The ALC hold setting is one of the values stored within the header file. If the newly selected waveform file has an associated header file, the ALC hold setting is updated with the value from the header file. The ALC hold setting will remain unchanged if the newly selected waveform does not have an associated header file.
Range	None M1 M2 M3 M4
Initial S/W Revision	A.05.00

None

Sets no marker to be used for the ALC hold function, essentially turning the ALC hold function off.

Key Path	Source, Modulation Setup, ARB, Marker Utilities, Marker Routing, ALC Hold
Example	:SOUR:RAD:ARB:MDES:PULS NONE
Initial S/W Revision	A.05.00

Marker 1

Sets marker 1 to be used for the ALC hold function.

Key Path	Source, Modulation Setup, ARB, Marker Utilities, Marker Routing, ALC Hold
Example	:SOUR:RAD:ARB:MDES:PULS M1
Initial S/W Revision	A.05.00

Marker 2

Sets marker 2 to be used for the ALC hold function.

Key Path	Source, Modulation Setup, ARB, Marker Utilities, Marker Routing, ALC Hold
Example	:SOUR:RAD:ARB:MDES:PULS M2
Initial S/W Revision	A.05.00

Marker 3

Sets marker 3 to be used for the ALC hold function.

Key Path	Source, Modulation Setup, ARB, Marker Utilities, Marker Routing, ALC Hold
Example	:SOUR:RAD:ARB:MDES:PULS M3
Initial S/W Revision	A.05.00

Marker 4

Sets marker 4 to be used for the ALC hold function.

Key Path	Source, Modulation Setup, ARB, Marker Utilities, Marker Routing, ALC Hold
Example	:SOUR:RAD:ARB:MDES:PULS M4
Initial S/W Revision	A.05.00

Header Utilities

Allows access to the header utilities sub-menu. Pressing this key also causes the central display area to change to display the File Header Information view.

Key Path	Source, Modulation Setup, ARB
Dependencies	This key is only available if there is currently a waveform selected for playback. If no waveform is selected, the key is grayed out.
Initial S/W Revision	A.05.00

Clear Header

Allows you to clear the header information from the file header associated with the currently selected waveform.

Key Path	Source, Modulation Setup, ARB, Header Utilities
Remote Command	:SOURce:RADio:ARB:HEADer:CLEar
Example	:SOUR:RAD:ARB:HEAD:CLE
Notes	Attempting to clear the header details via SCPI when no waveform was selected for playback will generate an error.
Initial S/W Revision	A.05.00

Save Setup To Header

Allows you to save new file header information details to the file.

Key Path	Source, Modulation Setup, ARB, Header Utilities
Remote Command	:SOURce:RADio:ARB:HEADer:SAVE
Example	:SOUR:RAD:ARB:HEAD:SAVE
Notes	Attempting to save the header details via SCPI when no waveform was selected for playback will generate an error.
Initial S/W Revision	A.05.00

Query Waveform Unique ID (Remote Command Only)

Each Signal Studio waveform contains a unique waveform ID, which recorded in the header. This command allows you to query the unique waveform ID from the header. This is a SCPI only command. User can also check [Error! Reference source not found.](#) for waveform unique ID display.

Remote Command	:MMEMory:HEADer:ID? "<file name>"
Example	:MMEM:HEAD:ID? "test.wfm" (query the waveform already loaded into the ARB memory) :MMEM:HEAD:ID? "D: VARB\test.wfm" (query the waveform on the hard disk by absolute path) :MMEM:HEAD:ID? "NVWFM:test.wfm" (query the waveform on the hard disk by MSUS)
Notes	SCPI query only. The queried waveform file can be in ARB memory, or on hard disk. If want to query ARB in ARB memory, then give out the file name directly. If want to query ARB on the hard disk, then absolute file path or MSUS should be given along with the file name. The valid MSUS is "NVWFM" which is mapped to D: VARB on hard disk. If the file cannot be found in ARB memory or on hard disk, an error is generated.and value -1 is returned
Initial S/W Revision	A.09.00

Bus Trigger Command (Remote Command Only)

Used to initiate an immediate trigger event if the trigger source is set to Bus.

Remote Command	:SOURce:RADio:ARB:TRIGger:INITiate
Example	:SOUR:RAD:ARB:TRIG:INIT
Initial S/W Revision	A.05.00

AM

Allows access to the menu for configuring the Amplitude Modulation.

Key Path	Source, Modulation Setup
Initial S/W Revision	A.05.00

AM

Enables or disables the amplitude modulation.

Turning AM on when another modulation format is already on results in the previous modulation format being turned off and the generation of an error.

Key Path	Source, Modulation Setup, AM
Remote Command	:SOURce:AM:STATe :SOURce:AM:STATe?
Example	:SOUR:AM:STAT OFF
Preset	Off
Range	On Off
Initial S/W Revision	A.05.00

AM Depth

Allows you to set the amplitude modulation depth in percent.

Key Path	Source, Modulation Setup, AM
Remote Command	:SOURce:AM[:DEPTh] [:LINear] :SOURce:AM[:DEPTh] [:LINear]?
Example	:SOUR:AM 0.1
Preset	0.1 %
Min	0.1 %
Max	95.0 %
Initial S/W Revision	A.05.00

AM Rate

Allows you to set the internal amplitude modulation rate.

Key Path	Source, Modulation Setup, AM
Remote Command	:SOURce:AM:INTernal:FREQuency :SOURce:AM:INTernal:FREQuency?
Example	:SOUR:AM:INT:FREQ 40.0 Hz
Preset	400.0 Hz
Min	10 Hz
Max	40 kHz
Initial S/W Revision	A.05.00

FM

Allows access to the menu for configuring the frequency modulation.

Key Path	Source, Modulation Setup
Initial S/W Revision	A.05.00

FM

Enables or disables the frequency modulation.

Turning FM on when another modulation format is already on results in the previous modulation format being turned off and the generation of an error.

Key Path	Source, Modulation Setup, FM
Remote Command	:SOURce:FM:STATe :SOURce:FM:STATe?
Example	:SOUR:FM:STAT OFF
Preset	Off
Range	On Off
Initial S/W Revision	A.05.00

FM Deviation

Allows you to set the frequency modulation deviation.

Key Path	Source, Modulation Setup, FM
----------	------------------------------

Remote Command	:SOURce:FM[:DEVIation] :SOURce:FM[:DEVIation]?
Example	:SOUR:FM 1.00 kHz
Preset	1.00 Hz
Min	1.00 Hz
Max	100.00 kHz
Initial S/W Revision	A.05.00

FM Rate

Allows you to set the internal frequency modulation rate.

Key Path	Source, Modulation Setup, FM
Remote Command	:SOURce:FM:INTernal:FREQuency :SOURce:FM:INTernal:FREQuency?
Example	:SOUR:FM:INT:FREQ 40.0 Hz
Preset	400.0 Hz
Min	10 Hz
Max	40 kHz
Initial S/W Revision	A.05.00

PM

Allows access to the menu for configuring the phase modulation.

Key Path	Source, Modulation Setup
Initial S/W Revision	A.05.00

PM

Enables or disables the phase modulation.

Turning PM on when another modulation format is already on results in the previous modulation format being turned off and the generation of an error.

Key Path	Source, Modulation Setup, PM
Remote Command	:SOURce:PM:STATe :SOURce:PM:STATe?
Example	:SOUR:PM:STAT OFF

Preset	Off
Range	On Off
Initial S/W Revision	A.05.00

PM Deviation

Allows you to set the phase modulation deviation.

Key Path	Source, Modulation Setup, PM
Remote Command	:SOURce:PM[:DEVIation] :SOURce:PM[:DEVIation]?
Example	:SOUR:PM 1.00 rad
Preset	0.1 rad
Min	0.1 rad
Max	20.0 rad
Initial S/W Revision	A.05.00

PM Rate

Allows you to set the internal phase modulation rate.

Key Path	Source, Modulation Setup, PM
Remote Command	:SOURce:PM:INTernal:FREQuency :SOURce:PM:INTernal:FREQuency?
Example	:SOUR:PM:INT:FREQ 40.0 Hz
Preset	400.0 Hz
Min	10 Hz
Max	40 kHz
Initial S/W Revision	A.05.00

List Sequencer

Allows you access to the sub-menus for configuring the list sequencer.

List sequences allows you to enter frequencies and amplitudes at unequal intervals in nonlinear ascending, descending or random order. Each step within the list can also include its own waveform file for playback, step duration, trigger event and trigger output.

The complexities involved in configuring the list sequencer do not lend itself to manual configuration; hence the manual configuration for this feature is limited. For easier configuration of the list sequencer, it is recommended that you use either SCPI or load a tab delimited file containing the setup parameters in a

tabular form. The details of the SCPI for configuring the list sequencer can be found in "[Step Configuration \(Remote Command Only\)](#)" on page 2554.

Once the List Sequencer has been configured using the front panel, SCPI, or loading in a tab delimited file, the sequence must be initiated using the front panel Initiate Sequence key or the corresponding SCPI command.

Key Path	Source
Initial S/W Revision	A.05.00

Sequencer

Allows you to set the state of the list sequencer. When the list sequencer is on, the source is outputting the sequence defined by the sequencer. When the list sequencer is off, the source outputs a single waveform segment or sequence (independent mode) at a single frequency and amplitude.

Key Path	Source, List Sequencer
Remote Command	:SOURce:LIST[:STATe] ON OFF 1 0 :SOURce:LIST[:STATe]?
Example	:SOUR:LIST OFF
Notes	When the sequencer is set to ON, the list sequencer controls the output of the source.
Couplings	When in Sequence Analyzer mode and the list sequencer state is Off, Include Source is forced to No, and the Include Source key is grayed out. When in Sequence Analyzer mode and the list sequencer state is On, Include Source is available to set. And, an ARB memory related operation, like load or delete will be rejected.
Preset	Off
Range	On Off
Initial S/W Revision	A.05.00

Initiate Sequence

Pressing this key arms the sequence for single execution. Once the sequence is armed the source begins the sequence as soon as the trigger is received. If the trigger is set to Free Run, the sequence starts immediately.

Key Path	Source, List Sequencer
Remote Command	:SOURce:LIST:TRIGger[:IMMediate]
Example	:SOUR:LIST:TRIG
Notes	When in Sequence Analyzer mode and Include Source is Yes, the Initiate list sequencer operation is rejected, and the key is grayed out, since source list sequence request is sent to physics via Parallel batch by sequence analyzer. If the file needed by the sequencer is not already in ARB memory, the sequence cannot be initiated

	and an error will be generated. There is a blocking SCPI query which can be used to query if source list sequence being initiated successfully or not. (see " Query List Sequence Initiation Armed Status (Remote Command Only) " on page 2565 Query Source List Sequence Armed Status)
Dependencies	Under the Sequence Analyzer Mode, if Meas Setup->Include Source is set to YES, Source->List Sequencer->Initiate Sequence is disabled.
Initial S/W Revision	A.05.00

List Sequencer Setup

Allows you access to the list sequencer setup menus.

Key Path	Source, List Sequencer
----------	------------------------

Number of Steps

Allows you to specify the number of steps within the list sequence.

Key Path	Source, List Sequencer, List Sequencer Setup
Remote Command	:SOURce:LIST:NUMBer:STEPs <integer> :SOURce:LIST:NUMBer:STEPs?
Example	:SOUR:LIST:NUMB:STEP 1
Notes	Increasing the number of steps creates additional steps at the end of the list, with all the settings within the steps set to their default values. Decreasing the number of steps removes steps from the end of the list. The settings within the removed steps are not reset. This means that increasing the number of steps again would allow you to retrieve these steps.
Dependencies	The Step Count parameter is increased or decreased when you insert or delete a point from within the GUI interface to the sequencer.
Preset	1
Min	1
Max	1000
Initial S/W Revision	A.05.00

Current Step

Allows you to select the step number you wish to view or edit.

Key Path	Source, List Sequencer, List Sequencer Setup
----------	--

Notes	No remote command, front panel only.
Preset	1
Min	1
Max	Step Count
Initial S/W Revision	A.05.00

Insert Step Before

Allows you to insert a new step, containing default values, before the currently selected step. Inserting a step will automatically increase the Step Count parameter by 1. If sequence already reaches upper limit of 1000 steps, then insert more step will be rejected and popup error –221, “Setting Conflict; Cannot insert more steps, maximum number of steps reached”

Key Path	Source, List Sequencer, List Sequencer Setup
Notes	No remote command, front panel only. If the list already contains the maximum limit of 1000 steps, no operation will be made after pressing this key.
Initial S/W Revision	A.05.00

Delete Step

Allows you to delete the current step. Deleting a step will automatically decrease the Step Count parameter by 1. If sequence only has one step left, delete step will be rejected and popup error –221, “Setting conflict; Cannot delete current step, minimum number of steps reached”

Key Path	Source, List Sequencer, List Sequencer Setup
Notes	No remote command, Front Panel key only. If the list already contains the minimum limit of 1 step, no operation will be made after pressing this key
Initial S/W Revision	A.05.00

Clear List

Allows you to clear the list. Clearing the list sets the number of steps to the default value of 1 and sets the parameters for the only step to their default values.

Key Path	Source, List Sequencer, List Sequencer Setup
Initial S/W Revision	A.05.00

Step Trigger

Allows access to the sub-menu for selecting the trigger input for the current step.

Key Path	Source, List Sequencer, List Sequencer Setup
Remote Command	:SOURCE:LIST:STEP[1] 2 3...1000:SETup:INPut:TRIGger IMMEDIATE INTERNAL EXTERNAL2 KEY BUS EXTERNAL4 :SOURCE:LIST:STEP[1] 2 3...1000:SETup:INPut:TRIGger?
Example	:SOUR:LIST:STEP2:SET:INP:TRIG BUS :SOUR:LIST:STEP2:SET:INP:TRIG?
Notes	SCPI is supported after A.09.40
Preset	Free Run
Range	Free Run Internal Manual (Trigger Key) Bus External 2 EXTERNAL4
Initial S/W Revision	A.05.00

Free Run

Sets the trigger input for the current step to Free Run.

Key Path	Source, List Sequencer, List Sequencer Setup, Step Trigger
Example	:SOUR:LIST:STEP2:SET:INP:TRIG IMM
Notes	SCPI is supported after A.09.40
Initial S/W Revision	A.05.00

Internal

Sets the trigger input for the current step to Internal.

Key Path	Source, List Sequencer, List Sequencer Setup, Step Trigger
Example	:SOUR:LIST:STEP2:SET:INP:TRIG INT
Notes	SCPI is supported after A.09.40
Initial S/W Revision	A.05.00

Manual (Trigger Key)

Sets the trigger input for the current step to Manual (Trigger Key). Any step in the sequence set to Manual will cause the sequence execution to stop until the manual trigger key is pressed. Sending the Bus Trigger SCPI command will have no effect. At any point in the sequence where the list sequencer is paused waiting for a software trigger, a pop up dialog is displayed until the trigger event occurs.

Key Path	Source, List Sequencer, List Sequencer Setup, Step Trigger
Example	:SOUR:LIST:STEP2:SET:INP:TRIG KEY
Notes	SCPI is supported after A.09.40
Initial S/W Revision	A.05.00

Bus

Sets the trigger input for the current step to Bus. Any step in the sequence set to Bus will cause the sequence execution to stop until the Bus Trigger SCPI command is sent. Pressing the manual trigger key has no effect. At any point in the sequence where the list sequencer is paused waiting for a software trigger, a pop up dialog is displayed until the trigger event occurs.

Key Path	Source, List Sequencer, List Sequencer Setup, Step Trigger
Example	:SOUR:LIST:STEP2:SET:INP:TRIG BUS
Notes	SCPI is supported after A.09.40
Initial S/W Revision	A.05.00

External 2

Sets the trigger input for the current step to External 2.

Key Path	Source, List Sequencer, List Sequencer Setup, Step Trigger
Example	:SOUR:LIST:STEP2:SET:INP:TRIG EXT2
Notes	SCPI is supported after A.09.40
Notes	Note: When on E6640A, trigger 2 is a bi-directional trigger port. So when trigger 2 has been configured as OUTPUT type, choosing External 2 as the input trigger for the current step will generate error.
Initial S/W Revision	A.05.00

Transition Time

Allows you to specify the transition time for the current step.

The transition time is the amount of time allowed for the source to settle at the current frequency or amplitude value.

Transition Time should not be taken as additional time before or inside the Step Duration. You can set a value for the settling time to allow the source output frequency or amplitude to become stable. Make sure that during this period of time, you do not use the source output signal.

The following table lists recommended values for appropriate settling times to allow for changes within the source.

Value Changed	Recommended Transition Time
Frequency	500 μ s
Amplitude	100 μ s to within 0.1 dB 20 μ s to within 1.0 dB

If the Transition Time value is shorter than the time necessary for the hardware to settle and a List Sequence is initiated, a **warning** is generated.

If the Transition Time value is longer than the Step Duration, an error is generated when initiating a source list sequence. For source list sequence, transition time is included in the step duration length. If the Transition Time value is longer than the Step Duration Time, the real step duration length is extended to equal the transition time and cause a timing shift.

Key Path	Source, List Sequencer, List Sequencer Setup
Remote Command	:SOURce:LIST:STEP[1] 2 3...1000:SETup:TRANsition:TIME <time> :SOURce:LIST:STEP[1] 2 3...1000:SETup:TRANsition:TIME?
Example	:SOUR:LIST:STEP2:SET:TRAN:TIME 1ms :SOUR:LIST:STEP2:SET:TRAN:TIME?
Notes	SCPI is supported after A.09.40
Preset	1.0 ms
Min	0.0 ms
Max	4.0 ks
Initial S/W Revision	A.05.00

Radio Setup

Allows you access to the sub-menus for setting up the radio standard, band, and radio band link direction for the current step.

Key Path	Source, List Sequencer, List Sequencer Setup
Notes	No remote command, front panel only.
Initial S/W Revision	A.05.00

Radio Standard

Allows access to the sub-menus for selecting the radio standard and the associated radio band for use in the current step.

Key Path	Source, List Sequencer, List Sequencer Setup, Radio Setup
Remote Command	:SOURce:LIST:STEP[1] 2 3...1000:SETup:RADio:BAND NONE PGSM EGSM RGSM DCS1800 PCS1900 TGSM810 GSM450 GSM480 GSM700 GSM850 BANDI BANDII BANDIII BANDIV BANDV BANDVI BANDVII BANDVIII BANDIX BANDX BANDXI BANDXII BANDXIII BANDXIV BANDXIX USCELL USPCS JAPAN KOREAN NMT IMT2K UPPER SECOND PAMR400 PAMR800 IMTEXT PCS1DOT9G AWS US2DOT5G PUBLIC LOWER NONE BAND1 BAND2 BAND3 BAND4 BAND5 BAND6 BAND7 BAND8 BAND10 BAND11 BAND12 BAND13 BAND14 BAND17 BAND18 BAND19 BAND20 BAND21 BAND24 BAND25 BAND26 BAND27 BAND28 BAND31 BAND33 BAND34 BAND35 BAND36 BAND37 BAND38

BAND39 | BAND40 | BAND41 | BAND42 | BAND43 | BAND44 | BANDA | BANDB |
BANDC | BANDD | BANDE | BANDF

:SOURce:LIST:STEP[1]|2|3...1000:SETup: RADio:BAND?

Example :SOUR:LIST:STEP2:SET:RAD:BAND PGSM
:SOUR:LIST:STEP2:SET:RAD:BAND?

Notes SCPI is supported after A.09.40

Initial S/W Revision A.05.00

None

Selects no radio standard for use on the current step.

Key Path Source, List Sequencer, List Sequencer Setup, Radio Setup, Radio Standard

Example :SOUR:LIST:STEP2:SET:RAD:BAND NONE

Notes SCPI is supported after A.09.40

Initial S/W Revision A.05.00

GSM/EDGE

Pressing this key once selects GSM/EDGE as the radio standard and the current GSM/EDGE band as the active channel band. Pressing this key again allows access to the sub-menus for selecting a different GSM/EDGE band.

Key Path Source, List Sequencer, List Sequencer Setup, Radio Setup, Radio Standard

Initial S/W Revision A.05.00

P-GSM

Selects P-GSM as the band for the current step.

Key Path Source, List Sequencer, List Sequencer Setup, Radio Setup, Radio Standard, GSM/EDGE

Initial S/W Revision A.05.00

E-GSM

Selects E-GSM as the band for the current step.

Key Path Source, List Sequencer, List Sequencer Setup, Radio Setup, Radio Standard, GSM/EDGE

Initial S/W Revision A.05.00

R-GSM

Selects R-GSM as the band for the current step.

Key Path	Source, List Sequencer, List Sequencer Setup, Radio Setup, Radio Standard, GSM/EDGE
Initial S/W Revision	A.05.00

DCS 1800

Selects DCS 1800 as the band for the current step.

Key Path	Source, List Sequencer, List Sequencer Setup, Radio Setup, Radio Standard, GSM/EDGE
Initial S/W Revision	A.05.00

PCS 1900

Selects PCS 1900 as the band for the current step.

Key Path	Source, List Sequencer, List Sequencer Setup, Radio Setup, Radio Standard, GSM/EDGE
Initial S/W Revision	A.05.00

GSM 450

Selects GSM 450 as the band for the current step.

Key Path	Source, List Sequencer, List Sequencer Setup, Radio Setup, Radio Standard, GSM/EDGE
Initial S/W Revision	A.05.00

GSM 480

Selects GSM 480 as the band for the current step.

Key Path	Source, List Sequencer, List Sequencer Setup, Radio Setup, Radio Standard, GSM/EDGE
Initial S/W Revision	A.05.00

GSM 850

Selects GSM 850 as the band for the current step.

Key Path	Source, List Sequencer, List Sequencer Setup, Radio Setup, Radio Standard, GSM/EDGE
Initial S/W Revision	A.05.00

GSM 700

Selects GSM 700 as the band for the current step.

Key Path	Source, List Sequencer, List Sequencer Setup, Radio Setup, Radio Standard, GSM/EDGE
Initial S/W Revision	A.05.00

T-GSM 810

Selects T-GSM 810 as the band for the current step.

Key Path	Source, List Sequencer, List Sequencer Setup, Radio Setup, Radio Standard, GSM/EDGE
Initial S/W Revision	A.05.00

WCDMA

Pressing this key once selects WCDMA as the radio standard and the current WCDMA band as the active channel band. Pressing this key again allows access to the sub-menus for selecting a different WCDMA band.

Key Path	Source, List Sequencer, List Sequencer Setup, Radio Setup, Radio Standard
Initial S/W Revision	A.05.00

Band I

Selects Band I as the band for the current step.

Key Path	Source, List Sequencer, List Sequencer Setup, Radio Setup, Radio Standard, WCDMA
Initial S/W Revision	A.05.00

Band II

Selects Band II as the band for the current step.

Key Path	Source, List Sequencer, List Sequencer Setup, Radio Setup, Radio Standard, WCDMA
Initial S/W Revision	A.05.00

Band III

Selects Band III as the band for the current step.

Key Path	Source, List Sequencer, List Sequencer Setup, Radio Setup, Radio Standard, WCDMA
Initial S/W Revision	A.05.00

Band IV

Selects Band IV as the band for the current step.

Key Path	Source, List Sequencer, List Sequencer Setup, Radio Setup, Radio Standard, WCDMA
Initial S/W Revision	A.05.00

Band V

Selects Band V as the band for the current step.

Key Path	Source, List Sequencer, List Sequencer Setup, Radio Setup, Radio Standard, WCDMA
Initial S/W Revision	A.05.00

Band VI

Selects Band VI as the band for the current step.

Key Path	Source, List Sequencer, List Sequencer Setup, Radio Setup, Radio Standard, WCDMA
Initial S/W Revision	A.05.00

Band VII

Selects Band VII as the band for the current step.

Key Path	Source, List Sequencer, List Sequencer Setup, Radio Setup, Radio Standard, WCDMA
Initial S/W Revision	A.05.00

Band VIII

Selects Band VIII as the band for the current step.

Key Path	Source, List Sequencer, List Sequencer Setup, Radio Setup, Radio Standard, WCDMA
Initial S/W Revision	A.05.00

Band IX

Selects Band IX as the band for the current step.

Key Path	Source, List Sequencer, List Sequencer Setup, Radio Setup, Radio Standard, WCDMA
Initial S/W Revision	A.05.00

Band X

Selects Band X as the band for the current step.

Key Path	Source, List Sequencer, List Sequencer Setup, Radio Setup, Radio Standard, WCDMA
Initial S/W Revision	A.05.00

Band XI

Selects Band XI as the band for the current step.

Key Path	Source, List Sequencer, List Sequencer Setup, Radio Setup, Radio Standard, WCDMA
Initial S/W Revision	A.05.00

Band XII

Selects Band XII as the band for the current step.

Key Path	Source, List Sequencer, List Sequencer Setup, Radio Setup, Radio Standard, WCDMA
Initial S/W Revision	A.05.00

Band XIII

Selects Band XIII as the band for the current step.

Key Path	Source, List Sequencer, List Sequencer Setup, Radio Setup, Radio Standard, WCDMA
Initial S/W Revision	A.05.00

Band XIV

Selects Band XIV as the band for the current step.

Key Path	Source, List Sequencer, List Sequencer Setup, Radio Setup, Radio Standard, WCDMA
Initial S/W Revision	A.05.00

Band XIX

Selects Band XIX as the band for the current step.

Key Path	Source, List Sequencer, List Sequencer Setup, Radio Setup, Radio Standard, WCDMA
Initial S/W Revision	A.14.50

CDMA 2000 / 1xEVDO

Pressing this key once selects CDMA 2000/1xEVDO as the radio standard and the current CDMA 2000/1xEVDO band as the active channel band. Pressing this key again allows access to the sub-menus for selecting a different CDMA 2000/1xEVDO band.

Key Path	Source, List Sequencer, List Sequencer Setup, Radio Setup, Radio Standard
Initial S/W Revision	A.05.00

US CELL

Selects US Cell as the band for the current step.

Key Path	Source, List Sequencer, List Sequencer Setup, Radio Setup, Radio Standard, CDMA 2000 / 1xEVDO
Initial S/W Revision	A.05.00

US PCS

Selects US PCS as the band for the current step.

Key Path	Source, List Sequencer, List Sequencer Setup, Radio Setup, Radio Standard, CDMA 2000 / 1xEVDO
Initial S/W Revision	A.05.00

Japan Cell

Selects Japan Cell as the band for the current step.

Key Path	Source, List Sequencer, List Sequencer Setup, Radio Setup, Radio Standard, CDMA 2000 / 1xEVDO
Initial S/W Revision	A.05.00

Korean PCS

Selects Korean PCS as the band for the current step.

Key Path	Source, List Sequencer, List Sequencer Setup, Radio Setup, Radio Standard, CDMA 2000 / 1xEVDO
Initial S/W Revision	A.05.00

NMT 450

Selects NMT 450 as the band for the current step.

Key Path	Source, List Sequencer, List Sequencer Setup, Radio Setup, Radio Standard, CDMA 2000 / 1xEVDO
Initial S/W Revision	A.05.00

IMT 2000

Selects IMT 2000 as the band for the current step.

Key Path	Source, List Sequencer, List Sequencer Setup, Radio Setup, Radio Standard, CDMA 2000 / 1xEVDO
Initial S/W Revision	A.05.00

Upper 700

Selects Upper 700 as the band for the current step.

Key Path	Source, List Sequencer, List Sequencer Setup, Radio Setup, Radio Standard, CDMA 2000 / 1xEVDO
Initial S/W Revision	A.05.00

Secondary 800

Selects Secondary 800 as the band for the current step.

Key Path	Source, List Sequencer, List Sequencer Setup, Radio Setup, Radio Standard, CDMA 2000 / 1xEVDO
Initial S/W Revision	A.05.00

400 Euro PAMR

Selects 400 Euro PAMR as the band for the current step.

Key Path	Source, List Sequencer, List Sequencer Setup, Radio Setup, Radio Standard, CDMA 2000 / 1xEVDO
Initial S/W Revision	A.05.00

800 PAMR

Selects 800 PAMR as the band for the current step.

Key Path	Source, List Sequencer, List Sequencer Setup, Radio Setup, Radio Standard, CDMA 2000 / 1xEVDO
Initial S/W Revision	A.05.00

2.5GHz IMT EXT

Selects 2.5 GHz IMT EXT as the band for the current step.

Key Path	Source, List Sequencer, List Sequencer Setup, Radio Setup, Radio Standard, CDMA 2000 / 1xEVDO
Initial S/W Revision	A.05.00

US PCS 1.9GHz

Selects US PCS 1.9 GHz as the band for the current step.

Key Path	Source, List Sequencer, List Sequencer Setup, Radio Setup, Radio Standard, CDMA 2000 / 1xEVDO
Initial S/W Revision	A.05.00

AWS

Selects AWS as the band for the current step.

Key Path	Source, List Sequencer, List Sequencer Setup, Radio Setup, Radio Standard, CDMA 2000 / 1xEVDO
Initial S/W Revision	A.05.00

US 2.5GHz

Selects US 2.5 GHz as the band for the current step.

Key Path	Source, List Sequencer, List Sequencer Setup, Radio Setup, Radio Standard, CDMA 2000 / 1xEVDO
Initial S/W Revision	A.05.00

700 Public Safety

Selects 700 Public Safety as the band for the current step.

Key Path	Source, List Sequencer, List Sequencer Setup, Radio Setup, Radio Standard, CDMA 2000 / 1xEVDO
Initial S/W Revision	A.05.00

C2K Lower 700

Selects C2K Lower 700 as the band for the current step.

Key Path	Source, List Sequencer, List Sequencer Setup, Radio Setup, Radio Standard, CDMA 2000 / 1xEVDO
Initial S/W Revision	A.05.00

LTE

Pressing this key once selects LTE FDD as the radio standard and the current LTE FDD band as the active channel band. Pressing this key again allows access to the sub-menus for selecting a different LTE FDD band.

Key Path	Source, List Sequencer, List Sequencer Setup, Radio Setup, Radio Standard
Initial S/W Revision	A.09.50

BAND 1

Selects BAND 1 as the band for the current step.

Key Path	Source, List Sequencer, List Sequencer Setup, Radio Setup, Radio Standard, LTE
Initial S/W Revision	A.09.50

BAND 2

Selects BAND 2 as the band for the current step.

Key Path	Source, List Sequencer, List Sequencer Setup, Radio Setup, Radio Standard, LTE
Initial S/W Revision	A.09.50

BAND 3

Selects BAND 3 as the band for the current step.

Key Path	Source, List Sequencer, List Sequencer Setup, Radio Setup, Radio Standard, LTE
Initial S/W Revision	A.09.50

BAND 4

Selects BAND 4 as the band for the current step.

Key Path	Source, List Sequencer, List Sequencer Setup, Radio Setup, Radio Standard, LTE
Initial S/W Revision	A.09.50

BAND 5

Selects BAND 5 as the band for the current step.

Key Path	Source, List Sequencer, List Sequencer Setup, Radio Setup, Radio Standard, LTE
Initial S/W Revision	A.09.50

BAND 6

Selects BAND 6 as the band for the current step.

Key Path	Source, List Sequencer, List Sequencer Setup, Radio Setup, Radio Standard, LTE
Initial S/W Revision	A.09.50

BAND 7

Selects BAND 7 as the band for the current step.

Key Path	Source, List Sequencer, List Sequencer Setup, Radio Setup, Radio Standard, LTE
Initial S/W Revision	A.09.50

BAND 8

Selects BAND 8 as the band for the current step.

Key Path	Source, List Sequencer, List Sequencer Setup, Radio Setup, Radio Standard, LTE
Initial S/W Revision	A.09.50

BAND 9

Selects BAND 9 as the band for the current step.

Key Path	Source, List Sequencer, List Sequencer Setup, Radio Setup, Radio Standard, LTE
Initial S/W Revision	A.09.50

BAND 10

Selects BAND 10 as the band for the current step.

Key Path	Source, List Sequencer, List Sequencer Setup, Radio Setup, Radio Standard, LTE
Initial S/W Revision	A.09.50

BAND 11

Selects BAND 11 as the band for the current step.

Key Path	Source, List Sequencer, List Sequencer Setup, Radio Setup, Radio Standard, LTE
Initial S/W Revision	A.09.50

BAND 12

Selects BAND 12 as the band for the current step.

Key Path	Source, List Sequencer, List Sequencer Setup, Radio Setup, Radio Standard, LTE
Initial S/W Revision	A.09.50

BAND 13

Selects BAND 13 as the band for the current step.

Key Path	Source, List Sequencer, List Sequencer Setup, Radio Setup, Radio Standard, LTE
Initial S/W Revision	A.09.50

BAND 14

Selects BAND 14 as the band for the current step.

Key Path	Source, List Sequencer, List Sequencer Setup, Radio Setup, Radio Standard, LTE
Initial S/W Revision	A.09.50

BAND 17

Selects BAND 17 as the band for the current step.

Key Path	Source, List Sequencer, List Sequencer Setup, Radio Setup, Radio Standard, LTE
Initial S/W Revision	A.09.50

BAND 18

Selects BAND 18 as the band for the current step.

Key Path	Source, List Sequencer, List Sequencer Setup, Radio Setup, Radio Standard, LTE
Initial S/W Revision	A.09.50

BAND 19

Selects BAND 19 as the band for the current step.

Key Path	Source, List Sequencer, List Sequencer Setup, Radio Setup, Radio Standard, LTE
Initial S/W Revision	A.09.50

BAND 20

Selects BAND 20 as the band for the current step.

Key Path	Source, List Sequencer, List Sequencer Setup, Radio Setup, Radio Standard, LTE
Initial S/W Revision	A.09.50

BAND 21

Selects BAND 21 as the band for the current step.

Key Path	Source, List Sequencer, List Sequencer Setup, Radio Setup, Radio Standard, LTE
Initial S/W Revision	A.09.50

BAND 24

Selects BAND 24 as the band for the current step.

Key Path	Source, List Sequencer, List Sequencer Setup, Radio Setup, Radio Standard, LTE
Initial S/W Revision	A.09.50

BAND 25

Selects BAND 25 as the band for the current step.

Key Path	Source, List Sequencer, List Sequencer Setup, Radio Setup, Radio Standard, LTE
Initial S/W Revision	A.09.50

BAND 26

Selects BAND 26 as the band for the current step.

Key Path	Source, List Sequencer, List Sequencer Setup, Radio Setup, Radio Standard, LTE
Initial S/W Revision	A.12.53

BAND 27

Selects BAND 27 as the band for the current step.

Key Path	Source, List Sequencer, List Sequencer Setup, Radio Setup, Radio Standard, LTE
Initial S/W Revision	A.14.00

BAND 28

Selects BAND 28 as the band for the current step.

Key Path	Source, List Sequencer, List Sequencer Setup, Radio Setup, Radio Standard, LTE
Initial S/W Revision	A.14.00

BAND 31

Selects BAND 31 as the band for the current step.

Key Path	Source, List Sequencer, List Sequencer Setup, Radio Setup, Radio Standard, LTE
Initial S/W Revision	A.14.00

LTE TDD

Sets LTE TDD as the radio standard for use and accesses the LTE TDD specific channel band sub-menus..

Key Path	Source, Frequency, Radio Setup, Radio Standard
Initial S/W Revision	A.11.50

BAND 33

Selects BAND 33 as the band for the current step.

Key Path	Source, Frequency, Radio Setup, Radio Standard, LTE TDD
Example	:SOUR:FREQ:CHAN:BAND BAND33
Initial S/W Revision	A.11.50

BAND 34

Selects BAND 34 as the band for the current step.

Key Path	Source, Frequency, Radio Setup, Radio Standard, LTE TDD
Example	:SOUR:FREQ:CHAN:BAND BAND34
Initial S/W Revision	A.11.50

BAND 35

Selects BAND 35 as the band for the current step.

Key Path	Source, Frequency, Radio Setup, Radio Standard, LTE TDD
Example	:SOUR:FREQ:CHAN:BAND BAND35
Initial S/W Revision	A.11.50

BAND 36

Selects BAND 36 as the band for the current step.

Key Path	Source, Frequency, Radio Setup, Radio Standard, LTE TDD
Example	:SOUR:FREQ:CHAN:BAND BAND36
Initial S/W Revision	A.11.50

BAND 37

Selects BAND 37 as the band for the current step.

Key Path	Source, Frequency, Radio Setup, Radio Standard, LTE TDD
Example	:SOUR:FREQ:CHAN:BAND BAND37
Initial S/W Revision	A.11.50

BAND 38

Selects BAND 38 as the band for the current step.

Key Path	Source, Frequency, Radio Setup, Radio Standard, LTE TDD
Example	:SOUR:FREQ:CHAN:BAND BAND38
Initial S/W Revision	A.11.50

BAND 39

Selects BAND 39 as the band for the current step.

Key Path	Source, Frequency, Radio Setup, Radio Standard, LTE TDD
Example	:SOUR:FREQ:CHAN:BAND BAND39
Initial S/W Revision	A.11.50

BAND 40

Selects BAND 40 as the band for the current step.

Key Path	Source, Frequency, Radio Setup, Radio Standard, LTE TDD
Example	:SOUR:FREQ:CHAN:BAND BAND40
Initial S/W Revision	A.11.50

BAND 41

Selects BAND 41 as the band for the current step.

Key Path	Source, Frequency, Radio Setup, Radio Standard, LTE TDD
Example	:SOUR:FREQ:CHAN:BAND BAND41
Initial S/W Revision	A.11.50

BAND 42

Selects BAND 42 as the band for the current step.

Key Path	Source, Frequency, Radio Setup, Radio Standard, LTE TDD
Example	:SOUR:FREQ:CHAN:BAND BAND42
Initial S/W Revision	A.11.50

BAND 43

Selects BAND 43 as the band for the current step.

Key Path	Source, Frequency, Radio Setup, Radio Standard, LTE TDD
Example	:SOUR:FREQ:CHAN:BAND BAND43
Initial S/W Revision	A.11.50

BAND 44

Selects BAND 44 as the band for the current step.

Key Path	Source, List Sequencer, List Sequencer Setup, Radio Setup, Radio Standard, LTE TDD
Initial S/W Revision	A.14.00

TDSCDMA

Sets TDSCDMA as the radio standard for use and accesses the TDSCDMA specific channel band sub-menus..

Key Path	Source, Frequency, Radio Setup, Radio Standard
Initial S/W Revision	A.11.50

BAND A

Selects BAND A as the band for the current step.

Key Path	Source, Frequency, Radio Setup, Radio Standard, TDSCDMA
Example	:SOUR:FREQ:CHAN:BAND BANDA
Initial S/W Revision	A.11.50

BAND B

Selects BAND B as the band for the current step.

Key Path	Source, Frequency, Radio Setup, Radio Standard, TDSCDMA
Example	:SOUR:FREQ:CHAN:BAND BANDB
Initial S/W Revision	A.11.50

BAND C

Selects BAND C as the band for the current step.

Key Path	Source, Frequency, Radio Setup, Radio Standard, TDSCDMA
Example	:SOUR:FREQ:CHAN:BAND BANDC
Initial S/W Revision	A.11.50

BAND D

Selects BAND D as the band for the current step.

Key Path	Source, Frequency, Radio Setup, Radio Standard, TDSCDMA
Example	:SOUR:FREQ:CHAN:BAND BANDD
Initial S/W Revision	A.11.50

BAND E

Selects BAND E as the band for the current step.

Key Path	Source, Frequency, Radio Setup, Radio Standard, TDSCDMA
----------	---

Example	:SOUR:FREQ:CHAN:BAND BANDE
Initial S/W Revision	A.11.50

BAND F

Selects BAND F as the band for the current step.

Key Path	Source, Frequency, Radio Setup, Radio Standard, TDSCDMA
Example	:SOUR:FREQ:CHAN:BAND BANDF
Initial S/W Revision	A.11.50

Radio Band Link

Allows you to specify the radio band link direction for the steps within the list sequence. The link is used in conjunction with the channel band and channel number to determine the output frequency.

When set to “Uplink”, the source will calculate the uplink frequency according to an uplink formula together with selected channel band and channel number. When set to “Downlink”, the source will calculate the downlink frequency according to a downlink formula together with selected channel band and channel number.

Key Path	Source, List Sequencer, List Sequencer Setup, Radio Setup
Remote Command	:SOURce:LIST:STEP [1] 2 3...1000:SETup:RADio:BAND:LINK DOWN UP :SOURce:LIST:STEP [1] 2 3...1000:SETup:RADio:BAND:LINK?
Example	:SOUR:LIST:STEP2:SET:RAD:BAND:LINK UP :SOUR:LIST:STEP2:SET:RAD:BAND:LINK?
Notes	SCPI is supported after A.09.40
Preset	DOWN
Range	DOWN UP
Initial S/W Revision	A.05.00

Channel

Allows you to specify the frequency of the current step via a channel number.

Key Path	Source, List Sequencer, List Sequencer Setup
Remote Command	:SOURce:LIST:STEP [1] 2 3...1000:SETup:CNFRrequency <double> :SOURce:LIST:STEP [1] 2 3...1000:SETup:CNFRrequency?
Example	:SOUR:LIST:STEP2:SET:CNFR 124 :SOUR:LIST:STEP2:SET:CNFR?
Notes	SCPI is supported after A.09.40.

	This SCPI is used to setup channel number or frequency setting, according to current Radio Band setting. If Radio Band is "NONE", then it's frequency. If Radio Band is not "NONE", then it's channel number.
Couplings	The channel number is coupled to the step frequency value. When the step frequency value is changed, the channel number will increase or decrease to match the new step frequency. If the step frequency is not at an exact match for a channel number, the nearest channel number is displayed, along with a greater than, or less than sign to indicate the frequency is above or below the channel number.
Preset	1
Min	0 (Please refer to for valid ranges.)
Max	10838 (Please refer to for valid ranges.)
Initial S/W Revision	A.05.00

Frequency

Allows you to specify a frequency value for the current step.

Key Path	Source, List Sequencer, List Sequencer Setup
Remote Command	:SOURce:LIST:STEP[1] 2 3...1000:SETup:CNFRfrequency <double> :SOURce:LIST:STEP[1] 2 3...1000:SETup:CNFRfrequency?
Example	:SOUR:LIST:STEP2:SET:CNFR 1GHz :SOUR:LIST:STEP2:SET:CNFR?
Notes	SCPI is supported after A.09.40. This SCPI is used to setup channel number or frequency setting, according to current Radio Band setting. If Radio Band is "NONE", then it's frequency. If Radio Band is not "NONE", then it's channel number.
Couplings	The frequency value is coupled to the channel band and number for the step, such that updates to the radio band and channel number will update the frequency value to the corresponding absolute frequency. The reverse is also true, changing the frequency value causes the value of the channel number to be updated.
Preset	1.00 GHz
Min	10.00 MHz
Max	Hardware Dependant: Option 503 = 3.6 GHz Option 504 = 3.9 GHz Option 506 = 6.00 GHz
Initial S/W Revision	A.05.00

Power

Allows you to specify a power value for the current step.

Key Path	Source, List Sequencer, List Sequencer Setup
Remote Command	:SOURce:LIST:STEP[1] 2 3...1000:SETup:AMPLitude <double> :SOURce:LIST:STEP[1] 2 3...1000:SETup:AMPLitude?
Example	:SOUR:LIST:STEP2:SET:AMPL -50dBm :SOUR:LIST:STEP2:SET:AMPL?
Notes	SCPI is supported after A.09.40
Notes	<p>Amplitude corrections can be specified for use with the source. In the event of amplitude corrections being applied, the valid ranges for the RF power do not change dependant on the current amplitude correction setting. Instead, if the combination of RF power + amplitude correction is higher or lower than the source output range, the Source Unleveled bit is set and the “Source Unleveled” indicator will appear on status panel to indicate that the source cannot maintain the output power that has been requested.</p> <p>The multiport adapter RFIO TX ports and GPS ports cannot ensure power accuracy when power setting is lower than -130dBm, this power setting value is defined by the sum of RF Power setting and related amplitude correction value. But user settable value could be lower than this limit. When application detected there exists power setting lower than -130dBm on MPA RFIO TX ports, then popup warning message . When application detected there exists power setting lower than -130dBm on MPA GPS ports, then popup warning message . These are only warning messages, and check is performed when RF is ON.</p>
Notes	The Min and Max value here defined UI settable amplitude range. This range is larger than actual amplitude range with level accuracy defined in spec.
Dependencies	The RF power is dependent on the RF output port and frequency, such that the current frequency and selected output port determine the valid range of power values.
Preset	-100 dBm
Min	The range of values depends on the current frequency and selected RF output port. Please refer to "RF Power" on page 2442 and the table RF Power Range for the valid ranges.
Max	The range of values depends on the current frequency and selected RF output port. Please refer to "RF Power" on page 2442 and the table RF Power Range for the valid ranges.
Initial S/W Revision	A.05.00

Waveform

Allows you access to the sub-menus for selecting the waveform to be played back during the current step. Pressing this key also changes the central display area to show the Waveform File Selection view.

Key Path	Source, List Sequencer, List Sequencer Setup
Remote Command	:SOURce:LIST:STEP[1] 2 3...1000:SETup:WAVEform <string> :SOURce:LIST:STEP[1] 2 3...1000:SETup:WAVEform?
Example	:SOUR:LIST:STEP2:SET:WAV "CW" :SOUR:LIST:STEP2:SET:WAV?
Notes	SCPI is supported after A.09.40
Remote Command Notes	String type, takes “Off” “CW” “Cont” “waveform name”

Preset	CW
Range	Waveform Continue Previous CW Off
Initial S/W Revision	A.05.00

CW

Sets the current step to output a CW tone.

Key Path	Source, List Sequencer, List Sequencer Setup, Waveform
Example	:SOUR:LIST:STEP2:SET:WAV "CW"
Notes	SCPI is supported after A.09.40
Initial S/W Revision	A.05.00

Selected Waveform

Inserts the currently selected waveform in the waveform selection view as the waveform for playback during the current step.

Key Path	Source, List Sequencer, List Sequencer Setup, Waveform
Example	:SOUR:LIST:STEP2:SET:WAV "waveform name"
Notes	SCPI is supported after A.09.40 If the selected waveform contains header (which contains ARB play parameters), source list sequence will automatically apply header settings of the selected waveform in that step.
Initial S/W Revision	A.05.00

Continue Previous

Sets the current step to continue with playback of the waveform from the previous step. When continuing the previous waveform, the ARB playback will not pause while the source retunes to the new frequency or amplitude that may be defined for the new step.

Key Path	Source, List Sequencer, List Sequencer Setup, Waveform
Example	:SOUR:LIST:STEP2:SET:WAV "Cont"
Notes	SCPI is supported after A.09.40
Initial S/W Revision	A.05.00

Off

Disable RF output of the current step.

Key Path	Source, List Sequencer, List Sequencer Setup, Waveform
Example	:SOUR:LIST:STEP2:SET:WAV "Off"
Notes	SCPI is supported after A.09.40
Initial S/W Revision	A.05.00

Segments on Hard Disk

Allows you access to the sub-menus for loading waveform segments from the hard disk into ARB memory. The default directory is: D: varb.

Pressing this key changes the current view to the Waveform Management View.

Key Path	Source, Modulation Setup, ARB, Select Waveform
Initial S/W Revision	A.05.00

Load Segment To ARB Memory

Allows you to load the selected file into ARB memory. On the front panel you select the file for loading to the ARB memory by highlighting the desired file in the list. Using the SCPI command, you specify the file name on the HDD.

“NVWFM” (none-volatile storage) MSUS (Mass Storage Unit Specifier) is supported in the memory subsystem because the ARB memory cannot be accessed directly. Therefore, files must be downloaded to the instrument hard disk and then loaded into the ARB memory. “NVWFM” MSUS will be mapped to the default directory D: VARB. The SCPI command supports using either “NVWFM” MSUS or specifying a full path. For more information, see [Memory Subsystem \(Remote Command Only\)](#).

If a file of the same name already exists within ARB memory, it is overwritten. If you wish to load two segments of the same name, you must rename one of the segments before loading it into ARB memory. To rename a segment, you can either use Windows File Explorer, or the :MMEMory:COPY command.

NOTE: When a waveform file is loaded to ARB memory, burst timing adjustments are made automatically, based on whether or not a Multiport Adapter is connected to the test set and powered on. If the connection/power status of the Multiport Adapter is changed after a waveform file has been loaded, it needs to be loaded again.

Key Path	Source, Modulation Setup, ARB, Select Waveform, Segments on Hard Disk
Remote Command	:SOURce:RADio:ARB:LOAD <string>
Example	:SOUR:RAD:ARB:LOAD "D: VARB\testwaveform.bin" or :SOUR:RAD:ARB:LOAD "NVWFM:testwaveform.bin"
Notes	Because loading the file involves a delay of unpredictable length, this command should be followed by the query *OPC?, which holds off subsequent commands until the loading operating is complete. <string> – specifies the path name of the file to load from the HDD into ARB memory. It could be a <full path + filename>, or <"NVWFM" MSUS + colon + filename>.

When in Sequence Analyzer mode, and Include Source is Yes, an attempt to load a file to ARB memory will be rejected with an error.

When Include Source is No and if there is insufficient free ARB memory to load the selected waveform, an error is generated. .

If you specify a file over SCPI, but the file is not at the specified location, an error is generated.

If you try to load a waveform file but the file contains less than 500 IQ samples, an error is generated.

If you try to load a Signal Studio waveform “*.wfm” which contains invalid waveform header, an error is generated.

If the ARB is ON when you load a file to ARB memory or delete a file from ARB memory, the playing waveform segment may not keep phase continuity during the ARB memory operation. The waveform will be replayed after the ARB operation is finished.

ARB can be loaded into ARB memory even required licenses do not present on the instrument. In this case, a GUI only warning message -800, “Operation complete; Loaded <filename> successfully, but no license <required licenses> installed”. User can install required licenses according to <required licenses> string to license it, or multi-pack license it.

Initial S/W Revision A.05.00

Load All To ARB Memory

Allows you to load all the segment files within the currently selected directory into ARB memory. If a file of the same name already exists within ARB memory, it is overwritten. If you wish to load two segments of the same name, you must rename one of the segments before loading it into ARB memory. To rename a segment, you can either use Windows File Explorer, or the :MEMory:COpy command.

NOTE: When a waveform file is loaded to ARB memory, burst timing adjustments are made automatically, based on whether or not a Multiport Adapter is connected to the test set and powered on. If the connection/power status of the Multiport Adapter is changed after a waveform file has been loaded, it needs to be loaded again.

Key Path	Source, Modulation Setup, ARB, Select Waveform, Segments on Hard Disk
Remote Command	:SOURce:RADio:ARB:LOAD:ALL <string>
Example	:SOUR:RAD:ARB:LOAD:ALL “D: varb”
Notes	<p><string> - specifies the directory on the HDD to load the files into ARB memory from.</p> <p>When in Sequence Analyzer mode, and Include Source is Yes, an attempt to load all files from a directory to ARB memory is rejected with an error.</p> <p>When Include Source is No and there is insufficient free ARB memory to load all the waveforms, when the ARB memory is full, the copy ceases, and an error is generated.</p> <p>If you specify a directory over SCPI, but the directory does not exist, an error is generated.</p> <p>If the ARB is ON, a user then loads or deletes file to ARB memory, the playing waveform segment may not keep phase continuity during the ARB memory operation. The waveform will be replayed after the ARB operation is finished.</p>
Initial S/W Revision	A.05.00

Change Directory...

Allows you to change the currently selected directory on the hard disk. Pressing this key opens a standard windows change directory dialog allowing you to select the new directory of interest.

The current directory is used for manually loading waveform segments into ARB memory for playback, and as a search location for waveform segments that are required to be loaded into ARB memory for playback of a waveform sequence or a list sequence.

Key Path	Source, Modulation Setup, ARB, Select Waveform, Segments on Hard Disk
Notes	No remote command, SCPIfront panel only.
Initial S/W Revision	A.05.00

Default Directory...

Allows you to change the default directory. It is used as a search location for waveform segments that are required to be loaded into ARB memory for playback of a waveform sequence, and as a search location for selecting waveforms using SCPI.

Key Path	Source, Modulation Setup, ARB, Select Waveform, Segments on Hard Disk
Remote Command	:SOURce:RADio:ARB:DEFault:DIRectory <string> :SOURce:RADio:ARB: DEFault:DIRectory?
Example	:SOUR:RAD:ARB:DEF:DIR "D:\ArbFiles" :SOUR:RAD:ARB:DEF:DIR?
State Saved	Persistent, survives a power cycle and a preset but not saved in the instrument state
Initial S/W Revision	A.05.00

Segments in ARB Memory

Allows you access to the sub-menus for managing the files within ARB memory.

Key Path	Source, Modulation Setup, ARB, Select Waveform
Initial S/W Revision	A.05.00

Delete Segment From ARB Mem

Allows you to remove a segment from ARB playback memory.

Key Path	Source, Modulation Setup, ARB, Select Waveform, Segments in ARB Memory
Remote Command	:SOURce:RADio:ARB:DELeTe <string>
Example	:SOUR:RAD:ARB:DEL "testwaveform.bin"
Notes	<string> - specifies the waveform to be deleted from the ARB playback memory. When in Sequence Analyzer mode and Include Source is Yes, an attempt to delete a file from ARB

memory is rejected with an error.

When Include Source is No and you specify a file that does not exist within ARB memory, an error is generated.

It is possible to delete files from within the ARB memory when the ARB is ON. However, if you attempt to delete the file that is currently playing an error is generated.

It is possible to delete a file from within the ARB memory when the sequencer state is ON and the file is not being used by the List Sequencer. If you attempt to delete a file which is being used by the list sequencer, an error is generated.

When sequencer state is On, even if ARB state is On, the selected waveform will not be played. In this case, if the selected waveform is not used in List Sequence, it can be deleted and the ARB state is turned Off.

If the ARB is ON and you load a file to ARB memory or delete a file from ARB memory, the playing waveform segment may not keep phase continuity during the ARB memory operation. The waveform will be replayed after the ARB operation is finished.

Initial S/W Revision	A.05.00
----------------------	---------

Delete All From ARB Memory

Allows you to remove all segments from ARB playback memory.

Key Path	Source, Modulation Setup, ARB, Select Waveform, Segments in ARB Memory
Remote Command	:SOURce:RADio:ARB:DELeTe:ALL
Example	:SOUR:RAD:ARB:DELeTe:ALL
Notes	<p>When in Sequence Analyzer mode and Include Source is Yes, an attempt to delete all files from ARB memory is rejected with an error.</p> <p>When Include Source is No and you attempt to delete all files from ARB memory when the ARB is currently playing a file, all files except the one playing are deleted and an error is generated.</p> <p>If you attempt to delete all files from ARB memory when there are waveform files used in "List Sequencer" on page 2520 and "Sequencer" on page 2521 state is ON, all files except the files currently being used in list sequencer are deleted, and an error is generated.</p> <p>If the ARB is ON and you load a file to ARB memory or delete a file from ARB memory, the playing waveform segment may not keep phase continuity during the ARB memory operation. The waveform will be replayed after the ARB operation is finished.</p>

Initial S/W Revision	A.05.00
----------------------	---------

Segments on Hard Disk

This key functions the same as "[Segments on Hard Disk](#)" on page 2547.

Key Path	Source, List Sequencer, List Sequencer Setup, Waveform
Initial S/W Revision	Prior to A.09.00

Load Segment To ARB Memory

This key functions the same as ["Load Segment To ARB Memory" on page 2547](#).

Key Path	Source, List Sequencer, List Sequencer Setup, Waveform, Segment on Hard Drive
Initial S/W Revision	Prior to A.09.00

Load All To ARB Memory

This key functions the same as ["Load All To ARB Memory" on page 2548](#).

Key Path	Source, List Sequencer, List Sequencer Setup, Waveform, Segment on Hard Drive
Initial S/W Revision	Prior to A.09.00

Change Directory ...

This key functions the same as ["Change Directory..." on page 2549](#).

Key Path	Source, List Sequencer, List Sequencer Setup, Waveform, Segment on Hard Drive
Initial S/W Revision	Prior to A.09.00

Default Directory ...

This key functions the same as ["Default Directory..." on page 2549](#)

Key Path	Source, List Sequencer, List Sequencer Setup, Waveform, Segment on Hard Drive
Initial S/W Revision	Prior to A.09.00

Segments in ARB Memory

This key functions the same as ["Segments in ARB Memory" on page 2549](#).

Key Path	Source, List Sequencer, List Sequencer Setup, Waveform, Segments in ARB Memory
Initial S/W Revision	Prior to A.09.00

Delete Segment From ARB Memory

This key functions the same as ["Delete Segment From ARB Mem" on page 2549](#).

Key Path	Source, List Sequencer, List Sequencer Setup, Waveform, Segments in ARB Memory, Segment in ARB Memory
Initial S/W Revision	Prior to A.09.00

Delete All From ARB Memory

This key functions the same as "Delete All From ARB Memory" on page 2550.

Key Path	Source, List Sequencer, List Sequencer Setup, Waveform, Segments in ARB Memory, Segment in ARB Memory
Initial S/W Revision	Prior to A.09.00

Step Duration

Allows access to the sub-menus for setting up the duration of play for the current step.

The duration can be set to be either the number of times for the ARB file associated with the sequence to play, or a specific time value, or continuous. If the step is set to play a CW tone, the step duration cannot be set to a play count.

Key Path	Source, List Sequencer, List Sequencer Setup
Remote Command	:SOURce:LIST:STEP[1] 2 3...1000:SETup:DURation:TYPE TIME COUNT CONTInuous CABort :SOURce:LIST:STEP[1] 2 3...1000:SETup:DURation:TYPE?
Example	:SOUR:LIST:STEP2:SET:DUR:TYPE TIME :SOUR:LIST:STEP2:SET:DUR:TYPE?
Notes	SCPI is supported after A.09.40
Notes	If "Step Duration" is set to "Time" or "Play Count" for the last step, the last step of ARB keeps playing as if set to "Continuous", until the set "Time" has expired or until the "Play Count" setting is reached. However, you can query Error! Reference source not found. Source Sweeping Condition Message to find out if the current list sequence is complete or not.
Range	Time Play Count Continuous Continuous Abort
Initial S/W Revision	A.05.00

Time

Sets the duration of the current step to be a time value for the length of time the step will play. Pressing this key again opens another menu which allows you to set the time value for the step duration.

Key Path	Source, List Sequencer, List Sequencer Setup, Step Duration
Example	:SOUR:LIST:STEP2:SET:DUR:TYPE TIME
Notes	SCPI is supported after A.09.40
Initial S/W Revision	A.05.00

Duration Time

Allows you to specify the length of time the current step will play.

When Step Duration is **Continuous Abort** this parameter specifies the maximum duration that the waveform will continue to play after a step trigger is received before the transition to the next waveform will occur. Duration is limited to a maximum of 20 seconds.

If the Transition Time value is longer than the Step Duration Time, an error is generated when initiating a source list sequence. For source list sequence, transition time is included in the step duration length (not occupy additional time). If the Transition Time value is longer than the Step Duration Time, the real step duration length is extended to equal the transition time and cause a timing shift. This check is also described in section **Error! Reference source not found.** List Sequence Step Validation.

Key Path	Source, List Sequencer, List Sequencer Setup, Step Duration, Time
Remote Command	:SOURce:LIST:STEP[1] 2 3...1000:SETup:DURation:TCOUNT <double> :SOURce:LIST:STEP[1] 2 3...1000:SETup:DURation:TCOUNT?
Example	:SOUR:LIST:STEP2:SET:DUR:TCO 1s :SOUR:LIST:STEP2:SET:DUR:TCO?
Notes	SCPI is supported after A.09.40 This SCPI is reused by "Play Count", "Duration Time" and "Continuous Abort" according to current Duration Type setting is "Play Count" or "Duration Time" or "Continuous Abort". If current "Duration Type" is "Continuous", then popup error -221, "Settings conflict; Cannot accept time or count input when step duration type is Continuous on step #"
Notes	If "Duration Time" is set for the last step, the last step of ARB keeps playing as if set to "Continuous" after set time expires. However, you can query Source Sweeping Condition Message (:STAT:OPER:COND?) to find out if the current list sequence is complete or not.
Preset	1.00 ms
Min	100 μ s
Max	1800 s
Initial S/W Revision	A.05.00

Play Count

Sets the duration of the current step to be an integer value for the number of times (play count) the ARB file is selected for playback during this step. For example, a 5 second ARB will be set to play 5 times during the step.

Key Path	Source, List Sequencer, List Sequencer Setup, Step Duration
Example	:SOUR:LIST:STEP2:SET:DUR:TYPE COUN
Notes	SCPI is supported after A.09.40 This key is unavailable and is grayed out if the current step is configured to CW tone rather than an ARB waveform.
Initial S/W Revision	A.05.00

Header Utilities

Allows access to the header utilities sub-menu. Pressing this key also causes the central display area to change to display the File Header Information view.

Key Path	Source, Modulation Setup, ARB
Dependencies	This key is only available if there is currently a waveform selected for playback. If no waveform is selected, the key is grayed out.
Initial S/W Revision	A.05.00

Continuous

Sets the current step to be played continuously until the next step starts. The waveform will always play completely before transitioning to the next step.

Key Path	Source, List Sequencer, List Sequencer Setup, Step Duration
Example	:SOUR:LIST:STEP2:SET:DUR:TYPE CONT
Notes	SCPI is supported after A.09.40
Initial S/W Revision	A.05.00

Output Trigger

Allows you to specify the trigger output for the current step. The trigger output signal is sent at the start of the step.

When select “On”, trigger event will occur on both Internal and External2 paths. Select “Off” will turn off trigger output.

Key Path	Source, List Sequencer, List Sequencer Setup
Remote Command	:SOURce:LIST:STEP[1] 2 3...1000:SETup:OUTPut:TRIGger ON OFF 1 0 :SOURce:LIST:STEP[1] 2 3...1000:SETup:OUTPut:TRIGger
Example	:SOUR:LIST:STEP2:SET:OUTP:TRIG ON :SOUR:LIST:STEP2:SET:OUTP:TRIG?
Notes	SCPI is supported after A.09.40
Preset	Off
Range	On Off
Initial S/W Revision	A.05.00

Step Configuration (Remote Command Only)

This SCPI command is used to configure the List Sequencer and is detailed in the table below. The command is defined such that you send one command per step, with the step number being specified as a subopcode of the SCPI command. Each command includes all the parameter settings for the step. As a step is setup, the values entered are run through several levels of validation.

Remote Command	:SOURce:LIST:STEP[1] 2 ... 4..1000:SETup IMMEDIATE INTernal KEY
-----------------------	---

```

BUS | EXTERNAL2, <time>, NONE | PGSM | EGSM | RGSM | DCS1800 | PCS1900
| TGSM810 | GSM450 | GSM480 | GSM700 | GSM850 | BANDI | BANDII |
BANDIII | BANDIV | BANDV | BANDVI | BANDVII | BANDVIII | BANDIX | BANDX
| BANDXI | BANDXII | BANDXIII | BANDXIV | BANDXIX | USCELL | USPCS |
JAPAN | KOREAN | NMT | IMT2K | UPPER | SECOND | PAMR400 | PAMR800 |
IMTEXT | PCS1DOT9G | AWS | US2DOT5G | PUBLIC | LOWER | NONE | BAND1 |
BAND2 | BAND3 | BAND4 | BAND5 | BAND6 | BAND7 | BAND8 | BAND10 | BAND11
| BAND12 | BAND13 | BAND14 | BAND17 | BAND18 | BAND19 | BAND20 | BAND21
| BAND24 | BAND25 | BAND26 | BAND33 | BAND34 | BAND35 | BAND36 | BAND37
| BAND38 | BAND39 | BAND40 | BAND41 | BAND42 | BAND43 | BANDA | BANDB |
BANDC | BANDD | BANDE | BANDF, DOWN | UP, <freq>, <ampl>, <string>,
TIME | COUNT | CONTinuous, <time>, ON | OFF | 1 | 0, [<int>],

:SOURce:LIST:STEP[1]|2|...|4..1000:SETup?

```

Example :SOUR:LIST:STEP1:SET INT, 1ms, PGSM, DOWN, 10, -25 dBm, "GSM_Test1.bin", TIME, 10ms, OFF, 255

Notes

The parameters are:

(There is a total of 11 items in each step, the following is a list of the items in the order they must appear in the remote command.)

1. Step Trigger <enum> – specifies the input trigger for the step. For details of the valid types of step trigger see ["Step Trigger" on page 2523](#).
 2. Transition Time <time> – specifies the transition time for the step in seconds. For details of the valid ranges for the transition time see ["Transition Time" on page 2525](#).
 3. Radio Band <enum> – specifies the radio band for the step. For details of the valid radio bands see ["Radio Setup" on page 2526](#).
 4. Radio Band Link <enum> – specifies the radio band link direction for the step. For details of the valid link types, see ["Radio Band Link" on page 2543](#).
 5. Frequency/Channel Number <freq>/<chan num> – specifies the frequency in Hz or the channel number for the step. The channel number and frequency are combined as one parameter that represents the frequency or channel number depending on the radio band setting. If the radio band is set to NONE, this value is interpreted as a frequency value in Hz. If the radio band is set to a valid band, this value is interpreted as a channel number. For details of the valid ranges for frequency and channel numbers, see ["Channel" on page 2543](#) and ["Frequency" on page 2544](#).
 6. Power <ampl> – specifies the output power for the step in dBm. For details of the valid ranges see ["Power" on page 2544](#).
 7. Waveform <string> – specifies the waveform for playback during the step. The step can output either a new ARB waveform, continue playback of the previous waveform, or output a CW tone. The options for specifying these are:
 - <filename> - plays the specified waveform from the start. The filename value is the name of the file within ARB playback memory, it does not include the windows path to the file on the HDD. If you enter a filename for a waveform that does not reside within ARB playback memory, an error is generated.
 - CONT – continues playback of the ARB file from the previous step
 - CW – outputs a CW tone
 - OFF – disable RF output
 8. Step Duration <enum> – specifies the duration of the step. The duration can be specified to be either time, or play count of the ARB file associated with the step, or continuous. If Waveform is set to "CW", this value cannot be set to Play Count and an error will be generated. If continuous is selected, the following Time or Count value is ignored. For further details of this setting, see ["Step](#)
-

	<p>Duration" on page 2552.</p> <p>9. Time or Count <time/int> – specifies time duration in seconds or play count of the ARB file associated with the step. For further details of this setting, including the valid ranges for the time or play count setting, "Time" on page 2552 and "Play Count" on page 2553.</p> <p>10. Output Trigger <Boolean> – specifies the output trigger for the step. For details of the ranges for this setting see "Output Trigger" on page 2554.</p>
Dependencies	<p>The range of subopcode values is 1 to 1000 and the value you enter is determined by the number of steps you have configured. For details see "Number of Steps" on page 2522.</p> <p>If you attempt to remotely set or query a subopcode that is out of range, an error is generated.</p>
Initial S/W Revision	A.05.00

Step Configuration of Step Trigger parameter list (Remote Command Only)

This SCPI command is to configure “Step Trigger” parameter array of the whole List Sequencer at one time. The number of array is same as step number defined in "**Number of Steps" on page 2522** Number of Steps. As a step is setup, the value entered run through several levels of validation.

Remote Command	<pre>:SOURce:LIST:SETup:INPut:TRIGger <enum>, <enum>, <enum>, ... :SOURce:LIST:SETup:INPut:TRIGger?</pre>
Example	<pre>:SOUR:LIST:SET:INP:TRIG IMM,INT,EXT2 :SOUR:LIST:SET:INP:TRIG?</pre>
Notes	<p>The command is to setup below parameter array of whole list sequence.</p> <p>Step Trigger <enum> – specifies the input trigger for the step. For details of the valid types of step trigger see "Step Trigger" on page 2523.</p> <p>If input parameter number exceeds the step number defined by "Number of Steps" on page 2522Number of Steps then generate error ", and only those parametes whose index number falls in number of steps will be updated.</p>
Remote Command Notes	IMMEDIATE INTERNAL KEY BUS EXTERNAL2
Dependencies	<p>The range is 1 to 1000 which is determined by the number of steps you have configured. For details see "Number of Steps" on page 2522.</p>
Initial S/W Revision	A.09.40

Step Configuration of Transition Time parameter list (Remote Command Only)

This SCPI command is to configure “Transition Time” parameter array of the whole List Sequencer at one time. The number of array is same as step number defined in "**Number of Steps" on page 2522** Number of Steps. As a step is setup, the value entered run through several levels of validation.

Remote Command	<pre>:SOURce:LIST:SETup:TRANSition:TIME <time>, <time>, <time>, ... :SOURce:LIST:SETup:TRANSition:TIME?</pre>
Example	<pre>:SOUR:LIST:SET:TRAN:TIME 1ms,1ms,1ms</pre>

	:SOUR:LIST:SET:TRAN:TIME?
Notes	<p>The command is to setup below parameter array of whole list sequence.</p> <p>Transition Time <time> – specifies the transition time for the step in seconds. For details of the valid ranges for the transition time see "Transition Time" on page 2525</p> <p>If input parameter number exceeds the step number defined by "Number of Steps" on page 2522 Number of Steps then generate error ", and only those parameters whose index number falls in number of steps will be updated.</p>
Dependencies	The range is 1 to 1000 which is determined by the number of steps you have configured. For details see "Number of Steps" on page 2522 .
Initial S/W Revision	A.09.40

Step Configuration of Radio Band parameter list (Remote Command Only)

This SCPI command is to configure "Radio Band" parameter array of the whole List Sequencer at one time. The number of array is same as step number defined in ["Number of Steps" on page 2522](#) Number of Steps. As a step is setup, the value entered run through several levels of validation.

R :SOURce:LIST:SETup:RADio:BAND <enum>, <enum>, <enum>, ...

e :SOURce:LIST:SETup:RADio:BAND?

m

o

t

e

C

o

m

m

a

n

d

E :SOUR:LIST:SET:RAD:BAND PGSM, EGSM, RGSM

X :SOUR:LIST:SET:RAD:BAND?

a

m

p

l

e

N The command is to setup below parameter array of whole list sequence.

O Radio Band <enum> – specifies the radio band for the step. For details of the valid radio bands see ["Radio Setup" on page 2526](#).

t If input parameter number exceeds the step number defined by ["Number of Steps" on page 2522](#) Number of Steps then generate error ", and only those parameters whose index number falls in number of steps will be updated.

e R NONE|PGSM|EGSM|RGSM|DCS1800|PCS1900|TGSM810|GSM450|GSM480|GSM700|GSM850|BANDI|BANDII|BANDIII|BANDIV|BANDV|BANDVI|BANDVII|BANDVIII|BANDIX|BANDX|BANDXI|BANDXII|BANDXIII|BANDXIV|BANDXIX|USCELL|USPCS|JAPAN|KOREAN|NMT|IMT2K|UPPER|SECOND|PAMR400|PAMR800|IMTEXT|PCS1DOT9G|AWS|US2DOT5G|PUBLIC|LOWER|NONE|BAND1|BAND2|BAND3|BAND4|BAND5|BAND6|BAND7|BAND8|BAND10|BAND11|BAND12|BAND13|BAND14|BAND17|BAND18|BAND1

o 9|BAND20|BAND21|BAND24|BAND25|BAND26|BAND33|BAND34|BAND35|BAND36|BAND37|BAND38|BAND39|BAND40|BAN
t D41|BAND42|BAND43|BANDA|BANDB|BANDC|BANDD|BANDE|BANDF
e

C
o
m
m
a
n
d

N
o
t
e
s

D The range is 1 to 1000 which is determined by the number of steps you have configured. For details see "[Number of Steps](#)" on
e [page 2522](#).

p
e
n
d
e
n
c
i
e
s

I A.09.40

n
i
t
i
a
l

S
/
W

R
e
v
i
s
i
o
n

Step Configuration of Radio Band Link parameter list (Remote Command Only)

This SCPI command is to configure “Radio Band Link” parameter array of the whole List Sequencer at one time. The number of array is same as step number defined in ["Number of Steps" on page 2522](#) Number of Steps. As a step is setup, the value entered run through several levels of validation.

Remote Command	:SOURce:LIST:SETup:RADio:BAND:LINK <enum>, <enum>, <enum>, ... :SOURce:LIST:SETup:RADio:BAND:LINK?
Example	:SOUR:LIST:SET:RAD:BAND:LINK DOWN,UP,UP :SOUR:LIST:SET:RAD:BAND:LINK?
Notes	The command is to setup below parameter array of whole list sequence. Radio Band Link <enum> – specifies the radio band link direction for the step. For details of the valid link types, see "Radio Band Link" on page 2543 . If input parameter number exceeds the step number defined by "Number of Steps" on page 2522 Number of Steps then generate error ", and only those parametes whose index number falls in number of steps will be updated.
Remote Command Notes	DOWN UP
Dependencies	The range is 1 to 1000 which is determined by the number of steps you have configured. For details see "Number of Steps" on page 2522 .
Initial S/W Revision	A.09.40

Step Configuration of Frequency/Channel Number parameter list (Remote Command Only)

This SCPI command is to configure “Frequency” or “Channel Number” parameter array of the whole List Sequencer at one time. The number of array is same as step number defined in ["Number of Steps" on page 2522](#) Number of Steps. As a step is setup, the value entered run through several levels of validation.

Remote Command	:SOURce:LIST:SETup:CNFRequency <double>, <double>, <double>, ... :SOURce:LIST:SETup:CNFRequency?
Example	:SOUR:LIST:SET:CNFR 1GHz,100MHz,100MHz :SOUR:LIST:SET:CNFR? SOUR:LIST:SET:CNFR 124,124,124 :SOUR:LIST:SET:CNFR?
Notes	The command is to setup below parameter array of whole list sequence. Frequency/Channel Number <freq>/<chan num> – specifies the frequency in Hz or the channel number for the step. The channel number and frequency are combined as one parameter that represents the frequency or channel number depending on the radio band setting. If the radio band is set to NONE, this value is interpreted as a frequency value in Hz. If the radio band is set to a valid band, this value is interpreted as a channel number. For details of the valid ranges for frequency and channel numbers, see "Channel" on page 2543 and "Frequency" on page 2544 This SCPI is used to setup/query channel number or frequency setting, according to current Radio Band setting of that step. If Radio Band is “NONE”, then it’s frequency. If Radio Band is not “NONE”, then it’s channel number If input parameter number exceeds the step number defined by "Number of Steps" on page 2522 Number of Steps then generate error ", and only those parametes whose index number falls in

	legal step number will be updated.
Dependencies	The range is 1 to 1000 which is determined by the number of steps you have configured. For details see "Number of Steps" on page 2522 .
Initial S/W Revision	A.09.40

Step Configuration of Power parameter list (Remote Command Only)

This SCPI command is to configure “Power” parameter array of the whole List Sequencer at one time. The number of array is same as step number defined in ["Number of Steps" on page 2522](#) Number of Steps. As a step is setup, the value entered run through several levels of validation.

Remote Command	:SOURce:LIST:SETup:AMPLitude <ampl>, <ampl>, <ampl>, ... :SOURce:LIST:SETup:AMPLitude?
Example	:SOUR:LIST:SET:AMPL -50dBm,-40dBm,-30dBm :SOUR:LIST:SET:AMPL?
Notes	The command is to setup below parameter array of whole list sequence. Power <ampl> – specifies the output power for the step in dBm. For details of the valid ranges see "Power" on page 2544 . If input parameter number exceeds the step number defined by "Number of Steps" on page 2522 Number of Steps then generate error ", and only those parametes whose index number falls in legal step number will be updated.
Dependencies	The range is 1 to 1000 which is determined by the number of steps you have configured. For details see "Number of Steps" on page 2522 .
Initial S/W Revision	A.09.40

Step Configuration of Waveform parameter list (Remote Command Only)

This SCPI command is to configure “Waveform” parameter array of the whole List Sequencer at one time. The number of array is same as step number defined in ["Number of Steps" on page 2522](#) Number of Steps. As a step is setup, the value entered run through several levels of validation.

Remote Command	:SOURce:LIST:SETup:WAVeform <string>, <string>, <string>, ... :SOURce:LIST:SETup:WAVeform?
Example	:SOUR:LIST:SET:WAV "CW","Off","CONT" :SOUR:LIST:SET:WAV?
Notes	The command is to setup below parameter array of whole list sequence. Waveform <string> – specifies the waveform for playback during the step. The step can output either a new ARB waveform, continue playback of the previous waveform, or output a CW tone. The options for specifying these are: <filename> - plays the specified waveform from the start. The filename value is the name of the file within ARB playback memory, it is does not include the windows path to the file on the HDD. If you enter a filename for a waveform that does not reside within ARB playback memory, an error is generated.

	<p>CONT – continues playback of the ARB file from the previous step</p> <p>CW – outputs a CW tone</p> <p>OFF – disable RF output</p> <p>If input parameter number exceeds the step number defined by "Number of Steps" on page 2522 Number of Steps then generate error ", and only those parametes whose index number falls in number of steps will be updated.</p>
Dependencies	The range is 1 to 1000 which is determined by the number of steps you have configured. For details see " Number of Steps " on page 2522.
Range	"filename" "CW" "Off" "CONT"
Initial S/W Revision	A.09.40

Step Configuration of Step Duration parameter list (Remote Command Only)

This SCPI command is to configure "Step Duration" parameter array of the whole List Sequencer at one time. The number of array is same as step number defined in "[Number of Steps](#)" on page 2522 Number of Steps. As a step is setup, the value entered run through several levels of validation.

Remote Command	<pre>:SOURce:LIST:SETup:DURation:TYPE <enum>, <enum>, <enum>, ... :SOURce:LIST:SETup:DURation:TYPE?</pre>
Example	<pre>:SOUR:LIST:SET:DUR:TYPE COUN,TIME,CONT :SOUR:LIST:SET:DUR:TYPE?</pre>
Notes	<p>The command is to setup below parameter array of whole list sequence.</p> <p>Step Duration <enum> – specifies the duration of the step. The duration can be specified to be either time, or play count of the ARB file associated with the step, or continuous. If Waveform is set to "CW", this value cannot be set to Play Count and an error will be generated. If continuous is selected, the following Time or Count value is ignored. For further details of this setting, see "Step Duration" on page 2552.</p> <p>If input parameter number exceeds the step number defined by "Number of Steps" on page 2522 Number of Steps then generate error ", and only those parametes whose index number falls in number of steps will be updated.</p>
Remote Command Notes	TIME COUNT CONTinuous
Dependencies	The range is 1 to 1000 which is determined by the number of steps you have configured. For details see " Number of Steps " on page 2522.
Initial S/W Revision	A.09.40

Step Configuration of Duration Time or Play Count parameter list (Remote Command Only)

This SCPI command is to configure "Duration Time" or "Play Count" parameter array of the whole List Sequencer at one time. The number of array is same as step number defined in "[Number of Steps](#)" on page 2522 Number of Steps. As a step is setup, the value entered run through several levels of validation.

Remote Command	<pre>:SOURce:LIST:SETup:TOCount <time/int>, <time/int>, <time/int>, ... :SOURce:LIST:SETup:TOCount?</pre>
-----------------------	---

Example	:SOUR:LIST:SET:TOC 1s,2s,3s :SOUR:LIST:SET:TOC? :SOUR:LIST:SET:TOC 5,6,7 :SOUR:LIST:SET:TOC?
Notes	The command is to setup below parameter array of whole list sequence. Time or Count <time/int> – specifies time duration in seconds or play count of the ARB file associated with the step. For further details of this setting, including the valid ranges for the time or play count setting, " Time " on page 2552 and " Play Count " on page 2553. If input parameter number exceeds the step number defined by " Number of Steps " on page 2522 Number of Steps then generate error ", and only those parametes whose index number falls in number of steps will be updated. If current " Step Duration " on page 2552 is "Continuous", then generate error -221,"Settings conflict;Cannot accept time or count input when step duration type is Continuous on step #"
Dependencies	The range is 1 to 1000 which is determined by the number of steps you have configured. For details see " Number of Steps " on page 2522.
Initial S/W Revision	A.09.40

Step Configuration of Output Trigger parameter list (Remote Command Only)

This SCPI command is to configure "Output Trigger" parameter array of the whole List Sequencer at one time. The number of array is same as step number defined in "[Number of Steps](#)" on page 2522 Number of Steps. As a step is setup, the value entered run through several levels of validation.

Remote Command	:SOURce:LIST:SETup:OUTPut:TRIGger <bool>, <bool>, <bool>, ... :SOURce:LIST:SETup:OUTPut:TRIGger ?
Example	:SOUR:LIST:SET:OUTP:TRIG ON,OFF,ON :SOUR:LIST:SET:OUTP:TRIG?
Notes	The command is to setup below parameter array of whole list sequence. Output Trigger <Boolean> – specifies the output trigger for the step. For details of the ranges for this setting see " Output Trigger " on page 2554. If input parameter number exceeds the step number defined by " Number of Steps " on page 2522 Number of Steps then generate error ", and only those parametes whose index number falls in legal step number will be updated.
Remote Command Notes	ON OFF 1 0
Dependencies	The range is 1 to 1000 which is determined by the number of steps you have configured. For details see " Number of Steps " on page 2522.
Initial S/W Revision	A.09.40

Clear List (Remote Command Only)

This command is the SCPI equivalent of the Clear List UI feature described in.

Remote Command	:SOURce:LIST:SETup:CLEar
Example	:SOUR:LIST:SETup:CLE
Initial S/W Revision	A.05.00

Trigger Type

Allows access to the sub-menu for selecting the output trigger type for the list sequencer globally. It cannot be changed between different sequence steps.

Key Path	Source, List Sequencer
Remote Command	:SOURce:LIST:TRIGgerout:TYPe BEGinningofstep DATamarker
Example	:SOUR:LIST:TRIG:TYP BEG :SOUR:LIST:TRIG:TYP?
Notes	SCPI is supported after A.14.00
Preset	BEGinningofstep
Range	BEGinningofstep DATamarker
Initial S/W Revision	A.14.00

BeginningOfStep

Sets the output trigger type as BeginningOfStep for the whole source sequence.

Key Path	Source, List Sequencer, Trigger Type
Example	:SOUR:LIST:TRIG:TYP BEG
Notes	SCPI is supported after A.14.00
Initial S/W Revision	A.14.00

DataMarker

Sets the output trigger type as DataMarker for the whole source sequence. When DataMarker is selected, which marker to route is also needed to be set.

Key Path	Source, List Sequencer, Trigger Type
Example	:SOUR:LIST:TRIG:TYP DAT
Notes	SCPI is supported after A.14.00
Initial S/W Revision	A.14.00

Marker 1

Sets the output trigger maker routing to Marker 1 for DataMarker in the whole source sequence.

Key Path	Source, List Sequencer, Trigger Type, DataMarker
Example	:SOUR:LIST:TRIG:TYPE:MARK M1
Notes	SCPI is supported after A.14.00
Initial S/W Revision	A.14.00

Marker 2

Sets the output trigger maker routing to Marker 2 for DataMarker in the whole source sequence.

Key Path	Source, List Sequencer, Trigger Type, DataMarker
Example	:SOUR:LIST:TRIG:TYPE:MARK M2
Notes	SCPI is supported after A.14.00
Initial S/W Revision	A.14.00

Marker 3

Sets the output trigger maker routing to Marker 3 for DataMarker in the whole source sequence.

Key Path	Source, List Sequencer, Trigger Type, DataMarker
Example	:SOUR:LIST:TRIG:TYPE:MARK M3
Notes	SCPI is supported after A.14.00
Initial S/W Revision	A.14.00

Marker 4

Sets the output trigger maker routing to Marker 4 for DataMarker in the whole source sequence.

Key Path	Source, List Sequencer, Trigger Type, DataMarker
Example	:SOUR:LIST:TRIG:TYPE:MARK M4
Notes	SCPI is supported after A.14.00
Initial S/W Revision	A.14.00

Manual Trigger Now

Pressing this key provides a software trigger event to the list sequencer. During execution of sequence, if the sequencer is halted on any step that has been configured with a “Manual” step trigger, then this key press will cause the sequencer to continue and execute the step.

Key Path	Source, List Sequencer
Remote Command	No remote command, front panel only.
Initial S/W Revision	A.05.00

Remote Software Trigger (Remote command Only)

During execution of a list sequence, the sequence will halt and wait at any step that has Step Trigger set to “Bus”. Sending this command will trigger the step and continue the sequence.

Remote Command	:SOURce:LIST:TRIGger:INITiate[:IMMediate]
Example	:SOUR:LIST:TRIG:INIT
Initial S/W Revision	A.05.00

Query List Sequence Initiation Armed Status (Remote Command Only)

This is a blocking SCPI query to determine if source list sequence being initiated successfully or not.

Remote Command	:SOURce:LIST:INITiation:ARMed?
Example	:SOUR:LIST:INIT:ARMed?
Notes	The return data is in the following format: Integer
Notes	Query only SCPI. Returning “1” if list sequence has been initiated successfully, returning “0” if not. Once get “0”, you can use :SYST:ERR? to query what error happened. Just like “*OPC?”, this command can be blocked until event/status “IsSourceSweeping” happens, and then returns. Doing so can help user’s script query armed status only once during the time interval of the initiation. As an ancillary SCPI of existing SCPI “:SOUR:LIST:TRIGger[:IMMediate]” (see "Initiate Sequence" on page 2521 Initiate Sequence), the right usage of this command is to use it after “:SOUR:LIST:TRIG”. If not, this command will return “1” immediately.
Notes	There is an alias SCPI “:SOURce:LIST:TRIGger:INITiation:ARMed?”.
Initial S/W Revision	A.09.40

Source Preset

Allows you to preset the source settings to their default values.

Key Path	Source
Remote Command	:SOURce:PRESet
Example	:SOUR:PRES

SPAN X Scale

There is no Span X Scale functionality implemented for this measurement.

Key Path	Front-panel key
----------	-----------------

Sweep/Control

There is no Sweep/Control functionality implemented in this measurement.

Key Path	Front-panel key
----------	-----------------

14 Conformance EVM
System

System

See "System" on page 272

Trace/Detector

There is no Trace/Detector functionality implemented for this measurement.

Key Path	Front-panel key
----------	-----------------

Trigger

See ["Trigger" on page 328](#)

Free Run

See ["Free Run " on page 335](#)

Video

See ["Video \(IF Envelope\) " on page 1556](#)

Trigger Level

See ["Trigger Level " on page 1557](#)

Trig Slope

See ["Trig Slope " on page 1558](#)

Trig Delay

See ["Trig Delay " on page 338](#)

External 1

See ["External 1 " on page 1571](#)

Trigger Level

See ["Trigger Level " on page 1571](#)

Trig Slope

See ["Trig Slope " on page 1572](#)

Trig Delay

See ["Trig Delay " on page 341](#)

Zero Span Delay Comp

See ["Zero Span Delay Comp On/Off" on page 1560](#)

External 2

See ["External 2 " on page 1572](#)

Trigger Level

See ["Trigger Level " on page 1573](#)

Trig Slope

See ["Trig Slope " on page 1574](#)

Trig Delay

See "Trig Delay " on page 344

Zero Span Delay Comp

See "Zero Span Delay Comp On/Off" on page 1562

RF Burst

See "RF Burst " on page 1574

Absolute Trigger

See "Absolute Trigger Level" on page 1575

Relative Trigger

See "Relative Trigger Level" on page 1564

Trig Slope

See "Trigger Slope " on page 1576

Trig Delay

See "Trig Delay " on page 348

Periodic Timer

See "Periodic Timer (Frame Trigger) " on page 1566

Period

See "Period " on page 1567

Offset

See "Offset " on page 1568

Offset Adjust (Remote Command Only)

See "Offset Adjust (Remote Command Only)" on page 1569

Reset Offset Display

See "Reset Offset Display " on page 1570

Sync Source

See "Sync Source " on page 1570

Off

See "Off " on page 1571

External 1

See "[External 1](#) " on page 1571

Trigger Level

See "[Trigger Level](#) " on page 1571

Trig Slope

See "[Trig Slope](#) " on page 1572

External 2

See "[External 2](#) " on page 1572

Trigger Level

See "[Trigger Level](#) " on page 1573

Trig Slope

See "[Trig Slope](#) " on page 1574

RF Burst

See "[RF Burst](#) " on page 1574

Absolute Trigger

See "[Absolute Trigger Level](#)" on page 1575

Trig Slope

See "[Trigger Slope](#) " on page 1576

Trig Delay

See "[Trig Delay](#)" on page 359

Auto/Holdoff

See "[Auto/Holdoff](#) " on page 1577

Auto Trig

See "[Auto Trig](#) " on page 1577

Trig Holdoff

See "[Trig Holdoff](#) " on page 1578

Holdoff Type

See "[Holdoff Type](#)" on page 361

User Preset

Accesses a menu that gives you the following three choices:

- User Preset – recalls a state previously saved using the Save User Preset function.
- User Preset All Modes – presets all of the modes in the analyzer
- Save User Preset– saves the current state for the current mode

NOTE

In products that run multiple instances of the X-Series Application, all instances use the same location to save User Preset state. So Save User Preset of one instance will overwrite the Save User Preset of another instance.

Key Path	Front-panel key
Backwards Compatibility Notes	<p>User Preset is actually loading a state, and in legacy analyzers, it was possible to load a state without affecting the trace data, limit lines or correction data. Similarly it was possible to do a User Preset without affecting the trace data, limit lines or correction data.</p> <p>In the X-Series, “state” always includes all of this data; so whenever state is loaded, or User Preset is executed, all of the traces, limit lines and corrections are affected. Although this differs from previous behavior, it is desirable behavior, and should not cause adverse issues for users.</p> <p>On ESA and PSA, User Preset affected the entire instrument’s state. In the X-Series, User Preset only recalls the state for the active mode. There is a User Preset file for each mode. User Preset can never cause a mode switch as it can in legacy analyzers. If you want to recall all modes to their user preset file state, you will need to do a User Preset after mode switching into each mode.</p> <p>User Preset recalls mode state which can now include data like traces; whereas on ESA and PSA, User Preset did not affect data.</p>
Initial S/W Revision	Prior to A.02.00

User Preset

User Preset sets the state of the currently active mode back to the state that was previously saved for this mode using the Save User Preset menu key or the SCPI command, SYST:PRES:USER:SAV. It not only recalls the Mode Preset settings, but it also recalls all of the mode persistent settings, and the Input/Output system setting that existed at the time Save User Preset was executed.

If a Save User Preset has not been done at any time, User Preset recalls the default user preset file for the currently active mode. The default user preset files are created if, at power-on, a mode detects there is no user preset file. There will never be a scenario when there is no user preset file to restore. For each mode, the default user preset state is the same state that would be saved if a Save User Preset is performed in each mode right after doing a Restore Mode Default and after a Restore Input/Output Defaults.

The User Preset function does the following:

- Aborts the currently running measurement.
- Sets the mode State to the values defined by Save User Preset.
- Makes the saved measurement for the currently running mode the active measurement.
- Brings up the saved menu for the power-on mode.

- Clears the input and output buffers.
- Sets the Status Byte to 0.

Key Path	User Preset
Remote Command	:SYSTem:PRESet:USER
Example	:SYST:PRES:USER:SAVE:SYST:PRES:USER
Notes	:SYST:PRES:USER:SAVE is used to save the current state as the user preset state. Clears all pending OPC bits. The Status Byte is set to 0. Pressing the User Preset front-panel key while already in the User Preset menu will cause the User Preset to get executed
Couplings	A user preset will cause the currently running measurement to be aborted and cause the saved measurement to be active. Recalling a User Preset file has the same issues that recalling a Save State file has. Some settings may need to be limited and therefore re-coupled, since the capabilities of the mode may have changes when the User Preset file was last saved.
Initial S/W Revision	Prior to A.02.00

User Preset All Modes

Recalls all of the User Preset files for each mode, switches to the power-on mode, and activates the saved measurement from the power-on mode User Preset file.

NOTE

When the instrument is secured, all of the user preset files are converted back to their default user preset files.

The User Preset function does the following:

- Aborts the currently running measurement.
- Switches the Mode to the power-on mode.
- Restores the User Preset files for each mode.
- Makes the saved measurement for the power-on mode the active measurement.
- Brings up the saved menu for the power-on mode.
- Clears the input and output buffers.
- Sets the Status Byte to 0.

Key Path	User Preset
Remote Command	:SYSTem:PRESet:USER:ALL
Example	:SYST:PRES:USER:SAVE:SYST:PRES:USER:ALL
Notes	Clears all pending OPC bits. The Status Byte is set to 0. :SYST:PRES:USER:SAVE is used to save the current state as the user preset state.
Couplings	A user preset will cause the currently running measurement to be aborted, cause a mode switch to the power-on mode, and cause the saved measurement to be active in the power-on mode.

Recalling a User Preset file has the same issues that recalling a Save State file has. Some settings may need to be limited and therefore re-coupled, since the capabilities of the mode may have changes when the User Preset file was last saved.

Initial S/W Revision Prior to A.02.00

Save User Preset

Saves the currently active mode and its State. You can recall this User Preset file by pressing the User Preset menu key or sending the SYST:PRES:USER remote command. This same state is also saved by the Save State function.

Key Path	User Preset
Remote Command	:SYSTem:PRESet:USER:SAVE
Example	:SYST:PRES:USER:SAVE
Notes	:SYST:PRES:SAVE creates the same file as if the user requested a *SAV or a MMEM:STOR:STAT, except User Preset Save does not allow the user to specify the filename or the location of the file.
Initial S/W Revision	Prior to A.02.00

View Selection

Allows you to select the desired measurement view from the following selections:

- MLISt – **Measurement List view**
- PARAmeter – **Parameter List view**
- RESult – **Measurement List view**
- RFENvelope – **RF Envelope view**

Key Path	View/Display
Mode	LTEAFDD,LTEATDD
Remote Command	:DISPlay:CEVM:VIEW[:SElect] MLISt PARAmeter RESult RFENvelope :DISPlay:CEVM:VIEW[:SElect]?
Example	DISP:CEVM:VIEW RES DISP:CEVM:VIEW?
Preset	RESult
State Saved	Saved in instrument state.
Range	Measurement List Parameter List Result Metrics RF Envelope
Backwards Compatibility SCPI	:DISPlay:CEVM:VIEW[:SElect] MLISt PARAmeter RESult RFENvelope
Initial S/W Revision	A.14.00
Modified at S/W Revision	A.14.50

Display

The Display menu is common to most measurements, and is used for configuring items on the display. Some Display menu settings apply to all the measurements in a mode, and some only to the current measurement. Those under the System Display Settings key apply to all measurements in all modes.

Key Path	Display
Key Path	View/Display
Initial S/W Revision	Prior to A.02.00

Annotation

Turns on and off various parts of the display annotation. The annotation is divided up into four categories:

1. Meas Bar: This is the measurement bar at the top of the screen. It does not include the settings panel or the Active Function. Turning off the Meas Bar turns off the settings panel and the Active Function. When the Meas Bar is off, the graticule area expands to fill the area formerly occupied by the Meas Bar.

2. Screen Annotation: this is the annotation and annunciation around the graticule, including any annotation on lines (such as the display line, the threshold line, etc.) This does NOT include the marker number or the N dB result. When off, the graticule expands to fill the entire graticule area.
 3. Trace annotation: these are the labels on the traces, showing their detector (or their math mode).
 4. Active Function annotation: this is the active function display in the meas bar, and all of the active function values displayed on softkeys.
- See the figure below. Each type of annotation can be turned on and off individually.

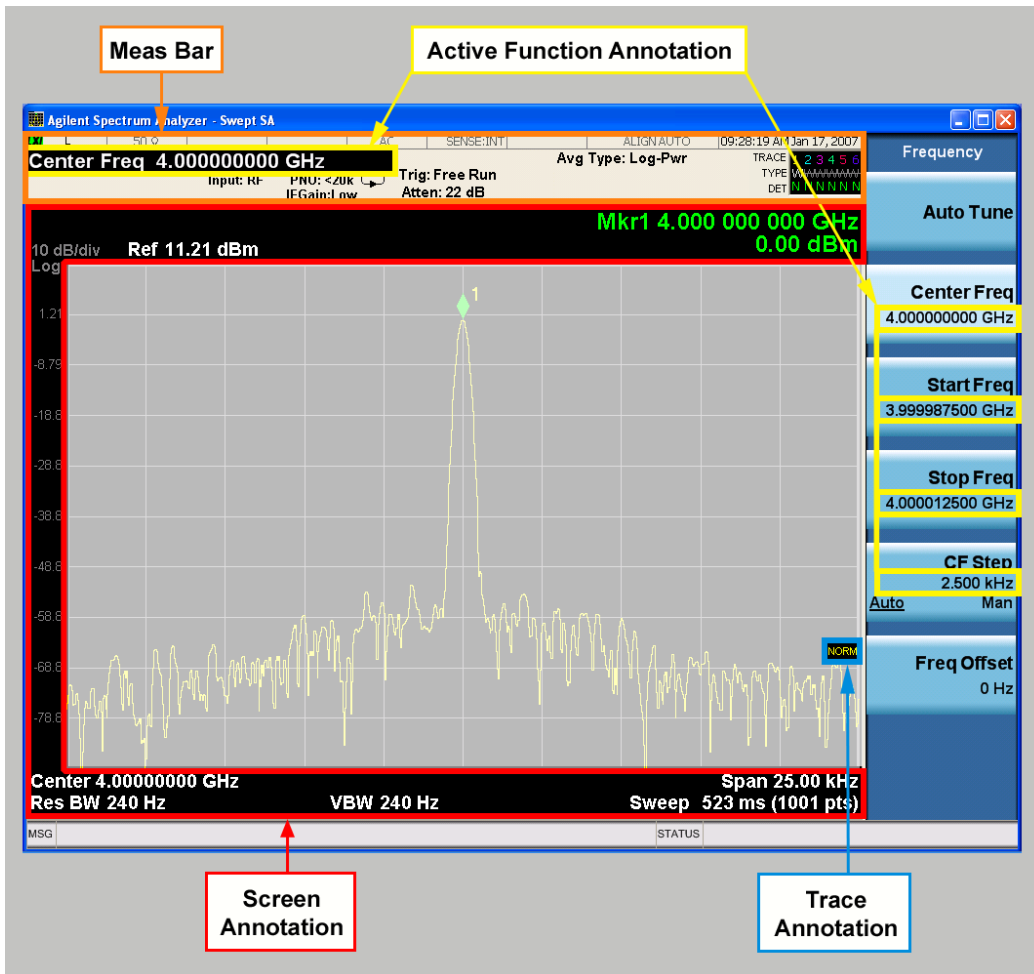

Key Path	View/Display, Display
Initial S/W Revision	Prior to A.02.00

Meas Bar On/Off

This function turns the Measurement Bar on and off, including the settings panel. When off, the graticule area expands to fill the area formerly occupied by the Measurement Bar.

Key Path	View/Display, Display, Annotation
Remote Command	:DISPlay:ANNotation:MBAR[:STATe] OFF ON 0 1 :DISPlay:ANNotation:MBAR[:STATe]?
Example	DISP:ANN:MBAR OFF
Dependencies	Grayed out and forced to OFF when System Display Settings, Annotation is set to Off.
Preset	On This should remain Off through a Preset when System DisplaySettings, Annotation is set to Off.
State Saved	Saved in instrument state.
Initial S/W Revision	Prior to A.02.00

Screen

This controls the display of the annunciation and annotation around the graticule, including any annotation on lines (such as the display line, the threshold line, etc.) and the y-axis annotation. This does NOT include marker annotation (or the N dB result). When off, the graticule expands to fill the entire graticule area, leaving only the 1.5% gap above the graticule as described in the Trace/Detector chapter.

Key Path	View/Display, Display, Annotation
Remote Command	:DISPlay:ANNotation:SCReen[:STATe] OFF ON 0 1 :DISPlay:ANNotation:SCReen[:STATe]?
Example	DISP:ANN:SCR OFF
Dependencies	Grayed-out and forced to OFF when System Display Settings, Annotation is set to Off.
Preset	On This should remain Off through a Preset when System DisplaySettings, Annotation is set to Off
State Saved	Saved in instrument state.
Initial S/W Revision	Prior to A.02.00

Active Function Values On/Off

Turns on and off the active function display in the Meas Bar, and all of the active function values displayed on the softkeys.

Note that all of the softkeys that have active functions have these numeric values blanked when this function is on. This is a security feature..

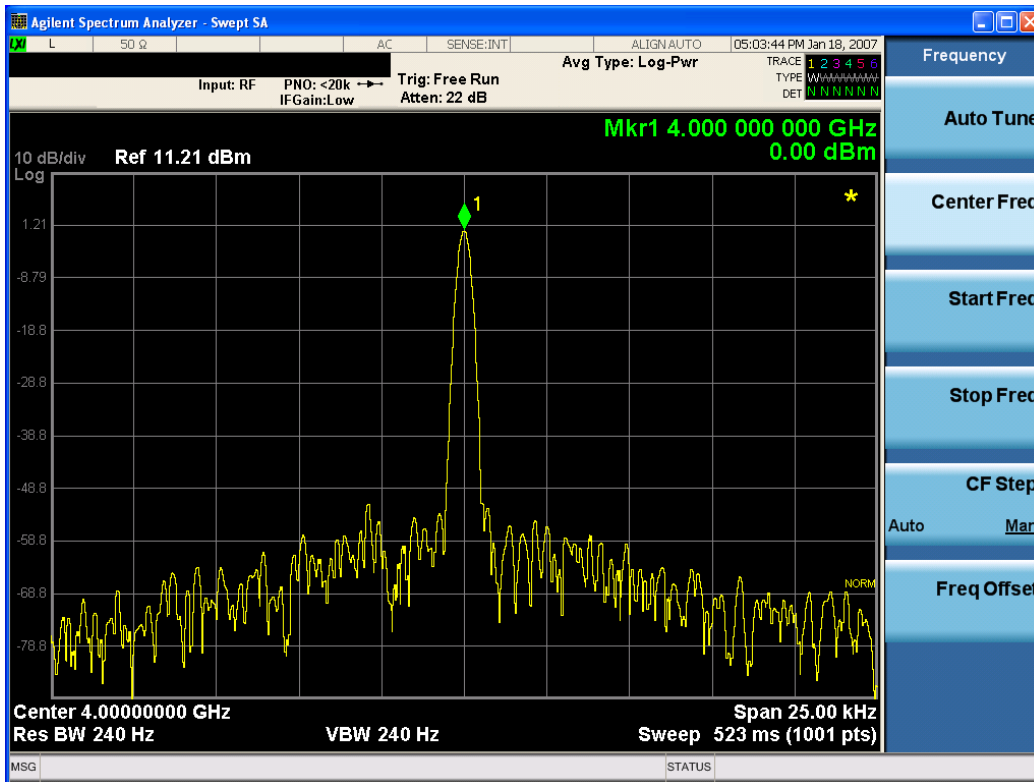

Key Path	View/Display, Display, Annotation
Remote Command	:DISPlay:ACTivefunc[:STATE] ON OFF 1 0 :DISPlay:ACTivefunc[:STATE]?
Example	DISP:ACT OFF
Dependencies	Grayed out and forced to OFF when System Display Settings, Annotation is set to Off.
Preset	On This should remain Off through a Preset when System DisplaySettings, Annotation is set to Off
State Saved	Saved in instrument state.
Initial S/W Revision	Prior to A.02.00

Title

Displays menu keys that enable you to change or clear a title on your display.

Key Path	View/Display, Display
Initial S/W Revision	Prior to A.02.00

Change Title

Writes a title into the "measurement name" field in the banner, for example, "Swept SA".

Press Change Title to enter a new title through the alpha editor. Press Enter or Return to complete the entry. Press ESC to cancel the entry and preserve your existing title.

The display title will replace the measurement name. It remains for this measurement until you press Change Title again, or you recall a state, or a Preset is performed. A title can also be cleared by pressing Title, Clear Title.

NOTE

Notice the inclusion of the <measurement> parameter in the command below. Because each measurement remembers the Display Title, the command must be qualified with the measurement name. For the Swept SA measurement this is not the case; no <measurement> parameter is used when changing the Display Title for the Swept SA measurement.

Key Path	View/Display, Display, Title
Mode	All
Remote Command	:DISPlay:<measurement>:ANNotation:TITLe:DATA <string> :DISPlay:<measurement>:ANNotation:TITLe:DATA?
Example	DISP:ANN:TITL:DATA "This Is My Title" This example is for the Swept SA measurement in the Spectrum Analyzer mode. The SANalyzer <measurement> name is not used. DISP:ACP:ANN:TITL:DATA "This Is My Title" This example is for Measurements other than Swept SA. Both set the title to: This Is My Title
Notes	Pressing this key cancels any active function. When a title is edited the previous title remains intact (it is not cleared) and the cursor goes at the end so that characters can be added or BKSP can be used to go back over previous characters.
Preset	No title (measurement name instead)
State Saved	Saved in instrument state.
Initial S/W Revision	Prior to A.02.00

Clear Title

Clears a title from the front-panel display. Once cleared, the title cannot be retrieved. After the title is cleared, the current Measurement Name replaces it in the title bar.

Key Path	View/Display, Display, Title
Example	The following commands clear the title and restore the measurement's original title: DISP:ANN:TITL:DATA "" This example is for the Swept SA measurement in the Spectrum Analyzer mode. The SANalyzer <measurement> name is not used. DISP:ACP:ANN:TITL:DATA "" This example is for ACP; in measurements other than Swept SA the measurement name is required.
Notes	Uses the :DISPlay:<measurement>:ANNotation:TITLe:DATA <string> command with an empty string (in the Swept SA, the <measurement> is omitted).
Preset	Performed on Preset.
Initial S/W Revision	Prior to A.02.00

Graticule

Pressing Graticule turns the display graticule On or Off. It also turns the graticule y-axis annotation on and off.

Key Path	View/Display, Display
Remote Command	:DISPlay:WINDow[1]:TRACe:GRATicule:GRID[:STATe] OFF ON 0 1 :DISPlay:WINDow[1]:TRACe:GRATicule:GRID[:STATe]?
Example	DISP:WIND:TRAC:GRAT:GRID OFF
Notes	The graticule is the set of horizontal and vertical lines that make up the grid/divisions for the x-axis and y-axis.
Preset	On
State Saved	Saved in instrument state
Initial S/W Revision	Prior to A.02.00

System Display Settings

These settings are "Mode Global" – they affect all modes and measurements and are reset only by Restore Misc Defaults or Restore System Defaults under System.

Key Path	View/Display, Display
Initial S/W Revision	Prior to A.02.00

Annotation Local Settings

This is a Mode Global override of the meas local annotation settings. When it is All Off, it forces ScreenAnnotation, Meas Bar, Trace, and Active Function Values settings to be OFF for all measurements in all modes. This provides the security based "annotation off" function of previous analyzers; hence it uses the legacy SCPI command.

When it is All Off, the Screen, Meas Bar, Trace, and Active Function Values keys under the Display, Annotation menu are grayed out and forced to Off. When Local Settings is selected, you are able to set the local annotation settings on a measurement by measurement basis.

Key Path	View/Display, Display, System Display Settings
Remote Command	:DISPlay:WINDow[1]:ANNotation[:ALL] OFF ON 0 1 :DISPlay:WINDow[1]:ANNotation[:ALL]?
Example	:DISP:WIND:ANN OFF
Preset	On (Set by Restore Misc Defaults)
State Saved	Not saved in instrument state.
Backwards Compatibility Notes	The WINDow parameter and optional subopcode is included for backwards compatibility but ignored – all windows are equally affected.
Initial S/W Revision	Prior to A.02.00

Themes

Accesses a menu of functions that enable you to choose the theme to be used when saving the screen image.

The **Themes** option is the same as the **Themes** option under the **Display** and **Page Setup** dialogs. It allows you to choose between themes to be used when saving the screen image.

Key Path	Save, Screen Image
Remote Command	:MMEMory:STORe:SCReen:THEMe TDColor TDMonochrome FCOLor FMONochrome :MMEMory:STORe:SCReen:THEMe?
Example	:MMEM:STOR:SCR:THEM TDM
Preset	3D Color; Is not part of Preset, but is reset by Restore Misc Defaults or Restore System Defaults All and survives subsequent running of the modes.
Readback	3D Color 3D Mono Flat Color Flat Mono
Backwards Compatibility Notes	In ESA and PSA we offer the choice of "Reverse Bitmap" or "Reverse Metafile" when saving screen images. This is much like the "Flat Color" theme available in X-Series. Also, if you selected Reverse Bitmap AND a black & white screen image, that would be much like "Flat Monochrome". In other words, each of the X-Series themes has a similar screen image type in ESA/PSA. But they are not identical.
Initial S/W Revision	Prior to A.02.00

3D Color

Selects a standard color theme with each object filled, shaded and colored as designed.

Key Path	Save, Screen Image, Themes
Example	MMEM:STOR:SCR:THEM TDC
Readback	3D Color
Initial S/W Revision	Prior to A.02.00

3D Monochrome

Selects a format that is like 3D color but shades of gray are used instead of colors.

Key Path	Save, Screen Image, Themes
Example	MMEM:STOR:SCR:THEM TDM
Readback	3D Mono
Initial S/W Revision	Prior to A.02.00

Flat Color

Selects a format that is best when the screen is to be printed on an ink printer.

Key Path	Save, Screen Image, Themes
Example	MMEM:STOR:SCR:THEM FCOL
Readback	Flat Color
Initial S/W Revision	Prior to A.02.00

Flat Monochrome

Selects a format that is like Flat Color. But only black is used (no colors, not even gray), and no fill.

Key Path	Save, Screen Image, Themes
Example	MMEM:STOR:SCR:THEM FMON
Readback	Flat Mono
Initial S/W Revision	Prior to A.02.00

Show All Items

When “Show All Items” is enabled, all available measurements and items are displayed.

The measurement name and items which belong to the unavailable measurements are grayed out.

Key Path	View/Display, Measurement List
Initial S/W Revision	A.14.00

Value

Allows you to refer to and modify the value on the selected row.

Key Path	View/Display, Parameter List
Initial S/W Revision	A.14.00

Result Metrics view

This view shows measurement results in the same order as the remote command measurement results returned when index (n=1) is sent.

14 Conformance EVM
View Selection



Key Path	View/Display
Initial S/W Revision	A.14.00

Component Carrier

Selects which component carrier is the source Component Carrier when Copy CC To operation is performed, it also specifies which component carrier's parameter list will be shown when Parameter List view is selected.

Key Path	View/Display
Mode	LTEAFDD, LTEATDD
Remote Command	[:SENSe] :CEVM:SELEcted CC0 CC1 CC2 CC3 CC4 [:SENSe] :CEVM:SELEcted?
Example	CEVM:SEL CC0 CEVM:SEL?
Dependencies	Component Carrier is coupled to Number of Component Carriers. For example, Component Carrier list will include CC0~CC1 if the number Component Carriers is 2.
Preset	CC0
State Saved	Saved in instrument state

Range	CC0 CC1 CC2 CC3 CC4
Readback	CC0 CC1 CC2 CC3 CC4
Initial S/W Revision	A.14.00

Copy CC To

This parameter provides parameter copy function of selected Component Carrier to another Component Carrier or all Component Carrier.

NOTE

This parameter copies LTE-Advanced demodulation parameters from one Component Carrier to other Component Carrier or all Component Carriers.

Key Path	Meas Setup
Mode	LTEAFDD, LTEATDD
Remote Command	[:SENSe] :EVM:COPIY CC0 CC1 CC2 CC3 CC4 All
Example	EVM:COPIY All
Notes	The options CC0~CC4 can be enabled with 9080B/9082B-2FP license.
Couplings	Copy the parameters settings of selected Component Carrier to the target Component Carrier.
Preset	All
State Saved	Saved in instrument state.
Range	CC0 CC1 CC2 CC3 CC4 All
Initial S/W Revision	A.14.00

RF Envelope view

For diagnostic purposes, the RF Envelope view shows a time-domain magnitude plot of selected Component Carrier.

14 Conformance EVM
View Selection



Key Path	View/Display
Initial S/W Revision	A.14.50

15 Remote SCPI Commands and Data Queries

Remote SCPI Results described in this section include:

[":READ and :FETCh Commands" on page 2588](#)

[":CALCulate:DATA" on page 2591](#)

[":CALCulate:DATA:RAW" on page 2593](#)

[":CALCulate:DATA:RAW:COMPLex" on page 2594](#)

[":CALCulate:DATA:POINts commands" on page 2595](#)

[":CALCulate:DATA:TABL commands" on page 2596](#)

[":CALCulate:DATA:HEADer commands" on page 2600](#)

[":CALC:CLIMits:FAIL?" on page 2602](#)

["IQ Data Transfers " on page 2603](#)

VSA based Measurements produce a rich variety of results that can be displayed in any of 4 traces. A result can consist of an array of X,Y trace data that is typically shown as a graph or scalar results that are displayed as a table. The Symbol/Error result that is part of many demodulation measurements actually displays both a trace table (the error statistics) and trace data (the symbol information, which is not graphed but listed). The CALC:<meas>:DATA<n> commands enable you to retrieve any trace data or trace table. This family of commands also enable you to get information about the names of data results available and the units associated with them, as well as names and results of meta-data associated with traces.

Selected results are available via the FETCh and READ SCPI interfaces. These commands refer to data results by arbitrary index number rather than by trace number.

Key Path	SCPI Only
Mode	LTE, LTETDD, IDEN, VSA

:READ and :FETCh Commands

The SCPI MEASure, READ, and FETCh are typically offered by applications with focus on manufacturing test, where a fixed set of desired results is known in advance and seldom changes. The VSA based measurements are many, due to a focus on development. Thus, for most VSA based measurements there is no standard configuration that yields a useful measurement 90% of the time. Thus, the MEASure function is not offered for most measurements in the VSA Application. However, READ and FETCh can be implemented for select results. Note that these results are also still available using the CALC:<meas>:DATA:TABLE family of commands.

ACP and OBW are available in all VSA based measurements. To retrieve the ACP or OBW data, the function must be enabled on a frequency-domain trace and the associated summary data table must be assigned to another trace. Note however, the index n in the following commands is not trace number but an index picked out of the tables shown below.

:FETCh:<meas> [n] ?

:READ:<meas> [n] ?

The results available for various values of n are shown below:

Condition	N	Results Returned
Mode = VSA LTE IDEN	Not specified or n=1	Reserved for selected results of VSA measurements. If not used for a particular measurement, no result is returned and error -114 Header suffix out of range is generated.
Mode = VSA LTE IDEN	2 - 50	Reserved for selected results of VSA measurements. If not used for a particular measurement, no result is returned and error -114 Header suffix out of range is generated.
Mode = VSA LTE IDEN, ACP on trace 1	51	ACP Summary for trace 1 Returns 28 comma-separated scalar results, corresponding to the swept ACP results where possible; n/a elsewhere: Returns 28 comma-separated scalar results, in the following order. 1. 0.0 2. Total carrier power (dBm) (same as item 4, because only 1 carrier supported) 3. 0.0 4. Reference carrier power (dBm) 5. Lower offset A - relative power (dB) 6. Lower offset A - absolute power (dBm) 7. Upper offset A - relative power (dB) 8. Upper offset A - absolute power (dBm) 9. Lower offset B - relative power (dB) 10. Lower offset B - absolute power (dBm) 11. Upper offset B - relative power (dB) 12. Upper offset B - absolute power (dBm) ... 21. Lower offset E - relative power (dB)

		22. Lower offset E - absolute power (dBm)
		23. Upper offset E - relative power (dB)
		24. Upper offset E - absolute power (dBm)
		25. n/a
		26. n/a
		27. n/a
		28. n/a
		29. Overall ACP test result summary (0 indicates at least 1 failure, 1 indicates all passed) If any result is not available, NaN (9.91 E 37) is returned. This can happen if ACP is turned off (all results unavailable) or when an offset is entirely off-screen. In the case where it is partially off-screen, the measured result is returned even though its validity is questionable.
Mode = VSA LTE IDEN, ACP on trace 2	52	ACP Summary for trace 2 see list for trace 1 summary
Mode = VSA LTE IDEN, ACP on trace 3	53	ACP Summary for trace 3 see list for trace 1 summary
Mode = VSA LTE IDEN, ACP on trace 4	54	ACP Summary for trace 4 see list for trace 1 summary
Mode = VSA LTE IDEN, ACP on trace 5	55	ACP Summary for trace 5 see list for trace 1 summary
Mode = VSA LTE IDEN, ACP on trace 6	56	ACP Summary for trace 6 see list for trace 1 summary
	57-60	no result returned; error -114, Header suffix out of range generated
Mode = VSA LTE IDEN, OBW on trace 1	61	OBW Summary for trace 1 Returns 9 comma-separated scalar results corresponding exactly to the items in the OBW Summary trace: 1. OBW (Hz) 2. Pwr (dBm) 3. Total Pwr (dBm) 4. Pwr Ratio (no unit, E.g. 0.99) 5. OBW upper freq (Hz) 6. OBW lower freq (Hz) 7. Centroid freq (Hz) 8. Offset freq (Hz) 9. OBW Test Result (0 for fail, 1 for pass) If the results are not available, NaN (9.91 E 37) is returned.
Mode = VSA LTE IDEN,	62	OBW Summary for trace 2 see list for trace 1 summary

OBW on trace 2		
Mode = VSA LTE IDEN, OBW on trace 3	63	OBW Summary for trace 3 see list for trace 1 summary
Mode = VSA LTE IDEN, OBW on trace 4	64	OBW Summary for trace 4 see list for trace 1 summary
Mode = VSA LTE IDEN, OBW on trace 5	65	OBW Summary for trace 5 see list for trace 1 summary
Mode = VSA LTE IDEN, OBW on trace 6	66	OBW Summary for trace 6 see list for trace 1 summary

Key Path	SCPI Only
Mode	LTE, LTETDD, IDEN, VSA

:CALCulate:DATA

Once measurement data result is assigned to a trace, the data can be retrieved by using one of the following commands (where <n> is the trace number and <meas> is the current VSA based measurement).

:CALC:<meas>:DATA<n>?

:CALC:<meas>:DATA<n>:RAW?

The first form of the command retrieves the data as formatted on the display. For example, if (in a vector measurement) you have the Spectrum result in LogMag format on trace 1, then

:CALC:VECT:DATA1?

returns an array of spectrum amplitude (Y data) in units of dBm, and

:CALC:VECT:DATA1:RAW?

returns the Y data in its underlying units of Volts (peak) squared.

(To get data from displayed tables, see "[:CALCulate:DATA:TABL commands](#)" on page 2596.)

The CALC:<meas>:DATA commands get data from traces. There are many results available from a VSA based measurement and only 4 traces in which to view them. View Preset commands are one way of displaying frequently-used results in standard trace locations. Or you can assign any measurement result to any trace using the softkeys under Trace/Detector, Data. The SCPI command for doing this is:

:DISP:<meas>:TRAC<n>:FEED "<data_name>"

For example, if (in a vector measurement) you want to view the CCDF result in trace 4, you send:

:DISP:VECT:TRAC4:FEED "CCDF1"

(If the measurement has not run yet, use INIT:IMM to run it.) Then the CCDF data can be retrieved using

CALC:VECT:DATA4?

or

CALC:VECT:DATA4:RAW?

Key Path	SCPI Only
Mode	VSA, LTE, LTETDD, IDEN
Measurement	<meas>:=VECTor ADEMod DDEMod W11A W11B EVM IPOWER IDEMod MOTotalk
Remote Command	:CALCulate:<meas>:DATA[1 2 ... 4? [Y X XY[,OFF ON 0 1] LL UL]
Example	CALC:VECT:DATA1? CALC:VECT:DATA1? Y,ON CALC:VECT:DATA1? X CALC:VECT:DATA1? XY
Notes	Query only. This retrieves the data in the designated trace as displayed. For example, if Trace 1 is assigned Spectrum data and formatted as LogMag, then :CALC:VECT:DATA1? returns the Y data in dBm. If the X axis is scaled to show only a portion of the

trace data, only the data shown is returned.

The numeric format of the returned data is controlled by `FORMat[:TRACe][:DATA]` command

The optional parameters control what data is returned.

`:CALC:VECT:DATA1? Y` is the same as `:CALC:VECT:DATA1?` with no parameter. It returns an array of Y values.

`:CALC:VECT:DATA1? X` returns an array of X values that correspond to the Y values above.

`:CALC:VECT:DATA1? XY` returns interleaved X and Y data. That is: `<x1><y1><x2><y2>...`

Normally, this command only returns the data between the current X scale limits. If the optional ",OFF" or ",0" switch is included at the end of the command, then all data is returned (regardless of X scaling or the state of All Frequency Points).

`:CALC:EVM:DATA1? LL|UL` returns an array of Lower/Upper Limit values when Limit Test is enabled and the trace includes limit values. When Limit Test is disabled or the trace does not include limit value, this query is the same as `:CALC:EVM:DATA1?` with no parameter.

Note: LL and UL are available only for the EVM measurement in the LTE/LTE TDD modes.

Note: the X and Y parameters in this command refer to the display's horizontal and vertical axes.

Normally the X axis is the independent variable, but if the display format is Constellation or IQ, then `CALC:<meas>:DATA<n>? [Y]` returns the imaginary part of the data and `CALC:<meas>:DATA<n>? X` returns the real part of the data. If you want the values of the independent variable, change to a non-vector format (such as Log Mag) and use `CALC:<meas>:DATA<n>? X`

Initial S/W Revision	Prior to A.02.00
Modified at S/W Revision	A.02.00, A.08.00

:CALCulate:DATA:RAW

Retrieves trace data in its underlying units, before the formatting calculation that converts it to displayed units. Underlying units are typically Volts peak (for signal results) or Volts peak squared (for power results). All data points are returned, whether or not they are displayed.

Key Path	SCPI Only
Mode	VSA, LTE, LTETDD, IDEN
Measurement	<meas>:=VECTor ADEMod DDEMod W11A W11B EVM IPOWER IDEMod MOTotalk
Remote Command	:CALCulate:<meas>:DATA[1] 2 ... 4:RAW?
Example	CALC:VECT:DATA1:RAW?
Notes	Query only. This retrieves the unformatted Y data in the designated trace. If Y data is complex, it is returned as <y_real1><y_imag1><y_real2><y_imag2> etc.
Initial S/W Revision	Prior to A.02.00
Modified at S/W Revision	A.02.00

:CALCulate:DATA:RAW:COMPLex

Determines if the data retrieved by CALC:<meas>:DATA:RAW<n>? is complex.

Key Path	SCPI Only
Mode	VSA, LTE, LTETDD, IDEN
Measurement	<meas>:=VECTor ADEMod DDEMod W11A W11B EVM IPOWER IDEMod MOTotalk
Remote Command	:CALCulate:<meas>:DATA[1] 2 ... 4:RAW:COMPLex?
Example	CALC:VECT:DATA1:RAW:COMP?
Notes	Query only. Returns 1 if the trace data is complex, 0 if it is real.
Initial S/W Revision	Prior to A.02.00
Modified at S/W Revision	A.02.00

:CALCulate:DATA:POINTS commands

Returns the number of points that are returned by

CALCulate:<meas>:DATA<n>?

X axis scaling and whether All Frequency Points is on or off can affect this number.

NOTE For the CALCulate:<meas>:DATA<n>? XY command there are 2 numbers returned per data point.

Key Path	SCPI Only
Mode	VSA, LTE, LTETDD, IDEN
Measurement	<meas>:=VECTor ADEMod DDEMod W11A W11B EVM IPOWER IDEMod MOTotalk
Remote Command	:CALCulate:<meas>:DATA [1] 2 . . . 4 : POINTs? [OFF ON 0 1]
Example	CALC:VECT:DATA1:POINTs?
Notes	<p>Query only.</p> <p>Use the optional "OFF 0" parameter to determine the number of points that are returned by the optional command form:</p> <p>:CALCulate:<meas>:DATA<n>? Y X XY,OFF 0</p> <p>Note that this is points, not array size. If the XY parameter is included, there are 2 numbers returned per point.</p> <p>(ON or 0, which means use the X-scaled version, is the default and the result is the same as if the parameter is omitted).</p>
Initial S/W Revision	Prior to A.02.00
Modified at S/W Revision	A.02.00

This query returns the number of points that are returned by

CALCulate:<meas>:DATA:RAW<n>?

NOTE For complex trace data, there are 2 numbers returned per data point.

Key Path	SCPI Only
Mode	VSA, LTE, LTETDD, IDEN
Measurement	<meas>:=VECTor ADEMod DDEMod W11A W11B EVM IPOWER IDEMod MOTotalk
Remote Command	:CALCulate:<meas>:DATA [1] 2 . . . 4 : RAW : POINTs?
Example	CALC:VECT:DATA1:RAW:POINTs?
Notes	Query only.
Initial S/W Revision	Prior to A.02.00
Modified at S/W Revision	A.02.00

:CALCulate:DATA:TABL commands

Some traces have tabular data associated with them. In fact, there may be only a table and no trace data. Each entry in the table consists of a name, a measured value, and units. The units are sometimes not shown. You can programmatically retrieve arrays of all the names, all the values, and all the units of a table. These arrays are all ordered so that corresponding indices have associated values, for example, the 4th name in the names array corresponds to the 4th value in the results array. (Note that the array order cannot be the same as the displayed order.) You can also get a particular result from the table by name. Here is a summary of the remote table data commands.

Command	Returns	Example
CALCulate:<meas>:DATA<n>:TABL?	All table data results (as an array)	CALC:DDEM:DATA4:TABL?
CALCulate:<meas>:DATA<n>:TABL? "<name>"	The table data result referred to by name	CALC:DDEM:DATA4:TABL? "EvmPeak"
CALCulate:<meas>:DATA<n>:TABL:NAMes?	Comma-separated list of all table data names	CALC:DDEM:DATA4:TABL:NAM?
CALCulate:<meas>:DATA<n>:TABL:UNIT?	Comma-separated list of all table data units	CALC:DDEM:DATA4:TABL:UNIT?

For example, if within the Vector Analysis measurement, you have an OBW Summary Table displayed in trace 2, CALC:DDEM:DATA2:TABL:NAM? would return the table names as follows:

```
"Obw,Pwr,TotalPwr,PwrRatio,ObwUpper,ObwLower,Centroid,Offset"
```

and CALC:DDEM:DATA2:TABL:UNIT? would return the units. (A null string means the result is unitless.)

```
"Hz,Vrms^2,Vrms^2,,Hz,Hz,Hz,Hz"
```

You can then get all the table results by sending

```
CALC:DDEM:DATA2:TABL?
```

Result number 1 is Obw and has units of Hz, result number 2 is Pwr with units of Vrms^2, and so on.

You can also get individual table entries by asking for them by name. Any name returned from the CALC:DDEM:DATA2:TABL:NAM? query can be used. For example, to get TotalPwr you can send the following query:

```
CALC:DDEM:DATA2:TABL? "TotalPwr"
```

Query Table Data as Number

Gets data from a table shown in the designated trace. Tables shown on the display typically have the name of a parameter followed by its measured value

Key Path	SCPI Only
Mode	VSA, LTE, LTETDD, IDEN
Measurement	<meas>:=VECTor ADEMod DDEMod W11A W11B EVM IPOWER IDEMod MOTotalk
Remote Command	:CALCulate:<meas>:DATA[1] 2 ... 4:TABLE[:NUMBER]? [<string>]
Example	CALC:DDEM:DATA2:TABL? "Obw"
Notes	Query only. If sent without a string specifier, this returns the entire table for the designated trace. If sent with a string specifier, returns a specific table entry in the designated trace. The string specifier must be delimited by single or double quotes. A list of valid strings can be obtained using CALC:<meas>:DATA:TABL:NAM? If an invalid string is sent, an error is generated. The returned results are in numeric format, under control of the FORMat[:TRACe][:DATA] command. For table data that is non-numeric, NaN is returned. To get the value of these data, use the CALC:<meas>:DATA2:TABL:STR? command.
Initial S/W Revision	Prior to A.02.00
Modified at S/W Revision	A.02.00

Query Table Data as String

Some tables have string data. The above Trace Table Data query cannot return it and sends NaN in its place. Here is a form of Trace Table Data query that can return string data from tables.

Key Path	SCPI Only
Mode	VSA, LTE, LTETDD, IDEN
Measurement	<meas>:=VECTor ADEMod DDEMod W11A W11B EVM IPOWER IDEMod MOTotalk
Remote Command	:CALCulate:<meas>:DATA[1] 2 ... 4:TABLE:STRing? [<string>]
Example	CALC:DDEM:DATA2:TABL:STR? "Obw"
Notes	Query only. If sent without a string specifier, this returns the entire table for the designated trace in comma-separated format. If sent with a string specifier, returns a specific table entry in the designated trace. The string specifier must be delimited by single or double quotes. A list of valid strings can be obtained using CALC:<meas>:DATA:TABL:NAM? If an invalid string is sent, an error is generated.
Initial S/W Revision	Prior to A.02.00
Modified at S/W Revision	A.02.00

Query Table Names

Returns a comma-separated list of names of the table data entries for the designated trace. Each of the names can be used (surrounded by quotes or double quotes) as a parameter in the Trace Table Data commands. The names appear in the same order as the corresponding data values returned by the CALC:<meas>:DATA<n>:TABL[:NUMB|STR]? query.

Key Path	SCPI Only
Mode	VSA, LTE, LTETDD, IDEN
Measurement	<meas>:=VECTor ADEMod DDEMod W11A W11B EVM IPOWER IDEMod MOTotalk
Remote Command	:CALCulate:<meas>:DATA[1] 2 ... 4:TABLE:NAMEs?
Example	CALC:VECT:DATA1:TABL:NAME?
Notes	Query only. This retrieves the names of the table entries for the designated trace. Each of these names can be used in the CALC:<meas>:DATA:TABL? '<name>' command to access a single table entry.
Initial S/W Revision	Prior to A.02.00
Modified at S/W Revision	A.02.00

Query Table Units

Returns a comma-separated list of all the units for the table data entries for the designated trace. If a data result is unitless, an empty string appears in the list for that result. The units appear in the same order as the corresponding data values returned by the CALC:<meas>:DATA<n>:TABL[:NUMB|STR]? query.

Key Path	SCPI Only
Mode	VSA, LTE, LTETDD, IDEN
Measurement	<meas>:=VECTor ADEMod DDEMod W11A W11B EVM IPOWER IDEMod MOTotalk
Remote Command	:CALCulate:<meas>:DATA[1] 2 ... 4:TABLE:UNIT?
Example	CALC:VECT:DATA1:TABL:UNIT?
Notes	Query only. This retrieves a list of units for table entries for the designated trace. The units are given in the order that the entries are sent from the :CALC:<meas>:DATA:TABL? command.
Initial S/W Revision	Prior to A.02.00
Modified at S/W Revision	A.02.00

The following table data is available in all measurements when the ACP function is turned on and the associated summary table is shown in a trace:

Result name	Displayed Unit	Remote Name	Remote Unit
Reference Bandwidth	Hz	RefBw	Hz
Reference Alpha		RefAlpha	
Reference Power	dBm	RefPwr	Vrms^2

Offset	Hz	Offset1, Offset2, Offset3, Offset4, Offset5	Hz
BW	Hz	Bw1, Bw2, Bw3, Bw4, Bw5	Hz
Alpha		Alpha1, Alpha2, Alpha3, Alpha4, Alpha5	
Lower Pwr	dBm	LowPwr1, LowPwr2, LowPwr3, LowPwr4, LowPwr5	Vrms^2
Lower ACPR	dB	LowRatio1, LowRatio2, LowRatio3, LowRatio4, LowRatio5	
Upper Pwr	dBm	HiPwr1, HiPwr2, HiPwr3, HiPwr4, HiPwr5	Vrms^2
Upper ACPR	dB	HiRatio1, HiRatio2, HiRatio3, HiRatio4, HiRatio5	
Max ACPR	dB	MaxRatio1, MaxRatio2, MaxRatio3, MaxRatio4, MaxRatio5	

The following table data is available in all measurements when the OBW function is turned on and the associated summary table is shown in a trace:

Result name	Displayed Unit	Remote Name	Remote Unit
Occupied Bandwidth	Hz	Obw	Hz
Power	dBm	Pwr	Vrms^2
Total Power	dBm	TotalPwr	Vrms^2
Power Ratio	%	PwrRatio	
Upper Freq	Hz	ObwUpper	Hz
Lower Freq	Hz	ObwLower	Hz
Centroid Freq	Hz	Centroid	Hz
Offset Freq	Hz	Offset	Hz

:CALCulate:DATA:HEADer commands

Trace data also has meta-data associated with it, called headers, which is visible if you export trace data in text format. The headers have a name and a value that can be obtained from any trace by using the CALCulate:<meas>:DATA:HEADer commands described in this section.

The following Remote Commands are described in this section:

"Query Header Names" on page 2600

"Query Header Type" on page 2600

"Query Header as String" on page 2601

"Query Numeric Header" on page 2601

":CALC:CLIMits:FAIL?" on page 2602

Query Header Names

Returns a comma-separated list of all the header names associated with the designated trace. Each of the names can be used (surrounded by quotes or double quotes) as a parameter in the other CALC:<meas>:DATA<n>:HEAD queries.

Key Path	SCPI Only
Mode	VSA, LTE, LTETDD, IDEN
Measurement	<meas>:=VECTor ADEMod DDEMod W11A W11B EVM IPOWER IDEMod MOTotalk
Remote Command	:CALCulate:<meas>:DATA[1] 2 ... 4:HEADer:NAMes?
Example	CALC:VECT:DATA1:HEAD:NAM?
Notes	Query only. Returns a comma-separated list of header names.
Initial S/W Revision	Prior to A.02.00
Modified at S/W Revision	A.02.00

Query Header Type

Returns whether the designated header on the designated trace can be queried as a number or by a string only.

Key Path	SCPI Only
Mode	VSA, LTE, LTETDD, IDEN
Measurement	<meas>:=VECTor ADEMod DDEMod W11A W11B EVM IPOWER IDEMod MOTotalk
Remote Command	:CALCulate:<meas>:DATA[1] 2 ... 4:HEADer:TYPE? <string>
Example	CALC:VECT:DATA1:HEAD:TYPE? 'XDelta'
Notes	Query only. This retrieves the type of the named header for the designated trace. The name (delimited by single or double quotes) is one of the names returned by CALC:<meas>:DATA:HEAD:NAMes? If a valid header name is passed in, the return value from this query is either STR or NUMB. NONE is

	returned if there is no such header.
Initial S/W Revision	Prior to A.02.00
Modified at S/W Revision	A.02.00

Query Header as String

Gets a header by name from the designated trace and returns its value as a string.

Key Path	SCPI Only
Mode	VSA, LTE, LTETDD, IDEN
Measurement	<meas>:=VECTor ADEMod DDEMod W11A W11B EVM IPOWER IDEMod MOTotalk
Remote Command	:CALCulate:<meas>:DATA[1] 2 ... 4:HEADer:STRing? <string>
Example	CALC:VECT:DATA1:HEAD:STR? 'WindowType'
Notes	Query only. This retrieves the named header for the designated trace. The name (delimited by single or double quotes) is one of the names returned by the CALC:<meas>:DATA:HEAD:NAMes? The return value is a string. If the requested header value is a numeric or if there is no such header, an empty string is returned.
Initial S/W Revision	Prior to A.02.00
Modified at S/W Revision	A.02.00

Query Numeric Header

Gets a numeric header by name from the designated trace and returns its value in a format determined by the last FORM command.

Key Path	SCPI Only
Mode	VSA, LTE, LTETDD, IDEN
Measurement	<meas>:=VECTor ADEMod DDEMod W11A W11B EVM IPOWER IDEMod MOTotalk
Remote Command	:CALCulate:<meas>:DATA[1] 2 ... 4:HEADer[:NUMBer]? <string>
Example	CALC:VECT:DATA1:HEAD? 'XDelta'
Notes	Query only. This retrieves the named header for the designated trace. This form of the HEAD? query is for headers whose type is NUMB (as determined by :CALC:<meas>:DATA:HEAD:TYPE?). The name parameter (delimited by single or double quotes) is one of the names returned by CALC:<meas>:DATA:HEAD:NAMes? The format of the return data is determined by the FORMat [:TRACe][:DATA] command. If used to query a header whose type is STR or there is no such header, NaN (9.91e37) is returned
Initial S/W Revision	Prior to A.02.00
Modified at S/W Revision	A.02.00

15 Remote SCPI Commands and Data Queries
:CALC:CLIMits:FAIL?

:CALC:CLIMits:FAIL?

If one or more ACP or OBW limit tests are active, then the CALC:CLIMits:FAIL? command returns the aggregate pass or fail status.

IQ Data Transfers

Fast capture/transfer of a large amount of IQ data is supported over SCPI. To do this, first set up the desired measurement range, center frequency, span, triggering, and so on. Use a time length that is convenient for setting up the measurement. The time length for the captured data is set indirectly as shown below.

To perform the capture, a typical SCPI sequence is as follows:

```
FCAP:LENG <num_samples>
```

This command sets the length for the next capture in samples. The sample rate is proportional to the current span and can be determined by a SCPI query, for example, in the Vector measurement the query:

```
VECT:SWE:ISR?
```

returns the input sample rate. For the IQAnalyzer (Basic) mode, the sample rate SCPI query is defined as follows:

```
:SPEC:SRAT? (Complex spectrum measurement)
```

```
:WAV:SRAT? (Waveform measurement)
```

Multiply the time length desired for the captured data by this sample rate to get the number of samples needed.

```
INIT:FCAP
```

pauses the current measurement and starts capturing IQ data using the current setup and trigger conditions. (The instrument front panel display does not change nor show the captured data.)

To read the captured data via SCPI in blocks, set the read block size using the command:

```
FCAP:BLOC <num_points_per_read_block>
```

The maximum read block size is typically less than the total fast capture buffer size and can be determined by the query "FCAP:BLOC? MAX". Now you can repeatedly use the following query to read out successive blocks of data:

```
FETC:FCAP?
```

The returned data is formatted according to the most recent :FORMat[:DATA] and :FORMat:BORDER commands. A read pointer that indicates the next sample to be transferred is advanced automatically following each FETC:FCAP? query. This pointer position can be read or manually set via the SCPI commands:

```
FCAP:POIN?
```

```
FCAP:POIN <read_pointer_position>
```

The fast capture data can be read as long as you use only the commands to set read block size and pointer position, or queries that return the state of the current measurement. The capture data is cleared by any command that changes the measurement state or initiates a new measurement, or via SCPI device clear or :ABORT commands.

Fast capture data word size can be set to either 32 bit or 64 bit via the FCAP:WLEN command. This enables you to trade off precision for total capture length.

Note: when the word size is 32 bit, points can only be retrieved on even sample number boundaries, that is, the pointer and block length should be even numbers. Therefore, when the word size is set to auto, it is recommended that the pointer and block size be only set to even numbers.

Fast Capture Length

Sets the length of the SCPI Fast Capture in samples (points). This is constrained to be an even number.

Query returns the most recent length setting.

Key Path	SCPI Only
Mode	VSA, BASIC
Remote Command	[:SENSe] :FCAPture:LENGth <integer> [:SENSe] :FCAPture:LENGth?
Example	FCAP:LENG 1000 FCAP:LENG?
Notes	This is affected by the IF path currently used, which can in turn be affected by span. It is also affected by the internal Fast Capture Word Length. The current maximum fast capture length can be found by using the query: FCAP:LENG? MAX Changing the Capture Length after initiating a fast capture clears the capture memory in preparation for a new fast capture of a different length. No Front panel access; SCPI only
Preset	1048576 Samples
Min	2
Max	536 870 908 Samples for internal 40 MHz and 140 MHz options with FCAP:WLEN BIT32
Initial S/W Revision	A.04.00

Fast Capture Word Length

Enables choice of internal fast capture word length. Shorter word length enables twice the time length to be captured at the cost of quantization noise. Note that this does not affect the format of data returned by FETCh:FCAPture, only the internal representation.

Key Path	SCPI Only
Mode	VSA, BASIC
Remote Command	[:SENSe] :FCAPture:WLENGth AUTO BIT32 BIT64 [:SENSe] :FCAPture:WLENGth?
Example	FCAP:WLEN AUTO FCAP:WLEN?
Notes	No Front panel access; SCPI only.

Preset	AUTO
Initial S/W Revision	A.04.00

Initiate Fast Capture

Waits for the sweep to trigger and then captures the fast capture data. Sweep is then set to pause. The amount of data captured is controlled by the Fast Capture Length command (FCAP:LENG).

Key Path	SCPI Only
Mode	VSA, BASIC
Remote Command	:INITiate:FCAPture
Example	INIT:FCAP
Notes	This is an overlapped command. It returns immediately, but the capture may not be complete. Use *OPC?, *WAI, or *OPC to determine when the capture is complete.
Notes	No Front panel access; SCPI only This command resets the Fast Capture Pointer to 0
Initial S/W Revision	A.04.00

Fast Capture Block

Sets the block size for the Fast Capture transfer in samples (points). This is the number of points that are returned from the Capture buffer by the FETC:FCAP? command. This is constrained to be an even number.

Query returns most recent block size setting.

Key Path	SCPI Only
Mode	VSA, BASIC
Remote Command	[:SENSe] :FCAPture:BLOCK <integer> [:SENSe] :FCAPture:BLOCK?
Example	FCAP:BLOC 100 FCAP:BLOC?
Notes	No Front panel access. SCPI only.
Preset	1024 Samples
Min	0
Max	131072 or Fast Capture Length, whichever is smaller
Initial S/W Revision	A.04.00

Fast Capture Pointer

Sets the pointer position for the Fast Capture transfer in samples (points). The pointer is incremented by the block size each time the fetch is performed. Preset value (0) is the first sample in the record. Thus repetitive fetches result in contiguous data without needing to increment the pointer over SCPI. This is constrained to be an even number. Query returns most recent pointer setting.

Key Path	SCPI Only
Mode	VSA, BASIC
Remote Command	[:SENSe] :FCAPture:POINter <integer> [:SENSe] :FCAPture:POINter?
Example	FCAP:POIN 100 FCAP:POIN?
Notes	INIT:FCAP or FCAP:ABOR resets the pointer to 0. No front panel access; SCPI only.
Preset	0 Samples
Min	0
Max	Must be less than the Fast Capture length
Initial S/W Revision	A.04.00

Fetch Fast Capture

Transfers the block of data starting at the pointer. The number of samples transferred is set with the block size. The pointer is incremented by the block size after the fetch.

Key Path	SCPI Only
Mode	VSA, BASIC
Remote Command	:FETCh:FCAPture?
Example	FETC:FCAP?
Notes	The returned data is formatted according to the most recent :FORMat[:DATA] and :FORMat:BORDER commands. If the read pointer position plus read block size exceeds the Fast Capture Length, only the data between the pointer and the end of the fast capture buffer are returned, and error -200 is reported. If Fetch is attempted before an INIT:FCAP or if the captured data is cleared by some other operation (e.g., REC), error -230 is reported and no data is returned. No front panel access; SCPI only.
Initial S/W Revision	A.04.00

Input Sample Rate Query

Returns the complex sample rate in Hz for the current VXA measurement setup conditions. The sample rate can be used to convert between time and number of sample points when using the Fast Capture feature.

Sample rate depends on the settings for `FREQ:SPAN` and `IFPath`. You need to set these before making this query. Though the measurement name is specified in the query, you can only query the currently configured measurement. That is, if you have sent `CONF:VECT`, the query `ADEM:SWE:ISR?` generates an error.

Key Path	SCPI Only
Mode	VSA
Measurement	<meas>:=VECTor ADEMod DDEMod W11A W11B
Remote Command	[:SENSe] :<meas>:SWEep:ISRate?
Example	VECT:SWE:ISR?
Notes	<p>Query returns the complex sample rate in Hz for the current VXA Vector measurement setup conditions.</p> <p>If the measurement in the query is not the active measurement, error -230 is reported and no data is returned.</p> <p>This query is SCPI only, no Front Panel softkey.</p>
Preset	Depends on the licensed IF path
Initial S/W Revision	A.04.00

Parameter Update Enable

Refers only to measurements that use the VSA measurement engine. These are all the measurements in the Vector Signal Analyzer (VXA) Application and the EVM measurement in the LTE Applications.

When a measurement parameter is changed, the new value is used to update any dependent parameters and measurement results. This update process is normally done after every parameter change. This enables visual feedback during interactive GUI operation. However, with SCPI controlled measurements, typically a lot of parameter changes are done at once with the measurement stopped and then the measurement is run once and data retrieved. Here, is not necessary, and the accumulated update time for each parameter change can become significant. The Parameter Update Enable command enables you to postpone update while sending setup commands and then enable one update to occur just before the measurement.

For example, if you are programmatically setting up a complex LTE measurement, you could save some setup time by first sending EVM:PUPD:ENAB OFF, then sending the whole group of measurement setup commands. When you are done with the setup, send EVM:PUPD:ENAB:ON. This causes the measurement state to be updated with all dependencies resolved. After this, you can read back the parameters' actual values. As a convenience, starting or continuing a measurement (INITiate:REStart, INITiate:IMMEDIATE, INITiate:<meas> or INITiate:RESume) automatically sets <meas>:PUPD:ENAB to ON. So does CONFigure:<meas> or any of the reset and recall state commands.

This command should be used with caution.

It is only valid to turn <meas>:PUPD:ENAB OFF when <meas> is the currently active measurement and the measurement is paused (i.e., INIT:CONT is OFF).

If you try to set and then read back a parameter value while Parameter Update Enable is off, you are not guaranteed to get back the true value that is used in the measurement because no parameter limiting is being done nor are any dependencies between parameters being resolved.

If you try to set coupled parameters independently when Parameter Update Enable is off, then when it is turned on, at most one of the parameter settings remain the same and the others change due to dependency resolution.

Key Path	SCPI Only
Mode	VSA, LTE, LTETDD, IDEN
Measurement	<meas>:=VECTor ADEMod DDEMod W11A W11B EVM IPOWER IDEMod MOTotalk
Remote Command	[:SENSe] : <meas> : PUPDate : ENABle OFF ON 0 1 [:SENSe] : <meas> : PUPDate : ENABle ?
Example	EVM:PUPD:ENAB OFF
Notes	Commands that cause a measurement to run, that switch measurements, or that preset or recall measurement state, set Parameter Update state to ON. These include INIT:IMM, INIT:REST, INIT:RES, INIT:<meas>, and CONF:<meas>.
Preset	1
State Saved	No
Initial S/W Revision	A.03.00