

Startup Guide

LTE/LTE-Advanced Multi-Channel Reference Solution



Notice: This document contains references to Agilent. Please note that Agilent's Test and Measurement business has become Keysight Technologies. For more information, go to www.keysight.com.

Notices

© Keysight Technologies, Inc. 2013, 2014

No part of this manual may be reproduced in any form or by any means (including electronic storage and retrieval or translation into a foreign language) without prior agreement and written consent from Keysight

Technologies, Inc. as governed by United States and international copyright laws.

Manual Part Number
Y1299-90001

Edition

October 2014. Build 2014.10.29.1439

Sales and Technical Support

For product specific information and support, and to obtain the latest software and documentation, refer to

www.keysight.com/find/pxi-mimo.

Worldwide contact information for repair and service can be found at

www.keysight.com/find/assist.

Information on preventing damage to your Keysight equipment can be found at

www.keysight.com/find/tips.

Regulatory Compliance

This product has been designed and tested in accordance with accepted industry standards, and has been supplied in a safe condition. To review the Declaration of Conformity, go to <http://regulations.corporate.keysight.com/DoC/search.htm>.

Warranty

The material contained in this document is provided “as is,” and is subject to being changed, without notice, in future editions. Further, to the maximum extent permitted by applicable law, Keysight disclaims all warranties, either express or implied, with regard to this manual and any information contained herein, including but not limited to the implied warranties of merchantability and fitness for

a particular purpose. Keysight shall not be liable for errors or for incidental or consequential damages in connection with the furnishing, use, or performance of this document or of any information contained herein. Should Keysight and the user have a separate written agreement with warranty terms covering the material in this document that conflict with these terms, the warranty terms in the separate agreement shall control. Keysight Technologies does not warrant third-party system-level (combination of chassis, controllers, modules, etc.) performance, safety, or regulatory compliance, unless specifically stated.

Technology Licenses

The hardware and/or software described in this document are furnished under a license and may be used or copied only in accordance with the terms of such license.

Restricted Rights Legend

If software is for use in the performance of a U.S. Government prime contract or sub-contract, Software is delivered and licensed as “Commercial computer software” as defined in DFAR 252.227-7014 (June 1995), or as a “commercial item” as defined in FAR 2.101(a) or as “Restricted computer software” as defined in FAR 52.227-19 (June 1987) or any equivalent agency regulation or contract clause. Use, duplication or disclosure of Software is subject to Keysight Technologies’ standard commercial license terms, and non-DOD Departments and Agencies of the U.S. Government will receive no greater than Restricted Rights as defined in FAR 52.227-19(c)(1-2) (June 1987). U.S. Government users will receive no greater than Limited Rights as defined in FAR 52.227-14 (June 1987) or DFAR 252.227-7015 (b)(2) (November 1995), as applicable in any technical data.

Safety Notices

The following safety precautions should be observed before using this product and any associated instrumentation.

This product is intended for use by qualified personnel who recognize shock hazards and are familiar with the safety precautions required to avoid possible injury. Read and follow all installation, operation, and main-

tenance information carefully before using the product.

WARNING

If this product is not used as specified, the protection provided by the equipment could be impaired. This product must be used in a normal condition (in which all means for protection are intact) only.

The types of product users are:

- **Responsible body** is the individual or group responsible for the use and maintenance of equipment, for ensuring that the equipment is operated within its specifications and operating limits, and for ensuring operators are adequately trained.
- **Operators** use the product for its intended function. They must be trained in electrical safety procedures and proper use of the instrument. They must be protected from electric shock and contact with hazardous live circuits.
- **Maintenance personnel** perform routine procedures on the product to keep it operating properly (for example, setting the line voltage or replacing consumable materials). Maintenance procedures are described in the user documentation. The procedures explicitly state if the operator may perform them. Otherwise, they should be performed only by service personnel.
- **Service personnel** are trained to work on live circuits, perform safe installations, and repair products. Only properly trained service personnel may perform installation and service procedures.

WARNING

Operator is responsible to maintain safe operating conditions. To ensure safe operating conditions, modules should not be operated beyond the full temperature range specified in the Environmental and physical specification. Exceeding safe operating conditions can result in shorter lifespans, improper module performance and user

safety issues. When the modules are in use and operation within the specified full temperature range is not maintained, module surface temperatures may exceed safe handling conditions which can cause discomfort or burns if touched. In the event of a module exceeding the full temperature range, always allow the module to cool before touching or removing modules from chassis.

Keysight products are designed for use with electrical signals that are rated Measurement Category I and Measurement Category II, as described in the International Electrotechnical Commission (IEC) Standard IEC 60664. Most measurement, control, and data I/O signals are Measurement Category I and must not be directly connected to mains voltage or to voltage sources with high transient over-voltages. Measurement Category II connections require protection for high transient over-voltages often associated with local AC mains connections. Assume all measurement, control, and data I/O connections are for connection to Category I sources unless otherwise marked or described in the user documentation.

Exercise extreme caution when a shock hazard is present. Lethal voltage may be present on cable connector jacks or test fixtures. The American National Standards Institute (ANSI) states that a shock hazard exists when voltage levels greater than 30V RMS, 42.4V peak, or 60VDC are present. A good safety practice is to expect that hazardous voltage is present in any unknown circuit before measuring.

Operators of this product must be protected from electric shock at all times. The responsible body must ensure that operators are prevented access and/or insulated from every connection point. In some cases, connections must be exposed to potential human contact. Product operators in these circumstances must be trained to protect themselves from the risk of electric shock. If the circuit is capable of operating at or above 1000V, no conductive part of the circuit may be exposed.

Do not connect switching cards directly to unlimited power circuits. They are intended to be used with impedance-limited sources. NEVER connect switching cards directly to AC

mains. When connecting sources to switching cards, install protective devices to limit fault current and voltage to the card.

Before operating an instrument, ensure that the line cord is connected to a properly-grounded power receptacle. Inspect the connecting cables, test leads, and jumpers for possible wear, cracks, or breaks before each use.

When installing equipment where access to the main power cord is restricted, such as rack mounting, a separate main input power disconnect device must be provided in close proximity to the equipment and within easy reach of the operator.

For maximum safety, do not touch the product, test cables, or any other instruments while power is applied to the circuit under test. ALWAYS remove power from the entire test system and discharge any capacitors before: connecting or disconnecting cables or jumpers, installing or removing switching cards, or making internal changes, such as installing or removing jumpers.

Do not touch any object that could provide a current path to the common side of the circuit under test or power line (earth) ground. Always make measurements with dry hands while standing on a dry, insulated surface capable of withstanding the voltage being measured.

The instrument and accessories must be used in accordance with its specifications and operating instructions, or the safety of the equipment may be impaired.

Do not exceed the maximum signal levels of the instruments and accessories, as defined in the specifications and operating information, and as shown on the instrument or test fixture panels, or switching card.

When fuses are used in a product, replace with the same type and rating for continued protection against fire hazard.

Chassis connections must only be used as shield connections for measuring circuits, NOT as safety earth ground connections.

If you are using a test fixture, keep the lid closed while power is applied to the device under test. Safe operation requires the use of a lid interlock.

CAUTION

A **CAUTION** notice denotes a hazard. It calls attention to an operating procedure, practice,

or the like that, if not correctly performed or adhered to, could result in damage to the product or loss of important data. Do not proceed beyond a **CAUTION** notice until the indicated conditions are fully understood and met.

WARNING

A **WARNING** notice denotes a hazard. It calls attention to an operating procedure, practice, or the like that, if not correctly performed or adhered to, could result in personal injury or death. Do not proceed beyond a **WARNING** notice until the indicated conditions are fully understood and met.

Instrumentation and accessories shall not be connected to humans.

Before performing any maintenance, disconnect the line cord and all test cables.

To maintain protection from electric shock and fire, replacement components in mains circuits – including the power transformer, test leads, and input jacks – must be purchased from Keysight. Standard fuses with applicable national safety approvals may be used if the rating and type are the same. Other components that are not safety-related may be purchased from other suppliers as long as they are equivalent to the original component (note that selected parts should be purchased only through Keysight to maintain accuracy and functionality of the product). If you are unsure about the applicability of a replacement component, call an Keysight office for information.

WARNING

No operator serviceable parts inside. Refer servicing to qualified personnel. To prevent electrical shock do not remove covers. For continued protection against fire hazard, replace fuse with same type and rating.
PRODUCT MARKINGS:



The CE mark is a registered trademark of the European Community.



Australian Communication and Media Authority mark to indicate regulatory compliance as a registered supplier.

ICES/NMB-001
ISM GRP.1 CLASS A

This symbol indicates product compliance with the Canadian Interference-Causing Equipment Standard (ICES-001). It also identifies the product is an Industrial Scientific and Medical Group 1 Class A product (CISPR 11, Clause 4).



South Korean Class A EMC Declaration. This equipment is Class A suitable for professional use and is for use in electromagnetic environments outside of the home. A급 기기 (업무용 방송통신기자재) 이 기기는 업무용 (A급) 전자파적합기기로서 판매자 또는 사용자는 이 점을 주의하시기 바라며, 가정외의 지역에서 사용하는 것을 목적으로 합니다.



This symbol indicates separate collection for electrical and electronic equipment, mandated under EU law as of August 13, 2005. All electric and electronic equipment are required to be separated from normal waste for disposal (Reference WEEE Directive, 2002/96/EC).



This symbol indicates the instrument is sensitive to electrostatic discharge (ESD). ESD can damage the highly sensitive components in your instrument. ESD damage is most likely to occur as the module is being installed or when cables are connected or disconnected. Protect the circuits from ESD damage by wearing a grounding strap that provides a high resistance path to ground. Alternatively, ground yourself to discharge any built-up static charge by touching the outer shell of any grounded instrument chassis before touching the port connectors.



This symbol on an instrument means caution, risk of danger. You should refer to the operating instructions located in the user doc-

umentation in all cases where the symbol is marked on the instrument.



This symbol indicates the time period during which no hazardous or toxic substance elements are expected to leak or deteriorate during normal use. Forty years is the expected useful life of the product.

CLEANING PRECAUTIONS:

WARNING

To prevent electrical shock, disconnect the Keysight Technologies instrument from mains before cleaning. Use a dry cloth or one slightly dampened with water to clean the external case parts. Do not attempt to clean internally. To clean the connectors, use alcohol in a well-ventilated area. Allow all residual alcohol moisture to evaporate, and the fumes to dissipate prior to energizing the instrument.

Table of Contents

MIMO Introduction	9
Related Documentation	9
Step 1: Unpack and Inspect the Modules	11
Inspect for Damage	11
Return an Instrument for Service	11
Step 2: Verify Shipment Contents	12
Step 3: Install the Modules	12
Items You Will Need	12
Recommended best practices to ensure proper and safe module operating conditions	12
If Your Solution Contains a Keysight M9021A Cable Interface Module	13
If Your Solution Contains a Keysight M9021A Cable Interface Module in Slot 1	14
Module Installation Process Overview	15
MIMO Instrument Connections	17
Recommended MIMO Configurations	18
Sharing the M9300A Frequency Reference	20
2x2 MIMO Configuration in a Single PXIe Chassis	22
3x3 MIMO Configuration in Two PXIe Chassis with External Controller	23
3x3 MIMO Configuration in Two PXIe Chassis with Embedded Controller	24
4x4 MIMO Configuration in Two PXIe Chassis with External Controller	25
4x4 MIMO Configuration in Two PXIe Chassis with Embedded Controller	27
Step 4: Install the Software	28
Requirements	28
Items You Will Need	28
Software Installation Procedure	29
Step 5: Redeem Your Software Licenses	30
Step 6: Configure Your MIMO Solution and Verify Operability	31
Procedure	31
Step 7: Installation is Complete	32
API Overview	33

MIMO Introduction

Multi-channel and MIMO transmitter and receiver testing may require synchronization of multiple signal generators and/or signal analyzers in time and frequency. For example, wireless LAN transmitters can be measured by multiple receivers operating at the same frequency and with acquisition timing aligned, and receivers can be tested using synchronized signal generators.

The M9381A VSG and M9391A VSA can be configured to operate in multi-channel configurations with a shared 100 MHz frequency reference, and an independent local oscillator (synthesizer) for each channel. This allows them to operate at the same frequency for MIMO operation, and at different frequencies for modes in which multiple carriers are used, but baseband timing alignment is still required.

The arbitrary waveform playback of the M9381A VSG can be synchronized using a common external trigger on the backplane of the PXIe chassis. The IQ acquisitions made by the M9391A PXIe VSA for demodulating MIMO waveforms can be synchronized using a synchronization technique using the backplane of the PXIe chassis. Refer to the [Keysight M9391A PXIe Vector Signal Analyzer and M9381A PXIe Vector Signal Generator Programming Guide](#) for details.

The scope of this document is to present the processes of receiving and verifying operation of the Keysight MIMO PXI Test Solution (see www.keysight.com/find/pxi-mimo). The overall process is:

1. Unpack and inspect your solution.
2. Verify the contents of each box in your shipment matches the respective box content list.
3. Install and cable the modules.
4. Install the software.
5. Redeem your software licenses.
6. Complete the configuration of your MIMO solution and verify operability.
7. Installation is complete. Proceed to use the MIMO Demo Tool, and develop your control programs with the help of the MIMO Demo Tool source code and the product drivers.

NOTE If you ordered an assembled MIMO solution, go directly to [Step 5](#) to finish installation and configuration.

For more information on LTE/LTE-A Multi-Channel Systems see:

- Solution Brochure 5991-4684EN
- Configuration Guide 5991-4647EN

Related Documentation

The documentation associated with this solution is available at the respective product pages on keysight.com (go to **Document Library > Manuals**).

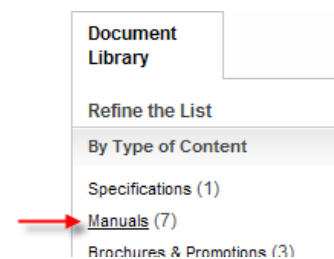

M9381A Vector Signal Generator (see www.keysight.com/find/M9381A)

- M9381A VSG and M9391A VSA Startup Guide
- M9381A VSG and M9391A VSA Programming Guide
- M9381A Soft Front Panel help system
- M9381A device driver API references (IVI-C/IVI-COM and LabVIEW G)
- M9381A Data Sheet
- M9381A Specifications Guide

M9391A Vector Signal Analyzer (see www.keysight.com/find/M9391A)

- M9391A Soft Front Panel help system
- M9393A Soft Front Panel help system
- M9391A device driver API references (IVI-C/IVI-COM and LabVIEW G)
- M9393A device driver API references (IVI-C/IVI-COM and LabVIEW G)
- M9391A Data Sheet
- M9391A Specifications Guide

NOTE Depending upon your particular order, you may find the following product documentation useful.

Keysight Multiple PXIe and AXIe Chassis System Configuration Tool

Download and save this CHM file from www.keysight.com/find/pxie-multichassis.

M9018A PXIe Chassis (see www.keysight.com/find/M9018A)

- M9018A PXIe Chassis Startup Guide

M9036A or M9037A PXIe Embedded Controller

- M9036A PXIe Embedded Controller Startup Guide (optional) – see www.keysight.com/find/M9036A
- M9037A PXIe Embedded Controller Startup Guide (optional) – see www.keysight.com/find/M9037A

M9021A PCIe Cable Interface – *optional* (see www.keysight.com/find/M9021A)

- keysight M9021A PCIe Cable Interface Module Installation Guide

Keysight MIMO Demo Tool

- keysight PXI MIMO Demo Program User Guide
- keysight PXI MIMO Demo Program Developer Guide

Step 1: Unpack and Inspect the Modules

CAUTION The modules are shipped in materials which prevent damage from static. The module should only be removed from the packaging in an anti-static area ensuring that correct anti-static precautions are taken. Store all modules in anti-static envelopes when not in use.

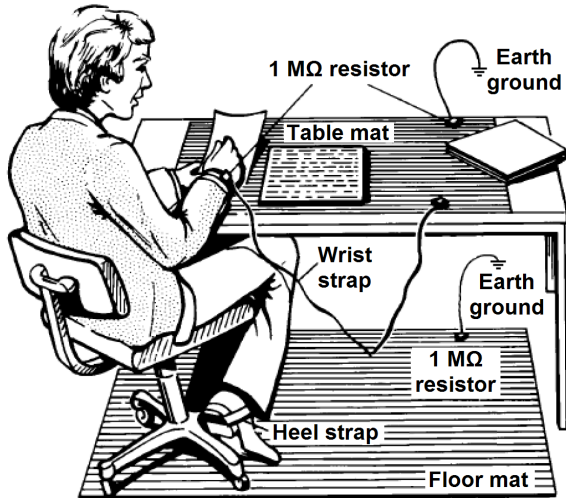

Electrostatic discharge (ESD) can damage or destroy electronic components. Use a static-safe work station to perform all work on electronic assemblies. The figure (left) shows a static-safe work station using two types of ESD protection: conductive table-mat and wrist-strap combination, and conductive floor-mat and heel-strap combination. Both types, when used together, provide a significant level of ESD protection. Of the two, only the table-mat and wrist-strap combination provides adequate ESD protection when used alone. To ensure user safety, the static-safe accessories must provide at least 1 M Ω of isolation from ground.

WARNING DO NOT use these techniques for a static-safe work station when working on circuitry with a voltage potential greater

than 500 volts.

Inspect for Damage

After unpacking a solution, inspect all components for any shipping damage. Report any damage to the shipping agent immediately, as such damage is not covered by the [warranty](#) (see [page 3](#)).

NOTE See www.keysight.com/find/tips for information on preventing damage to your keysight equipment.

Return an Instrument for Service

Should it become necessary to return an instrument for repair or service, follow the steps below:

NOTE It is recommended that you return all modules and cables of the M9381A or M9391A instrument for repair and calibration. If your Keysight M9300A PXIe Frequency Reference is operating properly, you need not send it in with the other modules because your instrument may be repaired and calibrated without your M9300A. Doing so, however, will effect your calibration schedule, since repairs are followed by calibration. The Calibration Due Date for your M9300A will not match the date of your other modules.

NOTE All component modules for an M9381A M9391A instrument are factory tested, aligned, calibrated and shipped as a "bundle". It is important that you maintain the bundle when installing modules or returning an instrument for repair. See [explanation](#) ([page 32](#)).

1. Review the warranty information shipped with your product.

Step 2: Verify Shipment Contents

2. Contact Keysight to obtain a Return Material Authorization (RMA) and return address. For assistance finding contact information, go to www.keysight.com/find/assist.
3. Write the following information on a tag and attach it to the malfunctioning equipment:
 - Name and address of owner. A P.O. box is not acceptable as a return address.
 - Description of failure or service required.
4. Pack the instrument in its original packaging. Include all cables. If the original packaging material is not available, use anti-static bubble wrap or packing peanuts and place the instrument in a sealed container and mark the container "FRAGILE".
5. On the shipping label, write ATTENTION REPAIR DEPARTMENT and the RMA number.

NOTE In your correspondence, refer to the modules by serial number and the instrument by model number.

NOTE For components other than the M9381A, M9391A, and M9300A, see the product's documentation.

Step 2: Verify Shipment Contents

Your solution shipped in multiple boxes. Refer to the box content list attached to each box.

Step 3: Install the Modules

CAUTION PXI hardware does not support "hot-swap" (changing modules while power is applied to the chassis) capabilities. Before installing or removing a module to/from the chassis, power off the chassis to prevent damage to the module.

NOTE All component modules for an M9381A or M9391A instrument are factory tested, aligned, calibrated and shipped as a "bundle". It is important that you maintain the bundle when installing modules or returning an instrument for repair. See [explanation \(page 32\)](#).

Items You Will Need

- Pozidriv P1 or slotted screwdriver to secure the modules into the chassis
- Adjustable torque wrench (at minimum, accommodate an 8 Lb-In [0.904 Nm] torque on SMA connectors).

Recommended best practices to ensure proper and safe module operating conditions

- Ensure proper chassis air flow is maintained
- Select a chassis that provides thermal protection if fans become inoperable or forced air cooling is obstructed
- Use slot blockers (Keysight model [Y1212A](#), 5 per kit) and EMC filler panels in empty module slots to

ensure proper operating temperatures. Keysight chassis [Keysight M9018A chassis](#) and slot blockers optimize module temperature performance and reliability of test.

- Set chassis fans to high or auto. Do not disable fans.
- Position chassis to allow plenty of space around chassis air intake and fan exhaust.
- At environment temperatures above 45 °C, set chassis fan speed to high.

M9018A Chassis Air Flow



The M9018A has multiple air intakes. They are located at the lower sides, lower front, and bottom of the chassis.

If Your Solution Contains a Keysight M9021A Cable Interface Module

For greater detail on configuring your Keysight M9018A Chassis and Keysight M9021A PCIe Cable Interface, download the [Keysight Multiple PXIe and AXIe Chassis System Configuration Tool](#). Save the file to your local hard drive; do not try to open the file from the Internet location.

Verify that the M9021A switches S301 and S201 are in the correct position. Refer to the following figure for M9021A switch positions.

Step 3: Install the Modules

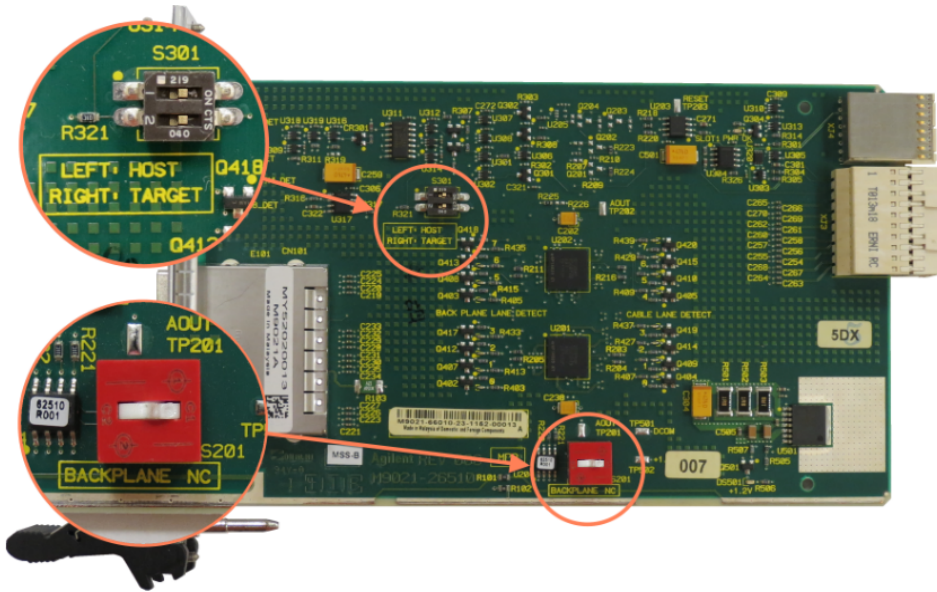

For applications where the M9021A provides a cabled PCIe link between the M9018A chassis and an external host computer, install the M9021A in the system slot (slot 1) of the M9018A PXIe chassis. The two switches on S301 must be in the Target (right) position. This is the default setting. For connecting to a downstream solution, the M9021A should be installed in a x8 hybrid slot in the PXIe chassis (slots 2, 6, 11, or 15 in the M9018A chassis). In

this case, both switches on S301 should be in the Host (left) position.

If Your Solution Contains a Keysight M9021A Cable Interface Module in Slot 1

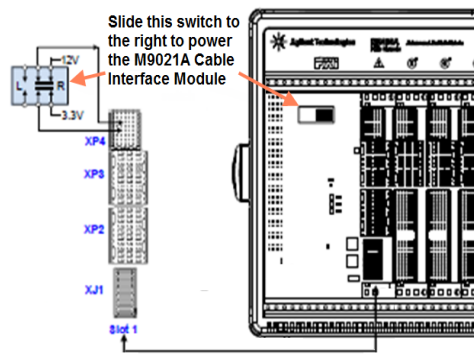

The M9021A Cable Interface Module does not derive power from the chassis connector used by PXI embedded controllers. Instead, the M9021A uses the top connector on the chassis backplane for its 3.3V and 12V power. However, a switch on the M9018A chassis backplane must be set to supply those voltages to the connector. The default position of the switch is to the **left** and does not supply the voltages to the connector. To use the M9021A in Slot 1 of the M9018A chassis, you must move the slide switch to the **right** before installing the module. Refer to the M9018A chassis documentation for more information.

ation.

1. Locate Slot 1 in the chassis. It has the icon (▲) above it.
2. Remove the M9021A module from its protective bag. Observe ESD precautions.
3. Hold the module by the injector/ejector handle; guide the module into chassis slot number 1.
 - a. Install the module into the PXI slot of the chassis by placing the module card edges into the front module guides (top and bottom).
 - b. Slide the module to the rear of the chassis and assure that the injector/ejector handle is pushed down in the unlatched (downward) position.
 - c. Slide the module completely into the chassis. When you begin to feel resistance, push up on the handle to fully seat the module into the chassis.
 - d. Tighten the module retaining screws and torque to 5 Lb-In (0.57 N-m).

4. Attach the PCIe cable by first pulling back on the retaining ring. With the keyed slot aligned with the keyed ridge on the PCIe adaptor, insert the cable connector into the cable port connector on the adaptor until the cable locks in place.
5. Attach the other end of the cable to the PCIe adaptor on your system computer.

NOTE If you are using a remote controller, you must power up the chassis BEFORE you power up the PC. When you power down your solution, shut down the PC BEFORE you power down the chassis.

Module Installation Process Overview

1. Make sure that the line cord is plugged in to establish earth ground and that the chassis power switch is **Off**.
2. If the chassis has multiple fan speed settings, ensure that the fan switch is set to **AUTO** and the inhibit switch is set to **DEF**.



3. Position the chassis to provide ample space between the chassis fan intake and exhaust vents. Blockage by walls or obstructions affects the air flow needed for cooling. (Refer to the chassis documentation for more information about cooling).
4. Before inserting a module into the chassis, back the mounting screws out to ensure that there is no interference between the screws and the mounting rails.
5. Refer to [MIMO Instrument Connections \(page 17\)](#) for M9381A and M9391A cabling. For MIMO configurations, refer to the appropriate details between [page 22](#) and [page 27](#).
6. Holding the module by the injector/ejector handle, slide it into an available PXI (or hybrid) slot, as shown in the following figure.

- a. Install the module into the slot of the chassis by placing the module card edges into the front module guides (top and bottom).
- b. Slide the module to the rear of the chassis and ensure that the injector/ejector handle is pushed down in the unlatched (downward) position.
- c. Slide the module completely into the chassis. When you begin to feel resistance, pull up on the injector/ejector handle to fully inject the module into the chassis.

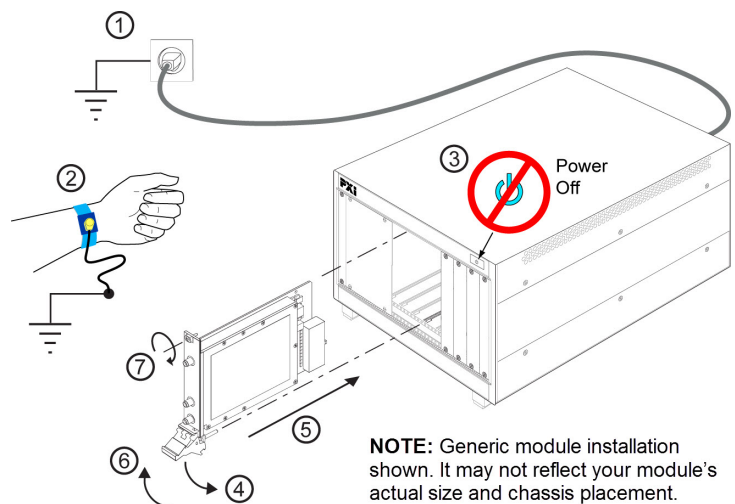

7. Secure all modules to the chassis using the module mounting screws. Use a #1 Pozidriv® or a slotted screwdriver and torque to 5 Lb-In (0.57 N-m). Performance may suffer if the screws are not tightened properly.
8. Install filler panels and slot blockers after installing the modules. Missing filler panels or slot blockers may disrupt air circulation in the chassis. The left-most slot does not accept a slot blocker.

Step 3: Install the Modules

9. Your shipment included an Keysight M9310A PXIe Source Output. With you received a straight, coaxial adapter (1250-2316) (SMA female to SMA male). Connect this adapter to the RF Out connector of each M9310A, and torque to 8 Lb-In (0.904 Nm). **This will extend the life of often-used connector.**
10. Cable the system according to the information on [MIMO Instrument Connections \(page 17\)](#).
11. Power up the PXI chassis.
12. If you are using a remote PC, reboot the PC host.

MIMO Instrument Connections

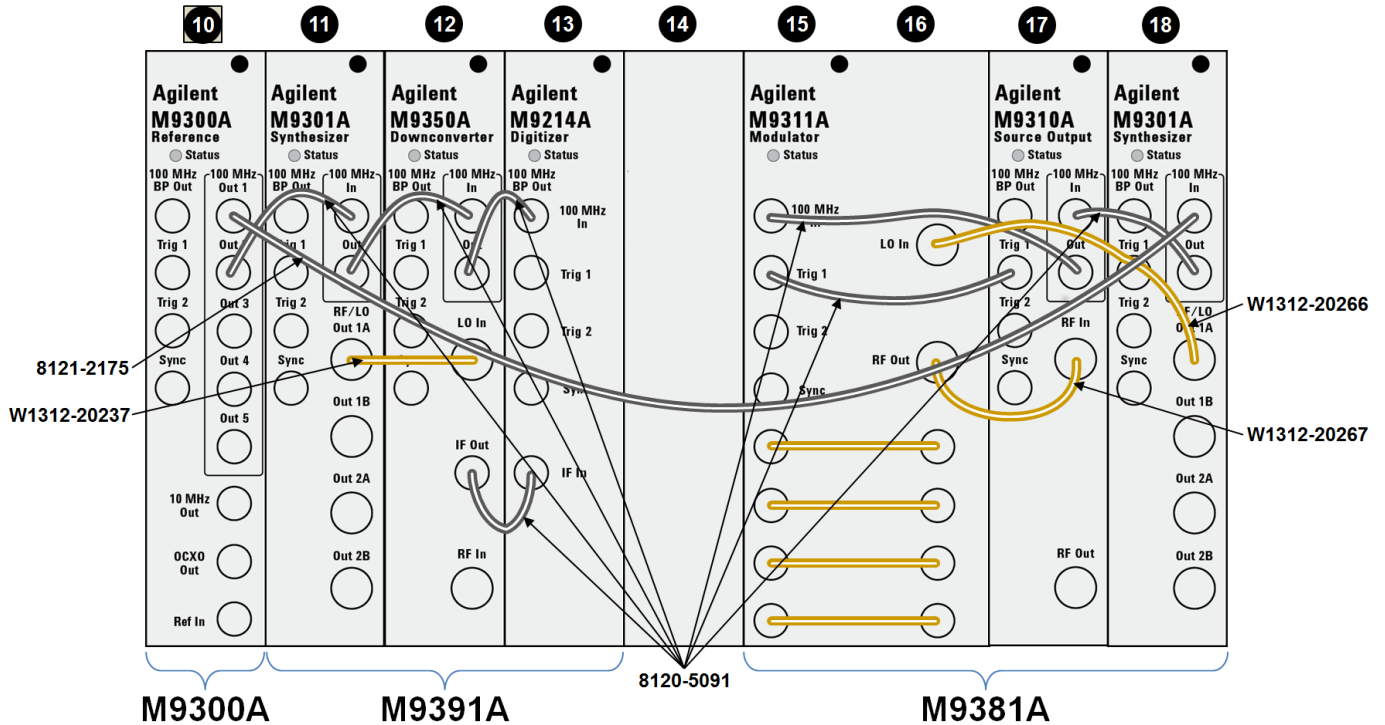

Recommendation: Install semi-rigid cables first. **Torque specification** on SMA connectors: 8 Lb-In (0.904 Nm).

NOTE For all MIMO configurations, the M9300A Reference should be installed in slot 10 (the timing slot).

M9381A Cable and Module Table

Part Number	Connection	Cable Description
8121-2063	This cable can be used to direct an External Reference into the M9300A Ref In connector.	Cable, coaxial, BNC (male) - SMB (female), 1200 mm
8120-5091	M9300A 100 MHz Out 1 to M9301A 100 MHz In	Cable, coaxial, SMB (female) - SMB (female)
8120-5091	M9301A 100 MHz Out to M9310A 100 MHz In	Cable, coaxial, SMB (female) - SMB (female)
8120-5091	M9310A 100 MHz Out to M9311A 100 MHz In	Cable, coaxial, SMB (female) - SMB (female)
8120-5091	M9310A Trig 1 to M9311A Trig 1 for Pulse Mod.	Cable, coaxial, SMB (female) - SMB (female)
W1312-20266	M9301A RF/LO Out 1A to M9311A LO In	Cable, semi-rigid, SMA (male) - SMA (male)
W1312-20267	M9311A RF Out to M9310A RF In	Cable, semi-rigid, SMA (male) - SMA (male)

M9391A Cable and Module Table

Part Number	Connection	Cable Description
1250-23161	M9350A RF In connector saver	Adaptor, coaxial straight SMA (male) - SMA (female)
8121-20631	This cable can be used to direct an External Reference into the M9300A Ref In connector.	Cable, coaxial, BNC (male) - SMB (female) 1200 mm
8120-5091	M9300A 100 MHz Out 1 to M9301A 100 MHz In	Cable, coaxial, SMB (female) - SMB (female) 120 mm

Step 3: Install the Modules

Part Number	Connection	Cable Description
8120-5091	M9301A 100 MHz Out to M9350A 100 MHz In	Cable, coaxial, SMB (female) - SMB (female) 120 mm
8120-5091	M9350A 100 MHz Out to M9214A 100 MHz In	Cable, coaxial, SMB (female) - SMB (female) 120 mm
8120-5091	M9350A IF Out to M9214A IF In	Cable, coaxial, SMB (female) - SMB (female) 120 mm
W1312-20237	M9301A RF/LO Out 1A to M9350A LO In	Cable, semi-rigid, SMA (male) - SMA (male)

Recommended MIMO Configurations

2x2: One PXIe Chassis

This configuration consists of two Keysight M9381A PXIe Vector Signal Generators and two Keysight M9391A PXIe Vector Signal Analyzers in a single M9018A PXIe Chassis - with or without an M9036A/M9037A PXIe Embedded Controller. A single Keysight M9300A PXIe Frequency Reference is shared across all sources and receivers. This configuration occupies 16 slots. Refer to [2x2 MIMO Configuration in a Single PXIe Chassis \(page 22\)](#).

3x3: Two PXIe Chassis

The first configuration consists of three sources (M9381A) in a single M9018A Chassis - with or without an M9036A/M9037A PXIe Embedded Controller. A single Keysight M9300A PXIe Frequency Reference is shared across all sources. Refer to [3x3 MIMO Configuration in Two PXIe Chassis with External Controller \(page 23\)](#). The next configuration consists of three receivers (M9391A) in a single M9018A Chassis - with or without an M9036A/M9037A PXIe Embedded Controller. A single Keysight M9300A PXIe Frequency Reference is shared across all receivers. Refer to [3x3 MIMO Configuration in Two PXIe Chassis with External Controller \(page 23\)](#).

4x4: Two PXIe Chassis

The first configuration consists of four sources (M9381A) in a single M9018A Chassis - with or without an M9036A/M9037A PXIe Embedded Controller. A single Keysight M9300A PXIe Frequency Reference is shared across all sources. Refer to [4x4 MIMO Configuration in Two PXIe Chassis with External Controller \(page 25\)](#).

The next configuration consists of four receivers (M9391A) in a single M9018A Chassis - with or without an M9036A/M9037A PXIe Embedded Controller. A single Keysight M9300A PXIe Frequency Reference is shared across all receivers. Refer to [4x4 MIMO Configuration in Two PXIe Chassis with External Controller \(page 25\)](#).

NOTE For all MIMO configurations, the Keysight M9300A PXIe Frequency Reference should be installed in slot 10 (the timing slot).

NOTE For all MIMO configurations, the Keysight M9300A PXIe Frequency Reference 100 MHz reference cables **must** be of equal length. The appropriate number of 8121-2175 cables are provided.

NOTE Additional source only (for receiver test) or analyzer only (for transmitter tests) may be configured by configuring 2 to 4 sources or analyzers in a single chassis. See the 3x3 or 4x4 configurations for module placements within a single chassis.

Placing the M9391A VSAs (recommendation)

Install the M9391A VSA instruments in the chassis with the Keysight M9036A/M9037A Embedded Controller, or in the chassis with an Keysight M9021A Cable Interface Module in both slots 1 and slot 2.

Sharing the M9300A Frequency Reference

The M9300A Frequency Reference module can be shared by the all M9391A and M9381A instruments in your solution. If you connect to a hardware configuration that includes a currently connected M9300A (either independently or as part of another hardware configuration) the latest instance of the SFP will take control of the M9300A. You will see no warning or error message.

CAUTION While the M9300A module is being shared, any of the configurations that share this reference can control it fully, including setting the reference to use an external frequency reference source. If the external frequency reference setting does not match that of the supplied frequency, the reference will be unlocked, as expected. However, only the instance of the SFP that creates the reference unlock condition can correct the problem. This is done by either correcting the frequency or by setting the reference back to internal, so that a subsequent instance will not take control of the reference module unintentionally.

CAUTION The Reference module can also be shared among multiple measurement applications, such as the Keysight 89600 VSA software. The Reference module must be initialized before use, so including it in all configurations allows applications to be started in any order. However, when sharing a module the user interface of some applications may not reflect M9300A settings made by other applications. For example, the Keysight 89600 software can control the Reference module internal/external setting, but the changes made by other applications will not be reflected in the Keysight 89600.

NOTE FPGA updates are not allowed on a Keysight M9300A PXIe Frequency Reference while it is being shared. To perform M9300A FPGA updates, reserve the Reference.

Reserving the Reference for a Configuration

If you are running a test in the background with a certain M9300A setting and then connect a hardware configuration that also contains the same M9300A, you may alter the test setup that is already running.

If you would prefer to be keep the reference control with the first instance of the hardware configuration so that a subsequent instance will not take control of the reference module unintentionally:

1. On the SFP Connect to Instrument screen, click the **Advanced** control to open the **Options:** dialog.
2. Type the following string: `ShareReferenceVisaSession=0`

This configuration will retain control of the M9300A if you try to open a new configuration. If you connect a new configuration, that includes the same M9300A, you will see the following error:

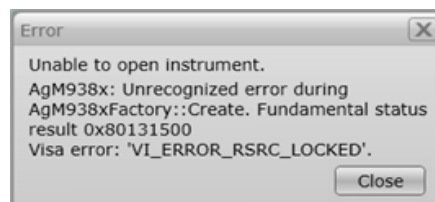
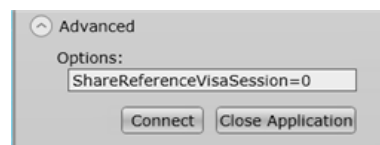

CAUTION

If an existing instance of the SFP is connected to the reference module in a shared (default) mode, and you try to connect a second instance of the SFP to the same reference with `ShareReferenceVisaSession=0` Advanced Option, you will get the resource locked error shown above.

Step 3: Install the Modules

2x2 MIMO Configuration in a Single PXIe Chassis

2x2 MIMO Configuration with M9036A/M9037A Embedded Controller

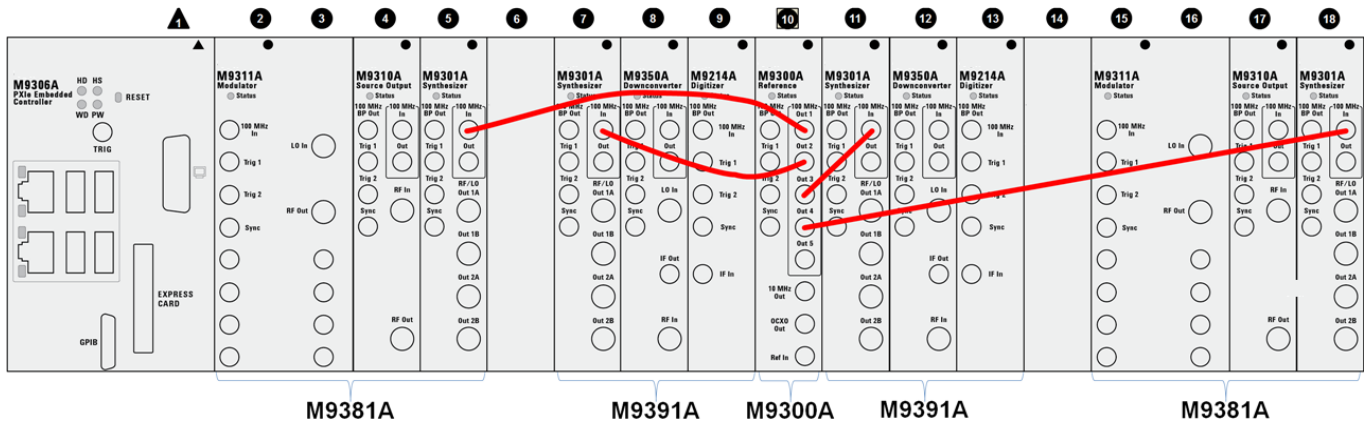

For cabling details of the M9381A and M9391A refer to [MIMO Instrument Connections \(page 17\)](#).

From the M9300A (slot 10) use four 8121-2175 cables to make the following connections:

- 100 MHz Out 1 to M9301A 100 MHz In (slot 5)
- 100 MHz Out 2 to M9301A 100 MHz In (slot 7)
- 100 MHz Out 3 to M9301A 100 MHz In (slot 11)
- 100 MHz Out 4 to M9301A 100 MHz In (slot 18)

2x2 MIMO Configuration with External Controller

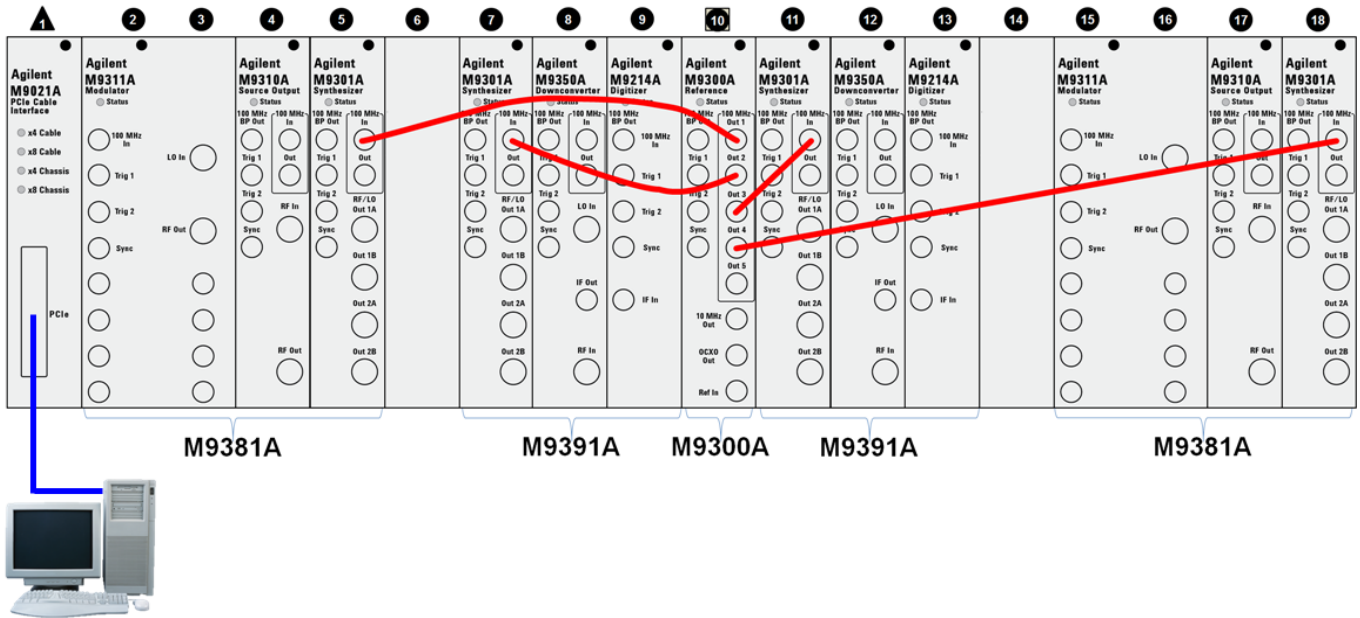

From the M9300A (slot 10) use four 8121-2175 cables to make the following connections:

- 100 MHz Out 1 to M9301A 100 MHz In (slot 5)
- 100 MHz Out 2 to M9301A 100 MHz In (slot 7)
- 100 MHz Out 3 to M9301A 100 MHz In (slot 11)
- 100 MHz Out 4 to M9301A 100 MHz In (slot 18)

3x3 MIMO Configuration in Two PXle Chassis with External Controller

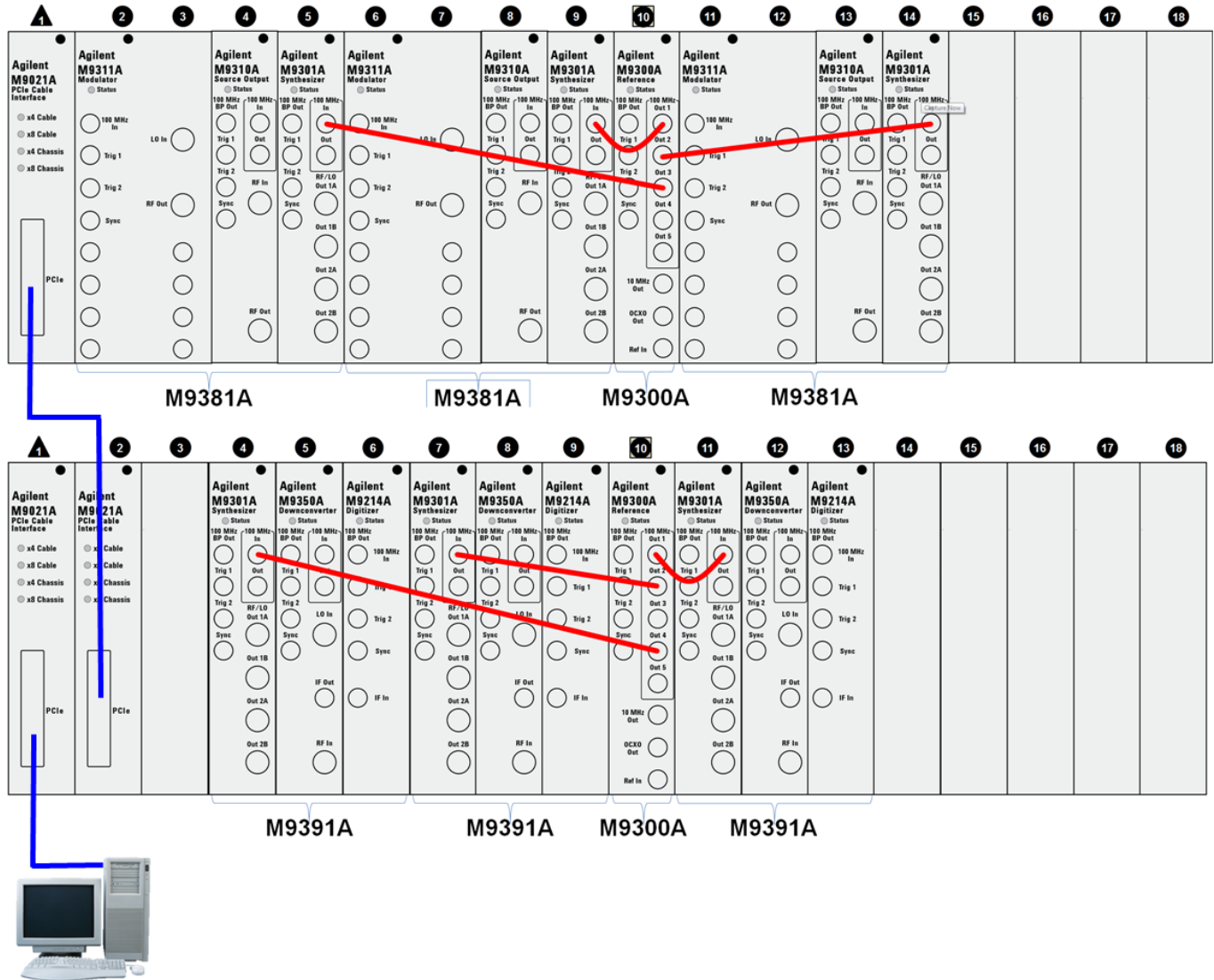

For cabling details of the M9381A and M9391A refer to [MIMO Instrument Connections \(page 17\)](#).

For the first (top) configuration - slave

From the M9300A (slot 10) use three 8121-2175 cables to make the following connections:

- 100 MHz Out 1 to M9301A 100 MHz In (slot 9)
- 100 MHz Out 2 to M9301A 100 MHz In (slot 14)
- 100 MHz Out 3 to M9301A 100 MHz In (slot 5)

For the second (bottom) configuration - master

From the M9300A (slot 10) use three 8121-2175 cables to make the following connections:

- 100 MHz Out 1 to M9301A 100 MHz In (slot 11)
- 100 MHz Out 2 to M9301A 100 MHz In (slot 7)
- 100 MHz Out 4 to M9301A 100 MHz In (slot 4)

NOTE These configurations can be used for x2 or x3 source only or analyzer only configurations.

Step 3: Install the Modules

3x3 MIMO Configuration in Two PXle Chassis with Embedded Controller

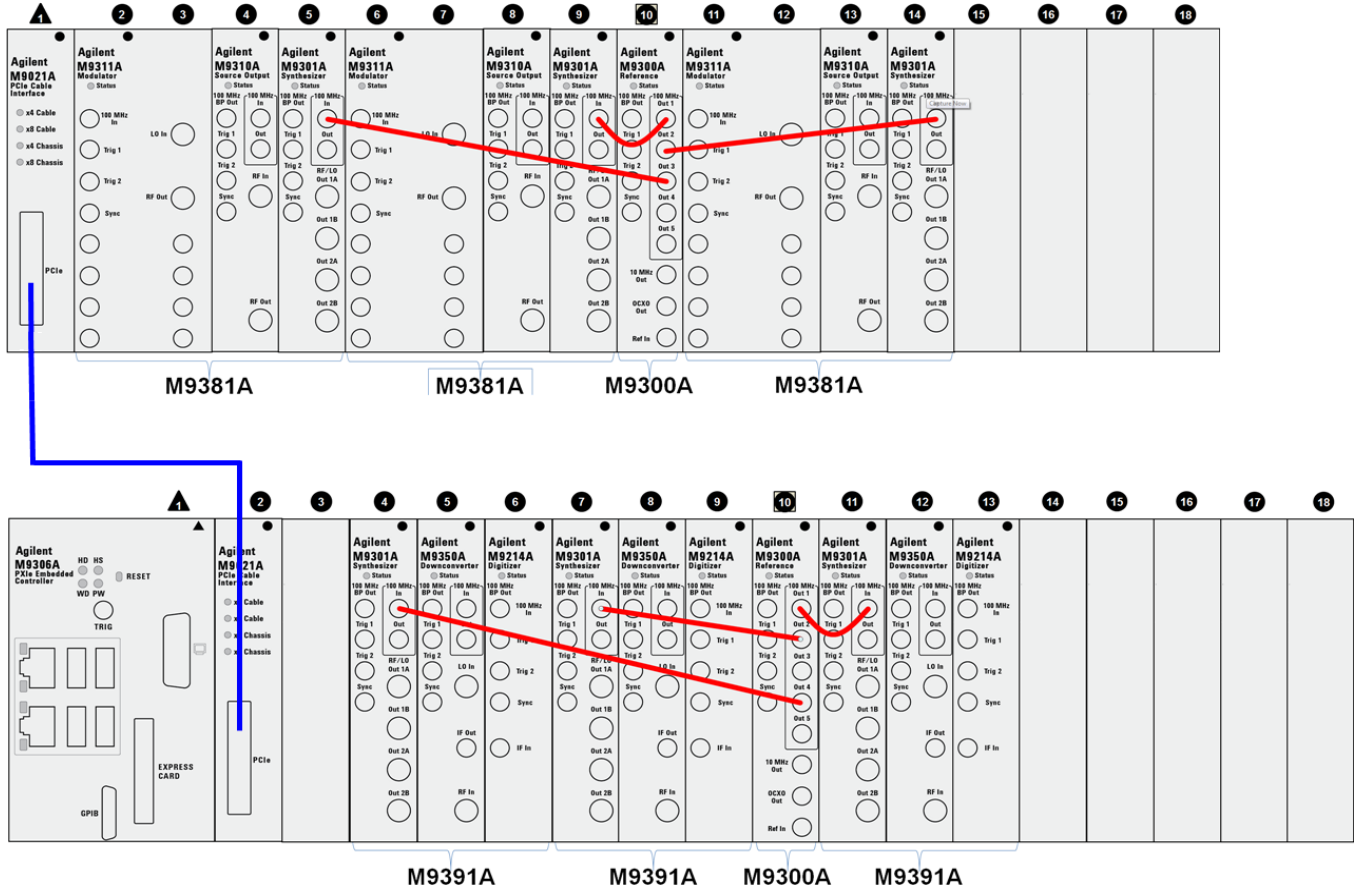

For cabling details of the M9381A and M9391A refer to [MIMO Instrument Connections \(page 17\)](#).

For the first (top) configuration - slave

From the M9300A (slot 10) use three 8121-2175 cables to make the following connections:

- 100 MHz Out 1 to M9301A 100 MHz In (slot 9)
- 100 MHz Out 2 to M9301A 100 MHz In (slot 14)
- 100 MHz Out 3 to M9301A 100 MHz In (slot 5)

For the second (bottom) configuration - master

From the M9300A (slot 10) use three 8121-2175 cables to make the following connections:

- 100 MHz Out 1 to M9301A 100 MHz In (slot 11)
- 100 MHz Out 2 to M9301A 100 MHz In (slot 7)
- 100 MHz Out 4 to M9301A 100 MHz In (slot 4)

NOTE These configurations can be used for x2 or x3 source only or analyzer only configurations.

4x4 MIMO Configuration in Two PXle Chassis with External Controller

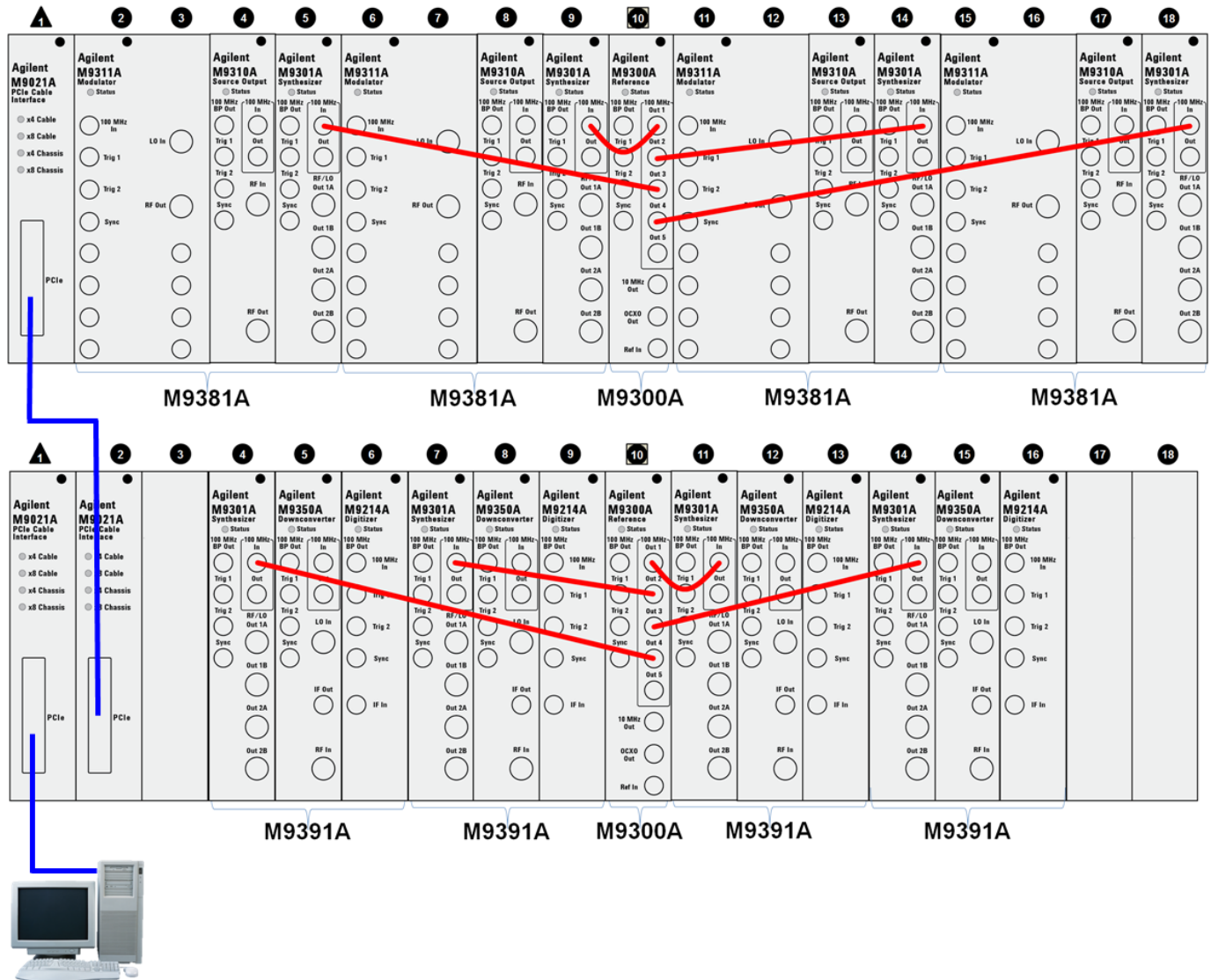

For cabling details of the M9381A and M9391A refer to [MIMO Instrument Connections \(page 17\)](#).

For the first (top) configuration - slave

From the M9300A (slot 10) use four 8121-2175 cables to make the following connections:

- 100 MHz Out 1 to M9301A 100 MHz In (slot 9)
- 100 MHz Out 2 to M9301A 100 MHz In (slot 14)
- 100 MHz Out 3 to M9301A 100 MHz In (slot 5)
- 100 MHz Out 4 to M9301A 100 MHz In (slot 18)

For the second (bottom) configuration - master

From the M9300A (slot 10) use four 8121-2175 cables to make the following connections:

- 100 MHz Out 1 to M9301A 100 MHz In (slot 11)
- 100 MHz Out 2 to M9301A 100 MHz In (slot 7)
- 100 MHz Out 3 to M9301A 100 MHz In (slot 14)
- 100 MHz Out 4 to M9301A 100 MHz In (slot 4)

Step 3: Install the Modules

NOTE These configurations can be used for x4 source only or analyzer only configurations.

4x4 MIMO Configuration in Two PXle Chassis with Embedded Controller

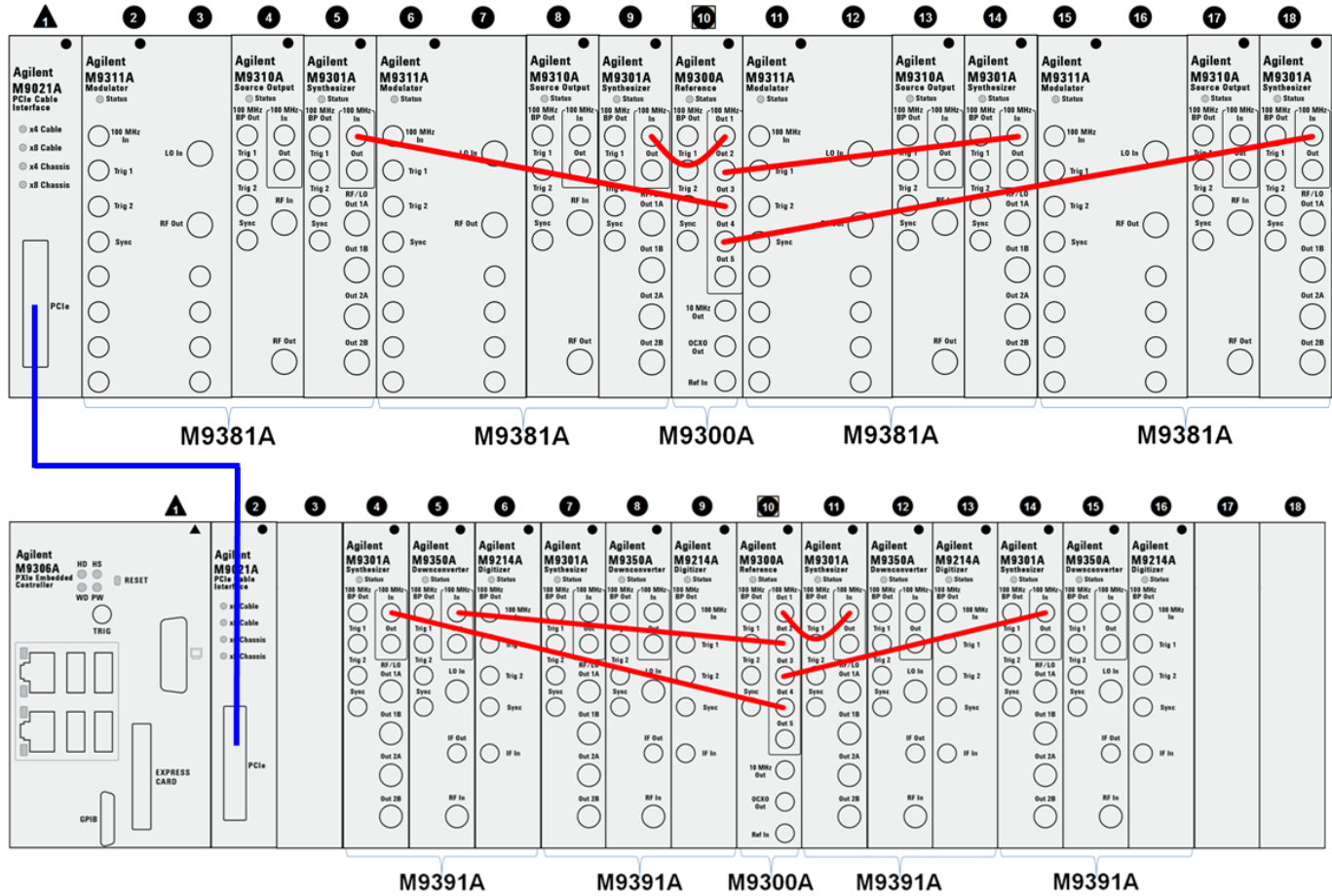

For cabling details of the M9381A and M9391A refer to [MIMO Instrument Connections \(page 17\)](#).

For the first (top) configuration - slave

From the M9300A (slot 10) use four 8121-2175 cables to make the following connections:

- 100 MHz Out 1 to M9301A 100 MHz In (slot 9)
- 100 MHz Out 2 to M9301A 100 MHz In (slot 14)
- 100 MHz Out 3 to M9301A 100 MHz In (slot 5)
- 100 MHz Out 4 to M9301A 100 MHz In (slot 4)

For the second (bottom) configuration - master

From the M9300A (slot 10) use four 8121-2175 cables to make the following connections:

- 100 MHz Out 1 to M9301A 100 MHz In (slot 9)
- 100 MHz Out 2 to M9301A 100 MHz In (slot 5)
- 100 MHz Out 3 to M9301A 100 MHz In (slot 14)
- 100 MHz Out 4 to M9301A 100 MHz In (slot 4)

NOTE These configurations can be used for x4 source only or analyzer only configurations.

Step 4: Install the Software

Requirements

System	Requirements
Operating system	Windows 7 (32 bit and 64 bit), WES7
Processor speed	1 GHz 32-bit (x86), 1 GHz 64-bit (x64), no support for Itanium64
Available memory	4 GB minimum (8 GB recommended for 64-bit operating systems)
Available disk space	1.5 GB available hard disk space (includes 1 GB for Microsoft .NET Framework 3.5 SP1 4, and 100 MB for Keysight IO Libraries Suite)
Video	Support for DirectX 9 graphics with 128 MB graphics memory recommended (Super VGA is supported)
Browser	Microsoft Internet Explorer 7.0 or greater
Hardware Requirements	
Controllers	A PXI or PXI Express embedded controller or remote controller (external PC connected to the chassis by a PCI-to-PXI interface) is required.
Embedded controller	Keysight M9036A or M9037A or an embedded controller that meets the following requirements: <ul style="list-style-type: none"> • PXIe system controller (PXI-1 embedded controllers are not compatible) • Utilize a 2x8, or 4x4, PXIe system slot link configuration. • Run one of the operating systems listed in System Requirements (above).
Remote controller	(Keysight M9018A chassis only) A PC running one of the operating systems listed in System Requirements above and an Keysight M9021A Cable Interface x8 with one of the following PC interface options: <ul style="list-style-type: none"> • Keysight M9045B PCIe ExpressCard Adaptor x1, with cable (for a laptop PC) • Keysight M9048A PCIe Desktop Adaptor x8, with cable (for desktop PCs)

Items You Will Need

To complete the startup process and begin using the solution, you will need the following items:

- If your solution contains an embedded controller, such as the M9036A or M9037A:
 - Monitor. Use the DVI-to-VGA adaptor (an accessory to the M9036A, or M9037A) if necessary.
 - USB compatible keyboard
 - USB compatible mouse
- If you are installing the software from CDs onto an embedded controller, you may wish to use a USB CD/DVD drive. As an alternative, copy the installer files to a computer, transfer the installer files to a USB flash drive, and install the software from the USB flash drive.
- A high-quality SMA (male) to SMA (male) cable at least 10 inches (25.4 cm) long

Software Installation Procedure

1. Install the Embedded Controller (optional)

If your solution contains an Keysight M9036A/M9037A PXIe Embedded Controller, you should now install it into your Keysight M9018A PXIe 18 Slot Chassis.

1. Make sure the chassis is plugged into your AC mains power (to establish earth ground) and powered **OFF**.
2. Install the controller into chassis slot 1 as shown in [2x2 MIMO Configuration in a Single PXIe Chassis \(page 22\)](#).
3. **Power up** the chassis.

NOTE For greater detail on configuring your Keysight M9018A Chassis and Keysight M9021A PCIe Cable Interface, download the [Keysight Multiple PXIe and AXIe Chassis System Configuration Tool](#). Save the file to your local hard drive; do not try to open the file from the Internet location.

2. Install the Software

Install the software in the order indicated in the following table into the embedded controller, or PC if your solution contains an M9021A PXIe Cable Interface (**do not install the M9021A until instructed**).

Restart your controller when prompted by the respective software installer.

Order	Software	Where To Get the Software
1 *	Keysight IO Libraries Suite version 16.3 update 2 (version 16.3.16603.3) or newer; includes Keysight Connection Expert	www.keysight.com/find/iosuite
2 *	M9018A 18 Slot PXIe Chassis Drivers	www.keysight.com/find/M9018A
3 **	Keysight 89600 VSA Software (optional, install before M9391A software). The minimum version is 16.01.254.0 or newer. This software is used to verify MIMO operation.	www.keysight.com/find/89600
4	M9381A PXIe Vector Signal Generator version 1.3.300.0 pr newer)	www.keysight.com/find/M9381A
5	M9391A PXIe Vector Signal Analyzer (version 1.1.300.0 or newer)	www.keysight.com/find/M9391A
6	Signal Studio (optional)	www.keysight.com/find/signalstudio
7	Keysight X-Series Measurement Applications for Modular Instruments (optional)	www.keysight.com/find/M90XA
8	MIMO Config Utility software (sets backplane triggers, runs Self Test)	www.keysight.com/find/pxi-mimo
9	MIMO Demo Tool software	www.keysight.com/find/pxi-mimo

* Software that is already installed if you ordered the M9036A or M9037A Embedded Controller.

** If you install or upgrade the Keysight 89600 VSA Software after installing the M9391A drivers, you need to run the 89600 VSA Integration utility. Go to Start > All Programs > Keysight > M9391 > 89600 VSA Integration.

3. Cycle Power

Make sure that both your chassis and PC are powered down before you connect them.

Step 5: Redeem Your Software Licenses

4. Connect Your M9021A to your Laptop or Desktop PC (optional)

If your solution contains an M9021A PXIe Cable Interface, you will find your adaptor and cable in one of the accessory boxes.

If you are using a **laptop** as your controller, connect to your M9021A using the following components:

NOTE

Keysight does not support the use of a laptop computer for controlling multiple PXIe chassis.

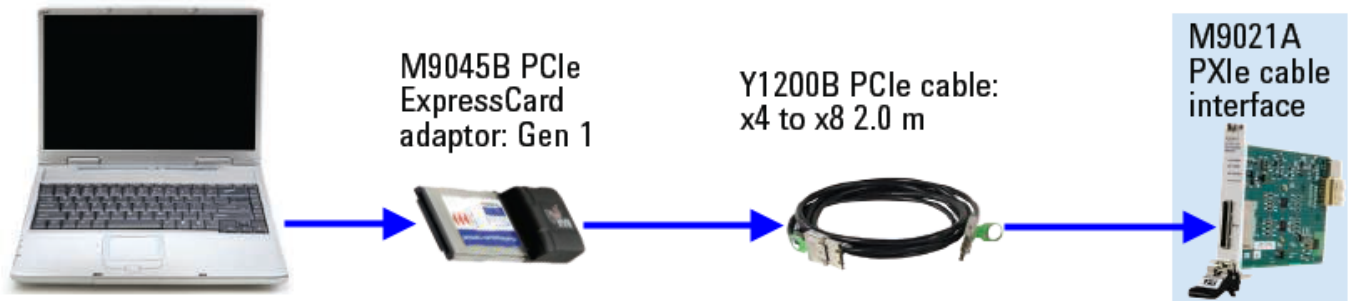

If you are using a **desktop** PC as your controller, connect to the M9021A using the following components:

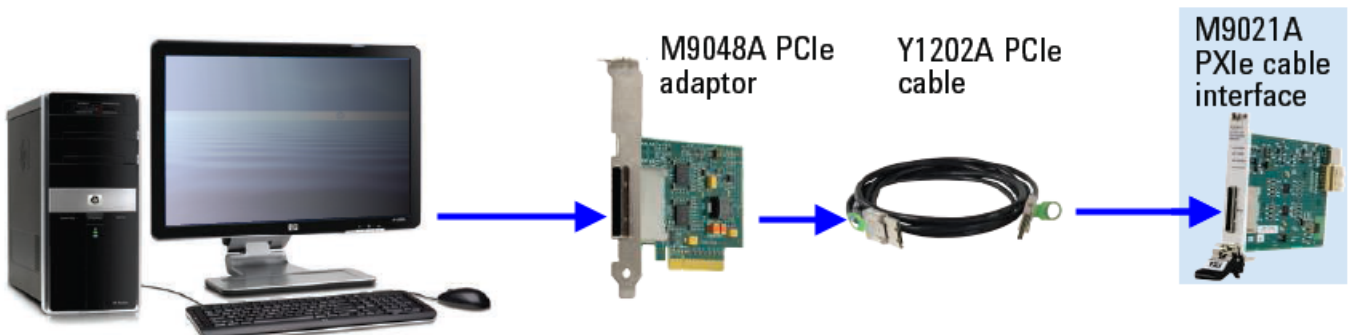

5. Power up Your Solution

CAUTION

If you are using a remote controller and you have installed the interface cable, you must power up the chassis BEFORE you power up the PC. When you power down your chassis, shut down the PC BEFORE you power down the chassis.

Step 5: Redeem Your Software Licenses

The basic software required to operate your solution requires no license. This includes:

- Keysight IO Libraries Suite
- Keysight M9381A VSG Software
- Keysight M9391A VSA Software
- Keysight M9018A 18 Slot PXIe Chassis Drivers

Additional software may be included with your solution that requires licensing. For any additional licensed software products that you include in your solution you receive a Software Entitlement Certificate, for example:

- Keysight 89600 VSA Software (if you are using M9391A VSAs)
- Keysight Signal Studio Applications Software
- Keysight Waveform 5 or 50 packs (optional)
- Keysight X-Series Measurement Applications for Modular Instruments (optional)

For each of these licensed products, whether installed on your M9036A/M9037A Embedded Controller, or installed on your PC, you must redeem your license. Follow the instructions on your Software Entitlement Certificate to license and enable your new software.

Step 6: Configure Your MIMO Solution and Verify Operability

In this section you will run the Keysight MIMO Configuration Utility that you installed in Step 4. See [2. Install the Software \(page 29\)](#). After installing the files on the Keysight MIMO Accessory Kit Software and Information CD (Keysight part number Y1299-10001) the MIMO Configuration Utility software can be found at C:\Program Files (x86)\Keysight\MIMO Config Utility. Select Start > All Programs > Keysight > MIMO Config Utility.exe.

NOTE It is important that this program, or the MIMO Demo Tool be run before the Keysight 89600 VSA software is started and connected to the hardware, so that backplane trigger routings are set properly. For more information on the MIMO Demo Tool see [Step 7: Installation is Complete \(page 32\)](#). To use step 5 of the following functionality, you must restart as Administrator.

Procedure

1. Select **Run Auto-Config**.
2. Select **Properties > Run Chassis Trigger Configuration on Windows Startup**.
3. Select **Run Self-Test**.
4. Select **Run Sample Waveform**.
5. Select **Configure 89600**. **NOTE:** To use this functionality, please restart as Administrator.

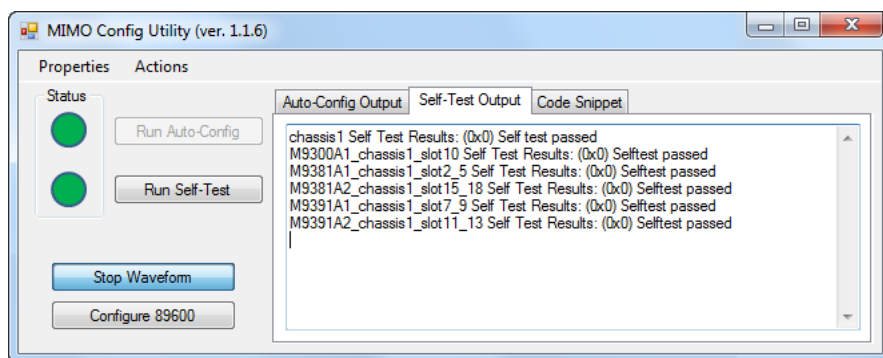

You now see the waveform shown in the following figure.

Step 7: Installation is Complete

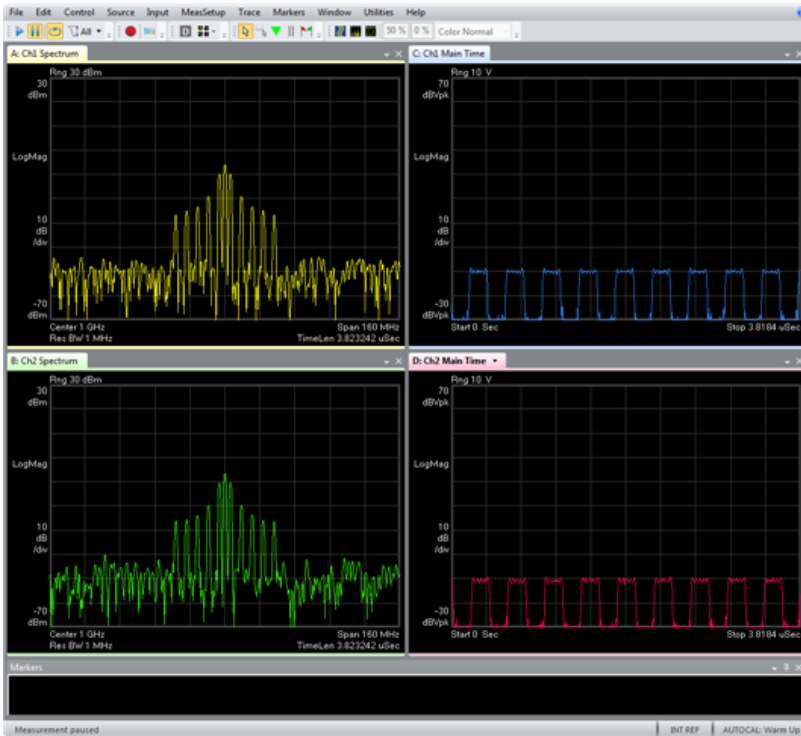

You have completed verifying the operability of your solution. Please proceed to Step 7.

If the Self Test does not pass for any of the instruments, the test indicates which module is likely to need service. However, you should return all modules (except the M9300A) and all cables for that particular instrument. All component modules for an M9381A or M9391A instrument are factory tested and calibrated as a "bundle". It is important that you maintain the bundle when installing modules or returning an instrument for repair.

To ensure that you send in the group of modules that was reported in a Self Test failure, open the SFP and go to **Utilities > Calibration Options...** to view this screen.

The string pointed out in this image is the Cal ID. The first 10 characters represent the Unique ID and the remaining characters show the modules (and their serial numbers) that constitute the M9381A or M9391A instrument. A Certificate of Calibration for that instrument contains the same information. Additionally, you may see this same information from the SFP by using **Help > About**.

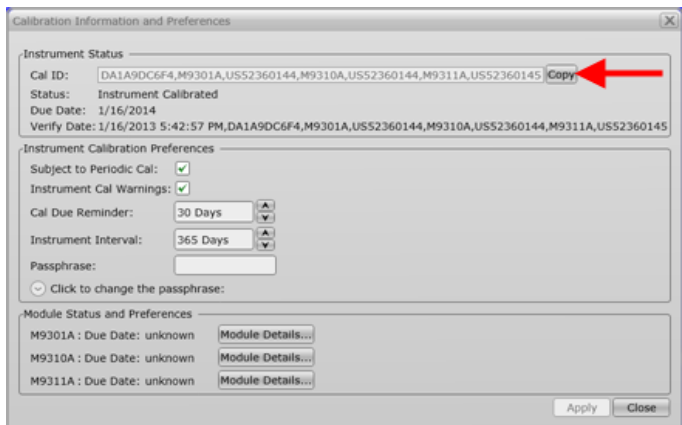

Step 7: Installation is Complete

Now that you have completed the installation and validated operation, you can proceed to:

- Use the MIMO Demo Tool to run provided waveforms (you must have Keysight Signal Studio license)
- Program with:
 - MIMO Demo Tool source code
 - Supported driver APIs for the products that comprise your solution

Proceed to program your product by means of the applications programming interface (API) for the supplied drivers.

API Overview

IVI Drivers

Keysight's IVI drivers simplify the creation and maintenance of instrument control applications in a variety of development environments; they allow programmatic control of instrumentation while providing a greater degree of instrument interchangeability and code reuse. IVI drivers currently come in two basic types: IVI-COM and IVI-C. Although the functionality offered by both types of drivers is often very similar, the fundamental differences in interface technology results in a very different end-user experience. The IVI drivers support compiling application programs for 32- or 64-bit platforms.

Supported ADEs (application development environments) Arguably the most important consideration in comparing IVI-COM and IVI-C drivers is the end user experience in various ADEs. Since IVI-COM drivers are based on Microsoft COM technology, it's not surprising that IVI-COM drivers offer the richest user experience in Microsoft ADEs. Users working in Visual C++, Visual C#, Visual Basic.NET, and Visual Basic 6 enjoy a host of features, such as object browsers, IntelliSense, and context-sensitive help.

When you install the product software, the IVI driver files are installed in the standard IVI Foundation directories (for example, C:\Program Files\IVI Foundation\IVI\Drivers\AgM9391). Example programs are provided to demonstrate most driver functionality (for example, C:\Program Files\IVI Foundation\IVI\Drivers\AgM9391\Examples). The reference material for the driver functions (a Microsoft HTML Help .chm file) is installed with the IVI driver and is available for Microsoft Visual Studio's IntelliSense context linking. In addition, you can directly access the .chm file (AgM9391.chm) from this Start menu location: **Start > All Programs > Keysight IVI Drivers > AgM9391 VSA > Documentation.**

LabVIEW Drivers

In addition to the IVI drivers, Keysight provides a LabVIEW driver that includes all the functionality of the IVI-C driver. When you install the product software, the LabVIEW driver is installed to each LabVIEW instr.lib directory for each version of LabVIEW you have on your computer (for example, C:\Program Files (x86)\National Instruments\<LabVIEW version>\instr.lib\<Agilent product model>). If you install LabVIEW drivers before you install LabVIEW itself, drivers will be installed in the Agilent directory instead of the National Instruments directory (for example, C:\Program Files (x86)\Agilent\<Agilent product model>\LabVIEW Driver->\<LabVIEW version>\...). Example programs are provided to demonstrate most driver functionality. The reference information for the driver (a Microsoft HTML Help .chm file) is also installed with the driver and the content is available from LabVIEW's Context Help window. In addition, you can directly access the chm file (AgM9391 LabVIEW_Help) from this Start menu location: **Start > All Programs > Keysight > AgM9391 LabVIEW Help.**

