



Medalist i3070 Series 5i Inline ICT System

System Installation



Agilent Technologies

Notices

© Agilent Technologies, Inc. 2013

No part of this manual may be reproduced in any form or by any means (including electronic storage and retrieval or translation into a foreign language) without prior agreement and written consent from Agilent Technologies, Inc. as governed by United States and international copyright laws.

Manual Part Number

E9988-96004

Edition

First edition, August 2013

Printed in Malaysia

Agilent Technologies Microwave Products (Malaysia) Sdn. Bhd.
Bayan Lepas Free Industrial Zone
11900 Penang, Malaysia

Warranty

The material contained in this document is provided "as is," and is subject to being changed, without notice, in future editions. Further, to the maximum extent permitted by applicable law, Agilent disclaims all warranties, either express or implied, with regard to this manual and any information contained herein, including but not limited to the implied warranties of merchantability and fitness for a particular purpose. Agilent shall not be liable for errors or for incidental or consequential damages in connection with the furnishing, use, or performance of this document or of any information contained herein. Should Agilent and the user have a separate written agreement with warranty terms covering the material in this document that conflict with these terms, the warranty terms in the separate agreement shall control.

Technology Licenses

The hardware and/or software described in this document are furnished under a license and may be used or copied only in accordance with the terms of such license.

Restricted Rights Legend

If software is for use in the performance of a U.S. Government prime contract or subcontract, Software is delivered and licensed as "Commercial computer software" as defined in DFAR 252.227-7014 (June 1995), or as a "commercial item" as defined in FAR 2.101(a) or as "Restricted computer software" as defined in FAR 52.227-19 (June 1987) or any equivalent agency regulation or contract clause. Use, duplication or disclosure of Software is subject to Agilent Technologies' standard commercial license terms, and non-DOD Departments and Agencies of the U.S. Government will receive no greater than Restricted Rights as defined in FAR 52.227-19(c)(1-2) (June 1987). U.S. Government users will receive no greater than Limited Rights as defined in FAR 52.227-14 (June 1987) or DFAR 252.227-7015 (b)(2) (November 1995), as applicable in any technical data.

Safety Notices

CAUTION

A **CAUTION** notice denotes a hazard. It calls attention to an operating procedure, practice, or the like that, if not correctly performed or adhered to, could result in damage to the product or loss of important data. Do not proceed beyond a **CAUTION** notice until the indicated conditions are fully understood and met.

WARNING

A **WARNING** notice denotes a hazard. It calls attention to an operating procedure, practice, or the like that, if not correctly performed or adhered to, could result in personal injury or death. Do not proceed beyond a **WARNING** notice until the indicated conditions are fully understood and met.

Contents

Legal Notices, Warranty, and Safety iv

Emergency Stop viii

Site Preparation 1

Site Preparation Process and Responsibilities 2

Structural Requirements 4

 Floor Space Requirements 4

 Moving Access Requirements 7

Power Requirements 8

 Medalist i3070 Series 5i Main Power 8

 Medalist i3070 Series 5i PDU 9

 Mains Disconnect 10

 Power Cord 11

Compressed Air Requirements 13

SMEMA Communication 14

Uncrating the System 25

Overview 26

 Handling Guidelines 27

Uncrating Procedure 28

Installing the System 31

Installation Overview 32

Open the Shutters 33

Release the Press Safety Locks 34

Install the Tower Light 36

Connect Compressed Air Supply 37

Connect SMEMA Cables 38

Adjust Conveyor Height and Alignment 38

Power Up and Verify the System 40

Connect to the Network 43

Install the Barcode Reader (Optional) 44

Legal Notices, Warranty, and Safety

- [Legal Notices](#)
- [Service and Support](#)
- [Safety Summary](#)
- [Warning and Hazard Labels](#)
- [Emergency Stop](#)

Legal Notices

This section provides important legal information about this product.

Notice

The material contained in this documentation is provided “as is” and is subject to being changed without notice in future editions. Further, to the maximum extent permitted by applicable law, Agilent disclaims all warranties, either express or implied, with regard to this documentation and any information contained herein, including but not limited to the implied warranties of merchantability and fitness for a particular purpose. Agilent shall not be liable for errors or for incidental or consequential damages in connection with the furnishing, use, or performance of this documentation or of any information contained herein. Should Agilent and the user have a separate written agreement with warranty terms covering the material in this documentation that conflict with these terms, the warranty terms in the separate agreement shall control.

Copyrights

© 2013 Agilent Technologies, Inc. All rights reserved.

No part of this documentation may be reproduced in any form or by any means (including electronic storage and retrieval or translation into a foreign language) without prior agreement and written consent from Agilent Technologies, Inc. as governed by United States and international copyright laws.

Warranty

The material contained in this documentation is subject to change without notice. Agilent Technologies makes no warranty of any kind with regard to this material, including, but not limited to, the implied warranties of merchantability and fitness for a particular purpose. Agilent Technologies shall not be liable for errors contained herein or for incidental or consequential damages in connection with the furnishing, performance, or use of this material.

U.S. Government Restricted Rights

If software is for use in the performance of a U.S. Government prime contract or subcontract, Software is delivered and licensed as "Commercial computer software" as defined in DFAR 252.227-7014 (June 1995), or as a "commercial item" as defined in FAR 2.101(a) or as "Restricted computer software" as defined in FAR 52.227-19 (June 1987) or any equivalent agency regulation or contract clause. Use, duplication or disclosure of Software is subject to Agilent Technologies' standard commercial license terms, and non-DOD Departments and

Agencies of the U.S. Government will receive no greater than Restricted Rights as defined in FAR 52.227-19(c)(1-2) (June 1987). U.S. Government users will receive no greater than Limited Rights as defined in FAR 52.227-14 (June 1987) or DFAR 252.227-7015 (b)(2) (November 1995), as applicable in any technical data.

Technology Licenses Notice

The Hardware and/or Software described in this documentation are furnished under a license and may be used or copied only in accordance with the terms of such license.

Service and Support

To contact Agilent technical support, go to www.agilent.com/find/contactus and select your country for the support phone numbers.

Any adjustment, maintenance, or repair of this product must be performed by qualified personnel. Contact a customer engineer through your local Agilent representative.

Safety Summary

The following general safety precautions must be observed during all phases of operation, service and repair of this product. Failure to comply with these precautions or with specific warnings elsewhere in this documentation violates safety standards of design, manufacture, and intended use of the product. Agilent Technologies, Inc. assumes no liability for the customer's failure to comply with these requirements.

General

For Safety Class 1 equipment (equipment provided with a protective earth terminal), an uninterruptible safety earth ground must be provided from the main power source to the product input wiring terminal or supplied power cable. The protective features of this product may be impaired if it is used in a manner not specified in the operation instructions.

Before Applying Power

Verify that the product is set to match the available line voltage, the correct fuses or circuit breakers are installed, and all safety precautions are taken.

Ground the Equipment

To minimize shock hazard, the system chassis and cover must be connected to an electrical protective earth ground. The system must be connected to the AC power mains through a grounded power cable, with the ground wire firmly connected to an electrical ground (safety ground) at the power outlet. Any interruption of the protective (grounding) conductor or disconnection of the protective earth terminal will cause a potential shock hazard that could result in personal injury.

Fuses

For continued protection against fire, use only fuses with the required rated current, voltage, and specified type (normal blow, time delay, etc.) Do not use repaired fuses or short-circuited fuse holders. To do so could cause a shock or fire hazard.

Do Not Operate in an Explosive Atmosphere

Do not operate the product in an explosive atmosphere or the presence of flammable gases or fumes.

Do Not Remove Equipment Cover

Operating personnel must not remove equipment covers or shields. Component replacement and internal adjustments must be made only by qualified service personnel. Under certain conditions, dangerous voltages may exist even with the equipment switched off. To avoid dangerous electrical shock, DO NOT perform procedures involving cover or shield removal.

Equipment that appears damaged or defective should be made inoperative and secured against unintended operation until it can be repaired by qualified service personnel.

Do Not Operate Damaged Equipment

Whenever it is possible that the safety protection features built into this product have been impaired, either through physical damage, excessive moisture, or any other reason, REMOVE POWER and do not use the product until safe operation can be verified by qualified service personnel. If necessary, request service and repair from your Agilent Sales and Service Office to ensure that safety features are maintained.

Do Not Service or Adjust Alone

Do not attempt internal service or adjustment of this equipment unless another person, capable of rendering first aid and resuscitation, is present.

Do Not Substitute Parts or Modify Equipment

Because of the danger of introducing additional hazards, do not install substitute parts or perform any unauthorized modification to the product. If necessary, request service and repair from your Agilent Sales and Service Office to ensure that safety features are maintained.

Radiated Immunity

When subjected to high RFI fields (greater than 1 V/m), reduced performance may be experienced when making low-level analog measurements.

Insulation Rating for Wires Connected to Agilent Medalist ICT Systems

Use only external wiring with insulation rated for the maximum voltage (Vrms, Vpk or Vdc) and temperature to which the wire may be subjected in a fault condition.

Example: The system is connected to a source whose output is set for 50 Vrms. The source could be set for as high as 300 Vrms, intentionally or unintentionally. Therefore, the external wiring connected between this source and the system must be rated for 300 Vrms.

Maintain the System as Recommended

The recommended preventive maintenance for the system is documented in the on-line help. Preventive Maintenance should always include testing the Emergency Stop Switch by pressing it and verifying that all AC and DC power to the testhead turns off.

Warning, Caution, and Note

WARNING

The **WARNING** symbol denotes a hazard. It calls attention to a procedure, practice, or condition, which, if not correctly performed or adhered to, could result in personal injury or death. Do not proceed beyond a **WARNING** symbol until the indicated conditions are fully understood and met.

CAUTION

The **CAUTION** symbol denotes a hazard. It calls attention to an operating procedure, or condition, which, if not correctly performed or adhered to, could result in damage to or destruction of part or all of the product or permanent loss of data. Do not proceed beyond a **CAUTION** symbol until the indicated conditions are fully understood and met.

NOTE

The **NOTE** symbol contains important information.

Warning and Hazard Labels

Pay attention to the following labels when they appear on the equipment.

Table 1 Warning Labels on System





Label	Description
	DANGER: High Voltage Do not detach the protective covers. Operating this equipment without covers may cause electric shock.
	WARNING: Moving Parts (General) Do not touch the equipment while it is running. Keep clear of moving machinery.
	WARNING: Moving Parts (Hand) Do not touch the equipment while it is running. Keep hands clear of moving machinery.

Table 1 Warning Labels on System

Label	Description
	WARNING: Pinch Hazard Do not touch the equipment while it is running. Keep hands away from the indicated areas to avoid pinched fingers.

Emergency Stop

In case of emergency, press the red **Emergency Stop** switch ([Figure 1](#)) to cut off power to the system.

Resetting the Emergency Stop

- 1 Turn the red **Emergency Stop** switch clockwise to release it.
- 2 Press the **Reset** button to reset the safety relay and resume operation.

Figure 1 Emergency Stop Button

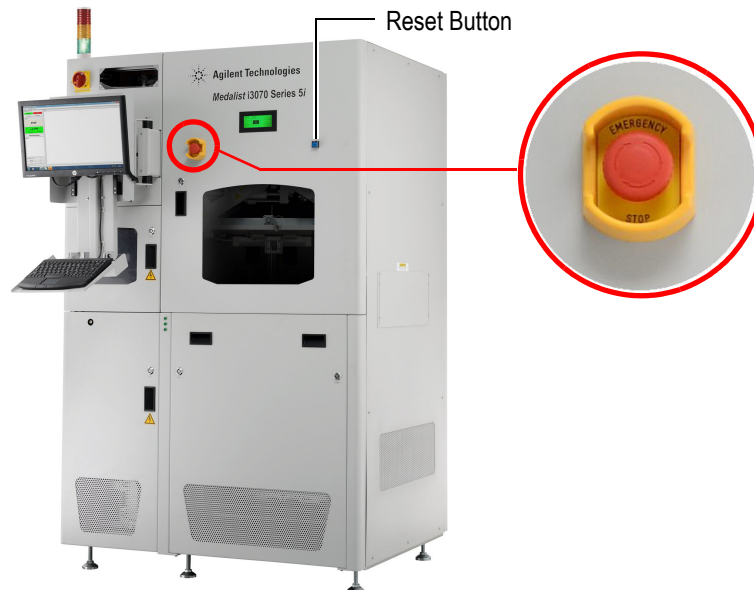

NOTE

DO NOT use the Emergency Shutdown Switch as a substitute for correct power-down (unboot) procedures

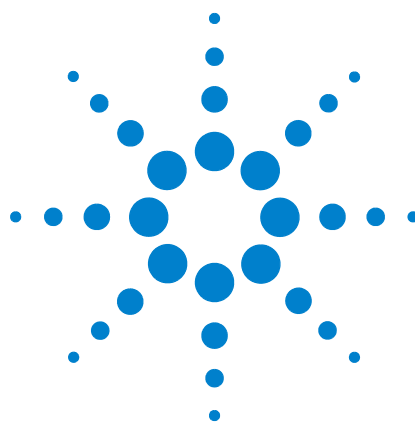

Site Preparation

Site Preparation Process and Responsibilities	2
Structural Requirements	4
Power Requirements	8
Compressed Air Requirements	13
SMEMA Communication	14

This chapter describes the requirements for installation of the Medalist i3070 Series 5i system. Please read it carefully and follow the recommendations to ensure that your site is prepared and properly equipped, and to minimize the possibility of problems or delays in system installation.

If you have any questions, please contact your Agilent representative.

Site Preparation Process and Responsibilities

Table 1 Site Preparation Process

Agilent's Responsibilities	Customer's Responsibilities
<p>Site Preparation Visit The Agilent representative will help you understand what you will need to do to make your site ready.</p>	<p>You are responsible for all site construction and maintenance. You are also responsible for obtaining any building permits and licenses required by local laws and regulations. Refer to the requirements and recommendations for site preparation:</p> <ul style="list-style-type: none"> • Structural Requirements • Power Requirements • Compressed Air Requirements • SME MA Communication
<p>Site Verification Visit After primary power has been installed at the site, an Agilent representative will carry out an inspection to verify that your electrical power is suitable for the system, and verify that the site's environmental characteristics conform to the requirements.</p>	<p>Site Planning and Implementation</p> <ul style="list-style-type: none"> • Plan your system area and prepare a system plan drawing that can be used to install your system. • Schedule and implement all site preparation activities. • Wiring primary power to the system is your responsibility, as is installing communications cabling to the system.
	<p>Receiving the System Moving the equipment from the receiving dock to the installation site is the customer's responsibility.</p> <ul style="list-style-type: none"> • Check the Tilt and Shock indicators for signs of damage. • Uncrate the system and move it to the site where it will be installed, or to a safe storage area. See Uncrating the System for details. • You may inventory the shipment using the enclosed packing list. You may leave the smaller boxes for the Agilent representative to unpack when the system is installed.

Table 1 Site Preparation Process

Agilent's Responsibilities	Customer's Responsibilities
<p>Installation An Agilent representative will complete the system installation. Installation includes unpacking the smaller boxes, connecting cabling, starting the system, and performing a complete system verification.</p>	
<p>Other Matters</p> <ul style="list-style-type: none"> • Insurance – The system is insured by Agilent until it is delivered to your loading dock. • Warranty – The Agilent board test systems include a one-year warranty that provides on-site hardware repair, software support and software updates. 	<ul style="list-style-type: none"> • Insurance – You must provide insurance coverage for your system from the time it is delivered to your facility. • Software Support Contract – You are responsible for initiating and renewing support contracts for software, documentation updates, and telephone support. Software support and updates are included during the warranty period.

Structural Requirements

- Floor Space Requirements
- Moving Access Requirements

Floor Space Requirements

The floor plan in [Figure 1](#) incorporates areas needed around the Medalist i3070 Series 5i to access panels and connection points for devices. The plan shows the dimensions of the system with doors open, and the recommended and minimum clearance.

Figure 1 Floor Plan with Recommended and Minimum Clearance

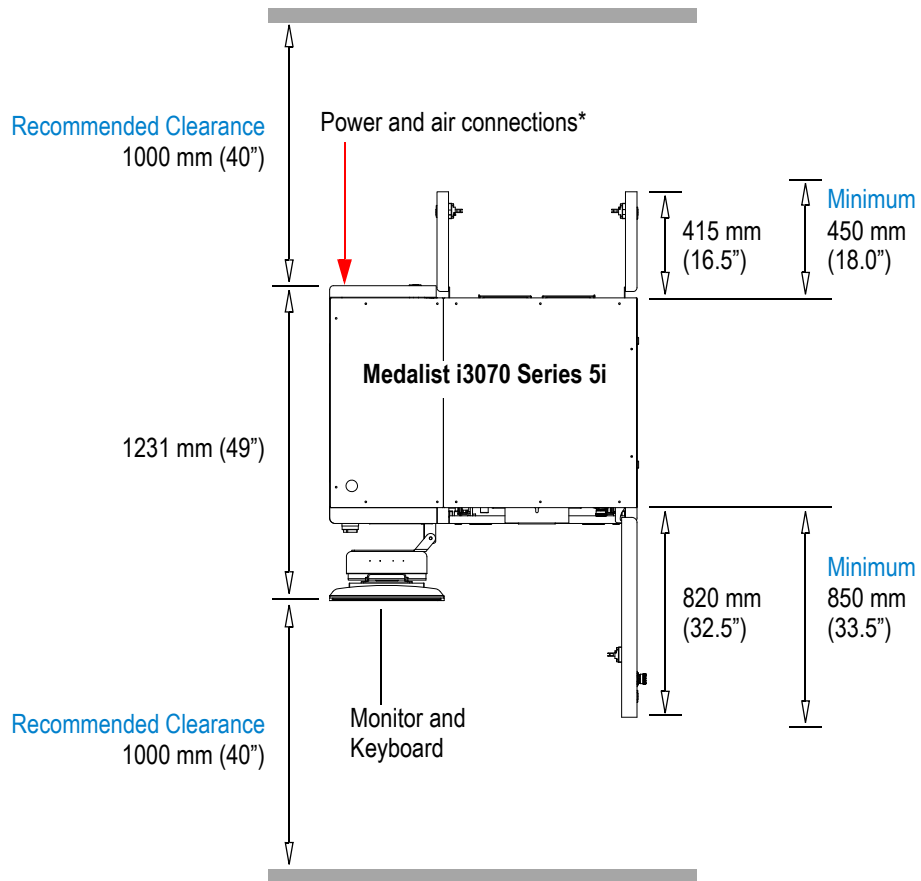

* Location shown for left-to-right configuration.
Connections are at the right side for right-to-left configuration.

Board flow options are from left-to-right or right-to-left (Figure 2). This is configured according to customer request prior to delivery. It cannot be reconfigured on-site.

Figure 2 Board Flow Options

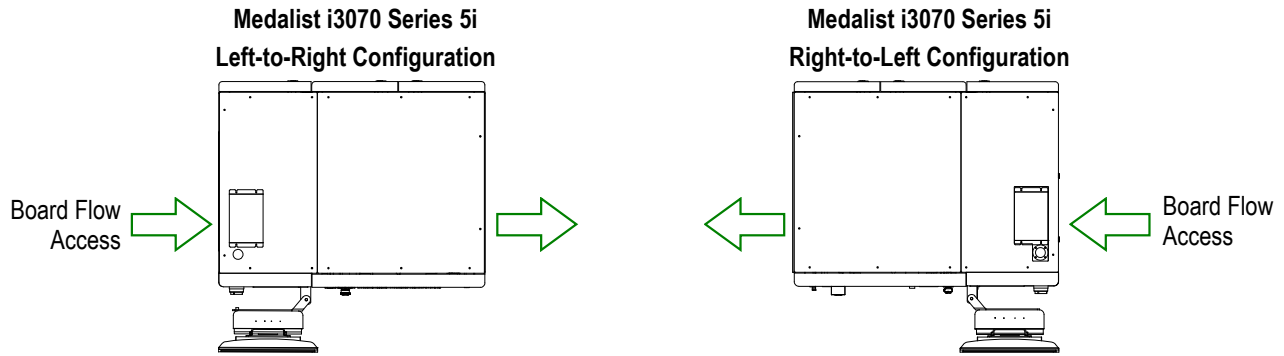

Dimensions of the Medalist i3070 Series 5i

Table 2 Medalist i3070 Series 5i Dimensions and Weight

Ref*	Dimension	Measurement
A	Width	1203 mm (48")
B	Depth (with arm straight)	1231 mm (49")
C	Depth (without arm)	933 mm (38")
D	Maximum height of system (including tower light)	2108 mm (83")
E	Maximum height of system (excluding tower light)	1892 mm (75")
F	Height range setting of feet (clearance under base)	36 mm to 122 mm (nominal 90 mm) (1.5" to 4.8"; nominal 3.5")
	Weight	976 kg (2152 lb)
	Maximum floor point loading (each leg)	1600 kg (3528 lb)

* See Figure 3.

Figure 3 Top and Front Views

Left-to-Right Configuration

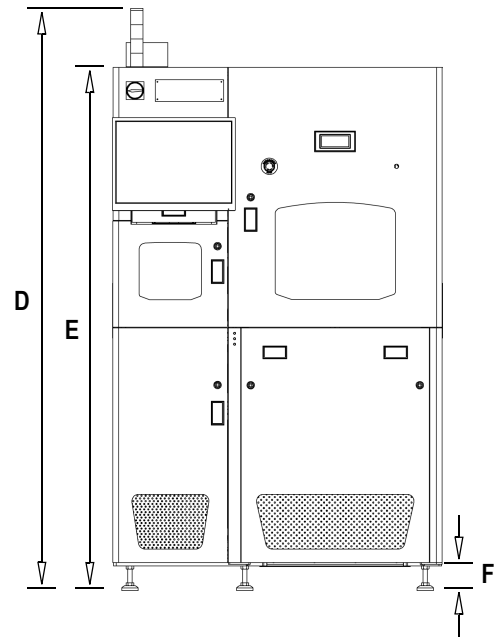
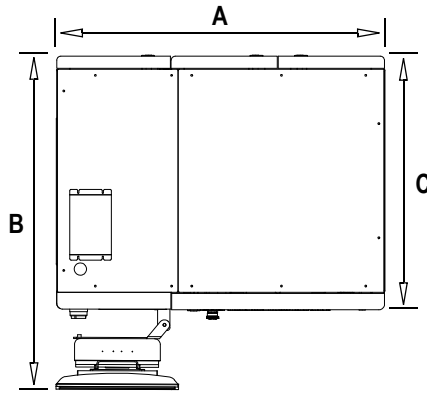

Right-to-Left Configuration

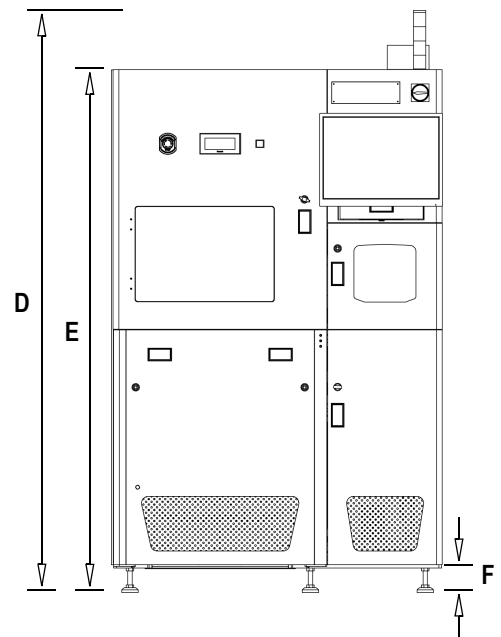
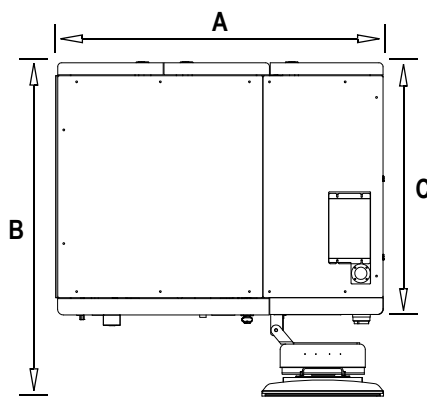

Moving Access Requirements

Space for Moving

The Medalist i3070 Series 5i will be crated for delivery. The crated system requires a vertical clearance of at least 1500 mm (75") and a horizontal clearance of at least 1730 mm (56") in all areas.

This is the minimum space required for the system to pass. Take into account the turning radius of the forklift or moving equipment as well.

Table 3 Dimensions of the Crated System

Dimension	Measurement
Width	1440 mm (57")
Depth	1460 mm (57")
Height	2400 mm (94")
Weight	1014 kg (2235 lb)

Forklift Requirements

A forklift with tines of at least 1530 mm (54") and capable of lifting at least 1500 kg (5000 lb) at a load centre of 1140 mm (45") is needed to unload and move the system.

Other transportation can be used as long as the full weight of the main unit is fully and properly supported.

WARNING

Failure to meet the above requirements could result in serious injury to personnel and/or damage to the Medalist i3070 Series 5i system.

Power Requirements

- [Medalist i3070 Series 5i Main Power](#)
- [Medalist i3070 Series 5i PDU](#)
- [Mains Disconnect](#)
- [Power Cord](#)

The system power and PDU must be factory configured to match the power at the customer site. This is done prior to delivery and installation at the customer site. The power cannot be reconfigured on-site.

The power configuration for the system is shown on a label at the rear of the system (bottom right). The voltage of the PDU is indicated on the front panel of the PDU.

Customer Responsibilities

It is the customer’s responsibility to (a) prepare the site with adequate AC power for the system, and (b) connect the system to the AC power source. These are not Agilent’s responsibilities.

CAUTION

After connecting power to the system, do not power up the system. An Agilent service representative will verify the power and complete the system installation and verification.

Medalist i3070 Series 5i Main Power

This is the main 3-phase AC power input connected from the customer site.

Table 4 Main Power Options

	Power Option	Frequency	Voltage line-to-neutral/ line-to-line
200–240V 3-Phase Delta	3PD	50/60 Hz	200 220 230 240
208–220V 3-Phase Wye	3PY	50/60 Hz	208 220
380–415V 3-Phase Wye with Neutral	3PN	50/60 Hz	220 / 380 230 / 400 240 / 415

Medalist i3070 Series 5i PDU

The PDU (Power Distribution Unit) is the device in the system to which AC power is connected. The PDU is wired differently for different power configurations and will be configured to match the system power configuration. The voltage of the PDU is marked on the front panel of the PDU.

The E1135 PDU is connected via a 3-phase AC terminal block wired out from the system main power.

Figure 4 PDU (Power Distribution Unit)

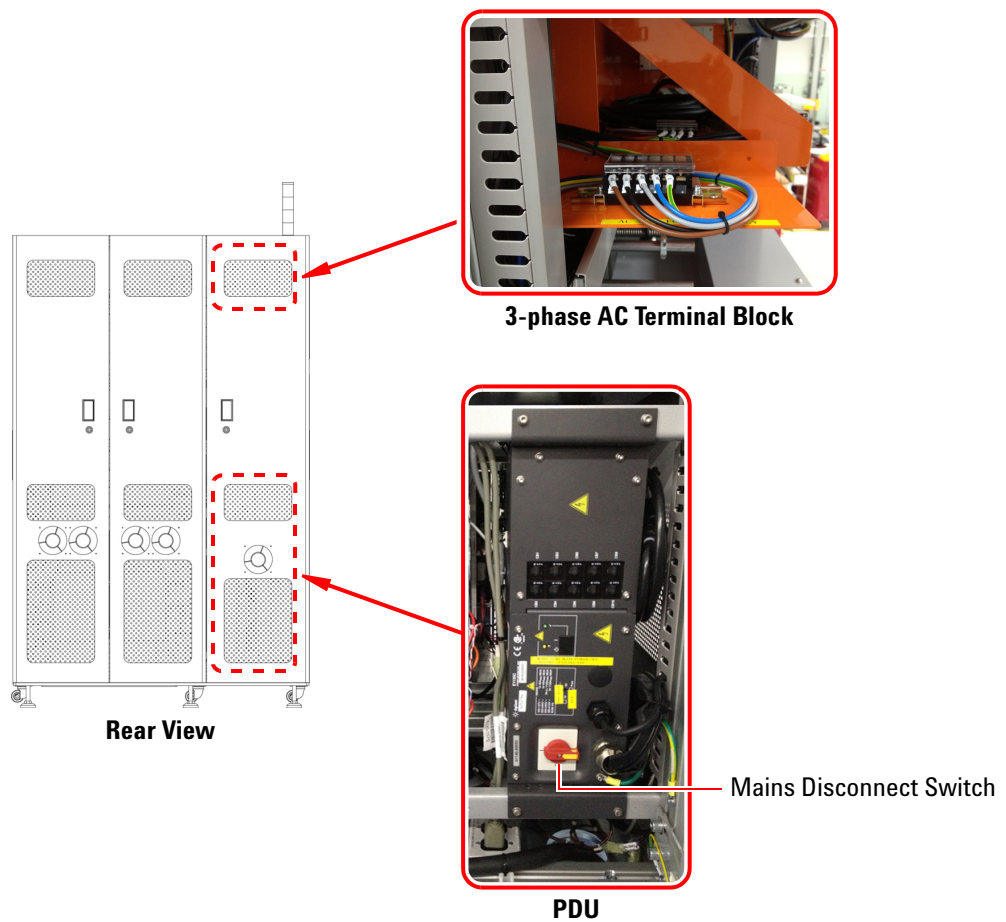

Mains Disconnect

The system must be equipped with a mains disconnect that provides over-current and short-circuit protection. It may be a fused disconnect or a circuit breaker (see [Figure 5](#)).

If a fused disconnect is used, it must:

- Be rated for 30 amps in each phase.
- Open all line conductors and neutral conductors where local code applies, but not the protective earth conductor.
- Be marked “System Mains Disconnect” or the equivalent in your local language.
- Be marked with a “ON” for the On position or “OFF” for the Off position.
- Be capable of being locked in the Off position, but not in the On position.
- Be installed within 3 m (10 ft) of the system, where it can be easily reached by the system operator without requiring the system to be moved to access the disconnect.

If a circuit breaker is used, it must meet all of the above requirements plus:

- Be rated for a minimum of 10,000 Amperes Interrupting Capacity (AIC) if used on a 200–240 volt circuit, or 14,000 AIC if used on a higher voltage circuit.

Figure 5 Wiring Diagram for Customer Site

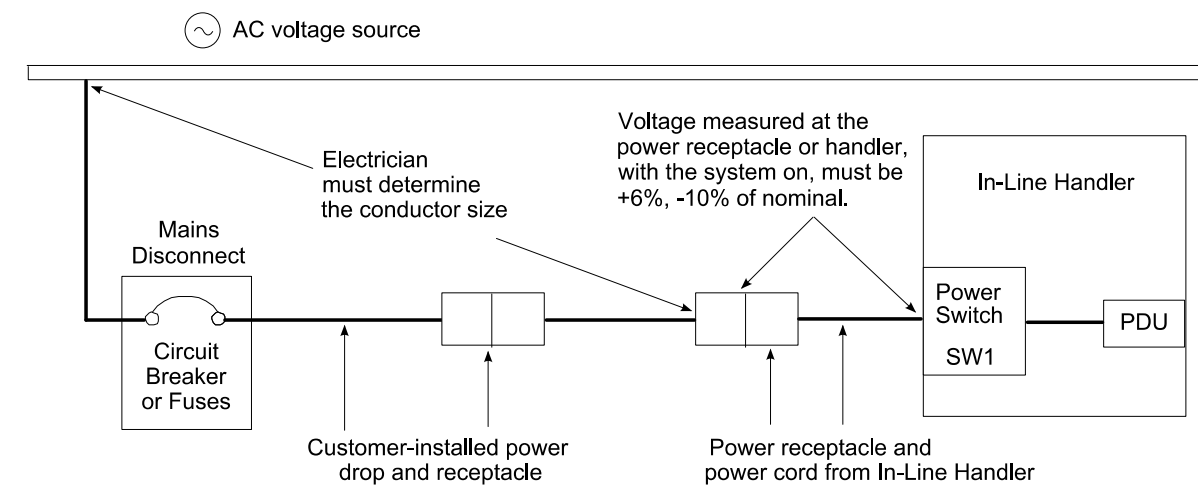

Power Cord

The power cord to the Medalist i3070 Series 5i depends on the country where the system will be installed:

- International (E1135-61610): Uses 5x6 mm² 5-conductor cord with a IEC 60309 plug and mating receptacle.
- North America (E1135-61611): Uses #10 AWG 5-conductor cord with NEMA plug that mates with NEMA L21-30. The female receptacle is available locally.

Figure 6 Power cord and plugs



International



North America

Figure 7 International 3-phase systems

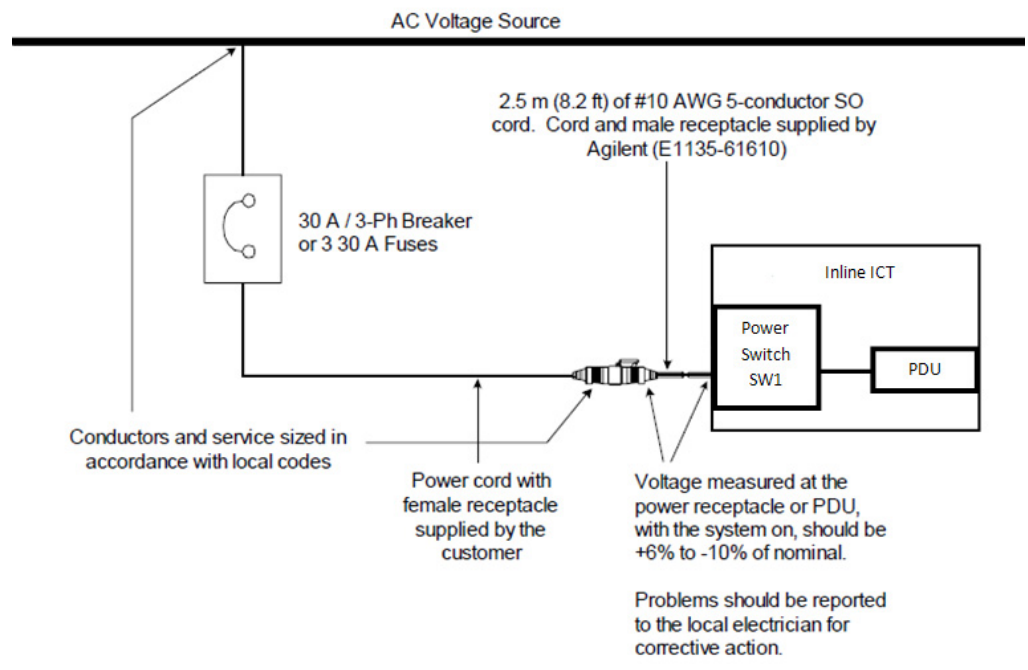
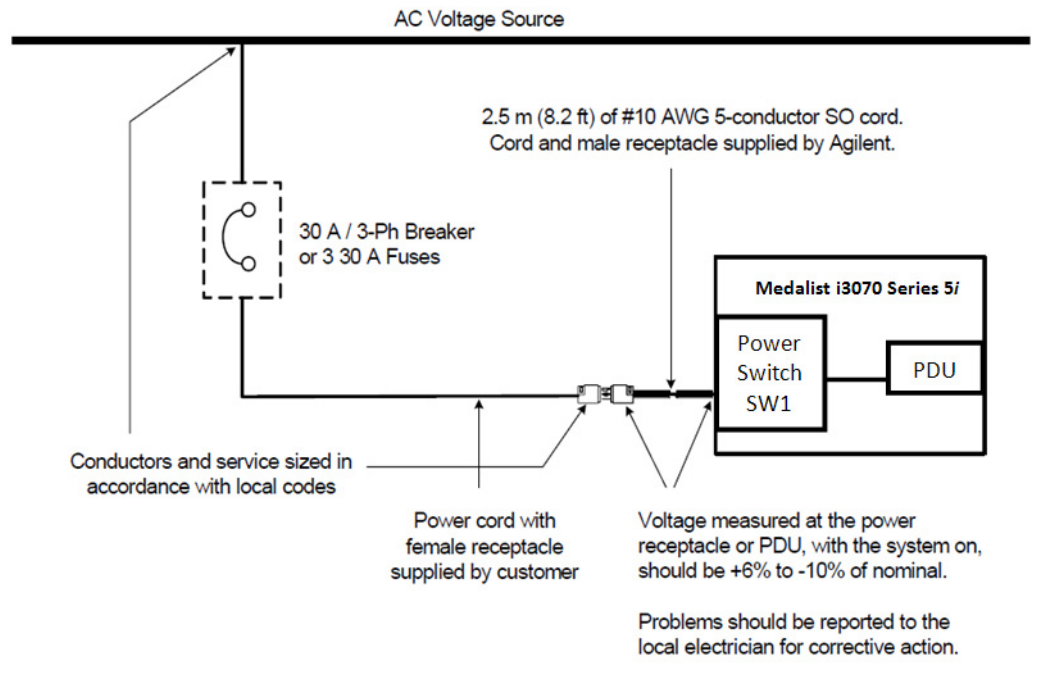

Figure 8 North America 3-phase systems



Compressed Air Requirements

The Medalist i3070 Series 5i uses compressed air to pressurize air cylinders that actuate the fixture drawer and fixture pull-down towers. The pull-down towers pull and hold a fixture down onto the testhead, enabling contact between the pins on the fixture and the spring-loaded interface pins in the testhead.

Install compressed air lines (using rigid lines, 8 mm diameter) to a point at the rear of the system (Figure 1). A male quick-disconnect air fitting is provided at the rear of the system to connect to the compressed air supply.

Figure 9 Compressed Air Supply

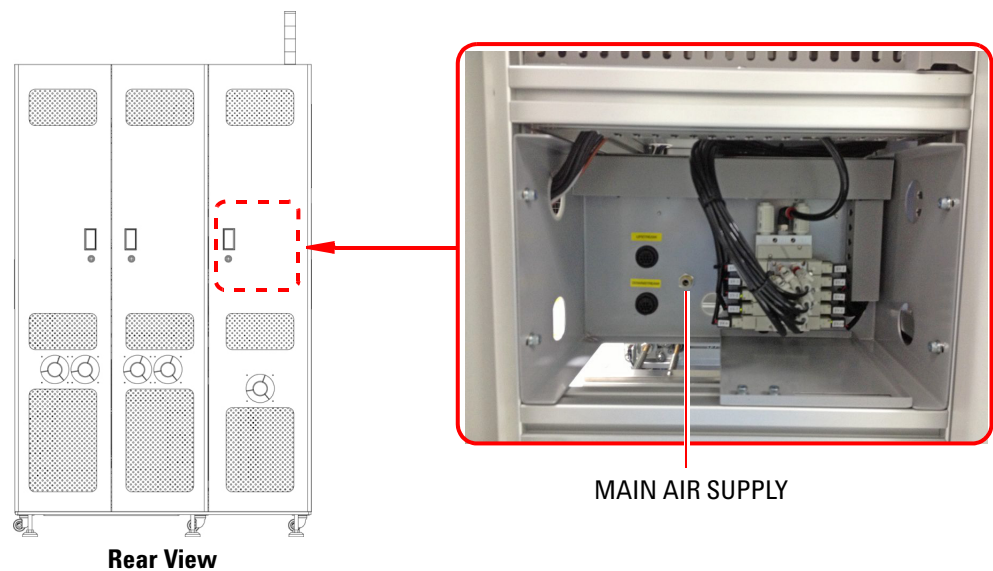

An air cutoff valve is recommended for situations when the air line must be disconnected.

Table 5 Compressed Air Requirements

Description	Measurement
Maximum Pressure	700 kPa (7 bar/102 psi)
Minimum Pressure	500 kPa (5 bar/73 psi)
Minimum Flow Rate	0.66 L/s at STP (1.4 SCFM)
Relative Humidity Allowed	70% for compressed air (150 psi) at 25°C 50% for compressed air (150 psi) at 40°C Dew point must be not more than 5°C

SMEMA Communication

The communication interface between adjacent machines is provided by a SMEMA-compliant protocol, allowing the Medalist i3070 Series 5i to integrate directly into printed circuit assembly manufacturing process.

14 way AMP sockets are provided at the rear of the system to connect to the upstream and downstream systems.

Figure 10 SMEMA Connectors

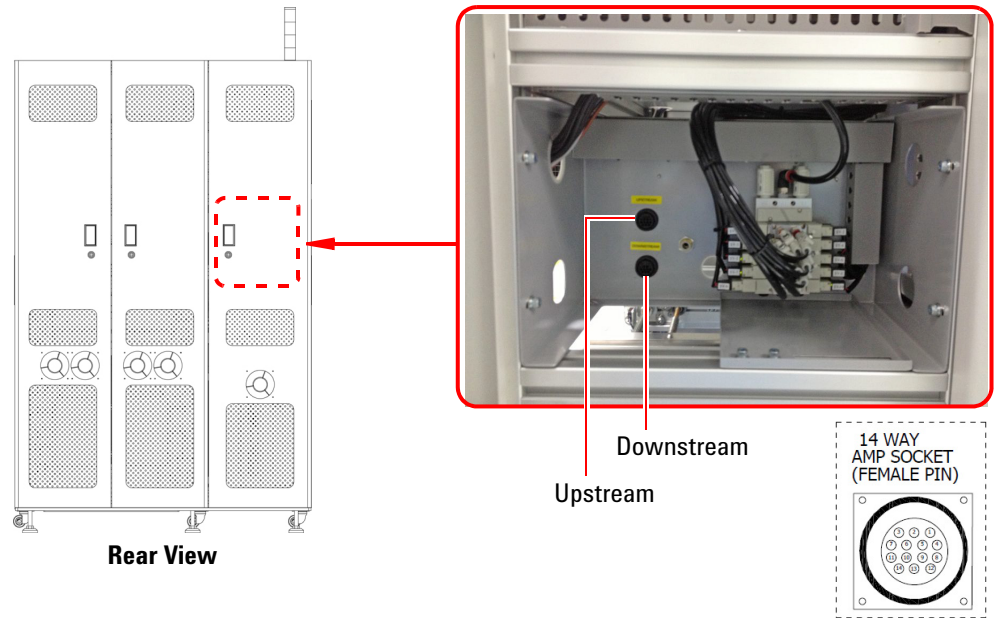

Use 5-wire SMEMA connections to the upstream and downstream systems. In [Figure 11](#), the numbers are the signals associated with PLC input or output modules.

Figure 11 SMEMA Communication

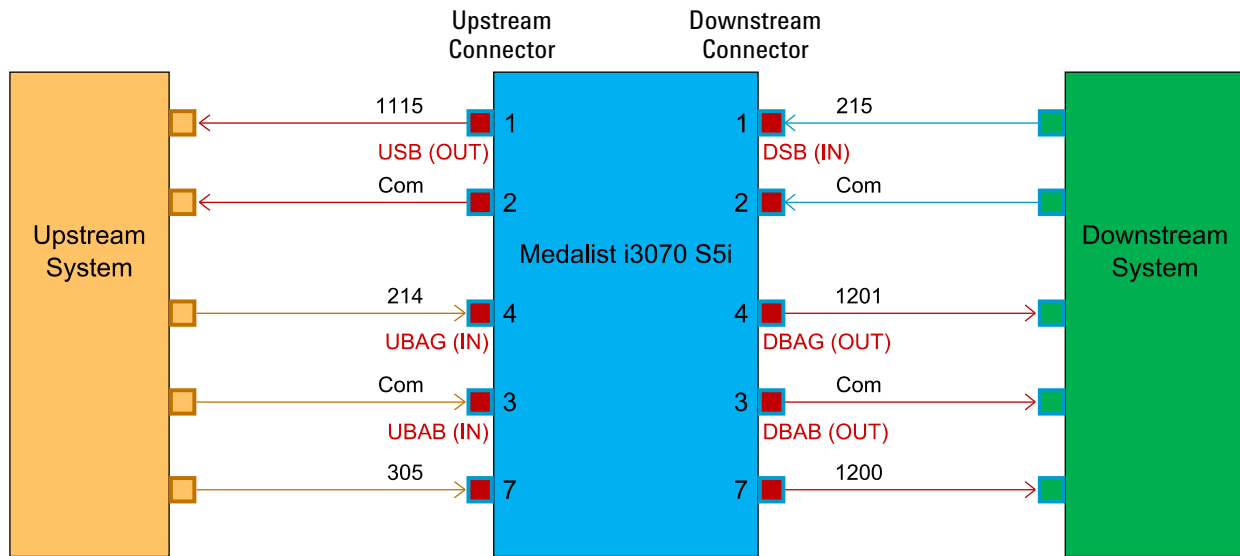

Table 6 SMEMA Signals

Signal	Description
UBAG	Upstream Board Available Good Input signal to ICT system. Upstream system forces this signal to low when Good board is available to send to downstream (ICT) system.
UBAB	Upstream Board Available Bad Input signal to ICT system. Upstream system forces this signal to low when Bad board is available to send to downstream (ICT) system.
USB	Upstream System Ready Output signal to upstream system. ICT system forces this signal to low when it is ready to receive a board.
DSB	Downstream System Busy Input signal to ICT system. Downstream system forces this signal to low when it is ready to receive a board.
DBAG	Good Board Available For Downstream Output signals from ICT system. ICT system forces these signals to low when it ready to transfer the board with status to downstream system.
DBAB	Bad Board Available For Downstream

Upstream and ICT SMEMA Interface

- 1 Upstream system closes UBA relay to indicate to ICT system that a board is available for testing.
- 2 After a delay of 500 ms, ICT system closes USB relay to indicate to upstream system that it is ready to receive the board.
- 3 Once upstream system detects USB, it starts transferring the board to ICT system.
- 4 Upstream system opens the UBA relay once the board exits the upstream system.
- 5 ICT system opens USB relay when the board is in the ICT system. This signal remains until the board clears the system (that is, Zone 1 for the Medalist i3070 Series 5i).

NOTE

Usually the transfer is initiated by the upstream system.

ICT and Downstream SMEMA Interface

- 1 A board status (either PASS or FAIL) will be sent to the PLC when testing is completed. At the same time, ICT system closes the DBAG or DBAB relay to indicate to downstream system that a board is available.
- 2 When downstream system detects DBAG or DBAB, it closes DSB relay to indicate to ICT system that it is ready to receive the board.
- 3 When ICT system detects DSB signal, it starts transferring the board.
- 4 After the board exits the ICT system, ICT system opens DBAG or DBAB relay after a 500 ms delay.
- 5 Downstream system opens DSB relay when the board is in the downstream system.

NOTE

Usually the transfer is initiated by the ICT system.



Uncrating the System

Overview 26
Uncrating Procedure 28

Overview

To uncrate the Medalist i3070 Series 5i system you will need a space approximately 2.5 m (8 feet) by 4 m (13 feet).

NOTE

Save all packaging materials in case the system is to be reshipped or moved to another site.

Check for Shipping Damage

Before uncrating the system, check the Tilt and Shock indicators and notify the carrier if any of them have been triggered.



Tools Required

- Safety glasses
- Gloves
- Utility knife or scissors
- 14 mm (9/16") wrench or socket

Precautions

WARNING

Only qualified personnel should uncrate the system. A minimum of two people are required.

Avoid injury by following the instructions carefully.

A fully loaded test system with shipping pallet can weigh in excess of 1100 kg (2400 lb) and should be moved with caution using a forklift. See [Handling Guidelines](#).

CAUTION

The test system is wrapped in plastic wrap. Do not move the crate or the system to a static sensitive area until you have removed the plastic wrap from the system.

Handling Guidelines

Forklift Requirements

A forklift with tines of at least 1530 mm (54") and capable of lifting at least 1500 kg (5000 lb) at a load centre of 1140 mm (45") is needed to unload and move the system.

Other transportation can be used as long as the full weight of the main unit is fully and properly supported.

WARNING

Failure to meet the above requirements could result in serious injury to personnel and/or damage to the Medalist i3070 Series 5i system.

General Handling Guidelines

- Do not carry or lift the system by its doors or any openings in the covers.
- Always handle the system at the base.
- Care must be taken to prevent damage to the system through rough handling.
- It is recommended that the forklift be positioned at the rear of the system. Insert the fork at the base of the system, as indicated by the labels (Figure 12). Ensure that the system is as far as possible from the end of the fork.

Figure 12 Forklift Positioning

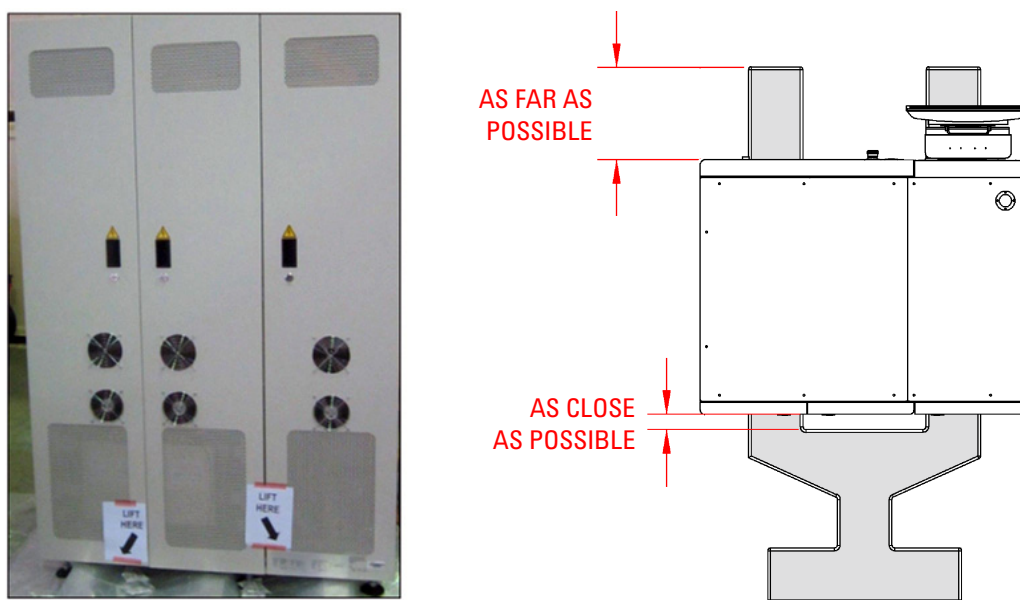

Uncrating Procedure

NOTE

Crates are custom built for individual systems and may have slight differences in how they are assembled. For instance, the front wall may be attached with ¼-turn draw latches or by bolts. Another variation is how the system is secured to the base. It may be secured using poly straps or braced by wooden blocks that are attached by screws from the side walls.

- 1 With one person on each side of the front wall, release the latches and remove the front wall from the crate.

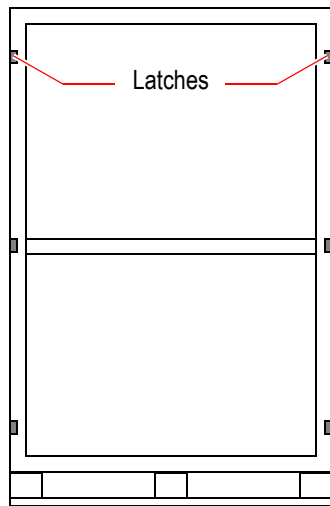

Front view of crated system on pallet



Front wall removed

- 2 Remove the bolts along the bottom of the rear and side walls.

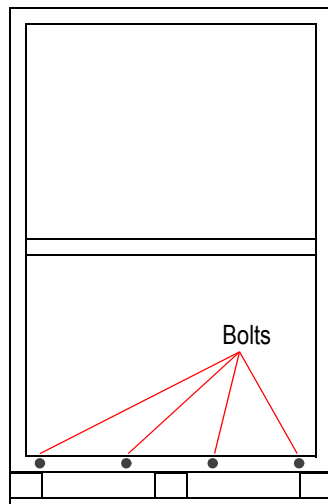

Rear and side walls

WARNING

At least two people are required for the next step.

- 3 Remove the tri-wall assembly by sliding it back and away from the pallet.



- 4 If the system is secured with poly straps, cut them at both sides of the system.

WARNING

Poly straps securing the system to the pallet are stretched taut and may whip when cut. Wear eye protection and be very careful when cutting the straps.



Cut the poly straps

- 5 Release the bolts to remove the following from the pallet:
 - a Front support
 - b Front stopper
 - c Back stopper

Uncrating the System

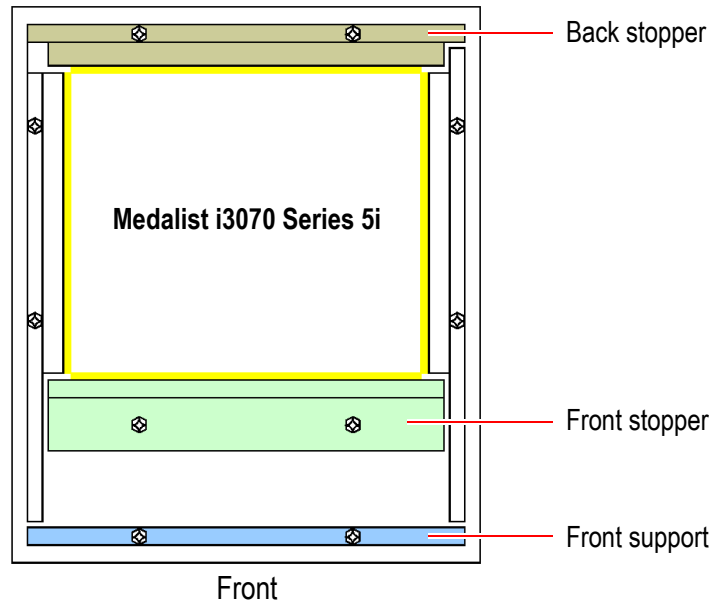

- 6 Use a forklift to move the system off the pallet. Note the [Handling Guidelines](#) on page 27.
- 7 Remove the plastic wrap and any other packaging materials. Be careful not to scratch or nick the system when removing the wrap.

CAUTION

Remove the plastic wrap from the system before moving the system to a static sensitive area.

- 8 Move the system to the site where it will be installed, or to a safe storage area. An Agilent representative will complete the installation.

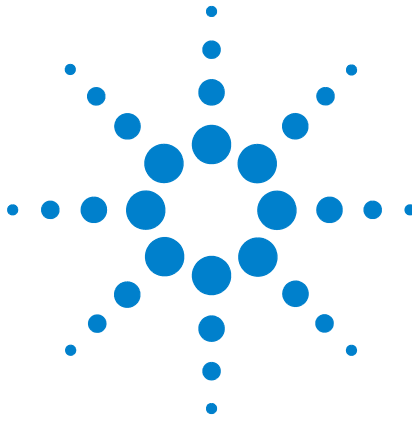

Installing the System

Installation Overview	32
Open the Shutters	33
Release the Press Safety Locks	34
Install the Tower Light	36
Connect Compressed Air Supply	37
Connect SMEMA Cables	38
Adjust Conveyor Height and Alignment	38
Power Up and Verify the System	40
Connect to the Network	43
Install the Barcode Reader (Optional)	44

CAUTION

The system should only be installed by an Agilent-authorized service representative.

CAUTION

If the system has been kept in low temperature storage conditions (0°C to -40°C), it must be allowed to soak for at least 24 hours in a normal operating environment (10°C to 35°C) prior to installation. Make sure the system is completely dry prior to connecting power.



Installation Overview

Tools Required

- T10 and T20 Torx drivers
- #2 Phillips or Posi screwdriver
- 1/4 inch flat-blade screwdriver
- Hex key wrenches (2, 2.5, 5 and 10 mm)
- Diagonal cutters to cut straps
- Utility knife to open boxes
- Square-drive sockets (7/16, 9/16 and 3/8 inch)
- 6-inch-long, 3/8-inch square-drive extension
- 3/8-inch square-drive ratchet
- Cordless drill (14.4 V, 3/8-inch drill/driver kit)
- Adjustable spanner
- For running Diagnostics:
 - BNC-to-dual banana coaxial cable
 - BNC(F)-to-BNC(F) (barrel) connector
 - In-line Pin Verification Fixture (PVF)

Verify that site preparation is complete and requirements are met before installation.

- 1 Open the Shutters
- 2 Release the Press Safety Locks
- 3 Install the Tower Light
- 4 Connect Compressed Air Supply
- 5 Connect SMEMA Cables
- 6 Adjust Conveyor Height and Alignment
- 7 Power Up and Verify the System
- 8 Connect to the Network
- 9 Install the Barcode Reader (Optional)

Open the Shutters

Open the shutters on both sides of the Medalist i3070 Series 5i to allow board access.

Loosen the screws to slide the shutters to the required position. Then tighten the screws to secure the shutters.



Release the Press Safety Locks

Remove Press Brackets

Red press brackets below the Press assembly prevent movement during shipping.

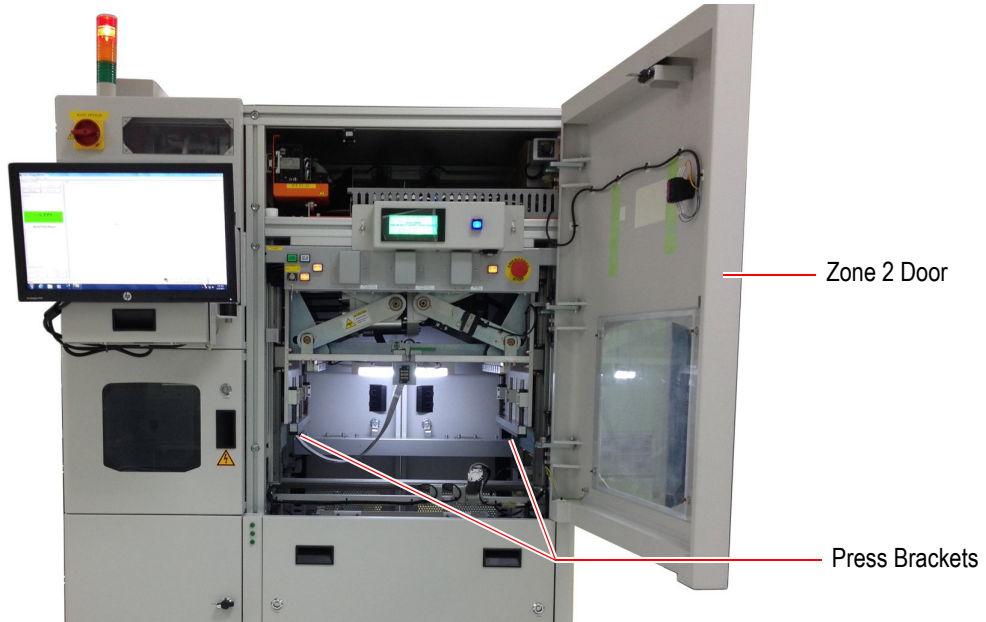

- 1 Open the Zone 2 door to access the Press assembly.
- 2 Carefully remove the screws and the press bracket.

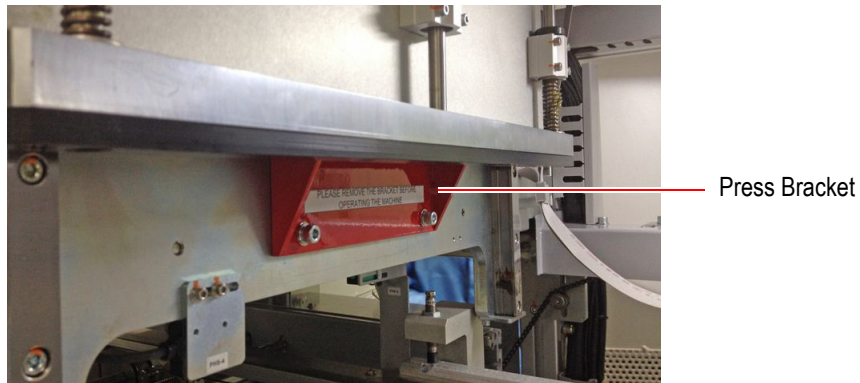

CAUTION

Take care not to drop the screws into the testhead, which may cause a short circuit or damage the cards in the testhead.

- 3 Remove the press bracket on the other side.

Unlock Press Hooks

Locked press hooks prevent the Press from moving down accidentally when the system is not in use.

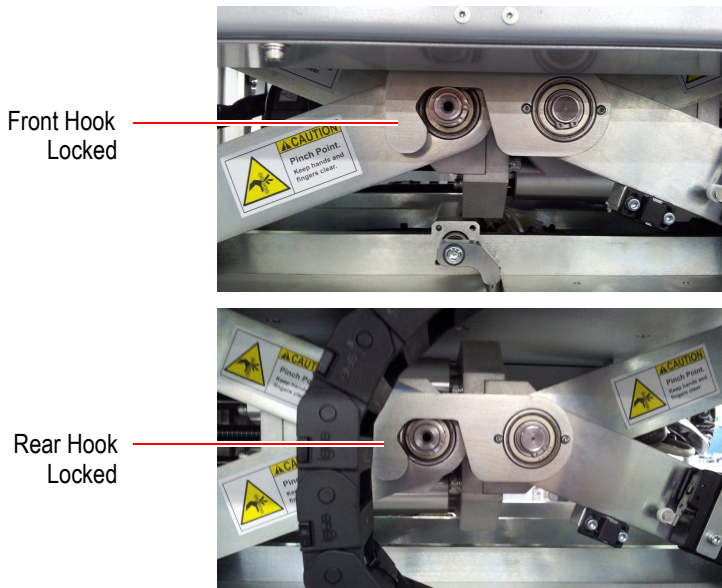

CAUTION Make sure power to the system is off before unlocking the press hooks.

Push each hook clockwise to unlock it.

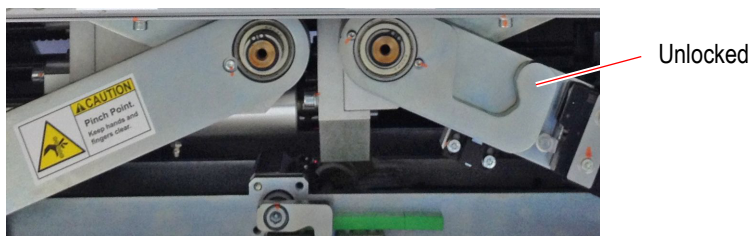

Install the Tower Light

The connector for the tower light will be visible at the top of the system.

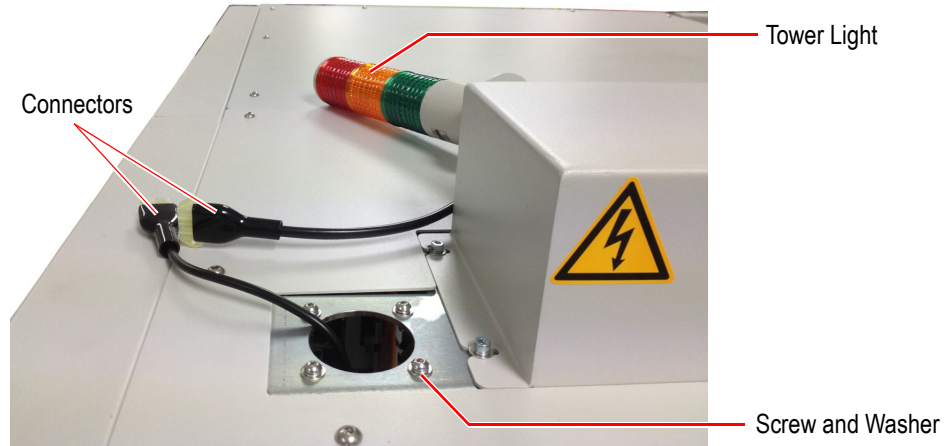

- 1 Connect the tower light connectors.
- 2 Use an Allen key to remove the four sets of screws and washers from around the hole.

CAUTION

Be careful not to drop any of the screws and washers into the system.

- 3 Gently push the connectors and cable into the system.
- 4 Align the mounting holes and secure the tower light with the screws.



Connect Compressed Air Supply

- 1 Connect the air supply with a flexible line directly to the connector labeled **MAIN AIR SUPPLY** on the Medalist i3070 Series 5i system.

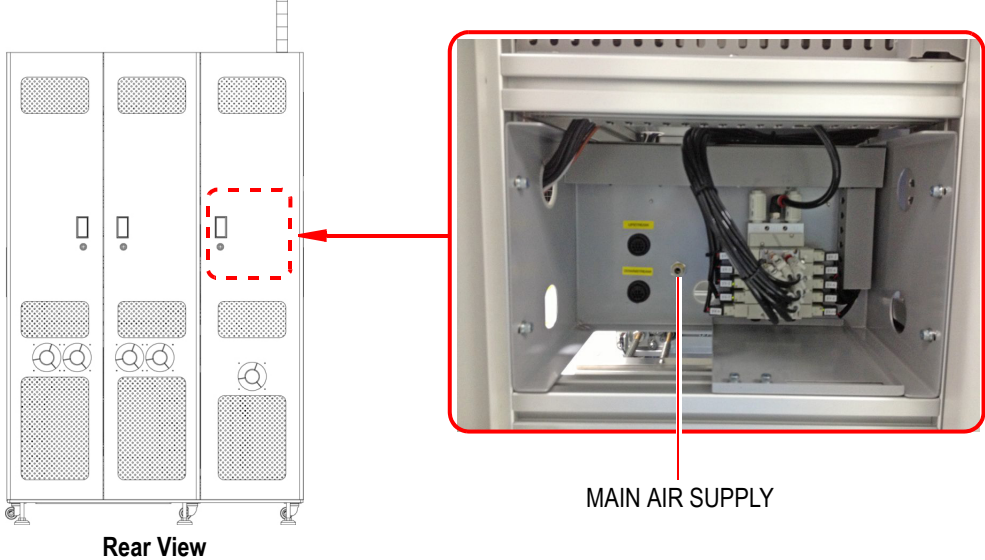

- 2 Turn on the air regulator.

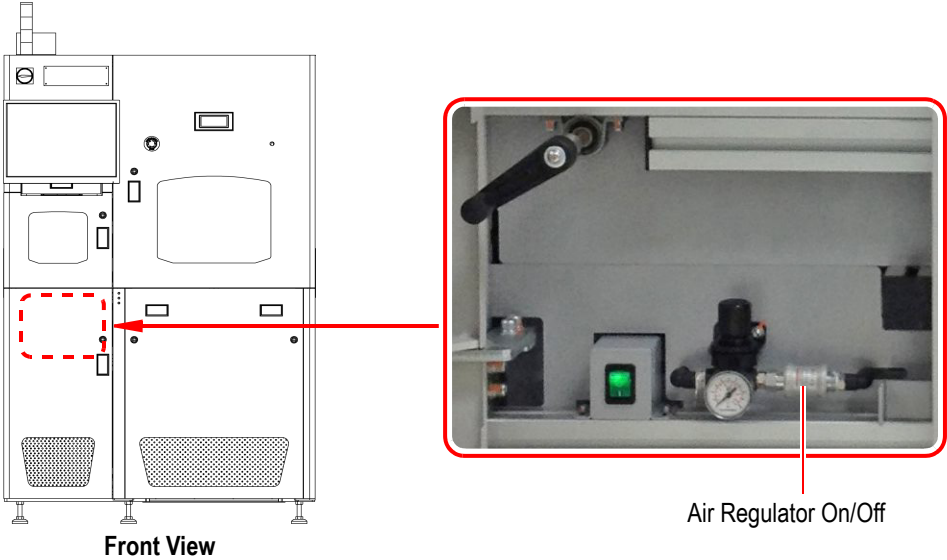

Connect SMEMA Cables

- 1 Connect the cables to the upstream and downstream systems. Route the cables through the cutout at the base of the system.

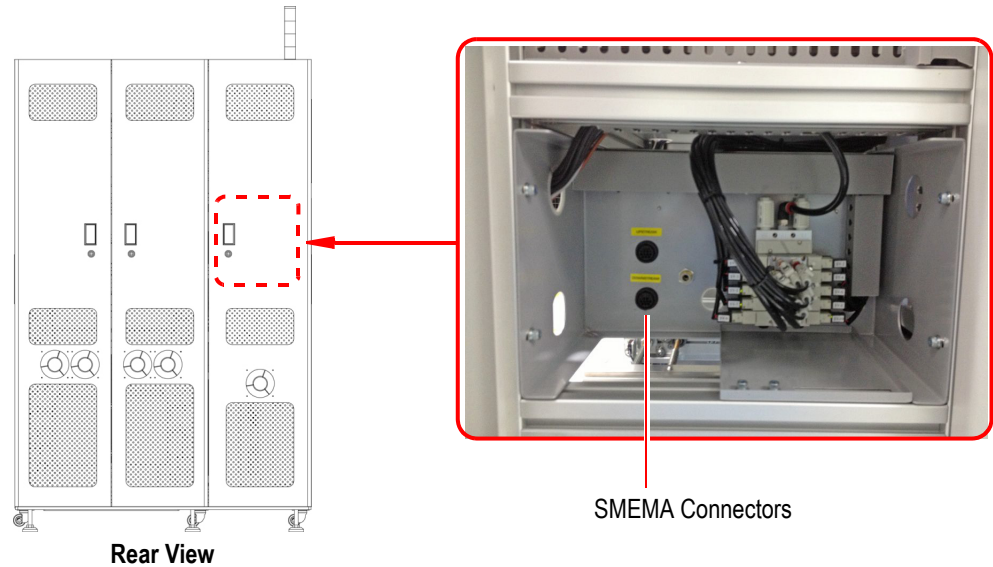

Adjust Conveyor Height and Alignment

Conveyor Height

Adjust the height of the Medalist i3070 Series 5i conveyor to the site requirements, using the six adjustable feet.

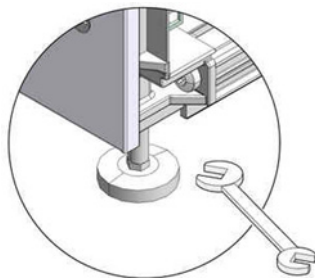

Conveyor Alignment

Adjust the conveyor alignment and offset between upstream and downstream systems. Use PCBs as a visual aid to checking the alignment.

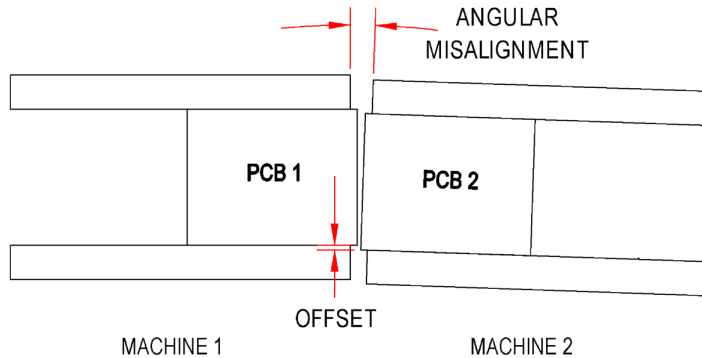

- 1 Place a board on each conveyor.
- 2 Adjust the position of the machines until the angular misalignment and offset are minimized.
- 3 Adjust the height so that the upstream system is slightly higher than the downstream system.
- 4 Test the alignment by sliding the boards across the conveyor. Adjust the alignment if necessary.

Transport Height

To facilitate the smooth transfer of PCBs, it is suggested that the height of the upstream conveyor be slightly higher than the downstream conveyor.

- 1 Place a board on each conveyor.

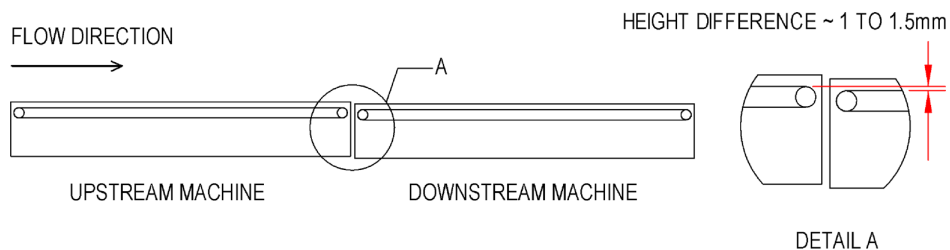

Power Up and Verify the System

WARNING

High Leakage Current

The safety ground in most installations is included in the AC cord. The system has a high leakage current therefore a safety ground must be connected to the same panel or location where the AC voltage is connected. A shock hazard can arise if the AC input and the safety ground are not grounded to the same point.

WARNING

DO NOT open the PDU for any reason.

Voltages capable of causing injury or death are present inside the PDU, even with the switches off.

CAUTION

To avoid damage to the testhead, disconnect testhead power before connecting or disconnecting testhead cables.

NOTE

The PDU is not serviceable; if it is defective, it must be replaced.

Connect Power

- 1 Ensure that the voltage of the system is correct for the site.
The power configuration for the system is shown on a label at the rear of the system ([Figure 13](#)).
- 2 Connect the power cable from the system to the power source.
- 3 Ensure that the Emergency Stop switch is not activated.
- 4 Ensure that all the doors are closed.
- 5 Turn ON the Mains Disconnect Switch ([Figure 13](#)).

Figure 13 Powering Up

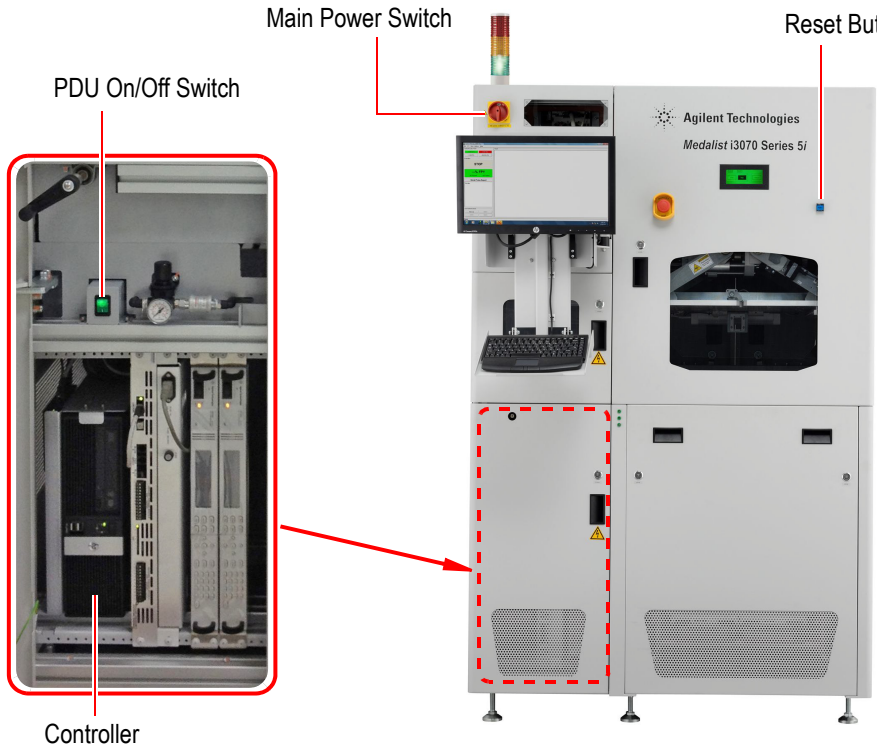
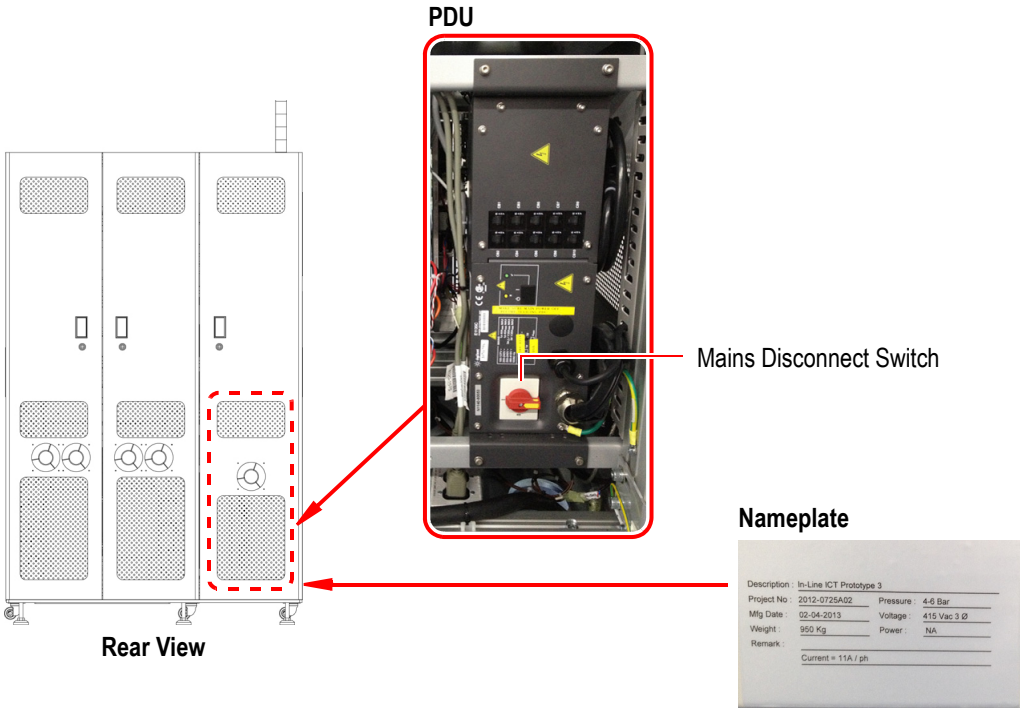

Boot the Testhead

- 1 Turn the Main Power Switch to ON.
- 2 Turn ON the PDU on/off switch that enables power to the testhead.
- 3 Turn on the controller and monitor.
- 4 Log on as **calibrate** (the default password is **Agilent1**).
- 5 Start DGN (Diagnostics) if it does not start automatically.
 - a Select **Start > All Programs > Agilent ICT > KornShell**.
 - b At the KornShell prompt, type **dgn**.
- 6 In the DGN window, boot the testhead using the **Testhead Functns** and **Testhead Power On** function keys.

Run AutoAdjust All

- 1 Select **AutoAdjust** on the **Service Package - Level 1** menu, and click **f1, Enter**.
- 2 On the **AutoAdjust - Level 2** menu, click **f6, AutoAdj All**.
- 3 Verify that there are no errors.

If there are errors, isolate the cause by running Full Diagnostics.

Run Full Diagnostics

NOTE

Compressed air must be attached to the system to run full Diagnostics.

- 1 Place a pin verification fixture on the testhead and lock it down.
- 2 Change **Manual Intervention** to **Yes** (press **Next Value**).

NOTE

Do not press **Save Config** as that will make the **Manual Intervention** selection permanent.

- 3 Run **Full Diagnostics**.
- 4 Verify that there are no errors.

Connect to the Network

If the system will be connected to a network,

- 1 Connect the LAN cable from the RJ45 coupler at the rear of the controller pod to the site network.

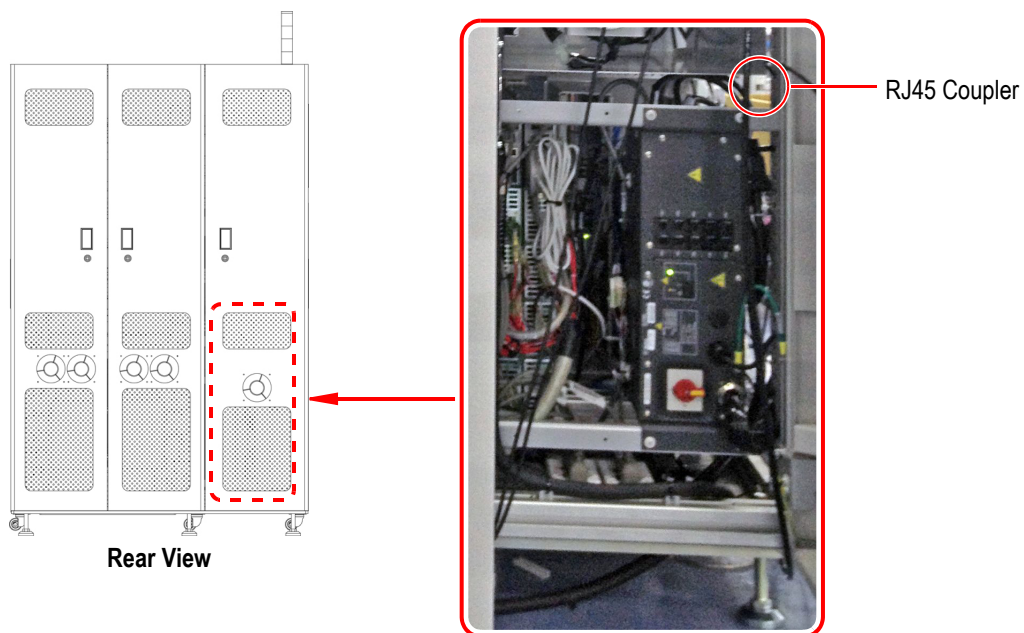

- 2 Configure the network. Instructions for network configuration can be found in *System Administration* in the online help.

Install the Barcode Reader (Optional)

This procedure installs the optional barcode reader for top-side barcode scanning. (For bottom-side scanning, attach it to the bottom metal plate.)

- 1 Open the Zone 1 door.
- 2 Attach the magnetic holder to the metal plate above the Zone 1 conveyor. Turn the latch to the ON position to lock the holder in place.



- 3 Secure the barcode reader to the holder plate with two screws. Then attach the holder to the arm.



- 4 Connect the USB cable from the barcode reader to a USB port on the controller.
- 5 Adjust the position of the barcode reader as required.

www.agilent.com

© Agilent Technologies, Inc. 2013
Printed in Malaysia
First edition, November 2013



E9988-96004