

OPERATION MANUAL

SPECTRUM ANALYZER

AN1820

**PUBLISHED BY
IFR AMERICAS, INC.**

COPYRIGHT © IFR Americas, Inc. 1998

All rights reserved. No part of this publication may be reproduced, stored in a retrieval system, or transmitted in any form or by any means, electronic, mechanical, photocopying, recording or otherwise without the prior permission of the publisher.

10200 West York / Wichita, Kansas 67215 U.S.A. / (316) 522-4981 / FAX 524-2623

Cable Statements:

Double shielded and properly terminated external interface cables must be used with this equipment when interfacing with the EXT DISPLAY, FUNCTION, PRINTER, RS-232 and/or IEEE-488 GPIB Connectors.

Semi-rigid coaxial cables less than 12" (≈ 30 cm) in length must be used when connecting to the EXTERNAL MIXER IF and EXTERNAL MIXER LO Connectors.

SAFETY FIRST: TO ALL OPERATIONS PERSONNEL

REFER ALL SERVICING OF UNIT TO QUALIFIED TECHNICAL PERSONNEL. THIS UNIT CONTAINS NO OPERATOR SERVICEABLE PARTS.

WARNING: USING THIS EQUIPMENT IN A MANNER NOT SPECIFIED BY THE ACCOMPANYING DOCUMENTATION MAY IMPAIR THE SAFETY PROTECTION PROVIDED BY THE EQUIPMENT.

CASE, COVER OR PANEL REMOVAL

Removing protective covers, casings or panels from this Test Set exposes the operator to electrical hazards that can result in electrical shock or equipment damage. Do not operate this Test Set with the case, cover or panels removed.

SAFETY IDENTIFICATION IN TECHNICAL MANUAL

This manual uses the following terms to draw attention to possible safety hazards, that may exist when operating this equipment.

CAUTION: THIS TERM IDENTIFIES CONDITIONS OR ACTIVITIES THAT, IF IGNORED, CAN RESULT IN EQUIPMENT OR PROPERTY DAMAGE (E.G., FIRE).

WARNING: THIS TERM IDENTIFIES CONDITIONS OR ACTIVITIES THAT, IF IGNORED, CAN RESULT IN PERSONAL INJURY OR DEATH.

SAFETY SYMBOLS IN MANUALS AND ON UNITS



CAUTION: Refer to accompanying documents.



INFORMATION: Refer to accompanying documents.



AC OR DC TERMINAL: Terminal that may supply or be supplied with ac or dc voltage.



DC TERMINAL: Terminal that may supply or be supplied with dc voltage.



AC TERMINAL: Terminal that may supply or be supplied with ac or alternating voltage.



SWITCH IN STAND-BY: AC line power is applied but the device is in stand-by mode.



SWITCH OFF: AC line power to the device is OFF.



SWITCH ON: AC line power to the device is ON.

EQUIPMENT GROUNDING PRECAUTION

Improper grounding of equipment can result in electrical shock.

USE OF PROBES

Check specifications for the maximum voltage, current and power ratings of any connector on the Test Set before connecting it with a probe from a terminal device. Be sure the terminal device performs within these specifications before using it for measurement, to prevent electrical shock or damage to the equipment.

POWER CORDS

Power cords must not be frayed, broken nor expose bare wiring when operating this equipment.

USE RECOMMENDED FUSES ONLY

Use only fuses specifically recommended for the equipment at the specified current and voltage ratings.

INTERNAL BATTERY

This unit contains Lithium Batteries, serviceable only by a qualified technician.

CAUTION: SIGNAL GENERATORS CAN BE A SOURCE OF ELECTROMAGNETIC INTERFERENCE (EMI) TO COMMUNICATION RECEIVERS. SOME TRANSMITTED SIGNALS CAN CAUSE DISRUPTION AND INTERFERENCE TO COMMUNICATION SERVICES OUT TO A DISTANCE OF SEVERAL MILES. USERS OF THIS EQUIPMENT SHOULD SCRUTINIZE ANY OPERATION THAT RESULTS IN RADIATION OF A SIGNAL (DIRECTLY OR INDIRECTLY) AND SHOULD TAKE NECESSARY PRECAUTIONS TO AVOID POTENTIAL COMMUNICATION INTERFERENCE PROBLEMS.

LIST OF EFFECTIVE PAGES

The manual pages listed below that are affected by a current change or revision, are so identified by a revision number.

Date of Issue for original and changed pages are:

Original 0 June 1997

TOTAL NUMBER OF PAGES IN THIS MANUAL IS 272 CONSISTING OF THE FOLLOWING

Pg. No.	Rev. No.	Pg. No.	Rev. No.
Title	0	4-1 through 4-58	0
Copyright	0	5-1 through 5-8	0
Cable Statements	0	6-1 through 6-23	0
Safety	0	6-24	0
A	0	7-1 through 7-9	0
B Blank	0	7-10 Blank	0
i through xv	0	A-1 through A-6	0
xvi Blank	0	B-1 through B-9	0
1-1 through 1-14	0	B-10 Blank	0
2-1 through 2-4	0	C-1 through C-2	0
3-1 Blank	0	D-1 through D-3	0
3-2 through 3-11	0	D-4 Blank	0
3-12 Blank	0	E-1 through E-2	0
3-13 through 3-22	0	F-1	0
3-23 Blank	0	F-2 Blank	0
3-24 through 3-40	0	G-1 through G-2	0
3-41 Blank	0	H-1 through H-3	0
3-42 through 3-58	0	H-4 Blank	0
3-59 Blank	0	Index-1 through Index-4 ..	0
3-60 through 3-94	0		

PREFACE

SCOPE

This manual contains instructions for operating the AN1820 9 kHz-2.9 GHz Spectrum Analyzer. The instruction level is relatively basic and presupposes no previous experience on the part of the operator with a Spectrum Analyzer of this type. A basic understanding of communication electronics and practical troubleshooting methods is helpful. It is strongly recommended that the operator be thoroughly familiar with Sections 1 through 4 of this manual before attempting to operate the unit.

ORGANIZATION

The AN1820 Operation Manual is composed of the following sections:

SECTION 1 - INTRODUCTION

Provides an introduction to the unit and a brief overview of unit functions.

SECTION 2 - INSTALLATION

Provides a step-by-step procedure for placing the AN1820 into operation.

SECTION 3 - DESCRIPTION OF CONTROLS, CONNECTORS AND INDICATORS

Identifies and functionally describes all AN1820 controls, connectors and indicators. Provides complete descriptions of all Display operation screens, menus and parameters.

SECTION 4 - OPERATION

Provides general procedures for operating the AN1820 and test applications, using the AN1820 to measure various types of input signals.

SECTION 5 - PERFORMANCE EVALUATION

Identifies and explains procedures the operator can use to insure the AN1820 is performing properly.

SECTION 6 - REMOTE OPERATION

Contains procedures for configuring and operating the AN1820 remotely via GPIB or RS-232 external connections. Lists unit specific commands for remote operations and commands mandated by IEEE-488.2 1987.

SECTION 7 - OPTIONS

Contains information on the Tracking Generator (Option 02) and Quasi-Peak Detector (Option 08). Provides a general procedure for measuring Electromagnetic Interference (EMI) using the Quasi-Peak Detector.

TABLE OF CONTENTS

Paragraph	Title	Page
	List of Effective Pages	A
	Preface	i
	Table of Contents	ii
	List of Illustrations	viii
	List of Tables	xiv

SECTION 1 - INTRODUCTION

1-1	General	1-1
1-2	Standard Features	1-1
1-2-1	Display	1-1
1-2-2	Measurements With The AN1820 Spectrum Analyzer	1-1
1-2-3	Input Level	1-1
1-2-4	Markers	1-1
1-2-5	External Attenuation/Gain Offset	1-1
1-2-6	Frequency Counter	1-1
1-2-7	External Interface	1-2
1-2-8	AM/FM Receiver	1-2
1-2-9	Mixer Function	1-2
1-2-10	FFT Operation	1-2
1-2-11	Memory	1-2
1-3	Optional Features and Accessories	1-2
1-3-1	Option 02 - Tracking Generator	1-2
1-3-2	Option 08 - Quasi-Peak Detector	1-2
1-3-3	Option 09 - High Stability Time Base	1-2
1-4	Specifications	1-3

SECTION 2 - INSTALLATION

2-1	General.....	2-1
2-2	Precautions	2-1
2-3	Lid Assembly Removal and Replacement.....	2-1
2-3-1	Removal.....	2-1
2-3-2	Replacement.....	2-1
2-4	Power Up Procedure.....	2-2
2-5	Fuse Verification/Replacement Procedure.....	2-3
2-6	Factory Preset Initialization Procedure.....	2-4
2-7	External Cleaning.....	2-4

SECTION 3 - DESCRIPTION OF CONTROLS, CONNECTORS AND INDICATORS

3-1	AN1820 Front Panel	3-4
3-2	AN1820 Rear Panel	3-10
3-3	Operation Screens and Soft Function Key Configurations.....	3-13
3-3-1	Center Frequency Operation Screen	3-14
3-3-2	Span Frequency Operation Screen.....	3-16
3-3-3	Start Frequency Operation Screen	3-18
3-3-4	Stop Frequency Operation Screen	3-20
3-3-5	Attenuation Amplitude Operation Screen.....	3-22
3-3-6	Reference Amplitude Operation Screen	3-24
3-3-7	Bandwidth Amplitude Operation Screen	3-26
3-3-8	Scale Amplitude Operation Screen	3-28
3-3-9	Marker Mode Operation Screen	3-31
3-3-10	Sweep Mode Operation Screen.....	3-36
3-3-11	Tracking Generator Mode Operation Screen.....	3-42
3-3-12	Auxiliary Mode Operation Screen.....	3-44

Paragraph	Title	Page
3-3-13	Copy Operation Screen.....	3-50
3-3-14	Preset.....	3-52
3-3-15	Display Operation Screens.....	3-53
3-3-16	Demod Operation Screen	3-60
3-3-17	Store Operation Screen	3-62
3-3-18	Recall Operation Screen.....	3-66
3-3-19	Application Operation Screens	3-72
3-3-20	Analyzer Utility Menu and Screens.....	3-77

SECTION 4 - OPERATION

4-1	General.....	4-1
4-2	Basic Instrument Operation.....	4-2
4-2-1	Spectrum Analyzer.....	4-2
4-2-2	Frequency Counter.....	4-5
4-2-3	Digital Oscilloscope	4-6
4-2-4	Enhanced Logarithmic Display Mode.....	4-8
4-3	Harmonic Distortion Measurements.....	4-10
4-4	Intermodulation Distortion Measurements	4-14
4-5	Modulation	4-16
4-5-1	Demodulating Input Signals.....	4-16
4-5-2	AM Measurements.....	4-17
4-5-3	FM Measurements.....	4-21
4-5-4	Pulsed RF Measurements	4-25
4-6	External Mixer Function.....	4-30
4-7	FFT Mode.....	4-33
4-8	Frequency-Selective Device Measurements	4-35
4-8-1	Bandwidth Application Program	4-35

Paragraph	Title	Page
4-8-2	Return Loss Bridge (ACCESS NO: AC4101) Measurements	4-41
4-9	Memory Operations	4-44
4-9-1	Memory Storage.....	4-44
4-9-2	Memory Recall.....	4-47
4-9-3	Limits Trace Creation	4-49
4-9-4	Sending Out Plots	4-50
4-9-5	Printing Out Screens	4-52
4-9-6	Memory Edits.....	4-53
4-10	Macro Operations.....	4-56
4-10-1	Assigning Macros From Front Panel.....	4-56
4-10-2	Operating Macros From Front Panel.....	4-58
4-10-3	Display Limit Alarms Operation Screen Macro	4-58

SECTION 5 - PERFORMANCE EVALUATION

5-1	General.....	5-1
5-2	Power Up Self Test	5-1
5-3	Diagnostics (Self Test)	5-1
5-3-1	Diagnostics Operation Screen	5-2
5-3-2	CPU Diagnostics Operation Screen.....	5-6
5-4	Diagnostics Procedures	5-7
5-4-1	Single Test Procedure	5-7
5-4-2	Loop Test Procedure	5-8
5-4-3	Print Test Procedure	5-8

Paragraph	Title	Page
-----------	-------	------

SECTION 6 - REMOTE OPERATION

6-1	General.....	6-1
6-2	Operating Procedures.....	6-1
6-2-1	RS-232 Configuration For Direct Remote Operation.....	6-1
6-2-2	RS-232 Configuration For Direct Remote Operation.....	6-5
6-2-3	GPIB Configuration	6-7
6-3	Test Macro Language (TMAC)	6-8
6-4	Command Syntax	6-8
6-5	Mandatory IEEE 488.2 Commands	6-10
6-6	AN1820 Specific Command Set	6-11

SECTION 7 - OPTIONS

7-1	Tracking Generator (Option 02)	7-1
7-1-1	Description.....	7-1
7-1-2	Response	7-1
7-2	Quasi-Peak Detector (Option 08)	7-1
7-2-1	Purpose	7-1
7-2-2	Time Constants.....	7-1
7-2-3	Antenna Factor	7-2
7-2-4	Line Impedance Stabilization Network (LISN).....	7-2
7-2-5	Quasi-Peak Detector Measurement Procedure	7-3

APPENDICES

Appendix	Title	Page
Appendix A	Connector Pin-Out Tables	A-1
Appendix B	Optimization Tables.....	B-1
Appendix C	Oversampling	C-1
Appendix D	FFT	D-1
Appendix E	Repacking for Shipment.....	E-1
Appendix F	Options and Accessories.....	F-1
Appendix G	Soft Function Key Flowchart.....	G-1
Appendix H	Abbreviations.....	H-1

INDEX

Index.....	Index-1
------------	---------

LIST OF ILLUSTRATIONS

Figure No.	Title	Page
2-1	Rear Panel Power Up Controls, Connectors and Indicators	2-2
2-2	Front Panel Power Up Controls and Indicators	2-3
2-3	Fuse Replacement	2-3
3-1	Front Panel Controls, Connectors and Indicators.....	3-2
3-2	Rear Panel Controls, Connectors and Indicators	3-2
3-3	Center Frequency Operation Screen	3-14
3-4	Span Frequency Operation Screen.....	3-16
3-5	Start Frequency Operation Screen	3-18
3-6	Stop Frequency Operation Screen	3-20
3-7	Attenuation Amplitude Operation Screen	3-22
3-8	Reference Amplitude Operation Screen	3-24
3-9	Bandwidth Amplitude Operation Screen	3-26
3-10	Scale Amplitude Operation Screen.....	3-28
3-11	Scale Amplitude LOG UNITS Soft Function Keys	3-30
3-12	Scale Amplitude LINEAR UNITS Soft Function Keys	3-30
3-13	Marker Mode Operation Screen	3-31
3-14	Marker Mode MKR SEL Soft Function Keys.....	3-32
3-15	Marker Mode PK FUNC Soft Function Keys.....	3-33
3-16	Marker Mode DELTA Soft Function Keys	3-34
3-17	Sweep Mode Operation Screen.....	3-36
3-18	Sweep Mode MODE Soft Function Keys.....	3-37
3-19	Sweep Mode SOURCE Soft Function Keys.....	3-38
3-20	Sweep Mode TRIG Soft Function Keys	3-39
3-21	Tracking Generator Mode Operation Screen	3-42
3-22	Auxiliary Mode Operation Screen.....	3-44

Figure No.	Title	Page
3-23	Auxiliary Mode Counter Operation Screen.....	3-45
3-24	Auxiliary Mode External Mixer Operation Screen	3-46
3-25	Auxiliary Mode Oscilloscope Operation Screen.....	3-47
3-26	Auxiliary Mode FFT Operation Screen	3-49
3-27	Copy Operation Screen.....	3-50
3-28	Copy Operation PLOT Soft Function Keys.....	3-51
3-29	Preset Operation Screen.....	3-52
3-30	Display Operation Screen	3-53
3-31	Display Operation HOLD Soft Function Keys	3-54
3-32	Display Limit Alarms Operation Screen.....	3-55
3-33	Display Limits Trace Creation Screen.....	3-56
3-34	Demod AM/FM Receiver Operation Screen.....	3-60
3-35	Store Memory Operation Screen	3-62
3-36	Store Trace Directory	3-63
3-37	Store Trace Directory MORE Soft Function Keys	3-64
3-38	Store Setup Directory	3-65
3-39	Recall Memory Operation Screen.....	3-66
3-40	Recall Trace Directory	3-67
3-41	Edit Trace Directory	3-68
3-42	Recall Setup Directory.....	3-69
3-43	Edit Setup Directory	3-70
3-44	Application Operation Screens.....	3-72
3-45	Macro Directory	3-73
3-46	Bandwidth Application Soft Function Keys	3-74
3-47	Analyzer Utility Menu.....	3-77
3-48	RS-232 (Serial) Screen.....	3-78

Figure No.	Title	Page
3-49	IEEE-488 (GPIB) Screen.....	3-80
3-50	General Options Screen.....	3-81
3-51	Keyboard Options Screen	3-84
3-52	Version Number Screen	3-86
3-53	Modify Memory Main Menu.....	3-87
3-54	Modify Trace Memory Menu	3-88
3-55	Modify Trace Memory LIM Soft Function Keys	3-88
3-56	Modify Trace Memory Menu LABEL Function.....	3-89
3-57	Modify Setup Memory Menu	3-90
3-58	Real Time Clock Set Screen.....	3-91
3-59	User Cals Screen.....	3-92
3-60	Printer Options Screen	3-93
4-1	Spectrum Analyzer Operation.....	4-2
4-2	Frequency Counter Operation.....	4-5
4-3	Digital Oscilloscope Operation	4-6
4-4	Enhanced Logarithmic Display Mode Operation.....	4-8
4-5	Harmonic Distortion Measurements.....	4-10
4-6	Harmonic Distortion Percentage	4-12
4-7	AM With Harmonic Distortion.....	4-13
4-8	Intermodulation Distortion Measurements	4-14
4-9	AM Measurements.....	4-17
4-10	AM1 Demodulation Screen	4-19
4-11	AM Percentage	4-20
4-12	FM Measurements.....	4-21
4-13	FM1 Demodulation Screen	4-23
4-14	FM Adjustments	4-24

Figure No.	Title	Page
4-15	Pulsed RF Measurements	4-25
4-16	PRF Measurement for Dense Spectrum	4-27
4-17	PRF Measurement for Line Spectrum	4-28
4-18	Bandwidth Application Pulse Measurements	4-29
4-19	External Mixer Function	4-30
4-20	External Mixer Function Operation Hook-Up.....	4-31
4-21	FFT Mode.....	4-33
4-22	Bandwidth Application Filter Measurements	4-35
4-23	-Slope Operation With Markers Inactive.....	4-37
4-24	+Slope Operation With Marker(s) Active	4-38
4-25	-Slope Operation With Marker(s) Active	4-39
4-26	0 dB Function	4-41
4-27	Return Loss Bridge Measurements	4-41
4-28	Return Loss Bridge Measurements Hook-Up	4-42
4-29	Memory Operations	4-44
4-30	Store Trace Directory Operation	4-45
4-31	Store Setup Directory Operation	4-46
4-32	Recall Trace Directory Operation.....	4-47
4-33	Recall Setup Directory Operation.....	4-48
4-34	Display Limits Trace Creation Screen Operation.....	4-49
4-35	RS-232 Plotter Cable Configuration	4-51
4-36	Edit Trace Directory Operation	4-53
4-37	Move Memory Operation	4-53
4-38	Confirm Memory Operation.....	4-54
4-39	Copy Memory Operation.....	4-54
4-40	Delete Memory Operation.....	4-55

Figure No.	Title	Page
4-41	Macro Operations.....	4-56
4-42	Macro Directory Operation.....	4-57
4-43	Assigning Macro to Soft Function Key.....	4-57
5-1	Diagnostics Operation Screen.....	5-1
5-2	Diagnostics LOOP Soft Function Keys.....	5-4
5-3	Diagnostics OUTPUT Soft Function Keys.....	5-5
5-4	CPU Diagnostics Operation Screen.....	5-7
6-1	AN1820 - Host Cable Connections (9-Pin).....	6-1
6-2	AN1820 - Host Cable Connections (25-Pin).....	6-2
6-3	AN1820 - Modem Cable Connections (9-Pin).....	6-5
6-4	AN1820 - Modem Cable Connections (25-Pin).....	6-2
7-1	Line Impedance Stabilization Network (LISN).....	7-2
7-2	Quasi-Peak Measurements.....	7-3
7-3	Conducted EMI Test Hook-Up.....	7-4
7-4	Radiated EMI Test Hook-Up.....	7-4
7-5	Ambient Signals.....	7-5
7-6	Trace Reference Function Without UUT Signals.....	7-6
7-7	Trace Reference Function With UUT Signals.....	7-6
7-8	Normal Peak Detector.....	7-7
7-9	Normal Peak Detector in Linear Display Mode.....	7-8
7-10	Quasi-Peak Detector.....	7-9
A-1	EXT DISPLAY Connector.....	A-2
A-2	FUNCTION Connector.....	A-3
A-3	IEEE-488 GPIB Connector.....	A-4
A-4	RS-232 Connector.....	A-5
A-5	PRINTER Connector.....	A-6

Figure No.	Title	Page
C-1	Sampling-Normal RBW (One Tenth of a Division)	C-1
C-2	Sampling-Narrow RBW (One Tenth of a Division)	C-2
C-3	Oversampling (One Tenth of a Division)	C-2
E-1	Repacking for Shipment	E-2
G-1	Soft Function Key Flowchart.....	G-1

LIST OF TABLES

Table No.	Title	Page
2-1	Initial Factory Preset Conditions.....	2-4
3-1	Reference Level Limitation with Attenuation Uncoupled	3-24
3-2	Scale Unit Prefixes and Display Indications	3-25
3-3	Trigger Delay Ranges.....	3-40
4-1	AN1820 Digital Oscilloscope Maximum Frequency (25/Sweep Time).....	4-7
4-2	Modulation Index	4-24
4-3	Power Level and Duration Cycle	4-42
4-4	Return Loss-VSWR-Reflected Power Conversion.....	4-43
4-5	Trace Creation Undo Actions.....	4-49
5-1	Test Result Field Indications	5-2
5-2	Phase Noise Tolerances	5-2
5-3	Noise Floor Tolerances.....	5-2
5-4	Phase Lock Monitor Test Frequencies	5-3
6-1	Terminal Settings for RS-232 Host Operation.....	6-4
6-2	Command Syntax Punctuation Marks.....	6-9
6-3	Mandatory GPIB Commands	6-10
6-4	AN1820 Specific Commands.....	6-11
7-1	Quasi-Peak Time Constants	7-2
A-1	I/O Connectors	A-1
A-2	Pin-Out for EXT DISPLAY Connector	A-2
A-3	Pin-Out for FUNCTION Connector.....	A-3
A-4	Pin-Out for IEEE-488 GPIB Connector.....	A-4
A-5	Pin-Out for RS-232 Connector	A-5
A-6	Pin-Out for PRINTER Connector	A-6
B-1	Signal Display Optimization	B-1

Table No.	Title	Page
B-2	RBW Adjustment Optimization	B-2
B-3	VBW Adjustment Optimization	B-5
B-4	Sweep Time Adjustment Optimization	B-8
C-1	AN1820 Sampling	C-1
D-1	FFT Equivalent Bandwidths	D-1
D-2	FFT Data Window Equations	D-2
D-3	Data Windows	D-3
F-1	Internal Options	F-1
F-2	Standard Accessories	F-1
F-3	Optional Accessories	F-1

SECTION 1 - INTRODUCTION

1-1 GENERAL

The AN1820 is a microprocessor controlled, digitally synthesized spectrum analyzer. The AN1820 utilizes a numeric keypad, dedicated function keys, multitask Soft Function Keys and a high resolution LCD to display, enter and edit functions and data. Testing is done manually using external front panel controls or remotely through the RS-232 or IEEE-488 external interface. Microprocessor controlled memory allows storage and recall of parameters for each of the major testing modes as well as storage and recall of traces for signal comparison.

1-2 STANDARD FEATURES

The AN1820 Spectrum Analyzer spans a range from 0 Hz to 2.9 GHz, at up to +30 dBm. The AN1820 input impedance is 50 Ω . The AN1820 operates as a Spectrum Analyzer, Frequency Counter, Digital Oscilloscope or AM/FM Receiver.

1-2-1 DISPLAY

The AN1820 Display is a color VGA thin film transistor (TFT) LCD. The graticule area on the LCD has 500 horizontal pixels by 256 vertical lines. The Display shows up to 4 traces on the screen for comparison of live or previously stored signals. The 80 dB of dynamic range in the Logarithmic display mode is expandable to 120 dB. The Linear display mode provides dB units in addition to the regular power and voltage units, eliminating the need for external conversions.

1-2-2 MEASUREMENTS WITH THE AN1820 SPECTRUM ANALYZER

The AN1820 tests and measures spectral purity, mixer products, modulation, carrier levels, suppression in Single Side Band Radios, harmonic levels, RF, EMI, FM deviation, AM % modulation, signal limits and distortion. The AN1820 is not limited to only these measurements.

1-2-3 INPUT LEVEL

Maximum input level to the AN1820 is +20 dBm with <10 dB internal attenuation or +30 dBm with \geq 10 dB internal attenuation. Maximum pulsed level is +40 dBm with \geq 10 dB internal attenuation.

CAUTION: SIGNALS EXCEEDING THE MAXIMUM INPUT LEVEL OF +30 dBm MAY CAUSE DAMAGE TO THE SPECTRUM ANALYZER.

1-2-4 MARKERS

The AN1820 Spectrum Analyzer incorporates the use of single and dual markers on the Display. Markers provide easy measurement of any portion of displayed signal. The Delta function shows differences in levels and time or frequency. Markers have peak search capability.

1-2-5 EXTERNAL ATTENUATION/GAIN OFFSET

An offset value compensating for external attenuation and gain eliminates manual calculations. By setting an offset value equal to the sum of all external attenuation and gain factors, the AN1820 automatically displays true levels for signals requiring amplification or attenuation prior to entry into the AN1820. The offset also compensates for losses present when dealing with antenna factors.

1-2-6 FREQUENCY COUNTER

The frequency counter provides selectable resolution at narrow or wide frequency span settings. Resolution is set to 1, 10, 100 or 1000 Hz.

1-2-7 EXTERNAL INTERFACE

The IEEE-488 GPIB Connector provides parallel communications between the AN1820 and an external controller. The RS-232 Connector provides serial communications between the AN1820 and an external controller. Both connectors provide remote operation and monitoring capabilities. An output from memory may be sent directly to an HPGL-compatible plotter through the IEEE-488 GPIB Connector or RS-232 Connector. Also, the AN1820 provides a print screen output through the Printer Connector, IEEE-488 GPIB Connector or RS-232 Connector.

1-2-8 AM/FM RECEIVER

The AM/FM Receiver provides for modulation and deviation measurements. AM/FM Receiver audio is available through the internal speaker or a headphone connected to the PHONES Connector. The SQUELCH Control and VOLUME Control adjust the audio output to desired levels when operating the AM/FM Receiver.

1-2-9 MIXER FUNCTION

The External Mixer Function allows the AN1820 to measure signals with frequencies greater than 2.9 GHz, up to 1300 GHz. An external mixer with known amplitude characteristics is required.

1-2-10 FFT OPERATION

The AN1820 provides FFT measurement operation with selectable window functions. Uniform, Bartlett, Blackman, Blackman-Harris, Hamming, Hanning or Nuttall may be selected.

1-2-11 MEMORY

The AN1820 has internal memory capacity to store 99 traces (including user defined traces and test limits) and 99 setups. Also available are 64 kilobytes of user definable memory for custom applications.

1-3 OPTIONAL FEATURES AND ACCESSORIES

The following features are added to the AN1820 as desired:

1-3-1 OPTION 02 - TRACKING GENERATOR

Enables swept measurements in the 100 kHz to 2.9 GHz range.

1-3-2 OPTION 08 - QUASI-PEAK DETECTOR

Performs Electromagnetic Interference (EMI) measurements. Also includes additional resolution bandwidth (RBW) filters (200 Hz, 1 kHz, 9 kHz, 120 kHz and 1 MHz).

1-3-3 OPTION 09 - HIGH STABILITY TIME BASE

Increases time base stability to 0.01 ppm. Stabilizes aging to 0.2 ppm after first year of usage. (Time base stability is 0.2 ppm, aging to 2 ppm after one year, without Option 09 installed.)

1-4 SPECIFICATIONS

NOTE: The AN1820 requires 15 minutes of warm-up time to meet specifications.

Specifications only apply with TIME CALIBRATION set to ENABLE in the General Options Screen (accessed from the Analyzer Utility Menu) or immediately after manually activating a TIME CALIBRATION.

Specifications and features are subject to change without notice.

FREQUENCY

Tuning Range:	0 Hz to 2.9 GHz
Tuning Resolution:	1 Hz, Frequency Span ≤ 200 Hz/Div; 25 Hz, Frequency Span > 200 Hz/Div, ≤ 2 kHz/Div; 100 Hz, Frequency Span > 2 kHz/Div, ≤ 20 kHz/Div; 1 kHz, Frequency Span > 20 kHz/Div, ≤ 200 kHz/Div; 10 kHz, Frequency Span > 200 kHz/Div, ≤ 2 MHz/Div; 100 kHz, Frequency Span > 2 MHz/Div, ≤ 20 MHz/Div; 1 MHz, Frequency Span > 20 MHz/Div, ≤ 200 MHz/Div; 10 MHz, Frequency Span > 200 MHz/Div
Frequency Span Width:	
Center/Span Function:	100 Hz (10 Hz/Div) to 2.9 GHz (290 MHz/Div) continuously variable
ZERO Span:	0 Hz
FULL Span:	2.9 GHz (290 MHz/Div)
Start/Stop Function:	0 Hz to 2.9 GHz
Displayed Linearity:	$\pm 5\%$ of indicated Span ($\pm 50\%$ of selected Span/Div)
Readout Accuracy:	$\pm (3\%$ of Frequency Span Width + Frequency Standard Accuracy + 50% of RBW)
Frequency Counter:	
Resolution:	1 Hz, 10 Hz, 100 Hz, 1 kHz
Accuracy:	$\pm (\text{Frequency Standard Accuracy} + \text{Counter Resolution})$
Sensitivity (at 120 MHz with 0 dB attenuation):	≤ -85 dBm with 3 kHz RBW, ≤ -65 dBm with 5 MHz RBW
Stability:	
Residual FM (peak to peak in 20 ms) (Spans < 1 MHz/Div) (100 Hz Video Filter):	< 10 Hz

Noise Sidebands
(Spans ≤ 100 kHz/Div):

FREQUENCY RANGE	10 kHz OFFSET	30 kHz OFFSET
0.1 to 1.0 GHz	-97 dBc/Hz	-101 dBc/Hz
1.0 to 2.9 GHz	-92 dBc/Hz	-95 dBc/Hz

System Related Sidebands
(300 Hz RBW):

<-65 dBc

AMPLITUDE

Measurement Range:

-135 to +30 dBm

Frequency Range:

9 kHz to 2.9 GHz

Average Displayed Noise Level
(3 Hz RBW, Video Filter N/A)
(300 Hz RBW, 10 Hz Video Filter):

FREQUENCY RANGE	RBW	
	3 Hz	300 Hz
9 to 100 kHz	≤ -115 dBm	≤ -95 dBm
100 kHz to 2.9 GHz	≤ -135 dBm	≤ -115 dBm

1 dB Gain Compression:

≥ -5 dBm (0 dB attenuation)

Displayed Dynamic Range:

80 dB in 10 dB/Div log scale,
40 dB in 5 dB/Div log scale,
16 dB in 2 dB/Div log scale,
8 dB in 1 dB/Div log scale,
8 divisions with linear amplitude scale,
120 dB in Enhanced mode.

Amplitude Units:

Logarithmic Display Mode:

dBmW (dBm), dBmV or dB μ V

Linear Display Mode:

Autoscaled with W, μ W, dBmW (dBm), dB μ W,
V, μ V, dBmV or dB μ V

Display Linearity:

5 or 10 dB/Div:

± 0.15 dB/dB, $\leq \pm 1.5$ dB over 8 divisions

1 or 2 dB/Div:

± 0.5 dB over 8 divisions

Linear:

(≤ 5 MHz RBW):

$\pm 2\%$ of Reference Level over 8 divisions

(10 MHz and 30 MHz RBW)
(Attenuation coupled with
Reference Level):

$\pm 10\%$ of Reference Level over 8 divisions

Frequency Response
(10 dB Attenuation) (referenced
to REF OUT Connector output and
to peak of RBW filter response):

±1.5 dB, 9 kHz to 2.9 GHz

Resolution Bandwidth (RBW):

Selection:

Standard:

3 Hz, 10 Hz, 30 Hz, 100 Hz (Digital Resolution);
300 Hz, 3 kHz, 30 kHz, 300 kHz and 5 MHz (at 3 dB);
10 and 30 MHz (at 3 dB) (Linear display and FM modes)

Bandwidth Filters (Option 08):

1 kHz and 1 MHz (at 3 dB);
200 Hz, 9 kHz and 120 kHz (at 6 dB)

Accuracy:

±20%, 300 Hz to 30 kHz;
±30%, 300 kHz to 30 MHz;
±10%, 200 Hz, 9 kHz and 120 kHz

Selectivity:

60 dB/3 dB ratio <5:1, 3 kHz, 30 kHz, 300 kHz,
1 MHz, 5 MHz;
<12:1, 1 kHz

60 dB/6 dB ratio <5:1, 9 kHz and 120 kHz

50 dB/3 dB ratio <10:1, 300 Hz

50 dB/6 dB ratio <10:1, 200 Hz

**Flatness (referenced to
Peak Filter response):**

<1 dB_{P-P}, 200 Hz to 10 MHz
<3 dB_{P-P}, 30 MHz

**Switching Error (referenced
to 30 kHz RBW):**

±0.5 dB, 1 kHz to 5 MHz;
±1.0 dB, <1 kHz
±2.0 dB, 10 MHz, 30 MHz

Video Bandwidth (VBW):

Selection:

10 Hz to 1 MHz in decade steps or Full BW (no Video
Filter activated [NONE])

Attenuator:

Range:

0 to 60 dB, selected manually or automatically coupled to
Reference Level

Resolution:

10 dB steps

Accuracy (9 kHz to 2.9 GHz):

Greater of ±0.5 dB or ±2% of dB setting

Reference Level:

Range:

(<10 MHz RBW, 0 dB Attenuation):	-95 to +30 dBm
(10 MHz or 30 MHz RBW):	-50 to +30 dBm
External Mixer:	-85 to -20 dBm

NOTE: The External Mixer Reference Level is the level required at the EXTERNAL MIXER IF Connector to place the signal at the top of the display screen.

Resolution (≤ 5 MHz RBW): 0.1 dB steps

Accuracy: Referenced to Frequency Response and REF OUT (Calibrator) Specifications with 10 dB Attenuation, -30 dBm Reference Level and 30 kHz RBW plus ± 0.25 dB, -40 to -20 dBm Reference Level; ± 0.5 dB, -85 to -40 dBm Reference Level; ± 2 dB, 10 MHz or 30 MHz RBW

External Reference Offset: -99.9 to +99.9 dB in 0.1 dB steps

NOTE: Negative numbers imply an external gain is connected to the ANALYZER INPUT Connector. Positive numbers imply an external attenuation is used, or external mixer conversion loss.

External Mixer Attenuation (CON LOSS): 0 to 99.9 dB (External Mixer function)

Residual Response (input terminated with 50 Ω , 0 dB Attenuation): ≤ -90 dBm, 9 to 100 kHz;
 ≤ -100 dBm, 100 kHz to 2.9 GHz

Harmonic Distortion (-30 dBm input and 10 dB attenuation): ≤ -70 dBc, Band 0;
(-10 dBm input and 10 dB Attenuation): ≤ -100 dBc, Bands 1 and 2

Intermodulation Distortion (3rd order) (-30 dBm input and 10 dB Attenuation): ≤ -80 dBc

Other Input Related Spurious (-30 dBm input and 10 dB Attenuation): ≤ -70 dBc

SWEEP

Time (Frequency Span >200 Hz/Div): 1 ms to 10 s/Div in 1-2-5 sequence
Frequency Span =0): 200 ns/Div to 10 s/Div in 1-2-5 sequence (resolution reduced <2 μ s/Div)

Sweep Rate Accuracy: $\pm 1\%$ of Full Scale, $\geq 2\mu$ s/Div

Trigger:

Source:	Internal (video), External (front panel), External (rear panel) or Line (ac input)
Mode:	Free Run, Auto, Normal or Single Sweep
Coupling:	ac, dc, High-Pass Filter, Low-Pass Filter, TV line or TV field
Bandwidth:	≥5 MHz (-3 dB) (at EXTERNAL INPUT Connector)
Level:	
Video:	Adjustable over 8 divisions, positive or negative polarity
External Front:	-2.5 V, -1.0 V, -0.5 V, 0.0 V, 0.5 V, 1.0 V, 2.5 V; nominal
External Rear:	+2.5 V nominal
Sensitivity:	
Internal:	1 division
External Front:	200 mV _p
External Rear:	+2 V _{p-p} (TTL)
Delay (Frequency Span =0):	Lesser of 0 to ±300 divisions at Sweep Time/Div (Trigger Delay field setting) or 200 seconds

DISPLAY

Type:	≈6.4" (16 cm) color VGA TFT LCD
Digital Resolution:	640 pixels x 480 (total Display) 500 pixels x 256 lines (graticule area)
Marker Modes:	Single, Dual, Delta, Peak Search, Peak Track, Marker Track, Marker to center, Marker to reference, Marker to Start Frequency, Marker to Stop Frequency
Bandwidth:	
Linear display mode:	≥5 MHz (-3 dB), 30 MHz RBW; ≥2.5 MHz (-3 dB), 5 MHz RBW; at ≤2μs/Div Sweep Time
Logarithmic display mode:	≥1 MHz (-3 dB), 5 MHz RBW; at ≤10μs/Div Sweep Time

MEMORY

Trace Storage Capacity:	99 traces (including user defined traces and test limits)
Recall to Display at one time:	4 traces
Setup Storage Capacity:	99 setups
Macro Storage Capacity:	64 kbytes

INPUTS

ANALYZER INPUT:

Connector:	Precision Type N Female Connector, 50 Ω nominal
Impedance (VSWR) (≥ 10 dB input attenuation):	$< 1.3:1$
Maximum Input Level:	0 Vdc, +20 dBm, +30 dBm CW or +40 dBm peak; ($< 10 \mu\text{s}$, $< 1\%$ duty cycle) with ≥ 10 dB input Attenuation

EXTERNAL MIXER IF:

Connector:	Type SMA Female, terminated in 50 Ω when not in use
Signal Characteristics:	410.7 MHz at -30 dBm (± 3 dB) top of screen
1 dB Gain Compression:	≥ -5 dBm

EXTERNAL INPUT:

Connector:	Type BNC Female
Impedance:	1 M Ω and 27 pF nominal
Coupling:	ac, dc, Ground
Time Domain (Scope):	
Amplitude:	5 mV/Div to 5 V/Div ($\pm 3\%$ of Full Scale) in 1-2-5 sequence (1 kHz input)
Frequency Range:	dc to ≥ 5 MHz (-3 dB) at $\leq 2 \mu\text{s}/\text{Div}$ Sweep Time
Trigger Use:	Selectable external trigger (time-gate) capabilities
Pulse Width:	≥ 100 ns

Frequency Domain (FFT):

Amplitude:

Gain: 0 to 20 dB in 0.1 dB steps
Attenuation: 0 to 60 dB in 20 dB steps
Range: 2.23 mV to 22.3 V Full Scale
(-40 to +40 dBm/50 Ω reference voltage)

Response: +0/-3 dB (0 Hz to 20 kHz)

Display Range: 80 dB

Average Noise Level: <1 μ V

Spurious: <7 μ V

Frequency Range: 0 to 20 kHz

Span: 10 to 200 Hz/Div continuously variable

Bandwidths: 3, 10, 30 or 100 Hz

FUNCTION (Auxiliary
[External] Trigger, pin 8): 10 k Ω nominal

EXT REF IN:

Connector: Type BNC Female

Signal Characteristics: 10 MHz at 1 to 10 V_{P-P}, 1 k Ω nominal

OUTPUTS

PHONES:

Connector: 1/8" (\approx 3.5 mm) phone jack

Signal Characteristics: Mono sound applied in parallel to both left and right channels

EXTERNAL MIXER LO:

Connector: Type SMA, 50 Ω nominal
(must be terminated when not in use)

Frequency: 3 to 13 GHz

Amplitude: \geq +8 dBm

REF OUT (Calibrator):

Connector: Type BNC Female, 50 Ω nominal
Frequency: 100 MHz
Accuracy: Same as Frequency Standard
Amplitude: -30 dBm
Accuracy: ± 0.5 dB

10.7 MHz IF OUT:

Connector: Type BNC Female, 50 Ω nominal
Frequency: 10.7 MHz nominal
Active: ≤ 5 MHz RBW

410.7 MHz IF OUT:

Connector: Type BNC Female, 50 Ω nominal
Frequency: 410.7 MHz nominal
Active: > 5 MHz RBW

EXT DISPLAY:

Connector: HD-15 pin D-sub
Signal: VESA-VGA color display compatible/31.5 kHz scan rate

VIDEO OUT:

Connector: Type BNC Female
Signal Characteristics: 100 mV/Div ($\pm 10\%$) into 1 M Ω

FUNCTION:

(Auxiliary Video, pin 7): 100 mV/Div ($\pm 10\%$) into 1 M Ω
(Sweep, pin 14): 0 to +5 V ramp (± 0.5 V)
(Sweep Hold [Pen Lift], pin 6): TTL Level

INTERFACE CONNECTORS

IEEE-488 GPIB:

Conforms to:	IEEE-Standard 488-1987
Implemented Subsets:	SH1, AH1, T1, TE0, L2, LE0, SR1, RL2, PP0, DC1, DT1 and C0
Compatibility:	IEEE-488.3 Command Set. High Speed waveform transfer supported.
Plotter Output:	HPGL Compatible

RS-232:

Type:	Full or Half-Duplex RS-232 (operates as slave to controller [DTE])
Baud Rate (bits per second):	110, 150, 300, 600, 1200, 2400, 4800, 9600, 19200 or 38400
Handshake Modes:	XON/XOFF (Software), CTS/RTS (Hardware)
Parity Check:	Odd, Even or None
Data Bits per Word:	7 or 8
Stop Bits per Word:	1 or 2
Plotter Output:	HPGL Compatible

PRINTER:

Operation:	Parallel (standard 25 pin D-sub connector)
Compatible Printers:	Epson 24 pin, Epson 9 pin, IBM ThinkJet, HP LaserJet, HP DeskJet

FREQUENCY STANDARD

Standard:

Temperature Stability: ± 0.2 ppm

Aging:

First Year: ± 2 ppm

Thereafter: ± 1 ppm

High Stability Time Base (Option 09):

Temperature Stability: ± 0.02 ppm

Aging:

First Year: ± 0.2 ppm

Thereafter: ± 0.1 ppm/yr
 $\pm 5 \times 10^{-10}$ /day

RECEIVER

Frequency Range: Same as Frequency Tuning Range Specification

Frequency Resolution: Same as Frequency Tuning Resolution Specification

Sensitivity
(Typical at room temperature): $5 \mu\text{V}$ at 121 MHz (30 kHz RBW, 3 kHz Video Bandwidth, 5 kHz deviation FM at 1 kHz rate, 10 dB SINAD) (10 dB IF Gain)

Bandwidths: Available analyzer RBW between 200 Hz and 30 MHz

Demodulation: AM, FM (ac or dc)

AM Scales (≤ 5 MHz RBW): 10%, 20%, 50%

FM Scales (≤ 5 MHz RBW): 1 kHz to 100 kHz
(≥ 10 MHz RBW): 200 kHz to 5 MHz in 1-2-5 sequence

TRACKING GENERATOR (OPTION 02)

Frequency Range:	100 kHz to 2.9 GHz
Flatness (at -10 dBm):	±2.0 dB, 100 kHz to 1 MHz; ±1.5 dB, 1 to 2.9 MHz
Output Level:	0 to -70 dBm in 1 dB steps
Attenuator Accuracy:	±1 dB or 0.05 dB/dB
Nonharmonic Spurious:	<-30 dBc
Harmonics:	<-20 dBc
Leakage (Dynamic Range):	-120 dBm

QUASI-PEAK DETECTOR (OPTION 08)

SELECTED BANDWIDTH	RECOMMENDED FREQUENCY RANGE	CHARGE TIME (ms)	DISCHARGE TIME (ms)	DISPLAY TIME (ms)
200 Hz	10 to 150 kHz	45 ±20%	500 ±20%	160 ±20%
9 kHz	150 kHz to 30 MHz	1 ±20%	160 ±20%	160 ±20%
120 kHz	30 MHz to 1 GHz	1 ±20%	550 ±20%	100 ±20%

GENERAL CHARACTERISTICS

Dimensions:	≈16" (406 mm) wide (including handle); ≈7.5" (191 mm) high ≈22" (559 mm) deep
Weight:	≤37.1 lbs (16.8 kg) without options, with lid and RS-232 cable ≤34.1 lbs (15.5 kg) basic unit only
Warm-up Time:	
Operation:	≥1 minute
For Specified Accuracy:	≥15 minutes

POWER REQUIREMENTS

Source Voltage and Frequency:	100 to 120 VAC at 50-60/400 Hz 220 to 240 VAC at 50-60 Hz
Power Consumption:	170 W Maximum 132 W Nominal at 110 VAC, 60 Hz 138 W Nominal at 110 VAC, 400 Hz 121 W Nominal at 230 VAC, 50 Hz
Nominal Input Current:	1.85 A at 110 VAC 1.03 A at 230 VAC

FUSE REQUIREMENTS

F1 and F2:

100 to 120 VAC: 3.15 A, 250 V, Type F

220 to 240 VAC: 3.15 A, 250 V, Type F

ENVIRONMENT

Use: Indoors

Temperature/Humidity:

Operating Temperature: 0° to 50° C

Storage Temperature: -25° to 71° C

Temperature Change: 1° C per minute for specified accuracy

Relative Humidity: 80% at <11° C, ≤95% (non-condensing) at 11° to 31° C, decreasing linearly to 50% at 40° C

Vibration/Shock:

Designed to retain specified functionality, accuracy and structural integrity following the tests specified in MIL-T-28800E for Type 2, Class 5, Style E equipment. Equipment calibration may be required following tests.

This product is not required to function accurately or to retain calibration accuracy during or immediately following the physical acceleration imposed in the tests.

Altitude:

Operational: 10,000 feet (3,048 meters)

Nonoperational: 40,000 feet (12,192 meters)

ELECTRO-MAGNETIC COMPATIBILITY (EMC)

RF Emissions: Complies with EN 55011: 1991 Group 1 Class B

RF Immunity: Complies with EN 50082-1: 1992

Power Line Disturbance: Complies with EN 60555-2: 1987

SAFETY

Product Safety: Complies with EN 61010-1

Supplemental Environmental Conditions:

Mains Supply Voltage Fluctuations: ≤±10% of the nominal voltage

Transient Overvoltages: According to Installation Category II

Pollution Degree: 2

SECTION 2 - INSTALLATION

2-1 GENERAL

This section contains information on preparing the AN1820 for use. Also listed are installation and operating precautions for safe use of the unit.

2-2 PRECAUTIONS

Before operating this instrument, the operator should be thoroughly familiar with all aspects of this manual.

For operator safety and to prevent damage to the instrument, the following operating precautions should be observed at all times:

WARNING: THE AN1820 MUST BE CONNECTED TO ELECTRICAL GROUND. CONNECT AC POWER CORD TO PROPERLY GROUNDED 3-PIN RECEPTACLE. DO NOT USE A THREE-PRONG TO TWO-PRONG ADAPTER PLUG. DOING SO CREATES A SHOCK HAZARD BETWEEN THE CHASSIS AND ELECTRICAL GROUND.

CAUTION: MAXIMUM ANALYZER INPUT MUST NOT EXCEED +20 dBm, PEAK OR AVERAGE, WITH INTERNAL ATTENUATION <10 dB. MAXIMUM ANALYZER INPUT MUST NOT EXCEED +30 dBm AVERAGE OR +40 dBm PEAK WITH INTERNAL ATTENUATION \geq 10 dB. FREQUENCY MUST BE >0 Hz (NO dc VOLTAGE).

DO NOT APPLY SIGNAL INPUT TO TRACKING GENERATOR CONNECTOR (OPTION 02), IF INSTALLED.

THIS EQUIPMENT CONTAINS PARTS SENSITIVE TO DAMAGE BY ELECTROSTATIC DISCHARGE (ESD).

2-3 LID ASSEMBLY REMOVAL AND REPLACEMENT

2-3-1 REMOVAL

STEP	PROCEDURE
1.	Pull Lid Assembly latches away from front panel and toward rear panel.
2.	Remove Lid Assembly latches from front panel slots.
3.	Remove Lid Assembly from AN1820.

2-3-2 REPLACEMENT

STEP	PROCEDURE
1.	Hold back latches on Lid Assembly and place bottom edge under AN1820 front panel. Insure EXTERNAL MIXER IF and LO Connector Cover chains are above bottom edge of Lid Assembly.
2.	Rotate Lid Assembly top edge up and over AN1820 front panel. Snap into place.
3.	Place Lid Assembly latches into front panel slots.
4.	Pull Lid Assembly latches toward front of Lid Assembly and clip into place.

2-4 POWER UP PROCEDURE

The following procedure is used to apply ac power to the AN1820 Spectrum Analyzer. Refer to Figures 2-1 and 2-2 for specific controls, connectors and indicators.

STEP	PROCEDURE
------	-----------

CAUTION: KEEP ALL VENT OPENINGS CLEAR AND UNOBSTRUCTED FOR PROPER EQUIPMENT COOLING AND CONTINUED RELIABILITY. DO NOT OPERATE EQUIPMENT IN THE VERTICAL POSITION ON PLUSH CARPET OR UPHOLSTERY TO AVOID IMPAIRING THE AIR EXHAUST. WHEN OPERATING IN THE NORMAL HORIZONTAL OR TILT BAIL POSITION, MAINTAIN AT LEAST 1.6 INCHES (\approx 4 CENTIMETERS) OF CLEARANCE BETWEEN THE EQUIPMENT REAR EXHAUST FAN SCREEN AND OBJECTS OR WALLS.

1. Place AN1820 in horizontal operating position.
2. Verify correct fuses are in AC FUSE Housing according to 2-5.
3. Connect AC Line Cord to AC IN Connector on rear panel.
4. Plug AC Line Cord into power source compatible with voltage selected.
5. Verify MAIN POWER CUTOFF Switch is set to *ON (I)*.
6. Verify STAND-BY Indicator illuminates.
7. Press SUPPLY Switch on front panel.
8. Verify SUPPLY ON Indicator illuminates.

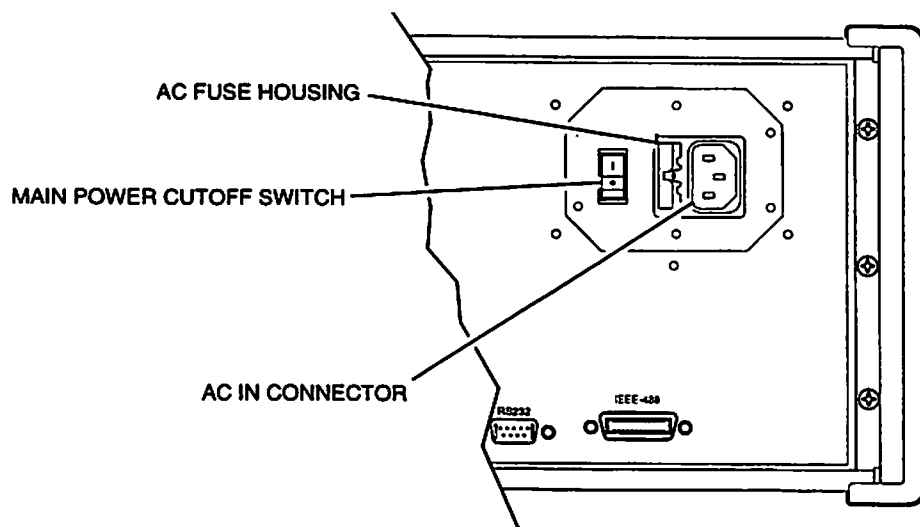

01907001

Figure 2-1 Rear Panel Power Up Controls, Connectors and Indicators

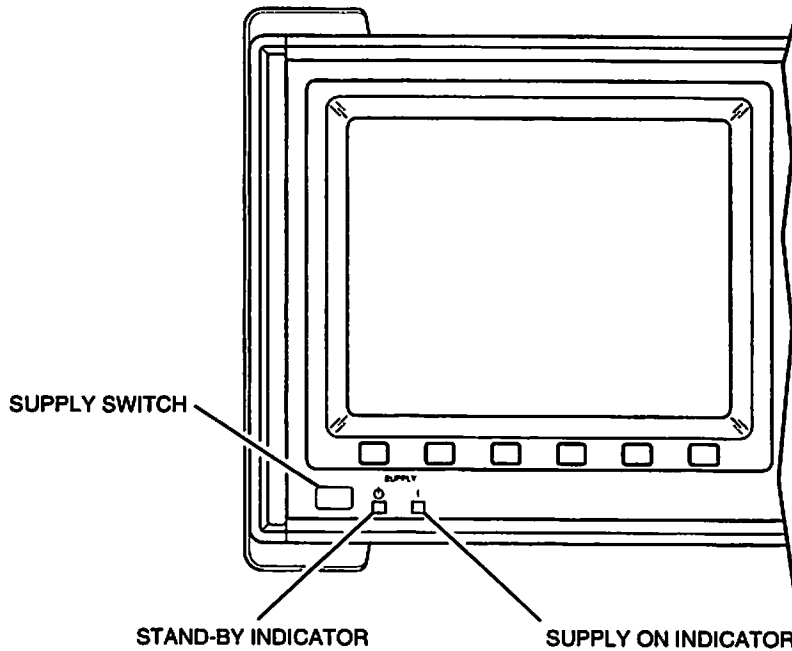

01907002

Figure 2-2 Front Panel Power Up Controls and Indicators

2-5 FUSE VERIFICATION/REPLACEMENT PROCEDURE

The following procedure should be followed when verifying or replacing the ac fuse in the AN1820 Spectrum Analyzer. Refer to Figure 2-3 for specific controls, connectors and indicators.

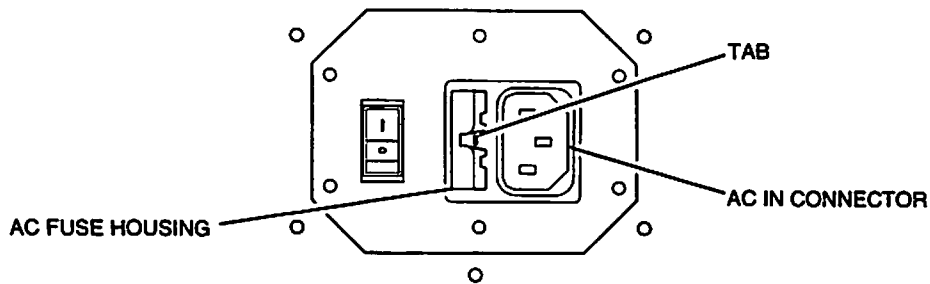

01907023

Figure 2-3 Fuse Replacement

STEP

PROCEDURE

1. Remove ac power from AN1820.
2. Disconnect AC Line Cord from AC IN Connector.
3. Push tab to left and pull out AC FUSE Housing.
4. Verify two 3.15 A fast blow ac line fuses are installed. Replace if incorrect or blown.
5. Insert AC FUSE Housing into Rear Panel until tab locks into place.

2-6 FACTORY PRESET INITIALIZATION PROCEDURE

The following procedure resets the AN1820 to initial factory preset conditions and may be used anytime. Refer to Table 2-1 for initial factory preset conditions.

PARAMETER	SETTING
Center Frequency	100.0 MHz
Frequency Span	1 MHz/Div
Attenuation	10 dB
Reference	-30.0 dBm
RBW	300 kHz or 120 kHz RBW (Option 08 installed)
Video Filter	10 kHz
Sweep Time	2 ms/Div

Table 2-1 Initial Factory Preset Conditions

Refer to Figure 3-1 for location of controls.

STEP	PROCEDURE
------	-----------

1. Apply power and activate AN1820.
2. Press PRESET Key.
3. If needed, press CONFIRM Soft Function Key F6.

2-7 EXTERNAL CLEANING

The following procedure contains routine instructions for cleaning the outside of the Test Set.

CAUTION: DISCONNECT POWER FROM TEST SET TO AVOID POSSIBLE DAMAGE TO ELECTRONIC CIRCUITS.

STEP	PROCEDURE
------	-----------

1. Clean front panel, buttons and display face with soft lint-free cloth. If dirt is difficult to remove, dampen cloth with water and a mild liquid detergent.
2. Remove grease, fungus and ground-in dirt from surfaces with soft lint-free cloth dampened (not soaked) with isopropyl alcohol.
3. Remove dust and dirt from connectors with soft-bristled brush.
4. Cover connectors, not in use, with suitable dust cover to prevent tarnishing of connector contacts.
5. Clean cables with soft lint-free cloth.
6. Paint exposed metal surface to avoid corrosion.

SECTION 3 - DESCRIPTION OF CONTROLS, CONNECTORS AND INDICATORS

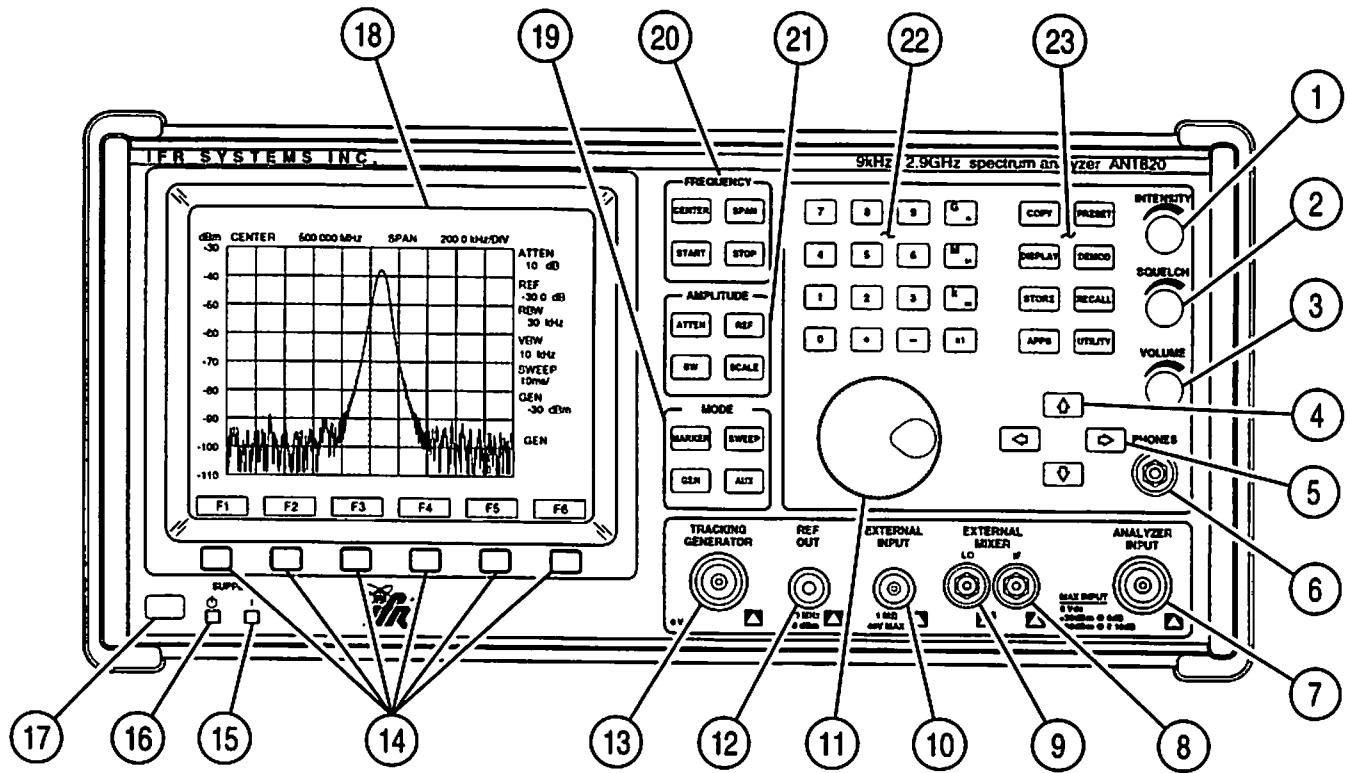

00207001

Figure 3-1 Front Panel Controls, Connectors and Indicators

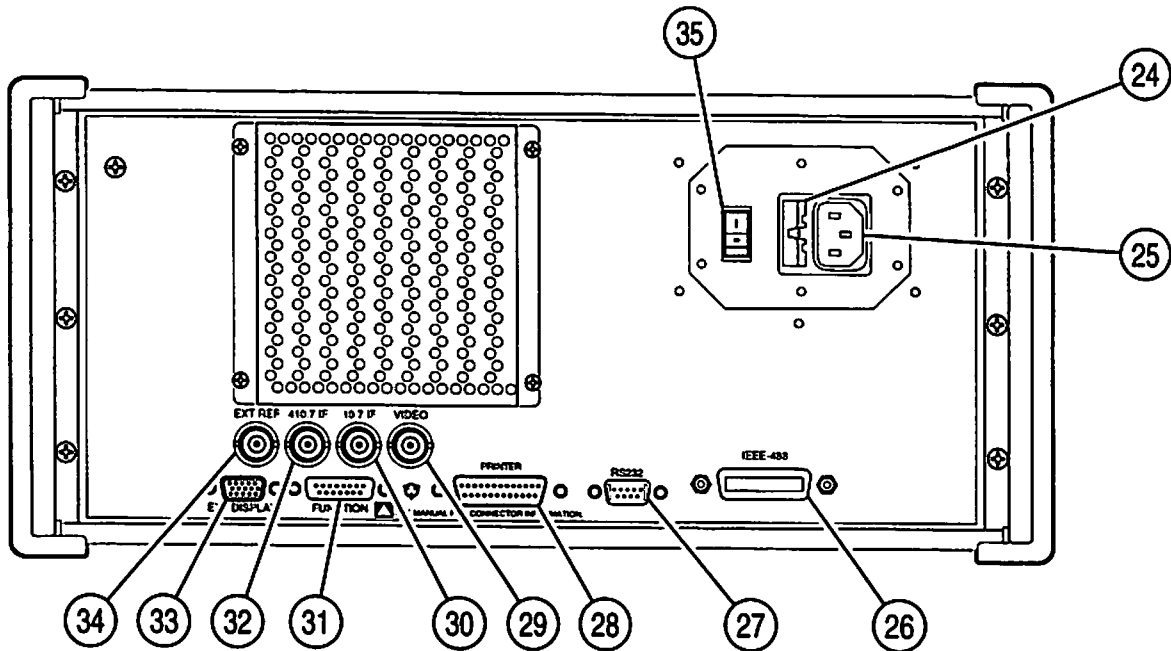

01907021

Figure 3-2 Rear Panel Controls, Connectors and Indicators

Numerical Location List (Front Panel):

1. INTENSITY Control
2. SQUELCH Control
3. VOLUME Control
4. ↑ and ↓ Keys
5. ← and → Keys
6. PHONES Connector
7. ANALYZER INPUT Connector
8. EXTERNAL MIXER IF Connector
9. EXTERNAL MIXER LO Connector
10. EXTERNAL INPUT Connector
11. DATA SCROLL Spinner
12. REF OUT Connector
13. TRACKING GENERATOR Connector (Option 02)
14. Soft Function Keys
15. SUPPLY ON Indicator
16. STAND-BY Indicator
17. SUPPLY Switch
18. Display
19. MODE Keys
20. FREQUENCY Keys
21. AMPLITUDE Keys
22. DATA ENTRY Keypad
23. General Function Keys

Numerical Location List (Rear Panel):

24. AC FUSE Housing
25. AC IN Connector
26. IEEE-488 GPIB Connector
27. RS-232 Connector
28. PRINTER Connector
29. VIDEO OUT Connector
30. 10.7 MHz IF OUT Connector
31. FUNCTION Connector
32. 410.7 MHz IF OUT Connector
33. EXT DISPLAY Connector
34. EXT REF IN Connector
35. MAIN POWER CUTOFF Switch



Alphabetical Location List (Front Panel):

- | | |
|---|----|
| ← and → Keys | 5 |
| ↑ and ↓ Keys | 4 |
| AMPLITUDE Keys | 21 |
| ANALYZER INPUT Connector..... | 7 |
| DATA ENTRY Keypad..... | 22 |
| DATA SCROLL Spinner | 11 |
| Display | 18 |
| EXTERNAL INPUT Connector..... | 10 |
| EXTERNAL MIXER IF Connector | 8 |
| EXTERNAL MIXER LO Connector | 9 |
| FREQUENCY Keys..... | 20 |
| General Function Keys | 23 |
| INTENSITY Control | 1 |
| MODE Keys..... | 19 |
| PHONES Connector | 6 |
| REF OUT Connector..... | 12 |
| Soft Function Keys..... | 14 |
| SQUELCH Control..... | 2 |
| STAND-BY Indicator..... | 16 |
| SUPPLY ON Indicator..... | 15 |
| SUPPLY Switch | 17 |
| TRACKING GENERATOR Connector (Option 02)..... | 13 |
| VOLUME Control..... | 3 |

Alphabetical Location List (Rear Panel):





- | | |
|---------------------------------|----|
| 10.7 MHz IF OUT Connector | 30 |
| 410.7 MHz IF OUT Connector..... | 32 |
| AC FUSE Housing..... | 24 |
| AC IN Connector..... | 25 |
| EXT DISPLAY Connector | 33 |
| EXT REF IN Connector..... | 34 |
| FUNCTION Connector | 31 |
| IEEE-488 GPIB Connector | 26 |
| MAIN POWER CUTOFF Switch..... | 35 |
| PRINTER Connector..... | 28 |
| RS-232 Connector..... | 27 |
| VIDEO OUT Connector | 29 |

3-1 AN1820 FRONT PANEL

ITEM	DESCRIPTION
1.	INTENSITY Control Adjusts contrast and brightness of the Display.
2.	SQUELCH Control Adjusts squelch level of internal AM/FM receiver.
3.	VOLUME Control Adjusts audio output level of internal AM/FM receiver.
4.	↑ and ↓ Keys Steps data within a selected field or selects menu list items. Data increases or decreases by a preset amount or next higher or lower data setting appears.
5.	← and → Keys Moves data entry cursor to digit position. The digit selected becomes the significant digit and is displayed in reverse video on the Display. Digits to the left of the significant digit increment or decrement as the significant digit increases past 9 or decreases past 0.
6.	PHONES Connector Provides audio output (≤ 1 W through 8Ω impedance) to external headphones. Requires a 1/8 inch (≈ 3.5 mm) jack. The AN1820 disconnects the audio output to the internal speaker when using the PHONES Connector.
7.	ANALYZER INPUT Connector  CAUTION: MAXIMUM ANALYZER INPUT MUST NOT EXCEED +20 dBm, PEAK OR AVERAGE, WITH INTERNAL ATTENUATION <10 dB. MAXIMUM ANALYZER INPUT MUST NOT EXCEED +30 dBm AVERAGE OR +40 dBm PEAK WITH INTERNAL ATTENUATION ≥ 10 dB. FREQUENCY MUST BE >0 Hz (NO dc VOLTAGE). Receives the RF signal input to the AN1820 Spectrum Analyzer. Input impedance is nominally 50Ω .
8.	EXTERNAL MIXER IF Connector  CAUTION: MAXIMUM EXTERNAL MIXER IF INPUT MUST NOT EXCEED -10 dBm. WHEN NOT IN USE, EXTERNAL MIXER IF CONNECTOR MUST BE TERMINATED. Receives 410.7 MHz IF input from external mixer through 50Ω . Used with EXTERNAL MIXER LO Connector to measure signals with frequencies >2.9 GHz.

ITEM



DESCRIPTION

-
9. EXTERNAL MIXER LO Connector 
CAUTION: SIGNAL INPUT MUST NOT BE APPLIED TO EXTERNAL MIXER LO CONNECTOR.
Sends local oscillator output from 3 to 12 GHz to external mixer. Used with EXTERNAL MIXER IF Connector to measure signals with frequencies >2.9 GHz.
10. EXTERNAL INPUT Connector 
CAUTION: MAXIMUM EXTERNAL INPUT MUST NOT EXCEED 40 V PEAK.
Receives external trigger signal, input to digital oscilloscope or low frequency input to FFT circuits. Input impedance is nominally 1 M Ω .
11. DATA SCROLL Spinner
Increases or decreases data within a selected field or chooses entries from lists.
12. REF OUT Connector 
CAUTION: SIGNAL INPUT MUST NOT BE APPLIED TO REF OUT CONNECTOR.
Provides 100 MHz output at -30 dBm (± 0.5 dB). Used for calibration purposes.
13. TRACKING GENERATOR Connector (Option 02) 
CAUTION: SIGNAL INPUT MUST NOT BE APPLIED TO TRACKING GENERATOR CONNECTOR.
Provides synchronized sweeper output from 100 kHz to 2.9 GHz at 0 to -70 dBm in 1 dB steps, when Option 02 is installed. Synchronous detection filters the effect of sweeper harmonics.
14. Soft Function Keys
Activates or selects various functions depending on operating mode and Display. Refer to Appendix G for Soft Function Key Flowchart.
- Non-Numeric Soft Function Keys
Activates or deactivates selected functions. Pressing a non-numeric Soft Function Key to activate causes the label above the Soft Function Key to highlight with reverse video. Pressing an activated Soft Function Key deactivates the function and turns off the label highlight. Some non-numeric Soft Function Keys are mutually exclusive. For example, LOG Soft Function Key F1 and LINEAR Soft Function Key F2 for the Scale Amplitude Operation Screen are never active at the same time. Pressing either Soft Function Key to activate the associated function deactivates the opposing Soft Function Key. Other Soft Function Keys may be active at the same time. For example MAX HOLD Soft Function Key F1 and MIN HOLD Soft Function Key F2 (HOLD functions under Display Operation) may be active at the same time.

- **Numeric Soft Function Keys**

Accepts data from the DATA ENTRY Keypad, ↑ and ↓ Keys, ← and → Keys or DATA SCROLL Spinner. When a numeric Soft Function Key is activated, the label above the Soft Function Key is highlighted with reverse video indicating the function is accepting numeric entry. Numeric Soft Function Keys remain active until terminated by pressing any one of the Soft Function Keys, MODE Keys, FREQUENCY Keys, AMPLITUDE Keys or Keys. Terminating a numeric Soft Function Key retains the last entered value except when using the ESC Soft Function Key.

-  Soft Function Keys

Provides access to a second level of Soft Function Keys. When pressed,  Soft Function Keys replace current Soft Function Key labels with Soft Function Key labels associated with the function of the selected  Soft Function Key. The RETURN Soft Function Key removes the  Soft Function Key labels and returns the current operation screen Soft Function Key labels.

- **ESC Soft Function Key**

Aborts entry in process and restores selected function to previous entry.

15. SUPPLY ON Indicator |

Green LED illuminates when SUPPLY Switch is pressed On and ac power is supplied to the AN1820.

16. STAND-BY Indicator 

Yellow LED illuminates when ac power is applied to AN1820. STAND-BY Indicator illuminates whether unit power is On or Off.

17. SUPPLY Switch

Connects supplied ac power to unit when pressed On (*I*) or sets unit to stand by mode when pressed Off (*O*). Under extreme operating conditions (i.e., high temperature indication), power may be switched Off under processor control.

18. Display

Provides visual information via a flat panel color VGA screen (≈6.1 inches [15.5 cm]).

19. MODE Keys

Provides for direct entry of marker(s), sweep, tracking generator and auxiliary function parameters.

- **MARKER MODE Key**

Accesses Marker Mode Operation Screen. Allows activation and control of on-screen marker functions for direct measurement of values on the Display. Refer to 3-3-9 for description of the Marker Mode Operation Screen and associated Soft Function Keys.

ITEM**DESCRIPTION**

- **SWEEP MODE Key**

Accesses Sweep Mode Operation Screen. Allows direct entry of Sweep Time using DATA ENTRY Keypad, ↑ and ↓ Keys or DATA SCROLL Spinner. Refer to 3-3-10 for description of the Sweep Mode Operation Screen and associated Soft Function Keys.

- **GEN MODE Key**

Accesses Tracking Generator Mode Operation Screen if Option 02 is installed. Refer to 3-3-11 for information on Tracking Generator Mode Operation Screen and associated Soft Function Keys.

- **AUX MODE Key**

Accesses Auxiliary Mode Operation Screen for activating and controlling auxiliary functions. Refer to 3-3-12 for description of the Auxiliary Mode Operation Screen and associated Soft Function Keys.

20. FREQUENCY Keys

Provides direct entry of frequencies and frequency ranges.

- **CENTER FREQUENCY Key**

Accesses Center Frequency Operation Screen. Allows direct entry of the Center Frequency using the DATA ENTRY Keypad, ↑ and ↓ Keys, ← and → Keys or DATA SCROLL Spinner. Refer to 3-3-1 for description of the Center Frequency Operation Screen and associated Soft Function Keys.

- **SPAN FREQUENCY Key**

Accesses Span Frequency Operation Screen. Allows direct entry of the Frequency Span per division using the DATA ENTRY Keypad, ↑ and ↓ Keys or DATA SCROLL Spinner. Refer to 3-3-2 for description of the Span Frequency Operation Screen and associated Soft Function Keys.

- **START FREQUENCY Key**

Accesses Start Frequency Operation Screen. Allows direct entry of the Start Frequency for the Start/Stop function using the DATA ENTRY Keypad, ↑ and ↓ Keys, ← and → Keys or DATA SCROLL Spinner. Refer to 3-3-3 for description of the Start Frequency Operation Screen and associated Soft Function Keys.

- **STOP FREQUENCY Key**

Accesses Stop Frequency Operation Screen. Allows direct entry of the Stop Frequency for the Start/Stop function using DATA ENTRY Keypad, ↑ and ↓ Keys, ← and → Keys or DATA SCROLL Spinner. Refer to 3-3-4 for description of the Stop Frequency Operation Screen and associated Soft Function Keys.

ITEM	DESCRIPTION
21. AMPLITUDE Keys	<p>Provides for direct entry of attenuation, reference, and resolution levels.</p> <ul style="list-style-type: none"> ● ATTEN AMPLITUDE Key Accesses Attenuation Amplitude Operation Screen. Allows entry of internal RF attenuation settings, when uncoupled, using DATA ENTRY Keypad, ↑ and ↓ Keys or DATA SCROLL Spinner. Refer to 3-3-5 for description of the Attenuation Amplitude Operation Screen and associated Soft Function Keys. ● REF AMPLITUDE Key Accesses Reference Amplitude Operation Screen. Allows direct entry of Reference Amplitude (top of scale) using DATA ENTRY Keypad, ↑ and ↓ Keys, ← and → Keys or DATA SCROLL Spinner. Refer to 3-3-6 for description of the Reference Amplitude Operation Screen and associated Soft Function Keys. ● BW AMPLITUDE Key Accesses Bandwidth Amplitude Operation Screen. Allows entry of the Resolution Bandwidth (RBW) or Video Bandwidth (VBW) using DATA ENTRY Keypad, ↑ and ↓ Keys or DATA SCROLL Spinner. The BW Key also allows access to the Quasi-Peak Detector, if Option 08 is installed. Refer to 3-3-7 for description of the Bandwidth Amplitude Operation Screen and associated Soft Function Keys. ● SCALE AMPLITUDE Key Accesses Scale Amplitude Operation Screen. Allows selection of logarithmic or linear Amplitude Scales and Units. Refer to 3-3-8 for description of the Scale Amplitude Operation Screen and associated Soft Function Keys.
22. DATA ENTRY Keypad	<p>Provides direct numeric entry of parameters in selected data field. Pressing a Multiplier Key ends data entry. Parameters do not change until a Multiplier Key is pressed.</p> <ul style="list-style-type: none"> ● Numeric Keys Allows numeric data entry. Numeric keys automatically repeat if held in for more than one second and repeat at a rate of approximately two per second. ● Decimal Point Key Places a decimal point at current position in selected data field. ● - Key Toggles selected data entry between a positive (+) and negative (-) value. ● Multiplier Keys Selects G/n ($10^9/10^{-9}$), M/μ ($10^6/10^{-6}$), k/m ($10^3/10^{-3}$) or x1 (Hz/dB) as multiplier for selected data entry. Keys multiply numeric entry by selected factor. Type of data entry determines applicable multipliers. Hz factors are for frequency, dB factor is for amplitude and the other factors are for sweep time. k/m and x1 Keys also select millivolts and volts respectively when operating in Scope mode. <p>NOTE: The x1 Key also functions the same as the ENTER Soft Function Key to avoid wasted movement when using the DATA ENTRY Keypad.</p>

23. General Function Keys**● COPY Key**

Accesses plotting and printing functions. Refer to 3-3-13 for description of the Copy operation and associated Soft Function Keys.

● PRESET Key

Resets all parameters to the factory default settings. Refer to 3-3-14 for description of PRESET Key operation.

● DISPLAY Key

Accesses trace Display functions (Sweep Average, Hold, Alarms and Limits). Refer to 3-3-15 for description of trace Display operation and associated Soft Function Keys.

● DEMOD Key

Enters the AM/FM Receiver Operation Screen for demodulated signal operation. Refer to 3-3-16 for description of the AM/FM Receiver Screen and associated Soft Function Keys.

● STORE Key

Accesses Store memory functions for storage of waveform traces and control setups. Refer to 3-3-17 for description of Store memory operation and associated Soft Function Keys.

● RECALL Key

Accesses Recall memory functions for recalling stored waveform traces or control setups. Allows editing of stored trace or setup memory locations. Refer to 3-3-18 for description of Recall memory operation and associated Soft Function Keys.

● APPS Key

Accesses Macro program memory and the Bandwidth Application program. Refer to 3-3-19 for description of Application memory operation and associated Soft Function Keys.

● UTILITY Key

Accesses the Analyzer Utility Menu. Allows customized changes in certain instrument controls and operations. Provides access to instrument calibration and diagnostic functions. Refer to 3-3-20 for description of the Analyzer Utility Menu and associated Soft Function Keys.

3-2 AN1820 REAR PANEL

ITEM	DESCRIPTION
24. AC FUSE Housing	Contains two 3.15 A fast blow ac line fuses.
25. AC IN Connector	Provides ac power input to unit.
26. IEEE-488 GPIB Connector	Provides parallel communication between the AN1820 and an external controller. The IEEE-Standard 488-1987 format connector allows the AN1820 Spectrum Analyzer to upload and download parameter sets, transfer test results, drive an HPGL compatible plotter or be controlled by an external test controller. The IEEE-488 (GPIB) Screen, accessed from the Analyzer Utility Menu, selects the operation mode.
27. RS-232 Connector	Provides serial communication between the AN1820 and an external controller. The RS-232C format connector allows the AN1820 Spectrum Analyzer to upload and download parameter sets, transfer test results, drive an HPGL compatible plotter or be controlled by an external test controller. The RS-232 (Serial) Screen, accessed from the Analyzer Utility Menu, selects the operation mode.
28. PRINTER Connector	Provides a parallel printer interface for printing out Display information to an external printer. The Printer Options Screen, accessed from the Analyzer Utility Menu, selects the type of printer.
29. VIDEO OUT Connector	Provides demodulated vertical (Y-axis) information from the AN1820 detector circuit. Output is directly related to Y-axis level (100 mV/Div) on the Display. Recommended load impedance is $\geq 500 \Omega$.
30. 10.7 MHz IF OUT Connector	Allows monitoring of internal 10.7 MHz IF signal.
31. FUNCTION Connector 	Provides access to lines used in various functions: <ul data-bbox="172 1491 1455 1774" style="list-style-type: none"><li data-bbox="172 1491 1455 1640">● Supply Monitor Provides the test points to verify the -12 V power supply (pin 1), +5 V power supply (pin 2) and +12 V power supply (pin 9). Test points provide probe power with current limited to approximately 100 mA.<li data-bbox="172 1659 1455 1774">● Auxiliary Video Provides auxiliary video output on pin 7. Refer to VIDEO OUT Connector for signal description.

ITEM

DESCRIPTION

● Sweep

Provides an analog sweep output signal to drive external devices such as X-Y Monitors or Plotters. Voltage range from 0 to +5 V corresponds to the x-axis position of the sweep on the Display. The sweep output signal is on pin 14.

● Sweep Hold

Provides the TTL level signal to control Pen Lift on pin 6.

● Auxiliary (external) Trigger

Receives external trigger on pin 8 when EXT REAR is selected as sweep Trigger Source. Internal sweep circuit triggers on positive-going TTL level signal when +SLOPE is active or negative-going signal when -SLOPE is active.

● Relay Drivers



CAUTION: MAXIMUM CURRENT RATING OF FUNCTION CONNECTOR, PINS 5 AND 13 IS 200 mA. MAXIMUM VOLTAGE RATING OF FUNCTION CONNECTOR, PINS 5 AND 13 IS 50 V (OPEN) OR 1.2 V (CLOSED). EXCEEDING THESE RATINGS MAY RESULT IN DAMAGE TO THE AN1820.

Relay driving circuits on pins 5 and 13 may be set to activate external relays when certain trace limits are exceeded.

32. 410.7 MHz IF OUT Connector

Allows monitoring of internal 410.7 MHz IF signal.

33. EXT DISPLAY Connector

Allows an external CRT monitor (VGA compatible) to be connected to the AN1820. The external CRT monitor echoes the current AN1820 Display.

34. EXT REF IN Connector

Receives external precision reference. Requires 2 to 5 V_p (TTL) drive level. Internal time base circuit phase locks onto the 10 MHz signal applied to the EXT REF IN Connector when selected in the General Options Screen, accessed from the Analyzer Utility Menu.

35. MAIN POWER CUTOFF Switch

Disconnects ac from internal power supply (O) (STAND-BY Indicator not illuminated). The STAND-BY Indicator illuminates when ac power is connected and MAIN POWER CUTOFF Switch is On (I).

3-3 OPERATION SCREENS AND SOFT FUNCTION KEY CONFIGURATIONS

Operation screens and accompanying Soft Function Keys vary according to the type of operation screen displayed, current active functions and input source used.

An operation screen is accessed by pressing one of the FREQUENCY Keys, AMPLITUDE Keys, MODE Keys or General Function Keys. Options for each operation screen are accessed by pressing Soft Function Keys directly below displayed option labels. Highlighted labels above Soft Function Keys indicate displayed options are active. Refer to Appendix G for Soft Function Key Flowchart.

NOTE: Some operation screens may differ only in labels for Soft Function Keys and editable field. For clarity, each display is considered a separate operation screen because each particular operation or field is only editable by pressing a particular key. The cursor cannot be moved to each field using ↑ and ↓ Keys or ← and → Keys.

The DATA ENTRY Keypad, ↑ and ↓ Keys or DATA SCROLL Spinner is used to enter numerical data. The ← and → Keys select individual digits for the ↑ and ↓ Keys or DATA SCROLL Spinner to change. The ↑ and ↓ Keys or DATA SCROLL Spinner are used to select parameters. The message, **USE DATA SCROLL** appears in the Message field when the DATA ENTRY Keypad cannot be used for data entry. Parameters with only two possible settings automatically switch to the opposite setting when selected. For memory labeling, the DATA SCROLL Spinner or ↑ and ↓ Keys and ← and → Keys are used to select specific characters.

CENTER or START Frequency, Frequency SPAN or STOP Frequency, ATTEN (Attenuation), REF (top of scale Reference), RBW (Resolution Bandwidth), VIDEO Bandwidth, SWEEP Time and GEN (Tracking Generator Output Level) (if Option 02 is installed) fields appear in most operation screens. The fields are manually edited only in the applicable operation screen. The Display indicates a field ready for edit in reverse video with the cursor. The information on markers, when activated in the Marker Mode Operation Screen, appears below the graticule. The Amplitude Scale on the left side of the Display and Units on the upper left side of the Display, vary according to the operating mode and the settings in the Attenuation, Reference and Scale Amplitude Operation Screens.

The Message field, located at the top of the Display, indicates invalid entries, errors or other information dependent on user input. When invalid data is entered, the message **INVALID ENTRY** is displayed in the Message field and the entry is ignored.

When the operating (internal) temperature changes according to the TIME CALIBRATION temperature change setting in the General Options Screen (accessed from the Analyzer Utility Menu), the AN1820 conducts an automatic internal calibration of the YIG oscillator. If the YIG oscillator fails, the message **YIG** is displayed in the Message field. If **YIG** appears in the Message field, a more detailed calibration, activated in the User Cals Screen (accessed from the Analyzer Utility Menu), should be performed. Refer to 3-3-20H.

When TIME CALIBRATION is set to ENABLE in the General Options Screen (accessed from the Analyzer Utility Menu), internal calibrations are performed every five minutes if the temperature changes according to the temperature change setting. **CAL** appears in the Message field each time the AN1820 performs an internal calibration.

Parameters and some numeric data are only changed with the DATA SCROLL Spinner or ↑ and ↓ Keys. If the DATA ENTRY Keypad is used to try and change such data, **ONLY** appears in the Message field. An example is moving x or y axis position lines in the Limits Display Screen.

3-3-1 CENTER FREQUENCY OPERATION SCREEN

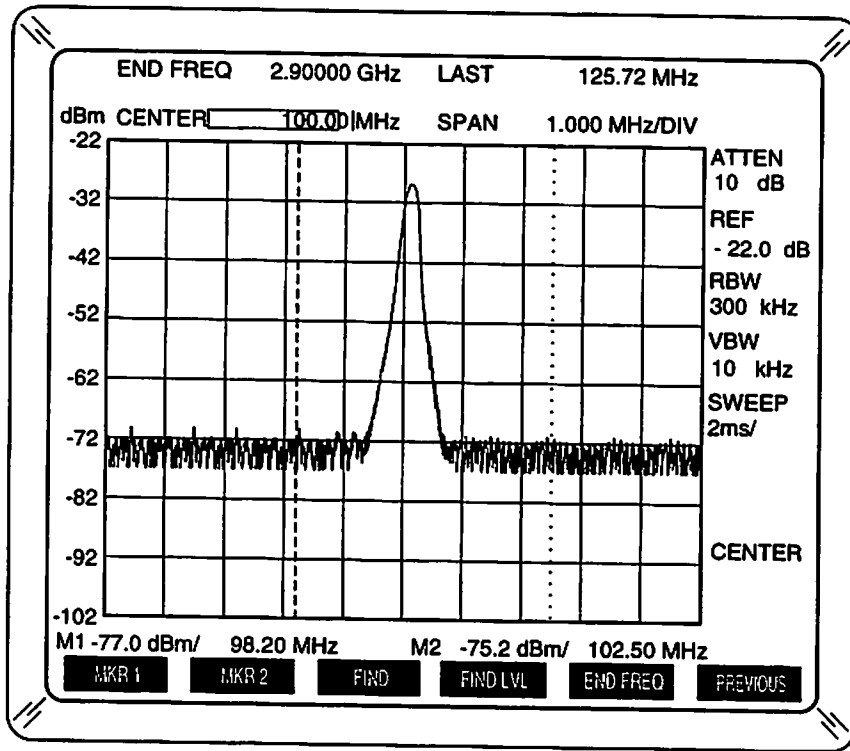

01917001

Figure 3-3 Center Frequency Operation Screen

Pressing the CENTER FREQUENCY Key displays the Center Frequency Operation Screen. The Center Frequency Operation Screen provides for direct entry of the Center Frequency and operation of the Find function. The Center Frequency ranges from 0 Hz to 3.0 GHz for normal operation, 50 Hz to 23 kHz in FFT mode or 3 to 1300 GHz with the External Mixer function activated.

NOTE: If the Tracking Generator (Option 02) is installed and active, the Center Frequency is limited according to the Frequency Span and the AN1820 does not display frequencies above 2.9 GHz. The Tracking Generator must be deactivated to access the full frequency range available.

A. DISPLAY INFORMATION

The CENTER Frequency field above the left side of the graticule is highlighted and ready for edit upon accessing the Center Frequency Operation Screen. **CENTER**, located on the lower right side of graticule, indicates the Center Frequency Operation Screen is accessed. The END FREQ field above the CENTER Frequency field, displayed after pressing the END FREQ Soft Function Key F5, shows the ending frequency for the Find function. The SEARCH field above the Frequency SPAN field indicates the current frequency location of the active Find function sweep (**SEARCH**), a qualifying signal was located (**FOUND**) or the last searched frequency of the now inactive Find function (**LAST**).

B. SOFT FUNCTION KEYS

KEY	DESCRIPTION
F1 MKR 1	Sets Center Frequency to Marker 1 frequency, if Marker 1 is activated. (Refer to 3-3-9 for description of Marker Mode Operation Screen.) If Marker 1 is not activated, no label appears above F1.
F2 MKR 2	Sets Center Frequency to Marker 2 frequency, if Marker 2 is activated. (Refer to 3-3-9 for description of Marker Mode Operation Screen.) If Marker 2 is not activated, no label appears above F2.
F3 FIND	Activates the Find function. Locates signals above the Find Level within the current Center Frequency Band (Band 0, Band 1 or Band 2) or until the sweep reaches the end frequency selected by the operator (END FREQ field). Starting with the highest displayed frequency, the Find function locates the first signal exceeding the Find Level and sets that as Center Frequency. The Find function searches signals to the right of the current Frequency Span. If a signal exceeding the Find Level is not located, the Center Frequency is not changed. The Find Function does not operate if Frequency Span is <500 Hz/Div.
F4 FIND LVL	Allows edits to the Find Level, used when FIND Soft Function Key F3 is active. The Find Level function displays a horizontal dashed line on the graticule indicating the current Find Level. The Find Level is adjusted to any displayed amplitude level using the DATA SCROLL Spinner or ↑ and ↓ Keys. NOTE: The Find function requires a signal level ≥ -85 dBm to operate correctly, regardless of Find Level setting.
F5 END FREQ	Allows edits to the END FREQ field, setting the last (highest) frequency searched by the Find function.
F6 PREVIOUS/ESC	PREVIOUS restores Center Frequency to the previous Center Frequency entered prior to the current entered Center Frequency, not considering frequency set using MKR 1 Soft Function Key F1 or MKR 2 Soft Function Key F2. ESC cancels out an edit in progress (restores to current setting) or terminates an operation, such as the Find function, in progress. The ESC label above F6 only appears when editing a parameter.

3-3-2 SPAN FREQUENCY OPERATION SCREEN

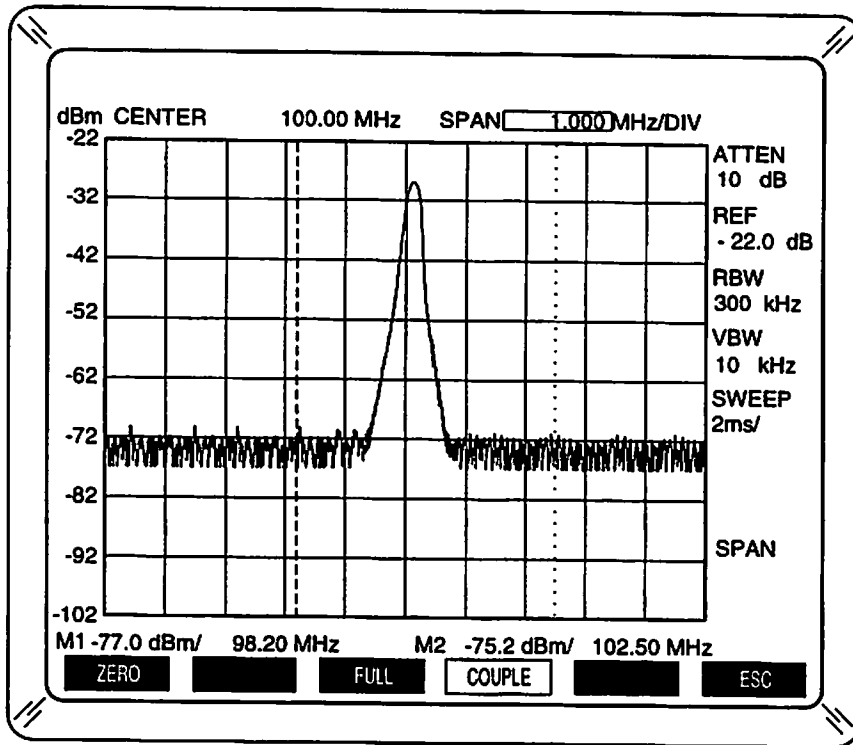

Figure 3-4 Span Frequency Operation Screen

00217002

Pressing the SPAN FREQUENCY Key displays the Span Frequency Operation Screen. The Span Frequency Operation Screen provides for direct entry of the Frequency Span per division displayed on the Display. Frequency Span varies from 0 Hz/Div to 290 MHz/Div, continuously using the DATA SCROLL Spinner or in 1-2-5 sequence using the \uparrow and \downarrow Keys. The DATA ENTRY Keypad provides direct entry. Frequency Span settings are automatically coupled with the Resolution Bandwidth, Video Bandwidth and Sweep settings to maintain a calibrated Display. Refer to Appendix B for optimization tables. The Frequency Span selection is limited according to the Center Frequency setting to prevent the Display from displaying <-50 MHz or >3 GHz. Operating in FFT mode through the EXTERNAL INPUT Connector limits the Frequency Span to ≤ 200 Hz/Div.

NOTE: Automatic coupling may be disabled in the Resolution Bandwidth Amplitude and/or Sweep Mode Operation Screens.

A. DISPLAY INFORMATION

The Frequency SPAN field above the right side of the graticule is highlighted and ready for edit upon accessing the Span Frequency Operation Screen. **SPAN**, located on lower right side of graticule, indicates Span Frequency Operation Screen is accessed. If the selected Frequency Span setting uncalibrates the screen display, the Display indicates **UNCAL**, highlighted in the Message field. The AN1820 requires 5 to 10 seconds of delay when adjusting the Frequency Span to ≤ 200 Hz/Div for the first time after power up. The Display indicates the delay with **WAIT** in the Message.

B. SOFT FUNCTION KEYS

KEY	DESCRIPTION
F1 ZERO	Sets Frequency Span to 0 Hz (ZERO Span), enabling operation of time domain functions.
F3 FULL	Sets Frequency Span to 2.9 GHz (290 MHz/Div) and Center Frequency to 1.45 GHz.
F4 COUPLE	Causes the Start/Stop and Center/Span functions to track together. The CENTER and SPAN FREQUENCY Keys are used in the Center/Span function. The START and STOP FREQUENCY Keys are used in the Start/Stop function. With COUPLE activated (F4 highlighted), both functions operate together and setting any frequency (Center, Span, Start or Stop) automatically adjusts the other frequencies, keeping the displays of both functions the same. With COUPLE deactivated, the functions are independent of each other.
F6 ESC	Aborts entry in process and restores Frequency Span to last entered setting. Label above F6 appears only when editing a parameter.

3-3-3 START FREQUENCY OPERATION SCREEN

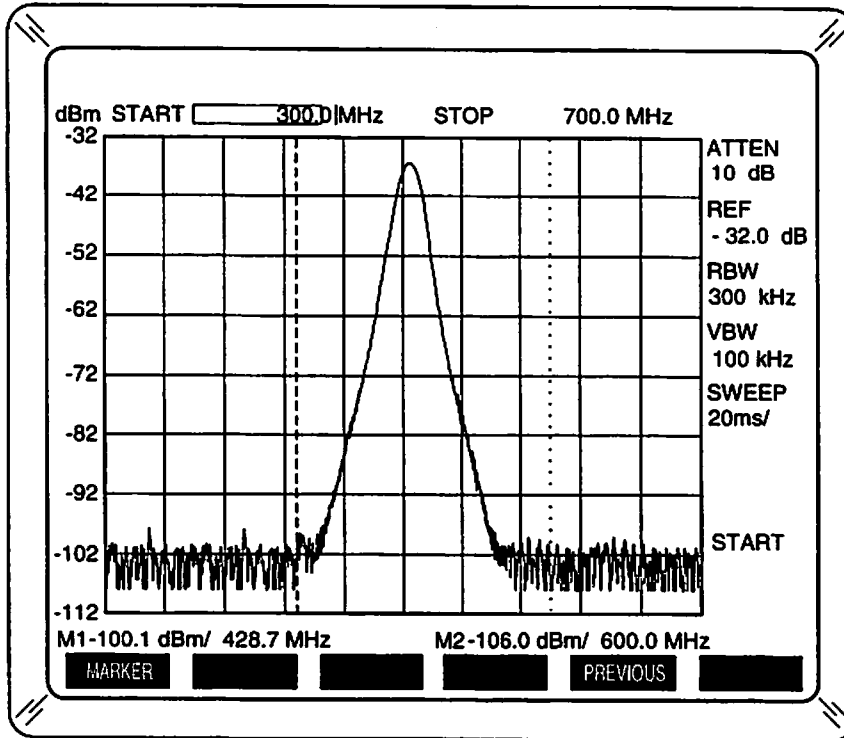

Figure 3-5 Start Frequency Operation Screen

01917003

Pressing the START FREQUENCY Key displays the Start Frequency Operation Screen. The Start Frequency Operation Screen is used to enter the Start Frequency for the Start/Stop function. The Start/Stop function is used to set the Frequency Span, displayed on the Display or Sweep Range, from one specific frequency to another specific frequency. The Start/Stop function operates independently of the Center/Span function unless both functions are coupled in the Span Frequency Operation Screen. The Start Frequency ranges from 0 Hz to 3.0 GHz for normal operation or 3 to 1300 GHz with the External Mixer function activated.

NOTE: Start Frequency must be equal to (ZERO Span) or ≥ 10 Hz below Stop Frequency. Setting Start Frequency above current Stop Frequency moves the Stop Frequency to equal the Start Frequency.

If Tracking Generator (Option 02) is active, the Start Frequency cannot be set > 2.9 GHz.

A. DISPLAY INFORMATION

Start Frequency removes Center Frequency and Frequency Span from the Display, if previously displayed. The START Frequency field above the left side of the graticule is highlighted and ready for edit upon accessing the Start Frequency Operation Screen. **START**, located on lower right side of graticule, indicates Start Frequency Operation Screen is accessed. The STOP Frequency field replaces the Frequency SPAN field above the right side of the graticule.

Center Frequency and Frequency Span settings are restored when either the CENTER or SPAN FREQUENCY Key is pressed with the Start/Stop and Center/Span functions not coupled together. New Center Frequency and Frequency Span settings reflect new Start/Stop Frequency settings when either the CENTER or SPAN FREQUENCY Key is pressed with the Start/Stop and Center/Span functions coupled together.

B. SOFT FUNCTION KEYS

KEY	DESCRIPTION
F1 MARKER	Sets Start Frequency to lowest marker frequency, either at Marker 1 or Marker 2, if marker(s) are active. No label appears above F1 if Marker 1 is not activated.
F5 PREVIOUS	Restores Start Frequency to previous Start Frequency entered prior to current Start Frequency, not considering frequency set using MARKER Soft Function Key F1.
F6 ESC	Aborts entry in process and restores Start Frequency to last entered setting. Label above F6 appears only when editing a parameter.

3-3-4 STOP FREQUENCY OPERATION SCREEN

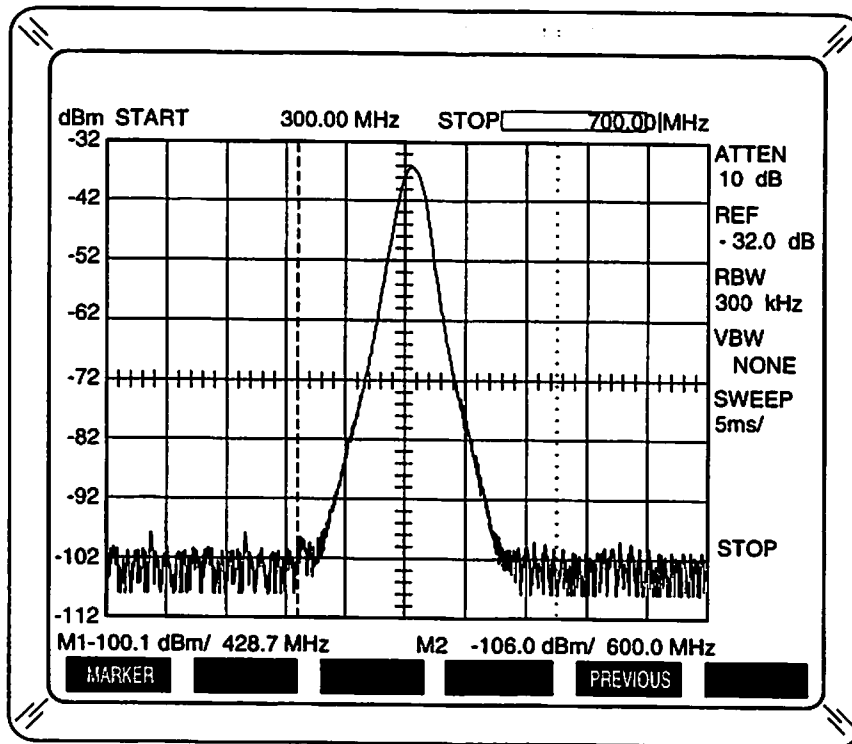

Figure 3-6 Stop Frequency Operation Screen

01917004

Pressing the STOP FREQUENCY Key displays the Stop Frequency Operation Screen. The Stop Frequency Operation Screen is used to enter the Stop Frequency for the Start/Stop function. The Stop Frequency ranges from the Start Frequency (ZERO Span) to 3.0 GHz for normal operation or Start Frequency to 1300 GHz with the External Mixer function activated.

NOTE: The Stop Frequency cannot be set below Start Frequency or between the Start Frequency and the Start Frequency + 10 Hz.

If Tracking Generator (Option 02) is active, the Stop Frequency cannot be set >2.9 GHz.

A. DISPLAY INFORMATION

Stop Frequency removes Center Frequency and Frequency Span from the Display, if previously displayed. The STOP Frequency field above the right side of the graticule is highlighted and ready for edit upon accessing the Stop Frequency Operation Screen. **STOP**, located on lower right side of graticule, indicates the Stop Frequency Operation Screen is accessed.

B. SOFT FUNCTION KEYS

KEY	DESCRIPTION
F1 MARKER	Sets Stop Frequency to highest marker frequency, either at Marker 1 or Marker 2, if marker(s) are active. No label appears above F1 if Marker 1 is not activated.
F5 PREVIOUS	Restores Stop Frequency to previous Stop Frequency entered prior to current Stop Frequency, not considering frequency set using MARKER Soft Function Key F1.
F6 ESC	Aborts entry in process and restores Stop Frequency to last entered setting. Label above F6 appears only when editing a parameter.

3-3-5 ATTENUATION AMPLITUDE OPERATION SCREEN

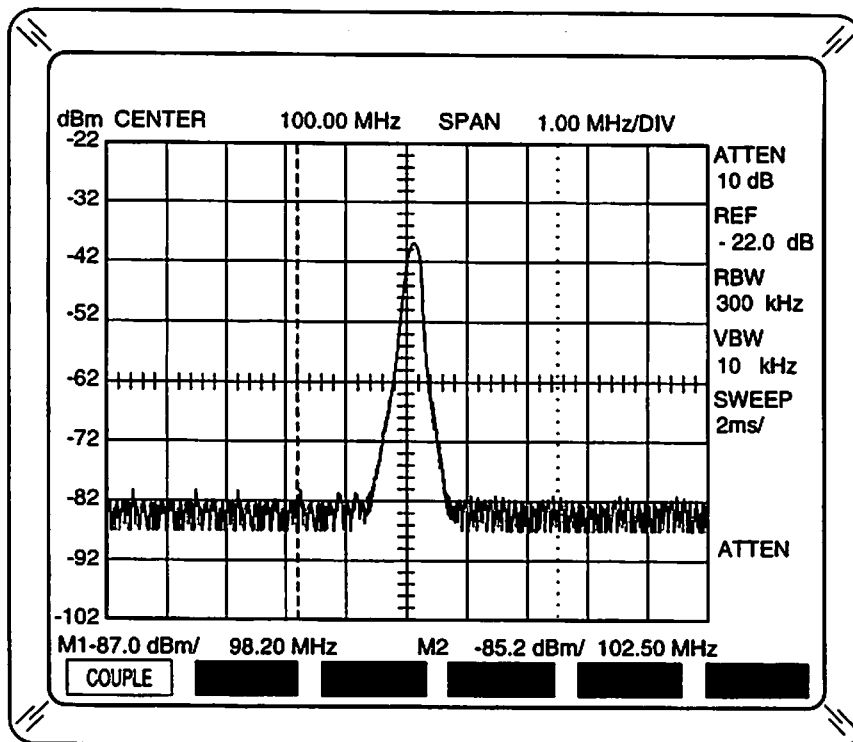

Figure 3-7 Attenuation Amplitude Operation Screen

01917005

Pressing the ATTEN AMPLITUDE Key displays the Attenuation Amplitude Operation Screen. The Attenuation Amplitude Operation Screen provides for direct entry of internal Attenuation when not coupled with the reference level. Attenuation ranges from 0 to 60 dB in 10 dB steps (limited to 20 dB steps in FFT mode). Attenuation cannot be set lower than the MINIMUM ATTENUATION (internal) limit set in the General Options Screen, accessed from the Analyzer Utility Menu.

A. DISPLAY INFORMATION

After pressing the COUPLE Soft Function Key F1 to deselect the couple function (not highlighted), the ATTEN (Attenuation) field on the top right side of the Display is highlighted and ready for edit. The AM/FM Receiver mode (DEMOM Key) automatically uncouples attenuation (reference level not used). **ATTEN**, located on the lower right side of the Display, indicates the Attenuation Amplitude Operation Screen is accessed. Attempting to set the internal attenuation below the MINIMUM ATTENUATION limit causes **INVALID ENTRY** to appear in the Message field.

B. SOFT FUNCTION KEYS

KEY	DESCRIPTION
F2 COUPLE	Highlighted and automatically selected as default for normal operation. Couples internal attenuation to the reference level set in the Reference Amplitude Operation Screen and prevents edits to internal attenuation when active. Deactivating COUPLE allows edits to the Attenuation field.
F6 ESC	Aborts entry in process and restores attenuation to last entered setting. Label above F6 appears only when editing a parameter.

3-3-6 REFERENCE AMPLITUDE OPERATION SCREEN

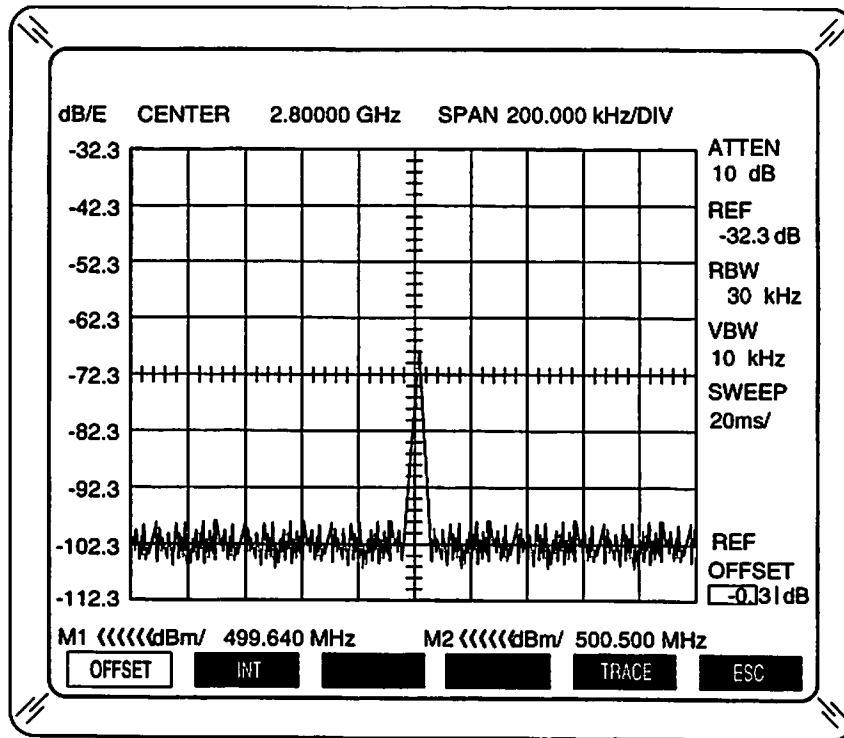

Figure 3-8 Reference Amplitude Operation Screen

00217003

Pressing the REF AMPLITUDE Key displays the Reference Amplitude Operation Screen. The Reference Amplitude Operation Screen provides for direct entry of the top of scale reference level. The reference level is set from -85.0 to +30.0 dBm in 0.1 dB steps. Internal gain and attenuation are automatically adjusted according to reference level setting during normal operation. Uncoupling internal attenuation from the reference level in the Attenuation Amplitude Operation Screen limits the reference level setting according to the manually adjusted internal attenuation level. Refer to Table 3-1. The reference level is limited to -40 to +40 dBm in the FFT mode with signals through the EXTERNAL INPUT Connector.

If the Resolution Bandwidth is ≥ 10 MHz, the coupled reference level range is 100 nW to 100 mW or 2.2 mV to 7.0 V depending on Linear display mode Units selected in the Scale Amplitude Operation Screen. Regular Linear display mode reference level range is 3.1 pW (316.2 fW, uncoupled/0 dB attenuation) to 10 W or 12.5 μ V (3.9 μ V, uncoupled/0 dB attenuation) to 22.3 V.

In the AM/FM Receiver mode (DEMODO Key), internal gain (not reference level) is set from -10.0 to 65.0 dB in 0.1 dB steps.

MANUAL ATTENUATION	REFERENCE LEVEL	MANUAL ATTENUATION	REFERENCE LEVEL
0 dB	-95 to -20 dBm	40 dB	-55 to +20 dBm
10 dB	-85 to -10 dBm	50 dB	-45 to +30 dBm
20 dB	-75 to 0 dBm	60 dB	-35 to +30 dBm
30 dB	-65 to +10 dBm		

Table 3-1 Reference Level Limitation with Attenuation Uncoupled

A. DISPLAY INFORMATION

The REF field on the right side of the Display is highlighted and ready for edit upon accessing the Reference Amplitude Operation Screen. **REF**, located on the lower right side of the Display, indicates the Reference Amplitude Operation Screen is accessed. The Amplitude Scale on the left side of the Display, automatically changes to reflect the REF field values. Settings in the Attenuation and Scale Amplitude Operation Screens also affect the Amplitude Scale. When the AM/FM Receiver mode is active, the GAIN field replaces the REF field on the right side of the Display and allows entry of receiver IF gain.

Letters to the right of the REF field value indicate the linear unit prefix corresponding to the units scale, shown as a power of 10 displayed below the Units field (upper left side of Display). Refer to Table 3-2.

LETTER	PREFIX	10 ^E	LETTER	PREFIX	10 ^E	LETTER	PREFIX	10 ^E
<i>m</i>	milli	<i>E-3</i>	<i>n</i>	nano	<i>E-9</i>	<i>f</i>	femto	<i>E-15</i>
<i>u</i>	micro	<i>E-6</i>	<i>p</i>	pico	<i>E-12</i>	<i>a</i>	atto	<i>E-18</i>

Table 3-2 Scale Unit Prefixes and Display Indications

B. SOFT FUNCTION KEYS

KEY	DESCRIPTION
F1	OFFSET Deactivates INT Soft Function Key F2 and allows edits to the OFFSET field in the lower right side of the Display. The offset (from -99.9 to +99.9 dB) adjusts the reference level to compensate for the gain (negative values) or loss (positive values) of external amplifiers or devices. The offset tracks through all subsequent control changes until set to 0.0 dB . An external offset factor other than 0.0 dB is indicated with /E after the Units in the upper left side of the Display. When operating with the Trace Reference function active (TRACE Soft Function Key F5 highlighted) the offset range is -40 to +40 dB in 1 dB steps.
F2	INT Deactivates OFFSET Soft Function Key F1 and allows edits to the REF field. The REF field value controls internal attenuation and gain to set the top of scale level.
F5	TRACE Activates or deactivates Trace Reference function. The Trace Reference function displays the algebraic difference between the live trace and the top recalled trace or itself, if no recalled trace is displayed. All traces are removed and only the algebraic difference trace is shown on the Display. The Amplitude Scale and Units are changed to show algebraic difference in dB using current Logarithmic display mode scale or 10 dB/Div if AN1820 is in Linear display mode. Scale , displayed in upper right corner of the graticule, indicates the recalled trace has different display and scale settings than the live trace.
F6	ESC Aborts entry in process and restores gain to last entered setting. Label above F6 appears only when editing a parameter.

3-3-7 BANDWIDTH AMPLITUDE OPERATION SCREEN

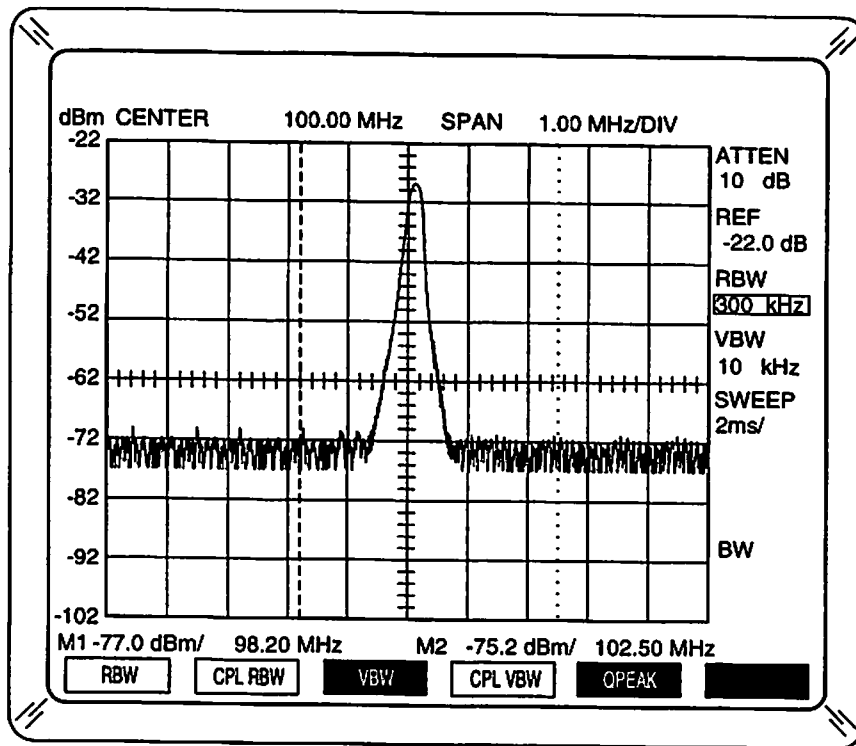

Figure 3-9 Bandwidth Amplitude Operation Screen

01917007

Pressing the BW AMPLITUDE Key displays the Bandwidth Amplitude Operation Screen. The Bandwidth Amplitude Operation Screen provides for direct entry of desired Resolution Bandwidth (RBW), Video Bandwidth (VBW), automatic coupling control or Quasi-Peak Detector operation (if Option 08 is installed). Selected RBW is 3 Hz, 10 Hz, 30 Hz, 100 Hz, 200 Hz (Option 08), 300 Hz, 1 kHz (Option 08), 3 kHz, 9 kHz (Option 08), 30 kHz, 120 kHz (Option 08), 300 kHz, 1 MHz (Option 08), 5 MHz, 10 MHz or 30 MHz. RBW is limited to 3, 10, 30 or 100 Hz in FFT mode. Setting the RBW \geq 10 MHz automatically selects the Linear display mode using the Units selected in the Scale Amplitude Operation Screen.

A. DISPLAY INFORMATION

The RBW (Resolution Bandwidth) field on the right side of the Display is highlighted and ready for edit upon accessing the Bandwidth Amplitude Operation Screen. The VBW (Video Bandwidth) field on the right side of the Display is highlighted and ready for edit upon accessing F3 of the Soft Function Keys. **BW**, located on the lower right side of the Display, indicates the Bandwidth Amplitude Operation Screen is accessed. The value in the SWEEP Time field on the right side of the Display depends on the RBW and VBW selections if the Sweep Time Couple function is active (normally active by default). Refer to Appendix B for optimization tables. If the selected RBW or VBW setting uncalibrates the Display, the screen displays **UNCAL**, highlighted in the Message field. Increasing the RBW greater than or equal to 10 MHz causes the screen to display **LINEAR**, highlighted in the Message field to indicate the active Linear display mode.

B. SOFT FUNCTION KEYS

KEY	DESCRIPTION
F1 RBW	Accesses and highlights RBW field for editing, removing highlight from VBW field. Allows entry of the RBW.
F2 CPL RBW	Activates automatic optimization algorithm to couple RBW settings to Frequency Span selections. The Resolution Bandwidth Couple function is normally activated. When the Resolution Bandwidth Couple function is deactivated, the RBW is in manual control and not affected by Frequency Span settings. Manual control is indicated with an <i>m</i> , displayed to the right of the RBW field title.
F3 VBW	Accesses and highlights VBW field for editing, removing highlight from RBW field. Activates video filters, allowing entry of the Video Bandwidth (10 Hz, 100 Hz, 1 kHz, 10 kHz, 100 kHz, 1 MHz or None). Setting the VBW field to NONE deactivates internal video filters. The Video Bandwidth cannot be manually adjusted in FFT mode.
F4 CPL VBW	Activates automatic optimization algorithm to couple VBW settings to Frequency Span selections. The Video Bandwidth Couple function is normally activated. When the Video Bandwidth Couple function is deactivated, the VBW is in manual control and not affected by Frequency Span settings. Manual control is indicated with an <i>m</i> , displayed to the right of the VBW field title.
F5 QPEAK	Activates Quasi-Peak Detector. Activating the Quasi-Peak Detector function sets the AN1820 to Linear display mode and limits RBW to 200 Hz, 9 kHz or 120 kHz. Deactivating the Quasi-Peak Detector function restores the display mode, RBW and Amplitude Scale to previous settings. The Quasi-Peak Detector function operates and the label above F4 appears only when Option 08 (Quasi-Peak Detector) is installed. Refer to 7-2 for Quasi-Peak Detector operation.
F6 ESC	Aborts entry in process and restores RBW or VBW to last entered setting. Label above F6 appears only when editing a parameter.

3-3-8 SCALE AMPLITUDE OPERATION SCREEN

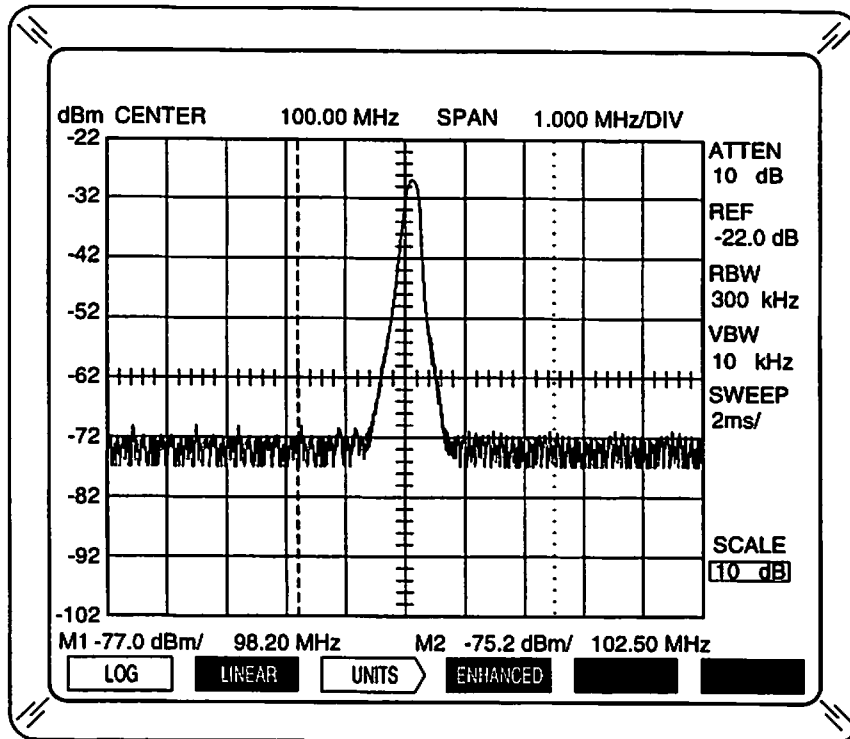

Figure 3-10 Scale Amplitude Operation Screen

01917008

Pressing the SCALE AMPLITUDE Key displays the Scale Amplitude Operation Screen. The Scale Amplitude Operation Screen provides for direct entry of desired Amplitude Display Scales and Units. Amplitude Scale selection is 1, 2, 5 or 10 dB per division for normal analyzer operation. Amplitude Scale selection is from 5 mV to 5 V in 1-2-5 sequence per division in Scope mode.

A. DISPLAY INFORMATION

The SCALE field on the lower right side of the Display is highlighted and ready for edit upon accessing the Scale Amplitude Operation Screen. **SCALE**, located on the lower right side of the Display, indicates the Scale Amplitude Operation Screen is accessed. The Amplitude Scale on the left side of the Display and Units on the upper left side of the Display, change automatically to reflect the display mode and SCALE field value. Settings in Attenuation and Reference Amplitude Operation Screens also affect the Amplitude Scale.

B. SOFT FUNCTION KEYS

KEY	DESCRIPTION
F1 LOG	Selects Logarithmic display mode, deactivating Linear or Enhanced Logarithmic display modes. Deactivates demodulation Scale field, if active, and allows entry of SCALE field setting.

F2 LINEAR

Selects Linear display mode. The top of screen reference level (value shown on the upper left side of the Display) is adjusted in the Reference Amplitude Operation Screen.

F4 ENHANCED

Selects Enhanced Logarithmic display mode. Dynamic display range increases to 120 dB, vertically scaling the graticule to 12 divisions at 10 dB/Div. The Enhanced Logarithmic function provides 40 dB extra range by adjusting internal attenuation and reference level according to ENHANCE SCALE PRIORITY setting in the General Options Screen, accessed from the Analyzer Utility Menu.

CAUTION: SETTING THE ENHANCE SCALE PRIORITY TO ATTEN ONLY OR ATTEN THEN GAIN REMOVES ANY INTERNAL ATTENUATION SET ≤ 40 dB ABOVE MINIMUM INTERNAL ATTENUATION LIMIT. FOR SIGNALS $> +20$ dBm, MINIMUM INTERNAL ATTENUATION LIMIT MUST BE ≥ 10 dB OR TOTAL INTERNAL ATTENUATION MUST BE ≥ 50 dB.

SETTING THE ENHANCE SCALE PRIORITY TO ATTEN ONLY OR ATTEN THEN GAIN AND INTERNAL ATTENUATION TO > 0 dB ABOVE MINIMUM INTERNAL ATTENUATION LIMIT CAUSES A RELAY ON THE RF ATTENUATOR TO CONTINUALLY OPERATE. THE AN1820 SHOULD NOT BE OPERATED WITH THOSE SETTINGS FOR EXTENDED PERIODS OF TIME TO PREVENT EXCESSIVE WEAR ON RELAY CONTACTS.

The following messages appear in the top right half of the graticule when control settings do not allow increasing the dynamic range 40 dB:

● **REF** (Reference level too low)

ENHANCE SCALE PRIORITY is set to GAIN ONLY. The coupled reference level is set < -45 dBm or uncoupled reference level is set < -55 dBm.

● **ATTEN** (Not enough internal attenuation)

ENHANCE SCALE PRIORITY is set to ATTEN ONLY. The coupled reference level is set $< +10$ dBm or uncoupled internal attenuation is set < 40 dB

● **ATTEN REF** (Not enough internal attenuation and reference level too low)

ENHANCE SCALE PRIORITY is set to ATTEN THEN GAIN. The coupled or uncoupled reference level is set < -55 dBm.

F5 DEMOD

Allows entry of Demodulation Scale and is available only when the User-Defined demodulation mode is selected in the AM/FM Receiver Operation Screen. The AM scale sets the percentage of modulation (10%, 20% or 50%) per division. The FM scale sets frequency per division from 1 kHz to 5 MHz in 1-2-5 sequence.

KEY	DESCRIPTION
-----	-------------

F3 UNITS/ZERO



01908001

Figure 3-11 Scale Amplitude LOG UNITS Soft Function Keys

Enters secondary labels for Soft Function Keys to set scale units according to display mode if Demodulation Scale is not active.

With FM Demodulation Scale active and FM COUPLING set to DC in the General Options Screen (accessed from the Analyzer Utility Menu), the ZERO function zeros the FM Demodulation Screen (clears any dc offset).

- Logarithmic or Enhanced Logarithmic display mode:

- F1 dBm sets Units to decibels referenced to one mW (milliwatt).
- F2 dBmV sets Units to decibels referenced to one mV (millivolt).
- F3 dBuV sets Units to decibels referenced to one μ V (microvolt).
- F6 RETURN returns to primary labels for Soft Function Keys.

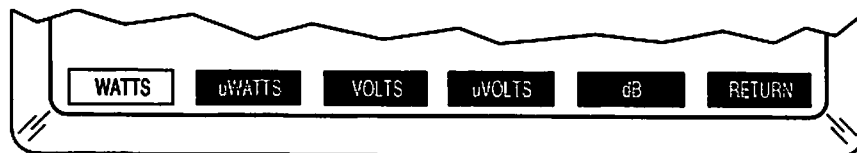

00308001

Figure 3-12 Scale Amplitude LINEAR UNITS Soft Function Keys

- Linear display mode:

- F1 WATTS sets Units to Watts.
- F2 uWATTS sets Units to μ Watts.
- F3 VOLTS sets Units to Volts.
- F4 uVOLTS sets Units to μ Volts.
- F5 dB selects Linear display in logarithmic units, referenced to mW, μ W, mV or μ V; depending on Soft Function Key F1, F2, F3 or F4 selection.
- F6 RETURN returns primary labels for Soft Function Keys.

The reference level and offset parameters set in the Reference Amplitude Operation Screen determine the power of 10 (*E* setting underneath the Units field) prefix. Refer to 3-3-6 and Table 3-2.

F6 ESC

Aborts entry in process and restores Scale to last entered setting. Label above F6 appears only when an entry is in process.

3-3-9 MARKER MODE OPERATION SCREEN

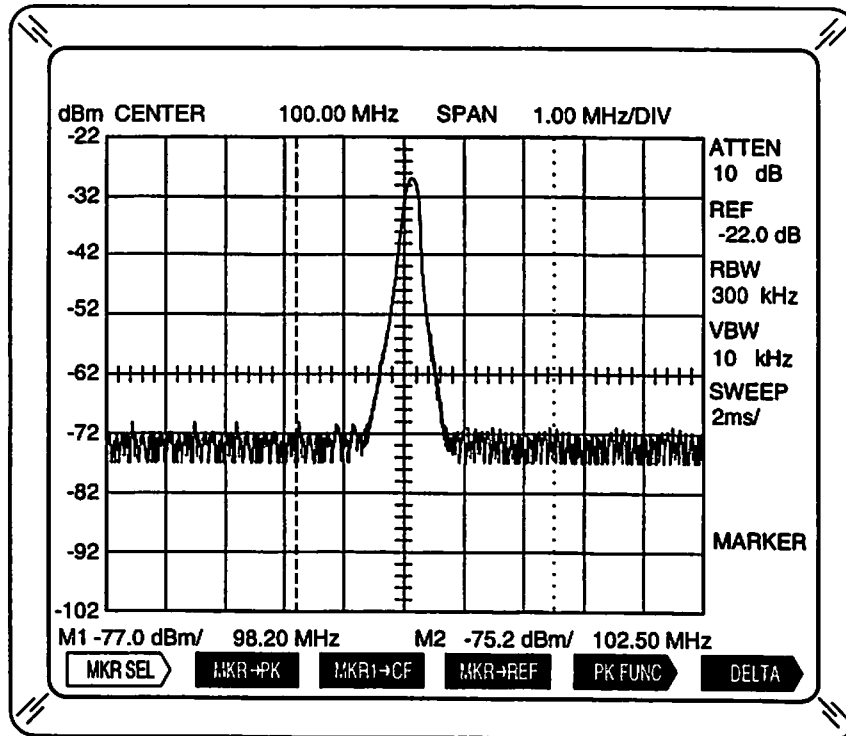

Figure 3-13 Marker Mode Operation Screen

01917009

Pressing the **MARKER MODE** Key displays the Marker Mode Operation Screen. The Marker Mode Operation Screen provides for activation and control of marker(s) to help in various Display measurements. Marker positions are only changed when active and applicable edit field (M1 or M2) is highlighted (having edit control). The last marker position entered is retained upon deactivation.

A. DISPLAY INFORMATION

Marker fields, M1 and M2, are located below the graticule. Each marker field has two values. The first value indicates the amplitude of the signal at the marker position. The second value is the adjustable setting of the horizontal marker position. M1 (Marker 1) field, below the left side of the graticule, is activated, highlighted and ready for edit after pressing the **MKR SEL** Soft Function Key F1 in the Marker Mode Operation Screen with no markers active. The last previously accessed field, M1 or M2 (Marker 2), is highlighted and ready for edit after pressing the **MKR SEL** Soft Function Key F1 in the Marker Mode Operation Screen with marker(s) active. **MARKER**, located on lower right side of graticule, indicates the Marker Mode Operation Screen is accessed. Marker 1 is shown as a dashed line on the Display. Marker 2 is shown as a dotted line on the Display. Marker positions out of the Display area are indicated in the amplitude section of the marker field. <<<<< indicates the marker is off screen to the left. >>>>> indicates the marker is off screen to the right.

B. SOFT FUNCTION KEYS

KEY	DESCRIPTION
-----	-------------

F1 MKR SEL

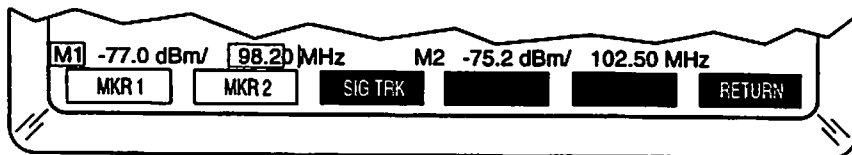

01908003

Figure 3-14 Marker Mode MKR SEL Soft Function Keys

Activates Marker 1, if inactive, and enters secondary labels for Soft Function Keys to provide access to the Marker Select functions.

F1 MKR 1

Activates or deactivates Marker 1. Returns edit control to Marker 1 if edit control was previously with Marker 2. M1 in the Marker field is highlighted in all applicable screens to indicated edit control. Deactivating Marker 1 also deactivates Marker 2, if previously active.

F2 MKR 2

Activates or deactivates Marker 2. Returns edit control to Marker 2 if edit control was previously with Marker 1. M2 in the Marker field is highlighted in all applicable screens to indicated edit control. Activating Marker 2 also activates Marker 1, if previously inactive.

F3 SIG TRK

Activates (if not active) and moves Marker 1 to Center Frequency (± 1 graticule) if there is a signal exceeding the Peak Threshold Level (see F4 PK LVL under primary Marker Mode Operation Screen PK FUNC Soft Function Key F5). If Marker 1 is already on a displayed signal exceeding the Peak Threshold Level, the current Marker 1 signal moves to become the Center Frequency.

F6 RETURN

Returns primary Marker Mode Operation Screen labels for Soft Function Keys.

F2 MKR \rightarrow PK

Activates (if not active) and moves Marker 1 to the highest displayed signal exceeding the Peak Threshold Level (see F4 PK LVL under PK FUNC Soft Function Key F5). Moving Marker 1 to a located signal also activates the Peak Tracking function (see F5 PK TRK under PK FUNC Soft Function Key F5).

F3 MKR1 \rightarrow CF

Sets Marker 1 frequency to Center Frequency. Label above F3 appears only when Marker 1 is active.

F4 MKR \rightarrow REF

Sets the reference level to the amplitude of Marker 1. Label above F4 appears only when Marker 1 is active.

KEY

DESCRIPTION

F5 PK FUNC

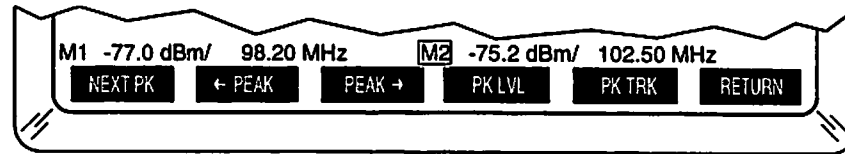

01908004

Figure 3-15 Marker Mode PK FUNC Soft Function Keys

Enters secondary labels for Soft Function Keys to provide access to Peak Search and Peak Tracking functions. No label appears above F5 if Marker 1 is not active or the Frequency Span is set to 0 Hz/Div.

F1 NEXT PK

Moves Marker 1 to the second or next highest displayed signal exceeding the Peak Threshold Level and activates the Peak Tracking function.

F2 ← PEAK

Activates Left Peak Search function. Positions marker having edit control to the first displayed peak exceeding the Peak Threshold Level, left of current location. The Peak Search function only locates peaks $\geq 1/2$ division higher than adjacent signal levels. After locating a peak, Peak Tracking starts. If the signal changes frequency, the Peak Tracking function repositions marker to the peak. Peak Tracking continues until the function is deactivated or signal fails Peak Tracking criteria. Pressing ← PEAK Soft Function Key F2 repeatedly, moves marker to successively lower frequency signal peaks within the displayed Frequency Span. When no signals above the Peak Threshold Level are found, the marker retains current position.

F3 PEAK →

Activates Right Peak Search function. Positions marker having edit control to the first displayed peak exceeding the Peak Threshold Level, right of the current location. The Peak Search function only locates peaks $\geq 1/2$ division higher than adjacent signal levels. After locating a peak, Peak Tracking starts. If the signal changes frequency, the Peak Tracking function repositions marker to the peak. Peak Tracking continues until the function is deactivated or signal fails Peak Tracking criteria. Pressing PEAK → Soft Function Key F3 repeatedly, moves marker to successively higher frequency signal peaks within the displayed Frequency Span. When no signals above the Peak Threshold Level are found, the marker retains current position.

F4 PK LVL

Allows edits to the Peak Threshold Level used in Peak Search functions. The Peak Threshold Level function displays a horizontal dashed line on the graticule indicating the current Peak Threshold Level. The Peak Threshold Level is adjusted to any displayed amplitude point using the DATA SCROLL Spinner or ↑ and ↓ Keys.

F5 PK FUNC (Continued)

F5 PK TRK

Manually activates or deactivates Peak Tracking function. Highlights to indicate Peak Tracking function is operating when either Left or Right Peak Search function is activated. Holds marker having edit control, on peak of displayed signal. If marker is positioned manually to a peak, Peak Tracking function is activated to keep marker tracking current peak. Peak must remain within graticule area for Peak Tracking function to operate. If peak amplitude falls below Peak Threshold Level or leaves graticule area, the Peak Tracking function is deactivated. Peak Tracking is only used with one marker at a time. Peak Tracking also does not function if peak amplitude drifts more than 1/2 division between sweeps.

F6 RETURN/ESC

RETURN returns primary Marker Mode Operation Screen labels for Soft Function Keys. Active peak functions remain active.

ESC aborts entry in process and restores parameter to last entered setting.

F6 DELTA

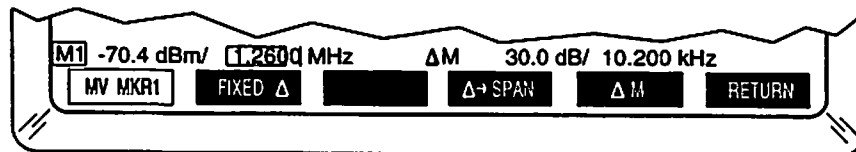

01908005

Figure 3-16 Marker Mode DELTA Soft Function Keys

Activates Marker 1, if needed, and a Delta Marker (in the same location and with the same dotted line indication as Marker 2). Enters secondary labels for Soft Function Keys. The ΔM field, displayed on the right side below the graticule contains two values. The first value indicates the difference in amplitude (y axis) between the displayed markers. The second value is the difference in frequency or time (x axis) between the displayed markers. Initial activation allows edits to the ΔM second value field. When active, the ΔM field is displayed in other operation screens.

NOTE: If either marker is repositioned off screen, the amplitude section of the ΔM field displays >>>>>. The frequency or time section of the ΔM field still maintains the current value difference between the markers.

NOTE: The Delta Marker and Marker 2 are not the same marker, but moving one moves the other to provide Delta measurements after setting up Marker 2 as desired.

F1 MV MKR1

Returns edit control to Marker 1. With Delta function active, moving Marker 1 automatically moves the Delta Marker position as necessary to maintain a constant x axis separation between the markers. With Delta function inactive (edit control to Marker 2), only Marker 1 moves with edit control returned to Marker 1.

KEY**DESCRIPTION**

F6 DELTA (Continued)**F2 FIXED Δ**

Sets the current difference in frequency or time (x axis) between the displayed markers as a fixed value. The Fixed Δ function automatically gives edit control to the Delta Marker, moving Marker 1 position as necessary to maintain a constant x axis separation between the markers. The DATA SCROLL Spinner, DATA ENTRY Keypad, \uparrow and \downarrow Keys and \leftarrow and \rightarrow Keys can all be used to move the Delta Marker. The ΔM second value field initially indicates the movement factor before returning back to the fixed value.

F4 $\Delta \rightarrow$ SPAN

Sets the Frequency Span and Center Frequency by setting the Start Frequency to the left marker frequency and the Stop Frequency to the right marker frequency. The function only works in the frequency domain. If in the time domain, pressing the $\Delta \rightarrow$ SPAN Soft Function Key F4 automatically enters the frequency domain.

F5 MKR 2/ ΔM

Deactivates the Delta function and returns edit control to Marker 2 (MKR 2) or reactivates the Delta function, allowing edits to the ΔM second value field (ΔM), to move the Delta Marker independent of Marker 1.

F6 RETURN

Returns primary Marker Mode Operation Screen labels for Soft Function Keys. The active Delta function remains active.

3-3-10 SWEEP MODE OPERATION SCREEN

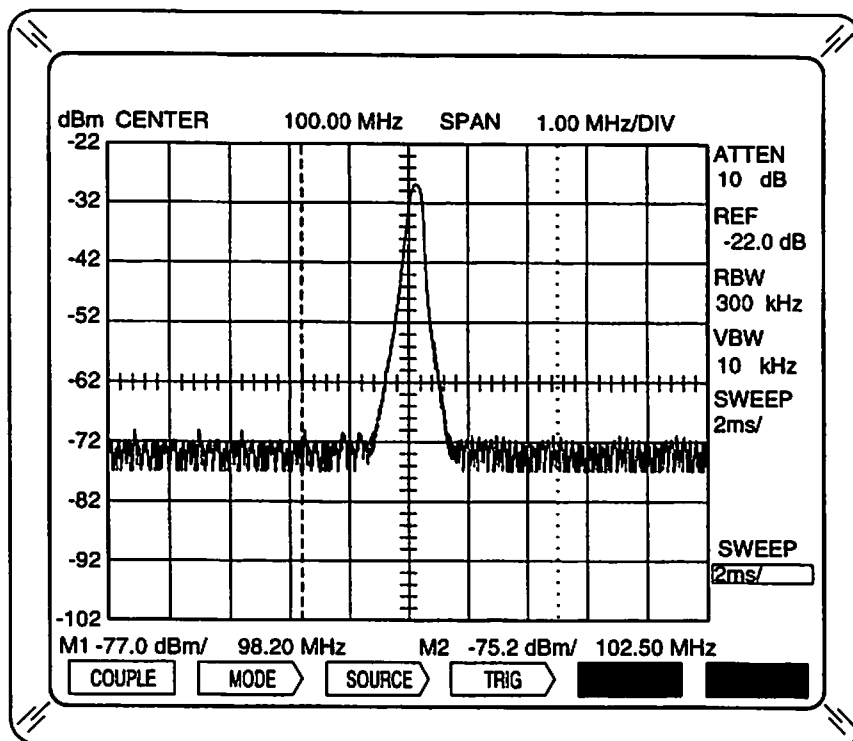

Figure 3-17 Sweep Mode Operation Screen

01917010

Pressing the SWEEP MODE Key displays the Sweep Mode Operation Screen. The Sweep Mode Operation Screen provides for direct entry of analyzer Sweep Time, automatic coupling control and Trigger functions. Sweep Time per division is set from 1 ms to 10 s in 1-2-5 sequence when the Frequency Span is >200 Hz/Div. In ZERO Span or during Scope operation, Sweep Time per division is adjustable from 200 ns to 10 s in 1-2-5 sequence. The 200 ns, 500 ns and 1 μ s settings are displayed with reduced resolution.

A. DISPLAY INFORMATION

The SWEEP Time field on the right side of the Display indicates the current sweep time setting per division. **SWEEP**, located on the lower right side of the Display, indicates the Sweep Mode Operation Screen is accessed. The Sweep Time edit field below **SWEEP** is highlighted and ready for edit upon accessing the Sweep Mode Operation Screen. If selected Sweep Time setting uncalibrates the Display, **UNCAL** appears highlighted in the Message field. Also, below the Sweep Time edit field, the Display shows digital oversampling with **2 X OS**, **4 X OS** or **8 X OS** indications. Refer to Appendix C for information on oversampling.

B. SOFT FUNCTION KEYS

KEY	DESCRIPTION
F1 COUPLE	Activates automatic optimization algorithm to couple Sweep Time settings to Frequency Span, RBW and VBW controls. The Sweep Time Couple function is normally activated. Refer to Appendix B for optimization tables. When the Sweep Time Couple function is deactivated, Sweep Time is in manual control and not affected by Frequency Span, RBW or VBW settings. Manual control is indicated with an <i>m</i> , displayed to the right of the SWEEP Time field title.

F2 MODE

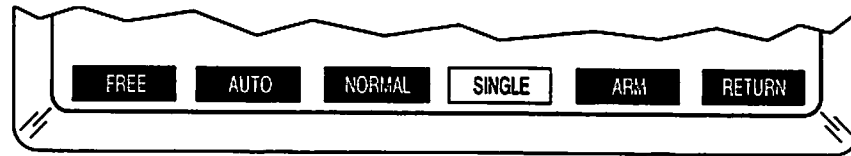

01908006

Figure 3-18 Sweep Mode MODE Soft Function Keys

Enters secondary labels for Soft Function Keys to provide access to the Sweep Trigger Modes. Sweep Trigger Modes are mutually exclusive. Only one Sweep Trigger Mode is active at one time.

F1 FREE

Causes sweep to free run continuously. Trigger signals are ignored. Labels for F3 SOURCE and F4 TRIG in the Sweep Mode Operation Screen do not appear when FREE run is active.

F2 AUTO

Causes sweep to run when triggered or in the absence of an accepted trigger. Accepted triggers exceed the set Trigger Level and provide the correct slope according to selected trigger function. If an accepted trigger is not received within a time set by the Sweep Time, the AN1820 internally triggers a sweep.

F3 NORMAL

Causes sweep to run only when triggered by an accepted trigger. The sweep runs once when accepted trigger is received. The Display is held until next acceptable trigger is received, overwriting data from previous sweep.

F4 SINGLE

Activates Single Sweep function. The AN1820 runs a single sweep when an acceptable trigger signal is received and ARM Soft Function Key F5 is active. The Display is held until the Arming function is reactivated and an acceptable trigger received or another Sweep Mode is selected.

F5 ARM

Activates Arming function. Sets the Single Sweep function to look for an acceptable trigger. The Arming function stays active (F5 label highlighted) until an acceptable trigger is received or another Sweep Mode is selected. Pressing ARM Soft Function Key F5 when Arming function is active generates a manual trigger to initiate the sweep. The Arming function operates and the label above F5 appears only when SINGLE Soft Function Key F4 is active.

F6 RETURN

Returns primary Sweep Mode Operation Screen labels for Soft Function Keys. The current Sweep Mode remains active.

KEY

DESCRIPTION

F3 SOURCE



01908007

Figure 3-19 Sweep Mode SOURCE Soft Function Keys

Enters secondary labels for Soft Function Keys to provide access to the Trigger Sources. Trigger Sources are mutually exclusive. Only one Trigger Source is active at one time.

F1 VIDEO

Sets the signal displayed on the Display as the sweep Trigger Source.

F2 LINE

Sets the ac line frequency as the sweep Trigger Source.

F3 EXT FRNT

Sets the signal received through the EXTERNAL INPUT Connector on the front panel as the sweep Trigger Source.

NOTE: External front Trigger Source does not function if the EXTERNAL INPUT Connector is activated in the Auxiliary Mode Operation Screen (Scope or FFT mode).

F4 EXT REAR

Sets the signal received on pin 8 of the FUNCTION Connector on the rear panel as the sweep Trigger Source.

F5 FILTER

Allows selection of the frequency selectivity of the sweep trigger circuit. The Filter Select field appears on the lower right side of the Display. The ↑ and ↓ Keys or DATA SCROLL Spinner is used to select the filter (AC, DC, TV FIELD, LF REJ [low frequency reject], HF REJ [high frequency reject] or TV LINE).

F6 RETURN

Returns primary Sweep Mode Operation Screen labels for Soft Function Keys. The current Trigger Source and filter remain active.

F4 TRIG

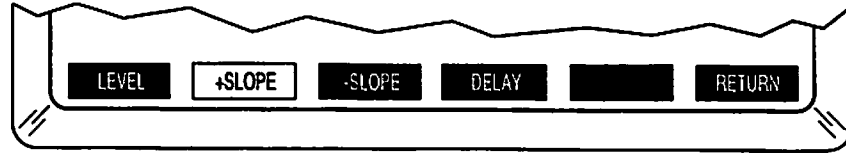

01908008

Figure 3-20 Sweep Mode TRIG Soft Function Keys

Enters secondary labels for Soft Function Keys to provide access to the trigger functions.

F1 LEVEL

Allows entry of the sweep Trigger Level according to Trigger Source. The sweep Trigger Level function operates and the label above F1 only appears if VIDEO or EXT FRNT is the selected Trigger Source.

If VIDEO is the Trigger Source, a horizontal dashed line appears on the graticule indicating the current Trigger Level. The Trigger Level is adjusted to any displayed amplitude point using the DATA SCROLL Spinner or \uparrow and \downarrow Keys.

If EXT FRNT is the Trigger Source, the Trigger Level field appears on the lower right side of the Display. The DATA ENTRY Keypad or DATA SCROLL Spinner is used to set the Trigger Level to -2.5, -1.0, -0.5, 0.0, 0.5, 1.0 or 2.5 V.

If EXT REAR is the Trigger Source, the Trigger Level is set at +2.5 V.

F2 +SLOPE

Selects rising edge or positive going signal to trigger sweep and is the normal sweep trigger operating mode. Sweep is generated when a positive going trigger signal passes through the Trigger Level setting.

F3 -SLOPE

Selects falling edge or negative going signal to trigger sweep. Sweep is generated when a negative going trigger signal passes through the Trigger Level setting.

F4 TRIG (Continued)

F4 DELAY

Allows entry of pretrigger or posttrigger delay in the Trigger Delay field, on the lower right side of the Display. The Trigger Delay is set from -300 (pretrigger) to +300 (posttrigger) divisions of the current Sweep Time units. Refer to Table 3-2. The Display indicates the first 500 digitized points occurring after the Trigger Delay interval. If the Sweep Time is reduced, causing the Trigger Delay to go beyond the allowable range of ± 300 divisions, the Trigger Delay automatically resets to the maximum range for the new Sweep Time. Trigger Delay range is limited to ± 200 seconds at Sweep Times of 1 s or slower. The Trigger Delay function operates and label above F4 appears only when the AN1820 is in ZERO Span or Scope mode. Measurements made with markers are relative to the trigger point including Trigger Delay value.

Continuous storage of digitized data, much wider than the Display window, allows precision viewing of the signal at different points in time by moving the time reference. Pretrigger sweeps view time before the signal. Posttrigger sweeps view signals past the time range of the Display.

SWEEP TIME	TRIGGER DELAY RANGE	SWEEP TIME	TRIGGER DELAY RANGE
200 ns	-600.0 to +600.0 μ s	2 ms	-600.0 to +600.0 ms
500 ns	-600.0 to +600.0 μ s	5 ms	-1.500 to +1.500 s
1 μ s	-600.0 to +600.0 μ s	10 ms	-3.000 to +3.000 s
2 μ s	-600.0 to +600.0 μ s	20 ms	-6.000 to +6.000 s
5 μ s	-1.500 to +1.500 ms	50 ms	-15.00 to +15.00 s
10 μ s	-3.000 to +3.000 ms	100 ms	-30.00 to +30.00 s
20 μ s	-6.000 to +6.000 ms	200 ms	-60.00 to +60.00 s
50 μ s	-15.00 to +15.00 ms	500 ms	-150.0 to +150.0 s
100 μ s	-30.00 to +30.00 ms	1 s	-200.0 to +200.0 s
200 μ s	-60.00 to +60.00 ms	2 s	-200.0 to +200.0 s
500 μ s	-150.0 to +150.0 ms	5 s	-200.0 to +200.0 s
1 ms	-300.0 to +300.0 ms	10 s	-200.0 to +200.0 s

Table 3-3 Trigger Delay Ranges

F6 RETURN

Returns primary Sweep Mode Operation Screen labels for Soft Function Keys. Current trigger functions remain active.

F6 ESC

Aborts entry in process and restores Sweep Time to last entered setting. Label above F6 appears only when an entry is in process.

3-3-11 TRACKING GENERATOR MODE OPERATION SCREEN

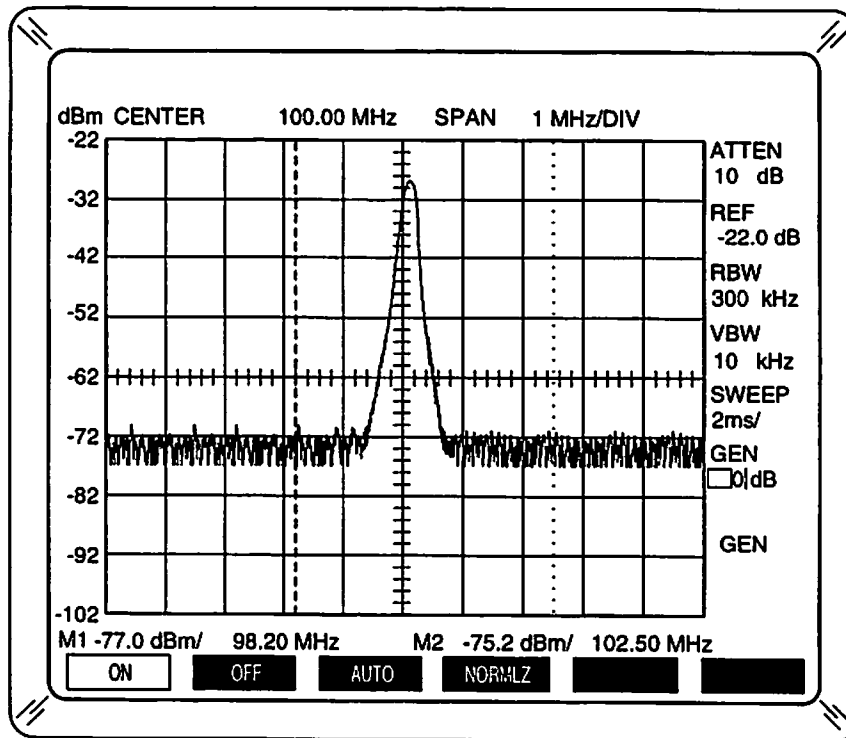

Figure 3-21 Tracking Generator Mode Operation Screen

01917011

Pressing the GEN MODE Key displays the Tracking Generator Mode Operation Screen. The Tracking Generator Mode Operation Screen provides control of the Tracking Generator (Option 02) out the TRACKING GENERATOR Connector. The Tracking Generator Output Level is set from 0 to -70 dBm in 1 dB steps. The Tracking Generator Output Level is adjustable with the Tracking Generator On or Off. The Frequency Sweep Range (100 kHz to 2.9 GHz) of the Tracking Generator is controlled in the Frequency Operation Screens. Refer to 7-1 for Tracking Generator operation.

A. DISPLAY INFORMATION

The GEN (Tracking Generator Output Level) field, on the right side of the Display, is highlighted and ready for edit upon accessing the Tracking Generator Mode Operation Screen, if Option 02 is installed. **GEN**, located on the lower right side of the Display, indicates the Tracking Generator Mode Operation Screen is accessed.

NOTE: Pressing the GEN MODE Key on an AN1820 not equipped with the Tracking Generator Option 02 displays **NOT INSTALLED** in the Message field.

B. SOFT FUNCTION KEYS

KEY	DESCRIPTION
F1 ON	Activates Tracking Generator. Highlights F1 label and removes highlight from F2 label.
F2 OFF	Deactivates Tracking Generator. Highlights F2 label and removes highlight from F1 label.
F3 AUTO	Automatically tunes the Tracking Generator output frequency to correctly track the ANALYZER INPUT Connector signal. The Auto Tune function should be used when changing Frequency Spans and as needed to keep the Tracking Generator tuned. Label above F3 appears only when the Tracking Generator is active. NOTE: The TRACKING GENERATOR Connector must be connected to the ANALYZER INPUT Connector for correct operation.
F4 NORMLZ	Activates or deactivates Normalization function. The Normalization function, used with the TRACKING GENERATOR Connector connected to the ANALYZER INPUT Connector, sets the current trace to the top of scale 0 dB reference. The Normalization function cancels out the frequency response of connectors and cables before testing a frequency selective device. Label above F4 appears only when the Tracking Generator is active.
F6 ESC	Aborts entry in process and restores Tracking Generator Output Level to last entered setting. Label above F6 appears only when editing a parameter.

3-3-12 AUXILIARY MODE OPERATION SCREEN

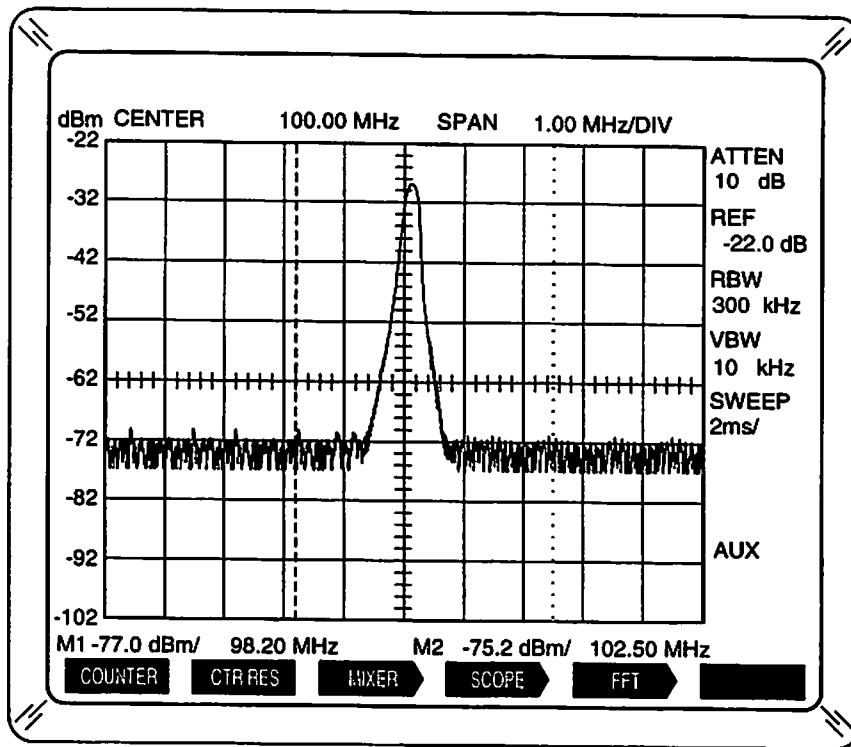

Figure 3-22 Auxiliary Mode Operation Screen

01917012

Pressing the AUX MODE Key displays the Auxiliary Mode Operation Screen. The Auxiliary Mode Operation Screen provides access and control of auxiliary test functions and features: Frequency Counter, External Mixer, Low Frequency Spectrum Analyzer (FFT) and Digital Oscilloscope operation.

A. DISPLAY INFORMATION

AUX, located on lower right side of graticule, indicates the Auxiliary Mode Operation Screen is accessed. The Display changes according to auxiliary test functions activated.

B. SOFT FUNCTION KEYS

KEY	DESCRIPTION
-----	-------------

F1 COUNTER

The Frequency Counter function improves frequency resolution and measurement accuracy at wide Frequency Span settings. When a Frequency Counter Resolution is selected, the Frequency Counter measurement is displayed in the CTR (Counter) field appearing at the top of the Display. If no markers are active, the Frequency Counter counts the Center Frequency. If only Marker 1 is active, the Frequency Counter counts the frequency of the signal at the Marker 1 position. If both markers are active, the Frequency Counter counts the frequency at the position of the marker having edit control.

NOTE: The Frequency Counter gating interval affects the sweep repetition rate.

If the active marker having edit control is positioned off screen, the Counter field displays -----. The frequency count can only be made at a marker position displayed on the Display.

F1 COUNTER (Continued)

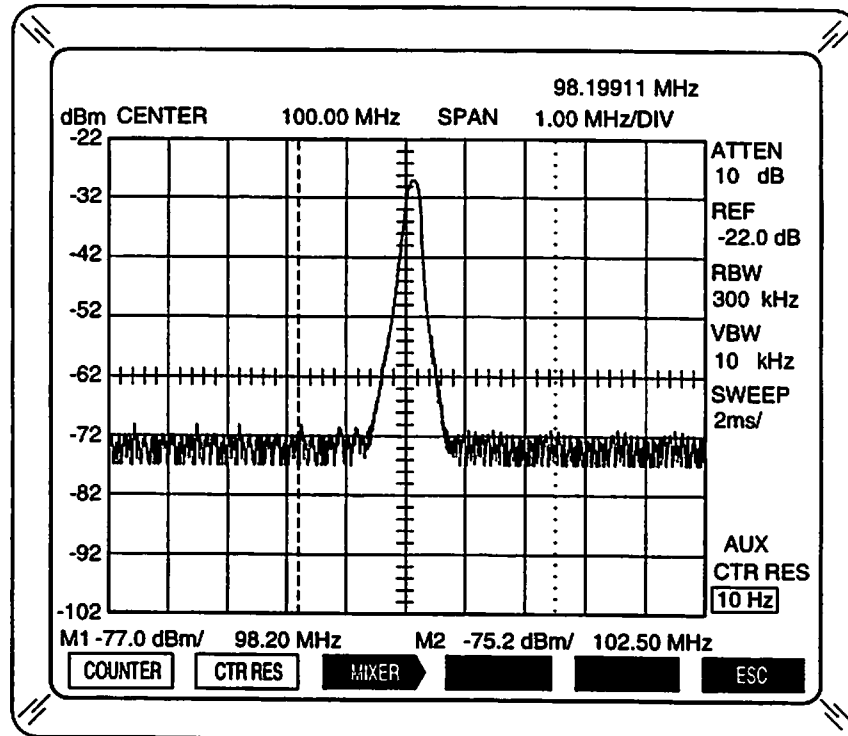

Figure 3-23 Auxiliary Mode Counter Operation Screen

00317013

F2 CTR RES

Allows edits to the CTR RES (Counter Resolution) field on the lower right side of the Display. A valid entry selects a 1 Hz, 10 Hz, 100 Hz or 1 kHz Frequency Counter Resolution.

F3 MIXER

Enters secondary labels for Soft Function Keys to control the External Mixer function. The External Mixer function allows the AN1820, with an external mixer, to measure signals with higher frequencies than the 2.9 GHz range available through the ANALYZER INPUT Connector. The External Mixer function activates the EXTERNAL MIXER IF Connector and EXTERNAL MIXER LO Connector, deactivating the ANALYZER INPUT Connector and EXTERNAL INPUT Connector. Center Frequency ranges from 3 to 1300 GHz. Referencing the Center Frequency and Frequency Span, the External Mixer function adjusts the LO output through the EXTERNAL MIXER LO Connector to the external mixer, providing a fixed 410.7 MHz input through the EXTERNAL MIXER IF Connector. A compatible LO Harmonic, set in the External Mixer function, allows the AN1820 to display and measure the original signal from the mixed down input signal. Activating the External Mixer function automatically switches Attenuation to External for setting the external mixer conversion loss factor and any other added external attenuation factors. Label above F3 only appears when the Tracking Generator (Option 02) is inactive.

F3 MIXER (Continued)

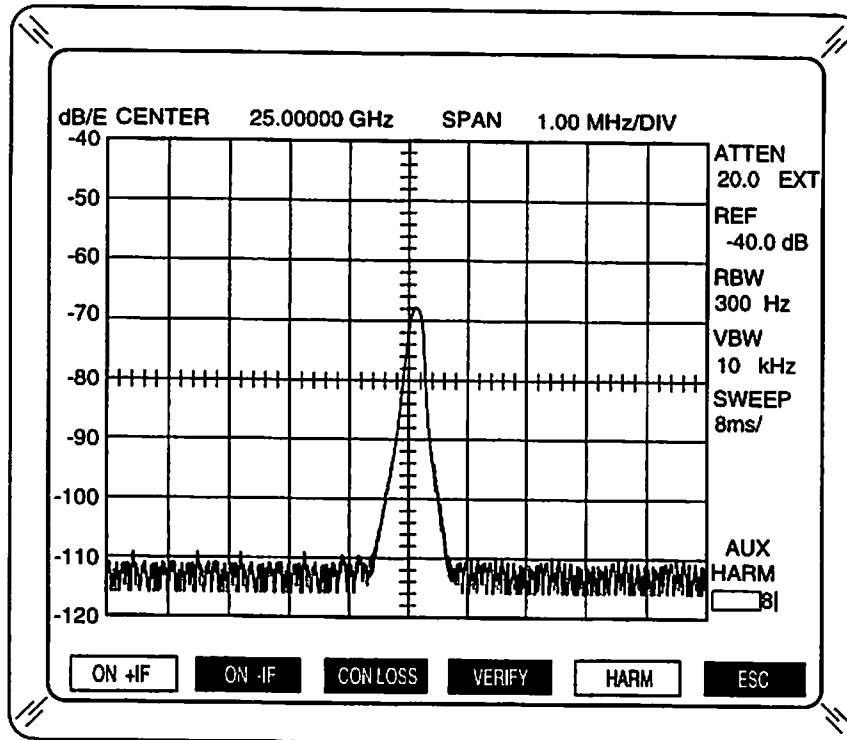

Figure 3-24 Auxiliary Mode External Mixer Operation Screen

00317004

F1 ON +IF

Activates External Mixer function and sets LO frequency above the receive frequency according to the LO Harmonic selected ($RF+IF=LO$) or deactivates External Mixer function.

F2 ON -IF

Activates External Mixer function and sets LO frequency below the receive frequency according to the LO Harmonic selected ($RF+[-IF]=LO$) or deactivates External Mixer function.

F3 CON LOSS

Allows edits to the ATTEN (Attenuation) field on the top right side of the Display. External attenuation, from 0 to 99.9 dB in 0.1, 1 or 10 dB steps, offsets the amplitude scale to compensate for mixer conversion loss or any other external attenuation factors. The offset value tracks through all subsequent control changes until external attenuation is set to 0.0 dB. An external attenuation factor other than 0.0 dB is indicated with /E after the Units in the upper left side of the Display and EXT after the Attenuation field. Entering the external conversion loss allows the AN1820 to display accurate signal levels without having to manually figure in external attenuation. Label above F3 appears only when the External Mixer function (ON Soft Function Key F1 or F2) is active.

KEY

DESCRIPTION

F3 MIXER (Continued)

F4 VERIFY

Increments the Harmonic field value by 1 to verify the desired signal is being displayed. An unwanted signal image resulting from the mixing processes would track the harmonic and disappear on the Display. The Verify function may be activated only when the External Mixer function (ON Soft Function Key F1 or F2) is active. VERIFY Soft Function Key F4 must be pressed again to deactivate the Verify function.

F5 HARM

Allows edits to the HARM (Harmonic) field on the lower right side of the Display. The LO Harmonic is set from 1 to 100. After setting the applicable Center Frequency and desired Frequency Span or Start and Stop Frequencies, the LO harmonic is entered. Messages appearing in the upper section of the Display are used as a guide when setting the LO Harmonic. A compatible harmonic is entered when no message appears. An *L.O. too High* (increase LO Harmonic) or *L.O. too Low* (decrease LO Harmonic) message indicates using the set LO Harmonic to mix down the real signal frequency is beyond the operational range (3 to 12 GHz) of the LO.

F6 RETURN/ESC

RETURN returns primary Auxiliary Mode Operation Screen labels for Soft Function Keys. External Mixer function, if activated, remains active.

ESC aborts entry in process and restores parameter to last entered setting.

F4 SCOPE

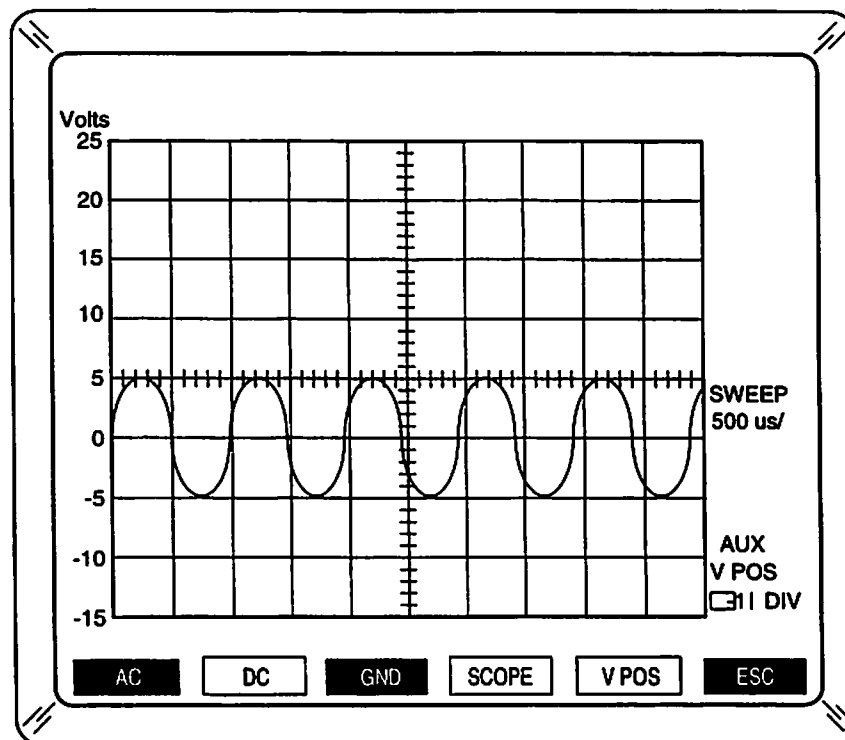

00317005

Figure 3-25 Auxiliary Mode Oscilloscope Operation Screen

KEY

DESCRIPTION

F4 SCOPE (Continued)

Activates Digital Oscilloscope function (Scope mode) through the EXTERNAL INPUT Connector. Enters the Auxiliary Mode Oscilloscope Operation Screen, setting the Frequency Span to 0 Hz/Div and Amplitude Scale Units to Volts. Signals received through the EXTERNAL INPUT Connector are digitized and displayed as time domain data. The Amplitude Scale per division ranges from 5 mV to 5 V in 1-2-5 sequence in the Scale Amplitude Operation Screen. Sweep Time ranges from 200 ns to 10 s in 1-2-5 sequence in the Sweep Mode Operation Screen. Pressing ATTEN, REF or BW AMPLITUDE Key or any FREQUENCY Key deactivates Scope mode.

F1 AC

Sets input coupling to ac.

F2 DC

Sets input coupling to dc.

F3 GND

Sets input coupling to ground.

F4 SCOPE

Deactivates Scope mode and returns to Auxiliary Mode Operation Screen.

F5 V POS

Allows edits to Amplitude Scale Offset. The V POS (Vertical Position) field for Amplitude Scale Offset appears below **AUX** to the right of the graticule. Amplitude Scale Offset range is ± 6 divisions in 1 division steps.

F5 FFT

Activates or deactivates Low Frequency (≤ 24 kHz) Spectrum Analyzer operation (FFT mode) through the EXTERNAL INPUT Connector. The FFT mode limits Center Frequency range (50 Hz to 23 kHz), Frequency Span (≥ 10 Hz/Div, ≤ 200 Hz/Div) and RBW (3, 10, 30 or 100 Hz). Center Frequency is limited by Frequency Span to keep 0 Hz from displaying right of the left edge of the graticule or signals > 24 kHz from displaying left of the right edge of the graticule. The VBW is not manually adjustable. Attenuation is set from 0 to 60 dB in 20 dB steps, if uncoupled. Reference level is set from -40 to +40 dBm in 0.1, 1 or 10 dB steps. Pressing START or STOP FREQUENCY Key; GEN MODE Key; ZERO Soft Function Key F1 or FULL Soft Function Key F3 in Span Frequency Operation Screen or QPEAK Soft Function Key F3 in Bandwidth Amplitude Operation Screen deactivates FFT mode.

F1 AC

Sets input coupling to ac.

F2 DC

Sets input coupling to dc.

F3 GND

Sets input coupling to ground.

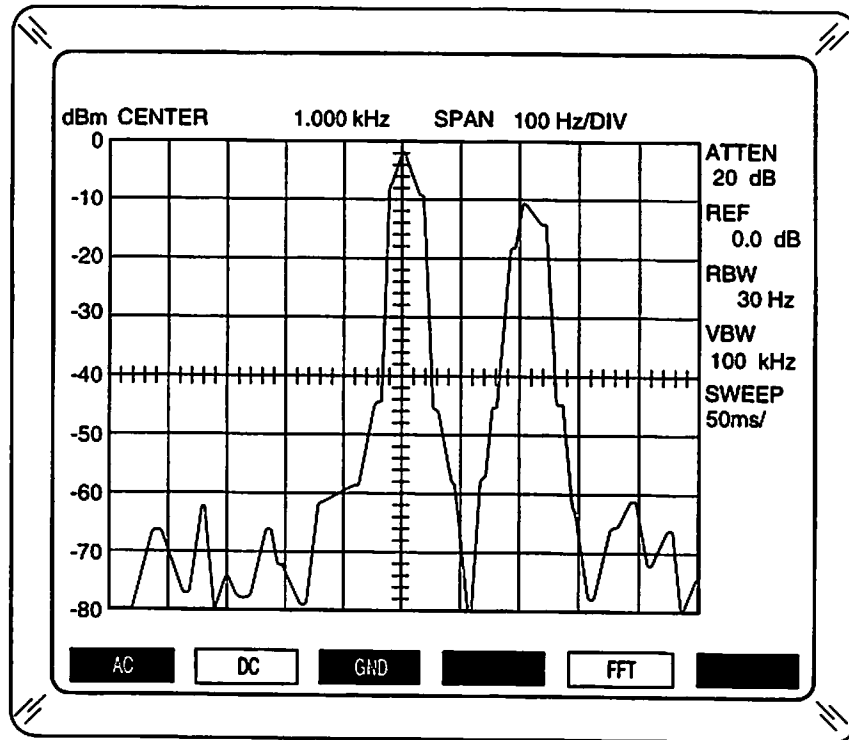
KEY**DESCRIPTION****F5 FFT (Continued)****Figure 3-26 Auxiliary Mode FFT Operation Screen**

01917016

F5 FFT

Deactivates FFT mode and returns to Auxiliary Mode Operation Screen.

F6 ESC

Aborts entry in process and restores parameter to last entered setting. Label above F6 appears only when editing a parameter.

3-3-13 COPY OPERATION SCREEN

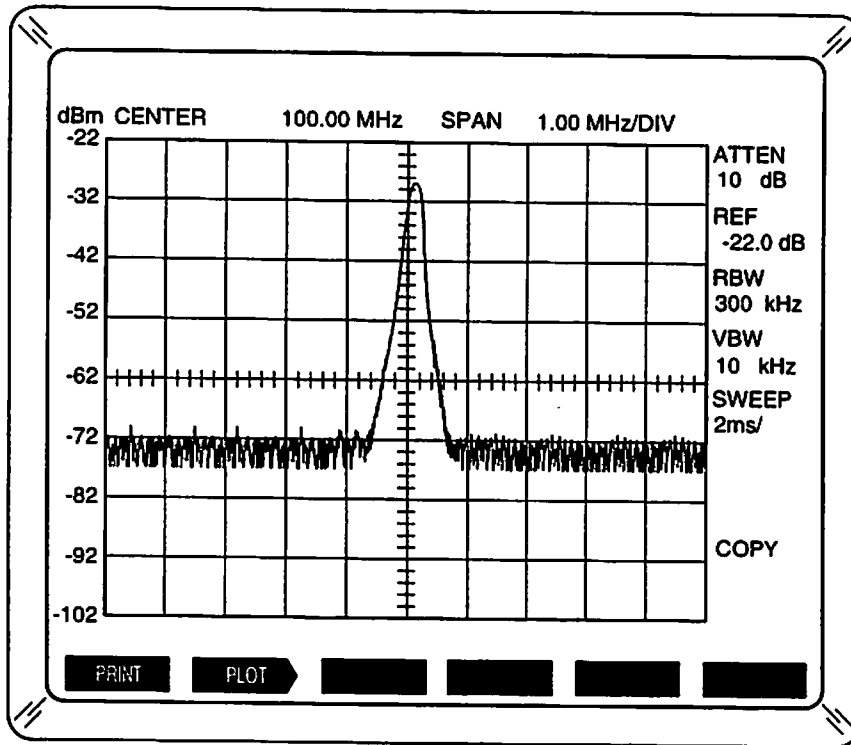

Figure 3-27 Copy Operation Screen

01917017

Pressing the COPY Key displays the Copy Operation Screen. The Copy Operation Screen prints screens to a printer or sends plots of displayed traces and/or setup to an HPGL compatible plotter. Refer to 4-9-4 for operation procedures to send out plots and 4-9-5 for operation procedures to print out screens.

A. DISPLAY INFORMATION

COPY, located on the lower right side of the Display, indicates the Copy Operation Screen is accessed. The Copy function freezes the screen before printing or plotting. The AN1820 sends prints and plots with time and date stamps (current for live traces/date and time of storage for recalled traces). For recalled traces, prints or plots only show the date/time stamp for the top trace.

B. SOFT FUNCTION KEYS

KEY	DESCRIPTION
F1 PRINT	Prints the current screen with Test Set identification through the RS-232, IEEE-488 GPIB or PRINTER Connector. The Printer Options Screen, accessed from the Analyzer Utility Menu, sets the connector, configuration and type of printer.
F2 PLOT	

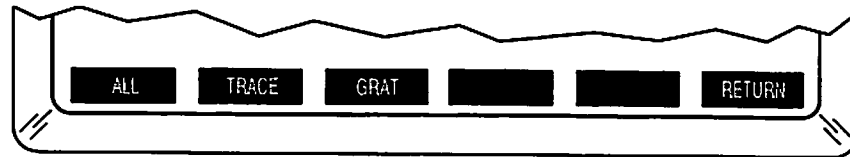

01908009

Figure 3-28 Copy Operation PLOT Soft Function Keys

Enters secondary labels for Soft Function Keys to provide access to the selectable items to plot through the RS-232 (Serial) or IEEE-488 (GPIB) Connector. The plotter is selected in the RS-232 (Serial) or IEEE-488 (GPIB) Screen, accessed from the Analyzer Utility Menu.

F1 ALL

Sends trace, graticule and scaling (setup parameters) to the plotting device.

F2 TRACE

Sends plot of only the trace (without the graticule and scaling) to the plotting device. Allows multiple traces to be plotted on previously plotted data.

F3 GRAT

Sends plot of only the graticule and scaling (without the trace) to the plotting device.

F6 RETURN/ABORT

RETURN returns primary Copy Operation Screen labels for Soft Function Keys.

ABORT stops Plot function in process and resets plotting device. Label above F6 appears only when the Plot function has been activated.

3-3-14 PRESET

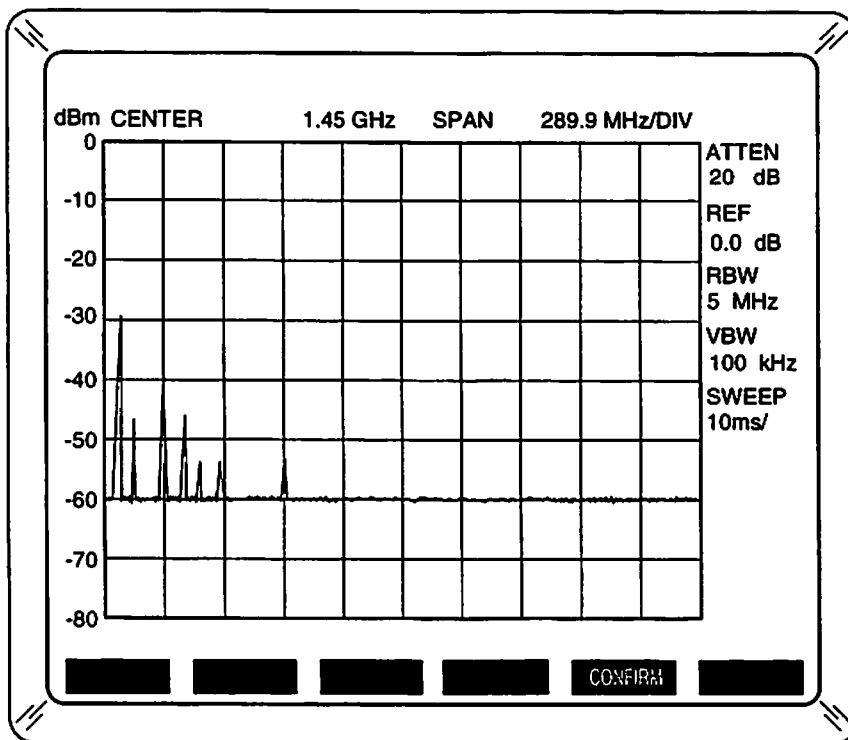

Figure 3-29 Preset Operation Screen

01917018

Pressing the PRESET Key either resets the AN1820 to the preset factory defaults or provides the Soft Function Key to reset the AN1820 to the preset factory defaults.

A. DISPLAY INFORMATION

The Preset Operation Screen displays no word indication of being the active screen. The Preset Operation Screen indicates the preset factory conditions (see 2-6) and the no label or CONFIRM F5 label Soft Function Keys

B. SOFT FUNCTION KEYS

KEY	DESCRIPTION
-----	-------------

F5 CONFIRM	
------------	--

	Resets the AN1820 to the preset factory defaults. Label above F5 only appears when PRESET CONFIRM is set to ENABLE in the Keyboard Options Screen, accessed from the Analyzer Utility Menu.
--	---

3-3-15 DISPLAY OPERATION SCREEN

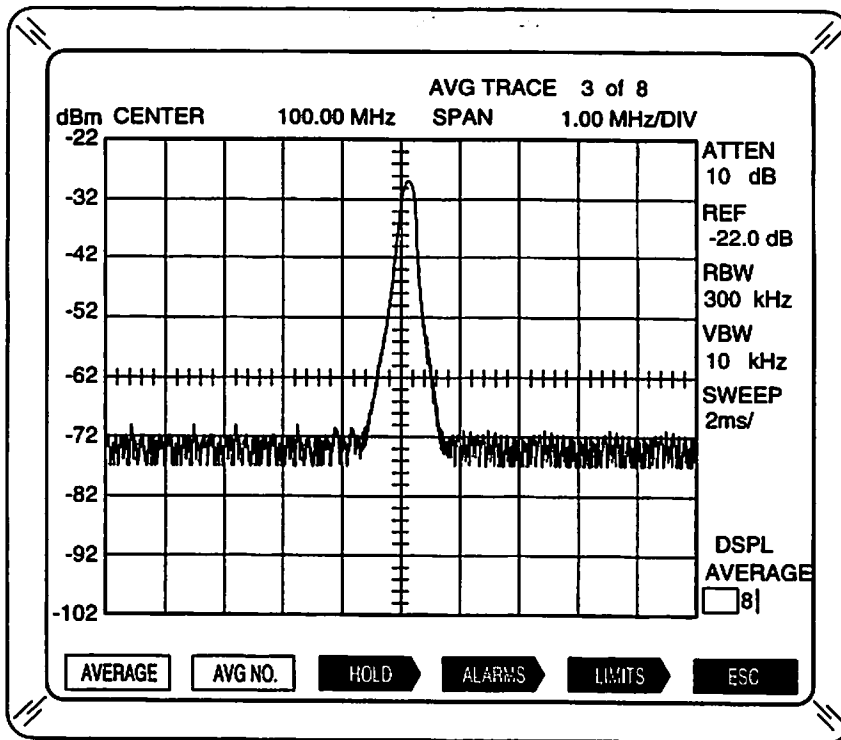

Figure 3-30 Display Operation Screen

0031700E

Pressing the DISPLAY Key enters the Display Operation Screen. The Display Operation Screen allows changes to how the AN1820 displays traces, providing useful measurement information. Trace Averaging, Hold functions, Limit Alarms and Limits Trace Creation function are accessed from the Display Memory Operation Screen.

A. DISPLAY INFORMATION

DSPL, located on the lower right side of the Display, indicates the Display Memory Operation Screen is accessed.

B. SOFT FUNCTION KEYS

All functions in the Display Memory Operation Screen may operate at the same time.

KEY	DESCRIPTION
F1 AVG	Activates or deactivates the Trace Averaging function. The Trace Averaging function displays the average of two to 16 sweeps, depending on Average Number set with the AVG NO. Soft Function Key F2.
F2 AVG NO.	Allows edits to the AVERAGE Number field on the lower right side of the Display. The value from 2 to 16 in the AVERAGE Number field sets the Average Number used in the Trace Averaging function.

KEY

DESCRIPTION

F3 HOLD

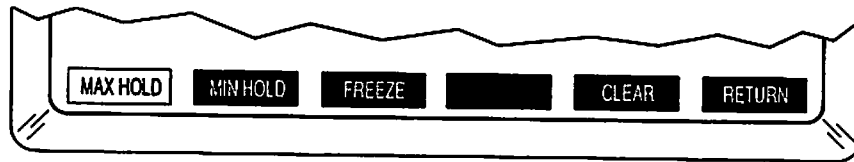

Figure 3-31 Display Operation HOLD Soft Function Keys

01908010

Enters secondary labels for Soft Function Keys to provide access to the Hold functions.

F1 MAX HOLD

Activates or deactivates Maximum Hold function. The Maximum Hold function displays, in addition to the live trace, a trace representing the maximum signal level occurring over the displayed frequency span. The Maximum Hold trace continually changes as new maximum levels are set by the live signal.

F2 MIN HOLD

Activates or deactivates Minimum Hold function. The Minimum Hold function displays, in addition to the live trace, a trace representing the minimum signal level occurring over the displayed frequency span. The Minimum Hold trace continually changes as new minimum levels are set by the live signal.

F3 FREEZE

Freezes the current Maximum and/or Minimum Hold trace(s) (no more updating to the live trace) when activated (highlighted). Releases hold traces from frozen state when deactivated (not highted). Label above F3 only appears when the Maximum and/or Minimum Hold function(s) are active.

F5 CLEAR

Deactivates all active Hold functions and clears the Display of any hold traces.

F6 RETURN

Returns primary Display Operation Screen labels for Soft Function Keys. Any active Hold functions remain active.

F4 ALARMS

The Display Limit Alarms Operation Screen provides options for monitoring signal limits. The Limit Alarms verify the live signal stays within the limits defined by recalled Upper and/or Lower Limit traces. When a signal exceeds or falls below the defined limits, one or more Limit Alarms selected are activated.

The Display indicates recalled limit traces (*U* for Upper Limit and *L* for Lower Limit) in the Trace Display Stack (see 3-3-18) located in the upper left corner of the graticule. If displaying more than one Upper or Lower Limit trace, the Limit Alarms use the traces closest to the top of the Trace Display Stack. *Scale*, displayed in upper right corner of the graticule, indicates recalled traces have different display and scale settings than the live trace. When *Scale* is displayed, some limit traces may not be shown accurately on the Display.

Refer to 4-9-2 for recalling Limit trace(s). Refer to 4-9-1 for storing and designating traces as Upper or Lower Limit traces.

F4 ALARMS (Continued)

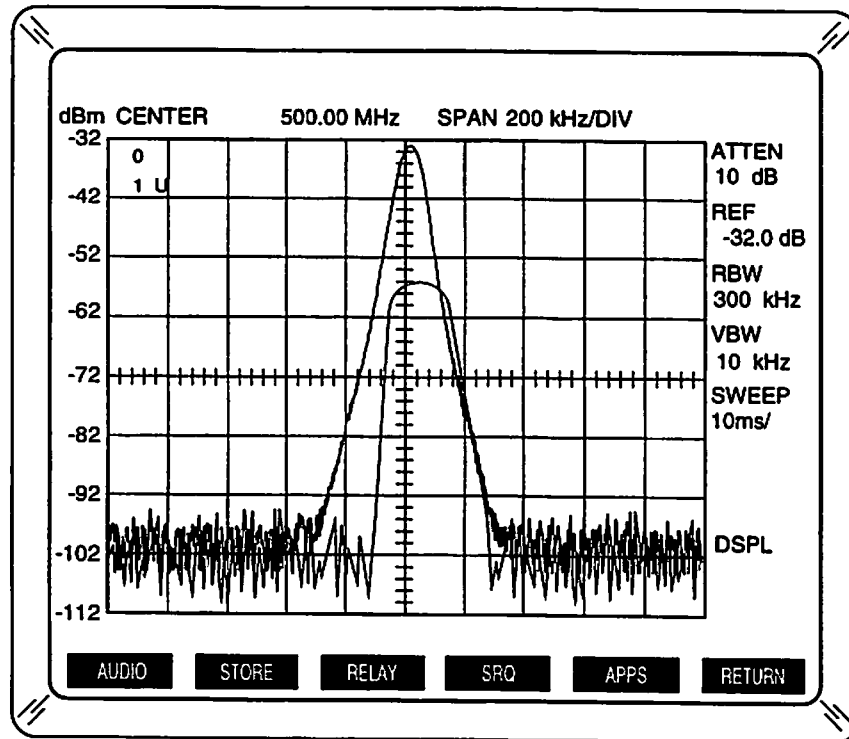

Figure 3-32 Display Limit Alarms Operation Screen

01917020

F1 AUDIO

Activates or deactivates an audible alarm through the internal speaker when the live signal exceeds the displayed Upper Limit trace and/or Lower Limit trace.

F2 STORE

Stores live trace with time/date stamp in sequential, unprotected Memory Locations when the live signal exceeds the displayed Upper Limit trace and/or Lower Limit trace. Storing begins with the lowest unprotected Memory Location and terminates when all available Memory Locations are filled.

F3 RELAY 

CAUTION: MAXIMUM CURRENT RATING OF FUNCTION CONNECTOR, PINS 5 AND 13 IS 200 mA. MAXIMUM VOLTAGE RATING OF FUNCTION CONNECTOR, PINS 5 AND 13 IS 50 V (OPEN) OR 1.2 V (CLOSED). EXCEEDING THESE RATINGS MAY RESULT IN DAMAGE TO THE AN1820.

Activates external switching Relay function through FUNCTION Connector on rear panel. When the Relay function is active, a live trace exceeding a displayed Upper Limit trace causes the RLY DRV2 line on pin 13 to switch from high (open collector) to low. A live trace falling below a displayed Lower Limit trace causes the RLY DRV1 line on pin 5 to switch from high (open collector) to low. The pull down state on pins 13 and/or 5 starts at the end of the sweep that the displayed limits were exceeded and holds until the end of the first sweep that the live trace stays within the displayed limit trace(s).

KEY

DESCRIPTION

F4 ALARMS (Continued)

F4 SRQ

Generates a Service Request to a remote controller through the IEEE-488 GPIB Connector, when the live signal exceeds the displayed Upper Limit trace and/or Lower Limit trace. The live signal, exceeding the displayed Upper Limit trace and/or Lower Limit trace with SRQ Soft Function Key F4 active, also sets an internal status register. The internal status register information is retrieved through the IEEE-488 GPIB Connector or RS-232 Connector, when queried. Refer to the TMAC Users Manual (1002-0401-600) for more detailed information concerning remote operation and programming.

F5 APPS

Activates a user definable macro program when the live trace exceeds displayed limit trace(s). Label above F5 appears only when a macro program for the limits application has been loaded and assigned. Macro programs are loaded and assigned remotely. Refer to the TMAC Users Manual (1002-0401-600) for more detailed information concerning remote operation and programming.

F6 RETURN

Returns primary Display Operation Screen labels for Soft Function Keys. Any active Limit Alarms remain active.

F5 LIMITS

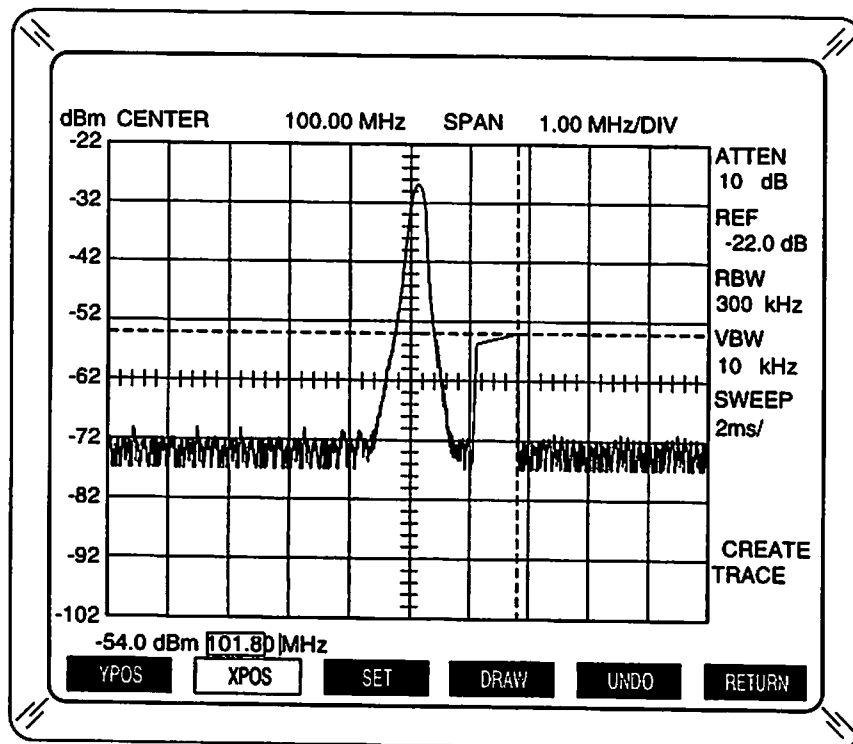

Figure 3-33 Display Limits Trace Creation Screen

01917021

Enters the Display Limits Trace Creation Screen and secondary labels for Soft Function Keys. The Display Limits Trace Creation Screen allows creation of a new trace, using a live trace or previously recalled trace.

F5 LIMITS (Continued)

The AN1820 performs the Limits Trace Creation function on the live trace, if displayed. If not, the AN1820 performs the Limits Trace Creation function on the top trace in the Trace Display Stack (see 3-3-18). The Limits Trace Creation function removes all other traces and markers, if active, from the Display.

Refer to 4-9-3 for Creating Traces procedure.

NOTE: Pressing any control causing the live trace to be displayed, overwrites the created trace data. Created trace data must be stored to prevent overwriting.

F1 YPOS

Allows adjustments to the y axis position with the DATA SCROLL Spinner. A horizontal dashed line on the graticule indicates the current y axis position. The Y Axis Position field, first value below the left side of the graticule, displays the y axis position value using the current Amplitude Scale Units.

Pressing YPOS Soft Function Key F1 deactivates XPOS Soft Function Key F2, if active. The highlighted label for Soft Function Key F1 and Y Axis Position field indicate a y axis position edit is in progress.

Initial y axis position is the trace amplitude value at the left edge of the graticule. The y axis position automatically tracks the trace amplitude value when adjusting the x axis position, unless the y axis position has been adjusted off the trace. If the y axis position has been adjusted off the trace, all x axis positions have the adjusted y axis position value. Readjusting the y axis position to the trace, deactivates the y axis position edit at the intersection point with the displayed trace. Subsequent adjustment of the x axis position causes the y axis position to track the trace amplitude value.

F2 XPOS

Allows adjustments to the x axis position with the DATA SCROLL Spinner. A vertical dashed line on the graticule indicates the current x axis position. The X Axis Position field, second value below the left side of the graticule, displays the x axis position value using the current time or frequency units.

Pressing XPOS Soft Function Key F2 deactivates YPOS Soft Function Key F1, if active. The highlighted label for Soft Function Key F2 and X Axis Position field indicate an x axis position edit is in progress.

Initial x axis position is the left edge of the graticule.

F3 SET

Sets the current x and y axis position values into the Create Trace function. An intensified dot on the Display indicates the set position. Only one position at a time is set before initiating a Draw action. Moving the x and y axis positions and pressing the SET Soft Function Key F3 again prior to a Draw action, changes the set position and removes the old set position.

F5 LIMITS (Continued)**F4 DRAW**

Initiates the Draw action to create new trace data. A Draw action occurs in one of two ways depending on the last set x and y axis position values and current x and y axis position values.

If the current x and y axis position values and the last set x and y axis position values are equal (same point), the Draw action replaces the trace amplitude value at the set x axis position with the new set y axis position value. A new trace segment is created by drawing straight lines from the trace amplitude value at the x axis position point before the set point (x-1 point) to the set point and from the set point to the trace amplitude value at the x axis position after the set point (x+1 point).

If the current x and y axis position values and the last set x and y axis position values are not equal (different points), the Draw action replaces the trace amplitude values between the last set x axis position and the current x axis position with the new y axis position values derived from the straight linear interpolation between the set point and current point. A new trace segment is created by drawing straight lines from the trace amplitude value at the x axis position point before the set (or current) point (x-1 point) to the set (or current) point, from the set (or current) to the current (or set) point and from the current (or set) point to the trace amplitude value at the x axis position after the current (or set) point (x+1 point).

F5 UNDO

Undoes the last Draw action, restoring trace to levels displayed before the last Draw action was initiated. Label above F5 appears only after a Draw action has been initiated.

F6 RETURN/ESC

RETURN freezes the created limits trace and returns primary Display Operation Screen labels for Soft Function Keys. The frozen created limits trace must be stored in memory before entering any other operation screen (see 4-9-1 for Memory Storage).

ESC aborts x and y axis position adjustments in progress. Aborting adjustments in progress resets the x and y axis positions to the last set positions.

Current x and y position edits must be set or aborted and deactivated before a return to the Display Operation Screen can be initiated.

3-3-16 DEMOD OPERATION SCREEN

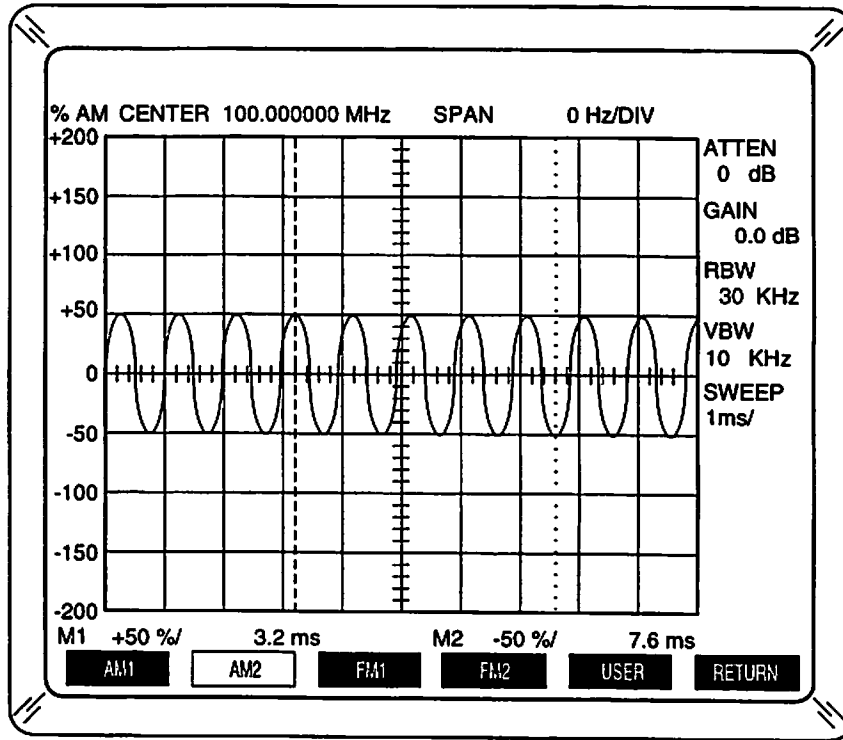

Figure 3-34 Demod AM/FM Receiver Operation Screen

01917022

Pressing the DEMOD Key enters the Demod AM/FM Receiver Operation Screen. Accessing an AM/FM Receiver mode forces the Frequency Span to 0 Hz/Div at the current Center Frequency setting. Resolution Bandwidth, Video Bandwidth and Amplitude Scale and Units are set according to AM/FM Receiver mode selected. Pressing the active Receiver mode Soft Function Key or accessing the Frequency Span Operation Screen deactivates current Receiver mode and restores previous Frequency Span, Resolution Bandwidth, Video Bandwidth and Amplitude Scale and Unit settings. Accessing the Bandwidth Amplitude Operation Screen in any Receiver mode except User-Defined also deactivates current Receiver mode and restores previous control settings. If User-Defined mode is selected, the Bandwidth and/or Scale Amplitude Operation Screens may be accessed and edited.

Refer to 4-5 for AM and FM measurements.

SOFT FUNCTION KEYS

KEY	DESCRIPTION
F1 AM1	Activates or deactivates narrow band AM demodulation mode. Sets Resolution and Video Bandwidths to 3 kHz. Amplitude display indicates percent modulation at 50% per division from 0% to +200% for up modulation and 0% to -200% for down modulation. (-100% is zero power.)
F2 AM2	Activates or deactivates wide band AM demodulation mode. Sets Resolution Bandwidth to 30 kHz and Video Bandwidth to 10 kHz. Amplitude display indicates percent modulation at 50% per division from 0% to +200% for up modulation and 0% to -200% for down modulation. (-100% is zero power.)
F3 FM1	Activates or deactivates narrow band FM demodulation mode. Sets Resolution Bandwidth to 30 kHz and Video Bandwidth to 3 kHz. Amplitude display indicates frequency deviation at 2 kHz per division from 0 to ± 8 kHz.
F4 FM2	Activates or deactivates wide band FM demodulation mode. Sets Resolution Bandwidth to 300 kHz and Video Bandwidth to 10 kHz. Amplitude display indicates FM deviation at 20 kHz per division from 0 to ± 80 kHz.
F5 USER	Activates or deactivates User-Defined demodulation mode. Demodulation mode and units are selected in the Scale Amplitude Operation Screen. Resolution and Video Bandwidths are selected in the Bandwidth Amplitude Operation Screen.

3-3-17 STORE OPERATION SCREEN

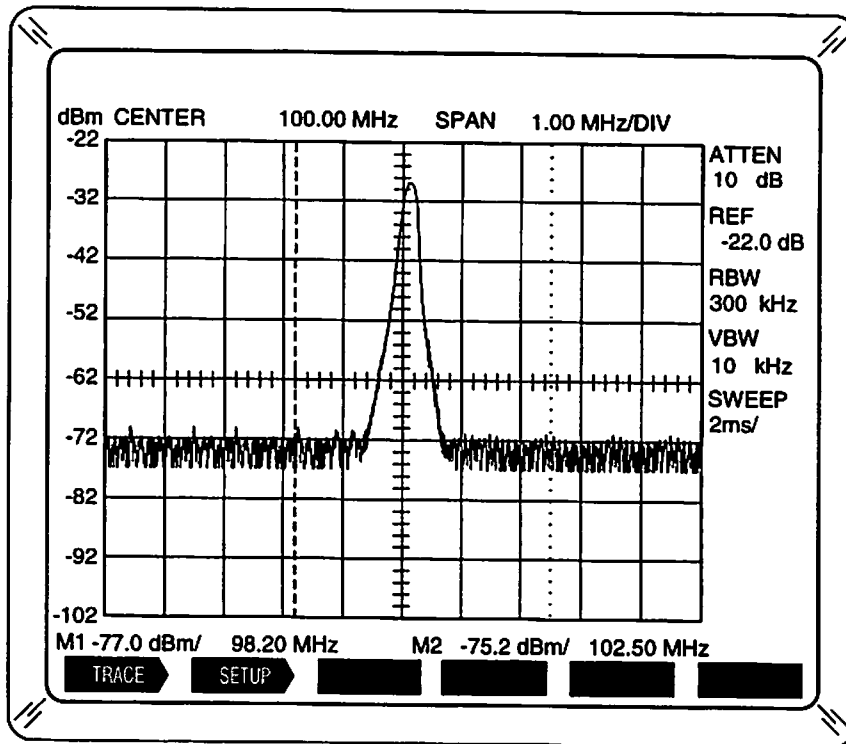

Figure 3-35 Store Memory Operation Screen

01917023

Pressing the STORE Key freezes the current signal and settings on the Display and enters the Store Memory Operation Screen. The Store Memory Operation Screen controls storage of waveforms (traces) and control settings (setups). Contents in Memory Locations remain intact, when power is removed from the AN1820. Pressing any of the FREQUENCY Keys, AMPLITUDE Keys or MODE Keys resumes sweep operation.

SOFT FUNCTION KEYS

KEY	DESCRIPTION
-----	-------------

F1 TRACE

Enters Store Trace Directory and secondary labels for Soft Function Keys. The Store Trace Directory displays a list of trace Memory Locations with protection designations, limit designations, time/date stamps and Storage Labels. The complete Store Memory function is accomplished in the Store Directory using the Soft Function Keys. The Memory Location is selected using the DATA SCROLL Spinner or ↑ and ↓ Keys. The Store Directory contains multiple pages. Selection is indicated by a cursor box around the Memory Location number.

F1 ENTER

Stores currently frozen trace (live or created) in selected Memory Location, if unprotected, overwriting previously stored data. Selected protection designation, selected limit designation, time/date stamp and created Storage Label are saved with the trace. Refer to note under 3-3-13A for storing traces with hold functions active.

NOTE: The x1 Key of the DATA ENTRY Keypad also performs the same function as the ENTER Soft Function Key F1.

F1 TRACE (Continued)

STORE TRACE DIRECTORY					
1	L	P	09:53:21	11-23-1992	SIGNAL
2	U	P			WAVEFORM
3					
4					
5					
6					
7					
8					
9					
10					

ENTER PROTECT UP LIM LO LIM LABEL ESC

00317007

Figure 3-36 Store Trace Directory

F2 PROTECT

Protects selected Memory Location from being overwritten by a subsequent Store Memory function. Protection designation is indicated with a **P** displayed before the time/date stamp.

F3 UP LIM

Designates currently frozen trace (live or created) as an Upper Limit trace for use in Limits functions. Memory Location is indicated as containing an Upper Limit trace with **U** displayed after the Memory Location number.

NOTE: A trace Memory Location cannot be designated simultaneously as an Upper and Lower Limit trace.

F4 LO LIM

Designates currently frozen trace (live or created) as a Lower Limit trace for use in Limits functions. Memory Location is indicated as containing a Lower Limit trace with **L** displayed after the Memory Location number.

NOTE: A trace Memory Location cannot be designated simultaneously as an Upper and Lower Limit trace.

F1 TRACE (Continued)**F5 LABEL/MORE**

LABEL enters the LABEL field located in right half of graticule in the selected Memory Location line. Allows entry of up to 20 characters for an optional Storage Label. Storage Labels are created from the 26-letter alphabet in upper case, base 10 numbers and a space. Storage Labels are entered using the DATA SCROLL Spinner, ↑ and ↓ Keys and ← and → Keys. Numeric Storage Labels may be entered using the DATA ENTRY Keypad. LABEL Soft Function Key F5 is pressed again to exit the LABEL field. Storage Labels are saved and trace is stored when ENTER Soft Function Key F1 or x1 Key is pressed.

MORE, displayed only with Hold function (accessed from the Display Operation Screen) active, enters another set of labels for Soft Function Keys.

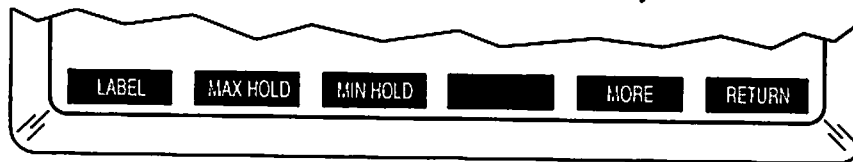

01908011

Figure 3-37 Store Trace Directory MORE Soft Function Keys

F1 LABEL

Functions same as LABEL Soft Function Key F5 when Hold function is inactive.

F2 MAX HOLD

Selects the displayed Maximum Hold trace to store in the currently selected Memory Location. The label above F2 appears only when the Maximum Hold function is active and the Display shows a Maximum Hold trace.

F3 MIN HOLD

Selects the displayed Minimum Hold trace to store in the currently selected Memory Location. The label above F3 appears only when the Minimum Hold function is active and the Display shows a Minimum Hold trace.

F5 MORE

Returns to the first set of Soft Function Keys in the Store Trace Directory.

F6 RETURN/ESC

RETURN returns to Store Memory Operation Screen with primary labels for Soft Function Keys.

ESC aborts entries in progress. Moving cursor box to another Memory Location also aborts entries in process.

F6 RETURN/ESC

RETURN returns to Store Memory Operation Screen with primary labels for Soft Function Keys.

ESC aborts entries in progress. Moving cursor box to another Memory Location also aborts entries in process.

F2 SETUP

STORE SETUP DIRECTORY				
1	P	09:30:25	12-19-1992	AM TEST
2		10:45:40	12-19-1992	FILTER TEST
3				
4				
5				
6				
7				
8				
9				
10				

ENTER PROTECT [] [] LABEL RETURN

01917025

Figure 3-38 Store Setup Directory

Enters Store Setup Directory and secondary labels for Soft Function Keys. The Store Setup Directory displays the list of setup Memory Locations with protection designations, time/date stamps and Storage Labels. Only basic operation and differences between the Soft Function Keys in the Store Trace and Store Setup Directories are described. Otherwise, operation is the same.

F1 ENTER

Stores current control settings in selected Memory Location, if unprotected, overwriting previously stored data. Selected protection designation, time/date stamp and created Storage Label are saved with the setup.

F2 PROTECT

Protects selected Memory Location from being overwritten by a later Store Memory function.

F5 LABEL

Enters LABEL field, located in right half of graticule, in the selected Memory Location line. Allows entry of ≤ 20 characters for an optional Storage Label.

F6 RETURN/ESC

RETURN returns to Store Memory Operation Screen with primary labels for Soft Function Keys.

ESC aborts entries in progress. Moving cursor box to another Memory Location also aborts entries in process.

3-3-18 RECALL OPERATION SCREEN

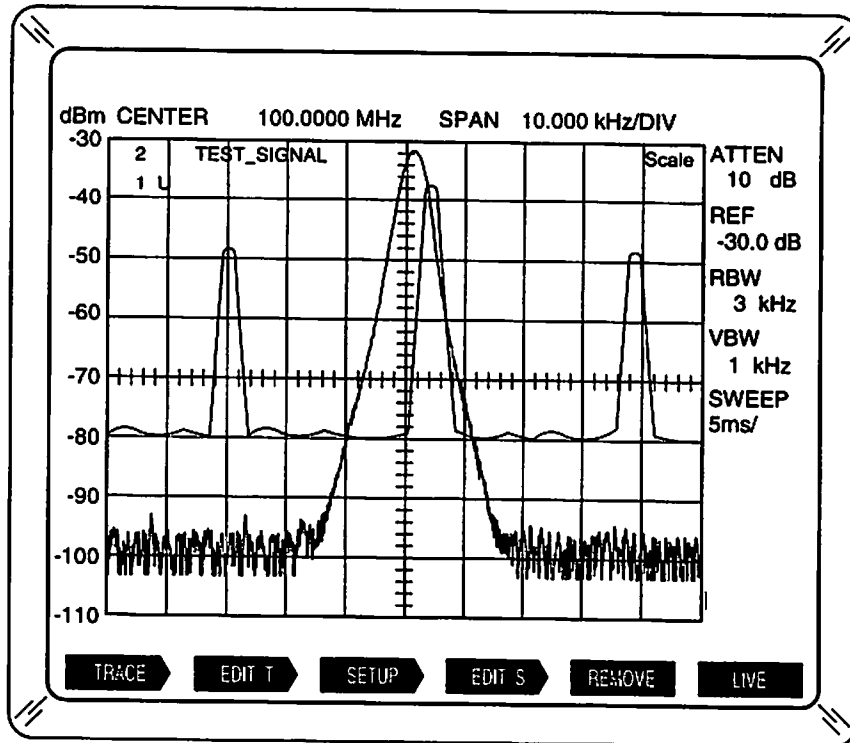

Figure 3-39 Recall Memory Operation Screen

01917026

Pressing the RECALL Key displays the Recall Memory Operation Screen. The Recall Memory Operation Screen controls recall of stored waveforms (traces) and control settings (setups).

A. DISPLAY INFORMATION

The AN1820 displays recalled traces with fields set to values as stored. Any protection designations (*P*), limit designations (Upper [*U*] or Lower [*L*]) and Storage Labels (top trace only) are displayed with the recalled Memory Location numbers in the Trace Display Stack. The Trace Display Stack is located in the upper left corner of the graticule. The last trace recalled or live trace, if displayed, is shown at the top of the Trace Display Stack. Control settings for the top trace are active as indicated on the Display. *Scale*, displayed in upper right corner of the graticule, indicates the recalled traces have different Display and scale settings. When *Scale* is displayed, only the top trace is shown accurately on the Display. Up to four traces, including the live trace, may be recalled and displayed at one time. Recalling a fifth trace removes the bottom trace in the Trace Display Stack.

The first trace recalled removes the live trace from the Display. Pressing any of the FREQUENCY Keys, AMPLITUDE Keys or MODE Keys displays the live trace with current control settings and last three recalled traces. If four recalled traces were displayed, the bottom trace is removed from the Display. The Trace Display Stack is displayed until recalled traces are removed.

B. SOFT FUNCTION KEYS

KEY	DESCRIPTION
-----	-------------

F1 TRACE

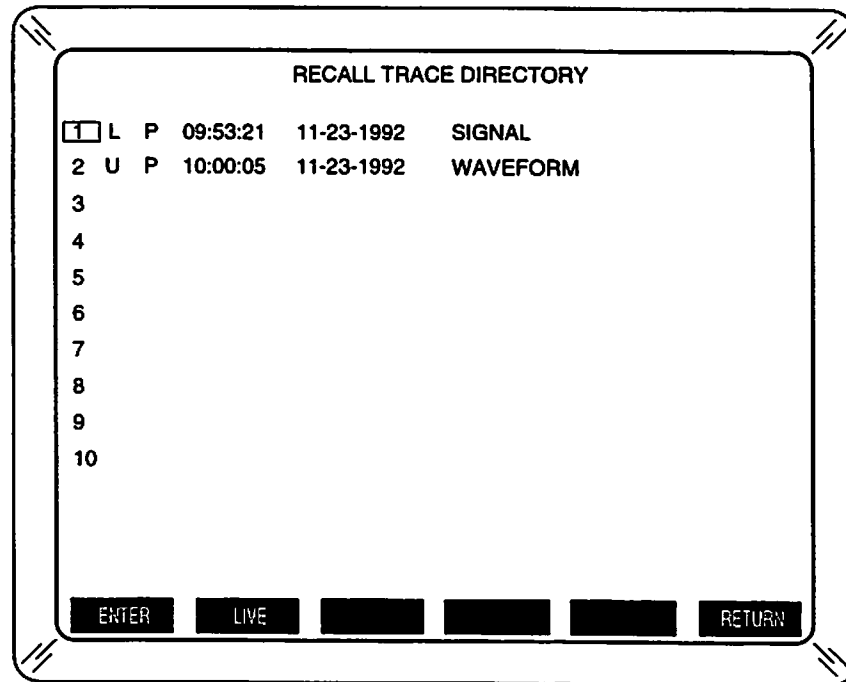

Figure 3-40 Recall Trace Directory

01917027

Enters Recall Trace Directory and secondary labels for Soft Function Keys. The Recall Trace Directory displays the list of trace Memory Locations with protection designations, limit designations, time/date stamps and Storage Labels. Memory Locations are selected using the DATA SCROLL Spinner or \uparrow and \downarrow Keys. The Recall Directory contains multiple pages. Selection is indicated by a cursor box around the Memory Location number.

F1 ENTER

Recalls selected Memory Location.

F2 LIVE

Recalls the current live trace indicated as Memory Location 0.

F6 RETURN

Returns to Recall Memory Operation Screen with primary labels for Soft Function Keys.

F2 EDIT T

Enters Edit Trace Directory and secondary labels for Soft Function Keys to edit contents of Memory Locations. The Edit Trace Directory displays the list of trace Memory Locations with protection designations, limit designations, time/date stamps and Storage Labels. The Soft Function Keys allow moving, copying and deleting the contents of Memory Locations.

F2 EDIT T (Continued)

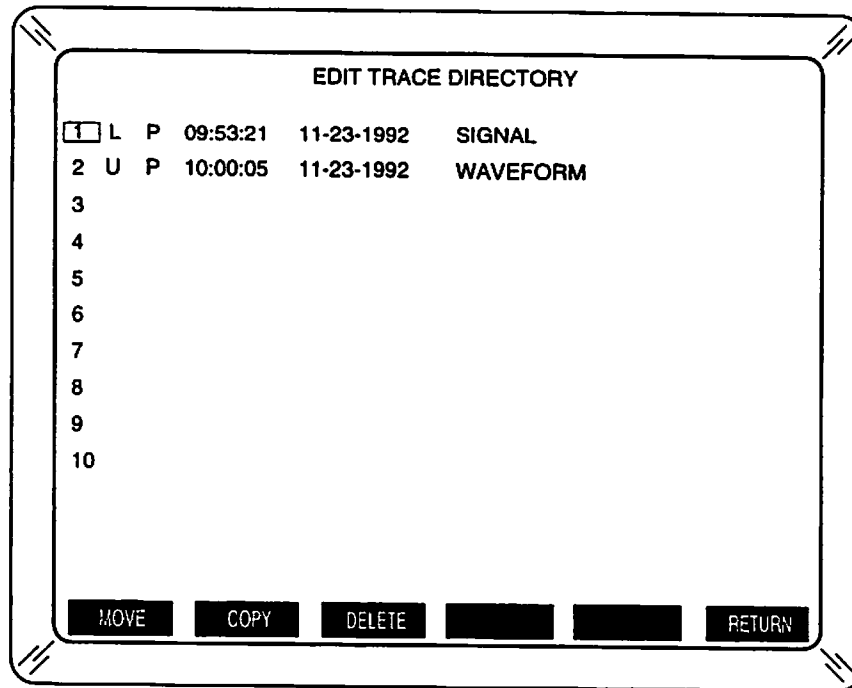

Figure 3-41 Edit Trace Directory

01917028

F1 MOVE

Moves contents of one trace Memory Location into another Memory Location. MOVE Soft Function Key F1 is pressed after selecting source Memory Location. **MOVE FROM X TO** (where X is selected source Memory Location) is displayed in lower left corner of Display. Selecting an unprotected Memory Location finishes the command: **MOVE FROM X TO Y** (where Y is selected destination Memory Location). Pressing highlighted MOVE Soft Function Key F1 causes the CONFIRM Soft Function Key F4 label to appear. Pressing highlighted CONFIRM Soft Function Key F5 completes the Move function. The destination Memory Location is overwritten with the contents from the source Memory Location. The source Memory Location is cleared after the Move function.

F2 COPY

Copies contents of one trace Memory Location into another Memory Location. COPY Soft Function Key F2 is pressed after selecting source Memory Location. **COPY FROM X TO** (where X is selected source Memory Location) is displayed in lower left corner of Display. Selecting an unprotected Memory Location finishes the command: **COPY FROM X TO Y** (where Y is the selected destination Memory Location). Pressing highlighted COPY Soft Function Key F1 causes the CONFIRM Soft Function Key F5 label to appear. Pressing highlighted CONFIRM Soft Function Key F5 completes the Copy function. The destination Memory Location is overwritten with the contents from source Memory Location. The contents of the source Memory Location are unchanged.

KEY

DESCRIPTION

F2 EDIT T (Continued)

F3 DELETE

Deletes contents of unprotected Memory Location. DELETE Soft Function Key F2 is pressed after selecting Memory Location. **DELETE FROM X TO** (where X is selected starting Memory Location) is shown in lower left corner of Display. Selecting an unprotected ending Memory Location finishes the command: **CLEAR FROM X TO Y** (where Y is selected ending Memory Location). Pressing highlighted DELETE Soft Function Key F3 causes the CONFIRM Soft Function Key F5 label to appear. Pressing highlighted CONFIRM Soft Function Key F5 completes the Delete function. All unprotected Memory Locations between and including the selected starting and ending Memory Locations are cleared (contents deleted).

F5 CONFIRM

Verifies and activates Memory Location edit in progress. Confirm function operates and label above F5 appears only as the final step of Memory Location edits.

F6 RETURN/ESC

RETURN returns to Recall Memory Operation Screen with primary labels for Soft Function Keys.

ESC aborts Memory Location edits in process.

F3 SETUP

RECALL SETUP DIRECTORY				
1	P	09:30:25	12-19-1992	AM TEST
2		10:45:40	12-19-1992	FILTER TEST
3				
4				
5				
6				
7				
8				
9				
10				

ENTER [] [] [] RETURN

Figure 3-42 Recall Setup Directory

01917029

Enters Recall Setup Directory and secondary labels for Soft Function Keys. The Recall Setup Directory displays the list of setup Memory Locations with protection designations, time/date stamps and Storage Labels.

KEY**DESCRIPTION****F3 SETUP (Continued)****F1 ENTER**

Recalls selected Memory Location.

F6 RETURN

Returns to Setup Recall Memory Operation Screen with primary labels for Soft Function Keys.

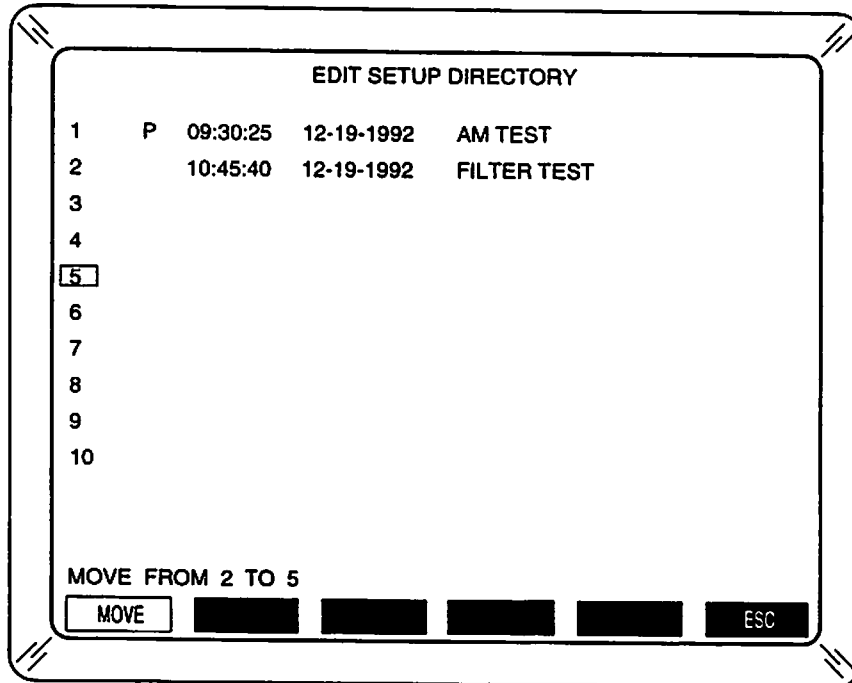
F4 EDIT S

00317008

Figure 3-43 Edit Setup Directory

Enters Edit Setup Directory and secondary labels for Soft Function Keys to edit contents of Memory Locations. The Edit Setup Directory displays the list of trace Memory Locations with protection designations, time/date stamps and Storage Labels. Soft Function Keys allow moving, copying and deleting the contents of Memory Locations. Only basic operation and differences between the Soft Function Keys in the Edit Trace and Edit Setup Directories are described. Otherwise, operation is the same.

F1 MOVE

Moves contents of one setup Memory Location into another Memory Location.

F2 COPY

Copies contents of one setup Memory Location into another Memory Location.

F3 DELETE

Deletes contents of a selected sequential group of unprotected Memory Locations.

KEY**DESCRIPTION**

F4 EDIT S (Continued)

F5 CONFIRM

Verifies and activates Memory Location edit in progress.

F6 RETURN/ESC

RETURN returns to Recall Memory Operation Screen with primary labels for Soft Function Keys.

ESC aborts Memory Location edits in progress.

F5 REMOVE

Removes recalled traces from Display as selected by entering applicable two digit Memory Location numbers in the REMOVE TRACE field located in the lower right side of the Display. The Trace Display Stack rotates and control settings are changed accordingly. Label above F5 only appears when the Display shows one or more recalled traces.

F6 LIVE/ESC

LIVE returns live trace to the Display, removing the Trace Display Stack and all other recalled traces. The LIVE label above F6 only appears when the Display shows one or more recalled traces.

ESC aborts Memory Location selection in process.

3-3-19 APPLICATION OPERATION SCREENS

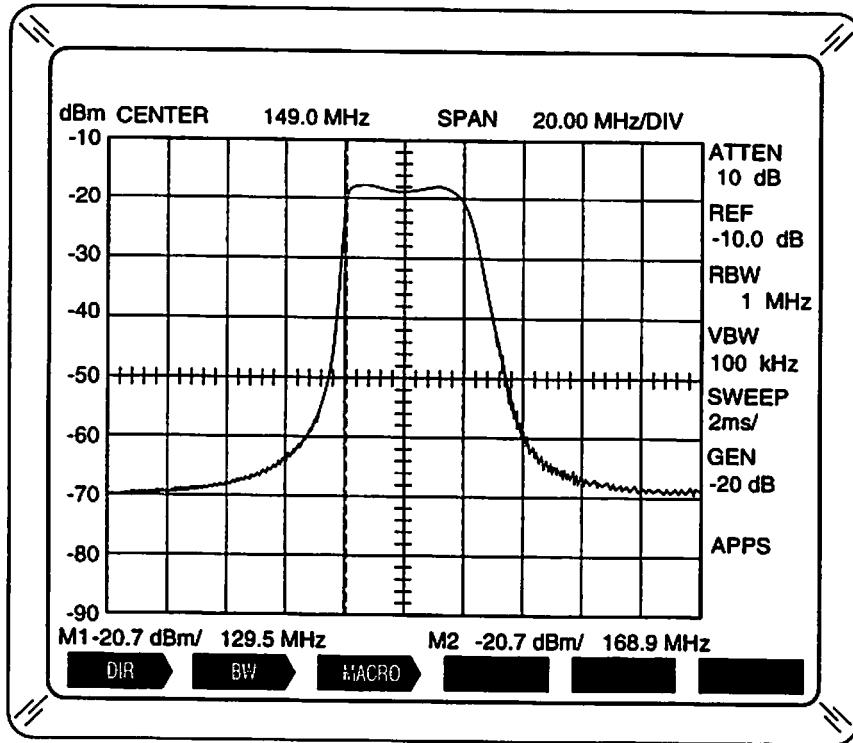

Figure 3-44 Application Operation Screen

01917031

Pressing the APPS Key enters the Application Operation Screen. The Application Operation Screen allows recall and operation of application programs from internal user memory and the predefined Bandwidth Application program. User-Defined application programs are activated using second level Soft Function Keys. The maximum size and number of application programs residing in memory at once are limited by the amount of available macro program memory. The AN1820 has 64 kilobytes of macro program memory available. User programs are entered via the RS-232 Connector or IEEE-488 GPIB Connector. Refer to the TMAC Users Manual (1002-0401-600) for programming application programs.

A. DISPLAY INFORMATION

APPS, located on the lower right side of the Display, indicates the Application Memory Operation Screen is accessed.

B. SOFT FUNCTION KEYS

KEY	DESCRIPTION
-----	-------------

F1 DIR

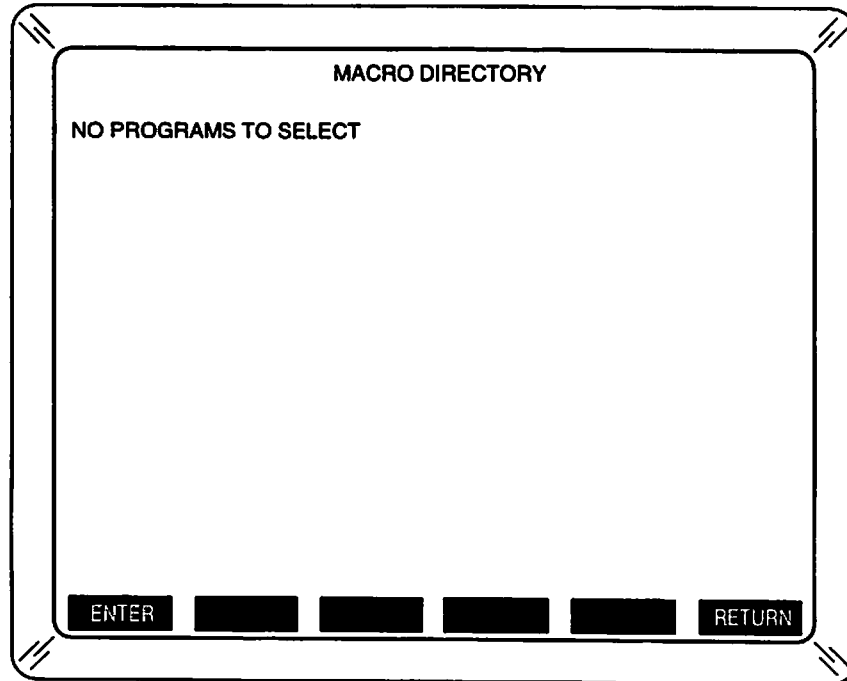

01917032

Figure 3-45 Macro Directory

Enters Macro Directory and secondary labels for Soft Function Keys. The Macro Directory displays the list of macro programs currently loaded into memory. Numbers from 1 to 5, located between the macro program number and the macro program name indicate a Soft Function Key assignment (shown and activated in the User-Defined Application Memory Operation Screen). Macro program names above the current Soft Function Key labels also indicate actual assignments in the User Defined Application Memory Operation Screen.

The DATA SCROLL Spinner or ↑ and ↓ Keys select macro programs. Selection is indicated by a cursor box around the macro program number. Macro programs are listed in reverse chronological order from the time loaded into memory (most recent is 1).

F1 ENTER

Enters Soft Function Key Assignment field for selected macro program. The DATA SCROLL Spinner or ↑ and ↓ Keys assign a Soft Function Key from 1 to 5 or 0 (removes assignment) to a macro program. Pressing highlighted ENTER Soft Function Key F1 completes the assignment. Refer to 4-10-1 for Assigning Macros From Front Panel procedure.

F6 RETURN/ESC

RETURN returns to Application Memory Operation Screen with primary labels for Soft Function Keys.

ESC aborts macro program assignment in progress.

KEY

DESCRIPTION

F2 BW

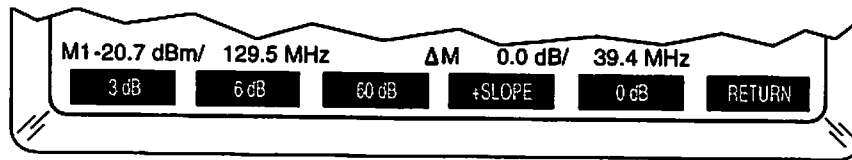

Figure 3-46 Bandwidth Application Soft Function Keys

01908012

Enters secondary labels for Soft Function Keys for the Bandwidth Application program. The Bandwidth Application program uses Marker 1 and the Delta Marker (see 3-3-9) to identify and measure the absolute frequency or frequency separation at the 3, 6 or 60 dB points on the displayed signal trace. Measurements are made on the live or top recalled trace. The program does not operate on AM/FM Receiver or Scope mode traces. Marker status and SLOPE Soft Function Key F4 setting determine how the Bandwidth Application program operates. Refer to 4-8-1 for Bandwidth Application program operation.

NOTE: The Bandwidth Application program does not reside in macro program memory.

Continued pressing of Soft Function Key F1, F2 or F3 causes the markers to alternately pass over each other to the applicable level as edit control is exchanged between the markers. When no applicable level is found, both markers are removed from the Display.

F1 3 dB

Marker(s) Inactive: Activates and sets marker(s) to first 3 dB points on both sides below maximum trace level or above minimum trace level (according to +SLOPE/-SLOPE Soft Function Key F4 setting). Markers move and are active only when 3 dB points are found.

Marker(s) Active: Activates and sets marker without edit control to first 3 dB point to the right of and above or below (according to +SLOPE/-SLOPE Soft Function Key F4 setting) the trace level at the marker with edit control position. Returns edit control to marker without edit control. If 3 dB point is not found, marker without edit control is removed from the Display. Both markers are removed if Marker 1 is without edit control.

KEY**DESCRIPTION**

F2 BW (Continued)**F2 6 dB**

Marker(s) Inactive: Activates and sets marker(s) to first 6 dB points on both sides below maximum trace level or above minimum trace level (according to +SLOPE/-SLOPE Soft Function Key F4 setting). Markers move and are active only when 6 dB points are found.

Marker(s) Active: Activates and sets marker without edit control to the first 6 dB point to the right of and above or below (according to +SLOPE/-SLOPE Soft Function Key F4 setting) the trace level at the marker with edit control position. Returns edit control to marker without edit control. If 6 dB point is not found, marker without edit control is removed from the Display. Both markers are removed if Marker 1 is without edit control.

F3 60 dB

Marker(s) Inactive: Activates and sets marker(s) to first 60 dB points on both sides below maximum trace level or above minimum trace level (according to +SLOPE/-SLOPE Soft Function Key F4 setting). Markers move and are active only when 60 dB points are found.

Marker(s) Active: Activates and sets marker without edit control to the first 60 dB point to the right of and above or below (according to +SLOPE/-SLOPE Soft Function Key F4 setting) the trace level at the marker with edit control position. Returns edit control to marker without edit control. If 60 dB point is not found, marker without edit control is removed from the Display. Both markers are removed if Marker 1 is without edit control.

F4 +SLOPE/-SLOPE

Toggles between +SLOPE and -SLOPE to set Search Slope. Bandwidth Application program operation depends on Search Slope setting.

● +SLOPE

Marker(s) Inactive: Bandwidth Application program searches for first 3, 6 or 60 dB points (according to Soft Function Key F1, F2 or F3 selection) on both sides below the maximum trace level.

Marker(s) Active: Bandwidth Application program searches for first 3, 6 or 60 dB point (according to Soft Function Key F1, F2 or F3 selection) to the right and above the trace level at the marker with edit control position.

KEY	DESCRIPTION
-----	-------------

F2 BW (Continued)

F4 +SLOPE/-SLOPE

● -SLOPE

Marker(s) Inactive: Bandwidth Application program searches for first 3, 6 or 60 dB points (according to Soft Function Key F1, F2 or F3 selection) on both sides above the minimum trace level.

Marker(s) Active: Bandwidth Application program searches for first 3, 6 or 60 dB point (according to Soft Function Key F1, F2 or F3 selection) to the right and below the trace level at the marker with edit control position.

F5 0 dB

Activates and sets marker without edit control to first point to the right of and equal to (0 dB point) the trace level at the marker with edit control position. Returns edit control to marker without edit control. If 0 dB point is not found, marker without edit control is removed from the Display. Both markers are removed if Marker 1 is without edit control. The 0 dB function operates and label above F5 appears only when one or both markers are active.

F3 MACRO

Enters the Macro Operation Screen with secondary labels for Soft Function Keys. The Macro Operation Screen provides access to assigned macro programs loaded into memory. Pressing assigned Soft Function Keys activate the associated macro programs. Refer to 4-10-2 for Operating Macros From Front Panel procedure. Refer to the TMAC Users Manual (1002-0401-600) for programming application programs.

C. APPLICATION NOTES:

NOTE: Space is provided to note User-Defined application programs and definition of Soft Function Keys.

3-3-20 ANALYZER UTILITY MENU AND SCREENS

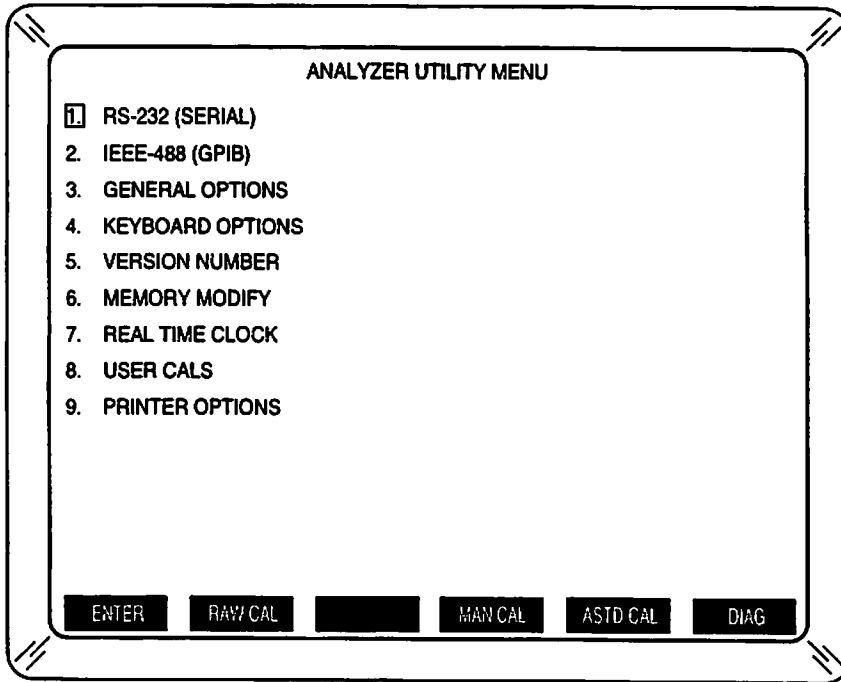

01917033

Figure 3-47 Analyzer Utility Menu

Pressing the UTILITY Key removes all displayed traces and enters the Analyzer Utility Menu. The Analyzer Utility Menu provides access to connector setups, configuration options, memory protection control, time/date edits, calibrations and self tests. Calibrations and self tests are entered by pressing Soft Function Keys. Other Analyzer Utility functions are entered through the displayed menu list. Menus and menu items are accessed by selecting desired submenu or item using ↑ and ↓ Keys, DATA ENTRY Keypad or DATA SCROLL Spinner. A cursor box around the menu or item number indicates selection. Pressing ENTER Soft Function Key F1 accesses the selected menu or item field. Pressing the UTILITY Key or any of the MODE Keys, FREQUENCY Keys or AMPLITUDE Keys exits the Analyzer Utility Menu and restores previous settings.

A. RS-232 (SERIAL) SCREEN

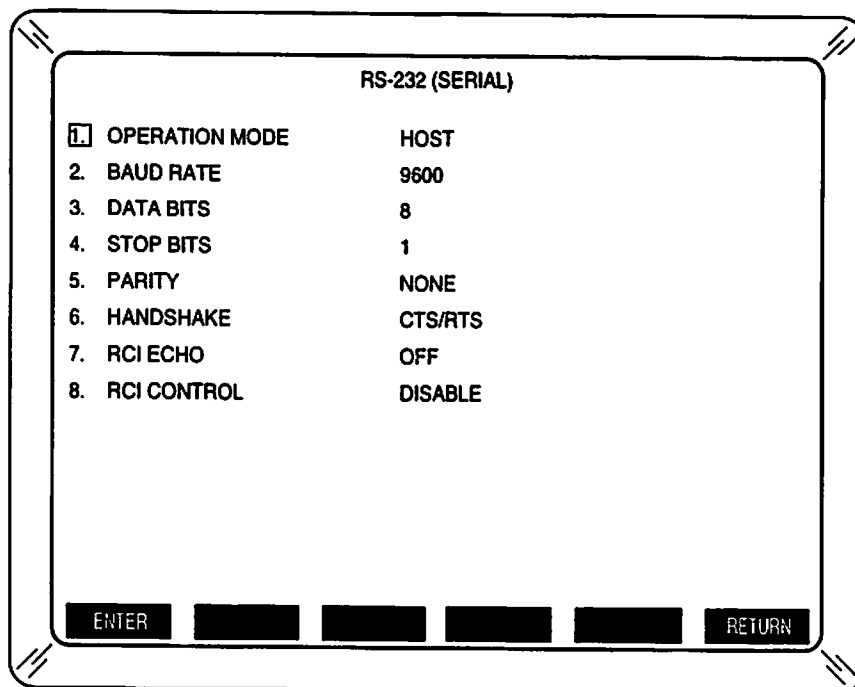

Figure 3-48 RS-232 (Serial) Screen

01917034

The RS-232 (Serial) Screen allows edits to the RS-232 Connector interface settings. Refer to Section 6 for operation procedures. The ↑ and ↓ Keys or DATA SCROLL Spinner selects interface parameters. The RS-232 (Serial) Screen uses three Soft Function Keys:

F1 ENTER

Enters or exits (saving the edit) the selected item field.

NOTE: The x1 Key of the DATA ENTRY Keypad also performs the same function as the ENTER Soft Function Key F1.

F6 RETURN/ESC

RETURN returns to the Analyzer Utility Menu.

ESC aborts an interface parameter edit in process.

ITEM	DESCRIPTION
1. OPERATION MODE	Selects OFF, HOST (remote control of AN1820) or PLOTTER (to send a plot to HPGL compatible plotter) for RS-232 operating mode. NOTE: PLOTTER does not appear if PLOTTER (HPGL) is selected for OPERATION MODE in Analyzer Utility Menu IEEE-488 (GPIB) Screen.
2. BAUD RATE	Selects rates of 110, 150, 300, 600, 1200, 2400, 4800, 9600, 19200 or 38400 bps.
3. DATA BITS	Selects number of data bits per word, 7 or 8.

ITEM**DESCRIPTION**

4. STOP BITS

Selects number of stop bits per word, 1 or 2.

5. PARITY

Selects parity check mode. Selection is NONE, ODD or EVEN.

6. HANDSHAKE

Selects handshake mode. Selection is NONE, CTS/RTS (hardware) or XON/XOFF (software).

NOTE: HANDSHAKE should be set to NONE or XON/XOFF when nothing is connected to RS-232 Connector.

7. RCI ECHO

Enables (ON) or disables (OFF) RCI echo.

8. RCI CONTROL

Activates (ENABLE) or deactivates (DISABLE) RCI control.

B. IEEE-488 (GPIB) SCREEN

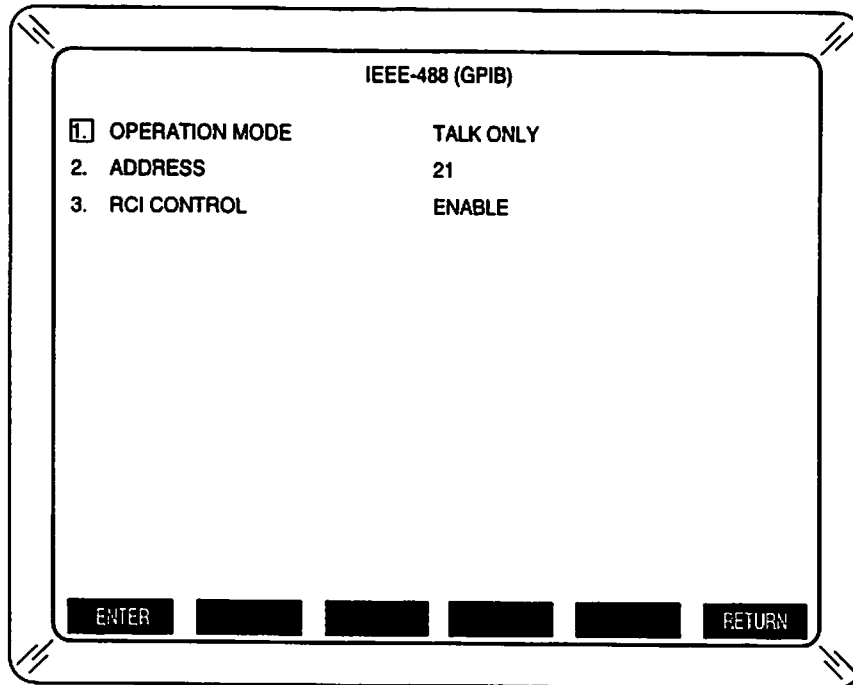

Figure 3-49 IEEE-488 (GPIB) Screen

01917035

The IEEE-488 (GPIB) Screen allows edits to the IEEE-488 GPIB Connector operating mode, address settings and RCI Control. Refer to Section 6 for operation procedures. The ↑ and ↓ Keys or DATA SCROLL Spinner selects mode, address and RCI Control parameters. The IEEE-488 (GPIB) Screen uses three Soft Function Keys:

F1 ENTER

Enters or exits (saving the edit) the selected item field.

NOTE: The x1 Key of the DATA ENTRY Keypad also performs the same function as the ENTER Soft Function Key F1.

F6 RETURN/ESC

RETURN returns to the Analyzer Utility Menu.

ESC aborts an operating mode or address parameter edit in process.

ITEM	DESCRIPTION
1. OPERATION MODE	Selects OFF, TALK/LISTEN, TALK ONLY, LISTEN ONLY or PLOTTER (HPGL) for GPIB operating mode. NOTE: PLOTTER (HPGL) does not appear if PLOTTER is selected for OPERATION MODE in Analyzer Utility Menu RS-232 (SERIAL) Screen.
2. ADDRESS	Selects address from 0 to 31 for GPIB bus operation.
3. RCI CONTROL	Activates (ENABLE) or deactivates (DISABLE) RCI control.

C. GENERAL OPTIONS SCREEN

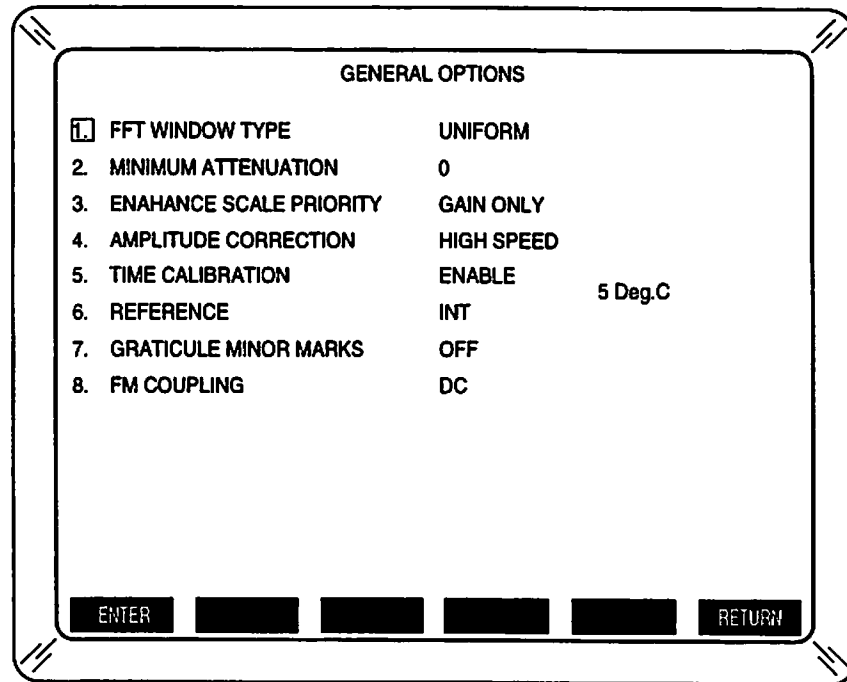

01917036

Figure 3-50 General Options Screen

The General Options Screen allows edits to general operation parameters. The ↑ and ↓ Keys or DATA SCROLL Spinner selects parameters. The General Options Screen uses three Soft Function Keys:

F1 ENTER

Enters or exits (saving the edit) the selected item field.

NOTE: The x1 Key of the DATA ENTRY Keypad also performs the same function as the ENTER Soft Function Key F1.

F6 RETURN/ESC

RETURN returns to the Analyzer Utility Menu.

ESC aborts an operation parameter edit in process.

ITEM	DESCRIPTION
1. FFT WINDOW TYPE	<p>Selects data window function used with the 3 to 100 Hz digital RBW filters when operating in the FFT mode (see 3-3-12). The data window function selected depends on the type of signal and desired display characteristics. Selection is UNIFORM (Dirichlet or rectangular), BARTLETT (Fejer or triangular), BLACKMAN, BLACKMAN-HARRIS, HAMMING, HANN (Hanning), or NUTTALL. See Appendix D.</p> <p>NOTE: The AN1820 requires 5 to 10 seconds to display the signal after changing the FFT WINDOW TYPE. <i>WAIT</i> in the Message field indicates the delay.</p>

ITEM

DESCRIPTION

2. MINIMUM ATTENUATION

Selects the Minimum Internal Attenuation Limit. Internal attenuation, set in the Attenuation Amplitude Screen, cannot be adjusted below the Minimum Internal Attenuation Limit. Selection range is from 0 to 60 dB in 10 dB steps.

3. ENHANCE SCALE PRIORITY

Selects the internal gain and attenuation switching when the Enhanced Logarithmic display mode is active (see 3-3-8). Enhanced Logarithmic display mode increases dynamic display range to 120 dB at 10 dB/Div by switching in 40 dB of attenuation (ATTEN ONLY), 40 dB of gain (GAIN ONLY) or a combination (attenuation first and then gain, if needed [ATTEN THEN GAIN]) to provide the additional 40 dB of range.

4. AMPLITUDE CORRECTION

Selects digitizer mode of operation (HIGH SPEED or CALIBRATED) for Frequency Spans above 200 Hz/Div. HIGH SPEED digitizes trace data using the high speed 25 MHz flash converter. HIGH SPEED provides a high sweep repetition rate at reduced accuracy for Frequency Spans above 1 MHz/Div. CALIBRATED digitizes trace data using the high resolution 100 kHz digitizer. CALIBRATED provides maximum measurement accuracy at reduced sweep repetition rates.

5. TIME CALIBRATION

Activates (ENABLE) or deactivates (DISABLE) internal automatic calibrations. Internal automatic calibrations are performed every five minutes when activated.

Setting TIME CALIBRATION to ENABLE moves the cursor box to the temperature change field. The temperature change field determines the amount of internal temperature change required to initiate the automatic calibration. The temperature change field ranges from 2° to 10° C in 1° increments.

NOTE: Internal automatic calibrations may interfere with some measurements. In a stable temperature environment, deactivating the TIME CALIBRATION may be preferable. Manually activating the TIME CALIBRATION periodically is strongly recommended for consistent operation.

The TIME CALIBRATION is manually activated one time by:

- Entering the General Options Screen,
- Setting TIME CALIBRATION to ENABLE,
- Exiting from both the General Options Screen and Analyzer Utility Menu,
- Waiting for **CAL** to appear and disappear in the Message field,
- Reentering the Analyzer Utility Menu General Options Screen,
- Setting TIME CALIBRATION to DISABLE,
- Exiting from both the General Options Screen and Analyzer Utility Menu.

6. REFERENCE

Selects system time base reference, internal (INT) or external (EXT). The external reference requires a 10 MHz signal applied to the EXT REF IN Connector.

ITEM**DESCRIPTION**

7. GRATICULE MINOR MARKS

Controls activation of the graticule minor marks on the Display. OFF displays no minor marks, VERTICAL displays only the y scale minor marks, HORIZONTAL displays only the x scale minor marks or BOTH displays x and y scale minor marks.

8. FM COUPLING

Selects coupling (AC or DC) when operating in FM demodulation modes. DC displays the absolute carrier and is useful for looking at frequency hopping devices or FM digital with data rates ≤ 10 Hz. AC, the default used for regular FM audio signals, displays relative frequency.

D. KEYBOARD OPTIONS SCREEN

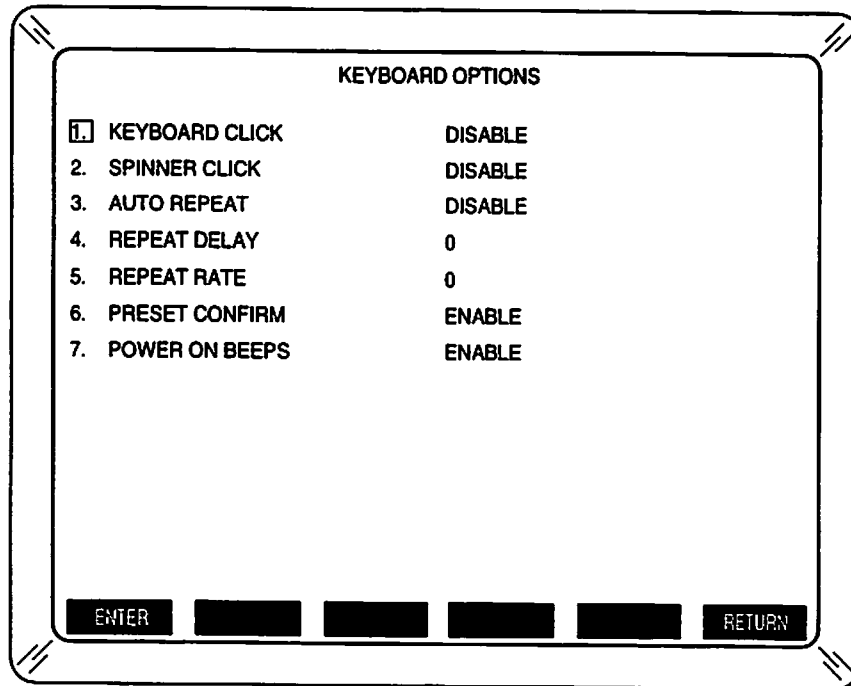

00317011

Figure 3-51 Keyboard Options Screen

The Keyboard Options Screen allows edits to Keyboard operation parameters. The ↑ and ↓ Keys or DATA SCROLL Spinner selects parameters. The Keyboard Options Screen uses three Soft Function Keys:

F1 ENTER

Enters or exits (saving the edit) the selected item field.

NOTE: The x1 Key of the DATA ENTRY Keypad also performs the same function as the ENTER Soft Function Key F1.

F6 RETURN/ESC

RETURN returns to the Analyzer Utility Menu.

ESC aborts an operation parameter edit in process.

ITEM	DESCRIPTION
1. KEYBOARD CLICK	Enables (ENABLE) or disables (DISABLE) annunciator beep when any front panel key is pressed.
2. SPINNER CLICK	Enables (ENABLE) or disables (DISABLE) annunciator beep when DATA SCROLL Spinner is adjusted.
3. AUTO REPEAT	Enables (ENABLE) or disables (DISABLE) ability to press and hold down a key for multiple input.

ITEM**DESCRIPTION**

4. REPEAT DELAY

Sets delay between pressing a key and when input is repeated if key is held down with AUTO REPEAT set to ENABLE. The delay is set from 1 to 10 in 200 ms increments (200 ms to 2 s). Default 0 is 800 ms.

5. REPEAT RATE

Sets time period for each subsequent repetition of key input when key is held down with AUTO REPEAT set to ENABLE. The repetition period is set from 0 (100 ms) or 1 to 10 in 200 ms increments (200 ms to 2 s). The default is 0.

6. PRESET CONFIRM

Enables (ENABLE) or disables (DISABLE) the CONFIRM Soft Function Key F5 to verify setting the AN1820 to the preset factory defaults.

7. POWER ON BEEPS

Enables (ENABLE) or disables (DISABLE) the beep sound during power up used to indicate okay operation status.

E. VERSION NUMBER SCREEN

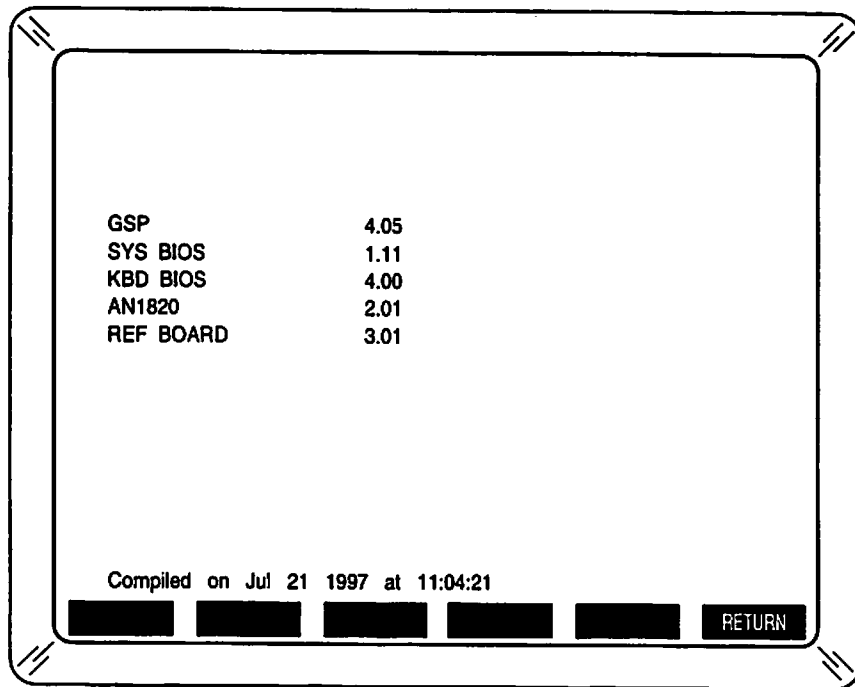

00217001

Figure 3-52 Version Number Screen

The Version Number Screen displays numbers of firmware versions currently installed in the AN1820. The Version Number Screen uses one Soft Function Key: RETURN Soft Function Key F5 returns to Analyzer Utility Menu.

The Version Number Screen displays the following:

- **GSP**
Indicates the version number of the graphics signal processor (GSP) (Video Controller) firmware.
- **SYS BIOS**
Indicates the version number of the Basic Input/Output System (BIOS) firmware for the System Controller.
- **KBD BIOS**
Indicates the version number of the BIOS firmware for the Keyboard (KBD) Controller.
- **AN1820**
Indicates the version number of the AN1820 operation firmware.
- **REF BOARD**
Indicates the version number of the Frequency Reference firmware.
- **Compilation Date and Time**
Indicates the compilation date and time (shown at the bottom of the Display).

F. MODIFY MENUS

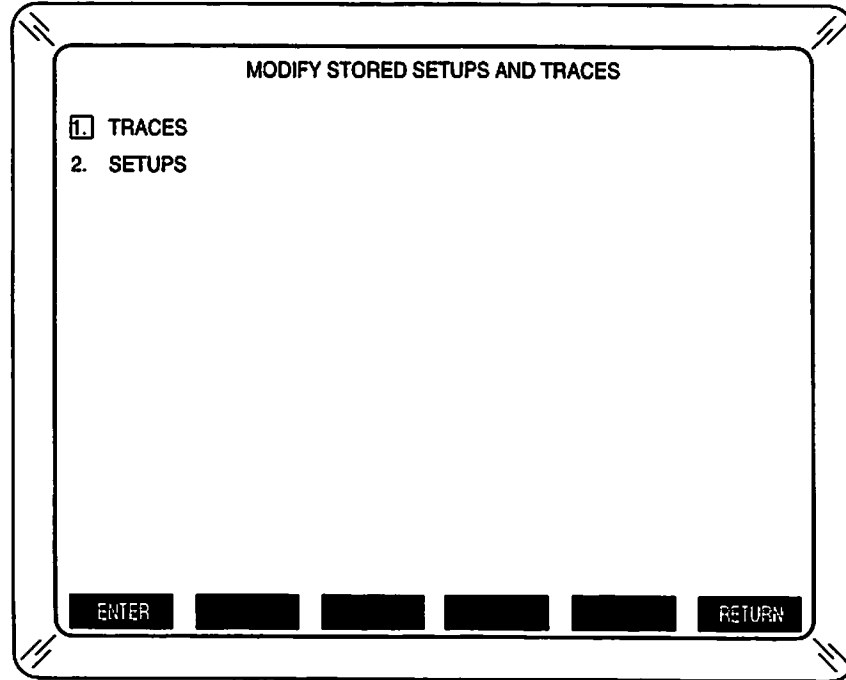

01917039

Figure 3-53 Modify Memory Main Menu

The Modify Memory Main Menu provides access to the Modify Trace Memory and Modify Setup Memory Menus. Modify Memory Menus allow modification of Storage Labels and designations without overwriting the stored data. The only way to change protected Memory Locations to unprotected is through the Modify Memory Menus. The desired submenu is selected using the ↑ and ↓ Keys or DATA SCROLL Spinner. The Modify Memory Main Menu uses two Soft Function Keys:

F1 ENTER

Enters the selected submenu.

NOTE: The x1 Key of the DATA ENTRY Keypad also performs the same function as the ENTER Soft Function Key F1.

F6 RETURN

Returns to the Analyzer Utility Menu.

ITEM	DESCRIPTION
------	-------------

1. TRACES	
-----------	--

Enters Modify Trace Memory Menu.	
----------------------------------	--

2. SETUPS	
-----------	--

Enters Modify Setup Memory Menu.	
----------------------------------	--

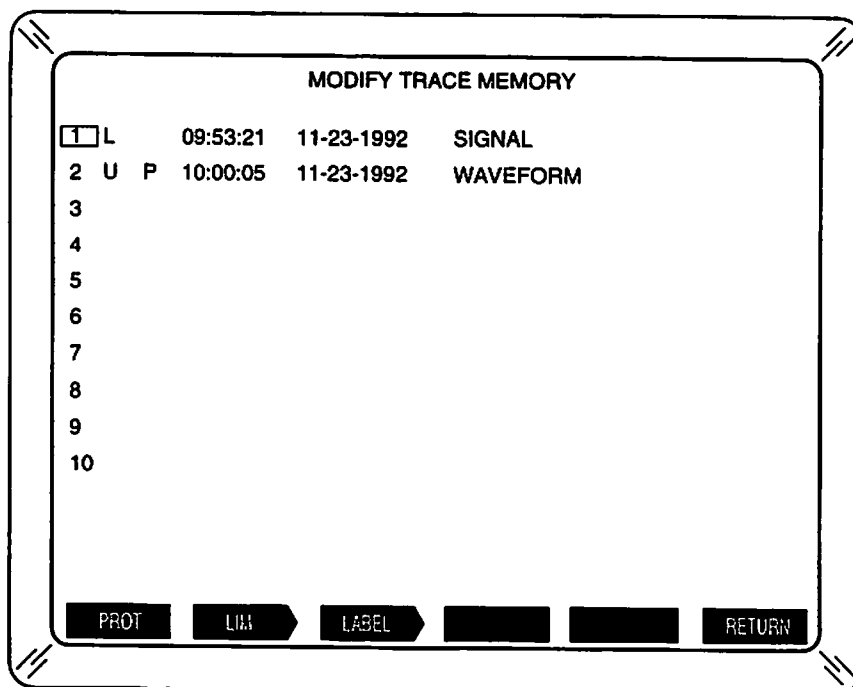

01917040

Figure 3-54 Modify Trace Memory Menu

The Modify Trace Memory Menu allows edits to protection designations, limit designations and Storage Labels of trace Memory Locations. The Modify Trace Memory Menu displays a list of trace Memory Locations with protection designations, limit designations, time/date stamps and Storage Labels (same as Store Trace Directory). The Modify Trace Memory Menu contains multiple pages. Selection is indicated by a cursor box around the Memory Location number. The desired Memory Location is selected using the ↑ and ↓ Keys or DATA SCROLL Spinner. The Modify Trace Memory Menu uses four primary Soft Function Keys:

ITEM	DESCRIPTION
------	-------------

F1 PROT/UNPROT

Sets Memory Location to Protected to prevent chance of overwriting stored trace. No other modifications can be made if Memory Location is Protected. If Protected, UNPROT Soft Function Key F1 sets Memory Location to Unprotected.

F2 LIM

Enters secondary labels for Soft Function Keys, to edit the limit designation:



01908013

Figure 3-55 Modify Trace Memory LIM Soft Function Keys

F1 REMOVE

Removes limit designation.

F2 UP LIM

Designates selected trace as an Upper Limit trace.

ITEM

DESCRIPTION

F3 LO LIM

Designates selected trace as a Lower Limit trace.

F6 RETURN

Returns primary labels for Modify Trace Memory Menu Soft Function Keys.

F3 LABEL

Enters secondary labels for Soft Function Keys to edit the Storage Label:

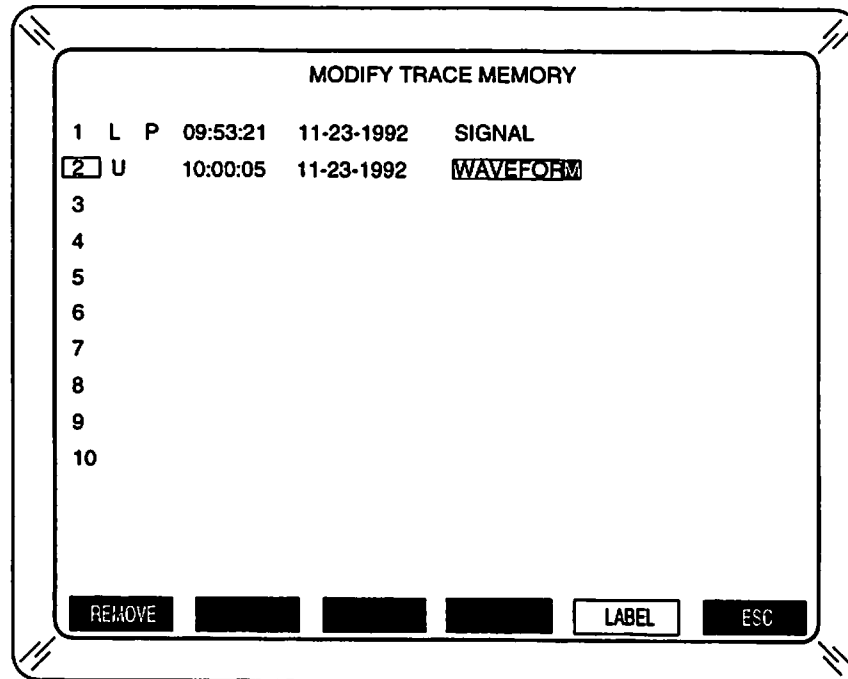

Figure 3-56 Modify Trace Memory LABEL Function

00317012

F1 REMOVE

Removes Storage Label.

F5 LABEL

Allows edits to the existing Storage Label or allows creation of a Storage Label. Storage Labels, up to 20 characters in length, are created from the 26-letter alphabet in upper case, base 10 numbers and a space. Storage Labels are entered using the ↑ and ↓ Keys, ← and → Keys and DATA SCROLL Spinner. Numeric Storage Labels may be entered using the DATA ENTRY Keypad. Pressing the LABEL Soft Function Key F5 again saves and exits the LABEL field.

F6 RETURN/ESC

RETURN returns primary labels for Modify Trace Memory Menu Soft Function Keys.

ESC aborts Storage Label edit in progress.

F6 RETURN

Returns to Modify Memory Main Menu.

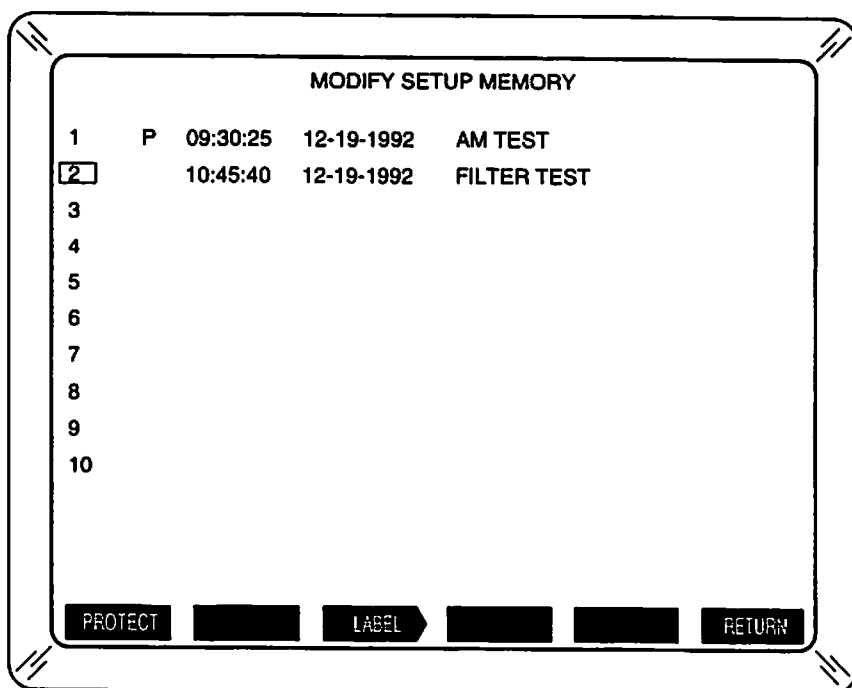

01917042

Figure 3-57 Modify Setup Memory Menu

The Modify Setup Memory Menu allows edits to protection designations and Storage Labels of setup Memory Locations. The Modify Setup Memory Menu displays a list of setup Memory Locations with protection designations, time/date stamps and Storage Labels (same as Store Setup Directory). The Modify Setup Memory Menu contains multiple pages. Selection is indicated by a cursor box around the Memory Location number. The desired Memory Location is selected using the ↑ and ↓ Keys or DATA SCROLL Spinner. The Modify Setup Memory Menu uses three primary Soft Function Keys:

- **PROT/UNPROT Soft Function Key F1** sets Memory Location to Protected to prevent chance of overwriting stored trace. No other modifications can be made if Memory Location is Protected. If Protected, UNPROT Soft Function Key F1 sets Memory Location to Unprotected.
- **LABEL Soft Function Key F3** enters same secondary labels as in Modify Trace Memory Menu for Soft Function Keys to edit the Storage Label (see Figure 3-56):

REMOVE Soft Function Key F1 removes Storage Label.

LABEL Soft Function Key F5 allows edits to the existing Storage Label or allows creation of a Storage Label. Storage Labels, up to 20 characters in length, are created from the 26-letter alphabet in upper case, base 10 numbers and a space. Storage Labels are entered using the ↑ and ↓ Keys, ← and → Keys and DATA SCROLL Spinner. Numeric Storage Labels may be entered using the DATA ENTRY Keypad. LABEL Soft Function Key F5 is pressed again to exit and save the LABEL field.

RETURN/ESC Soft Function Key F6 returns primary labels for Modify Setup Memory Menu Soft Function Keys or aborts Storage Label edit in progress.

- **RETURN Soft Function Key F6** returns to Modify Memory Main Menu.

G. REAL TIME CLOCK SET SCREEN

REAL TIME CLOCK

DATE : MAY 17 , 1997

TIME : 11 : 24 : 45

RUN TIME

HOURS 24 MINUTES 37

ENTER [] PREVIOUS NEXT RETURN []

01917043

Figure 3-58 Real Time Clock Set Screen

The Real Time Clock Set Screen allows edits to the date/time settings and also displays accumulated operating time. Soft Function Keys select data field to edit. Data fields are set using the ↑ and ↓ Keys or DATA SCROLL Spinner The DATA ENTRY Keypad may be used for numeric data. The Real Time Clock Set Screen uses five Soft Function Keys:

F1 ENTER

Enters current data setting for the selected data field and advances cursor box to the next data field.

F3 PREVIOUS

Moves cursor box to previous data field.

F4 NEXT

Advances cursor box to next data field.

F6 RETURN/ESC

RETURN returns to Analyzer Utility Menu.

ESC aborts data field edit in process.

The Real Time Clock Set Screen displays the following data fields:

- **DATE:** Three-part data field (each part separately editable) sets current date. The first part sets the month from JAN to DEC. The second part sets the day from 01 to 28, 29, 30 or 31 depending on month and year. The third part sets the year from 1997 to 9999.
- **TIME:** Three-part data field (each part separately editable) sets current time to the nearest second. The first part sets the hour from 00 to 23. The second part sets the minutes from 00 to 59. The third part sets the seconds from 00 to 59.
- **RUN TIME** displays the HOURS and MINUTES of accumulated operating time.

H. USER CALS SCREEN

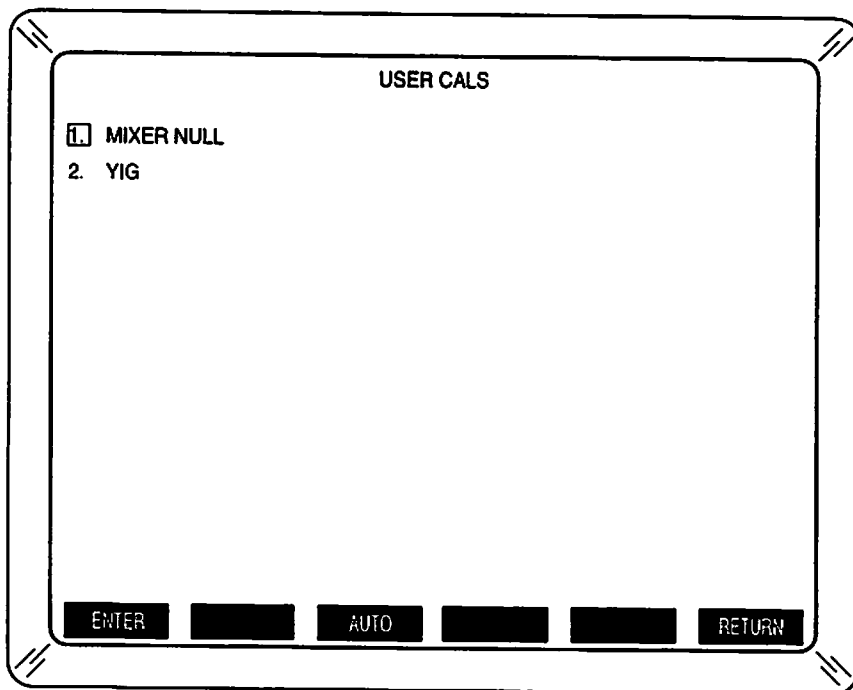

Figure 3-59 User Cals Screen

01917044

The User Cals Screen allows an operator to perform some internal calibrations as needed. The ↑ and ↓ Keys or DATA SCROLL Spinner selects the specific calibration. The User Cals Screen uses three Soft Function Keys:

F1 ENTER

Performs selected user calibration.

F3 AUTO

Performs all user calibrations.

F6 RETURN/ESC

RETURN returns to Analyzer Utility Menu.

ESC aborts the current calibration in progress.

ITEM	DESCRIPTION
------	-------------

1. MIXER NULL	
---------------	--

	Selects the mixer null calibration. Used when displaying low frequencies to provide a quiet and stable noise floor.
--	---

2. YIG	
--------	--

	Selects YIG oscillator calibration (more detailed than the automatic calibration performed when the internal operating temperature changes). Used when the YIG oscillator fail message, <i>YIG</i> , appears in the Message field.
--	--

I. PRINTER OPTIONS SCREEN

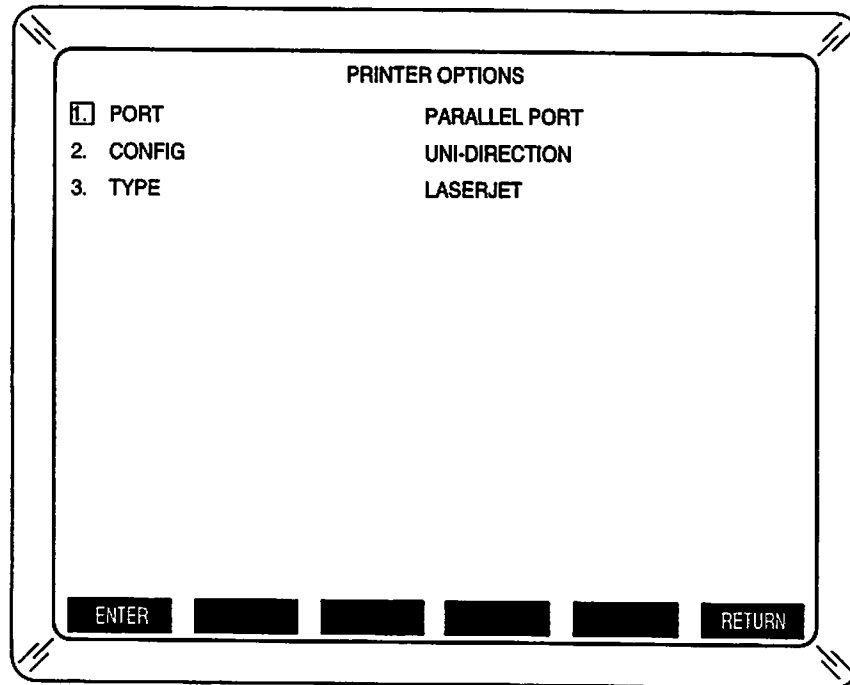

Figure 3-60 Printer Options Screen

01917045

The Printer Options Screen allows edits to printer operation parameters. The \uparrow and \downarrow Keys or DATA SCROLL Spinner selects parameters. The Printer Options Screen uses two Soft Function Keys:

F1 ENTER

Enters or exits (saving the edit) the selected item field.

NOTE: The x1 Key of the DATA ENTRY Keypad also performs the same function as the ENTER Soft Function Key F1.

F6 RETURN/ESC

RETURN returns to the Analyzer Utility Menu.

ESC aborts an operation parameter edit in process.

ITEM	DESCRIPTION
1. PORT	Selects the output connector for the print screen function accessed from the Copy Operation Screen. PARALLEL PORT selects the PRINTER Connector. GPIB selects the IEEE-488 GPIB Connector. RS232 selects the RS-232 Connector.
2. CONFIG	Selects printer communication configuration, UNI-DIRECTION for receive only printers or BI-DIRECTION for transmit-receive capable printers.
3. TYPE	Selects the drivers for the type of external printer (EPSON 24, EPSON 9, THINKJET or LASERJET) connected to the AN1820.

J. ANALYZER UTILITY MENU SOFT FUNCTION KEYS

KEY	DESCRIPTION
F1 ENTER	Accesses selected menu or screen.
F2 RAW CAL	Manual setting of calibration parameters only accessible by authorized maintenance personnel. Refer to AN1800 Series Maintenance Manual (1002-0401-400).
F4 MAN CAL	Internal manual calibration only accessible by authorized maintenance personnel. Refer to AN1800 Series Maintenance Manual (1002-0401-400).
F5 ASTD	Assisted internal calibration only accessible by authorized maintenance personnel. Refer to AN1800 Series Maintenance Manual (1002-0401-400).
F6 DIAG	Initiates the diagnostic sequence in the AN1820 for self test performance evaluation and fault isolation (see Section 5).

SECTION 4 - OPERATION

4-1 GENERAL

This section contains information for setting up and operating the AN1820. Operation includes performing basic measurements and utilizing common applications. Operation Procedures also contain instructions for using AN1820 special features, such as the Enhanced Logarithmic display mode, External Mixer function, FFT mode, trace creation and Bandwidth Application program. The Operation Procedures provide general guidelines for using the AN1820. AN1820 operation is not limited to the procedures given.

NOTE: All functions are explained in Section 3. Refer to the Figure 3-1 for front panel controls, connectors and indicators used in the operation procedures. Refer to Figure 3-2 for rear panel controls, connectors and indicators used in the operation procedures.

Unless specified otherwise:

- Use ↑ and ↓ Keys, DATA ENTRY Keypad or DATA SCROLL Spinner to enter data or move markers.
- Use ← and → Keys to select digits for ↑ and ↓ Keys or DATA SCROLL Spinner to edit in numerical data.
- Use ↑ and ↓ Keys or DATA SCROLL Spinner to select parameters or move horizontal reference lines.

PROCEDURE	OPERATION	PAGE
4-2	Basic Instrument Operation	4-2
4-2-1	Spectrum Analyzer	4-2
4-2-2	Frequency Counter	4-5
4-2-3	Digital Oscilloscope	4-6
4-2-4	Enhanced Logarithmic Display Mode	4-8
4-3	Harmonic Distortion Measurements	4-10
4-4	Intermodulation Distortion Measurements	4-14
4-5	Modulation	4-16
4-5-1	Demodulating Input Signals	4-16
4-5-2	AM Measurements	4-17
4-5-3	FM Measurements	4-21
4-5-4	Pulsed RF Measurements	4-25
4-6	External Mixer Function	4-30
4-7	FFT Mode	4-33
4-8	Frequency-Selective Device Measurements	4-35
4-8-1	Bandwidth Application Program	4-35
4-8-2	Return Loss Bridge (ACCESS NO: AC4101) Measurements	4-41
4-9	Memory Operations	4-44
4-9-1	Memory Storage	4-44
4-9-2	Memory Recall	4-47
4-9-3	Limits Trace Creation	4-49
4-9-4	Sending Out Plots	4-50
4-9-5	Printing Out Screens	4-52
4-9-6	Memory Edits	4-53
4-10	Macro Operations	4-56
4-10-1	Assigning Macros From Front Panel	4-56
4-10-2	Operating Macros From Front Panel	4-58
4-10-3	Display Limit Alarms Operation Screen Macro	4-58

4-2 BASIC INSTRUMENT OPERATION

4-2-1 SPECTRUM ANALYZER

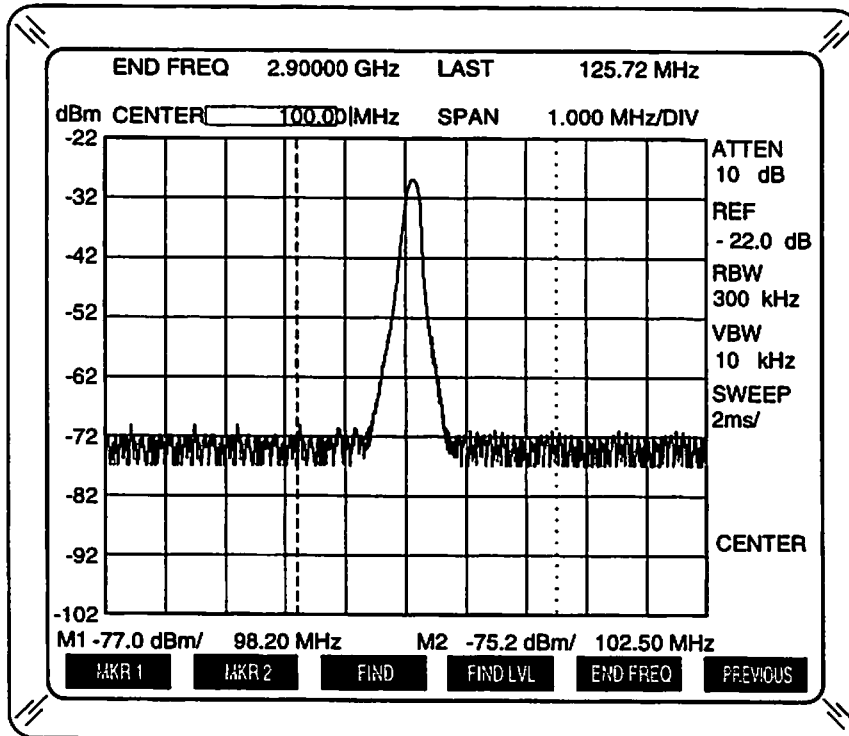

Figure 4-1 Spectrum Analyzer Operation

01917001

STEP PROCEDURE

1. Apply power and activate AN1820. Allow 15 minute warm-up time.

2. Connect input signal (1 Hz to 2.9 GHz) to ANALYZER INPUT Connector. 

CAUTION: MAXIMUM ANALYZER INPUT MUST NOT EXCEED +20 dBm, PEAK OR AVERAGE, WITH INTERNAL ATTENUATION <10 dB. MAXIMUM ANALYZER INPUT MUST NOT EXCEED +30 dBm AVERAGE OR +40 dBm PEAK WITH INTERNAL ATTENUATION \geq 10 dB. FREQUENCY MUST BE >0 Hz (NO dc VOLTAGE).

3. Set reference level as follows:

- Press REF AMPLITUDE Key.
- If needed, press INT Soft Function Key F2.
- Set top of scale reference level from -85.0 to +30.0 dBm.
- If using external devices with known gain or attenuation, press OFFSET Soft Function Key F1 to set Offset field from -99.9 to +99.9 dB. (Negative values offset gain and positive values offset attenuation.)

NOTE: If input signal has known Center Frequency, go to Step 4. If input signal varies or is known to be within specific frequency band, go to Step 7.

4. Press CENTER FREQUENCY Key for Center/Span function. Enter desired Center Frequency.

STEP**PROCEDURE**

5. Verify Display shows input signal. If signal is not displayed or frequency is unsure, use Find function as follows:
 - Press FIND LVL Soft Function Key F4. Set Find Level slightly below suspected level of input signal.
 - If needing to search for signals across bands or desiring narrower search window within current band, press END FREQ Soft Function Key F5. Set desired end frequency (Find function stops searching for signals at selected frequency). Press END FREQ Soft Function Key F5.
 - Press FIND Soft Function Key F3 to set Center Frequency to first signal exceeding Find Level. (SEARCH field above Frequency SPAN field indicates current search status.)
 - Continue pressing FIND Soft Function Key F3 until desired signal is found.
6. Press SPAN FREQUENCY Key. Enter desired Frequency Span per division. Go to Step 9.
7. Press START FREQUENCY Key for Start/Stop function. Enter desired Start Frequency.
8. Press STOP FREQUENCY Key. Enter desired Stop Frequency.
9. Press BW AMPLITUDE Key.

NOTE: Bandwidth functions are default coupled to Frequency Span for optimum Display accuracy and should only be adjusted if necessary. The Display shows **UNCAL** in Message field if adjustment uncalibrates display.

Adjust bandwidths as follows:

- Verify RBW field is highlighted. If not, press RBW Soft Function Key F1. Adjust Resolution Bandwidth (RBW). Decrease RBW to separate signals appearing as single response due to closeness in frequency.
 - Press VBW Soft Function Key F3 to access Video Bandwidth (VBW) field. Adjust Video Bandwidth, as required, to view signals mixed with noise.
10. Press SCALE AMPLITUDE Key.
 - Press LOG Soft Function Key F1 for Logarithmic display mode or LINEAR Soft Function Key F2 for Linear display mode.
 - Press UNITS Soft Function Key F3 and corresponding secondary Soft Function Key to select desired Units.
 - Set Amplitude Scale as desired.
 11. Repeat Steps 3, 9 and 10 as needed, for desired signal display.

NOTE: Placing signal peak at reference level (top of graticule) provides best measurement accuracy.

Preselector function may be needed to display frequencies >2.9 GHz (see 3-3-6B).

-
12. If signal compression is suspected, proceed as follows:
 - Press ATTEN AMPLITUDE Key while observing displayed signal peak.
 - Press COUPLE Soft Function Key F1 to deactivate (not highlighted).
 - Press ↑ Key once to increase internal attenuation by 10 dB. Verify signal peak shifts with Amplitude Scale to indicate same level. (If peak shifts more than 1 dB from original signal level, signal is in compression.)
 - Continue pressing ↑ Key to increase internal attenuation until peak shifts less than 1 dB from previous level (signal is out of compression).
 - Press ↓ Key once to decrease internal attenuation by one step.
 13. If markers are desired, press MARKER MODE Key. Set markers as follows:
 - Press MKR SEL Soft Function Key F1.
 - Move Marker 1 to desired location on trace display. Verify amplitude and frequency at Marker 1 position (displayed in Marker 1 field).
 - If Marker 2 is desired, press MKR 2 Soft Function Key F2. Move Marker 2 to desired location on trace display. Verify amplitude and frequency at Marker 2 position (displayed in Marker 2 field).
 - Press RETURN Soft Function Key F6.
 14. If Delta function is desired, press DELTA Soft Function Key F6. Verify amplitude and frequency difference between displayed markers in ΔM field.

4-2-2 FREQUENCY COUNTER

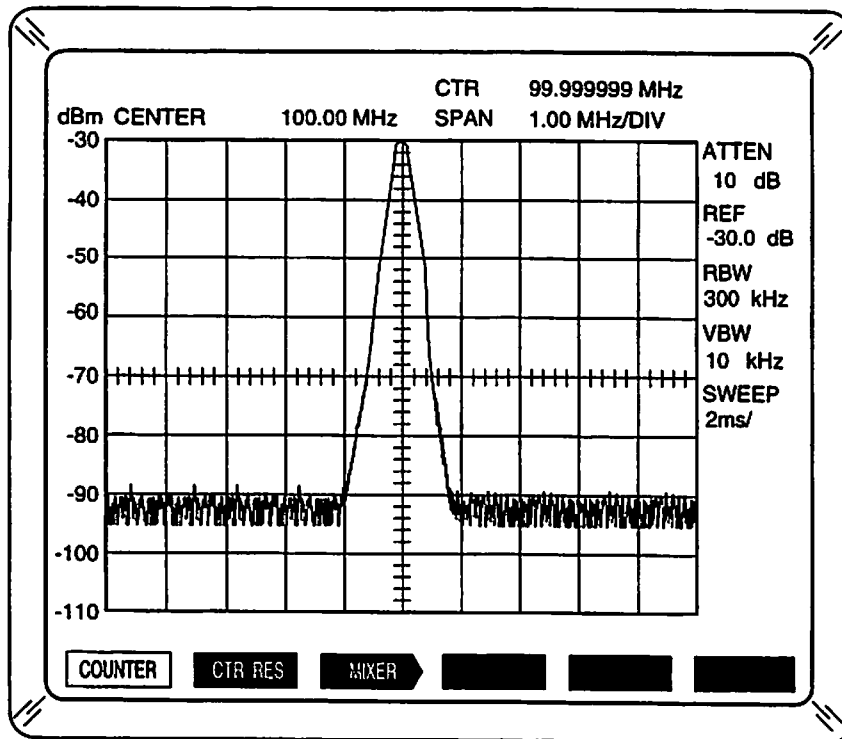



Figure 4-2 Frequency Counter Operation

01917067

STEP PROCEDURE

1. Apply power and activate AN1820. Allow 15 minute warm-up time.
2. Connect input signal (1 Hz to 2.9 GHz) to ANALYZER INPUT Connector. 
CAUTION: MAXIMUM ANALYZER INPUT MUST NOT EXCEED +20 dBm, PEAK OR AVERAGE, WITH INTERNAL ATTENUATION <10 dB. MAXIMUM ANALYZER INPUT MUST NOT EXCEED +30 dBm AVERAGE OR +40 dBm PEAK WITH INTERNAL ATTENUATION ≥10 dB. FREQUENCY MUST BE >0 Hz (NO dc VOLTAGE).
3. Adjust amplitude and frequency according to 4-2-1, Steps 3 through 11.
4. Press AUX MODE Key.
5. Press COUNTER Soft Function Key F1.
6. Press CTR RES Soft Function Key F2.
7. Set CTR RES field as desired to select Frequency Counter Resolution.
8. Verify frequency (Center Frequency signal) in CTR field.
9. Press MKR SEL Soft Function Key F1.
10. If markers are desired, press MARKER MODE Key.
11. Move Marker 1 to desired location on trace display.
12. Verify frequency (signal frequency at marker position) in CTR field.

4-2-3 DIGITAL OSCILLOSCOPE

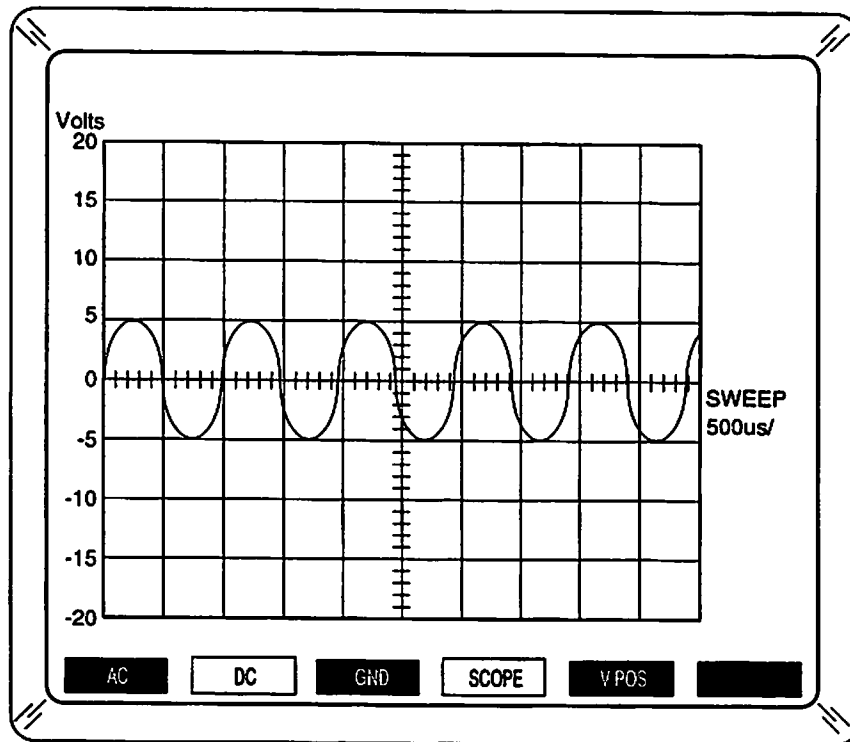



Figure 4-3 Digital Oscilloscope Operation

01917068

STEP

PROCEDURE

1. Apply power and activate AN1820. Allow 15 minute warm-up time.
2. Connect input signal to EXTERNAL INPUT Connector. 
CAUTION: INPUT MUST NOT EXCEED +40 V_{P-P}.
3. Press AUX MODE Key.
4. Press SCOPE Soft Function Key F4.
5. Set input coupling:
 - Press AC Soft Function Key F1 for ac coupling.
 - Press DC Soft Function Key F2 for dc coupling.
 - Press GND Soft Function Key F3 for ground reference display.
6. If vertical position of signal requires adjustment, press V POS Soft Function Key F5.
 - Adjust position as desired.
 - Press V POS Soft Function Key F5.
7. Press SCALE AMPLITUDE Key to adjust voltage scale.
8. Set desired voltage per division from 5 mV to 5 V.
9. Press SWEEP MODE Key.

STEP

PROCEDURE

10. Set desired Sweep Time per division from 200 ns to 10 s.

NOTE: The maximum usable frequency of the Digital Oscilloscope is a function of Sweep Time. Refer to Table 4-1. Input signal components greater than half the sampling rate produce aliases at unexpected levels. Decrease Sweep Time to verify displayed signal is not an alias. (Aliases change frequency as the Sweep Time changes.)

SWEEP TIME/DIV	MAXIMUM FREQUENCY	SWEEP TIME/DIV	MAXIMUM FREQUENCY	SWEEP TIME/DIV	MAXIMUM FREQUENCY
≤2 μs	12.5 MHz	500 μs	50 kHz	100 ms	250 Hz
5 μs	5 MHz	1 ms	25 kHz	200 ms	125 Hz
10 μs	2.5 MHz	2 ms	12.5 kHz	500 ms	50 Hz
20 μs	1.25 MHz	5 ms	5 kHz	1 s	25 Hz
50 μs	500 kHz	10 ms	2.5 kHz	2 s	12.5 Hz
100 μs	250 kHz	20 ms	1.25 kHz	5 s	5 Hz
200 μs	125 kHz	50 ms	500 Hz	10 s	2.5 Hz

Table 4-1 AN1820 Digital Oscilloscope Maximum Frequency (25/Sweep Time)

11. Press MODE Soft Function Key F2. Set Sweep Trigger Mode as follows:
- Press Soft Function Key below desired Sweep Trigger Mode. For trigger control, use NORM or SNGL (one sweep). If FREE run or AUTO, go to Step 14.
 - Press RETURN Soft Function Key F6.
12. Press TRIG Soft Function Key F4. Set Trigger functions as follows:
- Press LEVEL Soft Function Key F1. Move Trigger Level (horizontal dashed line) to desired position.
 - Press +SLOPE Soft Function Key F2 for positive going or -SLOPE Soft Function Key F3 for negative going signal direction required to trigger sweep.
 - Press DELAY Soft Function Key F4 to delay or advance sweep from trigger position. Set delay or advance in current Sweep Time units as desired.
13. If markers are desired, press MARKER MODE Key. Set markers as follows:
- Press MKR SEL Soft Function Key F1.
 - Move Marker 1 to desired location on trace display. Verify amplitude and time at Marker 1 position (displayed in Marker 1 field).
 - If Marker 2 is desired, press MKR 2 Soft Function Key F2. Move Marker 2 to desired location on trace display. Verify amplitude and time at Marker 2 position (displayed in Marker 2 field).
 - Press RETURN Soft Function Key F6.
14. If Delta function is desired, press DELTA Soft Function Key F6. Verify amplitude and time difference between displayed markers in ΔM field.

4-2-4 ENHANCED LOGARITHMIC DISPLAY MODE

The Enhanced Logarithmic display mode allows inspection of signals with wide amplitude differences.

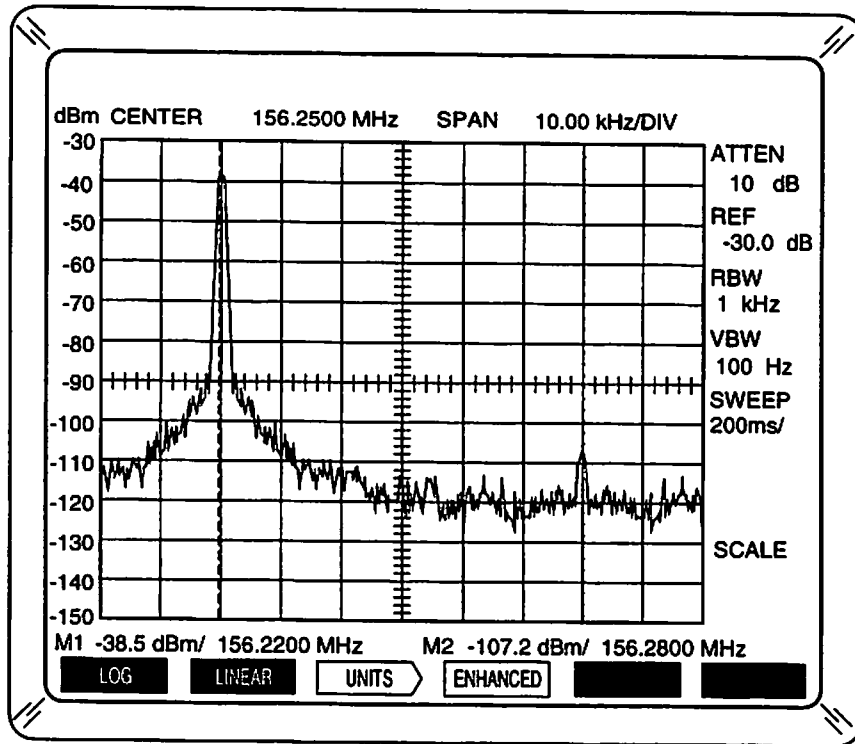

Figure 4-4 Enhanced Logarithmic Display Mode Operation

01917069

STEP PROCEDURE

1. Apply power and activate AN1820. Allow 15 minute warm-up time.
2. Press UTILITY Key.
3. Press 3 on DATA ENTRY Keypad to select General Options Menu.
4. Press ENTER Soft Function Key F1 to display General Options Menu.
5. If total input level is > -5 dBm, set Minimum Internal Attenuation Limit as follows:
 - Press 2 on DATA ENTRY Keypad to select MINIMUM ATTENUATION.
 - Press ENTER Soft Function Key F1 to edit MINIMUM ATTENUATION.
 - Use \uparrow and \downarrow Keys to set MINIMUM ATTENUATION $>$ Maximum input level + 5 dB (to stay below 1 dB compression point of analyzer front end circuit). If Tracking Generator (Option 02) is used as signal source, set MINIMUM ATTENUATION $<$ Maximum input level - 20 dB (to prevent damage if input overloads during sweep). (Using Tracking Generator as signal source allows some overload without invalidating displayed data.)
 - Press ENTER Soft Function Key F1.
6. Press 3 on DATA ENTRY Keypad to select ENHANCE SCALE PRIORITY.
7. Press ENTER Soft Function Key F1 to edit ENHANCE SCALE PRIORITY.

8. Use ↑ and ↓ Keys to select **GAIN ONLY** (reduces reference level 40 dB every other sweep), **ATTEN ONLY** (removes 40 dB of internal attenuation every other sweep) or **ATTEN THEN GAIN** (removes up to 40 dB of available internal attenuation and/or reduces reference level until 40 dB total display range is added every other sweep).

CAUTION: SETTING THE ENHANCE SCALE PRIORITY TO ATTEN ONLY OR ATTEN THEN GAIN REMOVES ANY INTERNAL ATTENUATION SET ≤40 dB ABOVE MINIMUM INTERNAL ATTENUATION LIMIT. FOR SIGNALS >+20 dBm, MINIMUM INTERNAL ATTENUATION LIMIT MUST BE ≥10 dB OR TOTAL INTERNAL ATTENUATION MUST BE ≥50 dB.

SETTING ENHANCE SCALE PRIORITY TO ATTEN ONLY OR ATTEN THEN GAIN, WITH INTERNAL ATTENUATION >0 dB ABOVE MINIMUM INTERNAL ATTENUATION LIMIT AND ENHANCED LOGARITHMIC DISPLAY MODE ACTIVE, CAUSES A RELAY ON THE RF ATTENUATOR TO CONTINUALLY OPERATE. THE AN1820 SHOULD NOT BE OPERATED WITH SETTINGS THAT KEEP THE RELAY ACTIVE FOR EXTENDED PERIODS OF TIME TO PREVENT EXCESSIVE WEAR ON RELAY CONTACTS.

9. Press CENTER FREQUENCY Key to exit General Options Menu.

10. Connect input signal (1 Hz to 2.9 GHz) to ANALYZER INPUT Connector. 

CAUTION: MAXIMUM ANALYZER INPUT MUST NOT EXCEED +20 dBm, PEAK OR AVERAGE, WITH INTERNAL ATTENUATION <10 dB. MAXIMUM ANALYZER INPUT MUST NOT EXCEED +30 dBm AVERAGE OR +40 dBm PEAK WITH INTERNAL ATTENUATION ≥10 dB. FREQUENCY MUST BE >0 Hz (NO dc VOLTAGE).

11. Press REF AMPLITUDE Key.

- If ENHANCE SCALE PRIORITY is set to **GAIN ONLY**, set reference level >-45 dBm. If ENHANCE SCALE PRIORITY is set to **ATTEN ONLY**, set reference level >+10 dBm (+ MINIMUM ATTENUATION set in Step 5). If ENHANCE SCALE PRIORITY is set to **ATTEN THEN GAIN**, set reference level ≥-55 dBm.
- If using external devices with known gain or attenuation, press OFFSET Soft Function Key F1 to set Offset field from -99.9 to +99.9 dB. (Negative values offset gain and positive values offset attenuation.)

12. Adjust frequency and bandwidths according to 4-2-1, Steps 4 through 9.

13. Press SCALE AMPLITUDE Key.

14. Press ENHANCED Soft Function Key F4.

15. If markers are desired, press MARKER MODE Key.

- Press MKR SEL Soft Function Key F1.
- Activate desired markers by pressing appropriate Soft Function Keys.
- Move selected markers to desired locations on trace display.

4-3 HARMONIC DISTORTION MEASUREMENTS

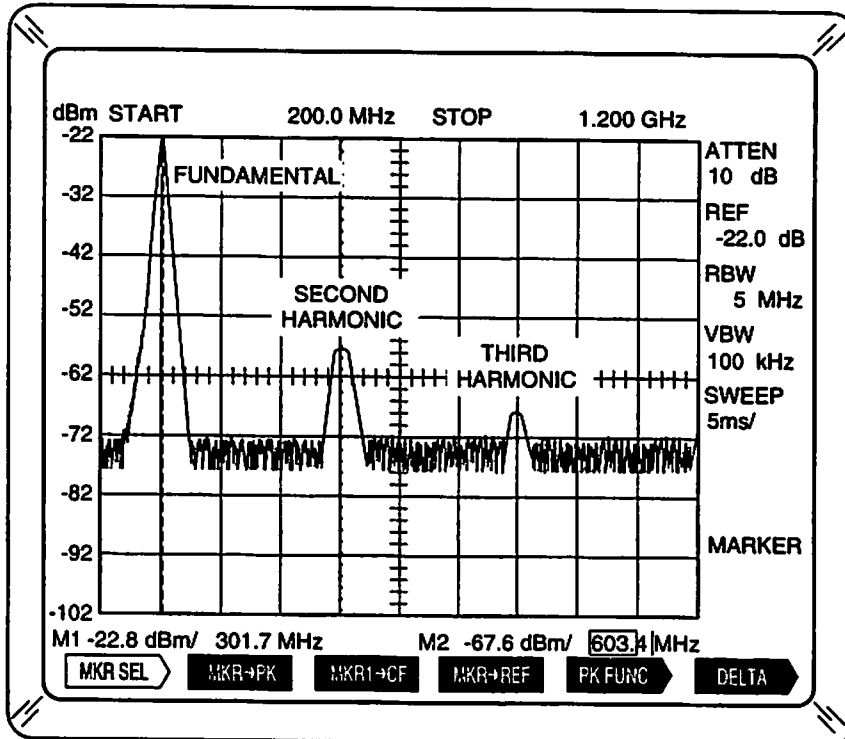



Figure 4-5 Harmonic Distortion Measurements

01917070

STEP

PROCEDURE

1. Apply power and activate AN1820. Allow 15 minute warm-up time.
2. Connect input signal (1 Hz to 2.9 GHz) to ANALYZER INPUT Connector. 

CAUTION: MAXIMUM ANALYZER INPUT MUST NOT EXCEED +20 dBm, PEAK OR AVERAGE, WITH INTERNAL ATTENUATION <10 dB. MAXIMUM ANALYZER INPUT MUST NOT EXCEED +30 dBm AVERAGE OR +40 dBm PEAK WITH INTERNAL ATTENUATION ≥10 dB. FREQUENCY MUST BE >0 Hz (NO dc VOLTAGE).
3. Adjust amplitude and frequency according to 4-2-1, Steps 3 through 11. Adjust Frequency Span for Display to show all desired harmonics.

NOTE: Placing fundamental or carrier frequency signal peak at reference level (top of graticule) provides best measurement accuracy.
4. Press MARKER MODE Key.
5. If Markers are not active or Delta function is active, press MKR SEL Soft Function Key F1.
 - Press MKR 2 Soft Function Key to activate Marker 2 (highlighted) (deactivates Delta function).
 - Press MKR 1 Soft Function Key to give edit control to Marker 1.
 - Press RETURN Soft Function Key F6.
6. Press PK FUNC Soft Function Key F5.

STEP

PROCEDURE

7. Press PK LVL Soft Function Key F4 to adjust Peak Threshold Level. Move Peak Threshold Level (horizontal dashed line) to desired position (slightly below lowest desired harmonic level, but above noise floor). Press PK LVL Soft Function Key F4 to deactivate (not highlighted).
8. If Marker 1 is left of fundamental signal (displayed left or M1 field indicates <<<), press PEAK → Soft Function Key F3. If Marker 1 is right of fundamental signal (displayed right or M1 field indicates >>>), press ← PK FUNC Soft Function Key F2. Continue pressing respective key until Marker 1 is on fundamental signal.
9. Press RETURN Soft Function Key F6.
10. Press MKR → REF Soft Function Key F4.
11. Press MKR SEL Soft Function Key F1.
12. Press MKR 2 Soft Function Key F2 to give edit control to Marker 2.
13. Press RETURN Soft Function Key F6.
14. Press PK FUNC Soft Function Key F5.
15. If Marker 2 is left of second harmonic (displayed left or M2 field indicates <<<), press PEAK → Soft Function Key F2 or if Marker 2 is right of second harmonic signal (displayed right or M2 field indicates >>>), press ← PK FUNC Soft Function Key F1. Continue pressing until Marker 2 is on second harmonic signal.
16. Verify M2 field displays harmonic amplitude referenced to fundamental signal level. Refer to Figure 4-6. Note percent of distortion.

For more precision, use following equation: $\left(1/10^{\frac{\text{xdB}}{20}}\right) \times 100$.

17. Press PEAK → Soft Function Key F2 to set Marker 2 to next harmonic.
18. Repeat Step 16.
19. Repeat Steps 17 and 18 until all harmonic distortion percentages have been noted.
20. Calculate Total Harmonic Distortion (THD) using following equation:

$$\text{THD}(\%) = \sqrt{H_2(\%)^2 + H_3(\%)^2 + H_4(\%)^2 + H_n(\%)^2}$$

Where: $H_2(\%)$ = Harmonic Distortion Percentage of Second Harmonic
 $H_3(\%)$ = Harmonic Distortion Percentage of Third Harmonic
 $H_4(\%)$ = Harmonic Distortion Percentage of Fourth Harmonic
 $H_n(\%)$ = Harmonic Distortion Percentage of nth Harmonic

Using Figure 4-7 as an example, THD is calculated as follows:

- Amplitude Differences: $H_2 = -30$ dB, $H_3 = -42.5$ dB, $H_4 = -51.6$ dB
- Harmonic Distortion Percentages: $H_2(\%) = 3.16$, $H_3(\%) = 0.75$, $H_4(\%) = 0.26$
- $\text{THD}(\%) = \sqrt{3.16^2 + 0.75^2 + 0.26^2} = \sqrt{9.99 + 0.56 + 0.07} = \sqrt{10.62} = 3.26$

NOTE: Equation only works when both harmonic sideband levels are equal (<2 dB apart).

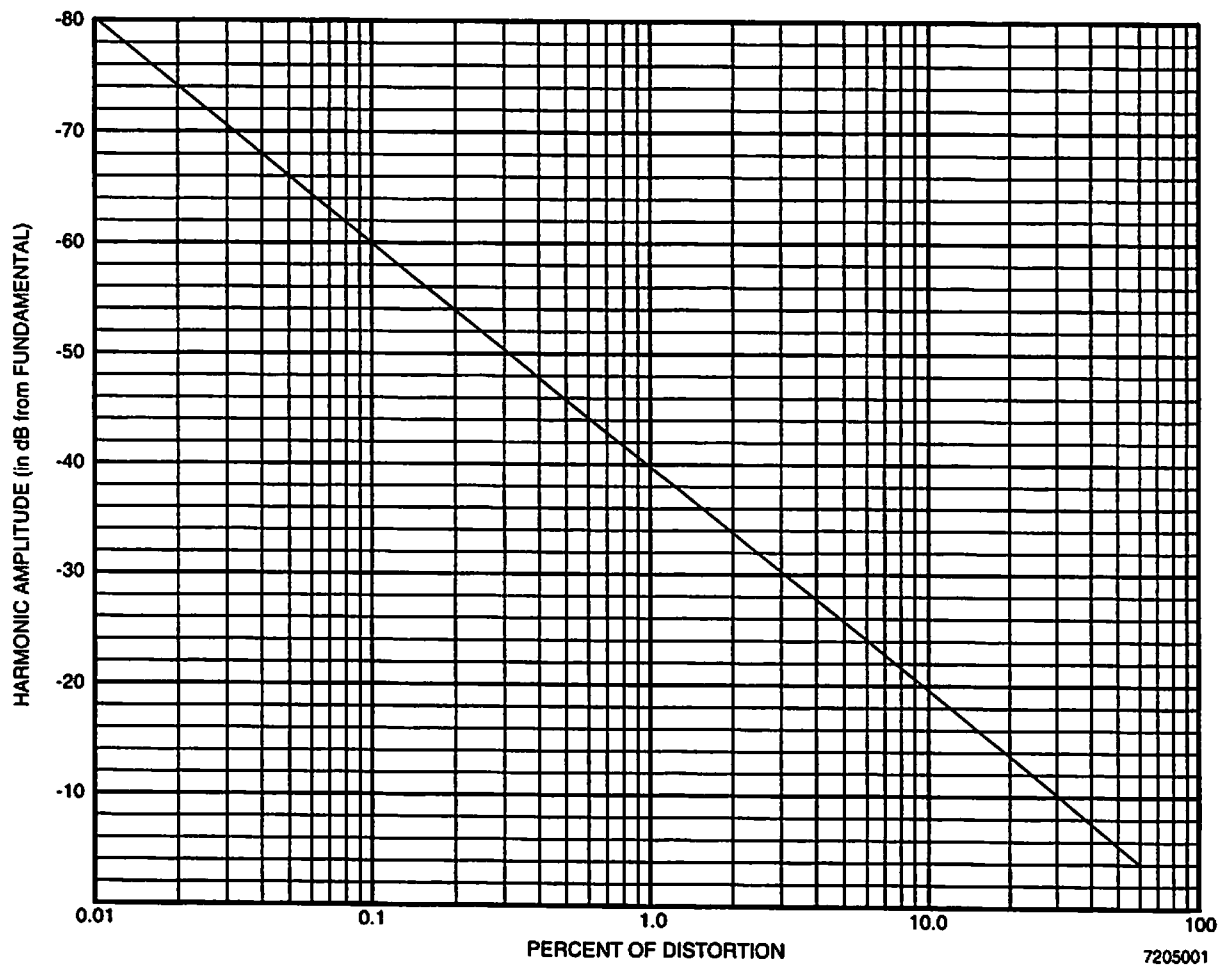

Figure 4-6 Harmonic Distortion Percentage

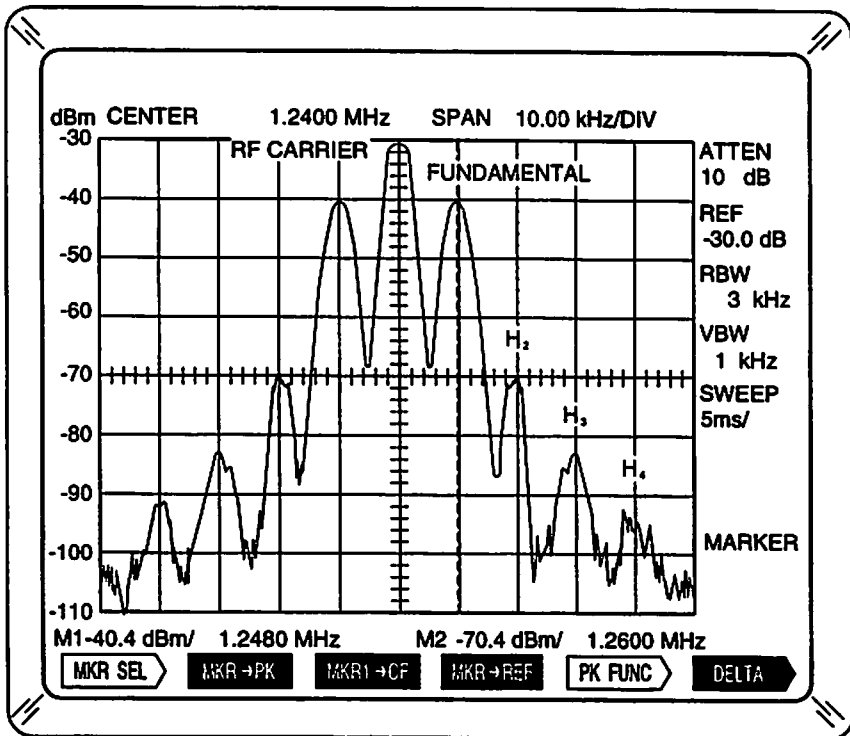

Figure 4-7 AM with Harmonic Distortion

01917046

4-4 INTERMODULATION DISTORTION MEASUREMENTS

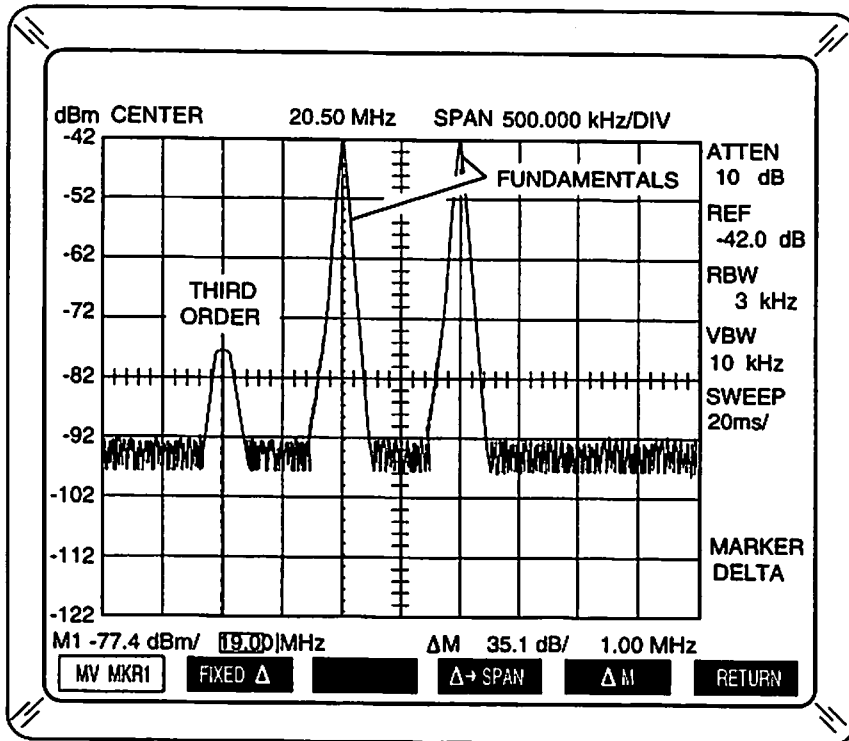



Figure 4-8 Intermodulation Distortion Measurements

01917071

STEP PROCEDURE

1. Apply power and activate AN1820. Allow 15 minute warm-up time.
2. Connect input containing two or more signals at different frequencies (two separate RF signals, Single Sideband [SSB] modulated by two-tone audio or other multifrequency signal) to ANALYZER INPUT Connector. 

CAUTION: MAXIMUM ANALYZER INPUT MUST NOT EXCEED +20 dBm, PEAK OR AVERAGE, WITH INTERNAL ATTENUATION <10 dB. MAXIMUM ANALYZER INPUT MUST NOT EXCEED +30 dBm AVERAGE OR +40 dBm PEAK WITH INTERNAL ATTENUATION ≥10 dB. FREQUENCY MUST BE >0 Hz (NO dc VOLTAGE).

3. Press CENTER FREQUENCY Key. Enter center of fundamental frequencies.
4. Press REF AMPLITUDE Key. Set reference level to place fundamental frequency signal peaks at or near top of scale for best measurement accuracy.
5. Press SPAN FREQUENCY Key. Set Frequency Span wide enough to display all distortion products (greater than three times amount of separation between both fundamental frequencies).

EXAMPLE: For two fundamental signals, one at 20 MHz and one at 21 MHz, set center frequency to 20.5 MHz and frequency span to 500 kHz per division (5 MHz display span > (1 MHz x 3).

NOTE: For SSB, the two fundamentals, modulating tones, are separated by the difference in frequency between the two-tone audio (i.e.; 800 Hz and 1800 Hz = 1 kHz separation).

6. To increase visibility of distortion products, press **BW AMPLITUDE** Key.

NOTE: *UNCAL* appears in the Message field if the selected Resolution Bandwidth (RBW) is too narrow for the selected Sweep Time or the selected Sweep Time is too fast.

Adjust bandwidths as follows:

- Decrease RBW, as necessary and without uncalibrating display, for third order distortion products having large amplitude differences (typically 40 dB).
- Press **VBW Soft Function Key F3** to access VBW field. Adjust VBW, as required, for best display of distortion products.

NOTE: Reducing RBW and/or VBW increases Sweep Time. For fastest measurement times, use widest possible RBW and VBW settings still allowing resolution of all desired signals.

7. Press **MARKER MODE** Key.
8. Activate and/or select Marker 1 for edit control as follows:
- Press **MKR SEL Soft Function Key F1**.
 - If Marker 2 has edit control, press **MKR 1 Soft Function Key F1**.
 - Press **RETURN Soft Function Key F6**.
9. Press **PK FUNC Soft Function Key F5**.
10. Press **PK LVL Soft Function Key F4** to adjust Peak Threshold Level. Move Peak Threshold Level (horizontal dashed line) to desired position (slightly below lowest desired distortion product level, but above noise floor).
11. If Marker 1 is left of fundamental signals (displayed left or M1 field indicates <<<<<<), press **PEAK → Soft Function Key F3**. If Marker 1 is right of fundamental signal (displayed right or M1 field indicates >>>>>>), press **← PK FUNC Soft Function Key F2**. Continue pressing until Marker 1 is on one of fundamental signals.
12. Press **RETURN Soft Function Key F6**.
13. Press **DELTA Soft Function Key F6**.
14. Move Delta Marker to distortion product.
15. Note level difference in ΔM field. Verify intermodulation distortion: verify frequency in M2 field equals expected frequency of intermodulation distortion products (second order = $F_1 + F_2$ and $F_2 - F_1$; third order = $2F_1 + F_2$, $2F_1 - F_2$, $2F_2 - F_1$ and $2F_2 - F_1$; fourth order = $2F_1 + 2F_2$, $2F_2 - 2F_1$; fifth order = $3F_1 + 2F_2$, $3F_1 - 2F_2$, $3F_2 - 2F_1$, $3F_2 - 2F_1$; etc.).
- EXAMPLE:** Third order product shows $2F_1$ (2×20 MHz) - F_2 (21 MHz) = 19 MHz.
intermodulation distortion level is 42.3 dB below fundamental.
16. Repeat Steps 14 and 15 for all distortion products to be measured.

4-5 MODULATION

4-5-1 DEMODULATING INPUT SIGNALS

STEP	PROCEDURE
------	-----------

1. Apply power and activate AN1820. Allow 15 minute warm-up time.
2. Connect input signal to ANALYZER INPUT Connector , using coaxial cable or accessory antenna.

CAUTION: MAXIMUM ANALYZER INPUT MUST NOT EXCEED +20 dBm, PEAK OR AVERAGE, WITH INTERNAL ATTENUATION <10 dB. MAXIMUM ANALYZER INPUT MUST NOT EXCEED +30 dBm AVERAGE OR +40 dBm PEAK WITH INTERNAL ATTENUATION \geq 10 dB. FREQUENCY MUST BE >0 Hz (NO dc VOLTAGE).

3. Press CENTER FREQUENCY Key. Enter desired center frequency.
4. Press REF AMPLITUDE Key and set desired reference level.
5. Press DEMOD Key. Select demodulation mode according to input signal:
 - Press AM1 Soft Function Key F1 for narrow band (3 kHz RBW) AM signals.
 - Press AM2 Soft Function Key F2 for wide band (30 kHz RBW) AM signals.
 - Press FM1 Soft Function Key F3 for narrow band (30 kHz RBW) FM signals.
 - Press FM2 Soft Function Key F4 for wide band (300 kHz RBW) FM signals.
 - Press USER Soft Function Key F5 for User-Defined demodulation mode.
 - Press BW AMPLITUDE Key. Adjust Resolution Bandwidth (RBW) as desired.
 - Press VBW Soft Function Key F3 to access VBW field. Adjust Video Bandwidth (VBW) as desired.
 - Press SCALE AMPLITUDE Key. (DEMODO Soft Function Key F5 label is highlighted.) Set SCALE field as desired.
6. If needed, press REF AMPLITUDE Key and adjust internal gain from -10 to 65.0 dB.
7. Adjust SQUELCH Control as needed.
8. Adjust VOLUME Control as needed.
9. Verify audio through external speaker or headphones connected to PHONES Connector.

4-5-2 AM MEASUREMENTS

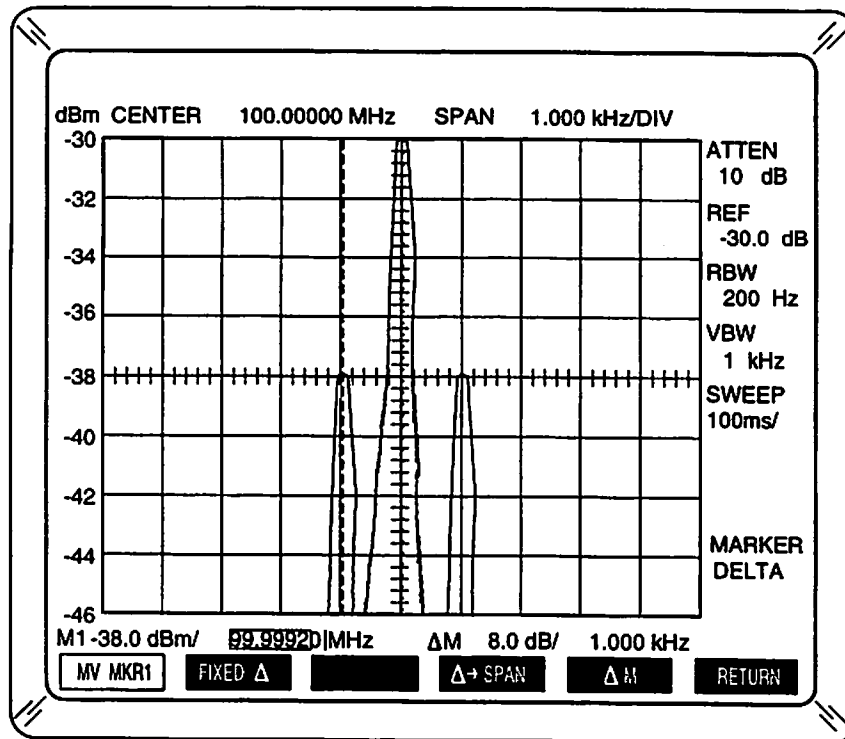



Figure 4-9 AM Measurements

01917072

STEP

PROCEDURE

1. Apply power and activate AN1820. Allow 15 minute warm-up time.
2. Connect AM input signal to ANALYZER INPUT Connector , using coaxial cable or accessory antenna.
CAUTION: MAXIMUM ANALYZER INPUT MUST NOT EXCEED +20 dBm, PEAK OR AVERAGE, WITH INTERNAL ATTENUATION <10 dB. MAXIMUM ANALYZER INPUT MUST NOT EXCEED +30 dBm AVERAGE OR +40 dBm PEAK WITH INTERNAL ATTENUATION ≥10 dB. FREQUENCY MUST BE >0 Hz (NO dc VOLTAGE).
3. Press CENTER FREQUENCY Key. Enter desired Center (carrier) Frequency.
4. Press SPAN FREQUENCY Key. Set Frequency Span for displaying carrier and modulating signals.

FINDING AM PERCENTAGE

5. Press DEMOD Key. Select demodulation mode according to input signal:
 - Press AM1 Soft Function Key F1 for narrow band (3 kHz RBW) AM signals.
 - Press AM2 Soft Function Key F2 for wide band (30 kHz RBW) AM signals.
 - Press USER Soft Function Key F5 for User-Defined demodulation mode.
 - Press BW AMPLITUDE Key. Adjust Resolution Bandwidth (RBW) as desired.
 - Press VBW Soft Function Key F3 to access VBW field. Adjust Video Bandwidth (VBW) as desired.
 - Press SCALE AMPLITUDE Key. (DEMOM is highlighted.) Set SCALE field to **10%**, **20%** or **50%** per division.
 6. If needed, press REF AMPLITUDE Key and set internal gain from -10.0 to 65.0 dB.
 7. Press SWEEP MODE Key. Adjust Sweep Time for best display of modulating signal.
 8. Press MARKER MODE Key and set Marker 1 as follows:
 - Press MKR SEL Soft Function Key F1.
 - If needed, press MKR 1 Soft Function Key F1 to give edit control to Marker 1.
 - Move Marker 1 to desired position on Display.
 9. Note AM percentage. Refer to Figure 4-10.
 10. For widely varying modulating signals, press DISPLAY Key and perform Steps 11 and 12.
 11. Press AVERAGE Soft Function Key F1 to display average of multiple sweeps. Set Average Number as follows:
 - Press AVG NO. Soft Function Key F2 to edit AVERAGE Number field.
 - Set Average Number as desired.
 - Press AVG NO. Soft Function Key F2 (not highlighted).
 12. If desired, press HOLD Soft Function Key F3.
 - Press MAX HOLD Soft Function Key F1 to display high levels.
 - Press MIN HOLD Soft Function Key F2 to display low levels.
 - Note and verify AM percentages.
 - Press MAX HOLD Soft Function Key F1 to deactivate Maximum Hold function.
 - Press MIN HOLD Soft Function Key F2 to deactivate Minimum Hold function.
 - Press RETURN Soft Function Key F6.
- SPECTRUM ANALYZER AM PERCENTAGE VERIFICATION**
13. Press SPAN FREQUENCY Key for Center/Span function. If necessary, reenter Frequency Span to clear uncalibrated display.

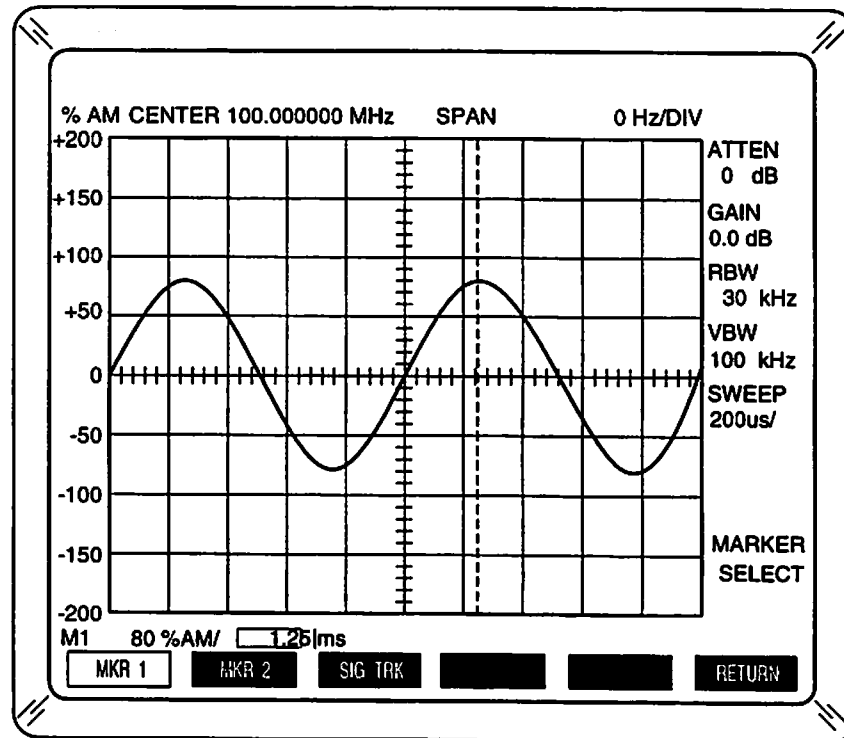

Figure 4-10 AM1 Demodulation Screen

01917047

14. Press BW AMPLITUDE Key.

NOTE: *UNCAL* appears in the Message field if the adjustment uncalibrates the Display.

Adjust bandwidths as follows:

- Decrease RBW for best signal resolution.
- Press VBW Soft Function Key F3. Adjust VBW, as needed, to view signals mixed with noise.

15. Press MARKER MODE Key.

16. Press PK FUNC Soft Function Key F5.

17. Press PK LVL Soft Function Key F4 to adjust Peak Threshold Level. Move Peak Threshold Level (horizontal dashed line) to desired position (slightly below fundamental sidebands).

18. If Marker 1 is left of carrier signal (displayed left or M1 field indicates <<<<<<), press PEAK → Soft Function Key F3. If Marker 1 is right of carrier signal (displayed right or M1 field indicates >>>>>>), press ← PK FUNC Soft Function Key F2. Continue pressing until Marker 1 is on carrier signal.

19. Press RETURN Soft Function Key F6.

20. Press MKR → REF Soft Function Key F4 to set carrier signal peak as top of scale reference.

21. Press SCALE AMPLITUDE Key. Set SCALE field, as desired, to **1 dB**, **2 dB**, **5 dB** or **10 dB** per division.

22. Press DELTA Soft Function Key F6.
23. Move Delta Marker to one modulating sideband signal.
NOTE: Unequal amplitudes of lower and upper sidebands indicate incidental FM on the input signal. Incidental FM reduces accuracy of modulation depth measurements.
24. Verify modulating frequency in ΔM field.
25. Use amplitude difference indicated in ΔM field to find AM percentage using chart in Figure 4-11.

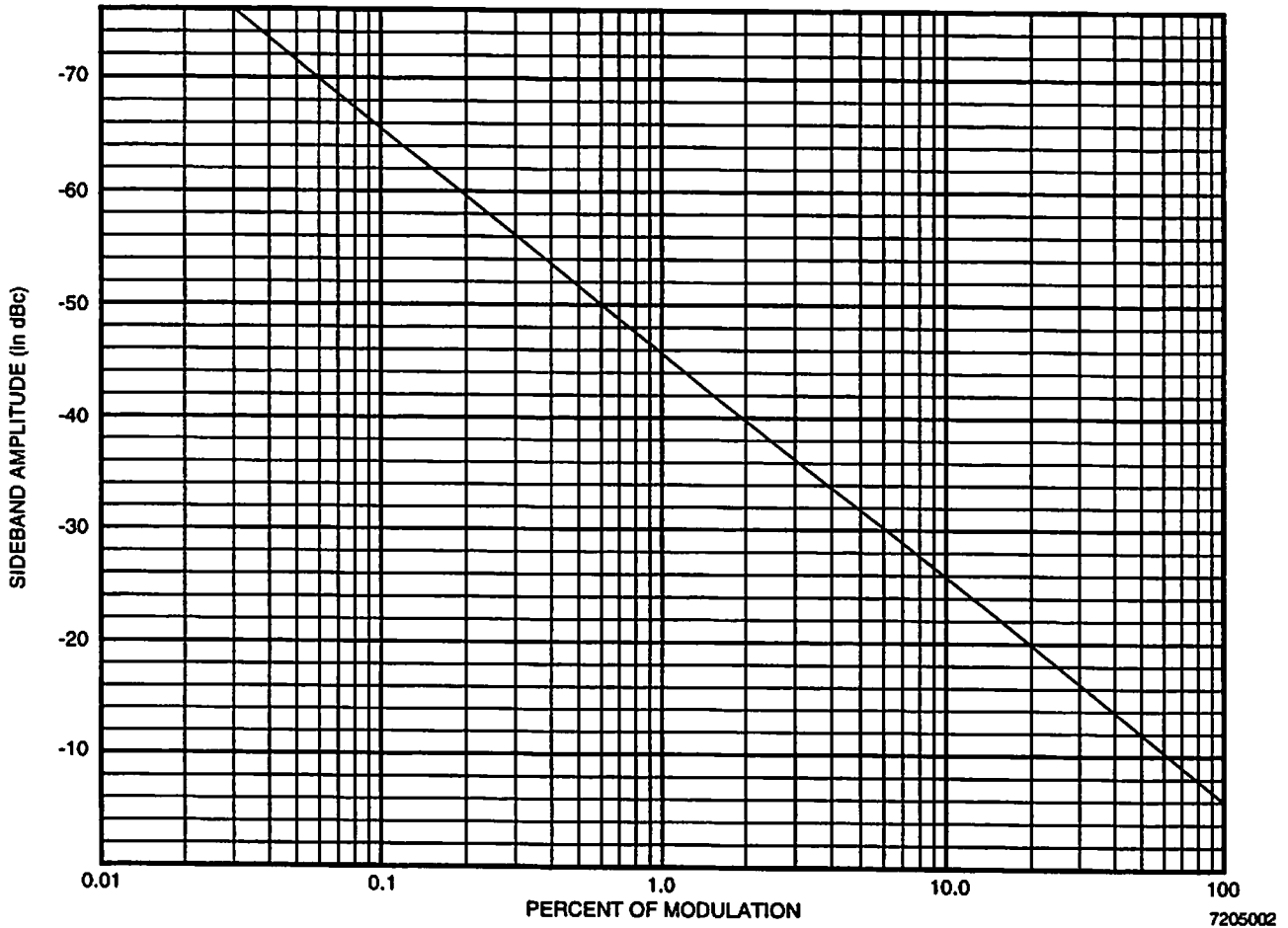

Figure 4-11 AM Percentage

NOTE: Figures 4-9 and 4-10 show a 1 kHz tone modulating a 100 MHz carrier. The AM1 Demodulation Screen (Figure 4-10) indicates 80% modulation. Modulation level is 8 dB below the carrier level (Figure 4-9). The chart in Figure 4-11 also indicates 80% modulation for an 8 dB amplitude difference.

4-5-3 FM MEASUREMENTS

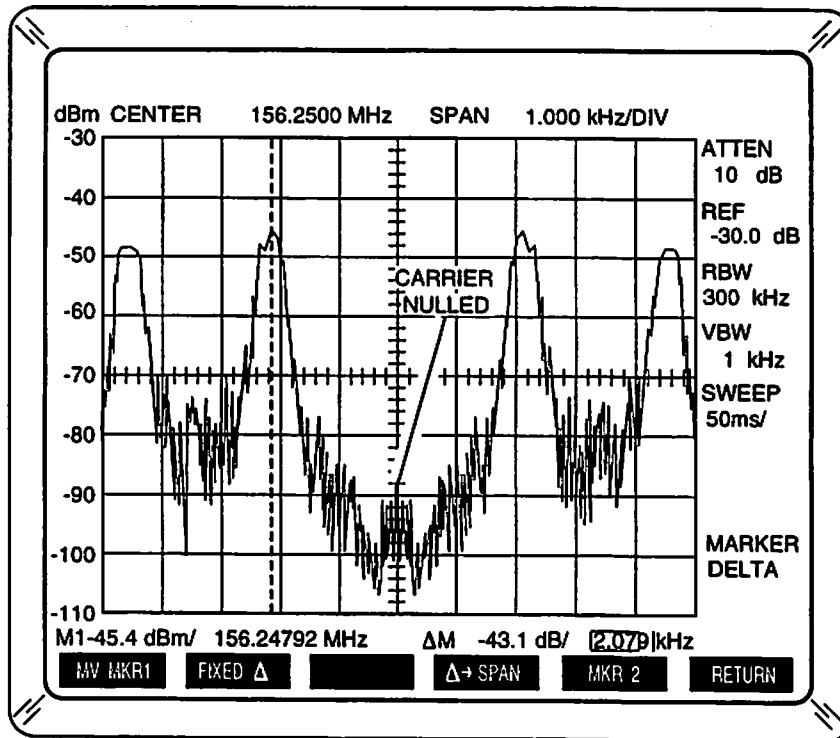

Figure 4-12 FM Measurements

01917073

STEP

PROCEDURE

1. Apply power and activate AN1820. Allow 15 minute warm-up time.
2. Connect FM input signal to ANALYZER INPUT Connector, using coaxial cable or accessory antenna. ▲

CAUTION: MAXIMUM ANALYZER INPUT MUST NOT EXCEED +20 dBm, PEAK OR AVERAGE, WITH INTERNAL ATTENUATION <10 dB. MAXIMUM ANALYZER INPUT MUST NOT EXCEED +30 dBm AVERAGE OR +40 dBm PEAK WITH INTERNAL ATTENUATION ≥10 dB. FREQUENCY MUST BE >0 Hz (NO dc VOLTAGE).

3. Press CENTER FREQUENCY Key. Enter desired center (carrier) frequency.
4. Press SPAN FREQUENCY Key. Set Frequency Span for displaying carrier and modulating signal peaks.

FINDING FREQUENCY DEVIATION

5. Press DEMOD Key. Select demodulation mode according to input signal:
 - Press FM1 Soft Function Key F3 for narrow band (30 kHz RBW) FM signals (± 8 kHz deviation).
 - Press FM2 Soft Function Key F4 for wide band (300 kHz RBW) FM signals (± 80 kHz deviation).
 - Press USER Soft Function Key F5 for User-Defined demodulation mode.
 - Press BW AMPLITUDE Key. Adjust Resolution Bandwidth (RBW) as desired.
 - Press VBW Soft Function Key F3 to access VBW field. Adjust Video Bandwidth (VBW) as desired.
 - Press SCALE AMPLITUDE Key. (DEMOD is highlighted.) Set SCALE field to desired deviation per division (1 kHz to 5 MHz).
6. If needed, press REF AMPLITUDE Key and set internal gain from -10.0 to 65.0 dB.
7. Press SWEEP MODE Key. Adjust Sweep Time for best display of modulating signal.
8. Press MARKER MODE Key and set Marker 1 as follows:
 - Press MKR SEL Soft Function Key F1.
 - If needed, press MKR 1 Soft Function Key F1 to give edit control to Marker 1.
 - Move Marker 1 to desired position on Display.
9. Note FM deviation. Refer to Figure 4-13.
10. For widely varying modulating signals, press DISPLAY Key and perform Steps 11 and 12.
11. Press AVERAGE Soft Function Key F1 to display average of multiple sweeps. Set Average Number as follows:
 - Press AVG NO. Soft Function Key F2 to edit AVERAGE Number field.
 - Set Average Number as desired.
 - Press AVG NO. Soft Function Key F2 (not highlighted).
12. If desired, press HOLD Soft Function Key F3.
 - Press MAX HOLD Soft Function Key F1 to display high levels.
 - Press MIN HOLD Soft Function Key F2 to display low levels.
 - Note and verify AM percentages.
 - Press MAX HOLD Soft Function Key F1 to deactivate Maximum Hold function.
 - Press MIN HOLD Soft Function Key F2 to deactivate Minimum Hold function.
 - Press RETURN Soft Function Key F6.

ADJUSTING MODULATION FREQUENCY

13. Press SPAN FREQUENCY Key for Center/Span function. If necessary, reenter Frequency Span to clear uncalibrated display.

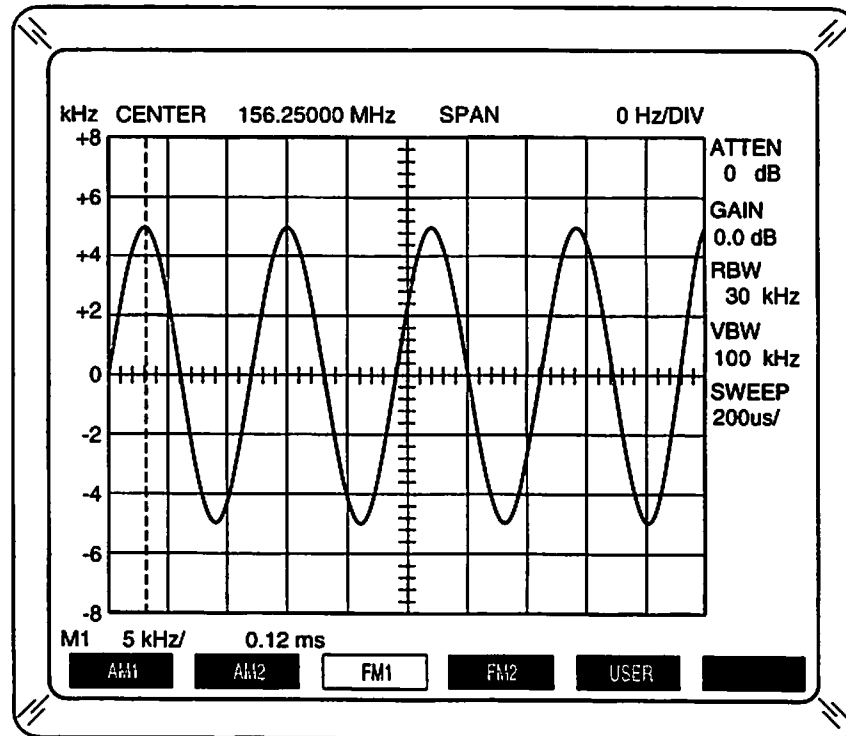

Figure 4-13 FM1 Demodulation Screen

01917048

14. Press BW AMPLITUDE Key.

NOTE: *UNCAL* appears in the Message field if the adjustment uncalibrates the Display.

It may be necessary to adjust modulating frequency to verify carrier (if nulled) and modulating signals.

Adjust bandwidths as follows:

- Decrease RBW for best resolution of carrier and nearest sideband.
- Press VBW Soft Function Key F3. Set VBW, as needed, to view signals mixed with noise.

15. Calculate modulation frequency (MF) required for desired frequency deviation (FD) using modulation index (MI) in Table 4-2 and following equation:

$$MF = FD + MI$$

Select desired carrier null to be used. Carrier null may depend on frequency and amplitude ranges of modulation source. First or second carrier null is recommended for easier observation on Spectrum Analyzer.

The example shown in Figure 4-12 shows first carrier null for ± 5 kHz deviation. The following equation proves the frequency difference in the Delta field:

$$MF = 5000 + 2.405 = 2079 \text{ Hz}$$

The example shown in Figure 4-14 shows second carrier null for ± 5 kHz deviation. The following equation is used to find the desired modulation frequency:

$$MF = 5000 + 5.52 = 905.8 \text{ Hz}$$

STEP

PROCEDURE

16. Set modulation source to calculated frequency from Step 15.
17. Starting with zero output from modulation source, increase modulation source output level until carrier is at desired null.

NOTE: Incidental AM on input signal causes frequency nulls to shift, reducing adjustment accuracy.

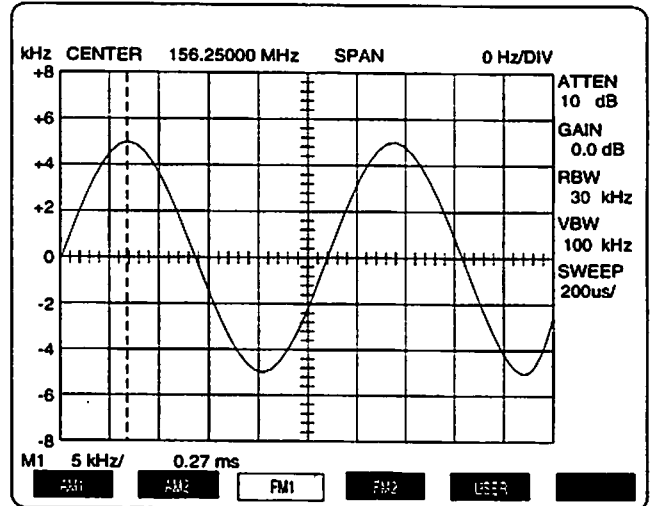
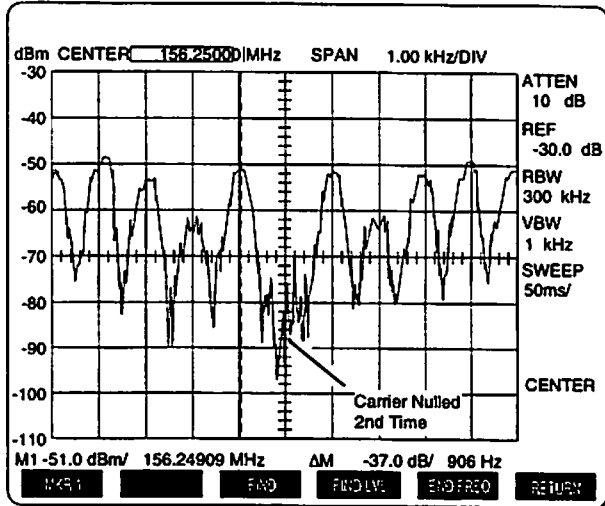

01917049

Figure 4-14 FM Adjustments

CARRIER NULL	MODULATION INDEX
First	2.405
Second	5.520
Third	8.653
Fourth	11.792
Fifth	14.931

Table 4-2 Modulation Index

4-5-4 PULSED RF MEASUREMENTS

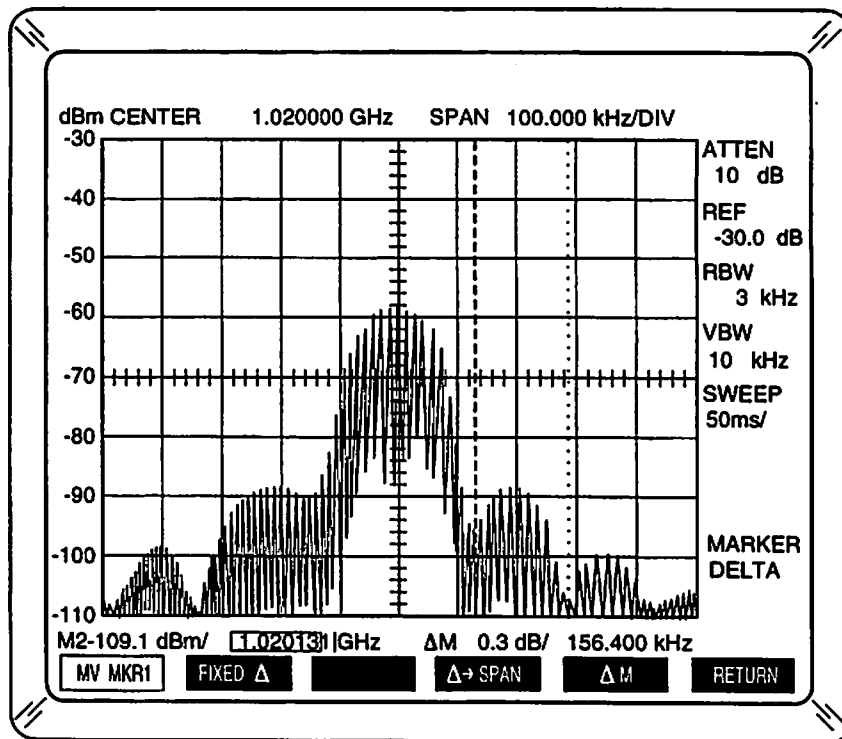



Figure 4-15 Pulsed RF Measurements

01917074

STEP

PROCEDURE

1. Apply power and activate AN1820. Allow 15 minute warm-up time.

2. Connect pulsed RF input signal to ANALYZER INPUT Connector. 

CAUTION: MAXIMUM ANALYZER INPUT MUST NOT EXCEED +20 dBm, PEAK OR AVERAGE, WITH INTERNAL ATTENUATION <10 dB. MAXIMUM ANALYZER INPUT MUST NOT EXCEED +30 dBm AVERAGE OR +40 dBm PEAK WITH INTERNAL ATTENUATION ≥10 dB. FREQUENCY MUST BE >0 Hz (NO dc VOLTAGE).

3. Press CENTER FREQUENCY Key. Enter desired center (carrier) frequency.

4. Press REF AMPLITUDE Key and set desired reference level.

PULSE WIDTH

NOTE: Frequency Span, RBW and Sweep Time are interactively adjusted in Steps 5 through 8. It may be necessary to uncouple optimization algorithms for best display. RBW and VBW couple functions are deactivated by pressing CPL RBW Soft Function Key F2 and CPL VBW Soft Function Key F4 respectively in the Bandwidth Amplitude Operation Screen. Sweep Time couple function is deactivated by pressing COUPLE Soft Function Key F1 in Sweep Mode Operation Screen.

UNCAL appears in the Message field if an adjustment uncalibrates the Display.

5. Press SPAN FREQUENCY Key. Set Frequency Span for displaying pulse modulated RF spectrum. Refer to Figure 4-15.

6. Press **BW AMPLITUDE** Key. Adjust **RBW** until Display displays spectrum with side lobe nulls having good shape and depth. Use following equation as guide:

$$(\text{Pulse Width [PW]} \times \text{RBW}) \leq 0.1$$
 7. Press **VBW Soft Function Key F3**. Set **VBW** to **NONE**.
 8. Press **SWEEP MODE** Key. Increase **Sweep Time**, as needed, to adequately define spectrum shape. Use following equation as guide:

$$\text{Sweep Time per division} \geq 10/\text{Pulse Repetition Frequency (PRF)}$$
 9. Repeat Steps 5 through 8, as needed, for desired Display.
 10. For signals with low **PRF** causing Display to show inadequate spectrum shape, press **DISPLAY** Key. Use **Peak Hold** function as follows:
 - Press **HOLD Soft Function Key F3**.
 - Press **MAX HOLD Soft Function Key F1**.
 - After ample time (≤ 5 minutes) for Display to show spectrum shape, disconnect input signal from **ANALYZER INPUT** Connector.
 11. Press **MARKER MODE** Key. Set markers as follows:
 - Press **DELTA Soft Function Key F6**.
 - Press **MV MKR1 Soft Function Key F1**.
 - Move Marker 1 to center of main lobe.
 - Press **Δ M Soft Function Key F5**.
 - Move Delta Marker to either side lobe null next to Marker 1 position.
 - Record frequency difference (ΔF) between markers indicated in second part of Δ M field.
 12. Calculate pulse width from reciprocal: $PW = 1/\Delta F$. (Example in Figure 4-15 is 6.39 μ s.)

NOTE: Measuring one side lobe null to the next side lobe null also indicates pulse width.

Setting **AN1820** to **ZERO** Span, decreasing **Sweep Time** and using the **Bandwidth Application** program with **Delta** function provides another method for measuring pulse width (Steps 26 through 29).
 13. If Step 10 was performed, reconnect input signal to **ANALYZER INPUT** Connector. Press **DISPLAY** Key, **HOLD** Soft Function Key **F3** and **MAX HOLD** Soft Function Key **F1** (inactive).
- AMPLITUDE LOSS/PULSE DESENSITIZATION**
14. Note amplitude level in **M1** field.
 15. Remove pulse modulation.
 16. Press **MV MKR1 Soft Function Key F1**.
 17. Move Marker 1 to center of carrier signal. Note carrier level indicated in **M1** field.

NOTE: It may be necessary to readjust reference level according to Step 4.
 18. Reapply pulse modulation to **RF** carrier.
 19. Subtract Step 14 measurement from Step 17 measurement to get amplitude loss.

20. Verify following equations are true:

$$RBW \geq PRF \text{ (Display shows dense spectrum.)}$$

$$(PW \times RBW) \leq 0.1$$

If so, verify amplitude loss with following applicable equation:

$$\text{Amplitude Loss} = 20 \text{ Log } 1.5 \text{ RBW} \times \text{PW} \text{ (RBW} \neq 200 \text{ Hz, } 9 \text{ kHz or } 120 \text{ kHz)}$$

$$\text{Amplitude Loss} = 20 \text{ Log } 1.06 \text{ RBW} \times \text{PW} \text{ (RBW} = 200 \text{ Hz, } 9 \text{ kHz or } 120 \text{ kHz)}$$

PULSE REPETITION FREQUENCY (PRF)

21. Press SPAN FREQUENCY Key.
 22. Press ZERO Soft Function Key F1 to set AN1820 to ZERO Span.
 23. Press SWEEP MODE Key. Set Sweep Time and Trigger Delay as follows:
 - Adjust Sweep Time until two pulses or more are displayed on Display.
 - Press TRIG Soft Function Key F4.
 - If Display is unstable or pulses are not shown, press LEVEL Soft Function Key F1. Verify Trigger Level is above noise level and positioned so input pulses are able to trigger sweep. If not, adjust Trigger Level.
- NOTE:** It may be necessary to readjust RBW and VBW according to Steps 6 and 7 for accurate display.
- Press DELAY Soft Function Key F4.
 - Adjust Trigger Delay until Display shows desired horizontal position of pulses. Refer to Figure 4-16.

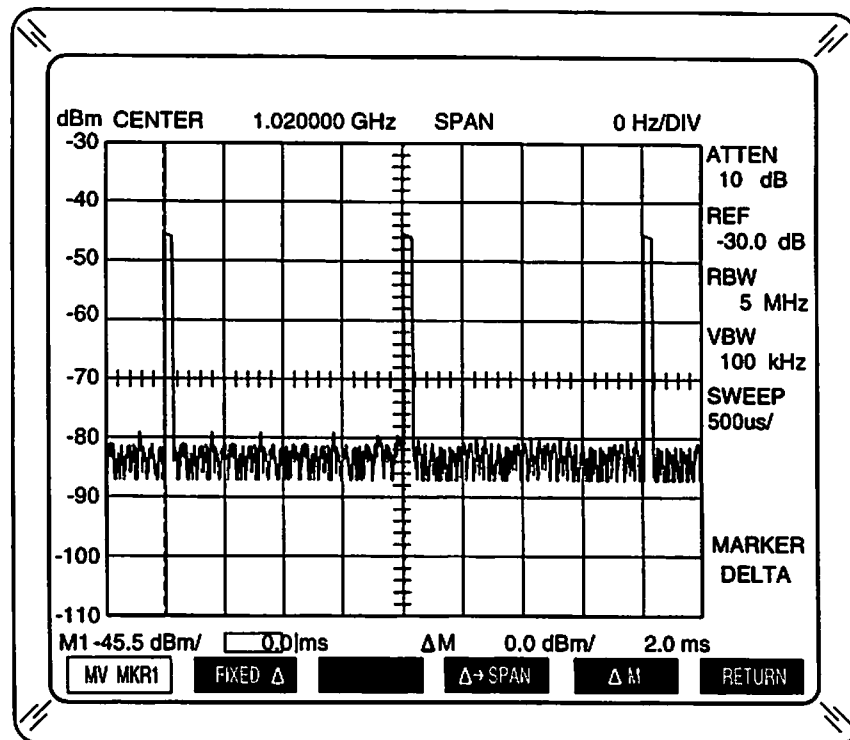

Figure 4-16 PRF Measurement for Dense Spectrum

01817004

24. Press MARKER MODE Key. Set markers as follows:
- Press DELTA Soft Function Key F6.
 - Move Delta Marker to leading edge of second pulse approximately 3 dB down from peak amplitude level.
 - Press MV MKR1 Soft Function Key F1. Move Marker 1 to leading edge of first pulse approximately 3 dB down from peak amplitude level.
 - Record time difference (ΔT) between markers indicated in second part of ΔM field.
25. Calculate PRF from reciprocal: $PRF = 1/\Delta T$ (Example in Figure 4-16 is 500 Hz.).

NOTE: If RBW is adjustable to $>PRF$, set Frequency Span and RBW to display line spectrum for another way of measuring PRF. Refer to Figure 4-17. PRF is measured as frequency difference between spectrum line peaks.

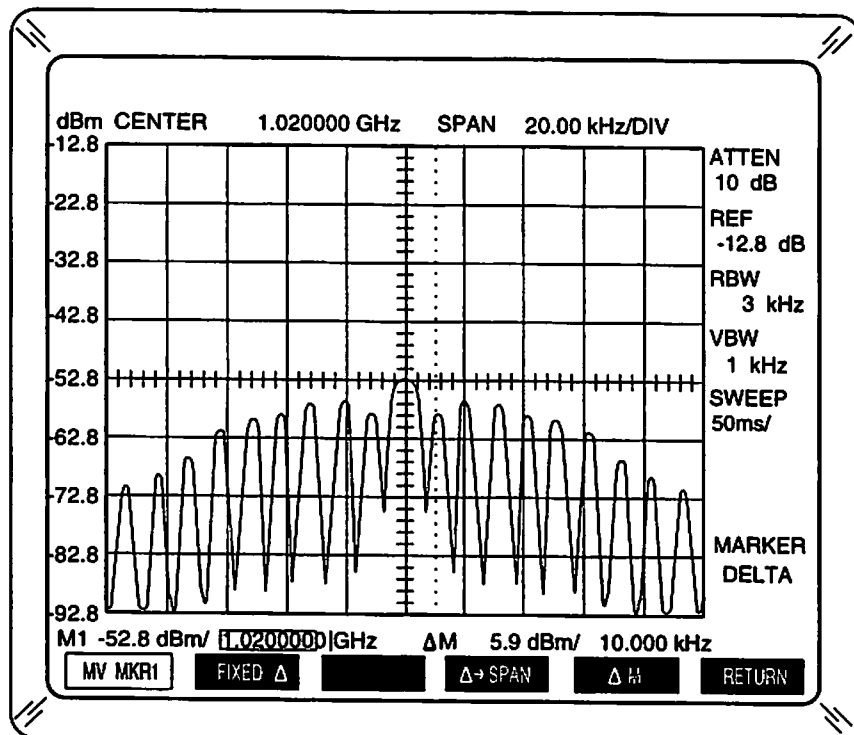
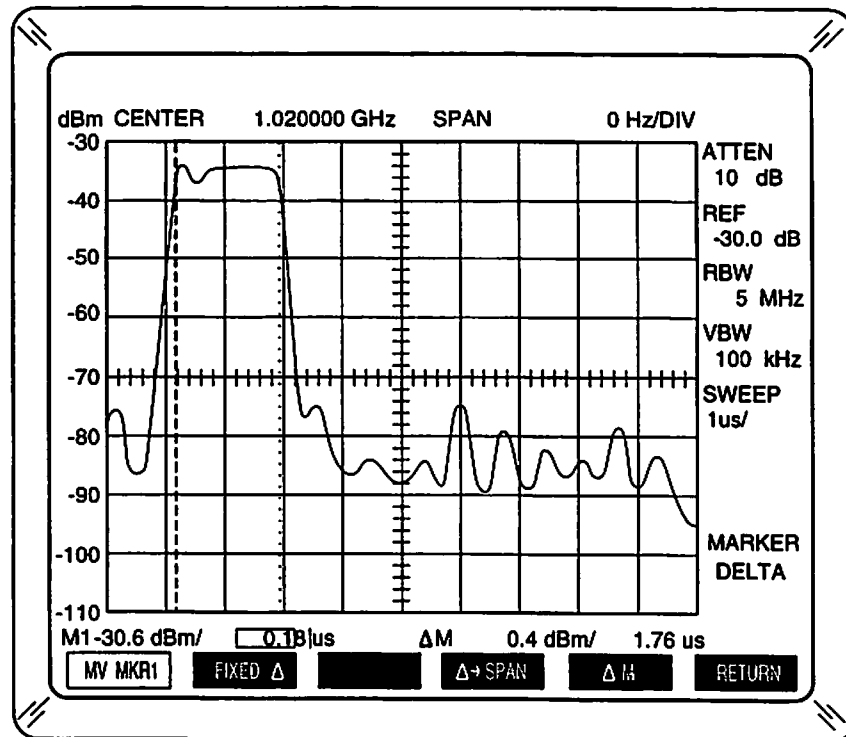

Figure 4-17 PRF Measurement for Line Spectrum

01917051

PULSE MEASUREMENTS USING BANDWIDTH APPLICATION PROGRAM

26. Press RETURN Soft Function Key F6, MKR SEL Soft Function Key F1 and MKR 1 Soft Function Key F1 in succession to remove markers.
27. Press SWEEP MODE Key. Adjust Sweep Time until Display shows one measurable pulse. Refer to Figure 4-.



01817005

Figure 4-18 Bandwidth Application Pulse Measurements

28. Press APPS Key. Press BW Soft Function Key F2. Set Bandwidth Application program as follows:
 - Verify Soft Function Key F4 is set to **+SLOPE**. If not, press **-SLOPE** Soft Function Key F4.
 - Press 3 dB Soft Function Key F1 to set markers at 50% amplitude points (-3 dB from peak amplitude level) on leading and trailing edges.
 - Record pulse width (time difference [ΔT] between markers) indicated in second part of ΔM field.
29. Press MARKER MODE Key. Set markers as follows:
 - Press DELTA Soft Function Key F6.
 - Press MV MKR1 Soft Function Key F1. Move Marker 1 to 10% amplitude point (≈ 10 dB down from peak amplitude level) on leading edge.
 - Press ΔM Soft Function Key F5. Move Marker 2 to 90% amplitude point (≈ 0.5 dB down from peak amplitude level) on leading edge.
 - Verify pulse rise time in second part of ΔM field.
 - Press MKR 1 Soft Function Key F1. Move Marker 1 to 10% amplitude point (≈ 10 dB down from peak amplitude level) on trailing edge.
 - Press ΔM Soft Function Key F5. Move Marker 2 to 90% amplitude point (≈ 0.5 dB down from peak amplitude level) on trailing edge.
 - Verify pulse fall time in second part of ΔM field.

4-6 EXTERNAL MIXER FUNCTION

NOTE: The External Mixer function requires an external mixer capable of mixing down the RF input signal using an LO input of 3 to 12 GHz to provide a 410.7 MHz IF output.

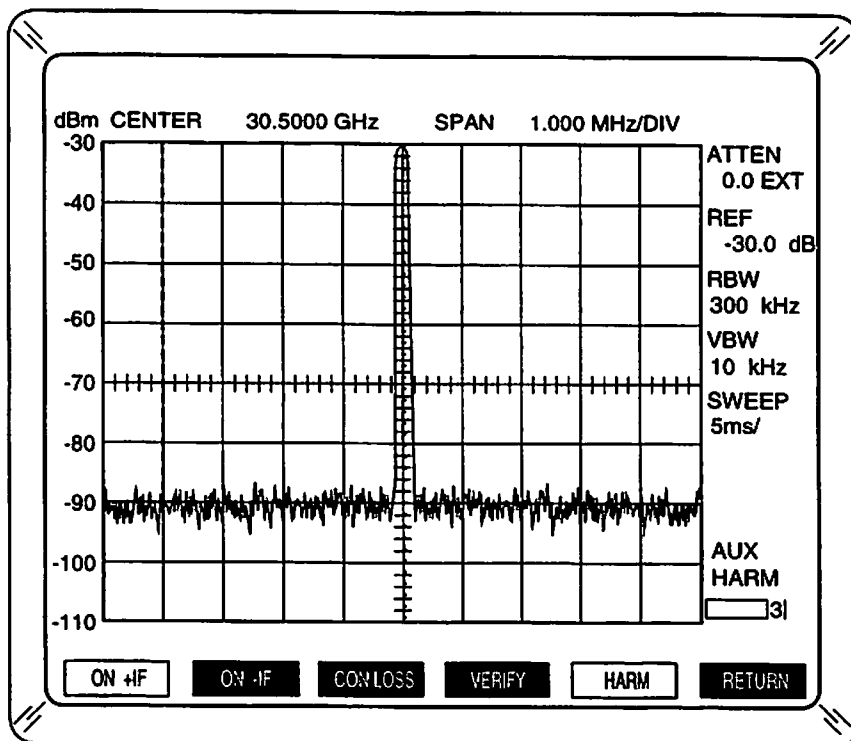

Figure 4-19 External Mixer Function

01917075

STEP

PROCEDURE

1. Apply power and activate AN1820. Allow 15 minute warm-up time.
2. Press AUX MODE Key.
3. Press MIXER Soft Function Key F3.
4. Press ON +IF Soft Function Key F1 to activate External Mixer function.
NOTE: If only the input frequency range is known, go to Step 7.
5. Press CENTER FREQUENCY Key. Enter desired Center Frequency from 3 to 1300 GHz, according to expected input signal.
6. Press SPAN FREQUENCY Key. Set Frequency Span wide enough for displaying expected input signal. Go to Step 9.
7. Press START FREQUENCY Key. Enter low end of known input frequency range (Start Frequency) from 3 to 1300 GHz.
8. Press STOP FREQUENCY Key. Enter high end of known input frequency range (Stop Frequency) from Start Frequency + 10 Hz to 1300 GHz.
9. Press AUX MODE Key.
10. Press MIXER Soft Function Key F3.
11. Press CON LOSS Soft Function Key F3. Set external attenuation according to external mixer conversion loss and any other added external attenuation factors.

12. Enter LO Harmonic according to messages appearing in upper section of Display. Adjust LO Harmonic until no message appears.



If *L.O. too Low* message appears, perform one or more steps as follows:

- Press HARM Soft Function Key F5 and decrease LO Harmonic.
- Press SPAN FREQUENCY Key. Reduce Frequency Span. Press AUX MODE Key. Press MIXER Soft Function Key F3.

If *L.O. too High* message appears, perform one or more steps as follows:

- Press HARM Soft Function Key F5 and increase LO Harmonic.
- Press ON -IF Soft Function Key F2.

13. Refer to Figure 4-20 and connect external mixer to AN1820 as follows:

- Connect IF output from external mixer to EXTERNAL MIXER IF Connector. 
CAUTION: MAXIMUM INPUT MUST NOT EXCEED -10 dBm.
- Connect EXTERNAL MIXER LO Connector  to LO input on external mixer.
CAUTION: SIGNAL INPUT MUST NOT BE APPLIED TO EXTERNAL MIXER LO CONNECTOR.
- Connect input signal to RF input on external mixer.

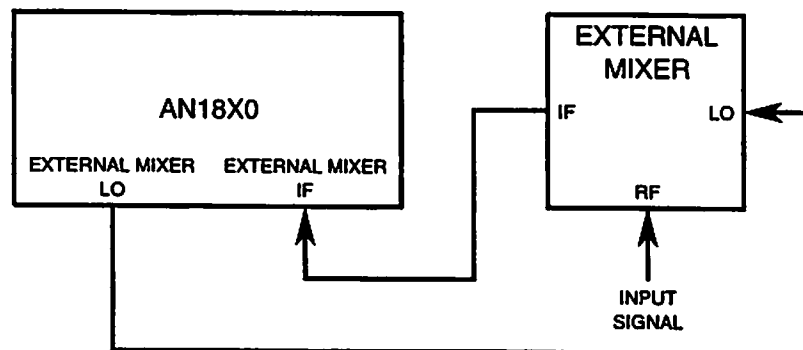

00303001

Figure 4-20 External Mixer Function Operation Hook-Up

14. Press BW AMPLITUDE Key.

NOTE: *UNCAL* appears in the Message field if an adjustment uncalibrates the Display.

Adjust bandwidths as follows:

- Adjust RBW for desired display. Decrease RBW for better signal to noise response.
- Press VBW Soft Function Key F3 to access VBW field. Adjust VBW as required to view signals mixed with noise.

-
15. Set reference level, if needed, as follows:
 - Press REF AMPLITUDE Key.
 - Set top of scale reference level from -85.0 to +30.0 dBm. If needed, press INT Soft Function Key F2.
 - Press OFFSET Soft Function Key F1. Set external gain factor (negative value), if used, or set to *0.0*.
 16. Repeat Steps 5 through 8, 14 and 15 as needed, for desired signal display.

NOTE: Placing signal peak near or at reference level (top of graticule) provides best measurement accuracy.
 17. Verify signal display as follows:
 - Press AUX MODE Key.
 - Press MIXER Soft Function Key F3.
 - Press VERIFY Soft Function Key F4. Verify false signals disappear from Display. (True signals remain at the same frequency position but may change amplitude slightly. New signals appearing on the Display are false signals and should disappear when the Verify function is deactivated.) Press VERIFY Soft Function Key F4.
 18. If markers are desired, press MARKER MODE Key. Set markers as follows:
 - Press MKR SEL Soft Function Key F1.
 - Move Marker 1 to desired location on trace display. Verify amplitude and frequency at Marker 1 position (displayed in Marker 1 field).
 - If Marker 2 is desired, press MKR 2 Soft Function Key F2. Move Marker 2 to desired location on trace display. Verify amplitude and frequency at Marker 2 position (displayed in Marker 2 field).
 - Press RETURN Soft Function Key F6.
 19. If Marker 1 is active and Delta function is desired, press DELTA Soft Function Key F6.
 20. With Delta function active, move Delta Marker to desired location on trace display. Verify amplitude and frequency difference between displayed markers in ΔM field.

4-7 FFT MODE

FFT mode automatically operates through the ANALYZER INPUT Connector when setting the Frequency Span from 10 to 200 Hz per division. This procedure covers FFT mode operation through the EXTERNAL INPUT Connector.

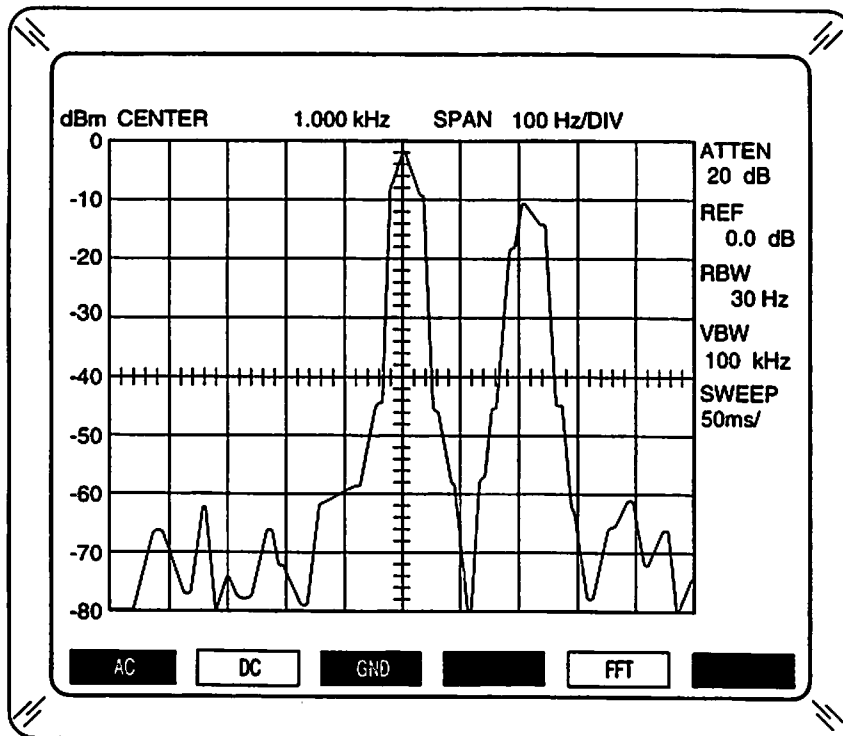



Figure 4-21 FFT Mode

01917016

STEP

PROCEDURE

1. Apply power and activate AN1820. Allow 15 minute warm-up time.
2. Connect input signal (≤ 24 kHz) to EXTERNAL INPUT Connector. 
CAUTION: MAXIMUM INPUT MUST NOT EXCEED 40 V PEAK.
3. Press AUX MODE Key.
4. Press FFT Soft Function Key F5.
5. Select input coupling as follows:
 - Press AC Soft Function Key F1 for ac coupling.
 - Press DC Soft Function Key F2 for dc coupling.
 - Press GND Soft Function Key F3 for ground reference Display.
6. Press CENTER FREQUENCY Key. Enter desired Center Frequency from 50 Hz to 23 kHz, according to input signal.
7. Press SPAN FREQUENCY Key. Set Frequency Span from 10 to 200 Hz per division.
NOTE: Center Frequency and Frequency Span are interactively limited in FFT mode.

-
8. Set reference level as follows:
 - Press REF AMPLITUDE Key.
 - Set top of scale reference level from -40.0 to +40.0 dBm. If needed, press INT Soft Function Key F2.
 - If using external devices with known gain or attenuation, press OFFSET Soft Function Key F1 to set Offset field from -99.9 to +99.9 dB. (Negative values offset gain and positive values offset attenuation.)
 9. Press BW AMPLITUDE Key. Adjust RBW from 3 to 100 Hz for desired display.

NOTE: FFT mode sets the fixed Amplitude Scale to 10 dB per division.
 10. Press UTILITY Key to display Analyzer Configuration Screen. Select desired FFT data window function as follows:
 - Select **3. GENERAL OPTIONS.**
 - Press x1 Key to display General Options Menu.
 - Select **1. FFT WINDOW TYPE.**
 - Press x1 Key.
 - Select desired FFT data window function. Refer to Appendix D for more information on FFT and data window functions.
 11. Press UTILITY Key twice to resume FFT signal display.

4-8 FREQUENCY-SELECTIVE DEVICE MEASUREMENTS

NOTE: The Bandwidth Application program and Return Loss Bridge procedures use the Tracking Generator Option 02. When the Tracking Generator Option 02 is installed, no other test equipment is necessary to test filters and most other frequency-selective related equipment. If the Tracking Generator Option 02 is not installed, an alternate signal source is required. The alternate signal source must provide a frequency sweeping signal wider than the band specified for the Unit Under Test (UUT).

Refer to Bandwidth Application program procedures in 4-8-1 to measure frequency response of filters and most other frequency-selective devices. Refer to 4-8-2 for procedures on using an external Return Loss Bridge to measure frequency response of antennas.

4-8-1 BANDWIDTH APPLICATION PROGRAM

The Bandwidth Application program is useful for measuring frequency response in the frequency domain or pulse information in the time domain (ZERO Span). Filters and other frequency-selective devices are easily verified using the Bandwidth Application program. Pulse information; such as rise time, fall time and pulse width; are measured using the Bandwidth Application program without having to demodulate the pulsed RF (see 4-5-4).

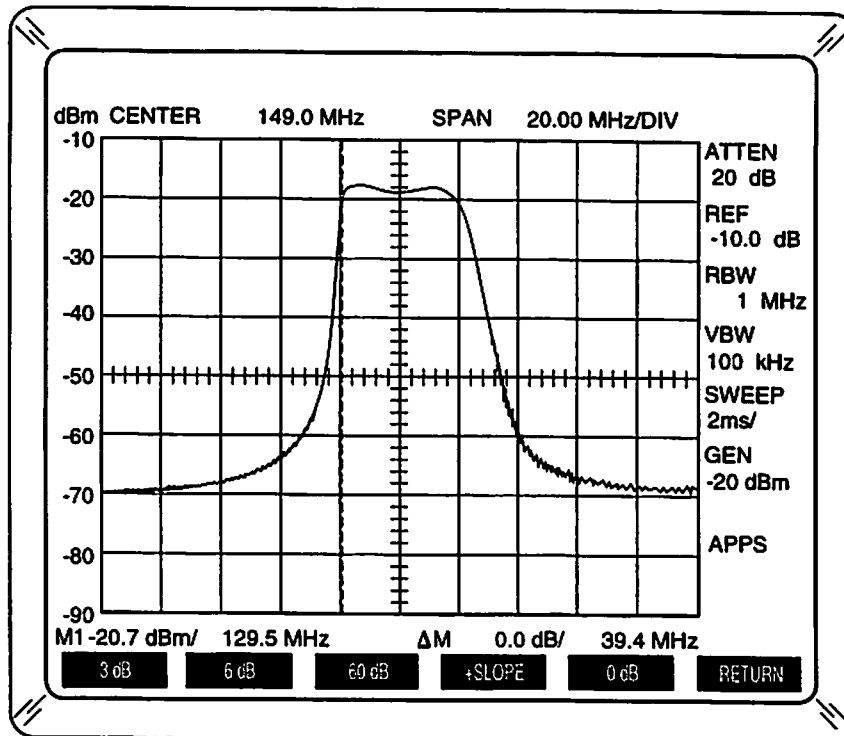



Figure 4-22 Bandwidth Application Filter Measurements

01917076

A. GENERAL PROCEDURE

STEP	PROCEDURE
------	-----------

1. Apply power and activate AN1820. Allow 15 minute warm-up time.
2. Connect UUT input to TRACKING GENERATOR Connector. 

CAUTION: SIGNAL INPUT (UUT OUTPUT) MUST NOT BE APPLIED TO TRACKING GENERATOR CONNECTOR.

3. Connect UUT output to ANALYZER INPUT Connector. 

CAUTION: MAXIMUM ANALYZER INPUT MUST NOT EXCEED +20 dBm, PEAK OR AVERAGE, WITH INTERNAL ATTENUATION <10 dB. MAXIMUM ANALYZER INPUT MUST NOT EXCEED +30 dBm AVERAGE OR +40 dBm PEAK WITH INTERNAL ATTENUATION ≥10 dB. FREQUENCY MUST BE >0 Hz (NO dc VOLTAGE).

4. Press CENTER FREQUENCY Key. Set Center Frequency to center of expected UUT frequency bandwidth.
5. Press GEN MODE Key.
6. Press ON Soft Function Key F1. Use DATA SCROLL Spinner to set tracking generator output for desired Display level.
7. Press SPAN FREQUENCY Key. Adjust Frequency Span per division until Display shows full frequency response bandwidth of UUT.
8. Press APPS Key.
9. Press BW Soft Function Key F2.
10. Set +SLOPE/-SLOPE Soft Function Key F4 for function according to UUT:
 - **+SLOPE** for bandpass filters and similar frequency response equipment.
 - **-SLOPE** for notch filters and similar frequency response equipment.
11. Set markers for bandwidth measurement:
 - Press 3 dB Soft Function Key F1 to measure frequency response at 3 dB points.
 - Press 6 dB Soft Function Key F2 to measure frequency response at 6 dB points.
 - Press 60 dB Soft Function Key F3 to measure frequency response at 60 dB points.
12. Verify UUT frequency response bandwidth in ΔM field.

B. EXAMPLES

Figure 4-22 shows a bandpass filter with a 39.4 MHz bandwidth (129.5 to 168.9 MHz) at the 3 dB points. The maximum value of the trace is -17.7 dBm.

The Bandpass Application program was set as follows:

- Markers were initially inactive.
- +SLOPE/-SLOPE Soft Function Key F4 was set to +**SLOPE** in Bandwidth Application Memory Operation Screen.
- 3 dB Soft Function Key F1 was pressed in Bandwidth Application Memory Operation Screen. The Bandwidth Application program activated and positioned markers at 3 dB points below maximum trace value, as shown.

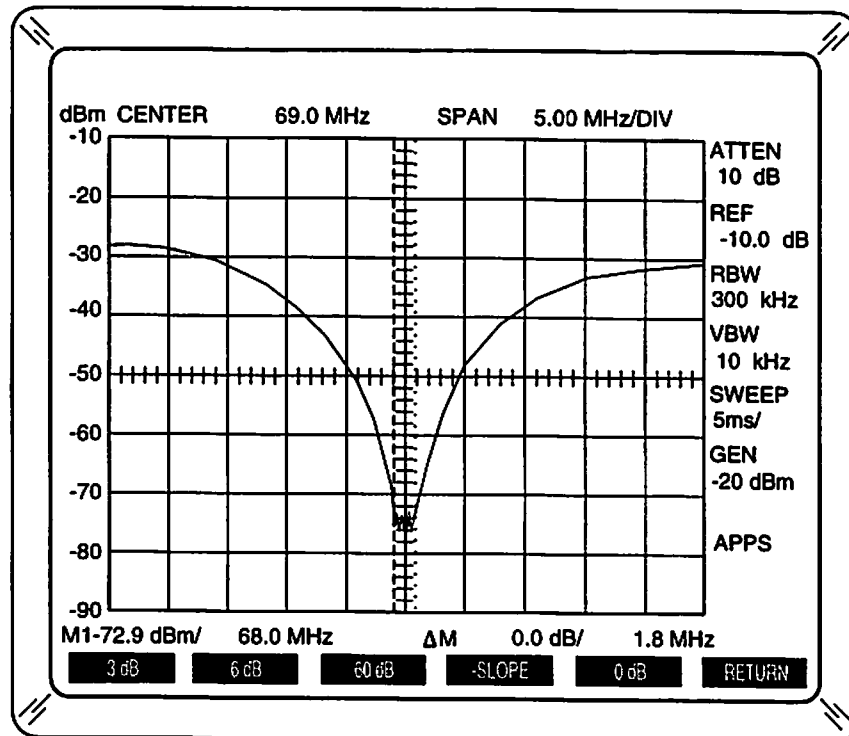

Figure 4-23 -Slope Operation with Markers Inactive

01917053

Figure 4-23 shows a notch filter with a 1.8 MHz notch (68.0 to 69.8 MHz) at the 3 dB points above the minimum trace value. The minimum value of the trace is -75.9 dBm.

The Bandpass Application program was set as follows:

- Markers were initially inactive.
- +SLOPE/-SLOPE Soft Function Key F4 was set to -**SLOPE** in Bandwidth Application Memory Operation Screen.
- 3 dB Soft Function Key F1 was pressed in Bandwidth Application Memory Operation Screen. The Bandwidth Application program activated markers at 3 dB points above minimum trace level, as shown.

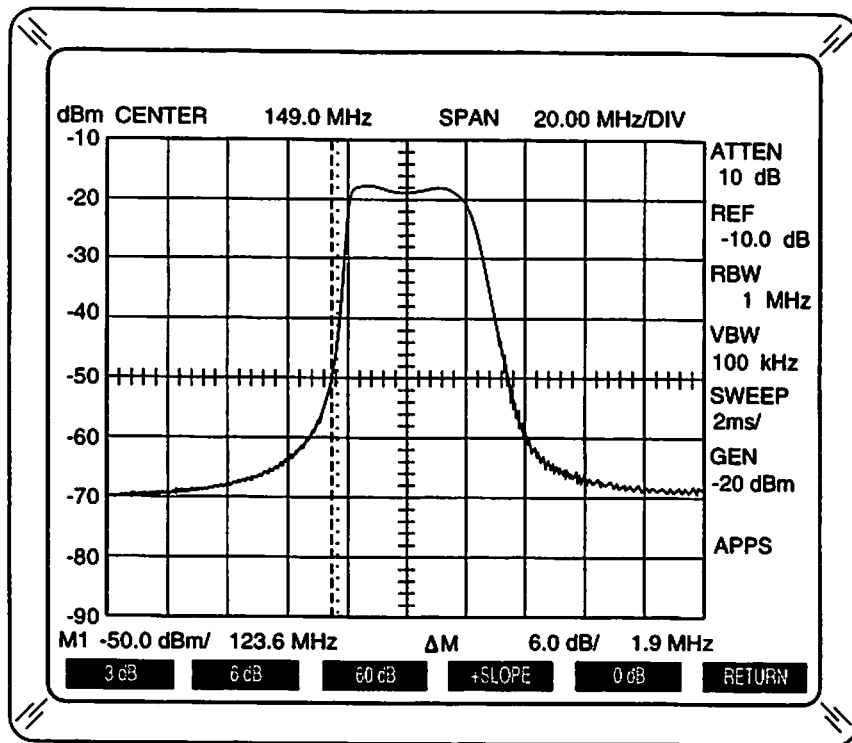

Figure 4-24 +Slope Operation with Marker(s) Active

01917054

Figure 4-24 shows a bandpass filter frequency response. The Bandwidth Application program was activated to look at specific frequencies and levels at the low end of the bandpass. The Display displays a 1.9 MHz difference between the trace at -50 dBm and at -44 dBm.

The Bandpass Application program was set as follows:

- Markers were initially active. Marker 1 was set at 123.6 MHz for a -50 dBm level. Marker 1 had edit control.
- +SLOPE/-SLOPE Soft Function Key F4 was set to +SLOPE in Bandwidth Application Memory Operation Screen.
- 6 dB Soft Function Key F2 was pressed in Bandwidth Application Memory Operation Screen. The Bandwidth Application program positioned Delta Marker to the right of Marker 1 at the first 6 dB point above the level at Marker 1, as shown.

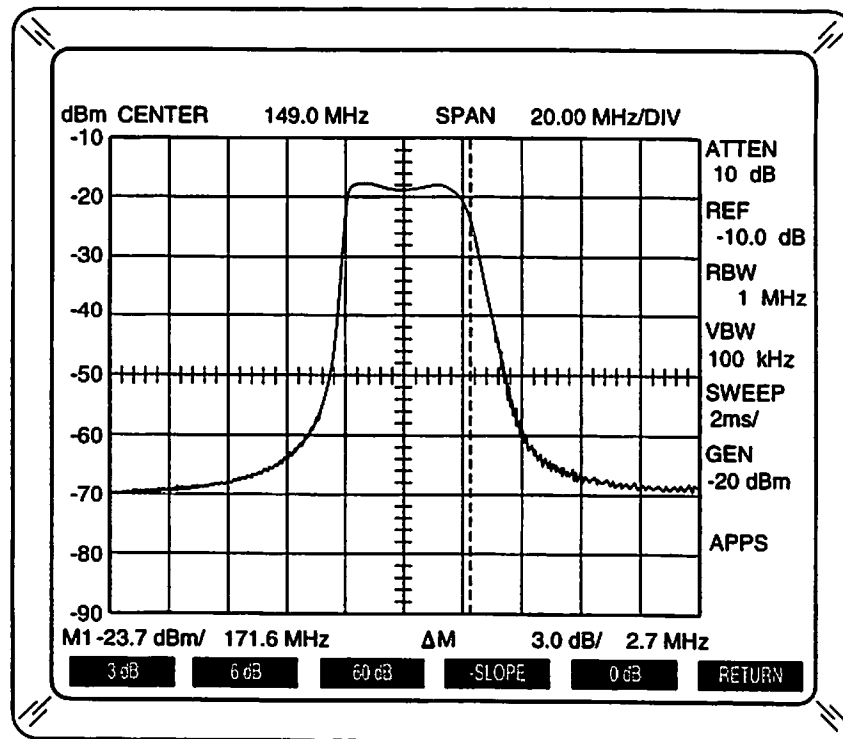

01917055

Figure 4-25 -Slope Operation with Marker(s) Active

Figure 4-25 shows a bandpass filter frequency response. The Bandwidth Application program was activated to look at specific frequencies and levels at the high end of the bandpass. The Display displays a 2.7 MHz difference between the trace at the 3 dB point and the trace at the 6 dB point.

The Bandpass Application program was set as follows:

- Markers were initially active. Markers were set at the 3 dB points below the maximum trace level. Delta Marker had edit control.
- +SLOPE/-SLOPE Soft Function Key F4 was set to **-SLOPE** in Bandwidth Application Memory Operation Screen.
- 3 dB Soft Function Key F1 was pressed in Bandwidth Application Memory Operation Screen. The Bandwidth Application program positioned Marker 1 to the right of Delta Marker at the first 3 dB point below the level at Marker 1, as shown.

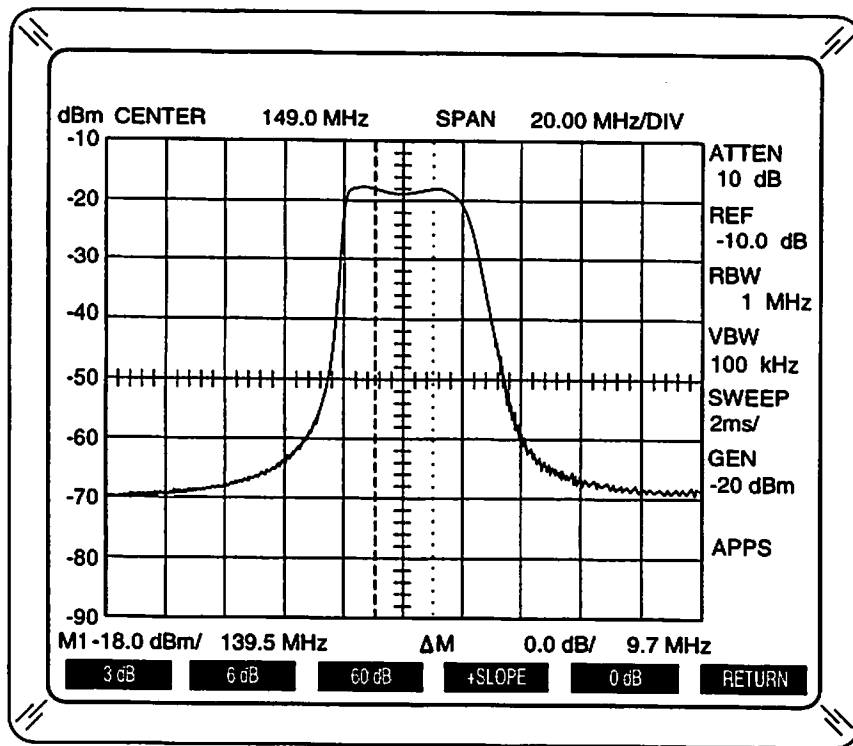

Figure 4-26 0 dB Function

01917056

Figure 4-26 shows a bandpass filter frequency response. The Bandwidth Application program was activated to look at the dip in the middle of the bandpass. The Display shows a 9.7 MHz bandwidth (139.5 to 149.2 MHz) across the dip.

The Bandpass Application program was set as follows:

- Markers were initially active. Marker 1 was set to a desired point (level where the dip required consideration). Marker 1 had edit control.
- 0 dB Soft Function Key F5 was pressed in Bandwidth Application Memory Operation Screen. The Bandwidth Application program positioned Delta Marker to the right of Marker 1 at the first point where the trace was at the same level as at the Marker 1 position, as shown.

NOTE: +SLOPE/-SLOPE Soft Function Key F4 setting does not matter when using the 0 dB function.

4-8-2 RETURN LOSS BRIDGE (ACCESS NO: AC4101) MEASUREMENTS

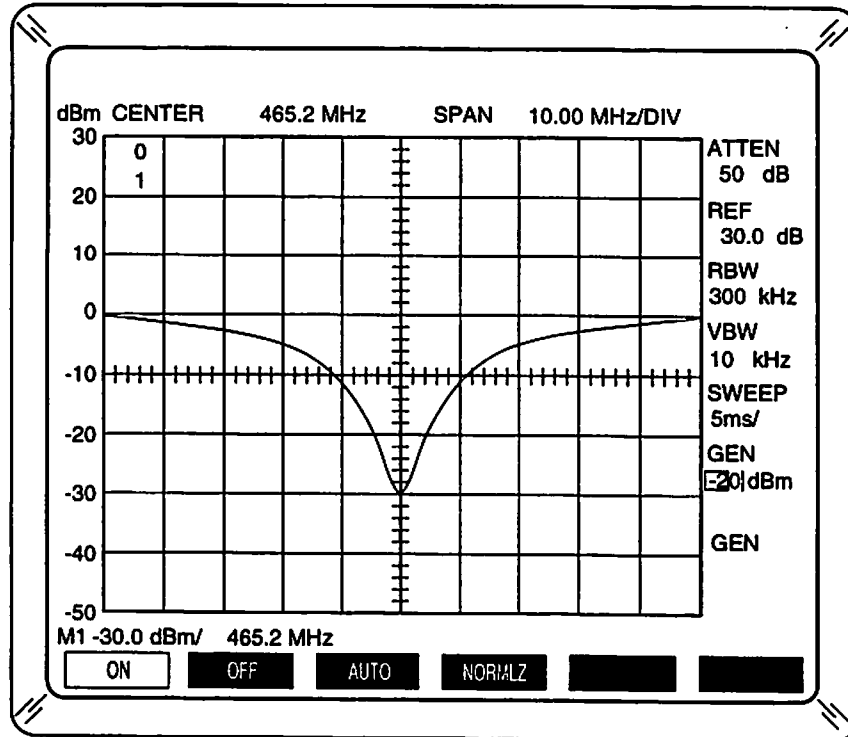



Figure 4-27 Return Loss Bridge Measurements

01971077

STEP

PROCEDURE

1. Apply power and activate AN1820. Allow 15 minute warm-up time.
2. Connect TRACKING GENERATOR Connector  to SOURCE Connector of Return Loss Bridge (see Figure 4-28).

CAUTION: SIGNAL INPUT MUST NOT BE APPLIED TO TRACKING GENERATOR CONNECTOR.

IF USING RF SOURCE OTHER THAN INTERNAL TRACKING GENERATOR, DO NOT EXCEED MAXIMUM INPUT TO BRIDGE. REFER TO TABLE 4-3 FOR SUPPLY LEVEL AND DURATION CYCLE.

3. Connect ANALYZER INPUT Connector  to REFLECTED Connector of Return Loss Bridge (see Figure 4-28).

CAUTION: MAXIMUM ANALYZER INPUT MUST NOT EXCEED +20 dBm, PEAK OR AVERAGE, WITH INTERNAL ATTENUATION <10 dB. MAXIMUM ANALYZER INPUT MUST NOT EXCEED +30 dBm AVERAGE OR +40 dBm PEAK WITH INTERNAL ATTENUATION ≥10 dB. FREQUENCY MUST BE >0 Hz (NO dc VOLTAGE).

SUPPLY RATING TABLE					
AMBIENT TEMPERATURE (°C)	TIME INTERVAL				
	5 MINUTES	4 MINUTES	3 MINUTES	2 MINUTES	1 MINUTE
0	2.5 W	2.5 W	3.5 W	5.0 W	6.0 W
10	2.0 W	2.5 W	3.0 W	4.5 W	5.5 W
20	1.8 W	2.0 W	2.5 W	4.0 W	5.0 W
30	1.5 W	1.8 W	2.0 W	3.5 W	4.5 W
40	1.3 W	1.5 W	1.8 W	3.0 W	3.8 W
50	1.3 W	1.5 W	1.8 W	2.5 W	3.3 W
60	1.0 W	1.3 W	1.5 W	2.0 W	2.8 W
70	1.0 W	1.3 W	1.5 W	1.8 W	2.5 W

Table 4-3 Power Level and Duration Cycle

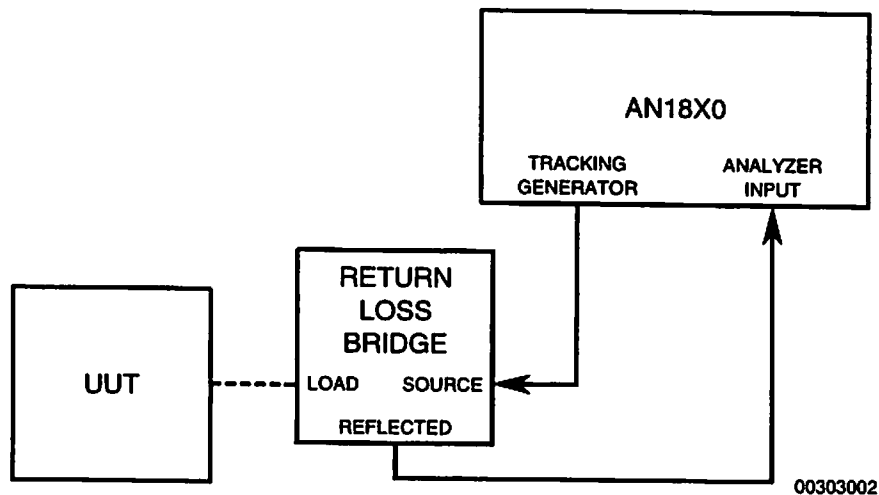

Figure 4-28 Return Loss Bridge Measurements Hook-Up

4. For Start/Stop function, go to Step 5. For Center/Span operation:
 - Press CENTER FREQUENCY Key. Enter fundamental Center Frequency.
 - Press SPAN FREQUENCY Key. Enter desired Frequency Span per division. Go to Step 6.
5. For Start/Stop function:
 - Press START FREQUENCY Key. Enter desired Start Frequency.
 - Press STOP FREQUENCY Key. Enter desired Stop Frequency.
6. Press GEN MODE Key.
7. Press ON Soft Function Key F1.
8. Set Tracking Generator Output Level to 0 dB using DATA SCROLL Spinner.

STEP

PROCEDURE

9. Press AUTO Soft Function Key F3 to peak Tracking Generator Output Level over displayed Frequency Span.
NOTE: Peaking Tracking Generator Output Level is only necessary if procedure is being performed over Frequency Spans <10 kHz/Div.
10. Press NORMLZ Soft Function Key F4 to set current trace to top of scale reference.
11. Connect unit under test (UUT) to LOAD Connector of Return Loss Bridge according to Figure 4-28.
NOTE: If not possible to connect UUT directly to LOAD Connector of Return Loss Bridge, use coaxial cable shorter than 10% wavelength of frequency being tested.
12. Verify Display shows entire amplitude range of UUT Return Loss trace. If not, offset Display as follows:
 - Press REF AMPLITUDE Key.
 - Press OFFSET Soft Function Key F1.
 - Use DATA SCROLL Spinner to adjust Amplitude Scale Offset for desired Display.
13. Press MARKER MODE Key.
14. Press MKR SEL Soft Function Key F1.
15. Move marker having edit control to any point of interest on trace.
16. Verify UUT Return Loss in applicable marker field.
17. Determine VSWR and Reflected Power using UUT Return Loss in Step 16 and Table 4-4.

RET LOSS	VSWR	REFLD PWR	RET LOSS	VSWR	REFLD PWR	RET LOSS	VSWR	REFLD PWR
-1.0 dB	17.4	79.4%	-11.0 dB	1.78	7.9%	-22.0 dB	1.17	0.6%
-2.0 dB	8.72	63.1%	-12.0 dB	1.67	6.3%	-24.0 dB	1.13	0.4%
-3.0 dB	5.85	50.1%	-13.0 dB	1.58	5.0%	-26.0 dB	1.11	0.3%
-4.0 dB	4.42	39.8%	-14.0 dB	1.49	4.0%	-28.0 dB	1.08	0.16%
-5.0 dB	3.57	31.6%	-15.0 dB	1.43	3.2%	-30.0 dB	1.07	0.10%
-6.0 dB	3.01	25.1%	-16.0 dB	1.38	2.5%	-32.0 dB	1.05	0.06%
-7.0 dB	2.61	20.0%	-17.0 dB	1.33	2.0%	-34.0 dB	1.04	0.04%
-8.0 dB	2.32	15.8%	-18.0 dB	1.29	1.6%	-36.0 dB	1.03	0.03%
-9.0 dB	2.10	12.6%	-19.0 dB	1.25	1.3%	-38.0 dB	1.03	0.02%
-10.0 dB	1.93	10.0%	-20.0 dB	1.22	1.0%	-40.0 dB	1.02	0.01%

Table 4-4 Return Loss-VSWR-Reflected Power Conversion

18. Repeat Steps 15 through 17, as desired, for different frequency positions on UUT Return Loss Trace.

4-9 MEMORY OPERATIONS

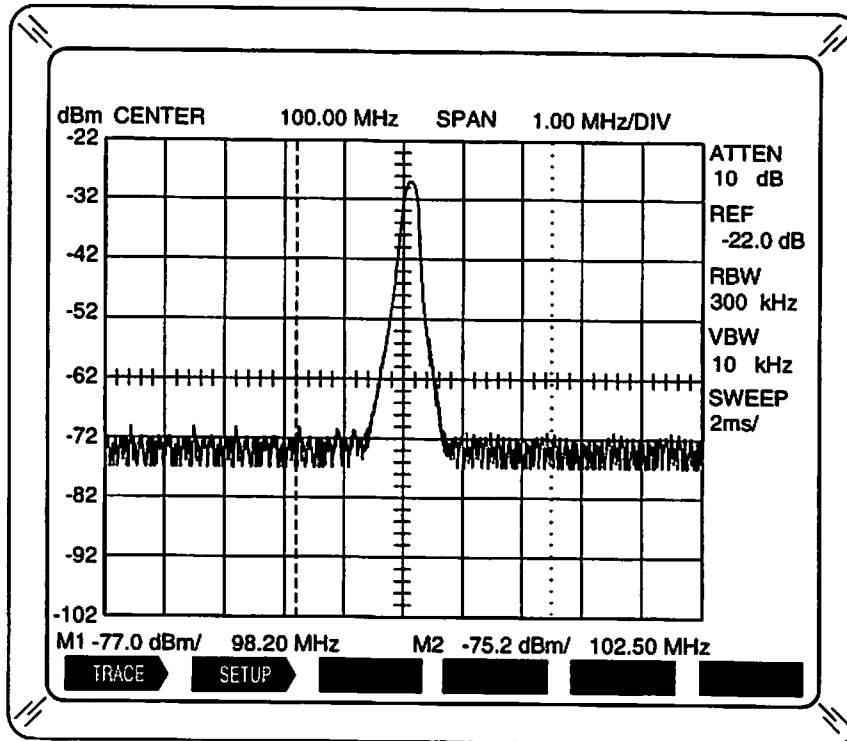

Figure 4-29 Memory Operations

01917023

4-9-1 MEMORY STORAGE

A. TRACE STORAGE

STEP	PROCEDURE
------	-----------

1. Apply power and activate AN1820. Allow 15 minute warm-up time.
2. Set AN1820 to display desired signal. Refer to any procedure listed in 4-2 to 4-8.
3. Press STORE Key to freeze live trace.
4. Press TRACE Soft Function Key F1 to enter Store Trace Directory.
5. Use DATA SCROLL Spinner, ← and → Keys (advances or recedes entire Display of Memory Locations), and/or ↑ and ↓ Keys to select desired unprotected Memory Location from 01 to 99.
6. Set limit and/or protection designations as follows:

NOTE: A trace cannot be designated as an upper limit and lower limit trace at the same time.

- Press PROTECT Soft Function Key F2 to protect Memory Location from overwrite.
- Press UP LIM Soft Function Key F3 to designate trace as upper limit trace.
- Press LO LIM Soft Function Key F4 to designate trace as lower limit trace.

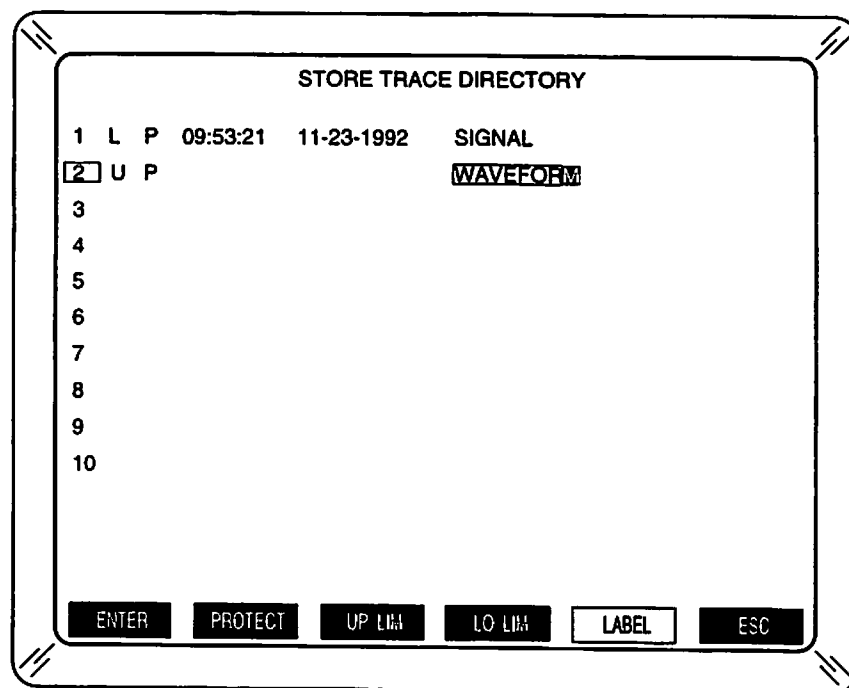

00317007

Figure 4-30 Store Trace Directory Operation

7. If Storage Label is desired, proceed as follows:
 - Press LABEL Soft Function Key F5. (LABEL is highlighted.) If Hold function is active, press MORE Soft Function Key F5 and LABEL Soft Function Key F1 in sequence.
 - Use ↑ and ↓ Keys or DATA SCROLL Spinner to enter each character, up to 20 characters, in LABEL field. Use ← and → Keys to position cursor. If desired, use DATA ENTRY Keypad to enter numeric characters. Press ESC Soft Function Key F6 to abort Storage Label entry and start over, if needed.
 - Press applicable LABEL Soft Function Key F5 or F1. (LABEL is not highlighted.)
8. If Hold function is active, perform following:
 - To store peak hold trace, if desired, press MAX HOLD Soft Function Key F2 (Maximum Hold trace) or MIN HOLD Soft Function Key F3 (Minimum Hold trace).
 - Press MORE Soft Function Key F5.
9. Press ENTER Soft Function Key F1 to store desired trace.
10. Repeat Steps 5 through 9, as desired, to store peak hold and active traces.
11. Press RETURN Soft Function Key F6.

B. SETUP STORAGE

STEP

PROCEDURE

1. Apply power and activate AN1820. Allow 15 minute warm-up time.
2. Set AN1820 with desired control settings. Refer to any procedure listed in 4-2 to 4-8.
3. Press STORE Key.
4. Press SETUP Soft Function Key F2 to enter Store Setup Directory.

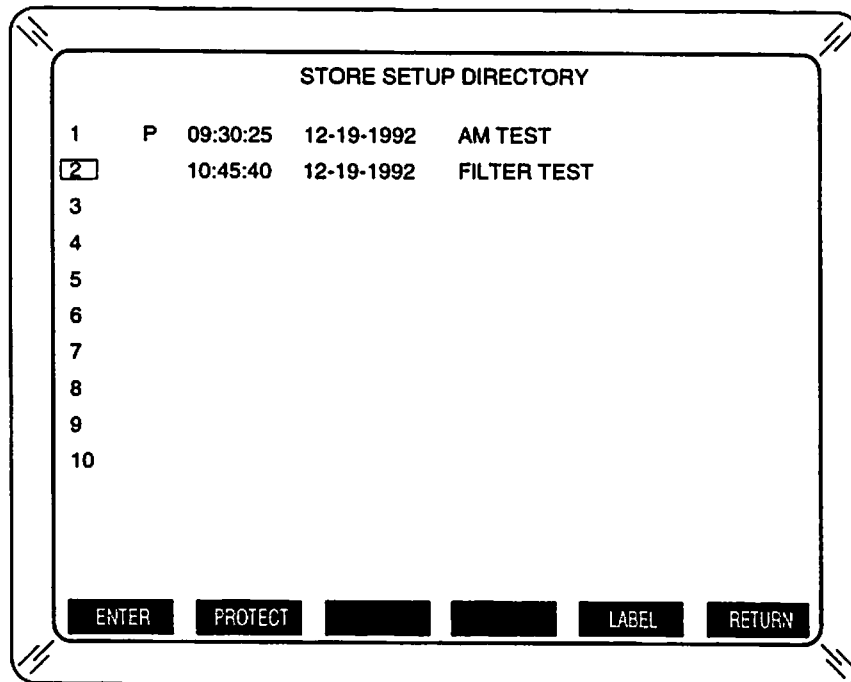

01917025

Figure 4-31 Store Setup Directory Operation

5. Use DATA SCROLL Spinner, ← and → Keys (advances or recedes entire Display of Memory Locations), and/or ↑ and ↓ Keys to select desired unprotected Memory Location from 01 to 99.
6. If desired, press PROTECT Soft Function Key F2 to protect Memory Location from overwrite.
7. If Storage Label is desired, proceed as follows:
 - Press LABEL Soft Function Key F5. (LABEL is highlighted.)
 - Use ↑ and ↓ Keys or DATA SCROLL Spinner to enter each character, up to 20 characters, in LABEL field. Use ← and → Keys to position cursor. If desired, use DATA ENTRY Keypad to enter numeric characters. Press ESC Soft Function Key F6 to abort Storage Label entry and start over, if needed.
 - Press LABEL Soft Function Key F5. (LABEL is not highlighted.)
8. Press ENTER Soft Function Key F1 to store setup.
9. Press RETURN Soft Function Key F6.

4-9-2 MEMORY RECALL

A. TRACE RECALL

STEP	PROCEDURE
------	-----------

1. Apply power and activate AN1820. Allow 15 minute warm-up time.
2. Press RECALL Key.
3. Press TRACE Soft Function Key F1 to enter Recall Trace Directory.

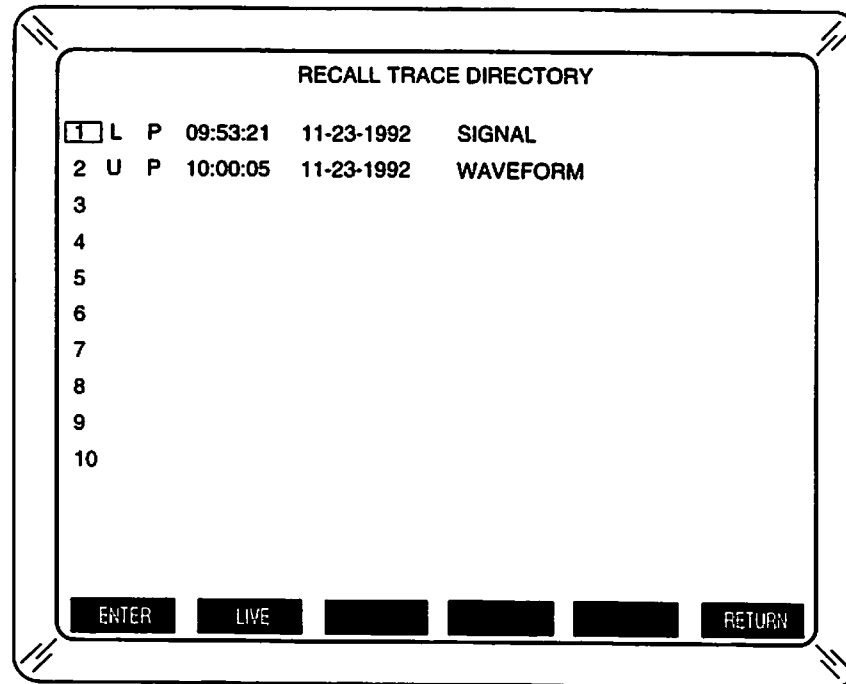

Figure 4-32 Recall Trace Directory Operation

01917027

4. Use DATA SCROLL Spinner, ← and → Keys (advances or recedes entire Display of Memory Locations), and/or ↑ and ↓ Keys to select desired trace Memory Location.
5. Press ENTER Soft Function Key F1 to recall selected trace or press LIVE Soft Function Key F2 to show live trace without clearing Display.
6. Repeat Step 3 through 5, as desired, to display up to four traces on Display.
7. Press REMOVE Soft Function Key F5 to remove trace from Display. Enter Memory Location number for trace to be removed (0 for live trace).
8. Press LIVE Soft Function Key F6 to clear display of all recalled traces and return to live trace.

B. SETUP RECALL

STEP

PROCEDURE

1. Apply power and activate AN1820. Allow 15 minute warm-up time.
2. Press RECALL Key.
3. Press SETUP Soft Function Key F1 to enter Recall Setup Directory.

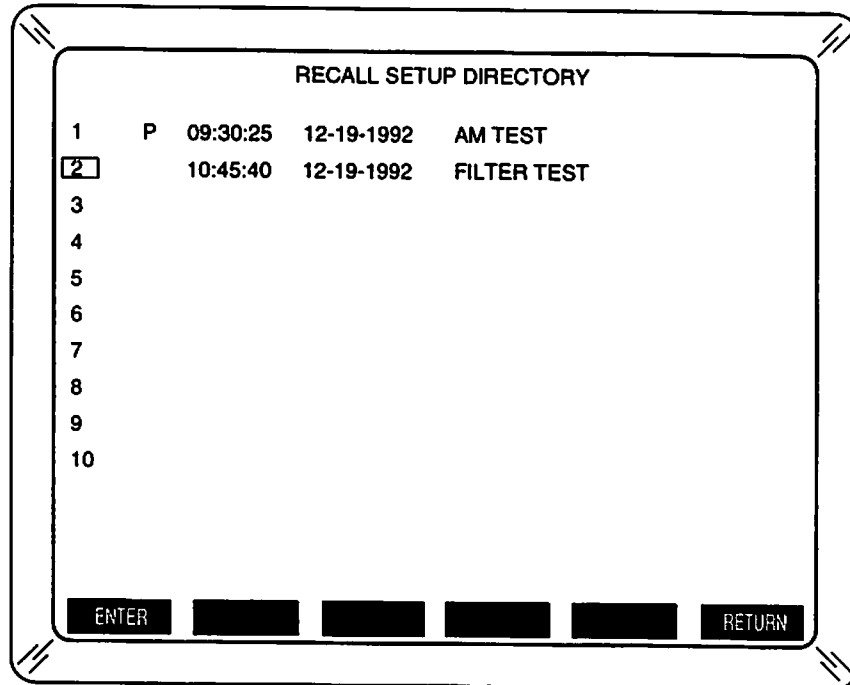

Figure 4-33 Recall Setup Directory Operation

01917029

4. Use DATA SCROLL Spinner, ← and → Keys (advances or recedes entire Display of Memory Locations), and/or ↑ and ↓ Keys to select desired setup Memory Location.
5. Press ENTER Soft Function Key F1 to recall selected setup.
6. Press RETURN Soft Function Key F6. (Display shows live trace with recalled control settings.)

4-9-3 LIMITS TRACE CREATION

NOTE: If the results of a trace creation function are in error or not desired, refer to Table 4-5.

FUNCTION	ACTION
SET	Reposition x-y axis lines to desired point and press SET Soft Function Key F3 again to move set position.
DRAW	Press UNDO Soft Function Key F5 to undo last Draw action.
x-y Axis Position Edit	Press ESC Soft Function Key F6 to return to last set position.

Table 4-5 Trace Creation Undo Actions

STEP	PROCEDURE
------	-----------

1. Apply power and activate AN1820. Allow 15 minute warm-up time.
2. Set AN1820 to display live trace or desired recall trace according to 4-9-2.
3. Press DISPLAY Key.
4. Press LIMITS Soft Function Key F5 to enter Display Limits Trace Creation Screen.

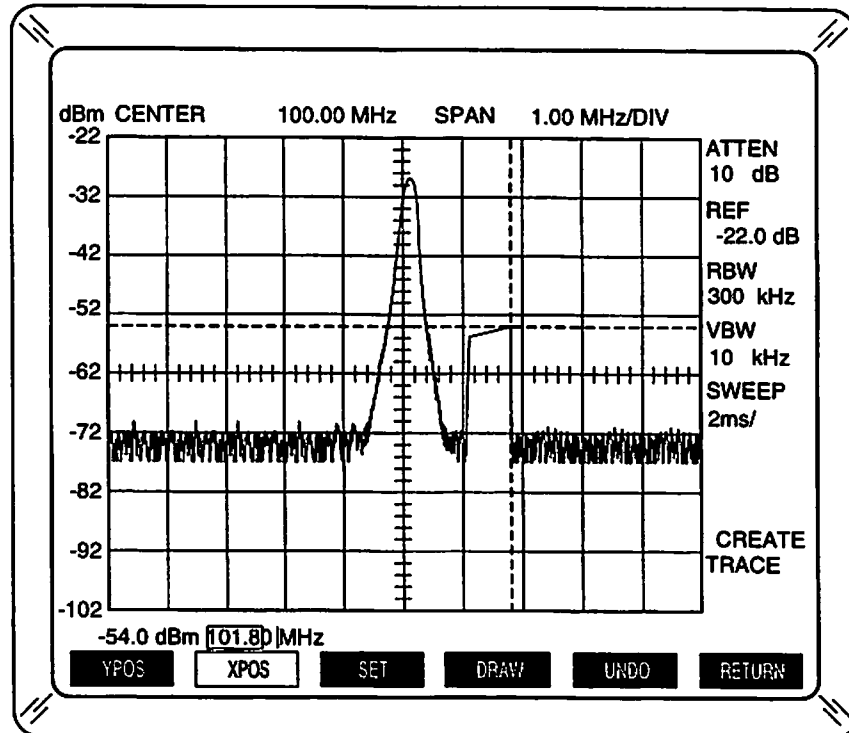

Figure 4-34 Display Limits Trace Creation Screen Operation

01917021

5. Create new trace sections as follows:**● Adding Single Points**

Press YPOS Soft Function Key F1. Use DATA SCROLL Spinner to move y axis position to desired amplitude level of new point.

Press XPOS Soft Function Key F2. Use DATA SCROLL Spinner to move x axis position to desired frequency or time setting of new point. (Intersection of axis lines indicates new point position.)

Press DRAW Soft Function Key F4 to add new point into trace.

● Adding Line Segments

Press YPOS Soft Function Key F1. Use DATA SCROLL Spinner to move y axis position to desired amplitude level of first point on new line segment.

Press XPOS Soft Function Key F2. Use DATA SCROLL Spinner to move x axis position to desired frequency or time setting of first point on new line segment. (Intersection of axis lines indicates first point on new line segment.)

Press SET Soft Function Key F3 to set first point of line segment.

Use DATA SCROLL Spinner to move x axis position to desired frequency or time setting of second point on new line segment.

Press YPOS Soft Function Key F1. Use DATA SCROLL Spinner to move y axis position to desired amplitude level of second point on new line segment. (Intersection of axis lines indicates second point on new line segment.)

Press DRAW Soft Function Key F4 to add new line segment into trace.

6. Repeat Step 5, as desired, to complete trace creation.**7. Press RETURN Soft Function Key F6 to return to Display Operation Screen.****8. Store trace according to 4-9-1A.**

4-9-4 SENDING OUT PLOTS

STEP

PROCEDURE

1. Apply power and activate AN1820. Allow 15 minute warm-up time.
2. Connect HPGL compatible plotter to RS-232 Connector for serial operation or IEEE-488 GPIB Connector for parallel operation. Refer to Figure 4-35 for RS-232 cable configuration. Use standard IEEE-488 GPIB cable for GPIB parallel operation.

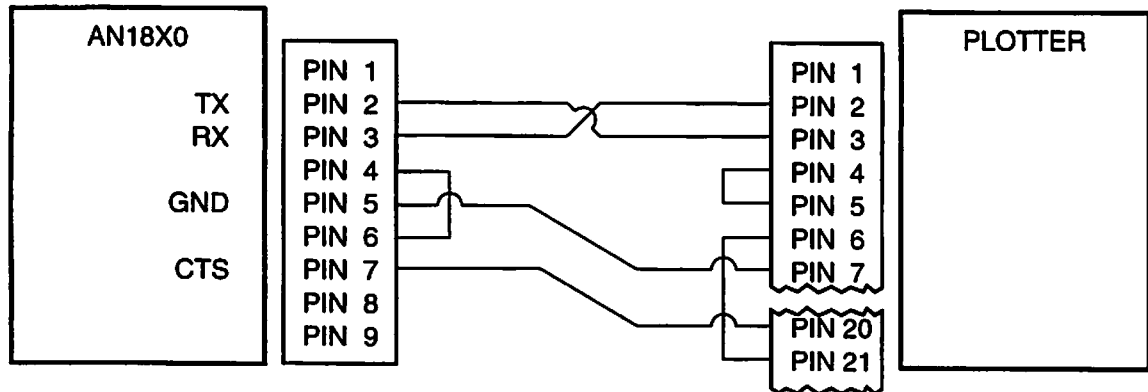

Figure 4-35 RS-232 Plotter Cable Configuration

00303003

3. Set plotter, as desired for compatibility. For GPIB operation, set plotter to Listen Only.
4. Press UTILITY Key.
 - Select applicable submenu, RS-232 (SERIAL) or IEEE-488 (GPIB).
 - Press ENTER Soft Function Key F1.
 - Set OPERATION MODE to **PLOTTER** in RS-232 (SERIAL) Menu or **PLOTTER (HPGL)** in IEEE-488 (GPIB) Menu.
NOTE: If the OPERATION MODE for one connector is set for plotter operation, the OPERATION MODE for the other connector cannot be set for plotter operation.
 - Use ENTER Soft Function Key F1 and ↑ and ↓ Keys to configure applicable connector interface according to plotter settings. For RS-232 plotters, set HANDSHAKE to **CTS/RTS** and RCI CONTROL to **DISABLE**.
 - Press RETURN Soft Function Key F5.
5. Set AN1820 for desired trace or setup. Set operation as desired (use 4-2 to 4-8 procedures as guide) or recall according to 4-9-2.
6. Press COPY Key.
7. Press PLOT Soft Function Key F2.
 - Press ALL Soft Function Key F1 to plot trace, graticule and scaling.
 - Press TRACE Soft Function Key F2 to plot trace only (for plotting multiple traces on already plotted graticule and scaling).
 - Press GRAT Soft Function Key F3 to plot graticule and scaling only.
8. Repeat Steps 5 through 7 as desired.

4-9-5 PRINTING OUT SCREENS

STEP	PROCEDURE
------	-----------

1. Apply power and activate AN1820. Allow 15 minute warm-up time.
2. Connect compatible printer (Epson 9, Epson 24, ThinkJet, LaserJet or DeskJet) to PRINTER Connector.
3. Press UTILITY Key.
 - Select **9. PRINTER OPTIONS.**
 - Press ENTER Soft Function Key F1.
 - Use ENTER Soft Function Key F1 and ↑ and ↓ Keys to set PORT to **PARALLEL PORT**, CONFIG to **UNI-DIRECTION** (unless specified otherwise by printer operation manual) and TYPE according to connected printer type (LASERJET for DeskJet).
 - Press RETURN Soft Function Key F5.
4. Set AN1820 for desired trace and/or setup. Set operation as desired (use 4-2 to 4-8 procedures as guide) or recall according to 4-9-2.
5. Press COPY Key.
6. Press PRINT Soft Function Key F1.

4-9-6 MEMORY EDITS

A. MOVE FUNCTION

STEP	PROCEDURE
------	-----------

1. Apply power and activate AN1820. Allow 15 minute warm-up time.
2. Press RECALL Key.
3. Press EDIT T Soft Function Key F2 to enter Edit Trace Directory or press EDIT S Soft Function Key F4 to enter Edit Setup Directory.

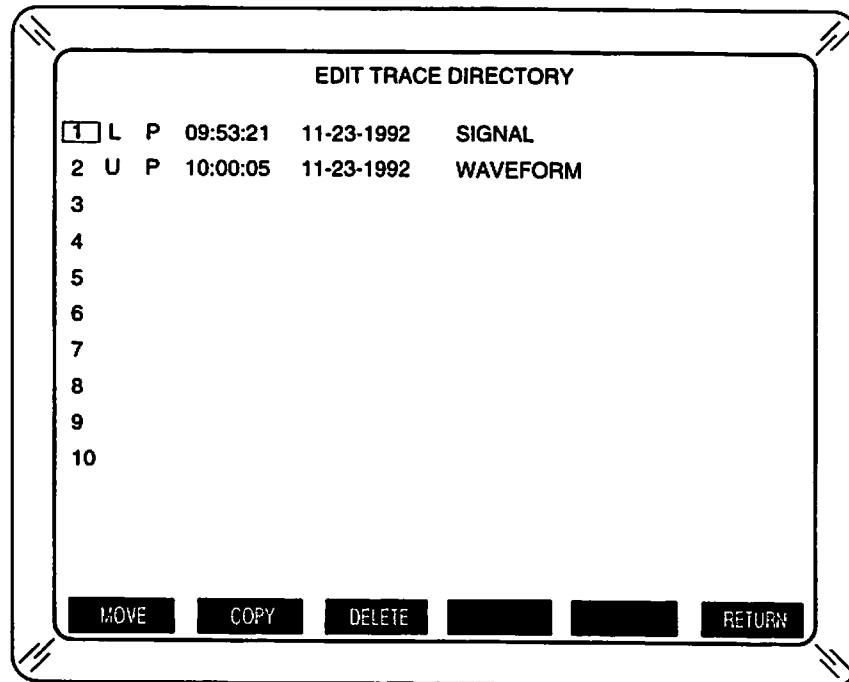

Figure 4-36 Edit Trace Directory Operation

01917028

4. Use DATA SCROLL Spinner, ← and → Keys (advances or recedes entire Display of Memory Locations), and/or ↑ and ↓ Keys to select desired Memory Location with contents.
5. Press MOVE Soft Function Key F1 (MOVE is highlighted).
6. Use DATA SCROLL Spinner, ← and → Keys (advances or recedes entire Display of Memory Locations), and/or ↑ and ↓ Keys to select desired empty or unprotected Memory Location.



Figure 4-37 Move Memory Operation

00308004

7. Press MOVE Soft Function Key F1.

STEP**PROCEDURE**

Figure 4-38 Confirm Memory Operation

00308005

8. Press CONFIRM Soft Function Key F5.

B. COPY FUNCTION**STEP****PROCEDURE**

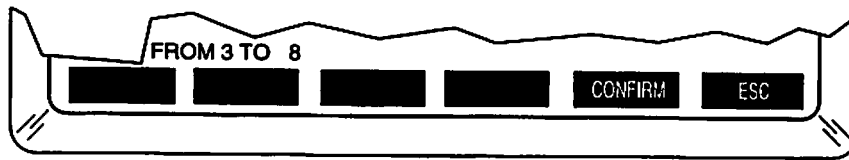
1. Apply power and activate AN1820. Allow 15 minute warm-up time.
2. Press RECALL Key.
3. Press EDIT T Soft Function Key F2 to enter Edit Trace Directory or press EDIT S Soft Function Key F4 to enter Edit Setup Directory.
4. Use DATA SCROLL Spinner, ← and → Keys (advances or recedes entire Display of Memory Locations), and/or ↑ and ↓ Keys to select desired Memory Location with contents.
5. Press COPY Soft Function Key F2 (COPY is highlighted).
6. Use DATA SCROLL Spinner, ← and → Keys (advances or recedes entire Display of Memory Locations), and/or ↑ and ↓ Keys to select desired empty or unprotected Memory Location.



Figure 4-39 Copy Memory Operation

00308002

7. Press COPY Soft Function Key F2.
8. Press CONFIRM Soft Function Key F5.

C. DELETE FUNCTION

STEP

PROCEDURE

1. Apply power and activate AN1820. Allow 15 minute warm-up time.
2. Press RECALL Key.
3. Press EDIT T Soft Function Key F2 to enter Edit Trace Directory or press EDIT S Soft Function Key F4 to enter Edit Setup Directory.
4. Use DATA SCROLL Spinner, ← and → Keys (advances or recedes entire Display of Memory Locations), and/or ↑ and ↓ Keys to select desired Memory Location with contents.
5. Press DELETE Soft Function Key F3 (DELETE is highlighted).
6. If deleting more than one Memory Location contents, use DATA SCROLL Spinner, ← and → Keys (advances or recedes entire Display of Memory Locations), and/or ↑ and ↓ Keys to select desired end of sequence Memory Location with contents. (Delete function erases contents from first selected Memory Location through the last selected Memory Location in sequence.)

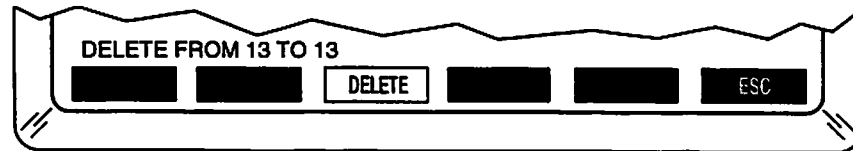

Figure 4-40 Delete Memory Operation

00308003

7. Press DELETE Soft Function Key F3.
8. Press CONFIRM Soft Function Key F5.

4-10 MACRO OPERATIONS

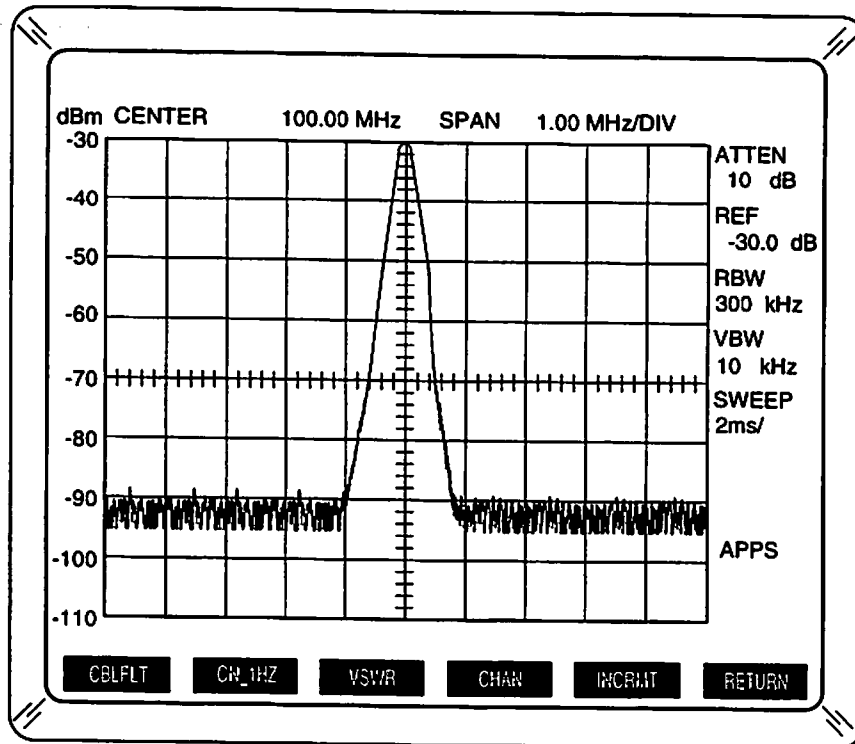

Figure 4-41 Macro Operations

01917078

Macros must already be loaded into Test Set memory. Refer to the TMAC Users Manual (1002-2001-600) for TMAC programming and loading macros into memory.

4-10-1 ASSIGNING MACROS FROM FRONT PANEL

STEP PROCEDURE

1. Press APPS Key to enter Application Memory Operation Screen.
 2. Press DIR Soft Function Key F1 to enter Macro Directory.
 3. Use DATA SCROLL Spinner or \uparrow and \downarrow Keys to select macro program.
 4. Press ENTER Soft Function Key F1 to enter Soft Function Key Assignment field.
 5. Use DATA SCROLL Spinner, DATA ENTRY Keypad or \uparrow and \downarrow Keys to assign macro to Soft Function Key F1 (1), F2 (2), F3 (3), F4 (4) or F5 (5). Set to 0 to remove macro program assignment.
 6. Press ENTER Soft Function Key F1 to exit and save Soft Function Key Assignment field.
- (The Display shows the macro name above the selected Soft Function Key. The number entered in the Soft Function Key Assignment field also remains beside the macro name in the Macro Directory. If another macro was previously assigned to the selected Soft Function Key, the new assignment automatically deletes the previous assignment.)

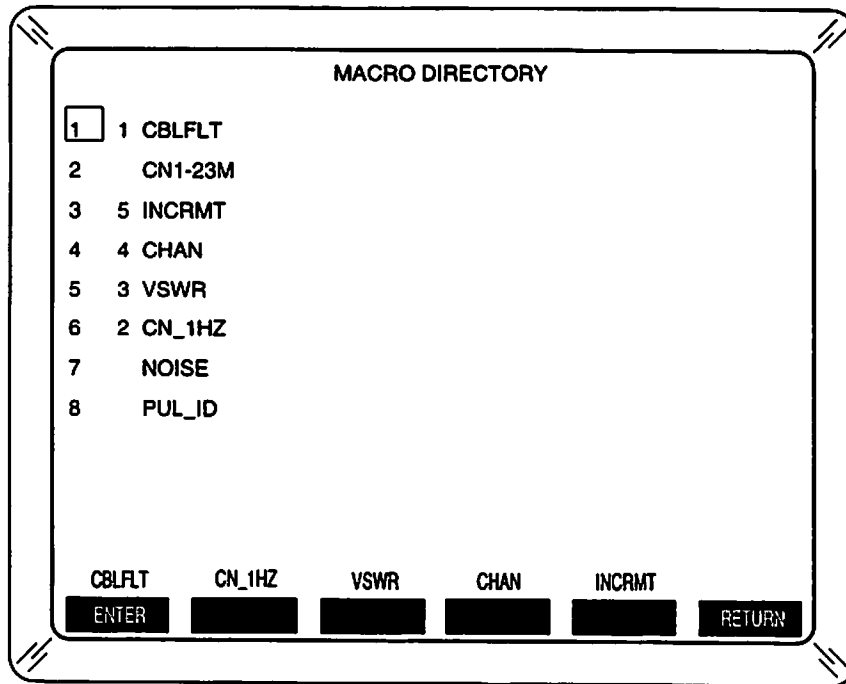

01917057

Figure 4-42 Macro Directory Operation

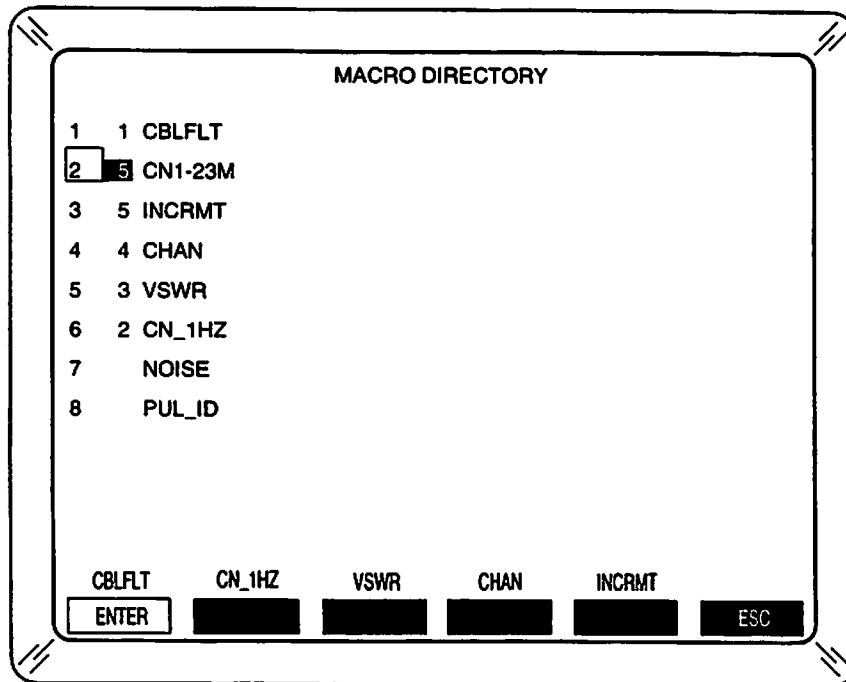

00317009

Figure 4-43 Assigning Macro to Soft Function Key

4-10-2 OPERATING MACROS FROM FRONT PANEL

STEP	PROCEDURE
------	-----------

1. Press APPS Key to enter Application Memory Operation Screen.
2. Press MACRO Soft Function Key F3 to enter Macro Operation Screen.
3. Press applicable Soft Function Key to activate desired macro program.

4-10-3 DISPLAY LIMIT ALARMS OPERATION SCREEN MACRO

STEP	PROCEDURE
------	-----------

1. Press RECALL Key to enter Recall Operation Screen.
2. Press TRACE Soft Function Key F1 to enter Recall Trace Directory.
3. Use DATA SCROLL Spinner, ↑ and ↓ Keys and DATA ENTRY Keypad to select Memory Location of desired Limit trace(s).
4. Press DISPLAY Key to enter Display Operation Screen.
5. Press ALARMS Soft Function Key F4 to enter Display Limit Alarms Operation Screen.
6. Press APPS Soft Function Key F5 to have user-loaded macro activate when live trace exceeds limits set by displayed Limit trace(s).

NOTE: For the APPS Soft Function Key F5 to appear, the user-loaded macro must be created and loaded according to the TMAC Users Manual (1002-0401-600).

SECTION 5 - PERFORMANCE EVALUATION

5-1 GENERAL

This section contains information on test procedures for assessing the performance of the AN1820. All tests are self tests performed by the unit. No additional equipment is needed to conduct these tests. For maximum benefit, the operator should be thoroughly familiar with all aspects of the AN1820 Operation Manual before performing these procedures.

NOTE: The internal self tests only verify operation. The internal self tests do not verify specifications.

Refer to Figure 3-1 for location of controls, connectors and indicators used in Section 5.

5-2 POWER UP SELF TEST

When power is switched On to the AN1820, the unit performs a power up self test. (Power up self test contains the tests in the CPU Diagnostics Operation Screen.) A normally functioning AN1820 beeps (if enabled in the Keyboard Options Screen, accessed from the Analyzer Utility Menu) and displays the IFR Logo Screen briefly before automatically entering the Center Frequency Operation Screen. A displayed error message indicates abnormal operation. If an error message occurs, switch power Off. Wait approximately 30 seconds and power AN1820 On again. If error reoccurs, refer AN1820 to maintenance for corrective action.

5-3 DIAGNOSTICS (SELF TEST)

The Diagnostics Operation Screen is accessed from the Analyzer Utility Menu. A full self test incorporates the six individual tests in the Diagnostics Operation Screen and the eleven individual tests in the CPU Diagnostics Operation Screen. Each individual test is performed alone or as part of a group of selected tests (Loop Test function).

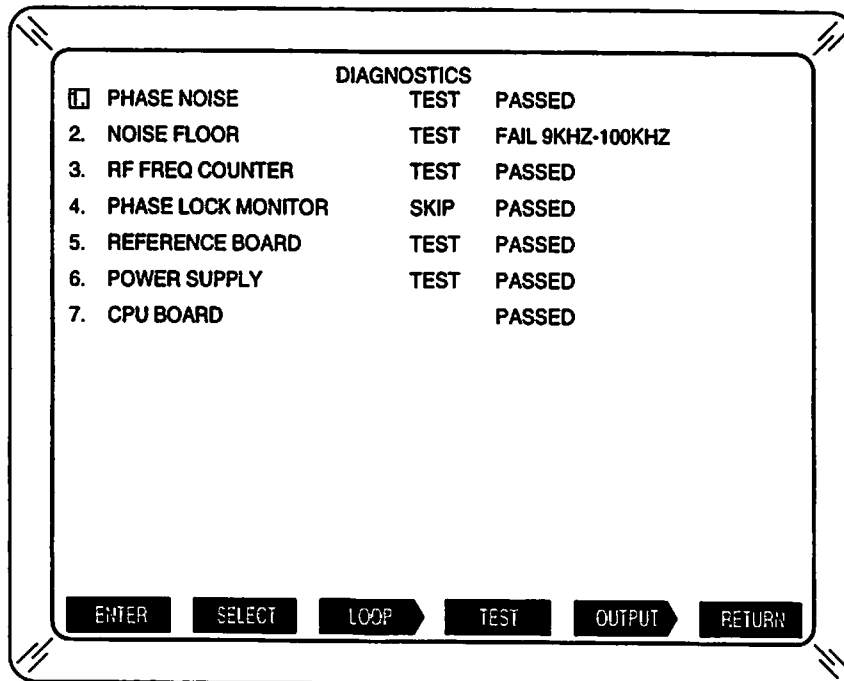

Figure 5-1 Diagnostics Operation Screen

01917059

5-3-1 DIAGNOSTICS OPERATION SCREEN

A. DISPLAY INFORMATION

The Diagnostics Operation Screen is divided into three fields: test name, selection status and test result.

The test name field is self explanatory. The selection status field indicates the test is (TEST) or is not (SKIP) included in the group of selected tests ran in the Loop Test function. The test result field indicates results of latest tests performed since last power up. Table 5-1 lists possible test result indications.

INDICATION	DEFINITION
PASSED	Test Passed.
FAILED or FAIL	Test Failed.
TESTING...	Test in Progress.
NOT TESTED	Not Tested Since Power Up.
POST	Tested on Power Up.

Table 5-1 Test Result Field Indications

TEST	DESCRIPTION
------	-------------

1. PHASE NOISE

Verifies phase noise is within tolerance at three offsets from the 100 MHz internal reference. Table 5-2 lists phase noise tolerances at the offsets tested. If out of tolerance, the test result field indicates a failed condition and the last failed offset.

OFFSET	TOLERANCE
30 kHz	<-69 dB
10 kHz	<-59 dB
1 kHz	<-49 dB

Table 5-2 Phase Noise Tolerances

2. NOISE FLOOR

Verifies noise level is within tolerance across five specified bands. If out of tolerance, the test result field indicates a failed condition and the last failed band. Table 5-3 lists the noise tolerance for each of the five bands tested.

BAND	TOLERANCE
9 to 100 kHz	\leq -73 dBm
100 kHz to 10 MHz	\leq -83 dBm
10 MHz to 2.9 GHz	\leq -103 dBm

Table 5-3 Noise Floor Tolerances

TEST**DESCRIPTION****3. RF FREQ COUNTER**

Verifies Frequency Counter accuracy. The internal counter measures the 100 MHz internal reference, present at the REF OUT Connector, and verifies measurement is within two counts of actual frequency.

4. PHASE LOCK MONITOR

Verifies operation of the phase-locked loop (PLL) synthesizers. Table 5-4 lists synthesizers and frequencies tested. The test result field indicates failed synthesizers (either or both) and one failed frequency.

PLL SYNTHESIZER	OSCILLATOR RANGE	FREQUENCY
YIG	Low	-50 MHz
	High	3.0 GHz
	Offset-Low	100.05 MHz
	Offset-High	100.299 MHz
Sampler	Loop-Low	-8 MHz
	Loop-High	2.991 MHz
	100-200 MHz Low	91.4 MHz
		117.2 MHz
	100-200 MHz Mid	117.4 MHz
		150.2 MHz
	100-200 MHz High	150.4 MHz
		191.2 MHz

Table 5-4 Phase Lock Monitor Test Frequencies

5. REFERENCE BOARD

Checks memory (SRAM, PROM and EEPROM) operation in the Frequency Reference Firmware Assembly.

6. POWER SUPPLY

Compares the +12 and -12 V power outputs with the +5 V power output. An overvoltage (OVER) or undervoltage (UNDER) error is indicated in the test result field with the first voltage (-12 or +12 V) having the failure.

7. CPU BOARD

Displays the CPU Diagnostics Operation Screen for access to 11 individual CPU Board tests.

B. SOFT FUNCTION KEYS

The Soft Function Keys control and activate the Diagnostics test operations.

KEY	DESCRIPTION
F1 ENTER	Performs individual test selected or enters CPU Diagnostics Operation Screen if CPU Board Test is selected.
F2 SELECT	Sets selection status for the Loop Test function. Toggles between TEST (tested as part of the selected Loop Test function group) or SKIP (not tested). Enters CPU Diagnostics Operation Screen if CPU Board Test is selected.
F3 LOOP	



01908018

Figure 5-2 Diagnostics LOOP Soft Function Keys

Enters secondary labels for Soft Function Keys to activate the Loop Test function. The Loop Test function performs a controlled series of selected individual tests. The selected group of tests are performed once, continuously until aborted or continuously until an error is indicated. The secondary Soft Function Keys control how the Loop Test function operates.

- F1 ONCE
Activates the Loop Test function. Selected individual tests run one time in succession.
- F2 FOREVER
Activates the Loop Test function. Selected individual tests run in succession until aborted by pressing any of the Soft Function Keys.
- F3 TIL ERR
Activates the Loop Test function. Selected individual tests run in succession until a failed condition causes an error indication.
- F5 RETURN
Returns primary Diagnostics Operation Screen labels for Soft Function Keys.

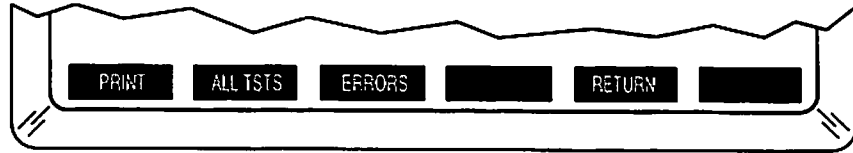
KEY**DESCRIPTION****F3 LOOP (Continued)****F6 OUTPUT**

01908019

Figure 5-3 Diagnostics OUTPUT Soft Function Keys

Enters ternary labels for Soft Function Keys to activate the Print Test function. The Print Test function sends the selected test information through the RS-232 Connector to an external printer.

F1 PRINT

Activates the Print Test function.

F2 ALL TSTS

Selects all tests, passed or failed, and all error indications for each test to be printed.

F3 ERRORS

Selects only failed tests with all error indications to be printed.

F5 RETURN

Returns secondary labels for Loop Test function Soft Function Keys.

F4 TEST

Performs individual test selected or enters CPU Diagnostics Operation Screen if CPU Board Test is selected.

F5 RETURN

Returns to Analyzer Utility Menu.

F6 OUTPUT

Enters secondary labels for Soft Function Keys to activate the Print Test function. The Print Test function sends the selected test information through the RS-232 Connector to an external printer.

F1 PRINT

Activates the Print Test function.

F2 ALL TSTS

Selects all tests, passed or failed, and all error indications for each test to be printed.

F3 ERRORS

Selects only failed tests with all error indications to be printed.

F5 RETURN

Returns to primary Diagnostics Operation Screen labels for SOFT FUNCTION Keys.

5-3-2 CPU DIAGNOSTICS OPERATION SCREEN

A. DISPLAY INFORMATION

The CPU Diagnostics Operation Screen contains the same fields for the CPU tests as the Diagnostics Operation Screen has for the hardware tests. CPU tests are pass/fail tests without error indications.

TEST	DESCRIPTION
1. BIOS CHECKSUM	Verifies sum of Basic Input/Output System bits.
2. DRAM TESTS	Verifies dynamic RAM operation.
3. HEARTBEAT TICK	Verifies operating system clock.
4. REAL TIME CLOCK	Verifies real time clock.
5. CMOS RAM	Verifies non-volatile RAM operation.
6. RS-232	Verifies RS-232 driver operation.
7. KEYBOARD/SPI BUS	Verifies keyboard and Serial Peripheral Interface (SPI) bus operation.
8. PARAMETER RAM	Verifies setup memory operation.
9. EXTRA RAM	Verifies Expanded Memory operation.
10. PROGRAM ROM	Verifies sum of program ROM bits.
11. GPIB	Verifies GPIB status.

B. SOFT FUNCTION KEYS

The Soft Function Keys operate the same as in the Diagnostics Operation Screen.

5-4 DIAGNOSTICS PROCEDURES

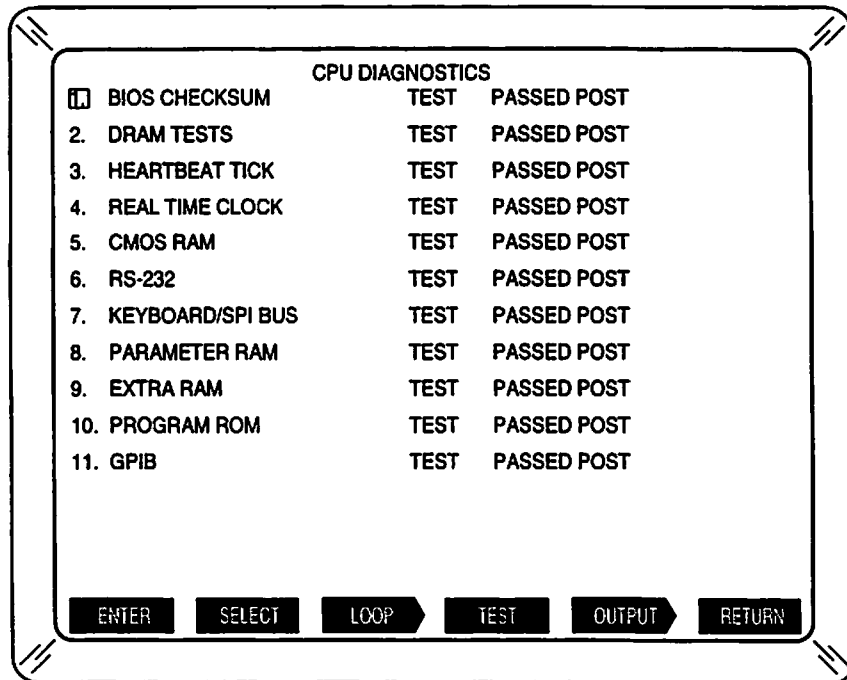

01917060

Figure 5-4 CPU Diagnostics Operation Screen

5-4-1 SINGLE TEST PROCEDURE

STEP	PROCEDURE
------	-----------

1. Disconnect any input from all AN1820 external connectors.
2. Press UTILITY Key to enter Analyzer Utility Menu.
3. Press DIAG Soft Function Key F6 to enter Diagnostics Operation Screen.
4. Use ↑ and ↓ Keys or DATA SCROLL Spinner to select desired test.
5. Press TEST Soft Function Key F4 to run selected test.
6. Verify result, displayed in test result field.

5-4-2 LOOP TEST PROCEDURE

STEP	PROCEDURE
1.	Disconnect any input from all AN1820 external connectors.
2.	Press UTILITY Key to enter Analyzer Utility Menu.
3.	Press DIAG Soft Function Key F6 to enter Diagnostics Operation Screen.
4.	Use ↑ and ↓ Keys or DATA SCROLL Spinner to select desired test.
5.	Press SELECT Soft Function Key F2 to include (TEST) or exclude test (SKIP) in Loop Test group.
6.	Repeat Steps 3 and 4 until all desired tests are included in Loop Test group.
7.	Press LOOP Soft Function Key F3.
8.	Activate Loop Test. Perform one of following steps: <ul style="list-style-type: none">● Press ONCE Soft Function Key F1 to run Loop Test one time through.● Press FOREVER Soft Function Key F2 to run Loop Test continuously.● Press TIL ERR Soft Function Key F3 to run Loop Test until an error is indicated.
9.	Verify results, displayed in test result field. NOTE: Failure of a specific test may lead to failure of other specific tests, though the modules being tested may be operating properly.
10.	Press any ABORT Soft Function Key to stop Loop Test.

5-4-3 PRINT TEST PROCEDURE

STEP	PROCEDURE
1.	Press UTILITY Key to enter Analyzer Utility Menu.
2.	Press 1 on DATA ENTRY Keypad to select RS-232 (Serial) Screen.
3.	Press ENTER Soft Function Key F1 to display RS-232 (Serial) Screen.
4.	Use ↑ and ↓ Keys or DATA SCROLL Spinner and ENTER Soft Function Key F1 to select and edit menu items. Configure RS-232 according to printer being used.
5.	Press RETURN Soft Function Key F5 to return to Analyzer Utility Menu.
6.	Press DIAG Soft Function Key F6 to enter Diagnostics Operation Screen.
7.	Press OUTPUT Soft Function Key F6.
8.	Select desired information to print. Perform one of following steps: <ul style="list-style-type: none">● Press ALL TSTS Soft Function Key F2 to print all tests.● Press ERRORS Soft Function Key F3 to print only tests with errors.
9.	Press PRINT Soft Function Key F1 to print out selected test results.

SECTION 6 - REMOTE OPERATION

6-1 GENERAL

The AN1820 Spectrum Analyzer is designed to operate remotely through an external controller. All data available through Front Panel Operation is available through the External Controller. The External Controller can generate any command available except Display Intensity Control and Power On.

Refer to Figures 3-1 and 3-2 for location of controls, connectors and indicators used in Section 6.

Remote Operation is performed using the RS-232 Connector or the IEEE-488 GPIB Connector. Refer to Appendix A for pin-out information.

It is important for the operator to be familiar with the AN1820 Operation Manual and front panel operation of the AN1820 before initiating remote operations. Refer to Section 3 for information regarding controls, connectors, indicators, operation screens and menus. For more detailed information concerning remote operation, see the TMAC Users Manual (1002-0401-600).

6-2 OPERATING PROCEDURES

6-2-1 RS-232 CONFIGURATION FOR DIRECT REMOTE OPERATION

STEP	PROCEDURE
------	-----------

- | | |
|----|--|
| 1. | Refer to Figure 6-1 and connect Host System Comm Connector to AN1820 Spectrum Analyzer RS-232 Connector on rear panel, using standard 9-pin to 9-pin RS-232 cable (provided with AN1820 Spectrum Analyzer). For 9-pin to 25-pin operation, refer to Figure 6-2. Connect CD and DTR only as needed. |
|----|--|

NOTE: A PC (using Terminal Emulation Software) or RS-232 Terminal can be used as the Host System. The Same Host System connections are used when connecting the AN1820 to a printer.

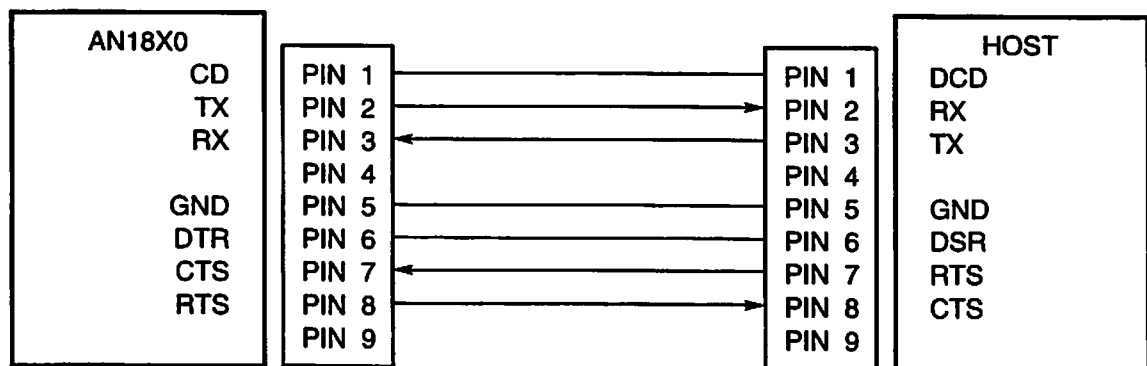
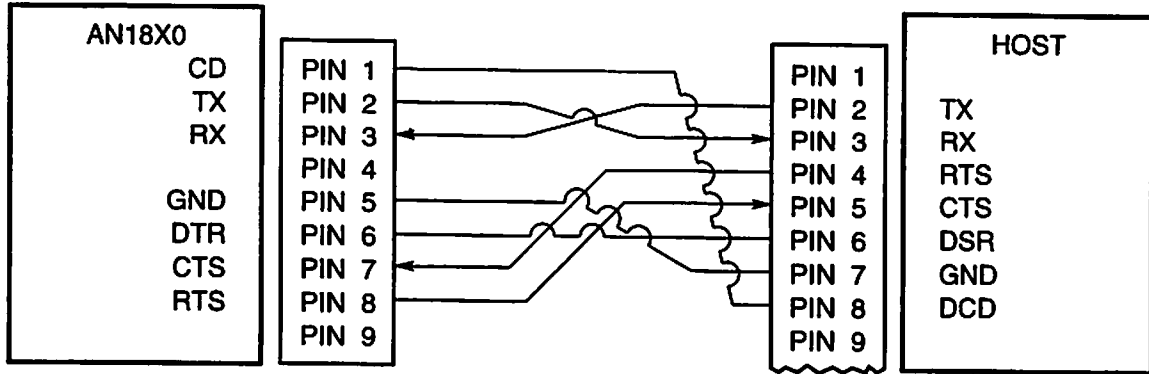

Figure 6-1 AN1820 - Host Cable Connections (9-Pin)

00303004



00303005

Figure 6-2 AN1820 - Host Cable Connections (25-Pin)

2. Press UTILITY Key to enter Analyzer Utility Menu:

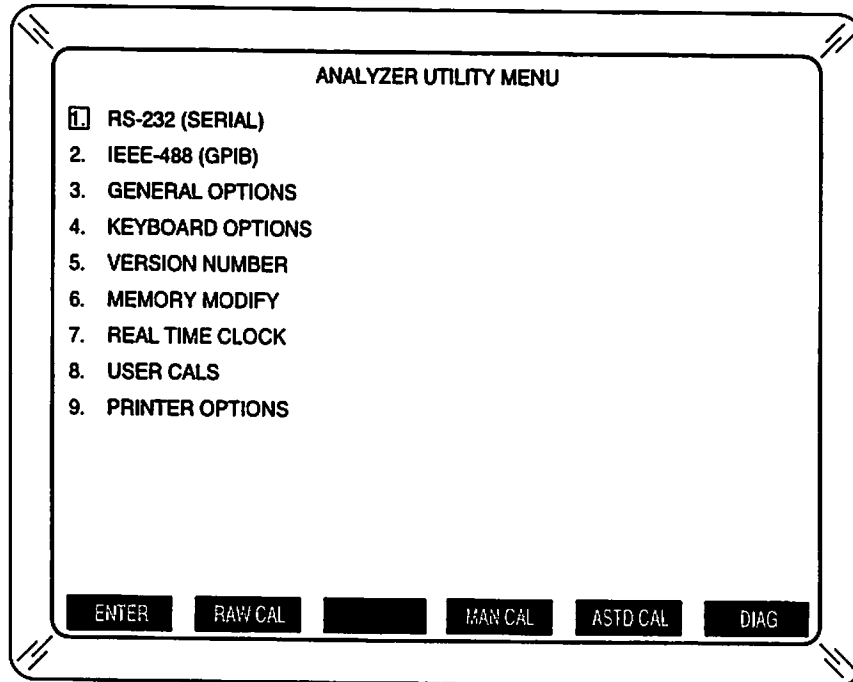

01917033

3. Press 1 and x1 Keys in sequence on DATA ENTRY Keypad to enter RS-232 (Serial) Screen:

RS-232 (SERIAL)	
1. OPERATION MODE	HOST
2. BAUD RATE	9600
3. DATA BITS	8
4. STOP BITS	1
5. PARITY	NONE
6. HANDSHAKE	CTS/RTS
7. RCI ECHO	OFF
8. RCI CONTROL	DISABLE

ENTER [] [] [] [] [] RETURN

01917034

4. Press 1 and x1 Keys in sequence on DATA ENTRY Keypad to edit OPERATION MODE. Use ↑ and ↓ Keys to select *HOST* for remote control operation. Press x1 Key or ENTER Soft Function Key F1 to save edit.
5. Press 2 and x1 Keys in sequence on DATA ENTRY Keypad to edit BAUD RATE. Use ↑ and ↓ Keys to set Baud Rate in bps, as desired according to Host System capabilities. Press x1 Key or ENTER Soft Function Key F1 to save edit.
6. Press 3 and x1 Keys in sequence on DATA ENTRY Keypad to edit DATA BITS. Use ↑ and ↓ Keys to set number of data bits per word to *8*. Press x1 Key or ENTER Soft Function Key F1 to save edit.
7. Press 4 and x1 Keys in sequence on DATA ENTRY Keypad to edit STOP BITS. Use ↑ and ↓ Keys to set number of stop bits per word to *1*. Press x1 Key or ENTER Soft Function Key F1 to save edit.
8. Press 5 and x1 Keys in sequence on DATA ENTRY Keypad to edit PARITY. Use ↑ and ↓ Keys to select parity setting of *NONE*. Press x1 Key or ENTER Soft Function Key F1 to save edit.
9. Press 6 and x1 Keys in sequence on DATA ENTRY Keypad to edit HANDSHAKE. Use ↑ and ↓ Keys to select *XON/XOFF* (software). Press x1 Key or ENTER Soft Function Key F1 to save edit.
10. Press 7 and x1 Keys in sequence on DATA ENTRY Keypad to edit RCI ECHO. Use ↑ and ↓ Keys to select *ON* for repeating transmissions back to Host System device or *OFF*. Press x1 Key or ENTER Soft Function Key F1 to save edit.

STEP**PROCEDURE**

11. Press 8 and x1 Keys in sequence on DATA ENTRY Keypad to edit RCI CONTROL. Use ↑ and ↓ Keys to select **ENABLE**. Press x1 Key or ENTER Soft Function Key F1 to save edit.
12. Set Terminal Emulator Software or RS-232 Terminal parameters to match Table 6-1.

PARAMETER	SETTING
Baud Rate	according to Step 5
Data Bits	8
Stop Bits	1
Parity	None
Handshaking	Xon/Xoff

Table 6-1 Terminal Settings for RS-232 Host Operation

13. Initiate serial remote operation.

6-2-2 RS-232 CONFIGURATION FOR MODEM OPERATION

STEP

PROCEDURE

1. Connect Modem to AN1820 Spectrum Analyzer RS-232 Connector on rear panel as shown in Figure 6-3 for 9-pin to 9-pin operation. A null modem adapter may be used. For 9-pin to 25-pin operation, connect Modem to AN1820 Spectrum Analyzer RS-232 Connector on rear panel as shown in Figure 6-4. Connect CD and DTR only as needed.

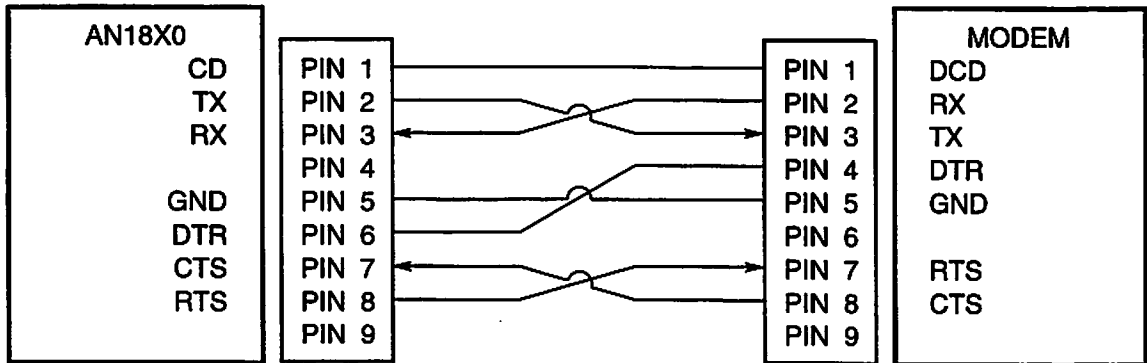

00303006

Figure 6-3 AN1820 - Modem Cable Connections (9-Pin)

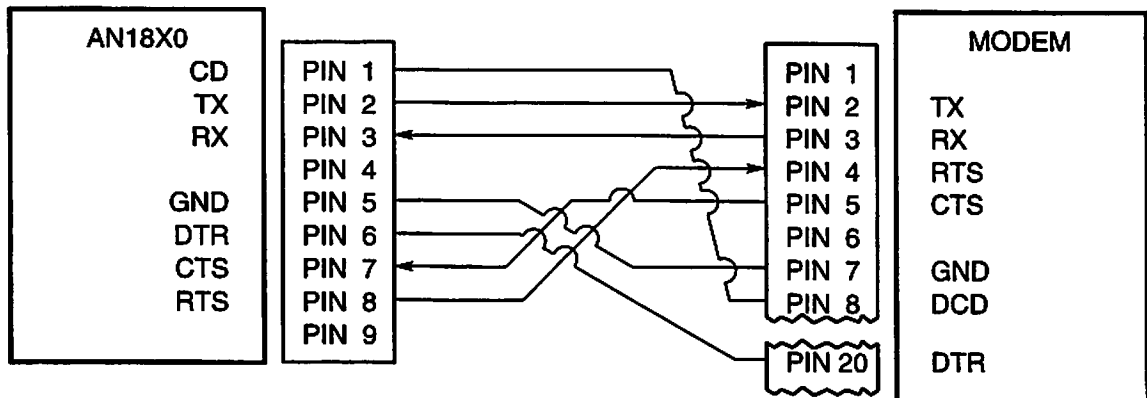

00303007

Figure 6-4 AN1820 - Modem Cable Connections (25-Pin)

2. Press UTILITY Key to enter Analyzer Utility Menu.
3. Press 1 and x1 Keys in sequence on DATA ENTRY Keypad to enter RS-232 (Serial) Screen.
4. Press 1 and x1 Keys in sequence on DATA ENTRY Keypad to edit OPERATION MODE. Use ↑ and ↓ Keys to select *HOST* for remote control operation. Press x1 Key or ENTER Soft Function Key F1 to save edit.
5. Press 2 and x1 Keys in sequence on DATA ENTRY Keypad to edit BAUD RATE. Use ↑ and ↓ Keys to set Baud Rate in bps, as desired according to Modem requirements. Press x1 Key or ENTER Soft Function Key F1 to save edit.

STEP**PROCEDURE**

6. Press 3 and x1 Keys in sequence on DATA ENTRY Keypad to edit DATA BITS. Use ↑ and ↓ Keys to set number of data bits per word to **8**. Press x1 Key or ENTER Soft Function Key F1 to save edit.
7. Press 4 and x1 Keys in sequence on DATA ENTRY Keypad to edit STOP BITS. Use ↑ and ↓ Keys to set number of stop bits per word to **1**. Press x1 Key or ENTER Soft Function Key F1 to save edit.
8. Press 5 and x1 Keys in sequence on DATA ENTRY Keypad to edit PARITY. Use ↑ and ↓ Keys to select parity setting of **NONE**. Press x1 Key or ENTER Soft Function Key F1 to save edit.
9. Press 6 and x1 Keys in sequence on DATA ENTRY Keypad to edit HANDSHAKE. Use ↑ and ↓ Keys to select **NONE**. Press x1 Key or ENTER Soft Function Key F1 to save edit.
10. Press 7 and x1 Keys in sequence on DATA ENTRY Keypad to edit RCI ECHO. Use ↑ and ↓ Keys to select **OFF**. Press x1 Key or ENTER Soft Function Key F1 to save edit.
11. Press 8 and x1 Keys in sequence on DATA ENTRY Keypad to edit RCI CONTROL. Use ↑ and ↓ Keys to select **ENABLE**. Press x1 Key or ENTER Soft Function Key F1 to save edit.
12. Call Modem and AN1820 Spectrum Analyzer for originating PC.

6-2-3 GPIB CONFIGURATION

STEP PROCEDURE

1. Press UTILITY Key to enter Analyzer Utility Menu.
2. Press 2 and x1 Keys in sequence on DATA ENTRY Keypad to enter IEEE-488 (GPIB) Screen:

IEEE-488 (GPIB)

1. OPERATION MODE	TALK ONLY
2. ADDRESS	21
3. RCI CONTROL	ENABLE

ENTER [] [] [] [] RETURN

01917035

3. Press 1 and x1 Keys in sequence on DATA ENTRY Keypad to edit OPERATION MODE. Use ↑ and ↓ Keys to select **TALK/LISTEN** for remote control operation or **LISTEN ONLY** to operate Spectrum Analyzer as a slave unit. Press x1 Key or ENTER Soft Function Key F1 to save edit.
4. Press 2 and x1 Keys in sequence on DATA ENTRY Keypad to edit ADDRESS. Use ↑ and ↓ Keys to set AN1820 GPIB address from 0 to 31. Set address to not conflict with another device (30 is advised). Press ENTER Soft Function Key F1 to save edit.
5. Press 3 and x1 Keys in sequence on DATA ENTRY Keypad to edit RCI CONTROL. Use ↑ and ↓ Keys to select **ENABLE** for **TALK/LISTEN** OPERATION MODE (remote control operation) or **DISABLE** for any other OPERATION MODE.
6. Connect IEEE-488 GPIB Cable to AN1820 Spectrum Analyzer IEEE-488 GPIB Connector on rear panel.
7. Initiate parallel remote operation through IEEE-488 GPIB Connector.

6-3 TEST MACRO LANGUAGE (TMAC)

TMAC is the Remote Command Interpreter (RCI) used to remotely operate the AN1820 Spectrum Analyzer and provide a format to store and perform user defined test sequences. TMAC is based on the IEEE-488.2 format and supports the SCPI Standard.

A main strength of TMAC is the capability to define macro commands. Step by step test procedures are developed, stored and remotely implemented through TMAC. Flow control commands allow decision making and looping within the macro. TMAC also provides a variety of data structures to assist in developing test procedures. Macros can be executed from other macros, passing parameters from one macro to the other, allowing complicated procedures to be divided into smaller tasks. Multitasking commands allow several macros to alternate command execution, giving the appearance of being executed simultaneously.

Macros declared as programs can be assigned Soft Function Keys by remote operation or in the Macro Directory. Macro programs may then be activated through front panel operation in the User-Defined Application Memory Operation Screen.

A full explanation of the TMAC language is beyond the scope of the AN1820 Operation Manual. Table 6-4 lists the specific instrument commands. For a complete explanation of the TMAC language including the use of macros, macro programs, variables, data structures, flow control commands and multitasking commands, see the TMAC Users Manual (1002-0401-600).

6-4 COMMAND SYNTAX

TMAC structures commands hierarchically through the use of a colon (:) delimiter. To allow access to command paths, the AN1820 interpreter keeps track of the current path or command level where it expects to find the next command. The current path is determined by using a set of rules. On power up or after a *RST command, the current path is set to the root command node, the highest level of the command tree structure. The end of a message or command line (pressing Return or Enter on controller keyboard) resets current path to the root node.

When a colon is used as the delimiter between commands, the current path is moved down one level in the command structure (e.g., The colon in `FREQ:CENT` specifies `CENT` is one level down from `FREQ`). When a colon is used as the first character of a command, it specifies the command is found at the root node. A semicolon is used to separate multiple commands in the same message line. A semicolon does not change the current path. The four commands to turn the External Mixer function On, set to the fourth harmonic above the 1st LO frequency and verify correct signal is displayed; are accomplished in one line as follows:

```
MIX ON;MIX:IFT PLUS;HARM 4;VER
```

is equivalent to:

```
MIX ON  
MIX:IFT PLUS  
MIX:HARM 4  
MIX:VER
```

Commands with multiple parameter fields separate the parameters with a comma (.). An example of a multiple parameter command is: TRAC:STOR 1,SAMPLE WAVE (storing current live trace in Memory Location 1 with Storage Label). At least one space is needed between commands and the first parameter. Other spaces or lack of them do not affect the command. Query commands contain a question mark (?) at the end of the command and before any parameters. Query commands request data from the AN1820. Various Command Syntax punctuation marks are shown in Table 6-2.

PUNCTUATION MARK	NAME	DESCRIPTION
;	Message Separator	Separates commands on same line.
:	Compound Command Separator	Allows hierarchy of command structure.
,	Parameter Separator	Separates parameters in multiple parameter command line.
?	Query Command Ending	Requests return data.
\	End of Line Continuation	Allows command to continue on next line. Command words cannot be broken.

Table 6-2 Command Syntax Punctuation Marks

Commands are entered using short or long form. The short form is shown in upper case. The long form is shown as the upper and lower case together. Brackets [] indicate optional parameters.

6-5 MANDATORY IEEE 488.3 COMMANDS

In compliance with IEEE-488.3 1987, Table 6-3 lists reserved commands for remote operations. When these commands are used, they must include the leading asterisk (*).

MNEMONIC	COMMAND
*CLS	Clear Status Command
*DDT	Define Device Trigger Command
*DDT?	Define Device Trigger Query
*DMC	Define Macro Command
*ESE X	Standard Event Status Enable Command X=0 to 255
*ESE?	Standard Event Status Enable Query
*ESR?	Standard Event Status Register Query
*IDN?	Identification Query
*LMC?	Learn Macro Query
*OPC	Operation Complete Command
*OPC?	Operation Complete Query
*OPT?	Option Identification Query
*PMC	Purge Macro Command
*RST	Reset Command
*SRE	Service Request Enable Command
*SRE?	Service Request Enable Query
*STB?	Read Status Byte Query
*TRG	Trigger Command
*TST?	Self Test Query
*WAI	Wait-to-Continue Command

Table 6-3 Mandatory GPIB Commands

6-6 AN1820 SPECIFIC COMMAND SET

COMMAND	RANGE	DEFINITION
FREQUENCY		
FREQuency:MODE?	0 or 1 (0=Center/Span, 1=Start/Stop)	Returns Frequency Mode of Operation.
CENTER FREQUENCY		
FREQuency:CENTer XU	XU=0Hz to 3.0GHz X=Value U=Units (Hz, kHz, MHz or GHz)	Sets Center Frequency. Units are MHz unless specified.
FREQuency:CENTer:MARKer		Sets Center Frequency to Active Marker Frequency.
FREQuency:CENTer:MARKer1		Sets Center Frequency to Marker 1 Frequency.
FREQuency:CENTer:MARKer2		Sets Center Frequency to Marker 2 Frequency.
FREQuency:CENTer:FIND?		Returns Peak Value in MHz.
FREQuency:CENTer:FLEVel X	X=0 to 255	Sets Find Threshold by vertical position on display.
FREQuency:CENTer:FLEVel?	0 to 255	Returns Find Threshold.
FREQuency:CENTer:FEND XU	XU=0Hz to 3.0GHz X=Value, U=Units (Hz, kHz, MHz or GHz)	Sets ending frequency for the Find function.
FREQuency:CENTer:FEND?		Returns current ending frequency setting in MHz.
FREQuency:CENTer:PREVious		Toggles current Center Frequency with previous setting.
FREQuency:CENTer?	0.000000 to 3000	Returns Center Frequency in MHz.
SPAN FREQUENCY		
FREQuency:SPAN XU	XU=0Hz to 290MHz X=Value, U=Units (Hz, kHz, MHz or GHz).	Sets Frequency Span per division. Units are MHz unless specified.
FREQuency:SPAN:FULL		Sets Frequency Span to 2.9 GHz.
FREQuency:SPAN?	0.000000 to 290	Returns Span Frequency in MHz/Div.
FREQuency:SPAN:COUPlE X	X=ON or OFF or 1 (On) or 0 (Off)	Couples Center/Span with Start/Stop settings.
FREQuency:SPAN:COUPlE?	1 (On) or 0 (Off)	Return Center/Span-Start/Stop Couple status.

Table 6-4 AN1820 Specific Commands

COMMAND	RANGE	DEFINITION
START FREQUENCY		
FREQuency:STARt <i>XU</i>	<i>XU</i> =0Hz to 3.0GHz <i>X</i> =Value, <i>U</i> =Units (Hz, kHz, MHz or GHz).	Sets Start Frequency. Units are MHz unless specified.
FREQuency:STARt:MARKer		Sets Start Frequency to Marker Frequency.
FREQuency:STARt:PREVious		Toggles current Start Frequency with previous setting.
FREQuency:STARt?	0.000000 to 3000	Returns Start Frequency in MHz.
STOP FREQUENCY		
FREQuency:STOP <i>XU</i>	<i>XU</i> =0Hz to 3.0GHz <i>X</i> =Value <i>U</i> =Units (Hz, kHz, MHz or GHz)	Sets Stop Frequency. Units are MHz unless specified.
FREQuency:STOP:MARKer		Sets Stop Frequency to Marker Frequency.
FREQuency:STOP:PREVious		Toggles current Stop Frequency with previous setting.
FREQuency:STOP?	0.000000 to 3000	Returns Stop Frequency in MHz.
ATTENUATION AMPLITUDE		
INPut:ATTenuation:EXTernal <i>X</i>	<i>X</i> =0.0 to 99.9	Sets External Attenuation Factor in dB, only with External Mixer function active.
INPut:ATTenuation:EXTernal?	0.0 to 99.9	Returns External Attenuation Factor.
INPut:ATTenuation:INTernal <i>X</i>	<i>X</i> =0, 20, 40 (EXTERNAL INPUT) or 0, 10, 20, 30, 40, 50 or 60 (ANALYZER INPUT)	Sets Internal Attenuation in dB, if uncoupled. Range depends on Input Connector and Minimum Internal Attenuation Limit.
INPut:ATTenuation:INTernal?	0 to 60	Returns Internal Attenuation in dB.
INPut:ATTenuation:AUTO <i>X</i>	<i>X</i> =ON or OFF or 1 (On) or 0 (Off)	Sets internal attenuation/reference level coupling On or Off.
INPut:ATTenuation:AUTO?	1 (On) or 0 (Off)	Returns internal attenuation reference level coupling status.
REFERENCE AMPLITUDE		
INPut:RLevel <i>XU</i>	<i>X</i> =(Range varies according to display scale and units.) <i>U</i> =Unit prefix (m, u, n, p) (LIN display scale only)	Sets top of scale reference level in basic units unless Unit prefix m (milli), u (micro), n (nano) or p (pico) is specified.
INPut:RLevel?		Returns top of scale reference level in dBm or dBmV (LOG display scale) or Watts, Volts, dBm, dBμW, dBmV or dBμV (LIN display scale).

Table 6-4 AN1820 Specific Commands (Continued)

COMMAND	RANGE	DEFINITION
INPut:RLevel:OFFset X	X=-99.9 to +99.9	Sets reference level Offset value in dB (normal).
INPut:RLevel:OFFset?	-99.9 to 99.9	Returns Offset value in dB.
MODe:REFeRence:OFFSet X	X=-40 to +40 (1 dB steps)	Offsets Trace Reference function Amplitude Scale.
MODe:REFeRence:OFFSet?	-40 to +40	Returns Trace Reference function Amplitude Scale Offset in dB.
INPut:GAIN X	X=0.0 to 20.0 (RBW>5 MHz or EXTERNAL INPUT) or -10.0 to 65.0 (RBW≤5 MHz)	Sets Internal Gain in dB, if uncoupled or in AM/FM Receiver mode. Range depends on RBW setting and Input Connector.
INPut:GAIN?	-10.0 to 65.0	Returns Internal Gain in dB.
MODe:REFeRence X	X=ON or OFF or 1 (On) or 0 (Off)	Activates or deactivates Trace Reference function.
MODe:REFeRence?	1 (On) or 0 (Off)	Returns Trace Reference function status.
BANDWIDTH AMPLITUDE		
BANDwidth:RESolution XU	XU=3kHz, 30kHz, 300kHz, 5MHz, 10MHz or 30MHz (>200 Hz/Div) 200Hz, 1kHz, 9kHz, 120kHz or 1MHz (Option 08,>200 Hz/Div) 100Hz or 30Hz (≤200 Hz/Div) 3Hz or 10Hz (≤20 Hz/Div) 200Hz, 9kHz or 120kHz (Quasi-Peak Selected)	Sets Resolution Bandwidth (RBW). Range depends on Frequency Span setting (shown in parentheses) and if Option 08 is installed.
BANDwidth:RESolution?	0.000003 to 30	Returns RBW setting in MHz.
BANDwidth:VIDeo XU	XU=0Hz, 10Hz, 100Hz, 1kHz, 10kHz, 100kHz or 1MHz	Sets Video Bandwidth (VBW). Units are Hz unless specified.
BANDwidth:VIDeo?	0 to 1000000	Returns VBW setting in Hz.
BANDwidth:AUTO X	X=ON or OFF or 1 (On) or 0 (Off)	Sets RBW coupling On or Off.
BANDwidth:AUTO?	1 (On) or 0 (Off)	Returns RBW coupling status.
BANDwidth:QPEak X	X=ON or OFF or 1 (On) or 0 (Off)	Sets Quasi-Peak Detector On or Off (only available with Option 08 installed).
BANDwidth:QPEak?	1 (On) or 0 (Off)	Returns Quasi-Peak Detector status (only available with Option 08 installed).

Table 6-4 AN1820 Specific Commands (Continued)

COMMAND	RANGE	DEFINITION
SCALE AMPLITUDE		
SCALE: <i>XU</i>	<i>XU</i> =1dB, 2dB, 5dB or 10dB (Analyzer Operation) <i>XU</i> =5mV, 10mV, 20mV, 50mV, 100mV, 200mV, 500mV, 1V, 2V or 5V (Scope Operation)	Sets vertical Display Scale per Division. An error occurs if command does not agree with current Display Scale mode.
SCALE?	1, 2, 5 or 10 (Analyzer Operation) 100, 200, 500, 1000, 2000 or 5000 (Scope Operation)	Returns vertical Display Scale in dB/Div for Analyzer Operation or mV/Div for Scope Operation.
SCALE:UNITs <i>X</i>	<i>X</i> =DBM or DBMV (LOG) or WATTS, UWatts, VOLTS or UVolts (LIN) or DBUV (QPEAK)	Sets Scale units.
SCALE:UNITs?		Returns Scale units.
SCALE:DB <i>X</i>	<i>X</i> =ON or OFF or 1 (On) or 0 (Off) (LIN display scale)	Sets linear unit status (dB-Scale unit reference or Scale units).
SCALE:DB?	1 (On) or 0 (Off)	Returns linear unit status.
SCALE:TYPE <i>X</i>	LOGarithmic, LINEar or ENHanced	Sets display scale mode.
SCALE:TYPE?	LOGARITHMIC, LINEAR or ENHANCED	Returns display scale mode.
SCALE:TOP?		Returns current top of Scale.
MARKER MODE		
MARKer1 <i>X</i>	<i>X</i> =ON or OFF or 1 (On) or 0 (Off)	Activates and/or gives edit control to Marker 1.
MARKer1?	1 (On) or 0 (Off)	Returns Marker 1 active status.
MARKer2 <i>X</i>	<i>X</i> =ON or OFF or 1 (On) or 0 (Off)	Activates and/or gives edit control to Marker 2.
MARKer2?	1 (On) or 0 (Off)	Returns Marker 2 active status.
MARKer <i>M</i> :FREQUency <i>XU</i>	<i>M</i> =1 or 2 <i>XU</i> =0Hz to 3.0GHz <i>X</i> =Value, <i>U</i> =Units (Hz, kHz, MHz or GHz).	Sets Frequency of Marker 1 or Marker 2. Valid with Frequency Span >0 Hz. Units are MHz unless specified.
MARKer <i>M</i> :FREQUency?	<i>M</i> =1 or 2 0.000000 to 3000	Returns Frequency of Marker 1 or Marker 2 in MHz. Valid with Frequency Span >0 Hz.
MARKer <i>M</i> :TIME <i>X</i>	<i>M</i> =1 or 2 <i>X</i> =0 to 10 times current Sweep Rate	Sets specified marker time in ms.
MARKer <i>M</i> :TIME?	<i>M</i> =1 or 2 0 to 10 times current Sweep Rate	Returns specified marker time in ms.

Table 6-4 AN1820 Specific Commands (Continued)

COMMAND	RANGE	DEFINITION
MARK:TRACe:TRACK?		Activates and moves Marker 1 to Center Frequency signal exceeding Peak Threshold Level.
MARKerM:CENTer	M=1 or 2	Moves specified marker to center.
MARKerM:POINT X	M=1 or 2 X=0 to 100	Sets Marker 1 or Marker 2 to specific horizontal position on display in half minor divisions.
MARKerM:POINT?	M=1 or 2 0 to 100	Returns position of specified marker in half minor divisions.
MARKer:AMPLitude?	Range depends on current scale and units.	Returns active marker Amplitude.
MARKer:UNITs?		Returns current marker amplitude units.
MARKer:AOFF		Turns Off both markers.
MARKer:TRACK X	X=ON or OFF or 1 (On) or 0 (Off)	Sets Marker Tracking On or Off.
MARKer:TRACK?	1 (On) or 0 (Off)	Returns Marker Tracking State.
MARKer:DELTA X	X=ON or OFF or 1 (On) or 0 (Off)	Sets Delta function On or Off.
MARKer:DELTA?	1 (On) or 0 (Off)	Returns Delta function status.
MARKer:DELTA:AMPLitude?	Range depends on current scale and units.	Returns Amplitude difference between both markers in dB (LOG display scale) or LIN display scale units.
MARKer:DELTA:POINT?	0 to 100	Returns horizontal position difference between both markers in half minor divisions.
MARKer:DELTA:TIME?	0 to 10000	Returns horizontal position difference between both markers in ms. Valid in ZERO Span or Scope Operation.
MARKer:DELTA:FREQuency?	0 to 3000	Returns Frequency difference between both markers in MHz. Valid with Frequency Span >0 Hz.
MARKerM:TRACe:PEAK:\nTRACK X	M=1 or 2 X=ON or OFF or 1 (On) or 0 (Off)	Sets Peak Track status for specified marker (must have edit control and be on peak).
MARKerM:TRACe:PEAK:TRACK?	M=1 or 2 ON or OFF or 1 (On) or 0 (Off)	Returns Peak Track status for specified marker.
MARK:TRACe:PEAK:NEXT?		Moves Marker 1 to the second or next highest displayed signal exceeding Peak Threshold Level.

Table 6-4 AN1820 Specific Commands (Continued)

COMMAND	RANGE	DEFINITION
MARKerM:TRACe:PEAK:LEFT	M=1 or 2	Moves specified marker left to next peak above Peak Threshold and activates Peak Track (must have edit control).
MARKerM:TRACe:PEAK:RIGHT	M=1 or 2	Moves specified marker right to next peak above Peak Threshold and activates Peak Track (must have edit control).
MARKer:TRACe:PEAK:LEVel X	X=0 to 255	Sets Peak Threshold by vertical position on display.
MARKer:TRACe:PEAK:LEVel?	0 to 255	Returns Peak Threshold setting.
SWEEP MODE		
SWEep:TIME XU	XU=1ms, 2ms, 5ms, 10ms, 20ms, 50ms, 100ms, 200ms, 500ms, 1s, 2s, 5s or 10s (all functions) XU=200ns, 500ns, 1us, 5us, 10us, 20us, 50us, 100us, 200us or 500us (ZERO Span or Scope Operation)	Sets Sweep Time per division. Units are ms unless specified.
SWEep:TIME?	0.0002 to 10000	Returns Sweep Time in ms per division.
SWEep:TIME:AUTO X	X=ON or OFF or 1 (On) or 0 (Off)	Sets auto coupling On or Off.
SWEep:TIME:AUTO?	1 (On) or 0 (Off)	Returns auto coupling status.
TRIGger:MODE X	X=FREE, AUTO, NORMAl or SINGleshot	Sets Sweep Trigger mode.
TRIGger:MODE?	FREE, AUTO, NORM or SING	Returns Sweep Trigger mode.
TRIGger:ARM		Sets Sweep to trigger in Singleshot mode.
TRIGger:SOURce X	X=VIDeo, LINE, EXTFrnt or EXTRear	Sets Sweep Trigger Source. EXTFrnt is not valid when EXTERNAL INPUT Connector is active (INPut:SCOPE X).
TRIGger:SOURce?	VIDeo, LINE, EXTFrnt or EXTRear	Returns Sweep Trigger Source.
TRIGger:FILTer X	X=AC, DC, TVLine, TVField, LFRej or HFRej	Sets Sweep Trigger Filter. If Sweep Trigger Source is LINE, Sweep Trigger Filter is automatically set to DC.
TRIGger:FILTer?	AC, DC, TVLine, TVField, LFRej or HFRej	Returns Sweep Trigger Filter.

Table 6-4 AN1820 Specific Commands (Continued)

COMMAND	RANGE	DEFINITION
TRIGger:LEVel X	X=0 to 255 (VIDeo) X=-2.5, -1.0, -.5, 0.0, 0.5, 1.0 or 2.5 (EXTFrnt) Not valid with LINE or EXTReAr.	Sets Level, according to Sweep Trigger Source, required to Trigger a Sweep. VIDeo is vertical position on display. EXTFrnt Level is in volts.
TRIGger:LEVel?	0 to 255	Returns Level Required to Trigger a Sweep.
TRIGger:SLOPe X	X=POSitive or NEGative	Sets Slope for Sweep Trigger
TRIGger:SLOPe?	POS or NEG	Returns Sweep Trigger Slope.
TRIGger:DELay XU	XU=-200s to +200s (depends on Sweep Rate) U=Units (s, ms or us)	Sets Trigger to Sweep Delay. Units are ms unless specified.
TRIGger:DELay?	-200000 to +200000	Returns Trigger to Sweep Delay in ms.
TRACKING GENERATOR MODE (OPTION 02 INSTALLED)		
TRACKgen X	X=ON or OFF or 1 (On) or 0 (Off)	Sets Tracking Generator status.
TRACKgen?	1 (On) or 0 (Off)	Returns Tracking Generator status.
TRACKgen:LEVel X	X=0 to -70 (1 dB steps)	Sets Tracking Generator Output Level in dBm.
TRACKgen:LEVel?	0 to -70	Returns Tracking Generator Output Level in dBm.
TRACKgen:AUTO?	0 (when completed)	Tunes Tracking Generator.
TRACKgen:NORMLz[:STATe] X	X=ON or OFF or 1 (On) or 0 (Off)	Sets Normalization function status.
TRACKgen:NORMLz[:STATe]?	1 (On) or 0 (Off)	Returns Normalization function status.
AUXILIARY MODE		
COUNter:STATe X	X=ON or OFF or 1 (On) or 0 (Off)	Activates Frequency Counter.
COUNter:STATe?	1 (On) or 0 (Off)	Returns Frequency Counter status.
COUNter:RESolution X	X=1 Hz, 10 Hz, 100 Hz or 1000 Hz	Sets Frequency Counter Resolution.
COUNter:RESolution?	1 Hz, 10 Hz, 100 Hz or 1000 Hz	Returns Frequency Counter Resolution.
COUNter?		Returns Frequency Counter reading in MHz.
MIXer X	X=ON or OFF or 1 (On) or 0 (Off)	Sets External Mixer status.
MIXer?	1 (On) or 0 (Off)	Returns External Mixer status.

Table 6-4 AN1820 Specific Commands (Continued)

COMMAND	RANGE	DEFINITION
MIXer:HARMonic X	1 to 100	Sets LO Harmonic for External Mixer.
MIXer:HARMonic?	1 to 100	Returns LO Harmonic setting.
MIXer:IFToggle X	PLUS or MINUS	Toggles LO Harmonic IF above or below LO.
MIXer:IFToggle?	PLUS or MINUS	Returns LO Harmonic IF status.
MIXer:VERify X	X=ON or OFF or 1 (On) or 0 (Off)	Sets Mixer to Verify display by increasing LO Harmonic by 1.
MIXer:VERify?	1 (On) or 0 (Off)	Returns Mixer Verify status.
INPut:EXtErnal:SCOPE X	X=ON or OFF or 1 (On) or 0 (Off)	Sets EXTERNAL INPUT Connector mode for Digital Oscilloscope.
INPut:EXtErnal:SCOPE?	1 (On) or 0 (Off)	Returns Digital Oscilloscope status.
INPut:EXtErnal:COUPling X	X=AC, DC, GROund or OFF	Sets EXTERNAL INPUT Connector Coupling.
INPut:EXtErnal:COUPling?	AC, DC, GROund or OFF	Returns EXTERNAL INPUT Connector Coupling status.
INPut:EXtErnal:ANALyzer X	X=ON or OFF or 1 (On) or 0 (Off)	Sets EXTERNAL INPUT Connector mode for FFT Spectrum Analyzer.
INPut:EXtErnal:ANALyzer?	1 (On) or 0 (Off)	Returns FFT Spectrum Analyzer status.
TRIGger:VERTical X	X=-6 to 6	Sets Amplitude Scale Offset.
TRIGger:VERTical?	-6 to 6	Returns Amplitude Scale Offset.
COPY		
PLOT X	X=TRACe, ALL or GRATICule	Sends trace, entire display or graticule and scaling to plotter.
PRESET		
PRESET:CONFirm		Sets AN1820 to factory preset conditions.
DEMODO		
RECEiver:DEMod:X	X=AM1, AM2, FM1, FM2, USER or OFF	Sets Receiver Demodulation mode.
RECEiver:DEMod?	AM1, AM2, FM1, FM2, USER or OFF	Returns Receiver Demodulation mode.
RECEiver:DEMod:SCALE:AM X	X=10, 20 or 50	Sets AM % Modulation Display Scale per division.
RECEiver:DEMod:SCALE:FM X	X=1 kHz, 2 kHz, 5 kHz, 10 kHz, 20 kHz, 50 kHz, 100 kHz, 200 kHz, 500 kHz, 1 MHz, 2 MHz or 5 MHz	Sets FM Frequency Deviation Scale per division.

Table 6-4 AN1820 Specific Commands (Continued)

COMMAND	RANGE	DEFINITION
RECEiver:DEMod:SCALE:ZERO		Zeros FM Demodulation Screen.
RECEiver:DEMod:SCALE?	AM 10, AM 20, AM 50, FM 1 kHz, FM 2 kHz, FM 5 kHz, FM 10 kHz, FM 20 kHz, FM 50 kHz, FM 100 kHz, FM 200 kHz, FM 500 kHz, FM 1 MHz, FM 2 MHz or FM 5 MHz	Returns Receiver Demodulation Scale and Units.
DISPLAY		
MODE:AVERage X	X=ON or OFF or 1 (On) or 0 (Off)	Sets Trace Averaging function status.
MODE:AVERage?	1 (On) or 0 (Off)	Returns Trace Averaging function status.
MODE:AVERage:COUNt X	X=2 to 8	Sets number of traces to average in Trace Averaging function.
MODE:AVERage:COUNt?	2 to 8	Returns number of traces to average in Trace Averaging function.
MODE:PKHold X	X=ON or OFF or 1 (On) or 0 (Off)	Sets Peak Hold function status.
MODE:PKHold?	1 (On) or 0 (Off)	Returns Peak Hold function status.
MODE:MINhold X	X=ON or OFF or 1 (On) or 0 (Off)	Sets Minimum Hold function status.
MODE:MINhold?	1 (On) or 0 (Off)	Returns Minimum Hold function status.
TRACe:LIMits X	X=ALARm, STORe, RELAY, SRQ, APPS or OFF	Activates Limits function(s).
TRACe:DATA X,Y,Z,Z,Z,...,Z	X=1 to 99 Y=0 to 499 (horizontal offset or start) Z=0 to 255 (vertical settings for points)	Creates or modifies trace, pixel by pixel (each subsequent point), at Memory Location X.
TRACe:DATA? X,Y,Z	X=0 to 99 Y=0 to 499 (horizontal offset or start) Z=1 to 500 (points) y,y,y,...,y (each point=0 to 255)	Returns position(s) of trace data point(s) in Memory Location X or live trace (X=0). X=0, if not specified. Y=0, if not specified. Z=500, if not specified.
TRACe:MAXimum? X,Y,Z	X=0 to 99 Y=0 to 499 Z=1 to 500 X,Y (position, X=0 to 499, Y=0 to 255)	Returns X,Y position of maximum vertical point in selected trace data point(s) of Memory Location or live trace (X=0). X=0, if not specified. Y=0, if not specified. Z=500, if not specified.

Table 6-4 AN1820 Specific Commands (Continued)

COMMAND	RANGE	DEFINITION
TRACe:MINimum? X,Y,Z	X=0 to 99 Y=0 to 499 Z=1 to 500 X,Y (position, X=0 to 499, Y=0 to 255)	Returns X,Y position of minimum vertical point in selected trace data point(s) of Memory Location or live trace (X=0). X=0, if not specified. Y=0, if not specified. Z=500, if not specified.
TRACe:AVERage? X,Y,Z	X=0 to 99 Y=0 to 499 Z=1 to 500 Y (position, Y=0 to 255)	Returns average vertical position of selected trace data point(s) of Memory Location or live trace (X=0). X=0, if not specified. Y=0, if not specified. Z=500, if not specified.
STORE MEMORY		
TRACe:STORe X["LABEL"]	X=1 to 99 LABEL=0 to 20 ASCII Character Storage Label	Stores current trace in Memory Location X with or without Storage Label.
TRACe:UPPer X	X=1 to 99	Designates trace in Memory Location X as Upper Limit Trace.
TRACe:LOWer X	X=1 to 99	Designates trace in Memory Location X as Lower Limit Trace.
TRACe:PROTect X,Y	X=1 to 99 Y=ON or OFF or 1 (On) or 0 (Off)	Sets trace protection status.
TRACe:PROTect? X	X=1 to 99 1 (On) or 0 (Off)	Returns trace protection status.
SETup:STORe X["LABEL"]	X=1 to 99 LABEL=0 to 20 ASCII Character Storage Label	Stores current setup in Memory Location X with or without Storage Label.
TRACe:STORe:\ MAXHid X[LABEL]	X=1 to 99 LABEL=0 to 20 ASCII Character Storage Label	Stores displayed Maximum Hold trace in Memory Location X with or without Storage Label.
TRACe:STORe:\ MINHid X[LABEL]	X=1 to 99 LABEL=0 to 20 ASCII Character Storage Label	Stores displayed Minimum Hold trace in Memory Location X with or without Storage Label.
SETup:PROTect X,Y	X=1 to 99 Y=ON or OFF or 1 (On) or 0 (Off)	Sets setup protection status.
SETup:PROTect? X	X=1 to 99 1 (On) or 0 (Off)	Returns setup protection status.
RECALL MEMORY		
TRACe:DIRectory[:ENTry]? X	X=0 to 99	Returns Trace Directory Entry information on Memory Location X.
TRACe:RECall X	X=0 to 99	Displays trace in Memory Location X. X=0 is live trace.
TRACe:RECall LABEL	LABEL=0 to 20 ASCII Character Storage Label	Displays trace in Memory Location having Storage Label, LABEL.

Table 6-4 AN1820 Specific Commands (Continued)

COMMAND	RANGE	DEFINITION
TRACe:REMOve X	X=0 to 99	Removes trace in Memory Location X from Display. X=0 is live trace.
TRACe:LIVe		Removes all traces from Display and shows only live trace.
SETUp:RECall X	X=0 to 99	Sets AN1820 to setup in Memory Location X. X=0 is current setup.
SETUp:RECall LABEL	LABEL=0 to 20 ASCII Character Storage Label	Sets AN1820 to setup in Memory Location having Storage Label, LABEL.
APPLICATION		
PROGram:NAME "NAME",X	NAME=name of macro X=0 to 5 (1 to 5 assign Soft Function Keys, 0 removes assignment)	Defines and assigns Soft Function Key to macro program.
PROGram:NAME?		Returns name of currently active macro program.
PROGram:CATalog?		Returns list of all macro programs (Macro Directory).
PROGram:CATalog:SElected?		Returns list of all macro programs assigned to Soft Function Keys.
PROGram:DELeTe		Deletes macro program defined by last PROGram:NAME command.
PROGram:DELeTe:ALL		Deletes all macro programs from Macro Directory.
APPLication:DB0		Finds next 0 dB point from and referenced to trace level at marker with edit control position.
APPLication:DB3		Sets markers to 3 dB points from maximum or minimum trace level or finds next 3 dB point from and referenced to trace level at marker with edit control position.
APPLication:DB6		Sets markers to 6 dB points from maximum or minimum trace level or finds next 6 dB point from and referenced to trace level at marker with edit control position.
APPLication:DB60		Sets markers to 60 dB points from maximum or minimum trace level or find next 60 dB point from and referenced to trace level at marker with edit control position.
APPLication:SLOPe X	X=POSitive or NEGative	Sets search slope status.

Table 6-4 AN1820 Specific Commands (Continued)

COMMAND	RANGE	DEFINITION
APPLICATION:SLOPe?	POSitive or NEGative	Returns search slope status.
ANALYZER UTILITY		
SYSTem:COMMunicate:SERial:\ BAUD X	X=110, 150, 300, 600, 1200, 2400, 4800, 9600, 19200 or 38400	Sets RS-232 Baud Rate in bps.
SYSTem:COMMunicate:SERial:\ BITS X	X=7 or 8	Sets number of data bits per word.
SYSTem:COMMunicate:SERial:\ SBITs X	X=1 or 2	Sets number of stop bits per word.
SYSTem:COMMunicate:SERial:\ PARity X	X=NONE, ODD or EVEN	Sets parity check mode.
SYSTem:COMMunicate:SERial:\ PACE X	X=XON or NONE	Sets software handshake (pacing) mode.
SYSTem:COMMunicate:SERial:\ ECHO X	X=ON or OFF or 1 (On) or 0 (Off)	Sets RCI echo.
SYSTem:COMMunicate:SERial:\ CONTRol:RTS X	X=ON, STANDard or RFR	Sets hardware handshake (pacing) mode.
SYSTem:COMMunicate:GPIB:\ ADDRess X	X=0 to 31	Sets address for GPIB bus operation.
WINDow X	X=UNIForm, BARTlett, BLACKman, HARRis, HAMMING, HANNing or NUTTall	Sets FFT data window function.
WINDow?	UNIFORM, BARTLETT, BLACKMAN, HARRIS, HAMMING, HANNING or NUTTALL	Returns FFT data window function.
INPut:ATTenuation:MINimum X	X=0, 10, 20, 30, 40, 50 or 60	Sets Minimum Internal Attenuation Limit in dB.
INPut:ATTenuation:MINimum?	0, 10, 20, 30, 40, 50 or 60	Returns Minimum Internal Attenuation Limit in dB.
SCALE:ENHanced X	X=GAIN, ATTenuation or ATTGain	Sets Enhance Scale Priority.
SCALE:ENHanced ?	GAIN ONLY, ATTEN ONLY or ATTEN THEN GAIN	Returns Enhance Scale Priority setting.
CORREction X	X=ON (Calibrated mode) or OFF (High Speed mode) or 1 (On) or 0 (Off)	Sets digitizer mode of operation.
CORREction?	ON or OFF	Returns digitizer mode of operation.
CALibration:TIME X	X=ON or OFF or 1 (On) or 0 (Off)	Enables or disables internal automatic calibrations.
CALibration:TIME?	ON or OFF	Returns operation status of internal automatic calibrations.

Table 6-4 AN1820 Specific Commands (Continued)

COMMAND	RANGE	DEFINITION
SYSTem:REFerence <i>X</i>	<i>X</i> =EXTernal or INTernal	Sets system time base reference.
SYSTem:REFerence?	EXTernal or INTernal	Returns system time base reference.
RECEiver:DEMod:COUPling <i>X</i>	<i>X</i> =AC or DC	Sets FM coupling.
RECEiver:DEMod:COUPling?	AC or DC	Returns FM coupling.
SYSTem:KEYBoard <i>X</i>	<i>X</i> =ON or OFF or 1 (On) or 0 (Off)	Sets keyboard click status.
SYSTem:KEYBoard?	1 (On) or 0 (Off)	Returns keyboard click status.
SYSTem:SPINner <i>X</i>	<i>X</i> =ON or OFF or 1 (On) or 0 (Off)	Sets DATA SCROLL Spinner click status.
SYSTem:SPINner?	1 (On) or 0 (Off)	Returns DATA SCROLL Spinner click status.
SYSTem:DATE <i>Y,M,D</i>	<i>Y</i> =1997 to 9999 (year) <i>M</i> =01 to 12 (month) <i>D</i> =01 to 31 (day)	Sets system date.
SYSTem:DATE?	1997 to 9999 (year), 01 to 12 (month), 01 to 31 (day)	Returns system date set.
SYSTem:TIME <i>H,M,S</i>	<i>H</i> =00 to 23 (hour) <i>M</i> =00 to 59 (minute) <i>S</i> =00 to 59 (second)	Sets system time.
SYSTem:TIME?	00 to 23 (hour), 00 to 59 (minute), 00 to 59 (second)	Returns system time set.

Table 6-4 AN1820 Specific Commands (Continued)

SECTION 7 - OPTIONS

7-1 TRACKING GENERATOR (OPTION 02)

Refer to Figure 3-1 for controls, connectors and indicators called out in 7-1.

7-1-1 DESCRIPTION

The Tracking Generator (Option 02) is used to measure frequency response of filters, amplifiers, antennas, couplers and other frequency-selective devices. The Tracking Generator provides an output signal through the TRACKING GENERATOR Connector. Output signal frequency, ranging from 100 kHz to 2.9 GHz, is synchronous with the signal frequency received through the ANALYZER INPUT Connector. Output level is adjustable from -70 to 0 dBm in 1 dB steps.

Refer to 4-8 for procedures using the Tracking Generator.

7-1-2 RESPONSE

Tracking Generator flatness is affected by the AMPLITUDE CORRECTION setting in the Analyzer Configuration Screen General Options Menu. Setting the AMPLITUDE CORRECTION to CALIBRATED provides the best Tracking Generator response.

7-2 QUASI-PEAK DETECTOR (OPTION 08)

Refer to Figure 3-1 for controls, connectors and indicators called out in 7-2.

7-2-1 PURPOSE

Quasi-Peak Detection was developed by the Comite International Special des Perturbation Radioelectroniques (CISPR) as a way to characterize Electromagnetic Interference (EMI) to communications equipment. Quasi-Peak Detection has become a standard measurement method recognized by most regulatory agencies for testing digital devices. More information is found in CISPR Publication 16 and ANSI Standard C63.2-1980.

The Quasi-Peak Detector provides an easy and efficient way of measuring EMI.

The Quasi-Peak Detector also offers a larger dynamic range for measuring pulse modulated frequencies.

NOTE: The Quasi-Peak Detector, Option 08, also includes five extra resolution bandwidth filters (200 Hz, 1 kHz, 9 kHz, 120 kHz and 1 MHz). The 200 Hz, 9 kHz and 120 kHz filters are used with the Quasi-Peak Detector. All the extra filters are available for RBW selection in normal operation, when Option 08 is installed.

7-2-2 TIME CONSTANTS

EMI measurements are performed within constraints of Table 7-1. The RBW setting determines the Time Constants. The Charge Time Constant is the time required, after application of RF voltage at the ANALYZER INPUT Connector, for output voltage to reach 63% of final value. The Discharge Time Constant is the time required, after removal of input voltage from the ANALYZER INPUT Connector, for output voltage to fall to 37% of initial value. The Indicator Time Constant is the time required to indicate the correct level of the input voltage.

FREQUENCY RANGE	BANDWIDTH AT 6 dB	CHARGE TIME CONSTANT	DISCHARGE TIME CONSTANT	INDICATOR TIME CONSTANT
10 to 150 kHz	200 Hz	45 ms	500 ms	160 ms
150 kHz to 30 MHz	9 kHz	1 ms	160 ms	160 ms
30 MHz to 1 GHz	120 kHz	1 ms	550 ms	100 ms

Table 7-1 Quasi-Peak Time Constants

7-2-3 ANTENNA FACTOR

The antenna factor is supplied by the antenna manufacturer. The antenna gain is entered into the AN1820 as part of the external offset factor set in the Reference Amplitude Operation Screen. The AN1820 uses the antenna gain to correct and display the actual signal field strength.

7-2-4 LINE IMPEDANCE STABILIZATION NETWORK (LISN)

Measurements for conducted emissions require a Line Impedance Stabilization Network (LISN) in the test circuit. The LISN provides a fixed impedance to the UUT, isolates UUT EMI for measurement by the AN1820 and prevents power line EMI from entering the test circuit. Refer to Figure 7-1 for a diagram of the LISN used for FCC testing.

CAUTION: DAMAGE TO THE AN1820 IS POSSIBLE WHEN SWITCHING LISN LINES CONNECTED TO THE AN1820. CHECK UNIT SPECIFICATIONS BEFORE CONNECTING THE LISN TO ANALYZER INPUT CONNECTOR.

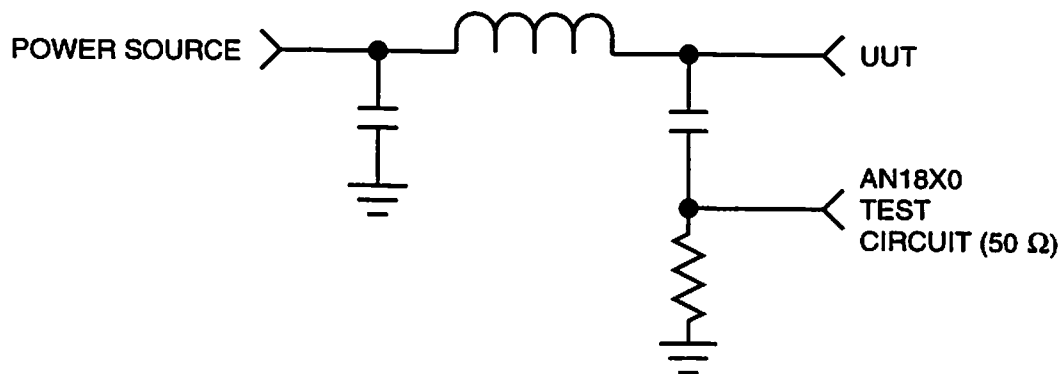
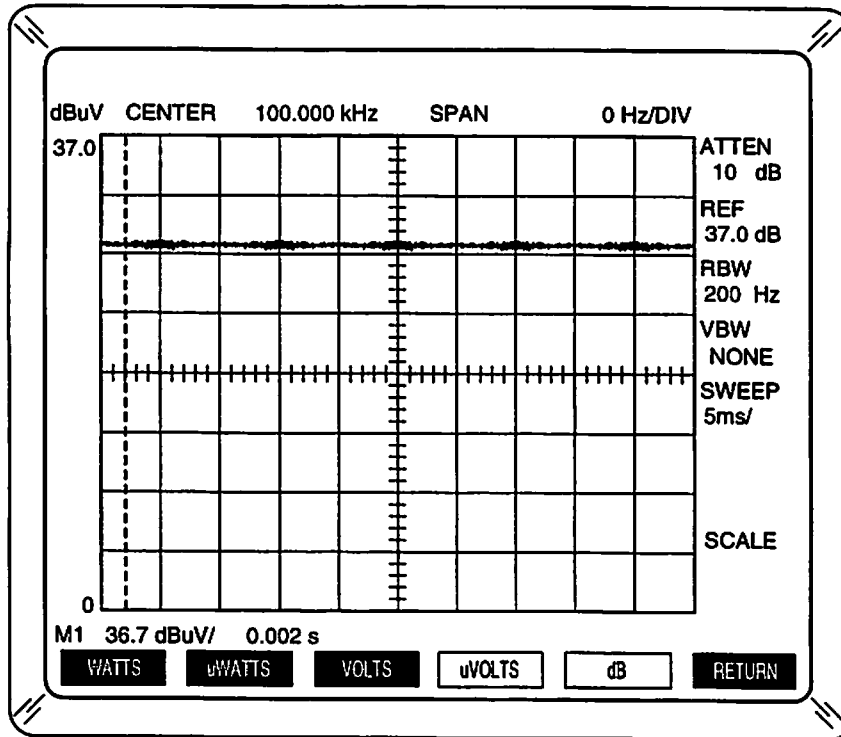

Figure 7-1 Line Impedance Stabilization Network (LISN)

00318001

7-2-5 QUASI-PEAK DETECTOR MEASUREMENT PROCEDURE



01917079

Figure 7-2 Quasi-Peak Measurements

The following procedure provides one general way to isolate signals and take Quasi-Peak measurements. The operator is recommended to consult applicable measurement standards and procedures such as the CISPR and ANSI Standards. Advantages of this procedure are:

- Ambient signals are eliminated before introducing UUT signals.
- Quasi-Peak testing at all frequencies is not required.

NOTE: Storing test control settings in a Setup Memory Location is suggested for easier testing and faster test times.

CAUTION: MAXIMUM ANALYZER INPUT MUST NOT EXCEED +20 dBm, PEAK OR AVERAGE, WITH INTERNAL ATTENUATION <10 dB. MAXIMUM ANALYZER INPUT MUST NOT EXCEED +30 dBm AVERAGE OR +40 dBm PEAK WITH INTERNAL ATTENUATION ≥10 dB. FREQUENCY MUST BE >0 Hz (NO dc VOLTAGE).

STEP	PROCEDURE
------	-----------

1. For radiated EMI testing, go to Step 2. For conducted EMI testing, set up and connect test equipment as shown in Figure 7-3:
 - Use High-Pass Filter (with cutoff frequency below UUT frequency range) to prevent mixer overload and consequent gain compression and distortion.
 - Use Limiter or carefully monitor peak power to prevent damage to AN1820 caused by LISN transients.

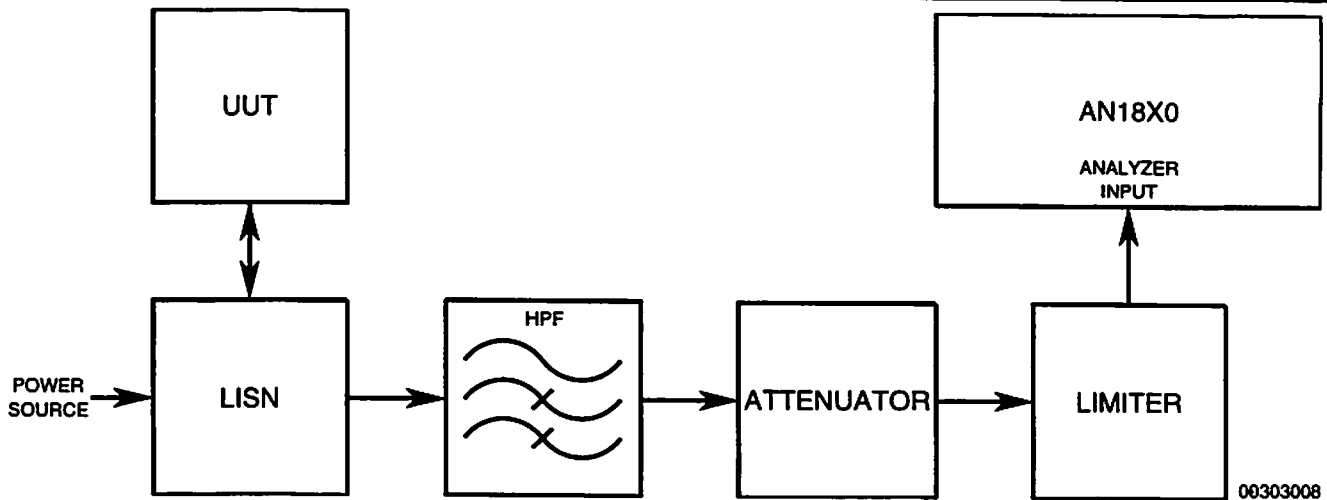

Figure 7-3 Conducted EMI Test Hook-Up

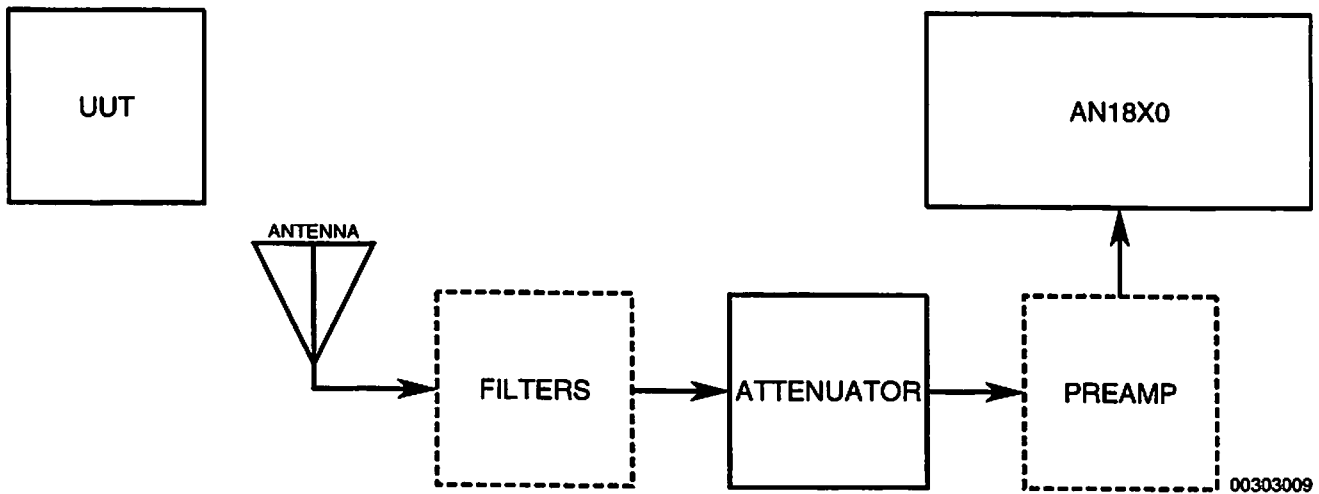

Figure 7-4 Radiated EMI Test Hook-Up

2. For radiated EMI testing, set up and connect equipment as shown in Figure 7-4:
 - Use Preamp, as needed, to provide adequate sensitivity.
 - Use Filters, as needed, to eliminate overload and unwanted frequency signals.
3. Apply power and activate AN1820 with UUT Off. Allow 15 minute warm-up time.
4. Press CENTER FREQUENCY Key.
5. Use DATA ENTRY Keypad to set Center Frequency to **500 MHz**.
6. Press SPAN FREQUENCY Key.
7. Use DATA ENTRY Keypad to set Frequency Span to **100 MHz/DIV**.
8. Press REF AMPLITUDE Key.
9. Use ↑ and ↓ Keys, DATA ENTRY Keypad or DATA SCROLL Spinner to adjust top of scale reference level to **-30.0 dB**.

10. If needed, set external offset factor as follows:
- Calculate external offset factor by subtracting all external gain values (Antenna and Preamplifier) and adding all external attenuation values (LISN, Attenuator, Loss through Filter[s] and Limiter).
 - Press OFFSET Soft Function Key F1 to enter OFFSET field.
 - Use ↑ and ↓ Keys, DATA ENTRY Keypad or DATA SCROLL Spinner to set external offset factor to calculated value.
11. Verify Display shows relatively flat trace with limited spikes (ambient signals). Refer to Figure 7-5.

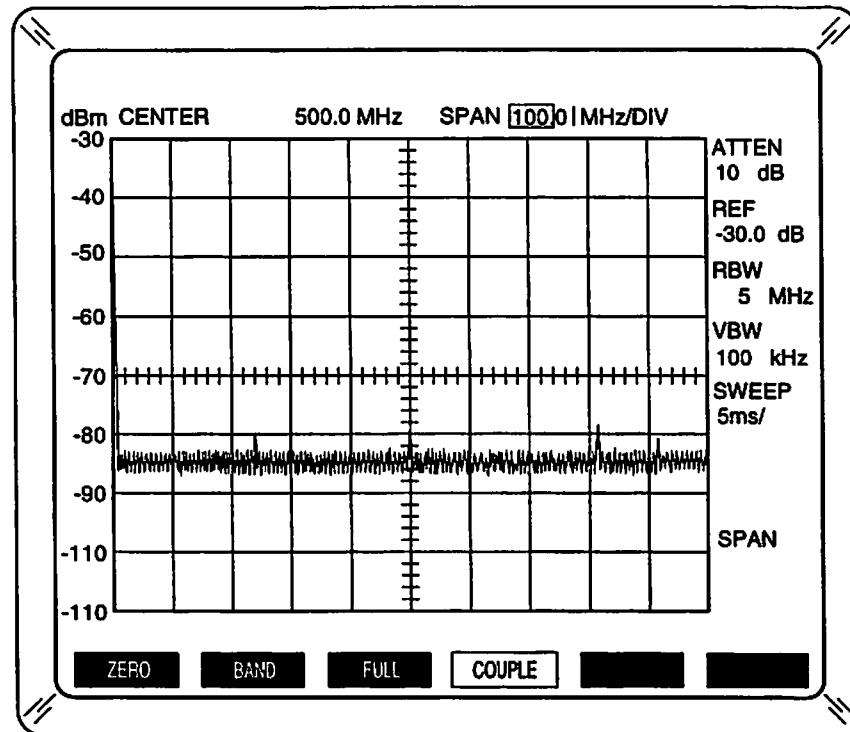

Figure 7-5 Ambient Signals

01917061

ELIMINATING AMBIENT SIGNALS

12. Press TRACE Soft Function Key F5 to activate Trace Reference function.
13. Activate UUT.
14. If needed, adjust Trace Reference display Amplitude Scale Offset:
- Press OFFSET Soft Function Key F1.
 - Use ↑ and ↓ Keys, DATA ENTRY Keypad or DATA SCROLL Spinner to set Trace Reference display Amplitude Scale Offset for best display.
15. Note frequencies of any signals exceeding predetermined limits.

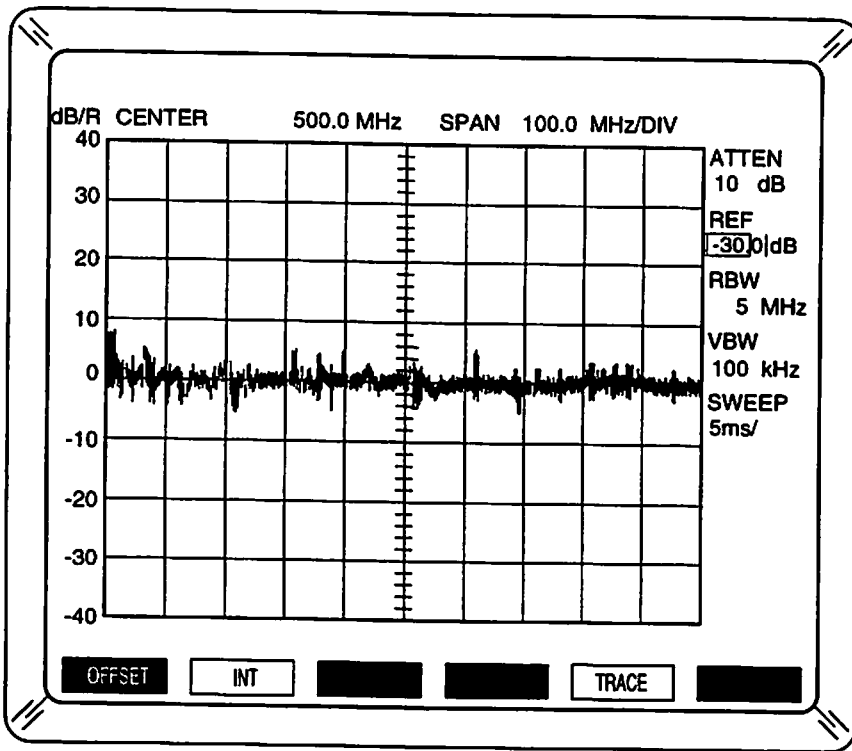

Figure 7-6 Trace Reference Function Without UUT Signals

01917062

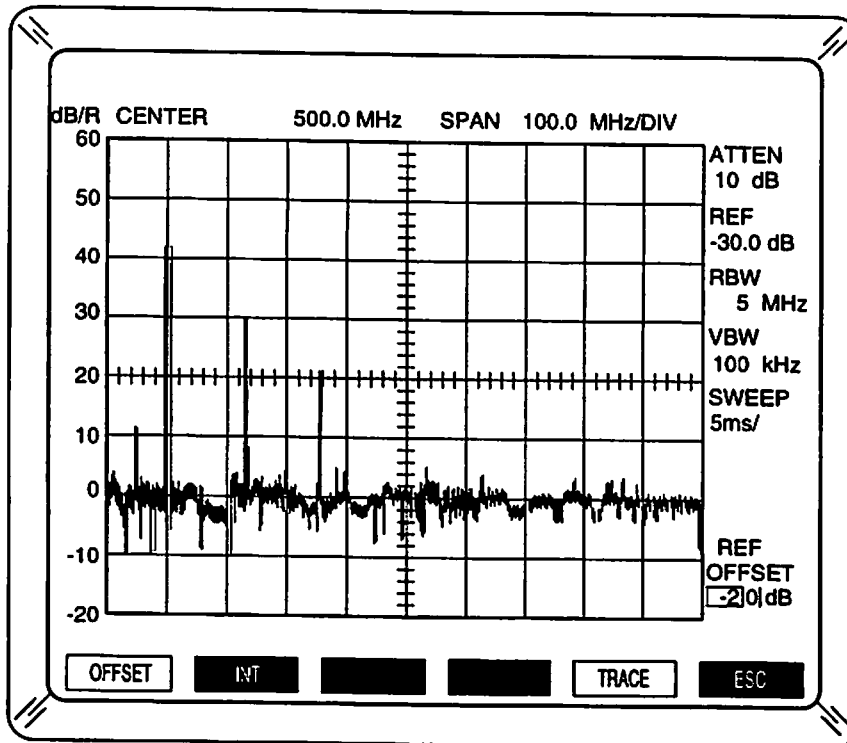

Figure 7-7 Trace Reference Function With UUT Signals

00317010

PEAK DETECTOR (QUICK-LOOK) TEST

NOTE: When the levels of the signals to the ANALYZER INPUT Connector are determined to be within the safe operation of the AN1820 according to the Caution in 7-2-4, the Limiter, if used, should be removed for best accuracy.

16. Press TRACE Soft Function Key F5 to deactivate Trace Reference function.
17. Press CENTER FREQUENCY Key.
18. Use DATA SCROLL Spinner or DATA ENTRY Keypad to set Center Frequency to any frequency noted in Step 15.
19. Press SPAN FREQUENCY Key. Use DATA SCROLL Spinner or DATA ENTRY Keypad to decrease Frequency Span (RBW automatically adjusted) until signal characters are clearly visible.

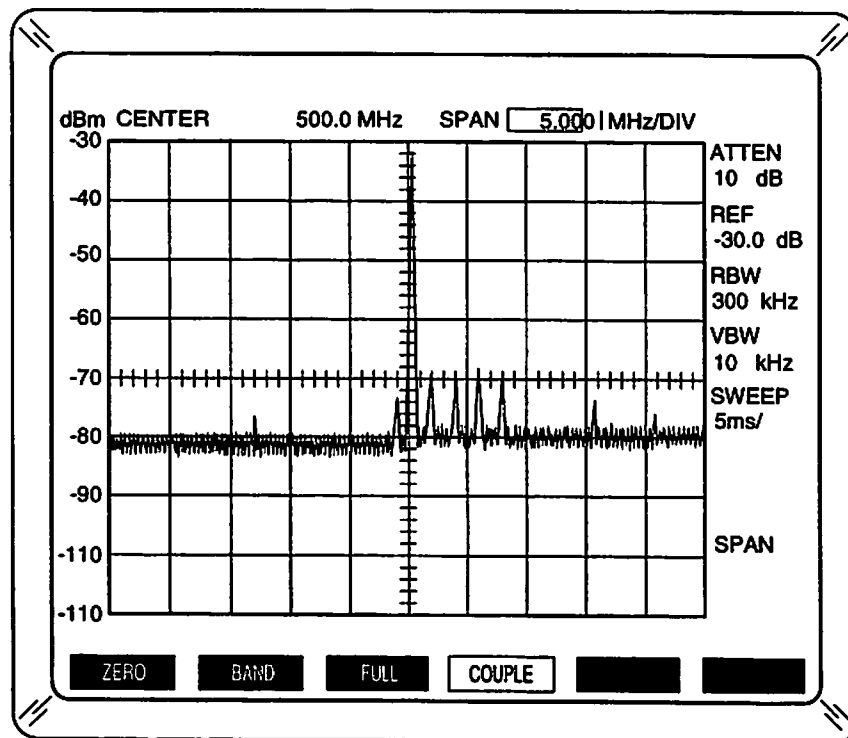

Figure 7-8 Normal Peak Detector

01917064

20. Press SCALE AMPLITUDE Key.
21. Press LINEAR Soft Function Key F2.
22. Press UNITS Soft Function Key F3.
23. Press VOLTS Soft Function Key F3.
24. Press REF AMPLITUDE Key.
25. Use ↑ and ↓ Keys, DATA ENTRY Keypad or DATA SCROLL Spinner to adjust top of scale reference level for best display of signal.
26. Press MARKER MODE Key.
27. Press MKR SEL Soft Function Key F1.

STEP**PROCEDURE**

28. Press RETURN Soft Function Key F6.
29. Press PK FUNC Soft Function Key F5.
30. Press PK LVL Soft Function Key F4.
31. Use DATA SCROLL Spinner to move Peak Threshold Level to EMI test limit or below.
32. Press ← PEAK Soft Function Key F2 or PEAK → Soft Function Key F3 to move Marker 1 to signal peak exceeding Peak Threshold Level (level may be fluctuating).
33. If signal exceeds limit, go to Step 35 for Quasi-Peak Detector Close-Look Test.
34. Repeat Steps 17 to 33 for other frequencies noted in Step 15.

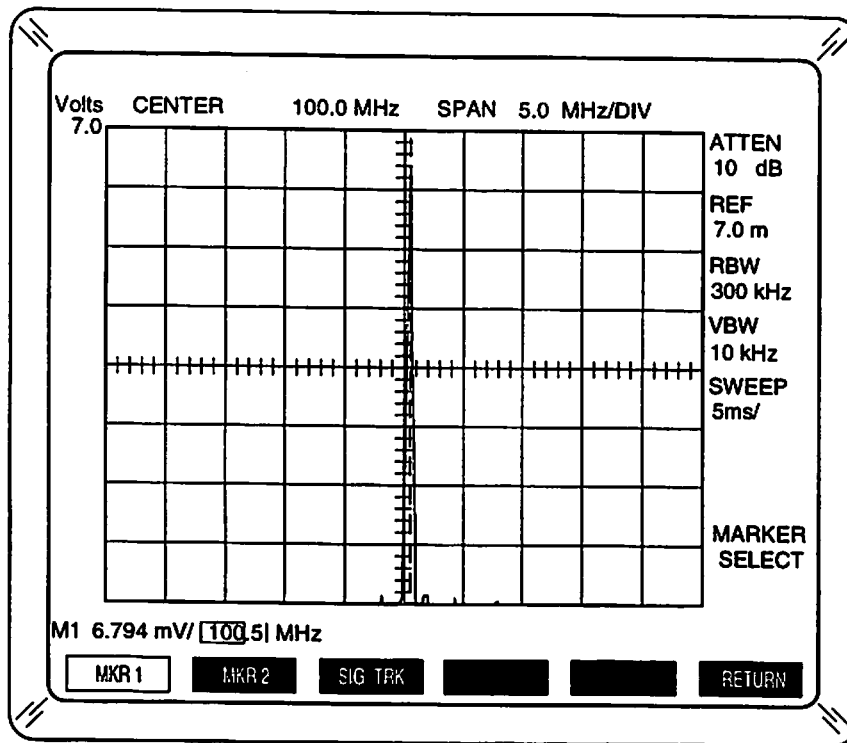
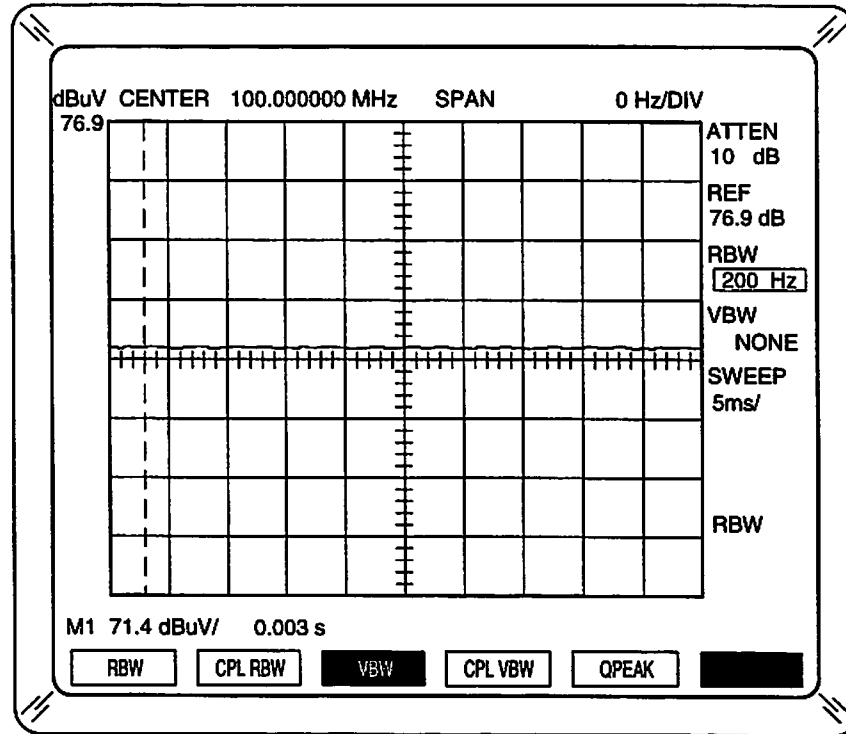

Figure 7-9 Normal Peak Detector in Linear Display Mode

01917065

QUASI-PEAK DETECTOR (CLOSE-LOOK) TEST

35. Press BW AMPLITUDE Key.
36. Press QPEAK Soft Function Key F4.
37. Press ↓ Key as needed to set RBW to **200 Hz**.



01917066

Figure 7-10 Quasi-Peak Detector

38. Press SPAN FREQUENCY Key.
39. Press ZERO Soft Function Key F1.
40. Verify Marker 1 level is within EMI limits applicable for UUT (and separation distance for radiated EMI testing).
41. Set units as follows:
 - Press SCALE AMPLITUDE Key.
 - Press UNITS Soft Function Key F3.
 - Press uVOLTS Soft Function Key F4 or WATTS Soft Function Key F1.
 - For dB μ V or dBm, press dB Soft Function Key F5.
42. Verify signal level indicated in M1 second value field.
43. Repeat Steps 17 to 33 for other frequencies noted in Step 15.

APPENDIX A - CONNECTOR PIN-OUT TABLES

A-1 TABLE OF I/O CONNECTORS

CONNECTOR	NUMBER	TYPE	IN/OUT	SIGNAL
10.7 MHz IF OUT	02A1J2A	BNC	OUT	10.7 MHz Reference
410.7 MHz IF OUT	02A1J3A	BNC	OUT	410.7 MHz
AC IN	02A1A21J6	ac Plug	IN	ac Power
ANALYZER INPUT	02A1A9J1	N	IN	RF
EXT DISPLAY	02A1W47J1	15-Pin, D Receptacle	OUT	Video, VESA-VGA Color Display Compatible, See Pin-Out (Table A-2).
EXTERNAL INPUT	02A1A12J2	BNC	IN	≤40 V Trigger, Oscilloscope Input or Low Frequency FFT Input
EXTERNAL MIXER IF	02A1W6J1	SMA	IN	410.7 MHz IF
EXTERNAL MIXER LO	02A1W9J1/ W10J1	SMA	OUT	3 to 12 GHz
EXT REF IN	02A1J4A	BNC	IN	10 MHz, 2 to 5 V _p TTL
FUNCTION	02A1W40J1	15-Pin, D Receptacle	IN/OUT	See Pin-Out (Table A-3).
IEEE-488 GPIB	02A1W39J1	24-Pin Champ	IN/OUT	See Pin-Out (Table A-4).
PHONES	02A1A12J3	1/8" (3.2 mm) Phone Jack	OUT	Audio (≤1 W through 8 Ω impedance)
PRINTER	02A1W49J1	25-Pin, DB Receptacle	OUT	Screen Print Data, See Pin-Out (Table A-6).
REF OUT	02A1A12J1A	BNC	OUT	100 MHz at -30 dBm (±0.5 dB)
RS-232	02A1W39J2	9-Pin, D Plug	IN/OUT	See Pin-Out (Table A-5).
TRACKING GENERATOR (Option 02)	02A1W12J1	N	OUT	100 kHz to 2.9 GHz at 0 to -70 dBm
VIDEO OUT	02A1J1A	BNC	OUT	Demodulated Video

Table A-1 I/O Connectors

A-2 EXT DISPLAY CONNECTOR

PIN NUMBER	SIGNAL
1	Red
2	Green
3	Blue
4	Ground
5	Not Connected
6	Ground
7	Ground
8	Ground
9	Not Connected
10	Ground
11	Ground
12	Not Connected
13	$\overline{\text{EHSYNC}}$
14	$\overline{\text{EVSNC}}$
15	Not Connected

Table A-2 Pin-Out for EXT DISPLAY Connector

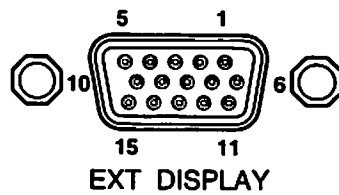

Figure A-1 EXT DISPLAY Connector

01918001

A-3 FUNCTION CONNECTOR

PIN NUMBER	SIGNAL
1	-12 V
2	+5 V
3	SER-CLK
4	SER-CNTRL
5	RLY DRV 1
6	$\overline{\text{SWEEP HOLD}}$
7	AUX VIDEO
8	AUX TRIGGER
9	+12 V
10	IRQ-SER
11	SER-STATUS
12	$\overline{\text{SLAVE - SELECT}}$
13	RLY DRV 2
14	SWEEP
15	Ground

Table A-3 Pin-Out for FUNCTION Connector

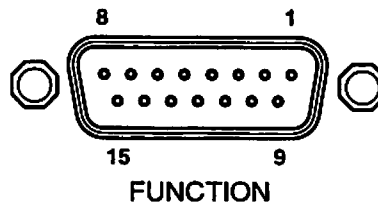

Figure A-2 FUNCTION Connector

01918002

15

A-4 IEEE-488 GPIB CONNECTOR

The IEEE-488 GPIB Connector complies with ANSI/IEEE Standard 488.2-1987.

PIN NUMBER	SIGNAL	PIN NUMBER	SIGNAL
1	DIO 1	13	DIO 5
2	DIO 2	14	DIO 6
3	DIO 3	15	DIO 7
4	DIO 4	16	DIO 8
5	EQI	17	REN
6	DAV	18	Ground
7	NRFD	19	Ground
8	NDAC	20	Ground
9	IFC	21	Ground
10	SRQ	22	Ground
11	ATN	23	Ground
12	Ground	24	Ground

Table A-4 Pin-Out for IEEE-488 GPIB Connector

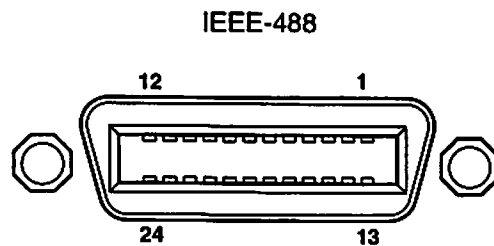

Figure A-3 IEEE-488 GPIB Connector

01918003

A-5 RS-232 CONNECTOR

PIN NUMBER	SIGNAL
1	CD
2	TXD
3	RXD
4	Not Connected
5	Ground
6	DTR
7	$\overline{\text{CTS}}$
8	$\overline{\text{RTS}}$
9	Not Connected

Table A-5 Pin-Out for RS-232 Connector

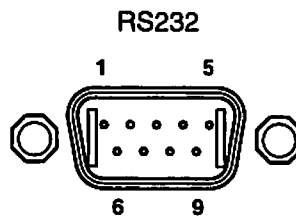

Figure A-4 RS-232 Connector

01918004

A-6 PRINTER CONNECTOR

PIN NUMBER	SIGNAL
1	STB
2	PD0
3	PD1
4	PD2
5	PD3
6	PD4
7	PD5
8	PD6
9	PD7
10	$\overline{\text{ACK}}$
11	BUSY
12	PE
13	SLCT
14	$\overline{\text{AFD}}$
15	$\overline{\text{ERROR}}$
16	$\overline{\text{INIT}}$
17	$\overline{\text{SLIN}}$
18	Ground
19	Ground
20	Ground
21	Ground
22	Ground
23	Ground
24	Ground
25	Ground

Table A-6 Pin-Out for PRINTER Connector

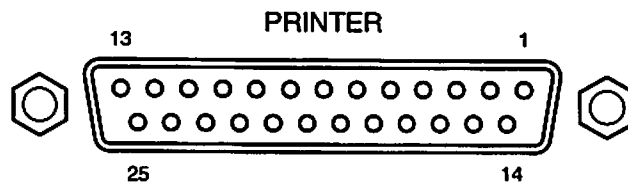

Figure A-5 PRINTER Connector

01918005

APPENDIX B - OPTIMIZATION TABLES

FREQUENCY SPAN (PER DIVISION)	RBW	VBW	SWEEP TIME (PER DIVISION)
10 Hz	3 Hz	100 kHz	50 ms
20 Hz	10 Hz	100 kHz	50 ms
50 Hz	30 Hz	100 kHz	50 ms
100 Hz	30 Hz	100 kHz	50 ms
200 Hz	30 Hz	100 kHz	50 ms
500 Hz	300 Hz (200 Hz-Option 08)	100 Hz	50 ms
1 kHz	300 Hz	1 kHz	50 ms
2 kHz	300 Hz	1 kHz	100 ms
5 kHz	3 kHz (1 kHz-Option 08)	1 kHz	5 ms (20 ms-Option 08)
10 kHz	3 kHz	1 kHz	5 ms
20 kHz	3 kHz	1 kHz	10 ms
50 kHz	3 kHz	1 kHz	20 ms
100 kHz	30 kHz (9 kHz-Option 08)	10 kHz	5 ms (10 ms-Option 08)
200 kHz	30 kHz	10 kHz	20 ms
500 kHz	30 kHz	10 kHz	50 ms
1 MHz	300 kHz (120 kHz-Option 08)	10 kHz	2 ms
2 MHz	300 kHz (120 kHz-Option 08)	10 kHz	5 ms
5 MHz	300 kHz	10 kHz	5 ms
10 MHz	300 kHz	10 kHz	10 ms
20 MHz	5 MHz (1 MHz-Option 08)	100 kHz	2 ms
50 MHz	5 MHz (1 MHz-Option 08)	100 kHz	2 ms (5 ms [4 X OS]-Option 08)
100 MHz	5 MHz	100 kHz	5 ms
200 MHz	5 MHz	100 kHz	5 ms
290 MHz	5 MHz	100 kHz	5 ms (2 X OS)

Table B-1 Signal Display Optimization

FREQUENCY SPAN (PER DIVISION)	RBW	VBW	SWEEP TIME (PER DIVISION)	DISPLAY
200 kHz	≤300 Hz	10 kHz	100 ms (8 X OS)	Uncalibrated
	1 kHz	10 kHz	100 ms (8 X OS)	Normal
	3 kHz	10 kHz	50 ms (2 X OS)	Normal
	9 kHz to 5 MHz	10 kHz	20 ms	Normal
	≥10 MHz	10 kHz	20 ms	Linear
500 kHz	≤1 kHz	10 kHz	50 ms (8 X OS)	Uncalibrated
	3 kHz	10 kHz	50 ms (8 X OS)	Normal
	9 kHz	10 kHz	50 ms (2 X OS)	Normal
	30 kHz to 5 MHz	10 kHz	50 ms	Normal
	≥10 MHz	10 kHz	50 ms	Linear
1 MHz	≤3 kHz	10 kHz	50 ms (8 X OS)	Uncalibrated
	9 kHz	10 kHz	50 ms (4 X OS)	Normal
	30 kHz	10 kHz	50 ms	Normal
	120 kHz to 5 MHz	10 kHz	2 ms	Normal
	≥10 MHz	10 kHz	2 ms	Linear
2 MHz	≤3 kHz	10 kHz	50 ms (8 X OS)	Uncalibrated
	9 kHz	10 kHz	50 ms (8 X OS)	Normal
	30 kHz	10 kHz	100 ms (2 X OS)	Normal
	120 kHz to 5 MHz	10 kHz	5 ms	Normal
	≥10 MHz	10 kHz	5 ms	Linear
5 MHz	≤9 kHz	10 kHz	100 ms (8 X OS)	Uncalibrated
	30 kHz	10 kHz	200 ms (4 X OS)	Normal
	120 kHz	10 kHz	5 ms (2 X OS)	Normal
	300 kHz to 5 MHz	10 kHz	5 ms	Normal
	≥10 MHz	10 kHz	5 ms	Linear
10 MHz	≤9 kHz	10 kHz	200 ms (8 X OS)	Uncalibrated
	30 kHz	10 kHz	200 ms (8 X OS)	Normal
	120 kHz	10 kHz	10 ms (4 X OS)	Normal
	300 kHz to 5 MHz	10 kHz	10 ms	Normal
	≥10 MHz	10 kHz	10 ms	Linear
20 MHz	≤30 kHz	100 kHz	5 ms (8 X OS)	Uncalibrated
	120 kHz	100 kHz	5 ms (8 X OS)	Normal
	300 kHz	100 kHz	2 ms (2 X OS)	Normal
	1 to 5 MHz	100 kHz	2 ms	Normal
	≥10 MHz	100 kHz	2 ms	Linear

Table B-2 RBW Adjustment Optimization (Continued)

FREQUENCY SPAN (PER DIVISION)	RBW	VBW	SWEEP TIME (PER DIVISION)	DISPLAY
10 Hz	3 to 10 Hz	100 kHz	50 ms	Normal
20 Hz	3 to 10 Hz	100 kHz	50 ms	Normal
50 Hz	30 to 100 Hz	100 kHz	50 ms	Normal
100 Hz	30 to 100 Hz	100 kHz	50 ms	Normal
200 Hz	30 to 100 Hz	100 kHz	50 ms	Normal
500 Hz	200 Hz to 5 MHz	100 Hz	50 ms	Normal
	≥10 MHz	100 Hz	50 ms	Linear
1 kHz	200 Hz	1 kHz	100 ms	Normal
	300 Hz to 5 MHz	1 kHz	50 ms	Normal
	≥10 MHz	1 kHz	50 ms	Linear
2 kHz	200 Hz	1 kHz	200 ms	Normal
	300 Hz to 5 MHz	1 kHz	100 ms	Normal
	≥10 MHz	1 kHz	100 ms	Linear
5 kHz	200 Hz	1 kHz	500 ms	Normal
	300 Hz	1 kHz	100 ms	Normal
	1 kHz to 5 MHz	1 kHz	20 ms	Normal
	≥10 MHz	1 kHz	20 ms	Linear
10 kHz	200 Hz	1 kHz	500 ms (2 X OS)	Normal
	300 Hz	1 kHz	200 ms	Normal
	1 kHz	1 kHz	50 ms	Normal
	3 kHz to 5 MHz	1 kHz	5 ms	Normal
	≥10 MHz	1 kHz	5 ms	Linear
20 kHz	200 Hz	1 kHz	500 ms (4 X OS)	Normal
	300 Hz	1 kHz	200 ms (2 X OS)	Normal
	1 kHz	1 kHz	100 ms	Normal
	3 kHz to 5 MHz	1 kHz	10 ms	Normal
	≥10 MHz	1 kHz	10 ms	Linear
50 kHz	200 Hz	1 kHz	500 ms (8 X OS)	Uncalibrated
	300 Hz	1 kHz	500 ms (4 X OS)	Normal
	1 kHz	1 kHz	100 ms (2 X OS)	Normal
	3 kHz to 5 MHz	1 kHz	20 ms	Normal
	≥10 MHz	1 kHz	20 ms	Linear
100 kHz	≤300 Hz	10 kHz	100 ms (8 X OS)	Uncalibrated
	1 kHz	10 kHz	100 ms (4 X OS)	Normal
	3 kHz	10 kHz	50 ms	Normal
	9 kHz to 5 MHz	10 kHz	10 ms	Normal
	≥10 MHz	10 kHz	10 ms	Linear

Table B-2 RBW Adjustment Optimization

FREQUENCY SPAN (PER DIVISION)	RBW	VBW	SWEEP TIME (PER DIVISION)	DISPLAY
50 MHz	≤120 kHz	100 kHz	5 ms (8 X OS)	Uncalibrated
	300 kHz	100 kHz	5 ms (8 X OS)	Normal
	1 MHz	100 kHz	5 ms (4 X OS)	Normal
	5 MHz	100 kHz	5 ms	Normal
	≥10 MHz	100 kHz	5 ms	Normal
100 MHz	≤120 kHz	100 kHz	5 ms (8 X OS)	Uncalibrated
	300 kHz	100 kHz	5 ms (8 X OS)	Normal
	1 MHz	100 kHz	5 ms (4 X OS)	Normal
	5 MHz	100 kHz	5 ms	Normal
	≥10 MHz	100 kHz	5 ms	Linear
200 MHz	≤120 kHz	100 kHz	5 ms (8 X OS)	Uncalibrated
	300 kHz to 1 MHz	100 kHz	5 ms (8 X OS)	Normal
	5 MHz	100 kHz	5 ms	Normal
	≥10 MHz	100 kHz	5 ms	Linear
290 MHz	≤300 kHz	100 kHz	5 ms (8 X OS)	Uncalibrated
	1 MHz	100 kHz	5 ms (8 X OS)	Normal
	5 MHz	100 kHz	5 ms (2 X OS)	Normal
	≥10 MHz	100 kHz	5 ms	Linear

Table B-2 RBW Adjustment Optimization (Continued)

FREQUENCY SPAN (PER DIVISION)	RBW	VBW	SWEEP TIME (PER DIVISION)
10 Hz	3 Hz	100 kHz	50 ms
20 Hz	10 Hz	100 kHz	50 ms
50 Hz	30 Hz	100 kHz	50 ms
100 Hz	30 Hz	100 kHz	50 ms
200 Hz	30 Hz	100 kHz	50 ms
500 Hz	200 Hz (Option 08)	10 Hz	500 ms
		NONE, 100 Hz to 1 MHz	50 ms
	300 Hz	10 Hz	200 ms
		NONE, 100 Hz to 1 MHz	50 ms
1 kHz	300 Hz	10 Hz	500 ms
		NONE, 100 Hz to 1 MHz	50 ms
2 kHz	300 Hz	10 Hz	1 s
		NONE, 100 Hz to 1 MHz	100 ms
5 kHz	1 kHz (Option 08)	10 Hz	2 s
		100 Hz	100 ms
		NONE, 1 kHz to 1 MHz	20 ms
	3 kHz	10 Hz	200 ms
NONE, 100 Hz to 1 MHz		20 ms	
10 kHz	3 kHz	10 Hz	500 ms
		100 Hz	50 ms
		NONE, 1 kHz to 1 MHz	5 ms
20 kHz	3 kHz	10 Hz	1 s
		100 Hz	100 ms
		NONE, 1 kHz to 1 MHz	10 ms
50 kHz	3 kHz	10 Hz	2 s
		100 Hz	200 ms
		NONE, 1 kHz to 1 MHz	20 ms
100 kHz	9 kHz (Option 08)	10 Hz	2 s
		100	200 ms
		1 kHz	20 ms
		NONE, 10 kHz to 1 MHz	10 ms
	30 kHz	10 Hz	500 ms
		100 Hz	50 ms
NONE, 1 kHz to 1 MHz		10 ms	
200 kHz	30 kHz	10 Hz	1 s
		100 Hz	100 ms
		NONE, 1 kHz to 1 MHz	20 ms

Table B-3 VBW Adjustment Optimization

FREQUENCY SPAN (PER DIVISION)	RBW	VBW	SWEEP TIME (PER DIVISION)
500 kHz	30 kHz	10 Hz	5 s
		100 Hz	500 ms
		NONE, 1 kHz to 1 MHz	50 ms
1 MHz	120 kHz (Option 08)	10 Hz	1 s
		100 Hz	100 ms
		1 kHz	10 ms
		NONE, 10 kHz to 1 MHz	2 ms
	300 kHz	10 Hz	500 ms
		100 Hz	50 ms
		1 kHz	5 ms
		NONE, 10 kHz to 1 MHz	2 ms
2 MHz	120 kHz (Option 08)	10 Hz	2 s
		100 Hz	200 ms
		1 kHz	20 ms
		NONE, 10 kHz to 1 MHz	5 ms
	300 kHz	10 Hz	1 s
		100 Hz	100 ms
		1 kHz	10 ms
		NONE, 10 kHz to 1 MHz	5 ms
5 MHz	300 kHz	10 Hz	5 s
		100 Hz	500 ms
		1 kHz	50 ms
		NONE, 10 kHz to 1 MHz	5 ms
10 MHz	300 kHz	10 Hz	5 s
		100 Hz	500 ms
		1 kHz	50 ms
		NONE, 10 kHz to 1 MHz	10 ms
20 MHz	1 MHz (Option 08)	10 Hz	2 s
		100 Hz	200 ms
		1 kHz	20 ms
		NONE, 10 kHz to 1 MHz	2 ms
	5 MHz	10 Hz	500 ms
		100 Hz	50 ms
		1 kHz	5 ms
		NONE, 10 kHz to 1 MHz	2 ms

Table B-3 VBW Adjustment Optimization (Continued)

FREQUENCY SPAN (PER DIVISION)	RBW	VBW	SWEEP TIME (PER DIVISION)
50 MHz	1 MHz (Option 08)	10 Hz	2 s (4 X OS)
		100 Hz	200 ms (4 X OS)
		1 kHz	20 ms (4 X OS)
		NONE, 10 kHz to 1 MHz	5 ms (4 X OS)
	5 MHz	10 Hz	2 s
		100 Hz	200 ms
		1 kHz	20 ms
		NONE, 10 kHz to 1 MHz	5 ms
100 MHz	5 MHz	10 Hz	5 s
		100 Hz	500 ms
		1 kHz	50 ms
		NONE, 10 kHz to 1 MHz	5 ms
200 MHz	5 MHz	10 Hz	5 s
		100 Hz	500 ms
		1 kHz	50 ms
		10 kHz	10 ms
		NONE, 100 kHz to 1 MHz	5 ms
290 MHz	5 MHz	10 Hz	5 s (2 X OS)
		100 Hz	500 ms (2 X OS)
		1 kHz	50 ms (2 X OS)
		10 kHz	10 ms (2 X OS)
		NONE, 100 kHz to 1 MHz	5 ms (2 X OS)

Table B-3 VBW Adjustment Optimization (Continued)

FREQUENCY SPAN (PER DIVISION)	RBW	VBW	SWEEP TIME (PER DIVISION)	DISPLAY
0 Hz			200 ns to 10 s	Normal
10 Hz	3 Hz	100 kHz	50 ms	Normal
20 Hz	10 Hz	100 kHz	50 ms	Normal
50 Hz	30 Hz	100 kHz	50 ms	Normal
100 Hz	30 Hz	100 kHz	50 ms	Normal
200 Hz	30 Hz	100 kHz	50 ms	Normal
500 Hz	200 Hz (Option 08)	100 Hz	1 to 20 ms	Uncalibrated
			50 ms to 10 s	Normal
	300 Hz	100 Hz	1 to 10 ms	Uncalibrated
			20 ms to 10 s	Normal
1 kHz	300 Hz	1 kHz	1 to 10 ms	Uncalibrated
			20 ms to 10 s	Normal
2 kHz	300 Hz	1 kHz	1 to 20 ms	Uncalibrated
			50 ms to 10 s	Normal
5 kHz	1 kHz (Option 08)	1 kHz	1 to 10 ms	Uncalibrated
			20 ms to 10 s	Normal
	3 kHz	1 kHz	1 ms	Uncalibrated
			2 ms to 10 s	Normal
10 kHz	3 kHz	1 kHz	1 to 2 ms	Uncalibrated
			5 ms to 10 s	Normal
20 kHz	3 kHz	1 kHz	1 to 5 ms	Uncalibrated
			10 ms to 10 s	Normal
50 kHz	3 kHz	1 kHz	1 to 10 ms	Uncalibrated
			20 ms to 10 s	Normal
100 kHz	9 kHz (Option 08)	10 kHz	1 to 5 ms	Uncalibrated
			10 ms to 10 s	Normal
	30 kHz	10 kHz	1 to 2 ms	Uncalibrated
			5 ms to 10 s	Normal
200 kHz	30 kHz	10 kHz	1 to 10 ms	Uncalibrated
			20 ms to 10 s	Normal
500 kHz	30 kHz	10 kHz	1 to 20 ms	Uncalibrated
			50 ms to 10 s	Normal
1 MHz	120 kHz (Option 08)	10 kHz	1 ms	Uncalibrated
			2 ms to 10 s	Normal
	300 kHz	10 kHz	1 ms to 10 s	Normal

Table B-4 Sweep Time Adjustment Optimization

FREQUENCY SPAN (PER DIVISION)	RBW	VBW	SWEEP TIME (PER DIVISION)	DISPLAY
2 MHz	120 kHz (Option 08)	10 kHz	1 to 2 ms	Uncalibrated
			5 ms to 10 s	Normal
5 MHz	300 kHz	10 kHz	1 ms to 10 s	Normal
			1 to 2 ms	Uncalibrated
10 MHz	300 kHz	10 kHz	5 ms to 10 s	Normal
			1 to 2 ms	Uncalibrated
20 MHz	1 MHz (Option 08)	100 kHz	5 ms to 10 s	Normal
			1 ms to 10 s	Normal
50 MHz	1 MHz (Option 08)	100 kHz	1 ms to 10 s	Normal
			1 ms to 10 s (4 X OS)	Normal
100 MHz	5 MHz	100 kHz	1 ms to 10 s	Normal
200 MHz	5 MHz	100 kHz	1 ms to 10 s	Normal
290 MHz	5 MHz	100 kHz	1 ms to 10 s (2 X OS)	Normal

Table B-4 Sweep Time Adjustment Optimization (Continued)

APPENDIX C - OVERSAMPLING

C-1 DESCRIPTION

More signal samples than normal are used when oversampling is active. Refer to Table C-1 for the AN1820 sampling rates. Increasing the number of samples prevents any break across a wide Frequency Span when looking at a signal through a narrow Resolution Bandwidth (RBW). Without oversampling, parts of the frequency spectrum may be missed entirely on every sweep.

The AN1820 displays 500 samples. Digital peak detection provides the highest signal value from the total number of samples taken across each frequency in the Frequency Span to compress the number of samples taken to the 500 displayed points. Normal sampling (RBW > frequency range per sample) allows multiple samples across each frequency in the Frequency Span. As the Frequency Span widens, the RBW also widens to provide adequate sampling across the frequencies. A narrow RBW may be desired for accuracy in resolving signals with frequencies close together. As the RBW decreases, samples move apart until frequencies normally overlapped with multiple samples are not even sampled at all. Oversampling (RBW < frequency range per sample) provides enough samples to fill the frequency gaps. Sweep rate is slowed by the oversample rate. The result allows better resolution with assurance that no signals are being missed. One drawback to oversampling, the noise floor rising slightly, due to the digital peak detection process, can be minimized with the video filter.

SAMPLING RATE	TOTAL SAMPLES	SAMPLES/DIVISION
NORMAL	500	50
2 X OS	1000	100
4 X OS	2000	200
8 X OS	4000	400

Table C-1 AN1820 Sampling

C-2 EXAMPLES

C-2-1 NORMAL SAMPLING (Figure C-1)

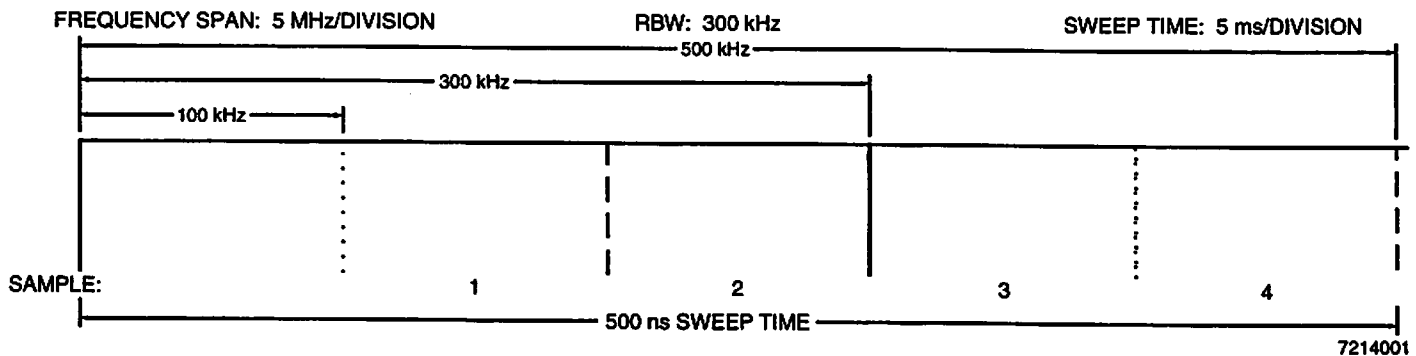
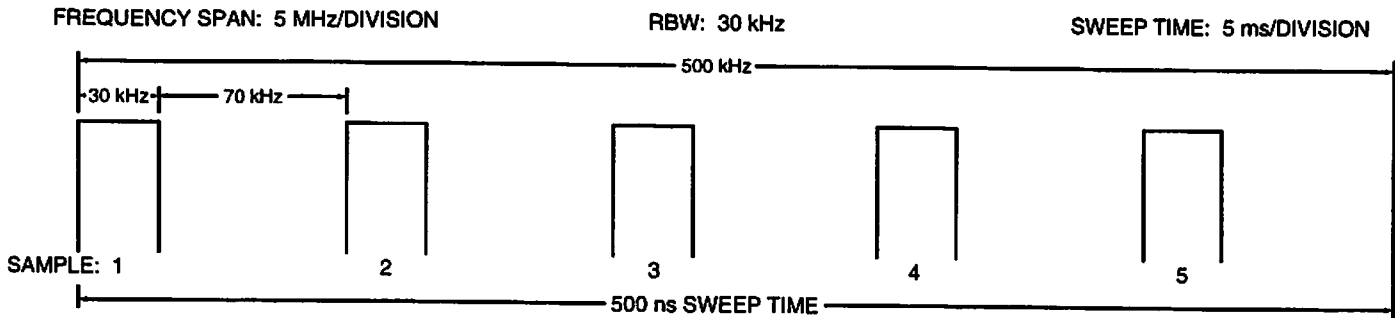

Figure C-1 Sampling-Normal RBW (One Tenth of a Division)

Normally the AN1820 takes 50 samples per division. Each sample is the RBW wide. For Figure C-1, the RBW and width of each sample is 300 kHz. The Frequency Span is 5 MHz per division. Because 50 samples are taken across 5 MHz, each sample is 100 kHz apart allowing three samples for every frequency in the Frequency Span.

C-2-2 NORMAL SAMPLING THROUGH NARROW RESOLUTION BANDWIDTH (Figure C-2)



7214002

Figure C-2 Sampling-Narrow RBW (One Tenth of a Division)

The same 5 MHz per division Frequency Span through a 30 kHz RBW (sample width) would cause a 70 kHz missed frequency range between samples if only normal sampling was used.

C-2-3 OVERSAMPLING

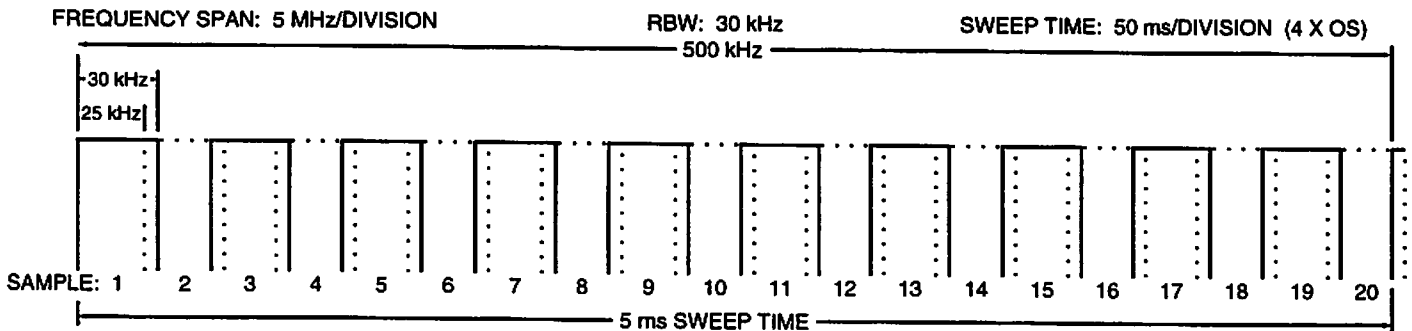

7214003

Figure C-3 Oversampling (One Tenth of a Division)

The same 5 MHz per division Frequency Span through a 30 kHz RBW (sample width) requires a four times sampling rate (**4 X OS**) to avoid missing frequency gaps. Oversampling by taking 2000 samples provides 200 samples per division. Because 200 samples are taken across 5 MHz, each sample is 25 kHz apart. Because the RBW (30 kHz) is greater than the frequency per sample (25 kHz), no frequency is missed.

With oversampling, Frequency Spans up to eight times the normal width can be used without missing information. Frequencies are not missed across wide Frequency Spans when operating with narrow Resolution Bandwidths. The AN1820 displays **UNCAL** in the Message field when the Frequency Span is too great for eight times oversampling (**8 X OS**).

APPENDIX D - FFT

D-1 TERMS

Alias: False signal resulting from the property of any sampled system to observe any signal greater than half the sampling frequency, as the difference between that signal and any multiple of the sampling frequency.

Fourier Transform: Mathematical method of converting a continuous voltage versus time function into a voltage versus frequency function.

Discrete Fourier Transform (DFT): Method of numerically performing the Fourier Transform on discrete samples instead of a continuous function.

Fast Fourier Transform (FFT): Optimized algorithm for performing the DFT. FFT uses samples to powers of two and eliminates common inner terms in the computation. The number of computations required becomes proportional to approximately 1.2 times the number of samples instead of the number of samples squared.

D-2 THEORY

Refer to Figures 3-1 and 3-2 for location of controls, connectors and indicators.

D-2-1 FFT OPERATION THROUGH ANALYZER INPUT CONNECTOR

The input signal to the AN1820 is mixed down to the IF signal used in normal Spectrum Analyzer Operation. For FFT, the IF signal is down converted again to an audio range IF. The AN1820 digitizes the IF with a 16-bit digitizer. The digitizing process preserves the frequency and amplitude information of the entire input signal. The signal is processed using the FFT algorithm to provide a display equivalent to the display obtained at wider bandwidths using regular analog RF methods.

The existing analyzer IF filters, providing alias protection for the digitizing process, determines the maximum display span and IF. The 10.7 MHz IF signal, going through a 3 kHz wide IF filter, is converted to 4 kHz (usable ± 1 kHz) and sampled at a 50 kHz rate to provide a 200 Hz/Div Frequency Span. FFT results, from 3 to 5 kHz, are shown on the Display as the desired spectrum. The 10.7 MHz IF signal, going through the 300 Hz wide IF filter, is converted to 1 kHz (usable ± 100 Hz) and sampled at a 12.5 kHz rate to provide a 20 Hz/Div Frequency Span. FFT results, from 900 to 1100 Hz, are shown on the Display as the desired spectrum.

D-2-2 FFT OPERATION THROUGH EXTERNAL INPUT CONNECTOR

RESOLUTION	BIN WIDTH	SAMPLE RATE	FFT SIZE	DISPLAY SPAN	AUDIO INPUT (IF)
3 Hz	3.05 Hz	12.5 kHz	512 point	≤ 200 Hz	≤ 3 kHz
10 Hz	12.2 Hz	12.5 kHz	1024 point	≤ 200 Hz	≤ 3 kHz
		50.0 kHz	512 point	≤ 2 kHz	≤ 24 kHz
30 Hz	24.4 Hz	50.0 kHz	2048 point	≤ 2 kHz	≤ 24 kHz
100 Hz	48.8 Hz	50.0 kHz	2048 point	≤ 2 kHz	≤ 24 kHz

Table D-1 FFT Equivalent Bandwidths

When using the EXTERNAL INPUT Connector in FFT mode, the AN1820 directly digitizes the audio input signal, providing a display in the frequency domain. Input signals are $\leq 1/2$ the sample rate to prevent aliasing.

NOTE: Anti-aliasing filters are not provided when using the EXTERNAL INPUT Connector. Some signals may require external filters for optimum display.

D-3 WINDOWS

A window is the mathematical process of obtaining usable results when using an FFT with real-world signals (non-synchronous). The FFT is performed on a fixed time sample. The mathematics assume an infinite long, continual function where the beginning and end match exactly in slope and amplitude. Unfortunately, such a match only occurs when the input signal is synchronous with the sample signal (not a practical real-world application). A very high noise floor occurs when the input signal and sample signal are not synchronous. To make the FFT work with a significant discontinuity between the beginning and end of the time sample, all the data over the time sample is weighted, forcing the beginning and end to zero and eliminating the discontinuity.

Applying no window (sometimes called Uniform or Rectangular) provides basic FFT with no weighting. The Bartlett window is a simple triangular function uniformly increasing the 0 weighting at the edges (beginning and end) to full weighting in the middle. More complicated functions provide better performing windows. However, there are trade-offs involved. Therefore, different windows are better suited for different applications. Tables D-2 and D-3 provide information concerning windows used in the AN1820. For more information on performance and trade-offs concerning window selection, IFR Systems Inc. recommends, "On the Use of Windows for Harmonic Analysis with the Discrete Fourier Transform" by Fredric J. Harris (Proceedings of the IEEE, Vol. 66, No. 1, January 1978).

WINDOW	EQUATION
UNIFORM	$w(n) = 1.0n$
BARTLETT	$w(n) = \frac{2n}{N-1}, \text{ For } 0 \leq n \leq N-1 \text{ or}$ $w(n) = 2 - \frac{2n}{N-1}, \text{ For } \frac{N-1}{2} \leq n \leq N-1$
BLACKMAN	$w(n) = 0.42 - 0.5 \cos \frac{2\pi n}{N-1} + 0.08 \cos \frac{4\pi n}{N-1}$
BLACKMAN-HARRIS	$w(n) = 0.40217 - 0.49703 \cos \frac{2\pi n}{N-1} + 0.09392 \cos \frac{4\pi n}{N-1} - 0.00183 \cos \frac{6\pi n}{N-1}$
HAMMING	$w(n) = 0.54 - 0.46 \cos \frac{2\pi n}{N-1}$
HANN	$w(n) = 0.5 (1 - \cos \frac{2\pi n}{N-1})$
NUTTALL	$w(n) = 0.3635819 - 0.4891775 \cos \frac{2\pi n}{N-1} + 0.1365995 \cos \frac{4\pi n}{N-1} - 0.0106411 \cos \frac{6\pi n}{N-1}$
N=Total Number of Samples, n=Display Point	

Table D-2 FFT Data Window Equations

WINDOW	RESOLUTION BANDWIDTH (HZ)	EQUIVALENT NOISE BANDWIDTH (HZ)	3.0 dB BANDWIDTH (Hz)	6.0 dB BANDWIDTH (Hz)
UNIFORM	3	3.05	2.71	3.69
	10	12.2	10.9	14.8
	30	24.4	21.7	29.5
	100	48.8	43.4	59.0
BARTLETT	3	4.06	3.90	5.43
	10	16.2	15.6	21.7
	30	32.5	31.2	43.4
	100	64.9	62.5	86.9
BLACKMAN	3	5.28	5.10	7.17
	10	21.1	20.5	28.7
	30	42.2	41.0	57.3
	100	84.4	82.0	115.0
BLACKMAN-HARRIS	3	5.46	5.30	7.44
	10	21.8	21.2	29.8
	30	43.7	42.5	59.5
	100	87.4	84.9	119.0
HAMMING	3	4.15	3.97	5.52
	10	16.6	15.9	22.1
	30	33.2	31.7	44.2
	100	66.4	63.4	88.3
HANN	3	4.56	4.39	6.10
	10	18.3	17.6	24.4
	30	36.6	35.1	48.8
	100	73.2	70.2	97.6

Table D-3 Data Windows

APPENDIX E - REPACKING FOR SHIPMENT

E-1 SHIPPING INFORMATION

IFR Test Sets returned to the service center for calibration, service or repair must be repackaged and shipped subject to the following conditions:

E-1-1 AUTHORIZATION

Do not return any products to the service center without authorization.

CONTACT: IFR Systems, Inc.
Customer Service Dept.
10200 West York Street
Wichita, Kansas 67215-8935

Telephone: 800-835-2350

FAX: 316-524-2623

E-1-2 TAGGING TEST SETS

All test sets must be tagged with:

- Owner's identification and address.
- Nature of service or repair required.
- Model No. and Serial No.

E-1-3 SHIPPING CONTAINERS

Test Sets must be repackaged in original shipping containers using IFR packing materials. If original shipping containers and materials are not available, contact the IFR Customer Service Department for shipping instructions.

E-1-4 FREIGHT COSTS

All freight costs on non-warranty shipments are assumed by the customer. (See "Warranty Packet" for freight charge policy on warranty claims.)

E-2 REPACKING PROCEDURE (Figure E-1)

- Make sure bottom packing mold is seated on floor of shipping container.
- Adjust handle to lay unlocked against Test Set as shown.
- Place Elastic Retainer around Test Set to secure handle.
- Carefully wrap Test Set with polyethylene sheeting.
- Place Test Set into shipping container, making sure Test Set is securely seated in bottom packing mold.
- Place top packing mold over top of Test Set and press down until mold rests solidly on bottom packing mold.
- Close shipping container lids and seal with shipping tape or an industrial stapler. Tie all sides of container with break resistant rope, twine or equivalent.

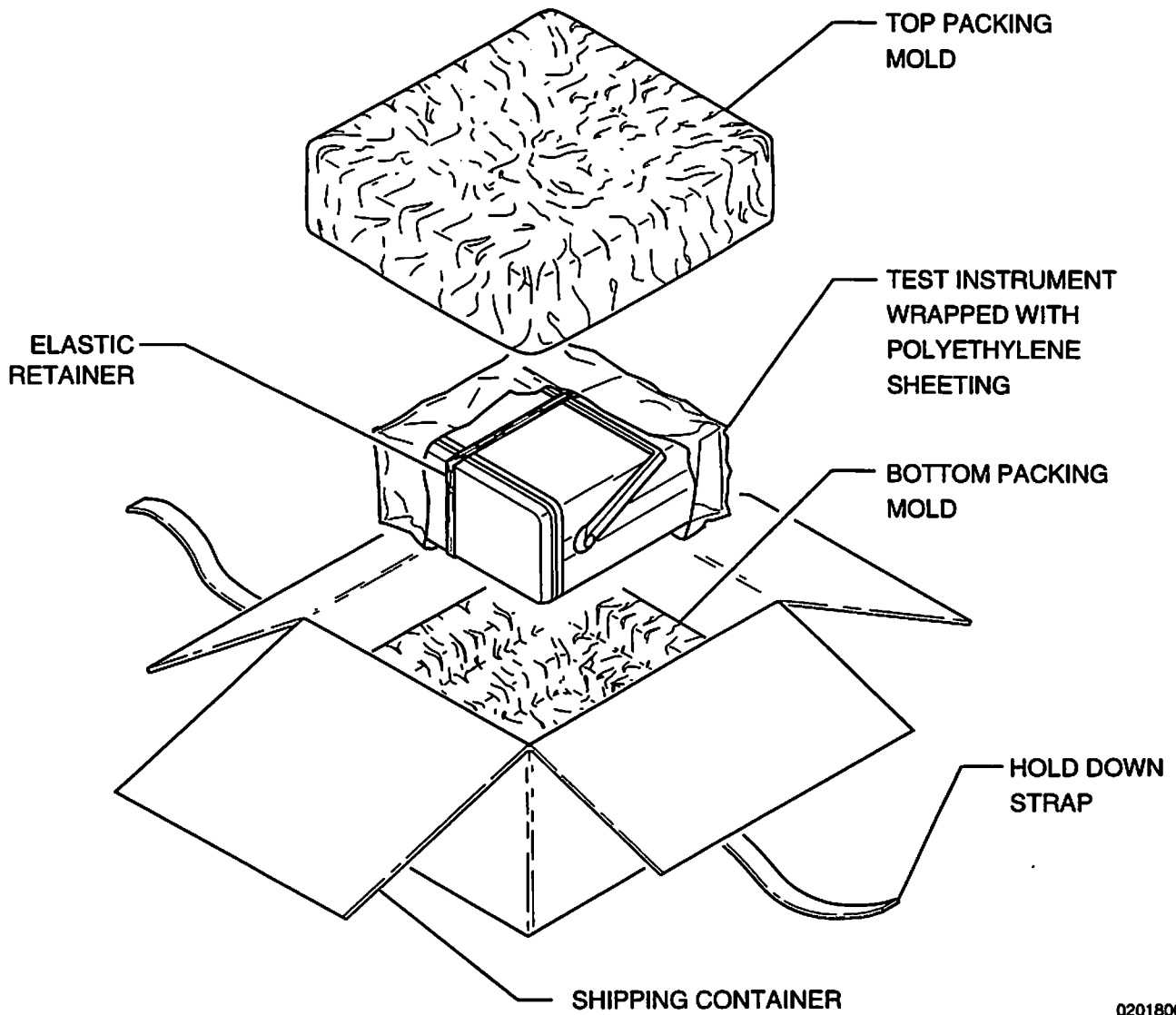

Figure E-1 Repacking for Shipment

02018001

APPENDIX F - OPTIONS AND ACCESSORIES

OPTION NUMBER	DESCRIPTION	PART NUMBER
Option 02	2.9 GHz Tracking Generator	7001-2041-800
Option 08	Supplemental RBW Filters and Quasi-Peak Detector	7001-2042-000
Option 09	High Stability Time Base	7001-7244-400

Table F-1 Internal Options

DESCRIPTION	PART NUMBER
1 inch Manual Binder	1003-0001-100
Lid Assembly	7005-2040-900
Operation Manual	1002-0201-200
RS-232 Cable	6041-9001-200
Two Spare ac Fuses (3.15 A Fast Blow)	5106-0000-049

Table F-2 Standard Accessories

ACCESSORY NUMBER	DESCRIPTION	PART NUMBER
AC0100	Near Field Probe Set	1053-5400-200
AC4101	Return Loss Bridge	4101-0000-100
AC4700	Rack Mount Adapter	7001-7244-700
AC5007	Padded Carrying Case	1412-0006-004
AC5008	dc Block	2100-0400-300
AC1009W	EasySpan for Windows	1009-0001-600
AC1046	ANXXX Series Applications Library	1009-0002-600
	Maintenance Manual	1002-0401-400
	TMAC Users Manual (Programming)	1002-0401-600

Table F-3 Optional Accessories

APPENDIX G - SOFT FUNCTION KEY FLOWCHART

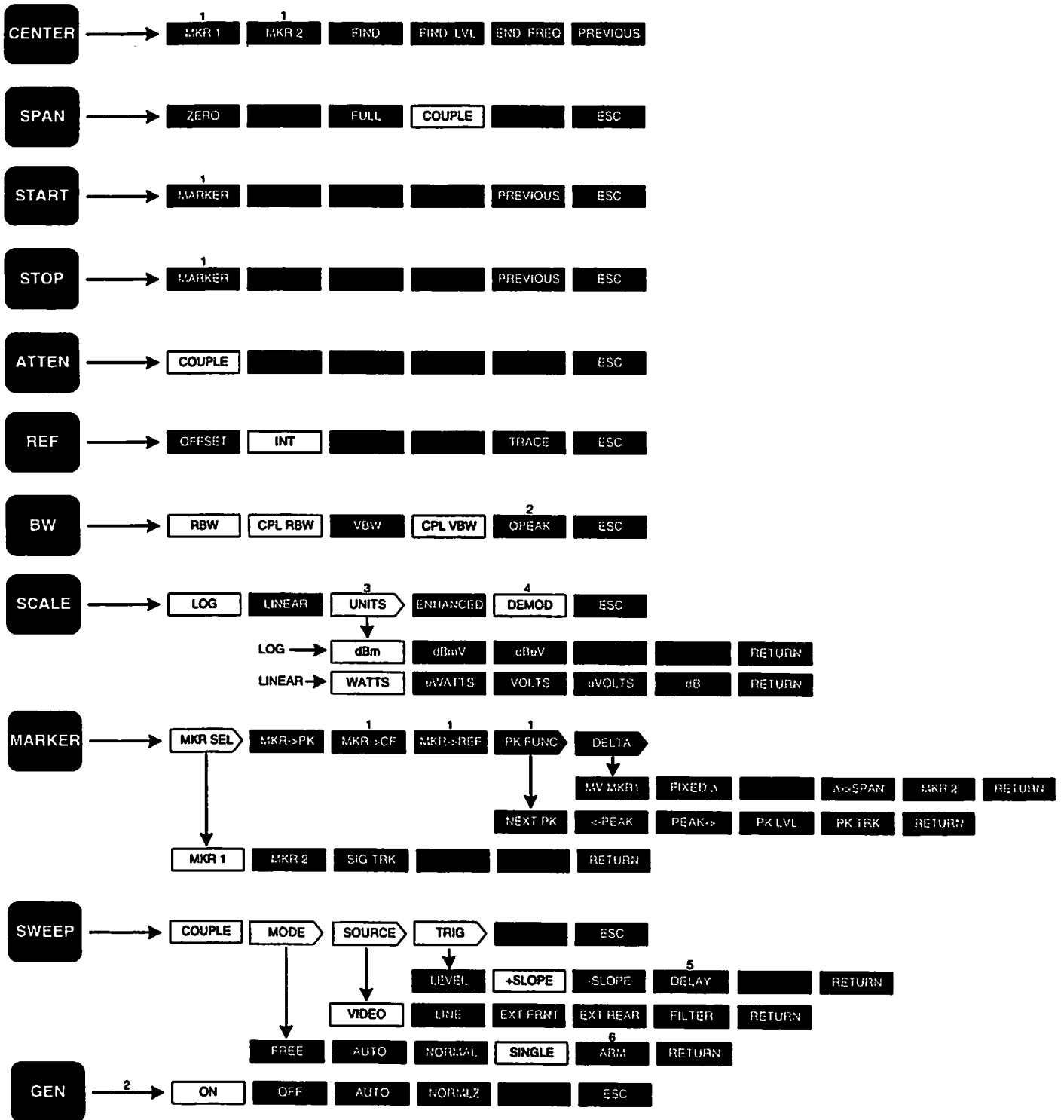

NOTES:

- 1 With Marker(s) active
- 2 With Option installed
- 3 ZERO with dc coupled FM demodulation mode selected
- 4 With User-Defined demodulation mode selected
- 5 With ZERO Span or Scope mode
- 6 With SINGLE Source selected

00208001

Figure G-1 Soft Function Key Flowchart

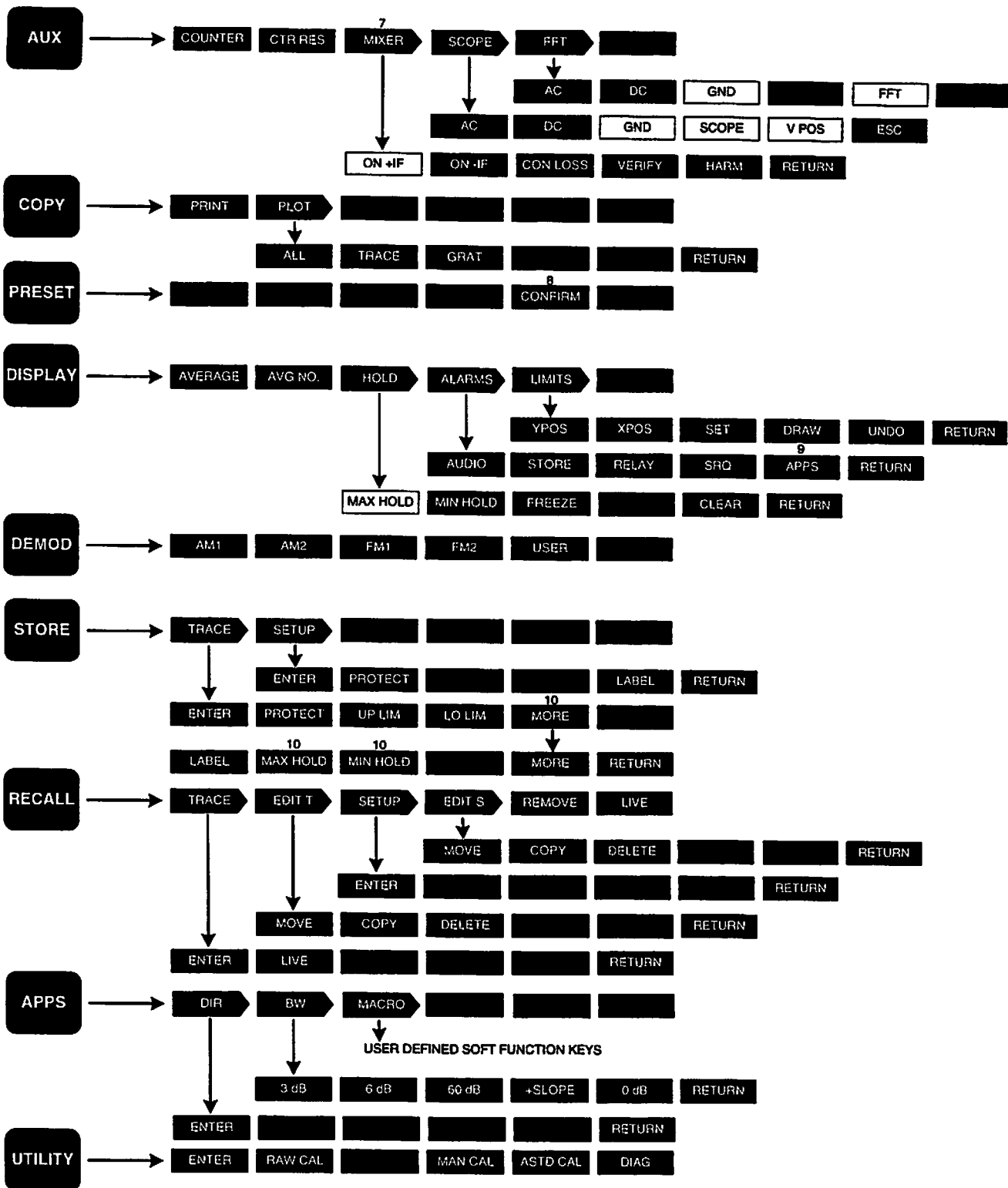

NOTES:

7 With Tracking Generator inactive
 8 If selected in Keyboard Options Screen

9 With user macro program loaded and assigned
 10 With (applicable) Hold function(s) active

00208002

Figure G-1 Soft Function Key Flowchart (Continued)

APPENDIX H - ABBREVIATIONS

A			
A	Amperes	dB	Decibels
a	Atto (10^{-18})	dBc	Decibels above carrier
AC	Alternating Current	$dB\mu W$	Decibels relative to 1 microwatt
ac	Alternating Current	$dB\mu V$	Decibels relative to 1 microvolt
ACCESS	Accessory	dBmV	Decibels relative to 1 millivolt
AM	Amplitude Modulation	dBm	Decibels relative to 1 milliwatt
ANLZ	Analyzer	dB_{P-P}	Decibels, Peak to Peak
ANSI	American National Standards Institute		D
APPS	Applications	DC	Direct Current
ASCII	American National Standard Code for Information Interchange	dc	Direct Current
ASTD	Assisted	DEMOD	Demodulation
ATTEN	Attenuation	DFT	Discrete Fourier Transform
ATTN	Attenuation	DIAG	Diagnostics
AUTO	Automatic	DIR	Directory
AUX	Auxiliary	DIV	Division
AVG	Average	Div	Division
aW	Attowatt (10^{-18} watts)	DLY	Delay
aWatts	Attowatts	DSPL	Display
	B	DTE	Data Terminal Equipment
BAT	Battery		E
BFO	Beat Frequency Oscillator	EEPROM	Electrically Erasable, Programmable Read-Only Memory
BINS	Sample Points	EIA	Electronics Industries Association
BIOS	Basic Input/Output System	ENH	Enhanced
bps	Bits per second	EMC	Electromagnetic Compatibility
BW	Bandwidth	EMI	Electromagnetic Interference
	C	ERR	Error
C	Celsius or Centigrade	ESC	Escape
CAL	Calibration	ESD	Electrostatic discharge
ccw	Counterclockwise	EXT	External
CENT	Center		F
CISPR	Comite Internation Special des Perturbation Radio- electroniquis (International Special Committee on Radio Interference	f	Femto (10^{-15})
cm	Centimeter (10^{-2} meters)	FCC	Federal Communications Commission
CMOS	Complementary Metal-Oxide Semiconductor	FD	Frequency Deviation
CONFIG	Configure	FFT	Fast Fourier Transform
Cont	Continued	FM	Frequency Modulation
CPL	Couple	FREQ	Frequency
CPU	Central Processing Unit	FRNT	Front
CRT	Cathode Ray Tube	fW	Femtowatt (10^{-15} watts)
CTR	Counter	fWatts	Femtowatts
CTS	Clear to Send		
CW	Continuous Wave		
cw	Clockwise		

G		M	
GHz	Gigahertz (10 ⁹ Hertz)	m	Milli (10 ⁻³)
GND	Ground	MAN	Manual
GPIO	General Purpose Interface Bus	MAX	Maximum
GRAT	Graticule	MF	Modulation Frequency
GSP	Graphics Signal Processor	MHz	Megahertz (10 ⁶ Hertz)
	H	MI	Modulation Index
		MIL	Military
HARM	Harmonic	MIN	Minimum
HF	High Frequency	MKR	Marker
HPF	High-Pass Filter	MΩ	Megaohm (10 ⁶ Ohms)
HPGL	Hewlett-Packard Graphic Language	μF	Microfarad (10 ⁻⁶ farads)
Hr	Hour	μH	Microhenry (10 ⁻⁶ henries)
Hz	Hertz	μs	Microsecond (10 ⁻⁶ seconds)
	I	μV	Microvolt (10 ⁻⁶ volts)
		μW	Microwatt (10 ⁻⁶ watts)
IF	Intermediate Frequency	mm	millimeter (10 ⁻³ meters)
IEEE	Institute of Electrical and Electronic Engineers	ms	Millisecond (10 ⁻³ seconds)
in	Inch	MTRK	Marker Track
INIT	Initial	mV	Millivolt (10 ⁻³ volts)
INT	Internal	mVolts	Millivolts
I/O	Input/Output	mV _{P-P}	Millivolt, Peak to Peak
	K	mW	Milliwatt (10 ⁻³ watts)
		mWatts	Milliwatts
KBD	Keyboard		N
kbytes	Kilobyte (10 ³ bytes)	n	Nano (10 ⁻⁹)
kg	Kilogram (10 ³ grams)	NEG	Negative
kHz	Kilohertz (10 ³ Hertz)	NO	Number
kΩ	Kilo Ohm (10 ³ Ohms)	No.	Number
	L	NORMLZ	Normalize
		nV	Nanovolt (10 ⁻⁹ volts)
lbs	Pounds	nVolts	Nanovolts
LF	Low Frequency	nW	Nanowatt (10 ⁻⁹ watts)
LIN	Linear	nWatts	Nanowatts
LISN	Line Impedance Stabilization Network		O
LLIM	Lower Limit	OS	Oversampling
LO	Local Oscillator		
LOG	Logarithmic		
log	Logarithm		
LPF	Low-Pass Filter		
LVL	Level		

P

p Pico (10^{-12})
 PEP Peak Envelope Power
 pF Picofarad (10^{-12} farads)
 Pg. Page
 PK Peak
 PLL Phase-Locked Loop
 POS Position
 POS Positive
 P-P Peak to Peak
 ppm Parts per Million
 PREAMP Preamplifier
 PREV Previous
 PRF Pulse Repetition Frequency
 PROM Programmable Read-Only Memory
 PROT Protect
 PS Preselector
 pV Picovolt (10^{-12} volts)
 pVolts Picovolts
 PW Pulswidth
 pW Picowatt (10^{-12} watts)
 pWatts Picowatts
 PWR Power

Q

QPEAK Quasi-Peak

R

RAM Random Access Memory
 RBW Resolution Bandwidth

R

RCI Remote Command Interpreter
 RCL Recall
 RCVR Receiver
 REF Reference
 REFLD Reflected
 REJ Reject
 RES Resolution
 RET Return
 Rev. Revision
 RF Radio Frequency
 RFI Radio Frequency Interference
 RLY DRV Relay Driver
 RFR Ready For Receiving
 ROM Read-Only Memory
 RTS Request to Send

S

s Second
 SCOP Oscilloscope
 SCPI Standard Commands for Programmable Instruments
 SDR Signal-to-Distortion Ratio
 SINAD Signal, Noise and Distortion
 SNGL Single
 SNR Signal-to-Noise Ratio
 SPI Serial Peripheral Interface
 SRAM Static Random Access Memory
 SRQ Service Request
 SSB Single Sideband
 STD Standard
 SWR Standing Wave Ratio
 SYS System

T

TIA Telecommunications Industries Association
 THD Total Harmonic Distortion
 TIL Until
 TMAC Test Macro Language
 TRIG Trigger
 TRK Tracking
 TSTS Tests
 TTL Transistor-Transistor Logic
 TV Television

U

u Micro (10^{-6})
 ULIM Upper Limit
 UNPROT Unprotect
 UUT Unit Under Test
 uVolts Microvolts
 uWatts Microwatts

V

V Vertical
 V Volt
 VAC Volts, Alternating Current
 VBW Video Bandwidth
 Vdc Volts, Direct Current
 Vp Volts, Peak
 Vp-P Volts, Peak to Peak
 VSWR Voltage Standing Wave Ratio

W

W Watt

Y

YIG Yttrium Iron Garnett

INDEX

0 dB Function	4-40
A	
Abbreviations	H-1
Accessories	F-1
AM1 Demodulation Screen	4-19
AM/FM Receiver	
Description	3-60
Introduction	1-2
Operation (Modulation)	4-16
Specifications	1-12
AM Measurements	4-18
Amplitude	
Attenuation	3-22
Bandwidth	3-26
Reference	3-24
Scale	3-28
Specifications	1-4
AM Percentage	4-21
AM With Harmonic Distortion	4-13
AN1820 Front Panel	3-3
AN1820 Digital Oscilloscope Maximum Frequency Table	4-7
AN1820 - Host Cable Connections (9-Pin)	6-1
AN1820 - Host Cable Connections (25-Pin)	6-2
AN1820 - Modem Cable Connections (9-Pin)	6-5
AN1820 - Modem Cable Connections (25-Pin)	6-5
AN1820 Rear Panel	3-10
AN1820 Sampling Table	C-1
AN1820 Specific Commands Table	6-11
Analyzer	
Introduction	1-1
Operation	4-2
Specifications	1-3
Analyzer Utility Menu	3-77
Antenna Factor	7-2
Application Operation Screen	3-72
Attenuation Amplitude Operation Screen	3-22
Attenuator Specifications	1-5
Auxiliary Mode Operation Screen	3-44
Auxiliary Mode Counter Operation Screen	3-45
Auxiliary Mode External Mixer Operation Screen	3-46
Auxiliary Mode Oscilloscope Operation Screen	3-47
B	
Bandwidth	
Description	3-26
Optimization	B-1
Specifications	1-5
Bandwidth Amplitude Operation Screen	3-26
Bandwidth Application Filter Measurements	4-35
Bandwidth Application Program	3-74, 4-35
Bandwidth Application Pulse Measurements	4-29
Bandwidth Filters Specifications	1-5
Basic Instrument Operation	4-2
C	
Center Frequency Operation Screen	3-14
Clock Set Screen, Real Time	3-91
Command Syntax	6-8
Command Syntax Punctuation Marks Table	6-9
Connector Pin-Out Tables	A-1
Copy Function (Memory Edits)	4-54
Copy Operation Screen	3-50

C (Continued)	
Counter	
Description	3-44
Introduction	1-1
Operation	4-5
Specifications	1-3
CPU Diagnostics Operation Screen	5-6
Creation, Limits Trace	4-49
Creation Screen, Display Limits Trace	3-56
D	
Data Windows Table	D-3
Delete Function (Memory Edits)	4-55
Demod Operation Screen	3-60
Demodulating Input Signals	4-16
Description of Controls, Connectors and Indicators	3-2
Diagnostics Operation Screen	5-1
Diagnostics Procedures	5-7
Diagnostics (Self Test)	5-1
Digital Oscilloscope	
Description	3-48
Operation	4-6
Specifications	1-8
Display	
Introduction	1-1
Specifications	1-7
Display Limit Alarms Operation Screen Macro	4-58
Display Limits Trace Creation Screen	3-56
Display Operation Screen	3-53
E	
Edit Setup Directory	3-70
Edit Trace Directory	3-68
Eliminating Ambient Signals	7-5
EMI Test Hook-Up	
Conducted	7-4
Radiated	7-4
Enhanced Logarithmic Display Mode	
Description	3-29
Operation	4-8
Environment Specifications	1-14
EXT DISPLAY Connector	A-2
External Attenuation/Gain Offset	1-1
External Cleaning	2-4
External Interface	1-2
External Mixer Function	
Description	3-45
Hook-Up	4-31
Introduction	1-2
Operation	4-30
F	
Factory Preset Initialization Procedure	2-4
Features, Standard	1-1
FFT	
Description	D-1
Introduction	1-2
Operation	4-33
Operation Screen Description	3-48
Specifications	1-9
FFT Data Window Equations Table	D-2
FFT Equivalent Bandwidths Table	D-1

F (Continued)

Find Function	3-15
FM1 Demodulation Screen	4-23
FM Adjustments	4-25
FM Measurements	4-21
Frequency	
Center	3-14
Span	3-16
Specifications	1-3
Start	3-18
Stop	3-20
Frequency Counter	
Description	3-44
Introduction	1-1
Operation	4-5
Specifications	1-3
Frequency-Selective Device Measurements	4-35
Frequency Span	
Description	3-16
Specifications	1-3
Frequency Standard	1-12
Front Panel Controls, Connectors and Indicators	3-2
Front Panel Power-Up Controls and Indicators	2-3
FULL Span	3-17
FUNCTION Connector	A-3
Fuse	
Requirements	1-14
Verification/Replacement Procedure	2-3

G

General Options Screen	3-81
GPIO Configuration	6-7
(GPIO) Screen, IEEE-488	3-80

H

Harmonic Distortion Measurements	4-10
Harmonic Distortion Percentage	4-12
High Stability Time Base (Option 09)	
Introduction	1-2
Specifications	1-12
Hold Functions	3-54

I

IEEE-488 GPIO Connector	A-4
IEEE-488 (GPIO) Screen	3-80
Initialization Procedure, Factory Preset	2-4
Input Level	1-1
Installation	2-1
Interface Connectors	
GPIO Operation	4-51, 6-7
Printer Operation	4-52
RS-232 Operation	4-51, 6-1
Specifications	1-11
Intermodulation Distortion Measurements	4-14
Introduction	1-1
I/O Connectors	
Pin-Out for EXT DISPLAY Connector Table	A-2
Pin-Out for FUNCTION Connector Table	A-3
Pin-Out for IEEE-488 GPIO Connector Table	A-4
Pin-Out for PRINTER Connector Table	A-6
Pin-Out for RS-232 Connector Table	A-5
Specifications	1-8
Table	A-1

K

Keyboard Options Screen	3-84
-------------------------	------

L

Lid Assembly Removal and Replacement	2-1
Limit Alarms Operation Screen Macro, Display	4-58
Limits Trace Creation Screen, Display	3-56
Linear Display Mode Operation Description	3-29
Line Impedance Stabilization Network (LISN)	7-2
Logarithmic Display Mode Operation Description	3-28
Loop Test Procedure	5-8

M

Macro(s)	
Directory	3-71
Display Limit Alarms Operation Screen Macro	4-58
Operations	4-56
Assigning From Front Panel	4-56
Operating From Front Panel	4-58
Mandatory GPIO Commands Table	6-10
Mandatory IEEE 488.2 Commands	6-10
Marker Mode Operation Screen	3-31
Markers	
Delta Function	3-34
Delta Marker	3-34
Description	3-31
Introduction	1-1
Marker Select (MKR SEL)	3-32
Mode Specifications	1-7
Peak Function (PK FUNC)	3-33
Measurements With The AN1820 Spectrum	
Analyzer	1-1
Memory	
Introduction	1-2
Modify	3-87
Operations	4-44
Edits	4-53
Limits Trace Creation	4-49
Printing Out Screens	4-52
Recall	4-47
Sending Out Plots	4-51
Storage	4-44
Specifications	1-8
Mixer Function	
Description	3-45
Hook-Up	4-31
Introduction	1-2
Operation	4-30
Mixer Null Calibration	3-92
Mode	
Auxiliary	3-44
Marker	3-31
Sweep	3-36
Tracking Generator	3-42
Modify Memory Main Menu	3-87
Modify Setup Memory Menu	3-90
Modify Trace Memory Menu	3-88
Modify Trace Memory Menu LABEL Function	3-89
Modulation	4-16
Modulation Index Table	4-24
Move Function (Memory Edits)	4-53

N
Noise Floor Tolerances Table 5-2

O
Operation Procedures 4-1
Operation Screens and
Soft Function Key Configurations 3-13
Optimization Tables B-1
Optional Features and Accessories 1-2
Options
Option 02 - Tracking Generator 1-2
Option 08 - Quasi-Peak Detector 1-2
Option 09 - High Stability Time Base 1-2
Options and Accessories F-1
Options Screens
General Options Screen 3-81
Keyboard Options Screen 3-84
Oscilloscope
Description 3-48
Operation 4-6
Specifications 1-8
Outputs 1-9
Oversampling C-1

P
Peak Detector (Quick-Look) Test 7-7
Phase Lock Monitor Test Frequencies Table 5-3
Phase Noise Tolerances Table 5-2
Pin-Out for EXT DISPLAY Connector Table A-2
Pin-Out for FUNCTION Connector Table A-3
Pin-Out for IEEE-488 GPIB Connector Table A-4
Pin-Out for PRINTER Connector Table A-6
Pin-Out for RS-232 Connector Table A-5
Performance Evaluation 5-1
Loop Test Procedure 5-8
Print Test Procedure 5-8
Single Test Procedure 5-7
Plots, Sending Out 4-51
Power Level and Duration Cycle Table 4-42
Power Requirements 1-13
Power Up Procedure 2-2
Power Up Self Test 5-1
Precautions 2-1
Preset
Initialization Procedure, Factory 2-4
Operation Screen 3-52
PRINTER Connector A-6
Printer Options Screen 3-93
Printing Out Screens 4-52
PRF Measurement for Dense Spectrum 4-27
PRF Measurement for Line Spectrum 4-28
Print Test Procedure 5-8
Pulsed RF Measurements 4-25

Q
Quasi-Peak Detector (Option 08)
(Close-Look) Test 7-9
Description 3-27
Introduction 1-2
Measurement Procedure 7-3
Purpose 7-1
Specifications 1-13
Time Constants Table 7-2

R
RBW Adjustment Optimization Table B-2
Real Time Clock Set Screen 3-91
Rear Panel Controls, Connectors and Indicators 3-2
Rear Panel Power Up Controls, Connectors
and Indicators 2-2
Recall Memory Operation Screen 3-66
Recall Setup Directory 3-69
Recall Trace Directory 3-67
Receiver
Description 3-60
Introduction 1-2
Operation (Modulation) 4-16
Specifications 1-12
Reference Amplitude Operation Screen 3-24
Reference Level Limitation with Attenuation
Uncoupled Table 3-24
Remote Commands
Analyzer Utility 6-22
Application 6-21
Attenuation Amplitude 6-12
Auxiliary Mode 6-17
Copy 6-18
Demod 6-18
Center Frequency 6-11
Display 6-19
Frequency 6-11
Marker Mode 6-14
Preset 6-18
Recall Memory 6-20
Reference Amplitude 6-12
Resolution Bandwidth Amplitude 6-13
Scale Amplitude 6-14
Span Frequency 6-11
Start Frequency 6-12
Stop Frequency 6-12
Store Memory 6-20
Sweep Mode 6-16
Tracking Generator Mode 6-17
Remote Operation
Command Syntax 6-8
Mandatory IEEE 488.2 Commands 6-10
Operating Procedures 6-1
Specific Command Set, AN1820 6-11
Repacking for Shipment E-1
Resolution Bandwidth
Description 3-26
Optimization B-1
Specifications 1-5
Return Loss Bridge Measurements 4-41
Return Loss Bridge Measurements Hook-Up 4-42
Return Loss-VSWR- Reflected Power
Conversion Table 4-43
RS-232 Configuration
Direct Remote Operation 6-1
Modem Operation 6-5
RS-232 Connector A-5
RS-232 (Serial) Screen 3-78

S

Safety Specifications	1-14
Sampling-Narrow RBW	C-2
Sampling-Normal RBW	C-1
Scale Amplitude Operation Screen	3-28
Scale Unit Prefixes and Display Indications	3-25
Scope	
Description	3-48
Operation	4-6
Specifications	1-8
Sending Out Plots	4-51
Setup Recall	4-48
Setup Storage	4-46
Shipment, Repacking for	E-1
Signal Display Optimization Table	B-1
Single Test Procedure	5-8
-Slope Operation With Marker(s) Active	4-39
-Slope Operation With Markers Inactive	4-37
+Slope Operation With Marker(s) Active	4-38
Soft Function Key Flowchart	G-1
Specifications	1-3
Amplitude	1-4
Display	1-7
Electro-Magnetic Compatibility	1-14
Environment	1-14
Frequency	1-3
Frequency Standard	1-12
Fuse Requirements	1-14
General Characteristics	1-13
Inputs	1-8
Interface Connectors	1-11
Memory	1-8
Outputs	1-9
Power Requirements	1-13
Quasi-Peak Detector (Option 08)	1-13
Receiver	1-12
Safety	1-14
Sweep	1-6
Tracking Generator (Option 02)	1-13
Span Frequency	
Description	3-16
Specifications	1-3
Span Frequency Operation Screen	3-16
Spectrum Analyzer	
Introduction	1-1
Operation	4-2
Specifications	1-3
Standard Features	1-1
Start Frequency Operation Screen	3-18
Stop Frequency Operation Screen	3-20
Store Memory Operation Screen	3-62
Store Setup Directory	3-65
Store Trace Directory	3-63
Store Trace Directory Operation	4-44
Sweep Mode Operation Screen	3-36
Sweep Specifications	1-6
Sweep Time Adjustment Optimization Table	B-8

T

Test Macro Language (TMAC)	6-8
Test Result Field Indications Table	5-2
Time Clock Set Screen, Real	3-91
Time Constants	7-1
Trace Creation, Limits	4-49
Trace Creation Undo Actions Table	4-49
Trace Recall	4-47
Trace Storage	4-44
Tracking Generator Mode Operation Screen	3-42
Tracking Generator (Option 02)	
Description	7-1
Introduction	1-2
Operation	4-35
Operation Screen Description	3-42
Response	7-1
Specifications	1-13
Trigger Delay Ranges Table	3-40

U

User Cals Menu	3-92
----------------	------

V

Version Number Screen	3-82
Video Bandwidth	
Description	3-26
Specifications	1-5
VBW Adjustment Optimization Table	B-5

Y

YIG Oscillator Calibration	3-92
----------------------------	------

Z

ZERO Span	3-17
-----------	------