

00827



SYSTEMS, INC.

# OPERATION MANUAL

## COM - 120B COMMUNICATIONS SERVICE MONITOR

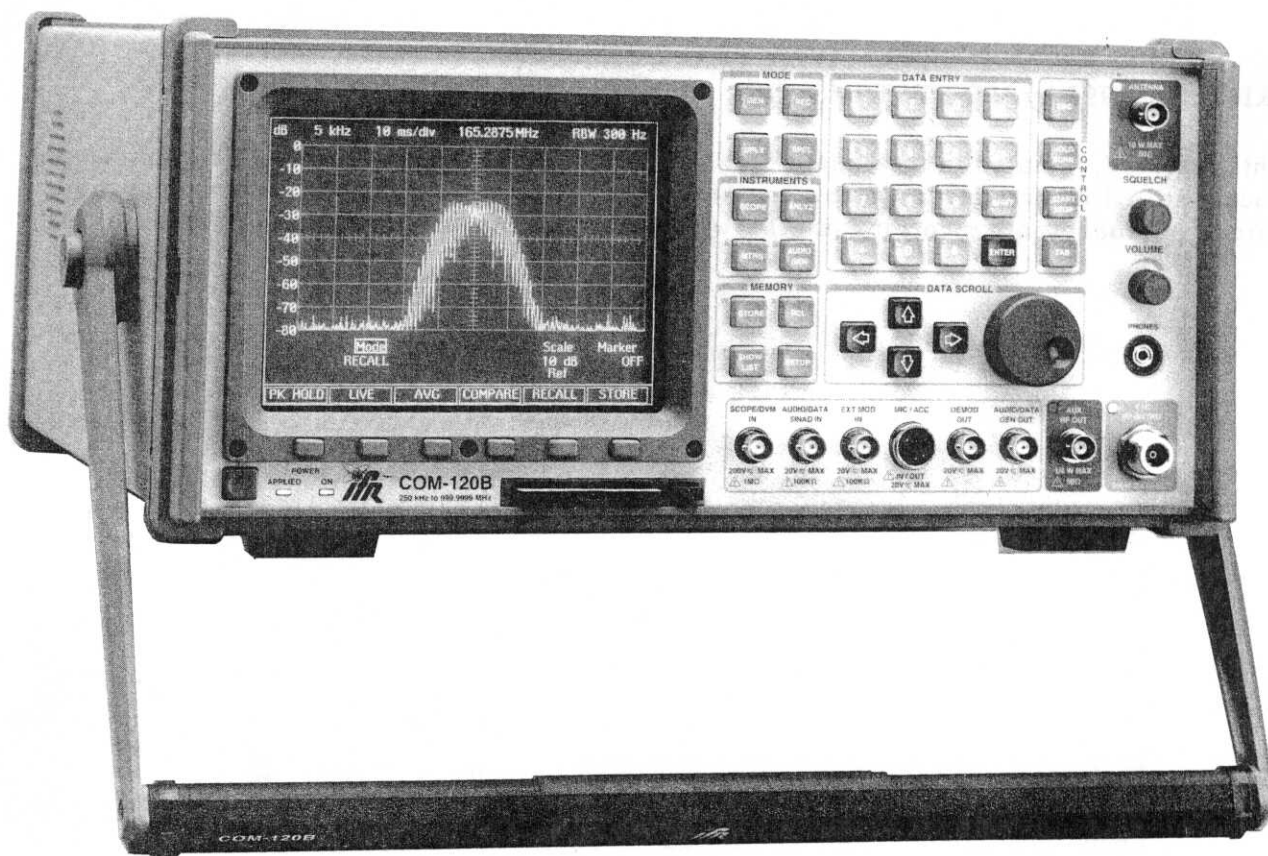

10200 West York Street / Wichita, Kansas 67215 U.S.A. / (316) 522-4981 / FAX (316) 524-2623

1002-0601-200

Ver - 3.04

01

ORTHODONTIC  
JOURNAL

PUBLISHED BY  
IFR SYSTEMS INC.  
Wichita, Kansas

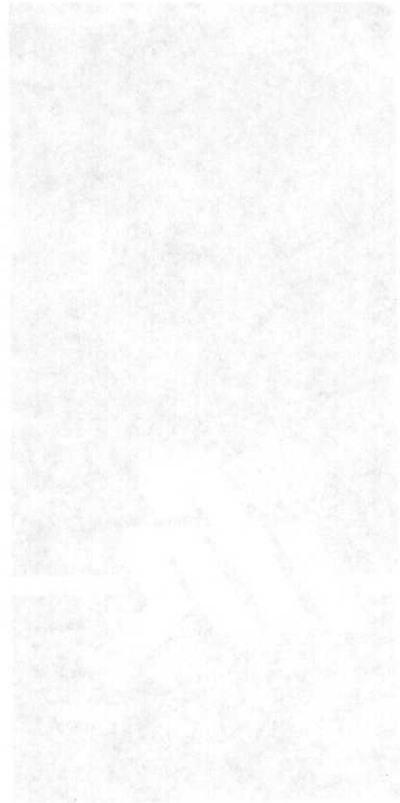

COPYRIGHT © 1995 by IFR SYSTEMS, INC.

All rights reserved. Printed in the United States of America. No part of this publication may be reproduced, stored in a retrieval system, or transmitted in any form or by any means, electronic, mechanical, photocopying, recording or otherwise without the prior permission of the publisher.

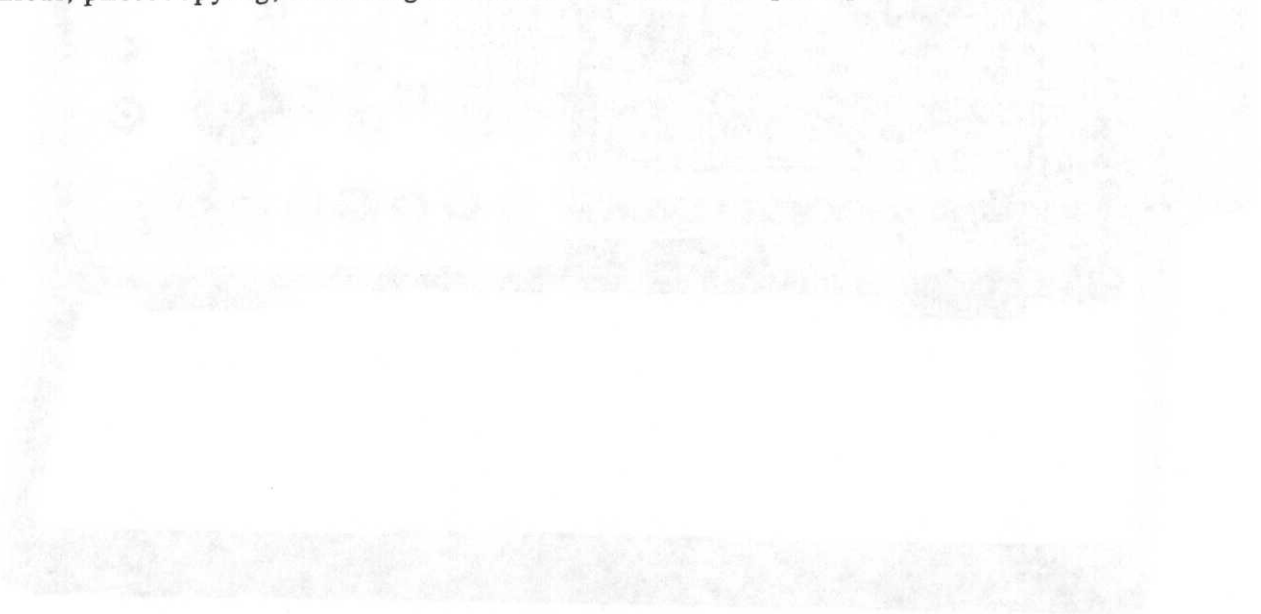

Very faint, illegible text at the bottom of the page, possibly a footer or contact information.



TO: HOLDERS OF COM-120B OPERATION MANUAL  
(1002-0600-100)

The pages contained in Revision 01 are listed below. Please remove and insert the affected pages in the COM-120B Operation Manual.

REMOVE PAGES

Title/Copyright Page  
None  
Page vii to x  
Page 3-9/3-10  
Page 3-27 to 3-32  
Page 3-45/3-46  
Page 3-49/3-50  
Page 3-53/3-54  
None  
Page 3-55 to 3-58  
Page 3-79 to 3-82  
Page 3-89 to 3-94  
Page 3-123 to 3-125  
None  
Page 3-126  
Page 3-129 to 3-134  
Page 3-141 to 3-144  
Page 3-153 to 3-160  
Page 3-163/3-164  
Page 3-181/3-182  
Page 4-3 to 4-8  
Page 4-13/4-14  
Page 4-23 to 4-30  
Page 4-45/4-46  
Page 4-49/4-50  
Page 4-67 to 4-71  
None  
Page 4-72 to 4-76  
Page 4-99 to 4-104  
Page 4-113 to 4-116  
Page 5-3 to 5-24  
Page 5-27 to 5-30  
Page 6-37 to 6-44  
Page 7-1 to 7-12  
Page 7-13h/7-13i  
Page 7-103 to 7-120  
Page Index-1 to Index-6

INSERT PAGES

Title/Copyright Page  
Page A and B  
Page vii to x  
Page 3-9/3-10  
Page 3-27 to 3-32  
Page 3-45/3-46  
Page 3-49/3-50  
Page 3-53/3-54  
Page 3-54a/3-54b  
Page 3-55 to 3-58  
Page 3-79 to 3-82  
Page 3-89 to 3-94  
Page 3-123 to 3-125  
Page 3-125a/3-125b  
Page 3-126  
Page 3-129 to 3-134  
Page 3-141 to 3-144  
Page 3-153 to 3-160  
Page 3-163/3-164  
Page 3-181/3-182  
Page 4-3 to 4-8  
Page 4-13/4-14  
Page 4-23 to 4-30  
Page 4-45/4-46  
Page 4-49/4-50  
Page 4-67 to 4-71  
Page 4-71a/4-71b  
Page 4-72 to 4-76  
Page 4-99 to 4-104  
Page 4-113 to 4-116  
Page 5-3 to 5-24  
Page 5-27 to 5-30  
Page 6-37 to 6-44  
Page 7-1 to 7-12  
Page 7-13h/7-13i  
Page 7-103 to 7-122  
Page Index-1 to Index-6

# LIST OF EFFECTIVE PAGES

The manual changes listed below which are affected by a current change or revision, are so identified by a revision number.

Date of issue for original and changed pages are:

Original ..... 0 ..... July 31, 1995  
 Revision..... 1 ..... October 20, 1995

**TOTAL NUMBER OF PAGES IN THIS MANUAL IS 612 CONSISTING OF THE FOLLOWING:**

Pg. No.	Change No.	Pg. No.	Change No.
Title .....	1	3-132 .....	0
Copyright.....	0	3-133 .....	1
Warning .....	0	3-134 through 3-141 ...	0
Caution.....	0	3-142 through 3-143 ...	1
A through B.....	1	3-144 through 3-152 ...	0
i through vi .....	0	3-153.....	1
vii through x .....	1	3-154.....	0
1-1 through 1-19.....	0	3-155.....	1
1-20 Blank.....	0	3-156 through 3-157 ...	0
2-1 through 2-6 .....	0	3-158 through 3-159 ...	1
3-1 through 3-8 .....	0	3-160 through 3-162 ...	0
3-9 .....	1	3-163 through 3-164 ...	1
3-10 through 3-27.....	0	3-165 through 3-180 ...	0
3-28 through 3-31.....	1	3-181 through 3-182 ...	1
3-32 through 3-44.....	0	3-183 through 3-213 ...	0
3-45 through 3-46.....	1	3-214 Blank.....	0
3-47 through 3-48.....	0	4-1 through 4-3 .....	0
3-49 through 3-50.....	1	4-4 through 4-8 .....	1
3-51 through 3-52.....	0	4-9 through 4-13 .....	0
3-53 through 3-54.....	1	4-14 .....	1
3-54a.....	1	4-15 through 4-23.....	0
3-54b Blank .....	1	4-24 through 4-25.....	1
3-55 through 3-57.....	1	4-26 .....	0
3-58 through 3-79.....	0	4-27 through 4-30.....	1
3-80 through 3-82.....	1	4-31 through 4-44.....	0
3-83 through 3-89.....	0	4-45 .....	1
3-90 through 3-93.....	1	4-46 through 4-49.....	0
3-94 through 3-123 ...	0	4-50 .....	1
3-124 through 3-125 ...	1	4-51 through 4-66.....	0
3-125a .....	1	4-67 .....	1
3-125b Blank .....	1	4-68 through 4-69.....	0
3-126 through 3-128 ...	0	4-70 through 4-71.....	1
3-129 through 3-131 ...	1	4-71a.....	1

## LIST OF EFFECTIVE PAGES

Pg. No.	Change No.	Pg. No.	Change No.
4-71b Blank.....	1	5-24 through 5-27 .....	0
4-72 through 4-73 .....	0	5-28 through 5-30 .....	1
4-74 through 4-76 .....	1	5-31 through 5-33 .....	0
4-77 through 4-99 .....	0	5-34 Blank .....	0
4-100 .....	1	6-1 through 6-36 .....	0
4-101 .....	0	6-37 through 6-43 .....	1
4-102 through 4-103.....	1	6-44 Blank .....	0
4-104 through 4-113.....	0	7-1 through 7-11 .....	1
4-114 through 4-115.....	1	7-12 through 7-13 .....	0
4-116 through 4-121.....	0	7-13a through 7-13h.....	0
4-122 Blank.....	0	7-13i.....	1
5-1 through 5-3 .....	0	7-13j through 7-13k ....	0
5-4 through 5-5 .....	1	7-14 .....	0
5-6 .....	0	7-14a Blank.....	0
5-7 .....	1	7-15 through 7-103.....	0
5-8 .....	0	7-104 through 7-122....	1
5-9 through 5-11 .....	1	A-1 through A-4 .....	0
5-12 through 5-13 .....	0	B-1 through B-3 .....	0
5-14 .....	1	B-4 Blank .....	0
5-15 .....	0	C-1 through C-2.....	0
5-16 through 5-23 .....	1	Index-1 thru Index-6....	1

## SECTION 7 - OPTIONS

Paragraph	Title	Page
7-1	Internal Battery (Option 01) . . . . .	7-1
7-2	Oven Crystal Oscillator Frequency Standard (Option 02) . . . . .	7-1
7-3	30 kHz IF Filter (Option 03) . . . . .	7-1
7-4	Variable Audio Generator 2 (Option 04) . . . . .	7-1
7-5	Generate Amplifier (Option 05) . . . . .	7-1
7-6	Data Generator/Bit Error Rate (BER) Meter (Option 07) . . . . .	7-1
7-6-1	BER Meter Description . . . . .	7-1
7-7	Single Sideband Receive Filter (Option 08) . . . . .	7-12
7-7-1	General . . . . .	7-12
7-7-2	Description of Receive Function . . . . .	7-12
7-8	RCC Signaling Formats (Option 09) . . . . .	7-13
7-9	Audio/Digital Signaling Formats (Option 11) . . . . .	7-13
7-9-1	Modulating RF Signals With Digital Signaling Formats . . . . .	7-13b
7-9-2	Encoding Digital Signaling Formats for Audio Signal . . . . .	7-13e
7-9-3	Decoding Digital Signal Formats . . . . .	7-13h
7-9-4	Testing A Receiver Using Digital Signaling Formats . . . . .	7-13j
7-9-5	Testing A Transmitter Using Digital Signaling Formats . . . . .	7-13k
7-10	Spectrum Analyzer Tracking Generator (Option 12) . . . . .	7-14
7-11	IEEE 488 (GPIB) Interface (Option 13) . . . . .	7-14
7-11-1	General . . . . .	7-14
7-11-2	Configuring for Remote Operation using GPIB . . . . .	7-14
7-12	CLEARCHANNEL LTR <sup>®</sup> (Option 14) . . . . .	7-15
7-12-1	General . . . . .	7-15
7-12-2	Accessing the CLEARCHANNEL LTR <sup>®</sup> Trunking Test System . . . . .	7-15
7-12-3	LTR Trunking Repeater Simulation . . . . .	7-16
7-12-4	LTR Trunking Radio Simulation . . . . .	7-25

Paragraph	Title	Page
7-12-5	LTR Trunking Auxiliary Setup Screen . . . . .	7-33
7-12-6	Auxiliary Setup Screen Configuration . . . . .	7-35
7-12-7	Repeater Simulator Operation . . . . .	7-36
7-12-8	Radio Simulator Operation . . . . .	7-46
7-13	AMPS Cellular Testing (Option 15) . . . . .	7-52
7-13-1	AMPS Cell Site Simulator Setup . . . . .	7-52
7-13-2	AMPS Cell Site Simulator Main and Setup Menus . . . . .	7-53
7-13-3	AMPS Cell Site Simulator Automatic Tests . . . . .	7-62
7-13-4	AMPS Cell Site Simulator Manual Tests . . . . .	7-74
7-14	EDACS Trunking (Option 16) . . . . .	7-83
7-14-1	EDACS Trunking Setup Screen . . . . .	7-84
7-14-2	EDACS Trunking Channel Assignments . . . . .	7-86
7-14-3	EDACS Trunking Automatic Test . . . . .	7-88
7-14-4	EDACS Trunking Automatic Test Execution . . . . .	7-90
7-14-5	EDACS Trunking Automatic Test Results . . . . .	7-93
7-14-6	EDACS Trunking Manual Test . . . . .	7-103
7-14-7	EDACS Trunking Manual Test-Repeater Simulator . . . . .	7-104
7-14-8	EDACS Trunking Manual Test-Radio Simulator . . . . .	7-112
7-14-9	EDACS Trunking Operational Notes . . . . .	7-120
7-14-10	EDACS Store and Recall . . . . .	7-121
7-14-11	EDACS Trunking Operational Notes . . . . .	7-122

## APPENDICES

Appendix	Title	Page
Appendix A	User I/O Connectors and Pin-Out Tables . . . . .	A-1
Appendix B	Abbreviations . . . . .	B-1
Appendix C	Repacking For Shipping . . . . .	C-1

# INDEX

Index

Index-1

## LIST OF ILLUSTRATIONS

Title	Page
COM-120B Rear Panel . . . . .	2-2
COM-120B Front Panel . . . . .	2-2
COM-120B DC Fuse Location . . . . .	2-4
COM-120B Battery and Battery Cable . . . . .	2-6
COM-120B Front Panel Controls . . . . .	3-1
COM-120B Rear Panel Controls . . . . .	3-6
RF Generator Operation Screen . . . . .	3-9
RF Receive Operation Screen . . . . .	3-60
Duplex Operation Screen . . . . .	3-136
Duplex Generate Operation Screen . . . . .	3-142
Duplex Receive Operation Screen . . . . .	3-146
Oscilloscope Operation Screen . . . . .	3-157
Spectrum Analyzer Operation Screen . . . . .	3-160
Audio/Data/Signaling Generator Operation Screen . . . . .	3-166
Meters Menu . . . . .	3-175
List Setup Menu . . . . .	3-194
Setup Screen . . . . .	3-199
RF Generator Operation Screen . . . . .	4-4
RF Receive Operation Screen . . . . .	4-38
Duplex Operation Screen . . . . .	4-90
COM-120B Status Event Registers . . . . .	5-31
MIC/ACC Connector Pin Identification . . . . .	A-2
GPIO Pin Identification . . . . .	A-3



## LIST OF ILLUSTRATIONS (Cont'd)

Title	Page
RS-232 Connector Pin Identification . . . . .	A-4

## LIST OF TABLES

Title	Page
Mandatory GPIB Commands . . . . .	5-3
OR Operation Results Table . . . . .	6-9
AND Operation Results Table . . . . .	6-10
XOR Operation Results Table . . . . .	6-11
Table of I/O Connectors . . . . .	A-1
Pin-Out for MIC/ACC Connector Table . . . . .	A-2
Pin-Out for GPIB Connector Table . . . . .	A-3
Pin-Out for RS-232 Connector Table . . . . .	A-4

## A. RF GENERATE GENERAL OPERATION SCREEN

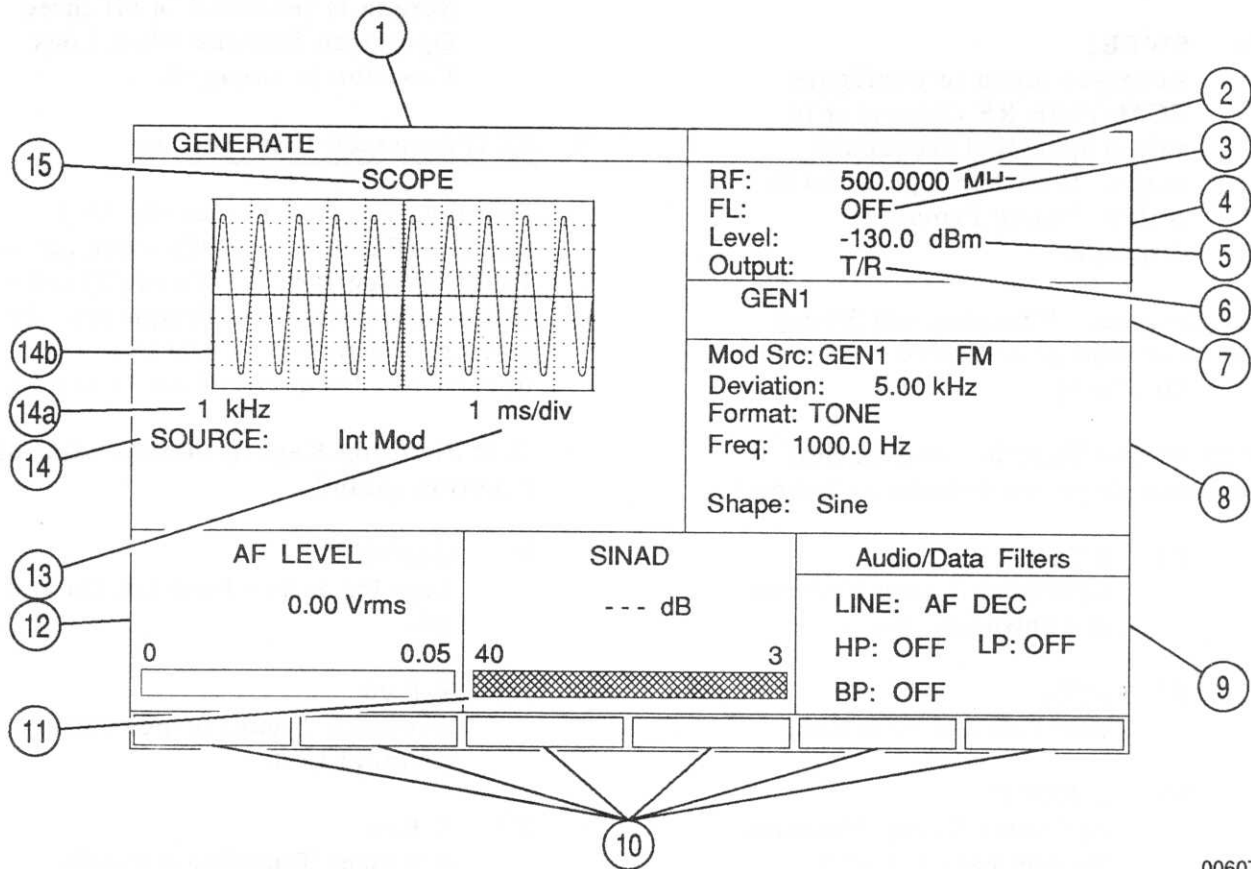

00607078

RF Generator Operation Screen

### 1. Header Bar

Displays current operation mode.

### 2. RF Field

Displays current RF Generate Frequency from 0.0000 to 1000.0000 MHz.

Soft Function Keys available with this function include:

F1  $\Delta$ =  
Accesses window to set RF Field change increment ( $\Delta$  Freq). With  $\Delta$ = active, Soft

Function Keys are defined as follows:

F6 RETURN  
Closes window and returns to normal operation.

F2  $\Delta$  On/Off  
Toggles  $\Delta$  Function OFF and ON. If  $\Delta$  Function is active, " $\Delta$ " is displayed by Frequency Readout.

F3 SET REF  
Changes frequency in current RF Field to reference frequency. RF Field displays offset from reference frequency when activated. If Set Reference

Function is active, "R" is displayed.

- F4 SWEEP  
Accesses menu to configure COM-120B RF Generator to sweep specified frequency range. If Sweep Operation is active, Sweep Prompt is displayed.

Set Reference Function and Sweep Function cannot be active simultaneously.

With Sweep Function active, Soft Function Keys are defined as follows:

- F1 START  
Activates Sweep Function in continuous loop.
- F2 STOP  
Stops Sweep Function.
- F3 SINGLE  
Activates Sweep Function for one pass through frequency range.
- F5 RESUME  
Restarts Sweep Function after STOP Soft Function Key F2 is pressed.
- F6 RETURN  
Exits Sweep Function into normal RF Generate operation.
- F5 LOCK/UNLOCK  
Sets frequency used for Receive Operation and Spectrum Analyzer Operation to same frequency as current RF Field. If LOCK Function is active, "L" is displayed and UNLOCK is displayed for F5 definition. Pressing F5, when UNLOCK is displayed, toggles LOCK

Function OFF. Editing Frequency in any Operation Screen is reflected in all three Operation Screens when Lock Function is engaged.

### 3. FL (Frequency List) Setting

Displays selected Frequency List number (FL-00 to FL-99) when active. Blank if inactive. RF Field (3) echoes frequency of selected Frequency List setting. Editing RF Field (3) deactivates Frequency List Function.

Soft Function Keys available with this function include:

- F1 On/Off  
Toggles active function On and Off.
- F2 T-Fwd  
Accesses Trunking-Forward Channel List.
- F3 T-Rvs  
Accesses Trunking-Reverse Channel List.
- F4 C-Fwd  
Accesses Cellular-Forward Channel List.
- F5 C-Rvs  
Accesses Cellular-Reverse Channel List.
- F6 FL  
Accesses User Defined Frequency List.

### 4. Frequency List Label

Displays optional Frequency List Label. Blank if Frequency List Label is not used.

DTMF/SINAD Low-Pass Filter Field  
(54) to OFF.

Soft Function Keys available with  
this function include:

- F1 OFF  
Deactivates Bandpass Filtering  
on DTMF/SINAD Line.
- F2 C-MSG  
Routes DTMF/SINAD Signal  
through C-Message Weighted  
Bandpass Filter.

F5 EXEC  
Executes all edits made on this  
screen. Edits made are not valid  
if EXEC Soft Function Key is  
not pressed before returning to  
any other operation mode.

F6 RETURN  
Returns to RF Generate  
Operation Screen.

## D. SINAD METER

The SINAD Meter for the RF Generate measures SINAD for a 1 kHz tone passed through the AUDIO/DATA IN Connector. Filtering for the signal passed to the SINAD Meter is provided by the Audio/Data Filters.

Information provided from the RF Generate Operation Screen is displayed as follows:

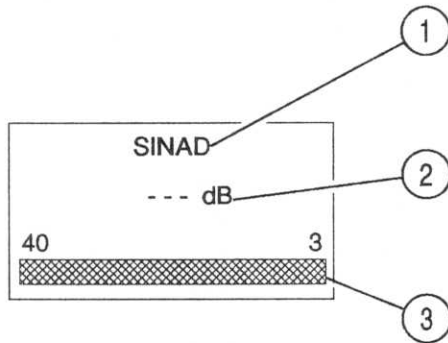

00607079

### 1. SINAD/Distortion Meter Label

Displays label for selected Meter Operation. Selections include SINAD and Distortion Meters. Refer to para 3-3-1(E) for description of Distortion Meter.

Soft Function Keys available with this function include:

- F1 ZOOM  
Expands current meter into full-size meter.
- F2 SINAD  
Selects SINAD Meter as active meter. Not displayed if meter is currently active.
- F3 DIST  
Selects Distortion Meter as active meter. Not displayed if meter is currently active.

### 2. Meter Reading

Displays current SINAD Meter Reading in dB.

### 3. Meter Bar

Provides graphic display of current SINAD Meter reading in dB.

Pressing ZOOM Soft Function Key F1 when cursor is at SINAD/Distortion Meter Label (1) accesses full screen SINAD Meter.

Available features and editable fields are listed as follows:

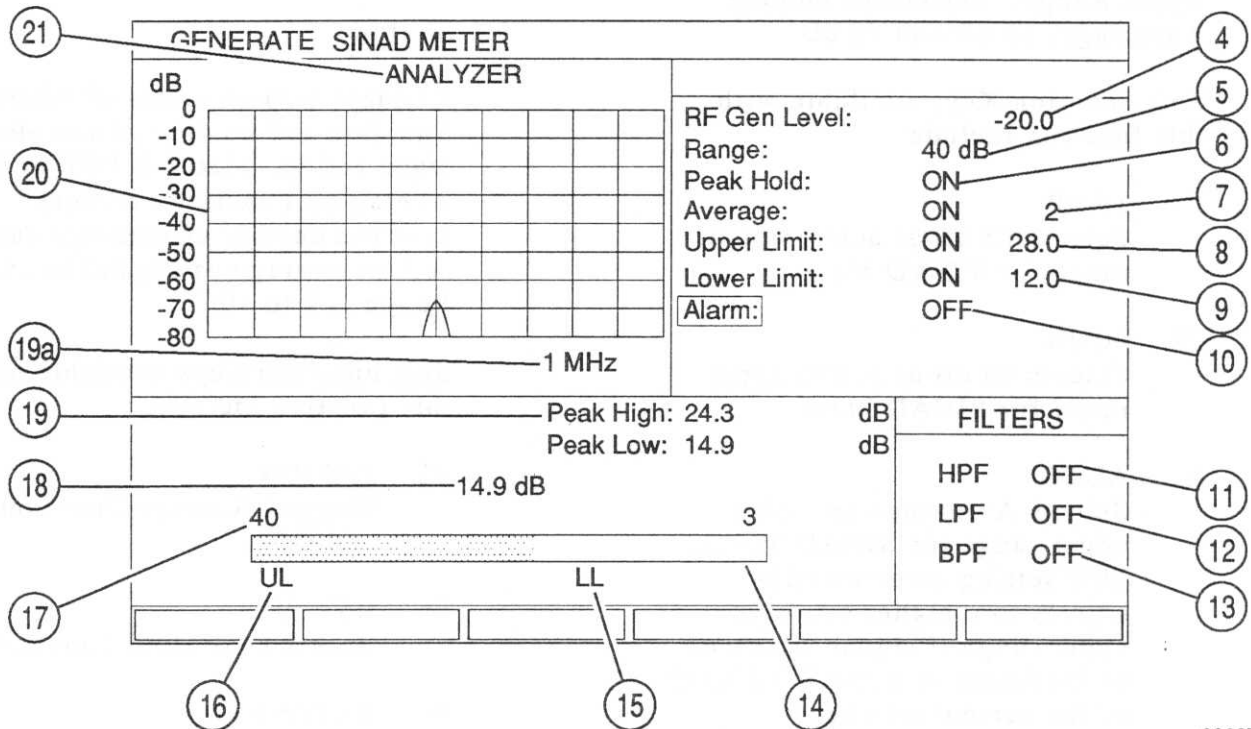

00607080

#### 4. RF Gen Level

Displays Output Level in selected units. If T/R Connector is selected for Output (7), range is -130 to -20 dBm, .07 to 22360.6  $\mu$ V, 0.0000 to 22.3606 mV and 0.000000 to 0.022360 V. If AUX RF Connector is selected for Output (7), range is -130 to -13 dBm, .07 to 50059.3  $\mu$ V, 0.0000 to 50.0593 mV and 0.000000 to 0.050059 V.

Soft Function Keys available with this function include:

- F1 dBm  
Sets Output Level Units to dBm.
- F2  $\mu$ V  
Sets Output Level Units to  $\mu$ V.

- F3 mV  
Sets Output Level Units to mV.
- F4 V  
Sets Output Level Units to V.
- F5 SINAD=  
Access field to set SINAD Search Function value.
- F5 S=On/Off  
Toggles SINAD Search Function On and Off. SINAD Search Function changes Output Level to search for SINAD= value from UUT. S= Prompt is displayed with function ON.

## 5. Range

Displays selected SINAD Meter Upper Range. Selections include Autorange, 15 dB and 40 dB.

Soft Function Keys available with this function include:

- F1 15 dB  
Selects 15 dB as active upper range for SINAD Meter.
- F2 40 dB  
Selects 40 dB as active upper range for SINAD Meter.
- F3 AUTO  
Selects Autorange as active upper range for SINAD Meter. This setting automatically adjusts to a higher or lower upper range if signal increases or decreases to a specified level of the current setting.
- F5 RST PK  
Resets Peak Readings displayed to 0.
- F6 RETURN  
Returns Test Set to RF Generate Operation Screen.

## 6. Peak Hold

Displays current status of Peak Hold function. Displays OFF or ON. When ON, Peak Readings (19) are displayed. Invalid in Autorange.

Soft Function Keys available with this function include:

- F1 OFF/ON  
Toggles Peak Hold Function ON and OFF.
- F5 RST PK  
Resets Peak Hold Function.

- F6 RETURN  
Returns Test Set to RF Generator Operation Screen.

## 7. Average

Displays current status of Averaging Function and number of samples when active. Status is OFF or ON. Averaging Function averages selected number of readings and reports average as Digital Readout. Range is 2 to 10.

Soft Function Keys available with this function include:

- F1 OFF/ON  
Toggles Average Function ON and OFF.
- F5 RST PK  
Resets Peak Hold Function.
- F6 RETURN  
Returns Test Set to RF Generator Operation Screen.

## 8. Upper Limit

Displays current status of Upper Limit Function and Upper Limit value when active. Status is OFF or ON. Range is 0 to 40 dB. When ON, Upper Limit Bar (16) is displayed.

Soft Function Keys available with this function include:

- F1 OFF/ON  
Toggles Upper Limit Function ON and OFF.
- F5 RST PK  
Resets Peak Hold Function.
- F6 RETURN  
Returns Test Set to RF Generator Operation Screen.

9. Lower Limit

Displays current status of Lower Limit Function and Lower Limit value when active. Status is OFF or ON. Range is 0 to 40 dB. When ON, Lower Limit Bar (15) is displayed.

Soft Function Keys available with this function include:

- F1 OFF/ON  
Toggles Lower Limit Function ON and OFF.
- F5 RST PK  
Resets Peak Hold Function.
- F6 RETURN  
Returns Test Set to RF Generator Operation Screen.

10. Alarm

Displays current status of Alarm Function. Status is OFF or ON. When ON, Audible alarm sounds when signal exceeds Upper Limit (8) or is below Lower Limit (9).

Soft Function Keys available with this function include:

- F1 OFF/ON  
Toggles Alarm Function ON and OFF.
- F5 RST PK  
Resets Peak Hold Function.
- F6 RETURN  
Returns Test Set to RF Generator Operation Screen.

11. High-Pass Filter (HPF)

Displays current High-Pass Filter setting for SINAD Meter.

12. Low-Pass Filter (LPF)

Displays current Low-Pass Filter setting for SINAD Meter.

13. Bandpass Filter (BPF)

Displays current Bandpass Filter Setting for SINAD Meter.

14. Bar Meter

Relative Graphic display of current SINAD Meter reading.

15. Lower Limit Bar

Indicates position of Lower Limit (9) on Bar Meter (14). If Lower Limit (9) exceeds Range (5), marker is not visible.

16. Upper Limit Bar

Indicates position of Upper Limit (8) on Bar Meter (14). If Upper Limit (8) exceeds Range (5), marker is not visible.

17. Upper Range Limit Readout

Displays current value of Range (4). Redefined as needed if Autorange function is active.

18. Digital Readout

Displays current SINAD Meter Reading.

19. Peak Readings

Displays current high and low Peak Readings when Peak Hold (6) is set to ON. Readings are reinitialized when RST PK Soft Function Key F5 is pressed.



19a. Scan Width

Displays current Scan Width. This field is editable. Available Scan Widths include:

0 kHz	1 kHz	2 kHz
5 kHz	10 kHz	20 kHz
50 kHz	100 kHz	200 kHz
500 kHz	1 MHz	

Soft Function Keys available with this function include:

- F1 MENU  
Selects a Scan Width pop up menu.
- F6 RETURN  
Returns to Generate SINAD Meter screen.
- F2 CONFIG  
Accesses a pop up screen to configure Scan width, RBW (Resolution Bandwidth) and Sweep rate.

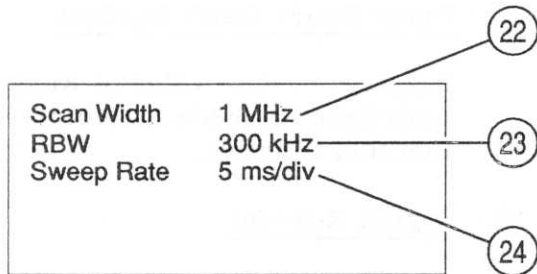

00607032

20. SCOPE/ANALYZER Screen

Displays digitized trace of specified signal as Oscilloscope or Spectrum Analyzer.

21. SCOPE/ANALYZER Prompt

Displays current operation function. Used to toggle between two functions.

22. Scan Width

Displays current Analyzer Scan Width. This field is editable. Available Scan Widths include:

0 kHz	1 kHz	2 kHz
5 kHz	10 kHz	20 kHz
50 kHz	100 kHz	200 kHz
500 kHz	1 MHz	

Soft Function Keys available with this function include:

- F1 COUPLE  
Sets the Sweep and RBW to factory default state for the current scan width.
- F6 RETURN  
Returns to Generate SINAD Meter screen.

23. RBW (Resolution Bandwidth)

Displays current Analyzer Resolution Bandwidth. This field is editable. Available Resolution Bandwidths include:

300 Hz	3 kHz	30 kHz
300 kHz	3 MHz	

Soft Function Keys available with this function include:

- F1 COUPLE  
Sets the Sweep and RBW to factory default state for the current scan width.
- F2 DEFAULT  
Sets only the current field to factory default state for the current scan width.

## G. OSCILLOSCOPE OPERATION SCREEN

The abbreviated Oscilloscope, as follows below, is visible from the RF Generate Operation Screen and the following operation screens:

SINAD Meter Operation Screen  
Distortion Meter Operation Screen  
Audio Frequency Level Meter Operation Screen.

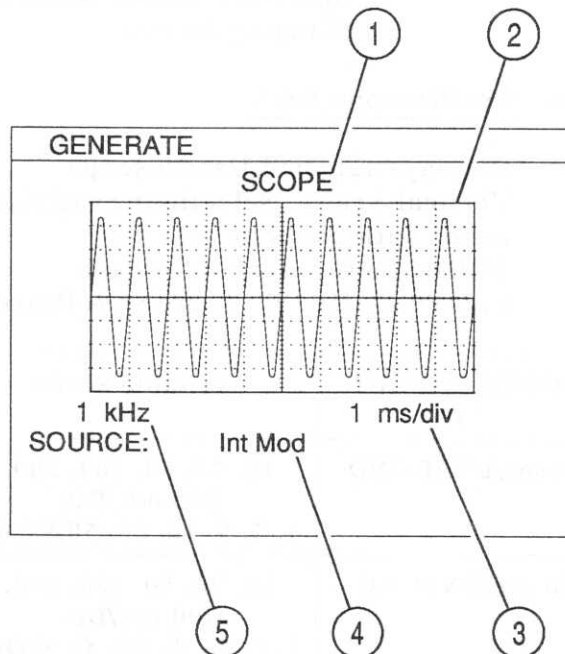

00607004

### 1. SCOPE/ANALYZER Prompt

Displays current operation function.  
Used to toggle between two functions.

Soft Function Keys are available on  
RF Generate Operation Screen only:

F1 ZOOM  
Accesses expanded version of  
active function.

F2 ANALY/SCOPE  
Accesses inactive function. If  
SCOPE is active, displays  
ANALY. If ANALYZER is  
active, displays SCOPE.

### 2. Oscilloscope Screen

Displays digitized trace of specified  
signal.

### 3. Sweep

Displays selected Oscilloscope Sweep  
Selections include:

100 $\mu$ s/div	200 $\mu$ s/div	500 $\mu$ s/div
1 ms/div	2 ms/div	5 ms/div
10 ms/div	20 ms/div	50 ms/div
100 ms/div	200 ms/div	500 ms/div

Soft Function Keys available with  
this function include:

F1 MENU  
Accesses Menu to set  
Oscilloscope Scale. Soft  
Function Keys available with  
this function include:

F6 RETURN  
Exits Menu into Generate  
Operation Screen.

F2 ROLL  
Views the scope trace in a roll  
mode when the selected sweep  
rate is 100 ms/Div or higher.

F2 SLOW  
Returns to the normal  
mode of operation.

#### 4. SCOPE SOURCE

Displays selected Oscilloscope Source. Selections include:

Source	Signal Input	Signal Type
Scope/DVM-GND	SCOPE/DVM Connector	External GND-Coupled Signal
Scope/DVM-AC	SCOPE/DVM Connector	External AC-Coupled Signal
Scope/DVM-DC	SCOPE/DVM Connector	External DC-Coupled Signal
Ext Mod	EXT MOD IN Connector	External Modulation
Notch Residual	Internal Filtered Signal	Notch Filtered Signal passed to SINAD and Distortion Meters. Reading is relative with no units applied.
Audio/Data In	AUDIO/DATA IN Connector	External Audio or Data Signal
Int Mod	Internal Modulation	Composite Modulation Signal generated by Internal Audio/Data Generators

Soft Function Keys available with this function include:

#### F1 MENU

Accesses MENU to set active Oscilloscope Source. Soft Function Keys available with this function include:

#### F6 RETURN

Exits Menu into Generate Operation Screen without changing Source.

#### 5. Oscilloscope Scale

Displays selected Oscilloscope Vertical Scale. Selections available differ with different SCOPE SOURCE (4). Scales for each SCOPE SOURCE (4) are as follows:

SCOPE SOURCE (4)	Available Scales
Scope/DVM-GND	10, 20, 50, 100, 200, 500 mV/Div 1, 2, 5, 10, 20, 50 V/Div
Scope/DVM-AC	10, 20, 50, 100, 200, 500 mV/Div 1, 2, 5, 10, 20, 50 V/Div
Scope/DVM-DC	10, 20, 50, 100, 200, 500 mV 1, 2, 5, 10, 20, 50 V
Ext Mod	100, 200, 500 mV/Div 1, 2, 5 V/Div
Notch Residual	0.02, 0.04, 0.10, 0.20, 0.40, 1.00
Audio/Data In	100, 200, 500 mV/Div 1, 2, 5 V/Div
<u>Int Mod</u>	
GEN1 FM >25 kHz:	1, 2, 5, 10, 20, 50 kHz/Div
GEN1 FM 2.5 to 12.75 kHz:	1, 2, 5, 10, 20, 50 kHz/Div

8. Marker Position

Displays current Marker Position if Marker (14) is active or OFF if inactive. Value for Marker Position is in same units as Sweep (6) with Trigger point as reference.

Soft Function Keys available with this function include:

F1 ON/OFF  
Toggles Marker (14) between ON and OFF.

9. Trigger Type

Displays current Trigger Type. Selections include Auto, One Shot and Normalized.

Soft Function Keys available with this function include:

F1 NORM  
Selects Normalized Trigger Type.

F2 AUTO  
Selects Auto as Trigger Type.

F3 1 SHOT  
Selects and enables One Shot as Trigger Type.

10. Trigger

Adjusts trigger level as indicated by Trigger Level Indicator (15) when accessed.

11. Mode

Displays selected Operation Mode. Selections include Menu, Average, Pk Hold, Min Hold and Store. Menu displays a menu window with selections Live, Recall, Compare, Live-Ref and Ref-Live. Live displays current signal without modification.

Recall displays Stored trace only. Compare displays Stored trace and live trace simultaneously. In Live-Ref, the value of each point of the reference trace is subtracted from the current reading and the result is displayed. In Ref-Live, the value of current reading is subtracted from the stored value and the result is displayed. Both Live-Ref and Ref-Live require a previously stored trace. Average displays average of last four traces. Pk Hold displays and holds the trace peak. Min Hold displays and holds minimum trace. Store places copy of current trace in memory.

Soft Function Keys available with this function include:

F1 MENU  
Accesses a Menu with Mode selections.

F1 LIVE  
Selects LIVE as Oscilloscope Operation Mode.

F2 RECALL  
Selects RECALL as Oscilloscope Operation Mode.

F3 COMPARE  
Selects COMPARE as Oscilloscope Operation Mode.

F4 LIVE-REF  
Selects LIVE-REF as Oscilloscope Operation Mode.

F5 REF-LIVE  
Selects REF-LIVE as Oscilloscope Operation Mode.

F6 RETURN  
Exits Menu into Generate  
Operation Screen.

F2 AVG  
Activates/deactivates Average  
Oscilloscope Operation Mode.

F3 PK HOLD  
Activates/deactivates Peak Hold  
Oscilloscope Operation Mode.

F4 MIN HOLD  
Activates/deactivates Minimum  
Hold Oscilloscope Operation  
Mode.

F6 STORE  
Stores the current trace.

12. H Pos

Displays selected horizontal offset in  
major divisions. Selections range  
from -10 to +10 Divisions.

13. V Pos

Accesses vertical position of trace.

14. Marker

User editable Marker controlled using  
Marker Position (8). Movable  
through extent of visible screen.

15. Trigger Level Indicator

Indicates level of Oscilloscope  
Trigger Level. Editable using  
Trigger (10).

16. Oscilloscope Scale

Displays selected Oscilloscope  
Vertical Scale. Selections available  
differ with different Source as set in  
RF Generate Operation Screen.  
Scales are as follows:

SCOPE SOURCE (4)	Available Scales
Scope/DVM-GND	10, 20, 50, 100, 200, 500 mV/Div 1, 2, 5, 10, 20, 50 V/Div
Scope/DVM-AC	10, 20, 50, 100, 200, 500 mV/Div 1, 2, 5, 10, 20, 50 V/Div
Scope/DVM-DC	10, 20, 50, 100, 200, 500 mV 1, 2, 5, 10, 20, 50 V
Ext Mod	100, 200, 500 mV/Div 1, 2, 5 V/Div
Notch Residual	0.02, 0.04, 0.10, 0.20, 0.40, 1.00
Audio/Data In	100, 200, 500 mV/Div 1, 2, 5 V/Div
Int Mod	
GEN1 FM >25 kHz:	1, 2, 5, 10, 20, 50 kHz/Div
GEN1 FM 2.5 to 12.75 kHz:	1, 2, 5, 10, 20, 50 kHz/Div
GEN1 FM 12.75 to 25 kHz:	.2, .4, 1, 2, 4, 10 kHz/Div
GEN1 FM <2.5 kHz:	.2, .4, 1, 2, 4, 10 kHz/Div
GEN1 PM <2.55 RAD:	.2, .4, 1, 4, 10 kHz/Div
GEN1 PM >2.55 RAD:	1, 2, 5, 10, 20,50 RAD/Div
GEN1 AM:	all settings 20%

Soft Function Keys available with  
this function include:

F1 MENU  
Accesses Menu to set  
Oscilloscope Scale. Soft  
Function Keys available with  
this function include:

F1 Set Ref  
Adjusts Spectrum Analyzer to an internal reference level at current frequency. Function must be initiated at each new frequency to achieve maximum accuracy.

#### 6. Marker Position

Displays current Marker Position if Marker (12) is active or OFF if inactive. Value for Marker Position is MHz.

Soft Function Keys available with this function include:

F1 ON/OFF  
Toggles Marker (12) between ON and OFF.

#### 7. Marker Level

Displays current Marker Level if Marker (12) is active. Displays Blank if Marker (12) is OFF.

#### 8. Scale

Displays selected Logarithmic Scale for Spectrum Analyzer Vertical Scale (11). Selections are 2 and 10 dB.

F1 10 dB  
Selects 10 dB Logarithmic Scale for Spectrum Analyzer Vertical Scale (11).

F2 2 dB  
Selects 2 dB Logarithmic Scale for Spectrum Analyzer Vertical Scale (11).

#### 9. Reference

Adjusts Spectrum Analyzer Vertical Scale (11)  $\pm 10$  dB when Scale (8) is set to 10 dB. When Scale (8) is set to

2 dB, adjusts Spectrum Analyzer Vertical Scale (11) through full range, displaying 16 dB window and incrementing in 1 dB steps.

#### 10. Mode

Displays selected Operation Mode. Selections include Menu, Average, Peak Hold, Minimum Hold and Store. Menu displays a menu window with selections Live, Recall, Compare, Live-Ref and Ref-Live. Live displays current signal without modification. Recall displays Stored trace only. Compare displays Stored trace and live trace simultaneously. In Live-Ref, the value of each point of the reference trace is subtracted from the current reading and the result is displayed. In Ref-Live, the value of current reading is subtracted from the stored value and the result is displayed. Both Live-Ref and Ref-Live require a previously stored trace. Average displays average of last four traces. Pk Hold displays and holds the trace peak. Min Hold displays and holds minimum trace. Store places copy of current trace in memory.

Soft Function Keys available with this function include:

F1 MENU  
Accesses a Menu with Mode selections.

F1 LIVE  
Selects LIVE as Spectrum Analyzer Operation Mode.

F2 RECALL  
Selects RECALL as Spectrum Analyzer Operation Mode.

- F3 COMPARE  
Selects COMPARE as Analyzer Spectrum Operation Mode.
- F4 LIVE-REF  
Selects LIVE-REF as Spectrum Analyzer Operation Mode.
- F5 REF-LIVE  
Selects REF-LIVE as Spectrum Analyzer Operation Mode.
- F6 RETURN  
Exits Menu into Generate Operation Screen.

- F2 AVG  
Activates/deactivates Average Spectrum Analyzer Operation Mode.
- F3 PK HOLD  
Activates/deactivates Peak Hold Spectrum Analyzer Operation Mode.
- F4 MIN HOLD  
Activates/deactivates Minimum Hold Spectrum Analyzer Operation Mode.
- F6 STORE  
Selects STORE as Spectrum Analyzer Operation Mode.

11. Vertical Scale

Provides logarithmic scale for Spectrum Analyzer. Position is controlled by Reference (9).

12. Marker

User editable Marker controlled using Marker Position (6).

13. Zero Scan Sweep

Displays selected Sweep per division. Selections include:

- |                 |                 |            |
|-----------------|-----------------|------------|
| 200 $\mu$ s/div | 500 $\mu$ s/div | 1 ms/div   |
| 2 ms/div        | 5 ms/div        | 10 ms/div  |
| 20 ms/div       | 50 ms/div       | 100 ms/div |
| 200 ms/div      | 500 ms/div      |            |

Soft Function Keys available with this function include:

- F1 MENU  
Accesses Menu to set Scan Width. Soft Function Keys available with this function include:
- F6 RETURN  
Exits Menu into Generate Analyzer Screen.

- F5 DEFLT  
Sets only the current field to factory default.

- F6 COUPLE  
Sets the sweep and RBW to factory default state for the current scan width.

14. Scan Width

Displays selected Scan Width per division. Selections include zero scan and:

- |         |         |         |
|---------|---------|---------|
| 1 kHz   | 2 kHz   | 5 kHz   |
| 10 kHz  | 20 kHz  | 50 kHz  |
| 100 kHz | 200 kHz | 500 kHz |
| 1 MHz   | 2 MHz   | 5 MHz   |
| 10 MHz  | 20 MHz  | 50 MHz  |
| 100 MHz |         |         |

Soft Function Keys available with this function include:

**F1 MENU**

Accesses Menu to set Scan Width. Soft Function Keys available with this function include:

**F6 RETURN**

Exits Menu into Generate Analyzer Screen.

**F6 COUPLE**

Sets the sweep and RBW to factory default state for the current scan width.





## I. STORE AND RECALL OPERATION

Pressing STORE Memory Key allows the operator to store up to 50 RF Generate Operation Screen configurations. Storage Locations 0 through 49 can be used to store an RF Generate Operation configuration,

RF Receive Operation configuration or Duplex Operation configuration (Receive and Generate pair).

Pressing STORE Memory Key when in RF Generate Operation Screen accesses the following fields:

The screenshot shows the 'GENERATE' screen with the following layout:

- ANALYZER:** A graph with a vertical axis labeled 'dB' ranging from 0 to -80 and a horizontal axis labeled '1 kHz'.
- Store setup as ...:** A section containing:
  - Setup # (callout 1)
  - Name: ----- (callout 2)
  - Type: ----- (callout 3)
  - Deviation: 1.00 kHz
  - Format: TONE
  - Freq: 1000.0 Hz
  - Shape: Sine
- AF LEVEL:** A section with a value of 0.01 and a range from 0 to 0.05.
- SINAD:** A section with a value of 40 dB and a range from 40 to 3.
- Audio/Data Filters:** A section with settings:
  - LINE: AF DEC
  - HP: OFF LP: OFF
  - BP: OFF
- Buttons:** 'SAVE' (callout 5) and 'ABORT' (callout 4).

### 1. Setup #

Displays selected Memory Location for storage of current configuration.

### 2. Name

Displays optional alphanumeric label for selected Memory Location.

### 3. Type

Displays the type of data currently saved in the specified setup number. Available types to save and recall are: DUPLEX, GENERATOR, RECEIVER, GENERATOR & RECEIVER and EMPTY.

00607081

4. ABORT Soft Function Key F6

Escapes Storage Operation without performing edit. SAVE Soft Function Key F1 (5) or ABORT Soft Function Key F6 must be pressed to return to normal operation.

5. SAVE Soft Function Key F1

Finalizes Storage Operation. SAVE Soft Function Key F1 or ABORT Soft Function Key F6 (4) must be pressed to return to normal operation.

Pressing RCL Memory Key allows the operator to recall up to 50 previously stored operation screens. RF Receive, RF Generate or Duplex Operation Screen configurations can all be accessed from the RF Generate Operation Screen. Accessing anything other than an RF Generate Operation Screen

configuration, automatically switches the COM-120B to the selected mode of operation.

Pressing RCL Memory Key when in RF Generate Operation Screen accesses the following fields:

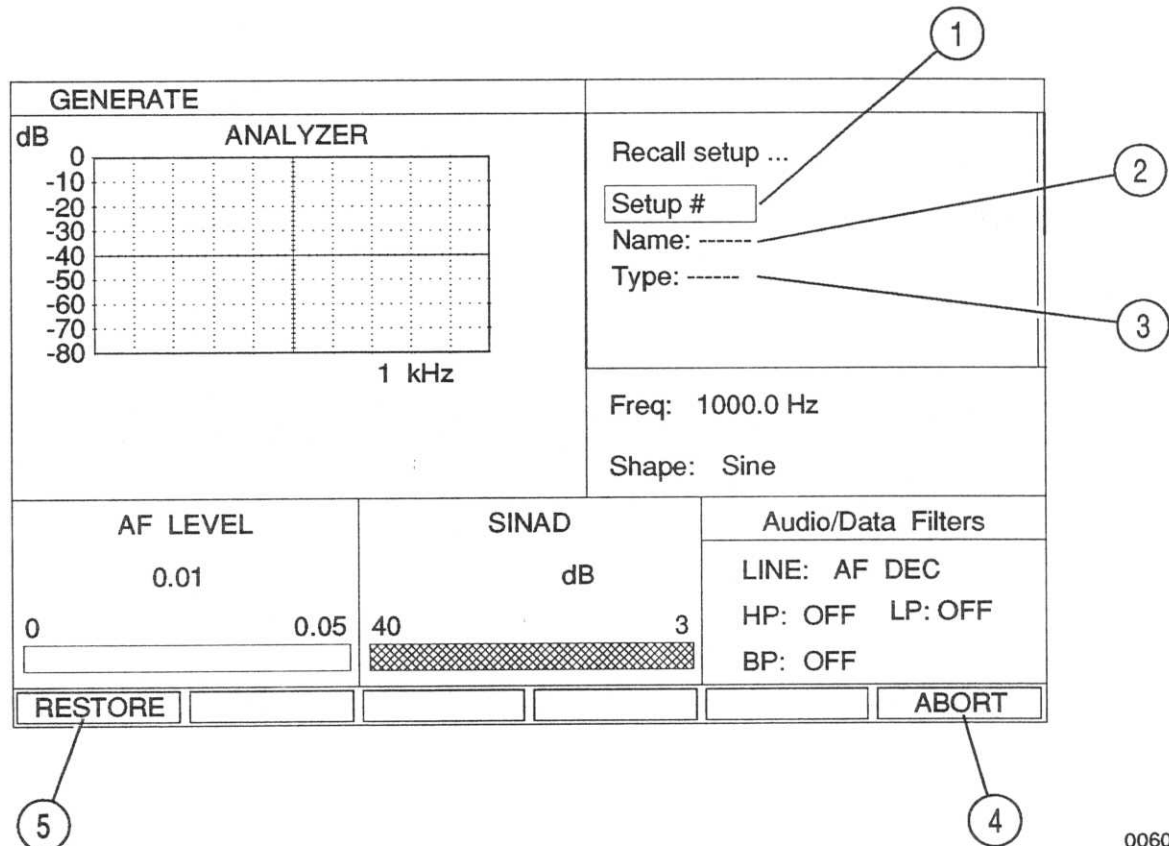

1. Setup #

Displays selected Memory Location for recall of stored configuration.

2. Name

Displays optional alphanumeric label for selected Memory Location.

3. Type

Displays the type of data saved in the specified setup number. Available types to save and recall are: DUPLEX, GENERATOR, RECEIVER, GENERATOR & RECEIVER and EMPTY.

00607082

4. ABORT Soft Function Key F6

Escapes Storage Operation without performing edit. RESTORE Soft Function Key F1 (5) or ABORT Soft Function Key F6 must be pressed to return to normal operation.

5. RESTORE Soft Function Key F1

Finalizes Recall Operation. RESTORE Soft Function Key F1 or ABORT Soft Function Key F6 (4) must be pressed to return to normal operation.

50. FORMAT

Displays selected Signalling Format for decoding. Selections are limited to USER for standard configuration. Additional selections are shown, but are unusable unless Option 09 or Option 11 is installed. Additional selections available include:

TONE	CCIRH
TONE REMOTE	CCIRH4
USER	NATEL
EEA	EURO
EIA	5/6 TONE
ZVEI	10 PS
DZVEI	20 PS
DDZVEI	MTS
CCIR	

Soft Function Keys available with this function include:

- F1 MENU  
Displays Menu of Signalling Format selections.
- F2 DECODE  
Activates Decode Function. Field is highlighted when Decode Function is active.
- F3 PG UP  
Pages screen up to view decoded information.
- F4 PG DN  
Pages screen down to view decoded information.
- F6 RETURN  
Returns to RF Receive Operation Screen.

## D. SINAD METER

The RF Receive Operation Screen SINAD Meter measures SINAD for a 1 kHz tone modulation for an RF signal passed to the RF Receiver. The RF signal is demodulated and filtered before being passed to the SINAD Meter. Filtering for the signal passed to the SINAD Meter is provided by the Audio/Data Filters.

The SINAD Meter can be shown as reading in dB only or as a meter. Information provided from the RF Receive Operation Screen is displayed as follows:

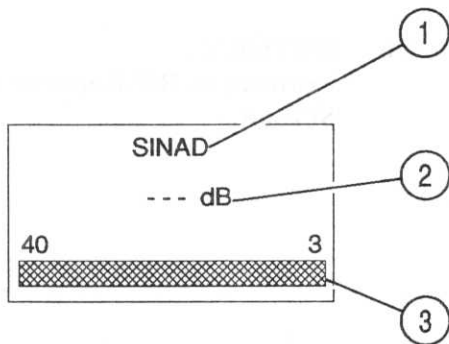

00607079

### 1. SINAD/Distortion/Modulation Meter Label

Displays label for selected Meter Operation. Selections include SINAD, Distortion and Modulation Meters.

Soft Function Keys available with this function include:

- F1 ZOOM  
Expands current meter into full-size meter.
- F2 SINAD  
Selects SINAD Meter as active meter. Not displayed if meter is active.
- F3 DIST  
Selects Distortion Meter as active meter. Not displayed if meter is active.
- F4 DEV  
Selects Modulation Meter associated with Demodulation type as active meter. Not displayed if meter is active.

### 2. Meter Reading

Displays current SINAD Meter Reading in dB.

### 3. Meter Bar

Provides graphical display of current SINAD Meter reading in dB.

Pressing ZOOM Soft Function Key F1 when cursor is at SINAD/Distortion/Modulation Meter Label (1) accesses full screen SINAD

Meter. Available features and editable fields are as follows:

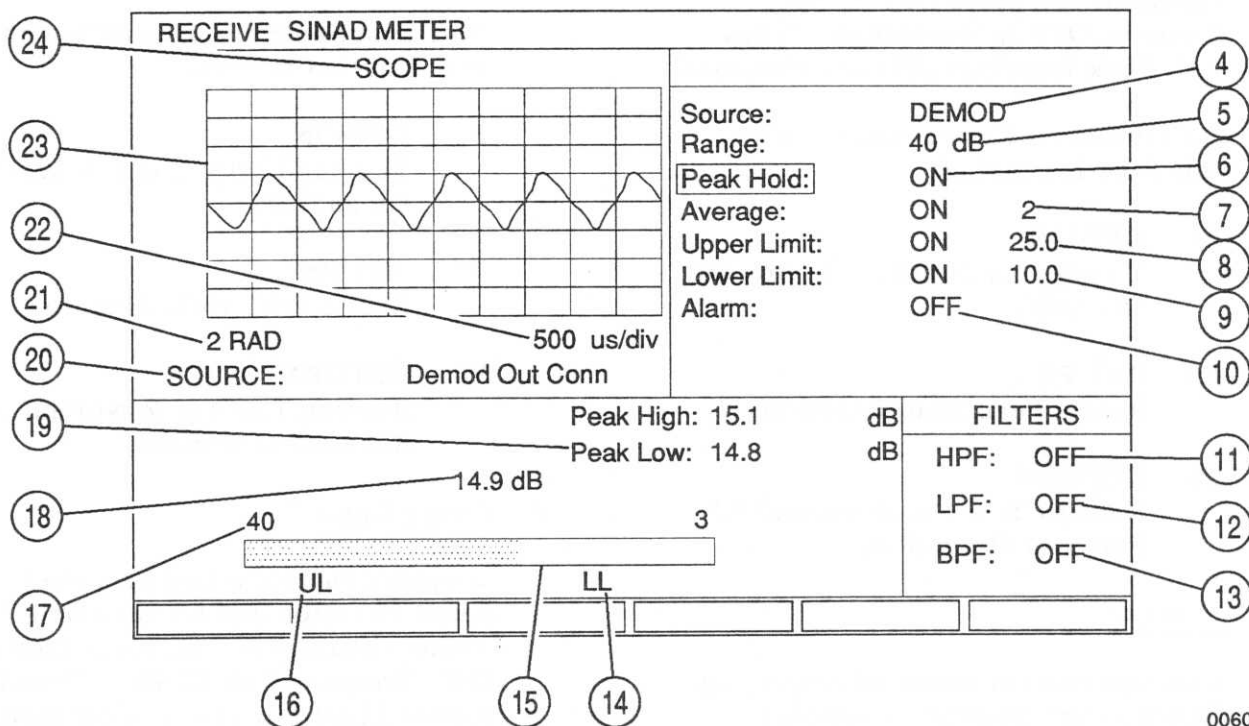

00607083

4. Source

Displays DEMOD, indicating signal source for SINAD measurement is demodulated signal. Field is for display only.

5. Range

Displays selected SINAD Meter Upper Range. Selections include Autorange, 15 dB and 40 dB.

Soft Function Keys available with this function include:

- F1 15 dB  
Selects 15 dB as active upper range for SINAD Meter.

- F2 40 dB  
Selects 40 dB as active upper range for SINAD Meter.
- F3 AUTO  
Selects Autorange as active upper range for SINAD Meter. This setting automatically adjusts to a higher or lower upper range if signal increases or decreases to a specified level of the current setting.
- F5 RST PK  
Resets Peak Readings displayed to 0.
- F6 RETURN  
Returns Test Set to normal RF Receive Operation Screen.



## 6. Peak Hold

Displays current status of Peak Hold function. Displays OFF or ON. Remains OFF in Autorange. When ON, Peak Readings (19) are displayed.

Soft Function Keys available with this function include:

- F1 OFF/ON  
Toggles Peak Hold Function ON and OFF.
- F5 RST PK  
Resets Peak Hold Function.
- F6 RETURN  
Returns Test Set to Normal RF Receiver Operation.

## 7. Average

Displays current status of Averaging Function and number of samples when active. Status is OFF or ON. Averaging Function averages a selected number of readings and reports average as Digital Readout (18). Range is 2 to 10.

Soft Function Keys available with this function include:

- F1 OFF/ON  
Toggles Average Function On and Off.
- F5 RST PK  
Resets Peak Hold Function.
- F6 RETURN  
Returns Test Set to Normal RF Receiver Operation.

## 8. Upper Limit

Displays current status of upper Limit Function and Upper Limit value when

active. Status is OFF or ON. Range is 0 to 40 dB. When ON, Upper Limit Bar (16) is displayed.

Soft Function Keys available with this function include:

- F1 OFF/ON  
Toggles Upper Limit Function On and Off.
- F5 RST PK  
Resets Peak Hold Function.
- F6 RETURN  
Returns Test Set to Normal RF Receiver Operation.

## 9. Lower Limit

Displays current status of Lower Limit Function and Lower Limit value when active. Status is OFF or ON. Range is 0 to 40 dB. When ON, Lower Limit Bar (14) is displayed.

Soft Function Keys available with this function include:

- F1 OFF/ON  
Toggles Lower Limit Function On and Off.
- F5 RST PK  
Resets Peak Hold Function.
- F6 RETURN  
Returns Test Set to Normal RF Receiver Operation.

## 10. Alarm

Displays current status of Alarm Function. Status is OFF or ON. When ON, alarm sounds when signal exceeds Upper Limit (8) or is below Lower Limit (9).

## F. FM DEVIATION METER

The FM Deviation Meter for the RF Receive Operation Screen measures FM Deviation for an RF signal passed to the RF Receiver. The RF signal is demodulated and filtered before being passed to the FM Deviation Meter. Filtering for the signal passed to the FM Deviation Meter is provided by the Audio/Data Filters.

The FM Deviation Meter can be shown as reading in kHz only or as a meter. Information provided from the RF Receive Operation Screen is displayed as follows:

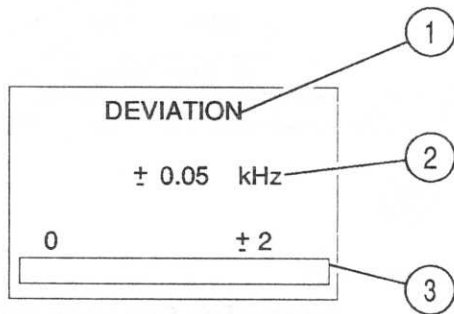

00607074

### 1. SINAD/Distortion/Modulation Meter Label

Displays label for selected Meter Operation. Selections include SINAD, Distortion and Modulation Meters.

Soft Function Keys available with this function include:

- F1 ZOOM  
Expands current meter into full-size meter.
- F2 SINAD  
Selects SINAD Meter as active meter. Not displayed if meter is active.
- F3 DIST  
Selects Distortion Meter as active meter. Not displayed if meter is active.
- F4 DEV  
Selects Modulation Meter associated with Demodulation type as active meter. Not displayed if meter is active.

### 2. Meter Reading

Displays current FM Deviation Meter Reading in kHz.

### 3. Meter Bar

Provides graphical display of current FM Deviation Meter reading in kHz.

Pressing ZOOM Soft Function Key F1 when cursor is at SINAD/Distortion/Modulation Meter Label (1) accesses full screen FM

Deviation Meter. Available features and editable fields are as follows:

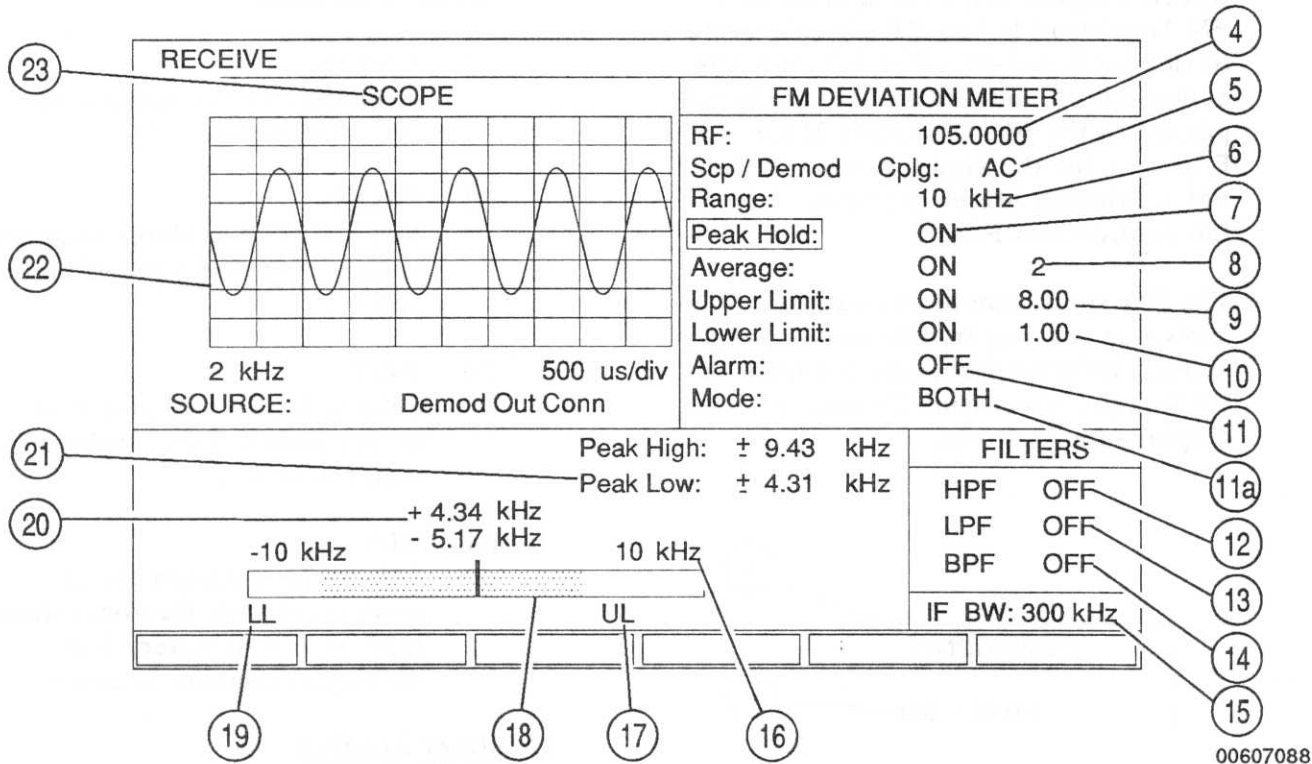

00607088

4. RF

Displays selected RF Receiver Frequency. Selections range from .000 to 1000 MHz.

5. Scope/DEMOM Connector Coupling

Displays selected coupling for Oscilloscope and DEMOD Connector. Selections are AC or DC.

Soft Function Keys available with this function include:

F1 AC  
Selects AC Coupling for Oscilloscope and DEMOD Connector.

F2 DC

Selects DC Coupling for Oscilloscope and DEMOD Connector.

F5 FM-Z

Automatically calibrates FM Zero.

F6 RETURN

Returns unit to RF Receive Operation Screen.

6. Range

Displays selected FM Deviation Meter Upper Range. Selections include Autorange and the following:

2 kHz	5 kHz	10 kHz
20 kHz	50 kHz	100 kHz

Soft Function Keys available with this function include:

- F1 MENU  
Accesses Menu to set Oscilloscope Scale.
- F2 AUTO  
Selects Autorange for Deviation Meter Range.
- F5 RST PK  
Resets Peak Deviation Meter readings.
- F6 RETURN  
Returns unit to RF Receive Operation Screen.

#### 7. Peak Hold

Displays current status of Peak Hold function. Displays OFF or ON. Remains OFF in Autorange. When ON, Peak Readings (21) are displayed.

Soft Function Keys available with this function include:

- F1 OFF/ON  
Toggles Peak Hold Function On and Off.
- F5 RST PK  
Resets Peak Hold Function.
- F6 RETURN  
Returns Test Set to Normal RF Receiver Operation.

#### 8. Average

Displays current status of Averaging Function and number of samples when active. Status is OFF or ON. Averaging Function averages selected number of readings and reports average as Digital Readout (20). Range is 2 to 10.

Soft Function Keys available with this function include:

- F1 OFF/ON  
Toggles Average Function ON and OFF.
- F5 RST PK  
Resets Peak Hold Function.
- F6 RETURN  
Returns Test Set to Normal RF Receiver Operation.

#### 9. Upper Limit

Displays current status of Upper Limit Function and Upper Limit value when active. Status is OFF or ON. Range is 0 to 99.99 kHz. When ON, Upper Limit Bar (17) is displayed.

Soft Function Keys available with this function include:

- F1 OFF/ON  
Toggles Upper Limit Function ON and OFF.
- F5 RST PK  
Resets Peak Hold Function.
- F6 RETURN  
Returns Test Set to Normal RF Receiver Operation.

#### 10. Lower Limit

Displays current status of Lower Limit Function and Lower Limit value when active. Status is OFF or ON. Range is 0 to 99.99 kHz. When ON, Lower Limit Bar (19) is displayed.

Soft Function Keys available with this function include:

- F1 OFF/ON  
Toggles Lower Limit Function ON and OFF.

- F5 RST PK  
Resets Peak Hold Function.
- F6 RETURN  
Returns Test Set to Normal RF Receiver Operation.

and the lower limit applies to the largest Negative reading. For Peak Hold readings, Peak Hi applies to the largest Positive peak reading found and Peak Lo applies to the largest Negative reading found.

### 11. Alarm

Displays current status of Alarm Function. Status is OFF or ON. When ON, Audible alarm sounds when signal exceeds Upper Limit (9) or is below Lower Limit (10).

Soft Function Keys available with this function include:

- F1 OFF/ON  
Toggles Alarm Function ON and OFF.
- F5 RST PK  
Resets Peak Hold Function.
- F6 RETURN  
Returns Test Set to Normal RF Receiver Operation.

- F5 RST PK  
Resets Peak Hold Function.
- F6 RETURN  
Returns Test Set to Normal RF Receiver Operation.

### 12. High-Pass Filter (HPF)

Displays current High-Pass Filter setting for FM Deviation Meter.

### 13. Low-Pass Filter (LPF)

Displays current Low-Pass Filter setting for FM Deviation Meter.

### 14. Bandpass Filter (BPF)

Displays current Bandpass Filter setting for FM Deviation Meter.

### 15. IF Bandwidth

Displays selected IF Bandwidth. Selections include 15 and 300 kHz.

Soft Function Keys available with this function include:

- F1 300 kHz  
Selects 300 kHz bandpass filter as active filter.
- F2 15 kHz  
Selects 15 kHz bandpass filter as active filter.

### 11a. Mode

Toggles the Deviation Meter between the standard mode (+/- div by 2) and peak mode (+ and - peak deviation as two separate readings/bars).

Soft Function Keys available with this function include:

- F1 NORM  
Selects Normal for +/- peak div by 2.
- F2 BOTH  
Selects + and - peak deviation. The upper limit applies to the largest peak Positive reading

16. Upper Range Limit Readout

Displays current value of Range (6). Redefined as needed if Autorange function is active.

17. Upper Limit Bar

Indicates position of Upper Limit (9) on Bar Meter (18). If Upper Limit (9) exceeds Range (6), marker is not visible.

18. Bar Meter

Relative Graphic display of current FM Deviation Meter reading. Displays NORM (+/- div by 2) or BOTH (+ and - peak deviation).

19. Lower Limit Bar

Indicates position of Lower Limit (10) on Bar Meter (18). If Lower Limit (10) exceeds Range (6), marker is not visible.

20. Digital Readout

Displays current FM Deviation Meter Reading.

21. Peak Readings

Displays current high and low Peak readings when Peak Hold (7) is set to ON. Readings are reinitialized when RST PK Soft Function Key F5 is pressed.

22. SCOPE/ANALYZER Screen

Displays digitized trace of specified signal as Oscilloscope or Spectrum Analyzer.

23. SCOPE/ANALYZER Prompt

Displays current operation function. Used to toggle between two functions.

## G. AM MODULATION METER

The AM Modulation Meter for the RF Receive Operation Screen measures AM Modulation for an RF signal passed to the RF Receiver. The RF signal is demodulated and filtered before being passed to the AM Modulation Meter. Filtering for the signal passed to the AM Modulation Meter is provided by the Audio/Data Filters.

The AM Modulation Meter can be shown as reading in % only or as a meter. Information provided from the RF Receive Operation Screen is displayed as follows:

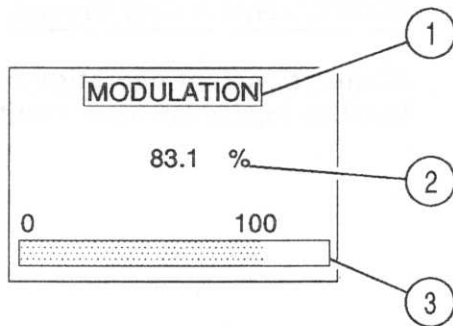

8717058

### 1. SINAD/Distortion/Modulation Meter Label

Displays label for selected Meter Operation. Selections include

SINAD, Distortion and Modulation Meters.

Soft Function Keys available with this function include:

- F1 ZOOM  
Expands current meter into full-size meter.
- F2 SINAD  
Selects SINAD Meter as active meter. Not displayed if meter is currently active.
- F3 DIST  
Selects Distortion Meter as active meter. Not displayed if meter is currently active.
- F4 DEV  
Selects Modulation Meter associated with Demodulation type as active meter. Not displayed if meter is currently active.

### 2. Meter Reading

Displays current AM Modulation Meter Reading in % Modulation.

### 3. Meter Bar

Provides graphical display of current AM Modulation Meter reading in % Modulation.

Pressing ZOOM Soft Function Key F1 accesses full screen Oscilloscope, when cursor is on SCOPE/ANALYZER Prompt (1).

Available features and parameters are as follows:

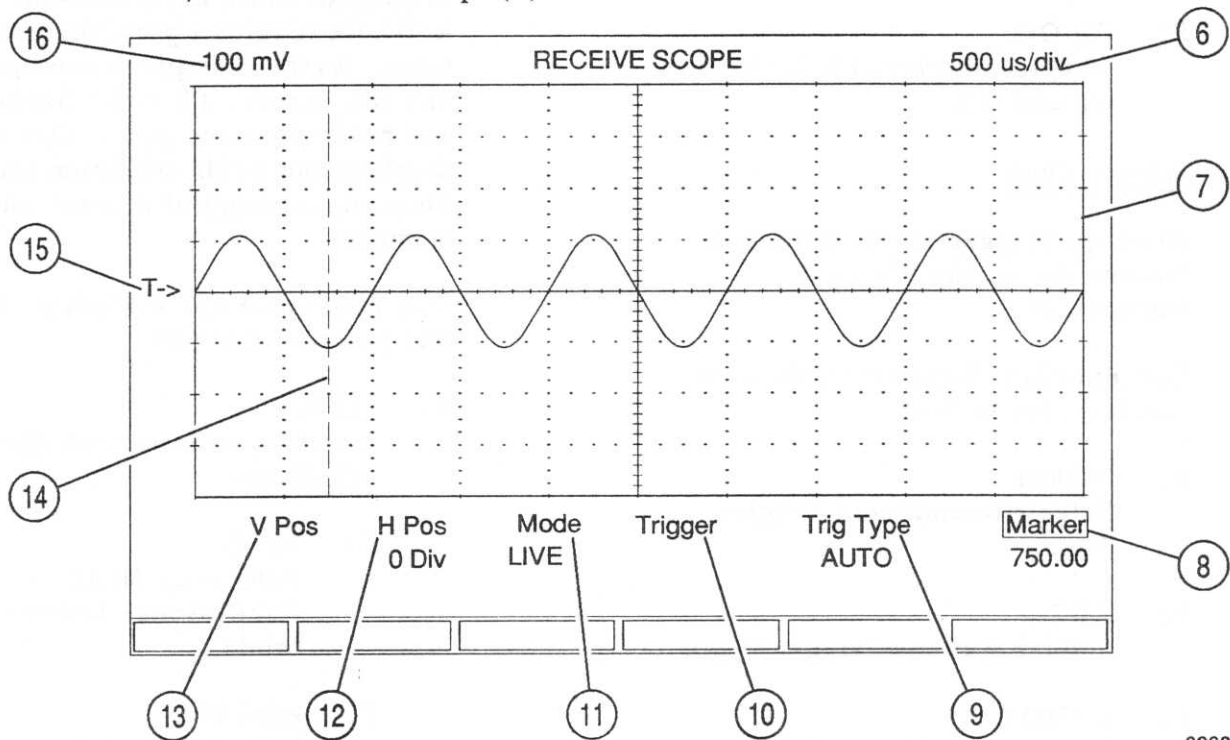

00607021

## 6. Sweep

Displays selected Oscilloscope Sweep. Selections include:

100 $\mu$ s/div	200 $\mu$ s/div	500 $\mu$ s/div
1 ms/div	2 ms/div	5 ms/div
10 ms/div	20 ms/div	50 ms/div
100 ms/div	200 ms/div	500 ms/div

Soft Function Keys available with this function include:

### F1 MENU

Accesses Menu to set Oscilloscope Sweep.

### F6 RETURN

Exits Menu into normal operation.

### F2 ROLL

Views the scope trace in a roll mode when the selected sweep rate is 100 ms/div or higher.

### F2 SLOW

Returns to the normal mode of operation.

## 7. Oscilloscope Screen

Displays digitized trace of specified signal.

## 8. Marker Position

Displays Marker Position if Marker (14) is active or OFF if inactive. Value for Marker Position is in same units as Sweep (6) with Trigger Level (15) as reference.



Soft Function Keys available with this function include:

- F1 On/Off  
Toggles Marker (14) between On and Off

## 9. Trigger Type

Displays Trigger Type. Selections include Auto, One Shot and Normalized.

Soft Function Keys available with this function include:

- F1 NORM  
Selects Normalized Trigger Type.
- F2 AUTO  
Selects Auto as Trigger Type.
- F3 1 SHOT  
Selects One Shot as Trigger Type. Pressing 1 Shot Soft Function Key reenables Trigger.

## 10. Trigger

Adjusts trigger level as indicated by Trigger Level Indicator (15) when accessed.

## 11. Mode

Displays selected Operation Mode. Selections include Menu, Average, Pk Hold, Min Hold and Store. Menu displays a menu window with selections Live, Recall, Compare, Live-Ref and Ref-Live. Live displays current signal without modification. Recall displays Stored trace only. Compare displays Stored trace and live trace simultaneously. In Live-Ref, the value of each point of the reference trace is subtracted from the current reading and the result is displayed. In Ref-Live, the value of

current reading is subtracted from the stored value and the result is displayed. Both Live-Ref and Ref-Live require a previously stored trace. Average displays average of last four traces. Pk Hold displays and holds the trace peak. Min Hold displays and holds minimum trace. Store places copy of current trace in memory.

Soft Function Keys available with this function include:

- F1 MENU  
Accesses a Menu with Mode selections.
- F1 LIVE  
Selects LIVE as Oscilloscope Operation Mode.
- F2 RECALL  
Selects RECALL as Oscilloscope Operation Mode.
- F3 COMPARE  
Selects COMPARE as Oscilloscope Operation Mode.
- F4 LIVE-REF  
Selects LIVE-REF as Oscilloscope Operation Mode.
- F5 REF-LIVE  
Selects REF-LIVE as Oscilloscope Operation Mode.
- F6 RETURN  
Exits Menu into Generate Operation Screen.
- F2 AVG  
Activates/deactivates Average Oscilloscope Operation Mode.

- F3 **PK HOLD**  
Activates/deactivates Peak Hold Oscilloscope Operation Mode.
- F4 **MIN HOLD**  
Activates/deactivates Minimum Hold Oscilloscope Operation Mode.
- F6 **STORE**  
Stores the current trace.

12. H Pos

Displays selected horizontal offset in major divisions. Selections range from -10 to +10 Divisions.

13. V Pos

Accesses vertical position of trace.

14. Marker

User editable Marker controlled using Marker Position (8). Movable through extent of visible screen.

15. Trigger Level Indicator

Indicates approximate Oscilloscope Trigger Level. Editable using Trigger (10).

16. Oscilloscope Scale

Displays Oscilloscope Vertical Scale. Selections available differ with different Source. Scales for each SCOPE SOURCE (4) are as follows:

SCOPE SOURCE (4)	Available Scales
Scope/DVM-GND	10, 50, 100, 200, 500 mV/Div 1, 2, 5, 10, 20, 50 V/Div
Scope/DVM-AC	10, 50, 100, 200, 500 mV/Div 1, 2, 5, 10, 20, 50 V/Div

SCOPE SOURCE (4)	Available Scales
Scope/DVM-DC	10, 50, 100, 200, 500 mV 1, 2, 5, 10, 20, 50 V
AF Cntr	0.02, 0.04, 0.10, 0.20, 0.40, 1.00
Notch Residual	0.02, 0.04, 0.10, 0.20, 0.40, 1.00
Audio/Data/Gen Out	20, 40, 100, 200, 400 mV 1 V
DTMF/SINAD	FM DEMOD TYPES: <u>&lt;20 kHz</u> 0.1, 0.2, 0.5, 1, 2, 5 kHz <u>≥20 kHz</u> 0.2, 0.4, 1, 2, 4, 10 kHz <u>50 kHz</u> 0.5, 1, 2.5, 5, 10, 25 kHz <u>100 kHz</u> 1, 2, 5, 10, 20, 50 kHz AM DEMOD TYPE: <u>20%</u> PM DEMOD TYPE <u>Radians</u> 0.1, 0.2, 0.5, 1, 2, 5
Data Decoder	FM DEMOD TYPES: <u>&lt;20 kHz</u> 0.1, 0.2, 0.5, 1, 2, 5 kHz <u>≥20 kHz</u> 0.2, 0.4, 1, 2, 4, 10 kHz <u>50 kHz</u> 0.5, 1, 2.5, 5, 10, 25 kHz <u>100 kHz</u> 1, 2, 5, 10, 20, 50 kHz AM DEMOD TYPE: <u>20%</u> PM DEMOD TYPE <u>Radians</u> 0.1, 0.2, 0.5, 1, 2, 5
RF Power	Low, Med, High (Selection is automatic depending on power provided T/R Connector)
Detector Out	FM DEMOD TYPE - 0.1, 0.2, 0.5, 1, 2, 5 kHz AM DEMOD TYPE - 20% PM DEMOD TYPE - 0.1, 0.2, 0.5, 1, 2, 5 Radians

SCOPE SOURCE (4)	Available Scales
Demod Out Connector	0.02, 0.04, 0.10, 0.20, 0.40, 1.00
Mod Meters	FM DEMOD TYPE - 1, 2, 5, 10, 20, 50 kHz AM DEMOD TYPE - 20% PM DEMOD TYPE - 0.1, 0.2, 0.5, 1, 2, 5 Radians

Soft Function Keys available with this function include:

- F1 MENU  
Accesses Menu to set Oscilloscope Scale. Soft Function Keys available with this function include:
- F6 RETURN  
Exits Menu to RF Receive Operation Screen.



## N. SPECTRUM ANALYZER OPERATION SCREEN

The abbreviated Spectrum Analyzer, as follows, is visible from the RF Receive Operation Screen and the following full-size Meter Operation Screens:

SINAD Meter  
 Distortion Meter  
 FM Deviation Meter  
 AM Modulation Meter  
 Phase Modulation Meter  
 RF Power Meter  
 Receive Level Meter  
 RF Frequency Error Meter  
 Audio Frequency Counter

An abbreviated Oscilloscope is available in the same position. All set parameters are reflected in all of the above Operation Screens. Features and parameters of the abbreviated Spectrum Analyzer are as shown:

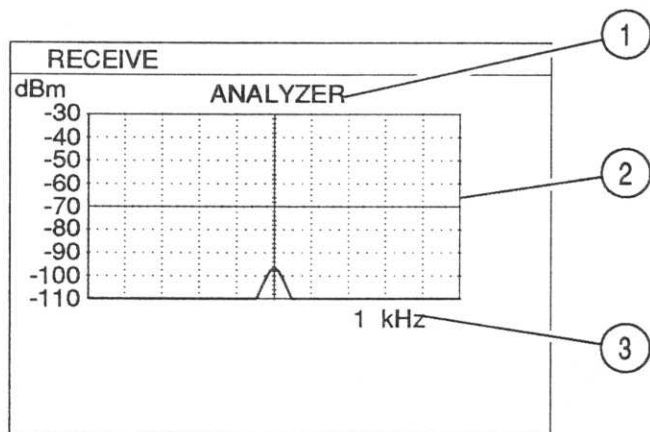

00607040

### 1. SCOPE/ANALYZER Prompt

Displays current operation function. Used to toggle between two functions.

Soft Function Keys available with this field include:

- F1 ZOOM  
Accesses expanded version of active function.
- F2 ANALY/SCOPE  
Accesses inactive function. If SCOPE is active, displays ANALY. If ANALYZER is active, displays SCOPE.

### 2. Spectrum Analyzer Screen

Displays digitized trace of specified signal.

### 3. Scan Width

Displays selected Scan Width per division. Selections include zero scan and:

1 kHz	50 kHz	2 kHz
100 kHz	5 kHz	200 kHz
10 kHz	500 kHz	20 kHz
1 MHz		

Soft Function Keys available with this function include:

- F1 MENU  
Accesses Menu to set Scan Width. Soft Function Keys available with this function include:
- F6 RETURN  
Exits Menu into normal operation.
- F2 CONFIG  
Accesses a pop up screen to configure Scan width, RBW

Soft Function Keys available with this function include:

- F1 T/R  
Selects T/R Connector as RF Input Connector.
- F2 ANT  
Selects ANTENNA Connector as RF Input Connector.

### 11. Atten

Displays Attenuation for RF Input (10). Selections include 0 dB and 30 dB.

Soft Function Keys available with this function include:

- F1 30 dB  
Selects 30 dB Attenuation for RF Input (10).
- F2 0 dB  
Selects 0 dB Attenuation for RF Input (10).

### 12. Mode

Displays selected Operation Mode. Selections include Menu, Average, Peak Hold, Minimum Hold and Store. Menu displays a menu window with selections Live, Recall, Compare, Live-Ref and Ref-Live. Live displays current signal without modification. Recall displays Stored trace only. Compare displays Stored trace and live trace simultaneously. In Live-Ref, the value of each point of the reference trace is subtracted from the current reading and the result is displayed. In Ref-Live, the value of current reading is subtracted from the stored value and the result is displayed. Both Live-Ref and Ref-Live require a previously stored trace. Average displays average of last four traces. Pk Hold displays

and holds the trace peak. Min Hold displays and holds minimum trace. Store places copy of current trace in memory.

Soft Function Keys available with this function include:

- F1 MENU  
Accesses a Menu with Mode selections.
- F1 LIVE  
Selects LIVE as Spectrum Analyzer Operation Mode.
- F2 RECALL  
Selects RECALL as Spectrum Analyzer Operation Mode.
- F3 COMPARE  
Selects COMPARE as Analyzer Spectrum Operation Mode.
- F4 LIVE-REF  
Selects LIVE-REF as Spectrum Analyzer Operation Mode.
- F5 REF-LIVE  
Selects REF-LIVE as Spectrum Analyzer Operation Mode.
- F6 RETURN  
Exits Menu into Generate Operation Screen.
- F2 AVG  
Activates/deactivates Average Spectrum Analyzer Operation Mode.
- F3 PK HOLD  
Activates/deactivates Peak Hold Spectrum Analyzer Operation Mode.

F4 MIN HOLD  
Activates/deactivates Minimum Hold Spectrum Analyzer Operation Mode.

F6 STORE  
Stores the current trace.

### 13. Vertical Scale

Provides scale for Spectrum Analyzer. Position is controlled by Reference (9).

### 14. Marker

User editable Marker controlled using Marker Position (8).

### 15. Zero Scan Sweep

Displays selected Sweep per division when Scan Width (16) is set to Zero Scan. Selections include:

200 $\mu$ s/div	500 $\mu$ s/div	1 ms/div
2 ms/div	5 ms/div	10 ms/div
20 ms/div	50 ms/div	100 ms/div
200 ms/div	500 ms/div	

### 16. Scan Width

Displays selected Scan Width per division. Selections include zero scan and:

1 kHz	50 kHz	2 kHz
100 kHz	5 kHz	200 kHz
10 kHz	500 kHz	20 kHz
1 MHz	2 MHz	5 MHz
10 MHz	20 MHz	50 MHz
100 MHz		

Soft Function Keys available with this function include:

F1 MENU  
Accesses Menu to set Scan Width. Soft Function Keys

available with this function include:

F6 RETURN  
Exits Menu into normal operation.

### F6 COUPLE

Sets the sweep and RBW to factory default state for the current scan width.

### 17. Logarithmic Function

Displays selected Logarithmic Function for referencing Vertical Scale (13). Selections include dBm, dB $\mu$ V, dBmV, dBV, dB $\mu$ W and dBW.

Soft Function Keys available with this function include:

F1 dBm  
Selects dBm as Logarithmic Function.

F2 dB $\mu$ V  
Selects dB $\mu$ V as Logarithmic Function.

F3 dBmV  
Selects dBmV as Logarithmic Function.

F4 dBV  
Selects dBV as Logarithmic Function.

F3 dB $\mu$ W  
Selects dB $\mu$ W as Logarithmic Function.

F4 dBW  
Selects dBW as Logarithmic Function.

## O. STORE AND RECALL OPERATION

Pressing STORE Memory Key allows the operator to store up to 50 RF Receive Operation Screen configurations. Storage Locations 0 through 49 can be used to store a RF Generate Operation configuration, a RF Receive Operation configuration

or a Duplex Operation configuration (Receive and Generate pair).

Pressing STORE Memory Key while in RF Receive Operation Screen accesses the following fields:

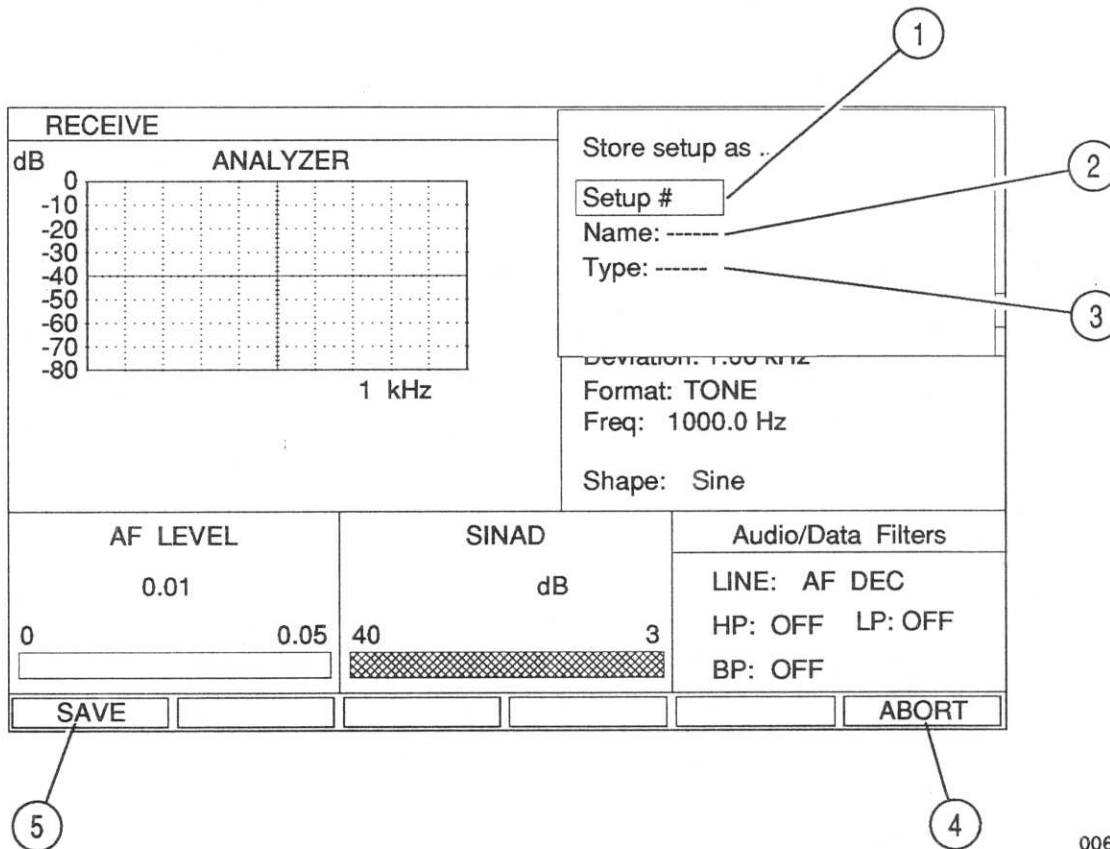

00607084

### 1. Setup #

Displays selected Memory Location for storage of current configuration.

### 2. Name

Displays optional alphanumeric label for selected Memory Location.

### 3. Type

Displays the type of data saved in the specified setup number. Available types to save and recall are: DUPLEX, GENERATOR, RECEIVER, GENERATOR & RECEIVER and EMPTY.



4. ABORT Soft Function Key F6

Escapes Storage Operation without performing edit. SAVE Soft Function Key F1 (5) or ABORT Soft Function Key F6 must be pressed to return to normal operation.

5. SAVE Soft Function Key F1

Finalizes Storage Operation. SAVE Soft Function Key F1 or ABORT Soft Function Key F6 (4) must be pressed to return to normal operation.

Pressing RCL Memory Key allows the operator to recall up to 50 previously stored operation screens. RF Receive, RF Generate or Duplex Operation Screen configurations and all be accessed from the RF Generate Operation Screen. Accessing anything other than an RF Generate Operation Screen

configuration, automatically switches the COM-120B to the selected mode of operation.

Pressing RCL Memory Key while in RF Receive Operation Screen accesses the following fields:

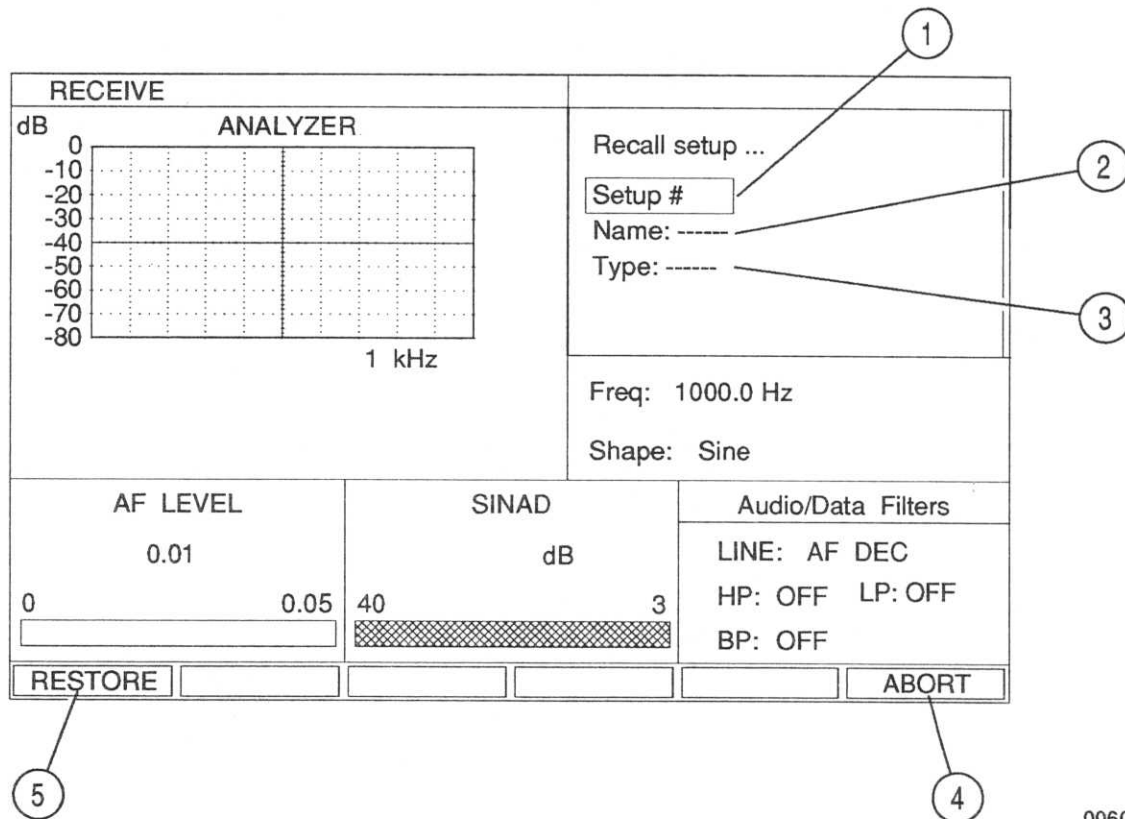

00607085

1. Setup #

Displays selected Memory Location for recall of stored configuration.

2. Name

Displays optional alphanumeric label for selected Memory Location.

3. Type

Displays the type of data saved in the specified setup number. Available types to save and recall are: DUPLEX, GENERATOR, RECEIVER, GENERATOR & RECEIVER and EMPTY.

4. ABORT Soft Function Key F6

Escapes Storage Operation without performing edit. RESTORE Soft Function Key F1 (5) or ABORT Soft Function Key F6 must be pressed to return to normal operation.

5. RESTORE Soft Function Key F1

Finalizes Recall Operation. RESTORE Soft Function Key F1 or ABORT Soft Function Key F6 (4) must be pressed to return to normal operation.

Soft Function Keys available with this function include:

F1  $\Delta$ =  
Accesses window to set Duplex Receive RF Field change increment. With  $\Delta$ = active, Soft Function Keys are defined as follows:

F6 RETURN  
Closes window and returns to normal operation.

F2  $\Delta$  On/Off  
Toggles  $\Delta$  Function OFF and ON. If  $\Delta$  Function is active, " $\Delta$ " is displayed by Frequency Readout.

F5 PAIR/UNPAIR  
Toggles PAIR Function ON and OFF. With function active, UNPAIR is displayed. Function Ties Duplex Generate RF Field (3) and Duplex Receive RF Field together as a Pair with specified Frequency Offset (4). With Pair Function active, editing Duplex Generate RF Field (3) changes Duplex Receive RF Field. Editing Frequency Offset (4) or Duplex Receive RF Field changes Duplex Generate RF Field (3).

## 21. Attenuation

Displays selected attenuation of input signal. Displays either 0 or 30.

Soft Function Keys available with this function include:

F1 30 dB  
Selects 30 dB Attenuation.

F2 0 dB  
Selects 0 dB Attenuation.

## 22. Duplex Receive Prompt

Accesses Duplex Receive Operation Screen.

Soft Function Keys available with this function include:

F1 ZOOM  
Accesses Duplex Receive Operation Screen.

**B. DUPLEX GENERATE GENERAL OPERATION SCREEN**

The Duplex Generate Operation Screen is used to define and activate the COM-120B RF Generator for Duplex Operation. The Duplex Generate Operation Screen is accessed by pressing ZOOM Soft Function

Key F1 or by pressing ENTER Key while cursor is on the Duplex Generate Prompt on the Duplex Operation Screen.

Features and editable parameters on the Duplex Generate Operation Screen are listed as follows:

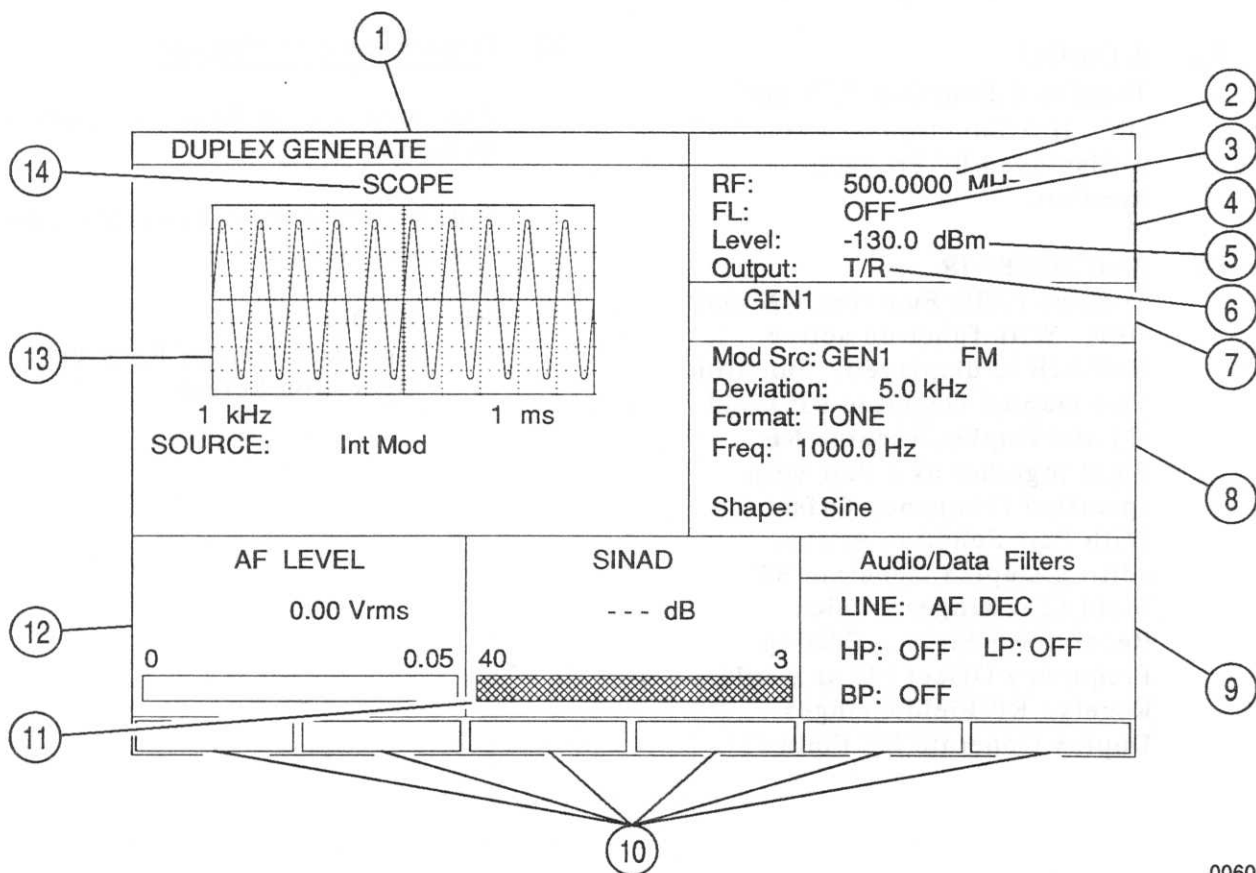

00607086

Duplex Generate Operation Screen

**1. Header Bar**

Displays current operation mode.

**2. RF Field**

Displays current Duplex Generate Frequency from 0.0000 to 1000.0000 MHz.

Soft Function Keys available with this function include:

F1  $\Delta$ =  
Accesses window to set Duplex Generate RF Field change increment. With  $\Delta$ = active, Soft Function Keys are defined as follows:

F6 RETURN  
Closes window and returns to normal operation.

F2  $\Delta$  On/Off  
Toggles  $\Delta$  Function OFF and ON. If  $\Delta$  Function is active, " $\Delta$ " is displayed by Frequency Readout.

F3 SET REF  
Makes frequency in current Duplex Generate RF Field reference frequency. Duplex Generate RF Field displays offset from reference frequency when activated. If Set Reference Function is active, "R" is displayed.

F5 PAIR/UNPAIR  
Toggles PAIR Function ON and OFF. With function active, UNPAIR is displayed for Soft Function Key field and "P" is displayed next to RF Field. Function ties Duplex Generate RF Field and Duplex Receive Frequency together as Pair with specified Frequency Offset. With Pair Function active, editing Duplex Generate RF Field changes Duplex Receive Frequency.

### 3. FL (Frequency List) Setting

Displays selected Frequency List number (FL-00 to FL-99) when active. Blank if inactive. RF Field

(2) echoes frequency of selected Frequency List setting. Editing RF Field (2) deactivates Frequency List Function.

Soft Function Keys available with this function include:

F1 ON/OFF  
Toggles active function ON and OFF.

F2 T-Fwd  
Accesses Trunking-Forward Channel List.

F3 T-Rvs  
Accesses Trunking-Reverse Channel List.

F4 C-Fwd  
Accesses Cellular-Forward Channel List.

F5 C-Rvs  
Accesses Cellular-Reverse Channel List.

F6 FL  
Accesses User Defined Frequency List.

### 4. Frequency List Label

Displays optional Frequency List Label if used. Displays Blank if unused.

### 5. Output Level

Displays Output Level. If T/R Connector is selected for Output (6), range is -130 to -40 dBm, 0 to .002236 V, 0 to 2.2360 mV or 0.07 to 2236.0  $\mu$ V. If AUX RF Connector is selected for Output (6), range is -130 to -13 dBm, 0 to 0.050059 V, 0 to 50.0593 mV or 0.07 to 50059.3  $\mu$ V.

Soft Function Keys available with this function include:

- F1 dBm  
Selects units of dBm for Output Level.
- F2  $\mu$ V  
Selects units of  $\mu$ V for Output Level.
- F3 mV  
Selects units of mV for Output Level.
- F4 V  
Selects units of V for Output Level.
- F5 SINAD=  
Access field to set SINAD Search Function value.
- F6 S=On/Off  
Toggles SINAD Search Function ON and OFF. SINAD Search Function changes Output Level to search for SINAD= value from UUT. S= Prompt is displayed with function ON.

## 6. Output

Displays Output Connector. Displays T/R, T/R Gate, AUX or AUX Gate. Gated Output is active only when microphone attached to MIC/ACC Connector is keyed.

Soft Function Keys available with this function include:

- F1 T/R  
Selects T/R Connector as output connector.
- F2 AUX  
Selects AUX RF OUT Connector as output connector.

- F3 T/R Gate  
Selects T/R Connector as output connector. Output is only active when microphone, attached to MIC/ACC Connector, is keyed.

- F4 AUX Gate  
Selects AUX RF OUT Connector as output connector. Output is only active when microphone, attached to MIC/ACC Connector, is keyed.

## 7. Modulation Source Window

Displays active Modulation Sources. Inactive Modulation Sources are not shown. If two (or more) sections of the RF Modulator are set in conflict (e.g. GEN1 set for PM and GEN2 set for FM, or GEN1 set for 0.01 kHz deviation and GEN2 set for 2.60 kHz deviation) the screen displays the invalid source grayed out.

## 8. Modulation Source Block

Displays Modulation Source. Selections include GEN1 (Audio Generator 1), GEN2 (Audio Generator 2), DTMF (DTMF Tone Generator), DATA (DATA Generator), EXT (External Modulation) and MIC (Microphone Modulation).

## 9. AUDIO/DATA FILTERS Block

Displays current filter information for selected analog signal. Selections include AF Decode Line, Data Decode Line and Speaker/Headphones Line.

## 10. Soft Function Key Definitions

Functions are redefined with each field of the current operation screen.

## D. STORE AND RECALL OPERATION

Pressing STORE Memory Key allows the operator to store up to 50 Duplex Operation Screen configurations. Storage Locations 0 through 49 can be used to store an RF Generate Operation configuration, RF Receive

Operation configuration or Duplex Operation configuration (Receive and Generate pair).

Pressing STORE Memory Key when in Duplex Operation Screen accesses the following fields:

RECEIVE		GENERATE	
RF :	105.0000 MHz	Mod Src :	DATA FM
FL :	OFF	Deviation :	10.0 kHz
Input :	ANT Atten: 30 dB	Format :	DCS
Demod :	FM IF BW: 15 kHz	Code :	114
Tone/Data Code: POCSAG			
DEVIATION:	87.3 kHz		
AF FREQUENCY	4371 Hz		
<b>DISTORTION:</b>	--- %		
RF Level:	-77.4 dBm		
RF Error Freq:	2.967 kHz		
<b>SAVE</b>			<b>ABORT</b>

Callout 1: Store setup as ..

Callout 2: Setup #

Callout 3: Name: -----

Callout 4: Type: -----

Callout 5: SAVE button

00607044

### 1. Setup #

Displays selected Memory Location for storage of current configuration.

### 2. Name

Displays optional alphanumeric label for selected Memory Location.

### 3. Type

Displays the type of data currently saved in the specified setup number. Available types to save and recall are: DUPLEX, GENERATOR, RECEIVER, GENERATOR & RECEIVER and EMPTY.



4. ABORT Soft Function Key F6

Escapes Storage Operation without editing. Press SAVE Soft Function Key F1 (5) or ABORT Soft Function Key F6 to return to normal operation.

5. SAVE Soft Function Key F1

Finalizes Storage Operation. Press SAVE Soft Function Key F1 or ABORT Soft Function Key F6 (4) to return to normal operation.

Pressing RCL Memory Key allows the operator to recall up to 100 previously stored operation screens. RF Receive, RF Generate or Duplex Operation Screen configurations and all can be accessed from the Duplex Operation Screen. Accessing anything other than a Duplex Operation Screen

configuration, automatically switches the COM-120B to the selected mode of operation.

Pressing RCL Memory Key when in Duplex Operation Screen accesses the following fields:

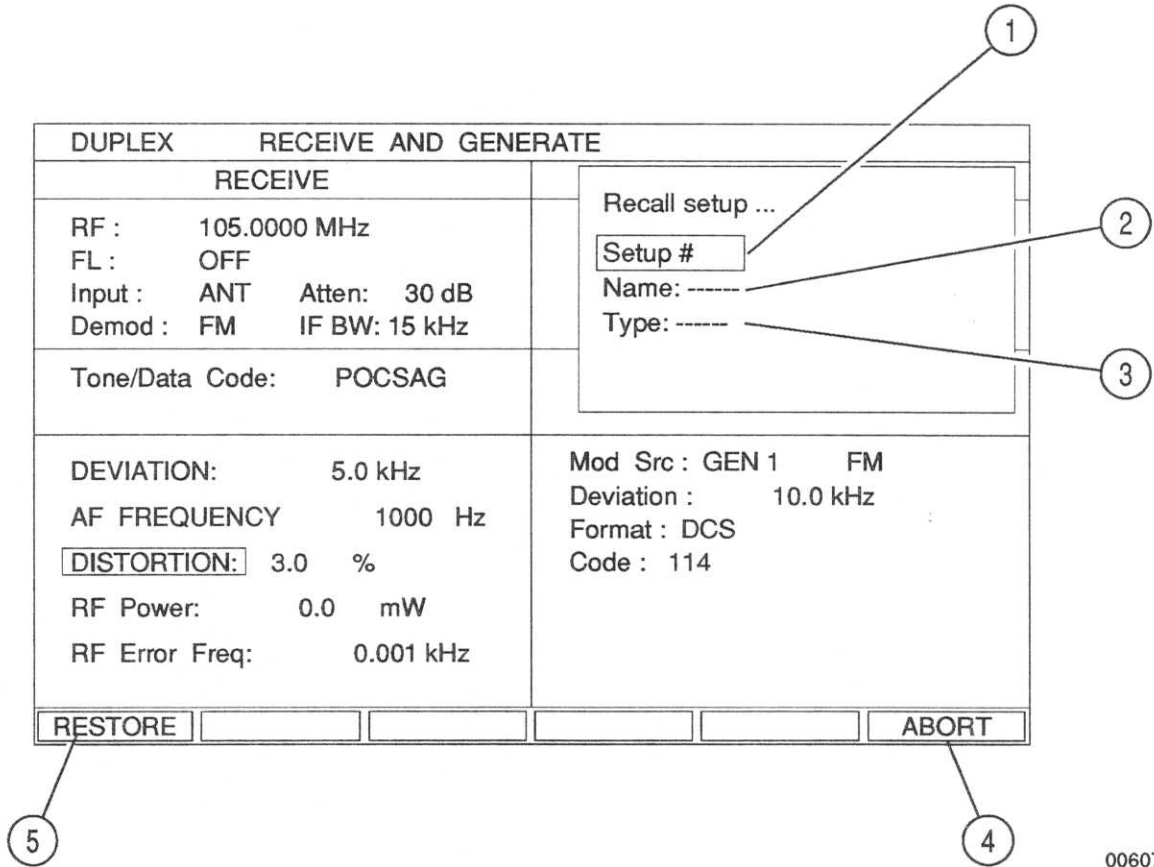

00607045

1. Setup #

Displays selected Memory Location for recall of stored configuration.

2. Name

Displays optional alphanumeric label for selected Memory Location.

3. Type

Displays the type of data saved in the specified setup number. Available types to save and recall are: DUPLEX, GENERATOR, RECEIVER, GENERATOR & RECEIVER and EMPTY.

4. ABORT Soft Function Key F6

Escapes Storage Operation without performing any edit. Press RESTORE Soft Function Key F1 (5) or ABORT Soft Function Key F6 to return to normal operation.

5. RESTORE Soft Function Key F1

Finalizes Recall Operation. Press RESTORE Soft Function Key F1 or ABORT Soft Function Key F6 (4) to return to normal operation.

### 3-3-4 OSCILLOSCOPE OPERATION SCREEN

The Independent Oscilloscope Operation Screen operates as an independent piece of test equipment. Input for Oscilloscope Operation is through the SCOPE/DVM Connector. The Oscilloscope Operation

Screen is accessed by pressing the SCOPE Instruments Key. When accessed, the Oscilloscope Operation Screen is set up in the configuration last used.

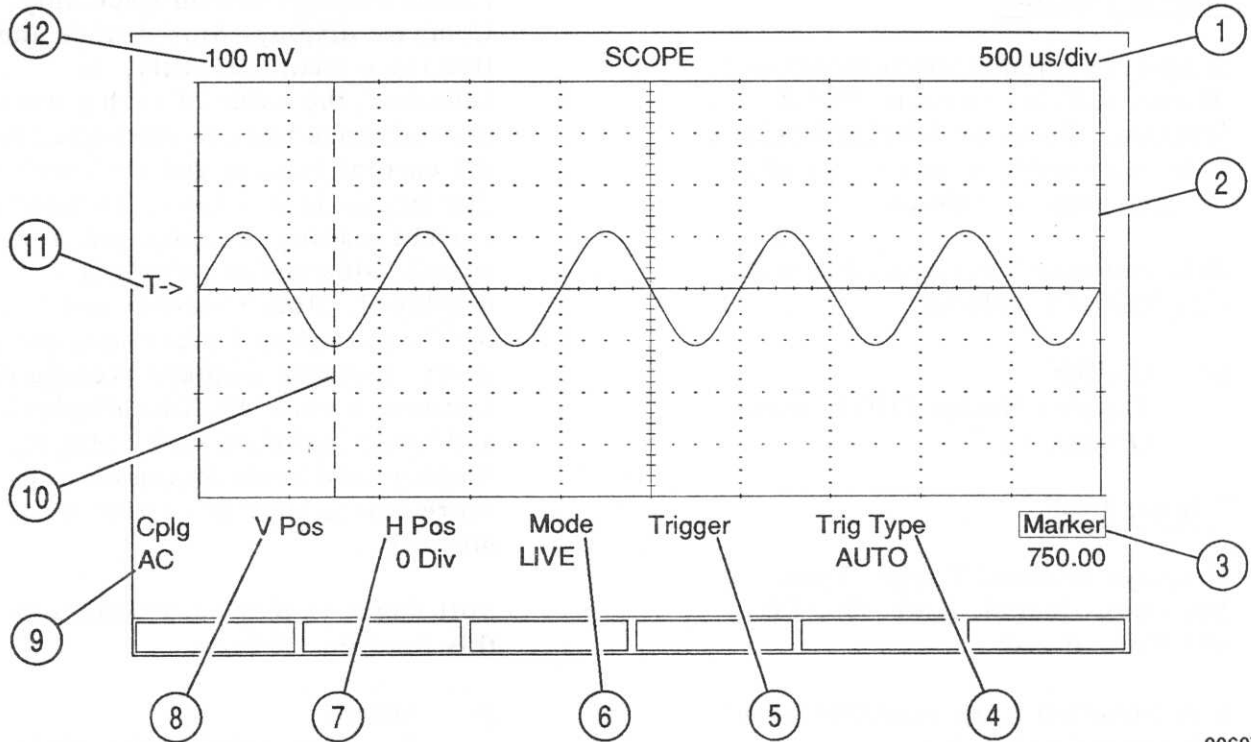

00607046

Oscilloscope Operation Screen

#### 1. Sweep

Displays selected Oscilloscope Sweep. Selections include:

100 $\mu$ s/div	200 $\mu$ s/div	500 $\mu$ s/div
1 ms/div	2 ms/div	5 ms/div
10 ms/div	20 ms/div	50 ms/div
100 ms/div	200 ms/div	500 ms/div

Soft Function Keys available with this function include:

- F1 MENU  
Accesses Menu to set Oscilloscope Scale.
- F6 RETURN  
Exits Menu into normal operation.
- F2 ROLL  
Views the scope trace in a roll mode when the selected sweep rate is 100 ms/div or higher.

F2 SLOW  
Returns to the normal  
mode of operation.

2. Oscilloscope Screen

Displays digitized trace of specified  
signal.

3. Marker Position

Displays current Marker Position if  
Marker (10) is active or OFF if  
inactive. Value for Marker Position  
is in same units as Sweep (1) with  
Trigger point as reference.

Soft Function Keys available with  
this function include:

F1 On/Off  
Toggles Marker (10) between  
ON and OFF.

4. Trigger Type

Displays selected Trigger Type.  
Selections include Auto, One Shot  
and Normalized.

Soft Function Keys available with  
this function include:

F1 NORM  
Selects Normalized as Trigger  
Type.

F2 AUTO  
Selects Auto as Trigger Type.

F3 1 SHOT  
Selects One Shot as Trigger  
Type. Pressing 1 SHOT Soft  
Function Key reenables Trigger.

5. Trigger

Adjusts trigger level as indicated by  
Trigger Level Indicator (11) when  
accessed.

6. Mode

Displays selected Operation Mode.  
Selections include Menu, Average, Pk  
Hold, Min Hold and Store. Menu  
displays a menu window with  
selections Live, Recall, Compare,  
Live-Ref and Ref-Live. Live displays  
current signal without modification.  
Recall displays Stored trace only.  
Compare displays Stored trace and  
live trace simultaneously. In  
Live-Ref, the value of each point of  
the reference trace is subtracted from  
the current reading and the result is  
displayed. In Ref-Live, the value of  
current reading is subtracted from the  
stored value and the result is  
displayed. Both Live-Ref and  
Ref-Live require a previously stored  
trace. Average displays average of  
last four traces. Pk Hold displays  
and holds the trace peak. Min Hold  
displays and holds minimum trace.  
Store places copy of current trace in  
memory.

Soft Function Keys available with  
this function include:

F1 MENU  
Accesses a Menu with Mode  
selections.

F1 LIVE  
Selects LIVE as  
Oscilloscope Operation  
Mode.

F2 RECALL  
Selects RECALL as  
Oscilloscope Operation  
Mode.

F3 COMPARE  
Selects COMPARE as  
Oscilloscope Operation  
Mode.

- F4 LIVE-REF  
Selects LIVE-REF as Oscilloscope Operation Mode.
- F5 REF-LIVE  
Selects REF-LIVE as Oscilloscope Operation Mode.
- F6 RETURN  
Exits Menu into Generate Operation Screen.

- F2 AVG  
Activates/deactivates Average Oscilloscope Operation Mode.
- F3 PK HOLD  
Activates/deactivates Peak Hold Oscilloscope Operation Mode.
- F4 MIN HOLD  
Activates/deactivates Minimum Hold Oscilloscope Operation Mode.
- F6 STORE  
Stores the current trace.

7. H Pos

Displays selected horizontal offset in major divisions. Selections range from -10 to +10 Divisions.

8. V Pos

Accesses vertical position of trace. Trace above or below screen is indicated by straight line trace at top or bottom graticule.

9. Coupling

Displays selected Oscilloscope Coupling. Selections include AC, DC and GND (Ground).

Soft Function Keys available with this function include:

- F1 GND  
Selects GND (Ground) as Oscilloscope Coupling.
- F2 AC  
Selects AC as Oscilloscope Coupling.
- F3 DC  
Selects DC as Oscilloscope Coupling.

10. Marker

User editable Marker controlled using MARKER Position (3). Movable through extent of visible screen.

11. Trigger Level Indicator

Indicates approximate level of Oscilloscope Trigger Level. Editable using TRIGGER (5).

12. Oscilloscope Scale

Displays selected Oscilloscope Vertical Scale. Scales available include:

10 mV	20 mV	50 mV
100 mV	200 mV	500 mV
1 V	2 V	5 V
10 V	20 V	50 V

Soft Function Keys available with this function include:

- F1 MENU  
Accesses Menu to set Oscilloscope Scale. Soft Function Keys available with this function include:
- F6 RETURN  
Exits Menu into normal operation.

### 3-3-5 SPECTRUM ANALYZER OPERATION SCREEN

The Independent Spectrum Analyzer Operation Screen operates independent of the Test Modes. The Spectrum Analyzer Operation Screen is accessed by pressing the

ANLYZ Instruments Key. When accessed, the Spectrum Analyzer Operation Screen is set up in the configuration last used.

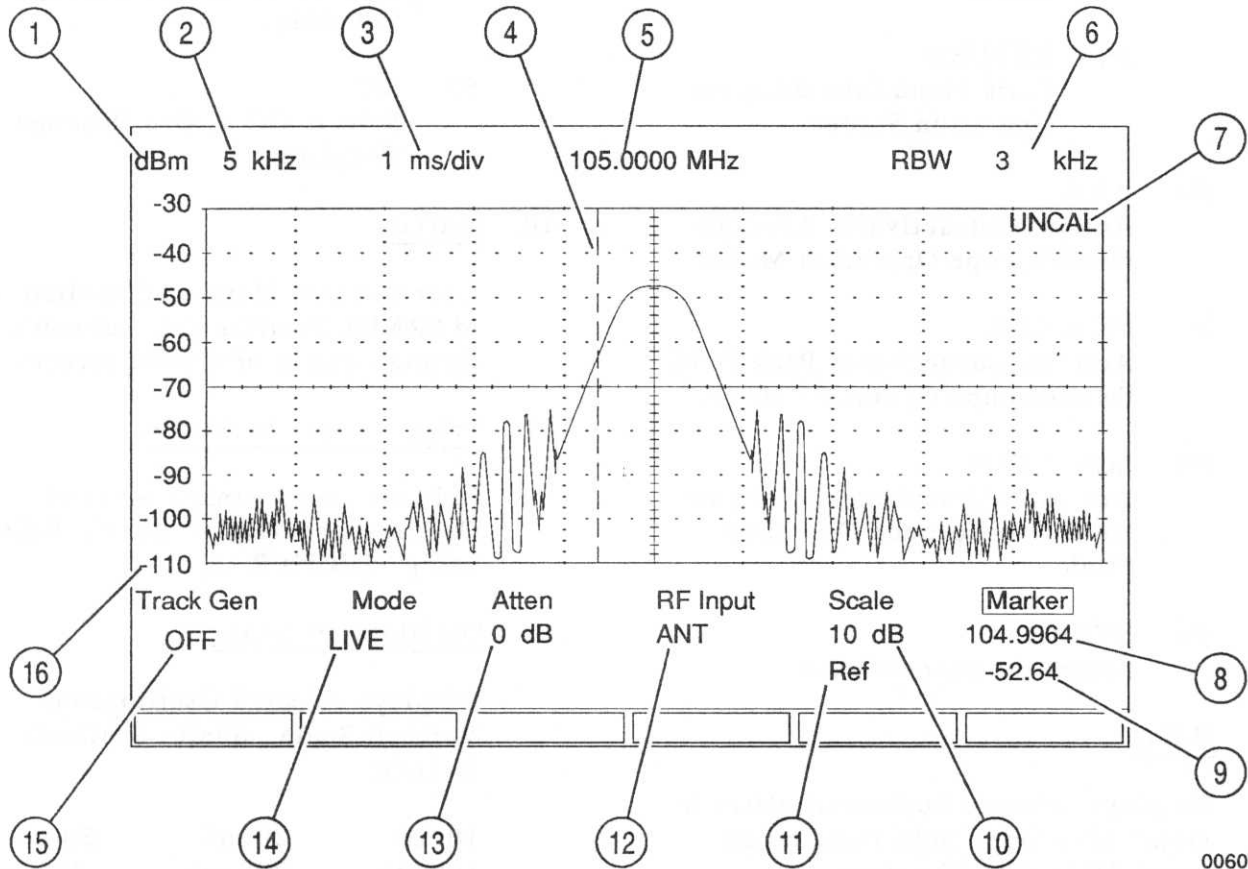

00607047

Spectrum Analyzer Operation Screen

#### 1. Logarithmic Function

Displays Logarithmic Function for referencing Vertical Scale (14). Selections include dBm, dB $\mu$ V, dBmV, dBV, dB $\mu$ W and dBW.

Soft Function Keys available with this function include:

F1 dBm  
Selects dBm as Logarithmic Function.

F2 dB $\mu$ V  
Selects dB $\mu$ V as Logarithmic Function.

Soft Function Keys available with this function include:

F1 On/Off  
Toggles Marker (3) between ON and OFF.

#### 9. Marker Level

Displays current Marker Level if Marker (4) is active. Displays Blank if Marker (4) is OFF.

#### 10. Scale

Displays Logarithmic Scale for Vertical Scale (16). Selections are 2 and 10 dB.

F1 10 dB  
Selects 10 dB Logarithmic Scale for Spectrum Analyzer Vertical Scale (14).

F2 2 dB  
Selects 2 dB Logarithmic Scale for Spectrum Analyzer Vertical Scale (14).

#### 11. Reference

Adjusts Spectrum Analyzer Vertical Scale (16)  $\pm 10$  dB when Scale (10) is set to 10 dB. When Scale (10) is set to 2 dB, adjusts Spectrum Analyzer Vertical Scale (16) through full range, displaying 16 dB window and incrementing in 1 dB steps.

#### 12. RF Input

Displays RF Input. Selections are ANT (ANTENNA Connector) and T/R (T/R Connector).

Soft Function Keys available with this function include:

F1 T/R  
Selects T/R Connector as RF Input Connector.

F2 ANT  
Selects ANTENNA Connector as RF Input Connector.

#### 13. Attenuation

Displays selected Attenuation for RF Input (12). Selections include 0 and 30 dB.

Soft Function Keys available with this function include:

F1 30 dB  
Selects 30 dB Attenuation for RF Input (12).

F2 0 dB  
Selects 0 dB Attenuation for RF Input (12).

#### 14. Mode

Displays selected Operation Mode. Selections include Menu, Average, Peak Hold, Minimum Hold and Store. Menu displays a menu window with selections Live, Recall, Compare, Live-Ref and Ref-Live. Live displays current signal without modification. Recall displays Stored trace only. Compare displays Stored trace and live trace simultaneously. In Live-Ref, the value of each point of the reference trace is subtracted from the current reading and the result is displayed. In Ref-Live, the value of current reading is subtracted from the stored value and the result is displayed. Both Live-Ref and Ref-Live require a previously stored trace. Average displays average of last four traces. Pk Hold displays and holds the trace peak. Min Hold displays and holds minimum trace.



Store places copy of current trace in memory.

Soft Function Keys available with this function include:

- F1 MENU  
Accesses a Menu with Mode selections.
- F1 LIVE  
Selects LIVE as Spectrum Analyzer Operation Mode.
- F2 RECALL  
Selects RECALL as Spectrum Analyzer Operation Mode.
- F3 COMPARE  
Selects COMPARE as Analyzer Spectrum Operation Mode.
- F4 LIVE-REF  
Selects LIVE-REF as Spectrum Analyzer Operation Mode.
- F5 REF-LIVE  
Selects REF-LIVE as Spectrum Analyzer Operation Mode.
- F6 RETURN  
Exits Menu into Generate Operation Screen.
- F2 AVG  
Activates/deactivates Average Spectrum Analyzer Operation Mode.

F3 PK HOLD  
Activates/deactivates Peak Hold Spectrum Analyzer Operation Mode.

F4 MIN HOLD  
Activates/deactivates Minimum Hold Spectrum Analyzer Operation Mode.

F6 STORE  
Stores the current trace.

#### 15. Tracking Generator (Option 12)

Displays Tracking Generator Signal level available at AUX RF OUT Connector when active and OFF when inactive. Displayed only with Option 12 installed.

Soft Function Keys available with this function include:

F1 On/Off  
Sets Tracking Generator (Option 12) ON or OFF.

#### 16. Vertical Scale

Provides logarithmic scale for trace. Position is controlled by Reference (11).

## B. SINAD METER

The SINAD Meter determines SINAD for a 1 kHz tone passed to the COM-120B through the specified

Source. Information provided the user is displayed below:

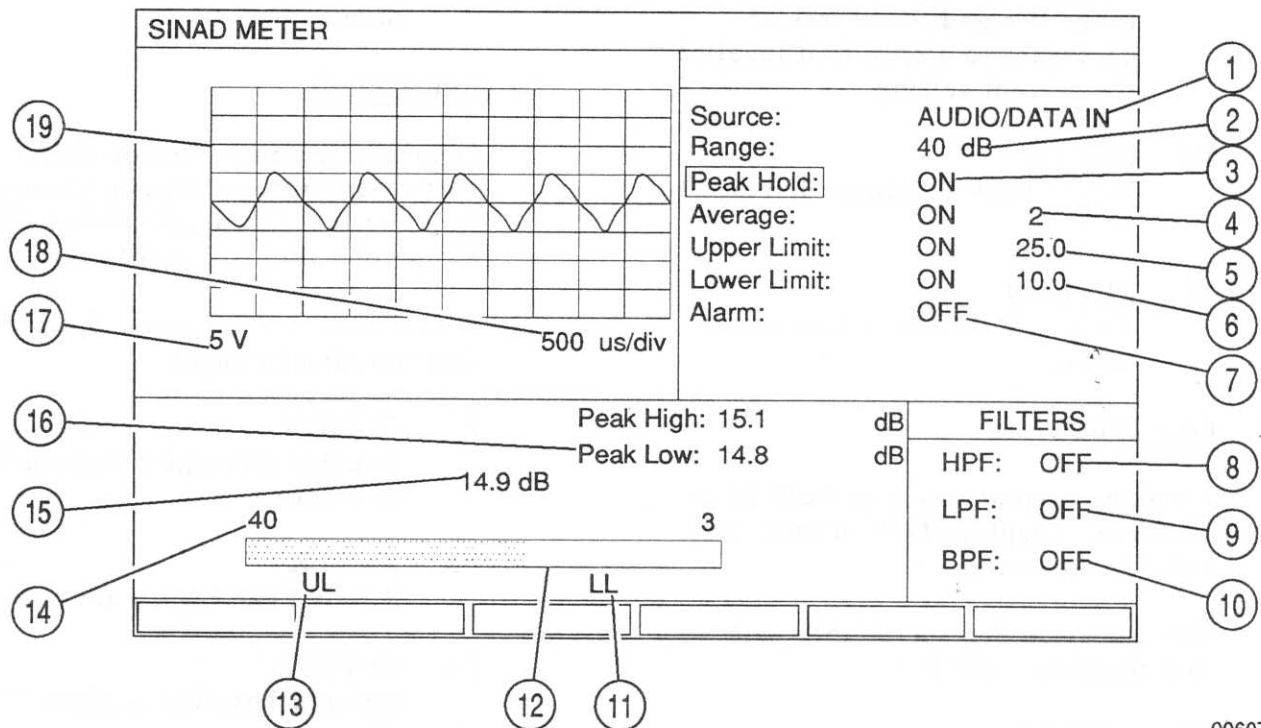

00607087

### 1. Source

Displays selected source for SINAD Meter. Selections include AUDIO/DATA IN Connector and Scope/DVM Connector.

Soft Function Keys available with this function include:

- F1 AUD/DAT  
Selects AUDIO/DATA IN Connector as Source for SINAD Meter.
- F2 SCP/DVM  
Selects Scope/DVM Connector as Source for SINAD Meter.
- F5 RST PK  
Resets Peak Hold Function.

### F6 RETURN

Returns Test Set to Meters Menu.

### 2. Range

Displays selected SINAD Meter Upper Range. Selections include Autorange, 15 dB and 40 dB.

Soft Function Keys available with this function include:

- F1 15 dB  
Selects 15 dB as active upper range for SINAD Meter.
- F2 40 dB  
Selects 40 dB as active upper range for SINAD Meter.

F3 AUTO  
Selects Autorange as active upper range for SINAD Meter. This setting will automatically adjust to a higher or lower upper range if signal increases or decreases to a specified level of the current setting.

F5 RST PK  
Resets Peak Readings displayed to 0.

F6 RETURN  
Returns Test Set to Meters Menu.

### 3. Peak Hold

Displays current status of Peak Hold function. Displays OFF or ON. Not valid in Autorange.

Soft Function Keys available with this function include:

F1 OFF/ON  
Toggles Peak Hold Function On and Off.

F5 RST PK  
Resets Peak Hold Function.

F6 RETURN  
Returns Test Set to Meters Menu.

### 4. Average

Displays current status of Averaging Function and number of samples when active. Status is Off or On. Range of samples is 2 to 10.

Soft Function Keys available with this function include:

F1 OFF/ON  
Toggles Average Function On and Off.

F5 RST PK  
Resets Peak Hold Function.

F6 RETURN  
Returns Test Set to Meters Menu.

### 5. Upper Limit

Displays current status of Upper Limit Function and Upper Limit value when active. Status is OFF or ON. Range of value is 0 to 40 dB.

Soft Function Keys available with this function include:

F1 OFF/ON  
Toggles Average Function On and Off.

F5 RST PK  
Resets Peak Hold Function.

F6 RETURN  
Returns Test Set to Meters Menu.

### 6. Lower Limit

Displays current status of Lower Limit Function and Lower Limit value when active. Status is OFF or ON. Range of value is 0 to 40 dB.

Soft Function Keys available with this function include:

F1 OFF/ON  
Toggles Average Function On and Off.

F5 RST PK  
Resets Peak Hold Function.

F6 RETURN  
Returns Test Set to Meters Menu.

## 4-2 RF GENERATE OPERATION

Pressing the GEN MODE Key accesses the RF Generate Operation Screen. The purpose of the RF Generate Mode is for the COM-120B to act as a transmitter and test a receiver. This section provides information in configuring the COM-120B to perform tests on the receiver.

This section is provided to explain how each of the active fields are edited and what selections are available. It is not designed to perform a specific test, but instead is provided as a reference for operating the RF Generate Operation Screen. Below is a list of Operations available with the RF Generate Operation Screen:

### 4-2-1 RF Generate General Operation

### 4-2-2 Generating FM Modulated RF Signal

### 4-2-3 Generating AM Modulated RF Signal

### 4-2-4 Generating PM Modulated RF Signal

### 4-2-5 Generating DCS Coded RF Signal

### 4-2-6 Generating DTMF Coded RF Signal

### 4-2-7 Generating RF Signal Using External Modulation

### 4-2-8 Generating Microphone Modulated RF Signal

### 4-2-9 Measuring Receiver Center Frequency

### 4-2-10 Measuring Receiver Sensitivity

### 4-2-11 Measuring Receiver Selectivity

### 4-2-12 Measuring Receiver Audio Output Level

### 4-2-13 Measuring Modulation Acceptance Bandwidth

### 4-2-14 Measuring Receiver IF Bandwidth

## 4-2-1 RF GENERATOR GENERAL OPERATION

### A. RF GENERATE GENERAL OPERATION SCREEN

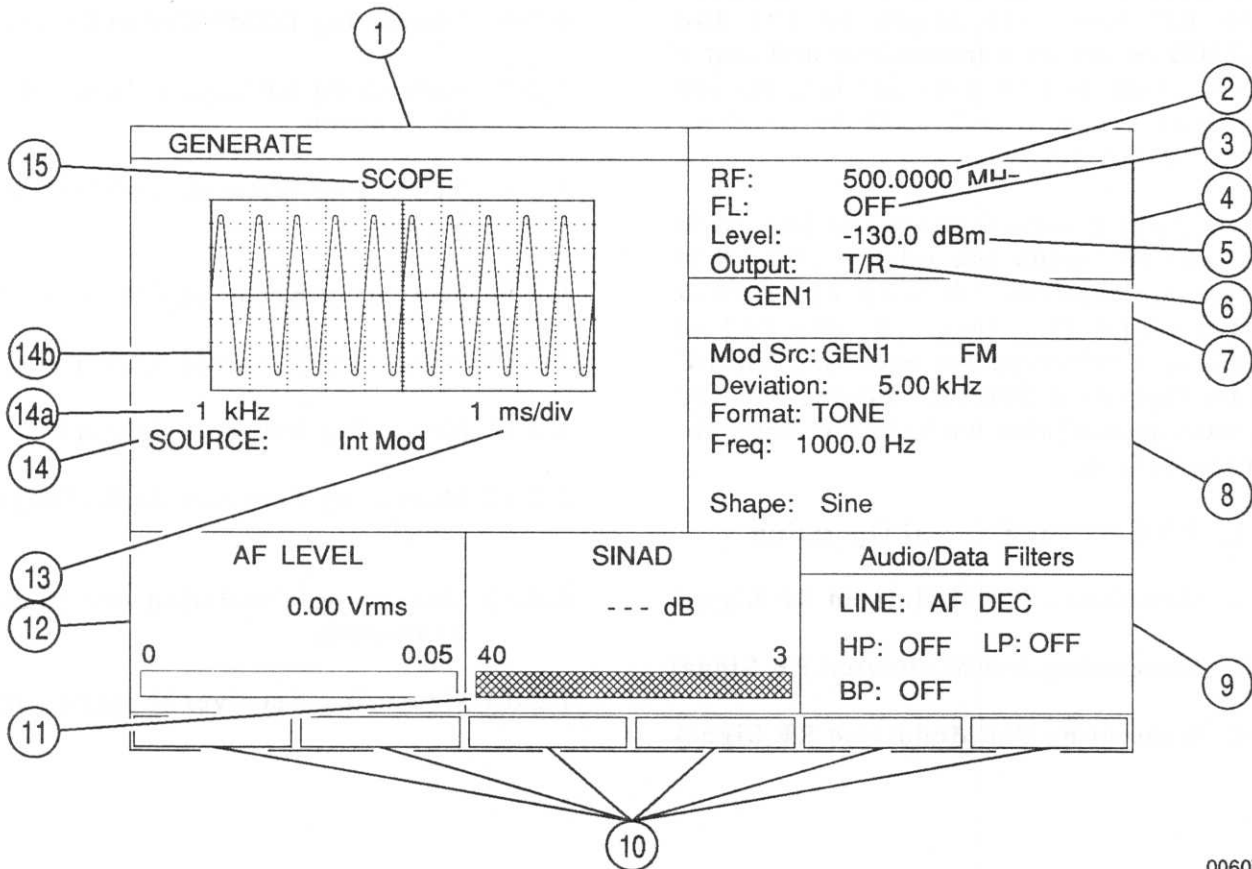

00607078

RF Generator Operation Screen

1. Enter desired frequency in RF Field (2). Frequency range is .0000 to 1000 MHz. Activate additional functions as required as follows:

- To operate with  $\Delta$  Function active:

- Press  $\Delta$  On/Off Soft Function Key F2 until  $\Delta$  prompt appears beside RF Field (2).
- $\Delta$ = increment is accessed by pressing  $\Delta$ = Soft Function Key F1, activating window to set RF Field (2) change increment. Range is 0 to 500 MHz. Press

RETURN Soft Function Key F6 to close Change Window.

- To deactivate  $\Delta$  Function, press  $\Delta$  On/Off Soft Function Key F2 until  $\Delta$  prompt no longer appears beside RF Field (2).
- To Operate with Set Reference Function, press SET REF Soft Function Key F3 until *R* appears beside RF Field (2). When active, RF Field (2) is set to 0 MHz and changes made to RF Field (2) display offset from Reference

Frequency. To deactivate Set Reference Function, press SET REF Soft Function Key until R is not visible.

- To Operate with Sweep Operation, press SWEEP Soft Function Key F4 to open Sweep Configuration Window. Once Sweep Configuration Window is opened:
  - Move Cursor to Start Field. Enter Start Frequency for Sweep Operation.
  - Move Cursor to Stop Field. Enter Stop Frequency for Sweep Operation.
  - Move Cursor to Increment Field. Enter Increment for Sweep Operation.
  - Move Cursor to Pause Time Field. Enter time to pause at each frequency.
  - If single sweep is desired, press SINGLE Soft Function Key F3. If continuous sweep is desired, press START Soft Function Key F1. To stop Sweep Function, press STOP Soft Function Key F2. To resume Sweep Operation once stopped, press RESUME Soft Function Key F5.
  - Press RETURN Soft Function Key F6 to exit Sweep Function.

Set Reference Function and Sweep Function cannot be active simultaneously.

- To Operate with RF Generate, RF Receive and Spectrum Analyzer RF Frequencies locked, press LOCK/UNLOCK Soft Function Key F5 until L is displayed beside

RF Field and UNLOCK is displayed for F5 definition. Press UNLOCK Soft Function Key F5 to set LOCK Function to OFF.

2. If Frequency List Operation is desired instead of entering frequency in RF Field (2), select Frequency List (3) Setting as follows:

- Select desired Frequency List (3) Type as follows:
  - Press T-Fwd Soft Function Key F2 to select Trunking Forward Channel List.
  - Press T-Rvs Soft Function Key F3 to select Trunking Reverse Channel List.
  - Press C-Fwd Soft Function Key F4 to select Cellular Forward Channel List.
  - Press C-Rvs Soft Function Key F5 to select Cellular Reverse Channel List.
  - Press FL Soft Function Key F6 to select User Defined Frequency List.
- Press ON/OFF Soft Function Key F1 to active Frequency List (3) Setting.
- If Cellular Channel List or User Defined Frequency List is selected, enter channel/frequency number. Range of cellular channels is 1 to 1023. Range of Frequency List is 0 to 99.
- If Trunking Channel List is selected, select channel number. Select Frequency Band by moving cursor to Frequency Band Field and pressing ENTER. Select desired Frequency Band using DATA

SCROLL Keys or DATA SCROLL Spinner. Press ENTER Key.

3. Set Output Level (5) as follows:

- Select Output Level Units as follows:
  - Press dBm Soft Function Key F1 to select dBm as Output Level Units.
  - Press uV Soft Function Key F2 to select  $\mu$ V as Output Level Units.
  - Press mV Soft Function Key F3 to select mV as Output Level Units.
  - Press V Soft Function Key F4 to select V as Output Level Units.
- Once Output Level Units are selected, select Output Level.
- To operate with SINAD Search Function:
  - Press SINAD= Soft Function Key F5 to access field to set SINAD Search Function value. Range of SINAD = is 6 to 30 dB.
  - Press RETURN Soft Function Key F6.
  - Press S=On/Off Soft Function Key F6 until S= is displayed beside Output Level Field to activate SINAD Search Function.
  - Press S=On/Off Soft Function Key F6 until S= disappears to deactivate SINAD Search Function.

4. Select Output (6) as follows:

- Press T/R Soft Function Key F1 to select T/R Connector as output connector.
- Press AUX Soft Function Key F2 to select AUX RF Connector as output connector.
- Press T/R Gate Soft Function Key F3 to select T/R Connector as output connector.
- Press AUX Gate Soft Function Key F4 to select AUX RF Connector as gated output connector.

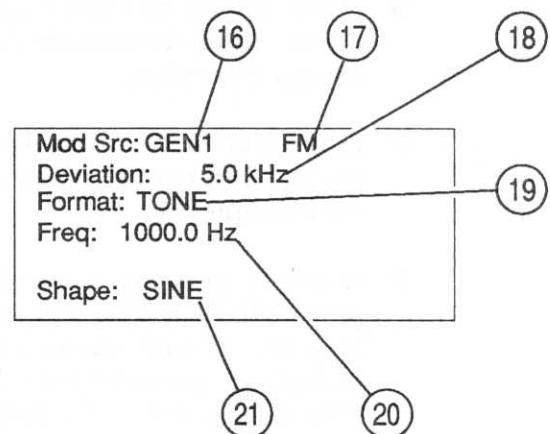

8717021

5. Modulation Source Window (7) displays all active Function Generators. To activate or deactivate Function Generators, each Function Generator must be edited separately. If two (or more) sections of the RF Modulator are set in conflict (e.g. GEN1 set for PM and GEN2 set for FM, or GEN1 set for 0.001 kHz deviation and GEN2 set for 2.60 kHz deviation) the screen displays the invalid source grayed out. Set Modulation Source Block (8) as follows:

- If Audio Generator 1 (GEN1) Operation is desired, perform Step 6.
  - If Audio Generator 2 (GEN2) Operation is desired, perform Step 7.
  - If DATA Generator (DATA) Operation is desired, perform Step 8.
  - If DTMF Generator (DTMF) Operation is desired, perform Step 9.
  - If External Modulation (EXT) Operation is desired, perform Step 10.
  - If Microphone Modulation (MIC) Operation is desired, perform Step 11.
6. If Audio Generator 1 (GEN1) Operation is desired, set Modulation Source Block (8) as follows:
- Press GEN1 Soft Function Key F1 to select GEN1 for Modulation Source (16).
  - Select Modulation Type (17) as follows:
    - Press OFF Soft Function Key F1 to deactivate GEN1.
    - Press AM Soft Function Key F2 if AM Modulation is desired.
    - Press FM Soft Function Key F3 if FM Modulation is desired.
    - Press PM Soft Function Key F4 if PM Modulation is desired.
  - Enter Deviation/Modulation Level (18). Range is 0.00 to 100 kHz
    - for FM Modulation, 0.0% to 100.0% for AM Modulation and 0.00 to 10 Radians for PM Modulation.
- Select Format (19). Formats available include TONE and USER.
  - With cursor on Format (19), select transmission type:
    - Press CONT Soft Function Key F2 to select continuous transmission of signal.
    - Press BURST Soft Function Key F3 if single transmission of selected signal.
    - If TONE is selected as Format (19), press TIME Soft Function Key F4 to access Burst Time Window. Enter Burst Time. Press RETURN Soft Function Key F6 to exit Window.
    - IF USER is selected as Format (19), press CONFIG Soft Function Key F4 to access Configuration Window for configuring User Selectable Frequency and Duration for codes 0 through 9 and A through T. Enter desired frequencies and durations for codes. Range of frequencies are 0 to 9999.9 Hz. Range of durations are 0 to 99.999 seconds. Use PG UP Soft Function Key F1 to scroll up through Configuration Window. Use PG DN to scroll down through Configuration Window. Use FILL Soft Function Key F3 to fill remainder of current column with value of current cursor position. Press RETURN Soft Function Key F6 to exit Window.



- If TONE is selected as Format (19):
  - Enter Audio Tone Frequency (20). Range is 5 Hz to 20000 Hz with Shape (21) set to SINE. Range is 5 Hz to 10000 Hz otherwise.

- Select Shape (21) of Wave as follows:

- Press SINE Soft Function Key F1 to select SINE Wave Shape.
- Press RAMP Soft Function Key F2 to select RAMP Wave Shape.
- Press TRIANGLE Soft Function Key F3 to select TRIANGLE Wave Shape.
- Press SQUARE Soft Function Key F4 to select SQUARE Wave Shape.

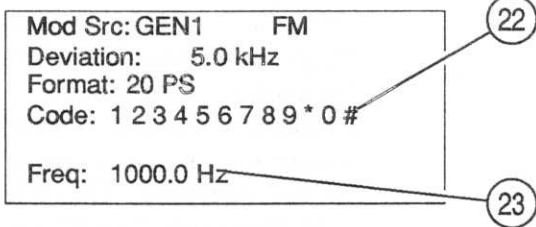

8717023

- If TONE is not selected Format (19):

- Enter Code (22). Pressing CLEAR Soft Function Key F1 clears current code entry.

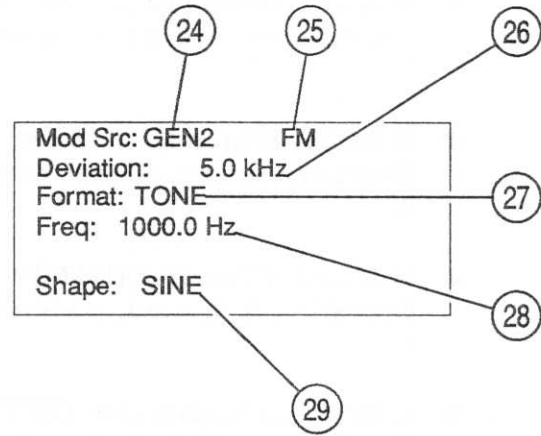

8717024

7. If Audio Generator 2 (GEN2) Operation is desired, set Modulation Source Block (8) as follows:

- Press GEN2 Soft Function Key F2 to select GEN2 for Modulation Source (24).
- Select Modulation Type (25) as follows:
  - Press OFF Soft Function Key F1 to deactivate GEN2.
  - Press AM Soft Function Key F2 if AM Modulation is desired.
  - Press FM Soft Function Key F3 if FM Modulation is desired.
  - Press PM Soft Function Key F4 if PM Modulation is desired.
- Enter Deviation/Modulation Level (26). Range is 0.00 to 100 kHz for FM Modulation, 0.0% to 100.0% for AM Modulation and 0.00 to 10 Radians for PM Modulation.

- Select DTMF/SINAD Low-Pass Filter Field (54) setting as follows:
    - Press OFF Soft Function Key F1 to set Filter to OFF.
    - Press 4 kHz Soft Function Key F3 to activate 4 kHz Low-Pass Filter.
    - Press 20 kHz Soft Function Key F4 to activate 20 kHz Low-Pass Filter.
  - Press EXEC Soft Function Key F5 to Execute all edits made to the screen.
  - Select Speaker/Headphones Filter Field (56) setting as follows:
    - Press OFF Soft Function Key F1 to set Filter to OFF.
    - Press C-MSG Soft Function Key F2 to select C-Message Weighted Filter.
    - Press W.B. Soft Function Key F3 to select no filtering.
    - Press INT-MOD Soft Function Key F4 to route from Internal Modulation Sources to Speaker.
  - Move Cursor off Speaker/Headphones Filter Field (56) and press RETURN Soft Function Key F6 to return to RF Generate Operation Screen.
  - To display different Filter Line (48) settings:
    - Press AF DEC Soft Function Key F1 to display DTMF/SINAD Filter Settings.
    - Press SPKR Soft Function Key F2 to display Speaker/Headphones Filter Settings.
13. Select desired Meter Operation as follows:
- Press SINAD Soft Function Key F2 to select SINAD Meter as active meter. Not displayed if meter is currently active.
  - Press DIST Soft Function Key F3 to select Distortion Meter as active meter. Not displayed if meter is currently active.
14. If desired instrument is not shown, press ANALY/SCOPE Soft Function Key F2.

## B. SINAD METER

The SINAD Meter for the RF Generate Operation Screen measures SINAD for an audio signal passed through the AUDIO/DATA IN Connector. Filtering for the signal passed to the SINAD Meter is provided by the Audio/Data Filters.

Configure and operate the SINAD Meter as follows:

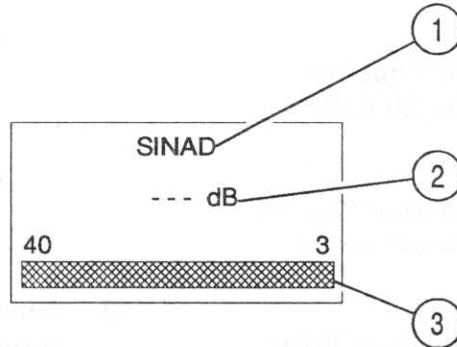

00607079

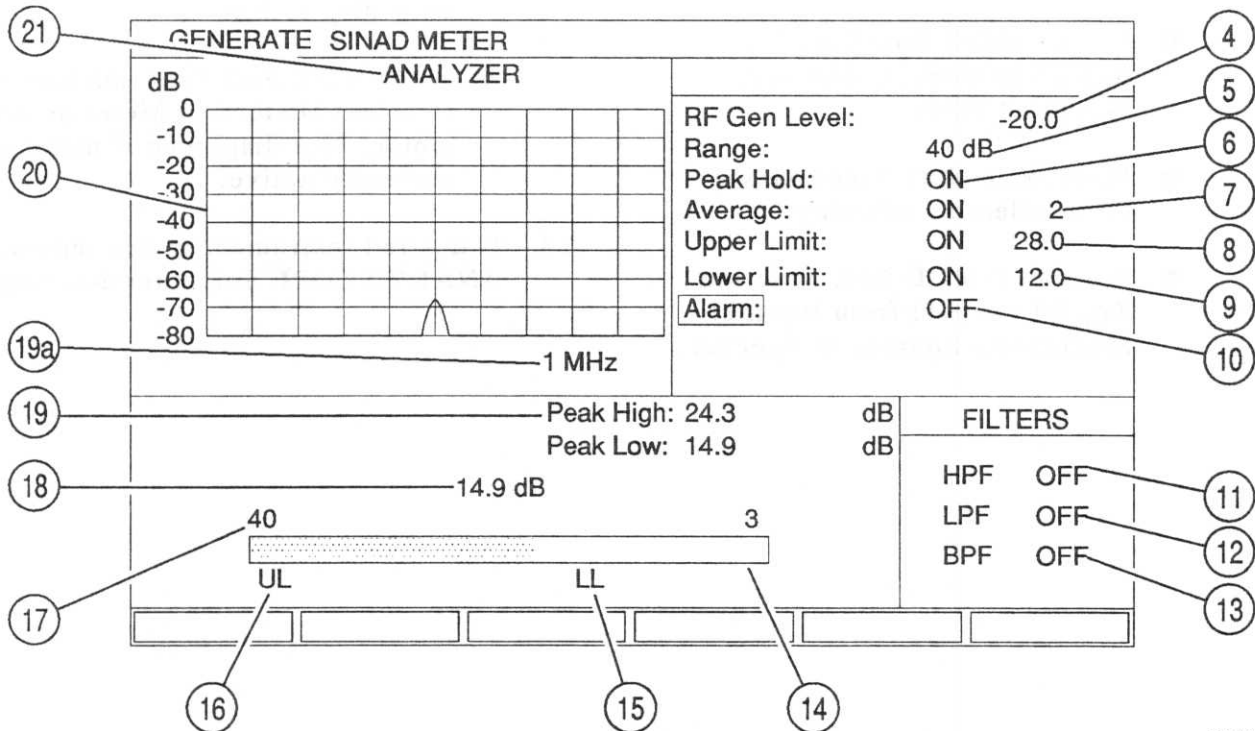

00607080

Source	Signal Input	Signal Type
Scope/DVM-GND	SCOPE/DVM Connector	External Ground-Coupled Signal
Scope/DVM-AC	SCOPE/DVM Connector	External AC-Coupled Signal
Scope/DVM-DC	SCOPE/DVM Connector	External DC-Coupled Signal
Ext Mod	EXT MOD IN Connector	External Modulation
Notch Residual	Internal Filtered Signal	Notch Filtered Signal passed to SINAD and Distortion Meters. Reading is relative with no units applied.
Audio/Data In	AUDIO/DATA IN Connector	External Audio or Data Signal
Int Mod	Internal Modulation	Composite Modulation Signal generated by Internal Audio/Data Generators

3. Select Oscilloscope Scale (5).  
Selections include:

SCOPE SOURCE (4)	Available Scales
Scope/DVM-GND	10, 20, 50, 100, 200, 500 mV/Div 1, 2, 5, 10, 20, 50 V/Div
Scope/DVM-AC	10, 20, 50, 100, 200, 500 mV/Div 1, 2, 5, 10, 20, 50 V/Div
Scope/DVM-DC	10, 20, 50, 100, 200, 500 mV 1, 2, 5, 10, 20, 50 V
Ext Mod	100, 200, 500 mV/Div 1, 2, 5 V/Div
Notch Residual	0.002, 0.004, 0.10, 0.20, 0.40, 1.00
Audio/Data In	100, 200, 500 mV/Div 1, 2, 5 V/Div
<u>Int Mod</u>	
GEN1 FM >25 kHz:	1, 2, 5, 10, 20, 50 kHz/Div
GEN1 FM 2.5 to 12.75 kHz:	1, 2, 5, 10, 20, 50 kHz/Div
GEN1 FM 12.75 to 25 kHz:	.2, .4, 1, 2, 4, 10 kHz/Div
GEN1 FM <2.5 kHz:	.2, .4, 1, 2, 4, 10 kHz/Div
GEN1 PM <2.55 RAD:	.2, .4, 1, 4, 10 RAD/Div
GEN1 PM >2.55 RAD:	1, 2, 5, 10, 20, 50 RAD/Div
GEN1 AM:	all settings 20%

Pressing ZOOM Soft Function Key F1 accesses full screen Oscilloscope, when cursor is on SCOPE/ANALYZER Prompt (1) of RF Generate Operation Screen and abbreviated Oscilloscope is displayed. SCOPE SOURCE (4) must be selected before Full Screen Oscilloscope is accessed. Configure the full screen Oscilloscope as follows:

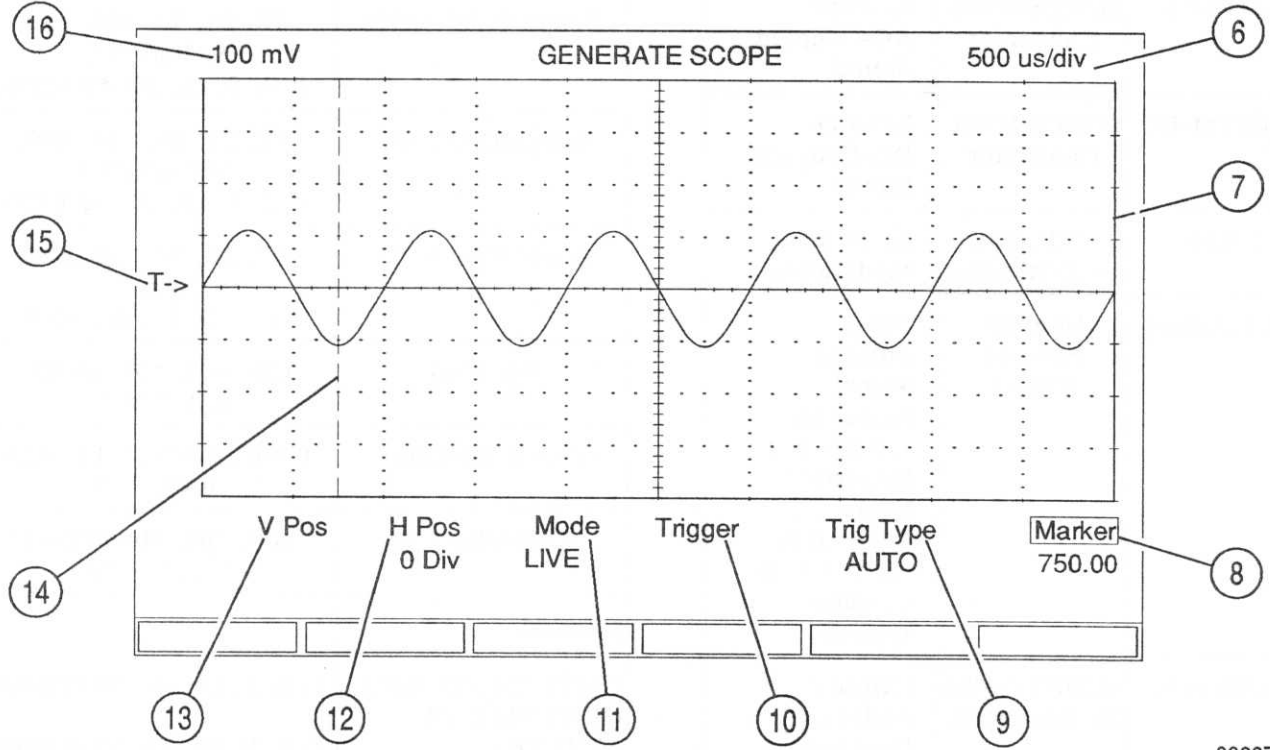

00607005

1. Select Sweep (6). Selections include:

- |                 |                 |                 |
|-----------------|-----------------|-----------------|
| 100 $\mu$ s/div | 200 $\mu$ s/div | 500 $\mu$ s/div |
| 1 ms/div        | 2 ms/div        | 5 ms/div        |
| 10 ms/div       | 20 ms/div       | 50 ms/div       |
| 100 ms/div      | 200 ms/div      | 500 ms/div      |

Press ROLL Soft Function Key F2 to view the scope trace in a roll mode when the selected sweep rate is 100 ms/div or higher. Press SLOW Soft Function Key F2 to return to the normal mode of operation.

2. Select Trigger Type (9) as follows:

- Press NORM Soft Function Key F1 to select Normalized Trigger.

- Press AUTO Soft Function Key F2 to select Auto Trigger.

- Press 1 SHOT Soft Function Key F3 to select One Shot Trigger. Press 1 SHOT Soft Function Key F3 as needed to reset Trigger.

3. Set Trigger Level (15) as follows:

- Move cursor to Trigger (10).
- Use DATA SCROLL Spinner or DATA SCROLL Keys to set Trigger.

4. Select Operation Mode (11) as follows:

- Press MENU Soft Function Key F1 to access Operation Mode menu selections.

- Press LIVE Soft Function Key F1 to select Live Operation Mode.
  - Press RECALL Soft Function Key F2 to select Recall Operation Mode.
  - Press COMPARE Soft Function Key F3 to select Compare Operation Mode.
  - Press LIVE-REF Soft Function Key F4 to select Live-Ref Operation Mode.
  - Press REF-LIVE Soft Function Key F5 to select Ref-Live Operation Mode.
  - Press RETURN Soft Function Key F6 to exit to Generate Scope.
- Press AVG Soft Function Key F2 to select Average Operation Mode.
  - Press PK HOLD Soft Function Key F3 to select Peak Hold Operation Mode.
  - Press MIN HOLD Soft Function Key F4 to select Minimum Hold Operation Mode.
  - Press STORE Soft Function Key F6 to store the current trace.
5. Select H Pos (12) Offset as needed. Range is -10 to 10 Divisions.
  6. Set Vertical Position of trace as needed by accessing V Pos (13) and editing with DATA SCROLL Keys or DATA SCROLL Spinner.
  7. Select Oscilloscope Scale (16). Selections available are dependent on Scope Source (4). Selections include:

SCOPE SOURCE (4)	Available Scales
Scope/DVM-GND	10, 20, 50, 100, 200, 500 mV/Div 1, 2, 5, 10, 20, 50 V/Div
Scope/DVM-AC	10, 20, 50, 100, 200, 500 mV/Div 1, 2, 5, 10, 20, 50 V/Div
Scope/DVM-DC	10, 20, 50, 100, 200, 500 mV 1, 2, 5, 10, 20, 50 V
Ext Mod	100, 200, 500 mV/Div 1, 2, 5 V/Div
Notch Residual	0.02, 0.04, 0.10, 0.20, 0.40, 1.00
Audio/Data In	100, 200, 500 mV/Div 1, 2, 5 V/Div
<u>Int Mod</u>	
GEN1 FM >25 kHz:	1, 2, 5, 10, 20, 50 kHz/Div
GEN1 FM 2.5 to 12.75 kHz:	1, 2, 5, 10, 20, 50 kHz/Div
GEN1 FM 12.75 to 25 kHz:	.2, .4, 1, 2, 4, 10 kHz/Div
GEN1 FM <2.5 kHz:	.2, .4, 1, 2, 4, 10 kHz/Div
GEN1 PM <2.55 RAD:	.2, .4, 1, 4, 10 kHz/Div
GEN1	1, 2, 5, 10, 20,50 RAD/Div
GEN1 AM:	all settings 20%

8. Activate Marker (14), as required, as follows:

- With Cursor on Marker Position (8), press On/Off Soft Function Key F1.
- Enter Desired Marker Position using DATA ENTRY Keys or DATA SCROLL Keys and/or DATA SCROLL Spinner.

## F. SPECTRUM ANALYZER OPERATION SCREEN

The RF Generator Spectrum Analyzer is usable as an abbreviated Spectrum Analyzer or as a Full Screen Spectrum Analyzer. Configuring one is reflected in the other.

The abbreviated Spectrum Analyzer, as shown below, is visible from the RF Generate Operation Screen and the following Meters:

SINAD Meter Operation Screen  
Distortion Meter Operation Screen  
Audio Frequency Level Meter Operation Screen

Parameters set on any of the above Operation Screens are reflected in all. Configuring the abbreviated Spectrum Analyzer is as follows:

1. Select Scan Width (3). Selections include zero scan and:

1 kHz	2 kHz	5 kHz
10 kHz	20 kHz	50 kHz
100 kHz	200 kHz	500 kHz
1 MHz		

- Press MENU Soft Function Key F1 for menu selections.
- Press CONFIG Soft Function Key F2 to access a pop up screen to configure Scan Width, Resolution Bandwidth (RBW) and Sweep rate.

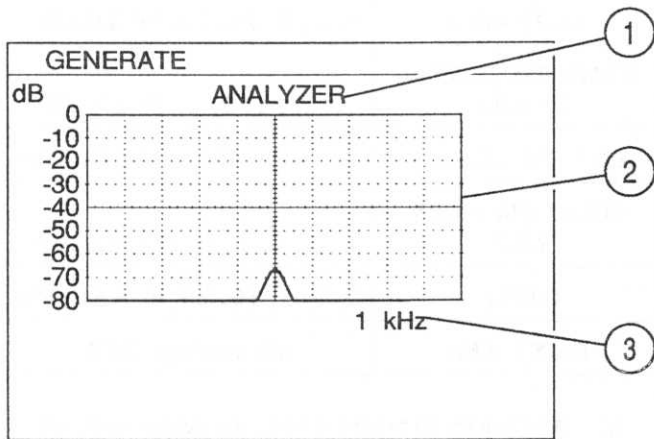

00607025

Pressing ZOOM Soft Function Key F1 accesses full screen Spectrum Analyzer, when cursor is on SCOPE/ANALYZER Prompt (1) of RF Generate Operation Screen and abbreviated Spectrum Analyzer is displayed. Available features and parameters are described below:

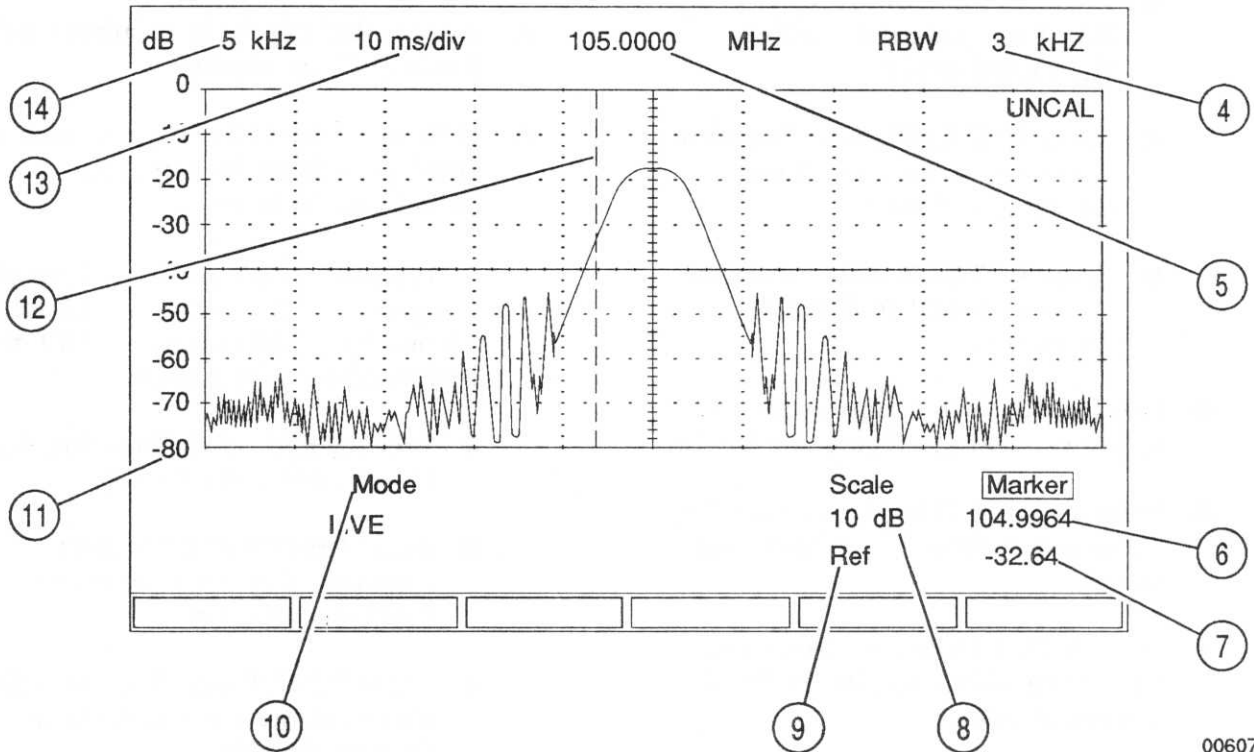

00607006

1. Set Center Frequency (5). Press Set Ref Soft Function Key F1 to set current Center Frequency as Reference Frequency.

2. Select Scan Width (14). Selections include zero scan and:

1 kHz	2 kHz	5 kHz
10 kHz	20 kHz	50 kHz
100 kHz	200 kHz	500 kHz
1 MHz	2 MHz	5 MHz
10 MHz	20 MHz	50 MHz
100 MHz		

The word "UNCAL" appears in the display when combinations of RBW, frequency span and sweep rate for which the analyzer is not calibrated are used.

3. Set Scale (8) as follows:

- Press 10 dB Soft Function Key F1 to select 10 dB for Vertical Scale (11).
- Press 2 dB Soft Function Key F2 to select 2 dB for Vertical Scale (11).

4. Select Mode (10) as follows:

- Press MENU Soft Function Key F1 to access Operation Mode menu selections.
- Press LIVE Soft Function Key F1 to select Live Operation Mode.
- Press RECALL Soft Function Key F2 to select Recall Operation Mode.



- Press COMPARE Soft Function Key F3 to select Compare Operation Mode.
  - Press LIVE-REF Soft Function Key F4 to select Live-Ref Operation Mode.
  - Press REF-LIVE Soft Function Key F5 to select Ref-Live Operation Mode.
  - Press RETURN Soft Function Key F6 to exit to Generate Analyzer.
5. Press AVG Soft Function Key F2 to select Average Operation Mode.
  - Press PK HOLD Soft Function Key F3 to select Peak Hold Operation Mode.
  - Press MIN HOLD Soft Function Key F4 to select Minimum Hold Operation Mode.
  - Press STORE Soft Function Key F6 to store the current trace.
5. Activate Marker (12), as required, as follows:
    - With Cursor on Marker Position (6), press On/Off Soft Function Key F1.
- Enter Desired Marker Position using DATA ENTRY Keys or DATA SCROLL Keys and/or DATA SCROLL Spinner.
6. Access Ref (9) Field to adjust Vertical Scale (11), as needed.
  7. If Scan Width (14) is set to zero scan, enter Zero Scan Sweep (13). Selections Include:
 

200 $\mu$ s/div	500 $\mu$ s/div	1 ms/div
2 ms/div	5 ms/div	10 ms/div
20 ms/div	50 ms/div	100 ms/div
200 ms/div	500 ms/div	
- Press MENU Soft Function Key F1 to set Zero Scan Sweep.
  - Press Press RETURN Soft Function Key F6 to exit into normal operation.
  - Press DEFLT Soft Function Key F5 to set the current field to factory default.
  - Press COUPLE Soft Function Key F6 to set the sweep and RBW to factory default state for the current scan width.

## G. STORE AND RECALL OPERATION

Pressing STORE Memory Key allows the operator to store up to 50 RF Generate Operation Screen configurations. Storage Locations 0 through 49 can be used to store a RF Generate Operation configuration, a RF Receive Operation configuration or a Duplex Operation configuration (Receive and Generate pair).

STORE Operation for RF Generate Operation is as follows:

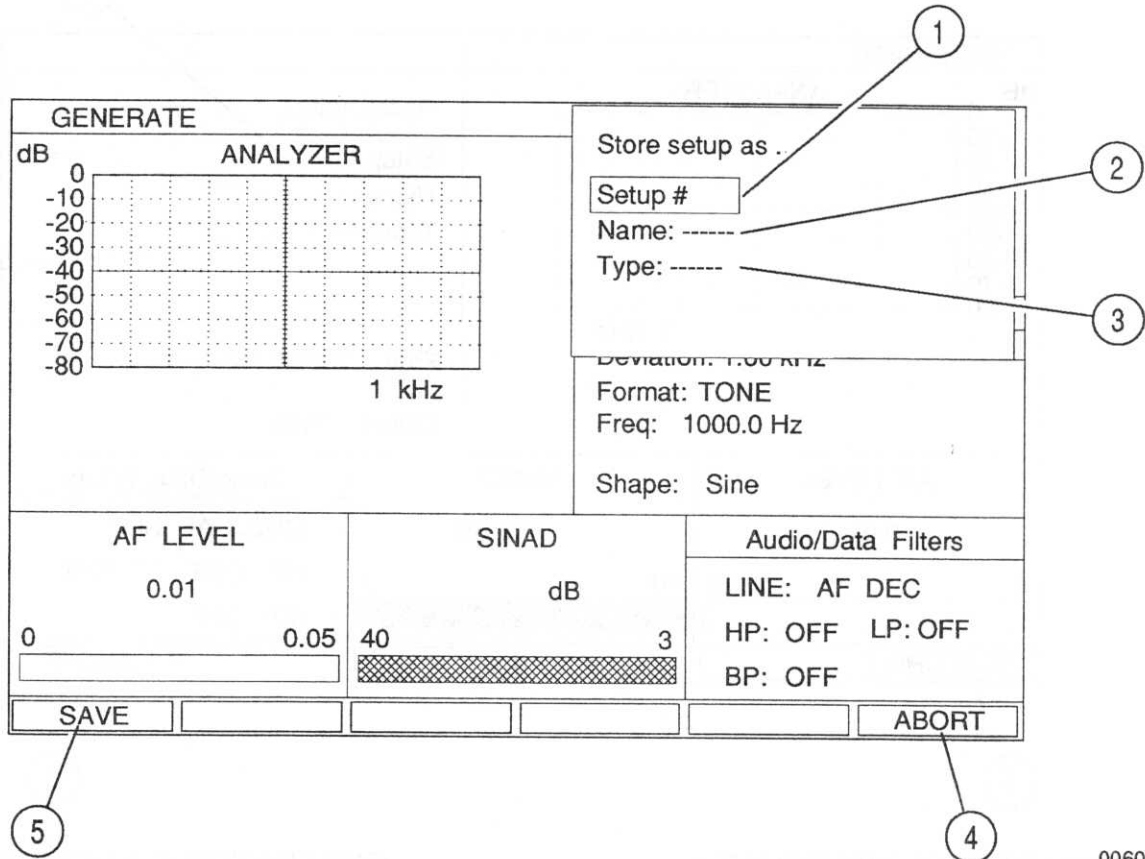

00607081

1. Press STORE MEMORY Key.
2. Enter or scroll through Setup # (1) value. Range is 0 to 49. Press ENTER Key.
3. If Name (2) is desired, press ENTER Key, with Cursor on Name (2). Enter Name using DATA ENTRY Keys. Name can be alphabetic and/or numeric characters. Press ENTER Key.
4. Type (3) displays the type of data currently saved in the specified setup number. Types saved are: DUPLEX, GENERATOR, RECEIVER, GENERATOR & RECEIVER and EMPTY.
5. Press SAVE Soft Function Key F1 (5) to accept selections and save Setup. Press ABORT Soft Function Key F6 (4) to escape without saving Setup.

Pressing RCL Memory Key allows the operator to recall up to 50 previously stored setups. RF Receive, RF Generate or Duplex Operation Screen configurations and all be accessed from the RF Generate Operation Screen. Accessing anything other than an RF Generate Operation Screen configuration, automatically switches the COM-120B to the selected mode of operation.

RECALL Operation for RF Generate Operation is as follows:

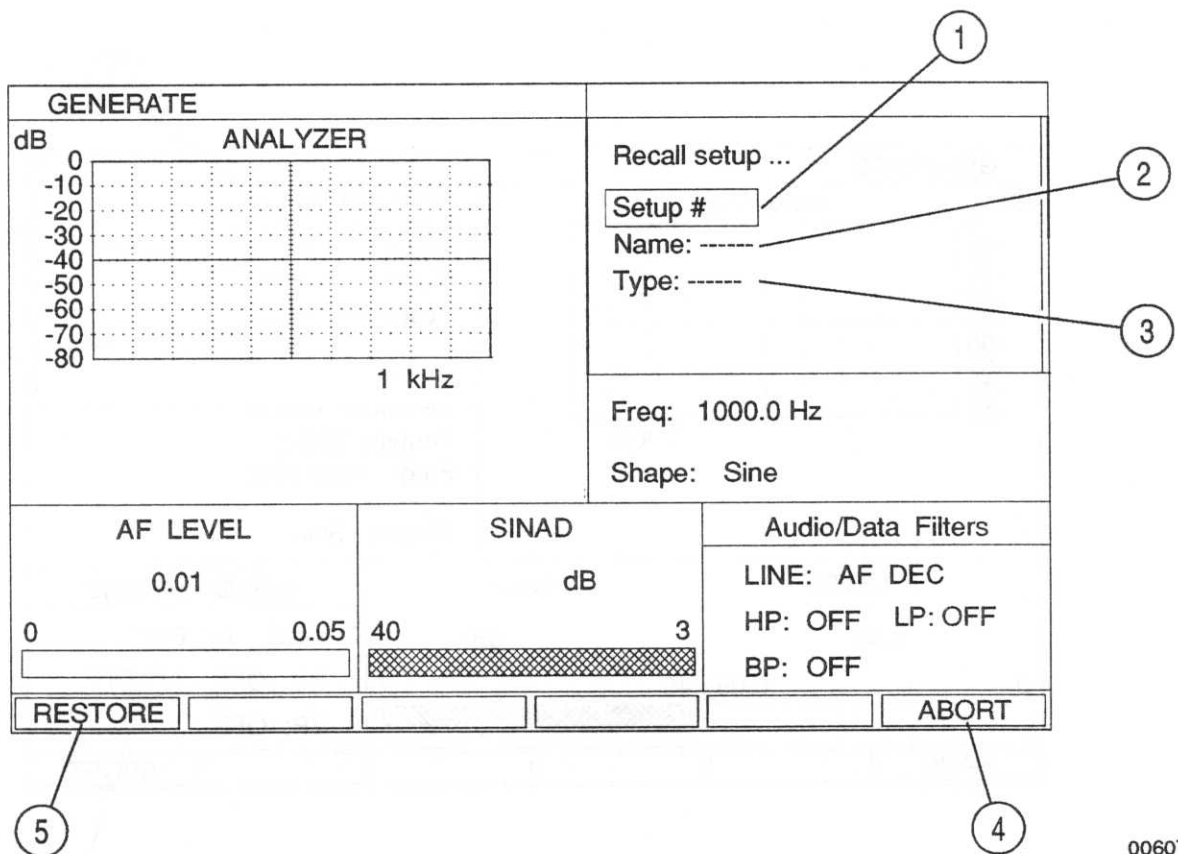

00607082

1. Press RECALL MEMORY Key.
2. Enter Setup # (1) value. Range is 0 to 49. Press ENTER Key.
3. Type (3) displays the type of data currently saved in the specified setup number. Types recalled are: DUPLEX, GENERATOR, RECEIVER, GENERATOR & RECEIVER and EMPTY.
4. Press RESTORE Soft Function Key F1 (5) to accept selections and recall Setup. Press ABORT Soft Function Key F6 (4) to escape without recalling Setup.

## B. SINAD METER

The SINAD Meter for the RF Receiver measures SINAD for a 1 kHz tone demodulated from an RF Signal. Filtering, for the signal passed to the SINAD Meter, is provided by the Audio/Data Filters.

Configure and operate the SINAD Meter as follows:

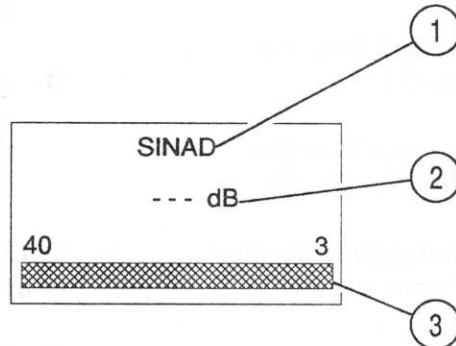

00607079

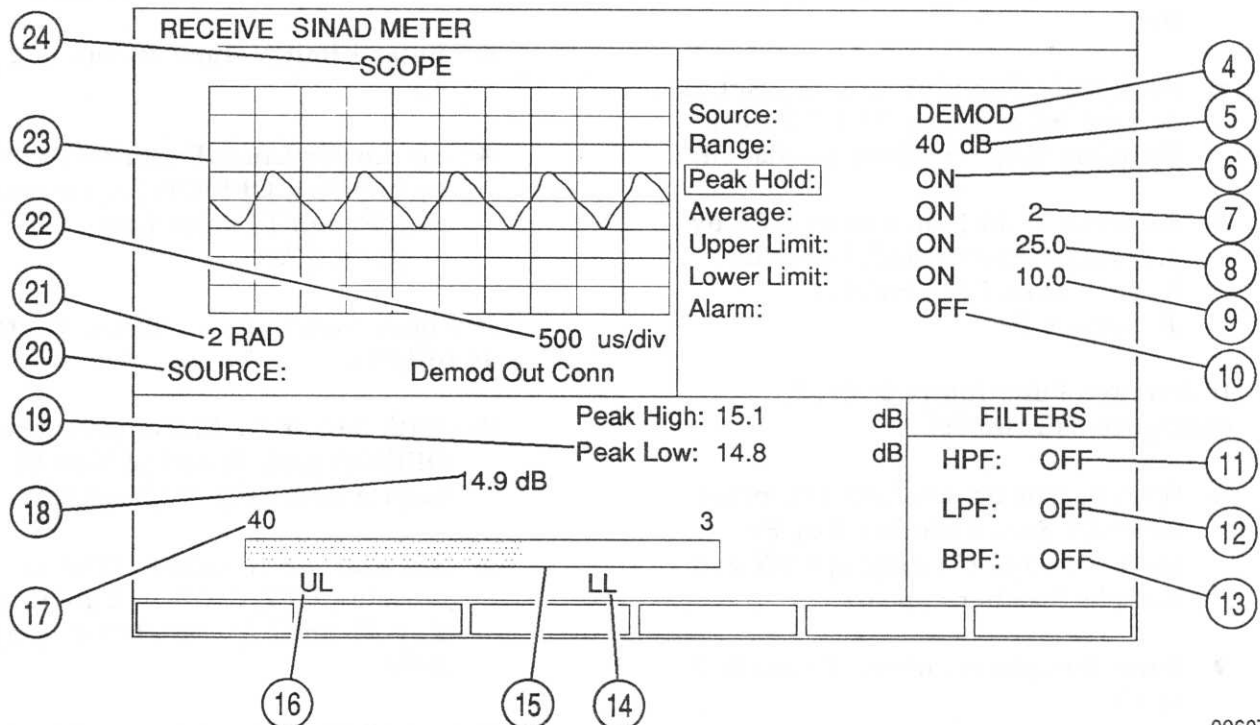

00607083

1. With cursor on SINAD/Distortion/Modulation Meter Label (1), press ZOOM Soft Key F1. Full Screen SINAD Meter is displayed.
2. Select Range (5) as follows:
  - Press 15 dB Soft Function Key F1 to select 15 dB Range (5).
  - Press 30 dB Soft Function Key F2 to select 30 dB Range (5).
  - Press AUTO Soft Function Key F3 to select Autorange for Range (5).
3. If Peak Hold Function is desired, do not select Autorange. Configure as follows:
  - With cursor on Peak Hold (6), press OFF/ON Soft Function Key F1 until Peak Hold (6) displays *ON*.
  - Peak Hold Function can be reset as desired by pressing RST PK Soft Function Key F5 where displayed.
  - Set Peak Hold Function to OFF by pressing OFF/ON Soft Function Key F1 until Peak Hold (6) displays *OFF*.
4. If Average Function is desired, configure as follows:
  - With cursor on Average (7), press OFF/ON Soft Function Key F1 until Average (7) displays *ON* and Sample Number appears.
  - Enter Sample Number. Range is 2 to 10.
  - Set Average Function to OFF by pressing OFF/ON Soft Function Key F1 until Average (7) displays *OFF*.
5. If Upper Limit Function is desired, configure as follows:
  - With cursor on Upper Limit (8), press OFF/ON Soft Function Key F1 until Upper Limit (8) displays *ON* and Limit Value appears.
  - Enter Limit Value. Range is 0 to 40.
  - Set Upper Limit Function to OFF by pressing OFF/ON Soft Function Key F1 until Upper Limit (8) displays *OFF*.
6. If Lower Limit Function is desired, configure as follows:
  - With cursor on Lower Limit (9), press OFF/ON Soft Function Key F1 until Lower Limit (9) displays *ON* and Limit Value appears.
  - Enter Limit Value. Range is 0 to 40.
  - Set Lower Limit Function to OFF by pressing OFF/ON Soft Function Key F1 until Lower Limit (9) displays *OFF*.
7. If Alarm Function is desired, configure as follows:
  - With cursor on Alarm (10), press OFF/ON Soft Function Key F1 until Alarm (10) displays *ON*.
  - Set Alarm Function to OFF by pressing OFF/ON Soft Function Key F1 until Alarm (10) displays *OFF*.
8. If desired instrument is not shown, press ANALY/SCOPE Soft Function Key F2.

1. With cursor on SINAD/Distortion/Modulation Meter Label (1), press ZOOM Soft Key F1. Full Screen Distortion Meter is displayed.
2. If Peak Hold Function is desired, do not select Autorange. Configure as follows:
  - With cursor on Peak Hold (6), press OFF/ON Soft Function Key F1 until Peak Hold (6) displays *ON*.
  - Peak Hold Function can be reset as desired by pressing RST PK Soft Function Key F5 where displayed.
  - Set Peak Hold Function to OFF by pressing OFF/ON Soft Function Key F1 until Peak Hold (6) displays *OFF*.
3. If Average Function is desired, configure as follows:
  - With cursor on Average (7), press OFF/ON Soft Function Key F1 until Average (7) displays *ON* and Sample Number appears.
  - Enter Sample Number. Range is 2 to 10.
  - Set Average Function to OFF by pressing OFF/ON Soft Function Key F1 until Average (7) displays *OFF*.
4. If Upper Limit Function is desired, configure as follows:
  - With cursor on Upper Limit (8), press OFF/ON Soft Function Key F1 until Upper Limit (8) displays *ON* and Limit Value appears.
    - Enter Limit Value. Range is 0% to 20%.
    - Set Upper Limit Function to OFF by pressing OFF/ON Soft Function Key F1 until Upper Limit (8) displays *OFF*.
5. If Lower Limit Function is desired, configure as follows:
  - With cursor on Lower Limit (9), press OFF/ON Soft Function Key F1 until Lower Limit (9) displays *ON* and Limit Value appears.
    - Enter Limit Value. Range is 0% to 20%.
    - Set Lower Limit Function to OFF by pressing OFF/ON Soft Function Key F1 until Lower Limit (9) displays *OFF*.
6. If Alarm Function is desired, configure as follows:
  - With cursor on Alarm (10), press OFF/ON Soft Function Key F1 until Alarm (10) displays *ON*.
  - Set Alarm Function to OFF by pressing OFF/ON Soft Function Key F1 until Alarm (10) displays *OFF*.
7. If desired instrument is not shown, press ANALY/SCOPE Soft Function Key F2.
8. If displayed, press RETURN Soft Function Key F6 to return to RF Receive Operation Screen. Alternately, press REC MODE Key to return to RF Receive Operation Screen.

## D. FM DEVIATION METER

The FM Deviation Meter for the RF Receiver measures FM Deviation for an RF Signal. Filtering, for the signal passed to the FM Deviation Meter, is provided by the Audio/Data Filters.

Configure and operate the FM Deviation Meter as follows:

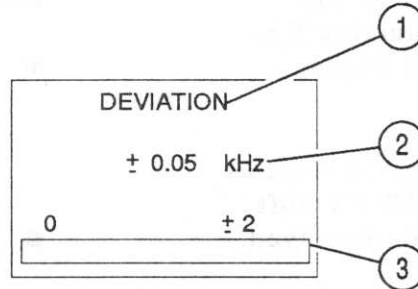

00607074

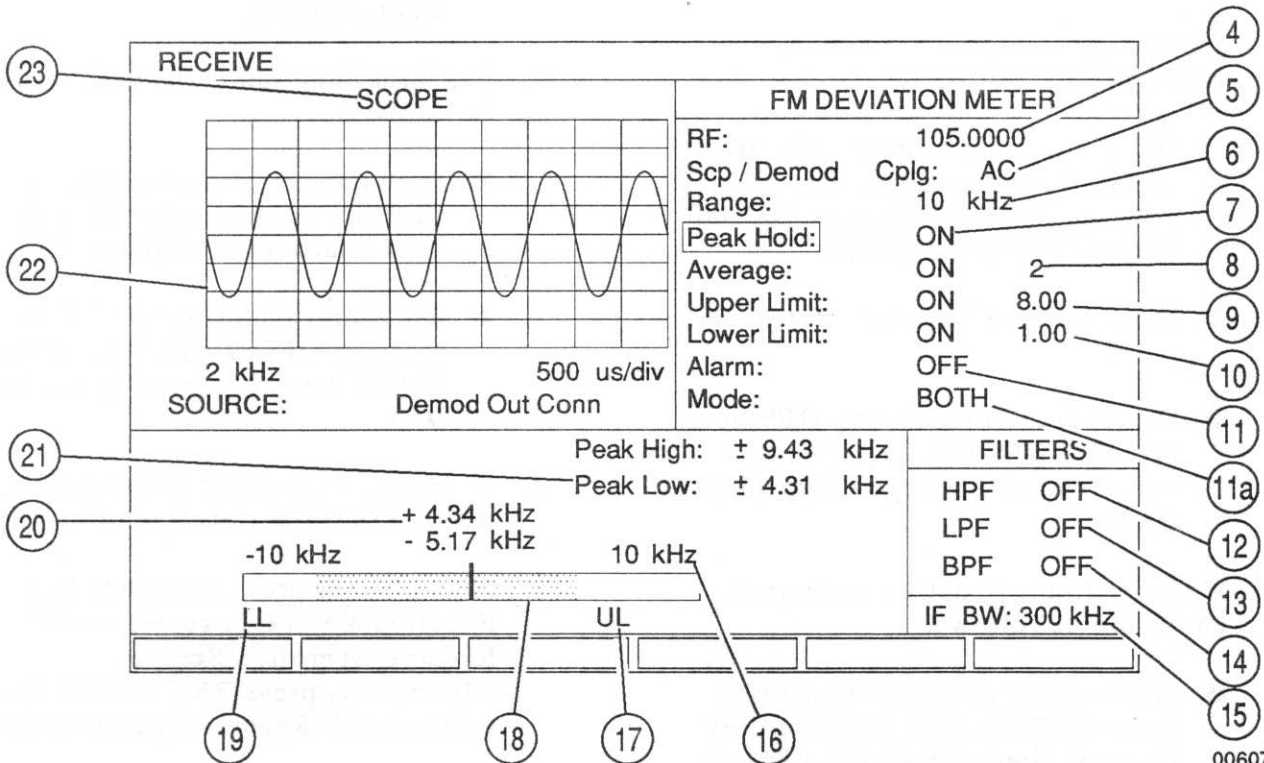

00607088

## K. OSCILLOSCOPE OPERATION SCREEN

The RF Receive Oscilloscope is usable as an abbreviated Oscilloscope and as a Full Screen Oscilloscope. Configuring one is reflected in the other.

The abbreviated Oscilloscope, as shown below, is visible from the RF Receive Operation Screen and the following meters:

SINAD Meter Operation Screen  
Distortion Meter Operation Screen  
FM Deviation Meter Operation Screen  
Phase Modulation Meter Operation Screen  
RF Power Meter Operation Screen  
Received Level Meter Operation Screen  
RF Frequency Error Meter Operation Screen  
Audio Frequency Counter Operation Screen

Parameters set on any of the Operation Screens are reflected in all. Configuring the abbreviated Oscilloscope is as follows:

1. Select Sweep (3). Selections include:

100 $\mu$ s/div	200 $\mu$ s/div	500 $\mu$ s/div
1 ms/div	2 ms/div	5 ms/div
10 ms/div	20 ms/div	50 ms/div
100 ms/div	200 ms/div	500 ms/div

Press ROLL Soft Function Key F2 to view the scope trace in a roll mode when the selected sweep rate is 100 ms/div or higher. Press SLOW Soft Function Key F2 to return to the normal mode of operation.



2. Select SCOPE SOURCE (4). Selections include:

SCOPE SOURCE (4)	Signal Input	Signal Type
Scope/DVM-GND	SCOPE/DVM Connector	External Ground-Coupled Signal
Scope/DVM-AC	SCOPE/DVM Connector	External AC-Coupled Signal
Scope/DVM-DC	SCOPE/DVM Connector	External DC-Coupled Signal
AF Cntr	Audio Frequency Counter Signal	Demodulated Signal passed through filters to Audio Frequency Counter.
Notch Residual	Internal Filtered Signal	Notch Filtered Signal passed to SINAD and Distortion Meters. Reading is relative with no units applied.
Audio/Data/Gen Out	AUDIO/DATA OUT Connector	Composite signal of Audio/Data Generators
DTMF/SINAD	Signal applied to Audio Frequency Decoder, SINAD and Distortion Meters	Demodulated Signal passed through filters to Audio Frequency Decoder, SINAD and Distortion Meters

SCOPE SOURCE (4)	Signal Input	Signal Type
Data Decoder	Signal applied to Data Decoder	Demodulated Signal passed through filters to Data Decoder
RF Power	RF Power Meter Input	Relative to detected signal applied to RF Power Meter
Detector Out	Demodulated Audio	Unfiltered Demodulated Signal
Demod Out Connector	DEMOD Connector	Filtered Demodulated Signal applied to DEMOD Connector
Mod Meters	Modulation Meters source	Filtered Demodulated Signal applied to selected Modulation Meter.

3. Select Oscilloscope Scale. Selections include:

SCOPE SOURCE (4)	Available Scales
Scope/DVM-GND	10, 20, 50, 100, 200, 500 mV/Div 1, 2, 5, 10, 20, 50 V/Div
Scope/DVM-AC	10, 20, 50, 100, 200, 500 mV/Div 1, 2, 5, 10, 20, 50 V/Div
Scope/DVM-DC	10, 20, 50, 100, 200, 500 mV 1, 2, 5, 10, 20, 50 V
AF Cntr	0.02, 0.04, 0.10, 0.20, 0.40, 1.00

SCOPE SOURCE (4)	Available Scales
Notch Residual	0.02, 0.04, 0.10, 0.20, 0.40, 1.00
Audio/Data/Gen Out	20, 40, 100, 200, 400 mV 1 V
DTMF/SINAD	FM DEMOD TYPE - 1, 2, 5, 10, 20, 50 kHz AM DEMOD TYPE - 20% PM DEMOD TYPE - 0.1, 0.2, 0.5, 1, 2, 5 Radians
Data Decoder	FM DEMOD TYPE - 1, 2, 5, 10, 20, 50 kHz AM DEMOD TYPE - 20% PM DEMOD TYPE - 0.1, 0.2, 0.5, 1, 2, 5 Radians
RF Power	Low, Med, High (Selection is automatic depending on power provided to T/R Connector)

SCOPE SOURCE (4)	Available Scales
Detector Out	FM DEMOD TYPE - 1, 2, 5, 10, 20, 50 kHz AM DEMOD TYPE - 20% PM DEMOD TYPE - 0.1, 0.2, 0.5, 1, 2, 5 Radians
Demod Out Connector	.02, .04, .1, .2, .4, 1.00
Mod Meters	FM DEMOD TYPE - 1, 2, 5, 10, 20, 50 kHz AM DEMOD TYPE - 20% PM DEMOD TYPE - 0.1, 0.2, 0.5, 1, 2, 5 Radians

Pressing ZOOM Soft Function Key F1 accesses full screen Oscilloscope, when cursor is on SCOPE/ANALYZER Prompt (1) of RF Receive Operation Screen and abbreviated Oscilloscope is displayed. Scope Source (4) must be selected before Full Screen Oscilloscope is accessed. Configuring the full screen Oscilloscope is as follows:

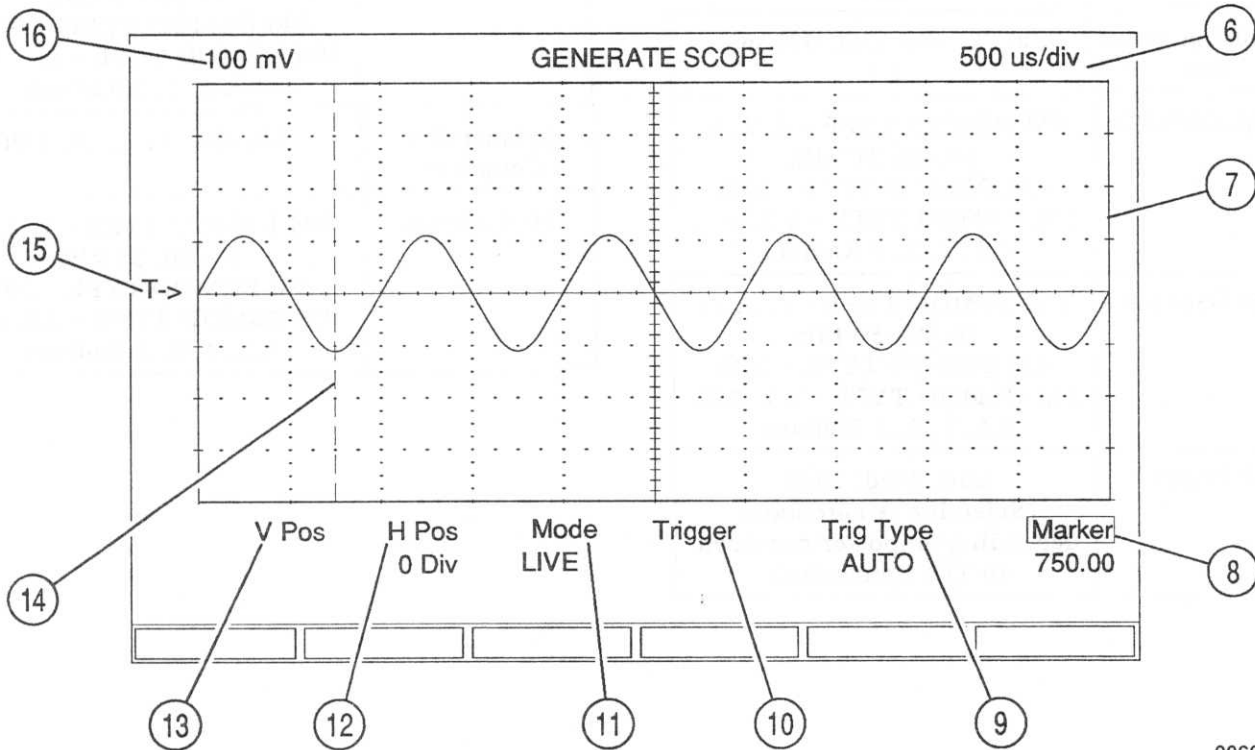

00607005

1. Select Sweep (6). Selections include:

100 $\mu$ s/div	200 $\mu$ s/div	500 $\mu$ s/div
1 ms/div	2 ms/div	5 ms/div
10 ms/div	20 ms/div	50 ms/div
100 ms/div	200 ms/div	500 ms/div

- Press ROLL Soft Function Key F2 to view the scope trace in a roll mode when the selected sweep rate is 100 ms/div or higher.
- Press SLOW Soft Function Key F2 to return to the normal mode of operation.

2. Select Trigger Type (9) as follows:

- Press NORM Soft Function Key F1 to select Normalized Trigger.

- Press AUTO Soft Function Key F2 to select Auto Trigger.

- Press 1 SHOT Soft Function Key F3 to select One Shot Trigger. Press 1 SHOT Soft Function Key F3 as needed to reset Trigger.

3. Set Trigger (10) using DATA SCROLL Spinner or DATA SCROLL Keys. Trigger Level (15) displays level required to trigger Oscilloscope in 1 SHOT or NORM.

4. Select Operation Mode (11) as follows:

- Press MENU Soft Function Key F1 to access Operation Mode menu selections.

- Press LIVE Soft Function Key F1 to select Live Operation Mode.
  - Press RECALL Soft Function Key F2 to select Recall Operation Mode.
  - Press COMPARE Soft Function Key F3 to select Compare Operation Mode.
  - Press LIVE-REF Soft Function Key F4 to select Live-Ref Operation Mode.
  - Press REF-LIVE Soft Function Key F5 to select Ref-Live Operation Mode.
  - Press RETURN Soft Function Key F6 to exit to Generate Scope.
5. Press AVG Soft Function Key F2 to select Average Operation Mode.
  6. Press PK HOLD Soft Function Key F3 to select Peak Hold Operation Mode.
  7. Press MIN HOLD Soft Function Key F4 to select Minimum Hold Operation Mode.
  8. Press STORE Soft Function Key F6 to store current trace.
5. Select H POS (12) Offset as needed. Range is -10 to 10 Divisions.
  6. Set Vertical Position of trace as needed by accessing V POS (13) and editing with DATA SCROLL Keys or DATA SCROLL Spinner.
  7. Select Oscilloscope Scale (16). Selections available are dependent on Scope Source (4). Selections include:

SCOPE SOURCE (4)	Available Scales
Scope/DVM-GND	10, 20, 50, 100, 200, 500 mV/Div 1, 2, 5, 10, 20, 50 V/Div
Scope/DVM-AC	10, 20, 50, 100, 200, 500 mV/Div 1, 2, 5, 10, 20, 50 V/Div
Scope/DVM-DC	10, 20, 50, 100, 200, 500 mV 1, 2, 5, 10, 20, 50 V
AF Cntr	0.02, 0.04, 0.10, 0.20, 0.40, 1.00
Notch Residual	0.02, 0.04, 0.10, 0.20, 0.40, 1.00
Audio/Data/Gen Out	20, 40, 100, 200, 400 mV 1 V
AF Dec/SINAD	FM DEMOD TYPE - 1, 2, 5, 10, 20, 50 kHz AM DEMOD TYPE - 20% PM DEMOD TYPE - 0.1, 0.2, 0.5, 1, 2, 5 Radians
Data Decoder	FM DEMOD TYPE - 1, 2, 5, 10, 20, 50 kHz AM DEMOD TYPE - 20% PM DEMOD TYPE - 0.1, 0.2, 0.5, 1, 2, 5 Radians
RF Power	Low, Med, High (Selection is automatic depending on power provided to T/R Connector)
Detector Out	FM DEMOD TYPE - 1, 2, 5, 10, 20, 50 kHz AM DEMOD TYPE - 20% PM DEMOD TYPE - 0.1, 0.2, 0.5, 1, 2, 5 Radians
Demod Out Connector	.02, .04, .1, .2, .4, 1.00
Mod Meters	FM DEMOD TYPE - 1, 2, 5, 10, 20, 50 kHz AM DEMOD TYPE - 20% PM DEMOD TYPE - 0.1, 0.2, 0.5, 1, 2, 5 Radians

8. Activate Marker (14), as required, as follows:

- With Cursor on Marker Position (8), press On/Off Soft Function Key F1.

- Enter Desired Marker Position using DATA ENTRY Keys or DATA SCROLL Keys and/or DATA SCROLL Spinner.



## L. SPECTRUM ANALYZER OPERATION SCREEN

The RF Receive Spectrum Analyzer is usable as an abbreviated Spectrum Analyzer or as a Full Screen Spectrum Analyzer. Configuring one is reflected in the other.

The abbreviated Spectrum Analyzer, as shown below, is visible from the RF Receive Operation Screen and the following Meters:

SINAD Meter Operation Screen  
Distortion Meter Operation Screen  
FM Deviation Meter Operation Screen  
AM Modulation Meter Operation Screen  
Phase Modulation Meter Operation Screen  
RF Power Meter Operation Screen  
Received Level Meter Operation Screen  
RF Frequency Error Meter Operation Screen  
Audio Frequency Counter Operation Screen

Parameters set on any of the above Operation Screens are reflected in all. Configuring the abbreviated Spectrum Analyzer is as follows:

1. Select Scan Width (3). Selections include zero scan and:

1 kHz	2 kHz	5 kHz
10 kHz	20 kHz	50 kHz
100 kHz	200 kHz	500 kHz
1 MHz		

Press MENU Soft Function Key F1 to access a scan width menu. Press RETURN Soft Function Key F6 to exit to normal operation.

Press CONFIG Soft Function Key F2 to access a pop up screen to configure scan width. Press COUPLE Soft Function Key F1 to set the sweep and RBW to factory default state for the current scan width. Press RETURN Soft Function Key F6 to exit to normal operation.

Pressing ZOOM Soft Function Key F1 accesses full screen Spectrum Analyzer, when cursor is on SCOPE/ANALYZER Prompt (1) of RF Receive Operation Screen and abbreviated Spectrum Analyzer is displayed. Available features and parameters are described below:

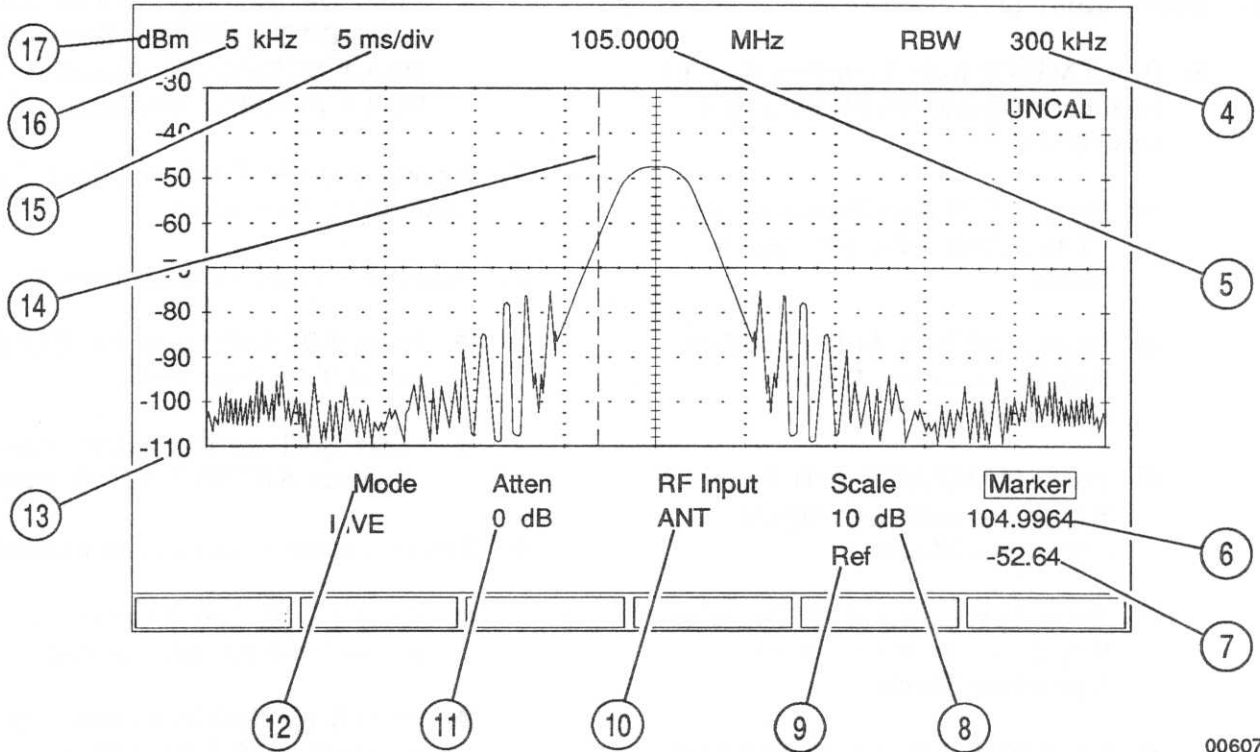

00607022

1. Set Center Frequency (5). Press Set Ref Soft Function Key F1 if current Center Frequency is to be used as Reference Frequency.

2. Select Scan Width (15). Selections include zero scan and:

1 kHz	2 kHz	5 kHz
10 kHz	20 kHz	50 kHz
100 kHz	200 kHz	500 kHz
1 MHz	2 MHz	5 MHz
10 MHz	20 MHz	50 MHz
100 MHz		

3. Set Logarithmic Function (16) as follows:

- Press dBm Soft Function Key F1 to select dBm.

- Press dB $\mu$ V Soft Function Key F2 to select dB $\mu$ V.
- Press dBmV Soft Function Key F3 to select dBmV.
- Press dBV Soft Function Key F4 to select dBV.
- Press dB $\mu$ W Soft Function Key F5 to select dB $\mu$ W.
- Press dBW Soft Function Key F6 to select dBW.

4. Set Scale (8) as follows:

- Press 10 dB Soft Function Key F1 to select 10 dB for Vertical Scale (13).



- Press 2 dB Soft Function Key F2 to select 2 dB for Vertical Scale (13).
5. Select Mode (12) as follows:
- Press MENU Soft Function Key F1 to access Operation Mode menu selections.
    - Press LIVE Soft Function Key F1 to select Live Operation Mode.
    - Press RECALL Soft Function Key F2 to select Recall Operation Mode.
    - Press COMPARE Soft Function Key F3 to select Compare Operation Mode.
    - Press LIVE-REF Soft Function Key F4 to select Live-Ref Operation Mode.
    - Press REF-LIVE Soft Function Key F5 to select Ref-Live Operation Mode.
    - Press RETURN Soft Function Key F6 to exit to Generate Analyzer.
  - Press AVG Soft Function Key F2 to select Average Operation Mode.
  - Press PK HOLD Soft Function Key F3 to select Peak Hold Operation Mode.
  - Press MIN HOLD Soft Function Key F4 to select Minimum Hold Operation Mode.
  - Press STORE Soft Function Key F6 to store the current trace.
6. Activate Marker (14), as required, as follows:
- With Cursor on Marker Position (6), press On/Off Soft Function Key F1.
  - Enter Desired Marker Position using DATA ENTRY Keys or DATA SCROLL Keys and/or DATA SCROLL Spinner.
7. Access Ref (9) Field to adjust Vertical Scale (13), as needed.
8. Select RF Input (10) as needed.
- Press T/R Soft Function Key F1 to select T/R Connector.
  - Press ANT Soft Function Key F2 to select ANTENNA Connector.
9. Select Attenuation (11) as needed.
- Press 30 dB Soft Function Key F1 to select 30 dB Attenuation.
  - Press 0 dB Soft Function Key F2 to select 0 dB Attenuation.
10. If Scan Width (15) is set to zero scan, enter Zero Scan Sweep (17). Selections Include:
- |                 |                 |            |
|-----------------|-----------------|------------|
| 200 $\mu$ s/div | 500 $\mu$ s/div | 1 ms/div   |
| 2 ms/div        | 5 ms/div        | 10 ms/div  |
| 20 ms/div       | 50 ms/div       | 100 ms/div |
| 200 ms/div      | 500 ms/div      |            |
- Press MENU Soft Function Key F1 to access the sweep menu. Press RETURN to exit into normal operation.
  - Press DEFLT Soft Function Key F5 to set only the current field to factory default.
  - Press COUPLE Soft Function Key to set the sweep and RBW to factory default state for the current scan width.

## M. STORE AND RECALL OPERATION

Pressing STORE Memory Key allows the operator to store up to 100 RF Receive Operation Screen configurations. Storage Locations 0 through 49 can be used to store a RF

Generate Operation configuration, a RF Receive Operation configuration or a Duplex Operation configuration (Receive and Generate pair).

STORE Operation for the RF Receive Operation is as follows:

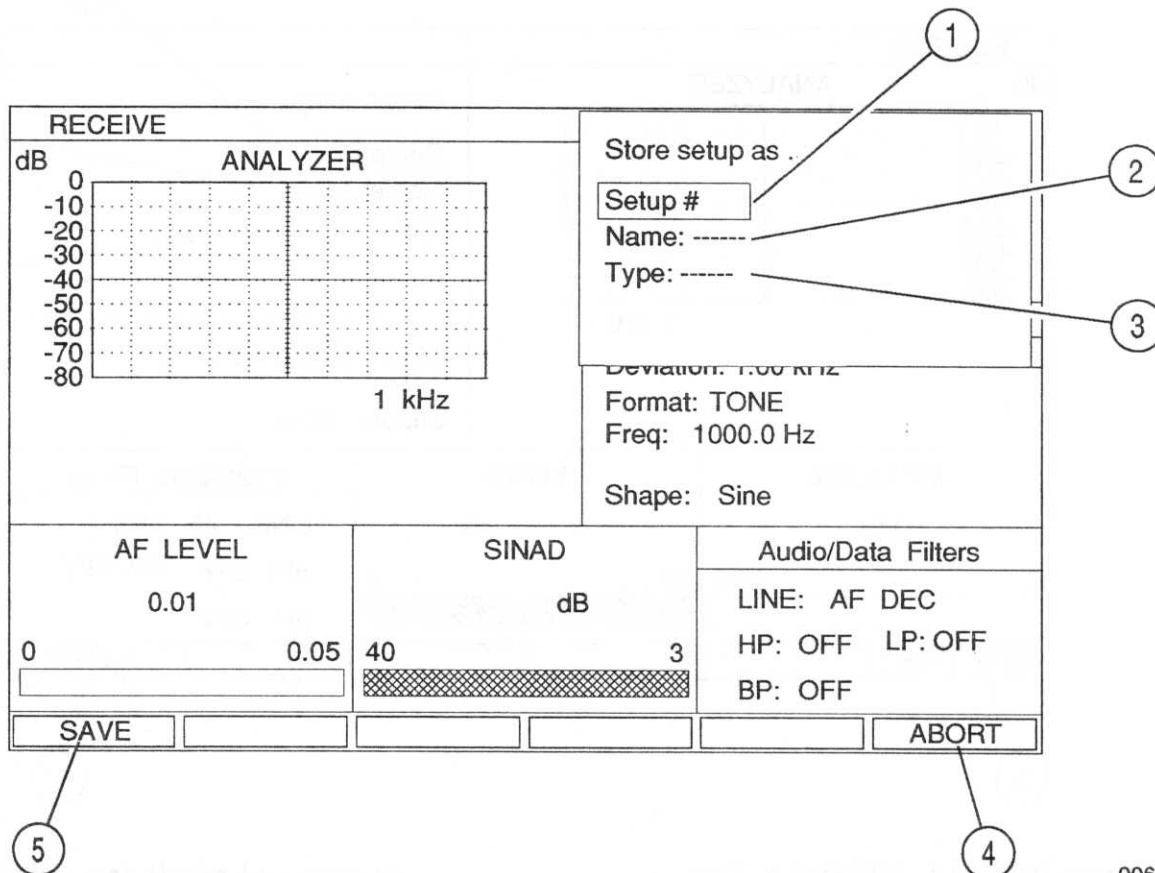

1. Press STORE MEMORY Key.
2. Enter Setup # (1) value. Range is 0 to 49. Press ENTER Key.
3. If Name (2) is desired, press ENTER Key, with Cursor on Memory Location Label (2) field. Enter Label using DATA ENTRY Keys. Label can be alphabetic and/or numeric characters. Press ENTER Key.
4. Type (3) displays the type of data saved in the specified setup number. Types to save and recall are: DUPLEX, GENERATOR, RECEIVER, GENERATOR & RECEIVER and EMPTY.
5. Press SAVE Soft Function Key F1 (5) to accept selections and save Setup. Press ABORT Soft Function Key F6 (4) to escape without saving Setup.

00607084

Pressing RCL Memory Key allows the operator to recall up to 50 previously stored operation screens. RF Receive, RF Generate or Duplex Operation Screen configurations can all be accessed from the RF Generate Operation Screen. Accessing anything other than an RF Generate Operation Screen configuration, automatically switches the COM-120B to the selected mode of operation.

RECALL Operation for the RF Receive Operation is as follows:

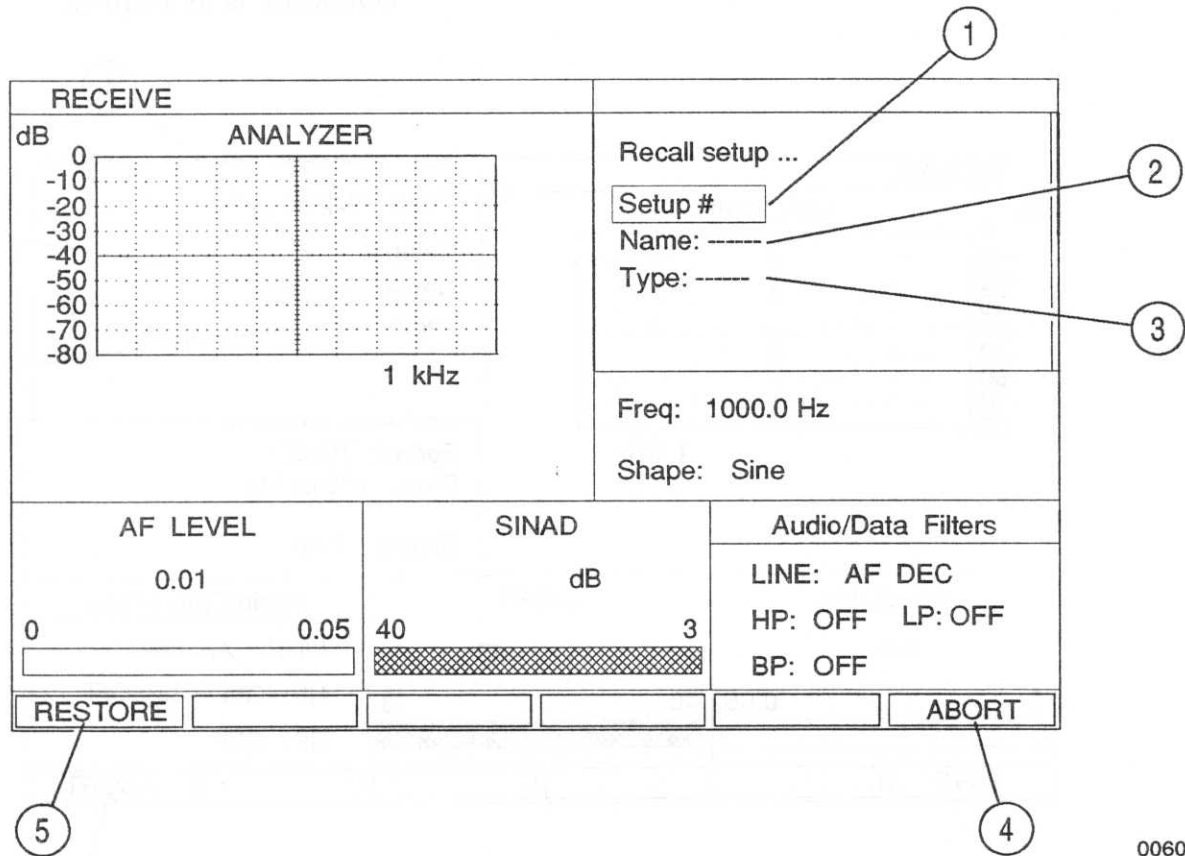

00607093

1. Press RECALL MEMORY Key.
2. Enter Setup # (1) value. Range is 0 to 49. Press ENTER Key.
3. Press RESTORE Soft Function Key F1 (5) to accept selections and recall Setup. Press ABORT Soft Function Key F6 (4) to escape without recalling Setup.
4. Type (3) displays the type of data saved in the specified setup number. Types to save and recall are: DUPLEX, GENERATOR, RECEIVER, GENERATOR & RECEIVER and EMPTY.
5. Press RESTORE Soft Function Key F1 (5) to accept selections and save Setup. Press ABORT Soft Function Key F6 (4) to escape without recalling Setup.

## 4-5 OSCILLOSCOPE OPERATION SCREEN

Pressing the SCOPE INSTRUMENTS Key accesses the Oscilloscope Operation Screen. The purpose of the Independent Oscilloscope is to provide a test instrument that is independent of the other Operation Modes. What this section does is provide information for configuring the Oscilloscope in a generic sense. It is provided to explain how the active fields are edited and what selections are available. It is not designed to perform a specific test, but instead is provided as a reference for configuring the Independent Oscilloscope Operation Screen.

Configure and operate the Independent Oscilloscope Operation Screen as follows:

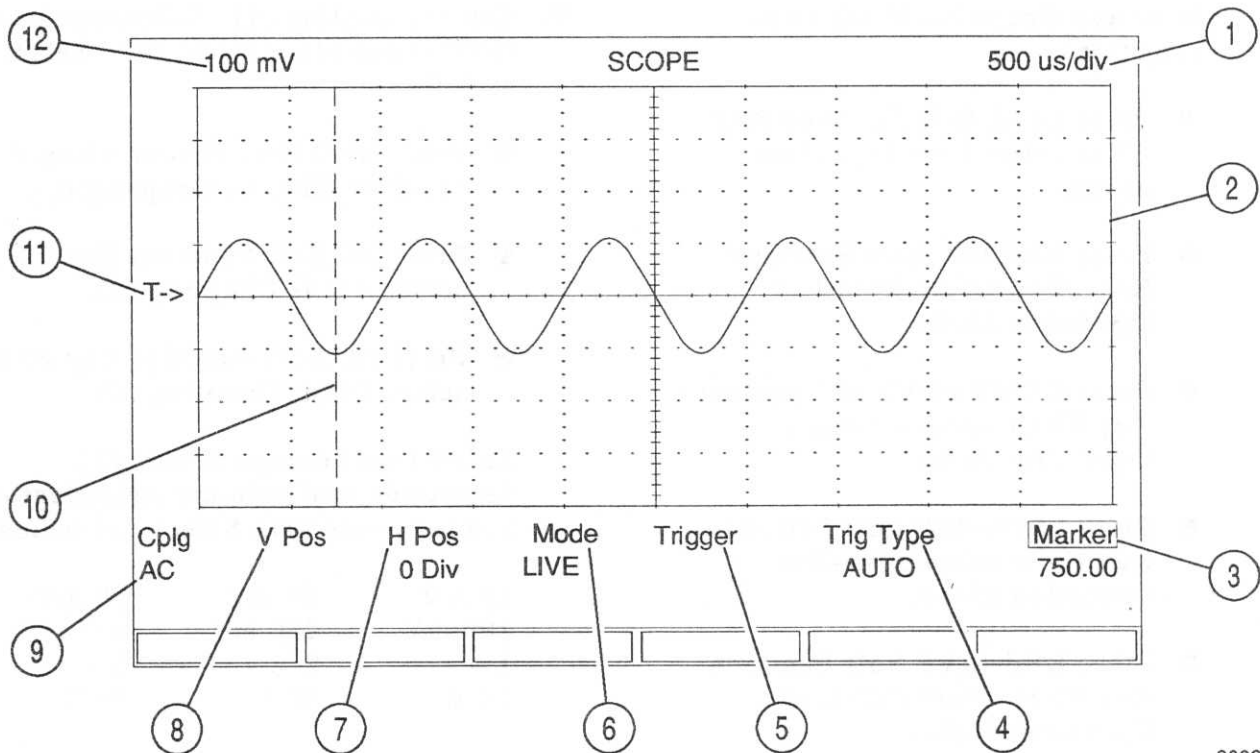

00607046

1. Select Sweep (1). Selections include:

100 $\mu$ s/div	200 $\mu$ s/div	500 $\mu$ s/div
1 ms/div	2 ms/div	5 ms/div
10 ms/div	20 ms/div	50 ms/div
100 ms/div	200 ms/div	500 ms/div

- Press ROLL Soft Function Key F2 to view the scope trace in a roll mode when the selected sweep rate is 100 ms/div or higher.
- Press SLOW Soft Function Key F2 to return to the normal mode of operation.

2. Select Trigger Type (4) as follows:

- Press NORM Soft Function Key F1 to select Normalized Trigger.
- Press AUTO Soft Function Key F2 to select Auto Trigger.
- Press 1 SHOT Soft Function Key F3 to select One Shot Trigger. Press 1 SHOT Soft Function Key F3 as needed to reset Trigger.

3. Set Trigger Level (11) as follows:

- Move cursor to Trigger (5).

- Press ENTER Key.
  - Use DATA SCROLL Spinner or DATA SCROLL Keys to set Trigger.
  - Press ENTER Key to complete edit.
4. Select Operation Mode (6) as follows:
- Press MENU Soft Function Key F1 to access Operation Mode menu selections.
    - Press LIVE Soft Function Key F1 to select Live Operation Mode.
    - Press RECALL Soft Function Key F2 to select Recall Operation Mode.
    - Press COMPARE Soft Function Key F3 to select Compare Operation Mode.
    - Press LIVE-REF Soft Function Key F4 to select Live-Ref Operation Mode.
    - Press REF-LIVE Soft Function Key F5 to select Ref-Live Operation Mode.
    - Press RETURN Soft Function Key F6 to exit to Scope Operation.
  - Press AVG Soft Function Key F2 to select Average Operation Mode.
  - Press PK HOLD Soft Function Key F3 to select Peak Hold Operation Mode.
  - Press MIN HOLD Soft Function Key F4 to select Minimum Hold Operation Mode.
- Press STORE Soft Function Key F6 to store the current trace.
5. Select H POS (7) Offset as needed. Range is -10 to 10 Divisions.
6. Set Vertical Position of trace as needed by accessing V POS (8) and editing with DATA SCROLL Keys or DATA SCROLL Spinner.
7. Select Coupling (9). Selections include GND (Ground), AC and DC. Select as follows:
- Press GND Soft Function Key F1 to select GND as Coupling (9).
  - Press AC Soft Function Key F2 to select AC as Coupling (9).
  - Press DC Soft Function Key F3 to select DC as Coupling (9).
8. Select Oscilloscope Scale (12). Selections available are dependent on Scope Source (4). Selections include:
- |        |        |        |
|--------|--------|--------|
| 10 mV  | 20 mV  | 50 mV  |
| 100 mV | 200 mV | 500 mV |
| 1 V    | 2 V    | 5 V    |
| 10 V   | 20 V   | 50 V   |
9. Activate Marker (10), as required, as follows:
- With Cursor on Marker Position (3), press On/Off Soft Function Key F1.
  - Enter Desired Marker Position using DATA ENTRY Keys or DATA SCROLL Keys and/or DATA SCROLL Spinner.

## 4-6 SPECTRUM ANALYZER OPERATION SCREEN

Pressing the ANALYZ INSTRUMENTS Key accesses the Spectrum Analyzer Operation Screen. The purpose of the Independent Spectrum Analyzer is to provide a test instrument that is independent of the Operation Modes. What this section does is provide information in configuring the Spectrum Analyzer in a generic sense. It is provided to explain how the active fields are edited and what selections are available. It is not designed to perform a specific test, but instead is provided as a reference for configuring the Independent Spectrum Analyzer Operation Screen.

Configure and operate the Independent Spectrum Analyzer Operation Screen as follows:

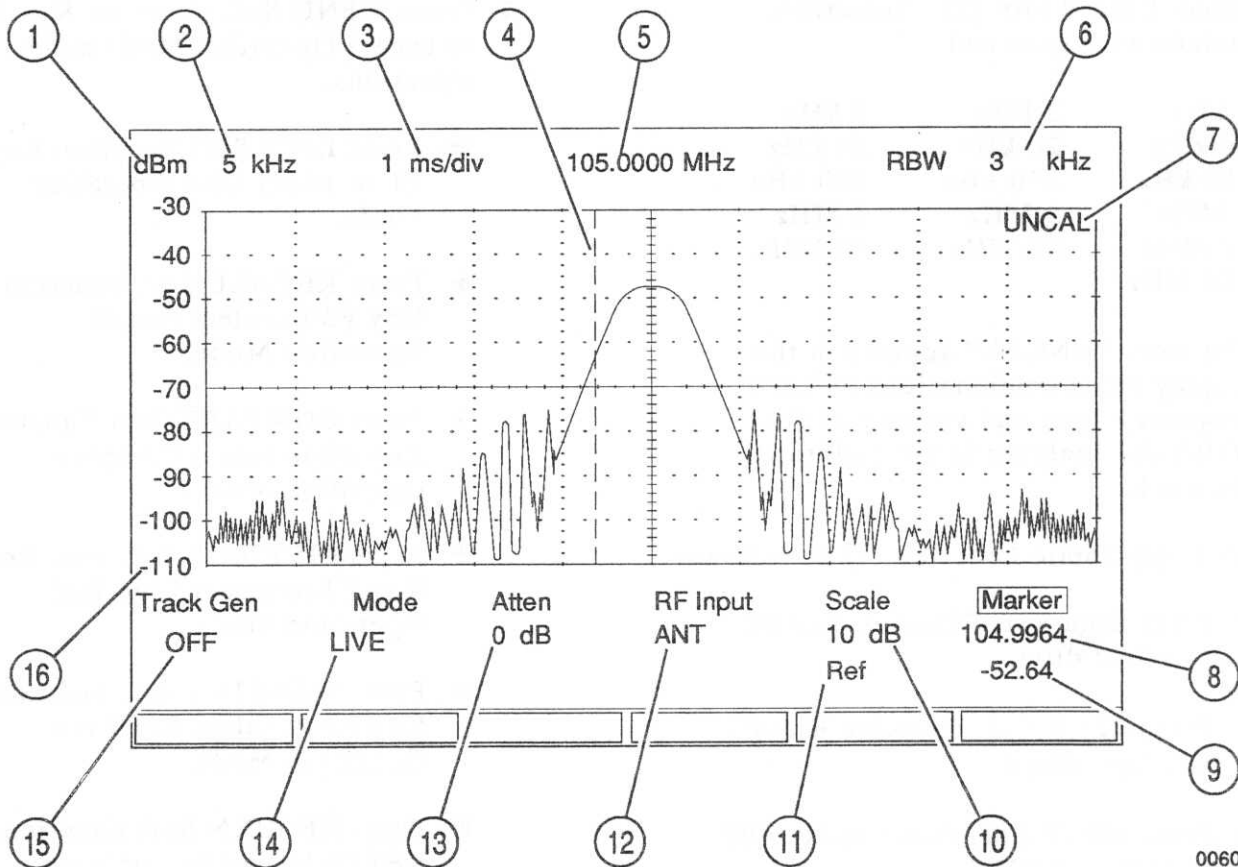

00607047

1. Set Center Frequency (5). Press Set Ref Soft Function Key F1 if current Center Frequency is to be used as Reference Frequency. Press Split Soft Function Key F5 If Split Screen Operation is desired. If Find Function Operation is desired, configure as follows:

- Press Config Soft Function Key F4 to access Sweep Width Window. Enter Sweep Width. Press highlighted Config Soft Function Key F4 to close Window.

- Press Find Lvl Soft Function Key F3 to activate Marker for setting Find Level Reference. Use DATA SCROLL Spinner or DATA SCROLL Keys to edit Marker Level. Press Highlighted Find Lvl Soft Function Key F3 to complete operation.
- Press Find Soft Function Key F2 to activate Find Function.

2. Select Scan Width (2). Selections include zero scan and:

1 kHz	2 kHz	5 kHz
10 kHz	20 kHz	50 kHz
100 kHz	200 kHz	500 kHz
1 MHz	2 MHz	5 MHz
10 MHz	20 MHz	50 MHz
100 MHz		

The word "UNCAL" appears in the display when combinations of RBW, frequency span and sweep rate for which the analyzer is not calibrated are used.

3. Set Logarithmic Function (1) as follows:

- Press dBm Soft Function Key F1 to select dBm.
- Press dB $\mu$ V Soft Function Key F2 to select dB $\mu$ V.
- Press dBmV Soft Function Key F3 to select dBmV.
- Press dBV Soft Function Key F4 to select dBV.
- Press dB $\mu$ W Soft Function Key F5 to select dB $\mu$ W.
- Press dBW Soft Function Key F6 to select dBW.

4. Set Scale (10) as follows:

- Press 10 dB Soft Function Key F1 to select 10 dB for Vertical Scale (15).
- Press 2 dB Soft Function Key F2 to select 2 dB for Vertical Scale (13).

5. Select Mode (14) as follows:

- Press MENU Soft Function Key F1 to access Operation Mode menu selections.
- Press LIVE Soft Function Key F1 to select Live Operation Mode.
- Press RECALL Soft Function Key F2 to select Recall Operation Mode.
- Press COMPARE Soft Function Key F3 to select Compare Operation Mode.
- Press LIVE-REF Soft Function Key F4 to select Live-Ref Operation Mode.
- Press REF-LIVE Soft Function Key F5 to select Ref-Live Operation Mode.
- Press RETURN Soft Function Key F6 to exit to Analyzer Operation.
- Press AVG Soft Function Key F2 to select Average Operation Mode.
- Press PK HOLD Soft Function Key F3 to select Peak Hold Operation Mode.
- Press MIN HOLD Soft Function Key F4 to select Minimum Hold Operation Mode.

- Press STORE Soft Function Key F6 to store the current trace.
6. Activate Marker (4), as required, as follows:
    - With Cursor on Marker Position (8), press On/Off Soft Function Key F1.
    - Enter Desired Marker Position using DATA ENTRY Keys or DATA SCROLL Keys and/or DATA SCROLL Spinner.
  7. Access Ref (11) Field to adjust Vertical Scale (14), as needed.
  8. Select RF Input (12) as needed.
- Press T/R Soft Function Key F1 to select T/R Connector.
  - Press ANT Soft Function Key F2 to select ANT Connector.
9. Select Attenuation (13) as needed.
    - Press 30 dB Soft Function Key F1 to select 30 dB Attenuation.
    - Press 0 dB Soft Function Key F2 to select 0 dB Attenuation.
  10. Scan Sweep Selections Include:
 

200 $\mu$ s/div	500 $\mu$ s/div	1 ms/div
2 ms/div	5 ms/div	10 ms/div
20 ms/div	50 ms/div	100 ms/div
200 ms/div	500 ms/div	



## 4-7 AUDIO/DATA/SIGNALING GENERATORS

Pressing the AUDIO GEN INSTRUMENTS Key accesses the Independent Audio/Data/Signaling Generators Operation Screen. The purpose of the Independent Audio/Data/Signaling Generators is to provide baseband signal generators that are independent of the other Operation Modes. This section provides information on configuring the Audio/Data/Signaling Generators in the COM-120B. Configuring the Audio/Data/Signaling Generators is covered in a generic sense. It is provided to explain how each of the active fields are edited and what selections are available. It is not designed to perform a specific test, but instead is provided as a reference.

The Audio/Data/Signaling Generators Operation Screen is composed of four sections, each of which represents a different generator. These generators are covered separately. Restrictions that apply to the generators are primarily related to the output level. The sum of the generators output level should not exceed 2.5 volts in X1 mode and 25 mV in /10 (divide by 10) mode. If /10 mode is selected, ALL signal generators are affected:

Audio Generator 1 Operation

Audio Generator 2 Operation

DATA Generator Operation

DTMF Generator Operation

- Press C-MSG Soft Function Key F2 to set Bandpass Filter (11) to C-Message Weighted Filter (C-MSG).

12. Set Scope Scale (18). Selections change depending on selected Source (1). Selections include:

Source (1)	Scale
RF POW	LOW (2 mW to 20 mW signal) MED (>20 mW to 2 W signal) HIGH (>2 W to 200 W signal)
AUD/DAT or EXT MOD	100, 200, 500 mV 1, 2, 5 V
SC/DVM	10, 20, 50, 100, 200, 500 mV 1, 2, 5, 10, 20, 50 V

13. Set Scope Sweep (19). Selections include:

100 $\mu$ s/div	200 $\mu$ s/div	500 $\mu$ s/div
1 ms/div	2 ms/div	5 ms/div
10 ms/div	20 ms/div	50 ms/div
100 ms/div	200 ms/div	500 ms/div

- Press ROLL Soft Function Key F2 to view the scope trace in a roll mode when the selected sweep rate is 100 ms/div or higher.
- Press SLOW Soft Function Key F2 to return to the normal mode of operation.

## 4-8-2 SINAD METER OPERATION

Configure and operate SINAD Meter as follows:

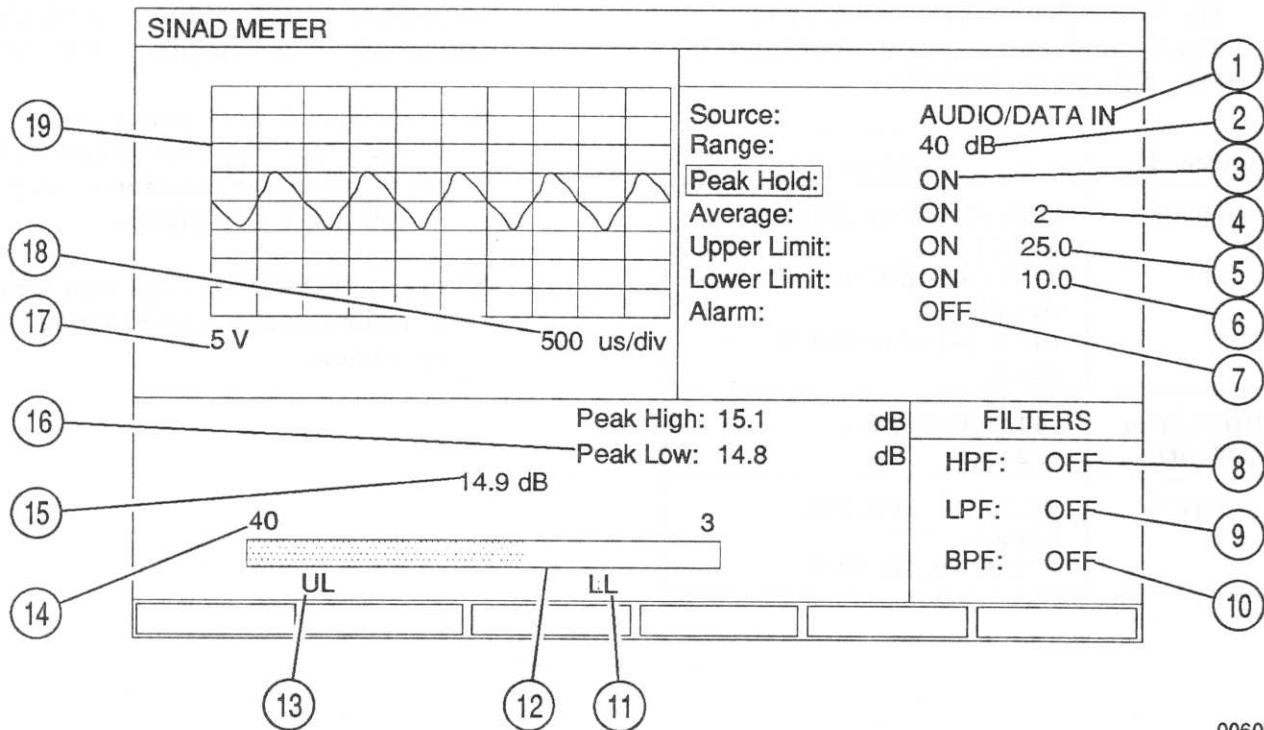

00607089

1. Select Source (1) as follows:
  - Press AUD/DAT Soft Function Key F1 to select AUDIO/DATA IN Connector as Source (1).
  - Press SC/DVM Soft Function Key F2 to select SCOPE/DVM Connector as Source (1).
2. Select Range (2) as follows:
  - Press 15 dB Soft Function Key F1 to select 15 dB as Range (2).
  - Press 40 dB Soft Function Key F2 to select 40 dB as Range (2).
  - Press AUTO Soft Function Key F3 to select Autorange for Range (2).
3. If Peak Hold Function is desired, do not select Autorange. Configure as follows:
  - With cursor on Peak Hold (3), press OFF/ON Soft Function Key F1 until Peak Hold (3) displays *ON*.
  - Peak Hold Function can be reset as desired by pressing RST PK Soft Function Key F5 where displayed.
  - Set Peak Hold Function to OFF by pressing OFF/ON Soft Function Key F1 until Peak Hold (3) displays *OFF*.

4. If Average Function is desired, configure as follows:

- With cursor on Average (4), press OFF/ON Soft Function Key F1 until Average (4) displays *ON* and Sample Number appears.
- Enter Sample Number. Range is 2 to 10.
- Set Average Function to OFF by pressing OFF/ON Soft Function Key F1 until Average (4) displays *OFF*.

5. If Upper Limit Function is desired, configure as follows:

- With cursor on Upper Limit (5), press OFF/ON Soft Function Key F1 until Upper Limit (5) displays *ON* and Limit Value appears.
- Enter Limit Value. Range is 0 to 40.
- Set Upper Limit Function to OFF by pressing OFF/ON Soft Function Key F1 until Upper Limit (5) displays *OFF*.

6. If Lower Limit Function is desired, configure as follows:

- With cursor on Lower Limit (6), press OFF/ON Soft Function Key F1 until Lower Limit (6) displays *ON* and Limit Value appears.
- Enter Limit Value. Range is 0 to 40.
- Set Lower Limit Function to OFF by pressing OFF/ON Soft Function Key F1 until Lower Limit (6) displays *OFF*.

7. If Alarm Function is desired, configure as follows:

- With cursor on Alarm (7), press OFF/ON Soft Function Key F1 until Alarm (7) displays *ON*.
- Set Alarm Function to OFF by pressing OFF/ON Soft Function Key F1 until Alarm (7) displays *OFF*.

8. Set High-Pass Filter (8) as follows:

- Press OFF Soft Function Key F1 to set High-Pass Filter (8) to *OFF*.
- Press 300 Hz Soft Function Key F2 to set High-Pass Filter (8) to *300 Hz*.
- Press 4 kHz Soft Function Key F3 to set High-Pass Filter (8) to *4 kHz*.

9. Set Low-Pass Filter (9) as follows:

- Press OFF Soft Function Key F1 to set Low-Pass Filter (9) to *OFF*.
- Press 300 Hz Soft Function Key F2 to set Low-Pass Filter (9) to *300 Hz*.
- Press 4 kHz Soft Function Key F3 to set Low-Pass Filter (9) to *4 kHz*.
- Press 20 kHz Soft Function Key F4 to set Low-Pass Filter (9) to *20 kHz*.

10. Set Bandpass Filter (10) as follows:

- Press OFF Soft Function Key F1 to set Bandpass Filter (10) to *OFF*.
- Press C-MSG Soft Function Key F2 to set Bandpass Filter (10) to C-Message Weighted Filter (*C-MSG*).

11. Set Scope Scale (12). Selections change depending on selected Source (1). Selections include:

100 $\mu$ s/div	200 $\mu$ s/div	500 $\mu$ s/div
1 ms/div	2 ms/div	5 ms/div
10 ms/div	20 ms/div	50 ms/div
100 ms/div	200 ms/div	500 ms/div

Source (1)	Scale
AUD/DAT	100, 200, 500 mV 1, 2, 5 V
SC/DVM	10, 20, 50, 100, 200, 500 mV/Div 1, 2, 5, 10, 20, 50 V/Div

12. Set Scope Sweep (18). Selections include:

- Press ROLL Soft Function Key F2 to view the scope trace in a roll mode when the selected sweep rate is 100 ms/div or higher.
- Press SLOW Soft Function Key F2 to return to the normal mode of operation.

### 5-3 MANDATORY IEEE 488.2 COMMANDS

Mnemonic	Command
*CLS	Clear Status Command
*ESE X	Standard Event Status Enable, x = 0 to 255
*ESE?	Standard Event Status Enable Query
*ESR?	Standard Event Status Register Query
*IDN?	Identification Query
*OPC	Operation Complete Command
*OPC?	Operation Complete Query
*OPT?	Returns Software Option of Test Set
*RST	Restart Command
*SRE X	Service Request Command, x = 0 to 255
*SRE?	Service Request Enable Query
*STB?	Read Status Byte Query
*TST?	Self Test Query
*WAI	Wait-To-Continue Command

Mandatory GPIB Commands

## 5-4 COM-120B SPECIFIC COMMANDS

The following list of commands is broken up by function. All string values must be entered within Quotation marks (" "). Within the list, the commands are listed in hierarchal order. Each hierarchy is separated by a colon(:). For example, the command "RECeiver:INPut:ATTenuation 30" is listed as follows:

```

R ECeiver
:INPut
:ATTenuation v          Set input ATTenuation.
  
```

The v is a variable parameter. At least one space is required between commands and parameters. When more than one parameter is required, they are separated by a comma (.). The example given is a command to set the COM-120B. Another type of command used is a Query Command. Query Commands contain a question mark (?) at the end of the command and before any parameters.

Commands are listed in upper and lower case letters. This is to identify the short and long form of the command. The upper case letters identify the short form of the command. The upper and lower case letters, together, identify the long form of the command.

## ANALYZER COMMANDS

**NOTE1:** Assumed units are MHz. Valid units are Hz, kHz, MHz or GHz. Accepted frequency range is from 250 kHz through 1 GHz in 0.1 kHz steps.

```

ANALyzer
:ADJust          Adjusts vertical scale using internal -40 dB
                  reference signal.
:BANDwidth v[units] Sets the Resolution Bandwidth of the analyzer.
                  v may be: 300 Hz, 3 kHz, 30 kHz, 300 kHz or 3 MHz.
                  [units] may be Hz, kHz, or MHz. The default is Hz.
                  Sets the Resolution Bandwidth to the default value
                  for the current analyzer SPAN-width.
:DEFault
:RESolution v[units] Identical to BAND. Included for SCPI standard.
:BANDwidth?      Returns the current analyzer Resolution Bandwidth.
:FIND
:INITiate        Starts Find function.
:LEVel v         0 to 255      Sets Find level in pixels. Top of Screen is 255.
:LEVel?          Queries Find level.
:SWEep
:WIDth v         .2000 to 500.0000 Sets Find sweep width in MHz with .0001 MHz
                  increments.
:WIDth?          Returns sweep width in MHz.
:FREQuency v[units] .0000 to 1000.0000 Sets Center Frequency . See Note 1.
:FREQuency?      Queries Center Frequency.
:INPut
:ANTenna         Sets ANTENNA Connector as input.
:ATTenuation v   0 or 30      Sets input ATTenuation in dB.
:ATTenuation?    Queries input ATTenuation.
:TR              Sets T/R Connector as input.
:INPut?          Queries selected input connector.
:MARKer
:AMPLitude?     Queries level at active marker location.
  
```

ANALyzer			
:MARKer			
:FREQUency v[units]			Sets marker frequency. Range of value is dependent on scan width. Marker frequency must be in displayed frequency window. See Note 1.
:FREQUency?			Queries Marker Frequency.
:STATe b	0 or 1		Sets Marker to ON or OFF.
:STATe?			Queries Marker state.
:MODE	AVERAge COMPare LIVE LMINus MINhold PEAKhold RECALL RMINus STORE		Sets Mode to Average. Sets Mode to Compare. Sets Mode to Live. Live minus (i.e. Reference-Live). Sets Mode to Min Hold. Sets Mode to Peakhold. Recalls stored trace. Reference minus (i.e. Live-Reference). Stores current trace in memory. Queries Mode Type.
:MODE?			
:REFerence			
:LEVel v			Sets Reference Level. Range is dependent on Scale. Range is 0 to 2 in 10 dB mode. Range is 0 to 64 in 2 dB mode.
:LEVel?			Queries Reference Level.
:SCALE v	2 or 10		Sets Scale in dB.
:UNITs	DBM DBW DBMV DBUV DBUW DBV		Sets Scale Units to dBm. Sets Scale Units to dBW. Sets Scale Units to dBmV. Sets Scale Units to dBµV. Sets Scale Units to dBµW. Sets Scale Units to dBV.
:UNITs?			Queries Units selected.
:SCALE?			Returns Scale value.
:SPAN v[units]	1, 2, 5, 10, 20, 50,		Sets Spanwidth. Assumed units are kHz.
:SPAN	100, 200, 500 kHz, 1, 2, 5, 10, 20, 50, 100 MHz		Accepted units are kHz and MHz.
:DEFault			Sets the Sweep Rate and Resolution Bandwidth to the default values for the current SPAN-width.
:SPAN?			Returns Spanwidth value and units.
:SPLIT			Sets the analyzer to Split-mode of operation. Only applies to independent analyzer. Does not update screen.
:NORMAL			Sets the analyzer to Normal-mode of operation. Only applies to independent analyzer. Does not update screen.
:SWEEP v[units]			Sets the analyzer sweep rate per division. v may be: 200 µs, 500 µs, 1 ms, 2 ms, 5 ms, 10 ms, 20 ms, 50 ms, 100 ms, 200 ms, or 500 ms. [units] may be: microseconds or milliseconds. Microseconds is the default.
:TIME v[units]			Identical to SWEEP. Included for SCPI standard.
:DEFault			Sets the Sweep Rate to the default value for the current analyzer SPAN-width.
:SWEEP?			Returns the current analyzer sweep rate.
:TRACe			
:DATA?[v1,v2,v3]			Queries current data trace values. v1 specifies Mode (0[live], 1[recall], 2[peakhold]). v2 specifies start point in pixels, with range of 0 to 499. v3 specifies number of returned points in pixels with range of 0 to 499, where v1 + v2 @500. Defaults are 0,0,500.



ANALyzer			
:TRACkgen b	0 or 1		Sets Tracking Generator to ON or OFF. Requires Option 12.
:LEVel v	-130 to +13 dBm		Sets Tracking Generator level in dBm.
:LEVel?			Queries Tracking Generator level.
:TRACkgen?			Queries Tracking Generator state.

## BER COMMANDS

Refer to Measure Commands for initiating BER Meter operation and obtaining data.  
Send SYST:KEY:STOP command to halt BER Meter operation.

BER			
:ALARm			
:STATe b	0 or 1		Sets Alarm to ON or OFF.
:STATe?			Queries Alarm status.
:BAUD v	75, 150, 300, 600, 1200, 2400, 4800, 9600		Sets baud rate of data transfer.
:BAUD?			Queries baud rate for data transfer.
:COUPling	AC or DC		Sets coupling for input signal.
:COUPling?			Queries Coupling status.
:FM			
:RANGe v[units]	10, 20, 50, 100		Sets Deviation Range in kHz.
:RANGe?			Queries Deviation Range.
:INPut	AUDIN DEMODulation		Sets Input to Audio Data In. Sets input to demodulated signal.
:INPut?			Queries input setting.
:MODE			
:CONTInuous			Sets BER Meter to loop continuously.
:LOOP v	1 to 100000		Sets BER Meter to loop for specified number of tests.
:LOOP?			Queries number of loops for LOOP Mode.
:MODE?			Queries Mode type.
:OUTPut	AUDOUT GENERator		Sets output to AUDIO/DATA GEN Connector. Sets output to RF Generator.
:OUTPut?			Queries output destination.
:PATTern	FIXed RANDOm		Sets Data Pattern to Fixed. Sets Data Pattern to Random.
:PATTern?			Queries Data Pattern type.
:PEAKhold			
:MAXimum?			Queries Maximum Peak Hold value.
:RESet			Resets Peak Hold function.
:STATe b	0 or 1		Sets Peak Hold to ON or OFF
:STATe?			Queries Peak Hold setting.
:POLarity	INVerted NORmal		Sets Data Polarity to Inverted. Sets Data Polarity to Normal.
:POLarity?			Queries DATA Polarity.
:SIZE v	128 to 100000		Sets size of data word in bits.
:SIZE?			Queries data word size.
:UPPer v1,v2			Sets Upper Limit to value defined as v1 EXP - v2. Range of v1 is 0 to 999. Range of v2 is 3 to 6.
:STATe b	0 or 1		Sets Upper Limit to ON or OFF.
:STATe?			Queries Upper Limit state.
BER			
:UPPer?			Queries Upper Limit values.

## DECODER COMMANDS

DECode			
:FORMat	EEA		Set DECode format for desired decode format.
	EIA		
	ZVEI		
	DZVei		
	DDZVei		
	CCIR		
	CCIRH		
	CCIRH4		
	NATel		
	EURO		
	TONE5_6		
	USER		
	DTMF		
	DCS		
	DCSINVerted		
	POCSag		
	POCInv		
:POCSag			
:BAUD v			
:BAUD?			
:BAUD			
:AUTO			
	512, 1200, 2400		Sets POCSAG receive baud rate.
			Queries POCSAG receive baud rate.
			Sets the POCSAG receive baud rate to Auto baud rate detect (1200 or 2400).
:MESSAge?			Queries ASCII decode string. DCS and DCSINV are returned in SCPI #Q Octal format.

## DISPLAY COMMANDS

The DISPlay subsystem changes the screen. Fields on the current display are updated as they are changed. New screens are displayed with this command.

DISPlay?			Queries current screen number.
DISPlay			
:ANALyzer			Displays independent Spectrum Analyzer.
:BER			Displays BER Meter.
:DUPLex			
:GENErator			No parameter for GEN screen.
	DISTortion		Displays dependent Distortion Meter.
	AFLevel		Displays AF Level Meter.
	SINad		Displays dependent SINAD Meter.
	SCOPE		Displays dependent Oscilloscope.
	ANALyzer		Displays dependent Analyzer.
:RECEiver			Displays Duplex Receive Operation Screen when no parameter is used.
	LEVel		Displays dependent Received Level Meter.
	MODulation		Displays Modulation Meter if demod is AM, Deviation Meter if demod is FM, Phase Meter if demod is PM.
	DISTortion		Displays dependent Distortion Meter.
	AFCounter		Displays dependent AF Counter.
	POWER		Displays RF Power Meter.
	SINad		Displays dependent SINAD Meter.
	SCOPE		Displays dependent Oscilloscope.
	ANALyzer		Displays dependent Spectrum Analyzer.
	RFERror		Displays RF Error Meter.
:RECGen			Displays Duplex Screen.

DISPlay		Displays Audio/Data/Signal Generators
:FGENERator		Displays RF Generate Operation Screen when
:GENERator		no parameter is used.
	DISTortion	Displays dependent Distortion Meter.
	AFLevel	Displays AF Level Meter.
	SINad	Displays dependent SINAD Meter.
	SCOPE	Displays dependent Oscilloscope.
:METers	ANALyzer	Displays dependent Analyzer.
	DISTortion	Displays Independant Distortion Meter.
	SINad	Displays Independant SINAD Meter.
	AFCounter	Displays Independant AF Counter.
	DVM	Displays Independant DVM.
:RECEiver		Displays RF Receive Operation Screen when
		no parameter is used.
	LEVel	Displays dependent Received Level Meter.
	MODulation	Displays Modulation Meter same as Duplex Receiver.
	DISTortion	Displays dependent Distortion Meter.
	AFCounter	Displays dependent AF Counter.
	POWer	Displays RF Powe Meter.
	SINad	Displays dependent SINAD Meter.
	SCOPE	Displays dependent Oscilloscope.
	ANALyzer	Displays dependent Spectrum Analyzer.
	RFERror	Displays RF Error Meter.
:SCOPE		Displays independent Oscilloscope.
:SETup		Displays Setup Menu.
:TRUNKing	RADIOSimulation	Displays LTR Radio Simulator Screen.
	REPeater	Displays LTR Repeater Simulator Screen.
	AUXSetup	Displays LTR Auxiliary Setup Screen,

## DUPLEX COMMANDS

DUPLex			
:LOCK b	0 or 1		Sets Offset Lock to OFF and ON.
:LOCK?			Queries Offset Lock state.
:OFFSet v[units]	.2500 to 1000.0000		Sets offset frequency. Assumed units are MHz. Valid units are Hz, kHz, MHz or GHz.
:RECALL v	0 to 49		Restores duplex screen values from specified storage location.
:STORE v	0 to 49		Stores current settings at specified location.
:LABEL v,string	0 to 49		Attaches character string (0 to 8 characters) to specified storage location.
:LABEL? v	0 to 49		Queries LABEL for specified storage location.

## FILTER COMMANDS

FILTer			
:SPEaker OFF			Sets Speaker Operation to OFF.
:BANDwidth			Sets Filter to C-Message Weighted Filter.
:CMESsage			Sets Filter to Wideband.
:WIDE			Sets Internal Modulation as Speaker source.
:AUDio			Valid only on Generate and Receive Operation Screens.
:SPEaker?			Queries current Speaker setting.
:MODMeter			
:HPASs v[units]	0, 300, 4000		Sets Filter to specified value. Default units are Hz. Accepted units are Hz and kHz. Setting filter to 0 sets filter OFF.

FILTer

:MODMeter			Queries Filter setting.
:HPASs?			Sets Filter to OFF.
:BPASs	OFF		Sets Filter to C-Message Weighted Filter.
	CMESsage		Queries Filter setting.
:BPASs?			Sets Filter to specified value. Default units are Hz. Accepted units are Hz and kHz. Setting filter to 0 sets filter OFF.
:LPASs v[units]	0, 300, 4000, 20000		Queries Filter setting.
:LPASs?			Queries Filter setting.
:AFDecode			Sets Filter to specified value. Default units are Hz. Accepted units are Hz and kHz. Setting filter to 0 sets filter OFF.
:HPASs v[units]	0, 300, 4000		Queries Filter setting.
:HPASs?			Sets Filter to OFF.
:BPASs	OFF		Sets Filter to C-Message Weighted Filter.
	CMESsage		Queries Filter setting.
:BPASs?			Sets Filter to specified value. Default units are Hz. Accepted units are Hz and kHz. Setting filter to 0 sets filter OFF.
:LPASs v[units]	0, 300, 4000, 20000		Queries Filter setting.
:LPASs?			Queries Filter setting.
:AFCounter			Sets Filter to specified value. Default units are Hz. Accepted units are Hz and kHz. Setting filter to 0 sets filter OFF.
:HPASs v[units]	0, 300, 4000		Queries Filter setting.
:HPASs?			Sets Filter to OFF.
:BPASs	OFF		Sets Filter to C-Message Weighted Filter.
	CMESsage		Queries Filter setting.
:BPASs?			Sets Filter to specified value. Default units are Hz. Accepted units are Hz and kHz. Setting filter to 0 sets filter OFF.
:LPASs v[units]	0, 300, 4000, 20000		Queries Filter setting.
:LPASs?			Queries Filter setting.
:DATADeCode			Sets Filter to specified value. Default units are Hz. Accepted units are Hz and kHz. Setting filter to 0 sets filter OFF.
:HPASs v[units]	0, 300, 4000		Queries Filter setting.
:HPASs?			Sets Filter to OFF.
:BPASs	OFF		Sets Filter to C-Message Weighted Filter.
	CMESsage		Queries Filter setting.
:BPASs?			Sets Filter to specified value. Default units are Hz. Accepted units are Hz and kHz. Setting filter to 0 sets filter OFF.
:LPASs v[units]	0, 300, 4000, 20000		Queries Filter setting.
:LPASs?			Queries Filter setting.
:CLEar			Sets all filters to OFF. Does not affect speaker.

## FORMAT COMMANDS

The format commands set data formats for transferring numeric information. The data format for response data may override the definition of FORMat.

EXAMPLE: Floating point requirements always override a non-base10 FORMat.

FORMat type		
ASCIi		Returns all data (including integers and real numbers) as an ASCII representation. Numbers are returned in base 10.
BINary		Returns data encoded as numeric base 2, preceded by #B. Example: 15 is #B1111.
HEXadecimal		Returns data encoded as numeric base 16, preceded by #H. Example: 255 is #HFF.
INTeger		Returns ONLY block data encoded as 8 bit binary data with header and checksum.
OCTal		Returns data encoded as numeric base 8, preceded by #Q. Example: 255 is #Q377.

## FUNCTION GENERATOR COMMANDS

FGENERator		
:ATTenuation b	0 or 1	Turning Attenuation on activates divide-by-100 attenuator.
:ATTenuation?		Queries Attenuation state.
:DATA		
:CODE v	#Q0 to #Q777	Sets octal Code Value for DCS/ (DCS Inverted).
:CODE?		Queries DCS/DCS Inverted octal Code Value.
:FORMat	DCS	Sets DATA Format to DCS.
	INVDCS	Sets DATA Format to DCS Inverted.
	INVPOC	Sets DATA Format to POCSAG Inverted.
	POCSag	Sets DATA Format to POCSAG.
:FORMat?		Queries DATA Format.
:LEVel v		Sets output level for DATA Generator. Value is dependent on status of Attenuation. Value is 0 to 2.5 Vp if OFF and 0 to .250 Vp if ON.
:LEVel?		Queries DATA Generator LEVl.
:POCSag		
:BAUD v	512, 1200, 2400	Selects Baud rate for POCSAG Generation.
:BAUD?		Queries POCSAG Baud rate.
:CAPCode v1[,v2]	0 to 9999999	Sets capcode range. v1 corresponds to start value and v2 corresponds to end value. Start value must be ≤ end value.
:CAPCode?		Queries current pocsag capcode.
:ENCode		Activates POGSAG Generation.
:MODE	BEEP1	Sets POCSAG Mode to 1 Beep.
	BEEP2	Sets POCSAG Mode to 2 Beep.
	BEEP3	Sets POCSAG Mode to 3 Beep.
	BEEP4	Sets POCSAG Mode to 4 Beep.
	NUMeric	Sets POCSAG Mode to Numeric.
	NUMSeq	Sets POCSAG Mode to Numeric Sequence.
	ANUM	Sets POCSAG Mode to Alpha-Numeric.

FGENERator

:DATA			
:POCSag			
:MODE		ANUM_LC	Sets POCSAG Mode to Alpha-Numeric lower case.
		ANUM_UC	Sets POCSAG Mode to Alpha-Numeric upper case.
		ANUM_SPeC	Sets POCSAG Mode to Alpha-Numeric special characters.
:MODE?			Queries POCSAG Mode.
:STATe b		0 or 1	Sets DATA Generator to ON or OFF.
:STATe?			Queries DATA Generator status.
:DTMF			
:CODe string			Sets DTMF Code where string is code.
:CODe?			Queries DTMF Code.
:ENCode			Starts DTMF burst message.
:LEVel v			Sets output level for DTMF Generator. Value is dependent on status of Attenuation. Value is 0 to 2.5 Vp if OFF and 0 to .250 Vp if ON.
:LEVel?			Queries DTMF Generator LEVel.
:MARK v		25 to 999	Sets Mark Time in ms.
:MARK?			Queries Mark Time.
:MODE		CONTInuous	Sets operation to continuous generation.
		BURSt	Sets operation to single burst.
:MODE?			Returns operation mode.
:PAUSE v		25 to 999	Sets Pause Time in ms.
:PAUSE?			Queries Pause Time.
:SPACE v		25 to 999	Sets Space Time in ms.
:SPACE?			Queries Space Time.
:STATe b		0 or 1	Sets DTMF Generator to ON or OFF.
:STATe?			Queries DTMF Generator status.
:GEN1			
:ENCode			Issues burst message of current format.
:FORMat			
:EEA string		0-9, A, G, R	Sets EEA Format with Code set to string.
:EIA string		0-9, A, G, R	Sets EIA Format with Code set to string.
:ZVEI string		0-9, A, G, R	Sets ZVEI Format with Code set to string.
:DZVei string		0-9, A, G, R	Sets DZVEI Format with Code set to string.
:DDZVei string		0-9, A, G, R	Sets DDZVEI Format with Code set to string.
:CCIR string		0-9, A, G, R	Sets CCIR Format with Code set to string.
:CCIRH string		0-9, A, G, R	Sets CCIRH Format with Code set to string.
:CCIRH4 string		0-9, A, G, R	Sets CCIRH4 Format with Code set to string.
:NATel string		0-9, A, G, R	Sets NATEL Format with Code set to string.
:EURO string		0-9, A, G, R	Sets EURO Format with Code set to string.
:TONE5_6 string		0-9, A, G, R	Sets 5/6 TONE Format with Code set to string.
:USER string		0-9, A-T	Sets USER Format with Code set to string.
:TONE10ps string		0-9, A-D, #, *	Sets 10 PS Format with Code set to string.
:TONE20ps string		0-9, A-D, #, *	Sets 10 PS Format with Code set to string.
:MTS string		0-9, A-D, #, *	Sets MTS Format with Code set to string.
:IMTS string		0-9, A-D, #, *	Sets IMTS Format with Code set to string.
:TREM			Sets Tone Remote Format.
:TONE			Sets Tone Format.
:FORMat?			Queries current GEN1 format.
:FREQuency v			Sets GEN1 Frequency. Range of value is 5.0 to 20000.0 Hz for Sine Shape and Tone Format. 5.0 to 10000.0 Hz for other shapes and Tone Format. Selections for Tone remote are: 1950, 1850, 1350,1250, 2050, 1750, 1650,1550, 1450, 1150, or 1050 Hz.
:FREQuency?			Queries GEN1 frequency.
:LEVel v			Sets output level for Audio Generator 1. Value is dependent on status of Attenuation.

FGENERator

:GEN1

:LEVel?

Queries Audio Generator 1 LEVel.

0 to 2.5 Vp if OFF and 0 to .250 Vp if ON.

:MODE

CONTInuous

Sets mode for continous operation.

BURSt

Initiates a burst of current format.

:MODE?

Queries mode.

:STATe b

0 or 1

Sets Audio Generator 1 to ON or OFF.

:STATe?

Queries Audio Generator 1 status.

:SHAPE

SINe

Sets Shape to Sine.

SQUare

Sets Shape to Square.

RAMP

Sets Shape to Ramp.

TRIangle

Sets Shape to Triangle.

:SHAPE?

Queries Shape.

:TIMe v

0 to 32.000

Sets burst time for Tone format in seconds.

:TIMe?

Queries Tone burst time.

:USER "char",v1,v2

Sets User Codes. "char" is 0 to 9 or A to T enclosed in quotes. Code frequency (v1) is 0.0 to 9999 Hz. Duration (v2) is 0.000 to 9.999 seconds.

:USER? "char"

Returns frequency and duration of specified code.

:GEN2

:FREQuency v

Sets GEN2 Frequency. Range of value is 5.0 to 20000.0 Hz for Sine Shape and 5.0 to 10000.0 Hz for other shapes. Requires Option 04 for frequency other than 1000.0 Hz.

:FREQuency?

Queries Frequency.

:LEVel v

Sets output level for Audio Generator 2. Value is dependent on status of Attenuation. Value is 0 to 2.5 Vp if OFF and 0 to .250 Vp if ON.

:LEVel?

Queries Audio Generator 2 LEVel.

:SHAPE

SINe

Sets Shape to Sine.

SQUare

Sets Shape to Square. Requires Option 04.

RAMP

Sets Shape to Ramp. Requires Option 04.

TRIangle

Sets Shape to Triangle. Requires Option 04.

:SHAPE?

Queries Shape.

:STATe b

0 or 1

Sets Audio Generator 2 to ON or OFF.

:STATe?

Queries Audio Generator 2 status.

## GENERATOR COMMANDS

**NOTE1:** Set frequency to value. Assumed units are MHz. Valid optional units are Hz, kHz, MHz or GHz. Frequency range is from 0.0 to 1000.0000 MHz.

**NOTE2:** Set output level in DBM, uV, mV or V. Assumed units are dBm. Ranges are as follows:

UNITS	T/R	AUX w/o 20dB AMP	AUX w/20dBm AMP
DBM	-130 to -20	-130 to -13	-130 to 13
uV	0 to 999.9	0 to 999.9	0 to 999.9

UNITS	T/R	AUX w/o 20dB AMP	AUX w/20dBm AMP
mV	0 to 22.3	0 to 50.5	0 to 999.9
V	0 to 0.022	0 to 0.050	0 to 0.988

**NOTE3:** Cannot have FM and PM modulation chosen on two different function generator devices.

**NOTE4:** Must set the "MODE" before using this command.

### GENerator

:FREQuency v[units]	0.0 to 1000.0000	See NOTE 1.
:CELLular v	1 to 1023	Sets Cellular channel. See NOTE 4.
:CELLular?		Queries current Cellular channel.
:LIST v	0 to 99	Sets frequency list value. Refer to NOTE 4.
:FREQuency v1,v2[units]	0 to 99, 0.0 to 1000.0000	Sets frequency list value (v1) to frequency (v2). See NOTE 1.
:FREQuency? v	0 to 99	Queries frequency of specified frequency list value.
:LABel v,string	0 to 99	Attaches character string (@6 characters) to specified frequency list value.
:LABel? v	0 to 99	Queries LABEL for specified frequency list value.
:LIST?		Queries frequency list value.
:MODE		
:CELLular	FORward REVerse	Sets cellular forward channel as MODE Type. Sets cellular reverse channel as MODE Type.
:FIXed		Sets frequency as MODE Type.
:LIST		Sets Frequency LIST as MODE Type.
:TRUNKing	FORward REVerse	Sets trunking forward channel as MODE Type. Sets trunking reverse channel as MODE Type.
:MODE?		Returns current MODE.
:TRUNKing v1,v2	1 to 760, 800 or 900	Sets Trunking Channel in specified band. See NOTE 4.
:TRUNKing?		Queries Trunking Channel.
:FREQuency?		Returns frequency in MHz.
:METer		
:ANALyzer		Sets Spectrum Analyzer on RF Generate Operation Screen.
:DISTortion		Sets Distortion Meter on RF Generate Operation Screen.
:SCOPE		Sets Oscilloscope on RF Generate Operation Screen.



GENERator			
:METer			
:SINad			Sets SINAD Meter on RF Generate Operation Screen.
:OUTPut			
:AUX			Sets AUX RF OUT Connector as output.
:DATA			
:AM			
[:MODulation] v	0% to 100%		Sets AM Modulation Level.
[:MODulation]?			Queries AM Modulation Level.
:FM			
[:DEVIation] v	0.0 to 100.0		Sets FM Deviation in kHz.
[:DEVIation]?			Queries FM Deviation.
:MODulation		AM	Sets Modulation Type to AM.
		FM	Sets Modulation Type to FM. See NOTE 3.
		OFF	Sets Modulation Type to OFF.
		PM	Sets Modulation Type to PM. See NOTE 3.
:MODulation?			Queries Modulation Type.
:PM			
[:DEVIation] v	0.0 to 10.0		Sets PM Deviation in Radians.
[:DEVIation]?			Queries PM Deviation.
:DTMF			
:AM			
[:MODulation] v	0% to 100%		Sets AM Modulation Level.
[:MODulation]?			Queries AM Modulation Level.
:FM			
[:DEVIation] v	0.0 to 100.0		Sets FM Deviation in kHz.
[:DEVIation]?			Queries FM Deviation.
:MODulation		AM	Sets Modulation Type to AM.
		FM	Sets Modulation Type to FM. See NOTE 3.
		OFF	Sets Modulation Type to OFF.
		PM	Sets Modulation Type to PM. See NOTE 3.
:MODulation?			Queries Modulation Type.
:PM			
[:DEVIation] v	0.0 to 10.0		Sets PM Deviation in Radians.
[:DEVIation]?			Queries PM Deviation.
:EXTErnal			
:MODulation		AM	Sets Modulation Type to AM.
		FMNARR1	Sets Modulation Type to FM NAR 1. See NOTE 3.
		FMNARR2	Sets Modulation Type to FM NAR 2. See NOTE 3.
		FMNARR3	Sets Modulation Type to FM NAR 3. See NOTE 3.
		FMWIDE	Sets Modulation Type to FM WIDE. See NOTE 3.
		OFF	Sets Modulation Type to OFF.
		PMNARR1	Sets Modulation Type to PM NAR 1. See NOTE 3.
		PMNARR2	Sets Modulation Type to PM NAR 2. See NOTE 3.
		PMNARR3	Sets Modulation Type to PM NAR 3. See NOTE 3.
:MODulation?			Queries Modulation Type.
:GATE		TR	Sets T/R Connector as output connector, as selected by MIC PTT switch.
		AUX	Sets AUX RF OUT Connector as output, as selected by MIC PTT switch.
:GEN1			
:AM			
[:MODulation] v	0% to 100%		Sets AM Modulation Level.
[:MODulation]?			Queries AM Modulation Level.
:FM			
[:DEVIation] v	0.0 to 100.0		Sets FM Deviation in kHz.
[:DEVIation]?			Queries FM Deviation.

GENERator		
:OUTPut		
:GEN1		
:MODulation	AM FM OFF PM	Sets Modulation Type to AM. Sets Modulation Type to FM. See NOTE 3. Sets Modulation Type to OFF. Sets Modulation Type to PM. See NOTE 3. Queries Modulation Type.
:MODulation?		
:PM		
[:DEVIation] v	0.0 to 10.0	Sets PM Deviation in Radians.
:[:DEVIation]?		Queries PM Deviation.
:GEN2		
:AM		
[:MODulation]	0% to 100%	Sets AM Modulation Level.
[:MODulation]?		Queries AM Modulation Level.
:FM		
[:DEVIation] v	0.0 to 100.0	Sets FM Deviation in kHz.
[:DEVIation]?		Queries FM Deviation.
:MODulation	AM FM OFF PM	Sets Modulation Type to AM. Sets Modulation Type to FM. See NOTE 3. Sets Modulation Type to OFF. Sets Modulation Type to PM. See NOTE 3. Queries Modulation Type.
:MODulation?		
:PM		
[:DEVIation] v	0.0 to 10.0	Sets PM Deviation in Radians.
:[:DEVIation]?		Queries PM Deviation.
:LEVel v[units]		Sets Output level. See NOTE 2.
:LEVel?		Queries Output level.
:LEVel		
:UNITs	DBM UV MV V	Sets UNITs for LEVel? command to dBm. Sets UNITs for LEVel? command to $\mu$ V. Sets UNITs for LEVel? command to mV. Sets UNITs for LEVel? command to V. Queries UNITs Type.
:UNITs?		
:MIC		
:MODulation	AM FMNARR1 FMNARR2 FMNARR3 FMWIDE OFF PMNARR1 PMNARR2 PMNARR3	Sets Modulation Type to AM. Sets Modulation Type to FM NAR 1. See NOTE 3. Sets Modulation Type to FM NAR 2. See NOTE 3. Sets Modulation Type to FM NAR 3. See NOTE 3. Sets Modulation Type to FM WIDE. See NOTE 3. Sets Modulation Type to OFF. Sets Modulation Type to PM NAR 1. See NOTE 3. Sets Modulation Type to PM NAR 2. See NOTE 3. Sets Modulation Type to PM NAR 3. See NOTE 3. Queries Modulation Type.
:MODulation?		
:TR		
:OUTPut?		Sets T/R Connector as output connector. Queries selected output connector.
:RECALL v	0 to 49	Restore GENERATE Screen values from specified location.
:STORE v	0 to 49	Stores current screen locations at specified location.
:LABEL v,string	0 to 49	Attaches character string (0 to 8 characters) to specified storage location.
:LABEL? v	0 to 49	Queries LABEL for storage location.

## GENerator

:SWEep

:ABORt

:CONTinuous

:INCRement v

0.0001 to 1000.0000

:INCRement?

:PAUSE v

0.0 to 9.5

:PAUSE?

:ONCE

:STARt v

0.0 to 1000.0000

:STARt?

:STOP v

0.0 to 1000.0000

:STOP?

:RESUme

:FREQuency?

:SWEep?

Stops Sweep Function.

Sets Sweep Function to Continuous Operation.

Use ABORt to halt.

Sets Increment Frequency in MHz.

Queries Increment Frequency.

Sets Pause time for Sweep Function in 0.5 second increments.

Queries Pause time for Sweep Function.

Sets Sweep Function for one pass.

Use ABORt after pass.

Sets Start RF in MHz.

Queries Start RF.

Sets Stop RF in MHz.

Queries Stop RF.

Continue sweeping where stopped or continue sweeping if in squelch mode.

Return current Sweep Function frequency in MHz.

Queries Sweep Function Status. Returns 0 if off.

## MEASURING COMMANDS

### MEASure

:SINAd?

:FM

:NEG?

:POS?

:FM?

:PM

:NEG?

:POS?

:PM?

:AM?

:RECLevel?

:AFCounter?

:POWer?

:DVM?

:DISTortion?

:RFERror?

:AFLevel?

:BER?

Commands require specified meter be active.

Queries SINAD Meter reading.

Returns the Negative peak FM Deviation Meter reading.

Returns the Positive peak FM Deviation Meter reading.

Returns +/- peak div by 2 FM Deviation Meter reading.

Returns the Negative peak FM Deviation Meter reading.

Returns the Positive peak FM Deviation Meter reading.

Queries PM Deviation Meter reading.

Queries AM Modulation Meter reading.

Queries Received Level Meter reading.

Queries AF Counter reading. Return value resolution is .1 Hz if input frequency is <500 Hz or gatetime is 10 sec. Otherwise resolution is 1 Hz.

Queries Power Meter reading.

Queries DVM reading.

Queries Distortion Meter reading.

Queries RF ERROR Meter reading and input

frequency. Resolution is 1 Hz if gatetime is 1 sec. Otherwise, resolution is 10 Hz.

Queries AF Level Meter reading.

Initiates BER Meter, then queries BER Meter reading.

BER Meter reading as string consists of mantissa, "EXP" and exponent.

Initiates measurement of slow meters. SRQ

indicates completion, if SRQ mask for meter is enabled.

Starts AF Counter Measurement.

Starts RF Error Meter Measurement.

Starts BER Meter Measurement.

Starts next trunking decode.

### INITiate

:AFCounter

:RFERror

:BER

:TRUNKing

## FETCH

:AFCounter?  
:RFERror?

:BER?

:TRUNKing?

Returns value(s) created by INIT command,  
or error code -230.

Queries AF Counter reading.

Queries RF ERROR Meter reading and input  
frequency. Resolution is 1 Hz if gatetime is  
1 sec. Otherwise, resolution is 10 Hz.

Queries BER Meter reading. BER Meter reading  
as string consists of mantissa, "EXP" and  
exponent.

Returns decoded trunking data.

## METER COMMANDS

### METer

:SINad

:ALARm

:STATe b

0 or 1

Sets Alarm to ON or OFF.

:STATe?

Queries Alarm state.

:AVERage

:COUNt v

2 to 10

Sets number of Average samples when active.

:COUNt?

Queries number of Average samples.

:STATeb

0 or 1

Sets Average to ON or OFF.

:STATe?

Queries Average state.

:INPut

AUDIN

Sets input to AUDIO/DATA IN Connector.

SCOPedvm

Sets Input to SCOP/DVM Connector.

:SINad

:INPut?

Queries Input setting.

:LOWer v

0.0 to 40.0

Sets Lower Limit values in dB.

:STATe b

0 or 1

Sets Lower Limit to ON or OFF.

:STATe?

Queries Lower Limit state.

:LOWer?

Queries Lower Limit value

:PEAKhold

:MINimum?

Queries minimum peak value.

:MAXimum?

Queries maximum peak value.

:RESet

Resets Peak Hold setting.

:STATe b

0 or 1

Sets Peak Hold to ON or OFF.

:STATe?

Queries Peak Hold setting.

:RANGe v [units]

15 or 40

Sets display range in dB.

:AUTO

Sets display range to autorange.

:RANGe?

Queries Range.

:UPPer v

0.0 to 40.0

Sets Upper Limit value in dB.

:STATe b

0 or 1

Sets Upper Limit to ON or OFF.

:STATe?

Queries Upper Limit state.

:UPPer?

Queries Upper Limit value.

:FM

[:DEViation]

:ADJust

Performs FM-Z.

:ALARm

:STATe b

0 or 1

Sets Alarm to ON or OFF.

:STATe?

Queries Alarm state.

:AVERage

:COUNt v

2 to 10

Sets number of Average samples when active.

:COUNt?

Queries number of Average samples.

:STATeb

0 or 1

Sets Average to ON or OFF.

:STATe?

Queries Average state.

:COUPLing

AC

Set Meter for AC Coupled operation.

DC

Set Meter for DC Coupled operation.

:COUPLing?

METer

:FM

```

[:DEVIation]
:LOWer v          0.0 to 99.99    Sets Lower Limit values in kHz.
:STATe b          0 or 1        Sets Lower Limit to ON or OFF.
:STATe?           Queries Lower Limit state.
:LOWer?           Queries Lower Limit value
:PEAKhold
:MINimum?        Queries minimum peak value.
:MAXimum?        Queries maximum peak value.
:RESet           Resets Peak Hold setting.
:STATe b          0 or 1        Sets Peak Hold to ON or OFF.
:STATe?           Queries Peak Hold setting.
:RANGe v[units]   2, 5, 10, 50, 100 Sets display range in kHz. Hz are also
                                     acceptable units.
:AUTo             Sets display range to autorange.
:RANGe?           Queries Range.
:UPPer v          0.0 to 99.99    Sets Upper Limit value in kHz.
:STATe b          0 or 1        Sets Upper Limit to ON or OFF.
:STATe?           Queries Upper Limit state.
:UPPer?           Queries Upper Limit value.
[:MODE]
:NORMal           Reads Deviation +/- peak div by 2.
:BOTH            Reads Positive and Negative Deviation.
[:MODE?]         Returns Deviation Meter Mode.

```

:PM

```

[:DEVIation]
:ALARm
:STATe b          0 or 1        Sets Alarm to ON or OFF.
:STATe?           Queries Alarm state.
:AVERage
:COUNT v        2 to 10        Sets number of Average samples when active.
:COUNT?         Queries number of Average samples.
:STATeb          0 or 1        Sets Average to ON or OFF.
:STATe?           Queries Average state.
:LOWer v          0.0 to 9.99    Sets Lower Limit values in Radians.
:STATe b          0 or 1        Sets Lower Limit to ON or OFF.
:STATe?           Queries Lower Limit state.
:LOWer?           Queries Lower Limit value.
:PEAKhold
:MINimum?        Queries minimum peak value.
:MAXimum?        Queries maximum peak value.
:RESet           Resets Peak Hold setting.
:STATe b          0 or 1        Sets Peak Hold to ON or OFF.
:STATe?           Queries Peak Hold setting.
:RANGe v[units]   1, 2, 5, 10    Sets display range in Radians.
:AUTo             Sets display range to autorange.
:RANGe?           Queries Range.
:UPPer v          0.0 to 9.99    Sets Upper Limit value in Radians.
:STATe b          0 or 1        Sets Upper Limit to ON or OFF.
:STATe?           Queries Upper Limit state.
:UPPer?           Queries Upper Limit value.
[:MODE]
:NORMal           Reads Deviation +/- peak div by 2.
:BOTH            Reads Positive and Negative Deviation.
[:MODE?]         Returns Deviation Meter Mode.

```

:AM

```

:ALARm
:STATe b          0 or 1        Sets Alarm to ON or OFF.
:STATe?           Queries Alarm state.

```

METer  
:AM

:AVERage			Sets number of Average samples when active.
:COUNT v	2 to 10		Queries number of Average samples.
:COUNT?			Sets Average to ON or OFF.
:STATEb	0 or 1		Queries Average state.
:STATE?			Sets Lower Limit values.
:LOWer v	0.0% to 99.9%		Sets Lower Limit to ON or OFF.
:STATE b	0 or 1		Sets Lower Limit values.
LOWer v	0.0% to 99.9%		Queries Lower Limit state.
:STATE?			Queries Lower Limit value.
:LOWer?			
:AM			
:PEAKhold			
:MINimum?			Queries minimum peak value.
:MAXimum?			Queries maximum peak value.
:RESet			Resets Peak Hold setting.
:STATE b	0 or 1		Sets Peak Hold to ON or OFF.
:STATE?			Queries Peak Hold setting.
:RANGe v[units]	40% or 100%		Sets display range.
:AUTO			Sets display range to autorange.
:RANGe?			Queries Range.
:UPPer v	0.0% to 99.9%		Sets Upper Limit value.
:STATE b	0 or 1		Sets Upper Limit to ON or OFF.
:STATE?			Queries Upper Limit state.
:UPPer?			Queries Upper Limit value.
:RECLLevel			
:ADJust			Performs runtime adjustment. Requires external connection between ANTENNA Connector and T/R Connector for valid adjustment.
:ALARm			
:STATE b	0 or 1		Sets Alarm to ON or OFF.
:STATE?			Queries Alarm state.
:AVERage			
:COUNT v	2 to 75		Sets number of Average samples when active.
:COUNT?			Queries number of Average samples.
:STATEb	0 or 1		Sets Average to ON or OFF.
:STATE?			Queries Average state.
:RECLLevel			
:LOWer v			Sets Lower Limit values. Range of value is dependent on Receiver Attenuation and Units. If REC:INP:ATT is set to 30 dB, range is -80 to 0 dBm or 22.3 to 223606 $\mu$ V. If REC:INP:ATT is set to 0 dB, range is -110 to -30 dBm or 0 to 70710 $\mu$ V.
:STATE b	0 or 1		Sets Lower Limit to ON or OFF.
:STATE?			Queries Lower Limit state.
:LOWer?			Queries Lower Limit value.
:PEAKhold			
:MINimum?			Queries minimum peak value.
:MAXimum?			Queries maximum peak value.
:RESet			Resets Peak Hold setting.
:STATE b	0 or 1		Sets Peak Hold to ON or OFF.
:STATE?			Queries Peak Hold setting.
:UNITs	DBM		Sets units for meter to dBm.
	UV		Sets units for meter to $\mu$ V.
:UNITs?			Return the units.

METer

:AFCounter		Sets Upper Limit values. Range of value is dependent on Receiver Attenuation and Units. If REC:INP:ATT is set to 30 dB, range is -80 to 0 dBm or 22.3 to 223606 $\mu$ V. If REC:INP:ATT is set to 0 dB, range is -110 to -30 dBm or 0 to 70710 $\mu$ V.
:ALARm		
:UPPer v		
:STATe b	0 or 1	Sets Upper Limit to ON or OFF.
:STATe?		Queries Upper Limit state.
:UPPer?		Queries Upper Limit value.
:STATe b	0 or 1	Sets Alarm to ON or OFF.
:STATe?		Queries Alarm state.
:AVERage		
:COUNT v	2 to 10	Sets number of Average samples when active.
:COUNT?		Queries number of Average samples.
:STATeb	0 or 1	Sets Average to ON or OFF.
:STATe?		Queries Average state.
:GATE		
:TIME v	1 or 10	Sets Gate Time in seconds.
:TIME?		Queries Gate Time.
:INPut	AUDIN	Sets AF Counter Input to AUDIO/DATA IN Connector.
	RFPower	Sets AF Counter Input to RF Power line.
	EXTMod	Sets AF Counter Input to EXT MOD Connector.
	SCOPedvm	Sets AF Counter Input to SCOPE/DVM Connector.
:INPut?		Queries meter Input.
:LOWer v	0.0 to 20000.0	Sets Lower Limit values in Hz.
:STATe b	0 or 1	Sets Lower Limit to ON or OFF.
:STATe?		Queries Lower Limit state.
:LOWer?		Queries Lower Limit value.
:PEAKhold		
:MINimum?		Queries minimum peak value.
:MAXimum?		Queries maximum peak value.
:RESet		Resets Peak Hold setting.
:STATe b	0 or 1	Sets Peak Hold to ON or OFF.
:STATe?		Queries Peak Hold setting.
:AFCounter		
:RANGE v[units]	200, 2000, 20000	Sets display range. Assumed units are Hz, If kHz is specified, values are 0.2, 2 and 20.
:AUTO		Sets display range to autorange.
:RANGE?		Queries Range.
:UPPer v	0.0 to 20000.0	Sets Upper Limit value in Hz.
:STATe b	0 or 1	Sets Upper Limit to ON or OFF.
:STATe?		Queries Upper Limit state.
:UPPer?		Queries Upper Limit value.
:AFLevel		
:ALARm		
:STATe b	0 or 1	Sets Alarm to ON or OFF.
:STATe?		Queries Alarm state.
:AVERage		
:COUNT v	2 to 10	Sets number of Average samples when active.
:COUNT?		Queries number of Average samples.
:STATeb	0 or 1	Sets Average to ON or OFF.
:STATe?		Queries Average state.
:IMPedance v	0 to 1000	Specify input impedance of user signal.
:IMPedance?		Queries impedance.
:LOWer v	0.00 to 10.00	Sets Lower Limit values in V.
:STATe b	0 or 1	Sets Lower Limit to ON or OFF.
:STATe?		Queries Lower Limit state.

METer

:AFLevel			
:LOWer?			Queries Lower Limit value.
:PEAKhold			
:MINimum?			Queries minimum peak value.
:MAXimum?			Queries maximum peak value.
:RESet			Resets Peak Hold setting.
:STATe b	0 or 1		Sets Peak Hold to ON or OFF.
:STATe?			Queries Peak Hold setting.
:RANGe v[units]	.05, .1, .2, .5, 1, 2, 5, 10		Sets display range. Assumed units are V, allowed units are mV and V.
:AUTO			Sets display range to autorange.
:RANGe?			Queries Range.
:UNITs	DBM VRMS DB		Sets units for meter to dBm. Sets units for meter to Vrms. Sets units for meter to dB.
:UNITs?			Queries units setting.
:UPPer v	0.00 to 10.00		Sets Upper Limit value in V.
:STATe b	0 or 1		Sets Upper Limit to ON or OFF.
:STATe?			Queries Upper Limit state.
:UPPer?			Queries Upper Limit value.
:POWer			
:ADJust			Zeroes Power Meter. Requires Power applied to T/R Connector be removed.
:ALARm			
:STATe b	0 or 1		Sets Alarm to ON or OFF.
:STATe?			Queries Alarm state.
:AVERage			
:COUNT v	2 to 75		Sets number of Average samples when active.
:COUNT?			Queries number of Average samples.
:STATeb	0 or 1		Sets Average to ON or OFF.
:STATe?			Queries Average state.
:LOSS v	-9.9 to 9.9		Sets Cable Loss in dB.
:LOSS?			Queries Cable Loss value.
:LOWer v	0.0000 to 200.0000		Sets Lower Limit values in W.
:STATe b	0 or 1		Sets Lower Limit to ON or OFF.
:STATe?			Queries Lower Limit state.
:LOWer?			Queries Lower Limit value.
:POWer			
:PEAKhold			
:MINimum?			Queries minimum peak value.
:MAXimum?			Queries maximum peak value.
:RESet			Resets Peak Hold setting.
:STATe b	0 or 1		Sets Peak Hold to ON or OFF.
:STATe?			Queries Peak Hold setting.
:RANGe v[units]	.002, .005, .01, .02, .05, .1, .2, .5, 1, 2, 5, 10, 20, 50, 100,200		Sets display range. Assumed units are W, allowed units are mW and W.
:AUTO			Sets display range to autorange.
:RANGe?			Queries Range.
:UNITs	DBM W		Sets units for meter to dBm. Sets units for meter to W.
:UNITs?			Queries units setting.
:UPPer v	0.0000 to 200.0000		Sets Upper Limit value in W.
:STATe b	0 or 1		Sets Upper Limit to ON or OFF.
:STATe?			Queries Upper Limit state.
:UPPer?			Queries Upper Limit value.
:DVM			
:ALARm			
:STATe b	0 or 1		Sets Alarm to ON or OFF.
:STATe?			Queries Alarm state.



METer

:DVM

:AVERage			
:COUNT v	2 to 10		Sets number of Average samples when active.
:COUNT?			Queries number of Average samples.
:STATEb	0 or 1		Sets Average to ON or OFF.
:STATE?			Queries Average state.
:IMPedance v	2 to 1000		Specifies input impedance of user signal.
:IMPedance?			Queries impedance.
:INPut	AC		Sets meter input to ac coupled SCOPE/DVM
:INPut?			Queries DVM Meter input.
	AUDIN		Connector.
	DC		Sets meter input to AUDIO/DATA IN Connector.
			Sets meter input to dc coupled SCOPE/DVM
			Connector.
	EXTMod		Sets meter input to EXT MOD Connector.
	GROund		Sets meter input to GND coupled SCOPE/DVM
			Connector.
:LOWer v	0.000 to 200.000		Sets Lower Limit values in V.
:STATE b	0 or 1		Sets Lower Limit to ON or OFF.
:STATE?			Queries Lower Limit state.
:LOWer?			Queries Lower Limit value.
:PEAKhold			
:MINimum?			Queries minimum peak value.
:MAXimum?			Queries maximum peak value.
:RESet			Resets Peak Hold setting.
:STATE b	0 or 1		Sets Peak Hold to ON or OFF.
:STATE?			Queries Peak Hold setting.
:RANGe v[units]	.05, .1, .2, .5, 1, 2 5, 10, 20, 50, 100, 200		Sets display range. Assumed units are V, allowed units are mV and V.
:RANGe?			Queries Range.
:UNITs	DBM		Sets units for meter to dBm.
	VRMS		Sets units for meter to Vrms.
	DB		Sets units for meter to dB.
:UNITs?			Queries units setting.
:UPPer v	0.000 to 200.000		Sets Upper Limit value in V.
:STATE b	0 or 1		Sets Upper Limit to ON or OFF.
:STATE?			Queries Upper Limit state.
:UPPer?			Queries Upper Limit value.
:DISTortion			
:ALARm			
:STATE b	0 or 1		Sets Alarm to ON or OFF.
:STATE?			Queries Alarm state.
:AVERage			
:COUNT v	2 to 10		Sets number of Average samples when active.
:COUNT?			Queries number of Average samples.
:STATEb	0 or 1		Sets Average to ON or OFF.
:STATE?			Queries Average state.
:INPut	AUDIN		Sets meter input to AUDIO/DATA IN Connector.
:INPut?	SCOPedvm		Sets meter input to SCOPE/DVM Connector.
			Queries Distortion Meter input.
:LOWer v	0.0% to 20.0%		Sets Lower Limit values.
:STATE b	0 or 1		Sets Lower Limit to ON or OFF.
:STATE?			Queries Lower Limit state.
:LOWer?			Queries Lower Limit value.
:PEAKhold			
:MINimum?			Queries minimum peak value.
:MAXimum?			Queries maximum peak value.
:RESet			Resets Peak Hold setting.
:STATE b	0 or 1		Sets Peak Hold to ON or OFF.
:STATE?			Queries Peak Hold setting.

METer

:DISTortion			
:UPPer v	0.0% to 20.0%		Sets Upper Limit value.
:STATe b	0 or 1		Sets Upper Limit to ON or OFF.
:STATe?			Queries Upper Limit state.
:UPPer?			Queries Upper Limit value.
:RFErroR			
:ALARm			
:STATe b	0 or 1		Sets Alarm to ON or OFF.
:STATe?			Queries Alarm state.
:AVErAge			
:COUNt v	2 to 10		Sets number of Average samples when active.
:COUNt?			Queries number of Average samples.
:STATe b	0 or 1		Sets Average to ON or OFF.
:STATe?			Queries Average state.
:GATE			
:TIME v	0.1 or 1.0		Sets Gate Time in seconds.
:TIME?			Queries Gate Time.
:PEAKhold			
:MINimum?			Queries minimum peak value.
:MAXimum?			Queries maximum peak value.
:RESet			Resets Peak Hold setting.
:STATe b	0 or 1		Sets Peak Hold to ON or OFF.
:STATe?			Queries Peak Hold setting.
:RANGe v[units]	.1, 1, 10, 100		Sets display range. Assumed units are kHz, allowed units are Hz and kHz.
:AUTO			Sets display range to autorange.
:RANGe?			Queries Range.
:UPPer v	0.0 to 100000.0		Sets Upper Limit value in Hz.
:STATe b	0 or 1		Sets Upper Limit to ON or OFF.
:STATe?			Queries Upper Limit state.
:UPPer?			Queries Upper Limit value.

## RECEIVER COMMANDS

**NOTE1:** Set frequency to value. Assumed units are MHz. Valid optional units are Hz, kHz, MHz or GHz. Accepted frequency range is from 0.0000 through 1000.0000 MHz in 0.1 kHz steps.

**NOTE2:** Must set the "MODE" before using this command.

REceiver			
:BANDwidth v[units]	3, 15, 30, 300		Sets Receiver IF Bandwidth in kHz. 3 kHz requires Option 8. 30 kHz requires Option 3.
:BANDwidth?			Queries IF Bandwidth.
:DEMODulation	AM		Sets Demodulation to AM.
	FM		Sets Demodulation to FM.
	LB		Sets Demodulation to Lower SSB. Requires Option 8.
	PM		Sets Demodulation to PM.
	UB		Sets Demodulation to Upper SSB. Requires Option 8.
:DEMODulation?			Queries Demodulation type.
:FREQuency v[units]	0.0000 to 1000.0000		See NOTE 1.
:CELLular v	1 to 1023		Sets Cellular channel. See NOTE 2.
:CELLular?			Queries current Cellular channel.
:LIST v	0 to 99		Sets frequency list value. See NOTE 2.
:FREQuency v1,v2[units]	0 to 99, 0.0000 to 1000.0000		Sets frequency list value (v1) to frequency (v2). See NOTE 1.
:FREQuency? v	0 to 99		Queries frequency of specified frequency list value.
:LABel v,string	0 to 99		Attaches character string (@6 characters) to specified frequency list value.
:LABel? v	0 to 99		Queries LABEL for specified frequency list value.
:LIST?			Queries frequency list value.
:MODE			
:CELLular	FORward		Sets cellular forward channel as MODE Type.
	REVerse		Sets cellular reverse channel as MODE Type.
:FIXed			Sets frequency as MODE Type.
:LIST			Sets Frequency LIST as MODE Type.
:TRUNKing	FORward		Sets trunking forward channel as MODE Type.
	REVerse		Sets trunking reverse channel as MODE Type.
:MODE?			Returns current MODE.
:TRUNKing v1,v2	1 to 760, 800 or 900		Sets Trunking Channel in specified band. See NOTE 2.
:TRUNKing?			Queries Trunking Channel.
:FREQuency?			Returns frequency in MHz.
:INPut			
:ANTenna			Selects Antenna input connector.
:ATTenuation v	0, 30		Sets input ATTenuation in dB.
:ATTenuation?			Returns input ATTenuation in dB.
:TR			Selects TR input connector.
:INPut?			Returns selected input connector.
[[:METER]			
:ANALyzer			Sets Spectrum Analyzer on RF Receive Operation Screen.
:DEVIation			Sets appropriate Modulation/Deviation Meter on RF Receive Operation Screen.
:DISTortion			Sets Distortion Meter on RF Receive Operation Screen.

## SCOPE

:MODE	AVERAge COMParE LIVE RECALL STORE	Sets Mode to Average. Sets Mode to Compare. Sets Mode to LIVE. Recalls stored trace. Stores current trace in memory. Queries Mode Type.
:MODE?		Queries Mode Type.
:SCALE v[units]		Sets Vertical Scale. Default units are V. Valid units are V and mV. Values include; 10, 20, 50, 100, 200, 500 mV, 1, 2, 5, 10, 20 and 50 V.
:SCALE?		Returns vertical scale with units.
:SWEep[:TIME] v[units]		Sets duration of sweep per division. Assumed units are ms. Valid units are $\mu$ s (US) and ms (MS). Accepted values are 100, 200, 500 $\mu$ s, 1, 2, 5, 10, 20, 50 and 100 ms.
:SWEep[:TIME]?		Returns SWEep setting with units.
:TRACe		Queries current data trace values. v1 specifies Mode (0[live], 1[recall]). v2 specifies start point in pixels, with range of 0 to 499. v3 specifies number of returned points in pixels with range of 0 to 499, where v1 + v2 @500. Defaults are 0,0,500.
:DATA?[v1,v2,v3]		
:TRIGger		Arms Trigger for Singleshot Mode.
:ARM		Sets trigger level.
:LEVel v	0 to 255	Queries trigger level.
:LEVel?		Sets Trigger Mode to automatic.
:MODE	AUTO SINGleshot NORMAL	Sets Trigger Mode to Singleshot. Sets Trigger Mode to Normalized.
:MODE?		Queries Trigger Mode setting.

## STATUS COMMANDS

See Status Bit definitions and SCPI manuals for further descriptions.

## STATus

:OPERation		Returns operation condition register.
:CONDition?		Sets enable mask in event register.
:ENABle v		Returns state of event register's enable bit.
:ENABle?		Returns, then clears operation's event register.
:EVENT?		
:INSTrument		Queries Operation complete status-1.
:CONDition?		Sets extension bits.
:EBIT		Returns operation complete status-2.
:CONDition?		Sets enable mask in INST EBIT EVENT register.
:ENABle v		Queries enable mask in INST EBIT EVENT register.
:ENABle?		Queries INSTRument EBIT EVENT register.
:EVENT?		Sets enable mask in INSTRument EVENT register.
:ENABle v		Queries enable mask in INSTRument EVENT register.
:ENABle?		Queries INSTRument EVENT register.
:EVENT?		
:MEASuring		Returns operation measuring status-1.
:CONDition?		

## STATus

:OPERation

:MEASuring

:EBIT

:CONDition?

:ENABle v

:MEASuring

:ENABle?

:EVENT?

:ENABle v

:ENABle?

:EVENT?

:PRESet

:QUESTionable

:CONDition?

:ENABle v

:ENABle?

:EVENT?

:INSTrument

:CONDition?

:EBIT

:CONDition?

:ENABle v

:ENABle?

:EVENT?

:ENABle v

:ENABle?

:EVENT?

Returns operation measuring status-2.  
Set enable mask in MEAS EBIT EVENT register.

Queries enable mask in MEAS EBIT EVENT register.

Queries MEAS EBIT EVENT register.

Sets enable mask in MEAS EVENT register.

Queries enable mask in MEAS EVENT register.

Queries MEAS EVENT register.

Initializes enable and transition filter registers for SCPI mandated data structures.

Queries QUEST CONDition register.

Sets enable mask in QUES EVENT register.

Queries enable mask in QUES EVENT register.

Queries QUEST EVENT register.

Returns questionable status-1.

Returns questionable status-2.

Sets enable mask in QUES INST EBIT EVENT register.

Queries enable mask in QUES INST EBIT EVENT register.

Queries QUES INST EBIT EVENT register.

Sets enable mask in QUES INST EVENT register.

Queries enable mask in QUES INST EVENT register.

Queries QUES INST EVENT register.

## SYSTEM COMMANDS

### SYSTEM

:ERRor?

Returns error code + error message.

Refer to para 5-5 for codes/messages.

:VERSion?

Returns version of SCPI used.

:KEY v

Sends keycode to execute.

Refer to para 5-6 for definitions.

:START

Sends start key.

:STOP

Sends stop key.

:KEY?

Returns key pressed or -1 if none.

:KLOCK b

0 = off, 1 = on

OFF enables front panel keyboard usage.

SYST:SEC OFF must be sent before setting this command to OFF. ON disables front panel keyboard.

Returns keyboard lock state.

:KLOCK?

:COMMunicate

:SERial

:BAUD v

110, 150, 300, 600,  
1200, 2400, 4800,  
9600, 19200, 38400

Sets Baud rate.

:BAUD?

Queries Baud rate.

:PARity xxx

EVEN, ODD, NONE

Sets Data Parity.

:PARity?

Queries Parity.

:BITS v

7 or 8

Sets Data Bits.

:BITS?

Queries Data Bits.

## SYSTEM

:COMMunicate		
:SERial		
:SBITs v	1 or 2	Sets Stop Bits.
:SBITS?		Queries Stop Bits.
:PACE	XON, NONE	Sets XON/XOFF handshake control.
:PACE?		Queries XON/XOFF handshake control.
:CONTRol:		
RTS xxx	ON, STANDard, RFR	Sets hardware handshake control.
RTS?		Queries hardware handshake control.
:ECHO b	0 = off, 1 = on	Sets RCI ECHO on/off.
:ECHO?		Returns RCI ECHO state.
:GPIB		
:ADDRess v	1 to 30	Sets GPIB Address.
:DATE v,v,v		Sets numeric year, month and day.
:DATE?		Query numeric year, month and day.
:DEFault		Resets all unit settings to factory defaults.
:TIME v,v,v		Sets numeric hour, minute and second.
:TIME?		Query numeric hour, minute and second.
:SECurity		Refer to SCPI Volume 1 manual.
[:STATe] b	0 = off, 1 = on	Sets SECurity STATe.
[:STATe]?		
:SECurity?		

## TRUNKING COMMANDS

These commands require Option 14, CLEARCHANNEL LTR<sup>®</sup> be installed.

### TRUNKing

:BORDER v	0 or 1	Sets Border Offset to DISABLED or ENABLED.
:BORDER?		Queries Border Offset state.
:FREEChan v	1 to 760	Sets Free Repeater channel number.
:FREEChan?		Queries Free Repeater channel number.
:RADIOSimulation		
:CHANnel v	1 to 760	Sets Channel Number for testing.
:CHANnel?		Queries Channel Number.
:BAND	800 or 900	Sets Bandwidth in MHz.
:BAND?		Queries Bandwidth.
:AREA b	0 or 1	Sets Area Bit ON or OFF.
:AREA?		Queries Area Bit setting.
:INUSE v	0 to 31	Sets Inuse Number.
:INUSE?		Queries Inuse Number.
:HOME v	0 to 31	Sets Home Repeater Number
:HOME?		Queries Home Repeater Number.
:GROUP v	0 to 255	Sets Group Number.
:GROUP?		Queries Group Number.
:FREE v	0 to 31	Sets Free Repeater Number.
:FREE?		Queries Free Repeater Number.
:ENCode		Starts Test.
:REPeater		
:MODE	FREE BUSY	Sets Mode to Free Home Repeater.
:MODE?		Sets Mode to Busy Home Repeater.
:CHANnel v	1 to 760	Queries simulation mode type.
:CHANnel?		Sets Channel Number for testing.
:BAND	800 or 900	Queries Channel Number.
:BAND?		Sets Bandwidth in MHz.
:AREA b	0 or 1	Queries Bandwidth.
		Sets Area Bit ON or OFF.

TRUNKing

:REPeater

:AREA? 0 to 31  
:GOTO v  
:GOTO? 0 to 31  
:HOME v  
:HOME? 0 to 255  
:GROUP v  
:GROUP? 0 to 31  
:FREE v  
:FREE? 0 to 250  
:ENCode  
:RICGroup v #H0 TO #H1FF  
:RICGroup?  
:SYNC v  
:SYNC?

Queries Area Bit setting.  
Sets Goto Number.  
Queries Goto Number.  
Sets Home Repeater Number.  
Queries Home Repeater Number.  
Sets Group Number.  
Queries Group Number.  
Sets Free Repeater Number.  
Queries Free Repeater Number.  
Starts Test.  
Sets Radio RIC ID.  
Queries Radio RIC ID.  
Sets System Sync value.  
Queries System Sync value.

The DELAY command delays for 2 seconds to allow time for the DCS Code generation

#### **TPAUSE**

This command passes command execution to the next macro any Test Set activity in the schedule queue.

### **6-16 SYSTEM RS-232 CONFIGURE COMMANDS**

The following commands allow the Test Set to control another device using serial RS-232 communication. Commands unique to the device controlled are sent as strings. Responses are received as strings.

**SYSTEM:PTHRough:SERial "string"**  
Passes the *string* through the RS-232 Connector.

**SYSTEM:PTHRough:SERial?**  
Waits for and returns a string from the RS-232 Connector.

**SYSTEM:PTHRough:SERial:QUEue?**  
Returns a non-zero value if data is in the RS-232 queue, 0 if the RS-232 queue is empty.

**SYSTEM:PTHRough:SERial:KEY?**  
Waits for and returns one character from the RS-232 Connector.

**SYSTEM:DEFault**  
Resets all unit settings to factory defaults with these exceptions: 1) All RCI macros are defined, 2) Any currently executing RCI macro continues to execute and 3) All stored setups, stored frequency lists and stored scope/analyzer traces are not affected.

**NOTE:** Communications parameters reset to default values! If this command is issued via RS-232 or GPIB, follow the command on the same line with instructions to restore communications with the host.

Example: SYST:SEC OFF  
          SYST:DEFAULT;:SYST:COMM:SER:BAUD 38400

### **6-17 SETUP COMMANDS**

SETUP commands establish the routings for various Operation Modes without displaying the Operation Screens on the CRT. The SETUP commands force the COM-120B to switch to page 1 (a blank screen) but performs all the hardware setups.

**SETUP:ANALyzer**  
Configures for independent Spectrum Analyzer.

**SETUP:BER**  
Configures for the BER meter.



SETUP:DUplex:GENerator  
Configures for the Duplex Generator Operation.

SETUP:DUplex:GENerator DISTortion  
Configures for the Dependent Distortion Meter Operation.

SETUP:DUplex:GENerator AFLevel  
Configures for the AF Level Meter Operation.

SETUP:DUplex:GENerator SINad  
Configures for the Dependent SINAD Meter Operation.

SETUP:DUplex:GENerator SCOPE  
Configures for the Dependent Oscilloscope Operation.

SETUP:DUplex:GENerator ANALyzer  
Configures for the Dependent Spectrum Analyzer Operation.

SETUP:DUplex:RECeiver  
Configures for the Duplex Receiver Operation.

SETUP:DUplex:RECeiver LEVEL  
Configures for the Dependent Received Level Meter.

SETUP:DUplex:RECeiver MODulation  
Configures for the Modulation Meter.

SETUP:DUplex:RECeiver DISTortion  
Configures for the Dependent Distortion Meter.

SETUP:DUplex:RECeiver AFCounter  
Configures for the Dependent AF Meter.

SETUP:DUplex:RECeiver POWER  
Configures for the Power Meter.

SETUP:DUplex:RECeiver SINad  
Configures for the Dependent SINAD Meter.

SETUP:DUplex:RECeiver SCOPE  
Configures for the Dependent Oscilloscope.

SETUP:DUplex:RECeiver ANALyzer  
Configures for the Dependent Spectrum Analyzer Operation.

SETUP:DUplex:RFERror  
Configures for the Frequency Error Meter.

SETUP:DUplex:RECGen  
Configures for the Duplex Operation.

**SETUP:FGENERator**  
Configures for the Audio/Data/Signal Generators.

**SETUP:GENERator**  
Configures for the Generator Operation.

**SETUP:GENERator DISTortion**  
Configures for the Dependent Distortion Meter Operation.

**SETUP:GENERator AFLevel**  
Configures for the AF Level Meter Operation.

**SETUP:GENERator SINad**  
Configures for the Dependent SINAD Meter.

**SETUP:GENERator SCOPE**  
Configures for the Dependent Oscilloscope Operation.

**SETUP:GENERator ANALyzer**  
Configures for the Dependent Spectrum Analyzer Operation.

**SETUP:METers DISTortion**  
Configures for the Independent Distortion Meter Operation.

**SETUP:METers SINad**  
Configures for the Independent SINAD Meter Operation.

**SETUP:METers AFCounter**  
Configures for the Independent AF Counter Meter.

**SETUP:METers DVM**  
Configures for the Independent DVM.

**SETUP:RECeiver**  
Configures for the Receiver Screen Operation.

**SETUP:RECeiver LEVEL**  
Configures for the Dependent Received Level Meter.

**SETUP:RECeiver MODulation**  
Configures for the Modulation Meter.

**SETUP:RECeiver DISTortion**  
Configures for the Dependent Distortion Meter Operation.

**SETUP:RECeiver AFCounter**  
Configures for the Dependent AF Counter Meter.

**SETUP:RECeiver POWER**  
Configures for the Power Meter.

SETUP:RECeiver SINad  
Configures for the Dependent SINAD Meter.

SETUP:RECeiver SCOPE  
Configures for the Dependent Oscilloscope.

SETUP:RECeiver ANALYzer  
Configures for the Dependent Spectrum Analyzer Operation.

SETUP:RECeiver RFErRor  
Configures for the RF Error Meter.

SETUP:SCOPE  
Configures for the Independent Oscilloscope Operation.

SETUP:SETup  
Configures for the Setup Menu.

SETUP:TRUNKing RADIOSimulation  
Configures for the LTR<sup>®</sup> Radio Simulator Operation

SETUP:TRUNKing REPeater  
Configures for the LTR<sup>®</sup> Repeater Simulator Operation.

SETUP:TRUNKing AUXSetup  
Configures for the LTR<sup>®</sup> Auxillary Setup Operation.

SETUP:FLIST  
Configures for the Frequency List Operation.

SETUP:STFList  
Configures for the Stored Frequency List Operation.

## 6-18 DISPLAY COMMANDS

DISPLAY commands establish the routings for various Operation Modes and display the Operation Screens on the CRT.

DISPLAY:ANALYzer  
Displays independent Spectrum Analyzer.

DISPLAY:BER  
Displays the BER meter.

DISPLAY:DUPEX:GENerator  
Displays the Duplex Generator Operation.

DISPLAY:DUPEX:GENerator DISTortion  
Displays the Dependent Distortion Meter Operation.

DISPLAY:DUplex:GENerator AFLevel  
Displays the AF Level Meter Operation.

DISPLAY:DUplex:GENerator SINad  
Displays the Dependent SINAD Meter Operation.

DISPLAY:DUplex:GENerator SCOPE  
Displays the Dependent Oscilloscope Operation.

DISPLAY:DUplex:GENerator ANALyzer  
Displays the Dependent Spectrum Analyzer Operation.

DISPLAY:DUplex:RECeiver  
Displays the Duplex Receiver Operation.

DISPLAY:DUplex:RECeiver LEVEL  
Displays the Dependent Received Level Meter.

DISPLAY:DUplex:RECeiver MODulation  
Displays the Modulation Meter.

DISPLAY:DUplex:RECeiver DISTortion  
Displays the Dependent Distortion Meter.

DISPLAY:DUplex:RECeiver AFCOUNTER  
Displays for the Dependent AF Meter.

DISPLAY:DUplex:RECeiver POWER  
Displays the Power Meter.

DISPLAY:DUplex:RECeiver SINad  
Displays the Dependent SINAD Meter.

DISPLAY:DUplex:RECeiver SCOPE  
Displays the Dependent Oscilloscope.

DISPLAY:DUplex:RECeiver ANALyzer  
Displays the Dependent Spectrum Analyzer Operation.

DISPLAY:DUplex:RFERror  
Displays the Frequency Error Meter.

DISPLAY:DUplex:RECGen  
Displays the Duplex Operation.

DISPLAY:FGENERator  
Displays the Audio/Data/Signal Generators.

DISPLAY:GENerator  
Displays the Generator Operation.

**DISPLAY:GENERator DISTortion**  
Displays the Dependent Distortion Meter Operation.

**DISPLAY:GENERator AFLevel**  
Displays the AF Level Meter Operation.

**DISPLAY:GENERator SINad**  
Displays the Dependent SINAD Meter.

**DISPLAY:GENERator SCOPE**  
Displays the Dependent Oscilloscope Operation.

**DISPLAY:GENERator ANALyzer**  
Displays the Dependent Spectrum Analyzer Operation.

**DISPLAY:METers DISTortion**  
Displays the Independent Distortion Meter Operation.

**DISPLAY:METers SINad**  
Displays the Independent SINAD Meter Operation.

**DISPLAY:METers AFCOUNTER**  
Displays the Independent AF Counter Meter.

**DISPLAY:METers DVM**  
Displays the Independent DVM.

**DISPLAY:RECeiver**  
Displays the Receiver Screen Operation.

**DISPLAY:RECeiver LEVEL**  
Displays the Dependent Received Level Meter.

**DISPLAY:RECeiver MODulation**  
Displays the Modulation Meter.

**DISPLAY:RECeiver DISTortion**  
Displays for the Dependent Distortion Meter Operation.

**DISPLAY:RECeiver AFCOUNTER**  
Displays the Dependent AF Counter Meter.

**DISPLAY:RECeiver POWER**  
Displays the Power Meter.

**DISPLAY:RECeiver SINad**  
Displays the Dependent SINAD Meter.

**DISPLAY:RECeiver SCOPE**  
Displays the Dependent Oscilloscope.

DISPLAY:RECEiver ANALyzer  
Displays the Dependent Spectrum Analyzer Operation.

DISPLAY:RECEiver RFErroR  
Displays the RF Error Meter.

DISPLAY:SCOPE  
Displays the Independent Oscilloscope Operation.

DISPLAY:SETup  
Displays the Setup Menu.

DISPLAY:TRUNKing RADIOSimulation  
Displays the LTR<sup>®</sup> Radio Simulator Operation

DISPLAY:TRUNKing REPeater  
Displays the LTR<sup>®</sup> Repeater Simulator Operation.

DISPLAY:TRUNKing AUXSetup  
Displays the LTR<sup>®</sup> Auxillary Setup Operation.

DISPLAY:FLIST  
Displays the Frequency List Operation.

DISPLAY:STFList  
Displays the Stored Frequency List Operation.

DISPLAY:FLIST  
Displays the Frequency List Screen.

DISPLAY:STFList  
Displays the Stored Frequency List Operation Screen.



# SECTION 7 - OPTIONS

## 7-1 INTERNAL BATTERY (OPTION 01)

Provides self-contained dc power when external ac or dc power is unavailable.

## 7-2 OVEN CRYSTAL OSCILLATOR FREQUENCY STANDARD (OPTION 02)

OCXO replaces the standard TCXO as system time base. Provides  $0.01 \times 10^{-6}$  accuracy.

## 7-3 30 kHz IF FILTER (OPTION 03)

Provides additional band limiting between 15 kHz and 300 kHz offered in standard set. Required for AMPS Mobile Station Test (Option 15).

## 7-4 VARIABLE AUDIO GENERATOR 2 (OPTION 04)

Replaces standard fixed 1 kHz Audio Generator with variable frequency Audio Generator. Optional Audio Generator has frequency range of 5 to 20000 Hz with sine wave shape and 5 to 10000 Hz with ramp, triangle and square wave shapes.

Optional Audio Generator 2 is available for use on the RF Generate, Duplex and Duplex Generate Operation Screens as a modulation source. Additionally, it is available for baseband output from the Audio/Data/Signalling Generators Operation Screen.

## 7-5 GENERATE AMPLIFIER (OPTION 05)

The Generate Amplifier is an internal RF Amplifier providing 26 dB gain for AUX RF OUT Connector. With Option 05 installed, RF AUX OUT Connector output range is -130 to +13 dBm for all Operation Modes.

## 7-6 DATA GENERATOR/BIT ERROR RATE (BER) METER (OPTION 07)

### 7-6-1 BER METER DESCRIPTION

The BER Meter is accessed by first pressing SPCL TEST MODE Key and selecting the Bit Error Rate Test. The BER Meter is designed to be used in Baseband, RF Generate, RF Receive or Duplex Mode. The complexity of the BER Meter is best described in four separate sections.

BER Meter General Operation Screen

BER Meter Configuration Section

Receive Data Configuration Section

Send Data Configuration Section



## A. BER METER GENERAL OPERATION SCREEN

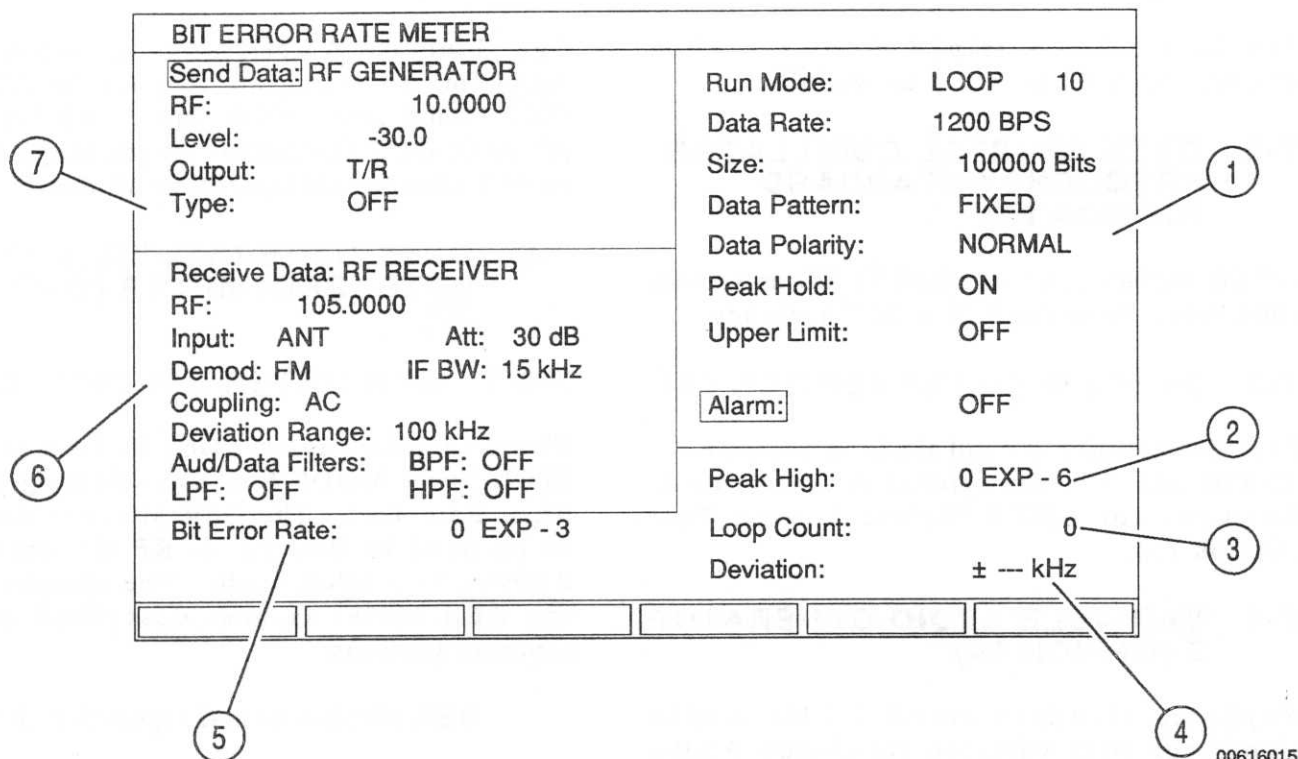

00616015

### 1. BER Meter Configuration Section

Contains configuration data for signal.

### 2. Peak Reading

Displays highest Bit Error Rate for current test.

### 3. Loop Count

Displays number of times Data has been sent.

### 4. Input Level Indicator

Displays the modulation or voltage level of the Receive Data input source. The level indicator displays an AF Level Meter reading when the field is set for AUDIO/DATA IN.

When the field is set for RF RECEIVER, the Demod field determines the display (i.e., FM-Deviation Meter in kHz, AM-Modulation Meter in % or PM-Phase Meter in Rad).

### 5. Bit Error Rate

Displays Bit Error Rate. Exponent changes depending on Data Pattern Size (11).

### 6. Receive Data Configuration Section

Contains configuration data for Receive.

### 7. Send Data Configuration Section

Contains configuration data for Generate Section.

## B. BER METER CONFIGURATION SECTION

This section contains the parameters for setting the message size, rate and pattern as well as information on configuring the BER Meter.

Functions and parameters for the BER Meter Configuration Section are as follows:

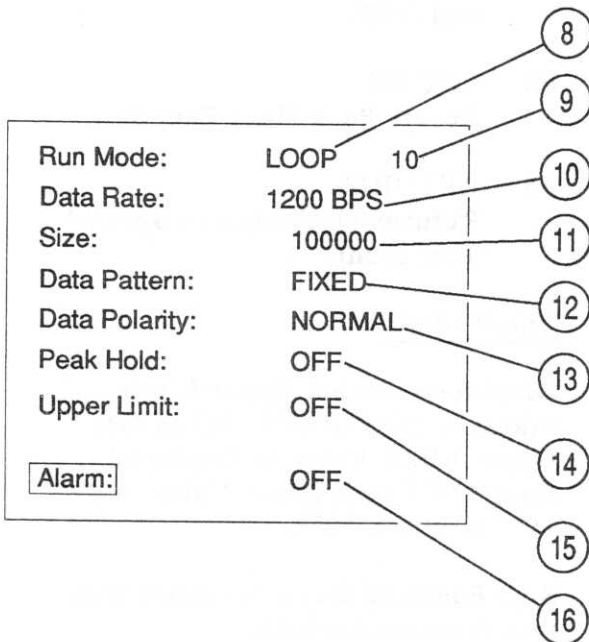

00607094

### 8. Run Mode

Displays selected Operation Mode. Selections include Continuous (CONTIN.) and LOOP. When LOOP Mode is selected, LOOP Number (9) is displayed.

Soft Function Keys available with this function include

F1 CONTIN  
Selects Continuous Run Mode.

F2 LOOP  
Selects LOOP Run Mode.

F6 RETURN  
Returns Operation to Special Test Menu.

### 9. LOOP Number

Displays selected number of Data Patterns to be Generated. Displayed only with LOOP selected for Run Mode (8). Range is 1 to 100000.

### 10. Data Rate

Displays selected Data Rate in Bits Per Second (BPS). Selections include:

75 BPS	150 BPS	300 BPS
600 BPS	1200 BPS	2400 BPS
4800 BPS	9600 BPS	

Soft Function Keys available with this function include:

F1 MENU  
Accesses menu for selecting Data Rate.

F5 RST PK  
Resets Peak Hold Function.

F6 RETURN  
Returns Operation to Special Test Menu.

### 11. Data Pattern Size

Displays selected Data Pattern Size. Selections range from 128 to 100000 bits.

### 12. Data Pattern Type

Displays selected Data Pattern Type. Selections are RANDOM and FIXED.

FIXED is an 8 bit hexadecimal pattern that is repeated. RANDOM is based on a pseudorandom seed.

Soft Function Keys available with this function include:

- F1 RANDOM  
Selects RANDOM Data Pattern Type.
- F2 FIXED  
Selects FIXED Data Pattern Type.
- F5 RST PK  
Resets Peak Hold Function.
- F6 RETURN  
Returns Operation to Special Test Menu.

### 13. Data Polarity

Displays selected Data Polarity Type. Displays NORMAL or INVERTED. INVERTED is the opposite code of NORMAL.

Soft Function Keys available with this function include:

- F1 NORMAL  
Selects NORMAL Data Polarity.
- F2 INVERTED  
Selects INVERTED Data Polarity.
- F5 RST PK  
Resets Peak Hold Function.
- F6 RETURN  
Returns Operation to Special Test Menu.

Operation Mode. Selections include Continuous (CONTIN.) and LOOP. When LOOP Mode is selected, LOOP Number (2) is displayed.

### 14. Peak Hold

Displays selected Peak Hold Function Status. Status is OFF or ON. When ON, Peak Reading (2) is displayed.

Soft Function Keys available with this function include:

- F1 OFF/ON  
Toggles Peak Hold Function ON and OFF.
- F5 RST PK  
Resets Peak Hold Function.
- F6 RETURN  
Returns Operation to Special Test Menu.

### 15. Upper Limit

Displays selected Upper Limit. Status is OFF or ON. When ON Upper Limit Value is displayed. Range of Upper Limit Value is  $0 \times 10^{-6}$  to  $999 \times 10^{-3}$ .

Soft Function Keys available with this function include:

- F1 OFF/ON  
Toggles Peak Hold Function ON and OFF.
- F5 RST PK  
Resets Peak Hold Function.
- F6 RETURN  
Returns Operation to Special Test Menu.

### 16. Alarm

Displays Alarm status. Status is OFF or ON. Alarm sounds when Upper Limit (15) is exceeded.

Soft Function Keys available with this function include:

**F1 OFF/ON**  
Toggles Peak Hold Function ON and OFF.

**F5 RST PK**  
Resets Peak Hold Function.

**F6 RETURN**  
Returns Operation to Special Test Menu.

### C. RECEIVE DATA CONFIGURATION SECTION

This section contains the parameters for setting the Receiver Portion of the BER Meter. Functions and parameters for the Receiver portion of the BER Meter are as follows:

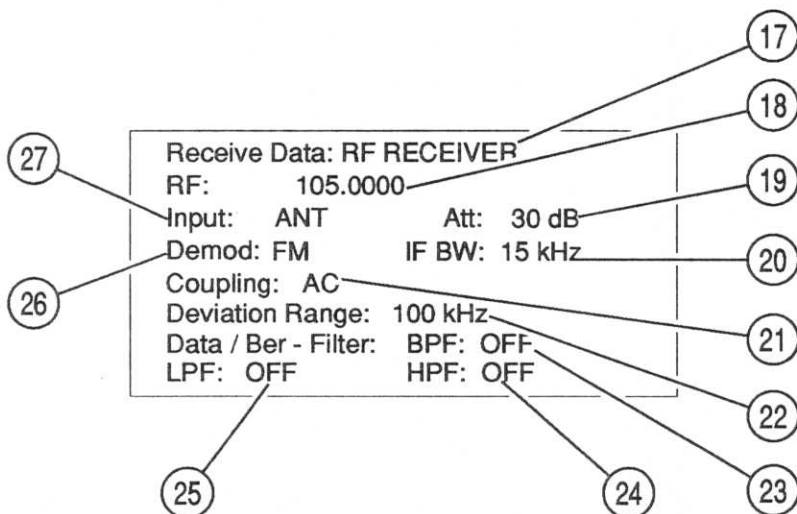

00607095

#### 17. Receive Data Input

Displays selected Input for BER Meter. Selections include RF RECEIVER and AUDIO DATA IN. Selecting RF RECEIVER means an RF Carrier is demodulated to receive the Data Signal. Selecting AUDIO DATA IN means Data Signal is received directly through the AUDIO/DATA IN Connector.

Soft Function Keys available with this function include:

- F1 RF REC  
Selects RF RECEIVER (either T/R or ANT ports) as BER Meter Input.
- F2 DATA IN  
Selects AUDIO DATA IN as BER Meter Input.

#### F6 RETURN

Returns Operation to Special Test Menu.

The following items are displayed only when RF RECEIVER is selected as Receive Data Input (17):

#### 18. RF Field

Displays RF Receive Frequency. Selections range from .0000 to 1000 MHz.

#### 19. Attenuation

Displays Input Attenuation. Selections are 0 or 30 dB.

Soft Function Keys available with this function include:

- F1 30 dB  
Selects 30 dB Input Attenuation.
- F2 0 dB  
Selects 0 dB Input Attenuation.

## 20. IF Bandwidth

Displays IF Filter Bandwidth. Selections are 300 and 15 kHz.

Soft Function Keys available with this function include:

- F1 300 kHz  
Selects 300 kHz IF Filter.
- F2 15 kHz  
Selects 15 kHz IF Filter.

## 21. Coupling

Displays Coupling Type for RF Receiver. Displayed only with FM selected for Demod Type (26). Selections are AC or DC.

Soft Function Keys available with this function include:

- F1 AC  
Selects AC Coupling.
- F2 DC  
Selects DC Coupling.
- F5 FM-Z  
Zeroes the FM Deviation Meter for proper readings.
- F6 RETURN  
Returns Operation to Special Test Menu.

## 22. Deviation Range

Displays FM Deviation Range. Displayed only with FM selected for Demod Type (26). Selections are 10, 20, 50 and 100 kHz.

Soft Function Keys available with this function include:

- F1 10 kHz  
Selects 10 kHz Deviation Range.
- F2 20 kHz  
Selects 20 kHz Deviation Range.
- F3 50 kHz  
Selects 50 kHz Deviation Range.
- F4 100 kHz  
Selects 100 kHz Deviation Range.
- F6 RETURN  
Returns Operation to Special Test Menu.

## 23. Bandpass Filter

Displays Bandpass Filter setting for demodulated signal. Selections include OFF and C-MSG (C-Message Weighted Filter).

High-Pass Filter/Low-Pass Filter combination and Bandpass Filter cannot be active simultaneously.

Soft Function Keys available with this function include:

- F1 OFF  
Sets Bandpass Filter to OFF.
- F2 C-MSG  
Activates C-Message Weighted Bandpass Filter.

24. High-Pass Filter

Displays current High-Pass Filter setting for demodulated signal. Selections include OFF, 300 Hz and 4 kHz.

High-Pass Filter/Low-Pass Filter combination and Bandpass Filter cannot be active simultaneously.

Soft Function Keys available with this function include:

- F1 OFF  
Sets Bandpass Filter to OFF.
- F2 300 Hz  
Activates 300 Hz High-Pass Filter.
- F3 4 kHz  
Activates 4 kHz High-Pass Filter.

25. Low-Pass Filter

Displays current Low-Pass Filter setting for demodulated signal. Selections include OFF, 300 Hz, 4 kHz and 20 kHz.

High-Pass Filter/Low-Pass Filter combination and Bandpass Filter cannot be active simultaneously.

Soft Function Keys available with this function include:

- F1 OFF  
Sets Bandpass Filter to OFF.
- F2 300 Hz  
Activates 300 Hz Low-Pass Filter.
- F3 4 kHz  
Activates 4 kHz Low-Pass Filter.

- F4 20 kHz  
Activates 20 kHz Low-Pass Filter

26. Demod Type

Displays Demodulation Type. Selections include FM, AM and PM. Selection of FM activates Coupling (21) and Deviation Range (22) Fields.

Soft Function Keys available with this function include:

- F1 FM  
Selects FM as Demodulation Type.
- F2 AM  
Selects AM as Demodulation Type.
- F3 PM  
Selects PM as Demodulation Type.

27. Input

Displays signal Input Connector. Selections include T/R (T/R Connector) and ANT (ANTENNA Connector).

Soft Function Keys available with this function include:

- F1 T/R  
Selects T/R Connector as Input Connector.
- F2 ANT  
Selects ANTENNA Connector as Input Connector.

The following items are displayed only when AUDIO DATA IN is selected as Receive Data Input (17):

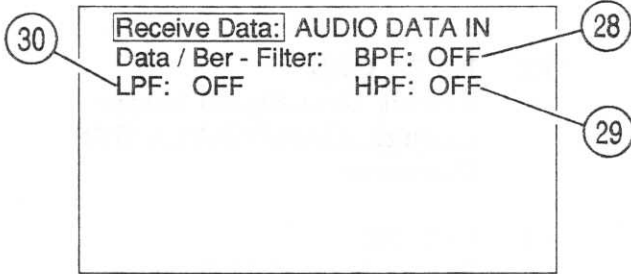

00607096

## 28. Bandpass Filter

Displays current Bandpass Filter setting for signal passed through AUDIO/DATA IN Connector. Selections include OFF and C-MSG (C-Message Weighted Filter).

High-Pass Filter/Low-Pass Filter combination and Bandpass Filter cannot be active simultaneously.

Soft Function Keys available with this function include:

- F1 OFF  
Sets Bandpass Filter to OFF.
- F2 C-MSG  
Activates C-Message Weighted Bandpass Filter.

## 29. High-Pass Filter

Displays current High-Pass Filter setting for signal passed through AUDIO/DATA IN Connector. Selections include OFF, 300 Hz and 4 kHz.

High-Pass Filter/Low-Pass Filter combination and Bandpass Filter cannot be active simultaneously.

Soft Function Keys available with this function include:

- F1 OFF  
Sets Bandpass Filter to OFF.
- F2 300 Hz  
Activates 300 Hz High-Pass Filter.
- F3 4 kHz  
Activates 4 kHz High-Pass Filter.

## 30. Low-Pass Filter

Displays current Low-Pass Filter setting for signal passed through AUDIO/DATA IN Connector. Selections include OFF, 300 Hz, 4 kHz and 20 kHz.

High-Pass Filter/Low-Pass Filter combination and Bandpass Filter cannot be active simultaneously.

Soft Function Keys available with this function include:

- F1 OFF  
Sets Bandpass Filter to OFF.
- F2 300 Hz  
Activates 300 Hz Low-Pass Filter.
- F3 4 kHz  
Activates 4 kHz Low-Pass Filter.
- F4 20 kHz  
Activates 20 kHz Low-Pass Filter.



**D. SEND DATA CONFIGURATION SECTION**

This section contains the parameters for setting the Transmitter Portion of the BER Meter. Functions and parameters for the Transmitter portion of the BER Meter are as follows:

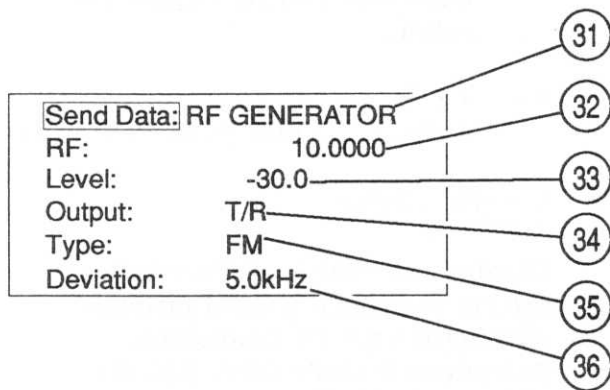

00607097

**31. Send Data Output**

Displays selected Output for BER Meter. Selections include RF GENERATOR and AUD/DATA GEN OUT. Selecting RF GENERATOR means an RF Carrier is modulated with the Data Signal before transmission. Selecting AUD/DATA GEN OUT means Data Signal is transmitted directly through the AUDIO/DATA GEN Connector.

Soft Function Keys available with this function include:

- F1 RF GEN**  
Selects RF Generator as BER Meter source.

- F2 DATA GEN**  
Selects Data Signal output through AUDIO/DATA GEN Connector.

- F5 RST PK**  
Resets Peak Hold Function.

- F6 RETURN**  
Returns Operation to Special Test Menu.

The following items are displayed only when RF GENERATOR is selected as Send Data Output (31):

**32. RF Field**

Displays RF Generator Frequency. Selections range from .0000 to 1000 MHz.

**33. Level**

Displays RF Generator output Level. Selections range from -130 to -30 dBm with T/R Connector selected as Output (34). Selections range from -130 to -13 dBm with AUX RF OUT Connector selected as Output (34).

**34. Output**

Displays Output Connector. Selections include AUX (AUX RF OUT Connector) and T/R (T/R Connector).

Soft Function Keys available with this function include:

- F1 T/R**  
Selects T/R Connector for Output.

- F2 AUX  
Selects AUX RF OUT Connector  
for Output.

The following items are displayed  
only when AUD/DATA GEN OUT is  
selected as Send Data Output (31):

### 35. Modulation Type

Displays Modulation Type.  
Selections include OFF, AM, FM and  
PM.

Soft Function Keys available with  
this function include:

- F1 OFF  
Set Modulation Source to OFF.
- F2 AM  
Selects AM for Modulation Type.
- F3 FM  
Selects AM for Modulation Type.
- F4 PM  
Selects AM for Modulation Type.

### 36. Modulation/Deviation Level

Displays Modulation Level.  
Selections range from 0.0% to 100%  
for AM Modulation Type (35), 0.00  
to 100 kHz for FM Modulation Type  
(35) and 0.00 to 10 Rad for PM  
Modulation Type.

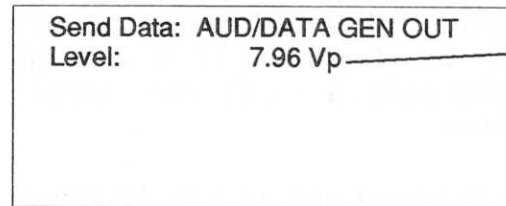

37

00607098

### 37. Output Level

Displays Output Level of Data Signal.  
Selections range from 0.0 to 2.5 Vp in  
x1 (times 1) Mode or 0 to 25 mVp in  
/10 (divide by 10) Mode.

- F1 x1  
Selects x1 Output Mode.
- F2 /10  
Selects /10 Output Mode.

## 7-7 SINGLE SIDEBAND RECEIVE FILTER (OPTION 08)

### 7-7-1 GENERAL

Installation of the Single Sideband Receive IF Filter provides the ability to monitor SSB signals. When Filter is installed, 3 kHz Selection is available for IF Bandwidth Filter. Additionally, a 3 kHz Soft Function Keys is defined.

The Single Sideband and 30 kHz IF Filters are mutually exclusive. Only one additional IF Filter can be installed.

### 7-7-2 DESCRIPTION OF RECEIVE FUNCTION

RF Receive Operation is changed as follows:

- Analyzer Center Frequency is offset from center graticule  $\pm 1800$  Hz, depending on whether Upper Sideband (UB) or Lower Sideband (LB) is selected as Demodulation Type.
- No Modulation Meter is provided for Single Sideband. Either Modulation Reading or Modulation Meter, whichever was last selected, is blanked from the screen.
- RF Error Meter is not provided for Single Sideband. RF Error Meter is blanked from the screen.

Additions and Redefinitions of parameters on the RF Receiver Operation Screen are as follows:

#### 1. Demodulation Type

Includes two additional settings: UB (Upper Sideband) and LB (Lower Sideband).

Soft Function Keys available with this function include:

F4 LB  
Selects Lower Sideband Demodulation.

F5 UB  
Selects Upper Sideband Demodulation.

#### 2. IF Bandwidth

Includes additional 3 kHz setting.

Soft Function Keys available with this function include:

F3 3 kHz  
Selects 3 kHz Optional IF Bandwidth Filter. Renamed depending on Demodulation Type (1).

#### 3. BFO Frequency

Tone/Data Code Field is renamed when UB or LB is selected as Demodulation Type (1). Displays selected adjustment for BFO Frequency. Adjustment range is  $\pm 4.0$  kHz. No Soft Function Keys are defined when BFO Frequency is displayed.

#### 4. AGC Setting

Displays current AGC Setting, AUTO or MANUAL. AUTO provides automatic gain control while MANUAL sets feedback level for automatic gain control to defined level. Selection of MANUAL accesses Feedback Level Data Field. Range is 0 to 1023.

## 7-9-3 DECODING DIGITAL SIGNALING FORMATS

With Option 11 installed, the RF Receive Operation Screen and the Duplex Receive Operation Screen can be configured to decode POCSAG and Inverted POCSAG signals. A specific decode screen is provided for each Digital Signaling format type.

Information provided from the Decode Screens is as follows:

POCSAG DECODE		FUNC BITS: AUTO		RATE 512	
CAPCODE:	5130	TYPE:	ALPHANUMERIC	MESSAGE: abcdefghijklmnopqrstuvwxyz	
CAPCODE:	5130	TYPE:	ALPHANUMERIC	MESSAGE: ABCDEFGHIJKLMNOPQRSTUVWXYZ	
CAPCODE:	5130	TYPE:	ALPHANUMERIC	MESSAGE: 0123456789	
CAPCODE:	5130	TYPE:	ALPHANUMERIC	MESSAGE: !"#\$%()*+,-./:;<=>?'	
CAPCODE:	5130	TYPE:	TONE 4 BEEPS	MESSAGE:	

8717038

### 1. Decode Screen Label

Identifies whether Decode Screen format is POCSAG or POCSAG INV (Inverted POCSAG).

### 2. Function

Allows user to set Message Type to ALPHANO (ALPHANUMERIC), NUMERIC or AUTO. ALPHANO and NUMERIC settings force Decode Function to decode message as specified type. AUTO setting allows Decode Function to determine Message Type from received data.

Soft Function Keys available with this field include:

- F1 DECODE  
Activates Decode Function.  
Field is highlighted when active.
- F2 STOP  
Stops Decode Function.
- F3 MENU  
Accesses menu for selecting format. Soft Function Keys available with this function include:

F1 AUTO  
Allows Decode Function to determine Message Type from received data.

F2 NUMERIC  
Forces Decode Function to decode message as specified type.

F3 ALPHANO  
Forces Decode Function to decode message as specified type.

F5 SCROLL  
Toggles Scroll Function On and Off. Decode Screen (4) holds five messages. With Scroll Function active, when sixth message is received, previous five messages are scrolled up (losing one) and sixth message is displayed. Softkey is highlighted when Scroll Function is active.

F6 RETURN  
Returns to previous Operation Screen.

### 3. Data Rate

Displays selected Data Rate for decoding messages. Selections include 512 and 1200 bps.

Soft Function Keys available with this field include:

F1 DECODE  
Activates Decode Function. Field is highlighted when active.

F2 STOP  
Stops Decode Function.

F3 MENU  
Accesses menu for selecting Data Rate. Soft Function Keys available with this function include:

F1 512  
Sets Data Rate to 512 bps.

F2 1200  
Sets Data Rate to 1200 bps.

F3 2400  
Sets Data Rate to 2400 bps.

F4 AUTO  
Automatically decodes 1200 or 2400 baud rate incoming POCSAG data. It *does not* handle 512 baud rate.

F5. SCROLL  
Toggles Scroll Function On and Off. Decode Screen (4) holds five messages. With Scroll Function active, when sixth message is received, previous five messages are scrolled up (losing one) and sixth message is displayed. Softkey is highlighted when Scroll Function is active.

F6 RETURN  
Returns to previous Operation Screen.

### 4. Data Screen

Displays up to five decoded messages. Information displayed includes Capcode, Message Type and Message for each received transmission.

## 7-14-6 EDACS TRUNKING MANUAL TEST

EDACS Trunking Manual Test Screen:

EDACS Trunking Manual Test					
Repeater Simulator					
Radio Simulator					
Rept Sim	Radio Sim				RETURN

00616002

The EDACS Trunking Manual Test consists of 2 main parts. A Repeater Simulator for testing EDACS Radios and a Radio Simulator for testing EDACS Repeaters.

Soft Function Keys available with this function include:

F1 Rept Sim  
Accesses the EDACS Repeater Simulator Screen.

F2 Radio Sim  
Accesses the EDACS Radio Simulator Screen.

F3 RETURN  
Returns to the EDACS Trunking Test screen.

# 7-14-7 EDACS TRUNKING MANUAL TEST-REPEATER SIMULATOR

EDACS REPEATER SIMULATOR		
CH #: 2	Band: USER	Extended Meas:
RECEIVE		GENERATE
RF: 812.2125 MHz Atten: 0 dB Input: T/R	RF: 857.2125 MHz Level: -40.0 dBm Output: T/R	
Group ID 273 Logical ID 1 Call Type: SYSTEM ALL	Status: IDLE Message:	
RF Power: 837.8 mW RF Error Freq: 0.210 kHz Deviation: 0.78 kHz (D) AF Frequency: 300 Hz Distortion: 2.3 %	DATA	
	Mod Source: DATA FM Deviation: 3.2 kHz: Subaud dev: 0.70 kHz	
	Sinad:	
CALL	DISC	PRGM
		RETURN

00616014

Entering the Repeater Simulator causes the COM-120B to perform an FM-Zero operation to adjust the Receiver's DC offset to zero. The screen displays the message: "Doing FMZ...please wait."

While in the Repeater Simulator and the Radio is not transmitting, or the repeater is not calling the Radio, the Site ID message is continuously transmitting. In this idle mode, the Repeater Simulator is looking for a Call (or Login) request from the Radio. When the request is found, the Repeater Simulator allows the Radio to transmit (until the Radio releases). The Group/Logical ID's are captured (and displayed) when the Group Call is made (and used to call a Radio). A Radio's Login is also decoded by the simulator and the ID's captured. There is also a mode of operation (activated by softkey) where the repeater simulates a Radio calling the Radio Under Test. In this mode, there are softkeys to disconnect and return back to the idle state.

## 1. CH#:

This field is used to change the EDACS Repeater Simulator Working Channel, as specified by the Channel Number pre-programmed in the Setup Screen. Value range: 1 to 20. The corresponding RF Frequencies are shown in the RF fields as the CH# field is edited. This only sets the Working Channel. The Control Channel is taken from the Setup Screen and must be changed there if necessary.

If the Band field is set to 'Manual' there is no channel number to edit. The PRGM Soft Function Key F3 may then be used to return to the channel Band mode.

Soft Function Keys available with this function include:

- F1 CALL  
Makes a Group Call to the Radio, simulating a call from another radio. The ID's used to make the call are taken from the Group/Logical ID fields.
- F2 DISC  
Disconnects a call to the Radio which was made previously using the CALL softkey.
- F3 PRGM  
Puts the 'Band' mode back to one of the channel modes: 800 MHz, 900 MHz or USER. The logical channels from the Setup Screen are then active. The simulator is taken out of the pre-programmed channel mode when the RF Frequencies are manually edited.
- F6 RETURN  
Returns to the EDACS Trunking Manual Test Screen.

2. Band:

This field shows the channel format for the Repeater Simulator Working Channel. Valid values are: 800 MHz, 900 MHz, USER or Manual. Display-only field. If 'Manual' is displayed, the RF Frequencies have been set manually in the Repeater Simulator. All other values are taken from the pre-programmed logical channels from the Setup Screen, according to the channel number set in the CH# field.

3. RF: (Receive)

This field shows the current RF Frequency of the EDACS Working Channel for the Receiver side of the

Repeater Simulator. This field is editable (which puts the Working Channel in 'Manual' mode). Value range: 0 to 1000.0000 MHz.

Soft Function Keys available with this function include:

- F1 CALL  
Makes a Group Call to the Radio, simulating a call from another radio. The ID's used to make the call are taken from the Group/Logical ID fields.
- F2 DISC  
Disconnects a call to the Radio which was made previously using the CALL softkey.
- F6 RETURN  
Returns to the EDACS Trunking Manual Test Screen.

4. Atten:

This field is used to set the Receiver Attenuation. Value range: 0 or 30 dB.

- F1 30 dB  
Sets the Receiver Attenuation to 30 dB.
- F2  
Sets the Receiver Attenuation to 0 dB.
- F6 RETURN  
Returns to the EDACS Trunking Manual Test Screen.

5. Input:

This field is used to select the Receiver's RF Input for the Repeater Simulator to the T/R or Antenna connector. Valid values are T/R or ANT.



Soft Function Keys available with this function include:

- F1 T/R  
Sets the Receiver Input to T/R.
- F2 ANT  
Sets the Receiver Input to ANT.
- F6 RETURN  
Returns to the EDACS Trunking Manual Test Screen.

6. Group ID:

This field shows the Radio's Group ID acquired from a Group Call or Login operation (if performed). This field is also used for the Group ID when making a call to the Radio Under Test. This field is editable. Value range: 0 to 2047.

Soft Function Keys available with this function include:

- F1 CALL  
Makes a Group Call to the Radio, simulating a call from another radio. The ID's used to make the call are taken from the Group/Logical ID fields.
- F2 DISC  
Disconnects a call to the Radio which was made previously using the CALL softkey.
- F6 RETURN  
Returns to the EDACS Trunking Manual Test Screen.

7. Call Type:

This field handles outgoing call processing selections Group, Individual or System-All calls, for Radio and Repeater-initiated calls.

Soft Function Keys available with this function include:

- F1 CALL  
Makes current selected Call to the Radio, simulating a call from another radio. The ID's used to make the call are taken from the Group/Logical ID fields. For Individual Call, the Caller ID used is one less than the programmed Logical ID.

- F2 DISC  
Disconnects a call to the Radio which was made previously using the CALL softkey.

- F3 GROUP  
Group Call is selected and starts when softkey is pressed.

- F4 SYS ALL  
System-All Call is selected and starts when softkey is pressed.

- F5 INDV  
Individual Call is selected and starts when softkey is pressed.

- F6 RETURN  
Returns to the EDACS Trunking Manual Test Screen.

8. Logical ID:

This field shows the Radio's Logical ID acquired from a Group Call or Login operation (if performed). This field is also used for the Logical ID when making a call to the Radio Under Test. This field is editable. Value range: 0 to 16383.

Soft Function Keys available with this function include:

- F1 CALL  
Makes the current selected Call to the Radio, simulating a call

from another radio. The ID's used to make the call are taken from the Group/Logical ID fields.

F2 DISC  
Disconnects a call to the Radio which was made previously using the CALL softkey.

F6 RETURN  
Returns to the EDACS Trunking Manual Test Screen.

9. RF Power:

This field shows the Radio's Transmitter RF Power in Watts (or mW). It is a display-only field (meter) with no cursor position. Value range: 0.0 mW to 10.00 W.

10. RF Error Freq:

This field shows the Radio's Transmitter RF Frequency Error in kHz. It is a display-only field (meter) with no cursor position. Value range:  $\pm 0.000$  to 5.000 kHz.

11. Deviation: (Receive)

This field shows the Radio's Transmit Deviation for Voice or Data in kHz. Voice Deviation is designated with a 'V' symbol, and Data Deviation (low-frequency data) is designated with a 'D' symbol. Value range: 0.00 to 10.00 kHz.

Soft Function Keys available with this function include:

F1 DATA  
Shows deviation of low-frequency (data) modulations.

F2 VOICE  
Shows voice-range frequency modulations.

F3 FMZ  
Used to FM-Zero the Receiver, which adjusts the DC offset to zero. Do this operation if the Radio is having trouble completing a Group Call.

F4 FM CAL  
Makes an attempt to move the DC offset to zero in the Receiver. *Not a recommended operation. The FMZ softkey should be tried first if the Radio does not complete a Group Call. This operation may work on a Radio Under Test that is extremely far off frequency. May require more than one try.*

F6 RETURN  
Returns to the EDACS Trunking Manual Test Screen.

12. AF Frequency:

This field shows the Radio's Transmitter Audio Frequency in Hz. It is a display-only field (meter) with no cursor position. Measuring range: 300 to 4500 Hz.

13. Distortion: (Receive)

This field shows the Radio's Transmitter Distortion in %. Value range: 0.0 to 20.0%. Also used to show decoded DTMF digits by pressing the DTMF softkey.

Soft Function Keys available with this function include:

- F1 DIST  
Selects Distortion readings (meter).
- F2 OFF  
Disable Distortion or DTMF readings.
- F3 DTMF Selects DTMF decoding.
- F6 RETURN  
Returns to the EDACS Trunking Manual Test Screen.

14. Extended Meas:

This field allows access to one of three external screens: Scope, Analyzer or Digital Voltmeter (DVM). Radio-initiated Group Calls are still performed while in any of the three screens. If a call was made to the Radio and is still in progress, it is possible to access any of the three screens without interrupting the call. *However, there is no way to call the Radio Under Test or disconnect a made call while in the extended screens. The call must be made before entering an extended screen.* The *only* way to enter the extended screens is to use the softkeys. The 'Return' field in the extended screen allows a return to the Repeater Simulator.

Soft Function Keys available with this function include:

- F1 SCOPE  
Accesses the Scope Screen.
- F2 ANALY  
Accesses the Analyzer Screen.

F3 DVM  
Accesses the Digital Voltmeter Screen.

F6 RETURN  
Returns to the EDACS Trunking Manual Test Screen.

15. RF: (Generate)

This field shows the current RF Frequency of the EDACS Working Channel for the Generator side of the Repeater Simulator. This field is editable (which puts the Working Channel in 'Manual' mode). Value range: 0 to 1000.0000 MHz.

Soft Function Keys available with this function include:

F1 CALL  
Makes a Group Call to the Radio, simulating a call from another radio. The ID's used to make the call are taken from the Group/Logical ID fields.

F2 DISC  
Disconnects a call to the Radio which was made previously using the CALL softkey.

F6 RETURN  
Returns to the EDACS Trunking Manual Test Screen.

16. Level:

This field is used to set the Generator's RF Output Level in dBm. Value range: -40 to -130.0 dBm (T/R), 13.0 to -130.0 dBm (AUX) with AUX option.

Soft Function Keys available with this function include:

F6 RETURN  
Returns to the EDACS Trunking Manual Test Screen.

17. Output:

This field is used to set the Generator's RF Output source to the T/R port or the Auxiliary (AUX) RF port. Valid values: T/R or AUX.

F1 T/R  
Sets the Generator RF Output to the T/R connector.

F2 AUX  
Sets the Generator RF Output to the AUX connector.

F6 RETURN  
Returns to the EDACS Trunking Manual Test Screen.

18. Status:

This field shows the current status of the Repeater Simulator. It is a display-only field. Valid status values:

IDLE  
Repeater is in the idle state, generating overhead (Site ID) messages. In this state, the Radio may initiate a Group Call, do a Login or the simulator may initiate another call to another radio.

RADIO SETUP  
Repeater is in the process of processing a Call from the Radio. *This message is usually very brief and may not be noticeable.*

RADIO INIT

Repeater successfully completes a Call from the Radio and call is in progress.

REP INIT

Repeater made a Group Call to the Radio.

19. Message:

Briefly shows the last EDACS message received from the Radio. Display-only field.

GROUP CALL

A Group Call message is received from the Radio

UN-KEYED

An un-keyed message is received from the Radio.

EMER GROUP

An Emergency Group Call message is received from the Radio.

LOGIN

A Login message is received from the Radio.

STATUS

A Status message is received from the Radio.

INDV CALL (*Log ID*)

An Individual Call is received from the radio. The Logical ID of the radio being called is shown in parenthesis.

SYSTEM ALL

A System-All Call is received from the radio.

20. Mod Source:

This field is used to select a Generator source for modulation. GEN1, GEN2 and DTMF are only modulated when a call is made to the Radio. The DATA modulation field is used to modulate the EDACS signaling data. All enabled modulation sources display above the Mod Source field.

Soft Function Keys available with this function include:

- F1 GEN1  
Selects Function Generator 1 as the modulation source.
- F2 GEN2  
Selects Function Generator 2 as the modulation source.
- F3 DATA  
Selects Data Generator as the modulation source.
- F4 DTMF  
Selects DTMF as the modulation source.
- F6 RETURN  
Returns to the EDACS Trunking Manual Test Screen.

In the field to the right of Mod Source, select the modulation type for the selected source.

Soft Function Keys available with this function include:

- F1 OFF  
Turn off the selected Generator source.
- F2 AM  
Sets the selected Generator source for AM modulation.

F3 FM  
Sets the selected Generator source for FM modulation.

F4 PM  
Sets the selected Generator source for PM modulation.

F6 RETURN  
Returns to the EDACS Trunking Manual Test Screen.

21. Deviation: (Generate)

This field is active when the selected source is FM or PM modulation type. This controls the deviation of the modulated source. Value range: 0.00 to 100.0 kHz for FM and 0.00 to 10.0 Rad for PM. *For deviation of DATA, 3.2 kHz is the recommended default value.*

F6 RETURN  
Returns to the EDACS Trunking Manual Test Screen.

22. Modulation:

This field is active when the selected source is AM modulation type. This controls the modulation of the selected source. Value range: 0.0% to 100.0%.

F6 RETURN  
Returns to the EDACS Trunking Manual Test Screen.

23. Frequency:

This field is active when the selected source, GEN1 or GEN2, is modulated. This selects the Audio Frequency of the selected Function Generator source (sine wave). Value range: 0.0 Hz to 20000.0 Hz.

F6 RETURN  
Returns to the EDACS Trunking  
Manual Test Screen.

24. Subaud dev:

This field is active when the selected source, DATA, is modulated. This controls the deviation of the sub-audible data used during established call processing with the EDACS Radio. Value range: 0.00 to 100.0 kHz. *Should be  $\leq$  Deviation (20). The recommended default value is 0.70 kHz.*

F6 RETURN  
Returns to the EDACS Trunking  
Manual Test Screen.

25. Code:

This field is active when the selected source, DTMF, is modulated. This allows the entry of desired DTMF digits to use for DTMF source generation.

F1 CLEAR  
Clears out any DTMF digits  
previously programmed in.

F2 CONT  
Puts the DTMF Generation in  
the continuous mode.

F3 BURST  
Used to one-shot the DTMF  
Generator source.

F6 RETURN  
Returns to the EDACS Trunking  
Manual Test Screen.

26. Sinad:

This field is used to select a meter to read signals from the Audio/Data/SINAD input baseband jack. The measurements appear to the right of this field. Valid selections:

Soft Function Keys available with this function include:

F1 DIST  
Selects the Distortion meter for  
baseband measurements.

F2 SINAD  
Selects the SINAD meter for  
baseband measurements.

F3 AF LVL  
Selects the AF Level meter for  
baseband measurements.

F4 OFF  
Disables baseband measuring.

F6 RETURN  
Returns to the EDACS Trunking  
Manual Test Screen.

*When baseband measurements are made, all receiver measurements including the DSP data decoding are disabled due to hardware limitations. Therefore an EDACS Radio-initiated call cannot be made with any baseband measurements enabled. The Radio-initiated call must be made first, then the baseband measurements may be enabled during the call. Calling the Radio may be done at any time.*

## 7-14-8 EDACS TRUNKING MANUAL TEST-RADIO SIMULATOR

EDACS RADIO SIMULATOR					
CH #: 2		Band: USER		Extended Meas:	
RECEIVE			GENERATE		
RF: 812.2125 MHz Atten: 0 dB Input: T/R			RF: 857.2125 MHz Level: -40.0 dBm Output: T/R		
Group ID 273 Logical ID 1			Status: NC Message:		
RF Power: 837.8 mW RF Error Freq: 0.210 kHz Deviation: 0.78 kHz (D) AF Frequency: 300 Hz Distortion: 2.3 %			DATA		
			Mod Source: DATA FM Deviation: 3.2 kHz: Subaud dev: 0.70 kHz		
			Sinad:		
CALL	DISC	PRGM			RETURN

00616013

Entering the Repeater Simulator causes the COM-120B to perform an FM-Zero operation to adjust the Receiver's DC offset to zero. The screen displays the message: "Doing FMZ...please wait."

While in the Radio Simulator the Control Channel is continually monitored looking for SITE-ID from the controller. If not found, the NC status is shown. When a SITE-ID message is found, the status goes to IDLE. This allows Group Calls to be made (Push-to-Talk) or calls to be made to the COM-120B from another Radio as dictated by the Repeater. There are 3 main call-processing sequences supported in the Radio Simulator. Perform a Group Call, receive a call in response to a Channel Assignment message from a Repeater and receive a call in response to a Channel Update message from a Repeater (if coming on-line during a call).

Several error conditions can occur during the Radio Simulation. Error messages display briefly under these conditions. The error messages:

### LOST CHANNEL

The Radio has lost contact with the Repeater during a Group Call.

### CHAN OUT OF RANGE

A channel assignment from the Repeater was out of pre-programmed Channel range.

### INVALID ID

An ID other than what was set in the Logical/Group ID fields was used to call the Radio Simulator.

### NO UN-MUTE FOUND

The Repeater has transmitted the channel assignment to the Radio Simulator for calling the simulator, but did not send the Un-mute message on the Working Channel.

### NO CHAN ASSGN FOUND

The Channel Assignment message was not received from the Repeater when a Group Call

(PTT) was executed from the Radio Simulator.

1. CH#:

This field is used to change the EDACS Control Channel Number (pre-programmed in the Setup Screen). Value range: 1 to 20. The corresponding RF Frequencies are shown in the RF fields as the CH# field is edited.

If the Band field is set to 'Manual', there is no channel number to edit. The PRGM Soft Function Key F3 may then be used to return to the channel Band mode.

Soft Function Keys available with this function include:

- F1 CALL  
Simulates a Group Call (PTT) to another radio. The ID's used to make the call are taken from the Group/Logical ID fields.
- F2 DISC  
Disconnects a call (release PTT) which was made previously using the CALL softkey.
- F3 PRGM  
Puts the 'Band' mode back to one of the channel modes: 800 MHz, 900 MHz or USER. The logical channels from the Setup Screen are then active. The simulator is taken out of the channel mode when the RF Frequencies are manually edited.
- F6 RETURN  
Returns to the EDACS Trunking Manual Test Screen.

2. Band:

This field shows the channel format

for the Radio Simulator Control Channel. Valid values are: 800 MHz, 900 MHz, USER or Manual. Display-only field. If 'Manual' is displayed, the RF Frequencies have been set manually in the Radio Simulator. All other values are taken from the pre-programmed logical channels from the Setup Screen, according to the channel number set in the CH# field.

3. RF: (Receive)

This field shows the current RF Frequency of the EDACS Control Channel for the Receiver side of the Radio Simulator. This field is editable (which puts the Control Channel in 'Manual' mode). Value range: 0 to 1000.0000 MHz.

Soft Function Keys available with this function include:

- F1 CALL  
Simulates a Group Call (PTT) to another radio. The ID's used to make the call are taken from the Group/Logical ID fields.
- F2 DISC  
Disconnects a call (release PTT) which was made previously using the CALL softkey.
- F6 RETURN  
Returns to the EDACS Trunking Manual Test Screen.

4. Atten:

This field is used to set the Receiver Attenuation. Value range: 0 or 30 dB.

- F1 30 dB  
Sets the Receiver Attenuation to 30 dB.



F2 Sets the Receiver Attenuation to 0 dB.

F6 RETURN  
Returns to the EDACS Trunking Manual Test Screen.

5. Input:

This field is used to select the Receiver's RF Input for the Radio Simulator to the T/R or the Antenna port. Valid values are T/R or ANT.

Soft Function Keys available with this function include:

F1 T/R  
Sets the Receiver Input to T/R.

F2 ANT  
Sets the Receiver Input to ANT.

F6 RETURN  
Returns to the EDACS Trunking Manual Test Screen.

6. Group ID:

This field is used to select Radio Simulator's Group ID that is used when simulating a Group Call (PTT) to another Radio. This field is editable. Value range: 0 to 2047.

Soft Function Keys available with this function include:

F1 CALL  
Simulates a Group Call (PTT) to another radio. The ID's used to make the call are taken from the Group/Logical ID fields.

F2 DISC  
Disconnects a call (release PTT) which was made previously using the CALL softkey.

F6 RETURN  
Returns to the EDACS Trunking Manual Test Screen.

7. Logical ID:

This field is used to select Radio Simulator's Logical ID that is used when simulating a Group Call (PTT) to another Radio. This field is editable. Value range: 0 to 16383.

F1 CALL  
Simulates a Group Call (PTT) to another radio. The ID's used to make the call are taken from the Group/Logical ID fields.

F2 DISC  
Disconnects a call (release PTT) made previously using the CALL softkey.

F6 RETURN  
Returns to the EDACS Trunking Manual Test Screen.

8. RF Power:

This field shows the Repeater's Transmitter RF Power in Watts (or mW). A display-only field (meter). Value range: 0.0 mW to 10.00 W.

9. RF Error Freq:

This field shows the Repeater's Transmitter RF Frequency Error in kHz. A display-only field (meter). Value range:  $\pm 0.000$  to 5.000 kHz.

10. Deviation: (Receive)

This field shows the Repeater's Transmit Deviation for Voice or Data in kHz. A 'V' symbol means Voice Deviation. A 'D' symbol means Data Deviation (low-frequency data). Value range: 0.00 to 100.0 kHz.

Soft Function Keys available with this function include:

- F1 DATA  
Shows deviation of low-frequency (data) modulations.
- F2 VOICE  
Shows voice-range frequency modulations.
- F3 FMZ  
Used to FM-Zero the Receiver, which adjusts the DC offset to zero. Do this operation if the Simulator is having trouble completing a Group Call or going to IDLE status.
- F4 FM CAL  
Makes an attempt to move the DC offset to zero in the Receiver. *Not a recommended operation. The FMZ softkey should be tried first if the Radio does not complete a Group Call. This operation may work on a Simulator Under Test that is extremely far off frequency. May require more than one try.*
- F6 RETURN  
Returns to the EDACS Trunking Manual Test Screen.

11. AF Frequency:

This field shows the Repeater's Transmitter Audio Frequency in Hz. It is a display-only field (meter) with no cursor position. Measuring range: 300 to 4500 Hz.

12. Distortion: (Receive)

This field shows the Repeater's Transmitter Distortion in %. Value range: 0.0 to 20.0%. Also used to

show decoded DTMF digits by pressing the DTMF softkey.

Soft Function Keys available with this function include:

- F1 DIST  
Selects Distortion readings (meter).
- F2 OFF  
Disable Distortion or DTMF readings.
- F3 DTMF Selects DTMF decoding.
- F6 RETURN  
Returns to the EDACS Trunking Manual Test Screen.

13. Extended Meas:

This field allows access to one of three external screens: Scope, Analyzer or Digital Voltmeter (DVM). If a Group Call (PTT) was made to another Radio and is still in progress, it is possible to access any of the three screens without interrupting the call. The *only* way to enter the extended screens is to use the softkeys. The 'Return' field in the extended screen allows a return to the Repeater Simulator.

Soft Function Keys available with this function include:

- F1 SCOPE  
Accesses the Scope Screen.
- F2 ANALY  
Accesses the Analyzer Screen.
- F3 DVM  
Accesses the Digital Voltmeter Screen.

F6 RETURN  
Returns to the EDACS Trunking Manual Test Screen.

14. RF: (Generate)

This field shows the current RF Frequency of the EDACS Control Channel for the Generator side of the Radio Simulator. This field is editable (which puts the Control Channel in 'Manual' mode). Value range: 0 to 1000.0000 MHz.

Soft Function Keys available with this function include:

F1 CALL  
Simulates a Group Call (PTT) to another radio. The ID's used to make the call are taken from the Group/Logical ID fields.

F2 DISC  
Disconnects a call (release PTT) which was made previously using the CALL softkey.

F6 RETURN  
Returns to the EDACS Trunking Manual Test Screen.

15. Level:

This field is used to set the Generator's RF Output Level in dBm. Value range: -40 to -130.0 dBm (T/R), 13.0 to -130.0 dBm (AUX) with AUX option.

Soft Function Keys available with this function include:

F6 RETURN  
Returns to the EDACS Trunking Manual Test Screen.

16. Output:

This field is used to set the Generator's RF Output source to the T/R port or the Auxiliary (AUX) RF port. Valid values: T/R or AUX.

F1 T/R  
Sets the Generator RF Output to the T/R connector.

F2 AUX  
Sets the Generator RF Output to the AUX connector.

F6 RETURN  
Returns to the EDACS Trunking Manual Test Screen.

17. Status

This field shows the current status of the Radio Simulator. Display-only field. Valid status values:

NC  
No Control Channel overhead found from the Repeater. No calls accepted in this state.

IDLE  
Radio is locked into a Repeater Site and is waiting to make a Group Call or accept a Group Call.

BEGIN CALL  
A Group Call is initiated and call processing with the Repeater is in progress. This message is usually brief.

GROUP CALL  
Radio Simulator successfully executed a Group Call and is transmitting/receiving on the Working Channel assigned by the Repeater Under Test. The Working Channel is displayed in parenthesis.

**CALLED**

A call is made to the Radio Simulator and is transmitting/receiving on the Working Channel assigned by the Repeater Under Test. The words "EMG" is displayed if an Emergency Group Call was made.

18. Message:

Briefly shows the last EDACS message received from the Repeater. Display-only field.

**GRP CHAN ASSGN**

A Group Call Channel Assignment message is received from the Repeater.

**CH UPDATE**

A Channel Update message is received from the Repeater.

**CALL DROP**

A Call Drop message is received from the Repeater.

19. Mod Source:

This field is used to select a Generator source for modulation. Sources are only modulated when a call (PTT) is initiated from the Radio Simulator. The DATA modulation field is to modulate the EDACS signaling data. All enabled modulation sources display above the Mod Source field.

Soft Function Keys available with this function include:

**F1 GEN1**

Selects Function Generator 1 as the modulation source.

**F2 GEN2**

Selects Function Generator 2 as the modulation source.

**F3 DATA**

Selects Data Generator as the modulation source.

**F4 DTMF**

Selects DTMF as the modulation source.

**F6 RETURN**

Returns to the EDACS Trunking Manual Test Screen.

To the right of Mod Source, select the modulation type for the selected source.

Soft Function Keys available with this function include:

**F1 OFF**

Turn off the selected Generator source.

**F2 AM**

Sets the selected Generator source for AM modulation.

**F3 FM**

Sets the selected Generator source for FM modulation.

**F4 PM**

Sets the selected Generator source for PM modulation.

**F6 RETURN**

Returns to the EDACS Trunking Manual Test Screen.

20. Deviation: (Generate)

This field is active when the selected source is FM or PM modulation type. This controls the deviation of the modulated source. Value range: 0.00 to 100.0 kHz for FM and 0.00 to

10.0 Rad for PM. *For deviation of DATA, 3.2 kHz is the recommended default value.*

F6 RETURN  
Returns to the EDACS Trunking Manual Test Screen.

21. Modulation:

This field is active when the selected source is AM modulation type. This controls the modulation of the selected source. Value range: 0.0% to 100.0%.

F6 RETURN  
Returns to the EDACS Trunking Manual Test Screen.

22. Frequency:

This field is active when the selected source, GEN1 or GEN2, is modulated. This selects the Audio Frequency of the selected Function Generator source (sine wave). Value range: 0.0 Hz to 20000.0 Hz.

F6 RETURN  
Returns to the EDACS Trunking Manual Test Screen.

23. Subaud dev:

This field is active when the selected source, DATA, is modulated. This controls the deviation of the sub-audible data used during an established call initiated from the Radio Simulator. Value range: 0.00 to 100.0 kHz. *Should be  $\leq$  Deviation (20). The recommended default value is 0.70 kHz.*

F6 RETURN  
Returns to the EDACS Trunking Manual Test Screen.

24. Code:

This field is active when the selected source, DTMF, is modulated. This allows the entry of desired DTMF digits to use for DTMF source generation.

F1 CLEAR  
Clears out any DTMF digits previously programmed in.

F2 CONT  
Puts the DTMF Generation in the continuous mode.

F3 BURST  
Used to one-shot the DTMF Generator source.

F6 RETURN  
Returns to the EDACS Trunking Manual Test Screen.

25. Sinad:

This field is used to select a meter to read signals from the Audio/Data/SINAD input baseband jack. The measurements appear to the right of this field. Valid selections:

Soft Function Keys available with this function include:

F1 DIST  
Selects the Distortion meter for baseband measurements.

F2 SINAD  
Selects the SINAD meter for baseband measurements.

F3 AF LVL  
Selects the AF Level meter for baseband measurements.

F4 OFF  
Disables baseband measuring.

F6 RETURN  
Returns to the EDACS Trunking  
Manual Test Screen.

*When baseband measurements are made, all receiver measurements including the DSP data decoding are disabled due to hardware limitations.*

*Therefore an EDACS Call Processing cannot be made with any baseband measurements enabled. The Call Processing must be made first, then the baseband measurements may be enabled during the call.*

## 7-14-9 EDACS HIGH-SPEED DATA CAPTURE (SCOPE)

The COM-120B provides a reliable capture of the data burst.

Access the EDACS Repeater or Radio Simulator Extended Meas Scope.

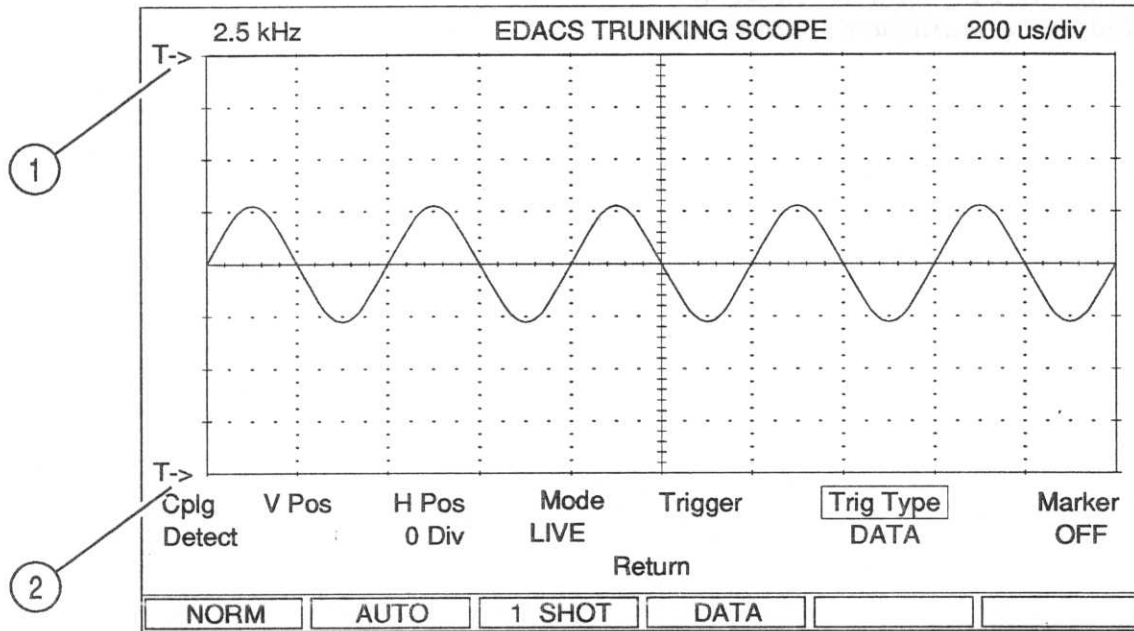

00607090

To view the dotting or barker code before the data, set the horizontal position selection negative. Cursor to the *Trig Type* field. The "DATA" type acts like the 1-SHOT mode, triggering when the High-Speed EDACS data is decoded. Use the START/STOP Hard Key or press the DATA Soft Function Key F4 to re-arm the trigger.

*It is very important to set the EDACS Trunking Scope trigger level high (top of screen) or low (bottom of screen) enough to avoid causing a trigger before the EDACS Data Burst occurs. Set the scope trigger level to its maximum (1). If the EDACS Data Burst is not visible, set the trigger level to its minimum (2).*

## 7-14-10 EDACS STORE AND RECALL

The COM-120B provides the ability to store and recall EDACS system configurations. Data is stored to one of 50 standard stored test setups under the *Type* EDACS. Press the STORE Hard Key in any EDACS option screen for this menu window:

Store setup as ...

Setup # 0

Name: -----

Type: EDACS

00607091

1. Setup #

Displays selected Memory Location for storage of current configuration.

2. Name

Displays optional alphanumeric label for selected Memory Location.

3. Type

Displays the type of data currently saved in the specified setup number. Available types to save and recall are: DUPLEX, GENERATOR, RECEIVER, GENERATOR & RECEIVER and EDACS.

Soft Function Keys available with this function include:

F1 SAVE  
Finalizes Storage Operation.

F6 ABORT  
Escapes Storage Operation without editing.

Press the RECALL Hard Key in any EDACS option screen for this menu window:

Recall setup ...

Setup # 0

Name: -----

Type: EDACS

00607092

1. Setup #

Displays selected Memory Location for storage of current configuration.

2. Name

Displays optional alphanumeric label for selected Memory Location.

3. Type

Displays the type of data currently saved in the specified setup number. Available types to save and recall are: DUPLEX, GENERATOR, RECEIVER, GENERATOR & RECEIVER and EDACS.

Soft Function Keys available with this function include:

F1 RESTORE  
Finalizes Recall Operation.

F6 ABORT  
Escapes Storage Operation without editing.



## 7-14-11 EDACS TRUNKING OPERATIONAL NOTES

This section provides some notes and hints on operating the EDACS Trunking Option of the COM-120B unit.

### **Squelch Setting**

The squelch knob setting on the COM-120B unit is very important for all testing.

While in the EDACS Trunking Main Screen with no RF being transmitted into the COM-120B unit, turn the squelch knob full counter-clockwise. The green squelch light is ON. Slowly turn the knob clockwise until the green light just goes off (make sure there is no flickering). This setting is valid for all EDACS testing.

### **Control/Working Channels**

If a radio is having trouble locking onto the Repeater Simulator, completing calls or the Radio Simulator is showing NC, check the programming of the Control and/or Working Channels in the Setup menu. These channels must be valid for the particular system under test.

### **Data Generation**

If the radio won't lock onto the Repeater Simulator, won't stay up when being called or the Radio Simulator is having trouble completing calls, check the DATA Mod Source. The DATA Mod Source must be set for FM Modulation. The recommended deviation is 3.2 kHz with a sub-audible deviation of 0.70 kHz.

### **Logical/Group ID**

If a radio can not be called in the Repeater Simulator or can not make a call in the Radio Simulator, check the Group/Logical ID. The Group ID must valid for the system under test.

### **FM-Zero**

If a radio is having trouble completing a Group Call (maybe works 50% of the time), an FM-Zero (FMZ) operation may be necessary. Do this in the Automatic Test using FMZ Soft Function Key F4 while in the idle state, or do it in any manual mode simulator by cursoring to the Deviation field in the left column and pressing FMZ Soft Function Key F3.

# INDEX

30 kHz IF Filter (Option 03)	7-1
<b>A</b>	
Abbreviations	B-1
AM Modulation Meter	
Description of	3-94
Operation of	4-53
AMPS Cell Site Simulator Automatic Tests	7-62
AMPS Cell Site Simulator Main and Setup Menus	7-53
AMPS Cell Site Simulator Manual Tests	7-74
AMPS Cell Site Simulator Setup	7-52
AMPS Cellular Testing (Option 15)	7-52
AMPS Cell Site Simulator Automatic Tests	7-62
AMPS Cell Site Simulator Main and Setup Menus	7-53
AMPS Cell Site Simulator Manual Tests	7-74
AMPS Cell Site Simulator Setup	7-52
Analyzer Commands	5-4
Applying AC Power	2-3
Applying External DC Power	2-4
Audio/Data/Signaling Generators	4-104
Description of	
Audio Generator 1	3-168
Audio Generator 2	3-171
DATA Generator	3-174
DTMF Generator	3-172
General Operation Screen	3-166
Screen Access	3-165
Operation of	
Audio Generator 1 Operation	4-105
Audio Generator 2 Operation	4-107
DATA Generator Operation	4-108
DTMF Generator Operation	4-109
Audio/Digital Signaling Formats (Option 11)	7-13
Audio Frequency Counter	
Independent Operation	
Description of	3-117
Operation of	4-111
Receive Operation	
Description of	3-117
Operation of	4-65
Audio Frequency Level (AF LVL) Meter	
Description of	3-39
Operation of	4-19
Audio Function Generators	
Audio/Tone Coding	1-2
Data	1-2
DTMF	1-3
Audio Tones	6-36
Auxiliary Setup Screen Configuration	7-35

## B

Battery Fuse Replacement	2-6
Battery Power Operation	2-5
Battery Replacement	2-5
BER (Bit Error Rate) Commands	5-6
Bit Error Rate (BER) General Operation Screen	7-2
BER Meter Configuration Section	7-3
BER Meter Description	7-1

## C

CLEARCHANNEL LTR® (Option 14)	7-15
Auxiliary Setup Screen Configuration	7-35
LTR Trunking Auxiliary Setup Screen	7-33
LTR Trunking Radio Simulation	7-25
LTR Trunking Repeater Simulation	7-16
Radio Simulator Operation	7-46
Repeater Simulator Operation	7-36
COM-120B Product Specifications ( <i>see Specifications</i> )	
COM-120B Specific Commands	5-4
Analyzer Commands	5-4
BER Commands	5-6
Decoder Commands	5-7
Display Commands	5-7
Duplex Commands	5-8
Error Codes	5-32
Filter Commands	5-8
Format Commands	5-10
Function Generator Commands	5-10
Generator Commands	5-13
Key Code Definitions	5-33
Measuring Commands	5-16
Meter Commands	5-17
Receiver Commands	5-24
Scope Commands	5-26
Status Commands	5-27
System Commands	5-28
Trunking Commands	5-29
Configuring RS-232 Connector for Remote Operation	5-1
CONTROLS, CONNECTORS & INDICATORS	3-1
Front Panel Controls	3-1
Rear Panel Controls	3-6
Operation Screens and Menus	3-8
Audio/Data/Signaling Generators Operation Screen	3-165
Duplex Operation Screen	3-135
Memory Lists and Storage Parameters	3-194
Meters Operation	3-175
Oscilloscope Operation Screen	3-157
RF Generate Operation Screen	3-8
RF Receive Operation Screen	3-59
Spectrum Analyzer Operation Screen	3-160
Utility Functions	3-199

## D

Data Generator/Bit Error Rate (BER) Meter (Option 07)	7-1
Decoder Commands	5-7
Decoding Digital Signaling Formats	7-13h
Delay	6-36
Digital Voltmeter Operation Screen	
Description of	3-186
Operation of	4-117
Display Commands	5-7
Display Commands (TMAC)	6-40
Distortion Meter	
Generate Operation	
Description of	3-34
Operation of	4-17

## D (Cont'd)

Distortion Meter	
Independent Operation	
Description of	3-190
Operation of	4-119
Receiver Operation	
Description of	3-85
Operation of	4-48
Duplex Commands	5-8
Duplex Generate General Operation Screen	3-142
Duplex Operation	1-2
Duplex Operation Screen	
Description of	
Duplex Operation Screen	3-135
Duplex Generate Operation Screen	3-136
Duplex Receive Operation Screen	3-146
Store and Recall Operation	3-153
Operation of	4-89

## E

EDACS High-Speed Data Capture (Scope)	7-120
EDACS Store and Recall	7-121
EDACS Trunking Automatic Test	7-88
EDACS Trunking Automatic Test Execution	7-90
EDACS Trunking Automatic Test Results	7-93
EDACS Trunking Channel Assignments	7-86
EDACS Trunking Manual Test	7-103
Radio Simulator	7-112
Repeater Simulator	7-104
EDACS Trunking Operational Notes	7-122
EDACS Trunking (Option 16)	7-83
EDACS Trunking Setup Screen	7-84
Edit Commands	6-25
Encoding Digital Signaling Formats for Audio Signal	7-13e
Error Codes	5-32

## F

Filter Commands	5-8
FM Deviation Meter	
Description of	3-89
Operation of	4-50
Format Commands	5-10
Front Panel Controls	3-1
Function Generator Commands	5-10

## G

GENERAL TMAC (Test Macro Language)	6-1
Audio Tones	6-36
Comments	6-2
Conditional Expressions	6-22
Constants Datas and Data Arrays	6-5
Creating Windows and Graphics	6-29
Delay	6-36

## G (Cont'd)

GENERAL TMAC (Test Macro Language)(Cont'd)	6-1
Display Commands	6-40
Edit Commands	6-25
Macros	6-19
Mathematical Functions	6-12
Mathematical Operators	6-7
Numeric Formats	6-6
Setup Commands	6-37
String Variables and Functions	6-15
Syntax	6-1
System RS-232 Configure Commands	6-37
Variables and Arrays	6-3
Variables and Arrays In Macros	6-24
Generate Amplifier (Option 05)	7-1
Generating	1-1
Generating AM Modulated RF Signal	4-31
Generating DCS Coded RF Signal	4-32
Generating DTMF Coded RF Signal	4-32
Generating FM Modulated RF Signal	4-31
Generating Microphone Modulated Signal	4-33
Generating PM Modulated RF Signal	4-32
Generating RF Signal Using External Modulation	4-33
Generator Commands	5-13
GPIB Connector	
Configuring for Remote Operation	7-14
Pinout	A-3

## I

IEEE 488.2 Commands	5-3
INSTALLATION	2-1
General	2-1
Precautions	2-1
Power Up Procedures	2-3
Applying AC Power	2-3
Applying External DC Power	2-4
Battery Power Operation (Option 01)	2-5
Battery and Battery Fuse Replacement	2-5
Battery Replacement	2-5
Battery Fuse Replacement	2-6
Internal Battery Option (Option 01)	7-1
INTRODUCTION	1-1
General	1-1
RF Generate Operation	1-1
RF Receive Operation	1-2
Duplex Operation	1-2
Audio Function Generators	1-2
Oscilloscope	1-3
Spectrum Analyzer	1-4
Meters	1-5
Options	1-5
COM-120B Product Specifications	1-7

## K

Key Code Definitions	5-33
----------------------	------

## L

LTR Trunking Auxiliary Setup Screen	7-33
LTR Trunking Radio Simulation	7-25

## M

Machine Specific Remote Commands	5-4
Mandatory IEE 488.2 Commands	5-3
Measuring Commands	5-16
Measuring Modulation Acceptance Bandwidth	4-35
Measuring Receiver Audio Output Level	4-35
Measuring Receiver Center Frequency	4-34
Measuring Receiver IF Bandwidth	4-36
Measuring Receiver Sensitivity	4-34
Measuring Receiver Selectivity	4-34
Measuring Transmitter AM Modulation	4-83
Measuring Transmitter Audio Frequency	4-87
Measuring Transmitter Distortion	4-88
Measuring Transmitter Frequency Error	4-86
Measuring Transmitter FM Deviation	4-82
Measuring Transmitter Phase Modulation	4-84
Measuring Transmitter Power	4-85
Memory Lists and Storage of Parameters	3-194
Stored Frequency List	3-195
Stored Setup List	3-197
Meter Commands	5-17
Meters (General Description)	
Dependent	1-5
Independent	1-5
Meters	
Description of	
Operation	3-175
Audio Frequency Counter	3-176
Digital Voltmeter	3-186
Distortion Meter	3-190
SINAD Meter	3-181
Operation of	
Audio Frequency Counter Operation	4-111
Digital Voltmeter Operation	4-117
Distortion Meter Operation	4-119
SINAD Meter Operation	4-114
Modulating RF Signals with	
Digital Signaling Formats	7-13b

## O

OPERATION	4-1
Audio/Data/Signaling Generators	4-104
Duplex Operation	4-89
Meters Operation	4-110
Oscilloscope Operation	4-99
General Notes	4-1
RF Generate Operation	4-3
RF Receive Operation	4-37
Spectrum Analyzer Operation	4-101
Operation Notes	
Cursor Movement	4-1
Editing Fields Using Data Scroll Keys	
and Spinner	4-1

## O (Cont'd)

Operation Notes	
Editing Numeric Data Fields	4-1
Escaping From Edit Without Change	4-2
Making Selections From Menus	4-2
Operation Screens, Description of	
Audio/Data/Signaling Generators	
Operation Screen	
Audio Generator 1	3-168
Audio Generator 2	3-171
DATA Generator	3-174
DTMF Generator	3-172
General Operation Screen	3-166
Duplex Operation Screen	
Duplex General Operation Screen	3-136
Duplex Generate Operation Screen	3-142
Duplex Receive Operation Screen	3-146
Store and Recall Operation	3-153
Memory Lists	3-194
Meters Operation	3-175
AF Counter Operation Screen	3-176
Digital Voltmeter Operation Screen	3-186
Distortion Meter Operation Screen	3-190
SINAD Meter Operation Screen	3-181
Oscilloscope Operation Screen	3-157
RF Generate Operation Screen	
Audio/Data Filters Block	3-24
Audio Frequency Level	
(AF LVL) Meter	3-39
Distortion Meter	3-34
General Operation Screen	3-9
Modulation Source Block	3-14
Oscilloscope Operation Screen	3-45
SINAD Meter	3-28
Spectrum Analyzer Operation Screen	3-51
Store and Recall Operation	3-55
RF Receive Operation Screen	
AM Modulation Meter	3-94
Audio/Data Filters Block	3-68
Audio Frequency Counter	3-117
Decoding Screens	3-78
Distortion Meter	3-85
FM Deviation Meter	3-89
General Operation Screen	3-60
Phase Modulation Meter	3-99
RF Power Meter	3-104
Received Level Meter	3-109
RF Frequency Error Meter	3-113
Oscilloscope Operation Screen	3-120
SINAD Meter	3-80
Spectrum Analyzer Operation Screen	3-126
Store and Recall Operation	3-131
Spectrum Analyzer Operation Screen	3-157
Storage of Parameters	3-194
Utility Functions	3-199
Clock/Calendar Screen	3-200
DSP Selftest	3-212
GPIB Configuration Screen (Option 13)	3-202
Keyboard Setup Screen	3-211
RS-232 Configuration Screen	3-203
Run Time Screen	3-205
Software Version Screen	3-201
Systems Diagnostics Menu	3-206

## O (Cont'd)

Options (General Descriptions)	
Option 01-Internal Battery	1-5
Description	7-1
Option 02-0.01 OCXO	1-5
Description	7-1
Option 03-30 kHz IF Filter	1-5
Description	7-1
Option 04-Variable Audio Generator 2	1-5
Description	7-1
Option 05-Generate Amplifier	1-5
Description	7-1
Option 07-Data Generator/Bit Error Rate (BER) Meter	1-5
Description	7-1
Option 08-SSB Receive Filter	1-5
Description	7-12
Option 09-RCC Signaling	1-5
Description	7-13
Option 11-Audio/Digital Signaling	1-5
Description	7-13
Option 12-Tracking Generator	1-6
Description	7-14
Option 13-IEEE 488 (GPIB) Interface	1-6
Description	7-14
Option 14-CLEARCHANNEL LTR®	1-6
Description	7-15
Option 15-AMPS Mobile Station Test	1-6
Description (Cellular Testing)	7-52
Option 16-EDACS	1-6
Description	7-83
Oscilloscope Operation (General Description)	
Dependent	1-3
Independent	1-3
Oscilloscope Operation Screen	
Generate Operation	
Description of	3-45
Operation of	4-22
Independent Operation	
Description of	3-157
Operation of	4-99
Receive Operation	
Description of	3-120
Operation of	4-67
Oven Crystal Oscillator Frequency Standard (Option 02)	7-1

## P

Phase Modulation (PM) Meter ( <i>see also, ΦM Meter</i> )	
Description of	3-99
Operation of	4-55
Specifications	1-13
Power Up Procedure	2-3
Applying AC Power	2-3
Applying External DC Power	2-4
Power Up Procedure	2-3
Battery Power Operation (Option 01)	2-5
Precautions	2-1
Product Specifications ( <i>see also, Specifications</i> )	1-7
AF Frequency Counter	1-12
AM Modulation Meter	1-13

## P (Cont'd)

Product Specifications ( <i>see also, Specifications</i> )	1-7
Audio/Data Generators	1-9
Digital Voltmeter	1-15
Distortion Meter	1-15
Frequency Modulation Meter	1-13
General Characteristics	1-18
Input/Output Connectors	1-18
Master Oscillator	1-18
Modulation	1-8
Options	1-19
Oscilloscope	1-16
Φ M Meter ( <i>also, Phase Modulation Meter</i> )	1-13
Power Requirements	1-18
Receive Level Meter	1-14
Receiver	1-11
RF Frequency Error Meter	1-12
RF Power Meter	1-14
RF Signal Generator	1-7
Selective RF Counter	1-11
SINAD Meter	1-15
Spectrum Analyzer	1-16

## R

Radio Simulator Operation	7-46
RCC Signaling Formats (Option 09)	7-13
Rear Panel Controls	3-6
Receive Data Configuration Section	7-6
Received Level Meter	
Description of	3-109
Operation of	4-60
Receiver Commands	5-24
Receiving	1-2
Receiving AM Modulated RF Signal	4-78
Receiving DCS Coded RF Signal	4-80
Receiving DTMF Coded RF Signal	4-81
Receiving FM Modulated RF Signal	4-77
Receiving PM Modulated RF Signal	4-79
REMOTE OPERATION	5-1
Configuring GPIB Connector	7-14
Configuring RS-232 Connector	5-1
Error Codes	5-32
Key Code Definitions	5-33
Machine Specific Remote Commands	5-4
Mandatory IEEE 488.2 Commands	5-3
Repacking For Shipping	C-1
Repeater Simulator Operation	7-36
RF Frequency Error Meter	
Description of	3-113
Operation of	4-63
RF Generate Operation	
Generating	1-1
Information	4-3
Meters	1-2
Testing	1-2
RF Generate Operation Screen	
Description of	
Audio/Data Filters Block	3-24
Audio Frequency Level (AF LVL) Meter	3-39
Distortion Meter	3-34

## R (Cont'd)

RF Generate Operation Screen (Cont'd)	
Description of	
General Operation Screen	3-9
Modulation Source Block	3-14
Oscilloscope Operation Screen	3-45
SINAD Meter	3-28
Spectrum Analyzer Operation Screen	3-51
Store and Recall Operation	3-55
Operation of	
General Operation	4-4
Generating AM Modulated RF Signal	4-31
Generating DCS Coded RF Signal	4-32
Generating DTMF Coded RF Signal	4-32
Generating FM Modulated RF Signal	4-31
Generating Microphone Modulated Signal	4-33
Generating PM Modulated RF Signal	4-32
Generating RF Signal Using External Modulation	4-33
Measuring Receiver Center Frequency	4-34
Measuring Receiver Sensitivity	4-34
Measuring Receiver Selectivity	4-34
Measuring Receiver Audio Output	4-35
Measuring Modulation Acceptance BW	4-35
Measuring Receiver IF Bandwidth	4-36
RF Power Meter	
Description of	3-104
Operation of	4-57
RF Receive Operation	
Meters	1-2
Receiving	1-2
Testing	1-2
RF Receive Operation Screen	
Description of	
AM Modulation Meter	3-94
Audio/Data Filters Block	3-68
Audio Frequency Counter	3-117
Decoding Screens	3-78
Distortion Meter	3-85
FM Deviation Meter	3-89
General Operation Screen	3-60
Phase Modulation Meter	3-99
RF Power Meter	3-104
Received Level Meter	3-109
RF Frequency Error Meter	3-113
Oscilloscope Operation Screen	3-120
SINAD Meter	3-80
Spectrum Analyzer Operation Screen	3-126
Store and Recall Operation	3-131
Operation of	
Measuring Transmitter AM Modulation	4-83
Measuring Transmitter Audio Frequency	4-87
Measuring Transmitter Distortion	4-88
Measuring Transmitter Frequency Error	4-86
Measuring Transmitter FM Deviation	4-82
Measuring Transmitter Phase Modulation	4-84
Measuring Transmitter Power	4-85

## R (Cont'd)

RF Receive Operation Screen (Cont'd)	
Operation of	
Receiving AM Modulated RF Signal	4-78
Receiving FM Modulated RF Signal	4-77
Receiving PM Modulated RF Signal	4-79
Receiving DCS Coded RF Signal	4-80
Receiving DTMF Coded RF Signal	4-81
RF Receive General Operation Screen	4-38
RS-232 Connector	
Configuring for Remote Operation	5-1
Pinout	A-4

## S

Scope Commands	5-26
Send Data Configuration Section	7-10
Setup Commands	6-37
SINAD Meter	
Generate Operation	
Description of	3-28
Operation of	4-14
Independent Operation	
Description of	3-181
Operation of	4-114
Receive Operation	
Description of	3-80
Operation of	4-45
Single Sideband Receive Filter (Option 08)	7-12
General	7-12
Description of Receive Function	7-12
Specifications ( <i>see also, Product Specifications</i> )	
AF Frequency Counter	1-12
AM Modulation Meter	1-13
Audio/Data Generators	1-9
Digital Voltmeter	1-15
Distortion Meter	1-15
Frequency Modulation Meter	1-13
General Characteristics	1-18
Input/Output Connectors	1-18
Master Oscillator	1-18
Modulation	1-8
Options	1-19
Oscilloscope	1-16
Φ M Meter ( <i>also, Phase Modulation Meter</i> )	1-13
Power Requirements	1-18
Receive Level Meter	1-14
Receiver	1-11
RF Frequency Error Meter	1-12
RF Power Meter	1-14
RF Signal Generator	1-7
Selective RF Counter	1-11
SINAD Meter	1-15
Spectrum Analyzer	1-16
Spectrum Analyzer	
Generate Operation	
Description of	3-51
General Description	1-4
Operation of	4-26

## S (Cont'd)

Spectrum Analyzer	
Spectrum Analyzer (Cont'd)	
Generate Operation	
Independent Operation	
Description of	3-160
General Description	1-4
Operation of	4-101
Receive Operation	
Description of	3-126
General Description	1-4
Operation of	4-72
Spectrum Analyzer Tracking Generator (Option 12)	7-14
Status Commands	5-27
Store and Recall Operation	
Duplex	3-153
Generate	3-55
Operation of	4-29
Receive	3-131
Operation of	4-75
System Commands	5-28
System RS-232 Configure Commands	6-37

## T

Testing a Receiver using Digital Signaling Formats	7-13j
Testing a Transmitter using Digital Signaling Formats	7-13k
Trunking Commands	5-29

## U

User I/O Connectors and Pin-Out Tables	A-1
GPIO Connector Pinout	A-3
MIC/ACC Connector Pinout	A-2
RS-232 Connector Pinout	A-4
Utility Functions	3-199
Clock/Calendar Screen	3-200
DSP Selftest	3-206
GPIO Configuration Screen (Option 13)	3-202
Keyboard Setup Screen	3-211
RS-232 Configuration Screen	3-203
Run Time Screen	3-205
Software Version Screen	3-201
Systems Diagnostics Menu	3-206

## V

Variable Audio Generator 2 (Option 04)	7-1
--	-----