

**AvionTEq**

□ □ □ □ □ □ □ □ □ □  
Test with full trust

[www.avionteq.com](http://www.avionteq.com)

**AEROFLEX**

# **SDX 2000**

## **OPERATION MANUAL**

**MANUAL NUMBER:** 06-0728-A1 (Hard Copy)  
E6-0728-A1 (CD-ROM)  
**REVISION:** 01  
**DATE:** 05/12/2006

**WARNING: INFORMATION SUBJECT TO EXPORT CONTROL LAWS**

*This manual may contain information subject to the International Traffic in Arms Regulation (ITAR) or the Export Administration Regulation (EAR) which may not be exported, released, or disclosed to foreign nationals inside or outside of the United States without first obtaining an export license. A violation of the ITAR or EAR may be subject to a penalty of imprisonment and/or fines under 22 U.S.C.2778 of the Arms Export Control Act or section 2410 of the Export Administration Act. Include this notice with any reproduced portion of this document.*

This document is proprietary to Aeroflex JcAIR Test Systems,  
and is not to be reproduced or otherwise disseminated without the written consent of  
Aeroflex JcAIR Test Systems.

400 New Century Parkway – New Century, Kansas – 66031  
Telephone: (800) 237-2831 / (913) 764-2452 Fax: (913) 782-5104  
[www.aeroflex.com](http://www.aeroflex.com)



## ELECTROSTATIC DISCHARGE GENERAL WARNINGS FOR ALL EQUIPMENT

**CAUTION:** THIS EQUIPMENT MAY CONTAIN ELECTROSTATIC DISCHARGE (ESD) SENSITIVE COMPONENTS. TO PREVENT ESD SENSITIVE EQUIPMENT FROM POSSIBLE DAMAGE, OBSERVE THE FOLLOWING PRECAUTIONS WHEN HANDLING ANY ESD SENSITIVE COMPONENTS, OR UNITS CONTAINING ESD SENSITIVE COMPONENTS:

- a. Maintenance or service personnel must be grounded through a conductive wrist strap, or a similar grounding device, using a 1 M $\Omega$  series resistor for equipment protection against static discharge, and personal protection against electrical shock.
- b. All tools must be grounded (including soldering tools) that may come into contact with the equipment. Hand contact will provide sufficient grounding for tools that are not otherwise grounded, provided the operator is grounded through an acceptable grounding device such as a wrist strap.
- c. Maintenance or service of the unit must be done at a grounded, ESD workstation.
- d. Before maintenance or service of the equipment, disconnect all power sources, signal sources, and loads connected to the unit.
- e. If maintenance or service must be performed with power applied, take precautions against accidental disconnection of equipment components. Specifically, do not remove integrated circuits or printed circuit boards from equipment while the equipment has power applied.
- f. All ESD sensitive components are shipped in protective tubes or electrically conductive foam. The components should be stored using the original container/package when not being used or tested. If the original storage material is not available, use similar or equivalent protective storage material.
- g. When ESD sensitive components are removed from a unit, the components must be placed on a conductive surface, or in an electrically conductive container.
- h. When in storage or not being repaired, all printed circuit boards must be kept in electrically conductive bags, or other electrically conductive containers.
- i. Do not unnecessarily pick up, hold, or directly carry ESD sensitive devices.

Failure to comply with these precautions may cause permanent damage to ESD sensitive devices. This damage can cause devices to fail immediately, or at a later time without apparent cause.

**RECORD OF REVISIONS**

REV NO.	ISSUE DATE	INSERT DATE	BY	REV NO.	ISSUE DATE	INSERT DATE	BY
0	OCT 30/04						
1	MAY 12/06						

# Declaration of Conformity

## DECLARATION OF CONFORMITY

**Manufacturer's Name:** BFGoodrich Aerospace, JcAIR Test Systems Division

**Manufacturer's Address:** 400 New Century Parkway  
New Century, KS 66031-0009  
USA

Declares that the products

**Product Name:** SDX 2000 -- ATC/DME Generator

**Model Number(s):** 01-0728-00, 01-0728-01, 01-0728-02, 01-0728-03  
01-0728-10, 01-0728-11, 01-0728-12, 01-0728-13  
01-0728-20, 01-0728-21, 01-0728-22, 01-0728-23  
01-0728-30, 01-0728-31, 01-0728-32, 01-0728-33

**Product Options:** All options associated with listed models are covered.

Conform to the following product specifications and carry the CE-marking accordingly.

Low Voltage Directive 73/23/EEC: IEC 61010-1:1990 / EN 61010-1:1993

EMC Directive 89/336/EEC: EN 61326:1998  
IEC 61326:1997

Date: 5/30/2001

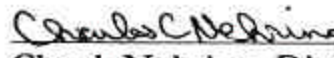
  
\_\_\_\_\_  
**Chuck Nehring, Director**  
Quality Assurance/Customer Support

# Safety and Regulatory Information

**Review this product and related documentation to familiarize yourself with safety markings and instructions before you operate this equipment.**

**WARNING** The **WARNING** notice denotes a hazard. It calls attention to a procedure, practice, or the like, that, if not correctly performed or adhered to, could result in personal injury. Do not proceed beyond a **WARNING** notice until the indicated conditions are fully understood and met.

**CAUTION** The **CAUTION** notice denotes a hazard. It calls attention to an operating procedure, practice, or the like, which, if not correctly performed or adhered to, could result in damage to the product or loss of important data. Do not proceed beyond a **CAUTION** notice until the indicated conditions are fully understood and met.



**Caution (refer to accompanying documents).** Attention – refer to the manual. This symbol indicates that information about usage of a feature is contained in the manual.

## Equipment Markings

The following markings may appear on this equipment:



**Direct current.** This symbol indicates that the equipment requires direct current input.

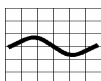

**Alternating current.** This symbol indicates that the equipment requires alternating current input.



**Both direct and alternating current.** This symbol indicates that the equipment requires either ac or dc input at the same connector.

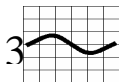

**Three-phase alternating current.** This symbol indicates that the equipment requires 3-phase ac input.

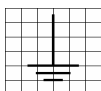

**Earth (ground) terminal.** This symbol indicates the ground (earth) terminal.

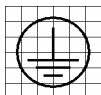

**Protective conductor terminal.** This symbol indicates the protective ground (earth) terminal.

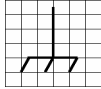

**Frame or chassis terminal.** This symbol indicates the frame or chassis terminal for connection to ground.

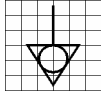

**Equipotentiality.** This symbol indicates an equipotentiality terminal.

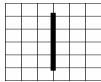

**On (Supply).** This symbol indicates that the power line switch is ON.

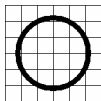

**Off (Supply).** This symbol indicates that the power line switch is OFF.

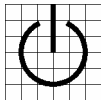

**Standby.** This symbol indicates that the power line switch is in STANDBY.

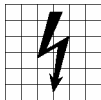

**Caution, risk of electric shock.** Danger – high voltage.

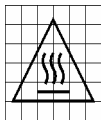

**Caution, hot surface.** Danger – high temperature surface.



**Caution (refer to accompanying documents).** Attention – refer to the manual. This symbol indicates that information about usage of a feature is contained in the manual.

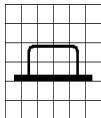

**In-position of a bistable push control.** This symbol indicates the in (on) position of a bistable push control.

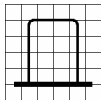

**Out-position of a bistable push control.** This symbol indicates the out (off) position of a bistable push control.



**CE Mark.** <sup>TM</sup> of the European Community.

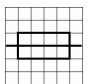

**Fuse Symbol.** To indicate a fuse.

## Warnings

### WARNING

Do not use the equipment in a manner not specified in this manual!

**WARNING** Equipment should only be serviced by authorized personnel.

**Proper Fuse**



To avoid fire hazard, use only a fuse identical in type, voltage rating, and current rating as specified on the fuse rating label and/or in the manual.

**Proper Power Cord**

Use only the power cord and connector appropriate for the voltage and plug configuration in your country. Use only a power cord that is in good condition. Refer cord and connector changes to qualified service personnel.

**Do Not Operate in Explosive Atmospheres**

To avoid explosion, do not operate the equipment in an atmosphere of explosive gas.

**Do Not Attempt to Operate if Protection may be Impaired.**

If the equipment appears damaged or operates abnormally, protection may be impaired. Do not attempt to operate it. When in doubt, have the equipment serviced.

**Cleaning Warning**

Keep the equipment dry to avoid electrical shock to personnel or damage to the equipment. To prevent damage, never apply solvents to the equipment housing. For cleaning, wipe the equipment with a cloth that is lightly dampened with water, mild detergent, or alcohol. Do not use aromatic hydrocarbons, chlorinated solvents, or methanol-based fluids.

**Operating Position**

Normal operating position is horizontal, on a flat surface. Vertical position is not considered normal operation.

**WARNING**

This is a Safety Class 1 Product (provided with a protective earthing ground incorporated in the power cord). The mains plug shall only be inserted in a socket-outlet provided with a protective earth contact. Any interruption of the protective conductor inside or outside of the product is likely to make the product dangerous. Intentional interruption is prohibited.

**WARNING**

Equipment is not intended for wet locations. Miscellaneous liquids on or in the equipment could cause hazardous conditions.

**Safety Maintenance**

The operator should check the detachable power supply cord condition. The equipment should not be operated if the mains inlet is cracked or broken. Any obvious damage to the case (from a drop or fall) should be checked by service personnel for loose or damaged parts inside. See parts lists for approved replacement parts.

**WARNING TO SERVICE PERSONNEL**

Ensure that power is disconnected before removal of any covers.

**WARNING**

The Power switch on the Front Panel is not the mains disconnect. Mains disconnect is accomplished by disconnecting the detachable power supply cord at the appliance coupler or at the mains plug. Ensure the power cord is easily accessible and removable, in the event of an emergency, which requires immediate disconnection.

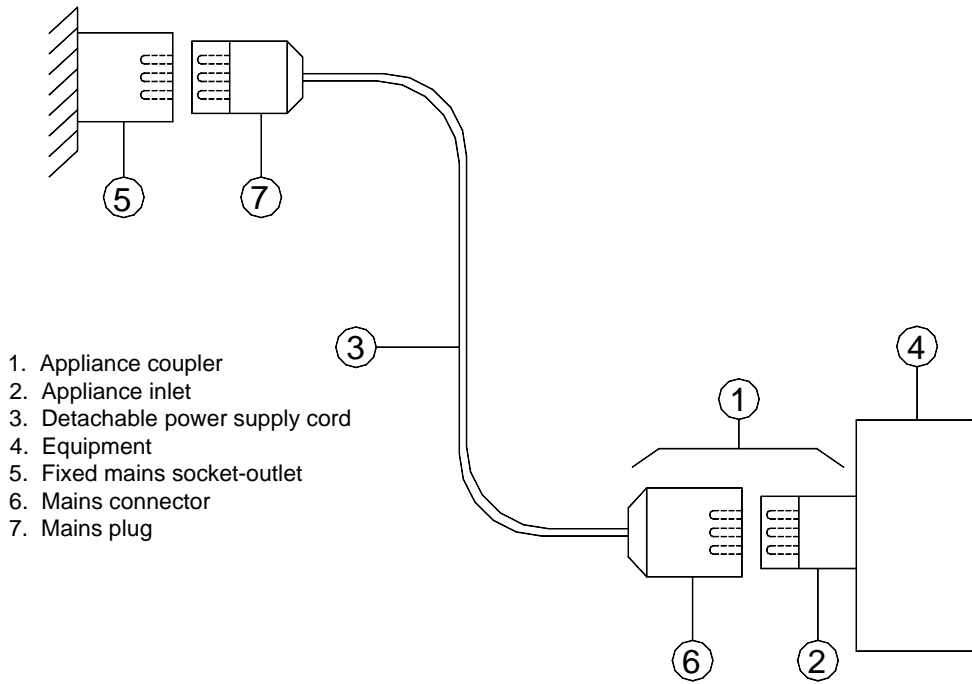

**WARNING**

Equipment has mass of 23,1 kg. A pair of handles is provided. Use both handles for lifting and carrying.



## LIST OF EFFECTIVE PAGES

<u>CHAPTER/ SECTION</u>	<u>PAGE</u>	<u>DATE</u>	<u>CHAPTER/ SECTION</u>	<u>PAGE</u>	<u>DATE</u>
Record of Revisions	1	May 12/06		20	May 12/06
				21	May 12/06
				22	May 12/06
Warranty				23	May 12/06
				24	May 12/06
ESD Warning				25	May 12/06
				26	May 12/06
Declaration of Conformity				27	May 12/06
			1-2	1	May 12/06
Safety and Regulatory Information	1	May 12/06	1-3	1	May 12/06
	2	May 12/06			
	3	May 12/06	1-4	1	May 12/06
	4	May 12/06		2	May 12/06
List of Effective Pages	1	May 12/06	1-5 Table of Contents	1	May 12/06
	2	May 12/06			
	3	May 12/06	1-5	1	May 12/06
	4	May 12/06		2	May 12/06
				3	May 12/06
Introduction	1	May 12/06		4	May 12/06
				5	May 12/06
Table of Contents	1	May 12/06		6	May 12/06
	2	May 12/06		7	May 12/06
				8	May 12/06
1-1	1	May 12/06		9	May 12/06
	2	May 12/06		10	May 12/06
	3	May 12/06		12	May 12/06
	4	May 12/06		13	May 12/06
	5	May 12/06		14	May 12/06
	6	May 12/06		15	May 12/06
	7	May 12/06		16	May 12/06
	8	May 12/06		17	May 12/06
	9	May 12/06		18	May 12/06
	10	May 12/06		19	May 12/06
	11	May 12/06		20	May 12/06
	12	May 12/06		21	May 12/06
	13	May 12/06		22	May 12/06
	14	May 12/06		23	May 12/06
	15	May 12/06		24	May 12/06
	16	May 12/06		25	May 12/06
	17	May 12/06		26	May 12/06
	18	May 12/06			
	19	May 12/06			

## LIST OF EFFECTIVE PAGES

<u>CHAPTER/ SECTION</u>	<u>PAGE</u>	<u>DATE</u>	<u>CHAPTER/ SECTION</u>	<u>PAGE</u>	<u>DATE</u>
1-5	27	May 12/06	1-6	TOC-1	May 12/06
	28	May 12/06		TOC-2	May 12/06
	29	May 12/06		1	May 12/06
	30	May 12/06		2	May 12/06
	31	May 12/06		3	May 12/06
	32	May 12/06		4	May 12/06
	33	May 12/06		5	May 12/06
	34	May 12/06		6	May 12/06
	35	May 12/06		7	May 12/06
	36	May 12/06		8	May 12/06
	37	May 12/06		9	May 12/06
	38	May 12/06		10	May 12/06
	39	May 12/06		11	May 12/06
	40	May 12/06		12	May 12/06
	41	May 12/06		13	May 12/06
	42	May 12/06		14	May 12/06
	43	May 12/06		15	May 12/06
	44	May 12/06		16	May 12/06
	45	May 12/06		17	May 12/06
	46	May 12/06		18	May 12/06
	47	May 12/06			
	48	May 12/06	1-7	1	May 12/06
	49	May 12/06			
	50	May 12/06	1-8	1	May 12/06
	51	May 12/06			
	52	May 12/06	2-1	1	May 12/06
	53	May 12/06			
	54	May 12/06	2-2	1	May 12/06
	55	May 12/06		2	May 12/06
	56	May 12/06			
	57	May 12/06	2-3	1	May 12/06
	58	May 12/06			
	59	May 12/06	2-4	1	May 12/06
	60	May 12/06			
	61	May 12/06	3-1	1	May 12/06
	62	May 12/06			
	63	May 12/06	Appendix A		
	64	May 12/06	Table of Contents	1	May 12/06
	65	May 12/06		2	May 12/06
	66	May 12/06		3	May 12/06
	67	May 12/06		4	May 12/06
	68	May 12/06		5	May 12/06
	69	May 12/06			
	70	May 12/06			
	71	May 12/06			
	72	May 12/06			

## LIST OF EFFECTIVE PAGES

<u>CHAPTER/ SECTION</u>	<u>PAGE</u>	<u>DATE</u>	<u>CHAPTER/ SECTION</u>	<u>PAGE</u>	<u>DATE</u>
Appendix A	1	May 12/06		48	May 12/06
	2	May 12/06		49	May 12/06
	3	May 12/06		50	May 12/06
	5	May 12/06		51	May 12/06
	6	May 12/06		52	May 12/06
	7	May 12/06		53	May 12/06
	8	May 12/06		54	May 12/06
	9	May 12/06		55	May 12/06
	10	May 12/06		56	May 12/06
	11	May 12/06		57	May 12/06
	12	May 12/06		58	May 12/06
	13	May 12/06		59	May 12/06
	14	May 12/06		60	May 12/06
	15	May 12/06		61	May 12/06
	16	May 12/06		62	May 12/06
	17	May 12/06		63	May 12/06
	18	May 12/06		64	May 12/06
	19	May 12/06		65	May 12/06
	20	May 12/06		66	May 12/06
	21	May 12/06			
	22	May 12/06	Appendix B		
	23	May 12/06	Table of Contents	1	May 12/06
	24	May 12/06			
	25	May 12/06	Appendix B	1	May 12/06
	26	May 12/06		2	May 12/06
	27	May 12/06		3	May 12/06
	28	May 12/06		4	May 12/06
	29	May 12/06		5	May 12/06
	30	May 12/06		6	May 12/06
	31	May 12/06		7	May 12/06
	32	May 12/06		8	May 12/06
	33	May 12/06		9	May 12/06
	34	May 12/06		10	May 12/06
	35	May 12/06		11	May 12/06
	36	May 12/06		12	May 12/06
	37	May 12/06		13	May 12/06
	38	May 12/06		14	May 12/06
	39	May 12/06		15	May 12/06
	40	May 12/06			
	41	May 12/06	Appendix C	1	May 12/06
	42	May 12/06		2	May 12/06
	43	May 12/06		3	May 12/06
	44	May 12/06			
	45	May 12/06			
	46	May 12/06			
	47	May 12/06			

## LIST OF EFFECTIVE PAGES

<u>CHAPTER/ SECTION</u>	<u>PAGE</u>	<u>DATE</u>	<u>CHAPTER/ SECTION</u>	<u>PAGE</u>	<u>DATE</u>
Appendix D	1	May 12/06	Appendix F	1	May 12/06
	2	May 12/06		2	May 12/06
	3	May 12/06		3	May 12/06
	4	May 12/06		4	May 12/06
	5	May 12/06		5	May 12/06
	6	May 12/06	Appendix G	1	May 12/06
	7	May 12/06		2	May 12/06
	8	May 12/06			
	9	May 12/06			
	10	May 12/06			
	11	May 12/06			
	12	May 12/06			
	13	May 12/06			
	14	May 12/06			
	15	May 12/06			
	16	May 12/06			
	17	May 12/06			
	18	May 12/06			
	19	May 12/06			
Appendix E Table of Contents	1	May 12/06			
Appendix E	1	May 12/06			
	2	May 12/06			
	3	May 12/06			
	4	May 12/06			
	5	May 12/06			
	6	May 12/06			
	7	May 12/06			
	8	May 12/06			
	9	May 12/06			
	10	May 12/06			
	11	May 12/06			
	12	May 12/06			
	13	May 12/06			
	14	May 12/06			
	15	May 12/06			
	16	May 12/06			
	17	May 12/06			
	18	May 12/06			
	19	May 12/06			
	20	May 12/06			
	21	May 12/06			
	22	May 12/06			
	23	May 12/06			



## **INTRODUCTION**

### **A. Content**

This manual provides general information, programming/operational information, and routine maintenance information for the JcAIR SDX 2000. The SDX 2000 is a fully programmable RF tester that provides complete test capability for all commercial pulsed L-band avionics including ATCRBS and DME.

For testing, troubleshooting, and non-routine maintenance, the SDX 2000 Maintenance Manual (JPN: 06-0728-A0 for hard copy, E6-0728-A0 for CD-ROM) is available separately from JcAIR.

### **B. Arrangement**

The information in this manual is divided into chapters/sections with major headings as shown below.

Chapter One covers General Information, and User/Operating Instructions.

Chapter Two covers Service and Maintenance.

Chapter Three contains the Appendices.



**TABLE OF CONTENTS**

**RECORD OF REVISIONS**

**WARRANTY**

**ESD WARNING**

**DECLARATION OF CONFORMITY**

**SAFETY AND REGULATORY INFORMATION**

**LIST OF EFFECTIVE PAGES**

**INTRODUCTION**

**CHAPTER ONE - GENERAL INFORMATION AND OPERATING INSTRUCTIONS**

**SECTION 1. INSTRUMENT DEFINITIONS ..... 1**

**ATCRBS INSTRUMENT ..... 3**

**MODE S INSTRUMENT ..... 8**

**DATALINK INSTRUMENT ..... 17**

**DME INSTRUMENT ..... 23**

**SECTION 2. EQUIPMENT DESCRIPTION ..... 1**

**SECTION 3. UNPACKING AND INSPECTING EQUIPMENT ..... 1**

**SECTION 4. EQUIPMENT INSTALLATION ..... 1**

**SECTION 5. OPERATING INSTRUCTIONS**

**TABLE OF CONTENTS ..... TOC-1**

**SECTION 6. SPECIFICATIONS**

**TABLE OF CONTENTS ..... TOC-1**

**SECTION 7. UNITS AND ACCESSORIES ..... 1**

**UNITS AND ACCESSORIES SUPPLIED ..... 1**

**SECTION 8. SHIPPING AND STORAGE ..... 1**



**TABLE OF CONTENTS**

**CHAPTER TWO - MAINTENANCE**

**SECTION 1. SERVICING ..... 1**

**SECTION 2. PREVENTATIVE MAINTENANCE..... 1**

**SECTION 3. TROUBLESHOOTING ..... 1**

**SECTION 4. REASSEMBLY ..... 1**

**CHAPTER THREE - MANUFACTURERS' APPENDICES**

**SECTION 1. APPENDICES..... 1**

**APPENDIX A - SDX 2000 GPIB COMMAND SET**

**APPENDIX B - SDX 2000 I/O DEFINITION TABLES**

**APPENDIX C - PERCENT REPLY CALCULATIONS**

**APPENDIX D - ATCRBS MODE A ALTITUDE CODES**

**APPENDIX E - EXAMPLE TEST PROCEDURES**

**APPENDIX F - DME CHANNEL PAIR FREQUENCIES**

**APPENDIX G - DEFINITION OF TERMS AND ACRONYMS**

**CHAPTER ONE - GENERAL INFORMATION AND OPERATING INSTRUCTIONS**

**SECTION 1. INSTRUMENT DEFINITIONS**

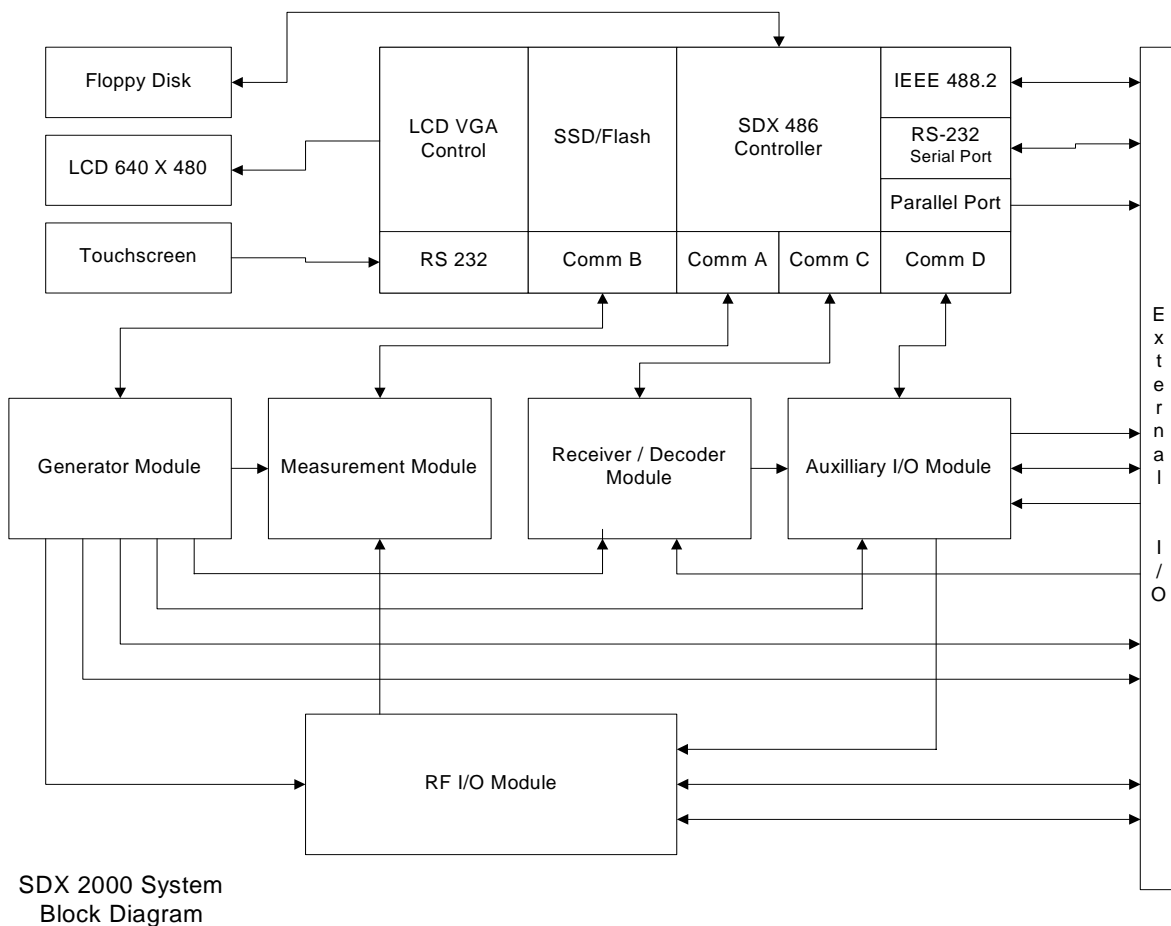

**Figure 1-1**





## **CHAPTER ONE - GENERAL INFORMATION AND OPERATING INSTRUCTIONS**

### **SECTION 1. INSTRUMENT DEFINITIONS**

The SDX-2000 has four normal modes of operation, termed "Instruments"; ATCRBS (for ATCRBS - only transponder testing), MODE S (for combination ATCRBS and Mode Select transponders), DATALINK (for testing COMM-C uplink and COMM-D downlink), and DME (for testing the common DMEN style distance measuring interrogators). Refer to Figure 1 for a system level Block Diagram of the SDX 2000.

With the installation of optional software, the SDX 2000 can also be used to test TACAN (Tactical Air Navigation) systems or IFF (Identification Friend or Foe) systems or both if both options are installed.

Two additional modes are provided:

- SETUP Mode allows the operator to select various optional parameters when testing one or more of the systems supported.
- CAL Mode allows the operator and calibration technician a means to verify proper operation of the SDX system.



## **CHAPTER ONE - GENERAL INFORMATION AND OPERATING INSTRUCTIONS**

### **SECTION 1. INSTRUMENT DEFINITIONS**

#### **ATCRBS INSTRUMENT**

The ATCRBS (Air Traffic Control Radar Beacon System) instrument provides the ability to test airborne transponders. The operator may select any of the interrogation formats shown in Figure 2, ATCRBS Interrogation/Reply Formats. In addition, the user may choose Mode A/C which results in the output of alternating Mode A and Mode C interrogations or Double Interrogation Mode which outputs a pair of interrogations whose spacing is programmable from 0 to 400 us as measured from P1 of the first interrogation to P1 of the second interrogation. Double Mode timing is shown in Figure 3, ATCRBS Double Interrogation Timing. The interrogation rate (PRF) may be varied from 0 to 10,000 Hz in normal mode, but is limited to a maximum of 400 Hz when operating in Double Interrogation Mode.

**CHAPTER ONE - GENERAL INFORMATION AND OPERATING INSTRUCTIONS**

**SECTION 1. INSTRUMENT DEFINITIONS**

**ATCRBS INSTRUMENT cont.**

**ATCRBS INTERROGATION**

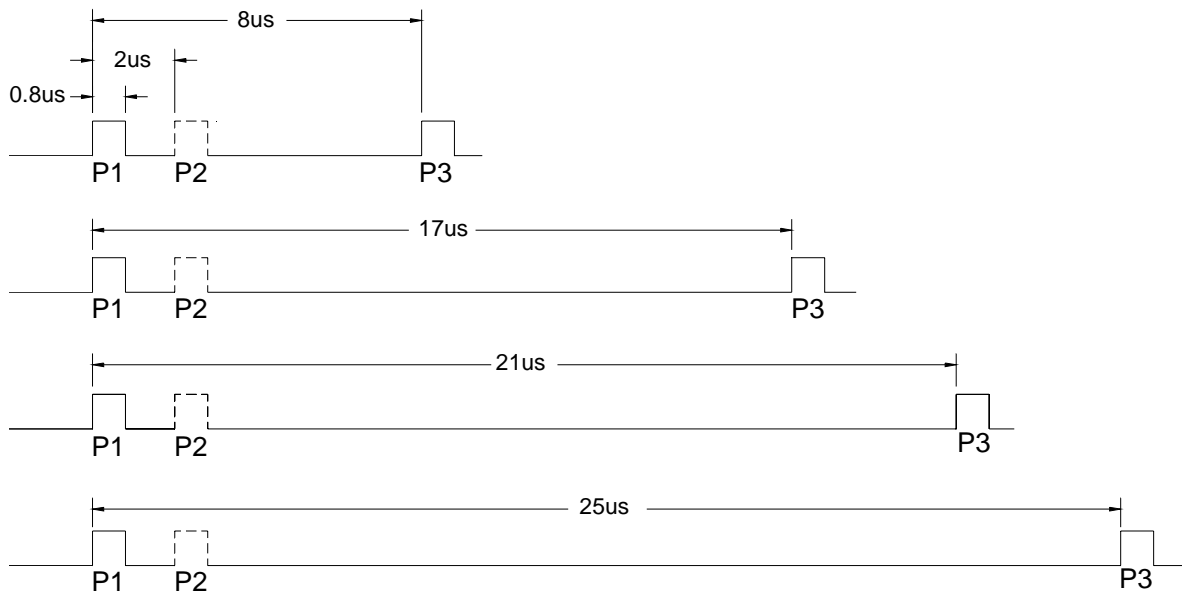

**ATCRBS REPLY**

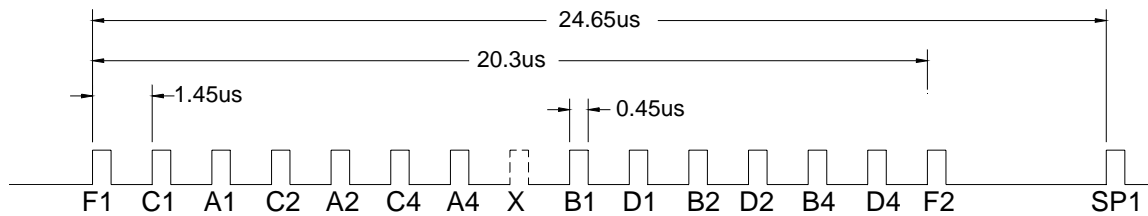
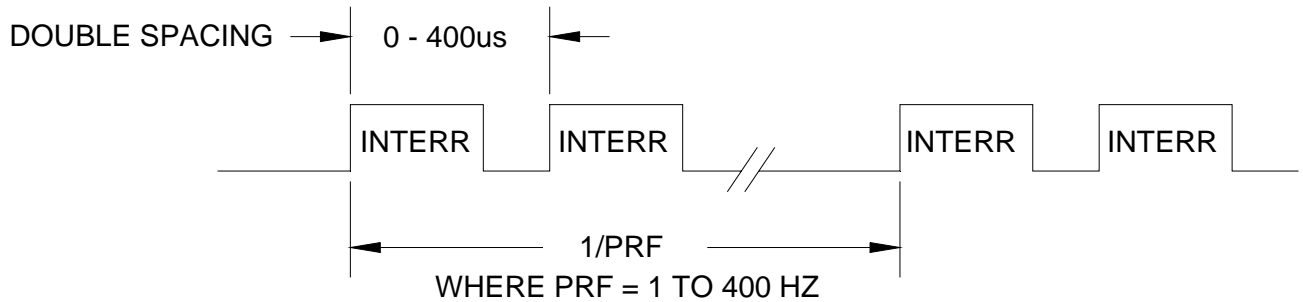

**Figure 2. ATCRBS Interrogation / Reply Formats**

## CHAPTER ONE - GENERAL INFORMATION AND OPERATING INSTRUCTIONS

### SECTION 1. INSTRUMENT DEFINITIONS

#### ATCRBS INSTRUMENT cont.



**Figure 3. ATCRBS Double Interrogation Timing**

#### RF OUTPUT SETTINGS

The nominal ATC interrogation and reply transmit frequencies are 1030 and 1090 MHz respectively. The SDX2000 allows the operator to deviate from the nominal interrogation frequency. The user is free to select any frequency within the 952 to 1223 MHz limits with a resolution of 10 KHz. Interrogation power can be adjusted in 0.1 dB increments from 0 to -110 dBm.

Generator power can be adjusted in 0.1 dB increments from 0 to -110 dBm. Accurate power levels are generated and maintained through the use of an automatic leveling circuit that monitors the output and servos the level accordingly. This topology requires multiple interrogations and/or replies to obtain the desired power level after a level change. For example, during transponder operation the required time for the automatic leveling circuit to servo the output to the desired level is a function of the selected PRF. Higher PRF values will result in faster leveling of the output.

#### PULSE TIMING

Features have been built into the SDX2000 which allow the operator to alter the interrogation's nominal timing parameters as shown in Figure 2. P1 and P3 pulses may be programmed for widths longer or shorter than the 0.8 us default value. The offset or deviation range is -0.2 to +1.95 us. Pulse position may also be offset from the nominal values shown in Figure 2. The offset limit for P2 and P3 position is +/- 1.95 us.

#### SPECIAL FUNCTIONS

Three special functions are available to the user; SLS, INTERFERENCE, and PULSE AMPLITUDE. Only one of these special functions may be invoked at a time.

##### SLS

The operator may include an SLS (P2) in the output interrogation if required. The operator may adjust SLS position from the nominal location (see Figure 2, ATCRBS Interrogation Format) by +/- 1.95us. SLS pulse width may be varied from 0.2 to 1.95 us. SLS amplitude may be adjusted from -15.0 to +5.0 dB relative to P1.

**CHAPTER ONE - GENERAL INFORMATION AND OPERATING INSTRUCTIONS****SECTION 1. INSTRUMENT DEFINITIONS****ATCRBS INSTRUMENT cont.***INTERFERENCE*

One or two interference pulses may be selected by the user. If two interference pulses are used their pulse width and pulse amplitude will be the same (Only one entry for width and amplitude is allowed.). Pulse width limits are 0.2 to 7.0 us. The first interference pulse is positioned from -15 to +400 us relative to the rising edge of P1. The second interference pulse is positioned relative to the rising edge of the first interference pulse. Position entry limits are 0.0 us to the end of the first pulse's range. For example, if the first interference pulse is positioned at +100 us following P1 then the maximum delay for the second pulse is +300 us (400us - 100us = 300us). Interference pulse amplitude may be adjusted from -15.0 to +5.0 dB relative to P1.

*PULSE AMPLITUDE*

P3 pulse amplitude may be adjusted from -15.0 to 5.0 dB relative to P1.

**REPLY PASS/FAIL CRITERIA**

For a transponder reply to be considered valid it must meet or exceed the SDX2000 reply pass/fail criteria. Invalid replies will be counted as no-replies toward calculation of the % Reply value. Testing of the UUT reply delay and framing pulse spacing (F1/F2) is performed. First pulse of the reply must fall within a 2.0 us window, centered at 3.0 us following P3 of the interrogation (50% point, rising edge). The user may select one of two F1-to-F2 spacing limits: narrow or wide. As shown below the narrow option is the tighter of the two pass/fail windows.

- Narrow: Selects a 250 ns F2, pulse-position window, centered at 20.3 us following F1 of the reply (50% point, rising edge).
- Wide: Selects a 750 ns F2, pulse-position window, centered at 20.3 us following F1 of the reply (50% point, rising edge).

**REPLY DECODE**

The choice of narrow or wide also determines the allowable deviation of the data pulses and SPI from their nominal positions. If any of these pulses are determined to be out of limit an error message is inserted into the reply data field of the ATCRBS instrument screen, but the reply is counted for percent reply purposes as long as the reply delay and framing pulses are within the pass/fail limits.

Reply data is displayed in two formats. The data is presented in its raw received form where active pulses are highlighted and as decoded octal data. An exception is the Mode C reply where altitude data is displayed in engineering units (ft) rather than octal.

**SYNC SELECT**

The SYNC SELECT function gives the user the ability to output a pulse (SCOPE SYNC) coincident to the UUT reply or at any desired location from -1 to 600us relative to P1 of the interrogation. In the Double Interrogation mode the sync pulse is output for the first interrogation only.



## **CHAPTER ONE - GENERAL INFORMATION AND OPERATING INSTRUCTIONS**

### **SECTION 1. INSTRUMENT DEFINITIONS**

#### **ATCRBS INSTRUMENT cont.**

#### **UUT MEASUREMENTS**

The following UUT parameters are measured and displayed to the operator:

1. Frequency
2. Power
3. Percent Reply
4. Reply Delay
5. Reply Jitter
6. F1/F2 Spacing
7. Pulse Width

Of these Frequency, Power, and Pulse Width measurements are taken from the reply pulse selected by the operator (MEASURED PULSE: button).

#### **SUPPRESSOR PULSE**

The SUPPRESSOR PULSE output is a 33 us pulse beginning 0.8 us prior to P3, when P3 is in its nominal position. Both digital and analog outputs are available. The analog output's voltage range is 3 to 27 Volts.

## CHAPTER ONE - GENERAL INFORMATION AND OPERATING INSTRUCTIONS

### SECTION 1. INSTRUMENT DEFINITIONS

#### MODE S INSTRUMENT

The Mode S (Mode Select) instrument provides the ability to test Mode S airborne transponders. The operator may choose from any of the interrogation types shown in Figure 4, Pulse Patterns for Mode S PAM Interrogations or Figure 5, Pulse Pattern for Mode S DPSK Interrogations.

### ATCRBS

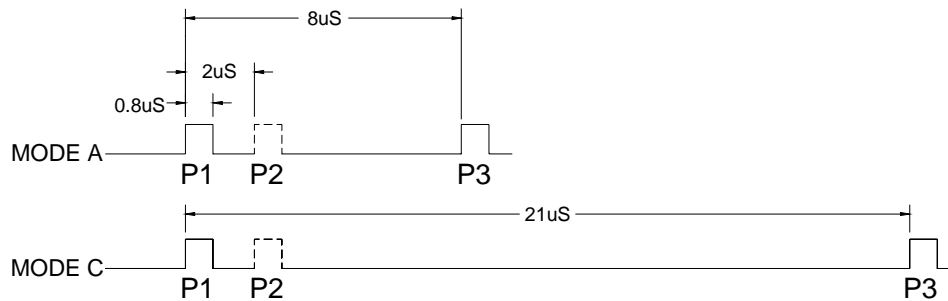

### INTER MODE

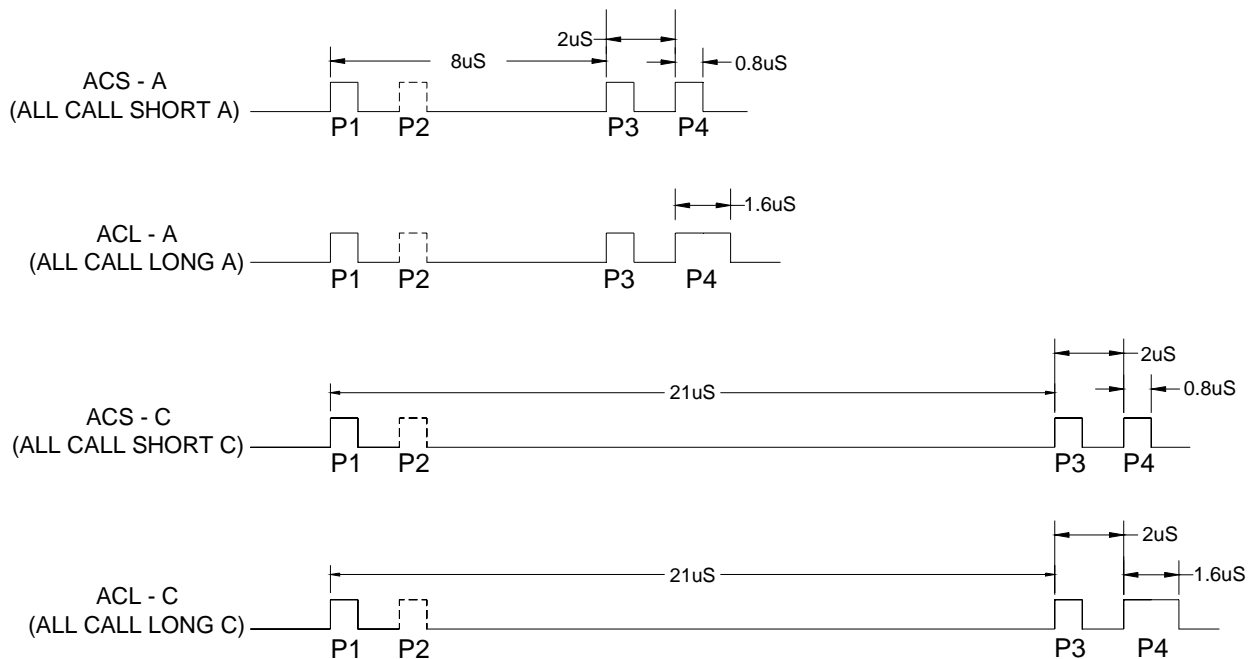

Figure 4. Pulse Patterns for Mode S PAM Interrogations

**CHAPTER ONE - GENERAL INFORMATION AND OPERATING INSTRUCTIONS**

**SECTION 1. INSTRUMENT DEFINITIONS**

**MODE S INSTRUMENT cont.**

**MODE S INTERROGATION  
DISCRETE ADDRESSING (DPSK)**

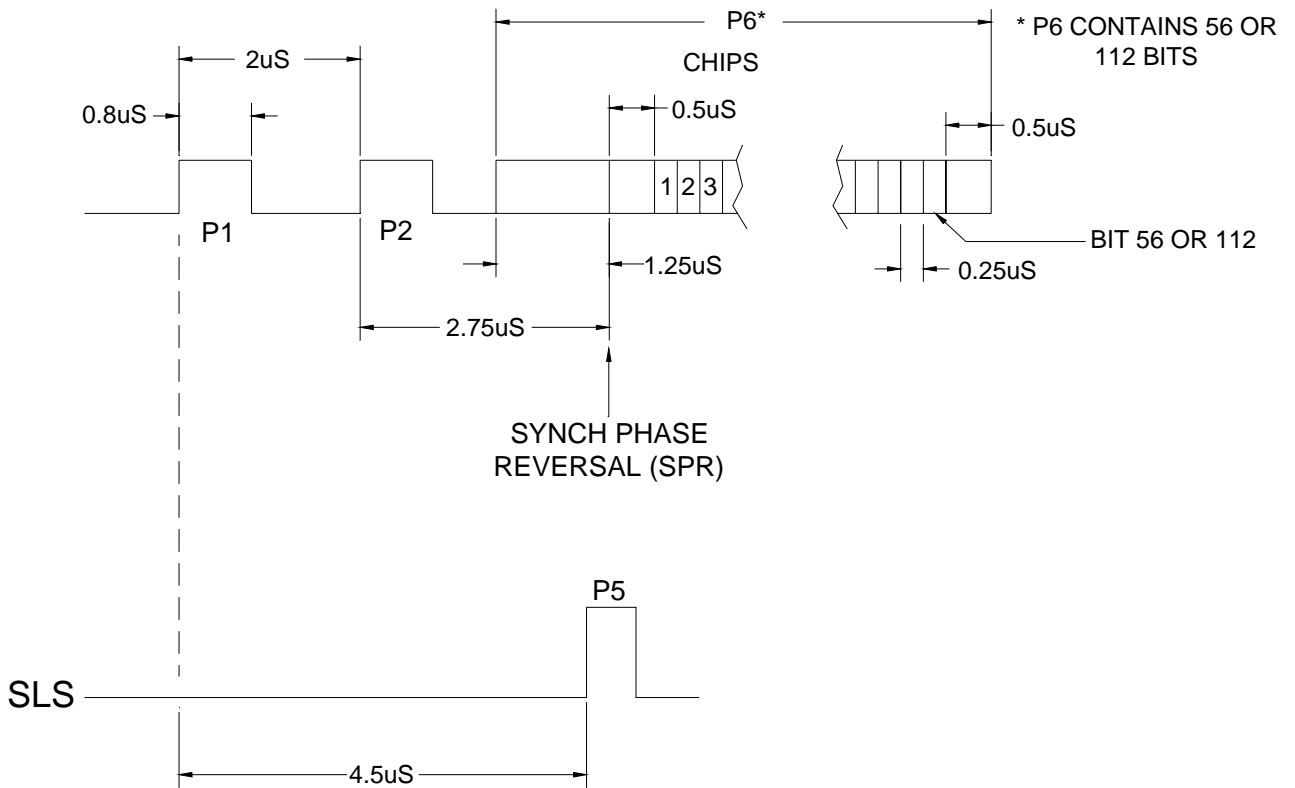

**Figure 5, Pulse Pattern for Mode S DPSK Interrogations**

**RF OUTPUT SETTINGS**

Same as ATCRBS instrument.



**CHAPTER ONE - GENERAL INFORMATION AND OPERATING INSTRUCTIONS**

**SECTION 1. INSTRUMENT DEFINITIONS**

**MODE S INSTRUMENT cont.**

**OPERATING MODES**

Within the Mode S Instrument there are four separate test modes; NORMAL, DOUBLE, BURST, and INTERLACED.

**NORMAL TEST MODE**

NORMAL test mode provides for programming from 1 to 30 unique interrogations to be output sequentially at a selectable rate (PRF) of 1 to 400 Hz.

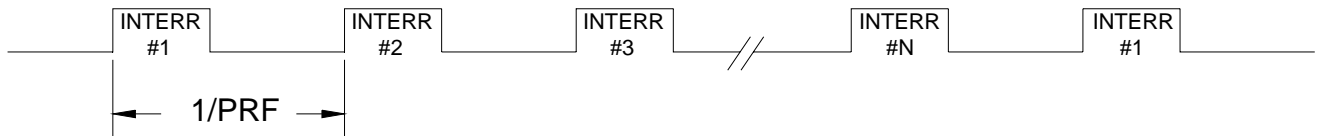

WHERE N = 1 TO 30 and  
PRF = 1 TO 400 Hz

**Figure 6. Normal Test Mode Timing**

**DOUBLE TEST MODE**

DOUBLE test mode operation in the Mode S instrument is the same as the ATCRBS instrument with one exception, in ATCRBS Mode the same interrogation is output twice to generate an output pair while the Mode S instrument allows the operator to output two like or different interrogations (Interrogation 1 and Interrogation 2). The spacing between the interrogation pair is programmable from 0 to 400 us. The rate at which the pair is transmitted (PRF) is programmable from 1 to 400 Hz.

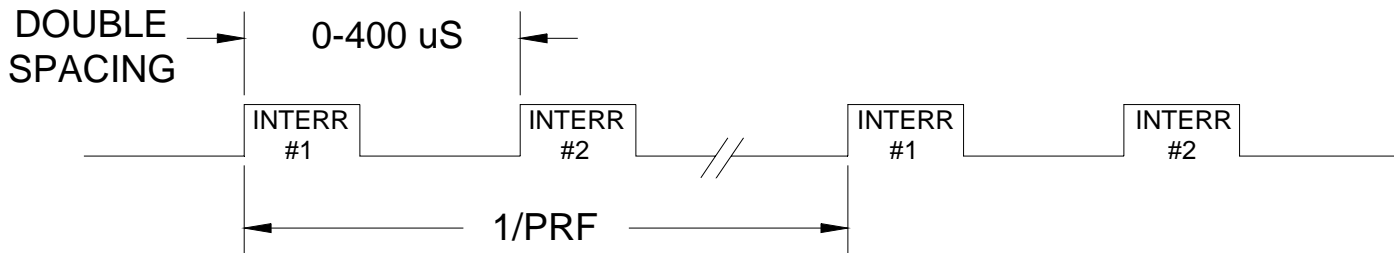

WHERE PRF = 1 TO 400 Hz

**Figure 7. Double Test Mode Interrogation Timing**

**CHAPTER ONE - GENERAL INFORMATION AND OPERATING INSTRUCTIONS**

**SECTION 1. INSTRUMENT DEFINITIONS**

**MODE S INSTRUMENT cont.**

**BURST TEST MODE**

In the BURST test mode interrogations which the user has enabled (turned ON) from the INTERR/REPLIES menu or the INTERROGATIONS SUMMARY page are output sequentially at the selected PRF rate. The number of interrogations output per burst (BURST COUNT) as well as the period between bursts (BURST SPACING) is programmed by the operator from the BURST mode SETUP menu. The maximum BURST COUNT for different PRF ranges is shown below.

Max Burst Count	PRF Range (Hz)
256	1 to 2000
2000	1 to 400
2000 (ATCRBS only)	1 to 2500

NOTE: Finite reply throughput of the SDX decoder limits the number of interrogations (BURST COUNT) which can be processed over a given period. The decoder can process continuous reply data at a maximum rate of 400Hz. Therefore, the burst count is of no consequence at a PRF of 400 or less. Also, the decoder can buffer (store on the decoder FIFO) up to 256 long Mode S replies. Thus, the PRF is unlimited if the burst count is 256 or less. The minimum burst spacing is 1 second, which is more than enough time to process the 256 buffered replies before the next burst arrives.

The maximum number of unique interrogations that the operator can enable is 30, as was the case in the NORMAL test mode. The ON/OFF status of all 30 interrogations is most easily determined from the INTERROGATIONS SUMMARY page. If the BURST COUNT exceeds the number of interrogations enabled by the operator the SDX2000 will continue outputting the ON interrogations until the burst count has been satisfied. Every burst sequence begins with the first enabled (ON) interrogation in the INTERR/REPLIES, SUMMARY page. If the BURST COUNT has been reached before all enabled ON interrogations have been output (BURST COUNT < # of ON Interrogations) no further interrogations will be output until the next scheduled burst. Burst spacing is the period between the end of the burst sequence (last pulse of the last interrogation output) and the beginning of the next burst (first pulse of the first interrogation). The BURST SPACING timer determines the period between consecutive bursts. BURST SPACING is programmable from 0.1 to 20 seconds in 0.1 second steps. If the user wishes to execute only one burst sequence this can be accomplished using SINGLE BURST mode. UUT squitter may be used in lieu of the default BURST SPACING timer to trigger a burst output. The operator may program the SDX2000 to trigger a burst output upon receipt of the nth UUT squitter, where n can be any user selected hole number from 1 to 20.

**CHAPTER ONE - GENERAL INFORMATION AND OPERATING INSTRUCTIONS**

**SECTION 1. INSTRUMENT DEFINITIONS**

**MODE S INSTRUMENT cont.**

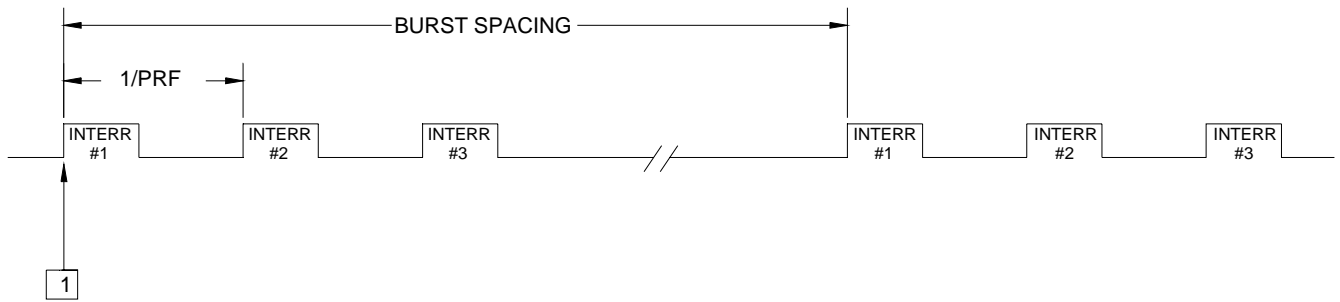

Where: Interrogation Count = 1 to 2000  
 PRF = 1 to 2500  
 Burst Spacing = 0.1 to 20 sec

1 First interrogation output of each burst is the first enabled interrogation in the INTERR/REPLIES summary menu.

**Figure 8, Burst Mode Timing**

**INTERLACED TEST MODE**

INTERLACED test mode makes it possible to output two interrogations (Mode A and Mode S, Mode S and Mode C, etc.) at a programmable ratio. The mode is best understood by examining Figure 9, Interlaced Mode Timing. A ratio of first interrogation to second is entered by the user. Interrogation 2 is at a fixed location of 200 us following the first pulse of interrogation 1. The frequency at which interrogation 1 is output is programmable from 1 to 400 Hz.

**CHAPTER ONE - GENERAL INFORMATION AND OPERATING INSTRUCTIONS**

**SECTION 1. INSTRUMENT DEFINITIONS**

**MODE S INSTRUMENT cont.**

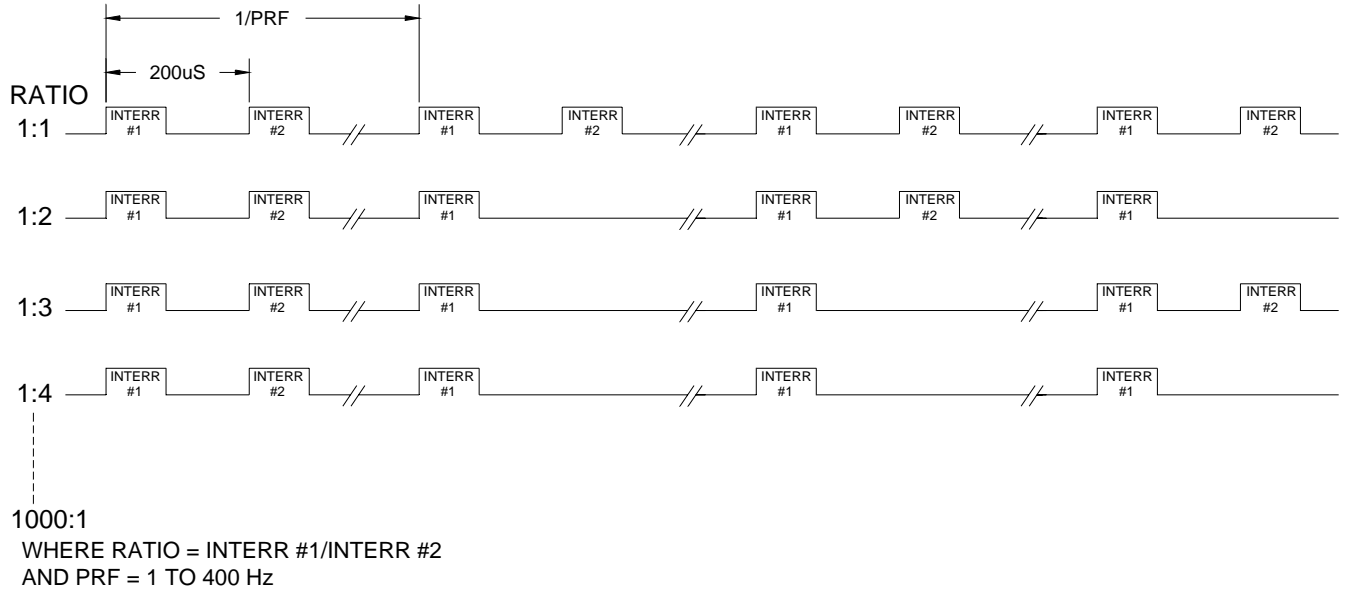

**Figure 9. Interlaced Mode Timing**

**CHAPTER ONE - GENERAL INFORMATION AND OPERATING INSTRUCTIONS****SECTION 1. INSTRUMENT DEFINITIONS****MODE S INSTRUMENT cont.****PULSE TIMING**

The same pulse timing adjustment options which were described in the ATRCBS instrument are available in the Mode S instrument. However, this feature has been expanded upon to cover pulse timing adjustment of interrogations which are not present in the ATRCBS instrument (ACS-A, ACL-A, ACS-C, ACL-C, Mode S Long, and Mode S Short).

Any deviation of an interrogation's nominal (default) settings, such as pulse timing or amplitude or the addition of SLS or interference pulses, is limited to the interrogation which is identified by the SYNC designation within the INTERR/REPLIES menu. To attach the SYNC tag to an interrogation, the operator must open the INTERR/REPLIES menu, scroll to the interrogation of interest, and assert the NEW SYNC button.

**SPECIAL FUNCTIONS**

The SLS, INTERFERENCE, and PULSE AMPLITUDE functions work much the same as in the ATRCBS instrument, however, the Mode S instrument provides an additional special function called DIVERSITY. The DIVERSITY function outputs the same interrogation out both TOP and BOTTOM (BTM) antennas. TOP and BTM absolute output amplitudes may be adjusted independently via the DIVERSITY SETUP menu. Timing of the BTM antenna transmission can be advanced or delayed relative to the TOP transmission.

**REPLY PASS/FAIL CRITERIA**

The pass/fail criteria for replies in the Mode S instrument are identical to the ATRCBS instrument with regards to ATRCBS replies. Reply delay and framing pulse position (F1 and F2) are tested for validity before being counted toward percent reply and data decoding. A similar process is used to handle Mode S replies shown in Figure 10, Mode S Reply Pattern.

## CHAPTER ONE - GENERAL INFORMATION AND OPERATING INSTRUCTIONS

### SECTION 1. INSTRUMENT DEFINITIONS

#### MODE S INSTRUMENT cont.

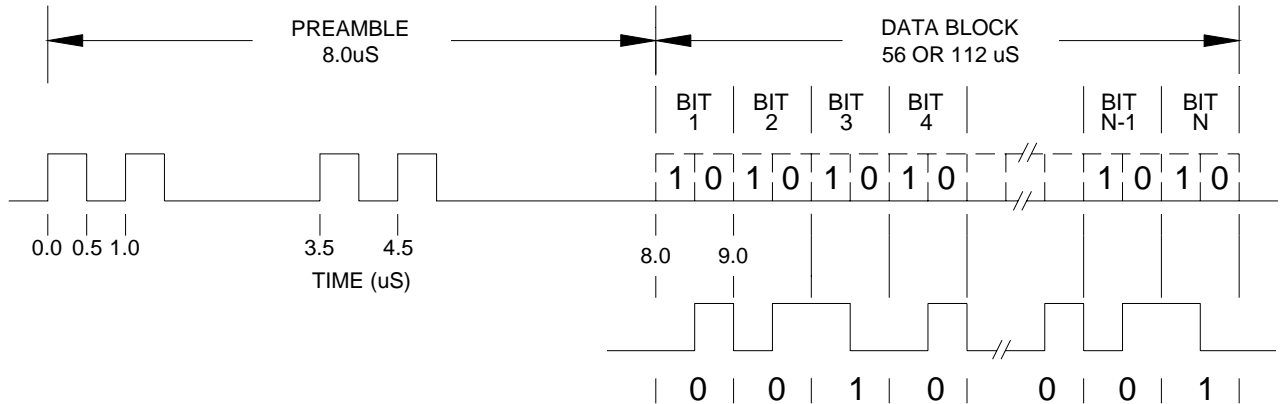

**Figure 10. Mode S Reply Pattern**

First pulse of the Mode S reply must fall within a 4.0 us window centered at 128 us following the SPR of the interrogation. Each of the preamble pulses (P2, P3, and P4) must fall within a 150ns window centered at their respective nominal pulse positions (relative to P1). Mode S replies which satisfy these criteria will be counted as valid for percent reply calculation.

#### REPLY DECODE

The decode criteria for ATRBS replies is the same in the Mode S instrument as the ATRBS instrument (See ATRBS INSTRUMENT, REPLY DECODE) including the wide/narrow decode window option. Mode S data pulses must fall within a fixed 150ns window to be considered valid. The window is centered on the nominal position of each data pulse. Selection of a wide or narrow decode will effect ATRBS replies only, not Mode S replies. If a position error is found within a Mode S reply a data error message will be inserted into the reply data field. Replies whose delay and preamble/framing pulses are within timing limits will be counted as valid for percent reply purposes regardless of the validity of their data. ATRBS reply data is displayed in the same two formats as in the ATRBS instrument. Received pulses are highlighted in the data field and decoded data is also displayed in octal except Mode C where the data is in engineering units (ft) rather than octal. Mode S reply data is displayed in hex only. To view the reply data associated with a specific interrogation the user must open the INTERR/REPLIES menu unless the reply is in response to the interrogation which has been assigned the SYNC tag. The reply which is in response to the SYNC interrogation will have its data and other parameters displayed on the main Mode S menu at all times. If the DOUBLE function is asserted both replies are displayed simultaneously on the main Mode S menu.



## **CHAPTER ONE - GENERAL INFORMATION AND OPERATING INSTRUCTIONS**

### **SECTION 1. INSTRUMENT DEFINITIONS**

#### **MODE S INSTRUMENT cont.**

##### **SYNC SELECT**

The SYNC SELECT function gives the user the ability to output a pulse (SCOPE SYNC) coincident to the UUT reply or at any desired location from -1 to 600us relative to P1 of the interrogation. If more than one interrogation has been enabled the user must tag the interrogation or reply of interest with SYNC. The SYNC tag is assigned from the INTERR/REPLIES menu. In the Double Interrogation mode SYNC is restricted to the first interrogation only.

##### **UUT MEASUREMENTS**

The following UUT parameters are measured and displayed to the operator:

1. Frequency
2. Power
3. Percent Reply
4. Reply Delay
5. Reply Jitter
6. F1/F2 Spacing (ATCRBS only)
7. Preamble Spacing (Mode S only)
8. Pulse Width

All measurements are taken from the reply assigned SYNC or the reply associated with the interrogation assigned the SYNC tag. Of these Frequency, Power, and Pulse Width measurements are taken from the reply pulse selected by the operator (MEASURED PULSE: button).

##### **SUPPRESSOR PULSE**

The SUPPRESSOR PULSE output is a 33 us pulse beginning 0.8 us prior to SPR, when SPR is in its nominal position. Both digital and analog outputs are available. The analog output's voltage range is 3 to 27 Volts.

**CHAPTER ONE - GENERAL INFORMATION AND OPERATING INSTRUCTIONS**

**SECTION 1. INSTRUMENT DEFINITION**

**DATALINK INSTRUMENT**

**GENERAL DESCRIPTION**

In addition to supporting the basic transponder surveillance functions the minimum data link transponder will provide the following capability:

- a. Bidirectional air-to-air information exchange
- b. Ground-to-air data uplink, Comm-A
- c. Air-to-ground data downlink, Comm-B
- d. Multisite message protocol

Uplink ELM transponders can receive ELMs (extended length messages) from sensors (ground stations) in addition to the above capabilities of the minimum data link radio. ELMs are received in the Comm-C format and consist of a burst of uplink transmissions that need not be replied to individually but are acknowledged in a reply containing a summary of the received interrogations. The following table (Table 1, Uplink ELM Sequence) shows the order of transmissions which constitutes an uplink ELM sequence.

- |                    |  |
|--------------------|--|
| 1. Ground Station: | Transmit ELM Reservation (UF=4,5,20,or 21)<br><b>Reply Delay=128us</b>   |
| 2. Transponder:    | Transmit Comm-B Reservation Reply (DF=20 or 21)<br><b>Sensor Delay</b>   |
| 3. Ground Station: | Transmit Comm-C, Initial ELM Segment (UF=24)<br><b>Sensor Delay</b><br>If n=2 (only two segments to be transmitted) proceed to step 5.         |
| 4. Ground Station: | Transmit Comm-C, Intermediate ELM Segment (UF=24)<br><b>Sensor Delay</b><br>Repeat step 4 until all intermediate ELM segments are transmitted. |
| 5. Ground Station: | Transmit Comm-C, Final ELM Segment (UF=24)<br><b>Reply Delay=128us</b>   |
| 6. Transponder:    | Transmit Comm-D, Acknowledge Reply (DF=24)<br><b>Sensor Delay</b>  |
| 7. Ground Station: | Transmit ELM Closeout (UF=4,5,20,or 21)<br><b>Reply Delay=128us</b>  |
| 8. Transponder:    | Transmit Comm-B, ELM Closeout Reply (DF=20 or 21)  |

**Table 1. Uplink ELM Sequence**



**CHAPTER ONE - GENERAL INFORMATION AND OPERATING INSTRUCTIONS**

**SECTION 1. INSTRUMENT DEFINITION**

**DATALINK INSTRUMENT cont.**

Full ELM capable transponders can generate ELMs for transmittal to the ground sensor in addition to the before mentioned capabilities of the uplink transponder. ELMs are transmitted using the Comm-D format. The following table (Table 2, Downlink ELM Sequence) shows the order of transmissions which constitutes a downlink ELM sequence.

1. Ground Station: Transmit ELM Reservation (UF=4,5,20,or 21)  
**Reply Delay=128us**
2. Transponder: Transmit Comm-B Reservation Reply (DF=20 or 21)  
**Sensor Delay**
3. Ground Station: Transmit Comm-C,ELM Authorization (UF=24)  
**Reply Delay=128us**
4. Transponder: Transmit Comm-D, ELM Segment (DF=24)  
If n=1 (only one segment to be transmitted) proceed to step 5 following sensor Delay.  
If n>1 delay for 136us and repeat step 4 until all segments have been transmitted.  
**Sensor Delay**
5. Ground Station: Transmit ELM Closeout (UF=4,5,20or 21)  
**Reply Delay=128us**
6. Transponder: Transmit Comm-B, ELM Closeout Reply (DF=20 or 21)

**Table 2. Downlink ELM Sequence**

The SDX2000, DATA LINK instrument provides for uplink and downlink, ELM-performance testing of data link transponders. Testing of the minimum data link functions common to all data link transponders (surveillance, Comm-A, Comm-B, etc.) is performed from the SDX2000, Mode S instrument. The DATA LINK instrument is very similar to BURST MODE operation of the Mode S instrument. It is recommended that the user have a good understanding of this operating mode before attempting to use the DATA LINK instrument. The following Mode S instrument, special functions are not available in the DATA LINK instrument: SLS, INTERFERENCE, PULSE AMPLITUDE and DIVERSITY.

**CHAPTER ONE - GENERAL INFORMATION AND OPERATING INSTRUCTIONS**

**SECTION 1. INSTRUMENT DEFINITION**

**DATALINK INSTRUMENT cont.**

Burst programming of up to 16 unique uplink and/or downlink ELMs of 16 segments each is available. While the spacing between consecutive interrogations within a burst is uniform in the Mode S instrument (a function of the selected PRF), interrogation delays in the DATA LINK instrument may be programmed with different values. These interrogation delays are labeled "Sensor Delay" in Tables 1 and 2 above and are programmable as shown below in Table 3, ELM Timing. Refer to figures at the end of this section for timing diagrams.

**UPLINK SENSOR DELAYS**

Initial Segment Delay Range	125us to 63ms
Segment Interval	50us to 63ms
Closeout Delay	125us to 63ms

**DOWNLINK SENSOR DELAYS**

Authorization Delay	125us to 63ms
Closeout Delay	125us to 63ms

**Table 3. ELM Timing**

A series of ELMs making up a burst sequence may also be spaced in a non-uniform fashion. Message spacing is defined as the period beginning at P1 of the last interrogation of a message and ending at P1 of the first interrogation of the following message. The programmable range for message spacing is 400 us to 100 s. Burst spacing is the period between the first interrogations of consecutive bursts (P1 to P1). Burst spacing has a programmable range of 1 to 130 s. If the user wishes to execute only one burst sequence this can be accomplished by selecting the Single option from the Burst Trigger menu.

Programming a burst sequence begins at the ELM level. Messages are numbered from 1 to 16. ELM setup is accomplished from the DATA LINK MESSAGE SETUP page. Access this page by pushing the Interr/Replies button on the top level DATA LINK page. From the Protocol menu the user selects either the uplink or downlink ELM template. From these templates all data and timing entries required for creating an ELM are made. After the desired number and type of ELMs have been programmed, the spacing between each message must be entered. The message spacing is entered from the MESSAGE SUMMARY AND SPACING page, which is accessible from the DATA LINK MESSAGE SETUP screen (Summary button). From this screen the user can quickly ascertain the overall burst format and timing. Individual messages can be turned "ON" and "OFF" or copied by dragging and dropping the desired message to another messages location. This feature can reduce the time to create a burst sequence where multiple messages of identical or similar format are required.

**RF OUTPUT SETTINGS**

Same as ATCRBS instrument.

**CHAPTER ONE - GENERAL INFORMATION AND OPERATING INSTRUCTIONS**

**SECTION 1. INSTRUMENT DEFINITION**

**DATALINK INSTRUMENT cont.**

**REPLY PASS/FAIL CRITERIA**

The pass/fail criteria for replies in the Data Link instrument are identical to the Mode S instrument (see MODE S INSTRUMENT, REPLY PASS/FAIL CRITERIA). Reply delay and preamble pulse position (P2, P3, and P4) are tested for validity before the reply data is decoded. Mode S replies must fall within a 4.0 us window, centered at the nominal reply delay position. Each preamble pulse must fall within a 150us window centered at the nominal location of each pulse All pulse positions are relative to P1 of the reply.

**REPLY DECODE**

Same as Mode S instrument.

**ERROR MESSAGES**

**UPLINK ELM**

**Reservation Reply Errors**

1. No Reply
2. DF!=20,21
3. Reply Delay Error
4. Data Decode Error
5. IIS!=(IIS from ELM Res.)

**Acknowledge Reply Errors**

1. No Reply
2. DF!=24
3. Reply Delay Error
4. Data Decode Error
5. TAS!=bitmap of #segments received

**Closeout Reply Errors**

1. No Reply
2. DF!=20,21
3. Reply Delay Error
4. Data Decode Error

**DOWNLINK ELM**

**Reservation Reply Errors**

1. No Reply
2. DF!=20,21
3. Reply Delay Error
4. Data Decode Error
5. DR<16
6. Programmed segment count!= DR + 15
7. IIS!=(IIS from ELM Res.)

**Segment Errors**

1. No Reply
2. DF!=24
3. Reply Delay Error
4. Data Decode Error
5. # of received segments!= programmed segment count

**Closeout Reply Errors**

1. No Reply
2. DF!=20,21
3. Reply Delay Error
4. Data Decode Error

**SCOPE SYNC**

The SCOPE SYNC function gives the user the ability to output a sync pulse coincident to the interrogation or the UUT reply.

**UUT MEASUREMENTS**

The following UUT parameters are measured and displayed to the operator:

1. Frequency
2. Power
3. Reply Delay
4. Reply Jitter
5. Preamble Spacing
6. Pulse Width

**CHAPTER ONE - GENERAL INFORMATION AND OPERATING INSTRUCTIONS**

**SECTION 1. INSTRUMENT DEFINITION**

**DATALINK INSTRUMENT cont.**

Measurements are taken from the UUT reply selected by the user from the MEASURED REPLY menu. Frequency, Power, and Pulse Width measurements are taken from the reply pulse selected from the MEASURED PULSE menu.

**SUPPRESSOR PULSE**

The SUPPRESSOR PULSE output is a 33 us pulse beginning 0.8 us prior to SPR, when SPR is in its nominal position. Both digital and analog outputs are available. The analog output's voltage range is 3 to 27 Volts.

**DATALINK TIMING DEFINITIONS**

Datalink timing is illustrated using the example burst sequence shown below. The sequence is composed of two ELMs. The first message (MES1) is a 16 segment UPLINK while the second message (MES2) is a 16 segment DOWNLINK.

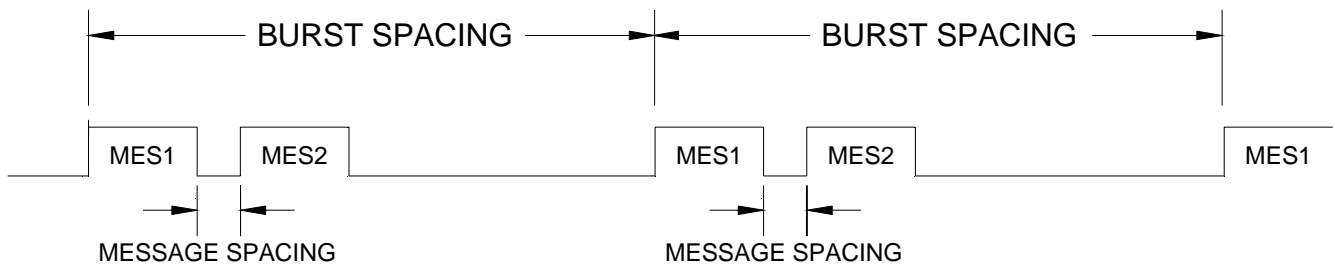

**EXAMPLE BURST SEQUENCE**

**BURST SPACING:** The period beginning at P1 of the first interrogation of MES1 and ending at P1 of the first interrogation of MES2 (range = 1 to 130 s).

**MESSAGE SPACING:** The period beginning at P1 of the last interrogation of MES1 and ending at P1 of the first interrogation of MES2 (range = 400 us to 100 s).

**CHAPTER ONE - GENERAL INFORMATION AND OPERATING INSTRUCTIONS**

**SECTION 1. INSTRUMENT DEFINITION**

**DATALINK INSTRUMENT**

**DATALINK TIMING DEFINITIONS cont.**

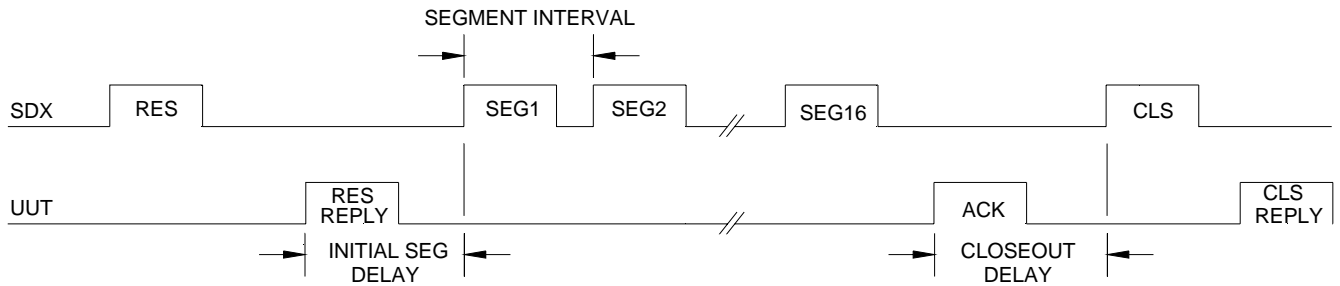

**EXAMPLE UPLINK ELM SEQUENCE**

**INITIAL SEGMENT DELAY:** The delay from P1 of the reservation reply to P1 of the initial UPLINK segment (range = 125 us to 63 ms).

**SEGMENT INTERVAL:** The period from P1 to P1 of adjacent UPLINK segments (range = 50 us to 63 ms).

**CLOSEOUT DELAY:** The delay from P1 of the acknowledge to P1 of the closeout interrogation (range = 125 us to 63 ms).

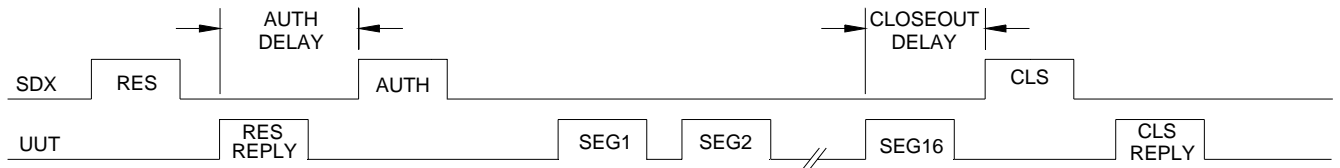

**EXAMPLE DOWNLINK ELM SEQUENCE**

**AUTHORIZATION DELAY:** The delay from P1 of the reservation reply to P1 of the authorization (range = 125 us to 63 ms).

**CLOSEOUT DELAY:** The delay from P1 of the last DOWNLINK segment to P1 of the closeout interrogation (range = 125 us to 63 ms).

**CHAPTER ONE - GENERAL INFORMATION AND OPERATING INSTRUCTIONS****SECTION 1. INSTRUMENT DEFINITION****DME INSTRUMENT**

The DME (Distance Measuring Equipment) instrument provides the capability for testing and calibration of DME receivers in both X and Y channel modes as well as ARINC 568 Digital DME Indicators. The instrument responds to UUT interrogations with two gaussian shaped reply pulses. DME interrogation and reply timing is shown in the first two illustrations of Figure 11, DME Interrogation/Reply Pulse Timing. The operator is given the ability to deviate from the nominal pulse spacing by a maximum of +/- 7.9us if desired.

**RF OUTPUT SETTINGS**

The user is free to select any frequency within the 952 to 1223 MHz SDX generator limits with a resolution of 10 KHz. There are three different methods the operator may use for selecting generator frequency. The generator frequency may be entered directly with a virtual keypad, by selecting the DME channel, or by selection of the VOR channel paired to the desired DME channel. Interrogation power can be adjusted in 0.1 dB increments from 0 to -110 dBm.

Generator power can be adjusted in 0.1 dB increments from 0 to -110 dBm. Accurate power levels are generated and maintained through the use of an automatic leveling circuit that monitors the output and servos the level accordingly. This topology requires multiple interrogations and/or replies to obtain the desired power level after a level change. For example, during transponder operation the required time for the automatic leveling circuit to servo the output to the desired level is a function of the selected PRF. Higher PRF values will result in faster leveling of the output.

**PULSE TIMING**

As shown in the first two illustrations of Figure 11, nominal spacing of reply pulses in X and Y modes is 12 and 30 us respectively. The operator may program the SDX to deviate from the nominal P1 to P2 spacing by +/- 7.9 us.

**INTERROGATOR PASS/FAIL CRITERION**

For a DME interrogation to be considered valid it must meet or exceed the SDX2000 interrogation pass/fail criterion. Invalid interrogations will not be included when calculating UUT Interrogation Rate. Testing of interrogation pulse widths and spacing is performed. To pass the interrogation pulse width requirement the pulses must be a minimum of 2.5 us and a maximum of 4.5 us wide (ARINC 568 pulse duration specification is 3.5 +/- 0.5 us). As shown below, there are two pass/fail options for P1 and P2 spacing which the user may choose from: narrow or wide.

- Narrow: Selects a 1.0 us P2, pulse-position window, centered at 12 us (X Mode) or 36 us (Y Mode) following the 50% point, rising edge of P1.
- Wide: Selects a 4.0 us P2, pulse-position window, centered at 12 us (X Mode) or 36 us (Y Mode) following the 50% point, rising edge of P1.

**CHAPTER ONE - GENERAL INFORMATION AND OPERATING INSTRUCTIONS**

**SECTION 1. INSTRUMENT DEFINITION**

**DME INSTRUMENT cont.**

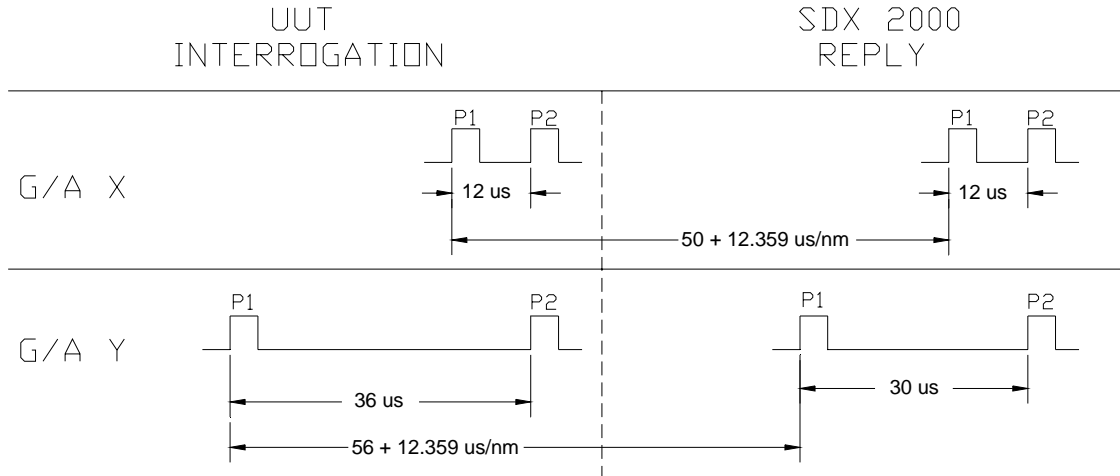

**Figure 11. DME Interrogation/Reply Pulse Timing**

**CHAPTER ONE - GENERAL INFORMATION AND OPERATING INSTRUCTIONS****SECTION 1. INSTRUMENT DEFINITION****DME INSTRUMENT cont.****RANGE SIMULATION**

The interval between the received interrogation and transmitted reply is a function of the user programmed RANGE whose limits are 0 to 400 nmi. In addition, a -1 nmi offset feature is provided to the user. If asserted, the actual simulated range is 1 nmi less than the displayed RANGE value. Two other user programmed parameters affect the simulated range, VELOCITY and ACCELERATION. VELOCITY can be programmed for either inbound or outbound simulation. Inbound velocity decrements programmed range to zero nmi then increments to 400 nmi. Outbound velocity increments programmed range to 400 nmi then decrements to zero nmi. The velocity limits are 0 to 10,000 kts. Velocity rate of change is affected by the programmed ACCELERATION. Non-zero acceleration increments the velocity to 10,000 kts then decrements to 0 kts.

**SQUITTER**

The operator may adjust the SQUITTER RATE from 0 to 8000 Hz. Squitter is compliant with ARINC 568 at 2700 Hz.

**ECHO**

When selected, ECHO pulses are generated at a constant simulated distance of 30 nmi (regardless of the reply range).

**IDENT/EQUALIZER**

When selected, IDENT can be programmed to produce a unique Morse code or a constant tone (1350 Hz). The operator is free to vary a number of code parameters such as CODE RATE, DOT TIME, DASH TIME, etc., and may turn EQUALIZER pulses on or off.

**REPLY EFFICIENCY**

Reply efficiency range is 0 to 100 percent with 1 percent resolution. Only valid interrogations (see INTERROGATOR PASS/FAIL CRITERION above) are relevant to the SDX for percent reply. Non-valid interrogations are ignored.

**ARINC 568 SERIAL DATA**

A Serial Data Output is provided which conforms to ARINC Characteristic 568 requirements. The serial BCD distance word is controlled from the touch screen and has a user selectable range of 0 to 400 nmi. A Serial Data Input is provided for observing the UUT's measured range. The range value is displayed in the MEASURED DISTANCE window of the SDX2000 display and can be compared to the SDX2000's simulated range which is present on the same DME Instrument page.

**UUT CHANNELING**

Frequency channeling of the UUT can be accomplished using the SDX2000, 2-out-of-5, VOR, paired-channel output. This output provides a convenient method of UUT channel control when in a frequency stepping test mode.



**CHAPTER ONE - GENERAL INFORMATION AND OPERATING INSTRUCTIONS****SECTION 1. INSTRUMENT DEFINITION****DME INSTRUMENT cont.****SELF INTERROGATION**

A SELF INTERROGATION operating mode is available. In this mode two pulse outputs, RANGE RATE and R/NAV, are active without requiring external DME interrogation of the SDX2000. For each change in simulated range of 0.1 nmi a 7 us RANGE RATE pulse is output. The R/NAV output provides a pulse pair whose spacing is equal to the interrogation-to-reply delay period.

**SCOPE SYNC**

A SCOPE SYNC output at the front of the SDX2000 provides a means for triggering an oscilloscope or other instrument to the following operator selectable events:

1. Squitter
2. Reply
3. Echo
4. Ident

**UUT MEASUREMENTS**

The following UUT parameters are measured and displayed to the operator:

1. Frequency
2. Power
3. Interrogation Rate
4. Measured Distance (568 Serial Data Input)

**SUPPRESSOR PULSE**

The SUPPRESSOR PULSE output is a 33 us pulse beginning 3.5 us prior to P1 of a range reply. Both digital and analog outputs are available. The analog output's voltage range is 3 to 27 Volts.



## **CHAPTER ONE - GENERAL INFORMATION AND OPERATING INSTRUCTIONS**

### **SECTION 1. INSTRUMENT DEFINITION**

#### **SETUP AND SPECIAL FUNCTIONS**

The SETUP menu contains special conditions or selections that allow the user to configure certain operations prior to use of the SDX 2000 or infrequently during the course of a test. This menu also allows the user to store and recall up to 10 SDX 2000 "states". Any conditions set in any and all of the other menus will be saved for later recall. The following lists the SETUP menu functions:

- Store and recall of complete SDX 2000 current configuration
- Set the IEEE 488 interface address
- Rear I/O Control
- Display Screen Color Control
- Touchpanel Calibration
- Software/Hardware Version Display
- Software Update (through upload to flash memory)
- Cable Loss
- Input Power Control



## **CHAPTER ONE - GENERAL INFORMATION AND OPERATING INSTRUCTIONS**

### **SECTION 2. EQUIPMENT DESCRIPTION**

The SDX-2000 has four normal modes of operation, termed "Instruments"; ATCRBS (for ATCRBS - only transponder testing), MODE S (for combination ATCRBS and Mode Select transponders, including DATALINK, Level 5), DATALINK (for testing COMM-C uplink and COMM-D downlink), and DME (for testing the common DMEN style distance measuring interrogators).

The additional modes, SETUP and CAL, are provided to allow the operator to select various optional parameters when testing one or more of the systems supported. This allows the operator and the calibration technician a means to verify proper operation of the SDX system.



## **CHAPTER ONE - GENERAL INFORMATION AND OPERATING INSTRUCTIONS**

### **SECTION 3. UNPACKING AND INSPECTING EQUIPMENT**

Exercise extreme care when unpacking the unit and accessories. Make a visual inspection of the unit for evidence of damage incurred during shipment. If a claim for damage is to be made, save the shipping container to substantiate the claim. When equipment has been unpacked, return all the packing material to the container for future use in storing or shipping the equipment. Remove any connector covers before using the TUA. Replace connector covers on the connectors when the equipment is not in use.

**CHAPTER ONE - GENERAL INFORMATION AND OPERATING INSTRUCTIONS**

**SECTION 4. EQUIPMENT INSTALLATION - RACK MOUNT**

The SDX 2000 is designed to mount in a 48.26 cm rack mount (19"). The SDX 2000 can also operate as a desk top unit.

**CAUTION** VISUAL INSPECTION OF ALL INTERFACE CONNECTORS MUST BE DONE BEFORE MOUNTING THE EQUIPMENT. INSURE THAT ALL CONNECTORS ARE SECURE AND FLUSH.

**CAUTION:** INSPECT CONNECTORS FOR DAMAGE TO CONTACTS OR PINS. DO NOT ATTEMPT TO MATE CONNECTORS IF CONTACTS OR PINS ARE DAMAGED.

To mount the SDX 2000 into a 19" rack:

1. Route all wires and cables through the rack, then position the SDX 2000 in the desired position within the rack assembly.
2. Insert and tighten all rack mounting screws.
3. Connect all cables and power cords.

Note: The SDX2000 employs an automatic voltage sensing power supply and does not require that the line voltage be selected at the rear panel connector prior to connection to the power source. Although it is not necessary to select the appropriate line voltage at the rear panel connector, please ensure that the proper value of line fuse is installed prior to power supply connection. Refer to general specifications , section 6, 1.18 power requirements for power line requirements.

4. Connect the power cord as shown in the photo below. The power cord requires a ferrite, JPN 13-0026-02, to be attached to pass the EMI requirement for the unit. The Ferrite must be installed as close to the unit as possible with the power cord passing through the ferrite twice as shown in the illustration on the following page.
5. If an external mouse is to be used with this unit, a 9-pin EMI PI filter adapter (JPN: 30-5037-02) is required to pass EMI requirements for this unit. First plug the 9-pin adapter in J36 (mouse port), then plug the mouse cable into the 9-pin EMI filter adapter.

**CHAPTER ONE - GENERAL INFORMATION AND OPERATING INSTRUCTIONS**

**SECTION 4. EQUIPMENT INSTALLATION - RACK MOUNT (Cont.)**

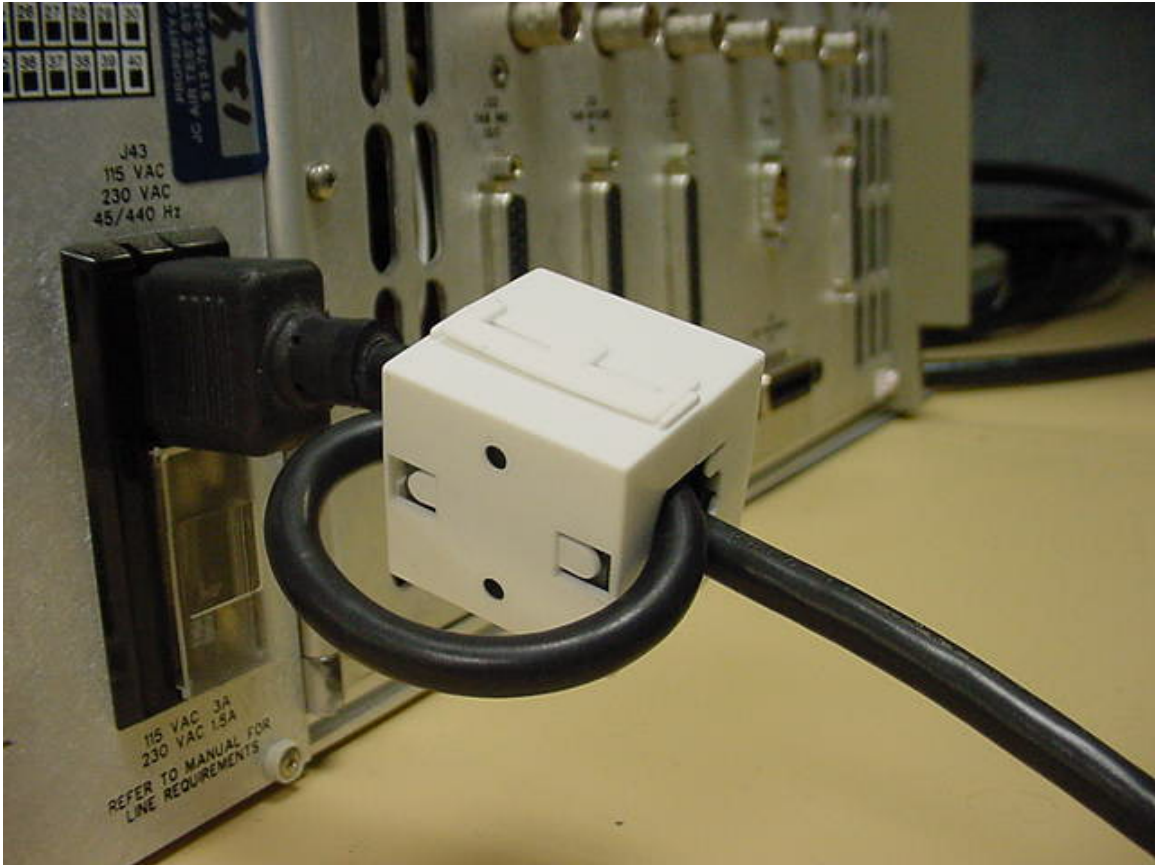

Figure 12. Power Cord Installation

**NOTE:** The front and rear panels of the SDX 2000 must not be obstructed. Recommended minimum clearance for front and rear panels is 10,16 cm (4"). Airflow through the SDX 2000 is required for proper operation of the unit.

**NOTE:** For regulatory compliance this equipment may need further testing in the end system when rack mounted.

**POST INSTALLATION CHECK**

The SDX 2000 completes a limited power-on-self-test (POST) on every power-up cycle. A successful completion (no errors) of the POST is an indication that the unit is operating within specification.



**CHAPTER ONE – GENERAL INFORMATION AND OPERATING INSTRUCTIONS**

**SECTION 5. OPERATING INSTRUCTIONS**

**TABLE OF CONTENTS**

5.0	Main Screens .....	1
5.1	ATCRBS .....	2
5.1.1	Measured Pulse Screens.....	3
5.1.2	Measured UUT Parameters Screen .....	4
5.1.3	Control Panel .....	5
5.1.4	Special Functions Panel .....	12
5.2	Mode S .....	14
5.2.1	Measured Pulse Screens.....	15
5.2.2	Measured UUT Parameters Screens .....	16
5.2.3	Control Panel .....	17
5.2.4	Special Functions Panel .....	26
5.2.5	Interrogation Pattern Type Selection Screen.....	30
5.3	DME .....	35
5.3.1	Measured Pulse Screens.....	36
5.3.2	Measured UUT Parameters Screen .....	36
5.3.3	Control Panel .....	37
5.3.4	Special Functions Panel .....	45
5.4	Datalink .....	46
5.4.1	Measured Pulse Screen .....	48
5.4.2	Measured UUT Parameters Screen .....	50
5.4.3	Control Panel .....	51
5.4.4	Burst Start.....	55
5.4.5	Interr/Replies .....	56
5.5	System Setup and Control Screen .....	63
5.5.1	System Parameters Store / Recall Screen .....	64
5.5.2	External Communication Setup .....	66
5.5.3	Time Set Control.....	66
5.5.4	Rear I/O Control Screen .....	67
5.5.5	Touchpanel Adjustment.....	67
5.5.6	Calibration.....	68
5.5.7	Version Display Control .....	68
5.5.8	Software Load.....	69
5.5.9	Cable Loss Compensation Control.....	69
5.5.10	Software Configuration .....	70
5.6	Miscellaneous Screens .....	71
5.6.1	Numeric Entry .....	71
5.6.2	Typewriter Entry.....	72

**CHAPTER ONE GENERAL INFORMATION AND OPERATING INSTRUCTIONS**

**SECTION 5. OPERATING INSTRUCTIONS**

**5.0 MAIN SCREENS**

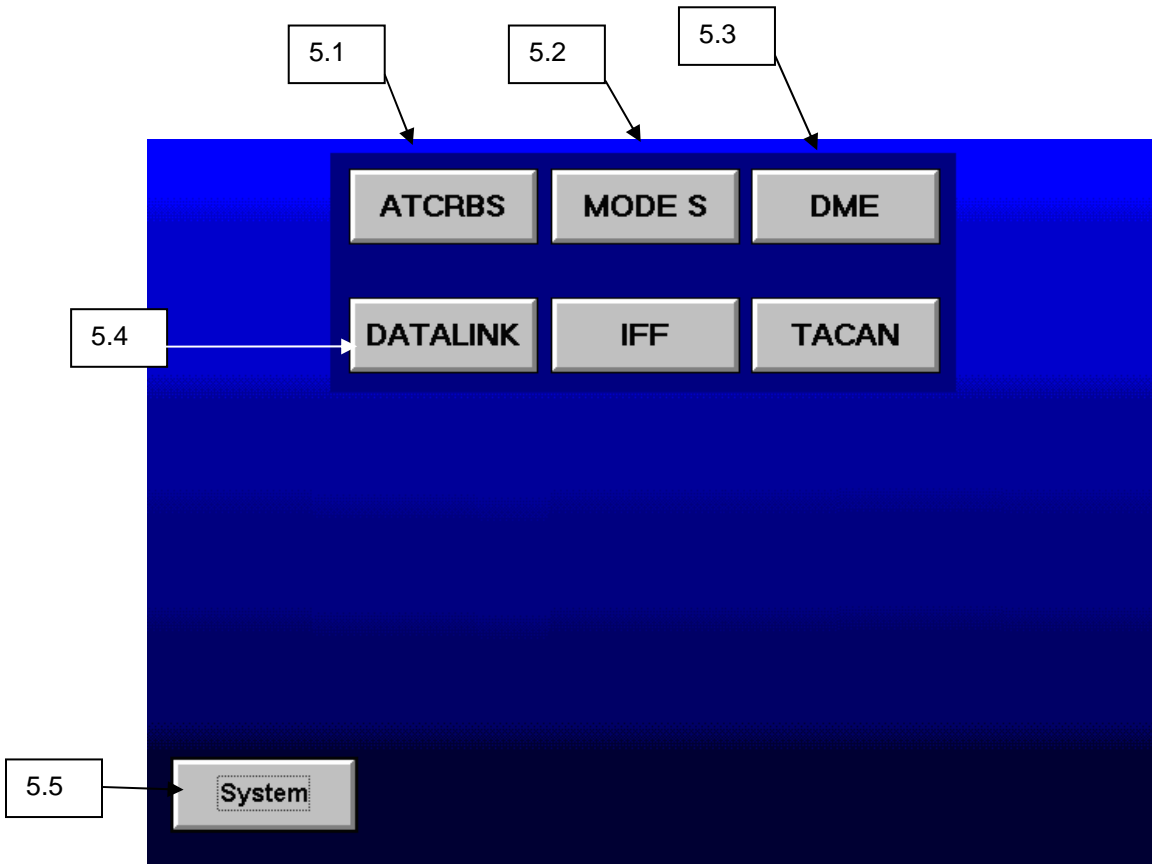



**CHAPTER ONE - GENERAL INFORMATION AND OPERATING INSTRUCTIONS**

**SECTION 5. OPERATING INSTRUCTIONS**

**5.1 ATCRBS**

5.1.2

The screenshot displays the ATCRBS control interface. At the top, the title 'ATCRBS' is centered, and the time '3:46 PM' is shown in the top right corner. The interface is divided into several sections:

- Left Panel (Callout 5.1.1):** Contains 'Measured Pulse: F1' with a right-pointing arrow. Below it are two icons (a vertical bar chart and a grid). Further down are settings for 'Interr Type' (Mode A), 'Pulse Timing' (None), 'PRF' (100), 'Gen Frequency' (1030.00 MHz), and 'Gen Power' (-50.0 dBm).
- Top Right Panel (Callout 5.1.2):** Labeled 'UUT', it includes 'Frequency' (displayed as '----'), 'Power' (displayed as '---'), and '%Reply' (displayed as '----'). A red 'Unlocked' status indicator is positioned below the Frequency field.
- Center Panel:** Features a 'Code' field (displayed as '----') and a sequence of buttons: C1, A1, C2, A2, C4, A4, B1, D1, B2, D2, B4, D4.
- Bottom Section:** Includes 'Reply Delay', 'Reply Jitter', 'F1/F2 Spacing', and 'F1 Pulse Width' fields, each with a '----' display. Below these are three buttons: 'SLS', 'Interference', and 'Pulse Amplitude'. A 'Main Menu' button is located in the bottom right corner.

Callout 5.1.3 points to the 'Interr Type' section, and callout 5.1.4 points to the 'SLS' button.

**CHAPTER ONE - GENERAL INFORMATION AND OPERATING INSTRUCTIONS**

**SECTION 5. OPERATING INSTRUCTIONS**

**5.1 APCRBS**

**5.1.1 MEASURED PULSE SCREENS**

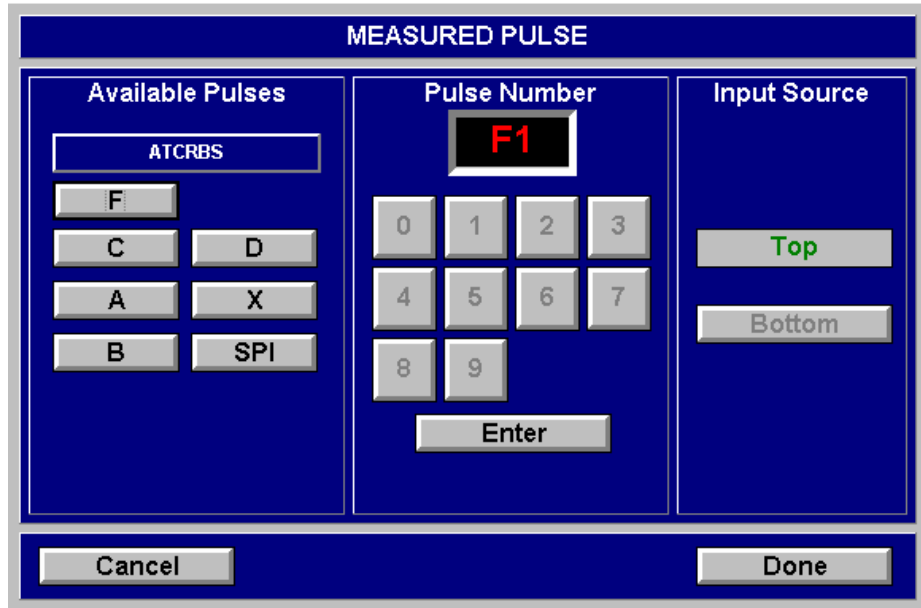

**CHAPTER ONE - GENERAL INFORMATION AND OPERATING INSTRUCTIONS**

**SECTION 5. OPERATING INSTRUCTIONS**

**5.1 ATRCBS**

**5.1.2 MEASURED UUT PARAMETERS SCREEN**

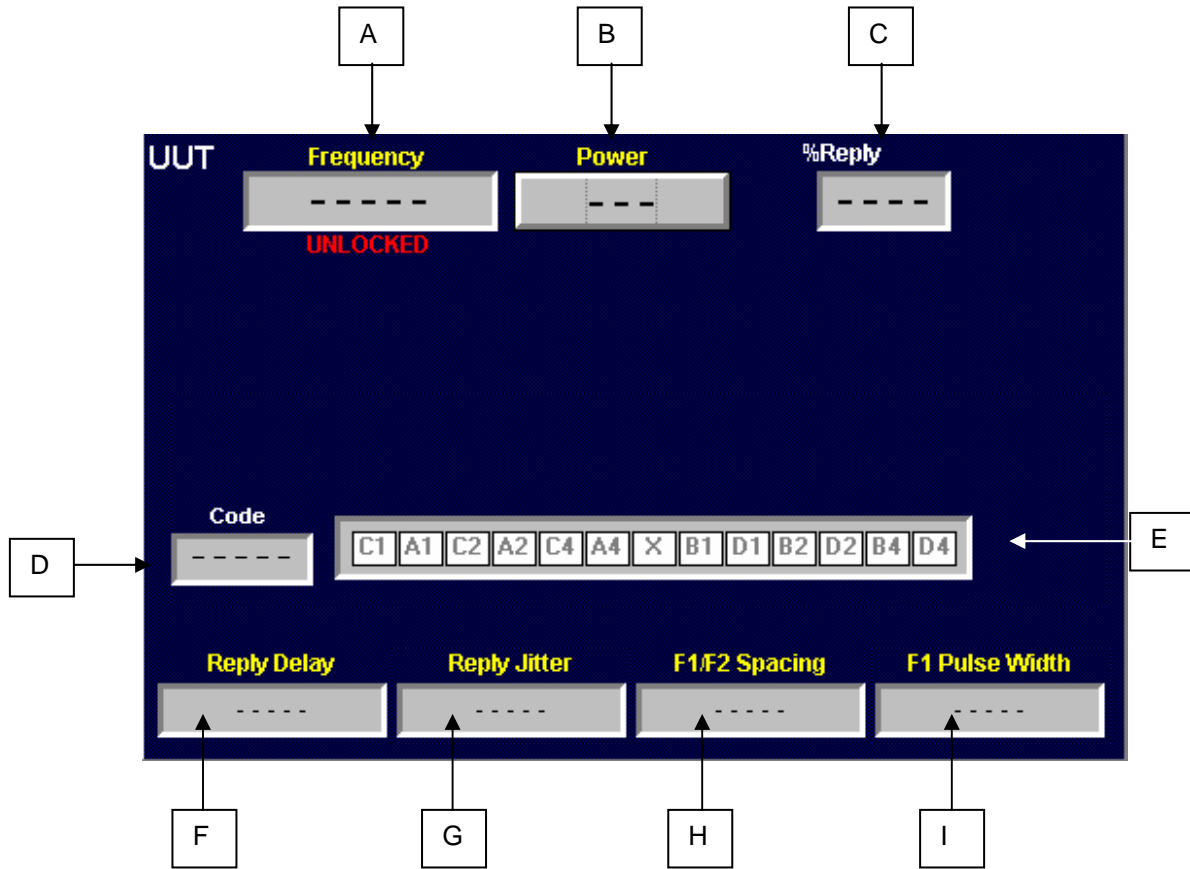

- A – Measured Frequency
- B – Measured Power
- C – Percent Reply
- D – Code
- E – Decoded ATRCBS Pulses

- F – Reply Delay
- G – Reply Jitter
- H – F1/F2 Spacing
- I – F1 Pulse Width

**CHAPTER ONE - GENERAL INFORMATION AND OPERATING INSTRUCTIONS**

**SECTION 5. OPERATING INSTRUCTIONS**

**5.1 ATCRBS**

**5.1.3 CONTROL PANEL**

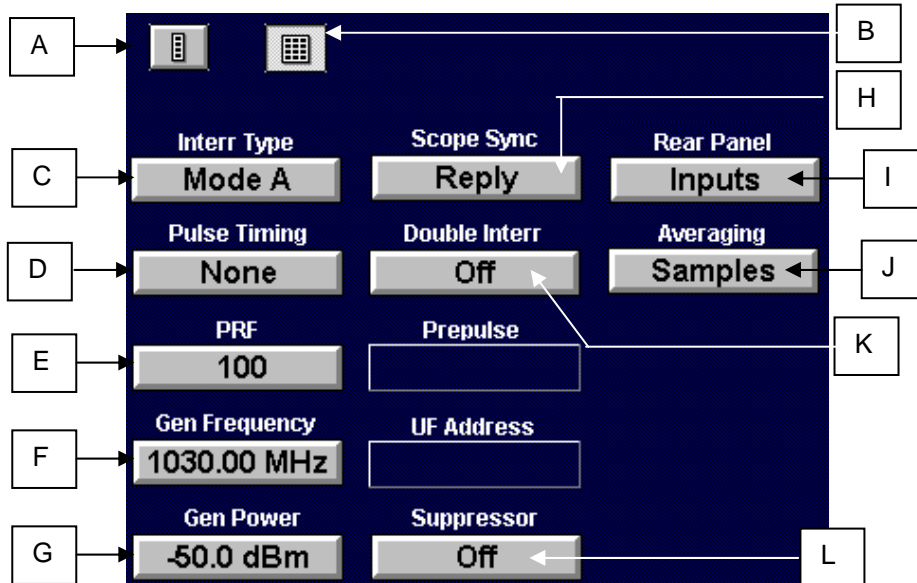

After selecting the Expand Control Panel button, this screen is displayed. Selecting button A will restore the main ATCRBS screen on the display.

- |                                      |                            |
|--------------------------------------|----------------------------|
| A - Compress Control Panel           | G - Generator Output Power |
| B - Expand Control Panel             | H - Scope Sync Control     |
| C - Interrogation Type               | I - Rear Input Panel       |
| D - Pulse Timing                     | J - Averaging              |
| E - Pulse Repetition Frequency (PRF) | K - Double Interrogation   |
| F - Generator Output Frequency       | L - Suppressor             |

**CHAPTER ONE - GENERAL INFORMATION AND OPERATING INSTRUCTIONS**

**SECTION 5. OPERATING INSTRUCTIONS**

**5.1 ATCRBS**

**5.1.3 CONTROL PANEL**

**A: COMPRESS CONTROL PANEL**

Press 

**B: EXPAND CONTROL PANEL**

Press 

**C: Interrogation Type**

Press 

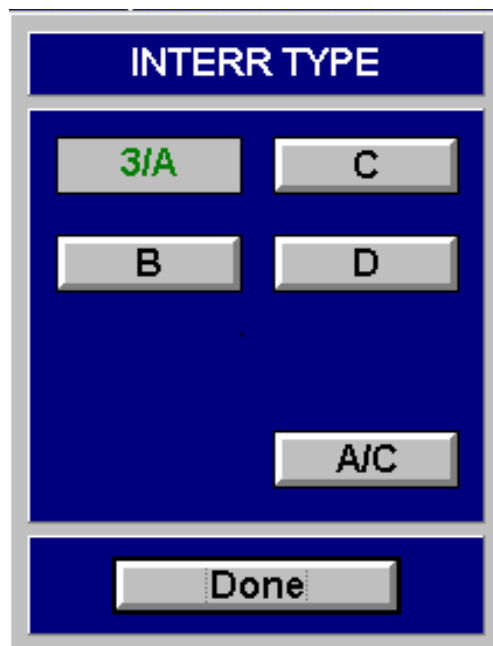

**CHAPTER ONE - GENERAL INFORMATION AND OPERATING INSTRUCTIONS**

**SECTION 5. OPERATING INSTRUCTIONS**

**5.1 APCRBS**

**5.1.3 CONTROL PANEL**

**D: PULSE TIMING  
SCREENS**

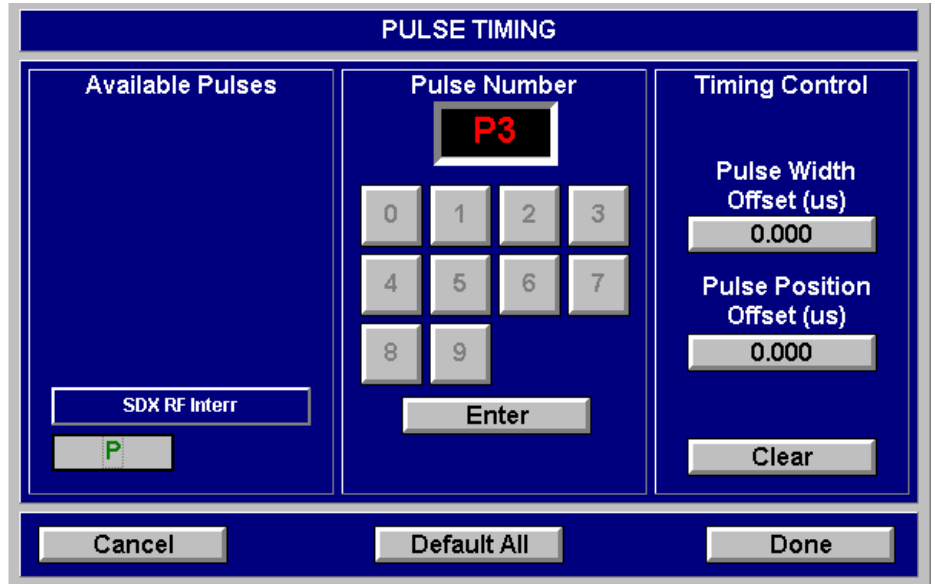

**CHAPTER ONE - GENERAL INFORMATION AND OPERATING INSTRUCTIONS**

**SECTION 5. OPERATING INSTRUCTIONS**

**5.1 ATCRBS**

**5.1.3 CONTROL PANEL**

**E: PULSE REPETITION FREQUENCY**

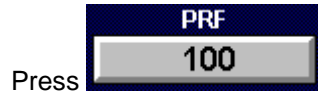

Press

**F: GENERATOR FREQUENCY SCREENS**



Press

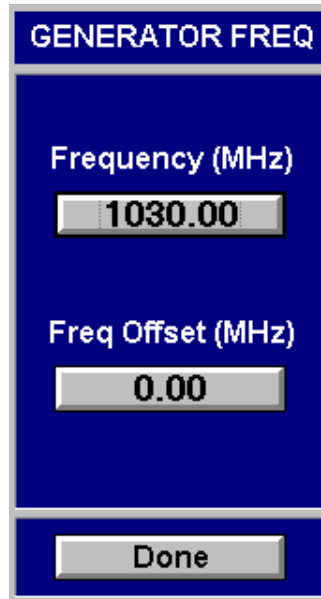

**G: GENERATOR POWER SCREENS**

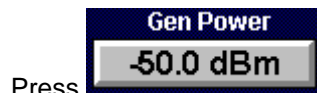

Press

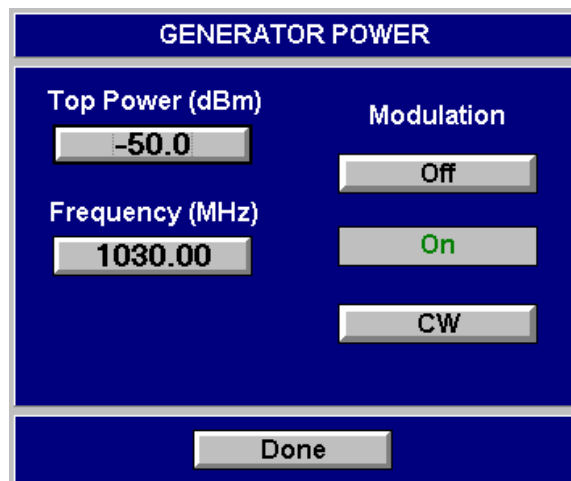

**CHAPTER ONE - GENERAL INFORMATION AND OPERATING INSTRUCTIONS**

**SECTION 5. OPERATING INSTRUCTION**

**5.1 ATCRBS**

**5.1.3 CONTROL PANEL**

**H: SCOPE SYNC CONTROL**



**I: REAR PANEL INPUTS**

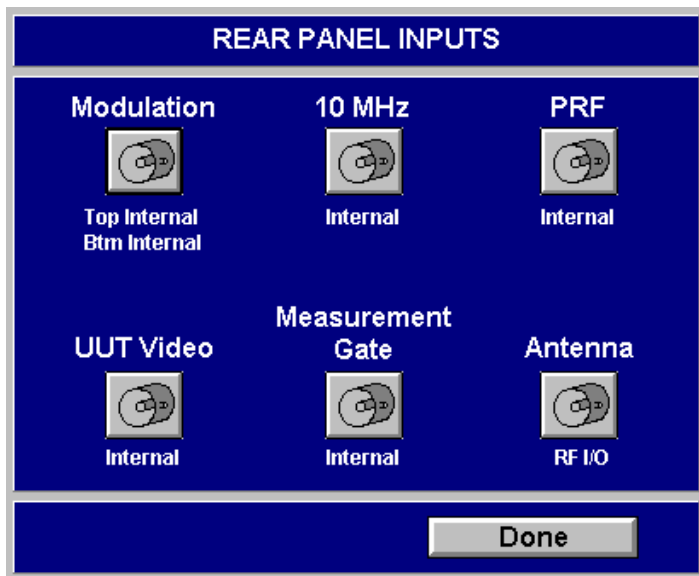



**CHAPTER ONE - GENERAL INFORMATION AND OPERATING INSTRUCTIONS**

**SECTION 5. OPERATING INSTRUCTION**

**5.1 ATCRBS**

**5.1.3 CONTROL PANEL**

**J: AVERAGING**

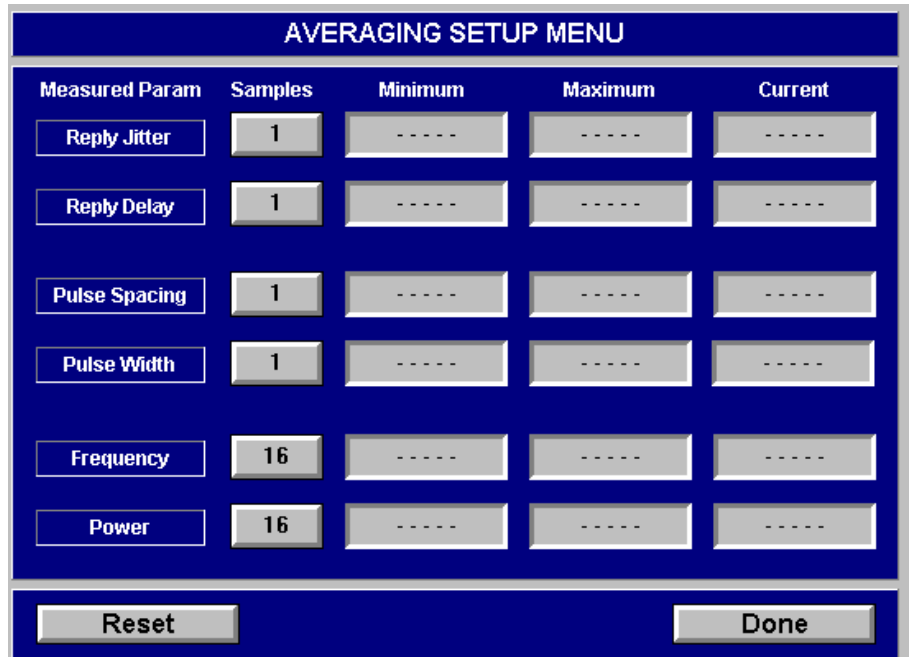

**K: DOUBLE INTERROGATION**



**CHAPTER ONE - GENERAL INFORMATION AND OPERATING INSTRUCTIONS**

**SECTION 5. OPERATING INSTRUCTION**

**5.1 ATCRBS**

**5.1.3 CONTROL PANEL**

**L: SUPPRESSOR**

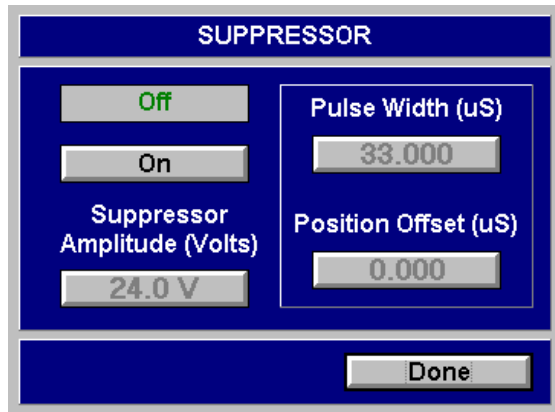

**CHAPTER ONE - GENERAL INFORMATION AND OPERATING INSTRUCTIONS****SECTION 5. OPERATING INSTRUCTIONS****5.1 ATCRBS****5.1.4 SPECIAL FUNCTIONS PANEL****SLS**

To activate SLS press 

SLS pulse position, width and amplitude can be modified by pressing  which will open the SLS settings screen.

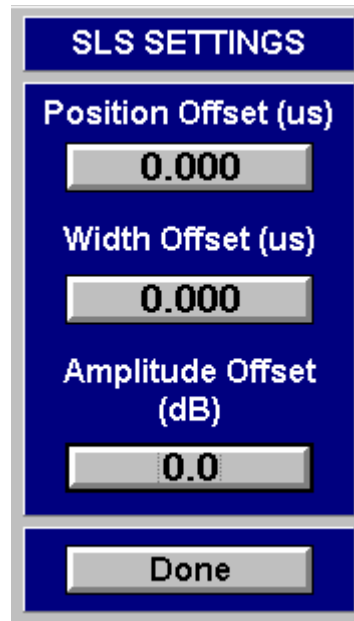

**CHAPTER ONE - GENERAL INFORMATION AND OPERATING INSTRUCTIONS**

**SECTION 5. OPERATING INSTRUCTIONS**

**5.1 ATCRBS**

**5.1.4 SPECIAL FUNCTIONS PANEL**

**Interference:**

To activate Interference press



, then press



to modify position offset,

absolute width, amplitude offset and spacing.

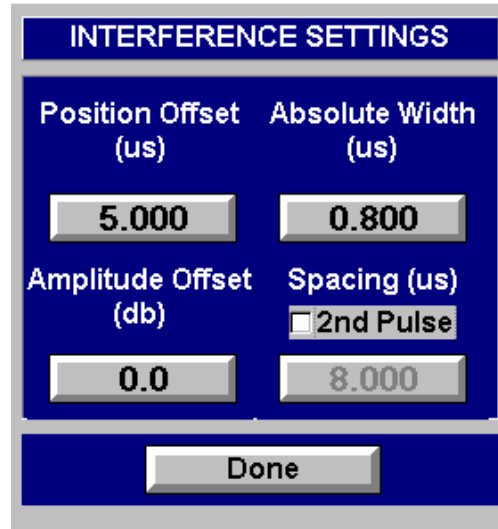

**Pulse Amplitude:**

To activate Pulse Amplitude press



, then press



to modify amplitude offset.

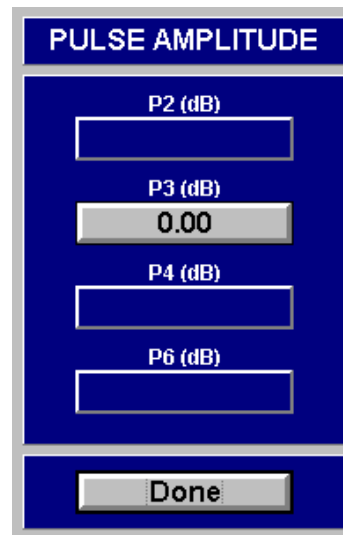

**CHAPTER ONE - GENERAL INFORMATION AND OPERATING INSTRUCTIONS**

**SECTION 5. OPERATING INSTRUCTIONS**

**5.2 MODE S**

5.2.2

5.2.1

5.2.3

The screenshot shows the Mode S test interface. On the left, a vertical menu includes:
 

- Measure Reply: 1: UF 11, Measured Pulse P1 (pointed to by 5.2.1)
- Test Mode: Normal (pointed to by 5.2.3)
- Pulse Timing: None
- PRF: 100
- Gen Frequency: 1030.00 MHz
- Gen Power: -50.0 dBm

 The main display area shows:
 

- UUT: Frequency (UNLOCKED), Power
- %Reply: ATCRBS, Mode S
- Data Format: Field/Hex
- DF=, FS=, DR=, UM=, AC=, MB=, AA=
- Reply Delay, Reply Jitter, P1/P2 Spacing, P1 Pulse Width
- Squitter Data: DF=, CA=, AA=, II=
- Interval (sec): Top, Bot, Total, Extended
- Buttons: SLS, Interference, Pulse Amplitude, Diversity
- Bottom buttons: Interr/Replies (pointed to by 5.2.5), Main Menu (pointed to by 5.2.4)

5.2.5

5.2.4

**CHAPTER ONE - GENERAL INFORMATION AND OPERATING INSTRUCTIONS**

**SECTION 5. OPERATING INSTRUCTIONS**

**5.2 MODE S**

**5.2.1 MEASURED PULSE SCREENS**

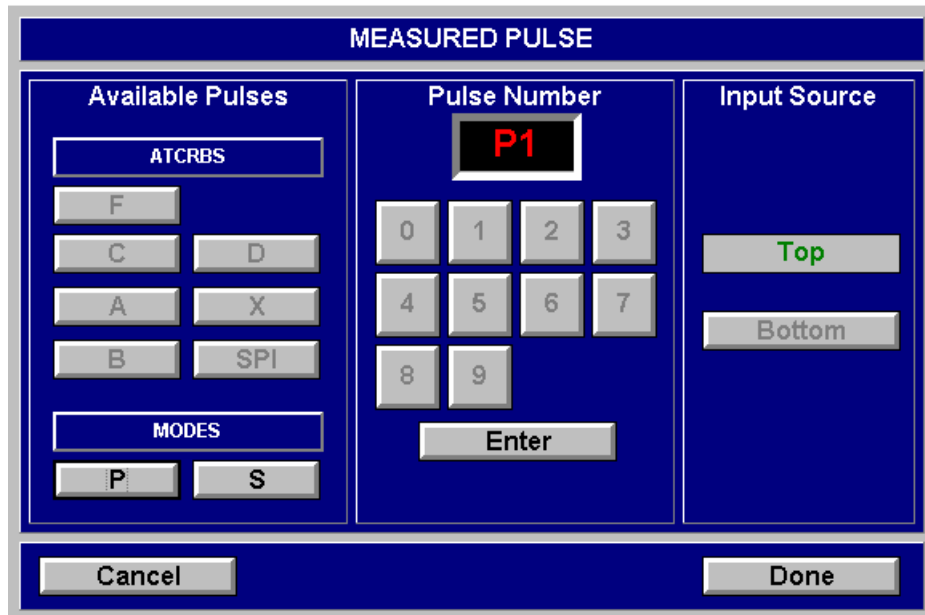

**CHAPTER ONE - GENERAL INFORMATION AND OPERATING INSTRUCTIONS**

**SECTION 5. OPERATING INSTRUCTIONS**

**5.2 MODE S**

**5.2.2 MEASURED UUT PARAMETERS SCREEN**

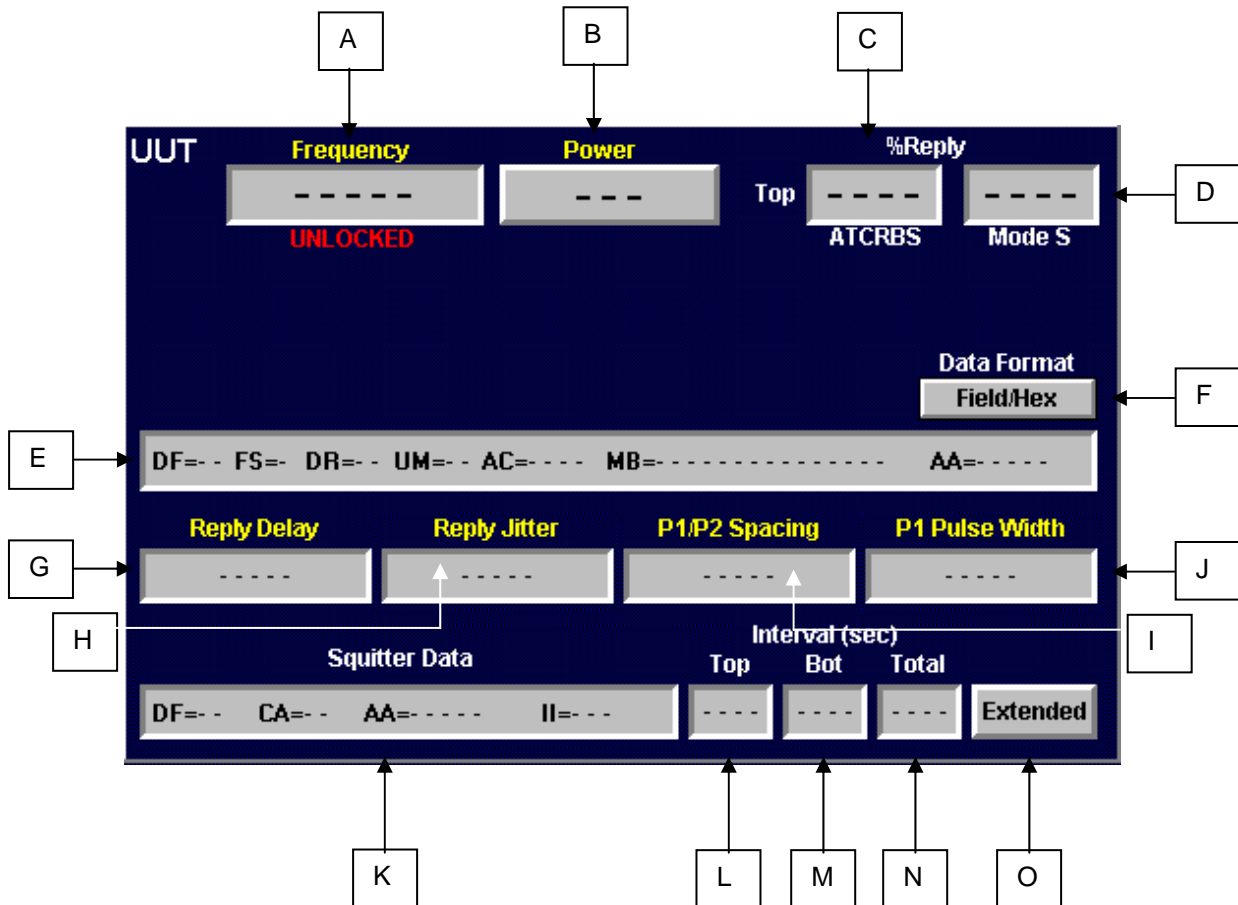

- A – Frequency
- B – Power
- C – Percentage Reply ATCRBS
- D – Percentage Reply Modes
- E – Reply Data
- F – Data Format
- G – Reply Delay
- H – Reply Jitter

- I – P1/P2 Spacing
- J – Pulse Width
- K – Decoded Squitter Data
- L – Top Antenna Squitter Interval
- M – Bottom Antenna Squitter Interval
- N – Total Squitter Interval
- O – Extended Squitter

**CHAPTER ONE - GENERAL INFORMATION AND OPERATING INSTRUCTIONS**

**SECTION 5. OPERATING INSTRUCTIONS**

**5.2 MODE S**

**5.2.3 CONTROL PANEL**

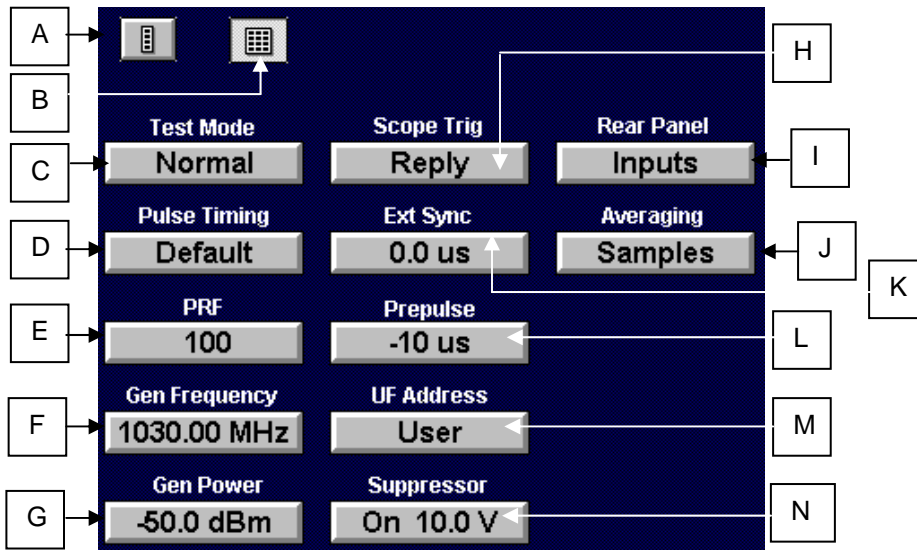

- A – Compress Control Panel
- B – Expand Control Panel
- C - Interrogation Setup
- D - Pulse Timing Setup
- E - PRF Rate Setup
- F - Generator Frequency Setup
- G - Generator Power Setup

- H - Scope Trigger Control
- I – Rear Panel
- J - Averaging
- K – External Sync
- L – Prepulse
- M – UF Address Selection
- N - Suppressor

**A: COMPRESS CONTROL PANEL**

Press 

**B: EXPAND CONTROL PANEL**

Press 



## CHAPTER ONE - GENERAL INFORMATION AND OPERATING INSTRUCTIONS

### SECTION 5. OPERATING INSTRUCTIONS

#### 5.2 MODE S

##### 5.2.3 CONTROL PANEL

##### C: INTERROGATION MODE SELECTION SCREEN

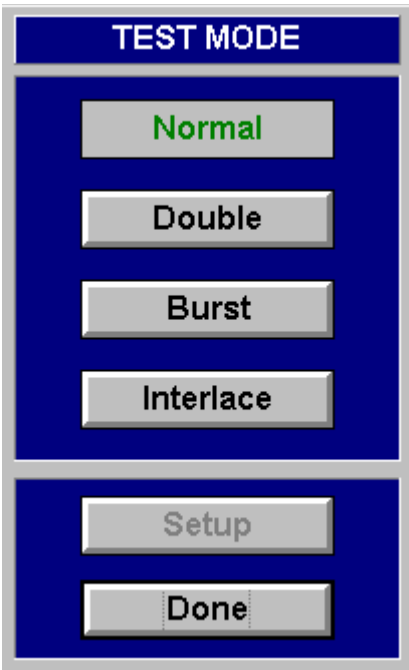

The method of Interrogation is controlled using this screen. It is accessed by selecting the INTERROGATION button.

**NORMAL:** In the NORMAL mode, the 'ON' interrogations will be transmitted in the sequence set up in the interrogation table. The Interrogations will be sent at the PRF Rate.

**DOUBLE:** In DOUBLE mode and INTERLACE mode, the interrogations in table entries 1 and 2 will be turned on and all others turned off. On return to either BURST or NORMAL mode, the previous state of the interrogation table will be restored. In DOUBLE mode, the two interrogations will be sent at the PRF separated by the value for DOUBLE SPACING.

**BURST:** In BURST mode, the rate of interrogations is controlled by the user. The user can select how many interrogations are sent at the PRF rate. The process is initiated by pressing the BURST START button, which will appear on the MODE S main page when the BURST Mode is selected. The bursts will continue at a user defined burst spacing until BURST STOP is pressed, or another mode is selected. Setting the burst spacing to zero allows a burst to occur only when the BURST START button is pressed. This is referred to as single burst mode of operation. An alternative to using the BURST SPACING is to utilize the incoming SQUITTER to trigger the BURST of interrogations.

The number of received squitters can be programmed.

**INTERLACE:** Interlace test mode makes it possible to output two interrogations (ATCRBS followed by Mode S) at a programmable ratio. A ratio of first to second is entered by the user. The rate of the first interrogation is defined by the PRF rate.

**SETUP:** After selecting a function (Double, Burst, or Interlace), select the SETUP button to enter the setup screen for that function.

**CHAPTER ONE - GENERAL INFORMATION AND OPERATING INSTRUCTIONS**

**SECTION 5. OPERATING INSTRUCTIONS**

**5.2 MODE S**

**5.2.3 CONTROL PANEL**

**C: INTERROGATION MODE SELECTION SCREEN (cont.)**

**SETUP**

After selecting the Double mode of Interrogation setup, this screen will be displayed. Selecting "GO BACK" will return you to Interrogation mode selection without making any changes. To change the spacing between Double Interrogation Pulses, select the "SPACING (us)" button. Enter the desired value, or select the default timing. Select "DONE" to continue



After selecting the Burst Interrogation mode setup, this screen will be displayed. Selecting "GO BACK" will return you to Interrogation mode selection without making any changes. The Burst Gap timing can be changed by selecting the "BURST GAP" button. Enter the desired value, or select the default timing. To use Squitter, select the "USE SQUITTER" check box. Select "DONE" to continue. A new control will be displayed at the bottom of the SDX 2000 screen. Select "BURST START" to start the Burst Pulses, and select "BURST STOP" to stop the pulses after being started.

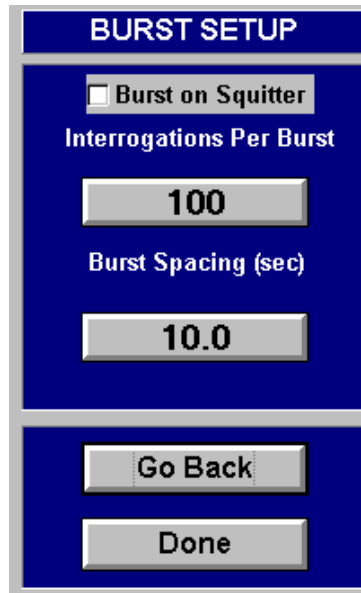

**CHAPTER ONE - GENERAL INFORMATION AND OPERATING INSTRUCTIONS**

**SECTION 5. OPERATING INSTRUCTIONS**

**5.2 MODE S**

**5.2.3 CONTROL PANEL**

**C: INTERROGATION MODE SELECTION SCREEN (cont.)**

**INTERLACE SETUP SCREEN**



**CHAPTER ONE - GENERAL INFORMATION AND OPERATING INSTRUCTIONS**

**SECTION 5. OPERATING INSTRUCTIONS**

**5.2 MODE S**

**5.2.3 CONTROL PANEL**

**D: PULSE TIMING  
SCREENS**

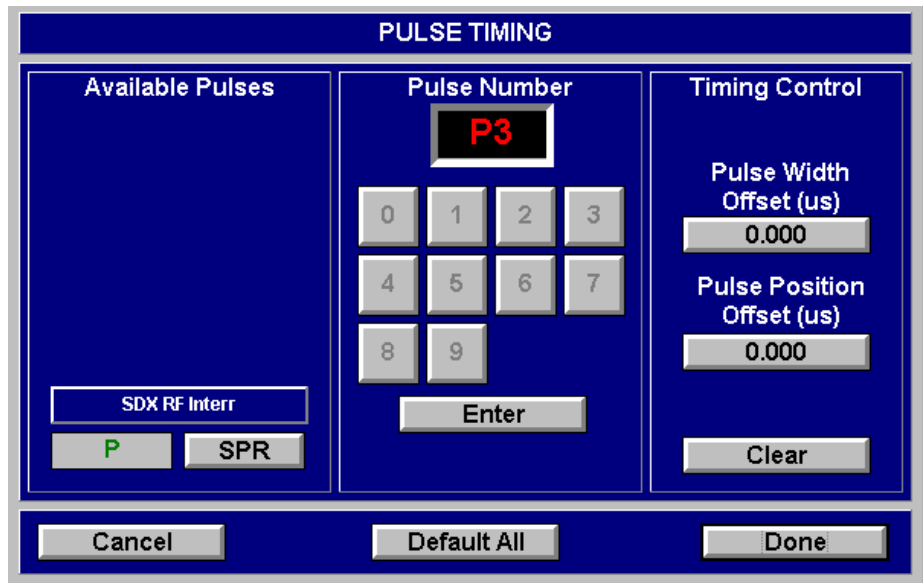

**CHAPTER ONE - GENERAL INFORMATION AND OPERATING INSTRUCTIONS**

**SECTION 5. OPERATING INSTRUCTIONS**

**5.2 MODE S**

**5.2.3 CONTROL PANEL**

**E: PRF Rate Setup**

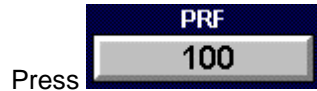

**F: GENERATOR FREQUENCY SCREENS**

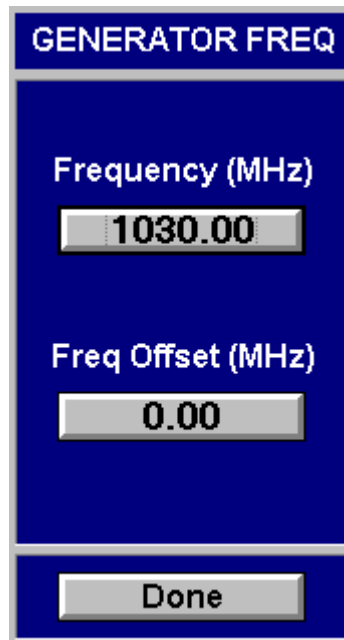

**G: GENERATOR POWER SCREENS**

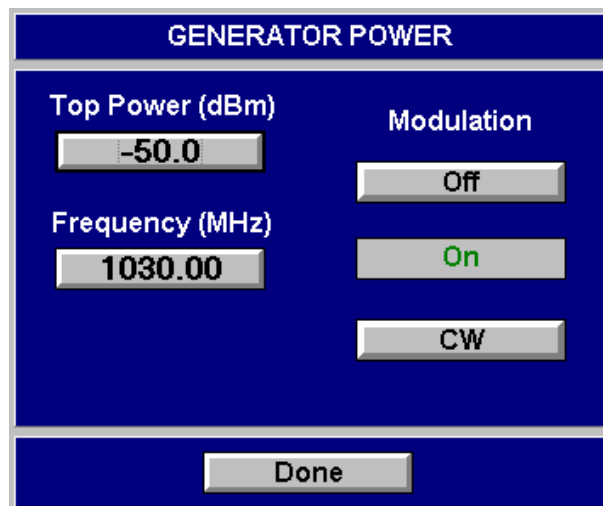
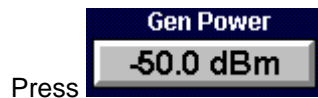

**CHAPTER ONE - GENERAL INFORMATION AND OPERATING INSTRUCTIONS**

**SECTION 5. OPERATING INSTRUCTIONS**

**5.2 MODE S**

**5.2.3 CONTROL PANEL**

H: Scope Sync Control



I: Rear Panel

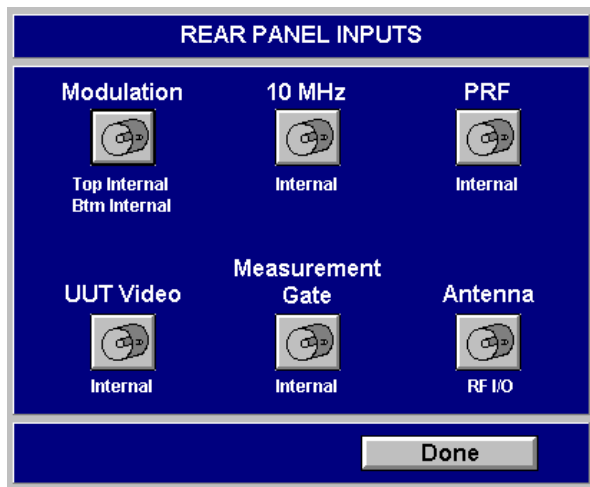

**CHAPTER ONE - GENERAL INFORMATION AND OPERATING INSTRUCTIONS**

**SECTION 5. OPERATING INSTRUCTIONS**

**5.2 MODE S**

**5.2.3 CONTROL PANEL**

**J: Averaging**

Press



AVERAGING SETUP MENU				
Measured Param	Samples	Minimum	Maximum	Current
Reply Jitter	1	-----	-----	-----
Reply Delay	1	-----	-----	-----
Pulse Spacing	1	-----	-----	-----
Pulse Width	1	-----	-----	-----
Frequency	16	-----	-----	-----
Power	16	-----	-----	-----
Reset		Done		

**CHAPTER ONE - GENERAL INFORMATION AND OPERATING INSTRUCTIONS**

**SECTION 5. OPERATING INSTRUCTIONS**

**5.2 MODE S**

**5.2.3 CONTROL PANEL**

**K: External Sync Timing Control**



**L: Prepulse Timing Control**



**M: UF Address Selection**



**N: Suppressor**

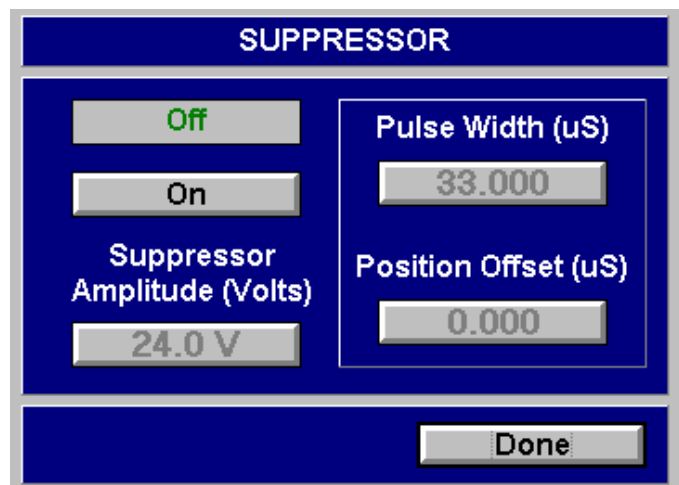



**CHAPTER ONE - GENERAL INFORMATION AND OPERATING INSTRUCTIONS**

**SECTION 5. OPERATING INSTRUCTIONS**

**5.2 MODE S**

**5.2.4 SPECIAL FUNCTIONS PANEL**

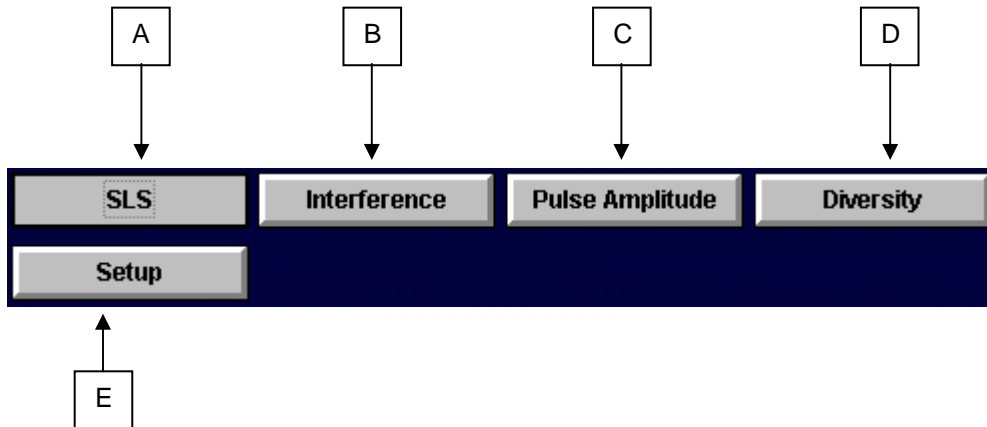

- A – SLS
- B – Interference
- C – Pulse Amplitude
- D – Diversity
- E – Setup

**CHAPTER ONE - GENERAL INFORMATION AND OPERATING INSTRUCTIONS**

**SECTION 5. OPERATING INSTRUCTIONS**

**5.2 MODE S**

**5.2.4 SPECIAL FUNCTIONS PANEL**

**A: SLS**

To activate SLS press 

SLS pulse position, width and amplitude can be modified by pressing  which will open the SLS settings screen.

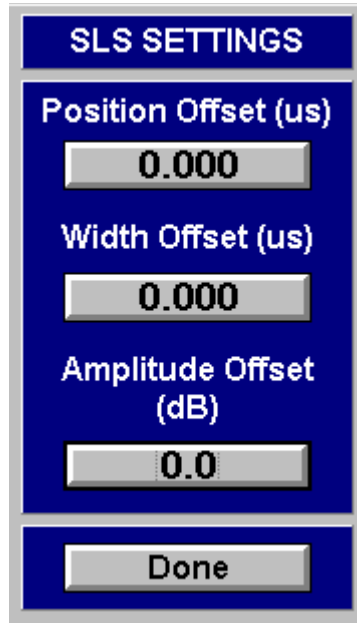

**B: Interference:**

To activate Interference press

, then press

 to modify position offset, absolute width, amplitude offset and spacing.

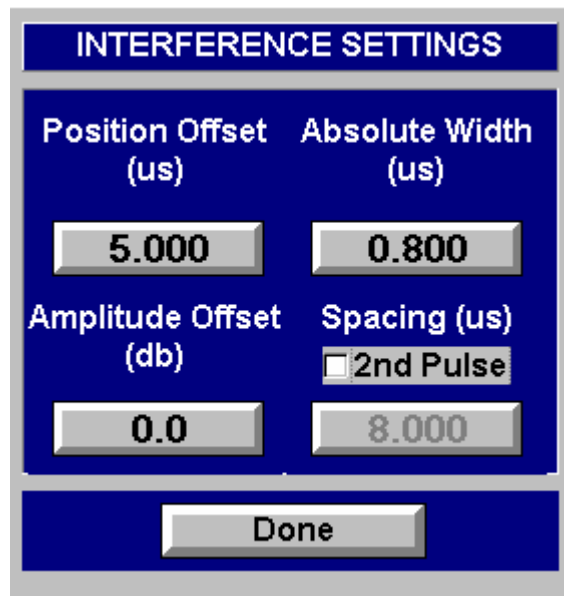

**CHAPTER ONE - GENERAL INFORMATION AND OPERATING INSTRUCTIONS**

**SECTION 5. OPERATING INSTRUCTIONS**

**5.2 MODE S**

**5.2.4 SPECIAL FUNCTIONS PANEL**

**C: Pulse Amplitude:**

To activate Pulse Amplitude press

**Pulse Amplitude**

, then press

**Setup**

to modify amplitude offset.

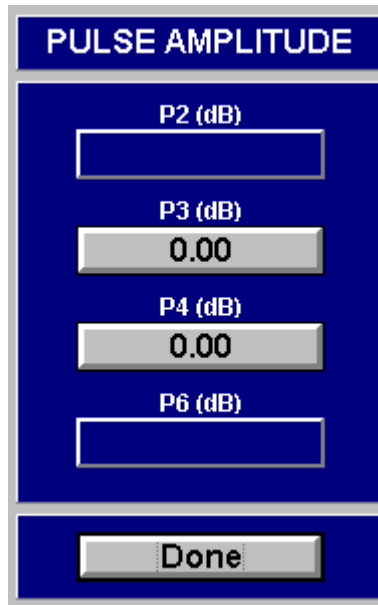

**CHAPTER ONE - GENERAL INFORMATION AND OPERATING INSTRUCTIONS**

**SECTION 5. OPERATING INSTRUCTIONS**

**5.2 MODE S**

**5.2.4 SPECIAL FUNCTIONS PANEL**

D: Diversity:

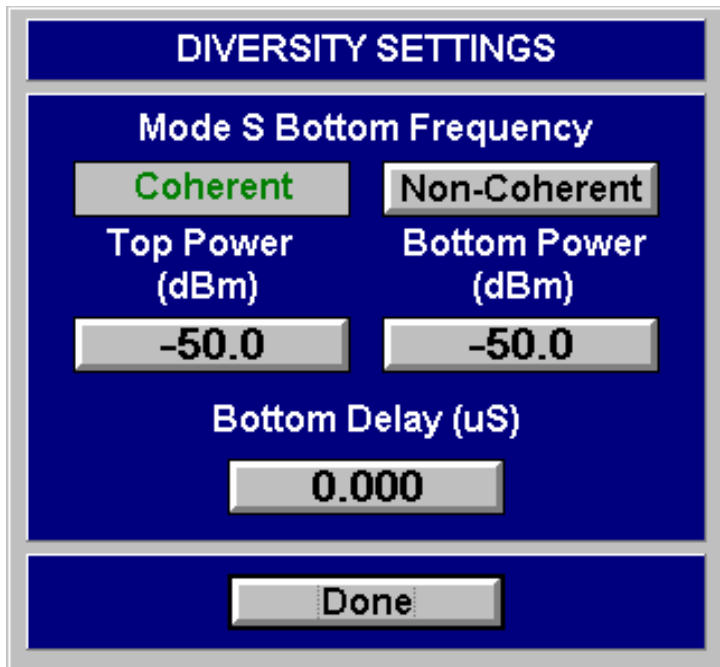

**CHAPTER ONE - GENERAL INFORMATION AND OPERATING INSTRUCTIONS**

**SECTION 5. OPERATING INSTRUCTIONS**

**5.2 MODE S**

**5.2.5 INTERROGATION PATTERN TYPE SELECTION SCREEN**

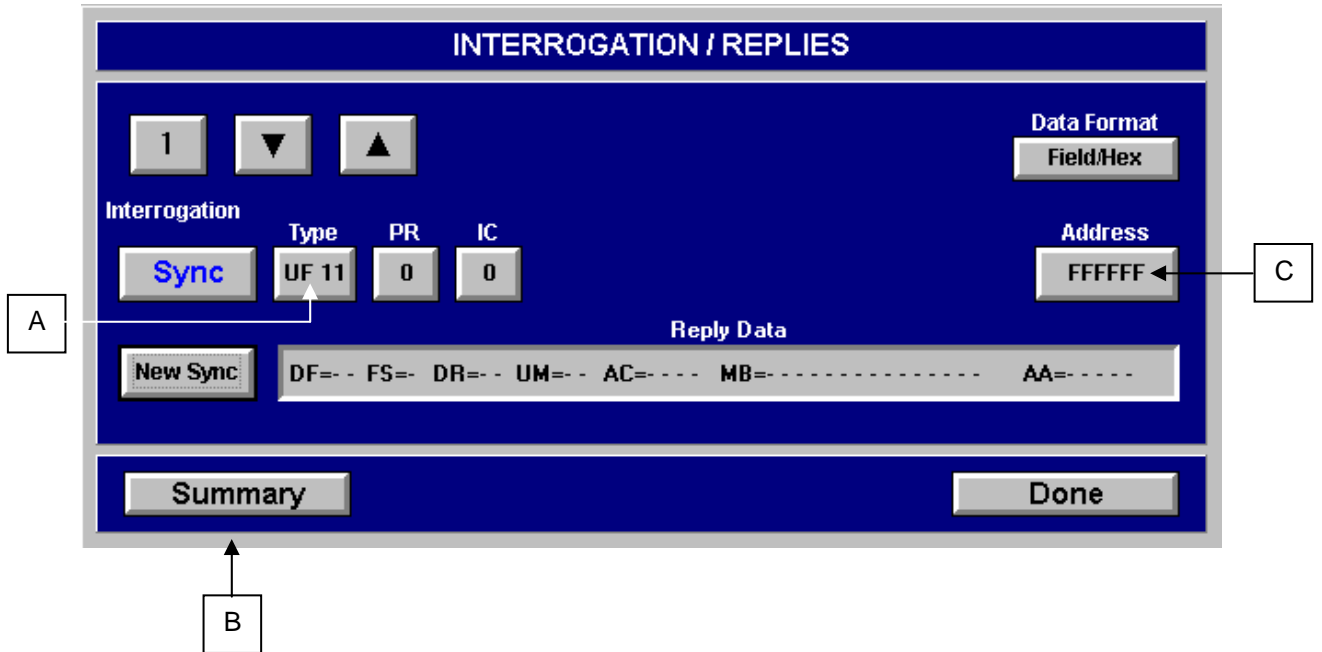

**CHAPTER ONE - GENERAL INFORMATION AND OPERATING INSTRUCTIONS**

**SECTION 5. OPERATING INSTRUCTIONS**

**5.2 MODE S**

**5.2.5 INTERROGATION PATTERN TYPE SELECTION SCREEN**

A:

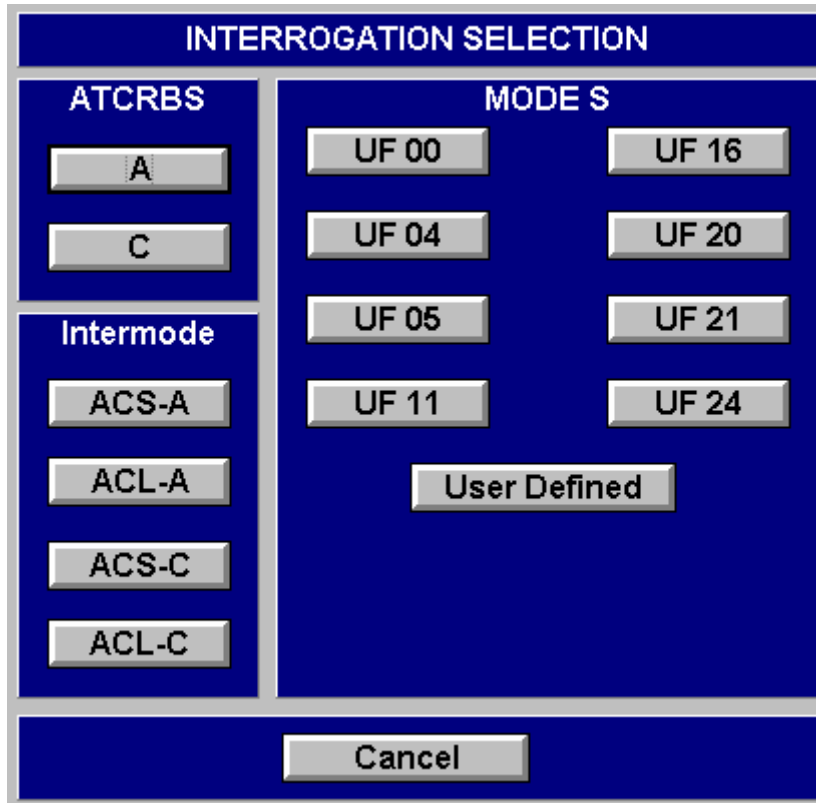

**CHAPTER ONE - GENERAL INFORMATION AND OPERATING INSTRUCTIONS**

**SECTION 5. OPERATING INSTRUCTIONS**

**5.2 MODE S**

**5.2.5 INTERROGATION PATTERN TYPE SELECTION SCREEN**

A (cont.):

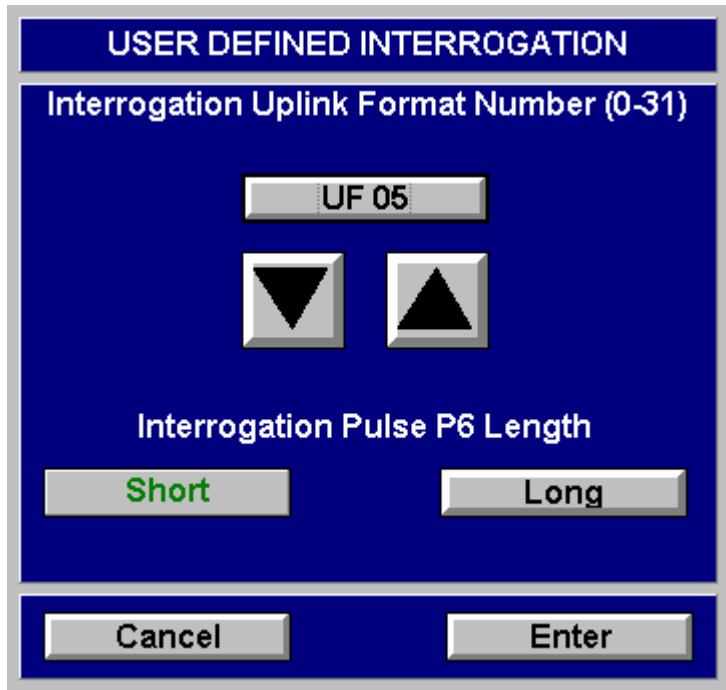

**CHAPTER ONE - GENERAL INFORMATION AND OPERATING INSTRUCTIONS**

**SECTION 5. OPERATING INSTRUCTIONS**

**5.2 MODE S**

**5.2.5 INTERROGATION SUMMARY SCREEN**

**B:**

The screenshot displays the 'INTERROGATION SUMMARY' screen. At the top, the title 'INTERROGATION SUMMARY' is centered. Below the title, the text 'Total on = 1' is displayed. The main area contains a 6x5 grid of buttons, each representing a different interrogator. The buttons are labeled as follows:

1: UF 11	7: UF 21	13: ACL-C	19: UF 0	25: UF 0
2: UF 4	8: A	14: UF 0	20: UF 0	26: UF 0
3: UF 5	9: C	15: UF 0	21: UF 0	27: UF 0
4: UF 11	10: ACS-A	16: UF 0	22: UF 0	28: UF 0
5: UF 16	11: ACL-A	17: UF 0	23: UF 0	29: UF 0
6: UF 20	12: ACS-C	18: UF 0	24: UF 0	30: UF 0

At the bottom right of the screen, there is a 'Done' button.



**CHAPTER ONE - GENERAL INFORMATION AND OPERATING INSTRUCTIONS**

**SECTION 5. OPERATING INSTRUCTIONS**

**5.2 MODE S**

**5.2.5 INTERROGATION ADDRESS ENTRY SCREEN**

**C:**

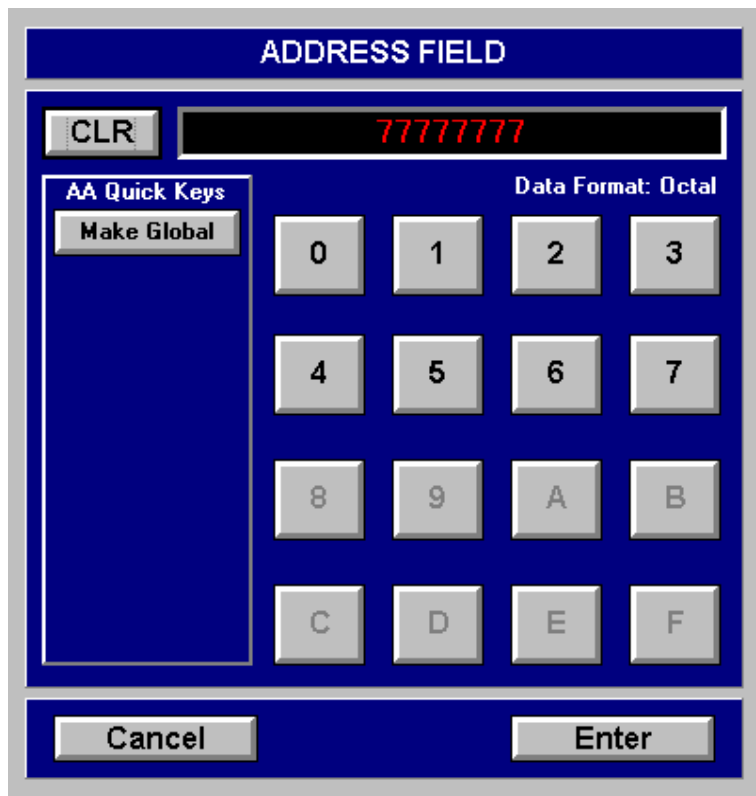

**CHAPTER ONE - GENERAL INFORMATION AND OPERATING INSTRUCTIONS**

**SECTION 5. OPERATING INSTRUCTIONS**

**5.3 DME**

The screenshot displays the DME control panel interface. At the top center, the title "DME" is shown, and at the top right, the time "12:24 PM" is displayed. The interface is divided into several sections:

- Left Column (Callout 5.3.3):** A vertical stack of controls including "P2 Pos. Offset" (0.0 us), "Efficiency" (100%), "DME Mode" (MHz X), "Gen Frequency" (978.00), "Squitter Rate" (2700), and "Gen Power" (-50.0 dBm).
- Top Left (Callout 5.3.1):** A "Measured Pulse" section with a "P1" indicator.
- Top Right (Callout 5.3.2):** A section with four fields: "Frequency", "Power", "Interr. Rate", and "Meas. Distance", each containing a dashed line. Below these is a red "Unlocked" status indicator and two fields: "Pulse Width" and "P1/P2 Spacing", both containing dashed lines.
- Bottom Right (Callout 5.3.4):** A section labeled "UUT" containing three fields: "Range (nmi)" (0.00), "Velocity (kts)" (0), and "Accel (ft/s/s)" (0). Below these are two fields: "Normal /-1" (Normal) and "Direction" (Outbound).
- Bottom Center:** A "Main Menu" button.

Callout boxes 5.3.1, 5.3.2, 5.3.3, and 5.3.4 are positioned around the interface with arrows pointing to the respective elements described above.

**CHAPTER ONE - GENERAL INFORMATION AND OPERATING INSTRUCTIONS**

**SECTION 5. OPERATING INSTRUCTIONS**

**5.3 DME**

**5.3.1 MEASURED POWER PULSE SCREEN**



**5.3.2 MEASURED UUT PARAMETERS SCREEN**

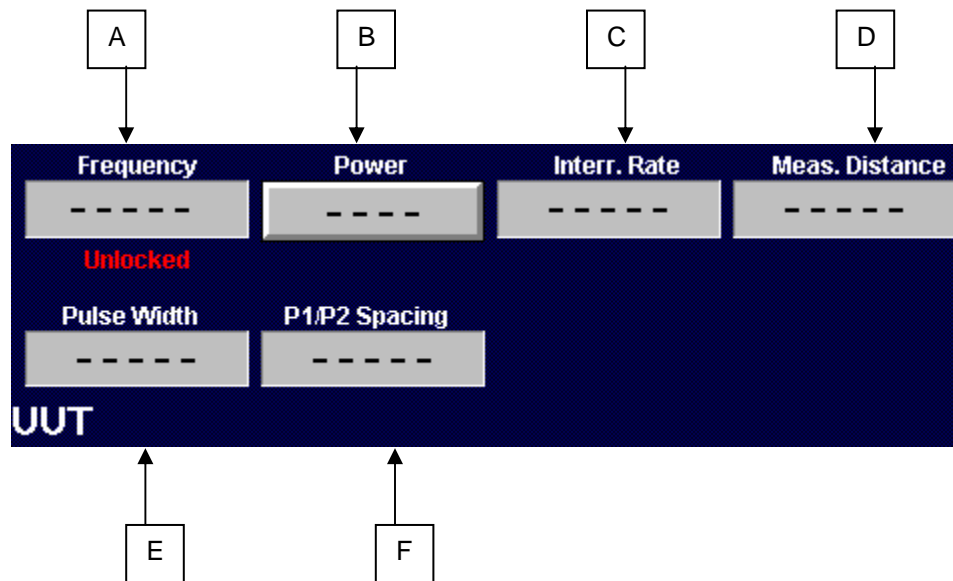

- A – Frequency
- B – Power
- C – Interrogation Rate
- D – Measured Distance
- E – Pulse Width
- F – P1/P2 Spacing

**CHAPTER ONE - GENERAL INFORMATION AND OPERATING INSTRUCTIONS**

**SECTION 5. OPERATING INSTRUCTIONS**

**5.3 DME**

**5.3.3 CONTROL PANEL**

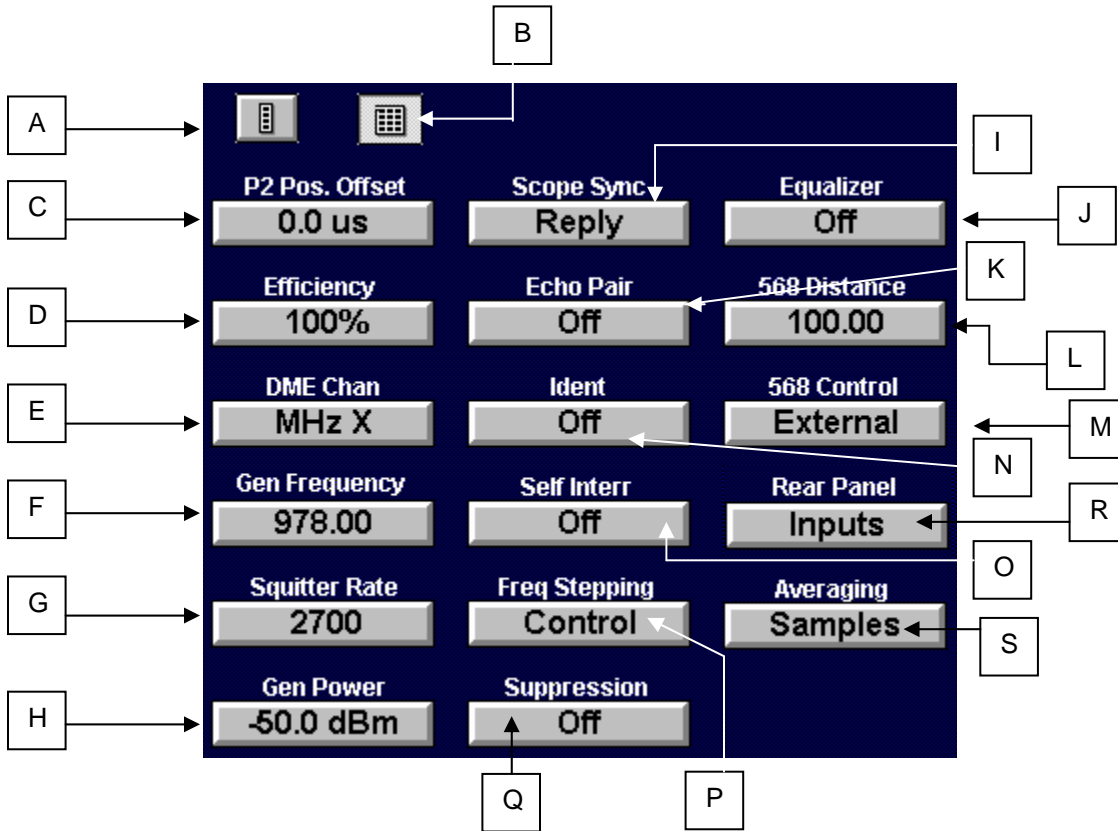

- A – Compress Control Panel
- B – Expand Control Panel
- C – P2 Position Offset
- D – Efficiency
- E – DME Mode
- F – Generator Frequency
- G – Squitter Rate
- H – Generator Power
- I – Scope Sync

- J - Equalizer
- K - Echo Pulse Control (Amplitude Offset)
- L - ARINC 568 Distance Setup
- M- ARINC 568 Control Setup
- N – IDENT State Control
- O – Self Interrogation
- P – Frequency Stepping
- Q – Suppression
- R – Rear Panel
- S – Averaging

**CHAPTER ONE - GENERAL INFORMATION AND OPERATING INSTRUCTIONS**

**SECTION 5. OPERATING INSTRUCTIONS**

**5.3 DME**

**5.3.3 CONTROL PANEL**

**A: Compress Control Panel**

Press 

**B: Expand Control Panel**

Press 

**C: P2 Position Offset**



**D: Efficiency**

Press 

**E: DME Mode**

Press 

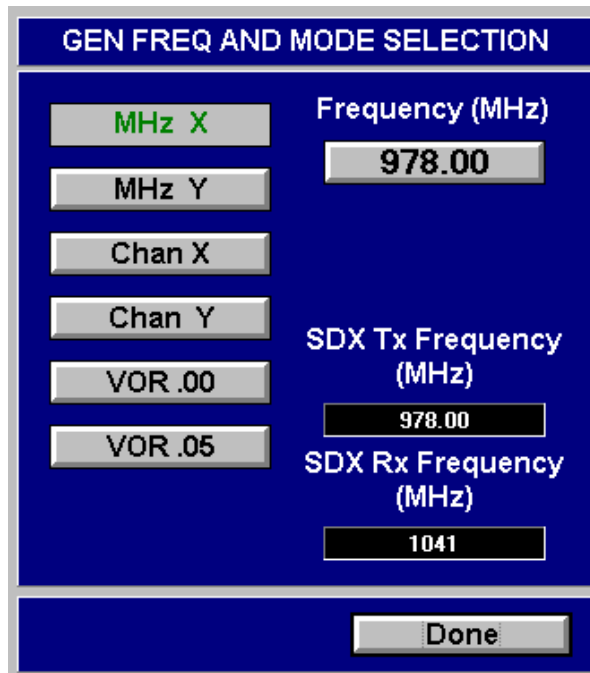

**CHAPTER ONE - GENERAL INFORMATION AND OPERATING INSTRUCTIONS**

**SECTION 5. OPERATING INSTRUCTIONS**

**5.3 DME**

**5.3.3 CONTROL PANEL**

**F: Generator Frequency**

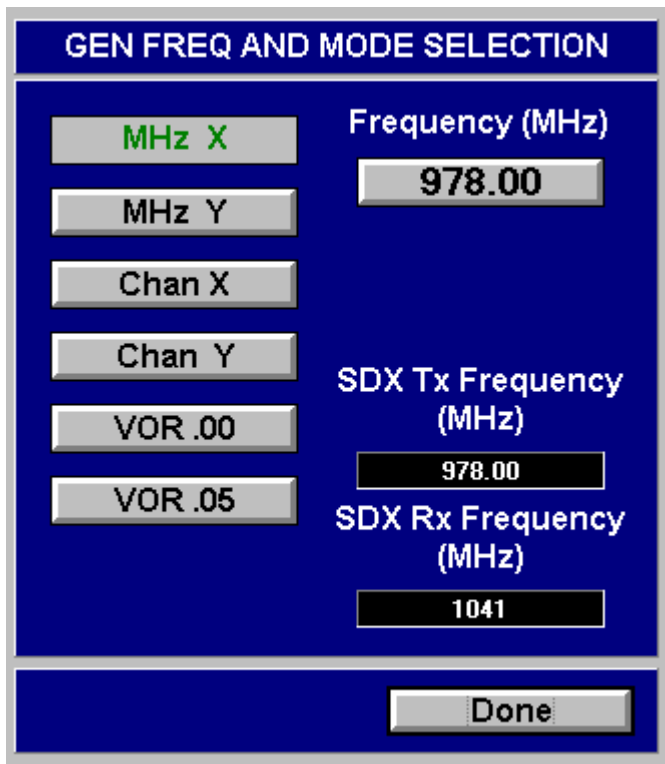

**G: Squitter Rate**



**CHAPTER ONE - GENERAL INFORMATION AND OPERATING INSTRUCTIONS**

**SECTION 5. OPERATING INSTRUCTIONS**

**5.3 DME**

**5.3.3 CONTROL PANEL**

**H: Generator Power**

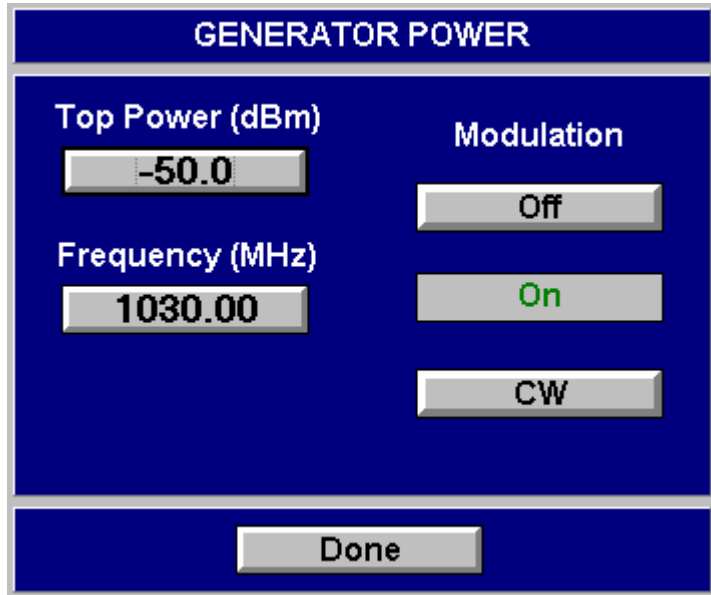
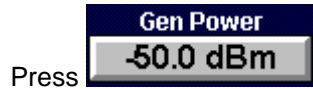

**I: Scope Sync**

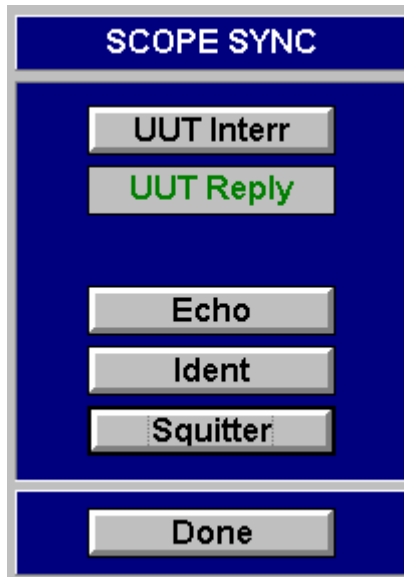

**CHAPTER ONE - GENERAL INFORMATION AND OPERATING INSTRUCTIONS**

**SECTION 5. OPERATING INSTRUCTIONS**

**5.3 DME**

**5.3.3 CONTROL PANEL**

**J: Equalizer**



**K: Echo Pair**

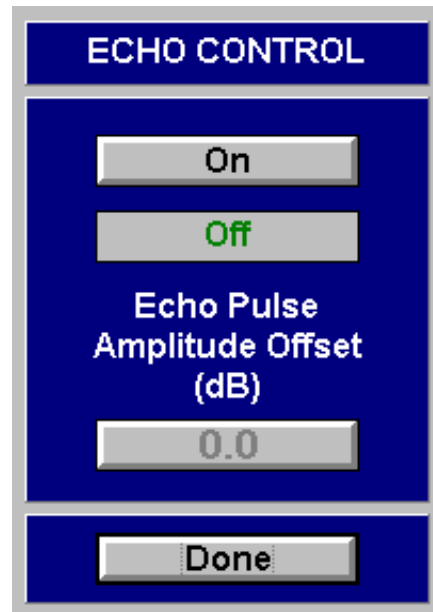

**L: ARINC 568 Distance**

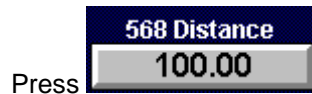

**M: ARINC 568 Control**





**CHAPTER ONE - GENERAL INFORMATION AND OPERATING INSTRUCTIONS**

**SECTION 5. OPERATING INSTRUCTIONS**

**5.3 DME**

**5.3.3 CONTROL PANEL**

**N: Ident State Control**

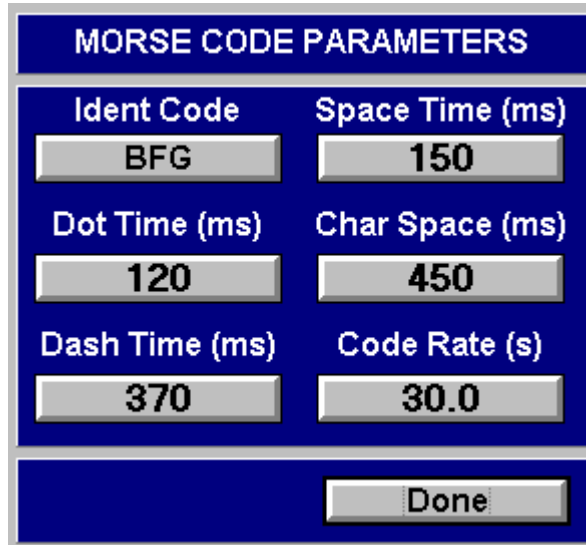
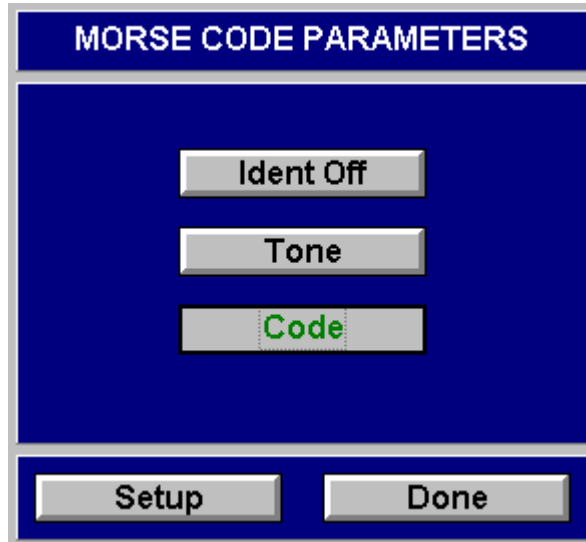

**CHAPTER ONE - GENERAL INFORMATION AND OPERATING INSTRUCTIONS**

**SECTION 5. OPERATING INSTRUCTIONS**

**5.3 DME**

**5.3.3 CONTROL PANEL**

**O: Self Interrogation**



**P: Frequency Stepping**

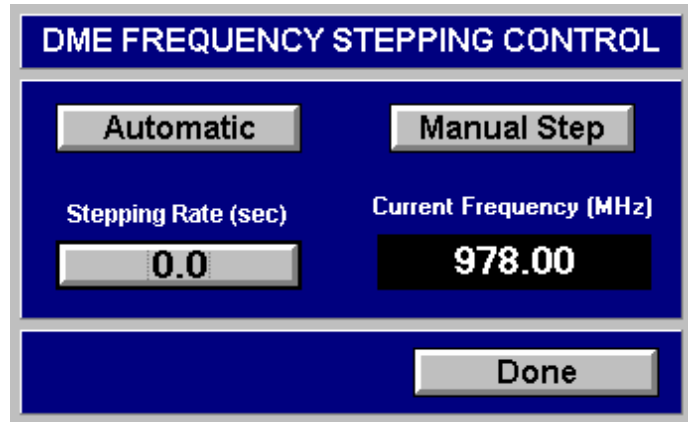

**Q: Suppression**

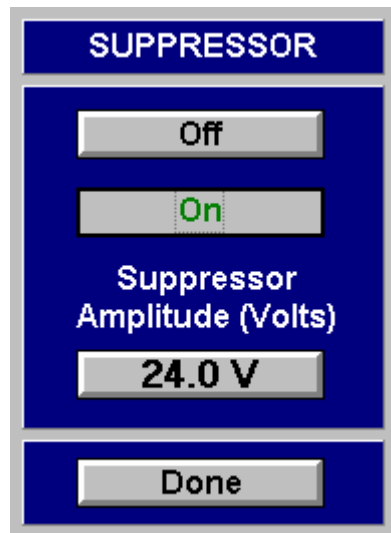

**CHAPTER ONE - GENERAL INFORMATION AND OPERATING INSTRUCTIONS**

**SECTION 5. OPERATING INSTRUCTIONS**

**5.3 DME**

**5.3.3 CONTROL PANEL**

R: Rear Panel

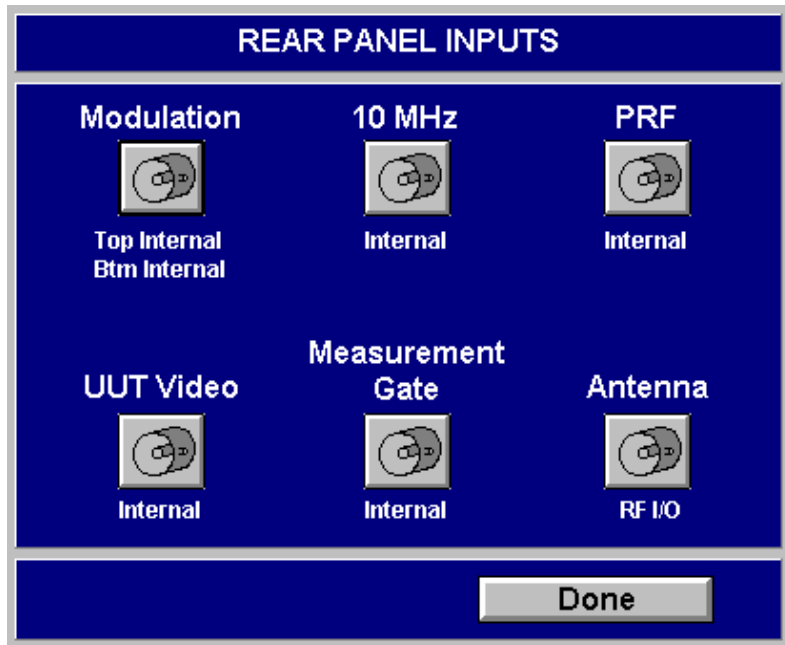

S: Averaging

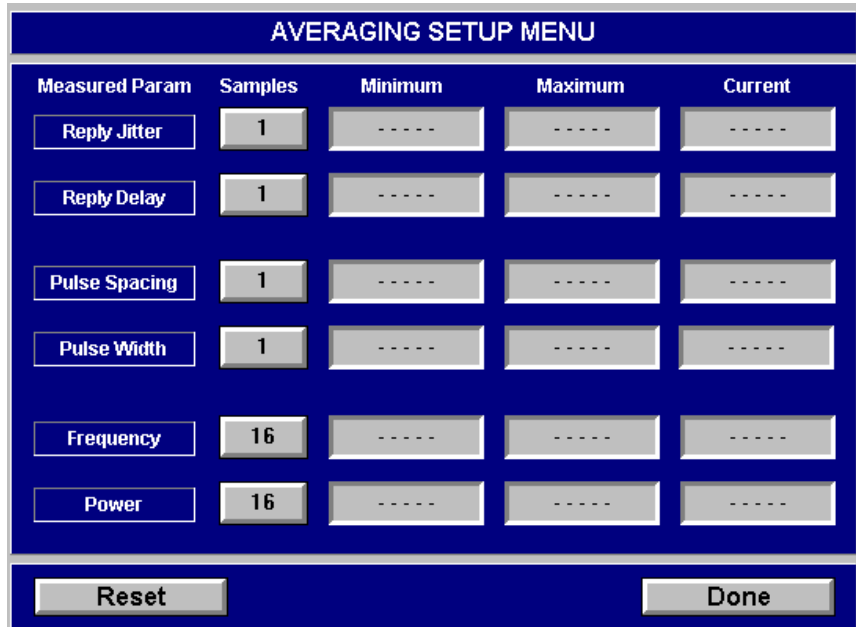

**CHAPTER ONE - GENERAL INFORMATION AND OPERATING INSTRUCTIONS**

**SECTION 5. OPERATING INSTRUCTIONS**

**5.3 DME**

**5.3.4 SPECIAL FUNCTIONS PANEL**

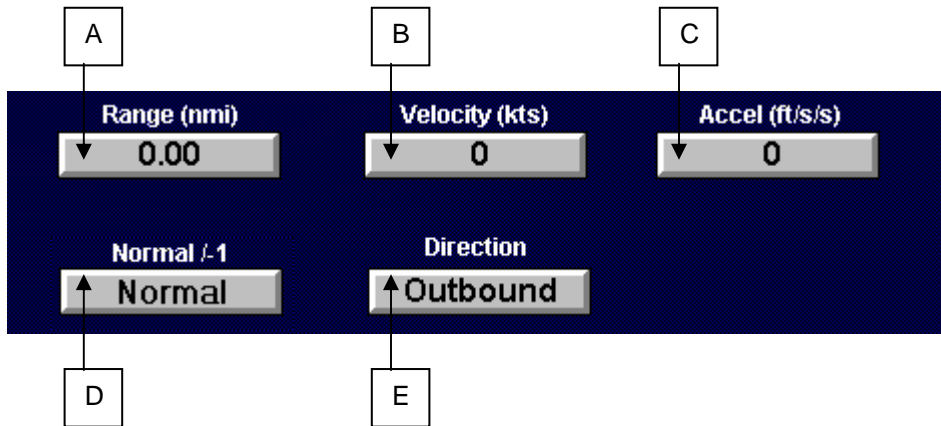

- A – Range
- B – Velocity
- C – Acceleration
- D – Normal
- E – Direction

**CHAPTER ONE - GENERAL INFORMATION AND OPERATING INSTRUCTIONS**

**SECTION 5. OPERATING INSTRUCTIONS**

**5.4 DATALINK**

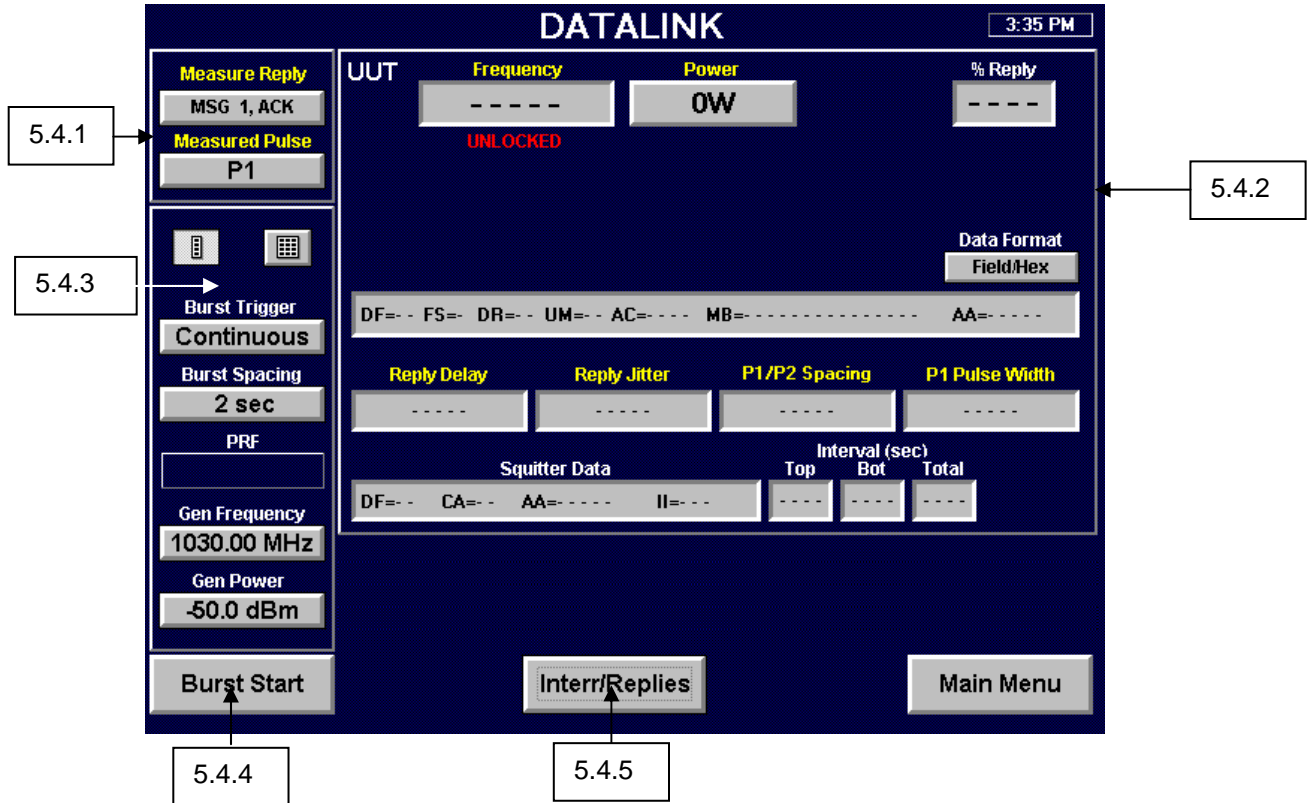

This screen represents the controls available from the DATALINK Instrument.

**General Datalink Operation**

The Datalink instrument provides the necessary functionality to fully test Mode S Datalink transponders. The instrument has the ability to test both normal and extended length messages and supports eight protocols: Comm A, Comm B Ground Initiated, Comm B Air Initiated, Multisite Comm B, Comm C, Multisite Comm C, Comm D, and Multisite Comm D. Sixteen message slots are available for Datalink messages. Each message can contain up to eighteen interrogations. Message interrogations are indexed from 1 to 18 with the Closeout interrogations always indexed 18. The following table indicates how interrogations are indexed for the eight message protocols.



**CHAPTER ONE - GENERAL INFORMATION AND OPERATING INSTRUCTIONS**

**SECTION 5. OPERATING INSTRUCTIONS**

**5.4 DATALINK**

	1	2	3	4	5	6	7	8	9
<b>Comm A</b>	Interr	x	x	x	x	x	x	x	x
<b>Comm B Gnd</b>	Interr	x	x	x	x	x	x	x	x
<b>Comm B Air</b>	Resv	Auth	x	x	x	x	x	x	x
<b>M Comm B</b>	Resv	Auth	x	x	x	x	x	x	x
<b>Comm C</b>	x	Seg1	Seg2	Seg3	Seg4	Seg5	Seg6	Seg7	Seg8
<b>M Comm C</b>	Resv	Seg1	Seg2	Seg3	Seg4	Seg5	Seg6	Seg7	Seg8
<b>Comm D</b>	Surv	Auth	Seg2	Seg3	Seg4	Seg5	Seg6	Seg7	Seg8
<b>M Comm D</b>	Surv	Auth	Seg2	Seg3	Seg4	Seg5	Seg6	Seg7	Seg8

	10	11	12	13	14	15	16	17	18
<b>Comm A</b>	x	x	x	x	x	x	x	x	x
<b>Comm B Gnd</b>	x	x	x	x	x	x	x	x	x
<b>Comm B Air</b>	x	x	x	x	x	x	x	x	Cls
<b>M Comm B</b>	x	x	x	x	x	x	x	x	Cls
<b>Comm C</b>	Seg9	Seg10	Seg11	Seg12	Seg13	Seg14	Seg15	Seg16	Cls
<b>M Comm C</b>	Seg9	Seg10	Seg11	Seg12	Seg13	Seg14	Seg15	Seg16	Cls
<b>Comm D</b>	Seg9	Seg10	Seg11	Seg12	Seg13	Seg14	Seg15	Seg16	Cls
<b>M Comm D</b>	Seg9	Seg10	Seg11	Seg12	Seg13	Seg14	Seg15	Seg16	Cls

Datalink messages are configured using the Message Setup screen. This screen allows selection of protocol, interrogations, segments, and timing. After the messages have been configured and the measured reply has been selected, the instrument is ready to interrogate the transponder. Upon receiving a burst trigger, the Datalink instrument bursts through all of the enabled messages and waits for the next trigger. Three burst triggers are available in the Datalink instrument: continuous, single, and squitter. In continuous burst trigger mode, the instrument will continually burst on a fixed user defined interval (*Burst Spacing*). In single burst trigger mode, the instrument will burst when the BURST START button is pressed. In squitter burst trigger mode, the instrument will burst when a user defined number of squitters (*Squitter Count*) has been received. Upon successful bursting, the reply data and measured parameters of the *Measure Reply* will be displayed on the main Datalink instrument screen. All remaining reply data is displayed on the Message Setup screen. Red error messages may become visible after bursting if the instrument has not detected a valid reply.

**CHAPTER ONE - GENERAL INFORMATION AND OPERATING INSTRUCTIONS**

**SECTION 5. OPERATING INSTRUCTIONS**

**5.4 DATALINK**

**5.4.1 MEASURED PULSE SCREEN**

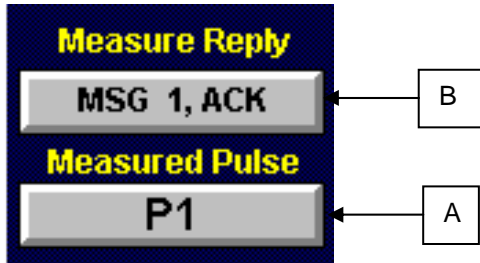

**A: MEASURED PULSE**

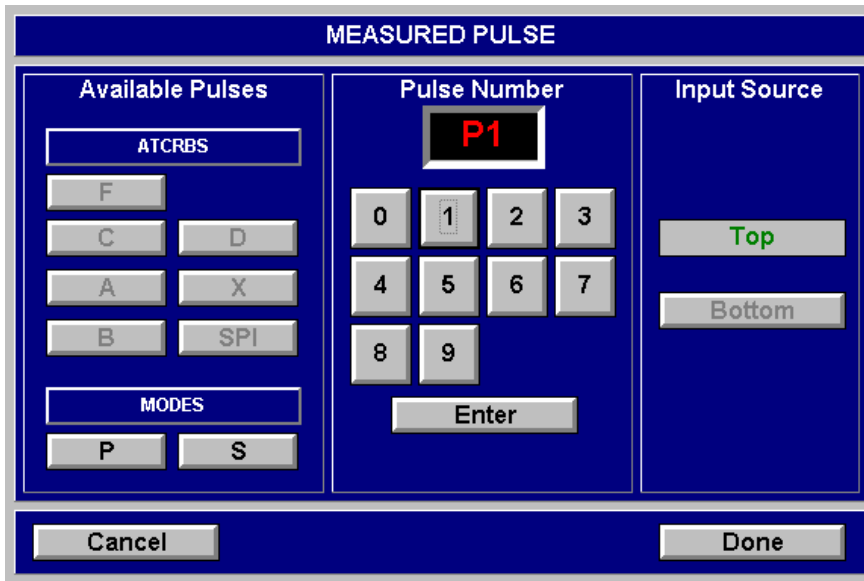

**CHAPTER ONE - GENERAL INFORMATION AND OPERATING INSTRUCTIONS**

**SECTION 5. OPERATING INSTRUCTIONS**

**5.4 DATALINK**

**5.4.1 MEASURED PULSE SCREEN**

**B: MEASURE REPLY**



**NOTE:** Available options will change depending on message protocol.

The Measure Reply screen is used to select the reply that will be decoded, measured, and displayed on the main Datalink instrument screen. When a selection is made, the button text will turn yellow. Yellow is used throughout the instrument to indicate association with the measured reply. To facilitate changing messages, the up and down arrows have been placed in the upper left corner of the screen. The available reply options are a function of interrogation state (on/off) and message protocol.



**CHAPTER ONE - GENERAL INFORMATION AND OPERATING INSTRUCTIONS**

**SECTION 5. OPERATING INSTRUCTIONS**

**5.4 DATALINK**

**5.4.2 MEASURED UUT PARAMETERS SCREEN**

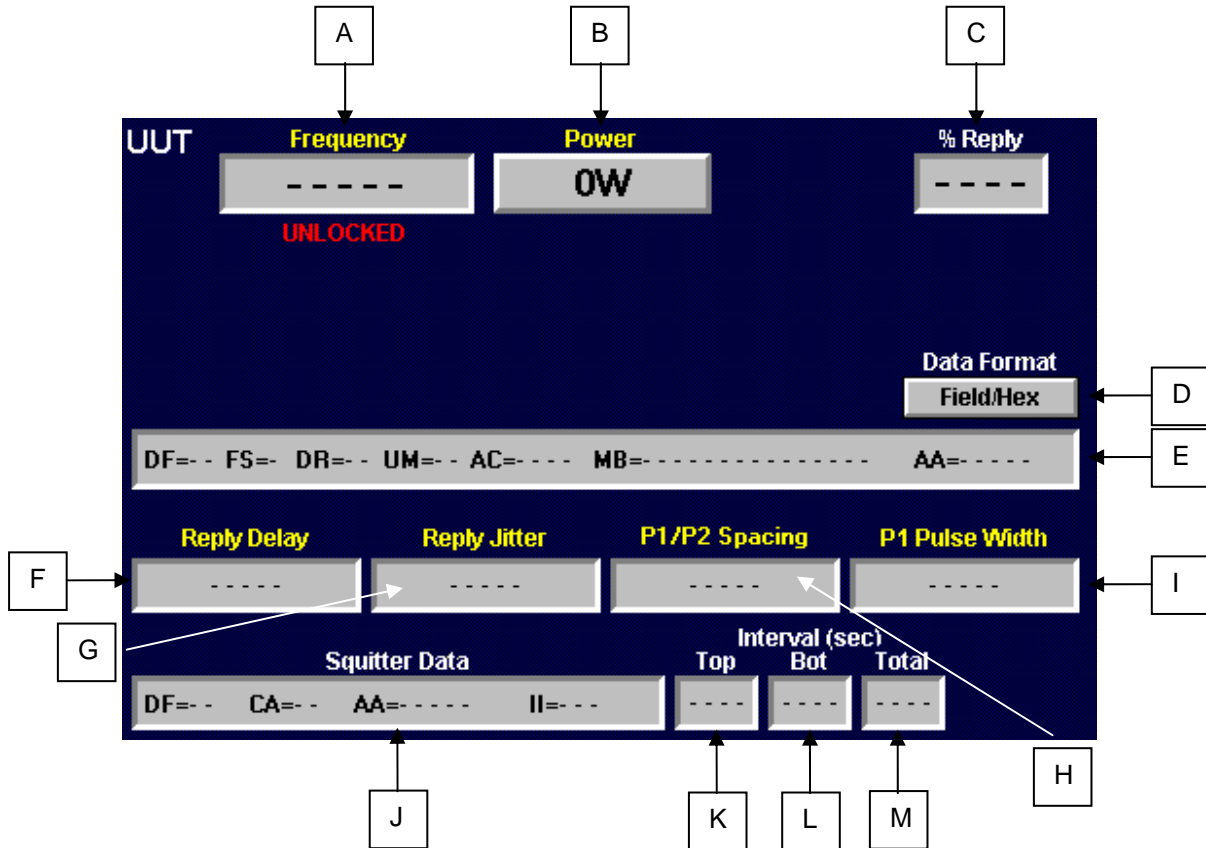

- A – Frequency
- B – Power
- C – Percentage Reply
- D – Data Format
- E – Decoded Reply Data
- F – Reply Delay
- G – Reply Jitter
- H – P1/P2 Spacing
- I – P1 Pulse Width
- J – Squitter Data
- K – Top Antenna Squitter Interval
- L – Bottom Antenna Squitter Interval
- M – Total Squitter Interval

**CHAPTER ONE - GENERAL INFORMATION AND OPERATING INSTRUCTIONS**

**SECTION 5. OPERATING INSTRUCTIONS**

**5.4 DATALINK**

**5.4.3 CONTROL PANEL**

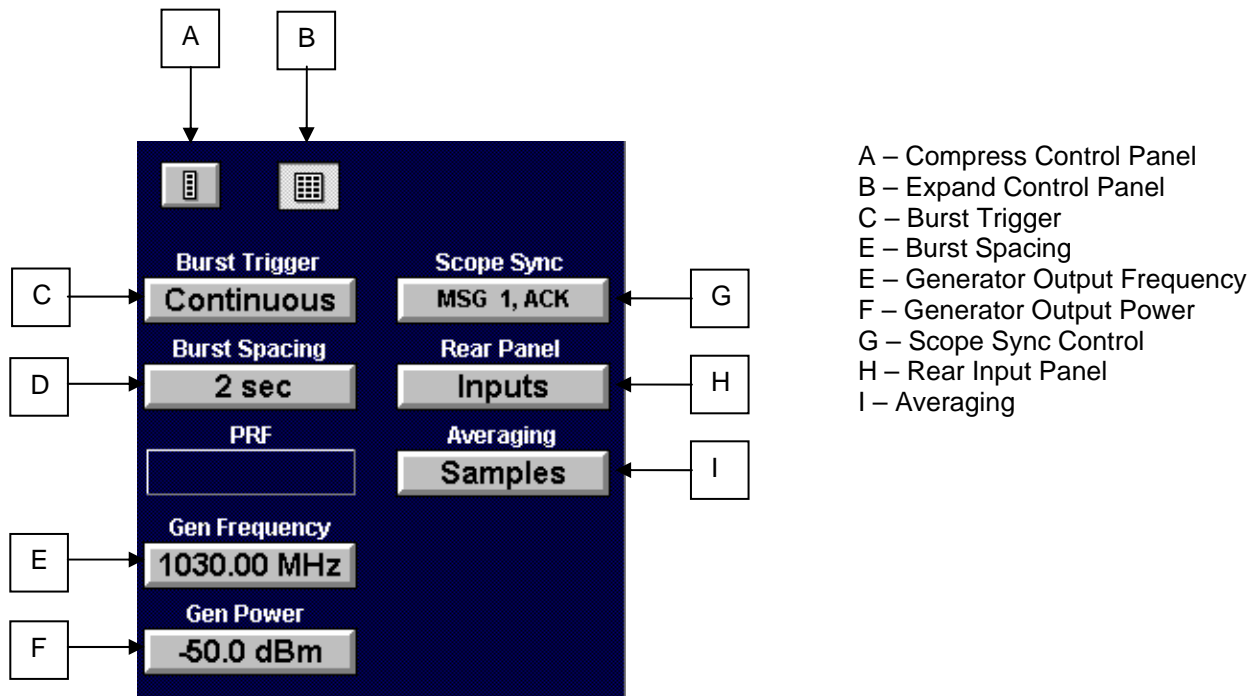

**A: COMPRESS CONTROL PANEL**

Press 

**B: EXPAND CONTROL PANEL**

Press 

**CHAPTER ONE - GENERAL INFORMATION AND OPERATING INSTRUCTIONS**

**SECTION 5. OPERATING INSTRUCTIONS**

**5.4 DATALINK**

**5.4.3 CONTROL PANEL**

**C: Burst Trigger**

Repeated pressing of Burst Trigger will toggle between the following screens.

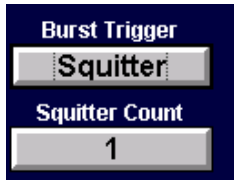

Trigger: Squitter

Squitters generate the burst trigger. User can enter the number of squitters to count before bursting.



Trigger: Continuous

Continuous timer generates the burst trigger. The timer is user adjustable from 1 to 130 seconds.



Trigger: Single

A single burst trigger is generated every time the user pushes

the  button.

**D: Burst Spacing / Squitter Count**

Burst Spacing and Squitter Count can be adjusted by pressing the respective keys after selection as detailed in item **C: Burst Trigger** above.

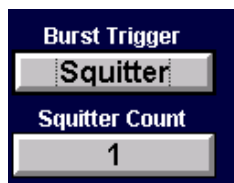

**CHAPTER ONE - GENERAL INFORMATION AND OPERATING INSTRUCTIONS**

**SECTION 5. OPERATING INSTRUCTIONS**

**5.4 DATALINK**

**5.4.3 CONTROL PANEL**

**E: Generator Frequency**

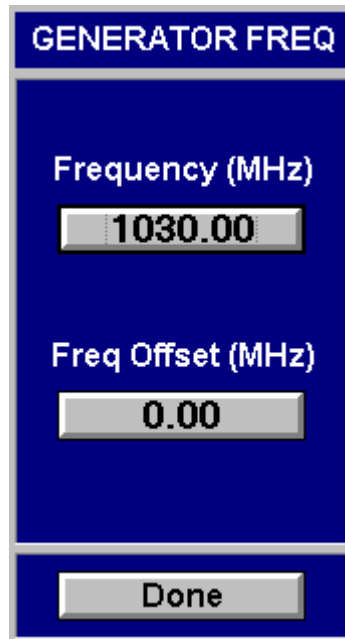

**F: Generator Power**

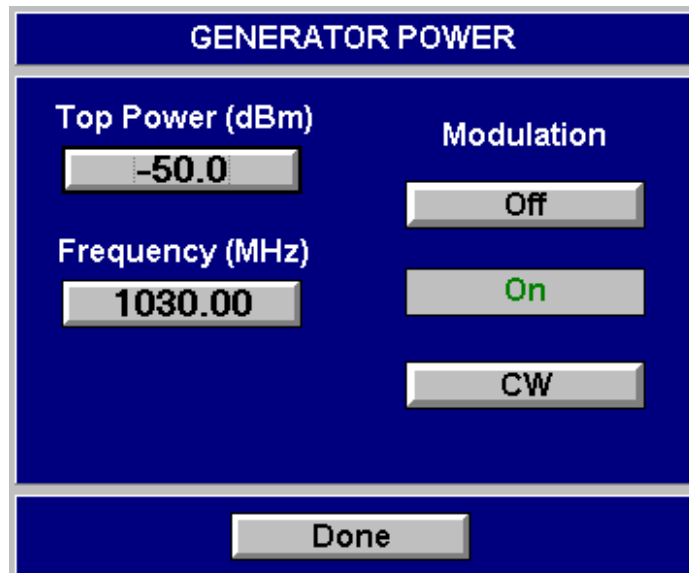
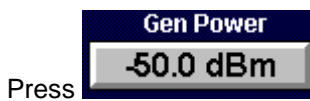

**CHAPTER ONE - GENERAL INFORMATION AND OPERATING INSTRUCTIONS**

**SECTION 5. OPERATING INSTRUCTIONS**

**5.4 DATALINK**

**5.4.3 CONTROL PANEL**

**G: Scope Sync**



**NOTE:** Available options will change depending on message protocol.

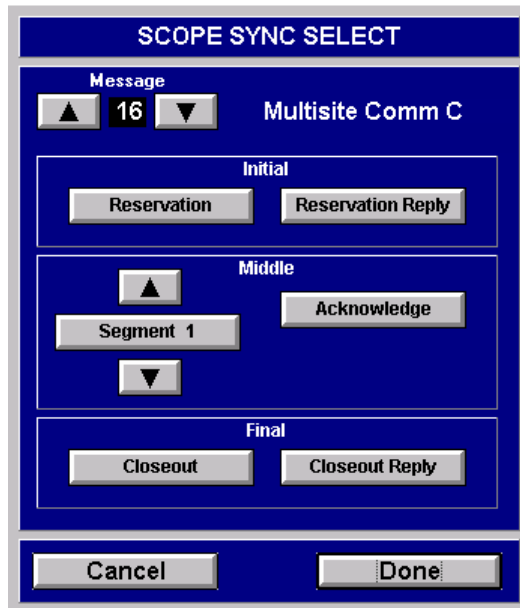

The Scope Sync screen is used to select the interrogation or reply that will be used to position the scope sync output. When a selection is made, the button text will turn yellow. To facilitate changing messages, the up and down arrows have been placed in the upper left corner of the screen. The available interrogation and reply options are a function of interrogation state (on/off) and message protocol.

**H: Rear Panel**

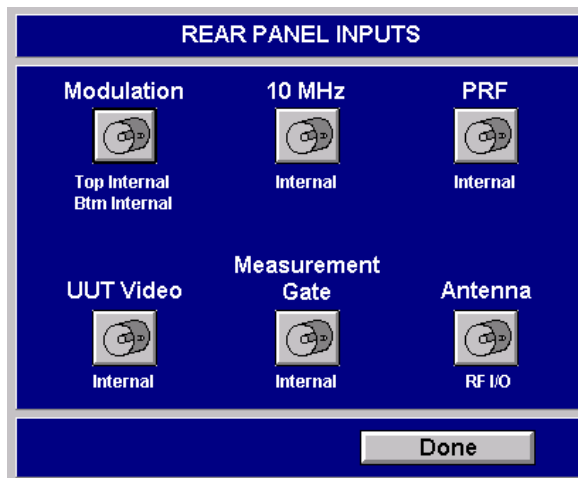

**CHAPTER ONE - GENERAL INFORMATION AND OPERATING INSTRUCTIONS**

**SECTION 5. OPERATING INSTRUCTIONS**

**5.4 DATALINK**

**5.4.3 CONTROL PANEL**

I: Averaging



AVERAGING SETUP MENU				
Measured Param	Samples	Minimum	Maximum	Current
Reply Jitter	1	-----	-----	-----
Reply Delay	1	-----	-----	-----
Pulse Spacing	1	-----	-----	-----
Pulse Width	1	-----	-----	-----
Frequency	16	-----	-----	-----
Power	16	-----	-----	-----
Reset		Done		

**5.4.4 BURST START**



**CHAPTER ONE - GENERAL INFORMATION AND OPERATING INSTRUCTIONS**

**SECTION 5. OPERATING INSTRUCTIONS**

**5.4 DATALINK**

**5.4.5 Interr/Replies**



Press

The Datalink Message Setup screen will appear.

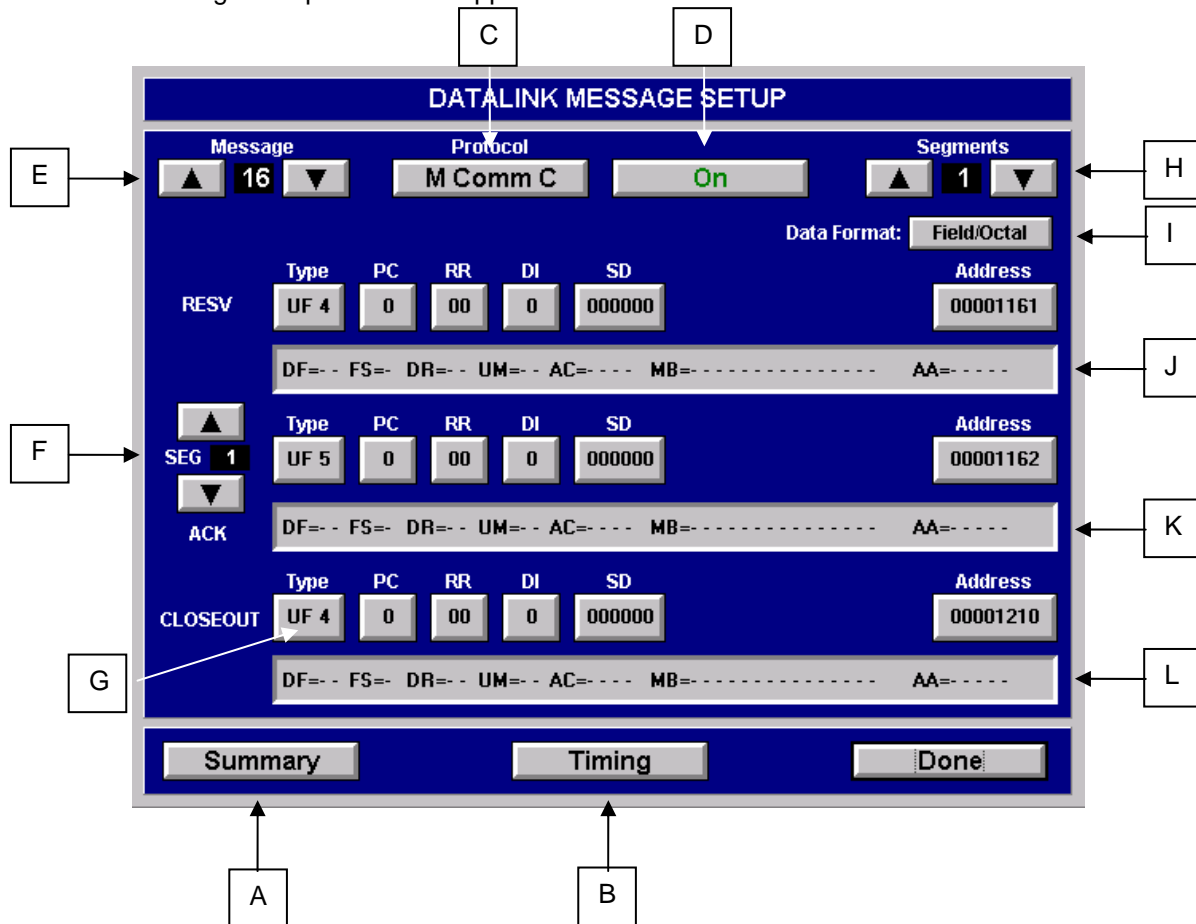

- A – Message Summary and Spacing
- B – Interrogation Timing
- C – Message Protocol
- D – Message State
- E – Message Select
- F – Segment Select

- G – Uplink Format Type
- H – Segments Per Message
- I – Data Format
- J – Reservation or Surveillance Reply Data
- K – Acknowledge or Segment Reply Data
- L – Closeout Reply Data

**CHAPTER ONE - GENERAL INFORMATION AND OPERATING INSTRUCTIONS**

**SECTION 5. OPERATING INSTRUCTIONS**

**5.4 DATALINK**

**5.4.5 Interr/Replies (Cont.)**

The Datalink Message Setup screen is used to configure all of the Datalink messages and interrogations. The reply data for each interrogation is displayed below the interrogation data. Sixteen message slots are available for Datalink messages. Selecting messages can be done through the use of up and down arrows located in the upper left corner of the screen. Message protocol is selected using the PROTOCOL button at the top of the screen. There are eight possible protocols supported by the Datalink instrument. For protocols that incorporate uplink or downlink segments, the instrument allows up to sixteen segments to be enabled. Using the up and down arrows located in the upper right corner of the screen allows the number of enabled segments to be entered. Selecting which segment to view or edit can be done using the up and down arrows located on the left side of the screen. Interrogation data can be entered in four different formats. Field formats subdivide the data entry and display into standard Mode S fields and can be entered in hexadecimal or octal numerical formats. Raw formats allow a string of data, not including UF or AP fields, to be entered in hexadecimal or octal numerical formats. The DATA FORMAT button can be used to select the desired format. For protocols that incorporate more than one interrogation, selecting the TIMING button allows interrogation timing to be configured.

**A: Summary**



The following screen will appear.

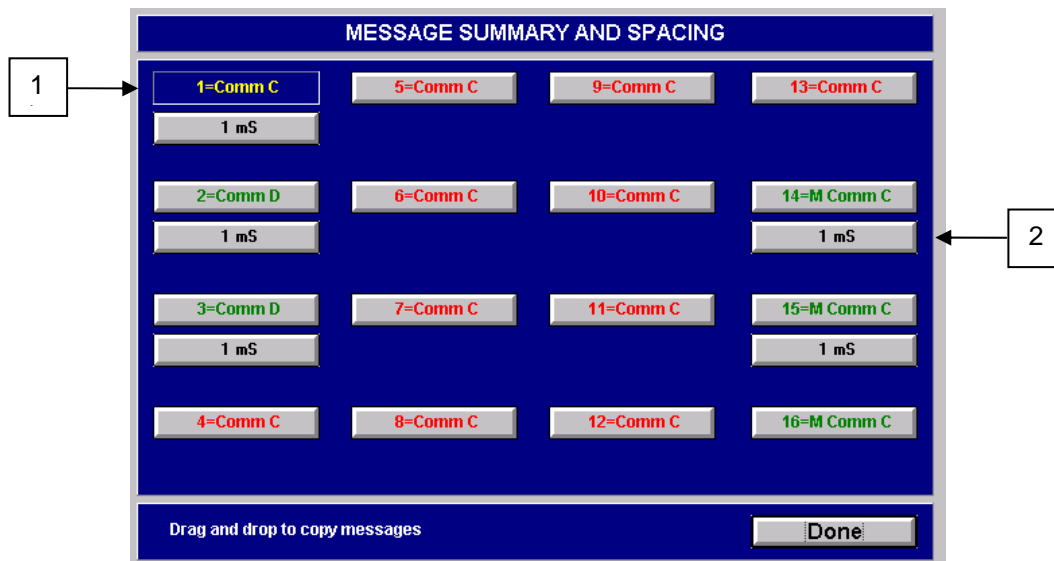



## 5.4 DATALINK

### 5.4.5 Interr/Replies (Cont.)

#### A: Summary (Cont.)

1. Yellow characters indicate message that contains the measured reply and cannot be turned off or copied over.
2. Message Spacing.

The Message Summary and Spacing screen is used to enable or disable Datalink messages, set the message spacing delay, and/or copy Datalink messages. Enabling and disabling of Datalink messages can be accomplished by selecting the desired message button. The color of the button text will indicate the current state of the message. For the message containing the measured reply, the button text will be yellow and the message may not be disabled or copied over. To set the spacing between messages a timing button has been provided under each enabled message. Selecting this allows the user to enter the time delay between Datalink messages from 100usec to 100sec. To copy Datalink messages press and hold the desired message to copy and drag to the desired message slot. A copy of the original message will be placed in the selected slot including message spacing information.

## 5.4 DATALINK

### 5.4.5 Interr/Replies

#### B: Timing

Press 

One of the following two screens will appear.

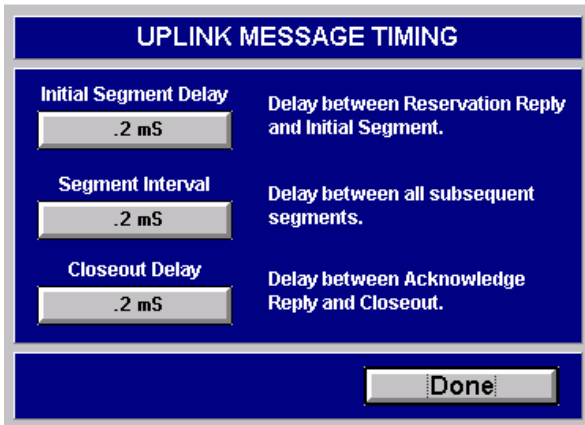

**UPLINK MESSAGE TIMING**

<b>Initial Segment Delay</b> [ .2 mS ]	Delay between Reservation Reply and Initial Segment.
<b>Segment Interval</b> [ .2 mS ]	Delay between all subsequent segments.
<b>Closeout Delay</b> [ .2 mS ]	Delay between Acknowledge Reply and Closeout.

[ Done ]

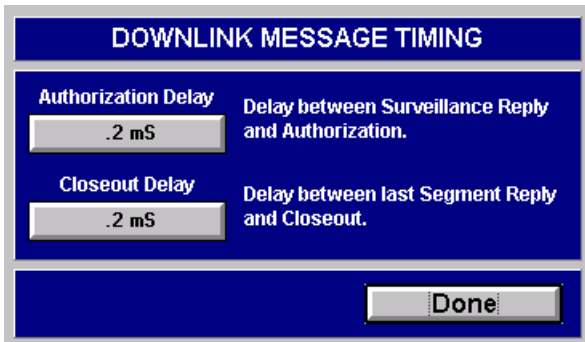

**DOWNLINK MESSAGE TIMING**

<b>Authorization Delay</b> [ .2 mS ]	Delay between Surveillance Reply and Authorization.
<b>Closeout Delay</b> [ .2 mS ]	Delay between last Segment Reply and Closeout.

[ Done ]

**CHAPTER ONE - GENERAL INFORMATION AND OPERATING INSTRUCTIONS**

**SECTION 5. OPERATING INSTRUCTIONS**

**5.4 DATALINK**

**5.4.5 Interr/Replies**

**C: Datalink Message Protocol**



The following screen will appear.

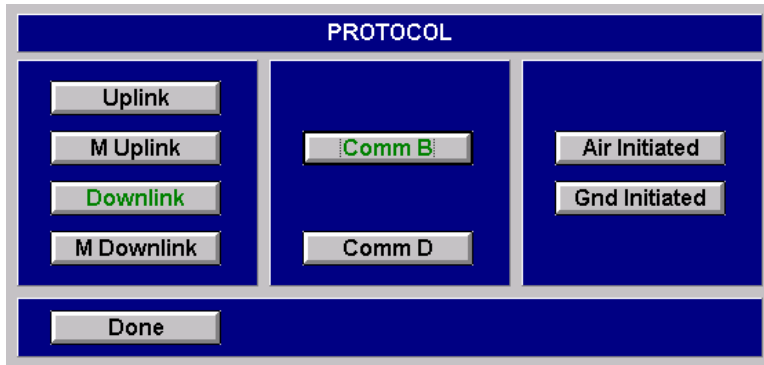

The Datalink Protocol screen is used to select one of eight possible Datalink message protocols. Four top-level protocols are presented when the screen opens and, after the initial selection is made, the screen expands to allow further options to be presented. If the protocol selected differs from the previous protocol, the instrument will reset the interrogation types and states (on or off) to the default condition.

**D: Message State Button**

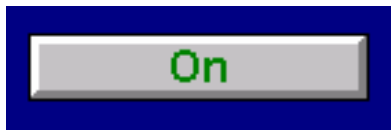

Yellow characters indicate that this message contains the measured reply and cannot be turned off.

**E: Message Select**



**CHAPTER ONE - GENERAL INFORMATION AND OPERATING INSTRUCTIONS**

**SECTION 5. OPERATING INSTRUCTIONS**

**5.4 DATALINK**

**5.4.5 Interr/Replies**

**F: Segment Select**



**G: Type**



Press

The following screen will appear.

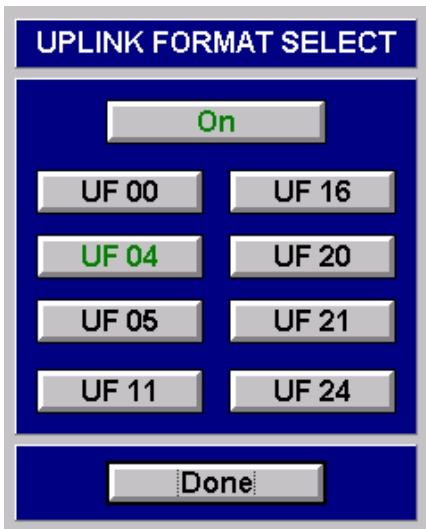

**CHAPTER ONE - GENERAL INFORMATION AND OPERATING INSTRUCTIONS**

**SECTION 5. OPERATING INSTRUCTIONS**

**5.4 DATALINK**

**5.4.5 Interr/Replies**

**H: Segments Per Message**



Gives number of segments in message.

**I: Data Format**



**J: Reservation or Surveillance Reply Data**

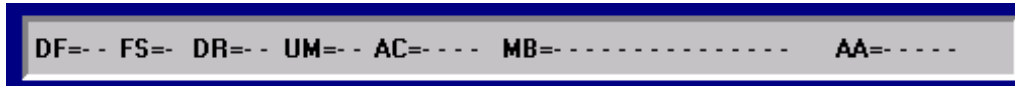

**K: Acknowledge or Segment Reply Data**

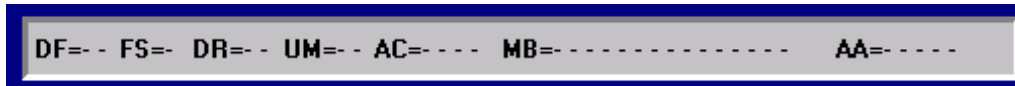

**L: Closeout Reply Data**

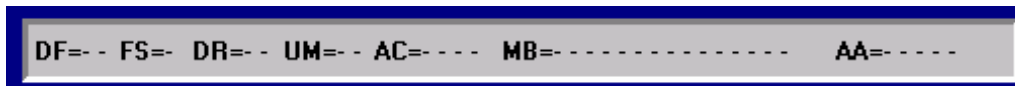

**CHAPTER ONE - GENERAL INFORMATION AND OPERATING INSTRUCTIONS**

**SECTION 5. OPERATING INSTRUCTIONS**

**5.5 SYSTEM SETUP AND CONTROL SCREEN**

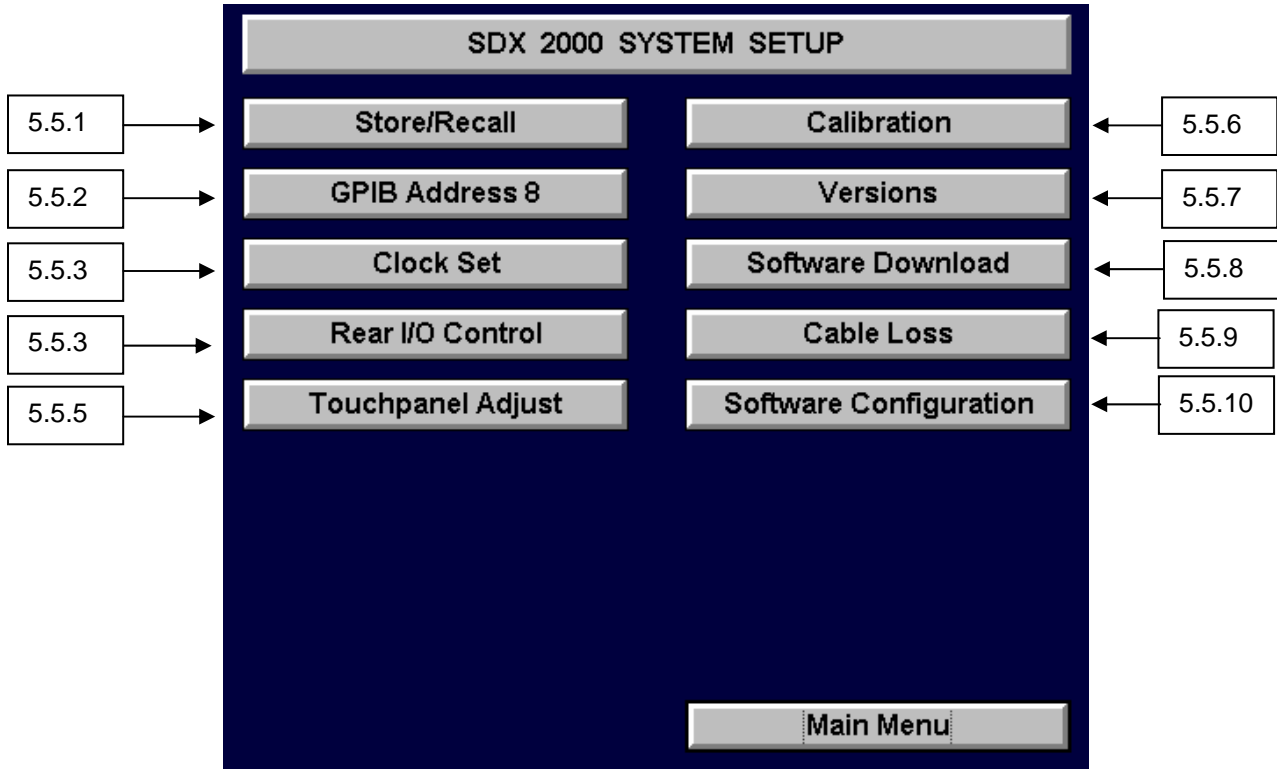

The System Setup allows for modification of parameters that are not specific to any single Instrument available on the SDX 2000.

**CHAPTER ONE - GENERAL INFORMATION AND OPERATING INSTRUCTIONS**

**SECTION 5. OPERATING INSTRUCTIONS**

**5.5 SYSTEM SETUP AND CONTROL SCREEN**

**5.5.1 SYSTEM PARAMETERS STORE/RECALL SCREEN**

Store/Recall is a function which allows the user to save any current configuration of the SDX 2000 and recall that configuration at a later time. The user is allowed to store up to 20 configurations in the SDX 2000 non-volatile memory or to a standard 1.44Mbyte floppy disk. The main control screen for Store/Recall can be accessed by selecting the "Store/Recall" button on the "SDX 2000 System Setup" screen.

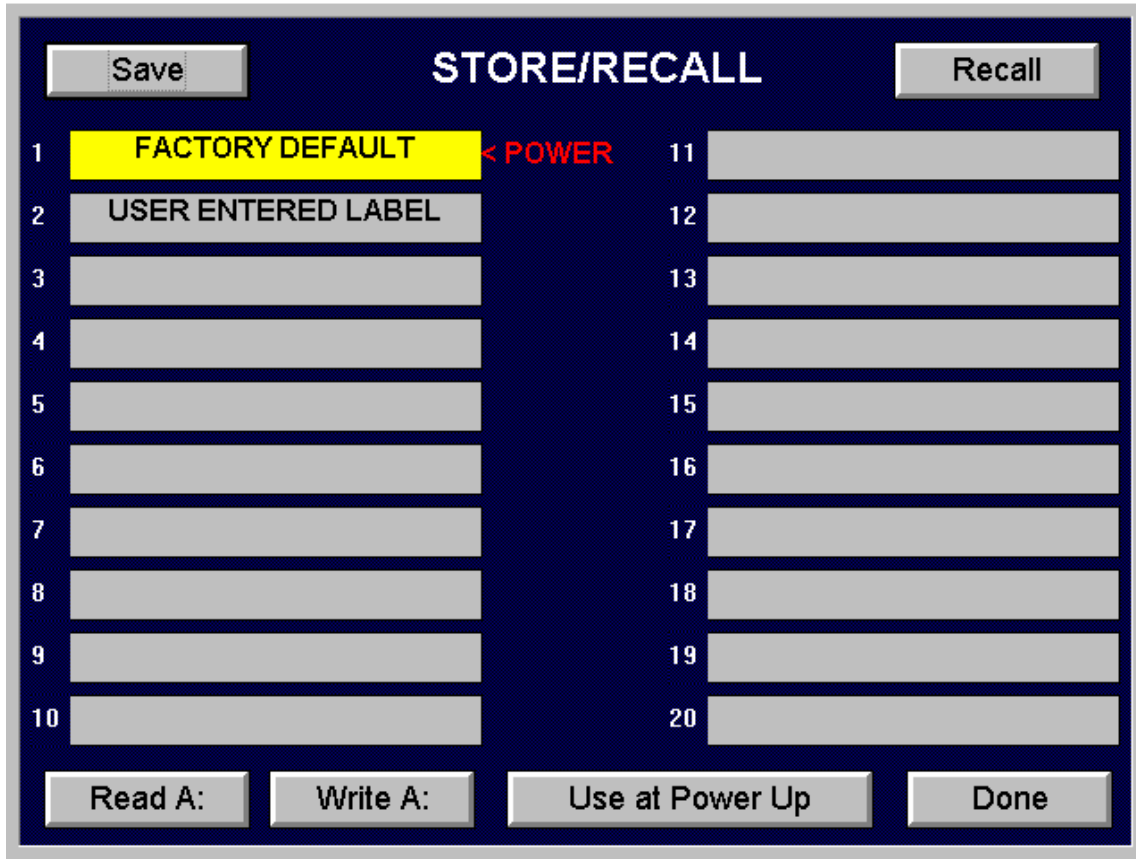

The screenshot shows a dark blue screen titled "STORE/RECALL". At the top left is a "Save" button and at the top right is a "Recall" button. The main area contains a list of 20 numbered slots. Slot 1 is highlighted in yellow and contains the text "FACTORY DEFAULT". To the right of slot 1, the word "POWER" is written in red. Slots 2 through 10 contain the text "USER ENTERED LABEL". Slots 11 through 20 are empty. At the bottom of the screen are four buttons: "Read A:", "Write A:", "Use at Power Up", and "Done".

Slot	Label	Slot	Label
1	FACTORY DEFAULT	11	
2	USER ENTERED LABEL	12	
3		13	
4		14	
5		15	
6		16	
7		17	
8		18	
9		19	
10		20	



## **CHAPTER ONE - GENERAL INFORMATION AND OPERATING INSTRUCTIONS**

### **SECTION 5. OPERATING INSTRUCTIONS**

#### **5.5 SYSTEM SETUP AND CONTROL SCREEN**

##### **5.5.1 SYSTEM PARAMETERS STORE/RECALL SCREEN**

###### **Storing a Configuration:**

To save a configuration, the user must select one of 19 available slots. The Factory Default configuration is stored in slot 1 and the user does not have access to overwrite this configuration.

The steps involved in creating a configuration and storing it to memory are as follows:

1. From the main screen, select the instrument that you wish to store a configuration for.
2. In the instrument, setup the SDX 2000 with the desired instrument settings.
3. Leave the instrument by selecting the "Main Menu" button in the lower right hand corner of the instrument.
4. If desired, configure the SDX 2000 system settings such as GPIB address or external antenna input, by using the "System Setup" menu.
5. Proceed to the "Store/Recall" screen by selecting the "Store/Recall" button on the "SDX 2000 System Setup" screen.
6. Select any slot to store the configuration in. When a slot is successfully selected, the background color will change from white to yellow.
7. Select the "Save" button in the upper left-hand corner of the "Store/Recall" screen.
8. Enter any label you wish to describe the stored setting and touch "Ok".
9. Wait for the SDX 2000 to successfully store the necessary files needed to perform a recall of that configuration.

###### **Recalling a Configuration:**

When the SDX 2000 performs a recall of a stored configuration, it will enter the instrument that the configuration was created for and recall the stored settings.

The steps involved in recalling an existing configuration are as follows:

1. Enter the "Store/Recall" screen by selecting the "Store/Recall" button on the "SDX 2000 System Setup" screen.
2. Select which configuration you wish to recall by touching the corresponding labeled slot. The background color of that labeled slot should change from white to yellow.
3. Touch the "Recall" button in the upper right hand corner of the "Store/Recall" screen.
4. Wait for the SDX 2000 to recall the configuration and transition to the recalled instrument.

###### **Setting the Power-Up Configuration:**

Store/Recall also allows the user to choose which configuration the SDX 2000 powers-up to. The user can select one of the available configurations for power-up by following the these steps:

1. Enter the "Store/Recall" screen by selecting the "Store/Recall" button on the "SDX 2000 System Setup" screen.
2. Select which configuration you wish the SDX 2000 to power-up to by touching the corresponding labeled slot. The background color of that labeled slot should change from white to yellow.
3. Select the "Use at Power Up" button at the bottom of the screen. A red arrow and "Power Up" label should appear in the middle of the screen pointing at the desired power-up configuration label.



## **CHAPTER ONE – GENERAL INFORMATION AND OPERATING INSTRUCTIONS**

### **SECTION 5. OPERATING INSTRUCTIONS**

#### **5.5 SYSTEM SETUP AND CONTROL SCREEN**

##### **5.5.1 SYSTEM PARAMETERS STORE/RECALL SCREEN cont.**

The power-up configuration is recalled when the SDX 2000 is turned on, however, the instrument corresponding to the power-up configuration is not displayed. The user must select the instrument from the main menu screen to realize the effects of the recall.

##### **Storing Configurations to the Floppy Drive:**

The SDX 2000 has the ability to save all the configurations entered by the user onto the floppy drive. This feature requires a blank 1.44Mbyte floppy disk and may take up to 10 minutes to perform depending on the number of stored configurations in the SDX 2000. The following steps explain how configurations can be saved onto a floppy disk:

1. Insert a 3.5 inch 1.44Mbyte floppy disk into the disk drive on the front panel of the SDX 2000.
2. Select the "Write A:" button in the lower left-hand corner of the "Store/Recall" screen.
3. Select "Ok".
4. Wait for the SDX 2000 to perform the necessary file transfer to the floppy disk drive. A bar graph will be displayed to inform the user of progress made during the transfer.

##### **Reading Configurations from the Floppy Drive:**

The "Read A:" button in the lower left corner of the "Store/Recall" screen allows the user to transfer configurations from a floppy disk to the SDX 2000. When a read is performed, all configurations currently residing in the SDX 2000 non-volatile memory are overwritten. The SDX 2000 will inform the user that stored configurations in memory will be lost and replaced with the configurations on the floppy disk. The following steps explain how configurations can be read from a floppy disk:

1. Insert a 3.5 inch floppy disk containing configuration files into the disk drive on the front panel of the SDX 2000. This disk was created by performing a "Write A:" described in the previous section.
2. Select the "Read A:" button in the lower left hand corner of the "Store/Recall" screen.
3. Select "Ok".
4. Wait for the SDX 2000 to perform the necessary file transfer from the floppy disk drive. A bar graph will be displayed to inform the user of progress made during the transfer.

##### **5.5.2 EXTERNAL COMMUNICATION SETUP**

To set the GPIB address for the SDX 2000, select the "EXTERNAL COMM" button from the "SYSTEM" screen. Select the GPIB address and select "DONE" to continue. The Default GPIB Address for the SDX 2000 is eight (8<sub>10</sub>).

##### **5.5.3 TIME SET CONTROL**

Select "HOURS" or "MINUTES" and use the up/down arrows to adjust the time. Select "DONE" to continue.

**CHAPTER ONE - GENERAL INFORMATION AND OPERATING INSTRUCTIONS**

**SECTION 5. OPERATING INSTRUCTIONS**

**5.5 SYSTEM SETUP AND CONTROL SCREEN**

**5.5.4 REAR I/O CONTROL SCREEN**

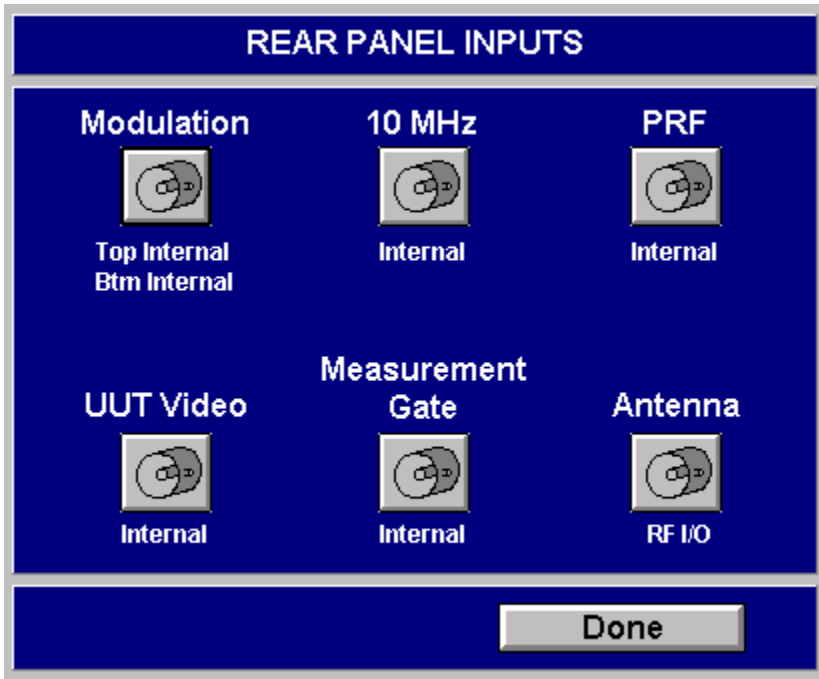

Pressing the REAR I/O CONTROL button displays this screen, allowing the user to optionally use external sources for various applications. Measurement Gate, Video Source, and Pulse Generation can be accomplished using this function.

**5.5.5 TOUCHPANEL ADJUSTMENT**

The touchpanel adjustment function allows the user to calibrate the accuracy of the touch grid used to select the buttons on the SDX 2000 touch screen.

This function is available through the System screen, then select the "TOUCHPANEL ADJUSTMENT" button. Follow the on screen instructions to complete the touchpanel adjustment.

**CHAPTER ONE - GENERAL INFORMATION AND OPERATING INSTRUCTIONS**

**SECTION 5. OPERATING INSTRUCTIONS**

**5.5 SYSTEM SETUP AND CONTROL SCREEN**

**5.5.6 CALIBRATION**

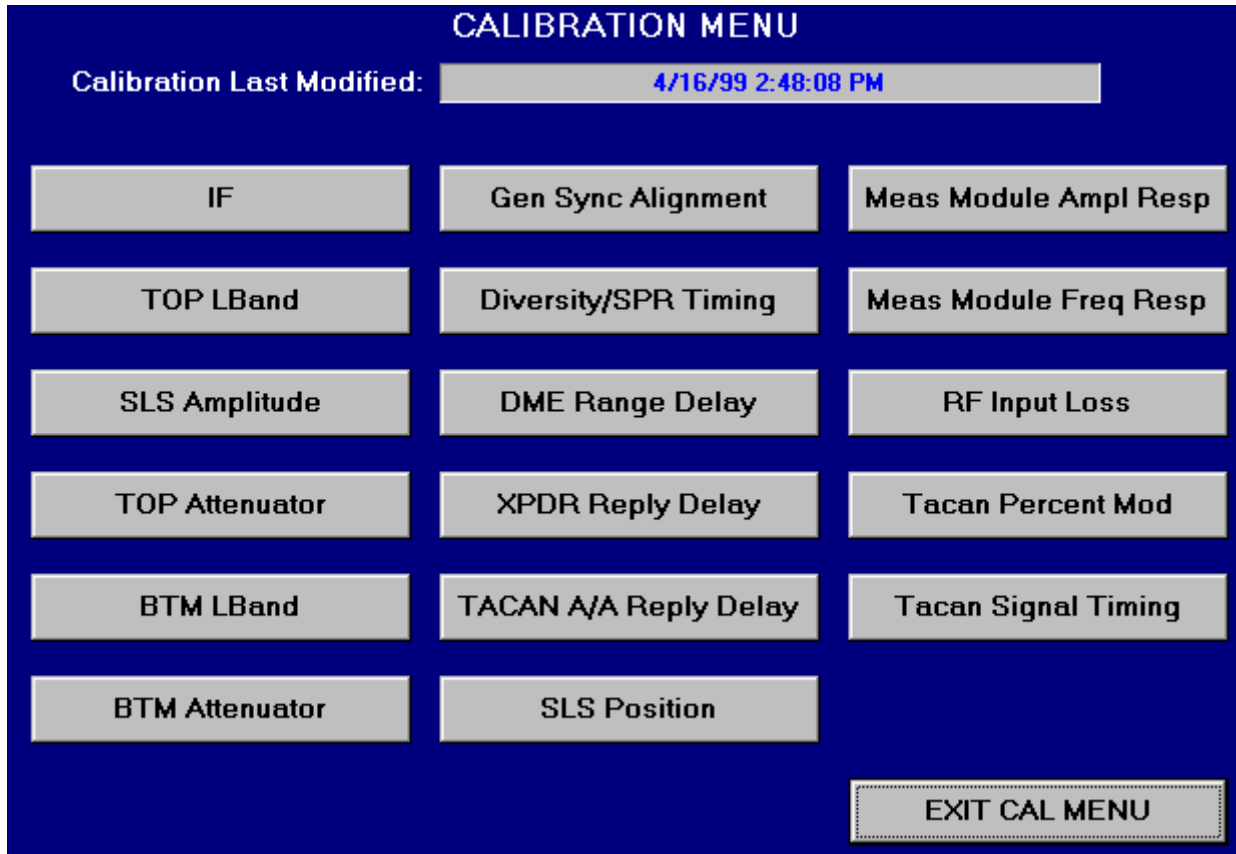

This is the SDX 2000 calibration screen.

To perform a calibration refer to the SDX 2000 Maintenance Manual (JPN: 06-0728-A0 for hard copy, E6-0728-A0 for CD-ROM), available separately from JcAIR.

**5.5.7 VERSION DISPLAY CONTROL**

This function is used to display the hardware, software, and GUI interface revision levels. The same screen is displayed on startup.

This function is available through the System screen, then select the "VERSIONS" button.

**CHAPTER ONE - GENERAL INFORMATION AND OPERATING INSTRUCTIONS**

**SECTION 5. OPERATING INSTRUCTIONS**

**5.5 SYSTEM SETUP AND CONTROL SCREEN**

**5.5.8 SOFTWARE LOAD**

This control button allows the user to update the SDX Software. Any of the individual hardware modules can be reprogrammed, as well as the user interface software.

**5.5.9 CABLE LOSS COMPENSATION CONTROL**

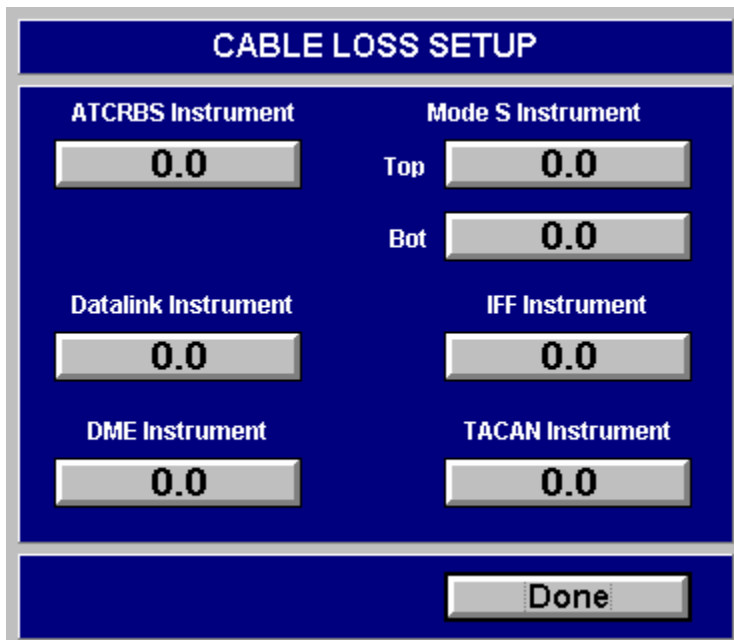

CABLE LOSS SETUP	
ATCRBS Instrument	Mode S Instrument
0.0	Top 0.0
	Bot 0.0
Datalink Instrument	IFF Instrument
0.0	0.0
DME Instrument	TACAN Instrument
0.0	0.0
Done	

The screen is displayed after selecting the "CABLE LOSS COMPENSATION" button from the System Screen. Enter the value of cable loss compensation in dB, selecting the desired value or the default value and select "DONE" to continue.

## **CHAPTER ONE - GENERAL INFORMATION AND OPERATING INSTRUCTIONS**

### **SECTION 5. OPERATING INSTRUCTIONS**

#### **5.5 SYSTEM SETUP AND CONTROL SCREEN**

##### **5.5.10 SOFTWARE CONFIGURATION**

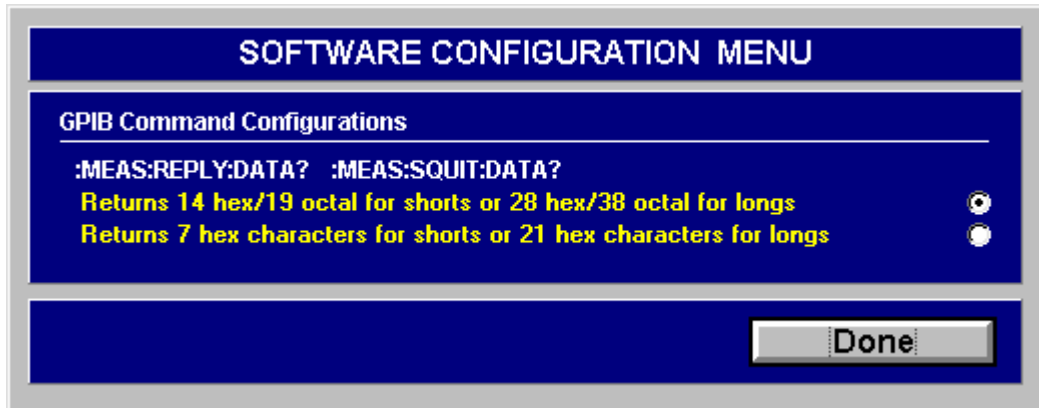

This screen is displayed after selecting the "SOFTWARE CONFIGURATION" button from the System Screen. All available software configuration options will be displayed through this screen.

#### **GPIB COMMAND CONFIGURATIONS:**

- MEAS:REPLY:DATA? :MEAS:SQUIT:DATA?, two options exist for command responses from the SDX-2000.

#### **OPTIONS:**

1. The response from the SDX-2000 will be a hexadecimal or octal formatted 56 bit (Mode S short reply) or 112 bit (Mode S long reply) response. ALL Mode S data bits are returned using this configuration. Therefore, for Mode S short replies and/or squitters, the SDX-2000 will return either 14 hexadecimal or 19 octal characters. For Mode S long replies and/or squitters, the SDX-2000 will return either 28 hexadecimal or 38 octal characters. The numeric format (hexadecimal/octal) can be selected through the "Data format" buttons or the GPIB command :INST:FORMAT.
2. The response from the SDX-2000 will be a hexadecimal formatted 27 bit (Mode S short data) or 83 bit (Mode S long data) response. Therefore, for Mode S short replies and/or squitters, the SDX-2000 will return 7 hexadecimal characters. For Mode S long replies and/or squitters, the SDX-2000 will return 21 hexadecimal characters. The DF and AP/PI fields are not returned using this configuration.

**CHAPTER ONE - GENERAL INFORMATION AND OPERATING INSTRUCTIONS**

**SECTION 5. OPERATING INSTRUCTIONS**

**5.6 MISCELLANEOUS SCREENS**

**5.6.1 NUMERIC ENTRY**



The Value Entry screen is displayed and used when the user must enter a value. This screen is used for all numerical user entries.

- 1 - These buttons represent the limits available to the user for that function. The four buttons in between are user programmable. To program the middle buttons, input a value through the keypad, then "DRAG" the value to the desired button.
- 2 - This button represent the default value for that function.
- 3 - The Slider bar is used to make course value adjustments.
- 4 - The Arrows are used to make fine adjustments.
- 5 - Select "DONE" to continue after entering a value.

**NOTE:** PRESSING A NUMBER MAY HAVE NO EFFECT IF THE RESULTING NUMBER IS OUTSIDE OF THE LIMITS FOR THAT FUNCTION.

**CHAPTER ONE GENERAL INFORMATION AND OPERATING INSTRUCTIONS**

**SECTION 5. OPERATING INSTRUCTIONS**

**5.6 MISCELLANEOUS SCREENS**

**5.6.2 TYPEWRITER ENTRY**



The Typewriter Keypad Entry screen is displayed when the SDX requires an alpha character input from the user. When the entry has been completed, select OK to continue.



**CHAPTER ONE – GENERAL INFORMATION AND OPERATING INSTRUCTIONS**

**SECTION 6. SPECIFICATIONS**

**TABLE OF CONTENTS**

1.0 Electrical Specifications, Standard System.....1

1.1 RF Output .....1

1.1.1 Output Frequency .....1

1.1.1.1 TOP Channel .....1

1.1.1.2 BTM Channel .....1

1.1.1.3 Ext Ref Input .....1

1.1.2 Output Amplitude (TOP and BTM channels).....1

1.1.3 Spectral Purity (TOP and BTM Channels).....1

1.2 TOP and BTM Port RF Characteristics .....1

1.3 Scope Sync Output.....2

1.4 Suppressor Pulse .....2

1.5 Prepulse Sync Output (Mode S Instrument).....3

1.6 Ext Sync Output.....3

1.7 Ext Sync Input .....3

1.8 ATCRBS Instrument .....3

1.8.1 Selectable Interrogations .....3

1.8.2 Interrogation Rates .....3

1.8.3 Pulse Characteristics .....3

1.8.3.1 Pulse Rise/Fall Time (all pulses) .....3

1.8.3.2 P1 and P3 Pulse Characteristics .....4

1.8.3.3 P2 (SLS) Pulse Characteristics .....4

1.8.3.4 Interference Pulse Characteristics .....5

1.8.4 ATCRBS Decoding .....5

1.8.4.1 Reply Delay Accept/Reject window .....5

1.8.4.2 F1/F2 (Framing Pulse) Spacing Limits .....5

1.8.4.3 ATCRBS Reply Decoder Window (relative to F1 of the reply) .....6

1.9 Mode S Instrument Option.....6

1.9.1 Interrogation Table.....6

1.9.2 Interrogation Rates .....6

1.9.3 Pulse Characteristics .....6

1.9.3.1 Pulse Rise/Fall Times (all pulses).....6

1.9.3.2 ATCRBS Interrogation Pulse Characteristics .....7

1.9.3.3 Mode S Pulse Characteristics.....7

1.9.3.4 Interference Pulse Characteristics.....8

1.9.3.5 DPSK Modulation Characteristics.....8

1.9.4 Mode S Decoding .....8

1.9.4.1 Reply Delay Accept/Reject Window .....8

1.9.4.2 Mode S Preamble Spacing Limits.....8

1.9.4.3 XPDR Reply Data Decoder Window (relative to F1/P1 of the reply) .....9

1.9.5 Double Mode .....9

1.9.6 Burst Mode .....9

1.9.7 Interlace Mode .....9

1.9.8 Diversity .....9





**CHAPTER ONE – GENERAL INFORMATION AND OPERATING INSTRUCTIONS**

**SECTION 6. SPECIFICATIONS**

**TABLE OF CONTENTS (CONT)**

1.10	Data Link Instrument (Mode S Instrument Option).....	9
1.10.1	Pulse Characteristics.....	9
1.10.2	Data Link Decoding.....	10
1.10.3	Burst Programming.....	10
1.10.4	Message Spacing.....	10
1.10.5	ELM Programming.....	10
1.10.6	Uplink ELM Timing.....	10
1.10.7	Downlink ELM Timing.....	11
1.11	DME Instrument.....	11
1.11.1	Pulse Characteristics.....	11
1.11.1.1	Pulse Shape.....	11
1.11.1.2	Pulse Spacing.....	11
1.11.2	Range Delay.....	11
1.11.3	Velocity.....	12
1.11.4	Acceleration.....	12
1.11.5	Squitter.....	12
1.11.6	Identification.....	12
1.11.7	Echo Pulse Pair.....	12
1.11.8	Reply Efficiency.....	13
1.11.9	RNAV Pulse.....	13
1.11.10	Serial Data Output (ARINC 568 DME).....	13
1.11.11	Serial Data Input (ARINC 568 DME).....	13
1.12	UUT Measurements.....	13
1.12.1	Frequency.....	13
1.12.2	Power.....	13
1.12.3	Transponder Reply Delay.....	14
1.12.4	Transponder Reply Delay Jitter.....	14
1.12.5	Transponder Percent Reply (TOP/BTM).....	14
1.12.6	Pulse Width/Spacing.....	14
1.12.7	Mode S Squitter Rate.....	15
1.12.8	DME Interrogation Rate.....	15
1.12.9	TOP/BTM Antenna RF Detector.....	15
1.12.10	TOP/BTM Gen RF Detector.....	15
1.13	Antenna Input (low level input for radiated power).....	15
1.14	Remote Interface.....	15
1.15	Parallel Port.....	15
1.16	RS-232 Port.....	15
1.17	Keyboard.....	15
1.18	Power Requirements.....	16



**CHAPTER ONE - GENERAL INFORMATION AND OPERATING INSTRUCTIONS**

**SECTION 6. SPECIFICATIONS**

**1.0 Electrical Specifications, Standard System**

**Certification of the accuracies will be performed at 23 +/- 5 deg C, assuming a standard factory calibration and a 30 minute warmup period.**

**1.1 RF Output**

**1.1.1 Output Frequency**

**1.1.1.1 TOP Channel**

Range	952 to 1223 MHz
Resolution	0.01 MHz
Accuracy	0.0003% (TCXO)
DME Auto Stepping	1 MHz steps at 0.1 to 10 Hz rate

**1.1.1.2 BTM Channel**

Fixed	1030 MHz with coherent/non-coherent control
Accuracy	0.0003% (TCXO)

**1.1.1.3 Ext. Ref. Input (J14)**

+7 to +13 dBm max., 50 ohm nominal, 10 MHz

**NOTE:** The RF I/O and Mode S Bottom Ports are referred to as the TOP and BTM ports respectively throughout this specification.

**1.1.2 Output Amplitude (TOP and BTM Channels)**

Range	0 to -110 dBm
Resolution	0.1 dB
Accuracy	
DME band (952 to 1223 MHz)	+/- 2 dB, 0 to -110 dBm
Transponder (1030 MHz)	+/- 0.5 dB, 0 to -80 dBm
	+/- 0.75 dB, -81 to -100 dBm
	+/- 1.25 dB, -101 to -110 dBm
TOP to BTM Tracking(1030 MHz)	+/- 0.5 dB @ -50 dBm
Frequency Response	+/- 0.3 dB, 952 to 1223 MHz
ATE Cable Loss (user programmable)	0 to 2.0 dB, 0.1 dB steps
Modulator ON/OFF Ratio	> 80 dB

**1.1.3 Spectral Purity (TOP and BTM Channels)**

Spurious	< -60 dBc (350 to 1800 MHz)
Residual FM	< 5 kHz p-p (0.3 to 3 kHz BW)
Phase Noise	< -90 dBc/Hz at 150 kHz from the carrier
DME Pulse Spectrum	< -47 dBc at +/- 800 Khz from the carrier
Harmonics	< -30 dBc

**1.2 TOP and BTM Port RF Characteristics**

Input Power Range	1W to 4000W (peak)
TOP to BTM Isolation	> 50 dB (1030 MHz)
Input Impedance	50 ohm
VSWR	< 1.2:1, 952 to 1223 MHz

**CHAPTER ONE - GENERAL INFORMATION AND OPERATING INSTRUCTIONS**

**SECTION 6. SPECIFICATIONS**

**1.3 Scope Sync Output (J7, J11)**

Level	TTL
Width	1.0 +/- 0.2 us
Position	
ATCRBS	1 us prior to P1 of interrogation or 1 us prior to F1 of reply.
Adjustable Range	-1 to +600 us (relative to P1 of interrogation)
Resolution	1.0 us
Accuracy	+/- 0.5 us
Mode S	1 us prior to P1 of selected transponder interrogation or 1 us prior to P1 of selected transponder reply.
Adjustable Range	-1 to +600 us (relative to P1 of interrogation)
Resolution	1.0 us
Accuracy	+/- 0.5 us
Data Link	0.5 us prior to P1 of selected interrogation or coincident to P1 of selected reply.
DME	2.5 us following leading edge of P1 of detected interrogation. 4.5 us prior to the first pulse of any selected output transmission.
Accuracy	+/- 0.5 us

**1.4 Suppressor Pulse (J10)**

Amplitude	
Range	3 to 27 V (into 2k ohm load)
Resolution	0.25 V
Accuracy	+/- 0.5 V (into 2k ohm load)
Width	33 +/- 2.0 us
ATCRBS, Mode S	
Range	2 to 50 us
Resolution	0.1 us
Accuracy	+/- 2.0 us (into 2k ohm load)
DME	33 +/- 2.0 us
Position	
ATCRBS	0.8 us prior to P3
Offset Range	+/- 10 us
Resolution	0.1 us
Accuracy	+/- 0.2 us
Mode S	0.8 us prior to SPR
Offset Range	+/- 10 us
Resolution	0.1 us
Accuracy	+/- 0.2 us
DME	3.5 +/- 0.3 us prior to P1 of range reply

**CHAPTER ONE - GENERAL INFORMATION AND OPERATING INSTRUCTIONS**

**SECTION 6. SPECIFICATIONS**



### 1.5 Prepulse Sync Output (J23)

Level	TTL
Width	1.0 +/- 0.2 us
Position	
Range	-260 to 0.0 us (relative to P1 of interrogation)
Resolution	1.0 us
Accuracy	+/- 0.5 us

### 1.6 Ext Sync Output (J18)

Level	TTL
Width	1.0 +/- 0.2 us
Position	coincident to P1 of interrogation
Deviation	+/- 10 us
Resolution	0.1 us
Accuracy	+/- 0.5 us

### 1.7 Ext Sync Input (J12, External PRF Input)

Input Level	TTL
Maximum Input Frequency	Instrument dependent specification. See interrogation rate limits for each SDX instrument for maximum allowable frequency input.

### 1.8 ATRBS Instrument

#### 1.8.1 Selectable Interrogations

Mode A  
Mode B  
Mode C  
Mode D  
Mode A/C

#### 1.8.2 Interrogation Rates

Range	0 to 10,000 Hz
Resolution	1 Hz
Accuracy	+/- 0.001% of setting

#### 1.8.3 Pulse Characteristics

##### 1.8.3.1 Pulse Rise/Fall Times (all pulses)

Rise Time	75 +/- 25 ns (10% to 90% amp points)
Fall Time	125 +/- 75 ns (90% to 10% amp points)



**CHAPTER ONE - GENERAL INFORMATION AND OPERATING INSTRUCTIONS**

**SECTION 6. SPECIFICATIONS**

**1.8.3.2 P1 and P3 Pulse Characteristics**

Amplitude (P3 relative to P1)	
Range	-15 to +5 dB, Off
Resolution	0.1 dB
Accuracy	+/- 0.5 dB
Width (P1 and P3)	
Offset Range	-0.6 to +1.15 us
Resolution	25 ns
Accuracy	+/- 25 ns
Position (P3 relative to P1)	
Mode 3/A	8.0
Mode B	17.0
Mode C	21.0
Mode D	25.0
Offset Range	+/- 1.95 us
Resolution	25 ns
Accuracy	+/- 10 ns

**1.8.3.3 P2 (SLS) Pulse Characteristics**

Amplitude (relative to P1)	
Range	-15 to +5 dB
Resolution	0.1 dB
Accuracy	+/- 0.5 dB
Width	
Offset Range	-0.6 to +1.15 us
Resolution	25 ns
Accuracy	+/- 25 ns
Position (relative to P1)	
Offset Range	+/- 1.95 us
Resolution	25 ns
Accuracy	+/- 10 ns

**CHAPTER ONE - GENERAL INFORMATION AND OPERATING INSTRUCTIONS**

**SECTION 6. SPECIFICATIONS**

**1.8.3.4 Interference Pulse Characteristics (1 or 2 pulses)**

Amplitude (relative to P1)	
Range	-15 to +5 dB
Resolution	0.1 dB
Accuracy	+/- 0.5 dB; from -15 to + 3 dB when overlapping another pulse
Width	
Range	0.2 to 7.0 us
Resolution	25 ns
Accuracy	+/- 25 ns
Position (1st pulse relative to P1)	
Offset Range	-15 to +400 us
Resolution	25 ns
Accuracy	+/- 10 ns
Interference Pulse Spacing (dual pulse interference mode)	
Range	0 to the end of the 1st pulse range (max 2nd pulse position = 400 us - 1st pulse position)
Resolution	25 ns
Accuracy	+/- 10 ns

**1.8.4 ATCRBS Decoding**

**1.8.4.1 Reply Delay Accept/Reject Window**

Accept Window	2.0 us window centered 3.0 us from the leading edge of P3 of the interrogation
Accuracy	+/- 25 ns

**NOTE:** Replies which do not fall within the reply delay window will be counted as no-replies for percent reply calculation.

**1.8.4.2 F1/F2 (Framing Pulse) Spacing Limits**

Spacing Limits	20.3 +/- 0.125 us
Accuracy	+/- 25 ns

**NOTE:** Replies which do not fall within the F1/F2 spacing limits will be counted as no-replies for percent reply calculation.



**CHAPTER ONE - GENERAL INFORMATION AND OPERATING INSTRUCTIONS**

**SECTION 6. SPECIFICATIONS**

**1.8.4.3 ATCRBS Reply Decoder Window (relative to F1 of the reply)**

Accept Window	250 ns centered at 1.45 us increments from F1 leading edge
Accuracy	+/- 25 ns

**1.9 Mode S Instrument Option**

**1.9.1 Interrogation Table**

Table Length	32 interrogations
Selectable Interrogations	Mode A Mode C ACS-A ACS-C ACL-A ACL-C Mode S (long and short)

**1.9.2 Interrogation Rates**

Range	
Normal Mode	0 to 400 Hz
Double Mode	0 to 400 Hz
Burst Mode	
Burst Count of 1 to 120	0 to 2500 Hz
Burst Count of 121 to 2000	0 to 400 Hz with Mode S interrogations 0 to 2500 Hz, ATCRBS interrogations only
Interlace Mode	0 to 400 Hz
Resolution	1 Hz
Accuracy	0.001% of setting

**1.9.3 Pulse Characteristics**

**1.9.3.1 Pulse Rise/Fall Times (all pulses)**

same as ATCRBS instrument



**CHAPTER ONE - GENERAL INFORMATION AND OPERATING INSTRUCTIONS**

**SECTION 6. SPECIFICATIONS**

**1.9.3.2 ATCRBS Interrogation Pulse Characteristics**

P4 (All-Call) Pulse Characteristics

Amplitude (relative to P1)	
Range	-15 to +5 dB
Resolution	0.1 dB
Accuracy	+/- 0.5 dB
Width	
	0.8 us, All-Call Short
	1.6 us, All-Call Long
Offset Range	
Offset Range	-0.6 to +1.15 us
Resolution	25 ns
Accuracy	+/- 25 ns
Position (relative to P3)	
Position (relative to P3)	2.0 us
Offset Range	+/- 1.95 us
Resolution	25 ns
Accuracy	+/- 10 ns

**NOTE:** All other ATCRBS pulse characteristics same as ATCRBS Instrument.

**1.9.3.3 Mode S Pulse Characteristics**

P1 and P2 Pulse Characteristics

Amplitude (P2 relative to P1)	
Range	-15 to +5 dB
Resolution	0.1 dB
Accuracy	+/- 0.5 dB
Width (P1 and P2)	
Width (P1 and P2)	0.8 us
Offset Range	
Offset Range	-0.6 to +1.15 us
Resolution	25 ns
Accuracy	+/- 25 ns
Position (P2 relative to P1)	
Position (P2 relative to P1)	2.0 us
Offset Range	+/- 1.95 us
Resolution	25 ns steps
Accuracy	+/- 10 ns

P6 Pulse Characteristics

Amplitude (relative to P1)	
Range	-15 to +5 dB
Resolution	0.1 dB
Accuracy	+/- 0.5 dB
Width	
	16.25 us, Mode S Short
	30.25 us, Mode S Long
Offset Range	
Offset Range	+/- 2.0 us
Resolution	25 ns
Accuracy	+/- 25 ns
Position (relative to P1)	
Position (relative to P1)	3.5 us
Offset Range	+/- 1.95 us
Resolution	25 ns
Accuracy	+/- 10 ns





**CHAPTER ONE - GENERAL INFORMATION AND OPERATING INSTRUCTIONS**

**SECTION 6. SPECIFICATIONS**

P5 (SLS) Pulse Characteristics	
Amplitude (relative to P1)	
Range	-15 to +5 dB
Resolution	0.1 dB
Accuracy	+/- 0.5 dB from -15 to + 3 dB
Width	
Offset Range	-0.6 to +1.15 us
Resolution	25 ns
Accuracy	+/- 25 ns
Position (relative to P1)	
Offset Range	+/- 1.95 us
Resolution	25 ns
Accuracy	+/- 10 ns

**1.9.3.4 Interference Pulse Characteristics**

same as ATRCBS Instrument

**1.9.3.5 DPSK Modulation Characteristics**

Phase Reversal	
Transition Time	< 80 ns (10 to 170 deg)
SPR Position	
Offset Range	+/- 1.0 us
Resolution	25 ns
Accuracy	+/- 10 ns
Chip-to-Chip Spacing	250 +/- 10 ns

**1.9.4 Mode S Decoding**

**1.9.4.1 Reply Delay Accept/Reject Window**

ATCRBS	same as ATRCBS instrument
Mode S	
Accept Window	4.0 us window centered 128.0 us from the interrogation SPR
Accuracy	+/- 25 ns

**NOTE:** Replies which do not fall within the reply delay window will be counted as no-replies for percent reply calculation.

**1.9.4.2 Mode S Preamble Spacing Limits**

Spacing Limits	
P1 to P2	1.0 +/- 0.075 us
P1 to P3	3.5 +/- 0.075 us
P1 to P4	4.5 +/- 0.075 us
Accuracy	+/- 25 ns

**NOTE:** Replies which do not fall within the preamble spacing limits will be counted as no-replies for percent reply calculation. See the ATRCBS instrument for F1/F2 spacing limits.

**CHAPTER ONE - GENERAL INFORMATION AND OPERATING INSTRUCTIONS**

**SECTION 6. SPECIFICATIONS**

**1.9.4.3 XPDR Reply Data Decoder Window (relative to F1/P1 of the reply)**

ATCRBS	same as ATCRBS instrument.
Mode S	
Accept Window	150 ns window centered at the middle of each data bit cell
Accuracy	+/- 25 ns

**1.9.5 Double Mode**

Spacing (P1 of 1st interrogation to P1 of 2nd interrogation)	
Range	0 to 400 us
Resolution	1.0 us
Accuracy	+/- 25 ns

**1.9.6 Burst Mode**

Burst Cycle Spacing (end of previous cycle to start of new cycle)	
Range	0.1 to 20 s
Resolution	0.1 s
Accuracy	+/- 30 ms
Squitter Delay Count	1 to 20 squitters (Burst occurs < 10 ms following completion of Mode S Squitter detection)

**NOTE:** See Mode S Interrogation Rates for burst rate specifications.

**1.9.7 Interlace Mode**

Interlaced Ratio (1st to 2nd interrogation ratio)	
Range	0 to 1000
Resolution	1

**NOTE:** See Mode S Interrogation Rates for interlace rate specifications.

**1.9.8 Diversity**

Timing (P1 TOP to P1 BTM)	
Range	+/- 0.95 us
Resolution	25 ns
Accuracy	+/- 10 ns
Amplitude (TOP/BTM Tracking)	+/- 0.5 dB @ -50 dBm, 1030 MHz

**NOTE:** See 1.1.2 Output Amplitude for additional amplitude specifications.

**1.10 Data Link Instrument (Mode S Instrument Option)**

**1.10.1 Pulse Characteristics**

same as Mode S Instrument

**NOTE:** SLS, Interference, Pulse Amplitude, and Diversity functions are disabled in the Data Link Instrument.

**CHAPTER ONE - GENERAL INFORMATION AND OPERATING INSTRUCTIONS**

**SECTION 6. SPECIFICATIONS**

**1.10.2 Data Link Decoding**

Downlink Segment Spacing Accept/Reject Window	
Accept Window	4.0 us window centered 136.0 from P1 of the preceding segment
Accuracy	+/- 25 ns

**NOTE:** For all other decoding specifications see the Mode S instrument.

**1.10.3 Burst Programming**

Modes	continuous, single, or burst on squitter
Messages Per Burst	1 to 16
Burst Spacing	
Range	1 to 130 s (spacing between first interrogations of consecutive bursts)
Resolution	0.1 s
Accuracy	+/- 0.1 s
Burst On Squitter	1 to 20 squitters (burst output < 10 ms following squitter detection.)

**1.10.4 Message Spacing** (period between last interrogation of message and first interrogation of next message)

Range	400 us to 100 s
Resolution	100 us
Accuracy	+/- 1.0 us + 0.003% of setting

**1.10.5 ELM Programming**

Segments Per ELM	
Uplink	1 to 16
Downlink	1 to 16

**1.10.6 Uplink ELM Timing**

Initial Segment Delay (P1 of reservation reply to P1 of initial uplink segment)	
Range	125 us to 63 ms
Resolution	1.0 us
Accuracy	+/- 1.0 us + 0.003% of setting
Segment Interval (P1 to P1 spacing between adjacent uplink segments)	
Range	60 us to 63 ms
Resolution	1.0 us
Accuracy	100 ns + 0.003% of setting
Closeout Delay (P1 of acknowledge to P1 of closeout interrogation)	
Range	125 us to 63 ms
Resolution	1.0 us
Accuracy	+/- 1.0 us + 0.003% of setting

**CHAPTER ONE - GENERAL INFORMATION AND OPERATING INSTRUCTIONS**

**SECTION 6. SPECIFICATIONS**

**1.10.7 Downlink ELM Timing**

Authorization Delay (P1 of reservation reply to P1 of authorization)	
Range	125 us to 63 ms
Resolution	1.0 us
Accuracy	+/- 1.0 us + 0.003% of setting
Closeout Delay (P1 of last downlink segment to P1 of closeout interrogation)	
Range	125 us to 63 ms
Resolution	1.0 us
Accuracy	+/- 2.0 us + 0.003% of setting

**1.11 DME Instrument**

**1.11.1 Pulse Characteristics**

**1.11.1.1 Pulse Shape**

Rise Time (10% to 90%)	< 3.0 us
Fall Time (10% to 90%)	< 3.0 us
Width (50% to 50%)	
Range	3.5 us to 9.0 us
Resolution	100 ns
Accuracy	+/- 0.5 us

**1.11.1.2 Pulse Spacing**

P2 Position (ref to P1)	12.0 us, X Mode 30.0 us, Y Mode
Offset Range	+/- 7.9 us
Resolution	0.1 us
Accuracy	+/- 0.1 us

**1.11.2 Range Delay**

Range	-1 to 400.00 nmi (P1 of Interr. to P1 of reply.)
Resolution	0.01 nmi
Accuracy	+/- 0.02 nmi +/- 0.0003% of simulated range



**CHAPTER ONE - GENERAL INFORMATION AND OPERATING INSTRUCTIONS**

**SECTION 6. SPECIFICATIONS**

**1.11.3 Velocity**

Range	0 to 10,000 kts
Resolution	1 kts
Accuracy	+/- 0.001%

**1.11.4 Acceleration**

Range	0 to 400 ft/s/s
Selectable Step	1 ft/s/s
Accuracy	+/- 0.05% of setting

**1.11.5 Squitter**

Range	10 to 8,000 Hz
Selectable Step	1 Hz
Accuracy	10 Hz or 2%, whichever is greater
Distribution	compliant with ARINC 568 @ 2700 Hz

**1.11.6 Identification**

Code Rep. Rate	30 s
Range	10 to 65 s
Resolution	0.1 s
Accuracy	0.1 s
Pulse Pair Rate	1350 Hz +/- 0.02%
Equalizing Pulse Pair	100 +/- 0.1 us after ident pulse pair
ASCII Code	
alphanumeric characters	1 to 8
Dot Time	0.05 to 0.25 s
Dash Time	0.15 to 0.75 s
Space Time	0.05 to 0.25 s
Character Space	0.15 to 0.75 s
Resolution (all code timing)	.01 s
Accuracy (all code timing)	0.001 s

**1.11.7 Echo Pulse Pair**

Amplitude (relative to reply)	
Range	-15 to +5 dB
Resolution	0.1 dB
Accuracy	+/- 0.5 dB
Position	30 +/- .02 nmi

**CHAPTER ONE - GENERAL INFORMATION AND OPERATING INSTRUCTIONS**

**SECTION 6. SPECIFICATIONS**

**1.11.8 Reply Efficiency**

Range	0 to 100%
Resolution	1%
Accuracy	+/- 0.5%
Distribution	Pseudo Random

**1.11.9 RNAV Pulse (J16)**

Level	0 +/- 1.0 V (logic 0) 12 +/- 1.0 V (logic 1)
Pulse Spacing	50 +/- 0.247 us (0.02 nmi) , X Channel, @ 0 nmi 56 +/- 0.247 us (0.02 nmi), Y Channel, @ 0 nmi
Pulse Width	7 +/- 1 us

**NOTE:** P1 is output at the interrogation, P2 at the reply.

**1.11.10 Serial Data Output (ARINC 568 DME, J32)**

Level	0 +/- 1.0 V (logic 0) 12 +/- 1.0 V (logic 1)
Clock Frequency	11.0 +/- 0.1 kHz
Range Rate Pulse Width	7.0 +/- 1.0 us

**1.11.11 Serial Data Input (ARINC 568 DME, J33)**

Input Levels	< 1.0 V (Logic 0) > 10.0 V (Logic 1)
Input Impedance	2000 ohm

**1.12 UUT Measurements**

**1.12.1 Frequency**

Transponder	
Range	1085 to 1095 MHz
Resolution	10 kHz
Accuracy	+/- 50 kHz
DME	
Range	1020 to 1155 MHz
Resolution	10 kHz
Accuracy	+/- 20 kHz

**1.12.2 Power**

Frequency Band	
Transponder	1085 to 1095 MHz
DME	1020 to 1155 MHz
Range	30 to 66 dBm
Resolution	0.1 dB
Accuracy	+/- 0.5 dB

**CHAPTER ONE - GENERAL INFORMATION AND OPERATING INSTRUCTIONS**  
**SECTION 6. SPECIFICATIONS**

**1.12.3 Transponder Reply Delay**

Range	
ATCRBS	2.0 to 4.0 us following P3 of the interrogation
Mode S	126.0 to 130.0 us following SPR of the interrogation or P4 if the interrogation is an ATCRBS/Mode S All- Call interrogation
Data Link	
Reply Delay	same as Mode S
Segment Interval (Comm-D)	134.0 to 138.0 us following P1 of the preceding segment
Resolution	12.5 ns
Accuracy	+/- 50 ns

**1.12.4 Transponder Reply Delay Jitter**

Range	0 to 500 ns
Resolution	12.5 ns
Accuracy	+/- 25 ns

**1.12.5 Transponder Percent Reply (TOP / BTM)**

Range	0.0 to 100.0%
Resolution	0.1%
Accuracy	+/- 0.05% (round-off error of displayed value)

**1.12.6 Pulse Width/Spacing**

Transponder	
Pulse Width (any reply pulse)	
Range	0.25 to 0.75 us
Resolution	12.5 ns
Accuracy	+/- 25ns
Pulse Spacing	ATCRBS - F1 to any other reply pulse, Mode-S - P1 to any other reply pulse
Range	
ATCRBS	+/- 150 ns from nominal
Mode S	+/- 100 ns from nominal
Resolution	12.5 ns
Accuracy	+/- 25 ns
DME	
Pulse Width (P1 or P2)	
Range	2.5 to 4.5 us
Resolution	12.5 ns
Accuracy	+/- 125 ns
Pulse Position (relative to P1)	
Range	8.0 to 40 us
Resolution	12.5 ns
Accuracy	+/- 50 ns

**CHAPTER ONE - GENERAL INFORMATION AND OPERATING INSTRUCTIONS**

**SECTION 6. SPECIFICATIONS**

**1.12.7 Mode S Squitter Rate**

Range	
Airborne Position	0.01 to 2.0 sec
Surface Position	0.01 to 15.0 sec
A/C Identification	0.01 to 25.0 sec
Airborne Velocity	0.01 to 2.0 sec
Event Driven	0.01 to 25.0 sec
Acquisition	0.01 to 4.0 sec
Resolution	10 ms
Accuracy	+/- 10 ms, +/- 0.001%

**1.12.8 DME Interrogation Rate**

Range	0 to 10,000 Hz
Resolution	1 Hz
Accuracy	+/- 0.001% +/- 1 count

**1.12.9 TOP/BTM Antenna RF Detector (J5, J6)**

Output Impedance	50 ohm, typical
Detector Response Time (Typical)	

<u>Stimulus</u>	<u>Typical Detector Response</u>
Step Function	45 ns
50 ns rise/fall time	57 ns
75 ns rise/fall time	81 ns
125 ns rise/fall time	126 ns

**1.12.10 TOP/BTM Gen RF Detector (J3, J4)**

same as TOP/BTM Antenna RF Detector

**1.13 Antenna Input (low level rf input, J8)**

Input Level	-10 dBm to +10 dBm
Frequency range	1025 to 1150 MHz
Input Impedance	50 ohm, VSWR < 2:1

**1.14 Remote Interface (J35)**

IEEE 488.1 and 488.2 compatible	
Response time	80 ms typical

**1.15 Parallel Port (J37)**

This connector provides a parallel printer port interface.

**1.16 RS-232 Port (J36)**

This connector provides a Microsoft Version 9.01 mouse drive.

**1.17 Keyboard (J38)**

A keyboard may be attached to this connector for printing the calfile.txt.



**CHAPTER ONE - GENERAL INFORMATION AND OPERATING INSTRUCTIONS**

**SECTION 6. SPECIFICATIONS**

**1.18 Power Requirements**

Alternating Current

115/230 V  $\pm 10\%$   
50-400 Hz 2,5 A 175 W



Line Fuse:



The equipment uses two type "F" 3,15 A, 250 V fuses (1\F1 and 1\F2).

To replace these fuses (located on the rear panel within the appliance inlet):

1. Disconnect the appliance coupler.
2. With a small screwdriver or similar tool open the voltage selection door.
3. With a small screwdriver or similar tool remove the voltage selector/fuse holder.
4. Replace fuses with kind stated above.
5. Replace voltage selector/fuse holder into appliance inlet.
6. Close the door. (Voltage selected is visible in window of door.)

Other Fuse:



The equipment has a surface mount device fuse on the inverter board assembly (1\2\A13). If 1\2\A13 is JPN 15-0631-00 (XENTEK Model LS460) the fuse (1\2\A13F1) is Littlefuse P/N 451001 rated 125 V, 1 A, very fast-acting. If 1\2\A13 is JPN 15-0631-10 (TAIYO YUDEN Model LS520) the fuse (1\2\A13F1) is DAITO TSUSHIN P/N KE20 rated 2 A.

Ac Power Source:

The equipment is intended to operate from an ac power source that will not apply more than 253 V ac between the supply conductors or between either supply conductor and ground. A protective ground connection by way of the grounding conductor in the power cord is required for safe operation.

Environmental Specifications:

The following environmental specifications are as follows:

Warm Up Time

30 min.

Operating Temperature

5 °C to 40 °C.

Relative Humidity (Non-Condensing)

Maximum relative humidity 80% for temperatures up to 31 °C decreasing linearly to 50% relative humidity at 40 °C.

Altitude

Operating: 2 000 m maximum.

Size:

27,2 cm H x 44,8 cm W x 52 cm D  
(10.7" H x 17.65" W x 20.5" D)

**CHAPTER ONE - GENERAL INFORMATION AND OPERATING INSTRUCTIONS****SECTION 6. SPECIFICATIONS****1.18 Power Requirements (Continued)**

Mass (Weight):	23 kg (51 lbs.)
Ventilation Requirements:	Recommended minimum clearance for front and rear panels is 10,16 cm (4").
IEC Overvoltage Category:	II
Pollution Degree:	1
Equipment Meets These Listed Standards:	EN 61010-1 (IEC 61010-1) EN 61326-1 Controlled EM EN 61000-3-2 EN 55011 Class A FCC

To maintain EMC the following connections must be adhered to:

1. All cables connecting to BNC terminals (connectors) on the front panel (5) and rear panel (24) shall use M17/84-RG223 double shielded coaxial cable, or equivalent, properly terminated to BNC connectors and no longer than 3 m in length.
2. Cables used to connect to the two N terminals (connectors) on the front panel shall use M17/75-RG214 double shielded coaxial cable, or equivalent, properly terminated to N connectors and no longer than 3 m in length.
3. Cables used to connect to the three DSUB 25 terminals (connectors) on the rear panel shall use double shielded cable with the shields terminated 360° to the connectors. It is suggested to use L-com model CS2N25MF-10 or equivalent.
4. Cable used to connect to the DSUB 9 terminal (connector) on the rear panel shall use double shielded cable with the shields terminated 360° to the connectors. It is suggested to use L-com model CS2N9MF-10 or equivalent.
5. Cable used to connect to the IEEE 488 REMOTE I/O terminal (connector) shall use a braided shield cable with the shield properly terminated 360° to the connectors. It is recommended that a HP type 10833X braided shield cable, or equivalent, be used.



**CHAPTER ONE - GENERAL INFORMATION AND OPERATING INSTRUCTIONS**

**SECTION 6. SPECIFICATIONS**

**1.18 Power Requirements (Continued)**

Mains Input Selection:

Selection of mains input range is done at the appliance inlet (1J43) on the back panel. Either 115 V ac  $\pm$  10% or 230 V ac  $\pm$  10% may be selected. Both selections will accept 50-400 Hz.

To change the voltage selection:

1. Disconnect the appliance coupler.
2. With a screw driver or similar tool open the front cover.
3. With a screw driver or similar tool remove the voltage selection/fuse holder subassembly.
4. Rotate this subassembly to the voltage wanted.
5. Reinsert the subassembly.
6. When the front cover is closed the voltage selected will appear in the window.

**SPECIFICATIONS AND FEATURES SUBJECT TO CHANGE WITHOUT NOTICE**



SDX 2000 Operation Manual

**CHAPTER ONE - GENERAL INFORMATION AND OPERATING INSTRUCTIONS**

**SECTION 7. UNITS AND ACCESSORIES**

**UNITS AND ACCESSORIES SUPPLIED**

SDX 2000  
POWER CORD

JPN: 01-0728-XX



**CHAPTER ONE - GENERAL INFORMATION AND OPERATING INSTRUCTIONS**

**SECTION 8. SHIPPING AND STORAGE**

The original shipping material and container should be retained for future use in shipping or storage. If the original container or packing material is lost, use material that will provide adequate protection when shipping or storing the equipment. If any connector covers are provided, replace the covers before shipping the unit.

**CHAPTER TWO - MAINTENANCE**

**SECTION 1. SERVICING**

**CAUTION:**     TURN POWER OFF BEFORE DISCONNECTING ANY EQUIPMENT FROM THE POWER SOURCE. DISCONNECTING EQUIPMENT WITH POWER APPLIED CREATES VOLTAGE TRANSIENTS THAT CAN SERIOUSLY DAMAGE THE EQUIPMENT.

**WARNING:**     REMOVE POWER CONNECTIONS BEFORE DISASSEMBLING ANY PORTION OF THIS EQUIPMENT. DISASSEMBLING THIS EQUIPMENT WITH POWER CONNECTED MAY PRESENT AN ELECTRICAL SHOCK HAZARD TO SERVICE PERSONNEL. LETHAL VOLTAGES MAY BE PRESENT INSIDE THE EQUIPMENT.

**WARNING:**     WHILE PERFORMING ANY MAINTENANCE WITH THE COVERS REMOVED FROM THIS EQUIPMENT, OBSERVE COMMON, STANDARD SAFETY PRECAUTIONS AGAINST ELECTROCUTION.

**CAUTION:**     ELECTROSTATIC DISCHARGE CAN DAMAGE ELECTRONIC COMPONENTS. SERVICE EQUIPMENT ONLY AT AN ESD WORKSTATION OR AREA.

## **CHAPTER TWO - MAINTENANCE**

### **SECTION 2. PREVENTATIVE MAINTENANCE**

#### **CLEANING ITEMS**

- Soft lint-free cloth
- Small soft-bristled brush
- Mild non-abrasive cleaner
- Isopropyl alcohol

#### **CLEANING**

**CAUTION:** DO NOT USE COMPRESSED AIR (SUCH AS FROM AN AIR COMPRESSOR) TO CLEAN THE UNIT WITHOUT AN APPROPRIATE AIR FILTER.

**CAUTION:** AFTER CLEANING ELECTRICAL CONNECTORS, ALLOW SUFFICIENT TIME FOR THE CONNECTORS TO DRY BEFORE RECONNECTING.

#### **1. EXTERIOR**

Use a small amount of cleaner and a soft cloth to remove residues such as dirt and dust. If other substances need to be removed from the equipment exterior, use an appropriate cleaner. Do not use solvent-based cleaners on any painted surfaces of the equipment.

#### **2. INTERIOR**

Remove any debris from the inside of the equipment. If compressed air is used to clean the interior, use low pressure (20 lbs). The air from a compressor must be filtered to remove any contaminants, such as oil.

## **CHAPTER TWO - MAINTENANCE**

### **SECTION 2. PREVENTATIVE MAINTENANCE**

#### **EQUIPMENT INSPECTION**

##### **1. EXTERIOR**

- Check that the covers are not warped, bent, or otherwise damaged.
- Verify correct mounting alignment for all covers and hardware.
- Check that all cover mounting hardware, such as screws and hinges, are present and secure.
- Check that strain relief fixtures on cables are not damaged or worn.

##### **2. INTERIOR**

- Check that all mounting hardware is present and secure. This includes screws, strain reliefs, wire or cable ties, standoffs or brackets, and mounting assemblies.
- Verify the routing of all cable harnesses and wires. There should be no pinched wires or harnesses when closing the equipment panels or replacing the covers.
- Check for defects or wear in the insulation of wires or wiring harnesses.
- Check connectors for pushed-back pins or sockets.
- Check connectors for broken or loose wires.
- Check that the mounting hardware on all connectors and plugs is present and secure.



**CHAPTER TWO - MAINTENANCE**

**SECTION 3. TROUBLESHOOTING**

Troubleshooting information is contained in the optional SDX 2000 Maintenance Manual (JPN: 06-0728-A0 for hard copy, E6-0728-A0 for CD-ROM, available separately from JcAIR). The SDX 2000 Maintenance Manual also contains schematics, assembly drawings, bills of materials, and test and calibration procedures. The assembly drawing will show locations of particular components on the printed circuit boards. The bill of material contains the JcAIR part number and, where appropriate, the manufacturers part number to help in local sourcing of parts when possible.

**CHAPTER TWO - MAINTENANCE**

**SECTION 4. REASSEMBLY**

**CAUTION:** ELECTROSTATIC DISCHARGE CAN DAMAGE ELECTRONIC COMPONENTS. SERVICE THE UNIT ONLY AT AN ESD STATION OR AREA.

**Note:** Insure that all connectors are seated correctly before closing the unit. When reassembling the unit, verify proper routing of wiring harnesses to prevent pinching of harnesses when closing or replacing covers.

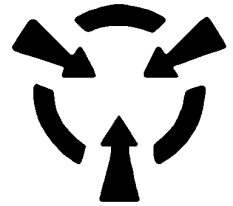

**CHAPTER THREE - MANUFACTURERS' APPENDICES**

**SECTION 1. APPENDICES**

**INTRODUCTION**

To assist in the operation of the JcAIR SDX 2000, Manufacturers' appendices are included in this section.

- APPENDIX A - SDX 2000 GPIB COMMAND SET
- APPENDIX B - SDX 2000 I/O DEFINITION TABLES
- APPENDIX C - SDX-2000 PERCENT REPLY CALCULATIONS
- APPENDIX D - ATCRBS MODE A ALTITUDE CODES
- APPENDIX E - EXAMPLE TEST PROCEDURES
- APPENDIX F - DME CHANNEL PAIR FREQUENCIES
- APPENDIX G - DEFINITION OF TERMS AND ACRONYMS



APPENDIX A - SDX 2000 GPIB COMMAND SET

- 1. GENERAL INFORMATION..... 1
  - 1.1 PROGRAMMING..... 1
  - 1.2 TERMINATION ..... 1
  - 1.3 COMMAND SEQUENCE..... 1
- 2. SDX-2000 GPIB COMMAND SET ..... 1
  - 2.1 Instrument Commands ..... 1
    - 2.1.1 :INSTrument..... 1
    - 2.1.2 :INSTrument?..... 2
    - 2.1.3 :INSTrument:SAVE..... 2
    - 2.1.4 :INSTrument:REStore ..... 2
    - 2.1.5 :INSTrument:CABLOS ..... 2
    - 2.1.6 :INSTrument:CABLOS? ..... 3
    - 2.1.7 :INSTrument:CABLOSbOT..... 3
    - 2.1.8 :INSTrument:CABLOSbOT? ..... 3
    - 2.1.9 :INSTrument:FORMAT ..... 3
    - 2.1.10 :INSTrument:FORMAT?..... 4
    - 2.1.11 :INSTrument:COMTEST?..... 4
    - 2.1.12 :INSTrument:StATE..... 4
  - 2.2 ATRCBS Mode Commands ..... 5
    - 2.2.1 :ATCRBS:MODE ..... 5
    - 2.2.2 :ATCRBS:MODE? ..... 5
    - 2.2.3 :ATCRBS:DOUBle ..... 5
    - 2.2.4 :ATCRBS:DOUBle:SPACing ..... 6
    - 2.2.5 :ATCRBS:DOUBle? ..... 6
    - 2.2.6 :ATCRBS:SUBmode..... 6
    - 2.2.7 :ATCRBS:SUBmode? ..... 6
  - 2.3 Mode S Commands ..... 7
    - 2.3.1 :MODES:MODE ..... 7
    - 2.3.2 :MODES:MODE? ..... 7
    - 2.3.3 :MODES:BURST ..... 7
    - 2.3.4 :MODES:BURST:SQUITter ..... 7
    - 2.3.5 :MODES:BURST:SQUITter:COUnT ..... 8
    - 2.3.6 :MODES:BURST:COUnT ..... 8
    - 2.3.7 :MODES:BURST:GAP ..... 8
    - 2.3.8 :MODES:BURST? ..... 9
    - 2.3.9 :MODES:DOUBle:SPACing ..... 9
    - 2.3.10 :MODES:DOUBle:SPACing? ..... 9
    - 2.3.11 :MODES:INTERLace:RATIO ..... 9
    - 2.3.12 :MODES:INTERLace:RATIO? ..... 10
    - 2.3.13 :MODES:DIVersity ..... 10
    - 2.3.14 :MODES:DIVersity? ..... 10
    - 2.3.15 :MODES:SUBmode ..... 10
    - 2.3.16 :MODES:SUBmode? ..... 10
    - 2.3.17 :MODES:TABLE..... 11
    - 2.3.18 :MODES:TABLE:StATE..... 11
    - 2.3.19 :MODES:TABLE:TYPE ..... 11
    - 2.3.20 :MODES:TABLE:DATA ..... 12
    - 2.3.21 :MODES:TABLE:ADDReSS..... 12
    - 2.3.22 :MODES:TABLE:StYLE ..... 12
    - 2.3.23 :MODES:TABLE? ..... 12
    - 2.3.24 :MODES:SYNC..... 13
    - 2.3.25 :MODES:SYNC?..... 13
    - 2.3.26 :MODES:PREPULSE:POStion..... 13
    - 2.3.27 :MODES:PREPULSE:POStion?..... 13



SDX 2000 Operation Manual

- 2.3.28 :MODES:ADDRess ..... 14
- 2.3.29 :MODES:ADDRess?..... 14
- 2.3.30 :MODES:EXTSQUITter ..... 14
- 2.3.31 :MODES:EXTSQUITter:?..... 15
- 2.4 DATALINK Commands ..... 16
  - 2.4.1 :DATALINK:TABLE ..... 16
  - 2.4.2 :DATALINK:TABLE:STATE ..... 16
  - 2.4.3 :DATALINK:TABLE:TYPE..... 16
  - 2.4.4 :DATALINK:TABLE:DATA ..... 16
  - 2.4.5 :DATALINK:TABLE:ADDRess..... 17
  - 2.4.6 :DATALINK:TABLE:DELAY ..... 17
  - 2.4.7 :DATALINK:TABLE:STYLE..... 17
  - 2.4.8 :DATALINK:TABLE? ..... 17
  - 2.4.9 :DATALINK:SYNC ..... 18
  - 2.4.10 :DATALINK:SYNC? ..... 18
  - 2.4.11 :DATALINK:MESSAge ..... 18
  - 2.4.12 :DATALINK:MESSAge?..... 18
  - 2.4.13 :DATALINK:MESSAge:TYPE ..... 19
  - 2.4.14 :DATALINK:MESSAge:STATE ..... 19
  - 2.4.15 :DATALINK:MESSAge:SEGments ..... 19
  - 2.4.16 :DATALINK:MESSAge:MEASure..... 20
  - 2.4.17 :DATALINK:MESSAge:TABLE..... 20
  - 2.4.18 :DATALINK:MESSAge:TABLE? ..... 20
  - 2.4.19 :DATALINK:MESSAge:TABLE:TYPE ..... 21
  - 2.4.20 :DATALINK:MESSAge:TABLE:STATE..... 21
  - 2.4.21 :DATALINK:MESSAge:TABLE:DATA ..... 21
  - 2.4.22 :DATALINK:MESSAge:TABLE:ADDRess ..... 22
  - 2.4.23 :DATALINK:MESSAge:TABLE:STYLE ..... 22
  - 2.4.24 :DATALINK:MESSAge:COPY..... 22
  - 2.4.25 :DATALINK:DELAY:INITial ..... 23
  - 2.4.26 :DATALINK:DELAY:SEGMENT ..... 23
  - 2.4.27 :DATALINK:DELAY:CLOSEout..... 23
  - 2.4.28 :DATALINK:DELAY:MESSAge ..... 24
  - 2.4.29 :DATALINK:DELAY? ..... 24
  - 2.4.30 :DATALINK:GLOADDRess ..... 24
- 2.5 DME Commands..... 27
  - 2.5.1 :DME:MODE ..... 27
  - 2.5.2 :DME:MODE? ..... 27
  - 2.5.3 :DME:EFFiciency..... 27
  - 2.5.4 :DME:EFFiciency?..... 27
  - 2.5.5 :DME:SQUITter ..... 28
  - 2.4.6 :DME:SQUITter? ..... 28
  - 2.4.7 :DME:RANGE..... 28
  - 2.5.8 :DME:RANGE:OFFset ..... 28
  - 2.5.9 :DME:RANGE? ..... 29
  - 2.5.10 :DME:VELocity..... 29
  - 2.5.11 :DME:VELocity:DIRection ..... 29
  - 2.5.12 :DME:VELocity? ..... 29
  - 2.5.13 :DME:ACCeleration ..... 29
  - 2.5.14 :DME:ACCeleration?..... 30
  - 2.5.15 :DME:IDENT:MODE ..... 30
  - 2.5.16 :DME:IDENT:CODE ..... 30
  - 2.5.17 :DME:IDENT:DOT ..... 30
  - 2.5.18 :DME:IDENT:DASH..... 31
  - 2.5.19 :DME:IDENT:SPACE ..... 31
  - 2.5.20 :DME:IDENT:CHARacter..... 31
  - 2.5.21 :DME:IDENT:RATE ..... 31



SDX 2000 Operation Manual

2.5.22	:DME:IDENT?	32
2.5.23	:DME:WINDow	32
2.5.24	:DME:WINDow?	32
2.5.25	:DME:ECHO:CONTRol	32
2.5.26	:DME:ECHO:AMPLitude	33
2.5.27	:DME:ECHO?	33
2.5.28	:DME:EQUALizer	33
2.5.29	:DME:EQUalizer?	33
2.5.30	:DME:TACAN	34
2.5.31	:DME:TACAN?	34
2.5.32	:DME:568:CONTRol	34
2.5.33	:DME:568:CONTRol?	34
2.5.34	:DME:568:DISTance	35
2.5.35	:DME:568:DISTance?	35
2.5.36	:DME:568: STATus?	35
2.5.37	:DME:WIDth	35
2.5.38	:DME:WIDth?	36
2.5.39	:DME:CHANX	36
2.5.40	:DME:CHANX?	36
2.5.41	:DME:CHANY	36
2.5.42	:DME:CHANY?	36
2.6	Pulse Commands	37
2.6.1	:PULSE:VARiable	37
2.6.2	:PULSE:VAR:AMPLitude	37
2.6.3	:PULSE:VAR:POSition	37
2.6.4	:PULSE:VAR:WIDth	38
2.6.5	:PULSE:VAR?	38
2.6.6	:PULSE:INTERFERENCE:AMPLitude	38
2.6.7	:PULSE:INTERFERENCE:WIDth	38
2.6.8	:PULSE:INTERFERENCE:POSition	39
2.6.9	:PULSE:INTERFERENCE:SPACing	39
2.6.10	:PULSE:INTERFERENCE:STATE	39
2.6.11	:PULSE:INTERFERENCE?	39
2.6.12	:PULSE:SLS:AMPLitude	40
2.6.13	:PULSE:SLS:POSition	40
2.6.14	:PULSE:SLS:WIDth	40
2.6.15	:PULSE:SLS?	40
2.6.16	:PULSE:IFFBIT	41
2.6.17	:PULSE:IFFBIT:CONTRol	41
2.6.18	:PULSE:IFFBIT?	41
2.6.19	:PULSE:VAR:STATE	41
2.7	Generator Commands	42
2.7.1	:GEN:FREQuency	42
2.7.2	:GEN:FREQuency?	42
2.7.3	:GEN:FREQuency:OFFset	42
2.7.4	:GEN:POWER:TOP	42
2.7.5	:GEN:POWER:TOP:CONTRol	43
2.7.6	:GEN:POWER:BOTtom	43
2.7.7	:GEN:POWER:TOP:OFFset	43
2.7.8	:GEN:POWER?	43
2.7.9	:GEN:PRF	44
2.7.10	:GEN:PRF?	44
2.7.11	:GEN:TRIGger	44
2.7.12	:GEN:TRIGger:POSition	44
2.7.13	:GEN:TRIGger:DME	45
2.7.14	:GEN:TRIGger:TACAN	45
2.7.15	:GEN:TRIGger?	45



2.7.16	:GEN:TRIGger:DME?	45
2.7.17	:GEN:TRIGger:TACAN?	45
2.7.18	:GEN:SUPPessor	46
2.7.19	:GEN:SUPPessor:AMPlitude	46
2.7.20	:GEN:SUPPessor?	46
2.7.21	:GEN:SUPPessor:POSition	46
2.7.22	:GEN:SUPPessor:WIDth	47
2.7.23	:GEN:EXTSYNC	47
2.7.24	:GEN:EXTSYNC?	48
2.7.25	:GEN:SETUP:REFerence	48
2.7.26	:GEN:SETUP:REFerence?	48
2.7.27	:GEN:SETUP:PRF	48
2.7.28	:GEN:SETUP:PRF?	48
2.7.29	:GEN:SETUP:MODulation	49
2.7.30	:GEN:SETUP:MODulation?	49
2.7.31	:GEN:SETUP:GATE	49
2.7.32	:GEN:SETUP:GATE?	49
2.7.33	:GEN:SETUP:VIDeo	49
2.7.34	:GEN:SETUP:VIDeo?	50
2.7.35	:GEN:SETUP:BOTtom	50
2.7.36	:GEN:SETUP:BOTtom?	50
2.8	Measurement Commands	51
2.8.1	:MEASure:TABLE	51
2.8.2	:MEASure:PULSE	51
2.8.3	:MEASure:PULSE?	51
2.8.4	:MEASure:FREQuency?	51
2.8.5	:MEASure:POWER?	52
2.8.6	:MEASure:POWERDBM?	52
2.8.7	:MEASure:REPLY:DF?	52
2.8.8	:MEASure:REPLY:DATA?	52
2.8.9	:MEASure:REPLY:ADDRes?	53
2.8.10	:MEASure:PREPLY:TOP:ATCRBS?	53
2.8.11	:MEASure:PREPLY:BOTtom:ATCRBS?	53
2.8.12	:MEASure:PREPLY:TOP:MODES?	53
2.8.13	:MEASure:PREPLY:TOP:FIRST?	53
2.8.14	:MEASure:PREPLY:TOP:SECOND?	54
2.8.15	:MEASure:PREPLY:BOTtom:MODES?	54
2.8.16	:MEASure:SQUITter:DF?	54
2.8.17	:MEASure:SQUITter:DATA?	54
2.8.18	:MEASure:SQUITter:INTerval?	55
2.8.19	:MEASure:SQUITter:REPLY?	55
2.8.20	:MEASure:SQUITter:II?	55
2.8.21	:MEASure:DELAY?	55
2.8.22	:MEASure:JITTER?	56
2.8.23	:MEASure:WIDTH?	56
2.8.24	:MEASure:SPACing?	56
2.8.25	:MEASure:CODE?	56
2.8.26	:MEASure:GREY?	57
2.8.27	:MEASure:ALTitude?	57
2.8.28	:MEASure:DMEPRF?	57
2.8.29	:MEASure:RANGE?	57
2.8.30	:MEASure:IFFPULSE	57
2.8.31	:MEASure:IFFPULSE?	58
2.8.32	:MEASure:PRF?	58
2.8.33	:MEASure:STABility?	58
2.8.34	:MEASure:RXCONF	58
2.8.35	:MEASure:SQUITter:AIRPOS:DATA?	59



2.8.36	:MEASure:SQUITter:AIRPOS:INTerval?	59
2.8.37	:MEASure:SQUITter:SURPOS:DATA?	59
2.8.38	:MEASure:SQUITter:SURPOS:INTerval?	59
2.8.39	:MEASure:SQUITter:ACIDENT:DATA?	60
2.8.40	:MEASure:SQUITter:ACIDENT:INTerval?	60
2.8.41	:MEASure:SQUITter:AIRVEL:DATA?	60
2.8.42	:MEASure:SQUITter:AIRVEL:INTerval?	60
2.8.43	:MEASure:SQUITter:EVNTDRIV:DATA?	60
2.8.44	:MEASure:SQUITter:EVNTDRIV:INTerval?	61
2.8.45	:MEASure:SQUITter:ACQquisition:DATA?	61
2.8.46	:MEASure:SQUITter:ACQquisition:INTerval?	61
2.8.47	:MEASure:AVGOFF	61
2.8.48	:MEASure:AVGON	62
2.8.49	:MEASure:AVG?	62
2.8.50	:MEASure:MINMAXRESet	62
2.8.51	:MEASure:AVGPARAMeter	63
2.8.52	:MEASure:AVGPARAMeter?	63
2.8.53	:MEASure:AVGPARAMeter:SAMPLES	63
2.8.54	:MEASure:MINDELAY?	63
2.8.55	:MEASure:MAXDELAY?	64
2.8.56	:MEASure:MINJITTER?	64
2.8.57	:MEASure:MAXJITTER?	64
2.8.58	:MEASure:MINWIDTH?	64
2.8.59	:MEASure:MAXWIDTH?	64
2.8.60	:MEASure:MINSPACing	65
2.8.61	:MEASure:MAXSPACing?	65
2.8.62	:MEASure:MINFREQuency?	65
2.8.63	:MEASure:MAXFREQuency?	65
2.8.64	:MEASure:MINPOWER?	65
2.8.65	:MEASure:MINPOWERDBM?	66
2.8.66	:MEASure:MAXPOWER?	66
2.8.67	:MEASure:MAXPOWERDBM?	66
2.8.68	:MEASure:PATH	66



## APPENDIX A - SDX 2000 GPIB COMMAND SET

### 1. GENERAL INFORMATION

#### 1.1 PROGRAMMING

The SDX 2000 is designed to be controlled through either the touch screen or through the GPIB interface. The individual GPIB commands are listed in this section, and the GPIB commands can be input using either the entire name, or the shortened name. An example of this is:

**:INSTrument**

This command can be input as :INSTRUMENT or :INST

**:ATCRBS:DOUBle:SPACing**

This command can be input as

:ATCRBS:DOUB:SPAC <DATA> or :ATCRBS:DOUBLE:SPACING <DATA>

#### 1.2 TERMINATION

All GPIB commands must be terminated in some manner. The commands that are written to the SDX 2000 must be terminated with a Carriage Return/Line Feed and EOI asserted on the last byte.

#### 1.3 COMMAND SEQUENCE

It is very important to note that attempting to perform two consecutive GPIB read operations from the SDX 2000 *will cause the GPIB bus to suspend*. To ensure proper GPIB operation, set the controller's timeout for > 3 seconds for the SDX 2000 Instrument. Recommended delay between GPIB commands is 80 milliseconds, except for the command to switch Instruments which will require up to a 10 second delay.

## 2. SDX-2000 GPIB COMMAND SET

### 2.1 Instrument Commands

#### 2.1.1 :INSTrument

This command will select one of the Instruments of the SDX 2000. This allows the user to select the desired Instrument out of the set of ATCRBS, MODE S, DME, DATALINK, IFF and TACAN (if installed). This command may take up to 10 seconds to execute.

**Note:** The Mode S, Datalink, IFF or TACAN commands will only be available when those option(s) have been purchased.

Command

:INST<INSTRUMENT>

where INSTRUMENT is:

ATCRBS | MODES | DATALINK | DME | IFF | TACAN | DATALINK2 |

**NOTE: The "DATALINK" option is not recommended for new development, use DATALINK2.**

Example

:INST MODES

### 2.1.2 :INSTrument?

This command returns the Instrument that the SDX is currently operating in.

Example Reply:  
" Instrument=ATCRBS"

### 2.1.3 :INSTrument:SAVE

This command allows the user to save the state of the SDX. This feature will save every parameter of every Instrument.

Command  
:INST:SAVE <VALUE>  
where VALUE is 2 to 10 (2 to 20 for SDX host software version 3.1 or greater)

Example  
:INST:SAVE 4

**Note:** User should allow sufficient time (approximately 10 seconds) for this command to be processed before sending additional GPIB commands.

### 2.1.4 :INSTrument:RESTore

This command allows the user to restore the state of the SDX. This feature will restore every parameter of every Instrument.

Command  
:INST:RESTore <VALUE>  
where VALUE is 1 to 10 (1 to 20 for SDX host software version 3.1 or greater)

Example  
:INST:REST 4

**Note:** User should allow sufficient time (approximately 10 seconds) for this command to be processed before sending additional GPIB commands.

### 2.1.5 :INSTrument:CABLOS

This command sets the cable loss for the current instrument.

Command:  
:INST:CABLOS <LOSS>  
where LOSS is a value from 0 to 2dB in .1dB steps.

Example:  
:INST:CABLOS 1.5

Example Reply:  
"OK"

**2.1.6 :INSTrument:CABLOS?**

This command returns the cable loss for the current instrument.

Example Command:  
:INST:CABLOS?

Example Reply:  
"CABLOS=1.5"

**2.1.7 :INSTrument:CABLOSBOT**

This command sets the bottom channel cable loss for the current instrument.

Command:  
:INST:CABLOSBOT <LOSS>  
where LOSS is a value from 0 to 2dB in .1dB steps.

Example:  
:INST:CABLOSBOT 1.5

Example Reply:  
"OK"

**2.1.8 :INSTrument:CABLOSBOT?**

This command returns the bottom channel cable loss for the current instrument.

Example Command:  
:INST:CABLOSBOT?

Example Reply:  
"CABLOSBOT=1.5"

**2.1.9 :INSTrument:FORMAT**

This command sets the data format for the Mode S and Datalink instruments.

Command:  
:INST:FORMAT <FORMAT>  
where FORMAT is HEX | OCTAL | RAWHEX | RAWOCTAL

Example:  
:INST:FORMAT RAWOCTAL

Example Reply:  
"OK"

**2.1.10 :INSTrument:FORMAT?**

This command returns the data format for the Mode S and Datalink instruments.

Example Command:  
:INST:FORMAT?

Example Reply:  
"FORMAT=RAWOCTAL"

**2.1.11 :INSTrument:COMTEST?**

This command invokes a communications self test and module software version query within the SDX-2000. The command returns a 4-bit integer value with each bit corresponding to the module level communication self test status (1=PASSED, 0=FAILED).

Bit position	Module
Bit 0	Aux I/O
Bit 1	Measurement
Bit 2	Receiver/Decoder
Bit 3	Transmitter

The command also returns strings for the software versions.

Abbreviation	Module
XMIT	Transmitter
RCVR	Receiver/Decoder
MEAS	Measurement
AUXIO	Aux I/O
GUI	Host (Graphical User Interface)

Example Command  
:INST:COMTEST?

Example Reply  
"COMTEST=15;XMIT= 4.2 ;RCVR= 3.3 ;MEAS= 2.6 ;AUXIO= 1.9 ;GUI=4.02"

**2.1.12 :INSTrument:STATE**

This command sets the SDX-2000 operational state: LOCAL (Touch-screen) or REMOTE (GPIB).

Command  
:INST:STATE<MODE>  
where MODE is:  
LOCAL | REMOTE

Example  
:INST:STATE LOCAL

## 2.2 ATCRBS Mode Commands

### 2.2.1 :ATCRBS:MODE

This command allows the user to select the type of interrogation to be sent. This command is specific to the ATCRBS Instrument and will only be executed if the selected Instrument is ATCRBS. This command will have the effect of defining the P1 to P3 spacing.

Command  
:ATCRBS:MODE <ATCMODE>  
where ATCMODE is: A | B | C | D | AC.

Example  
:ATCRBS:MODE C

### 2.2.2 :ATCRBS:MODE?

This command returns the selected ATCRBS Interrogation.

Example Command:  
:ATCRBS:MODE?

Example Reply:  
"MODE=C"

### 2.2.3 :ATCRBS:DOUBle

This command allows the user to enable or disable Double Interrogations.

Command  
:ATCRBS:DOUB <ENABLE>  
  
where ENABLE is ON | OFF.

Example  
:ATCRBS:DOUB OFF

#### 2.2.4 :ATCRBS:DOUBle:SPACing

This command allows the user to modify the spacing of the second interrogation from the first interrogation. This is the P1 to P1 spacing in microseconds.

Command  
:ATCRBS:DOUB:SPAC <DATA>  
where DATA is 0 to 400 us in 0.025 steps  
    MIN is 0.0  
    MAX is 400.00  
    DEF is 10.000.

Example  
:ATCRBS:DOUB:SPAC 1.05

#### 2.2.5 :ATCRBS:DOUBle?

This command returns the set values associated with Double Interrogation.

Example Command:  
:ATCRBS:DOUB?

Example Reply:  
"DOUBLE=OFF; SPACING=101.05"

#### 2.2.6 :ATCRBS:SUBmode

This command allows the user to control the additional features of the ATCRBS output. These features are mutually exclusive.

Command  
:ATCRBS:SUB <OPTION>  
where OPTION is NONE | SLS | PULSEAMP | INTERFERENCE

Example  
:ATCRBS:SUB NONE

#### 2.2.7 :ATCRBS:SUBmode?

This command returns the current setting of the ATCRBS additional features.

Example Command  
:ATCRBS:SUB?

Example Reply  
"SUBMODE=NONE"

## 2.3 Mode S Commands

### 2.3.1 :MODES:MODE

This command places the Mode S Instrument into Normal Mode S operation which will send out interrogations at the specified PRF using the current :MODES:TABLE parameters.

Command  
:MODES:MODE <OPTION>  
where OPTION is NORMAL | DOUBLE | INTERLACE | BURST

Example  
:MODES:MODE BURST

### 2.3.2 :MODES:MODE?

This command returns the state of the Mode for the Mode S Instrument.

Example Command  
:MODES:MODE?

Example Reply  
"MODE=BURST"

### 2.3.3 :MODES:BURST

This command controls the MODE-S Burst operation. The BURST operation will continually send out the number of interrogations specified by the :BURST:COUNT command at an interval defined by the :BURST:INTERVAL command.

Command  
:MODES:BURST <CONTROL>  
where CONTROL is START | STOP

Example  
:MODES:BURST START

### 2.3.4 :MODES:BURST:SQUITter

This command allows the user to select that the bursted interrogations are triggered after a specified number of received squitters.

Command  
:MODES:BURST:SQUITter <STATE>  
where STATE is ON | OFF

Example  
:MODES:BURST:SQUITter ON

### **2.3.5 :MODES:BURST:SQUITter:COUNT**

This command set the count for the number of squitters to receive prior to bursting interrogations.

Command  
:MODES:BURST:SQUITter:COUNT <NUM>  
where NUM is decimal 1 to 20 in integer steps  
MIN is 1  
MAX is 20

Example  
:MODES:BURST:SQUITter:COUNT 9

### **2.3.6 :MODES:BURST:COUNT**

This command set the Burst Count which is the number of interrogations that will be sent once a BURST:START command is received.

Command  
:MODES:BURST:COUNT <NUM>  
where NUM is decimal 1 to 1000 in integer steps  
MIN is 1  
MAX is 1000.

Example  
:MODES:BURST:COUNT 549

### **2.3.7 :MODES:BURST:GAP**

This command sets the Burst repetition gap time which is the delay time after one set of Burst interrogations.

Command  
:MODES:BURST:GAP <TIME>  
where TIME is decimal 0 to 20 seconds in 0.1 steps  
MIN is 1.00  
MAX is 20.00  
DEF is 0 (a single occurrence).

Example  
:MODES:BURST:GAP 20.0



### 2.3.8 :MODES:BURST?

This command returns the current settings of Burst parameters.

Example Command  
:MODES:BURST?

Example Reply  
"BURST=STOP;SQUITTER=ON;COUNT=9;COUNT=459;GAP=20"

The first "COUNT" returned is the squitter count.

### 2.3.9 :MODES:DOUBle:SPACing

This command sets the Double interrogation P1 to P1 spacing.

Command  
:MODES:DOUB:SPAC <SPACING>  
where SPACING is decimal 0 to 400 us in 0.025 steps  
MIN is 0.000  
MAX is 400.000

Example  
:MODES:DOUB:SPAC 167.500

### 2.3.10 :MODES:DOUBle:SPACing?

This command returns Double Interrogation parameters.

Example Command  
:MODES:DOUB:SPACing?

Example Reply  
"SPACING=231.100"

### 2.3.11 :MODES:INTERLace:RATIO

This command allows the user to set the ATCRBS/Mode S Interlace ratio. This ratio defines the number of interrogations in TABLE ENTRY number two that will be sent for every interrogation in TABLE ENTRY number one.

Command  
:MODES:INTERL:RATIO <DATA>  
where DATA is 1 to 1000 in integer steps  
MIN is 1  
MAX is 1000

Example  
:MODES:INTERL:RATIO 235

**2.3.12 :MODES:INTERLace:RATIO?**

This command returns the current ATCRBS/Mode S Interlace parameters.

Example Command  
 :MODES:INTERL:RATIO?  
 Example Reply  
 "RATIO=235"

**2.3.13 :MODES:DIVersity**

This command allows the user to set the diversity time delay.

Command  
 :MODES:DIV <DTIME>  
 where DTIME is -0.95 to +0.95 us in 0.025 steps  
 MIN is -0.950 MAX is +0.950  
 DEF is 0.000.

Example  
 :MODES:DIV -0.150

**2.3.14 :MODES:DIVersity?**

This command returns the current diversity time delay.

Example Command  
 :MODES:DIV?

Example Reply  
 "DIVERSITY =0.910"

**2.3.15 :MODES:SUBmode**

This command allows the user to control the additional features of the Mode S output. These features are mutually exclusive.

Command  
 :MODES:SUB <OPTION>  
 where OPTION is NONE | SLS | PULSEAMP | INTERFERENCE | DIVERSITY

Example  
 :MODES:SUB DIVERSITY

**2.3.16 :MODES:SUBmode?**

This command returns the current setting of the Mode S additional features.

Example Command  
 :MODES:SUB?

Example Reply  
 "SUBMODE=DIVERSITY"

**2.3.17 :MODES:TABLE**

This command selects a Mode S Table Entry to be used for modification.

Command  
 :MODES:TABLE <NUM>  
 where NUM is an integer from 1 to 32.

Example  
 :MODES:TABLE 3

**2.3.18 :MODES:TABLE:STATE**

This command allows the user to toggle the output state of the interrogation associated with the Table Entry selected.

Command  
 :MODES:TABLE:STATE <STATE>  
 where STATE is ON | OFF.

Example  
 :MODES:TABLE:STATE ON

**2.3.19 :MODES:TABLE:TYPE**

This command allows the user to set the current Table Entry interrogation.

Command  
 :MODES:TABLE:TYPE <MODE>  
 where MODE is NONE | MODEA | MODEC | ACSA | ACLA | ACSC | ACLC | UF00..UF31.

Example  
 :MODES:TABLE:TYPE UF21

Use UF25, 26, 27, 28, 29, 30, and 31 to select a UF24 with various RC and NC field values:

	RC	Uppermost bit of 4-bit NC field
UF24	0	0
UF25	0	1
UF26	1	0
UF27	1	1
UF28	2	0
UF29	2	1
UF30	3	0
UF31	3	1



### 2.3.20 :MODES:TABLE:DATA

This command allows the user to set current Table entry data field for those Table Entries of TYPE UF00 to UF31.

Command

```
:MODES:TABLE:DATA <DATA>
```

where DATA is right justified, 7 to 21 hexadecimal characters or 9 to 28 octal characters; 7 hex or 9 octal for short and 21 hex or 28 octal for long.

Example

```
:MODES:TABLE:DATA 03EF940
```

### 2.3.21 :MODES:TABLE:ADDRess

This command allows the user to set the current Table entry address for those Table Entries of TYPE UF00 to UF31.

Command

```
:MODES:TABLE:ADDR <ADDR>
```

where ADDR is right justified, 6 hexadecimal characters or 8 octal characters.

Example

```
:MODES:TABLE:ADDR 09FBA6
```

### 2.3.22 :MODES:TABLE:STYLE

This commands allows the user to modify the length of the P6 pulse for Mode S type interrogations.

Command

```
:MODES:TABLE:STYLE <TYPE>
```

where TYPE is SHORT | LONG

Example:

```
:MODES:TABLE:STYLE LONG
```

### 2.3.23 :MODES:TABLE?

This command will return the currently selected Table parameters.

Example Command:

```
:MODES:TABLE?
```

Example Reply:

```
" TABLE=3;STATE=ON; TYPE=UF21;  
  DATA=0123456789ABCDEF12345;  
  ADDRESS=09FBA6;STYLE=LONG"
```



#### 2.3.24 :MODES:SYNC

This command allows the user to select a MODES :TABLE # for Synchronization. The measured UUT values will be obtained from the reply associated with the interrogation selected for synchronization.

Command  
:MODES:SYNC <VALUE>  
where <VALUE> is from 1 to 32

Example:  
:MODES:SYNC 5

#### 2.3.25 :MODES:SYNC?

This command returns the interrogation being synched on.

Example Command  
:MODES:SYNC?

Example Reply:  
"SYNC= 5"

#### 2.3.26 :MODES:PREPULSE:POSition

This command allows the user to control the position of the Prepulse output. relative to P1 of the Interrogation.

Command  
:MODES:PREPULSE:POSition <VALUE>  
where VALUE is from 0 to -260us in 1us steps.  
DEF=-10

Examples  
:MODES:PREPULSE:POS -250

#### 2.3.27 :MODES:PREPULSE:POSition?

This command will return the position currently defined for the Prepulse output.

Example Command:  
:MODES:PREPULSE:POS?

Example Reply:  
"POSITION=-250"

### 2.3.28 :MODES:ADDRess

This command allows the user tie the Address used in Mode S interrogations to the received squitter address or leave it programmable by the user.

Command  
:MODES:ADDRess <OPTION>  
where OPTION is SQUITTER | USER

Example  
:MODES:ADDR USER

### 2.3.29 :MODES:ADDRess?

This command will return the parameters defined for the Address Field.

Example Command:  
:MODES:ADDR?

Example Reply:  
"ADDRESS=USER"

### 2.3.30 :MODES:EXTSQUITter <OPTION>

where OPTION is ON|OFF  
This command enables or disables the extended squitter mode.

Example Command  
:MODES:EXTSQUIT ON

Example Reply  
"OK"

Note: When Mode S Extended Squitter is "ON", only Mode S Extended Squitter GPIB commands are functional. Commands that start with the following sequences are classified as Mode S Extended Squitter commands:

:MEASure:SQUITter:AIRPOS  
:MEASure:SQUITter:EVNTDRIV  
:MEASure:SQUITter:SURPOS  
:MEASure:SQUITter:ACIDENT  
:MEASure:SQUITter:AIRVELocity  
:MEASure:SQUITter:ACQuisition

**2.3.31 :MODES:EXTSQUITter:?**

This command returns the state of the Mode S Extended Squitter.

Example Command  
:MODES:EXTSQUIT?

Example Reply  
"EXTSQUIT=ON"

## 2.4 DATALINK Commands

### 2.4.1 :DATALINK:TABLE

This command selects a DATALINK Table Entry to be used for modification.

Command  
 :DATALINK:TABLE <NUM>  
 where NUM is an integer from 1 to 288.

Example  
 :DATALINK:TABLE 3

**NOTE: This command is not recommended for new development.**

### 2.4.2 :DATALINK:TABLE:STATE

This command allows the user to toggle the output state of the interrogation associated with the Table Entry selected.

Command  
 :DATALINK:TABLE:STATE <STATE>  
 where STATE is ON | OFF.

Example  
 :DATALINK:TABLE:STATE ON

**NOTE: This command is not recommended for new development.**

### 2.4.3 :DATALINK:TABLE:TYPE

This command allows the user to set the current Table Entry interrogation.

Command  
 :DATALINK:TABLE:TYPE <MODE>  
 where MODE is NONE | MODEA | MODEC | ACSA | ACLA | ACSC | ACLC | UF00..UF31.  
 See Mode S.

Example  
 :DATALINK:TABLE:TYPE UF21

**NOTE: This command is not recommended for new development.**

### 2.4.4 :DATALINK:TABLE:DATA

This command allows the user to set current Table entry data field for those Table Entries of TYPE UF00 to UF31.

Command  
 :DATALINK:TABLE:DATA <DATA>  
 where DATA is 7 or 21 hexadecimal characters, 7 is short and 21 is long format.

Example  
 :DATALINK:TABLE:DATA 03EF940

**NOTE: This command is not recommended for new development.**



#### 2.4.5 :DATALINK:TABLE:ADDRess

This command allows the user to set the current Table entry address for those Table Entries of TYPE UF00 to UF31.

Command  
 :DATALINK:TABLE:ADDR <ADD>  
 where ADD is hexadecimal 000000 to FFFFFFFh

Example  
 :DATALINK:TABLE:ADDR 09FBA6

**NOTE: This command is not recommended for new development.**

#### 2.4.6 :DATALINK:TABLE:DELAY

This commands allows the user to select a time delay value for each interrogation position in the table. This value is the time between interrogations where interrogations are specified. For those interrogations of type NONE, this delay value represents the time between expected replies.

Command  
 :DATALINK:TABLE:DELAY <TIME>  
 where TIME is either 0 which represents that the PRF value should be used or from 45 to 2500 microseconds in 1 microseconds steps.

Example  
 :DATALINK:TABLE:DELAY 2000

**NOTE: This command is not recommended for new development.**

#### 2.4.7 :DATALINK:TABLE:STYLE

This commands allows the user to modify the length of the P6 pulse for DATALINK type interrogations.

Command  
 :DATALINK:TABLE:STYLE <TYPE>  
 where TYPE is SHORT | LONG

Example:  
 :DATALINK:TABLE:STYLE LONG

**NOTE: This command is not recommended for new development.**

#### 2.4.8 :DATALINK:TABLE?

This command will return the currently selected Table parameters.

Example Command:  
 :DATALINK:TABLE?  
 Example Reply:  
 " TABLE=3;STATE=ON; TYPE=UF21;  
 DATA=0123456789ABCDEF12345;  
 ADDRESS=09FBA6;DELAY=2000;STYLE=LONG"

**NOTE: This command is not recommended for new development.**

**2.4.9 :DATALINK:SYNC**

This command allows the user to select a DATALINK :TABLE # for Synchronization. The measured UUT values will be obtained from the reply associated with the interrogation selected for synchronization.

Command  
:DATALINK:SYNC <VALUE>  
where <VALUE> is from 1 to 288

Example:  
:DATALINK:SYNC 5

**2.4.10 :DATALINK:SYNC?**

This command returns the interrogation being synched on.

Example Command  
:DATALINK:SYNC?

Example Reply:  
"SYNC= 5"

**2.4.11 :DATALINK:MESSAge**

This command sets the current message number between 1 and 16.

Command  
:DATALINK:MESS <VALUE>  
where <VALUE> is from 1 to 16

Example:  
:DATALINK:MESS 2

Example Reply  
"OK"

**2.4.12 :DATALINK:MESSAge?**

This command returns the current message parameters.

Example Command  
:DATALINK:MESS?

Example Reply:  
"MESSAGE=1;TYPE=MCOMMC;STATE=ON;SEGMENTS=16;MEASURE=1;TABLE=2"

#### **2.4.13 :DATALINK:MESSAge:TYPE**

This command sets the current message protocol type.

Command:

:DATALINK:MESS:TYPE <PROTOCOL>

where <PROTOCOL> is COMMA | COMMC | MCOMMC | MCOMMB | COMMD | MCOMMD |  
COMMBAIR | COMMBGND.

Example:

:DATALINK:MESS:TYPE MCOMMC

Example Reply:

"OK"

#### **2.4.14 :DATALINK:MESSAge:STATE**

This command sets the current message state.

Command:

:DATALINK:MESS:STATE <STATE>

where STATE is ON | OFF

Example:

:DATALINK:MESS:STATE ON

Example Reply:

"OK"

#### **2.4.15 :DATALINK:MESSAge:SEGments**

This command sets total number of segments for the current message.

Command:

:DATALINK:MESS:SEG <SEGS>

where SEGS is from 1 to 16

Example:

:DATALINK:MESS:SEG 5

Example Reply:

"OK"



#### 2.4.16 :DATALINK:MESSAge:MEASure

This command sets the measured reply to a valid reply in the current message.

Command:

:DATALINK:MESS:MEAS <VALUE>

where VALUE is from 1 to 18

**Note:** See Note 2.4.XX at the end of Section 2.4 for details on reply indexing

Example:

:DATALINK:MESS:MEAS 18

note: 18 is the closeout

Example Reply:

"OK"

#### 2.4.17 :DATALINK:MESSAge:TABLE

This command sets the table entry to a valid interrogation within the current message. The selected table entry is used for interrogation setup.

Command:

:DATALINK:MESS:TABLE <VALUE>

where VALUE is from 1 to 18

**Note:** See Note 2.4.XX at the end of Section 2.4 for details on reply indexing

Example:

:DATALINK:MESS:TABLE 2

Note: 2 is the first segment

Example Reply:

"OK"

#### 2.4.18 :DATALINK:MESSAge:TABLE?

This command returns the currently selected table entry parameters.

Example Command:

:DATALINK:MESS:TABLE?

Example Reply:

"TABLE=1;STATE=SYNC;TYPE=UF24;DATA=0123456789ABCDEF12345;ADDRESS=FC01FF;STYLE=LONG"

#### **2.4.19 :DATALINK:MESSAge:TABLE:TYPE**

This command sets the currently selected table entry type.

Command:  
:DATALINK:MESS:TABLE:TYPE <TYPE>  
where TYPE is UF00..UF31|NONE

Example:  
:DATALINK:MESS:TABLE:TYPE UF4

Example Reply:  
"OK"

#### **2.4.20 :DATALINK:MESSAge:TABLE:STATE**

This command sets the state of the currently selected table entry.

Command:  
:DATALINK:MESS:TABLE:STATE <STATE>  
where STATE is ON|OFF|SYNC

Example:  
:DATALINK:MESS:TABLE:STATE OFF

Example Reply:  
"OK"

#### **2.4.21 :DATALINK:MESSAge:TABLE:DATA**

This command sets the current table entry data fields for types UF00..UF31. The data must be entered in the selected raw data format, not including UF or AP data fields.

Command:  
:DATALINK:MESS:TABLE:DATA <DATA>  
where DATA is right justified, 7 to 21 hexadecimal characters or 9 to 28 octal characters; 7 hex or 9 octal for short and 21 hex or 28 octal for long.

Example:  
:DATALINK:MESS:TABLE:DATA 123456789ABCDEF123456

Example Reply:  
"OK"



#### **2.4.22 :DATALINK:MESSAge:TABLE:ADDRess**

This command sets the current table entry address for types UF00..UF31. The data must be entered in the selected raw data format.

Command:

:DATALINK:MESS:TABLE:ADDR <ADDR>

where ADDR is right justified, 6 hexadecimal characters or 8 octal characters.

Example:

:DATALINK:MESS:TABLE:ADDR FC01FF

Example Reply

"OK"

#### **2.4.23 :DATALINK:MESSAge:TABLE:STYLE**

This command sets the length of the P6 pulse for the current table entry types UF00..UF31.

Command:

:DATALINK:MESS:TABLE:STYLE <TYPE>

where TYPE is SHORT | LONG

Example:

:DATALINK:MESS:TABLE:STYLE SHORT

Example Reply:

"OK"

#### **2.4.24 :DATALINK:MESSAge:COPY**

This command is used to copy a message to another slot. The entered slot is overwritten with a copy of the current message.

Command:

:DATALINK:MESS:COPY <SLOT>

where SLOT is a value from 1 to 16

Example:

:DATALINK:MESS:COPY 2

Example Reply:

"OK"

#### **2.4.25 :DATALINK:DELAY:INITial**

This command sets the initial segment delay of the current message.

Command:  
:DATALINK:DELAY:INIT <DELAY>  
where DELAY is a value from .1 to 63 milliseconds in 1 microsecond steps.

Example:  
:DATALINK:DELAY:INIT .2

Example Reply:  
"OK"

#### **2.4.26 :DATALINK:DELAY:SEGMENT**

This command sets the segment delay for the current message.

Command:  
:DATALINK:DELAY:SEGMENT <DELAY>  
where DELAY is a value from .05 to 63 milliseconds in 1 microsecond steps.

Example:  
:DATALINK:DELAY: SEGMENT.2

Example Reply:  
"OK"

#### **2.4.27 :DATALINK:DELAY:CLOSEout**

This command sets the closeout delay for the current message.

Command:  
:DATALINK:DELAY:CLOSE <DELAY>  
where DELAY is a value from .1 to 63 milliseconds in 1 microsecond steps.

Example:  
:DATALINK:DELAY:CLOSE .2

Example Reply:  
"OK"

**2.4.28 :DATALINK:DELAY:MESSage**

This command sets the message delay for the current message.

Command:

:DATALINK:DELAY:MESS <DELAY>

where DELAY is a value from .1 to 100000 milliseconds in .1 millisecond steps.

Example:

:DATALINK:DELAY:MESS 5

Example Reply:

"OK"

**2.4.29 :DATALINK:DELAY?**

This command returns the delay parameters for the current message.

Example Command:

:DATALINK:DELAY?

Example Reply:

"DELAY=.2;SEGMENT=.2;CLOSEOUT=.2;MESSAGE=5"

The first DELAY is the initial segment delay.

**2.4.30 :DATALINK:GLOADDRess**

This command sets the address for ALL UF00..UF31 interrogations. The data must be entered in the selected raw data format.

Command:

:DATALINK:GLOADDR <ADDR>

where ADDR is 6 hexadecimal characters or 8 octal characters.

Example Command:

:DATALINK:GLOADDR FC01FF

Example Reply

"OK"



**Note 2.4.XX Table Entry References**

**Comm A and Comm B Ground**

<u>Interrogation</u>	<u>Table Entry</u>
Interrogation	1
Don't Care	2
Don't Care	3
Don't Care	4
Don't Care	5
Don't Care	6
Don't Care	7
Don't Care	8
Don't Care	9
Don't Care	10
Don't Care	11
Don't Care	12
Don't Care	13
Don't Care	14
Don't Care	15
Don't Care	16
Don't Care	17
Don't Care	18

**Comm C**

<u>Interrogation</u>	<u>Table Entry</u>
Don't Care	1
Segment 1	2
Segment 2	3
Segment 3	4
Segment 4	5
Segment 5	6
Segment 6	7
Segment 7	8
Segment 8	9
Segment 9	10
Segment 10	11
Segment 11	12
Segment 12	13
Segment 13	14
Segment 14	15
Segment 15	16
Segment 16	17
Closeout	18

**Note 2.4.XX Table Entry References (Cont.)**

**Multisite Comm C**

<b><u>Interrogation</u></b>	<b><u>Table Entry</u></b>
Reservation	1
Segment 1	2
Segment 2	3
Segment 3	4
Segment 4	5
Segment 5	6
Segment 6	7
Segment 7	8
Segment 8	9
Segment 9	10
Segment 10	11
Segment 11	12
Segment 12	13
Segment 13	14
Segment 14	15
Segment 15	16
Segment 16	17
Closeout	18

**Comm D, Multisite Comm D, Comm B Air, and Multisite Comm B**

<b><u>Interrogation</u></b>	<b><u>Table Entry</u></b>
Surveillance	1
Authorization	2
Don't Care	3
Don't Care	4
Don't Care	5
Don't Care	6
Don't Care	7
Don't Care	8
Don't Care	9
Don't Care	10
Don't Care	11
Don't Care	12
Don't Care	13
Don't Care	14
Don't Care	15
Don't Care	16
Don't Care	17
Closeout	18

## 2.5 DME Commands

### 2.5.1 :DME:MODE

This commands allows the user to select the DME Mode.

Command  
:DME:MODE <MODE>  
where MODE is X | Y

Example  
:DME:MODE X

### 2.5.2 :DME:MODE?

This commands returns the current setting of DME Mode.

Command  
:DME:MODE?

Example Reply  
"MODE=X"

### 2.5.3 :DME:EFFiciency

This command allows the user to set the reply efficiency.

Command  
:DME:EFF <PERC>  
where PERC is 0 to 100 percent in integer steps  
MIN is 0        MAX is 100  
DEF is 100.

Example  
:DME:EFF 96

### 2.5.4 :DME:EFFiciency?

This command returns the current setting for reply efficiency.

Command  
:DME:EFF?

Example Reply  
"EFFICIENCY=100"

#### **2.5.5 :DME:SQUITter**

This command allows the user to set the DME squitter rate.

Command  
:DME:SQUIT <SQUIT>  
where SQUIT is 0 to 8000 in integer steps  
MIN is 0  
MAX is 8000  
DEF is 2700.

Example  
:DME:SQUIT 2700

#### **2.4.6 :DME:SQUITter?**

This command returns the current setting for DME squitter rate.

Command  
:DME:SQUIT?

Example Reply  
"SQUITTER=2700"

#### **2.4.7 :DME:RANGE**

This command allows the user to set the DME RANGE.

Command  
:DME:RANGE <VALUE>  
where VALUE is 0 to 399.99 nmi in steps of 0.01 nmi

Example  
:DME:RANGE 100.00

#### **2.5.8 :DME:RANGE:OFFset**

This command allows the user to set the DME RANGE OFFSET.

Command  
:DME:RANGE:OFFSET <VALUE>  
where VALUE is either -1 or NORMAL

Example  
:DME:RANGE:OFFSET NORMAL

**2.5.9 :DME:RANGE?**

This command returns the current setting of the RANGE Value.

Example Command  
:DME:RANGE?

Example Reply  
"RANGE=100.00";OFFSET=NORMAL"

**2.5.10 :DME:VELOCITY**

This command allows the user to set the DME Velocity.

Command  
:DME:VEL <VALUE>  
where VALUE is 0 to 9999 kts

Example  
:DME:VEL 100

**2.5.11 :DME:VELOCITY:DIRrection**

This command allows the user to set the DME Velocity Direction.

Command  
:DME:VEL:DIR <VALUE>  
where VALUE is IN or OUT

Example  
:DME:VEL:DIR OUT

**2.5.12 :DME:VELOCITY?**

This command returns the current setting of the Velocity value.

Example Command  
:DME:VELOCITY?

Example Reply  
"VELOCITY =100;DIRECTION=OUT"

**2.5.13 :DME:ACceleration**

This command allows the user to set the DME Acceleration.

Command  
:DME:ACC <VALUE>  
where VALUE is 0 to 399 ft/s/s

Example  
:DME:ACC 100

**2.5.14 :DME:ACCEleration?**

This command returns the current setting of the Acceleration value.

Example Command

```
:DME:ACC?
```

Example Reply

```
"ACCELERATION=100"
```

**2.5.15 :DME:IDENT:MODE**

This command allows the user to select the mode of operation for DME identification.

Command

```
:DME:IDENT:MODE <ID>  
where ID is: TONE | CODE | OFF.
```

Example

```
:DME:IDENT:MODE CODE
```

**2.5.16 :DME:IDENT:CODE**

This command allows the user to select the message that will be generated when DME:IDENT:MODE is set to CODE.

Command

```
:DME:IDENT:CODE <MESSAGE>  
where MESSAGE is alphanumeric 1 to 8 characters.
```

Example

```
:DME:IDENT:CODE BFG
```

**2.5.17 :DME:IDENT:DOT**

This command allows the user to adjust the time associated with generating a Morse Code dot.

Command

```
:DME:IDENT:DOT <DOTTIME>  
where DOTTIME is 50 to 250 ms in 10 ms steps  
MIN is 50 MAX is 250  
DEF is 100 ms.
```

Example

```
:DME:IDENT:DOT 180
```

**2.5.18 :DME:IDENT:DASH**

This command allows the user to adjust the time associated with generating a Morse Code Dash.

Command  
:DME:IDENT:DASH <DASHTIME>  
where DASHTIME is 150 to 750 ms in 10 ms steps  
MIN is 150 MAX is 750  
DEF is 500 ms

Example  
:DME:IDENT:DASH 600

**2.5.19 :DME:IDENT:SPACE**

This command allows the user to adjust the time for a space while generating Morse Code.

Command  
:DME:IDENT:SPACE <TIME>  
where TIME is 50 to 250 ms in 10 ms steps  
MIN is 50 MAX is 250  
DEF is 150 ms

Example  
:DME:IDENT:SPACE 100

**2.5.20 :DME:IDENT:CHARacter**

This command allows the user to adjust the time associated with generating a character for Morse Code.

Command  
:DME:IDENT:CHAR <TIME>  
where TIME is 150 to 750 ms in 10 ms steps  
MIN is 150 MAX is 750  
DEF is 450 ms

Example  
:DME:IDENT:CHAR 600

**2.5.21 :DME:IDENT:RATE**

This command allows the user to adjust the rate for the Morse Code.

Command  
:DME:IDENT:RATE <TIME>  
where TIME is 10.0 to 65.0 sec in 0.1 steps  
MIN is 10.0  
MAX is 65.0  
DEF is 30.0 sec.

Example  
:DME:IDENT:RATE 40.3

**2.5.22 :DME:IDENT?**

This command returns the DME ident mode and code parameters.

Example Command  
:DME:IDENT?

Example Reply  
"MODE=CODE;CODE=BFG;DOT=100;DASH=600;  
SPACE=200;CHARACTER=600;RATE=40.3"

**2.5.23 :DME:WINDow**

This command allows the user to adjust the width of the reply window.

Command  
:DME:WINDow <STATE>  
where STATE is NARROW | WIDE

Example  
:DME:WIND WIDE

**2.5.24 :DME:WINDow?**

This command returns the DME Window field parameters.

Example Command  
:DME:WIND?

Example Reply  
" WINDOW=WIDE"

**2.5.25 :DME:ECHO:CONTRol**

This command allows the user to control DME ECHO PULSES.

Command  
:DME:ECHO:CONTROL <OPTION>  
Where OPTION is ON|OFF

Example  
:DME:ECHO:CONTROL OFF



**2.5.26 :DME:ECHO:AMPLitude**

This command allows the user to control DME ECHO AMPLITUDE.

Command  
:DME:ECHO:AMPLitude <VALUE>  
Where VALUE is +5.0 to -15 dBm in 0.1 steps  
MIN is -15 dBm  
MAX is +5.0 dBm  
DEF is 0

Example  
:DME:ECHO:AMPLITUDE 5.0

**2.5.27 :DME:ECHO?**

This command returns the current DME ECHO AMPLITUDE and CONTROL settings.

Command  
:DME:ECHO?

Example Reply  
"CONTROL=ON;AMPLITUDE=5.000"

**2.5.28 :DME:EQUALizer**

This command allows the user to control the state of the DME Equalizer.

Command  
:DME:EQUALizer <STATE>  
Where STATE ON|OFF

Example  
:DME:EQUALIZER ON

**2.5.29 :DME:EQAlizer?**

This command returns the current DME Equalizer state.

Command  
:DME:EQAlizer?

Example Reply  
"EQUALIZER=ON"

**2.5.30 :DME:TACAN**

This command allows the user to control the TACAN output operation of the DME Instrument.

Command  
:DME:TACAN <OPTION>  
where OPTION is OFF | ON

Example  
:DME:TACAN ON

**NOTE: This command is not recommended for new development.**

**2.5.31 :DME:TACAN?**

This command returns the current setting of the state of the TACAN output of the DME Instrument..

Example Command  
:DME:TACAN?

Example Reply  
"TACAN = ON"

**NOTE: This command is not recommended for new development.**

**2.5.32 :DME:568:CONTRol**

This command will switch 568 control between INTERNAL and EXTERNAL. When control is set to INTERNAL, the value set with the command :DME:568:DISTANCE will be output on the 568 connector.

Command  
:DME:568:CONTROL <OPTION>  
where option is INTERNAL | EXTERNAL

Reply  
:DME:568:CONTROL INTERNAL

**2.5.33 : DME:568:CONTRol?**

This command returns the current state of the 568 Control

Example Command  
:DME:568:CONTROL?

Example Reply  
"CONTROL INTERNAL"

**2.5.34 :DME:568:DIStance**

This command allows the user to place a value on the 568 bus when control is set to internal.

Command  
 :DME:568:DISt <value>  
 where value is from 0 to 399.99 nmi in 0.01 steps  
 MIN is 0 MAX is 399.99  
 DEF is 100.00

Reply  
 :DME:568:DIStANCE ` 105.1

**2.5.35 : DME:568:DIStance?**

This command returns the current value of the 568 Distance

Example Command  
 :DME:568:DISt?

Example Reply  
 "DIStANCE=105.1"

**2.5.36 : DME:568:STATus?**

This command returns 568 status bits 32, 31, 10 and 9 in the format illustrated below:

0	0	(bit 32)	(bit 31)	0	0	(bit 10)	(bit 9)
---	---	----------	----------	---	---	----------	---------

Example Command  
 :DME:568: STAT?

Example Reply  
 "STAT=32"

**2.5.37 : DME:WIDth**

This command allows the user to enter the DME reply pulse width.

Command  
 :DME:WIDth<VALUE>  
 where VALUE is from 3.5 to 9.0 usec in 0.1 usec steps

Example Command  
 :DME:WIDth 6.4

Example Reply  
 "OK"

**2.5.38 :DME:WIDTH?**

This command returns the DME reply pulse width.

Example Command  
:DME:WIDTH?

Example Reply  
"WIDTH=3.5"

**2.5.39 :DME:CHANX**

This command sets the DME mode to X and selects the desired channel.

Command  
:DME:CHANX <CHANNEL>  
Where CHANNEL is 1 to 126 in steps of 1

Example  
:DME:CHANX 17

**2.5.40 :DME:CHANX?**

This command returns the current DME channel.

Example Command:  
:DME:CHANX?

Example Reply:  
"CHANX=17"

**2.5.41 :DME:CHANY**

This command sets the DME mode to Y and selects the desired channel.

Command  
:DME:CHANY <CHANNEL>  
Where CHANNEL is 1 to 126 in steps of 1

Example  
:DME:CHANY 17

**2.5.42 :DME:CHANY?**

This command returns the current DME channel.

Example Command:  
:DME:CHANY?

Example Reply:  
"CHANY=17"

## 2.6 Pulse Commands

### 2.6.1 :PULSE:VARiable

This command allows the user to select a pulse in the interrogation to modify. These commands effect only one pulse at a time. Once a new pulse is selected for modification, any previously modified pulse will return to its default parameters.

Command  
:PULSE:VAR <PULSE>

where PULSE is:

ATCRBS	: P1 P3;
Mode S	: P1 P2 P3 P4 P6 SPR;
DME	: P2 ECHO
IFF ATC XPDR	: P1 P3 I1 I2 F1 C1 A1 C2 A2 C4 A4 B1 D1 B2 D2 B4 D4 F2;
IFF MODE 4 XPDR INTERNAL	: P1 P2 P3 P4 R1 R2 R3;
IFF MODE 4 XPDR EXTERNAL	: N.A.
IFF ATC RADAR	:  F1 C1 A1 C2 A2 C4 A4 B1 D1 B2 D2 B4 D4 F2;
IFF MODE 4 RADAR INTERNAL	: P1 P2 P3 P4 R1 R2 R3;
IFF MODE 4 RADAR EXTERNAL	: N.A.

Example  
:PULSE:VAR P3

### 2.6.2 :PULSE:VAR:AMPlitude

This command allows the user to modify only the selected pulses offset amplitude in dB.

Command  
:PULSE:VAR:AMP <DATA>  
where DATA is -15 to +5 dB in 0.1 steps  
MIN is -15.0  
MAX is +5  
DEF is 0.0 dB.

Example  
:PULSE:VAR:AMP +4.3

### 2.6.3 :PULSE:VAR:POSition

This command allows the user to modify the selected pulses position offset in usec.

Command  
:PULSE:VAR:POS <DATA>  
where DATA is -1.95 to +1.95 us in 0.025 steps for Transponder Instruments  
and DATA is -7.9 to +7.9 us in 0.1 steps for DME and TACAN Instruments  
MIN is -1.95  
MAX is +1.95;  
DEF is 0

Example  
:PULSE:VAR:POS -0.150

#### 2.6.4 :PULSE:VAR:WIDth

This command allows the user to modify the selected pulse width offset in usec.

Command  
 :PULSE:VAR:WID <DATA>  
 where DATA is -0.6 to +1.5 us in 0.025 us steps  
 MIN is -0.6, except where 0.2 is the minimum  
 MAX is +1.5  
 DEF is 0.0 us.

Example  
 :PULSE:VAR:WID +0.90

#### 2.6.5 :PULSE:VAR?

This command returns the selected pulse settings.

Example Command  
 :PULSE:VAR?

Example Reply  
 "VARIABLE=P3;AMPLITUDE=1.5;POSITION=-1.10;WIDTH=.21;STATE=ON"

#### 2.6.6 :PULSE:INTERFERENCE:AMPLitude

This command allows the user to modify the interference pulse amplitude in dB. This will affect both interference pulses if enabled.

Command  
 :PULSE:INTERF:AMP <DATA>  
 where DATA is -15 to +5 dB in 0.1 steps  
 MIN is -15.0 MAX is +5  
 DEF is 0.0 dB

Example  
 :PULSE:INTERF:AMP 1.5

#### 2.6.7 :PULSE:INTERFERENCE:WIDth

This command allows the user to modify the interference pulse(s) width. This will affect both interference pulses.

Command  
 :PULSE:INTERF:WID <DATA>  
 where DATA is -0.6 to +4.2 in 0.025 steps  
 MIN is -0.6 MAX is +4.2  
 DEF is 0.8

Example  
 :PULSE:INTERF:WID 1.0

**2.6.8 :PULSE:INTERFERENCE:POSITION**

This command allows the user to set the first interference pulse position in usec.

Command

:PULSE:INTERF:POS <DATA>

where DATA is decimal -14.975 to 393.000 in 0.025 steps

MIN is -14.975

MAX is 393.000;

DEF is 5.000

Example

:PULSE:INTERF:POS 389.150

**2.6.9 :PULSE:INTERFERENCE:SPACING**

This command allows the user to set the spacing of the second interference pulse from the first in usec. The limit for all interference pulses is 400 us, and the interference pulses can not overlap.

Command

:PULSE:INTERF:SPAC <DATA>

where DATA is from end of first interference to 400 in 0.025 us steps.

MIN is 6.000

MAX is 393.000

DEF is 10.00

Example

:PULSE:INTERF:SPAC 137.150

**2.6.10 :PULSE:INTERFERENCE:STATE**

This command allows the user to modify the state of the second interference pulse.

Command

:PULSE:INTERF:STATE <STATE>

where STATE is ON | OFF

Example

:PULSE:INTERF:STATE ON

**2.6.11 :PULSE:INTERFERENCE?**

This command returns the Interference pulse settings.

Example Command

:PULSE:INTERF?

Example Reply

"AMPLITUDE=1.5;POSITION=100.125;WIDTH=1.00;SPACING=137.150;STATE=ON"

**2.6.12 :PULSE:SLS:AMPlitude**

This command allows the user to modify SLS pulse amplitude offset in dB.

Command  
:PULSE:SLS:AMP <DATA>  
where DATA is -15 to +5 dB in 0.1 steps  
MIN is -15.0  
MAX is +5  
DEF is 0.0 dB.

Example  
:PULSE:SLS:AMP -1.5

**2.6.13 :PULSE:SLS:POSition**

This command allows the user to set the SLS pulse offset position in usec.

Command  
:PULSE:SLS:POS <DATA>  
where DATA is -1.95 to +1.95 us in 0.025 us steps  
MIN is -1.95    MAX is +1.95  
DEF is 0.0 usec.

Example  
:PULSE:SLS:POS +1.150

**2.6.14 :PULSE:SLS:WIDth**

This command allows the user to set the SLS pulse width offset in usec.

Command  
:PULSE:SLS:WID <DATA>  
where DATA is -0.6 to +1.15 us in 0.025 steps  
MIN is -0.6  
MAX is +1.15  
DEF is 0.8 us.

Example  
:PULSE:SLS:WID 0.90

**2.6.15 :PULSE:SLS?**

This command returns the current SLS pulse settings.

Example Command  
:PULSE:SLS?

Example Reply  
"AMPLITUDE=1.500;POSITION=-1.100;WIDTH=0.210"



**2.6.16 :PULSE:IFFBIT**

This command selects the IFF Mode 4 Interrogation Word bit to modify. This command applies only to IFF MODE 4 XPDR INTERNAL and IFF MODE 4 RADAR INTERNAL testing modes.

Command  
 :PULSE:IFFBIT <BIT>  
 where BIT is: P6|P7|...|P36|P37.

Example  
 :PULSE:IFFBIT P35

**2.6.17 :PULSE:IFFBIT:CONTRol**

This command modifies the selected IFF Mode 4 Interrogation Word bit. The bit can be set to OFF or to ODD or EVEN spacing. This command applies only to IFF MODE 4 XPDR INTERNAL and IFF MODE 4 RADAR INTERNAL testing modes.

Command  
 :PULSE:IFFBIT:CONTRol <STATE>  
 where STATE is: OFF|ODD|EVEN.

Example  
 :PULSE:IFFBIT:CONT EVEN

**2.6.18 :PULSE:IFFBIT?**

This command returns the current IFFBIT settings.

Example Command  
 :PULSE:IFFBIT?

Example Reply  
 "IFFBIT=P35;CONTROL=EVEN"

**2.6.19 :PULSE:VAR:STATE**

ONLY TO BE USED WHEN SELECTED PULSE IS P3 IN MODE S OR ATCRBS  
 This command allows the user to control the state of the selected pulse.

Command  
 :PULSE:VAR:STATE<OPTION>  
 where OPTION is ON or OFF when selected pulse is P3 in Mode S or ATCRBS

Example Command  
 :PULSE:VAR:STATE ON

Example Reply  
 "OK"

## 2.7 Generator Commands

### 2.7.1 :GEN:FREQuency

This command allows the user to set the generator frequency in MHz.

Command

:GEN:FREQ <BASE>

where BASE is decimal 952 to 1223 MHz in 0.01 steps

MIN is 952.00

MAX is 1223.00

DEF is 1030.00.

Example

:GEN:FREQ 1030.55

### 2.7.2 :GEN:FREQuency?

This command returns the current generator frequency.

Example Command

:GEN:FREQuency?

Example Reply

"FREQUENCY=1031.55;OFFSET=-10.00"

### 2.7.3 :GEN:FREQuency:OFFset

This command allows the user to set a generator frequency offset in MHz. This offset will adjust any frequency set with the :GEN:FREQ command.

Command

:GEN:FREQ:OFF <OFFDATA>

where OFFDATA is -10 to 10 MHz in 0.01 steps.

Example

:GEN:FREQ:OFF 1.55

### 2.7.4 :GEN:POWER:TOP

This command allows the user to set the generator power for top antenna in dBm. Setting TOP to CW will place both TOP and BOTTOM in CW mode.

Command

:GEN:POWER:TOP <LEVEL>

where LEVEL is -110 to 0 dBm in 0.1 steps

MIN is -110.0

MAX is 0

DEF is -50.0.

Example

:GEN:POWER:TOP -51.5



### 2.7.5 :GEN:POWER:TOP:CONTROL

This command allows the user to set the top antenna generator state (OFF | ON | CW). Setting TOP to CW will place both TOP and BOTTOM in CW mode.

Command  
:GEN:POWER:TOP <OPTION>  
where OPTION is OFF | ON | CW

Example  
:GEN:POWER:TOP:CONTROL OFF|ON|CW

### 2.7.6 :GEN:POWER:BOTtom

This command allows the user to set the generator power for the bottom antenna in dBm and is only valid when power is CW or when in diversity mode.

Command  
:GEN:POWER:BOTtom <LEVEL>  
where LEVEL is -110 to 0 dBm in 0.1 steps  
MIN is -110.0  
MAX is 0  
DEF is -50.0 dBm.

Example  
:GEN:POWER:BOT -21.5

### 2.7.7 :GEN:POWER:TOP:OFFset

This command allows the user to adjust the generator power for the Top antenna.

Command  
:GEN:POWER:OFFset <LEVEL>  
where LEVEL is -3 to 0 dB in 0.1 steps  
MIN is -3.0  
MAX is 0  
DEF is 0 dB.

Example  
:GEN:POWER:OFF 0.5

### 2.7.8 :GEN:POWER?

This command returns the current generator power.

Example Command  
:GEN:POWER?

Example Reply  
"CONTROL=ON;TOP=-51.5;BOTTOM=-100;OFFSET=0.5"

### 2.7.9 :GEN:PRF

This command allows the user to set the PRF value. In ATCRBS the range is 0 to 10000. In burst Mode S the range is 0 to 2500, in normal Mode S the range is 0 to 400.

Command  
:GEN:PRF <DATA>  
where DATA is from 0 to 10000 in integer steps.  
DEF is 100

Example  
:GEN:PRF 490

### 2.7.10 :GEN:PRF?

This command returns the current PRF settings for the Generator.

Command  
:GEN:PRF?

Example Reply  
"PRF=220"

### 2.7.11 :GEN:TRIGger

This command allows the user to select the scope sync output to occur either 1 us prior to the interrogation (INT) or 1 us prior to the reply (REP). This command is valid for Mode S, ATCRBS, IFF and Datalink Instruments.

Command  
:GEN:TRIG <DATA>  
where DATA is INT or REP

Example  
:GEN:TRIG REP

### 2.7.12 :GEN:TRIGger:POSition

This command allows the user to set the scope trigger position in usec. Only valid when :TRIG is set to INT.

Command  
:GEN:TRIG:POS <DATA>  
where DATA is -1 to 600 us in 1 us steps  
MIN is -1  
MAX is 600  
DEF is -1 us.

Example  
"GEN:TRIG:POS 9



**2.7.13 :GEN:TRIGger:DME**

This command is used to select when the scope sync occurs in the DME Instrument.

Command

:GEN:TRIG:DME <DATA>

where DATA is: SQUITTER|REPLY|ECHO|IDENT|UUTINTERR

**2.7.14 :GEN:TRIGger:TACAN**

This command is used to select when the scope sync occurs in the TACAN Instrument.

Command

:GEN:TRIG:TACAN <DATA>

where DATA is: SQUITTER|SDXINTERR|REPLY|ECHO|IDENT|ARB|MRB|NORTHREF|  
UUTINTERR|15HZ|135HZ

**2.7.15 :GEN:TRIGger?**

This command returns scope sync output parameters. This command is valid for Mode S, ATCRBS, IFF and Datalink Instruments.

Example Command

:GEN:TRIG?

Example Reply

" TYPE=INT;POSITION=9"

**2.7.16 :GEN:TRIGger:DME?**

This command returns the location of the scope sync in the DME Instrument.

Example Command

:GEN:TRIG:DME?

Example Reply

" DME=IDENT"

**2.7.17 :GEN:TRIGger:TACAN?**

This command returns the location of the scope sync in the TACAN Instrument..

Example Command

:GEN:TRIG:TACAN?

Example Reply

" TACAN=UUTINTERR"

**2.7.18 :GEN:SUPPessor**

This command allows the user to control the state of the suppressor pulse. The suppressor pulse has a fixed width of 33 usec.

Command  
:GEN:SUPP <OPTION>  
where OPTION is OFF | ON

Example  
:GEN:SUPP ON

**2.7.19 :GEN:SUPPessor:AMPLitude**

This command allows the user to select the amplitude of the suppressor pulse.

Command  
:GEN:SUPP:AMPLitude <DATA>  
where DATA is 3 to 27 VDC in 0.25 volt steps.  
DEF is 24.0

Example  
:GEN:SUPP:AMP 4.50

**2.7.20 :GEN:SUPPessor?**

This command returns the current suppressor pulse parameters.

Example Command  
:GEN:SUPP?

Example Reply  
" SUPPRESSOR = ON; AMPLITUDE=4.500 , POSITION=-10.0, WIDTH=33"

**2.7.21 :GEN:SUPPessor:POSition**

This command allows the user to select the position of the suppressor pulse.

Command  
:GEN:SUPP:POSition <DATA>  
where DATA is -10 to +10 us in 0.1 microsecond steps.

Example  
:GEN:SUPP:POS -1.0

**2.7.22 :GEN:SUPPessor:WIDth**

This command allows the user to select the width of the suppressor pulse.

Command

:GEN:SUPP:WIDth <DATA>

where DATA is 2 to 50 us in 0.1 microsecond steps.

Example

:GEN:SUPP:WID 33.0

**2.7.23 :GEN:EXTSYNC**

This command allows the user to modify the location of the external Sync pulse around P1 of the interrogation.

Command

:GEN:EXTSYNC <TIME>

where TIME is -10 to +10 us in 0.1 us steps

DEF is 0.0

Example

:GEN:EXTSYNC -1.0

**2.7.24 :GEN:EXTSYNC?**

This command returns the parameters associated with generator External Sync field.

Example Command  
:GEN:EXTSync?

Example Reply  
" EXTSYNC=-1.0"

**2.7.25 :GEN:SETUP:REFerence**

This command allows the user to clock the SDX 2000 using an external reference.

Command  
:GEN:SETUP:REFerence <STATE>  
where STATE is: INTERNAL|EXTERNAL.

Example  
:GEN:SETUP:REF INTERNAL

**2.7.26 :GEN:SETUP:REFerence?**

This command returns the current state of the Reference Setup.

Example Command  
:GEN:SETUP:REF?

Example Reply  
" REFERENCE=INTERNAL"

**2.7.27 :GEN:SETUP:PRF**

This command allows the user to trigger to externally trigger interrogations.

Command  
:GEN:SETUP:PRF <INTERNAL|EXTERNAL>

Example  
:GEN:SETUP:PRF EXTERNAL

**2.7.28 :GEN:SETUP:PRF?**

This command returns the current state of the PRF Setup.

Command  
:GEN:SETUP:PRF?

Example Reply  
" PRF=INTERNAL"



**2.7.29 :GEN:SETUP:MODulation**

This command allows the user to control the modulation source for the generator. The MIXED option configures the generator for TOP channel internal modulation and BOTTOM channel external modulation.

Command  
:GEN:SETUP:MODULATION <INTERNAL|EXTERNAL|MIXED>

Example Command  
:GEN:SETUP:MOD MIXED

**2.7.30 :GEN:SETUP:MODulation?**

This command returns the current state of Modulation Setup.

Command  
:GEN:SETUP:MODULATION?

Example Reply  
" MODULATION=INTERNAL "

**2.7.31 :GEN:SETUP:GATE**

This command allows the user to control the position of the Measurement Gate.

Command  
:GEN:SETUP:GATE <STATE>  
Where STATE is INTERNAL | EXTERNAL

Example  
:GEN:SETUP:GATE INTERNAL

**2.7.32 :GEN:SETUP:GATE?**

This command returns the current state of the Gate Setup.

Command  
:GEN:SETUP:GATE?

Example Reply  
" GATE=INTERNAL "

**2.7.33 :GEN:SETUP:VIDeo**

This command allows the user to select the UUT video source for the SDX 2000.

Command  
:GEN:SETUP:VIDeo <SOURCE>  
where SOURCE is: INTERNAL|EXTERNAL.

Example  
:GEN:SETUP:VID INTERNAL

**2.7.34 :GEN:SETUP:VIDeo?**

This command returns the selected UUT video source for the SDX 2000.

Example Command:  
:GEN:SETUP:VID?

Example Reply:  
"VIDEO=INTERNAL"

**2.7.35 :GEN:SETUP:BOTtom**

This command allows the user to select the coherency of the bottom channel relative to the top channel on the SDX 2000.

Example Command:  
:GEN:SETUP:BOTtom <COHERENCY>  
where COHERENCY is: COHERENT| NONCOHERENT

Example Reply:  
:GEN:SETUP:BOT COHERENT

**2.7.36 :GEN:SETUP:BOTtom?**

This command returns the selected coherency of the bottom channel on the SDX 2000.

Example Command:  
:GEN:SETUP:BOT?

Example Reply:  
"BOTTOM=COHERENT"

## 2.8 Measurement Commands

### 2.8.1 :MEASure :TABLE

This command allows the user to select the interrogation/reply pair for subsequent query commands.

Command

:MEAS:TABLE <VALUE>

where VALUE is from 1 to 30 for MODE S Instrument

and VALUE is: from 1 to 300 for DATALINK Instrument (not recommended for new designs)

from 1 to 288 for DATALINK2

Example

:MEAS:TABLE 5

### 2.8.2 :MEASure :PULSE

In Mode S, ATRCBS and IFF Instruments, this command allows the user to select the specific pulse in a reply to be measured. The reply is defined as the Table Entry that is currently has :SYNC set. In DME and TACAN Instruments the user is allowed to select P1 or P2 of the UUT's interrogation for measurement.

Command

:MEAS:PULSE <PULSE>

where PULSE is:

ATCRBS: F1 | C1 | A1 | C2 | A2 | C4 | A4 | B1 | D1 | B2 | D2 | B4 | D4 | F2

Mode S: P1 | P2 | P3 | P4 or one of S1 to S112 (long) or S1 to S56 (short).

DME & TACAN: P1|P2

Example

:MEAS:PULSE P2

### 2.8.3 :MEASure:PULSE?

This command returns the selected reply pulse parameters.

Example Command

:MEAS:PULS?

Example Reply

"PULSE=D1"

### 2.8.4 :MEASure:FREQuency?

This command returns the Measured Frequency of the carrier on the selected pulse of the synchronized interrogation-reply pair.

Example Command

:MEAS:FREQ?

Example Reply

"FREQUENCY=1030.10"

**2.8.5 :MEASure:POWER?**

This command returns the Measured Power of the selected pulse of the synchronized interrogation-reply pair. The power is returned in watts.

Example Command  
:MEAS:POWER?

Example Reply  
"POWER=316"

**2.8.6 :MEASure:POWERDBM?**

This command returns the Measured Power of the selected pulse of the synchronized interrogation-reply pair. The power is returned in dBm.

**Note: Resolution is 0.1 dBm. If more digits are shown it is because of the addition of calibration factors to the measured data. This command is available on version 4.03 and above.**

Example Command  
:MEAS:POWERDBM?

Example Reply  
"POWERDBM=83.600"

**2.8.7 :MEASure:REPLY:DF?**

This command returns the decoded downlink format from the reply to the synchronized interrogation.

Example  
:MEAS:REPLY:DF?

Example Reply  
"DF=4"

**2.8.8 :MEASure:REPLY:DATA?**

This command returns the decoded raw data from the reply to the synchronized interrogation (Mode S only). Return data is right justified.

Example  
:MEAS:REPLY:DATA?

Example Hex Reply (Mode S Long 112 bits)  
"DATA=123456789A123456789A12345678"

Example Hex Reply (Mode S Short 56 bits)  
"DATA=123456789A1234"

The number of characters returned by this command can be configured through the "Software Configuration" menu and the selected data format (hex or octal). The "Software Configuration" menu allows for two configurations for this command:

1. Returns 14 hex/19 octal for shorts or 28 hex/38 octal for longs.
2. Returns 7 hex characters for shorts or 28 hex characters for longs.

**2.8.9 :MEASure:REPLY:ADDRess?**

This command returns the decoded address field from the reply to the synchronized interrogation.

Example

```
:MEAS:REPLY:ADDR?
```

Example Reply

```
"ADDRESS=ABCDEF"
```

**2.8.10 :MEASure:PREPLY:TOP:ATCRBS?**

This command returns the ATCRBS percent reply for the top antenna.

Example Command

```
:MEAS:PREPLY:TOP:ATCRBS?
```

Example Reply

```
"ATCRBS=98.0"
```

**2.8.11 :MEASure:PREPLY:BOTtom:ATCRBS?**

This command returns the ATCRBS percent reply for the bottom antenna.

Example Command

```
:MEAS:PREPLY:BOT:ATCRBS?
```

Example Reply

```
"ATCRBS=98.0"
```

**2.8.12 :MEASure:PREPLY:TOP:MODES?**

This command returns the MODE S percent reply for the top antenna.

Example Command

```
:MEAS:PREPLY:TOP:MODES?
```

Example Reply

```
"MODES=58.0"
```

**2.8.13 :MEASure:PREPLY:TOP:FIRST?**

This command can be used in XPDR Instruments when in Double mode to return the percent reply to the first interrogation.

Example Command

```
:MEAS:PREPLY:TOP:FIRST?
```

Example Reply

```
"FIRST=97.0"
```

**2.8.14 :MEASure:PREPLY:TOP:SECOND?**

This command can be used in XPDR Instruments when in Double mode to return the percent reply to the second interrogation.

Example Command  
 :MEAS:PREPLY:TOP:SECOND?

Example Reply  
 "SECOND=97.0"

**2.8.15 :MEASure:PREPLY:BOTtom:MODES?**

This command returns the MODE S percent reply for the bottom antenna.

Example Command  
 :MEAS:PREPLY:BOT:MODES?

Example Reply  
 "MODES=100.0"

**2.8.16 :MEASure:SQUITter:DF?**

This command returns decoded Downlink Format from the squitter reply.

Example Command  
 :MEAS:SQUIT:DF?

Example Reply  
 "SQUITTER=11"

**2.8.17 :MEASure:SQUITter:DATA?**

This command returns the decoded raw data from the squitter reply. Return data is right justified.

BIT position per DO-181, MSbit = bit position 1 and LSbit = bit position 56.

Bit position      Field

1-3	Transponder Capability (CA)
4-27	Aircraft Address (AA)

Example Command  
 :MEAS:SQUIT:DATA?

Example Hex Reply (Standard Squitter format of DF11 56 bits)  
 "DATA=123456789A1234"

The number of characters returned by this command can be configured through the "Software Configuration" menu and the selected data format (hex or octal). The "Software Configuration" menu allows for two configurations for this command:

1. Returns 14 hex/19 octal for shorts or 28 hex/38 octal for longs.
2. Returns 7 hex characters for shorts or 28 hex characters for longs.

**2.8.18 :MEASure:SQUITter:INTerval?**

This command returns the squitter reply interval.

Example Command  
:MEAS:SQUIT:INT?

Example Reply  
"INTERVAL=1.1"

**2.8.19 :MEASure:SQUITter:REPLY?**

This command returns all 56 data bits of the squitter reply in hexadecimal format.

BIT position per DO-181, MSbit = bit position 1 and LSbit = bit position 56.

Bit position      Field

1-5	Downlink Format (DF)
6-8	Transponder Capability (CA)
9-32	Aircraft Address (AA)
33-56	Parity/Interrogator Ident (PI)

Example Command  
:MEAS:SQUIT:REPLY?

Example Reply  
"DATA = 123456789ABCDE"

**2.8.20 :MEASure:SQUITter:II?**

This command returns the decoded Interrogator Ident (II) field in hexadecimal format (normally = 0).

Example Command  
:MEAS:SQUIT?

Example Reply  
"II = 0"

**2.8.21 :MEASure:DELAY?**

This command returns the reply delay of the reply to the synchronized interrogation.

Example Command  
:MEAS:DELAY?

Example Reply  
"DELAY=128.1"

**2.8.22 :MEASure:JITTER?**

This command returns the reply delay jitter of the reply to the synchronized interrogation.

Example Command  
:MEAS:JITTER?

Example Reply  
"JITTER = 0.05"

**2.8.23 :MEASure:WIDTH?**

This command returns the width for the measured pulse of the reply to the synchronized interrogation for XPDR Instruments and the width of the selected pulse of the UUT interrogation for DME and TACAN Instruments.

Example Command  
:MEAS:WIDTH?

Example Reply  
"WIDTH=0.800"

**2.8.24 :MEASure:SPACing?**

This command returns the F1 to F2 Spacing for the measured reply to a synchronized ATCRBS interrogation for XPDR modes and the P1 to P2 spacing of the UUT interrogation for DME and TACAN Instruments.

Example Command  
:MEAS:SPAC?

Example Reply  
"SPACING=20.300"

**2.8.25 :MEASure:CODE?**

This command returns the decoded Code for the measured reply associated with the scope synched ATCRBS interrogation.

Example Command  
:MEAS:CODE?

Example Reply  
"CODE = 7070"

If the IDENT flag is set, the command will return  
"CODE = 7070 IDENT"

If the EMERG flag is set, the command will return  
"CODE = 7070 EMERG"



**2.8.26 :MEASure:GREY?**

This command returns the Grey code of the reply associated with the scope synched ATCRBS interrogation.

Example Command  
:MEAS:GREY?

Example Reply  
"CODE = 7070"

**2.8.27 :MEASure:ALTitude?**

This command returns the decoded altitude for the measured reply to a synchronized ATCRBS interrogation.

Example Command  
:MEAS:ALT?

Example Reply  
"ALTITUDE = 10000"

**2.8.28 :MEASure:DMEPRF?**

This command returns the interrogation rate of the UUT.

Example Command  
:MEAS:DMEPRF?

Example Reply  
"DMEPRF = 12"

**2.8.29 :MEASure:RANGE?**

This command returns the range provided from the UUT via ARINC 568.

Example Command  
:MEAS:RANGE?

Example Reply  
"Range = 27.0 nm"

**2.8.30 :MEASure:IFFPULSE**

This command selects the specific pulse in a IFF reply to measure.

Command  
:MEASure:IFFPULSE <REPLY>  
where REPLY is:

IFF ATC XPDR	:	F1 C1 A1 C2 A2 C4 A4 X B1 D1 B2 D2 B4 D4 SPI;
IFF MODE 4 XPDR INTERNAL	:	R1 R2 R3;
IFF MODE 4 XPDR EXTERNAL	:	R1 R2 R3;
IFF ATC RADAR	:	P1 P3;
IFF MODE 4 RADAR INTERNAL	:	P1 P2 ... P36 P37;
IFF MODE 4 RADAR EXTERNAL	:	P1 P2 ... P36 P37.

Example  
:MEAS:IFFPULSE R1

**2.8.31 :MEASure:IFFPULSE?**

This command returns the selected IFF reply pulse.

Example Command  
:MEAS:IFFPULSE?

Example Reply  
"IFFPULSE=R1"

**2.8.32 :MEASure:PRF?**

This command returns the UUT PRF. This command is not supported on software before Version 4.00.

Example Command  
:MEAS:PRF?

Example Reply  
" PRF =100"

**2.8.33 :MEASure:STABILITY?**

This command returns the UUT Stability. The UUT is Stable (1) when the pulse repetition jitter is less than 0.45 usec; the UUT is Unstable (0) when the jitter is greater than 0.65 usec.

Example Command  
:MEAS:STAB?

Example Reply  
"STABILITY=1"

**2.8.34 :MEASure:RXCONF**

This command allows the user to select whether the SDX receives its RF signal from the RF I/O connector on the front panel or the back panel BNC connector.

Command  
:MEASure:RXCONF <SELECTION>  
where SELECTION is:

DIR	RF I/O Connector (Type N)
ANT	Back Panel Connector (BNC)

Example Command  
:MEAS:RXCONF ANT



**2.8.35 :MEASure:SQUITter:AIRPOS:DATA?**

This command returns the raw data (112 bits) of the Airborne Position Squitter. Data is returned as right justified, 28 hexadecimal characters or 38 octal characters depending on selected data format (hex or octal).

Example Command  
:MEAS:SQUIT:AIRPOS:DATA?

Example Hex Reply  
"DATA=89E800079000000000000000B6D7C1"

**2.8.36 :MEASure:SQUITter:AIRPOS:INTerval?**

This command returns top, bottom, and combined intervals between consecutive Airborne Position Squitters in seconds.

Example Command  
:MEAS:SQUIT:AIRPOS:INT?

Example Reply  
"INT=0.50; INTTOP=0.50; INTBOT=0.00"

**2.8.37 :MEASure:SQUITter:SURPOS:DATA?**

This command returns the raw data (112 bits) of the Surface Position Squitter. Data is returned as right justified, 28 hexadecimal characters or 38 octal characters depending on selected data format (hex or octal).

Example Command  
:MEAS:SQUIT:SURPOS:DATA?

Example Hex Reply  
"DATA=89E800074000000000000000B4D7C1"

**2.8.38 :MEASure:SQUITter:SURPOS:INTerval?**

This command returns top, bottom, and combined intervals between consecutive Surface Position Squitters in seconds.

Example Command  
:MEAS:SQUIT:SURPOS:INT?

Example Reply  
"INT=0.50; INTTOP=0.50; INTBOT=0.00"



**2.8.39 :MEASure:SQUITter:ACIDENT:DATA?**

This command returns the raw data (112 bits) of the Aircraft Ident Squitter. Data is returned as right justified, 28 hexadecimal characters or 38 octal characters depending on selected data format (hex or octal).

Example Command  
:MEAS:SQUIT:ACIDENT:DATA?

Example Hex Reply  
"DATA=89E8000720000000000000B2D7C1"

**2.8.40 :MEASure:SQUITter:ACIDENT:INTerval?**

This command returns top, bottom, and combined intervals between consecutive Aircraft Ident Squitters in seconds.

Example Command  
:MEAS:SQUIT:ACIDENT:INT?

Example Reply  
"INT=0.50; INTTOP=0.50; INTBOT=0.00"

**2.8.41 :MEASure:SQUITter:AIRVEL:DATA?**

This command returns the raw data (112 bits) of the Airborne Velocity Squitter. Data is returned as right justified, 28 hexadecimal characters or 38 octal characters depending on selected data format (hex or octal).

Example Command  
:MEAS:SQUIT:AIRVEL:DATA

Example Hex Reply  
"DATA=89E8000798000000000000B7D7C1"

**2.8.42 :MEASure:SQUITter:AIRVEL:INTerval?**

This command returns top, bottom, and combined intervals between consecutive Airborne Velocity Squitters in seconds.

Example Command  
:MEAS:SQUIT:AIRVEL:INT?

Example Reply  
"INT=0.50; INTTOP=0.50; INTBOT=0.00"

**2.8.43 :MEASure:SQUITter:EVNTDRIV:DATA?**

This command returns the raw data (112 bits) of the Event Driven Squitter. Data is returned as right justified, 28 hexadecimal characters or 38 octal characters depending on selected data format (hex or octal).

Example Command  
:MEAS:SQUIT:EVNTDRIV:DATA?

Example Hex Reply  
"DATA=89E80007F8000000000000B5D7C1"

**2.8.44 :MEASure:SQUITter:EVNTDRIV:INTerval?**

This command returns top, bottom, and combined intervals between consecutive Event Driven Squitters in seconds.

Example Command  
:MEAS:SQUIT:EVNTDRIV:INT?

Example Reply  
"INT=0.50; INTTOP=0.50; INTBOT=0.00"

**2.8.45 :MEASure:SQUITter:ACQuisition:DATA?**

This command returns the raw data (56 bits) of the Acquisition Squitter. Data is returned as right justified, 14 hexadecimal characters or 19 octal characters depending on selected data format (hex or octal).

Example Command  
:MEAS:SQUIT:ACQ:DATA?

Example Hex Reply  
"DATA=59EC0000000010FFFFFF"

**2.8.46 :MEASure:SQUITter:ACQuisition:INTerval?**

This command returns top, bottom, and combined intervals between consecutive Acquisition Squitters in seconds.

Example Command  
:MEAS:SQUIT:ACQ:INT?

Example Reply  
"INT=0.50; INTTOP=0.50; INTBOT=0.00"

**2.8.47 :MEASure:AVGOFF**

This command disables averaging of the selected reply parameter

Command:  
:MEAS:AVGOFF <OPTION>  
where OPTION is WIDTH | DELAY | JITTER | SPACING | FREQ | POWER | ALL.

Example  
:MEAS:AVGOFF DELAY

Example Reply  
"OK"

**2.8.48 :MEASure:AVGON**

This command enables averaging for the selected reply parameter.

Command:  
:MEAS:AVGON <OPTION>  
where OPTION is WIDTH | DELAY | JITTER | SPACING | FREQ | POWER | ALL.

Example  
:MEAS:AVGON JITTER

Example Reply  
"OK"

**2.8.49 :MEASure:AVG?**

This command returns a value indicating reply parameters with averaging enabled.

<u>Bit Position</u>	<u>Reply Parameter</u>
0	Reply Jitter
1	Reply Delay
2	Pulse Spacing
3	Pulse Width
4	Frequency
5	Power

Example:  
:MEAS:AVG?

Example Reply:  
"AVG=3" this would indicate Reply Jitter and Delay have averaging enabled

**2.8.50 :MEASure:MINMAXRESet**

This command resets the minimum and maximum buffers for ALL reply parameters.

Command:  
:MEAS:MINMAXRES <FLAG>  
where FLAG is 1 for reset.

Example:  
:MEAS:MINMAXRES 1

Example Reply:  
"OK"

**2.8.51 :MEASure:AVGPARAMeter**

This command sets the current reply parameter. The current reply parameter will be used to set the number of samples used in averaging.

Command:

:MEAS:AVGPARAM <OPTION>

where OPTION is WIDTH | DELAY | JITTER | SPACING | FREQ | POWER.

Example:

:MEAS:AVGPARAM JITTER

Example Reply:

"OK"

**2.8.52 :MEASure:AVGPARAMeter?**

This command returns the current reply parameter and the number of samples used for averaging.

Example:

:MEAS:AVGPARAM?

Example Reply:

"AVGPARAMETER=JITTER;SAMPLES=3"

**2.8.53 :MEASure:AVGPARAMeter:SAMPLES**

This command sets the number of samples used for averaging the current reply parameter.

Command:

:MEAS:AVGPARAM:SAMPLES <SAMPLES>

where SAMPLES is from 1 to 20000

Example:

:MEAS:AVGPARAM:SAMPLES 3

Example Reply:

"OK"

**2.8.54 :MEASure:MINDELAY?**

This command returns the minimum Reply Delay value.

Example:

:MEAS:MINDELAY?

Example Reply:

"MINDELAY=128.13"

**2.8.55 :MEASure:MAXDELAY?**

This command returns the maximum Reply Delay value.

Example:

:MEAS:MINDELAY?

Example Reply:

"MINDELAY=128.13"

**2.8.56 :MEASure:MINJITTER?**

This command returns the minimum Reply Jitter value.

Example:

:MEAS:MINJITTER?

Example Reply:

"MINJITTER=0.13"

**2.8.57 :MEASure:MAXJITTER?**

This command returns the maximum Reply Jitter value.

Example:

:MEAS:MAXJITTER?

Example Reply:

"MAXJITTER =0.25"

**2.8.58 :MEASure:MINWIDTH?**

This command returns the minimum Pulse Width value.

Example:

:MEAS:MINWIDTH?

Example Reply:

"MINWIDTH =.463"

**2.8.59 :MEASure:MAXWIDTH?**

This command returns the maximum Pulse Width value.

Example:

:MEAS:MAXWIDTH?

Example Reply:

"MAXWIDTH =.475"



**2.8.60 :MEASure:MINSPACing?**

This command returns the minimum Pulse Spacing value.

Example:  
:MEAS:MINSPAC?

Example Reply:  
"MINSPAC =1.00"

**2.8.61 :MEASure:MAXSPACing?**

This command returns the maximum Pulse Spacing value.

Example:  
:MEAS:MAXSPAC?

Example Reply:  
"MAXSPAC =1.02"

**2.8.62 :MEASure:MINFREQuency?**

This command returns the minimum Frequency value.

Example:  
:MEAS:MINFREQ?

Example Reply:  
"MINFREQ =1090.01"

**2.8.63:MEASure:MAXFREQuency?**

This command returns the maximum Frequency value.

Example:  
:MEAS:MAXFREQ?

Example Reply:  
"MAXFREQ =1090.03"

**2.8.64 :MEASure:MINPOWER?**

This command returns the minimum Power value.

Example:  
:MEAS:MINPOWER?

Example Reply:  
"MINPOWER =255"

**2.8.65 :MEASure:MINPOWERDBM?**

This command returns the minimum Power value.  
The power is returned in dBm.

**Note: Resolution is 0.1 dBm. If more digits are shown it is because of the addition of calibration factors to the measured data. This command is available on version 4.03 and above.**

Example:  
:MEAS:MINPOWERDBM?

Example Reply:  
"MINPOWERDBM =72.500"

**2.8.66 :MEASure:MAXPOWER?**

This command returns the maximum Power value.

Example:  
:MEAS:MAXPOWER?

Example Reply:  
"MAXPOWER =278"

**2.8.67 :MEASure:MAXPOWERDBM?**

This command returns the maximum Power value.  
The power is returned in dBm.

**Note: Resolution is 0.1 dBm. If more digits are shown it is because of the addition of calibration factors to the measured data. This command is available on version 4.03 and above.**

Example:  
:MEAS:MAXPOWERDBM?

Example Reply:  
"MAXPOWERDBM =97.800"

**2.8.68 :MEASure:PATH**

This command switches the measurement path between the top and bottom channel.

Example:  
:MEAS:PATH TOP

Example:  
:MEAS:PATH BOTTOM

**Note:** This command does **NOT** move the measurement window on the SDX display from the TOP antenna data line to the BOTTOM antenna data line so it is very important that the user **always** reset the measurement path to TOP after a BOTTOM command. Otherwise, data from the bottom antenna may appear to be from the top antenna.

<b>APPENDIX B - I/O DEFINITION TABLES</b> .....	1
<b>1.0 MODULE I/O DEFINITIONS</b> .....	1
<b>1.1 SDX 2000 CHASSIS, EXTERNAL I/O</b> .....	1
<b>1.1.1 SDX 2000, MODE SCOPE SYNC PROGRAMMING</b> .....	9
<b>1.2 ARINC 568 INDICATOR CONNECTOR PIN DEFINITIONS</b> .....	10
<b>1.3 ARINC 568 INTERROGATOR CONNECTOR PIN DEFINITIONS</b> .....	12
<b>1.4 TEST CONNECTOR PIN DEFINITIONS</b> .....	14

<b>APPENDIX B - I/O DEFINITION TABLES</b> .....	1
<b>1.0 MODULE I/O DEFINITIONS</b> .....	1
<b>1.1 SDX 2000 CHASSIS, EXTERNAL I/O</b> .....	1
<b>1.1.1 SDX 2000, MODE SCOPE SYNC PROGRAMMING</b> .....	9
<b>1.2 ARINC 568 INDICATOR CONNECTOR PIN DEFINITIONS</b> .....	10
<b>1.3 ARINC 568 INTERROGATOR CONNECTOR PIN DEFINITIONS</b> .....	12
<b>1.4 TEST CONNECTOR PIN DEFINITIONS</b> .....	14

APPENDIX B - I/O DEFINITION TABLES

1.0 MODULE I/O DEFINITIONS

1.1 SDX 2000 CHASSIS, EXTERNAL I/O

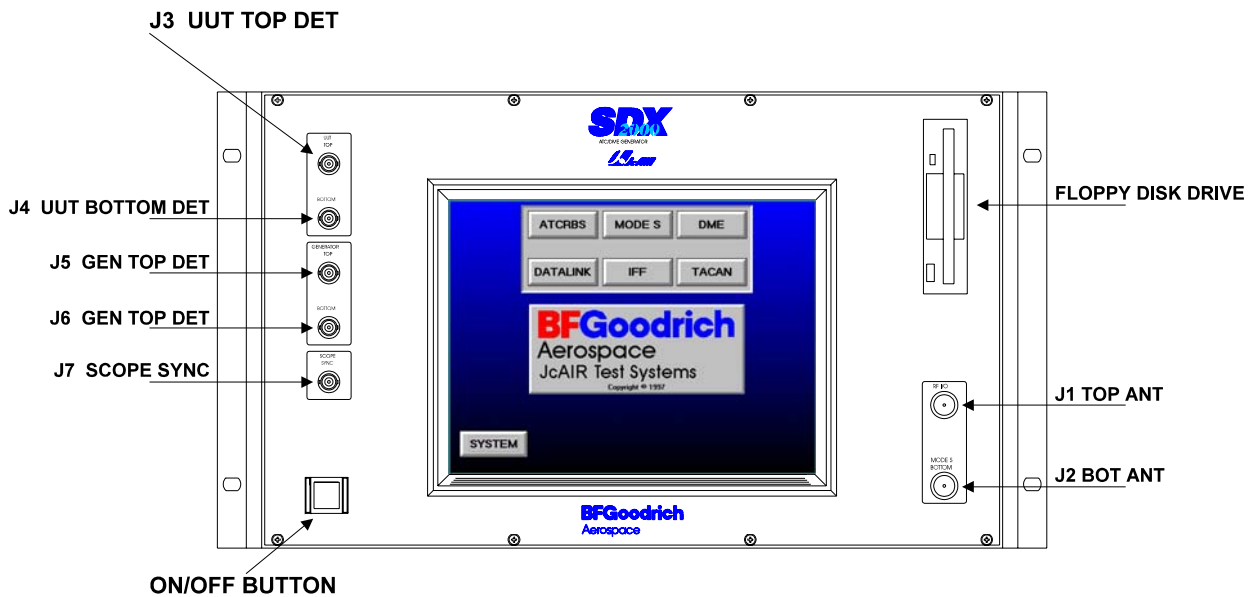

Figure 1

**APPENDIX B - I/O DEFINITION TABLES**

**1.1 SDX 2000 CHASSIS, EXTERNAL I/O cont.**

The RF I/O connectors for Top and Bottom channels are provided at the front panel, (Figure 1) with the option of rear panel access instead. All other signals are provided at the rear panel (Figure 2) through the Interface Module's connector plate. This plate is attached to the rear panel of the SDX 2000.

Front Panel See Figure 1	
J1 TOP ANT Connector (RF I/O) (To: RF I/O Module)	L-band I/O signal for the top channel I/O, Type N 50 Ohms Input, 1W to 4KW
J2 BOTTOM ANT Connector (MODE S BOT.) (To: RF I/O Module)	L-band signal for the bottom channel I/O, Type N 50 Ohms Input, 1W to 4KW Output, -11dBm to 0dBm
J3 UUT TOP DET Connector (To: RF I/O Module)	Linear detected video of the UUT top Tx Output, BNC Linear analog, 0 to 1 V, 50 ohms
J4 UUT BTM DET Connector (To: RF I/O Module)	Linear detected video of the UUT bottom Tx Output, BNC Linear analog, 0 to 1 V, 50 ohms
J5 GEN TOP DET Connector (To: GEN XMIT Module)	Linear detected video of the SDX top RF generator Output, BNC Linear analog, 0 to 1 V, 50 ohms
J6 GEN BTM DET Connector (To: GEN XMIT Module)	Linear detected video of the SDX bottom RF generator Output, BNC Linear analog, 0 to 1 V, 50 ohms
J7 SCOPE SYNC Connector (To: AUX I/O Module)	Scope sync, programmable according to table 1.1.2, below Output, BNC TTL

**1.1 SDX 2000 CHASSIS, EXTERNAL I/O cont.**

REAR PANEL FIXED MOUNTING See Figure 2	
(J1) Connector Top Ant. (RF I/O) (To: RF I/O Module)	(Optional) Rear Panel TOP RF Port I/O, Type N Input, 1W to 4KW L-band, 50 ohms
(J2) Connector Bottom Ant. (MODE S Bot.) (To: RF I/O Module)	(Optional) Rear Panel BOT RF Port I/O, Type N L-band, 50 ohms
(J43) Connector AC Input Fuse	Selectable Input: 115 VAC or 230VAC 45 to 440 Hz.

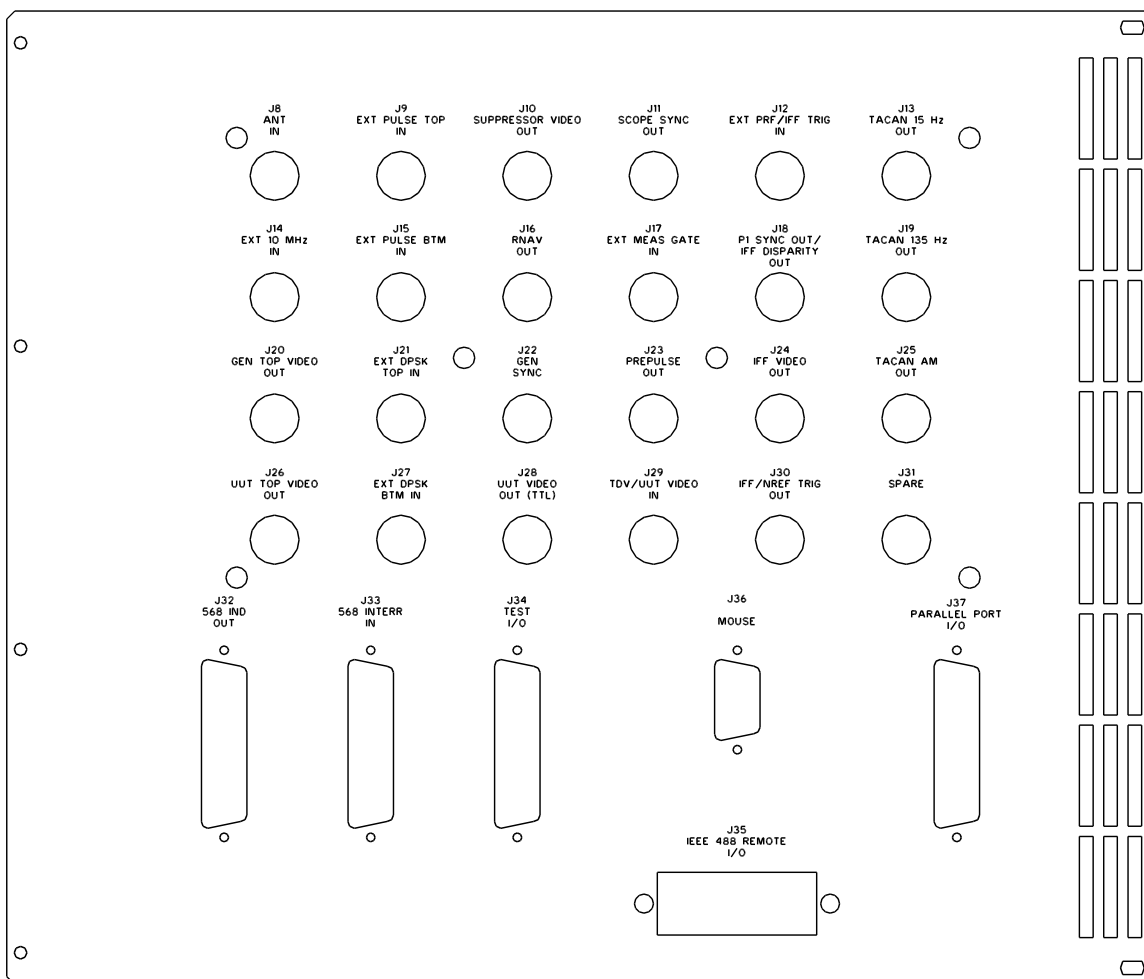

**Figure 2**



SDX 2000 Operation Manual

**1.1 SDX 2000 CHASSIS, EXTERNAL I/O cont.**

Rear Panel Connector Plate See Figure 2	
J8 ANT IN Connector (To: RF I/O Module)	Top Channel Antenna Port Input, BNC, 50 Ohm Signal level: -10 dBm to +10 dBm @1090 MHz.
J9 EXT Pulse TOP IN Connector (To: GEN Video Module)	External Modulation Top Channel (to IFF Pulse Interrogator RADAR KIR Challenge Video Out) Input, BNC TTL
J10 SUPPRESSOR VIDEO OUT Conn. (To: AUX I/O Module)	Suppression Video Output, BNC 3 to 27 VDC, programmable, >10kOhms
J11 SCOPE SYNC OUT Connector (To: AUX I/O Module)	Scope Sync (rear) Programmable accd. to table 1.1.2 Output, BNC TTL
J12 EXT PRF / IFF TRIG IN Connector (To: AUX I/O Module)	IFF External Sync Input (PRF) /IFF Interrogator UUT Trigger Input Input, BNC TTL
J13 TACAN 15 HZ OUT Connector (To: AUX I/O Module)	15 Hz audio signal output from the TACAN modulator Output, BNC 2K Ohms





**1.1 SDX 2000 CHASSIS, EXTERNAL I/O cont.**

Rear Panel Connector Plate cont. See Figure 2	
J14 10 MHZ REF IN Connector (To: GEN XMIT Module)	10 Mhz Reference Input, BNC 50 Ohms
J15 EXT Pulse BOTT IN Connector (To: GEN Video Module)	External Pulse Modulation Bottom Channel Input, BNC 0-12V @ 1K Ohms
J16 RNAV Out Connector (To: AUX I/O Module)	RNAV, DME pulse Output, BNC TTL
J17 EXT MEAS GATE IN Connector (To: AUX I/O Module)	External Meas. Gate Input, BNC TTL
J18 P1 SYNC OUT / IFF DISPARITY OUT Connector (To: AUX I/O Module)	Sync pulse for Mode S or IFF Disparity pulse Output, BNC TTL
J19 TACAN 135 HZ OUT Connector (To: AUX I/O Module)	135 Hz audio signal output for calibration and verification Output, BNC 2K Ohms
J20 TOP GEN VID OUT Connector (To: GEN XMIT Module)	Linear Detected Video, Top Channel Output, BNC Analog linear 0 to 1V, 50 Ohms
J21 EXT DPSK TOP IN Connector (To: GEN Video Module)	External Phase Modulation Top Ch. Input, BNC TTL

**1.1 SDX 2000 CHASSIS, EXTERNAL I/O cont.**

Rear Panel Connector Plate cont. See Figure 2	
J22 Gen SyncOut Connector	Gen Sync output for every Interrogation Output, BNC TTL  <i>ATCRBS</i> 1 us pulse @ P3 <i>MODE S</i> Short MODE S Interrogation 3 us pulse @ P6 Long MODE S Interrogation 27 us pulse @ P6  <i>IFF</i> <i>ATCRBS</i> 1 us pulse @ P3 Interrogator Mode 1 us pulse @ P4
J23 PREPULSE OUT Conn. (To: AUX I/O Module)	MODE S Prepulse 1.0 us wide pulse, occurring 0 to 260 us prior to P1 Output, BNC TTL
J24 IFF VIDEO OUT Connector (To: AUX I/O Module)	Generate video for IFF XPDR Encoder Input, also, simulated IFF encoded reply to Interrogator Challenge Video input Output, BNC TTL



SDX 2000 Operation Manual

**1.1 SDX 2000 CHASSIS, EXTERNAL I/O cont.**

Rear Panel Connector Plate cont. See Figure 2	
J25 TACAN AM Connector (To: AUX I/O Module)	TACAN Composite Audio Output, BNC 2K Ohms
J26 TOP UUT VID OUT Connector (To: GEN XMIT Module)	UUT Linear Detected Video from the Top Channel Output, BNC Linear Analog 0 to 1 V, 50 Ohms
J27 EXT DPSK BOTT IN Connector (To: GEN Video Module)	External Phase Modulation Bottom Ch. Input, BNC TTL
J28 UUT TTL VIDEO OUT Connector (To: AUX I/O Module)	Detected UUT video converted to a TTL signal Output, BNC TTL
J29 TDU/UUT VIDEO IN Connector (To: AUX I/O Connector)	Time Decoded Video In for IFF XPDR Input, BNC TTL
J30 IFF TRIG / NREF TRIG OUT Conn. (To: AUX I/O Module)	IFF Pre-Trigger and IFF RADAR Time- Decoded Video IFF Pretrigger to KIR (XPDR Interrogator Ext.) North Reference Trigger pulse (TACAN) Output, BNC Open Collector, Table (1.1.1)
J 31 Spare Connector	



**1.1 SDX 2000 CHASSIS, EXTERNAL I/O cont.**

Rear Panel Connector Plate cont. See Figure 2	
J32 568 IND OUT Connector (To: AUX I/O Module)	ARINC 568 DME Indicator interface Output, 25 pin D, Table (1.2)
J33 568 INTERR IN Connector (To: AUX I/O Module)	ARINC 568 DME Interrogator interface Input / Output, 25 pin D, Table (1.3) (2 of 5), (serial I/O)
J34 TEST I/O Connector (To: AUX I/O Module)	Test Interface(unspecified) I/O, 25 pin D Input/Output (Table 1.4)
J35 IEEE 488 REMOTE I/O Connector (To: CPU Module)	GPIB Remote interface control I/O, 24 pin, IEEE 488.2 Std.
J36 RS 232 MOUSE Connector. (To: CPU Module)	Microsoft7 Mouse Interface I/O 9 pin D RS 232C
J37 PARALLEL PORT I/O Connector (To: CPU Module)	Parallel bus / Printer Port I/O 25 pin D TTL

**1.1.1 SDX 2000, MODE SCOPE SYNC PROGRAMMING**

<p>ATCRBS Test Function</p>	<p>Selectable for 1.0 us prior to P1 of the interrogation or 2.0 us following P3 of the interrogation in normal or interference mode and for either the first or the second interrogation in Double Interrogation mode 1.0 us wide, TTL</p>
<p>MODE S Test Function</p>	<p>Selectable for 1.0 us prior to P1 of the interrogation or 2.0 us following P3 of the interrogation (ATCRBS or Internal Short) or 127 us following SPR of the interrogation (ModeS or intermode long) and for the first or the second interrogation in the Double Interrogation mode or for the ATCRBS or the Mode S interrogation in the Interlace mode. 1.0 us wide, TTL</p>
<p>DATALINK Test Function</p>	<p>Selectable for 1.0 us prior to P1 of the interrogation or 2.0 us following P3 of the interrogation (ATCRBS or Internal Short) or 127 us following SPR of the interrogation (ModeS or intermode long) and for the first or the second interrogation in the Double Interrogation mode or for the ATCRBS or the Mode S interrogation in the Interlace mode. 1.0 us wide, TTL</p>
<p>DME Test Function</p>	<p>Selectable Sync Functions: 1.0 us wide, TTL</p> <ul style="list-style-type: none"> <li>Squitter</li> <li>Reply</li> <li>Echo</li> <li>Ident</li> </ul>

### 1.2 ARINC 568 INDICATOR CONNECTOR PIN DEFINITIONS

25 pin subminiature "D" connector

PIN NO.	ASSIGNMENT	INPUT/OUTPUT	OUTPUT LOAD
1	Serial Data HI	Output	LO 0V ±1V HI 12V +3/-2V 12 kOhms ~ 600Ohms
2	Serial Data LO	Output	
3	Serial Clock HI	Output	LO 0V ±1V HI 12V +3/-2V 12 KOhms ~ 600Ohms
4	Serial Clock LO	Output	
5	Serial Sync HI	Output	
6	Serial Sync LO	Output	
7	N/C		
8	Analog Distance HI	Output	12V 1 KOhms
9	Analog Distance LO	Output	
10	Range Rate HI	Output	
11	Range Rate LO	Output	
12	Chassis Gnd.		

**1.2 ARINC 568 INDICATOR CONNECTOR PIN DEFINITIONS cont.**

25 pin subminiature "D" connector

PIN NO.	ASSIGNMENT	INPUT/OUTPUT	OUTPUT LOAD
13	N/C		
14	N/C		
15	Warning Flag	Output	27.5V @ 150 ma max.
16	Chassis Gnd		
17	5V Instr. Light Dim	Output	5VDC @ 100 ma
18	Chassis Gnd.		
19	N/C		
20	N/C		
21	N/C		
22	N/C		
23	N/C		
24	N/C		
25	N/C		

### 1.3 ARINC 568 INTERROGATOR CONNECTOR PIN DEFINITIONS

25 pin subminiature "D" connector

PIN NO.	ASSIGNMENT	INPUT/OUTPUT	INPUT/OUTPUT LOAD
1	Tens A	Output	Open Collector Output
2	Tens B	Output	
3	Units A	Output	
4	Units B	Output	
5	Units C	Output	
6	Units D	Output	
7	Units E	Output	
8	Tenths A	Output	
9	Tenths B	Output	
10	Tenths C	Output	
11	Tenths D	Output	
12	Tenths E	Output	
13	Hundredths C	Output	
14	Frequency Common	Output	
15	N/C		



**1.3 ARINC 568 INTERROGATOR CONNECTOR PIN DEFINITIONS cont.**

25 pin subminiature "D" connector

PIN NO.	ASSIGNMENT	INPUT/OUTPUT	INPUT/OUTPUT LOAD
16	N/C		
17	N/C		
18	Chassis Gnd		Input Equals 3 Loads
19	Chassis Gnd		
20	Serial Data HI	Input	
21	Serial Data LO	Input	
22	Serial Clock HI	Input	
23	Serial Clock LO	Input	
24	Serial Sync HI	Input	
25	Serial Sync LO	Input	

#### 1.4 TEST CONNECTOR PIN DEFINITIONS

The TEST pins A-G are designated test pins coming from the backplane. Test signals from any module may be routed to these pins and brought out of the SDX unit on the rear panel test connector. Various other test signals are brought out as well.

25 pin subminiature "D" connector

PIN NO.	ASSIGNMENT	INPUT/OUTPUT	INPUT/OUTPUT LOAD
1	Gnd		
2		OUT	
3	+5 VDC Test	OUT	+5V @ 10KOhms
4		OUT	
5		OUT	
6	+15 VDC Test	OUT	+15V @ 10KOhms
7	AUX I/O Ext AM Sum Input	IN	Analog Input +1V @ 2KOhms
8		OUT	
9	-15 VDC Test	OUT	-15V @ 10KOhms
10	AUX I/O 15Hz Sq. Wave	OUT	TTL
11	AUX I/O 135 Hz Sq. Wave	OUT	TTL
12	+29 VDC Test	OUT	+29V @ 10KOhms
13	AUX I/O TACAN Sync. Det.	OUT	TTL
14	GND		

**1.4 TEST CONNECTOR PIN DEFINITIONS cont.**

25 pin subminiature "D" connector

PIN NO.	ASSIGNMENT	INPUT/OUTPUT	INPUT/OUTPUT LOAD
15	MEASUREMENT GATE	OUT	TTL
16	GND		
17	TEST B	OUT	TTL
18	TEST C	OUT	
19	GND		
20	TEST D	OUT	TTL
21	TEST E	OUT	
22	GND		
23	TEST F	OUT	TTL
24	TEST G	OUT	
25	GND		



## Appendix C - SDX-2000 Percent Reply Calculation

This section describes the methods used to calculate percent reply in the SDX-2000. Because of the diverse setups and instruments available with the SDX-2000, seven unique cases have been included to describe the methods used for percent reply calculation.

### Case 1

Applicable Instruments: ATCRBS, IFF, Mode S

Setup: Normal or Interlace test modes, PRF greater than 10Hz, PRF greater than the number of enabled interrogations.

Percent reply is calculated every second by dividing the number of valid replies by the number of transmitted interrogations. During the one-second interval, the SDX-2000 accumulates interrogations and replies in four buckets. Two buckets are used to accumulate ATCRBS interrogations and replies and two for Mode S interrogations and replies. When the one-second interval has expired, the number in the ATCRBS replies bucket is divided by the number in the ATCRBS interrogations bucket. This calculation yields the ATCRBS percent reply. Similarly, the number in the Mode S replies bucket is divided by the number in the Mode S interrogations bucket yielding the Mode S percent reply. All-Call interrogations are accumulated in both the ATCRBS and Mode S interrogation buckets.

### Case 2

Applicable Instruments: ATCRBS, IFF, Mode S

Setup: Normal or Interlace test modes, PRF less than 10Hz.

Percent reply is calculated every ten seconds by dividing the number of valid replies by the number of transmitted interrogations. During the ten-second interval, the SDX-2000 accumulates interrogations and replies in four buckets. Two buckets are used to accumulate ATCRBS interrogations and replies and two for Mode S interrogations and replies. When the ten-second interval has expired, the number in the ATCRBS replies bucket is divided by the number in the ATCRBS interrogations bucket. This calculation yields the ATCRBS percent reply. Similarly, the number in the Mode S replies bucket is divided by the number in the Mode S interrogations bucket yielding the Mode S percent reply. All-Call interrogations are accumulated in both the ATCRBS and Mode S interrogation buckets.

### Case 3

Applicable Instruments: ATCRBS, IFF, Mode S

Setup: Normal or Interlace test modes, PRF greater than 10Hz, PRF less than the number of enabled interrogations.

Percent reply is calculated at the end of the interrogation table sequence by dividing the number of valid replies by the number of transmitted interrogations. During the table sequence, the SDX-2000 accumulates interrogations and replies in four buckets. Two buckets are used to accumulate ATCRBS interrogations and replies and two for Mode S interrogations and replies. At the end of the interrogation table sequence, the number in the ATCRBS replies bucket is divided by the number in the ATCRBS interrogations bucket. This calculation yields the ATCRBS percent reply. Similarly, the number in the Mode S replies bucket is divided by the number in the Mode S interrogations bucket yielding the Mode S percent reply. All-Call interrogations are accumulated in both the ATCRBS and Mode S interrogation buckets.



## SDX 2000 Operation Manual

### Case 4

Applicable Instruments: ATCRBS, IFF, Mode S

Setup: Double interrogation test mode, PRF greater than 10Hz, PRF greater than the number of enabled interrogations

Percent reply is calculated every second by dividing the number of valid replies by the number of transmitted interrogations. During the one-second interval, the SDX-2000 accumulates interrogations and replies in four buckets. Two buckets are used to accumulate First interrogations and replies and two for Second interrogations and replies. When the one-second interval has expired, the number in the First replies bucket is divided by the number in the First interrogations bucket. This calculation yields the percent reply to the first interrogation. Similarly, the number in the Second replies bucket is divided by the number in the Second interrogations bucket yielding the percent reply to the second interrogation.

### Case 5

Applicable Instruments: ATCRBS, IFF, Mode S

Setup: Double interrogation test mode, PRF less than 10Hz

Percent reply is calculated every ten seconds by dividing the number of valid replies by the number of transmitted interrogations. During the ten-second interval, the SDX-2000 accumulates interrogations and replies in four buckets. Two buckets are used to accumulate First interrogations and replies and two for Second interrogations and replies. When the ten-second interval has expired, the number in the First replies bucket is divided by the number in the First interrogations bucket. This calculation yields the percent reply to the first interrogation. Similarly, the number in the Second replies bucket is divided by the number in the Second interrogations bucket yielding the percent reply to the second interrogation.

### Case 6

Applicable Instruments: ATCRBS, IFF, Mode S

Setup: Double interrogation test mode, PRF greater than 10Hz, PRF less than the number of enabled interrogations

Percent reply is calculated at the end of the interrogation table sequence by dividing the number of valid replies by the number of transmitted interrogations. During the table sequence, the SDX-2000 accumulates interrogations and replies in four buckets. Two buckets are used to accumulate First interrogations and replies and two for Second interrogations and replies. At the end of the interrogation table sequence, the number in the First replies bucket is divided by the number in the First interrogations bucket. This calculation yields the percent reply to the first interrogation. Similarly, the number in the Second replies bucket is divided by the number in the Second interrogations bucket yielding the percent reply to the second interrogation.



**Case 7**

Applicable Instruments: Mode S, Datalink  
Setup: Burst test mode

Percent reply is calculated at the end of every burst by dividing the number of valid replies by the number of transmitted interrogations. During the burst, the SDX-2000 accumulates interrogations and replies in four buckets. Two buckets are used to accumulate ATCRBS interrogations and replies and two for Mode S interrogations and replies. At the end of the burst, the number in the ATCRBS replies bucket is divided by the number in the ATCRBS interrogations bucket. This calculation yields the ATCRBS percent reply. Similarly, the number in the Mode S replies bucket is divided by the number in the Mode S interrogations bucket yielding the Mode S percent reply. All-Call interrogations are accumulated in both the ATCRBS and Mode S interrogation buckets.

Note: Because All-Call interrogations are accumulated in both the ATCRBS and Mode S interrogation buckets, it is not recommended to enable All-Call interrogations with any other interrogation types.



**APPENDIX D - ALTITUDE CODES**

RANGE (altitude in thousands)	PULSE POSITION										
	D <sub>2</sub>	D <sub>4</sub> and SPI	A <sub>1</sub>	A <sub>2</sub>	A <sub>4</sub>	B <sub>1</sub>	B <sub>2</sub>	B <sub>4</sub>	C <sub>1</sub>	C <sub>2</sub>	C <sub>4</sub>
-1.0	0	0	0	0	0	0	0	0	0	1	0
-0.9	0	0	0	0	0	0	0	0	1	1	0
-0.8	0	0	0	0	0	0	0	0	1	0	0
-0.7	0	0	0	0	0	0	0	1	1	0	0
-0.6	0	0	0	0	0	0	0	1	1	1	0
-0.5	0	0	0	0	0	0	0	1	0	1	0
-0.4	0	0	0	0	0	0	0	1	0	1	1
-0.3	0	0	0	0	0	0	0	1	0	0	1
-0.2	0	0	0	0	0	0	1	1	0	0	1
-0.1	0	0	0	0	0	0	1	1	0	1	1
0.0	0	0	0	0	0	0	1	1	0	1	0
0.1	0	0	0	0	0	0	1	1	1	1	0
0.2	0	0	0	0	0	0	1	1	1	0	0
0.3	0	0	0	0	0	0	1	0	1	0	0
0.4	0	0	0	0	0	0	1	0	1	1	0
0.5	0	0	0	0	0	0	1	0	0	1	0
0.6	0	0	0	0	0	0	1	0	0	1	1
0.7	0	0	0	0	0	0	1	0	0	0	1
0.8	0	0	0	0	0	1	1	0	0	0	1
0.9	0	0	0	0	0	1	1	0	0	1	1
1.0	0	0	0	0	0	1	1	0	0	1	0
1.1	0	0	0	0	0	1	1	0	1	1	0
1.2	0	0	0	0	0	1	1	0	1	0	0
1.3	0	0	0	0	0	1	1	1	1	0	0
1.4	0	0	0	0	0	1	1	1	1	1	0
1.5	0	0	0	0	0	1	1	1	0	1	0
1.6	0	0	0	0	0	1	1	1	0	1	1
1.7	0	0	0	0	0	1	1	1	0	0	1
1.8	0	0	0	0	0	1	0	1	0	0	1
1.9	0	0	0	0	0	1	0	1	0	1	1
2.0	0	0	0	0	0	1	0	1	0	1	0
2.1	0	0	0	0	0	1	0	1	1	1	0
2.2	0	0	0	0	0	1	0	1	1	0	0
2.3	0	0	0	0	0	1	0	0	1	0	0
2.4	0	0	0	0	0	1	0	0	1	1	0

  
 SDX 2000 Operation Manual

RANGE (altitude in thousands)	PULSE POSITION										
	D <sub>2</sub>	D <sub>4</sub> and SPI	A <sub>1</sub>	A <sub>2</sub>	A <sub>4</sub>	B <sub>1</sub>	B <sub>2</sub>	B <sub>4</sub>	C <sub>1</sub>	C <sub>2</sub>	C <sub>4</sub>
2.5	0	0	0	0	0	1	0	0	0	1	0
2.6	0	0	0	0	0	1	0	0	0	1	1
2.7	0	0	0	0	0	1	0	0	0	0	1
2.8	0	0	0	0	1	1	0	0	0	0	1
2.9	0	0	0	0	1	1	0	0	0	1	1
3.0	0	0	0	0	1	1	0	0	0	1	0
3.1	0	0	0	0	1	1	0	0	1	1	0
3.2	0	0	0	0	1	1	0	0	1	0	0
3.3	0	0	0	0	1	1	0	1	1	0	0
3.4	0	0	0	0	1	1	0	1	1	1	0
3.5	0	0	0	0	1	1	0	1	0	1	0
3.6	0	0	0	0	1	1	0	1	0	1	1
3.7	0	0	0	0	1	1	0	1	0	0	1
3.8	0	0	0	0	1	1	1	1	0	0	1
3.9	0	0	0	0	1	1	1	1	0	1	1
4.0	0	0	0	0	1	1	1	1	0	1	0
4.1	0	0	0	0	1	1	1	1	1	1	0
4.2	0	0	0	0	1	1	1	1	1	0	0
4.3	0	0	0	0	1	1	1	0	1	0	0
4.4	0	0	0	0	1	1	1	0	1	1	0
4.5	0	0	0	0	1	1	1	0	0	1	0
4.6	0	0	0	0	1	1	1	0	0	1	1
4.7	0	0	0	0	1	1	1	0	0	0	1
4.8	0	0	0	0	1	0	1	0	0	0	1
4.9	0	0	0	0	1	0	1	0	0	1	1
5.0	0	0	0	0	1	0	1	0	0	1	0
5.1	0	0	0	0	1	0	1	0	1	1	0
5.2	0	0	0	0	1	0	1	0	1	0	0
5.3	0	0	0	0	1	0	1	1	1	0	0
5.4	0	0	0	0	1	0	1	1	1	1	0
5.5	0	0	0	0	1	0	1	1	0	1	0
5.6	0	0	0	0	1	0	1	1	0	1	1
5.7	0	0	0	0	1	0	1	1	0	0	1
5.8	0	0	0	0	1	0	0	1	0	0	1
5.9	0	0	0	0	1	0	0	1	0	1	1



  
 SDX 2000 Operation Manual

RANGE (altitude in thousands)	PULSE POSITION										
	D <sub>2</sub>	D <sub>4</sub> and SPI	A <sub>1</sub>	A <sub>2</sub>	A <sub>4</sub>	B <sub>1</sub>	B <sub>2</sub>	B <sub>4</sub>	C <sub>1</sub>	C <sub>2</sub>	C <sub>4</sub>
6.0	0	0	0	0	1	0	0	1	0	1	0
6.1	0	0	0	0	1	0	0	1	1	1	0
6.2	0	0	0	0	1	0	0	1	1	0	0
6.3	0	0	0	0	1	0	0	0	1	0	0
6.4	0	0	0	0	1	0	0	0	1	1	0
6.5	0	0	0	0	1	0	0	0	0	1	0
6.6	0	0	0	0	1	0	0	0	0	1	1
6.7	0	0	0	0	1	0	0	0	0	0	1
6.8	0	0	0	1	1	0	0	0	0	0	1
6.9	0	0	0	1	1	0	0	0	0	1	1
7.0	0	0	0	1	1	0	0	0	0	1	0
7.1	0	0	0	1	1	0	0	0	1	1	0
7.2	0	0	0	1	1	0	0	0	1	0	0
7.3	0	0	0	1	1	0	0	1	1	0	0
7.4	0	0	0	1	1	0	0	1	1	1	0
7.5	0	0	0	1	1	0	0	1	0	1	0
7.6	0	0	0	1	1	0	0	1	0	1	1
7.7	0	0	0	1	1	0	0	1	0	0	1
7.8	0	0	0	1	1	0	1	1	0	0	1
7.9	0	0	0	1	1	0	1	1	0	1	1
8.0	0	0	0	1	1	0	1	1	0	1	0
8.1	0	0	0	1	1	0	1	1	1	1	0
8.2	0	0	0	1	1	0	1	1	1	0	0
8.3	0	0	0	1	1	0	1	0	1	0	0
8.4	0	0	0	1	1	0	1	0	1	1	0
8.5	0	0	0	1	1	0	1	0	0	1	0
8.6	0	0	0	1	1	0	1	0	0	1	1
8.7	0	0	0	1	1	0	1	0	0	0	1
8.8	0	0	0	1	1	1	1	0	0	0	1
8.9	0	0	0	1	1	1	1	0	0	1	1
9.0	0	0	0	1	1	1	1	0	0	1	0
9.1	0	0	0	1	1	1	1	0	1	1	0
9.2	0	0	0	1	1	1	1	0	1	0	0
9.3	0	0	0	1	1	1	1	1	1	0	0
9.4	0	0	0	1	1	1	1	1	1	1	0

  
 SDX 2000 Operation Manual

RANGE (altitude in thousands)	PULSE POSITION										
	D <sub>2</sub>	D <sub>4</sub> and SPI	A <sub>1</sub>	A <sub>2</sub>	A <sub>4</sub>	B <sub>1</sub>	B <sub>2</sub>	B <sub>4</sub>	C <sub>1</sub>	C <sub>2</sub>	C <sub>4</sub>
9.5	0	0	0	1	1	1	1	1	0	1	0
9.6	0	0	0	1	1	1	1	1	0	1	1
9.7	0	0	0	1	1	1	1	1	0	0	1
9.8	0	0	0	1	1	1	0	1	0	0	1
9.9	0	0	0	1	1	1	0	1	0	1	1
10.0	0	0	0	1	1	1	0	1	0	1	0
10.1	0	0	0	1	1	1	0	1	1	1	0
10.2	0	0	0	1	1	1	0	1	1	0	0
10.3	0	0	0	1	1	1	0	0	1	0	0
10.4	0	0	0	1	1	1	0	0	1	1	0
10.5	0	0	0	1	1	1	0	0	0	1	0
10.6	0	0	0	1	1	1	0	0	0	1	1
10.7	0	0	0	1	1	1	0	0	0	0	1
10.8	0	0	0	1	0	1	0	0	0	0	1
10.9	0	0	0	1	0	1	0	0	0	1	1
11.0	0	0	0	1	0	1	0	0	0	1	0
11.1	0	0	0	1	0	1	0	0	1	1	0
11.2	0	0	0	1	0	1	0	0	1	0	0
11.3	0	0	0	1	0	1	0	1	1	0	0
11.4	0	0	0	1	0	1	0	1	1	1	0
11.5	0	0	0	1	0	1	0	1	0	1	0
11.6	0	0	0	1	0	1	0	1	0	1	1
11.7	0	0	0	1	0	1	0	1	0	0	1
11.8	0	0	0	1	0	1	1	1	0	0	1
11.9	0	0	0	1	0	1	1	1	0	1	1
12.0	0	0	0	1	0	1	1	1	0	1	0
12.1	0	0	0	1	0	1	1	1	1	1	0
12.2	0	0	0	1	0	1	1	1	1	0	0
12.3	0	0	0	1	0	1	1	0	1	0	0
12.4	0	0	0	1	0	1	1	0	1	1	0
12.5	0	0	0	1	0	1	1	0	0	1	0
12.6	0	0	0	1	0	1	1	0	0	1	1
12.7	0	0	0	1	0	1	1	0	0	0	1
12.8	0	0	0	1	0	0	1	0	0	0	1
12.9	0	0	0	1	0	0	1	0	0	1	1

  
 SDX 2000 Operation Manual

RANGE (altitude in thousands)	PULSE POSITION										
	D <sub>2</sub>	D <sub>4</sub> and SPI	A <sub>1</sub>	A <sub>2</sub>	A <sub>4</sub>	B <sub>1</sub>	B <sub>2</sub>	B <sub>4</sub>	C <sub>1</sub>	C <sub>2</sub>	C <sub>4</sub>
13.0	0	0	0	1	0	0	1	0	0	1	0
13.1	0	0	0	1	0	0	1	0	1	1	0
13.2	0	0	0	1	0	0	1	0	1	0	0
13.3	0	0	0	1	0	0	1	1	1	0	0
13.4	0	0	0	1	0	0	1	1	1	1	0
13.5	0	0	0	1	0	0	1	1	0	1	0
13.6	0	0	0	1	0	0	1	1	0	1	1
13.7	0	0	0	1	0	0	1	1	0	0	1
13.8	0	0	0	1	0	0	0	1	0	0	1
13.9	0	0	0	1	0	0	0	1	0	1	1
14.0	0	0	0	1	0	0	0	1	0	1	0
14.1	0	0	0	1	0	0	0	1	1	1	0
14.2	0	0	0	1	0	0	0	1	1	0	0
14.3	0	0	0	1	0	0	0	0	1	0	0
14.4	0	0	0	1	0	0	0	0	1	1	0
14.5	0	0	0	1	0	0	0	0	0	1	0
14.6	0	0	0	1	0	0	0	0	0	1	1
14.7	0	0	0	1	0	0	0	0	0	0	1
14.8	0	0	1	1	0	0	0	0	0	0	1
14.9	0	0	1	1	0	0	0	0	0	1	1
15.0	0	0	1	1	0	0	0	0	0	1	0
15.1	0	0	1	1	0	0	0	0	1	1	0
15.2	0	0	1	1	0	0	0	0	1	0	0
15.3	0	0	1	1	0	0	0	1	1	0	0
15.4	0	0	1	1	0	0	0	1	1	1	0
15.5	0	0	1	1	0	0	0	1	0	1	0
15.6	0	0	1	1	0	0	0	1	0	1	1
15.7	0	0	1	1	0	0	0	1	0	0	1
15.8	0	0	1	1	0	0	1	1	0	0	1
15.9	0	0	1	1	0	0	1	1	0	1	1
16.0	0	0	1	1	0	0	1	1	0	1	0
16.1	0	0	1	1	0	0	1	1	1	1	0
16.2	0	0	1	1	0	0	1	1	1	0	0
16.3	0	0	1	1	0	0	1	0	1	0	0
16.4	0	0	1	1	0	0	1	0	1	1	0

  
 SDX 2000 Operation Manual

RANGE (altitude in thousands)	PULSE POSITION										
	D <sub>2</sub>	D <sub>4</sub> and SPI	A <sub>1</sub>	A <sub>2</sub>	A <sub>4</sub>	B <sub>1</sub>	B <sub>2</sub>	B <sub>4</sub>	C <sub>1</sub>	C <sub>2</sub>	C <sub>4</sub>
16.5	0	0	1	1	0	0	1	0	0	1	0
16.6	0	0	1	1	0	0	1	0	0	1	1
16.7	0	0	1	1	0	0	1	0	0	0	1
16.8	0	0	1	1	0	1	1	0	0	0	1
16.9	0	0	1	1	0	1	1	0	0	1	1
17.0	0	0	1	1	0	1	1	0	0	1	0
17.1	0	0	1	1	0	1	1	0	1	1	0
17.2	0	0	1	1	0	1	1	0	1	0	0
17.3	0	0	1	1	0	1	1	1	1	0	0
17.4	0	0	1	1	0	1	1	1	1	1	0
17.5	0	0	1	1	0	1	1	1	0	1	0
17.6	0	0	1	1	0	1	1	1	0	1	1
17.7	0	0	1	1	0	1	1	1	0	0	1
17.8	0	0	1	1	0	1	0	1	0	0	1
17.9	0	0	1	1	0	1	0	1	0	1	1
18.0	0	0	1	1	0	1	0	1	0	1	0
18.1	0	0	1	1	0	1	0	1	1	1	0
18.2	0	0	1	1	0	1	0	1	1	0	0
18.3	0	0	1	1	0	1	0	0	1	0	0
18.4	0	0	1	1	0	1	0	0	1	1	0
18.5	0	0	1	1	0	1	0	0	0	1	0
18.6	0	0	1	1	0	1	0	0	0	1	1
18.7	0	0	1	1	0	1	0	0	0	0	1
18.8	0	0	1	1	1	1	0	0	0	0	1
18.9	0	0	1	1	1	1	0	0	0	1	1
19.0	0	0	1	1	1	1	0	0	0	1	0
19.1	0	0	1	1	1	1	0	0	1	1	0
19.2	0	0	1	1	1	1	0	0	1	0	0
19.3	0	0	1	1	1	1	0	1	1	0	0
19.4	0	0	1	1	1	1	0	1	1	1	0
19.5	0	0	1	1	1	1	0	1	0	1	0
19.6	0	0	1	1	1	1	0	1	0	1	1
19.7	0	0	1	1	1	1	0	1	0	0	1
19.8	0	0	1	1	1	1	1	1	0	0	1
19.9	0	0	1	1	1	1	1	1	0	1	1

  
 SDX 2000 Operation Manual

RANGE (altitude in thousands)	PULSE POSITION										
	D <sub>2</sub>	D <sub>4</sub> and SPI	A <sub>1</sub>	A <sub>2</sub>	A <sub>4</sub>	B <sub>1</sub>	B <sub>2</sub>	B <sub>4</sub>	C <sub>1</sub>	C <sub>2</sub>	C <sub>4</sub>
20.0	0	0	1	1	1	1	1	1	0	1	0
20.1	0	0	1	1	1	1	1	1	1	1	0
20.2	0	0	1	1	1	1	1	1	1	0	0
20.3	0	0	1	1	1	1	1	0	1	0	0
20.4	0	0	1	1	1	1	1	0	1	1	0
20.5	0	0	1	1	1	1	1	0	0	1	0
20.6	0	0	1	1	1	1	1	0	0	1	1
20.7	0	0	1	1	1	1	1	0	0	0	1
20.8	0	0	1	1	1	0	1	0	0	0	1
20.9	0	0	1	1	1	0	1	0	0	1	1
21.0	0	0	1	1	1	0	1	0	0	1	0
21.1	0	0	1	1	1	0	1	0	1	1	0
21.2	0	0	1	1	1	0	1	0	1	0	0
21.3	0	0	1	1	1	0	1	1	1	0	0
21.4	0	0	1	1	1	0	1	1	1	1	0
21.5	0	0	1	1	1	0	1	1	0	1	0
21.6	0	0	1	1	1	0	1	1	0	1	1
21.7	0	0	1	1	1	0	1	1	0	0	1
21.8	0	0	1	1	1	0	0	1	0	0	1
21.9	0	0	1	1	1	0	0	1	0	1	1
22.0	0	0	1	1	1	0	0	1	0	1	0
22.1	0	0	1	1	1	0	0	1	1	1	0
22.2	0	0	1	1	1	0	0	1	1	0	0
22.3	0	0	1	1	1	0	0	0	1	0	0
22.4	0	0	1	1	1	0	0	0	1	1	0
22.5	0	0	1	1	1	0	0	0	0	1	0
22.6	0	0	1	1	1	0	0	0	0	1	1
22.7	0	0	1	1	1	0	0	0	0	0	1
22.8	0	0	1	0	1	0	0	0	0	0	1
22.9	0	0	1	0	1	0	0	0	0	1	1
23.0	0	0	1	0	1	0	0	0	0	1	0
23.1	0	0	1	0	1	0	0	0	1	1	0
23.2	0	0	1	0	1	0	0	0	1	0	0
23.3	0	0	1	0	1	0	0	1	1	0	0
23.4	0	0	1	0	1	0	0	1	1	1	0

  
 SDX 2000 Operation Manual

RANGE (altitude in thousands)	PULSE POSITION										
	D <sub>2</sub>	D <sub>4</sub> and SPI	A <sub>1</sub>	A <sub>2</sub>	A <sub>4</sub>	B <sub>1</sub>	B <sub>2</sub>	B <sub>4</sub>	C <sub>1</sub>	C <sub>2</sub>	C <sub>4</sub>
23.5	0	0	1	0	1	0	0	1	0	1	0
23.6	0	0	1	0	1	0	0	1	0	1	1
23.7	0	0	1	0	1	0	0	1	0	0	1
23.8	0	0	1	0	1	0	1	1	0	0	1
23.9	0	0	1	0	1	0	1	1	0	1	1
24.0	0	0	1	0	1	0	1	1	0	1	0
24.1	0	0	1	0	1	0	1	1	1	1	0
24.2	0	0	1	0	1	0	1	1	1	0	0
24.3	0	0	1	0	1	0	1	0	1	0	0
24.4	0	0	1	0	1	0	1	0	1	1	0
24.5	0	0	1	0	1	0	1	0	0	1	0
24.6	0	0	1	0	1	0	1	0	0	1	1
24.7	0	0	1	0	1	0	1	0	0	0	1
24.8	0	0	1	0	1	1	1	0	0	0	1
24.9	0	0	1	0	1	1	1	0	0	1	1
25.0	0	0	1	0	1	1	1	0	0	1	0
25.1	0	0	1	0	1	1	1	0	1	1	0
25.2	0	0	1	0	1	1	1	0	1	0	0
25.3	0	0	1	0	1	1	1	1	1	0	0
25.4	0	0	1	0	1	1	1	1	1	1	0
25.5	0	0	1	0	1	1	1	1	0	1	0
25.6	0	0	1	0	1	1	1	1	0	1	1
25.7	0	0	1	0	1	1	1	1	0	0	1
25.8	0	0	1	0	1	1	0	1	0	0	1
25.9	0	0	1	0	1	1	0	1	0	1	1
26.0	0	0	1	0	1	1	0	1	0	1	0
26.1	0	0	1	0	1	1	0	1	1	1	0
26.2	0	0	1	0	1	1	0	1	1	0	0
26.3	0	0	1	0	1	1	0	0	1	0	0
26.4	0	0	1	0	1	1	0	0	1	1	0
26.5	0	0	1	0	1	1	0	0	0	1	0
26.6	0	0	1	0	1	1	0	0	0	1	1
26.7	0	0	1	0	1	1	0	0	0	0	1
26.8	0	0	1	0	0	1	0	0	0	0	1
26.9	0	0	1	0	0	1	0	0	0	1	1

  
 SDX 2000 Operation Manual

RANGE (altitude in thousands)	PULSE POSITION										
	D <sub>2</sub>	D <sub>4</sub> and SPI	A <sub>1</sub>	A <sub>2</sub>	A <sub>4</sub>	B <sub>1</sub>	B <sub>2</sub>	B <sub>4</sub>	C <sub>1</sub>	C <sub>2</sub>	C <sub>4</sub>
27.0	0	0	1	0	0	1	0	0	0	1	0
27.1	0	0	1	0	0	1	0	0	1	1	0
27.2	0	0	1	0	0	1	0	0	1	0	0
27.3	0	0	1	0	0	1	0	1	1	0	0
27.4	0	0	1	0	0	1	0	1	1	1	0
27.5	0	0	1	0	0	1	0	1	0	1	0
27.6	0	0	1	0	0	1	0	1	0	1	1
27.7	0	0	1	0	0	1	0	1	0	0	1
27.8	0	0	1	0	0	1	1	1	0	0	1
27.9	0	0	1	0	0	1	1	1	0	1	1
28.0	0	0	1	0	0	1	1	1	0	1	0
28.1	0	0	1	0	0	1	1	1	1	1	0
28.2	0	0	1	0	0	1	1	1	1	0	0
28.3	0	0	1	0	0	1	1	0	1	0	0
28.4	0	0	1	0	0	1	1	0	1	1	0
28.5	0	0	1	0	0	1	1	0	0	1	0
28.6	0	0	1	0	0	1	1	0	0	1	1
28.7	0	0	1	0	0	1	1	0	0	0	1
28.8	0	0	1	0	0	0	1	0	0	0	1
28.9	0	0	1	0	0	0	1	0	0	1	1
29.0	0	0	1	0	0	0	1	0	0	1	0
29.1	0	0	1	0	0	0	1	0	1	1	0
29.2	0	0	1	0	0	0	1	0	1	0	0
29.3	0	0	1	0	0	0	1	1	1	0	0
29.4	0	0	1	0	0	0	1	1	1	1	0
29.5	0	0	1	0	0	0	1	1	0	1	0
29.6	0	0	1	0	0	0	1	1	0	1	1
29.7	0	0	1	0	0	0	1	1	0	0	1
29.8	0	0	1	0	0	0	0	1	0	0	1
29.9	0	0	1	0	0	0	0	1	0	1	1
30.0	0	0	1	0	0	0	0	1	0	1	0
30.1	0	0	1	0	0	0	0	1	1	1	0
30.2	0	0	1	0	0	0	0	1	1	0	0
30.3	0	0	1	0	0	0	0	0	1	0	0
30.4	0	0	1	0	0	0	0	0	1	1	0

  
 SDX 2000 Operation Manual

RANGE (altitude in thousands)	PULSE POSITION										
	D <sub>2</sub>	D <sub>4</sub> and SPI	A <sub>1</sub>	A <sub>2</sub>	A <sub>4</sub>	B <sub>1</sub>	B <sub>2</sub>	B <sub>4</sub>	C <sub>1</sub>	C <sub>2</sub>	C <sub>4</sub>
30.5	0	0	1	0	0	0	0	0	0	1	0
30.6	0	0	1	0	0	0	0	0	0	1	1
30.7	0	0	1	0	0	0	0	0	0	0	1
30.8	0	1	1	0	0	0	0	0	0	0	1
30.9	0	1	1	0	0	0	0	0	0	1	1
31.0	0	1	1	0	0	0	0	0	0	1	0
31.1	0	1	1	0	0	0	0	0	1	1	0
31.2	0	1	1	0	0	0	0	0	1	0	0
31.3	0	1	1	0	0	0	0	1	1	0	0
31.4	0	1	1	0	0	0	0	1	1	1	0
31.5	0	1	1	0	0	0	0	1	0	1	0
31.6	0	1	1	0	0	0	0	1	0	1	1
31.7	0	1	1	0	0	0	0	1	0	0	1
31.8	0	1	1	0	0	0	1	1	0	0	1
31.9	0	1	1	0	0	0	1	1	0	1	1
32.0	0	1	1	0	0	0	1	1	0	1	0
32.1	0	1	1	0	0	0	1	1	1	1	0
32.2	0	1	1	0	0	0	1	1	1	0	0
32.3	0	1	1	0	0	0	1	0	1	0	0
33.4	0	1	1	0	0	0	1	0	1	1	0
32.5	0	1	1	0	0	0	1	0	0	1	0
32.6	0	1	1	0	0	0	1	0	0	1	1
32.7	0	1	1	0	0	0	1	0	0	0	1
32.8	0	1	1	0	0	1	1	0	0	0	1
32.9	0	1	1	0	0	1	1	0	0	1	1
33.0	0	1	1	0	0	1	1	0	0	1	0
33.1	0	1	1	0	0	1	1	0	1	1	0
33.2	0	1	1	0	0	1	1	0	1	0	0
33.3	0	1	1	0	0	1	1	1	1	0	0
33.4	0	1	1	0	0	1	1	1	1	1	0
33.5	0	1	1	0	0	1	1	1	0	1	0
33.6	0	1	1	0	0	1	1	1	0	1	1
33.7	0	1	1	0	0	1	1	1	0	0	1
33.8	0	1	1	0	0	1	0	1	0	0	1
33.9	0	1	1	0	0	1	0	1	0	1	1



  
 SDX 2000 Operation Manual

RANGE (altitude in thousands)	PULSE POSITION										
	D <sub>2</sub>	D <sub>4</sub> and SPI	A <sub>1</sub>	A <sub>2</sub>	A <sub>4</sub>	B <sub>1</sub>	B <sub>2</sub>	B <sub>4</sub>	C <sub>1</sub>	C <sub>2</sub>	C <sub>4</sub>
34.0	0	1	1	0	0	1	0	1	0	1	0
34.1	0	1	1	0	0	1	0	1	1	1	0
34.2	0	1	1	0	0	1	0	1	1	0	0
34.3	0	1	1	0	0	1	0	0	1	0	0
34.4	0	1	1	0	0	1	0	0	1	1	0
34.5	0	1	1	0	0	1	0	0	0	1	0
34.6	0	1	1	0	0	1	0	0	0	1	1
34.7	0	1	1	0	0	1	0	0	0	0	1
34.8	0	1	1	0	1	1	0	0	0	0	1
34.9	0	1	1	0	1	1	0	0	0	1	1
35.0	0	1	1	0	1	1	0	0	0	1	0
35.1	0	1	1	0	1	1	0	0	1	1	0
35.2	0	1	1	0	1	1	0	0	1	0	0
35.3	0	1	1	0	1	1	0	1	1	0	0
35.4	0	1	1	0	1	1	0	1	1	1	0
35.5	0	1	1	0	1	1	0	1	0	1	0
35.6	0	1	1	0	1	1	0	1	0	1	1
35.7	0	1	1	0	1	1	0	1	0	0	1
35.8	0	1	1	0	1	1	1	1	0	0	1
35.9	0	1	1	0	1	1	1	1	0	1	1
36.0	0	1	1	0	1	1	1	1	0	1	0
36.1	0	1	1	0	1	1	1	1	1	1	0
36.2	0	1	1	0	1	1	1	1	1	0	0
36.3	0	1	1	0	1	1	1	0	1	0	0
36.4	0	1	1	0	1	1	1	0	1	1	0
36.5	0	1	1	0	1	1	1	0	0	1	0
36.6	0	1	1	0	1	1	1	0	0	1	1
36.7	0	1	1	0	1	1	1	0	0	0	1
36.8	0	1	1	0	1	0	1	0	0	0	1
36.9	0	1	1	0	1	0	1	0	0	1	1
37.0	0	1	1	0	1	0	1	0	0	1	0
37.1	0	1	1	0	1	0	1	0	1	1	0
37.2	0	1	1	0	1	0	1	0	1	0	0
37.3	0	1	1	0	1	0	1	1	1	0	0
37.4	0	1	1	0	1	0	1	1	1	1	0

  
 SDX 2000 Operation Manual

RANGE (altitude in thousands)	PULSE POSITION										
	D <sub>2</sub>	D <sub>4</sub> and SPI	A <sub>1</sub>	A <sub>2</sub>	A <sub>4</sub>	B <sub>1</sub>	B <sub>2</sub>	B <sub>4</sub>	C <sub>1</sub>	C <sub>2</sub>	C <sub>4</sub>
37.5	0	1	1	0	1	0	1	1	0	1	0
37.6	0	1	1	0	1	0	1	1	0	1	1
37.7	0	1	1	0	1	0	1	1	0	0	1
37.8	0	1	1	0	1	0	0	1	0	0	1
37.9	0	1	1	0	1	0	0	1	0	1	1
38.0	0	1	1	0	1	0	0	1	0	1	0
38.1	0	1	1	0	1	0	0	1	1	1	0
38.2	0	1	1	0	1	0	0	1	1	0	0
38.3	0	1	1	0	1	0	0	0	1	0	0
38.4	0	1	1	0	1	0	0	0	1	1	0
38.5	0	1	1	0	1	0	0	0	0	1	0
38.6	0	1	1	0	1	0	0	0	0	1	1
38.7	0	1	1	0	1	0	0	0	0	0	1
38.8	0	1	1	1	1	0	0	0	0	0	1
38.9	0	1	1	1	1	0	0	0	0	1	1
39.0	0	1	1	1	1	0	0	0	0	1	0
39.1	0	1	1	1	1	0	0	0	1	1	0
39.2	0	1	1	1	1	0	0	0	1	0	0
39.3	0	1	1	1	1	0	0	1	1	0	0
39.4	0	1	1	1	1	0	0	1	1	1	0
39.5	0	1	1	1	1	0	0	1	0	1	0
39.6	0	1	1	1	1	0	0	1	0	1	1
39.7	0	1	1	1	1	0	0	1	0	0	1
39.8	0	1	1	1	1	0	1	1	0	0	1
39.9	0	1	1	1	1	0	1	1	0	1	1
40.0	0	1	1	1	1	0	1	1	0	1	0
40.1	0	1	1	1	1	0	1	1	1	1	0
40.2	0	1	1	1	1	0	1	1	1	0	0
40.3	0	1	1	1	1	0	1	0	1	0	0
40.4	0	1	1	1	1	0	1	0	1	1	0
40.5	0	1	1	1	1	0	1	0	0	1	0
40.6	0	1	1	1	1	0	1	0	0	1	1
40.7	0	1	1	1	1	0	1	0	0	0	1
40.8	0	1	1	1	1	1	1	0	0	0	1
40.9	0	1	1	1	1	1	1	0	0	1	1

  
 SDX 2000 Operation Manual

RANGE (altitude in thousands)	PULSE POSITION										
	D <sub>2</sub>	D <sub>4</sub> and SPI	A <sub>1</sub>	A <sub>2</sub>	A <sub>4</sub>	B <sub>1</sub>	B <sub>2</sub>	B <sub>4</sub>	C <sub>1</sub>	C <sub>2</sub>	C <sub>4</sub>
41.0	0	1	1	1	1	1	1	0	0	1	0
41.1	0	1	1	1	1	1	1	0	1	1	0
41.2	0	1	1	1	1	1	1	0	1	0	0
41.3	0	1	1	1	1	1	1	1	1	0	0
41.4	0	1	1	1	1	1	1	1	1	1	0
41.5	0	1	1	1	1	1	1	1	0	1	0
41.6	0	1	1	1	1	1	1	1	0	1	1
41.7	0	1	1	1	1	1	1	1	0	0	1
41.8	0	1	1	1	1	1	0	1	0	0	1
41.9	0	1	1	1	1	1	0	1	0	1	1
42.0	0	1	1	1	1	1	0	1	0	1	0
42.1	0	1	1	1	1	1	0	1	1	1	0
42.2	0	1	1	1	1	1	0	1	1	0	0
42.3	0	1	1	1	1	1	0	0	1	0	0
42.4	0	1	1	1	1	1	0	0	1	1	0
42.5	0	1	1	1	1	1	0	0	0	1	0
42.6	0	1	1	1	1	1	0	0	0	1	1
42.7	0	1	1	1	1	1	0	0	0	0	1
42.8	0	1	1	1	0	1	0	0	0	0	1
42.9	0	1	1	1	0	1	0	0	0	1	1
43.0	0	1	1	1	0	1	0	0	0	1	0
43.1	0	1	1	1	0	1	0	0	1	1	0
43.2	0	1	1	1	0	1	0	0	1	0	0
43.3	0	1	1	1	0	1	0	1	1	0	0
43.4	0	1	1	1	0	1	0	1	1	1	0
43.5	0	1	1	1	0	1	0	1	0	1	0
43.6	0	1	1	1	0	1	0	1	0	1	1
43.7	0	1	1	1	0	1	0	1	0	0	1
43.8	0	1	1	1	0	1	1	1	0	0	1
43.9	0	1	1	1	0	1	1	1	0	1	1
44.0	0	1	1	1	0	1	1	1	0	1	0
44.1	0	1	1	1	0	1	1	1	1	1	0
44.2	0	1	1	1	0	1	1	1	1	0	0
44.3	0	1	1	1	0	1	1	0	1	0	0
44.4	0	1	1	1	0	1	1	0	1	1	0

  
 SDX 2000 Operation Manual

RANGE (altitude in thousands)	PULSE POSITION										
	D <sub>2</sub>	D <sub>4</sub> and SPI	A <sub>1</sub>	A <sub>2</sub>	A <sub>4</sub>	B <sub>1</sub>	B <sub>2</sub>	B <sub>4</sub>	C <sub>1</sub>	C <sub>2</sub>	C <sub>4</sub>
44.5	0	1	1	1	0	1	1	0	0	1	0
44.6	0	1	1	1	0	1	1	0	0	1	1
44.7	0	1	1	1	0	1	1	0	0	0	1
44.8	0	1	1	1	0	0	1	0	0	0	1
44.9	0	1	1	1	0	0	1	0	0	1	1
45.0	0	1	1	1	0	0	1	0	0	1	0
45.1	0	1	1	1	0	0	1	0	1	1	0
45.2	0	1	1	1	0	0	1	0	1	0	0
45.3	0	1	1	1	0	0	1	1	1	0	0
45.4	0	1	1	1	0	0	1	1	1	1	0
45.5	0	1	1	1	0	0	1	1	0	1	0
45.6	0	1	1	1	0	0	1	1	0	1	1
45.7	0	1	1	1	0	0	1	1	0	0	1
45.8	0	1	1	1	0	0	0	1	0	0	1
45.9	0	1	1	1	0	0	0	1	0	1	1
46.0	0	1	1	1	0	0	0	1	0	1	0
46.1	0	1	1	1	0	0	0	1	1	1	0
46.2	0	1	1	1	0	0	0	1	1	0	0
46.3	0	1	1	1	0	0	0	0	1	0	0
46.4	0	1	1	1	0	0	0	0	1	1	0
46.5	0	1	1	1	0	0	0	0	0	1	0
46.6	0	1	1	1	0	0	0	0	0	1	1
46.7	0	1	1	1	0	0	0	0	0	0	1
46.8	0	1	0	1	0	0	0	0	0	0	1
46.9	0	1	0	1	0	0	0	0	0	1	1
47.0	0	1	0	1	0	0	0	0	0	1	0
47.1	0	1	0	1	0	0	0	0	1	1	0
47.2	0	1	0	1	0	0	0	0	1	0	0
47.3	0	1	0	1	0	0	0	1	1	0	0
47.4	0	1	0	1	0	0	0	1	1	1	0
47.5	0	1	0	1	0	0	0	1	0	1	0
47.6	0	1	0	1	0	0	0	1	0	1	1
47.7	0	1	0	1	0	0	0	1	0	0	1
47.8	0	1	0	1	0	0	1	1	0	0	1
47.9	0	1	0	1	0	0	1	1	0	1	1

  
 SDX 2000 Operation Manual

RANGE (altitude in thousands)	PULSE POSITION										
	D <sub>2</sub>	D <sub>4</sub> and SPI	A <sub>1</sub>	A <sub>2</sub>	A <sub>4</sub>	B <sub>1</sub>	B <sub>2</sub>	B <sub>4</sub>	C <sub>1</sub>	C <sub>2</sub>	C <sub>4</sub>
48.0	0	1	0	1	0	0	1	1	0	1	0
48.1	0	1	0	1	0	0	1	1	1	1	0
48.2	0	1	0	1	0	0	1	1	1	0	0
48.3	0	1	0	1	0	0	1	0	1	0	0
48.4	0	1	0	1	0	0	1	0	1	1	0
48.5	0	1	0	1	0	0	1	0	0	1	0
48.6	0	1	0	1	0	0	1	0	0	1	1
48.7	0	1	0	1	0	0	1	0	0	0	1
48.8	0	1	0	1	0	1	1	0	0	0	1
48.9	0	1	0	1	0	1	1	0	0	1	1
49.0	0	1	0	1	0	1	1	0	0	1	0
49.1	0	1	0	1	0	1	1	0	1	1	0
49.2	0	1	0	1	0	1	1	0	1	0	0
44.3	0	1	0	1	0	1	1	1	1	0	0
49.4	0	1	0	1	0	1	1	1	1	1	0
49.5	0	1	0	1	0	1	1	1	0	1	0
49.6	0	1	0	1	0	1	1	1	0	1	1
49.7	0	1	0	1	0	1	1	1	0	0	1
49.8	0	1	0	1	0	1	0	1	0	0	1
49.9	0	1	0	1	0	1	0	1	0	1	1
50.0	0	1	0	1	0	1	0	1	0	1	0
50.1	0	1	0	1	0	1	0	1	1	1	0
50.2	0	1	0	1	0	1	0	1	1	0	0
50.3	0	1	0	1	0	1	0	0	1	0	0
50.4	0	1	0	1	0	1	0	0	1	1	0
50.5	0	1	0	1	0	1	0	0	0	1	0
50.6	0	1	0	1	0	1	0	0	0	1	1
50.7	0	1	0	1	0	1	0	0	0	0	1
50.8	0	1	0	1	1	1	0	0	0	0	1
50.9	0	1	0	1	1	1	0	0	0	1	1
51.0	0	1	0	1	1	1	0	0	0	1	0
51.1	0	1	0	1	1	1	0	0	1	1	0
51.2	0	1	0	1	1	1	0	0	1	0	0
51.3	0	1	0	1	1	1	0	1	1	0	0
51.4	0	1	0	1	1	1	0	1	1	1	0

  
 SDX 2000 Operation Manual

RANGE (altitude in thousands)	PULSE POSITION										
	D <sub>2</sub>	D <sub>4</sub> and SPI	A <sub>1</sub>	A <sub>2</sub>	A <sub>4</sub>	B <sub>1</sub>	B <sub>2</sub>	B <sub>4</sub>	C <sub>1</sub>	C <sub>2</sub>	C <sub>4</sub>
51.5	0	1	0	1	1	1	0	1	0	1	0
51.6	0	1	0	1	1	1	0	1	0	1	1
51.7	0	1	0	1	1	1	0	1	0	0	1
51.8	0	1	0	1	1	1	1	1	0	0	1
51.9	0	1	0	1	1	1	1	1	0	1	1
52.0	0	1	0	1	1	1	1	1	0	1	0
52.1	0	1	0	1	1	1	1	1	1	1	0
52.2	0	1	0	1	1	1	1	1	1	0	0
52.3	0	1	0	1	1	1	1	0	1	0	0
52.4	0	1	0	1	1	1	1	0	1	1	0
52.5	0	1	0	1	1	1	1	0	0	1	0
52.6	0	1	0	1	1	1	1	0	0	1	1
52.7	0	1	0	1	1	1	1	0	0	0	1
52.8	0	1	0	1	1	0	1	0	0	0	1
52.9	0	1	0	1	1	0	1	0	0	1	1
53.0	0	1	0	1	1	0	1	0	0	1	0
53.1	0	1	0	1	1	0	1	0	1	1	0
53.2	0	1	0	1	1	0	1	0	1	0	0
53.3	0	1	0	1	1	0	1	1	1	0	0
53.4	0	1	0	1	1	0	1	1	1	1	0
53.5	0	1	0	1	1	0	1	1	0	1	0
53.6	0	1	0	1	1	0	1	1	0	1	1
53.7	0	1	0	1	1	0	1	1	0	0	1
53.8	0	1	0	1	1	0	0	1	0	0	1
53.9	0	1	0	1	1	0	0	1	0	1	1
54.0	0	1	0	1	1	0	0	1	0	1	0
54.1	0	1	0	1	1	0	0	1	1	1	0
54.2	0	1	0	1	1	0	0	1	1	0	0
54.3	0	1	0	1	1	0	0	0	1	0	0
54.4	0	1	0	1	1	0	0	0	1	1	0
54.5	0	1	0	1	1	0	0	0	0	1	0
54.6	0	1	0	1	1	0	0	0	0	1	1
54.7	0	1	0	1	1	0	0	0	0	0	1
54.8	0	1	0	0	1	0	0	0	0	0	1
54.9	0	1	0	0	1	0	0	0	0	1	1

  
 SDX 2000 Operation Manual

RANGE (altitude in thousands)	PULSE POSITION										
	D <sub>2</sub>	D <sub>4</sub> and SPI	A <sub>1</sub>	A <sub>2</sub>	A <sub>4</sub>	B <sub>1</sub>	B <sub>2</sub>	B <sub>4</sub>	C <sub>1</sub>	C <sub>2</sub>	C <sub>4</sub>
55.0	0	1	0	0	1	0	0	0	0	1	0
55.1	0	1	0	0	1	0	0	0	1	1	0
55.2	0	1	0	0	1	0	0	0	1	0	0
55.3	0	1	0	0	1	0	0	1	1	0	0
55.4	0	1	0	0	1	0	0	1	1	1	0
55.5	0	1	0	0	1	0	0	1	0	1	0
55.6	0	1	0	0	1	0	0	1	0	1	1
55.7	0	1	0	0	1	0	0	1	0	0	1
55.8	0	1	0	0	1	0	1	1	0	0	1
55.9	0	1	0	0	1	0	1	1	0	1	1
56.0	0	1	0	0	1	0	1	1	0	1	0
56.1	0	1	0	0	1	0	1	1	1	1	0
56.2	0	1	0	0	1	0	1	1	1	0	0
56.3	0	1	0	0	1	0	1	0	1	0	0
56.4	0	1	0	0	1	0	1	0	1	1	0
56.5	0	1	0	0	1	0	1	0	0	1	0
56.6	0	1	0	0	1	0	1	0	0	1	1
56.7	0	1	0	0	1	0	1	0	0	0	1
56.8	0	1	0	0	1	1	1	0	0	0	1
56.9	0	1	0	0	1	1	1	0	0	1	1
57.0	0	1	0	0	1	1	1	0	0	1	0
57.1	0	1	0	0	1	1	1	0	1	1	0
57.2	0	1	0	0	1	1	1	0	1	0	0
57.3	0	1	0	0	1	1	1	1	1	0	0
57.4	0	1	0	0	1	1	1	1	1	1	0
57.5	0	1	0	0	1	1	1	1	0	1	0
57.6	0	1	0	0	1	1	1	1	0	1	1
57.7	0	1	0	0	1	1	1	1	0	0	1
57.8	0	1	0	0	1	1	0	1	0	0	1
57.9	0	1	0	0	1	1	0	1	0	1	1
58.0	0	1	0	0	1	1	0	1	0	1	0
58.1	0	1	0	0	1	1	0	1	1	1	0
58.2	0	1	0	0	1	1	0	1	1	0	0
58.3	0	1	0	0	1	1	0	0	1	0	0
58.4	0	1	0	0	1	1	0	0	1	1	0

  
 SDX 2000 Operation Manual

RANGE (altitude in thousands)	PULSE POSITION										
	D <sub>2</sub>	D <sub>4</sub> and SPI	A <sub>1</sub>	A <sub>2</sub>	A <sub>4</sub>	B <sub>1</sub>	B <sub>2</sub>	B <sub>4</sub>	C <sub>1</sub>	C <sub>2</sub>	C <sub>4</sub>
58.5	0	1	0	0	1	1	0	0	0	1	0
58.6	0	1	0	0	1	1	0	0	0	1	1
58.7	0	1	0	0	1	1	0	0	0	0	1
58.8	0	1	0	0	0	1	0	0	0	0	1
58.9	0	1	0	0	0	1	0	0	0	1	1
59.0	0	1	0	0	0	1	0	0	0	1	0
59.1	0	1	0	0	0	1	0	0	1	1	0
59.2	0	1	0	0	0	1	0	0	1	0	0
59.3	0	1	0	0	0	1	0	1	1	0	0
59.4	0	1	0	0	0	1	0	1	1	1	0
59.5	0	1	0	0	0	1	0	1	0	1	0
59.6	0	1	0	0	0	1	0	1	0	1	1
59.7	0	1	0	0	0	1	0	1	0	0	1
59.8	0	1	0	0	0	1	1	1	0	0	1
59.9	0	1	0	0	0	1	1	1	0	1	1
60.0	0	1	0	0	0	1	1	1	0	1	0
60.1	0	1	0	0	0	1	1	1	1	1	0
60.2	0	1	0	0	0	1	1	1	1	0	0
60.3	0	1	0	0	0	1	1	0	1	0	0
60.4	0	1	0	0	0	1	1	0	1	1	0
60.5	0	1	0	0	0	1	1	0	0	1	0
60.6	0	1	0	0	0	1	1	0	0	1	1
60.7	0	1	0	0	0	1	1	0	0	0	1
60.8	0	1	0	0	0	0	1	0	0	0	1
60.9	0	1	0	0	0	0	1	0	0	1	1
61.0	0	1	0	0	0	0	1	0	0	1	0
61.1	0	1	0	0	0	0	1	0	1	1	0
61.2	0	1	0	0	0	0	1	0	1	0	0
61.3	0	1	0	0	0	0	1	1	1	0	0
61.4	0	1	0	0	0	0	1	1	1	1	0
61.5	0	1	0	0	0	0	1	1	0	1	0
61.6	0	1	0	0	0	0	1	1	0	1	1
61.7	0	1	0	0	0	0	1	1	0	0	1
61.8	0	1	0	0	0	0	0	1	0	0	1
61.9	0	1	0	0	0	0	0	1	0	1	1



  
 SDX 2000 Operation Manual

RANGE (altitude in thousands)	PULSE POSITION										
	D <sub>2</sub>	D <sub>4</sub> and SPI	A <sub>1</sub>	A <sub>2</sub>	A <sub>4</sub>	B <sub>1</sub>	B <sub>2</sub>	B <sub>4</sub>	C <sub>1</sub>	C <sub>2</sub>	C <sub>4</sub>
62.0	0	1	0	0	0	0	0	1	0	1	0
62.1	0	1	0	0	0	0	0	1	1	1	0
62.2	0	1	0	0	0	0	0	1	1	0	0
62.3	0	1	0	0	0	0	0	0	1	0	0
63.4	0	1	0	0	0	0	0	0	1	1	0
62.5	0	1	0	0	0	0	0	0	0	1	0
62.6	0	1	0	0	0	0	0	0	0	1	1
62.7	0	1	0	0	0	0	0	0	0	0	1
62.8	1	1	0	0	0	0	0	0	0	0	1
62.9	1	1	0	0	0	0	0	0	0	1	1
63.0	1	1	0	0	0	0	0	0	0	1	0
63.1	1	1	0	0	0	0	0	0	1	1	0
63.2	1	1	0	0	0	0	0	0	1	0	0
63.3	1	1	0	0	0	0	0	1	1	0	0
63.4	1	1	0	0	0	0	0	1	1	1	0
63.5	1	1	0	0	0	0	0	1	0	1	0
63.6	1	1	0	0	0	0	0	1	0	1	1
63.7	1	1	0	0	0	0	0	1	0	0	1
63.8	1	1	0	0	0	0	1	1	0	0	1
63.9	1	1	0	0	0	0	1	1	0	1	1
64.0	1	1	0	0	0	0	1	1	0	1	0
64.1	1	1	0	0	0	0	1	1	1	1	0
64.2	1	1	0	0	0	0	1	1	1	0	0
64.3	1	1	0	0	0	0	1	0	1	0	0
64.4	1	1	0	0	0	0	1	0	1	1	0
64.5	1	1	0	0	0	0	1	0	0	1	0
64.6	1	1	0	0	0	0	1	0	0	1	1
64.7	1	1	0	0	0	0	1	0	0	0	1
64.8	1	1	0	0	0	1	1	0	0	0	1
64.9	1	1	0	0	0	1	1	0	0	1	1



## **TABLE OF CONTENTS**

### **A. XPDR Test Examples**

- (1) General
- (2) Initial Settings
- (3) Test Examples
  - (a) Measuring Receiver Bandwidth and Minimum Threshold Level (MTL)
  - (b) Measuring Side Lobe Suppression (SLS)
  - (c) Measuring Pulse Deviation
  - (d) Verification of Interrogator Recovery Time
  - (e) Pulse Width Decoder Operation
  - (f) Measuring Frequency and Power Output
  - (g) Measuring Pulse Shape and Width, Transmitter Droop and Frequency Pulling
  - (h) Measuring Identification and Altitude Codes

### **B. DME Test Examples**

- (1) General
- (2) Initial Control Settings
- (3) Test Examples
  - (a) Measuring DME Transmitter Frequency and Power
  - (b) Measuring Transmitter Pulse Characteristics
  - (c) Measuring Receiver Memory Time
  - (d) Measuring Receiver Bandwidth and Sensitivity
  - (e) Measuring Pulse Position Decoder Accuracy
  - (f) Adjacent Channel Test
  - (g) Measuring Accuracy and Tracking
  - (h) Measuring Acquisition Time
  - (i) Measuring Echo and Co-Channel Performance

A. XPDR Test Examples

(1) General

The XPDR Test Examples are for general application of the SDX 2000 for testing ATC (air traffic control) XPDR aircraft equipment. Refer to XPDR manufacturer's instruction manual for detailed XPDR Test Procedures.

The XPDR Test Examples are used to illustrate operation of the SDX 2000 and are not intended to supersede or modify manufacturer's recommended test procedure or intended to include all tests necessary to certify XPDR equipment. Specifications called out in the following Test Examples are for illustration purposes only and do not apply to any specific XPDR equipment model.

(2) Initial Settings

<u>CONTROL</u>	<u>SETTING</u>
INSTRUMENT	ATCRBS
GEN POWER	-70 dBm
ON/OFF/CW	ON
MUTUAL SUPPR	OFF
SLS	OFF
PULSE TIMING	DEFAULT
TRIG SCOPE AT	REPLY
PRF	500
MEASURED PULSE	FI
INTERROGATION	MODE A
DOUBLE INTERR	OFF
DOUBLE SPACING	047.9 us
GEN FREQUENCY	1030 MHz
FREQ OFFSET	0.00 MHz
SLS AMPLITUDE OFFSET	0 dB

(3) Test Examples

(a) Measuring Receiver Bandwidth and Minimum Threshold Level (MTL)

TEST EQUIPMENT: None

SET-UP DIAGRAM: Figure 1

<u>STEP</u>	<u>PROCEDURE</u>
1.	Set controls for general XPDR operation as described in Initial Settings, Paragraph 2.
2.	Set XPDR (UUT) to stand-by, allow sufficient warm-up time and set to NORM position.
3.	Verify % reply is >90% in %REPLY window in UUT display area.
4.	Decrease GEN POWER control in 1 dB steps until <90% is displayed in %REPLY window in UUT display area.
5.	Increase GEN POWER control 1 dB. Minimum threshold level (MTL) of UUT is on GEN POWER control. Record level.
6.	Set GEN Power control 3 dB above level in Step 5.
7.	Increase FREQ OFFSET in 1 Mhz. steps until < 90% is displayed in %REPLY window in UUT display area. Record generator frequency (Fhi) on GEN FREQUENCY control.
8.	Decrease FREQ OFFSET in 1 Mhz. steps until < 90% is displayed in %REPLY window in UUT display area. Record generator frequency (Flo) on GEN FREQUENCY control.
9.	Determine 3 dB bandwidth and center frequency (Fo) by applying the following formulas: <div style="margin-left: 40px;">           Center Frequency:            <math>F_o = (F_{hi} + F_{lo}) / 2</math>            3 dB Bandwidth:                <math>3 \text{ dB BW} = F_{hi} - F_{lo}</math> </div>
10.	Set FREQ OFFSET control to 0.00 MHz.
11.	Increase GEN POWER control to increase level 17 dB above level in Step 5.
12.	Increase FREQ OFFSET in 1 MHz steps until < 90% is displayed in %REPLY window in UUT display area. Record generator frequency (Fhi) on GEN FREQUENCY control.
13.	Decrease FREQ OFFSET in 1 MHz steps until < 90% is displayed in %REPLY window in UUT display area. Record generator frequency (Flo) on GEN FREQUENCY control.
14.	Determine 20 dB bandwidth by applying the following formula: <div style="margin-left: 40px;">           20 dB Bandwidth:                <math>20 \text{ dB BW} = F_{hi} - F_{lo}</math> </div>
15.	Set FREQ OFFSET control to 0.00 MHz.

(b) Measuring Side Lobe Suppression (SLS)

TEST EQUIPMENT: None

SET-UP DIAGRAM: Figure 1

<u>STEP</u>	<u>PROCEDURE</u>
1.	Set controls for general XPDR operation as described in Initial Settings, Paragraph 2.
2.	Set XPDR (UUT) to stand-by, allow sufficient warm-up time and set to NORM position.
3.	Verify % reply is >90% in %REPLY window in UUT display area.
4.	Decrease GEN POWER control in 1 dB steps until <90% is displayed in %REPLY window in UUT display area.
5.	Increase GEN POWER control 1 dB. Minimum threshold level (MTL) of UUT is on GEN POWER control. Record level.
6.	Set GEN Power control 3 dB above level in Step 5.
7.	Select SLS control. Set SLS AMPLITUDE OFFSET to 0.0 dB.
8.	Using GEN POWER control, increase RF output in 10 dB steps to insure a 0% reply rate up to 50 dB above level in Step 5.
9.	Set GEN Power control 3 dB above level in Step 5.
10.	Set SLS AMPLITUDE OFFSET to -9 dB.
11.	Using GEN POWER control, increase RF output in 10 dB steps to insure a 100% reply rate up to 50 dB above level in Step 5.
12.	Set GEN Power control 3 dB above level in Step 5.
13.	Set SLS to OFF.
14.	Using GEN POWER control, increase RF output in 10 dB steps to insure a 90% reply rate up to 50 dB above level in Step 5.

(c) Measuring Pulse Deviation

TEST EQUIPMENT: None

SET-UP DIAGRAM: Figure 1

<u>STEP</u>	<u>PROCEDURE</u>
1.	Set controls for general XPDR operation as described in Initial Settings, Paragraph 2.
2.	Set XPDR (UUT) to stand-by, allow sufficient warm-up time and set to NORM position.
3.	Verify % reply is >90% in %REPLY window in UUT display area.
4.	Decrease GEN POWER control in 1 dB steps until <90% is displayed in %REPLY window in UUT display area.
5.	Increase GEN POWER control 1 dB. Minimum threshold level (MTL) of UUT is on GEN POWER control. Record level.
6.	Set PULSE TIMING P3 POSITION OFFSET to +0.20 us.
7.	Using GEN POWER control, increase RF output in 10 dB steps to verify % reply rate is >90% for a level of 50 dB above level in Step 5.
8.	Set PULSE TIMING P3 POSITION OFFSET to -0.20 us.
9.	Using GEN POWER control, decrease RF output in 10 dB steps to level in Step 5. Verify % reply rate is >90% for a level of 50 dB above level in Step 5, down to level in Step 5.
10.	Set PULSE TIMING P3 POSITION OFFSET to 1.05 s.
11.	Set GEN POWER control to level in Step 5.
12.	Using GEN POWER control, increase RF output in 10 dB steps to 50 dB above level in step 5. Verify % reply rate is <10% in %REPLY window in UUT display area
13.	Set PULSE TIMING P3 POSITION OFFSET to -1.05 us.
14.	Verify % reply is <10% in %REPLY window in UUT display area.
15.	Using GEN POWER control, decrease RF output in 10 dB steps down to level in Step 5. Verify % reply rate is <10% in %REPLY window in UUT display area.
16.	Set PULSE TIMING P3 POSITION OFFSET to 0.00 s.

(d) Verification of Interrogator Recovery Time

TEST EQUIPMENT: None

SET-UP DIAGRAM: Figure 1

<u>STEP</u>	<u>PROCEDURE</u>
1.	Set controls for general XPDR operation as described in Initial Settings, Paragraph 2.
2.	Set XPDR (UUT) to stand-by, allow sufficient warm-up time and set to NORM position.
3.	Verify % reply is >90% in %REPLY window in UUT display area.
4.	Decrease GEN POWER control in 1 dB steps until <90% is displayed in %REPLY window in UUT display area
5.	Increase GEN POWER control 1 dB. Minimum threshold level (MTL) of UUT is on GEN POWER control. Record level.
6.	Set GEN POWER control 3 dB above level in Step 5.
7.	Select SLS.
8.	Set DOUBLE INTERR to ON and DOUBLE SPACING to 47.9 us.
9.	Verify % reply is 50% in %REPLY window in UUT display area.
10.	Set SLS OFF.
11.	Set DOUBLE SPACING to 125.0 us.
12.	Verify % reply is >90% in %REPLY window in UUT display area.
13.	Set DOUBLE INTERR to OFF.

(e) Pulse Width Decoder Operation

TEST EQUIPMENT: None

SET-UP DIAGRAM: Figure 1

<u>STEP</u>	<u>PROCEDURE</u>	
1.	Set controls for general XPDR operation as described in Initial Settings, Paragraph 2.	
2.	Set XPDR (UUT) to stand-by, allow sufficient warm-up time and set to NORM position.	
3.	Verify % reply is >90% in %REPLY window in UUT display area.	
4.	Decrease GEN POWER control in 1 dB steps until <90% is displayed in %REPLY window in UUT display area.	
5.	Increase GEN POWER control 1 dB. Minimum threshold level (MTL) of UUT is on GEN POWER control. Record level.	
6.	Set controls as follows:	
	<u>CONTROL</u>	<u>SETTING</u>
	PULSE TIMING, P1, WIDTH OFFSET	-.55 us
	PULSE TIMING, P3, WIDTH OFFSET	-.55 us
7.	Verify % reply is <10% in %REPLY window in UUT display area.	
8.	Using GEN POWER control, increase RF output in 10 dB steps to 50 dB above level in Step 5. Verify % reply rate is <10% in %REPLY window in UUT display area.	
9.	Set WIDTH OFFSET controls to +.75 us. Verify % reply is <10% in %REPLY window in UUT display area.	
10.	Using GEN POWER control, decrease RF output in 10 dB steps to level in Step 5. Verify %reply rate is <10% in %REPLY window in UUT display area.	



(f) Measuring Frequency and Power Output

TEST EQUIPMENT: None

SET-UP DIAGRAM: Figure 1

<u>STEP</u>	<u>PROCEDURE</u>
1.	Set controls for general XPDR operation as described in Initial Settings, Paragraph 2.
2.	Set XPDR (UUT) to stand-by, allow sufficient warm-up time and set to NORM position.
3.	Verify UUT transmitter frequency displayed in the FREQUENCY window of the UUT display area is 1090 MHz ( $\pm 3$ MHz). Record transmitter frequency ( $F_{F1}$ ).
4.	Verify UUT transmitter power output displayed in the POWER window of the UUT display area is within Manufacturer's specifications. Record power Output ( $P_{F1}$ ).
5.	Set MEASURED PULSE to F2.
6.	Verify UUT transmitter frequency displayed in the FREQUENCY window of the UUT display area is 1090 MHz ( $\pm 3$ MHz). Record transmitter frequency ( $F_{F2}$ ).
7.	Verify UUT transmitter power output displayed in the POWER window of the UUT display area is within Manufacturer's specifications. Record power Output ( $P_{F2}$ ).
8.	Determine $\Delta F$ by applying following formula to values in Steps 3 and 6: $\Delta F = F_{F1} - F_{F2}$
	NOTE: Desired F is <3 MHz.
9.	Determine $\Delta P$ by applying following formula to values in Steps 4 and 7: $\Delta P = 10 \log (P_{F1} / P_{F2})$
	NOTE: Desired $\Delta P$ is <1 dB.

(g) Measuring Pulse Shape and Width, Transmitter Droop and Frequency Pulling

TEST EQUIPMENT:

(1) Oscilloscope

SET-UP DIAGRAM: Figure 1

<u>STEP</u>	<u>PROCEDURE</u>
1.	Set controls for general XPDR operation as described in Initial Settings, Paragraph 2.
2.	Set XPDR (UUT) to stand-by, allow sufficient warm-up time and set to NORM position.
3.	Verify reply delay displayed in the REPLY DELAY window of the UUT display area is 3.0 us ( $\pm 0.5$ us). Record measured delay (i.e. D1).
4.	Set INTERROGATION to MODE C. Verify reply delay displayed in the REPLY DELAY window of the UUT display area is 3.0 us ( $\pm 0.5$ us). Record measured delay (i.e. D2).
5.	Subtract D1 from D2. Verify $> -0.2$ to $< 0.2$ us difference in delay from Mode A to Mode C. Set INTERROGATION Control to MODE A.
6.	Sync Oscilloscope to leading edge of F1 pulse for a stable trace on display (use oscilloscope internal sync).
7.	Verify on Oscilloscope Channel A, a UUT reply train pulse rise time of 0.05 us to 0.1 us and fall time of 0.05 us to 0.2 us, measured between 90% and 10% amplitude points. Verify pulse width is 0.35 to 0.55 us, measured at 50% amplitude point.
8.	Verify the amplitude of the pulses between the F1 and F2 pulses are within amplitude of F1 and F2 with exception of X pulse.
9.	Verify SPI pulse width and shape is within specifications as outlined in Step 7 and amplitude of SPI pulse is within 12% of F1 framing pulse.
10.	Set PRF to 1200 Hz. Verify SPI pulse width and shape is within specifications as outlined in Step 7 and amplitude of SPI pulse is within 12% of F1 framing pulse.

(h) Measuring Identification and Altitude Codes

TEST EQUIPMENT: None

SET-UP DIAGRAM: Figure 1

<u>STEP</u>	<u>PROCEDURE</u>
1.	Set controls for general XPDR operation as described in Initial Settings, Paragraph 2.
2.	Set XPDR (UUT) to stand-by, allow sufficient warm-up time and set to NORM position.
3.	With 7777 set on UUT, verify 7777 is displayed in the REPLY DATA CODE window in the UUT display area.
4.	Enable squawk ident function of UUT. Verify UUT display area shows IDENT next to the received code in the REPLY DATA window.
5.	Step through UUT Mode A Codes. Verify correct code is displayed in the REPLY DATA CODE window in the UUT display area.
6.	Set INTERROGATION Control to MODE C.
7.	Enable C Mode operation on UUT.
8.	Step through UUT Mode C Codes. Verify correct altitude is displayed in the REPLY DATA ALTITUDE window in the UUT display area.



## SDX 2000 Operation Manual

### B. DME Test Examples

#### (1) General

The DME Test Examples are for general application of for testing ATC (Air Traffic Control) DME aircraft equipment. Refer to DME manufacturer's instruction manual for detailed DME Test Procedures.

The DME Test Examples are used to illustrate operation of and are not intended to supersede or modify manufacturer's recommended test procedure or intended to include all tests necessary to certify DME equipment. Specifications called out in the following Test Examples are for illustration purposes only and do not apply to any specific DME equipment model.

#### (2) Initial Control Settings

<u>CONTROL</u>	<u>SETTING</u>
INSTRUMENT	DME
GEN POWER	-48 dBm
ON/OFF/CW	ON
RANGE NORMAL/-1	NORMAL
VELOCITY DIRECTION	OUT
MUTUAL SUPPR	OFF
FREQUENCY STEPPING	MANUAL
PULSE TIMING	NOMINAL
IDENT	OFF
EFFICIENCY	70%
SQUITTER RATE	2700
REPLY FREQ	108.00 MHz, VOR PAIR
FREQ OFFSET	0.00 MHz
RANGE	0 Nmi
VELOCITY	0 kts
ACCEL	0 ft/s <sup>2</sup>
WINDOW SIZE	NARROW
EQUALIZER	ON

(3) Test Examples

(a) Measuring DME Transmitter Frequency and Power

TEST EQUIPMENT:

- (1) Spectrum Analyzer
- (1) 60 dB Pad

SET-UP DIAGRAM: Figure 2

<u>STEP</u>	<u>PROCEDURE</u>
1.	Set controls for general DME operation as described in paragraph B.2 at the beginning of this section.
2.	Set DME (UUT) to stand-by, allow sufficient warm-up time and set to NORM position.
3.	Set ACCEL, VELOCITY and RANGE controls to 0.
4.	Verify and record UUT transmitter frequency in the FREQUENCY window of the UUT display area (1041 MHz $\pm$ 0.07 MHz)
5.	Verify UUT transmitter power in the POWER window of the UUT display area is within Manufacturer's specifications.
6.	Connect output of UUT, through 60 dB Pad, to Spectrum Analyzer. Verify 90% of transmitted power falls within $\pm$ 0.5 MHz of assigned channel frequency.
7.	Connect UUT output to RF I/O Connector.
8.	Set REPLY FREQ control to 117.90 VOR PAIR.
9.	Perform Steps 4 through 9 for three other channels.

NOTE: For best results, select two X channels and two Y channels for testing.

(b) Measuring Transmitter Pulse Characteristics

TEST EQUIPMENT:

(1) Oscilloscope

SET-UP DIAGRAM: Figure 2

<u>STEP</u>	<u>PROCEDURE</u>
1.	Set controls for general DME operation as described in paragraph B.2 at the beginning of this section.
2.	Set DME (UUT) to stand-by, allow sufficient warm-up time and set to NORM position.
3.	Set ACCEL, VELOCITY and RANGE controls to 0.
4.	Connect BNC Tee Connector to Oscilloscope Channel A.
5.	Connect 50 Ohm Load to one end of BNC Tee Connector and 50 Ohm coaxial cable from other end of BNC Tee Connector to UUT Top Connector (12).
6.	Connect 50 Ohm coaxial cable from Oscilloscope External Trigger to SCOPE SYNC Connector.
NOTE: If viewing total P1 pulse is desired, remove Oscilloscope External Trigger coaxial cable from SCOPE SYNC Connector. Connect Oscilloscope External Trigger coaxial cable to UUT suppression output.	
7.	Verify UUT transmitted pulse rise and fall time is $<3.0$ us. Verify pulse width, measured between leading and trailing edges, is 3.5 us ( $\pm 0.5$ us).
8.	Verify Lock Mode pulse repetition frequency (PRF) is $\leq 30$ pp/s.
9.	Set EFFICIENCY Control to 0%. Pause for duration of memory time.
10.	Verify Search Mode PRF is in accordance to Manufacturer's specifications ( $<150$ pp/s).

(c) Measuring Receiver Memory Time

TEST EQUIPMENT:

(1) Stopwatch

SET-UP DIAGRAM: Figure 2

<u>STEP</u>	<u>PROCEDURE</u>
1.	Set controls for general DME operation as described in paragraph B.2 at the beginning of this section.
2.	Set ACCEL, VELOCITY and RANGE controls to 0.
3.	Set DME (UUT) to stand-by, allow sufficient warm-up period, set to NORM position and wait for a lock-on condition.
4.	Using Stopwatch, record elapsed time after EFFICIENCY Control is set to 0%, that the INTERROGATION RATE window in the UUT display area reflects an increase of UUT PRF. Verify elapsed time is 8 seconds ( $\pm 4$ seconds).
5.	Set VELOCITY control to 400 kts.
6.	Set EFFICIENCY control to 70%. Allow UUT to lock-on and track.
7.	Set EFFICIENCY control to 0% and allow an interval of 8 seconds ( $\pm 4$ seconds) for unit to exit from memory. Set EFFICIENCY control to 70%. Verify distance, in accuracy, is $< \pm 0.2$ NMi.

(d) Measuring Receiver Bandwidth and Sensitivity

TEST EQUIPMENT: None

SET-UP DIAGRAM: Figure 2

<u>STEP</u>	<u>PROCEDURE</u>
1.	Set controls for general DME operation as described in paragraph B.2 at the beginning of this section.
2.	Set ACCEL, VELOCITY and RANGE controls to 0.
3.	Set DME (UUT) to stand-by, allow sufficient warm-up period and set to NORM position.
4.	Set REPLY POWER control to -79 dBm.
5.	Decrease REPLY POWER control in 1 dB steps, pausing 10 to 15 seconds between steps, until UUT breaks lock-on condition and starts search.
6.	Increase REPLY POWER control 1 dB. Verify track sensitivity on REPLY POWER control. Record level.
7.	Set IDENT control to CODE. Verify a clear modulated tone with Morse Code "JCAIR". If tone is garbled, increase REPLY POWER control until code is clear and useful. This is receiver sensitivity level ( $\leq -90$ dBm).
8.	Set REPLY FREQ control to 117.90 MHz (DME [UUT] receive frequency 1213 MHz) VOR PAIR. Perform Steps 5 through 7.
9.	Set IDENT control to OFF.
10.	Increase FREQ OFFSET until frequency is assigned channel frequency plus receiver frequency stability of 0.06 MHz.
11.	Repeat Steps 4 through 8. Verify results are $\leq -90$ dBm.
12.	Decrease FREQ OFFSET until frequency is assigned channel frequency minus receiver frequency stability of 0.06 MHz.





## SDX 2000 Operation Manual

### (d) Measuring Receiver Bandwidth and Sensitivity cont.

- | <u>STEP</u>   | <u>PROCEDURE</u>  |                |                |             |          |                            |      |               |       |                         |          |
|---|---|----------------|----------------|-------------|----------|----------------------------|------|---------------|-------|-------------------------|----------|
| 13.   | Repeat Steps 4 through 8. Verify results are $\leq -90$ dBm.  |                |                |             |          |                            |      |               |       |                         |          |
| 14.   | Repeat Steps 4 through 13 for three other channels to assure proper receiver sensitivity of UUT.  |                |                |             |          |                            |      |               |       |                         |          |
| NOTE: For best results, select two X Channels and two Y Channels for testing. |   |                |                |             |          |                            |      |               |       |                         |          |
| 15.   | If DME connected to 568 INTERR IN Connector (J33) is automatically channeled using the 2-out-of-5 code, proceed at Step 16. If not, proceed at Step 18.   |                |                |             |          |                            |      |               |       |                         |          |
| 16.   | Set controls as follows: <table><thead><tr><th><u>CONTROL</u></th><th><u>SETTING</u></th></tr></thead><tbody><tr><td>REPLY POWER</td><td>(Step 8)</td></tr><tr><td>FREQUENCY STEPPING Control</td><td>AUTO</td></tr><tr><td>IDENT Control</td><td>-tone</td></tr><tr><td>REPLY FREQUENCY Control</td><td>1 CHAN X</td></tr></tbody></table> | <u>CONTROL</u> | <u>SETTING</u> | REPLY POWER | (Step 8) | FREQUENCY STEPPING Control | AUTO | IDENT Control | -tone | REPLY FREQUENCY Control | 1 CHAN X |
| <u>CONTROL</u>  | <u>SETTING</u>  |                |                |             |          |                            |      |               |       |                         |          |
| REPLY POWER   | (Step 8)  |                |                |             |          |                            |      |               |       |                         |          |
| FREQUENCY STEPPING Control  | AUTO  |                |                |             |          |                            |      |               |       |                         |          |
| IDENT Control   | -tone   |                |                |             |          |                            |      |               |       |                         |          |
| REPLY FREQUENCY Control   | 1 CHAN X  |                |                |             |          |                            |      |               |       |                         |          |
| 17.   | Set STEPPING RATE Control for maximum channeling delay of UUT in accordance with Manufacturer's specifications.   |                |                |             |          |                            |      |               |       |                         |          |
| 18.   | Verify clear IDENT Tone for all CHAN X Channels.  |                |                |             |          |                            |      |               |       |                         |          |
| 19.   | Set REPLY FREQUENCY control to 1, CHAN Y.   |                |                |             |          |                            |      |               |       |                         |          |
| 20.   | Set FREQUENCY STEPPING Control to auto and verify a clear IDENT Tone for all CHAN Y Channels.   |                |                |             |          |                            |      |               |       |                         |          |

(e) Measuring Pulse Position Decoder Accuracy

TEST EQUIPMENT: None

SET-UP DIAGRAM: Figure 2

<u>STEP</u>	<u>PROCEDURE</u>
1.	Set controls for general DME operation as described in paragraph B.2 at the beginning of this section.
2.	Set ACCEL, VELOCITY and RANGE controls to 0.
3.	Set DME (UUT) to stand-by, allow sufficient warm-up period and set to NORM position.
4.	Set REPLY POWER control to -79 dBm.
5.	Decrease REPLY POWER control in 1 dB steps, pausing 10 to 15 seconds between steps, until UUT breaks lock-on condition and starts search.
6.	Increase REPLY POWER control by 1 dB. Verify track sensitivity on REPLY POWER control. Record level.
7.	Set IDENT control to CODE. Verify a clear modulated tone with Morse Code "JCAIR". If tone is garbled, increase RF Level until code is clear and useful. This is receiver sensitivity level (<-90 dBm).
8.	Set RANGE control to 40 NMi. Allow 15 seconds for UUT to obtain lock-on.
9.	Set P2 POSITION OFFSET to +0.5 us. Pause for duration of memory time. Verify UUT does not break lock-on condition. Verify range is 040.00 NMi ( $\pm 1.2$ NMi) in MEASURED DISTANCE window of UUT display area.
10.	Set P2 POSITION OFFSET to -0.5 us. Pause for duration of memory time. Verify UUT does not break lock-on condition. Verify range is 040.00 NMi ( $\pm 1.2$ NMi) on DISPLAY SELECT Readout (43).
11.	Set REPLY POWER control to -20 dBm. Perform Steps 9 and 10.
12.	Repeat Steps 4 through 8 to establish previous receiver sensitivity level.
13.	Set P2 POSITION OFFSET to -6.0 us. Pause for duration of memory time. Verify UUT breaks lock-on condition.
14.	Set P2 POSITION OFFSET to 0.0 us. Pause for duration of memory time. Verify UUT lock-on condition.



SDX 2000 Operation Manual

(e) Measuring Pulse Position Decoder Accuracy cont.

<u>STEP</u>	<u>PROCEDURE</u>						
15.	Set P2 POSITION OFFSET to +6.0 us. Pause for duration of memory time. Verify UUT breaks lock-on condition.						
16.	Set controls as follows:						
	<table><thead><tr><th><u>CONTROL</u></th><th><u>SETTING</u></th></tr></thead><tbody><tr><td>REPLY POWER Control</td><td>-48 dBm</td></tr><tr><td>P2 POSITION OFFSET</td><td>0.0 us</td></tr></tbody></table>	<u>CONTROL</u>	<u>SETTING</u>	REPLY POWER Control	-48 dBm	P2 POSITION OFFSET	0.0 us
<u>CONTROL</u>	<u>SETTING</u>						
REPLY POWER Control	-48 dBm						
P2 POSITION OFFSET	0.0 us						
17.	Pause for duration of memory time. Verify UUT lock-on condition.						
18.	Set REPLY FREQUENCY control to 108.05 MHz (DME [UUT] receive frequency 983.00 MHz). Repeat Steps 9, 10, 13, 14 and 15.						

(f) Adjacent Channel Test

TEST EQUIPMENT: None

SET-UP DIAGRAM: Figure 2

<u>STEP</u>	<u>PROCEDURE</u>
1.	Set controls for general DME operation as described in paragraph B.2 at the beginning of this section.
2.	Set ACCEL, VELOCITY and RANGE controls to 0.
4.	Set DME (UUT) to stand-by, allow sufficient warm-up period and set to NORM position.
5.	Set FREQ OFFSET to +0.0 MHz.
6.	Adjust FREQ OFFSET for a frequency of +0.94 MHz above assigned channel frequency on REPLY FREQUENCY control.
7.	Set REPLY POWER control to -79 dBm.
8.	Decrease REPLY POWER control in 1 dB steps, pausing one second between steps, until UUT breaks lock-on condition.
9.	Increase REPLY POWER control 1 dB. Verify track sensitivity on REPLY POWER control. Record level.
10.	Set REPLY POWER control 30 dB above lock-on sensitivity (established in Step 9). Verify UUT does not lock-on for more than one out of five search cycles. If UUT lock-on, verify UUT does not track for more than five seconds.
<b>NOTE</b> To verify UUT is tracking and not in memory, PRF is $\leq 30$ pp/s for five seconds plus memory time.	
11.	Set FREQ OFFSET for a frequency of -0.94 MHz below assigned channel frequency on REPLY FREQUENCY control.
12.	Verify UUT does not lock-on for more than one out of five search cycles. If UUT lock-on, verify UUT does not track for more than five seconds.
<b>NOTE:</b> To verify UUT is tracking and not in memory, PRF is $\leq 30$ pp/s for five seconds plus memory time.	
13.	Set FREQ OFFSET to 0.0 MHz.

(g) Measuring Accuracy and Tracking

TEST EQUIPMENT: None

SET-UP DIAGRAM: Figure 2

<u>STEP</u>	<u>PROCEDURE</u>						
1.	Set controls for general DME operation as described in paragraph B.2 at the beginning of this section.						
2.	Set ACCEL, VELOCITY and RANGE controls to 0.						
3.	Set DME (UUT) to stand-by, allow sufficient warm-up period, set to NORM position and pause until UUT locks-on. Verify 0.00 NMi ( $\pm 0.5$ NMi).						
4.	Set VELOCITY control to 100.00 KTS. Verify reading of UUT distance indicator ( $\pm 0.5$ NMi) or 3%, whichever is greater in MEASURED DISTANCE window in the UUT display area.						
5.	Set RANGE control to 100.00 NMi. Pause until UUT locks-on. Verify UUT distance indicator is 100.00 NMi ( $\pm 3$ NMi). After 30 second delay, verify UUT distance is 100 NMi ( $\pm 0.13$ NMi).						
6.	Set VELOCITY DIRECTION control to INBOUND.						
7.	Set VELOCITY control to 600 KTS. Verify UUT tracks inbound.						
8.	Set VELOCITY DIRECTION control to OUTBOUND. Verify UUT does not lose lock-on and tracks outbound.						
9.	Set RANGE control to 600 NMi. Pause until UUT locks-on. Verify UUT tracks inbound.						
10.	Set EFFICIENCY control to 0%. Verify reading of UUT distance indicator ( $\pm 0.3$ NMi) or 3%, whichever is greater in MEASURED DISTANCE window of UUT display area for duration of memory.						
11.	Set controls as follows:						
	<table border="0" style="margin-left: 40px;"> <thead> <tr> <th style="text-align: left;"><u>CONTROL</u></th> <th style="text-align: left;"><u>SETTING</u></th> </tr> </thead> <tbody> <tr> <td>SQUITTER RATE</td> <td>0</td> </tr> <tr> <td>EFFICIENCY</td> <td>100%</td> </tr> </tbody> </table>	<u>CONTROL</u>	<u>SETTING</u>	SQUITTER RATE	0	EFFICIENCY	100%
<u>CONTROL</u>	<u>SETTING</u>						
SQUITTER RATE	0						
EFFICIENCY	100%						
12.	Verify UUT locks-on and tracks.						
13.	Set EFFICIENCY control to 0%. Pause for duration of memory time. Verify flag on UUT indicator comes into view.						

(h) Measuring Acquisition Time

TEST EQUIPMENT:

(1) Stopwatch

SET-UP DIAGRAM: Figure 2

<u>STEP</u>	<u>PROCEDURE</u>
1.	Set controls for general DME operation as described in paragraph B.2 at the beginning of this section.
2.	Set ACCEL, VELOCITY and RANGE controls to 0.
3.	Set DME (UUT) to stand-by and allow 2 minute warm-up period.
4.	Set RANGE control to 100 NMi.
5.	Set UUT to NORM position. Start a stopwatch to measure time required for UUT to reach lock-on and UUT indicator to display 100 NMi ( $\pm 0.23$ NMi).  If acquisition time is >1 second, repeat previous action several times. Verify UUT demonstrates >50% probability to lock-on in 1 second and >90% probability to lock-on in 1.5 seconds.
6.	Set DME (UUT) to stand-by.
7.	Set VELOCITY DIRECTION control to INBOUND.
8.	Set VELOCITY control to 1000 KTS. Pause 10 seconds before proceeding.
9.	Set UUT to NORM position. Start Stopwatch to measure time required for UUT to reach lock-on. Verify UUT indicator and MEASURED DISTANCE window in the UUT display area both display 100 NMi ( $\pm 0.23$ NMi).  If acquisition time is >1 second, repeat previous action several times. Verify UUT demonstrates >50% probability to lock-on in 1 second and >90% probability to lock-on in 1.5 seconds.

(i) Measuring Echo and Co-Channel Performance

TEST EQUIPMENT:

(1) Stopwatch

SET-UP DIAGRAM: Figure 2

<u>STEP</u>	<u>PROCEDURE</u>
1.	Set controls for general DME operation as described in paragraph B.2 at the beginning of this section.
2.	Set ACCEL, VELOCITY and RANGE controls to 0.
3.	Set DME (UUT) to stand-by, allow sufficient warm-up period and set UUT to NORM position.
4.	Set RANGE control to 40 NMi.
5.	Using Stopwatch, record elapsed time EFFICIENCY Control is set to 0% and INTERROGATION RATE window in the UUT display area reflects increase of UUT PRF. Verify elapsed time is 8 seconds ( $\pm 4$ seconds).
6.	Set ECHO PAIR control to ON. Set ECHO PULSE AMPLITUDE OFFSET control to -8 dB.
7.	Verify 40 NMi in MEASURED DISTANCE window in the UUT display area.
8.	Set ECHO PULSE AMPLITUDE OFFSET control to -0 dB.
9.	Pause for duration of elapsed time in Step 5 before proceeding.
12.	Verify 30 NMi nominal on UUT indicator.
13.	Set ECHO PULSE AMPLITUDE OFFSET control to -5 dB.
14.	Switch UUT to stand-by and back to NORM position. Verify UUT locks-on and displays approximately 40 NMi.

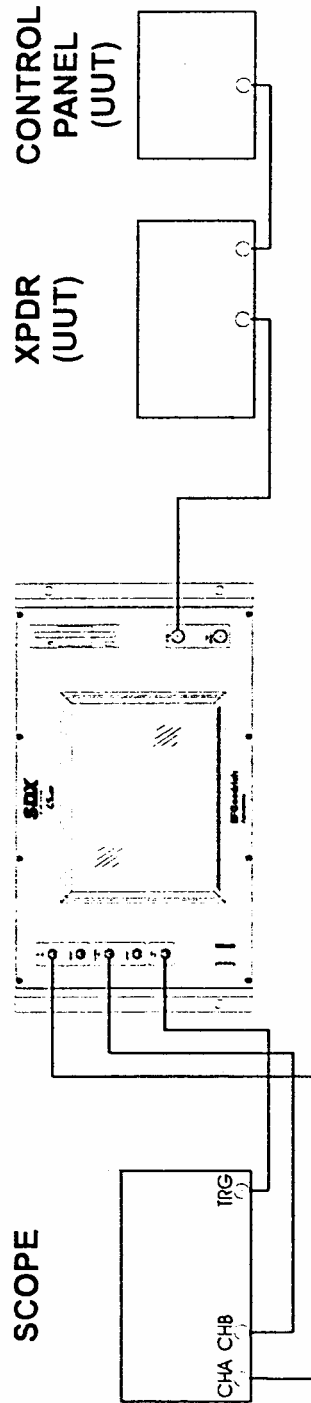

Figure 1



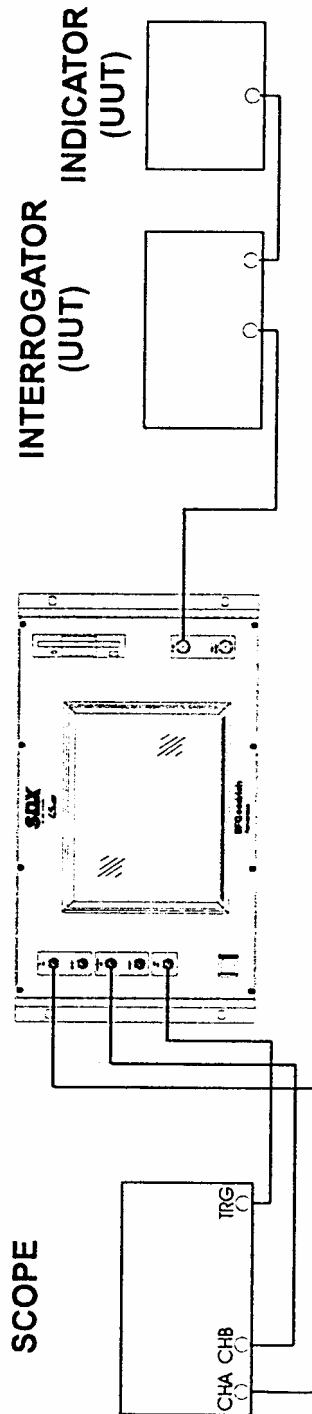

Figure 2



SDX 2000 Operation Manual

CHANNEL	AIRBORNE INTERROG. FREQ. MHZ.		AIRBORNE <u>2</u> / INTERROG. PULSE SPACING uSEC		GROUND REPLY FREQ. MHZ
1X	1025		12		962
1Y	1025		36		1088
2X	1026		12		963
2Y	1026		36		1089
3X	1027		12		964
3Y	1027		36		1090
4X	1028		12		965
4Y	1028		36		1091
5X	1029		12		966
5Y	1029		36		1092
6X	1030		12		967
6Y	1030		36		1093
7X	1031		12		968
7Y	1031		36		1094
8X	1032		12		969
8Y	1032		36		1095
9X	1033		12		970
9Y	1033		36		1096
10X	1034		12		971
10Y	1034		36		1097
11X	1035		12		972
11Y	1035		36		1098
12X	1036		12		973
12Y	1036		36		1099
13X	1037		12		974
13Y	1037		36		1100
14X	1038		12		975
14Y	1038		36		1101
15X	1039		12		976
15Y	1039		36		1102
16X	1040		12		977
16Y	1040		36		1103
17X	1041		12		978
17Y	1041		36		1104
18X	1042		12		979
18Y	1042		36		1105
19X	1043		12		980
19Y	1043		36		1106
20X	1044		12		981
20Y	1044		36		1107
21X	1045		12		982
21Y	1045		36		1108
22X	1046		12		983
22Y	1046		36		1109
23X	1047		12		984
23Y	1047		36		1110



SDX 2000 Operation Manual

CHANNEL	AIRBORNE INTERROG. FREQ. MHZ.		AIRBORNE 2/ INTERROG. PULSE SPACING uSEC		GROUND REPLY FREQ. MHZ
24X	1048		12		985
24Y	1048		36		1111
25X	1049		12		986
25Y	1049		36		1112
26X	1050		12		987
26Y	1050		36		1113
27X	1051		12		988
27Y	1051		36		1114
28X	1052		12		989
28Y	1052		36		1115
29X	1053		12		990
29Y	1053		36		1116
30X	1054		12		991
30Y	1054		36		1117
31X	1055		12		992
31Y	1055		36		1118
32X	1056		12		993
32Y	1056		36		1119
33X	1057		12		994
33Y	1057		36		1120
34X	1058		12		995
34Y	1058		36		1121
35X	1059		12		996
35Y	1059		36		1122
36X	1060		12		997
36Y	1060		36		1123
37X	1061		12		998
37Y	1061		36		1124
38X	1062		12		999
38Y	1062		36		1125
39X	1063		12		1000
39Y	1063		36		1126
40X	1064		12		1001
40Y	1064		36		1127
41X	1065		12		1002
41Y	1065		36		1128
42X	1066		12		1003
42Y	1066		36		1129
43X	1067		12		1004
43Y	1067		36		1130
44X	1068		12		1005
44Y	1068		36		1131
45X	1069		12		1006
45Y	1069		36		1132
46X	1070		12		1007
46Y	1070		36		1133



SDX 2000 Operation Manual

CHANNEL	AIRBORNE INTERROG. FREQ. MHZ.		AIRBORNE 2/ INTERROG. PULSE SPACING uSEC		GROUND REPLY FREQ. MHZ
47X	1071		12		1008
47Y	1071		36		1134
48X	1072		12		1009
48Y	1072		36		1135
49X	1073		12		1010
49Y	1073		36		1136
50X	1074		12		1011
50Y	1074		36		1137
51X	1075		12		1012
51Y	1075		36		1138
52X	1076		12		1013
52Y	1076		36		1139
53X	1077		12		1014
53Y	1077		36		1140
54X	1078		12		1015
54Y	1078		36		1141
55X	1079		12		1016
55Y	1079		36		1142
56X	1080		12		1017
56Y	1080		36		1143
57X	1081		12		1018
57Y	1081		36		1144
58X	1082		12		1019
58Y	1082		36		1145
59X	1083		12		1020
59Y	1083		36		1146
60X	1084		12		1021
60Y	1084		36		1147
61X	1085		12		1022
61Y	1085		36		1148
62X	1086		12		1023
62Y	1086		36		1149
63X	1087		12		1024
63Y	1087		36		1150
64X	1088		12		1151
64Y	1088		36		1025
65X	1089		12		1152
65Y	1089		36		1026
66X	1090		12		1153
66Y	1090		36		1027
67X	1091		12		1154
67Y	1091		36		1028
68X	1092		12		1155
68Y	1092		36		1029
69X	1093		12		1156
69Y	1093		36		1030

	AIRBORNE INTERROG.		AIRBORNE 2/ INTERROG.		GROUND
--	--------------------	--	-----------------------	--	--------



SDX 2000 Operation Manual

CHANNEL	FREQ. MHZ.		PULSE SPACING uSEC		REPLY FREQ. MHZ
70X	1094		12		1157
70Y	1094		36		1031
71X	1095		12		1158
71Y	1095		36		1032
72X	1096		12		1159
72Y	1096		36		1033
73X	1097		12		1160
73Y	1097		36		1034
74X	1098		12		1161
74Y	1098		36		1035
75X	1099		12		1162
75Y	1099		36		1036
76X	1100		12		1163
76Y	1100		36		1037
77X	1101		12		1164
77Y	1101		36		1038
78X	1102		12		1165
78Y	1102		36		1039
79X	1103		12		1166
79Y	1103		36		1040
80X	1104		12		1167
80Y	1104		36		1041
81X	1105		12		1168
81Y	1105		36		1042
82X	1106		12		1169
82Y	1106		36		1043
83X	1107		12		1170
83Y	1107		36		1044
84X	1108		12		1171
84Y	1108		36		1045
85X	1109		12		1172
85Y	1109		36		1046
86X	1110		12		1173
86Y	1110		36		1047
87X	1111		12		1174
87Y	1111		36		1048
88X	1112		12		1175
88Y	1112		36		1049
89X	1113		12		1176
89Y	1113		36		1050



SDX 2000 Operation Manual

CHANNEL	AIRBORNE INTERROG. FREQ. MHZ.		AIRBORNE <u>2</u> / INTERROG. PULSE SPACING uSEC		GROUND REPLY FREQ. MHZ
90X	1114		12		1177
90Y	1114		36		1051
91X	1115		12		1178
91Y	1115		36		1052
92X	1116		12		1179
92Y	1116		36		1053
93X	1117		12		1180
93Y	1117		36		1054
94X	1118		12		1181
94Y	1118		36		1055
95X	1119		12		1182
95Y	1119		36		1056
96X	1120		12		1183
96Y	1120		36		1057
97X	1121		12		1184
97Y	1121		36		1058
98X	1122		12		1185
98Y	1122		36		1059
99X	1123		12		1186
99Y	1123		36		1060
100X	1124		12		1187
100Y	1124		36		1061
101X	1125		12		1188
101Y	1125		36		1062

APPENDIX G DEFINITION OF TERMS AND ACRONYMS

	<b>A</b>		
A/A	Air To Air	KHz	KiloHertz (1x10 <sup>3</sup> cycles per second)
ACL	All Call Long	KTS	Knots
ACS	All Call Short		
ATCRBS	Air Traffic Control Radar Beacon System		<b>L</b>
	<b>B</b>		
BCD	Binary Coded Data	MHz	MegaHertz (1x10 <sup>6</sup> cycles per second)
	<b>C</b>	MTL	Minimum Threshold Level
CAL	Calibrate		
	<b>D</b>		<b>N</b>
dB	Decibel	Nmi	Nautical Mile
dBm	Decibel Relative To Milliwatt		<b>O</b>
DME	Distance Measuring Equipment		
DMEN			<b>P</b>
DPSK	Differential Phase Shift Keying	PRF	Pulse Repetition Frequency
	<b>E</b>		<b>Q</b>
	<b>F</b>		<b>R</b>
F <sub>1</sub>	First Framing Pulse (XPDR)	RF	Radio Frequency
F <sub>2</sub>	Second Framing Pulse (XPDR)		
	<b>G</b>		<b>S</b>
G/A	Ground To Air	SIF	Standard Interrogation Format
GPIB	General Purpose Interface Bus	SLS	Side Lobe Suppression
	<b>H</b>	SPI	Special Position ID Pulse
Hz	Hertz (cycles per second)	SPR	Synchronous Phase Reversal
IFF	Identification Friend Or Foe		
INV	Inverse		<b>T</b>
	<b>I</b>	TACAN	Tactical Air Navigation
	<b>J</b>		
	<b>K</b>		<b>U</b>
		UUT	Unit Under Test

APPENDIX G DEFINITION OF TERMS AND ACRONYMS

VOR	<b>V</b> Very High Frequency OMNI- Directional Radio Range
-----	--

**W**

XPDR	<b>X</b> Transponder
------	-------------------------

**Y**

**Z**