

# 2601 2602

# System SourceMeter® Multi-Channel I-V Test Solutions

## SPECIFICATION CONDITIONS

This document contains specifications and supplemental information for the Models 2601 and 2602. Specifications are the standards against which the Models 2601 and 2602 are tested. Upon leaving the factory the 2601 and 2602 meet these specifications. Supplemental and typical values are non-warranted, apply at 23°C, and are provided solely as useful information.

The source and measurement accuracies are specified at the SourceMeter CHANNEL A (2601 and 2602) or SourceMeter CHANNEL B (2602) terminals under the following conditions:

1. 23°C ± 5°C, <70% relative humidity.
2. After 2 hour warm-up.
3. Speed normal (1 NPLC).
4. A/D auto-zero enabled.
5. Remote sense operation or properly zeroed local operation.
6. Calibration period = 1 year.

## SOURCE SPECIFICATIONS

### VOLTAGE PROGRAMMING ACCURACY<sup>1</sup>

RANGE	PROGRAMMING RESOLUTION	ACCURACY (1 Year) 23°C ±5°C ±(% rdg. + volts)	TYPICAL NOISE (peak-peak) 0.1Hz–10Hz
100.000 mV	5 µV	0.02% + 250 µV	20 µV
1.00000 V	50 µV	0.02% + 400 µV	50 µV
6.00000 V	50 µV	0.02% + 1.8 mV	100 µV
40.0000 V	500 µV	0.02% + 12 mV	500 µV

TEMPERATURE COEFFICIENT (0°–18°C & 28°–50°C): ±(0.15 × accuracy specification)/°C.

MAXIMUM OUTPUT POWER AND SOURCE/SINK LIMITS<sup>2</sup>: 40.4W per channel maximum. ±40.4V @ ±1.0A, ±6.06V @ ±3.0A, four quadrant source or sink operation.

VOLTAGE REGULATION: Line: 0.01% of range. Load: ±(0.01% of range + 100µV).

NOISE 10Hz–20MHz (peak-peak): 25mV typical into a resistive load.

CURRENT LIMIT/COMPLIANCE<sup>3</sup>: Bipolar current limit (compliance) set with single value. Minimum value is 10nA. Accuracy same as current source.

OVERSHOOT: <±(0.1% + 10mV) typical (step size = 10% to 90% of range, resistive load, maximum current limit/compliance).

GUARD OFFSET VOLTAGE: <10mV typical (Iout ≤ 100mA).

### CURRENT PROGRAMMING ACCURACY

RANGE	PROGRAMMING RESOLUTION	ACCURACY (1 Year) 23°C ±5°C ±(% rdg. + amps)	TYPICAL NOISE (peak-peak) 0.1Hz–10Hz
100.000 nA	1 pA	0.06% + 100 pA	5 pA
1.00000 µA	10 pA	0.03% + 600 pA	25 pA
10.0000 µA	100 pA	0.03% + 2 nA	50 pA
100.000 µA	1 nA	0.03% + 30 nA	3 nA
1.00000 mA	10 nA	0.03% + 200 nA	5 nA
10.0000 mA	100 nA	0.03% + 3 µA	200 nA
100.000 mA	1 µA	0.03% + 20 µA	500 nA
1.00000 A <sup>2</sup>	10 µA	0.05% + 900 µA	60 µA
3.00000 A <sup>2</sup>	10 µA	0.06% + 1.5 mA	150 µA

TEMPERATURE COEFFICIENT (0°–18°C & 28°–50°C): ±(0.15 × accuracy specification)/°C.

MAXIMUM OUTPUT POWER AND SOURCE/SINK LIMITS<sup>2</sup>: 40.4W per channel maximum. ±1.01A @ ±40.0V, ±3.03A @ ±6.0V, four quadrant source or sink operation.

CURRENT REGULATION: Line: 0.01% of range. Load: ±(0.01% of range + 100pA).

VOLTAGE LIMIT/COMPLIANCE<sup>4</sup>: Bipolar voltage limit (compliance) set with a single value. Minimum value is 10mV. Accuracy same as voltage source.

OVERSHOOT: <0.1% typical (step size = 10% to 90% of range, resistive load; see CURRENT SOURCE OUTPUT SETTLING TIME for additional test conditions).

## ADDITIONAL SOURCE SPECIFICATIONS

TRANSIENT RESPONSE TIME: <70µs for the output to recover to 0.1% for a 10% to 90% step change in load.

VOLTA GE SOURCE OUTPUT SETTLING TIME: Time required to reach 0.1% of final value, when changing from 10% to 90% of range, after source level command is processed on a fixed range.

100mV, 1V Ranges: <50µs typical.

6V Range: <100µs typical.

40V Range: <150µs typical.<sup>5</sup>

CURRENT SOURCE OUTPUT SETTLING TIME: Time required to reach 0.1% of final value, when changing from 10% to 90% of range, after source level command is processed on a fixed range. Values below for Iout · Rload = 2V unless noted.

3A–10mA Ranges: <80µs typical (current less than 2.5A, Rload >1.5Ω).

1mA Range: <100µs typical.

100µA Range: <150µs typical.

10µA Range: <500µs typical.

1µA Range: <2.5ms typical.

100nA Range: <25ms typical.

DC FLOATING VOLTAGE: Output can be floated up to ±250VDC from chassis ground.

REMOTE SENSE OPERATING RANGE<sup>6</sup>:

Maximum voltage between HI and SENSE HI = 3V.

Maximum voltage between LO and SENSE LO = 3V.

VOLTAGE OUTPUT HEADROOM:

40V Range: Max. output voltage = 42V – total voltage drop across source leads (maximum 1Ω per source lead).

6V Range: Max. output voltage = 8V – total voltage drop across source leads.

OVER TEMPERATURE PROTECTION: Internally sensed temperature overload puts unit in standby mode.

VOLTAGE SOURCE RANGE CHANGE OVERSHOOT: Overshoot into a 100kΩ load, 20MHz BW, 300mV typical.

CURRENT SOURCE RANGE CHANGE OVERSHOOT: <5% + 300mV/Rload of larger range typical. (See CURRENT SOURCE OUTPUT SETTLING TIME for additional test conditions.)

## NOTES

1. Add 50µV to source accuracy specifications per volt of HI lead drop.
2. Full power source operation regardless of load to 30°C ambient. Above 30°C and/or power sink operation, refer to Section 8 – Operating Boundaries in the Series 2600 Reference Manual for additional power derating information.
3. For sink mode operation (quadrants II and IV), add 12% of limit range and ±0.02% of limit setting to corresponding current limit accuracy specifications. For 1A range add an additional 40mA of uncertainty.
4. For sink mode operation (quadrants II and IV), add 10% of compliance range and ±0.02% of limit setting to corresponding voltage source specification. For 100mV range add an additional 60mV of uncertainty.
5. Add 150µs when measuring on the 1A range.

# 2601 2602

# System SourceMeter® Multi-Channel I-V Test Solutions

## METER SPECIFICATIONS

### VOLTAGE MEASUREMENT ACCURACY<sup>1</sup>

RANGE	DISPLAY RESOLUTION <sup>3</sup>	INPUT RESISTANCE	ACCURACY (1 Year) 23°C ±5°C ±(% rdg. + volts)
100.000 mV	1 µV	>10 GΩ	0.015% + 150 µV
1.00000 V	10 µV	>10 GΩ	0.015% + 200 µV
6.00000 V	10 µV	>10 GΩ	0.015% + 1 mV
40.0000 V	100 µV	>10 GΩ	0.015% + 8 mV

TEMPERATURE COEFFICIENT (0°–18°C & 28°–50°C): ±(0.15 × accuracy specification)/°C.

### CURRENT MEASUREMENT ACCURACY

RANGE	DISPLAY RESOLUTION <sup>3</sup>	VOLTAGE BURDEN <sup>2</sup>	ACCURACY (1 Year) 23°C ±5°C ±(% rdg. + amps)
100.000 nA	1 pA	<1 mV	0.05 % + 100 pA
1.00000 µA	10 pA	<1 mV	0.025% + 300 pA
10.0000 µA	100 pA	<1 mV	0.025% + 1.5 nA
100.000 µA	1 nA	<1 mV	0.02 % + 25 nA
1.00000 mA	10 nA	<1 mV	0.02 % + 200 nA
10.0000 mA	100 nA	<1 mV	0.02 % + 2.5 µA
100.000 mA	1 µA	<1 mV	0.02 % + 20 µA
1.00000 A	10 µA	<1 mV	0.03 % + 1.5 mA
3.00000 A	10 µA	<1 mV	0.05 % + 3.5 mA

TEMPERATURE COEFFICIENT (0°–18°C & 28°–50°C): ±(0.15 × accuracy specification)/°C.

### CONTACT CHECK<sup>4</sup>

SPEED	MAXIMUM MEASUREMENT TIME TO MEMORY FOR 60Hz (50Hz) <sup>4</sup>	ACCURACY (1 Year) 23°C ±5°C ±(%rdg. + ohms)
FAST	1 (1.2) ms	5% + 10
MEDIUM	4 (5) ms	5% + 1
SLOW	36 (42) ms	5% + 0.3

### ADDITIONAL METER SPECIFICATIONS

LOAD IMPEDANCE: Stable into 10,000pF typical.

COMMON MODE VOLTAGE: 250VDC.

COMMON MODE ISOLATION: >1GΩ, <4500pF

OVERRANGE: 101% of source range, 102% of measure range.

MAXIMUM SENSE LEAD RESISTANCE: 1kΩ for rated accuracy.

SENSE INPUT IMPEDANCE: >10GΩ.

### NOTES

1. Add 50µV to source accuracy specifications per volt of HI lead drop.
2. Four-wire remote sense only.
3. Applies when in single channel display mode.
4. Includes measurement of SENSE HI to HI and SENSE LO to LO contact resistances.

## GENERAL

HOST INTERFACES: Computer control interfaces.

IEEE-488: IEEE-488.1 compliant. Supports IEEE-488.2 common commands and status model topology.

RS-232: Baud rates from 300 bps to 115200 bps. Programmable number of data bits, parity type, and flow control (RTS/CTS hardware or none). When not programmed as the active host interface, the SourceMeter can use the RS-232 interface to control other instrumentation.

EXPANSION INTERFACE: The TSP-Link expansion interface allows TSP enabled instruments to trigger and communicate with each other.

Cable Type: Category 5e or higher LAN crossover cable.

Length: 3 meters maximum between each TSP enabled instrument.

DIGITAL I/O INTERFACE:

Connector: 25-pin female D.

Input/Output Pins: 14 open drain I/O bits.

Absolute Maximum Input Voltage: 5.25V

Absolute Minimum Input Voltage: -0.25V

Maximum Logic Low Input Voltage: 0.7V +850µA max.

Minimum Logic High Input Voltage: 2.1V +570µA.

Maximum Source Current (flowing out of Digital I/O bit): +960µA.

Maximum Sink Current @ Maximum Logic Low Voltage (0.7V): -5.0mA.

Absolute Maximum Sink Current (flowing into Digital I/O pin): -11mA.

5V Power Supply Pin: Limited to 600mA, solid state fuse protected.

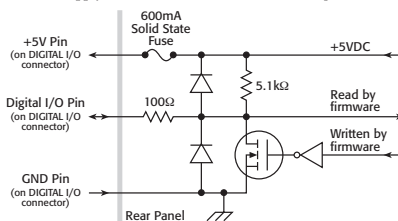

Output Enable Pin: Active high input pulled down internally to ground with 10kΩ resistor. When the Output Enable input function has been activated, each SourceMeter channel will not turn on unless the Output Enable pin is driven to >2.1V (nominal current = 2.1V / 10kΩ = 210µA).

POWER SUPPLY: 100V to 240VAC, 50–60Hz (manual setting), 240VA max.

COOLING: Forced air. Side intake and rear exhaust. One side must be unobstructed when rack mounted.

WARRANTY: 1 year.

EMC: Conforms to European Union Directive 89/336/EEC, EN 61326-1.

SAFETY: Conforms to European Union Directive 73/23/EEC, EN 61010-1, and UL 61010-1.

DIMENSIONS: 89mm high × 213mm wide × 460mm deep (3½ in × 8½ in × 17½ in). Bench Configuration (with handle & feet): 104mm high × 238mm wide × 460mm deep (4½ in × 9½ in × 17½ in).

WEIGHT: 2601: 4.75kg (10.4 lbs). 2602: 5.50kg (12.0 lbs).

ENVIRONMENT: For indoor use only.

Altitude: Maximum 2000 meters above sea level.

Operating: 0°–50°C, 70% R.H. up to 35°C. Derate 3% R.H./°C, 35°–50°C.

Storage: -25°C to 65°C.

# 2611 2612

# System SourceMeter® Multi-Channel I-V Test Solutions

## SPECIFICATION CONDITIONS

This document contains specifications and supplemental information for the Models 2611 and 2612. Specifications are the standards against which the Models 2611 and 2612 are tested. Upon leaving the factory the 2611 and 2612 meet these specifications. Supplemental and typical values are non-warranted, apply at 23°C, and are provided solely as useful information.

The source and measurement accuracies are specified at the SourceMeter CHANNEL A (2611 and 2612) or SourceMeter CHANNEL B (2612) terminals under the following conditions:

1. 23°C ± 5°C, <70% relative humidity.
2. After 2 hour warm-up.
3. Speed normal (1 NPLC).
4. A/D auto-zero enabled.
5. Remote sense operation or properly zeroed local sense operation.
6. Calibration period = 1 year.

## SOURCE SPECIFICATIONS

### VOLTAGE PROGRAMMING ACCURACY<sup>1</sup>

RANGE	PROGRAMMING RESOLUTION	ACCURACY (1 Year) 23°C ± 5°C ±(% rdg. + volts)	NOISE (peak-peak) 0.1Hz–10Hz
200.000 mV	5 μV	0.02% + 375 μV	20 μV
2.00000 V	50 μV	0.02% + 600 μV	50 μV
20.0000 V	500 μV	0.02% + 5 mV	300 μV
200.000 V	5 mV	0.02% + 50 mV	2 mV

TEMPERATURE COEFFICIENT (0°–18°C & 28°–50°C): ±(0.15 × accuracy specification)/°C.

MAXIMUM OUTPUT POWER AND SOURCE/SINK LIMITS<sup>2</sup>: 30.603W per channel maximum. ±20.2V @ ±1.515A, ±202V @ ±101mA, four quadrant source or sink operation.

VOLTAGE REGULATION: Line: 0.01% of range. Load: ±(0.01% of range + 100μV).

NOISE 10Hz–20MHz: <5mV RMS typical, 20V range, 1A limit.

CURRENT LIMIT/COMPLIANCE<sup>3</sup>: Bipolar current limit (compliance) set with single value. Minimum value is 10nA. Accuracy same as current source.

OVERSHOOT: <±(0.1% + 10mV) typical (step size = 10% to 90% of range, resistive load, maximum current limit/compliance).

GUARD OFFSET VOLTAGE: <4mV (current ≤10mA).

### CURRENT PROGRAMMING ACCURACY<sup>4</sup>

RANGE	PROGRAMMING RESOLUTION	ACCURACY (1 Year) 23°C ± 5°C ±(% rdg. + amps)	NOISE (peak-peak) 0.1Hz–10Hz
100.000 nA	2 pA	0.06% + 100 pA	5 pA
1.00000 μA	20 pA	0.03% + 800 pA	25 pA
10.0000 μA	200 pA	0.03% + 5 nA	60 pA
100.000 μA	2 nA	0.03% + 60 nA	3 nA
1.00000 mA	20 nA	0.03% + 300 nA	6 nA
10.0000 mA	200 nA	0.03% + 6 μA	200 nA
100.000 mA	2 μA	0.03% + 30 μA	600 nA
1.00000 A <sup>2</sup>	20 μA	0.05% + 1.8 mA	70 μA
1.50000 A <sup>2</sup>	50 μA	0.06% + 4 mA	150 μA
10.0000 A <sup>±5</sup>	200 μA	0.5 % + 40 mA	

TEMPERATURE COEFFICIENT (0°–18°C & 28°–50°C): ±(0.15 × accuracy specification)/°C.

MAXIMUM OUTPUT POWER AND SOURCE/SINK LIMITS<sup>2</sup>: 30.603W per channel maximum. ±1.515A @ ±20.2V, ±101mA @ ±202V, four quadrant source or sink operation.

CURRENT REGULATION: Line: 0.01% of range. Load: ±(0.01% of range + 100pA).

VOLTAGE LIMIT/COMPLIANCE<sup>3</sup>: Bipolar voltage limit (compliance) set with a single value. Minimum value is 10mV Accuracy same as voltage source.

OVERSHOOT: <0.1% typical (step size = 10% to 90% of range, resistive load; see CURRENT SOURCE OUTPUT SETTLING TIME for additional test conditions).

## ADDITIONAL SOURCE SPECIFICATIONS

TRANSIENT RESPONSE TIME: <70μs for the output to recover to 0.1% for a 10% to 90% step change in load.

VOLTAGE SOURCE OUTPUT SETTLING TIME: Time required to reach 0.1% of final value after source level command is processed on a fixed range.

200mV, 2V Ranges: <50μs typical. 20V Range: <100μs typical. 200V Range: <700μs typical.

CURRENT SOURCE OUTPUT SETTLING TIME: Time required to reach 0.1% of final value after source level command is processed on a fixed range. Values below for Iout · Rload = 2V unless noted.

1.5A–1A Ranges: <120μs typical (Rload >6Ω). 10μA Range: <500μs typical.

100mA–10mA Ranges: <80μs typical. 1μA Range: <2ms typical.

1mA Range: <100μs typical. 100nA Range: <20ms typical.

100μA Range: <150μs typical.

DC FLOATING VOLTAGE: Output can be floated up to ±250VDC from chassis ground.

REMOTE SENSE OPERATING RANGE<sup>1</sup>: Maximum voltage between HI and SENSE HI = 3V. Maximum voltage between LO and SENSE LO = 3V.

VOLTAGE OUTPUT HEADROOM:

200V Range: Max. output voltage = 202.3V – total voltage drop across source leads (maximum 1Ω per source lead).

20V Range: Max. output voltage = 23.3V – total voltage drop across source leads (maximum 1Ω per source lead).

OVER TEMPERATURE PROTECTION: Internally sensed temperature overload puts unit in standby mode.

VOLTAGE SOURCE RANGE CHANGE OVERSHOOT: Overshoot into a 100kΩ load, 20MHz BW, 300mV typical.

CURRENT SOURCE RANGE CHANGE OVERSHOOT: <5% + 300mV/Rload + 60nA of larger range typical. (See CURRENT SOURCE OUTPUT SETTLING TIME for additional test conditions.)

## PULSE SPECIFICATIONS

REGION	MAXIMUM CURRENT LIMIT	MAXIMUM PULSE WIDTH <sup>6</sup>	MAXIMUM DUTY CYCLE <sup>5</sup>
1	100 mA @ 200 V	DC, no limit	100%
1	1.5 A @ 20 V	DC, no limit	100%
2	1 A @ 180 V	8.5 ms	1%
3 <sup>10</sup>	1 A @ 200 V	2.2 ms	1%
4	10 A @ 5 V	1 ms	2.2%

MINIMUM PROGRAMMABLE PULSE WIDTH<sup>6</sup>: 200μs. NOTE: Minimum pulse width for settled source at a given I/V output and load can be longer than 200μs. See note 11 for typical settling times.

PULSE WIDTH PROGRAMMING RESOLUTION: 1μs.

PULSE WIDTH PROGRAMMING ACCURACY<sup>6</sup>: ±25μs.

TYPICAL PULSE WIDTH JITTER: 50μs.

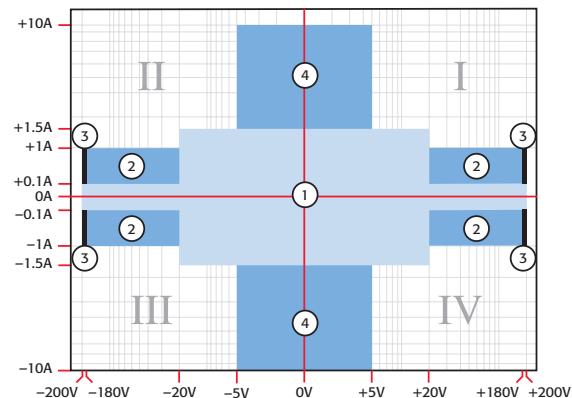

## SOURCE SPECIFICATIONS (continued)

### PULSE SPECIFICATIONS (continued)

#### NOTES

1. Add 50µV to source accuracy specifications per volt of HI lead drop.
2. Full power source operation regardless of load to 50°C ambient. Above 30°C and/or power sink operation, refer to Section 8 – Operating Boundaries in the Series 2600 Reference Manual for additional power derating information.
3. For sink mode operation (quadrants II and IV), add 12% of limit range and ±0.02% of limit setting to corresponding current limit accuracy specifications. For 1A range add an additional 40mA of uncertainty.
4. For sink mode operation (quadrants II and IV), add 10% of compliance range and ±0.02% of limit setting to corresponding voltage source specification. For 200mV range add an additional 120mV of uncertainty.
5. 10A range accessible only in pulse mode.
6. Accuracy specifications do not include connector leakage. Derate accuracy by  $V_{out}/2E11$  per °C when operating between 18°–28°C. Derate accuracy by  $V_{out}/2E11 + (0.15 * V_{out}/2E11)$  per °C when operating <18°C and >28°C.
7. 150mV under pulse conditions with compliance set to 1A.
8. Times measured from the start of pulse to the start of off-time; see figure below.

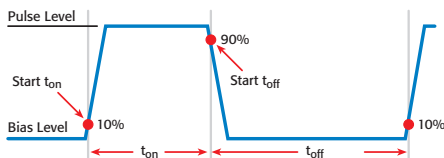

9. Thermally limited in sink mode (quadrants 2 and 4) and ambient temperatures above 30°C. See power equations in the reference manual for more information.
10. Voltage source operation with 1.5A current limit.
11. Typical performance for minimum settled pulse widths:

Source Value	Load	Source Settling (% of range)	Min. Pulse Width
5 V	0.5 Ω	1%	300 µs
20 V	200 Ω	0.2%	200 µs
180 V	180 Ω	0.2%	5 ms
200V (1.5A limit)	200 Ω	0.2%	1.5 ms
100 mA	200 Ω	1%	200 µs
1 A	20 Ω	1%	500 µs
1 A	180 Ω	0.2%	5 ms
10 A	0.5 Ω	0.5%	300 µs

Typical tests were performed using remote operation, 4W sense, Keithley 2600-BAN cables and best, fixed measurement range. For more information on pulse scripts, see the Series 2600 Reference Manual.

## METER SPECIFICATIONS

### VOLTAGE MEASUREMENT ACCURACY 1, 7

RANGE	DISPLAY RESOLUTION <sup>3</sup>	INPUT RESISTANCE	ACCURACY (1 Year) 23°C ±5°C ±(% rdg. + volts)
200.000 mV	1 µV	>10 GΩ	0.015% + 225 µV
2.00000 V	10 µV	>10 GΩ	0.02 % + 350 µV
20.0000 V	100 µV	>10 GΩ	0.015% + 5 mV
200.000 V	1 mV	>10 GΩ	0.015% + 50 mV

TEMPERATURE COEFFICIENT (0°–18°C & 28°–50°C): ±(0.15 × accuracy specification)/°C.

### CURRENT MEASUREMENT ACCURACY 6, 7

RANGE	DISPLAY RESOLUTION <sup>3</sup>	VOLTAGE BURDEN <sup>2</sup>	ACCURACY (1 Year) 23°C ±5°C ±(% rdg. + amps)
100.000 nA	1 pA	<1 mV	0.05 % + 100 pA
1.00000 µA	10 pA	<1 mV	0.025% + 500 pA
10.0000 µA	100 pA	<1 mV	0.025% + 1.5 nA
100.000 µA	1 nA	<1 mV	0.02 % + 25 nA
1.00000 mA	10 nA	<1 mV	0.02 % + 200 nA
10.0000 mA	100 nA	<1 mV	0.02 % + 2.5 µA
100.000 mA	1 µA	<1 mV	0.02 % + 20 µA
1.00000 A	10 µA	<1 mV	0.03 % + 1.5 mA
1.50000 A	10 µA	<1 mV	0.05 % + 3.5 mA
10.0000 A <sup>5</sup>	100 µA	<1 mV	0.4 % + 25 mA

TEMPERATURE COEFFICIENT (0°–18°C & 28°–50°C): ±(0.15 × accuracy specification)/°C.

### CONTACT CHECK<sup>4</sup>

SPEED	MAXIMUM MEASUREMENT TIME TO MEMORY FOR 60Hz (50Hz) <sup>4</sup>	ACCURACY (1 Year) 23°C ±5°C ±(%rdg. + ohms)
FAST	1 (1.2) ms	5% + 10
MEDIUM	4 (5) ms	5% + 1
SLOW	36 (42) ms	5% + 0.3

### ADDITIONAL METER SPECIFICATIONS

LOAD IMPEDANCE: Stable into 10,000pF typical.

COMMON MODE VOLTAGE: 250VDC.

COMMON MODE ISOLATION: >1GΩ, <4500pF

OVERRRANGE: 101% of source range, 102% of measure range.

MAXIMUM SENSE LEAD RESISTANCE: 1kΩ for rated accuracy.

SENSE INPUT IMPEDANCE: >10GΩ.

#### NOTES

1. Add 50µV to source accuracy specifications per volt of HI lead drop.
2. Four-wire remote sense only.
3. Applies when in single channel display mode.
4. Includes measurement of SENSE HI to HI and SENSE LO to LO contact resistances.
5. 10A range accessible only in pulse mode.
6. De-rate accuracy by  $V_{out}/2E11$  per °C when operating between 18°–28°C. Derate accuracy by  $V_{out}/2E11 + (0.15 * V_{out}/2E11)$  per °C when operating <18°C and >28°C.
7. De-rate accuracy specifications for NPLC setting <1 by increasing error term. Add appropriate % of range term using table below:

NPLC Setting	200mV Range	2V–200V Ranges	100nA Range	1µA–100mA Ranges	1A–1.5A Ranges
0.1	0.01%	0.01%	0.01%	0.01%	0.01%
0.01	0.08%	0.07%	0.1 %	0.05%	0.05%
0.001	0.8 %	0.6 %	1 %	0.5 %	1.1 %

2611  
2612

# System SourceMeter® Multi-Channel I-V Test Solutions

## GENERAL

**HOST INTERFACES:** Computer control interfaces.

**IEEE-488:** IEEE-488.1 compliant. Supports IEEE-488.2 common commands and status model topology.

**RS-232:** Baud rates from 300 bps to 115200 bps. Programmable number of data bits, parity type, and flow control (RTS/CTS hardware or none). When not programmed as the active host interface, the SourceMeter can use the RS-232 interface to control other instrumentation.

**EXPANSION INTERFACE:** The TSP-Link expansion interface allows TSP enabled instruments to trigger and communicate with each other.

**Cable Type:** Category 5e or higher LAN crossover cable.

**Length:** 3 meters maximum between each TSP enabled instrument.

**DIGITAL I/O INTERFACE** (see 2601/02 GENERAL specifications for circuit diagram):

**Connector:** 25-pin female D.

**Input/Output Pins:** 14 open drain I/O bits.

**Absolute Maximum Input Voltage:** 5.25V

**Absolute Minimum Input Voltage:** -0.25V

**Maximum Logic Low Input Voltage:** 0.7V +850 $\mu$ A max.

**Minimum Logic High Input Voltage:** 2.1V +570 $\mu$ A.

**Maximum Source Current (flowing out of Digital I/O bit):** +960 $\mu$ A.

**Maximum Sink Current @ Maximum Logic Low Voltage (0.7V):** -5.0mA.

**Absolute Maximum Sink Current (flowing into Digital I/O pin):** -11mA.

**5V Power Supply Pin:** Limited to 600mA, solid state fuse protected.

**Safety Interlock Pin:** Active high input. >3.4V @ 24mA (absolute maximum of 6V) must be externally applied to this pin to insure 200V operation. This signal is pulled down to chassis ground with a 10k $\Omega$  resistor. 200V operation will be blocked when the INTERLOCK signal is <0.4V (absolute minimum of -0.4V). See figure below:

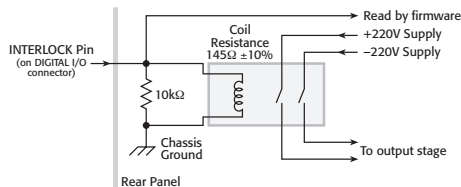

**POWER SUPPLY:** 100V to 240VAC, 50–60Hz (manual setting), 240VA max.

**COOLING:** Forced air. Side intake and rear exhaust. One side must be unobstructed when rack mounted.

**WARRANTY:** 1 year.

**EMC:** Conforms to European Union Directive 89/336/EEC, EN 61326-1.

**SAFETY:** Conforms to European Union Directive 73/23/EEC, EN 61010-1, and UL 61010-1.

**DIMENSIONS:** 89mm high  $\times$  213mm wide  $\times$  460mm deep (3½ in  $\times$  8½ in  $\times$  17½ in). Bench Configuration (with handle & feet): 104mm high  $\times$  238mm wide  $\times$  460mm deep (4¼ in  $\times$  9½ in  $\times$  17½ in).

**WEIGHT:** 2611: 4.75kg (10.4 lbs). 2612: 5.50kg (12.0 lbs).

**ENVIRONMENT:** For indoor use only.

**Altitude:** Maximum 2000 meters above sea level.

**Operating:** 0°–50°C, 70% R.H. up to 35°C. Derate 3% R.H./°C, 35°–50°C.

**Storage:** -25°C to 65°C.

# Series 2600

# System SourceMeter® Multi-Channel I-V Test Solutions

## SPEED SPECIFICATIONS 1

### MAXIMUM SWEEP OPERATION RATES (operations per second) FOR 60Hz (50Hz):

A/D CONVERTER SPEED	TRIGGER ORIGIN	MEASURE TO MEMORY	MEASURE TO GPIB	SOURCE MEASURE TO MEMORY	SOURCE MEASURE TO GPIB	SOURCE MEASURE PASS/FAIL TO MEMORY	SOURCE MEASURE PASS/FAIL TO GPIB
0.001 NPLC	Internal	10000 (10000)	8000 (8000)	5500 (5500)	3600 (3600)	4900 (4900)	3100 (3100)
0.001 NPLC	Digital I/O	2700 (2650)	2100 (2100)	2300 (2300)	1900 (1875)	2200 (2150)	1800 (1775)
0.01 NPLC	Internal	4000 (3500)	3600 (3200)	2750 (2700)	2300 (2100)	2800 (2500)	2100 (1975)
0.01 NPLC	Digital I/O	1900 (1775)	1600 (1500)	1700 (1600)	1450 (1400)	1600 (1500)	1400 (1325)
0.1 NPLC	Internal	565 (475)	555 (470)	540 (450)	510 (440)	535 (455)	505 (430)
0.1 NPLC	Digital I/O	490 (420)	470 (405)	470 (410)	450 (390)	470 (400)	450 (390)
1.0 NPLC	Internal	59 (49)	59 (49)	58 (49)	58 (48)	58 (49)	58 (48)
1.0 NPLC	Digital I/O	58 (48)	58 (48)	58 (48)	57 (48)	57 (48)	57 (48)

### MAXIMUM SINGLE MEASUREMENT RATES (operations per second) FOR 60Hz (50Hz):

A/D CONVERTER SPEED	TRIGGER ORIGIN	MEASURE TO GPIB	SOURCE MEASURE TO GPIB	SOURCE MEASURE PASS/FAIL TO GPIB
0.001 NPLC	Internal	1110 (1000)	880 (880)	840 (840)
0.01 NPLC	Internal	950 (900)	780 (760)	730 (710)
0.1 NPLC	Internal	390 (345)	355 (320)	340 (305)
1.0 NPLC	Internal	57 (48)	56 (47)	56 (47)

**MAXIMUM MEASUREMENT RANGE CHANGE RATE:** >4500/second typical. When changing to or from a range  $\geq 1A$ , maximum rate is >2000/second typical.

**MAXIMUM SOURCE RANGE CHANGE RATE:** >400/second, typical.

**MAXIMUM SOURCE FUNCTION CHANGE RATE:** >500/second, typical.

**EXTERNAL TRIGGER INPUT:** The Digital I/O interface signals can be configured to behave as trigger inputs.

**Input Latency (time from trigger input to start of measurement or source change):**  
<150 $\mu$ s, typical.

**Input Jitter:** <100 $\mu$ s, typical.

**COMMAND PROCESSING TIME:** Maximum time required for the output to begin to change following the receipt of the smux.source.levelv or smux.source.leveli command. <1ms typical.

## NOTES

1. See the Speed Specifications Test Conditions Appendix in the Series 2600 Reference Manual for more information regarding test conditions.

Specifications are subject to change without notice. Rev. B

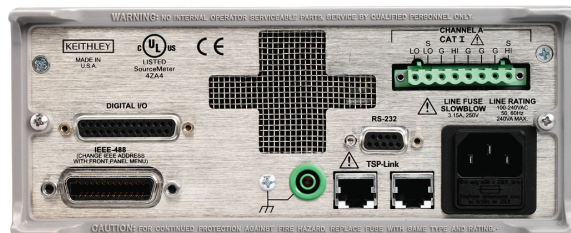

Model 2601/2611 Rear Panel

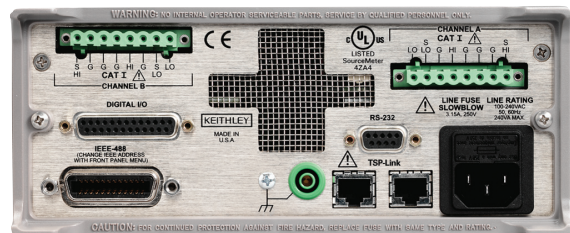

Model 2602/2612 Rear Panel

## SUPPLEMENTAL INFORMATION

**FRONT PANEL INTERFACE:** 2-line vacuum fluorescent display (VFD) with keypad and rotary knob.

**Display:**

- Show error messages and user defined messages
- Display source and limit settings
- Show current and voltage measurements
- View measurements stored in non-volatile reading buffers

**Keypad Operations:**

- Change host interface settings
- Save and restore instrument setups
- Load and run factory and user defined test scripts (i.e. sequences) that prompt for input and send results to the display
- Store measurements into non-volatile reading buffers

**PROGRAMMING:** Embedded Test Script Processor (TSP) accessible from any host interface. Responds to individual instrument control commands. Responds to high-speed test scripts comprised of instrument control commands and Test Script Language (TSL) statements (e.g. branching, looping, math, etc.). Able to execute high-speed test scripts stored in memory without host intervention.

**Minimum Memory Available:** 3 Mbytes (approximately 50,000 lines of TSL code).

**Test Script Builder:** Integrated Development Environment for building, running, and managing TSP scripts. Includes an Instrument Console for communicating with any TSP enabled instrument in an interactive manner. Requires:

- VISA (NI/VISA included on CD)
- Microsoft .NET Framework (included on CD)
- Keithley I/O Layer (included on CD)
- Pentium III 800MHz or faster personal computer
- Microsoft Windows 98, NT, 2000, or XP

**Drivers:** IVI/VISA drivers for VB, VC/C++, LabVIEW, TestPoint, and LabWindows/CVI

**READING BUFFERS:** Non-volatile storage area(s) reserved for measurement data. Reading buffers are arrays of measurement elements. Each element can hold the following items:

- Measurement
- Measurement status
- Timestamp
- Source setting (at the time the measurement was taken)
- Range information

Two reading buffers are reserved for each SourceMeter channel. Reading buffers can be filled using the front panel STORE key and retrieved using the RECALL key or host interface.

**Buffer Size, with timestamp and source setting:** >50,000 samples.

**Buffer Size, without timestamp and source setting:** >100,000 samples.

**Battery Backup:** Lithium-ion battery backup. 30 days of non-volatile storage @ 23°C, and >4 hours of charge time. 3 year battery life @ 25°C. 1.5 year battery life @ 50°C.

**FACTORY TSP SCRIPTS:** See [www.keithley.com](http://www.keithley.com) for Keithley-supported application-specific scripts.

**SYSTEM EXPANSION:** The TSP-Link expansion interface allows TSP enabled instruments to trigger and communicate with each other. See figure below:

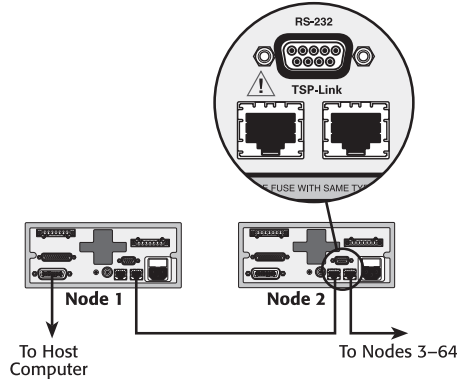

Each SourceMeter has two TSP-Link connectors to facilitate chaining instruments together.

- Once SourceMeter instruments are interconnected via TSP-Link, a computer can access all of the resources of each SourceMeter via the host interface of any SourceMeter.
- A maximum of 64 TSP-Link nodes can be interconnected. Each SourceMeter consumes one TSP-Link node.

**TIMER:** Free running 47 bit counter with 1MHz clock input. Reset each time instrument powers up. Rolls over every 4 years.

**Timestamp:** TIMER value automatically saved when each measurement is triggered.

**Resolution:** 1µs.

**Accuracy:** 50ppm.