



Powering Results with Precision and Simplicity

Addressing Today's Power Sourcing Applications from
Basic Needs to the Most Challenging Requirements

A GREATER MEASURE OF CONFIDENCE

KEITHLEY
A Tektronix Company

Powering Results with Precision and Simplicity

Addressing Today's Power Sourcing Applications from Basic Needs to the Most Challenging Requirements



Introduction

Whether being used to train the next generation of electrical engineers or for developing a breakthrough in ultra-low power, wearable products, power supplies must meet a wide range of power sourcing requirements. For applications ranging from basic power sourcing to those that push the limits of performance with high sensitivity sources or sources that can deliver thousands of volts, using the appropriate power supply is critical to successful teaching or obtaining successful test results. This e-guide offers guidance for selecting the appropriate general purpose power supply or specialized source for a wide range of testing needs, including even the most challenging requirements.

Table of Contents

Low Power, Portable Devices; Power Supplies with Advanced Measurement Capability	3
Verifying the Power Consumption in the Device; Monitoring Circuit Stability; Determining Peak Load Current when Drawn in Short Bursts; Automating Load Current Monitoring for Environmental or Production Testing	
Compact Supplies for Automated Test.....	7
Achieving More Power with Less Space; Controlling an External Device; Simulating a Wide Range of DC Output Conditions; Protecting Devices with Large In-rush Currents from Overshoot Damage	
Research and Design.....	12
Optimizing Instrument Flexibility with a Limited Instrument Budget; Automating Tests for Efficient Data Collection	
Education	14
Providing an Effective Learning Environment within a Tight Budget	
Testing Portable Wireless Devices	15
High Volume Production Testing of Portable, Wireless Devices	
When More Sensitivity is Needed than a Power Supply can Offer	16
Performing I-V Characterization or Studying Leakage Current on a Component	
High Voltage Breakdown Testing.....	17
Meeting High Voltage Operating Specifications	

Low Power, Portable Devices; Power Supplies with Advanced Measurement Capability Verifying Device Power Consumption Requires Low Current Measurement

To properly design and test low power, portable devices such as consumer products (cellular phones, tablets, laptops), industrial products (wireless transmitters, intrinsically safe instruments), or implantable medical devices (pacemakers, defibrillators, neurological stimulators), it's essential to verify that the goals for maximum battery life, maximum time between re-charges, or minimum current consumption can be met. But, these tests, which include measuring the sleep mode and standby mode currents drawn by these devices, require precise low current measurements that are often in the range of micro-amps to hundreds of micro-amps. In addition to good measurement techniques, sensitive instrumentation with special capabilities for measuring very small load currents is typically necessary, adding cost and complexity to the test circuit. It would be very convenient if the power supply used to power the device during testing could measure very low load currents, but conventional programmable power supplies have a current measuring resolution of only 0.1mA at best and, therefore, cannot be used to measure the ultra-low standby and sleep mode currents in today's and the next generation's low power products.

Now there is a power supply that can make very low load current measurements and provide a cost-effective solution. The Series 2280S Precision Measurement, Low Noise, Programmable DC Power Supplies provide the necessary sensitivity to measure low sleep mode and standby mode currents. With 6½ digits on a 10mA range, the display resolution is 10nA, enabling excellent quality measurements at µA load current levels. With 0.05% accuracy, 6½ digits, and four current ranges, the Series 2280S power supplies provide DMM-quality measurements.

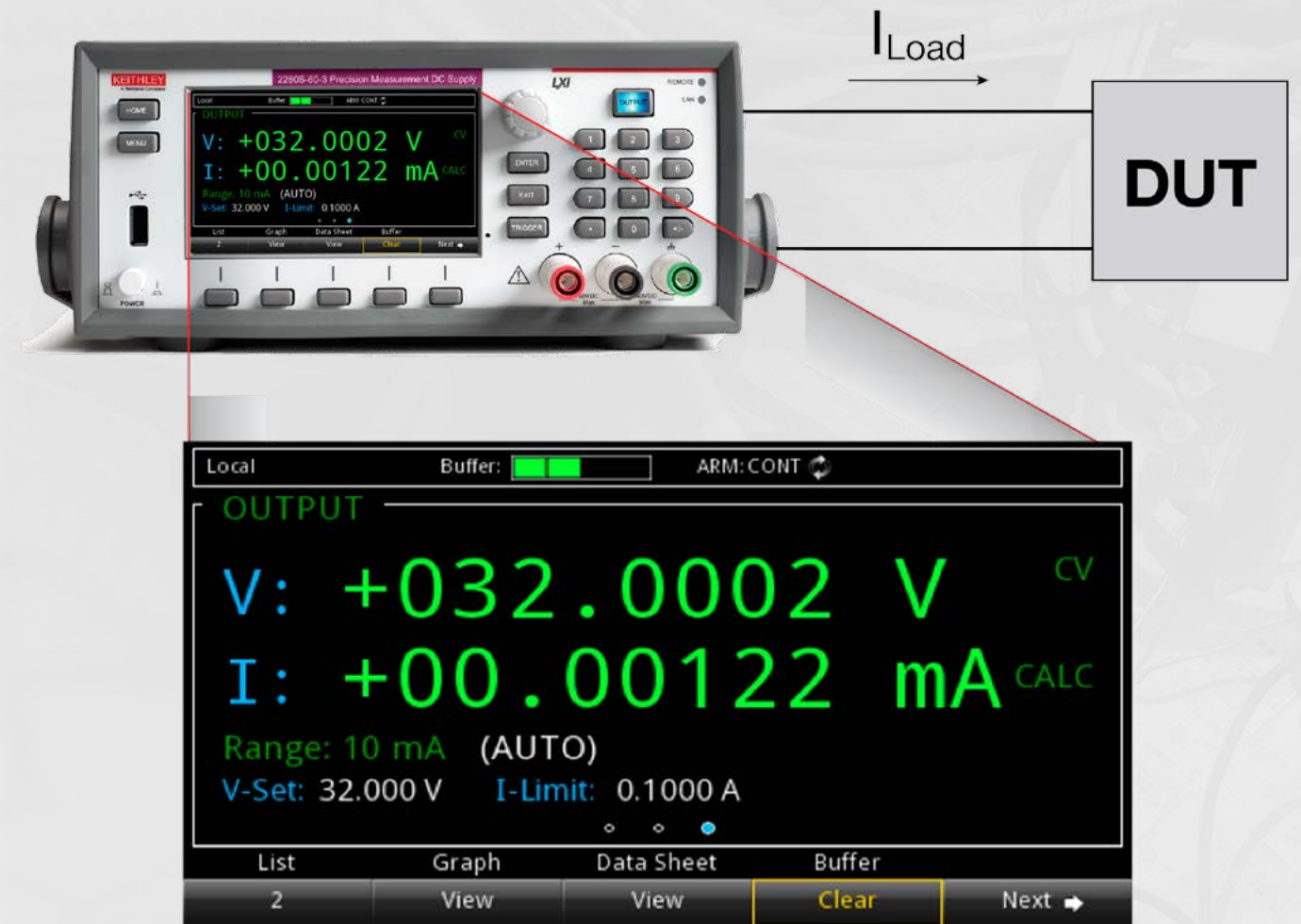

With its ability to control the integration time and to add filtering, the Series 2280S can measure very low currents down to 1µA and slightly lower with 10nA resolution.

Want to Learn More?
Read the Application Note "Making Low Current Measurements with a Series 2280S Precision Measurement DC Power Supply."



Low Power, Portable Devices; Power Supplies with Advanced Measurement Capability

Determining Peak Load Current when Drawn in Short Bursts

Monitoring the current consumption for all of a device's operating states is necessary to minimize the total power consumption of a design and to maximize the battery life. The problem is that many electronic devices, including automotive keyless entry devices, remotely-located wireless transmitters used in industrial processes, portable and implantable medical devices, and portable wireless consumer electronics, operate in standby mode most of the time and are typically in their full power, active states for only short intervals of time. These devices transition from a low power standby state to a full power, transmit or a fully operational state during which the load current will increase to its maximum value and then return back its standby level. The current loads during the active states are pulse-like and can be as narrow as hundreds of microseconds!

To fully characterize total power consumption, test instruments need to have the capability to measure dynamic load currents that are extremely narrow pulses. But, traditional power supplies take measurements only over an integral number of power line cycles, so adding a digital multimeter (DMM) or data acquisition instrument is needed in series with the power supply. When an additional instrument is used as a voltage measuring device, then a current sense resistor must also be added to the circuit. Unfortunately, this technique adds significant cost, more complexity to a test configuration, and an additional source of error.

The Series 2280S Precision Measurement DC Power Supplies can make fast current measurements on a load burst that is as narrow as 140µs and can easily monitor load currents during all operating modes of a device to determine its total power consumption without the need for extra equipment.



Make time-critical measurements on fast-changing or pulse-like loads. An external trigger initiates the acquisition. Programmable delay and measure times enable measurements at a specific time on the load current pulse.

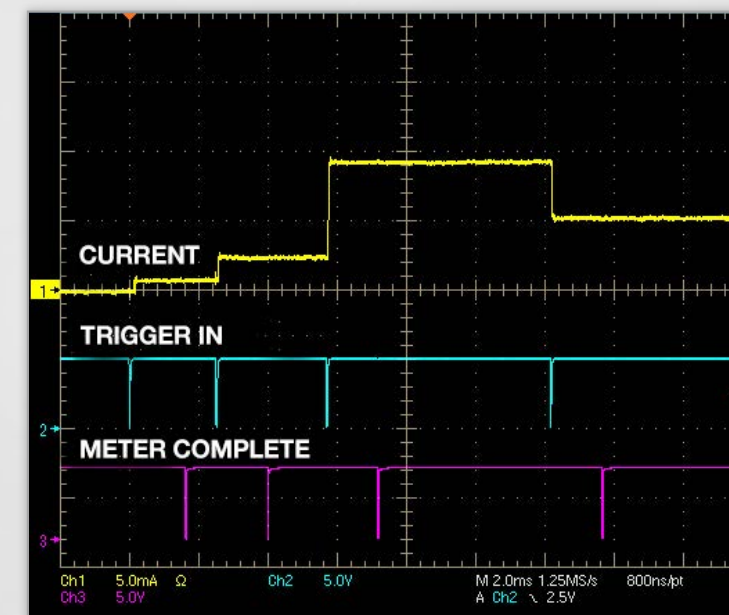

Measure the start-up load currents as a device powers up.



Want to Learn More? Read the application note "Making Pulse Current Measurements with the Series 2280S Precision Measurement DC Power Supplies."

Low Power, Portable Devices; Power Supplies with Advanced Measurement Capability Monitoring Circuit Stability

When you need to collect data for trend analysis but don't have the time it takes to write a program, the Series 2280S offers three options:

- Log 2500 data points in the internal memory and monitor the data using the graphing function on the high resolution display
- Use Keithley KickStart Point and Click Instrument Control Software to plot and store over 15,000 data points
- Monitor data remotely with the LXI web interface

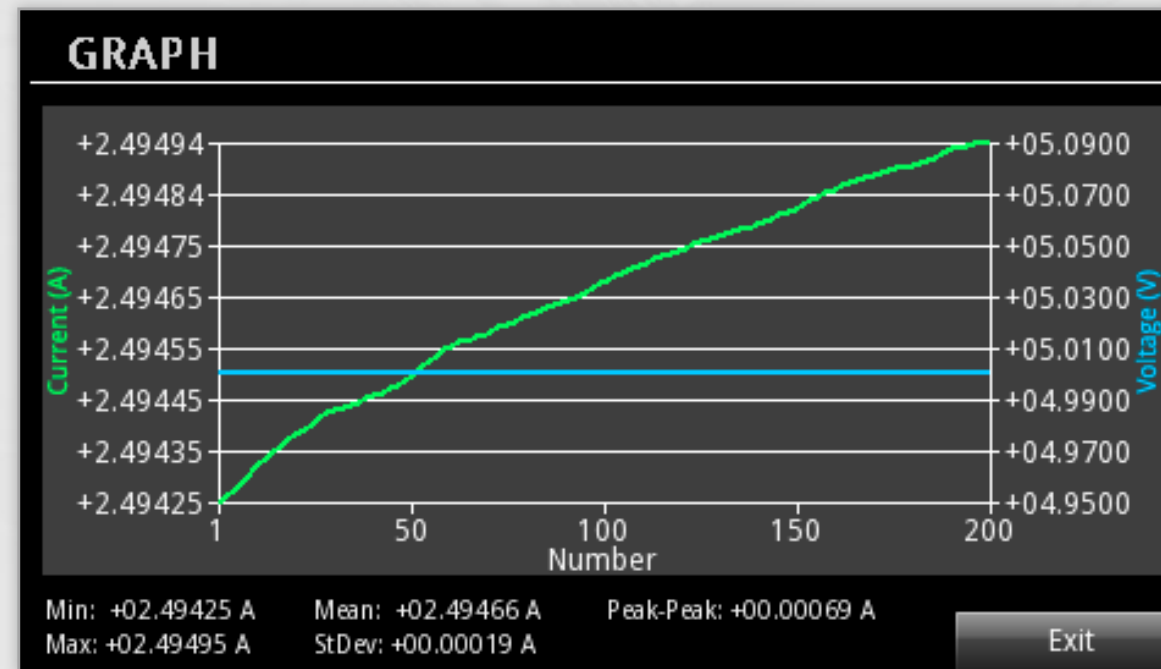

Monitor voltage, current, or both with the Series 2280S graphing function.

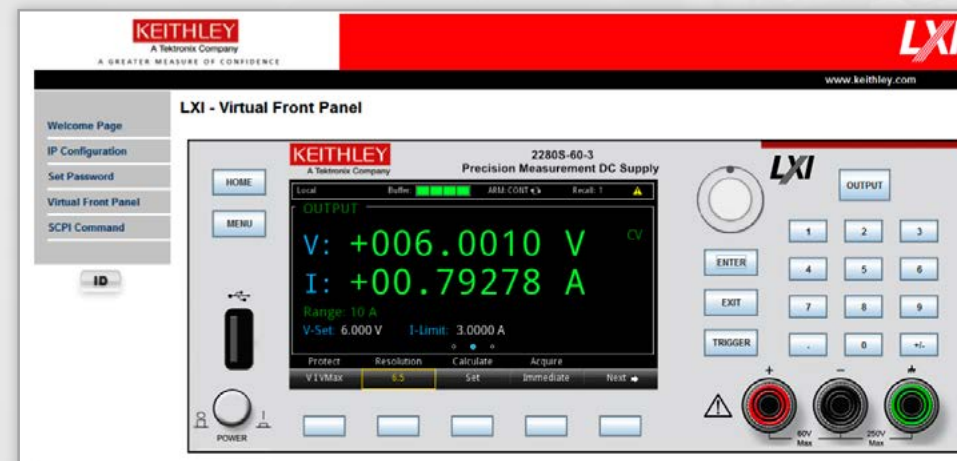

Control or monitor the power supply using its web browser over the LAN LXI interface.

Item	Supply1.I[1][1]	Supply1.V[1][1]	Supply1.Time[1][1]
1	-1.636689E-005	-3.033947E-004	0.000000E+000
2	1.542315E-005	7.897432E-004	8.900000E-002
3	-1.647107E-005	-3.352484E-004	1.718000E-001
4	-1.521143E-005	-3.284298E-004	2.577000E-001
5	-1.521140E-005	-3.215972E-004	3.436000E-001
6	-1.524638E-005	-3.102286E-004	4.295000E-001
7	-1.412527E-005	-2.806419E-004	5.154000E-001
8	1.369596E-005	2.738159E-004	6.013000E-001
9	-1.536534E-005	-3.284276E-004	6.872000E-001
10	-1.704939E-005	-3.375241E-004	7.731000E-001
11	9.969714E-002	2.000140E+000	9.559000E-001
12	9.968475E-002	2.000154E+000	1.041000E+000
13	9.968196E-002	2.000151E+000	1.127700E+000

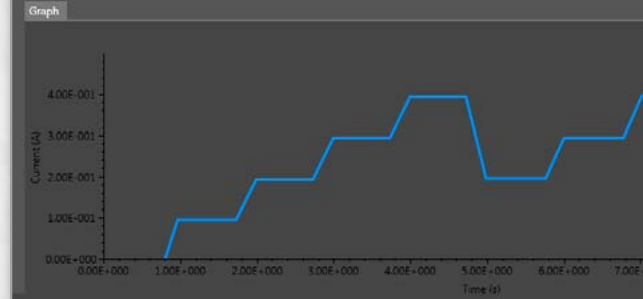

KickStart Software plot of voltage vs. time with a measurement table.

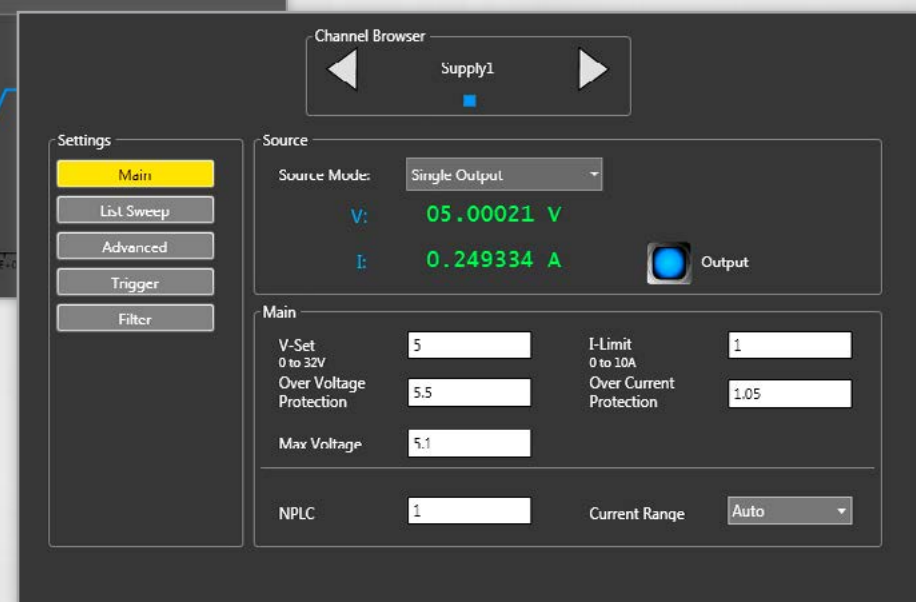

KickStart Software DC power supply control main screen.

Low Power, Portable Devices; Power Supplies with Advanced Measurement Capability Automating Load Current Monitoring for Environmental or Production Testing

It's easy to optimize the Series 2280S performance for production testing:

- Choose any one of the three standard interfaces: GPIB, USB, or LAN
- Interface with other instruments via hardware control lines to save PC communication time and to synchronize voltage changes and load current measurements with other test system events
- Optimize your test for speed or accuracy by selecting measurement resolutions of 4½, 5½, or 6½ digits.



Series 2280S rear panel showing the rear output connector with remote sense inputs, digital I/O, and the GPIB, USB, and LAN interfaces.

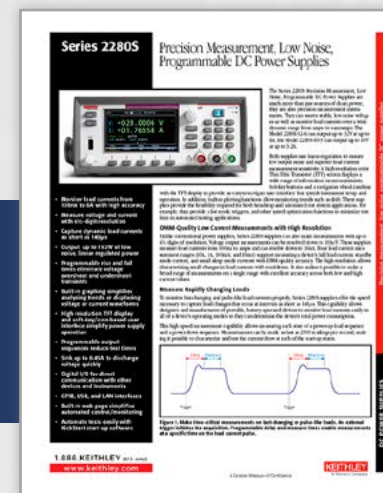

Want to Learn More?
 Download the data sheet on the "Series 2280S Precision Measurement, Low Noise, Programmable DC Power Supplies."

Get advice on maximizing the performance of your power supplies.
 Send us your question or join the discussion in our [application forum](#).

Compact Supplies for Automated Test Achieving More Power in Less Space

Reliability testing, such as environmental testing or life testing, requires testing many components, sub-assemblies, or products – and typically a large test system. If the test instruments are smaller, there's a better chance that all the necessary instrumentation will fit into the available space. Power supplies, however, get larger as the required power increases. And, if individual power supplies are needed for each device under test (DUT), then a rack can get consumed by power supplies. Similarly, if the production test system footprint needs to be minimized to ensure maximum production test capacity in the floor space allocated for testing, then the size of the test system must also be minimized. In this situation, as well, the power requirements and the space constraints are opposing forces.

The key is to get the maximum power density in the least amount of space. The Keithley Series 2268 Power Supplies provide up to 850W in a space-saving 1U high, half-rack power supply. In 4U of rack space, eight power supplies can be installed for a total of 6800W. These power supplies push air from front to back so that no additional space for cooling is required either above or below the supplies. They can be mounted right on top of each other and consume no more than 1U of rack space per power supply row. And, the Series 2268 Power Supplies are rated to perform reliability up to 50°C, so they can operate in high density racks in which the temperature rise can be significant.

When your power supply requirements call for less power in limited rack space, the Keithley Series 2260 Power Supplies provide 360W and 720W of space-saving output power. Six 360W 3U high power supplies and three 720W power supplies fill only one rack width.



Maximize the power in the least amount of rack space using Keithley's Series 2260B and 2268 Power Supplies.

Get advice on maximizing the performance of your power supplies.

[Send us your question](#) or join the discussion in our [application forum](#).

Compact Supplies for Automated Test Controlling an External Device

Many test systems need control outputs to signal a device handler or need to control an external device such as a power relay. Providing control voltage to either a device handler or a relay requires a separate power source. But, rather than adding more power supplies to the system, the Series 2268 Power Supplies feature two auxiliary outputs – one 15V and one 5V - that can be used as control signals or as relay drive power, eliminating the need for additional instrumentation.

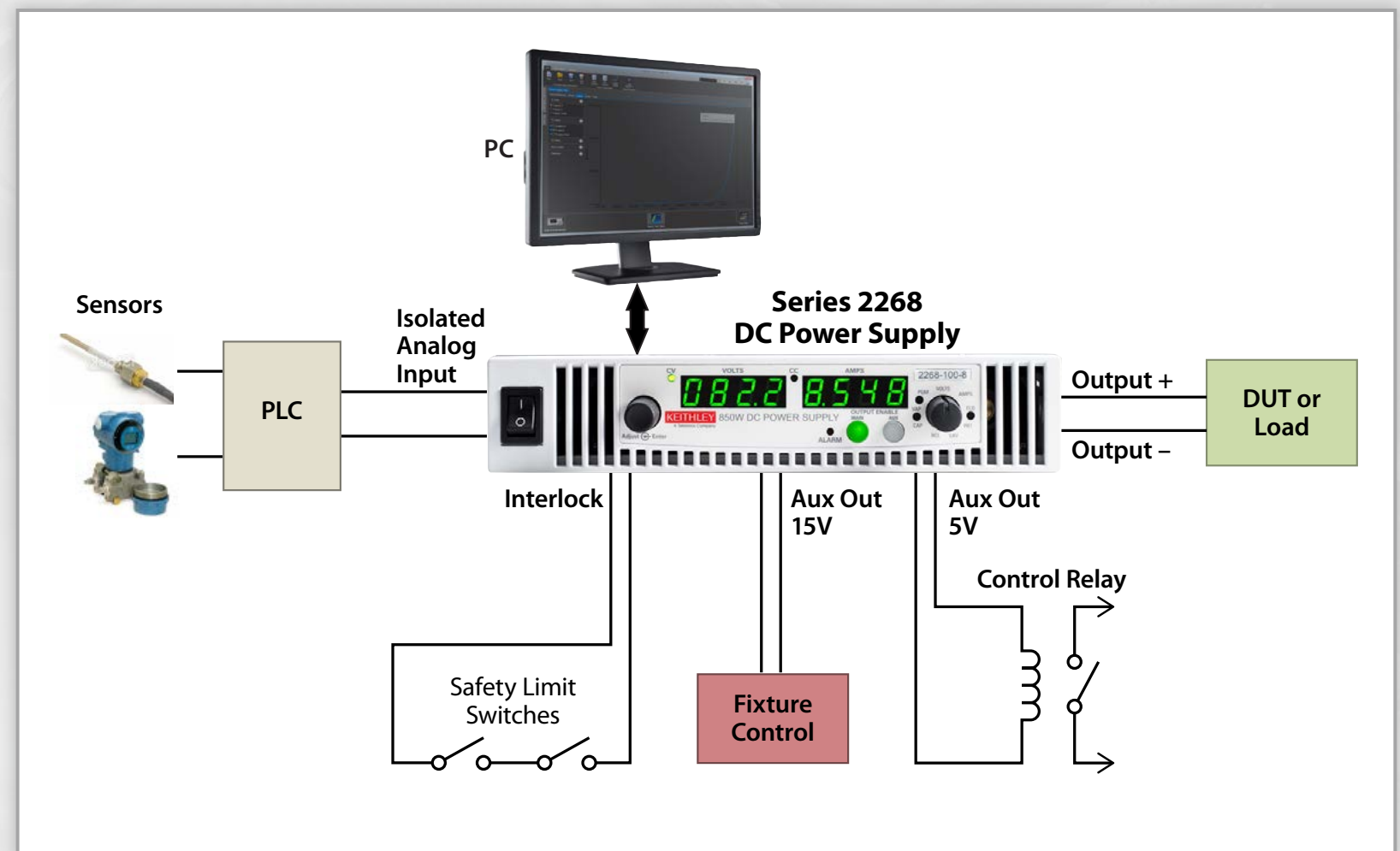

A Series 2268 DC Power Supply can be used as part of a control system. Analog control signals can program the supply's output. In addition to driving the load, two auxiliary outputs can drive external devices or circuits and can eliminate the need for extra power sources in a test system.

Want to Learn More?

Download the data sheet on the "Series 2268 850W DC Power Supplies."

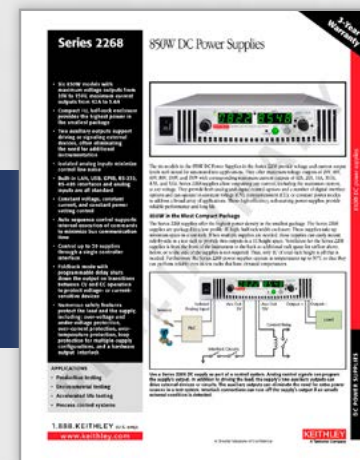

Compact Supplies for Automated Test Simulating a Wide Range of DC Output Conditions

Test requirements include determining how the DUT responds to a number of changes in the DC supply line.

- Does the DUT turn on and off smoothly without transient artifacts with the ramp up and ramp down of the supply voltage?
- Does the DUT meet its specifications over the stated operating voltage range and slightly below and above the rated voltage?
- How well does the DUT recover from transient DC supply voltage drops?
- Does the DUT continue to perform properly when subjected to a specific DC line voltage waveform specified by an industry standard such as an automotive industry standard?

Both the Series 2268 and Series 2260B DC supplies provide the capability to store voltage sequences or lists so that a device can be automatically swept through its full operating voltage range. Also, both these series provide analog inputs to enable the creation of special supply voltage wave shapes that are necessary to test a DUT.

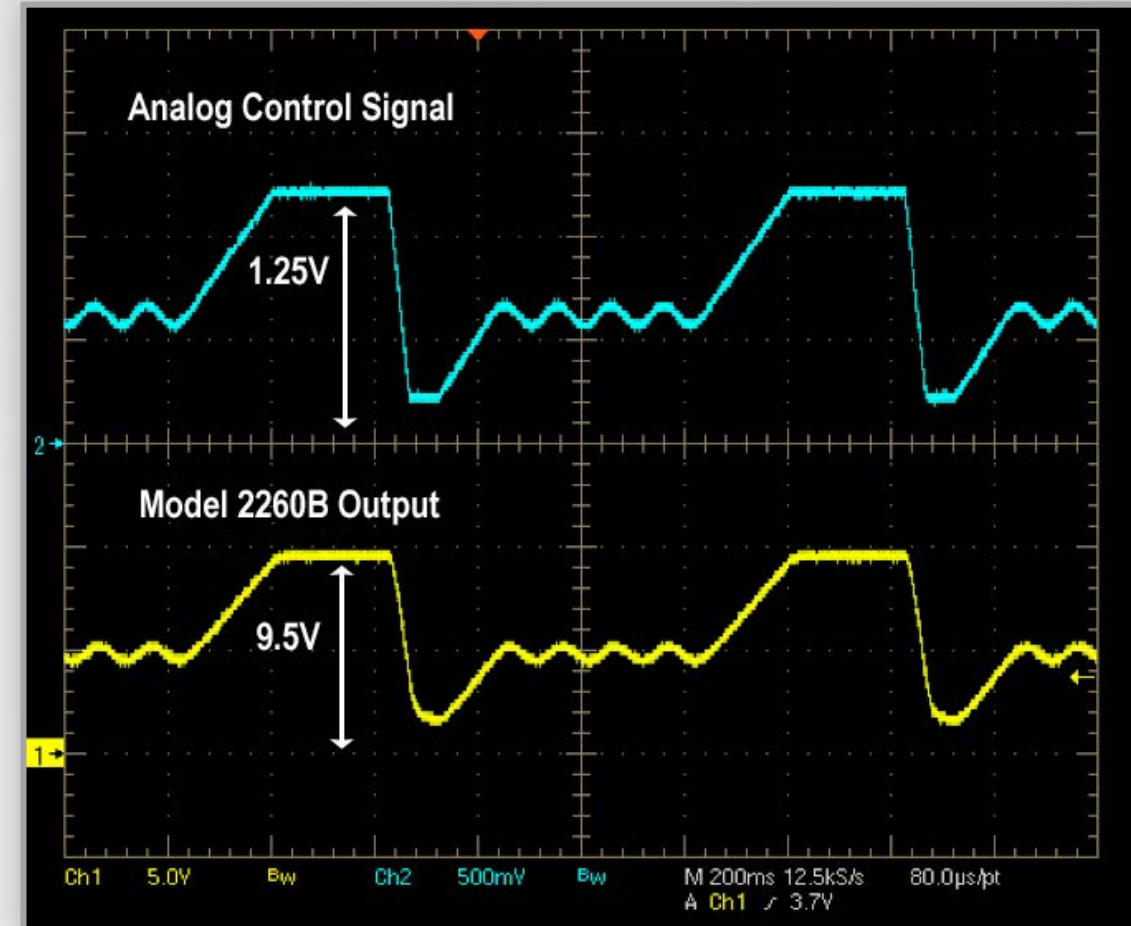

Analog inputs allow the generation of output voltage patterns to stress test devices and to simulate disturbances on DC supply lines.



Want to Learn More?
 Download the data sheet on the "Series 2260
 360W and 720W Programmable DC Power Supplies."

Compact Supplies for Automated Test Protecting Devices with Large In-rush Currents from Overshoot Damage

Potentially dangerous in-rush currents can flow into loads that have low resistance when power is initially supplied, damaging components, modules, or devices. The Series 2260B power supplies feature both programmable voltage and current rise and fall times.

Programmable current rise times allow the rate at which the load current builds up to be controlled. This eliminates any current overshoot that is created by powering a device with a characteristic, high in-rush current, and prevents any damage to the device from a large transient current overshoot.

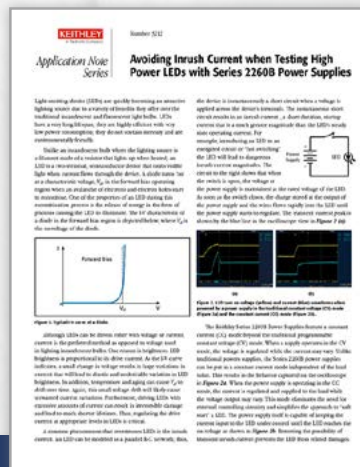

For more information read the application note "Avoiding Inrush Current when Testing High Power LEDs with Series 2260B Power Supplies."

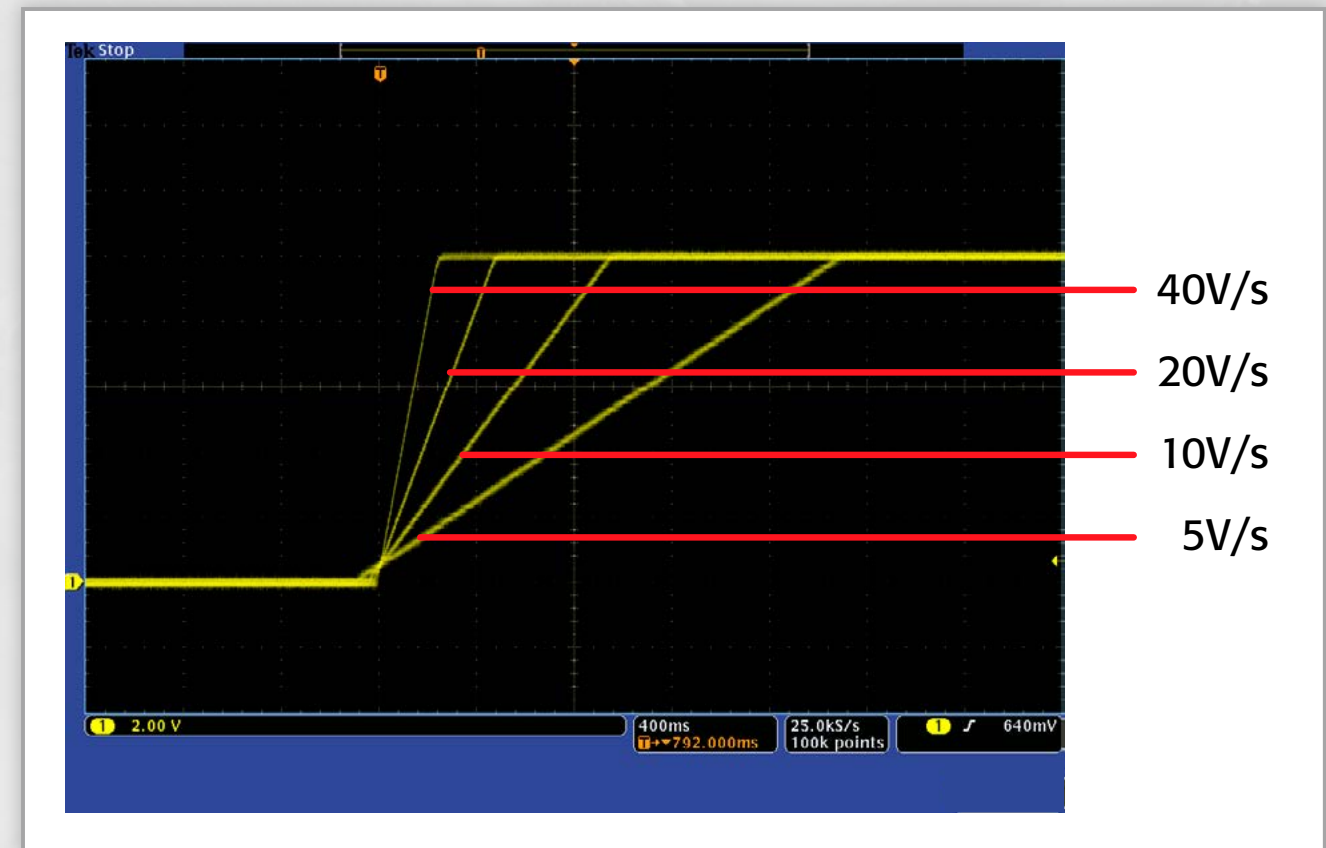

Series 2260B Power Supplies offer variable slew rate control for precise control of rise time to protect the DUT from overshoot damage.

Compact Supplies for Automated Test Simulating the Output Characteristics of an Automotive Battery

A lead-acid battery stores electricity through a chemical reaction that occurs when two electrodes are immersed in a sulfuric acid and water solution known as the electrolyte. These elements make up an electrochemical cell. This electrochemical cell construction leads to some amount of internal resistance, which reduces the amount of current supplied by the battery and reduces the battery voltage. When the load current increases, the battery voltage drops

by the product of the change in load current and the internal battery resistance: $\Delta V_{\text{Battery}} = \Delta I_{\text{Load}} \times R_{\text{Internal}}$. To test a battery-powered device under its actual operating conditions, the power source must emulate the response of an actual battery, including the effects of its internal resistance.

Series 2260B DC power supplies have a programmable output resistance. With this capability, a step increase in DUT load current causes the Series 2260B output voltage to drop by the product of the load current change and the output resistance: $\Delta V_{2260B} = \Delta I_{\text{Load}} \times R_{\text{Output}}$ just as an actual battery would respond, enabling testing under realistic sourcing conditions.

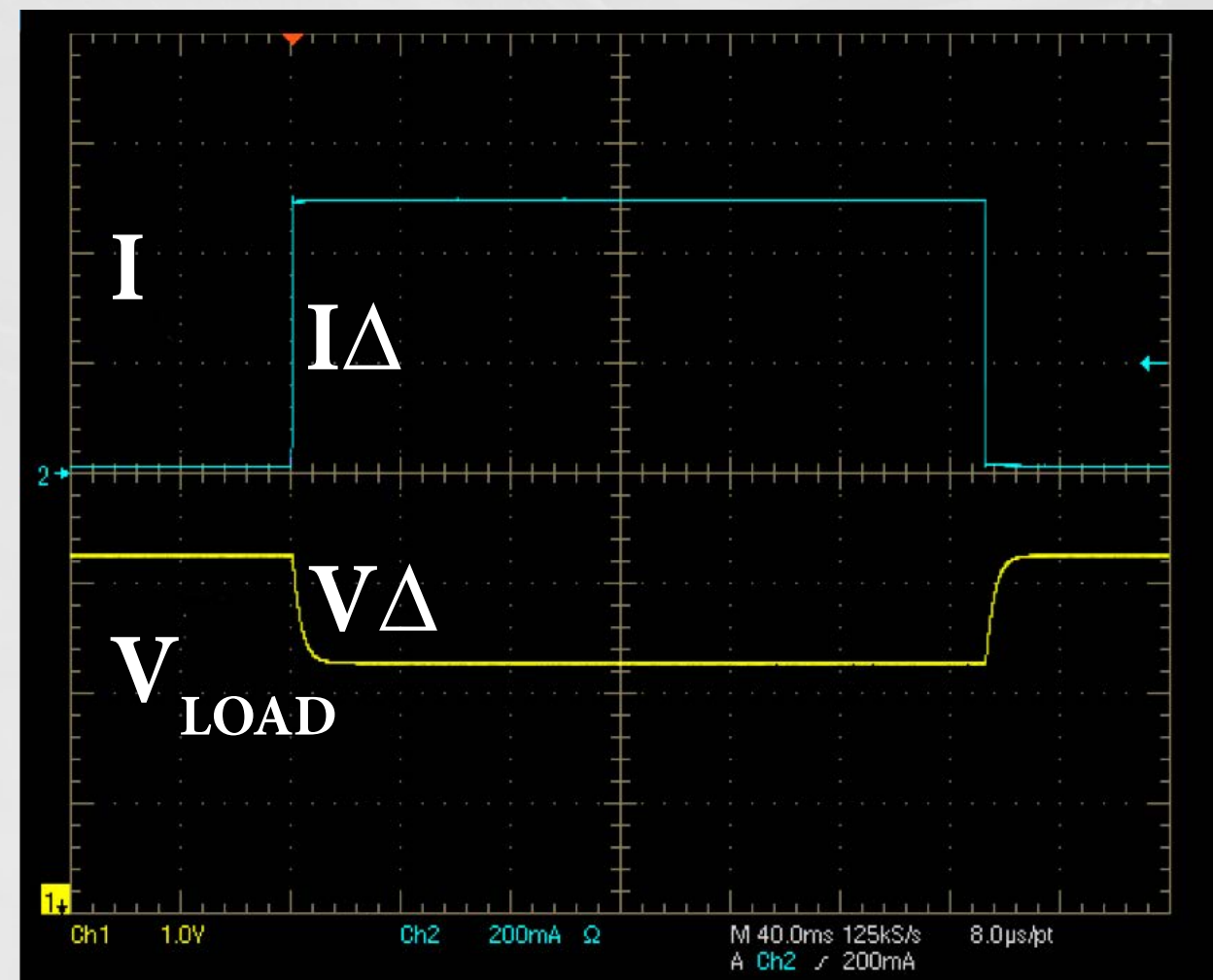
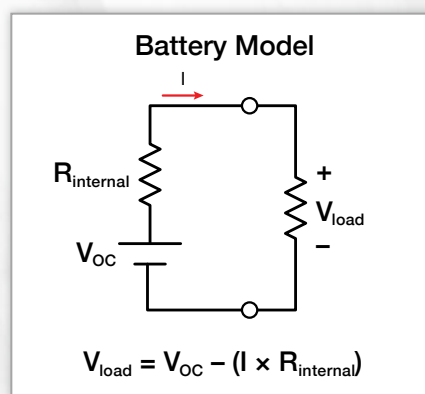

The programmable output resistance values featured in the Series 2260B Power Supplies enable these supplies to stimulate a battery's output for automotive circuit testing.

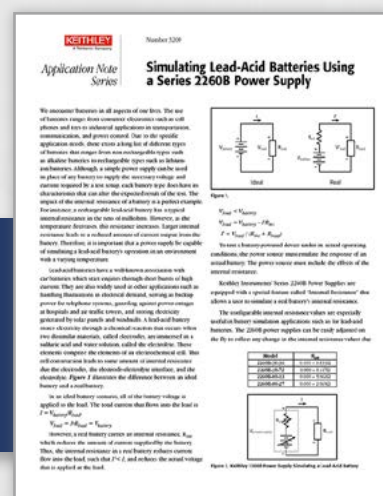

Want to Learn More?

Read the application note "Simulating Lead-Acid Batteries Using a Series 2260B Power Supply."

Research and Design

Optimizing Instrument Flexibility with a Limited Instrument Budget

Whether testing and troubleshooting analog, digital circuits or both, or evaluating components, the power supplies in today's ever-increasing cost-conscious environment need to meet the voltage, current, and power capacity for thorough testing. They must be able to test any type of circuit. They must be easy to use and display as much information as possible. The Tektronix/Keithley family of power supplies combines performance, versatility, and ease of use for even today's most restricting budget.

Deliver the necessary power capacity:

- With the Series PWS4000, 2200, 2220, and 2230 power supplies, Keithley offers a full complement of basic, single output, and multiple output power supplies that can provide up to 150W of power with voltages up to 72V and current up to 5A.
- The 30V channels of the multiple output power supplies can be combined in series or parallel to double the maximum available voltage when the supplies are connected in series or double the current capacity when the supplies are connected in parallel.

Test any type of circuit:

- All channels on the dual and triple output power supplies are isolated so that opto-isolated circuits and transformer-isolated circuits can be powered by a single power supply.
- Use the Series 2230 Triple Output Power Supplies to power a bipolar analog circuit and a digital circuit or three digital circuits.
- The single and multiple output power supplies with built-in interfaces have remote sense connections to ensure that the programmed voltage is accurately delivered to the load.
- Series PWS4000 and Series 2200 Single Output Power Supplies can resolve load current measurements to 0.1mA for powering and monitoring low power devices and circuits.



Provide the most information for testing and troubleshooting:

- Series 2220 and 2230 Multiple Output Supplies display the readings from all outputs simultaneously, eliminating the need to adjust the supply to display each individual output.
- The Series PWS4000 and the Series 2200 single output power supplies display both the settings and the readings, so it's easy to see how close the load current is to the current limit setting.

Get advice on maximizing the performance of your power supplies.
 Send us your question or join the discussion in our [application forum](#).

Research and Design

Automating Tests for Efficient Data Collection

The Series PWS4000, 2200, 2220, and 2230 power supplies provide PC interfaces for programmability:

- USB interface or both a USB and a GPIB interface
- Front and rear inputs for connection convenience on the bench or in a rack-mounted test system
- The Series PWS4000 and Series 2200 power supplies have list modes for semi-automated tests – A list with as many as 80 voltage levels can be programmed and automatically stepped through to test DUT performance at different voltage levels
 - A list can be controlled by an external trigger signal to synchronize voltage steps with other system events
- Available IVI and LabVIEW drivers for programming applications



Select the best Power Supply for your needs using the Selector Guide or the Tablet Application.

Download the Selector Guide for free Today.

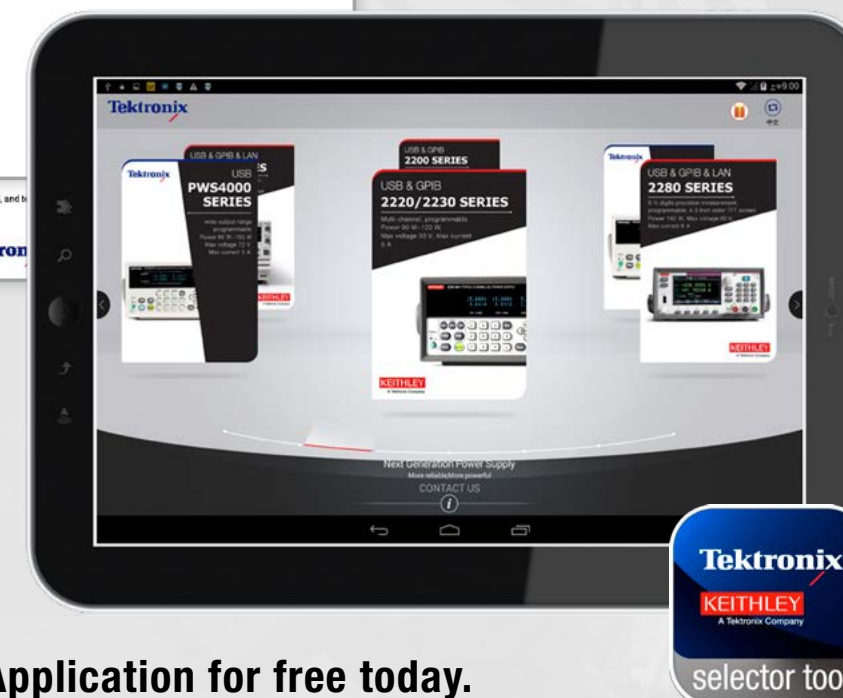

Introducing the First Power Supply Technical Guide Tablet Application for the Tektronix and Keithley Power Supply line.

Download the Tablet Application for free today.

Get advice on maximizing the performance of your power supplies.

Send us your question or join the discussion in our [application forum](#).

Education

Providing an Effective Learning Environment within a Tight Budget

Engineering educators are faced with many challenges in preparing students for life beyond the electronics lab. Curriculum must keep pace with rapidly-evolving technology so that students can quickly master the basics and move to advanced topics and independent research. Staff resources and equipment budgets are limited, so finding the best combination of price and value to equip classroom labs with rugged test equipment for diverse tasks is of critical importance. Test instrumentation must facilitate achieving these objectives, not hinder it.

The Model 2231A-30-3 Triple Output Power Supply and Series PWS2000 Single Output Power Supplies are cost-effective instruments that are ideal for student laboratories. They offer a number of features to enhance the student learning experience, and they also require very little time to learn how to use them. So, whether learning basic design skills or progressing to more advanced electrical engineering topics, students will get practical, hands-on experience for the real world now on the instruments they'll be using in the real world later.

With the Model 2231A-30-3, students are able to:

- Study analog and digital circuit combinations with one supply that has two 30V, 3A outputs and one 5V, 3A output
- Power and study the two sides of an optically isolated circuit with the Model 2231A-30-3 independent, isolated outputs
- Use the outputs in series or parallel to increase voltage output up to 60V or to increase current up to 6A
- Learn computer interfacing and instrument programming techniques with the optional USB adapter

When more power is needed, the Series PWS2000 power supplies provide from 18V and 5A up to 32V and 6A plus:

- Simplified control with a keypad for data entry
- A nice-sized, easy-to-read display showing both the voltage and the current output
- Setup storage so the student can simply power on the instrument and have it in the state required for a particular experiment

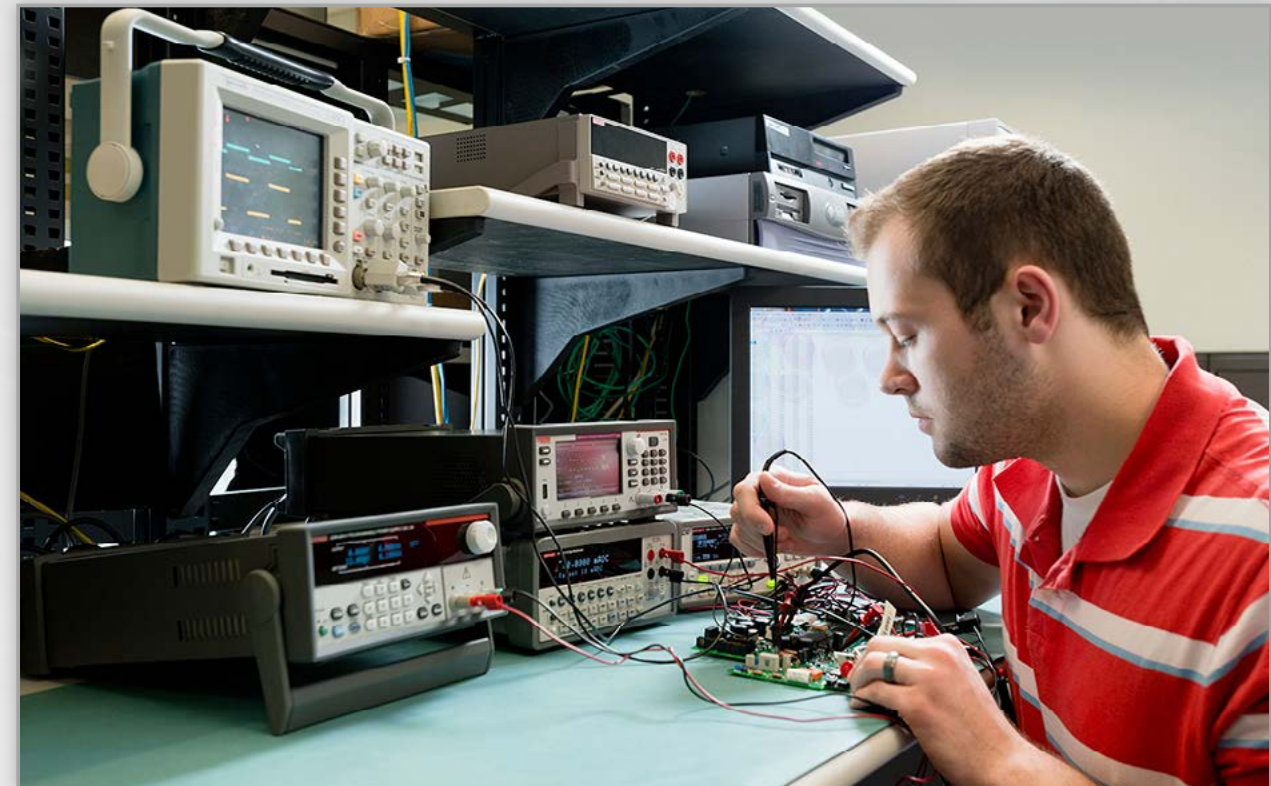

Want to give your students vital hands-on training with real-world instruments?
Go to www.keithley.com/edu to learn more.

Want to Learn More?

Download the poster and learn "Six Techniques for Optimal Performance from Power Supplies."

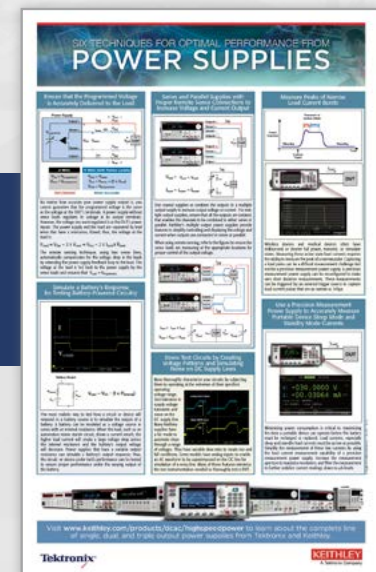

Testing Portable Wireless Devices

High Volume Production Testing of Portable, Wireless Devices

There are a number of demanding testing requirements that need to be met to bring a portable, wireless device to the consumer market. When these devices, such as a cellular phone for example, switch from standby mode to the full power mode of operation, the load current draw can change by as much as 1000%. When using a conventional power supply to test a portable wireless device, a conventional power supply will have a significant transient voltage drop (more than one volt) and take milliseconds to recover to the original voltage level when subjected to such a large, instantaneous load current change. For portable wireless devices that operate at full power for only short intervals such as 100s of microseconds, the full power event is over before a conventional power supply can recover, compromising DUT performance. And, if the power supply voltage drops below the threshold of the device's low-battery detection circuitry for a sufficient amount of time, a "low battery voltage" condition may be detected and shut down the device during testing, returning a false indication of a failed device. Power consumption, determined by measuring load current in all operating states, is also an important parameter that must be verified to be within specification. In addition, the battery monitor circuit needs to be calibrated, and other device functions need to be checked to ensure that they are operating properly. And, all of these tests should be done with the lowest cost test system, which means, of course, with minimal equipment.

The Series 2300 Fast Transient Response and Battery Simulating Power Supplies provide both constant voltage control even during large load current changes and power consumption monitoring for automated testing of portable, battery-operated devices. These specialty power supplies feature:

- Ultra-fast transient response to ensure that the output voltage has a minimal transient voltage droop and ultra-fast recovery even when the product transitions instantaneously from its lowest power state to its maximum power state and stays at the maximum power state for a short time
 - Some models simulate a battery's output impedance so that testing of the product can be performed as realistically as possible with the product being powered by a simulated battery
- Ability to simulate a rechargeable battery in a state of discharge by providing current sink capability
 - Dual channel Series 2300 power supplies offer a "battery" channel and a "charger" channel
- Measurement of sleep mode current with 0.1µA current sensitivity; and peak current during transmission bursts with current measurements as fast as 33µs
- Voltage output accuracy sufficient for calibrating the product's battery monitoring circuit
- Measurement circuitry that can be used as a digital multimeter for making DC voltage measurements at important test points when testing PC board sub-assemblies

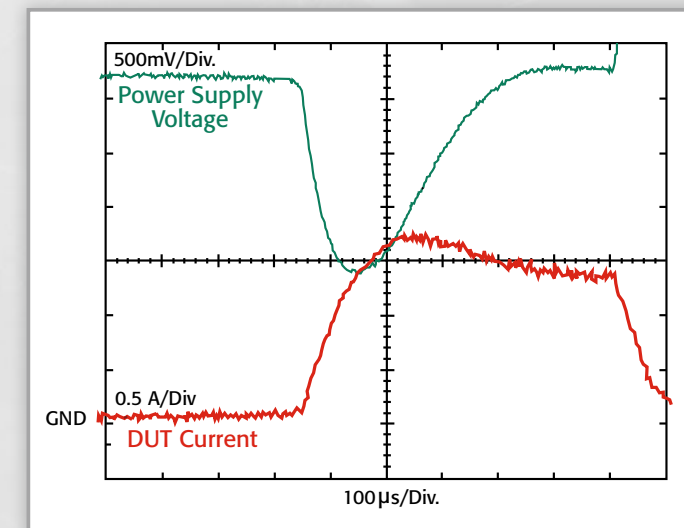

Typical Power Supply

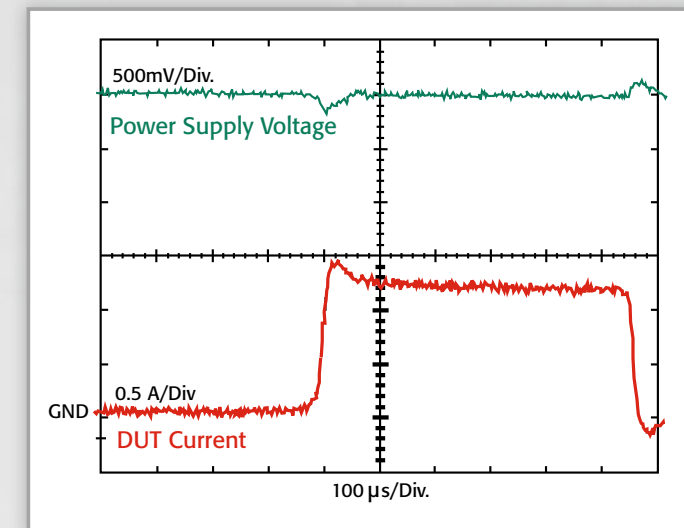

Keithley Series 2300 Power Supply

Comparison of transient response when the DUT transitions from standby to full power transmission between a typical power supply and a Keithley Series 2300 Power Supply. There is a 1Ω resistance and 4.5m of cable in each output lead to simulate a typical production test setup between the power supply and the DUT.



Want to Learn More?
Read the application note "Simulating Battery Impedance with Model 2302 and 2306 Battery Simulator/Chargers."

To learn more about the Series 2300 High Speed Power Supplies go to www.keithley.com/products/dcac/highspeedpower/battery

When More Sensitivity is Needed than a Power Supply can Offer Performing I-V Characterization or Studying Leakage Current on a Component

When sourcing and measurement needs require precision current sourcing or extremely low current measurement, power pulse generation, bipolar voltage or current output, voltage or current-controlled sinking, a conventional power supply cannot meet these needs. However, there is one type of instrument that can actually meet all of these needs. That instrument is a source measure unit (SMU) instrument. Keithley has the most extensive family of Keithley SourceMeter® SMU Instruments to address a wide range of applications. They employ Keithley's renowned measurement sensitivity and perform the functions of a number of different instruments in a compact package.

Important SMU Instrument Facts

- SMU instruments, with integrated sourcing and measuring sweep capability, are ideal for generating I-V curves. Furthermore, SMU instruments are bipolar supplies and can smoothly sweep from a negative output, through 0 to a positive output.
- SMU instruments are voltage sources like a power supply, but SMU instruments can also be a true constant current source so that components like LEDs or devices like laser diodes can be properly biased at a specific current level.
- Many Keithley SMU instruments can generate small duty cycle voltage or current pulses to avoid overheating damage when testing semiconductor wafers or power components that have not been attached to a heat sink.
- SMU instruments operate in all four quadrants so they are electronic loads as well as sources.
- SMU instruments have outstanding current measurement sensitivity that is far superior to a power supply. They can measure currents with incredible 10fA sensitivity and accurately measure such low level parameters as FET gate current and transistor leakage current.
- Keithley SMU instruments can source and measure voltage from millivolts to 3000V and can source and measure current from 100fA to 50A.

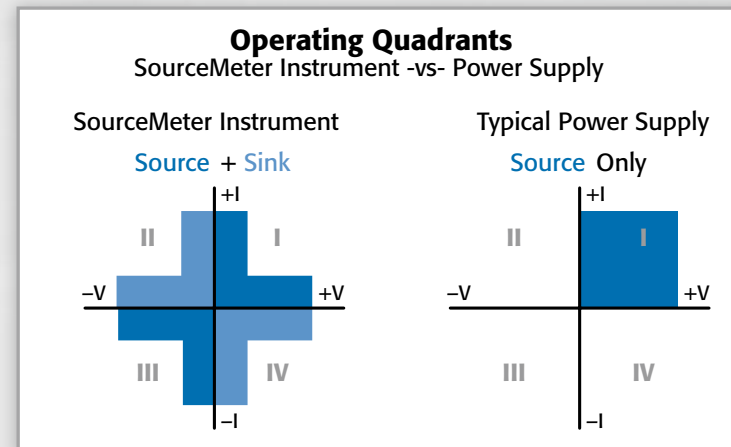

A power supply (right) generally offers only single-quadrant operation; an SMU instrument (left) can operate in all four quadrants.

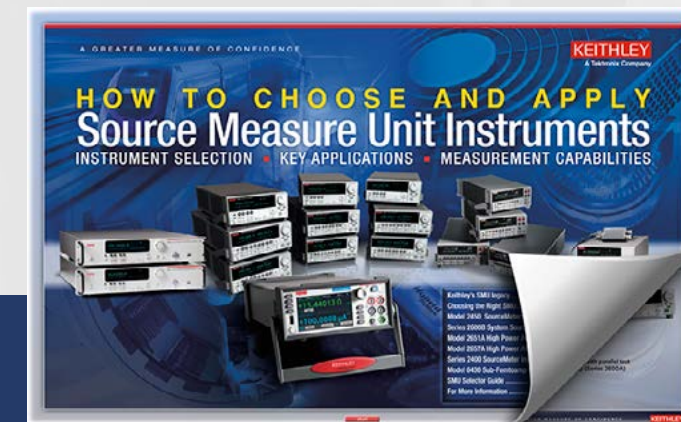

Want to learn more about how to choose and apply SMU instruments?

Download the e-guide for information on key applications, measurement capabilities, and instrument selection.

High Voltage Breakdown Testing Meeting High Voltage Operating Specifications

Developing and testing high voltage semiconductor devices involves a consideration of test system safety, wide voltage range, and accurate current measurement. The device breakdown voltage must be determined to ensure that the device will operate reliably at its maximum operating voltage. Similarly, efficiency is critical if the component, such as an SiC transistor, will operate as a switch in a high power system. Even small leakage currents can result in substantial power loss. Not only does high voltage need to be sourced, low currents need to be measured, as well. Above all, system safety must be verified to protect personnel and to protect low voltage instrumentation that might be in the system.

Keithley has a strong presence in high power semiconductor device test with its high voltage source measure unit (SMU) instruments and Series 2290 High Voltage Power Supplies to address any high voltage testing requirement:

- Series 2290 High Voltage Power Supplies can output up to 10,000V and can monitor leakage currents in the μA range
- SMU instruments can measure lower leakage current down to 100fA.
- A protection module rated to 10,000V protects low voltage instruments from a high voltage breakdown

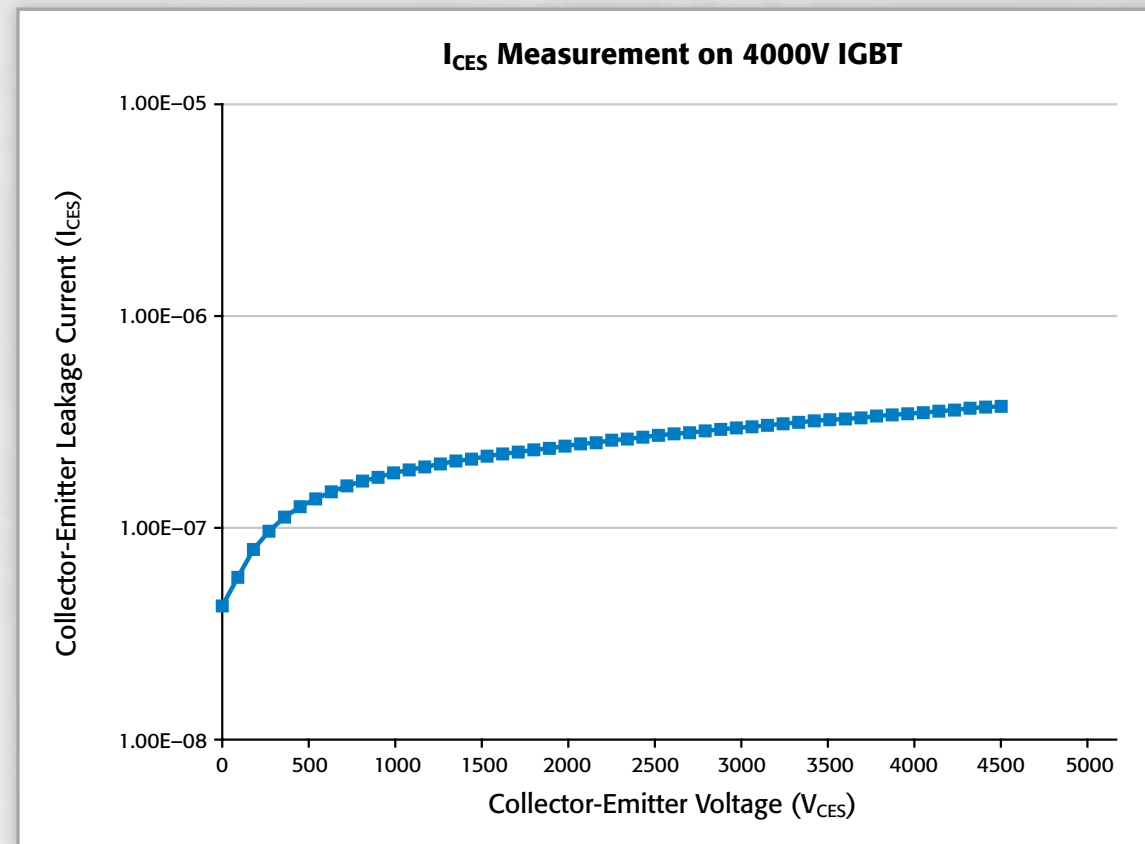

I_{CES} measurements on a 4000V IGBT. V_{CES} is applied with the Model 2290-5 Power Supply, and I_{CES} is measured with the Model 2635B SourceMeter[®] SMU Instrument. Gate and source terminals are shorted.

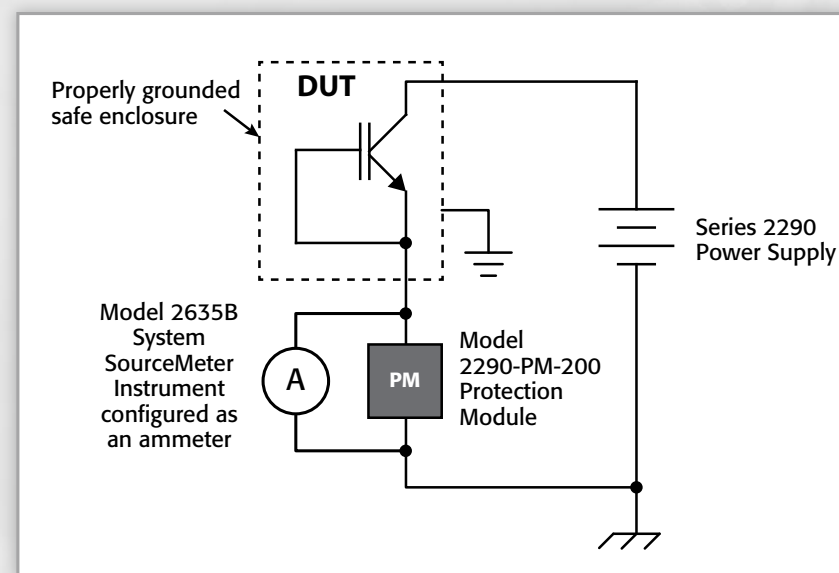

Test setup using a Series 2290 Power Supply and the Model 2635B SourceMeter SMU Instrument to measure the cutoff current (I_{CES}) of an IGBT. The short between the gate and emitter terminals keeps the device in the off-state.

The model 2290-PM-200 protects the SourceMeter SMU Instrument from high voltage if the transistor breaks down.



Keithley can provide a stand-alone high voltage breakdown/ leakage current monitoring system as well as complete low power and high power device characterization systems for more extensive testing.

Learn more about making breakdown and leakage current measurements on high voltage semiconductor devices. Download the application note.

Want to learn more?

Contact us by phone, fax, mail, or email:



Keithley Instruments hosts an online applications forum to encourage idea exchange, discussions among users. [Join the discussion today.](#)

KEITHLEY CORPORATE HEADQUARTERS

Keithley Instruments
28775 Aurora Road
Cleveland, Ohio 44139
Phone: 440-248-0400
Toll-free: 800-552-1115
Fax: 440-248-6168
info@keithley.com

Consult with a Keithley applications engineer and learn how to get the most from your Keithley products

WORLDWIDE HEADQUARTERS

Within the USA: 1-888-534-8453
Outside the USA: +1-440-248-0400
Email: applications@keithley.com
Additional contact information at www.keithley.com

EUROPE

Germany: (+49) 89 849 307 40

ASIA

China: (+86) 10 8447 5556
Japan: (+81) 3 6714 30 70
Korea: (+82) 2 574 7778
Taiwan: (+886) 3 572 9077



Specifications are subject to change without notice. All Keithley trademarks and trade names are the property of Keithley Instruments, Inc. All other trademarks and trade names are the property of their respective companies. Tektronix and Keithley maintain a comprehensive, constantly expanding collection of application notes, technical briefs, and other resources to help engineers stay on the cutting edge of technology.

For further information, please visit www.tektronix.com or www.keithley.com



KEITHLEY INSTRUMENTS ■ 28775 AURORA RD. ■ CLEVELAND, OH 44139-1891 ■ 440-248-0400 ■ Fax: 440-248-6168 ■ 1-888-KEITHLEY ■ www.keithley.com

BENELUX

+31-40-267-5506
www.keithley.nl

BRAZIL

55-11-4058-0229
www.keithley.com

CHINA

86-10-8447-5556
www.keithley.com.cn

FRANCE

+33-01-69-86-83-60
www.keithley.fr

GERMANY

+49-89-84-93-07-40
www.keithley.de

INDIA

080-30792600
www.keithley.in

ITALY

+39-049-762-3950
www.keithley.it

JAPAN

81-120-441-046
www.keithley.jp

KOREA

82-2-6917-5000
www.keithley.co.kr

MALAYSIA

60-4-643-9679
www.keithley.com

MEXICO

52-55-5424-7907
www.keithley.com

RUSSIA

+7-495-664-7564
www.keithley.ru

SINGAPORE

01-800-8255-2835
www.keithley.com.sg

TAIWAN

886-3-572-9077
www.keithley.com.tw

UNITED KINGDOM

+44-1344-39-2450
www.keithley.co.uk

For further information on how to purchase or to locate a sales partner please visit www.keithley.com/buy