

TECHNICAL MANUAL

**OPERATOR'S, ORGANIZATIONAL, DIRECT SUPPORT,
AND GENERAL SUPPORT MAINTENANCE MANUAL
VARIABLE FILTER, KROHN-HITE
MODELS 3200(R) AND 3202(R)**

HEADQUARTERS, DEPARTMENT OF THE ARMY

JULY 1972

This manual is an authentication to the manufacturer's commercial literature which, through usage, has not been found to cover the data required to operate and maintain this equipment. Since the manual was not prepared in accordance with military specifications, the format has not been structured to consider level of maintenance nor to include a formal section on depot overhaul standards.

Reproduced by permission of Krohn-Hite Corporation,
Cambridge, Massachusetts.

CHANGE }
No. 1 }

HEADQUARTERS
DEPARTMENT OF THE ARMY
WASHINGTON, D.C. 14 January 1975

TECHNICAL MANUAL

**OPERATOR'S, ORGANIZATIONAL, DIRECT SUPPORT,
AND GENERAL SUPPORT MAINTENANCE MANUAL,
INCLUDING REPAIR PARTS AND SPECIAL TOOLS LIST:
VARIABLE FILTER, KROHN-HITE
MODELS 3200(R) AND 3202(R)
Current as of 11 September 1974**

TM 9-6625-357-14-1, 6 July 1972, is changed as follows:

1. The title is changed to read as shown above.
2. Remove old pages and insert new pages as indicated below. New or changed material is indicated by a vertical bar in the margin of the page.

<i>Remove pages</i>	<i>Insert pages.</i>
i and ii-----	i and ii
-----	33 - 38
A-1-----	A-1

By Order of the Secretary of the Army:

Official:

FRED C. WEYAND
General, United States Army
Chief of Staff

VERNE L. BOWERS,
Major General, United States Army,
The Adjutant General.

Distribution:

To be distributed in accordance with DA Form 12-34, Section II, (qty rqr block No. 75) requirements for Calibration Procedures Publications.

**OPERATOR'S, ORGANIZATIONAL, DIRECT SUPPORT AND GENERAL SUPPORT MAINTENANCE
 MANUAL,
 INCLUDING REPAIR PARTS AND SPECIAL TOOLS LIST:
 VARIABLE FILTER, KROHN-HITE MODELS 3200(R) AND 3202(R)**

<i>Section</i>		<i>Page</i>
0	INTRODUCTION	0
1	GENERAL DESCRIPTION	1
2	OPERATION	7
3	CIRCUIT DESCRIPTION.....	11
4	MAINTENANCE	15
5	CALIBRATION AND ADJUSTMENT	21
6	PARTS LIST AND SCHEMATIC	27
7	CHANGE INFORMATION	29
8	PREVENTIVE MAINTENANCE INSTRUCTIONS.....	31
9	REPAIR PARTS LIST	33

ILLUSTRATIONS

<i>Figure</i>		<i>Page</i>
1	Model 3200 and 3202 Filters.....	ii
2	Multifunction Response Characteristics	4
3	Square Wave Response Characteristics	5
4	Normalized Attenuation Characteristics.....	5
5	Normalized Phase Characteristics	6
6	Simplified Schematic Diagram of Model 3200	11
7	Top and Bottom View of Model 3200 and 3202	16
8	Schematic Diagram of Model 3200	--

TABLES

<i>Table</i>		<i>Page</i>
1	Test Point Voltages for Low-Pass Operation.....	17
2	Test Point Voltages for High-Pass Operation	18
3	Detailed Test Procedure.....	24

APPENDIXES

A	REFERENCES	A-1
B	BASIC ISSUE ITEMS LIST AND TROOP INSTALLED OR AUTHORIZED LIST (Not Applicable).....	B-1
C	MAINTENANCE ALLOCATION CHART.....	C-1

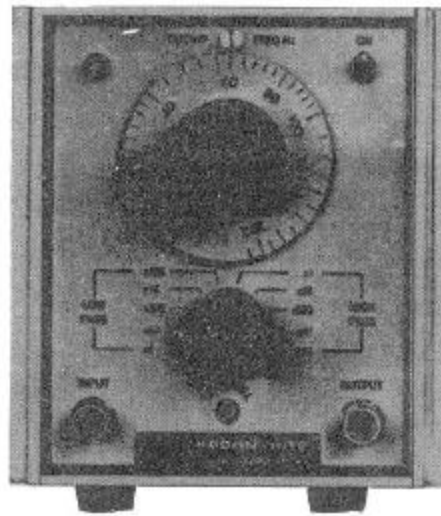

Model 3200

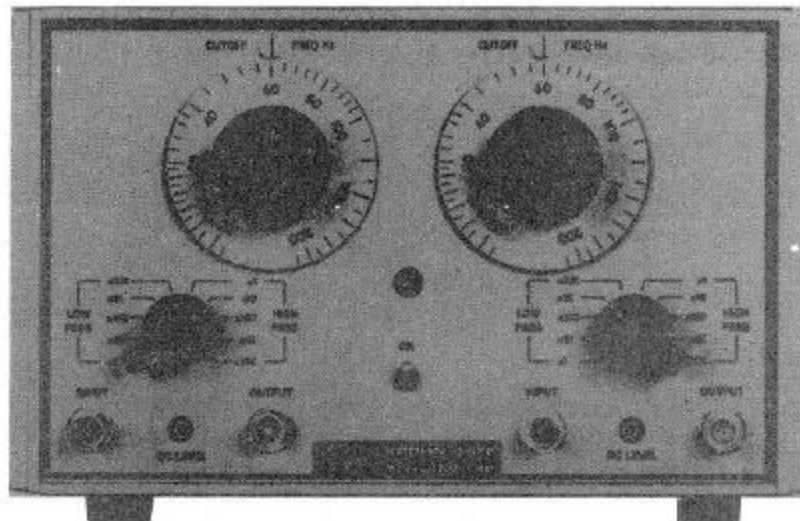

Figure 1. 3200 Series Filter

SECTION 0 INTRODUCTION

0.1 Scope

This manual includes installation and operation instructions and covers organizational, direct support (DS), and general support (GS) maintenance. It describes the Variable Filter, Krohn-Hite Models 3200(R) and 3202(R).

0.2 Indexes of Publications

DA Pam 3104. Refer to the latest issue of DA Pam 310-4 to determine if there are any new editions, changes, or additional publications pertaining to the equipment.

DA Pam 310-7. Refer to DA Pam 310-7 to determine whether there are Modification Work Orders (MWO) pertaining to the equipment.

0.3 Forms and Records

Reports of Maintenance and Unsatisfactory Equipment. Use equipment forms and records in accordance with instructions given in TM 38-750.

Report of Packaging and Handling Deficiencies. Fill out and forward DD Form 6 as prescribed in AR 700-58 (Army), NAVSUP Pub 378 (Navy), AFR 71-4 (Air Force), and MCO P4030.29 (Marine Corps).

Discrepancy in Shipment Report. Fill out and forward Discrepancy in Shipment Report (DISREP) (SF 361) as prescribed in AR 55-38 (Army), NAVSUP Pub 459 (Navy), AFM 75-34 (Air Force), and MCO P4610.19 (Marine Corps).

Reporting of Errors. The reporting of errors, omissions, and recommendations for improving this publication by the individual user is encouraged. Reports should be submitted on DA Form 2028, Recommended Changes to Publications, and forwarded direct to Commanding General, U.S. Army Missile Command, AMSMI-MFM, Redstone Arsenal, AL 35809.

SECTION 1

GENERAL DESCRIPTION

1.1 INTRODUCTION

The Models 3200 and 3202, illustrated in Figure 1, are solid state variable electronic Filters with cutoff frequencies continuously adjustable over the frequency range from 20 Hz to 2 MHz. The pass-band gain is unity (0 db), with an attenuation rate of 24 db per octave outside the pass-band. Maximum attenuation is greater than 80 db and the output hum and noise is less than 100 microvolts.

The Model 3200 can function as either a High-Pass or Low-Pass Filter. In the High-Pass mode of operation the maximum input signal is 3 volts rms and the upper 3 db point occurs at approximately 10 MHz. In the Low-Pass mode the Filter is direct-coupled and the combined ac plus dc input signal should not exceed 4.2 volts peak.

The Model 3202 consists of two Model 3200's mounted in a single cabinet isolated from each other with independent power supplies, and input and output connectors. When these two filter channels are switched to the same mode of operation and connected in series with both dials set to the same cutoff frequency, the Model 3202 will function as a High-Pass or Low-Pass Filter with an attenuation rate of 48 db per octave. If the two channels are connected in series, and one channel is operated in the Low-Pass mode and the other channel in the High-Pass mode, the Model 3202 will function as a Band-Pass Filter with attenuation rate of 24 db per octave outside the pass-band.

When the two channels are connected in parallel, as described in Section 2.3, the Model 3202 will function as either a Band-Reject Filter with cutoff frequency limits from 20 Hz to 2 MHz or provide a sharp null at any frequency between 40 Hz and 800 kHz.

This Filter has a maximally flat or Butterworth characteristic when the RESPONSE switch(s), located on the rear of the chassis, is in the MAX FLAT position. For pulse-type waveforms this switch should be in the SIMPLE RC position, optimum for transient-free filtering.

1.2 SPECIFICATIONS

FREQUENCY RANGE

High-Pass and Low-Pass cutoff frequencies continuously adjustable from 20 Hz to 2 MHz in five bands.

BAND	MULTIPLIER	FREQUENCY (Hz)
1	1	20 - 200
2	10	200 - 2,000
3	100	2,000 - 20,000
4	1K	20,000 - 200,000
5	10K	200,000 - 2,000,000

FREQUENCY DIALS

Each channel has a single decade frequency dial (calibrated from 19 to 210) and an associated high-pass/low-pass band switch providing five multiplier ranges for each mode.

CUTOFF FREQUENCY CALIBRATION ACCURACY

±5% with Response Switch in Max. Flat (Butterworth) position; less accurate in R-C position. Relative to mid-band level, the Filter output is down 3 db at cutoff in Max. Flat position, and approximately 13 db in R-C position.

BANDWIDTH (See "Input Characteristics")

Low-Pass Mode - Frequency response from dc to the cutoff frequency set within the range from 20 Hz to 2 MHz.

High-Pass Mode - Continuously adjustable between 20 Hz and 2 MHz with upper 3 db point at approximately 10 MHz.

Band-Pass Operation Model 3202 - Continuously variable within the cutoff frequency limits of 20 Hz to 2 MHz. For minimum bandwidth the high-pass and low-pass cutoff frequencies are set equal. This produces an insertion loss of 6 db, with the -3 db points at 0.8 and 1.25 times the midband frequency.

Band-Reject Operation Model 3202 - Continuously variable within the cutoff frequency limits of 20 Hz and 2 MHz or sharp null at any frequency between 40 Hz and 800 kHz. The low-pass band extends to dc. The high-pass band has its upper 3 db point at approximately 10 MHz. The null is sharper than that of a balanced "parallel T" filter, and is obtained by setting the high-pass cutoff at approximately twice the desired null frequency, and the lowpass cutoff at approximately one-half the desired null frequency. See Section 2.3.

RESPONSE CHARACTERISTICS (selected by rear panel switch)

Butterworth - Each channel exhibits maximally flat fourth order Butterworth response for optimum performance in frequency domain.

Simple RC - Fourth order RC response for transient-free time-domain performance.

Note: Higher order characteristics may be obtained by cascading individual channels.

ATTENUATION SLOPE

Nominal 24 db per octave per channel in high-pass or low-pass modes.

MAXIMUM ATTENUATION

Greater than 80 db.

INSERTION LOSS

Zero 1/2 db to 2 MHz; 3 db at approximately 10 MHz. 6 db in Band-Reject operation.

INPUT CHARACTERISTICS

Maximum Input Amplitude - 3 v rms up to 2 MHz, decreasing to 1 v rms at 10 MHz.

Maximum DC Component -

Low-Pass Mode: Combined ac plus dc should not exceed 4.2 v, peak.

High-Pass Mode: 200 v.

Impedance - 100 k ohms in parallel with 50 pf.

OUTPUT CHARACTERISTICS

Maximum Voltage - 3 v, rms, to 2 MHz (1.5 v, rms, in Band-Reject operation).

Maximum Current - 10 ma (less in Band-Reject operation).

Internal Impedance - 50 ohms, approx. (higher in Band-Reject operation).

FLOATING (UNGROUNDING) OPERATION

A switch is provided on rear of chassis to disconnect signal ground from chassis ground.

HUM AND NOISE

Less than 100 microvolts rms for a detector bandwidth of 2 MHz, rising to 150 microvolts for a detector bandwidth of 10 MHz.

OUTPUT DC LEVEL STABILITY

±2 millivolt per degree C.

FRONT PANEL CONTROLS

CUTOFF FREQUENCY Hz Dial and Multiplier/Function switch.

POWER-ON Switch.

TERMINALS

Front panel and rear of chassis, one BNC connector for INPUT, one for OUTPUT.

POWER REQUIREMENTS

105-125 or 210-250 volts, single-phase, 50-400 Hz, 15 watts.

OPERATING TEMPERATURE RANGE

0°C to 50°C.

DIMENSIONS AND WEIGHTS

Model	Height	Width	Depth	Ship Wgt lbs/kg	Net Wgt lbs/kg
(Bench Models)					
3200	5 1/4"	4 3/4"	15 1/4"	14/7	9/4
3202	5 1/4"	8 5/8"	15 1/4"	22/10	14/7
(Rack Units)					
3200R	3 1/2"	19"	15 1/4"	16/8	11/5
3202R	3 1/2"	19"	15 1/4"	22/10	18/9

1.3 FILTER CHARACTERISTICS

BANDWIDTH ADJUSTMENT

The flexibility of adjustment of bandwidth is shown in Figure 2. Low-Pass and High-Pass operation is shown in curves (1) and (2). The solid lines show the Maximally Flat or Butterworth operation while the dotted lines show the simple R-C characteristic. Curve (3) shows Band-Pass operation for two different bandwidths illustrated by curves A and B. Curve B shows the minimum pass-band width obtained by setting the two cutoff frequencies equal. In this condition the insertion loss is 6 db, and the -3 db cutoff frequencies occur at 0.8 and 1.25 times the mid-band frequency. Band-Reject operation for a reject band with a cutoff frequency separation ratio of 10,000 is shown by curve 4C. Curve 4D illustrates a sharp null with 3 db points at approximately 0.5 and 2.0 times the null center frequency and is obtained by setting the high and low cutoff frequencies a factor of approximately 2 from the desired null frequency.

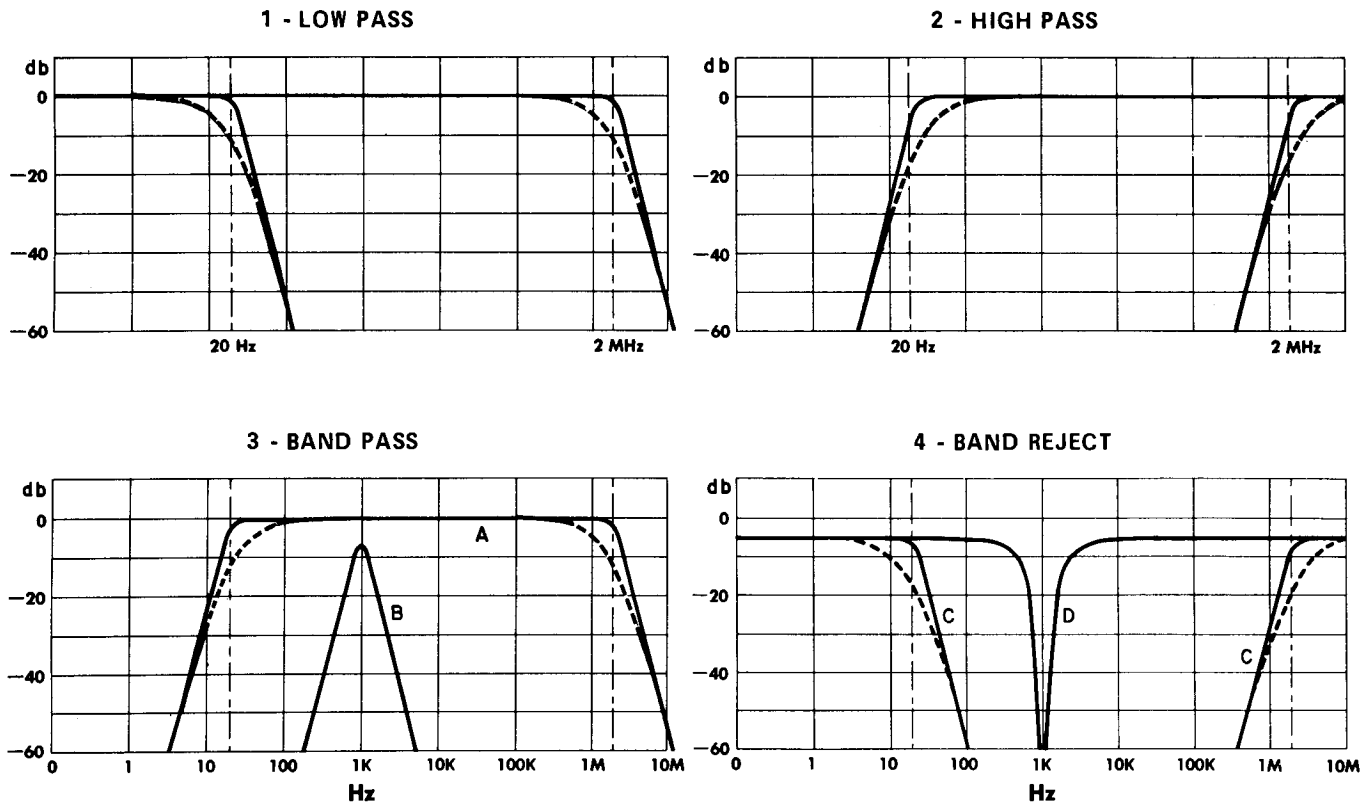
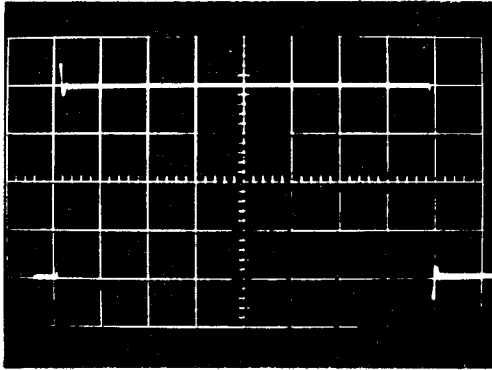

Figure 2. Multifunction Response of Butterworth (solid curves) and Simple R-C (dashed curves).

TRANSIENT RESPONSE

The frequency response characteristics of this Filter closely approximates a fourth-order Butterworth with maximal flatness, ideal for filtering in the frequency domain. For pulse-type signals a RESPONSE switch(s) located at the rear of the chassis is provided to change the response characteristic to the Simple R-C type, optimum for transient-free filtering. Figure 3 shows a comparison of the Filter output response in these modes to a square wave input signal.



Response (in low-pass mode) to 1-kHz square wave, with cut-off at 1 MHz. Overshoot is approximately 1 db with Response Switch in "Max. Flat" position.

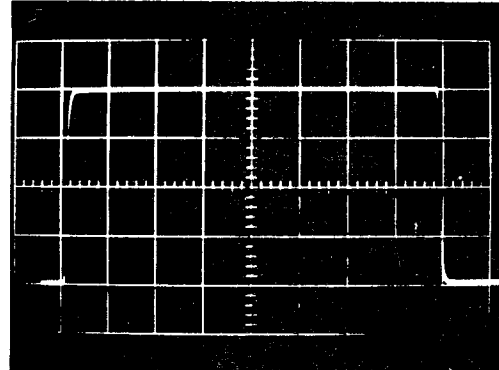

Response to same square wave with Response Switch in "R-C" position. Note slight rounding of leading edge, but complete removal of overshoot.

Figure 3. Square Wave Response Characteristics

CUTOFF RESPONSE

The attenuation characteristics of the Filter are shown in Figure 4. With the RESPONSE switch(s) in the MAXIMALLY FLAT or Butterworth mode, the gain, as shown by the solid curve, is virtually flat until the -3 db cutoff frequency. At approximately two times the cutoff frequency the attenuation rate coincides with the 24 db per octave straight line asymptote. In the Simple R-C mode, optimum for transient-free filtering, the dotted line shows that the gain is down approximately 13 db at cutoff and has approximately a 24 db per octave attenuation rate at five times the cutoff frequency. Beyond this frequency the filter attenuation rate and maximum attenuation, in either mode, are identical.

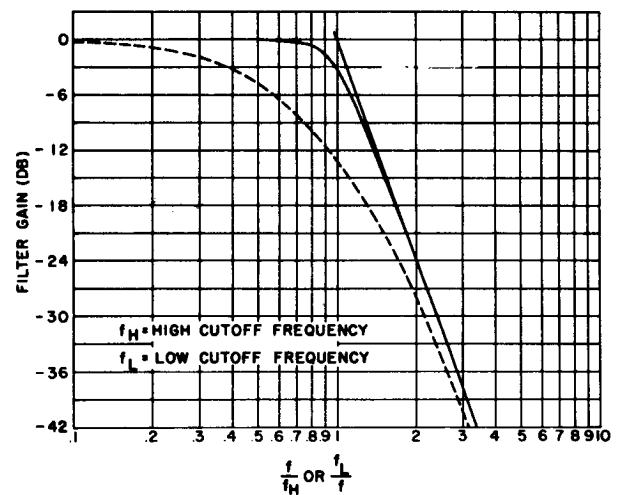

Figure 4. Normalized Attenuation

PHASE RESPONSE

The phase response of the Model 3200 or each channel of the Model 3202 can be obtained from Figure 5 which gives the phase characteristic for either mode of operation in degrees lead (+) or lag (-) as a function of ratio of the operating frequency f to the low cutoff frequency f_L (High-Pass mode) or high cutoff frequency f_H (Low-Pass mode). The solid curve is for the MAXIMALLY FLAT or Butterworth mode and the dotted curve is for the transient-free or Simple R-C mode.

Example:

Determine the phase shift of the filter in the MAXIMALLY FLAT or Butterworth mode, with the function switch set to the High-Pass mode at the X1 position, the cutoff frequency (f_L) set to 100 Hz and an input frequency (f) of 300 Hz.

$$\text{Since } \frac{f}{f_L} = \frac{300}{100} = 3$$

from Figure 5, $3 = +50^\circ$

The output of the filter leads the input by 50 degrees.

The phase response of the Model 3202 could be obtained in the same manner by taking the algebraic sum of the phase response of each channel.

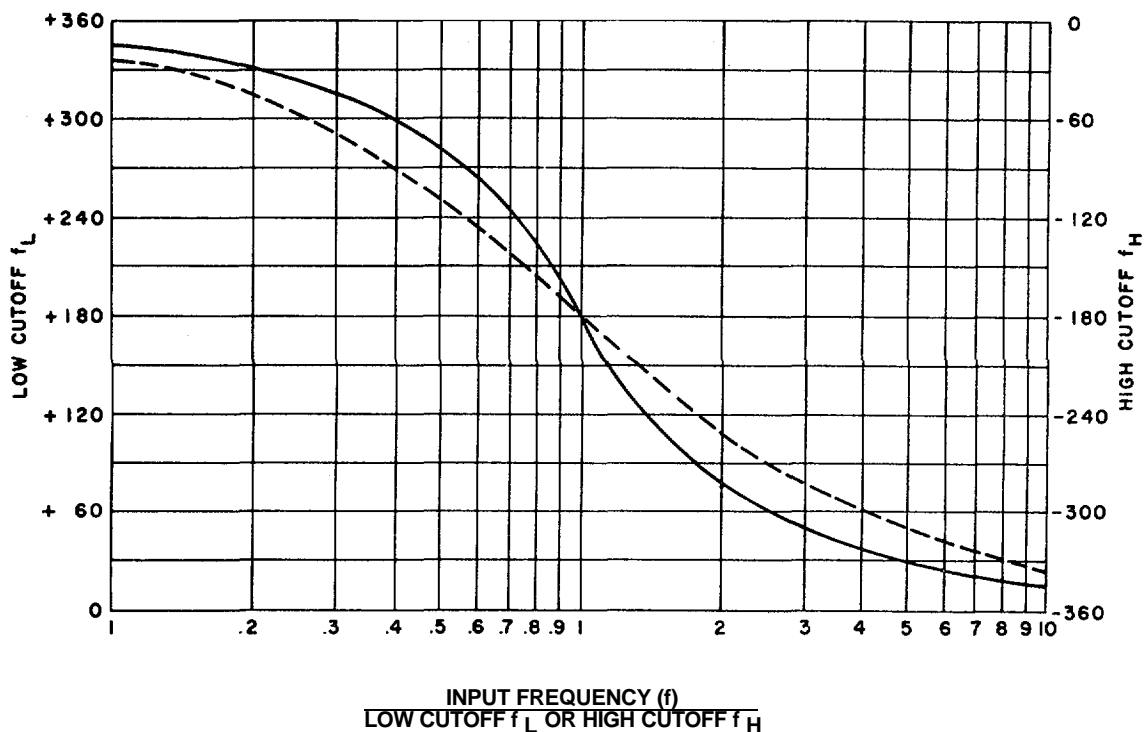

Figure 5. Normalized Phase Characteristics

SECTION 2

OPERATION

2.1 INTRODUCTION

On receipt of the Filter, carefully unpack and examine it for damage that may have occurred in transit. If signs of damage are observed, see section 0. Do not attempt to use the Filter if damage is suspected.

Rack-mounting models (designated by a suffix "R" after the model number) mount with four machine screws in the standard 19" rack space. No special brackets or attachments are needed.

2.2 FRONT AND REAR PANEL CONTROLS

The front panels of the Model 3200 and each channel of the Model 3202 includes a frequency dial, a band multiplier/function switch, two BNC coaxial connectors for the INPUT and OUTPUT signals, and a screwdriver control for the adjustment of the output dc level. A POWER-ON switch and indicator light is used in both models.

Each frequency dial is calibrated with a single logarithmic scale reading directly in Hz from 19 to 210. The dial is 2 1/4 inches in diameter with an effective scale length of approximately 6 inches per band, giving a total effective scale length of approximately 30 inches for the 20 Hz to 2 MHz range.

Each multiplier switch has ten positions, 5 bands for Low-Pass operation and 5 bands for High-Pass operation covering the frequency range as follows:

BAND	MULTIPLIER	FREQUENCY (Hz)
1	1	20 - 200
2	10	200 - 2,000
3	100	2,000 - 20,000
4	1K	20,000 - 200,000
5	10K	200,000 - 2,000,000

The rear chassis of the Model 3200 and each channel of the Model 3202 has two switches; one for selecting filter response of either the Butterworth type (Maximal flatness) or simple RC (Transient-free) and one for disconnecting the signal ground from chassis ground.

2.3 OPERATION

MODEL 3200

- a. Make appropriate power connections as described in Section 2.5.

- b. Make appropriate connections to the INPUT and OUTPUT connectors of the Filter. The rms INPUT voltage should not exceed 3 volts in the High-Pass mode and the combined AC and DC INPUT voltage should not exceed 4.2 volts peak in the Low-Pass mode. The Filter can sustain a combined ac and dc INPUT voltage of up to 200 volts peak without causing permanent damage. In the event of an overload the output waveform will appear distorted.
- c. Set mode of operation and cutoff frequency by means of the band multiplier switch(s) and the frequency dial(s).
- d. Turn power switch to ON.
- e. After sufficient warm-up time check output dc level, if necessary, adjust DC LEVEL potentiometer(s) for zero volts on the output(s).
- f. For normal Filter operation the FLOATING/CHASSIS GROUND switch(s), located on the rear of the chassis, should be in the CHASSIS position. If the Filter is used in a system where ground loops make ungrounded operation essential, this switch(s) should be in the FLOATING position.

CAUTION

In FLOATING operation the signal ground should be connected to system ground to prevent excessive hum and noise.

- g. When filtering consists principally of separating frequency components of a signal (frequency domain) the RESPONSE switch(s) located on the rear of the chassis, should be in the MAX-FLAT position. If the Filter is used to separate pulse-type signals from noise (time domain) this switch should be in the RC position.

MODEL 3202

TO OBTAIN HIGH-PASS OR LOW-PASS OPERATION WITH 48 DB PER OCTAVE ATTENUATION, PROCEED AS FOLLOWS:

- Connect the two channels in series by connecting the output of the left channel to the input of the right channel.
- Select identical mode of operation and multiplier position for both channels.
- Set both dials to the same cutoff frequency.

NOTE

When the two channels are in series and set to the same mode of operation with identical cutoff frequencies the gain at the cutoff frequency will be down 6 db from the pass-band gain with the two RESPONSE switches in the MAX-FLAT (Butterworth) position. In the Simple R-C position the gain at the cutoff frequency will be down approximately 26 db.

TO OBTAIN BAND-PASS OPERATION WITH 24 DB PER OCTAVE ATTENUATION, PROCEED AS FOLLOWS:

- Connect the two channels in series.
- Set the left channel to the High-Pass mode (this will control the Low-Cutoff frequency). Set the right channel to the Low-Pass mode (this will control the High-Cutoff frequency).

Band-Pass operation could also be obtained by setting the left channel to the Low-Pass mode and the right channel to the High-Pass mode. The first method has the advantage that the Low Cutoff Frequency(High-Pass mode) is on the left and the High Cutoff frequency (Low-Pass mode) is on the right, which is a logical arrangement since it coincides with our customary graphical representation of a Band-Pass Filter. This may be disadvantageous since the output is dc coupled because the Low-Pass channel is on the right. If the first method is used the output is ac coupled which is desirable in some applications where no dc fluctuations on the output can be tolerated.

c. The minimum Pass-Band is obtained by setting the high cutoff frequency equal to the low cutoff frequency. In this condition the insertion loss is 6 db, and the -3 db cutoff frequencies occur at 0.8 and 1.25 times the mid-band frequency. See curve B in Figure 2.

TO OBTAIN BAND-REJECT OR NOTCH FILTER OPERATION, PROCEED AS FOLLOWS:

a. Connect the two channels in parallel by connecting the input signal to the BNC INPUT connector of both channels simultaneously. The OUTPUT from both channels should be added through two equal external resistors in series with each output. The junction of these resistors become the output of the Filter. It is recommended that the resistors be approximately 1,000 ohms and of the carbon or metal film type if the Filter is used at high frequencies. If the two resistors are not equal the gain on one side of the notch will be different than the gain on the other. The smaller the adding resistors the greater the loss will be through the Filter in the Pass-Band region, due to the loading effect of the 50 ohm Filter output impedance.

b. The first channel should be set for Low-Pass operation.

c. The second channel should be set for High-Pass operation.

d. It should be noted that the output impedance in the band-reject mode will not be 50 ohms, but approximately one half the resistance of one adding resistor. The maximum input should not exceed 3 volts rms and the maximum output voltage in this mode will be 1.5 volts rms open circuit.

e. An accessory kit, which facilitates the procedure of paralleling the Model 3202 to obtain Band-Reject and notch Filter operation, is available. It consists of a small enclosure that contains two 1,000 ohm adding resistors and the necessary BNC connectors and cables.

2.4 TERMINALS

BNC coaxial connectors are provided on the front panel and on the rear of the chassis for both INPUT and OUTPUT connections.

2.5 LINE VOLTAGE AND FUSES

The Filter, unless otherwise specified is wired for operation from an ac power source of 105-125 volts, 50 to 400 Hz.

The Model 3200 uses a 1/8 ampere slo-blow line fuse and the Model 3202 uses a 1/4 ampere slo-blow line fuse that are mounted on the rear of the chassis. They may be modified to operate from a 210-250 volt line by removing the two jumpers connecting terminals 1 to 3, and 2 to 4 of the power transformer(s), and adding a jumper between terminals 2 and 3 of the power transformer(s). In the model 3202 there are two power transformers and both should be modified when the line voltage is changed. For 210-250 volt operation, a 1/16 ampere slo-blow fuse should be used for the Model 3200, and a 1/8 ampere slo-blow fuse for the Model 3202.

SECTION 3
CIRCUIT DESCRIPTION

3.1 INTRODUCTION

As shown in the Simplified Schematic Diagram, Figure 6, the Model 3200 and each channel of the Model 3202 consists of a four-pole variable electronic filter than can be operated as either a Low-Pass or a High-Pass Filter. It has a variable cutoff frequency that is adjustable between 20 Hz and 2 MHz by means of a tuning dial and a ten-position multiplier switch; five positions for the Low-Pass mode and five positions for the High-Pass mode. In the Low-Pass mode, it is direct-coupled and, in the High-Pass mode, its upper 3 db point is approximately 10 MHz. A Response switch selects either Butterworth (maximally flat response) or a Simple RC frequency characteristic, which improves the transient response by eliminating overshoot when pulsed input signals are used.

The Schematic Diagram of the Model 3200 Filter, Figure 8, is at the end of this manual. Bold lines on the Schematic Diagram show the main signal paths, while the dashed lines indicate feedback signal paths.

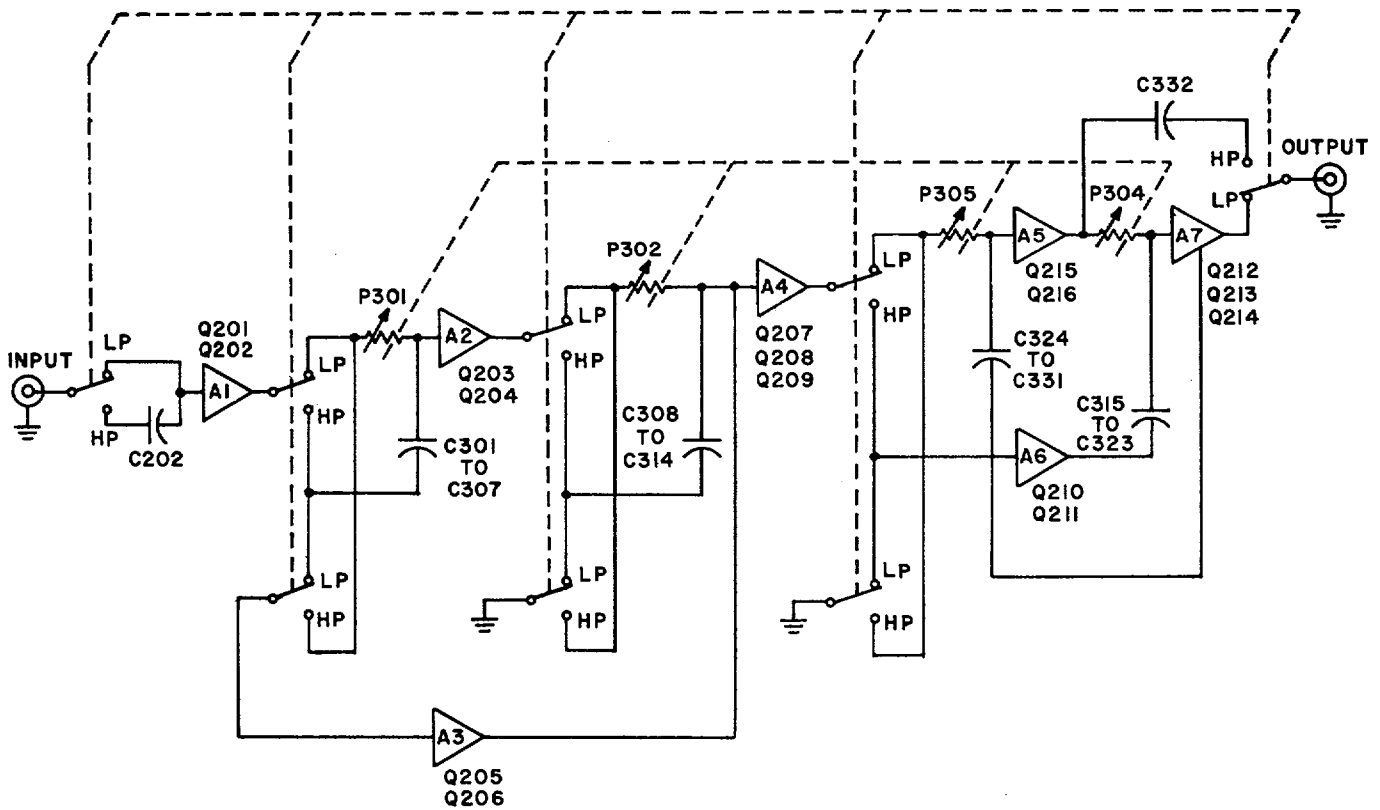

Figure 6. Simplified Schematic Diagram of Model 3200

As shown in Figure 6, the Model 3200 consists of four RC tuning elements isolated from each other by buffer amplifiers A2, A4 A5 and A7. The resistive part of the tuning elements P301, P302, P304 and P305, are potentiometers ganged by means of a gear train. The capacitors are ganged by a band switch that serves as both a multiplier and a "mode of operation" switch. The cutoff frequency is tuned capacitively in decade steps by the band switch, and continuously within each decade by the potentiometer assembly. Except for the highest band, the same capacitors are used in both the High-Pass and the Low-Pass mode. At the higher frequencies, separate capacitors are used to enable individual compensation for stray capacities in either mode of operation.

The Model 3200 Filter consists of two two-pole filters. Each two-pole filter has the correct response to give a Butterworth characteristic when they are cascaded. The first two-pole filter has very little loop gain and its response is very much like two cascaded R-C elements, i.e. the gain at the cutoff frequency is approximately 6 db down from mid-band gain. The second two-pole filter has more loop gain, resulting in a gain of approximately 3 db at the cutoff frequency, so that when the first and second filters are cascaded the overall gain at the cutoff frequency is 3 db down.

3.2 DETAILED DESCRIPTION

The input amplifier A1, consisting of emitter followers Q201 and Q202, isolates the input and provides the low impedance source necessary to drive the first RC filter network of potentiometer P301 and band capacitors C301 to C307, whichever is applicable. The signal input is direct-coupled in the Low-Pass mode, via current limiting series resistors R203, R206 and R207, to the input amplifier. Clamping diodes CR201 and CR202 in conjunction with these current limiting resistors prevent component damage in the event of excessive input signal. In the High-Pass mode the signal input is capacitor-coupled to the input amplifier through C202. A potentiometer P201 provides an offset voltage that maintains the Filter output dc level, in the Low-Pass mode, independent of the internal resistance of the input signal source. A divider network consisting of resistor R279 and thermistor R280, shown in the Filter Schematic Diagram Figure 8, generates a thermally sensitive offset voltage, that is added to the input amplifier via resistor R205, to maintain the Filter output dc level independent of ambient temperature variations. This thermal offset voltage is connected to the input stages of all the amplifiers in the Filter that require it.

The output of the first RC filter network is isolated by amplifier A2, which is similar to A1 and consists of transistors Q203 and Q204. This provides the required drive for the second RC filter network comprising potentiometer P302 and applicable band capacitor C308 to C314. A thermal offset voltage is also applied to amplifier A2 via resistor R213. Another offset voltage is applied to amplifier A2 via R214 to maintain the Filter output dc level independent of tuning. This voltage is derived from the divider network comprising potentiometer P206 and resistor R278, as shown in the Power Supply Schematic, Figure 9.

The output of the second RC filter network is connected to the input of amplifier A3 and A4. Amplifier A3, consisting of transistors Q205 and Q206, provides the necessary feedback gain to obtain the desired response for the first two-pole filter. Amplifier A4 is a two stage amplifier with a differential input stage using transistors Q207 and Q208. The output from the collector of the second stage, Q209, is fed back to the input stage through a network consisting primarily of resistors R238 and R242, and Potentiometer P202 that is used for unity gain adjust in the Low-Pass mode.

Amplifier A4, in the Low-Pass mode, drives the third RC filter network of potentiometer P305 and applicable band capacitor C324 to C331. The output of the third RC filter network is fed to amplifier A5, which consists of emitter followers Q215 and Q216. This amplifier, in the Low-Pass mode, drives the fourth RC Filter network of potentiometer P304 and applicable band capacitor C315 to C323. The output of the fourth RC filter network connects to amplifier A7, which consists of emitter followers Q212, Q213 and Q214. In the Low-Pass mode the output of the Filter comes from Q213 via resistor R313.

In the High-Pass mode of operation the circuit configuration of the second two-pole filter is modified. The output of amplifier A4 is connected to the input of amplifier A6, which is a two-stage degenerative amplifier and consists of transistors Q210 and Q211. The gain of this amplifier varies with band switching. It is increased on the highest band by inserting a network, consisting of R24, C212 and P203, in the degenerative feedback path. Amplifier A6 drives the fourth RC filter network and the output of this network is fed to amplifier A7 which drives the third RC filter network. The output of the third filter network connects to amplifier A5, and its output via capacitor C332, is the output of the Filter.

BUTTERWORTH/RC RESPONSE

This Filter has a maximally flat or Butterworth characteristic when the RESPONSE switch(s), S301, located on the rear of the chassis, is in the MAX FLAT position. To provide minimum overshoot to fast rise pulses the feedback of the second two-pole filter is disconnected by S202 when the RESPONSE switch(s) is in the SIMPLE RC position.

POWER SUPPLIES

The Power Supplies deliver a + 10 and -10 regulated voltage. It consists of a bridge rectifier CR101 and filter capacitors C101 and C102 to provide the necessary unregulated dc voltage. The -10 volt regulated supply is a typical series type using a zener reference, Z101, and amplifiers Q105 and Q108 which drives a series regulator Q106. To prevent damage when short circuits of the regulated voltage occur, a current limit circuit, consisting of Q102 and R103, turns off the -10 volt supply if the current in R103 exceeds a predetermined value. The + 10 volt supply uses the -10 volts as a reference. A divider network, consisting of R122 and R123, sets the proper voltage level for the amplifiers Q107 and Q104, which drive the series regulator Q103. Q101 and R102 limit the current in the +10 volt supply.

SECTION 4

MAINTENANCE

4.1 INTRODUCTION

If the Filter is not functioning properly and requires service, the following procedure may facilitate locating the source of trouble. Access to the Filter is accomplished easily without any hand tools by removing the top and bottom covers. It is first necessary to loosen (not remove) the two black thumb screws centered on each side at the rear of the chassis and then pulling out the two side covers. This unlocks the top and bottom covers which then may be pulled out.

The general layout of major components, test points, screwdriver controls and adjustments is shown in Figure 7. Detailed component layout for the printed circuit card is included in the Schematic Diagram, Figure 8 which is attached to the inside rear cover. Various check points are shown on the Schematic Diagram and are also marked on the printed circuit card. To allow for ease of service, the printed circuit card is provided with a swing-out mounting. Removal of two screws, one on each end, will allow the card to lift and provide access to the components. It is first necessary to move the card slightly towards the front panel, while lifting the card, to free it from its locking device which permits the card to remain in a vertical position to facilitate servicing.

Many troubles may easily be found by visual inspection. When a malfunction is detected, make a quick check of the unit for such things as broken wires, burnt or loose components, or similar conditions which could be a cause of trouble. Any trouble-shooting of the Filter will be greatly simplified if there is an understanding of the operation of the circuit.

Before any detailed trouble-shooting is attempted, reference should be made to Circuit Description, Section 3, to obtain this understanding.

4.2 POWER SUPPLY

If the Filter does not seem to be working properly, the two power supplies should be checked first. The supplies should measure +10 volts $\pm 5\%$ and -10 volts $\pm 5\%$. If the two supplies appear to be correct, refer to the signal tracing analysis, Section 4.3.

If the -10 volt supply is slightly out of tolerance and exceeds its upper limit of -10.5 volts, R116 should be increased or R118 should be reduced. When the -10 volt supply is slightly below its lower limit of -9.5 volts, R116 should be decreased or R118 increased. If the -10 volt supply is correct and the +10 volt supply is slightly out of tolerance, R122 or R123 may be defective. A fuse, F101 (1/8A for 115v or 1/16A for 230v operation), located at the rear of the chassis, is provided to protect the power supply from short circuits and overloads. The rating of this fuse was selected for proper protection of the Filter, and it should be replaced with one of the same type and rating.

Two regulated supplies are used to provide +10 volts and -10 volts with respect to the chassis. The -10 volt supply uses a zener (Z101) as its reference, while the +10 volt supply uses the minus supply as its reference. This fact should be kept in mind when doing any work on the supply, as an error in the minus will be reflected in the plus. Both supplies

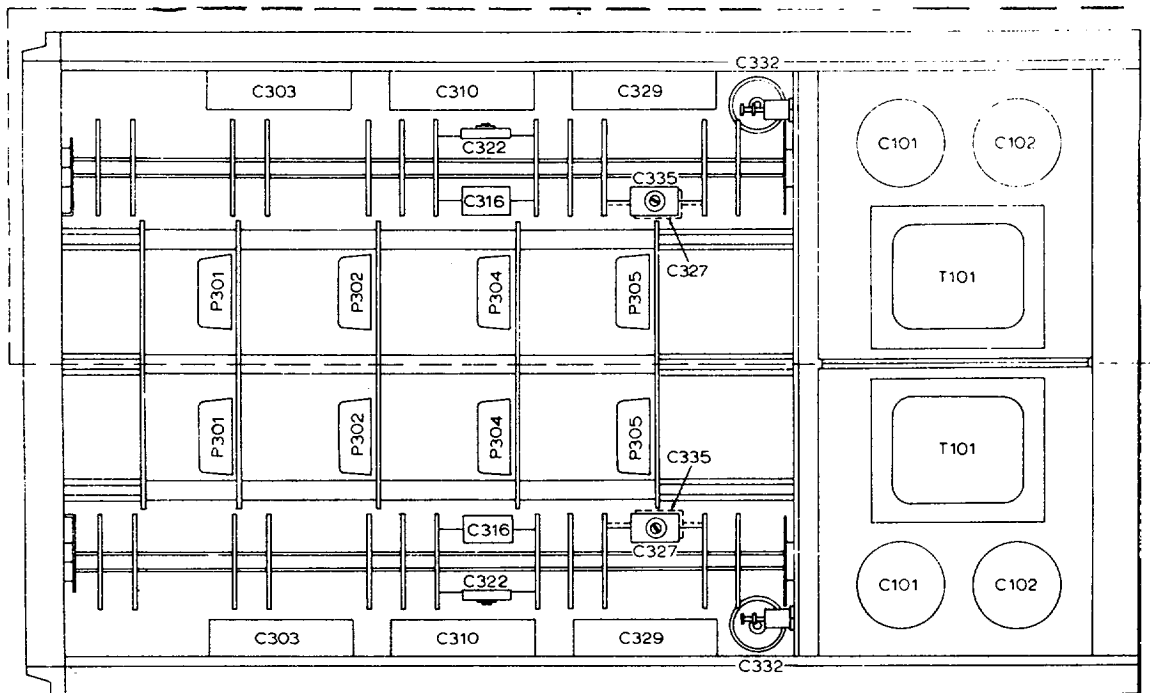

TOP VIEW

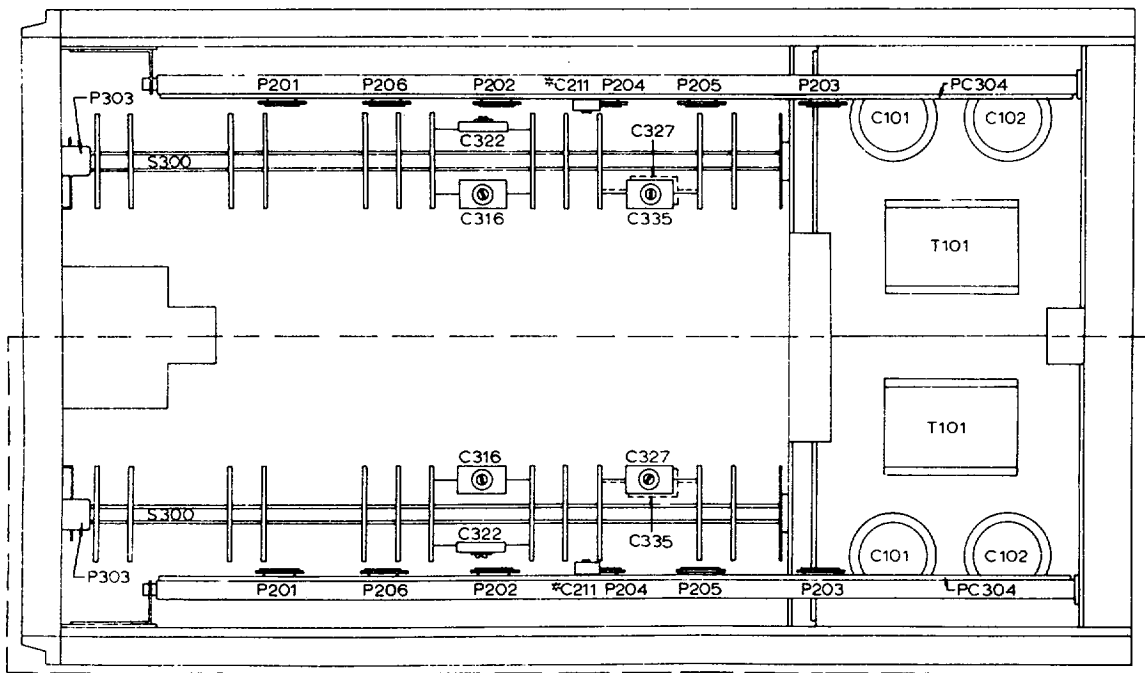

BOTTOM VIEW

Model 3200: Shown within dotted area.

Model 3202: As shown.

*On some models C211 is located on S300.

Figure 7. Top and Bottom View of Model 3200 and 3202

are provided with current limiting circuits that will shut down the supply when excessive current is being drawn from it. Because of this, an apparent power supply malfunction may be caused by an overload elsewhere in the Filter. This may be determined by measuring the voltage across R102 and R103. It should not exceed 0.4 volts.

If the supply does not appear to be working properly, the error signal thus developed should be traced through the regulator loop to find the faulty component. Correct voltages for various points in the supply are shown on the Schematic Diagram, Figure 8. As an example of the method of trouble-shooting, let us assume that the -10 volt supply is very low. This should make the base of Q108 more positive than normal, while making its collector more negative. The base of Q106 should then be made more positive than normal and the collector more negative, thus correcting the output of the supply. If a faulty component is present in the regulating loop this corrective action would be blocked. That component would then be found at the point in the loop where the action was blocked. The plus supply uses approximately the same type of circuit and the same basic method of trouble-shooting may be used there as well.

4.3 SIGNAL TRACING ANALYSIS

If the power supplies appear to be functioning properly, but the Filter is not working in one or both modes of operation, the following procedure should localize the malfunction.

4.3.1 Low-Pass and High-Pass Malfunction

If the Filter does not function properly in both the Low-Pass and High-Pass modes, it is recommended that the following signal tracing analysis, in the Low-Pass mode, be followed: Set the multiplier switch to the X10 position in the Low-Pass mode. Set the dial to 60. Connect a 600 Hz, 1 volt rms sine wave signal to the input of the Filter. If a 0.7 volt signal does not appear at the output, the malfunction may be localized by determining where the signal first deviates from normal in the Filter.

Table 1 shows various test points with their correct signal levels. If a test point is found whose signal differs appreciably from the correct value, the circuitry immediately proceeding that test point should be carefully checked. The test points basically trace the signal through the entire Filter, and should be checked in the order given. DC level voltages are shown on the schematic to aid in determining the defective component.

TABLE 1. TEST POINT VOLTAGES FOR LOW-PASS OPERATION

MODE OF OPERATION:	LOW-PASS
CUTOFF FREQUENCY:	600 Hz
RESPONSE SWITCH:	MAX FLAT
INPUT: 1 VOLT RMS	600 Hz
Test Point	Correct rms volts
3	1.0
4	.95
5	.72
7	.71
8	.51
12	.57
22	.83
19	.82
18	.72
21	.71
output	.71

4.3.2 High-Pass Malfunction

If the Filter appears to operate normally, and calibrates properly in the Low-Pass mode, but not in the High-Pass mode, the most likely source of trouble would be capacitors C202, C332, amplifier Q210, Q211 and associated circuitry, or a defective multiplier switch. These components and circuitry are not common to the Low-Pass mode. The following signal tracing analysis should localize the malfunction: Set the multiplier switch to the High-Pass mode and the cutoff frequency to 600 Hz. Connect a 600 Hz, 1 volt rms sine wave signal to the input of the Filter. If a 0.7 volt signal does not appear at the output, the malfunction may be localized by determining where the signal first deviates from normal in the Filter.

Table 2 shows various test points with their correct signal levels. If a test point is found whose signal level differs appreciably from the correct value, the circuitry immediately preceding that test point should be carefully checked. The test points basically trace the signal through the entire Filter, and they should be checked in the order given.

TABLE 2.
TEST POINT VOLTAGES FOR HIGH-PASS OPERATION

MODE OF OPERATION:	LOW-PASS
CUTOFF FREQUENCY:	600 Hz
RESPONSE SWITCH:	MAX FLAT
INPUT: 1 VOLT RMS	600 Hz
Test Point	Correct rms volts
2	1.0
4	.98
5	.75
7	.74
8	.52
12	.58
13	.58
17	.62
18	.92
20	.81
22	.72
23	.71
output	.71

4.4 TUNING CIRCUITS

If signal tracing shows one of the tuning circuits to be faulty, it should be determined if the trouble is in the resistive or capacitive element. If there is trouble in a capacitive element, this will show up only on a particular multiplier band. If there is a problem in a resistive element, the trouble will be of a general nature and will show up on all multiplier bands.

The range-determining capacitors, associated with the multiplier mode switch S300, are specially selected for close capacitance tolerance. All capacitor values fall within $\pm 5\%$ of the specified value, but in order to maintain accurate frequency calibration over the entire dial range and also between decade ranges, the capacitors are matched within $\pm 2\%$ of each other and generally within $\pm 2\%$ in decade ratios. The values of capacitance used on the higher bands are selected to compensate for stray capacitance and are therefore not completely in decade ratios of those used on the lower bands. For replacement purposes, a capacitor within $\pm 1\%$ of the specified value can be used with negligible effect

on the overall calibration accuracy. If more than one capacitor on a particular range is to be changed, it is recommended that several other capacitors on the switch be carefully measured on a capacitance bridge to determine the average percentage deviation from the nominal value. Any capacitors except those used on the two highest frequency ranges may be measured to determine this tolerance. Replacement can then be made with capacitors of exact value, and calibration will not be impaired.

The variable resistance element consists of four potentiometers ganged together with a gear assembly. Each potentiometer has series and shunt trims to insure proper tracking. The trims and the angular orientation of the potentiometers are carefully adjusted at the factory. If it becomes necessary to change one of these potentiometers in the field, it should be replaced only with a unit supplied by the factory complete with proper trims. The angular orientation should then be carefully adjusted following the procedure supplied with the parts.

SECTION 5

CALIBRATION AND ADJUSTMENT

5.1 INTRODUCTION

The following procedure is provided for the purpose of facilitating the calibration and adjustments of the Filter in the field. The steps outlined follow very closely the operations which are performed on the instrument by our Final Test Department and strict adherence to this procedure should restore the instrument to its original specifications. It should be noted that some of the tolerances given in this procedure are much tighter than our general specifications. This is to ensure, in test, that all general specifications are met with adequate safety factor. These nominal tolerances, therefore, should not be used for purposes of accepting or rejecting the instrument. If any difficulties are encountered, please refer to Maintenance, Section 4.

5.2 DETAILED SPECIFICATIONS

CUTOFF FREQUENCY CALIBRATION

The high and low cutoff frequencies, as defined below, should be within $\pm 5\%$ of the corresponding dial reading with exception of the highest band where the calibration accuracy is $\pm 10\%$. KROHN-HITE Filters are calibrated to conform to passive Filter terminology. The cutoff frequency in the maximally flat or Butterworth mode is the frequency at which the gain of the Filter is 3 db down from the gain at the middle of the pass-band. This pass-band varies with separation of the cutoff frequencies as shown in Figure 2. In the Simple RC or transient-free mode, this cutoff frequency gain is approximately 13 db down.

PASS-BAND GAIN

The Filter output voltage under open circuit conditions will be within $\pm 1/2$ db of the input voltage for all frequencies within the pass-band.

To determine the pass-band gain accurately, the high and low cutoff frequencies must be separated by a factor of at least four, and the measuring frequency must be the geometric mean of these frequencies.

ATTENUATION SLOPE

A typical attenuation curve is shown in Figure 4. At the cutoff frequency, in the maximally flat or Butterworth mode, the slope is approximately 12 db per octave, and at the 12 db point the slope has essentially reached its nominal value of 24 db per octave. The slope of the straight portion of the curve may vary slightly from 24 db per octave at certain frequencies because of cross-coupling effects.

MAXIMUM ATTENUATION

This Filter has a maximum attenuation specification of 80 db which applies over most of the frequency range. At the high frequency end this attenuation is reduced due to unavoidable cross coupling between input and output.

¹ This procedure is to be used only after maintenance. For Calibration Procedure, see TB 750-236.

OUTPUT IMPEDANCE

The Filter will operate into any load impedance providing the maximum output voltage and current specification is not exceeded. For a matched load impedance of 50 ohms the insertion loss will be approximately 6 db. Lower values of load resistance will not damage the instrument but will increase the distortion. Higher values of external load may be used with no sacrifice in performance and correspondingly lower insertion loss. In KROHN-HITE Filters, there is no requirement for the load impedance to match the output impedance.

INTERNALLY GENERATED HUM AND NOISE

The internally generated hum and noise measurement is based on the use of a Ballantine Model 310 Voltmeter, or equivalent. The measurement is made with the input connector shorted, with no other external signal connections to the instrument, and the voltmeter leads shielded.

DISTORTION

Filter distortion is a function of several variables and is difficult to specify exactly. In general if the Filter is operated within its ratings, distortion products introduced by the Filter and not present in the input signal will not exceed 0.5% of the output signal. In most cases distortion will be considerably less than 0.5%.

5.3 TEST EQUIPMENT REQUIRED

- a. Oscillator - capable of supplying at least 3 volts rms from 20 Hz to 10 MHz with frequency calibration better than $\pm 1\%$, distortion less than 0.1% and frequency response within ± 0.2 db.
- b. AC VTVM - frequency response, 10 Hz to 10 MHz; full scale sensitivity from 1.0 mv to 10 volts rms with db scale; input capacitance should be less than 20 pf. Ballantine Model 310 or equivalent.
- c. Oscilloscope - having direct coupled horizontal and vertical amplifiers with equal phase characteristics to at least 20 kHz and vertical sensitivity of 10 mv per division.
- d. Vacuum Tube Voltmeter - 15 volts dc full scale.
- e. Variable Auto-transformer - to adjust line voltage.
- f. AC Voltmeter - to measure line voltage.

5.4 POWER SUPPLIES

With the Filter operating at 115 or 230 volts line, whichever is applicable, check the plus and minus 10 volt supplies with respect to chassis ground. The floating/chassis grounding switch, located at the rear of the chassis, should be in the chassis position. The +10 volt supply may be checked most easily at the plus side of C109 (100ufd 25 volt electrolytic) and the -10 volt supply may be checked most easily at the negative side of C110 (100ufd 25 volt electrolytic). If the minus 10 volt supply is slightly out of tolerance and exceeds its upper limit of -10.5 volts, R116 should be increased or R118 should be reduced. When the -10 volt supply is slightly below its lower limit of minus 9.5 volts, R116 should be decreased or R118 increased.

5.5 DETAILED TEST PROCEDURE

Table 3 contains a detailed test procedure to check the performance of the Model 3200. The procedure is to be performed in the given order (1 through 17). For the Model 3202 this procedure should be repeated for the 2nd filter section. At the end of Table 3 there are some checks that apply to the Model 3202 only (steps 18 through 21). These will check performance of the Model 3202 when both sections are used. For all steps, the AC input line voltage should be at 115 or 230 volts, whichever is applicable.

Throughout the procedure, Low-Pass operation is abbreviated LP and refers to the operation using one of the 5 Low-Pass multipliers. High-Pass operation is abbreviated HP and refers to one of the 5 High-Pass multipliers.

The general layout of major components, test points, screwdriver controls and adjustments is shown in Figure 7.

In the event the Filter does not meet the correct tolerance as specified in each step of the Detailed Test Procedure, reference should be made to Section 4, Maintenance.

Before using this detailed test procedure, it is recommended that the output dc level of the 3200 and both output dc levels of the Model 3202 be zeroed. This should be done after the Filter has been operating for at least one half hour with the dust covers in position. Remove bottom cover only when it is necessary to adjust the internal controls and then replace it after this adjustment is completed.

- a. With the input shorted and the Filter in the Low-Pass mode, adjust the output dc level front panel potentiometer(s) P303 for zero output dc level.
- b. Adjust potentiometer P201 (see Figure 7 for location) for minimum output dc level change when short is removed from input.
- c. Adjust potentiometer P206 (see Figure 7 for location) for minimum output dc level change when tuning dial from 200 to 20.
- d. Repeat step a if necessary.

**NOTE: All frequencies should be set with counter.
Input voltage must be as described in tests (monitor input
or set with 310 and reconnect to output).**

Step 20 very sensitive and requires many adjustments due to interaction.

TABLE 3. DETAILED TEST PROCEDURE

STEP	PROCEDURE	FREQUENCY SETTING			INPUT SIGNAL	
		Dial	LP Multiplier	HP Multiplier	VOLTS (RMS)	Frequency
1.	LP dial calibration at 60 Connect oscillator output to scope horizontal input; adjust scope for horizontal deflection of 20 divisions. Remove oscillator output from scope horizontal input and connect to scope vertical input; adjust scope for vertical deflection of 20 divisions. Remove oscillator output from scope and connect to Filter input. Connect scope horizontal input to input of Filter and scope vertical input to Filter output. Set response switch (rear of chassis) to max flat position. Adjust dial to close the ellipse at about a 135 degree angle. If necessary, loosen dial screws and set dial to 60.	60	X10	-	1.0	600 Hz
2.	LP dial gain calibration at 60 Switch LP frequency multiplier to X100 position. Connect AC VTVM to Filter output. Adjust oscillator output until VTVM indicates exactly 20 db. Return LP frequency multiplier to X10 position. Adjust P205 until VTVM indicates 17 db. If P205 requires adjustment, recheck 20 db reference level.	60	X10	-	1.0	600 Hz
3.	LP dial gain calibration at 22 Switch LP frequency multiplier to X100 position. Adjust oscillator output until VTVM indicates exactly 20 db. Return LP frequency multiplier to X10 position. Adjust LP dial until VTVM indicates 17 db. Tolerance is a dial setting from 21.0 to 23.0.	22	X10	-	1.0	220 Hz
4.	LP dial gain calibration at 180 Switch LP frequency multiplier to X100 position. Adjust oscillator until VTVM indicates exactly 0 db. Return LP frequency multiplier to X10 position. Adjust LP dial until VTVM indicates 17 db. Tolerance is a dial setting from 170 to 190.	180	X10	-	1.0	1800 Hz
5.	LP dial gain calibration at 60 on all bands					
a.	X10K band calibration Adjust oscillator output until VTVM indicates exactly 20 db. Change oscillator frequency to 600 kHz. Adjust C322 until VTVM indicates 17 db. Check 22 on the dial using an oscillator frequency of 22 kHz and 220 kHz. Tolerance is a dial reading of 20 to 24. Check 180 on the dial using an oscillator frequency of 180 kHz and 1.8 MHz. Adjust C335 for a dial reading between 160 and 20. If C335 is adjusted, recheck 22 and 60.	60	X10K	-	1.0	60 kHz
b.	X1K band calibration Adjust oscillator output until VTVM indicates exactly 20 db. Switch LP multiplier to X1K position. Adjust dial until VTVM indicates 17 db. Tolerance is a dial setting from 57 to 63.	60	X10K	-	1.0	60 kHz
c.	X100 band calibration Adjust oscillator output until VTVM indicates exactly 20 db. Switch LP multiplier to X100 position. Adjust dial until VTVM indicates 17 db. Tolerance is a dial setting from 57 to 63.	60	X1K	-	1.0	6 kHz
d.	X1 band calibration Adjust oscillator output until VTVM indicates exactly 20 db. Switch LP multiplier to X1 position. Adjust dial until VTVM indicates 17 db. Tolerance is a dial setting from 57 to 63.	60	X10	-	1.0	60 Hz
6.	Unity gain adjustment at 5 kHz LP With VTVM, compare AC signal on input Filter with AC signal on output. If necessary, adjust P202 for unity gain.	35	X10K	-	1.0	5 kHz
7.	Unity gain adjustment at 5 kHz HP With VTVM compare the A-C signal on the input of the Filter with the A-C signal on the output. If necessary, adjust P204 for unity gain.	100	-	X1	1.0	5 kHz

TABLE 3. DETAILED TEST PROCEDURE (Cont.)

STEP	PROCEDURE	FREQUENCY SETTING			INPUT SIGNAL	
		Dial	LP Multiplier	HP Multiplier	VOLTS (RMS)	Frequency
8.	Frequency response Adjust C211 for unity gain from input to output Switch HP multiplier from X1 to X10K. Check that amplitude stays within 0.5 db.	20	-	X1	.05	2 MHz
9.	HP dial calibration at 60 Connect oscillator output to scope horizontal input; adjust scope for horizontal deflection of 20 divisions. Remove oscillator output from scope horizontal input and connect to scope vertical input; adjust scope for vertical deflection of 20 divisions. Remove oscillator output from scope and connect to Filter input. Connect scope horizontal input to input of Filter and scope vertical input to Filter output. Adjust dial to close ellipse at about a 135 degree angle. Tolerance is a dial setting of 58 to 62.	60	-	X10	1.0	600 Hz
10.	HP dial gain calibration at 60 Switch HP frequency multiplier to X1 position and adjust oscillator output until VTVM indicates exactly 20 db. Return HP frequency multiplier to X10 position. Adjust dial until VTVM indicates 17 db. Tolerance is a dial setting of 58 to 62.	60	-	X10	1.0	600 Hz
11.	X10K band calibration a. Switch HP multiplier to X10K position. Adjust P203 for minimum change (less than 0,3 db) in output amplitude when switching HP multiplier from X100 position to X10K position. b. Change input frequency to 110 kHz, switch HP multiplier to X100 position. Adjust oscillator amplitude until VTVM indicates exactly 14db on output of Filter. Switch HP multiplier to X10K position. If necessary, adjust C316 until VTVM indicates output of Filter is down 23 db to 25 db and repeat part a. c. Change input frequency to 220 kHz. Switch HP multiplier to X1K position. Adjust oscillator amplitude until VTVM indicates exactly 14 db on output of Filter. Switch HP multiplier to X10K position. Adjust HP dial until VTVM indicates 11 db. Tolerance is a dial setting from 20 to 24. If off (dial reading high) increase C327 and decrease C316 and if dial reading is low, decrease C327 and increase C316. Repeat parts a and b respectively. d. Set dial to 180. Set output frequency to 1.8 mHz. Switch HP multiplier to X1K position. Adjust oscillator amplitude until VTVM indicates exactly 14 db on output of Filter. Switch HP multiplier to X10K position. Adjust dial until VTVM indicates 11 db. Tolerance is a dial setting of 160 to 200. e. Set dial to 60. Set input frequency to 600kHz, Switch HP multiplier to X1K position, Adjust oscillator amplitude until VTVM indicates exactly 14db on output of Filter. Set HP multiplier to X10K position. Adjust dial until VTVM indicates 11db. Tolerance is a dial setting from 54 to 66. If out of tolerance, divide the error between 22 and 180 on the dial.	22	-	X100	0.5	600 kHz
12.	HP dial gain calibration at 60 on all bands a. X1 Calibration Connect VTVM to Filter output. Set oscillator frequency to 600 Hz. Adjust oscillator output until VTVM indicates exactly 20 db. Change frequency to 60 Hz. Adjust dial until VTVM indicates 17 db. Tolerance is a dial setting from 57 to 63. b. X100 calibration Adjust oscillator output until VTVM indicates exactly 20 db. Set HP frequency multiplier to X100 position. Adjust dial until VTVM indicates 17 db. Tolerance is a dial setting from 57 to 63. c. X1K Calibration Adjust oscillator output until VTVM indicates exactly 20 db. Set HP frequency multiplier to X1K position. Adjust dial until VTVM indicates 17 db. Tolerance is a dial setting from 57 to 63.	60	-	X1	1.0	As noted
		60	-	X1	1.0	6 kHz
		60	-	X100	1.0	60 kHz

TABLE 3. DETAILED TEST PROCEDURE (Cont.)

STEP	PROCEDURE	FREQUENCY SETTING			INPUT SIGNAL	
		Dial	LP Multiplier	HP Multiplier	VOLTS (RMS)	Frequency
13.	Maximum attenuation at 25 kHz Output signal should be below 300 microvolts.	20	X100		3.0	25 kHz
14.	Maximum input voltage Check that output signal is not distorted.	100		X1	3.0	220 kHz
15.	Output impedance Connect 50 ohm resistor to Filter output. Output signal should decrease to approximately 0.5 volts.	20		X1	1.0	1 kHz
16.	Hum and Noise Connect VTVM only to Filter output and a shorting jumper across the input connector. Replace all covers. Output signal level should be below 100 microvolts. Caution! If output level is greater than 100 microvolts, monitor output to be sure excessive output is not due to radio or television station interference. Vary line voltage from 115 to 105 and from 125. Output signal level should stay below 100 microvolts.	20		X1	0	

MODEL 3202 ONLY

STEP	PROCEDURE	FREQUENCY SETTING						INPUT SIGNAL	
		LEFT SECTION			RIGHT SECTION			Volts	Frequency
		Dial	LP Multi.	HP Multi.	Dial	LP Multi.	HP Multi.		
17.	Minimum Pass-Band Band Pass Operation Connect output of left section to input of right section. Connect oscillator to input of left section. Output signal of right section should be 0.45 to 0.55 volts.	100	-	X10	100	X10	-	1.0	1 kHz
18.	48 db slope Low Pass Operation Set oscillator to 2 kHz and adjust oscillator to maintain IV input. Output signal should be 2.8 to 5.8 mv.	100	X10	-	100	X10	-	1.0	1 kHz
19.	48 db slope High Pass Operation Set oscillator to 500 Hz. Output signal should be 2.8 to 5.8 mv.	100	-	X10	100	-	X10	1.0	1 kHz
20.	Band Reject Operation Connect right section output and left section output together through two 1000 ohm noninductive adding resistors. Connect both filter inputs to oscillator. Adjust both dials as often as required for a null. Output signal as viewed on oscilloscope should be less than 1.5 mv.	30	X10	-	120	-	X10	3.0	600 Hz

SECTION 6

SCHEMATIC AND PARTS LIST

REPLACEMENT PARTS

To obtain replacement parts, find the manufacturer's part number and description in this manual and then refer to the appropriate Repair Parts and Special Tools List (RPSTL) TM. In the RPSTL, find the assembly or subassembly first and then the description which corresponds with that in this manual. Under the description in the RPSTL find the manufacturer's part number, and then order the part by the listed Federal Stock Number. If the part is not listed in the RPSTL, it should be requisitioned from the NICP in accordance with AR 725-50.

See inside back cover for the foldout schematic and other parts information.

PARTS LIST SUPPLEMENT

<u>FSC</u>	<u>ABBR.</u>	<u>MANUFACTURER</u>	<u>ADDRESS</u>
(01121)	AB	Allen-Bradley Co.	Milwaukee, Wis.
(95146)	AL	Alco Electronics	Lawrence, Mass.
(71400)	BU	Bussman Mfg. Div.	St. Louis, Mo.
(10646)	CB	Carborundum	Niagara Falls, N.Y.
(88419)	CD	Cornell-Dubilier Elec.	Newark, N.J.
(71590)	CL	Centralab	Milwaukee, Wis.
(71450)	CT	CTS Corp.	Elkhart, Ind.
(79727)	CW	Continental-Wirt Elec.	Philadelphia, Pa.
(99800)	DL	Delevan Electronics	East Aurora, N.Y.
(03797)	ED	Eldema Corp.	Compton, Calif.
(72136)	EL	Electro Motive Mfg. Inc.	Willimantic, Conn.
(12406)	EP	Elpac, Inc.	Fullerton, Calif.
(75042)	IR	International Resistance Co.	Philadelphia, Pa.
(88865)	KH	Krohn-Hite Corp.	Cambridge, Mass.
(04713)	MO	Motorola Semiconductor	Phoenix, Ariz.
(49671)	RC	Radio Corp. of America	Harrison, N.J.
(06751)	SM	U.S. Semcor	Phoenix, Ariz.
(56289)	SP	Sprague Elec. Co.	N. Adams, Mass.
(94322)	TL	Tel Labs, Inc.	Needham, Mass.
(03877)	TR	Transitron Elec. Corp.	Wakefield, Mass.
(NONE)	TS	Trush, Inc.	Cazenovia, N.Y.

SECTION 7

CHANGE INFORMATION

The following component changes are made, starting with:

<u>Serial Number</u>	<u>Change</u>
1. All	Q103 and Q106 should have heat sinks.
2. All	R282 should be 100 ohms.
3. 3200 Bench: 144 3200 Rack : 136 3202 Bench: 273 3202 Rack : 200	Change Q103 from (37918) to (2N4234). Change Q106 (2N3053) to (2N4237).
4. 3200 Bench: 154 3200 Rack : 142 3202 Bench: 350 3202 Rack : 220	Change C104 (.001 mf 500V plus or minus 20% cer.) to (.01 mf 500V plus or minus 20% cer);
5. 3200 Bench: 154 3200 Rack : 132,143,148,153, 157,160,164,165,167 and above 3202 Bench: 352,354,357,359, 362,366,380,382,385 and above 3202 Rack : 234	Remove C333 (51pf). Remove R314 (100 ohms). Change R272 (220 ohm 1/2W 20%) to (100 ohms 1/2W 20%) Change R274 (220 ohms 1/2W 20%) to (100 ohms 1/2W 20%).

SECTION 8 PREVENTIVE MAINTENANCE INSTRUCTIONS

8.1 Scope of Maintenance

The maintenance duties assigned to the operator and organizational repairman of this equipment are listed below with a reference to the paragraphs covering the specific maintenance functions. The preventive maintenance procedures require no special tools or test equipment.

- a. Daily preventive maintenance checks and services (para 8.5).
- b. Weekly preventive maintenance checks and services (para 8.6).
- c. Monthly preventive maintenance checks and services (para 8.7).
- d. Quarterly preventive maintenance checks and services (para 8.9).
- e. Cleaning (para 8.11).
- f. Touchup painting instructions (para 8.12).

8.2 Materials Required For Maintenance

- a. Trichloroethane (Federal stock No. 6810-292-9625).

WARNING

The fumes of trichloroethane are toxic. Provide thorough ventilation whenever used. DO NOT use near an open flame. Trichloroethane is not flammable, but exposure of the fumes to an open flame converts the fumes to highly toxic, dangerous gases.

- b. Cleaning cloth.
- c. Fine sandpaper.
- d. Touchup paint.

8.3 Preventive Maintenance

Preventive maintenance is the systematic care, servicing, and inspection of the equipment to prevent the occurrence of trouble, to reduce downtime, and to assure that the equipment is serviceable.

a. *Systematic Care.* The procedure given in paragraphs 8.5 through 8.12 covers routine systematic care and cleaning essential to proper upkeep and operation of the equipment.

b. *Preventive Maintenance Checks and Services.* The maintenance checks and services charts outline functions to be performed at specific intervals. These checks and services are to maintain equipment in a combat serviceable condition; that is, in good general (physical) condition and in good operating condition. To assist operators in maintaining combat serviceability, the charts indicate what to check, how to check, and the normal conditions. The reference column lists the paragraphs that contain additional information. If the defect cannot be found by performing the corrective action indicated, higher category of maintenance or repair is required. Records and reports of these checks and services must be made in accordance with the requirements set forth in TM 38-750.

8.4 Preventive Maintenance Checks and Services Periods

Preventive maintenance checks and services of this equipment are required daily, weekly, monthly, and quarterly. Daily maintenance checks and services are specified in paragraph 8.5. Paragraph 8.6 specifies checks and services that must be performed weekly. If the equipment is maintained in a standby condition, the daily and weekly checks should be accomplished at the same time. The maintenance checks and services that are accomplished monthly are specified in paragraph 8.7. Quarterly maintenance checks and services are specified in paragraph 8.9.

8.5 Daily Preventive Maintenance Checks and Services Chart

Sequence No.	Items to be inspected	Procedure	Reference
1	Completeness	See that the equipment is complete.	Para 8.11
2	Cleanliness	Exterior of equipment must be clean and dry, free of fungus, dirt, dust, or grease.	
3	Operational check	Check the operational efficiency.	
4	Controls	See that controls operate smoothly and are fastened in place securely.	

8.6 Weekly Preventive Maintenance and Services Chart

Sequence No.	Items to be inspected	Procedure	Reference
1	Cables	Inspect cards and cables for chafed, cracked, or frayed insulation.	
2	Metal Surfaces	Replace connectors that are broken, stripped, or worn. Inspect exposed metal surface for rust and corrosion. Clean and touch up with paint as required.	Para 8.11 and 8.12

8.7 Monthly Maintenance

Perform the maintenance functions indicated in the monthly preventive maintenance checks and services chart (para 8.8) once each month. Periodic daily (para 8.5) and weekly (para 8.6) services constitute a part of the monthly checks.

8.8 Monthly Preventive Maintenance Checks and Services Chart

Sequence No.	Items to be inspected	Procedure
1	Terminations	Inspect for loose connections and cracked or broken insulation.
2	Control panel	Clean panel thoroughly and check all surfaces for chips, cracks, or abnormal wear.
3	Hardware	Inspect all hardware for possible damage.
4	Vent holes	Clean vent holes.

8.9 Quarterly Maintenance

Quarterly preventive maintenance checks and services are required for this equipment. Periodic daily, weekly, and monthly services constitute a part of the quarterly preventive maintenance checks and services and must be performed concurrently. All deficiencies or shortcomings will be recorded in accordance with the requirements of TM 38-750. Perform all the checks and services listed in the quarterly preventive maintenance checks and services chart (para 8.10) in the sequence listed. Adjustment of the maintenance interval must be made to compensate for any unusual operating conditions.

8.10 Quarterly Preventive Maintenance Checks and Services Chart

Sequence No.	Items to be inspected	Procedure	Reference
1	Publications	See that all publications are complete, serviceable, and current.	DA Pam 310-4
2	Modifications	Check DA Pam 310-7 to determine whether new applicable MWO's have been published. All URGENT MWO's must be applied immediately. All NORMAL MWO must be scheduled.	TM 38-750 and DA Pam 310-7

8.11 Cleaning

Inspect the exterior surfaces. The surfaces must be free of dust, dirt, grease, and fungus.

- a. Remove dust and loose dirt with a clean, soft cloth.
- b. Remove grease, fungus, and ground in dirt. Use a damp cloth (not wet) with trichloroethane to clean terminations. If dirt on the body of the unit is difficult to remove, use mild soap and water.
- c. Remove dust or dirt from the jacks and plugs with a brush.

8.12 Touchup Painting Instructions

Remove dust and corrosion from metal surfaces by lightly sanding them with fine sandpaper. Brush two thin coats of paint on the bare metal to protect it from further corrosion. Refer to applicable cleaning and refinishing practices specified in TB 746-10.

Section 9. REPAIR PARTS LIST

9.1 Introduction

This section lists repair parts that are required for maintenance of Variable Filter, Krohn-Hite Models 3202(R) and 3202(R) and is applicable to Army Area Calibration Laboratories (AACL's) and Army Area Calibration Teams (AACT's).

NOTE

Throughout this section, DS is used to indicate AACT, and GS is used to indicate AAACL.

9.2 General

This section is divided as follows:

(1) Repair Parts List. A list, in alphabetical sequence, of repair parts authorized for the performance of maintenance at the AACT and AAACL support levels.

(2) Federal Stock Number and Reference Number Index. A list, in ascending numerical sequence, of all Federal stock numbers (FSN's) appearing in the repair parts list, followed by a list of all reference numbers in alpha-numeric sequence appearing in the list. The FSN's and reference numbers are cross-referenced to a figure number and item number in column 10.

NOTE

The figure and item number columns represent cross-reference numbers, since illustrations are not included in this section.

Refer to section I of TM 9-4931-700-34P for explanation of columns (para 3), special information (para 4, except for subparagraph 40 which is not applicable to this section), and abbreviations (para 6).

9.3 How to Locate Repair Parts

When FSN or reference number is unknown, use the repair parts listing and locate the item by description.

When Federal stock number or reference number is known, use the list of FSN's or the reference numbers and locate the cross-referenced figure and item numbers. Locate the cross-referenced figure and item number under column 10 of the repair parts list for the complete description of the repair part.

REPAIR PARTS LIST

(1) SMR CODE	(2) FEDERAL STOCK NUMBER	(3) DESCRIPTION USABLE ON CODE	(4) UNIT OF MEAS	(5) QTY INC IN UNIT	(6) 30-DAY DS MAINT ALLOWANCE			(7) 30-DAY GS MAINT ALLOWANCE			(8) 1-YR ALW PER 100 EQUIP CNTGY	(9) DEPOT MAINT ALW PER 100 EQUIP	(10) ILLUS- TRATION	
					(a)	(b)	(c)	(a)	(b)	(c)			(a)	(b)
					1-20	21-50	51-100	1-20	21-50	51-100			FIG. NO.	ITEM NO.
		GROUP 6430 FILTER, VARIABLE 3202R 88865 MIS10329TYPE1 18876 3202 88865 MS10329TYPE2 18876												
PAHZZ	5910-138-5090	CAPACITOR, ELECTROLYTIC T50310 (72136)	EA	3				*	*	*		20	1	3
PAHZZ	5910-984-7588	CAPACITOR, FIXED, MICA DIELECTRIC 500 V DC, .. 100 UUF, TYPE CM05FD101G03 CM05FD101G03 (81349)	EA	2				*	*	*		15	1	5
PAHZZ	5910-832-5724	CAPACITOR, FIXED, MICA DIELECTRIC 500 V DC, .. 68 UUF, TYPE CM15FD680G03 CM15FD680G03 (81249)	EA	1				*	*	*		7	1	7
PAHZZ	5910-781-7930	CAPACITOR, FIXED, MICA DIELECTRIC CM05ED750G03 (81349)	EA	1				*	*	*		7	1	9
PAHZZ	5910-764-2660	CAPACITOR, FIXED, MICA DIELECTRIC CM20E272G500V (84171)	EA	1				*	*	*		7	1	11
PAHZZ	5910-725-4795	CAPACITOR, FIXED, MICA DIELECTRIC 500 V DC, .. 1, 000 UUF, TYPE CM20FD102G03 CM20FD102G03 (81349)	EA	2				*	*	*		15	1	13
PAHZZ	5910-880-4645	CAPACITOR FIXED, MICA DIELECTRIC CM05ED240JP3 (81349)	EA	1				*	*	*		7	1	15
PAHZZ	5910-772-1820	CAPACITOR, FIXED MICA DIELECTRIC 500 V DC, .. 180 UUF, TYPE CM15FD181G03 (+- 10 0/0) CH15FD181G03 (81349)	EA	1				*	*	*		7	1	19
PAHZZ	5910-902-0335	CAPACITOR, FIXED, MICA DIELECTRIC 500 V DC, .. 10 UUF (+- 5 0/0) CM0CD100D03 (81349)	EA	1				*	*	*		7	1	21
PAHZZ	5910-936-7405	CAPACITOR, FIXED, MICA DIELECTRIC 500 V DC, .. 15 UUF, TYPE CM05CD150J03 CM05CD150J03 (81349)	EA	1				*	*	*		7	1	23
PAHZZ	5910-938-7227	CAPACITOR, FIXED, MICA DIELECTRIC 500 V DC, .. 27 UUF, TYPE CM15ED270G03 CM15ED270G03 (81349)	EA	1				*	*	*		7	1	25
PAHZZ	5910-954-3546	CAPACITOR, FIXED, MICA DIELECTRIC 500 V DC, .. 200 UUF (+- 2 0/0) CM05FD201G03 (81349)	EA	1				*	*	*		7	1	27
PAHZZ	5910-954-5500	CAPACITOR, FIXED, MICA DIELECTRIC 500 V DC, .. 150 UUF, TYPE CM05F151G03 CM05FD151G03 (81349)	EA	1				*	*	*		7	1	29
PAHZZ	5910-882-0091	CAPACITOR, FIXED, PLASTIC DIELECTRIC 100 V. . DC, 10, 000 UUF (+- 20 0/0) WMF1S1 (14655)	EA	2				*	*	*		15	1	31
PAHZZ	5910-064-4624	CAPACITOR, VARIABLE, MICA DIELECTRIC T50410 (72136)	EA	1				*	*	*		7	1	33
PAHZZ	5950-819-1190	COIL, RADIO FREQUENCY SGLE LAYER WOUND.. TYPE, SOLID COIL FORM, 0.156 DIA, 0.375 LG, W/2 WIRE LEAD TYPE TERM. 10033265-23 (18876)	EA	2				*	*	*		15	1	35
PAHZZ	5905-909-4235	RESISTOR	EA	2				*	*	*		13	1	37
PAHZZ	5905-909-4235	RESISTOR, FIXED, COMPOSITION EB3915 (01121) CB1035 (01121)	EA	2				*	*	*		15	1	39

(1) SMR CODE	(2) FEDERAL STOCK NUMBER	(3) DESCRIPTION REFERENCE NUMBER & MFR CODE	(4) UNIT OF MEAS	(5) QTY INC IN UNIT	(6) 30-DAY DS MAINT ALLOWANCE			(7) 30-DAY GS MAINT ALLOWANCE			(8) 1-YR ALW PER 100 EQUIP CNTGY	(9) DEPOT MAINT ALW PER 100 EQUIP	(10) ILLUS- TRATION	
					(a)	(b)	(c)	(a)	(b)	(c)			(a)	(b)
					1-20	21-50	51-100	1-20	21-50	51-100			FIG. NO.	ITEM NO.
PAHZZ	5905-055-6121	RESISTOR, FIXED EB5105 (01121)	EA	1				*	*	*	7	1	41	
PAHZZ	5905-795-0771	RESISTOR 1/2 W, 10,000 OHMS (+- 10 0/0) EB1031 (01121)	EA	3				*	*	*	20	1	43	
PAHZZ	5905-072-0678	RESISTOR, FIXED EB5611 (01121)	EA	2				*	*	*	15	1	45	
PAHZZ	5905-104-8336	RESISTOR, FIXED, COMPOSITION 1/2 W, 100,000.. OHMS, TYPE RCR20G104JS (+- 5 0/0) RCR200104JS (81349)	EA	2				*	*	*	15	1	47	
PAHZZ	5905-043-0850	RESISTOR, FIXED, COMPOSITION GB2215 (01121)	EA	1				*	*	*	7	1	49	
PAHZZ	5905-097-9534	RESISTOR, FIXED, COMPOSITION CB1815 (01121)	EA	1				*	*	*	7	1	51	
PAHZZ	5905-116-8561	RESISTOR, FIXED, COMPOSITION 1/2 W, 27 OHMS, TYPE RCR20G270JS (+- 5 0/0) RCR20G270JS (81349)	EA	1				*	*	*	7	1	53	
PAHZZ	5905-254-7413	RESISTOR, FIXED, COMPOSITION EB1521 (01121)	EA	1				*	*	*	7	1	55	
PAHZZ	5905-403-7337	RESISTOR, FIXED, COMPOSITION EB1011 (01121)	EA	2				*	*	*	15	1	57	
PAHZZ	5905-415-1598	RESISTOR, FIXED, COMPOSITION EB7515 (01121)	EA	1				*	*	*	7	1	59	
PAHZZ	5905-415-1600	RESISTOR, FIXED, COMPOSITION EB9105 (01121)	EA	1				*	*	*	7	1	61	
PAHZZ	5905-252-1046	RESISTOR, FIXED, COMPOSITION 1/2 W, 2.7 MEG, TYPE RCR20G275JS (+- 5 0/0) RCR20G275JS (81349)	EA	1				*	*	*	7	1	63	
PAHZZ	5905-104-5755	RESISTOR, FIXED, COMPOSITION 1/2 W, 10 OHMS, TYPE RCR20G100JS (+- 5 0/0) RCR20G100JS (81349)	EA	2				*	*	*	*	1	65	
PAHZZ	5905-104-8368	RESISTOR, FIXED, COMPOSITION 1/4 W, 47 OHMS, TYPE RC07G470JS (+- 5 0/0) RCR07G470JS (81349)	EA	7				*	*	*	7	1	67	
PAHZZ	5905-110-0196	RESISTOR, FIXED, COMPOSITION 1/2 W, 1000 OHMS, TYPE RCR20G102JS (+- 5 0/0) RCR20G102JS (81349)	EA	2				*	*	*	*	1	69	
PAHZZ	5905-110-0992	RESISTOR, FIXED, COMPOSITION 1 W, 510 OHMS, TYPE RCR32G511JS (+- 5 0/0) RCR32G511JS (81349)	EA	1				*	*	*	7	1	71	
PAHZZ	5905-111-4734	RESISTOR, FIXED, COMPOSITION 1/2 W, 47 OHMS, TYPE RCR20G470JS (+- 5 0/0) RCR20G470JS (81349)	EA	6				*	*	*	*	1	73	
PAHZZ	5905-111-6010	RESISTOR, FIXED, COMPOSITION 1/2 W, 910,000.. OHMS, TYPE RCR20G914JS (+- 5 0/0) RCR20G914JS (81349)	EA	5				*	*	*	35	1	75	
PAHZZ	5905-113-4851	RESISTOR, FIXED, COMPOSITION 1/2 W, 5.1 MEG, TYPE RCR20G515JS (+- 5 0/0) RCR20G515JS (81349)	EA	3				*	*	*	20	1	77	
PAHZZ	5905-116-8569	RESISTOR, FIXED, COMPOSITION 1/2 W, 820 OHMS, TYPE RCR20G821JS (+- 5 0/0) RCR20G821JS (81349)	EA	1				*	*	*	7	1	79	
PAHZZ	5905-121-9860	RESISTOR, FIXED, COMPOSITION RCR32G301JS (81349)	EA	1				*	*	*	7	1	81	
PAHZZ	5905-121-9922	RESISTOR, FIXED, COMPOSITION 1/2 W, 430 OHMS, TYPE RCR20G431JS (+- 5 0/0) RCR20G431JS (81349)	EA	1				*	*	*	7	1	83	

(1) SMR CODE	(2) FEDERAL STOCK NUMBER	(3) DESCRIPTION REFERENCE NUMBER & MFR CODE	(4) UNIT OF MEAS	(5) QTY INC IN UNIT	(6) 30-DAY DS MAINT ALLOWANCE			(7) 30-DAY GS MAINT ALLOWANCE			(8) 1-YR ALW PER 100 EQUIP CNTGY	(9) DEPOT MAINT ALW PER 100 EQUIP	(10) ILLUS- TRATION	
					(a)	(b)	(c)	(a)	(b)	(c)			(a)	(b)
					1-20	21-50	51-100	1-20	21-50	51-100			FIG. NO.	ITEM NO.
PAHZZ	5905-141-0727	RESISTOR, FIXED, COMPOSITION 1/2 W, 200..... OHMS, TYPE RCR20G201JS (+- 5 0/0) RCR20G201JS (81349)	EA	1				*	*	*		7	1	85
PAHZZ	5905-141-0744	RESISTOR, FIXED, COMPOSITION 1/4 W, 5, 600..... OHMS, TYPE RCR07G562JS (+- 5 0/0) RCR07G562JS (81349)	EA	1				*	*	*		7	1	87
PAHZZ	5905-228-6088	RESISTOR, FIXED, COMPOSITION 1 W, 330 OHMS, TYPE RCR32G331JS (+- 5 0/0) RCR32G331JS (81349)	EA	2				*	*	*		15	1	89
PAHZZ	5905-106-9344	RESISTOR, FIXED, COMPOSITION 1/2 W, 100..... OHMS, TYPE RCR20G101JS (+- 5 0/0) RCR20G101JS (81349)	EA	6				*	*	*		40	1	91
PAHZZ	5905-104-8334	RESISTOR, FIXED, COMPOSITION 1/2 W, 330..... OHMS, TYPE RCR20G331JS (+- 5 0/0) RCR20G331JS (81349)	EA	2				*	*	*		15	1	93
PAHZZ	5905-104-8350	RESISTOR, FIXED, COMPOSITION 1/2 W, 220..... OHMS, TYPE RCR20GF221JS (+- 5 0/0) RCR20G221JS (81349)	EA	2				*	*	*		15	1	97
PAHZZ	5905-110-7620	RESISTOR, FIXED, COMPOSITION 1/4 W, 1,000 OHMS, TYPE RCR07G102JS (+- 5 0/0) RCR07G102JS (81349)	EA	3				*	*	*		20	1	99
PAHZZ	5905-114-5407	RESISTOR, FIXED, COMPOSITION 1/2 W, 270..... OHMS, TYPE RCR20G271JS (+- 5 0/0) RCR20G271JS (81349)	EA	2				*	*	*		15	1	101
PAHZZ	5905-121-9859	RESISTOR, FIXED, COMPOSITION 1/2 W, 10 MEG., TYPE RCR20G106JS (+- 5 0/0) RCR20G106JS (81349)	EA	1				*	*	*		7	1	105
PAHZZ	5905-279-1751	RESISTOR, FIXED, COMPOSITION 1/2 W, 3,000 OHMS, TYPE RC20GF302J (+- 5 0/0) RC20GF302J (81349)	EA	7				*	*	*		50	1	107
PAHZZ	5905-190-8880	RESISTOR, FIXED, COMPOSITION 1/2 W, 1,200 OHMS, TYPE RC20GF122J (+- 5 0/0) RC20GF122J (81349)	EA	1				*	*	*		7	1	109
PAHZZ	5905-111-1679	RESISTOR, FIXED, COMPOSITION 1/4 W, 5,100 OHMS, TYPE RCR07G512JS (+- 5 0/0) RCR07G512JS (81349)	EA	1				*	*	*		7	1	111
PAHZZ	5905-556-5256	RESISTOR, FIXED, COMPOSITION 1/2 W, 4,700 OHMS (+- 5 0/0) EB4725 (01121)	EA	1				*	*	*		7	1	113
PAHZZ	5905-627-3276	RESISTOR, FIXED EB1025 (01121)	EA	1				*	*	*		7	1	117
PAHZZ	5905-111-4742	RESISTOR, FIXED, COMPOSITION 1/2 W, 390..... OHMS, TYPE RCR20G391JS (+- 5 0/0) RCR20G391JS (81349)	EA	1				*	*	*		7	1	119
PAHZZ	5961-951-5123	SEMICONDUCTOR DEVICE, DIODE..... MDA920-2 (04713)	EA	3				*	*	*		25	1	121
PAHZZ	5961-892-0734	SEMICONDUCTOR DEVICE, DIODE TYPE 1N483B.. JAN1N483B (81349)	EA	2				*	*	*		25	1	123
PAHZZ	5961-103-4429	TRANSISTOR MPS6515 (04713)	EA	9				*	*	*		100	1	125

(1) SMR CODE	(2) FEDERAL STOCK NUMBER	(3) DESCRIPTION REFERENCE NUMBER & MFR CODE	(4) USABLE ON CODE	(5) UNIT OF MEAS	QTY INC IN UNIT	(6) 30-DAY DS MAINT ALLOWANCE			(7) 30-DAY GS MAINT ALLOWANCE			(8) 1-YR ALW PER 100 EQUIP CNTGY	(9) DEPOT MAINT ALW PER 100 EQUIP	(10) ILLUS- TRATION	
						(a)	(b)	(c)	(a)	(b)	(c)			(a)	(b)
						1-20	21-50	51-100	1-20	21-50	51-100			FIG. NO.	ITEM NO.
PAHZZ	5961-493-1102	TRANSISTOR 2N5189 (80131)		EA	1				*	*	*		10	1	127
PAHZZ	5961-944-9504	TRANSISTOR 2N3136 (04713)		EA	9				*	*	*		100	1	129

FSN, REFERENCE NUMBER INDEX

INDEX - FEDERAL STOCK NUMBER AND REFERENCE NUMBER
CROSS-REFERENCE TO FIGURE AND ITEM NUMBER

STOCK NUMBER	FIGURE NO.	ITEM NO.	STOCK NUMBER	FIGURE NO.	ITEM NO.
5905-043-0850	1	49	5905-252-1046	1	63
5905-055-6121	1	41	2 5905-254-7413	1	55
5905-072-0678	1	45	5905-403-7337	1	57
5905-097-9534	1	51	5905-415-1598	1	59
5905-104-5755	1	65	5905-415-1600	1	61
			3 5905-556-5256	1	113
5905-104-8334	1	93	5905-795-0771	1	43
5905-104-8336	1	47	5905-909-3885	1	39
5905-104-8350	1	97	5905-909-4235	1	37
5905-104-8368	1	67	5910-064-4624	1	33
5905-106-9344	1	91	5910-138-5090	1	3
5905-110-0196	1	69	5910-725-4795	1	13
			5910-764-2660	1	11
5905-110-0992	1	71	5910-772-1820	1	19
5905-110-7620	1	99	5910-781-7930	1	9
5905-111-1679	1	111	5910-832-5724	1	7
5905-111-4734	1	73	5910-880-4645	1	15
			5910-882-0091	1	31
5905-111-4742	1	119	5910-902-0335	1	21
5905-111-6010	1	75	5910-936-7405	1	23
5905-113-4851	1	77	5910-938-7227	1	25
5905-114-5407	1	101	5910-954-5497	1	27
5905-116-8561	1	53	5910-954-5500	1	29
5905-116-8569	1	79	5910-984-7588	1	5
5905-121-9589	1	105	5950-819-1990	1	35
5905-121-9560	1	81	5961-103-4429	1	125
5905-121-9922	1	83	5961-493-1102	1	127
5905-141-0727	1	85	5961-892-0734	1	123
1 5905-141-0744	1	87	5961-944-9504	1	129
5905-228-6088	1	89	5961-951-5123	1	121
1 5905-190-8880	1	109	2 5905-279-1751	1	107
			3 5905-627-3276	1	117

REFERENCE NO.	MFR CODE	FIG. NO.	ITEM NO.	REFERENCE NO.	MFR CODE	FIG. NO.	ITEM NO.
				RCR07G562JS	81349	1	87
CB1035	01121	1	39	RCR20G100JS	81349	1	65
CB1815	01121	1	51				
CM05CD100D03	81349	1	21	RCR20G101JS	81349	1	91
CM05CD150J03	81349	1	23	RCR20G102JS	81349	1	69
CM05ED240JP3	81349	1	15				
CM05ED750G03	81349	1	9	RCR20G104JS	81349	1	47
CM05FD101G03	81349	1	5	RCR20G106JS	81349	1	105
CM05FD151G03	81349	1	29	RCR20G201JS	81349	1	85
CM05FD201G03	81349	1	27	RCR20G221JS	81349	1	97
CM15ED270G03	81349	1	25	RCR20G270JS	81349	1	53
CM15FD181G03	81349	1	19	RCR20G271JS	81349	1	101
CM15FD680G03	81349	1	7	RCR20G275JS	81349	1	63
CM20F272G500V	84171	1	11	RCR20G331JS	81349	1	93
CM20FD102G03	81349	1	13	RCR20G391JS	81349	1	119
EB1011	01121	1	57	RCR20G431JS	81349	1	83
EB1025	01121	1	117	RCR20G470JS	81349	1	73
EB1031	01121	1	43				
EB1521	01121	1	55	RCR20G515JS	81349	1	77
EB3915	01121	1	37	RCR20G821JS	81349	1	79
EB4725	01121	1	113	RCR20G914JS	81349	1	75
EB5105	01121	1	41	RCR32G301JS	81349	1	81
EB5611	01121	1	45	RCR32G331JS	81349	1	89
EB7515	01121	1	59	RCR32G511JS	81349	1	71
EB9105	01121	1	61	RC20GF122J	81349	1	109
GB2215	01121	1	49	RC20GF302J	81349	1	107
JAN1N483B	81349	1	123	T50310	72136	1	3
MDA920-2	04713	1	121	T50410	72136	1	33
MPS6515	04713	1	125	WMF1S1	14655	1	31
RCRC7G102JS	81349	1	99	10033265-23	18876	1	35
RCR07G470JS	81349	1	67	2N3136	04713	1	129
RCR07G512JS	81349	1	111	2N5189	80131	1	127

APPENDIX A**REFERENCES**

Following is a list of publications available to 3200(R) and 3202(R) operator and maintenance personnel.

- DA Pam 310-4 Index of Technical Manuals, Technical Bulletins, Supply Manuals (types 7, 8 and 9), Supply Bulletins and Lubrication Orders.
- DA Pam 310-7 U.S. Army Equipment Index of Modification Work Orders.
- TM 38-750 The Army Maintenance Management System (TAMMS).
- SB 38-100 Preservation, Packaging, Packing, and Marketing Materials, Supplies, and Equipment used by the Army.
- TB 746-10 Field Instruction for Painting and Preserving Electronic Equipment.
- TB 750-236 Calibration Requirements for the Maintenance of Army Material.

APPENDIX B

BASIC ISSUE ITEMS LIST AND ITEMS TROOP INSTALLED OR AUTHORIZED LIST

(Not Applicable)

APPENDIX C

MAINTENANCE ALLOCATION CHART

MAINTENANCE ALLOCATION CHART

Date: 1 June 1972

Nomenclature of End Item or Component:
Variable Filter, Mis-10329

This Maintenance Allocation Chart designates overall responsibility for the performance of maintenance functions on the identified end item or component. The implementation of field maintenance tasks upon this end item or component will be consistent with the assigned maintenance operations which are defined as follows:

Operation	Definition
Depot	That level of logistics which has the facilities, personnel and capabilities to equal the quality of the equipment repair available at the contractor's facilities. (D)
Reference	That level in the maintenance of calibration equipment which provides DS and GS logistical support. (H)
Transfer	That level in the maintenance of calibration equipment which provides organizational and limited DS logistical support to Secondary Transfer equipment. (F)

TOOLS REQUIRED PAGE

TOOL CODE	CATEGORY	NOMENCLATURE	TOOL NUMBER
1-b, f, i, & j	F	Analyzer, Distortion	7911957
	F	Counter, Electrical, Digital	7910823
	F	Oscillator Test	MIS-10224
	F	Transformer, Variable Power	7910809
	F	Voltmeter	7910329-2
	F	Voltmeter, Digital	7912606
	F	Adapter	10519439
	F	Adapter, 2 Each	7909401
	F	Adapter Connector, 2 Each	7909402
	F	Adapter Connector	7912356
	F	Cable Assembly, Radio Frequency	7907467
	F	Cable Assembly, Radio Frequency	7907470
	F	Cable Assembly, Radio Frequency, 2 Each	7907471
	F	Lead Electrical	7907491
1-c	F	Cleaner, Electrical Contact	6850-973-3122
	F	Brush, Artist	8020-224-8022
	F	Brush, Dusting	7920-685-3980
	F	Soft Cloth	7920-205-3571
1-g & 1-h	F	Screwdriver. Flat Tip	5120-237-6985
1-i & 1-j	F	Capacitance Measuring Assembly	4931-916-5952
	F	Bridge, Wheatstone	6625-585-3635
	F	Detector, Galvanometer	4931-788-0021
	F	Semiconductor Tester with Probe	4931-914-5185
	F	Heat Sink	(28493) 30A
	F	Multimeter	6625-649-3290
	F	Tool Kit, Electricians	5180-650-7821
	F	Soldering Iron	3439-800-8898
	F	Solder (QQ-S-571)	3439-821-7674

RESISTORS							
Symbol	Description	Mfr.	Part No.	Symbol	Description	Mfr.	Part No.
R101	100K 10% 1/2W	AB	EB1041	R238	1.2K 5% 1/2W	AB	EB1225
R102	1.5 3% 1W	TL	EL15	R239	100 10% 1/2W	AB	EB1011
R103	1.5 3% 1W	TL	EL15	R240	270 5% 1/2W	AB	EB2715
R104	100 20% 1/4W	AB	CB1012	R241	1K 20% 1/4W	AB	EB1022
R105	100 20% 1/4W	AB	CB1012	R242	7.5K 5% 1/2W	AB	EB7525
R106	1K 5% 1/4W	AB	CB1025	R243	750 5% 1/2W	AB	EB7515
R107	1K 5% 1/4W	AB	CB1025	R244	1K 20% 1/2W	AB	EB1022
R108	47 20% 1/2W	AB	EB4702	R245	220 10% 1/2W	AB	EB2211
R109	47 20% 1/2W	AB	EB4702	R246	1K 20% 1/4W	AB	CB1022
R110	45 3% 5W	TL	EL-5	R247	560 10% 1/2W	AB	EB5611
R111	100 20% 1/4W	AB	CB1012	R248	270 10% 1/2W	AB	EB2711
R112	100 20% 1/4W	AB	CB1012	R249	560 10% 1/2W	AB	EB5611
R113	45 3% 5W	TL	EL-5	R250	200 5% 1/2W	AB	EB2015
R114	10K 5% 1/4W	AB	CB1035	R251	3K 5% 1/2W	AB	EB3025
R115	10K 5% 1/4W	AB	CB1035	R252	10 20% 1/2W	AB	EB1002
R116	Trim			R253	220 10% 1/2W	AB	EB2211
R117	5.1K 5% 1/4W	AB	CB5125	R254	100 20% 1/2W	AB	EB1012
R118	Trim			R255	390 5% 1/2W	AB	EB3915
R119	1K 10% 1/4W	AB	CB1021	R256	5.1M 5% 1/2W	AB	EB5155
R120	1K 10% 1/4W	AB	CB1021	R257	910K 5% 1/2W	AB	EB9145
R121	1K 5% 1/4W	AB	CB1025	R258	100 20% 1/2W	AB	EB1012
R122	8.66K 1% 1/4W	IR	CEB-TO	R259	10 20% 1/2W	AB	EB1002
R123	10K 1% 1/4W	IR	CEB-TO	R260	470 20% 1/2W	AB	EB4712
R124	1K 10% 1/2W	AB	EB1021	R261	270 10% 1/2W	AB	EB2711
R201	10K 10% 1/2W	AB	EB1031	R262	100 20% 1/2W	AB	EB1012
R202	120K 1% 1/4W	IR	CEB-TO	R263	3K 5% 1/2W	AB	EB3025
R203	3K 5% 1/2W	AB	EB3025	R264	68 20% 1/2W	AB	EB6802
R204	910K 5% 1/2W	AB	EB9145	R265	47 20% 1/2W	AB	EB4702
R205	2.7M 5% 1/2W	AB	EB2755	R266	100 20% 1/2W	AB	EB1012
R206	1.5K 10% 1/2W	AB	EB1521	R267	430 5% 1/2W	AB	EB4315
R207	1K 10% 1/2W	AB	EB1021	R268	330 5% 1W	AB	GB3315
R208	470 20% 1/2W	AB	EB4712	R269	47 20% 1/2W	AB	EB4702
R209	3K 5% 1/2W	AB	EB3025	R270	5.1M 5% 1/2W	AB	EB5155
R210	100 20% 1/4W	AB	CB1012	R271	910K 5% 1/2W	AB	EB9145
R211	300 5% 1W	AB	GB3015	R272	100 20% 1/2W	AB	EB1012
R212	47 20% 1/2W	AB	EB4702	R273	470 20% 1/2W	AB	EB4712
R213	5.1M 5% 1/2W	AB	EB5155	R274	100 20% 1/2W	AB	EB1012
R214	910K 5% 1/2W	AB	EB9145	R275	3K 5% 1/2W	AB	EB3025
R215	470 20% 1/2W	AB	EB4712	R276	330 5% 1W	AB	GB3315
R216	470 20% 1/2W	AB	EB4712	R277	47 20% 1/2W	AB	EB4702
R217	3K 5% 1/2W	AB	EB3025	R278	10K 10% 1/2W	AB	EB1031
R218	100 20% 1/4W	AB	EB1012	R279	100K 50% 1/2W	AB	EB1045
R219	220 5% 1W	AB	GB2215	R280	100K ±20% 1/2W	CB	763F
R220	47 20% 1/4W	AB	CB4702	R281	180 10% 1/2W	AB	EB1811
R221	510 5% 1/2W	AB	EB5115	R282	100 10% 1/2W	AB	EB1011
R222	100 20% 1/2W	AB	EB1012	R301	Trim		
R223	1K 20% 1/2W	AB	EB1022	R302	Trim		
R224	1K 5% 1/2W	AB	EB1025	R303	Trim		
R225	4.7K 5% 1/2W	AB	EB4725	R304	Trim		
R226	100 20% 1/2W	AB	EB1012	R305	91 5% 1/2W	AB	EB9105
R227	3K 5% 1/2W	AB	EB3025	R306	10 5% 1/2W	AB	EB1005
R228	1K 20% 1/2W	AB	EB1022	R307	Trim		
R229	10M 10% 1/2W	AB	EB1061	R308	Trim		
R230	910K 5% 1/2W	AB	EB9145	R309	Trim		
R231	1K 20% 1/2W	AB	EB1022	R310	Trim		
R232	330 5% 1/2W	AB	EB3315	R311	510 5% 1/2W	AB	EB5115
R233	390 5% 1/2W	AB	EB3915	R312	10K 10% 1/2W	AB	EB1031
R234	820 5% 1/2W	AB	EB8215	R313	51 5% 1/2W	AB	EB5105
R235	330 5% 1/2W	AB	EB3315				
R236	100 20% 1/2W	AB	EB1012	R315	27 10% 1/2W	AB	EB2701
R237	180 10% 1/2W	AB	EB1811				

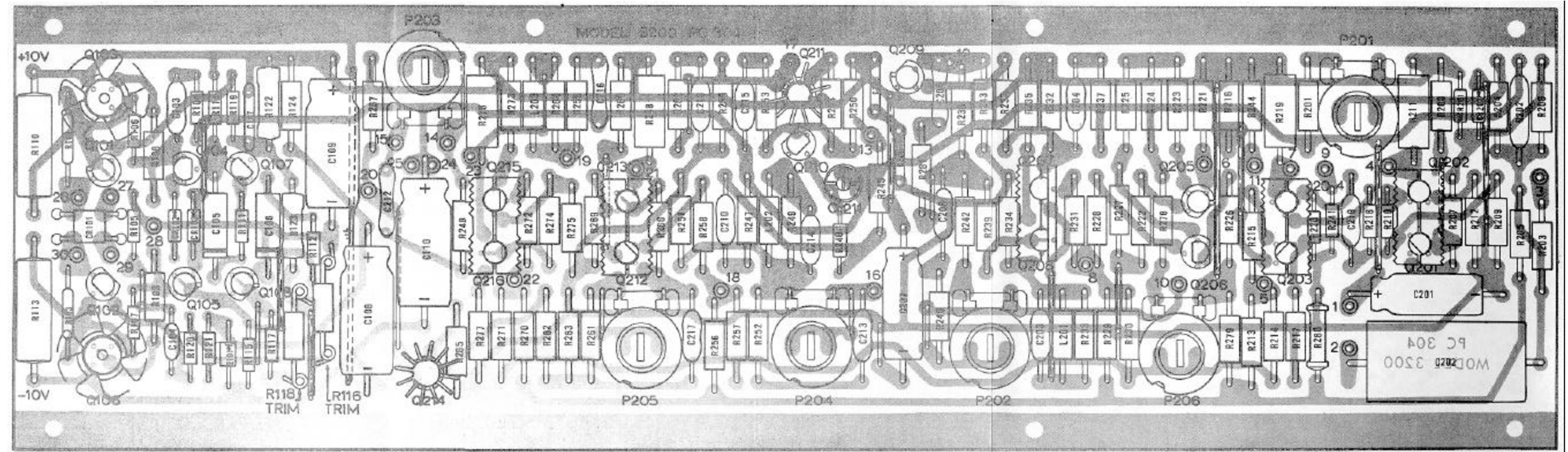

CAPACITORS (Cont.)							
Symbol	Description	Mfr.	Part No.	Symbol	Description	Mfr.	Part No.
C209	1mf +80% 25V	SP	5C023105X0250B3	C314	300pf 1% 500V	EL	DM15C301F
C210	33pf -20% 500V	EL	DM15C330K	C315	68pf 5% 500V	EL	CM29C680J
C211	7-35pf 10%	TS	75-Triko-027/35	C316	3-35pf 5% 500V	EL	T50310
C212	56pf 10% 500V	EL	DM15C560K	C317	1000pf 1% 500V	EL	CM19C102F
C213	75pf 10% 500V	EL	DM15C750K	C318	.01mf 1% 300V	EL	DM20C103F
C214	10pf 10% 500V	EL	DM15C100K	C319	.1mf 1% 100V	EP	BX6536
C215	22pf 10% 500V	EL	DM15C220K	C320	.1mf 5% 50V	EP	BX6534
C216	200pf 10% 500V	EL	DM15C201K	C321	27pf 10% 500V	EL	CM15C270K
C217	75pf 10% 500V	EL	DM15C750K	C322	3-35pf 5% 500V	EL	T50310
C218	51pf 10% 500V	EL	DM15C510K	C323	1000pf 1% 500V	EL	CM19C102F
C219	15pf 10% 500V	EL	DM15C150K	C324	300pf 5% 500V	EL	DM15C301J
C301	150pf 10% 500V	EL	DM15C151K	C325	2700pf 1% 300V	EL	CM20C272F
C303	3.2mf 1% 100V	EP	BX6538 B2417/C	C326	180pf 5% 500V	EL	CM19C181J
C304	.32mf 1% 100V	EP	BX6535	C327	8-60pf 5% 500V	EL	T-50410
C305	.032mf 1% 100V	EP	BX6537	C328	3200pf 1% 300V	EL	CM20C322F
C306	3000pf 1% 300V	EL	CM20C302F	C329	3.2mf 1% 100V	EP	BX6538 2417/C
C307	300pf 1% 500V	EL	DM15C301F	C330	.32mf 1% 100V	EP	BX6535
C308	62pf 5% 500V	EL	DM15C620J	C331	.032mf 1% 100V	EP	BX6537
C310	3.2mf 1% 100V	EP	BX6538 B2417/C	C332	500mf +75% -10% 12V	SP	D31924
C311	.32mf 1% 100V	EP	BX6535	C334	150pf 10% 500V	EL	DM15C151K
C312	.032mf 1% 100V	EP	BX6537	C335	3-35pf	EL	T50310
C313	3200pf 1% 300V	EL	CM20C322F				

TRANSISTORS, DIODES, & MISC. (Cont.)							
Symbol	Description	Mfr.	Part No.	Symbol	Description	Mfr.	Part No.
Q203	MPS6515	MO	MPS6515	P205	100 30% 1/4W	CT	RS9846
Q204	2N3136	MO	2N3136	P206	10K 30% 1/4W	CT	SA3432
Q205	2N3136	MO	2N3136	P301	6K ±10% 2W	AB	J92671A
Q206	MPS6515	MO	MPS6515	P302	6K ±10% 2W	AB	J92671A
Q207	MPS6515	MO	MPS6515	P303	5K ±20% 1/4W	AB	GA2G0205502MA
Q208	MPS6515	MO	MPS6515	P304	12.3K ±10% 2W	AB	J-93279B
Q209	2N3136	MO	2N3136	P305	12.3K ±10% 2W	AB	J-93279B
Q210	MPS6515	MO	MPS6515	L201	22mh 10% 1/4W	DL	1537-44
Q211	2N3136	MO	2N3136	L202	22mh 10% 1/4W	DL	1537-44
Q212	MPS6515	MO	MPS6515	L203	19mh 10% 1/4W	DL	1537-12
Q213	2N3136	MO	2N3136	S101	Toggle Switch	AL	MST-105D
Q214	2N3136	MO	2N3136	S102	Slide Switch	CW	G123
Q215	MPS6515	MO	MPS6515	S300	Rotary Switch	CL	C2570/A
Q216	2N3136	MO	2N3136	S301	Side Switch	CW	G-369
CR101	MDA-920-2	MO	MDA-920-2	T101	Transformer	KH	P100-89G
CR102	1N456	TR	1N456	I101	Pilot Light	ED	EG03-CBBNE2E
CR103	1N456	TR	1N456	F101	Model 3200(R), 1/4A Fuse, Slo-Blo	BU	MDL 1/8
CR201	SG5445	TR	SG5445	F101	Model 3202(R), 1/4A Fuse, Slo-Blo	BU	MDL 1/4
CR202	SG5445	TR	SG5445	F101	Model 3200(R), 1/16A Fuse, Slo-Blo	BU	MDL 1/16
Z101	LMZ-10 20% 10V	SM	LMZ-10-20	F101	Model 3202(R), 1/8A Fuse, Slo-Blo	BU	MDL 1/8
P201	10K 30% 1/4W	CT	SA3432				
P202	5K 30% 1/4W	CT	RS9847				
P203	5K 30% 1/4W	CT	RS9847				
P204	500 30% 1/4W	CT	SA3431				

CAPACITORS							
Symbol	Description	Mfr.	Part No.	Symbol	Description	Mfr.	Part No.
C101	500mf +75% -10% 25V	SP	62D/D46219	C110	100mf +100% -10% 25V	SP	30D107G025004
C102	500mf +75% -10% 25V	SP	62D/D46219	C201	50mf +100% -10% 25V	SP	30D506G025CC4
C103	100pf 10% 500V	EL	DM5C101K	C202	1mf 10% 200V	CD	BMM-2W1-1
C104	.01mf 20% 500V	SP	C023B501G103M	C203	10pf 10% 500V	EL	DM15C100K
C105	.01mf 10% 100V	CD	WMF1S1	C204	100pf 10% 500V	EL	DM15C101TK
C106	.01mf 10% 100V	CD	WMF1S1	C205	360pf 10% 500V	EL	DM15C361K
C107	1mf +80% -20% 25V	SP	5C023105X0250B3	C206	51pf 5% 500V	EL	DM15C510J
C108	100mf +100% -10% 25V	SP	30D107G025004	C207	50mf +100% -10% 25V	SP	30D506G025CC4
C109	100mf +100% -10% 25V	SP	30D107G025004	C208	1mf 80% -20% 25V	SP	5C023105X02503

TRANSISTORS, DIODES, & MISC.							
Symbol	Description	Mfr.	Part No.	Symbol	Description	Mfr.	Part No.
Q101	2N3136	MO	2N3136	Q106	2N4237	MO	2N24237
Q102	MPS6515	MO	MPS6515	Q107	MPS6515	MO	MPS6515
Q103	2N4234	MO	2N4234	Q108	2N3136	MO	2N3136
Q104	MPS6515	MO	MPS6515	Q201	MPS6515	MO	MPS6515
Q105	2N3136	MO	2N3136	Q202	2N3136	MO	2N3136

MANUFACTURERS CODE							
Symbol	Description	Mfr.	Part No.	Symbol	Description	Mfr.	Part No.
AB	Allen-Bradley Co.	Milwaukee, Wis.		EP	Elpac, Inc.	Fullerton, Calif.	
AL	Alcoswitch	Lawrence, Mass.		IR	International Resistance Co.	Philadelphia, Pa.	

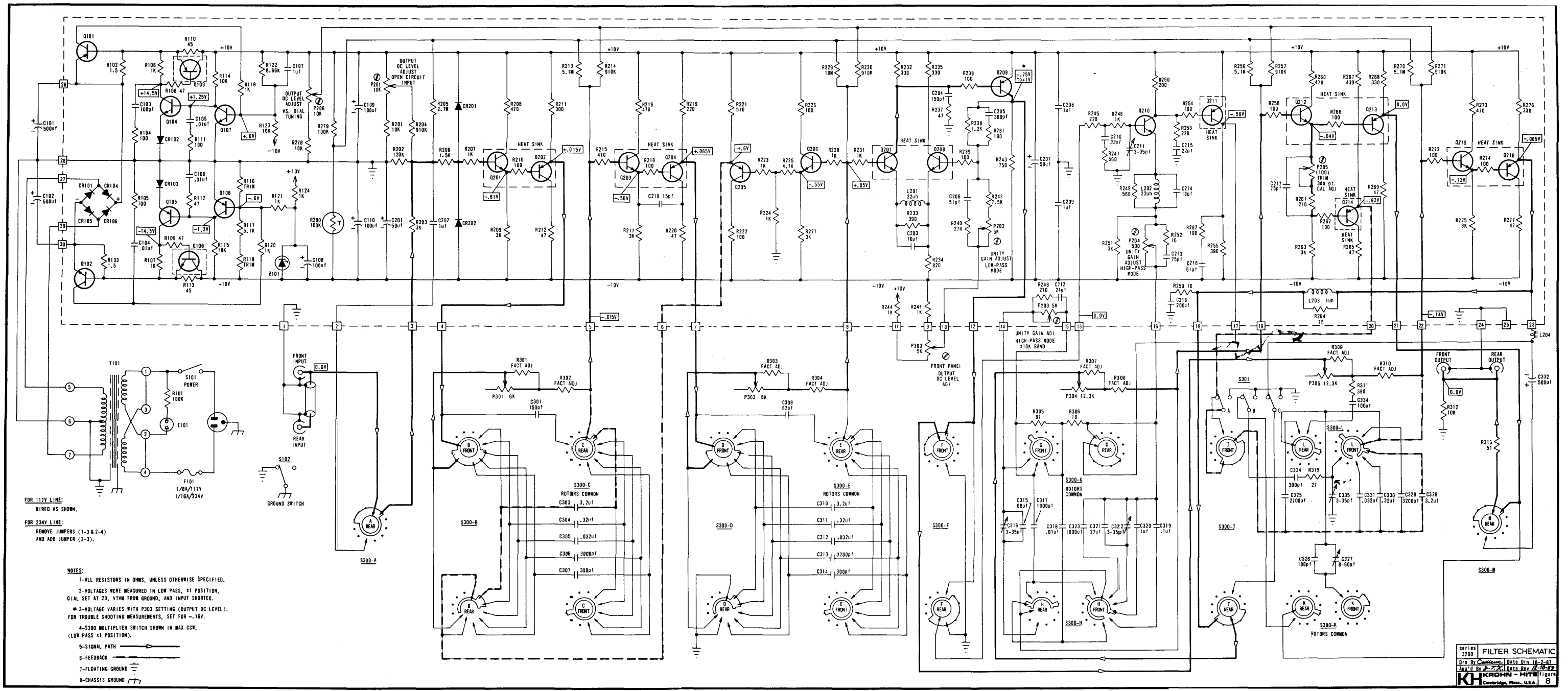

FOR 117V LINE:
WIRED AS SHOWN.

FOR 234V LINE:
REMOVE JUMPERS (1-3 & 2-4)
AND ADD JUMPER (2-3).

- NOTES:
- 1-ALL RESISTORS IN OHMS, UNLESS OTHERWISE SPECIFIED.
 - 2-VOLTAGES WERE MEASURED IN LOW PASS, X1 POSITION, DIAL SET AT 20, VENV FROM GROUND, AND INPUT SHORTED.
 - * 3-VOLTAGE VARIES WITH P303 SETTING (OUTPUT DC LEVEL). FOR TROUBLE SHOOTING MEASUREMENTS, SET FOR -.10V.
 - 4-S300 MULTIPLIER SWITCH SHOWN IN MAX. COM. (LOW PASS X1 POSITION).
 - 5-SIGNAL PATH
 - 6-FEEDBACK
 - 7-FLOATING GROUND
 - 8-CHASSIS GROUND

By Order of the Secretary of the Army:

Official:

BRUCE PALMER, JR.
General, United States Army
Acting Chief of Staff

VERNE L. BOWERS
Major General, United States Army
The Adjutant General

Distribution:

To be distributed in accordance with DA Form 12-34 (qty rqr block No. 75) requirements for calibration procedures publications.

