



Choosing the Right Trigger

Your oscilloscope offers many distinctive and useful techniques for triggering on and capturing data. These range from the simple *Edge* triggers to the advanced *SMART Trigger*® types, which trigger on multiple inputs.

Three triggering modes are available: AUTO, NORM and SNGL. Additionally, STOP enables the acquisition process to be aborted. All are directly accessible by pressing the respective front-panel buttons. (See *Chapter 6*.)

Modifying Trigger Settings Trigger adjustments are made directly using the front-panel controls and with the trigger menus.

Rotating  — for example — causes the scope to adjust the trigger level of the highlighted trace.

Pressing  accesses advanced trigger operations, such as changing the glitch width or the hold-off timeout, which are changed via the TRIGGER SETUP menu group (*Fig. 8-1*). Once the trigger configuration has been modified, changes are stored internally in a non-volatile memory.

This chapter describes the triggering operations and offers hints on how to perform them. Along with the standard menu descriptions, schematics show the trigger-menu structure, and diagrams explain how the main triggers work.

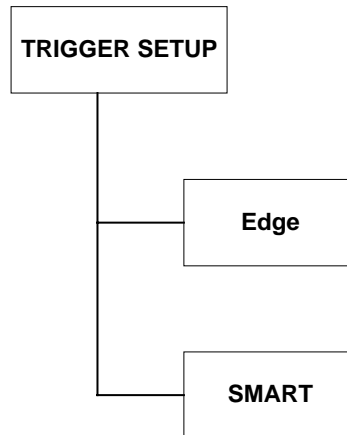

Figure 8-1. Main Trigger Menu.



Edge or SMART

A variety of triggers for different applications can be chosen from the two main trigger groups, the Edge and SMART trigger types.

Edge Triggers

In the Edge group of menus trigger conditions are defined by the vertical trigger level, coupling, and slope. Edge triggers use simple selection criteria to characterize a signal. They are most useful for triggering on simple signals (*see page 8–3*).

SMART Trigger

The SMART Trigger types allow additional qualifications to be set before a trigger is generated. These qualifications can be used to capture rare phenomena such as glitches or spikes, specific logic states, or missing bits. A qualification might include trigger generation only on a pulse wider or narrower than a user-specified limit. Or it might require — to take but another example — three trigger sources exceeding specific levels for a minimum time.

Generally speaking, SMART Trigger offers various trigger qualifications based on three basic abilities:

1. To count a specified number of events
2. To measure time intervals
3. To recognize a pattern input.

SMART explanations start page 8–10 and menus 8–Error! Bookmark not defined..

Trigger Symbols, illustrated throughout this chapter, allow immediate on-screen recognition of the current trigger conditions. There is a symbol for each Edge and SMART Trigger type, with the more heavily-marked transitions on the symbols indicating where a trigger will be generated.

Edge Trigger

Selecting Edge and its menus (*Fig. 8–2*) causes the scope to trigger whenever the selected signal source meets the trigger conditions. The trigger source is defined by the trigger level, coupling, slope or hold-off.

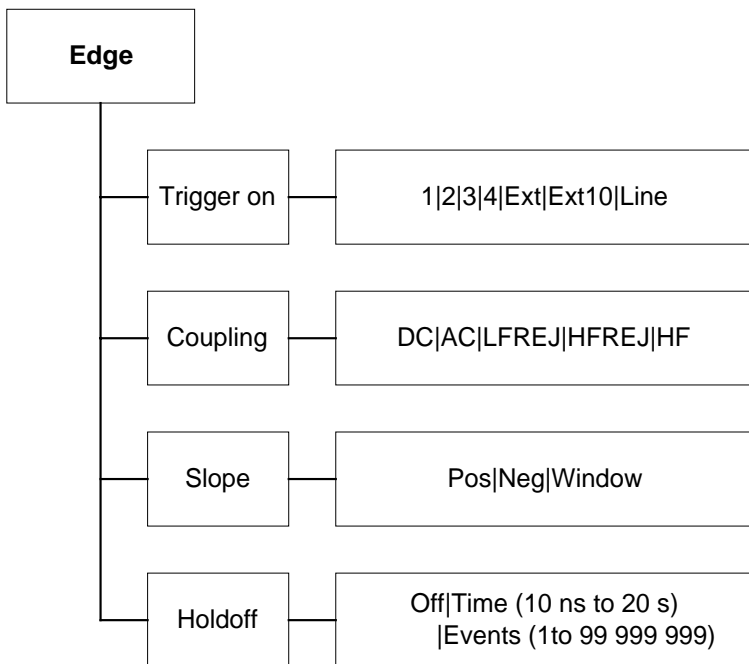

Figure 8–2. Edge Trigger Menu (see page 8–9).



Triggers and When to Use Them

Trigger Source

The trigger source may be:

- The acquisition channel signal (CH 1, CH 2 or CH 3, CH 4 on four-channel models) conditioned for the overall voltage gain, coupling, and bandwidth.
- The line voltage that powers the oscilloscope (LINE). This can be used to provide a stable display of signals synchronous with the power line. Coupling and level are not relevant for this selection.
- The signal applied to the EXT BNC connector (EXT). This can be used to trigger the oscilloscope within a range of ± 0.5 V, or ± 5 V with EXT/10 as trigger source.

Level

Level defines the source voltage at which the trigger circuit will generate an event (a change in the input signal that satisfies the trigger conditions). The selected trigger level is associated with the chosen trigger source. Note that the trigger level is specified in volts and is normally unchanged when the vertical gain or offset is modified.

The Amplitude and Range of the trigger level are limited as follows:

- ± 5 screen divisions with a channel as trigger source
- ± 0.5 V with EXT as trigger source
- ± 5 V with EXT/10 as trigger source
- None with LINE as trigger source (zero crossing is used).

Note: Once specified, Trigger Level and Coupling are the only parameters that pass unchanged from mode to mode for each trigger source.

Coupling

This is the particular type of signal coupling at the input of the trigger circuit. As with the trigger level, the coupling can be independently selected for each source. Thus changing the trigger source can change the coupling. The types of coupling able to be selected are:

-
- **DC:** All the signal's frequency components are coupled to the trigger circuit. This is used in the case of high-frequency bursts, or where the use of AC coupling would shift the effective trigger level.
 - **AC:** Here the signal is capacitively coupled. DC levels are rejected and frequencies below 50 Hz attenuated.
 - **LF REJ:** The signal is coupled via a capacitive high-pass filter network. DC is rejected and signal frequencies below 50 kHz attenuated. This mode is used when stable triggering on medium- to high-frequency signals is desired.
 - **HF REJ:** Signals are DC-coupled to the trigger circuit and a low-pass filter network attenuates frequencies above 50 kHz. The HF REJ trigger mode is used to trigger on low frequencies.
 - **HF:** Used for triggering on high-frequency repetitive signals in excess of 300 MHz. Maximum trigger rates greater than 500 MHz are possible. HF triggering should be used only when needed. It will be automatically overridden and set to AC when incompatible with other trigger characteristics — as is also the case for SMART Trigger. Only one slope is available, indicated by the trigger symbol.

Slope

Slope determines the direction of the trigger voltage transition used for generating a particular trigger event. Like coupling, the selected slope is associated with the chosen trigger source.

Hold-off

Hold-off disables the trigger circuit for a given period of time or a number of events after a trigger event occurs. It is used to obtain a stable trigger for repetitive, composite waveforms. For example, if the number or duration of sub-signals is known they can be disabled by choosing an appropriate hold-off value.

Without Hold-off, the time between each successive trigger event would be limited only by the input signal, the coupling, and the oscilloscope's bandwidth. Sometimes a stable display of complex repetitive waveforms can be achieved by placing a condition on this time. This hold-off is expressed either as a time or an event count, *described on the following pages.*



Triggers and When to Use Them

Hold-off by Time

This is the selection of a minimum time for triggers (*Fig. 8-3*). A trigger is generated when the trigger condition is met after the selected delay from the last trigger. The timing for the delay is initialized and started on each trigger. The hold-off timeout should exceed the duration of the signal displayed on screen. For instance, at a timebase setting of 1 ms/div, the time-out hold-off should at least exceed 10 ms.

Trigger Source: Positive Slope

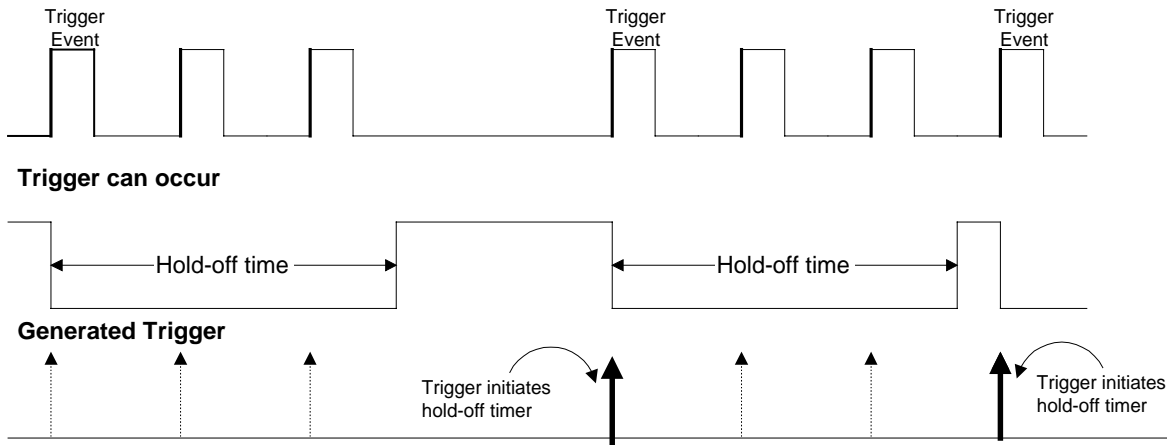

Figure 8-3. Edge Trigger with Hold-off by Time.

 1 LFREJ -0.52 V
H'off 426 μ s
NEGATIVE EDGE WITH HOLDOFF TRIGGER SYMBOL

Hold-off by Events

Hold-off by events is initialized and started on each trigger (Fig. 8-4). A trigger is generated when the trigger condition is met after the selected number of events from the last trigger. Event here refers to the number of times the trigger condition is met after the last trigger. For example, if the number selected is two, the trigger will occur on the third event.

Trigger Source: Positive Slope

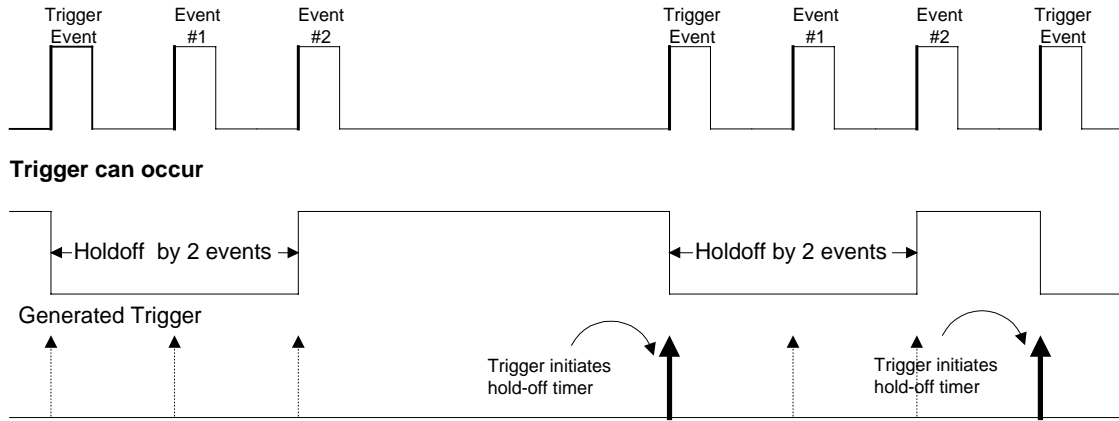
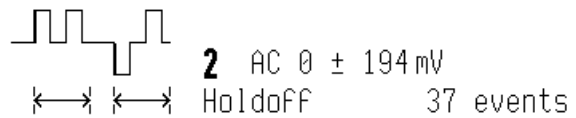

Figure 8-4. Edge Trigger with Hold-off by Events.



WINDOW TRIGGER WITH HOLDOFF SYMBOL

Triggers and When to Use Them

Window Trigger
AVAILABLE ONLY WITH
9304C, 9310C, 9314C
SERIES

On some scope models a “Window” Edge Trigger is also available (*Fig. 8–5*). Two trigger levels are defined and a trigger event occurs when the signal leaves the window region in either direction.

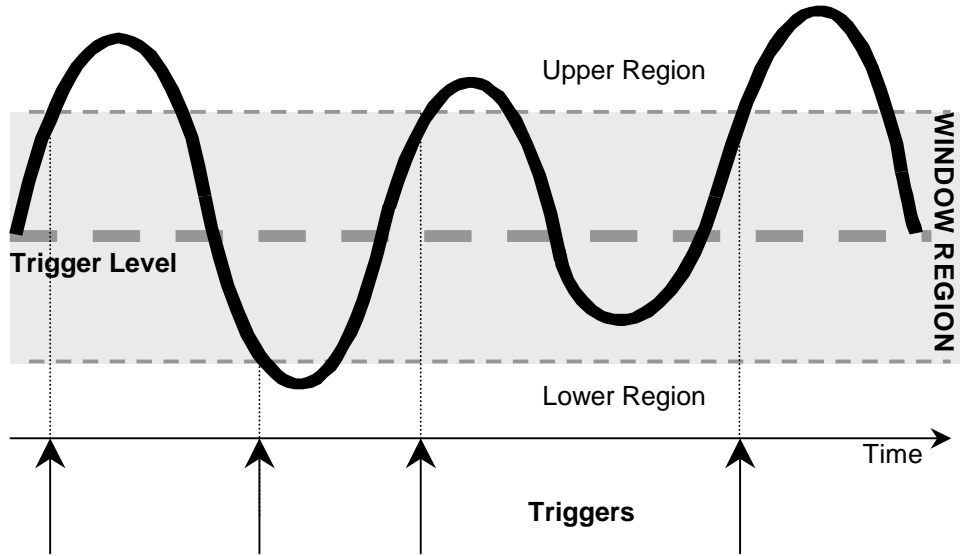
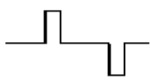

Figure 8–5. Edge Window Trigger.



2 HFREJ 28 ± 222 mV

WINDOW TRIGGER SYMBOL

TRIGGER SETUP: Edge

TRIGGER
SETUP

Press  to access menu selection of:

- Trigger source
- Coupling for each source
- Slope (positive or negative), and
- Hold-off by time or events.

Edge/SMART To select “Edge”

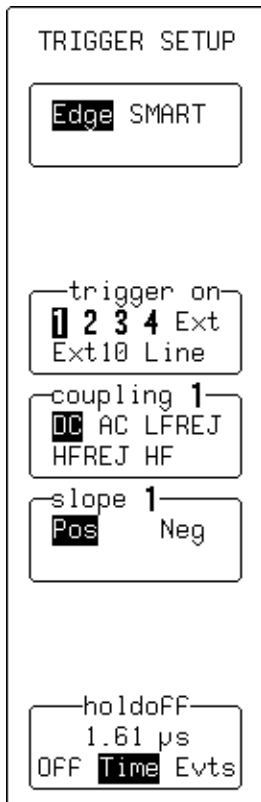

trigger on

For selecting the Edge trigger source (*four-channel menu shown*).

coupling

To select the trigger coupling for the current source.

slope

To place the trigger point on either the “**Pos**”-itive or “**Neg**”-ative slope of the selected source. On those models featuring Window Trigger (**9304C, 9310C, 9314C SERIES**), this menu will also include a “Window” option, which allows triggering whenever the input signal leaves a specified voltage window, defined in the “window size” menu. The “window size” menu becomes available on models featuring Window Trigger. It allows adjustment of the window around a level defined using the Trigger LEVEL knob.

holdoff

To allow the disabling of the oscilloscope's trigger circuit for a definable period of time or number of events *after* a trigger event occurs. When activated, “holdoff” can be defined as: a period of “**Time**”, or a number of “**Evts**” (an event being a change in the input signal that satisfies the trigger conditions). The menu knob is used to vary the “holdoff” value. Time hold-off values in the range 10 ns–20 s may be entered. Event counts in the range 1–10⁹ are allowed.



Triggers and When to Use Them

SMART Trigger

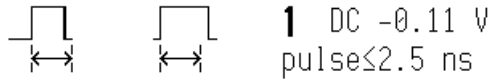

GLITCH TRIGGER SYMBOL

SMART Trigger allows the setting of additional qualifications before a trigger is generated. Depending on the oscilloscope model, this can include triggers adapted for glitches, intervals, abnormal signals, TV signals, state- or edge-qualified events, dropouts and patterns.

Glitch Trigger

Glitch Trigger (*Fig. 8-6*) is used to capture narrow pulses inferior to or exceeding a given time limit. In addition, a width range can be defined to capture any pulse that is comprised within or outside the specified range — an Exclusion Trigger.

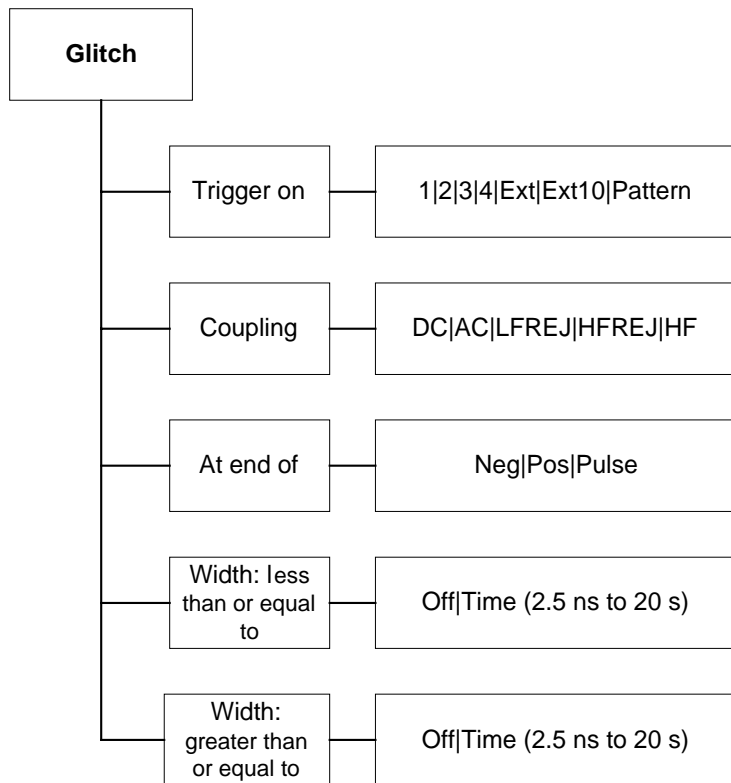

Figure 8-6. Glitch Trigger Menu (see page 8-30).

Applications

In digital electronics circuits normally use an internal clock, and for testing purposes a glitch can be defined as any pulse of width smaller than the clock- or half-period. But generally speaking a glitch is a pulse much faster than the waveform under observation. Glitch Trigger thus has a broad range of applications in digital and analog electronic development, ATE, EMI, telecommunications, and magnetic media studies.

Pulse Smaller than Selected Pulse Width

This Glitch Trigger selects a maximum pulse width (Fig. 8-7). It is generated on the selected edge when the pulse width is less than the selected width. The timing for the width is initialized and restarted on the slope opposite to the edge selected. Widths of between 2.5 ns and 20 s can be selected, but typically triggering will occur on glitches 1 ns wide.

Trigger Source



Trigger can occur

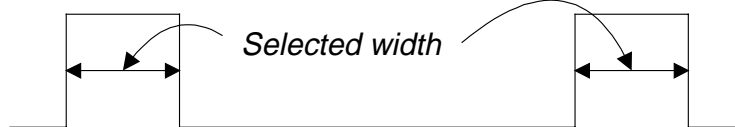

Generated Trigger



Figure 8-7. Glitch Trigger on pulse width < selected width.

 Ext AC 0.18 V 1M Ω
17.5 ns \leq pw \leq 37.5 ns

GLITCH TRIGGER WITH TIME WINDOW SYMBOL



Triggers and When to Use Them

Exclusion Trigger

Exclusion Trigger enables the exclusion of events over a determined time interval. Exclusion Trigger is generated on the selected edge when the pulse width is within or outside the selected width range. For example (Fig. 8-8), only pulses smaller than 25 ns or longer than 27.5 ns will generate the trigger. The timing for the width is initialized and restarted on the slope opposite to the edge selected. Widths of between 2.5 ns and 20 s can be selected.

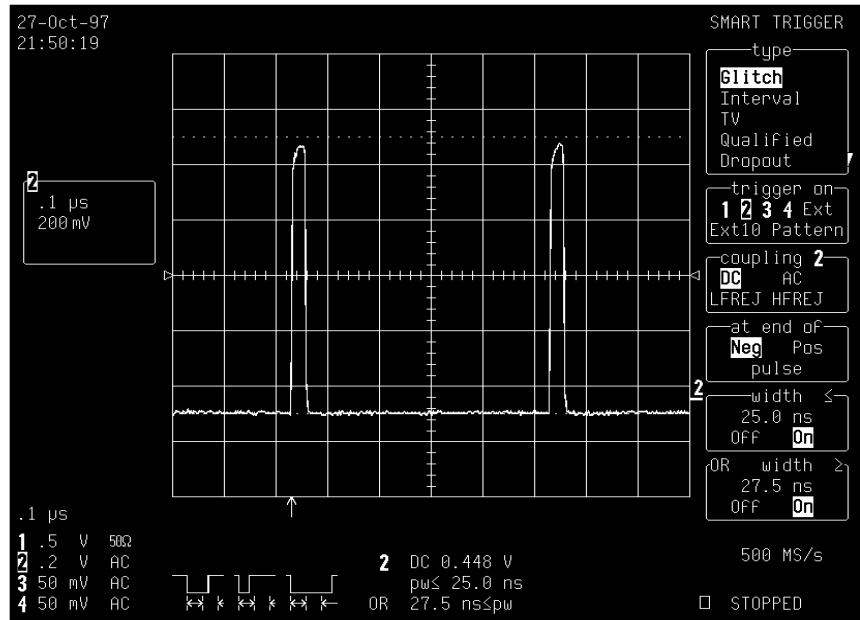
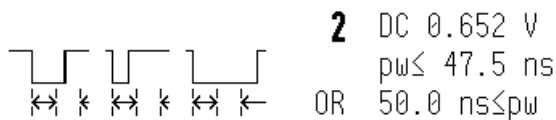

Figure 8-8. Exclusion Trigger. Only pulses within or outside the boundaries of the width range are captured.

Applications

Exclusion Triggers allow a signal's normal width or period to be specified, with the scope instructed to ignore the normally shaped signals and trigger only on abnormal ones. Circuit failures, for instance, can be looked for all the time.



EXCLUSION TRIGGER SYMBOL

Interval Trigger

Whereas Glitch Trigger performs over the width of a pulse, Interval Trigger (*Fig. 8–9*) performs over the width of an interval. An interval corresponds to the signal duration separating two consecutive edges of the same polarity. Interval Trigger is used to capture intervals that are inferior to or exceeding a given time limit. In addition, a width range can be defined to capture any interval that is comprised within or outside the specified range — an Exclusion Trigger by Interval.

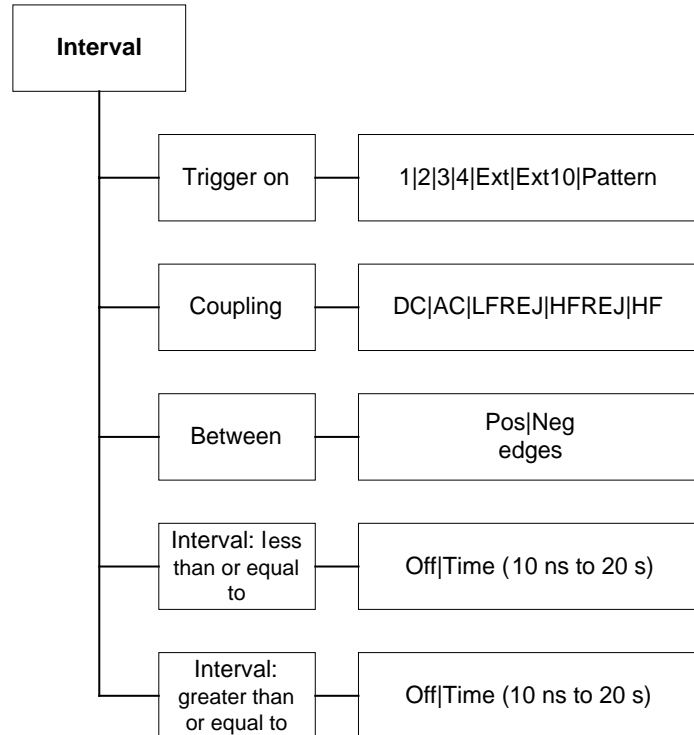

Figure 8–9. Interval Trigger Menu (see page 8–32).

Applications

Interval Trigger is helpful for determining missing cycles or transitions, and for ignoring unwanted signal reflections.



Triggers and When to Use Them

Interval Smaller

For this Interval Trigger, generated on a time interval *smaller* than the one selected, a *maximum* interval between the two edges of the same slope is chosen (Fig. 8-10). The trigger is generated on the second edge if it occurs within the selected interval. The timing for the interval is initialized and restarted whenever the selected edge occurs. Intervals of between 10 ns and 20 s can be selected.

Trigger Source: Positive Slope

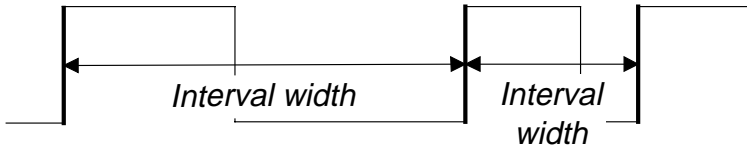

Trigger can occur

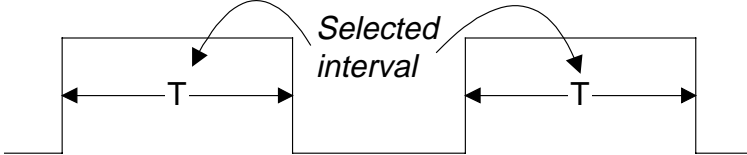

Generated Trigger



Figure 8-10. Interval Trigger: Trigger if the interval is smaller than the selected interval.

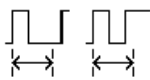

```
Ext10 AC 0.5 V 1MΩ
17.5 ns<interval
```

INTERVAL TRIGGER SYMBOL

Interval Larger

For this Interval Trigger, generated on an interval *larger* than the one selected, a *minimum* interval between the two edges of the same slope is chosen (Fig. 8-11). The trigger is generated on the second edge if it occurs after the selected interval. The timing for the interval is initialized and restarted whenever the selected edge occurs. Intervals of between 10 ns and 20 s can be selected.

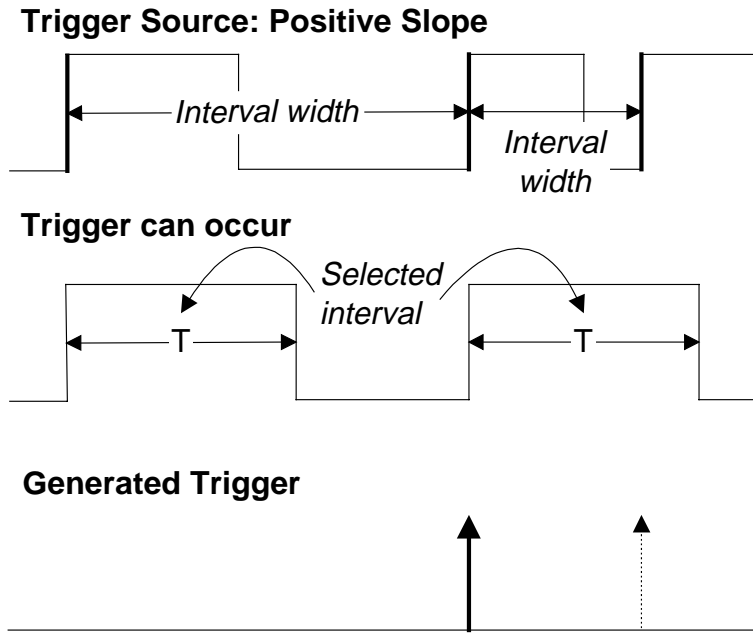

Figure 8-11. Interval Trigger: Trigger if the interval is greater than the selected width.



Triggers and When to Use Them

Interval Between Range

This Interval Trigger selects a maximum interval between the two edges of the same slope (Fig. 8-12). The trigger is generated on the second edge if it occurs within the selected interval range. The timing for the interval is initialized and restarted whenever the selected edge occurs. Intervals of between 10 ns and 20 s can be selected.

Trigger Source: Positive Slope

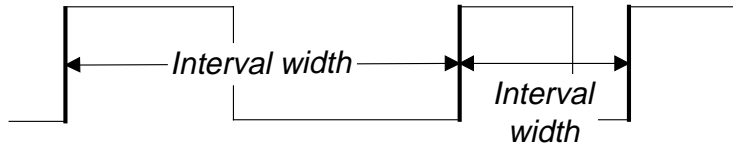

Trigger can occur

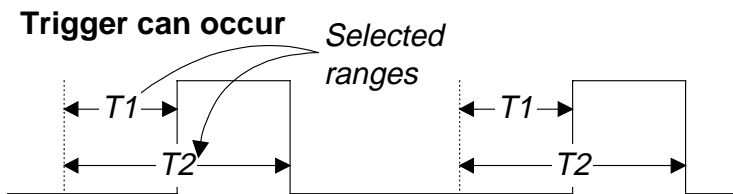

Generated Trigger



Figure 8-12. Interval Trigger: Trigger if the interval is between the selected ranges.

```

┌───┐ ┌───┐ ┌───┐ Ext10 AC 0.5 V 50Ω
│   │ │   │ │   │ 715 ns ≤ iw ≤ 1.37 μs
└───┘ └───┘ └───┘

```

INTERVAL TRIGGER WITH TIME WINDOW SYMBOL

Interval Outside Range

This Interval Trigger selects a minimum interval between the two edges of the same slope (*Fig. 8-13*). The trigger is generated on the second edge if it occurs after the selected interval range. The timing for the interval is initialized and restarted whenever the selected edge occurs. Intervals of between 10 ns and 20 s can be selected.

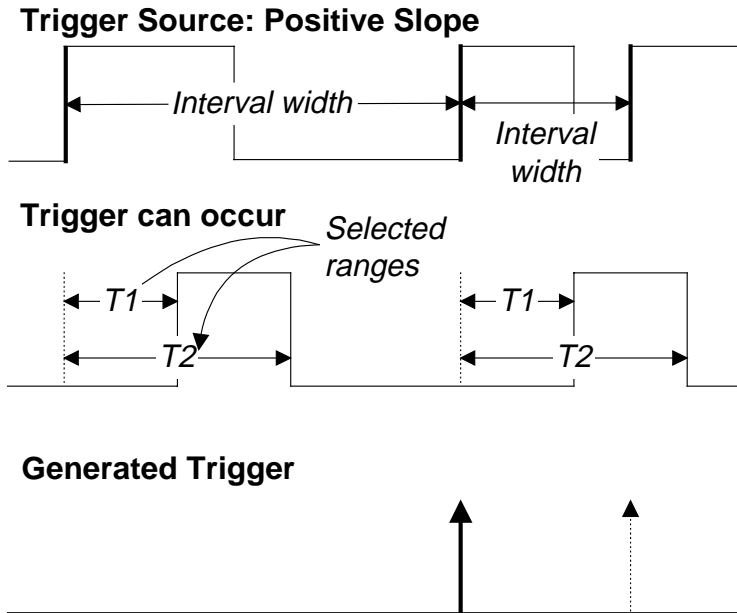

Figure 8-13. Interval Trigger: Trigger if the interval is outside the selected ranges.



Triggers and When to Use Them

Pattern Trigger

**NOT AVAILABLE ON 9304C,
9310C, 9314C SERIES**

Pattern Trigger (*Fig. 8-14*) enables triggering on a logical combination of the inputs CH 1, CH 2 (plus CH 3 and CH 4 on four-channels models) and EXT. This combination, called a pattern, is defined as the logical AND of trigger states. A trigger state is either high or low: high when a trigger source is greater than the trigger level (threshold); low when less than this threshold (*Fig. 8-15*). For example, the pattern could be defined as present when the trigger state for CH 1 is high, CH 2 is low, and EXT is irrelevant (X or don't care). If any of these conditions are not met, the pattern state is considered absent. Limits can be selected from 10 ns to 20 s.

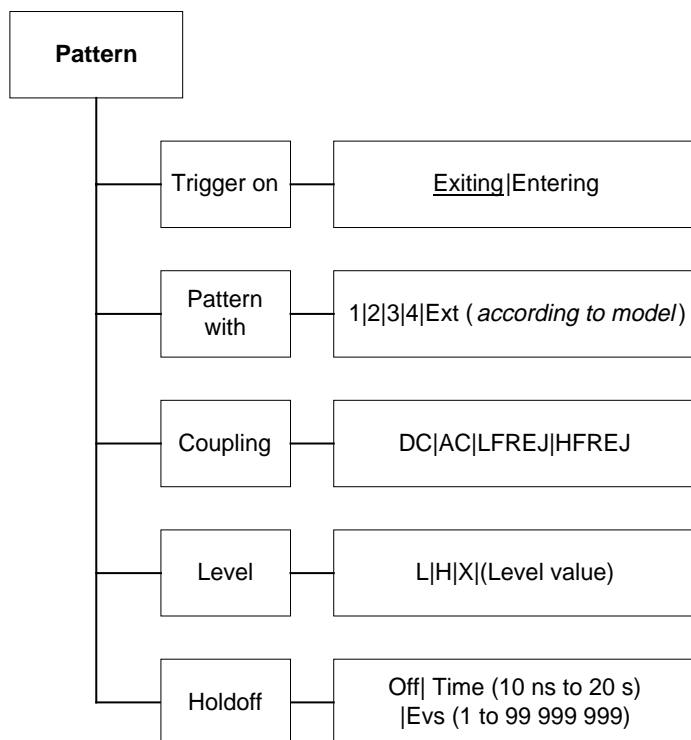

Figure 8-14. Pattern Trigger Menu (see page 8-33).

Applications

Pattern Trigger is useful in digital design for the testing of complex logic inputs or data transmission buses.

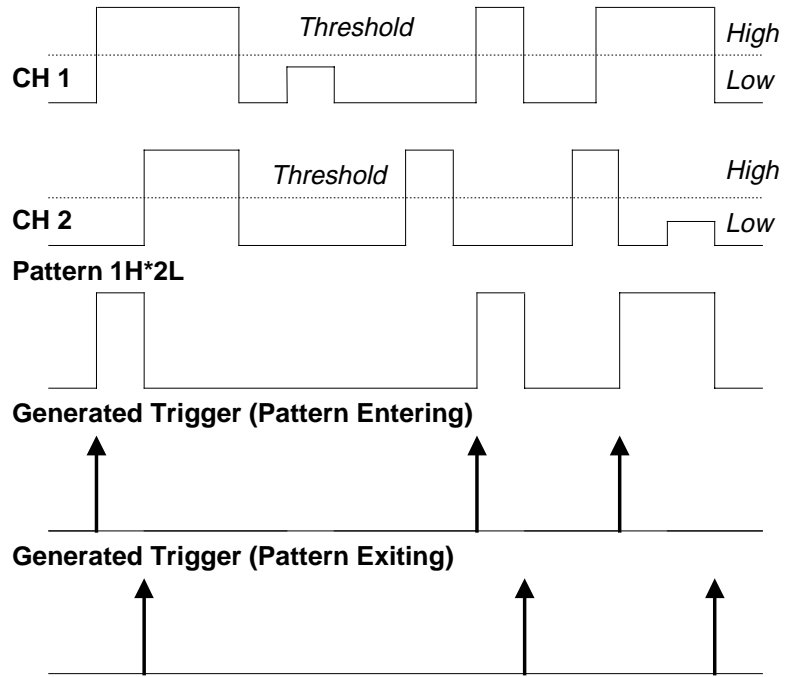

Figure 8–15. Pattern Trigger: Trigger when pattern conditions met.

 Enter **1L*2H*3H*4H*EL**
PATTERN TRIGGER SYMBOL



Triggers and When to Use Them

More About Pattern Trigger Once the pattern is defined, one of two transitions can be used to generate the trigger. When the pattern begins, called *entering* the pattern, a trigger can be generated. Alternatively, a trigger can be generated when the pattern ends, *exiting* the pattern.

With pattern triggering, as in single source, either of these qualifications can be selected: Hold-off for 10 ns up to 20 s, or Hold-off for 1 to 99 999 999 events.

Set to Pattern Trigger, the oscilloscope always checks the logic AND of the defined input logic states. However, with the help of de Morgan's laws, the pattern becomes far more generalized.

Consider the important example of the Bi-level or Window Pattern Trigger. Bi-level implies the expectation of a single-shot signal on which the amplitude will go in either direction outside a known range. To set up a Bi-level Pattern trigger, connect the signal to two inputs: Channels 1 and 2 or any other pair that can be triggered on. For example, the threshold of CH 1 could be set to +100 mV and that of CH 2 at -200 mV. The Bi-level Trigger will occur if the oscilloscope triggers on CH 1 for any pulse greater than +100 mV, or on CH 2 for any pulse less than -200 mV. For improved precision, the gains of the two channels should be at the same setting.

In Boolean notation we can write:

$$\text{Trigger} = \text{CH 1} + \overline{\text{CH 2}},$$

i.e. trigger when entering the pattern CH 1 = high OR CH 2 = low.

By de Morgan's laws this is equivalent to:

$$\text{Trigger} = \overline{\overline{\text{CH 1}} \cdot \overline{\text{CH 2}}},$$

i.e. trigger when exiting the pattern CH 1 = low AND CH 2 = high.

This configuration can be easily programmed.

The possibility of setting the threshold individually for each channel extends this method so that it becomes a more general Window Trigger: in order to trigger the input pulse amplitude must lie within or outside a given arbitrary window.

Pattern Trigger has been designed to allow a choice of the trigger point. By choosing *1L*2H entering*, the trigger will occur at the moment the pattern 1L*2H becomes true.

Qualified Triggers

In the case of Qualified Triggers (*Fig. 8–16*), a signal's transition above or below a given level, the *validation*, serves as an enabling, or qualifying, condition for a second signal that is the source of the trigger.

Two Qualified Triggers are available: State-Qualified, where the amplitude of the first signal must remain in the desired state until the trigger occurs, and Edge-Qualified, for which the validation is sufficient and no additional requirement is placed on the first signal.

A Qualified Trigger can occur immediately after the validation or within a set time after it. Or it can occur following a predetermined time delay or number of potential trigger events. The time delay or trigger count is restarted with every validation.

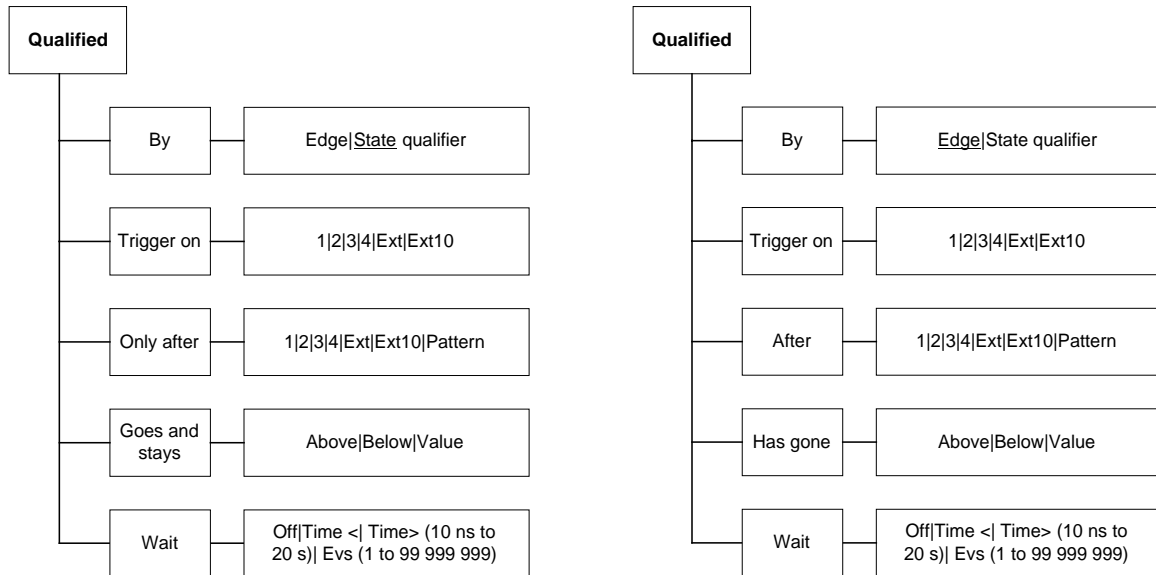

Figure 8–16. State- and Edge-Qualified Trigger Menus (see pages 8–35 and 8–36).



Triggers and When to Use Them

Qualified Triggers offer the choice of generating a trigger either when the selected pattern is present or absent. As with Pattern Trigger, the pattern is defined as a logical AND combination of trigger states that are either high or low: high when a trigger source is greater than the selected trigger level, and low when it is less than. For example, a pattern might be defined as present when the trigger states for Channels 1 and 2 are high and EXT is low. If any of these conditions is not met, the pattern state is considered absent.

Qualified Triggers allow an additional qualification once the selected pattern state occurs. For example: “wait for 10 ns up to 20 s, trigger on CH 1 to the 99 999 999th event”. The pattern is used to qualify the trigger without actually generating it. Triggering will occur when another signal, the trigger source, meets its trigger condition while the pattern is present. The trigger source itself is not allowed in the pattern.

Applications

Typical applications can be found wherever time violations occur, such as in micro-processor debugging or telecommunications.

State-Qualified with Wait

State-Qualified Trigger with Wait (*Fig. 8-17*) is determined by the parameters of Time and number of Events:

- **Time** selects a delay from the start of the desired pattern. After the delay (timeout) and while the pattern is present, a trigger can occur. The timing for the delay is restarted when the selected pattern begins
- **Events** selects a minimum number of events of the trigger source. An event is generated when a trigger source meets its trigger conditions. On the selected event of the trigger source and while the pattern is present, a trigger can occur. The count is initialized and started whenever the selected pattern begins, and continues while the pattern remains. When the selected count is reached, the trigger occurs.

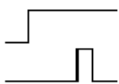

2 AC 84.0 mV
1 DC -0.12 V

STATE-QUALIFIED TRIGGER SYMBOL

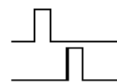

2 AC 84.0 mV
1 DC -0.12 V

EDGE-QUALIFIED TRIGGER SYMBOL

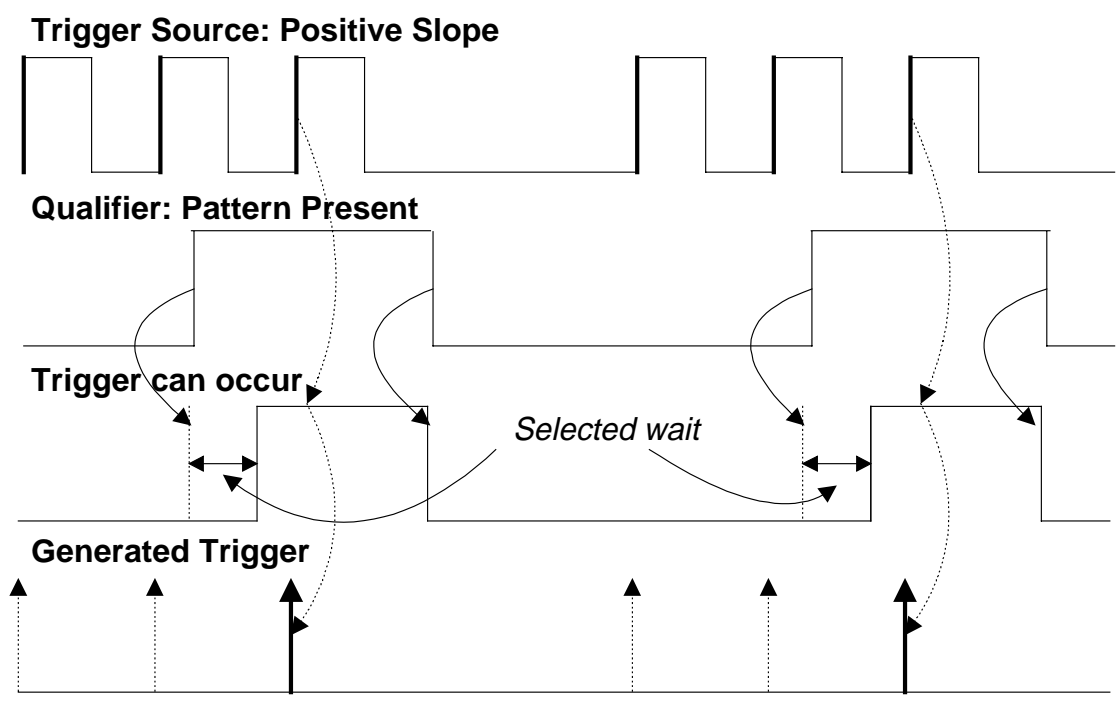
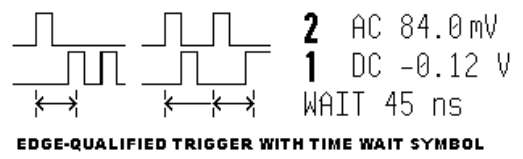

Figure 8–17. State-Qualified by Wait: Trigger after timeout.

As Figure 8–17 illustrates, a trigger is generated on a rising edge whenever the pattern is asserted (pattern present) and the wait timeout has expired. The timeout is, respectively, activated or disabled once the pattern is asserted or absent.





Triggers and When to Use Them

Edge-Qualified with Wait

Like its State-Qualified equivalent, Edge-Qualified with Wait (Fig. 8-18) is conditioned by Time and Events:

- **Time** Selects a delay from the start of the desired pattern. After the delay (timeout) and before the end of the pattern, a trigger can occur. The timing for the delay is restarted when the selected pattern begins.
- **Events** selects a minimum number of events of the trigger source. An event is generated when a trigger source meets its trigger conditions. On the selected event of the trigger source and before the end of the pattern, a trigger can occur. The count is initialized and started whenever the selected pattern begins. It continues while the pattern remains. When the selected count is reached, the trigger occurs.

Trigger Source: Positive Slope

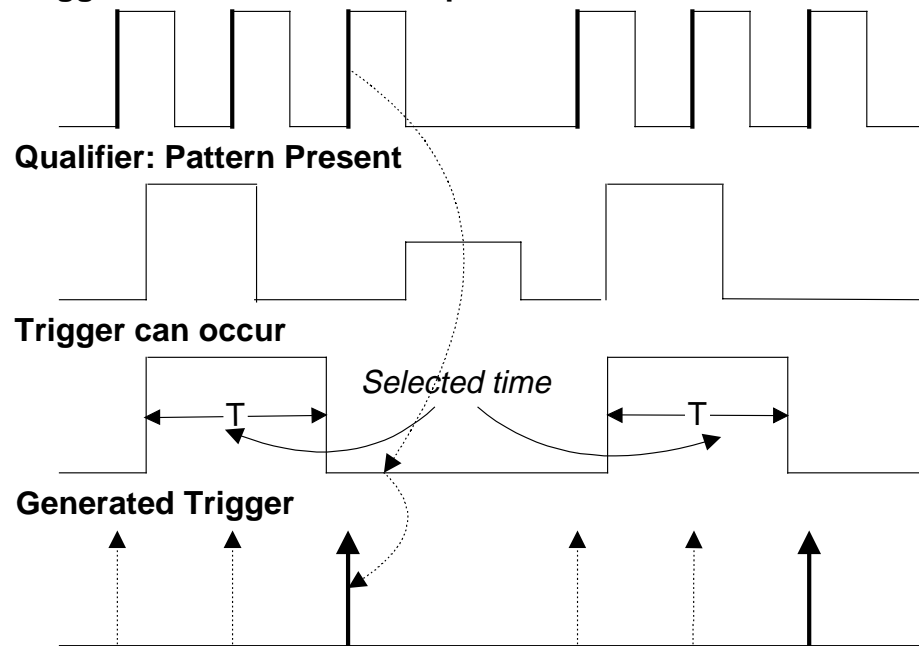

Figure 8-18. Edge-Qualified by Wait: Trigger after timeout.

TV Trigger

A special kind of Edge-Qualified Trigger, TV Trigger allows stable triggering on standard or user-defined composite video signals, on a specific line of a given field. Applications can be found wherever TV signals are present. And TV Trigger can be used on PAL, SECAM or NTSC systems.

A composite video signal on the trigger input is analyzed to provide a signal for the beginning of the chosen field — “any”, “odd” or “even” — and for a signal at the beginning of each line. The field signal provides the starting transition, and the beginnings of line pulses are counted to allow the final trigger on the chosen line.

Each field, the number of fields, the field rate, interlace factor, and number of lines per picture must be specified — although there are standard settings for the most common types of TV signals. TV Trigger can also function in a simple any-line mode.

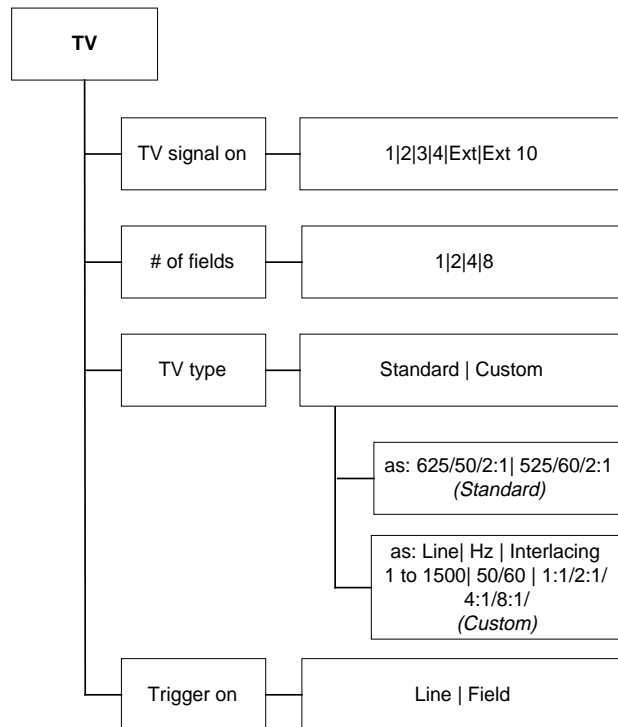

Figure 8–19. TV Trigger Menus (see page 8–34)



Triggers and When to Use Them

Notes for TV Trigger

- *Because most TV systems have more than two fields, the enhanced field-counting capability (FIELDLOCK) allows the oscilloscope to trigger consistently on a chosen line within a chosen field of the signal. The field-numbering system is relative, in that the oscilloscope cannot distinguish between lines 1, 3, 5, and 7 (or 2, 4, 6, and 8) in an absolute way.*
- *For each of the characteristics the following remarks apply:*
 - **625/50/2:1 (PAL and SECAM systems)**

This setting should be used for most of the standard 50-field signals. The lines may be selected in the range 1 to 626 where line 626 is identical to line 1.

Number of fields: eight is most useful for color PAL signals; four for SECAM signals.
 - **525/60/2:1 (NTSC systems)**

This setting should be used for standard 60-field NTSC signals. The lines can be selected in the range 1 to 1051, where line 1051 is identical to line 1.

Number of fields: four is most useful for US-type NTSC systems.
 - **?/50/?, ?/60/?**

In order to allow maximum flexibility, no line-counting convention is used. The line count should be thought of as a line-synchronizing pulse count. It includes the transitions of the equalizing pulses. For certain extreme cases, the field transition recognition will no longer work, and only the “any line” mode will be available.
- *The enhanced field-counting capability cannot be used for RIS acquisitions.*
- *Composite video signals must have negative-going synch to be decoded correctly.*

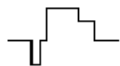

1 Line 283(20) Field 2,
525/60/2:1

TV TRIGGER SYMBOL

Dropout Trigger

Dropout Trigger (*Fig. 8–20*) provides triggering whenever the signal disappears for a selectable period of time. The trigger is generated at the end of the time-out period following the “last” trigger source transition. Time-outs of between 25 ns and 20 s can be selected.

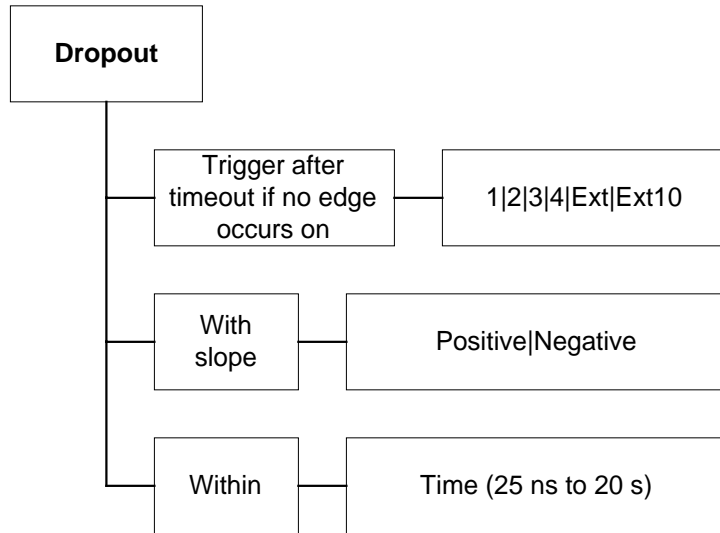

Figure 8–20. Dropout Trigger Menu (see page 8–37)

Applications

Dropout Trigger is useful for detecting interruptions in data streams such as network hang-ups and microprocessor crashes.

A typical application is on the last ‘normal’ interval of a signal that has disappeared completely. This is essentially a single-shot application, usually with a pre-trigger delay. RIS acquisition is not useful here because the timing of the trigger timeout is insufficiently correlated with the input channel signals.

Triggers and When to Use Them

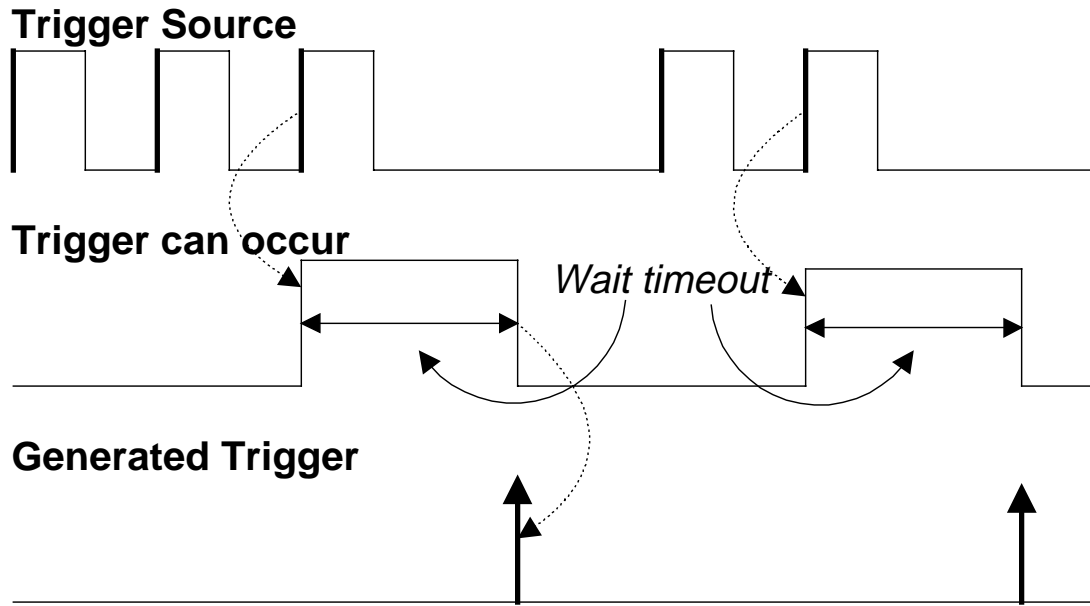



Figure 8–21. Dropout Trigger: A trigger occurs when the timeout has expired.



TRIGGER SETUP: SMART

TRIGGER
SETUP

Press  to access, too, the various SMART Trigger types, to trigger on:

- Glitches
- Intervals
- Abnormal signals (Exclusion Trigger)
- Patterns (*NOT AVAILABLE ON 9304C, 9310C, 9314C SERIES*)
- State- or edge-qualified events
- TV signals
- Dropouts.

Edge/SMART To select “SMART

SETUP SMART TRIGGER

This is primary menu that accesses the “SMART TRIGGER” menu group, for choosing the type of SMART Trigger required from the “type” secondary menu. *This and the other SMART menus are described starting page 8–30.*

TRIGGER SETUP

Edge **SMART**
(Glitch)

SETUP SMART
TRIGGER

trigger on
1 2 3 4 Ext
Ext10 Pattern

coupling **1**
DC AC
LFREJ HFREJ

at end of
Neg Pos
pulse

width ≤
7.5 ns
OFF **On**

& width ≥
2.5 ns
OFF **On**

Triggers and When to Use Them

SMART TRIGGER — Glitch

SMART TRIGGER

type
Glitch
Interval
TV
Qualified
Dropout

trigger on
1 2 3 4 Ext
Ext10 Pattern

coupling 1
DC AC
LFREJ HFREJ

at end of
Neg Pos
pulse

width ≤
12.5 ns
OFF On

& width ≥
2.5 ns
OFF On

type

To select “Glitch”.

trigger on

For selecting the trigger source (*four-channel menu shown*).

coupling

To select the trigger coupling.

at end of

To define the test on either “Pos”-itive or “Neg”-ative pulses.

width ≤

When “On” instructs the instrument to trigger if the pulse is smaller than the value defined in this field. The value can be adjusted with the associated menu knob, while the test can be turned on or off by pressing the menu button, and used in combination with the “width ≥” test. Width values in the range 2.5 ns to 20 s can be entered.

& width ≥

“On” instructs the instrument to trigger if the pulse is greater than the value defined in that field. The value can be adjusted using the associated menu knob, and the test turned on or off with the menu button in combination with the “width ≤” test menu selection. The two width limits are combined to select glitches within (“&”) a certain range if the “width ≤” value is greater than the “width ≥” value. Otherwise, they are combined to select glitches outside this range.

SMART TRIGGER — Glitch — Pattern*(NOT ON 9304C, 9310C, 9314C SERIES)*

SMART TRIGGER

type
Glitch
Interval
TV
Qualified
Dropout

trigger on
1 2 3 4 Ext
Ext10 Pattern

for pattern
Present
Absent

width ≤
12.5 ns
OFF On

& width ≥
2.5 ns
OFF On

When **“Pattern”** is selected in Glitch mode, the instrument triggers on the logic AND of up to five sources.

type

To select **“Glitch”**.

trigger on

To select **“Pattern”** (*four-channel menu shown*).

for pattern

For selecting pattern **“Present”** or **“Absent”**.

width ≤

To trigger if the pattern is present or absent for less than the time value defined in that field. The value can be adjusted with the associated menu knob and the test commuted to **“≥”** by pressing the corresponding menu button.

& width ≥

To trigger if the pattern is present or absent for more than the time value defined in that field. The value can be adjusted and the test commuted to **“≤”** as per **“width ≤”**.



Triggers and When to Use Them

SMART TRIGGER — Interval

SMART TRIGGER

type
Glitch
Interval
TV
Qualified
Dropout

trigger on
1 2 3 4 Ext
Ext10 Pattern

coupling 1
DC AC
LFREJ HFREJ

between
Pos Neg
edges

interval \leq
42.5 ns
OFF **On**

OR interval \geq
0.645 ms
OFF **On**

type

To select "Interval".

trigger on

For selecting the trigger source (*four-channel menu shown*).

coupling

For selecting the trigger coupling.

between

To define the interval between two adjacent "Pos"-itive or "Neg"-ative edges.

interval \leq

To trigger if the interval is smaller than the value defined here, which can be adjusted using the associated knob. The test can be turned on or off with the corresponding menu button, and can be used in combination with the "interval \geq " test. Interval values in the range 10 ns to 20 s may be entered.

OR interval \geq

To trigger if the interval is greater than the value defined here, which can be adjusted using the associated menu knob. The test can be turned on or off using the corresponding menu button, and can be used in combination with the "interval \leq " test. The two interval limits are combined to select intervals within ("&") a range if the "interval \leq " value is greater than the "interval \geq " value. Otherwise they are combined to select intervals outside ("OR") the range.

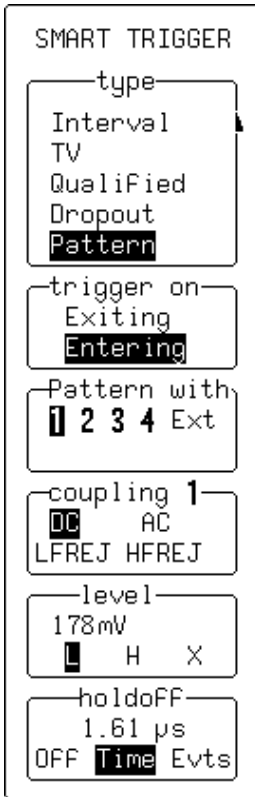

type

To select **“Pattern”**.

trigger on

To select **“Entering”** for the scope to trigger when the pattern starts being *true*, and **“Exiting”** for triggering when it stops being *true*.

Pattern with

For selecting the channel to be modified using the lower menus’ corresponding menu buttons (*four-channel menu shown*).

coupling

To select the desired coupling. HF coupling is not available for Pattern Trigger.

level

For modifying these values using the associated knob — adjusts the level — and the corresponding menu button, which chooses **“L”** (low), **“H”** (high), or **“X”** (Don’t care).

holdoff

To disable the trigger circuit for a definable period of time or number of events *after* a trigger event (a change in the input signal that satisfies the trigger conditions). When not turned off, holdoff can be defined as a period of **“Time”** or a number of **“Evts”** (events). Use the associated menu knob to vary the “holdoff” value. Time holdoff values in the range 10 ns–20 s may be entered. Event counts in the range 1–10⁹ are allowed.



Triggers and When to Use Them

SMART TRIGGER — TV

SMART TRIGGER	
type	
Glitch	
Interval	
TV	
Qualified	
Dropout	
TV signal on	
1 2 3 4 Ext	
Ext10	
# of Fields	
1	2
4	8
TV type	
Standard	
Custom	
as	
625/50/2:1	
525/60/2:1	
trigger on	
Line	Field
315	2

type

To select "TV" .

TV signal on

For selecting the trigger source (*four-channel menu shown*).

of fields

To define the number of fields — up to eight.

TV type

For selecting either "Standard" or "Custom" TV decoding.

as

When "Standard" is chosen, for selecting either "625/50/2:1" (PAL SECAM) or "525/60/2:1" (NTSC) standards.

When "Custom" is selected, for specifying the number of lines and cycles, and setting the interlacing factor for non-standard TV signals.

trigger on

For selecting the line and field number on which to trigger.

SMART TRIGGER — Qualified — State

SMART TRIGGER

type
Interval
TV
Qualified
Dropout
Pattern

by
Edge **State**
(qualifier)

trigger on
1 2 3 4 Ext
Ext10

only after
1 **2** 3 4 Ext
Ext10 Pattern

goes & stays
Above Below
248mV

wait
60 ns
OFF T< **T>** Evs

type

To select “Qualified”.

by

To select “State”.

trigger on

For selecting the trigger source — the other conditions for this source can be set up using Edge Trigger (*four-channel menu shown*).

only after

To select the qualifier source — the other conditions can be set up using Edge Trigger.

goes & stays

For selecting the qualifier threshold using the associated knob, and using the menu button to select whether the qualifier signal will be valid either “Above” or “Below” that threshold.

When “Pattern” is selected as the qualifier source, this menu is used to determine whether the pattern should be present or absent.

wait/within

To specify the time limit (“T<”) for accepting the trigger event. And alternatively, to specify how much time (“T>”) or how many trigger events (“Evs”) should be allowed before the acquisition is taken on the next trigger event. The qualifier signal must remain valid until the final trigger has been received. The time value can be chosen in the range 10 ns–20 s. The trigger event count can be chosen in the range 1–10⁹.

Triggers and When to Use Them

SMART TRIGGER — Qualified — Edge

SMART TRIGGER

type
Interval
TV
Qualified
Dropout
Pattern

by
Edge State
(qualifier)

trigger on
1 2 3 4 Ext
Ext10

after
1 2 3 4
Pattern

has gone
Above Below
-133mV

within
130 ns
OFF **T<** T> Evs

type

To select "Qualified".

by

To select "Edge".

trigger on

For selecting the trigger source — the other conditions for this source are set up using Edge Trigger (*four-channel menu shown*).

after

For selecting the qualifier source — other setup conditions use Edge Trigger (*four-channel menu shown*).

has gone

To adjust the qualifier threshold and determine whether the qualifier signal is valid once it "has gone" above or below that threshold. "Pattern" selected as the qualifier source determines whether the pattern should be present or absent.

wait/within

To specify the time limit ("T<") for accepting the trigger event. Or, to specify the delay in time ("T>") or number of trigger events ("Evs") after a valid transition has occurred. A trigger can only be accepted after this delay. Any subsequent qualifier event restarts this count. The time value can be chosen in the range 10 ns–20 s. The trigger event count can be chosen in the range 1–10⁹.

SMART TRIGGER — Dropout

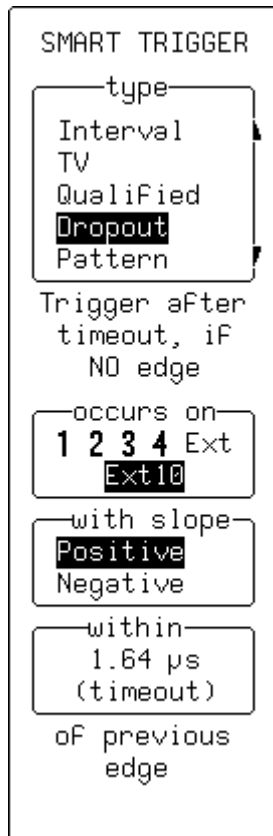

type

To select “Dropout”.

trigger after timeout, if NO edge occurs on

For selecting the trigger source (*four-channel menu shown*).

with slope

To define whether the measurement starts on a “Positive” or “Negative” slope of the trigger signal.

Within... of previous edge

For defining the time-out value in the range 25 ns–20 s.