

LeCroy 9374/M/L & 9374TM
Digital Storage Oscilloscopes
Basic Performance Test Procedure

Version 2.0

May 1996

Second Printing

Table of Contents

Section 1	General Information	Page
1.1	Initial Inspection	1-1
1.2	Warranty	1-1
1.3	Product Assistance	1-1
1.4	Address of Service Centers	1-1
1.5	Maintenance Agreements	1-5
1.6	Documentation Discrepancies	1-5
1.7	Service Procedure	1-5
1.8	Return Procedure	1-5
1.9	Safety Precautions	1-6
1.10	Antistatic Precautions	1-6
Section 2	Specifications	2-1
2.1	9374/M/L/TM Specifications	2-2
2.2	Hard Disk, Floppy, RAM Card, Internal Printer options	2-6
2.3	Active Fet Probes	2-9
2.4	Active Differential Probes	2-11
2.5	Trigger Pick-off	2-13
2.6	Current Probe	2-14
2.7	WP01 Waveform Processing Firmware	2-16
2.8	WP02 Spectrum Analysis Firmware	2-19
2.9	WP03 Parameter Distribution Analysis Firmware	2-22
2.10	Disk Drive Measurement Packages	2-25
2.11	CKTRIG option	2-29
2.12	64 Mega Bytes Extended Processing Memory	2-31
2.13	LeCalsoft Calibration Software	2-33
Section 3	Performance Verification	
3.1	Introduction	3-1
3.1.1	List of Warranted Specifications	3-1
3.2	Test Equipment Needed	3-2
3.3	Turn On	3-2
3.4	Input Impedance	3-3
3.4.1	Procedure	3-3
3.4.1.a	DC 1M Ω	3-3
3.4.1.b	AC 1M Ω	3-4
3.4.1.c	DC 50 Ω	3-5
3.4.2	External Trigger Input Impedance	3-6
3.4.2.a	DC 1M Ω	3-6
3.4.2.b	DC 50 Ω	3-7
3.4.3	Internal Protective resistor Verification	3-8
3.5	Leakage Current	3-9
3.5.1	Procedure	3-9
3.6	Average Noise Level	3-9

Section 3	Performance Verification	Page
3.6.1	Peak to Peak Noise.	3-9
3.6.1.a	DC 1M Ω	3-9
3.6.1.b	AC 1M Ω	3-12
3.6.1.c	DC 50 Ω	3-13
3.6.2	RMS Noise	3-15
3.6.2.a	DC 1M Ω	3-15
3.6.2.b	AC 1M Ω	3-17
3.6.2.c	DC 50 Ω	3-17
3.6.3	Input Grounded	3-18
3.7	DC Linearity	3-22
3.7.1	Description	3-22
3.7.1.a	DC 50 Ω	3-22
3.7.1.a.1	Positive DC Linearity	3-23
3.7.1.a.2	Negative DC Linearity	3-25
3.7.1.b	DC 1M Ω	3-27
3.8	Offset	3-30
3.8.1	Description	3-30
3.8.1.a	Negative Offset Control	3-30
3.8.1.b	Positive Offset Control	3-33
3.9	Bandwidth	3-35
3.9.1	Description	3-35
3.9.1.a	DC 50 Ω	3-35
3.9.1.a.1	Trigger Bandwidth	3-40
3.9.1.b	1M Ω	3-42
3.10	Trigger Level	3-44
3.10.1	Description	3-44
3.10.2	Channel	3-44
3.10.3	External Trigger	3-52
3.10.4	External/10 Trigger	3-60
3.11	Smart Trigger	3-68
3.11.1	Trigger on Pulse Width < 10 nsec	3-68
3.11.2	Trigger on Pulse Width > 10 nsec	3-68
3.11.3	Trigger on Pulse Width < 100 nsec	3-70
3.11.4	Trigger on Pulse Width > 100 nsec	3-71
3.12	Time Base Accuracy	3-72
3.12.1	Description	3-72
3.12.2	500 MHz Clock Manual Verification	3-72
3.13	Overshoot and Risetime	3-76
3.14	Probe Calibrator Verification	3-78
3.15	Overload	3-82
3.16	Combining Channels	3-84

SECTION 1 GENERAL INFORMATION**1.1 Initial Inspection**

It is recommended that the shipment be thoroughly inspected immediately upon delivery to the purchaser. All material in the container should be checked against the enclosed Packing List. LeCroy cannot accept responsibility for shortages in comparison with the Packing List unless notified promptly. If the shipment is damaged in any way, please contact the Customer Service Department or local field office immediately.

1.2 Warranty

LeCroy warrants its oscilloscope products to operate within specifications under normal use for a period of three years from date of shipment. Spares, replacement parts and repairs are warranted for 90 days. The instrument's firmware is thoroughly tested and thought to be functional, but is supplied "as is" with no warranty of any kind covering detailed performance. Products not manufactured by LeCroy are covered solely by the warranty of the original equipment manufacturer.

In exercising this warranty, LeCroy will repair or, at its option, replace any product returned to the Customer Service Department or an authorized service facility within the warranty period, provided that the warrantor's examination discloses that the product is defective due to workmanship or materials and that the defect has not been caused by misuse, neglect, accident or abnormal conditions or operation.

LeCroy will return all in-warranty products with transportation prepaid.

This warranty is in lieu of all other warranties, expressed or implied, including but not limited to any implied warranty of merchantability, fitness, or adequacy for any particular purpose or use. LeCroy shall not be liable for any special, incidental, or consequential damages, whether in contract or otherwise.

1.3 Product Assistance

Answers to questions concerning installation, calibration, and use of LeCroy equipment are available from the Customer Service Department, 700 Chestnut Ridge Road, Chestnut Ridge, New York 10977-6499, U.S.A., tel: (914) 578-6060, or 6061, and 2 rue du Pré-de-la-Fontaine, 1217 Meyrin 1, Geneva, Switzerland, tel : (41) 22.719.21.11, or your local field engineering office.

1.4 Addresses**Corporate Headquarters**

LECROY CORPORATION
700 CHESTNUT RIDGE ROAD
CHESTNUT RIDGE, NY 10977-6499
USA
TEL: (914) 425-2000 578-6060 or 6061
FAX: (914) 425-8967

European Headquarters

LECROY SA
2, CHEMIN PRE-DE-LAFONTAINE
CH-1217 MEYRIN 1 GENEVA
SWITZERLAND
TEL: 41 (22) 719-21-11
FAX: 41 (22) 782-39-15

Europe

LECROY GMBH
MANNHEIMERSTRASSE 177
POSTFACH 103767
D-6900 HEIDELBERG GERMANY
TEL: 49.6221.831001
FAX: 49.6221.834655

LECROY SARL
1, AVENUE DE L'ATLANTIQUE
LES ULIS 91976 COURTABOEUF
FRANCE
TEL: 33.1.69.18.83.20
FAX: 33.1.69.07.40.42

ESSA
EUIPOS Y SISTEMAS SA
APOLONIO MORALES 13-B
E-28036 MADRID
TEL: 34.1.359.0088
FAX: 34.1.359.0298

DEWETRON ELEKTRONISCHE
MESSGERAETE Ges.M.B.H.
FOELLINGERSTRASSE 9E
8044 GRAZ AUSTRIA
TEL: 43.316.391.804
FAX: 43.316.391.052

ORBIS OY
VANHA KAARELANTIE 9
01610 VANTAA
FINLAND
TEL: 358.0.566.4066
FAX: 358.0.531.604

AVANTEC
TVETENVEIEN 6
0661 OSLO NORWAY
TEL: 472.63.05.20
FAX: 472.65.84.14

LECROY LTD
28 BLACKLANDS WAY
ABINGDON, OXON OX14 1DY
GREAT BRITAIN
TEL: 44.23.553.31.14
FAX: 44.23.552.87.96

LECROY SA
LENZHARDWEG 43
5702 NIERDENLENZ
SWITZERLAND
TEL: 41.62.885.80.50
FAX: 41.62.885.80.55

M.T. BRANDAO, LDA
RUA DO QUANZA, 150
4000 PORTO
PORTUGAL
TEL: 351.2.830.2709
FAX: 351.2.830.2710

LUTRONIC APS
NAVERLAND 2
2600 GLOSTRUP
DENMARK
TEL: 45.4342.9764
FAX: 45.4342.9765

HELLENIC SCIENTIFIC REP., LTD
11 VRASSIDA STREET
115 28 ATHENS
GREECE
TEL: 30.1.721.1140 or 721.3154
FAX: 30.1.724.1374

ABB NERA A/S
KOKSTADVEGEN 23
KOKSTAD BERGEN NORWAY
TEL: 351.2.815.680
FAX: 351.2.815.630

Europe

MEASUREMENT SYSTEMS SCANDINAVIA AB
 P.O. BOX 393 FORETAGSALLEN 12, HUS 5 BV
 184 24 AKERSBERGA SWEDEN
 TEL: 46.8.540.68100
 FAX: 46.8.540.66536

Eastern Europe

ELSINCO GMBH
 ROTENMUHLGASSE 11
 1120 VIENNA
 AUSTRIA
 TEL: 43.222.812.1751
 FAX: 43.222.812.2329

Mideast

AMMO
 9, HARUGEI MALKHUT
 RAMAT HACHAYAL. P.O BOX 13132,
 61131 TEL AVIV ISRAEL
 TEL: 972.3.6478740
 FAX: 972.3.6478771

Asia

LECROY JAPAN CORPORATION
 ESAKA SANSHO BLDG - 3RD FLOOR
 16-3, 3-CHOME
 TARUMICHO, SUITA CITY
 OSAKA 564 JAPAN
 TEL: 816.330.0961
 FAX: 816.330.8096

LECROY JAPAN CORPORATION
 ZAIKEN BLDG 6TH FLOOR
 19-3, 2-CHOME
 SASAZUKA, SHIBUYA-KU
 TOKYO 151 JAPAN
 TEL: 813.3376-9400
 FAX: 813.3376.9587

SCIENTIFIC DEVICES AUSTRALIA
 2 JACKS ROAD
 SOUTH OAKLEIGH, VICTORIA
 AUSTRALIA
 TEL: 61.3579.3622
 FAX: 61.3579.0971

TATA-HONEYWELL
 55-A/8 & 9 HADAPSPAR
 INDUSTRIAL ESTATE
 PUNE 411 013 INDIA
 TEL: 91.212.670445
 FAX: 91.212.672205

E.C. GOUGH, LTD
 245 ST.ASAPH STREET
 P.O. BOX 22073
 CHRISTCHURCH NEW ZEALAND

ELECTRO TECH CORPORATION
 1ST FLOOR, 16 KAZI CHAMBERS
 BAHADURSHAH ZAFAR ROAD
 KARACHI-74800 PAKISTAN

TEL: 64.3.3798.740
 FAX: 64.3.3796.776

TEL: 92.21.493-8087
 FAX: 92.21.493-7749

SINGAPORE ELECTRONICS
 AND ENGINEERING, LTD
 24 ANG MO KIO STREET, 65
 SINGAPORE 2056
 TEL: 65.480.7783
 FAX: 65.481.4272

ABEX ENGINEERING PTE. LTD.
 37 KALLANG PUDDING ROAD 08-08
 TONG LEE BUILDING BLOCK B
 SINGAPORE 1334
 TEL: 8412818
 FAX: 8415988

Asia

LECOLN TECHNOLOGY CO.,LTD.
4F-1, NO. 214, SEC.1
HO PING E ROAD
TAIPEI TAIWAN R.O.C.
TEL: 886.2.365.0612
FAX: 886.2.367.1792

MEASURETRONIX
2102/31 RAMKAMHANG ROAD
BANGKOK 10240
THAILAND
TEL: 66.2.375.2733-4
FAX: 66.2.374.9965

SCHMIDT ELECTRONICS LTD
18 F, GREAT EAGLE CENTRE
23 HARBOUR ROAD WANCHAI
HONG KONG
TEL: 852.2507.0222
FAX: 852.2827.5656

WOOJOO HI-TECH CORP.
DONGHYUN BLDG.
102-4 MOONJUNG-DONG,
SONGPA-KU SEOUL 138-200 KOREA
TEL: 82.2.449.5472
FAX: 82.2.449.5475

P.T. DWI TUNGGAL JAYA SAKTI
WISMA RAJAWALI, 14TH FLOOR
JL JENDRAL SUDIRMAN
34 JAKARTA 10220INDONESIA
TEL: 62.21.570.4563
FAX: 62.21.583.218

North America

ALLAN CRAWFORD LTD
5835 COOPERS AV, MISSISSAUGA
ONTARIO L4Z 1Y2, CANADA
TEL: 416 890.2010
FAX: 416 890.1959

South America

SEARCH SA
VIAMONTE 1716 - PISO 7
1055 CAPITAL FEDERAL
ARGENTINA
TEL: 54.1.46.6156
FAX: 54.1.394.8374

ATP-HI-TEK
ALAMEDA AMAZONAS
422 ALPHAVILLE 06454-030
BARUEI, SP BRAZIL
TEL: 55.11.421.5477
FAX: 55.11.421.5032

Central America

NUCLEOELECTRONICA, SA
CALZ. LAS AGUILAS 101
DELEGACION ALVARO OBREGON
01710 MEXICO, 20, d.f.
MEXICO
TEL: 52.5593.604
FAX: 52.5593.6021

South Africa

WESTPLEX LTD
TUSCANY HOUSE
376 OAK AVENUE
RANDBURG 2194
REPUBLIC OF SOUTH AFRICA
TEL: 27.11.787.0473
FAX: 27.11.787.0237

1.5 Maintenance Agreements

LeCroy offers a selection of customer support services. Maintenance agreements provide extended warranty and allow the customer to budget maintenance costs after the initial three years warranty has expired. Other services such as installation, training, enhancements and on-site repair are available through specific Supplemental Support Agreements.

1.6 Documentation Discrepancies

LeCroy is committed to providing state-of-the-art instrumentation and is continually refining and improving the performance of its products. While physical modifications can be implemented quite rapidly, the corrected documentation frequently requires more time to produce. Consequently, this manual may not agree in every detail with the accompanying product. There may be small discrepancies in the values of components for the purposes of pulse shape, timing, offset, etc., and, occasionally, minor logic changes. Where any such inconsistencies exist, please be assured that the unit is correct and incorporates the most up-to-date circuitry. In a similar way the firmware may undergo revision when the instrument is serviced. Should this be the case, manual updates will be made available as necessary.

1.7 Service Procedure

Products requiring maintenance should be returned to the Customer Service Department or authorized service facility. LeCroy will repair or replace any product under warranty at no charge. The purchaser is only responsible for one way transportation charges.

For all LeCroy products in need of repair after the warranty period, the customer must provide a Purchase Order Number before repairs can be initiated. The customer will be billed for parts and labor for the repair, as well as for shipping.

1.8 Return Procedure

To determine your nearest authorized service facility, contact the Customer Service Department or your field office. All products returned for repair should be identified by the model and serial numbers and include a description of the defect or failure, name and phone number of the user, and, in the case of products returned to the factory, a Return Authorization Number (RAN).

The RAN may be obtained by contacting the customer service department in New York, tel: (914)578-6060, or 6061 ; in Geneva, tel: (41)22/719.21.11, or your nearest sales office. Return shipment should be made prepaid. LeCroy will not accept C.O.D. or Collect Return Shipments. Air-freight is generally recommended. The oscilloscope should be packed with the protective cover in place. Wherever possible, the original shipping carton should be used. If a substitute carton is used, it should be rigid and be packed such that the product is surrounded with a minimum of four inches of excelsior or similar shock-absorbing material. In addressing the shipment, it is important that the Return Authorization Number be displayed on the outside of the container to ensure its prompt routing to the proper department within LeCroy.

1.9 Safety Precautions

The following servicing instructions are for use by qualified personnel only. Do not perform any servicing other than contained in service instructions. Refer to procedures prior to performing any service.

Exercise extreme safety when testing high energy power circuits. Always turn the power OFF, disconnect the power cord, discharge the cathode ray tube and all capacitors before disassembling the instrument.

The **WARNING** symbol used in this manual indicates dangers that could result in personal injury.

The **CAUTION** symbol used in this manual identify conditions or practices that could damage the instrument.

1.10 Antistatic Precautions

CAUTION

Any static charge that builds on your person or clothing may be sufficient to destroy CMOS components, integrated circuits.

In order to avoid possible damage, the usual precautions against static electricity are required.

- Handle the boards in antistatic boxes or containers with foam specially designed to prevent static build-up.
- Ground yourself with a suitable wrist strap.
- Disassembly the instrument at a properly grounded work station equipped with antistatic mat.
- When handling the boards, do not touch the pins.
- Stock the boards in antistatic bags.

SECTION 2 SPECIFICATIONS

9374/M/L & 9374TM Digital Oscilloscopes



9370 Series Digital Oscilloscopes 1 GHz Bandwidth, 2 GS/s

Main Features

- Up to 8M-point record length
- 8-bit vertical resolution, 11-bit with ERES option
- Two- and four-channel versions
- Hard Disk (PCMCIA III), Memory Card and DOS-compatible Floppy Disk options
- Innovative Peak Detect
- Glitch, Pattern, Qualified, Interval, Dropout and TV triggers
- Fully programmable via GPIB and RS-232-C
- Internal graphics printer option
- Automatic PASS/FAIL testing
- Advanced signal processing

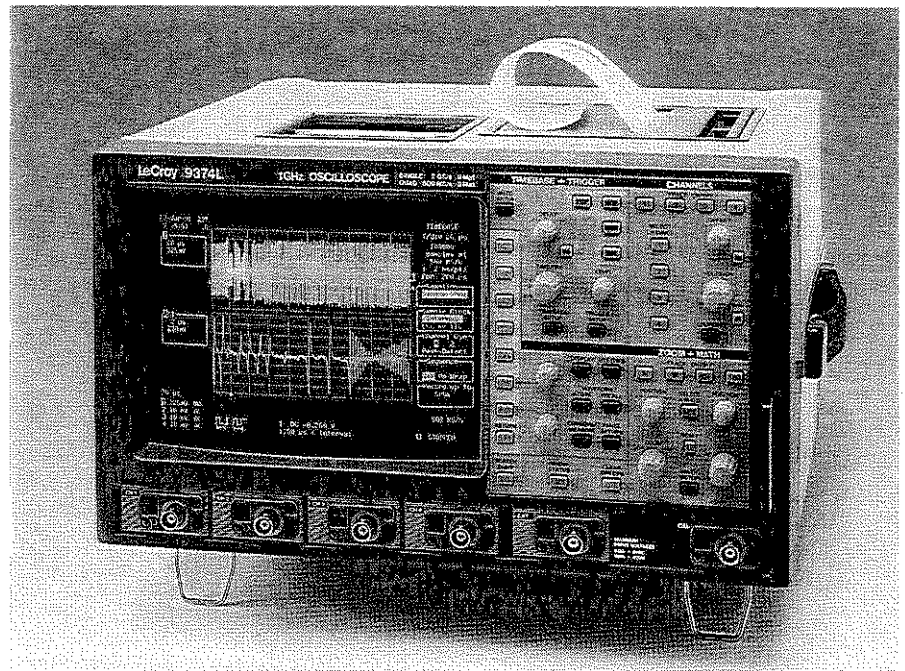

1 GHz Bandwidth

The 9370 series digital storage oscilloscope opens up new horizons for engineers and scientists at the leading edge of technological developments. With 1 GHz bandwidth and long acquisition memories, it is now possible to reveal previously hidden waveform details. Narrow glitches are more accurately defined; risetime measurements below 1 nanosecond are more precise; and high-frequency content, filtered out in lower bandwidth systems, is retained, thereby preserving signal amplitudes and overall signal integrity.

2 GS/s Sample Rate

The 2- and 4-channel models of the 9370 series sample simultaneously on all channels at 500 MS/s. Thus, they are ideal for demanding high speed applications. In addition, two channels can be combined to provide a sample rate of 1 GS/s. The 9374 provides 2 GS/s in single channel mode. Finer horizontal resolution and accuracy are guaranteed by high sample rates. This is especially critical in digital design where unpredictable circuit behavior has to be identified and analyzed in detail to be fully understood. Together with this excellent single-shot performance the 9370 series also provides a sample rate equivalent to 10 GS/s for repetitive signals.

8M Point Acquisition Memory

Channel memory lengths of 50k, 250k, 500k and 2M are available on the 9370 series 2- and 4-channel DSOs. The memory power is revealed when the user seeks to sample at the highest speed over many timebase settings. Short memory DSOs may boast a high sample rate for short waveforms, but only a long memory oscilloscope can deliver high sample rates for long waveforms. To exploit this capability to its fullest the LeCroy 9370 series combines its channel acquisition memories to give the user up to 8 million sample points, thereby providing the waveform detail required on long and complex signals. The combined capabilities of the 9370 series place it in the forefront of DSO capability.

Features and Benefits

WIDE BANDWIDTH

1 GHz bandwidth results in greater accuracy of amplitude measurements for high frequency signals and true representation of high speed digital signals.

HIGH SAMPLE RATES

Sample rates of 500 MS/s, 1 GS/s and 2 GS/s provide greater waveform fidelity, excellent zoom detail, protection against aliasing, better time resolution and wider frequency spectrum.

CHANNEL INTERLEAVING

Memory length is extended by combining the acquisition memories of multiple channels for both continuous or segmented waveform recording. Combining channels yields higher sample rates.

ADVANCED PEAK DETECT SYSTEM

The 9370 series offers an innovative peak detect capture mode. This captures fast glitches or other signal details that might have been missed due to undersampling by running the ADC's at a high sampling rate even on slow time bases. At the same time the scope also stores the underlying data to ensure no loss of time precision - unlike other peak detect systems.

SMART TRIGGER SYSTEM

SMART Trigger functions including Glitch, Pattern, Dropout, State- or Edge Qualified triggers are available.

Pre- and Post-trigger delay are fully variable, Time and Events Holdoff are also included.

The Smart Trigger system allows the scope to trigger on a large variety of signal types, specific signal characteristics and suspect behaviors.

ProBus™ HIGH PERFORMANCE PROBE INTERFACE

The proprietary ProBus interface is supplied as standard on all 93XX family models. It provides a probe interconnection architecture to support the most demanding circuit probing requirements, both now and in the future.

The ProBus interface allows automatic detection of the attached probe as well as complete control, setup and calibration at the probe tip. The probe is no longer an accessory, but an integral part of the measurement solution, with ease of setup and probe-tip measurement accuracy guaranteed.

The ProBus interface supports a rapidly growing range of high-performance and custom probe solutions including high-bandwidth, low-circuit load FET probes.

HIGH RESOLUTION DISPLAY AND EXCELLENT USER INTERFACE

A large high resolution CRT display supports uncluttered presentation of waveform data, information and control menus. Live waveforms can be viewed with up to three expansion regions showing all of the signal details.

The powerful processing capability provides a responsive feel even when extensive processing is being carried out. A proven multi-knob control panel combined with an intuitive menu system provide rapid access to the instrument's powerful capabilities.

PERSISTENCE AND XY DISPLAY MODES

Persistence: Sample points are displayed so that they accumulate on the screen over many acquisitions. "Eye diagrams" and "Constellation displays" can be achieved using this display mode. XY mode plots any two sources against one another.

WAVEFORM PROCESSING AND MEASUREMENT SYSTEM

Pass/Fail Testing and Waveform Limit Testing (Masks) can be performed. Measurements include Pulse Parameters, Statistics and Arithmetic functions. Any failure can cause preprogrammed actions such as Hardcopy, Save, GPIB Service Request, Pulse Out or Beep.

OPTIONAL WAVEFORM MATH PACKAGE - WP01*

Option WP01 provides Summed and Continuous Averaging, Waveform Math Functions, Extrema and Enhanced Resolution Modes.

Functions can be chained together, allowing complex computations. Waveform operations can be performed on live, stored, processed or expanded waveforms. The package is fully programmable over GPIB or RS-232-C. WP01 extends the processing capabilities of the 9370 and reduces the need for external computers and controllers for processing.

OPTIONAL SPECTRAL ANALYSIS PACKAGE - WP02*

Option WP02 provides comprehensive Spectral Analysis capabilities, permitting the system designer to identify characteristics which may not be apparent in the

time domain. WP02 provides a wide selection of windowing functions, as well as averaging in the frequency domain.

Spectral analysis can be performed on repetitive and single events. Users can obtain time and frequency values simultaneously and compare phases of the various frequency components with each other.

OPTIONAL STATISTICAL ANALYSIS PACKAGE - WP03

Option WP03 provides extensive statistical analysis capabilities. Detailed analysis can easily be performed on difficult to measure waveform phenomena such as amplitude fluctuation and timing jitter. Live histogram displays represent the statistical distribution of selected waveform parameter measurements. Statistical information can be extracted directly from the histograms using automatic statistical measurements including max, min, average, median, std deviation, etc.

MAGNETIC MEDIA MEASUREMENTS

The DDM/PRML disk drive firmware options provide a unique integrated tool for those developing and testing high-density storage media.

DOS COMPATIBLE MASS STORAGE OPTIONS*

The 9370 series offers 131MB removable hard disk (PCMCIA III), high speed memory card (PCMCIA II) and 3.5" 1.44 MB floppy disk. Traces, setups, screen graphics and Pass/Fail templates can be stored as DOS files and thus read directly by a PC for easy integration into reports.

PRINTING FACILITIES*

An optional internal thermal graphics printer produces full resolution screen dumps in under 10 seconds. The unique 'Strip-Chart' format expands the horizontal axis up to 2 meters per division for viewing fine waveform detail within long memory acquisitions.

A wide range of printer/plotter formats support external hardcopy via the standard GPIB, RS-232-C or optional Centronics interfaces.

REMOTE PROGRAMMING CAPABILITY

Remote programming capability enables DSO control from PC and easy transfer of data for further analysis. The full command set is available via remote control.

9370 Series Specifications

ACQUISITION SYSTEM

Bandwidth (-3 dB):
 @ 50 Ω: DC to 1 GHz
 10 mV/div and above
 @ 1 MΩ DC: DC to 500 MHz typ. at probe tip, with PP005 supplied standard. 1 GHz FET probe optional.

No. of Channels: 4 (9374) or 2 (9370)
No. of Digitizers: 4 (9374) or 2 (9370)
Maximum Sample Rate and Acquisition Memories: See table below.

Sensitivity:
 2 mV/div to 1 V/div, 50Ω, fully variable
 2 mV/div to 10 V/div, 1MΩ, fully variable.

Scale factors: A wide choice of probe attenuation factors are selectable.

Offset Range:
 2.00 - 4.99 mV/div: ±400 mV
 5.00 - 99 mV/div: ±1 V
 0.1 - 1.0 V/div: ±10 V
 1.0 - 10V/div: ± 100 V (1MΩ only)

DC Accuracy: Typically 1%.
Vertical Resolution: 8 bits.
Bandwidth Limiter: 25 MHz, 200 MHz.
Input Coupling: AC, DC, GND.
Input Impedance: 1 MΩ/15 pF or 50 Ω ±1%.

Max Input:
 1 MΩ: 400 V (DC+ peak AC ≤10 kHz)
 50 Ω: ±5 V DC (500 mW) or 5 V RMS

TIME BASE SYSTEM

Timebases: Main and up to 4 Zoom Traces.
Time/Div Range: 1 ns/div to 1,000 s/div.
Clock Accuracy: ≤10 ppm
Interpolator resolution: 10 ps
Roll Mode: Ranges 500 ms to 1,000 s/div. For > 50k points: 10 s to 1,000 s/div.
External Clock: ≤100 MHz on EXT input with ECL, TTL or zero crossing levels. Optional 50 MHz to 500 MHz rear panel fixed frequency clock input.
External Reference: Optional 10 MHz rear-panel input.

TRIGGERING SYSTEM

Trigger Modes: Normal, Auto, Single, Stop.
Trigger Sources: CH1, CH2, Line, Ext, Ext/10 (9374: CH3, CH4). Slope, Level and Coupling for each source can be set independently.
Slope: Positive, Negative.
Coupling: AC, DC, HF, LFREJ, HFREJ.
Pre-trigger recording: 0 to 100% of full scale (adjustable in 1% increments).
Post-trigger delay: 0 to 10,000 divisions (adjustable in 0.1 div increments).
Holdoff by time: 10 ns to 20 s.
Holdoff by events: 0 to 99,999,999 events.
Internal Trigger Range: ±5 div.
EXT Trigger Max Input: 1 MΩ/15 pF: 400 V (DC + peak AC ≤10 kHz) 50 Ω ±1%: ±5 V DC (500 mW) or 5 V RMS
EXT Trigger Range: ±0.5 V (±5 V with Ext/10)
Trigger Timing: Trigger Date and Time are listed in the Memory Status Menu.
Trigger Comparator: Optional ECL rear panel output.

SMART TRIGGER TYPES

Pattern: Trigger on the logic AND of 5 inputs - CH1, CH2, CH3, CH4, and EXT Trigger, (9370: 3 inputs - CH1, CH2, EXT) where each source can be defined as High, Low or Don't Care. The Trigger can be defined as the beginning or end of the specified pattern.
Signal or Pattern Width: Trigger on width between two limits selectable from ≤ 2.5ns to 20s. Will typically trigger on glitches 1ns wide.
Signal or Pattern Interval: Trigger on interval between two limits selectable from 10ns to 20s
Dropout: Trigger if the input signal drops out for longer than a time-out from 25ns to 20s.
State/Edge Qualified: Trigger on any source

only if a given state (or transition) has occurred on another source. The delay between these events can be defined as a number of events on the trigger channel or as a time interval.
TV: Allows selection of both line (up to 1500) and field number (up to 8) for PAL, SECAM, NTSC or nonstandard video.

ACQUISITION MODES

Random Interleaved Sampling (RIS): For repetitive signals from 1 ns/div to 5 μs/div.
Single shot: For transient and repetitive signals from 10 ns/div (all channels active).
Peak detect: Captures and displays 2.5 ns glitches or other high-speed events.
Sequence: Stores multiple events in segmented acquisition memories.
Number of segments available:
 9370-9374 2-200
 9370M-9374M 2-500
 9370L-9374L-9374TM 2-2,000
Max. Dead Time between segments: 100 μs

DISPLAY

Waveform style: Vectors connect the individual sample points, which are highlighted as dots. Vectors may be switched off.
CRT: 12.5x17.5 cm (9" diagonal) raster.
Resolution: 810 x 696 points.
Modes: Normal, X-Y, Variable or Infinite Persistence.
Real-time Clock: Date, hours, minutes, seconds.
Graticules: Internally generated; separate intensity control for grids and waveforms.
Grids: 1, 2 or 4 grids.
Formats: YT, XY, and both together.
Vertical Zoom: Up to 5x vertical expansion (50x with averaging, up to 40 μV sensitivity, only with WP01).
Maximum Horizontal Zoom Factors:
 9370-9374 2,000x
 9370M-9374M 10,000x
 9370L-9374L-9374TM 100,000x

Waveforms can be expanded to give 2-2.5 points/division. This allows zoom factors up to 400,000x for the 9374L when channels are combined.

INTERNAL MEMORY

Waveform Memory: Up to four 16-bit Memories (M1, M2, M3, M4).
Processing Memory: Up to four 16-bit Waveform Processing Memories (A, B, C, D).
Setup Memory: Four non-volatile memories. Optional Cards or Disks may also be used for high-capacity waveform and setup storage.

Channel Use	Maximum Sample rate	Memory per Channel				Active Channels
		9370 9374	9370M 9374M	9374TM	9370L 9374L	
All Peak Detect OFF	500 MS/s	50k	250k	500k	2M	All
Paired Peak Detect OFF	1 GS/s	100k	500k	1M	4M	9370: CH1 9374: CH2 & CH3
Paired + PP093 Peak Detect OFF	2 GS/s	200k	1M	2M	8M	One (PP093 input) 9374 models only
All Peak Detect ON	100 MS/s data + 400 MS/s peak	25k data + 25k peaks	100k data + 100k peaks	250k data + 250k peaks	1M data + 1M peaks	All 2.5 ns Peak Detect

CURSOR MEASUREMENTS

Relative Time: Two cursors provide time measurements with resolution of $\pm 0.05\%$ full scale for unexpanded traces; up to 10% of the sampling interval for expanded traces. The corresponding frequency value is displayed.

Relative Voltage: Two horizontal bars measure voltage differences up to $\pm 0.2\%$ of full scale in single-grid mode.

Absolute Time: A cross-hair marker measures time relative to the trigger and voltage with respect to ground.

Absolute Voltage: A reference bar measures voltage with respect to ground.

WAVEFORM PROCESSING

Up to four processing functions may be performed simultaneously. Functions available are: Add, Subtract, Multiply, Divide, Negate, Identity, Summation Averaging and Sine x/x.

Average: Summed averaging of up to 1,000 waveforms in the basic instrument. Up to 10^6 averages are possible with Option WP01.

Extrema*: Roof, Floor, or Envelope values from 1 to 10^6 sweeps.

ERES*: A selection of six Low-Pass digital filters provides up to 11 bits vertical resolution.

Sampled data is always available, even when a trace is turned off. Any of the above modes can be invoked without destroying the data.

FFT*: Spectral Analysis with five windowing functions and FFT averaging.

*Extrema and ERES modes are provided in Math Package WP01. FFT is in WP02.

AUTOSETUP

Pressing Autoseup sets timebase, trigger and sensitivity to display a wide range of repetitive signals. (Frequency above 50Hz; Duty Cycle greater than 0.1%).

Autosetup Time: Approximately 2 seconds.

Vertical Find: Automatically sets sensitivity and offset.

PROBES

Model: One PP005 (10:1, 10 M Ω // 11 pF) probe supplied per channel. 500 V max input. The 9370 series is fully compatible with LeCroy's range of FET probes, which may be purchased separately.

Probe calibration: Max 1 V into 1 M Ω , 500 mV into 50 Ω , frequency and amplitude programmable, pulse or square wave selectable, rise and fall time 1 ns typical.

Alternatively, the calibrator output can provide a trigger output or a PASS/FAIL test output.

INTERFACING

Remote Control: Possible by GPIB and RS-232-C for all front-panel controls, as well as all internal functions.

RS-232-C Port: Asynchronous up to 19200 baud for computer/terminal control or printer/plotter connection.

GPIB Port: (IEEE-488.1) Configurable as talker/listener for computer control and fast data transfer. Command Language complies with requirements of IEEE-488.2.

Centronics Port: Optional hardcopy parallel interface.

Hardcopy: Screen dumps are activated by a front-panel button or via remote control. TIFF and BMP formats are available for importing to Desktop Publishing programs. The following printers and plotters can be used to make hardcopies: HP DeskJet (color or BW), HP ThinkJet, QuietJet, LaserJet, PaintJet and EPSON printers; HP 7470 and 7550 plotters or similar, and HPGL-compatible plotters. An internal high resolution graphics printer is also available.

GENERAL

Auto-calibration ensures specified DC and timing accuracy.

Temperature: 5° to 40° C (41° to 104° F)

rated 0° to 50° C (32° to 122° F) operating.

Humidity: <80%.

Shock & Vibration: Meets MIL-STD-810C modified to LeCroy design specifications and MIL-T-28800C.

Safety: Conforms to EN 61010-1.

EMC: Conforms to EN50081-1, EN 50082-1.

Power: 90-250 V AC, 45-66 Hz, 230 W.

Battery Backup: Front-panel settings maintained for two years.

Dimensions: (HWD) 8.5"x14.5"x16.25", 210mm x 370mm x 410mm.

Weight: 13 kg (28.6 lbs) net, 18.5 kg (40.7 lbs) shipping.

Warranty: Three years.

Note: The 9374TM model includes WP01/02, floppy disk and graphics printer.

Ordering Information

- Option included with instrument
- Optional extra not included

Oscilloscopes:

- 9370/M/L 2 ch. Digital Oscilloscope
- 9374/M/L 4 ch. Digital Oscilloscope
- 9374TM 4 ch., +TP, +GP01

Software Options:

- 93XX-WP01 Waveform Math Package
- 93XX-WP02 FFT Processing Package
- 93XX-WP03 Statistical Analysis Package
- 93XX-DDM Disk Drive Measurements
- 93XX-PRML Supplementary Disk Drive Measurements

Hardware Options:

- 93XX-MC01/04 Memory Card Reader with 512K Memory Card
- 93XX-MC02 128K Memory Card
- 93XX-MC04 512K Memory Card
- 93XX-HDD HD01/HD02 combination
- 93XX-HD01 Hard Disk Adapter
- 93XX-HD02 PCMCIA Hard Disk 131MB
- 93XX-DA01-110 PCMCIA type III external desktop adaptor for PC (110V)
- 93XX-DA01-220 PCMCIA type III external desktop adaptor for PC (220V)
- 93XX-FD01 Internal 3.5" Floppy Drive with Centronics interface
- 93XX-GP01 Internal Graphics Printer with Centronics interface
- 937X-CKTRIG 500MHz External Clock, 10 MHz Reference Input, Trigger Comparator Output

- 930X-64 64MB Processing Memory
- 93XX-TP Total Performance Package WP01/WP02 + FD01

Manuals:

- 937X-OM Operator's manual
- 93XX-RCM Remote Control manual
- 937X-SM Service manual
- 93XX-HG Hands-On Guide

Warranty & Calibration:

- 93XX-CCMIL US Military Standard
- 93XX-CCOFMET Swiss OFMET Standard
- 93XX-CCNIST US NIST Standard
- 93XX-W5 5 Year Warranty
- 93XX-C5 5 year Calibration Contract
- 93XX-T5 5 year Warranty and Calibration

Probes & Accessories:

- AP020 1 GHz 10:1 FET Probe
- AP021 800 MHz 5:1 FET Probe
- AP030 15 MHz Differential Probe
- AP082 SDH STM-1E Trigger Pick-Off
- AP083 SONET Trigger Pick-Off
- AP54701A* 2.5 GHz 0.6pF Active Probe
- AP1143A* Probe Offset and Power Module
- PP005 500 MHz 10:1 10 M Ω Passive Probe (1 per channel)
- PP012 100:1 Probe
- PP062 1 GHz, 10:1, 500 Ω Passive Probe
- PP090 ProBus 75 to 50 Ω adaptor
- PP093 2 GS/s adaptor (only 9374/M/L/TM)

* Normally ordered together

USA Direct Sales: 1 (800) 5LE-CROY

LeCroy Worldwide Sales Offices

ASIA/PACIFIC	LeCroy Pty Ltd	61.38.90.7358
BENELUX	LeCroy BV	40.208.9285
FRANCE	LeCroy SARL	(1).69.18.83.20
GERMANY	LeCroy Europe GmbH	06221.82.700
ITALY	LeCroy SRL	06.336.797.00
JAPAN Osaka	LeCroy Japan	0816.330.0961
JAPAN Tokyo	LeCroy Japan	0813.3376.9400
SWITZERLAND	Geneva	022.719.21.11
SWITZERLAND	Lenzburg	062.885.80.50
United Kingdom	LeCroy Ltd	(01235) 533114

Copyright © February 1996. LeCroy is a registered trademark of LeCroy Corporation. All rights reserved. Information in this publication supersedes all earlier versions. Specifications subject to change without notice.

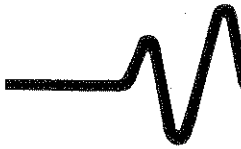

9300 Series PCMCIA Portable Hard Disk, Internal Printer, 3.5" Floppy Disk Drive and Ram Card

Main Features

- PCMCIA Type III Portable Hard Disk, DOS Compatible
- High-resolution Printer, ideal for fast, on-the-spot documentation
- 3.5" Floppy disk drive, DOS format - affordable and convenient
- Ultra-fast RAM card, DOS format, ideal for PASS/FAIL testing
- Convenient Hardcopy storage to card/disk



3.5" Floppy

The floppy drive is a convenient storage medium, not only for saving and retrieving waveforms or instrument settings, but also for storing hardcopies that can be printed from a PC when desired. The floppy supports both 720k and 1.44M DOS formats so that it can be read back on any PC with a 3.5" drive, avoiding the need to interface the oscilloscope to your PC. As with the RAM-card option, the floppy system capabilities include automatic storage of data under pre-programmed conditions.

PCMCIA Storage

PCMCIA Interfaces for RAM card and Hard Disk allow the use of fast, removable and compact storage media for saving and retrieving waveforms and instrument settings. They comply fully with the PC industry's PCMCIA and JEIDA standards. With the special Autostore feature, waveforms can be automatically stored after every acquisition and "played back" when desired. When used in combination with the PASS/FAIL feature, failure data can be saved automatically for later analysis.

Printer

The internal printer is an invaluable tool for instant, on-the-spot documentation. It generates a clear, crisp hardcopy of the screen in just a few seconds. The large size of the printout, combined with its high resolution, provide you with an excellent document that matches the screen's superior quality to its finest details. And because it frees you from the trouble of carrying and interfacing a bulky printer, it is the ideal solution for field measurements.

Mass Storage Features and Benefits

LeCroy's mass storage capabilities provide a range of benefits:

- Easy data transfers to PCs
- Waveform logging
- Waveform archiving for future use
- Faster troubleshooting
- Faster, more reproducible testing
- Shared oscilloscope resources

EASY DATA TRANSFER TO PC

Because the 9300 series oscilloscope uses DOS-formatted floppy disks, hard disks and memory cards, transferring waveform data to a PC is simple. The removable storage allows transfers without cables, programming, or any knowledge of GPIB, RS-232, or other interfaces.

In addition, LeCroy provides free of charge, a binary-to-ASCII format conversion program for the PC, accommodating those PC-based analysis packages (such as spreadsheets) that require ASCII format.

WAVEFORM LOGGING

By using Glitch or Dropout triggering in combination with the powerful AUTO-STORE mode, LeCroy oscilloscopes can monitor and log intermittent problems automatically. To store a waveform, the oscilloscope opens and names a DOS-compatible file and then stores the waveform data in the file. This logging feature requires no operator intervention and maintains data and the operational setup through power line failures. Logged waveforms can be selectively played back by trigger time/date or by sequence number, or can be scrolled through sequentially.

WAVEFORM ARCHIVING FOR FUTURE USE

- Recallable proof of performance
- Additional data analysis as needed
- Accurate trend or drift monitoring
- Calibration procedure verification

When storing waveforms, LeCroy DSOs also archive a header of setup information and the acquisition time/date. After recalling an archived waveform, the several hundred byte header ensures correct time and voltage scaling. When recalled into the oscilloscope, the waveform can be zoom expanded,

compared, or analyzed just like a live waveform. The time/date offers proof of measurement authenticity and trend sequence.

All LeCroy DSOs store raw waveform data using one byte per sample point. Signal averaged, Enhanced Resolution (ERES) filtered, and other processed data use two bytes per point, to take advantage of the added resolution.

HARDCOPY ARCHIVING

Hardcopies of the screen can also be stored for future use. For instance, a screen saved in TIFF format can be imported into a Word Processor to illustrate a report. Additionally, field-measurement screens can be saved in LaserJet format on the memory card or floppy disk, and then printed from a PC back in the lab.

FASTER FIELD MEASUREMENTS

Recallable reference waveforms and oscilloscope setups for each test point on a Device Under Test (DUT) can make fault troubleshooting faster and more accurate. A dedicated memory card or floppy disk will hold all of the correct test point waveforms and associated DSO setups for a particular DUT.

The technician can recall stored setups quickly and consistently, thereby avoiding incorrect measurement conditions. He can then compare actual waveforms to recalled reference waveforms taken from a known working system. He will therefore spend less time probing a large number of test points and verifying that the correct waveforms exist.

If a problem is found, the aberrant waveform may be saved. It can later be shown to laboratory-based engineers, for example, for problem-solving guidance or for improvement of DUT design.

Memory cards - rugged and pocket-sized - are ideal for this application.

FASTER, MORE REPRODUCIBLE TESTING

LeCroy oscilloscopes will compare measured waveforms against upper and lower waveshape tolerances or against parameter limits, such as risetime, overshoot, or peak voltage, and make PASS/FAIL decisions. This PASS/FAIL

testing decreases test times in GPIB-based ATE systems by reducing data transfers. It increases reproducibility and accuracy in manual tests by eliminating human errors.

Once defined, these tests may be saved by storing instrument setups which include the specified tolerances and/or reference waveforms. Different test personnel can easily share a common test library via a PC network.

Waveshape test limits can be generated by capturing a "golden" waveform and by then selecting amplitude and timing limits (in fractions of screen graticule divisions). Or a user can create standard waveform limit templates on a computer (e.g. ANSI/CCITT telecommunication templates).

With the LeCroy 9300 series DSOs, specific parameter tolerance test procedures are created by selecting limits for any five out of thirty plus pulse parameters with Boolean AND / OR conditions between them. During testing, FAIL responses can include an audible beep, GPIB SRQ, hardcopy output, or store to memory card.

SHARED OSCILLOSCOPE RESOURCES

By plugging-in your *personal* floppy disk, RAM card or PCMCIA Hard Disk you can restore your setup in seconds. Individual users can keep preferred setups on separate disks or cards or within separate directories.

COPY FILES	
-Direction-	
Card -> Flpy	
Flpy -> Card	
Card -> HDD	
HDD -> Card	
-Which Files-	
Panels	
Prints	
Auto Wfms	
Norm Wfms	
All Files	
DO COPY	
*OVERWRITES FILES WITH SAME NAME	

A selection of files can be copied between the available mass storage devices.

Hardcopy Features and Benefits

The internal printer adds a whole range of benefits to the LeCroy 9300 series:

- Ultra-fast printouts
- High resolution printing
- Easy transportation
- Trouble-free interfacing
- Auto Print on Trigger

ULTRA-FAST PRINTOUTS

Measurement documentation is made easier and faster since the internal printer produces a hardcopy in less than 10 seconds. In addition the document is date- and time-stamped: a real bonus for archiving test results.

HIGH RESOLUTION PRINTING

With a resolution of 190 dots-per-inch, the internal printer matches the screen's superior quality. And for even higher resolution, the printout can be stretched to a full 70 meter length so you can see those traces down to their finest details.

EASY TRANSPORTATION

A printer that is totally integrated in the instrument makes life much easier for field-measurement applications. Imagine carrying a scope, a printer (and perhaps a floppy drive) in one hand!

TROUBLE-FREE INTERFACING

The internal printer frees your mind from the struggle with cable schematics, baud rates, gender-changers and dip switches, for more productive tasks. Select the internal printer in the scope's utilities menu, hit the SCREEN DUMP button, and you're in business!

AUTO PRINT ON TRIGGER

The Auto Print feature is used to print a screen image on each acquisition.

The 9300 series oscilloscope supports a whole range of popular printers and plotters. Hardcopies can be either sent directly to the peripheral device or to the floppy disk, Ram Card or Hard disk for future use.

HARDCOPY	
output to	
Card	
Disk	
GPiB	
RS232	
Centronics	
page feed	
OFF	On
plotter	
DeskJet b/w	
HP 7470	
HP 7550	
TIFF	
TIFF compr.	
plot size	
A5(8.5"/5.5")	
A4 (11"/8.5")	
pen number	
2	

OTHER HARDCOPY SOLUTIONS

High quality project reports, presentation materials, technical manuals, and troubleshooting instructions often require integration of text and graphics on the same page.

Advanced PC desktop publishing and word processors such as Word-for-Windows, WordPerfect, or AMI Pro can directly import graphic files, size them, and position them anywhere on the page. Written text can then wrap around or be positioned within the graphics.

LeCroy 9300 oscilloscopes will save screens in TIFF (Tagged Image Format File), or BMP. After transferring the file to a PC, the DTP software can import and manipulate the document like any other graphic object.

The LeCroy 9300 series also offers a wide range of interfacing capabilities with external hardcopy devices:

- Plotters. HPGL, HP 7400 and 7500 compatible
- Printers. HP LaserJet, ThinkJet, Paintjet (including color), DeskJet (including color) and Epson
- Interfacing. RS-232, GPiB, or even Centronics (optional)

Specifications

MASS STORAGE

	Floppy Disk	Ram Card	Hard Disk
Compatibility	3.5" Floppy Drive	PCMCIA I, II JEIDA 3.0, 4.0	PCMCIA III
Supported Formats	DOS Format	Read/Write: SRAM Read: OTP, ROM, Flash DOS Format	DOS Format
Size	720k byte, 1.44M byte	Up to 8M byte	Up to 512M byte *Note 1
Max Transfer Rate	18k byte/sec	500k byte/sec	150k byte/sec
Typical waveform Transfer Speed (Store/Recall)			
1000 point	1.1s / 0.4s	40ms / 30ms	140ms / 120ms
10000 point	1.8s / 1.0s	70ms / 60ms	240ms / 220ms
100000 point	7.5s / 6.5s	300ms / 300ms	1.0s / 0.9s
1M point	57s / 55s	2s / 2s	7.0s / 6.5s

Waveform File size: A channel-trace will use 1 byte per sample plus approximately 360 bytes of waveform descriptor. A processed trace will use 2 bytes per sample.

Template Size: Approximately 21k bytes.

Panel Setup Size: Approximately 3k bytes.

*Note 1: When available

PRINTER

Type: Raster printer, thermal.

Resolution: 190 DPI.

Printout Size: 126 mm x 90 mm

Paper: Thermal printer paper, 30 meter roll, 110 mm width, type Seiko or similar.

Printing speed: 6 seconds approx. for one screen.

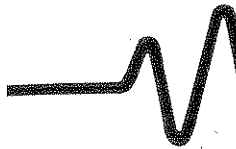

LeCroy

The Digital Scope Specialists

AP003, AP020 and AP021 Active FET Probes

Main Features

- Bandwidths to 1 GHz
- LeCroy ProBus™ interface for the AP020 and the AP021
- 1 MΩ input Impedance
- Low capacitance at probe tip
- Rugged mechanical construction
- Automatic sensing and control on scopes equipped with ProBus™

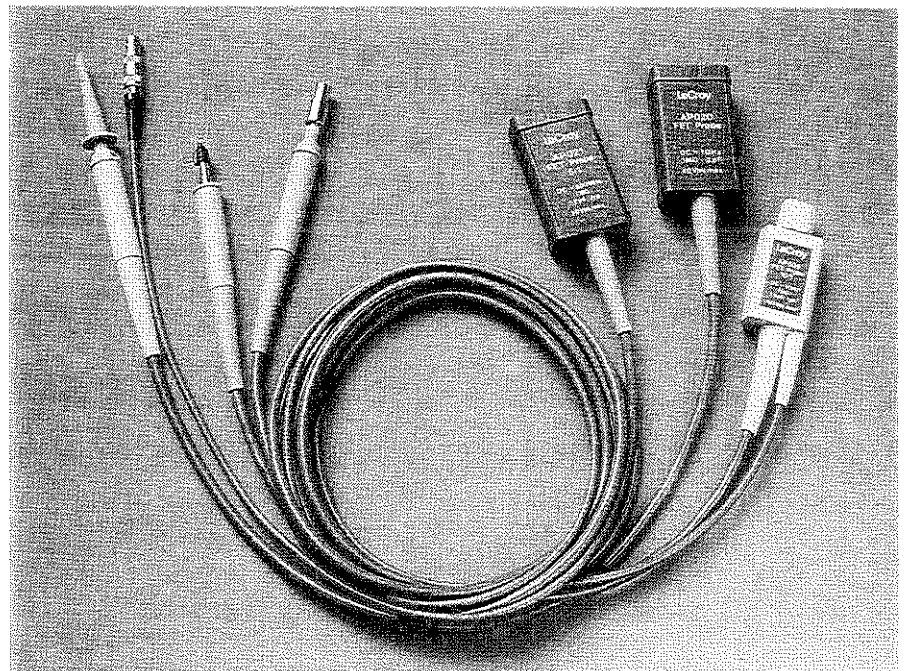

FET Probes provide the oscilloscope user with a higher level of measurement capability. Compared with passive probes, they offer low circuit loading, low capacitance and high bandwidth. This combination makes them the ideal tools for working on sensitive or high-speed electronics.

This performance is achieved by the integration of a high-impedance Field Effect Transistor (FET) amplifier into the probe tip. The circuit under test sees only the amplifier's input impedance - it is effectively buffered from the scope's input impedance and the probe cable.

LeCroy's AP series of FET probes are mechanically rugged in design, while their miniature construction allows them to be used in hand-held PCB probing applications. Their detachable tips are designed for simple replacement, and they are supplied with a full set of accessories.

Models AP020 and AP021 offer 1 GHz and 800 MHz Bandwidth respectively. AP020 features X10 signal attenuation and is especially recommended for LeCroy's 9320 and 9324 1 GHz oscilloscopes. The AP021 offers X5 attenuation when used with the new 9360.

As an active device, the FET probe requires a stabilized power supply. LeCroy provides an elegant solution to this with the ProBus™ probe interface.

ProBus™ provides probe power and signal connection in one integrated package. It also allows the scope to control other probe functions, such as input coupling and DC offset. The ProBus™ interface is now available on a growing range of LeCroy oscilloscopes and probes. AP003 has an external power connector for use with scopes which are not ProBus™ compatible. All other models use the ProBus™ interface.

Features and Benefits

Connecting a probe to a circuit can significantly distort its signals by adding undesired loading - mostly capacitive and resistive. FET probes offer high resistance and low capacitance therefore they present minimal loading to the circuit under test, and protect from making erroneous measurements.

HIGH RESISTANCE

Low resistance probes have significant DC effects when used in high impedance circuits. They can greatly affect the behaviour of the device under test by changing the swing and the DC offset of the probed signal. A 1 MΩ impedance FET probe will not affect gain or offset in virtually all the cases.

LOW CAPACITANCE

Although not important in DC measurements, capacitive loading is very

disruptive at high signal frequencies. The capacitive loading effects can be drastic. When probed with a 10 MΩ, 15

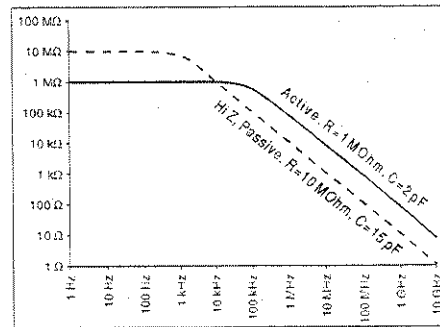

Probe Impedance versus Frequency

pF passive probe, a 100 MHz signal "sees" a 100 Ω load as illustrated on the picture below.

With only 2 pF of capacitance at the probe tip, LeCroy's FET probes reduce

circuit loading at high frequencies by a factor of 10. Minimizing tip capacitance can also push the probe's resonant frequency beyond the system bandwidth. Sensitivity to ground lead inductance is also minimized.

PROBUS

The ProBus™ system is a complete measurement solution from probe tip to oscilloscope display. It supplies power to active probes, while automatically sensing probe attenuation. ProBus™ enables direct control of the probe offset and input coupling from the scope's front panel, extending the instrument's accuracy up to the probe tip. In addition, ProBus™ automatically optimizes scope and probe offset adjustments, calibrates the gain at the probe tip and compensates for non-linearities, providing most accurate measurements.

Specifications

MODEL	AP003	AP020	AP021	MODEL	AP003	AP020	AP021
Bandwidth (MHz)	DC-1000	DC-1000	DC-800	Dynamic Range	±7 V	±5 V	±2.5 V
Risetime (psec)	< 350	< 350	< 437	DC Offset Range	N/A	±20 V	±10 V
Attenuation	10:1 ±2%	10:1 ±2%	5:1 ±2%	Input Coupling	DC	DC/AC	DC/AC
Input R (MΩ)	1 ±5%	1 ±2%	1 ±2%	Total length (m)	1.5	1.5	1.5
Input C (pF)	1.9 ±0.3	1.8 ±0.2	2.7 ±0.2	Power requirement	±12 V	±12 V	±12 V
Max Input Voltage	±100 V	±40 V	±20 V	Interface	N/A	ProBus™	ProBus™

Recommended Matching

LeCroy Model	AP-003	AP-020	AP-021
9304-10-14	XX		
9360-61			X
9320-24		X	
94XX	X		
7200	XX		
7200A	X		
ScopeStation	X		

X: External Power Supply not required
XX: External Power Supply required

Ordering Information

AP003	1 GHz active FET probe
AP020	1 GHz active FET probe
AP021	800 MHz active FET probe with ProBus™ interface. All probes are shipped with the following accessories: 1x Retractable hook 1x Ground Lead 1x BNC Adaptor 1x IC Tip 3x Ground Bayonets 1x Mini pincher with Lead Adaptor
AP501	Power Supply for the AP003

USA Direct Sales: 1 (800) 5LE-CROY

LeCroy Worldwide Sales Offices

ASIA/PACIFIC	LeCroy Pty Ltd	61.38.90.7358
BENELUX	LeCroy BV	04902.8.9285
CANADA	LeCroy Cnd	514.928.4707
FRANCE	LeCroy SARL	(1).69.18.83.20
GERMANY	LeCroy GmbH	06221.83.10.01
ITALY Milano	LeCroy SRL	02.204.70.82
ITALY Rome	LeCroy SRL	06.336.797.00
JAPAN Osaka	LeCroy Japan	0816.330.0961
JAPAN Tokyo	LeCroy Japan	0813.3376.9400
SWITZERLAND Geneva		022.719.21.11
SWITZERLAND Lenzburg		064.51.91.81
United Kingdom	LeCroy Ltd	0235-533114

Other sales and service representatives throughout the world.

Copyright © May, 1993. LeCroy is a registered trademark of LeCroy Corporation. All rights reserved. Information in this publication supersedes all earlier versions. Specifications subject to change without notice.



LeCroy

The Digital Scope Specialists

AP030, SI 9000 and SI 9000A Active Differential Probes

Main Features

- Bandwidths to 15 MHz
- Multiple:
 - Attenuations
 - Differential Voltage Ranges
 - Common Mode Voltages
- High Input Impedance
- Rugged and Lightweight
Mechanical Construction

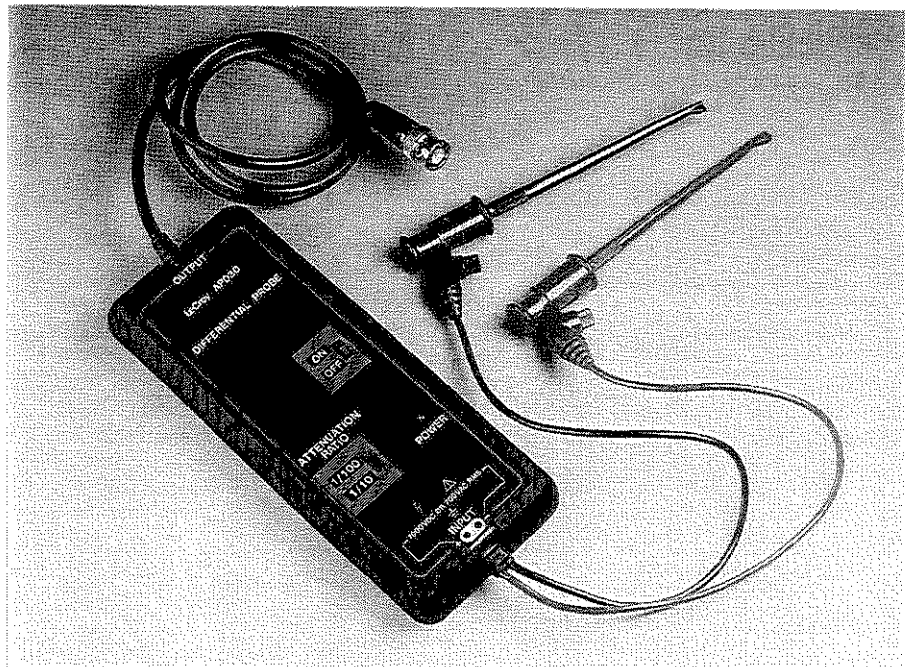

The Models AP030, SI 9000 and SI 9000A are fully differential active probes designed for applications where electric signals must be measured relative to a floating voltage, other than ground potential.

These probes are designed specifically for situations where:

- the reference voltage may be several hundreds volts above or below ground;

- measurements require the rejection of common-mode signals, (e.g. to evaluate small amplitude pulses riding on big common-mode signals);
- ground loops and currents produce so much interference that small signals cannot be detected.

With these differential probes the oscilloscope user avoids both the dangerous practice of floating the

scope, and the technique of using two scope channels in "Invert and Add" mode, which is limited both in common mode rejection and in dynamic range.

Models AP030, SI 9000 and SI 9000A are lightweight and easy to use. They have the rugged mechanical construction required for laboratory, manufacturing and field service environments, and are battery powered for greater safety and convenience.

Features and Benefits

FULLY DIFFERENTIAL INPUTS

The probes are fully differential active devices. The differential technique allows measurements to be made between two points in a circuit without reference to ground. The two input signals are processed inside the probe (as illustrated in figure) and the resulting single-ended signal may be measured by any grounded oscilloscope.

HIGH COMMON MODE VOLTAGE
The three probes offer a range of Common Mode Voltages from 40 V to 1000 V.

RUGGED CONSTRUCTION

The probes are designed to be compact and lightweight with power provided by four AA size 1.5 V batteries. A rubber casing enhances the probes' resistance to shocks.

SAFETY

Use of differential probes is safe within the specified voltages. Their

use avoids less reliable alternatives, or possible dangerous practices.

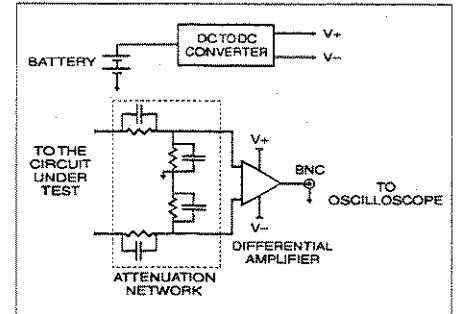

Specifications

MODEL	AP030	SI 9000	SI 9000A
Bandwidth (MHz)	15 MHz	15 MHz	15 MHz
Risetime	24 ns	24 ns	24 ns
Attenuation	1:10/1:100	1:20/1:200	1:50/1:500
Atten. Accuracy	2%	2%	2%
Input Resistance	2 MΩ	2 MΩ	2 MΩ
Input Capacitance	12 pF each side to ground		
Input Configuration	Differential		
Input Voltage			
Differential Max	±400 VDC or 280 Vrms for 1:100 ±40 VDC or 28 Vrms for 1:10	±700 VDC or 500 Vrms for 1:200 ±70 VDC or 50 Vrms for 1:20	±1000 VDC or 700 Vrms for 1:500 100 VDC or 70 Vrms for 1:50
Common Mode Max	±420 VDC or 300 Vrms	±700 VDC or 500 Vrms	±1000 VDC or 700 Vrms
Absolute Max	±1000 VDC or 700 Vrms		
CMRR			
50Hz	-90db	-80db	-80db
1KHz	-80db	-70db	-70db
1MHz	-53 db	-45db	-45db
Output Voltage			
Amplitude Max	±4 V	±3.5 V	±2 V
Offset	<± 5 mV	<±10 mV	<±10 mV
Noise	typical -10° C to +40° C 1.5 to 2mV typical		
Source Impedance	1Ω at 1 KHz, 8Ω at 1 MHz typical.		
Ambient Temperature			
Operating	-10° C to +40° C		
Storage	-30° C to +70° C		
Power requirement	Four internal 1.5 V AA size batteries or external AC to 6 Vdc adaptor Typical consumption 50 mA		
Dimensions	6.6" (168mm) x 2.4" (62mm) x 0.79" (20mm) excluding casing		
Weight	9.35 oz (265 gr) excluding batteries and casing		

Ordering Information

AP030	15 MHz differential probe 1:10 / 1:100
SI 9000	15 MHz differential probe 1:20 / 1:200
SI 9000A	15 MHz 1:50 / 1:500

All models are delivered with rubber casing.
Batteries not included

USA Direct Sales: 1 (800) 5LE-CROY

LeCroy Worldwide Sales Offices

ASIA/PACIFIC	LeCroy Pty Ltd	61.38.90.7358
BENELUX	LeCroy BV	04902.8.9285
FRANCE	LeCroy SARL	(1).69.18.83.20
GERMANY	LeCroy GmbH	06221.83.10.01
ITALY	LeCroy SRL	06.336.797.00
JAPAN Osaka	LeCroy Japan	0816.330.0961
JAPAN Tokyo	LeCroy Japan	0813.3376.9400
SWITZERLAND Geneva		022.719.21.11
SWITZERLAND Lenzburg		064.51.91.81
United Kingdom	LeCroy Ltd	(01235) 533114

Other sales and service representatives
throughout the world.

Copyright December, 1994. LeCroy is a registered trademark of LeCroy Corporation. All rights reserved. Information in this publication supersedes all earlier versions.

Specifications subject to change without notice.

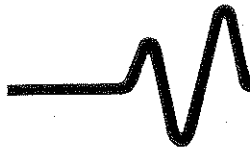

LeCroy

Innovators in Instrumentation

AP082 / AP083 Trigger Pick-off for SDH: STM-1E and SONET: STS-3

Main Features

- AP082 for SDH, AP083 for SONET.
- Ideal for pulse mask-testing (G.703 fig 24 and 25).
- Works with scrambled or live data streams.
- Automatic impedance matching and scaling.
- ProBus™ design, automatically sensed by the 93XX oscilloscopes.
- Includes ready-to-load G.703 masks fig. 24 and 25.

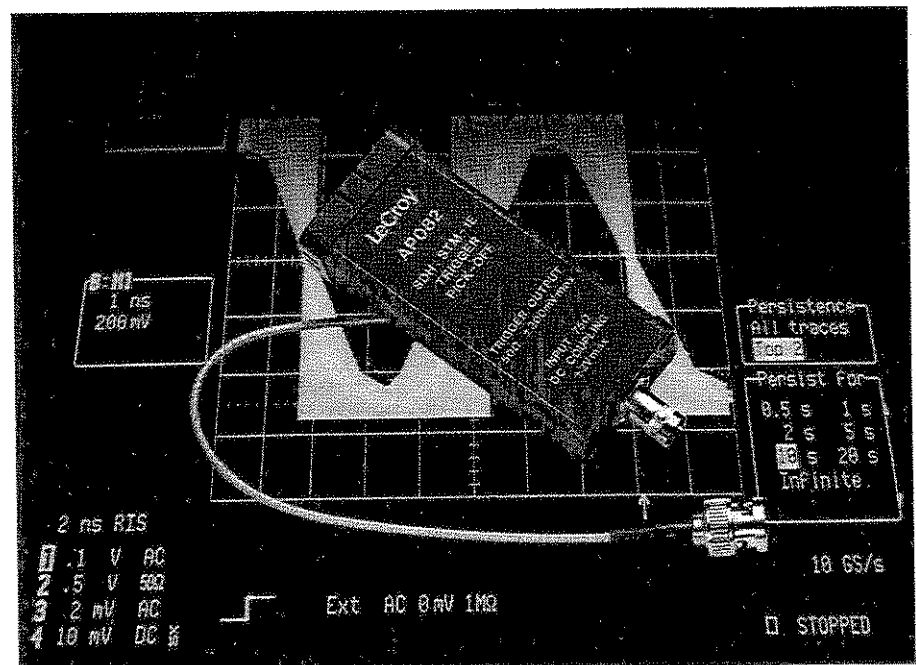

Choose to trigger on "0"s or on "1"s

155 Mbps electrical SDH and SONET signals use the CMI encoding. Using an oscilloscope to selectively trigger on the leading edge of a "1" pattern, and reject all the zeros (or vice versa) has been practically impossible until now. Thanks to its dedicated circuitry, the AP082/083 can easily isolate either

"0" or "1" patterns, allowing for further analysis such as jitter characterization or mask testing – G.703 Fig. 24 and 25 masks are supplied with the accessory.

Accurate readings

Both the AP082 and the AP083 have been designed to provide the correct impedance matching (50Ω for SONET and 75Ω for SDH) and because the accessory is automati-

cally sensed by the oscilloscope, the amplitude readings are correctly scaled on screen.

High Bandwidth

In addition, the accessory's high bandwidth make it suitable for testing with an oscilloscope of 1 GHz or greater, to minimize attenuation and distortion, and to comfortably analyze the signal well beyond its 5th harmonic.

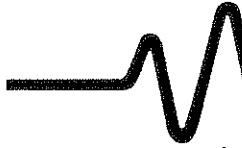

AP011 Current Probe

Main Features

- DC, AC or impulse currents
- 150A maximum current
- DC - 120 kHz Bandwidth
- Probe Accuracy $1\% \pm 2\text{mA}$
- Measurement units in amperes
- ProBus™ compatible, sensed automatically by the 93XX family of oscilloscopes.
- Rugged mechanical design

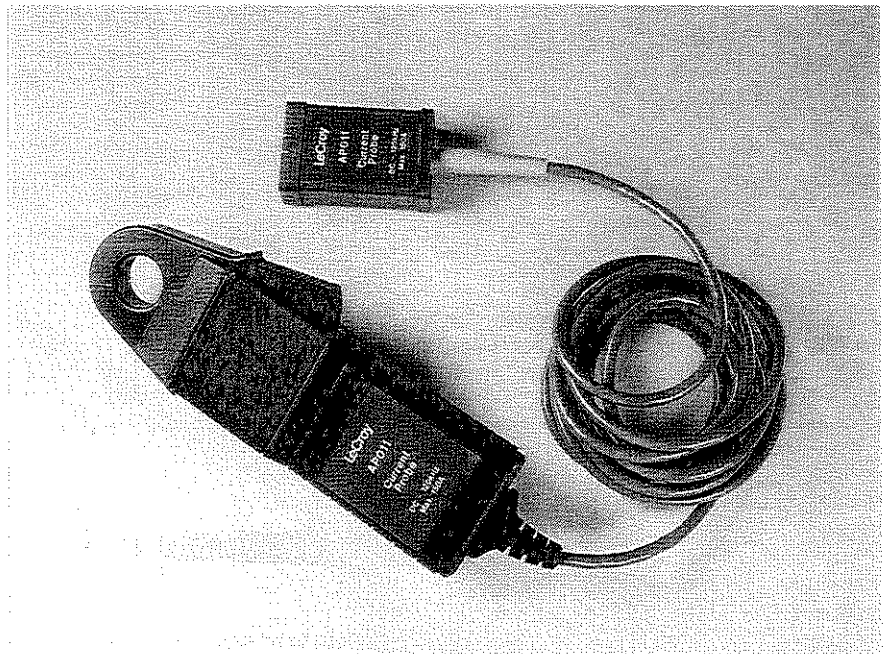

CURRENT MEASURING

The AP011 allows the oscilloscope to measure current flowing through a conductor. The AP011 is based on a combination of Hall effect and transformer technology which allows measurements to be made on DC, AC and impulse currents. It is rugged in design and uses a split-core transformer to allow the probe head to be clamped around a conductor that remains in circuit.

FULLY INTEGRATED

With the ProBus™ interface, the AP011 probe becomes an integral part of the oscilloscope. The probe is automatically detected with full calibration and control achieved from the on-screen menu system. No external power supplies or amplifiers are required.

Full Remote control is possible over GPIB or RS-232-C interfaces.

SCALED MEASUREMENTS

Waveform scaling factors and unit conversions are automatically applied.

The existing wide range of oscilloscope software analysis functions and parameter measurements are compatible and handle mixed unit conversion.

Features and Benefits

FULLY INTEGRATED SYSTEM

ProBus™ compatibility ensures full integration of the AP011 features into the oscilloscope. The probe is fully operational whenever it is attached to the instrument. There is no need for external amplifiers or power supplies. All controls are menu-driven from the oscilloscope screen, avoiding the need for accessing probe mounted controls which can be particularly difficult and dangerous in some applications.

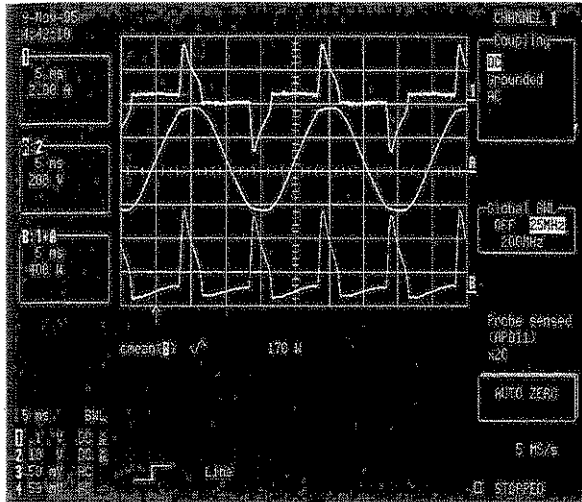

Figure 1: This example shows a power supply input current (top trace) vs. voltage (middle trace). These are multiplied to provide the input power waveform (lower trace). A parameter measurement is then made to calculate the mean input power.

Note that the input coupling menu is automatically configured to control the AP011 attached to that channel.

AUTOMATIC MEASUREMENT UNIT CONVERSION

Automatic unit conversion and calibration ensures correct interpretation of data and avoids the painstaking task of recording and applying conversion and scaling factors.

All waveforms acquired from the AP011 are automatically calibrated and adjusted to be scaled in ampere units. A wide range of functions can be applied to current waveforms. Advanced functions such as FFT's and statistical analysis are available as optional firmware packages.

All functions and measurements recognize ampere vertical scales and adjust the resulting waveform or calculation units, including mixed unit conversions (e.g. current multiplied by voltage as shown in Figure 1).

Specifications

ELECTRICAL CHARACTERISTICS

System Bandwidth: DC to 120kHz
 Measuring Range: 0 to $\pm 150A$
 Max. Overload Current: 1500A
 Offset Range: $\pm 150A$
 Output sensitivity: 50 mV/A
 DC Accuracy (@25°C): 1% of reading $\pm 2mA^*$
 AC Accuracy (@25°C): 1% of reading DC to 2kHz decreasing to 5% @ 120kHz
 Delay Time: < 1 μs
 di/dt Tracking: > 35A/ μs
 Dielectric Strength: 2.3kV, 50Hz, 1min
 External field rejection: 500:1 @ DC
 100:1 @ 10 kHz

GENERAL CHARACTERISTICS

Operating Temperature: 0°C to 50°C
 Max Conductor Size: 19mm
 Cable Length: 2m
 Interface: ProBus™, 1 M Ω only
 Weight: 300g
 Usage Environment: Indoor
 Max. Altitude: 2000m.
 Max. relative humidity: 80% (max. 31°C)

* Note: Accuracy is specified for probe operating in fixed orientation with respect to earth's magnetic field following an auto-zero operation

SAFETY

The probe has been designed to comply with IEC1010-2-032 Installation Category (Overvoltage Category) II, 300V, Pollution Degree 1.

PERFORMANCE DATA

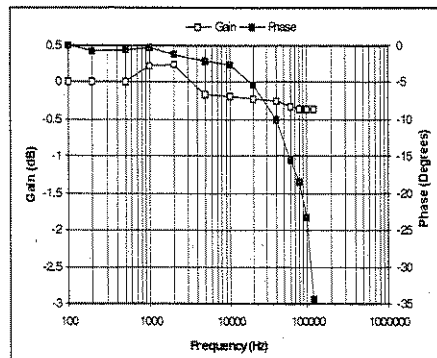

Typical probe amplitude and phase response

Ordering Information

AP011 Current Probe

Software Options:

93XX-WP01 Waveform Math Package
 93XX-WP02 FFT Processing Waveform
 93XX-WP03 Statistical Analysis Package

USA Direct Sales: 1 (800) 5LE-CROY

LeCroy Worldwide Sales Offices

ASIA/PACIFIC	LeCroy Pty Ltd	61.38.90.7358
BENELUX	LeCroy BV	0490.208.9285
FRANCE	LeCroy SARL	(1).69.18.83.20
GERMANY	LeCroy Europe GmbH	06221.87.200
ITALY	LeCroy SRL	06.336.797.00
JAPAN Osaka	LeCroy Japan	0816.330.0961
JAPAN Tokyo	LeCroy Japan	0813.3376.9400
SWITZERLAND	Geneva	022.719.21.11
SWITZERLAND	Niederlenz	062.885.80.50
United Kingdom	LeCroy Ltd	(01235) 533114

Other sales and service representatives throughout the world.

Copyright January, 1996. LeCroy is a registered trademark of LeCroy Corporation. All rights reserved. Information in this publication supersedes all earlier versions. Specifications subject to change without notice.

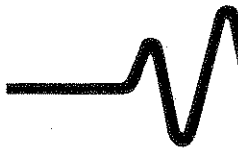

WP01 Waveform Processing Firmware for the 9300 Family of Digital Oscilloscopes

Main Features

- High-precision averaging up to 1 million sweeps
- Extended digital filtering capabilities
- Rescale function, with $(ax + b)$ correction factor
- Envelope mode
- Integration
- Differentiation
- $\text{Log}(e)$ and $\text{Log}(10)$
- $\text{Exp}(e)$ and $\text{Exp}(10)$
- Absolute, Reciprocal
- Square, Square root
- Powerful function chaining feature

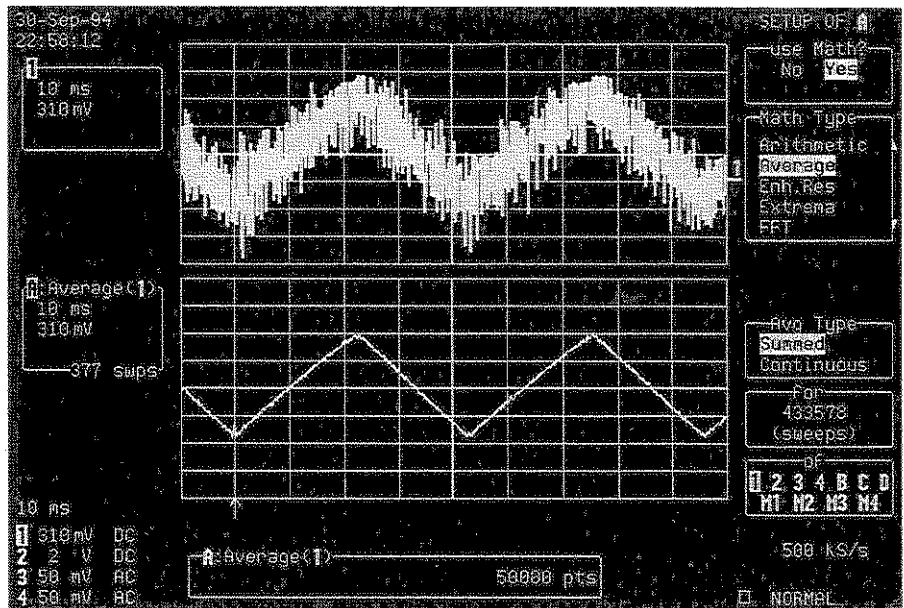

Summed Averaging is applied to the signal in Channel 1, to remove random noise. Trace A shows the result after 377 sweeps: the noise has practically disappeared.

The LeCroy WP01 Waveform Processing package features a powerful toolset that extends the processing power inside the 9300 oscilloscope, well beyond the capabilities of a traditional instrument.

In fact, all the processing is built-in to eliminate the need for external computers and controllers. High-speed microprocessors are used to ensure real-time updates of computed waveforms on the screen.

The package is fully programmable over GPIB or RS-232-C interfaces, and hard copies can be made directly on to a wide range of printers – including the optional internal printer – plotters or graphic formats.

Features and Benefits

EXTENSIVE SIGNAL AVERAGING

WP01 offers two powerful, high-speed averaging modes that can be used to reduce noise and improve the signal-to-noise ratio. Vertical resolution can be extended by several bits to improve dynamic range and increase the overall input sensitivity to as much as 50 $\mu\text{V}/\text{div}$.

Summed averaging, where up to 1,000,000 sweeps are repeatedly summed, with equal weight, in a 32-bit accumulation buffer for improved accuracy. The accumulated result is then divided by the number of sweeps.

Continuous/exponential averaging where a weighted addition of successive waveforms can be performed with weighting factors from 1:1 to 1:1023. The averaging goes on indefinitely with the contribution of "older" sweeps gradually decreasing. The method is particularly appropriate to reduce noise on signals drifting very slowly in time or amplitude.

ENHANCED RESOLUTION BY DIGITAL FILTERING

Allows low-pass F.I.R. filtering of the digitized signals, with 6 different cut-off frequencies per sampling rate setting. As a result, the vertical resolution of the captured signals – single-shot or repetitive – increases from 8 bits to 11 bits in 0.5-bit steps. This feature is a post-acquisition process which allows the user to capture, save and view the raw data as well as the processed data after applying one or more filters.

RESCALING

Allows an input signal to be rescaled using a $(ax + b)$ correction factor to compensate for gain and offset. This is very useful when dealing with various types of transducers, to read the correct temperature or pressure value directly from the scope's cursor.

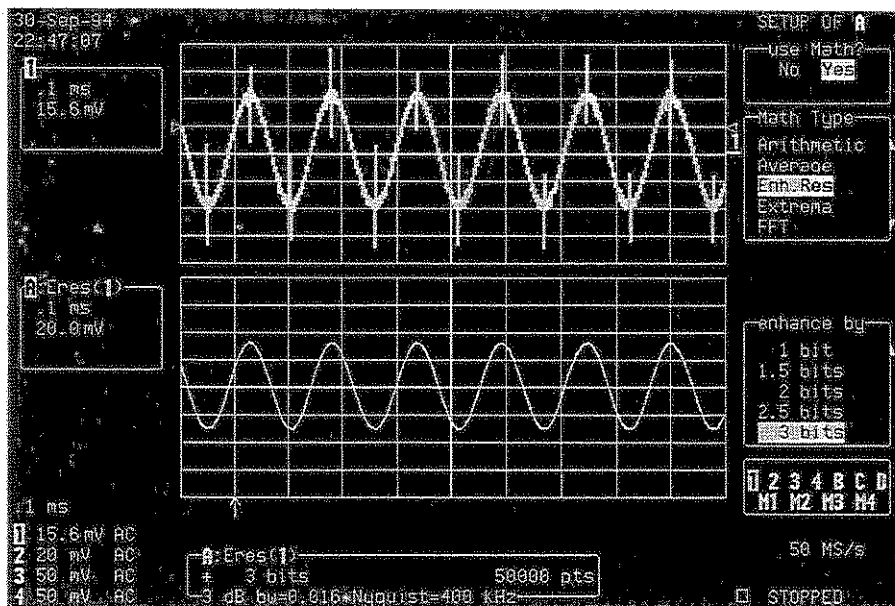

High-frequency glitches in Channel 1 have been dramatically reduced in Trace A by using the low-pass filtering properties of the Enhanced Resolution Function.

ENVELOPE MODE

Shows the signal envelope by retaining only the highest and lowest amplitudes for every sampling interval, over a user-definable number of sweeps. Ideal to visualize the time or amplitude jitter in a signal.

POWERFUL MATH TOOLSET

In addition to the basic arithmetic functions found in the standard models (+, -, ×, ÷), WP01 adds an impressive set of functions such as integration, differentiation, logarithms and exponential – in both bases 10 and e – square, square root, reciprocal and absolute value.

All these functions are updated automatically each time a new waveform is acquired, showing a "live" representation of a computed trace. This would be impossible to achieve on a separate computer.

FUNCTION CHAINING

When more than one math function is needed in the equation, WP01 supports function chaining, and allows the user to multiply, for instance, the "Voltage" and the "Current" channel and to integrate the result to get an instantaneous energy curve.

REMOTE CONTROL

All of the waveform processing can be controlled via GPIB or RS-232-C remote control. And the function traces do not even need to be called up on screen to be updated, an important feature that speeds up the computation.

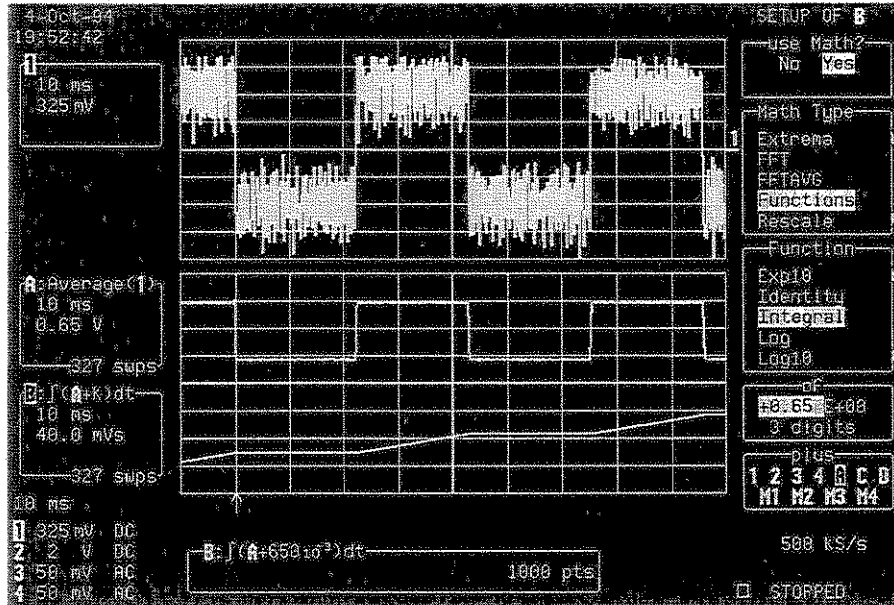

To illustrate WP01's function chaining ability, the noisy signal in Channel 1 has been averaged in Trace A to remove undesired noise, and the result integrated in trace B.

WP01 Specifications

GENERAL

Max. number data points: only limited by the available amount of system memory (indicated in the "memory used" status menu).

Min. number data points: Data points can be reduced down to 50 in the processing function to improve update rate.

Vertical Zoom: supported, 50x maximum.

Horizontal Zoom: supported, maximum zooming to a point where 20 samples of the source trace occupy the full screen.

Maximum Sensitivity: 50 μ V/div after vertical expansion.

SUMMATION AVERAGING

Number of Sweeps: 1 to 1,000,000.

Speed: up to 200,000 points/s.

CONTINUOUS AVERAGING

Possible Weighting Factors: 1:1, 1:3, 1:7, 1:15, 1:31, 1:63, 1:127, 1:255, 1:511 and 1:1023.

ENHANCED RESOLUTION

Choice of six low-pass filters to improve vertical resolution improvement from 8 to 11 bits in 0.5-bit steps.

Resulting bandwidth:

0.5 bit	$0.5 \times$ Nyquist BW
1 bit	$0.241 \times$ Nyquist BW
1.5 bit	$0.058 \times$ Nyquist BW
2 bit	$0.029 \times$ Nyquist BW
2.5 bit	$0.016 \times$ Nyquist BW

Nyquist BW = $1/2 \times$ sample frequency.

RESCALE

ax + b rescaling with a and b ranging from $\pm 0.00001 E-15$ to $\pm 9.99999 E+15$

ARITHMETIC

Addition, subtraction, multiplication and ratio on any two waveforms.

FUNCTIONS

Identity, negation, integration (including additive constant), differentiation, square, square root, logarithm and exponential (base e and 10), reciprocal and absolute value of any waveform.

EXTREMA

Shows the signal envelope by retaining only the highest and lowest amplitudes for every sampling interval. Logs all extreme values of a waveform over a programmable number of sweeps. Maxima and minima can be displayed together, or separately by choosing *roof* or *floor* traces.

Number of Sweeps: 1 to 1,000,000.

FUNCTION CHAINING

Up to four functions can be automatically chained using traces A, B, C and D. Using memories M1 to M4 for intermediate results, any number of operations can be chained manually or via remote control.

REMOTE CONTROL

All controls and waveform processing functions are fully programmable using simple commands over the oscilloscope's GPIB or RS-232-C interfaces.

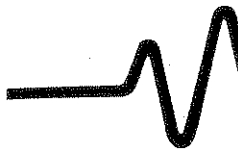

LeCroy

The Digital Scope Specialists

WP02 Spectrum Analysis Firmware for the 9300 Family of Digital Oscilloscopes

Main Features

- Frequency range from DC up to the instrument's full bandwidth
- Simultaneous FFTs on up to four channels
- Frequency resolution down to 100 μ Hz
- Frequency domain averaging
- Wide selection of scaling formats
- Five window functions
- Up to Five 1000-point FFTs per second
- Full support of cursors and automatic waveform parameters
- Full PASS/FAIL testing support

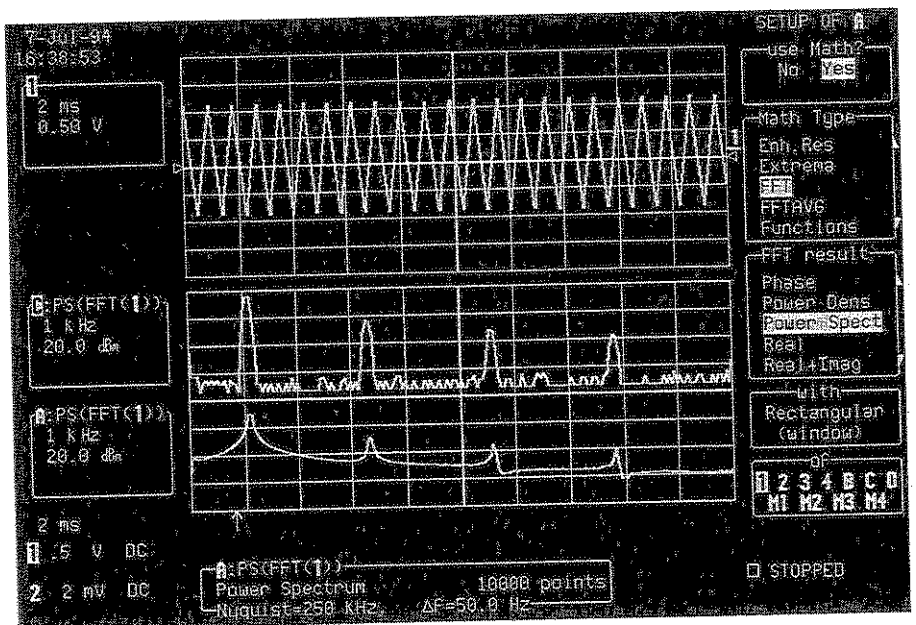

Adding the WP02 Spectrum Analysis Package to the 9300 family of digital oscilloscopes provides a fast and economical solution to frequency domain applications.

The WP02 Spectrum Analysis package provides the 9300 oscilloscope with a powerful frequency-domain toolset that extends its processing capabilities well beyond the realm of a standard instrument. In fact, all the processing is built-in to eliminate the need for external computers and controllers.

High-speed microprocessors are used to ensure real-time update of computed waveforms on the screen. Fast Fourier Transforms (FFTs) rapidly convert time domain waveforms into frequency domain records to reveal valuable spectral information such as phase, magnitude and power.

The package is fully programmable over GPIB and RS-232-C interfaces, and hardcopies can be made directly on to a wide range of printers – including the optional internal printer – plotters or graphic formats.

Features and Benefits

WHY FFT IN A SCOPE?

The FFT package on a LeCroy 9300 has at least four clear advantages over common swept spectrum analyzers:

- It can show the spectrum of a **transient signal**.
- Both **time and frequency** information can be monitored **simultaneously**.
- Phase information is **available**.
- The price is **attractive**.

It has two definite advantages over FFT analyzers:

- It can show higher-frequency components.
- Both **time and frequency** information can be monitored **simultaneously**.
- The price is **attractive**.

BROAD SPECTRUM COVERAGE

The frequency spectrum ranges from DC to the full bandwidth of the oscilloscope for repetitive signals, and to one half of the maximum sampling frequency for transients.

MULTI-CHANNEL ANALYSIS

All input channels can be analyzed simultaneously to look for common frequency-domain characteristics in independent signals.

VERSATILE SCALING FORMATS

Frequency-domain data may be presented as magnitude, phase, real, imaginary, complex, log-power and log-PSD (Power Spectral Density).

STANDARD WINDOW FUNCTIONS

Use rectangular for transient signals; von Hann (Hanning) and Hamming for continuous waveform data; Flattop for accurate amplitude measurements; Blackman-Harris for maximum frequency resolution.

FREQUENCY DOMAIN AVERAGING

Up to 50,000 FFT sweeps may be averaged to reduce base-line noise, enable analysis of phase-incoherent signals or signals which cannot be triggered on.

FREQUENCY CURSORS AND WAVEFORM PARAMETERS

Cursors can be set on the FFT trace to show up to 0.004% frequency resolution (up to 0.002% for 10,000 point memory) and measure power or voltage differences to 0.2% of full scale. Automatic waveform param-

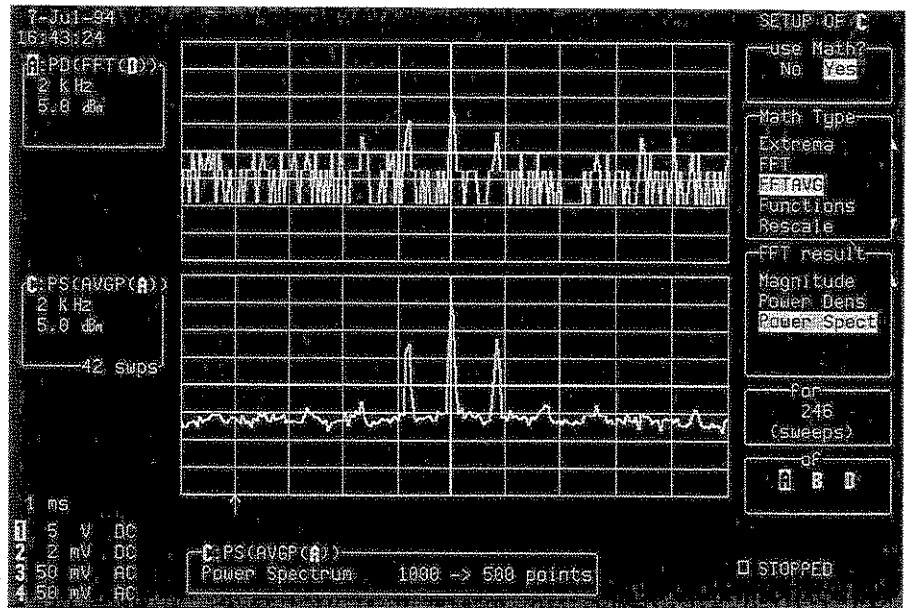

An FFT (top trace) with spectral components buried in noise. By applying the power averaging function (lower trace), all the baseline noise is removed, and the spectral components of an AM signal are clearly visible..

eters can also be applied to FFT traces.

PASS/FAIL TESTING ON FFT TRACES

PASS/FAIL testing is fully supported on FFT traces. The instrument can be setup to test incoming spectra against tolerance masks. In case the signal "fails", the instrument can be programmed to perform a choice of actions (screen dump, waveform storage, pulse out, etc.)

RESCALING

Allows an input signal to be rescaled using a $(ax + b)$ correction factor to compensate for gain and offset. This is very useful when dealing with various types of transducers, to read the correct temperature or pressure value directly from the scope's cursor.

FUNCTION CHAINING

When more than one math function is needed in the equation, WP02 supports function chaining, and allows the user to subtract a signal from a background reference stored in memory and then perform an FFT after the subtraction.

REMOTE CONTROL

All of the waveform processing can be controlled via GPIB or RS-232-C remote control. And the function traces do not even need to be called up on screen to be updated, an important feature that speeds up the computation.

FOURIER PROCESSING

Fourier processing is a mathematical technique which enables a time-domain waveform to be described in terms of frequency-domain magnitude and phase, or real and imaginary spectra. It is used, for example, in spectral analysis where a waveform is sampled and digitized, then transformed by a Discrete Fourier Transform (DFT). Fast Fourier Transforms (FFT) are a set of algorithms used to reduce the computation time (by better than a factor of 100 for a 1000 point FFT) needed to evaluate a DFT.

WP02 Specifications

GENERAL

Max. number data points: only limited by the available amount of system memory (indicated in the "memory used" status menu).

Min. number data points: Data points can be reduced down to 50 in the processing function to improve update rate.

Vertical Zoom: supported, 50x maximum.

Horizontal Zoom: supported, maximum zooming to a point where 20 samples of the source trace occupy the full screen.

Maximum Sensitivity: 50 μ V/div after vertical expansion.

Frequency Range:

Repetitive signals: DC to instrument bandwidth.

Transient signals: DC to 1/2 maximum single-shot sampling frequency

Frequency Scale Factors: 0.05 Hz/div to 0.2 GHz/div in a 1-2-5 sequence.

Frequency Accuracy: 0.01%.

AMPLITUDE AND PHASE

Amplitude Accuracy: Better than 2%.

Amplitude accuracy may be modified by the window function (see the window functions table).

Signal Overflow: A warning is provided at the top of the display when the input signal exceeds the ADC range.

Number of Traces: Time domain and frequency domain data can be displayed simultaneously (up to 4 waveforms).

Phase Range: -180° to +180°.

Phase Accuracy: $\pm 5^\circ$ (for amplitudes > 1.4 div).

Phase Scale Factor: 50° /division.

SPECTRUM SCALING FORMATS

Horizontal Scale: Linear, in Hz

Vertical Scales:

Power Spectrum in dBm (1 mW into 50 Ω).

Power Spectral Density (PSD) in dBm.

Magnitude, Real, Imaginary: Linear, in V/div

Phase Display: Linear, in degrees.

WINDOW FUNCTIONS

Rectangular, von Hann (Hanning), Hamming, Flattop and Blackman-Harris (see table below).

FFT EXECUTION TIMES*

100 points in less than 0.03 s.

1000 points in less than 0.3 s.

10000 points in less than 3 s.

* Only valid for 9370, 9350, 9360, and 9304/10 with MWP option. Other models, add 50%

FREQUENCY DOMAIN POWER AVERAGING

Summation averaging of power, PSD or magnitude for up to 50,000 sweeps.

FUNCTION CHAINING

Up to four functions can be automatically chained using traces A, B, C and D. Using memories M1 to M4 for intermediate results, any number of operations can be chained manually or via remote control.

REMOTE CONTROL

All controls and waveform processing functions are fully programmable using simple commands over the oscilloscope's GPIB or RS-232-C interfaces.

FILTER PASS BAND AND RESOLUTION				
Window type	Filter	Highest side lobe [dB]	Scallop loss [dB]	Noise bandwidth [freq. bins]
	bandwidth at -6 dB [freq. bins]			
Rectangular	1.21	-13	3.92	1.0
von Hann	2.00	-32	1.42	1.5
Hamming	1.81	-43	1.78	1.36
Flattop	1.78	-44	0.01	2.96
Blackman-Harris	1.81	-67	1.13	1.71

Filter Bandwidth at -6 dB characterizes the frequency resolution of the filter.

Highest Side Lobe indicates the reduction in leakage of signal components into neighboring frequency bins.

Scallop Loss is the loss associated with the picket fence effect.

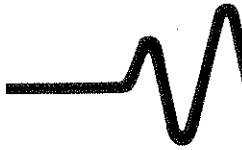

WP03 Parameter Distribution Analysis Firmware for the 9300 Family of Digital Oscilloscopes

Main Features

- Histogram function of over 40 different parameters
- Up to 2000 bins
- Population of up to 2,000,000,000
- 18 histogram parameters
- Autoscale on Histogram
- Histograms of all or individual segments in sequence waveforms

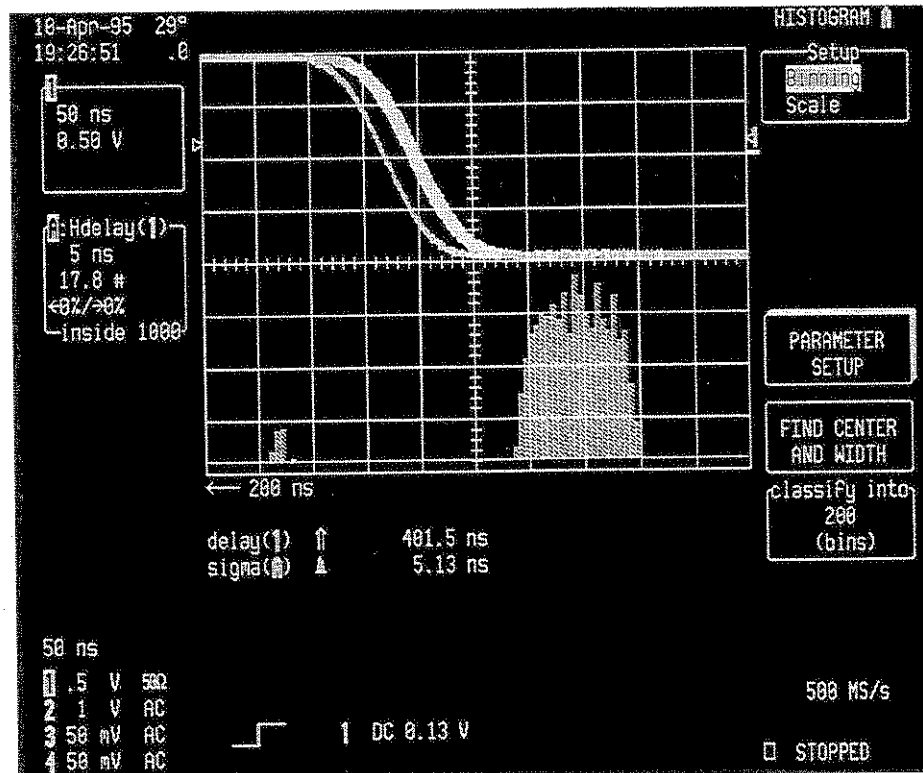

Parameter Histogram Display shows the statistical distribution of timing jitter.

The LeCroy WP03 Waveform Processing package extends the measurement capability of the 9300 oscilloscope by providing a new processing function – *built into the oscilloscope* – to perform in-depth statistical analysis of waveform parameters – a task that was formerly carried out either manually, with a notepad, or by means of an external computer, in a spreadsheet program.

The new function provides **histogramming** of any waveform parameter measurement, and can be conveniently **autoscaled** to display the center and width of the distribution. In addition, an already wide range of automated measurements are extended to provide a new category of statistical measurements specifically designed to analyze histogram distributions.

The package is fully programmable over GPIB and RS-232-C interfaces, and hardcopies can be made directly to a wide range of printers (including the optional internal printer), plotters or graphic formats.

WAVEFORM PARAMETER ANALYSIS

WPO3 adds a powerful dimension to waveform analysis by recording and analyzing the properties of a series of waveform parameter measurements. This is accomplished by a function that records the parameter values and presents the data in a statistical form – the Histogram.

The Histogram function produces a waveform consisting of one point for each histogram bin, where the value of each point is equal to the number of parameter values which fall into the corresponding bin. Analysis of histogram distributions is supported by a wide range of automated statistical parameters, which provide insight and quantitative analysis into difficult-to-measure phenomena such as jitter and amplitude fluctuation. This function is also invaluable in establishing production test limits.

A DATABASE IN THE OSCILLOSCOPE

The Histogram function performs calculations on a stored *history database* of waveform parameter values. This allows

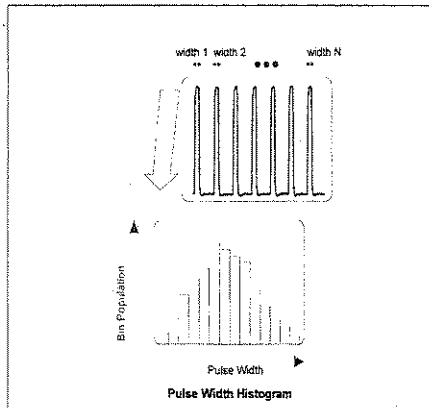

Histogram of a pulse width parameter recorded on a single or sequence acquisition with N occurrences of the parameter

detailed analysis to be performed on parameter data without the need to reacquire the source waveforms. Having the parameter database available also allows automatic scaling of histogram and graph displays.

WAVEFORM PARAMETER MEASUREMENTS

The LeCroy 9300 series has the capability to perform a wide range of automated waveform parameter measurements which make interpretation of waveform data easy, accurate and repeatable. The distribution of these parameter measurements can be analyzed by histogramming their values.

Some of the waveform parameters available include:

amplitude	Δt at level (abs)	overshoot+
area	Δt at level (%)	overshoot -
base	duty cycle	peak to peak
cmean	falltime	period
cmedian	f80-20%	risetime
crms	f@level (abs)	r20-80%
csdev	f@level (%)	r@level (abs)
cycles	frequency	r@level (%)
delay	maximum	RMS
Δ delay	mean	std dev
Δt at level (abs)	median	top
Δt at level (%)	minimum	width

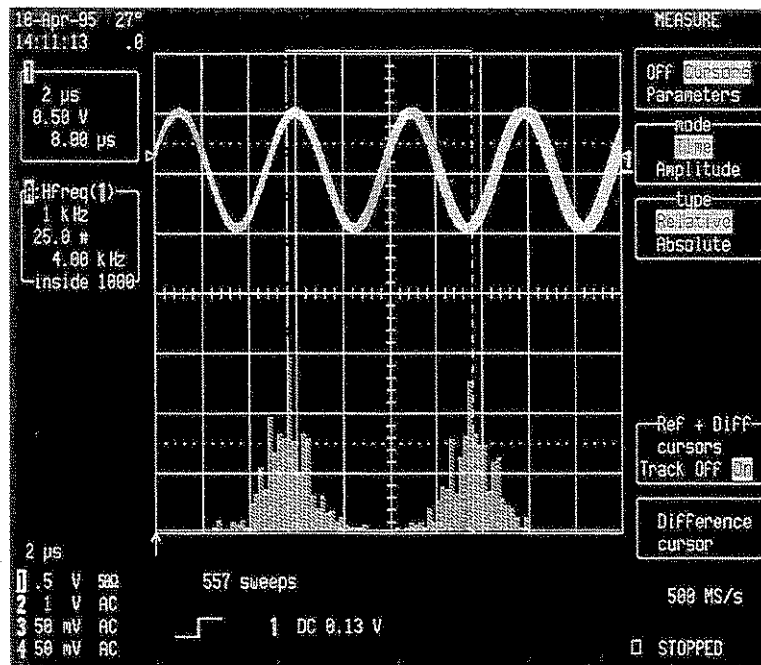

The upper trace shows a persistence display of a signal. A casual observer would assume there is some frequency drift. The histogram of frequencies in the lower display reveals much more detail. There are two dominant frequencies separated by 2 kHz. All scopes can measure frequency (and other parameters). The benefit of LeCroy's WPO3 is that it presents the information in a way which will help the observer understand and solve problems faster.

WP03 Specifications

HISTOGRAM FEATURES

Provided below are just some of the histogramming capabilities.

Vertical:

Autoscaling, choice of "Linear", "Log" or "Constant maximum" (linear) scales. Up to 50x expansion.

Horizontal:

20 to 2000 bins in a 1-2-5 sequence.
Autosetup of center and width.

Population:

20 to 2,000,000,000 selectable in a 1-2-5 sequence.

Data Source: Any waveform parameter.

Value:

The number of events binned, as well as the percent of overflow/underflow events are automatically displayed.

Measurements: 18 Statistical parameters operate directly on the histogram.

Cursor measurements can also be made directly on histograms.

Histogram Parameters

The standard 9300 series offers basic parameter statistics (maximum, minimum, average and standard deviation). WP03 ac 18 Parameters for use directly on the histogram displays. These additional measurements allow detailed analysis of the parameter distributions and can be monitored the pass/fail system to provide go/no-testing based on parameter statistics.

HISTOGRAM PARAMETERS

Parameter	Abbreviation	Explanation
histogram base	hbase	Horizontal position of left-most statistically significant bin.
histogram top	htop	Horizontal position of right-most statistically significant bin.
histogram amplitude	hampl	Horizontal difference between the htop and hbase values.
histogram rms value	hrms	Root Mean Square value of histogram distribution
sigma	sigma	Standard Deviation of histogram distribution
low	low	Horizontal position of left-most non-zero bin.
high	high	Horizontal position of right-most non-zero bin.
range	range	Horizontal difference between the high and low values.
total population	totp	Total population in the histogram.
maximum population	maxp	Maximum population in any histogram bin (i.e. vertical value at the mode).
peaks	pks	Number of peaks in the distribution.
mode	mode	Horizontal position of the bin with the maximum population.
average	avg	Horizontal mean of the distribution.
median	median	Horizontal median of distribution. The value of the mid-point of the distribution.
full width at half max	fwhm	The width of the distribution around the maximum population bin, including bins which contain at least one half of the maximum population.
full width at x% of max	fwxx	The width of the distribution around the maximum population bin, including bins which are at least x% of the maximum population.
x position at peak	xapk	Horizontal position of the nth largest peak by area.
percentile	pctl	Value in histograms for which % of population is smaller.

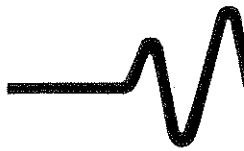

LeCroy

Innovators in Instrumentation

9300 Family Disk Drive Measurement Packages

Main Features

- **IDEMA Test Standards Measurements**
 - Pulse Width 50
 - Track Average Amplitude
 - Resolution
 - Overwrite
- **PRML Measurements**
 - Non Linear Transition Shift
 - Auto Correlation Signal-To-Noise
 - Auto Correlation
- **Peak/Trough Pair Measurements**
 - Time between peaks
 - Time between troughs
 - Time over threshold
 - And ten others...
- **Histograms for Statistical Analysis**
 - Histograms provide bar charts for easy analysis of measurement results over many events.

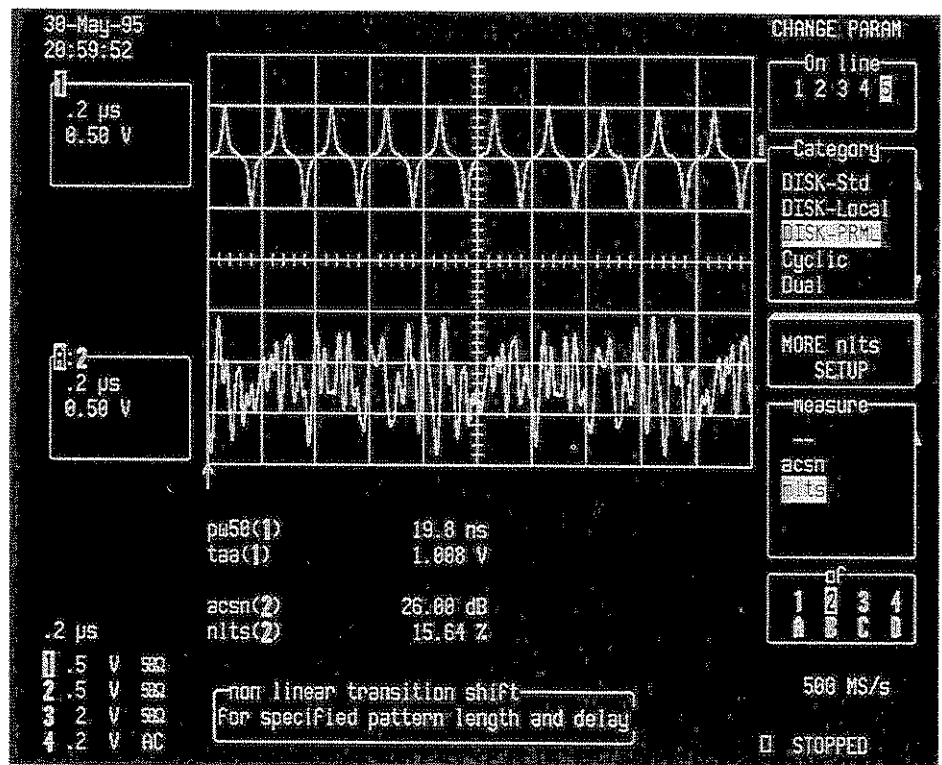

DISK DRIVE MEASUREMENT PACKAGES

LeCroy's Disk Drive Measurement Packages provide the ability to perform automated drive waveform measurements. The combination of automated measurements, long memory, and waveform display enables previously unavailable drive analysis capabilities.

The Disk Drive Measurement Packages include the DDM package and the PRML package. The DDM package provides IDEMA Test methods measurements and many other measurements for analysis of Lorentzian signals. The PRML package provides parameter measurements specifically for PRML

signals including PR4, EPR4 and E²PR4.

Also provided with the DDM package is a powerful histogram math function capability. The histogram math function allows any drive waveform parameter to be histogrammed and statistically analyzed.

DDM (Disk Drive Measurement) PACKAGE

IDEMA® TEST METHODS PARAMETERS

The DDM package includes processing functions specified in the International Disk Drive Equipment and Materials Association (IDEMA®) test standards document*.

Parameter	Description
PW50 ⁽¹⁾	Pulse Width 50: Provides an average pulse width, measured at 50% peak amplitude, of all peak/trough pairs in the specified waveform.
PW50(+)	Pulse Width 50 (+): Provides an average pulse width, measured at 50% peak amplitude, of all peaks in the specified waveform.
PW50 (-)	Pulse Width 50 (-): Provides an average pulse width, measured at 50% peak amplitude, of all troughs in the specified waveform.
TAA ± ⁽²⁾	Track Average Amplitude: Provides an average peak-to-peak amplitude of all Peak/Trough pairs in the specified waveform.
TAA (+)	Track Average Amplitude (+): Provides an average peak amplitude of all peaks in the specified waveform.
TAA (-)	Track Average Amplitude (-): Provides an average peak amplitude of all troughs in the specified waveform.
RESOLUTION ⁽³⁾	Specified as $(TAA(F1)/TAA(F2)) * 100\%$ Where: F1 = Low Frequency F2 = High Frequency
OW ⁽⁴⁾	Overwrite: Specified as: $10 \log (V/V_0)$ Where: V is the residual V_{rms} of F1 (low frequency) after F2 (high frequency) write V_0 is the V_{rms} of F1 (low frequency) after F1 write.

PEAK/TROUGH PAIR PARAMETERS

Parameters that measure amplitude and timing relationships between positive peaks and negative peaks (troughs) of a waveform are also included in the DDM package. Used in conjunction with the Histogram processing function a statistical description of the waveform can be calculated.

Parameter	Description
ibase	local baseline
lbsep	local baseline separation
lmax	peak maximum voltage
lmin	trough minimum voltage
lnum	number of local peak and trough pairs.
lpp	peak to trough amplitude (lmax - lmin)
ltbe	time between events (either peak to trough or trough to peak)
ltbp	time between peaks
ltbt	time between troughs
ltmn	time at minimum trough voltage
ltmw	time at maximum peak voltage
ltot	width of peak over threshold
ltpt	time between peak and trough
lttp	time between trough and peak
ltut	width of trough under threshold

*As specified in IDEMA Standards, 1994 Revised Edition

(1) Document No. T15-91

(2) Document No. T3-91

(3) Document No. T4-91

(4) Document No. T14-91

FREQUENCY DOMAIN PARAMETERS

These parameters provide a rapid technique to extract amplitude and phase of single frequencies from complex waveforms. These parameters are more efficient than using an FFT for specific frequencies of interest.

Parameter	Description
nbph	narrow band phase in degrees relative to start of waveform
nbpw	narrow-band power in dBv

Histograms

Any waveform parameter may be histogrammed. The histogram function produces a waveform with the vertical axis in units of 'Events' and the horizontal axis in parameter units (volts, nanoseconds,etc.). The histogram shows the statistical variation of the selected parameter and is an extremely valuable analysis tool. Using scope measurement cursors the value and population of any bin can be exactly determined.

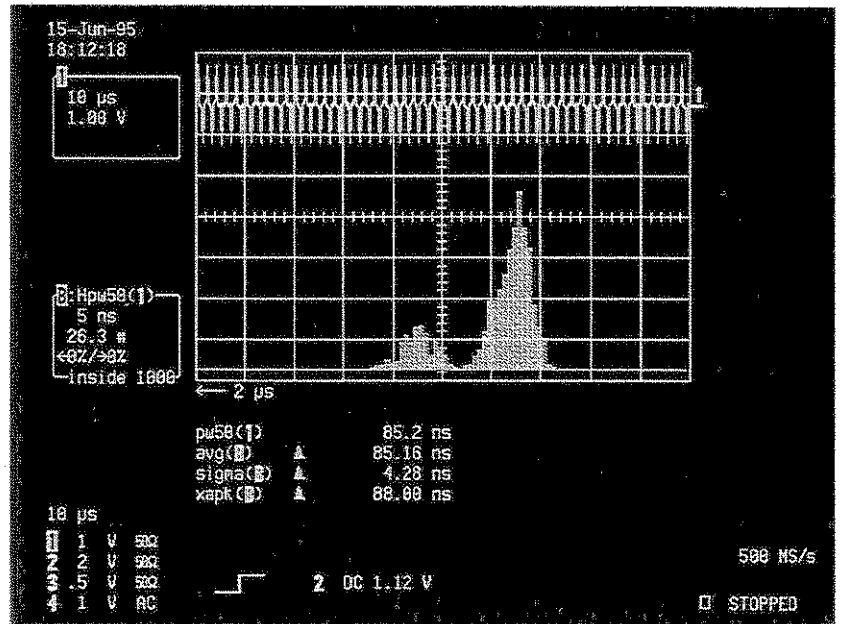

Histogram of PW50 for Trace 1 Signal

HISTOGRAM PARAMETERS

Histogram parameters provide the ability to obtain numeric values for statistics or other features of a histogram. When combined with the 9300 family parameter cursors the statistics or other characteristics of a selected section of interest in a histogram can be measured.

Name	Description
Low	Minimum value
High	Maximum value
Range	High - Low
FWHM	Width of largest peak at half amplitude
Maxp	Highest population (vertical value) in the histogram
Average	Mean value
Sigma	Standard deviation
Tpop	Total Population
XAPK	Horizontal position of the selected peak
Pks	Total number of peaks
Median	Horizontal position of the value which divides the histogram into two equal populations
Mode	Horizontal position of the most frequently occurring value
Percentile	Horizontal position separating histogram population to specified % on left such that the population on the left is a specified percentage of the total.

PRML Measurement Package

PRML PARAMETERS

PRML (Partial Response Maximum Likelihood) recording channels provide higher areal densities by allowing magnetic transitions to be written at closer spacing than peak detection channels. The following parameters provide a time domain technique to measure the time shift and S/N ratio created by this magnetic writing process.

NLTS Non-Linear Transition Shift
 $NLTS = -200^{\circ}r$
 Where r = auto correlation coefficient @ time delay

ACSN Auto Correlation Signal-to-Noise Ratio:
 $ACSN = 10 \log (R/1-R)$
 Where R = correlation coefficient

AutoCorrelation $R_x(u) = \int f_x(t)f_x(t-u)dt$

Ordering Information

93XX-DDM	Disk Drive Measurement Package
93XX-PRML	PRML Measurement Package
93XX-VP1	WP01, WP02 and DDM Package
93XX-VP2	WP01, WP02, DDM and PRML Package
93XX-VP3	DDM and PRML Package

Copyright © October LeCroy is a registered trademark of LeCroy Corporation. All rights reserved. Information in this publication supercedes all earlier versions.

Specifications subject to change without notice.

9510/B

LeCroy
 Innovators in Instrumentation

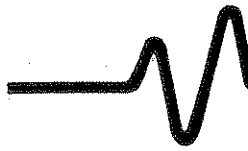

LeCroy

The Digital Scope Specialists

CKTRIG hardware option for the 9350A and 9370 series oscilloscopes

Main Features

- High speed 500 MHz external clock input.
- 10 MHz external clock reference input.
- Edge trigger comparator output.
- BNC, rear-panel mounted connectors.

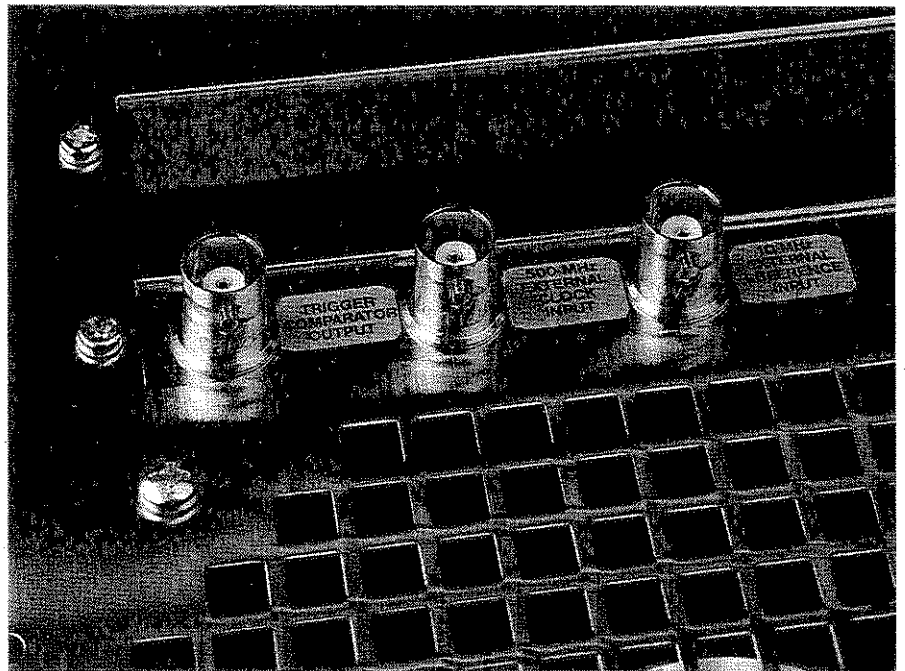

External clock

This feature allows the 9350A and 9370 series DSOs to be externally clocked at a fixed rate from 50 MS/s to 500 MS/s, enabling full phase control over the acquired signal. The sample rate can be fine-tuned to the exact speed required by the application.

External reference

The external reference allows the scope to be phase-synchronized to an external 10 MHz reference, either to match the stability of the external source or to phase lock the acquired signal. Several DSOs can then be synchronized using a simple source as reference.

Trigger comparator

The trigger comparator signal outputs a pulse for each valid edge-trigger condition on the trigger signal. This is an invaluable feature for event-counting and throughput applications.

Specifications

EXTERNAL CLOCK INPUT

Input signal requirements:

Amplitude: 800 mV p-p
Frequency range: 50 MHz to 500 MHz
Offset: 0 V

Input impedance: 50Ω.
Calibration must be initiated for each external clock change.

The negative pulse width must be less than 5ns.
(2ns recommended)

Swept Clock: Only a fixed frequency external clock is supported. Swept clocks will cause severe offset errors (10% worst-case).

EXTERNAL CLOCK REFERENCE INPUT

Input signal requirements:

Amplitude: 800 mV p-p
Frequency range: 10 MHz ±5%
Offset: 0 V

Input impedance: 50Ω.

TRIGGER COMPARATOR OUTPUT

The comparator operates in a 'time-over-threshold' mode and generates a pulse edge of the same polarity as the polarity of the selected triggering edge each time a valid EDGE TRIGGER condition is met on the trigger signal. The duration of the pulse will be equal to the time the trigger signal is above/below the trigger level.

Note: This does not operate in SMART TRIGGER mode.

Output signal characteristics: ECL, 50Ω, series-terminated.

Ordering Information

935XA-CKTRIG	CKTRIG option for the 9350A oscilloscope family.
935XA-RKCKTRIG	Retrofit kit for the 9350A oscilloscope family.
937X-CKTRIG	CKTRIG option for the 9370 oscilloscope family.
937X-RKCKTRIG	Retrofit kit for the 9370 oscilloscope family.

For further details, please request the CKTRIG Product Note from ITI Marketing.

USA Direct Sales: 1 (800) 5LE-CROY

LeCroy Worldwide Sales Offices

ASIA/PACIFIC	LeCroy Pty Ltd	61.38.90.7358
BENELUX	LeCroy BV	04902.8.9285
FRANCE	LeCroy SARL	(1).69.18.83.20
GERMANY	LeCroy GmbH	06221.83.10.01
ITALY	LeCroy SRL	06.336.797.00
JAPAN Osaka	LeCroy Japan	0816.330.0961
JAPAN Tokyo	LeCroy Japan	0813.3376.9400
SWITZERLAND	Geneva	022.719.21.11
SWITZERLAND	Lenzburg	064.51.91.81
United Kingdom	LeCroy Ltd	(01235) 533114

Other sales and service representatives throughout the world.

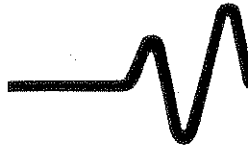

LeCroy

Innovators in Instrumentation

930x-64

64 Mega Bytes Extended Processing Memory

Main Features

- Extended memory capacity for processing long waveforms.
- High-speed signal processing.
- Fast Fourier Transforms on long waveforms.
- Improved trace update rate.

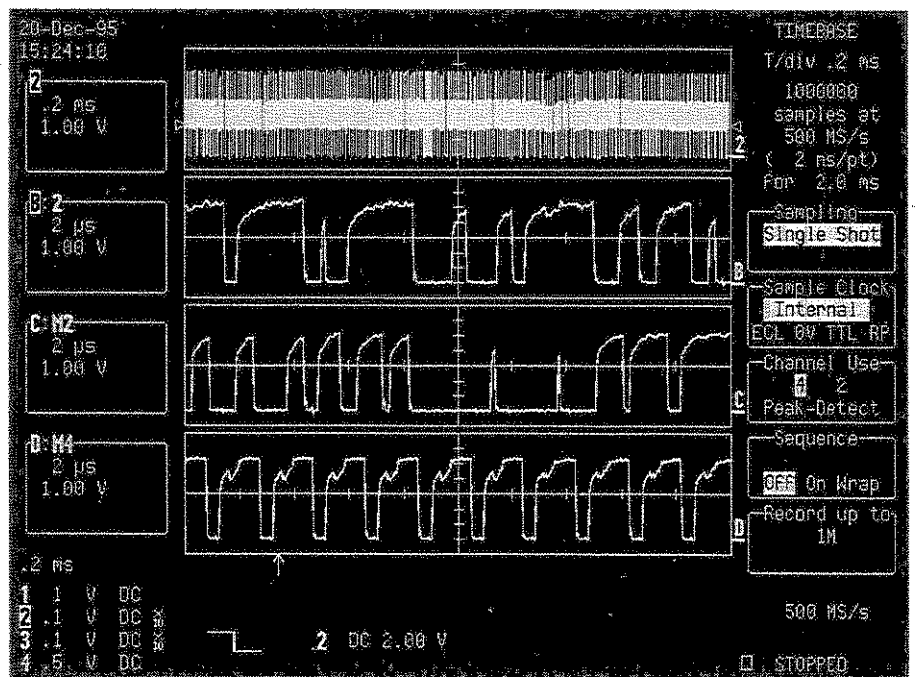

Power and Speed

This option offers 64 Mbytes of processing RAM for the 9300 series of DSOs that have a 68030 processor installed. One benefit of the 64 Mbyte option is its ability to handle longer FFTs, multiple zooms, math function chaining, and storage of very long waveforms. In addition to increased capability for memory intensive applications the extra memory results in higher processing speed for all operations.

Memory Usage

In a typical 9300 series oscilloscope about 1.5 MB of RAM is used by the operating system and the remainder (2.5 MB for standard models, 6.5 MB for 'M' models and 14.5 MB for 'L' models) is available for waveform processing. The amount of memory needed depends on the length of waveforms being processed. For example, performing a simple function on a 1 million point waveform requires 4 Mbytes, performing an FFT on a 1 million point signal requires 8 Mbytes.

Enough Memory?

Without sufficient processing memory users can run into application problems. Two 2 million point signals may be stored in the RAM of an 'L' model DSO but an additional oscilloscope operation may demand more than the remaining available RAM. The result is memory crunch, and the scope slows down. The 64 Mbyte option gives 'power users' the capability they need to ensure that processing of long waveforms does not cause a problem.

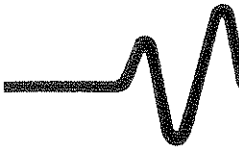

LeCroy

Innovators in Instrumentation

LeCalsoft—Calibration Software for LeCroy Digital Oscilloscopes

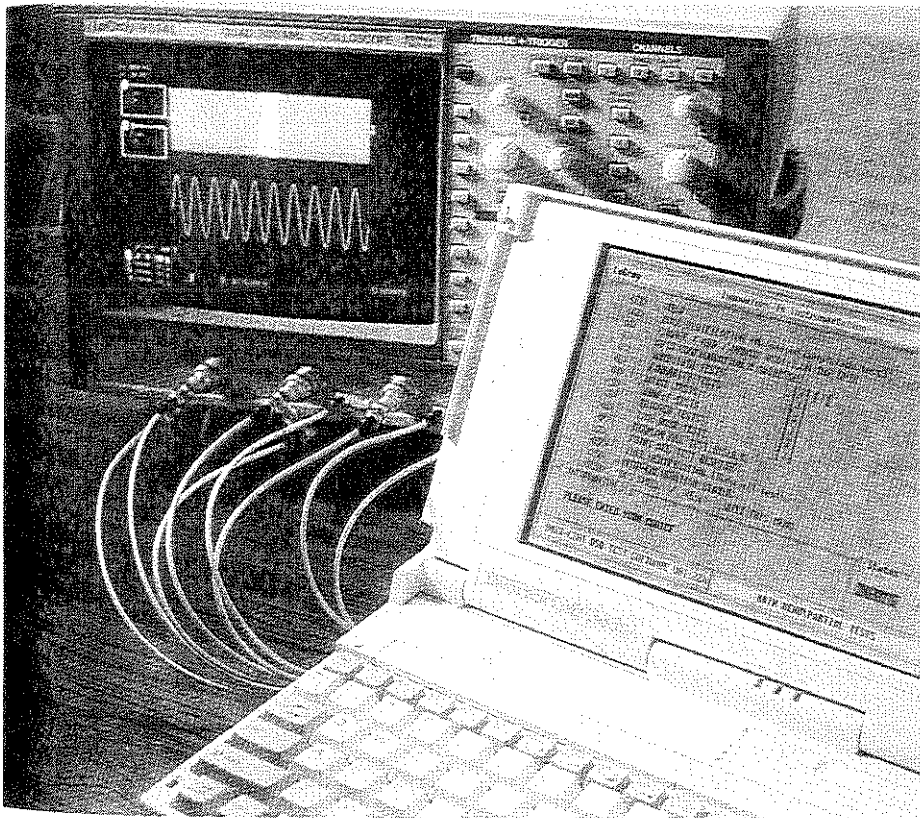

The LeCalsoft package enables a fast and thorough verification of all key specifications.

Main Features

- Traceability to reference standards
- Computer check of key specifications
- Computer-aided readjustment
- Fully automated configurations available
- Supports all 93XX and 94XX models
- IBM® PC-AT compatible

General

The LeCroy LeCalsoft (94XXCS05) test and calibration package provides a convenient, unambiguous check of LeCroy oscilloscopes. Designed for users who require traceability to reference standards (NIST, etc.), this package is ideally suited for use in calibration laboratories where the oscilloscopes are checked at fixed intervals.

Results of the calibration check are fully documented on hard copy, or they can be archived on hard disk or diskette.

LeCalsoft works on any PC compatible with the IBM®-AT standard. It controls the oscilloscope and the calibration sources through a National Instruments® GPIB interface.

Features

Calibration Check

All the essential specifications of the Digital Oscilloscope, such as bandwidth, linearity, noise, trigger, timebase and effective-bit count are tested. Deviations from nominal values are calculated and displayed on the screen, printed, or archived on hard disk or diskette.

Comprehensive Documentation of the Test Results

At the end of each calibration check, two types of documentation are available: a long form printout which gives details of the results of all the tests executed, and states whether or not the results are within the specifications, and a short form printout which gives a summary of the test results.

Calibration Traceable to National Standards (NIST, etc.)

By using signal sources traceable to a standard, the calibration will be traceable to the same standard, provided the relevant documentation is maintained.

Manual and Automated Calibration Check

Both manual operation with computer assistance, and automated operation are possible. Automated operation requires programmable multiplexer and signal sources. See the list of supported devices below.

Assisted Adjustment of the Oscilloscope

A computer-aided adjustment procedure is also provided. By following instructions on the screen, the trained technician is guided through the adjustments required to correct the settings of the oscilloscope so that it is within the specifications.

Calibration Certificate

On request, LeCroy will perform calibration traceable to National Standard Organizations. Calibration certificates are provided as part of this service.

Functional Description

Calibration Practice

LeCroy oscilloscopes are auto-calibrating digital oscilloscopes and therefore do not require regular calibration like analog oscilloscopes. However, for users who require traceability to reference standards (such as those provided by the National Institutes of Standards and Technology), and for calibration laboratories which must inspect incoming instruments and perform recalibration at prescribed intervals, the LeCalsoft computer-aided test and calibration packages provide an easy solution.

Under guidance of the LeCalsoft program, some adjustments to the oscilloscope can be made by an electronics technician. However major deviations from specifications usually require repair by a trained service engineer. LeCroy regularly schedules training classes. If no in-house trained person is available, the nearest LeCroy service center can carry out repairs and calibration, and provide traceability to reference standards.

Using the LeCroy LeCalsoft Packages

For calibration checking, digital oscilloscopes have a great advantage over analog oscilloscopes because waveforms can be transferred to a host computer. This simplifies the calibration procedure enormously, makes it potentially faster and allows an extensive range of tests with unambiguous interpretation of the results.

LeCalsoft performs an extensive series of tests which verify the specifications of the oscilloscope. It includes many tests relevant to analog scopes such as Noise and Linearity tests. Although these tests are difficult and time consuming on an analog oscilloscope, they can be computer controlled and are quickly and easily performed on a digital oscilloscope. Tests which are specific to digital oscilloscopes, such as Sinefit tests are also included.

The various test options in LeCalsoft are presented to the operator in the form of a simple menu system. The user has the choice of performing an automated calibration check of the oscilloscope, or individually testing any of the specifications. Some of the tests require the use of high-quality external signal generators. The user receives instructions on

the screen when it is necessary to change the cable connections, but apart from this minor intervention, the tests are fully computer controlled when supported GPIB-programmable instruments are used.

Supported Instrumentation

LeCalsoft software works on any AT-compatible equipped with a math coprocessor and a National Instruments GPIB interface. Automated calibration checking is possible using a set of instruments from the following list. (For an automated calibration check, either the LeCroy or Keithley programmable multiplexer is required to feed the calibration signals to the oscilloscope input.)

RF sinewave generators:
Marconi 2019A, 2022C, 2030, 2031
Fluke 6060B, 6061A
Hewlett-Packard 8642A, 8642B
Rohde & Schwarz SMX

AF sinewave generators:
Marconi 2019A, 2022C, 2030, 2031
Hewlett-Packard 8642A, 8642B
Rohde & Schwarz SMX
Tektronix FG5010
LeCroy AFG 9100

DC Precision Power Supply:
Tektronix PS5004
Datron 4708 Autocal Multifunction Standard

Fast Pulse Generator:
Tektronix CG5001/CG551AP

Power Meters:
Hewlett-Packard HP436A, HP437B

Multiplexers:
Keithley 199 SYSTEM DMM/
SCANNER with LeCroy interface board.
LeCroy 4951, 4973-1, 4973-2
Multiplexers.

Frequency standard:
WWV or HBG1500

Recommended Accessories

A full kit of calibration connectors and interfaces is available from LeCroy. It includes all the necessary cables, adapters, splitters and filters, as well as the Programmable Multiplexer. Also available is a repair package including special tools, board extenders, etc., for computer-aided adjustment.

Use of Other Instruments

It is possible to perform the calibration check with some other unsupported signal sources. However, the user is then required to set up these instruments manually and to perform one measurement at a time. The LeCalsoft package

guides the user step by step, and controls the oscilloscope data acquisition and the computation of the results.

LeCalsoft compares the signal measured by the oscilloscope with the signal it would expect to receive from the generator. Warning messages are displayed

whenever tolerances are exceeded. Some of the adjustments may be carried out by the user when the test sequence is finished. In this case, the software will guide the user through the correct adjustment procedure. At the end of the calibration check, a printout can be generated to list the results.

Specifications

Computer Required: Any PC compatible with the IBM-AT standard, and equipped with a mathematical coprocessor and a National Instrument Inc. GPIB interface.

Operating System: DOS 3.0 upward

Medium: 3 $\frac{1}{2}$ " 1.44 Mb
5 $\frac{1}{4}$ " 1.2 Mb diskette

Major Tests Supported by LeCalsoft

Internal

To ensure proper calibration of the oscilloscope, internal auto-calibration tests are automatically executed during normal operation. This standard sequence of internal auto calibration tests is initiated by the software and the results are transferred to the PC for analysis.

The tests are:

- Calibration of the resolution of the time-to-digital converter with respect to the system clock
- Determination of the gain constants of the input amplifiers
- Offset compensation versus gain variation
- Global internal non-linearity
- General functionality check

Bandwidth

To calculate the bandwidth, the amplitudes of sine waves of increasing frequencies are measured. The sine wave generator is first set to 500 kHz with an amplitude 75% of full screen, i.e. ± 3 vertical divisions. The frequency is then swept up to the point where an amplitude drop of 3 dB is observed. This indicates the bandwidth.

This test is executed on all channels for 1 M Ω and 50 Ω input impedance and for all vertical sensitivities. It requires a sine wave generator with good flatness.

Generators supported under program

control are listed on page 2.

Linearity

15 different known voltages, varying from 5% to 95% of full screen, are applied by the external voltage reference source. For each voltage value, a full waveform is acquired, and the mean value is compared to the known input voltage. The linearity is determined through a linear regression fit to the 15 measurements. The slope, the offset and the chi-square of the fit are computed.

With the linearity test, many other related tests are performed: response time of the overload protection of the 50 Ω input, linearity of the variable gain calibration, range and linearity of the offset setting, and quality of the input coupling.

This procedure is executed on all channels for both 1 M Ω and 50 Ω input impedance. The test requires a DC source with a precision and time stability of 0.1%, a voltage range of 0 V to 20 V adjustable in steps of 5 mV, and an output current capability of 300 mA.

Power supplies supported under program control are listed on page 2.

Noise

The noise tests are executed on all channels for both 1 M Ω and 50 Ω input impedance, with AC and DC coupling, five different time-base settings, and open inputs. Full waveforms are acquired with different offset values. The peak-to-peak as well as the RMS values of each measurement are computed, and the maximum values are recorded. The program also indicates the occurrence of any "flyers", i.e. short noise peaks generated by the ADC's.

The noise tests also include:

- checking the linearity of the variable offsets of all channels between 2.5% and 97.5% of full screen.

- checking the stability of the ground line when switching the inputs between GROUND and DC coupling modes.

Rise time/Overshoot

Executed on all channels for both 1 M Ω and 50 Ω input impedance, these tests measure the rise time of the oscilloscope response to the input voltage step, as well as the amount of pre-shoot and overshoot. They require a voltage step generator with calibrated fast rise-time amplitude.

The Voltage Step Generator supported under program control is the Tektronix CG5001.

Sinefit

The performance of the analog-to-digital converter is evaluated in terms of the number of effective bits (a measure of the signal-to-noise ratio). It is measured on all channels, at a sensitivity of 50 mV/div., by applying a pure sine wave at varying frequencies and timebase settings.

This test is a measurement of dynamic linearity. It shows the effect of such errors as noise, non-linearities and aperture jitter.

Timebase

The timebase test compares the internal clock with a very precise and stable external timebase reference (clock generator) such as the WWV standard or HBG 1500.

Trigger

The trigger capabilities are tested for all possible configurations. These include:

- Internal and external trigger sources
- DC, AC, HF-reject, and LF-reject couplings
- Trigger level settings in all slope modes.

ORDERING INFORMATION

LeCalsoft and Options

94XXCS05 Complete LeCalsoft for 93XX and 94XX (software and hardware), incl. cables, switch card, adapters, etc.
94XXCS01 LeCalsoft software for 93XX and 94XX
9400CS01 Calsoft software for 9400A

LeCalsoft Accessories

93XXKCS02 Calibration kit for 93XX and 94XX
9400KCS02 Calibration kit for 9400A
Individual system components available on request

U.S. REGIONAL SALES OFFICES 1 800-5-LeCroy (1-800-553-2769):

automatically connects you to your local sales office.

LeCroy has sales engineers in most major metropolitan areas, coordinated through a system of five Regional Sales and Service Offices:

NORTHEAST: 700 Chestnut Ridge Rd,
Chestnut Ridge, NY 10977

SOUTHEAST: 410 Ware Blvd Ste 716,
Tampa, FL 33619

FARWEST: 5912 Stoneridge Mall Rd
Ste 150, Pleasanton,
CA 94588

CENTRAL:

Midwest: 4811 S 76th St Ste 415,
Greenfield, WI 53220

Southwest: 14800 Central Ave SE
Albuquerque, NM 87123

WORLDWIDE

Argentina: Search SA, (01) 394-5882

Australia: Scientific Devices Pty Ltd,
(03) 579-3622

Austria: Dewetron GmbH, (0316) 391804

Benelux: LeCroy BV (0031) 4902-89285

Brazil: ATP-Hi-Tek, (011) 421-5477

Canada: LeCroy Canada Inc,
(514) 928-4707

Denmark: Lutronic, (42) 459 764

Eastern Europe: Elsinco GmbH, Vienna,
222 812 1751

Finland: Labtronic OY, (80) 847 144

France: LeCroy Sarl (1) 69 073 897

Germany: LeCroy GmbH, (06221) 831001

Greece: Hellenic S/R Ltd., (01) 721 1140

Hong Kong: Euro Tech (Far East) Ltd,
(052) 814-0311

India: Electronic Ent, (022) 4137096

Israel: Ammo, (03) 453157

Italy: LeCroy Srl, Roma (06) 300.97.00
or 331 31 46; Milano (02) 2940 5634

Japan: LeCroy Japan,
Tokyo (0081) 33 376 9400;
Osaka (0081) 6 330 0961

Korea: WOOJOO Hi-Tech Corp,
(02) 449-5472

Mexico: Nucleoelectronica SA,
(05) 5593 6043

New Zealand: E.C. Gough Ltd,
(03) 798-740

Norway: Avantec AS (02) 630520

Pakistan: Electronuclear Corp, (021) 418087

Portugal: M.T. Brandao, Lta, (02) 815680

Singapore: Sing. Electr. and Eng. Ltd
(65) 481-8888

S. Africa: Westplex Test & Meas.
(011) 787 0473

Sweden: MSS AB, (0764) 68100

Switzerland: LeCroy SA (064) 51 91 81

Taiwan: Topward El.Inst., Ltd, (02) 601 8801

Thailand: Measuretronix Ltd, (02) 374 2516

United Kingdom: LeCroy Ltd, (0235) 533 14

LeCroy

Innovators in Instrumentation

LeCROY CORPORATE HEADQUARTERS

700 Chestnut Ridge Road
Chestnut Ridge, NY 10977-6499
Phone: (914) 425-2000
TWX: (710) 577-2832
Fax: (914) 425-8967

LeCROY EUROPEAN HEADQUARTERS

2, rue du Pré-de-la-Fontaine
P.O.Box 341
1217 Meyrin 1 - Geneva, Switzerland
Telephone: (022) 719-21-11
Fax: (022) 782-39-15

SECTION 3 Performance Verification**3.1 Introduction**

This chapter contains procedures suitable for determining if the 9374/M/L/TM Digital Storage Oscilloscope performs as warranted.

They check all the characteristics that are designated as warranted specifications in subsection 3.1.1. A more complete list of specifications is given in section 2.1.

Because they require time and suitable test equipment, you may not need to perform all of these procedures, depending on what you want to accomplish.

In the absence of the computer automated calibration system based on LeCroy Calibration Software (LeCalsoft), this manual performance verification procedure can be followed to establish a traceable calibration.

It is the calibrating entities responsibility to ensure that all laboratory standards used to perform this procedure are operating within their specifications and traceable to required standards if a traceable calibration certificate is to be issued for the 9374/M/L/TM Digital Storage Oscilloscope.

3.1.1 List of Warranted Specifications

The electrical warranted specifications are listed in this subsection.

Warranted specifications are described in terms of quantifiable performance limits which are warranted.

- Input Impedance
- Leakage Current
- Peak to Peak and RMS Average noise level
- Positive and Negative DC linearity
- Positive and Negative Offset
- Bandwidth
- Trigger Level
- Smart Trigger
- Time Base Accuracy
- Overshoot and Rise Time
- Probe Calibrator
- Overload

Section 3 Performance Verification

3.2 Test Equipment Required

These procedures use external, traceable signal generators, DC precision power supply and digital multimeter, to directly check warranted specifications.

Instrument	Specifications	Recommended	Where used
Signal Generator (sine wave)	Frequency : .5 MHz to 2 GHz Frequency Accuracy : 1 PPM Amplitude : 5 V peak to peak	HP8648B or equivalent	3.9.1 3.11 3.12
Fast pulse Generator	Rise time < 70 psec <i>use TD pulser</i> <i>RT is \approx 125 ps</i>	Picosecond TD1107 B or equivalent	3.13
Sine Wave Generator	Frequency : 5 KHz Amplitude : 6 V peak to peak	LeCroy LW420 or equivalent	3.10 <i>TRIM</i>
DC precision Power Supply	Amplitude : 10 V, DC Accuracy : < 0.1 %	Tektronix PS5004 or equivalent	3.7, 3.8 3.15 <i>TRIM</i>
Digital Multimeter	4 digits	Keithley 199 or equivalent	3.4 3.5
10:1 Passive Probe	500 MHz , 10 M Ω	LeCroy PP005	3.9.1.b
Cable	BNC, 50 Ω , length 20 cm, 1ns (7.87 inches)	LeCroy 480232001	3.10.3 3.10.4
Cable	BNC, 50 Ω , length 100 cm, 5 ns (39.37 inches)	LeCroy 480020101	3.XX
Attenuator	50 Ω , 20 dB 1% accuracy	Suhner	3.7
Attenuator	1 M Ω , 20 dB 1% accuracy	Suhner	3.7
Attenuator	50 Ω , 3 dB 1% accuracy	Suhner	3.10
Terminator	50 Ω Feed through, 1% accuracy	Suhner	3.13
BNC T adapter	BNC, 50 Ω , T adapter	LeCroy 402222002	3.10.3 3.10.4

Table 3-1 : Test Equipment

3.3 Turn On

If you are not familiar with operating the 9374/M/L/TM oscilloscope, read the operator's manual.

- Switch on the power using the power switch on the rear panel and verify :
- The display turns on after about 10 seconds and is stable
- The range of intensity and grid intensity is reasonable
- Wait for about 10 minutes for the scope to reach a stable operating temperature.

3.4 Input Impedance

Specifications

- DC $1.00\text{ M}\Omega \pm 1\%$
- AC $1.11\text{ M}\Omega \pm 2\%$
- DC $50\ \Omega \pm 1\%$

3.4.1 Procedure

The impedance values for $50\ \Omega$ and $1\text{ M}\Omega$ couplings are measured, with a high precision digital multimeter.

3.4.1.a DC $1\text{ M}\Omega$

- Set DSO Channel 1 : **On**
- Input Coupling : **DC $1\text{ M}\Omega$**
- Input gain : **50 mV/div.**
- Trigger on : **Channel 1**
- Trigger mode : **Auto**
- Time base : **50 $\mu\text{sec/div.}$**

26-Feb-96
16:12:27

50 μs
50 mV

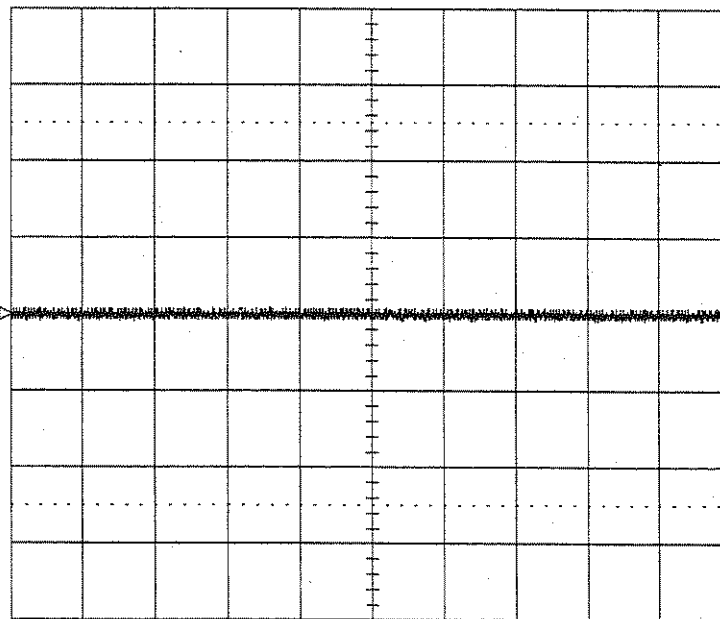

CHANNEL 1
Coupling
DC50 Ω
Grounded
DC1M Ω
Grounded
AC1M Ω
V/div Offset
NORMAL
ECL TTL
Global BWL
OFF 25MHz
200MHz

Probe Atten
x1
x2
x5
x10
x20

50 μs
1 50 mV DC
2 50 mV DC
3 50 mV DC
4 50 mV DC

1 DC 0mV

100 MS/s

AUTO

- Measure the impedance using a DMM with sense : must be $1.00\text{ M}\Omega \pm 1\%$.
- Repeat the above test for input volt/div. of **200 mV**.

Section 3 Performance Verification

3.4.1.b AC 1MΩ

- Set DSO Channel 1 : On
- Input Coupling : AC 1 MΩ
- Input gain : 50 mV/div.
- Trigger on : Channel 1
- Trigger mode : Auto
- Time base : 50 μsec/div.

26-Feb-96
16:28:34

50 μs
50 mV

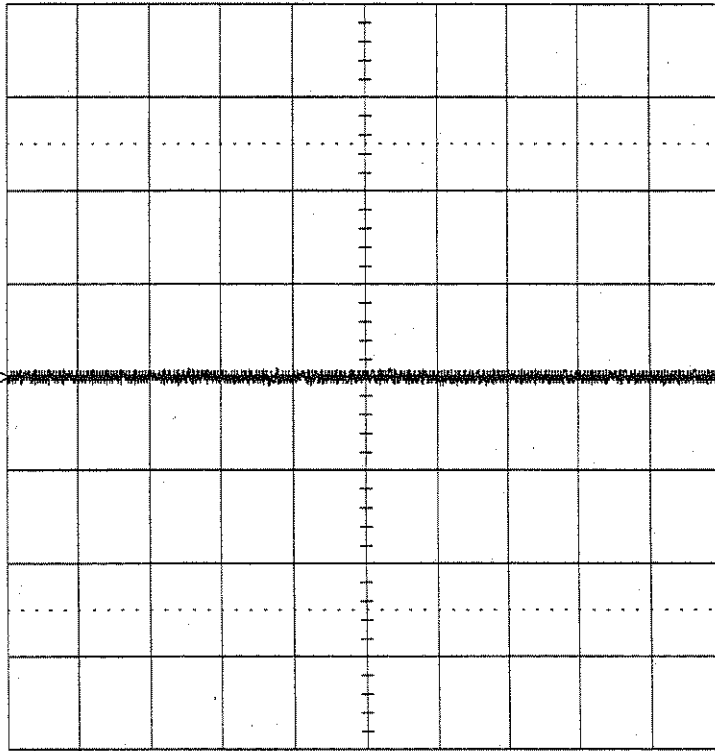

CHANNEL 1

Coupling
DC50Ω
Grounded
DC1MΩ
Grounded
AC1MΩ

V/div Offset
NORMAL
ECL TTL

Global BWL
OFF 25MHz
200MHz

Probe Atten
x1
x2
x5
x10
x20

50 μs

- 1 50 mV AC
- 2 50 mV AC
- 3 50 mV AC
- 4 50 mV AC

1 DC 0mV

100 MS/s

AUTO

- Measure the impedance using a DMM with sense : must be 1.11 MΩ ± 2%.
- Repeat the test for input volt/div. of 200 mV, the impedance must be 1.00 MΩ ± 2%.

3.4.1.c DC 50Ω

- Set DSO Channel 1 : **On**
- Input Coupling : **DC 50Ω**
- Input gain : **50 mV/div.**
- Trigger on : **Channel 1**
- Trigger mode : **Auto**
- Time base : **50 μsec/div.**

26-Feb-96
16:30:50

1
50 μs
50 mV

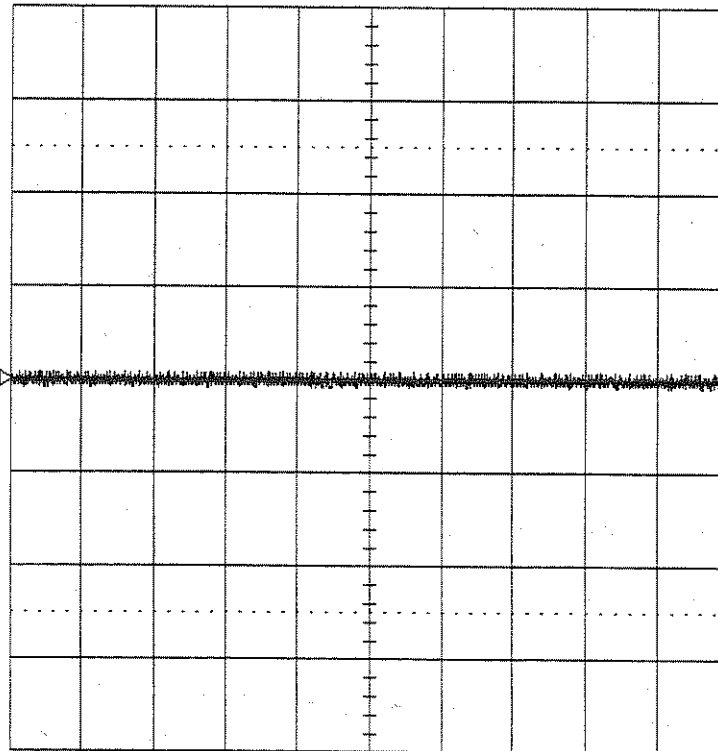

CHANNEL 1
Coupling
DC50Ω
Grounded
DC1MΩ
Grounded
AC1MΩ
V/div Offset
NORMAL
ECL TTL
Global BWL
OFF 25MHz
200MHz

Probe Atten
x1
x2
x5
x10
x20

50 μs

- 1 50 mV 50Ω
- 2 50 mV 50Ω
- 3 50 mV 50Ω
- 4 50 mV 50Ω

1 DC 0mV

100 MS/s

AUTO

- Measure the impedance using a high precision DMM with sense : must be **50 Ω ± 1%**
- Repeat the above test for input volt/div. of **200 mV**.
- Repeat steps 3.4.1.a, 3.4.1.b and 3.4.1.c for Channel 2, Channel 3 and Channel 4.

Section 3 Performance Verification

3.4.2 External Trigger Input Impedance

3.4.2.a DC 1MΩ

- Set Trigger on : EXT
- Trigger mode : Auto
- Coupling Ext : DC
- External : DC 1MΩ
- Time base : 50 μsec/div.

26-Feb-96
16:33:29

TRIGGER SETUP

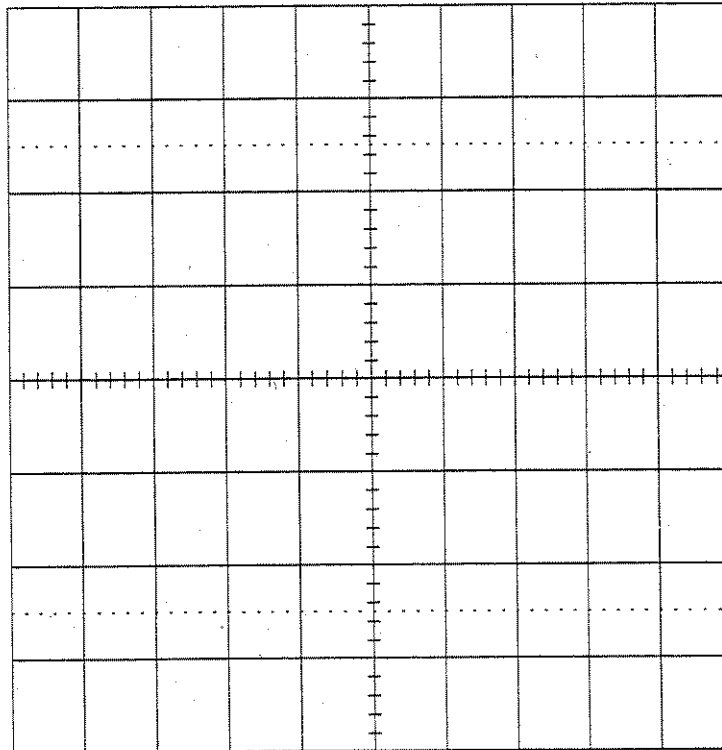

Edge SMART

trigger on
1 2 3 4 Ext
Ext10 Line

cplg Ext
DC AC LFREJ
HFREJ HF

slope Ext
Pos Neg

External
DC50Ω DC1MΩ

holdoff

OFF Time Evts

50 μs

- 1 50 mV 50Ω
- 2 50 mV 50Ω
- 3 50 mV 50Ω
- 4 50 mV 50Ω



Ext DC 0mV 1MΩ

100 MS/s

AUTO

- Measure the impedance using a high precision DMM : must be 1.00 MΩ ±1%.

3.4.2.b DC 50Ω

- Set Trigger on : **EXT**
- Trigger mode : **Auto**
- Coupling Ext : **DC**
- External : **DC 50Ω**
- Time base : **50 μsec/div.**

26-Feb-96
16:34:33

TRIGGER SETUP

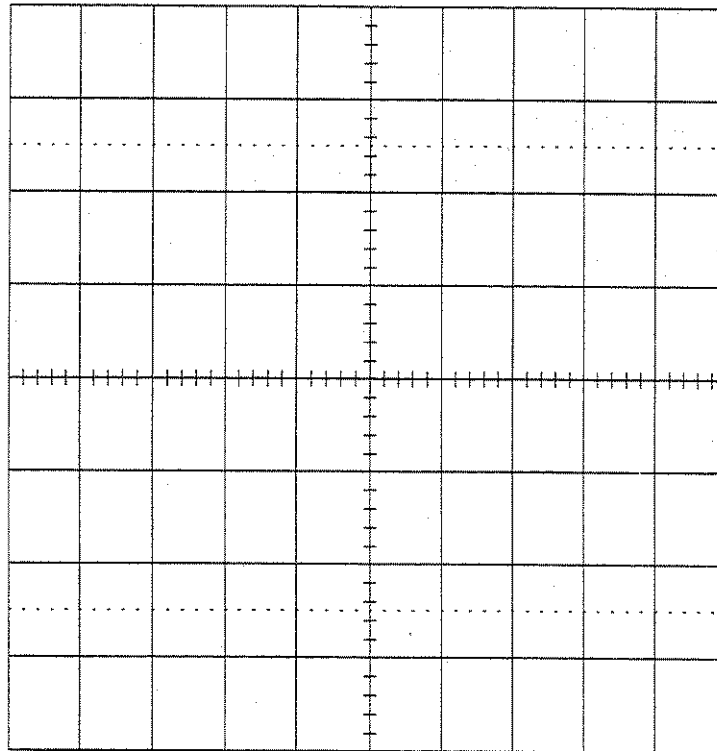

Edge SMART

trigger on
1 2 3 4 **Ext**
Ext10 Line

cp1g Ext
DC AC LFREJ
HFREJ HF

slope Ext
Pos Neg

External
DC50Ω DC1MΩ

holdoff
OFF Time Evts

50 μs

- 1 50 mV 50Ω
- 2 50 mV 50Ω
- 3 50 mV 50Ω
- 4 50 mV 50Ω

Ext DC 0mV 50Ω

100 MS/s

AUTO

- Measure the impedance using a high precision DMM with sense : must be **50 Ω ± 1%**.
- Repeat steps 3.4.2.a, for Ext/10, and check as above.

Section 3 Performance Verification

3.4.3 Internal Protective Resistor Verification

With any time base and gain, set DSO as follows :

- Input Coupling : **Grounded**
- Check with a high precision DMM : input impedance must be $1\text{ M}\Omega \pm 2\%$.

17-Jan-96
13:57:25

1
50 μs
100 mV

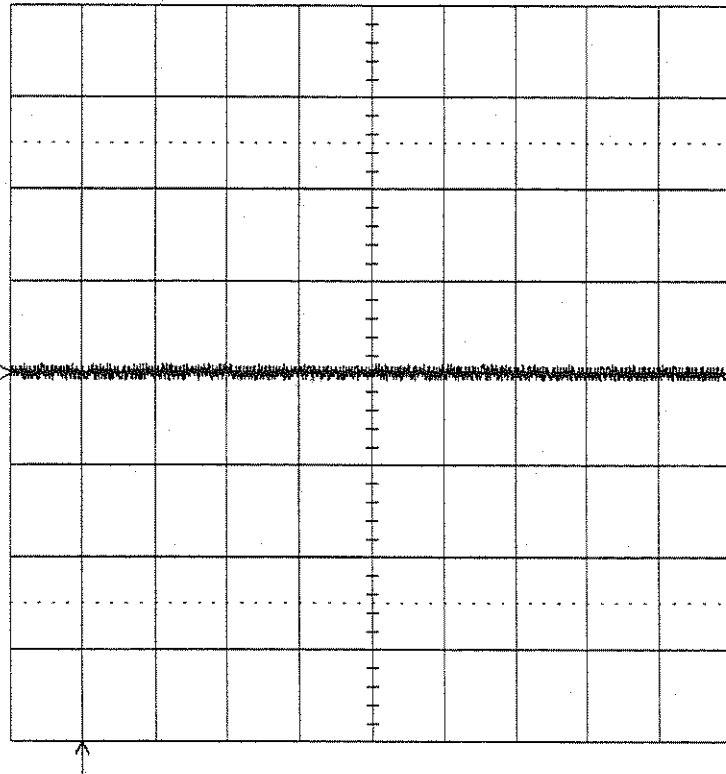

CHANNEL 1
Coupling
DC50 Ω
Grounded
DC1M Ω
Grounded
AC1M Ω
V/div Offset
NORMAL
ECL TTL
Global BWL
OFF 25MHz
200MHz

Probe Atten
x1
x2
x5
x10
x20

50 μs
1 .1 V \downarrow
2 .1 V \downarrow
3 .1 V \downarrow
4 .1 V \downarrow

1 DC 0 mV

100 MS/s
 AUTO

- Repeat the above test for Channel 2, Channel 3 and Channel 4.

3.5 Leakage Current

Specifications

DC 1 M Ω , AC 1 M Ω , DC 50 Ω : ± 1 mV

3.5.1 Procedure

The leakage current is tested by measuring the voltage across the input of each channel.

- Set DSO Ch1 : **On**
- Input Coupling : **DC 50 Ω**
- Input gain : **50 mV/div.**
- Trigger on : **Channel 1**
- Trigger mode : **Auto**
- Time base : **10 μ sec**

- Connect a high precision DMM to Channel 1, and verify that the reading is not larger than ± 1 mV.
- Repeat the above test for input volt/div. of **200 mV**.
- Repeat the procedure for **1M Ω DC** and **1M Ω AC**.
- Repeat step 3.5.1 for Channel 2, Channel 3, Channel 4 and External .

3.6 Average Noise Level

Description

The 9374/M/L/TM inputs average noise level is tested at 10 mV/div., with 0 mV offset. This is to verify the proper operation of the main board, front-end and ADC's. The scope parameters functions are used to measure the RMS and Peak amplitude of the noise.

3.6.1 Peak to Peak Noise

Specifications

< ± 7.2 mV Peak to Peak at 10 mV/div.

3.6.1.a DC 1M Ω

Procedure

- With no signal connected to the inputs, set 9374/M/L/TM DSO settings as follows :
- Turn on traces : **Ch1, Ch2, Ch3, Ch4**
- Display setup : **Standard, Dot Join on, Persistence off, Single grid**

Section 3 Performance Verification

- Input Coupling : DC 1M Ω
- V/div. offset : Normal
- Probe atten : X1
- Global BWL : Off
- Input gain : 10 mV/div.
- Trigger setup : Edge
- Trigger on : 1
- Coupling 1 : DC
- Slope 1 : Pos
- Holdoff : Off
- Trigger Mode : Auto
- Timebase : 20 msec/div.
- Channel use : 4
- Record up : 50 K

26-Feb-96
16:46:09

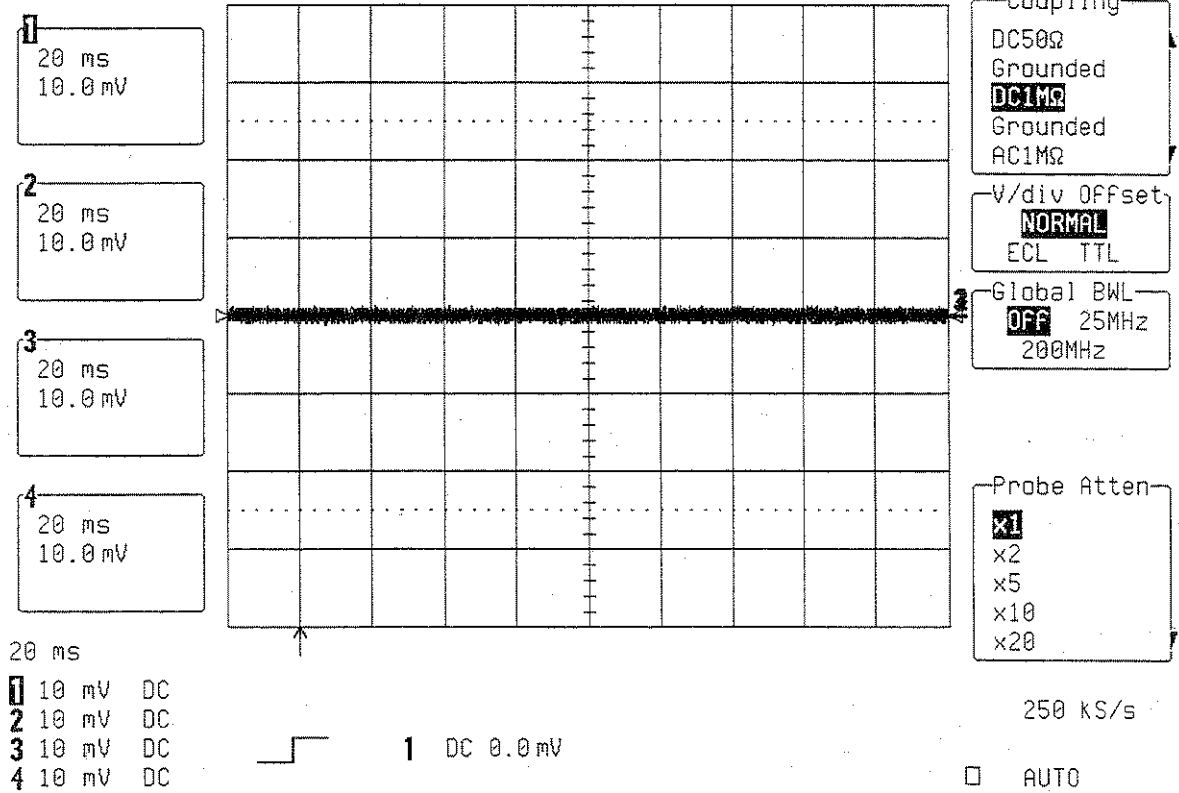

- Press : Cursors/Measure
- Measure : Parameters
- Mode : Custom
- Statistics : On
- Change parameters
- Category : All
- On line 1 : Measure pkpk of Ch1
- On line 2 : Measure pkpk of Ch2
- On line 3 : Measure pkpk of Ch3
- On line 4 : Measure pkpk of Ch4

27-Feb-96
8:37:46

1
20 ms
10.0 mV

2
20 ms
10.0 mV

3
20 ms
10.0 mV

4
20 ms
10.0 mV

20 ms
1 10 mV DC
2 10 mV DC
3 10 mV DC
4 10 mV DC

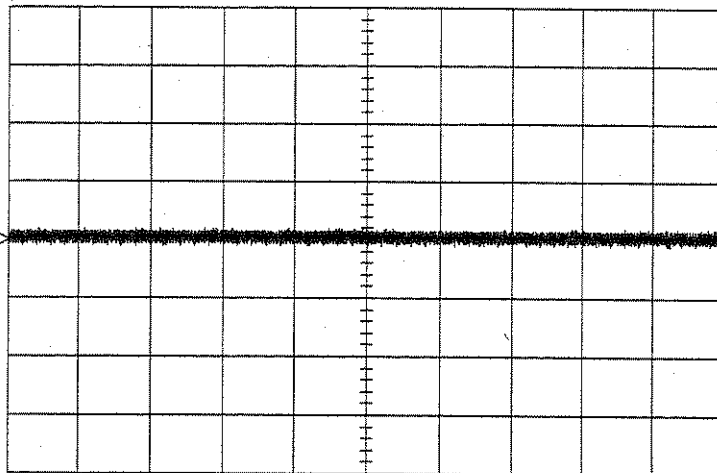

106 sweeps:

	average	low	high	sigma
pkpk(1)	2.2 mV	1.9	2.8	0.2
pkpk(2)	2.5 mV	2.2	2.8	0.1
pkpk(3)	2.3 mV	2.2	2.8	0.2
pkpk(4)	2.3 mV	1.9	2.5	0.1

1 DC 0.0 mV

MEASURE

OFF Cursors
Parameters

mode
Std Voltage
Std Time
Custom
Pass
Fail

statistics
OFF On

CHANGE
PARAMETERS

from
0.00 div
Track OFF On

to
10.00 div

250 KS/s

AUTO

27-Feb-96
8:39:41

1
20 ms
10.0 mV

2
20 ms
10.0 mV

3
20 ms
10.0 mV

4
20 ms
10.0 mV

20 ms
1 10 mV DC
2 10 mV DC
3 10 mV DC
4 10 mV DC

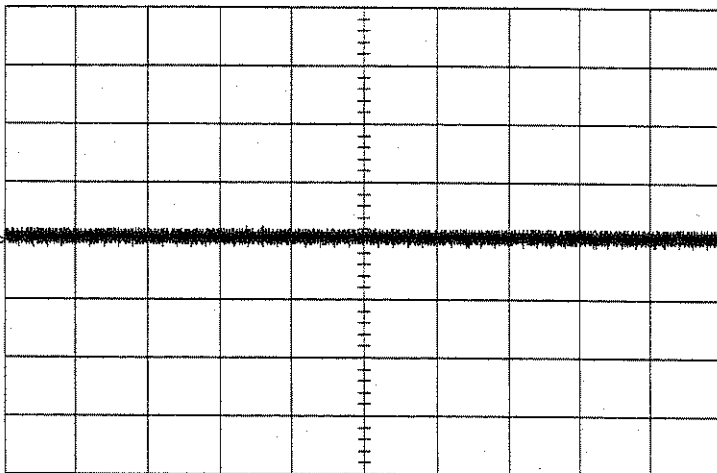

326 sweeps:

	average	low	high	sigma
pkpk(1)	2.3 mV	1.9	2.8	0.2
pkpk(2)	2.5 mV	2.2	3.1	0.2
pkpk(3)	2.4 mV	2.2	2.8	0.2
pkpk(4)	2.2 mV	1.9	2.5	0.1

peak to peak
difference between maximum and
minimum data values

CHANGE PARAM

On line
1 2 3 4 5

Category
All
DISK-Std
DISK-Local
DISK-PRML
Cyclic

DELETE ALL
PARAMETERS

measure
pctl
period
pkpk
pks
points

of
1 2 3 4
A B C D

250 KS/s

AUTO

Section 3 Performance Verification

- Check after at least 50 sweeps that : high pkpk readout is less than $\pm 7.2 \text{ mV}$, corresponding to 9% of full scale.
- Repeat the test for Timebase : 1 msec/div, 50 $\mu\text{sec/div}$, and 10 $\mu\text{sec/div}$. and check as above.

3.6.1.b AC 1M Ω

- Select Ch1, Ch2, Ch3 & Ch4 : AC 1M Ω
- Input gain : 10 mV/div.
- Timebase : 10 $\mu\text{sec/div}$.
- Check after at least 50 sweeps that the high pkpk readout is less than $\pm 7.2 \text{ mV}$, corresponding to 9% of full scale.

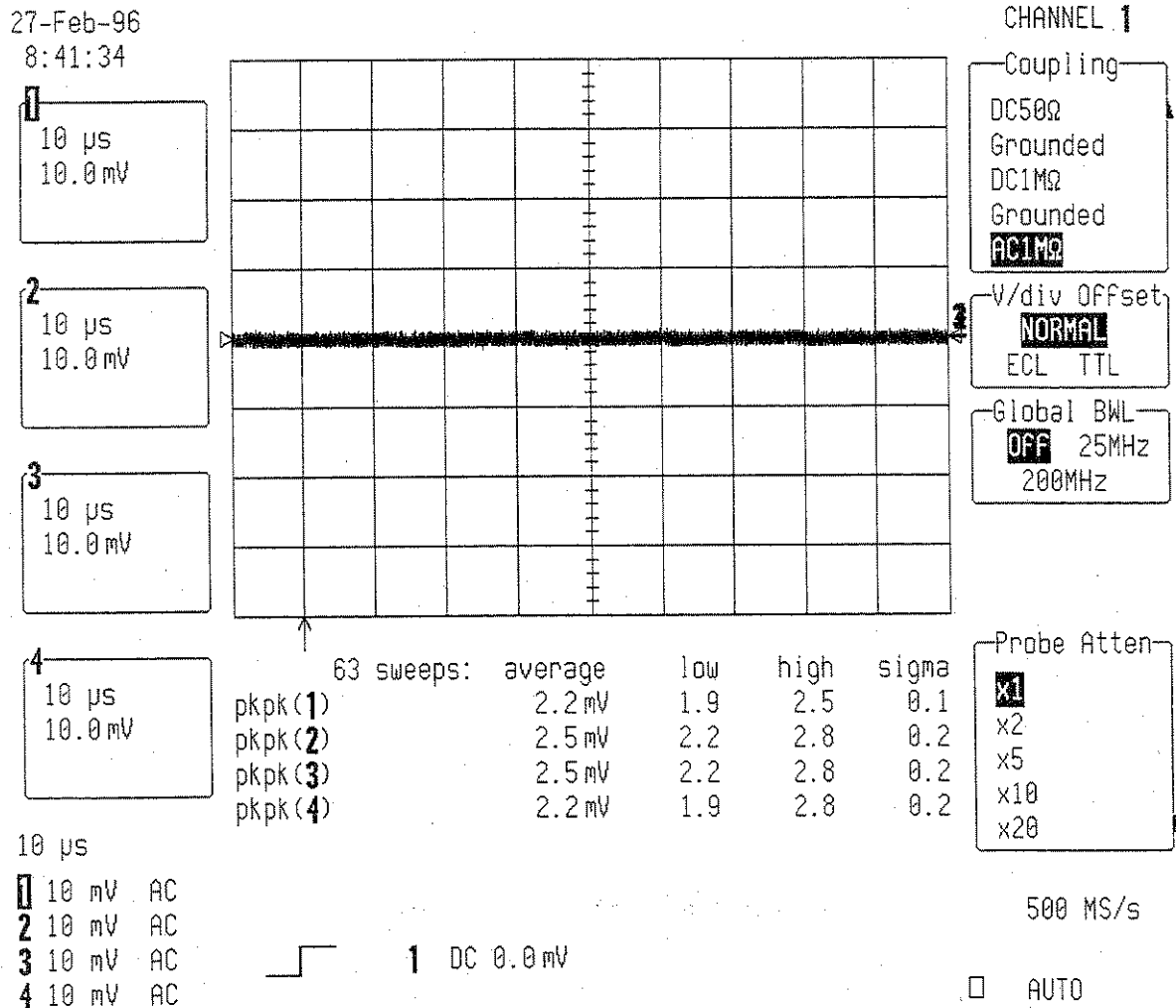

3.6.1.c DC 50Ω

- Select Ch1, Ch2, Ch3 & Ch4 : DC 50Ω
- Input gain : 10 mV/div.
- Set Timebase : 50 μsec/div.

- Check after at least 50 sweeps that the high pkpk readout is less than ± 7.2 mV, corresponding to 9% of full scale.

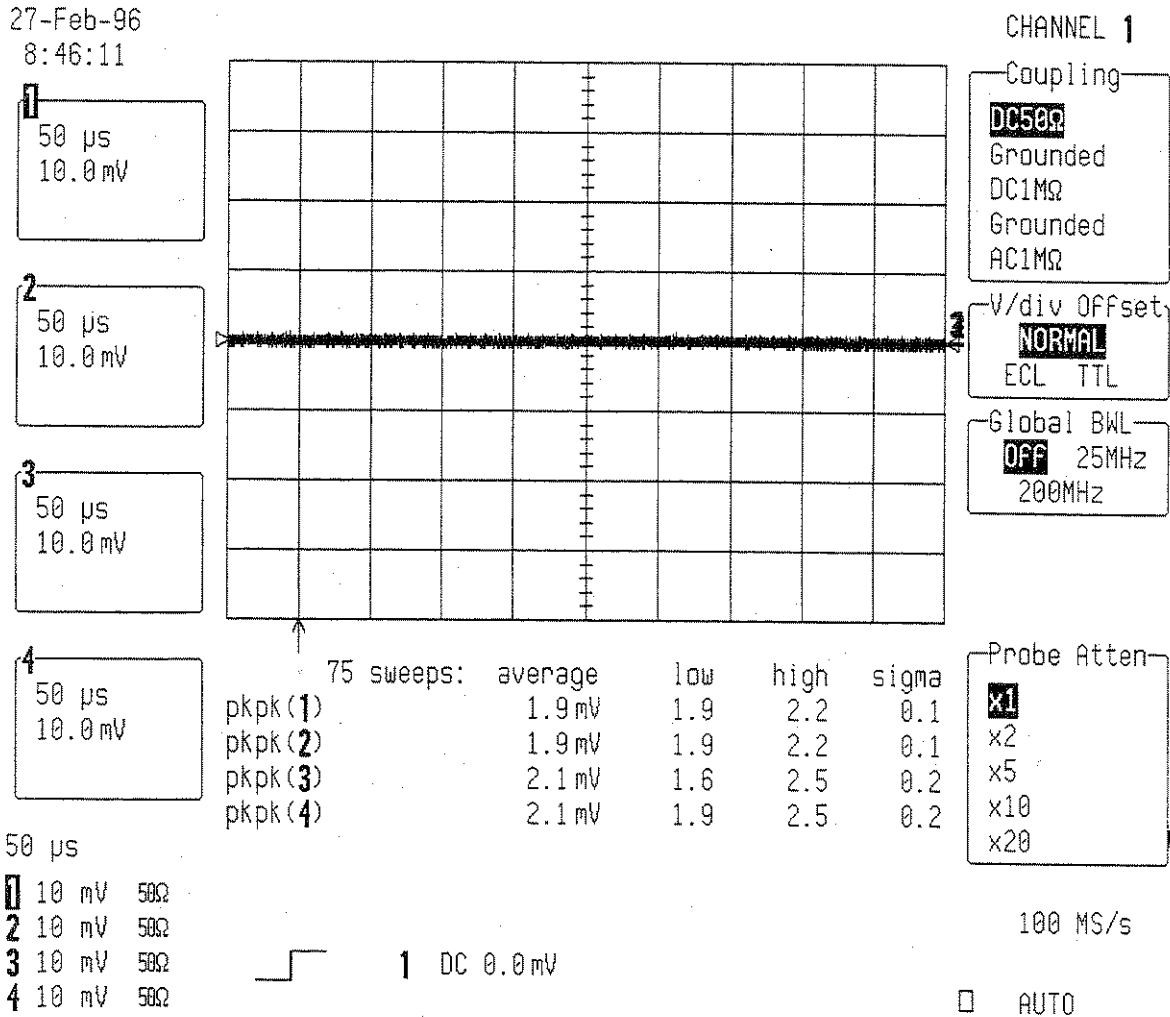

- Repeat the tests for Timebase : 10 μsec/div and check as above.

- Select : Timebase Setup
- Select Channel use : 2
- Set Timebase : 5 μsec/div.

Section 3 Performance Verification

27-Feb-96
8:49:05

1 ← 2
5 μ s
10.0 mV

2
5 μ s
10.0 mV

3
5 μ s
10.0 mV

4 ← 3
5 μ s
10.0 mV

5 μ s

1 disabled
2 10 mV 50 Ω
3 10 mV 50 Ω
4 disabled

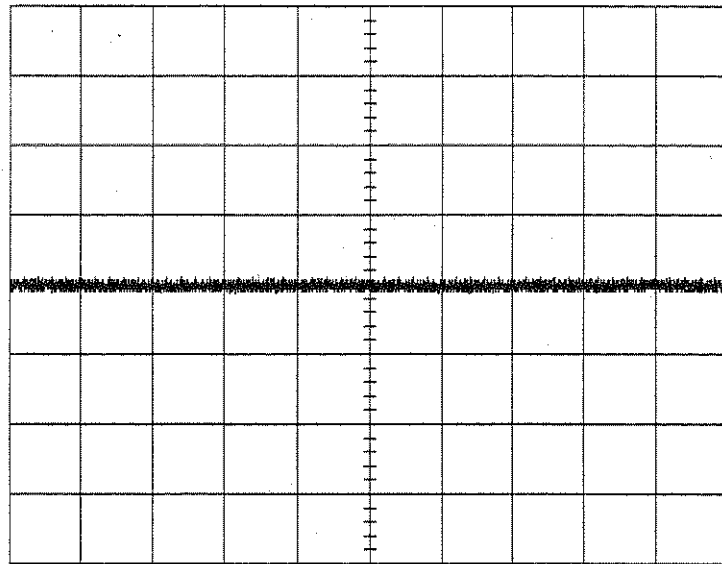

55 sweeps:

	average	low	high	sigma
pkpk (1)	2.0 mV	1.9	2.5	0.2
pkpk (2)	2.0 mV	1.9	2.5	0.2
pkpk (3)	2.2 mV	1.9	2.5	0.2
pkpk (4)	2.2 mV	1.9	2.5	0.2

2 AC 0.0 mV

TIMEBASE
T/div 5 μ s
50000
samples at
1 GS/s
(1 ns/pt)
for 50 μ s

Sampling
Single Shot

Channel Use
4 2
Peak-Detect

Sequence
Off On Wrap

Record up to
50k

1 GS/s

AUTO

- Check after at least 50 sweeps that the high pkpk readout is less than ± 7.2 mV, corresponding to 9% of full scale.

3.6.2 Rms Noise

Specifications

< $\pm 720 \mu\text{V}$ at 10 mV/div.

3.6.2.a DC 1M Ω

Procedure

- With no signal connected to the inputs, set 9374/M/L/TM DSO settings as follows :
 - Turn on traces : Ch1, Ch2, Ch3 & Ch4
 - Display setup : Standard, Dot Join on, Persistence off, Single grid
 - Input Coupling : DC 1M Ω
 - V/div. offset : Normal
 - Probe atten : X1
 - Global BWL : Off
 - Input gain : 10 mV/div.
 - Trigger setup : Edge
 - Trigger on : 1
 - Coupling 1 : DC
 - Slope 1 : Pos
 - Holdoff : Off
 - Trigger Mode : Auto
 - Timebase : 20 msec/div.
 - Channel use : 4
 - Record up : 50 K
- Press : Cursors/Measure
- Measure : Parameters
- Mode : Custom
- Statistics : On
- Change parameters
 - On line 1 : Measure sdev of Ch1
 - On line 2 : Measure sdev of Ch2
 - On line 3 : Measure sdev of Ch3
 - On line 4 : Measure sdev of Ch4
- Check after at least 50 sweeps that : high sdev readout is less than $\pm 720 \mu\text{V}$, corresponding to 0.9% of full scale.
- Repeat the test for Timebase : 1 msec/div, 50 $\mu\text{sec/div}$, and 10 $\mu\text{sec/div}$. and check as above.

Section 3 Performance Verification

27-Feb-96
8:53:57

1
20 ms
10.0 mV

2
20 ms
10.0 mV

3
20 ms
10.0 mV

4
20 ms
10.0 mV

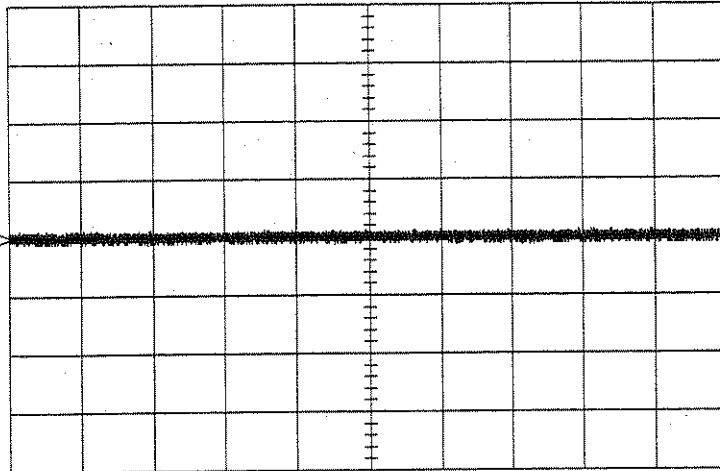

52 sweeps:

	average	low	high	sigma
sdev(1)	0.29 mV	0.27	0.29	0.01
sdev(2)	0.34 mV	0.34	0.34	0.00
sdev(3)	0.29 mV	0.29	0.29	0.00
sdev(4)	0.30 mV	0.30	0.30	0.00

20 ms
1 10 mV DC
2 10 mV DC
3 10 mV DC
4 10 mV DC

standard deviation
of the data values
from the mean value

CHANGE PARAM

On line
1 2 3 4 5

Category
All
DISK-Std
DISK-Local
DISK-PRML
Cyclic

DELETE ALL
PARAMETERS

measure
r@level
rms
sdev
sigma
taa

OF
1 2 3 4
A B C D

250 kS/s

AUTO

27-Feb-96
8:58:04

1
10 μ s
10.0 mV

2
10 μ s
10.0 mV

3
10 μ s
10.0 mV

4
10 μ s
10.0 mV

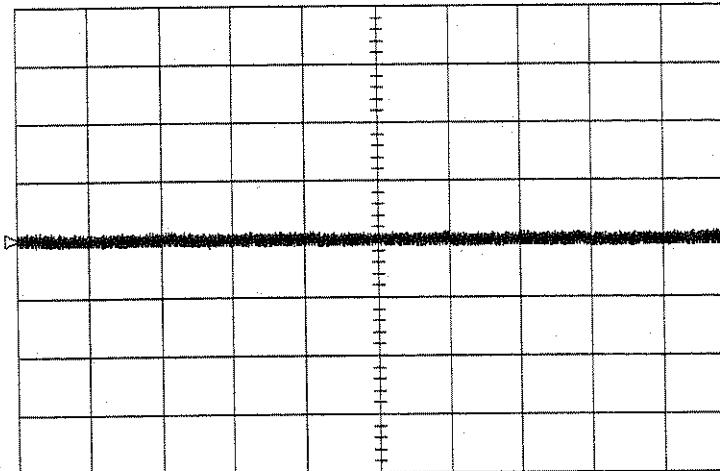

54 sweeps:

	average	low	high	sigma
sdev(1)	0.30 mV	0.29	0.32	0.01
sdev(2)	0.33 mV	0.30	0.35	0.01
sdev(3)	0.28 mV	0.26	0.30	0.01
sdev(4)	0.28 mV	0.25	0.32	0.01

10 μ s
1 10 mV AC
2 10 mV AC
3 10 mV AC
4 10 mV AC

1 DC 0.0 mV

CHANNEL 1

Coupling
DC50 Ω
Grounded
DC1M Ω
Grounded
AC1M Ω

V/div Offset
NORMAL
ECL TTL

Global BWL
OFF 25MHz
200MHz

Probe Atten
x1
x2
x5
x10
x20

500 MS/s

AUTO

3.6.2.b AC 1MΩ

- Select Ch1, Ch2, Ch3 & Ch4 : AC 1MΩ
 - Input gain : 10 mV/div.
 - Timebase : 10 μsec/div.
- Check after at least 50 sweeps that the high Sdev readout is less than ± 720 μV, corresponding to 0.9% of full scale.

3.6.2.c DC 50Ω

- Select Ch1, Ch2, Ch3 & Ch4 : DC 50Ω
 - Input gain : 10 mV/div.
 - Set Timebase : 50 μsec/div.
- Check after at least 50 sweeps that the high Sdev readout is less than ± 720 μV, corresponding to 0.9% of full scale.

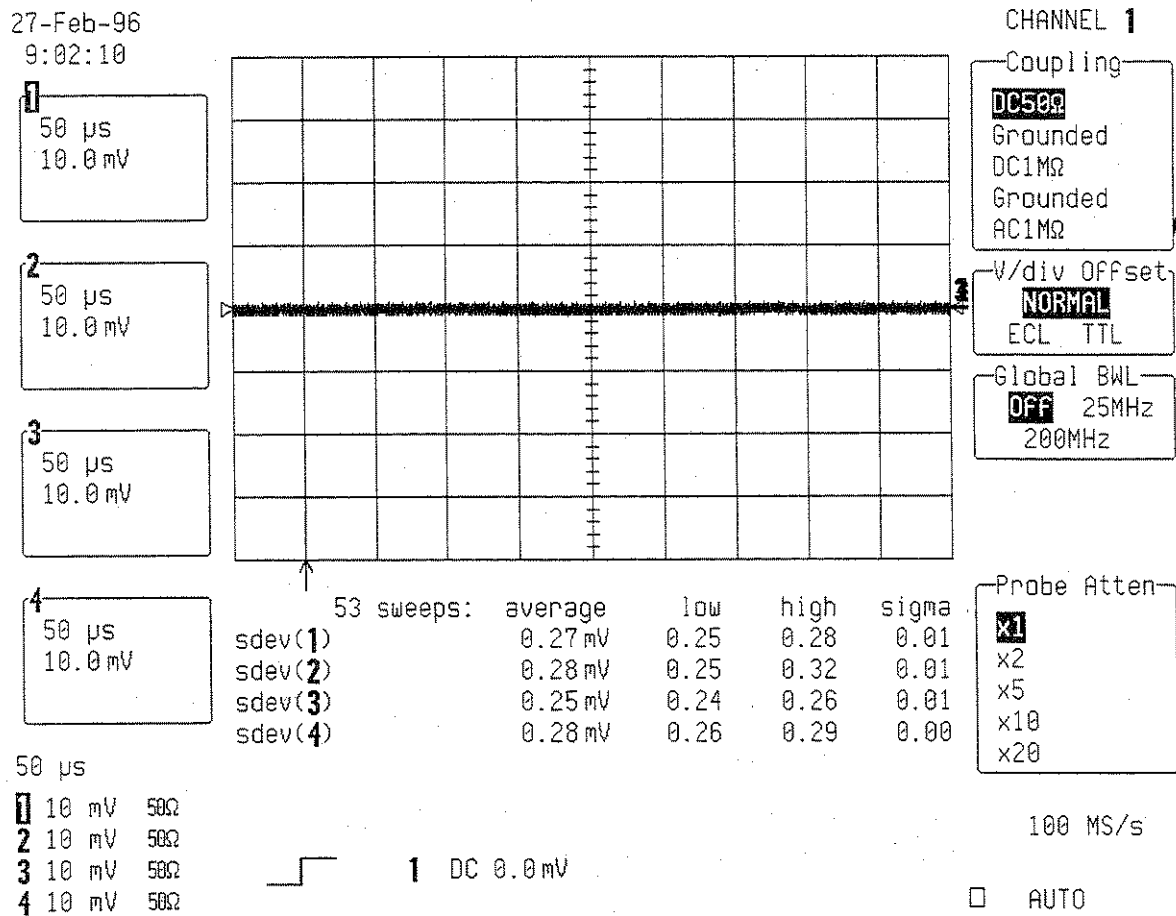

- Repeat the tests for Timebase : 10 μsec/div and check as above.

3.6.3 Inputs Grounded

With no cable plugged into scope, set the DSO as follows :

- Turn on trace : Channel 1, Channel 2, Channel 3 & Channel 4
- Input Coupling : DC 50 Ω
- Input gain : 10 mV/div.
- Offset : Zero
- Trigger on : Channel 1, DC
- Trigger mode : Auto
- Timebase : 10 μ sec/div.
- Channel use : 4
- Record up : 50 K
- Turn off trace : Channel 1, Channel 2, Channel 3 & Channel 4

- Turn on trace : A, B, C, D
- Select Math Setup
- For Math : Use at most 5000 points
- Redefine A, B, C, D : Channel 1, Channel 2, Channel 3 & Channel 4
- Use Math ? : Yes
- Math Type : Average
- Avg Type : Summed
- For : 1000 sweeps

- Cursors/Measure : Parameters
- Mode : Custom
- Statistics : off
- Change parameters
- On line 1 : Measure mean of A
- On line 2 : Measure mean of B
- On line 3 : Measure mean of C
- On line 4 : Measure mean of D

- Check after at least 100 sweeps that the **mean** value of A, B, C & D is less than ± 1.6 mV, corresponding to $\pm 2\%$ of full scale.
- Switch Channel 1, Channel 2, Channel 3 & Channel 4 between coupling DC 50 Ω and **Grounded**.
- Check after at least 100 sweeps that the **mean** value of A, B, C & D is less than ± 1.6 mV, corresponding to $\pm 2\%$ of full scale.

- Set coupling all Channel : DC 1M Ω
- Check after at least 100 sweeps that the **mean** value of A, B, C & D is less than ± 1.6 mV, corresponding to $\pm 2\%$ of full scale.

- Switch all Channel between coupling DC 1M Ω and **Grounded**.
- Check after at least 100 sweeps that the **mean** value of A, B, C & D is less than ± 1.6 mV, corresponding to $\pm 2\%$ of full scale.

27-Feb-96
9:08:12

A: Average(1)
10 μ s
10.0 mV
—326 swps

B: Average(2)
10 μ s
10.0 mV
—325 swps

C: Average(3)
10 μ s
10.0 mV
—324 swps

D: Average(4)
10 μ s
10.0 mV
—323 swps

10 μ s

- 1 10 mV 50 Ω
- 2 10 mV 50 Ω
- 3 10 mV 50 Ω
- 4 10 mV 50 Ω

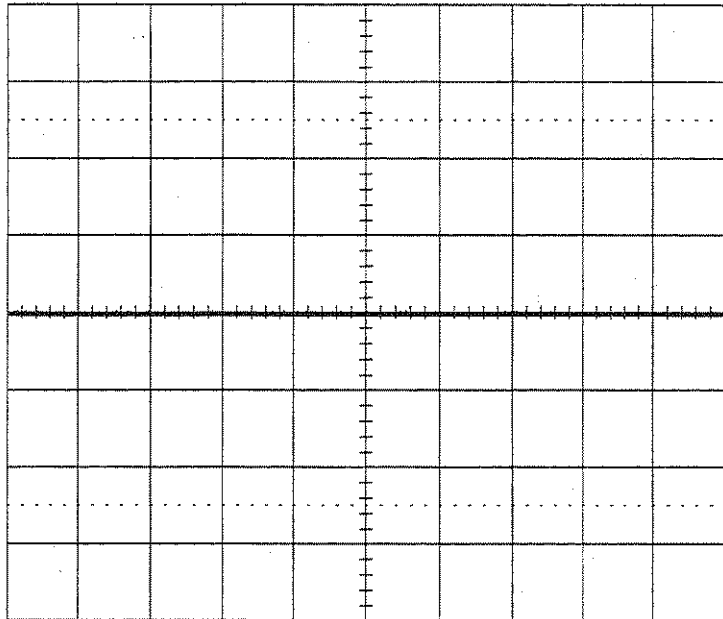

1 DC 0.0 mV

ZOOM + MATH

REDEFINE **A**
A=Average(1)

REDEFINE **B**
B=Average(2)

REDEFINE **C**
C=Average(3)

REDEFINE **D**
D=Average(4)

Multi-Zoom
OFF On

for Math use
max points
5000

500 MS/s

AUTO

27-Feb-96
9:08:37

A: Average(1)
10 μ s
10.0 mV
—448 swps

B: Average(2)
10 μ s
10.0 mV
—447 swps

C: Average(3)
10 μ s
10.0 mV
—446 swps

D: Average(4)
10 μ s
10.0 mV
—445 swps

10 μ s

- 1 10 mV 50 Ω
- 2 10 mV 50 Ω
- 3 10 mV 50 Ω
- 4 10 mV 50 Ω

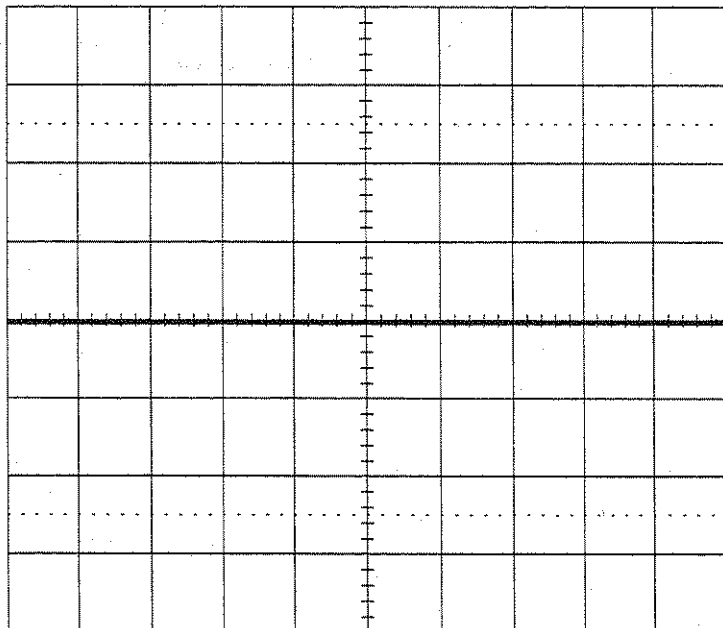

A: Average(1) 50000 -> 5000 pts

SETUP OF **A**

use Math?
No **Yes**

Math Type
Arithmetic
Average
Correlate
Enh.Res
Extrema

Avg Type
Summed
Continuous

for
1000
(sweeps)

of
1 2 3 4 B C D
M1 M2 M3 M4

500 MS/s

AUTO

Section 3 Performance Verification

27-Feb-96
9:10:30

A: Average(1)
10 μ s
10.0 mV
671 swps

B: Average(2)
10 μ s
10.0 mV
670 swps

C: Average(3)
10 μ s
10.0 mV
669 swps

D: Average(4)
10 μ s
10.0 mV
668 swps

10 μ s
1 10 mV 50 Ω
2 10 mV 50 Ω
3 10 mV 50 Ω
4 10 mV 50 Ω

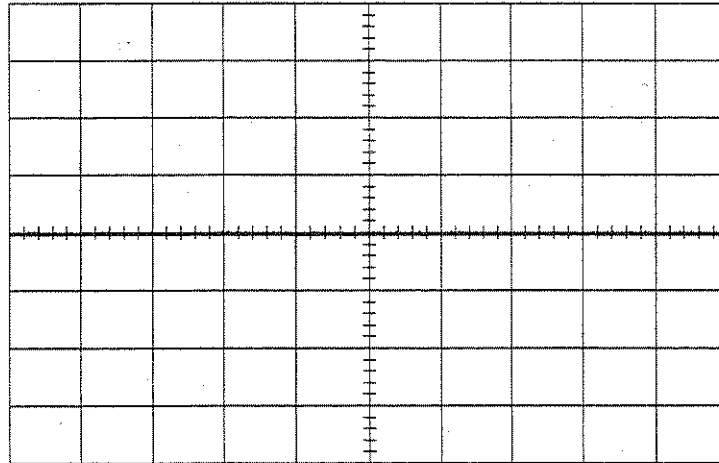

mean(A) -0.09 mV
mean(B) 0.01 mV
mean(C) -0.20 mV
mean(D) -0.18 mV

1 DC 0.0 mV

MEASURE

OFF Cursors
Parameters

mode
Std Voltage
Std Time
Custom
Pass
Fail

statistics
OFF On

CHANGE
PARAMETERS

from
0.00 div
Track **OFF** On

to
10.00 div

500 MS/s

AUTO

27-Feb-96
9:10:51

A: Average(1)
10 μ s
10.0 mV
743 swps

B: Average(2)
10 μ s
10.0 mV
742 swps

C: Average(3)
10 μ s
10.0 mV
741 swps

D: Average(4)
10 μ s
10.0 mV
740 swps

10 μ s
1 10 mV 50 Ω
2 10 mV 50 Ω
3 10 mV 50 Ω
4 10 mV 50 Ω

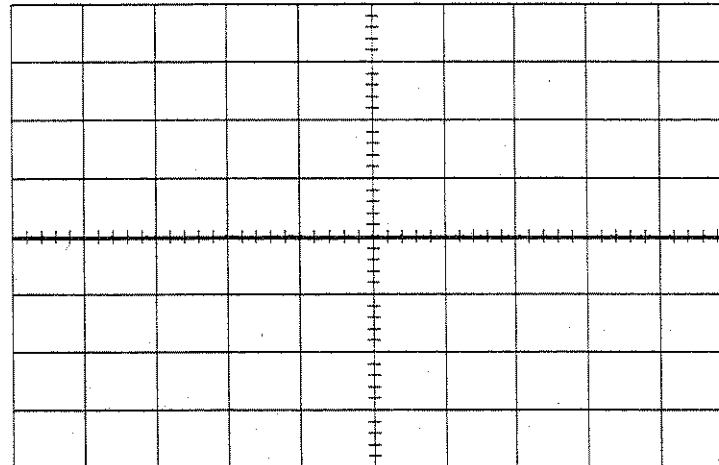

mean(A) -0.10 mV
mean(B) 0.01 mV
mean(C) -0.19 mV
mean(D) -0.18 mV

mean
average of data values

CHANGE PARAM

On line
1 2 3 4 5

Category
ALL
DISK-Std
DISK-Local
DISK-PRML
Cyclic

DELETE ALL
PARAMETERS

measure
maximum
maxD
mean
median
minimum

of
1 2 3 4
A B C D

500 MS/s

AUTO

27-Feb-96
9:11:26

A: Average (1)
10 μ s
10.0 mV
67 swps

B: Average (2)
10 μ s
10.0 mV
58 swps

C: Average (3)
10 μ s
10.0 mV
52 swps

D: Average (4)
10 μ s
10.0 mV
48 swps

10 μ s

- 1 10 mV \pm
- 2 10 mV \pm
- 3 10 mV \pm
- 4 10 mV \pm

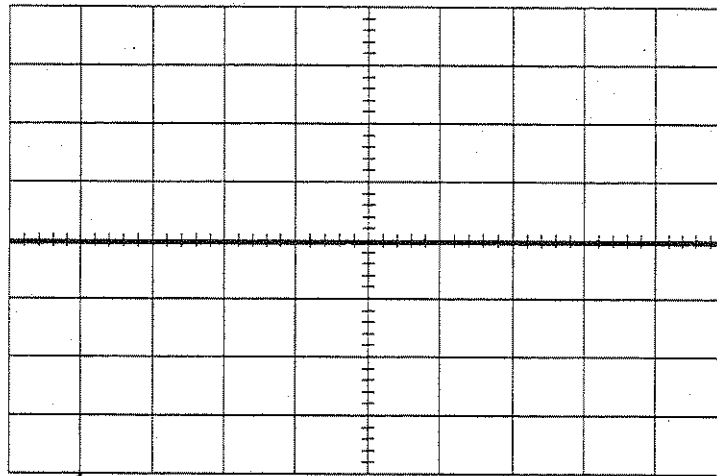

mean(A) -0.14 mV
mean(B) -0.19 mV
mean(C) -0.10 mV
mean(D) -0.27 mV

1 DC 0.0 mV

CHANNEL 1

Coupling
DC50 Ω
Grounded
DC1M Ω
Grounded
AC1M Ω

V/div Offset
NORMAL
ECL TTL

Global BWL
OFF 25MHz
200MHz

Probe Atten
x1
x2
x5
x10
x20

500 MS/s

AUTO

27-Feb-96
9:11:55

A: Average (1)
10 μ s
10.0 mV
86 swps

B: Average (2)
10 μ s
10.0 mV
71 swps

C: Average (3)
10 μ s
10.0 mV
67 swps

D: Average (4)
10 μ s
10.0 mV
63 swps

10 μ s

- 1 10 mV \pm
- 2 10 mV \pm
- 3 10 mV \pm
- 4 10 mV \pm

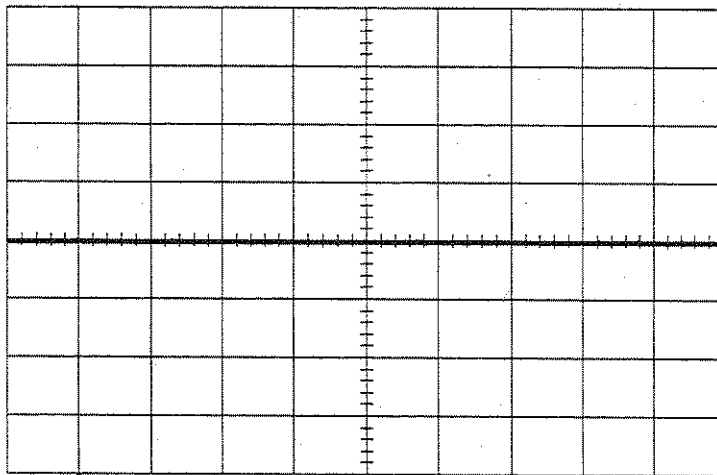

mean(A) -0.15 mV
mean(B) -0.18 mV
mean(C) -0.10 mV
mean(D) -0.28 mV

1 DC 0.0 mV

CHANNEL 1

Coupling
DC50 Ω
Grounded
DC1M Ω
Grounded
AC1M Ω

V/div Offset
NORMAL
ECL TTL

Global BWL
OFF 25MHz
200MHz

Probe Atten
x1
x2
x5
x10
x20

500 MS/s

AUTO

3.7 DC Linearity

Specification

$\leq \pm 5\%$ of full scale at 2mV/div, with 0 mV offset.

$\leq \pm 3\%$ of full scale at 5mV/div, with 0 mV offset.

$\leq \pm 2\%$ of full scale at 10mV/div and above.

3.7.1 Description

This test measures the DC Accuracy within the gain range specified.

The parameters Std voltage are used to measure the amplitude of the DC input signal.

3.7.1.a DC 50 Ω

Procedure

- Turn on trace : Ch1
- Display setup : Standard, Persistence off, Dot join on, Single grid
- Input Coupling : DC 50 Ω
- V/div. offset : Normal
- Global BWL : Off
- Probe atten : X1
- Input offset : 0.0 mV
- Input gain : from 2mV/div to 5 V/div. (see table 3-2 and 3-3)

- Trigger setup : Edge
- Trigger on : 1
- Coupling 1 : DC
- Slope 1 : Pos
- Mode : Auto
- Holdoff : Off

- Timebase : 2 msec/div.
- Channel use : 4
- Record up : 50 K

- Turn on trace : A
- Select Math Setup : Use at most 5000 points
- For Math : Use at most 5000 points
- Redefine A : Use at most 5000 points
- Use Math ? : Yes
- Math Type : Average
- Avg Type : Summed
- For : 1000 sweeps
- Of : Channel 1

- Turn off trace : Channel 1

- Cursors/Measure : **Parameters**
- Mode : **Std Voltage**
- Statistics : **off**
- on displayed trace : **A**

3.7.1.a.1 Positive DC Linearity

- For the ranges **2 mV/div. to 1 V/div.**, from the high precision voltage source, apply to Channel 1 : **+ 3 major screen divisions**.
- For the low sensitivities : **2 mV, 5 mV, 10 mV, 20 mV and 50 mV/div.**, use a **50 Ohm 20 dB** attenuator.

27-Feb-96

9:26:19

A: Average (1)
 2 ms
 2.00 mV
 106 swps

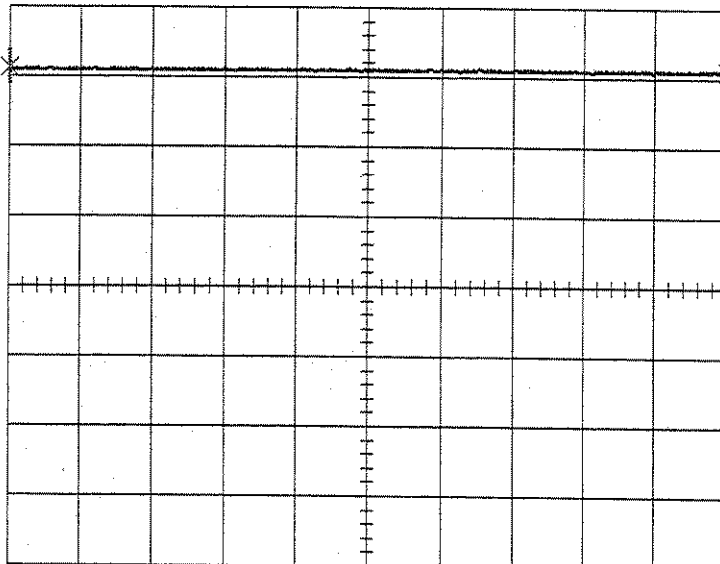

pkpk(A) 0.14 mV
 mean(A) 6.222 mV
 sdev(A) 20 µV
 rms(A) 6.222 mV
 ampl(A) ✖ 0.14 mV

- 0 2 mV 50Ω
- 2 2 mV 50Ω
- 3 2 mV 50Ω
- 4 2 mV 50Ω

A: Average (1) 50000 -> 5000 pts

SETUP OF **A**

use Math?
 No **Yes**

Math Type
 Arithmetic
Average
 Correlate
 Enh.Res
 Extrema

Avg Type
Summed
 Continuous

for
 1000
 (sweeps)

of
1 2 3 4 B C D
 M1 M2 M3 M4

2.5 MS/s

AUTO

Section 3 Performance Verification

gains all channels

Range	Attenuator	Conditions of Test			Average Mean Parameter Reading		
		PS Output	9374/ML/TM Input	9374/ML/TM Full scale	Min Value -X % of FS	Max. Value +X% of FS	X%
2 mV	Yes	+ 60 mV	+ 6 mV	16 mV	+ 5.2 mV	+ 6.8 mV	5%
5 mV	Yes	+ 150 mV	+ 15 mV	40 mV	+ 13.8 mV	+ 16.2 mV	3%
10 mV	Yes	+ 300 mV	+ 30 mV	80 mV	+ 28.4 mV	+ 31.6 mV	2%
20 mV	Yes	+ 600 mV	+ 60 mV	160 mV	+ 56.8 mV	+ 63.2 mV	2%
50 mV	Yes	+ 1.5 V	+150 mV	400 mV	+ 142 mV	+ 158 mV	2%
.1 V	No	+ 300 mV	+ 300 mV	800 mV	+ 284 mV	+ 316 mV	2%
.2 V	No	+ 600 mV	+ 600 mV	1.6 v	+ 568 mV	+ 632 mV	2%
.5 V	No	+ 1.5 V	+ 1.5 V	4 V	+ 1.42 V	+ 1.58 V	2%
1 V	No	+ 3 V	+ 3 V	8 V	+ 2.84 V	+ 3.16 V	2%

Table 3-2 : Positive DC Linearity Readout Accuracy

- For each point, read off the **Mean** parameter voltage, and compare it to the digital readout of the voltage reference
- The **Mean** parameter reading should be within the limits shown in table 3-2.

27-Feb-96
9:31:59

Average (1)
2 ms
2.00 mV
152 swps

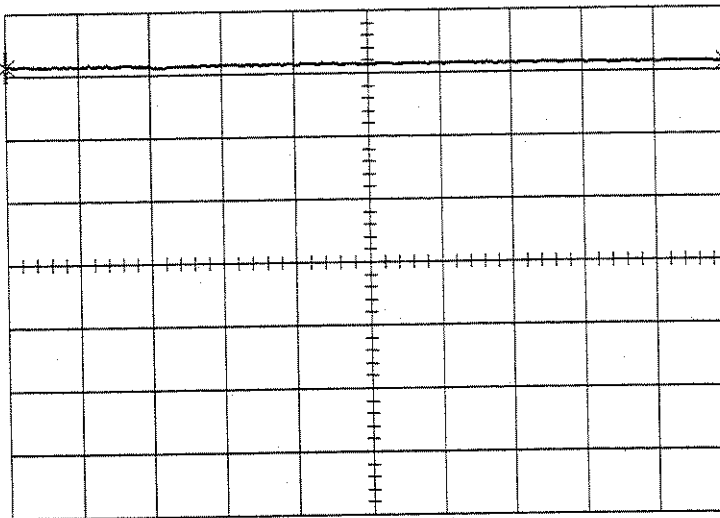

pkpk(A) 0.16 mV
mean(A) 6.323 mV
sdev(A) 20 µV
rms(A) 6.323 mV
ampl(A) 0.16 mV

2 ms
1 2 mV 50Ω
2 2 mV 50Ω
3 2 mV 50Ω
4 2 mV 50Ω

1 DC 0.00 mV

MEASURE

Off Cursors
Parameters

mode
Std Voltage
Std Time
Custom
Pass
Fail

statistics
OFF On

on displayed (trace)
A

from
0.00 div
Track OFF On

to
10.00 div
5000 pts

2.5 MS/s

AUTO

27-Feb-96

10:02:54

Average(1)
2 ms
1.00 V
1000 swps

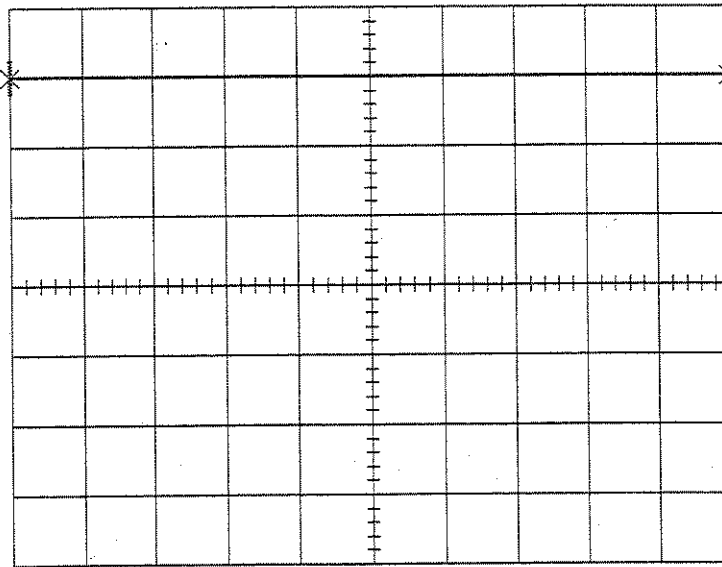

pkpk(A) 0.01 V
mean(A) 3.012 V
sdev(A) 1 mV
rms(A) 3.012 V
ampl(A) ✖ 0.01 V

2 ms

1 1 V 50Ω
2 1 V 50Ω
3 1 V 50Ω
4 1 V 50Ω

1 DC 0.00 V

MEASURE

OFF Cursors
Parameters

mode
Std Voltage
Std Time
Custom
Pass
Fail

statistics
OFF On

on displayed
(trace)
A

from
0.00 div
Track OFF On

to
10.00 div
5000 pts

2.5 MS/s

AUTO

3.7.1.a.2 Negative DC Linearity

- For the ranges **2 mV/div. to 1 V/div.**, from the high precision voltage source, apply to Channel 1 : - **3 major screen divisions.**
- For the low sensitivities : **2 mV, 5 mV, 10 mV, 20 mV and 50 mV/div.**, use a **50Ω 20 dB** attenuator.
- For each point, read off the **Mean** parameter voltage, and compare it to the digital readout of the voltage reference.
- The **mean** parameter reading should be within the limits shown in table 3-3.

Section 3 Performance Verification

Range	Attenuator	Conditions of Test			Average Mean Parameter Reading		
		PS Output	9374/M/L/TM Input	9374/M/L/TM Full scale	Min Value -X % of FS	Max. Value +X% of FS	X%
2 mV	Yes	- 60 mV	- 6 mV	16 mV	- 5.2 mV	- 6.8 mV	5%
5 mV	Yes	- 150 mV	- 15 mV	40 mV	- 13.8 mV	- 16.2 mV	3%
10 mV	Yes	- 300 mV	- 30 mV	80 mV	- 28.4 mV	- 31.6 mV	2%
20 mV	Yes	- 600 mV	- 60 mV	160 mV	- 56.8 mV	- 63.2 mV	2%
50 mV	Yes	- 1.5 V	-150 mV	400 mV	- 142 mV	- 158 mV	2%
.1 V	No	- 300 mV	- 300 mV	800 mV	- 284 mV	- 316 mV	2%
.2 V	No	- 600 mV	- 600 mV	1.6 v	- 568 mV	- 632 mV	2%
.5 V	No	- 1.5 V	- 1.5 V	4 V	- 1.42 V	- 1.58 V	2%
1 V	No	- 3 V	- 3 V	8 V	- 2.84 V	- 3.16 V	2%

Table 3-3 : Negative DC Linearity Readout Accuracy

27-Feb-96
10:22:53

Average(1)
2 ms
200 mV
109 swps

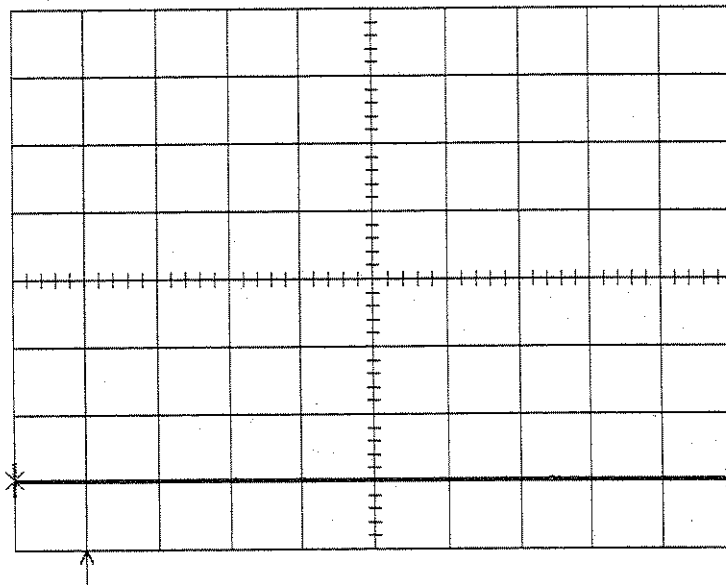

pkpk(A) 3 mV
mean(A) -591.4 mV
sdev(A) 0.4 mV
rms(A) 591.4 mV
ampl(A) 3 mV

- 1 .2 V 50Ω
- 2 .2 V 50Ω
- 3 .2 V 50Ω
- 4 .2 V 50Ω

1 DC 0.000 V

MEASURE

OFF Cursors
Parameters

mode
Std Voltage
Std Time
Custom
Pass
Fail

statistics
OFF On

on displayed (trace)
A

from
0.00 div
Track OFF On

to
10.00 div
5000 pts

2.5 MS/s

AUTO

27-Feb-96
10:21:43

Average(1)
2 ms
1.00 V
115 sups

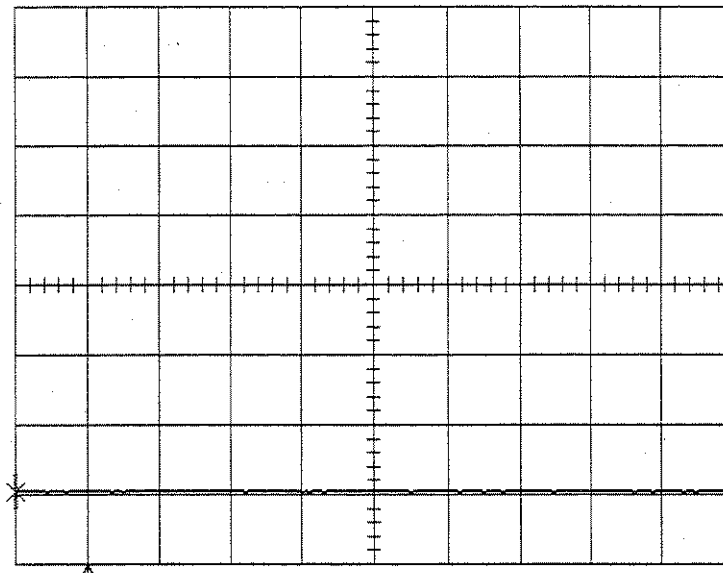

pkpk(A) 0.01 V
mean(A) -2.953 V
sdev(A) 2 mV
rms(A) 2.953 V
ampl(A) ✖ 0.01 V

2 ms

- 1 1 V 50Ω
- 2 1 V 50Ω
- 3 1 V 50Ω
- 4 1 V 50Ω

1 DC 0.00 V

MEASURE

OFF Cursors
Parameters

mode
Std Voltage
Std Time
Custom
Pass
Fail

statistics
OFF On

on displayed
(trace)
A

from
0.00 div
Track OFF On

to
10.00 div
5000 pts

2.5 MS/s

AUTO

3.7.1.b DC 1MΩ

Set the DSO as follows :

- Input Coupling : DC 1MΩ
- Input offset : 0.0 mV
- Input gain : from 2mV/div. to 5 V/div.

- For the ranges 2 mV/div. to 5 V/div., from the high precision voltage source, apply to Channel 1 the following 2 voltages values, one after another : + 3 major screen divisions, - 3 major screen divisions.

- For the low sensitivities : 2, 5, 10, 20 and 50 mV/div., use a 1MΩ 20 dB attenuator (1/10), see table 3-4.

Section 3 Performance Verification

Range	Attenuator	Conditions of Test			Average Mean Parameter Reading		
		PS Output	9374/M/L/TM Input	9374/M/L/TM Full scale	Min Value ±X% of FS	Max. Value ±X% of FS	± X%
Volts/div Control	20 dB						
2 mV	Yes	± 60 mV	± 6 mV	16 mV	± 5.2 mV	± 6.8 mV	5%
5 mV	Yes	± 150 mV	± 15 mV	40 mV	± 13.8 mV	± 16.2 mV	3%
10 mV	Yes	± 300 mV	± 30 mV	80 mV	± 28.4 mV	± 31.6 mV	2%
20 mV	Yes	± 600 mV	± 60 mV	160 mV	± 56.8 mV	± 63.2 mV	2%
50 mV	Yes	± 1.5 V	±150 mV	400 mV	± 142 mV	± 158 mV	2%
.1 V	No	± 300 mV	± 300 mV	800 mV	± 284 mV	± 316 mV	2%
.2 V	No	± 600 mV	± 600 mV	1.6 v	± 568 mV	± 632 mV	2%
.5 V	No	± 1.5 V	± 1.5 V	4 V	± 1.42 V	± 1.58 V	2%
1 V	No	± 3 V	± 3 V	8 V	± 2.84 V	± 3.16 V	2%
2 V	No	± 6 V	± 6 V	16 V	± 5.68 V	± 6.32 V	2%
5 V	No	± 15 V	± 15 V	40 V	± 14.2 V	± 15.8 V	2%

Table 3-4 : 1MΩ DC Linearity Readout Accuracy

- For each point, read off the **Mean** parameter voltage, and compare it to the digital readout of the voltage reference.
- The **mean** parameter reading should be within the limits shown in table 3-4.
- Repeat steps 3.7.1.a and 3.7.1.b for Channel 2, Channel 3 and Channel 4 substituting channel controls and input connector.

27-Feb-96
10:37:29

Average(1)
2 ms
1.00 V
1000 swps

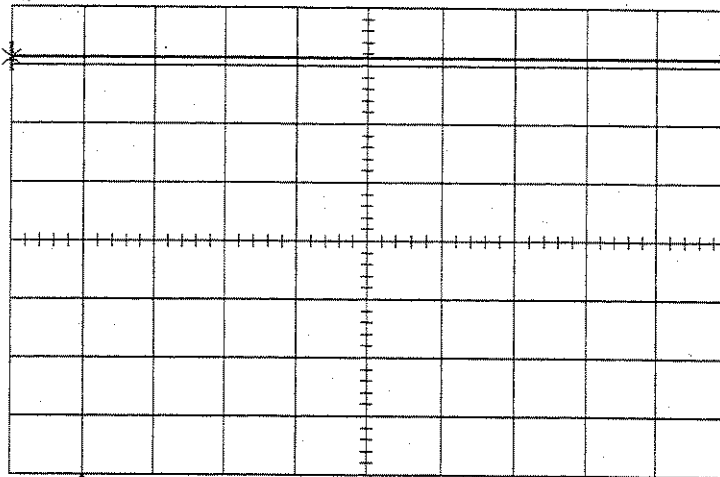

pkpk(A) 0.01 V
mean(A) 3.141 V
sdev(A) 1 mV
rms(A) 3.141 V
ampl(A) 0.01 V

2 ms
1 1 V DC
2 1 V DC
3 1 V DC
4 1 V DC

1 DC 0.00 V

CHANNEL 1
Coupling
DC50Ω
Grounded
DC1MΩ
Grounded
AC1MΩ
V/div Offset
NORMAL
ECL TTL
Global BWL
OFF 25MHz
200MHz

Probe Atten
x1
x2
x5
x10
x20

2.5 MS/s

AUTO

27-Feb-96
10:38:49

Average(1)
2 ms
5.0 V
135 swps

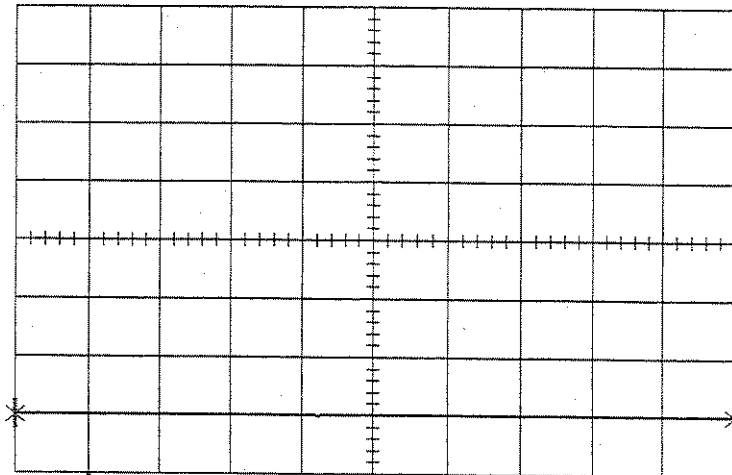

pkpk(A) 0.08 V
mean(A) -14.965 V
sdev(A) 9 mV
rms(A) 14.965 V
ampl(A) 0.08 V

2 ms
1 5 V DC
2 5 V DC
3 5 V DC
4 5 V DC

1 DC 0.0 V

CHANNEL 1
Coupling
DC50Ω
Grounded
DC1MΩ
Grounded
AC1MΩ
V/div Offset
NORMAL
ECL TTL
Global BWL
OFF 25MHz
200MHz

Probe Atten
x1
x2
x5
x10
x20

2.5 MS/s

AUTO

3.8 Offset

3.8.1 Description

The maximum allowed offsets depend on the sensitivity as described in the specifications, and is tested at 2 mV and 5 mV range.

Specifications

- ± 400 mV : for the range 2mV/div.
- ± 1 V : for 5 mV/div., 10 mV/div., 20 mV/div., 50 mV/div.,
- ± 10 V : for 100 mV/div., 200 mV/div., 500 mV/div., 1 V/div (50 Ω)
- ± 100 V : for (1 MΩ), 1 V/div., 2 V/div., 5 V/div., 10 V/div.

3.8.1.a Negative Offset Control Procedure

Set the DSO as follows :

- Turn on trace : Channel 1
- Display setup : Standard, Persistence off, Dot join on, Single grid
- Input Coupling : DC 1MΩ
- V/div. offset : Normal
- Global BWL : Off
- Probe atten : X1
- Input gain : 5 mV
- Trigger setup : Edge
- Trigger on : 1
- Coupling 1 : DC
- Slope 1 : Pos
- Mode : Auto
- Holdoff : Off
- Timebase : 2 msec/div.
- Channel use : 4
- Record up : 50 K
- Turn on trace : A
- Select Math Setup
- For Math : Use at most 5000 points
- Redefine A
- Use Math ? : Yes
- Math Type : Average
- Avg Type : Summed
- For : 1000 sweeps
- Of : Channel 1

- Turn off trace : Channel 1
- Cursors/Measure : Parameters
- Mode : Std Voltage
- Statistics : off
- On displayed trace : A

- From the high precision voltage source PS5004, apply to Channel 1 + 1 V.
- Using the offset control, move Channel 1 trace through the entire range until the maximum offset value is reached : - 1 V.
- Verify that the displayed trace A : Average (1) is in the screen, near to the center horizontal graticule line.
- Press clear sweeps.
- Check after at least 100 sweeps that the mean (A) parameter readout is : minimum + .985 V, maximum + 1.015 V. (see table 3-5).

offsets

Range	Conditions of Test		Offset Control	Mean Parameter Reading	
	PS Output	9374/M/L/TM Input		9374/M/L/TM Offset	Minimum Value,
5 mV	+ 1 V	+ 1 V	- 1 V	+ .985 V	+ 1.015 V
2 mV	+ 400 mV	+ 400 mV	- 400 mV	+ 392 mV	+ 408 mV

Table 3-5 : Negative offset control

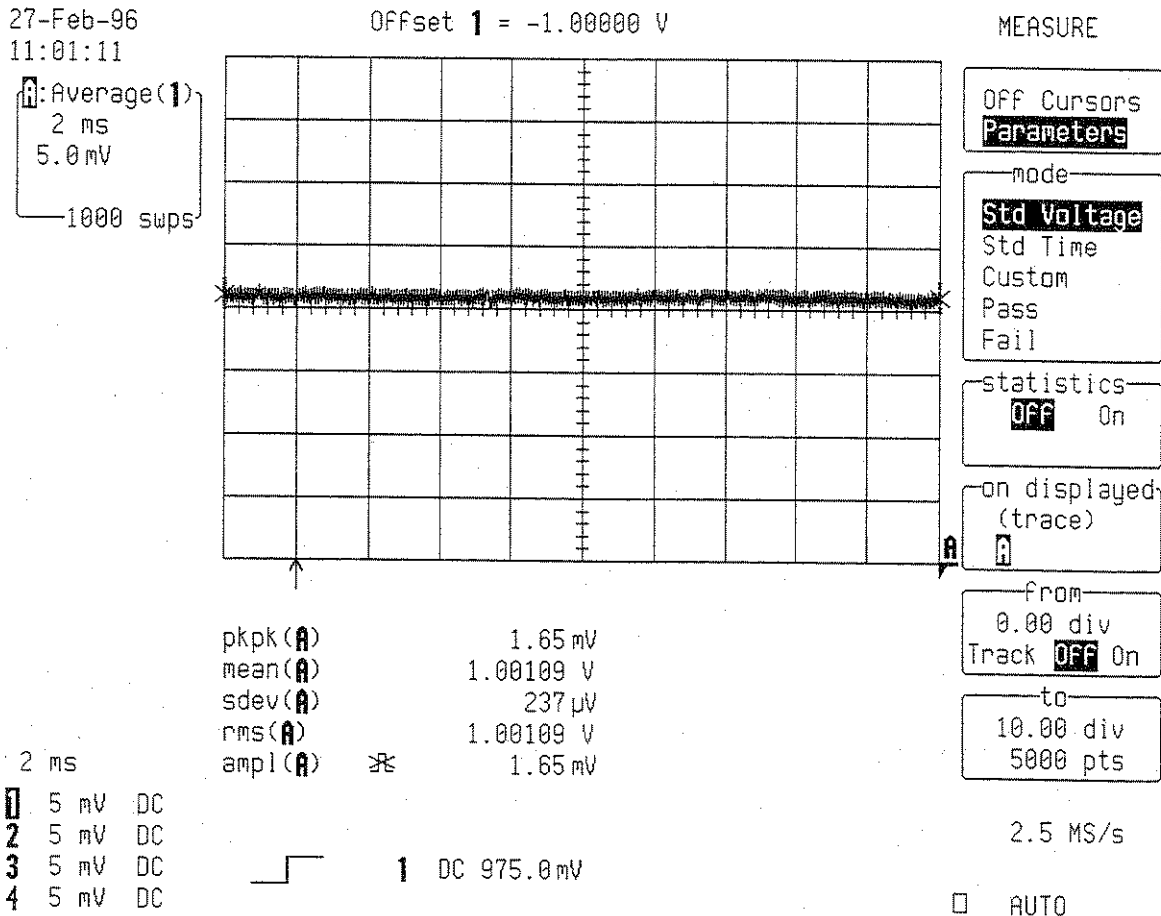

Section 3 Performance Verification

- Select Input Coupling : **DC 50Ω**
- Input gain : **5 mV**
- Press clear sweeps
- Check after at least 100 sweeps that the mean (A) parameter readout is : minimum + .985 V , maximum + 1.015 V.
- Set input gain to **2 mV/div** from the high precision voltage source, apply to Channel 1 the following voltage value : + **400 mV**.
- Using the offset control, move the Ch1 trace through the entire range until the following offset value is reached : - **400 mV**.
- Press clear sweeps
- Check after at least 100 sweeps that the mean (A) parameter readout is : minimum + **392 mV**, maximum + **408 mV** (see table 3-5).

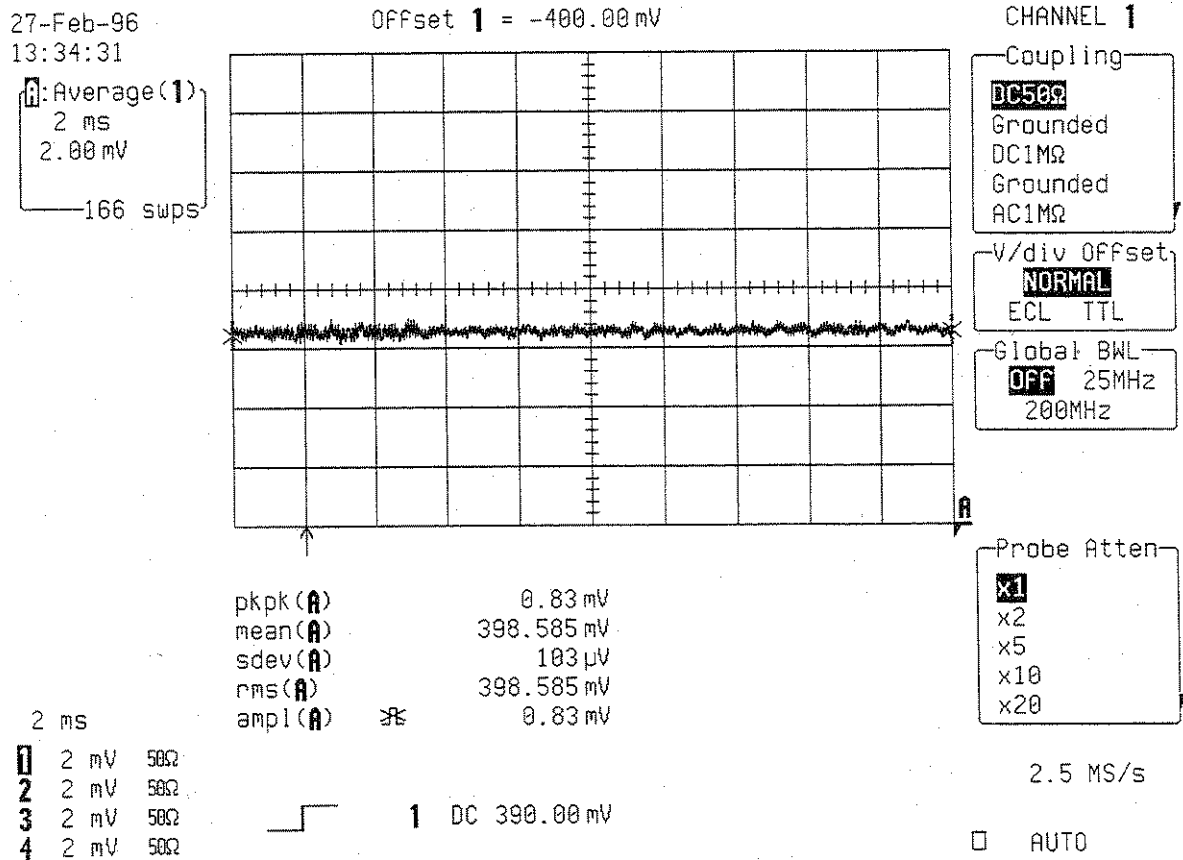

- Repeat step 3.8.1.a for Channel 2, Channel 3 and Channel 4 substituting channel controls and input connector.

3.8.1.b Positive Offset Control Procedure

Set the DSO as in 3.8.1.a:

- Input Coupling : DC 1MΩ
- Channel 1 input gain : 5 mV
- From the high precision voltage source PS5004, apply to Channel 1 - 1 V .
- Using the offset control, move Channel 1 trace through the entire range until the maximum offset value is reached : + 1 V.
- Verify that the displayed trace A : Average (1) is in the screen, near to the center horizontal graticule line.
- Check after at least 100 sweeps that the mean (A) parameter readout is : minimum - .985 V, maximum - 1.015 V. (see table 3-6).

+ Offset

Range	Conditions of Test		Offset Control	Mean Parameter Reading	
	PS Output	9374/M/L/TM Input		Minimum Value,	Maximum Value,
5 mV	- 1 V	- 1 V	+ 1 V	- .985 V	- 1.015 V
2 mV	- 400 mV	- 400 mV	+ 400 mV	- 392 mV	- 408 mV

Table 3-6 : Positive offset control

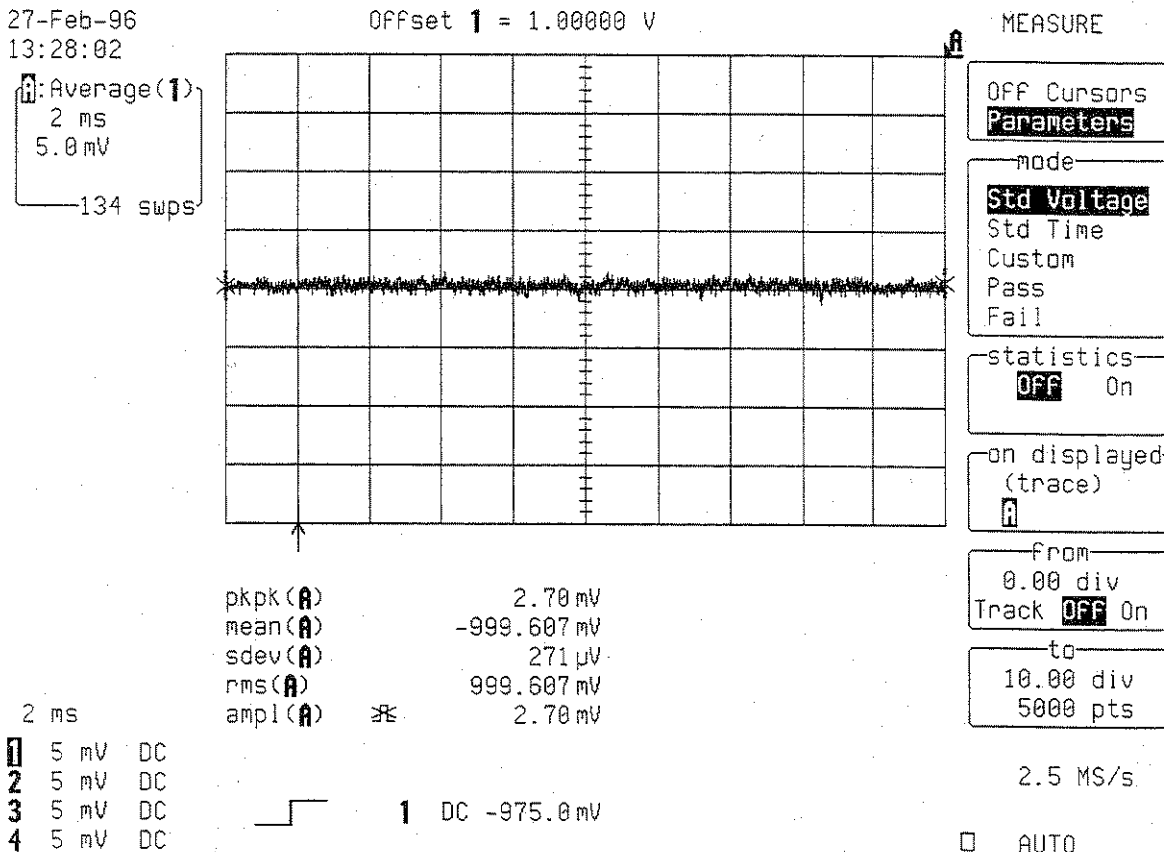

Section 3 Performance Verification

- Select Input Coupling: **DC 50Ω**
- Input gain : **5 mV**
- Press clear sweeps
- Check after at least 100 sweeps that the mean (A) parameter readout is : minimum - **.985 V** , maximum - **1.015 V**.
- Set input gain to **2 mV/div** from the high precision voltage source, apply to Channel 1 the following voltage value : **- 400 mV**.
- Using the offset control, move the Ch1 trace through the entire range until the following offset value is reached : **+ 400 mV**.
- Press clear sweeps
- Check after at least 100 sweeps that the mean (A) parameter readout is : minimum - **392 mV**, maximum - **408 mV** (see table 3-6).

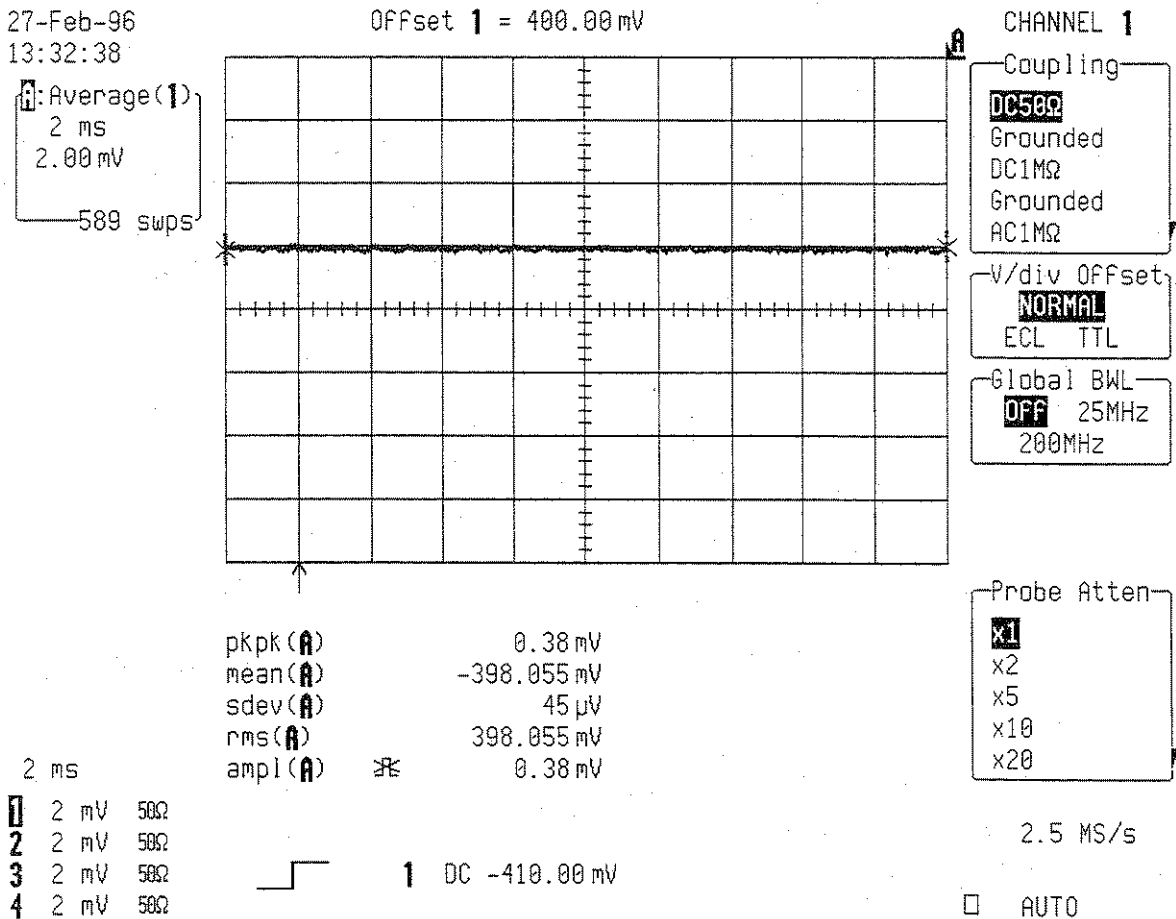

- Repeat step 3.8.1.b for Channel 2, Channel 3 and Channel 4 substituting channel controls and input connector.

3.9 Bandwidth

3.9.1 Description

The purpose of this test is to ensure that the entire system has a bandwidth of at least 1 GHz. An external source is used as the reference to provide a signal where amplitude and frequency are well controlled. A serious measurement of the bandwidth requires the use of a source whose amplitude does not change with frequency.

The LeCroy calibration software corrects for the measured amplitude variation of the generator used. Generators can have errors of - 1 dB above 500 MHz. The non flatness of the generator should be taken into consideration.

Specifications

DC to at least 1 GHz (- 3 dB) at 10 mV/div. and above.

DC to at least 400 MHz at 5 mV/div.

DC to at least 150 MHz at 2 mV/div.

3.9.1.a DC 50 Ω

Procedure

- Turn on trace : **Ch1**
 - Display setup : **Standard, Persistence off, Dot join on, Single grid**
 - Input Coupling : **DC 50 Ω**
 - V/div. offset : **Normal**
 - Global BWL : **Off**
 - Probe atten : **X1**
 - Input gain : **50 mV/div.**
 - Offset : **0 mV**
 - Trigger setup : **Edge**
 - Trigger on : **Line**
 - Slope Line : **Pos**
 - Mode : **Norm or Auto**
 - Timebase : **10 μ sec/div.**
 - Channel use : **4**
 - Record up : **50 K**
 - Press Cursors/Measure: **Parameters**
 - Mode : **Custom**
 - Statistics : **off**
 - Change parameters : **Measure**
 - On line 1 : **sdev of 1**
 - On line 2 : **freq of 1**
- Connect a HP8648B sine wave generator to Channel 1, set the frequency to **500 KHz**, adjust the generator output amplitude to get on DSO : **sdev(1) = 80 mV.**

Section 3 Performance Verification

27-Feb-96
14:05:29

1
10 μ s
50 mV

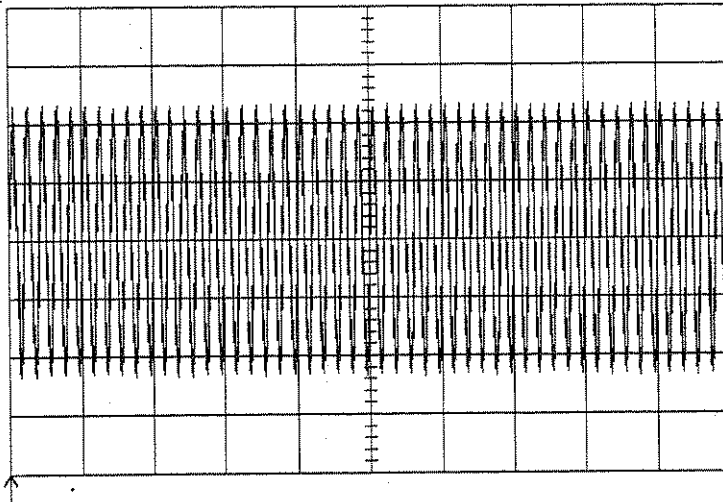

TRIGGER SETUP

Edge SMART

trigger on
1 2 3 4 Ext
Ext10 **Line**

slope **Line**
Positive
Negative

sdev(1) 80.66 mV
Freq(1) 499.849 kHz

10 μ s

- 1 50 mV 50 Ω
- 2 50 mV 50 Ω
- 3 50 mV 50 Ω
- 4 50 mV 50 Ω

Line

500 MS/s

AUTO

27-Feb-96
14:05:44

1
10 μ s
50 mV

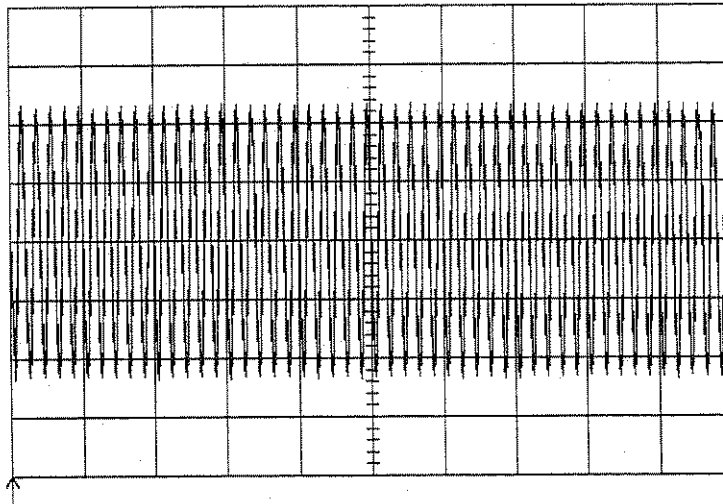

MEASURE

OFF Cursors
Parameters

mode
Std Voltage
Std Time
Custom
Pass
Fail

statistics
OFF On

CHANGE
PARAMETERS

from
0.00 div
Track **OFF** On

to
10.00 div

sdev(1) 80.73 mV
Freq(1) 499.838 kHz

10 μ s

- 1 50 mV 50 Ω
- 2 50 mV 50 Ω
- 3 50 mV 50 Ω
- 4 50 mV 50 Ω

Line

500 MS/s

AUTO

- Increase the generator frequency in multi **50 MHz** steps until the sine wave amplitude is 70% of the initial amplitude at 500 KHz .
- At each 50 MHz step, check that **sdev(1) > 56 mV**
- When **sdev(1) = 56 mV (3 dB point)** the frequency of the generator must be at least **1 GHz**.

27-Feb-96
14:09:20

1
10 μ s
50 mV

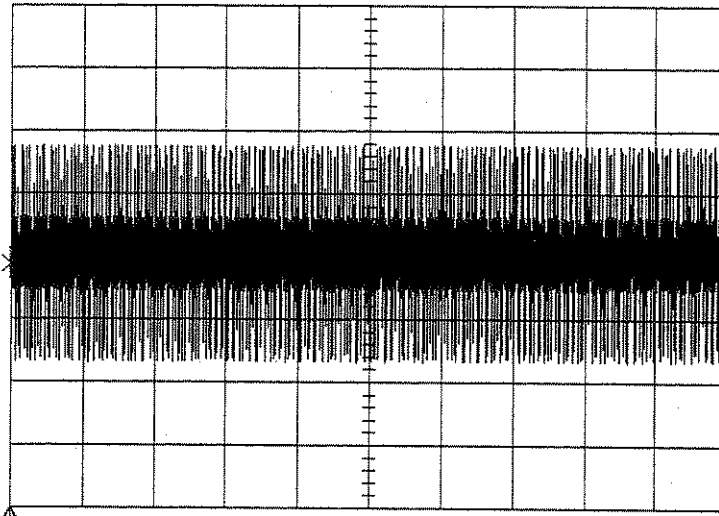

pkpk(1) 173.4 mV
mean(1) 1.08 mV
sdev(1) 58.57 mV
rms(1) 58.58 mV
ampl(1) 164.0 mV

10 μ s
1 50 mV 50 Ω
2 50 mV 50 Ω
3 50 mV 50 Ω
4 50 mV 50 Ω

 Line

MEASURE

OFF Cursors
Parameters

mode
Std Voltage
Std Time
Custom
Pass
Fail

statistics
OFF On

on displayed
(trace)
1

from
0.00 div
Track **OFF** On

to
10.00 div
50000 pts

500 MS/s

NORMAL

- Select Coupling and **Global BWL : 25 MHz** (bandwidth limiter on)
- Check that the frequency at the 3 dB point (**sdev(1) = 56 mV**) is typically **25 MHz** . (between 10 MHz and 37 MHz).

Section 3 Performance Verification

27-Feb-96
14:12:53

10 μ s
50 mV

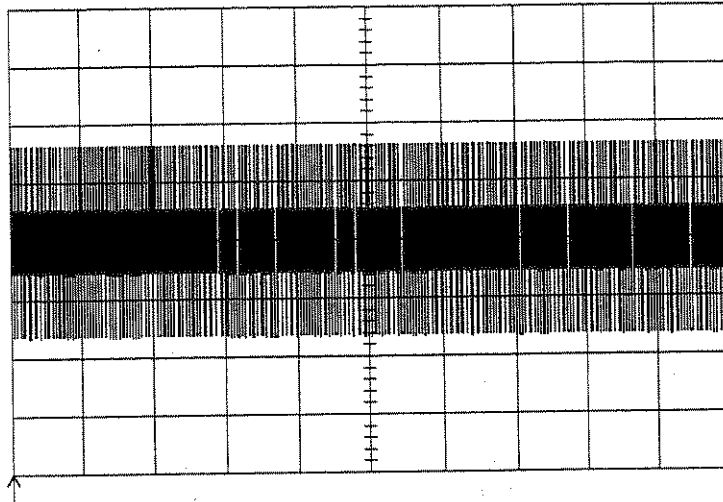

sdev(1) 57.23 mV
Freq(1) 24.0001 MHz

CHANNEL 1
Coupling
DC50 Ω
Grounded
DC1M Ω
Grounded
AC1M Ω
V/div Offset
NORMAL
ECL TTL
Global BWL
OFF 25MHz
200MHz

Probe Atten
x1
x2
x5
x10
x20

10 μ s BWL
50 mV 50 Ω

500 MS/e

- Select Coupling and **Global BWL : 200 MHz** (bandwidth limiter on)
- Check that the frequency at the 3 dB point (sdev(1) = 56 mV) is typically **200 MHz** . (between 110 MHz and 290 MHz) .

27-Feb-96
14:14:39

10 μ s
50 mV

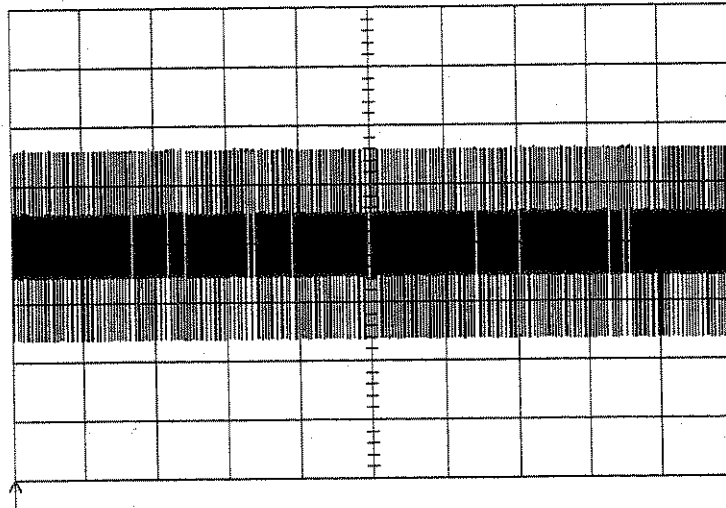

sdev(1) 56.27 mV
Freq(1) 175.108 MHz

CHANNEL 1
Coupling
DC50 Ω
Grounded
DC1M Ω
Grounded
AC1M Ω
V/div Offset
NORMAL
ECL TTL
Global BWL
OFF 25MHz
200MHz

Probe Atten
x1
x2
x5
x10
x20

10 μ s BWL
50 mV 50 Ω

500 MS/e

- Set DSO Input gain : 100 mV/div.
- Select Coupling and Global BWL : Off (bandwidth limiter off)
- Set sine wave generator frequency to 500 KHz, adjust the generator output amplitude to get on DSO : sdev(1) = 140 mV.
- Increase the generator frequency in multi 50 MHz steps until the sine wave amplitude is 70% of the initial amplitude at 500 KHz .
- At each 50 MHz step, check that sdev(1) > 98 mV
- When sdev(1) = 98 mV (3 dB point) the frequency of the generator must be at least 1 GHz.

27-Feb-96
14:29:46

1
10 μ s
100 mV

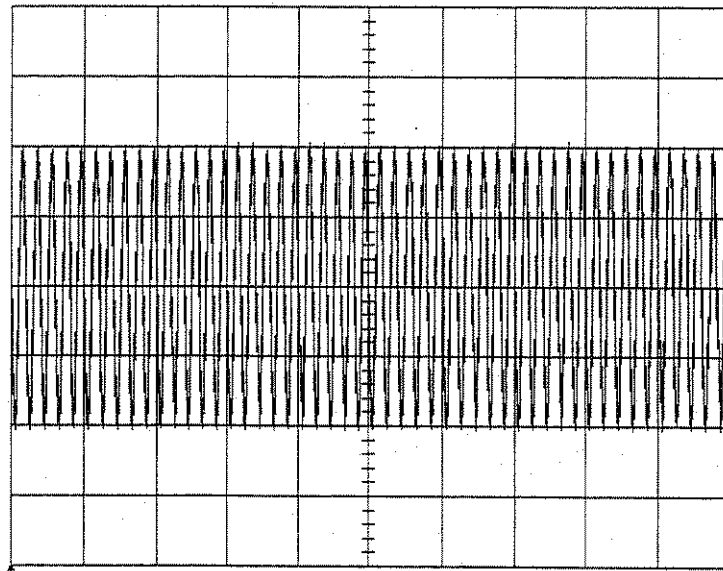

sdev(1) 140.3 mV
freq(1) 499.846 kHz

- 10 μ s
- 1 .1 V 50 Ω
 - 2 .1 V 50 Ω
 - 3 .1 V 50 Ω
 - 4 .1 V 50 Ω

Line

MEASURE

OFF Cursors
Parameters

mode
Std Voltage
Std Time
Custom
Pass
Fail

statistics
OFF On

CHANGE
PARAMETERS

from
0.00 div
Track OFF On

to
10.00 div

500 MS/s

NORMAL

Section 3 Performance Verification

27-Feb-96
14:23:33

10 μ s
100 mV

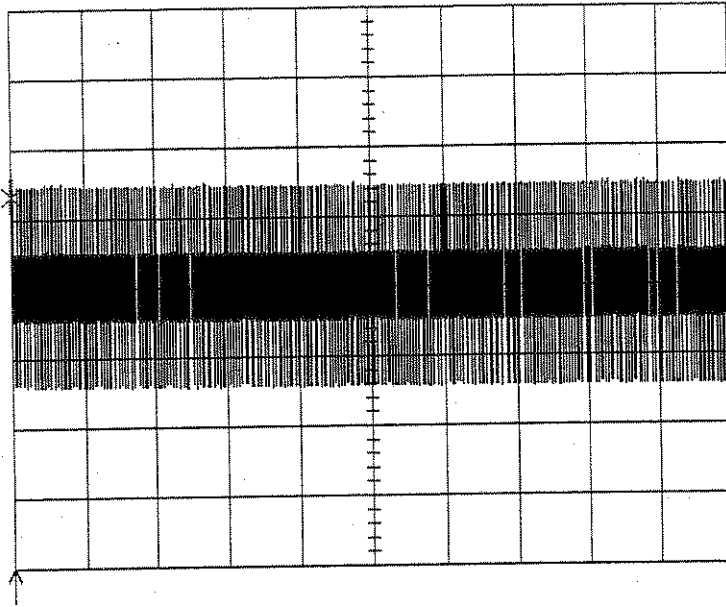

pkpk(1)	294 mV
mean(1)	0.9 mV
sdev(1)	98.7 mV
rms(1)	98.7 mV
ampl(1)	273 mV

10 μ s

1 .1 V 50 Ω
2 .1 V 50 Ω
3 .1 V 50 Ω
4 .1 V 50 Ω

 Line

MEASURE

OFF Cursors
Parameters

mode
Std Voltage
Std Time
Custom
Pass
Fail

statistics
OFF On

on displayed
(trace)
1

from
0.00 div
Track OFF On

to
10.00 div
50000 pts

500 MS/s

NORMAL

3.9.1.a.1 Trigger Bandwidth

- Set DSO Input gain : 100 mV/div.
- Set Trigger on : 1
- Coupling 1 : HF
- Mode : Norm
- Timebase : 1 nsec/div.

- Set sine wave generator frequency to 501 MHz

- Change Trigger level, until the scope triggers on Channel 1.

27-Feb-96
14:31:27

1
1 ns
100 mV

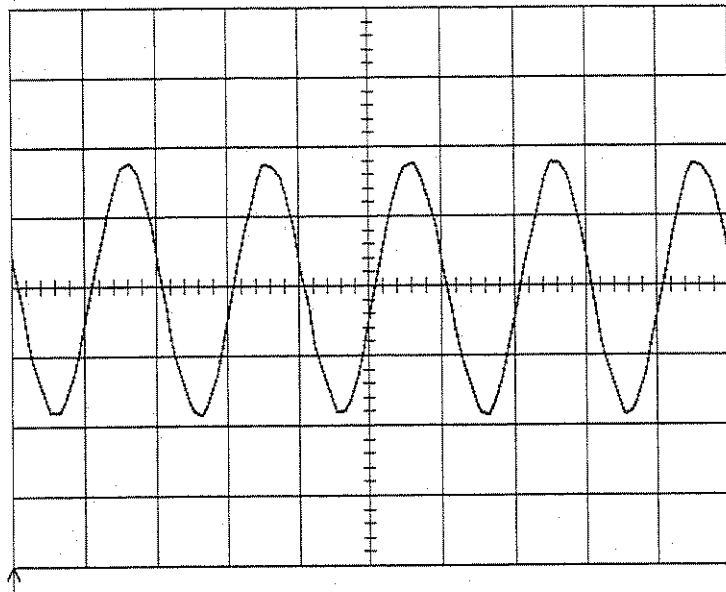

TRIGGER SETUP

Edge SMART

trigger on
1 2 3 4 Ext
Ext10 Line

coupling **1**
DC AC LFREJ
HFREJ **HF**

sdev(1) 126.4 mV
freq(1) 500.961 MHz

holdoff

OFF Time Evts

1 ns RIS

1 .1 V 50Ω
2 .1 V 50Ω
3 .1 V 50Ω
4 .1 V 50Ω

1 HF 6 mV

10 GS/s

NORMAL

- Check : The scope must keep triggering in a stable way, a smooth 501 MHz sine wave must be visible on the screen.
- Repeat step 3.9.1.a and 3.9.1.a.1 for Channel 2, Channel 3 and Channel 4 substituting channel controls and input connector.

3.9.1.b 1 MΩ

The purpose of this test is to ensure that the entire 9374/M/L/TM system has a bandwidth of at least 450 MHz at probe tip.

Set up a HP8648B sine wave generator or equivalent.

- Terminate the output of the HP8648B via a 50Ω feed through and connect it to the channel 1 input through a LeCroy PP005 10X-probe using a probe tip BNC Jack adapter.

Make sure the probe compensation is perfectly adjusted at low frequency.

- Turn on trace : Ch1
 - Display setup : Standard, Persistence off, Dot join on, Single grid
 - Input Coupling : AC 1MΩ
 - V/div. offset : Normal
 - Global BWL : Off
 - Input gain : 1 V/div.
 - Offset : 0 mV
 - Trigger setup : Edge
 - Trigger on : Line
 - Slope Line : Pos
 - Mode : Norm
 - Timebase : 10 μsec/div.
 - Channel use : 4
 - Record up : 50 K
 - Press Cursors/Measure: Parameters
 - Mode : Custom
 - Statistics : off
 - Change parameters : Measure
 - On line 1 : sdev of 1
 - On line 2 : freq of 1
-
- Set sine wave generator frequency to 500 KHz, adjust the generator output amplitude to get on DSO : sdev(1) = 2.5 V.
 - Increase the generator frequency in multi 50 MHz steps until the sine wave amplitude is 70% of the initial amplitude at 500 KHz .
 - At each frequency step, check that sdev(1) > 1.75 V
 - When sdev(1) = 1.75 V (3 dB point) the frequency of the generator must be at least 450 MHz.
 - Repeat step 3.9.1.b for Channel 2, Channel 3 and Channel 4 substituting channel control and input connector.

28-Feb-96
9:22:14

10 μ s
1.00 V

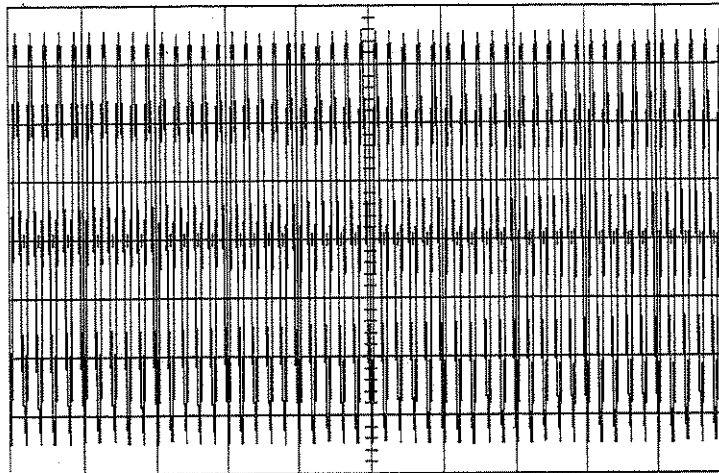

sdev(1) 2.507 V
Freq(1) 499.839 kHz

CHANNEL 1

Coupling
DC50 Ω
Grounded
DC1M Ω
Grounded
AC1M Ω

V/div Offset
NORMAL
ECL TTL

Global BWL
OFF 25MHz
200MHz

Probe sensed
(x10)

10 μ s

1 .1 V AC $\times \frac{10}{10}$
2 .1 V AC
3 .1 V AC
4 .1 V AC

Line

500 MS/s.

NORMAL

28-Feb-96
9:24:19

10 μ s
1.00 V

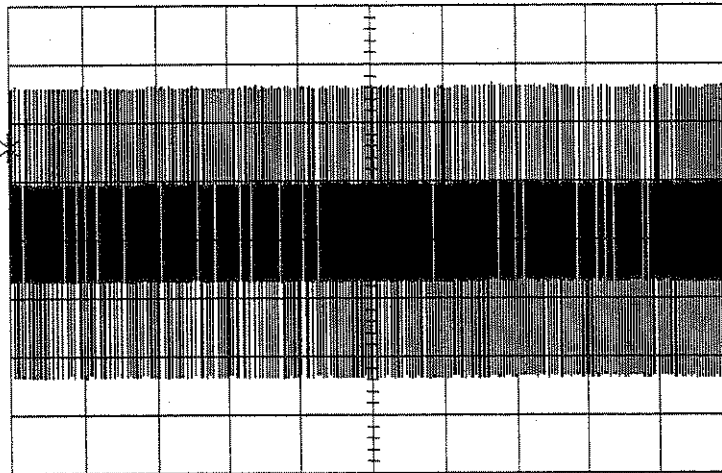

pkpk(1) 5.06 V
mean(1) 102 mV
sdev(1) 1.743 V
rms(1) 1.746 V
ampl(1) 4.78 V

MEASURE

OFF Cursors
Parameters

mode
Std Voltage
Std Time
Custom
Pass
Fail

statistics
OFF On

on displayed
(trace)
1

from
0.00 div
Track **OFF** On

to
10.00 div
50000 pts

500 MS/s

NORMAL

10 μ s

1 .1 V AC $\times \frac{10}{10}$
2 .1 V AC
3 .1 V AC
4 .1 V AC

Line

3.10 Trigger Level

3.10.1 Description

The trigger capabilities are tested for several cases of the standard edge trigger :

- Channel (internal), and External Trigger sources
- Three DC levels : -3, 0, +3 major screen divisions
- DC coupling
- Positive and negative slopes

3.10.2 Channel (internal)

The horizontal and vertical errors for a trigger at 0 v threshold are determined by comparing the crossing point of the same sine wave at two different amplitudes.

- Setup any sine wave generator capable of generating sine waves of **1 KHz, 4V pkpk**.
- Connect the generator output to Channel 1

- Turn on trace : **Ch1**
- Input Coupling Ch 1 : **DC 50 Ω**
- V/div. offset : **Normal**
- Input gain : **.5 V/div.**
- Input offset : **0 mV**
- Trigger setup : **Edge**
- Trigger on : **1**
- Coupling 1 : **DC**
- Slope 1 : **Pos**
- Set Trigger level : **DC 0.0 mV**
- Mode : **Single**
- Pre-Trigger Delay : **50 %**
- Timebase : **.1 msec/div.**
- Channel Use : **4**
- Record up to : **50 K samples**

- Adjust the sine wave generator's output amplitude to get **8 divisions peak to peak**, corresponding to a **4 V** amplitude.
- It is important that the offset of the input is set to **zero mV**, use show status and acquisition status to verify.

- Display setup : **Dot join Off**
- Set **Persistence On**, and acquire few sweeps in Single Trigger mode.
- Connect a **3 dB attenuator**, and acquire few more sweeps in Single mode.

- Select Cursors/Measure : **Cursors, Time, Absolute**
- Use the " cursor position " knob, to move the marker at the **horizontal crossing point** of the two sine waves.

- Check that the **time** difference obtained between the marker and the trigger is within $\pm 20 \mu \text{sec}$. The time readout is below 0.50 V in the icon **1**, at top left.

28-Feb-96
11:25:17

1
.1 ms
0.50 V

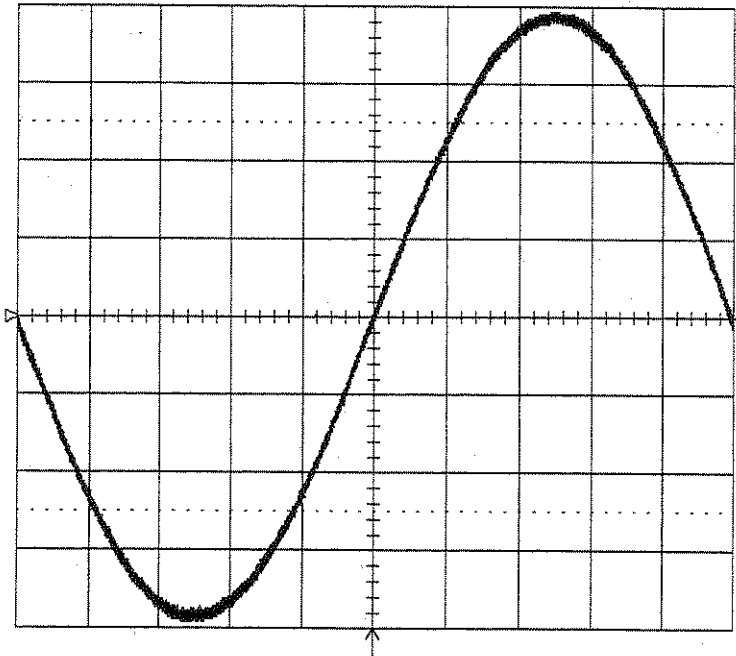

11 sweeps

1 DC 0.00 V

DISPLAY SETUP

- Standard XY
- Persistence OFF On (Infinite)
- Dot Join OFF On
- Persistence Setup
- Grids Single Dual Quad
- W' Form+Text intensity 90 %
- Grid intensity 60 %

50 MS/s

STOPPED

.1 ms

- 1** .5 V 50Ω
- 2** .5 V 50Ω
- 3** .5 V 50Ω
- 4** .5 V 50Ω

28-Feb-96
11:27:09

1
.1 ms
0.50 V
4 μs

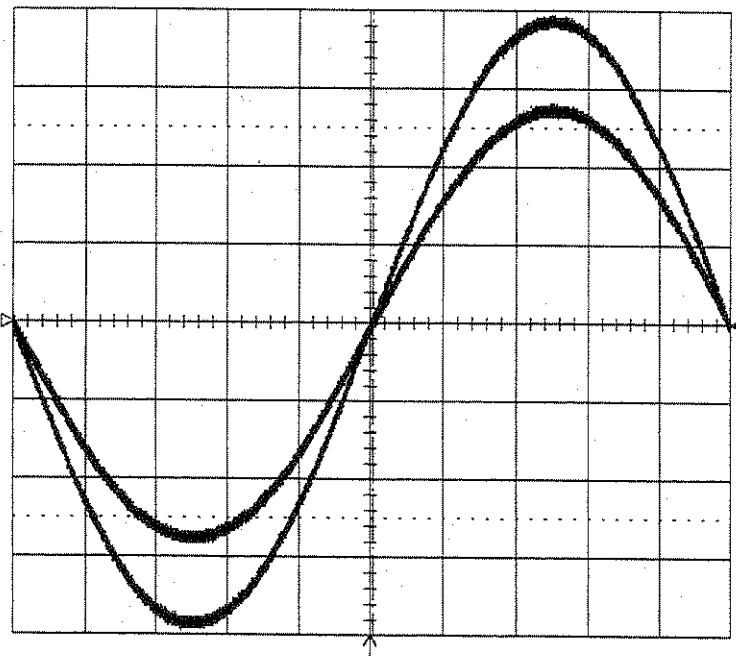

21 sweeps

1 DC 0.00 V

MEASURE

- OFF Cursors Parameters
- mode Time Amplitude
- type Relative Absolute

cursor Position

50 MS/s

STOPPED

.1 ms

- 1** .5 V 50Ω
- 2** .5 V 50Ω
- 3** .5 V 50Ω
- 4** .5 V 50Ω

Section 3 Performance Verification

- Select Cursors mode : **Amplitude, Absolute**
- Use the " cursor position " knob, to move the marker at the **vertical crossing point** of the two sine waves.
- Check that the **voltage** difference obtained between the marker and the trigger level is within ± 200 mV. The level readout is below 0.50 V in the icon 1, at top left.

28-Feb-96
11:28:31

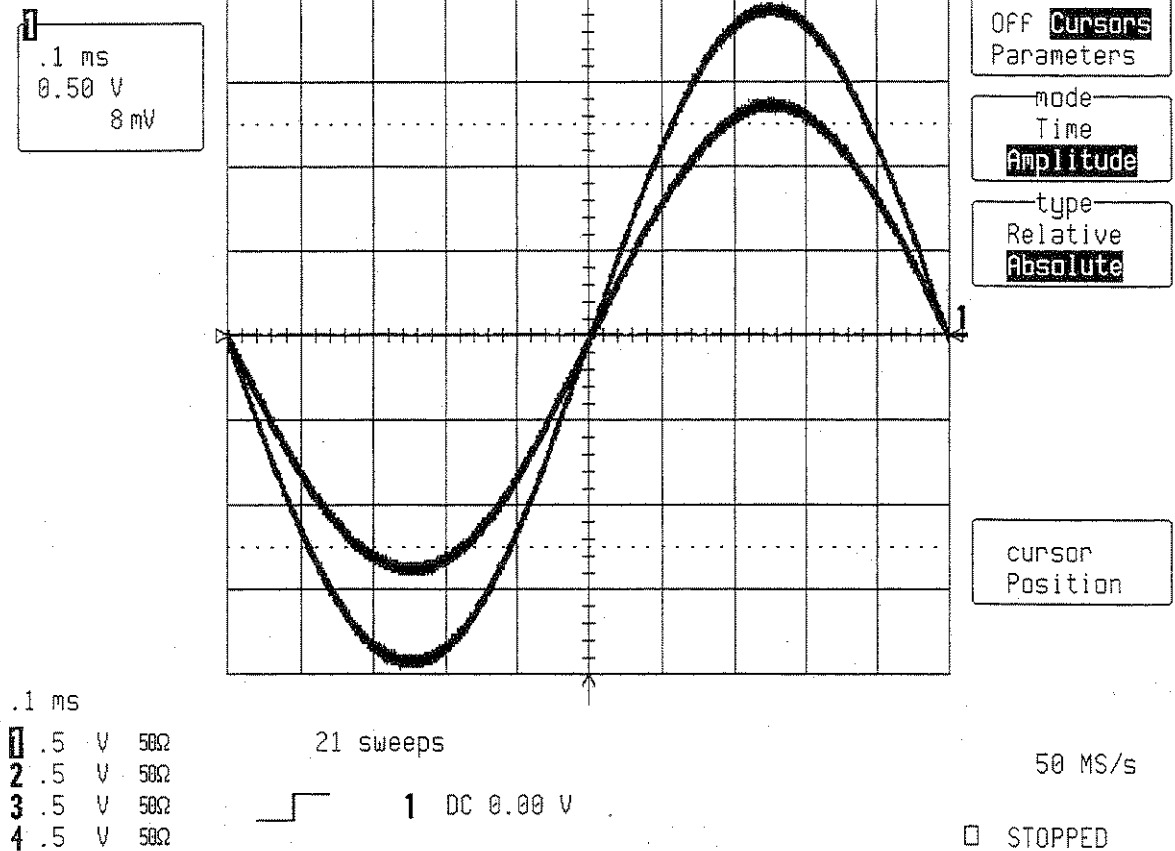

- Set Trigger Slope 1 : **Neg**
- Disconnect the **3 dB attenuator** from the BNC input
- Acquire few sweeps in Single Trigger mode.
- Connect the **3 dB attenuator**, and acquire few more sweeps in Single mode.
- Select Cursors/Measure : **Cursors, Time, Absolute**
- Use the " cursor position " knob, to move the marker at the **horizontal crossing point** of the two sine waves.
- Check that the **time** difference obtained between the marker and the trigger is within ± 20 μ sec. The time readout is below 0.50 V in the icon 1, at top left.
- Select Cursors mode : **Amplitude, Absolute**
- Use the " cursor position " knob, to move the marker at the **vertical crossing point** of the two sine waves.
- Check that the **voltage** difference obtained between the marker and the trigger level is within ± 200 mV. The level readout is below 0.50 V in the icon 1, at top left.

28-Feb-96
11:30:32

1
.1 ms
0.50 V
-2 μ s

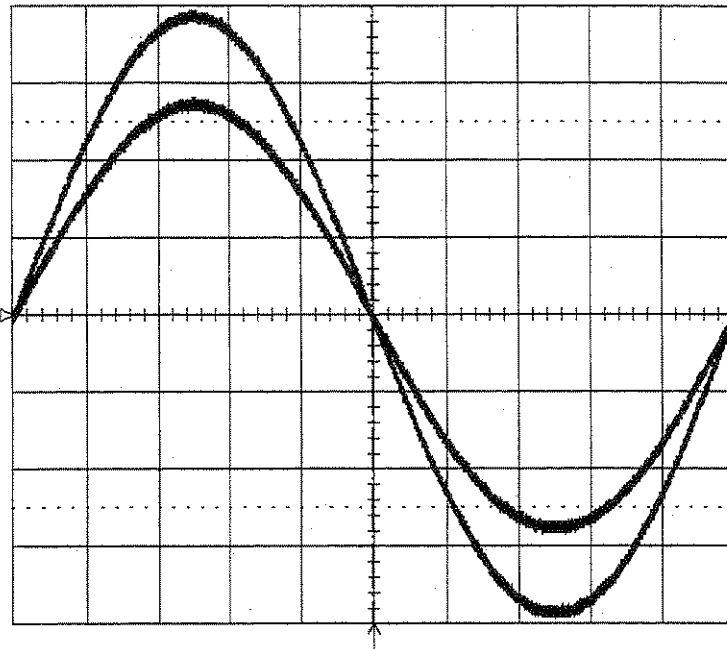

TRIGGER SETUP

Edge SMART

trigger on
1 2 3 4 Ext
Ext10 Line

coupling **1**
DC AC LFREJ
HFREJ HF

slope **1**
Pos Neg

holdoff
OFF Time Evts

.1 ms
1 .5 V 50 Ω
2 .5 V 50 Ω
3 .5 V 50 Ω
4 .5 V 50 Ω

21 sweeps

1 DC 0.00 V

50 MS/s

STOPPED

28-Feb-96
11:31:08

1
.1 ms
0.50 V
-16 mV

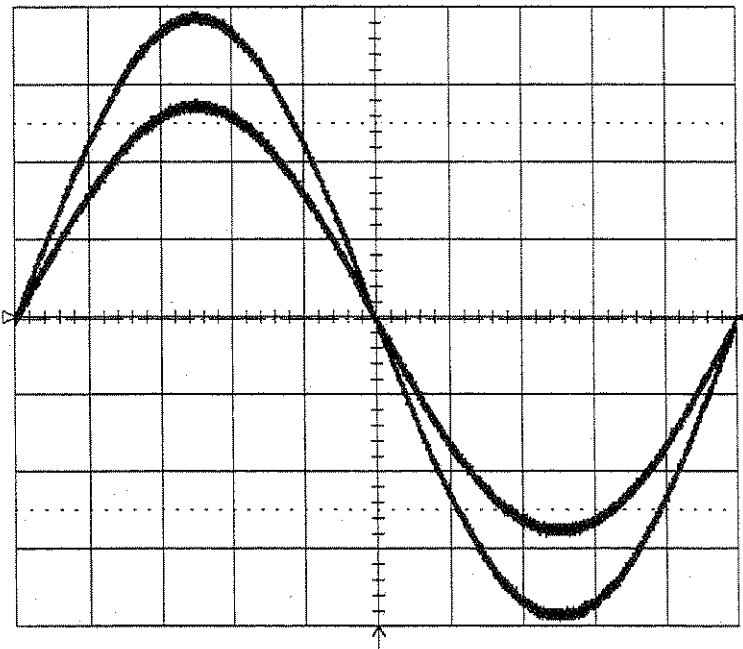

MEASURE

OFF **Cursors**
Parameters

mode
Time
Amplitude

type
Relative
Absolute

cursor
Position

.1 ms
1 .5 V 50 Ω
2 .5 V 50 Ω
3 .5 V 50 Ω
4 .5 V 50 Ω

21 sweeps

1 DC 0.00 V

50 MS/s

STOPPED

Section 3 Performance Verification

- Set Trigger level : DC + 1.5 V
- Disconnect the 3 dB attenuator from the BNC input
- Set Trigger Slope 1 : Pos

- Acquire few sweeps in Single Trigger mode.

- The sine wave must pass through the **horizontal center** of the screen at the **vertical + 3 divisions**.

- Select Cursors/Measure : **Cursors, Amplitude, Absolute**

- Use the " cursor position " knob, to move the marker, at the **crossing point** of the **sine wave** and the **horizontal center of the screen** (50% pre-trigger line).

- Check that the **vertical crossing point level is + 1.5 V ± .2 V**. See icon 1 at top left.

28-Feb-96
11:33:57

1
.1 ms
0.50 V
1.547 V

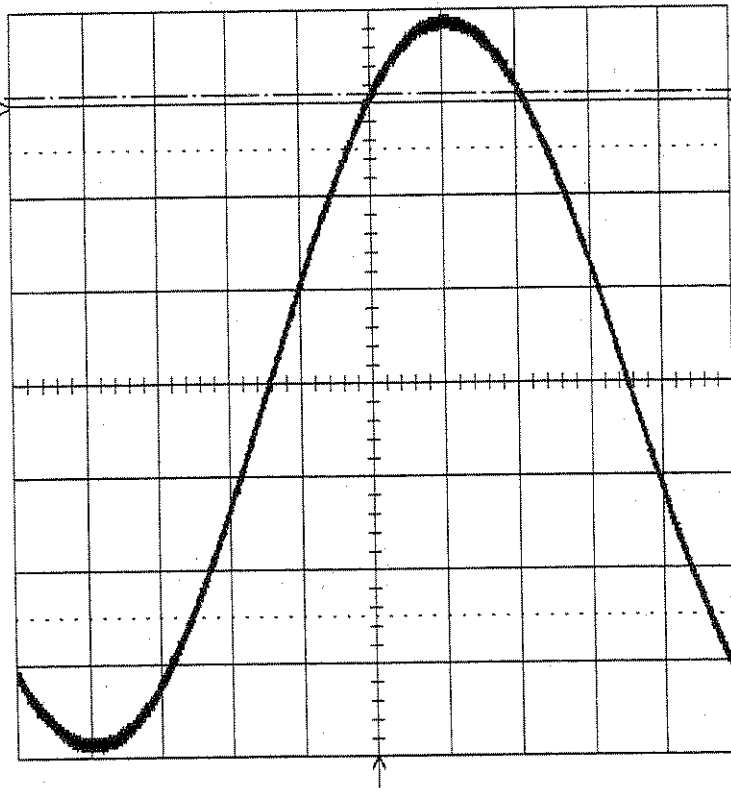

MEASURE

OFF **Cursors**
Parameters

mode
Time
Amplitude

type
Relative
Absolute

cursor
Position

.1 ms
1 .5 V 50Ω
2 .5 V 50Ω
3 .5 V 50Ω
4 .5 V 50Ω

11 sweeps

 **1** DC 1.50 V

50 MS/s

STOPPED

- Set Trigger Slope 1 : Neg
- Acquire few sweeps in Single Trigger mode.
- The sine wave must pass through the **horizontal center** of the screen at the **vertical + 3 divisions**.
- Select Cursors/Measure : **Cursors, Amplitude, Absolute**
- Use the " cursor position " knob, to move the marker, at the **crossing point** of the **sine wave** and the **horizontal center of the screen** (50% pre-trigger line).
- Check that the **vertical crossing point level is + 1.5 V ± .2 V**. See icon at top left.

28-Feb-96
11:34:47

1
.1 ms
0.50 V
1.484 V

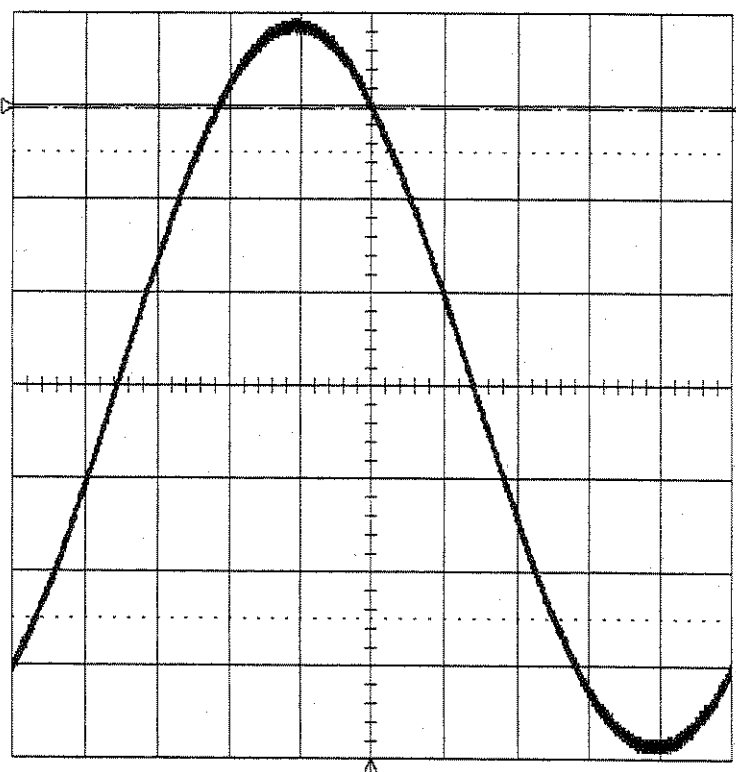

TRIGGER SETUP

Edge SMART

trigger on
 1 2 3 4 Ext
Ext10 Line

coupling 1
 DC AC LFREJ
HFREJ HF

slope 1
Pos Neg

holdoff
- - -
 OFF Time Evts

.1 ms
 1 .5 V 50Ω
 2 .5 V 50Ω
 3 .5 V 50Ω
 4 .5 V 50Ω

11 sweeps

DC 1.50 V

50 MS/s

STOPPED

Section 3 Performance Verification

- Set Trigger level : DC - 1.5 V
- Set Trigger Slope 1 : Pos
- Acquire few sweeps in Single Trigger mode.
- The sine wave must pass through the **horizontal center** of the screen at the **vertical - 3 divisions**.
- Select Cursors/Measure : **Cursors, Amplitude, Absolute**
- Use the " cursor position " knob, to move the marker, at the **crossing point** of the **sine wave** and the **horizontal center of the screen** (50% pre-trigger line).
- Check that the **vertical crossing point level is - 1.5 V ± .2 V**. See icon 1 at top left.

28-Feb-96
11:36:19

1
.1 ms
0.50 V
-1.477 V

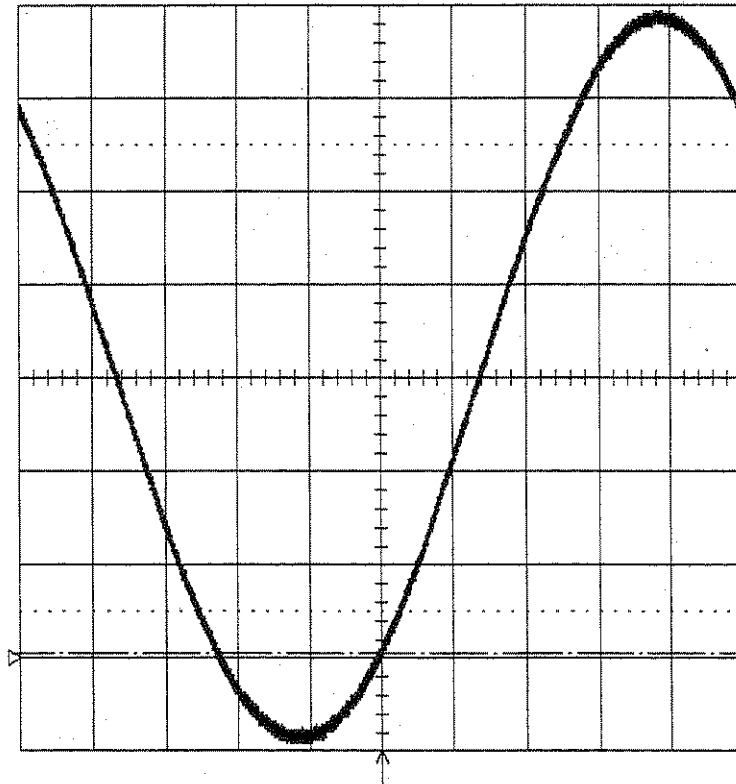

TRIGGER SETUP

Edge SMART

trigger on
1 2 3 4 Ext
Ext10 Line

coupling **1**
DC AC LFREJ
HFREJ HF

slope **1**
Pos Neg

holdoff
- - -
OFF Time Evts

.1 ms
1 .5 V 50Ω
2 .5 V 50Ω
3 .5 V 50Ω
4 .5 V 50Ω

11 sweeps
 **1** DC -1.50 V

50 MS/s

STOPPED

- Set Trigger Slope 1 : Neg
- Acquire few sweeps in Single Trigger mode.
- The sine wave must pass through the **horizontal center** of the screen at the **vertical - 3 divisions**.
- Select Cursors/Measure : **Cursors, Amplitude, Absolute**
- Use the " cursor position " knob, to move the marker, at the **crossing point** of the **sine wave** and the **horizontal center of the screen** (50% pre-trigger line).
- Check that the **vertical crossing point level is - 1.5 V ± .2 V**. See icon 1 at top left.

28-Feb-96
11:37:25

1
.1 ms
0.50 V
-1.508 V

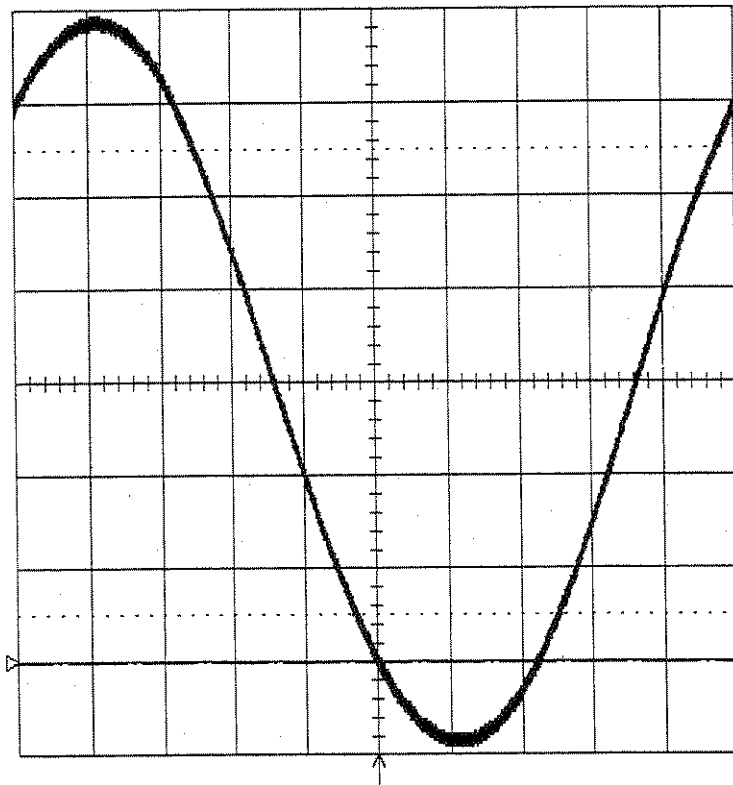

TRIGGER SETUP

Edge SMART

trigger on
1 2 3 4 Ext
Ext10 Line

coupling 1
DC AC LFREJ
HFREJ HF

slope 1
Pos Neg

holdoff

OFF Time Evts

.1 ms
1 .5 V 50Ω
2 .5 V 50Ω
3 .5 V 50Ω
4 .5 V 50Ω

12 sweeps

1 DC -1.50 V

50 MS/s

STOPPED

- Repeat step 3.10.2 for Channel 2, Channel 3 and Channel 4, substituting channel controls and input connector.

3.10.3 External Trigger

Specifications

External trigger range : DC \pm .5 V

Procedure

- Connect the output of the generator to External input and to Channel 2 via a coaxial T-connector. The cable length from External to Channel 2 must be short, at most 2 nsec.

- Set frequency : 1 KHz
- Turn on trace : Ch2
- Input Coupling Ch 2 : DC 50 Ω
- V/div. offset : Normal
- Input gain : 100 mV/div.
- Input offset : 0 mV
- Trigger setup : Edge
- Trigger on : Ext
- Coupling Ext : DC
- Slope Ext : Pos
- External : DC 1M Ω
- Set Ext Trigger level : DC 0.0 mV
- Mode : Single
- Pre-Trigger Delay : 50 %
- Timebase : .1 msec/div.
- Channel use : 4
- Record up to : 50 K samples

- Adjust the sine wave generator's output amplitude to get 8 divisions peak to peak, corresponding to a .8 V amplitude.
- It is important that the offset of the input is set to zero mV, use show status and acquisition status to verify.

- Display setup : Dot join Off
- Set Persistence On, and acquire few sweeps in Single Trigger mode.

- Connect a 3 dB attenuator, and acquire few more sweeps in Single mode.

- Select Cursors/Measure : Cursors, Time, Absolute
- Use the " cursor position " knob, to move the marker at the horizontal crossing point of the two sine waves.

- Check that the time difference obtained between the marker and the trigger is within \pm 20 μ sec. The time readout is below 100 mV in the icon 2, at top left.

28-Feb-96
11:44:42

2
.1 ms
100 mV

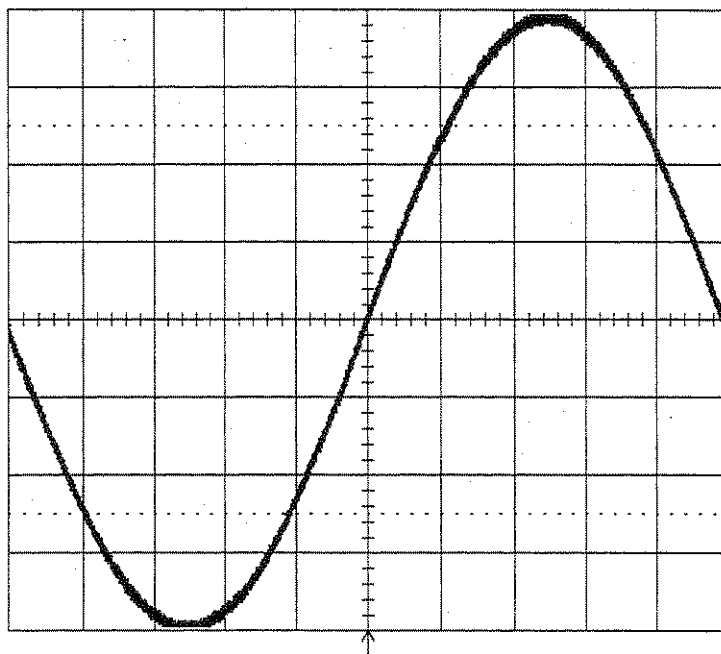

11 sweeps

Ext DC 0mV 1MΩ

TRIGGER SETUP

Edge SMART

trigger on
1 2 3 4 Ext
Ext10 Line

cp1g Ext
DC AC LFREJ
HFREJ HF

slope Ext
Pos Neg

External
DC50Ω DC1MΩ

holdoff
OFF Time Evts

50 MS/s

STOPPED

28-Feb-96
11:45:21

2
.1 ms
100 mV
-2 μs

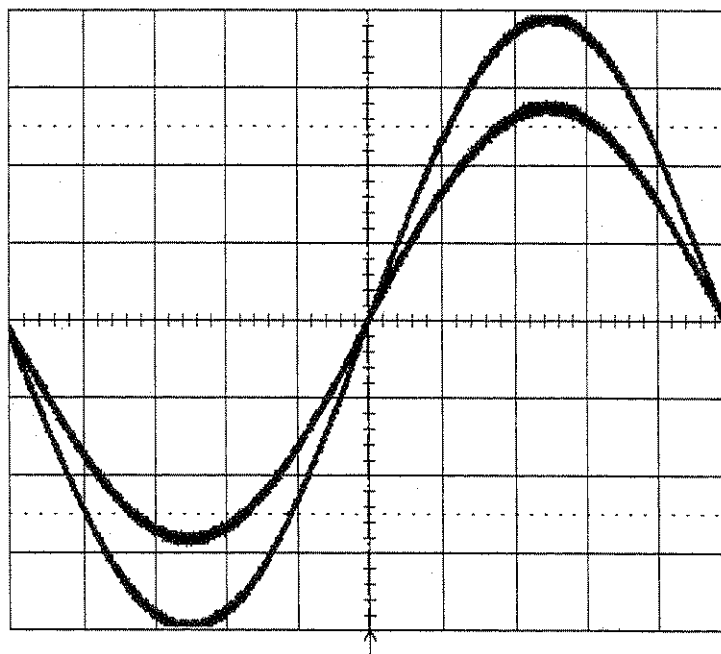

21 sweeps

Ext DC 0mV 1MΩ

MEASURE

OFF Cursors
Parameters

made
Time
Amplitude

type
Relative
Absolute

cursor
Position

50 MS/s

STOPPED

.1 ms
1 .1 V 50Ω
2 .1 V 50Ω
3 .1 V 50Ω
4 .1 V 50Ω

Section 3 Performance Verification

- Select Cursors mode : **Amplitude, Absolute**
- Use the " cursor position " knob, to move the marker at the vertical crossing point of the two sine waves.
- Check that the **vertical crossing point level is within ± 40 mV**. See icon 2 at top left.

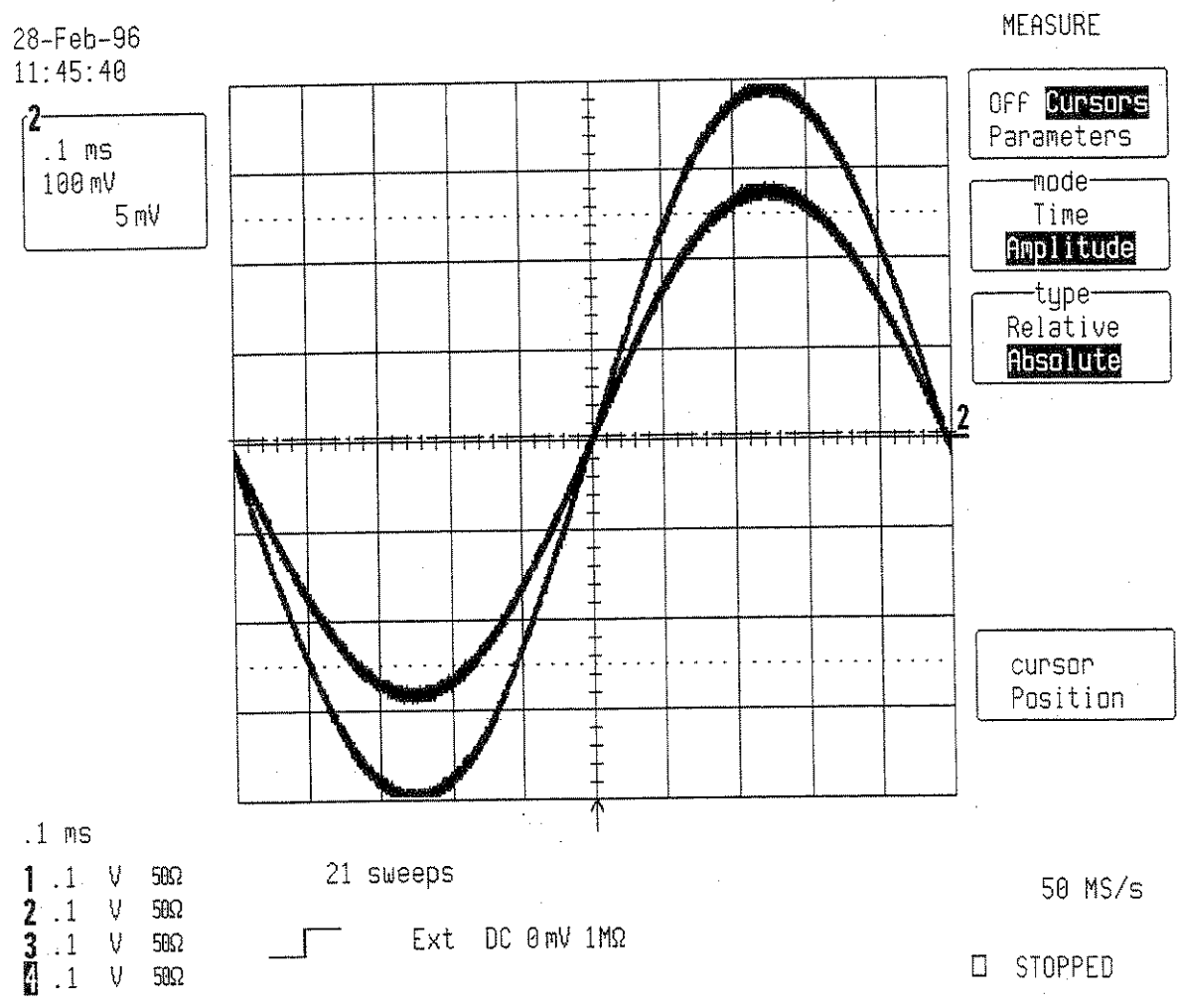

- Set Slope Ext : **Neg**
- Disconnect the **3 dB attenuator** from the BNC input
- Acquire few sweeps in Single Trigger mode.
- Connect the **3 dB attenuator**, and acquire few more sweeps in Single mode.
- Select Cursors/Measure : **Cursors, Time, Absolute**
- Use the " cursor position " knob, to move the marker at the **horizontal crossing point** of the two sine waves.
- Check that the **time** difference obtained between the marker and the trigger is within ± 20 μ sec. The time readout is below 100 mV in the icon 2, at top left.

28-Feb-96
11:48:00

2
.1 ms
100 mV

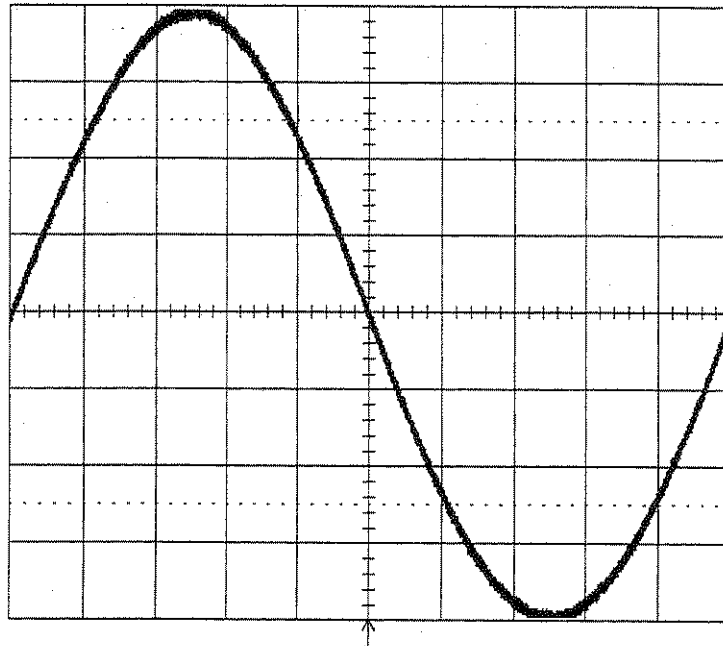

11 sweeps

Ext DC 0 mV 1MΩ

TRIGGER SETUP

Edge SMART

trigger on
1 2 3 4 Ext
Ext10 Line

cp1g Ext
DC AC LFREJ
HFREJ HF

slope Ext
Pos Neg

External
DC50Ω DC1MΩ

holdoff
OFF Time Evts

50 MS/s

STOPPED

.1 ms

- 1 .1 V 50Ω
- 2 .1 V 50Ω
- 3 .1 V 50Ω
- 4 .1 V 50Ω

28-Feb-96
11:48:51

2
.1 ms
100 mV
0 μs

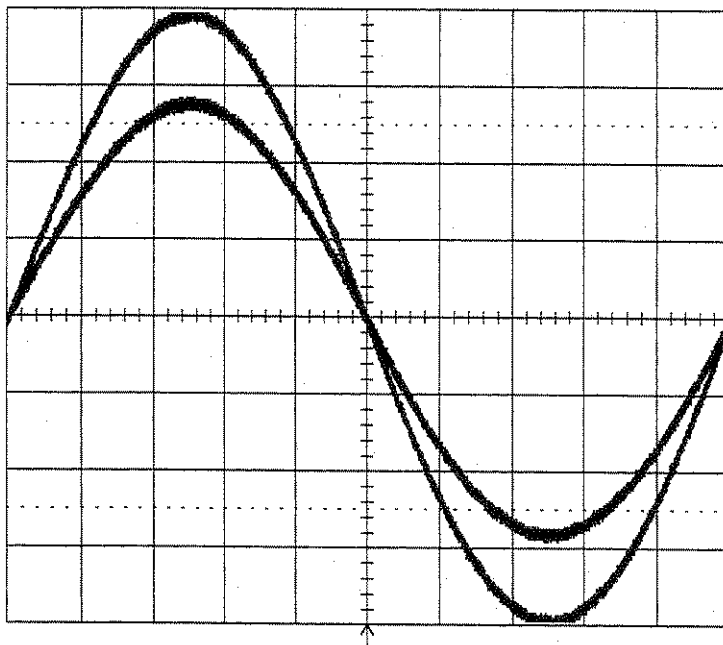

21 sweeps

Ext DC 0 mV 1MΩ

MEASURE

OFF Cursors
Parameters

mode
Time
Amplitude

type
Relative
Absolute

cursor
Position

50 MS/s

STOPPED

.1 ms

- 1 .1 V 50Ω
- 2 .1 V 50Ω
- 3 .1 V 50Ω
- 4 .1 V 50Ω

Section 3 Performance Verification

- Select Cursors mode : **Amplitude, Absolute**
- Use the " cursor position " knob, to move the marker at the **vertical crossing point** of the two sine waves:
- Check that the **voltage** difference obtained between the marker and the trigger level is within ± 40 mV. The level readout is below 100 mV in the icon 2, at top left.

28-Feb-96
11:49:29

2
.1 ms
100 mV
-8 mV

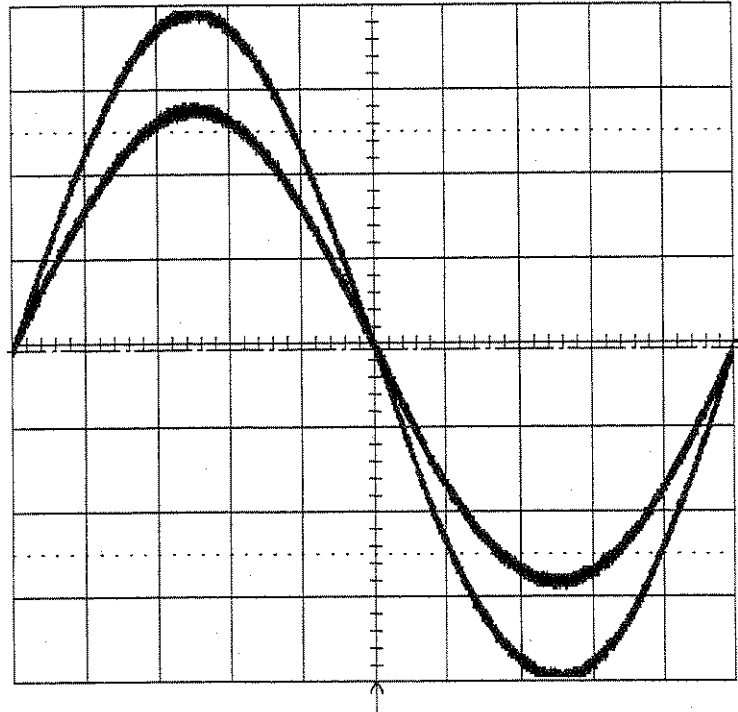

MEASURE

OFF **Cursors**
Parameters

mode
Time
Amplitude

type
Relative
Absolute

cursor
Position

.1 ms
1 .1 V 50Ω
2 .1 V 50Ω
3 .1 V 50Ω
4 .1 V 50Ω

21 sweeps

Ext DC 0 mV 1MΩ

50 MS/s

□ STOPPED

- Set Trigger level : **DC + 300 mV**
- Disconnect the **3 dB attenuator** from the BNC input
- Set Trigger Slope Ext : **Pos**
- Acquire few sweeps in Single Trigger mode.
- The sine wave must pass through the **horizontal center** of the screen at the **vertical + 3 divisions**.
- Select Cursors/Measure : **Cursors, Amplitude, Absolute**
- Use the " cursor position " knob, to move the marker, at the **crossing point** of the **sine wave** and the **horizontal center** of the screen (50% pre-trigger line).
- Check that the **vertical crossing point level** is $+ 300$ mV ± 40 mV. See icon 2 at top.

28-Feb-96
11:53:02

2
.1 ms
100 mV
313 mV

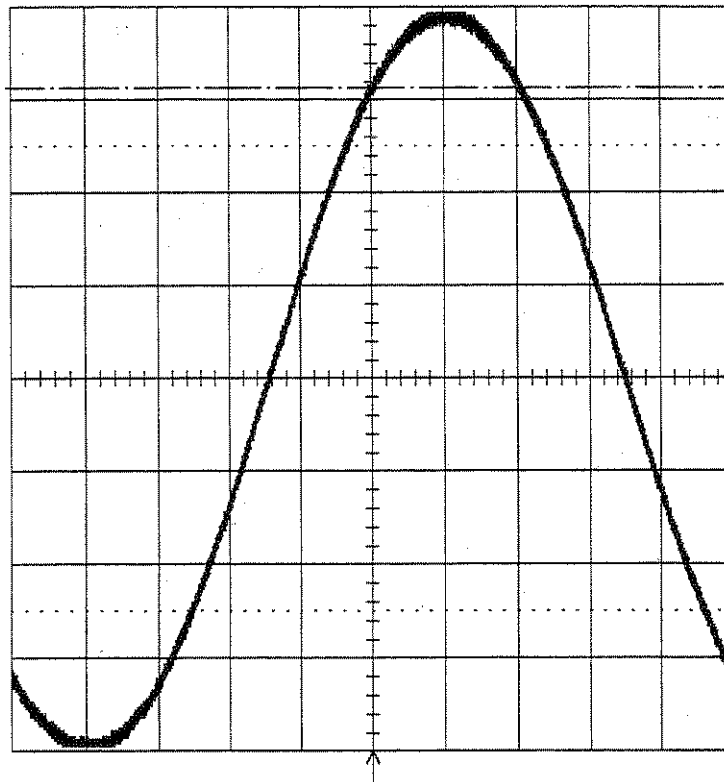

MEASURE

OFF **Cursors**
Parameters

mode
Time
Amplitude

type
Relative
Absolute

cursor
Position

.1 ms

1 .1 V 50Ω
2 .1 V 50Ω
3 .1 V 50Ω
4 .1 V 50Ω

11 sweeps



Ext DC 300 mV 1MΩ

50 MS/s

 STOPPED

- Set Trigger Slope Ext : **Neg**
- Acquire few sweeps in Single Trigger mode.
- The sine wave must pass through the **horizontal center** of the screen at the **vertical + 3 divisions**.
- Select Cursors/Measure : **Cursors, Amplitude, Absolute**
- Use the " cursor position " knob, to move the marker, at the **crossing point** of the **sine wave** and the **horizontal center of the screen** (50% pre-trigger line).
- Check that the **vertical crossing point level is + 300 mV ± 40 mV**. See icon 2 at top .

Section 3. Performance Verification

28-Feb-96
11:53:44

TRIGGER SETUP

2
.1 ms
100 mV
303 mV

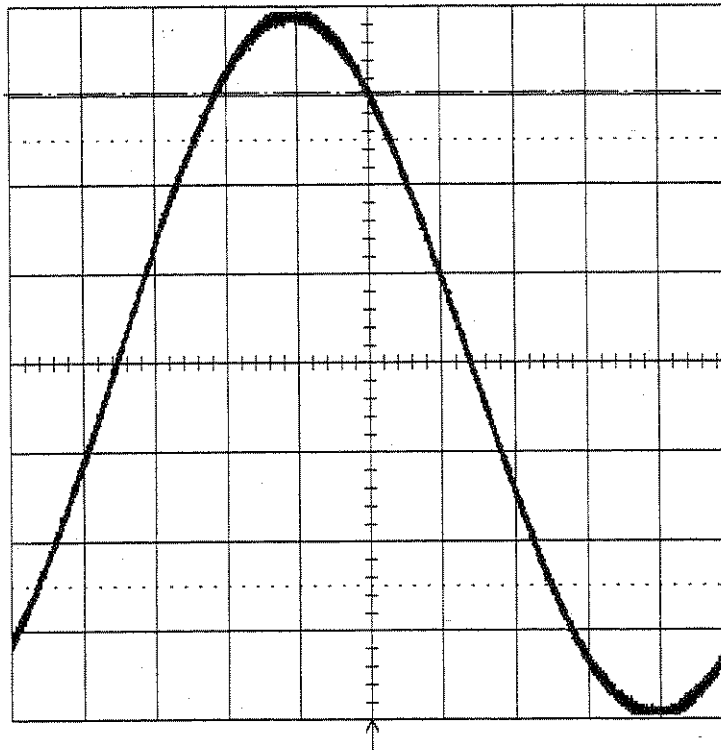

Edge SMART

trigger on
1 2 3 4 **EXT**
Ext10 Line

cpig Ext
DC AC LFREJ
HFREJ HF

slope Ext
Pos **Neg**

External
DC50Ω **DC1MΩ**

holdoff
OFF Time Evts

.1 ms

- 1 .1 V 50Ω
- 2 .1 V 50Ω
- 3 .1 V 50Ω
- 4 .1 V 50Ω

11 sweeps

Ext DC 300 mV 1MΩ

50 MS/s

□ STOPPED

- Set Trigger level : **DC - 300 mV**
- Set Trigger Slope Ext : **Pos**
- Acquire few sweeps in Single Trigger mode.
- The sine wave must pass through the **horizontal center** of the screen at the **vertical - 3 divisions**.
- Select Cursors/Measure : **Cursors, Amplitude, Absolute**
- Use the " cursor position " knob, to move the marker, at the **crossing point** of the **sine wave** and the **horizontal center of the screen** (50% pre-trigger line).
- Check that the **vertical crossing point level is - 300 mV ± 40 mV**. See icon 2 at top.
- Set Trigger Slope Ext : **Neg**
- Acquire few sweeps in Single Trigger mode.
- The sine wave must pass through the **horizontal center** of the screen at the **vertical - 3 divisions**.
- Select Cursors/Measure : **Cursors, Amplitude, Absolute**
- Use the " cursor position " knob, to move the marker, at the **crossing point** of the **sine wave** and the **horizontal center of the screen** (50% pre-trigger line).
- Check that the **vertical crossing point level is - 300 mV ± 40 mV**. See icon 2 at top.

28-Feb-96
11:55:25

2
.1 ms
100 mV
-306 mV

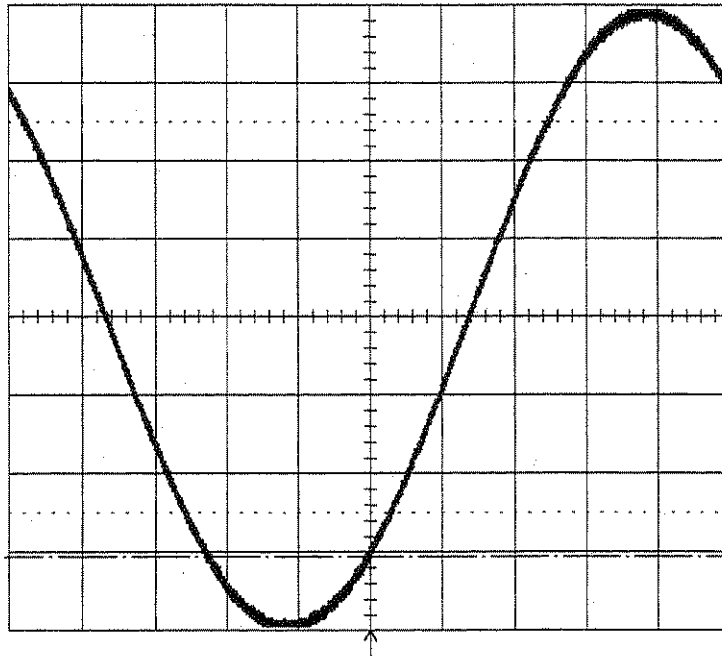

.1 ms
1 .1 V 50Ω
2 .1 V 50Ω
3 .1 V 50Ω
4 .1 V 50Ω

11 sweeps

Ext DC -300 mV 1MΩ

TRIGGER SETUP

Edge SMART

trigger on
1 2 3 4 Ext
Ext10 Line

cp1g Ext
DC AC LFREJ
HFREJ HF

slope Ext
Pos Neg

External
DC50Ω DC1MΩ

holdoff

OFF Time Evts

50 MS/s

STOPPED

28-Feb-96
11:55:55

2
.1 ms
100 mV
-298 mV

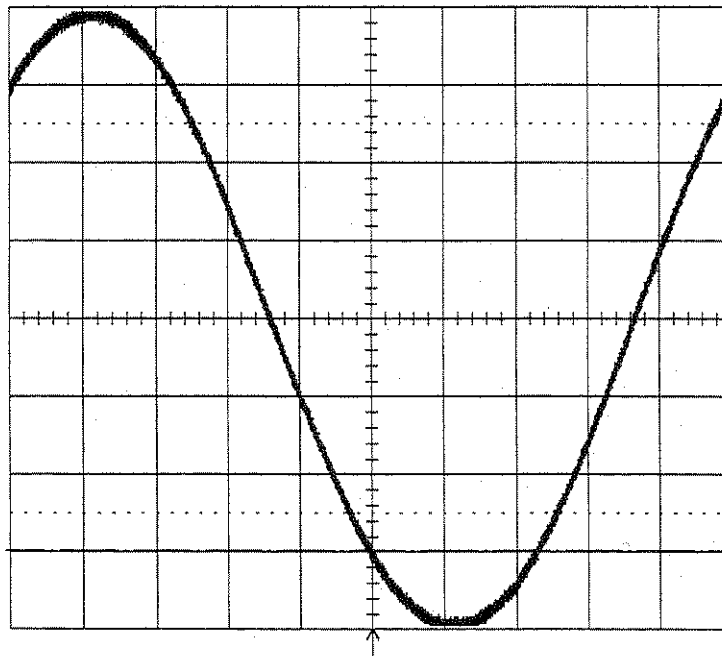

.1 ms
1 .1 V 50Ω
2 .1 V 50Ω
3 .1 V 50Ω
4 .1 V 50Ω

11 sweeps

Ext DC -300 mV 1MΩ

TRIGGER SETUP

Edge SMART

trigger on
1 2 3 4 Ext
Ext10 Line

cp1g Ext
DC AC LFREJ
HFREJ HF

slope Ext
Pos Neg

External
DC50Ω DC1MΩ

holdoff

OFF Time Evts

50 MS/s

STOPPED

3.10.4 External /10 Trigger

Specifications

External trigger range : DC \pm 5 V

Procedure

- Connect the output of the generator to External input and to Channel 2 via a coaxial T-connector. The cable length from External to Channel 2 must be short, at most 2 nsec.
- Set frequency : 1 KHz
- Turn on trace : Ch2
- Input Coupling Ch 2 : DC 50 Ω
- V/div. offset : Normal
- Input gain : 1 V/div.
- Input offset : 0 mV
- Trigger setup : Edge
- Trigger on : Ext10
- Coupling Ext10 : DC
- Slope Ext10 : Pos
- External : DC 1M Ω
- Set Ext Trigger level : DC 0.0 mV
- Mode : Single
- Pre-Trigger Delay : 50 %
- Timebase : .1 msec/div.
- Channel use : 4
- Record up to : 50 K samples
- Adjust the sine wave generator's output amplitude to get 8 divisions peak to peak, corresponding to a 8 V amplitude.
- It is important that the offset of the input is set to zero mV, use show status and acquisition status to verify.
- Display setup : Dot join Off
- Set Persistence On, and acquire few sweeps in Single Trigger mode.
- Connect a 3 dB attenuator, and acquire few more sweeps in Single mode.
- Select Cursors/Measure : Cursors, Time, Absolute
- Use the " cursor position " knob, to move the marker at the horizontal crossing point of the two sine waves.
- Check that the time difference obtained between the marker and the trigger is within \pm 20 μ sec. The time readout is below 1 V in the icon 2, at top left.

28-Feb-96
12:01:22

2
.1 ms
1.00 V
0 μ s

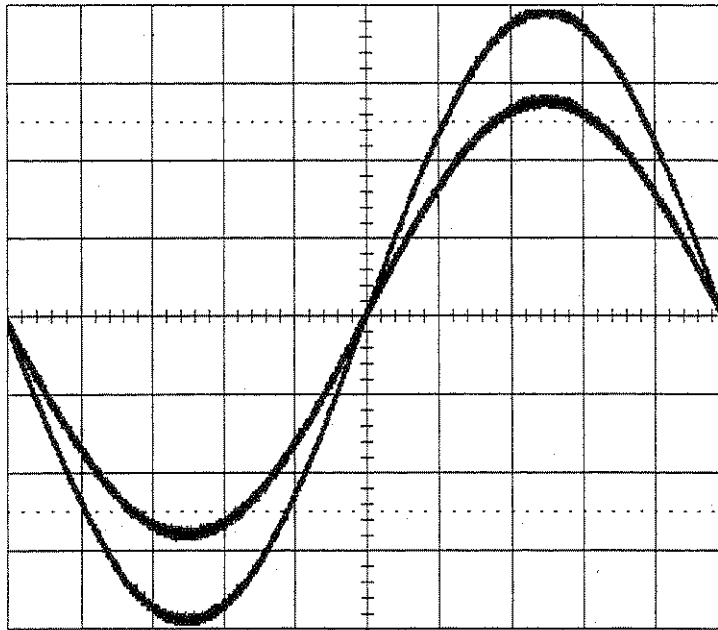

TRIGGER SETUP

Edge SMART

trigger on
1 2 3 4 Ext
Ext10 Line

cplg Ext10
DC AC LFREJ
HFREJ HF

slope Ext10
Pos Neg

External
DC50 Ω DC1M Ω

holdoff
OFF Time Evt

.1 ms
1 1 V 50 Ω
2 1 V 50 Ω
3 1 V 50 Ω
4 1 V 50 Ω

22 sweeps

Ext10 DC 0.00 V 1M Ω

50 MS/s
 STOPPED

28-Feb-96
12:01:44

2
.1 ms
1.00 V
0.02 V

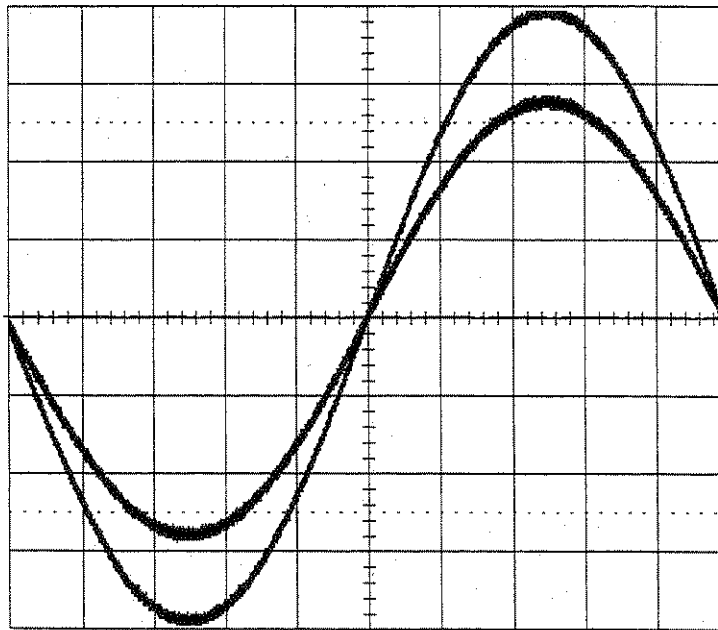

MEASURE

OFF Cursors
Parameters

mode
Time
Amplitude

type
Relative
Absolute

cursor
Position

.1 ms
1 1 V 50 Ω
2 1 V 50 Ω
3 1 V 50 Ω
4 1 V 50 Ω

22 sweeps

Ext10 DC 0.00 V 1M Ω

50 MS/s
 STOPPED

Section 3 Performance Verification

- Select Cursors mode : **Amplitude, Absolute**
- Use the " cursor position " knob, to move the marker at the **vertical crossing point** of the two sine waves.
- Check that the **voltage** difference obtained between the marker and the trigger level is within ± 400 mV. The level readout is below 1 V in the icon 2, at top left.

- Set Trigger Slope Ext10 : **Neg**
- Disconnect the **3 dB attenuator** from the BNC input
- Acquire few sweeps in Single Trigger mode.
- Connect the **3 dB attenuator**, and acquire few more sweeps in Single mode.
- Select Cursors/Measure : **Cursors, Time, Absolute**
- Use the " cursor position " knob, to move the marker at the **horizontal crossing point** of the two sine waves.
- Check that the **time** difference obtained between the marker and the trigger is within ± 20 μ sec. The time readout is below 1 V in the icon 2, at top left.

- Select Cursors mode : **Amplitude, Absolute**
- Use the " cursor position " knob, to move the marker at the **vertical crossing point** of the two sine waves.
- Check that the **vertical crossing point level** is within ± 400 mV. See icon 2 at left.

28-Feb-96
12:04:54

2
.1 ms
1.00 V
-2 μ s

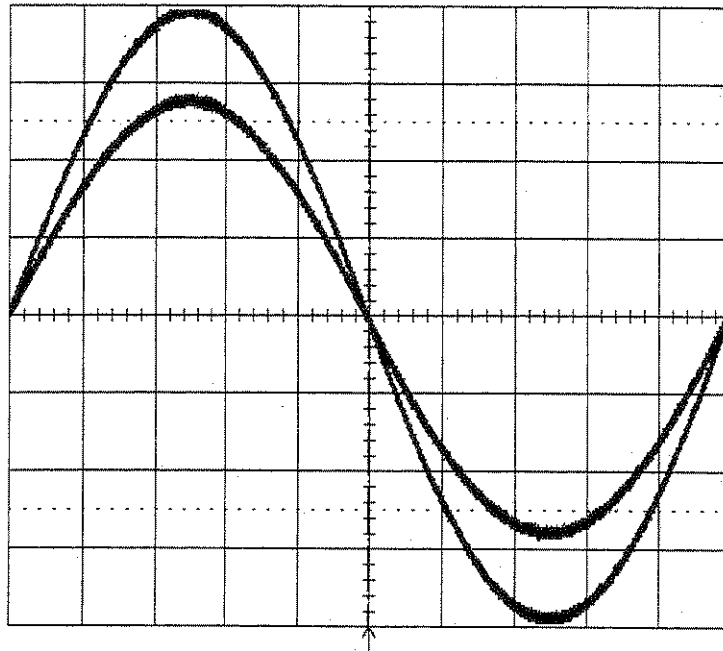

TRIGGER SETUP

Edge SMART

trigger on
1 2 3 4 Ext
Ext10 Line

cp1g Ext10
DC AC LFREJ
HFREJ HF

slope Ext10
Pos Neg

External
DC50 Ω DC1M Ω

holdoff
OFF Time Evts

.1 ms

- 1 1 V 50 Ω
- 2 1 V 50 Ω
- 3 1 V 50 Ω
- 4 1 V 50 Ω

21 sweeps



Ext10 DC 0.00 V 1M Ω

50 MS/s

STOPPED

28-Feb-96
12:05:11

2
.1 ms
1.00 V
-0.08 V

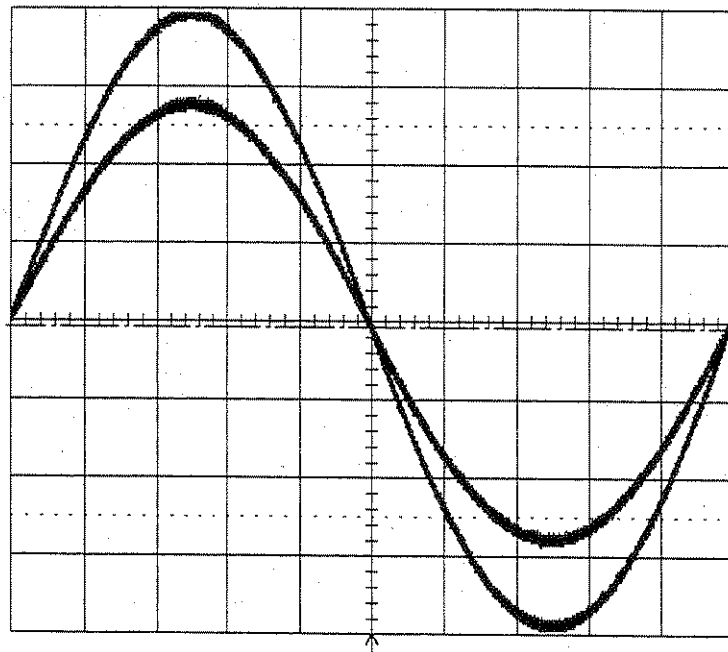

MEASURE

OFF Cursors
Parameters

mode
Time
Amplitude

type
Relative
Absolute

cursor
Position

.1 ms

- 1 1 V 50 Ω
- 2 1 V 50 Ω
- 3 1 V 50 Ω
- 4 1 V 50 Ω

21 sweeps



Ext10 DC 0.00 V 1M Ω

50 MS/s

STOPPED

Section 3 Performance Verification

- Set Trigger level : DC + 3 V
- Set Trigger Slope Ext10 : Pos
- Disconnect the 3 dB attenuator from the BNC input.
- Acquire few sweeps in Single Trigger mode.
- The sine wave must pass through the **horizontal center** of the screen at the **vertical + 3 divisions**.
- Select Cursors/Measure : **Cursors, Amplitude, Absolute**
- Use the " cursor position " knob, to move the marker, at the **crossing point** of the **sine wave** and the **horizontal center of the screen** (50% pre-trigger line).
- Check that the **vertical crossing point level is + 3 V ± 400 mV**. See icon 2 at top.

28-Feb-96
12:07:42

2
.1 ms
1.00 V
3.12 V

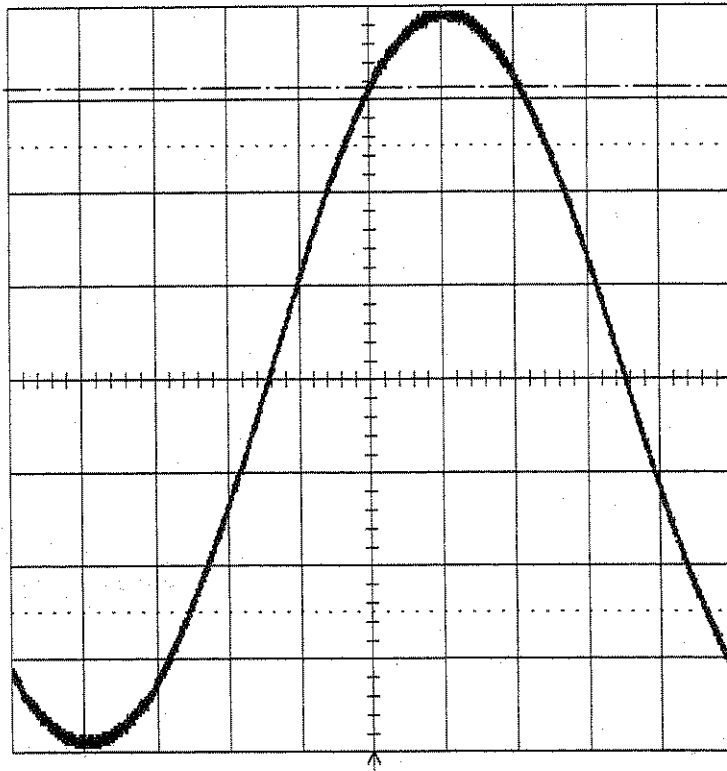

MEASURE

OFF **Cursors**
Parameters

mode
Time
Amplitude

type
Relative
Absolute

cursor
Position

.1 ms
1 1 V 50Ω
2 1 V 50Ω
3 1 V 50Ω
4 1 V 50Ω

10 sweeps



Ext10 DC 3.00 V 1MΩ

50 MS/s

□ STOPPED

- Set Trigger Slope Ext10 : Neg
- Acquire few sweeps in Single Trigger mode.
- The sine wave must pass through the **horizontal center** of the screen at the **vertical + 3 divisions**.
- Select Cursors/Measure : **Cursors, Amplitude, Absolute**
- Use the " cursor position " knob, to move the marker, at the **crossing point** of the **sine wave** and the **horizontal center of the screen** (50% pre-trigger line).
- Check that the **vertical crossing point level is + 3 V ± 400 mV**. See icon 2 at top .

28-Feb-96
12:08:22

2
.1 ms
1.00 V
3.05 V

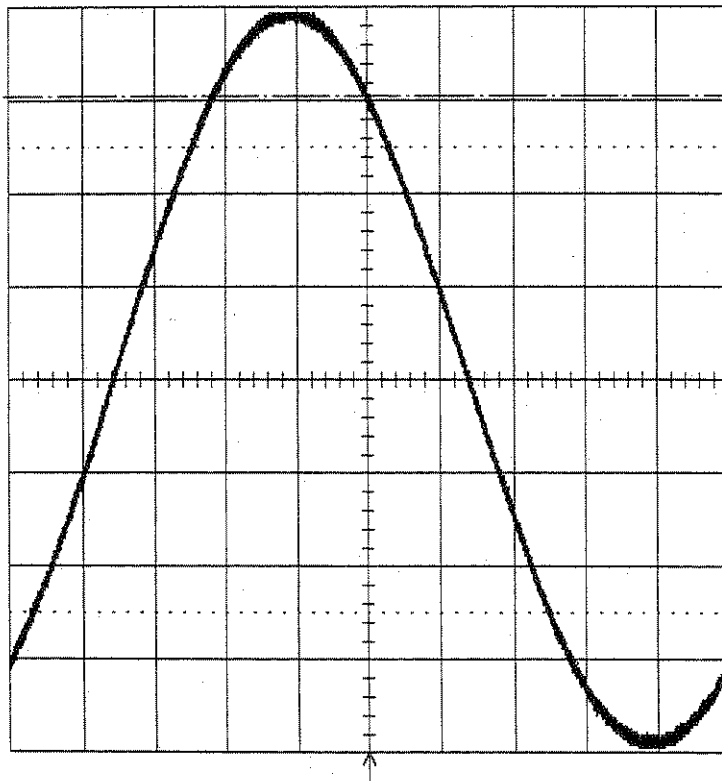

TRIGGER SETUP

Edge SMART

trigger on
1 2 3 4 Ext
Ext10 Line

cplg Ext10
DC AC LFREJ
HFREJ HF

slope Ext10
Pos Neg

External
DC50Ω DC1MΩ

holdoff
OFF Time Evts

.1 ms
1 1 V 50Ω
2 1 V 50Ω
3 1 V 50Ω
4 1 V 50Ω

11 sweeps



Ext10 DC 3.00 V 1MΩ

50 MS/s

□ STOPPED

Section 3 Performance Verification

- Set Trigger level : DC - 3 V
- Trigger Slope Ext10 : Pos
- Acquire few sweeps in Single Trigger mode.
- The sine wave must pass through the **horizontal center** of the screen at the **vertical - 3 divisions**.
- Select Cursors/Measure : **Cursors, Amplitude, Absolute**
- Use the " cursor position " knob, to move the marker, at the **crossing point** of the **sine wave** and the **horizontal center of the screen** (50% pre-trigger line).
- Check that the **vertical crossing point level is - 3 V ± 400 mV**. See icon 2 at top.

28-Feb-96
12:09:42

2
.1 ms
1.00 V
-2.95 V

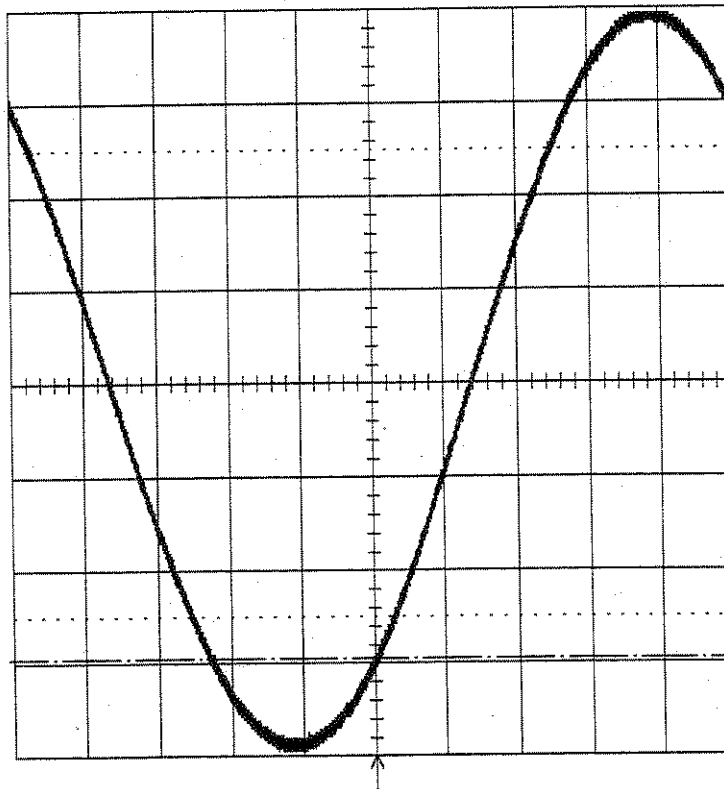

.1 ms
1 1 V 50Ω
2 1 V 50Ω
3 1 V 50Ω
4 1 V 50Ω

11 sweeps



Ext10 DC -3.00 V 1MΩ

TRIGGER SETUP

Edge SMART

trigger on
1 2 3 4 Ext
Ext10 Line

cplg Ext10
DC AC LFREJ
HFREJ HF

slope Ext10
Pos Neg

External
DC50Ω DC1MΩ

holdoff

OFF Time Evts

50 MS/s

STOPPED

- Trigger Slope Ext10 : Neg
- Acquire few sweeps in Single Trigger mode.
- The sine wave must pass through the **horizontal center** of the screen at the **vertical - 3 divisions**.
- Select Cursors/Measure : **Cursors, Amplitude, Absolute**
- Use the " cursor position " knob, to move the marker, at the **crossing point** of the **sine wave** and the **horizontal center of the screen** (50% pre-trigger line).
- Check that the **vertical crossing point level is - 3 V ± 400 mV**. See icon 2 at top.

28-Feb-96
12:10:14

2
.1 ms
1.00 V
-3.11 V

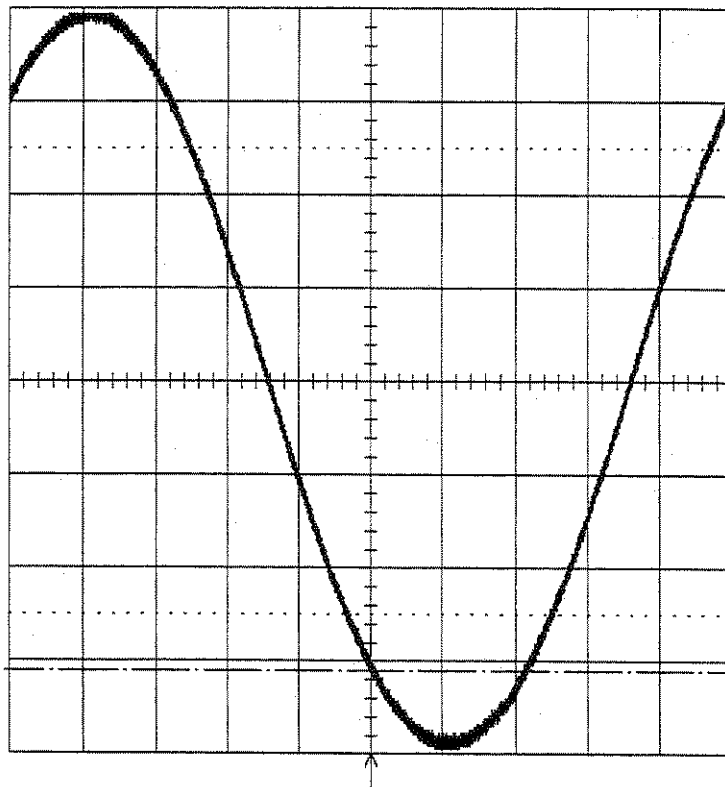

TRIGGER SETUP

Edge SMART

trigger on
1 2 3 4 Ext
Ext10 Line

cplg Ext10
DC AC LFREJ
HFREJ HF

slope Ext10
Pos Neg

External
DC50Ω DC1MΩ

holdoff

OFF Time Evt

.1 ms

- 1 1 V 50Ω
- 2 1 V 50Ω
- 3 1 V 50Ω
- 4 1 V 50Ω

11 sweeps



Ext10 DC -3.00 V 1MΩ

50 MS/s

□ STOPPED

3.11 Smart Trigger

Specifications

Pulse width < or > 2.5 nsec to 20 sec.

3.11.1 Trigger on Pulse Width < 10 nsec

Procedure

- Connect a sine wave generator to Channel 1

- Frequency : 100 MHz
- Turn on trace : Ch1
- Display setup : Standard, Persistence off, Dot join on, Single grid
- Input Coupling : DC 50 Ω
- V/div. offset : Normal
- Global BWL : Off
- Probe atten : X1
- Input gain : .5 V/div.
- Trigger setup : Smart
- Setup Smart Trigger : Glitch
- Trigger on : 1
- Coupling 1 : DC
- At end of : Neg
- Width : < 10 nsec
- Mode : Norm
- Timebase : 5 nsec/div.

- Adjust the generator output amplitude to get a five division amplitude sine wave.

- Check that the scope triggers

- Switch to Width : > 10 nsec

- Check that the scope **doesn't trigger** : slow trigger and no flashes in box next to normal.

3.11.2 Trigger on Pulse Width > 10 nsec

- Adjust the generator frequency to 40 MHz

- Check that the scope triggers

- Switch to Width : < 10 nsec

- Check that the scope **doesn't trigger** : slow trigger and no flashes in box next to normal.

28-Feb-96
9:41:43

5 ns
0.50 V
-20 mV

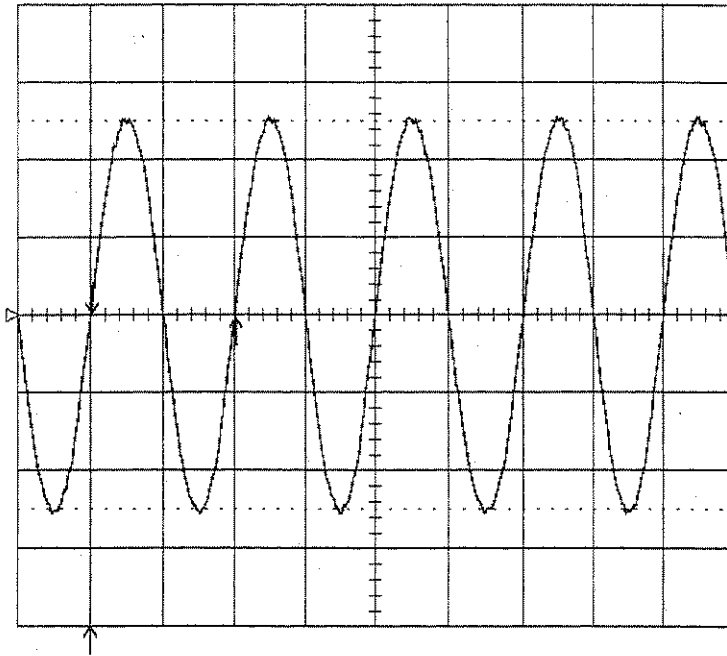

TRIGGER SETUP

Edge **SMART** (GLITCH)

SETUP SMART TRIGGER

trigger on **1** 2 3 4 Ext Ext10 Pattern

coupling **1** DC AC LFREJ HFREJ

at end of **Neg** Pos pulse

width < 10.0 ns OFF **On**

width > - - - OFF **On**

5 ns RIS

- 1** .5 V 50Ω
- 2** .5 V 50Ω
- 3** .5 V 50Ω
- 4** .5 V 50Ω

Δt 10.000 ns $\frac{1}{\Delta t}$ 100.00 MHz



1 DC 0.00 V pulse < 10.0 ns

10 GS/s

NORMAL

28-Feb-96
9:43:20

5 ns
0.50 V
35 mV

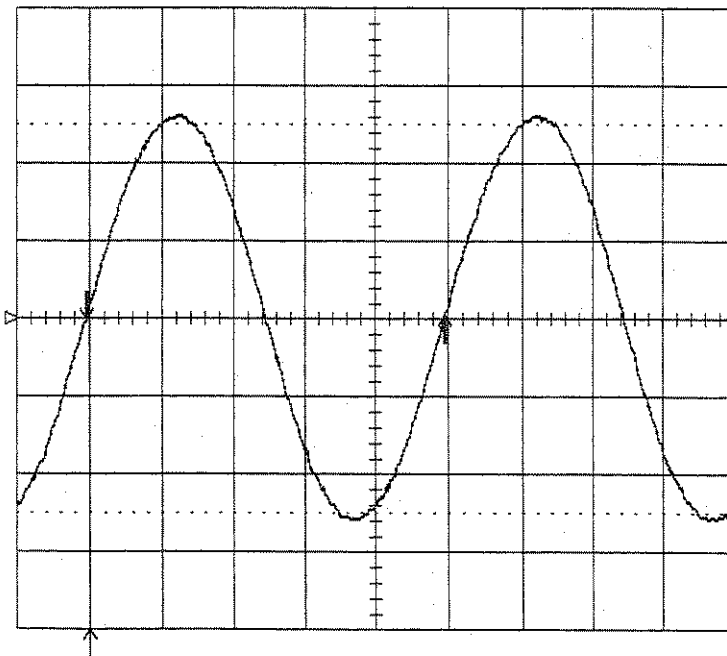

TRIGGER SETUP

Edge **SMART** (GLITCH)

SETUP SMART TRIGGER

trigger on **1** 2 3 4 Ext Ext10 Pattern

coupling **1** DC AC LFREJ HFREJ

at end of **Neg** Pos pulse

width < - - - OFF **On**

width > 10.0 ns OFF **On**

5 ns RIS

- 1** .5 V 50Ω
- 2** .5 V 50Ω
- 3** .5 V 50Ω
- 4** .5 V 50Ω

Δt 25.000 ns $\frac{1}{\Delta t}$ 40.000 MHz

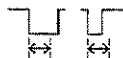

1 DC 0.00 V 10.0 ns < pulse

10 GS/s

NORMAL

3.11.3 Trigger on Pulse Width < 100 nsec

- Set the generator frequency to **10 MHz**
- Pulse width : < **100 nsec**
- Timebase : **20 nsec/div.**
- Check that the scope triggers.

28-Feb-96
9:47:47

20 ns
0.50 V
-1 mV

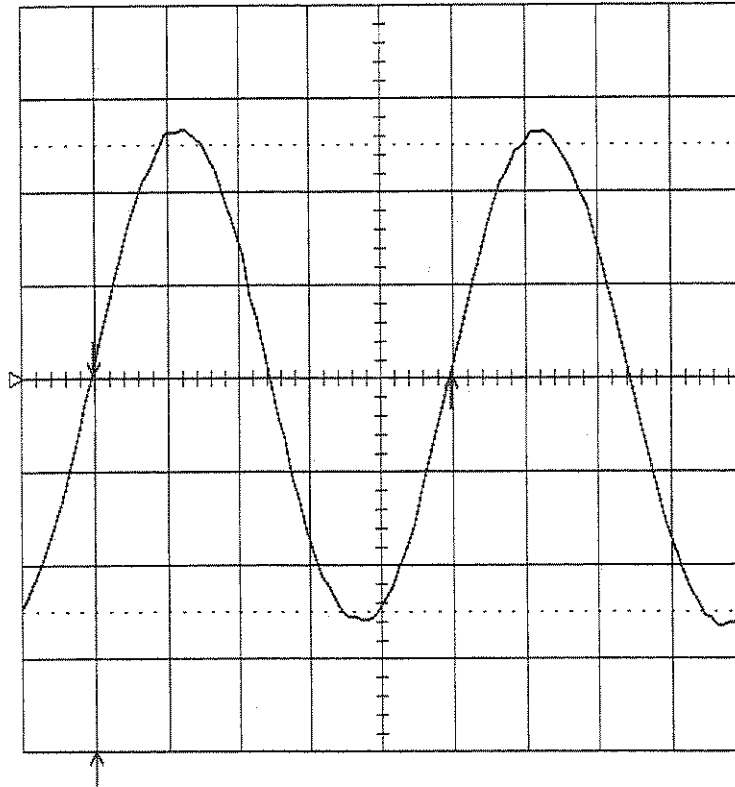

TRIGGER SETUP

Edge **SMART**
(GLITCH)

SETUP SMART TRIGGER

trigger on
1 2 3 4 Ext
Ext10 Pattern

coupling **1**
DC AC
LFREJ HFREJ

at end of
Neg Pos
pulse

width <
100.0 ns
OFF **On**

width >
OFF On

20 ns

1 .5 V 50Ω
2 .5 V 50Ω
3 .5 V 50Ω
4 .5 V 50Ω

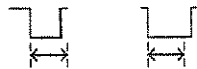

Δt 100.0 ns 1/Δt 10.00 MHz

500 MS/s

1 DC 0.00 V
pulse < 100.0 ns

NORMAL

- Switch to Width : > **100 nsec**
- Check that the scope **doesn't trigger** : slow trigger and no flashes in box next to normal.

3.11.4 Trigger on Pulse Width > 100 nsec

- Adjust the generator frequency to 4 MHz
- Pulse width : > 100 nsec
- Set Timebase : 50 nsec/div.
- Check that the scope triggers.

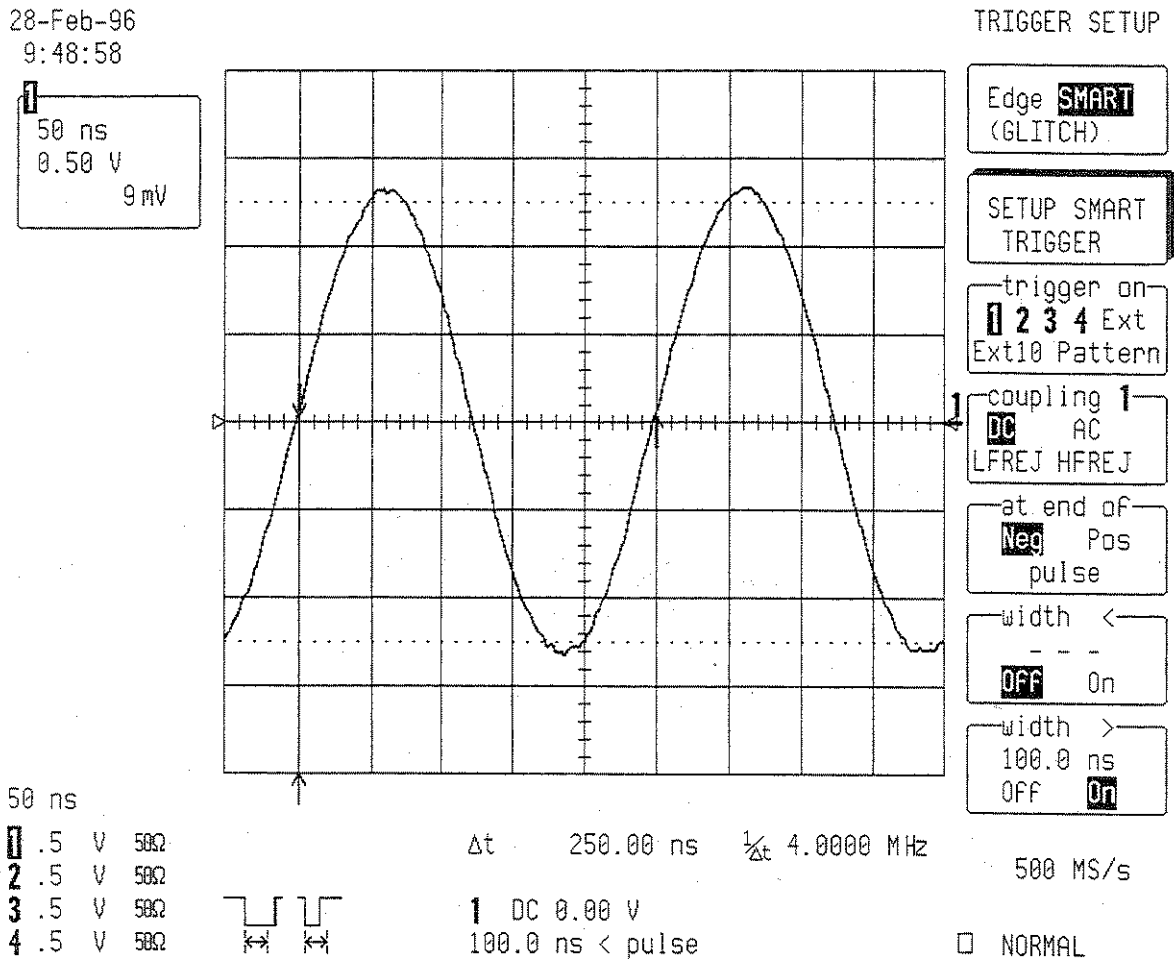

- Switch to Width : < 100 nsec
- Check that the scope **doesn't trigger** : slow trigger and no flashes in box next to normal.
- Repeat all the above tests for Channel 2, Channel 3 and Channel 4 substituting channel controls and input connector, and check as above.

3.12 Time Base Accuracy

3.12.1 Description

An external sine wave generator of **1 MHz** with a frequency accuracy better than 1 PPM is used.

Specifications

500 MHz clock : accuracy : $\leq \pm 0.001 \%$ or $\leq \pm 10$ PPM

3.12.2 500 MHz Clock Manual Verification Procedure

Setup a sine wave generator.

- Frequency : **1 MHz**
- Connect the generator output to Channel 1
- Turn on trace : **Ch1**
- Display setup : **Standard, Persistence off, Dot join on, Single grid**
- Input Coupling : **DC 50 Ω**
- V/div. offset : **Normal**
- Probe atten : **X1**
- Input gain : **.5 V/div.**
- Trigger setup : **Edge**
- Trigger on : **1**
- Coupling 1 : **DC**
- Slope 1 : **Pos**
- Level.1 : **0.5 V**
- Mode : **Norm**
- Holdoff : **Off**
- Delay : **0 %**
- Timebase : **.5 μ sec/div.**
- Channel use : **4**
- Record up to : **50 K**
- Adjust the generator output amplitude and Ch1 offset to get a five divisions peak to peak amplitude sine wave.
- Store Channel 1 in Memory 1
- Set Post-trigger delay to **5.00 msec**

This allows the accuracy of the time base clock to be checked **5000 periods** after the trigger point.

28-Feb-96
9:53:23

1 stored to M1

STORE W'FORMS

0 .5 μ s
0.50 V
-16 mV

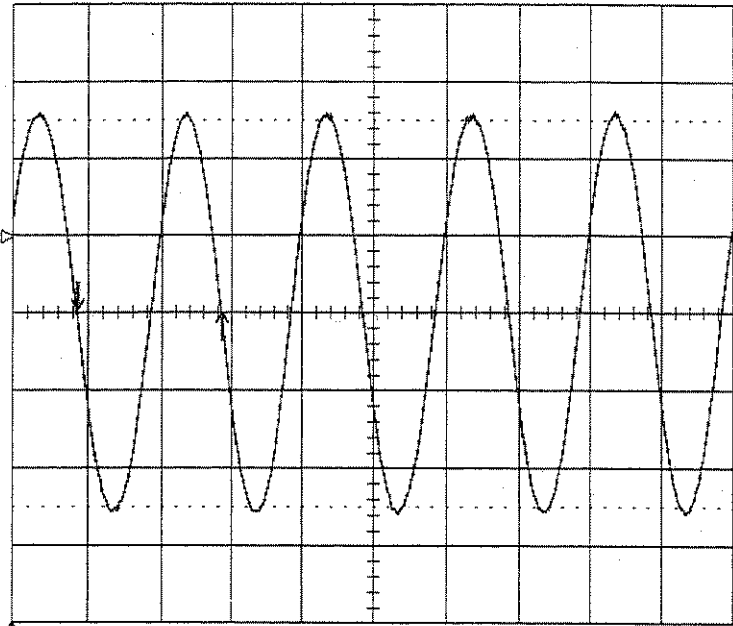

DO STORE
(1-M1)

store
0 2
3 4
A B
C D
All displayed

to
M1 M2 M3 M4
Card

.5 μ s
0 .5 V 50 Ω
2 .5 V 50 Ω
3 .5 V 50 Ω
4 .5 V 50 Ω

Δt 1.0000 μ s $\frac{1}{\Delta t}$ 1.0000 MHz

500 MS/s

1 DC 0.50 V

NORMAL

28-Feb-96
9:54:18

ACQUISITION STATUS

STATUS

	0	2	3	4
Vertical				
V/div	.5 V	.5 V	.5 V	.5 V
Probe	x1	x1	x1	x1
Offset	0 mV	0 mV	0 mV	0 mV
Coupling	DC50 Ω	DC50 Ω	DC50 Ω	DC50 Ω

Acquisition
System
Text & Times
Waveform
Memory Used

Bandwidth Limit OFF

Time base
Time/div .5 μ s Time/pnt 2 ns (500 MS/s)
RIS OFF
Sequence OFF Pts/div 250

Trigger Edge Mode NORMAL
External Attenuation x1

1 DC 0.50 V

Post-trigger Delay 5.00000 ms

500 MS/s

The currently preselected Smart Trigger type is
GLITCH

NORMAL

Section 3 Performance Verification

- Recall Memory 1 to A
- Turn on trace A
- Check that the displayed Channel 1 trace is aligned with the sine wave from memory 1.
- Press : Cursors/Measure
- Measure : Parameters
- Mode : Custom
- Statistics : Off
- Change parameters
- On line 1 : Delay of 1
- On line 2 : Delay of A
- Check that $(\text{delay}(A) - \text{delay}(1) + 5 \text{ msec}) \leq \pm 0.00005 \text{ msec}$ corresponding to 10 PPM.

28-Feb-96
10:31:37

.5 μ s
0.50 V

M1
.5 μ s
0.50 V

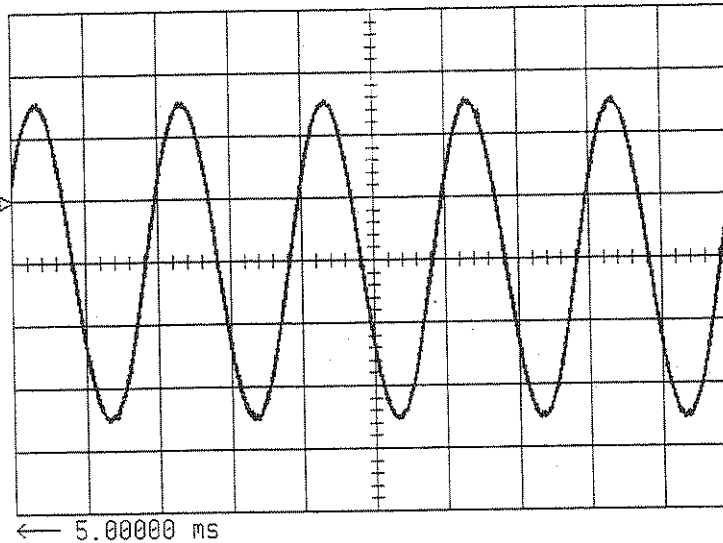

delay(1) 5.00041 ms
delay(A) 424.3 ns

.5 μ s
 .5 V 50 Ω
 2 .5 V 50 Ω
 3 .5 V 50 Ω
 4 .5 V 50 Ω

delay
time from the trigger (or t=0)
to the First 50% transition

CHANGE PARAM

On line
 1 2 3 4 5

Category
 All
 DISK-Std
 DISK-Local
 DISK-PRML
 Cyclic

DELETE ALL
PARAMETERS

measure
 cycles
 data
 delay
 Δ dly
 Δ t@lv

of
 2 3 4
 A B C D

500 MS/s

AUTO

A difference of $\pm 0.05 \mu\text{sec}$ corresponds to $\pm 10 \text{ PPM}$.

See screen dump below :

28-Feb-96
10:34:20

RECALL W'FORM

1
.5 μs
0.50 V

From
Memories
Card

M1
.5 μs
0.50 V

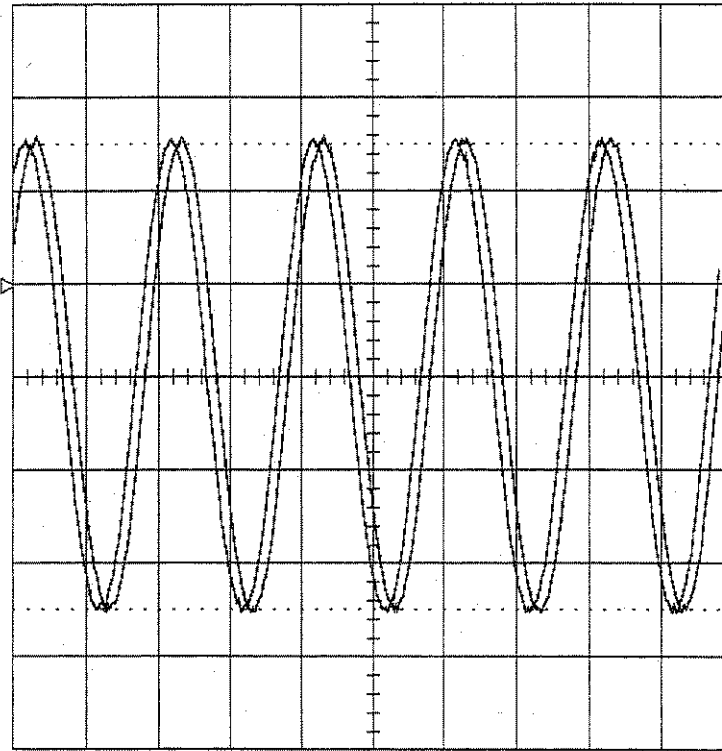

DO RECALL
M1 -> A

From Memory
 M1
M2
M3
M4

to
 B C D

.5 μs
1 .5 V 50 Ω
2 .5 V 50 Ω
3 .5 V 50 Ω
4 .5 V 50 Ω

← 5.00000 ms

1 DC 0.50 V

500 MS/s

AUTO

3.13 Overshoot and Rise time (10%-90%)

Specifications

DC 50 Ω , 50 mV/div., : overshoot < 20 %, rise time < 0.5 ns
 DC 1 M Ω , 100 mV/div., : rise time < 1.5 ns

Procedure

- Apply the fast pulse generator TD-1107B (< 70 psec) or equivalent, to Channel 1
- Set the DSO as follows :
 - Turn on trace : Ch1
 - Display setup : Standard, Persistence off, Dot join on, Single grid
 - Coupling Channel 1 : DC 50 Ω
 - V/div. offset : Normal
 - Global BWL : Off
 - Probe atten : X1
 - Input offset : - 250 mV
 - Input gain : 50 mV/div
 - Trigger setup : Edge
 - Trigger on : 1
 - Trigger level : DC 250 mV
 - Coupling 1 : DC
 - Slope 1 : Pos
 - Mode : Normal
 - Holdoff : Off
 - Timebase : 1 nsec/div
 - Record up to : 50K samples
 - Delay : 30 % Pre-Trigger
 - Turn on trace : A
 - Select Math Setup
 - For Math : Use at most 1000 points
 - Use Math ? : Yes
 - Math Type : Average
 - Avg Type : Summed
 - Of : Channel 1
 - Turn off trace : Channel 1
 - Cursors/Measure : Parameters
 - Mode : Custom
 - Statistics : On
 - Change Parameters
 - on displayed trace : A
 - On line 1 :
 - Measure : Over + of A
 - On line 2 :
 - Measure : Rise of A

28-Feb-96
11:06:35

Average(1)
1 ns
50 mV
1000 swps

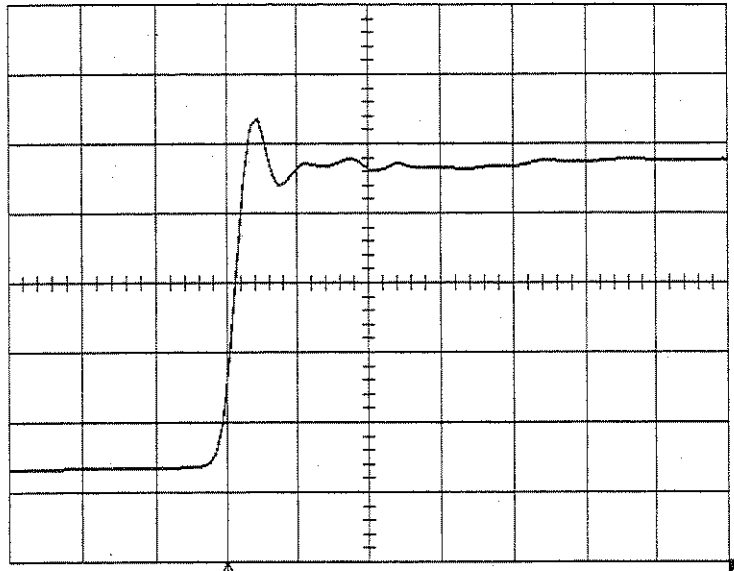

	16 sweeps:	average	low	high	sigma
over+(A)		15.13 %	14.25	16.20	0.45
rise(A)		0.34 ns	0.34	0.35	0.00

CHANGE PARAM

On line
1 **2** 3 4 5

Category
All
DISK-Std
DISK-Local
DISK-PRML
Cyclic

DELETE ALL
PARAMETERS

measure
range
res
rise
r20-80%
r@level

of
1 2 3 4
A B C D

1 ns RIS

- 1 50 mV 50Ω
- 2 50 mV 50Ω
- 3 50 mV 50Ω
- 4 50 mV 50Ω

 1 DC 250 mV

10 GS/s

NORMAL

- Check that the average overshoot is < 20 % and rise time is < 0.5 ns (measured in scope and not corrected for the effect of the step generator).
- Set Input Coupling : DC 1 MΩ
- Timebase : 2 nsec/div
- Terminate the output of the TD-1107B pulser with a 50Ω feed through and connect it to Ch1
- Check that the Average rise time is < 1.5 ns (measured in scope and not corrected for the effect of the step generator).

Section 3 Performance Verification

28-Feb-96

11:08:34

Average (1)
2 ns
50 mV
552 swps

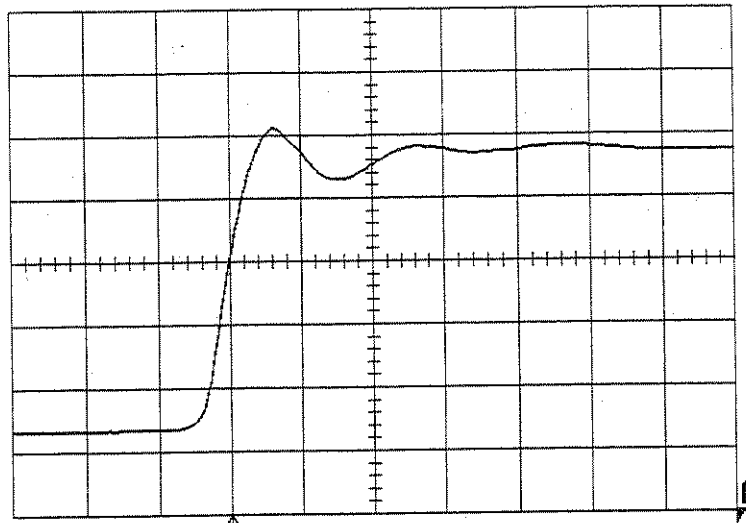

9 sweeps: average low high sigma
rise(A) 1.20 ns 1.19 1.24 0.02

CHANNEL 1

Coupling
DC50Ω
Grounded
DC1MΩ
Grounded
AC1MΩ
V/div Offset
NORMAL
ECL TTL
Global BWL
OFF 25MHz
200MHz

Probe Atten
x1
x2
x5
x10
x20

2 ns RIS

1 50 mV DC
2 50 mV DC
3 50 mV DC
4 50 mV DC



1 DC 250 mV

10 GS/s

NORMAL

- Repeat the above tests for Channel 2, Channel 3 and Channel 4 substituting channel controls and input connector, and check as above.

3.14 Probe Calibrator Verification

Specifications

Amplitude : 50 mV to 500 mV $\pm 2\%$ into 50Ω
: 50 mV to 1 V $\pm 2\%$ into 1 MΩ

Frequency : 500 Hz to 2 MHz $\pm 1\%$

Probe Calibrator Verification Procedure

- Connect the Probe Calibrator output to Channel 1, using a 5 nsec BNC cable
- Select : **Utilities**
- Press : **Cal BNC Setup**
- Mode : **Cal signal**
- Set Frequency : **500 Hz**
- Amplitude : **1 V (500 mV into 50 Ω)**

- Turn on trace : **Ch1**
- Display setup : **Standard, Persistence off, Dot join on, Single grid**
- Input Coupling : **DC 50 Ω**
- V/div. offset : **Normal**
- Probe atten : **X1**
- Input offset : **- 250 mV**
- Input gain : **100 mV/div.**

- Trigger setup : **Edge**
- Trigger on : **1**
- Trigger level : **DC 250 mV**
- Coupling 1 : **DC**
- Slope 1 : **Pos**
- Mode : **Normal**
- Holdoff : **Off**

- Timebase : **.5 msec/div.**
- Delay : **10 % Pre-Trigger**

- Cursors/Measure : **Parameters**
- Mode : **Custom**
- Change parameters :
- On line 1 : **Measure ampl of 1**
- On line 2 : **Measure freq of 1**

- Check parameters readout : freq (1) = **500 Hz \pm 1 %** , and ampl (1) = **500 mV \pm 6 %**
(\pm 2 % plus \pm 4 % due to the non linearity of the scope)

- Set Cal frequency : **2 MHz**
- Timebase : **.2 μ s**
- Check that freq (1) is **2 MHz \pm 1 %**

- Repeat test for amplitude of **0.05 V** (25 mV into 50 Ω)

- Set Cal amplitude : **50 mV** (25 mV into 50 Ω)
- DSO Input gain : **5 mV/div.**

- Check parameters readout ampl (1) = **25 mV \pm 6 %**

Section 3 Performance Verification

28-Feb-96
11:14:15

1
.5 ms
100 mV

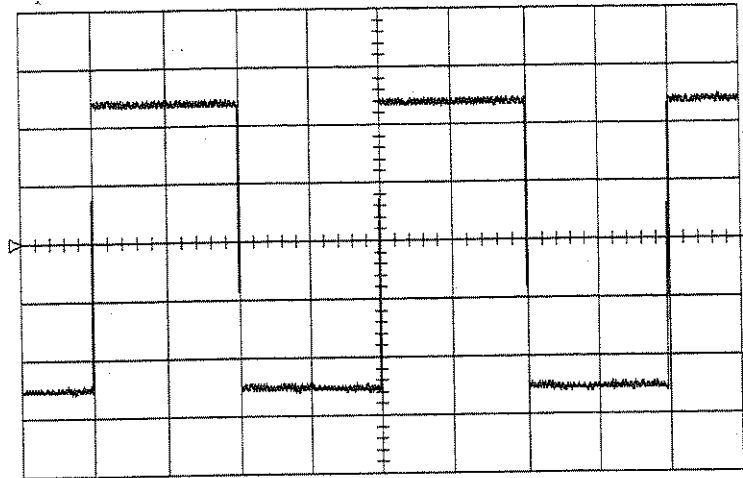

109 sweeps: average low high sigma
 ampl(1) 492 mV 491 492 1
 freq(1) 500.01 Hz 500.00 500.03 0.01

CAL BNC OUT

mode
CAL signal
 OFF
 Pass/Fail
 Trigger Out
 Trigger Rdy

SET TO 1 KHz
 1 V SQUARE

Shape
Square
 Pulse(25 ns)

Amplitude
 1.00 V
 into 1 MΩ

Frequency
 500 Hz

.5 ms

- 1 .1 V 50Ω
- 2 .1 V 50Ω
- 3 .1 V 50Ω
- 4 .1 V 50Ω

1 DC 250 mV

10 MS/s

NORMAL

28-Feb-96
11:15:26

1
.2 μs
100 mV

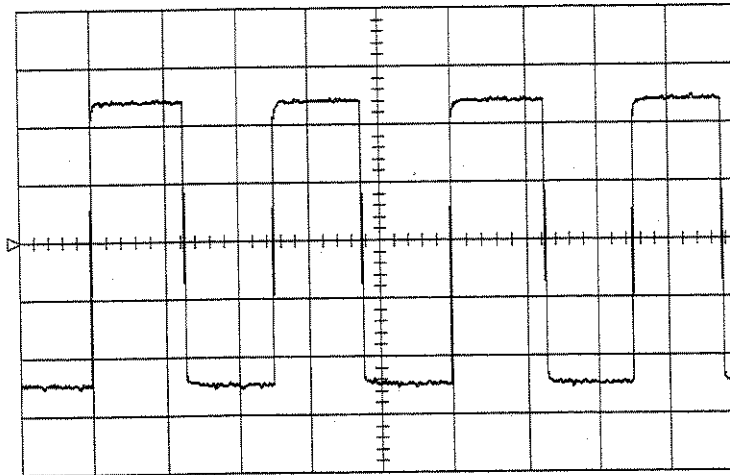

1285 sweeps: average low high sigma
 ampl(1) 487 mV 484 491 1
 freq(1) 1.99998 MHz 1.99557 2.00388 0.00065

CAL BNC OUT

mode
CAL signal
 OFF
 Pass/Fail
 Trigger Out
 Trigger Rdy

SET TO 1 KHz
 1 V SQUARE

Shape
Square
 Pulse(25 ns)

Amplitude
 1.00 V
 into 1 MΩ

Frequency
 2 MHz

.2 μs

- 1 .1 V 50Ω
- 2 .1 V 50Ω
- 3 .1 V 50Ω
- 4 .1 V 50Ω

1 DC 250 mV

500 MS/s

NORMAL

- Repeat the tests for the amplitude of 0.05 V and 1 V into 1 MΩ
- Cal amplitude : 50 mV
- Set Input Coupling : DC 1MΩ
- DSO Input gain : 10 mV/div.
- Check parameters readout $\text{ampl}(1) = 50 \text{ mV} \pm 6 \%$

28-Feb-96
11:18:52

.2 μs
10.0 mV

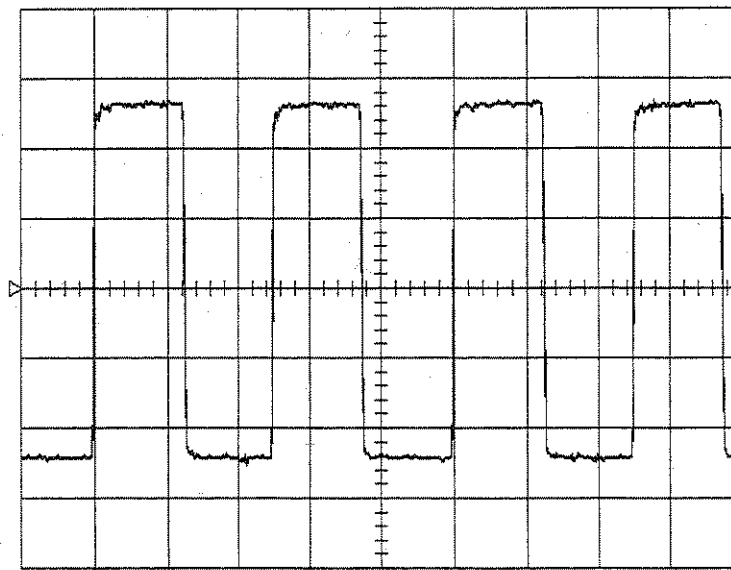

312 sweeps: average low high sigma
 ampl(1) 50.5 mV 49.9 50.8 0.1
 freq(1) 1.99998 MHz 1.99828 2.00241 0.00044

CAL BNC OUT

mode
 CAL signal
 OFF
 Pass/Fail
 Trigger Out
 Trigger Rdy

SET TO 1 kHz
 1 V SQUARE

Shape
 Square
 Pulse(25 ns)

Amplitude
 0.05 V
 into 1 MΩ

Frequency
 2 MHz

.2 μs
 10 mV DC
 2 10 mV DC
 3 10 mV DC
 4 10 mV DC

 1 DC 25.0 mV

500 MS/s

AUTO

- Set Cal amplitude : 1 V
- DSO Input gain : 200 mV/div.
- Check parameters readout $\text{ampl}(1) = 1 \text{ V} \pm 6 \%$

3.15 Overload

Specifications

1 Watt into 50 Ω : Overload < 17 seconds

Procedure

- Set the DSO as follows :
 - Display setup : **Standard, Persistence off, Dot join on, Single grid**
 - Input Coupling : **DC 50 Ω**
 - V/div. offset : **Normal**
 - Global BWL : **Off**
 - Probe atten : **X1**
 - Input offset : **- 3.5 V**
 - Input gain : **1 V/div.**
 - Trigger setup : **Edge**
 - Trigger on : **1**
 - Trigger level : **DC - 0.04 V**
 - Delay : **zero**
 - Coupling 1 : **DC**
 - Slope 1 : **Pos**
 - Mode : **Norm**
 - Holdoff : **Off**
 - Timebase : **2 sec/div.**
 - Channel Use : **4**
 - Record up to : **1000 samples**

- From Tektronix power supply PS5004, apply 7.07 V (1 Watt) to Channel 1.

- Check that the overload trips, within 17 seconds.

- Set Timebase : **5 sec/div.**

- From Tektronix power supply PS5004, apply 5 V (.5 Watt) to Channel 1

- Check that the overload doesn't trip for at least 30 seconds.

- Repeat the above tests for Channel 2, Channel 3 and Channel 4 substituting channel controls and input connector, and check as above.

27-Feb-96
13:48:29

Acquisition slowly starting

2 s
1.00 V

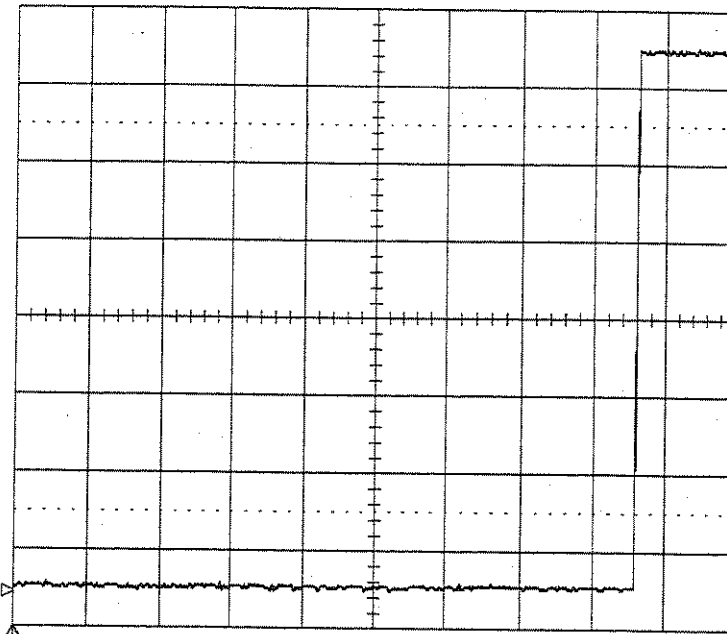

CHANNEL 1

Coupling
DC50Ω
OVERLOAD
DC1MΩ
Grounded
AC1MΩ

V/div Offset
NORMAL
ECL TTL

Global BWL
OFF 25MHz
200MHz

Probe Atten
x1
x2
x5
x10
x20

- 2 s
- 1 1 V **+**
 - 2 1 V 50Ω
 - 3 1 V 50Ω
 - 4 1 V 50Ω

1 DC -0.04 V

50 S/s

NORMAL

27-Feb-96
13:46:49

5 s
1.00 V

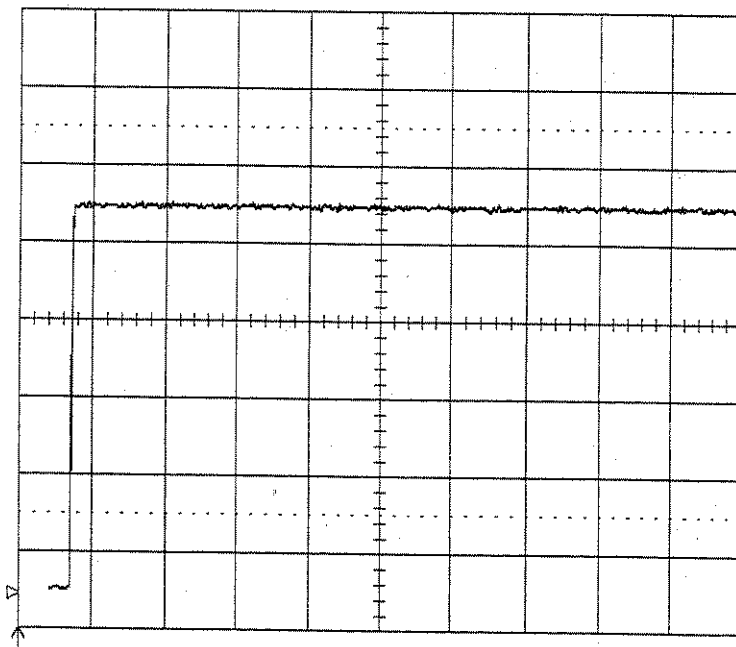

CHANNEL 1

Coupling
DC50Ω
Grounded
DC1MΩ
Grounded
AC1MΩ

V/div Offset
NORMAL
ECL TTL

Global BWL
OFF 25MHz
200MHz

Probe Atten
x1
x2
x5
x10
x20

- 5 s
- 1 1 V 50Ω
 - 2 1 V 50Ω
 - 3 1 V 50Ω
 - 4 1 V 50Ω

1 DC -0.04 V

20 S/s

NORMAL

3.16 Combining Channels

Channels can be combined to achieve more memory and more sampling rate by interleaving the ADC's in time. It is possible to achieve 2 GS/s and up to 8M record length (9374L) by means of a special adaptor call PP093.

- Set DSO Timebase : .2 μ sec/div.
- Connect the **PP093** adaptor to Channel 2 and Channel 3 and check that :
 - The PP093 is identified on **Channel 2**
 - Channel 1, Channel 3 and Channel 4 are **disabled**
 - Channel 2 is set to **DC 50 Ω , X2**
 - Sampling rate is **2 GS/s**
- Connect the **Probe calibrator** output to **PP093** input using a 5 nsec BNC cable.
- Set Cal frequency to **2 MHz** and Amplitude to **1 V** into **1 M Ω**
- Turn on **trace 2** and check that :
 - A Square wave of 500 mV is displayed on Channel 2

28-Feb-96
14:22:21

2
.2 μ s
100 mV

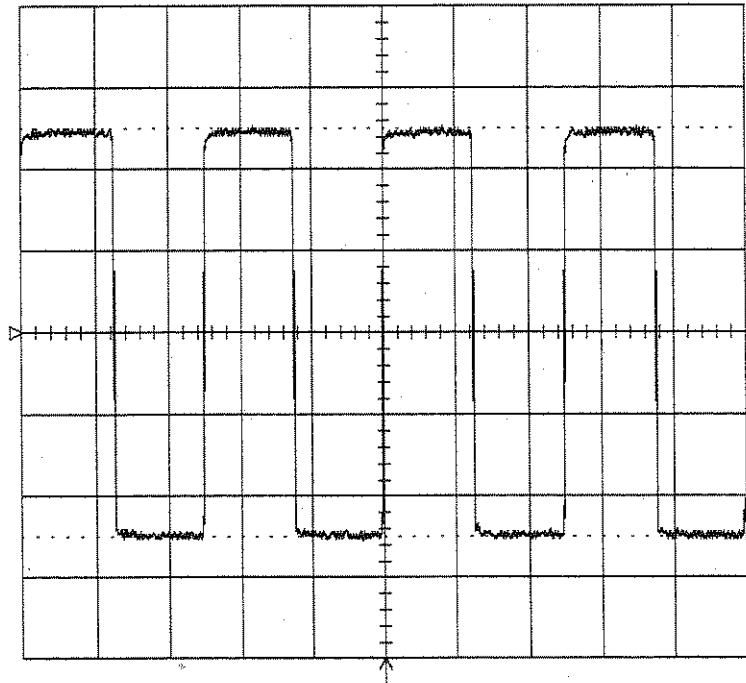

TIMEBASE
T/div .2 μ s
4000
samples at
2 GS/s
(.5 ns/pt)
for 2.0 μ s
Sampling
Single Shot
RIS

All Channels
combined for
2 Gs/s (2)

Sequence
OFF On Wrap
Record up to
50k

.2 μ s
1 disabled
2 50 mV 50 Ω X2
3 disabled
4 disabled



2 DC 250 mV

2 GS/s

NORMAL

- Turn on trace **1, 3, 4** and check that :
- A Square wave of 500 mV is displayed on Channel 1, Channel 3, and Channel 4.