Instruction Manual

Storagescope

LA354

LeCroy

Innovators in Instrumentation





Introduction

- ◇ Thank you very much for your purchase of LeCroy electronic measuring instruments.
- ◇ Please read this manual and understanding its contents before using this instrument. After reading this manual, please keep it for future reference.
- ◇ This instrument meets CE requirements per the Council Directive 89/336/EEC for Electromagnetic Compatibility and Low Voltage Directive 73/23/ECC for Product Safety.
- ◇ This instrument conforms to product safety requirements per UL3111 (as Pollution Degree 2 and Installation Category II) under file E183826.





Cautions for safe use

For safe operation of this instrument and for prevention of injury to operator and damage to property are described as “⚠ warnings” and “⚠ cautions” in this manual. The symbols are marked on the panel for attentions.

Explanation of “⚠ warnings” and “⚠ cautions” columns in this manual

 Warning	Incorrect operation may result in death or serious injury.
 Caution	Incorrect operation may result in injury or damage to equipment.

Explanation of the symbols on the panel

Symbol	Meaning
	This symbol used in reference with the statements in the manual to protect the operator against injury and this instrument against damage.
	Frame or chassis Terminal
	Risk of electric shock
	Earth (Ground) Terminal
	Protective Conductor Terminal

Cautions

- ◇ Parts of the contents of this manual may be modified without notice to accommodate improvements in performance and function.
- ◇ Reproduction of the contents of this manual without previous consent is prohibited.
- ◇ The TFT color LCD contains cold cathode fluorescent lamps. Please follow local ordinances or regulations for its disposal.

History

- ◇ May 1998 : Issue of the 1st edition

Warnings

● Do not use under explosive gas.

Otherwise it could result in explosion.

● If there is any smoke, anomaly, or strange noise from this instrument, immediately power switch to STBY and disconnect the power cord.

Otherwise it could result in electrical shock or fire. After contact to our service offices. Repair by the user is dangerous and should be strictly prohibited.

● Do not fall water into this instrument or wet to this instrument.

It result in electrical shock or fire. If water or other foreign liquid has felled into this instrument, turn the power switch to STBY and remove the power cord and then contact to our service offices.

● Do not place on an unstable place as a shaky stand or slanted.

It could result in electrical shock, injury, or fire. If this instrument has dropped turn the power switch to STBY and remove the power cord and then contact to our service offices.

● Do not fall any foreign matter from the air hole, etc.

It could result in fire, electrical shock, or power failure. If any foreign matter has been felled the power switch to STBY and remove the power cord and then contact to our service offices.

● Use a 3-prong power cord.

If not, it could result in electrical shock or power failure.

- When supplying power from a 2-wire receptacle using a 3-core/2-core conversion adapter, connect the grounding terminal of the 3-core/2-core conversion adapter to ground.
- When connecting the power from a 3-wire receptacle by the attached 3-core power cord, the grounding wire of the power cord is connected to ground.

! Warnings (cont'd)

● **Use this instrument with the rated AC power supply.**

If not, it could result in electrical shock, fire, or power failure. The usable power voltage range (100 to 240 VAC) is marked on the rear panel.

● **Connect the probe ground and input connectors to the ground of the measuring object.**

If not, it cause electrical shock or other accidents (damages to the measuring object, the instrument itself or other units) may occur. Refer to the "Example of improper way" shown below.

[Example of improper way]

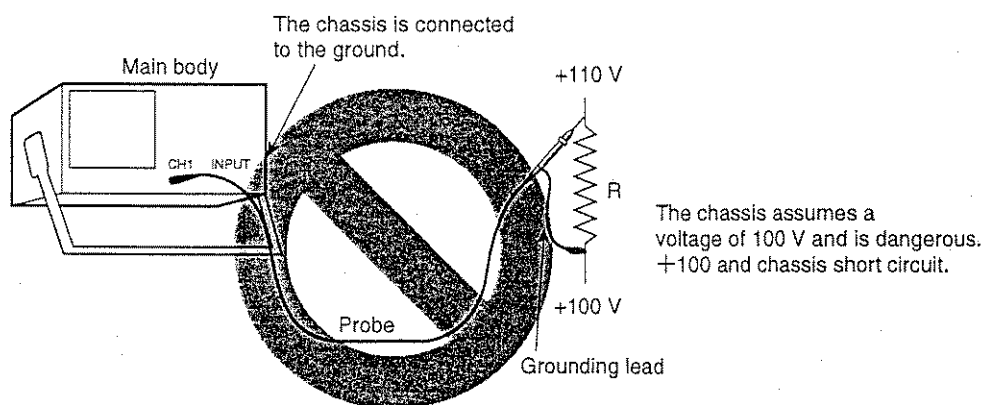

When measuring the floating potential, measurement by the differential method (CH1 and CH2 input) is recommended. Refer to the example shown below.

[Example of recommended measurement method]

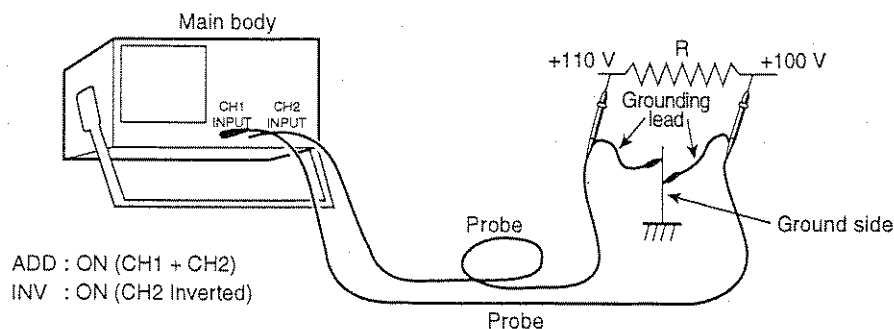



Warnings (cont'd)

● Do not remove either the cover or panel.

As there are high-voltage parts inside the cover, it could result in electrical shock. Please contact to our service offices for any inspection, calibration, or repair.

● Take care when measuring high voltages.

To measure a high-voltage part could result in electrical shock.

● Do not use the power cord under following conditions.

It could result in fire or electrical shock. If the power cord has been damaged, contact to service offices (at the end of this manual).

- Do not modify.
- Do not bend forcibly.
- Do not twist.
- Do not bundle.
- Do not pull.
- Do not heat.
- Do not dip into water.
- Do not put a heavy object.

● Do not modify this instrument.

It could result in electrical shock, fire, or power failure. Repair of a modified instrument may be refused.

Cautions

- **Use a specified fuse (ϕ 5 x 20 mm, 250 V, T5A) when replacing the fuse.**
The use of a not specified fuse could result in fire or power failure.
Disconnect the power cord when replacing the fuse.
- **Be sure to turn the power switch to STBY when connecting and disconnecting the power cord.**
Otherwise it could result in electrical shock or power failure.
- **When disconnecting the power cord from the receptacle, pull it by grabbing the plug.**
Pulling the cord may damage the cord and could result in fire or electrical shock.
- **Avoid use of any damaged cable or adapter.**
The use of any damaged cable or adapter could result in fire or electrical shock.
- **Avoid placing any object on this instrument.**
If any object is placed on this instrument, the cover short to the internal circuit and could result in electrical shock, fire, or power failure.
- **Do not place any object near the air ventilation hole or fan of this instrument.**
It could result internal heat and fire or electrical shock.
- **Do not place this instrument in a location with a high degree of moisture or dust.**
It could result in fire or electrical shock.
- **When using this instrument in an upright position, take care not to fall down.**
It could result in injury, fire, or electrical shock.
- **When probes or measuring cables, etc. are connected to this instrument, take care not to fall down by pulling them.**
It could result in injury, fire, or electrical shock.
- **Do not use this instrument if it has anomaly.**
It could result in fire or electrical shock. In case of anomaly, contact to our service offices for repair.

Read this page to assure safety.



Cautions (cont'd)

- **Always use this instrument under the rated operating range.**

The use of out of the range could result in power failure. The temperature and humidity ranges are as follows :

Operation : Indoor use only
Temperature : 0 °C to +40 °C
Relative humidity : 90% or less (at 0 °C to +40 °C)

- **Do not apply excess voltage to any input terminals (CH1, CH2, CH3, CH4 and Z AXIS IN).**

It could result in failure. The maximum voltage is as follows :

- CH1, CH2, CH3, CH4 input

Direct

At 1 M Ω : ± 400 V (DC+ACpeak)

At 50 Ω (CH1, CH2) : 5 V rms

With PP005 (10:1) or equivalent : ± 500 V (DC+ACpeak)

- Z AXIS IN : ± 40 V (DC+ACpeak)

[Note] The maximum input voltage is derated depending on frequency and high voltage pulse of an input signal.

- **To assure safe, disconnect the power cord if the instrument is not to be used for a long period.**

- **When transporting this instrument, use the original package or more enough packing material.**

Excess vibrations and/or shocks during transportation could result in power failure and fire. If no appropriate packing material is available, consult to our service offices.

Attach, label "precision instrument, fragile" on each face of the packing box.

Contents

Introduction	I
Cautions for safe use	I
Warnings	II
Cautions	V
Unpacking	IX
Components	IX
Terminology	X
Panel Controls	1
Front Panel	2
1 The Power Switch and Screen	3
2 Vertical Axis	4
3 Horizontal Axis, etc.	5
4 Trigger Section and Display Mode Section	6
5 Functions, Cursors, Sweep Modes, etc.	7
Rear Panel	8
Readout Locations	9
Menu	10
1 Menu Tree	10
2 Setting f:DISP-MENU	11
2.1 Setting Items	11
2.2 Operation in the DISP-MENU	12
3 Setting f:SYS-MENU	14
Operation	15
Basic Operation	15
1 General	15
2 Displaying CAL Signal with AUTO SET	16
3 Probe Compensation	18
4 Adjustment of the Screen (A INTEN, FOCUS, TRACE ROTATION)	20
5 Vertical and Horizontal Position	21
Vertical Deflection System	22
1 Deflection Factor	22
2 Input Coupling	23
3 Input Resistance	24
4 Display Channels	25
5 ALT and CHOP	25
6 Sum and Difference	26
7 Bandwidth Limiter	26
8 Offset	27
8.1 CH1/CH2 Offset	27
8.2 PROBE P1/P2 Offset	28
Horizontal Deflection System	29
1 Triggering	29
1.1 Trigger Source	29
1.2 Trigger Coupling	29

1.3	Trigger Slope (SLOPE)	30
1.4	TriggerLevel	30
1.5	TV Trigger	31
1.5.1	TV Format	31
1.5.2	TV-V Trigger (BOTH, ODD or EVEN)	31
1.5.3	TV Clamp	32
1.5.4	TV Scale	33
1.6	Event Trigger	33
2	Horizontal Display	35
2.1	Horiz Display	35
2.2	Trace Separation	36
3	A Sweep and B Sweep	37
4	Sweep Rate and Magnification	38
4.1	Sweep Rate	38
4.2	Magnification (MAG x 10)	38
4.3	CH2 Delay Adjust (CH2 DLY)	39
5	Sweep Mode	40
5.1	Repetitive Sweep	40
5.2	Single Sweep	40
6	Delayed Sweep	41
6.1	Continuous Delay	41
6.2	Triggered Delay	42
6.3	Selecting B ENDS A	42
7	Holdoff	43
	Storage	44
1	Scan Converter Tube	44
2	Inherent Phenomenon of Scan Converter Tube	45
3	Storage Operation	46
3.1	Measuring in [PERSISTENCE] Display	46
3.2	Measuring with [STORAGE]	47
3.3	Measuring in [SINGLE] Sweep Mode	48
	Counter and Cursors Measurement	49
1	Time Difference (Δt) and Frequency ($1/\Delta t$) Measurement	49
2	Voltage Difference (ΔV) Measurement	51
3	Counter	52
	Dual Delay Function	53
1	Setting the Dual Delay	53
1.1	Single Channel	53
1.2	Two or More Channels	54
2	Trace Separation Display in Dual Delay Function	54
3	Measuring with Delta Delay Time	55
	Save/Recall	56
1	Save	56
2	Recall	58
	Maintenance	59
	Specifications	62
	PP005 PROBE	68

Unpacking

The figure below shows the unpacking procedure.

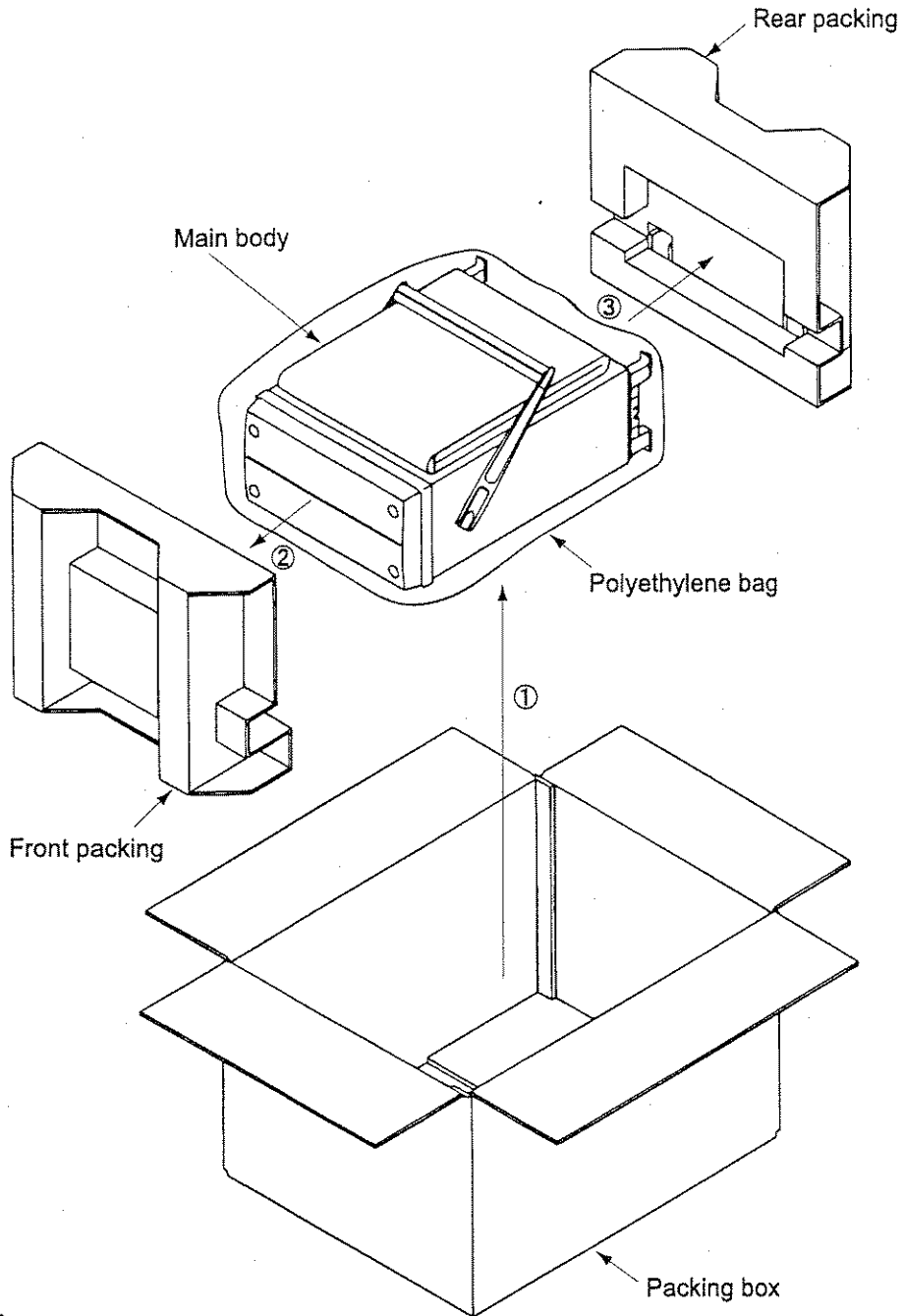

Components

Check that the following items are included:

- LA354..... 1
- Accessories
- Power cord (three-prong type) 1
- Panel cover 1
- Fuse (250V T5A) 2
- Operation manual 1
- Accessory bag 1

Terminology

A sweep	: Main sweep system
ADD	: Display of the sum of CH1 waveform and CH2 waveform (abbreviation from ADDITION)
AC (input coupling)	: An input coupling system where a filter is applied to the input circuit so that the DC (direct current) component is eliminated from the signal
AC (trigger coupling)	: A trigger coupling system where a filter is applied to the trigger circuit so that the DC (direct current) component is eliminated from the signal
ALT (vertical)	: Alternately switched sweep of multiple channel waveforms on the same screen (abbreviation of ALTERNATE)
ALT (horizontal)	: Alternately display of A sweep and B sweep on the same screen (abbreviation of ALTERNATE)
ATTACH	: Selection of the object channel for cursor measurement or offset
AXIS (scale)	: Cross hair scale
BACK LIGHT	: Brightness of LCD (Liquid Crystal Display)
B sweep	: The delayed sweep system
BEAM FIND	: Display the compressed waveform for the identification (abbreviation from BEAM FINDER)
B ENDS A	: To increase the brightness by shortening A sweep with delayed sweep (refer to "2.12 Delayed Sweep")
BOTH	: Both of the odd- and even-numbered fields of the TV vertical synchronizing signals
BURST	: One of event triggers, where a signal is triggered when the time interval of the trigger signal exceeds the specified period (refer to "2.9.6 Event Trigger")
BWL	: Limitation of the vertical bandwidth (abbreviation from BANDWIDTH LIMITER)
CAL	: A signal for calibration, which is used for calibration of deflection factor and the check of the operation of this instrument (abbreviation from CALIBRATION)
CCD	: Charge coupled device
CCIR	: One of TV observation scale
CH	: Channel (abbreviation from CHANNEL)
CHOP	: Alternately switches channel at 555kHz for displaying multiple waveforms on the same screen
CLAMP	: Display position of the TV signal is controlled as back porch level meet to ground level the reference level (ground level)
COUPLE	: Trigger coupling system (abbreviation from COUPLING)
COUNT	: One of event triggers, where a signal is triggered when the specified numbers of B trigger signals are counted after the A trigger signal occurred (refer to "2.9.6 Event Trigger")
CRT	: Cathode ray tube
DC (input coupling)	: The input coupling system that passes both DC and AC component of the signal

DC (trigger coupling) : The trigger coupling system that pass both DC and AC component of the signal

DIV : Division

EIA : One of TV observation scale

ERASE : Erases the STORAGE or PERSISTENCE waveform

EVEN : Even-numbered fields of TV vertical synchronizing signals

EVENT : Event trigger (this unit has the COUNT and BURST types)

FET : Field effect transistor

FET probe : An active probe with an FET at the tip

FRAME : Frame scale

GND : Grounding

H cursor : The cursor used for measuring time by moving in the horizontal direction

HD TV : TV system of high-definition type (abbreviation from HIGH DEFINITION TELEVISION)

HF REJ : Low-pass filter for eliminating high-frequency component (abbreviation from HIGH FREQUENCY REJECTION)

HOLDOFF : Holdoff time (facilitate the observation of complex pulse signals by adjusting the holdoff time)

HORIZ : Horizontal

INDEP : Move the cursor independently (abbreviation from INDEPENDENCE)

INTEN : Intensity, brightness of the trace (abbreviation from INTENSITY)

INV : Inverting the vertical display on the screen (abbreviation from INVERT)

LF REJ : High-pass filter for eliminating low-frequency component (abbreviation from LOW FREQUENCY REJECTION)

LINE (trigger signal source) : One of trigger signal sources. A power line is used as a trigger signal source.

LINE (TV) : Line No. of TV trigger mode

MAG : Magnifying waveform in the horizontal direction (abbreviation from MAGNIFICATION)

MAX : Maximum value

NTSC : A color television system (abbreviation from NATIONAL TELEVISION SYSTEM COMMITTEE)

ODD : Odd-numbered fields of TV vertical synchronizing signals

PAL : A color television system (abbreviation from PHASE ALTERNATION BY LINE)

PERSISTENCE : Persistence time of the storage waveforms

READOUT : Brightness of character display (abbreviation from READOUT INTEN)

RH : Relative humidity

RECALL : Recalling the setting conditions from internal memory

RST : Reset

SAVE : Saving the panel key setting conditions into internal memory

SCALE : Graticule (abbreviation from SCALE)

SECAM : A color television system (abbreviation from SEQUENTIEAL COULEUR A MEMOIRE in French)

SEP : Controlling B sweep position from A sweep (abbreviation from SEPARATION)

SGL : Sweeps only once (abbreviation from SINGLE)

SLOPE : Trigger slope

SOURCE : Trigger signal source

STBY : Stand-by

STORAGE : Store the waveforms

TCK : Moving 2 cursors with keeping the span (abbreviation from TRACKING)

TRACE ROTATION : Adjusting the alignment of a trace to horizontal graticule

TRIG : Trigger

Tr (rise time) : A pulse response characteristic - the transition time from 10 to 90% of the basic amplitude

TV-H : TV horizontal synchronizing signals

TV-V : TV vertical synchronizing signals

V cursor : The cursor used for measuring voltage by moving in the vertical direction

VSWR : Voltage standing wave ratio

X-Y : A system where different signals are input and displayed on the X and Y axes so as to observe the frequency ratio and/or phase difference between two signals

Panel Controls

Symbols on the panel



: Warning symbol

This symbol is marked for the user's attention to refer in the instruction manual. This symbol is marked near the CH1 to CH4 INPUT terminals.



: This is ground for measurement.



: Knob indication

One knob has two functions. While depressing the knob enables the other function (BEAM FIND (A INTEN), COARSE (FUNCTION)).



: Pushing the knob enables the other function (STORAGE, ERASE, VARIABLE ON/OFF).



: Key indication

Pressing A, B keys simultaneously enable alternate sweep.



Light indication

: The indicator lights when B (sweep and trigger) or CHOP is selected.

CAT II : Complies with IEC 1010 (installation (over voltage) category II)

Symbols in the instruction manual

◇ Expression of keys and knobs



: Indicates a key.



: Indicates a knob. There are two types of knobs as follows :

- To be operated by turning.
- To be operated by turning and pressing.

◇ Pressing two switches simultaneously, they are expressed with a symbol of "+" inserted between them.

[Example] : **A** + **B**

Front Panel

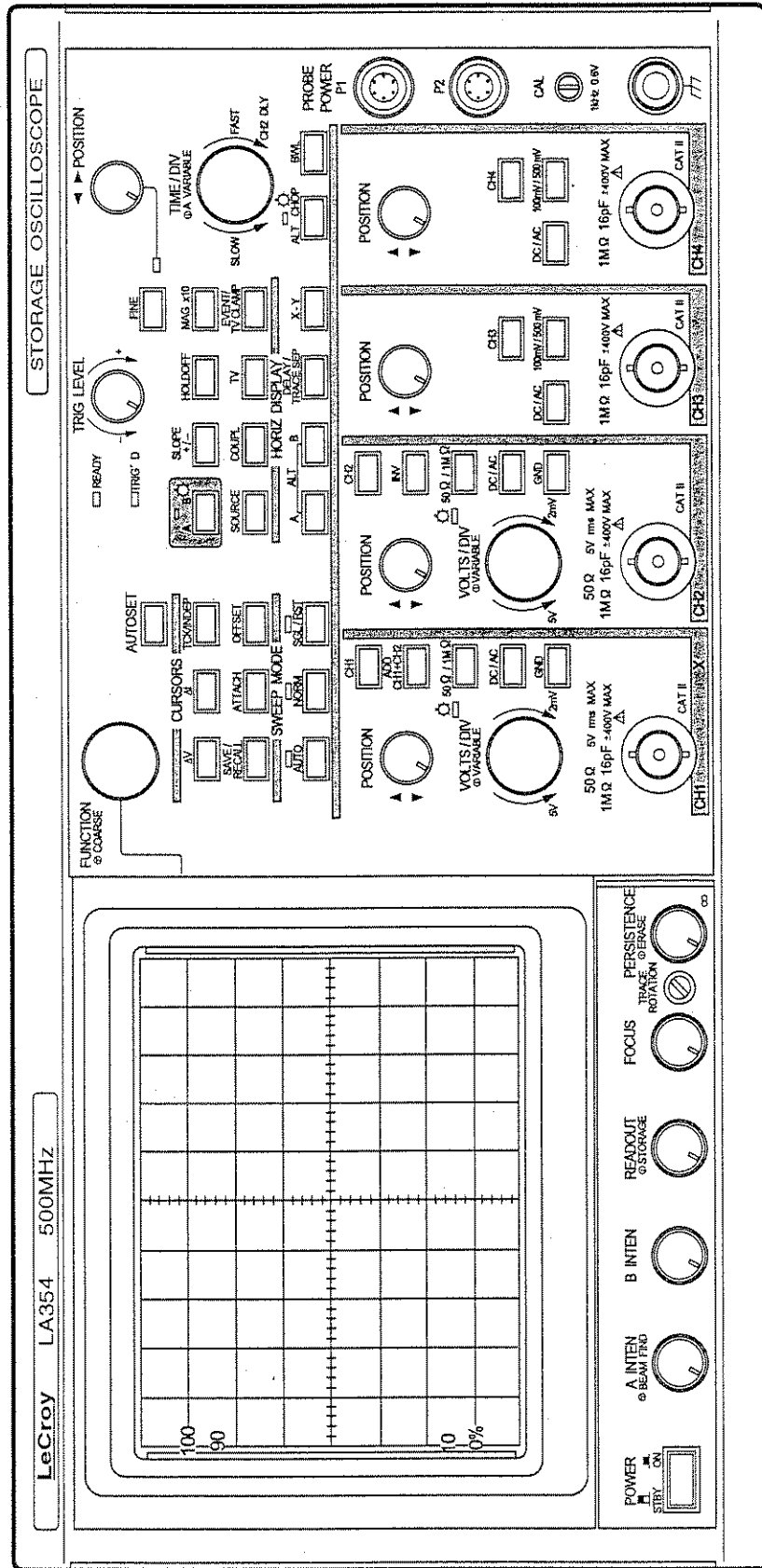

Figure 1 Front Panel I (Overall view)

1 The Power Switch and Screen

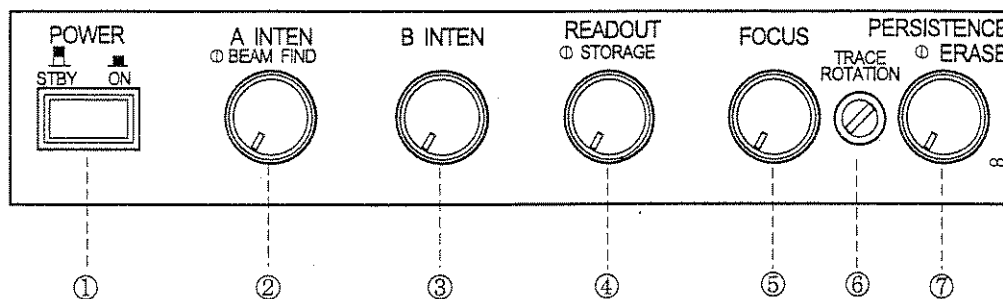

Figure 2 Front Panel II

- ① **POWER** key
Turn the AC power ON or STBY. Refer to the column shown below.
- ② **[A INTEN (BEAM FIND)]** knob
 - A INTEN knob : Adjusts the trace intensity of A sweep (refer to page 20 "Adjustment of the Screen").
 - BEAM FIND switch : Displays a compressed waveform on the screen while pressing the knob (refer to page 20 "Adjustment of the Screen").
- ③ **[B INTEN]** knob
Adjusts the trace intensity of B sweep (refer to page 20 "Adjustment of the Screen").
- ④ **[READOUT (STORAGE)]** knob
 - READOUT knob : Adjusts the intensity of characters (refer to page 11 "Setting f:DISP-MENU") at full counter clock wise is READOUT (OFF) condition.
 - STORAGE switch : Stores the all waveform on the screen (refer to page 46 "Storage Operation").
- ⑤ **[FOCUS]** knob
Adjusts the focus (refer to page 20 "Adjustment of the Screen").
- ⑥ **TRACE ROTATION**
Adjusts the alignment of the trace to horizontal graticule by using the driver (refer to page 20 "Adjustment of the Screen").
- ⑦ **[PERSISTENCE (ERASE)]** knob
 - PERSISTENCE knob : Adjusts the persistent time of displaying waveform. Turning the knob full clockwise set to infinite persistence.
 - ERASE switch : Erases the storage or persistent waveform (refer to page 46 "Storage Operation").

ON and STBY of the POWER switch



: Indicates power ON, power supplied to every circuit.



: Indicates a standby, main power supply is off.

When AC power is connected to AC LINE INPUT, power is supplied to the only microprocessor in this instrument.

When AC power is not connected to AC LINE INPUT, panel setup conditions are backed up by the internal battery.

2 Vertical Axis

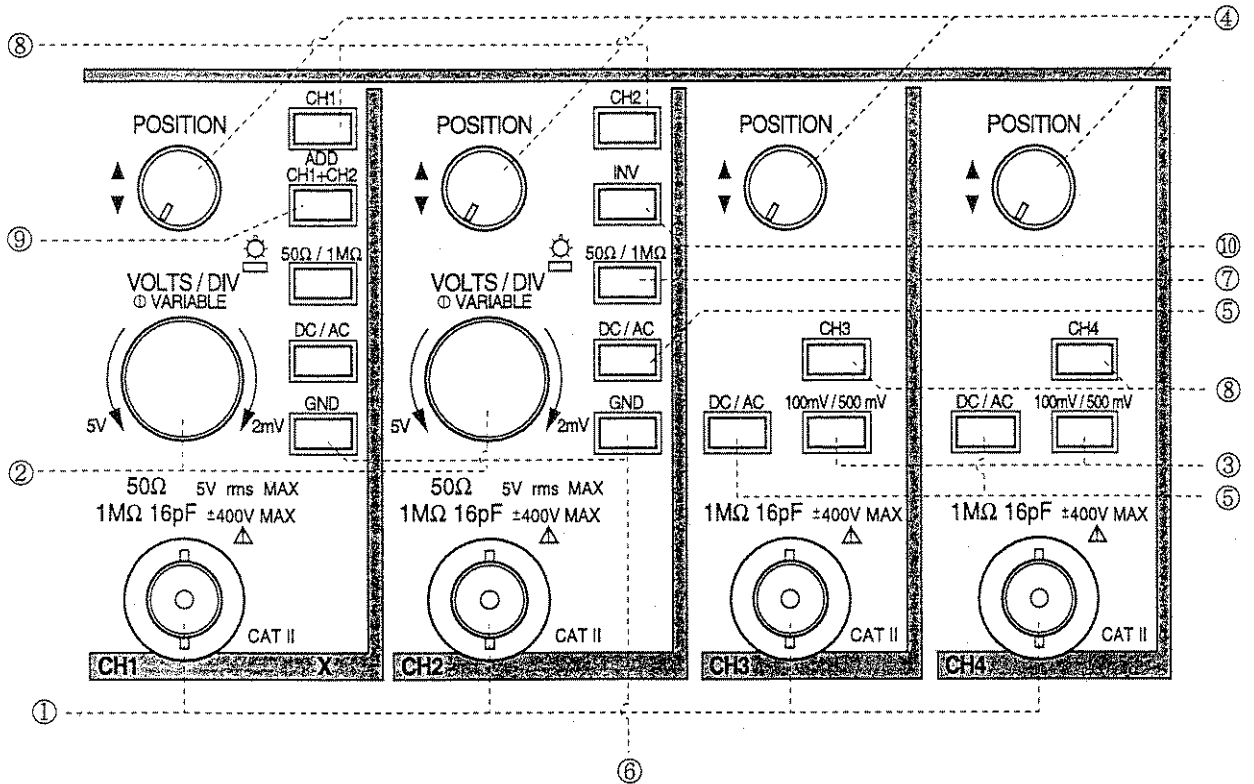

Figure 3 Front Panel III

- ⚠ ① **INPUT** connectors (CH1 to CH4)
Connector of input signals.
[Note] Do not apply over rating voltage to the input terminal.
- ② **[VOLTS/DIV (VARIABLE)]** (CH1, CH2) knob
VOLT/DIV switch : Selects the deflection factor in 1-2-5 steps (refer to page 22 "Deflection Factor").
VARIABLE switch : Finely adjusts the deflection factor continuously (refer to page 22 "Deflection Factor").
- ③ **100mV/500mV** (CH3, CH4) key
Selects the deflection factor (refer to page 22 "Deflection Factor").
- ④ **[▲POSITION▼]** (CH1 to CH4) knob
Controls the position in the vertical direction (refer to page 21 "Vertical and Horizontal Position").
- ⑤ **DC/AC** (CH1 to CH4) key
Selects the input coupling (refer to page 23 "Input Coupling").
- ⑥ **GND** (CH1, CH2) key
Connects the input coupling to the GND (refer to page 23 "Input Coupling").
- ⑦ **50 Ω/1 MΩ** (CH1, CH2) key
Selects the input resistance. The indicator lights when 50 Ω is selected (refer to page 24 "Input Resistance").
- ⑧ **CH1**, **CH2**, **CH3**, **CH4** key
Selects the display channel on the screen (refer to page 25 "Display Channels").
- ⑨ **ADD CH1 + CH2** key
Displays the sum of CH1 and CH2 (refer to page 26 "Sum and Difference").
- ⑩ **INV** key
Inverts the CH2 display (refer to page 26 "Sum and Difference").

3 Horizontal Axis, etc.

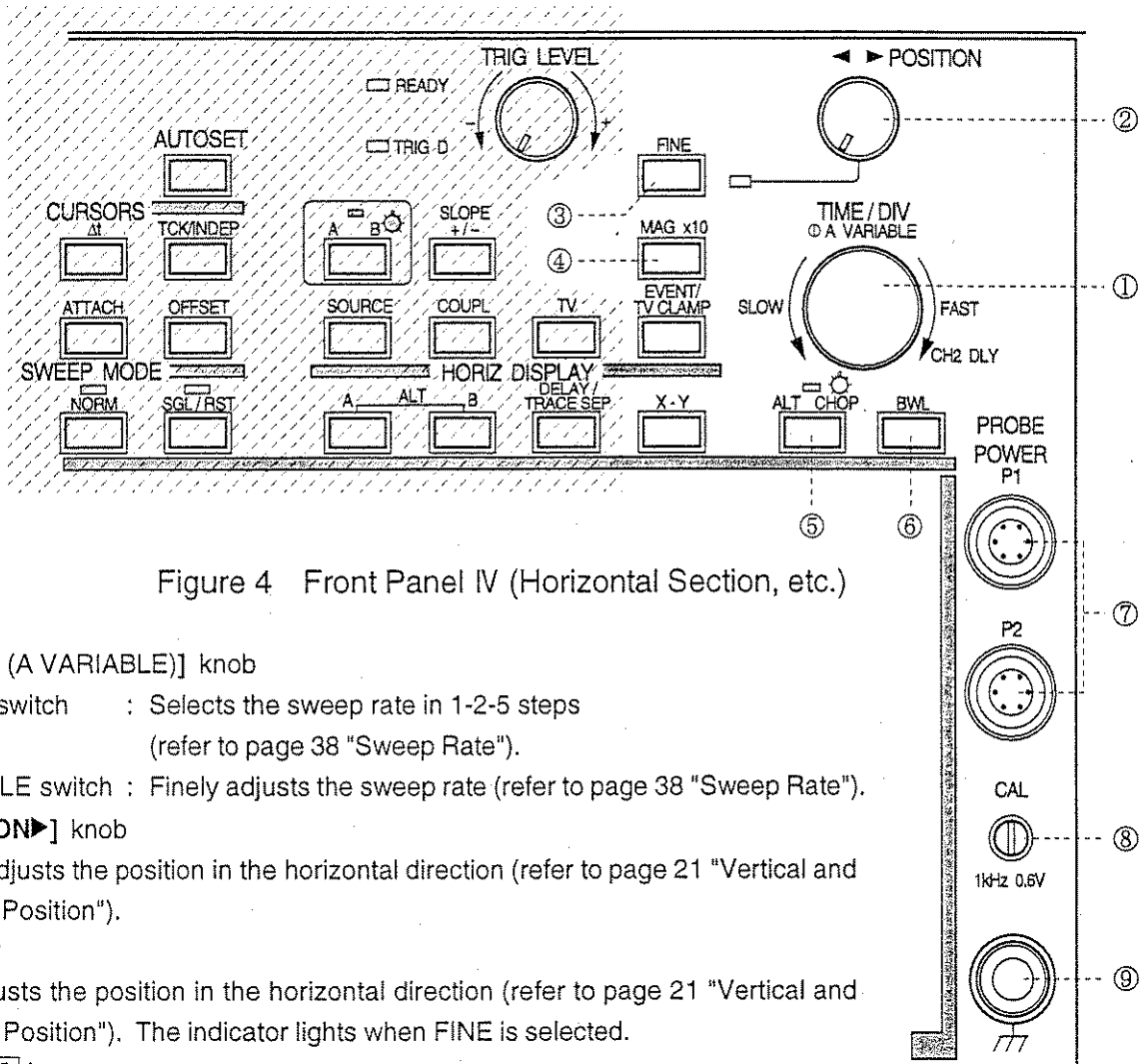

Figure 4 Front Panel IV (Horizontal Section, etc.)

- ① **[TIME/DIV (A VARIABLE)]** knob
 TIME/DIV switch : Selects the sweep rate in 1-2-5 steps
 (refer to page 38 "Sweep Rate").
 A VARIABLE switch : Finely adjusts the sweep rate (refer to page 38 "Sweep Rate").
- ② **[◀POSITION▶]** knob
 Roughly adjusts the position in the horizontal direction (refer to page 21 "Vertical and Horizontal Position").
- ③ **[FINE]** key
 Finely adjusts the position in the horizontal direction (refer to page 21 "Vertical and Horizontal Position"). The indicator lights when FINE is selected.
- ④ **[MAG X10]** key
 Magnifies the waveform display (X10) in the horizontal direction (refer to page 38 "Magnification").
- ⑤ **[ALT CHOP]** key
 Selects ALT or CHOP (refer to page 25 "ALT and CHOP"). The indicator lights when CHOP is selected.
- ⑥ **[BWL]** Key
 Selects the frequency band width (refer to page 26 "Bandwidth Limiter").
- ⑦ **PROBE POWER P1, P2** terminals
 Supplies power to FET probes.
- ⑧ **CAL** terminal
 Outputs calibration voltage signals. Used for operation check of this unit and the adjustment of the probe waveform (refer to page 16 "Displaying CAL Signal with AUTO.SET").
- ⑨ **⏏** (grounding) connector
 This is the ground for measurement.

4 Trigger Section and Display Mode Section

- ① **[TRIG LEVEL]** knob
Selects the trigger point of the trigger signal (refer to page 30 "Trigger Level").
- ② **READY** indicator
Lights while waiting for signals in single sweep (SGL).
- ③ **TRIG'D** indicator
Lights when a triggered.
- ④ **A B** key
Selects A (sweep and trigger) or B (sweep and trigger) (refer to page 41 "Delayed Sweep"). The indicator lights when B is selected.

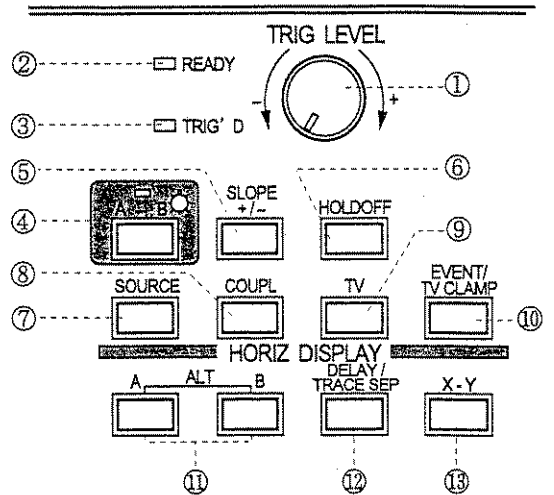

Figure 5 Front Panel V (Trigger Section and Display Mode Section)

- ⑤ **[SLOPE]** key
Selects the trigger slope (+, -) (refer to page 30 "Trigger Slope").
 - ⑥ **[HOLDOFF]** key
Selects the holdoff time (refer to page 43 "Holdoff").
 - ⑦ **[SOURCE]** key
Selects the trigger signal source (CH1, CH2, CH3, or LINE) (refer to page 29 "Trigger Source").
 - ⑧ **[COUPL]** key
Selects the trigger coupling mode (AC, DC, HF REJ, or LF REJ) (refer to page 29 "Trigger Coupling").
 - ⑨ **[TV]** key
Selects TV triggering with BOTH, ODD, EVEN, or TV-H (refer to page 31 "TV Signal").
 - ⑩ **[EVENT/TV CLAMP]** key
Selects event (refer to page 30 "Event Trigger") or TV clamp (refer to page 32 "TV Clamp").
- **HORIZ DISPLAY** (display mode) —
- ⑪ **[A or B]** key
Displays A sweep or B sweep (refer to page 35 "Horizontal Display"). Depressing **[A]** and **[B]** simultaneously selects ALT sweep.
 - ⑫ **[X-Y]** key
Selects X-Y mode (refer to page 35 "Horizontal Display").
 - ⑬ **[DELAY/TRACE SEP]** key
Selects DELAY (refer to page 41 "Delayed Sweep") or TRACE SEP (refer to page 36 "Trace Separation").

5 Functions, Cursors, Sweep Modes, etc.

- ① **[FUNCTION]** pulse switch
 The delay time, cursor position, menu etc. can be set by turning or pressing this knob. Turning this knob effect fine adjustment. Coarse adjustments can be made in the direction the knob has been turned so far by pressing or holding down the button.
- ② **AUTOSET** key
 Measuring conditions are set automatically. (refer to page 17 "CAL wave display with AUTO SET").

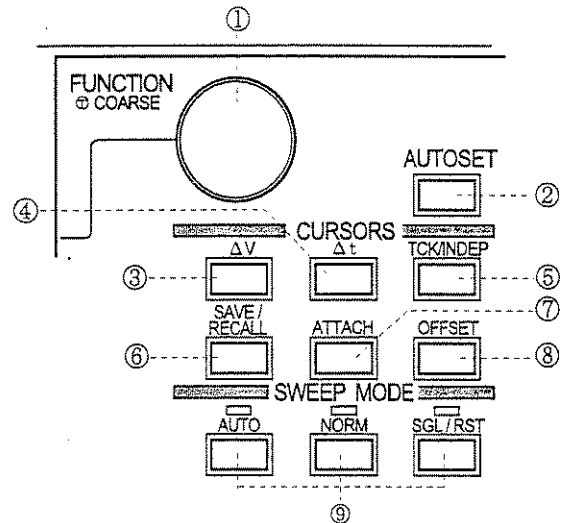

Figure 6 Front Panel VI (Functions, Cursors, Sweep Modes, etc.)

— CURSORS —

- ③ **ΔV** key
 Measures the voltage using a cursor (refer to page 49 "Counter and Cursor Measurement").
- ④ **Δt** key
 Measures the time using a cursor (refer to page 49 "Counter and Cursor Measurement").
- ⑤ **TCK/INDEP** key
 Selects the cursor (C1, C2, or tracking) to be moved (refer to page 49 "Counter and Cursor Measurement").
- ⑥ **SAVE/RECALL** key
 Selects Save or Recall (refer to page 56 "Save/Recall Setups").
- ⑦ **ATTACH** key
- Selects the object channel of the cursor measurement (refer to page 49 "Counter and Cursor Measurement").
 - Selects the channel (CH1/CH2) or terminal (P1/P2) for the offset (refer to page 27 "CH1/CH2 Offset").
- ⑧ **OFFSET** key
 Sets the offset of CH1/CH2 or FET probe (refer to page 28 "PROBE P1/P2 Offset").

— SWEEP MODE —

- ⑨ **AUTO**, **NORM**, **SGL/RST** key
 Selects repetitive sweep (AUTO, NORM) or single sweep (SGL) (refer to page 40 "Sweep Mode").

Rear Panel

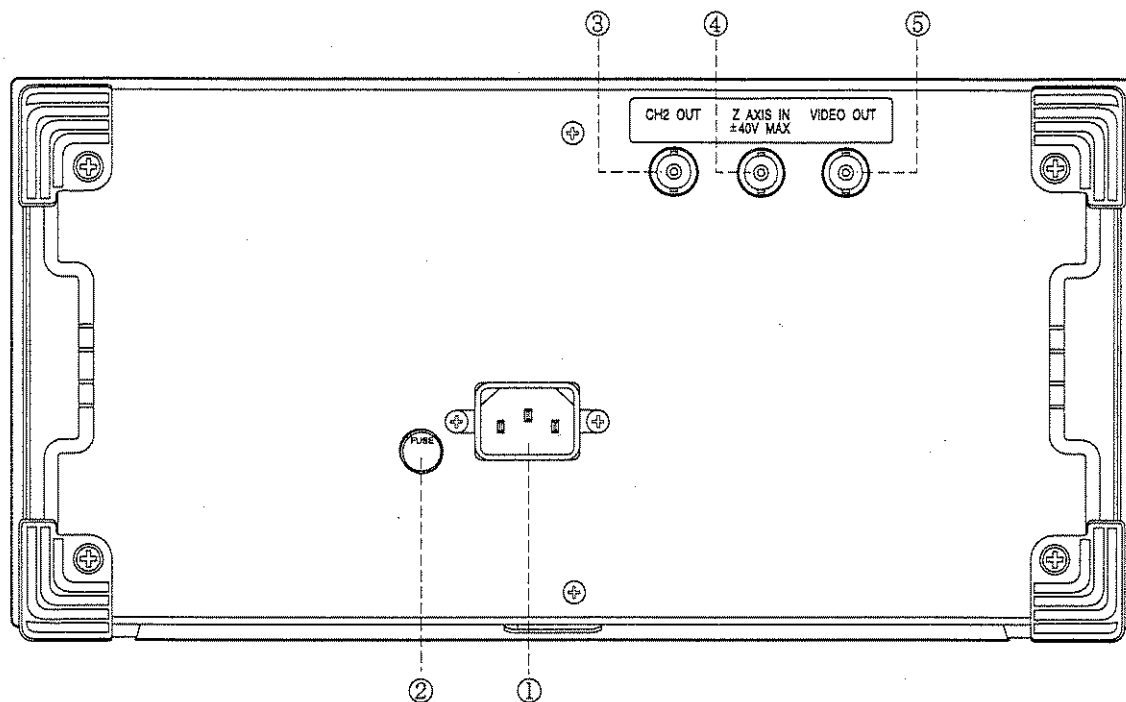

Figure 7 Rear Panel

- ① **AC LINE INPUT** terminal
Connects the power cord to this inlet.
- ② **FUSE**
φ 5×20 mm, 250 V, T5A fuse. (Installs the appropriate fuse)
- ③ **CH2 OUTPUT** terminal
Outputs the signal input to CH2 INPUT.
Amplitude of output signal = Amplitude on the screen × output voltage
- ④ **Z AXIS IN** terminal
Inputs the intensity modulation signal.
- ⑤ **VIDEO OUT** terminal
Outputs the color video composite signal displayed on the screen with NTSC format.

Readout Locations

• Contents of display

A SWEEP RATE	A TRIGGER SOURCE	A TRIGGER SLOPE	A TRIGGER COUPLE	A TRIGGER LEVEL	Sweep magnification	HOLD OFF TIME								
B SWEEP RATE	B TRIGGER SOURCE	B TRIGGER SLOPE	B TRIGGER COUPLE	B TRIGGER LEVEL		DELAY TIME								
						FUNCTION MODE								
Measurement of ΔV or Δt						Frequency measured								
CH1	Range	Coupling	ADD	CH2	INV	Range	Coupling	CH3	Range	Coupling	CH4	Range	Coupling	Bandwidth limiter

• An example of the display

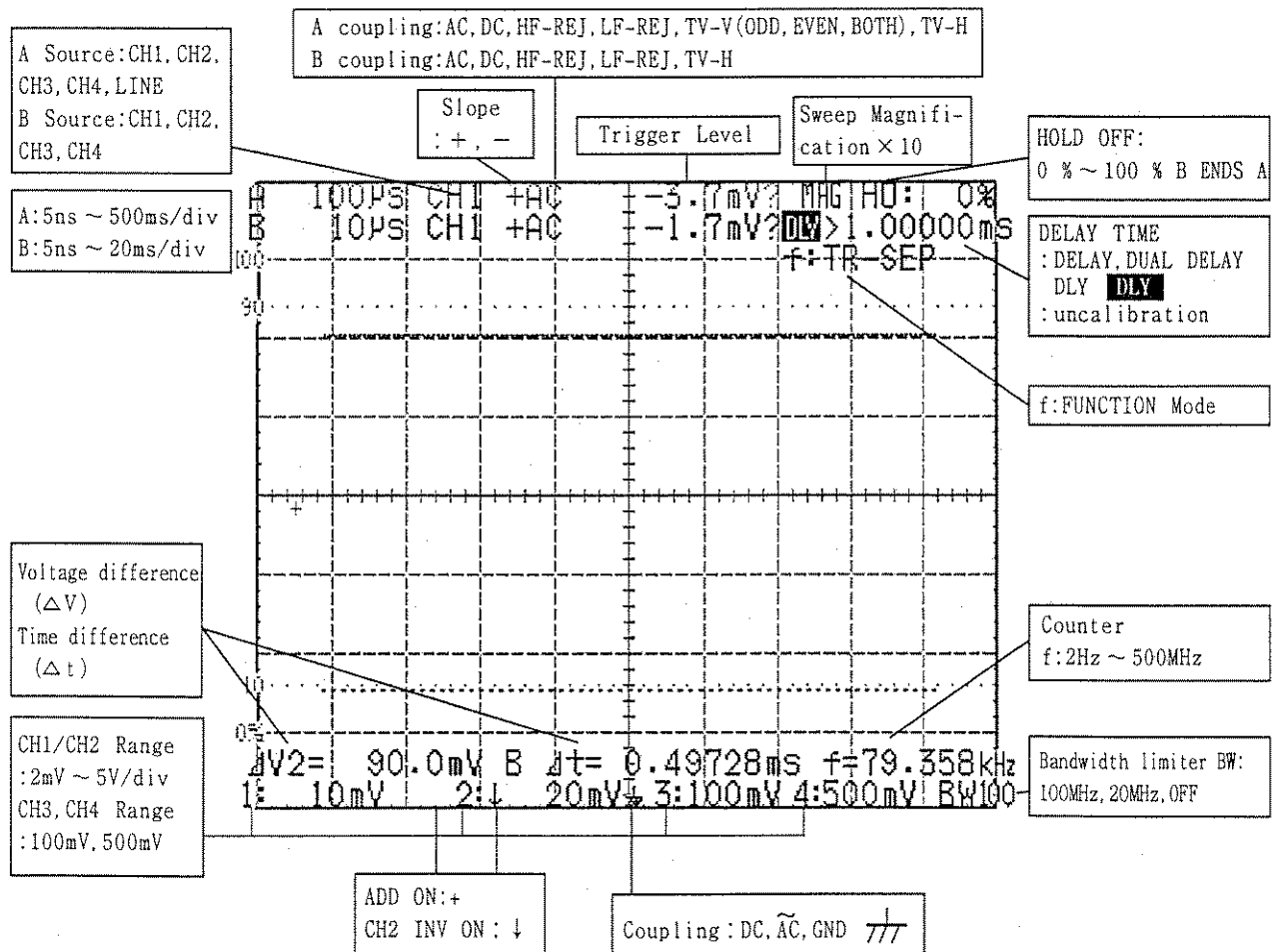

Menu

Selects the display conditions (DISP-MENU) and the setting of appendix functions (SYS-MENU).

1 Menu Tree

DISP-MENU

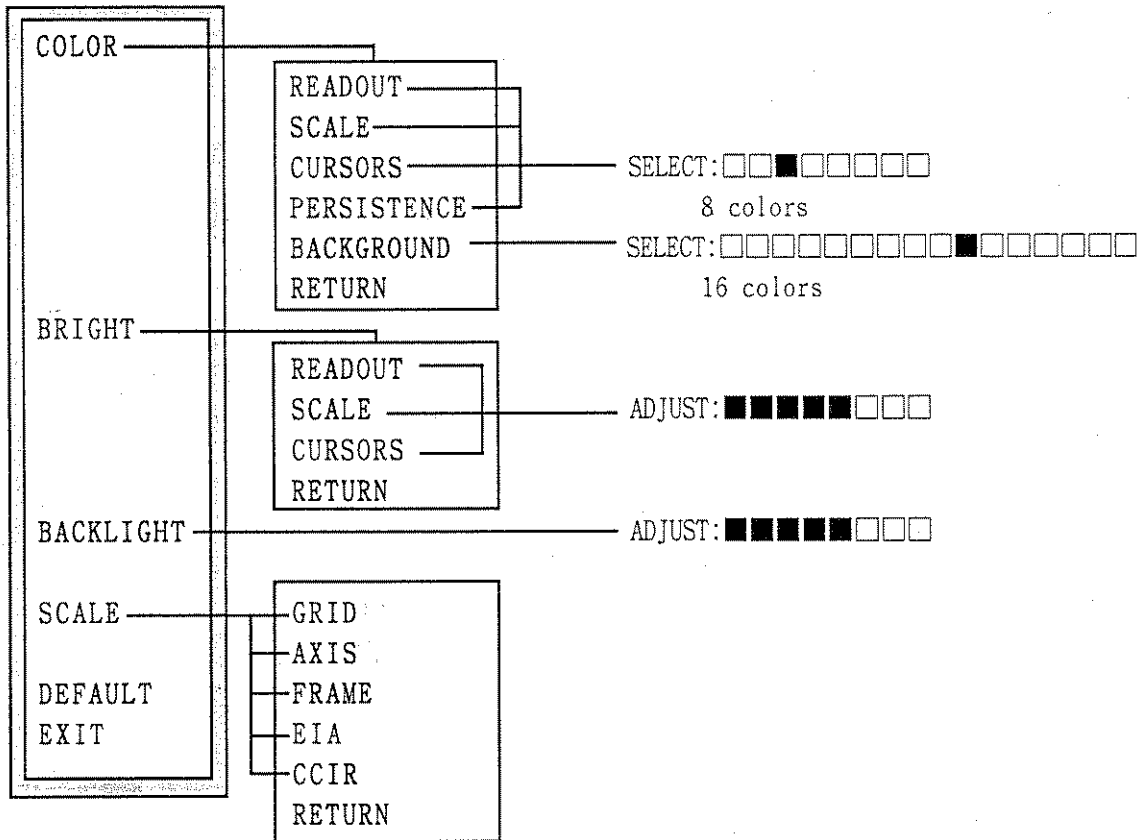

SYS-MENU

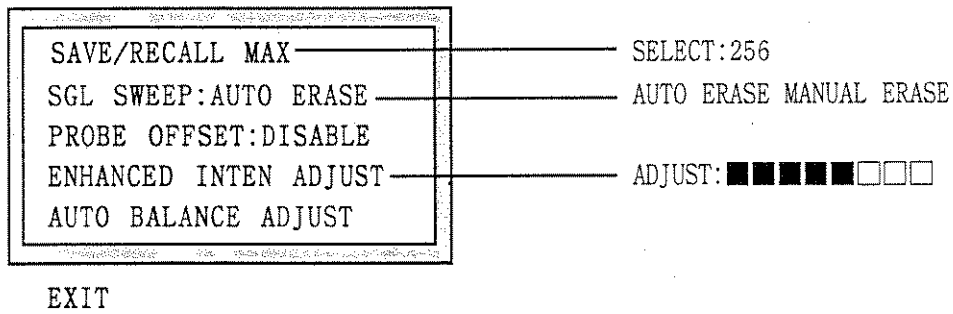

2 Setting f:DISP-MENU

Selects a color of READOUT, SCALE, CURSORS, PERSISTENCE, BACKGROUND. Adjusts brightness of READOUT, SCALE, CURSORS. Selects a measuring scale (GRID, AXIS, FRAME, EIA, CCIR).

2.1 Setting Items

COLOR

- READOUT : Selects the color of the characters.
 SCALE : Selects the color of the scale.
 CURSORS : Selects the color of the measurement cursor and trigger cursor.
 PERSISTENCE : Selects the color of the persistent waveform.
 BACKGROUND : Adjusts the color of the background.

BRIGHT

- READOUT : Adjusts the brightness of the characters.
 SCALE : Adjusts the brightness of the scale.
 CURSORS : Adjusts the brightness of the measurement cursor and trigger cursor.

BACKLIGHT : Adjusts brightness of LCD (Liquid Crystal Display).

SCALE : Selects a measuring scale from GRID, AXIS, FRAME, EIA, CCIR.

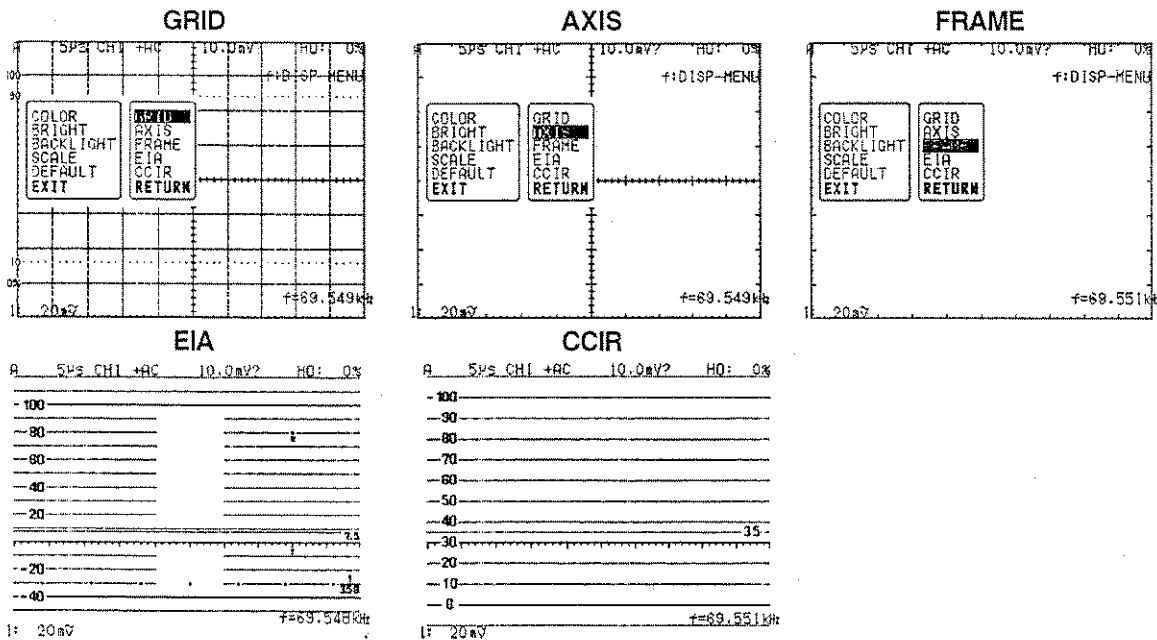

DEFAULT : Defaults set up conditions (COLOR, BRIGHT, BACKLIGHT, SCALE) at the factory shipment.

EXIT : Exit from the menu, return to measurement display.

RETURN : Return to the upper menu as the left box.

2.2 Operation in the DISP-MENU

You can enable the menu operations by turning or pressing the [FUNCTION] pulse switch.

Turn [FUNCTION] : Selects, and adjust the menu item.

Press [FUNCTION] : Determines the menu item.

Entering to DISP-MENU

- ① Turn off all the functions to disable [FUNCTION] ¹⁾.
- ¹⁾ Condition that f:XXXX is not being displayed at the upper right of the screen (the delay time, number of TV lines, etc.)
- ② Press [FUNCTION] for 2 sec, then the display menu (f:DISP-MENU) is appeared.

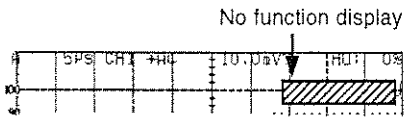

Selecting COLOR

(COLOR, BRIGHT, BACKLIGHT, SCALE, DEFAULT, EXIT)

◇ After procedure ④ are different by the selected item.

- ③ Turn [FUNCTION] to select COLOR and press it.

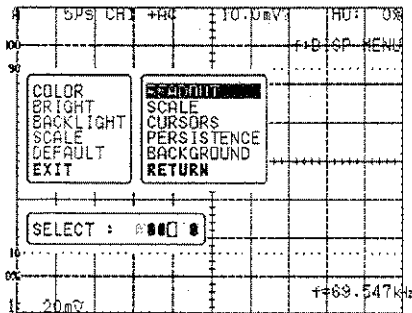
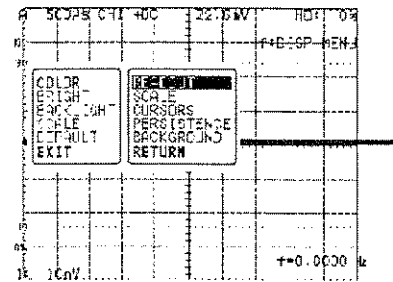
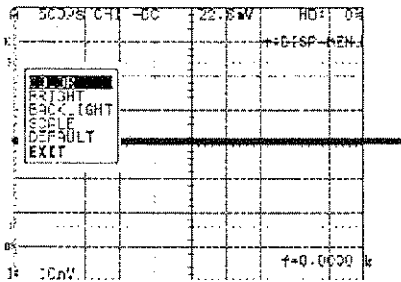

Selecting the READOUT

(READOUT, SCALE, CURSORS, PERSISTENCE, BACKGROUND)

- ④ Turn [FUNCTION] to select READOUT and press it.
 - ⑤ Turn [FUNCTION] to select a color with SELECT: and press it.
- ◇ READOUT,SCALE,CURSORS,PERSISTENCE has 8 colors.
BACKGROUND has 16 colors.

Return to previous menu screen

- ④ Turn [FUNCTION] to select RETURN and press it.
- ⑤ Turn [FUNCTION] to select EXIT and press it.

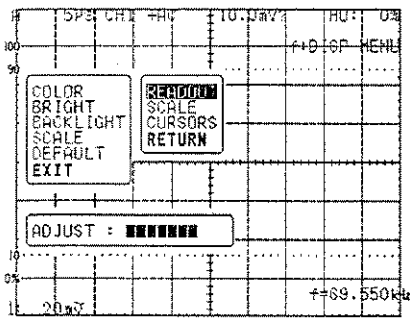
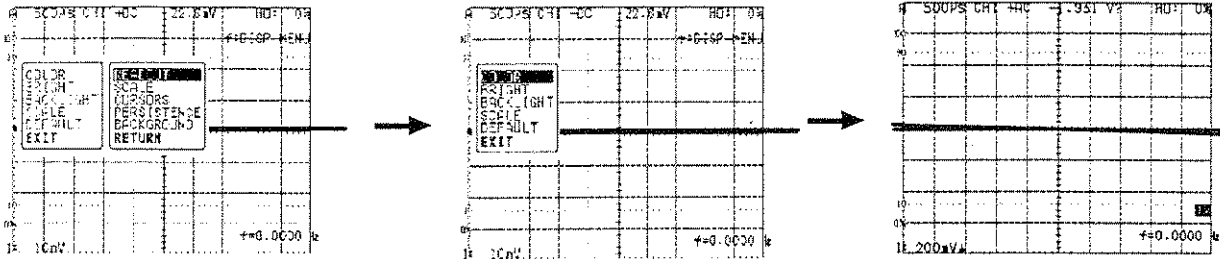

Adjusting the BRIGHT
(READOUT, SCALE, CURSORS)

- ④ Turn [FUNCTION] to select READOUT and press it.
- ⑤ Turn [FUNCTION] to select brightness with **ADJUST: ■■■■■■□□□□** and press it.

Adjusting the BACKLIGHT

- ⑤ Turn [FUNCTION] to adjust with **ADJUST: ■■■■■■□□□□** and press it.

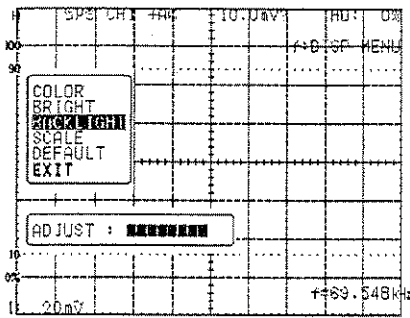

Setting the SCALE

- ⑤ Turn [FUNCTION] to select GRID or any and press it.

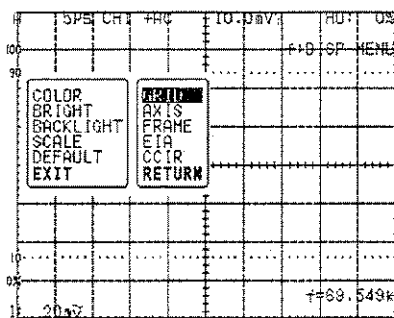

3 Setting f:SYS-MENU

Setting the maximum register number of the SAVE/RECALL. Select ENABLE or DISABLE of the offset voltage for the FET Probe connected to terminal PROBE POWER. Adjusts the vertical balance automatically.

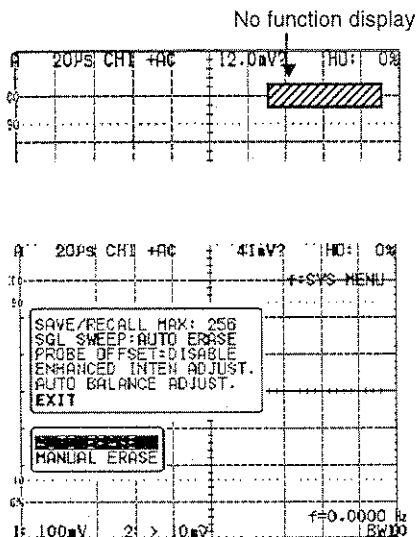

- ① Turn off all the functions to disable [FUNCTION] *1.
*1 Condition that f:XXXX is not being displayed at the upper right of the screen (the delay time, number of TV lines, etc.)
- ② Turn [READOUT] fully counter clockwise (no readout display).
- ③ Press [FUNCTION] for 2 sec, then the system menu (f:SYS-MENU) is appeared.

- **SAVE/RECALL MAX**

Set maximum number of panel settings (max 256).

- **SGL SWEEP:AUTO ERASE**

AUTO ERASE : ERASE waveform automatically when SGL/RST is pressed.

MANUAL ERASE : Press [ERASE]. (Enables over-write)

- **PROBE OFFSET**

ENABLE: Enables the offset voltage control of the FET Probe connected to PROBE POWER (P1/P2) terminal. (Refer to 28 pages to "PROBE P1/P2 Offset")

- **ENHANCED INTEN ADJUST**

Intensity is preset in single sweep mode to get adequate brightness at any sweep condition and ranges.

ENHANCED INTEN ADJUST function slightly adjust the brightness as you like.

In the following cases, the trace brightness is set automatically.

1. When you press **AUTO SET**.
 2. When you switch the sweep mode from AUTO or NORM to SINGLE.
 3. When you vary the sweep rate (TIME/DIV) in single sweep mode.
- ◇ After above 3 conditions the brightness is set by turning the INTEN knob. Waveform that has already stored waveform.

- **AUTO BALANCE ADJUST**

Adjusts the vertical trace shift when VOLTS/DIV is switched.

- ◇ Execute AUTO BAL ADJUST after warm up enough.

EXIT from the menu

- ④ Turn [FUNCTION] to select EXIT and press it.

Operation



Cautions

- Be sure the power switches to STBY position, before to connect or remove the power cord.
- Use this instrument with the rated AC power supply.
 - Voltage range : 100 to 240 VAC
 - Frequency : 50/60 Hz
 - Power consumption : 140 VA max.
- Use a 3-core power cord meet to the supply voltage.
- Do not place any object at the air ventilation hole or exhaust fan of this instrument.
- Use this instrument within the rated operating range.
 - Temperature : 0 to +40 °C, humidity : 90%RH (at 40 °C)
- Small power is applied to this instrument even if the power switch is set to STBY. Disconnect the power cord from the receptacle if the instrument is not used for a long time.
- Do not apply over rating voltage to the input terminal.
 - CH1, CH2, CH3, CH4 input at 1 M Ω
 - Direct : ± 400 V (DC+ACpeak).
 - With the PP005 or equivalent : ± 600 V (DC+ACpeak).
 - CH1, CH2 at 50 Ω : 5 Vrms

[Note] The maximum input voltage derates depending on frequency and high voltage pulse of an input signal (refer to page 68 "PP005 PROBE").
- Built-in Lithium primary battery
 - Lithium primary battery is used for save the panel set-up.
 - When the life is over, the panel setup is initialized. When this symptom occurs, the battery should be replaced to the new one. The customer may not replace the battery. Contact to our service offices.

Basic Operation

1 General

In order to understand the LA354 operations, CAL output and a signal generator are used. The signal generator is the Iwatsu FG-350.

◇ Setting when power is set STBY or OFF ^{*1}

When power is set STBY or OFF, the panel setup before STBY or OFF is stored. When power is turned on again, the panel setup resume to before STBY or OFF. After power cord is disconnected (OFF), the built-in batteries back up the panel setup.

^{*1} The condition of the power cord is disconnected.

2 Displaying CAL Signal with AUTO SET

Allows you to display the waveform on the screen automatically in the appropriate conditions.

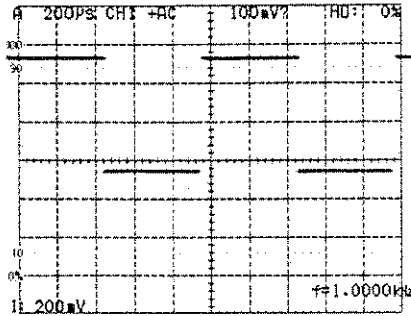

Procedures

Turning power on

- ① Set **POWER** to **STBY**.
- ② Connect the power cord to the AC LINE INPUT on the rear panel and to the AC power source.
- ③ Press **POWER** to turn **ON** the power.
 - Traces, characters, or both are displayed on the screen.
- ④ Connect the CH1 input connector and CAL connector with the probe.
- ⑤ Press **AUTO SET**.
 - The CAL signal (1 kHz, 0.6 V square wave) is displayed on the screen.
 - When the input resistance is 50 Ω , the CAL waveform does not appear on the screen.
 - Press **50 Ω /1M Ω** and select 1M Ω .
 - When you activate the AUTO SET function by pressing the AUTO SET, you may not move the signal position by controlling position knobs in some range. In this case, rotate the **[POSITION]** **[LEVEL]** further until it will be in action again.

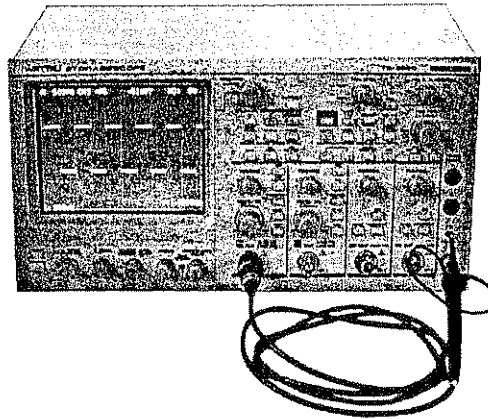

About the AUTO SET Function

- Press **AUTO SET** when you do not know “how to operate, amplitude or frequency of signal”. The instrument check the amplitude and frequency of the input signal, automatically set the proper scope conditions (refer to the next page), and displays the waveform on the screen.
- The proper scope conditions may not be found depending on the frequency, amplitude, or duty ratio of the input signal conditions.

Table 1 Setting conditions of AUTO SET

Vertical deflection system	Triggering
Deflection factor VOLTS/DIV : The frequency is between 50 Hz and 100 MHz, 2 mV to 5 V/div with amplitude of 1.5 to 8 div VARIABLE : OFF (CAL)	A/B : A SOURCE : Detected in the order of CH1 and CH2 COUPL : DC TV : When Last setup before AUTO SET is TV MODE, TV-H, NTSC, PAL, or HDTV is automatically set. When last setup is not TV-MODE, TV settings are skipped in spite of TV signal applying SLOPE : + ("-" in the case of TV mode) LEVEL : Around 0 div
Display channel CH1 : Last setup before AUTO SET *1 CH2 : Last setup before AUTO SET *1 CH3 : OFF (non-display) CH4 : OFF (non-display) *1 CH1 alone is set to ON if both CH1 and CH2 have been set to OFF.	
POSITION In case of 1-channel display : In the middle In case of 2-channel display CH1 : About + 2 div CH2 : About -2 div	Horizontal deflection system HORIZ DISPLAY : A TIME/DIV : 50 ms to 10 ns/div, approx. 2 to 5 cycles of signal VARIABLE : OFF
AC/DC : Last setup before AUTO SET *2 50 Ω/1M Ω : Last setup before AUTO SET *3 GND : OFF (GND released) ALT/CHOP : CHOP CH2 INV : OFF BWL : OFF (no Bandwidth limiter) ADD : OFF	SWEEP MODE : AUTO POSITION : Sweep starts from a position near the left end of the screen. READ OUT : ON AINTEN : Brightness is set to enough level

*1 When both CH1 and CH2 are OFF, CH1 is set to ON.

*2 When this is set to DC, AC coupling is selected when the waveform is out of position control range.

*3 When this is set to 50 Ω, 1 M Ω is selected when the waveform is out of position control range.
 After 1 M Ω is set, the setting of input coupling (AC/DC) becomes AC.

[Note] When an adequate amplitude cannot be detected, the following conditions will be set on that channel :

VOLTS/DIV : 10mV/DIV
 50 Ω/1M Ω : 1M Ω
 AC/DC : AC

3 Probe Compensation

Adjusts the waveform on the probe. Confirm that the waveform of the probe is compensated correctly before using the probe.

Procedures

Connect CH1 input terminal to CAL terminal over the attached probe.

① Set this unit as follows:

- CH1 VOLTS/DIV : 10 mV
- GND : OFF (GND released)
- AC/DC : DC
- SOURCE : CH1
- SEC : 200 μ s

② Set [TRIG LEVEL] to get a stable display.

③ Adjust the variable capacitor of the probe by turning with a screwdriver for flatness response on square wave.

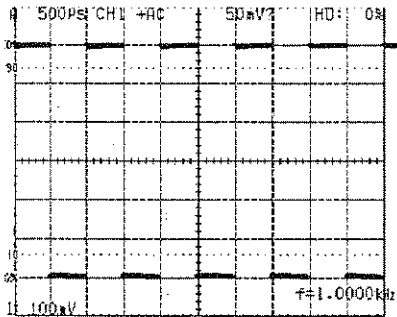

← • Correctly compensated waveform

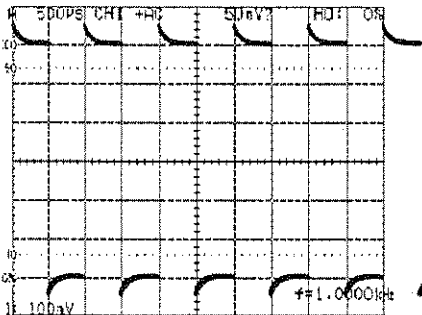

← • Overcompensated waveform

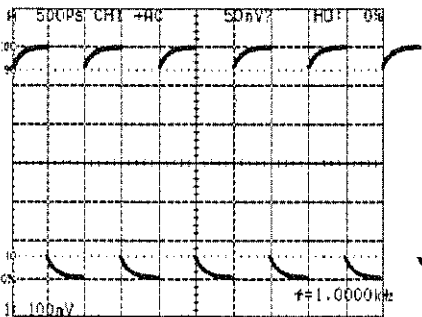

← • Undercompensated waveform

◇ Probe sense (display of deflection factor)

When the probe has a probe sense function, the voltage as compensated by the attenuation ratio of the probe is displayed.

◇ Releasing the loading effect by a probe

If a cable, etc. is directly connected to the circuit under measurement, observation may be disturbed by the load applied by the input impedance of the measuring equipment. The input RC of this unit is "1 M Ω , 16 pF".

If a 10:1 probe is used, the input RC becomes "10 M Ω , 13 pF" and thus the loading effect is largely released enabling the measurement with a high accuracy.

Purpose of Using Probes

What problems will occur if a wire is connected directly from the input terminal of the oscilloscope to the circuit under test?

- 1) Easily affected by noises.
- 2) The frequency band width is reduced.
- 3) Loading effect is large.

Problem 1) Can be improved by the use of coaxial cable or shielded wire.
By this method, however, problem 2) and 3) cannot be solved.

Problem 2) When the wire is directly connected, the frequency band width is limited by the inductance and stray capacitance of the wire.
The use of a 10:1 probe, however, can eliminate such influence.

Problem 3) When the oscilloscope input is viewed from the side of the circuit under measurement, if the wire is connected directly, the capacitance and inductance constitute a load as is the case of problem 2).
In this case, there is still a high load even if a shielded wire is used for connection.

Then, what will happen when a 10:1 probe is used?

Let's compare the 10:1 probe and shielded wire.

Probe : 1.5 m 10:1 probe with an input capacitance of 15 pF

Shielded wire : 1.5 m total capacitance 150 pF (unit capacitance 100 pF/m)

Oscilloscope : Input capacitance of 30 pF

Conclusion : Loading effect of the capacitance will be reduced from 180 pF (150+30) to 15 pF.
The amplitude will be attenuated to 1/10.

4 Adjustment of the Screen (A INTEN, FOCUS, TRACE ROTATION)

Adjusts the brightness (A INTEN), focus (FOCUS), and rotation of traces (TRACE ROTATION).

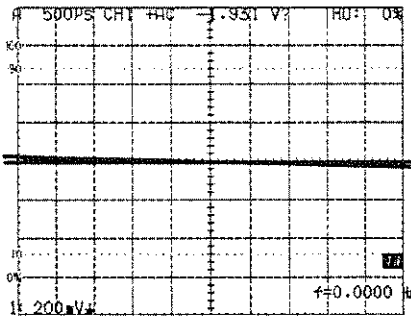
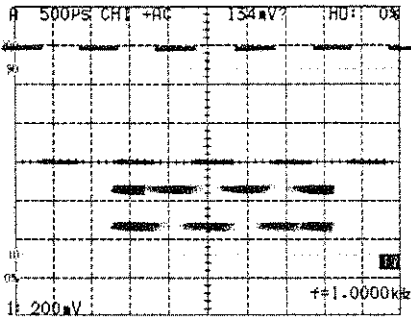

Procedures

A INTEN

- ① Adjust the A sweep brightness of traces by turning [A INTEN].

FOCUS

- ② Adjust the focus of traces and displayed characters by turning [FOCUS].

TRACEROTATION

- ③ Set the input coupling of CH1 to GND by pressing [GND].
- ④ Adjust the alignment of the trace to horizontal graticule by turning TRACE ROTATION on the front panel with the attached adjustment screwdriver.
- ⑤ Release the input coupling GND.

B INTEN

Turn [B INTEN] when adjusting the trace intensity of B sweep.

Refer to page 35 "Horizontal Display" for B sweep.

5 Vertical and Horizontal Position

Controls the vertical and horizontal position of the waveform.

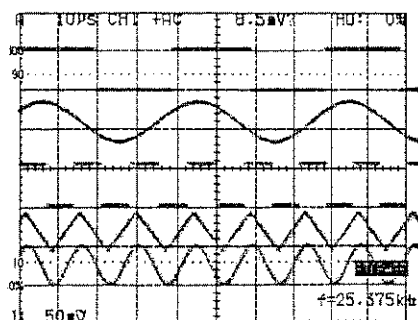

Procedures

Moving vertical positions

- ① Turn [**▲POSITION▼**] of CH1 to the clockwise ; the waveform moves upward.
- ② Turn [**▲POSITION▼**] of CH1 to the counterclockwise ; the waveform moves downward.

◇ CH2 to CH4 are same as CH1.

[Example] Moving position and storing waveform.

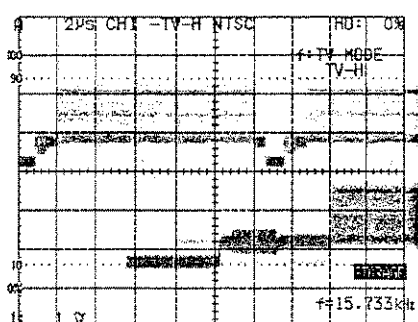

Moving horizontal position

- ① Turn [**◀ POSITION ▶**] to the clockwise; the waveform moves to the right.
- ② Turn [**◀ POSITION ▶**] to the counterclockwise ; the waveform moves to the left.
- ③ When every time **FINE** is pressed, the FINE indicator lights or goes off.
 - When the Fine indicator is lighted, [**◀ POSITION ▶**] is fine adjustment mode. If [**◀ POSITION ▶**] is fully turned in fine mode case, the waveform scrolls. To stop scroll, return [**◀ POSITION ▶**] slightly.

6 Position Check

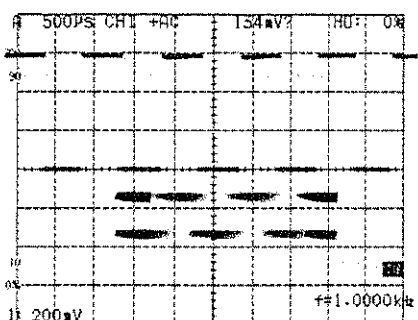

Press [**A INTEN (BEAM FIND)**].

- A vertically and horizontally compressed wave form is displayed.

Vertical Deflection System

1 Deflection Factor

Sets the amplitude of waveform to a suitable size for viewing.

a. CH1 and CH2

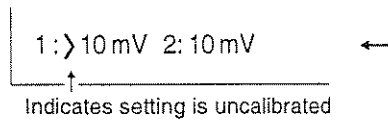
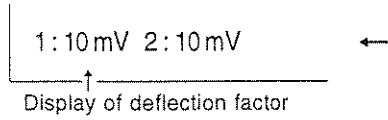

Procedures

Setting the VOLTS/DIV

- ① Select the deflection factor by turning [VOLTS/DIV] of CH1.
 - The deflection factor can be selected with a range of 2 mV/div to 5 V/div (in 1-2-5 steps).
 - The deflection factor is displayed at the lower left corner of the screen.

[Note] Perform AUTO BALANCE ADJUST if traces move upward or downward when the range is switched even if no signal. (refer to page 59 "Maintenance").

Setting the VARIABLE

- ② Press [VOLTS/DIV] of CH1 ; the deflection factor is displayed with ">" mark.
 - Fine adjustment is available in this condition.
- ③ Turn [VOLTS/DIV] of CH1 ; the deflection factor varies continuously between steps .
 - While [VOLTS/DIV] is turned, the rough ratio to the original range is displayed in percentage.
 - To release the variable setting mode, delete ">" by pressing [VOLTS/DIV] again.

◇ CH2 is same as CH1.

b. CH3 and CH4

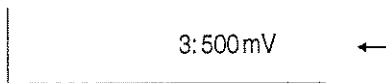

Procedures

- ① Select the deflection factor by pressing **100 mV/500 mV** of CH3.
 - One of the two ranges of 100 mV/div, or 500 mV/div can be selected. Fine adjustment is not available.

◇ CH4 is same as CH3.

[Example] Displaying

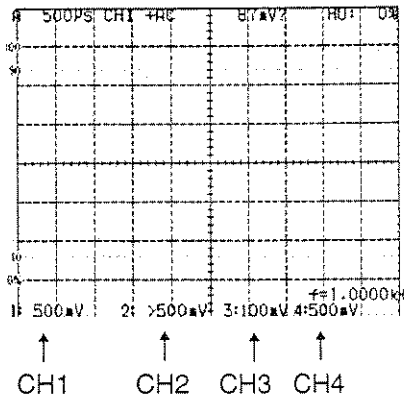

2 Input Coupling

Selects a suitable coupling mode for observation depending on the type of input signal.

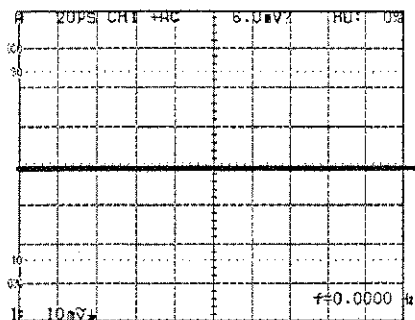

Procedures

Selecting GND

- ← ① Press **GND** of CH1 and set **GND** to **ON** (the GND mark is displayed at the lower left corner of the screen).
- The input of the vertical amplifier is connected to GND and a trace (grounding potential) is displayed.
 - CH3, CH4 has no GND.
- [Note] Perform AUTO BALANCE ADJUST if traces move upward or downward when the range has been switched (refer to page 59 "Maintenance").

Selecting DC or AC

- ① Press **GND** of CH1 and set **GND** to **OFF** (GND released).
- ② Press **DC/AC** of CH1 and set **DC** or **AC**.
- When the input resistance is selected the 50Ω , can not be set to AC.
- When AC is selected the 50Ω indicator goes off and the input resistance becomes $1M\Omega$.

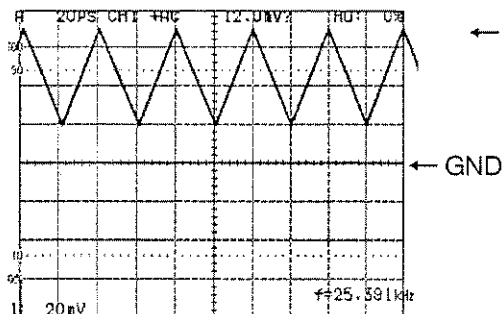

◇ DC

- The DC and AC components of the input signal are displayed.
 - The input signal is displayed on the basis of the GND level.
- [Example] The waveform include the DC component.

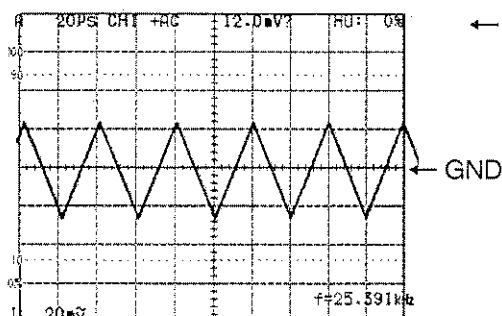

◇ AC

- Only the AC component of the input signal is displayed, and the DC component is cut.
- The input signal is displayed at the mean potential of signal.
- The "~" mark is displayed over the character "V".
- CH2 is same as CH1.

3 Input Resistance

Select the input resistance.

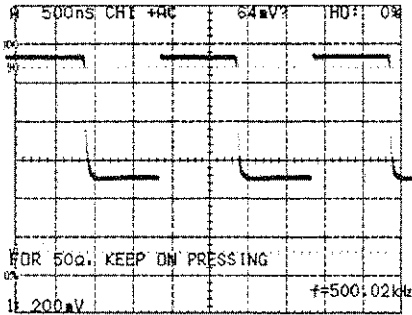

FOR 50Ω, KEEP ON PRESSING ←

Procedures

- ① Depress **50Ω/1MΩ** and select **50Ω** or **1MΩ**.
 - To select 50Ω, keep **50Ω/1MΩ** pressed for a while.
 - When the duration of pressing is too short, the left error message is displayed.
 - When 50Ω is selected, the indicator lights.
- [Note] When 50Ω is selected, the input coupling is automatically set to DC. AC cannot be set.
- ◇ Use this unit with the input resistance set to 1MΩ in usual cases.
 - ◇ How to use 50Ω
 - When measuring the signals in a high frequency band, connect this unit and the signal source with a coaxial cable having a characteristic impedance of 50Ω.
 - When the input resistance is set to 50Ω, the VSWR (voltage standing wave ratio) is 1.35 or less, so a waveform with few reflection can be observed.



Cautions

- When the input resistance is set to 50Ω, do not apply excess signals of 5Vrms or more.
- When a DC voltage of ±10 V or more is detected, the following error message is displayed for protection and the setting is changed from 50Ω to 1MΩ.

"INPUT OVERLOADED AND REVERTED TO 1MΩ"

4 Display Channels

Signals input to CH1, CH2, CH3 or CH4 are displayed.

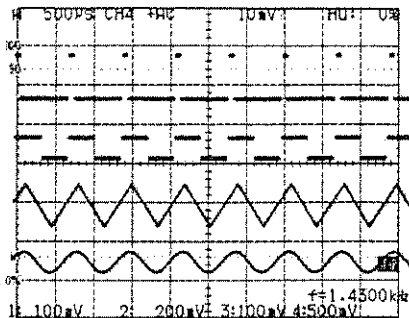

1: 10mV

Procedures

- Press **CH1**, **CH2**, **CH3** or **CH4** to select ON (display) or OFF (non-display).

[Example] **CH1**, **CH2**, **CH3** and **CH4** are set to ON is shown on the left.

- Every time the channel key is pressed, ON (display)/OFF (non-display) is selected alternately.

- The channel No., VOLTS/DIV, and input coupling of the channels set to ON are displayed in the lower left corner of the screen. The OFF channel disappear from the screen.

[Note] When all channels (CH1, CH2, CH3, CH4 and ADD) are set to OFF, CH1 is displayed.

5 ALT and CHOP

Allows you to select the display mode (ALT, CHOP) when two or more channels are displayed.

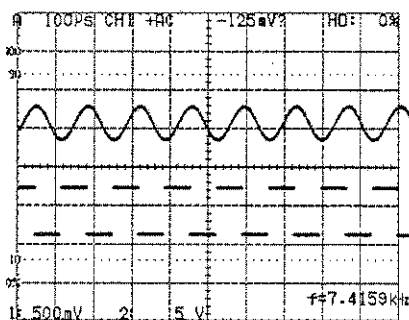

Procedures

- Select two or more channels from CH1, CH2, CH3 and CH4 (refer to above "Display Channels").
- Press **ALT CHOP** to select **ALT** or **CHOP** (the indicator lights).

ALT (alternate)

- Alternately two or more input signals are swept.
- This mode is suitable for observing high-frequency signals on two or more channels.

CHOP (chop)

- The chopped switching rate (CHOP frequency) is approx. 555kHz.
- This mode is suitable for observing low-frequency signals on two or more channels.

[Note] When sweep times are faster than 20 μ sec/div, even if LED of CHOP lights, ALT sweep is selected as sweep mode.

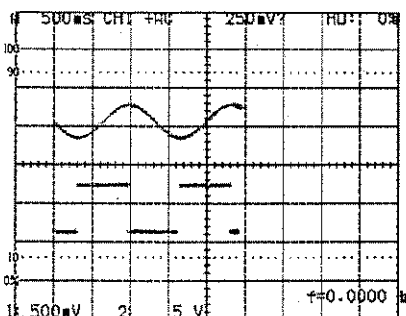

6 Sum and Difference

Adds two channels (CH1 + CH2) or subtracts one channel from another (CH1 - CH2). Addition or subtraction can be selected by selecting ADD and then setting INV.

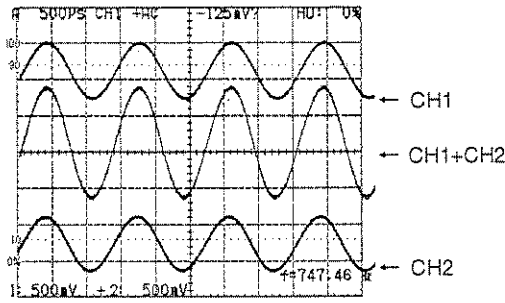

↑ When ADD is set to ON

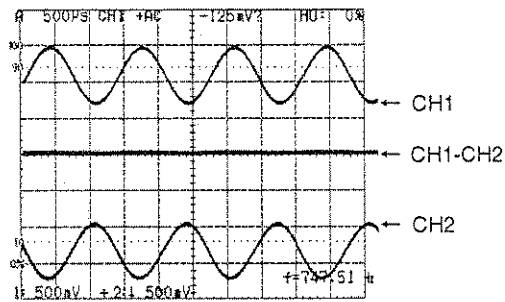

↑ When CH2 INV is set to ON

Procedures

- ① Set CH1 and CH2 to ON (display) (refer to page 25 "Display Channels").
- ② Press **ADD** to set ADD to ON ("+" is displayed in the lower left corner of the screen).
 - The sum of two signals (CH1 + CH2) is displayed on the screen.
- ③ Press **INV** to set INV to ON ("↓" is displayed in the lower left corner of the screen).
 - The polarity of CH2 is inverted and the difference between two signals (CH1 - CH2) is displayed on the screen.

7 Bandwidth Limiter

Bandwidth limiter reduces noises. The frequency band is limited to about 20 MHz or about 100 MHz.

Procedures

- ① Press **BWL** to select 100, 20, or OFF.
 - The bandwidth is displayed at the lower right corner of the screen. There is no display when OFF is selected.

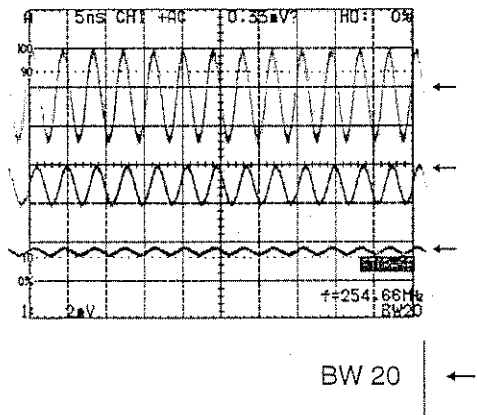

← OFF : No bandwidth limitation.

← 100 : The bandwidth is limited to 100 MHz.

← 20 : The bandwidth is limited to 20 MHz.

← BW 20

8 Offset

8.1 CH1/CH2 Offset

Adjusts the CH1/CH2 offset voltage. DC OFFSET is used for measure AC signal superimposed on DC voltage at the DC coupling mode.

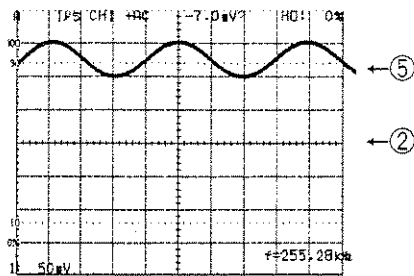

Function display

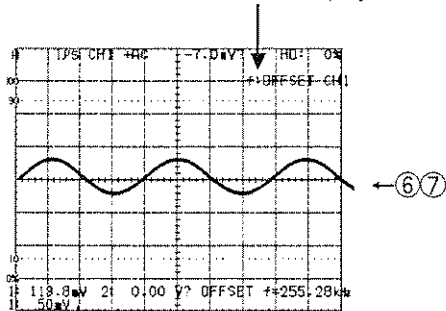

Offset Voltage VOLTS/DIV:50mV

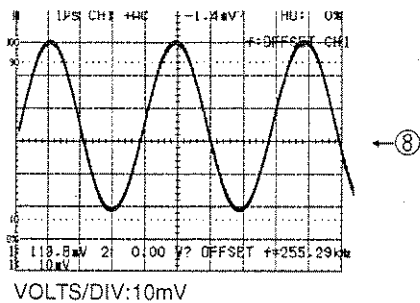

Procedures

Selecting the reference position

- ① Press **GND** to set GND to ON (refer to page 23 "Input Coupling").
- ② Turn **[▲POSITION▼]** to set the reference position for offset.
 - An example of setting the reference position is shown on the left.

Selecting the offset voltage

- ③ Press **GND** to set GND to OFF.
 - ④ Press **DC/AC** to select DC.
 - When the input coupling is set to AC, the display is followed by "?" mark.
 - The trigger level value does not include the offset value.
 - ⑤ Input AC signals included DC offset to the input terminal (CH1, CH2)
 - ⑥ Press **OFFSET** to select the OFFSET channel of CH1 or CH2.
 - Function display changes into f:OFFSET CH1.
 - ⑦ Set the offset VOLTAGE (CH1/CH2) to the reference position by turning **[FUNCTION]**.
 - The reference position set in procedure ⑦ becomes the offset voltage value.
 - ⑧ Turn **[FUNCTION]** to magnify the waveform.
- When **[FUNCTION]** is turned clockwise, the trace moves downward and the voltage display varies in the positive direction.

◇ Selecting the object channel

The channel as the object of setting (CH1 or CH2) can be selected by pressing **ATTACH**.

◇ Releasing CH1/CH2 offset

Select OFF (without the display of OFFSET) by pressing **OFFSET**.

Using the offset

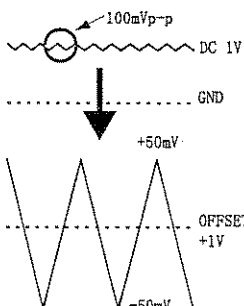

- OFFSET allows you to magnify the small AC signal included a big DC offset.
- If the input signal is measured with AC input coupling and turning **[▲POSITION▼]** fully counterclockwise, you cannot obtain enough magnifying rate and measuring the variation of the low frequency (4Hz or less).
- OFFSET voltage allows you to set within the range from zero volt to $\pm 100V$, $\pm 10V$ and $\pm 1V$ (depend on range).

8.2 PROBE P1/P2 Offset

Sets the offset voltage of the FET probe which is connected to the PROBE POWER terminal (P1/P2) of this unit. DC OFFSET is used for measure AC signal superimposed on DC voltage at the DC coupling mode. The lower frequency signal can be measured without any distortion.

Procedures

Selecting on SYS-MENU

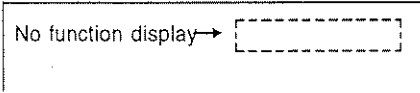

① Turn off all the function to disable [FUNCTION] '1.
 * Condition that f:XXXX is not being displayed at the upper right of the screen (the delay time, number of TV lines, etc.)

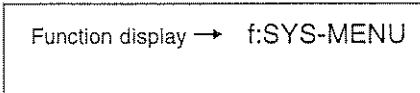

② Press [READOUT] to select OFF (non-display).
 ③ Press [FUNCTION] for 2 sec, then the system menu (SYS-MENU) is displayed.

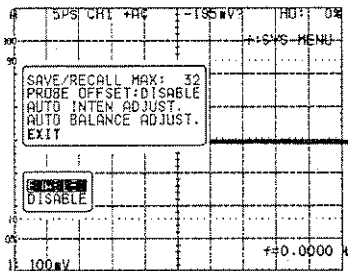

• The left figure is displayed on the screen.
 ④ Turn [FUNCTION] to Select PROBE OFFSET.
 • Press [FUNCTION] to display boxed ENABLE/DISABLE.
 ENABLE : The offset voltage can be set.
 DISABLE : The offset voltage cannot be set.

⑤ Press [FUNCTION] to select ENABLE.

Cancel SYS-MENU

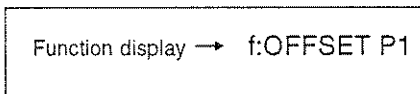

⑥ Press [FUNCTION] to select EXT.
 The settings are maintained after power is turned off.

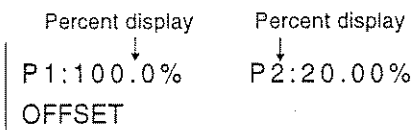

Setting PROBE offset

① Press [OFFSET] twice to select OFFSET P1/P2.
 • Function display changes into f:OFFSET P1.
 ② Turn [FUNCTION] to set the offset voltage (P1/P2).
 • This is the ratio (%) to the offset variable range of the FET probe.
 • This is valid with the SFP-5A/4A probe made by Iwatsu.

◇ Selection of the object terminal

The terminal as the object of setting (P1 or P2) can be selected by pressing [ATTACH].

FET probe

A probe with an FET attached to the tip is called an active probe.

- This is a probe with a high impedance and low input capacitance.
- When a probe for common oscilloscopes is connected, the signal under test may be affected (such as oscillation) by the input capacitance of the probe. In this case, the effect on the signal under test can be suppressed by the use of an FET probe.
- Main performance of the SFP-5A/4A probe are as follows :
 Input impedance : 1 MΩ, approx. 1.9 pF (SFP-5A)/1 MΩ, approx. 2.15 pF (SFP-4A)
 Attenuation ratio : 10:1
 Bandwidth : DC to 1 GHz (SFP-5A)/DC to 800 MHz (SFP-4A)

Horizontal Deflection System

1 Triggering

This is the basic operation to get a stable waveform on the screen.

1.1 Trigger Source

Selects the trigger source. Select B trigger when HORIZ DISPLAY is ALT or B. (Refer to 41 pages to "Delayed sweep")

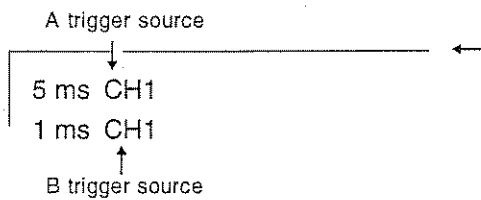

Procedures

- ① Press **AB** to select A trigger or B trigger (the indicator lights).
 - B trigger is set when performing a triggered delay (refer to page 42 "Triggered Delay").
- ② Press **SOURCE** to select the trigger source (CH1, CH2, CH3, CH4 or LINE).
 - Line is for A sweep only.

CH1 : The CH1 input signal is used as the trigger source.

CH2 : The CH2 input signal is used as the trigger source.

CH3 : The CH3 input signal is used as the trigger source.

CH4 : The CH4 input signal is used as the trigger source.

LINE (A sweep only) : The power line signal is used as the trigger source. This is suitable for line frequency synchronized signal observation.

1.2 Trigger Coupling

Selects the trigger coupling.

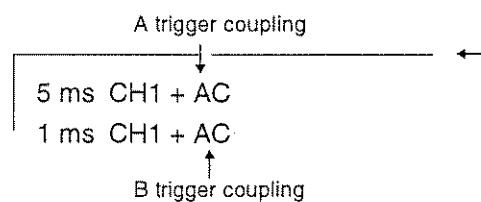

Procedures

- ① Press **AB** to select A trigger or B trigger (the indicator lights).
 - B trigger is set when performing a triggered delay (refer to page 42 "Triggered Delay").
- ② Press **COUPL** to select the trigger coupling (AC, DC, HF REJ or LF REJ).

AC : AC coupling. Eliminates the DC component of the trigger signal source. A lower limit of frequency is 10 Hz.

DC : DC coupling. Applies a trigger with a signal including all frequency components.

HF REJ : Low-pass filter coupling. Applies a trigger by attenuating the frequency component beyond 10 kHz. Use when a high-frequency noise is included in the trigger source and the trigger is unstable by that noise.

LF REJ : High-pass filter coupling. Applies a trigger by attenuating the frequency component below 10 kHz. Use when a low-frequency noise (hum of the line frequency, etc.) is included in the trigger signal source and a trigger signal is unstable by that noise.

1.3 Trigger Slope (SLOPE)

Selects at the positive or negative slope.

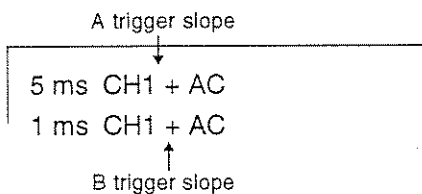

Procedures

- ① Press **[A B]** to select A trigger or B trigger (the indicator lights).
 - B trigger is set when performing a triggered delay (refer to page 42 "Triggered Delay").
- ② Press **[SLOPE]** to select the slope (+ or -).

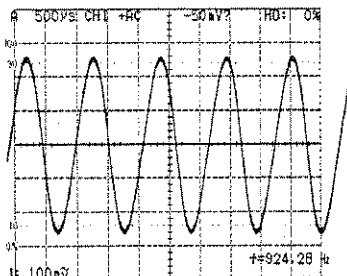

+ (Triggered at the positive going waveform portion)

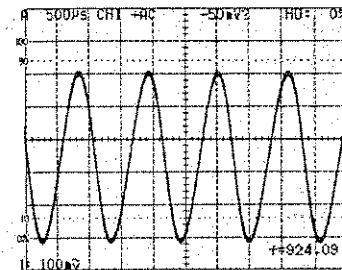

- (Triggered at the negative going waveform portion)

1.4 Trigger Level

Adjusts the trigger level(voltage at the trigger point).

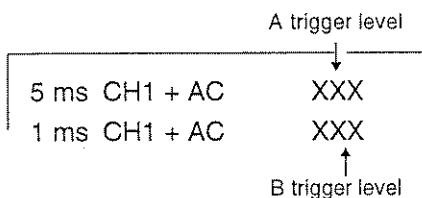

Procedures

- ① Press **[A B]** to select A trigger or B trigger (the indicator lights).
 - B trigger is set when performing a delayed sweep (refer to page 42 "Triggered Delay").
- ② Turning **[TRIG LEVEL]** to adjust the trigger level.
 - The TRIG'D indicator lights when the trigger signal is generated.
 - Sometimes "?" is displayed at the right of the trigger value displayed. This indicates that value is not exact when AC coupling or VARIABLE is set.

Turning [TRIG LEVEL] to right from the midrange

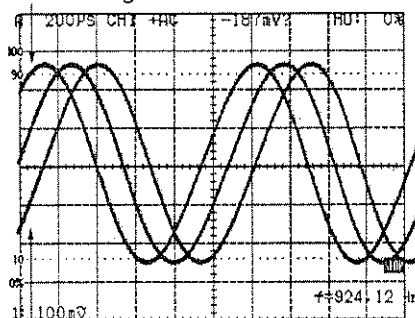

Turning [TRIG LEVEL] to left from the midrange

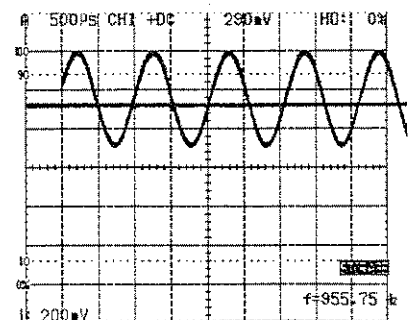

Trigger cursor

- While "A" or "B" trigger is setting, the trigger level cursor is displayed about 2 seconds.

Trigger cursor

- Trigger cursor display conditions are as follows :
 - Trigger source : CH1, CH2, CH3 or CH4
 - Trigger coupling : DC or HF-REJ
- The "B" trigger cursor for ALT sweep is not displayed.

1.5 TV Trigger

1.5.1 TV Format

Sets the TV format.

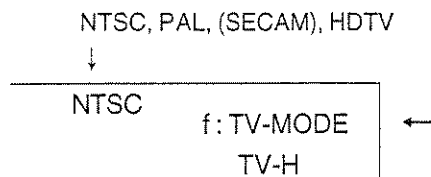

Procedures

- ① Every time pressing **TV** selects the TV-Coupling.
 BOTH → ODD → EVEN → TV-H → OFF
- ② Turn **[FUNCTION]** to select NTSC, PAL (SECAM) or HDTV.
 - Refer to page 32 "Table 2 TV formats and their features" for the details of TV modes.

1.5.2 TV-V Trigger (BOTH, ODD or EVEN)

Selects the TV-V trigger mode from BOTH, ODD or EVEN.

Additionally it can select a line number by turning **[FUNCTION]**.

The function display changes into f:TV-LINE.

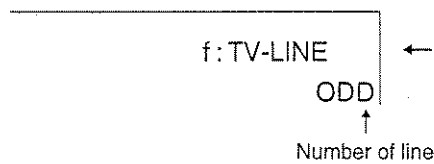

Procedures

- ① Select BOTH, ODD or EVEN by pressing **TV**.
- ② Turn **[FUNCTION]** to select a line number.
 The sweep starts from setting number point.
 - For coarse adjustment, press **[FUNCTION]**.
 - The setting range is shown in Table 3 Range of line number.

- ODD : The sweep starts by selected number of horizontal synchronization signal of the odd-numbered field.
- EVEN : The sweep starts by selected number of horizontal synchronization signal of the even-numbered field.
- BOTH : The sweep starts by selected number of horizontal synchronization signal of the odd-numbered or even-numbered field.
- TV-H : The sweep starts by horizontal synchronization pulse.
- OFF : The TV mode is released.

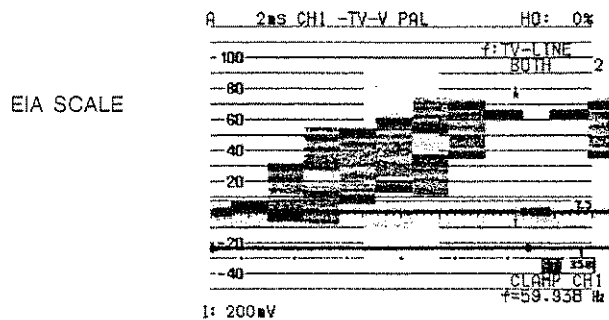

Triggering on a vertical synchronization pulse. The composite video signal between one vertical can be observed by changing the sweep time to 2ms.

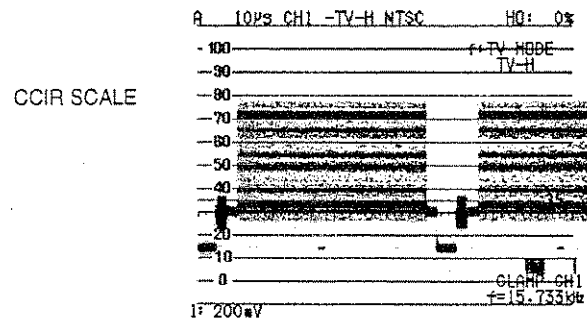

Triggering on a horizontal synchronization pulse. The composite video signal between one horizontal can be observed by changing the sweep time to 10 µs.

Table 2 TV formats and their features

Format	Number of scanning lines	Field frequency	Video signal bandwidth	Countries	Remarks
NTSC	525	Approx. 60 Hz	4.2 MHz	U.S.A., Canada, Japan	
SECAM	625	Approx. 50 Hz	6 MHz	France, Russia	
PAL	625	Approx. 50 Hz	5 MHz	Europe, etc.	
HDTV	1125	Approx. 60 Hz	20 MHz		High definition TV

Table 3 Range of line number

Format	Number of lines		
	BOTH	ODD	EVEN
NTSC	1 to 525	1 to 263	264 to 525
PAL (SECAM)	1 to 625	1 to 313	314 to 625
HDTV	1 to 1125	1 to 563	564 to 1125

[Note] The line number is counted by M mode in NTSC, is not by M mode in PAL (SECAM).

M mode : Sequential numbers are assigned to scanning lines from after the start of the vertical blanking period.

Other modes than M : The line number 1 is set to the start point of the vertical synchronizing signal of the first field.

1.5.3 TV Clamp

Clamps the back porch of composite signals to the reference level (ground level).

This procedure enables stable observation of those TV signals without the average voltage fluctuation.

Procedures

- ① Select the Formats by pressing **TV**.
 - Refer to page 31 "TV Trigger" for TV modes.
- ② Select the clamp (CLAMP CH1, CLAMP CH2, OFF) by pressing **EVENT/TV CLAMP**.
 - The selected clamp is displayed at the bottom of the screen. Shows the example of CLAMP CH1.
 - CLAMP CH1 : CH1 is clamped.
 - CLAMP CH2 : CH2 is clamped.
 - OFF : Clamp is released.

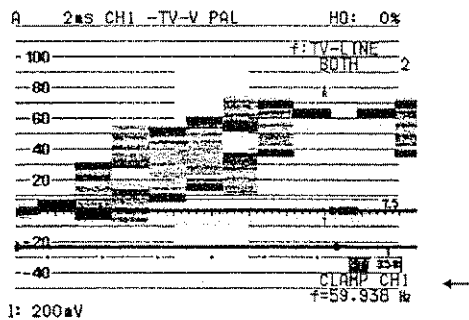

[Note 1] During the V synchronizing period of HDTV, waveform may be distorted due to the disabled clamp operation.

[Note 2] The reference level may not become stable if the TV signals are not synchronized.

[Note 3] The clamp level is ± 1 div or less from GND.

Back porch

The position of the back porch is shown in the figure on the right. Because the waveform is displayed with its back porch clamped to the ground level, a stable observation of fluctuating signals can be obtained.

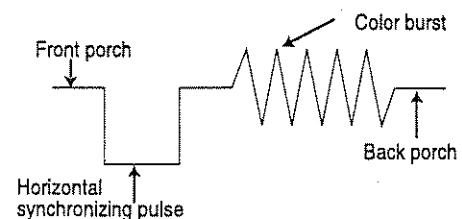

1.5.4 TV Scale

See page 11 "Setting Item" for detail.

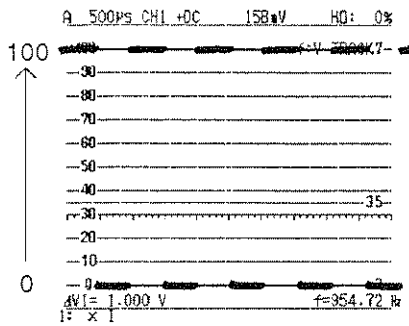

◇ When the EIA scale is selected, input 1V = 140 IRE (full scale) is set automatically.

Voltage sensitivity display : $\times 1$

◇ When the CCIR scale is selected, input 1V = 100 IRE (full scale) is set automatically.

Voltage sensitivity display : $\times 1$

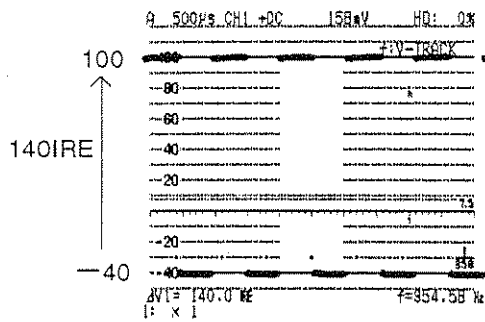

◇ When VARIABLE is selected in cursor (ΔV) measurement, $\Delta V1/V2 = \text{O O O}$ IRE is displayed.

◇ Voltage sensitivity is displayed in ratio.

[Example] $1/50 \dots \times 1 \dots \times 50$

1.6 Event Trigger

Selects the event trigger (count or burst).

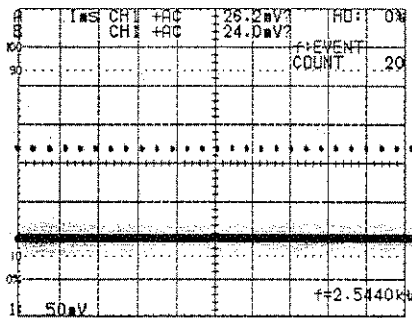

Procedures

- ① Set the TV trigger mode to OFF.
 - Refer to page 31 "TV Trigger" for the setting method.
- ② Press **EVENT/TV CLAMP** to select COUNT, BURST, or OFF.
 - Operations after procedure ② vary depending on the item selected.

When COUNT was selected

- Function display changes into f:EVENT.

- ③ Turn **[FUNCTION]** to set the number of counts.

- The range of the number of counts that can be set is 1 to 65535.
- Refer to the following page for the details of count trigger.

When BURST was selected

- Function display changes into f:EVENT.

- ④ Turn **[FUNCTION]** to set the Burst signal interval.

- The setting time range is 0.18 μ s to 9.99 s.
- Refer to the following page for the details of burst trigger.

When OFF was selected

- Quit from event trigger.

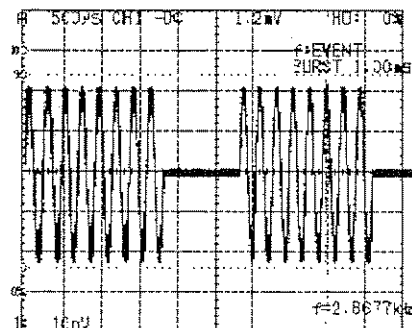

Count

This function is suitable for checking a counter circuit and so on.

An B trigger is effective when the specified number of B trigger signals have been counted after the A trigger.

[Example] An example where the count is set to 6 is shown below.

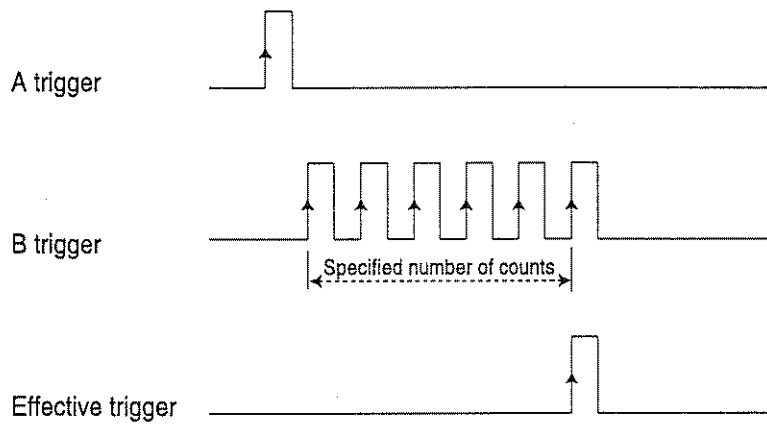

Burst

This function is suitable for observing a burst waveform.

An A trigger is effective for trigger signal after specified time interval.

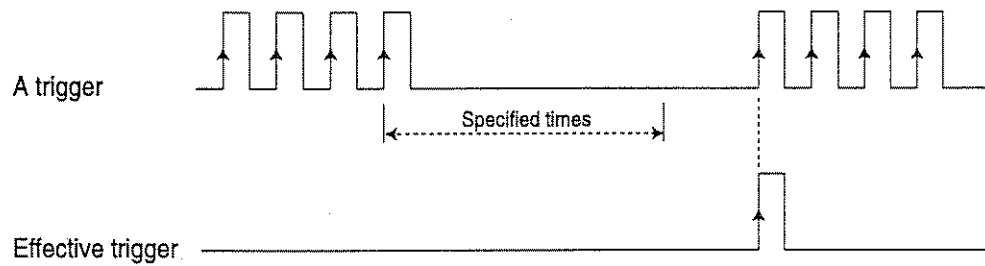

2 Horizontal Display

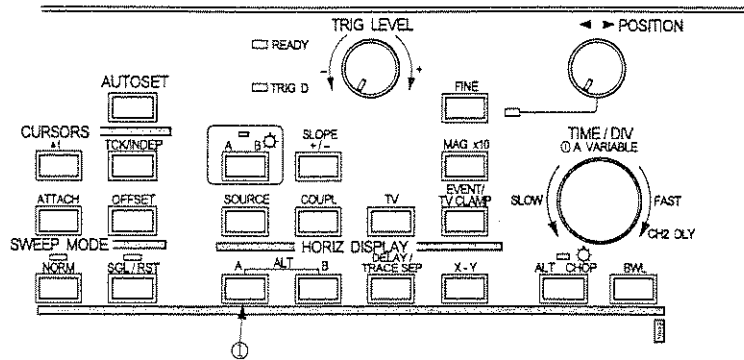

2.1 Horiz Display

Select the horizontal display A, ALT, B or X-Y.

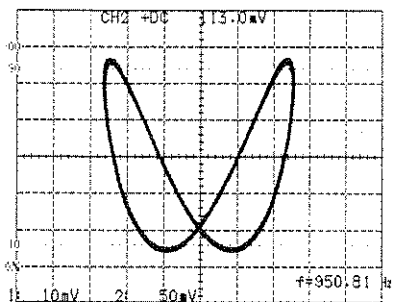
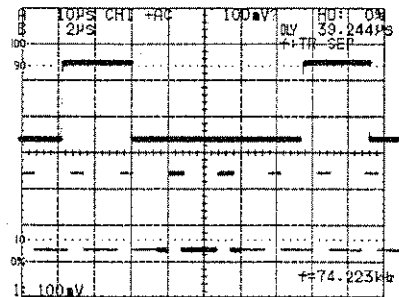
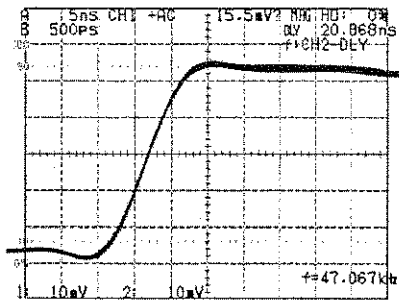
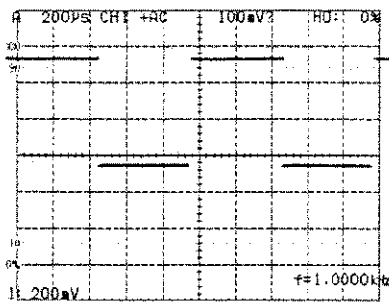

Procedures

① Select A, B, ALT or X-Y by pressing **A**, **B** or **X-Y** of the HORIZ DISPLAY mode.

• Press **A** and **B** simultaneously to select ALT.

◇ **A**

A sweep is displayed.

◇ **B**

B sweep (expanded waveform in ALT) is displayed.

Refer to page 41 "Delayed Sweep" for details.

◇ **ALT**

• A sweep (not expanded waveform) and B sweep (expanded waveform) are displayed simultaneously.

• Refer to page 41 "Delayed Sweep" for details.

• Vertical position of B sweep can be adjusted. B sweep is moved upward with respect to A sweep (refer to page 36 "Trace Separation").

◇ **X-Y**

• An X-Y display as CH1 input is the X axis and any channel (CH1, CH2, CH3, CH4, ADD) is the Y axis is displayed.

• This mode is used for hysteresis curves, lissajous waveforms, etc.

CH1 : Sine waveform approx. 950 Hz

CH2 : Sine waveform approx. 1900 Hz

2.2 Trace Separation

In ALT sweep mode, control the B-sweep waveform position.

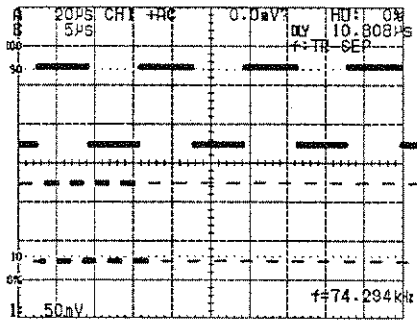
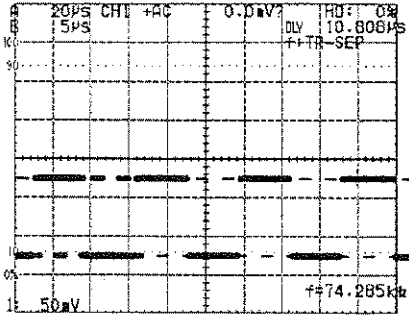

Procedures

Setting ALT sweep

- ① Set ALT by pressing **A** and **B** of the HORIZ DISPLAY mode.
 - A-sweep waveform and B-sweep waveform are overlapped.

Setting TRACE SEP

- ② Press **DELAY/TRACE SEP** to select TRACE SEP.
 - The function display changes as f:TR-SEP.

Control B waveform position

- ③ Set the vertical position of the B-sweep waveform by turning **[FUNCTION]** (only upward setting is available).
 - When pressing or depressing the **[FUNCTION]**, coarse adjustment is available.

◇ The further coarse adjustment is available by turning while depressing.

3 A Sweep and B Sweep

Selects A sweep or B sweep.

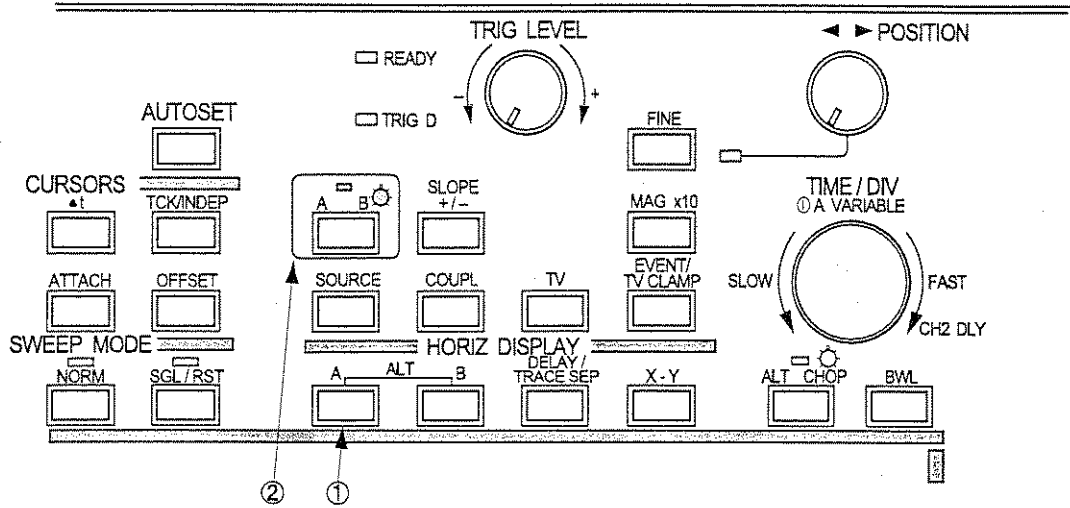

Procedures

① Select ALT or B HORIZ DISPLAY.

② Select A or B by pressing **A B**.

- The indicator lights when B is selected.

A : For setting the sweep rate and trigger for normal sweep
 B : For setting the sweep rate and trigger for delayed sweep

	Sweep rate	Slope	Level
	Signal source	Coupling	
A	5ms	CH1 +	DC 200mV
B	1ms	CH1 -	AC 20mV

◇ Select A for setting the following items.

- A sweep rate
- Trigger signal source for A trigger
- Trigger slope for A trigger
- Trigger coupling for A trigger
- Trigger level for A trigger

A	5ms	CH1 +	DC 200mV
B	1ms	CH1 -	AC 20mV

Labels below the table:
 A: Sweep rate, B: Signal source, CH1: Slope, +: Coupling, DC: Level

◇ Select B for setting the following items.

- B sweep rate
- Trigger signal source for B trigger
- Trigger slope for B trigger
- Trigger coupling for B trigger
- Trigger level for B trigger

4 Sweep Rate and Magnification

4.1 Sweep Rate

Selects the sweep rate (TIME/DIV) of A sweep or B sweep.

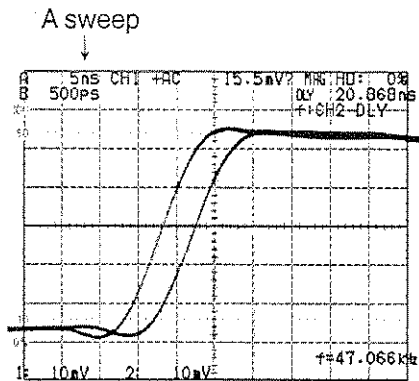

Procedures

Selecting A/B sweep

- Press **A B** to select A sweep or B sweep (the indicator lights).

Setting the TIME/DIV

- Turn **[TIME/DIV]** to select the sweep rate.
 - The sweep rate is displayed at the upper left corner of the screen.
 - The waveform is magnified or shrunk on the basis of the sweep start point.
 - Proceed to step ③ to set variable adjustment (A sweep only).

Setting the VARIABLE

- Press **[TIME/DIV]**; the variable sweep rate is displayed at the upper left corner of the screen.
- Turn **[TIME/DIV]**; the sweep rate varies continuously between steps.
 - "VAR LIMIT" is displayed when the set value reaches the maximum or minimum value.
 - To release the variable setting mode, press **[TIME/DIV]** again.

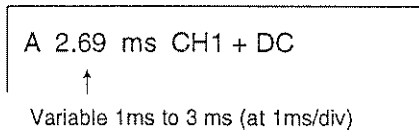

4.2 Magnification (MAG x 10)

Magnifies the waveform by 10 times from the center of the screen to the left and right.

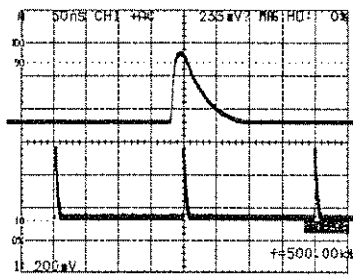

Center line (magnification reference point)

Procedures

- Set the portion of the waveform to be magnified to the center of the screen with horizontal **[◀ POSITION ▶]**.
- Press **x 10 MAG**.
 - The sweep rate is set to 10 times faster and the waveform is magnified to the left and right from the center line of the screen.
 - MAG is displayed at the upper right corner of the screen.

4.3 CH2 Delay Adjust (CH2 DLY)

When measuring the time difference between two signals, preliminary adjustment of the scope's CH1 and CH2 time difference enables highly accurate measurement. The available adjustment range (including the two connection cables) is within 1nsec.

Connection

Connect cables as follows :

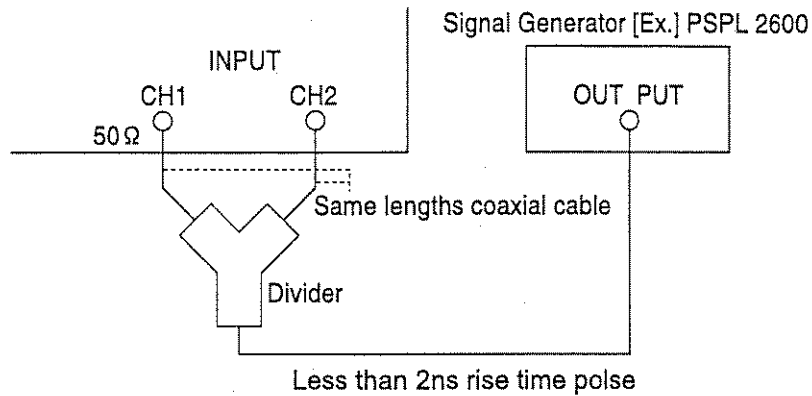

Procedures

- ① Set input resistance to 50Ω of CH1 and CH2.
- ② Set A sweep rate to 5 ns/div or 500 ps/div (x 10 MAG ON).
- ③ Select ALT by simultaneously pressing **A** and **B** of HORIZ DISPLAY.
- ④ Overlap the CH2 waveform to the CH1 waveform by turning **[FUNCTION]**.

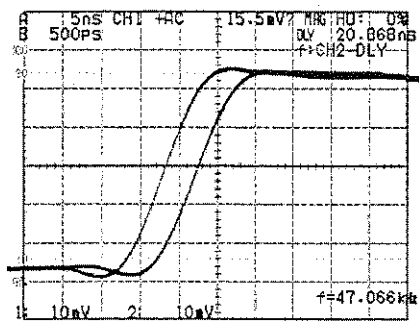

◇ Waveform before the adjustment

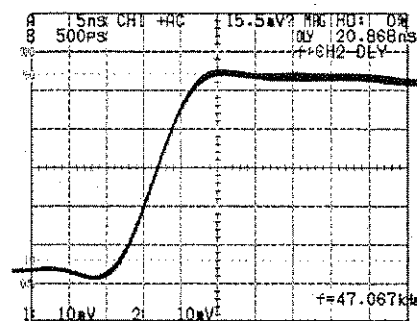

◇ Waveform after the adjustment

5 Sweep Mode

Selects the sweep mode (AUTO, NORM or SINGLE).

5.1 Repetitive Sweep

Selects AUTO or NORM.

Procedures

- ① Select repetitive sweep by pressing **AUTO** or **NORM** in the **SWEEP MODE**.
 - The AUTO indicator lights when AUTO is selected and NORM indicator, when NORM is selected.
 - If triggering is not stable, adjust **[TRIG LEVEL]**, etc.
Refer to page 29 "Triggering" for details.

AUTO (automatic sweep)

- If no trigger signal, the sweep freeruns.
- When the trigger signal frequency is approx. 10 Hz at a sweep rate between 500 ms and 10 ms/div, or less than approx. 50 Hz at a sweep rate of 5 ms/div or faster, triggering may be unstable. In this case, change to NORM.

NORM (normal sweep)

- If a new trigger does not occur, sweep stops.
- Only when the trigger source is CH1 or CH2 and the input coupling is GND, the sweep start freeruns for trace identification.

5.2 Single Sweep

Only once sweeps when a trigger signal is applied next trigger signals are ignored till set to ready.

"Pressing ERASE" can erase the displaying waveform.

[Note] In single sweep condition, the storage mode is always set to storage.

Procedures

- ① Select single sweep by pressing **SGL/RST** in the **SWEEP MODE** (the SGL/RST indicator lights).
 - The READY indicator lights to indicate the state waiting for trigger signal.
 - ◇ Sweep is starts once when a trigger signal is applied.
 - The READY indicator goes off.
 - In the CHOP mode, all channels are swept simultaneously (500ms to 50 μ s).
 - In the ALT mode, every time a trigger signal is applied, the sweep channel is changed sequentially as CH1 → CH2 → CH3 → CH4.
- ② To start the single sweep again, press **SGL/RST**.

6 Delayed Sweep

Selects the delayed sweep mode (continuous delay, triggered delay).

6.1 Continuous Delay

B sweep starts after a specified delay time period from the A sweep start point. The specified portion of the waveform is displayed as an expanded waveform. This function is valid when HORIZ DISPLAY is set to ALT or B.

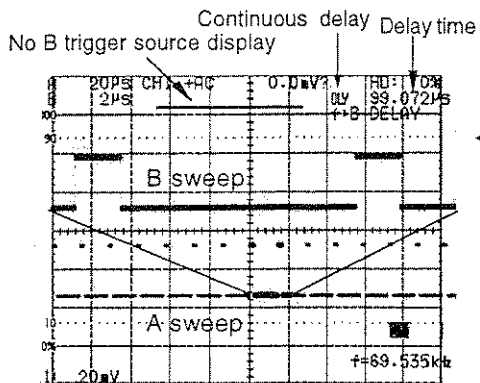

Procedures

Selecting ALT sweep

- ① Select ALT by pressing **A** and **B** in the HORIZ DISPLAY mode.
 - A sweep and B sweep are displayed.
 - The intensity-modulated portion of A sweep (in the lower area of the screen) is expanded and displayed as B sweep (in the upper area of the screen).
 - B sweep is separated from A sweep for convenience of explanation. For the method of separation, refer to page 36 "Trace Separation".

Selecting the B-sweep rate

- ② Select B by pressing **A B** (the B indicator lights).
- ③ Select the B-sweep rate by turning **[TIME/DIV]**.
 - The ratio between A sweep and B sweep varies.
 - The B-sweep rate cannot be set slower than the A-sweep rate.

Selecting of continuous delay

- ④ Select the B trigger source to blank on the screen display by pressing **SOURCE**.

Selecting the delay time

- ⑤ Select **DELAY** by pressing **DELAY/TRACE SEP**.
 - Function display changes into f:B-DELAY

A 5ms CH1 + DC A level
 B 1ms - AC B level
 No display of trigger source B

Delay time → DLY nnn
 Function display → f: B-DELAY

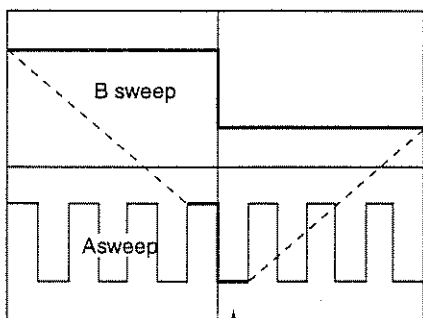

The intensified portion moves continuously

- ⑥ Adjust the delay time by turning **[FUNCTION]**.
 - When pressing or depressing the **[FUNCTION]**, coarse adjustment is available.

6.2 Triggered Delay

Triggers the B sweep with the trigger signal after the specified delay time. The triggered delay reduce the delay pick off jitter of the continuous delay.

Procedures

① to ③ same as those in page 41 "Continuous Delay".

Selecting of trigger delay

← ④ Select trigger source B by pressing **SOURCE**.

Triggering of B sweep

⑤ Trigger B sweep by turning **TRIG LEVEL**.

- The method for triggering is the same as that for A sweep (refer to page 29 "Triggering").

Selecting the delay time

← ⑥ Select **DELAY** by pressing **DELAY/TRACE SEP**.

- Function display changes into f:B-DELAY.

← ⑦ Adjust the delay time by turning **[FUNCTION]**.

- When pressing or depressing the **[FUNCTION]**, coarse adjustment is available.
- Although the DLY value varies continuously in trigger delay mode, it does not show the actual delay time, and it is added the ">" mark.

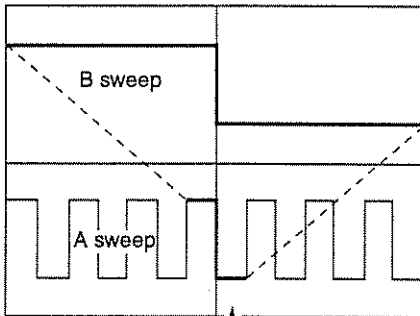
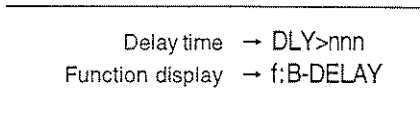
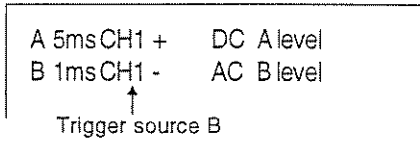

The intensified portion moves to the next trigger point.

6.3 Selecting B ENDS A

Terminates the A sweep at the end of B sweep.

The sweep length is shortened after the intensified portion (B trace) of the A trace.

The sweep repetition rate is increased by deleting A sweep time, and brightness is increased.

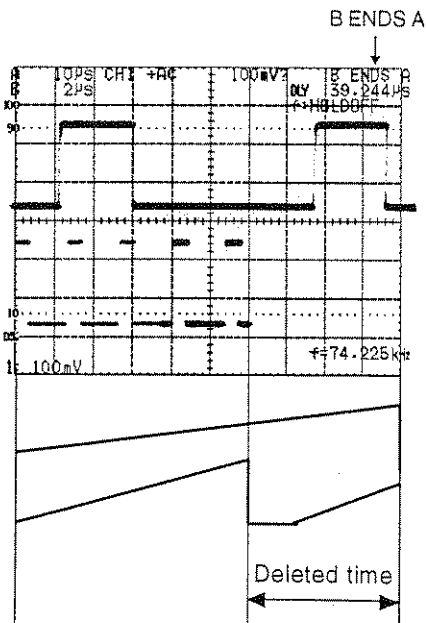

Procedures

① Select **HOLDOFF** by pressing **HOLDOFF**.

- For details of **HOLDOFF**, refer to page 43 "Holdoff".

② Set the hold-off time to a value larger than 100% by turning **[FUNCTION]**; the B ENDS A mode is set.

The following timing chart shows the difference between DLY value and actual delay time.

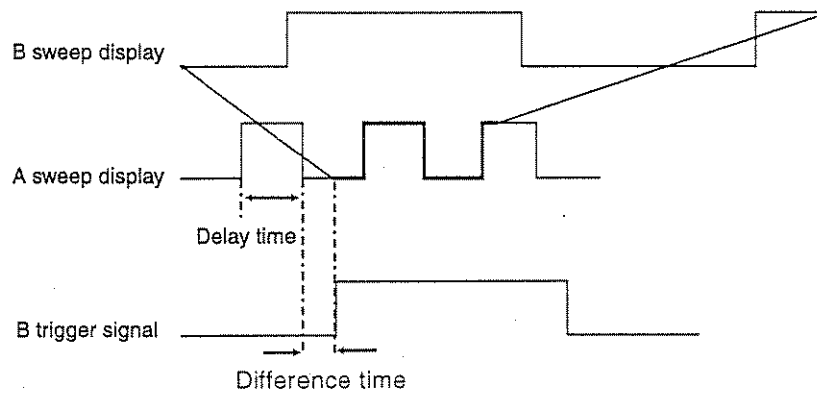

7 Holdoff

Sometimes stable triggering cannot be obtained when observing a complex pulse train. In this case, adjust the holdoff (sweep halt) time so that a stable waveform can be obtained.

H0 : nn%
f : HOLDOFF

Procedures

- ① Select HOLDOFF by pressing **HOLDOFF**.
 - Function display changes into f:HOLDOFF.
- ② Adjust the holdoff time by turning **[FUNCTION]**.
 - When pressing or depressing the **[FUNCTION]**, coarse adjustment is available.
 - The holdoff time becomes the maximum value (100%) when **[FUNCTION]** is fully turned clockwise, and the minimum value (0%) when fully turned counterclockwise.
 - Usually, the holdoff time is set to 0%.

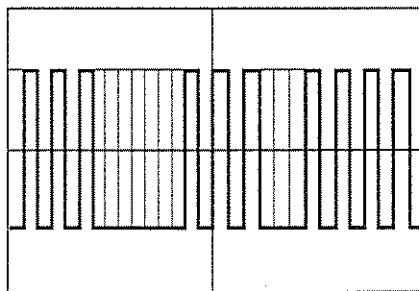

Waveform before adjustment (not one trace)

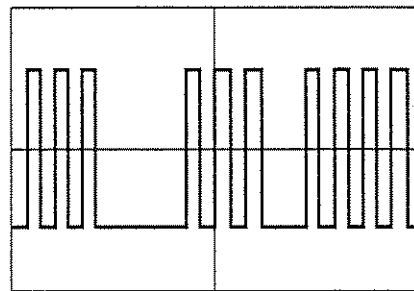

Waveform after holdoff adjustment

Adjustment of the hold-off (sweep halting) time

Adjust the period from the end of sweep to the ready to trigger (hold-off time) so as to prevent any triggering by an unnecessary trigger signal.

Storage

TS-8500 has 5cm/ns ultra high writing speed by using newly developed CCD type scan converter tube.

1 Scan Converter Tube

Electron beam from the cathode is deflected by the vertical and horizontal deflection plates, and expanded by box lens, finally reach to the screen then a waveform is drawn and visible.

The drawn waveform is captured by CCD (Charge Coupled Device) over OFP (Optical Fiber Plate).

The OFP is bundle of many thin optical fibers, for isolation of the screen potential (+20kV) to the CCD potential (zero voltage) and for getting clear waveform without diffusion.

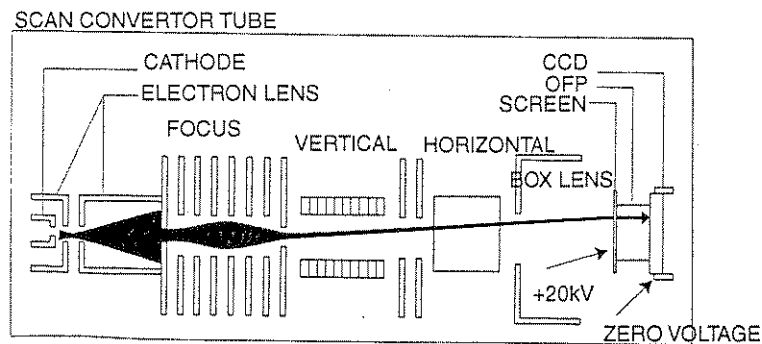

◇ Beam density

The drawing area of the screen is approximately 10mm×8mm.

Conventional oscilloscope has 10cm×8cm display-area.

From simple calculation the ratio of electron beam density is 100 times.

Distance

Distance between the drawn waveform and CCD is very close about 10mm.

Usually the distance between normal oscilloscope and eye is about 30cm.

The ratio of brightness is calculated 30 powered 2 equal 900.

Total brightness ratio

Total ratio of brightness is 100 times×900 times equal 90000.

But sensitivity of CCD and loss of OFP affect to reduce the number of ratio.

In conclusion, scanning converter tube has 20000-30000 times brightness.

◇ What is writing speed?

This guide number is similar to signal shot bandwidth of CCD.

It express storage ability of how high frequency or fast transition signal.

TS-8500 has 5 div/ns writing speed, the unit div/ns shows electron beam moving speed of CRT.

When the 500 MHz sine wave is input, up to 3.18 div amplitude (Peak-Peak div) is stored.

The calculation is as follows.

$Ws = A \pi f$. (The speed in the point that the sine wave crosses 0° , 180° and 360°)

Ws:(Writing speed) A:Amplitude (Peak-Peak) π :3.14 f:Frequency (Hz)

$5 \text{ div/ns} = 5 \times 10^9 \text{ div/s}$

$5 \times 10^9 = A[\text{div}] \times 3.14 \times 500 \times 10^6$ A=3.18[div]

Pulse

The pulse transition is assumed to be a straight line, Tr is defined the time from 10% to 90% of amplitude. So amplitude of pulse is supposed to A. Tr=rise time $A=1.25 \times Ws \times Tr$

Relation of writing speed and amplitude

Sine $WS = \pi \times Af$ $A = WS / \pi f$
 Pulse $WS = A / (1.25 \times sTr)$ $A = WS(1.25 \times Tr)$

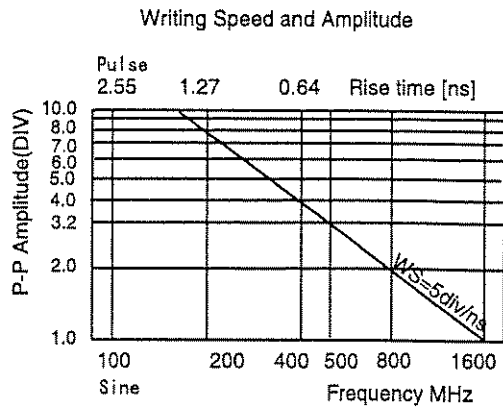

2 Inherent Phenomenon of Scan Converter Tube

Smear

Figure A

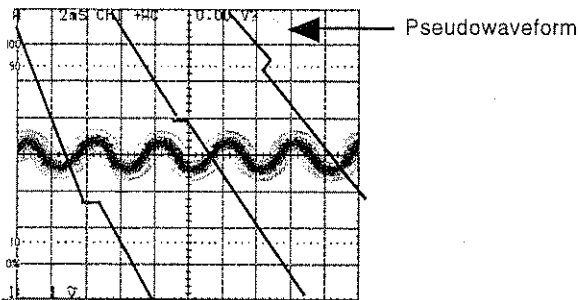

As shown in figure A, the pseudowaveform appears because of over brightness of the trace when the repeated signal is observed in slow sweep rate. It is called a smear. The smear is inherent of CCD (Charge coupled device) used for the scan converter tube.

Distortion on the tube

As shown in figure B, some trace shift are recognized at some parts of the LCD screen.

Figure B

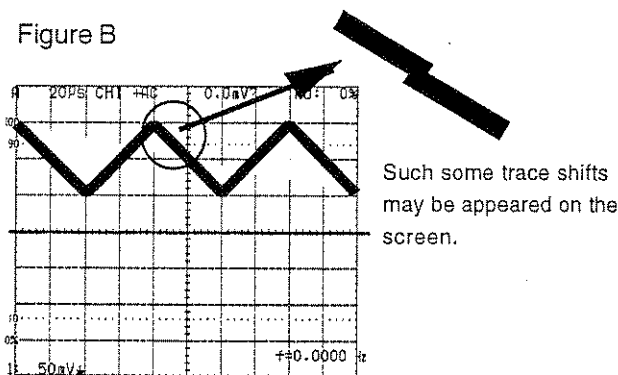

Those are called Shear distortion, and not failure of the scope. Shear distortion is caused by the O.F.P (Optical Fiber plate) used for the scan converter tube.

◇ TFT(thin film transistor) color liquid crystal display is carefully made by high technology. It has some defects such as some non-light points and always lighting points.

3 Storage Operation

◇ Storage : There are three ways of the storage operations to store the measuring signal.

Storage Operation	Persistence Time	Channels	Sweep Mode	Measuring Example
1. [PERSISTENCE]	Infinite persistence	1 to 4	AUTO/NORM	Jitter signal, intermittent noise
	Variable persistence	1 to 4	AUTO/NORM	Slow repetition rate signal
2. [STORAGE]	Infinite persistence ^{*1}	1 to 4	AUTO/NORM	Waveform comparison
3. [SINGLE]	Infinite persistence ^{*1}	1	SINGLE	Single shot signal

◇ ^{*1} PERSISTENCE time is set to infinite automatically, no adjusting available.

◇ [PERSISTENCE] : The persistence time of the displayed waveform can be adjustable.
 Infinite persistence : Keeps the stored waveform by turning [PERSISTENCE] fully clockwise.
 Variable persistence : The stored waveforms fade out gradually by determined persistence time.

◇ [STORAGE] : Current and stored waveforms are displayed simultaneously.
 It is convenient to compare both waveforms.

◇ ERASE : Erases the STORAGE or PERSISTENCE waveform. When AUTO ERASE is selected in the [SINGLE] mode, stored waveform is erased by whenever [SGL/RET] is pressed.

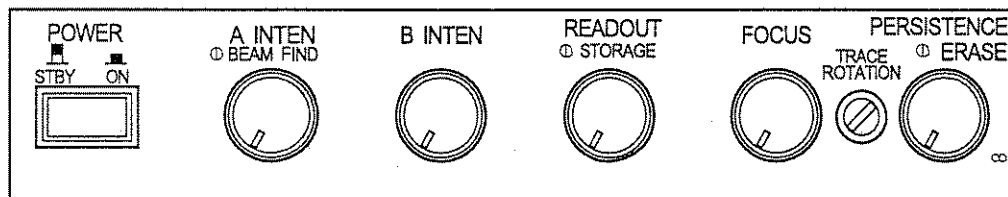

3.1 Measuring in [PERSISTENCE] Display

a. Measuring of jitter signal (infinite persistence)

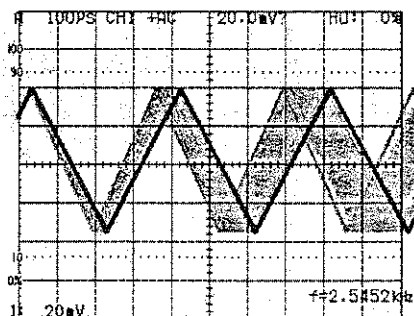

Procedures

- ① Turn [PERSISTENCE] to fully clockwise.
- ② Select AUTO or NORM of SWEEP MODE.
- ③ Set [A INTEN] to get the adequate trace intensity.
 - [Example] The fractured frequency.

b. Low repetition rate signal (variable persistence)

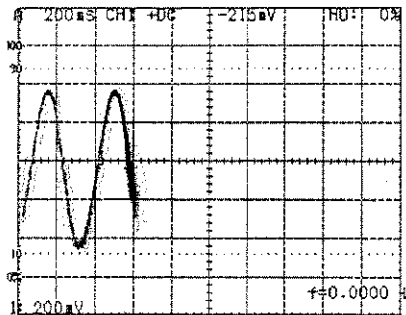
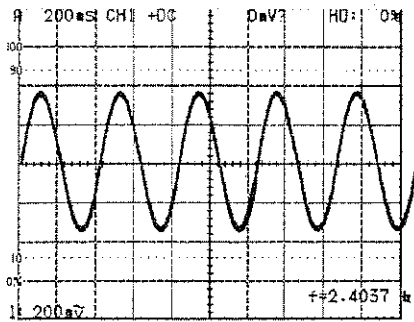

Procedures

- ① Set SWEEP MODE to **NORM**.
 - ② Set **[A INTEN]** to get the adequate trace intensity.
 - ③ Set **[PERSISTENCE]** to get the adequate persistent trace time.
 - ④ Repeat procedure ② and ③.
- ◇ Press **[ERASE]** to erase the waveform.
- [Example] Approx 2.5 Hz sine wave is measured by infinite persistence time.
The entire waveform is remained.
 - [Example] Approx 2.5 Hz sine wave is measured by minimum variable persistence (fully counterclockwise).
Only short tail of sweep spot is displayed since there is short persistence time.

3.2 Measuring with **[STORAGE]**

Allows you to store the all trace on the screen.

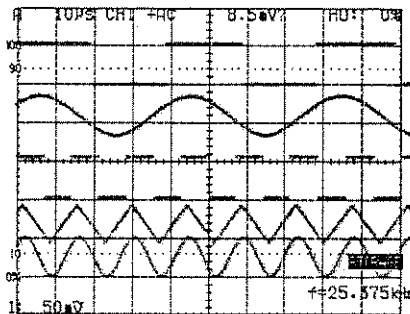
Waveform comparison

Procedures

- ① Set SWEEP MODE to **NORM**.
 - ② Set **[A INTEN]** to get the adequate trace intensity.
 - ③ Press **[STORAGE]** to store the waveform.
 - ④ [Example] This waveform are stored by changing **[▲POSITION▼]** and **[TIME/DIV]**.
 - ⑤ Whenever **[STORAGE]** is pressed, the all current sweep trace on the screen is stored.
- ◇ **STORAGE** is displayed at the under right of the screen.
- ◇ **[ERASE]** : Erases the **STORAGE** character and the waveform.
Press **[ERASE]** then **STORAGE** and STORED waveform are disappeared.

3.3 Measuring in [SINGLE] Sweep Mode

In single sweep condition, the storage mode is always set to storage. The value of intensity is set automatically to get proper brightness after TIME/DIV is changed. If you want to control the brightness, turn [A INTEN], the brightness is controlled.

- ◇ If automatic brightness setting is not proper, the value is adjusted by "AUTO INTEN ADJUST" of the system menu (Refer to page 14 "Setting of SYS-MENU").

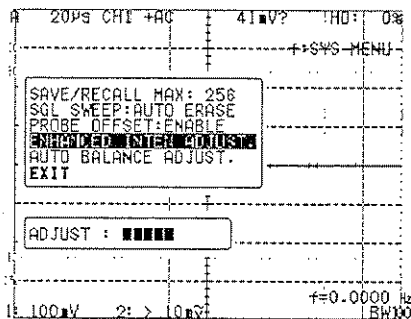
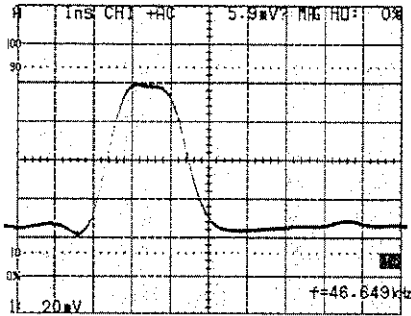

Capturing the single shot signal

Procedures

- ① Press [SGL/RST] to select single sweep in the SWEEP MODE (the SGL/RST indicator lights).
 - The READY indicator lights to indicate the state waiting for signal input.
- ◇ A sweep runs once when a trigger signal is applied.
 - The READY indicator goes off after the sweep ends.
 - After the sweep ends, **STOP** is displayed at the lower right of the screen.
 - In the CHOP mode, all channels are swept simultaneously (500 ms to 50 μ s).
 - In the ALT mode, every time trigger signal is applied, one channel is swept sequentially.
- ◇ Press [ERASE] to erase the waveform.
- ② Press [SGL/RST] to set the scope ready again.
 - Figure is a single sweep waveform with pulse width approx 2.0 ns and TIME/DIV is 1 ns/div.

[Example] When TIME/DIV is faster than 20 μ sec/div, the scope sets ALT even if LED of CHOP indicator lights.

ERASE by SINGLE (single sweep)

AUTO ERASE : ERASE occurs automatically whenever [SGL/RST] is pressed.

MANUAL ERASE : Press [ERASE]. (Enables over-write.)

Counter and Cursors Measurement

Measures the time difference and frequency (Δt , $1/\Delta t$) or voltage difference (ΔV) using cursors.

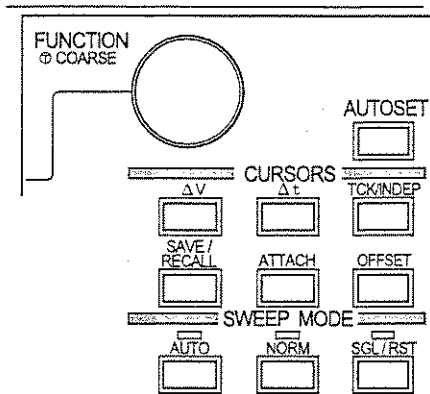

◇ Selecting of the measurement item

- Select ΔV (voltage measurement) by pressing ΔV or select Δt (time measurement) by pressing Δt .

◇ Methods of cursors measurement

- When Δt or ΔV has been selected, two cursors for measurement are displayed.
- When pressing or depressing the [FUNCTION], coarse adjustment is available.

1 Time Difference (Δt) and Frequency ($1/\Delta t$) Measurement

Measures the time difference (Δt) and frequency ($1/\Delta t$) between the cursors.

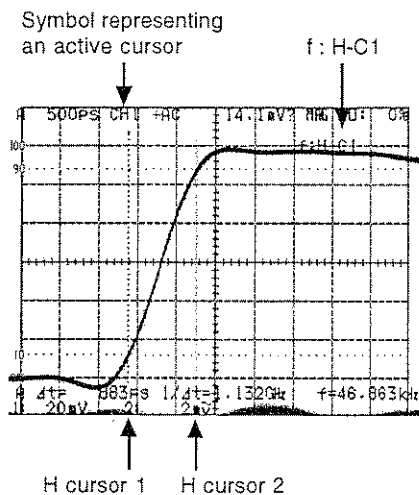

Procedures

- ① Press Δt to select Δt .

- H cursor 1 and H cursor 2 are displayed.
- The value of Δt (time difference) and $1/\Delta t$ (frequency) between cursor 1 and cursor 2 are displayed at the lower left corner of the screen.

Setting cursor 1

- ② Press TCK/INDEP to select C1 (cursor 1).

- The function display changes into f: H-C1.
- Symbol "I" displayed above H cursor 1 indicates that H cursor 1 is active.

- ③ Turn [FUNCTION] to set H cursor 1 (|) position.

Symbol representing an active cursor

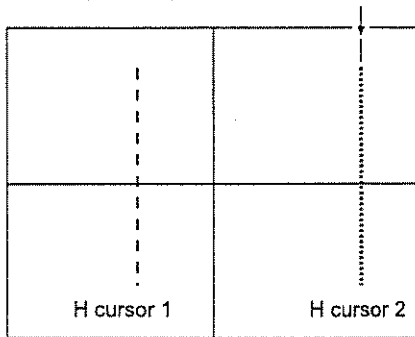

A $\Delta t=883$ ps $1/\Delta t=1.132$ GHz

Setting cursor 2

- ← ④ Press **TCK/INDEP** to select C2 (cursor 2)
 - The function display changes into f : H-C2.
 - Symbol " I " appears above H cursor 2 indicating that cursor 2 is active.
- ← ⑤ Turn **[FUNCTION]** to set H cursor 2 (|) position.

- ← • The value of Δt (time difference) and $1/\Delta t$ (frequency) between cursor 1 and cursor 2 are displayed at the lower left corner of the screen.

Symbol representing active cursors

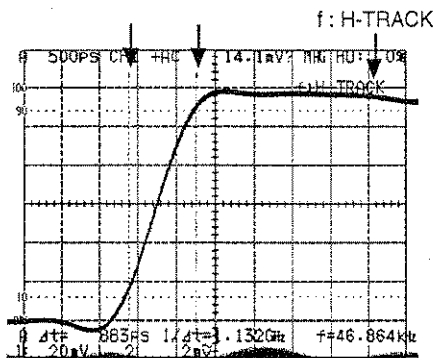

Setting the tracking

- ← ⑥ Press **TCK/INDEP** to select TCK (tracking).
 - Function display changes into f:H-TRACK.
 - Symbol " I " appears above H cursor 1 and H cursor 2 indicating that both cursors are active.
- ← ⑦ Turn **[FUNCTION]**, then H cursor 1 and H cursor 2 move together with keeping the span.

Releasing Δt measurement

Select OFF (no cursor display) by pressing **Δt** .

2 Voltage Difference (ΔV) Measurement

Measures the voltage between the cursors.

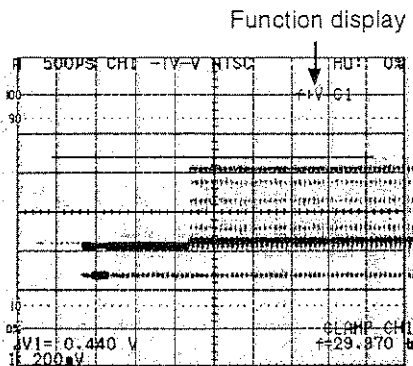

Symbol representing an active cursor

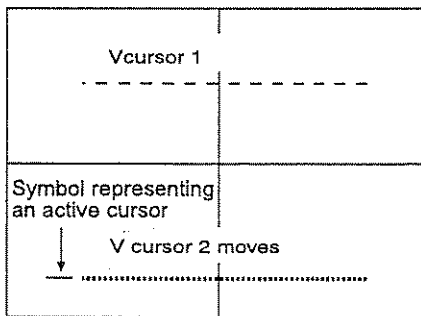
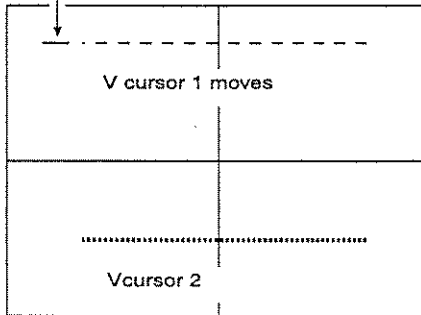

$\Delta V1 = 59.2 \text{ mV}$ $\Delta V2 = -0.592 \text{ Hz}$

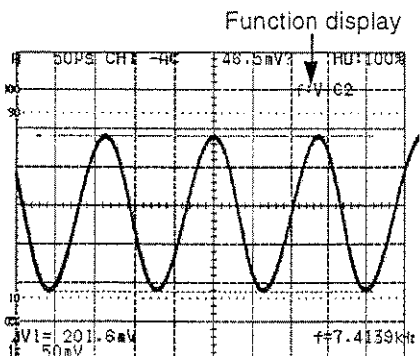

Procedures

- ← ① Press **ΔV** to select ΔV .
 - V cursor 1 and V cursor 2 are displayed.
 - The value of $\Delta V1$ (CH1) and $\Delta V2$ (CH2) between cursor 1 and cursor 2 are displayed at the lower left-hand corner of the screen.

Setting cursor 1

- ← ② Press **TCK/INDEP** to select f:V-C1.
 - The function display changes into f:V-C1.
- ← • Symbol "—" appears to the left of V cursor 1 indicating that V cursor 1 is movable.
- ③ Turn **[FUNCTION]** to set **V cursor 1** (----) position.
 - V cursor 1 and V cursor 2 move simultaneously.

Setting cursor 2

- ← ④ Press **TCK/INDEP** to select f:V-C2.
 - The function display changes into f:V-C2.
- ← • Symbol "—" appears to the left of V cursor 2 indicating that V cursor 2 is active.
- ⑤ Turn **[FUNCTION]** to set **V cursor 2** (.....) position.

- ← • The results of measurement of the voltage differences between the newly set cursors are displayed in the lower left-hand corner of the screen.

- When two or more channels of waveforms are displayed, select the channel to measure by pressing **ATTACH**.

Symbol representing a cursor movement

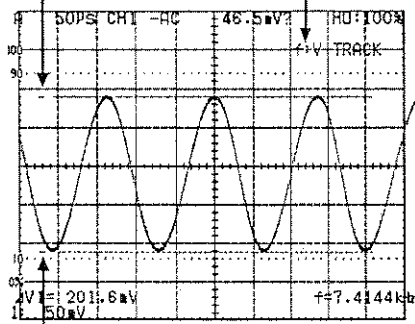

Symbol representing a cursor movement

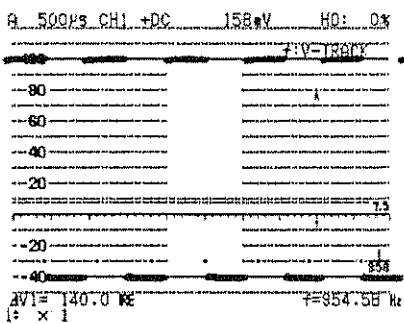

Setting the tracking

- ← ⑥ Press **TCK/INDEP** to select TCK (tracking).
 - Function display changes into f:V-TRACK.
 - Symbol "I" appears to the left of V cursor 1 and V cursor 2 indicating that both cursors are movable.
- ← ⑦ Turn **[FUNCTION]**, then V cursor 1 and V cursor 2 move together while maintaining the interval between them.

Release ΔV measurement

Press **ΔV** to select OFF (no cursor display).

ΔV1/V2=○○○ IRE display

- ◇ When the fine adjuster (VARIABLE) is selected on the EIA or CCIR scale, ΔV1/V2=○○○ IRE is displayed.

3 Counter

Measure the frequency of the input signal by the frequency counter.

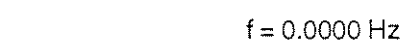
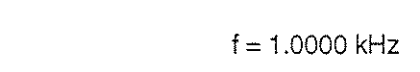

Procedures

- ① Trigger A (refer to page 29 "Triggering")
 - The A trigger frequency is always displayed at the lower right corner of the screen.
 - The frequency range is 2 Hz to 500 MHz.
 - When A triggering is not set or the input signal exceeds the measuring frequency range, 0 Hz is displayed.

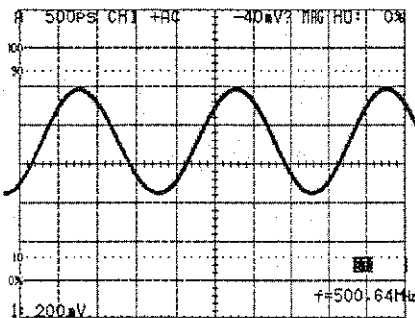

Dual Delay Function

Measures the time difference between two points of the signal with high accuracy and to compare those expanded waveforms.

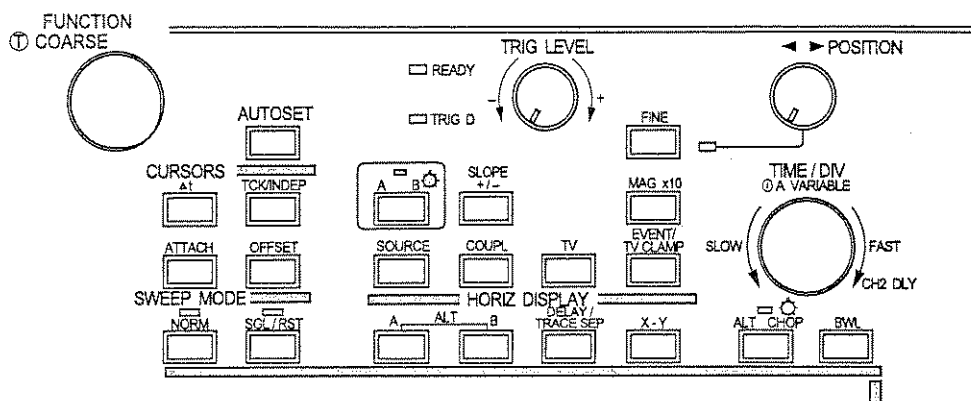

1. Setting the Dual Delay

1.1 Single Channel

Sets two intensified portions of one channel to display two expanded waveforms.

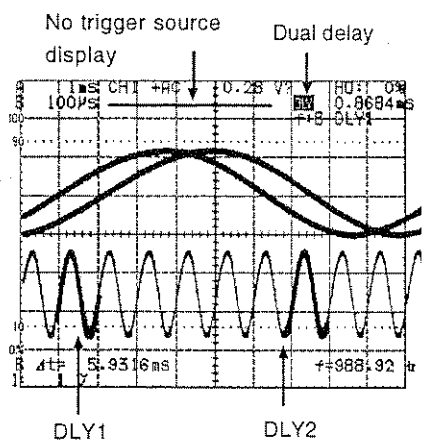

Procedure

Selection of display channel

- Press **CH1**, **CH2**, **CH3** or **CH4** to select single channel ON (display).

Setting the B sweep rate

- Press **A** and **B** of the **HORIZ DISPLAY** mode simultaneously to select **ALT**.
 - The B indicator lights.
 - Turn **[TIME/DIV]** to set the B-sweep time.
 - A sweep and B sweep are displayed.
- Press **A B** to select B.
- Press **SOURCE** to set the screen with no display of trigger source B.

Setting the Δt

- Press **Δt** (The delay mark "DLY" is changed to **DLY** dual delay mode).

Setting the DLY1

- Press **TCK/INDEP** to select f:B-DLY1 function item.
- Turn **[FUNCTION]** and set the first intensified portion to the measuring point.

Setting the DLY2

- Press **TCK/INDEP** to select f:B-DLY2 function item.
- Turn **[FUNCTION]** and set the second intensified portion to the measuring point.

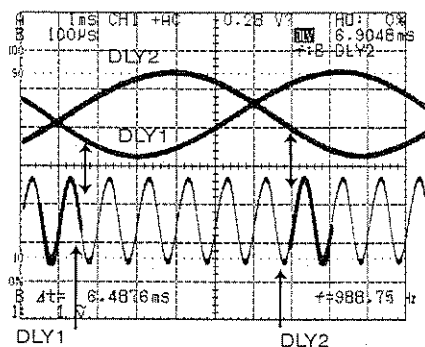

Setting of tracking

- ⑩ Press **TCK/INDEP** to select f:B-DLY-TCK function item.
- ⑪ Turn **[FUNCTION]**, the two intensified portion move together with keeping the span.

Release of dual delay

- Press **Δt** of CURSOR to select OFF.
- The delay indication is changed to DLY.

1.2 Two or More Channels

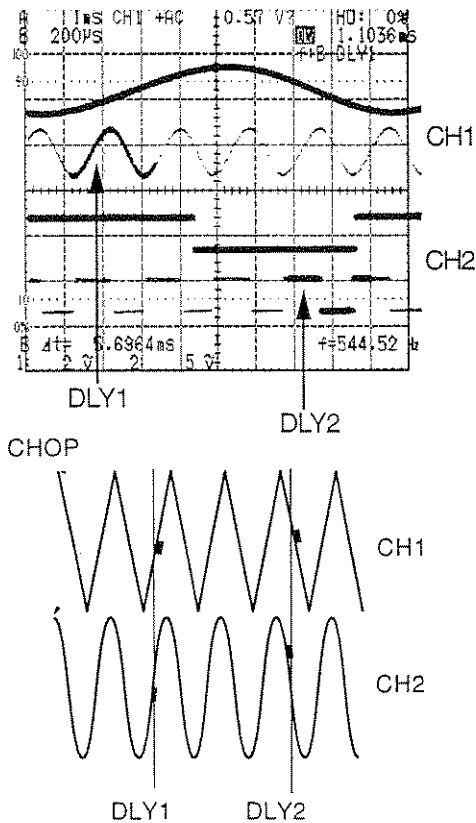

ALT

Two delay portions are set at the specified part of a different channel. The channel with the highest priority level is set to DLY1 and the other channels to DLY2.

The priority level is ADD→CH1→CH2→CH3→CH4.

Procedures (ALT of CH1 and CH2)

Dual delay operation procedure is the same (former page "one channel" ② to ⑤, ⑩ to ⑪).

Setting the DLY1

- ⑥ Press **TCK/INDEP** to select f:B-DLY1 function item.
- ⑦ Turn **[FUNCTION]** and set the first intensified portion to the measuring point of CH1.

Setting the DLY2

- ⑧ Press **TCK/INDEP** to select f:B-DLY2 function item.
- ⑨ Turn **[FUNCTION]** and set the second intensified portion to the measuring point of CH2.
 - [Example] CH1→DLY1, CH2→DLY2

CHOP

Sets the delay time at the two specified parts of the individual channel on the each displaying waveform. Dual delay operation is the same [former page "one channel" ② to ⑤, ⑩ to ⑪].

2 Trace Separation Display in Dual Delay Function

ALT or **B** of the horizontal display mode.

The trace separation display is varried by in dual delay, the vertical position of DLY1 and DLY2 is controllable to a suitable position by trace separation.

ALT : Controls [DLY1,DLY2] position from A sweep, can not separates DLY1 and DLY2. (A sweep can not be controled)

B : Controls DLY2 position from DLY1. (DLY1 can not be moved)

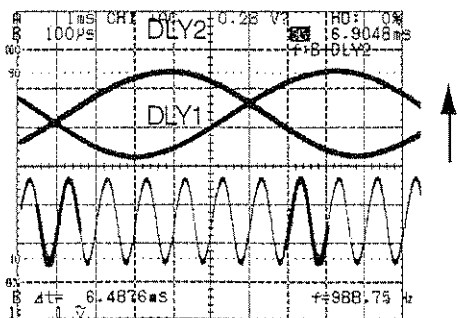

Procedures

Setting the ALT

- ① Press **A** and **B** of the HORIZONTAL DISPLAY.
- ② Press **DELAY/TRACE SEP** to select TRACE SEP.
 - The scope displays TR-SEP.
- ③ Turn **[FUNCTION]** to set the vertical position of the DLY2 (B sweep).
 - When pressing or depressing the **[FUNCTION]**, coarse adjustment is available.

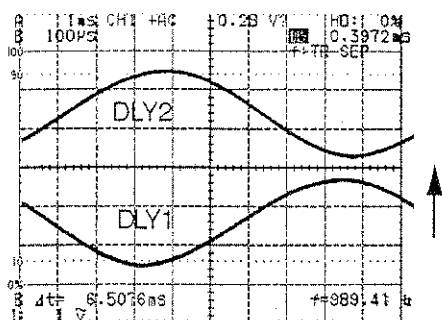

Selecting B

- ① Press **[B]** in HORIZ DISPLAY.
- ② Press **[DELAY/TRACE SEP]** to select TRACE SEP.
The scope displays TR-SEP.
- ③ Turn **[FUNCTION]** to set the vertical position of the DLY2 (B sweep).
 - When pressing or depressing the **[FUNCTION]**, coarse adjustment is available.

3 Measuring with Delta Delay Time

Dual delay can measure accurately the delay time difference (Δt) between DLY1 and DLY2.

$\Delta t = \text{DLY2} - \text{DLY1}$ one channel [Example : CH2 only]

$\Delta t = \text{CH2} - \text{CH1}$ two or more channels [Example : CH1 and CH2]

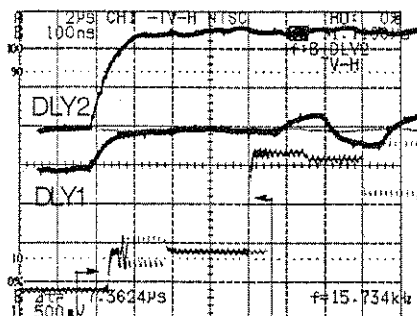

Measuring between two points of the intensified portions.

Expanded drawing

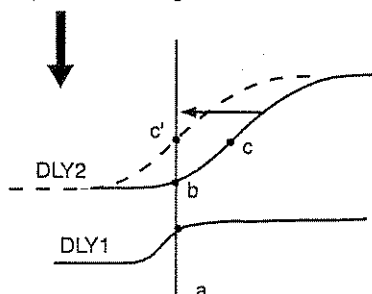

Procedures

Set DUAL DELAY.

Setting DLY1, DLY2

Refer to page 53 "Setting DLY1, DLY2".

Measuring the delta delay time

- ① Turn **[FUNCTION]** to set the DLY1 to the first and DLY2 to the second of the two intensified portions in order to measure the time interval on the A sweep waveform.
- ② Adjust **[FUNCTION]** precisely to overlap for expanded B-sweep waveform of DLY1 and DLY2.

Readout $\Delta t = \text{○○○○} \mu\text{s}$ displays the measured time difference.

[Example] Measuring TV signal

The left waveforms shows measured time difference between the DLY1-a point and the DLY2-b point.

Move DLY2-c to DLY2-c' to measure a-c interval.

◇ The delta delay time function can measure accurately between two points by overlapping two B-sweeps.

◇ Delta delay time is effective only by continuous delay (RUNS AFTER) mode.

Since the B sweep in trigger after delay mode starts by the first B trigger signal after the certain delay time, the readout value and delay time on the waveform are not correct (DLY>****ms). (refer to page 43 "Time chart")

◇ If you compensate CH2-Delay Adjust (refer to page 39), enable the time difference measuring more accurate.

Save/Recall

Panel setup conditions can be saved and/or recalled.

1 Save

Saves several panel setup conditions.

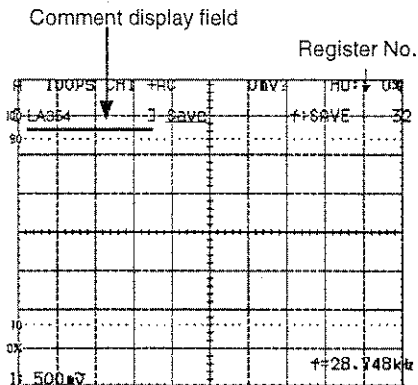

Procedures

- ① Set the panel setup conditions.

Setting the register number

- ② Press **[SAVE/RECALL]** to set to the save mode.
 - Function display changes into f:SAVE nn.
 - nn : Register number
- ③ Turn **[FUNCTION]** to select the register number to be saved.
 - The range of register numbers "n" is 1 to 32.
 - * Register numbers
- ◇ The max register numbers is set to 32 at the factory shipment. The maximum values is available up to 256 in the system menu. Refer to page 58 "SAVE/RECALL MAX".

Input of a comment

- ④ Press **[FUNCTION]**.
 - The comment-input screen is displayed.
- ⑤ Input the comment by pressing **[FUNCTION]** and turning **[FUNCTION]**.
 - Up to 12 characters can be input.
 - Refer to the following page for the details of the method to input the comment.
 - An example where comment "WAVE1" is input is shown.

Example of comment input

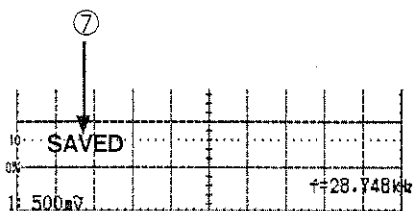
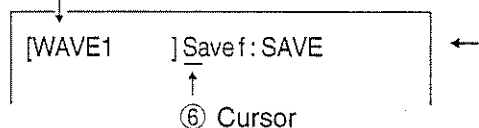

Executing save

- ⑥ Move the cursor to below S of Save by turning **[FUNCTION]**.
- ⑦ Press **[FUNCTION]**.
 - SAVED is displayed at the lower left corner of the screen.
 - The setup conditions is saved in the displayed number of register and then the save mode is released.
- ⑧ When saving multiple setup conditions, repeat procedures ① to ⑦.

Quitting from the save mode

- The **[SAVE/RECALL]** key
 The mode is switched as follows by pressing **[SAVE/RECALL]**.
 SAVE → RECALL → OFF (quit from the SAVE/RECALL mode)
 However, because the off after entering the RECALL mode, the panel setting is changed to newly recalled setting.
- Another function key
 When another function key (Example. : the **[HOLDOFF]** key) is pressed, it is possible to exit the SAVE mode without any change of the settings.

Comment input method

[_] Save f : SAVE
 32 ↑
 Changes from _ to ::

[_] Save f : SAVE 32
 ↑
 Cursor moving mode

[_] Save f : SAVE 32
 ↑
 Character input position

[: :] Save f : SAVE 32
 ↑
 Character selection mode

[: S :] Save f : SAVE 32
 ↑
 Select characters

xxxxxxx !
 ↑
 Input as the 12th character

[S] Save f : SAVE 32
 ↑
 Cursor moving mode

Procedures

- ① Cursor moving mode is switched alternately to character selection mode by pressing [FUNCTION].
 - [_] cursor display (cursor moving mode)
 The cursor moves to left or right as [FUNCTION] is turned.
 - [: :] cursor display (character selection mode)
 Characters can be selected as [FUNCTION] is turned.
- ② Set the cursor-moving mode by pressing [FUNCTION].
- ③ Move the cursor to the character input position by turning [FUNCTION].
- ④ Set the character selection mode by pressing [FUNCTION].
- ⑤ Select characters by turning [FUNCTION].
 - Characters can be selected among from numerals, capital letters, and 28 symbols.
 Space, ! " # \$ % & ' () * +, - . / : ; < = > ? @ [¥] ^ _
- ⑥ Input the selected characters by pressing [FUNCTION].
 - The cursor moving mode is set.
- ⑦ Repeat procedures ③ to ⑥.

SKIP

If you want to skip some step as step 1, 2, 3, 4, 5 to step 1, 2, 4, 5, if "!" is input at the 12th character of the comment, the register number is skipped in the recall mode. To release the skip function, delete "!" and "!" at 12th character position.

Setting and releasing a skip

When a comment has been input, that comment is immediately saved, so no more operation is needed to save the comment. After the comment is input, quit the save mode by pressing **SAVE/RECALL** or another function key.

The only comment part can be edited without affecting any setup conditions that are already saved.

2 Recall

Recalls the saved panel setup conditions.

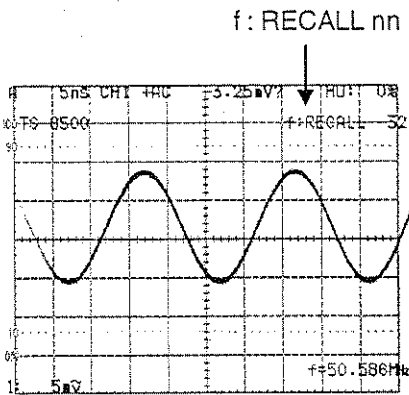

Procedures

- ① Press **SAVE/RECALL** twice to set the recall mode.
 - Function display changes into f:RECALL nn.
 - nn : is the register No. of the current recalling setup conditions.
 - ② Select the register no, by turning **[FUNCTION]**.
 - The setup conditions are recalled from the register of the selected no.
 - If "!" is written at the 12th character of the comment, that register number will be skipped. To release the skip, delete the "!" at the 12th character on the comment input screen.
- (Refer to page 57 "Comment Input Method").

Quitting the recall mode

Press **SAVE/RECALL**.

Setting the maximum register number of SAVE/RECALL (SAVE/RECALL MAX)

The maximum register number in the SAVE/RECALL mode can be expanded in the system menu.

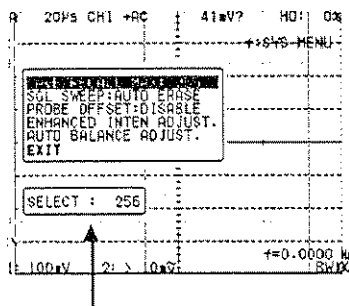
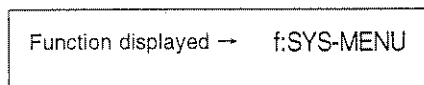
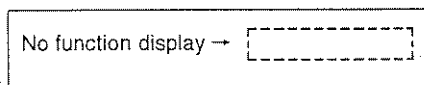

The setting value is 1 to 256.

Procedures

- ① Turn off all the functions to disable **[FUNCTION]** ".
 - * Condition that f:XXXX is not displayed at the upper right of the screen (the delay time, number of TV lines, etc.)
 - ② Turn **[READOUT]** fully counter clockwise (no readout display).
 - ③ Press **[FUNCTION]** for 2 sec, then the system menu is displayed.
 - ④ Select **SAVE/RECALL MAX** by turning **[FUNCTION]**.
 - ⑤ Press **[FUNCTION]** and turn **[FUNCTION]** to select values.
 - The range for setting is 1 to 256.
 - AUTO : Increases the register number.
 - NORM : Decreases the register number.
- ◆ Select **EXIT** and Press **[FUNCTION]** to cancel the system menu.

Maintenance

a. Daily care

◇ Cleaning

Wipe off the dirt on the cover with damp soft cloth with a small volume of water or mild detergent. If any solvent or cleanser not suitable for cleaning is used, it may cause discoloration or an unexpected fault.

- Solvent or cleanser that can be used : Water and mild detergent
- Solvent or cleanser that cannot be used : Alcohol, gasoline, acetone, lacquer, ether, thinner, and cleansers containing ketone

◇ Dirt on the CRT

Remove dirt in the following manner :

- Wipe off ordinary dirt with a soft cloth.
- Wipe off stubborn dirt with a cloth dampened with mild detergent.

b. Interval of periodical calibration

To ensure instrument accuracy calibrate once every year or, every 2000 hours in ordinal use.

Adjustment interval may be reduced if the instrument is heavy use or harsh environment.

c. Automatic balance adjustment

The following items are adjusted automatically :

- Trace shift of vertical position when switching the voltage deflection factor.
- GND position.
- Vertical position.

⚠ Cautions

- Do not push BEAM FIND while automatic balance adjustment.
- Do not apply any signal is input.

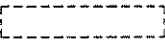
No function display → 

Function displayed → f:SYS-MENU

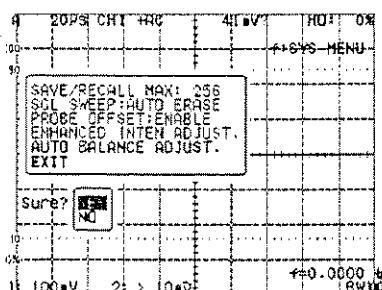

Procedures

- ① Turn off all the functions to disable **[FUNCTION]** *1.
*1 Condition that f:XXXX is not being displayed at the upper right of the screen (the delay time, number of TV lines, etc.)
- ② Turn **[READOUT]** fully counter clockwise (no readout display).
- ③ Press **[FUNCTION]** for 2 sec, then the system menu is displayed.
 - The message as the left picture is displayed at the center of the screen.
- ④ Select **AUTO BALANCE ADJUST** by turning **[FUNCTION]**.
- ⑤ Press **[FUNCTION]**.
 - Sure ? → Yes : Automatic balance adjustment starts.

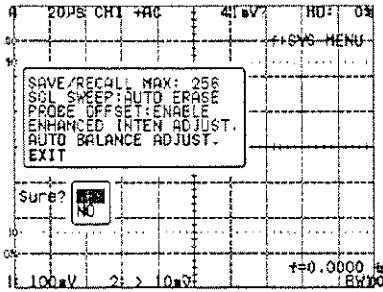

The message of adjusting blinks while executing the self adjustment. It will take the approx one minute. Select EXIT and Press [FUNCTION] to quit the system menu.

- ◇ If automatic adjusting does not be completed correctly, an error message is displayed. When an error message is displayed after executing automatic adjustment several times, contact to our service stations.

d. Guide to diagnosis

When this instrument does not work or seems to be out of order, check the guide to diagnosis in Table 4.

e. Storage and transportation

- ◇ Storage

Do not store in the following places:

- Under direct sunlight
- In dusty enviloment
- In corrosive gas

The conditions for storage of this instrument are as follows :

Storage temperature : -20 to +70 °C

Storage humidity : 80 %RH or less (-20 to + 70 °C)

- ◇ Transportation

When transporting this instrument, use original package or more enough cushioned package.

Table 4 Guide to Diagnosis

Symptom	Confirmation items	Remedy
No traces or spots appear.	Check that the power cord plug is connected to the AC receptacle.	Connect the plug to the AC receptacle.
	Check that the power switch is set to ON.	Set the power switch to ON.
	Check that INTEN is turned counter clockwise.	Turn INTEN clockwise until an adequate intensity is obtained.
	Check that SWEEP MODE is set to SINGLE.	Set SWEEP MODE to AUTO.
Characters are not displayed.	Check that READOUT is turned counterclockwise.	Turn READ OUT clockwise until an adequate intensity is obtained.
Focus of traces and characters is not clear.	Check the FOCUS adjustment of FOCUS.	Adjust FOCUS to clear.
Waveform does not appear when signals are input.	Check that the probe is wrong.	Replace the probe.
	Check that the input coupling is set to GND.	Release GND.
	Check whether a wrong channel is selected.	Set the channel to which input signals are connected to ON.
	Check whether the voltage sensitivity is too low.	Increase the sensitivity.
No trigger.		Press AUTO SET.
	Check whether the wrong trigger source is selected.	Select the channel to trigger.
	Check whether the wrong trigger coupling is selected.	Set the trigger coupling mode suitable for input signals.
	Check whether the level is set to an inadequate position.	Adjust the level to trigger.
Waveform is unstable.	Check whether the AC supply voltage is too low.	Use an AC power supply within the rating.
Former settings are not restored when power is turned on again.		Replace the battery by contacting your nearest Iwatsu sales agent.

Specifications

Display

Display type 5.5 inch type, color LCD (240×320 picture cell, 30 dot/div)
 Display area 8 div×10 div (1 div≈approx. 10 mm, selecting GRID graticule)

CRT storage tube

Storage type CCD scan converter tube
 Display area 480×600 pixel (8 div×10 div)
 Writing speed 5 div/ns
 Persistent time Variable persistence, Infinite persistence

Vertical deflection system (Y axis)

Vertical mode CH1, CH2, CH3, CH4, ADD (CH1±CH2), ALT/CHOP

CH1, CH2

Deflection factor

Range

2 mV/div to 5 V/div, 1-2-5 sequence, 11 steps, Accuracy ±2 %

Variable control range

2 mV/div to 12.5 V/div continuously variable

Frequency characteristics

with internal 50 Ω termination

Bandwidth

DC to 500 MHz -3 dB or less

[Note] AC coupled low cutoff frequency (-3 dB) is 10 Hz.

Bandwidth limiter

DC to approx. 20 MHz or DC to approx. 100 MHz

Step response

At 10 mV/div, with internal 50 Ω termination

Overshoot

6 %

Sag (at 1 kHz)

1 %

Signal delay

At least 20 ns of the sweep is displayed before the triggering point

Channels skew (CH2 DLY)

1 ns adjustable CH2 signal delay

Input coupling

AC, DC, GND

Input RC

1 MΩ ±1.5 % // 16 pF ±2 pF

With probe

10 MΩ ±3 % // 12.5 pF ±2 pF (SS-082R)

50 Ω

50 Ω ±1 %

Maximum input voltage

⚠ 1 MΩ

± 400 V (DC + ACpeak)

50 Ω

5 V rms

VSWR

1.35 MAX (50 Ω : DC to 500 MHz)

Offset voltage

Vertical deflection range	Offset voltage
2 mV/div to 50 mV/div	± 1 V
0.1 V/div to 0.5 V/div	± 10 V
1 V/div to 5 V/div	± 100 V

Position control range

Approx. ±10 div from the center line of the screen

Invert

Available on CH2

ADD

Accuracy of sum (at 1 kHz)

±3 %

Frequency band width

DC to 500 MHz -3 dB or less

Common-mode rejection ratio

at 10 mV/div, CH2 Invert

1 kHz sine wave

80 : 1.6

20 MHz sine wave

80 : 5.2

Dynamic range

8 div or more 500 MHz input signal at 10 mV/div full bandwidth

Probe sense

10 : 1, 100 : 1 detection

CH3, CH4

Deflection factor

Range

100 mV/div, 500 mV/div

Accuracy

±2 %

Bandwidth DC to 500 MHz -3dB or less
 [Note] AC coupled low cutoff frequency (-3 dB) is 10 Hz
 Input RC $1\text{ M}\Omega \pm 1.5\%$ // $16\text{ pF} \pm 3\text{ pF}$
 Maximum input voltage $\pm 400\text{ V}$ (DC+ACpeak)
 Position control range Approx. ± 10 div from the center line of the screen
 Dynamic range 8 div or more 500 MHz input signal full bandwidth
 Probe sense 10:1, 100:1 detection

Triggering

A triggering

Trigger sensitivity

Frequency	Peak to peak signal amplitude
DC to 10 MHz	0.4 div
10 MHz to 100 MHz	1.0 div
10 MHz to 500 MHz	2.0 div

HF-REJ : Attenuates at 10 kHz or more

LF-REJ : Attenuates at 10 kHz or less

CH1, CH2, CH3, CH4, LINE

AC, DC, HF-REJ, LF-REJ

+, -

Signal source

Coupling

Slope

B triggering

Trigger sensitivity

Frequency	Peak to peak signal amplitude
DC to 10 MHz	0.4 div
10 MHz to 100 MHz	1.0 div
10 MHz to 250 MHz	2.0 div

HF-REJ : Attenuates at 10 kHz or more

LF-REJ : Attenuates at 10 kHz or less

CH1, CH2, CH3, CH4

AC, DC, HF-REJ, LF-REJ

+, -

Signal source

Coupling

Slope

TV scale

Voltage setting

Scale	Automatic setting ($\times 1$ range/full scale)	Fine adjuster (continuously variable)
EIA	Input voltage $1\text{V}=140\text{IRE}$	65 % to 134 %
CCIR	Input voltage $1\text{V}=100\text{IRE}$	67 % to 132 %

Voltage display

1/50 to $\times 50$ 1-2-5 step

TV triggering

Mode

TV-V (ODD, EVEN, BOTH) TV-H

Formats

NTSC, PAL (SECAM), HDTV

Field and line selection

ODD, EVEN, or BOTH

NTSC

1 H to 525 H

PAL (SECAM)

1 H to 625 H

HDTV

1 H to 1125 H

TV level

[Note] TV : The ratio between the composite video signal and synchronization signal is 7:3 and synchronization signal amplitude is 1.5 div or more.

TV clamp

Clamp position

Back porch level

Back porch reference

± 1 div or less from ground reference

Signal amplitude range

1.5 to 8 div

Specifications

Event trigger	
Count mode	
Event count range	1 to 65535
Maximum frequency	50 MHz
Burst mode	
Burst signal interval time	0.15 μ s to 9.99 s
Trigger cursor	Enable (trigger level is indicated by the cursor)
Horizontal deflection system (X axis)	
Horiz display	A, ALT, B, X-Y
A sweep	
Sweep mode	AUTO, NORMAL, SINGLE
Sweep rates	
Maximum sweep	500 ps/div
Range	5 ns to 500 ms/div 1-2-5 sequence, 25 steps
Variable range	5 ns to 1.5 s/div
Accuracy I ^{**2}	± 2 % over center 8 div
Accuracy II ^{**2}	± 5 % over any 2 div within center 8 div
Hold-off time	Continuously variable
B sweep	
Delay	Triggered delay or continuous delay (RUNS AFTER)
B END A	Enable
Sweep rates	
Maximum sweep	500 ps/div
Range	5 ns to 20 ms/div 1-2-5 sequence, 21 steps
Accuracy I ^{**1}	± 2 % over center 8 div
Accuracy II ^{**1}	± 5 % over any 2 div within center 8 div
Delay time	
Position control range	0.2 to 10.2 div
Accuracy	$\pm [(set\ value \times 0.005) + (sweep\ rate \times 0.1)] - 55$ ns within the range of 1 μ s/div to 500 ms/div
Delay pickoff jitter	1/20000, at 1 ms/div of A sweep, at 500 ns/div of B sweep
Dual delay measuring	Enable
Sweep magnification	
Magnifying ratio	10 times
Accuracy I ^{**2}	over center 8 div
10 ns/div, 50 ns/div	± 5 %
100 ns/div to 500 ms/div	± 3 %
Accuracy II ^{**2}	over any 2 div within center 8 div
5 ns/div, 50 ns/div	± 10 %
100 ns/div to 500 ms/div	± 5 %
	^{**1} 20 ns or 1 div at the beginning of sweep and 20 ns at the end of sweep are excluded.
	^{**2} Add 1 % in case of VARIABLE ON
X-Y operation	
X axis (CH1)	
Deflection factor	Same as CH1.
Accuracy	± 2 %
Bandwidth	DC to 10 MHz, -3 dB or less
Y axis	CH1, CH2, CH3, CH4, ADD
PhasedifferencebetweenXaxisandYaxis	3° or less (DC to 5 MHz)

AUTO SETUP

Channels Available CH1 and CH2
 Frequency 50 Hz to 100 MHz

CAL (Probe calibration signal)

Waveform Rectangular wave
 Frequency 1 kHz \pm 0.1 %
 Duty ratio 49 to 51 %
 Output voltage 0.6 V \pm 1 %

VIDEO OUT

NTSC composite signal, 1 V \pm 0.3 V into 75 Ω

CH2 OUT

Output voltage 20 mV/div \pm 30 % (into 50 Ω)
 Output dynamic range \pm 100 mV (50 Ω)
 Output coupling DC coupling
 Frequency band width 200 MHz—3dB (into 50 Ω)
 Output resistance 50 Ω \pm 20 %

Z AXIS IN

Sensitivity 0.5 Vp-p or more
 Positive-going input decreases intensity.
 Frequency range DC to 5 MHz
 Input resistance 5 k Ω \pm 20 %
 Maximum input voltage \pm 40 V (DC+ACpeak)

FET probe power

SFP-5A, SFP-4A, probe power terminals P1, P2

Measurement with cursors

Measurement with cursors
 Type of measurement Time difference (Δt), voltage difference (ΔV)
 (When the fine adjuster [VARIABLE] is selected on the EIA or CCIR scale, this is displayed in units of IRE)

Cursor position control range
 X axis \pm 5 div from the center line of the screen
 Y axis \pm 4 div from the center line of the screen

Moving pitch step 1/30 div

Accuracy specified range
 X axis \pm 4 div from the center line of the screen
 Y axis \pm 3 div from the center line of the screen

Accuracy
 Voltage difference (ΔV) \pm [(2 % of reading) + (0.3 % of full scale)]
 Time difference (Δt)
 MAG OFF \pm [(2 % of reading) + (0.3 % of full scale)]
 MAG ON (MAG x 10)
 500 ms to 100 ns/div \pm [(3 % of reading) + (0.3 % of full scale)]
 50 ns, 5 ns/div \pm [(5 % of reading) + (0.3 % of full scale)]
 (Full scale : voltage is 8 div, time is 10 div)

Counter

Number of digits displayed 5 digits
 Accuracy \pm 0.01 %
 Frequency range 2 Hz to 500 MHz
 Input Sensitivity

Frequency	Amplitude (div)
2 Hz to 10 MHz	1.0 div
10 MHz to 500 MHz	3.0 div

[Note] The trigger level is set about the center of the waveform on the screen.

Specifications

Saving data

Type of data to be saved

Backup by built-in battery

- Panel setup conditions just before turning power off^{*1}
- Saved panel setup conditions (maximum 256)
- 12 characters comment of each panel setup condition

Data retention time

Approx. 27,000H (at approx. 25 °C)

^{*1} Under the power cord is disconnected.

Type of battery

Lithium primary battery CR2354-1HF, one piece

Power source

Voltage range

AC 100 V to 240 V AC

Frequency range

50/60 Hz

Power consumption

140VA MAX

Standby power consumption

Approx. 8VA

Weight and Dimension

Weight

Approx. 8.5 kg (without accessories)

Dimension

Approx. 320×160 H×406 D [mm]

[Note] Without accessories, and projections.

Environmental conditions

Specification assurance temperature

10 to 35 °C

Operating

Temperature

0 to 40 °C

Humidity

90 % RH or less (at 40 °C)

Storage

Temperature

−20 to 70 °C

Humidity

80 % RH or less (−20 to 70 °C)

Altitude

Operating

2,000 m, atmospheric pressure : Approx. 79 kPa

Nonoperating

15,000 m, atmospheric pressure : Approx. 12 kPa

Vibration

15 minutes along each of three axes at a total displacement of 0.67 mm p.p with frequency varied from 10 Hz to 55 Hz in 1 minute sweep. Lifting a side to height of 10 cm and dropping it naturally onto hard wood; 4 times on each side.

Shock

Dropping packaged

Dropping an instrument packaged for transportation from a height of 90 cm.

Warm up time

The specifications for this instrument are assured after more than 30 min of power on.

CE Declaration of Conformity

The Oscilloscope meets requirements of the Council Directive 89/336/EEC for Electromagnetic Compatibility and Low Voltage Directive 73/23/ECC for Product Safety.

Electromagnetic Emission

EN55011:1991

EN55011:1991

EN61000-3-2:1995

EN61000-3-3:1995

Class B Radiated and Conducted Emissions

AC Power Line Harmonic Current Emissions

Voltage Fluctuations and Flicker

Electromagnetic Susceptibility

EN50082-2:1995

EN61000-4-2:1995

ENV50140:1993

ENV50204:1995

EN61000-4-4:1995

ENV50141:1993

Electrostatic Discharge Immunity

RF Field Strength Susceptibility (Amplitude Moduration)

RF Field Strength Susceptibility (Pulse Moduration)

Electrical Fast Transient/Burst Immunity

Conducted Susceptibility

Low Voltage Directive

EN61010-1:1993+Amd.2:1995

Safety requirement for electrical equipment for measurement, control, and laboratory use.

The oscilloscope has been qualified to the following EN61010-1 category:

Installation (Overvoltage) Category II

Pollution Degree 2

Pollution Degree 2

Do not operate in environments where conductive pollutants may be present.

Installation (Overvoltage) Category II

Local Level mains, appliances, portable equipment.

PP005 PROBE

INSTRUCTION MANUAL

General

The PP005 is a passive probe to use with the LA354 oscilloscope which has frequency response from DC to 500 MHz.

Composition

The probe PP005 is composed of a probe body and accessories.

Probe body

Accessories

- Ground lead 11 cm 1
- Ground lead short on probe tip 1
- IC insulation tip (black) 2
- Spring tip 0.8 mm 1
- Straight tip 1
- BNC adapter 1
- Sprung hook (black) 1
- Trimmer tool 1
- Probe 1
- Color rings 10

Specification (combined PP005 and LA354)

Input RC	10 MΩ ± 3 %//11 pF ± 2 pF ^Δ
Attenuation ratio	10:1 within ± 2 % ^Δ
Frequency response	DC to 500 MHz -3 dB ^Δ • LA354 10mV/div • at the tip of probe
Input capacitance of applicable oscilloscope	10 to 20 pF
Maximum safety input voltage	500V (DC + peak AC)
Probe length	Approximately 1.2 m
Connector type	BNC type
Read-out compensating function	Provided

^Δ For LA354 oscilloscope.

The specification of the probe only describes the attached PP005 manual.

Cautions

● Figure 1 shows maximum input voltage. Do not apply excessive voltage.

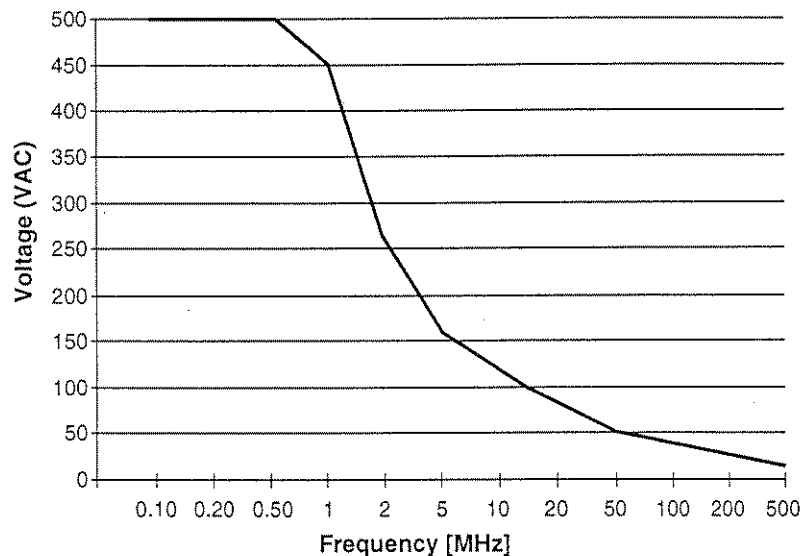

Figure 1

INDEX

[A]	Page	CHOP	25
A (Sweep)	37	Clamp	32
A (Trigger)	37	Cleaning	59
A INTEN	20	Components	IX
AC (Input coupling)	23	Continuous delay	41
AC (Trigger coupling)	29	COUNT (Event)	33, 34
AC LINE INPUT	8	Counter	52
Accessories	IX	COUPL (Trigger coupling)	29
Active probe	28	Cursor Measurement	49
ADD (Addition)	26		
Adjustment of the screen	20	[D]	
ALT (alternate) sweep (ALT CHOP)	25, 35	Daily care	59
AUTO (Sweep mode)	40	DC (Input coupling)	23
Automatic adjusting	59	DC (Trigger coupling)	29
AUTOSET	16	Deflection Factor	22
		Delay Adjust	39
[B]		Delayed sweep	41
B (sweep)	37	Diagnosis	60
B (Trigger)	37	Difference (CH1-CH2)	26
B ENDS A	42	Display channels	25
B INTEN	20		
Back porch level	32	[E]	
Bandwidth limiter (BWL)	26	EVEN (TV trigger mode)	31
Basic Operation	15	Event Trigger	33
BEAM FIND	21		
BOTH (TV trigger mode)	31	[F]	
Brightness (INTEN)	20	FET probe	28
Built-in battery	15	FOCUS	20
BURST (Event)	33, 34	Frequency (1/Δt)	49
		FUSE	8
[C]			
CAL	16	[G]	
Cautions for safe use	I	GND (Input coupling)	23
CH2 DLY	39	Grounding	III
CH2 OUT PUT	8		

[H]		Power OFF	15
HDTV	32	Power ON	3
HF REJ	29	Power STBY	3
Holdoff	43	Probe Compensation	18
Horizontal Display	35	PROBE POWER	5
[I]		[R]	
Input coupling	23	READOUT	9
Input resistance	24	READY	6
Interval of periodical calibration	59	Recall	58
INV	26	Repetitive sweep (AUTO, NORM)	40
 		RST (RESET)	40
[L]			
LF REJ	29	[S]	
LINE (Trigger coupling)	29	Save	58
LINE NUMBER (TV)	32	SCALE	11
Loading effect by a probe	18	SECAM	31
 		Single	40
[M]		Single sweep	40
MAG x 10	38	Slope	30
Magnification	38	Source	29
 		Storage	44
[N]		Subtract (CH1-CH2)	26
NORM (Sweep mode)	40	Sum (CH1+CH2)	26
NTSC	32	Sweep mode	40
number of lines	32	Sweep Rate (TIME/DIV)	38
 		Symbols in the instruction manual	1
[O]		Symbols on the panel	1
ODD (TV trigger mode)	31	SYS-MENU (system menu)	14, 28, 58
Offset	27		
 		[T]	
[P]		TCK	49, 50
P1, P2 (probe power)	28	Terminology	X
PAL	32	Time Difference (Δt)	49
POSITION	21	TIME/DIV	38
Power Cord	8	TRACE ROTATION	20
		Trace separation	36

tracking	50, 52
transportation	60
TriggerCoupling	29
TriggerLevel	30
TriggerSlope	30
TriggerSource	29
TriggeredDelay	42
Triggering	29
TRIG'D	6
TV CLAMP	32
TV signal	31
TV trigger mode	31
TV-H	31

[V]

Vertical Deflection System	22
Voltage Difference (ΔV)	51
VOLTS/DIV	22
VSWR (Voltage standing wave ratio)	24, 62

[X]

X-Y	35
-----------	----

[Z]

Z AXIS IN	8
-----------------	---

Numerals and Symbols

1M Ω (Input resistance)	24
50 Ω (Input resistance)	24
1/ Δt	49
Δt	49
ΔV	51

Knobs, Keys, etc.

[A] key	6, 35, 36
[AB] key	6, 37, 38
AC LINE INPUT terminal	8
[ADD CH1+CH2] key	4, 26
[A INTEN] knob	3
[ALT CHOP] key	5, 25
[ATTACH] key	7, 51
[AUTO] key	7, 40
[AUTOSET] key	7, 16
[A VARIABLE] knob	5
[B] key	6, 41, 53
[B INTEN] knob	3
[BEAM FIND] knob	3
[BWL] key	5, 26
CAL (OUT)	5, 16
[CH1] key	4, 25
[CH2] key	4, 25
CH2 OUTPUT TERMINAL	8
[CH3] key	4, 25
[CH4] key	4, 25
[COUPL] key	6, 29
[DC/AC] key	4, 23
[DELAY/TRACE SEP] key	6, 36
[FINE] key	5, 21
[FOCUS] knob	3
[FUNCTION] knob	7
FUSE	8
[EVENT/TV CLAMP] key	6, 32
[GND] key	4

[HOLDOFF] key	6, 43
INPUT (CH1 to CH4) connectors	4
[INV] key	4, 26
[MAG x10] key	5, 38
[NORM] key	7, 40
[OFFSET] key	7, 27
[▲POSITION▼] knob	4
[◀POSITION▶] knob	4
[POWER] key	3
PROBE POWER P1/P2 terminal	5
[READOUT] knob	3
READY indicator	6
[SAVE/RECALL] key	7, 56
[SGL/RST] key	7, 40
[SLOPE] key	6, 30
[SOURCE] key	6, 29
[TCK/INDEP] key	7, 49
[TIME/DIV] knob	5, 38
TRACE ROTATION	3
TRIG'D indicator	6
[TRIG LEVEL] knob	6, 30
[TV] key	6, 31
[VOLTS/DIV] knob	4, 22
[X-Y] key	6, 35
Z AXIS IN	8
[100mV/500mV] key	4, 22
[50 Ω /1M Ω] key	4, 24
[Δt] key	7, 49
[ΔV] key	7, 51

MEMO

LeCroy National Contact Numbers

Argentina: Search SA
1 777 4000

Australia: Philips Test and Measurement
2 9888 8222

Austria: Dewetron GmbH
0316 3070

Benelux: LeCroy UK, Ltd.
UU 1235 52y 288

Brazil: ATP/Hi-Tek Electronica Ltda
11 725 5822

Canada: Allan Crawford Assoc. Ltd.
Mississauga: 905 890 2010
N. Vancouver: 604 878 1002

Chile: Sistemas de Instrumentacion Ltda
2 6951137

Denmark: Lutronic ApS
43 42 9764

Eastern Europe: Elsinco GmbH, Vienna
1 815 04 00

Finland: Orbis OY, 0478 830

France: LeCroy Sarl,
1 69 18 83 20

Germany: LeCroy Europe GmbH,
6221 82700

Greece: IFIPCO, 1 67 25 970

Israel: Ammo, 3 547 2747

Italy: LeCroy S.r.l., Venice
41 456 9700

Mexico: Electroingenieria de Precision SA
559 7677

New Zealand: Philips Test and Measurement
649 8494 160

Norway: Avantec AS
22 76 38 70

Pakistan: Electro Tech Corp. Ltd.
21 493 9593/5171

Portugal: M.T. Brandao Lda.
2 830 27 09

Singapore: Abex Eng. Ltd.
841 2818

South Africa: Westplex Ltd.
11 787 0473

Spain: MT Brandao SL
1 803 1767

Sweden: MSS AB
8 544 107 00

Switzerland: LeCroy SA
North: 62 885 8050
West: 22 719 2228

Turkey: NETES
212 237 32 26

Unite Arab Emirates: Arab Engineers for
Trading Co. Ltd. 899 0220/0440

United Kingdom, Ireland: LeCroy Ltd.
1 235 524 288

United States: 1 800-5-LeCroy
(automatically connects you to your local sales office)

INTERNET : www.lecroy.com

Sales office : LeCroy Ltd.
Address : 10 High Street Twyford Berks R910AE U.K.
Phone : +44 1189 344882
Facsimile : +44 1189 349800

Sales office : LeCroy Corporation
Address : 700 Chestnut Ridge Road Chestnut Ridge, NY10977 USA
Phone : +1 (914) 425-2000
Facsimile : +1 (914) 578-5989
Home Page : <http://www.lecroy.com>

Manufacturer : Iwatsu Electric Co., Ltd.
Address : 7-41 Kugayama 1-chome Sugunami-ku, Tokyo, 168 Japan
Phone : +81 3 5370 5483
Facsimile : +81 3 5370 5492