

LECROY
WAVEJET SERIES
OSCILLOSCOPES

GETTING STARTED
MANUAL

FEBRUARY 2007



LeCroy Corporation
700 Chestnut Ridge Road
Chestnut Ridge, NY 10977-6499
Tel: (845) 578 6020, Fax: (845) 578 5985

Internet: www.lecroy.com

© 2007 by LeCroy Corporation. All rights reserved.

LeCroy, ActiveDSO, JitterTrack, WaveLink, WavePro, WaveMaster, WaveSurfer, WaveJet, and Waverunner are registered trademarks of LeCroy Corporation. Other product or brand names are trademarks or requested trademarks of their respective holders. Information in this publication supersedes all earlier versions. Specifications subject to change without notice.

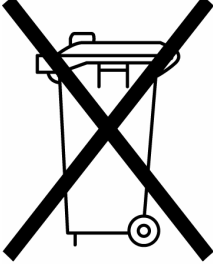
<p>Manufactured under an ISO 9000 Registered Quality Management System Visit www.lecroy.com to view the certificate.</p>		<p>This electronic product is subject to disposal and recycling regulations that vary by country and region. Many countries prohibit the disposal of waste electronic equipment in standard waste receptacles. For more information about proper disposal and recycling of your LeCroy product, please visit www.lecroy.com/recycle.</p>
--	---	--

WJ-GS-E Rev B
914863-00 Rev A

Getting Started Manual

INTRODUCTION	5
SAFETY REQUIREMENTS	6
Safety Symbols and Terms	6
Operating Environment	7
Cooling Requirements	8
AC Power Source.....	8
Power and Ground Connections	9
Calibration	9
Cleaning	9
Abnormal Conditions	10
WHEN YOUR SCOPE IS DELIVERED	11
Check that You Have Everything	11
Warranty.....	11
Maintenance Agreements	11
SPECIFICATIONS	13
 Max Input Range:	14
Horizontal System	15
Acquisition System	15
Acquisition Processing	16
Trigger System	16
Basic Triggers	16
SMART Triggers	16
Documentation and Connectivity	16
Display	17
Analog Persistence	17
Zoom	17
Internal Waveform Memory.....	17
Setup Storage	17
Math Tools	17
Measure Tools	18
General	18
POWER-UP AND INSTALLATION	23
Power-Up	23
Software	23
Updating the System Software.....	24
PROBES	25
Probe Compensation	25

WaveJet Series

FRONT PANEL CONTROLS	26
Front Panel Buttons and Knobs	26
Trigger Controls	27
Horizontal Controls.....	27
Vertical Controls.....	28
Zoom Control Knobs	28
Special Features Controls.....	29
General Control Buttons.....	30
UNDERSTANDING DISPLAY INFORMATION	32
Grid Area.....	32
Top Status Bar	33
Bottom Status Bar	34
Message Line	34
Trace Descriptors	34
TURNING ON TRACES	35
VERTICAL SETTINGS AND CHANNEL CONTROLS	36
Choosing Coupling	36
Bandwidth Limiting	36
Probe Attenuation.....	36
Inverting Waveforms	37
Adjusting Sensitivity	37
Adjusting the Waveform's Position.....	38
SAMPLING MODES.....	39
TIMEBASE SETUP	39
TRIGGERING	40
Trigger Types	40
Pulse Width Triggering	41
Period Triggering.....	42
Pulse Count Triggering	43
TV Triggering	44
Horizontal Trigger Setup	45
Vertical	45
To Set Up an Edge Trigger	46
WAVEFORM MEASUREMENTS.....	47
Measuring with Cursors.....	47
Cursor Measurement Selections	47
Cursor Placement	48

Getting Started Manual

PARAMETER MEASUREMENTS	49
Measure Modes	49
Standard Vertical Parameters	49
Standard Horizontal Parameters	50
Other Parameters.....	51
Statistics	51
DISPLAY FORMATS	52
Display Setup	52
Display Types.....	53
Zooming Waveforms	53
Replay Mode	54
SAVE AND RECALL	55
Saving and Recalling Scope Settings	55
Saving and Recalling Waveforms	56
WAVEFORM MATH	57
UTILITIES	58
Print Screen	58
Configuration -- Page 1/2	59
Configuration -- Page 2/2	60
Calibration	61
Status & Update	62

BLANK PAGE

INTRODUCTION

This brief guide includes important safety and installation information for your WaveJet Series oscilloscope, along with brief operating procedures to get you started capturing, viewing, and analyzing your waveforms.

WaveJet Series

SAFETY REQUIREMENTS

This section contains information and warnings that must be observed to keep the instrument operating in a correct and safe condition. You are required to follow generally accepted safety procedures in addition to the safety precautions specified in this section.

Safety Symbols and Terms

Where the following symbols or terms appear on the instrument's front or rear panels, or in this manual, they alert you to important safety considerations.



This symbol is used where caution is required. Refer to the accompanying information or documents in order to protect against personal injury or damage to the instrument.



This symbol warns of a potential risk of shock hazard.



This symbol is used to denote the measurement ground connection.



This symbol is used to denote a safety ground connection.



This symbol shows that the switch is a On/Standby switch. When it is pressed, the scope's state toggles between Operating and Standby state. This switch is not a disconnect device. To completely remove power to the scope, the power cord must be unplugged from the AC outlet after the scope is placed in Standby state.



This symbol is used to denote "Alternating Current."

CAUTION

The CAUTION sign indicates a potential hazard. It calls attention to a procedure, practice or condition which, if not followed, could possibly cause damage to equipment. If a CAUTION is indicated, do not proceed until its conditions are fully understood and met.

WARNING

The WARNING sign indicates a potential hazard. It calls attention to a procedure, practice or condition which, if not followed, could possibly cause bodily injury or death. If a WARNING is indicated, do not proceed until its conditions are fully understood and met.

Getting Started Manual

CAT I Installation (Overvoltage) Category rating per EN 61010-1 safety standard and is applicable for the oscilloscope front panel measuring terminals. CAT I rated terminals must only be connected to source circuits in which measures are taken to limit transient voltages to an appropriately low level.

Operating Environment

The instrument is intended for indoor use and should be operated in a clean, dry environment.

Note: Direct sunlight, radiators, and other heat sources should be taken into account when assessing the ambient temperature.

The design of the instrument has been verified to conform to EN 61010-1 safety standard per the following limits:

Installation (Overvoltage) Categories II (Mains Supply Connector) & I (Measuring Terminals)

Pollution Degree 2





Protection Class I

Note:

Installation (Overvoltage) Category II refers to local distribution level, which is applicable to equipment connected to the mains supply (AC power source).

Installation (Overvoltage) Category I refers to signal level, which is applicable to equipment measuring terminals that are connected to source circuits in which measures are taken to limit transient voltages to an appropriately low level.

Pollution Degree 2 refers to an operating environment where normally only dry non-conductive pollution occurs. Occasionally a

 WARNING
The scope must not be operated in explosive, dusty, or wet/damp atmospheres.
 CAUTION
Protect the scope's display touch screen from excessive impacts with foreign objects.
 CAUTION
Do not exceed the maximum specified front panel terminal (CH1, CH2, CH3, CH4, EXT) voltage levels. Refer to Specifications for more details.
 CAUTION
Do not connect or disconnect probes or test leads while they are connected to a voltage source.

WaveJet Series

temporary conductivity caused by condensation must be expected.

Protection Class 1 refers to a grounded equipment, in which protection against electric shock is achieved by Basic Insulation and by means of a connection to the protective ground conductor in the building wiring.



Cooling Requirements

The instrument relies on forced air cooling with internal fans and ventilation openings. Care must be taken to avoid restricting the airflow around the apertures (fan holes) at each side of the scope. To ensure adequate ventilation it is required to leave a 10 cm (4 inch) minimum gap around the sides of the instrument.

 **CAUTION**
Do not block the ventilation holes located on both sides of the scope.

 **CAUTION**
Do not allow any foreign matter to enter the scope through the ventilation holes, etc.

AC Power Source

The instrument operates from a single-phase, 100 to 240 V_{rms} (+/-10%) AC power source at 50/60 Hz (+/-5%), or single-phase 100 to 120 V_{rms} (+/-10%) AC power source at 400 Hz (+/-5%).

No manual voltage selection is required because the instrument automatically adapts to line voltage.

Depending on the accessories installed (PC port plug-ins, Ethernet & GPIB options, etc.), the instrument can draw up to 75 W (75 VA).

Note:

The instrument automatically adapts itself to the AC line input within the following ranges:

Voltage Range:	90 to 264 V_{rms}	90 to 132 V_{rms}
Frequency Range:	47 to 63 Hz	380 to 420 Hz

Power and Ground Connections

The instrument is provided with a grounded cord set containing a molded three-terminal polarized plug and a standard IEC320 (Type C13) connector for making line voltage and safety ground connection. The AC inlet ground terminal is connected directly to the frame of the instrument. For adequate protection against electrical shock hazard, the power cord plug must be inserted into a mating AC outlet containing a safety ground contact. Use only the power cord specified for this instrument and certified for the country of use.

The scope should be positioned to allow easy access to the socket-outlet. To completely remove power to the scope, unplug the instrument's power cord from the AC outlet.



It is recommended that the power cord be unplugged from the AC outlet if the scope is not to be used for an extended period of time.

Calibration

The recommended calibration interval is one year. Calibration should be performed by qualified personnel only.

Cleaning

Clean only the exterior of the instrument, using a damp, soft cloth. Do not use chemicals or abrasive elements. Under no circumstances allow moisture to penetrate the instrument. To avoid electrical shock, unplug the power cord from the AC outlet before cleaning.

	WARNING Electrical Shock Hazard! Any interruption of the protective conductor inside or outside of the scope, or disconnection of the safety ground terminal creates a hazardous situation. Intentional interruption is prohibited.
	CAUTION The outer shells of the front panel terminals (CH1, CH2, CH3, CH4, EXT) are connected to the instrument's chassis and therefore to the safety ground.

	WARNING Electrical Shock Hazard! No operator serviceable parts inside. Do not remove covers. Refer servicing to qualified personnel.
---	---

WaveJet Series

Abnormal Conditions

Operate the instrument only as intended by the manufacturer.

If you suspect the scope's protection has been impaired, disconnect the power cord and secure the instrument against any unintended operation.

The scope's protection is likely to be impaired if, for example, the instrument shows visible damage or has been subjected to severe transport stresses.

Proper use of the instrument depends on careful reading of all instructions and labels.



WARNING

Any use of the scope in a manner not specified by the manufacturer may impair the instrument's safety protection. The instrument and related accessories should not be directly connected to human subjects or used for patient monitoring.

WHEN YOUR SCOPE IS DELIVERED

Check that You Have Everything

First, verify that all items on the packing list or invoice copy have been shipped to you. Contact your nearest LeCroy customer service center or national distributor if anything is missing or damaged. If there is something missing or damaged, and you do not contact us immediately, we cannot be responsible for replacement.

NOTE: THE WARRANTY BELOW REPLACES ALL OTHER WARRANTIES, EXPRESSED OR IMPLIED, INCLUDING BUT NOT LIMITED TO ANY IMPLIED WARRANTY OF MERCHANTABILITY, FITNESS, OR ADEQUACY FOR ANY PARTICULAR PURPOSE OR USE. LECROY SHALL NOT BE LIABLE FOR ANY SPECIAL, INCIDENTAL, OR CONSEQUENTIAL DAMAGES, WHETHER IN CONTRACT OR OTHERWISE. THE CUSTOMER IS RESPONSIBLE FOR THE TRANSPORTATION AND INSURANCE CHARGES FOR THE RETURN OF PRODUCTS TO THE SERVICE FACILITY. LECROY WILL RETURN ALL PRODUCTS UNDER WARRANTY WITH TRANSPORT PREPAID.

Warranty

The oscilloscope is warranted for normal use and operation, within specifications, for a period of three years from shipment. LeCroy will either repair or, at our option, replace any product returned to one of our authorized service centers within this period. However, in order to do this we must first examine the product and find that it is defective due to workmanship or materials and not due to misuse, neglect, accident, or abnormal conditions or operation.

LeCroy shall not be responsible for any defect, damage, or failure caused by any of the following: a) attempted repairs or installations by personnel other than LeCroy representatives or b) improper connection to incompatible equipment, or c) for any damage or malfunction caused by the use of non-LeCroy supplies. Furthermore, LeCroy shall not be obligated to service a product that has been modified or integrated where the modification or integration increases the task duration or difficulty of servicing the oscilloscope. Spare and replacement parts, and repairs, all have a 90-day warranty.

The oscilloscope's firmware has been thoroughly tested and is presumed to be functional. Nevertheless, it is supplied without warranty of any kind covering detailed performance. Products not made by LeCroy are covered solely by the warranty of the original equipment manufacturer.

Maintenance Agreements

We offer a variety of services under the heading of Maintenance Agreements. These give extended warranty and allow you to budget maintenance costs after the initial three-year warranty has expired. Installation, training, enhancements, and on-site

WaveJet Series

repairs, among other services, are available through special supplemental support agreements. Inquire at your LeCroy customer service center or national distributor.

SPECIFICATIONS

Vertical System

Bandwidth (-3 dB @ 50 ohms):

WJ354	500 MHz
WJ352	
WJ334	350 MHz
WJ332	
WJ324	200 MHz
WJ322	
WJ314	100 MHz
WJ312	

Input Channels: 4 (WJ354/334/324/314); 2 (WJ352/332/322/312)

Rise Time (typical):

WJ354	750 ps
WJ352	
WJ334	1.00 ns
WJ332	
WJ324	1.75 ns
WJ322	
WJ314	3.50 ns
WJ312	

Bandwidth Limiters:

WJ354	20 MHz/100 MHz
WJ352	
WJ334	
WJ332	
WJ324	20 MHz
WJ322	
WJ314	
WJ312	

WaveJet Series

Input Impedance:

WJ354	1 Mohm \pm 1.5 % 16 pF, 50 ohm \pm 1.5 %
WJ352	
WJ334	
WJ332	
WJ324	1 Mohm \pm 1.5 % 20 pF
WJ322	
WJ314	
WJ312	

Input Coupling:

WJ354	GND, DC1Mohm, AC1Mohm, DC50ohm
WJ352	
WJ334	
WJ332	
WJ324	GND, DC1Mohm, AC1Mohm
WJ322	
WJ314	
WJ312	



Max Input Range:

WJ354	\pm 400 V _{pk} CAT I (1 Mohms), 5 V _{rms} (50 ohms)
WJ352	
WJ334	
WJ332	
WJ324	\pm 400 V _{pk} CAT I (1 Mohms)
WJ322	
WJ314	
WJ312	

Vertical Resolution: 8-bit

Getting Started Manual

Sensitivity:

WJ354	2 mV/div~10 V/div (1 Mohms), 2 mV/div~2 V/div (50 ohms)
WJ352	
WJ334	
WJ332	
WJ324	2 mV/div~10 V/div (1 Mohms)
WJ322	
WJ314	
WJ312	

DC Gain Accuracy: +/- (1.5 % + 0.5% of full scale)

Offset Range:

2 mV/div~50 mV/div	+/- 1 V
50.2m V/div~500m V/div	+/- 10 V
502 mV/div~10 V/div	+/- 100 V

Offset Accuracy: +/- (1 % + 0.5% of full scale + 1 mV)

Horizontal System

Timebase Range:

WJ354	500 ps/div - 50 s/div
WJ352	
WJ334	1 ns/div - 50 s/div
WJ332	
WJ324	2 ns/div - 50 s/div
WJ322	
WJ314	5 ns/div - 50 s/div
WJ312	

Clock Accuracy: 10 ppm

Acquisition System

Single-shot Sampling Rate: 1 GS/s

Sampling Rate -- Equivalent Time Sampling (RIS): 100 GS/s

2 Channel Max.: 2 GS/s (WJ354/352/334/332/324/322); 1 GS/s (WJ314/312)

Standard Record Length: 500 kpts/Ch

WaveJet Series

Standard Capture Time: up to 250 μ s at 2 GS/s (WJ354/352/334/332/324/322); up to 500 μ s at 1 GS/s (WJ314/312)

Acquisition Processing

Averaging: Up to 256 sweeps

Peak Detect: Period of 1 ns

Trigger System

Trigger Modes: Auto, Normal, Single, Stop

Trigger Types: Edge, Pulse Width, Period, Pulse Count, TV

Trigger Source: Any Channel, Ext (100 mV/div), Ext/10(1 V/div), Line

Trigger Slope: Positive, Negative

Trigger Coupling: AC, DC, LFRrej, HFRrej

Holdoff by Time: up to 50 s

External Trigger Range: EXT: +/-0.5 V, EXT10: +/-5.0 V

External Trigger Impedance: 1 Mohms +/-1.5% || 16 pF (WJ354/352/334/332)
1 Mohms +/-1.5% || 20 pF (WJ324/322/314/312)

Basic Triggers

Edge/Slope: Triggers when the signal meets the slope (positive, negative) and level condition

SMART Triggers

Pulse Width: 15 ns to 50 s

Period (Interval): 40 ns to 50 s

Pulse Count: Edge trigger with Holdoff between 1 and 9999 events

TV Trigger: NTSC, PAL, Custom

Line: up to 3000

Field: (1, 2, 4, 8)

Documentation and Connectivity

Waveform File Data: Save waveform data to internal reference traces or USB memory in binary, ASCII or Mathcad formats

Screen Images: Save screen images to USB memory in a variety of formats with white or black background

USB: 1 front panel mounted USB 1.1 port.

Probes

1 PP006A probe per channel (WJ354/352/334/332); 1 PP010 probe per channel (WJ324/322/314/312)

Scale Factors: Automatically or manually selected depending on probe used

Display

Type: Color, 7.5" Flat Panel TFT LCD

Resolution: VGA: 640 X 480 pixels

Real Time Clock: Date, Hours, Minutes, Seconds displayed with Waveforms

Grid Styles: YT, XY, XY Triggered

Waveform Display Styles: Sample dots joined or dots only

Analog Persistence

Analog and Color-graded Persistence: Variable saturation levels

Persistence Selections: Select Single or Spectrum.

Persistence Aging Time: 100 ms, 200 ms, 500 ms, 1 s, 2 s, 5 s, 10 s, Infinite

Zoom

Zoom Expansion Traces: Horizontal expansion of up to 4 zoom traces in a separate grid

Internal Waveform Memory

REF Waveforms: Store up to 5 waveforms to the internal reference memory

Setup Storage

Front Panel and Instrument Status: Store up to 5 setups to the internal memory or save to a USB memory device for recall later

Math Tools

1 math trace; choose between Sum, Difference, Product, FFT (up to 8 kpts with Rectangular, VonHann, and Flat Top windows)

WaveJet Series

Measure Tools

Standard Parameters:

Vertical	Horizontal	Other
Maximum	Tr 20-80%	Integral
Minimum	Tf 80-20%	Skew
Peak-Peak	Tr 10-90%	Skew@Level
RMS	Tf 90-10%	
Cycle RMS	Frequency	
Mean	Period	
Cycle Mean	No. of +Pulses	
Top	No. of -Pulses	
Base	+Pulse Width	
Top-Base	-Pulse Width	
+Overshoot	Duty Cycle	
-Overshoot		

General

Autocalibration: 3 minutes after power-up and whenever there is a change in ambient temperature of 5 °C

Calibrator Signal: 0.6 V +/-1 %, 1 kHz +/-0.5 %

AC Power In:

90 to 264 VAC	47 to 63 Hz
90 to 132 VAC	380 to 420 Hz

Power Consumption: 75 VA max.

Standby Power Consumption: 10 VA max. (90 to 264 VAC, 50/60 Hz)

Physical Dimensions (HxWxD): 190 mm (7.5") x 285 mm (11.2") x 102 mm (4.0")

Weight: 3.2 kg (approx.)

Warranty and Service: 3-year warranty, calibration recommended yearly

Optional service programs include extended warranty and calibration services

Getting Started Manual

Environmental: Temperature (operating): 10 to 35 °C
Temperature (storage): -20 to +60 °C
Humidity (operating): 5 to 80% RH (non-condensing)
Altitude (operating): up to 2000 m

Certifications:

CE	EN61326:1997 +A1:1998 +A2:2001 +A3:2003 EN61010-1:2001
UL	61010-1, 2nd edition
cUL	CAN/CSA C22.2 No 61010-1-04

WaveJet Series

Declaration of Conformity:

EC Declaration of Conformity	<p>Meets intent of the European Council Directives 73/23/EEC for product safety and 89/336/EEC for electromagnetic compatibility. This declaration is based upon compliance of the WaveJet oscilloscope to the following standards:</p> <p>EN 61326: 1997 +A1:1998 +A2:2001 +A3:2003 EMC requirements for electrical equipment for measurement, control, and laboratory use.</p> <p>Emissions:</p> <p>EN 55011: 1998+A2:2002 Radiated & Conducted Emissions (Class A)</p> <p>EN 61000-3-2:2000 Harmonic Current Emissions</p> <p>Immunity:</p> <p>EN 61000-4-2:1999 Electrostatic discharge (±4 kV contact discharge; ±8 kV air discharge)</p> <p>EN 61000-4-3: 2002+A1:2003RF Radiated Fields (3 V/m, 80 MHz to 1 GHz, 80% amplitude modulated)</p> <p>EN 61000-4-4: 2004 Electrical Fast Transient/Burst (1 kV on AC mains)</p> <p>EN 61000-4-5: 1995+A1:2001 Surge (1 kV differential mode, 2 kV common mode)</p> <p>EN 61000-4-6: 1996+A1:2001 RF Conducted Field (3 V, 150 kHz to 80 MHz, amplitude modulated with 1 kHz sine wave)</p> <p>EN 61000-4-11: 2004 Mains Dips and Interruptions (100% interruption for 1 full AC cycle)</p> <p>EN 61010-1: 2001 Safety requirements for electrical equipment for measurement control and laboratory use</p> <p>With the following limits:</p> <p>Installation (Overvoltage) Category II (Line voltage in equipment and to wall outlet)</p> <p>Installation (Overvoltage) Category I (All mains isolated terminals)</p> <p>Pollution Degree 2</p> <p>Protection Class I</p>
---------------------------------	---

Getting Started Manual

部件名称	有毒有害物质和元素					
	铅 (Pb)	汞 (Hg)	镉 (Cd)	六价铬 (Cr ⁶⁺)	多溴联苯 (PBB)	多溴二苯醚 (PBDE)
PCBA.s	X	O	X	X	X	X
机械硬件	O	O	X	O	O	O
金属片	O	O	X	O	O	O
塑料部件	O	O	O	O	X	X
电缆组件	X	O	X	O	X	X
显示器	X	O	X	X	X	X
电源	X	X	X	O	X	X
风扇	X	O	X	O	X	X
处理器电源	X	O	X	O	O	O
电源线	X	O	X	O	X	X
外部电源(如有)	X	X	X	O	X	X
探头(如有)	X	O	X	O	X	X
光驱(如有)	X	O	X	O	X	X
熔丝(如有)	X	O	X	O	O	O
产品外壳(如有)	O	O	O	O	X	X
适配器 模块(如有)	X	O	O	O	O	O
鼠标(如有)	X	O	X	O	X	X

O: 表明该有毒有害物质在该部件所有均质材料中的含量均在 SJ/T11363-2006 标准规定的限量要求之下。

X: 表明该有毒有害物质至少在该部件的某一均质材料中的含量超过 SJ/T11363-2006 标准规定的限量要求。

EFUP (对环境友好的使用时间) 使用条件: 参阅本手册“规范”部分规定的环境条件。

电池 EFUP: 5 年

WaveJet Series

Part Name	Toxic or Hazardous Substances and Elements					
	Lead (Pb)	Mercury (Hg)	Cadmium (Cd)	Hexavalent Chromium (Cr ⁶⁺)	Polybrominated Biphenyls (PBB)	Polybrominated Diphenyl Ethers (PBDE)
PCBAs	X	O	X	X	X	X
Mechanical Hardware	O	O	X	O	O	O
Sheet Metal	O	O	X	O	O	O
Plastic Parts	O	O	O	O	X	X
Cable Assemblies	X	O	X	O	X	X
Display	X	O	X	X	X	X
Power Supply	X	X	X	O	X	X
Fans	X	O	X	O	X	X
Battery for Processor	X	O	X	O	O	O
Power Cord	X	O	X	O	X	X
Ext Power Supply (if present)	X	X	X	O	X	X
Probes (if present)	X	O	X	O	X	X
CD Drive (if present)	X	O	X	O	X	X
Fuse (if present)	X	O	X	O	O	O
Product Case (if present)	O	O	O	O	X	X
Adapters/Modules (if present)	X	O	O	O	O	O
Mouse (if present)	X	O	X	O	X	X
O: Indicates that this toxic or hazardous substance contained in all of the homogeneous materials for this part is below the limit requirement specified in SJ/T11363-2006.						
X: Indicates that this toxic or hazardous substance contained in at least one of the homogenous materials used for this part is above the limit requirement specified in SJ/T11363-2006.						

EFUP (Environmental Friendly Use Period) Use Conditions: refer to the environmental conditions stated in the specifications section of this Manual.

EFUP for Battery: 5 Years

POWER-UP AND INSTALLATION

Power-Up



Press the power switch at bottom-left of the front of the scope to apply or remove power.

Software

You can find out the scope's software and hardware configuration as follows:

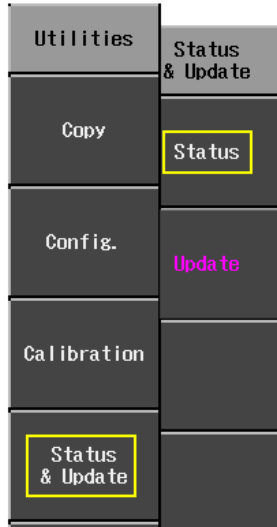

1. Press the front panel **UTILITIES** button.
2. From page 2/3 of the "Utilities" menu, select **Status & Update**, then **Status**.
3. A pop-up box opens:

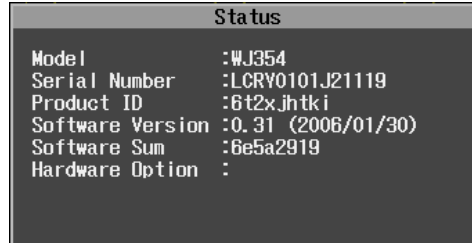

4. Press **CLOSE** to close the pop-up box.

WaveJet Series

Updating the System Software

System software updates are downloaded through the USB memory port in the front of the scope.

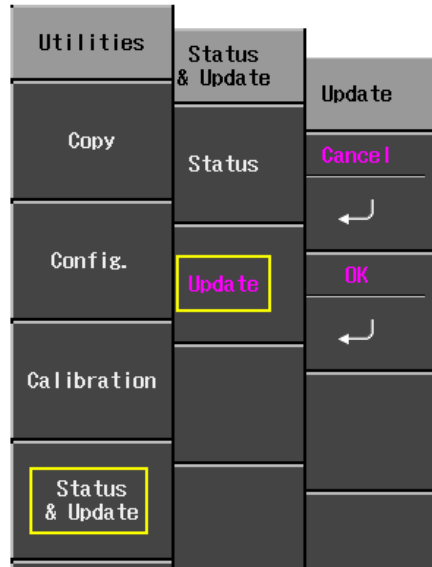

1. Insert the USB memory device, containing the software update file in a root directory, into the USB port at the front of the scope.
2. Press the front panel **UTILITIES** button.
3. From page 2/3 of the "Utilities" menu, select **Status & Update**, then **Update**.
4. Select **OK** from the "Update" menu; software download begins.

The Replay LED on the front panel flashes while download is in progress.

PROBES

LeCroy provides a passive probe for each WaveJet oscilloscope channel, as follows:

PP006A	350 and 500 MHz
PP010	100 and 200 MHz

Probe Compensation

Passive probes must be compensated to flatten overshoot. This is accomplished by means of a trimmer at the connector end of the probe.

1. Attach the connector end of your PP010 or PP011 probe to any channel.
2. Connect the probe end to the CAL output connector at the front of the scope.
3. Adjust the trim pot at the connector end of the probe until the square wave is as flat as possible.

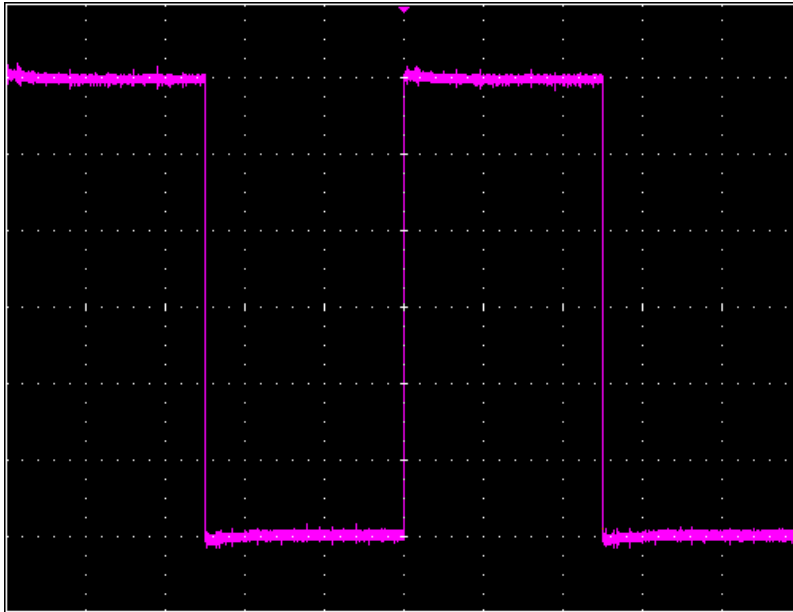

WaveJet Series

FRONT PANEL CONTROLS

Front Panel Buttons and Knobs

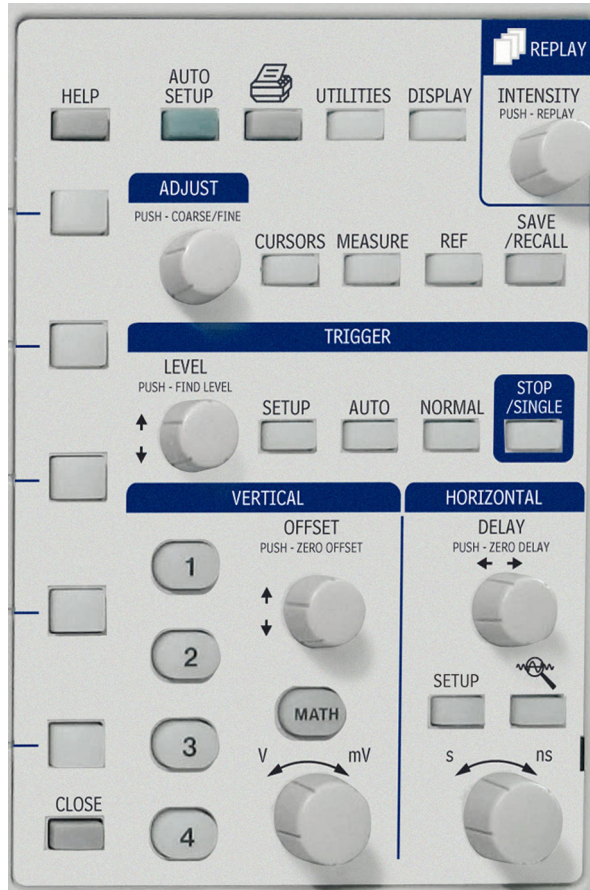

The control buttons of the WaveJet Series front panel are logically grouped into analog and special function areas. The following table provides an explanation of the front panel push buttons and knobs.

Getting Started Manual

Trigger Controls

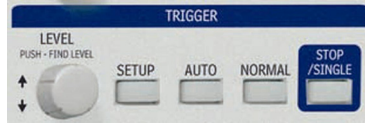

LEVEL -- Selects the trigger threshold level. Press the **LEVEL** knob to have the scope find the trigger level automatically.

SETUP -- Displays the trigger setup menu.

AUTO -- Triggers the scope after a time-out, even if the trigger conditions are not met.

NORMAL -- Triggers the scope each time a signal is present that meets the conditions set for the type of trigger selected.

SINGLE/STOP -- Arms the scope to trigger once (single-shot acquisition) when the input signal meets the trigger conditions set for the type of trigger selected. If the scope is already armed, it will force a trigger.

Horizontal Controls

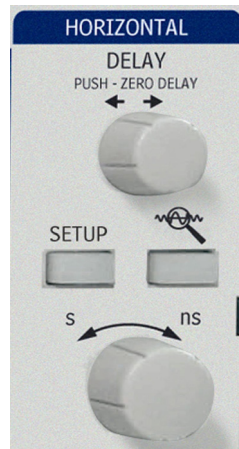

DELAY -- Horizontally positions the scope trace on the display so you can observe the signal prior to the trigger time. Press the button to reset the delay to zero.

TIME/DIVISION -- Sets the time/division of the scope timebase (acquisition system).

SETUP -- Displays the main horizontal setup menu.

WaveJet Series

Vertical Controls

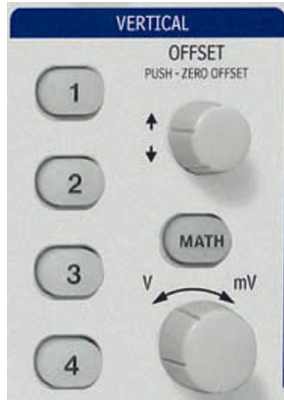

OFFSET -- Adjusts the vertical offset of each channel individually.

VOLTS/DIV -- Adjusts the volts/division setting (vertical gain) of the channel selected.

CHANNEL BUTTONS -- If the channel is already ON, the channel button makes the channel active.

If the channel is OFF, the channel button turns the channel ON.

When the channel is active, the channel button is lit, and the **OFFSET** and **VOLTS/DIV** knobs are dedicated to that channel.

Zoom Control Knobs



QUICKZOOM -- Automatically displays magnified views of up to four signal inputs.

Horizontal Delay -- In zoom mode, this knob adjusts the horizontal position of a zoom trace on the display. The zoom region is highlighted on the source trace between vertical markers. Unlike Delay, the position is not calibrated to the trigger position.

Time/Division -- In zoom mode, this knob adjusts the horizontal zoom (magnification factor) of the selected zoom trace.

Special Features Controls

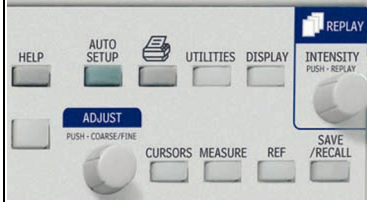

INTENSITY/REPLAY -- In intensity mode, use this knob to adjust the brightness of your waveforms. The intensity value is displayed at the top of the screen at far right. Pressing the button changes its function to Replay (history) mode, which allows you to scroll backwards in time to view past acquisitions. The number of acquisitions stored depends on the Max Memory Length setting. A count of the waveforms is displayed at top-right of the display.

In **Spectrum** (color-graded) persistence mode, the **INTENSITY** knob is also used to adjust the persistence saturation level.

ADJUST FINE/COARSE -- This dual-function knob, when not used for cursor placement, is used to dial values into data entry fields.

Press the knob to toggle between fine grain (hundredths place) and coarse grain (tenths place) adjustments. An icon located next to the data entry field indicates the current setting:





CURSORS -- This push button turns on the cursors and displays the "Cursors" menu. If you are in zoom mode, the cursors are placed on the zoom traces. Press the **CURSORS** button repeatedly to sequence through all available cursor types.

When in cursors mode (**CURSOR** button is lit), use the **ADJUST** knob to position the cursors. If you open a different menu (Horizontal, for example), the **CURSOR** button goes dark, and the **ADJUST** knob can be used to set values in another field.

MEASURE -- Displays a menu of measurement parameters. The "Display Type" must be set to **YT** mode.

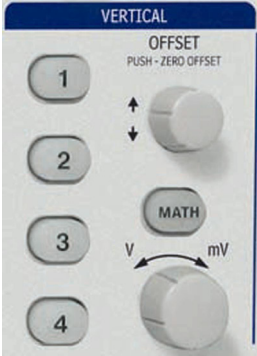
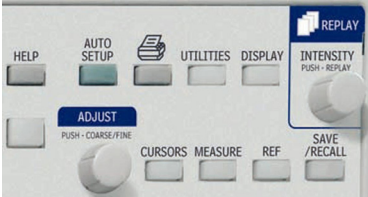
WaveJet Series

	<p>REF -- Enables you to save up to five waveforms in internal scope memory. You can also recall waveforms.</p> <p>SAVE/RECALL -- This button enables you to save or recall scope setups and waveforms from internal scope memory or from USB memory. It is also used to recall a default scope setup, which turns on all channels and sets the vertical gain to 100 mV/div.</p> <p>DISPLAY -- Allows you to set grid and waveform display styles, and persistence.</p> <p>MATH -- Displays a setup menu for math functions.</p>
<p>General Control Buttons</p> 	<p>HELP -- Displays context-sensitive on-line Help. Press HELP then another front panel button; information will be displayed about the functioning of that button.</p> <p>AUTO SETUP -- Automatically sets the scope's horizontal timebase (acquisition system), vertical gain and offset, as well as trigger conditions, to display your signal.</p> <p>UTILITIES -- This button displays a menu of configurable scope features.</p> <p> Print Screen -- Prints the displayed screen to a USB memory device.</p> <p>CLOSE -- This button closes menus and pop-</p>

Getting Started Manual

up boxes. When menus are more than one layer deep, it closes the top-most menu with each successive press of the button.

WaveJet Series

UNDERSTANDING DISPLAY INFORMATION

Grid Area

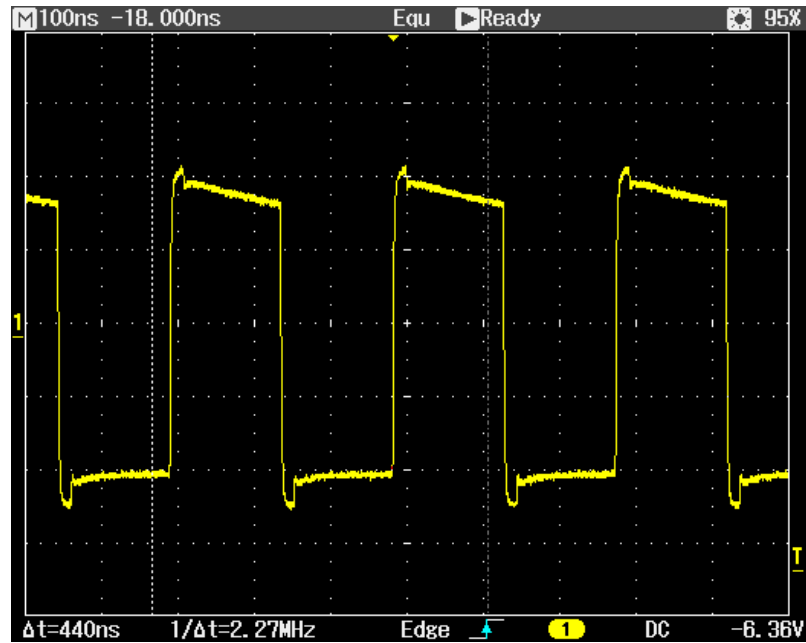

The grid area contains several indicators to help you understand triggering. Indicators are coded to the channel colors (yellow here for channel 1).

<p>The close-up shows the top edge of the grid with a vertical dashed line and a horizontal arrow pointing right, labeled 'TRIGGER DELAY'. Above this indicator, the value '-18.000ns' is displayed. To the right of the trigger delay indicator, the text 'Equ' and 'Ready' are visible. In the top right corner of the grid area, the text '95%' is displayed. Below the grid area, the text 'M 100ns', '-18.000ns', 'Equ', 'Ready', and '95%' are displayed.</p>	<p>Trigger Delay -- This indicator is located along the top edge of the grid. Trigger delay allows you to see the signal prior to the trigger time. Trigger delay values are displayed above the grid (-18.000 ns in this example). Zero delay is the horizontal center of the grid. Post-Trigger delay is indicated by a left-pointing arrow at the top of the grid.</p>
---	--

Getting Started Manual

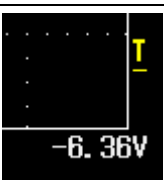
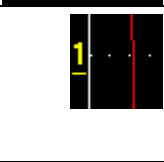
		<p>Trigger Level -- This indicator is located at the right edge of the grid. The value is displayed below the grid.</p> <p>Press the trigger level knob to reset the level to 50%.</p>
		<p>Zero Volts Level -- This indicator is located at the left edge of the grid. To change the zero volts level, turn the vertical offset knob. Press the knob to reset the indicator to the middle of the grid.</p>

Top Status Bar

This line displays acquisition and sampling information, and the setting of the intensity control. When persistence is set to **Spectrum** mode, the intensity value represents color saturation level.

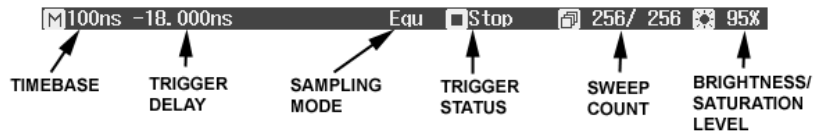

When zooming is enabled, this information also appears in the status bar:

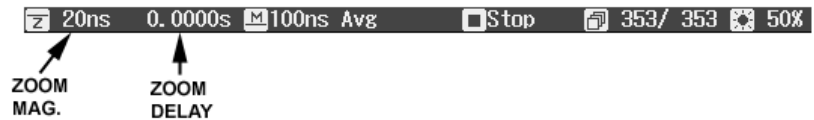

The zoom magnification factor is the ratio of the timebase of the zoom trace to that of the input waveform.

Zoom delay represents the portion of the input waveform being zoomed. As you turn the Horizontal delay knob, this value becomes positive or negative depending on whether the zoom is left (+) or right (-) of center.

The symbols **M** and **Z** indicate that the Main grid is on top and the Zoom grid is on the bottom of the scope display.

WaveJet Series

Bottom Status Bar

The status bar below the grid displays cursor (time and frequency) information and additional trigger setup information.

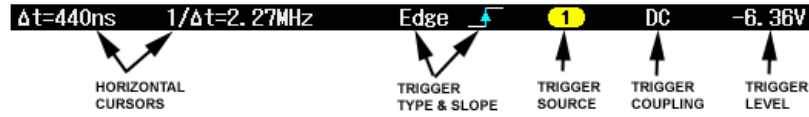

Message Line

At the very bottom of the scope display is the message line. Prompts and error messages are displayed on this line at far left. In addition, the following information is displayed:

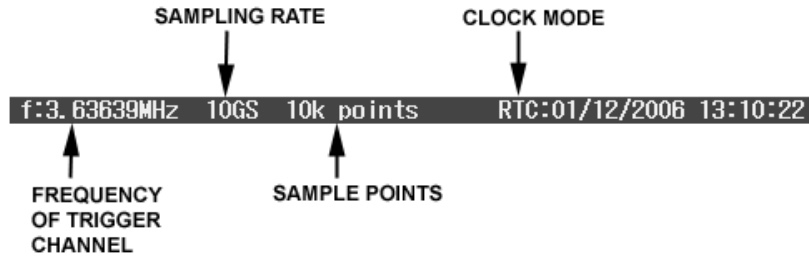

The clock mode can be either real time clock (RTC) or trigger time stamp (TRG).

Trace Descriptors

Channel and math trace descriptor labels are displayed below the grid.

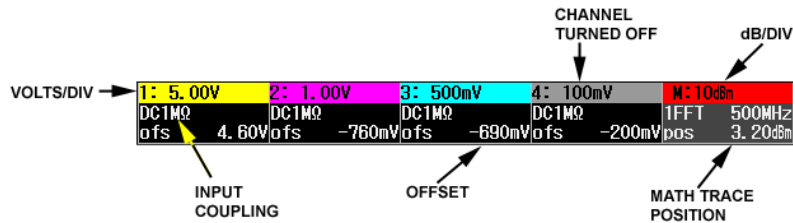

TURNING ON TRACES

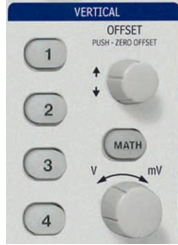

To turn on a channel trace, simply press the channel button. This action also displays a setup menu for that channel. The setup menu displayed (1/2 or 2/2) will be the one that was displayed when the trace was last turned on.

To turn a trace off, press the button again. The setup menu, however, will continue to be displayed until you press **CLOSE** or open another menu.

CH3	CH3
Coupling	Volts/div
DC1MΩ	Coarse
Bandwidth	Unit
Full	Volt
Probe	
Auto	
Invert	Deskew
Off On	+0.00ns
Next	Next
(1/2)	(2/2)

WaveJet Series

VERTICAL SETTINGS AND CHANNEL CONTROLS

Choosing Coupling

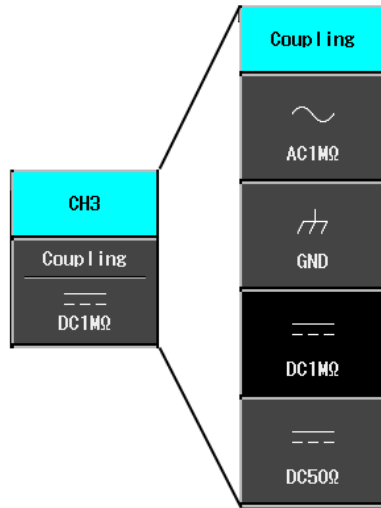

To select an input coupling mode, turn on the channel whose coupling you want to change by pressing the appropriate channel button. Select **Coupling** from page 1/2 of the channel menu, then the coupling mode from the next menu.

Bandwidth Limiting



Reducing the bandwidth reduces the signal and system noise, and prevents high frequency aliasing.

The choices of bandwidths are

- Full
- 100 MHz
- 20 MHz

Probe Attenuation



The WaveJet Series scope offers a wide variety of probe attenuations:

1:1	1000:1
10:1	2000:1
100:1	Auto

Inverting Waveforms



Set this item to **On** to invert the waveform.

Adjusting Sensitivity

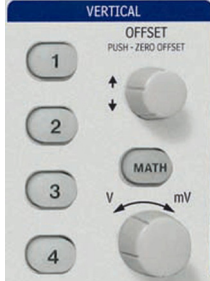

Activate the channel you want to adjust; there does not need to be a signal applied. Turn the volts per division knob in the VERTICAL group of controls.



The volts/div that you set is displayed in the top line of the trace descriptor label.



This menu selection sets the grain of the volts/div knob. **Coarse** sets the gain adjustment to 1-2-5 increments. **Fine** sets the gain to as small as 2-mV increments.



The "Unit" menu offers a choice of **Volts**, **Amperes**, **Watts**, **Degrees C**, or **No Units**.

WaveJet Series

Adjusting the Waveform's Position



Turn the vertical offset adjust knob in the VERTICAL group of controls.

The offset value is displayed in the bottom line of the trace descriptor label.

SAMPLING MODES

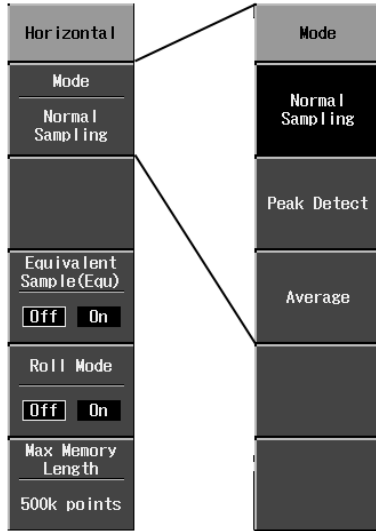

Sampling modes are accessed by pressing the **SETUP** button in the HORIZONTAL control group.

There are three basic sampling modes:

- Normal -- real-time mode
- Peak Detect -- the maximum and minimum values that occur in a zone twice the sampling period are detected.
- Average -- up to 256 waveforms

In addition, two other sampling modes are available:

- Equivalent Sampling Mode -- random interleaved sampling (RIS) mode
- Roll mode -- for slow acquisitions

TIMEBASE SETUP

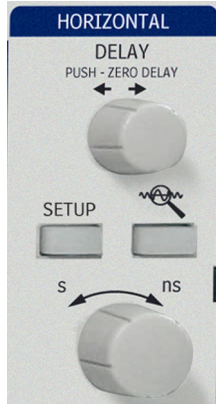

You can change the timebase at any time without displaying the "Horizontal" setup menu.

As you turn the time/div knob in the HORIZONTAL control group, the value is displayed at the top-left of the screen:









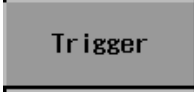
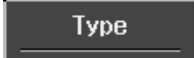

WaveJet Series

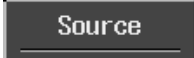
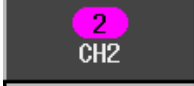

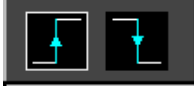
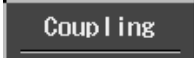
TRIGGERING

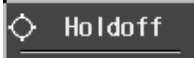
Trigger Types

Trigger modes are accessed by pressing the **SETUP** button in the TRIGGER control group of buttons and selecting **Type** from the "Trigger" menu:

	
	
	Press the Type menu button to select Edge, Pulse Width, Period, Pulse Count, or TV triggering.
	
	Source lets you choose a channel input or an external input.
	
	Use Slope to select a positive or negative edge for edge triggering. This menu item becomes Polarity for the Pulse Width trigger.
	
	Coupling modes comprise AC, DC, HF Reject, and LF Reject
	
	Use the ADJUST knob to dial in a Holdoff value in units of time.

Pulse Width Triggering

Trigger	
Type	
 Pulse Width	
Source	
2 CH2	Source lets you choose a channel input or an external input.
Polarity	
	Select positive or negative polarity.
Coupling	
--- DC	Coupling modes comprise AC, DC, HF Reject, and LF Reject
Pulse Width	
15.0ns ≤ t	Select Pulse Width to set “less than” and “greater than” criteria and range limits, and to set time values.

WaveJet Series

Period Triggering

Trigger

Type

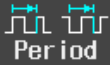

Period

Source

2
CH2

Slope



Coupling

DC

Interval Time

40.0ns ≤ t



Source lets you choose a channel input or an external input.

Select positive or negative polarity.

Coupling modes comprise AC, DC, HF Reject, and LF Reject

Select **Interval Time** to set "less than" and "greater than" criteria, and to set a time value.

Pulse Count Triggering

Trigger	
Type	 Pulse Count
Source	2 CH2
Slope	 
Coupling	-- DC
No. of Pulse	<input type="text" value="1"/>

Source lets you choose a channel input or an external input.

Select positive or negative polarity.

Coupling modes comprise AC, DC, HF Reject, and LF Reject

Select **No. of Pulse** to set the number of pulses to count before the scope triggers.

WaveJet Series

TV Triggering

Trigger	Setting
Type	Standard
 TV	NTSC
Source	Line number
2 CH2	33/262 525
Slope	Field sequence
	8
	Field No.
	8
TV Setting	TV Lines Line No. / Lines 525



Press the **Type** menu button to select a standard: NTSC, PAL, or Custom.

Source lets you choose a channel input or an external input.

Select **Slope** to set positive or negative polarity.

Select **TV Setting** to set up the TV trigger.

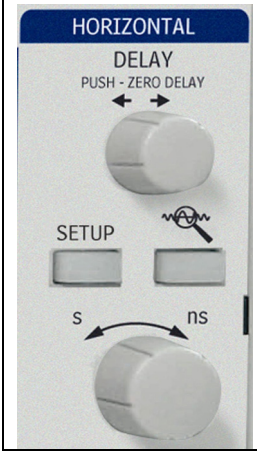
Horizontal Trigger Setup

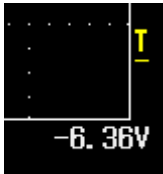

 <p>The image shows the HORIZONTAL control group. At the top is a knob labeled 'DELAY' with 'PUSH - ZERO DELAY' and a double-headed arrow above it. Below the knob are two buttons labeled 'SETUP'. At the bottom is another knob with 's' and 'ns' labels and a double-headed arrow between them.</p>	<p>Turn the DELAY knob in the HORIZONTAL control group to adjust the trigger's horizontal position. The trigger location is shown by a marker at the top of the grid and the time value is given in the status bar above the grid:</p>  <p>The image shows a grid with a yellow marker at the top. Above the grid, the text '-18.000ns' is displayed. Below the grid, the text 'TRIGGER DELAY' is shown with a white arrow pointing to the right towards the yellow marker.</p>
 <p>The image shows a status bar with 'M100ns' on the left and a yellow arrow pointing to the left.</p>	<p>Post-trigger delay is indicated by a left-pointing arrow at the left edge of the grid.</p>

Vertical

 <p>The image shows the TRIGGER control group. At the top is a knob labeled 'LEVEL' with 'PUSH - FIND LEVEL' and up/down arrows above it. To the right of the knob are three buttons labeled 'SETUP', 'AUTO', and 'NORMAL'. On the far right is a button labeled 'STOP /SINGLE'.</p>	<p>Turn the LEVEL knob in the TRIGGER control group to adjust the vertical threshold of the trigger or the highlighted trace. Level defines the source voltage at which the trigger will generate an event: a change in the input signal that satisfies the trigger conditions.</p>
 <p>The image shows a grid with a yellow 'T' marker on the right side. Below the grid, the text '-6.36V' is displayed.</p>	<p>The trigger level is indicated by a "T" to the right of the grid. The value is given below the grid</p> <p>A "T" with an underscore, as shown here, indicates a negative voltage level. A "T" with a superscore (overbar) indicates a positive voltage level.</p>

WaveJet Series

To Set Up an Edge Trigger

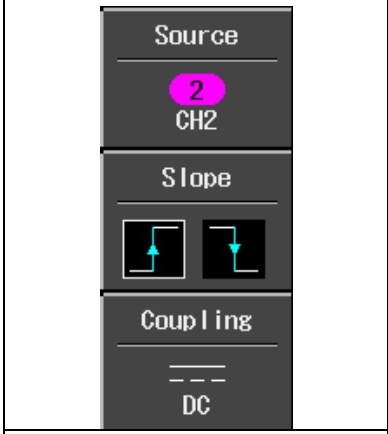
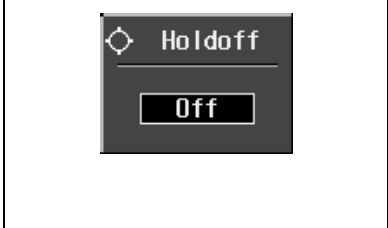



	<p>1. Press the front panel trigger SETUP button.</p>
	<p>2. Select Type from the "Trigger" menu, then Edge.</p>
	<p>3. Select a trigger source, positive or negative slope, and trigger coupling mode (AC, DC, HF Reject, or LF Reject).</p>
	<p>4. If you want to set a holdoff time, use the ADJUST knob to set a value. Push the ADJUST knob to toggle between fine and coarse adjustment.</p> <p>To set a holdoff time of zero seconds, turn the knob fully counterclockwise until Off is displayed in the "Holdoff" field.</p>

WAVEFORM MEASUREMENTS

Measuring with Cursors

Cursors are important tools that aid you in measuring signal values. Cursors are boundary markers that you can move across the grid. Use cursors to make fast, accurate measurements and to eliminate guesswork.

Cursor Measurement Selections

 <p>Time</p>	Time cursors are vertical lines that you move horizontally to measure the difference in time or frequency values between the cursors.
 <p>Amplitude</p>	Amplitude cursors measure the difference in Y values between the cursors.
 <p>Time & Amplitude</p>	You can display both time and amplitude measurements together in this mode.
 <p>Value at Cursor</p>	Gives the x value at a single point on your waveform.

Time values are displayed below the grid:



WaveJet Series

Amplitude cursor values are displayed in the bottom line of the trace label for each channel:

1: 500mV	2: 1.00V	3: 1.00V	4: 100mV	M:500mV	
DC1MΩ	DC1MΩ	DC1MΩ	DC1MΩ	CH1 + CH2	
ΔV	-2.77VΔV	-5.54VΔV	-5.54VΔV	-554mVΔV	-2.77V

Note that the value depends on the time/div setting shown in the top line of each trace label.

Cursor Placement



Use the **ADJUST** knob to move cursors horizontally and vertically.



The cursor selected for placement is indicated by a

highlighted fine grain icon in the menu  and the cursor itself has a higher brightness in the grid.

If **Track** is selected, both cursors move in unison and both appear brighter in the grid.

PARAMETER MEASUREMENTS

Waveform analysis typically begins with the measurement of parameters. Parameter measurement tools determine a wide range of waveform properties. Use them to automatically calculate many attributes of your waveform, like rise time, rms voltage, and peak-to-peak voltage, for example.

You can make common measurements on one or more waveforms. Parameter values are displayed below the grid.

A:	2	Peak-Peak	1.12V	1.12V(Max)	1.10V(Min)
B:	1	RMS	6.85V	6.86V(Max)	6.84V(Min)
C:	2	Integral	-522.8nVs	-522.5nVs(Max)	-524.0nVs(Min)
D:	3	Tr 20-80%	1.575ns	1.734ns(Max)	1.400ns(Min)

Measure Modes

Standard Vertical Parameters

- Maximum -- Measures highest point in waveform. Unlike top, it does not assume the waveform has two levels.
- Minimum -- Measures the lowest point in a waveform. Unlike base, it does not assume the waveform has two levels.
- Peak-Peak -- Difference between highest and lowest points in the waveform.
- RMS -- Root Mean Square of data between the cursors -- about the same as sdev for a zero-mean waveform.
- Cycle RMS -- Cyclic root mean square: Computes the square root of the sum of squares of data values divided by number of points. Contrary to rms, calculation is performed over an integer number of cycles, eliminating bias caused by fractional intervals.
- Mean -- Average of the data for a time domain waveform. Computed as centroid of distribution for a histogram.
- Cycle Mean -- Computes the average of the waveform data. Contrary to mean, computes the average over an integer number of cycles, eliminating bias caused by fractional intervals.
- Top -- Higher of two most probable states, the lower being base; it is characteristic of rectangular waveforms and represents the higher most probable state determined from the statistical distribution of data point values in the waveform.
- Base -- Lower of two most probable states (higher is top). Measures lower level in two-level signals. Differs from min in that noise, overshoot, undershoot, and ringing do not affect measurement.

WaveJet Series

- Top-Base -- Measures the difference between upper and lower levels in two-level signals. Differs from pkpk in that noise, overshoot, undershoot, and ringing do not affect the measurement.
- +Overshoot -- Amount of overshoot following a rising edge specified as percentage of amplitude.
- -Overshoot -- Amount of overshoot following a rising edge specified as percentage of amplitude.

Standard Horizontal Parameters

- Rise Time 10-90% -- Detects the first rise to pass through 50% of the amplitude (top - base) of the waveform within the measurement section, and then measures the time of transition from 10% to 90% at that rise.
- Rise Time 20-80% -- Detects the first rise to pass through 50% of the amplitude (top - base) of the waveform within the measurement section, and then measures the time of transition from 20% to 80% at that rise.
- Fall Time 80-20% -- Detects the first fall to pass through 50% of the amplitude (top - base) of the waveform within the measurement section, and then measures the time of transition from 80% to 20% at that fall.
- Fall Time 90-10% -- Detects the first fall to pass through 50% of the amplitude (top - base) of the waveform within the measurement section, and then measures the time of transition from 90% to 10% at that fall.
- Frequency -- Period of cyclic signal measured as time between every other pair of 50% crossings. Starting with first transition after left cursor, the period is measured for each transition pair. Values then averaged and reciprocal used to give frequency.
- Period -- Period of a cyclic signal measured as time between every other pair of 50% crossings. Starting with first transition after left cursor, period is measured for each transition pair, with values averaged to give final result.
- No. of +Pulses -- An integer number of positive pulses.
- No. of -Pulses -- An integer number of negative pulses.
- +Pulse Width -- Measures the time from the first rise until the first fall to pass through 50% of the amplitude (top-base) of the waveform within the measurement section.
- -Pulse Width -- Measures the time from the first fall until the first rise to pass through 50% of the amplitude (top-base) of the waveform within the measurement section.
- Duty Cycle -- Width as percentage of period.

Other Parameters

- Integral -- Computes area of waveform between cursors relative to zero level. Values greater than zero contribute positively to the area; values less than zero negatively.
- Skew -- Measures from the 50% crossing of the first edge of a channel to the 50% crossing of a second channel.
- Skew@Level -- Same as Skew, but with user-defined level.

Statistics





For each parameter, you can display minimum and maximum values by pressing the **MEASURE** button, then setting **Min/Max** to On.

WaveJet Series





DISPLAY FORMATS

Display Setup

The Display menu is accessed by pressing the **DISPLAY** button on the front panel.

Display	
Type  YT	Display types comprise YT (voltage versus time), XY, and XY Triggered.
Vector 	Select points if you want to see actual sample points only. Select lines if you want to see interpolated vectors between points.
Graticule  Grid	Besides a standard 8 x 10 matrix, you can elect to display your waveforms on X and Y axes only (Axis), or on no grid or axes (Frame).
 Persist. Time 	Persistence decay times can be set to 0.1 s, 0.2 s, 0.5 s, 1 s, 2 s, 5 s, 10 s, or infinity. To clear persistence, press either the V/div or time/div knobs.
Color Gradation Single Spectrum	In Single color gradation mode, all traces retain their specific channel trace color. In Spectrum color gradation mode, all traces are displayed at the same color saturation level. The saturation level is set by the front panel intensity knob.

Display Types

 YT	<p>This is volts versus time, or dBm versus frequency for the FFT function.</p>
 XY	<p>Asynchronous XY mode. Inputs must be connected to channel 1 and channel 2. When this mode is selected Auto is indicated as the trigger mode and the timebase control cannot be adjusted:</p> 
 XY(Triggered)	<p>Synchronous XY mode. Inputs must be connected to channel 1 and channel 2. Use this mode for periodic signals when only a portion of the period is of interest. Set the timebase and trigger level to acquire the desired portion.</p>

Zooming Waveforms



To zoom waveforms, simply press the **Zoom** front panel button. Zooms will be created in a second grid for all displayed traces.

Use the time/div knob to adjust the zoom magnification factor.

The zoom factor is displayed above the grid:



WaveJet Series

The zoom magnification factor is the ratio of the timebase of the zoom trace to that of the input waveform.

Zoom delay represents the portion of the input waveform being zoomed. As you turn the Horizontal delay knob, this value becomes positive or negative depending on whether the zoom is left (+) or right (-) of center.

The symbols **M** and **Z** indicate that the **M**ain grid is on top and the **Z**oom grid is on the bottom of the scope display.

Replay Mode

Replay mode provides a way to scroll backwards in time to view past acquisitions.



The number of sweeps that can be stored depends on the **Max Memory Length** selected in the "Horizontal" menu. Replay Mode does not function under the following conditions:

- in Roll Mode
- in Average Mode
- in Equivalent Sampling (RIS) mode



To access Replay mode and scroll through waveforms, press **STOP/SINGLE** to stop acquisitions, then press the **INTENSITY/REPLAY** knob. The Replay LED lights to confirm Replay Mode.

SAVE AND RECALL

Saving and Recalling Scope Settings

You can save scope settings to internal memory or USB memory. The "Save/Recall" menu is accessed by pressing the **SAVE/RECALL** front panel button.

Save/Recall	
Save Setup to Int. Memory	Five memory locations available. Setup files named with current time and date.
Recall Setup from Int. Memory	Files are identified by time and date saved.
Save/Delete to USB Memory	The Save function saves not only setup files but also waveforms in various file formats: Binary, ASCII, Mathcad. You can also save reference waveforms to USB memory. Delete lets you erase all setup, waveform, and screen image files from USB memory.
Recall from USB Memory	Recalls setups and waveform files from USB memory.
Recall Default Setup	The default setup turns on all channels and sets the following conditions with channel 1 as the trigger source: Timebase = 200 ns/div Gain = 100 mV/div Trigger mode = Auto Coupling = DC1Mohms

WaveJet Series

Saving and Recalling Waveforms

Reference waveforms can be saved in internal memory (five locations) or in USB memory (limited by memory capacity of USB device). When you save a waveform, the setup is saved also.

You can display up to five reference waveforms at the same time. Press **REF** to turn them all off together. The "Reference Waveform" menu is accessed by pressing the **REF** front panel button.

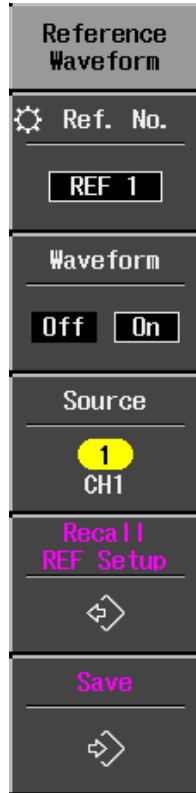

Select from five memory locations (REF 1 to REF 5). To scroll through the choices, you can use the **ADJUST** knob or press the **Ref. No.** button repeatedly.

Select **On** to display the reference waveform. All reference waveforms appear white.

When saving a reference waveform, select the source.

When **Recall REF Setup** is selected, the setup stored in the memory location selected above (REF 1 to REF 5) will be recalled. This does not include setups saved in USB memory, which are recalled through **SAVE/RECALL**.

When **Save** is selected, the source will be saved into the memory location selected above (REF 1 to REF 5).

WAVEFORM MATH

Standard math functions comprise addition, subtraction, multiplication, and FFT. The "Math" menu is accessed by pressing the **MATH** front panel button in the VERTICAL control group.



Source can be any channel, but not another math trace.

Select math operator $+$, $-$, \times , or **FFT**.

If FFT is selected, select a window type:

- **Rectangular** -- Normally used when the signal is transient (completely contained in the time-domain window) or known to have a fundamental frequency component that is an integer multiple of the fundamental frequency of the window.
- **VonHann** -- Reduces leakage and improves amplitude accuracy. However, frequency resolution is also reduced.
- **Flat Top** -- Provides excellent amplitude accuracy with moderate reduction of leakage, but with reduced frequency resolution.

WaveJet Series

UTILITIES

Print Screen

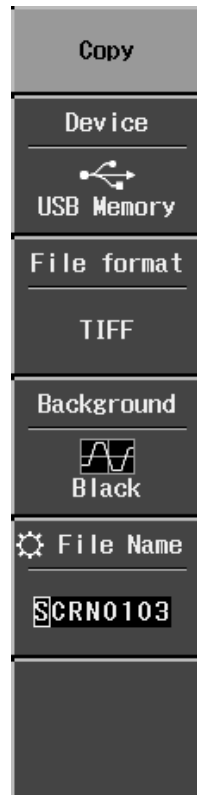

Device allows you to choose an output device, such as USB.

Selectable file formats are .tif, .bmp, and .png.

Background lets you select a black or white background for the grid. Select **White** to save printer ink.

You have the option to name your files. Use the **ADJUST** knob for this purpose. Rotate the knob to select a letter or number, then push the knob to accept it.

Configuration -- Page 1/2



Language selects a UI local language. No reboot is required to accept a change in language.

Select **Date & Time** to set the current time and to determine the clock mode at the bottom of the screen: real time clock (RTC) or trigger time stamp (TRG).







As you change the gain, **Offset Setting** allows you to either keep the vertical offset level indicator stationary (**Division**) or to have it move with the actual voltage level (**Volts**). When **Division** is selected, the waveform will remain on the grid as you increase the gain; whereas, if **Volts** is selected, the waveform could move off the grid.

If desired, use **Power Management** to set the screen saver timer (up to 15 minutes) and the power off timer (up to 60 minutes). These features can be set to **Never** also.

You can also set the backlight (screen) intensity (3 levels), which is different from grid intensity (see menu 2/2).

WaveJet Series

Configuration -- Page 2/2

Config.	
Beep	
 	Beep enabled gives audible confirmation of button presses and knob rotations.
Panel Lock	
 	Panel Lock disables all front panel buttons and knobs until unlock is selected from this menu, which remains continuously displayed.
Grid Intensity	
 60%	Use the front panel ADJUST knob to adjust the grid intensity from 0 to 100%.
Trigger Counter	
Off On	When Trigger Counter is On, the frequency of the trigger source is measured and displayed in the message line at the bottom of the screen:
Next	 f:3.64391MHz
(2/2)	

Calibration



Calibrations can be set to occur automatically. Autocalibration occurs three minutes after power-up and whenever there is a change in ambient temperature of 5 °C.

Select **Self Calibration** to perform a manual calibration.

WaveJet Series

Status & Update



The **Status** selection displays a pop-up box showing system status, including serial number and software revision. Press **CLOSE** to close the pop-up box.

Update is used to load firmware updates from USB memory.

§ § §