

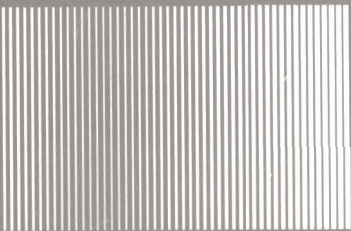

LeCroy 9320

Digital Storage Oscilloscope

SERVICE MANUAL



LeCroy

Innovators in Instrumentation

LeCroy 9320

Digital Storage Oscilloscope

S E R V I C E M A N U A L

Version 1.0

November 1993

First printing

LeCroy
Corporate Headquarters

700 Chestnut Ridge Road
Chestnut Ridge, NY 10977-6499

Tel : (914) 425-2000
Fax : (914) 425-8967

LeCroy
European Headquarters

2, rue du pré-de-la-Fontaine
1217 Meyrin 1 / Geneva, Switzerland

Tel : 41 (022) 719.21.11
Fax : 41 (022) 782.39.15

Table of Contents

Section 1	General Information	Page
1.1	Initial Inspection	1-1
1.2	Warranty	1-1
1.3	Product Assistance	1-1
1.4	Address of Service Centers	1-2
1.5	Maintenance Agreements	1-6
1.6	Documentation Discrepancies	1-6
1.7	Service Procedure	1-6
1.8	Return Procedure	1-6
1.9	Safety Precautions	1-7
1.10	Antistatic Precautions	1-7
Section 2	Specifications	2-1
2-1	9320 Specifications	2-2
2-2	Internal Floppy, RAM Card, Printer options	2-6
2-3	Active Fet Probes	2-9
2-4	WP01 Waveform Processing Package	2-11
2-5	WP02 Fast Fourier Processing Package	2-14
2-6	LeCalsoft Calibration Software	2-17
Section 3	Block Diagram and Sub-Assemblies	3-1
3.1	9320 Block Diagram	3-2
3.2	9320 Sub-Assemblies	3-3
3.3	9320 Hardware Options	3-3
Section 4	Theory of Operation	
4.1	F9314M-1 Processor	4-1
4.2	F9320-3 Main Card	4-4
4.2.1	Introduction	4-4
4.2.2	Front End Control	4-4
4.2.3	Trigger Control	4-8
4.2.4	Time Base Control	4-14
4.3	F9300-4 GPIB and RS232	4-15
4.3.1	RS232 Interface	4-15
4.3.2	GPIB Interface	4-15
4.4	F9320-5 Front Panel	4-15
4.5	F9300-6 Centronics Interface	4-15
4.5.1	Centronics Interface Option	4-15
4.5.2	Floppy Disk Drive Interface Option	4-15
4.5.3	Printer Interface Option	4-16
4.6	F9300-7 Printer Controller	4-16
4.7	93XX-Display	4-16
4.7.1	General Description	4-16
4.7.2	Basic Characteristics	4-16

Section 4	Theory of Operation	Page
4.7.3	Horizontal Deflection	4-16
4.7.4	Vertical Synchronization	4-17
4.7.5	Horizontal and Vertical Resolution	4-17
4.8	93XX-PS1715 Power Supply Specifications	4-18
	93XX-PS1715 Block Diagram	4-19
Section 5	Performance Verification	
5.1	Introduction	5-1
5.2	Test equipment needed	5-1
5.3	Turn On	5-1
5.4	Average noise level : DC 50 Ω	5-2
5.4.1	Peak to Peak noise	5-2
5.4.2	RMS noise	5-5
5.5	Offset Control	5-6
5.5.1	Negative Offset Control	5-6
5.5.2	Positive Offset Control	5-12
5.5.3	Input Grounded Verification	5-16
5.6	50 Ω Input Impedance	5-18
5.7	Bandwidth	5-18
5.8	Manual Linearity Test (NIST Traceable)	5-22
5.9	Trigger Level	5-26
5.9.1	Channel 1	5-27
5.9.2	Channel 2	5-34
5.9.3	External Trigger	5-35
5.9.4	External / 10 Trigger	5-39
5.10	Trigger Rate	5-43
5.10.1	Channel 1 Trigger Rate	5-43
5.10.2	Channel 2 Trigger Rate	5-43
5.10.3	External Trigger Rate	5-45
5.10.4	External/10 Trigger Rate	5-46
5.10.5	Channel 2 HF Trigger Rate	5-47
5.11	Smart Trigger	5-48
5.11.1	Trigger on Pulse Width < 10 nsec	5-48
5.11.2	Trigger on Pulse Width > 10 nsec	5-48
5.11.3	Trigger on Pulse Width < 100 nsec	5-50
5.11.4	Trigger on Pulse Width > 100 nsec	5-51
5.12	Time Base Accuracy	5-52
5.13	Overshoot Verification	5-57
5.14	Probe Calibrator Verification	5-58
Section 6	Internal Calibration and Diagnostics	Page
6.1	Introduction	6-1
6.2	Diagnostic Summary	6-2
6.2.1	Gain and Offset Calibration Description	6-3
6.2.2	Trigger Level Calibration	6-3
6.3	Diagnostic Results	6-3
6.3.1	Gain Curves	6-3
6.3.2	Trigger Level Calibration	6-4

Section 6	Internal Calibration and Diagnostics	Page
6.3.3	Integral Linearity	6-6
6.4	Board Test Results	6-7
6.4.1	Header	6-8
6.4.2	Time	6-8
6.4.3	Trigger	6-9
6.4.4	Trigger Times	6-9
6.4.5	Current	6-10
6.4.6	Vertical Offset and Gain	6-10
6.5	Probe Bus Verification	6-10
Section 7	Maintenance	
7.1	Introduction	7-1
7.2	Disassembly and Assembly Procedure	7-1
7.2.1	Removal of the Upper Cover	7-1
7.2.2	Removal of the 93XX-PS1715 Power Supply	7-1
7.2.3	Disassembly and Assembly Diagram	7-2
7.2.4	Removal of the F9300-4 GPIB/RS232 Interface	7-7
7.2.5	Removal of the Fan	7-7
7.2.6	Removal of the Fuse Holder	7-7
7.2.7	Removal of the 93XX-Video	7-7
7.2.8	Removal of the 93XX-Yoke	7-8
7.2.9	Removal of the Front Frame Assembly	7-8
7.2.10	Removal of the 93XX-Deflection	7-8
7.2.11	Removal of the 93XX-CRT	7-9
7.2.12	Removal of the F9320-5 Front Panel	7-9
7.2.13	Removal of the 9320 Keyboard	7-9
7.2.14	Removal of the F9314M-1 Processor	7-10
7.2.15	Removal of the F9320-3 Main Board	7-10
7.2.16	Removal of the Handle	7-11
7.2.17	Removal of the Foot Support	7-11
7.2.18	Removal of the 93XX-FD01 Floppy Disk	7-11
7.2.19	Removal of the 93XX-GP01 Graphic Printer	7-11
7.2.19	Removal of the F9300-7 Printer Controller	7-11
7.2.20	Removal of the F9300-6 Centronics Interface	7-11
7.3	Software Upgrade Procedure	7-14
7.3.1	Upgrading Firmware	7-14
7.3.2	Changing Software Option	7-14
7.3.3	Software Option Selection GAL	7-14
7.3.4	Processor Board Exchange Procedure	7-17
7.4	Equipment and Spare Parts Recommended for Service	7-17
7.4.1	Equipment	7-17
7.4.2	Spare Parts	7-18
7.5	Troubleshooting and Flow Charts	7-18
7.5.1	Introduction	7-18
7.5.2	Initial Troubleshooting Chart	7-18
7.5.3	Line Voltage Autoranging	7-20
7.5.4	No Power Supply	7-20
7.5.4.1	Line Fuses Replacement	7-20
7.5.5	No Display	7-21

Section 7	Maintenance	Page
7.5.6	Front Panel Controls do not Operate	7-22
7.5.7	Abnormal Image on Screen	7-23
7.5.8	No Remote Control GPIB or RS232	7-24
7.5.9	Performance Verification Fails	7-25
7.5.10	Internal Calibration Fails	7-26
7.5.11	Floppy Disk Drive Option Fails	7-27
7.5.12	Graphic Printer Option Fails	7-28
7.5.13	Centronics Option Fails	7-29
7.6	Calibration Procedures	7-30
7.6.1	93XX-PS1715 Power Supply Calibration	7-30
7.6.2	93XX-Display Adjustment Procedure	7-32
7.6.2.1	Introduction	7-32
7.6.2.2	Coarse Adjustment	7-33
7.6.2.3	Fine Adjustment	7-34
7.6.3	Front End Test and Calibration Procedure	7-36
7.6.3.1	Introduction	7-36
7.6.3.2	Channel 1 Gain HF Adjustment	7-36
7.6.3.3	Channel 2 Gain HF Adjustment	7-39
Section 8	Schematics Diagrams - Parts List	8-1
8.1	9324 Sub Assemblies	8-2
8.2	F9314M-1 Processor Board Schematic	8-3
8.2.1	F9314M-1 Processor Board Parts List	8-13
8.3	F9320-3 Main Board	8-18
8.3.1	F9320-3 Microprocessor Control	8-22
8.3.2	F9320-3 Power Supply Front End	8-25
8.3.3	F9320-3 Front End Control and ADC Control	8-37
8.3.4	F9320-3 External Trigger	8-46
8.3.5	F9320-3 Probe Calibrator	8-48
8.3.6	F9320-3 Front End and ADC Channel 1	8-55
8.3.7	F9320-3 Front End and ADC Channel 2	8-61
8.3.8	F9320-3 Time Base	8-71
8.3.9	F9320-3 Trigger	8-76
8.3.10	F9320-3 Parts List	8-91
8.4	F9300-4 GPIB/RS232 Interface Schematic	8-121
8.4.1	F9300-4 GPIB/RS232 Interface Parts List	8-125
8.5	F9320-5 Front Panel Schematic	8-127
8.5.1	F9320-5 Front Panel Parts List	8-134
8.6	F9300-6 Centronics Interface Schematic	8-136
8.6.1	F9300-6 Centronics Interface Parts List	8-141
8.7	F9300-7 Printer Controller Schematic	8-144
8.7.1	F9300-7 Printer Controller Parts List	8-149
8.8	M93XX Mechanical	8-153
8.9	Accessories for 9320	8-154
8.10	93XX-Display Deflection and Video	8-155
8.11	93XX-FDGP Options	8-160
8.12	93XX-FD01 Option	8-160
8.13	93XX-GP01 Option	8-161
8.14	93XX-PS1715 Power Supply	8-162

Section 9	Mechanical Parts	9-1
Figure 9.1	9320 Exploded View	9-2
	9320 Assembly Part Description	9-3
Figure 9.2	Lower Cover Exploded View	9-4
	Lower Cover Assembly Description	9-5
Figure 9.3	Front Frame Assembly Exploded View	9-6
	Front Frame Assembly Description	9-7
Figure 9.4	Rear Panel Assembly Exploded View	9-8
	Rear Panel Assembly Description	9-9
Figure 9.5	Power Supply Exploded View	9-10
	Power Supply Description	9-11
Figure 9.6	9320 Front View	9-12
Figure 9.7	9320 Rear View	9-13
Figure 9.8	9320 Dimensions	9-14
Figure 9.9	9320 Dimensions with Protective Cover	9-15
Figure 9.10	9320 with FDGP Options	9-16
Figure 9.11	93XX-FD01 Option Assembly	9-17
Figure 9.12	93XX-GP01 Option	9-18
Figure 9.13	93XX-GP01 Option Assembly	9-19
Section 10	Connecting the 9320 to a Plotter or a Printer	
10.1	Introduction	10-1
10.2	Plotters	10-3
10.2.1	HP 7470A Plotter	10-3
10.2.2	HP 7550A Plotter	10-3
10.2.3	Hitachi 672 Graph Plotter (or NSA 672)	10-4
10.3	Printers	10-4
10.3.1	Centronics Printers	10-4
10.3.2	RS 232 Printers	10-5
10.3.2.1	Epson FX80	10-5
10.3.2.2	Citizen 120D	10-5
10.3.2.3	HP LaserJet	10-5
10.3.2.4	HP QuietJet	10-6
10.3.2.5	HP ThinkJet	10-6
10.3.2.6	HP DeskJet	10-6
10.3.2.7	Brother Printers	10-6
10.3.3	GPIB Printers	10-7
10.3.3.1	HP QuietJet	10-7
10.3.3.2	HP ThinkJet	10-7
10.3.3.3	HP PaintJet	10-7
10.4	Information on GPIB	10-7
10.4.1	Introduction	10-7
10.4.2	Functions in the GPIB	10-8

SECTION 1 GENERAL INFORMATION**1.1 Initial Inspection**

It is recommended that the shipment be thoroughly inspected immediately upon delivery to the purchaser. All material in the container should be checked against the enclosed Packing List. LeCroy cannot accept responsibility for shortages in comparison with the Packing List unless notified promptly. If the shipment is damaged in any way, please contact the Customer Service Department or local field office immediately.

1.2 Warranty

LeCroy warrants its oscilloscope products to operate within specifications under normal use for a period of two years from date of shipment. Spares, replacement parts and repairs are warranted for 90 days. The instrument's firmware is thoroughly tested and thought to be functional, but is supplied "as is" with no warranty of any kind covering detailed performance. Products not manufactured by LeCroy are covered solely by the warranty of the original equipment manufacturer.

In exercising this warranty, LeCroy will repair or, at its option, replace any product returned to the Customer Service Department or an authorized service facility within the warranty period, provided that the warrantor's examination discloses that the product is defective due to workmanship or materials and that the defect has not been caused by misuse, neglect, accident or abnormal conditions or operation.

LeCroy will return all in-warranty products with transportation prepaid.

This warranty is in lieu of all other warranties, expressed or implied, including but not limited to any implied warranty of merchantability, fitness, or adequacy for any particular purpose or use. LeCroy shall not be liable for any special, incidental, or consequential damages, whether in contract or otherwise.

1.3 Product Assistance

Answers to questions concerning installation, calibration, and use of LeCroy equipment are available from the Customer Service Department, 700 Chestnut Ridge Road, Chestnut Ridge, New York 10977-6499, U.S.A., tel: (914) 578-6060, or 6061, and 2 rue du Pré-de-la-Fontaine, 1217 Meyrin 1, Geneva, Switzerland, tel : (41) 22.719.21.11, or your local field engineering office.

1.4 Addresses

Corporate Headquarters

LECROY CORPORATION
700 CHESTNUT RIDGE ROAD
CHESTNUT RIDGE, NY 10977-6499

USA

TEL: (914) 425-2000
FAX: (914) 425-8967

USA

LECROY CORPORATION
700 CHESTNUT RIDGE RD
CHESTNUT RIDGE
NY 10977-6499

TEL: (914) 578-6060 or 6061
FAX: (914) 425-8967

European Headquarters

LECROY SA
2, CHEMIN PRE-DE-LAFONTAINE
P.O. BOX 341
CH-1217 MEYRIN 1 GENEVA
SWITZERLAND

TEL: 41 (22) 719-21-11
FAX: 41 (22) 782-39-15

LECROY CORPORATION
5912 STONERIDGE MALL RD 150
PLEASANTON CA 94588

TEL: (510) 463-2600
FAX: (510) 463-9179

Europe

LECROY GMBH
MANNHEIMERSTRASSE 177
POSTFACH 103767
D-6900 HEIDELBERG
GERMANY

TEL: 49.6221.831001
FAX: 49.6221.834655

LECROY LTD
28 BLACKLANDS WAY
ABINGDON BUSINESS PARK
ABINGDON, OXON OX14 1DY
GREAT BRITAIN

TEL: 44.23.553.31.14
FAX: 44.23.552.87.96

LECROY BV
WAALRESEWEG 17
NL-5554 HA VALKENSWAARD
THE NETHERLANDS

TEL: 31.4902.8.9285
FAX: 31.4902.42628

LECROY SARL
B.P. 214
AVENUE DU PARANA
F-91941 LES ULIS CEDEX
FRANCE

TEL: 33.1.69.18.83.20
FAX: 33.1.69.07.40.42

LECORY SRL
VIA CONCESIO 325
I-00188 ROMA
ITALY

TEL: 39.6.300.97.00
FAX: 39.6.300.96.00

ESSA
EUIPOS Y SISTEMAS SA
APOLONIO MORALES 13-B
E-28036 MADRID

TEL: 34.1.359.0088
FAX: 34.1.359.0298

DEWETRON ELEKTRONISCHE
MESSGERAETE Ges.M.B.H.
FOELLINGERSTRASSE 9E
8044 GRAZ

AUSTRIA

TEL: 43.316.391.804
FAX: 43.316.391.052

ORBIS OY
VANHA KAARELANTIE 9
01610 VANTAA
FINLAND

TEL: 358.0.566.4066
FAX: 358.0.531.604

AVANTEC
TVETENVEIEN 6
0661 OSLO
NORWAY

TEL: 472.63.05.20
FAX: 472.65.84.14

MEASUREMENT SYSTEMS
SCANDINAVIA AB
P.O. BOX 393
FORETAGSALLEN 12, HUS 5 BV
184 24 AKERSBERGA
SWEDEN

TEL: 46.8.540.68100
FAX: 46.8.540.66536

LECROY SA
BAHNOFSTRASSE 18
5600 LENZBURG
SWITZERLAND

TEL: 4164.519.181
FAX: 4164.519.192

M.T. BRANDAO, LDA
RUA DO QUANZA, 150
4000 PORTO
PORTUGAL

TEL: 351.2.815.680
FAX: 351.2.815.630

LUTRONIC APS
VIBEHOLMS ALLE 11-15
2600 GLOSTRUP

DENMARK

TEL: 45.4245.9764
FAX: 45.4363.0720

HELLENIC SCIENTIFIC REP., LTD
11 VRASSIDA STREET
115 28 ATHENS
GREECE

TEL: 30.1.721.1140 or 721.3154
FAX: 30.1.724.1374

ABB NERA A/S
P.O BOX 10
KOKSTADVEGEN 23
KOKSTAD BERGEN
NORWAY

TEL: 351.2.815.680
FAX: 351.2.815.630

Eastern Europe

ELSINCO GMBH
ROTENMUEHLGASSE 11
1120 VIENNA
AUSTRIA

TEL: 43.222.812.1751
FAX: 43.222.812.2329

Asia

LECROY JAPAN CORPORATION
ESAKA SANSHO BLDG - 3RD FLOOR
16-3, 3-CHOME
TARUMICHO, SUITA CITY
OSAKA 564 JAPAN

TEL: 816.330.0961
FAX: 816.330.8096

SCIENTIFIC DEVICES AUSTRALIA
2 JACKS ROAD
SOUTH OAKLEIGH, VICTORIA
AUSTRALIA

TEL: 61.3579.3622
FAX: 61.3579.0971

E.C. GOUGH, LTD
245 ST. ASAPH STREET
P.O. BOX 22073
CHRISTCHURCH

TEL: 64.3.3798.740
FAX: 64.3.3796.776

SINGAPORE ELECTRONICS
AND ENGINEERING, LTD
24 ANG MO KIO STREET, 65
SINGAPORE 2056

TEL: 65.480.7783
FAX: 65.481.4272

LECOLN TECHNOLOGY CO.,LTD.
12F, NO 216, SEC 1,
HO PING E ROAD
TAIPEI TAIWAN R.O.C.

TEL: 886.2.365.0612
FAX: 886.2.367.1792

Mideast

AMMO
60 PINKAS STREET
P.O BOX 21384, 61213 TEL AVIV
ISRAEL

TEL: 972.3.453.157
FAX: 972.3.544.146

LECROY JAPAN CORPORATION
ZAIKEN BLDG 6TH FLOOR
19-3, 2-CHOME
SASAZUKA, SHIBUYA-KU
TOKYO 151 JAPAN

TEL: 813.3376-9400
FAX: 813.3376.9587

TATA-HONEYWELL
55-A/8 & 9 HADAPSPAR
INDUSTRIAL ESTATE
PUNE 411 013 INDIA

TEL: 91.212.670445
FAX: 91.212.672205

ELECTRO TECH CORPORATION
1ST FLOOR, 16 KAZI CHAMBERS
BAHADURSHAH ZAFAR ROAD
KARACHI-74800
NEW ZEALAND PAKISTAN

TEL: 92.21.493-8087 (dial slowly)
FAX: 92.21.493-7749

ABEX ENGINEERING PTE. LTD.
126 JOO SENG ROAD # 09-05
GOLD PINE INDUSTRIAL BLDG.
SINGAPORE 1336

TEL: 65.283.6288
FAX: 65.283.6628

MEASURETRONIX
2102/31 RAMKAMHANG ROAD
BANGKOK 10240
THAILAND

TEL: 66.2.375.2733-4
FAX: 66.2.374.9965

EURO TECH (FAR EAST), LTD.
18 F, GEE CHANG HONG CENTER
65 WONG CHUCK HAND RD
HONG KONG

TEL: 8.52.814.0311
FAX: 8.52.873.5974

WOOJOO HI-TECH CORP.
DONGHYUN BLDG.
102-4 MOONJUNG-DONG,
SONGPA-KU
SEOUL 138-200 KOREA

TEL: 82.2.449.5472
FAX: 82.2.449.5475

P.T. DWI TUNGGAL JAYA SAKTI
WISMA RAJAWALI, 14TH FLOOR
JL JENDRAL SUDIRMAN
34 JAKARTA 10220 INDONESIA

TEL: 62.21.570.4563
FAX: 62.21.583.218

North America

ROHDE & SCHWARZ CANADA
555 MARCH ROAD
KANATA, ONTARIO K2K 2M5
CANADA

TEL: 613.592.8000
FAX: 613.592.8009

South America

SEARCH SA
VIAMONTE 1716 - PISO 7
1055 CAPITAL FEDERAL
ARGENTINA

TEL: 54.1.46.6156
FAX: 54.1.394.8374

ATP-HI-TEK
ALAMEDA AMAZONAS
422 ALPHAVILLE 06454-030
BARUEI, SP BRAZIL

TEL: 55.11.421.5477
FAX: 55.11.421.5032

Central America

NUCLEOELECTRONICA, SA
CALZ. LAS AGUILAS 101
DELEGACION ALVARO OBREGON
01710 MEXICO, 20, d.f.
MEXICO

TEL: 52.5593.604
FAX: 52.5593.6021

South Africa

WESTPLEX LTD
TUSCANY HOUSE
376 OAK AVENUE
RANDBURG 2194
REPUBLIC OF SOUTH AFRICA

TEL: 27.11.787.0473
FAX: 27.11.787.0237

1.5 Maintenance Agreements

LeCroy offers a selection of customer support services. Maintenance agreements provide extended warranty and allow the customer to budget maintenance costs after the initial two year warranty has expired. Other services such as installation, training, enhancements and on-site repair are available through specific Supplemental Support Agreements.

1.6 Documentation Discrepancies

LeCroy is committed to providing state-of-the-art instrumentation and is continually refining and improving the performance of its products. While physical modifications can be implemented quite rapidly, the corrected documentation frequently requires more time to produce. Consequently, this manual may not agree in every detail with the accompanying product. There may be small discrepancies in the values of components for the purposes of pulse shape, timing, offset, etc., and, occasionally, minor logic changes. Where any such inconsistencies exist, please be assured that the unit is correct and incorporates the most up-to-date circuitry. In a similar way the firmware may undergo revision when the instrument is serviced. Should this be the case, manual updates will be made available as necessary.

1.7 Service Procedure

Products requiring maintenance should be returned to the Customer Service Department or authorized service facility. LeCroy will repair or replace any product under warranty at no charge. The purchaser is only responsible for one way transportation charges.

For all LeCroy products in need of repair after the warranty period, the customer must provide a Purchase Order Number before repairs can be initiated. The customer will be billed for parts and labor for the repair, as well as for shipping.

1.8 Return Procedure

To determine your nearest authorized service facility, contact the Customer Service Department or your field office. All products returned for repair should be identified by the model and serial numbers and include a description of the defect or failure, name and phone number of the user, and, in the case of products returned to the factory, a Return Authorization Number (RAN). The RAN may be obtained by contacting the customer service department in New York, tel: (914)578-6060, or 6061 ; in Geneva, tel: (41)22/719.21.11, or your nearest sales office.

Return shipment should be made prepaid. LeCroy will not accept C.O.D. or Collect Return Shipments. Air-freight is generally recommended. Wherever possible, the original shipping carton should be used. If a substitute carton is used, it should be rigid and be packed such that the product is surrounded with a minimum of four inches of excelsior or similar shock-absorbing material. In addressing the shipment, it is important that the Return Authorization Number be displayed on the outside of the container to ensure its prompt routing to the proper department within LeCroy.

1.9 Safety Precautions

The following servicing instructions are for use by qualified personnel only. Do not perform any servicing other than contained in service instructions. Refer to procedures prior to performing any service.

Exercise extreme safety when testing high energy power circuits. Always turn the power OFF, disconnect the power cord, discharge the cathode ray tube and all capacitors before disassembling the instrument.

The **W A R N I N G** symbol used in this manual indicates dangers that could result in personal injury.

The **C A U T I O N** symbol used in this manual identify conditions or practices that could damage the instrument.

1.10 Antistatic Precautions

C A U T I O N

Any static charge that builds on your person or clothing may be sufficient to destroy CMOS components, integrated circuits.

In order to avoid possible damage, the usual precautions against static electricity are required.

- Handle the boards in antistatic boxes or containers with foam specially designed to prevent static build-up.
- Ground yourself with a suitable wrist strap.
- Disassembly the instrument at a properly grounded work station equipped with antistatic mat.
- When handling the boards, do not touch the pins.
- Stock the boards in antistatic bags.

SECTION 2 SPECIFICATIONS

9320 Digital Oscilloscope

9320/24 PORTABLE DIGITAL OSCILLOSCOPES 1GHz Bandwidth

Main Features

- Two/Four Channels
- Main and Two Delayed Timebases for Accurate Time Measurement
- LeCroy ProBus™ Probe System
- Glitch, Pattern, State and Edge Qualified Triggers
- Automatic PASS/FAIL Testing
- Optional Built-in Printer
- DOS-Compatible Floppy Disk and Memory Card Options
- Persistence and XY Modes
- Fully Programmable via GPIB and RS-232

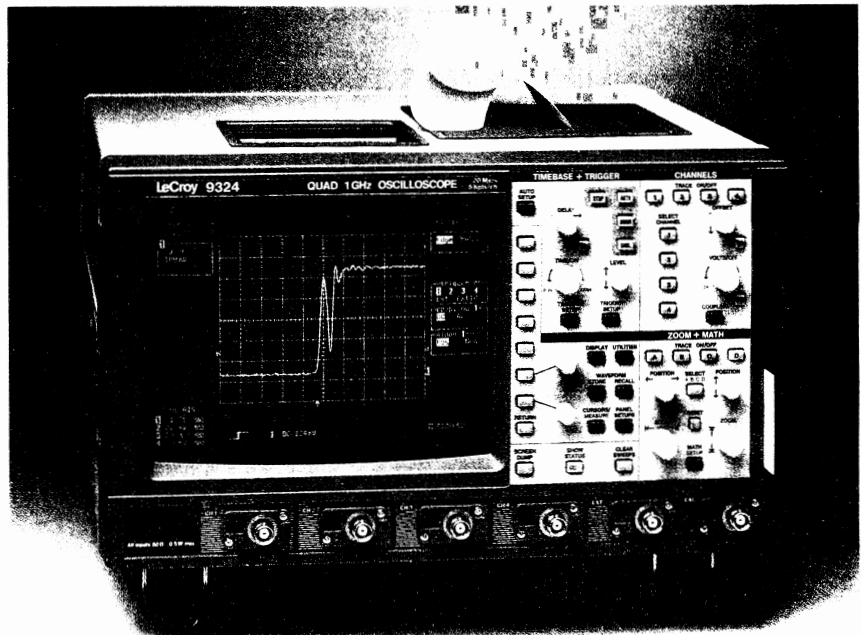

The 9320/24 is a general purpose instrument extending the power of digital oscilloscopes up to 1 GHz bandwidth. The oscilloscope is primarily intended for repetitive waveforms, which are sampled with an equivalent sampling rate of up to 20 GS/s. Single shot events up to a few MHz may also be acquired, with a single shot sampling rate of up to 20 MS/s. The digital technology used provides standard DSO features like pre-trigger view, hardcopy, full programmability, etc. The proven user interface of the 9300 oscilloscope family ensures ease of use and user efficiency.

The LeCroy ProBus™ intelligent probe system allows automatic sensing of the probe type. For LeCroy's active FET probes it also provides variable offset at the probe tip; offset and coupling are controlled from the scope front panel.

Up to two delayed timebases can be positioned on the main trace and displayed giving unrivaled resolution and precision and very low jitter in time measurements. Advanced triggering capabilities, which include glitch, pattern and state/edge qualified triggers, drastically simplify the testing and debugging of electronics systems.

DOS compatible floppy disk and memory card options store waveforms and test setups, and make transferring data to a PC easier than ever before. Hardcopies may be made on GPIB, RS-232 or Centronics printers or plotters. An optional built-in printer is also available. Additional firmware packages extend the oscilloscope's processing capabilities in both time and frequency domains.

Features and Benefits

TIME MEASUREMENT MADE EASY AND ACCURATE

Common applications in fields like digital electronics, computers, data communications, etc require precise time interval measurements. In order to make the measurements easier and more accurate, the 9320/24 features a main timebase and two delayed timebases which can be located almost anywhere on the main trace. The delayed timebases allow the selected portions of the waveform to be digitized at faster rates, thus providing higher horizontal resolution and more accurate measurements.

LECROY PROBUS™ INTELLIGENT PROBE SYSTEM

The ProBus™ system provides a complete measurement solution from probe tip to oscilloscope display. ProBus™ is an intelligent interconnection between LeCroy oscilloscopes and a growing range of innovative probes. ProBus™ provides automatic sensing of the probe type. For LeCroy's FET probes, it also allows offset at the probe tip and coupling to be controlled from the scope front panel.

A TRIGGER FOR EVERY APPLICATION

Two levels of trigger make catching difficult signals an easy task for the 9320/24. The standard trigger functions such as pre- and post- trigger, level, slope, mode and coupling are all accessed with simple and direct controls. Icon trigger graphics show the current setup at a glance. The touch of a button accesses further powerful trigger features (SMART trigger). SMART trigger modes allow the acquisition of complex phenomena. Trigger techniques include FAST-GLITCH mode for triggering on glitches down to 1 nsec, PATTERN trigger on the four input channels, STATE and EDGE QUALIFIED modes for tracking time violations.

AUTOMATIC MEASUREMENTS

In addition to cursor measurements, the 9320/24 performs fully automatic

measurements. PASS/FAIL testing allows waveforms to be continually compared with a tolerance mask. (Masks may either be generated inside the instrument, or supplied on memory cards.) In addition, the 9320/24 can calculate any 5 waveform parameters from a list of 32, and compare them with user-defined limits. Any failure will cause preprogrammed actions such as Hardcopy, Save or GPIB SRQ. Basic statistics (low, high, average, standard deviation) may also be calculated on these parameters.

DOS COMPATIBLE MASS STORAGE

The 9320/24 offers two options (available together or separately) for built-in Mass Storage. Option FD01 provides a 3.5" 1.44 MB floppy disk drive, which stores waveforms and setups as DOS files. This may be used as a convenient way of transferring data to a PC. Option MC01 provides high-speed storage to Industry-Standard memory cards, which are also DOS compatible. Up to 8 MB of data (waveforms or setups) may be stored on a single card.

Mass Storage simplifies archiving, and can also be used to ensure that measurements are always made in the same way. Golden Waveforms (or tolerance masks) may also be stored, so that signals are compared with a known reference. Waveform processing is possible on live or stored waveforms.

BUILT-IN PRINTER

As well as driving most printers and plotters via GPIB (IEEE-488.2), RS-232 and optional Centronics interfaces, the 9320/24 also offers an optional internal printer. This thermal printer produces full size screen dumps in approximately 10 seconds.

FLEXIBLE INTERFACING

Both GPIB and RS-232 interfaces may be used for full remote control of the instrument. All front-panel controls and internal processing functions can be controlled.

POWERFUL DISPLAY MODES

The 9320/24's high-resolution raster

display shows from one to four independent waveform grids. Persistence display mode allows easy viewing of signal changes over time, and XY mode plots any two sources against one another. Cursors are usable in all display modes.

MULTIPLE-WAVEFORM ZOOM

In addition to the two delayed timebases the 9320/24 has four Zoom/Math traces which may be used for signal processing or zooming waveforms. Up to four traces (e.g. a waveform and three different expansions) may be viewed simultaneously. Alternatively, four different expansions of the same waveform may be viewed.

The area to be expanded is selected by moving an intensified portion of the waveform. Cursor measurements may be made from one expanded portion to another, providing the most accurate time measurements possible.

EXTENSIVE WAVEFORM MATH

The 9320/24's built-in processing includes mathematics (Add, Subtract, Multiply and Divide, Negation and Identity) and Summation Averaging (up to 1000 sweeps). Option WP01 provides Averaging (Summed and Continuous) and Mathematics (including ABS, Differentiation, Identity, Integration, Log or Exp (base or base 10), Negation, Reciprocal, Rescale, Sin(x)/x, Square and Square root). Also included is Enhanced Resolution mode (up to 11 bits) and Extrema mode for storage of peak positive and negative values. More information is available in the 9300 WP01 datasheet.

OPTIONAL FFT PACKAGE

Option WP02 provides comprehensive Spectral Analysis capabilities. These permit the system designer to identify characteristics which may not be apparent in the time domain. WP02 provides a wide selection of displayed projections (magnitude, phase, real, imaginary, power spectrum, power density) and windowing functions, as well as averaging in the frequency domain. For more information, see the 9300 WP02 datasheet.

9320/24 Specifications

ACQUISITION SYSTEM

No. of Channels: 2 (9320) and 4 (9324).

Bandwidth (-3dB): DC to 1 GHz.

Rise-time: $t_r < 0,38/BW$

Input Impedance (working conditions):
50 $\Omega \pm 1\%$.

Input Impedance (power off and calibration): 50 $\Omega \pm 10\%$

Maximum Input Voltage: ± 5 V DC (500mW) or 5 V RMS, fuse protected.

Max Operating Input Voltage: Same as Max input voltage.

Voltage Standing Wave Ratio (VSWR):
 $\leq 1,25$ from 5 mV/div to 2 V/div, DC to 1 GHz.

Sensitivity Range: 5 mV/div to 2 V/div in 1-2-5 sequence and continuously variable.

Random Noise: $< 300\mu V$ RMS, 220 μV typical at 5mV/div;

0,025 div typ. at 10, 50, 200 mV/div, 1 V/div; 0,016 div typ. at 20, 100, 500 mV/div, 2 V/div.

Probe Calibrator: BNC connector, 250 mV into 50 Ω , generate rectangular pulses with 50% duty cycle; rise time < 750 psec; fall time < 500 psec; non-flatness $< 1\%$; zero offset; programmable frequency. The calibrator output can also alternatively provide, under menu control, a trigger output or a PASS/FAIL output.

No. of Digitizers: 2 or 4, one per channel.

Vertical Resolution: 8 bits, all on screen (up to 12 bit with processing).

Conversion Rate: Up to 20 MS/s for transients, up to 20 GS/s for repetitive signals, simultaneously on all channels.

DC Accuracy: $\leq \pm 2\%$ full scale, at 0 V offset.

Vertical Expansion: up to 5x normally, up to 50x with averaging.

Cross Talk: >100 : 1 DC to 1 GHz at any sensitivity and for any two channels having equal V/div setting.

> 300 : 1 DC to 300 MHz, same conditions.

Interchannel Skew: < 50 psec for channels having equal setting.

Offset: Maximum allowed offsets depend on the sensitivity as shown in the following table.

Sensitivity:	Offset range:	Overdrive Limit:
5 - 24,5 mV/div	$\pm 0,8$ V	0,4 V
25,0 - 124 mV/div	$\pm 4,0$ V	2,0 V
126 mV/div - 2 V/div	$\pm 10,0$ V	5,0 V

Overdrive Recovery Time: The acquisition

system tracks signals to within $\pm 2\%$ full scale 35 ns (typical) after overloads that do not differ from the signal by more than the Overdrive Limit shown in the table above.

TIMEBASE SYSTEM

Timebases: Three, main and two delayed.

Main Timebase Range: 100 psec/div to 200 msec/div in 1-2-5 sequence.

Delayed Timebase Range: 100 psec/div to main timebase setting.

Clock Accuracy: $\leq 0.005\%$.

Time Digitizer Resolution: 10 psec.

Max Record Length: 5000 samples per channel.

Acquisition Modes: Random Interleaved Sampling from 100 psec/div to 10 μ sec/div. Single shot from 20 μ sec/div to 200 msec/div.

TRIGGER SYSTEM

Pre-Trigger Time: Adjustable in 0.1 div increments up to 10 div full scale (grid width).

Post-Trigger Delay: Adjustable in 0.1 division increments up to 10,000 divisions.

Timing: Trigger date and time stored with each waveform.

External Trigger Input: 50 $\Omega \pm 1\%$.

External Trigger Voltage Range: ± 0.5 V in EXT, ± 5 V in EXT/10.

Trigger Rate: Up to 1.5 GHz on one channel only, (CH2 in 9320, CH4 in 9324) when HF coupling selected; 750 MHz for all other channels.

Total Jitter: < 8 psec RMS.

Trigger Holdoff Range: By time 50 nsec to 20 sec with minimum steps of 12.5 nsec, by events 1 to 10^9 , 75 MHz max rate.

STANDARD TRIGGER

Trigger Sources: CHAN1, CHAN2, (CHAN1 to CHAN4 in 9324), Ext, Ext/10. CH1 to CH4 and EXT have independent trigger circuits allowing individual setting of slope, level and coupling.

Slope: Positive, negative.

Coupling: DC, AC-AUTOLEVEL, and HF (for one channel only).

Modes: Stop, Auto, Normal, Single.

SMART TRIGGER

Single Source on any of CH1 to CH4 and

EXT.

Pulse or Pattern Width<: 1 nsec to 1 μ sec in steps varying from 500 psec to 20 nsec.

Pulse or Pattern Width>: Same ranges and steps as above.

Pattern: Trigger on the logic AND of the input channels (CH1 to CH4 in 9324, CH1 and CH2 in 9320), where each source can be defined as high (H), low (L) or don't care (X). The trigger can be selected at the beginning (entered) or at the end (exited) of the specified pattern. The pattern width or holdoff can also be specified as above.

State/Edge Qualified: Triggers on any source (CH1 to CH4 + EXT) after the entering of a qualifying condition- edge or state- that can be defined on a single source or on a pattern of the input channels. The trigger can take place after (or within) a programmable delay ranging from t_{min} to 1000 nsec in steps varying from 500 psec to 20 nsec,

where $t_{min} = 2,0$ nsec for State Qualified
 $t_{min} = 7$ nsec for Edge Qualified.

The state qualified trigger requires the continuing presence of the enabling pattern to trigger, while the Edge Qualified trigger doesn't.

DISPLAY

CRT: 12.5 X 17.5 cm (5 X 7 inches); magnetic deflection; raster scan.

Resolution: 810 X 696 pixels.

Graticules: Internally generated, separate intensity control for graticule and waveforms; single, dual and quad graticules.

Display modes: Normal, infinite persistence, XY, dot join ON/OFF.

MEASUREMENT SYSTEM

Automatic Measurements determine:

Amplitude	Frequency	Period
Area	Maximum	Peak to Peak
Base	Mean	Risetime
Cycles	Median	RMS
Delay	Minimum	Std dev
Duty Cycle	Overshoot +	Top
Falltime	Overshoot -	Width
Δ delay	Δ t at level	

As defined by ANSI/IEEE Std 181-1977
"Standard on Pulse Measurement and

Analysis by Objective Techniques".

In addition, Rise and Fall times may be measured at 10% and 90% levels, or 20% and 80% levels, or any other user-specified levels.

Δ delay provides time between midpoint transition of two sources, for making propagation delay measurements.

Δ t at level allows the same measurement to be made at any specified level.

Two cross-hair cursors are used to define the region over which these parameters are calculated. The following statistical calculations are also available for each measurement: Average, High, Low, Std. Deviation.

Cursor Measurements: Absolute and relative for voltage, time and frequency.

Cursor Types: Horizontal bars for voltages, cursors riding on waveforms for times.

WAVEFORM PROCESSING

Waveform processing routines, up to four simultaneously, are called and set up via menus. These include arithmetic functions (Add, Subtract, Multiply, Divide, Negate, Identity), and Summation Averaging (up to 1000 signals).

Function Memories: 4 x 5000 points, 16 bit.

Automatic Testing: Up to five waveform parameters may be tested against selectable thresholds. Waveforms may also be tested against tolerance templates which can be generated inside the instrument.

Optional Processing: Extra processing power can be added by installing LeCroy's waveform processing options.

Option WP01 provides Averaging, Summation and Continuous, Extended Mathematics including Integration, Differentiation, Log, Exp, ABS, Square, etc; High Resolution mode, up to 11 bits; Extrema mode for storage of extreme positive and negative values.

Option WP02 provides FFT spectral analysis with a wide selection of displayed parameters.

AUTOSETUP

Front panel button. Automatically scales timebase, trigger and sensitivity settings to correctly display repetitive signals with amplitudes between 10 mV and 5 V.

Autosetup Time: Approximately 2 sec, frequency above 50Hz; duty cycle greater than 0.1%.

Vertical Find: Individual per channel, automatically scales sensitivity and offset.

INTERFACING

Remote Control: Of all front-panel controls, as well as all internal functions is possible by GPIB and RS-232.

RS-232 Port: Asynchronous up to 19200 baud for computer/terminal control or printer/plotter connection.

GPIB Port: (IEEE-488.1) Configurable as talker/listener for computer control and fast data transfer. Command language complies with requirements of IEEE-488.2.

Centronics: Optional parallel interface.

Hardcopy: Screen dumps are activated by a front-panel button or via remote control. TIFF format is available for importing to DTP programs. The following printers and plotters can be used to make hardcopies: HP ThinkJet, QuietJet, LaserJet, PaintJet and EPSON compatible printers. HP 7400 and 7500 series, or HPGL compatible plotters.

STORAGE

Reference Memories: 4x5000 points, 16 bits, usable to store acquired and processed waveforms.

Setups: Up to four stored in battery backed-up memories. Front-panel settings are maintained for two years.

Two DOS Compatible Mass Storage

Options: 1.44 MB, 3.5" floppy disk and/or up to 8 MB fast storage memory card, provide non-volatile mass storage of waveforms and/or front-panel setups.

SELF TESTS

Auto-Calibration ensures specified DC and timing accuracy.

GENERAL

Temperature: 5° to 40° C (41° to 104° F) rated, 0° to 50° C (32° to 122° F) operating.

Humidity: < 80%.

Shock & Vibration: Meets MIL-STD-810C modified to LeCroy design specifications and MIL-T-28800C.

Power: 90-250 V AC, 45-66 Hz, 150 W.

Battery Backup: Front-panel settings maintained for two years.

Dimensions: (HWD) 8.5" x 14.5" x 16.25", 210 mm x 370 mm x 410 mm.

Weight: 10 Kg (22 lbs) net, 15.5 Kg (34 lbs) shipping.

Warranty: Two years.

Ordering Information

Oscilloscope and Options

9320	2 Channel Digital Oscilloscope
9324	4 Channel Digital Oscilloscope
9320WP01	Waveform Math
9320WP02	FFT Processing
9320-MC01/04	Card Reader + 512K Memory Card
9320-FD01	3.5" Floppy Disk Drive + Centronics Interface
9320-GP01	Internal Printer + Centronics Interface
9320-W5	5 Year Extended Warranty

Oscilloscope Accessories

Supplied with Instrument:

9320-OM	Operator's Manual
9320-RCM	Remote Control Manual
9320-FC	Front Cover
PP062	1 GHz, 500 Ω , 10:1 passive probe (two with Model 9320, four with Model 9324)

Ordered Separately:

AP020	1 GHz, 10:1 FET input ProBus™ probe
AP021	800 MHz, 5:1 FET input ProBus™ probe
PP090	75 Ω to 50 Ω , 2:1 ProBus™ adapter
9320-CC	Calibration Certificate
9320-SM	Service Manual
9320-MC02	128K Memory Card
9320-MC04	512K Memory Card
DC/GPIB-2	2 Meter GPIB Cable
OC9001	Oscilloscope Cart
93XX-RM01	Rackmount
93XX-TC1	Transit Case
93XX-TC2	Carrying Bag

USA Direct Sales: 1 (800) 5LE-CROY

LeCroy Worldwide Sales Offices

ASIA/PACIFIC	LeCroy Pty Ltd	61.38.90.7358
BENELUX	LeCroy BV	04902.8.9285
CANADA	LeCroy Canada	514.928.4707
FRANCE	LeCroy SARL	(1).69.07.38.97
GERMANY	LeCroy GmbH	06221.83.10.01
ITALY Roma	LeCroy SRL	06.336.797.00
ITALY Milano	LeCroy SRL	02.204.70.82
JAPAN Osaka	LeCroy Japan	0816.330.0961
JAPAN Tokyo	LeCroy Japan	0813.3376.9400
SWITZERLAND Geneva		022.719.21.11
SWITZERLAND Lenzburg		064.51.91.81
United Kingdom	LeCroy Ltd	023.553.31.14

Other sales and service representatives throughout the world.

LeCroy

The Digital Scope Specialists

9300 series internal 3.5" Floppy, RAM card, Printer

Main Features

- 3.5" Floppy drive, DOS format, affordable and convenient
- Ultra-fast RAM card, DOS format, ideal for PASS/FAIL testing
- High-resolution Printer, ideal for fast, on-the-spot documentation
- Convenient Hardcopy storage to card/disk

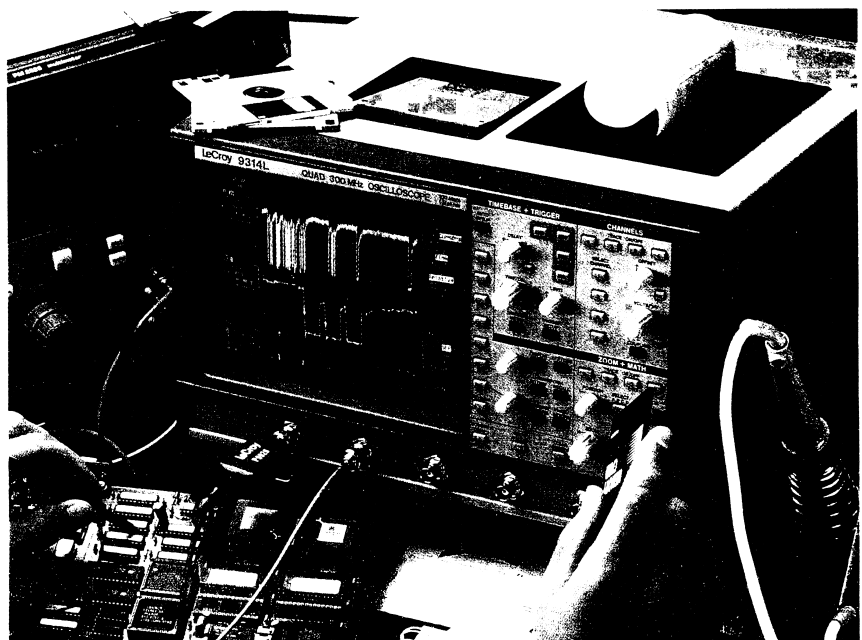

3.5" Floppy

The floppy drive is a convenient storage medium, not only for saving and retrieving waveforms or instrument settings, but also for storing hardcopies that can be printed from a PC when desired. The floppy supports both 720K and 1.44M DOS formats so that it can be read back on any PC with a 3.5" drive, avoiding the need to interface the oscilloscope to your PC. As with the RAM-card option, the floppy system capabilities include automatic storage of data under pre-programmed conditions.

RAM Card

The RAM card is a fast and compact storage medium for saving and retrieving waveforms or instrument settings. It complies fully with the PC industry's PCMCIA/JEIDA standard. With the special Autostore feature, waveforms can be automatically stored to the card after every acquisition, and "played back" when desired. And with the scope's powerful PASS/FAIL feature, failure data can also be saved automatically to the RAM card.

Printer

The internal printer is an invaluable tool for instant, on-the-spot documentation. It generates a clear, crisp hardcopy of the screen in just a few seconds. The printout's large size combined with its high-resolution provide you with an excellent document that matches the screen's superior quality even to the finest details. And because it frees you from the trouble of carrying and interfacing a bulky printer, it's the ideal solution for field measurements.

Mass-storage Features and Benefits

LeCroy's mass storage capabilities provide a range of benefits:

- Easy data transfers to PCs
- Waveform logging
- Waveform archiving for future use
- Faster troubleshooting
- Faster, more reproducible testing
- Shared oscilloscope resources

EASY DATA TRANSFERS TO PCs

Because the 9300 series oscilloscope uses DOS-formatted floppy disks and memory cards, transferring waveform data to a PC is a breeze. The removable storage allows transfers without cables, programming, or any knowledge of GPIB, RS-232, or other interfaces. And what's more, LeCroy provides, free of charge, a binary-to-ASCII format conversion program for the PC since some PC-based analysis packages (such as spreadsheets), require ASCII format.

WAVEFORM LOGGING

By using Glitch or Dropout triggering in combination with the powerful AUTO-STORE mode, LeCroy oscilloscopes can monitor and log intermittent problems automatically. To store a waveform, the oscilloscope opens and names a DOS-compatible file and then stores the waveform data into the file. This logging feature requires no operator intervention and maintains data and the operational setup through power line failures. Logged waveforms can be selectively played back by trigger time/date or by sequence number, or can be scrolled through sequentially.

WAVEFORM ARCHIVING FOR FUTURE USE

- Recallable proof of performance
- Additional data analysis as needed
- Accurate trend or drift monitoring
- Calibration procedure verification

When storing waveforms, LeCroy DSOs also archive a header of setup information and the acquisition time/date. After recalling an archived waveform, the several hundred byte header ensures correct time and voltage scaling. When recalled into the oscilloscope, the waveform can be zoom expanded,

compared, or analyzed just like a live waveform. The time/date offers proof of measurement authenticity and trend sequence.

All LeCroy DSOs store raw waveform data using one byte per sample point. Signal averaged, Enhanced Resolution (ERES) filtered, and other processed data use two bytes per point, to take advantage of the added resolution.

HARDCOPY ARCHIVING

Hardcopies of the screen can also be stored for future use. For instance, a screen saved in TIFF format can eventually be imported into a Word Processor to illustrate a report. As another example, field-measurement screens could be saved in LaserJet format on the memory card or floppy disk, and then printed from a PC back in the lab.

FASTER FIELD MEASUREMENTS

Recallable reference waveforms and oscilloscope setups for each test point on a Device Under Test (DUT) can make fault troubleshooting faster and more accurate. A dedicated memory card or floppy disk can hold all of the correct test point waveforms and associated DSO setups for a particular DUT.

The technician can recall stored setups quickly and consistently, thereby avoiding incorrect measurement conditions. He can then compare actual waveforms to recalled reference waveforms taken from a known working system. So the technician needs less knowledge and skill to quickly probe a large number of test points and verify that the correct waveforms exist.

If a problem is found, the aberrant waveform may be saved. It can later be shown to laboratory-based engineers, for example, for problem-solving guidance or for improvement of DUT design.

Memory cards, being rugged and shirt-pocket sized, are ideal for this application.

FASTER, MORE REPRODUCIBLE TESTING

LeCroy oscilloscopes can compare measured waveforms against upper and lower waveshape tolerances or against parameter limits, such as risetime,

overshoot, or peak voltage, and make PASS/FAIL decisions. This PASS/FAIL testing decreases test times in GPIB-based ATE systems by reducing data transfers. It increases reproducibility and accuracy in manual tests by eliminating human errors.

Once defined, these tests may be saved by storing instrument setups which include the specified tolerances and/or reference waveforms. Different test personnel can easily share a common test library via PC network.

Waveshape test limits can be generated by capturing a "golden" waveform and by then selecting amplitude and timing limits (in fractions of screen graticule divisions). Or a user can create standard waveform limit templates on a computer (e.g. ANSI/CCITT telecommunication templates)

On LeCroy 9300 series DSOs, specific parameter tolerance test procedures are created by selecting limits for any five out of twenty pulse parameters with Boolean AND or OR conditions between them. During testing, FAIL responses can include an audible beep, GPIB SRQ, hardcopy output, or store to memory card.

SHARED OSCILLOSCOPE RESOURCES

Tired of spending hours to recover your precious setup after someone else used your instrument? Just plug-in your *personal* RAM card or floppy and restore your setup in just seconds. Each individual user can keep his own preferred setups on his own floppy disk or RAM card.

A selection of files can be copied from the memory card to the disk and vice-versa.

COPY FILES	
Direction	
Card -> Disk	
Disk -> Card	
Which Files	
Panels	
Prints	
Auto Wfms	
Norm Wfms	
ALL Files	
DO COPY	
!OVERWRITES FILES WITH SAME NAME	

Hardcopy Features and Benefits

The internal printer adds a whole range of benefits to the LeCroy 9300 series:

- Ultra fast printouts
- High resolution printing
- No-trouble interfacing
- No-trouble carrying

ULTRA-FAST PRINTOUTS

Measurement documentation is made easier - and faster - than ever since the internal printer produces a hardcopy in less than 10 seconds. What's more the document is date- and time-stamped: a real bonus for archiving those test results.

HIGH RESOLUTION PRINTING

With a resolution of 190 dots-per-inch, the internal printer matches the screen's superior quality, to document the captured traces down to their finest details. And the size of the printout is impressive for an internal printer: a full 7" diagonal!

TROUBLE-FREE INTERFACING

Tired of struggling with cable schematics, baud rates, gender-changers, and dip switches? The internal printer frees

your mind for more productive tasks. Just select the internal printer in the scope's utilities menu, hit the SCREEN DUMP button, and you're in business!

TROUBLE-FREE TRANSPORTING

Having a printer totally integrated in the instrument makes life much easier for field-measurement applications. Imagine

The 9300 series oscilloscope supports a whole range of popular printers and plotters. Hardcopies of the screen can be either sent directly to the device or to the card/floppy for future use.

HARDCOPY	
output to	Card Floppy GPIB RS232 Centronics
page feed	OFF On
plotter	LaserJet ThinkJet TIFF HP 7470 HP 7550
plot size	A5 (8.5"/5.5") A4 (11"/8.5")
pen number	2

carrying a scope, a printer (and perhaps a floppy drive) in one hand!

OTHER HARDCOPY SOLUTIONS

High quality project reports, presentation materials, technical manuals, and troubleshooting instructions often require integration of text and graphics on the same page. Advanced PC desktop publishing - and more and more word processors - Such as Word-for-Windows, WordPerfect, or AMI Pro can directly import graphic files, size them, and position them anywhere on the page. Written text can then wrap around or be positioned within the graphics. LeCroy 9300 oscilloscopes can save screens in TIFF (Tagged Image Format File). After transferring the file to a PC, the DTP software can import and manipulate the document like any other graphic object.

The LeCroy 9300 series also offers a wide range of interfacing capabilities with external hardcopy devices:

- Plotters. HPGL, HP 7400 and 7500 compatible
- Printers. HP LaserJet, ThinkJet, Paintjet (including color), DeskJet (including color) and Epson
- Interfacing. RS-232, GPIB, or even Centronics (optional)

Floppy drive, RAM card and Printer Specifications

3.5" FLOPPY DRIVE

Type: 3.5 inch floppy drive, DOS format.
Supported disk formats: 720KB, 1.44MB
Maximum transfer rate: 15 kB/sec
Typical Waveform Transfer Speed:

Length	Store	Recall
1000	2.2 s	0.4 s
10000	2.7 s	1.0 s
50000	5.5 s	3.4 s

Waveform File Size: A channel-trace will use 1 byte per sample plus approximately 359 bytes of waveform descriptor. A processed trace will use 2 bytes per sample.

Template Size: Approximately 21K bytes.
Panel Setup Size: Approximately 3K bytes.

RAM CARD

Type: PCMCIA 1.0 JEIDA 3.0 & 4.0.
Supported card formats: SRAM for reading and writing, ROM, OTP, and FLASH for reading, the driver software supports card sizes up to 8MB.

Maximum transfer rate: 170 kB/sec
Typical Waveform Transfer Speed:

Length	Store	Recall
1000	25 ms	20 ms
10000	100 ms	80 ms
50000	400 ms	300 ms

Waveform File Size: Same as for the floppy.
Template Size: Approximately 21K bytes.
Panel Setup Size: Approximately 3K bytes.

PRINTER

Type: Raster printer, thermal.
Resolution: 190 DPI.
Printout Size: 126 mm x 90 mm
Paper: Thermal printer paper, 30 meter roll, 110 mm width, type Seiko or similar.
Printing speed: 6 seconds approx. for one screen.

AP003, AP020 and AP021 Active FET Probes

Main Features

- Bandwidths to 1 GHz
- LeCroy ProBus™ interface for the AP020 and the AP021
- 1 MΩ input Impedance
- Low capacitance at probe tip
- Rugged mechanical construction
- Automatic sensing and control on scopes equipped with ProBus™

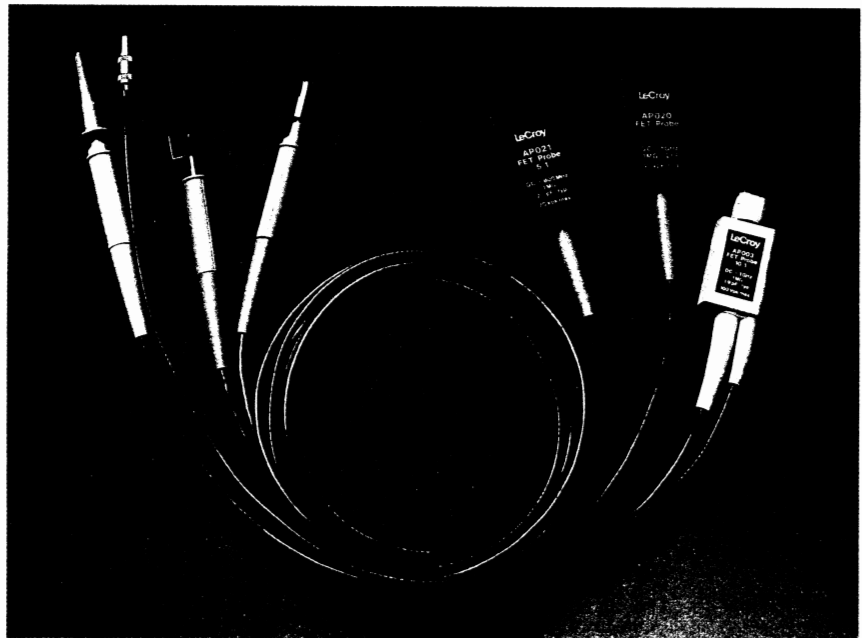

FET Probes provide the oscilloscope user with a higher level of measurement capability. Compared with passive probes, they offer low circuit loading, low capacitance and high bandwidth. This combination makes them the ideal tools for working on sensitive or high-speed electronics.

This performance is achieved by the integration of a high-impedance Field Effect Transistor (FET) amplifier into the probe tip. The circuit under test sees only the amplifier's input impedance - it is effectively buffered from the scope's input impedance and the probe cable.

LeCroy's AP series of FET probes are mechanically rugged in design, while their miniature construction allows them to be used in hand-held PCB probing applications. Their detachable tips are designed for simple replacement, and they are supplied with a full set of accessories.

Models AP020 and AP021 offer 1 GHz and 800 MHz Bandwidth respectively. AP020 features X10 signal attenuation and is especially recommended for LeCroy's 9320 and 9324 1 GHz oscilloscopes. The AP021 offers X5 attenuation when used with the new 9360.

As an active device, the FET probe requires a stabilized power supply. LeCroy provides an elegant solution to this with the ProBus™ probe interface.

ProBus™ provides probe power and signal connection in one integrated package. It also allows the scope to control other probe functions, such as input coupling and DC offset. The ProBus™ interface is now available on a growing range of LeCroy oscilloscopes and probes. AP003 has an external power connector for use with scopes which are not ProBus™ compatible. All other models use the ProBus™ interface.

Features and Benefits

Connecting a probe to a circuit can significantly distort its signals by adding undesired loading - mostly capacitive and resistive. FET probes offer high resistance and low capacitance therefore they present minimal loading to the circuit under test, and protect from making erroneous measurements.

HIGH RESISTANCE

Low resistance probes have significant DC effects when used in high impedance circuits. They can greatly affect the behaviour of the device under test by changing the swing and the DC offset of the probed signal. A 1 MΩ impedance FET probe will not affect gain or offset in virtually all the cases.

LOW CAPACITANCE

Although not important in DC measurements, capacitive loading is very

disruptive at high signal frequencies. The capacitive loading effects can be drastic. When probed with a 10 MΩ, 15

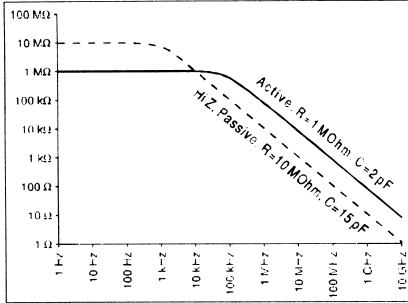

Probe Impedance versus Frequency

pF passive probe, a 100 MHz signal "sees" a 100 Ω load as illustrated on the picture below.

With only 2 pF of capacitance at the probe tip, LeCroy's FET probes reduce

circuit loading at high frequencies by a factor of 10. Minimizing tip capacitance can also push the probe's resonant frequency beyond the system bandwidth. Sensitivity to ground lead inductance is also minimized.

PROBUS

The ProBus™ system is a complete measurement solution from probe tip to oscilloscope display. It supplies power to active probes, while automatically sensing probe attenuation. ProBus™ enables direct control of the probe offset and input coupling from the scope's front panel, extending the instrument's accuracy up to the probe tip. In addition, ProBus™ automatically optimizes scope and probe offset adjustments, calibrates the gain at the probe tip and compensates for non-linearities, providing most accurate measurements.

Specifications

MODEL	AP003	AP020	AP021	MODEL	AP003	AP020	AP021
Bandwidth (MHz)	DC-1000	DC-1000	DC-800	Dynamic Range	±7 V	±5 V	±2.5 V
Risetime (psec)	< 350	< 350	< 437	DC Offset Range	N/A	±20 V	±10 V
Attenuation	10:1 ±2%	10:1 ±2%	5:1 ±2%	Input Coupling	DC	DC/AC	DC/AC
Input R (MΩ)	1 ±5%	1 ±2%	1 ±2%	Total length (m)	1.5	1.5	1.5
Input C (pF)	1.9 ±0.3	1.8 ±0.2	2.7 ±0.2	Power requirement	±12 V	±12 V	±12 V
Max Input Voltage	±100 V	±40 V	±20 V	Interface	N/A	ProBus™	ProBus™

Recommended Matching

LeCroy Model	AP-003	AP-020	AP-021
9304-10-14	XX		
9360-61			X
9320-24		X	
94XX	X		
7200	XX		
7200A	X		
ScopeStation	X		

X: External Power Supply not required
 XX: External Power Supply required

Ordering Information

AP003	1 GHz active FET probe
AP020	1 GHz active FET probe
AP021	800 MHz active FET probe with ProBus™ interface. All probes are shipped with the following accessories: 1x Retractable hook 1x Ground Lead 1x BNC Adaptor 1x IC Tip 3x Ground Bayonets 1x Mini pincher with Lead Adaptor
AP501	Power Supply for the AP003

USA Direct Sales: 1 (800) 5LE-CROY

LeCroy Worldwide Sales Offices

ASIA/PACIFIC	LeCroy Pty Ltd	61.38.90.7358
BENELUX	LeCroy BV	04902.8.9285
CANADA	LeCroy Cnd	514.928.4707
FRANCE	LeCroy SARL	(1).69.18.83.20
GERMANY	LeCroy GmbH	06221 83.10.01
ITALY Milano	LeCroy SRL	02.204.70.82
ITALY Rome	LeCroy SRL	06.336.797.00
JAPAN Osaka	LeCroy Japan	0816.330.0961
JAPAN Tokyo	LeCroy Japan	0813.3376.9400
SWITZERLAND Geneva		022.719.21.11
SWITZERLAND Lenzburg		064.51.91.81
United Kingdom	LeCroy Ltd	0235-533114

Other sales and service representatives throughout the world.

Copyright © May, 1993. LeCroy is a registered trademark of LeCroy Corporation. All rights reserved. Information in this publication supersedes all earlier versions. Specifications subject to change without notice.

Features and Benefits

EXTENSIVE SIGNAL AVERAGING

Two operation modes:

Summation averaging up to 1,000,000 waveforms.

Continuous averaging with weighting factors up to 1023.

Average speed up to 200,000 points/s in summation averaging mode.

EXTREMA MODE

Keeps track of time and amplitude drift by storing extreme positive and negative values, such as glitches, over a programmable number of sweeps.

POWERFUL ARITHMETIC

Processes addition, subtraction, multiplication or division on any pair of waveforms.

MATHEMATICAL FUNCTIONS

Computes identity, negation, reciprocal, integration, differentiation, square, square root, absolute value, $\sin x/x$, exponential and log on any waveform.

ENHANCED RESOLUTION

Allows filtering of the digitized signals, whether they are single-shot or repetitive, in order to increase the resolution of the displayed trace from 8 bits to 11 bits in steps of 0.5 bits.

VERTICAL EXPANSION

Provides vertical scale expansion by a factor of up to 50.

CHAINING OF OPERATIONS

Automatically chains up to four operations. An indefinite number of operations can be performed sequentially, either manually or via remote control.

REMOTE CONTROL

Controls remotely all front-panel settings, as well as all waveform processing options via either GPIB or RS-232-C interfaces.

Functional Description

The WP01 waveform processing package can be implemented in any of the models of the 9300 family of digital oscilloscopes. This firmware is optimized for processing signals in real time. A powerful 68020 microprocessor and a

68881 co-processor enable very rapid representation of results such as averages, integrations, exponentials and multiplications.

Waveform operations can be performed on live, stored, processed or expanded waveforms. They are selected through simple menus that allow functions to be chained together allowing more complex computations. For example, it is possible to perform the integration of an averaged waveform or the multiplication of a differentiated waveform.

All processing occurs in function memories A, B, C and D which may be displayed on the screen by simply pressing the appropriate function button. All the necessary processing is automatically performed for all the functions selected.

The number of points used in the calculations is selectable and goes from 50 to 10,000 points for models with 10,000 data points of memory per channel. It goes up to 50,000 points for all other models.

SIGNAL AVERAGING

WP01 offers two powerful, high-speed averaging modes that can be used to reduce noise and improve the signal-to-noise ratio. Vertical resolution can be extended by several bits to improve dynamic range and increase the overall input sensitivity to as much as 50 mV/division.

Summed Averaging consists of the repeated addition (with equal weight) of recurrences of the selected source waveform. The number of acquisitions averaged can be selected up to 1,000,000 sweeps with the accumulation automatically stopping when the number is reached.

Continuous Averaging, sometimes called exponential averaging, is the repeated weighted average of the source waveform with the previous average. Averaging goes on indefinitely with each new acquisition and the effect of previous waveforms gradually tends to zero. Relative weighting factors can be chosen from 1:1 to 1:1023. The method is

particularly useful for monitoring noisy signals which may change slowly over a period of time.

ENHANCED RESOLUTION

The WP01 package provides a selective filtering technique that improves vertical resolution for reduced bandwidth applications. By effectively removing high-frequency noise, with digital smoothing functions, waveforms can be analyzed with resolution from 8 to 11 bits. The technique can be used with both single-shot and repetitive signals and provides an ideal method for smoothing transient phenomena.

EXTREMA MODE

Tracking rare glitches or monitoring signals drifting in time and amplitude is made easy with EXTREMA mode. EXTREMA waveforms are produced by repeatedly comparing acquisitions of a source waveform with a stored waveform that contains previous maximum and/or minimum excursions. Whenever a given data point of a new acquisition exceeds the existing data point of the stored waveform, the old data point is replaced by the new. In this way the envelope of all waveforms is accumulated for up to a maximum of 1,000,000 sweeps.

ARITHMETIC

The 9300 family offers basic arithmetic operations such as addition, subtraction, division, multiplication and negation, even on the standard models. These arithmetic functions can be performed on any source waveform on a point-by-point basis. Different vertical gains and offsets of the source waveforms are automatically taken into account in the computed result.

MATHEMATICAL FUNCTIONS

Functions including differentiation, integration, absolute value, square, square root, logarithm (base 10 and e), exponential, reciprocal, and $\sin x/x$ interpolation may be performed on any source waveform. Arithmetical and mathematical functions can also be chained together to construct more complex processing routines.

9300 WP01

WP01 Waveform Processing Firmware for the 9300 Family of Digital Oscilloscopes

Main Features

- Averaging - summation and continuous
- Arithmetic - including addition, subtraction, ratio and multiplication
- Functions - including integration, differentiation, log, expansion, ABS, square root and more
- Extrema mode - storage of extreme positive and negative values

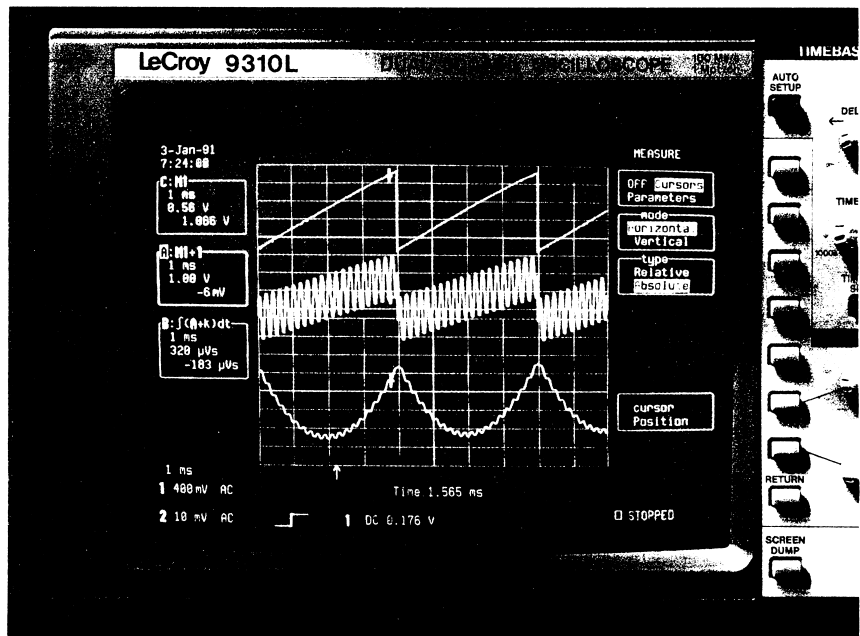

Added as a factory option or retrofitted in the field, the WP01 Waveform Processing Package adds high-speed averaging, filtering and mathematical capabilities to the 9300 family of digital oscilloscopes.

General

The LeCroy WP01 Waveform Processing package offers powerful routines that extend the processing capabilities of the 9300 family of Digital Oscilloscopes.

All processing is built in to eliminate the need for external computers and controllers. High-speed microprocessors are used to ensure that computed waveforms are displayed instantly on the screen.

The package is fully programmable over GPIB or RS-232-C interface and hard copies can be directly made onto a wide range of printers.

WP01 Specifications

SUMMATION AVERAGING

Number of Sweeps: 1 to 1,000,000.
Number of Input Points: 50 to 50,000 (50 to 10,000 for models with 10,000 data points per channel).
Vertical Expansion: 50 x maximum.
Maximum Sensitivity: 50 mV/div after vertical expansion.
Speed: up to 200,000 points/s.

CONTINUOUS AVERAGING

Possible Weighting Factors: 1:1, 1:3, 1:7, 1:15, 1:31, 1:63, 1:127, 1:255, 1:511 and 1:1023.
Number of Input Points: 50 to 50,000 (50 to 10,000 for models with 10,000 data points per channel).
Vertical Expansion: 50 x maximum.
Maximum Sensitivity: 50 mV/div after vertical expansion.

ARITHMETIC

Addition, subtraction, multiplication, and ratio on any two waveforms.
Number of Input Points: 50 to 50,000 (50 to 10,000 for models with 10,000 data points per channel).
Vertical Expansion: 5 x to 50 x depending on the source waveforms.

FUNCTIONS

Identity, negation, integration, differentiation, square, square root, logarithm and exponential (base e and 10), sin x/x, reciprocal and absolute value of any source waveforms.

Number of Input points: 50 to 50,000 (50 to 10,000 for models with 10,000 data points per channel).
Vertical Expansion: 5 x to 50 x depending on the source waveforms.

ENHANCED RESOLUTION

Choice of five low-pass filters for vertical resolution improvement from 8 to 11 bits at reduced bandwidth.

Vertical Expansion: 50 x maximum.
Maximum Sensitivity: 50 mV/div after vertical expansion.

EXTREMA

Logs all extreme values of a waveform over a programmable number of sweeps. Maxima and minima can be displayed together, or separately by choosing ROOF or FLOOR traces.

Number of Sweeps: 1 to 1,000,000.
Number of Input Points: 50 to 50,000 (50 to 10,000 for models with 10,000 data points per channel).

Glitches as short as 0.002% of the time base down to 10 ns are displayed.
Vertical Expansion: 5 x maximum.

CHAINING OF OPERATIONS

Up to four functions can be automatically chained using Functions A, B, C and D. Using memories M1 to M4 for intermediate results, any number of operations can be chained manually or via remote control.

REMOTE CONTROL

All controls and waveform processing functions are fully programmable using the oscilloscope's GPIB or RS-232-C interfaces. Simple English-like commands are used.

STORED FRONT PANELS

Up to four front-panel setups, including WP01 settings, can be stored in resident non-volatile memory and recalled using the menu buttons or via remote control.

9300 WP02

WP02 Spectrum Analysis Firmware for the 9300 Family of Digital Oscilloscopes

Main Features

- Up to 50,000-point FFTs over two or four channels simultaneously
- Frequency range from DC to up to 300 MHz
- Frequency resolution down to 20 μ Hz
- Up to 10 Gs/s sampling rates
- Frequency domain averaging
- Wide selection of display formats and window functions
- 1,000-point FFTs in less than 0.5 s

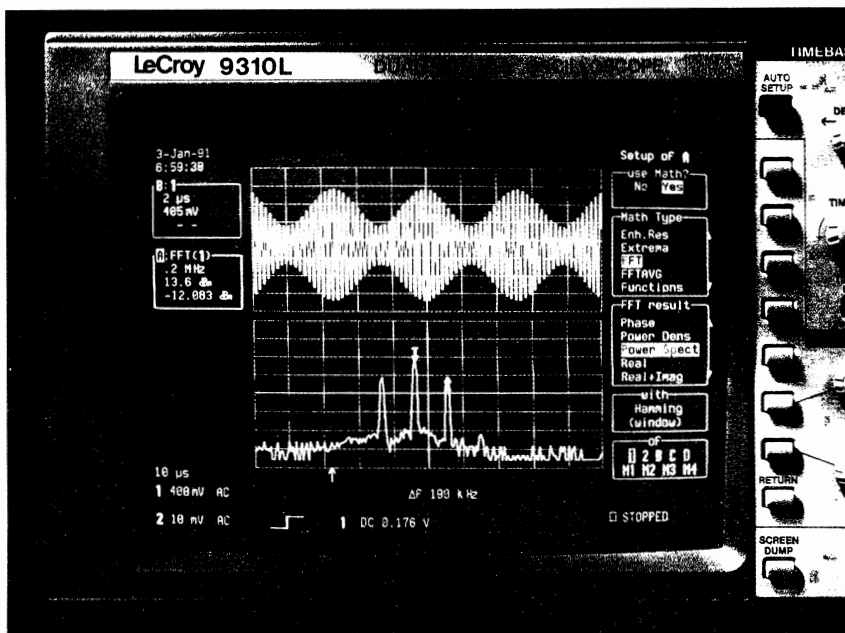

Adding the WP02 Spectrum Analysis Package to the 9300 family of digital oscilloscopes provides a fast and economical solution to frequency domain applications.

General

The WP02 Spectrum Analysis Package extends the range of measurement capabilities of the 9300 series of Digital Oscilloscopes. The package is fully programmable over GPIB and RS-232-C interfaces.

Fast Fourier Transforms (FFTs) rapidly convert time domain waveforms into frequency domain records to reveal valuable spectral information such as phase, magnitude and power.

Hardcopies can be directly made on a wide range of printers. As the package is a firmware option which is installed inside the oscilloscope, it eliminates the need for any external controller and is easy to retrofit.

Features and Benefits

LONG RECORD TRANSFORMS

Long record FFTs (up to 10,000 points or up to 50,000 points, depending on the model) provide significant signal-to-noise ratio improvement.

WIDE-BAND FREQUENCY ANALYSIS

DC to up to 300 MHz bandwidth with high resolution.

HIGH SAMPLING RATES

Up to 10 gigasamples/s effectively eliminates aliasing errors.

BROAD SPECTRUM COVERAGE

Up to 25,000 spectral components (5,000 for 10,000-point memory).

MULTI-CHANNEL ANALYSIS

All input channels can be analyzed simultaneously to allow comparison of independent signals for common frequency-domain characteristics.

VERSATILE DISPLAY FORMATS

Frequency-domain data may be presented as magnitude, phase, real, imaginary, complex, log-power and log-PSD (Power Spectral Density). These display formats can all be selected via menu options.

STANDARD WINDOW FUNCTIONS

Rectangular for transient signals; von Hann (Hanning) and Hamming for continuous waveform data; Flattop for accurate amplitude measurements; Blackman-Harris for maximum frequency resolution.

CALIBRATED VERTICAL SCALING

Flattop truncation window provides precisely calibrated vertical scaling for all spectral components.

FREQUENCY DOMAIN AVERAGING

Up to 50,00 FFT results may be averaged to reduce base-line noise and enable analysis of phase-incoherent signals or signals which cannot be triggered on.

TIME-DOMAIN AVERAGING

Averaging real-time signals prior to FFT execution can increase the dynamic range up to 70 dB.

FREQUENCY CURSORS

Cursors give up to 0.004% frequency resolution (up to 0.002% for 10,000 point memory) and measure power or voltage differences to 0.2% of full scale.

CHAINING OF OPERATIONS

Up to four operations can be automatically chained, e.g., Function D=FFT of (CH1 X CH2). Any number of operations can be performed sequentially, either manually or via remote control.

FULL REMOTE CONTROL

All front-panel settings and waveform processing functions are programmable via GPIB or RS-232-C interfaces. Acquired and processed waveforms can be down-loaded to a computer and can later be retrieved and displayed on the oscilloscope.

HARD COPIES

Provides hard copies of the screen using a wide range of printers.

PROCESSING OF EXPANSIONS

Up to four regions of the same waveform, or of different waveforms, can be expanded and processed simultaneously.

FFT ON SEGMENTED WAVEFORMS

Individual waveform segments can be expanded and then analyzed using FFT. Time and date information is automatically recorded for each segment.

FOURIER PROCESSING

Fourier processing is a mathematical technique which enables a time-domain waveform to be described in terms of frequency-domain magnitude and phase, or real and imaginary spectra. It is used, for example, in spectral analysis where a waveform is sampled and digitized, then transformed by a Discrete Fourier Transform (DFT). Fast Fourier Transforms (FFT) are a set of algorithms used to reduce the computation time (by better than a factor of 100 for a 1000 point FFT) needed to evaluate a DFT. The principal advantage of FFT is the speed with which it can analyze large quantities of waveform samples. Using standard measurement techniques, FFT converts a time-domain measurement instrument into a digital spectrum analyzer.

The Spectrum Analysis package enhances the outstanding features of the LeCroy 9300 family. It provides high resolution and wide-band spectrum analysis together with sophisticated window functions and fast processing.

FFT AND LeCROY OSCILLOSCOPES

In FFT mode, LeCroy oscilloscopes provide measurement capabilities superior to those of common swept spectrum analyzers. It is now possible to perform spectral analysis on repetitive and single events at an attractive price. Users can obtain time and frequency values simultaneously and compare phases of the various frequency components with each other.

Rather than the commonly used "power of two" record lengths, the routines used in the WP02 package feature decimal record lengths which can be selected in a 1, 2.5, 5 sequence. Resulting spectra are also calibrated in convenient decimal Hertz values.

The WP02 package is supported by the exceptional acquisition characteristics which are the hallmark of LeCroy oscilloscopes (+2% DC accuracy, high effective bits, improved resolution through averaging). Computations are made using 16-bit processing that allows high accuracy, stability and repeatability. With LeCroy oscilloscopes, signals may be acquired from up to four acquisition channels and processed simultaneously using up to four functions. This is particularly useful for network characterization or when looking for common frequency-domain characteristics on multiple signals.

IMPROVED RESOLUTION

Fast Fourier Transform calculates equally-spaced frequency components from DC to the full instrument bandwidth. By lowering the sampling rate, it is possible to make measurements with 20 μ Hz resolution up to 0.5 Hz (Nyquist). By increasing the sampling mode, the widest resolution becomes 100 MHz and the Nyquist frequency 5.0 GHz. This is comfortably above the highest frequency components recordable by the oscilloscope, thus virtually eliminates aliasing effects.

WP02 Specifications

MEMORIES

Acquisition memory/ch (8-bit) Reference memories (16-bit) Function memories (16-bit)	9304/10/14	9310M/L and 9314M/L
	10K points	50K points
	4 x 10K points	4 x 50K points
Function memories (16-bit)	4 x 10K points	4 x 50K points

FREQUENCY

Frequency resolution Horizontal expansion Transform size in out	9304/10/14	9310M/L and 9314M/L
	0.1 MHz to 50 MHz 100 X	20 µHz to 100 MHz 1000 X
	40 to 10000 points 20 to 5000 points	40 to 50000 points 20 to 25000 points

Frequency Range: DC to instrument bandwidth.

Nyquist Frequency Range: 0.5 Hz to 5 GHz.

Frequency Scale Factors: 0.05 Hz/div to 0.2 GHz/div in a 1-2-5 sequence.

Frequency Accuracy: 0.01%.

Selection of the Transform Size: The number of points can be selected in a 1, 2.5, 5 sequence. The transform size defines the decimation applied to the signal after acquisition. It can be adjusted and optimized after signal acquisition and prior to FFT execution.

AMPLITUDE AND PHASE

Amplitude Accuracy: Better than 2%. Amplitude accuracy may be modified by the window function (see the window functions table).

Signal Overflow: A warning is provided at the top of the display when the input signal exceeds the ADC range.

Number of Traces: Time domain and frequency domain data can be displayed simultaneously (up to 4 waveforms).

Phase Range: -180° to +180°.

Phase Accuracy: ±5 (for amplitude > 1.4 div).

Phase Scale Factor: 50° /division.

Zero Baseline: 0 div (center of screen).

SPECTRUM DISPLAY FORMATS AND SCALING

Frequency Scale: Linear, real, imaginary or complex spectrum, in V/div, zero base line at 0 div (center of screen).

Power Spectrum in dBm (1 mW into 50 Ω).

Power Spectral Density (PSD) in dBm.

Phase Display: Linear.

Magnitude Display: Linear. Power and PSD spectra displays have 160 dB range (20 dB/div), continuously expandable up to 0.5 dBm/div.

FREQUENCY DOMAIN POWER AVERAGING

Summation averaging of power, PSD or magnitude for up to 50,000 spectra.

VERTICAL EXPANSION

All spectral formats, up to 50 times, continuously.

DEFINITIONS

Filter Bandwidth at -6 dB characterizes the frequency resolution of the filter.

Highest Side Lobe indicates the reduction in leakage of signal components into neighboring frequency bins.

Scallop Loss is the maximum loss of an equivalent rectangular filter.

WINDOW FUNCTIONS

Rectangular, von Hann (Hanning), Hamming, Flattop and Blackman-Harris. The table below indicates the filter pass-band shape and the resolution.

CURSORS

Absolute (crosshair) and relative (arrow) cursors provide frequency and amplitude (phase, power, power density) measurements. Horizontal bars provide absolute and relative amplitude, (phase, power and power density) measurements.

FFT EXECUTION TIME

100 points in less than 0.05 s.
1000 points in less than 0.5 s.
10000 points in less than 5 s.

REMOTE CONTROL

All WP02 processing functions are fully programmable via the GPIB and RS-232-C interfaces. Simple English-like commands are used.

REMOTE READ AND WRITE

All waveform formats including complex can be read by computer for storage or further processing. Externally generated waveforms can be written into Memories M1 to M4 for FFT or other processing.

STORED FRONT PANELS

Up to 4 front-panel setups, including WP02 menu settings can be stored in non-volatile memory and recalled by the menu buttons at the right side of the screen.

WP02 INSTALLATION

A WP02 package may be retrofitted at any time.

Window type	FILTER PASS BAND AND RESOLUTION			
	Filter bandwidth at -6 dB [freq. bins]	Highest side lobe [dB]	Scallop loss [dB]	Noise bandwidth [freq. bins]
Rectangular	1.21	-13	3.92	1.0
von Hann	2.00	-32	1.42	1.5
Hamming	1.81	-43	1.78	1.36
Flattop	1.78	-44	0.01	2.96
Blackman-Harris	1.81	-67	1.13	1.71

LeCalsoft—Calibration Software for LeCroy Digital Oscilloscopes



The LeCalsoft package enables a fast and thorough verification of all key specifications.

Main Features

- Traceability to reference standards
- Computer check of key specifications
- Computer-aided readjustment
- Fully automated configurations available
- Supports all 93XX and 94XX models
- IBM[®] PC-AT compatible

General

The LeCroy LeCalsoft (94XXCS05) test and calibration package provides a convenient, unambiguous check of LeCroy oscilloscopes. Designed for users who require traceability to reference standards (NIST, etc.), this package is ideally suited for use in calibration laboratories where the oscilloscopes are checked at fixed intervals.

Results of the calibration check are fully documented on hard copy, or they can be archived on hard disk or diskette.

LeCalsoft works on any PC compatible with the IBM[®]-AT standard. It controls the oscilloscope and the calibration sources through a National Instruments[®] GPIB interface.

Features

Calibration Check

All the essential specifications of the Digital Oscilloscope, such as bandwidth, linearity, noise, trigger, timebase and effective-bit count are tested. Deviations from nominal values are calculated and displayed on the screen, printed, or archived on hard disk or diskette.

Comprehensive Documentation of the Test Results

At the end of each calibration check, two types of documentation are available: a long form printout which gives details of the results of all the tests executed, and states whether or not the results are within the specifications, and a short form printout which gives a summary of the test results.

Calibration Traceable to National Standards (NIST, etc.)

By using signal sources traceable to a standard, the calibration will be traceable to the same standard, provided the relevant documentation is maintained.

Manual and Automated Calibration Check

Both manual operation with computer assistance, and automated operation are possible. Automated operation requires programmable multiplexer and signal sources. See the list of supported devices below.

Assisted Adjustment of the Oscilloscope

A computer-aided adjustment procedure is also provided. By following instructions on the screen, the trained technician is guided through the adjustments required to correct the settings of the oscilloscope so that it is within the specifications.

Calibration Certificate

On request, LeCroy will perform calibration traceable to National Standard Organizations. Calibration certificates are provided as part of this service.

Functional Description

Calibration Practice

LeCroy oscilloscopes are auto-calibrating digital oscilloscopes and therefore do not require regular calibration like analog oscilloscopes. However, for users who require traceability to reference standards (such as those provided by the National Institutes of Standards and Technology), and for calibration laboratories which must inspect incoming instruments and perform recalibration at prescribed intervals, the LeCalsoft computer-aided test and calibration packages provide an easy solution.

Under guidance of the LeCalsoft program, some adjustments to the oscilloscope can be made by an electronics technician. However major deviations from specifications usually require repair by a trained service engineer. LeCroy regularly schedules training classes. If no in-house trained person is available, the nearest LeCroy service center can carry out repairs and calibration, and provide traceability to reference standards.

Using the LeCroy LeCalsoft Packages

For calibration checking, digital oscilloscopes have a great advantage over analog oscilloscopes because waveforms can be transferred to a host computer. This simplifies the calibration procedure enormously, makes it potentially faster and allows an extensive range of tests with unambiguous interpretation of the results.

LeCalsoft performs an extensive series of tests which verify the specifications of the oscilloscope. It includes many tests relevant to analog scopes such as Noise and Linearity tests. Although these tests are difficult and time consuming on an analog oscilloscope, they can be computer controlled and are quickly and easily performed on a digital oscilloscope. Tests which are specific to digital oscilloscopes, such as Sinefit tests are also included.

The various test options in LeCalsoft are presented to the operator in the form of a simple menu system. The user has the choice of performing an automated calibration check of the oscilloscope, or individually testing any of the specifications. Some of the tests require the use of high-quality external signal generators. The user receives instructions on

the screen when it is necessary to change the cable connections, but apart from this minor intervention, the tests are fully computer controlled when supported GPIB-programmable instruments are used.

Supported Instrumentation

LeCalsoft software works on any AT-compatible equipped with a math coprocessor and a National Instruments GPIB interface. Automated calibration checking is possible using a set of instruments from the following list. (For an automated calibration check, either the LeCroy or Keithley programmable multiplexer is required to feed the calibration signals to the oscilloscope input.)

RF sinewave generators:

Marconi 2019A, 2022C, 2030, 2031
Fluke 6060B, 6061A
Hewlett-Packard 8642A, 8642B
Rohde & Schwarz SMX

AF sinewave generators:

Marconi 2019A, 2022C, 2030, 2031
Hewlett-Packard 8642A, 8642B
Rohde & Schwarz SMX
Tektronix FG5010
LeCroy AFG 9100

DC Precision Power Supply:

Tektronix PS5004
Datron 4708 Autocal Multifunction Standard

Fast Pulse Generator:

Tektronix CG5001/CG551AP

Power Meters:

Hewlett-Packard HP436A, HP437B

Multiplexers:

Keithley 199 SYSTEM DMM/
SCANNER with LeCroy interface board.
LeCroy 4951, 4973-1, 4973-2
Multiplexers.

Frequency standard:

WWV or HBG1500

Recommended Accessories

A full kit of calibration connectors and interfaces is available from LeCroy. It includes all the necessary cables, adapters, splitters and filters, as well as the Programmable Multiplexer. Also available is a repair package including special tools, board extenders, etc., for computer-aided adjustment.

Use of Other Instruments

It is possible to perform the calibration check with some other unsupported signal sources. However, the user is then required to set up these instruments manually and to perform one measurement at a time. The LeCalsoft package

guides the user step by step, and controls the oscilloscope data acquisition and the computation of the results.

LeCalsoft compares the signal measured by the oscilloscope with the signal it would expect to receive from the generator. Warning messages are displayed

whenever tolerances are exceeded. Some of the adjustments may be carried out by the user when the test sequence is finished. In this case, the software will guide the user through the correct adjustment procedure. At the end of the calibration check, a printout can be generated to list the results.

Specifications

Computer Required: Any PC compatible with the IBM-AT standard, and equipped with a mathematical coprocessor and a National Instrument Inc. GPIB interface.

Operating System: DOS 3.0 upward

Medium: 3¹/₂" 1.44 Mb
5¹/₄" 1.2 Mb diskette

Major Tests Supported by LeCalsoft

Internal

To ensure proper calibration of the oscilloscope, internal auto-calibration tests are automatically executed during normal operation. This standard sequence of internal auto calibration tests is initiated by the software and the results are transferred to the PC for analysis.

The tests are:

- Calibration of the resolution of the time-to-digital converter with respect to the system clock
- Determination of the gain constants of the input amplifiers
- Offset compensation versus gain variation
- Global internal non-linearity
- General functionality check

Bandwidth

To calculate the bandwidth, the amplitudes of sine waves of increasing frequencies are measured. The sine wave generator is first set to 500 kHz with an amplitude 75% of full screen, i.e. ± 3 vertical divisions. The frequency is then swept up to the point where an amplitude drop of 3 dB is observed. This indicates the bandwidth.

This test is executed on all channels for 1 M Ω and 50 Ω input impedance and for all vertical sensitivities. It requires a sine wave generator with good flatness.

Generators supported under program

control are listed on page 2.

Linearity

15 different known voltages, varying from 5% to 95% of full screen, are applied by the external voltage reference source. For each voltage value, a full waveform is acquired, and the mean value is compared to the known input voltage. The linearity is determined through a linear regression fit to the 15 measurements. The slope, the offset and the chi-square of the fit are computed.

With the linearity test, many other related tests are performed: response time of the overload protection of the 50 Ω input, linearity of the variable gain calibration, range and linearity of the offset setting, and quality of the input coupling.

This procedure is executed on all channels for both 1 M Ω and 50 Ω input impedance. The test requires a DC source with a precision and time stability of 0.1%, a voltage range of 0 V to 20 V adjustable in steps of 5 mV, and an output current capability of 300 mA.

Power supplies supported under program control are listed on page 2.

Noise

The noise tests are executed on all channels for both 1M Ω and 50 Ω input impedance, with AC and DC coupling, five different time-base settings, and open inputs. Full waveforms are acquired with different offset values. The peak-to-peak as well as the RMS values of each measurement are computed, and the maximum values are recorded. The program also indicates the occurrence of any "flyers", i.e. short noise peaks generated by the ADC's.

The noise tests also include:

- checking the linearity of the variable offsets of all channels between 2.5% and 97.5% of full screen.

- checking the stability of the ground line when switching the inputs between GROUND and DC coupling modes.

Rise time/Overshoot

Executed on all channels for both 1M Ω and 50 Ω input impedance, these tests measure the rise time of the oscilloscope response to the input voltage step, as well as the amount of pre-shoot and overshoot. They require a voltage step generator with calibrated fast rise-time amplitude.

The Voltage Step Generator supported under program control is the Tektronix CG5001.

Sinefit

The performance of the analog-to-digital converter is evaluated in terms of the number of effective bits (a measure of the signal-to-noise ratio). It is measured on all channels, at a sensitivity of 50 mV/div., by applying a pure sine wave at varying frequencies and timebase settings

This test is a measurement of dynamic linearity. It shows the effect of such errors as noise, non-linearities and aperture jitter.

Timebase

The timebase test compares the internal clock with a very precise and stable external timebase reference (clock generator) such as the WWV standard or HBG 1500.

Trigger

The trigger capabilities are tested for all possible configurations. These include:

- Internal and external trigger sources
- DC, AC, HF-reject, and LF-reject couplings
- Trigger level settings in all slope modes.

SECTION 3 BLOCK DIAGRAM and SUB-ASSEMBLIES

9320 Digital Oscilloscope

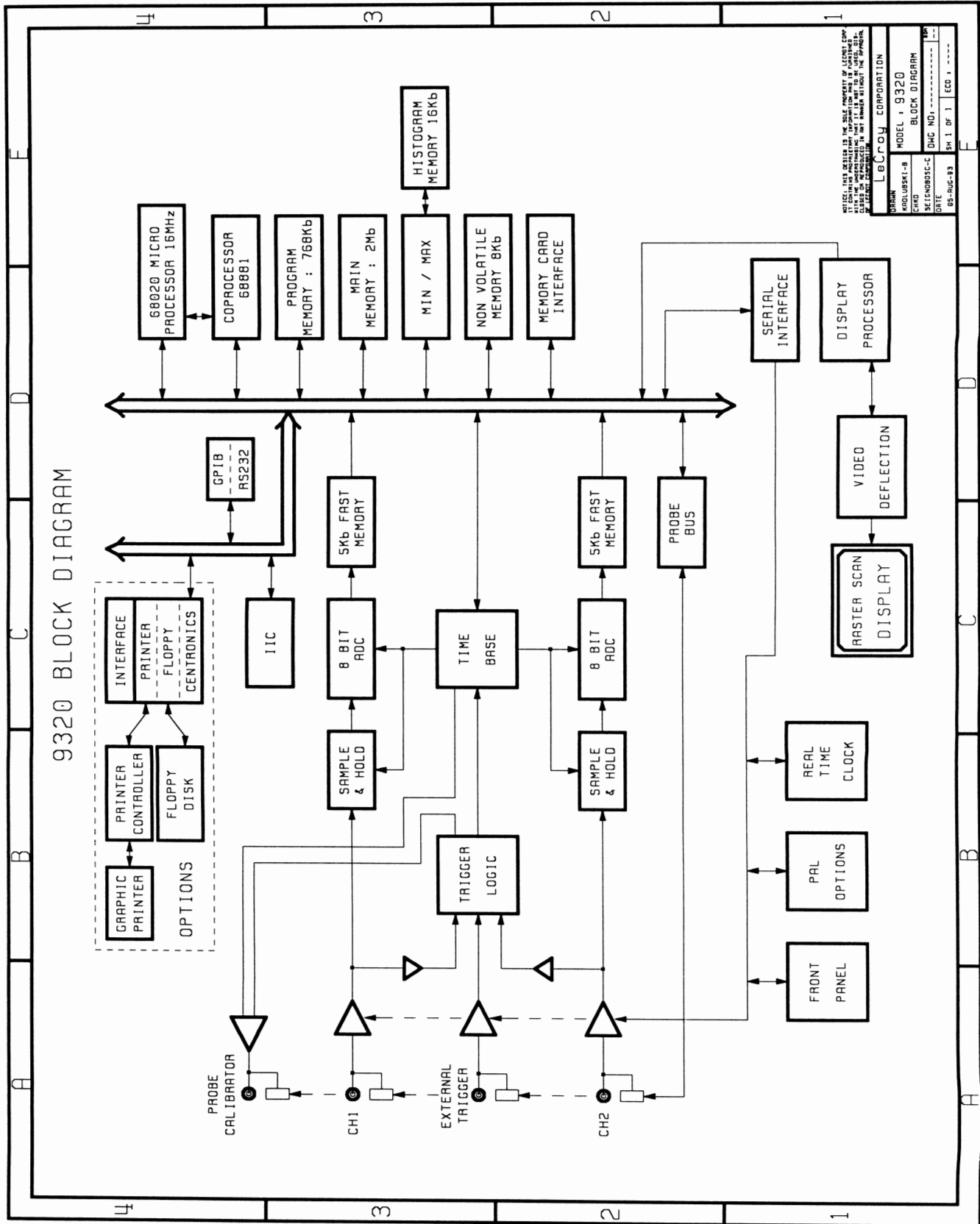

3.2 9320 Sub-Assemblies

F9314M-1	Processor with 2 Mbyte RAM
F9320-3	Main card, dual channel, 20Ms/s, 5 Kbytes memory
F9300-4	GPIB + RS232 interface
F9320-5	Dual channel front panel 9320
93XX-PS1715	Power supply +/- 5V, +/- 15V.
93XX-Display	Video, deflection, CRT, yoke
M93XX	Mechanical for 93XX series

3.3 9320 Hardware Options

9320-FDGP	Graphic Printer & Floppy Disk F9300-6 : Centronics, Floppy, Printer interface F9300-7 : Printer controller
9320-GP01	Graphic Printer F9300-6 : Centronics, Floppy, Printer interface F9300-7 : Printer controller
9320-FD01	Floppy Disk F9300-6 : Centronics, Floppy, Printer interface

SECTION 4 THEORY of OPERATION**4.1 F9314M-1 Processor Board**

The processor board is based on to the 68020 and 68881 coprocessor, with a clock frequency of 16 MHz, and 2 Mbytes memory

The internal Data Bus is 32 bits wide, the peripheral Data Bus set 8 or 16 bits, and the Address Bus has 27 bits (A0-A25 and A31).

The board contains the following sections:

Program memory (EPROM)

768 Kbytes : 2 x 2 Mbit Eproms and 2 x 1 Mbit Eproms
Data Bus : 16 bits.
Address : 0000 0000 to 000D FFFE.

Working memory (PS RAM)

2 Mbytes memory : 4 Pseudo static RAM of 4 Mbit.
Data Bus : 16 Bits.
Address : 0040 0000 to 004F FFFE or 005F FFFE.

Memory card

An interface is implemented to support an external memory card, whose size can range from 16 Kbytes to 4Mbytes.

Data bus : 8 bits.

Non volatile memory

A static RAM of 8 Kbytes contains the parameters used at power on to initialize the scope and the stored parameters (panels). This memory is battery backed up.

Data bus : 8 bits.

Min/Max calculation

A gate array MNX401 makes a histogram in its associated 16 Kbytes memory and remembers the minimum and maximum data values it sees.

Data bus: 16 bits.

Graphic processor

The graphic processor of the raster scan display is a gate array designated MDS410.

Clock frequency : 48 MHz.
Trace and characters memory : 32 Kbytes (CTRAM).
Bitmap memory : 40 Kbytes (BMRAM).
Character font EPROM : 32 Kbytes (FCRAM).
Data bus : 8 bits.

DAC command of the display intensity

The control of the display intensity is done by a 8 bits RAMDAC.

Status and command registers

Status (read) and command (write) registers control the memory card and front panel interface during the boot or after a RESET.

External interfaces

Serial RS232 interface
Parallel GPIB interface
See F9300-4 Description Section 4.3

Optional interfaces

Graphic Printer : F9300-6 interface and F9300-7 controller Floppy
Disk Drive : F9300-6 interface
Centronics : F9300-6 interface

Serial peripherals

The processor controls the digital and analog section with a double serial controller.

DAC's registers (read/write).
Front panel registers (68HC05C4).
RTC registers (68HC68T1).
Probe detection.
Software options (GAL).
Front end control.
Trigger control (MTR408).

Real time clock

Integrated circuit 68HC68T1 (Motorola or RCA).
Resolution : 1 sec to 99 years.
Clock frequency : 32.768 KHz.
Non volatile memory: 32 Kbytes.
Data & Address bus : 8 bits.
Interrupt level : 5.

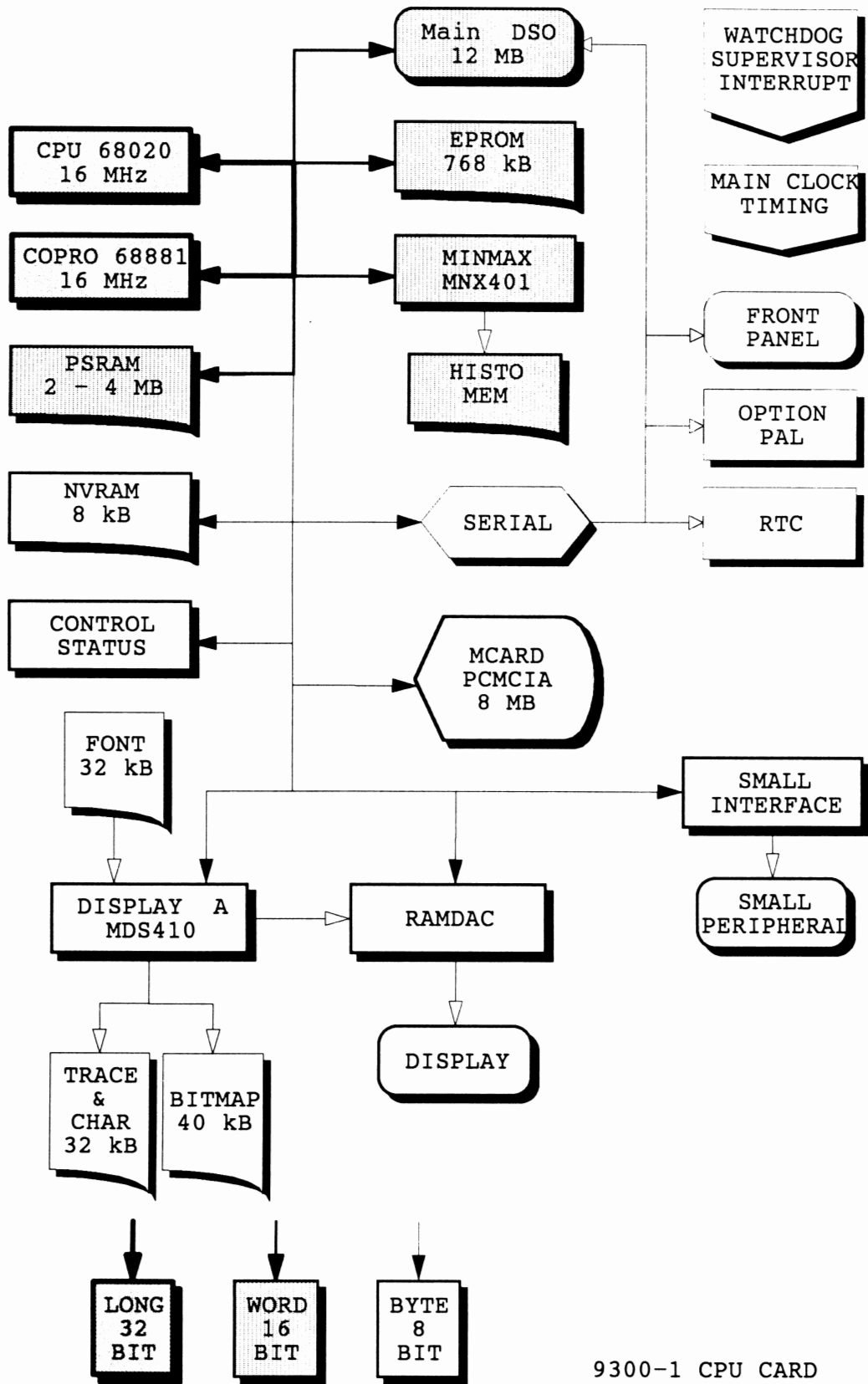

9300-1 CPU CARD

4.2 F9320-3 Main Board

4.2.1 Introduction

The board is divided in five parts :

- Front end control
- Channel 1 and Channel 2 front end's
- Channel 1 and Channel 2 ADC's
- Trigger control
- Time base

4.2.2 Front End Control, Channel front end's, and ADC's

Serial commands of Gain and Coupling

Address : 0141 0000

Three bytes are sent by the processor board to set :

- the attenuators
- the input signal of the VCAL
- the AC/DC trigger coupling

Control of the Trigger coupling : byte 2

D7	D6	D5	D4	D3	D2	D1	D0
-----	-----	-----	-----	-----	-----	-----	-----
nu	: 10	HF	AC	AC	AC	nu	nu
	Ext	Ch2	Ext	Ch2	Ch1		

Control of Channel 1 and Channel 2 : byte 3 (lower byte)

D7	D6	D5	D4	D3	D2	D1	D0
-----	-----	-----	-----	-----	-----	-----	-----
nu	: 5	: 20	VCAL	nu	: 5	: 20	VCAL
	Ch2	Ch2	Ch2		Ch1	Ch1	Ch1

- VCAL = 1 Calibration signal is sent to the input Channel
- : 20 = 0 : 20 attenuator is set
- : 5 = 0 : 5 attenuator is set
- AC = 0 Trigger AC coupling is set
- HF = 0 Enable the : 4 divider for Channel 2 HF trigger used with TRSEL1/3 (byte 2 of trigger control)
- :10 = 0 External Trigger / 10 is set
- nu = not used

Front end, Sample & Hold, ADC Block Diagram

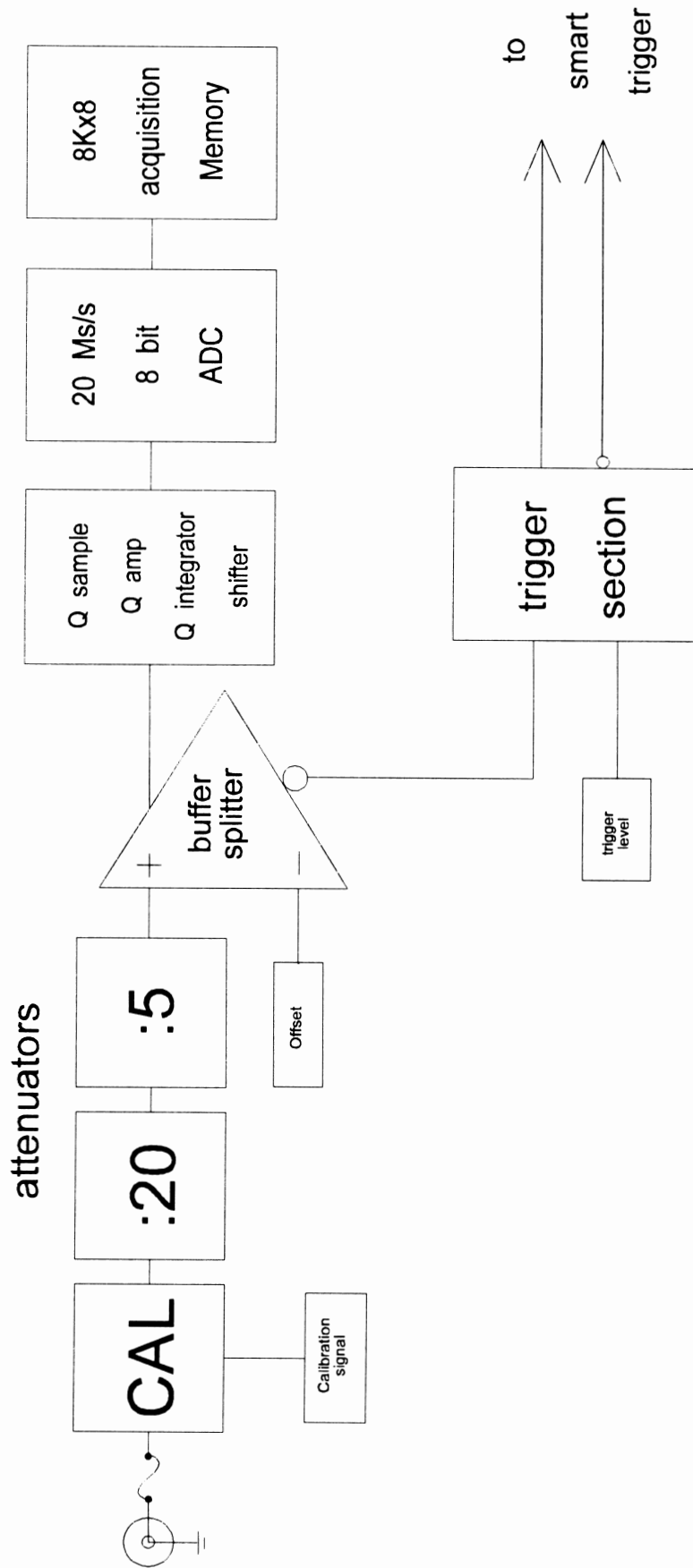

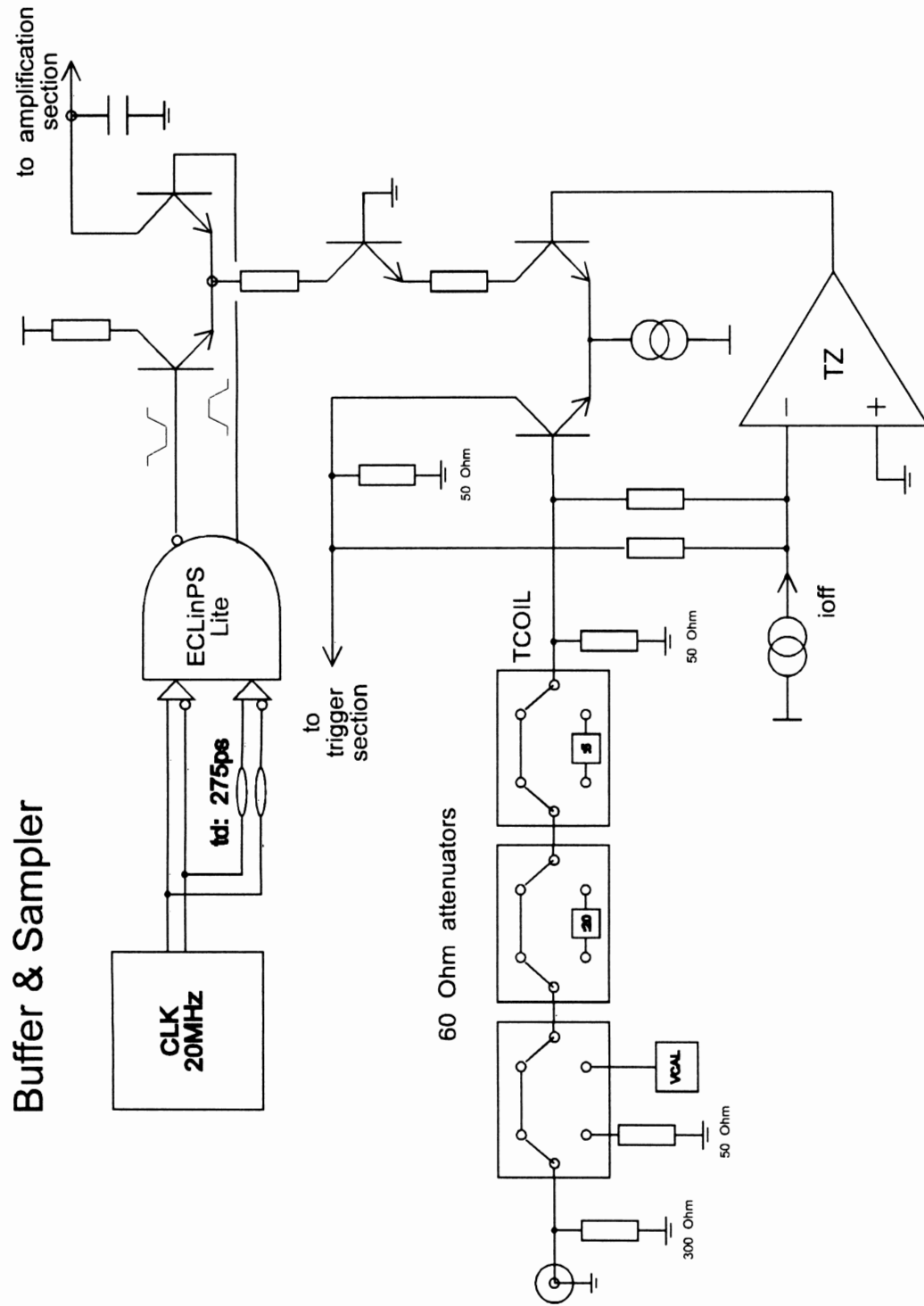

Front End Amplifier

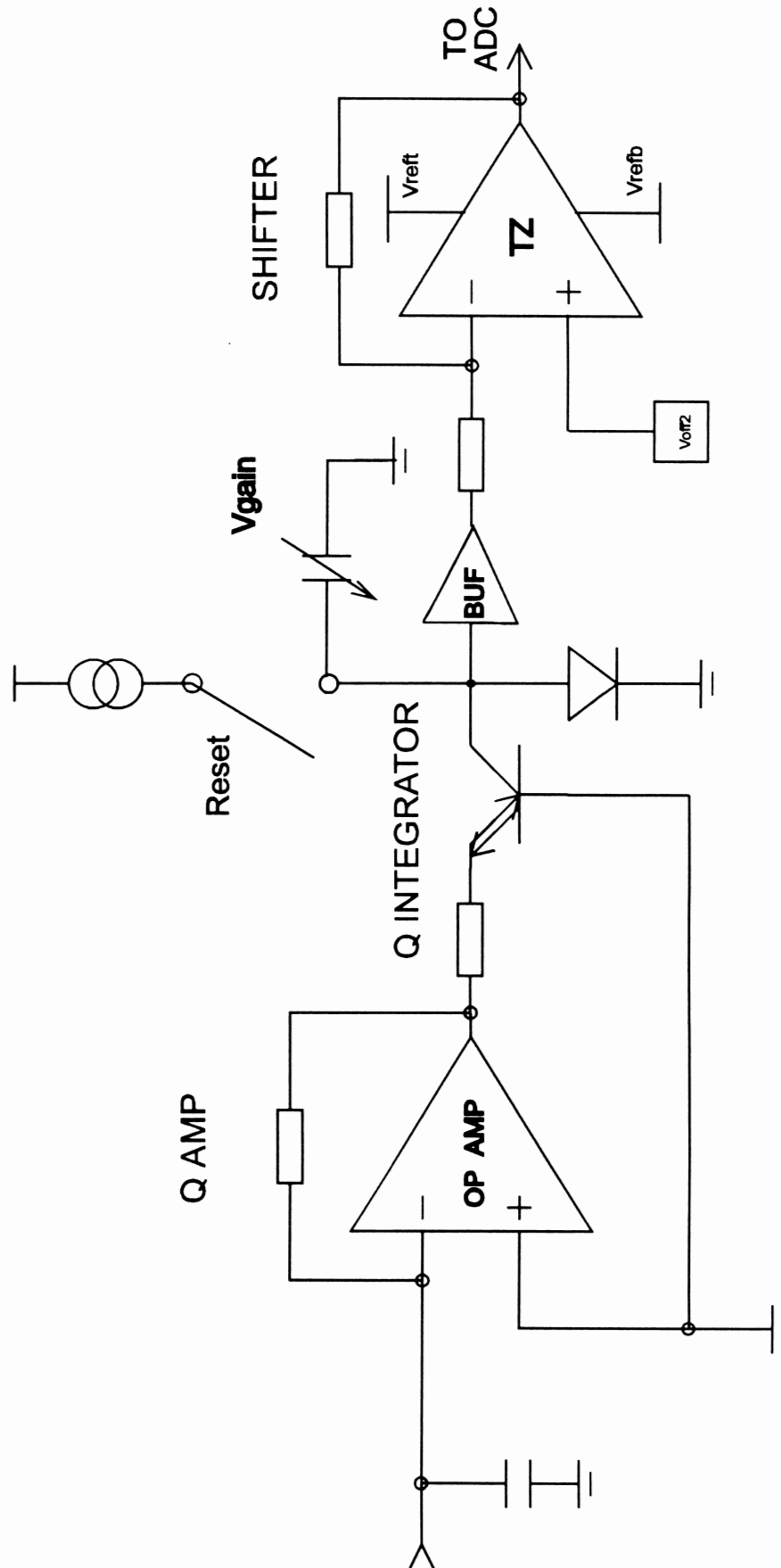

4.2.3 Trigger Control

Address : 0141 1000

Three bytes are sent by the processor board to select :

- Trigger source
- Trigger pattern
- Edge qualifier pattern
- Slope of the trigger edge
- Polarity and range of the pulse width
- < and > of the pulse width
- TDC and trigger calibration
- Holdoff by event or by time

Holdoff, Pattern, and Calibration control : byte 0

D7	D6	D5	D4	D3	D2	D1	D0
-----	-----	-----	-----	-----	-----	-----	-----
NOPAT	X Ch2	X Ch1	nu	nu	STATQ	TIM HLD	EVT HLD

NOPAT : select the negative output of the trigger

X (Ch) : Trigger pattern (when high the channel is not used for the pattern)

STATQ : validate the state qualifier pattern

TIMHLD : holdoff by time

EVTHLD : holdoff by event

note : bit active low

Holdoff, Pattern control and selection of the trigger validation : byte 1

D7	D6	D5	D4	D3	D2	D1	D0
-----	-----	-----	-----	-----	-----	-----	-----
nu	nu	HLDEN	ST Ch2	ST Ch1	nu	EDGEQ	VALID

ST (Ch) : Trigger pattern, state of the channel to validate the pattern
 ST ChX = 0 pattern true if ChX is high
 ST ChX = 1 pattern true if Ch X is low

HOLDEN : enable holdoff by time or by event

EDGEQ : validate the edge qualifier pattern

VALID : trigger validation
 low = single source
 high = multi source

Trigger source, slope and polarity : byte 2

D7	D6	D5	D4	D3	D2	D1	D0
-----	-----	-----	-----	-----	-----	-----	-----
TRSEL2	TRSEL1	NU	TRSEL3	PAT Ch	PW RANGE	SLOPE	PULSE <>

TRSEL 3,2,1 : Trigger source

TRSEL 3	2	1	
0	0	x	EX Trigger
0	1	x	HF Ch2, HF must be low (byte 2 of front-end control)
1	0	0	nu
1	0	1	Ch_2
1	1	0	Ch_1
1	1	1	nu

PAT Ch X : PAT or Ch 1, Ch 2 select pattern if bit high

PWRANGE : Pulse width range high => fastglitch (500ps to 50ns)
low => pulse width(50ns to 1Us)

SLOPE : slope edge , slope positive if bit high

PULSE <, > : pulse width condition, smaller than (<) if bit low

note : bits HLDEN, EDGEQ, STATQ: only one must be low.

Channel 2 Trigger Block Diagram

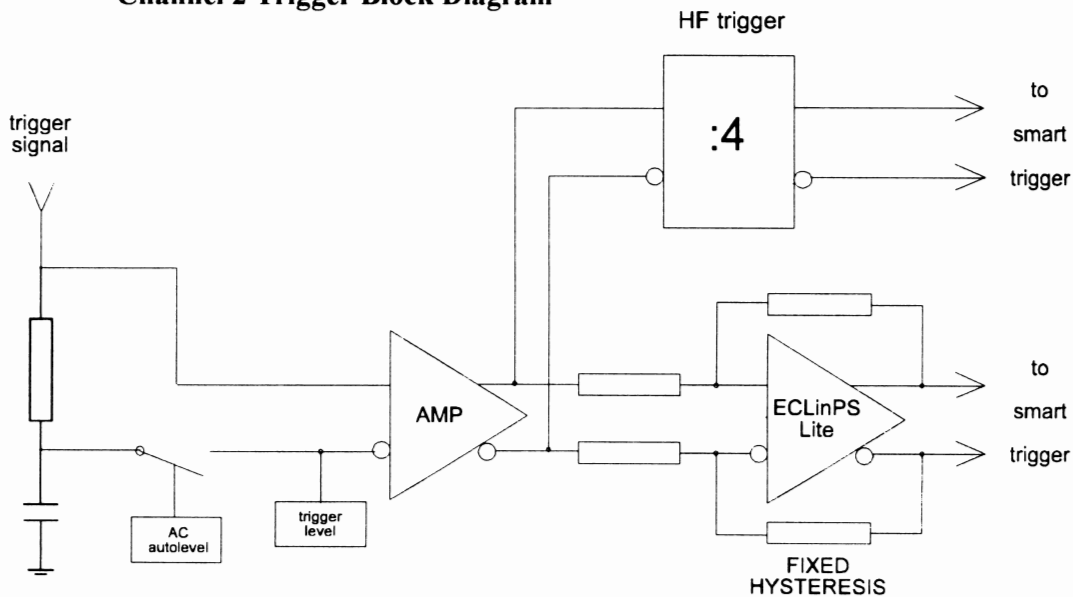

SMART TRIGGER

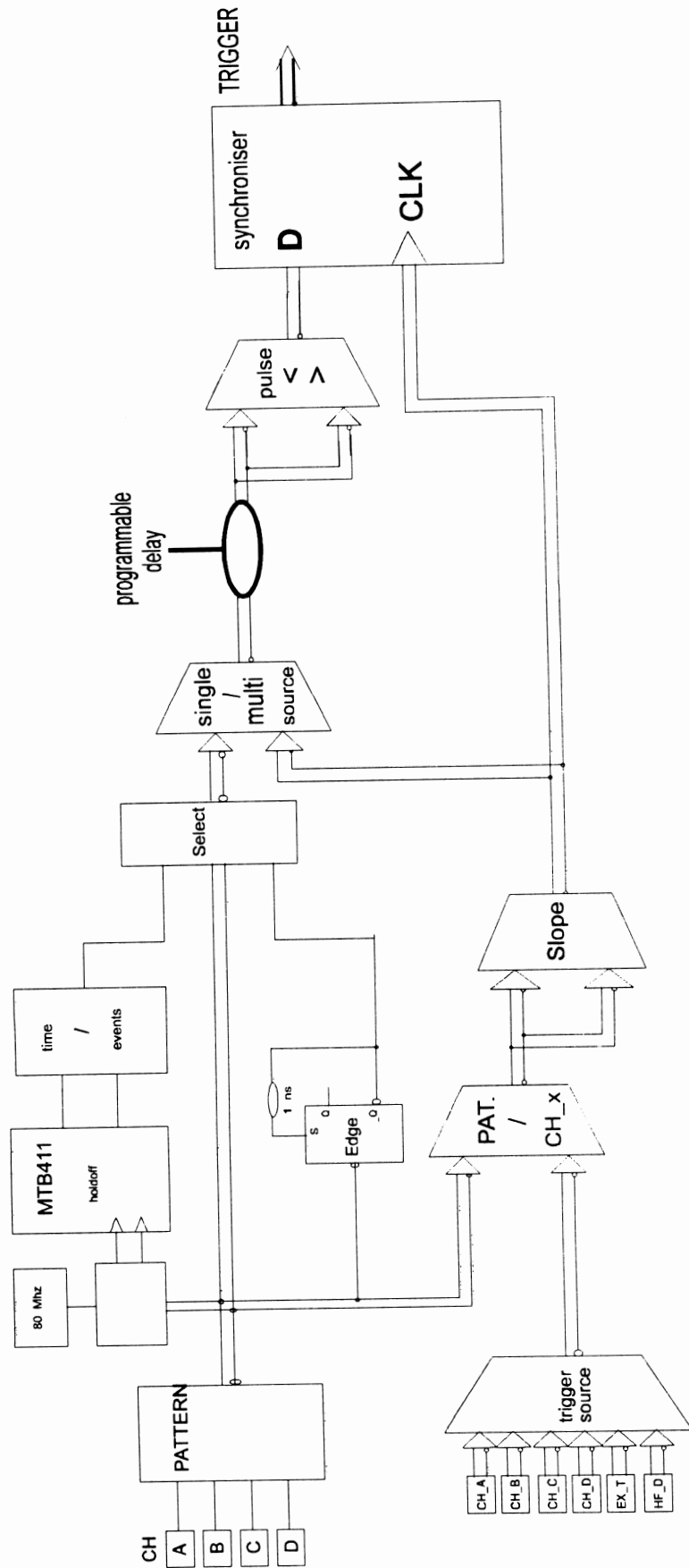

Smart trigger description

Edge,Pattern trigger

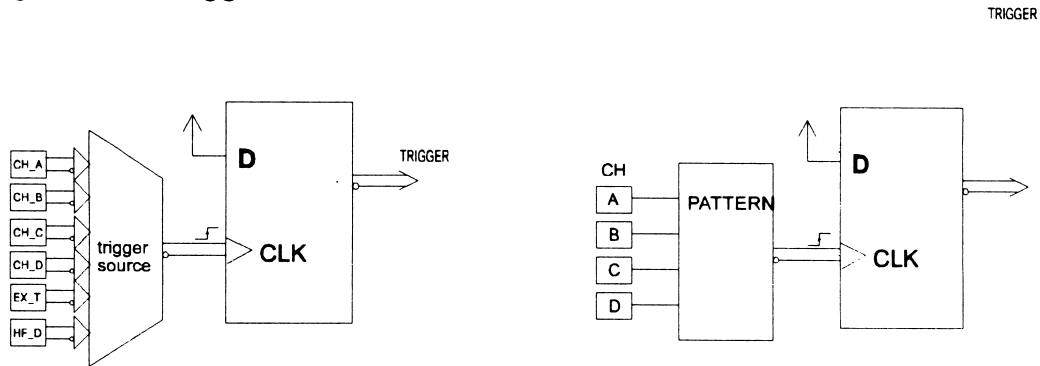

Edge pulse width trigger

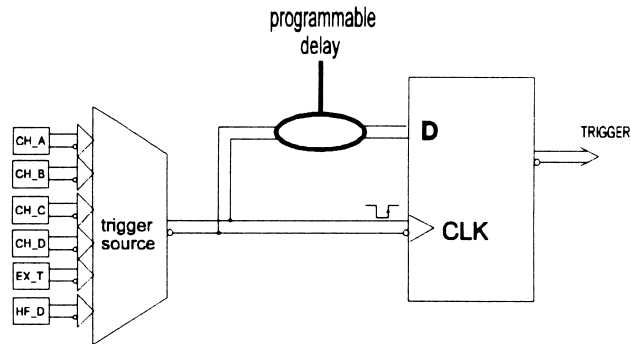

Pattern width trigger

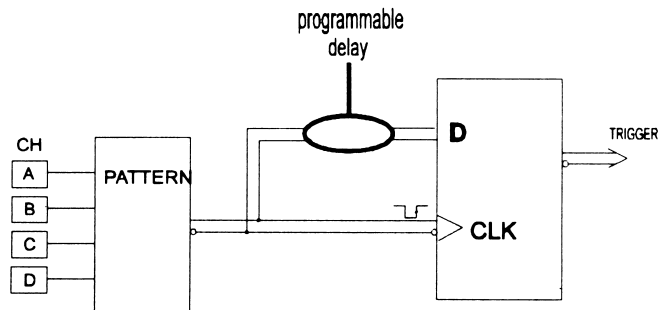

Smart trigger description

State qualified trigger

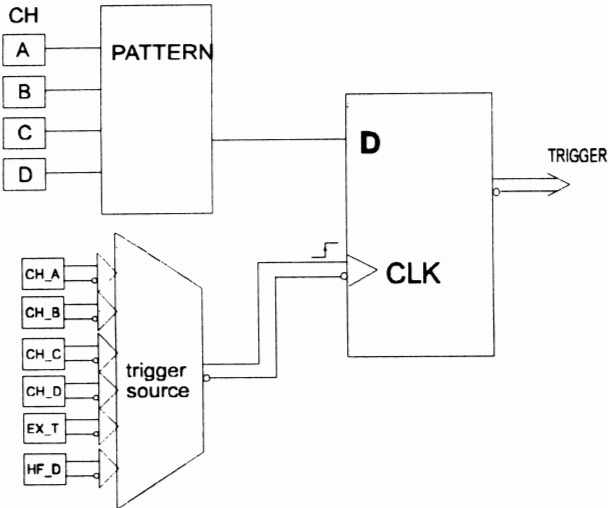

Edge qualified trigger

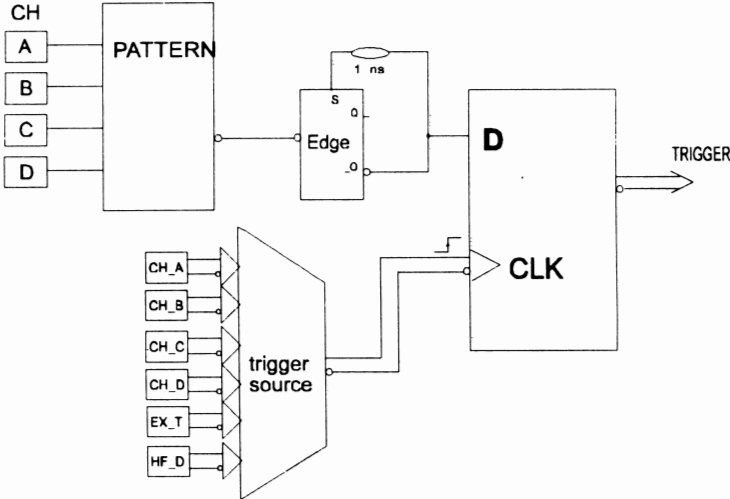

FASTGLITCH DETECT

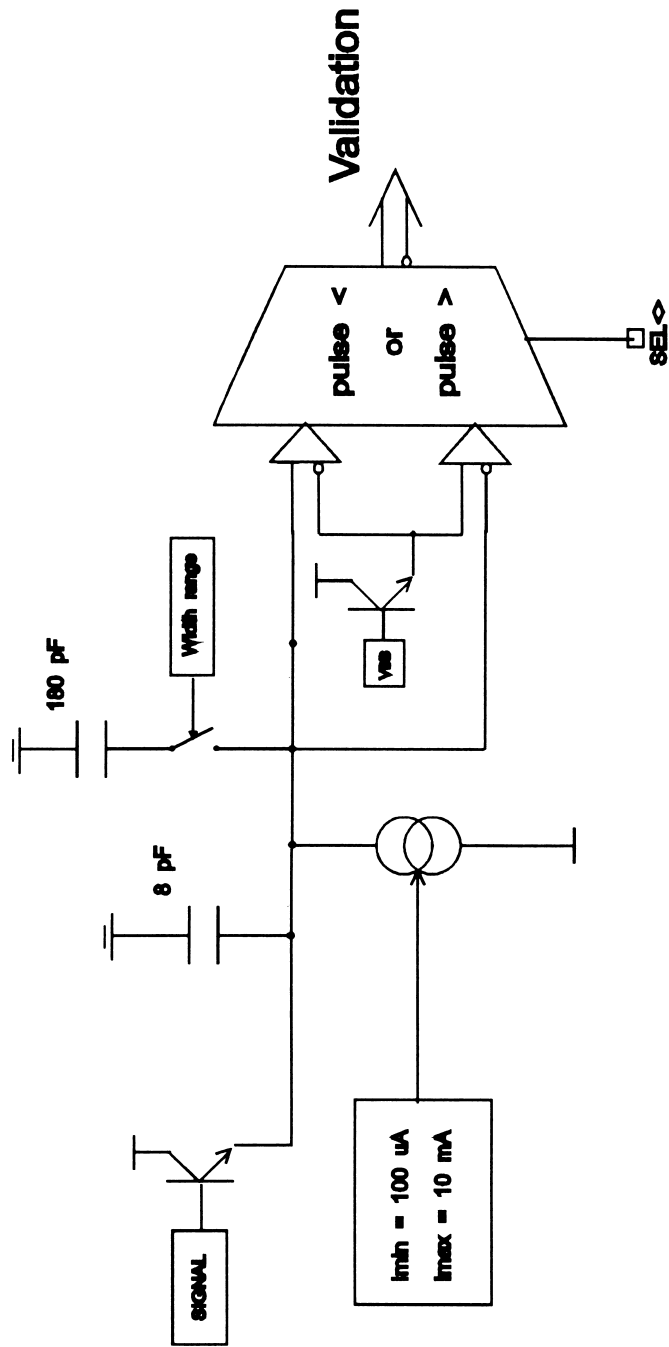

4.2.4 Time Base Control

Address : 0141 2000

One byte is sent by the processor board to select :

- Time base
- Probe calibrator output

D7	D6	D5	D4	D3	D2	D1	D0
-----	-----	-----	-----	-----	-----	-----	-----
PRB	PRB	PRB	X	TB3	Buzzer	STQ	X
CAL2	CAL1	CAL0				TB1	

STQ (TB1) : control for STATE or EDGE QUALIFIER

BUZZER : buzzer

TB3 : reset for HOLDOFF by TIME or EVENTS

PRBCAL0 : demux, select bit S0

PRBCAL1 : demux, select bit S1

PRBCAL2 : demux, select bit S2

S2	S1	S0	
0	0	0	16 MHz output
0	0	1	pattern or state Q output
0	1	0	trigger output
0	1	1	state '0' for pass fail
1	0	0	state '1' for pass fail
1	0	1	CLK 40 MHz (FDCK, MTB411)
1	1	0	CLK memory, (TBCK, MTB411)
1	1	1	not used

X : not used

4.3 F9300-4 GPIB and RS 232 Interface

This board is connected to the processor F9314M-1 through a flat cable. Data bus is 8 bits, address bus: 12 bits.

Address 0180 000 to 0180 00FF.

4.3.1 RS 232 Serial Interface

Based on the 2661A IC from Signetics or Philips.

- Clock frequency 4.9152 MHz.
- 4 internal registers of 8 bits.
- Interrupt level 2.
- Connector type DB9 with 9 male pins.

4.3.2 GPIB Interface

Based on the circuit 7210 IC from NEC.

- Clock frequency 5 MHz.
- 8 internal registers of 8 bits.
- Tri-state external GPIB drivers. - Low level output.
- Interrupt level 3.

The GPIB address is set by software and stored in non-volatile memory.

4.4 F9320-5 Front Panel

The front panel is connected to the processor board with a flat cable. Power supply and control signals are supplied from the processor. The front panel is divided in two sections:

- One board with Motorola 68HC05C4 processor, coders, and serial data interface.
- One matrix Keyboard with push buttons.

4.5 F9300-6 Centronics, Floppy, Printer interface option

4.5.1 Centronics interface option

This Centronics interface makes direct connection possible to external parallel printer.

- Address 0130 0180 to 0130 01A0
- Interrupt level 2

4.5.2 Floppy Disk drive interface option

Based on the circuit MCS3201 from Motorola.

- Address 0130 01C0 to 0130 01C7
- Interrupt level 4

Address	Read	Write
0130 01C0	Input register	----
0130 01C2	----	Digital output register
0130 01C4	Main status register	----
0130 01C5	Data register	Data register
0130 01C7	Data input register	Disk control register

4.5.3 Printer Interface option

Internal graphic printer : Seiko LPT5446

- Address 0130 0140 to 0130 0160
- Interrupt level 2

4.6 F9300-7 Printer Controller option

Based on the LPT5000 series control chip set from Seiko instrument Inc

- PT501P01 CPU
- PT500GA1 Gate array
- Technical reference 39019-2234-01
- Address 0130 0100

4.7 93XX-Display

4.7.1 General Description

The raster scan display module is divided into five sections:

- Graphic processor
- Deflection
- Video
- Yoke
- Cathode ray tube

4.7.2 Basic Characteristics

- Nine inches diagonal monochrome, yellowish, orange.
- CRT anti-glare treated
- Non interlaced resolution of (X)810 x (Y)696 pixels at 60 Hz or 50 Hz frequency.
- Landscape vertical raster
- Electromagnetic deflection.
- Intensity control rise and fall time > 12 ns.
- Analog intensity input
- TTL synchronization input.
- Horizontal nominal size: 165 mm for X-on = 15.39 Ms.
- Horizontal size adjustment: > +/- 5 mm.
- Horizontal offset adjustment: +/- 5 mm.
- Vertical nominal size: 120 mm for Y-on = 14.5 μ s.
- Vertical size adjustment: > +/- 5 mm.
- Vertical offset adjustment: +/- 5 mm.
- X and Y differential non linearity: 10%.

The line deflection is vertical, from bottom to top. The field deflection is horizontal, from left to right and is resynchronized to the power line frequency.

4.7.3 Horizontal Deflection

The horizontal deflection is synchronized to the 50 or 60 Hertz power line frequency. The on time display is the same for both frequencies, therefore the deflection is calculated for 60 Hz. The horizontal deflection is controlled by the HSYNC signal.

The trailing edge of HSYNC resets the horizontal spot position to a hardware predefined position at the left side of the screen: MAX_left. When ever HSYNC is high, the spot stays at this position.

The falling edge of HSYNC starts the horizontal deflection ramp. The ramp has the same rate for either 50 or 60 Hertz frequency.

When ever HSYNC is low, the horizontal deflection will rise left to right, until HSYNC becomes high, or the system has reached the maximum right position (MAX_RIGHT).

4.7.4 Vertical Synchronization

The timing of both VSYNC and HSYNC is synchronized to the pixel clock (PCLK).

The pixel rate is 48 MHz.

4.7.5 Horizontal and Vertical Resolution

	# of vertical line	Time in ms
HSYNC_T	842	15.998
HSYNC_W	22	0.418
HSYNC_E	4	0.076
HSYNC_S	6	0.114
X-ON	810	15.390
X-OFF	32	0.608

Values for the horizontal timing for the maximum field refresh frequency.

Vertical timing.

	# of Pixels	Time in μ s
VSYNC_T	912	19.000
VSYNC_W	136	2.833
VSYINC_E	0	0.000
VSYINC_S	80	1.666
Y-ON	696	14.500
Y-OFF	216	4.500

4.8 93XX-PS1715 Power Supply Specifications

Input voltage	: 90 to 132 V or 180 to 250 V. Auto ranging line voltage.
Input frequency	: 45 Hz to 66 Hz.
Input rush current	: Max 40 A peak at start up.
Environmental	: Operating temperature range 0 °C to 55 °C Storage temperature range -20 °C to 85 °C Relative humidity from 5% to 95%.
Shock vibration	: MIL-STD-810D MIL-T-28000C, para 4.5.5.4.2
Output voltages	: - 5.2 Vdc, 8 amp Max. + 5.2 Vdc, 4.5 amp Max. -15.1 Vdc, 4.5 amp Max +15.1 Vdc, 4.5 amp Max.
Output adjustment	: +/- 5%.
Regulation	: +/- 1%.
Transient response	: -5.2 V < 400 mV. +5.2 V < 250 mV. +/- 15.1 V < 1.5 V. Maximum recovery time 1.5 msec.
Ripple and noise	: Peak to peak value < 1%. Line frequency rejection < 5 mV.
Overshoot	: < 5% at start up.
Hold up time	: 20 msec.
Output short circuit protection	: Yes.
Output overvoltage protection	: No.
Input protection	: 5 amp fuses.
Thermal protection	: Yes.
Safety	: VDE 0806, IEC 380, UL478, CSAC22.2#154
EMI	: VDE 0871 class B, FCC 20780 part 15j, class B.
MTBF	: 80.000 hours.

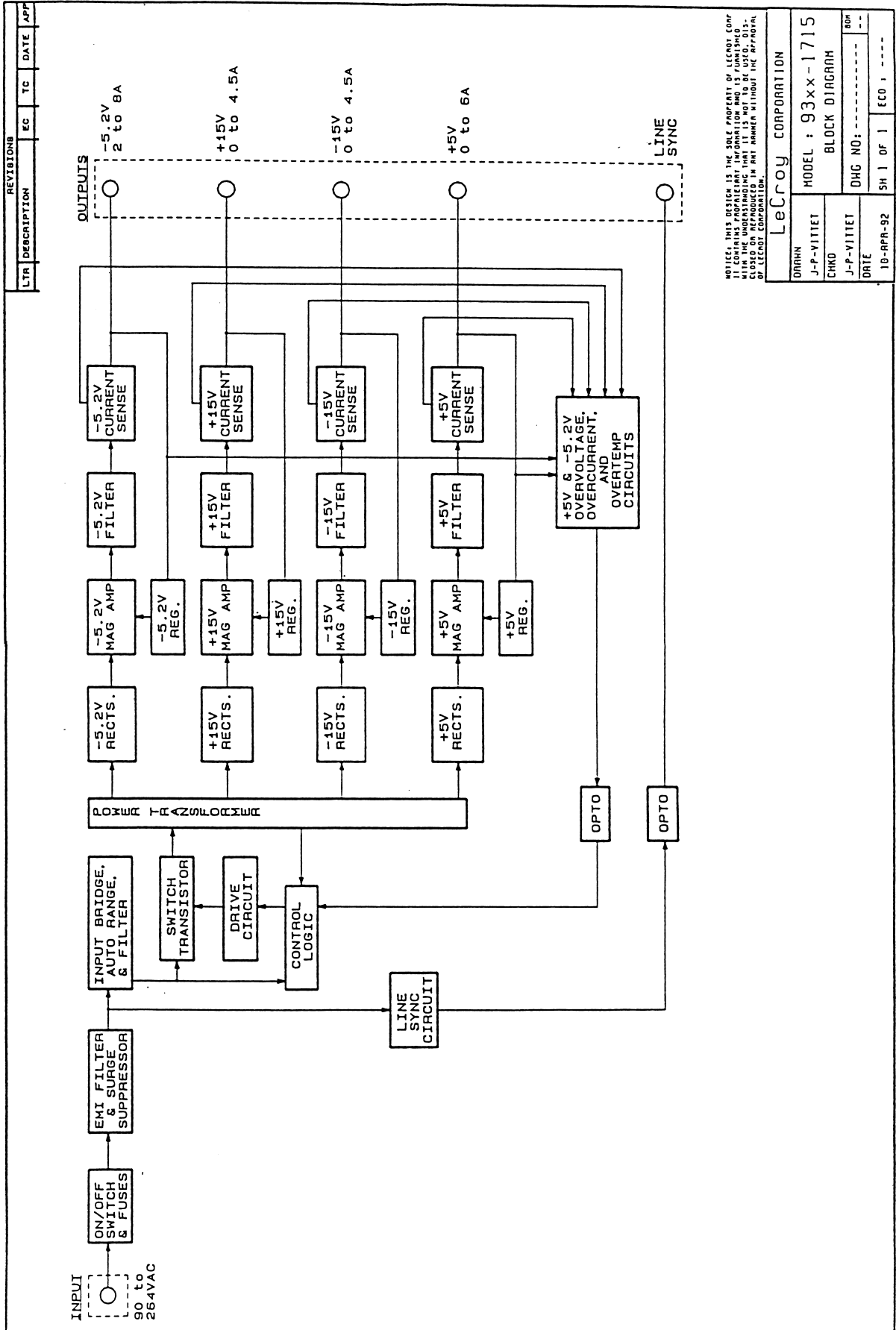

NOTICE: THIS DESIGN IS THE SOLE PROPERTY OF LECROY CORP. IT CONTAINS PROPRIETARY INFORMATION AND IS UNCLASSIFIED. IT IS THE PROPERTY OF LECROY CORP. AND IS TO BE KEPT CONFIDENTIAL AND NOT REPRODUCED OR TRANSMITTED IN ANY FORM OR BY ANY MEANS, ELECTRONIC OR MECHANICAL, INCLUDING PHOTOCOPYING, RECORDING, OR BY ANY INFORMATION STORAGE AND RETRIEVAL SYSTEM, WITHOUT THE WRITTEN PERMISSION OF LECROY CORPORATION.

LTRA DESCRIPTION		EC	TC	DATE	APP
REVISIONS					
LeCroy CORPORATION					
DRNHN	MODEL : 93xx-1715				
J-P-VIITET	BLOCK DIAGRAM				
CHKO	DWG NO: -----				
J-P-VIITET	80H				
DATE	SH 1 OF 1	ECC	----		
ID-RPR-92					

SECTION 5 PERFORMANCE VERIFICATION

5.1 Introduction

This procedure can be used to verify the main operating specifications of the LeCroy 9320 digital storage oscilloscope, it is useful as a calibration verification procedure as well as an incoming inspection checkout.

5.2 Test Equipment needed

Instrument	Qty	Specifications	Recommended	Where used
Signal Generator (sine wave)	1	Frequency : 500 KHz to 1 GHz Accuracy : 0.001 % Amplitude : 1 V peak to peak	Marconi 2030	5.7 5.10 5.11
Signal Generator (sine wave)	1	Frequency : 5 KHz Amplitude : 6 V peak to peak	Topward TFG-8101	5.9
DC precision Power Supply	1	Amplitude : 10 V, DC Accuracy : < 0.1 %	Tektronix PS5004	5.5 5.8
Digital Multimeter	1	5 digits	Keithley 199	5.6
Power meter	1	dBm mode	HP 436A	5.7
Cable	1	BNC, 50 Ω , length 20 cm (7.87 inches)	Suhner	5.10
Cable	1	BNC, 50 Ω , length 100 cm (39.37 inches)	Suhner	
BNC T adapter	1	BNC, 50 Ω , T adapter	Suhner	5.10
SMA power splitter	1	50 Ω , 6 dB, 0.5 W	Suhner 4901.19A	5.7
SMA adapter	1	50 Ω ,	Suhner SMA 50-1	5.7
Cable	2	BNC to SMA, 50 Ω length 100 cm (39.37 inches)	Suhner RG 58 C/U	5.7

Table 5-1 : Test Equipment**5.3 Turn On**

Switch On the power using the power switch on the rear panel and check :

- that the display turns on after about 10 seconds
- that the display is stable
- that the range of intensity and grid intensity is reasonable

Wait for about 10 minutes for the scope to reach a stable operating temperature.

5.4 Average noise level : DC 50Ω

Specification

- < 300 μV RMS at 5 mV/div
- < 3.6 mV Peak to Peak at 5 mV/div

Description

The average noise level is tested at 5 mV/div, this is to verify the proper operation of the main board, front-end and ADC's.

The scope parameters functions are used to measure the RMS and Peak amplitude of the noise.

5.4.1 Peak to Peak noise

Procedure

With no signal connected to the inputs, set 9320 DSO settings as follows :

- Turn on traces : Ch1 and Ch2
- Display setup : Standard, Dot Join on, Persistence off, Single grid
- Input coupling : Ch1 and Ch2 : DC 50 Ω
- V/div. offset : Normal
- Probe atten : X1
- Input gain : 5 mV/div
- Trigger setup : Edge
- Trigger on : 1
- Coupling 1 : DC
- Slope 1 : Pos
- Holdoff : Off
- Trigger Mode : Auto
- Timebase : 20 msec/div.

4-Nov-93

19:01:52

1
20 ms
5.0 mV

2
20 ms
5.0 mV

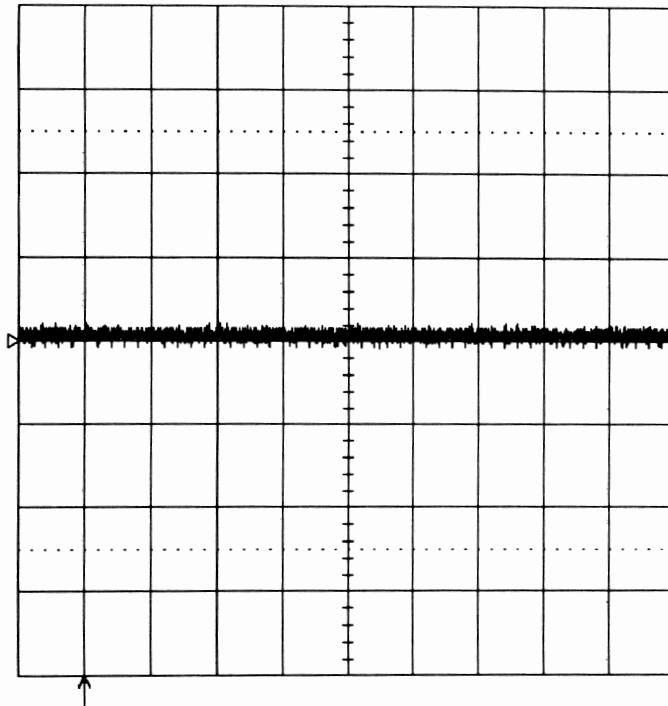

20 ms

1 5 mV 50Ω

2 5 mV 50Ω



1 DC 0.0 mV

TRIGGER SETUP

Edge SMART

trigger on
1 2
Ext Ext10

coupling 1
DC AC

slope 1
Pos Neg

holdoff
- - -
OFF Time Evts

20 ks/s

AUTO

- Press : Cursors/Measure
- Measure : Parameters
- Mode : Custom
- Statistics : On

- Change parameters

- On line 1 : Measure pkpk of Ch1
- On line 2 : Measure pkpk of Ch2

Check after at least 100 sweeps that the high pkpk readout is less than 3.6 mV, corresponding to 9% of full scale.

Repeat the tests for Timebase : 10 msec/div, 2 msec/div, .2 msec/div, and .02 msec/div, and check as above.

Section 5 Performance Verification

3-Nov-93
14:25:22

1
20 ms
5.0 mV

2
20 ms
5.0 mV

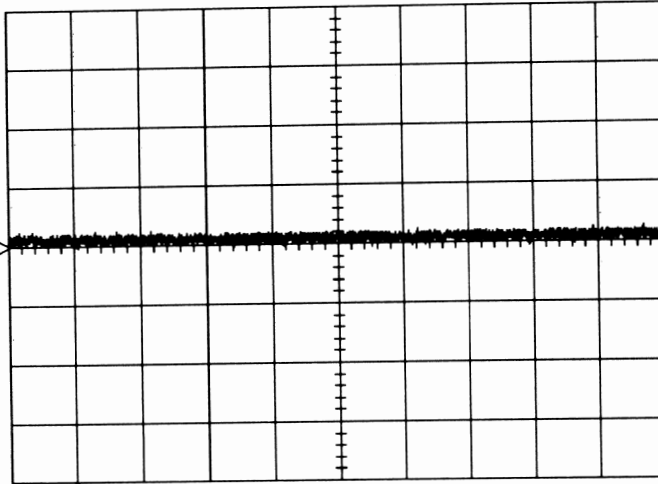

236 sweeps:

	average	low	high	sigma
pkpk (1)	1.57 mV	1.25	2.03	0.12
pkpk (2)	1.50 mV	1.25	1.87	0.12

MEASURE

Off Cursors
Parameters

mode
Std Voltage
Std Time
Custom
Pass
Fail

statistics
Off On

CHANGE PARAMETERS

from
0.00 div
Track Off On

to
10.00 div

20 ms

1 5 mV 50Ω

2 5 mV 50Ω

1 DC 0.0 mV

20 ks/s

AUTO

3-Nov-93
14:25:51

1
20 ms
5.0 mV

2
20 ms
5.0 mV

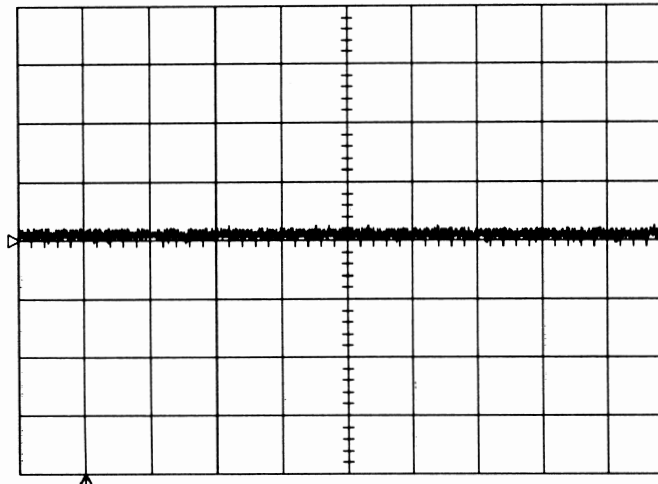

332 sweeps:

	average	low	high	sigma
pkpk (1)	1.57 mV	1.25	2.03	0.12
pkpk (2)	1.50 mV	1.25	1.87	0.12

CHANGE PARAM

On line
1 2 3 4 5

DELETE ALL PARAMETERS

measure
over-period
pkpk
points
rise

of
1 2
A B C D

20 ms

1 5 mV 50Ω

2 5 mV 50Ω

1 DC 0.0 mV

20 ks/s

AUTO

5.4.2 RMS noise

- Change Parameters

- On line 1 : Measure sdev of Ch1
- On line 2 : Measure sdev of Ch2

Check after at least 100 sweeps that high sdev readout is less than 300 μ V, corresponding to 0.75% of the full scale.

Repeat the tests for Timebase : 10 msec/div, 2 msec/div, .2 msec/div, and .02 msec/div, and check as above.

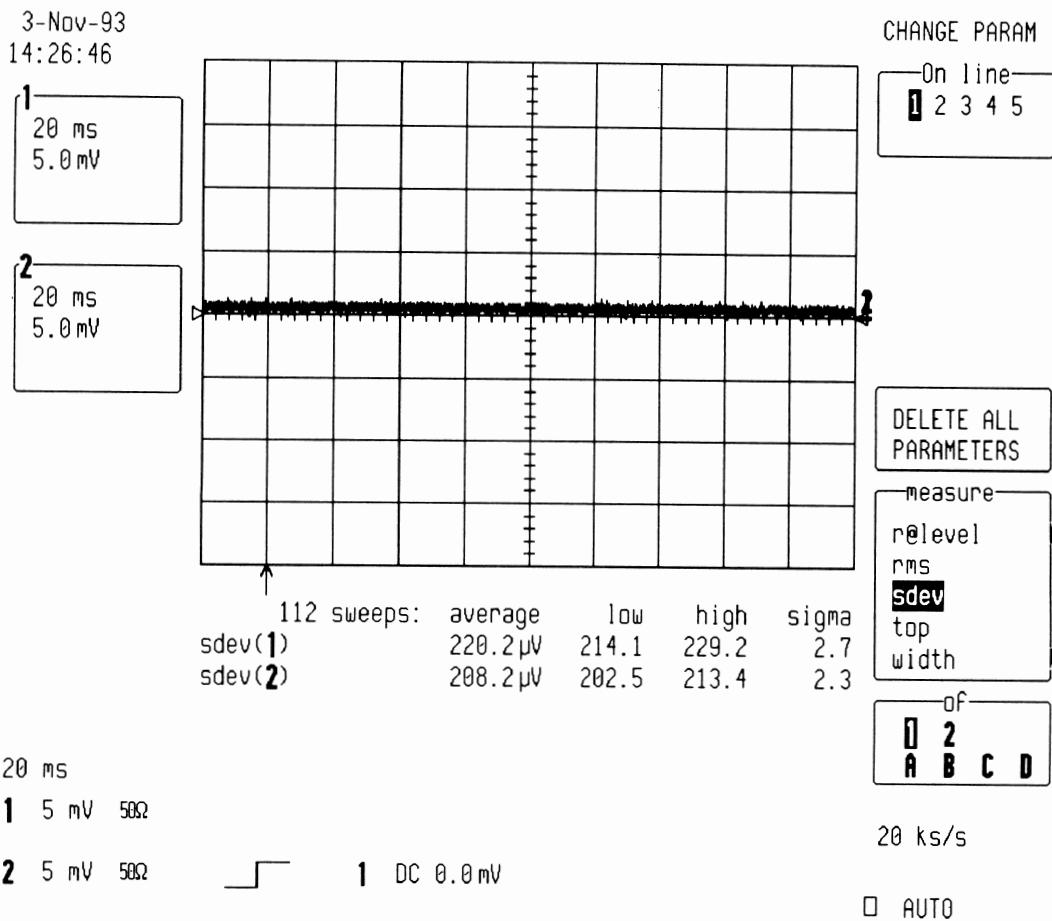

5.5 Offset control

Specification

- ± 8 V for the ranges : 5 mV/div, 10 mV/div, 20 mV/div.
- ± 4 V for the ranges : 50 mV/div, 100 mV/div.
- ± 10 V for the ranges : 200 mV/div, 500 mV/div, 1 V/div, 2 V/div.

Description

The maximum allowed offsets depend on the sensitivity as shown in table 5-2 and 5-3, and is tested over the full 5 mV to 2 V range.

5.5.1 Negative Offset control Procedure

Set the DSO as follows :

- Turn on trace : Ch1
- Display setup : Standard, Persistence off, Dot join on, Single grid
- Input coupling : Ch1 DC 50 Ω
- V/div. offset : Normal
- Probe atten : X1
- Input gain : 5 mV

- Trigger setup : Edge
- Trigger on : 1
- Coupling 1 : DC
- Slope 1 : Pos
- Mode : Auto
- Holdoff : Off
- Timebase : 1 msec/div.

- Turn on trace : A
- Select Math Setup
- For Math : Use at most 5000 points
- Redefine A
- Use Math ? : Yes
- Math Type : Average
- Avg Type : Summed
- Of : Channel 1

- Turn off trace : Channel 1

- Cursors/Measure : Parameters
- Mode : Std Voltage
- Statistics : on
- on displayed trace : A

3-Nov-93
14:29:12

1
1 ms
5.0 mV

2
1 ms
5.0 mV

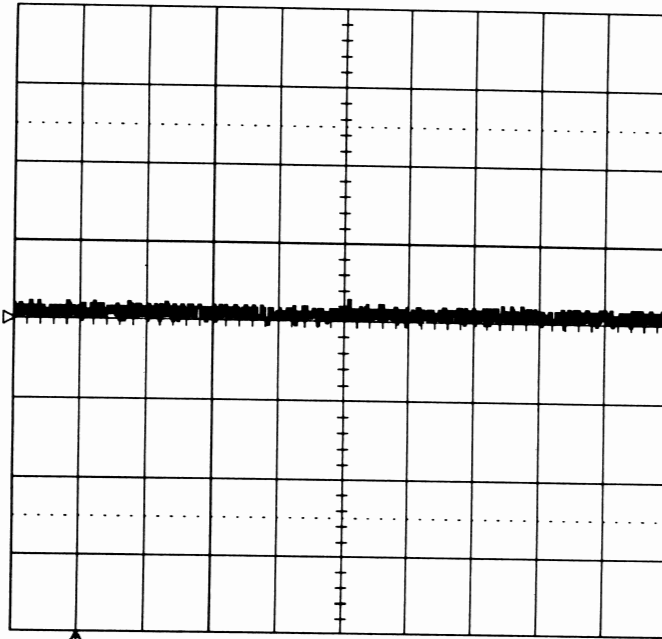

1 ms
1 5 mV 50Ω
2 5 mV 50Ω

1 DC 0.0 mV

ZOOM + MATH

REDEFINE A
A=1

REDEFINE B
B=2

REDEFINE C
C=1

REDEFINE D
D=2

Multi-Zoom
OFF On

for Math
use at most
5000 points

400 ks/s

AUTO

3-Nov-93
14:29:35

1
1 ms
5.0 mV

A: Average(1)
1 ms
5.0 mV
80 swps

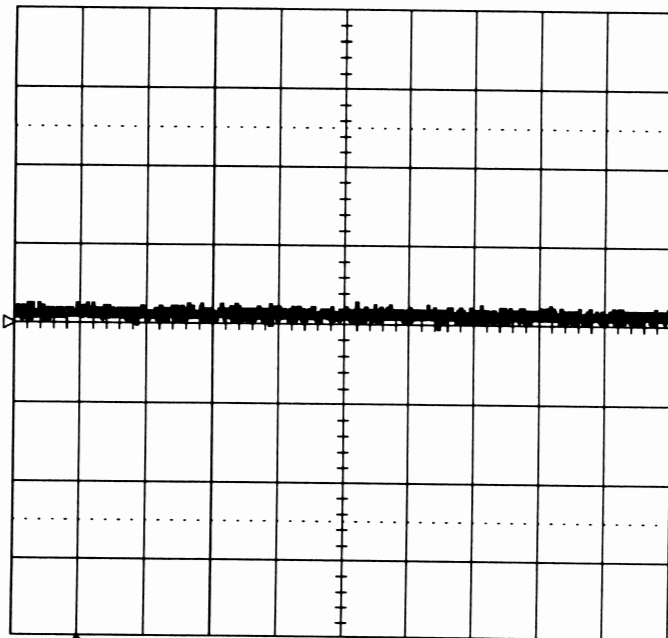

1 ms
1 5 mV 50Ω
2 5 mV 50Ω

A: Average(1) 4000 points

SETUP OF A

use Math?
No Yes

Math Type
Arithmetic
Average
Enh.Res
Extrema
FFT

Avg Type
Summed
Continuous

for
1000
(sweeps)

of
2 B C D
M1 M2 M3 M4

400 ks/s

AUTO

Section 5 Performance Verification

From the high precision voltage source PS5004, apply to Channel 1 the following voltage value : + .8 V.
 Using the offset control, move the Ch1 trace through the entire range until the following offset value is reached : - .8 V.
 Verify that the displayed trace A : Average (1) is in the screen (near to the center horizontal graticule line) .

- Press clear sweeps

Check after at least 100 sweeps that the average mean (A) parameter readout is :
 + 800 mV ± 2 %.

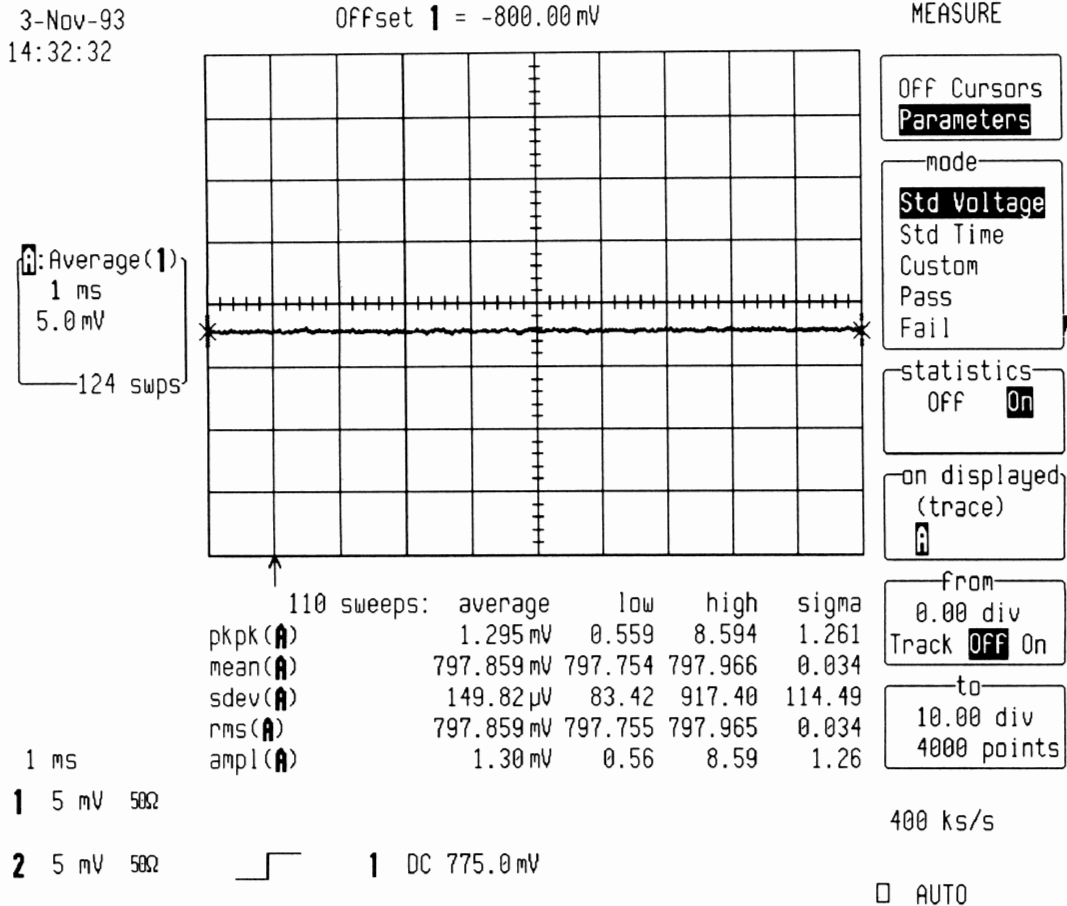

Range	Conditions of Test		Offset Control	Average Mean Parameter Reading		± X %
	PS Output	9320 Input		Minimum Value, -X %	Maximum Value, +X %	
5 mV	+ 800 mV	+ 800 mV	- 800 mV	+ 784 mV	+ 816 mV	2 %
50 mV	+ 4 V	+ 4 V	- 4 V	+ 3.9 V	+ 4.1 V	2.5 %
.2 V	+ 5 V	Max + 5 V	- 5 V	+ 4.85 V	+ 5.15 V	3 %
2 V	+ 5 V	Max + 5 V	- 10 V	+ 4.5 V	+ 5.5 V	10 %

Table 5-2 : Negative offset control

Set input gain to 50 mV/div, from the high precision voltage source, apply to Channel 1 the following voltage value : + 4 V.

Using the offset control, move the Ch1 trace through the entire range until the following offset value is reached : - 4 V.

Verify that the displayed trace A : Average (1) is in the screen (near to the center horizontal graticule line).

- Press clear sweeps

Check after at least 100 sweeps that the average mean (A) parameter readout is : + 4 V ± 2.5 %.

3-Nov-93
14:34:05

Offset 1 = -4.0000 V

MEASURE

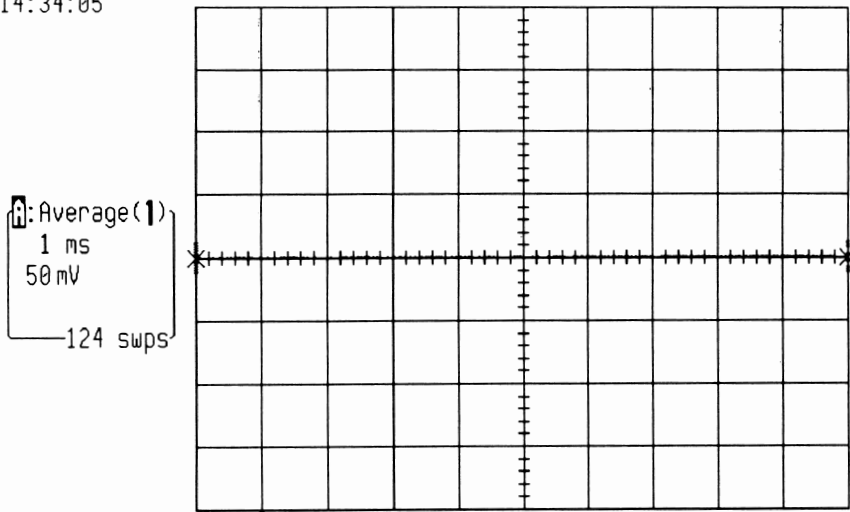

OFF Cursors
Parameters

mode
Std Voltage
Std Time
Custom
Pass
Fail

statistics
OFF On

on displayed
(trace)

from
0.00 div
Track On

to
10.00 div
4000 points

120 sweeps:

	average	low	high	sigma
pkpk(A)	2.06 mV	1.14	14.06	1.57
mean(A)	4.00115 V	4.00088	4.00207	0.00021
sdev(A)	0.2663 mV	0.1448	1.4654	0.1919
rms(A)	4.00115 V	4.00088	4.00207	0.00021
ampl(A)	2.0 mV	-0.4	14.1	1.7

1 ms
1 50 mV 50Ω

2 5 mV 50Ω



1 DC 3.750 V

400 ks/s

AUTO

Section 5 Performance Verification

Set input gain to 200 mV/div, from the high precision voltage source, apply to Channel 1 the following voltage value : + 5 V.

Using the offset control, move the Ch1 trace through the entire range until the following offset value is reached : - 5 V.

Verify that the displayed trace A : Average (1) is in the screen (near to the center horizontal graticule line) .

- Press clear sweeps

Check after at least 100 sweeps that the average mean (A) parameter readout is : + 5 V ± 3 %.

3-Nov-93
14:35:46

Average(1)
1 ms
200 mV
108 swps

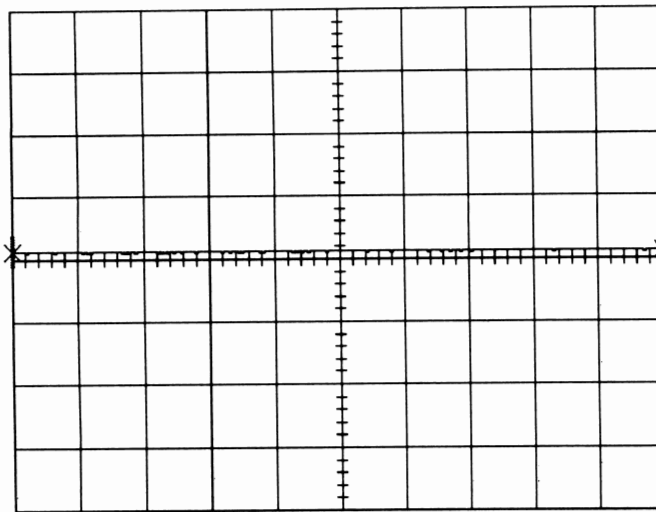

107 sweeps:

	average	low	high	sigma
pkpk(A)	6.6 mV	3.8	31.3	4.3
mean(A)	5.02672 V	5.02620	5.02820	0.00056
sdev(A)	0.947 mV	0.540	5.047	0.644
rms(A)	5.02672 V	5.02620	5.02820	0.00056
ampl(A)	7 mV	4	31	4

1 ms

1 .2 V 50Ω

2 5 mV 50Ω



1 DC 4.000 V

MEASURE

OFF Cursors
Parameters

mode
Std Voltage
Std Time
Custom
Pass
Fail

statistics
Off On

on displayed
(trace)
 A

from
0.00 div
Track Off On

to
10.00 div
4000 points

400 ks/s

AUTO

Set input gain to 2 V/div, from the high precision voltage source, apply to Channel 1 the following voltage value : + 5 V.

Using the offset control, move the Ch1 trace through the entire range until the following offset value is reached : - 10 V.

Verify that the displayed trace A : Average (1) is in the screen.

- Press clear sweeps

Check after at least 100 sweeps that the average mean (A) parameter readout is : + 5 V ± 10 %.

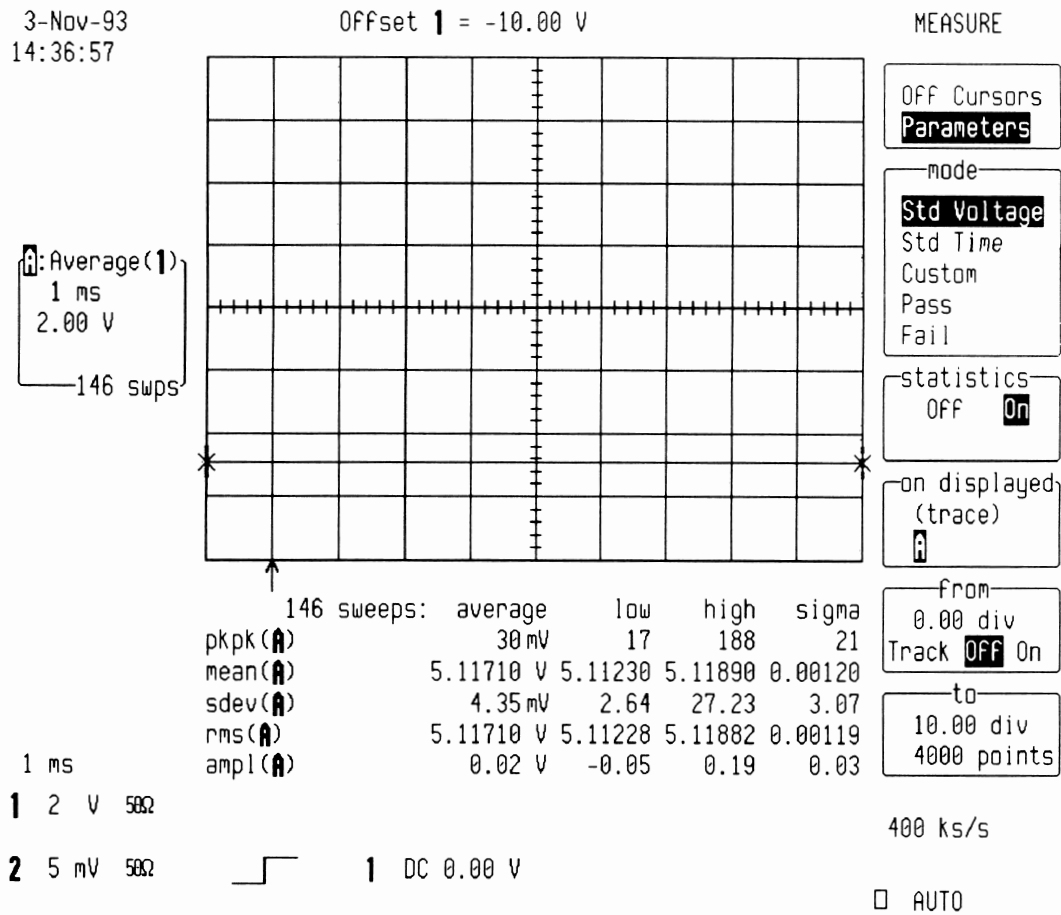

- Repeat all the tests for Channel 2 substituting channel controls and input connector.

5.5.2 Positive Offset control Procedure

Set Channel 1 input gain to 5 mV/div. From the high precision voltage source PS5004, apply to Channel 1 the following voltage value : - .8 V. Using the offset control, move the Ch1 trace through the entire range until the following offset value is reached + .8 V. Verify that the displayed trace A : Average (1) is in the screen (near to the center horizontal graticule line) .

- Press clear sweeps

Check after at least 100 sweeps that the average mean (A) parameter readout is :
 - 800 mV \pm 2%.

Range	Conditions of Test		Offset Control	Average Mean Parameter Reading		
	PS Output	9320 Input		Minimum Value, -X %	Maximum Value, +X %	\pm X %
5 mV	- 800 mV	- 800 mV	+ 800 mV	- 784 mV	- 816 mV	2 %
50 mV	- 4 V	- 4 V	+ 4 V	- 3.9 V	- 4.1 V	2.5 %
.2 V	- 5 V	Max - 5 V	+ 5 V	- 4.85 V	- 5.15 V	3 %
2 V	- 5 V	Max - 5 V	+ 10 V	- 4.5 V	- 5.5 V	10 %

Table 5-3 : Positive offset control

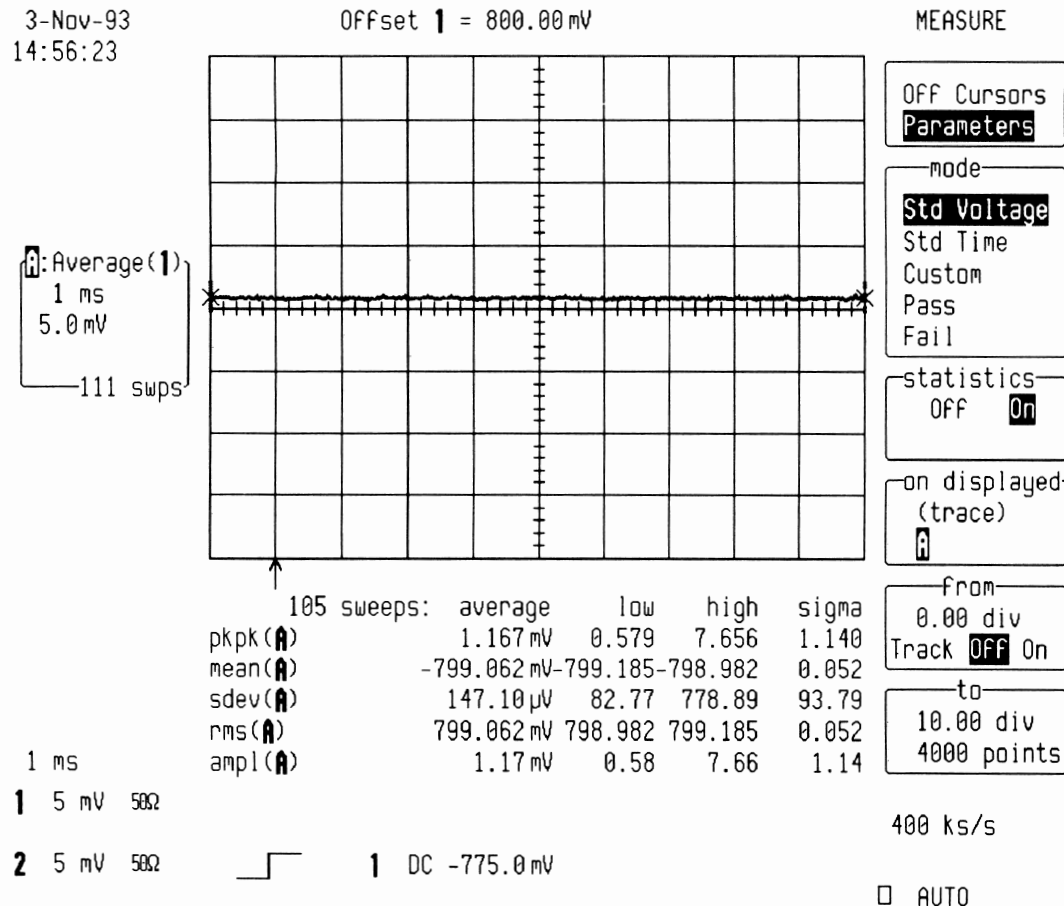

Set input gain to 50 mV/div, from the high precision voltage source, apply to Channel 1 the following voltage value : - 4 V.

Using the offset control, move the Ch1 trace through the entire range until the following offset value is reached : + 4 V.

Verify that the displayed trace A : Average (1) is in the screen (near to the center horizontal graticule line).

- Press clear sweeps

Check after at least 100 sweeps that the average mean (A) parameter readout is : - 4 V ± 2.5 %.

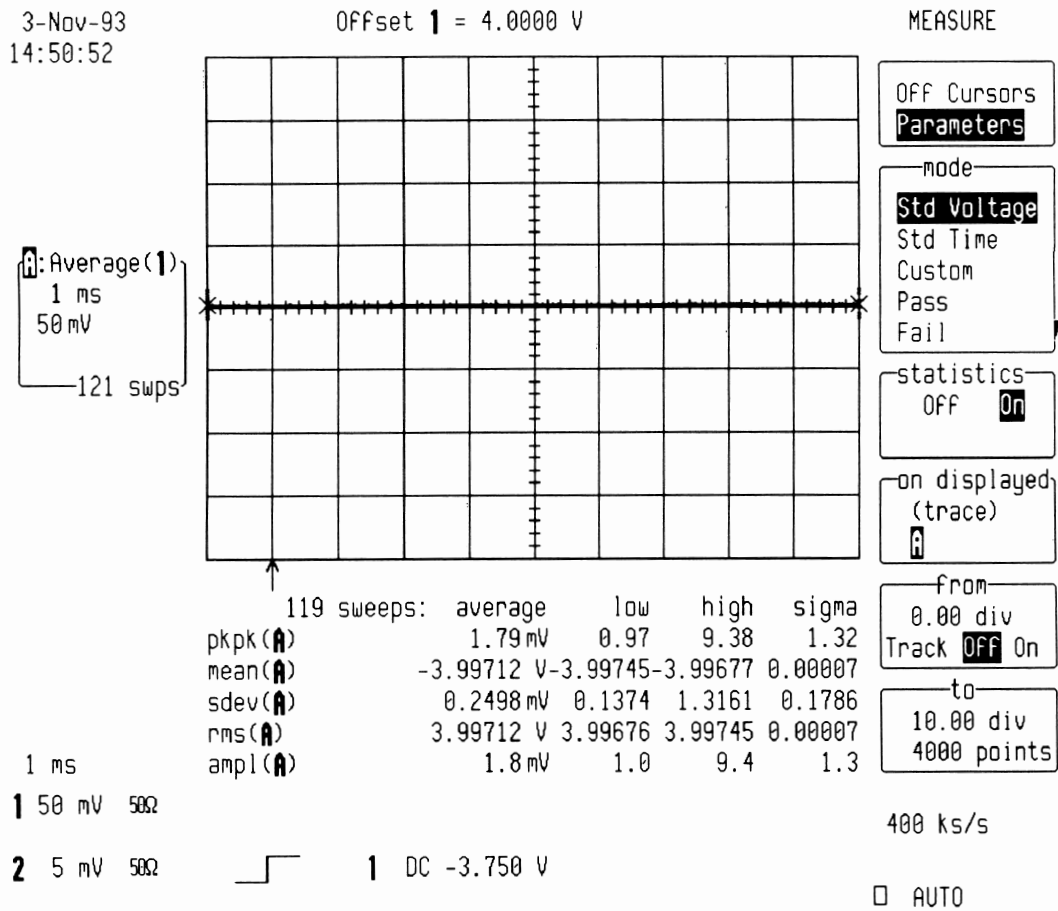

Section 5 Performance Verification

Set input gain to 200 mV/div, from the high precision voltage source, apply to Channel 1 the following voltage value : - 5 V.

Using the offset control, move the Ch1 trace until the following offset value is reached : + 5 V.

Verify that the displayed trace A : Average (1) is in the screen (near to the center horizontal graticule line) .

- Press clear sweeps

Check after at least 100 sweeps that the average mean (A) parameter readout is :
- 5 V ± 3 %.

3-Nov-93
14:40:06

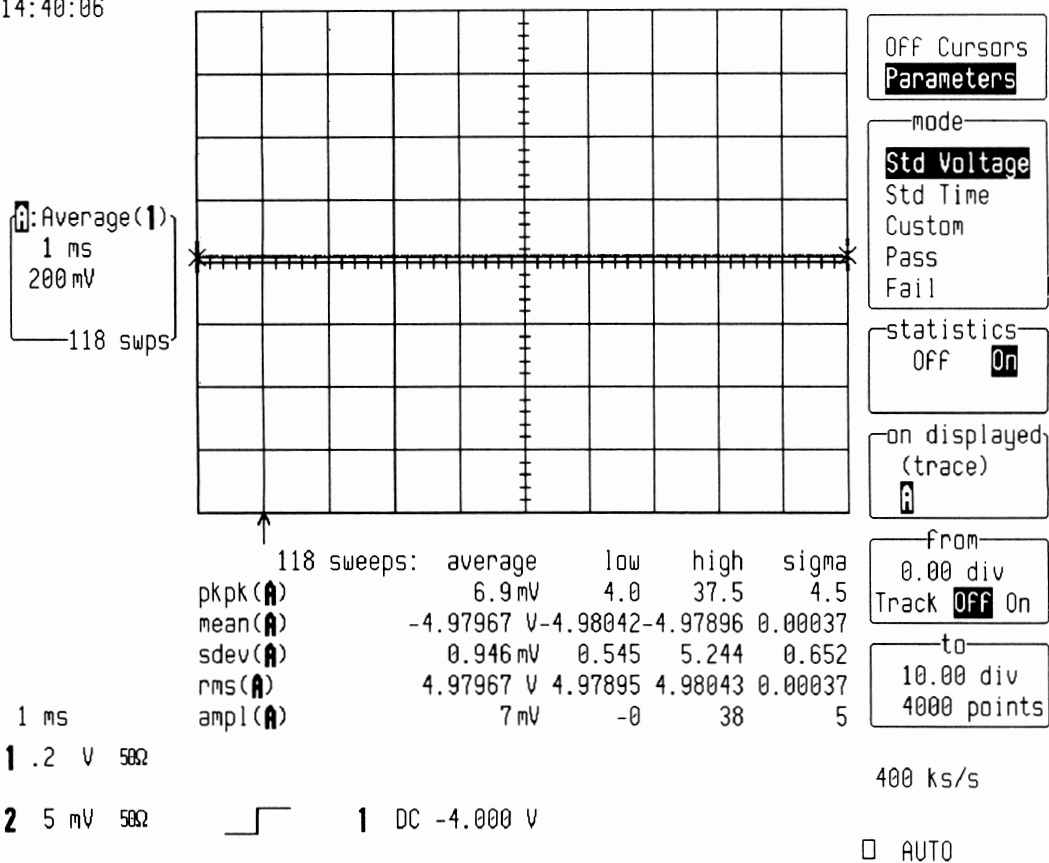

Set input gain to 2 V/div, from the high precision voltage source, apply to Channel 1 the following voltage value : - 5 V.

Using the offset control, move the Ch1 trace through the entire range until the following offset value is reached : + 10 V.

Verify that the displayed trace A : Average (1) is in the screen.

- Press clear sweeps

Check after at least 100 sweeps that the average mean (A) parameter readout is : - 5 V ± 10 %.

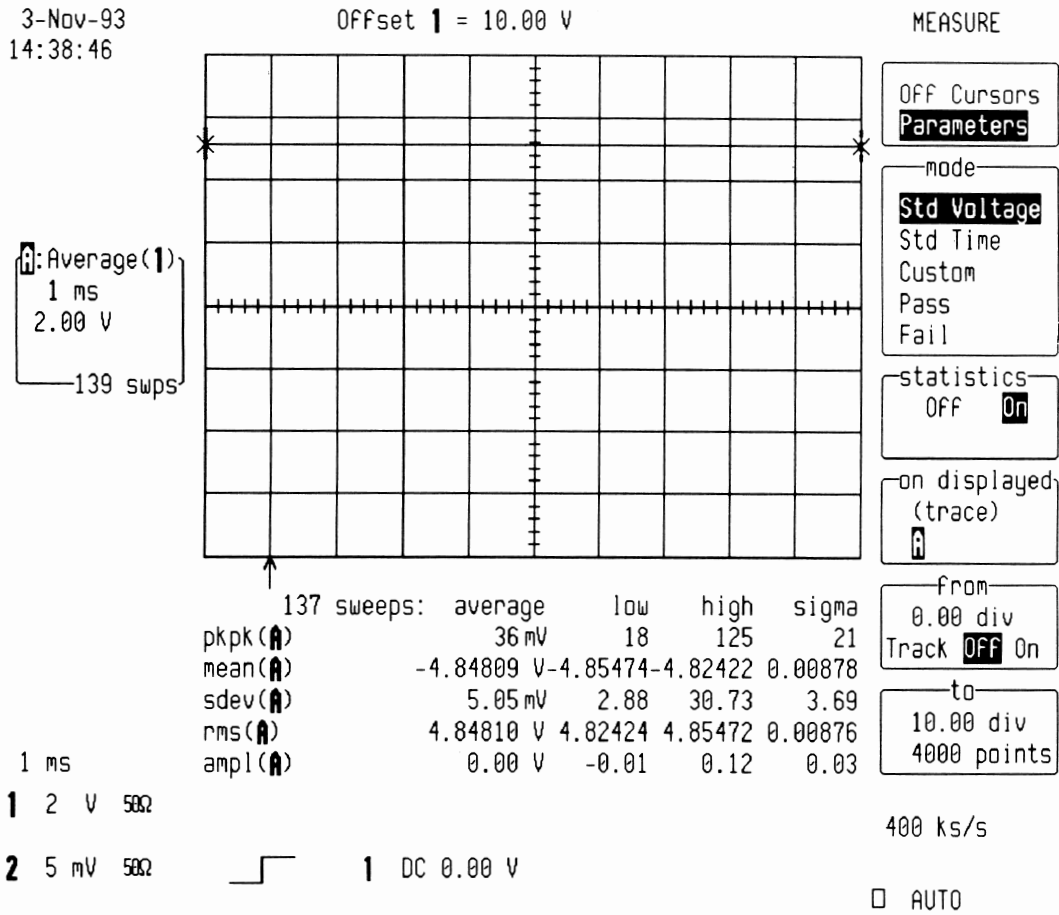

- Repeat all the tests for Channel 2, substituting channel controls and input connector.

5.5.3 Input Grounded Verification

With no cable plugged into scope.

Set the DSO as follows :

- Turn on trace : Channel 1
- Input gain : 5 mV/div
- Offset : Zero
- Timebase : 50 μ sec/div

- Turn on trace : A
- Select Math Setup
- For Math : Use at most 5000 points
- Redefine A
- Use Math ? : Yes
- Math Type : Average
- Avg Type : Summed
- Of : Channel 1

- Turn off trace : Channel 1

- Cursors/Measure : Parameters
- Mode : Std Voltage
- Statistics : on
- on displayed trace : A

- Coupling : DC 50 Ω

After at least 100 sweeps readout the mean(A) : Average.

- Switch between coupling 50 Ω and Grounded,

Check that the mean(A) : Average is not changing by more than 800 μ V.

- Repeat the test for Channel 2.

3-Nov-93
14:59:31

Average(1)
50 μ s
5.0 mV
262 swps

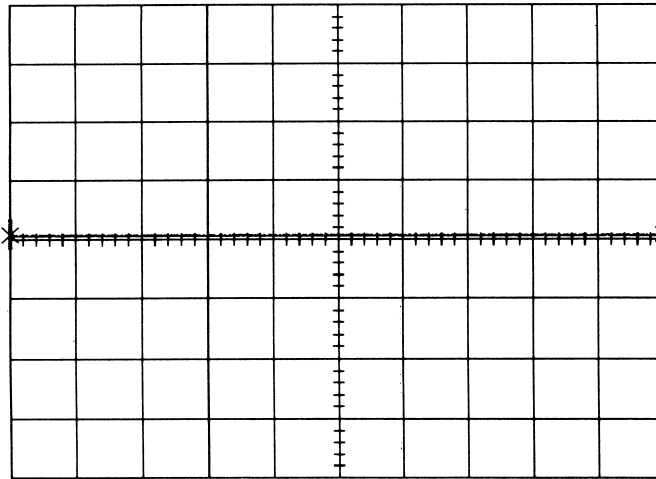

CHANNEL 1

Coupling
DC50 Ω
Grounded

V/div Offset
NORMAL
ECL TTL

Probe Atten
x1
x2
x5
x10
x20

	average	low	high	sigma
pkpk(A)	135 μ V	107	189	19
mean(A)	427.32 μ V	405.27	442.50	8.82
sdev(A)	17.71 μ V	14.16	24.72	2.82
rms(A)	427.71 μ V	405.80	442.55	8.76
ampl(A)	0.14 mV	0.11	0.19	0.02

50 μ s
1 5 mV 50 Ω

2 5 mV 50 Ω



1 DC 0.0 mV

10 Ms/s

AUTO

3-Nov-93
15:00:15

Average(1)
50 μ s
5.0 mV
115 swps

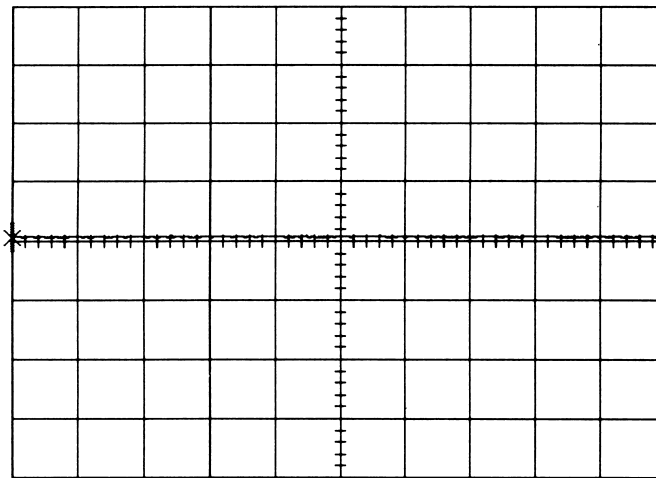

CHANNEL 1

Coupling
DC50 Ω
Grounded

V/div Offset
NORMAL
ECL TTL

Probe Atten
x1
x2
x5
x10
x20

	average	low	high	sigma
pkpk(A)	0.281 mV	0.147	1.562	0.200
mean(A)	451.15 μ V	390.01	495.00	24.70
sdev(A)	38.13 μ V	20.61	219.68	28.61
rms(A)	453.67 μ V	393.73	520.69	24.25
ampl(A)	0.28 mV	0.15	1.56	0.20

50 μ s
1 5 mV $\frac{1}{2}$

2 5 mV 50 Ω



1 DC 0.0 mV

10 Ms/s

AUTO

5.6 50 Ω input Impedance

Specification

50 $\Omega \pm 1 \%$

Description

The 50 Ω input impedance is tested in working conditions, with a high precision digital multimeter.

Procedure

- Set DSO Ch1 : On
- Input coupling : DC 50 Ω
- Input gain : 20 mV/div
- Time base : 50 μ sec/div

Check with a high precision DMM : input impedance must be 50 $\Omega \pm 1 \%$.

- Repeat the test for Input gain : 100 mV/div and .5 V/div, the input impedance must be 50 $\Omega \pm 1 \%$.

Repeat impedance checks for Channel 2, External Trigger and External / 10.

5.7 Bandwidth

Specification

- 3dB : DC to at least 1 GHz

Description

The purpose of this test is to ensure that the entire 9320 system has a bandwidth of at least 1 GHz at 100 mV/div. An external source is used as the reference to provide a signal where amplitude and frequency are well controlled.

Procedure

Setup a leveled sine wave generator.

- Frequency : 500 KHz

Connect the generator output to Channel 1 and Channel 2 via a SMA power splitter 50 Ω , 6 dB, 0.5 W type 4901.19A of Suhner, and two SMA / BNC cables 50 $\Omega \pm 2 \Omega$ of 5 ns (1 meter or 39.37 inches).

- Turn on trace : Ch1
- Display setup : Standard, Persistence off, Dot join on, Single grid
- Input coupling : Ch1 : DC 50 Ω
- V/div. offset : Normal
- Probe atten : X1
- Input gain : 100 mV/div

- Offset : 0 mV
- Trigger setup : Edge
- Trigger on : 1
- Trigger level : 0 mV
- Coupling 1 : DC
- Slope 1 : Pos
- Mode : Norm
- Holdoff : Off
- Timebase : .5 μ sec/div
- Cursors/Measure : Parameters
- Mode : Std Voltage
- Statistics : On
- On displayed trace : 1

Adjust the generator output amplitude to get a 500 mV amplitude sine wave (5 divisions), and check amplitude of the signal with parameter ampl(1).

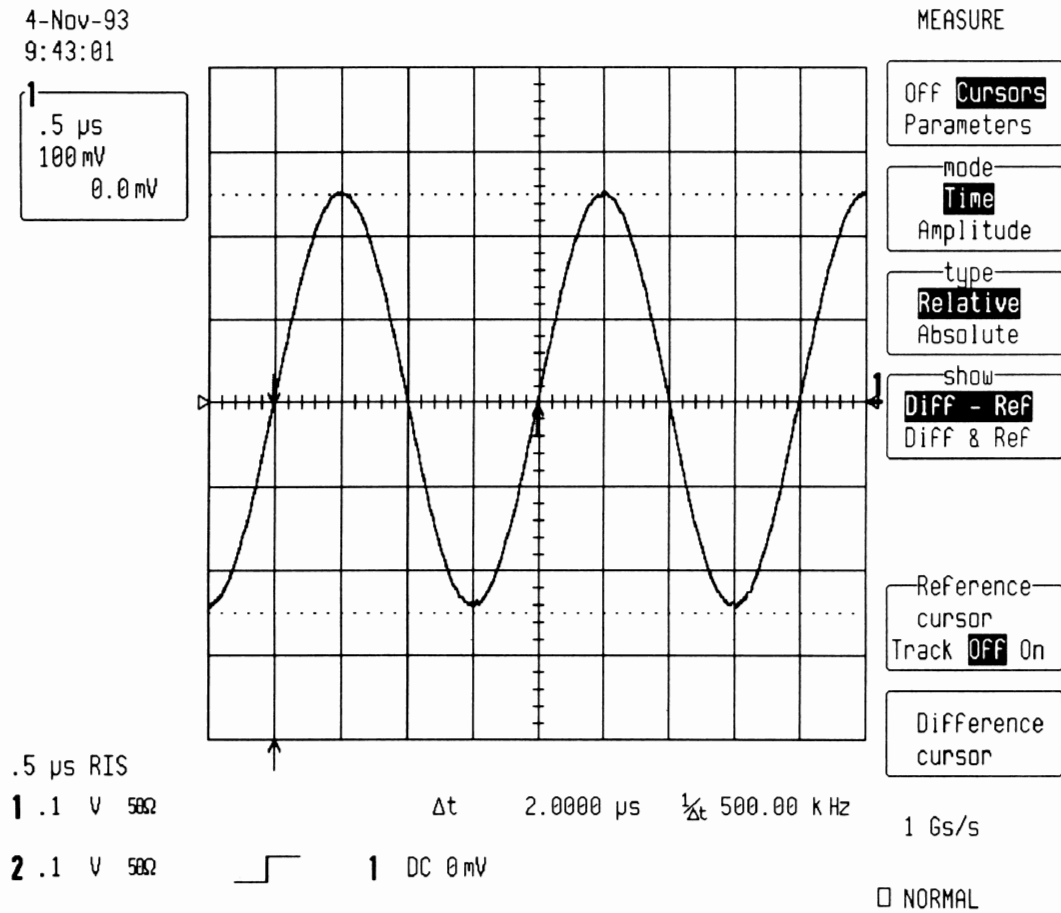

4-Nov-93
9:44:44

1
.5 μ s
100 mV

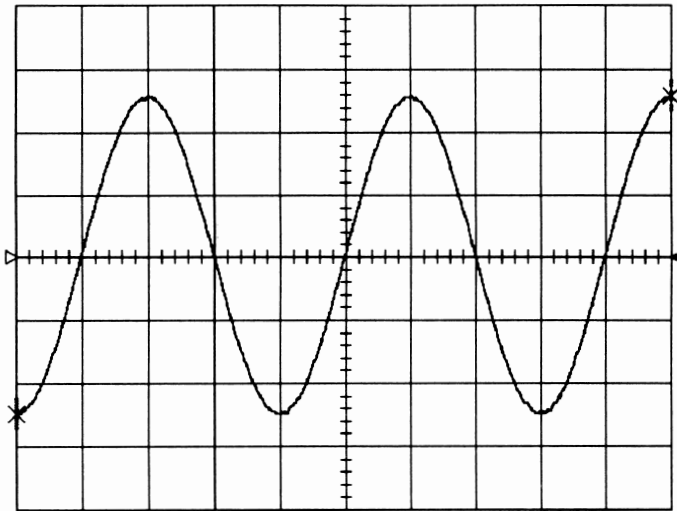

MEASURE

OFF Cursors
Parameters

mode
Std Voltage
Std Time
Custom
Pass
Fail

statistics
Off On

on displayed
(trace)

from
0.00 div
Track Off On

to
10.00 div
5000 points

	102 sweeps:	average	low	high	sigma
pkpk (1)		508 mV	506	509	2
mean (1)		5.18 mV	4.47	5.62	0.24
sdev (1)		177.99 mV	177.89	178.09	0.04
rms (1)		178.04 mV	177.94	178.14	0.04
ampl (1)		499 mV	497	500	1

.5 μ s RIS

1 .1 V 50 Ω

2 .1 V 50 Ω

1 DC 0 mV

1 Gs/s

NORMAL

- Disconnect the SMA power splitter with cables from the generator, and connect a power meter (HP436A or equivalent) with power sensor (HP 8482A) to the generator output.
- Record the power meter readout. i.e : $V1$ at 500 KHz = 4.05 dBm

- Set the generator frequency to 1 GHz
- Record the power meter readout. i.e : $V2$ at 1 GHz = 3.89 dBm

- Calculate the attenuator factor of the generator : $\Delta 1 = V1 - V2$ in mV

$$dBm = 20 \log_{10} \left(\frac{V}{V_{ref}} \right)$$

Where $V_{ref} = 0.224$ V Rms or 0.316 V peak (that is, 0 dBm is defined as a sine wave of 0.224 V Rms, giving 1.0 mW into 50Ω).

i.e : $4.05 \text{ dBm} = 20 \log_{10} \left(\frac{V1}{V_{ref}} \right) \Rightarrow V1 = 504 \text{ mV peak}$

i.e : $3.89 \text{ dBm} = 20 \log_{10} \left(\frac{V2}{V_{ref}} \right) \Rightarrow V2 = 494 \text{ mV peak}$

i.e : $\Delta 1 = 10 \text{ mV}$

At 1 GHz, the amplitude of the source is also typically decreased by ≈ 0.55 dBm, due to the 50Ω cable.

Attenuator factor of the cable : $\Delta 2 = 10^{\left(\frac{0.55}{20}\right)} = 1.065 \Rightarrow 6.5 \% \text{ of } 500 \text{ mV} \approx 32 \text{ mV}$

- Reconnect the SMA power splitter with cables to the 9320 DSO.

Set DSO settings as follows :

- Trigger on : Ch2
- Coupling 2 : HF
- Time/div : .5 ns

Check on the 9320, that the sine wave amplitude is :

$\text{ampl}(1) + \Delta 1 + \Delta 2 \geq 350 \text{ mV}$

corresponding to 70 % of the initial amplitude at .5 MHz (.7 X 500 mV = 350 mV, 3dB point) or greater, minus the attenuator factor of generator with 50Ω cable :

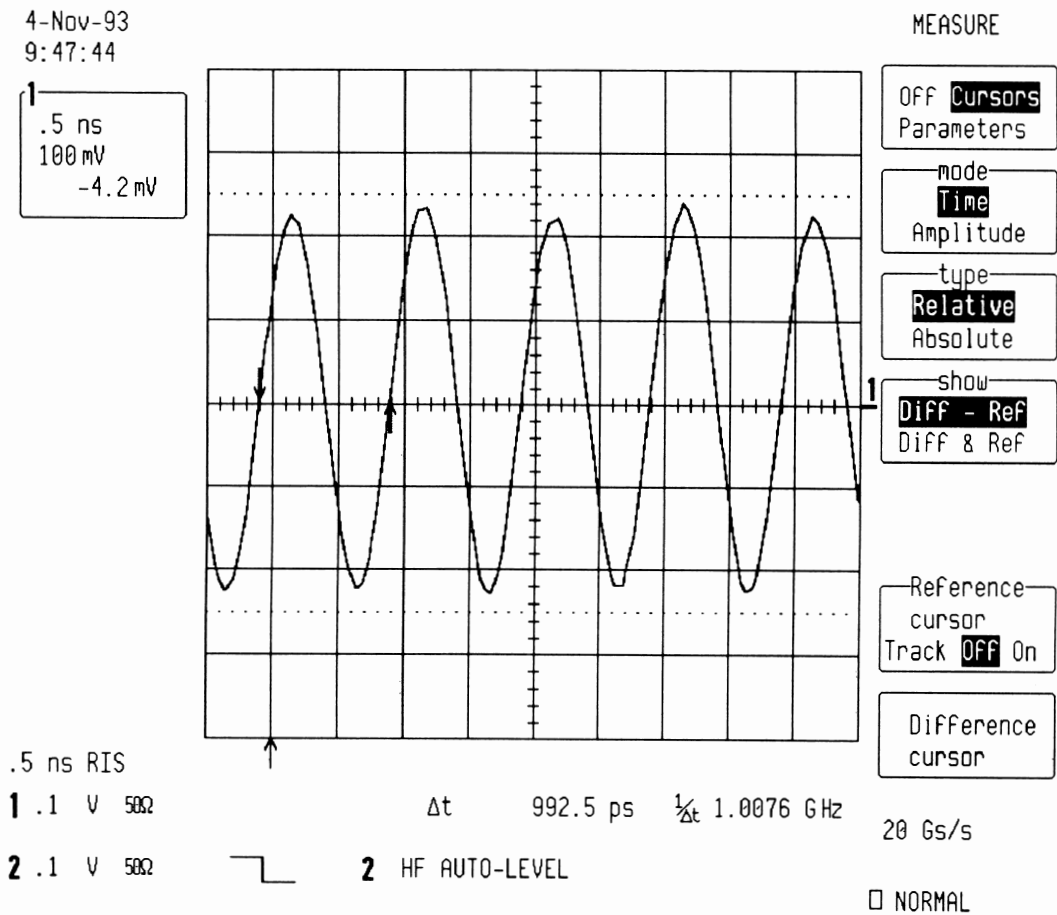

4-Nov-93
9:49:22

1
.5 ns
100 mV

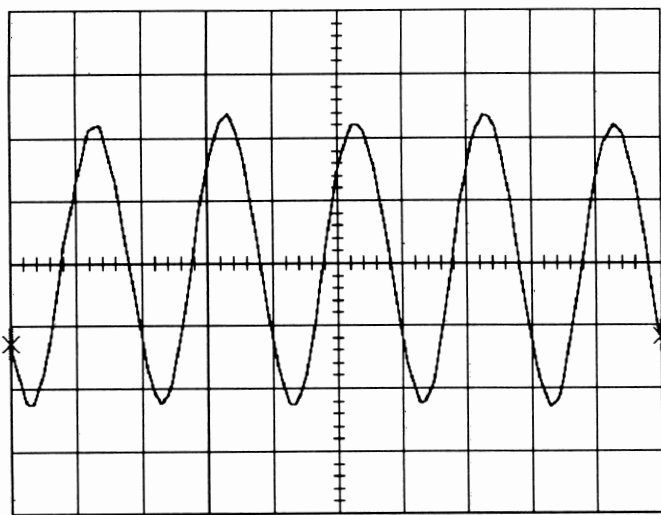

TRIGGER SETUP

Edge SMART

trigger on
1 2
Ext Ext10

coupling 2
DC AC HF

27 sweeps: average low high sigma

pkpk(1)	466 mV	463	469	3
mean(1)	8.5 mV	5.6	13.5	1.9
sdev(1)	162.1 mV	159.5	164.2	1.3
rms(1)	161.4 mV	158.7	163.3	1.3
ampl(1)	444 mV	280	469	36

.5 ns RIS
1 .1 V 50Ω

2 .1 V 50Ω

2 HF AUTO-LEVEL

holdoff
- - -
OFF Time Evt

20 Gs/s

NORMAL

Repeat the tests to check Channel 2 bandwidth, substituting channel controls and input connector.

5.8 Manual linearity test using an external high precision voltage source (NIST traceable)

Specification

≤ ± 2 % of full scale at 0 mv offset

Description

This test measures the DC Accuracy within the gain range specified. The parameters Std voltage are used to measure the amplitude of the DC input signal.

In the absence of the computer automated calibration system based on LeCroy Calibration Software (LeCalsoft) for the 9320 model oscilloscope, the manual performance test procedure can be followed to establish a NIST traceable calibration, provided the measurement instruments used are NIST traceable calibrated.

For a NIST calibration, follow the manual linearity test procedure using a calibrated and certified high precision (better than 0.1 %) voltage source, for example TEK PS5004 or equivalent.

Procedure

- Turn on trace : Ch1
- Display setup : Standard, Persistence off, Dot join on, Single grid

- Input coupling : Ch1 : DC 50 Ω
- V/div. offset : Normal
- Probe atten : X1
- Input offset : 0.0 mV
- Input gain : from 5mV/div to 2 V/div (see table 5-4)

- Trigger setup : Edge
- Trigger on : 1
- Coupling 1 : DC
- Slope 1 : Pos
- Mode : Auto
- Holdoff : Off

- Timebase : 2 msec/div.

- Cursors/Measure : Parameters
- Mode : Std Voltage
- Statistics : On
- On displayed trace : 1

For the ranges 5 mV/div to 1 V/div, from the high precision voltage source, apply the following 2 voltage values, one after another : + 3 major screen divisions, - 3 major screen divisions.

For the low sensitivities : 5 mV, 10 mV, 20 mV and 50 mV/div, use a 50 Ohm 20 dB attenuator.

For the range 2V/div, the maximum input voltage is ± 5 V (± 2.5 major divisions).

Section 5 Performance Verification

4-Nov-93
10:00:16

1
2 ms
5.0 mV

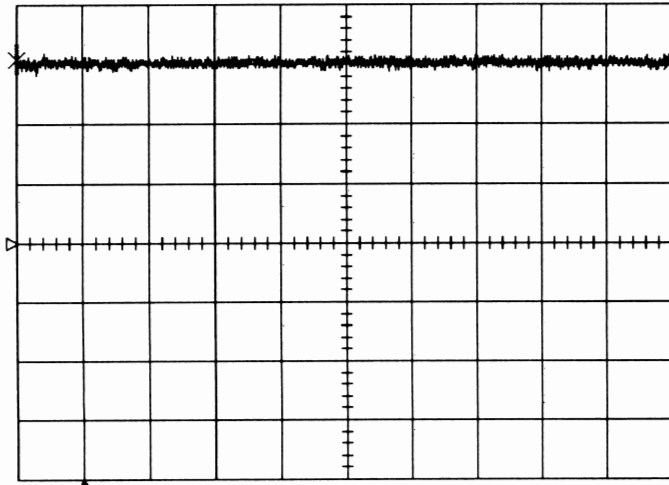

240 sweeps:

	average	low	high	sigma
pkpk(1)	1.75 mV	1.41	2.50	0.21
mean(1)	15.0973 mV	14.9860	15.2686	0.0532
sdev(1)	233.5 μV	224.5	242.1	3.6
rms(1)	15.0991 mV	14.9877	15.2705	0.0531
ampl(1)	1.75 mV	1.41	2.50	0.21

2 ms
1 5 mV 50Ω

2 5 mV 50Ω

1 DC 0.0 mV

MEASURE

OFF Cursors
Parameters

mode
Std Voltage
Std Time
Custom
Pass
Fail

statistics
OFF On

on displayed
(trace)
1

from
0.00 div
Track OFF On

to
10.00 div
4000 points

200 ks/s

AUTO

4-Nov-93
10:01:33

1
2 ms
5.0 mV

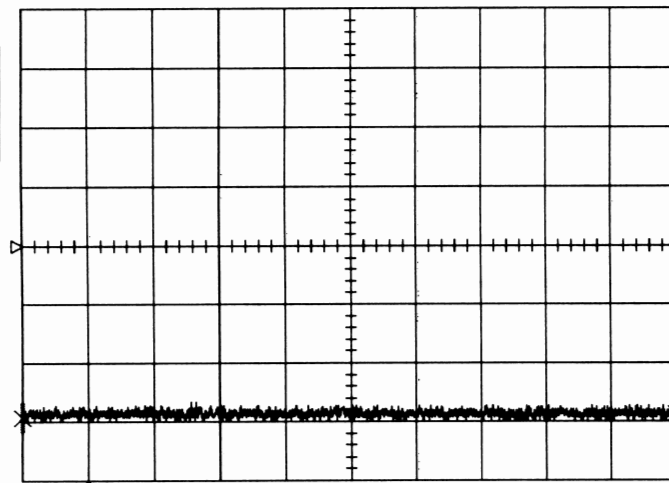

109 sweeps:

	average	low	high	sigma
pkpk(1)	1.96 mV	1.56	2.50	0.18
mean(1)	-14.3479 mV	-14.4659	-14.2322	0.0504
sdev(1)	252.2 μV	243.8	262.5	4.0
rms(1)	14.3502 mV	14.2342	14.4685	0.0504
ampl(1)	1.96 mV	1.56	2.50	0.18

2 ms
1 5 mV 50Ω

2 5 mV 50Ω

1 DC 0.0 mV

MEASURE

OFF Cursors
Parameters

mode
Std Voltage
Std Time
Custom
Pass
Fail

statistics
OFF On

on displayed
(trace)
1

from
0.00 div
Track OFF On

to
10.00 div
4000 points

200 ks/s

AUTO

4-Nov-93
10:03:05

1
2 ms
2.00 V

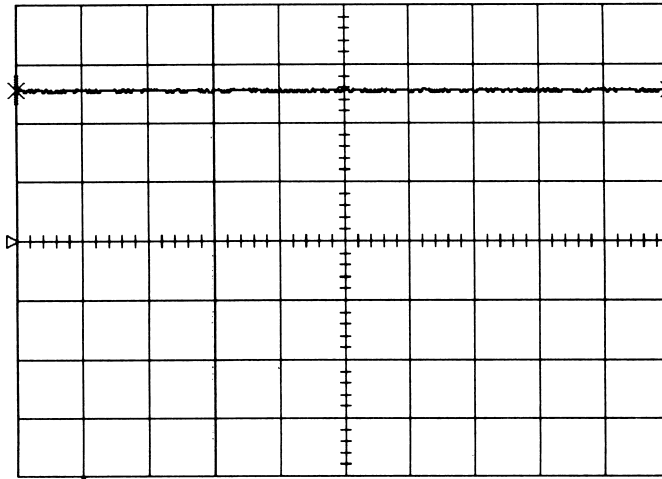

107 sweeps:

	average	low	high	sigma
pkpk(1)	0.14 V	0.12	0.19	0.03
mean(1)	5.1251 V	5.1165	5.1396	0.0050
sdev(1)	21.6 mV	19.6	27.5	1.6
rms(1)	5.1251 V	5.1164	5.1397	0.0050
ampl(1)	0.14 V	0.12	0.19	0.03

2 ms
1 2 V 50Ω
2 2 V 50Ω

1 DC 0.00 V

MEASURE

OFF Cursors
Parameters

mode
Std Voltage
Std Time
Custom
Pass
Fail

statistics
OFF On

on displayed
(trace)
1

from
0.00 div
Track OFF On

to
10.00 div
4000 points

200 ks/s

AUTO

4-Nov-93
10:03:56

1
2 ms
2.00 V

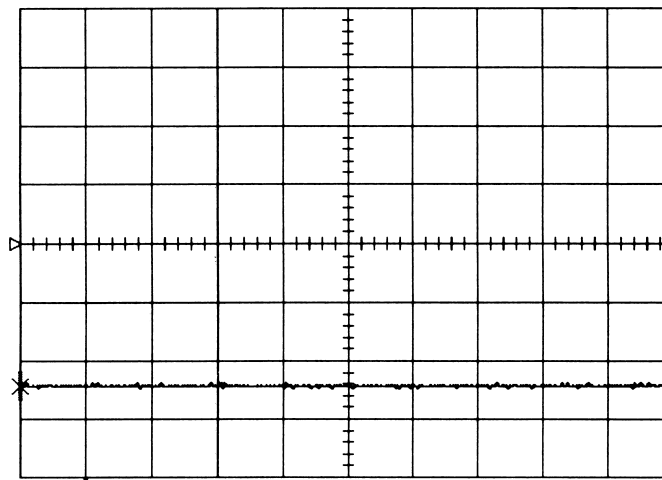

169 sweeps:

	average	low	high	sigma
pkpk(1)	0.19 V	0.19	0.25	0.01
mean(1)	-4.8541 V	-4.8665	-4.8394	0.0065
sdev(1)	31.1 mV	25.6	35.5	2.4
rms(1)	4.8542 V	4.8395	4.8665	0.0065
ampl(1)	0.19 V	0.19	0.25	0.01

2 ms
1 2 V 50Ω
2 2 V 50Ω

1 DC 0.00 V

MEASURE

OFF Cursors
Parameters

mode
Std Voltage
Std Time
Custom
Pass
Fail

statistics
OFF On

on displayed
(trace)
1

from
0.00 div
Track OFF On

to
10.00 div
4000 points

200 ks/s

AUTO

Range	Attenuator	Conditions of Test			Average Mean Parameter Reading	
		PS Output	9320 Input	9320 Full scale	Min Value -2 % of FS	Max Value +2 % of FS
5 mV	Yes	+ 150 mV	+ 15 mV	40 mV	+ 14.2 mV	+ 15.8 mV
10 mV	Yes	+ 300 mV	+ 30 mV	80 mV	+ 28.4 mv	+ 31.6 mV
20 mV	Yes	+ 600 mV	+ 60 mV	160 mV	+ 56.8 mV	+ 63.2 mV
50 mV	Yes	+ 1.5 V	+150 mV	400 mV	+ 142 mV	+ 158 mV
.1 V	No	+ 300 mV	+ 300 mV	800 mV	+ 284 mV	+ 316 mV
.2 V	No	+ 600 mV	+ 600 mv	1.6 v	+ 568 mV	+ 632 mV
.5 V	No	+ 1.5 V	+ 1.5 V	4 V	+ 1.42 V	+ 1.58 V
1 V	No	+ 3 V	+ 3 V	8 V	+ 2.84 V	+ 3.16 V
2 V	No	Max +5 V	Max +5 V	16 V	+ 4.68 V	+ 5.32 V
5 mV	Yes	- 150 mV	- 15 mV	40 mV	- 14.2 mV	- 15.8 mV
10 mV	Yes	- 300 mV	- 30 mV	80 mV	- 28.4 mv	- 31.6 mV
20 mV	Yes	- 600 mV	- 60 mV	160 mV	- 56.8 mV	- 63.2 mV
50 mV	Yes	- 1.5 V	- 150 mV	400 mV	- 142 mV	- 158 mV
.1 V	No	- 300 mV	- 300 mV	800 mV	- 284 mV	- 316 mV
.2 V	No	- 600 mV	- 600 mv	1.6 v	- 568 mV	- 632 mV
.5 V	No	- 1.5 V	- 1.5 V	4 V	- 1.42 V	- 1.58 V
1 V	No	- 3 V	- 3 V	8 V	- 2.84 V	- 3.16 V
2 V	No	Max -5 V	Max -5 V	16 V	- 4.68 V	- 5.32 V

Table 5-4 : DC Linearity Readout Accuracy

For each point, read off the average " Mean " parameter voltage, and compare to the digital readout of the voltage reference.

The difference of the two values in mV, should be within $\pm 2\%$ of full scale of the scope.

The average mean parameter reading should be within the limits shown in table 5-4.

Repeat the tests for Channel 2, substituting channel controls and input connector.

5.9 Trigger Level

Specification

Channel 1, Channel 2, External trigger and External/10 have independent trigger circuits allowing individual setting of slope, level and coupling.

External trigger voltage range : DC $\pm .5$ V

External /10 voltage range : DC ± 5 V

Description

The trigger level accuracy is tested at different DC levels : + 3, 0, - 3 major screen divisions.

5.9.1 Channel 1

Setup any sine wave generator capable of generating sine waves of 5 KHz.
Connect the generator output to Channel 1.

- Turn on trace : Ch1
- Display setup : Standard, Persistence off, Dot join on, Single grid
- Input coupling : Ch1 : DC 50 Ω
- V/div. offset : Normal
- Probe atten : X1
- Input gain : .5 V/div
- Input offset : 0 mV
- Trigger setup : Edge
- Trigger on : 1
- Coupling 1 : DC
- Slope 1 : Pos
- Mode : Auto or Norm
- Holdoff : Off
- Pre-Trigger Delay : 50 %
- Timebase : 20 μsec/div
- Cursors/Measure : Off
- Set Trigger level : DC 0.0 mV

Adjust the sine wave generator's output amplitude to get 8 divisions peak to peak, corresponding to a 2 V amplitude. It is important that the offset of the input is set to zero mV, use show status and acquisition status to verify.

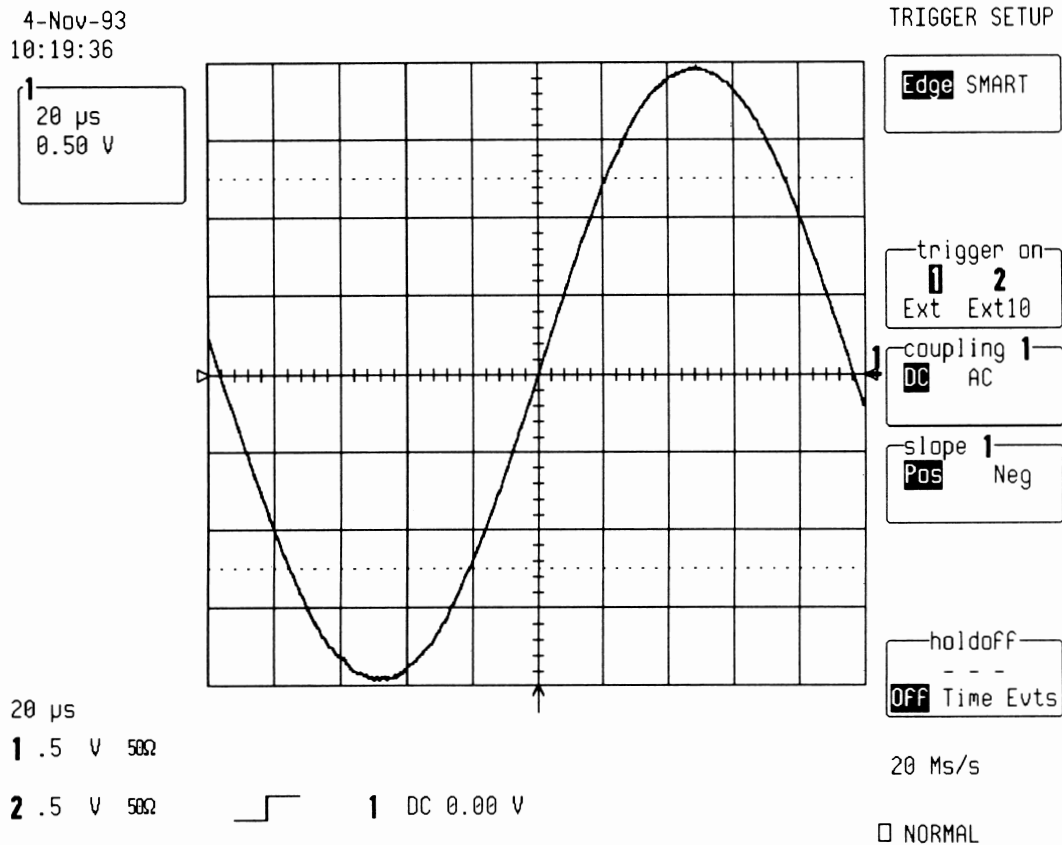

Section 5 Performance Verification

check : The sine wave must pass through the horizontal center of the screen (50 % pretrigger line) at the vertical position zero (vertical center) within ± 2 minor divisions.

- Repeat the test for the following conditions :

- Slope 1 : Neg

check : The sine wave must pass through the horizontal center of the screen (50 % pretrigger line) at the vertical position zero (vertical center) within ± 2 minor divisions.

4-Nov-93
10:20:05

1
20 μ s
0.50 V

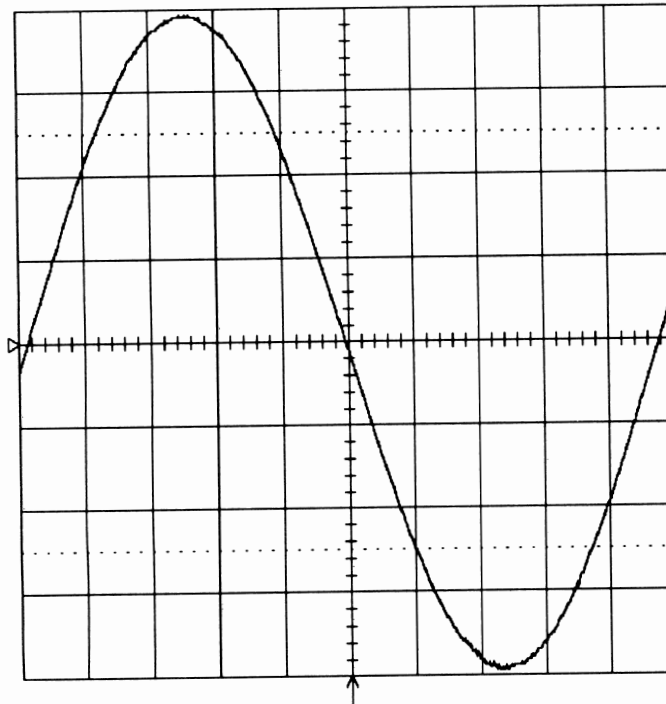

TRIGGER SETUP

Edge SMART

trigger on
1 2
Ext Ext10

coupling 1
DC AC

slope 1
Pos Neg

holdoff
- - -
OFF Time Evts

20 μ s

1 .5 V 50 Ω

2 .5 V 50 Ω

1 DC 0.00 V

20 Ms/s

NORMAL

- Set Trigger level : DC + 1.5 V

- Slope 1 : Pos

check : The sine wave must pass the horizontal center at + 3 divisions within ± 2 minor divisions.

4-Nov-93
10:21:23

1
20 μ s
0.50 V

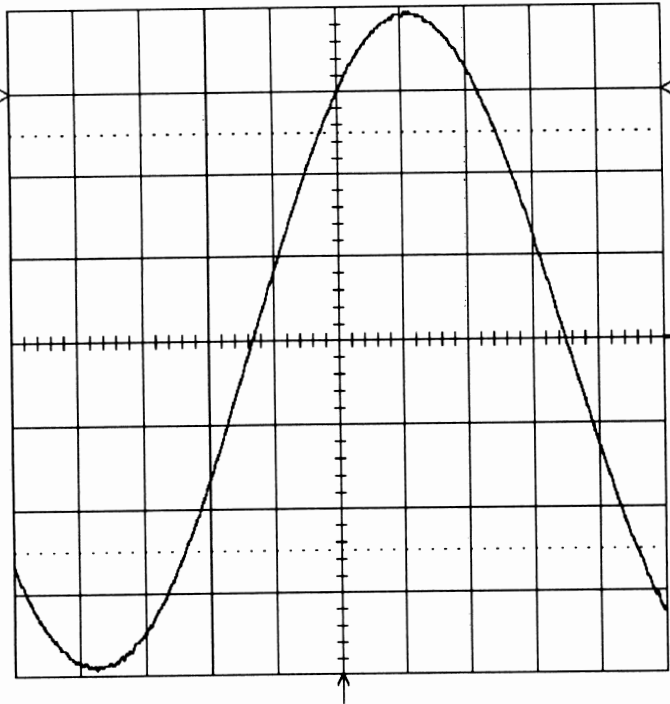

TRIGGER SETUP

Edge SMART

trigger on
1 2
Ext Ext10

coupling 1
DC AC

slope 1
Pos Neg

holdoff
- - -
OFF Time Evts

20 μ s
1 .5 V 50 Ω

2 .5 V 50 Ω

1 DC 1.50 V

20 Ms/s

NORMAL

Section 5 Performance Verification

- Repeat the test for the following conditions :

- Slope 1 : Neg

check : The sine wave must pass the horizontal center at + 3 divisions within ± 2 minor divisions.

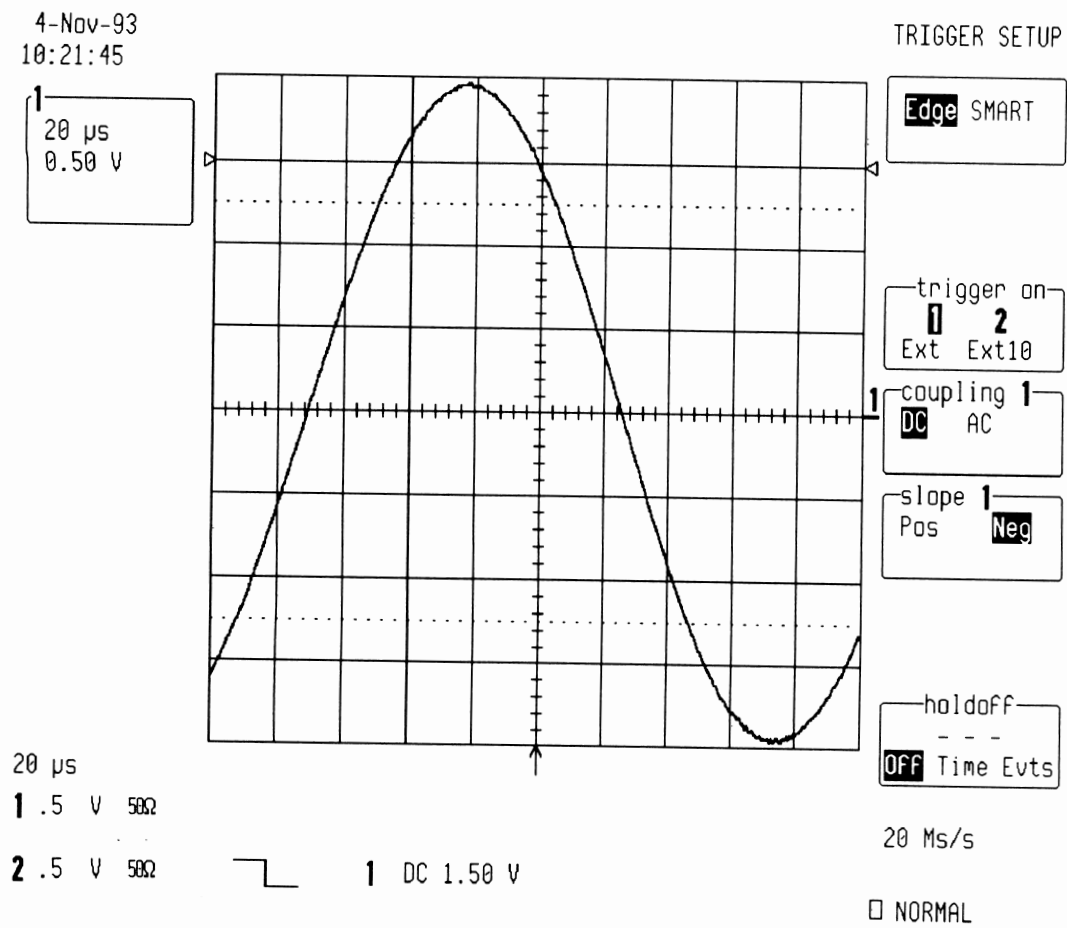

- Repeat the test for the following conditions :

- Trigger level : DC - 1.5 V

- Slope 1 : Pos

check : The sine wave must pass the horizontal center at - 3 divisions within ± 2 minor divisions.

4-Nov-93
10:22:13

1
20 μ s
0.50 V

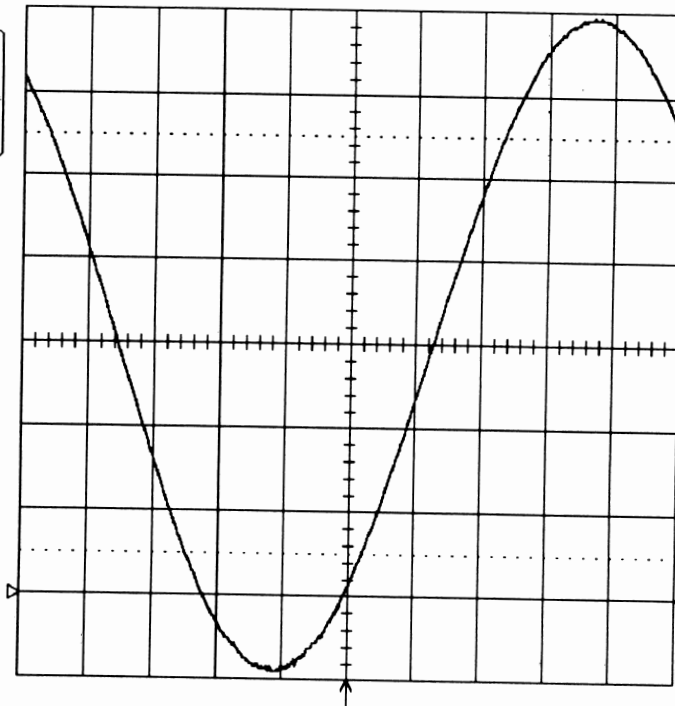

TRIGGER SETUP

Edge SMART

trigger on
1 2
Ext Ext10

coupling 1
DC AC

slope 1
Pos Neg

holdoff
- - -
OFF Time Evts

20 μ s
1 .5 V 50 Ω

2 .5 V 50 Ω



1 DC -1.50 V

20 Ms/s

NORMAL

Section 5 Performance Verification

- Select Slope 1 : Neg

check : The sine wave must pass the horizontal center at - 3 divisions within ± 2 minor divisions.

4-Nov-93
10:22:40

1
20 μ s
0.50 V

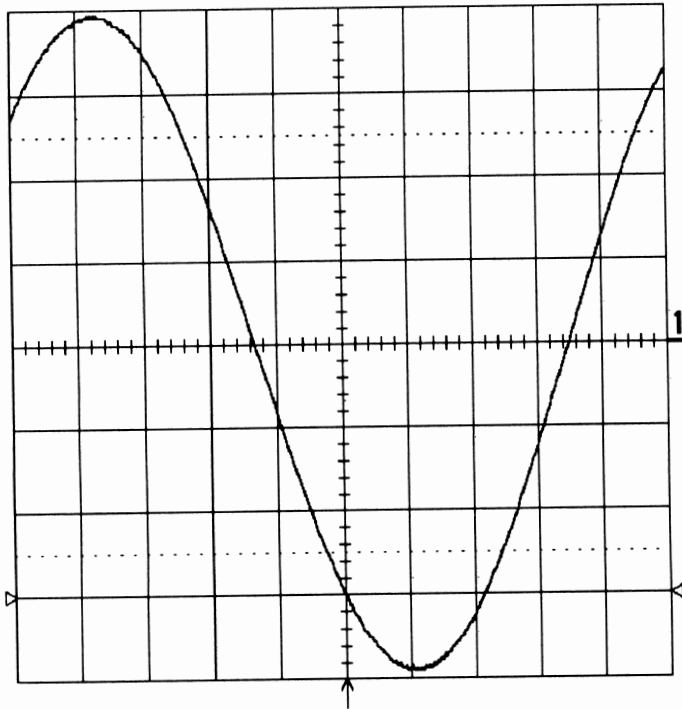

TRIGGER SETUP

Edge SMART

trigger on
1 2
Ext Ext10

coupling 1
DC AC

slope 1
Pos Neg

holdoff
- - -
Off Time Evts

20 μ s
1 .5 V 50 Ω
2 .5 V 50 Ω

1 DC -1.50 V

20 Ms/s

NORMAL

- Coupling 1 : AC Auto-Level

- Slope 1 : Pos

check : The sine wave must pass through the horizontal center of the screen (50 % pretrigger line) at the vertical position zero (vertical center) within ± 3 minor divisions.

4-Nov-93
10:23:01

1
20 μ s
0.50 V

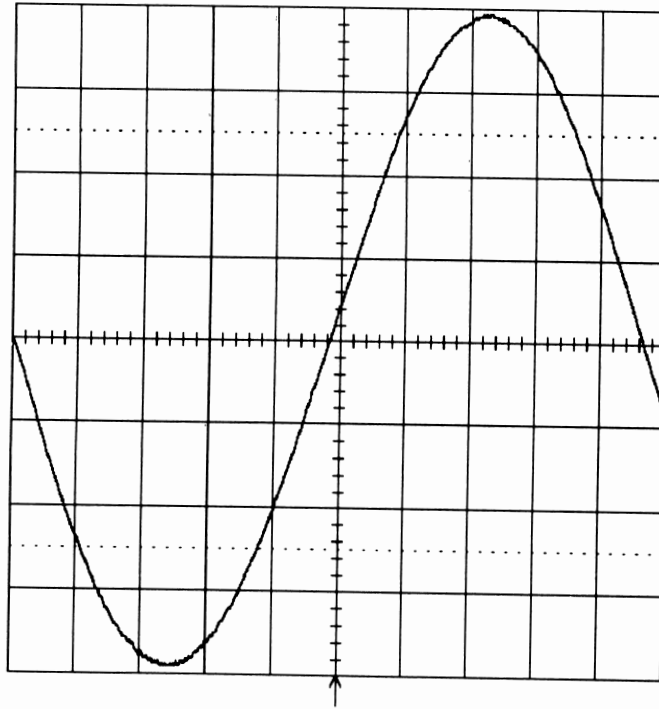

TRIGGER SETUP

Edge SMART

trigger on
0 2
Ext Ext10

coupling 1
DC AC

slope 1
Pos Neg

holdoff
- - -
Off Time Evts

20 μ s
1 .5 V 50 Ω
2 .5 V 50 Ω

1 AC AUTO-LEVEL

20 Ms/s

□ NORMAL

- Set Slope 1 : Neg

check : The sine wave must pass through the horizontal center of the screen (50 % pretrigger line) at the vertical position zero (vertical center) within ± 3 minor divisions.

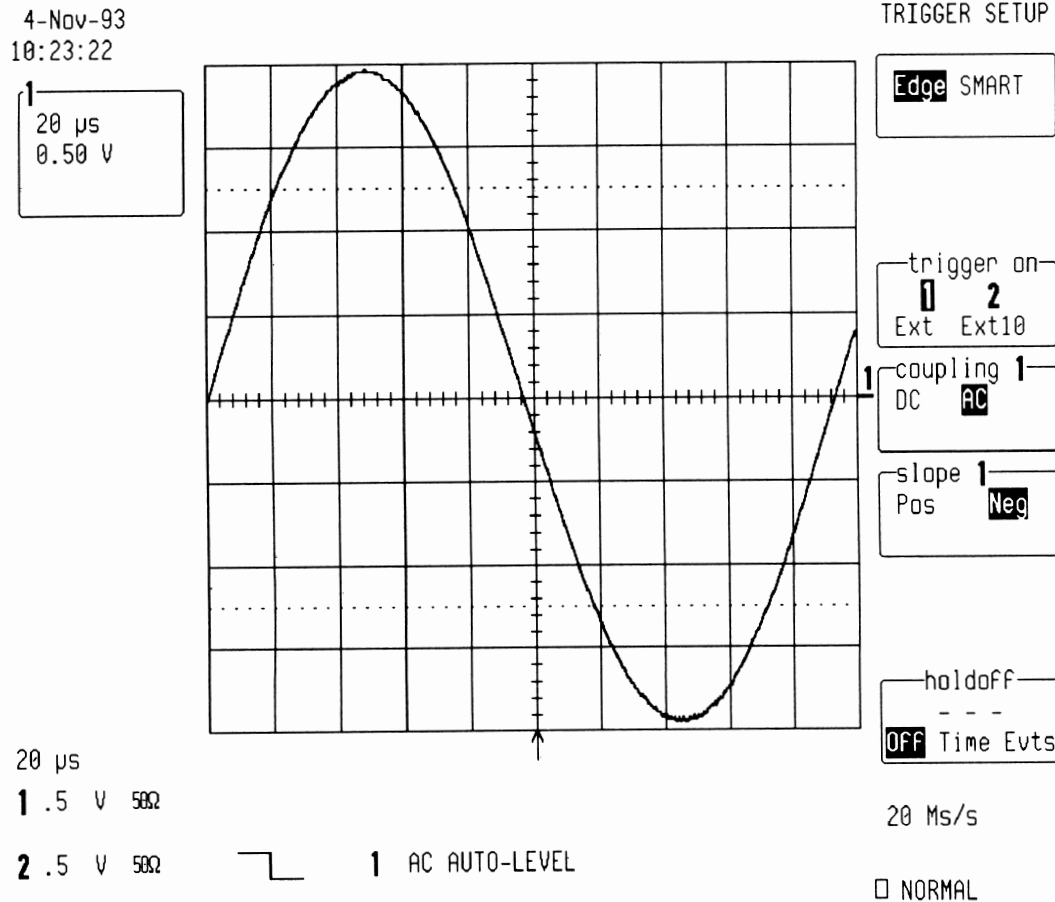

5.9.2 Channel 2

Disconnect the input from Channel 1 and connect it to Channel 2.

- Turn on trace : Ch2
- Input coupling : Ch2 : DC 50 Ω
- V/div. offset : Normal
- Probe atten : X1
- Input gain : .5 V/div
- Input offset : 0 mV
- Trigger setup : Edge
- Trigger on : 2
- Coupling 2 : DC
- Slope 2 : Pos

- Repeat the above check procedure for Channel 2, trigger slope positive and negative, trigger coupling DC and AC Auto-Level.

5.9.3 External Trigger

- Connect the output of the generator to External input and to Channel 2 via a coaxial T-connector. The cable length from External to Channel 2 must be short, at most 2 nsec.

- Set DSO as follows :

- Turn on trace : Ch2
- Input coupling : Ch2 : DC 50 Ω
- V/div. offset : Normal
- Probe atten : X1
- Input gain : .1 V/div
- Input offset : 0 mV
- Trigger setup : Edge
- Trigger on : Ext
- Coupling Ext : DC
- Slope Ext : Pos
- Set Trigger level : DC 0.0 mV

- Adjust the sine wave generator's output amplitude to get 8 divisions peak to peak, corresponding to a .4 V amplitude. It is important that the offset of the input is set to zero mV, use show status and acquisition status to verify.

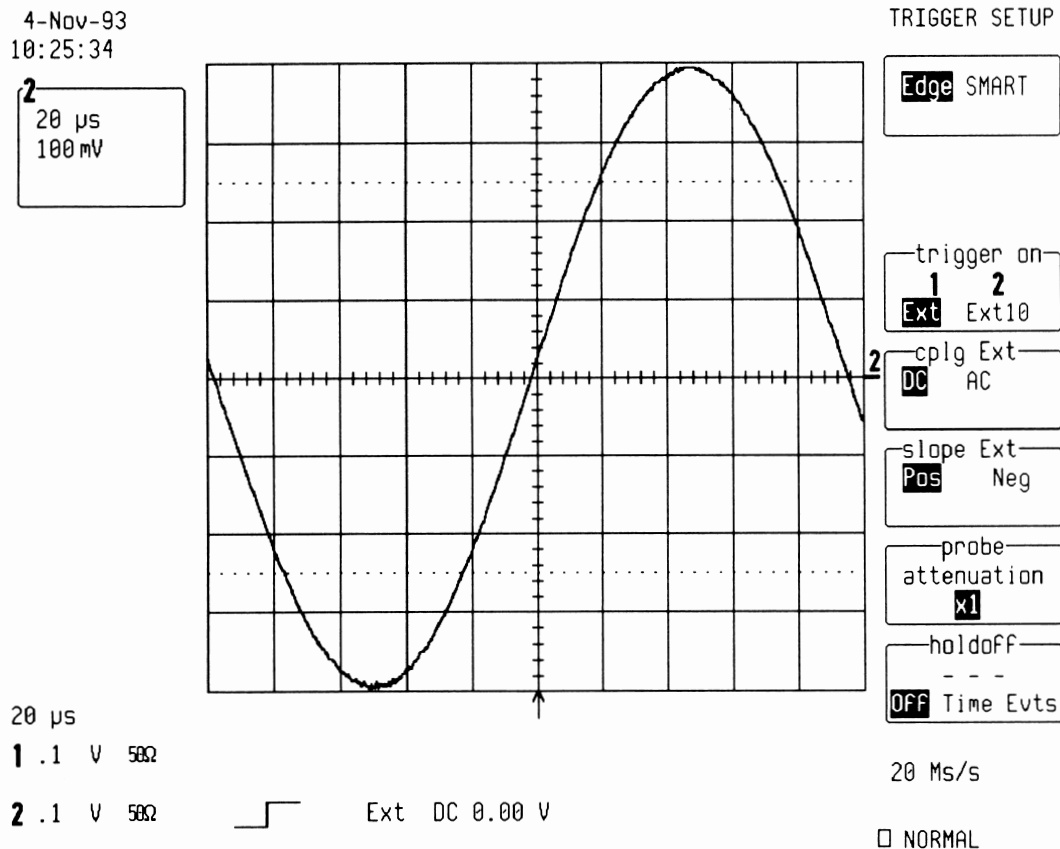

Section 5 Performance Verification

check : The sine wave must pass through the horizontal center of the screen (50 % pretrigger line) at the vertical position zero (vertical center) within ± 3 minor divisions.

- Set Slope Ext : Neg

check : The sine wave must pass through the horizontal center of the screen (50 % pretrigger line) at the vertical position zero (vertical center) within ± 3 minor divisions.

- Repeat the test for the following conditions :

- Trigger level : DC + 0.3 V
 - Slope Ext : Pos

check : The sine wave must pass the horizontal center at + 3 divisions within ± 3 minor divisions.

4-Nov-93
 10:26:03

2
 20 μ s
 100 mV

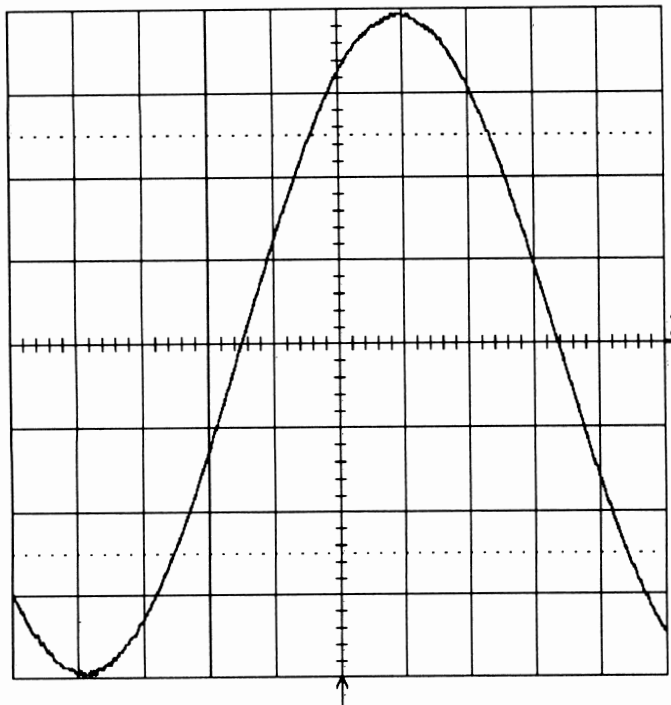

TRIGGER SETUP

Edge SMART

trigger on
 1 Ext 2 Ext10

cplg Ext
 DC AC

slope Ext
 Pos Neg

probe
 attenuation
 x1

holdoff

 OFF Time Evts

20 μ s

1 .1 V 50 Ω

2 .1 V 50 Ω



Ext DC 0.30 V

20 Ms/s

NORMAL

- Set Slope Ext : Neg

check : The sine wave must pass the horizontal center at + 3 divisions within ± 3 minor divisions.

- Repeat the test for the following conditions :

- Trigger level : DC - .3 V

- Slope Ext : Pos

check : The sine wave must pass the horizontal center at - 3 divisions within ± 3 minor divisions.

4-Nov-93
10:26:38

2
20 μ s
100 mV

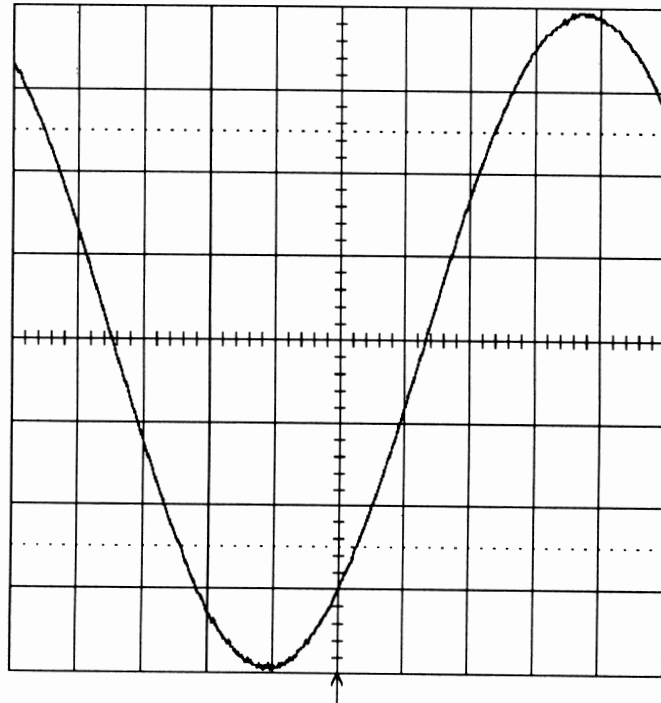

TRIGGER SETUP

Edge SMART

trigger on
1 Ext
2 Ext10

cp1g Ext
2 DC AC

slope Ext
Pos Neg

probe
attenuation
x1

holdoff
Off Time Evts

20 μ s
1 .1 V 50 Ω
2 .1 V 50 Ω

 Ext DC -0.30 V

20 Ms/s

NORMAL

- Set Slope Ext : Neg

check : The sine wave must pass the horizontal center at - 3 divisions within ± 3 minor divisions.

- Select Coupling Ext : AC Auto Level

check : The sine wave must pass through the horizontal center of the screen (50 % pretrigger line) at the vertical position zero (vertical center) within ± 3 minor divisions.

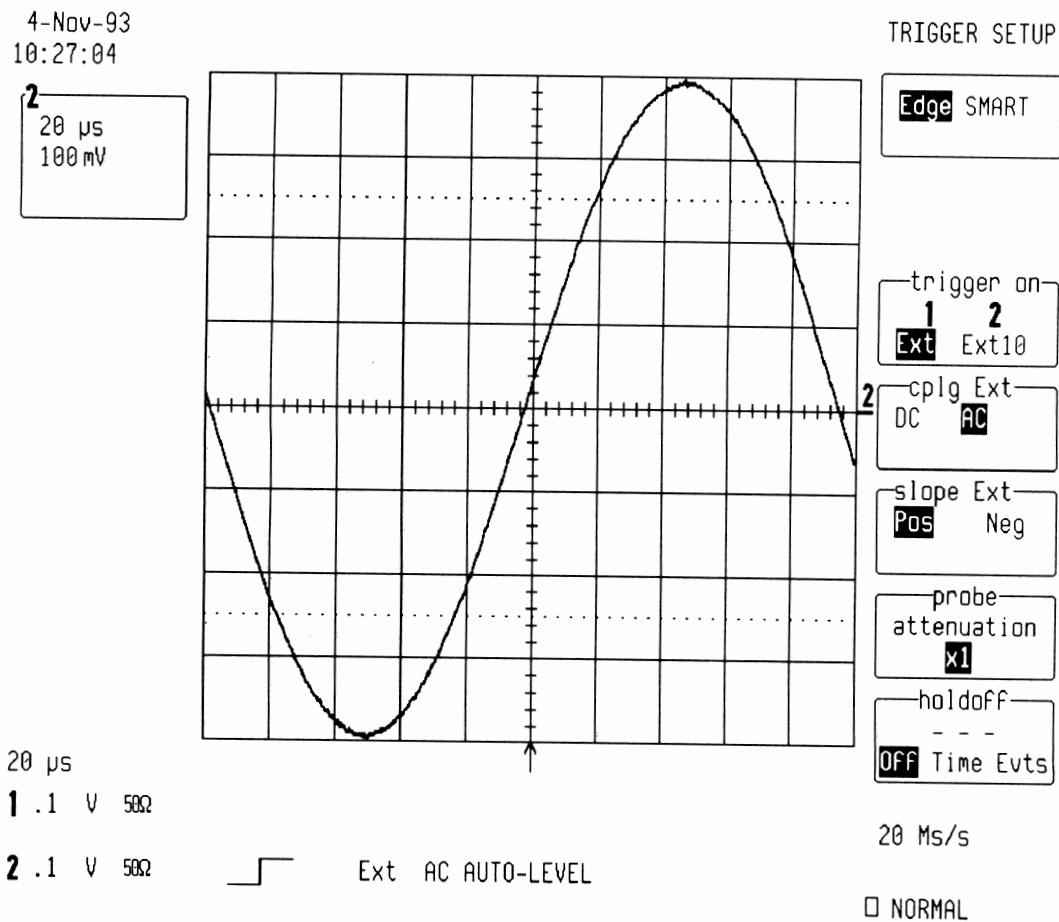

- Set Slope Ext : Neg

check : The sine wave must pass through the horizontal center of the screen (50 % pretrigger line) at the vertical position zero (vertical center) within ± 3 minor divisions.

5.9.4 External /10 Trigger

- Set DSO as follows :

- Input gain : 1 V/div
- Input offset : 0 mV
- Trigger setup : Edge
- Trigger on : Ext/10
- Coupling Ext/10 : DC
- Slope Ext/10 : Pos
- Ext/10 Trigger level : DC 0.0 mV

- Adjust the sine wave generator's output amplitude to get 6 divisions peak to peak, corresponding to a 3 V amplitude. It is important that the offset of the input is set to zero mV, use show status and acquisition status to verify.

check : The sine wave must pass through the horizontal center of the screen (50 % pretrigger line) at the vertical position zero (vertical center) within ± 3 minor divisions.

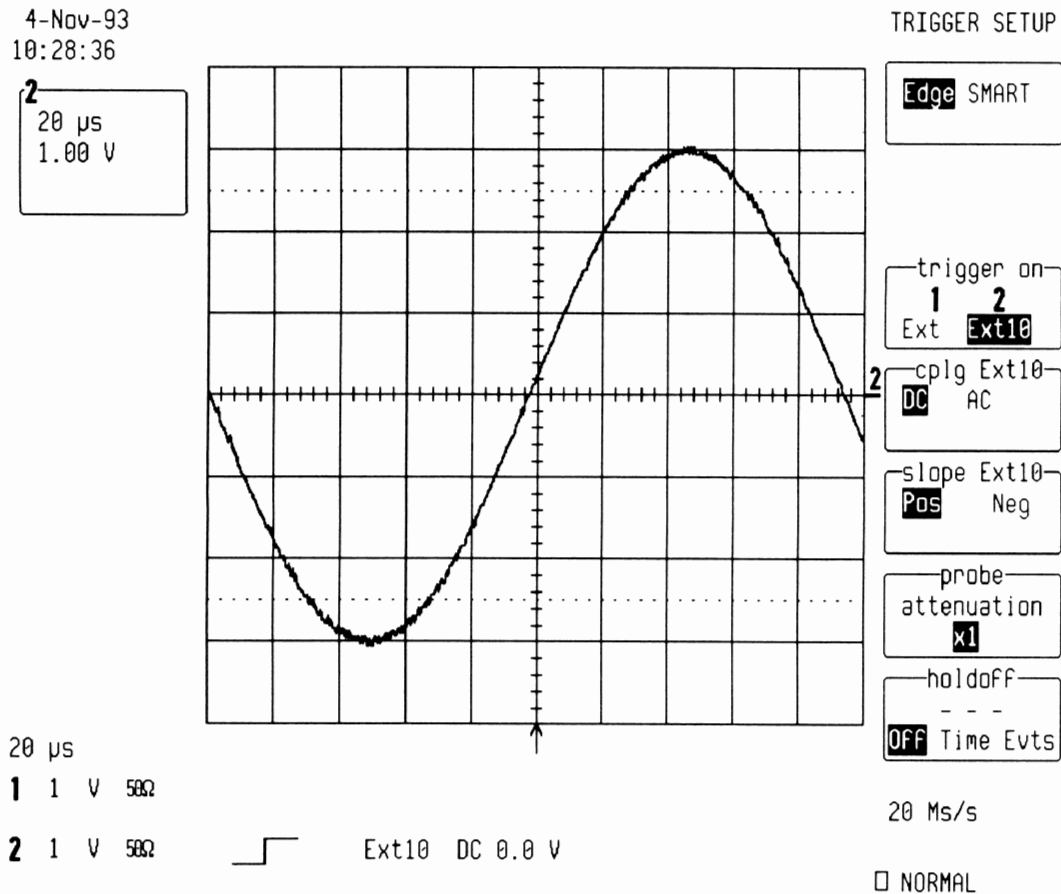

- Set Slope Ext/10 : Neg

check : The sine wave must pass through the horizontal center of the screen (50 % pretrigger line) at the vertical position zero (vertical center) within ± 3 minor divisions.

Section 5 Performance Verification

- Repeat the test for the following conditions :

- Ext/10 Trigger level : DC + 2.5 V

- Slope Ext/10 : Pos

check : The sine wave must pass the horizontal center at + 2.5 divisions within ± 3 minor divisions.

4-Nov-93
10:29:07

2
20 μ s
1.00 V

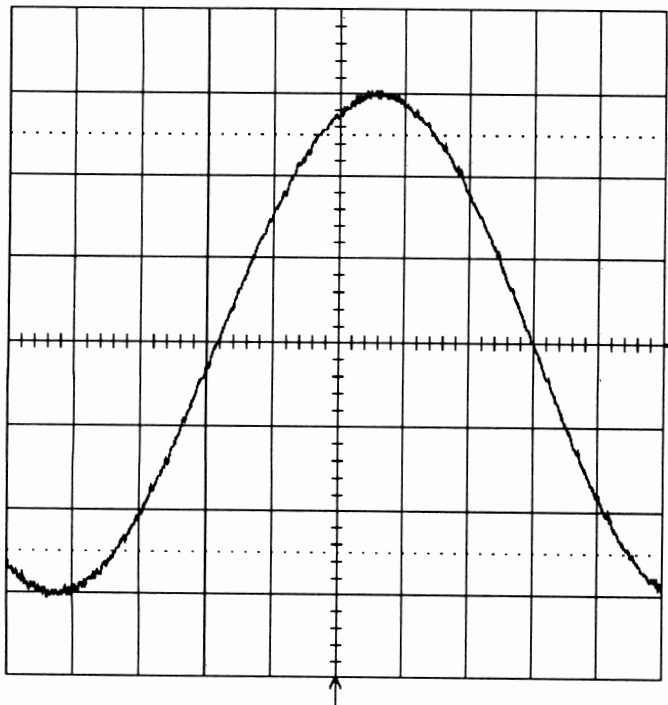

TRIGGER SETUP

Edge SMART

trigger on
1 Ext
2 Ext10

cplg Ext10
2 DC AC

slope Ext10
Pos Neg

probe
attenuation
x1

holdoff
Off Time Evts

20 μ s
1 1 V 50 Ω

2 1 V 50 Ω

 Ext10 DC 2.5 V

20 Ms/s

NORMAL

- Set Slope Ext/10 : Neg

check : The sine wave must pass the horizontal center at + 2.5 divisions within ± 3 minor divisions.

- Repeat the test for the following conditions :

- Ext/10 Trigger level : DC - 2.5 V

- Slope Ext/10 : Pos

check : The sine wave must pass the horizontal center at - 2.5 divisions within ± 3 minor divisions.

4-Nov-93
10:29:41

2
20 μ s
1.00 V

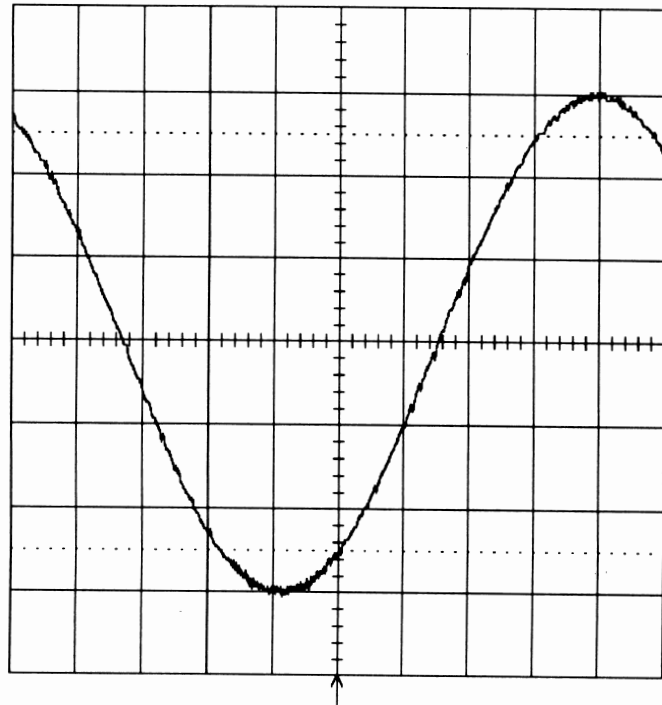

TRIGGER SETUP

Edge SMART

trigger on
1 2
Ext Ext10

cplg Ext10
DC AC

slope Ext10
Pos Neg

probe
attenuation
x1

holdoff
- - -
OFF Time Evts

20 μ s
1 1 V 50 Ω

2 1 V 50 Ω



Ext10 DC -2.5 V

20 Ms/s

NORMAL

- Set Slope Ext/10 : Neg

check : The sine wave must pass the horizontal center at - 2.5 divisions within ± 3 minor divisions.

- Select Coupling Ext/10 : AC Auto Level

- Slope Ext/10 : Pos

check : The sine wave must pass through the horizontal center of the screen (50 % pretrigger line) at the vertical position zero (vertical center) within ± 3 minor divisions.

4-Nov-93
10:30:10

2
20 μ s
1.00 V

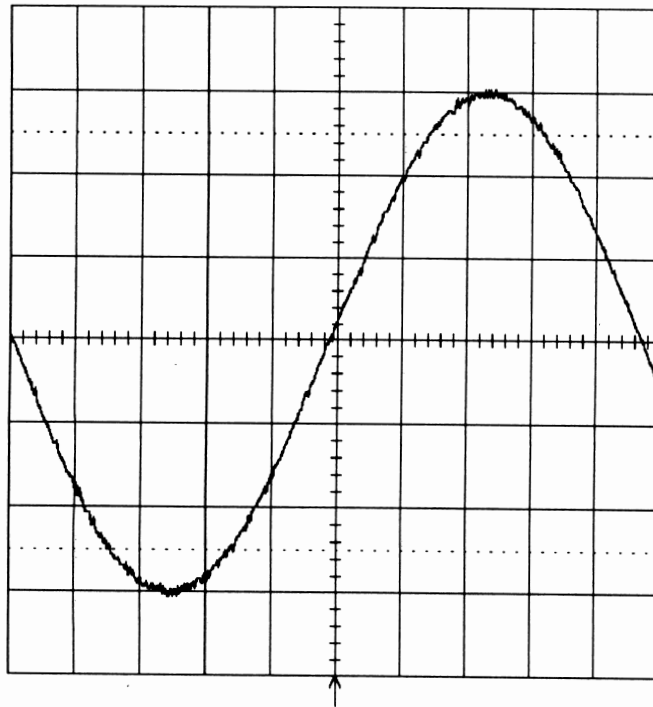

TRIGGER SETUP

Edge SMART

trigger on
1 Ext
2 Ext10

cplg Ext10
DC **AC**

slope Ext10
Pos Neg

probe
attenuation
x1

holdoff
- - -
OFF Time Evts

20 μ s
1 1 V 50 Ω

2 1 V 50 Ω

Ext10 AC AUTO-LEVEL

20 Ms/s

NORMAL

- Set Slope Ext/10 : Neg

check : The sine wave must pass through the horizontal center of the screen (50 % pretrigger line) at the vertical position zero (vertical center) within ± 3 minor divisions.

5.10 Trigger Rate**Specification**

Up to 750 MHz on Channel 1, Channel 2, and External Trigger
 Up to 1.5 GHz on Channel 2, only when HF coupling selected

Description

The purpose of this test is to ensure that the Trigger rate is at least 750 MHz on all Channels and 1 GHz on Channel 2 HF.

5.10.1 Channel 1 Trigger Rate**Procedure**

Setup a leveled sine wave generator.

- Frequency : 750 MHz

- Set DSO as follows :

- Turn on trace : Ch1
- Display setup : Standard, Persistence On, Dot join Off, Single grid
- Input coupling : Ch1 : DC 50 Ω
- V/div. offset : Normal
- Probe atten : X1
- Input gain : .1 V/div
- Input offset : 0 mV
- Time/div : .5 ns
- Trigger setup : Edge
- Trigger on : 1
- Coupling 1 : AC Auto-Level
- Slope 1 : Pos
- Holdoff : Off

- Adjust the sine wave generator's output amplitude to get 6 divisions peak to peak, corresponding to a .3 V amplitude.

Check : The scope must keep triggering in a stable way, a smooth 750 MHz sine wave must be visible on the screen.

5.10.2 Channel 2 Trigger Rate

- Repeat the test for Channel 2, substituting channel controls and input connector and check as above.

Section 5 Performance Verification

4-Nov-93
11:09:26

1
.5 ns
100 mV

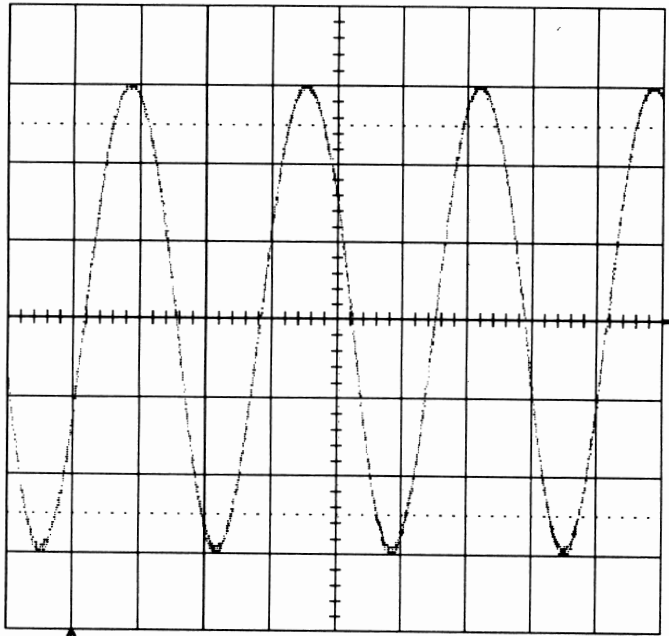

DISPLAY SETUP

Standard
XY

Persistence
OFF **On**

Dot Join
OFF On

Grids
Single Dual
Quad

W'Form+Text
intensity
90 %

Grid
intensity
60 %

.5 ns RIS
1 .1 V 50Ω
2 .1 V 50Ω

8+sweeps
 1 AC AUTO-LEVEL

20 Gs/s
 NORMAL

4-Nov-93
11:09:48

1
.5 ns
100 mV

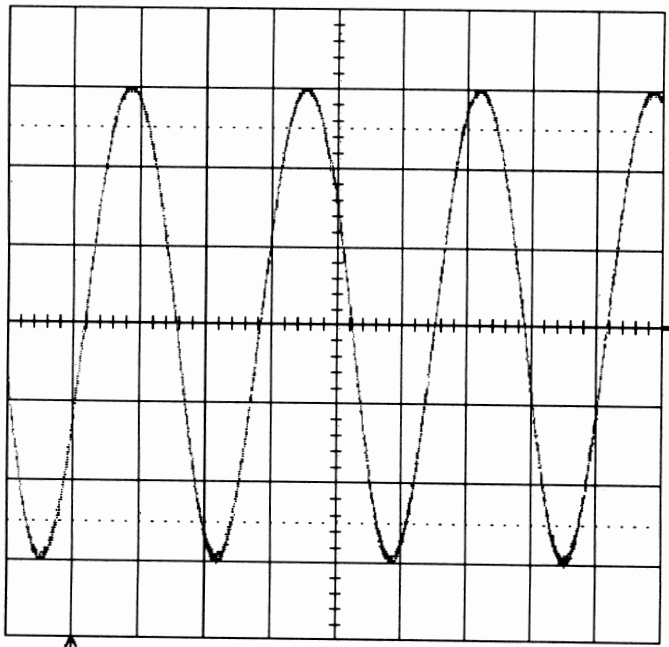

TRIGGER SETUP

Edge SMART

trigger on
1 **2**
Ext Ext10

coupling 1
DC **AC**

slope 1
Pos Neg

holdoff
- - -
OFF Time Evts

.5 ns RIS
1 .1 V 50Ω
2 .1 V 50Ω

16+sweeps
 1 AC AUTO-LEVEL

20 Gs/s
 NORMAL

5.10.3 External Trigger Rate

Set DSO as follows :

- Turn on trace : Ch2
- Input coupling : Ch2 : DC 50 Ω
- Input gain : .1 V/div
- Input offset : 0 mV
- Time/div : .5 ns
- Trigger setup : Edge
- Trigger on : Ext
- Coupling Ext : AC Auto-Level
- Slope Ext : Pos

- Connect the output of the generator to External input and to Channel 2 via a coaxial T-connector. The cable length from External to Channel 2 must be short, at most 2 nsec.

Adjust the sine wave generator's output amplitude to get 6 divisions peak to peak, corresponding to a .3 V amplitude.

Check : The scope must keep triggering in a stable way, a smooth 750 MHz sine wave must be visible on the screen.

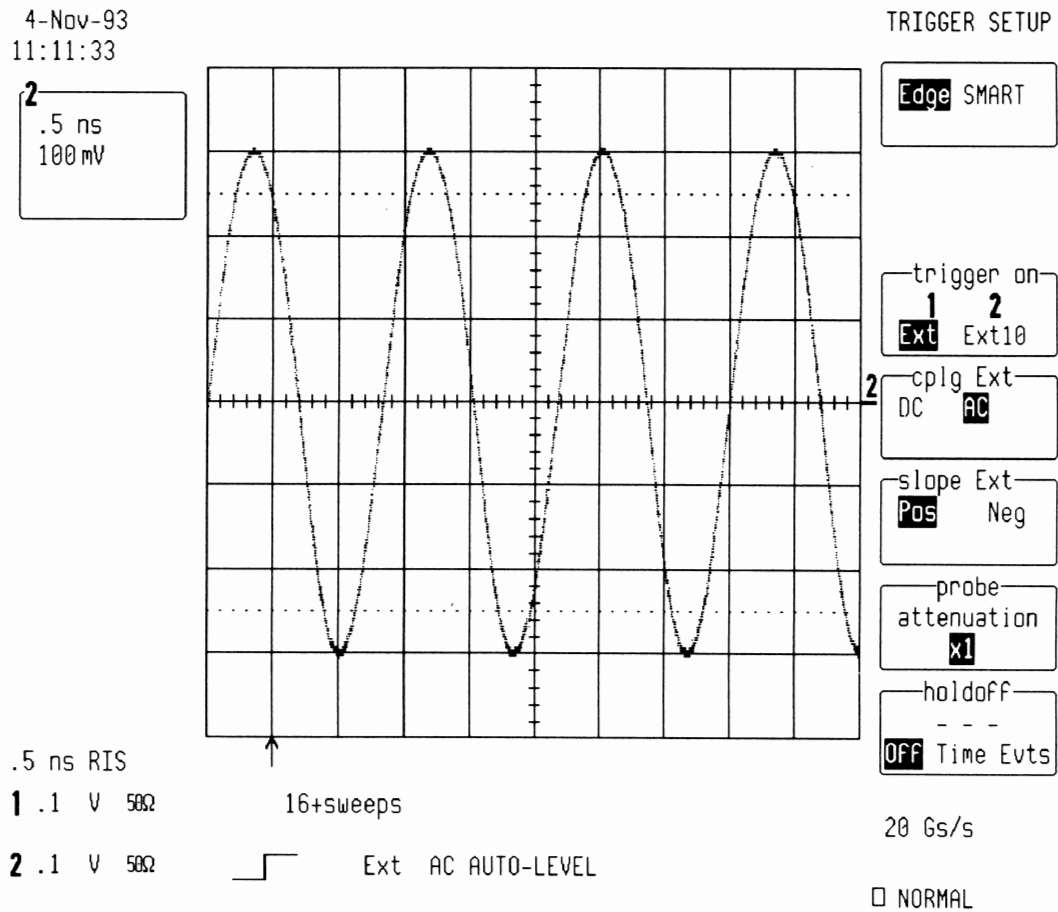

5.10.4 External/10 Trigger Rate

- Repeat the test for External /10, set the DSO and generator's output as follows :

- Input gain Ch2 : .5 V/div
- Trigger on : Ext/10
- Coupling Ext : AC Auto-Level
- Slope Ext : Pos

- Adjust the sine wave generator's output amplitude to get 4 divisions peak to peak, corresponding to a 1 V amplitude.

Check : The scope must keep triggering in a stable way, a smooth 750 MHz sine wave must be visible on the screen.

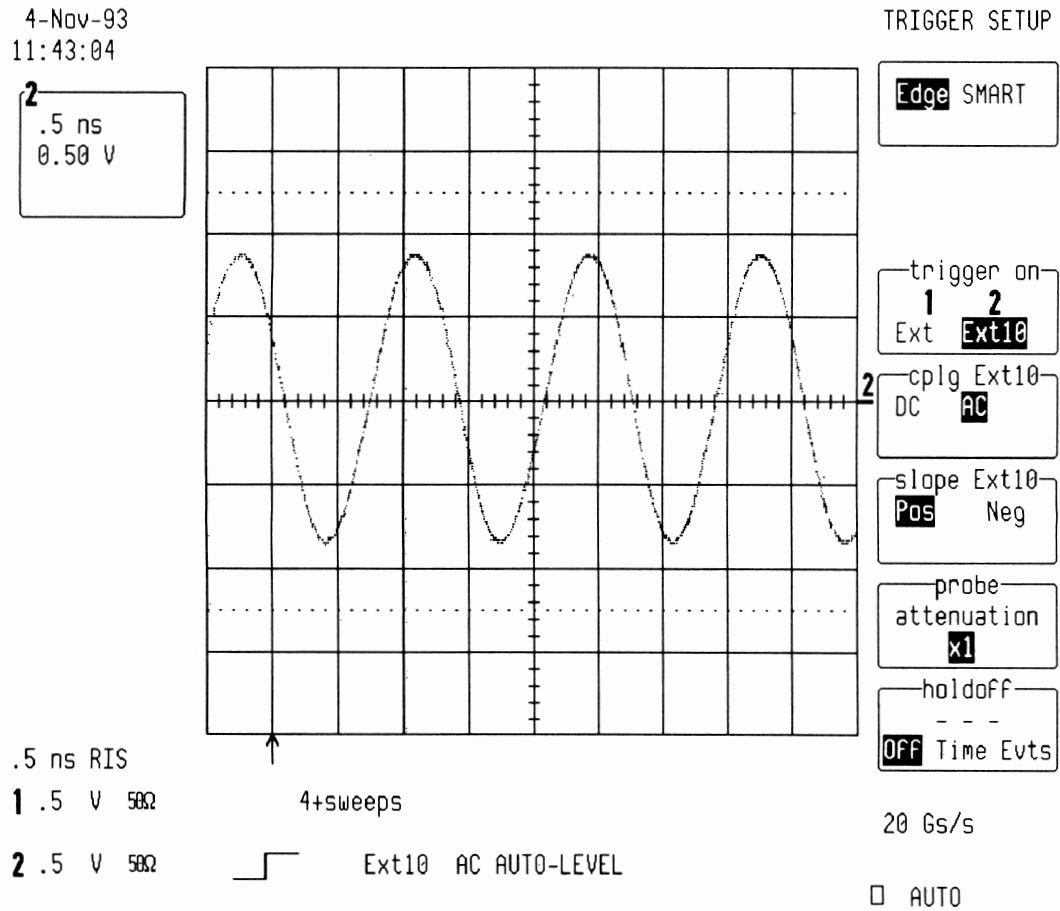

5.10.5 Channel 2 HF Trigger Rate

- Set DSO as follows :

- Turn on trace : Ch2
- Input gain : .1 V/div
- Input offset : 0 mV
- Time/div : .5 ns
- Trigger setup : Edge
- Trigger on : 2
- Coupling 2 : HF

- Set Frequency : 1 GHz

- Adjust the sine wave generator's output amplitude to get 6 divisions peak to peak, corresponding to a 0.3 V amplitude.

Check : The scope must keep triggering in a stable way, a smooth 1 GHz sine wave must be visible on the screen.

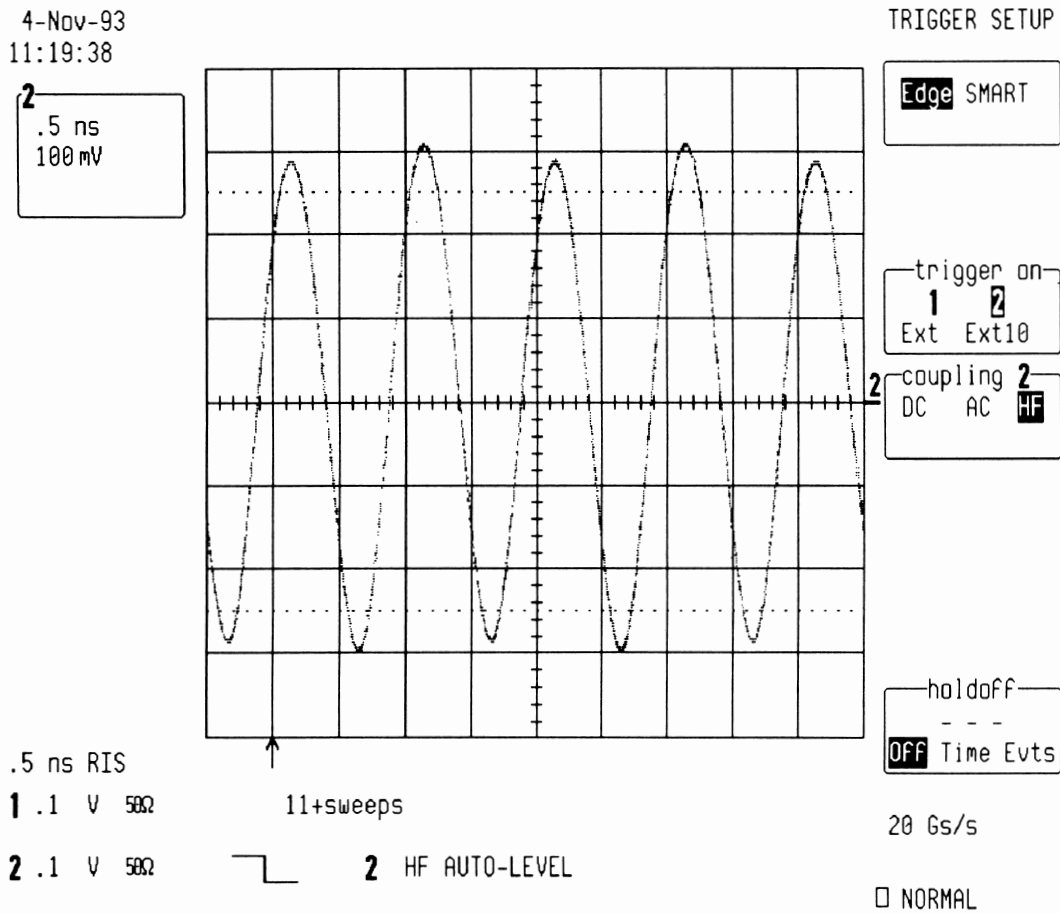

5.11 Smart Trigger

Specification

Pulse width < or > 1 nsec to 1 μ sec in steps varying from 500 psec to 20 nsec.

5.11.1 Trigger on Pulse Width < 10 nsec

Procedure

Setup a leveled sine wave generator.

- Frequency : 100 MHz

Connect the generator output to Channel 1

- Turn on trace : Ch1
- Display setup : Standard, Persistence off, Dot join on, Single grid
- Input coupling : Ch1 : DC 50 Ω
- V/div. offset : Normal
- Probe atten : X1
- Input gain : .5 V/div

- Trigger setup : Smart
- Setup Smart Trigger : Glitch
- Trigger on : 1
- Coupling 1 : DC
- At end of : Neg
- Width : < 10 nsec
- Mode : Norm
- Timebase : 5 nsec/div

- Adjust the generator output amplitude to get a five divisions amplitude sine wave.

Check that the scope triggers

- Switch to Width : > 10 nsec

Check that the scope doesn't trigger : slow trigger and no flashes in box next to normal.

5.11.2 Trigger on Pulse Width > 10 nsec

- Adjust the generator frequency to 40 MHz

Check that the scope triggers

- Switch to Width : < 10 nsec

Check that the scope doesn't trigger : slow trigger and no flashes in box next to normal.

4-Nov-93
11:46:13

1
5 ns
0.50 V
16 mV

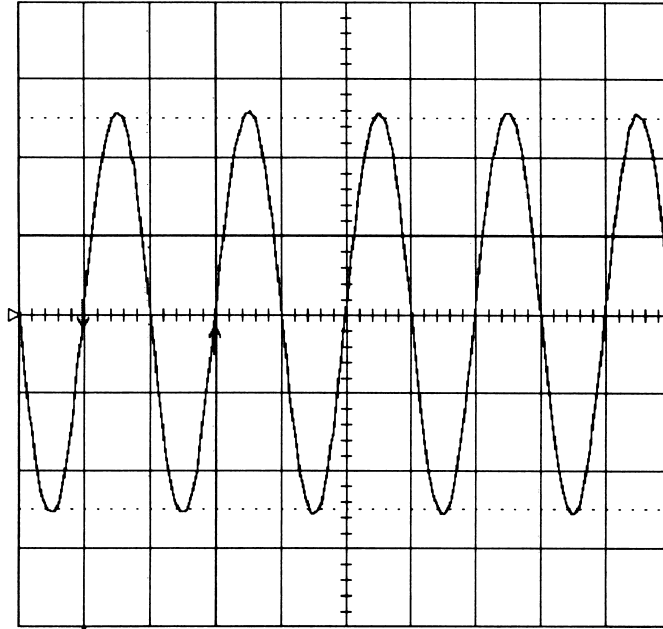

TRIGGER SETUP

Edge **SMART** (GLITCH)

SETUP SMART TRIGGER

trigger on **1** **2** Ext Ext10 Pattern

coupling **1** **DC** AC

at end of **Neg** Pos pulse

width **<** 10.0 ns **>** 10.0 ns

5 ns RIS

1 .5 V 50Ω

Δt 10.000 ns $\frac{1}{\Delta t}$ 100.00 MHz

4 Gs/s

2 .5 V 50Ω



1 DC 0.00 V pulse < 10.0 ns

NORMAL

4-Nov-93
11:47:30

1
5 ns
0.50 V
-12 mV

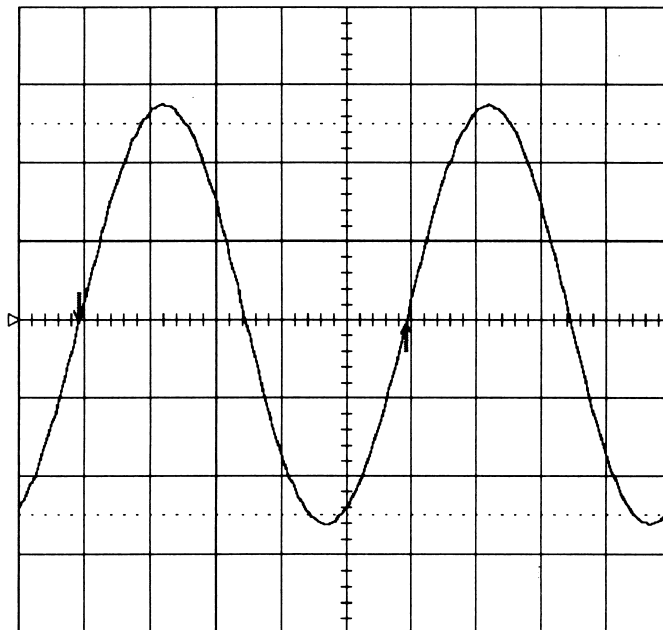

TRIGGER SETUP

Edge **SMART** (GLITCH)

SETUP SMART TRIGGER

trigger on **1** **2** Ext Ext10 Pattern

coupling **1** **DC** AC

at end of **Neg** Pos pulse

width **<** 10.0 ns **>** 10.0 ns

5 ns RIS

1 .5 V 50Ω

Δt 25.000 ns $\frac{1}{\Delta t}$ 40.000 MHz

4 Gs/s

2 .5 V 50Ω

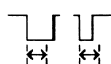

1 DC 0.00 V 10.0 ns < pulse

NORMAL

5.11.3 Trigger on Pulse Width < 100 nsec

- Set the generator frequency to 10 MHz
- Pulse width : < 100 nsec
- Timebase : 20 nsec/div

Check that the scope triggers.

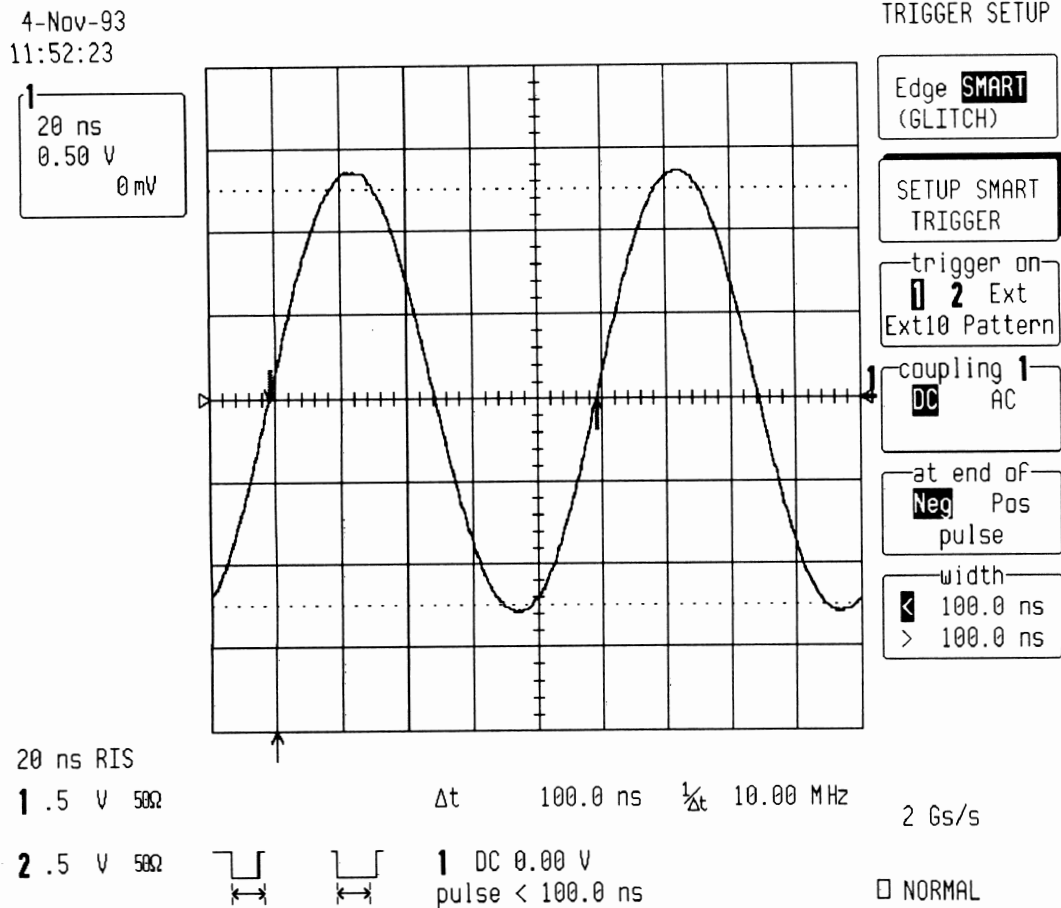

- Switch to Width : > 100 nsec

Check that the scope doesn't trigger : slow trigger and no flashes in box next to normal.

5.11.4 Trigger on Pulse Width > 100 nsec

- Adjust the generator frequency to 4 MHz

- Pulse width : > 100 nsec

- Set Timebase : 50 nsec/div

Check that the scope triggers.

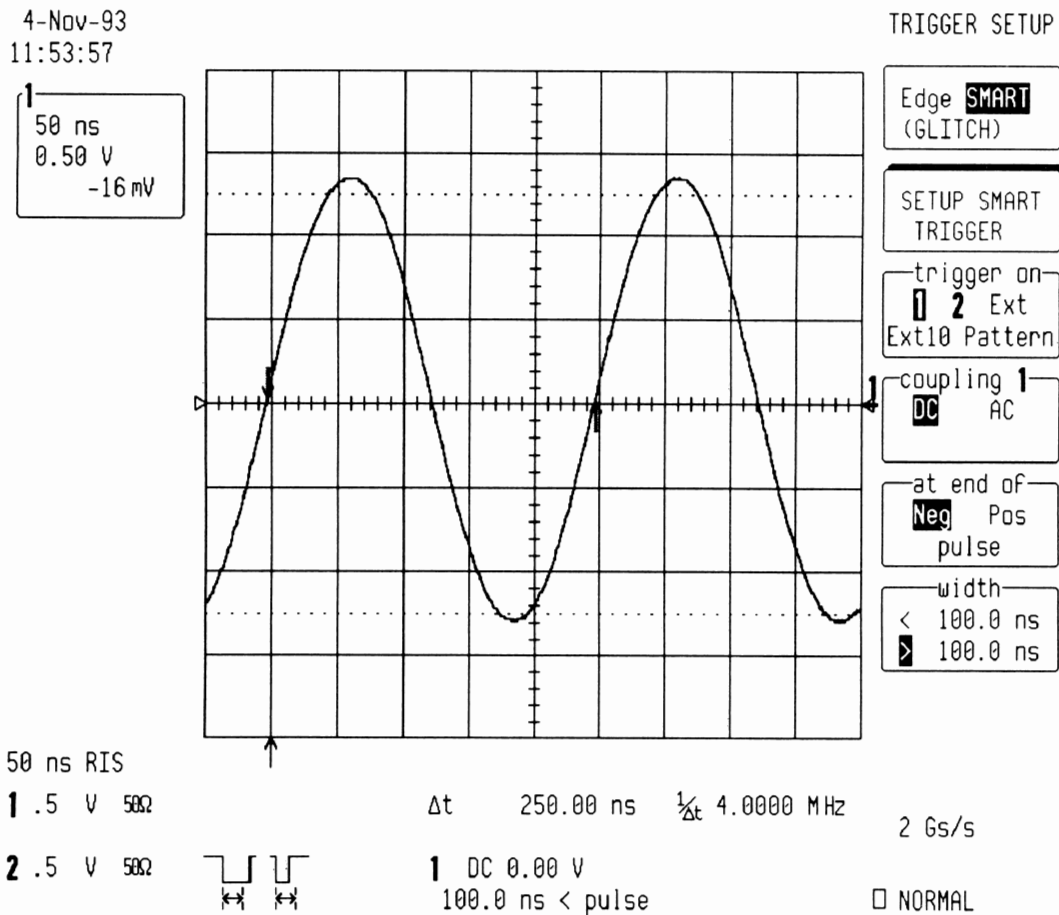

- Switch to Width : < 100 nsec

Check that the scope doesn't trigger : slow trigger and no flashes in box next to normal.

- Repeat all the above tests for Channel 2, substituting channel controls and input connector, and check as above.

5.12 Time Base Accuracy

Specification

Clock accuracy : $\leq \pm 0.0050 \%$ or $\leq \pm 50$ ppm

Description

This test measures the accuracy of the internal 80 MHz clock.

An external sine wave generator of 1 MHz with a frequency accuracy better than $\pm 0.001 \%$ is used.

Manual Time Base Verification Procedure

Setup a leveled sine wave generator.

- Frequency : 1 MHz

Connect the generator output to Channel 1

- Turn on trace : Ch1
- Display setup : Standard, Persistence off, Dot join on, Single grid
- Input coupling : Ch1 : DC 50 Ω
- V/div. offset : Normal
- Probe atten : X1
- Input gain : .5 V/div

- Trigger setup : Edge
- Trigger on : 1
- Coupling 1 : DC
- Slope 1 : Pos
- Mode : Norm
- Holdoff : Off
- Delay : 0 %
- Timebase : .2 μ sec/div

- Cursors/Measure : Off

Adjust the generator output amplitude and Ch1 offset to get a five divisions peak to peak amplitude sine wave.

- Store Channel 1 in memory 1

4-Nov-93
12:00:07

1
.2 μ s
0.50 V
0 mV

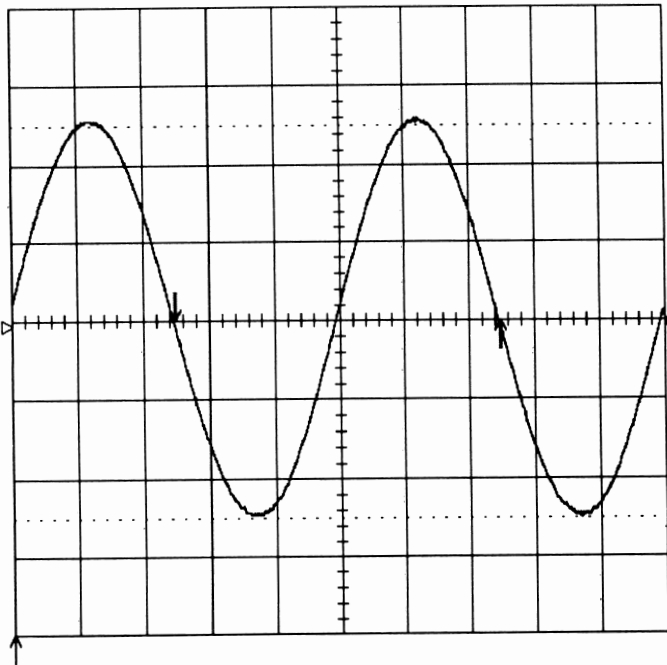

TRIGGER SETUP

Edge SMART

trigger on
0 2
Ext Ext10

coupling 1
DC AC

slope 1
Pos Neg

holdoff
- - -
OFF Time Evts

.2 μ s RIS
1 1.5 V 50 Ω
2 1.5 V 50 Ω

Δt 1.000 μ s $\frac{1}{2}\Delta t$ 1.000 MHz
1 DC -0.03 V

2 Gs/s

NORMAL

4-Nov-93
12:00:38

1
.2 μ s
0.50 V
0 mV

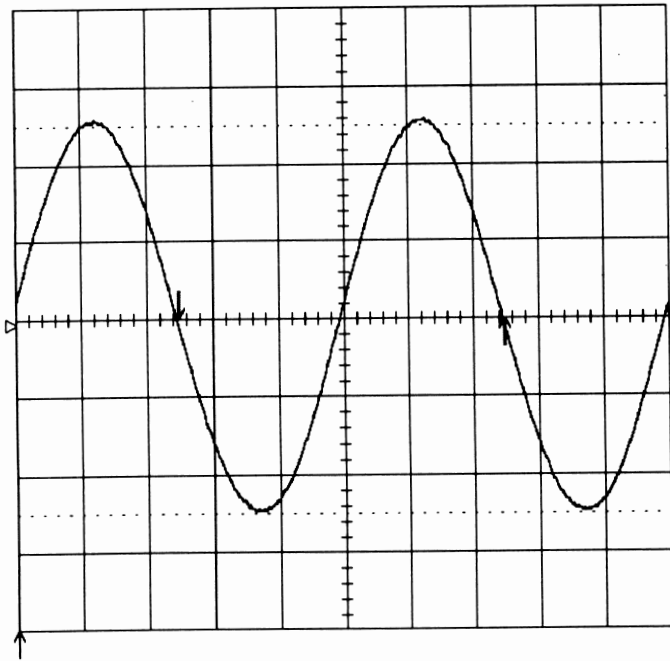

STORE W'FORMS

DO STORE
(1->M1)

store
0 2
A B
C D
All displayed

to
M1 M2 M3 M4
Card

.2 μ s RIS
1 1.5 V 50 Ω
2 1.5 V 50 Ω

Δt 1.000 μ s $\frac{1}{2}\Delta t$ 1.000 MHz
1 DC -0.03 V

2 Gs/s

NORMAL

- Set Post-trigger delay to 1.0000 msec

4-Nov-93
12:01:58

STATUS

ACQUISITION STATUS

	1	2
Vertical		
V/div	.5 V	.5 V
Probe	x1	x1
Offset	0 mV	0 mV
Coupling	DC50Ω	DC50Ω

Acquisition
System
Text & Times
Waveform

Bandwidth Limit OFF

Time base
Time/div .2 μs Time/pnt .5 ns (2 Gs/s)
RIS ON, typically needs 520 triggers for 100 bins

Trigger Edge Mode NORMAL

 1 DC -0.03 V

Post-trigger Delay 1.00000 ms 2 Gs/s

The currently preselected Smart Trigger type is
GLITCH NORMAL

This allows the accuracy of the time base clock to be checked 1000 periods after the trigger point.

- Recall memory 1 to A

- Turn on trace A

Check that the displayed Channel 1 trace is aligned with the sine wave from memory 1.

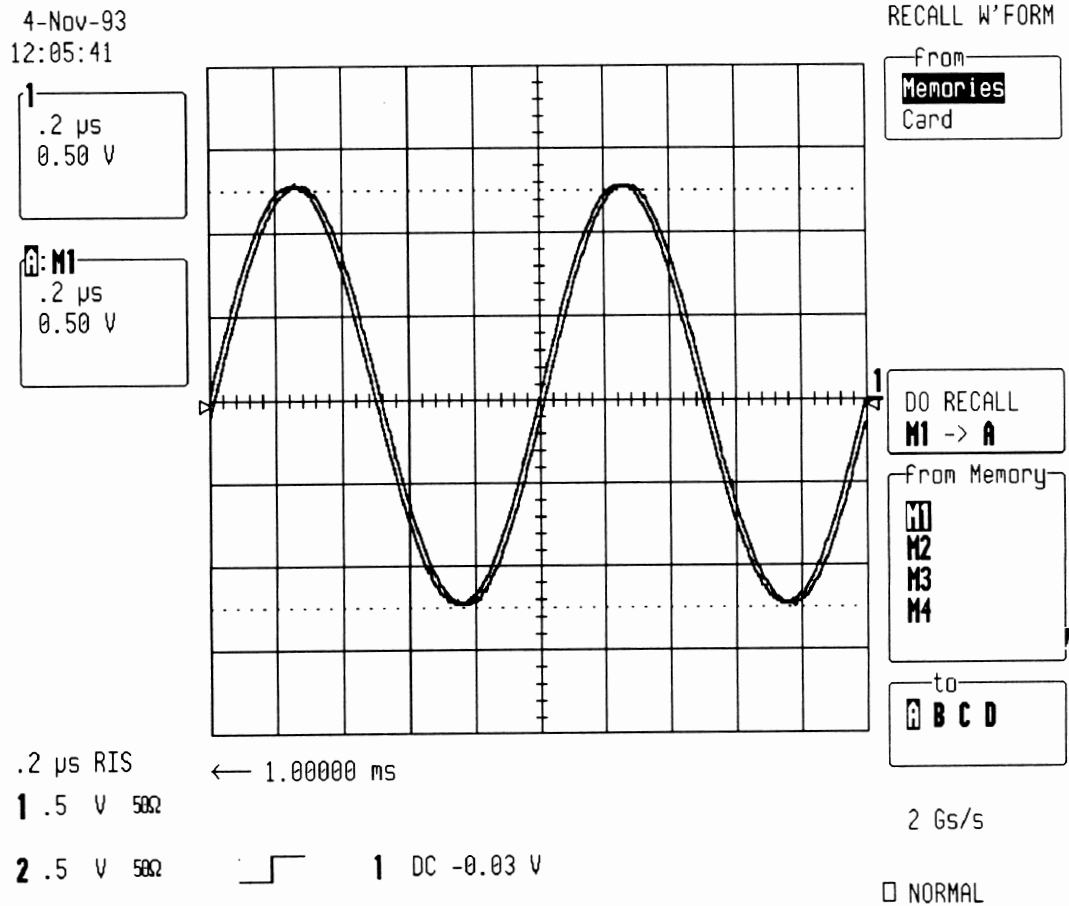

- Press : Cursors/Measure
- Measure : Parameters
- Mode : Custom
- Statistics : On

- Change parameters

- On line 1 : Delay of 1
- On line 2 : Delay of A

Check that (delay(A) - delay(1) + 1 msec) \leq \pm 0.00005 msec corresponding to 50ppm.

Section 5 Performance Verification

4-Nov-93
12:06:57

1
.2 μ s
0.50 V

A: M1
.2 μ s
0.50 V

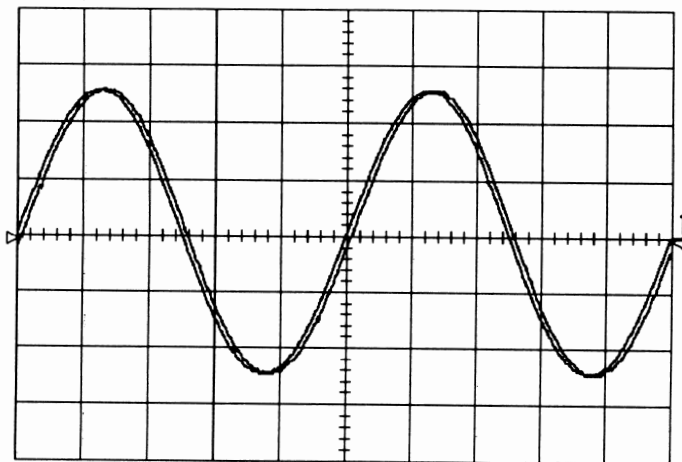

18 sweeps: average low high sigma

delay(1)	1.00052 ms	1.00052	1.00052	0.00000
delay(A)	500.90 ns	500.90	500.90	0.00

CHANGE PARAM

On line
1 2 3 4 5

DELETE ALL PARAMETERS

measure
base
cycles
delay
 Δ dly
 Δ t@lv

of
1 2
A B C D

.2 μ s RIS
1 1.5 V 50 Ω
2 1.5 V 50 Ω

1 DC -0.03 V

2 Gs/s

NORMAL

A difference of $\pm 0.05 \mu$ sec corresponds to ± 50 ppm. See screen dump below :

4-Nov-93
12:08:28

1
.2 μ s
0.50 V

A: M1
.2 μ s
0.50 V

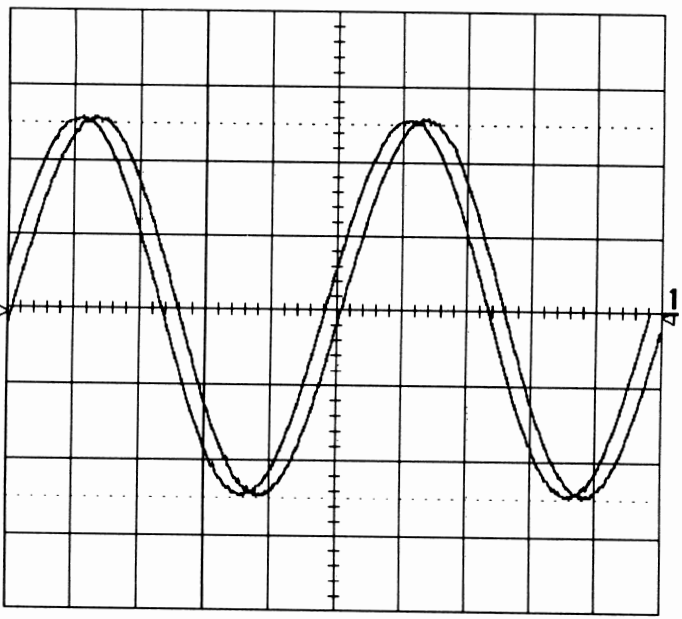

← 1.00000 ms

.2 μ s RIS
1 1.5 V 50 Ω
2 1.5 V 50 Ω

1 DC -0.03 V

2 Gs/s

NORMAL

5.13 Overshoot Verification

Specification

Overshoot < 10 %

Description

The probe calibrator with a frequency of 2 MHz is applied to the input channel.

Overshoot Verification Procedure

- Connect the Probe Calibrator output to Channel 1, using a 5 nsec BNC cable.

- Select : Utilities
- Press : Cal BNC Setup
- Mode : Cal signal
- Set Frequency : 2 MHz

- Turn on trace : Ch1
- Display setup : Standard, Persistence off, Dot join on, Single grid
- Input coupling : Ch1 : DC 50 Ω
- V/div. offset : Normal
- Probe atten : X1

- Input offset : - 140 mV
- Input gain : 50 mV/div

- Trigger setup : Edge
- Trigger on : 1
- Trigger level : DC 140 mV
- Coupling 1 : DC
- Slope 1 : Neg
- Mode : Normal
- Holdoff : Off

- Timebase : 1 nsec/div
- Delay : 50 % Pre-Trigger

- Cursors/Measure : Parameters
- Mode : Custom
- Statistics : On
- Change Parameters :
- On line 1 : Over - of Channel 1

Check that the Overshoot is < 10 %

4-Nov-93
12:30:13

1 ns
50 mV

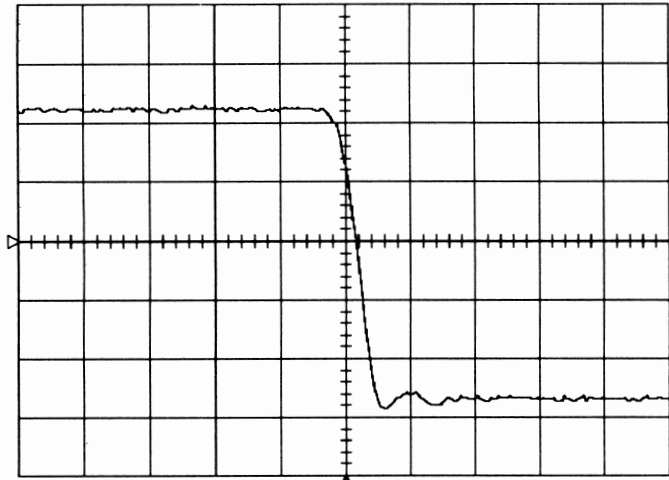

CAL BNC OUT

mode
CAL signal
OFF
Pass/Fail
Trigger Out

SET TO 1 KHz
0.5 V SQUARE

20 sweeps: average 4.1% low 3.3 high 4.8 sigma 0.4
over-(1)

Frequency
2 MHz

1 ns RIS

1 50 mV 50Ω

2 .5 V 50Ω



1 DC 140 mV

20 Gs/s

□ NORMAL

5.14 Probe Calibrator Verification

Specification

Amplitude : 250 mV into 50 Ω
Frequency : 500 Hz to 2 MHz
Rise time : typically 750 psec
Fall time : typically 500 psec
Flatness : < 1 %

Probe Calibrator Verification Procedure

- Connect the Probe Calibrator output to Channel 1, using a 5 nsec BNC cable

- Select : Utilities
- Press : Cal BNC Setup
- Mode : Cal signal
- Set Frequency : 500 Hz

- Turn on trace : Ch1
- Display setup : Standard, Persistence off, Dot join on, Single grid

- Input coupling : Ch1 : DC 50 Ω
- V/div offset : Normal

- Probe atten : X1
- Input offset : - 140 mV
- Input gain : 50 mV/div

- Trigger setup : Edge
- Trigger on : 1
- Trigger level : DC 140 mV
- Coupling 1 : DC
- Slope 1 : Neg
- Mode : Normal
- Holdoff : Off

- Timebase : .5 msec/div

- Delay : 10 % Pre-Trigger

- Cursors/Measure : Cursors
- Mode : Time
- Type : Relative

Check that the frequency is 500 Hz, and the amplitude 250 mV.

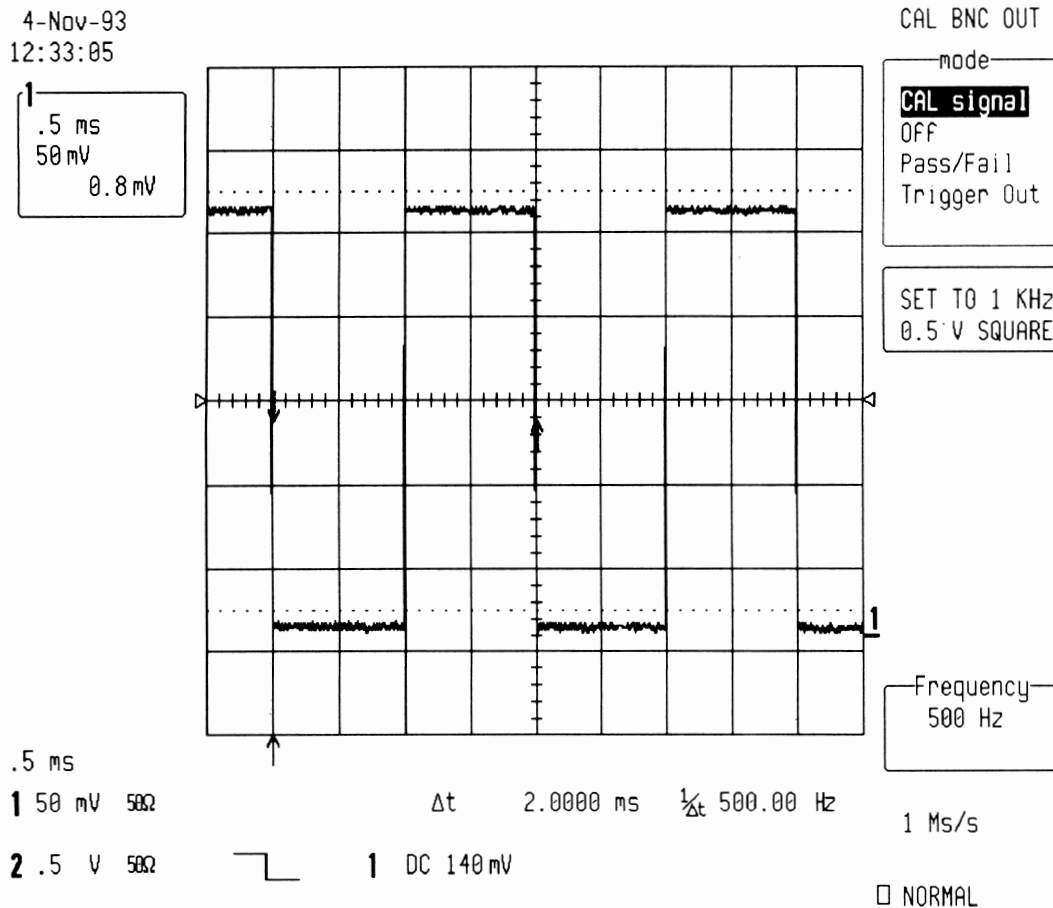

- Set frequency to 1 KHz and check correct amplitude and frequency.

Section 5 Performance Verification

- Set frequency : 2 MHz
- Trigger Slope 1 : Pos
- Mode : Normal
- Timebase : 1 nsec/div
- Delay : 50 % Pre-Trigger

- Cursors/Measure : Parameters
- Mode : Custom
- Statistics : On
- Change Parameters :
- On line 1 : Rise of Channel 1

Check that the rise time is typically < 750 psec

4-Nov-93
12:34:36

1
1 ns
50 mV

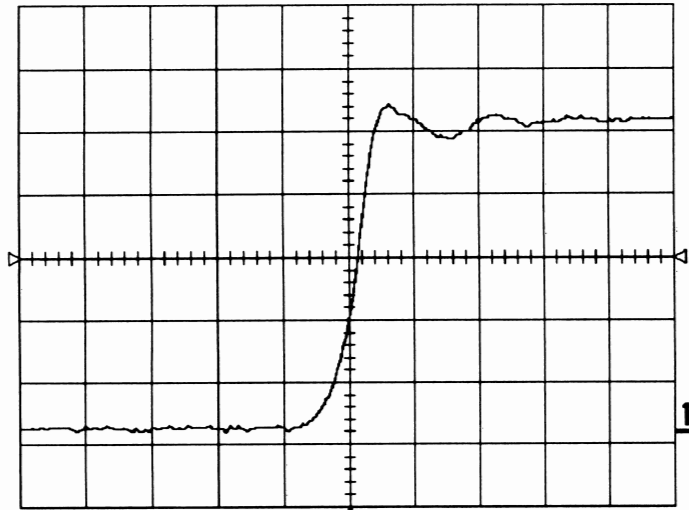

4 sweeps: average low high sigma
rise(1) 0.69 ns 0.69 0.70 0.01

CHANGE PARAM

On line
1 2 3 4 5

DELETE ALL
PARAMETERS

measure
pkpk
points
rise
r20-80%
r@level

of
1 2
A B C D

1 ns RIS
1 50 mV 50Ω
2 .5 V 50Ω



1 DC 140 mV

20 Gs/s

NORMAL

- Select Trigger Slope : Neg
- Change Parameters :
- On line 1 : Fall of Channel 1

Check that the fall time is typically < 500 psec

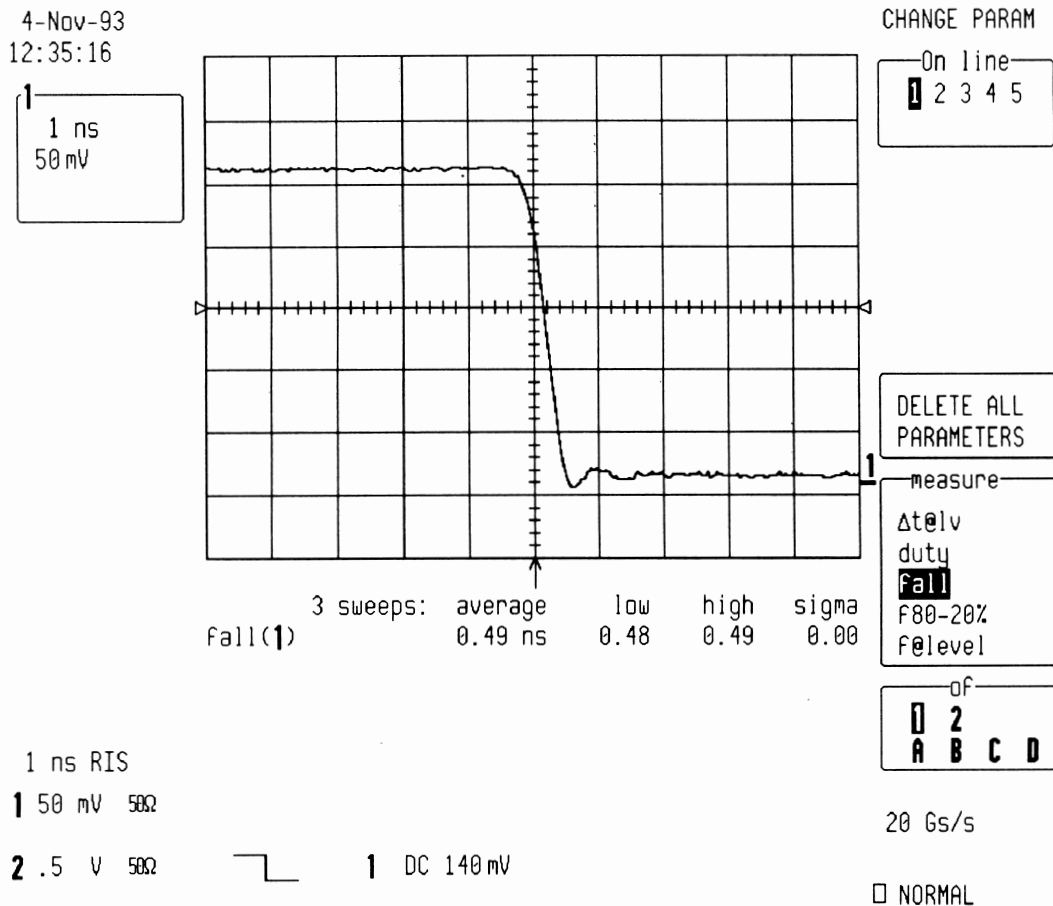

- Set frequency : 500 Hz
- Trigger Slope 1 : Pos
- Timebase : .1 msec/div
- Delay : 10 % Pre-Trigger
- Turn on trace : A
- Select Math Setup
- For Math : Use at most 5000 points
- Redefine A
- Use Math ? : Yes
- Math Type : Average
- Avg Type : Summed
- Of : Channel 1
- Turn off trace : Channel 1

Section 5 Performance Verification

- Cursors/Measure : Cursors
- Mode : Time
- Type : Relative

- Move the reference and difference cursors as shown below.

- After 1000 sweeps readout the amplitude. i.e : 248.56 mV

4-Nov-93
12:39:07

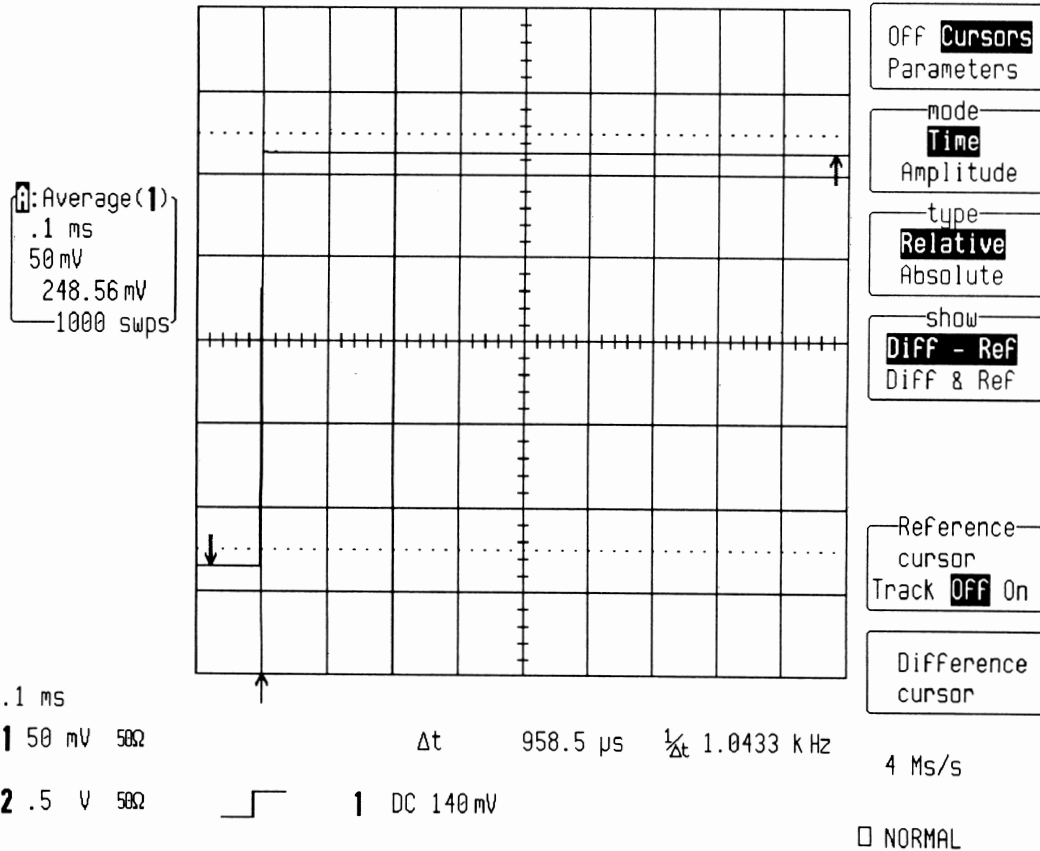

- Change vertical position of zoom, and place trace A in the middle of the screen.

- Expand A with vertical Zoom up to 2 mV

- Move the reference and difference cursors as shown below.

- Readout the amplitude. i.e : - 0.21 mV

4-Nov-93
12:40:52

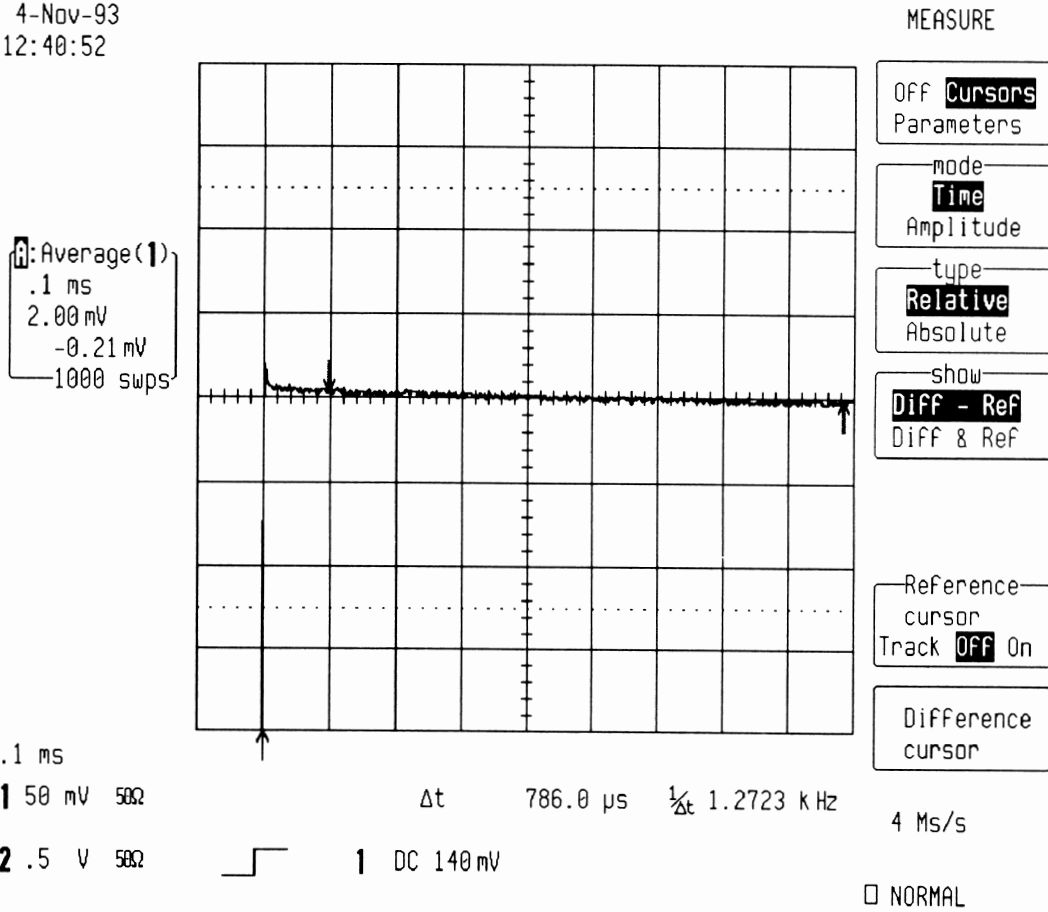

- Calculate the non flatness in % of the signal amplitude

$$\text{i.e. : } (-0.21 \text{ mV} - 248.56 \text{ mV}) : 248.56 \text{ mV} = -0.01 \%$$

Flatness must be $< \pm 1\%$

SECTION 6 INTERNAL CALIBRATION and DIAGNOSTICS

6.1 Introduction

The 9320 internal calibration and diagnostics menu is entered by simultaneously depressing the third and fourth menu push buttons on the right hand side of the CRT and then by depressing the fifth.

To quickly check the performance of the 9320 oscilloscope, select the calibration diagnostics.

Press the recalibrate completely button to do a full recalibration of the front end. it is advisable to perform this type of check when the scope is in a stable condition.

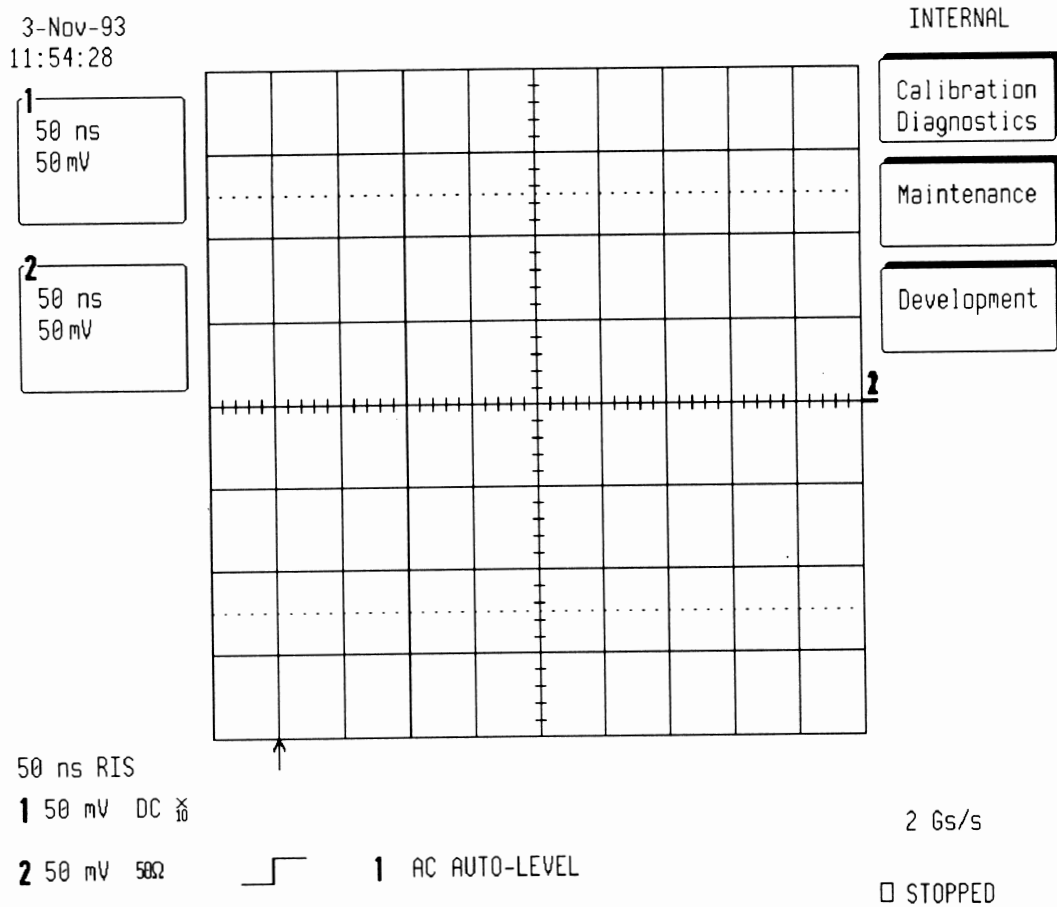

6.2 Diagnostic Summary

Press diagnostic summary.

This is a handy tool to perform a quick but comprehensive internal performance check, without touching the acquisition settings. The failures are indicated by channel identifiers.

If no problem is detected, the fields are left blank.

3-Nov-93
11:13:19

Calibration Diagnostic Summary

Gain and Offset Calibration:

	Gain	OFF2	Acc	Resid
ADC zero reading				
gain measurement				
gain is negative				
gain control range				
offset control range				
Final gain setting				
Final offset setting				

Trigger Level Calibration:

control
hysteresis

CALIBRATION

Diagnostic
Summary

Diagnostic
Results

Diagnostic
Measurements

Recalibrate
Completely

Failures are indicated by channel identifiers. Fields are left blank if no problem detected or a failure occurred previously.

Monitor: rc 6; 1: Δg -37, Δo 0 □

The gain and offset calibration results displayed for Channel 1 and Channel 2 are independent of the following conditions:

- Time base
- Trigger mode and coupling
- Variable gain
- Offset

6.2.1 Gain and Offset Calibration Description

- ADC zero reading : Failed to get 0 reading from ADC for some choice of Vgain, CAL signal, and Voff2 while varying the Offset
- Gain measurement : Failed to measure gain, the gain was not what was expected.
- Gain is negative : Measured a negative Gain or broken channel.
- Gain control range : Gain - the available range didn't include the interval (0.95*0.005, 1.05*0.025) V/div
- Off2 - Voff2 couldn't not be chosen so as to give $|ADC| < 1$ div
The shape of the offset curve is unreasonable.
- Acc - the 3 points used for the gain measurement didn't lie on a straight line.
- Offset control range : Not used
- Final gain setting : Gain - An error is detected if the Gain adjustment didn't converge to desired Gain.
- Off2 - the attenuators didn't agree with the board test.
- Final offset setting : An error is detected if the 3 Offset calibration points didn't lie on a straight line.

6.2.2 Trigger Level Calibration

The control of the trigger hysteresis is done in the trigger mode DC and AC.
If an error occurred 1, 2, or E is displayed corresponding to Channel 1, Channel 2, or External.

- Control : Failed if no transition of discriminator observed when stepping the treshold level.
- Hysteresis : Failed to get hysteresis in range 1-6 mv @ 10 mv/div

6.3 Diagnostic Results

6.3.1 Gain Curves

- Press diagnostic results
- Select results for gain
- Press recalibrate completely
- Select show results for Channel 1

Variable gain range, checked by software must be better than 0.005 to at least 0.026.
With regards to the illustration, the lower portion of the curve must extend below 0.005 limit, and the upper portion above the 0.026 limit.

If this is not true the Gain control range summary shows a violation for Channel 1. The maximum and minimum gain factors are displayed.

The attenuator values measured in board test are shown. The check value should be near 1.000. If it deviates significantly the Final Gain summary shows an Off2 violation.

The offset curve @ 10 mv/div is also given. A significant deviation of the a2 value gives a Gain control range Off2 error in the summary.

Repeat the test for Channel 2.

3-Nov-93
11:13:41

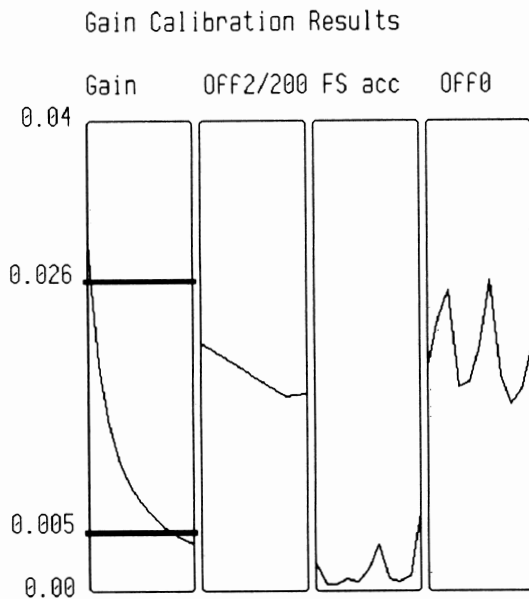

maximum factor	0.0298	Attenuator	4.6750	check	0.9962
minimum factor	0.00403	Attenuator	21.9020	check	0.9838
@10mv/div lump(mv)	15.15	a2	-0.12005		

CALIBRATION

1

Diagnostic Summary

Results for
Gain
Trigger Level

Diagnostic Measurements

Recalibrate Completely

Show Result For Channel
1 2

Monitor: rc 7; 1: Δg -24, Δa 0 □

6.3.2 Trigger Level Calibration

- Select results for trigger level

For Channel 1 and Channel 2 the hysteresis value is given in Volt. The trigger range is ± 0.5 V for the steep curve. The boxed region is zoomed to give the two lines with a vertical scale of ± 0.1 V.

The DAC voltages used for the AC AUTOLEVEL triggers are given. The slope and offset of the curve relating trigger threshold to DAC setting are given.

- Press recalibrate completely

The hysteresis in V should be 0.0035 ± 0.0025

3-Nov-93
11:14:04

Trigger Level Calibration Results

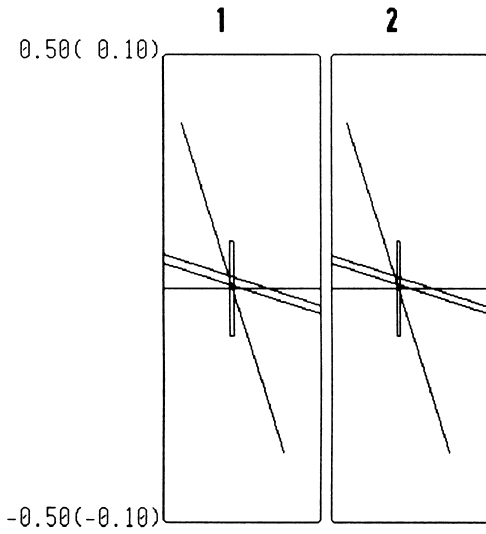

hysteresis [V]	0.0037	0.0032
offset [V]	-0.0621	-0.0803
ACslope+ [V]	0.243	0.194
ACslope- [V]	0.335	0.262
g1 [dac-v/level]	-0.479	-0.479

Monitor: rc 7; 1: Δg -24, Δo 0

CALIBRATION

Diagnostic Summary

Results for Gain
Trigger Level

Diagnostic Measurements

Recalibrate Completely

□

6.3.3 Integral Linearity

- Press diagnostic measurements
- Select integral linearity

The curve should be within the $\pm 0.02 * FS$ bars, for offset = 0.0 V.

3-Nov-93
11:14:29

MEASUREMENTS

Integral Linearity Curve

1

Integral Linearity

Gain 0.1000 [V/div] Offset -0.2500 [V]

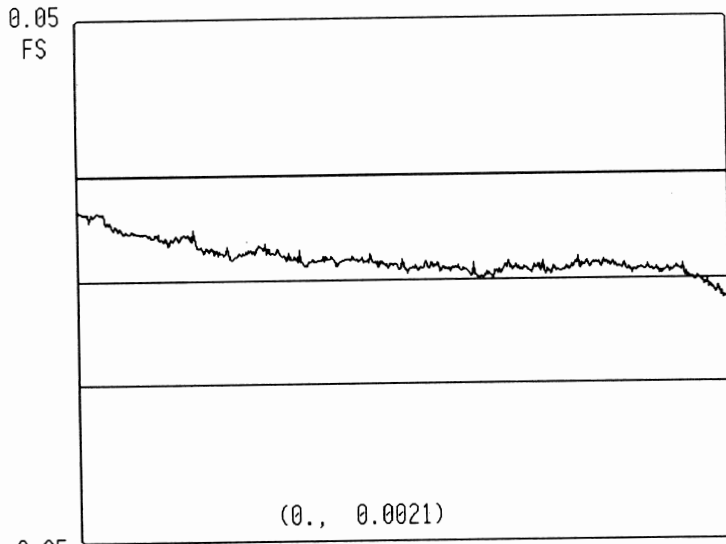

Level

Measure for Channel
2

ig 0.0214, ioF -0.053, vg -8.567, voF -0.561, vo2 4.12, vc 2.78
lump(mv) 13.97 a2 -0.12012

□

Repeat the test for Channel 2.

- Press level

The three plots show raw ADC data displayed around their mean value for 3 different CAL levels.

The data should be narrow and random.

The theoretical level is shown by the second horizontal line which should be near (< 4 steps) to the measured value for Offset = 0.

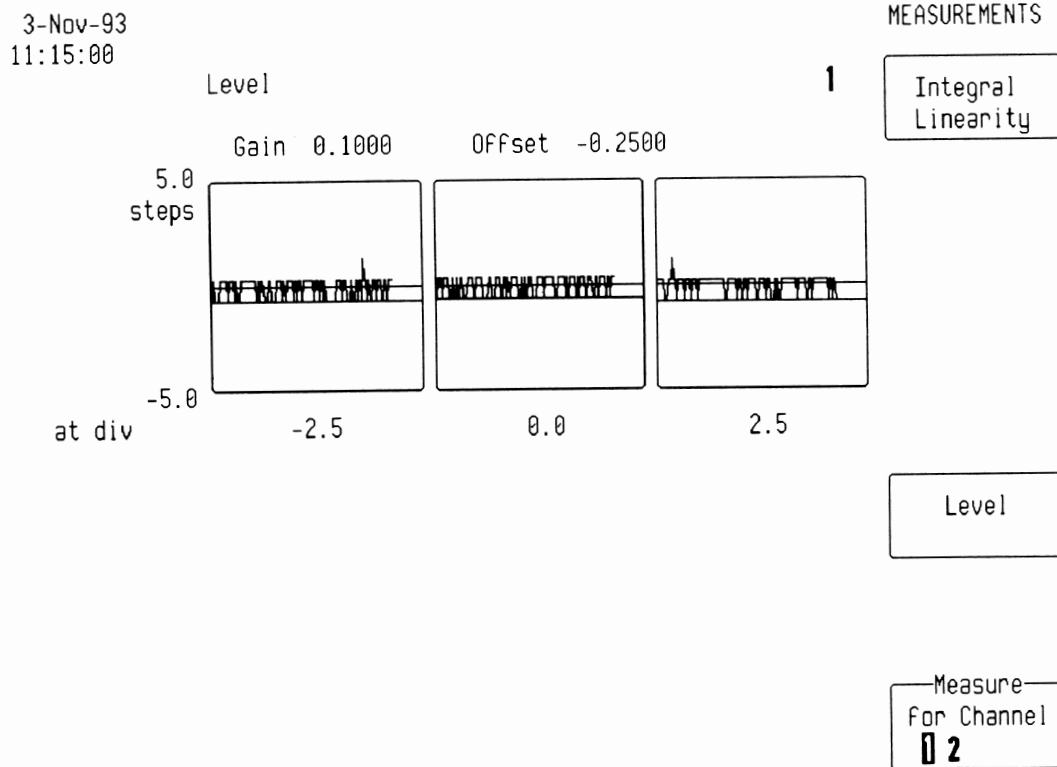

Repeat the test for Channel 2.

6.4 Board Test Results

- From the Internal menu press Maintenance
- Select Board Test Results

This menu displays the board calibration measured at the factory, the calibration values are loaded in the I2C Prom.

3-Nov-93
11:15:27

WA-Cont:starting when stopped

MAINTENANCE

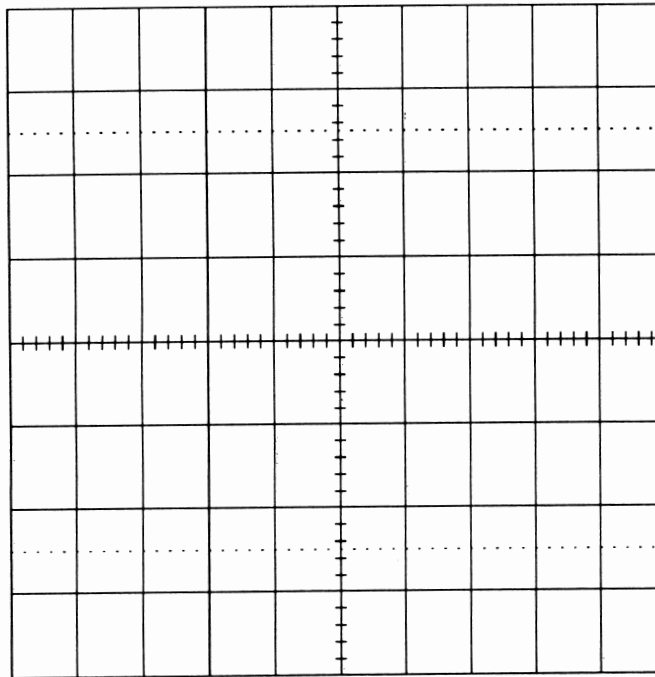

- Reset Panels
- Font Table
- Hard State
- Board Test Results
- Probe ADC Data

5 ns RIS

1 .1 V 50Ω

2 .1 V 50Ω



2 DC 6 mV

4 Gs/s

AUTO

6.4.1 Header

The header block indicates the following information :

- The revision of the printed circuit board : i.e Rev C
- The engineering change order level : i.e ECO 1003
- The work order number : i.e WO 9339-0004
- The tested date : i.e tested 1993-10-04 it should be : \geq 1993-xx-xx.
If the date says 1990-04-01 it is a sign that the I2C prom on the -3 board could not be read correctly.

6.4.2 Time

- ITCAL is the 16 bit DAC setting of the TDC interpolator for 10 psec resolution.
i.e : 95E9
- CAL represents the DAC setting for the three following values : -.4 V, 0.0 V, +.4 V
i.e : -.4 V = E6BE, 0.0 V = 8010, +.4 V = 1961

3-Nov-93
11:21:33

Board Test

Header: block lengths 20 114 12 Test version 56 2 chans
Rev: C, ECO 1003, WO 9339-0004, Tested: 1993-10-04 14:20

Time: itcal 95E9 CAL -0.4v E6BE 0.00v 8010 +0.4v 1961
Trigger: External offset 7646 slope 00A8 hysteresis 0074
atten*1000 4660
low Glitch: 1 2 3 5 7 10 15 20 32 50
0000 670B 87DD 9688 9B7C 9F24 A25A A3D9 A57E A677
high Glitch: 50 70 100 150 225 325 475 700 1000 10000
974B 9C10 9FAA A274 A454 A57F A655 A6EA A749 A818
Trigger times: Edge Pattern HiFreq Points
-1785 -1910 -1813 1 1 1
Icomp gains(mv/div*5): 20 25 50 100 125 200
Vertical: off1 Atten*1000 icomp-dac * 6
8173 4675 21902 71 92 107 133 164 184
81A3 4690 21770 71 92 107 133 164 184

□

6.4.3 Trigger

- External offset represents the 16 bit DAC setting for 0 V threshold of the external trigger, positive slope. i.e : 7646.
- Slope is the DAC change of setting for a 10 mV threshold change
- Hysteresis is the 16 bit DAC settings correspond to the Hysteresis value. i.e : 0074.
- Atten *1000 is the attenuator value * 1000 of the external trigger /10
i.e : 4660.
- Low glitch and High glitch are the calibration values of the fast glitch trigger.
low glitch : DAC settings for the range 1 nsec up to 50 nsec.
high glitch : DAC settings for the range 50 nsec up to 10000 nsec.

6.4.4 Trigger Times

- Edge is the time correction with a step of 10 psec, when the trigger is set to Edge.
i.e : -1785.
- Pattern is the time correction with a step of 10 psec, when the trigger is set to Pattern.
i.e : - 1910.
- Hifreq is the time correction with a step of 10 psec, when the High frequency trigger mode is set. i.e : -1813.

6.4.5 Current

- Icomp gains (mV/div*5) give the gain value used for the ICOM-DAC measurements that follow.
These are : 4 mV, 5 mV, 10 mV, 20 mV, 25 mV, and 40mV/div.

6.4.6 Vertical Offset and Gain

- Off1 is the DAC settings of the offset value set to zero, for Channel 1 and Channel 2.
- The first column represents the offset values of Ch1, Ch2 with no attenuator.
- The second column is the value * 1000 of Ch1, Ch2, ÷ 5 attenuator.
- The third column is the value * 1000 of Ch1, Ch2, ÷ 20 attenuator.
- ICOM-DAC * 6 represents the DAC settings of Channel 1 and Channel 2 of the buffer amplifier to get 4 mV, 5 mV, 10 mV, 20 mV, 25 mV, and 40 mV.

6.5 Probe Bus Verification

- From the Internal menu press Maintenance
- Select probe ADC data

This menu displays the probe bus and probe ring status.

With no probe connected to the input, check that the menu indicitates:
physical channel a, b, c, d, ext = 251 ± 3 .

```
20-Oct-93                                     Probe PROM
 6:14:06
Physical channel a    251
Physical channel b    252
Physical channel c    252
Physical channel d    251
Physical channel ext  252

ADC values: CAL 252, MON 125, Temperature 89 = 27 C

Interrupts since start-up:
a :2 b :0 c :0 d :0 ext:0 cal:0 mon:0 T :11
```

Connect a AP020 LeCroy active probe on channel 1 and check :

- the probe is identified on physical channel c
- the physical channel c readout has changed to 21
- an interrupt has been detected on c :

```

3-Nov-93                                     Probe PROM
11:53:59
Physical channel a      252
Physical channel b      253
Physical channel c      21 AP020
      108  41 5030 3230  406 9316  21 1106 4120  0
      1506 3dcc cccd 210a 400F 117b 388F 1091 220b c000
      0 4000  0 124 701 4642 100 3406  10  42
      3604 204 4106 3204 48F5 a0FF
Physical channel d      252
Physical channel ext    252

ADC values: CAL  253, MON  225, Temperature  90 =  28 C

Interrupts since start-up:
a :0 b :0 c :11 d :6 ext:0 cal:0 mon:0 T :2

```

Connect a LeCroy passive probe with probe ring i.e PP002 on channel 1 and check :

- the probe X10 is identified on physical channel c
- the readout of physical channel c has changed to 195
- an interrupt has been detected on c :

```

3-Nov-93                                     Probe PROM
11:58:17
Physical channel a      252
Physical channel b      253
Physical channel c      195 x10
Physical channel d      252
Physical channel ext    252

ADC values: CAL  253, MON  225, Temperature  90 =  28 C

Interrupts since start-up:
a :0 b :0 c :13 d :6 ext:0 cal:0 mon:0 T :2

```

Repeat the tests for Channel 2 and External Trigger. Check that the probe is identified on physical channel d or ext.

SECTION 7 MAINTENANCE**7.1 Introduction**

This section contains information necessary to disassemble, assemble, maintain, calibrate and troubleshoot the LeCroy 9320 oscilloscope.

7.2 Disassembly and Assembly Procedure

The disassembly and assembly procedures detailed below refer to the assembly and disassembly diagram 7.2.3, and the view of figures 7.1, 7.2, 7.3, 7.4, 7.5 and 7.6. Please study the diagram and figures before attempting disassembly.

WARNING

Before removing any parts from the LeCroy 9320, be sure to read carefully the instructions referring to those parts, noting any precautions needed to avoid problems caused by mechanical behavior, high voltage supplies, etc.

CAUTION

The usual precautions against static electricity are required, (see 1.10)

7.2.1 Removal of the Upper Cover (5.10)

The top cover (5.10) is secured by two M4x5 screws (5.12) on both sides of the front panel assembly (2), and by two M4x8 screws (5.11) on the rear panel (3). Remove the screws and carefully slide the cover off the unit to the rear. Removal of the top cover gives access to the boards and parts listed in section 7.2.3.

7.2.2 Removal of the 93XX-PS 1715 Power Supply (4)**WARNING**

Ensure the line cord is disconnected. Remove the following:

- Top cover (7.2.1).
- One M4X8 screw (5.2) from left side of the bottom cover (1.1).
- Two M4X8 screws (5.1) from left side of the rear panel (3).

Disconnect the following:

- Base card power cable (5.9) from connector J601.
- PS1715 line input cable (3.17) from connector J6.

The power supply can now be removed vertically from the oscilloscope.

7.2.3 Disassembly and Assembly Diagram

Disassembly : If it becomes necessary to replace a board or a part, use the disassembly diagram to disassemble the unit. Any board can be removed if items higher in the diagram and connected by a line are already out.

Assembly : Reassemble the unit in the reverse order.

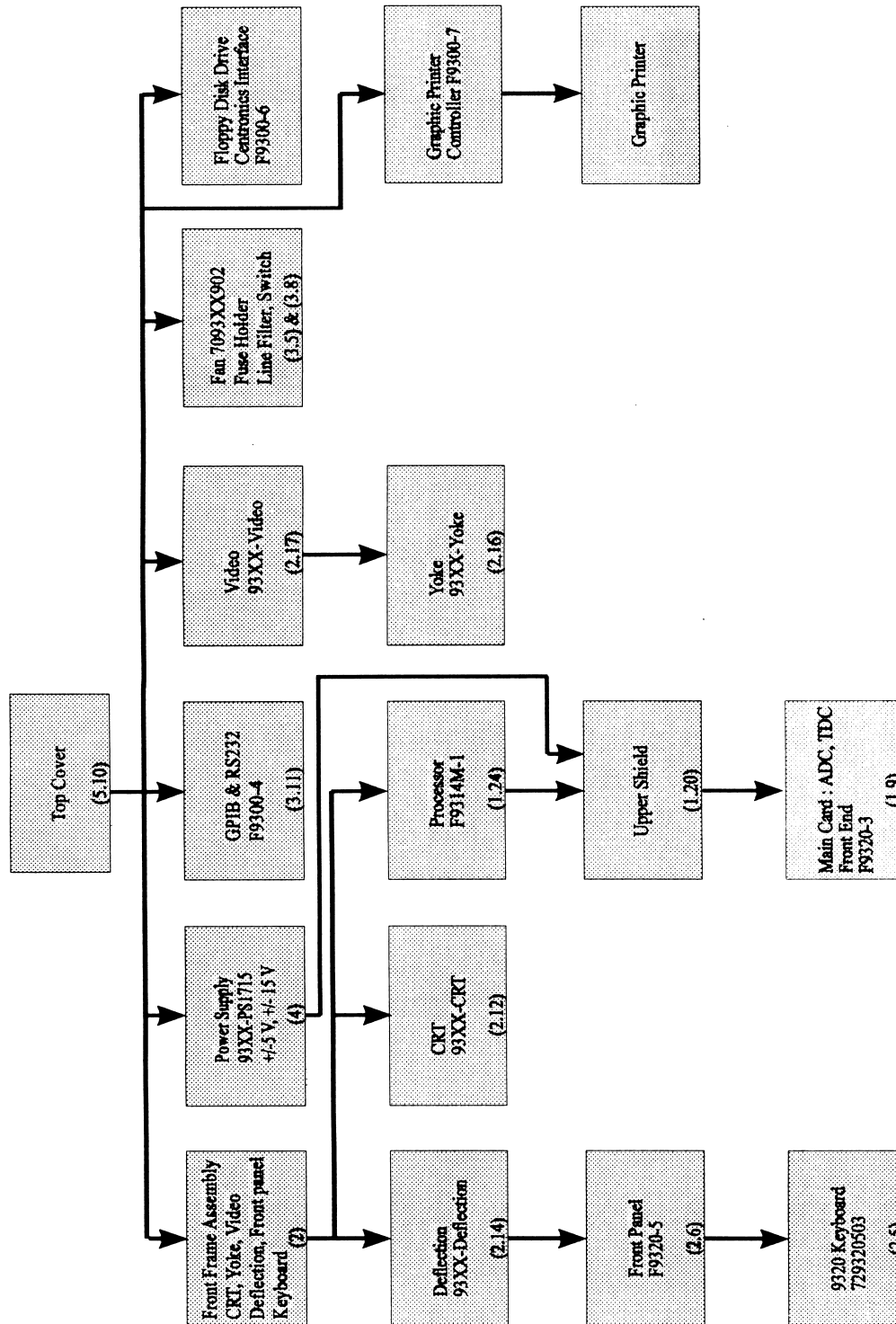

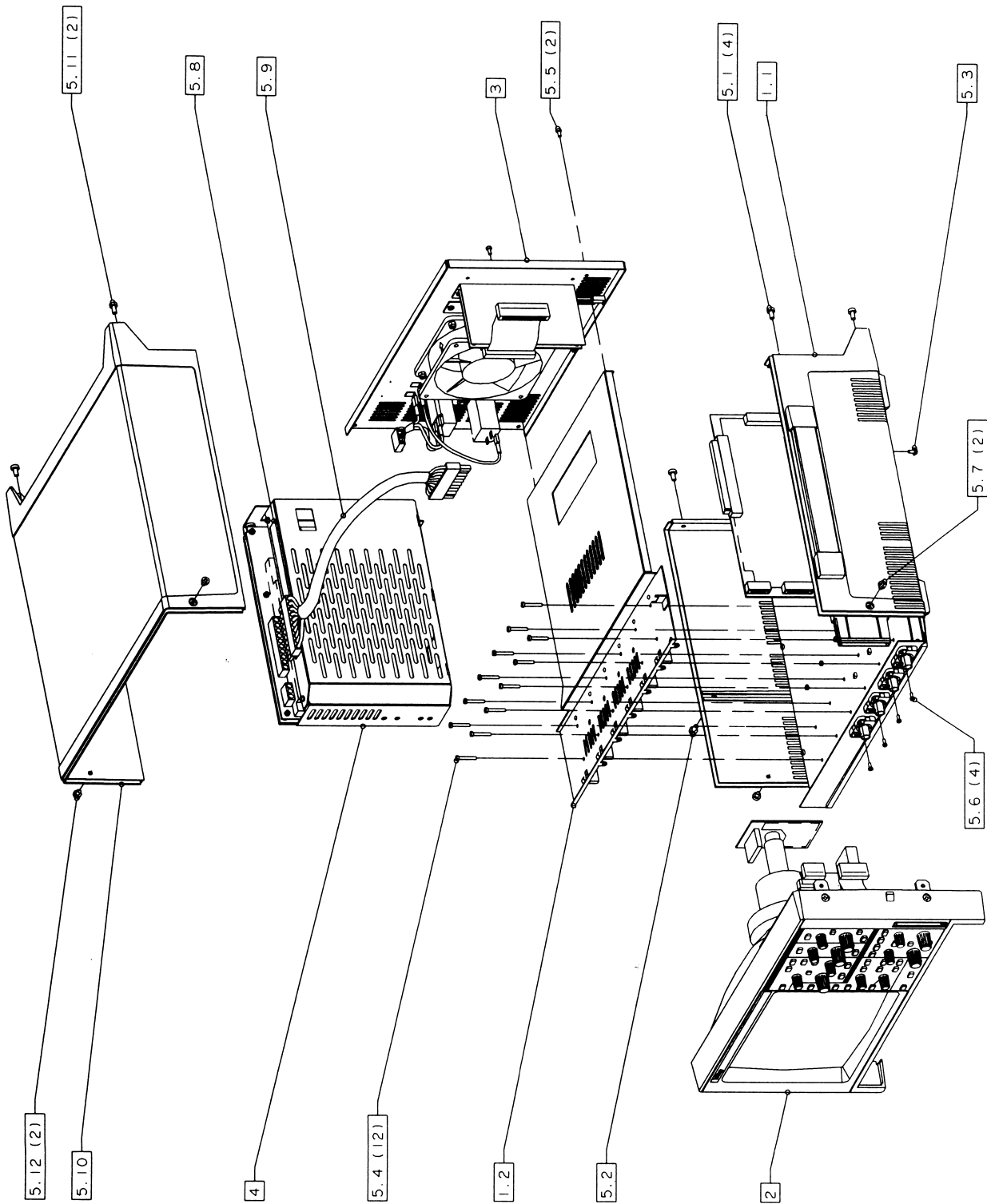

FIGURE 7.1: 9320 DSO EXPLODED VIEW

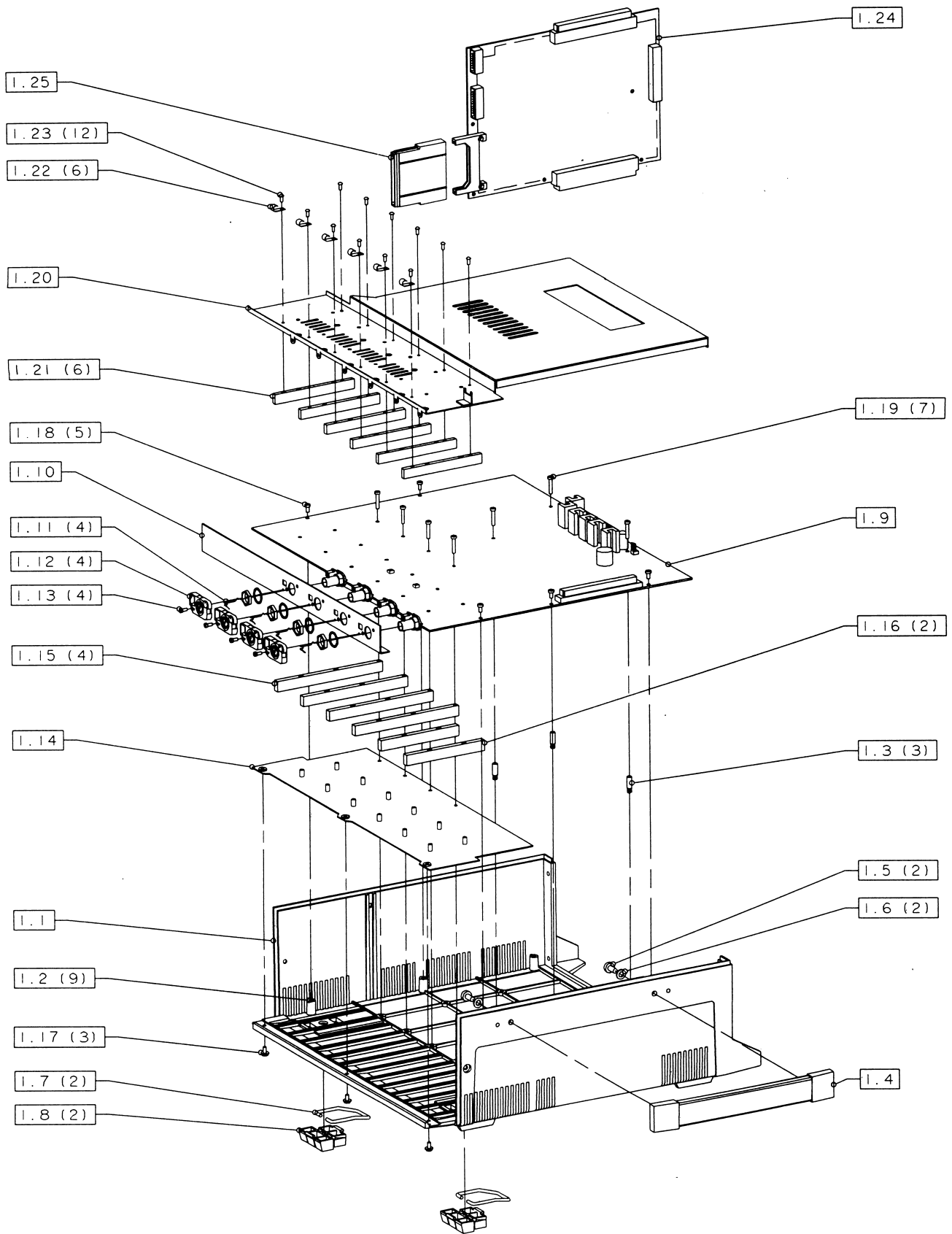

FIGURE 7.2: 9320 LOWER COVER EXPLODED VIEW

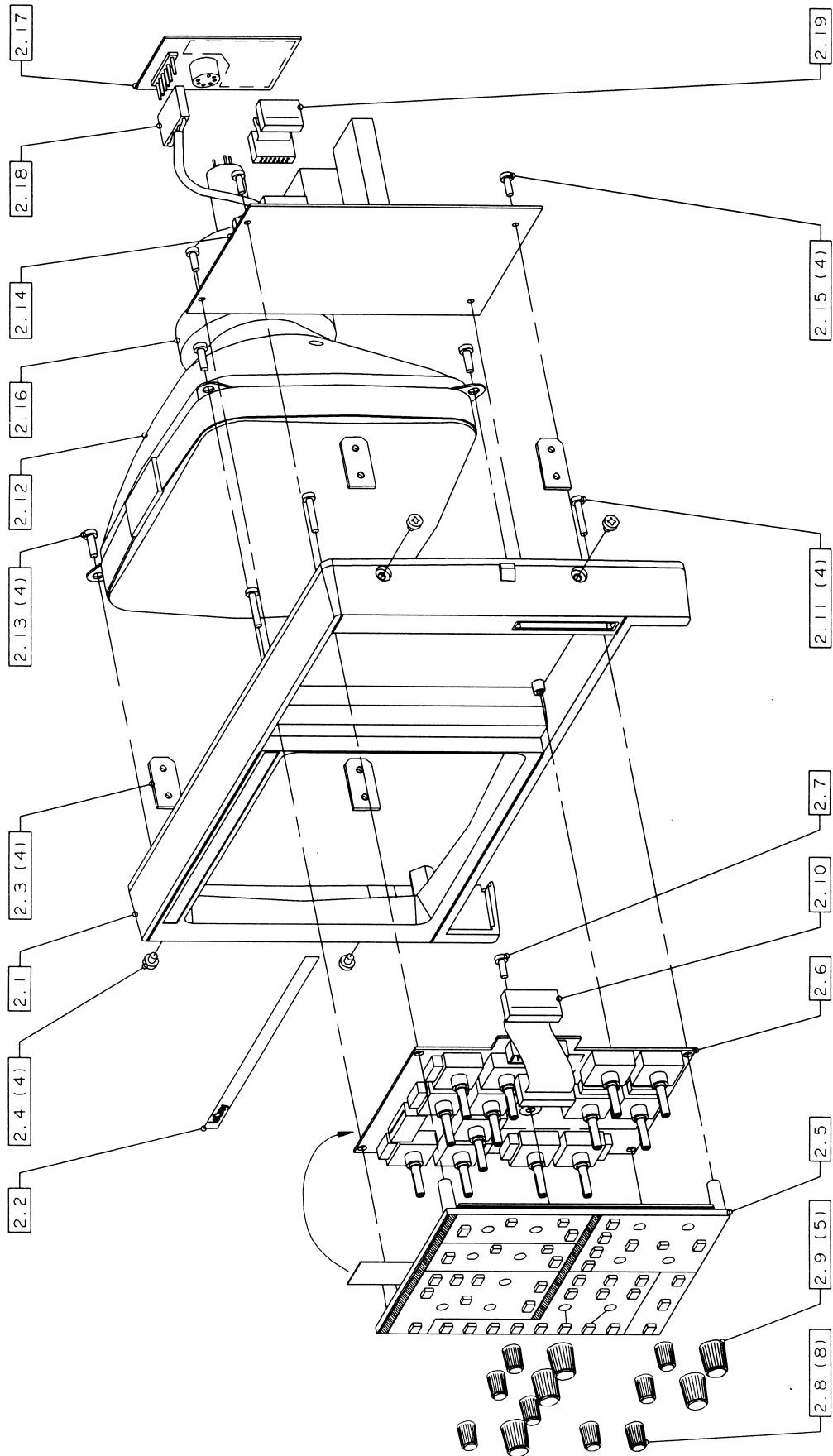

FIGURE 7.3: 9320 FRONT FRAME EXPLODED VIEW

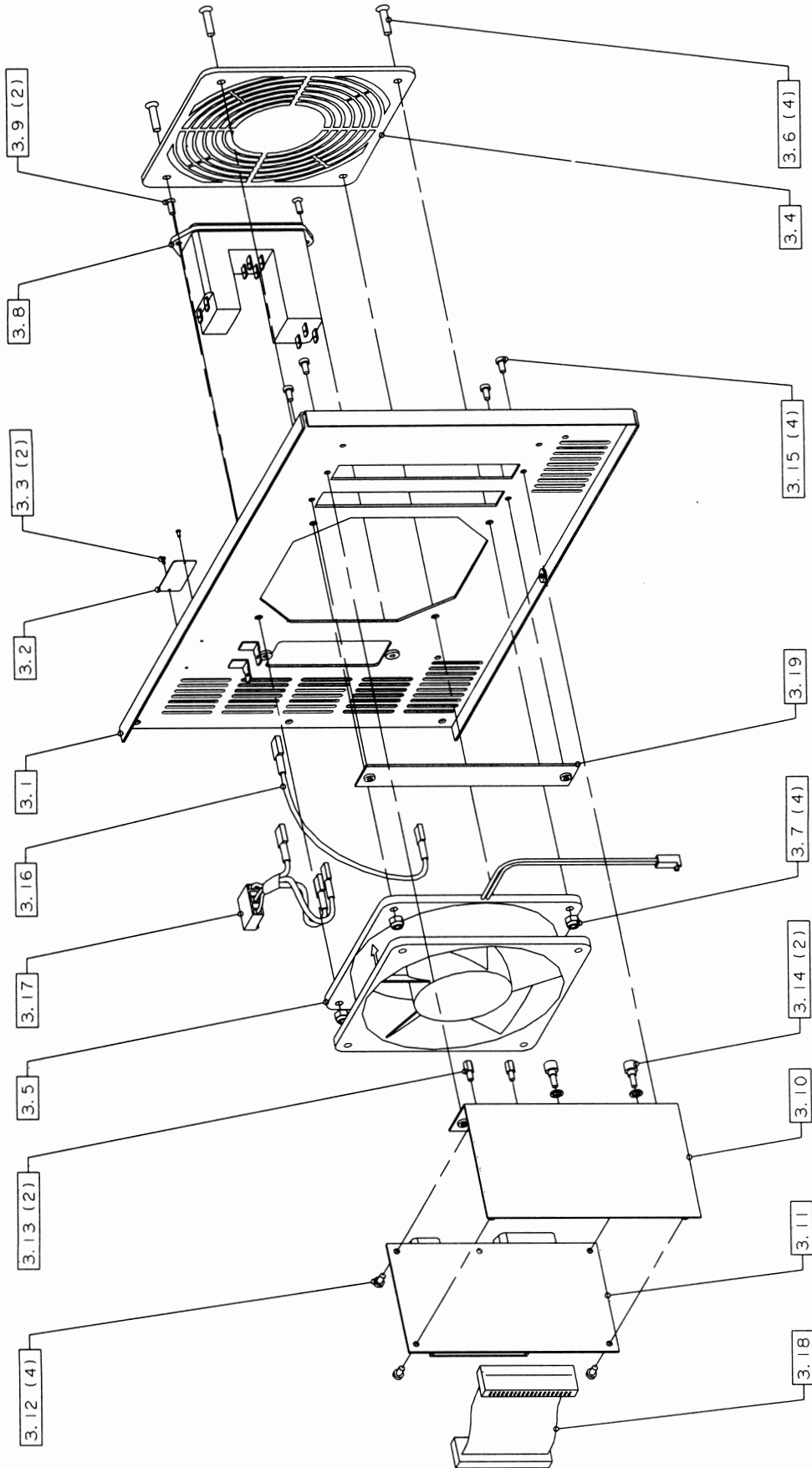

FIGURE 7.4: 9320 REAR PANEL EXPLODED VIEW

7.2.4 Removal of the F9300-4 GPIB/RS232 Interface (3.11)

The GPIB/RS232 interface (3.11) is vertically mounted on the rear panel (3.1).

Remove the following:

- Top cover (7.2.1).
- Two M3x6 screws (3.15) and washers from the rear panel (3.1).

Disconnect the flat cable (3.18) from the processor board (1.24) connector J5.

The GPIB/RS232 board can be removed forwards from the rear panel.

7.2.5 Removal of the Fan (3.5)

Remove the following:

- Top cover of 9320 (7.2.1)
- Four screws (3.6) and nuts (3.7) from the rear panel (3.1).
- Disconnect the fan power cable from the main card F9320-3 connector J602.
- Remove the fan grid (3.4).

The fan (3.5) can be removed from the unit.

CAUTION

Note the air flow, the fan extracts air from the unit and expels it.

7.2.6 Removal of the Fuse Holder (3.8)

WARNING

Disconnect the power cord.

Remove the following:

- Top cover (7.2.1).
- Two screws (3.9) from the rear panel.
- Disconnect the power cable (3.17) from the power supply connector J6.
- Disconnect the earth cable (3.16).

The fuse holder assembly (3.8) can be removed from the rear panel (3.1).

7.2.7 Removal of the 93XX-Video (2.17)

- Remove the top cover (7.2.1).
- Disconnect the ground cable from CRT (black wire)
- Disconnect the monitor cable (2.18) from the deflection board, connector W202 and W203.

Ease the video board (2.17) carefully toward the back of the DSO, until it is free.

7.2.8 Removal of the 93XX-Yoke (2.16)

- Remove the top cover (7.2.1).
- Remove the 93XX-video board (7.2.7)
- Disconnect the cable from the deflection board connector W201.
- Loose the screw on the yoke ring holder.

The deflection yoke (2.16) can be removed from the cathode ray tube (2.12).

7.2.9 Removal of the front frame Assembly (2)

Remove the following:

- Top cover (7.2.1)
- Two screws (5.7) that secure the front frame assembly (2) to the lower cover (1.1).
- Disconnect the front panel flat cable (2.10) from the processor board (1.24) connector J4.
- Disconnect the deflection flat cable (2.19) from the processor board (1.24) connector J6.

The front frame assembly (2) with the CRT (2.12), yoke (2.16), video (2.17), deflection (2.14), front panel (2.6) and keyboard (2.5) can with care be removed forward from the unit.

CAUTION

Hold the CRT very carefully, or place soft padding under it.

7.2.10 Removal of the 93XX-Deflection (2.14)

The deflection board (2.14) is situated to the back of the front panel (2.1).

Remove the following

- Top cover (7.2.1).
- Front frame assembly (7.2.9).
- Disconnect the monitor cable (2.18) which lead to the video board (2.17), connector W202 and W203.
- Disconnect the cable from the deflection yoke, connector W201.
- Disconnect the EHT plug from the receptable at the right side of the CRT (2.12).

WARNING

Touch the free end of the EHT cable to the ground, this ensures that no significant charge remains. The CRT must be discharged similarly, using a tool or a long screw driver which is first placed to the ground and on the CRT receptable.

Remove the four M35x10 screws (2.15) that secure the deflection board to the plastic front frame.

The board (2.14) can now be removed from the unit.

7.2.11 Removal of the 93XX-CRT (2.12)

It is necessary to remove the front frame assembly (7.2.9). The CRT is secured to the plastic front frame by four screws (2.13).

- Remove the 93XX-video (7.2.7).
- Remove the 93XX-yoke (7.2.8).
- Disconnect the EHT cable from the deflection board. - Discharge the tube.
- Remove the four screws.

The CRT can now be removed from the front frame.

WARNING

Use care when handling the CRT. Avoid striking it on any object which may cause the tube to implode. Store the cathode ray tube face down on a soft surface.

To avoid electrical shock the CRT should be discharged after the 9320 oscilloscope is powered OFF. After disconnecting the EHT plug, ground the CRT anode lead to the metallic display support, repeat the operation to fully dissipate the charge.

7.2.12 Removal of the F9320-5 Front Panel (2.6)

Remove the following:

- Upper cover (7.2.1).
- Front frame assembly (7.2.9).
- 93XX-deflection board (7.2.10).
- Four screws (2.11) that secure the front panel.

The front panel (2.6) with the keyboard (2.5) can be removed forward from the unit.

7.2.13 Removal of the 9320 Keyboard (2.5)

Remove the following:

- Upper cover (7.2.1).
 - Front frame assembly (7.2.9).
 - 93XX-deflection board (7.2.10).
 - F9320-5 front panel (7.2.12).
 - The 13 rotary knobs (2.8 and 2.9). Take great care of the soft plastic
 - One screw (2.7) that secures the keyboard to the front panel.
- Disconnect the flat ribbon cable from the front panel connector J2, and remove the keyboard P/N : 729320503.

CAUTION

When removing or installing the keyboard or the front panel, be careful of the fragile flat ribbon cable and connector.

7.2.14 Removal of the F9314M-1 Processor (1.24)

The processor board is located along the right side of the instrument.

Remove the following:

- Top cover (7.2.1).
- Front frame assembly (7.2.9).
- Disconnect the flat cable (3.18) from the F9300-4 GPIB interface connector J5

The processor can be removed vertically from the main card (1.9) F9320-3 connector J600

CAUTION

Static electricity can damage components (RAM, Eproms, microprocessor...).
Antistatic precautions are required.

7.2.15 Removal of the F9320 Main Card (1.9)

Remove the following:

- Top cover (7.2.1).
- Front frame assembly (7.2.9).
- Power supply (7.2.2).
- Processor (7.2.14).

The main board with the upper shield (1.2) is horizontally mounted to the lower case cover (1.1).

Remove the twelve M3x20 screws (5.4), two M3x6 (5.5) and six M2.5x6 that secure the upper shield (1.2) to the board, rear panel and front panel.

- Disconnect the fan cable from connector J602.

The upper shield (1.20) can be removed forward from the board.

Remove the five M3x6 screws (1.18), seven M3x16 (1.19) and three M3x6 flat head screws (1.17) that secure the board to the lower cover (1.1).

The main board F9320-3 with base shield and front panel can be removed from the scope.

CAUTION

Antistatic precautions are required.

7.2.16 Removal of the Handle (1.4)

The handle with two black end caps is secured to the right side of the lower cover (1.1) by two screws (1.5) and washers (1.6).

- Remove the upper cover (7.2.1), processor board (7.2.14).

The handle can be removed from the lower case.

7.2.17 Removal of the Foot Support (1.8)

The two foot supports are clipped on the lower cover (1.1).

Remove the foot (1.7) or the support (1.8) by inserting a small flat screwdriver under the support

7.2.18 Removal of the 93XX-FD01 Floppy Disk Drive Option

- Remove the upper cover (7.2.1).
- Disconnect the flat ribbon cable from the F9300-6 interface (see figure 7.5).
- Remove the two M3x6 screws that secure the floppy drive support to the upper cover.
- Remove the support 70FD01021 and frame 70FD01031 from the cover. - Remove the four M2.5x4 screws that secure the floppy to the support

The floppy disk drive can be removed from the frame

7.2.19 Removal of the 93XX-GP01 Graphic Printer and F9300-7 Controller Option

- Remove the upper cover (7.2.1).
- Disconnect the power cable (780210030) from the 93XX-PS1715 power supply (see figure 7.6).
- Disconnect the flat ribbon cable (780791604) from the F9300-7 controller (see figure 7.6).
- Disconnect the flat ribbon cable (780721022) between the F9300-6 interface and F9300-7 controller.
- Remove the four M3x6 screws that secure the F9300-7 controller to frame (70GP01031).
- Remove the F9300-7 controller
- Remove the two M3x6 screws that secure the printer to the frame

The graphic printer can now be removed from the upper cover.

7.2.20 Removal of the F9300-6 Centronics Interface Option

- Remove the upper cover (7.2.1).
- Remove the two M3x6 screws from the rear panel
- Disconnect the flat cable from the F9300-4 GPIB/RS232 board (see figure 7.5 or 7.6).

The graphic printer, floppy disk drive, and centronics interface board can be removed forward from the rear panel.

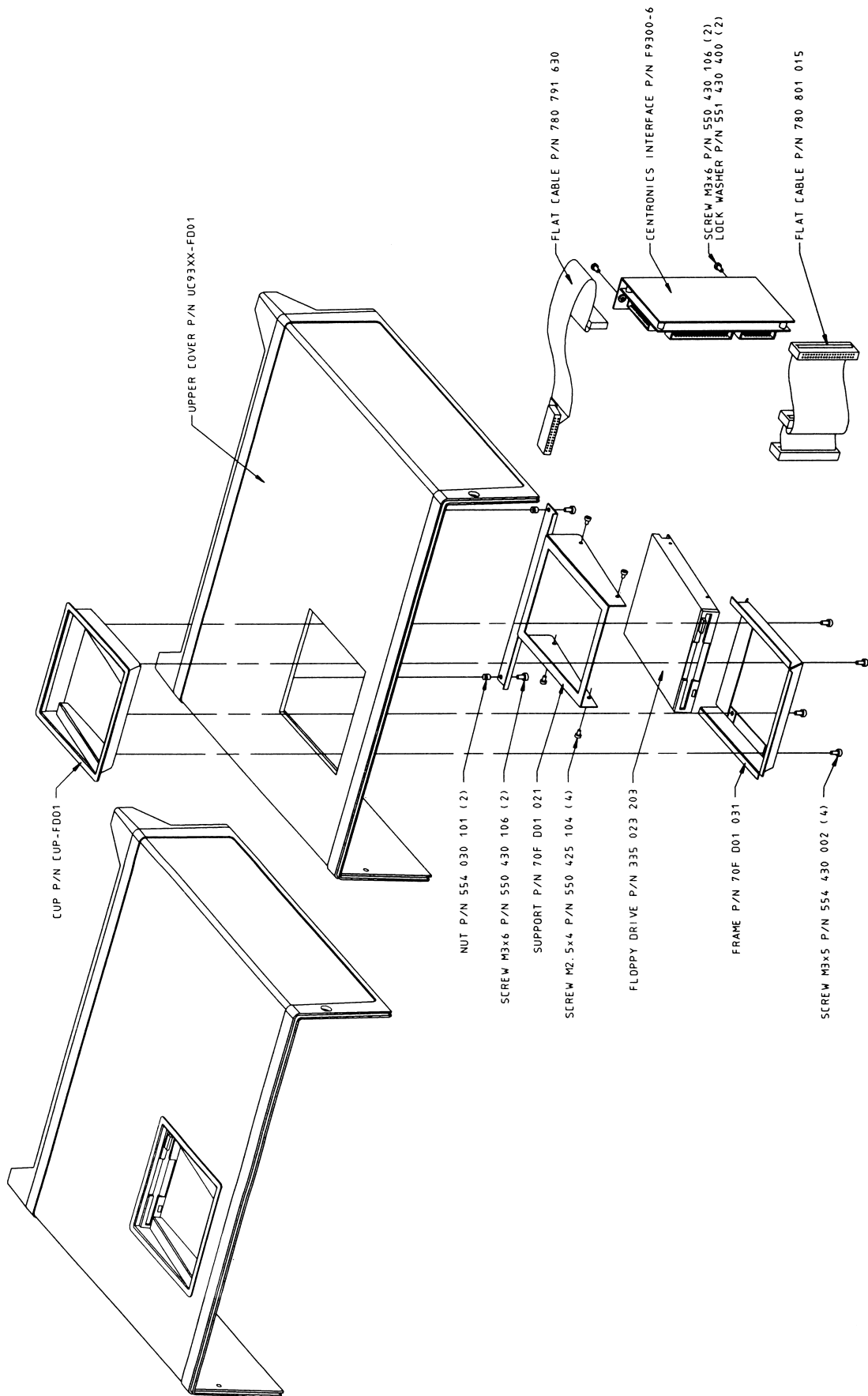

FIGURE 7.5: 9320-FD01 ASSEMBLY: FLOPPY OPTION

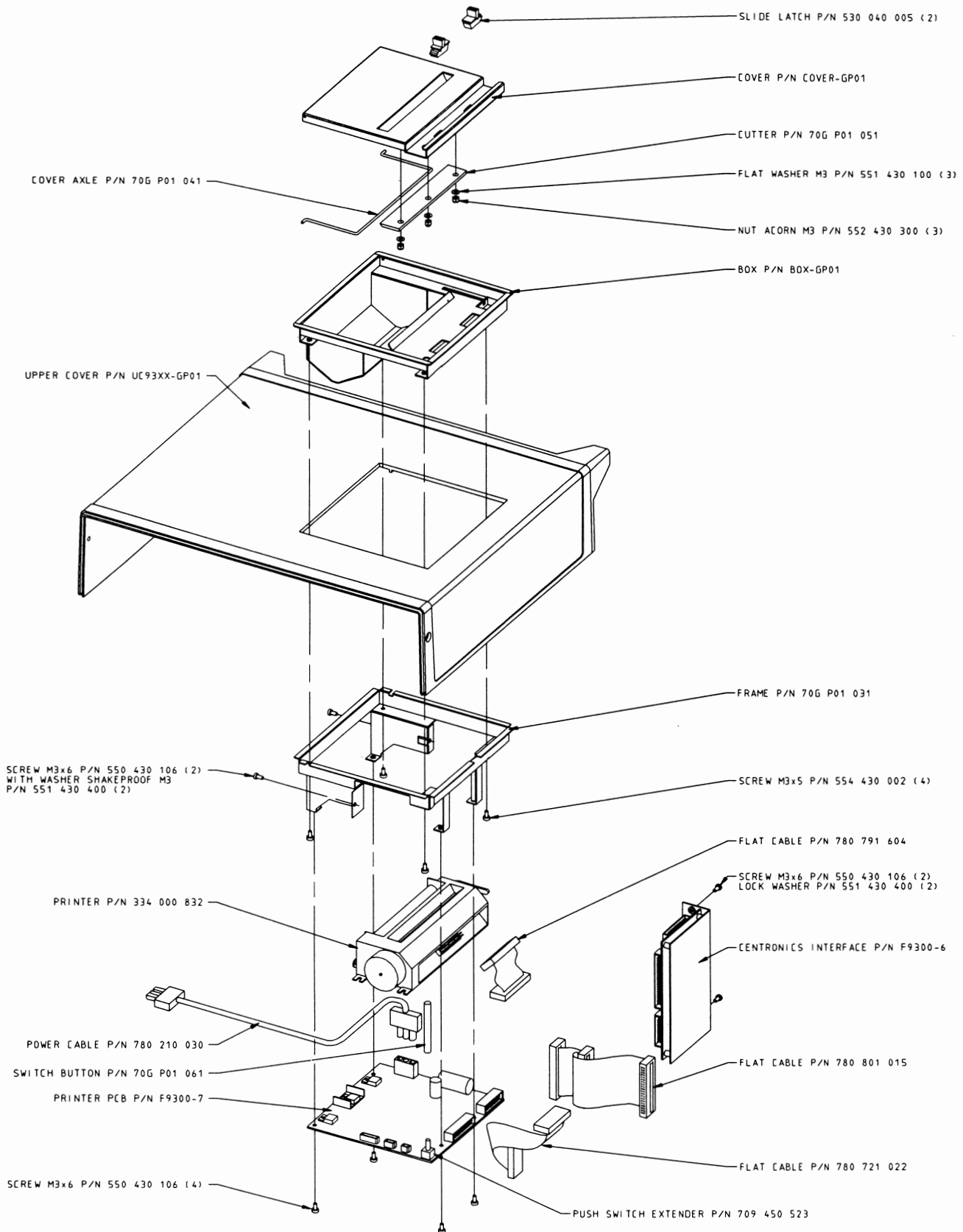

FIGURE 7.6: 9320-GP01 ASSEMBLY: PRINTER OPTION

7.3 Software Upgrade Procedure

The processor board carries the program memory (768 Kbytes) contained in four Eproms (Loc A22, A27, A29, A38), the character font Eprom (Loc A1) used by the graphic processor of the raster scan display, and the software option selection GAL (Loc A19). After any software change, a general instrument reset is mandatory. Simultaneously press the autsetup button, the top menu button and the return button.

7.3.1 Upgrading Firmware

LeCroy Corporation has a policy of continually improving and upgrading its products. The firmware can be upgraded to the latest version by changing the four Eproms 1H, 1L, 2H, 2L on the processor board at locations A22, A27, A29 and A38 (see figure 7.7). Access is possible by removing the upper cover (7.2.1).

The Eproms can be removed by using an IC extractor. Make sure that the guiding notch in the chip is aligned with the PCB. Same procedure for the character font Eprom at location A1.

7.3.2 Changing Software Options

The software option selection GAL is located on the processor board at location A19 (see figure 7.7). Insert or replace the GAL to select new options.

Make sure that the orientation notches are correctly aligned with the PCB.

7.3.3 Software Option Selection GAL

As of today the following software options are available:

0000:	Standard	GAL not necessary
0001:	WP01	Advanced Math package
0002:	WP02	Basic FFT package
0200:	CARD	Memory card

9300-1 Rev: E

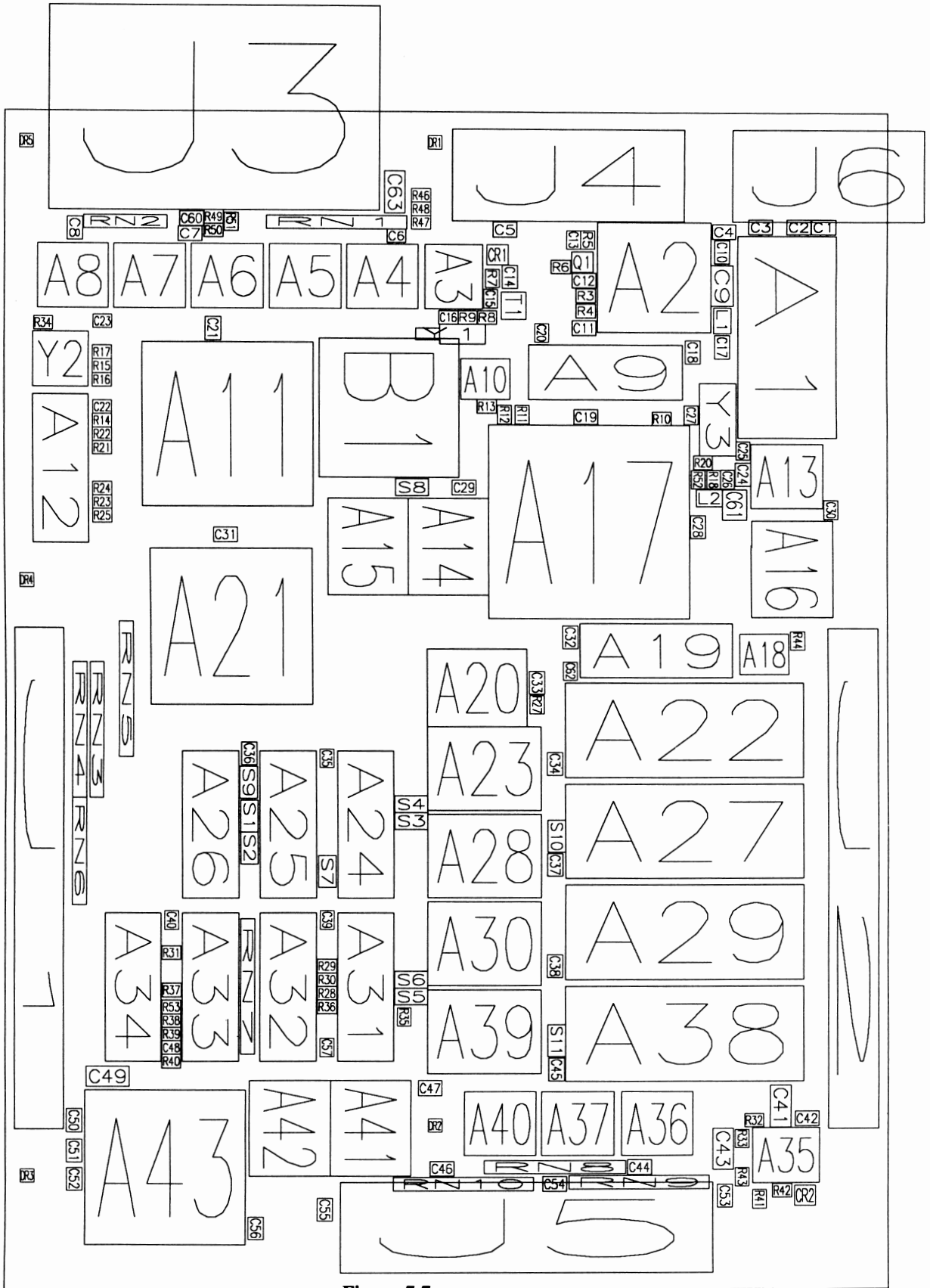

Figure 7.7

OPTIONS			
Memory Card	WP01	WP02	GAL DESCRIPTION
no	no	no	GAL NOT NECESSARY
no	no	yes	CLE 001-A
no	yes	no	CLE 002-A
no	yes	yes	CLE 003-A
yes	no	no	CLE 200-A
yes	no	yes	CLE 201-A
yes	yes	no	CLE 202-A
yes	yes	yes	CLE 203-A

GAL CLE XXX-R : XXX : Software option, R : Release

3-Nov-93
9:44:16

STATUS

```

Acquisition
System
Text & Times
Waveform
    
```

Serial Number 932001347

Soft Version 9320- 03.3

Soft Options

```

WP01  WP02
CKIO  MC01
    
```

Hard Options

```

GPIB  R232
CLBZ  I2C
    
```

20 Ms/s

AUTO

7.3.4 Processor Board Exchange Procedure

The replacement board is supplied without any firmware or options. Therefore the existing GAL (Loc A19) and eproms (Loc A22, A27, A29, A38) must be transferred from the faulty board to the new board. After upgrading firmware or changing the software option, check that the scope boots correctly. Then check in the system summary, by using the show status button on the front panel, the software version, software options and serial number.

The serial number of the 9320 oscilloscope is loaded in the real time clock memory which is battery backed up. If it becomes necessary to replace the processor board, the serial number must be loaded in the memory of the new board by using LeCroy program " LeCalsoft " under GPIB remote control.

To run " LeCalsoft " type SKP.exe, in the main menu type S, and follow the instructions, use five digits to enter the serial number (i.e. 01347).

7.4 Equipment and Spare Parts Recommended for Service

7.4.1 Equipment

The following equipment is needed to provide the technician access to the 9320 subassemblies during repair and calibration (see section 5 and 6).

Instrument	Qty	Specifications	Recommended
Signal Generator (sine wave)	1	Frequency : 500 KHz to 1 GHz Accuracy : 0.001 % Amplitude : 1 V peak to peak	Marconi 2030
Signal Generator (sine wave)	1	Frequency : 5 KHz Amplitude : 6 V peak to peak	Topward TFG-8101
DC precision Power Supply	1	Amplitude : 10 V, DC Accuracy : < 0.1 %	Tektronix PS5004
Digital Multimeter	1	5 digits	Keithley 199
Power meter	1	dBm mode	HP 436A
Fast pulser	1	Rise time < 500 psec	LeCroy 4969
Digital scope	1	Bandwith 350 MHz	LeCroy 9450A
Cable	1	BNC, 50 Ω , length 20 cm (7.87 inches)	Suhner
Cable	1	BNC, 50 Ω , length 100 cm (39.37 inches)	Suhner
BNC T adapter	1	BNC, 50 Ω , T adapter	Suhner
SMA power splitter	1	50 Ω , 6 dB, 0.5 W	Suhner 4901.19A
SMA adapter	1	50 Ω ,	Suhner SMA 50-1
Cable	2	BNC to SMA, 50 Ω length 100 cm (39.37 inches)	Suhner RG 58 C/U

7.4.2 Spare Parts

In order to make the repair of 9320 oscilloscope at board level, a minimum stock of boards is at least one each:

- F9314M-1 : Processor board
- F9320-3 : Main board
- F9300-4 : GPIB/RS232 interface
- F9320-5 : Front panel with keyboard
- 93XX-Display : Raster monitor kit
- 93XX-PS1715 : Power supply

If the unit is equipped with the 93XX-FD01 option :

- F9300-6 : Floppy, Graphic printer, Centronics Interface
- 335023203 : Floppy disk drive

If the unit is equipped with the 93XX-GP01 option :

- F9300-6 : Graphic printer, Floppy, Centronics Interface
- F9300-7 : Graphic printer controller
- 334000832 : LPT5446 Seiko Graphic printer

The other parts (fan, fuse holder, scope handle, covers, rear panel...) are not on the above list because they are reliable parts and the probability of failure is very low.

7.5 Troubleshooting and Flow Charts

7.5.1 Introduction

The troubleshooting information contained in this section is intended for use by qualified personnel having a basic understanding of electronics (analog and digital). In order to simplify servicing and minimize downtime, the following list of possible symptoms, likely causes, and troubleshooting steps have been prepared.

The first step in troubleshooting is to check for obvious items like blown fuses. The power supply is the next item to check before proceeding to more detailed troubleshooting, since noise or low power supply voltages can cause a variety of digital and analog problems.

7.5.2 Initial Troubleshooting Chart

Most procedures in this section will allow troubleshooting down to the board level.

Defective circuit boards will be repaired or exchange by the regional LeCroy service office or the local representative (see section 1.4).

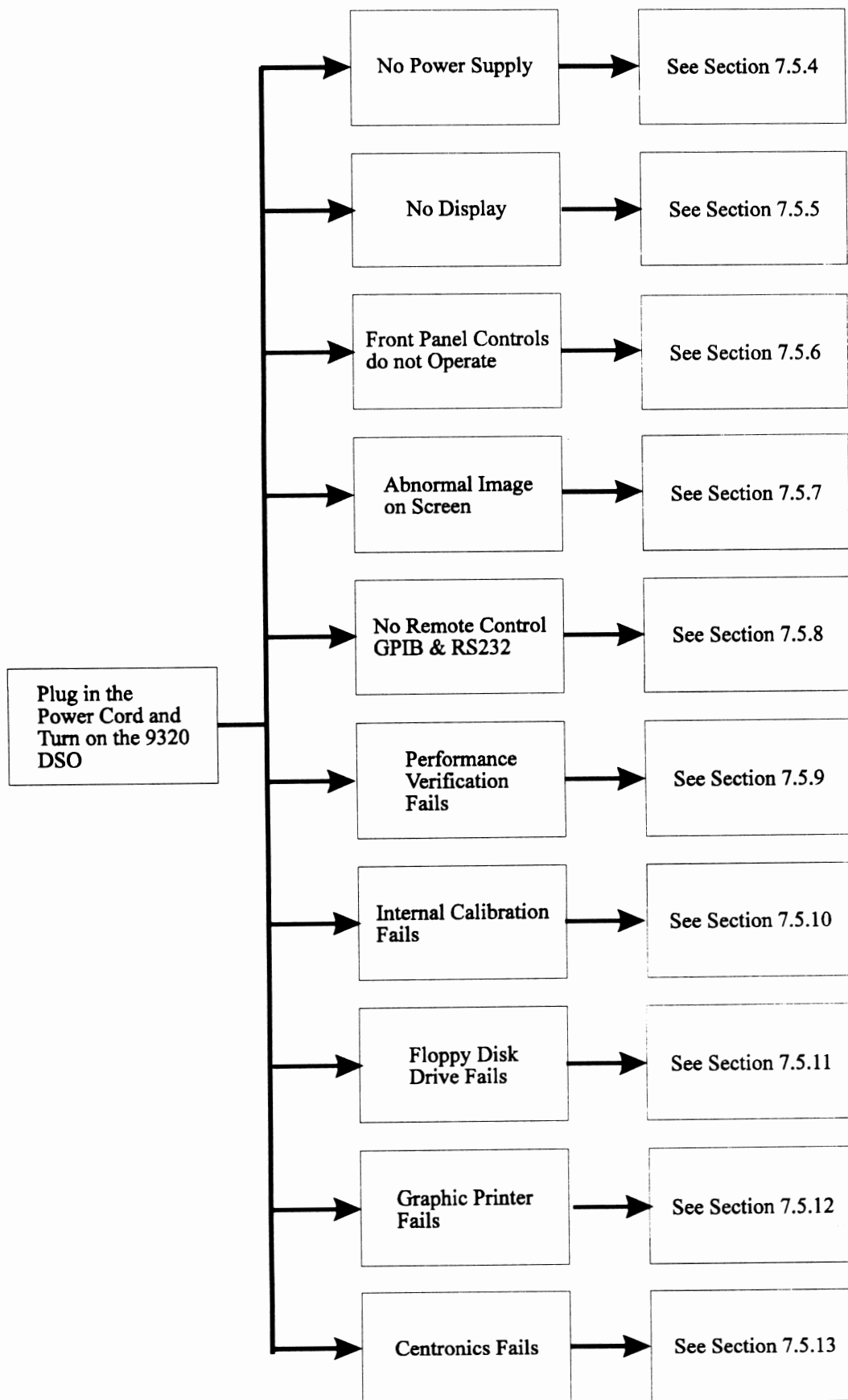

7.5.3 Line Voltage Autoranging

The 9320 oscilloscope operates from a 115 V (90 to 132 V) or 220 V (180 to 250 V) normal power source at 45 Hz to 66 Hz.

No voltage selection is required since the instrument automatically adapts to the line voltage which is present.

The instrument operates at line frequencies up to 440 Hz. However, at frequencies above 60 Hz, the leakage current from phase to ground slightly exceeds the safety recommendations for industrial instruments in some countries.

This current reaches 4 mA Max at 250 V/400 Hz.

7.5.4 No Power Supply

7.5.4.1 Line Fuses Replacement

The power supply of the oscilloscope is protected against short circuits and overload by means of two 5A/250 V fuses located above the main plugs.

WARNING

Disconnect the instrument from the power line and from other equipment before replacing fuses.

To replace line fuses, proceed as follow:

- Turn off the power and disconnect the line cord from the instrument
- Open the fuse box by inserting a small flat screwdriver under the plastic cover and remove the fuse carrier from the holder
- Remove the 5 amp fuse and replace it with the proper type:

5 amp/250 V, 3AG normal blowing.

LeCroy part number: 433 162 500

7.5.5 No Display

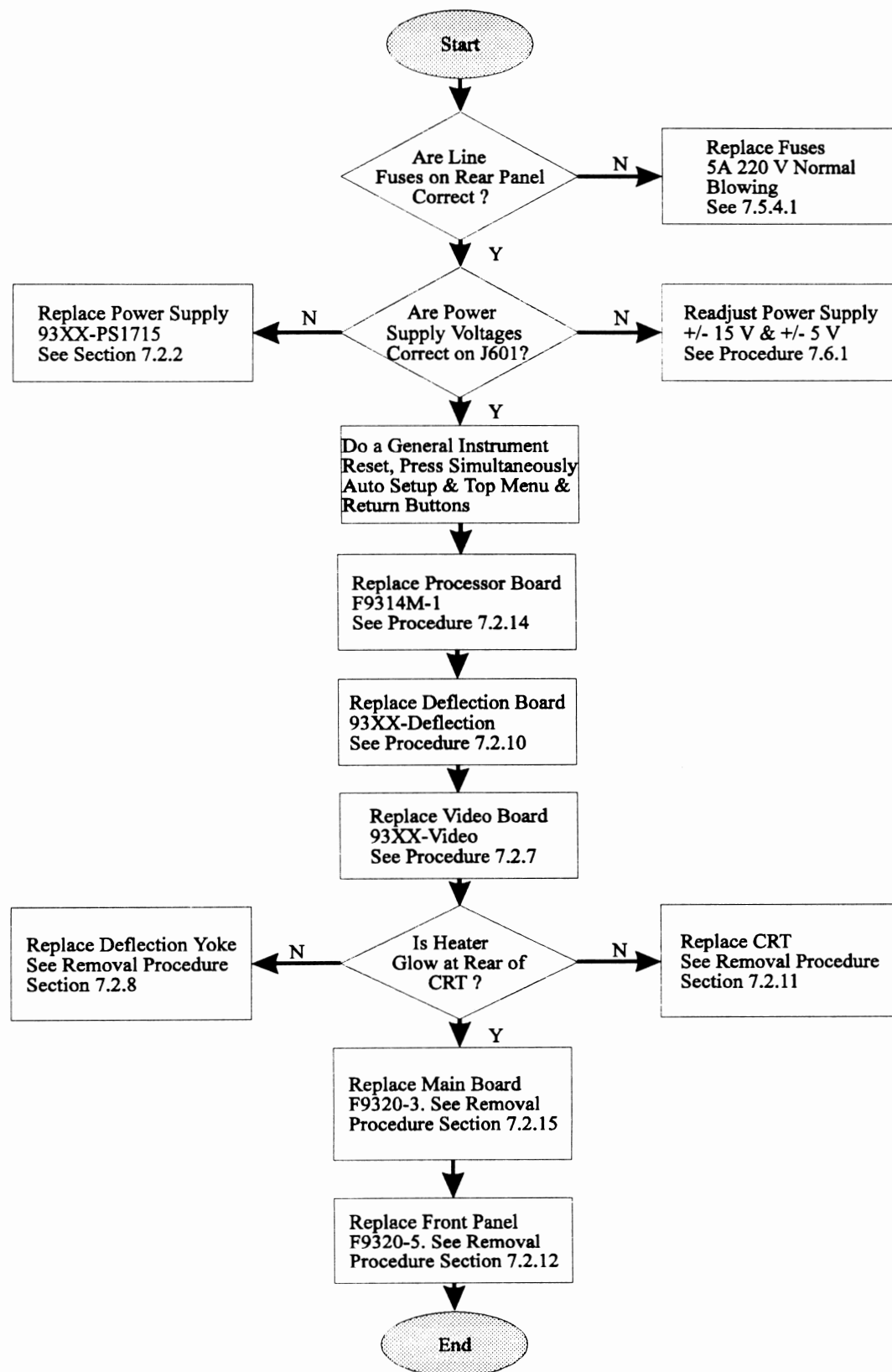

7.5.6 Front Panel Controls Do Not Operate

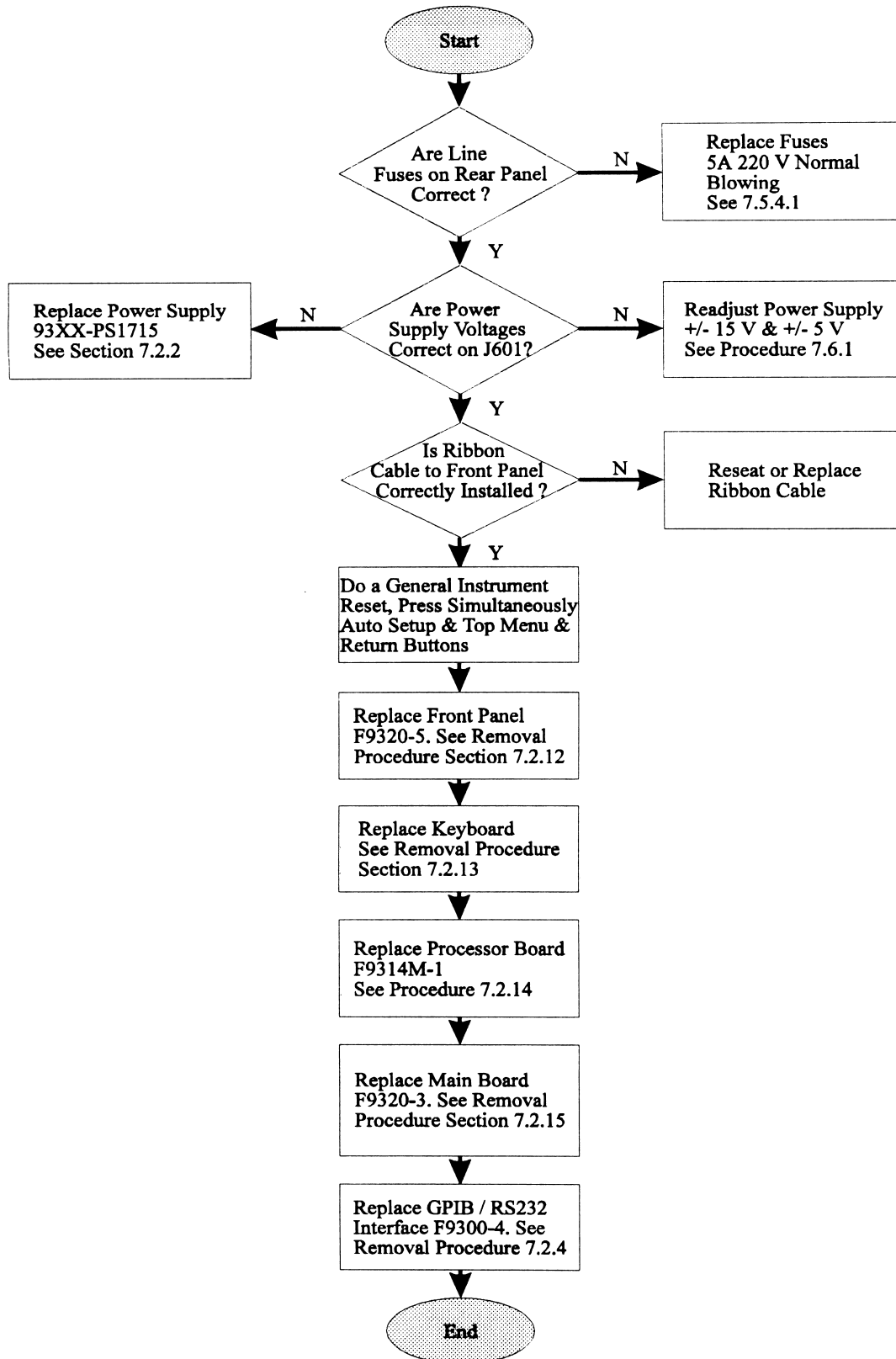

7.5.7 Abnormal Image On Screen

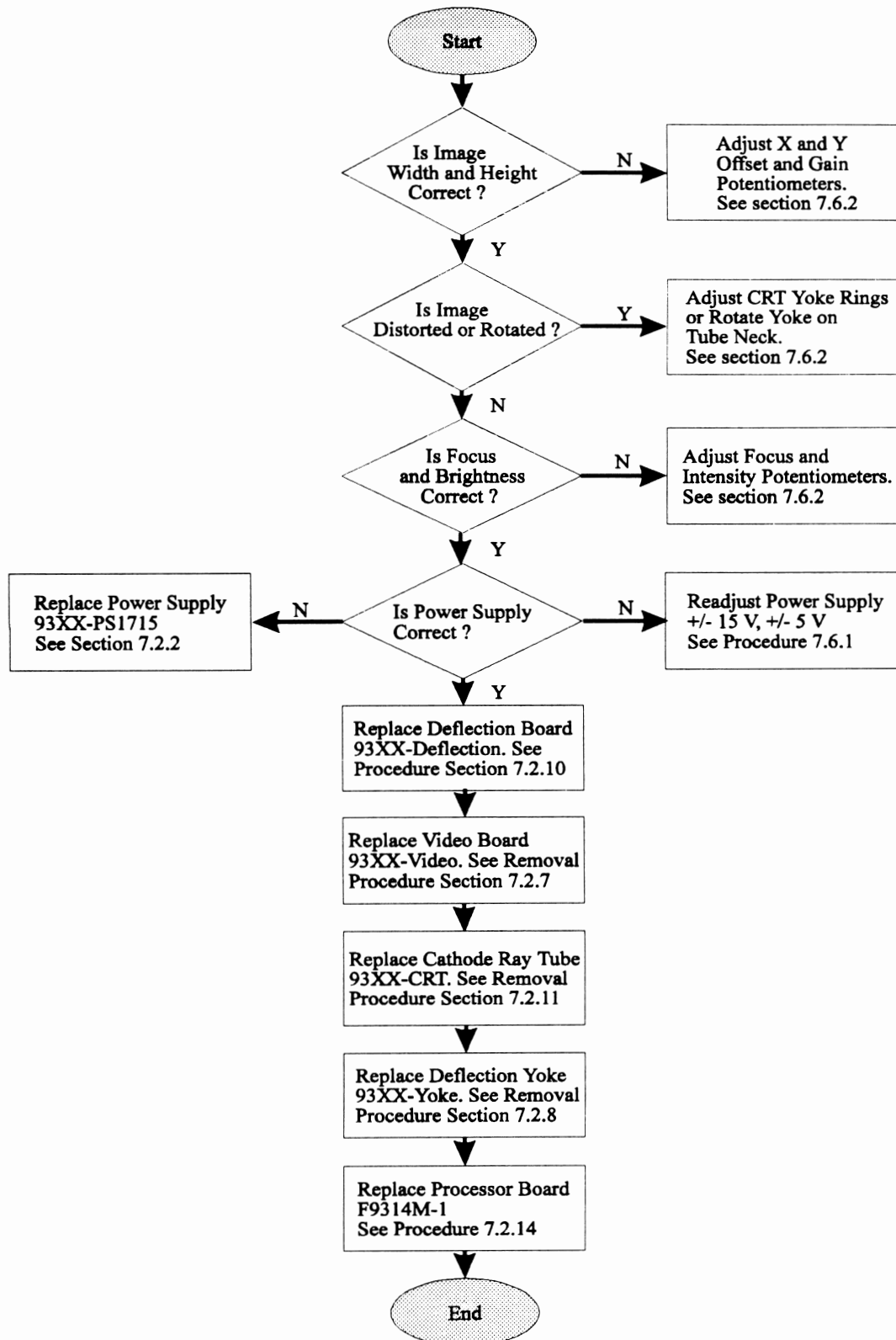

7.5.8 No Remote Control GPIB and RS232

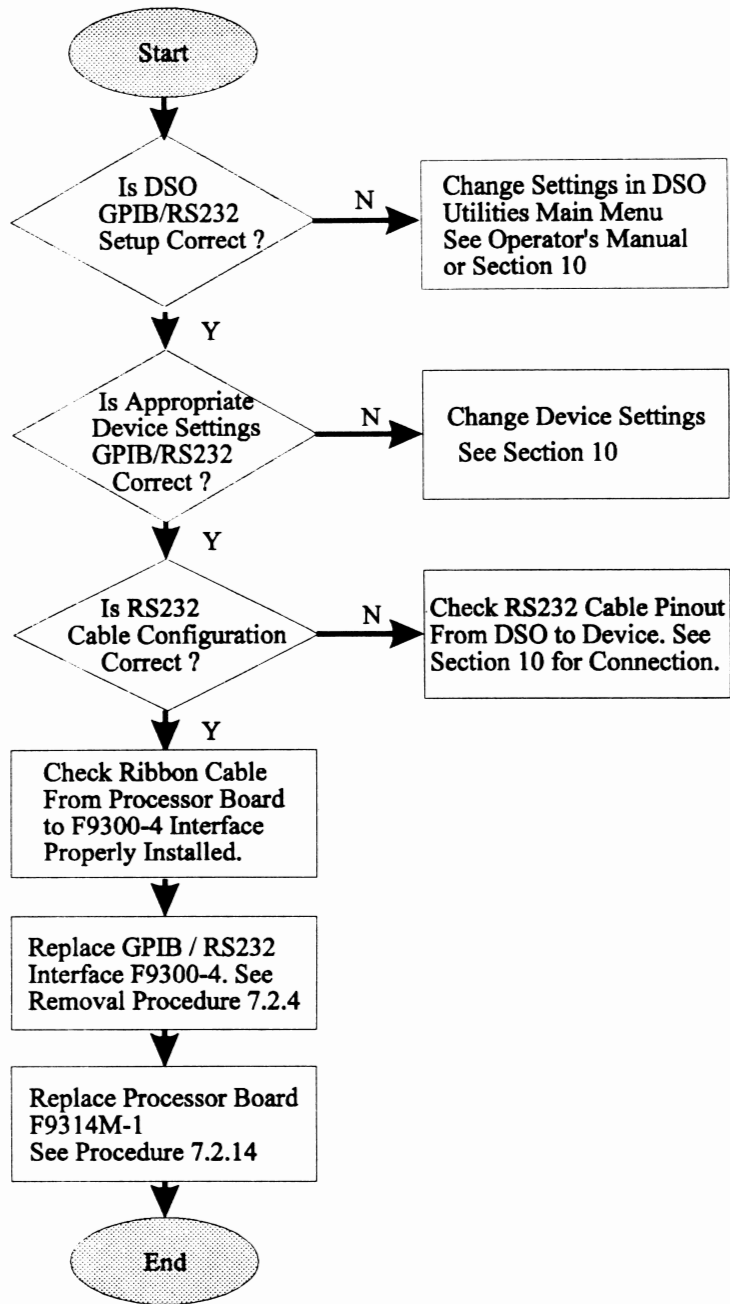

7.5.9 Performance Verification Fails

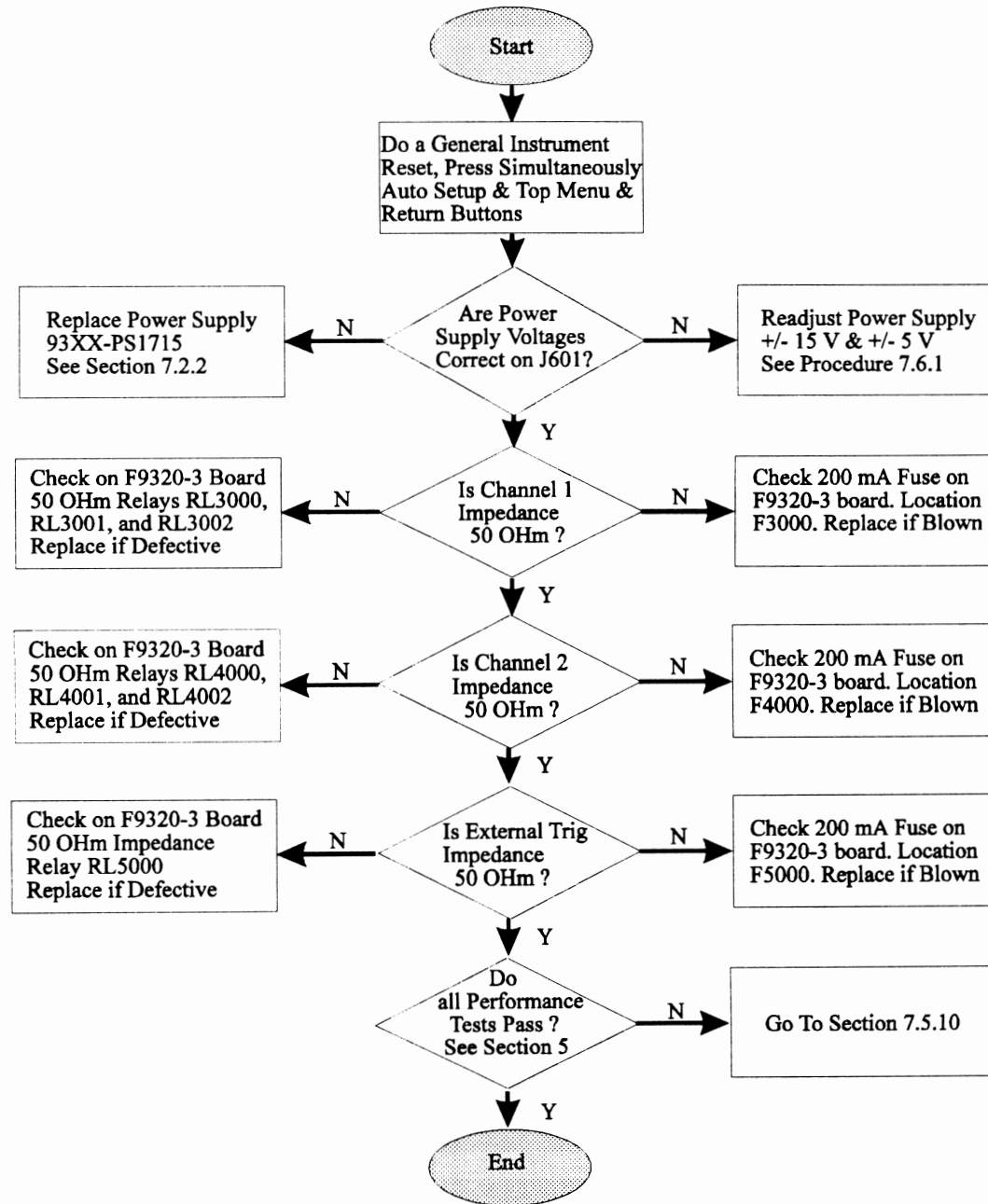

7.5.10 Internal Calibration Fails

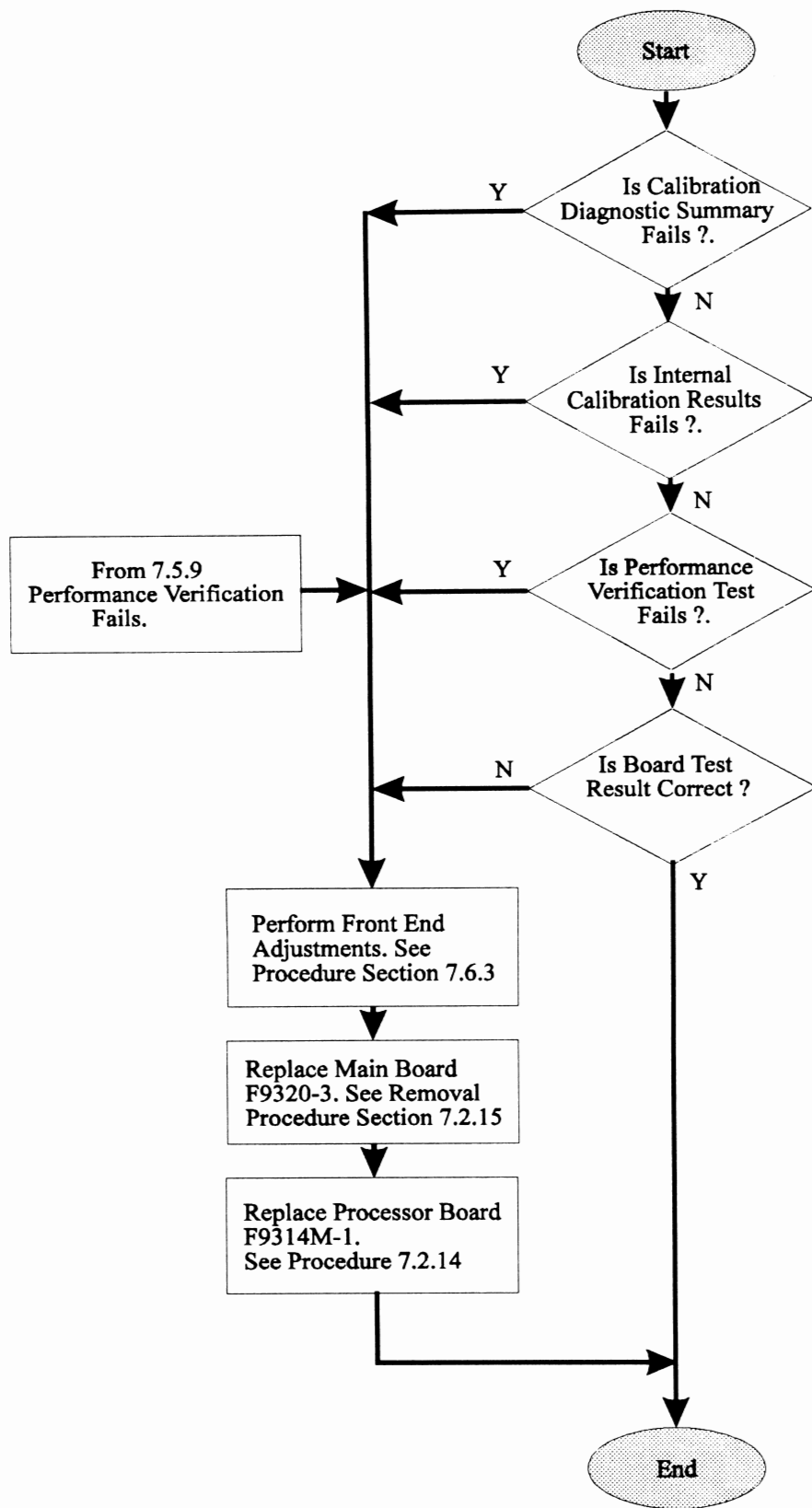

7.5.11 Floppy Disk Drive Fails

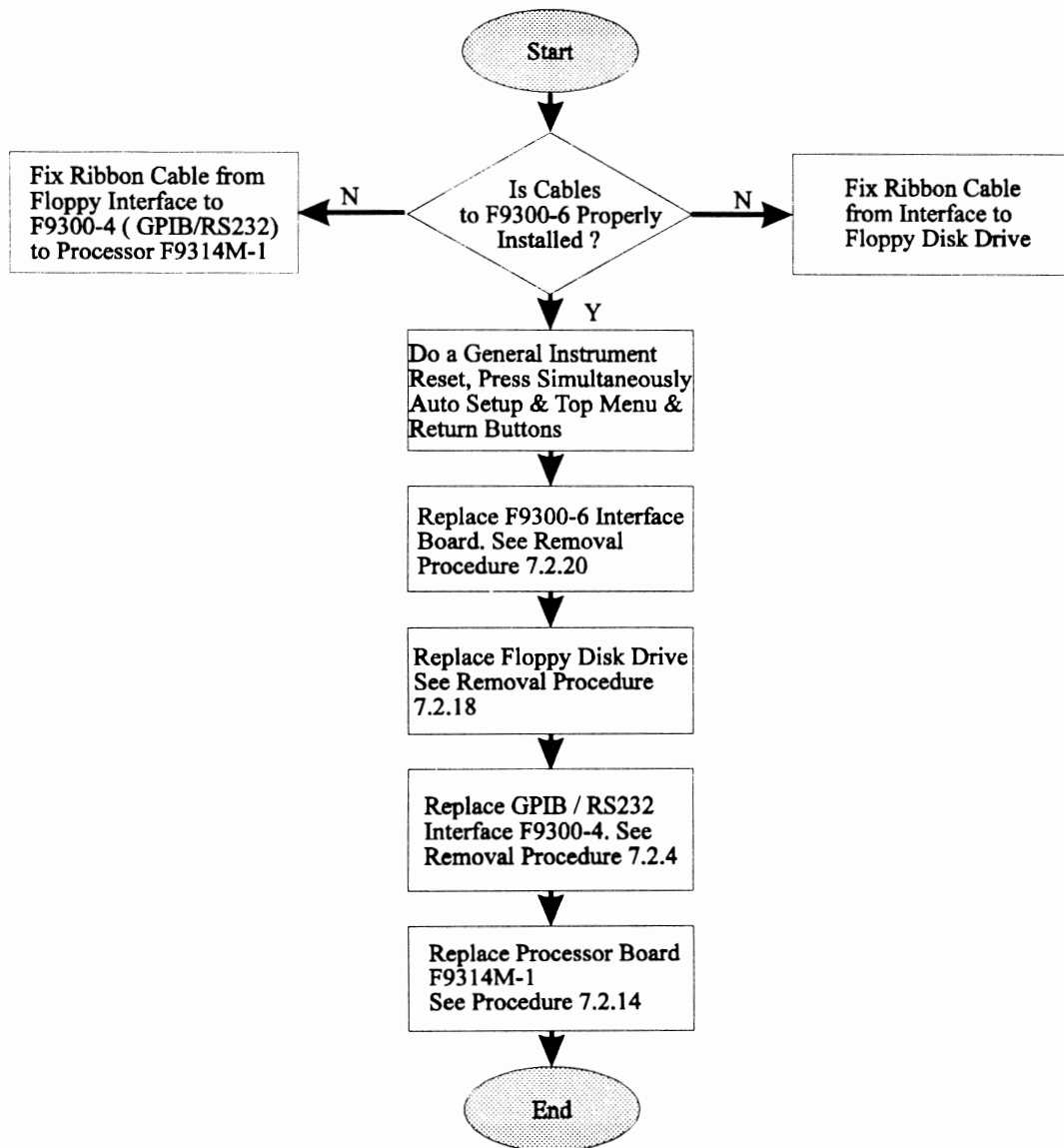

7.5.12 Graphic Printer Fails

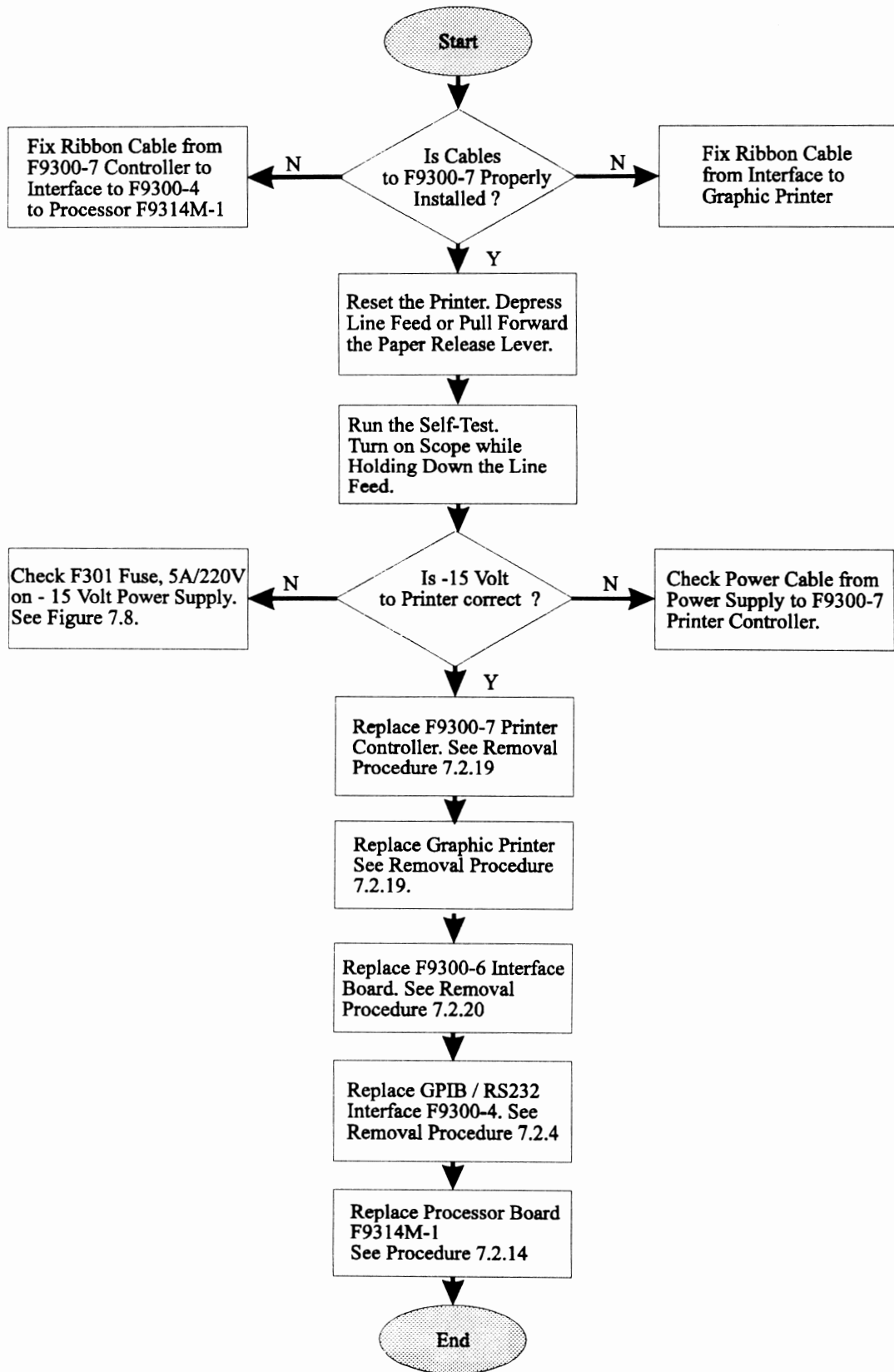

7.5.13 Centronics Fails

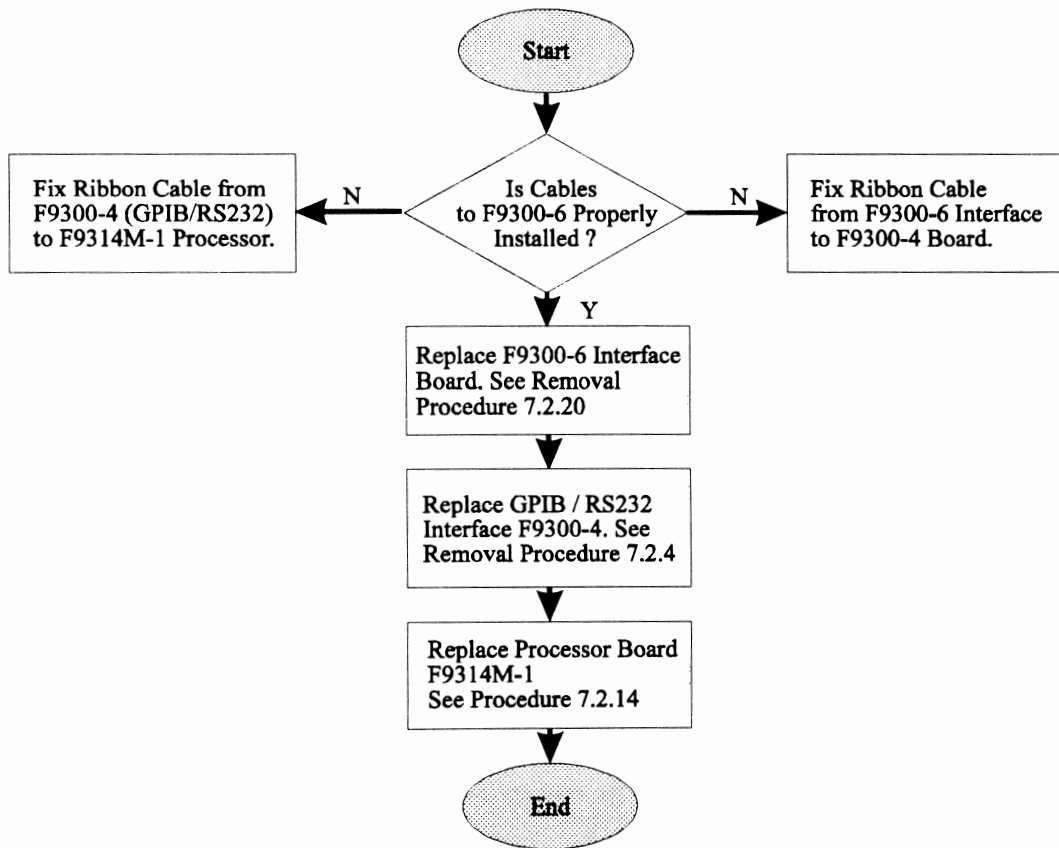

7.6 Calibration Procedures

The following section includes the adjustments required for the power supply, front end and display. It is recommended that they be verified at one year intervals.

7.6.1 93XX-PS1715 Power Supply Calibration

The four voltages are adjustable by $\pm 5\%$ of the nominal value.

The reference for the measurements are the pins on connector J601 located on the main board F9320-3.

From right to left:

Pin 10 :	-15.1 V (Min = -14.85 V, Max = -15.15 V)
Pin 9 :	+15.1 V (Min = +14.85 V, Max = +15.15 V)
Pin 8 :	- 5.2 V (Min = - 5.15 V, Max = - 5.25 V)
Pin 6 :	GND
Pin 5 :	+ 5.2 V (Min = + 5.15 V, Max = - 5.25 V)

For the calibration of the power supply proceed as follow:

- Turn off the power
- Remove the top cover (7.2.1)
- Remove the front frame assembly (7.2.9) and put it to the right of the unit.

- By using two extension cables, reconnect the processor board to the front panel (J4) and to the deflection board (J6).

The front frame assembly is now reconnected to the processor through the extension cables.

The four potentiometers are accessible from the front through holes in the power supply chassis.

Turn on the power and perform the adjustments (see figure 7.8).

Turn the potentiometer clockwise to increase the tension or counterclockwise to decrease the voltage.

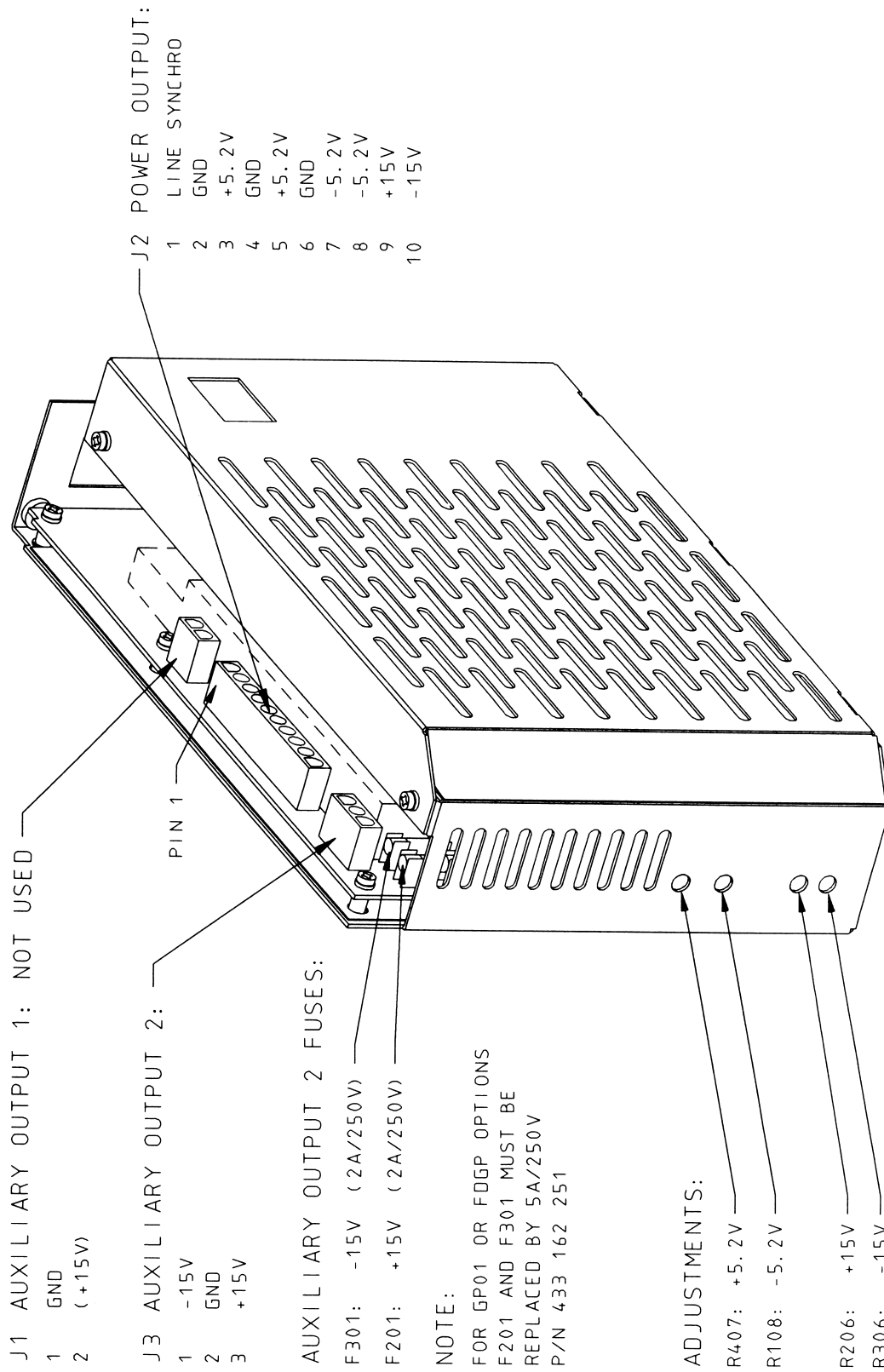

FIGURE 7.8: 93XX-PS1715 POWER SUPPLY

7.6.2 93XX-Display Adjustment Procedure

7.6.2.1 Introduction

There is a total of 12 potentiometers or variable coils to adjust the deflection and video board.

Video: (2 adjustments)

- Threshold : Level of the video board.
- Gain : Intensity of the screen.

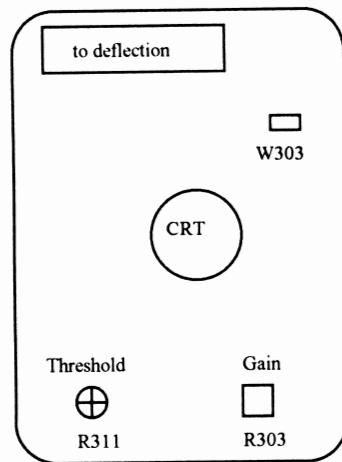

Video board component side

Deflection : (10 adjustments)

- Vosc : Frequency of the vertical oscillator.
- Slope : Speed of the horizontal ramp.
- Focus : Focus of the screen.
- Cut off : Cathode ray tube cut off.
- Quiescent : Standby current of the horizontal deflection amplifier.
- H Linearity : Horizontal linearity.
- H Size : Horizontal size (Max 165mm).
- H Offset : Horizontal position.
- V Size : Vertical size (Max 120mm).
- V Offset : Vertical position.

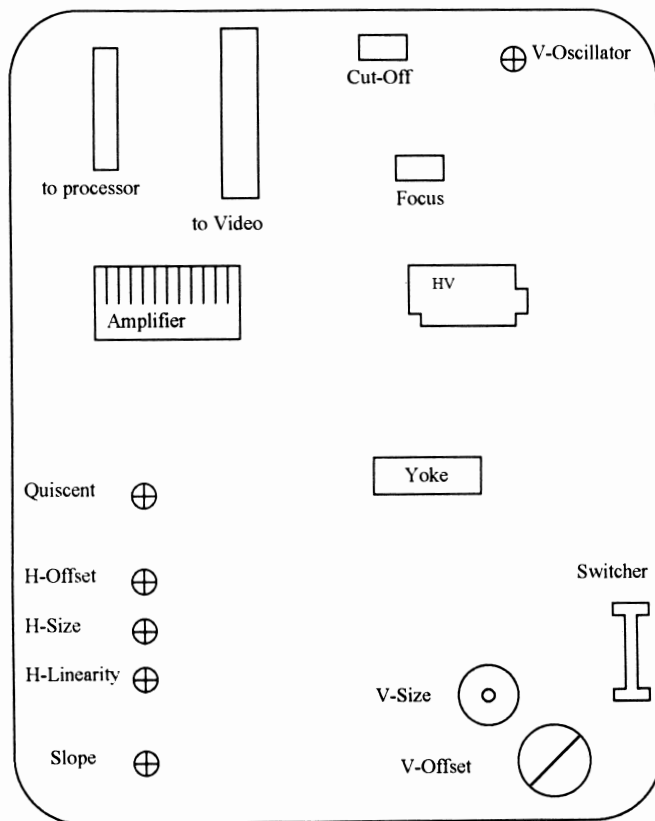

Deflection board component side

7.6.2.2 Coarse Adjustment

- Depress display button.
 - Set W'form + text intensity to 0%.
 - Set grid intensity to 0%

 - Turn fully clockwise the intensity potentiometer on the video board.
 - On the video board connect a digital multimeter on test point : W303
- Adjust threshold potentiometer to get $2\text{ V} \pm 0.1\text{ V}$ on W303.

3-Nov-93
10:03:16

DISPLAY SETUP

Standard
XY

Persistence
Off On

Dot Join
Off On

Grids
Single Dual
Quad

W'form+Text
intensity
0 %

Grid
intensity
0 %

20 μ s ↑
 1 10 mV 50 Ω
 2 10 mV 50 Ω  1 DC 0.0 mV

20 Ms/s

AUTO

- Set W'form intensity to 100%.
- Set grid intensity to 60%.

- Adjust H-size, H-offset, V-size, V-offset to center the image in the screen.
 The vertical position should be adjusted to get the push buttons of the front panel in front of the software menus, use the utilities set up.
 The small magnets mounted on the deflection yoke influence the vertical position.

- Turn the quiescent potentiometer clockwise until the default of the horizontal lines just disappears from the vertical center of the screen.

- Increase the cut off until a vertical line appears on the right side of the screen.

- Adjust the slope potentiometer to get 5mm gap between the highlighted vertical line and the right border of the selection menus.

- Adjust H-linearity to get the best linearity.

7.6.2.3 Fine Adjustment

The final adjustment of the intensity, cut off, and focus must be made in a dark room.

- Set W'form intensity to 30%.
- Set grid intensity to 0%.

- Adjust the cut off potentiometer until the highlighted vertical line disappears from the right side of the screen.
- Set W'form intensity to 20%.
- Display four traces.
- On the video board adjust the gain potentiometer (intensity) in order to get the text just readable.
- Set W'form + text intensity to 70%.
- Set grid intensity to 30%

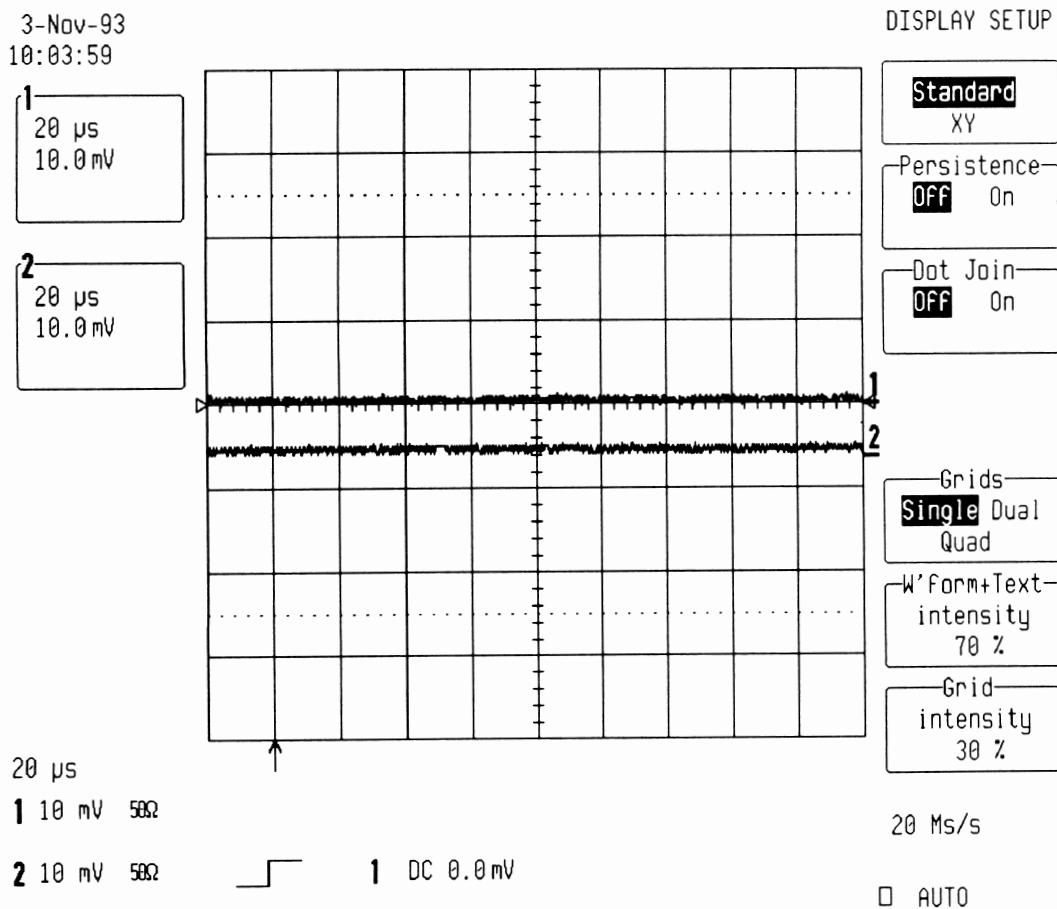

- Adjust the focus (usually fully clockwise) for most uniform focus over the entire screen.
- In a standard luminosity environment set W'form + text to 90%, and grid intensity to 60%.
- Verify the intensity, focus, and contrast adjustment, for best definition of the displayed text.

CAUTION

never change the Vosc calibration.

7.6.3 Front End Test and Calibration Procedure

7.6.3.1 Introduction

The adjustments describe in the following calibration procedure require extension of the front panel assembly out of the scope, using two flat cables.

In order to access the front end potentiometers and variable caps located underneath the Cathode Ray tube and deflection board, dismount the front panel assembly from the scope and reconnect it to the processor board connectors J4 and J6, using the extension cable set.

Once the top cover is removed and the front panel is disassembled from the scope, extra cooling of the main board is required. It's mandatory to disconnect the existing Fan from connector J602, located on F9320-3 card, and to use a Fan with the air flow oriented to the front end section of the board.

7.6.3.2 Channel 1 Gain HF Adjustment

Set the DSO as follows :

- Turn on trace : Ch1
- Display setup : Standard, Persistence off, Dot join on, Single grid
- Input coupling : Ch1 DC 50 Ω
- V/div. offset : Normal
- Probe atten : X1

- Input gain : 100 mV/div
- Input offset : - 250 mV

- Trigger setup : Edge
- Trigger on : 1
- Coupling 1 : DC
- Slope 1 : Neg
- Holdoff : Off

- Trigger level : DC 250 mV
- Mode : Norm

- Timebase : 5 nsec/div.

Apply the pulse generator LeCroy 4969 (or equivalent rise time < 500 psec) to Channel 1.

Set pulser to 61.05 μ sec.

3-Nov-93
10:15:47

TRIGGER SETUP

1
5 ns
100 mV

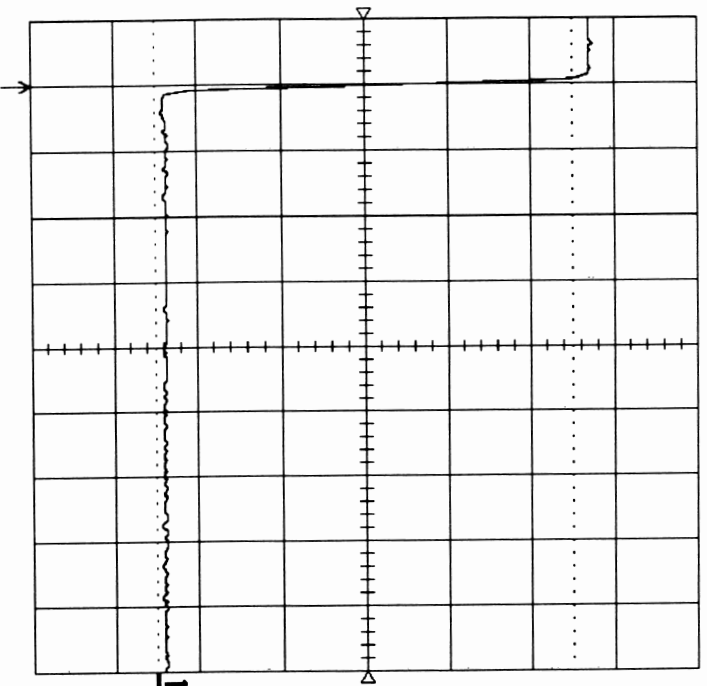

Edge SMART

trigger on
Ext Ext10 2

coupling 1
DC AC

slope 1
Pos Neg

holdoff
Time Evt's OFF

4 Gs/5

NORMML

5 ns RIS

1 .1 V 500

2 .1 V 500

1 DC 250 mV

- Turn on trace : A
- Select Math Setup : A
- For Math : Use at most 5000 points
- Redefine A : A = Average of 1
- Use Math ? : Yes
- Math Type : Average
- Avg Type : Summed
- Of : Channel 1

- Expand A with vertical Zoom

- A: Average (1) : 10.0 mV

- Place trace A in the middle of the screen with the vertical position cursor.

- Turn off : Trace 1

Adjut potentiometer R3021 in order to get a flat square wave

Section 7 Maintenance

3-Nov-93
10:28:29

1
5 ns
100 mV

A: Average(1)
5 ns
10.0 mV
225 swps



SETUP OF A

use Math?
No **Yes**

Math Type
Arithmetic
Average
Enh.Res
Extrema
FFT

Avg Type
Summed
Continuous

for
1000
(sweeps)

of
2 B C D
M1 M2 M3 M4

5 ns RIS
1 .1 V 50Ω
2 .1 V 50Ω

A: Average(1) 200 points

4 Gs/s

NORMAL

3-Nov-93
10:30:13

A: Average(1)
5 ns
10.0 mV
39 swps

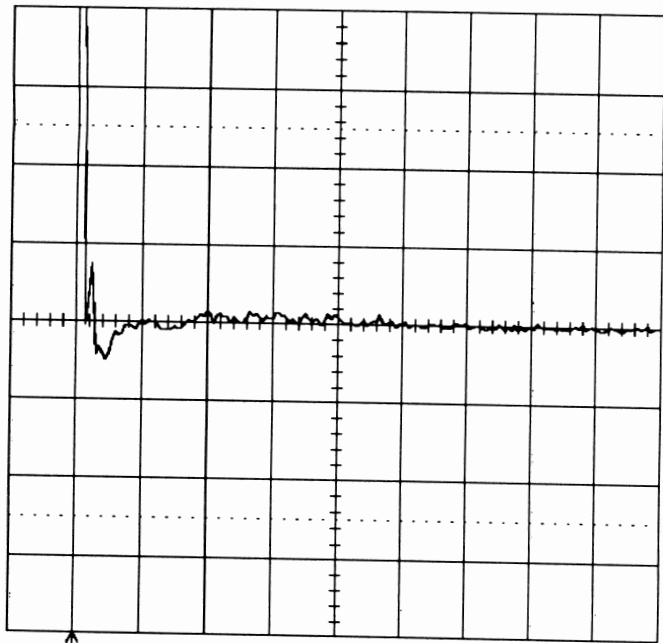

5 ns RIS
1 .1 V 50Ω
2 .1 V 50Ω

1 DC 250 mV

4 Gs/s

NORMAL

7.6.3.3 Channel 2 Gain HF Adjustment

Set the DSO as follows :

- Turn on trace : Ch2
- Display setup : Standard, Persistence off, Dot join on, Single grid
- Input coupling : Ch2 DC 50 Ω
- V/div. offset : Normal
- Probe atten : X1
- Input gain : 100 mV/div
- Input offset : - 250 mV
- Trigger setup : Edge
- Trigger on : 2
- Coupling 2 : DC
- Slope 2 : Neg
- Holdoff : Off
- Trigger level : DC 250 mV
- Mode : Norm
- Timebase : 5 nsec/div.

Apply the pulse generator LeCroy 4969 to Channel 2.

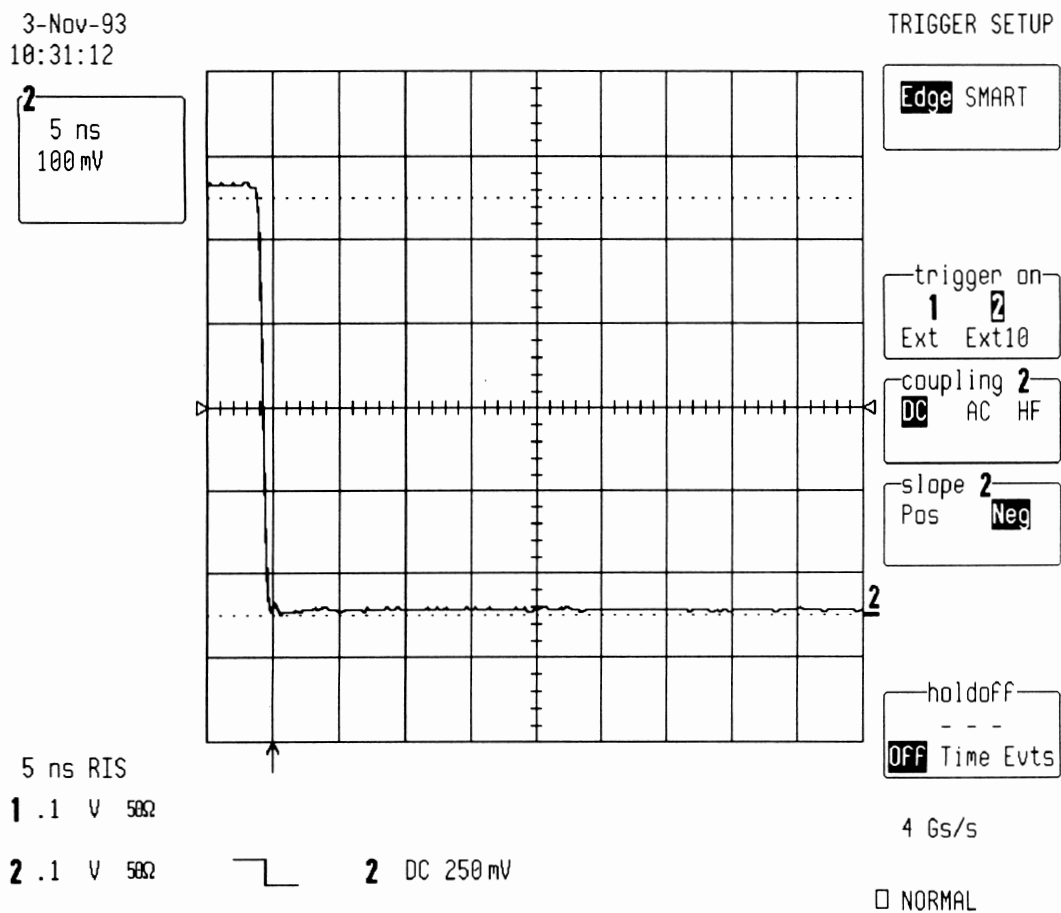

- Turn on trace : B
- Select Math Setup : B
- For Math : Use at most 5000 points
- Redefine B : B = Average of 2
- Use Math ? : Yes
- Math Type : Average
- Avg Type : Summed
- Of : Channel 2

- Expand B with vertical Zoom
- B: Average (2) : 10.0 mV

- Place trace B in the middle of the screen with the vertical position cursor.
- Turn off : Trace 2

Adjut potentiometer R4021 in order to get a flat square wave

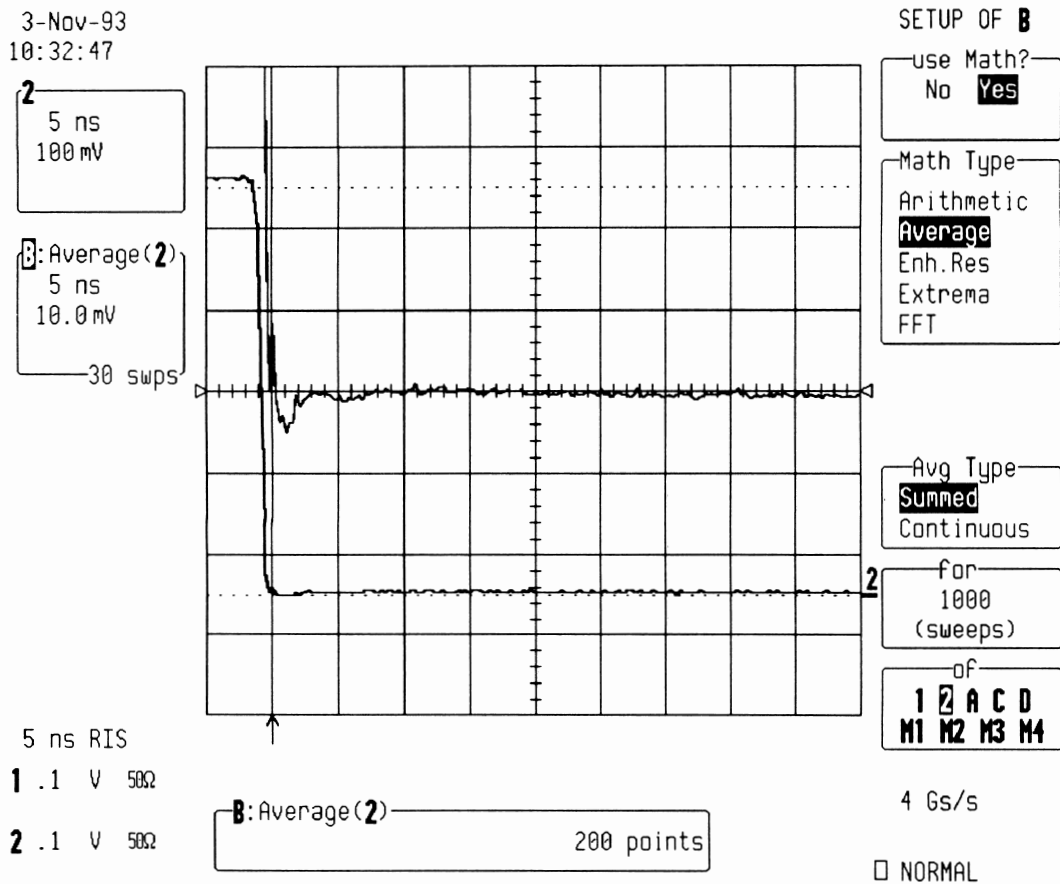

SECTION 8 SCHEMATICS, LAYOUTS, PARTS LIST
--

9320 Digital Oscilloscope

PART: 9320 DESC: 1 GHz DUAL CHANNEL 20 Ms/s DSO

COMPONENT -----	PART DESCRIPTION -----	QTY PER ASSEMBLY -----
205750000	IC AND-OR GATE ARRAY 16V8	1
554500001	TAPPING SCREW W/U-THREAD	2
709320013	FRONT LABEL	1
709320913	SERIAL NUMBER PLATE	1
ACCESSORIES-9320	ACCESSORIES FOR 9320	1
F9300-4	GPIB + RS232 INTERFACE CARD	1
F9314M-1	PROCESSOR CARD WITH 2Mb RAM	1
F9320-3	MAIN CARD DUAL 20Ms/s, 1GHz	1
F9320-5	DUAL CHANNEL FRONT PANEL	1
M932X	MECHANICAL FOR 932X-SERIES	1

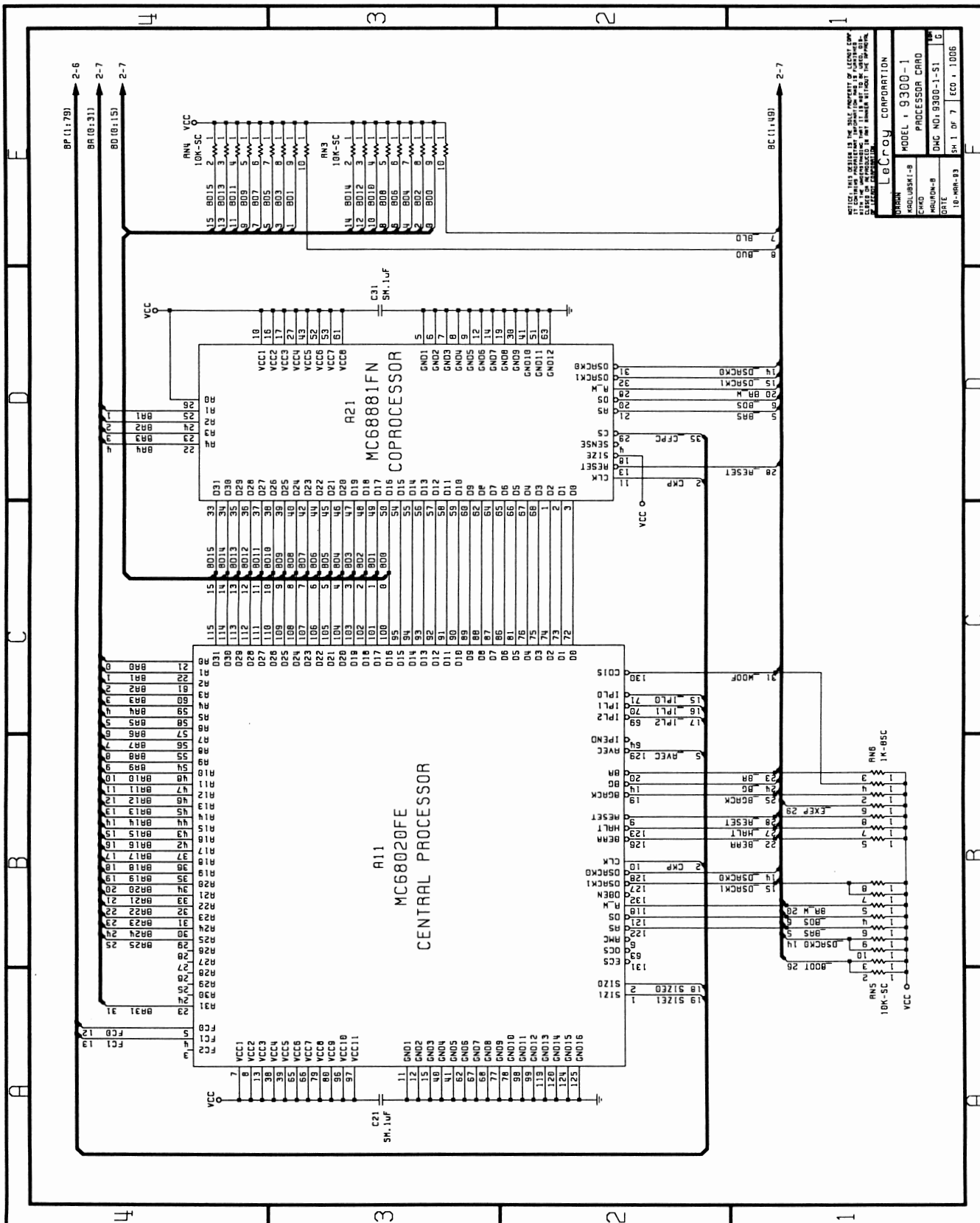

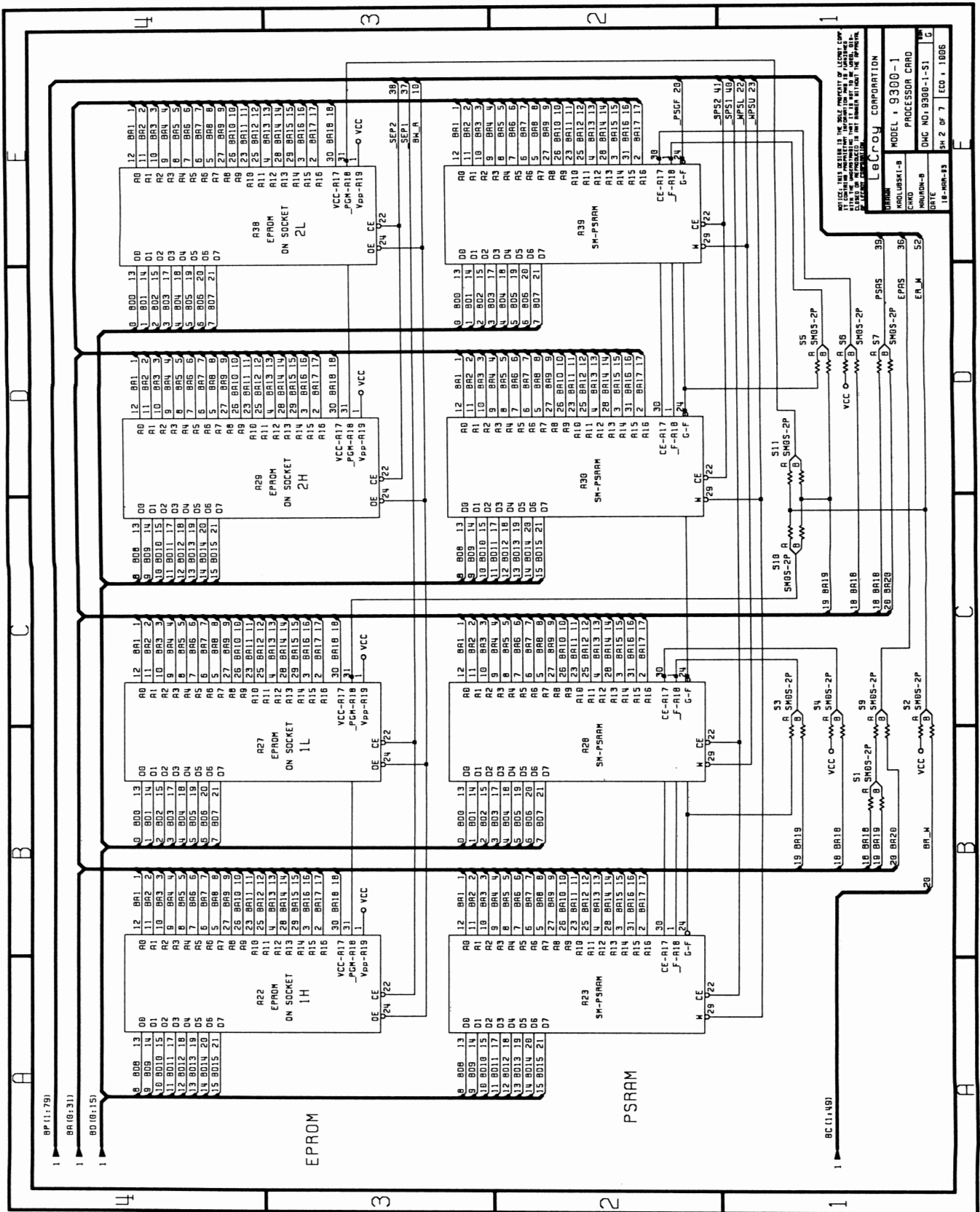

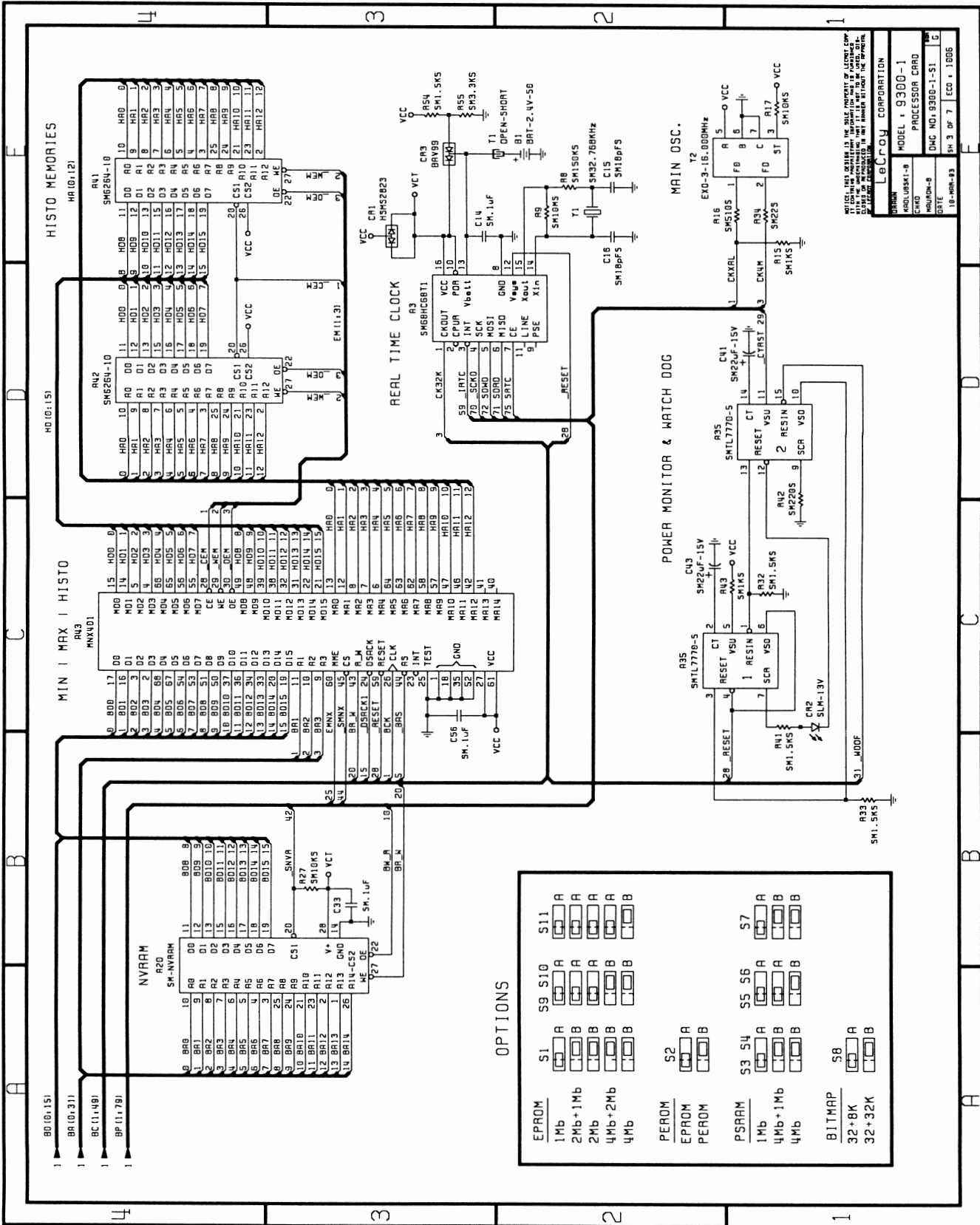

NOTICE: THIS DRAWING IS THE SOLE PROPERTY OF LECROY CORPORATION. IT IS TO BE USED ONLY FOR THE PROJECT AND QUANTITY SPECIFIED IN THE ORDER. IT IS NOT TO BE REPRODUCED, COPIED, OR TRANSMITTED IN ANY FORM OR BY ANY MEANS, WITHOUT THE EXPRESS WRITTEN PERMISSION OF LECROY CORPORATION.

REV **DATE** **BY**
 10-MAR-83 SH 3 OF 7 ECO * 1806

MODEL # 9300-1
PROCESSOR CARD
DATE

ECN **ECN** **DATE**
 10-MAR-83 SH 3 OF 7 ECO * 1806

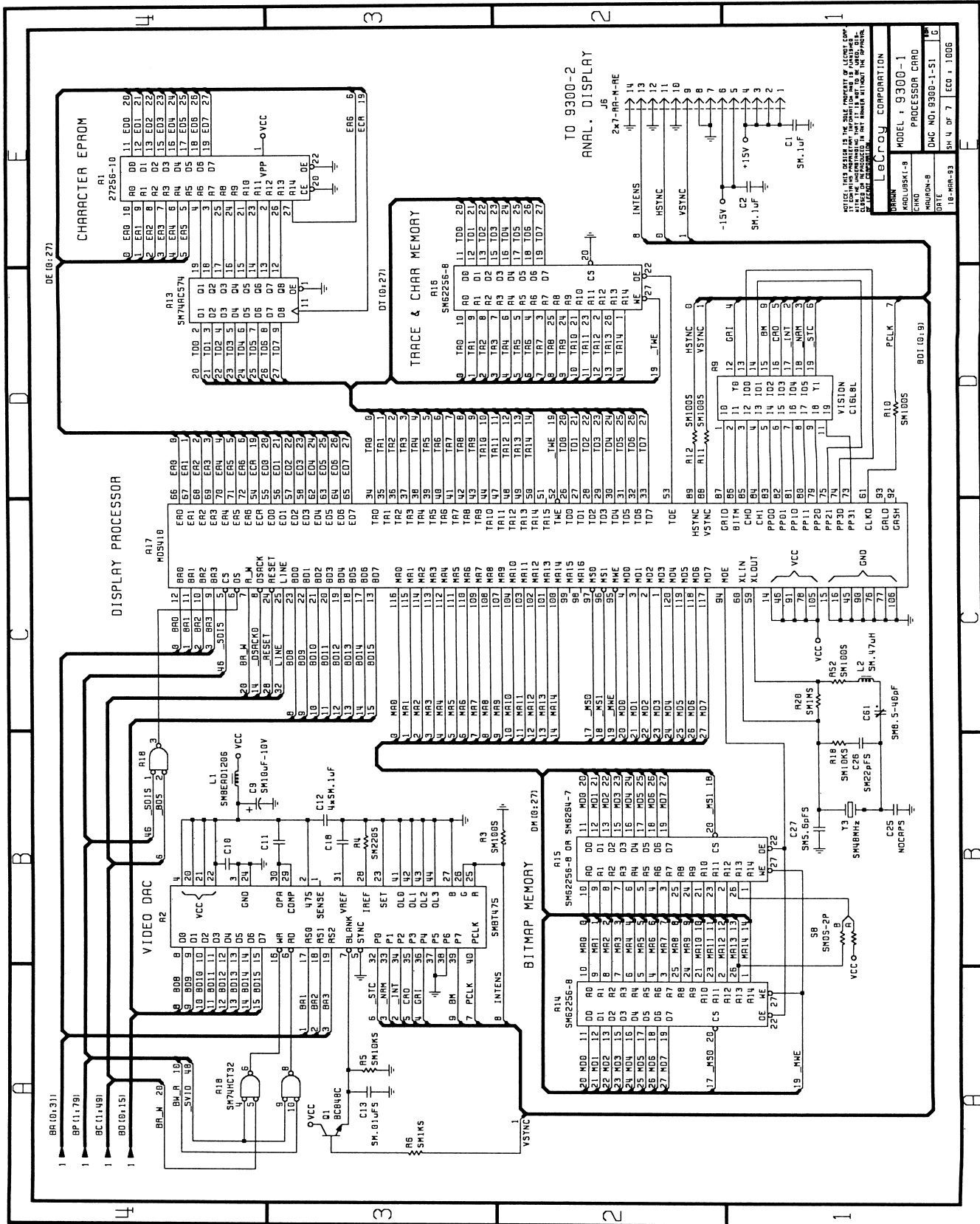

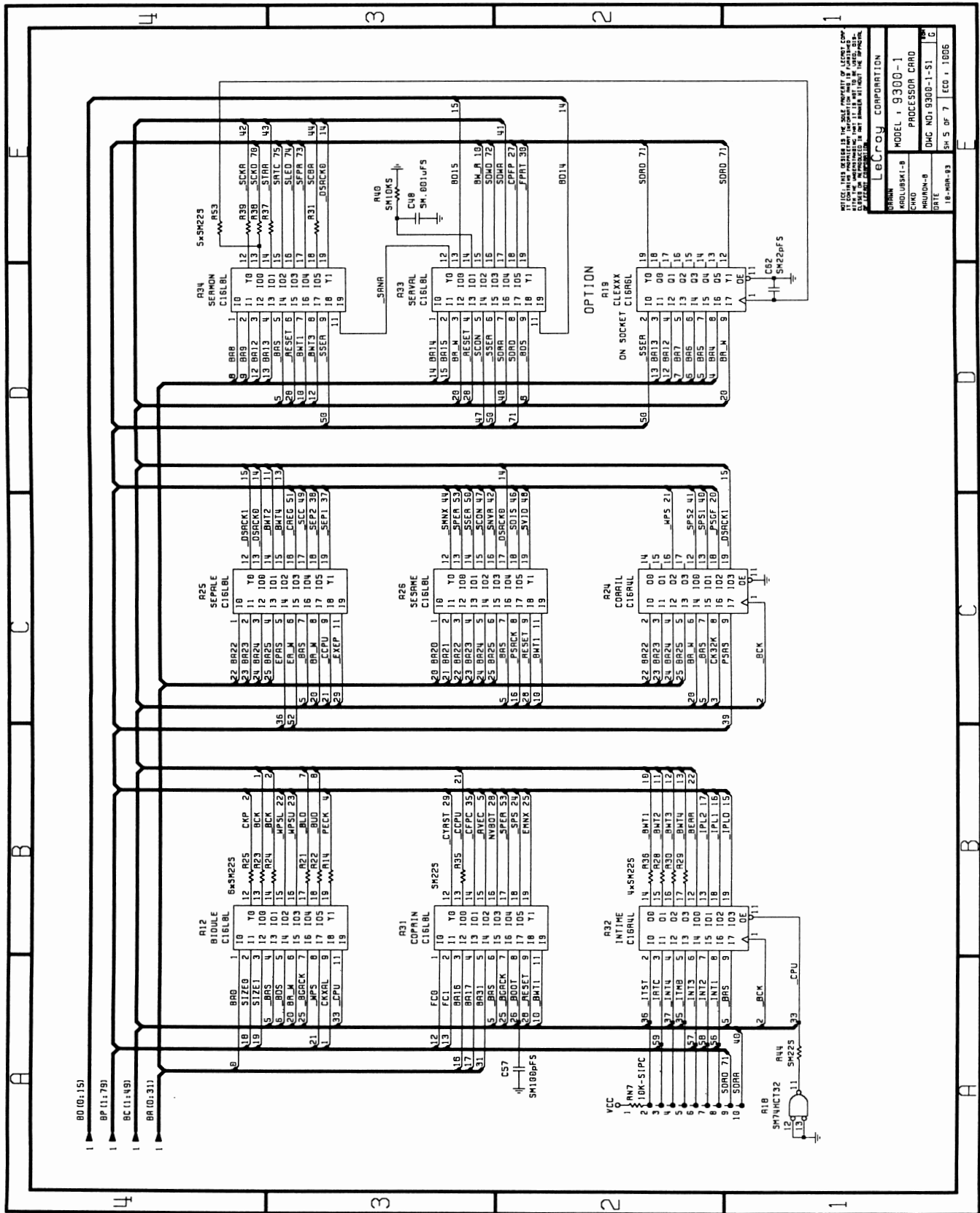

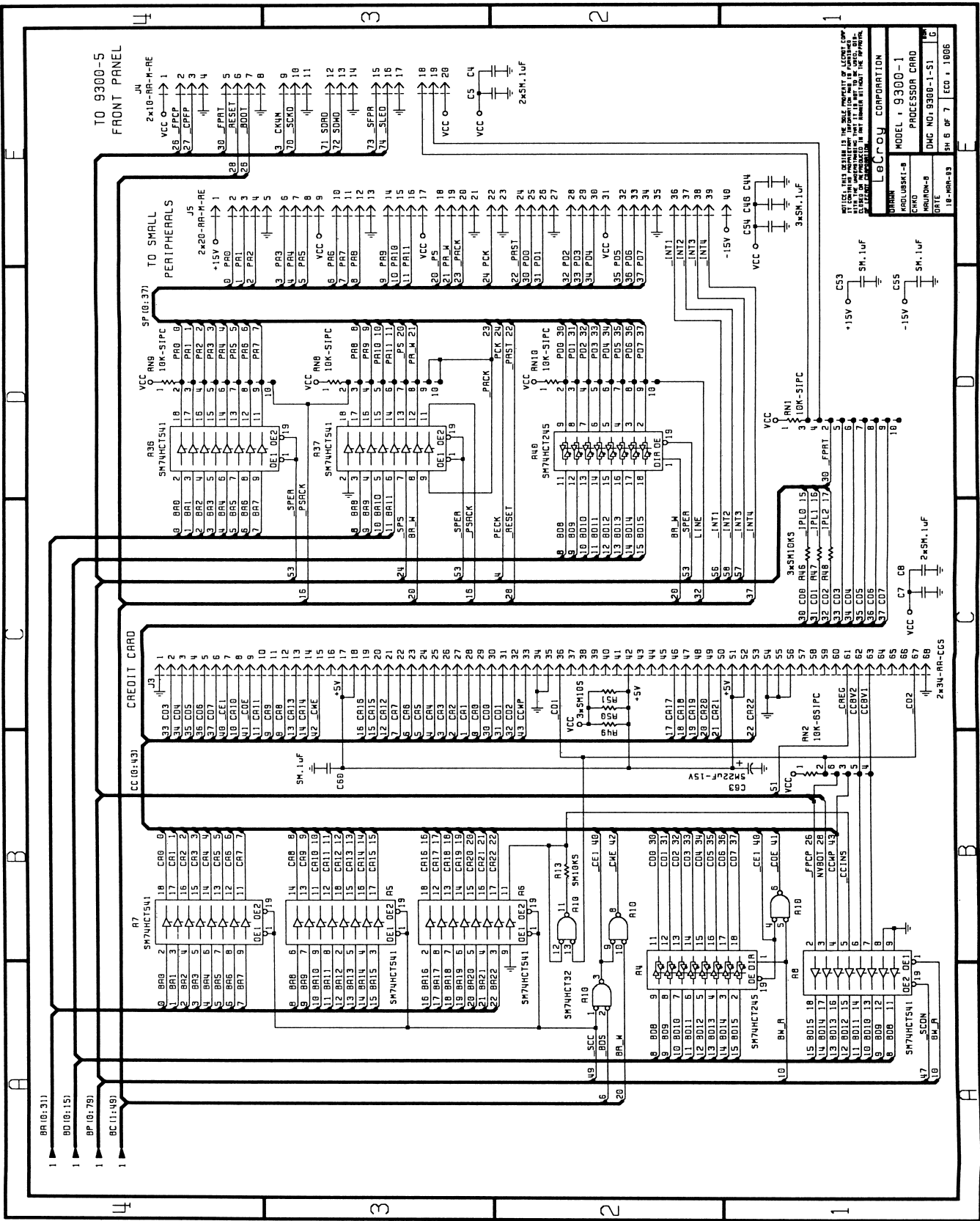

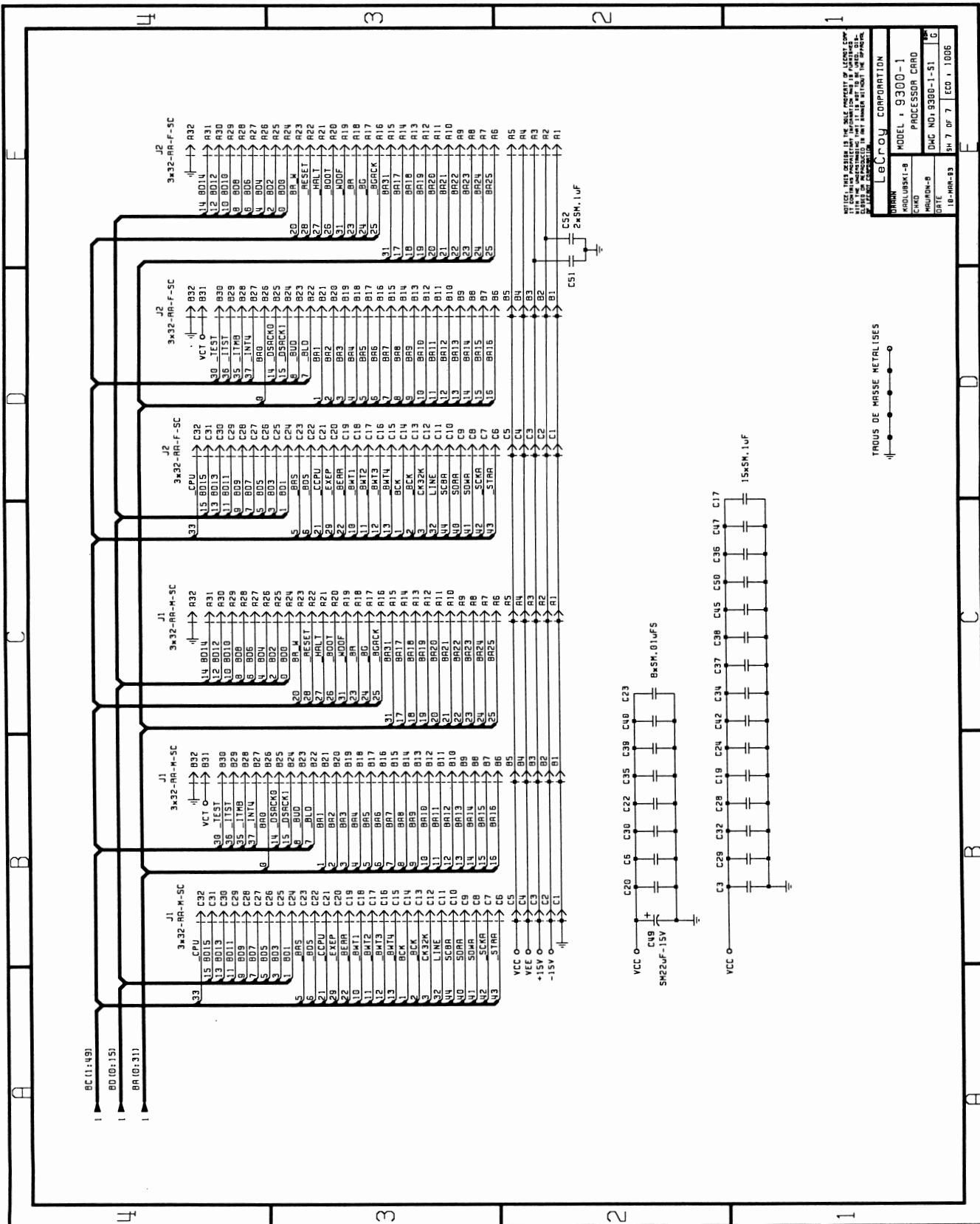

9300-1 Rev: E

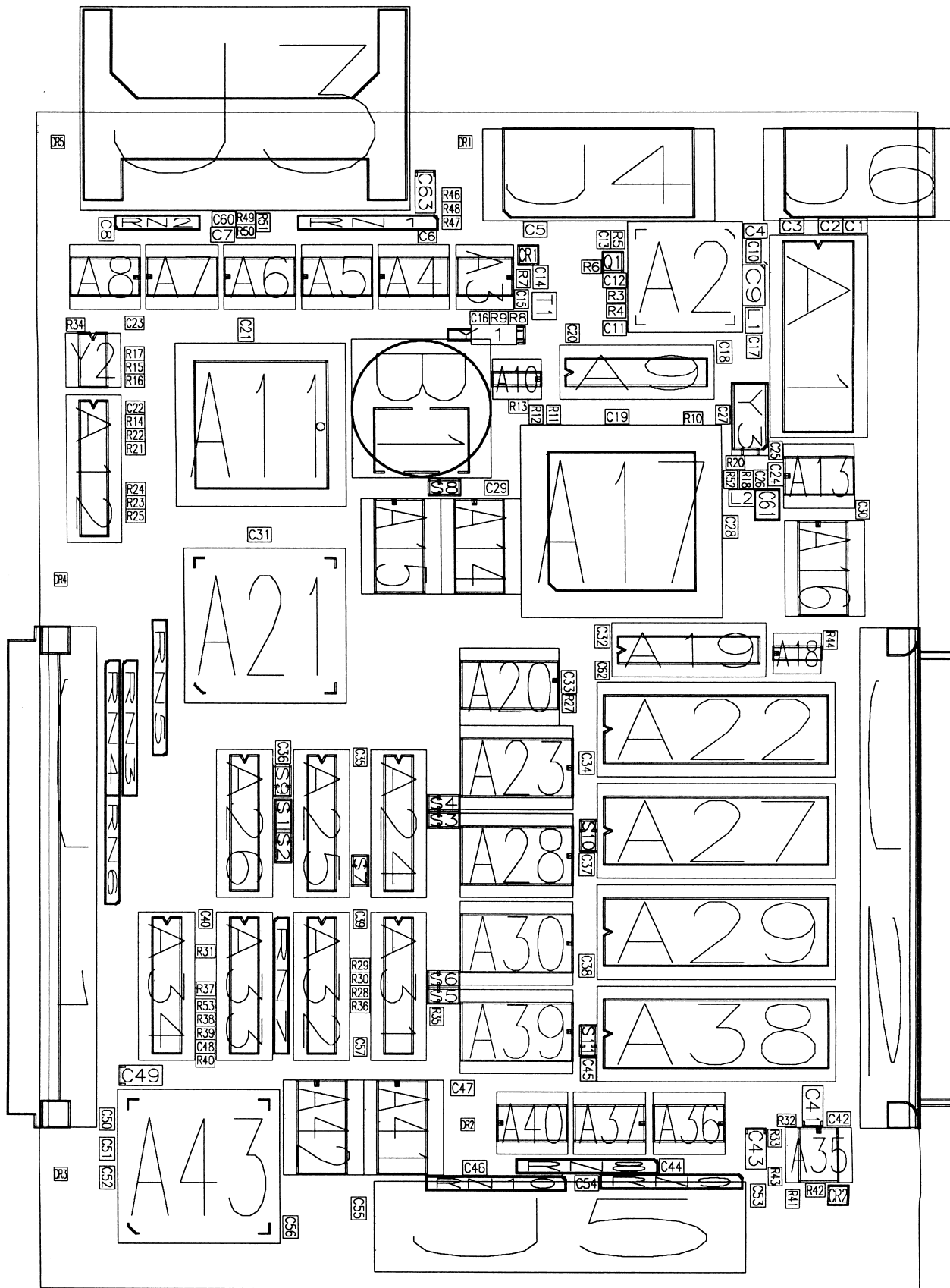

9300-1 Rev:E

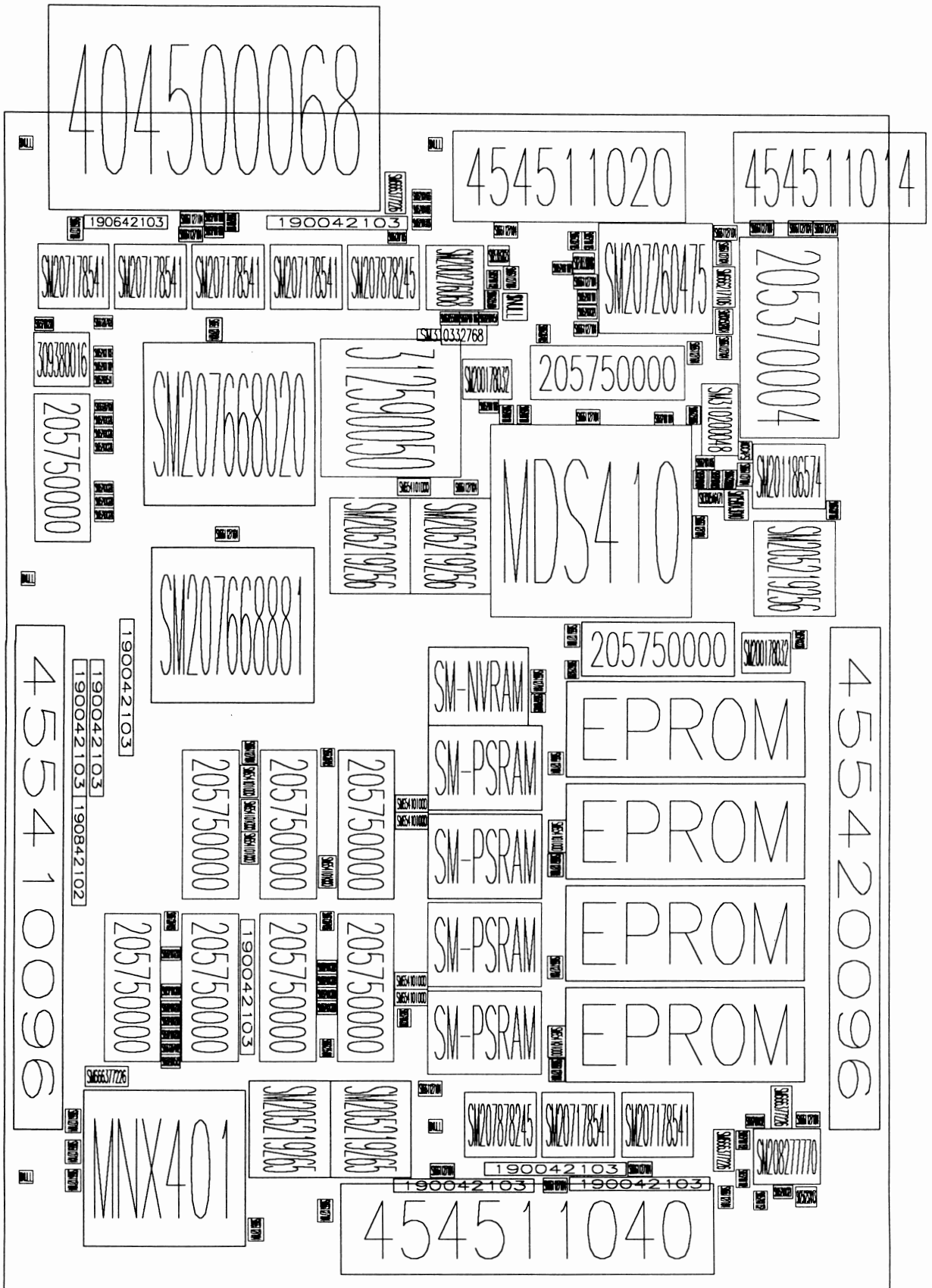

9300-1 Rev : E

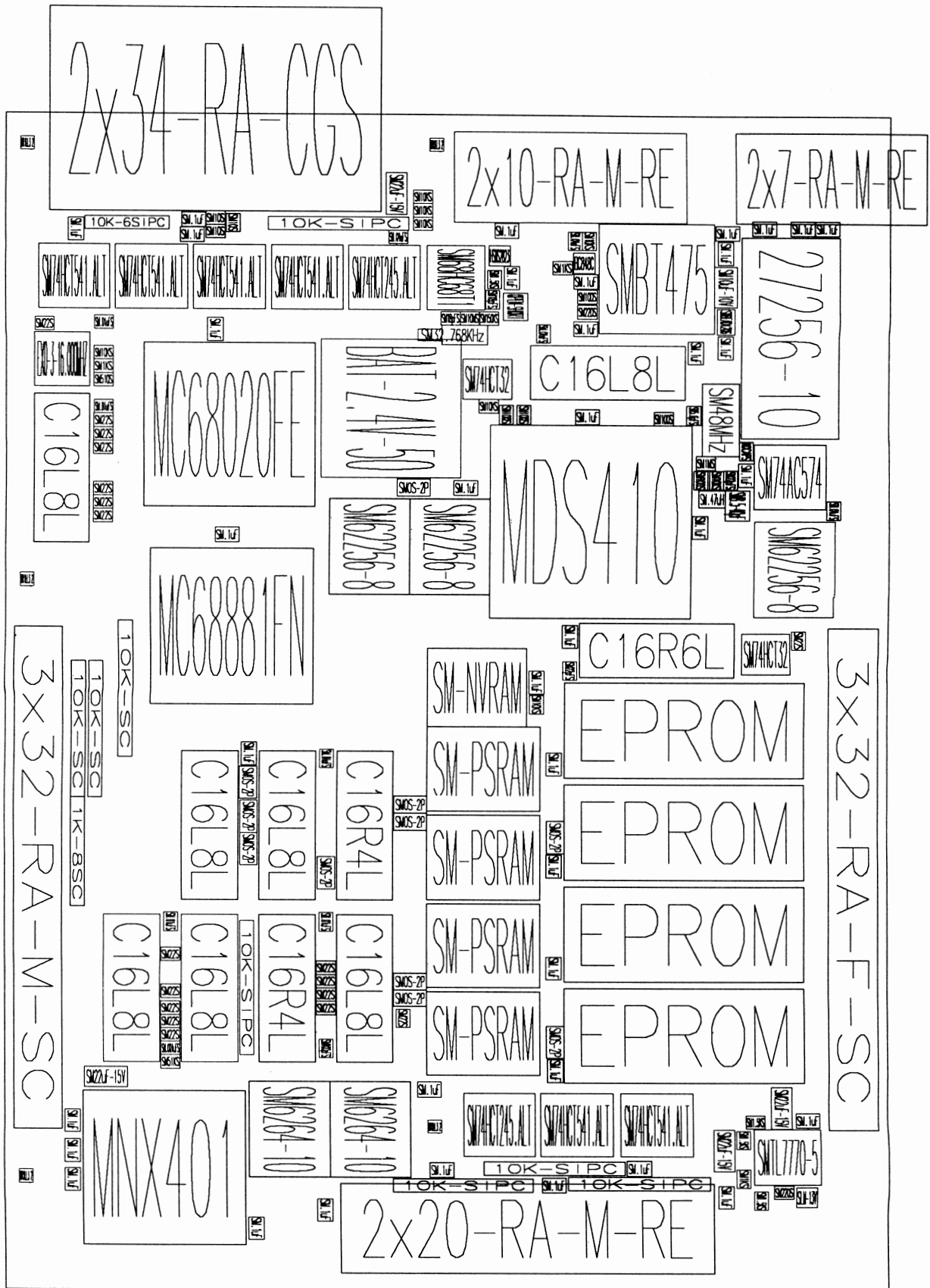

A1	205370004	27256-10	DIP28
A2	SM207260475	SMBT475	PLCC_44
A3	SM200276068	SM68HC68T1	SOIC_16L
A4	SM207878245	SM74HCT245.ALT	SOIC_20
A5	SM207178541	SM74HCT541.ALT	SOIC_20
A6	SM207178541	SM74HCT541.ALT	SOIC_20
A7	SM207178541	SM74HCT541.ALT	SOIC_20
A8	SM207178541	SM74HCT541.ALT	SOIC_20
A9	205750000	Cl6L8L	DIP20
A10	SM200178032	SM74HCT32	SOIC_14
A11	SM207668020	MC68020FE	QUAD_FP_132P
A12	205750000	Cl6L8L	DIP20
A13	SM201186574	SM74AC574	SOIC_20
A14	SM205219256	SM62256-8	SOIC_28
A15	SM205219256	SM62256-8	SOIC_28
A16	SM205219256	SM62256-8	SOIC_28
A17	MDS410	MDS410	PQFP_120
A18	SM200178032	SM74HCT32	SOIC_14
A19	205750000	Cl6R6L	DIP20
A20	SM-NVRAM	SM-NVRAM	SOIC_28
A21	SM207668881	MC68881FN	PLCC_68
A22	EPROM	EPROM	DIP32
A23	SM-PSRAM	SM-PSRAM	SOIC_32L
A24	205750000	Cl6R4L	DIP20
A25	205750000	Cl6L8L	DIP20
A26	205750000	Cl6L8L	DIP20
A27	EPROM	EPROM	DIP32
A28	SM-PSRAM	SM-PSRAM	SOIC_32L
A29	EPROM	EPROM	DIP32
A30	SM-PSRAM	SM-PSRAM	SOIC_32L
A31	205750000	Cl6L8L	DIP20
A32	205750000	Cl6R4L	DIP20
A33	205750000	Cl6L8L	DIP20
A34	205750000	Cl6L8L	DIP20
A35	SM208277770	SMTL7770-5	SOIC_16L
A36	SM207178541	SM74HCT541.ALT	SOIC_20
A37	SM207178541	SM74HCT541.ALT	SOIC_20
A38	EPROM	EPROM	DIP32
A39	SM-PSRAM	SM-PSRAM	SOIC_32L
A40	SM207878245	SM74HCT245.ALT	SOIC_20
A41	SM205219265	SM6264-10	SOIC_28
A42	SM205219265	SM6264-10	SOIC_28
A43	MNX401	MNX401	PLCC_68
B1	312590050	BAT-2.4V-50	BAT_MPFR
C1	SM661127104	SM.1uF	SM1206
C2	SM661127104	SM.1uF	SM1206
C3	SM661127104	SM.1uF	SM1206
C4	SM661127104	SM.1uF	SM1206
C5	SM661127104	SM.1uF	SM1206
C6	SM661207103	SM.01uFS	SM0805
C7	SM661127104	SM.1uF	SM1206
C8	SM661127104	SM.1uF	SM1206
C9	SM666217106	SM10uF-10V	SMCAPC
C10	SM661127104	SM.1uF	SM1206
C11	SM661127104	SM.1uF	SM1206
C12	SM661127104	SM.1uF	SM1206
C13	SM661207103	SM.01uFS	SM0805
C14	SM661127104	SM.1uF	SM1206
C15	SM661255180	SM18pFS	SM0805
C16	SM661255180	SM18pFS	SM0805
C17	SM661127104	SM.1uF	SM1206
C18	SM661127104	SM.1uF	SM1206
C19	SM661127104	SM.1uF	SM1206
C20	SM661207103	SM.01uFS	SM0805

C21	SM661127104	SM.1uF	SM1206
C22	SM661207103	SM.01uFS	SM0805
C23	SM661207103	SM.01uFS	SM0805
C24	SM661127104	SM.1uF	SM1206
C26	SM661255220	SM22pFS	SM0805
C27	SM661255056	SM5.6pFS	SM0805
C28	SM661127104	SM.1uF	SM1206
C29	SM661127104	SM.1uF	SM1206
C30	SM661207103	SM.01uFS	SM0805
C31	SM661127104	SM.1uF	SM1206
C32	SM661127104	SM.1uF	SM1206
C33	SM661127104	SM.1uF	SM1206
C34	SM661127104	SM.1uF	SM1206
C35	SM661207103	SM.01uFS	SM0805
C36	SM661127104	SM.1uF	SM1206
C37	SM661127104	SM.1uF	SM1206
C38	SM661127104	SM.1uF	SM1206
C39	SM661207103	SM.01uFS	SM0805
C40	SM661207103	SM.01uFS	SM0805
C41	SM666377226	SM22uF-15V	SMCAPETD5
C42	SM661127104	SM.1uF	SM1206
C43	SM666377226	SM22uF-15V	SMCAPETD5
C44	SM661127104	SM.1uF	SM1206
C45	SM661127104	SM.1uF	SM1206
C46	SM661127104	SM.1uF	SM1206
C47	SM661127104	SM.1uF	SM1206
C48	SM661207102	SM.001uFS	SM0805
C49	SM666377226	SM22uF-15V	SMCAPETD5
C50	SM661127104	SM.1uF	SM1206
C51	SM661127104	SM.1uF	SM1206
C52	SM661127104	SM.1uF	SM1206
C53	SM661127104	SM.1uF	SM1206
C54	SM661127104	SM.1uF	SM1206
C55	SM661127104	SM.1uF	SM1206
C56	SM661127104	SM.1uF	SM1206
C57	SM661255101	SM100pFS	SM0805
C60	SM661127104	SM.1uF	SM1206
C61	SM158043040	SM8.5-40pF	SMCAPVAR
C62	SM661255220	SM22pFS	SM0805
C63	SM666377226	SM22uF-15V	SMCAPETD5
CR1	SM253032823	HSMS2823	SOT23
CR2	SM256232013	SIM-13V	SOT23
J1	455410096	3x32-RA-M-SC	CONN3X32_RA_M_SC
J2	455420096	3x32-RA-F-SC	CONN3X32_RA_F_SC
J3	404500068	2x34-RA-CGS	CONN4X17_RA_CGS
J4	454511020	2x10-RA-M-RE	CONN2X10_RA_M_RE
J5	454511040	2x20-RA-M-RE	CONN2X20_RA_M_RE
J6	454511014	2x7-RA-M-RE	CONN2X7_RA_M_RE
L1	SM301502001	SMBEAD1206	SMSELF
L2	SM300546471	SM.47uH	SMSELF
Q1	SM270330848	BC848C	SOT23
R3	SM652101101	SM100S	SM0805
R4	SM652101221	SM220S	SM0805
R5	SM652101103	SM10KS	SM0805
R6	SM652101102	SM1KS	SM0805
R7	SM652101152	SM1.5KS	SM0805
R8	SM652101154	SM150KS	SM0805
R9	SM652101106	SM10MS	SM0805
R10	SM652101101	SM100S	SM0805
R11	SM652101101	SM100S	SM0805
R12	SM652101101	SM100S	SM0805
R13	SM652101103	SM10KS	SM0805
R14	SM652101220	SM22S	SM0805
R15	SM652101102	SM1KS	SM0805

PART: F9314M-1 DESC: PROCESSOR CARD WITH 2Mb RAM

COMPONENT	PART DESCRIPTION	QTY PER ASSEMBLY
190042103	RESISTOR NETWORK 10 K	1
190642103	RESISTOR NETWORK 10 K	1
190842102	RES NETWORK 1 K	1
205301000	UV E-PROM CMOS 1MBIT	2
205370004	IC CMOS UV EPROM 32K X 8 27C	1
205370020	IC UV EPROM CMOS 2MBIT	2
205750000	IC AND-OR GATE ARRAY 16V8	9
309380016	CRYSTAL OSC (PROGR) 16 MHZ	1
312590070	BATTERY LITHIUM 3V 70MAH	1
400331020	SOCKET IC ST DIP-20	1
400360028	SOCKET IC ST DIP-28	1
400360032	SOCKET IC ST DIP-32	4
404500068	CONN BD TO BD 68 POS	1
454511014	HDR SOLD TAIL/MALE/14/RT	1
454511020	HDR SOLD TAIL/MALE 20	1
454511040	HDR SOLD TAIL/MALE/40/RT	1
455410096	CONN RT ANGLE MALE 96 S-CLIP	1
455420096	HDR RT ANGLE FEM 96 S-CLIP	1
550130108	SCREW CYL HD M3X8	2
552130101	NUT HEX M3	2
719300103	PC BD PREASS'Y 9300-1 E	1
MDS410	IC RSDP GATE ARRAY MDS410	1
MNX401	ICMIN MAX GATEARR. MNX401	1
SM158043040	CAP VARIABLE 8.5 - 40 PF	1
SM200178032	IC 2-IN OR HCT32	2
SM200276068	IC RTC SERIAL 68HC68T1	1
SM201186574	IC OCTAL D-TYP FLOP 74AC574	1
SM205219256	IC 32K X 8 SRAM MS62256	2
SM205219264	IC 8K X 8 SRAM 70 NSEC 6264	4
SM205290512	IC 512K X 8 PSRAM HM658512	4
SM207178541	IC BUFFER/LINE DR HCT541	6
SM207260475	IC RAMDAC 256W 50MHZ BT475	1
SM207668020	IC 32-BIT U-PROC 68020	1
SM207668881	IC CO-PROCESSOR 68881	1
SM207878245	IC BUS TRANSCVR HCT 245	2
SM208277770	IC DUAL PWR SUPPLY SUP 7770-5	1
SM236030099	DIODE SO-PKG BAV99	1
SM253032823	DIODE SCHOTTKY 2823	1
SM256232013	DIODE LIGHT EMITTING RED	1
SM270330848	TRANSISTOR NPN BC848C	1
SM300546471	INDUCTOR .47UH	1
SM301502001	BEAD (FERRITE CHIP)	1
SM310200048	CRYSTAL 48 MHZ MA416	1
SM310332768	XTAL 32768HZ SMD MC316	1

R16	SM652101511	SM510S	SM0805
R17	SM652101103	SM10KS	SM0805
R18	SM652101103	SM10KS	SM0805
R20	SM652101105	SM1MS	SM0805
R21	SM652101220	SM22S	SM0805
R22	SM652101220	SM22S	SM0805
R23	SM652101220	SM22S	SM0805
R24	SM652101220	SM22S	SM0805
R25	SM652101220	SM22S	SM0805
R27	SM652101103	SM10KS	SM0805
R28	SM652101220	SM22S	SM0805
R29	SM652101220	SM22S	SM0805
R30	SM652101220	SM22S	SM0805
R31	SM652101220	SM22S	SM0805
R32	SM652101152	SM1.5KS	SM0805
R33	SM652101152	SM1.5KS	SM0805
R34	SM652101220	SM22S	SM0805
R35	SM652101220	SM22S	SM0805
R36	SM652101220	SM22S	SM0805
R37	SM652101220	SM22S	SM0805
R38	SM652101220	SM22S	SM0805
R39	SM652101220	SM22S	SM0805
R40	SM652101103	SM10KS	SM0805
R41	SM652101152	SM1.5KS	SM0805
R42	SM652101221	SM220S	SM0805
R43	SM652101102	SM1KS	SM0805
R44	SM652101220	SM22S	SM0805
R46	SM652101103	SM10KS	SM0805
R47	SM652101103	SM10KS	SM0805
R48	SM652101103	SM10KS	SM0805
R49	SM652101100	SM10S	SM0805
R50	SM652101100	SM10S	SM0805
R51	SM652101100	SM10S	SM0805
R52	SM652101101	SM100S	SM0805
R53	SM652101220	SM22S	SM0805
RN1	190042103	10K-SIPC	SIP10RES
RN2	190642103	10K-6SIPC	SIP6RES
RN3	190042103	10K-SC	SIP10RES
RN4	190042103	10K-SC	SIP10RES
RN5	190042103	10K-SC	SIP10RES
RN6	190842102	1K-8SC	SIP8RES
RN7	190042103	10K-SIPC	SIP10RES
RN8	190042103	10K-SIPC	SIP10RES
RN9	190042103	10K-SIPC	SIP10RES
RN10	190042103	10K-SIPC	SIP10RES
S1	SM654101000	SM0S-2P	SM0805_2P
S2	SM654101000	SM0S-2P	SM0805_2P
S3	SM654101000	SM0S-2P	SM0805_2P
S4	SM654101000	SM0S-2P	SM0805_2P
S5	SM654101000	SM0S-2P	SM0805_2P
S6	SM654101000	SM0S-2P	SM0805_2P
S7	SM654101000	SM0S-2P	SM0805_2P
S8	SM654101000	SM0S-2P	SM0805_2P
S9	SM654101000	SM0S-2P	SM0805_2P
S10	SM654101000	SM0S-2P	SM0805_2P
S11	SM654101000	SM0S-2P	SM0805_2P
Y1	SM310332768	SM32.768KHz	MC_316
Y2	309380016	EXO-3-16.000MHZ	DIP8
Y3	SM310200048	SM48MHZ	MA_416

PART: F9314M-1 DESC: PROCESSOR CARD WITH 2Mb RAM

COMPONENT -----	PART DESCRIPTION -----	QTY PER ASSEMBLY -----
SM652101100	RES CHIP (E24) 1% 10 OHMS	4
SM652101101	RES CHIP (E24) 1% 100 OHM	5
SM652101102	RES CHIP (E24) 1% 1 K	3
SM652101103	RES CHIP (E24) 1% 10 K	9
SM652101105	RES CHIP (E24) 1% 1 M	1
SM652101106	RES CHIP (E24) 1% 10 MEG	1
SM652101152	RES CHIP (E24) 1% 1.5 K	3
SM652101154	RES CHIP (E24) 1% 150 K	1
SM652101220	RES CHIP (E24) 1% 22 OHMS	17
SM652101221	RES CHIP (E24) 1% 220 OHM	2
SM652101332	RES CHIP (E24) 1% 3.3 K	1
SM652101511	RES CHIP (E24) 1% 510 OHM	1
SM653185152	RES THICK FILM 1.5 K	1
SM654101000	CHIP JUMPER ZERO OHMS	11
SM661127104	CAP CERA CHIP 20% .1 UF	37
SM661207102	CAP CERA CHIP 10% .001UF	1
SM661207103	CAP CERA CHIP 20% .01UF	9
SM661207104	CAP CERA CHIP 20% .1 UF	1
SM661255056	CAP CERA CHIP 5.6 PF	1
SM661255101	CAP CERA CHIP 5% 100 PF	1
SM661255180	CAP CERA CHIP 5% 18PF	2
SM661255220	CAP CERA CHIP 5% 22 PF	2
SM666217106	CAP MOLD TANT CHIP 10 UF	1
SM666377226	CAP MOLD TANT CHIP 22 UF	4

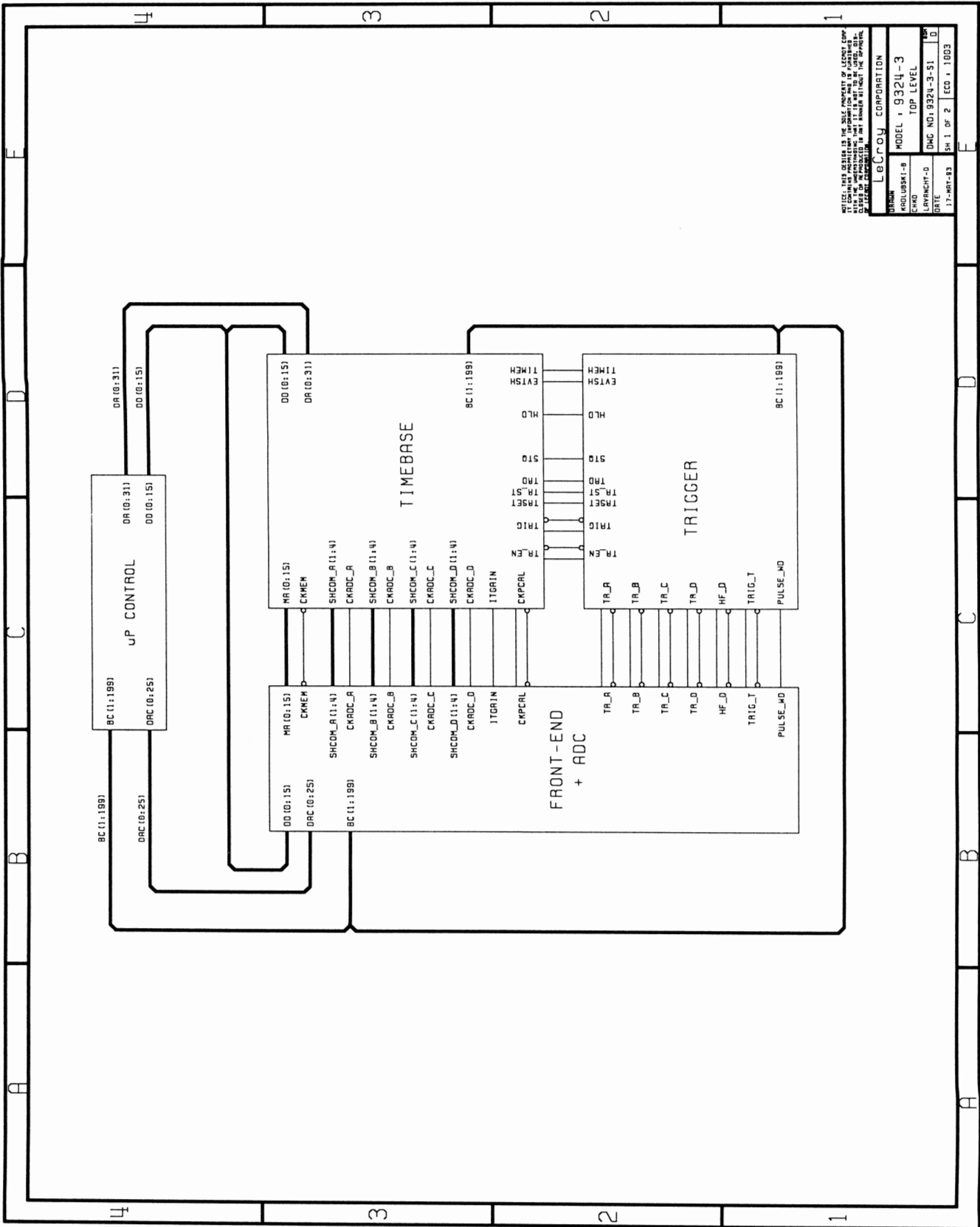

COMPONENT NOT MOUNTED ON THE 9320-3 :		A & B
FE / ADC CHANNELS :		
<u>uP CONTROL (SHEET4)</u>		A633 C661 L607
- LM340T-12 - SM2.2uF-20V - SMBERAD1206		
<u>FE / ADC CONTROL (SHEET1)</u>		A800 A801 C801 - C802 - C807 - C808 R801 - R802 - R803 - R804 L803 - L804
- SMLF347 - SMDG201 - SM.01uF-NPO - SM10KS - SMBERAD1206		
<u>FE / ADC CONTROL (SHEET2)</u>		A806 A808 A810 R806 - R807 - R814 - R816
- SMLF347 - SM74HC594 - SMULN2003 - SM10KS		
<u>FE / ADC CONTROL (SHEET3)</u>		C800 - C803 - C804 - C805 C828 - C830 - C832 - C836
- SM.01uFS		
<u>TIMEBASE (SHEET4)</u>		A303 C321 R321 - R322 - R325 - R326 R373 - R387 R328 - R330 - R331 R333 - R341 - R381 R384 - R385 R329 - R332 - R371 - R372
- SM10EL11 - SM.01uFS - SM05 - SM22S - SM51S - SM56S - SM200S		
<u>TIMEBASE (SHEET5)</u>		C317
- SM.01uFS		
<u>TRIGGER (SHEET3)</u>		R5 - R23
- SM05		

THIS DRAWING IS THE PROPERTY OF ADTECH CORP.
IT IS TO BE USED ONLY FOR THE PROJECT AND FOR THE QUANTITY OF PARTS SPECIFIED.
IT IS TO BE KEPT IN THE ORIGINAL FILE AND NOT REPRODUCED IN ANY MANNER WITHOUT THE WRITTEN
CONSENT OF ADTECH CORP.

LeCroy CORPORATION
 DRAWN: KADLURSKI-B MODEL: 9324-3
 CHECKED: TDP LEVEL
 LAYOUP: LAYOUP-0 DWG NO: 9324-3-S1
 DATE: SH 2 OF 2 ECD: 1083

9324-3 Rev:C

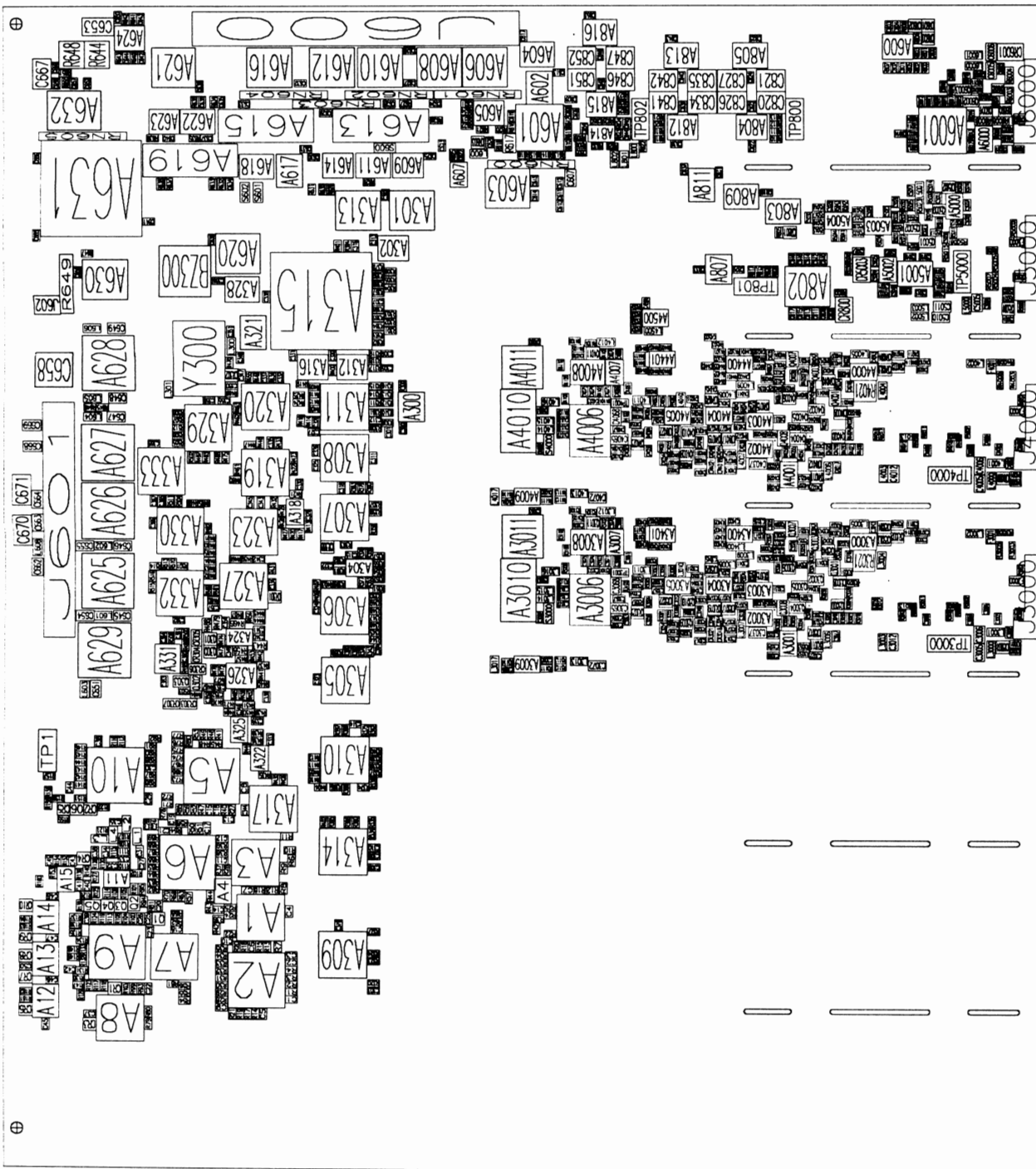

OVERVIEW

9324-3 Rev:C

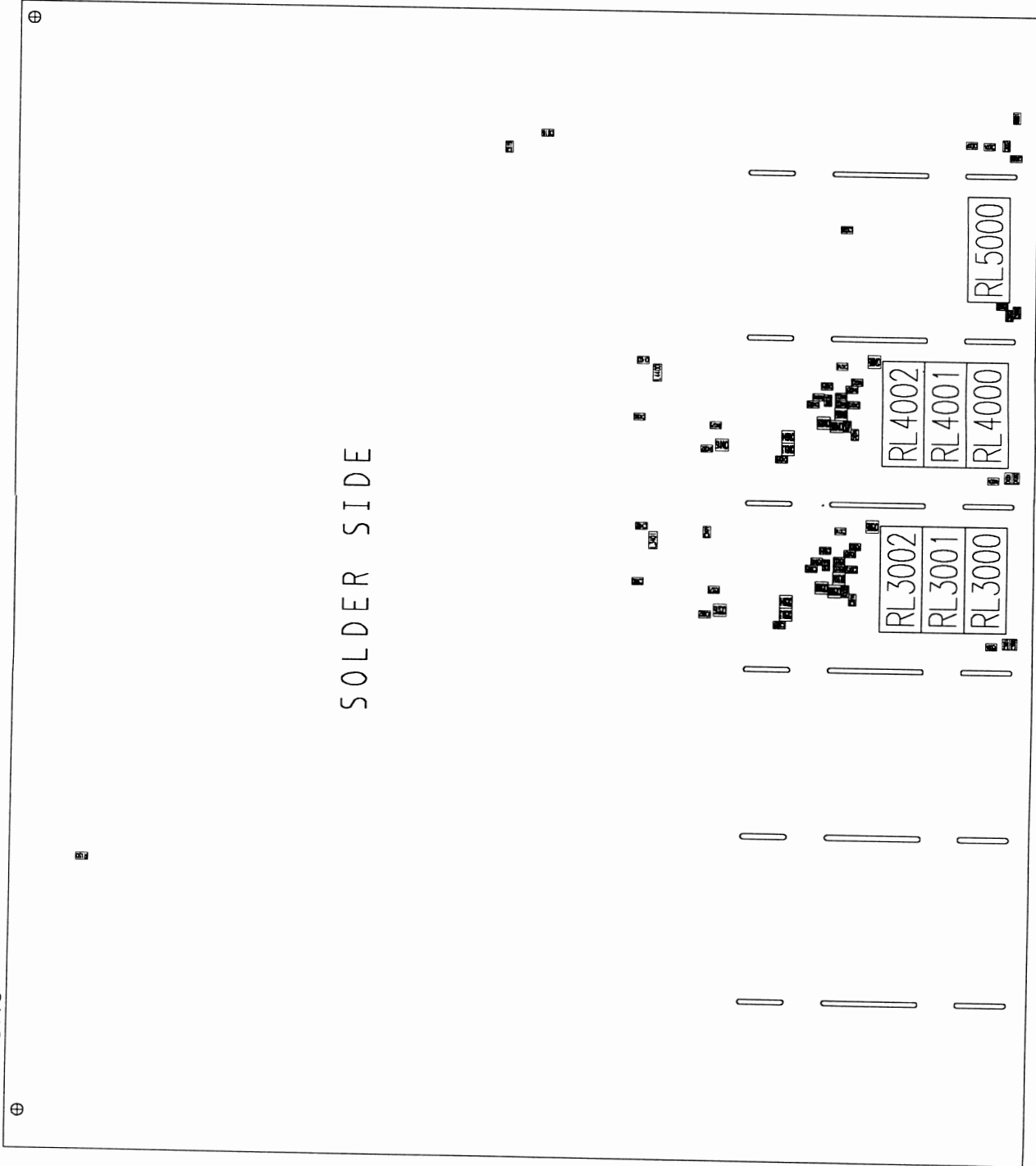

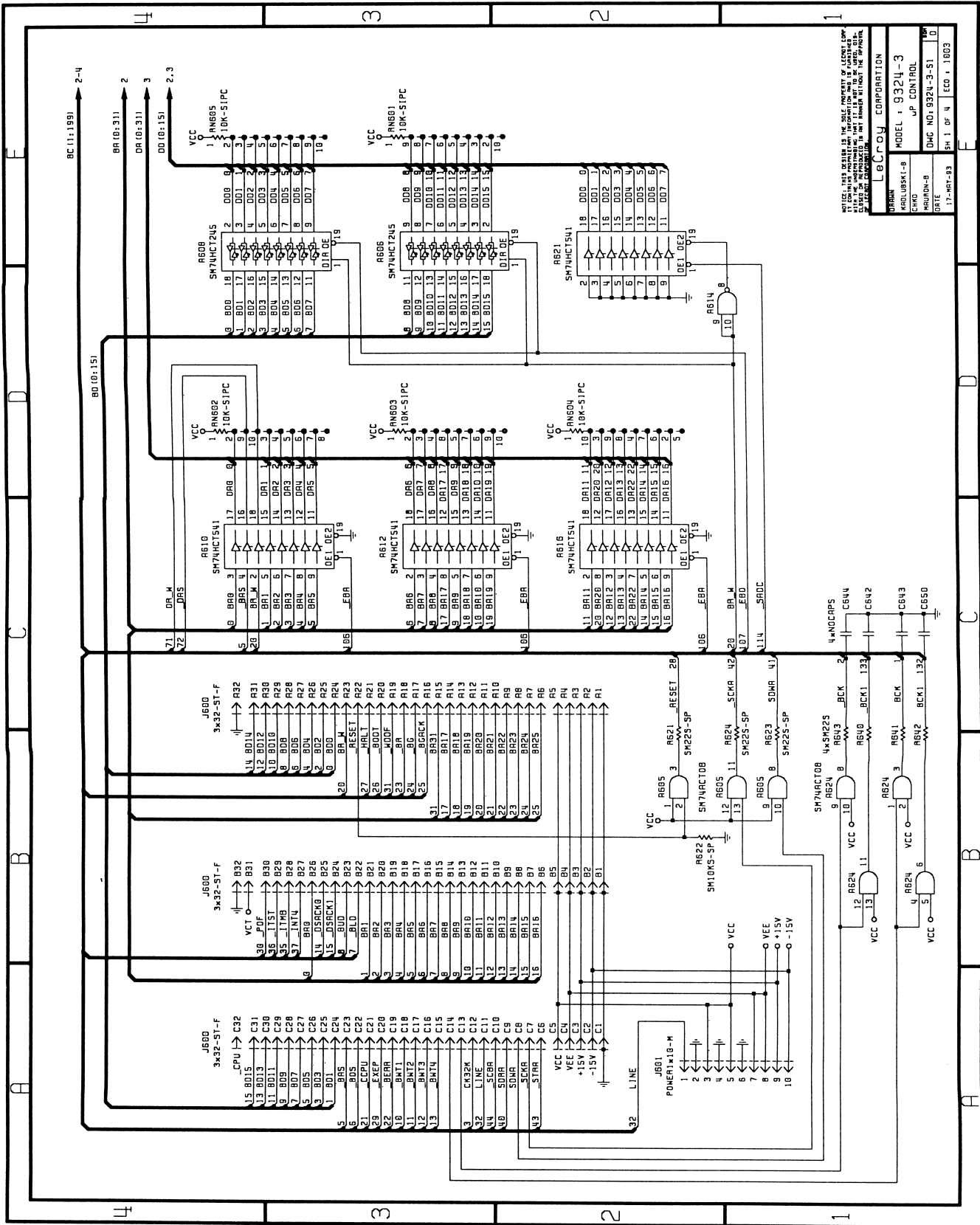

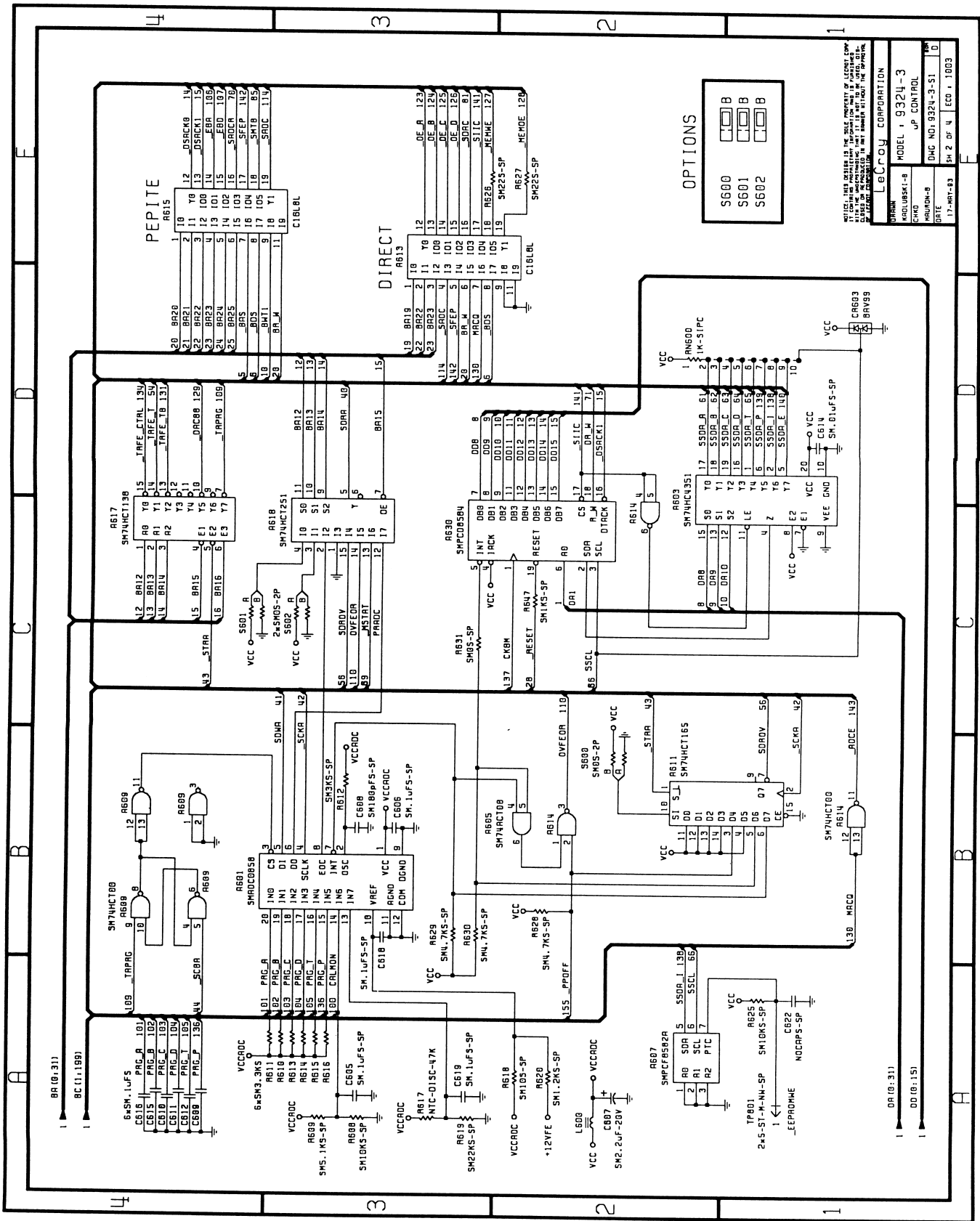

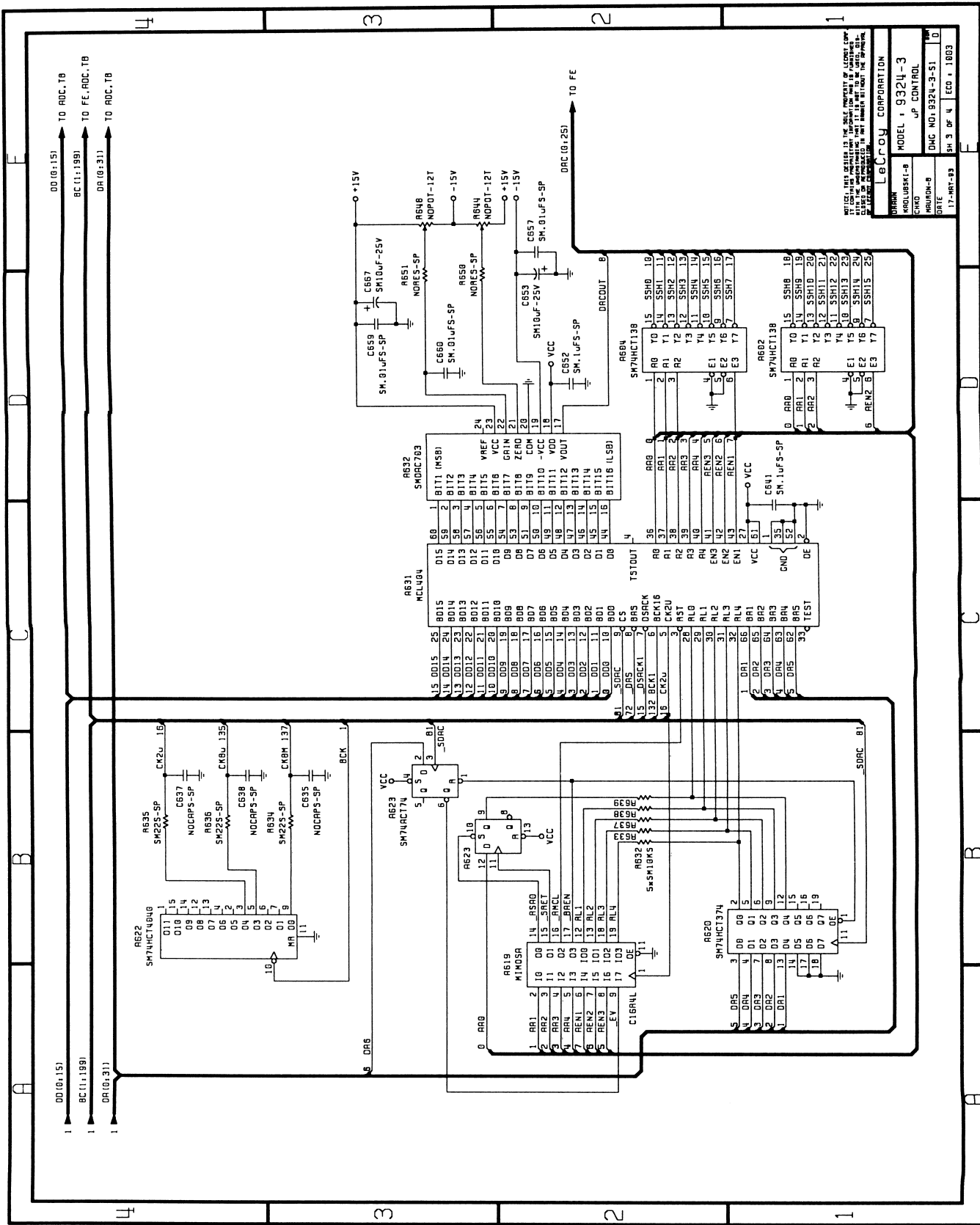

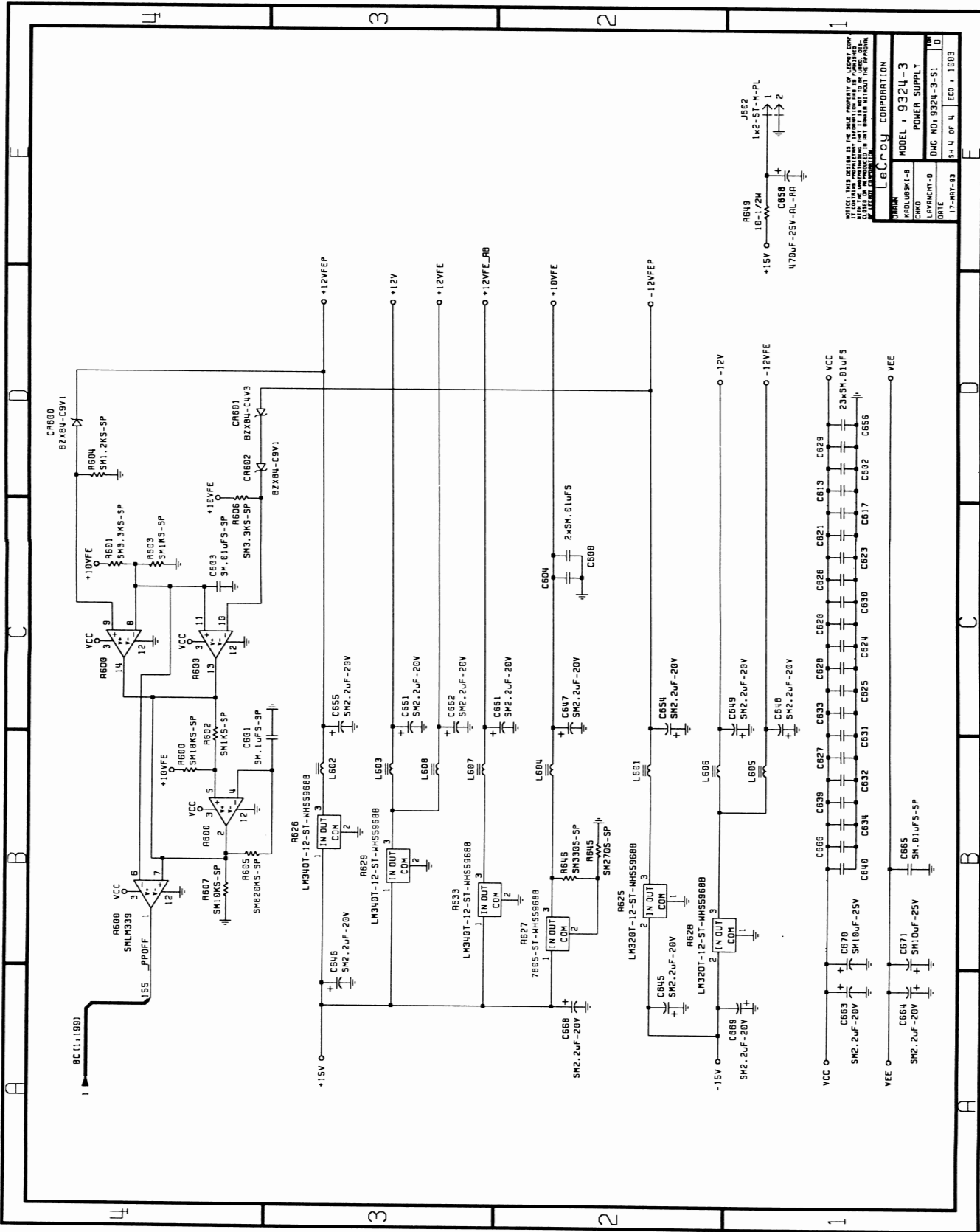

9324-3 Rev:C

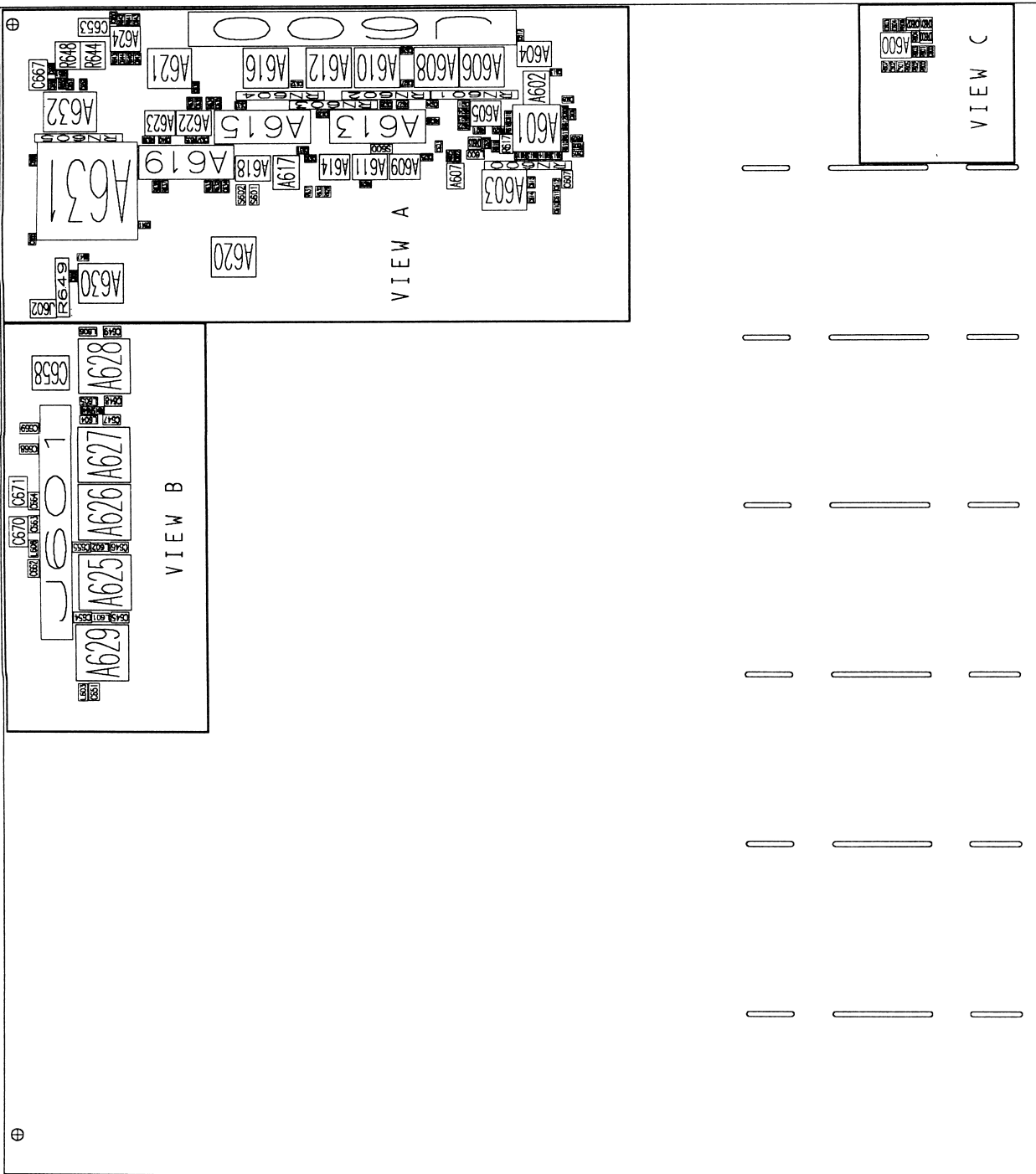

9324-3 Rev:C

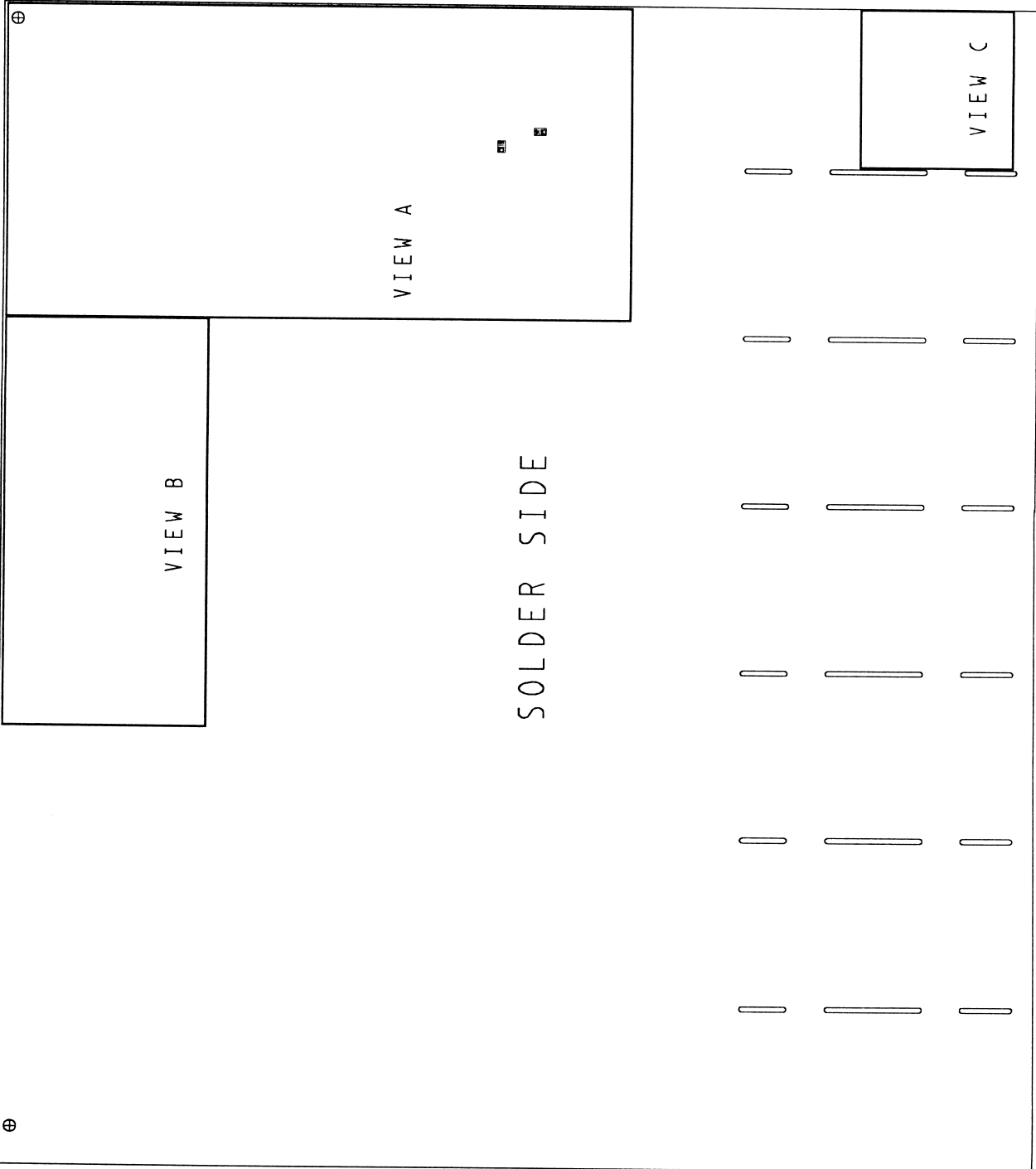

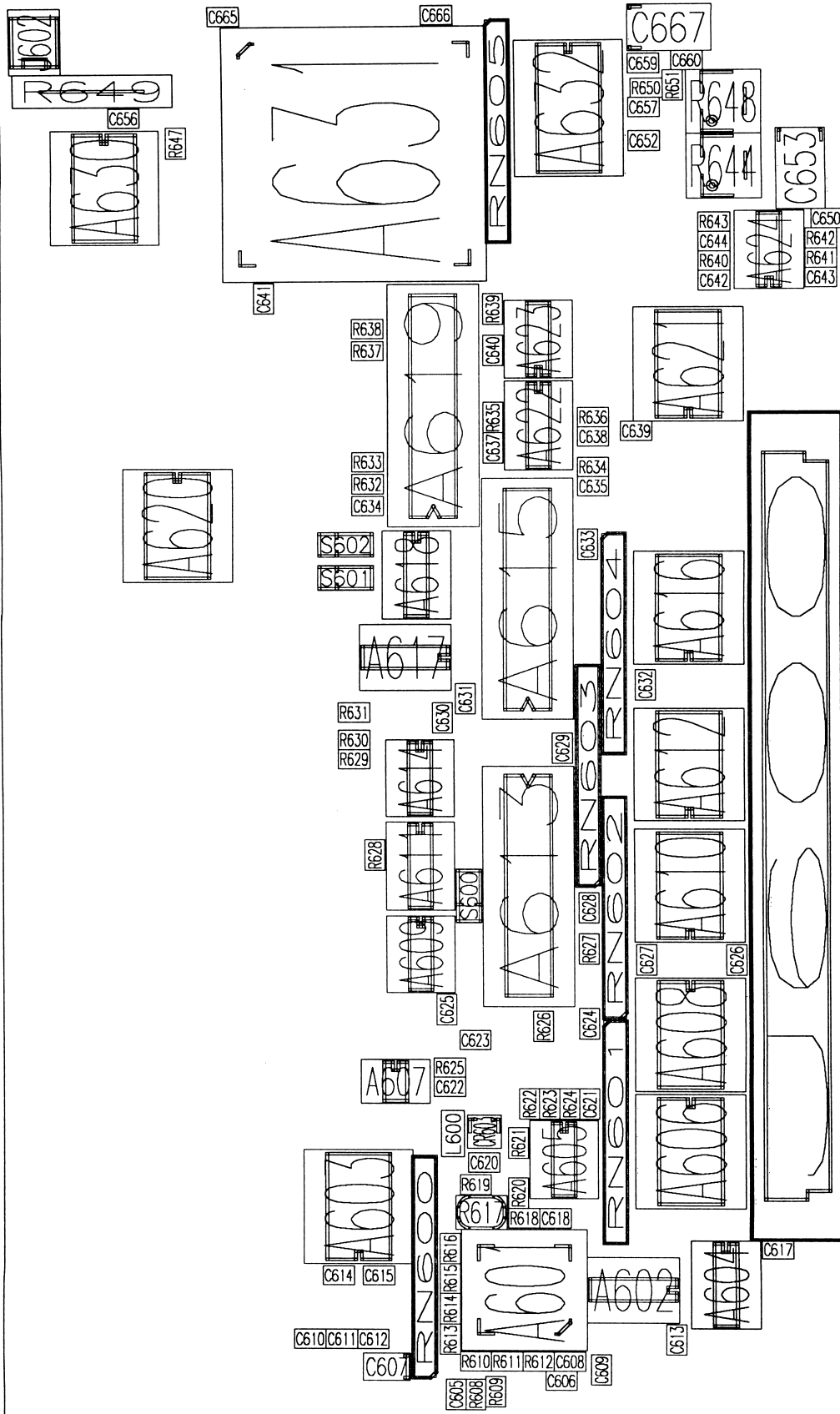

CONTROL VIEW A

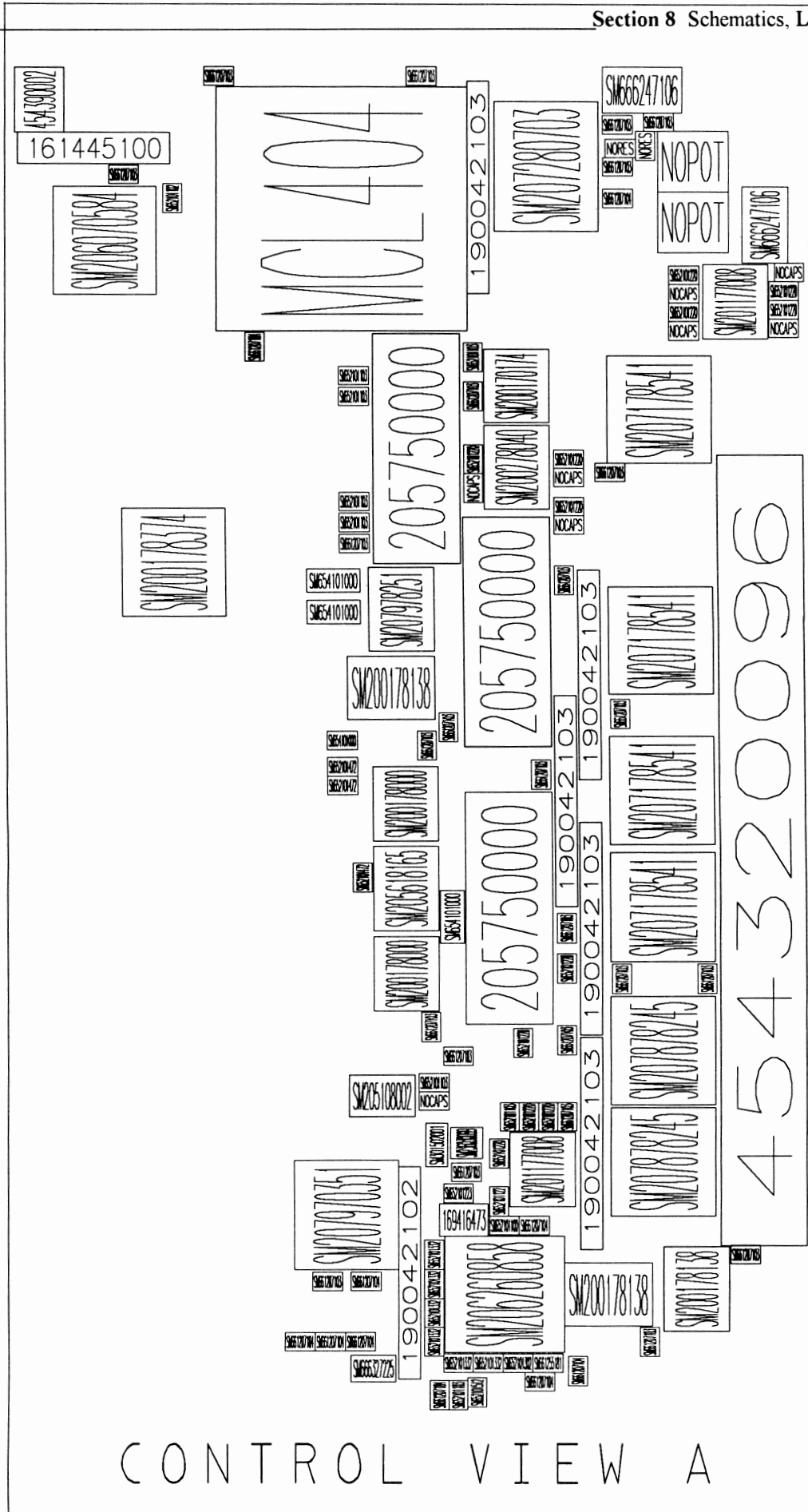

CONTROL VIEW A

SOLDER SIDE

619

616

CONTROL VIEW A

SOLDER SIDE



CONTROL VIEW A

SOLDER SIDE

SW. 12FS

SW. 12FS

CONTROL VIEW A

CONTROL VIEW B

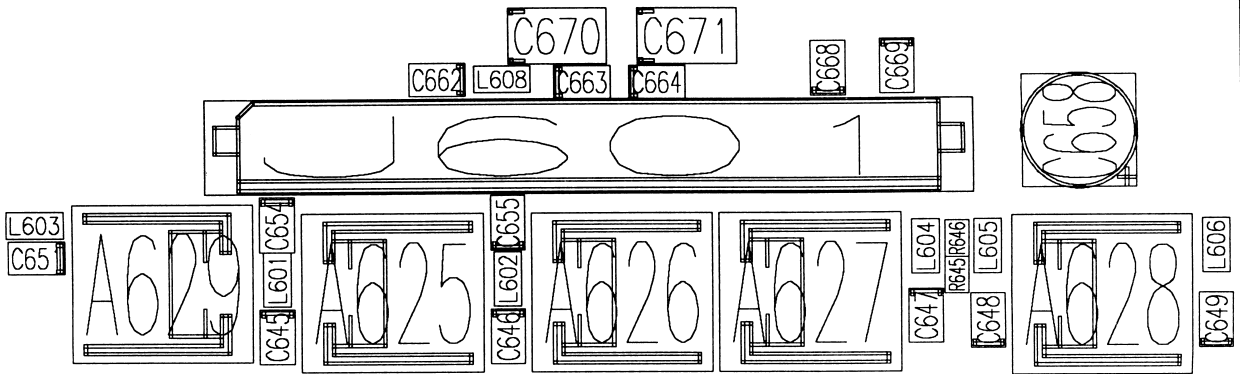

CONTROL VIEW B

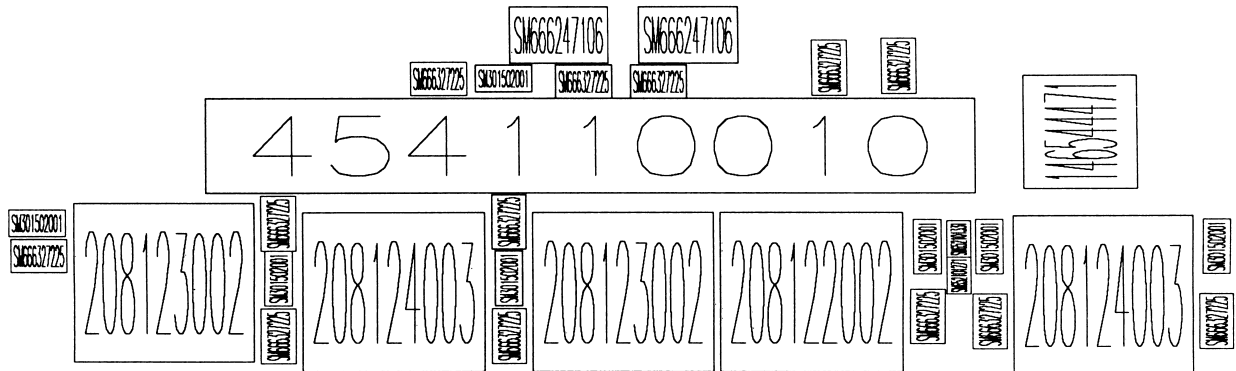

CONTROL VIEW B

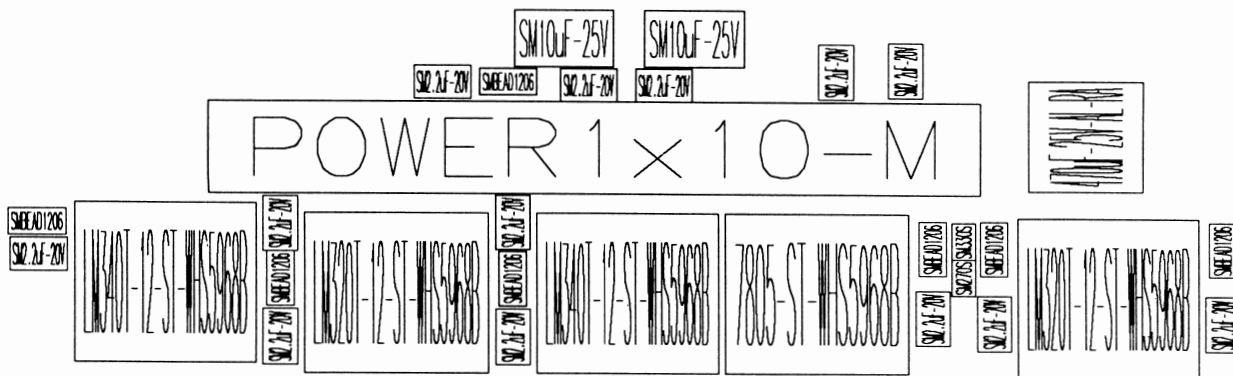

CONTROL VIEW C

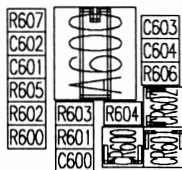

CONTROL VIEW C

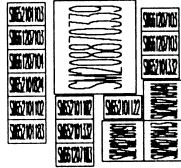

CONTROL VIEW C

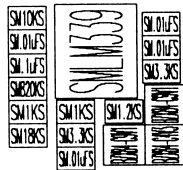

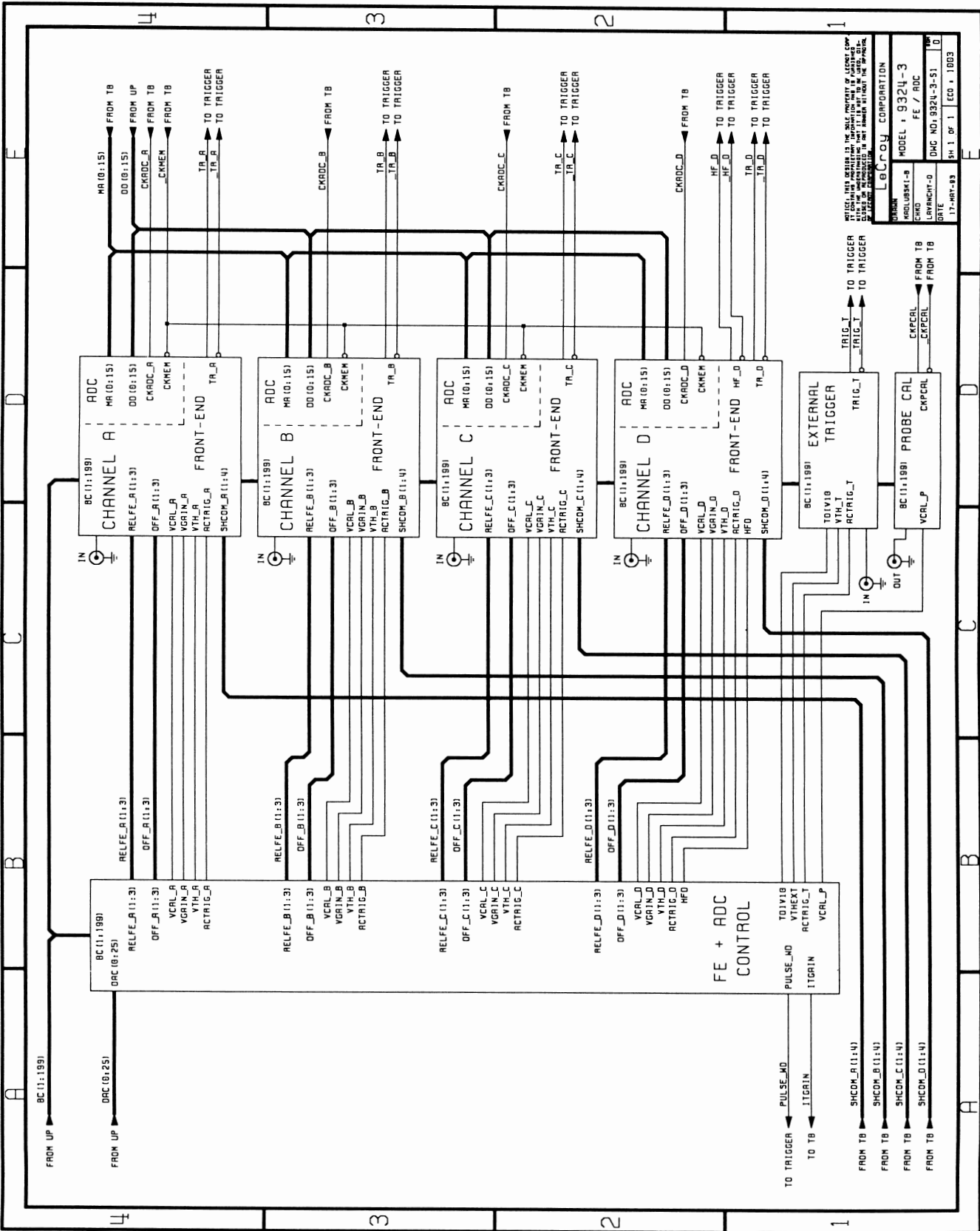

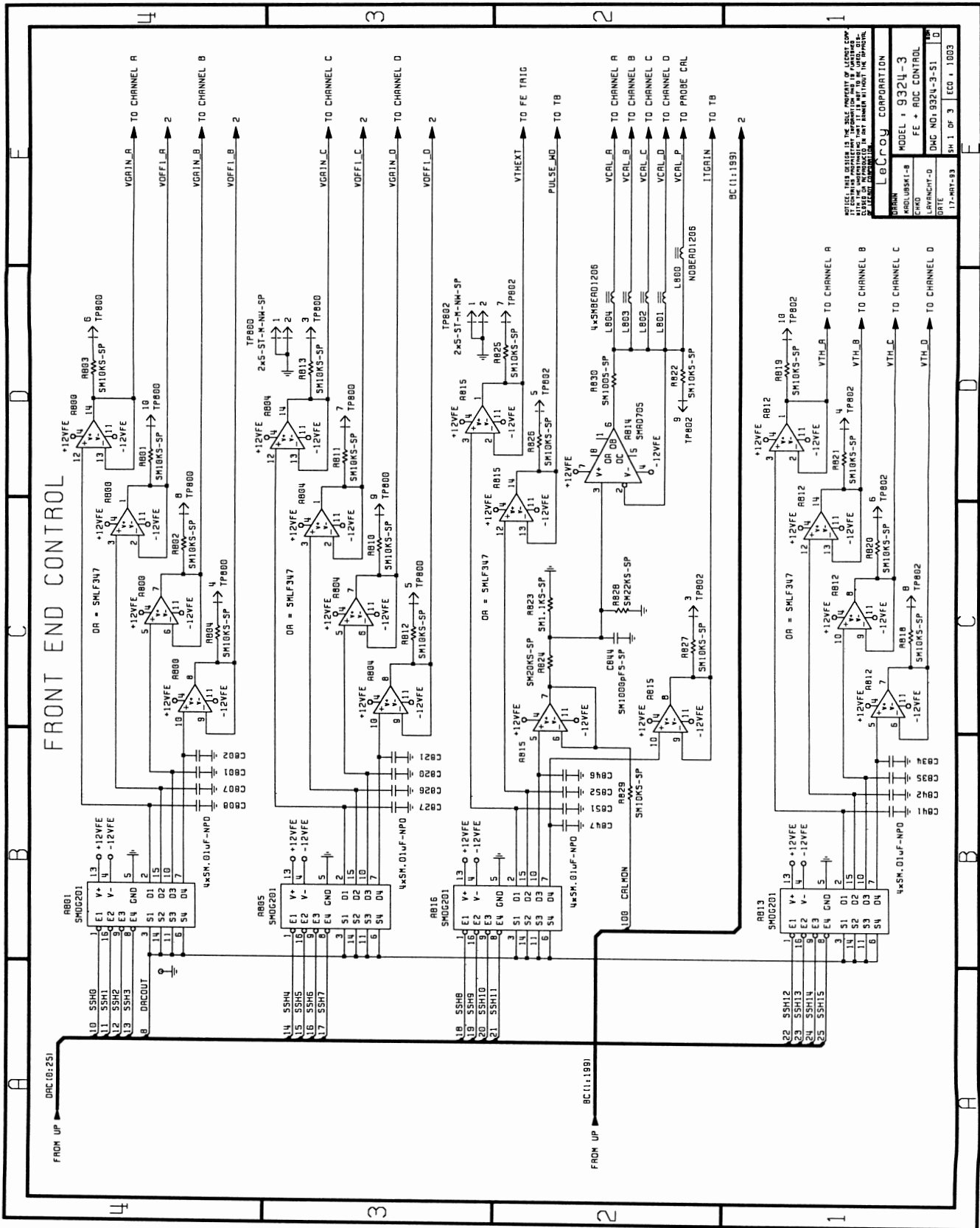

THIS DRAWING IS THE PROPERTY OF ALLENCO CORP. IT IS TO BE USED ONLY FOR THE PROJECT AND FOR THE QUANTITY SPECIFIED THEREON. IT IS TO BE RETURNED TO THE PROJECT MANAGER UPON COMPLETION OF THE PROJECT.

DATE: 17-MAY-93
 DMC NO. 9324-3-S1
 MODEL: 9324-3
 FE + ADC CONTROL
 LAYERCHIT-D
 SHEET 1 OF 3

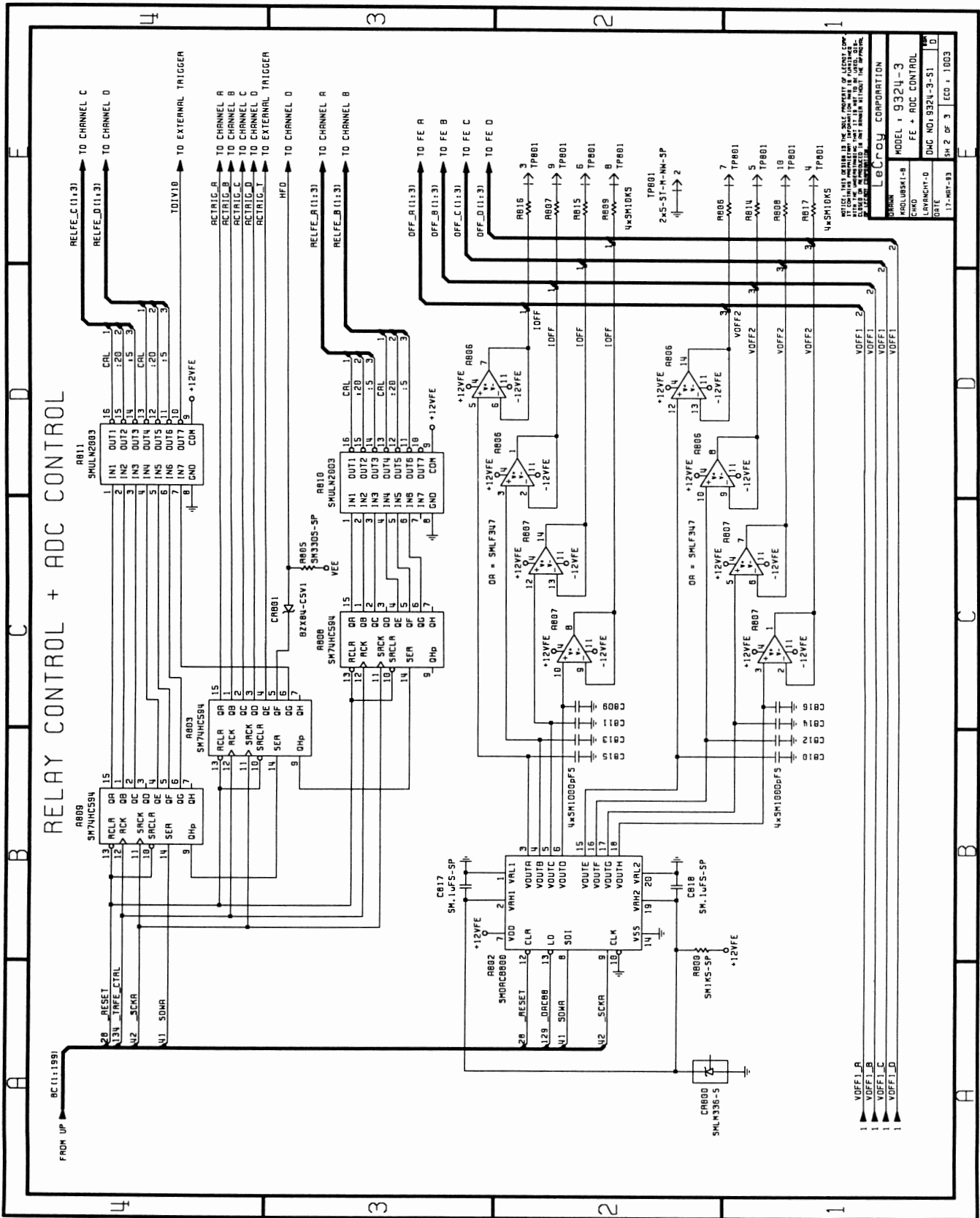

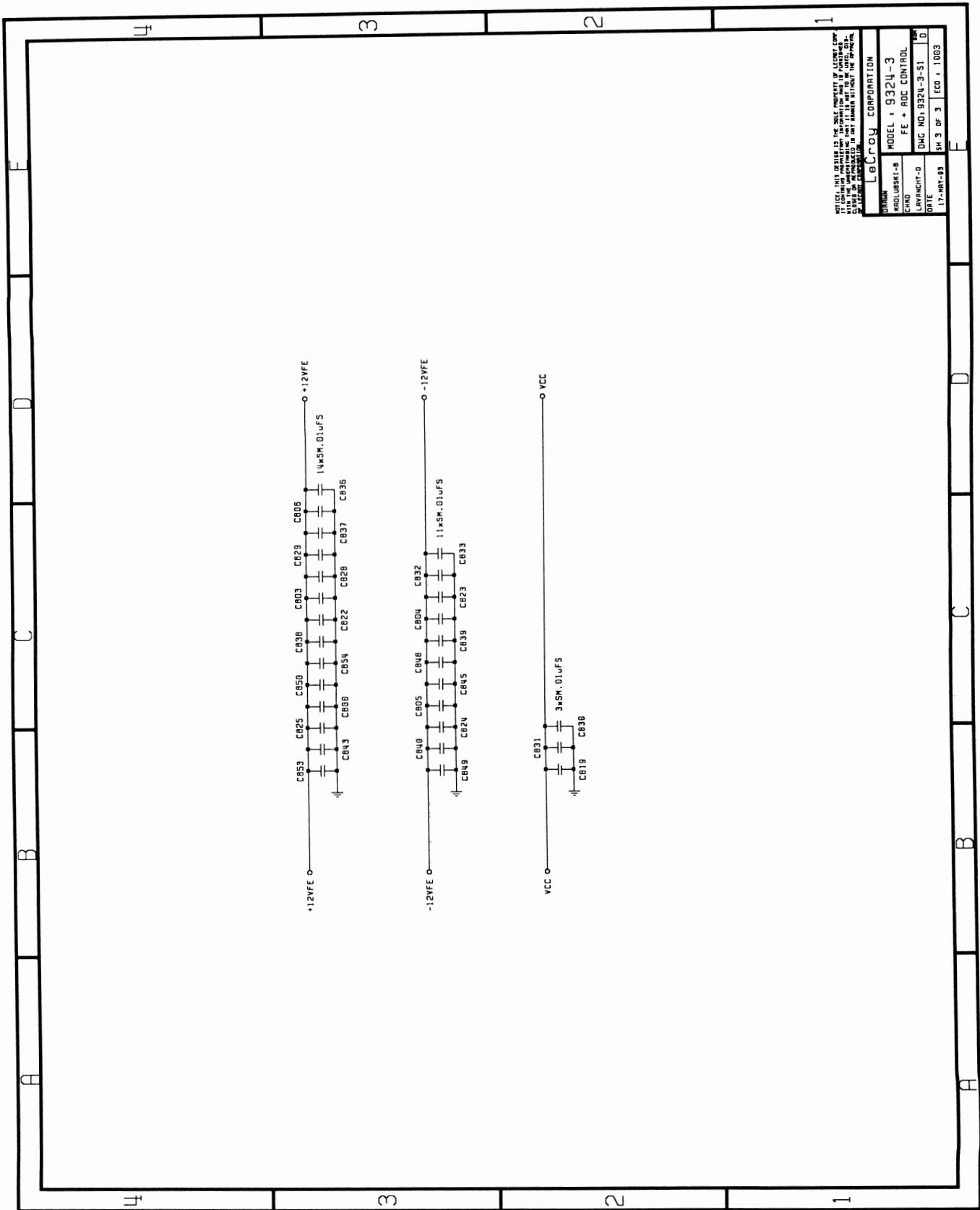

NOTICE: THIS DESIGN IS THE SOLE PROPERTY OF LEONET CORP.
 IT CONTAINS INFORMATION THAT IS UNCLASSIFIED AND IS BEING
 RELEASED TO THE PUBLIC IN ORDER TO PROMOTE THE OPEN SOURCE
 DESIGN OF THE PRODUCT. IT IS THE USER'S RESPONSIBILITY TO
 VERIFY THE INFORMATION IS CORRECT FOR THEIR APPLICATION.

LEONET CORPORATION	
UNCLASSIFIED	MODEL : 9324-3
ENCLOSURE-B	FE + ADC CONTROL
BRANCHIT-D	D
DATE	DHC NO: 9324-3-51
17-MAY-83	SH 3 OF 3 ECO : 1083

9324-3 Rev:C

VIEW A = FRONT-END & ADC CONTROL

VIEW B = EXTERNAL TRIGGER & PROBE CAL

VIEW C = FE-ADC-C - VIEW D = FE-ADC-D

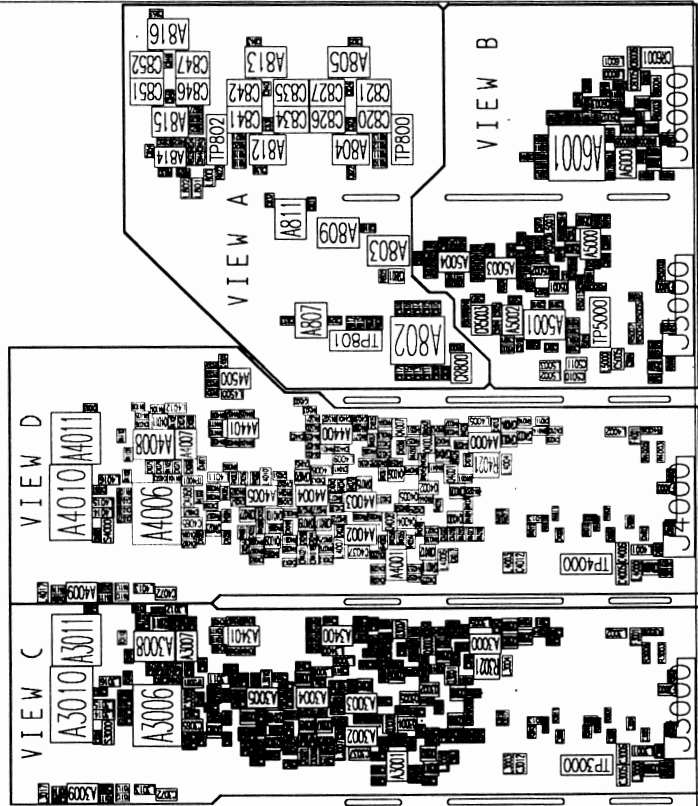

FRONT-END & ADC

9324-3 Rev:C

VIEW A = FRONT-END & ADC CONTROL

VIEW B = EXTERNAL TRIGGER & PROBE CAL

VIEW C = FE-ADC-C - VIEW D = FE-ADC-D

SOLDER SIDE

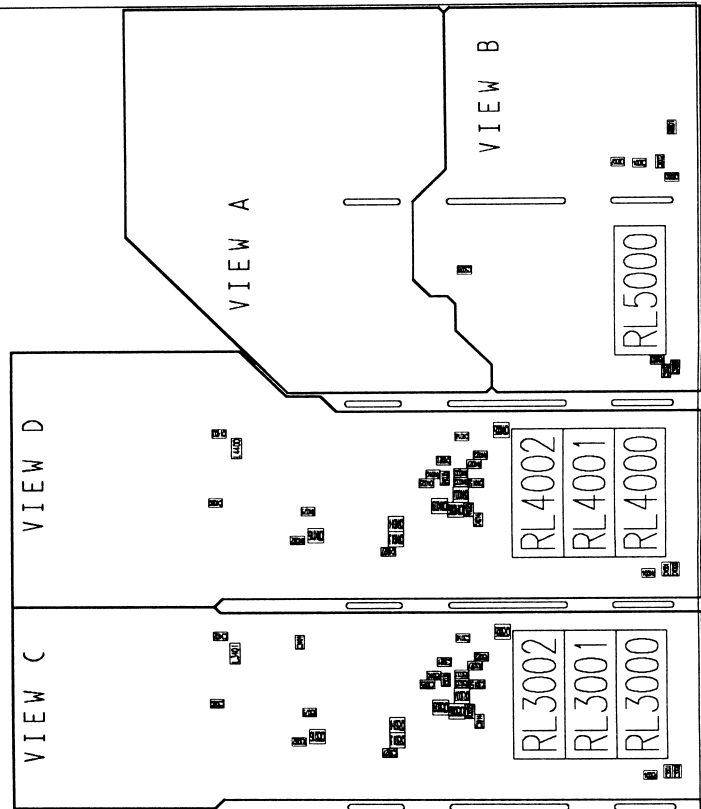

FRONT-END & ADC

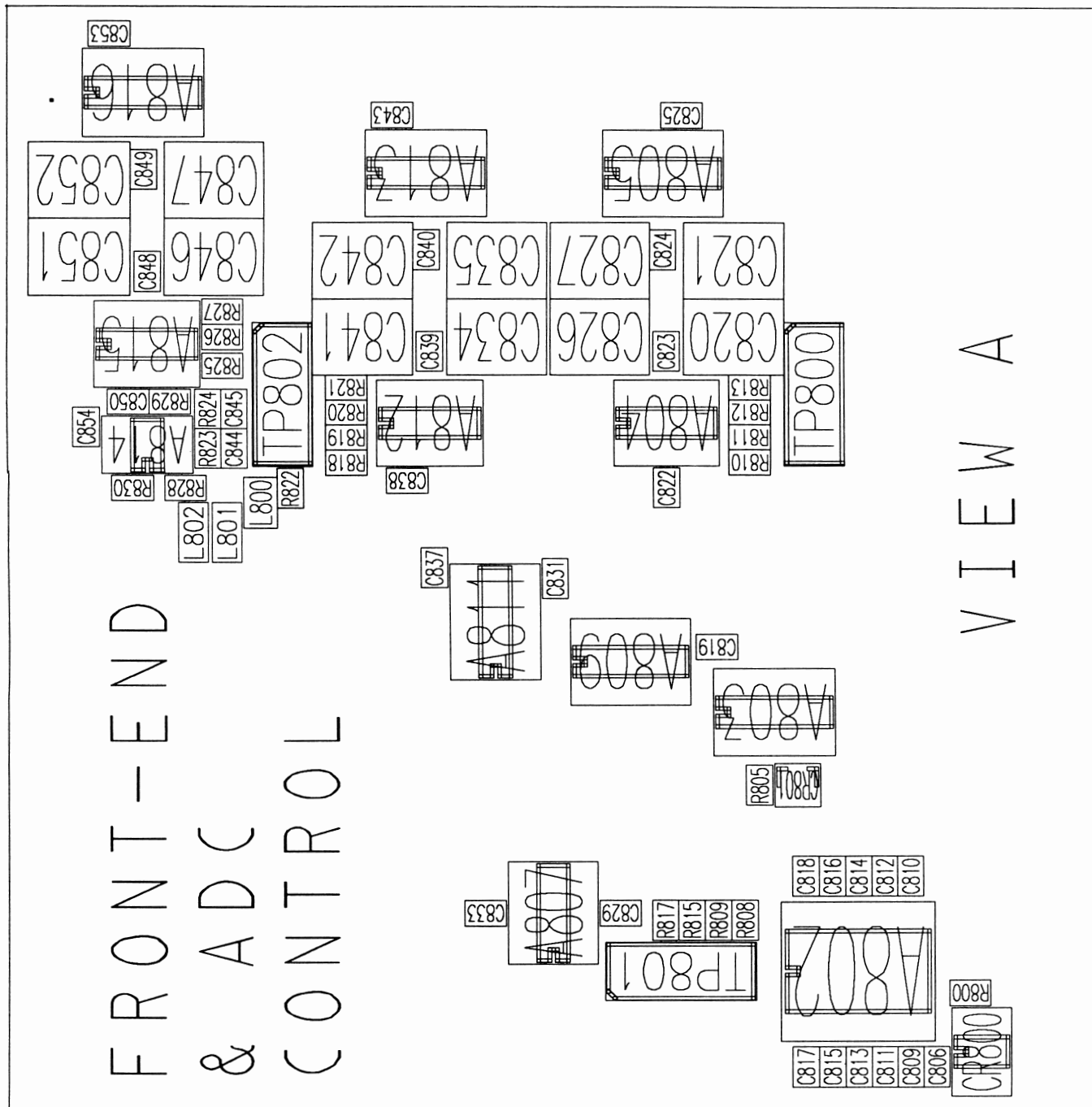

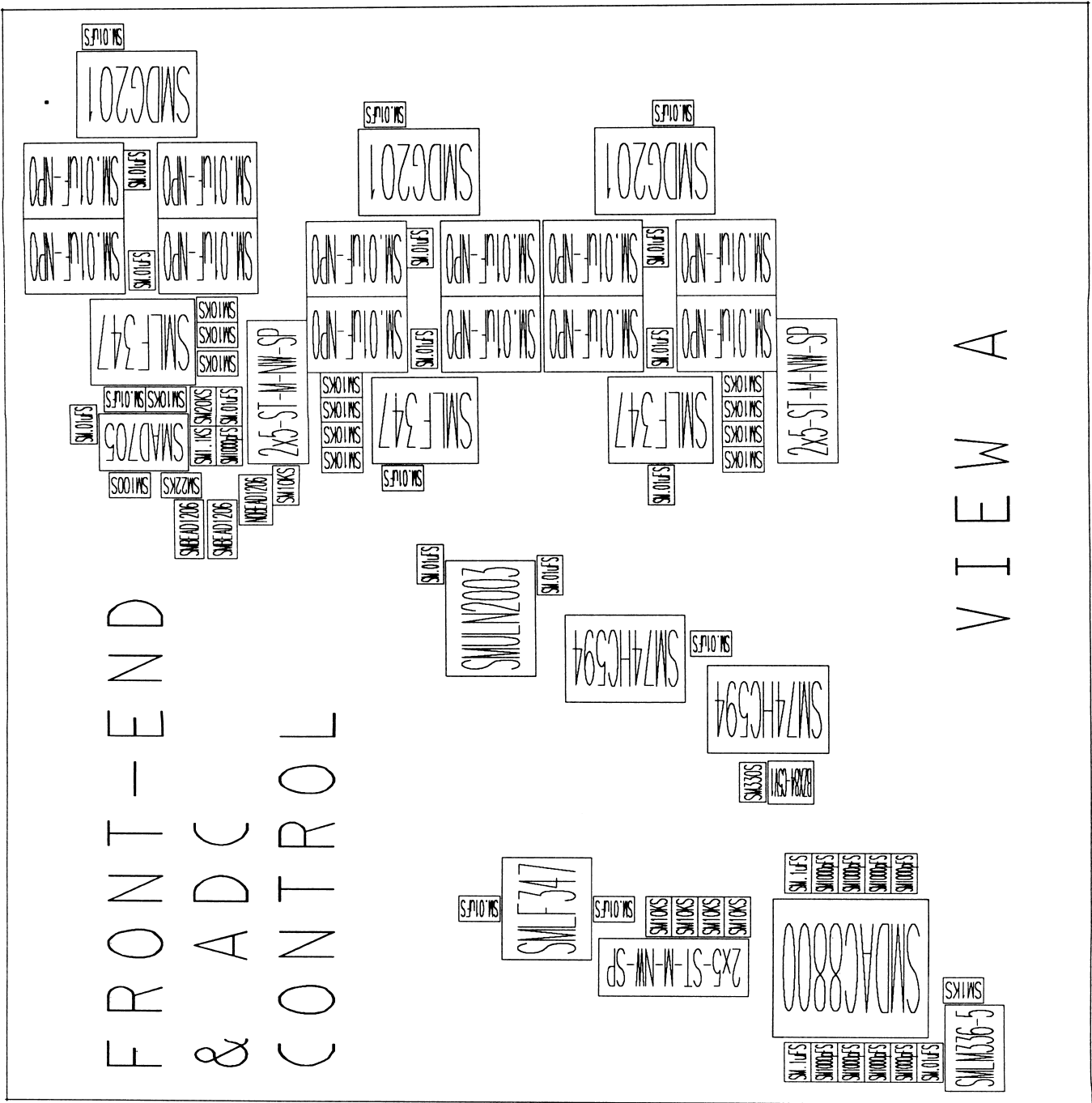

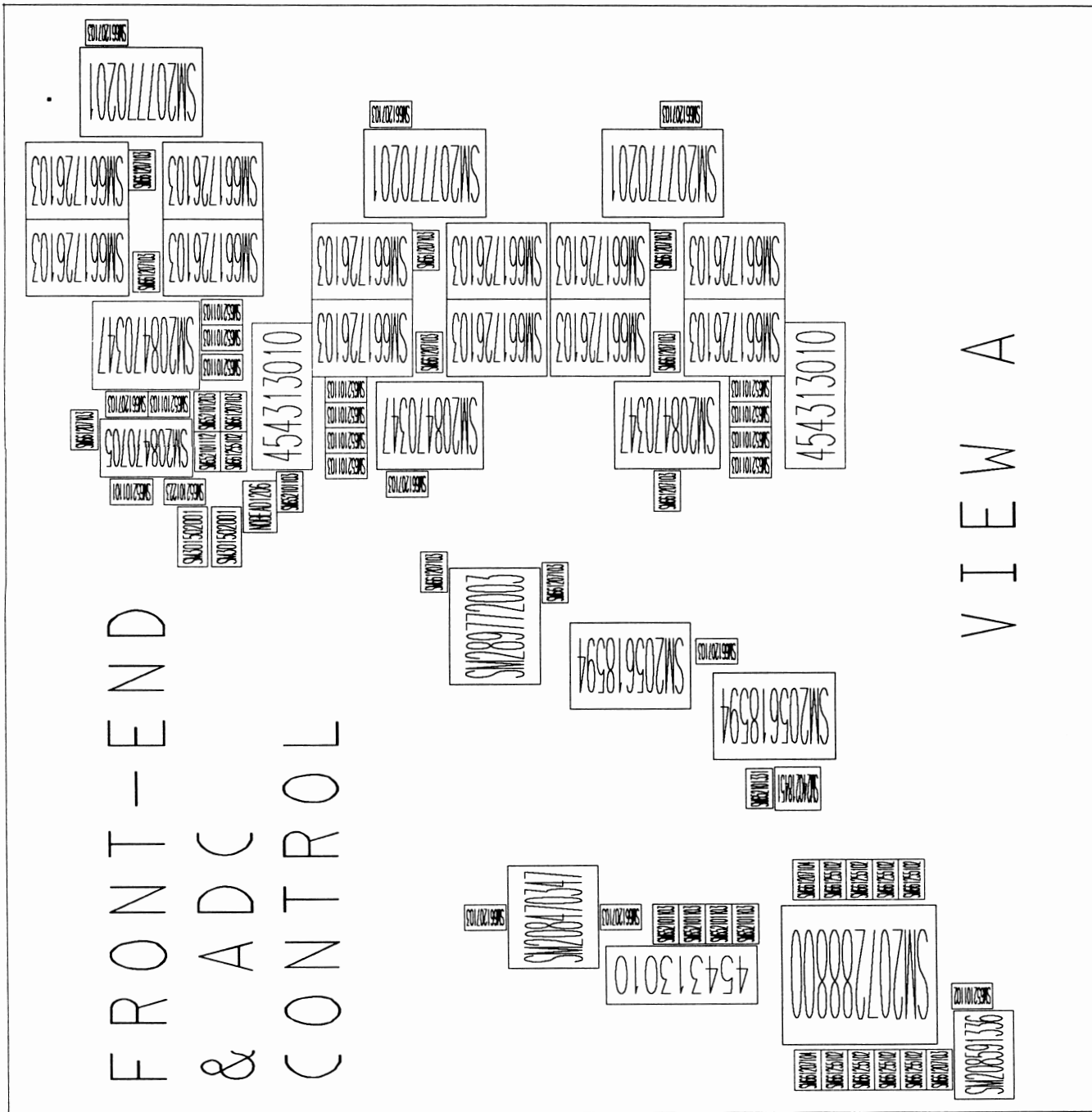

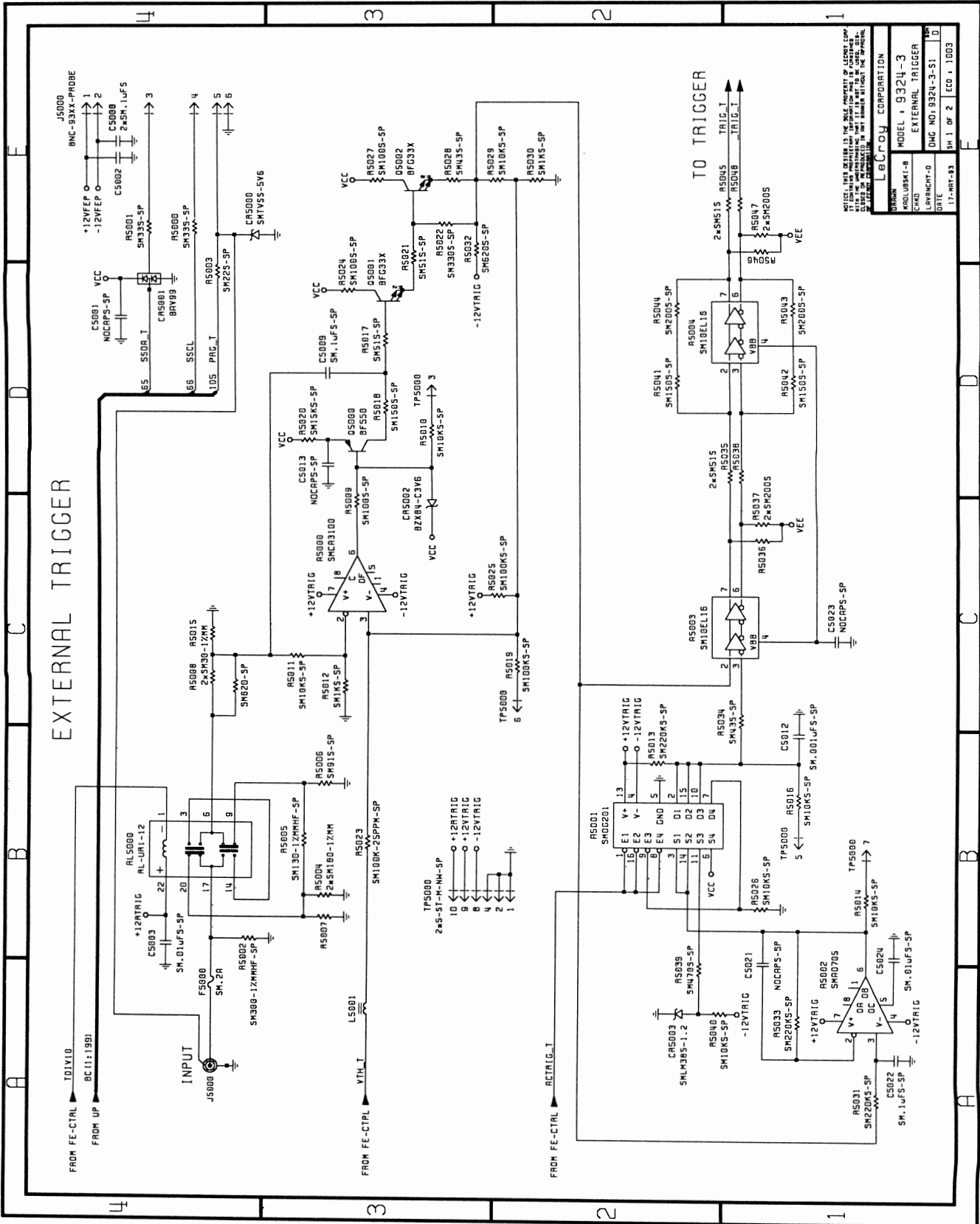

NOTICE: THIS DESIGN IS THE SOLE PROPERTY OF LEICROY CORP. ALL RIGHTS RESERVED. THIS IS A WORKING DRAWING. IT IS NOT TO BE USED FOR REPRODUCTION OR FABRICATION WITHOUT THE EXPRESS WRITTEN PERMISSION OF LEICROY CORPORATION.

DRAWN: _____
 CHECKED: _____
 DATE: _____
 MODEL: 9324-3
 EXTERNAL TRIGGER
 LAYOUT: _____
 DATE: _____
 SH 1 OF 2 ECO 1 1003

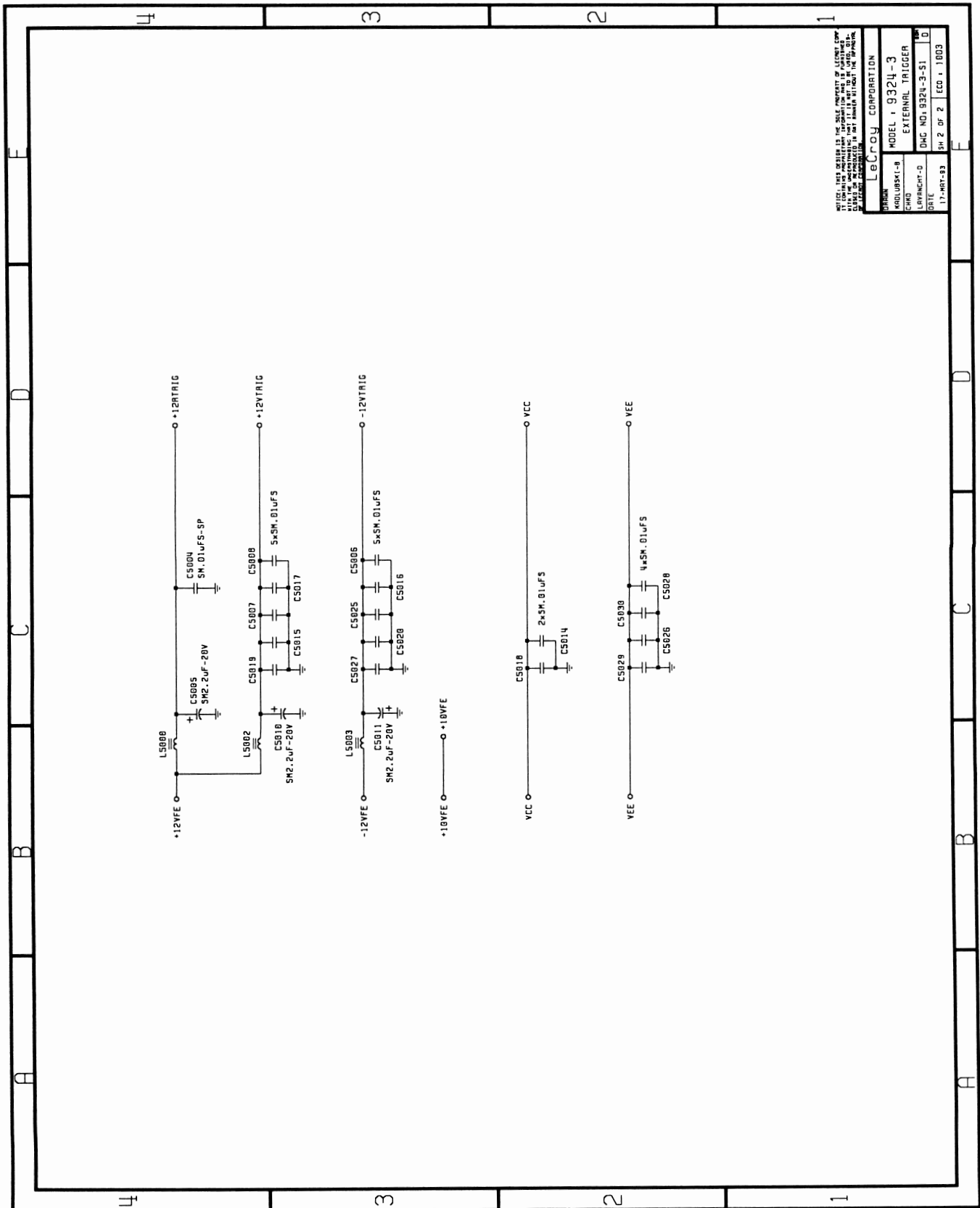

NOTICE: THIS DESIGN IS THE SOLE PROPERTY OF LEICROY CORPORATION. IT IS TO BE KEPT IN CONFIDENTIALITY AND NOT TO BE REPRODUCED OR TRANSMITTED IN ANY FORM OR BY ANY MEANS, ELECTRONIC OR MECHANICAL, INCLUDING PHOTOCOPYING, RECORDING, OR BY ANY INFORMATION STORAGE AND RETRIEVAL SYSTEM.

LeCroy CORPORATION
 MODEL : 9324-3
 EXTERNAL TRIGGER
 LAYOUCT-0
 DMC NO. 9324-3-S1
 17-MAT-83 SH 2 OF 2 ECO : 1003

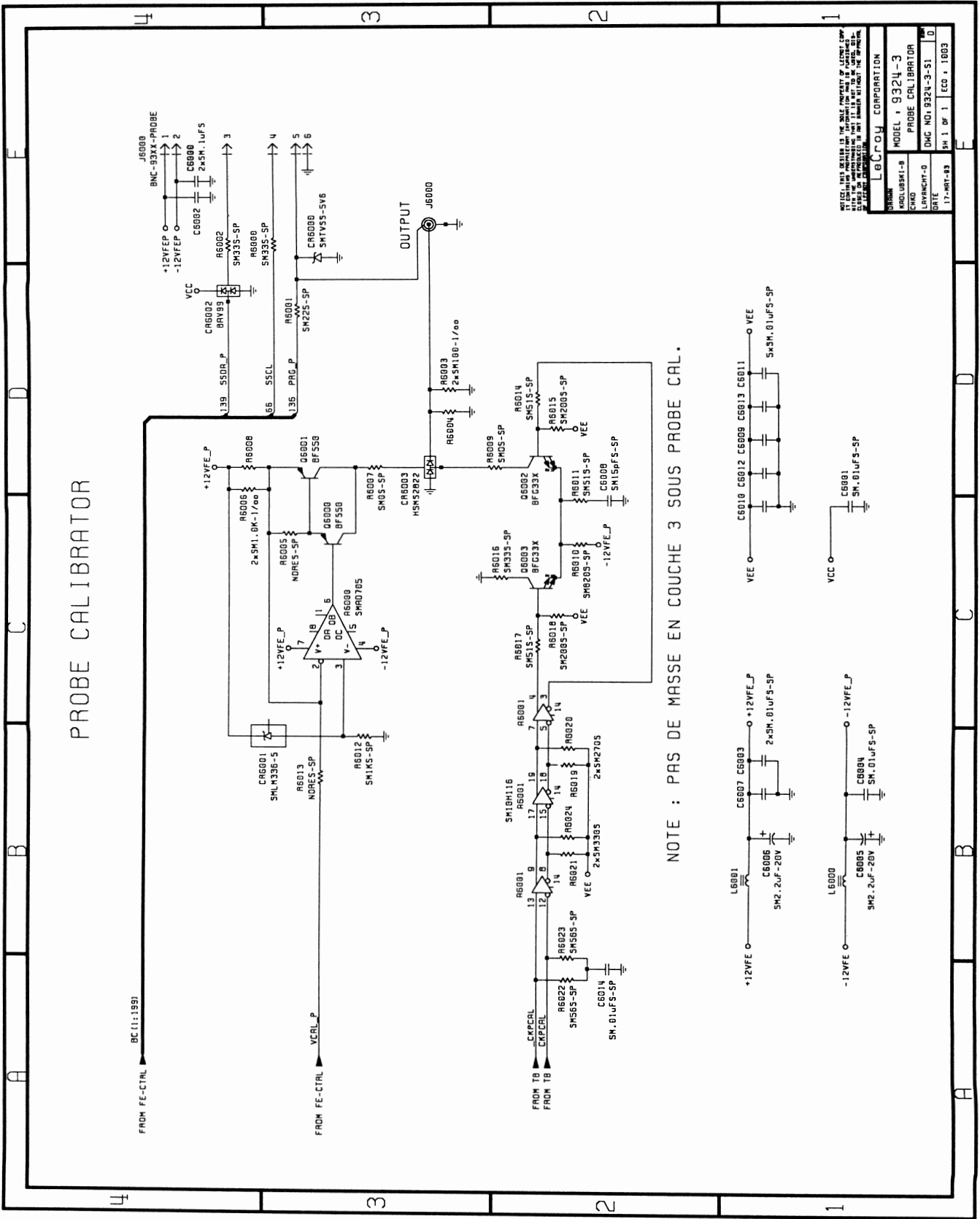

PROBE CALIBRATOR

NOTE : PAS DE MASSE EN COUCHE 3 SOUS PROBE CAL.

<small>WE SELL THIS DESIGN AS THE SOLE PROPERTY OF LECOY S.P.A. ALL RIGHTS RESERVED. THIS DOCUMENT IS NOT TO BE REPRODUCED OR TRANSMITTED IN ANY FORM OR BY ANY MEANS, ELECTRONIC OR MECHANICAL, INCLUDING PHOTOCOPYING, RECORDING, OR BY ANY INFORMATION STORAGE AND RETRIEVAL SYSTEM.</small>	
LECOY CORPORATION MODEL : 9324-3 PROBE CALIBRATOR	DATE : 17-MAR-83 SH 1 OF 1 ECO 1003

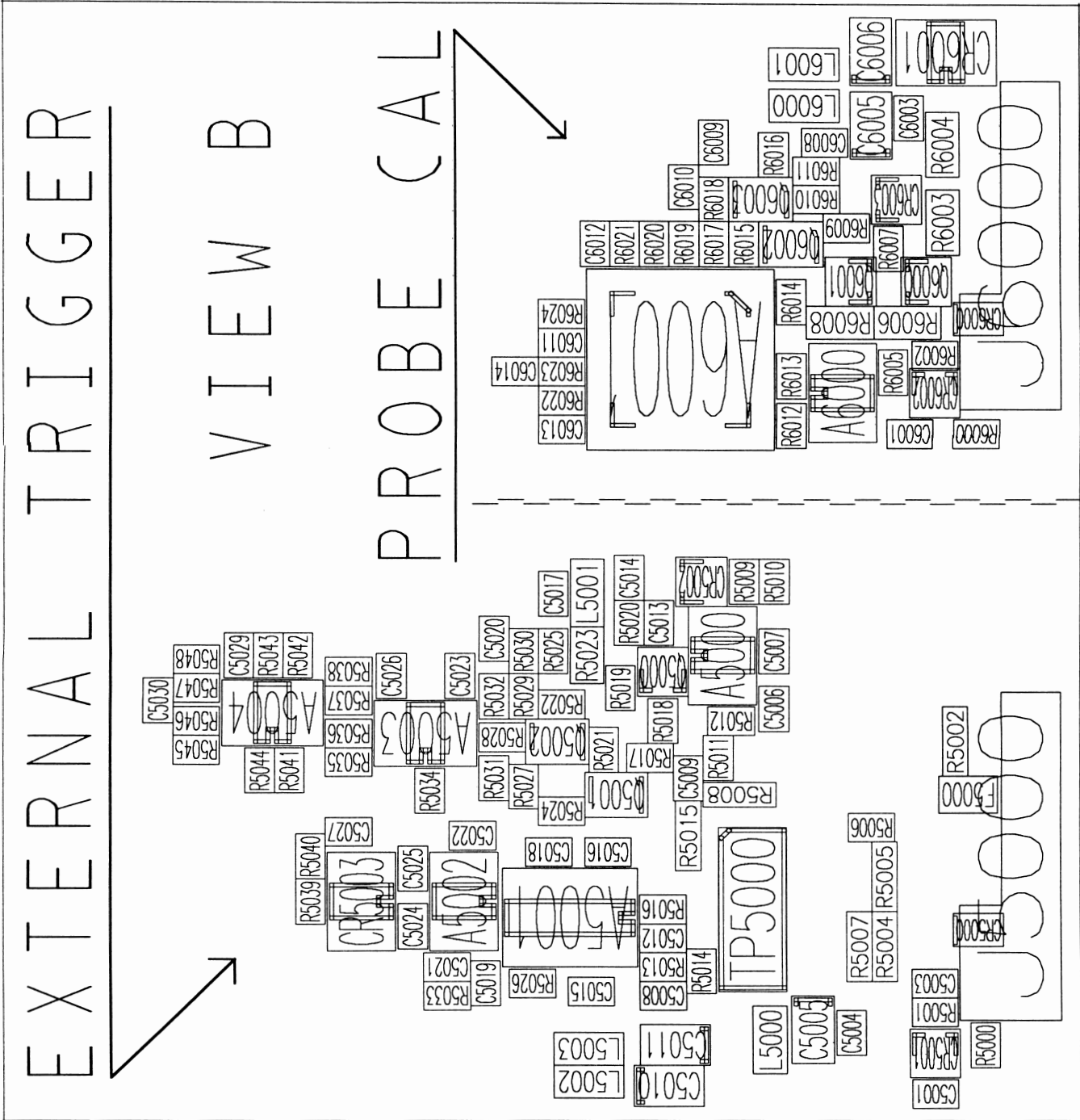

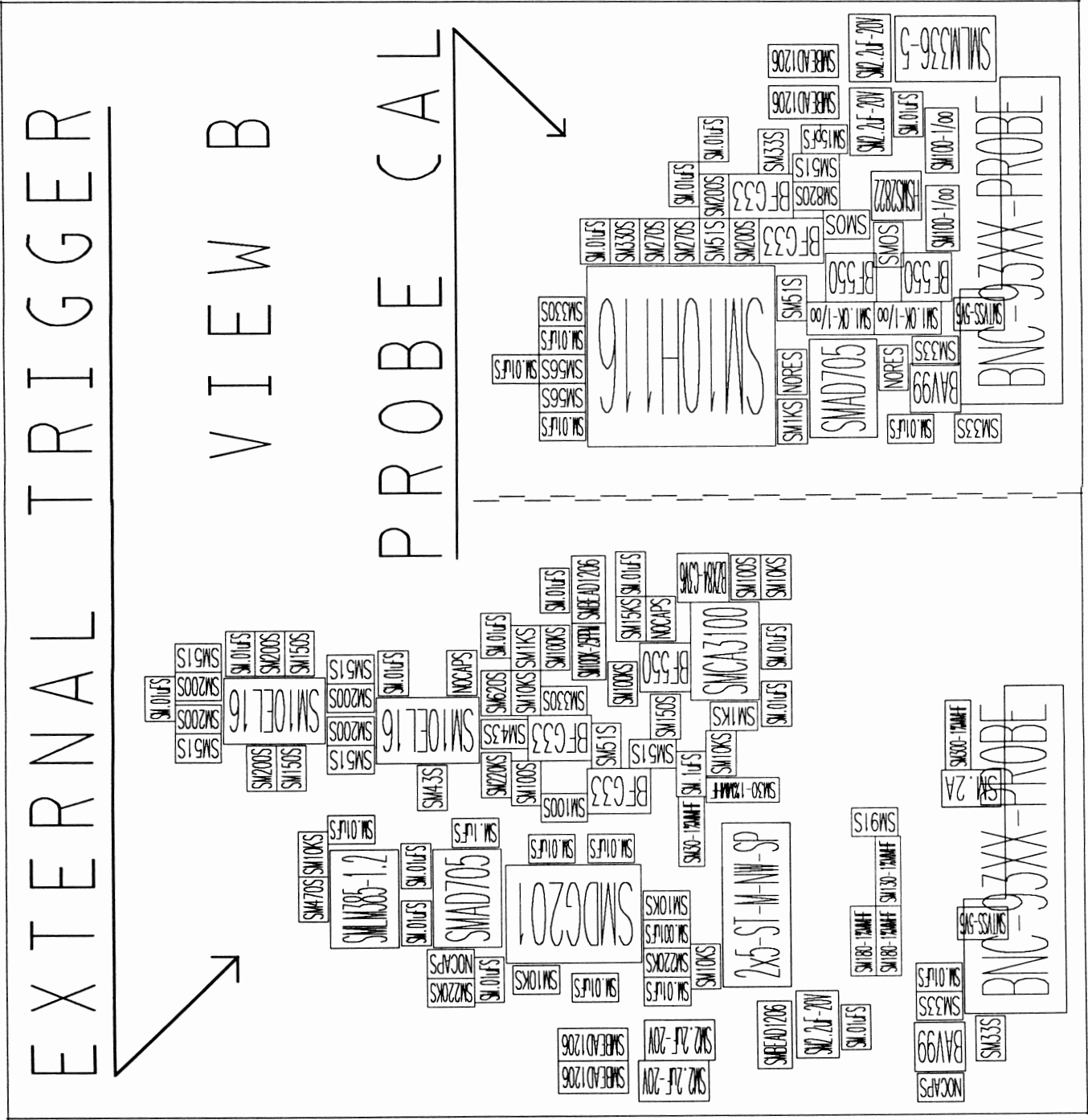

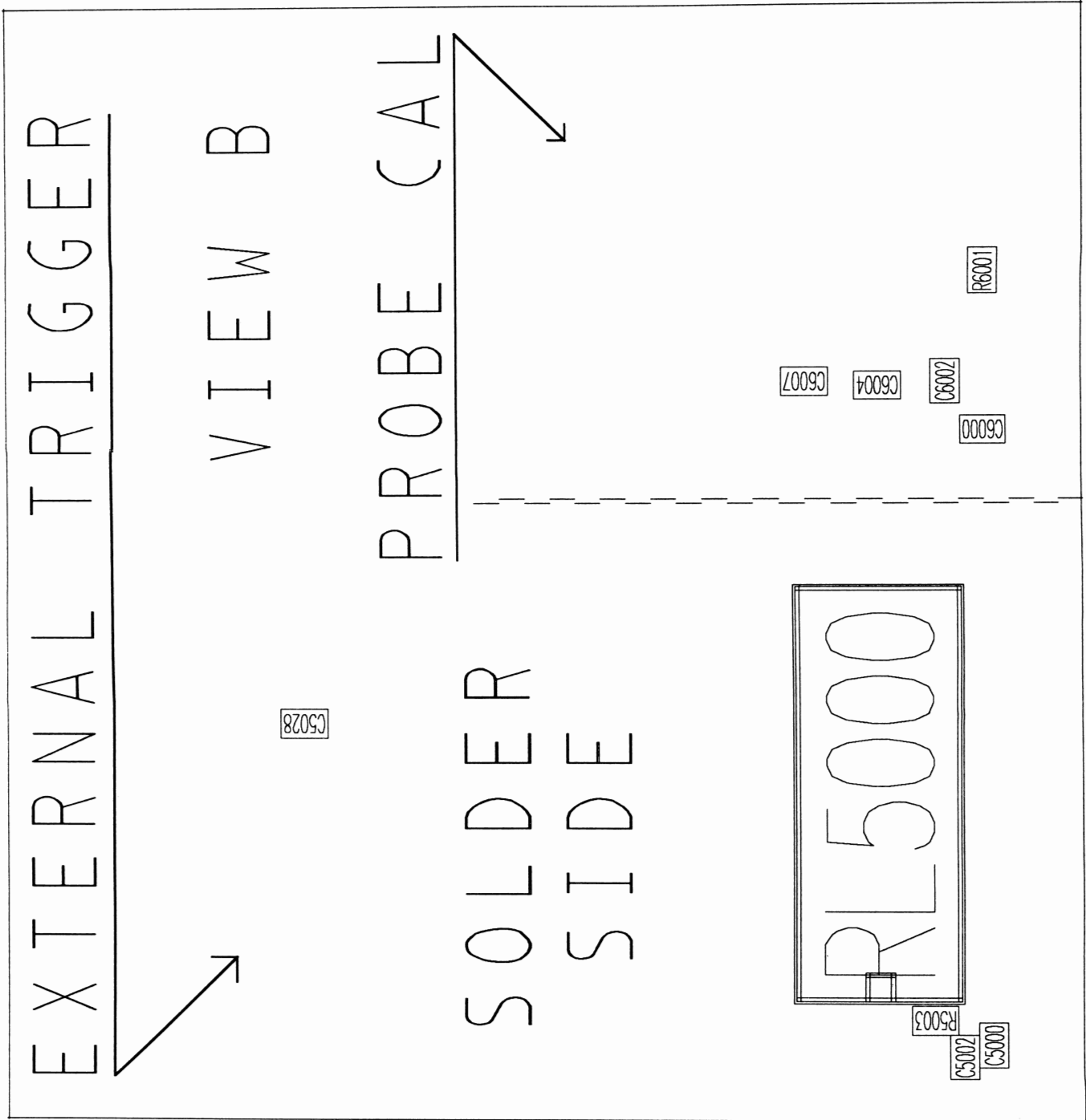

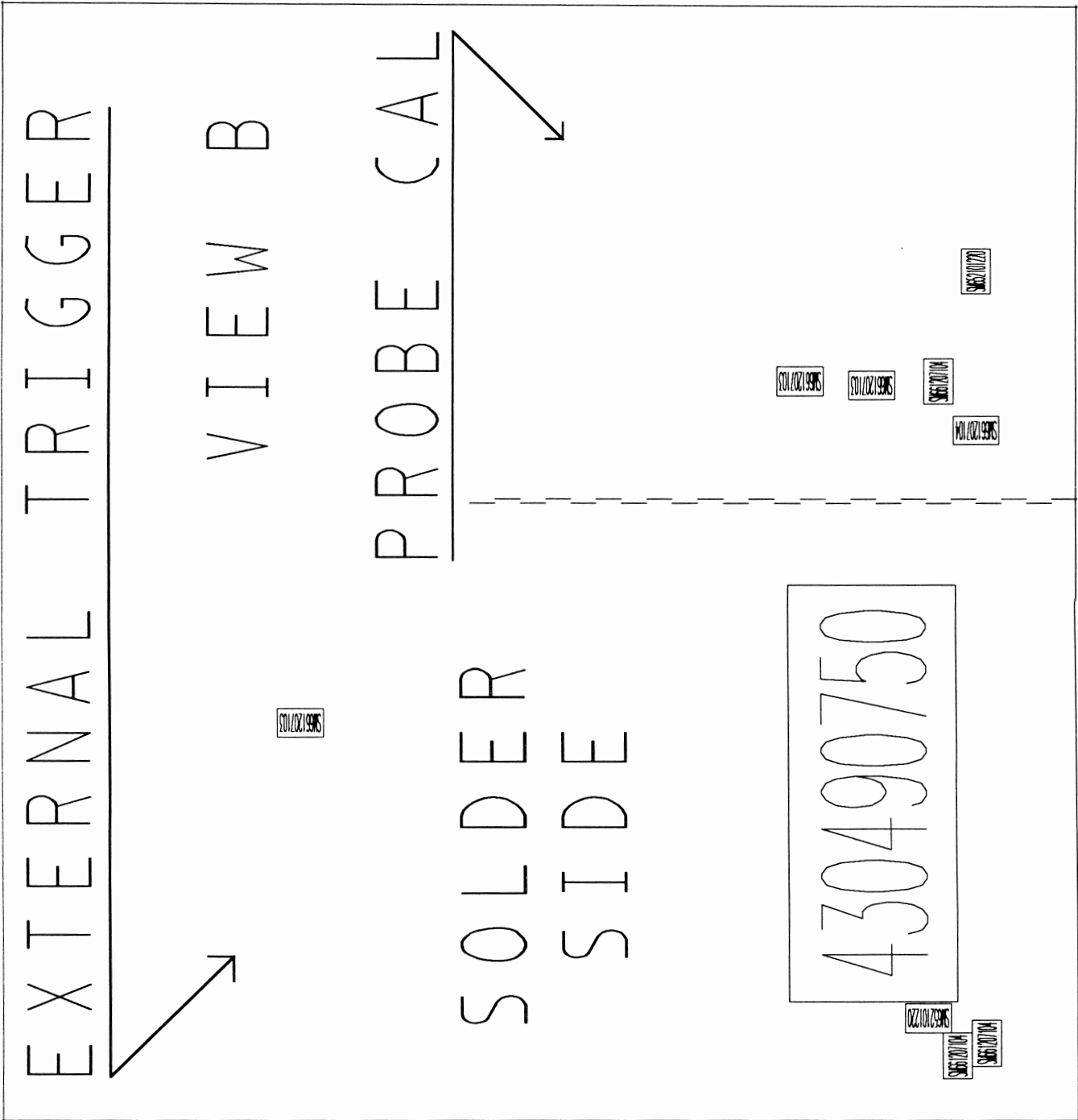

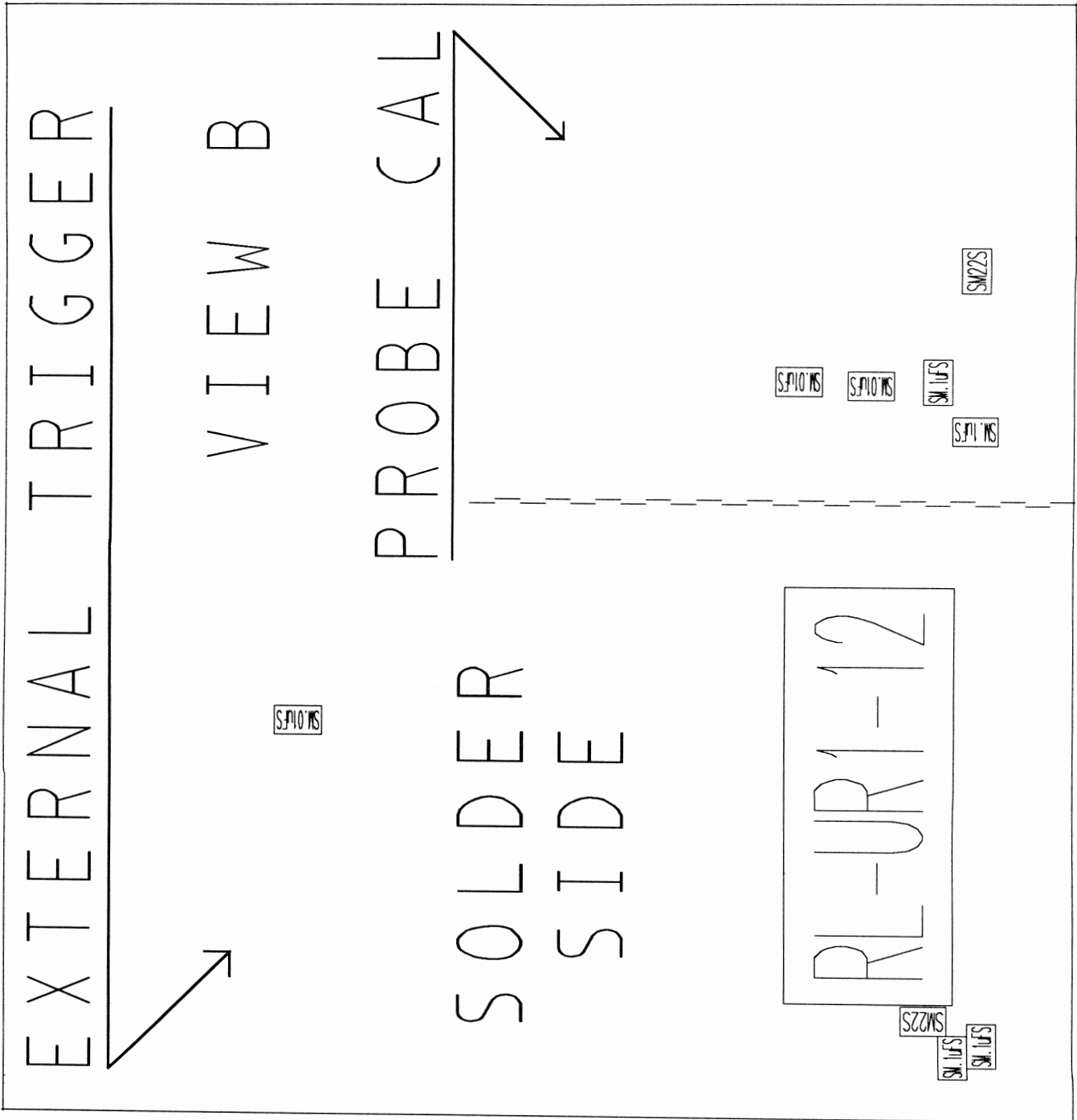

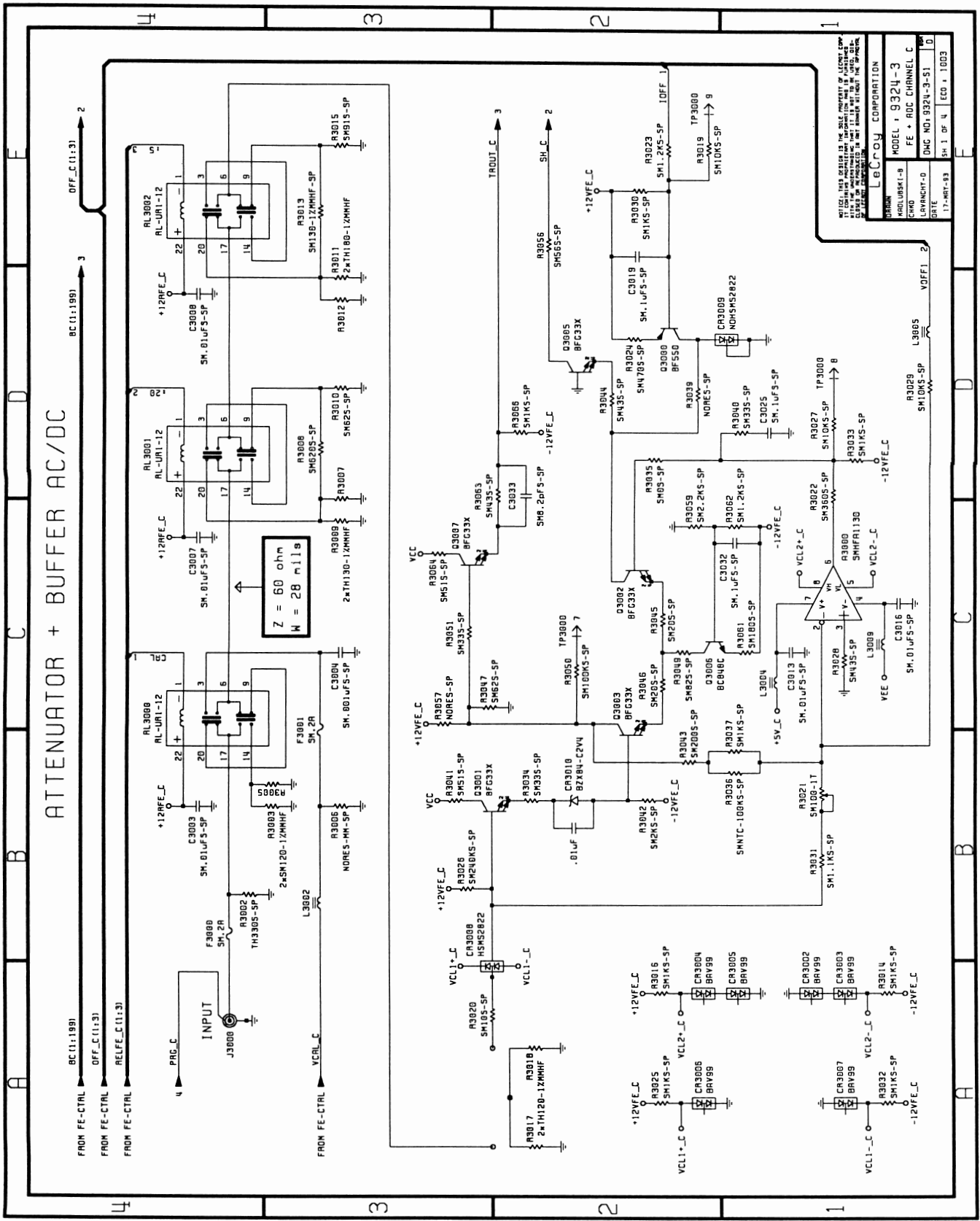

L3005			
VDF1.2			
R3029 SM10MS-SP			
L3006 SM10MS-SP			
R3031 SM1.1KS-SP			
R3032 SM1.1KS-SP			
R3033 SM1.1KS-SP			
R3034 SM1.1KS-SP			
R3035 SM1.1KS-SP			
R3036 SM1.1KS-SP			
R3037 SM1.1KS-SP			
R3038 SM1.1KS-SP			
R3039 SM1.1KS-SP			
R3040 SM1.1KS-SP			
R3041 SM1.1KS-SP			
R3042 SM1.1KS-SP			
R3043 SM1.1KS-SP			
R3044 SM1.1KS-SP			
R3045 SM1.1KS-SP			
R3046 SM1.1KS-SP			
R3047 SM1.1KS-SP			
R3048 SM1.1KS-SP			
R3049 SM1.1KS-SP			
R3050 SM1.1KS-SP			
R3051 SM1.1KS-SP			
R3052 SM1.1KS-SP			
R3053 SM1.1KS-SP			
R3054 SM1.1KS-SP			
R3055 SM1.1KS-SP			
R3056 SM1.1KS-SP			
R3057 SM1.1KS-SP			
R3058 SM1.1KS-SP			
R3059 SM1.1KS-SP			
R3060 SM1.1KS-SP			
R3061 SM1.1KS-SP			
R3062 SM1.1KS-SP			
R3063 SM1.1KS-SP			
R3064 SM1.1KS-SP			
R3065 SM1.1KS-SP			
R3066 SM1.1KS-SP			
R3067 SM1.1KS-SP			
R3068 SM1.1KS-SP			
R3069 SM1.1KS-SP			
R3070 SM1.1KS-SP			
R3071 SM1.1KS-SP			
R3072 SM1.1KS-SP			
R3073 SM1.1KS-SP			
R3074 SM1.1KS-SP			
R3075 SM1.1KS-SP			
R3076 SM1.1KS-SP			
R3077 SM1.1KS-SP			
R3078 SM1.1KS-SP			
R3079 SM1.1KS-SP			
R3080 SM1.1KS-SP			
R3081 SM1.1KS-SP			
R3082 SM1.1KS-SP			
R3083 SM1.1KS-SP			
R3084 SM1.1KS-SP			
R3085 SM1.1KS-SP			
R3086 SM1.1KS-SP			
R3087 SM1.1KS-SP			
R3088 SM1.1KS-SP			
R3089 SM1.1KS-SP			
R3090 SM1.1KS-SP			
R3091 SM1.1KS-SP			
R3092 SM1.1KS-SP			
R3093 SM1.1KS-SP			
R3094 SM1.1KS-SP			
R3095 SM1.1KS-SP			
R3096 SM1.1KS-SP			
R3097 SM1.1KS-SP			
R3098 SM1.1KS-SP			
R3099 SM1.1KS-SP			
R3100 SM1.1KS-SP			
R3101 SM1.1KS-SP			
R3102 SM1.1KS-SP			
R3103 SM1.1KS-SP			
R3104 SM1.1KS-SP			
R3105 SM1.1KS-SP			
R3106 SM1.1KS-SP			
R3107 SM1.1KS-SP			
R3108 SM1.1KS-SP			
R3109 SM1.1KS-SP			
R3110 SM1.1KS-SP			
R3111 SM1.1KS-SP			
R3112 SM1.1KS-SP			
R3113 SM1.1KS-SP			
R3114 SM1.1KS-SP			
R3115 SM1.1KS-SP			
R3116 SM1.1KS-SP			
R3117 SM1.1KS-SP			
R3118 SM1.1KS-SP			
R3119 SM1.1KS-SP			
R3120 SM1.1KS-SP			
R3121 SM1.1KS-SP			
R3122 SM1.1KS-SP			
R3123 SM1.1KS-SP			
R3124 SM1.1KS-SP			
R3125 SM1.1KS-SP			
R3126 SM1.1KS-SP			
R3127 SM1.1KS-SP			
R3128 SM1.1KS-SP			
R3129 SM1.1KS-SP			
R3130 SM1.1KS-SP			
R3131 SM1.1KS-SP			
R3132 SM1.1KS-SP			
R3133 SM1.1KS-SP			
R3134 SM1.1KS-SP			
R3135 SM1.1KS-SP			
R3136 SM1.1KS-SP			
R3137 SM1.1KS-SP			
R3138 SM1.1KS-SP			
R3139 SM1.1KS-SP			
R3140 SM1.1KS-SP			
R3141 SM1.1KS-SP			
R3142 SM1.1KS-SP			
R3143 SM1.1KS-SP			
R3144 SM1.1KS-SP			
R3145 SM1.1KS-SP			
R3146 SM1.1KS-SP			
R3147 SM1.1KS-SP			
R3148 SM1.1KS-SP			
R3149 SM1.1KS-SP			
R3150 SM1.1KS-SP			
R3151 SM1.1KS-SP			
R3152 SM1.1KS-SP			
R3153 SM1.1KS-SP			
R3154 SM1.1KS-SP			
R3155 SM1.1KS-SP			
R3156 SM1.1KS-SP			
R3157 SM1.1KS-SP			
R3158 SM1.1KS-SP			
R3159 SM1.1KS-SP			
R3160 SM1.1KS-SP			
R3161 SM1.1KS-SP			
R3162 SM1.1KS-SP			
R3163 SM1.1KS-SP			
R3164 SM1.1KS-SP			
R3165 SM1.1KS-SP			
R3166 SM1.1KS-SP			
R3167 SM1.1KS-SP			
R3168 SM1.1KS-SP			
R3169 SM1.1KS-SP			
R3170 SM1.1KS-SP			
R3171 SM1.1KS-SP			
R3172 SM1.1KS-SP			
R3173 SM1.1KS-SP			
R3174 SM1.1KS-SP			
R3175 SM1.1KS-SP			
R3176 SM1.1KS-SP			
R3177 SM1.1KS-SP			
R3178 SM1.1KS-SP			
R3179 SM1.1KS-SP			
R3180 SM1.1KS-SP			
R3181 SM1.1KS-SP			
R3182 SM1.1KS-SP			
R3183 SM1.1KS-SP			
R3184 SM1.1KS-SP			
R3185 SM1.1KS-SP			
R3186 SM1.1KS-SP			
R3187 SM1.1KS-SP			
R3188 SM1.1KS-SP			
R3189 SM1.1KS-SP			
R3190 SM1.1KS-SP			
R3191 SM1.1KS-SP			
R3192 SM1.1KS-SP			
R3193 SM1.1KS-SP			
R3194 SM1.1KS-SP			
R3195 SM1.1KS-SP			
R3196 SM1.1KS-SP			
R3197 SM1.1KS-SP			
R3198 SM1.1KS-SP			
R3199 SM1.1KS-SP			
R3200 SM1.1KS-SP			

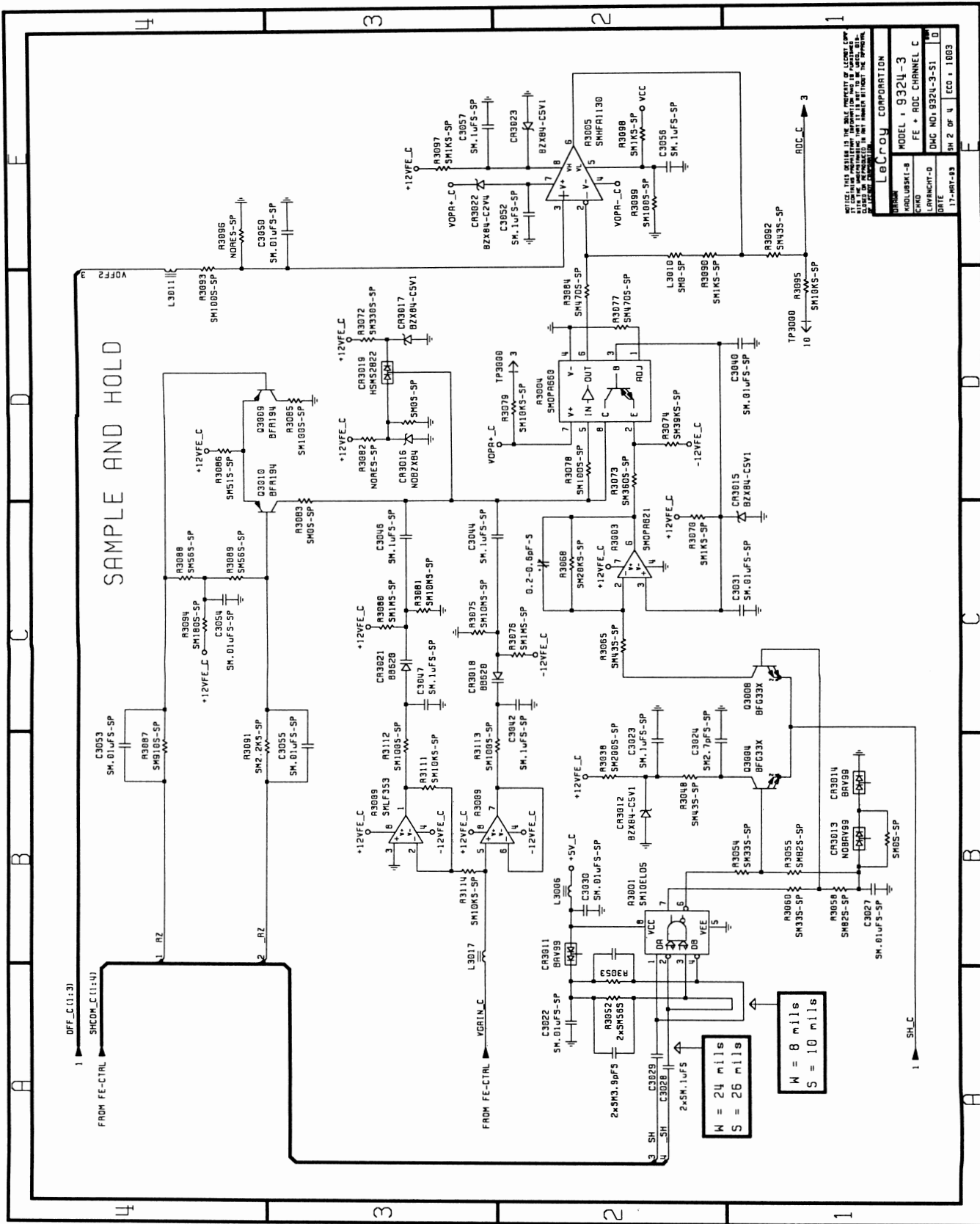

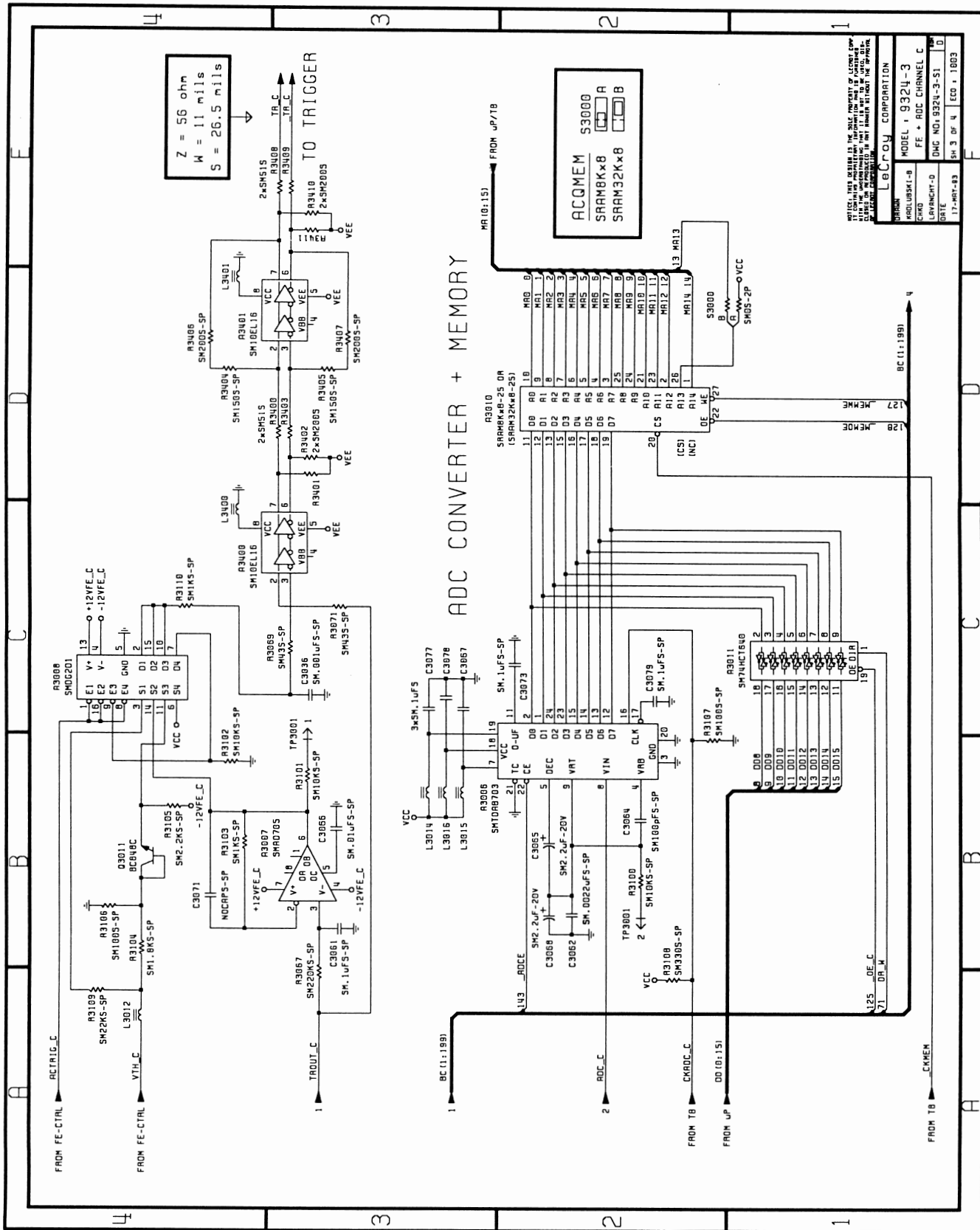

SERIAL PROBE TRANSFERT + POWER SUPPLY

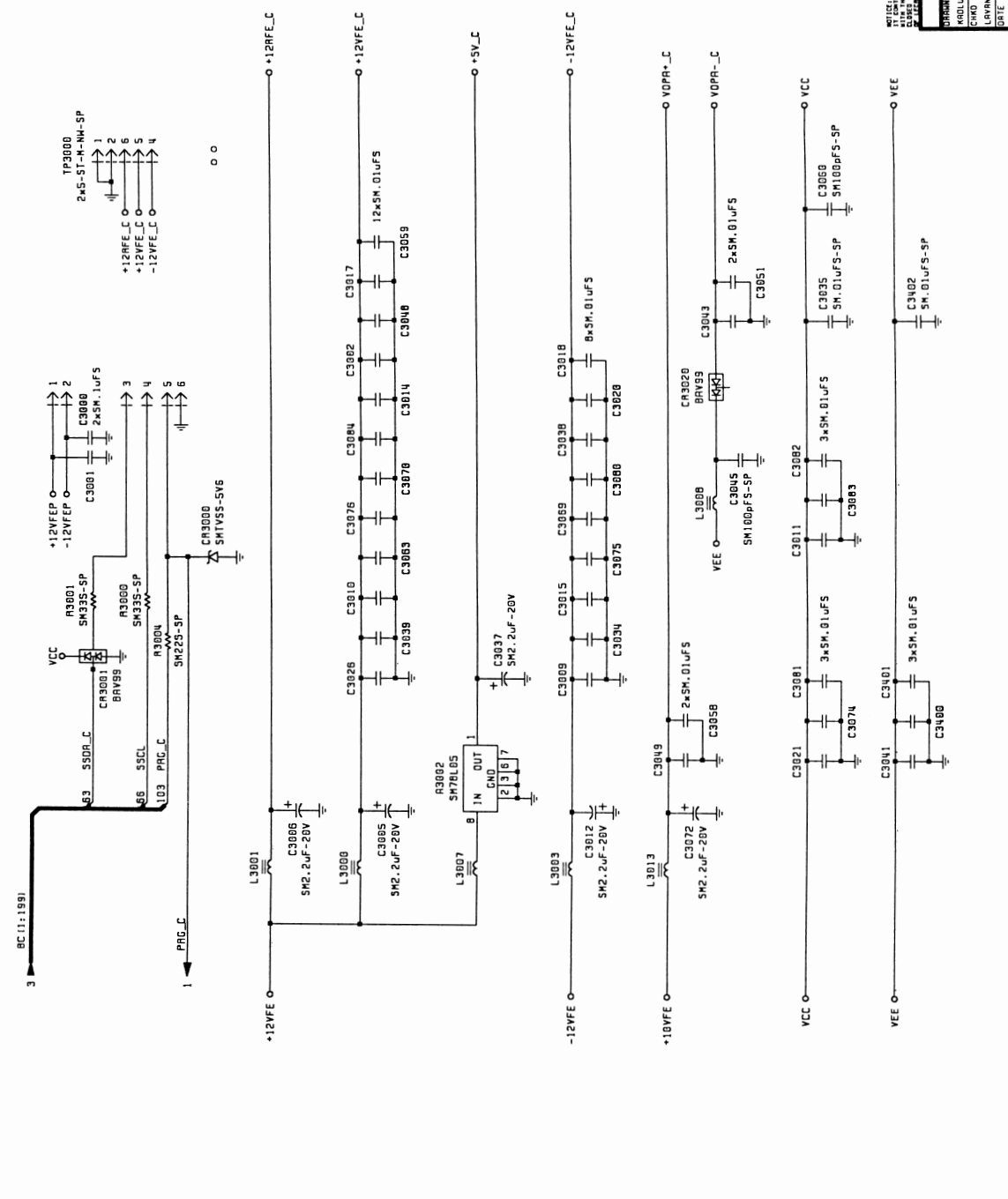

THIS IS THE PROPERTY OF LECROY CORPORATION IT IS TO BE USED ONLY FOR THE PURPOSES FOR WHICH IT WAS DESIGNED IT IS TO BE KEPT IN THE ORIGINAL PACKAGING AND RETURNED TO THE ORIGINAL SUPPLIER IF IT IS TO BE REUSED IN ANY OTHER APPLICATION, THE USER MUST OBTAIN THE NECESSARY PERMISSIONS FROM LECROY CORPORATION	
LECROY CORPORATION	
DRAWN: PROLUBSKI-A CHECK: FE DATE: 17-MAR-83	MODEL: 9324-3 FE: ROC CHANNEL C DMC: NDI-9324-3-S1 ECO: 1-1983

FRONT-END & ADC CHANNEL C

VIEW C

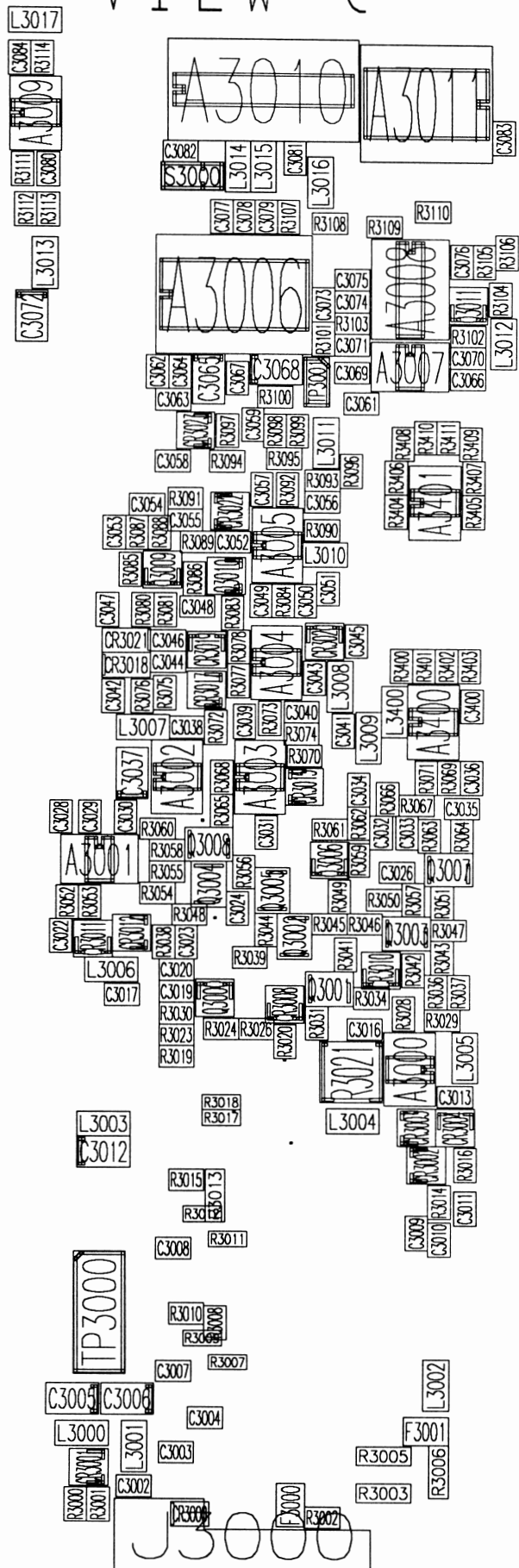

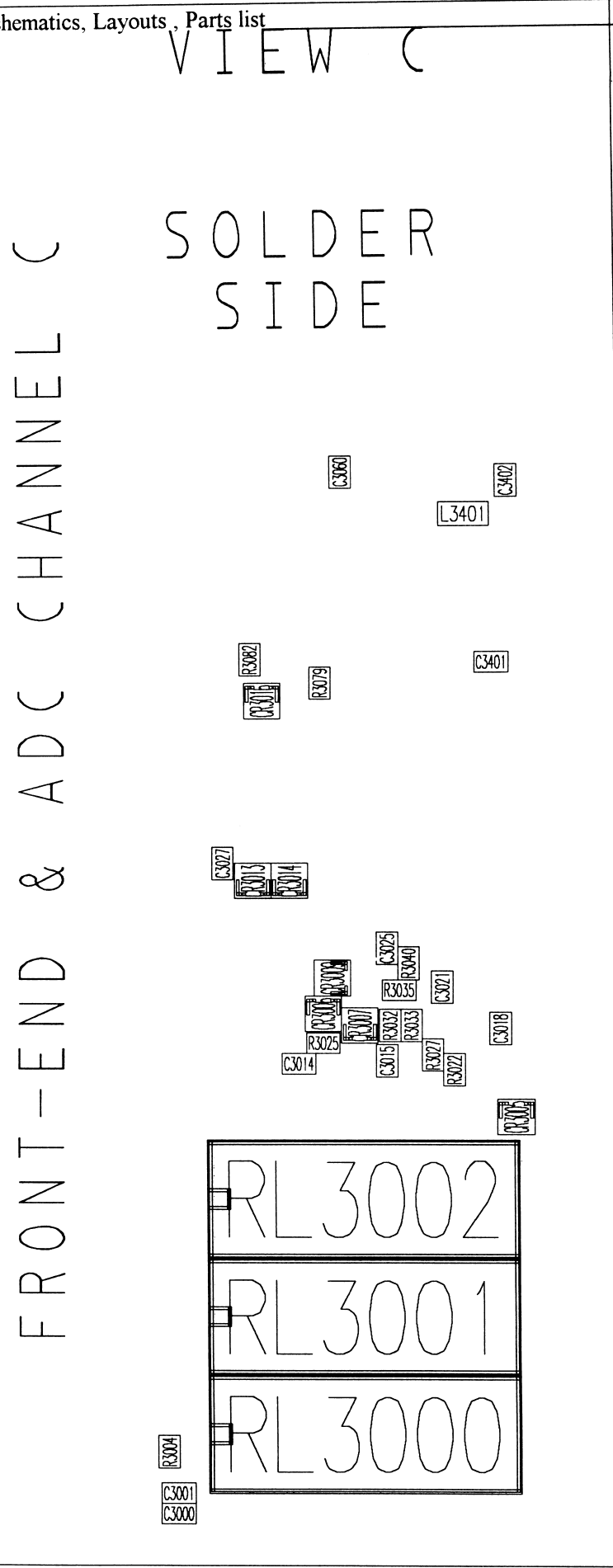

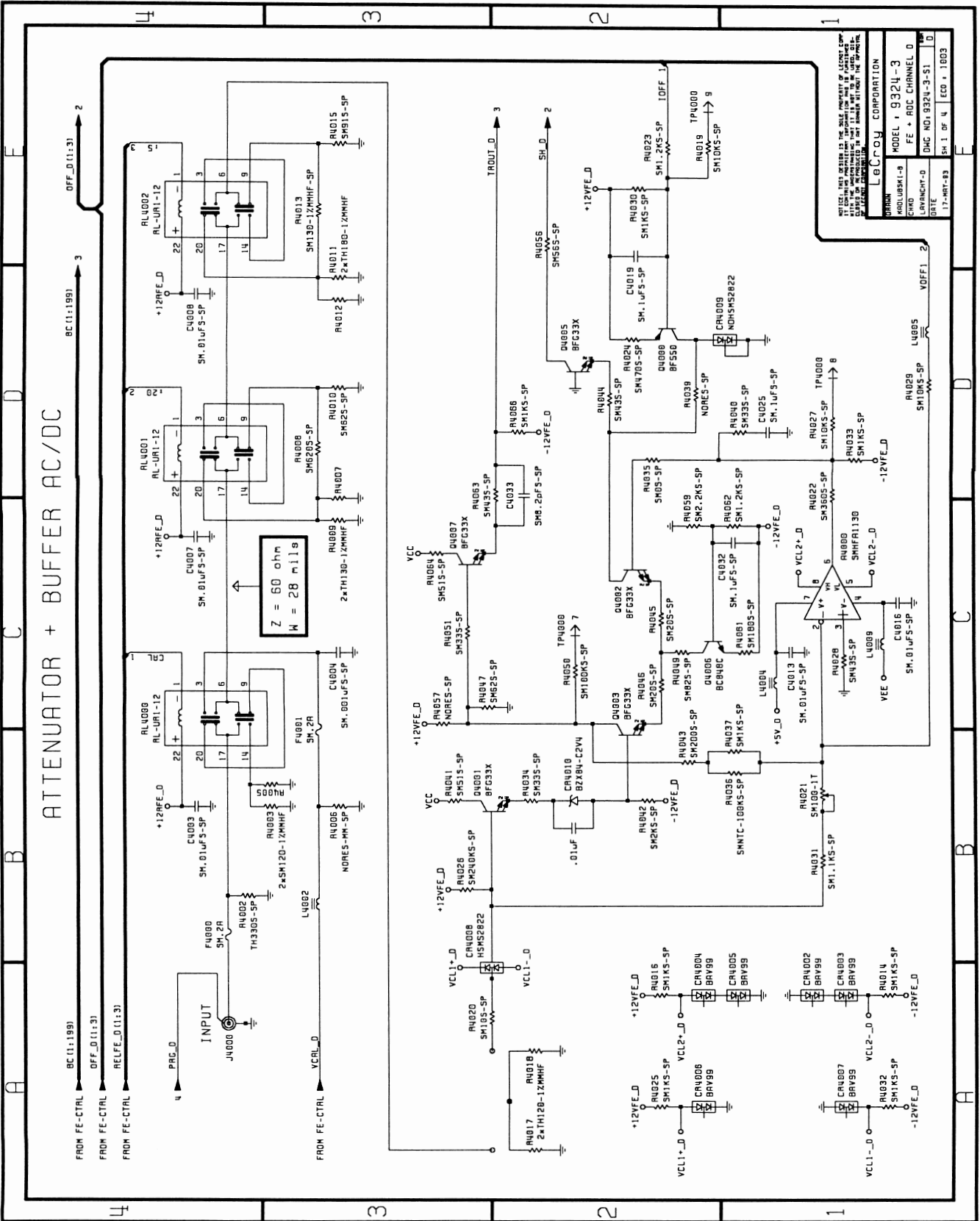

NOTE: THIS DRAWING IS THE PROPERTY OF LORICOR COMPANY. IT IS TO BE USED ONLY FOR THE PROJECT AND FOR THE PARTS LIST. IT IS NOT TO BE REPRODUCED OR TRANSMITTED IN ANY FORM OR BY ANY MEANS, ELECTRONIC OR MECHANICAL, INCLUDING PHOTOCOPYING, RECORDING, OR BY ANY INFORMATION STORAGE AND RETRIEVAL SYSTEM.	DATE
DESIGNED BY: KADLURSKI-B	17-MAY-83
CHECKED BY: LAYVANCH-D	SM 1 OF 4
APPROVED BY: JEFFREY D	ECO 1 1003
LORICOR CORPORATION	
MODEL 1 9324-3	
FE + ROC CHANNEL D	
DHC NO. 9324-3-S1	

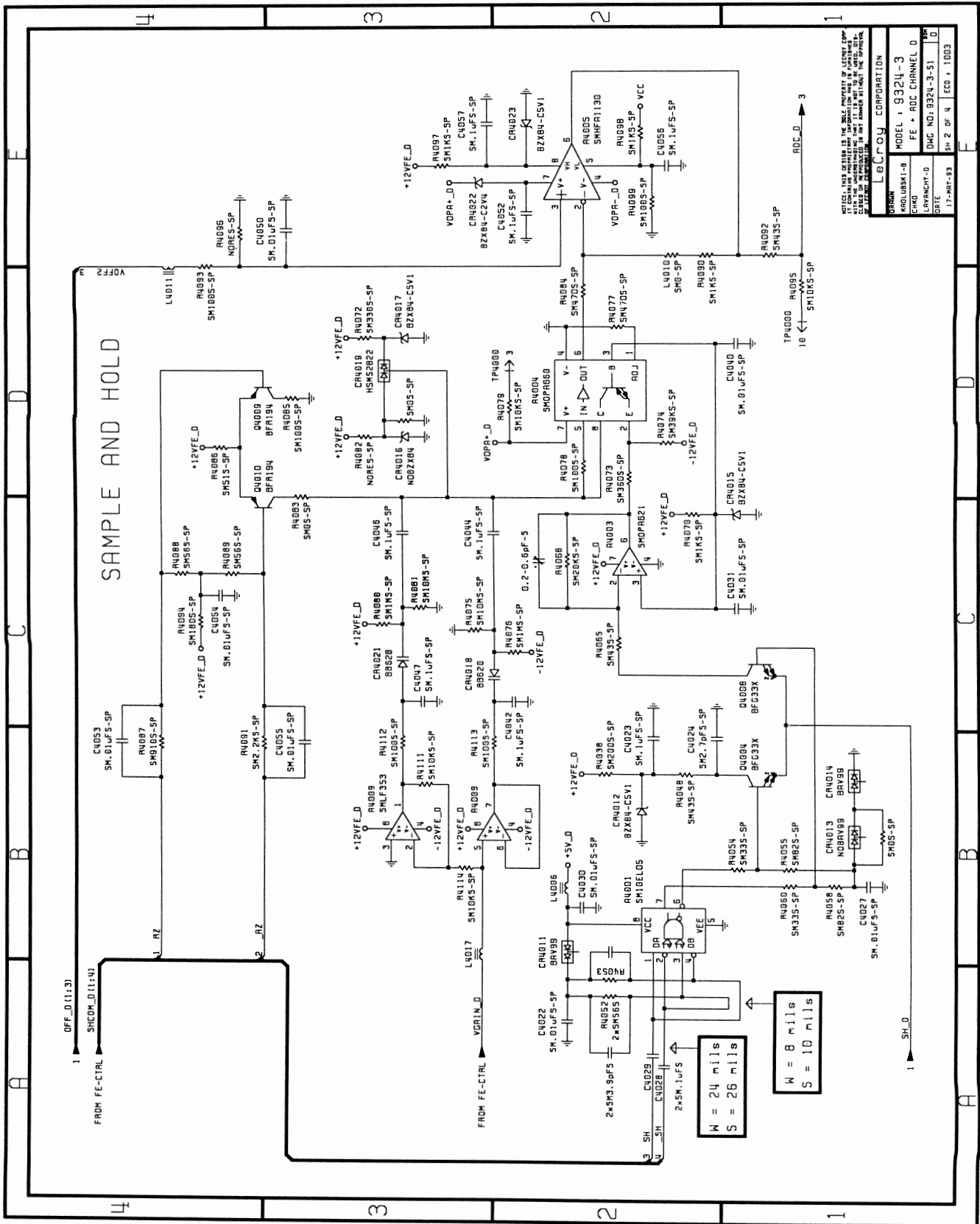

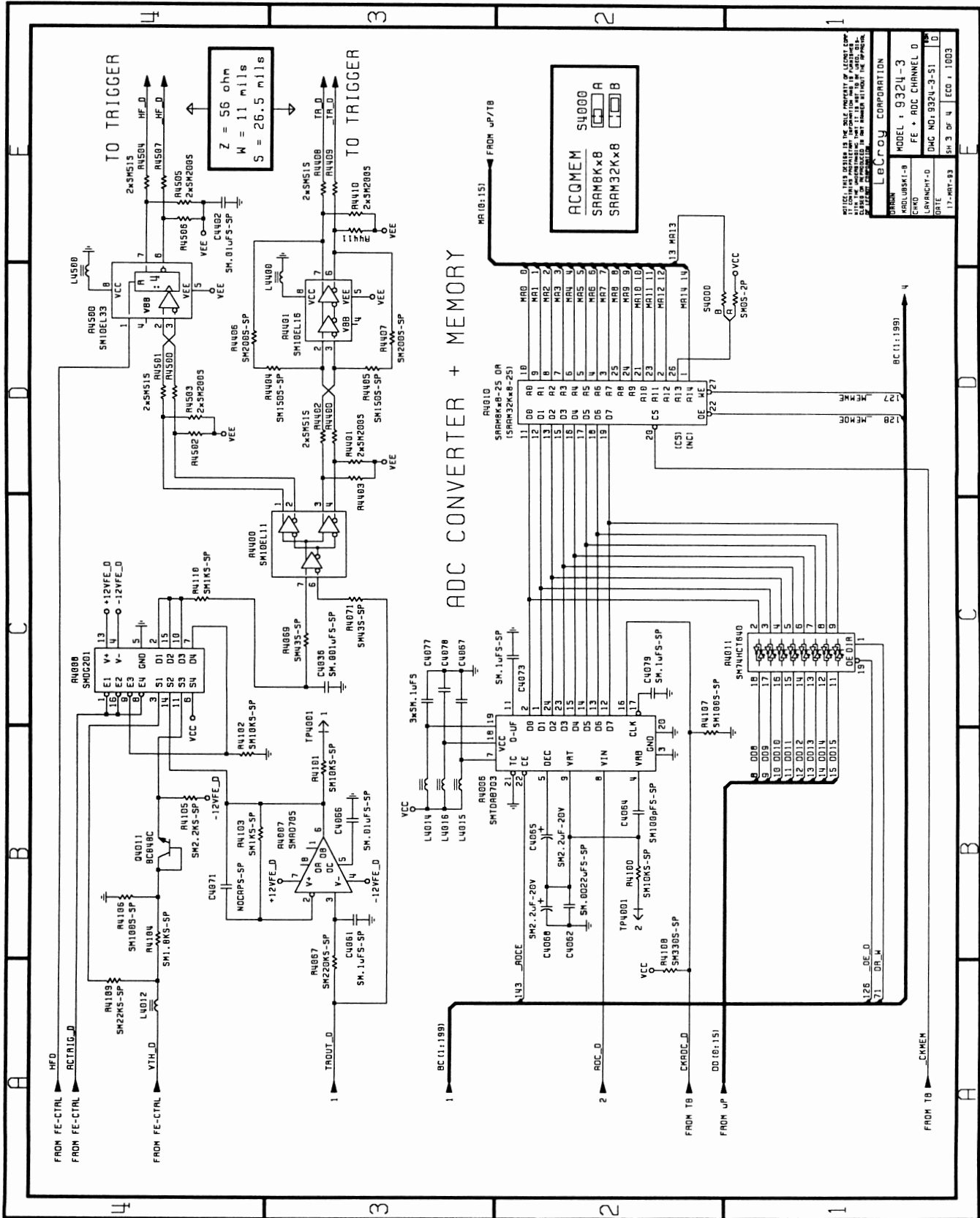

SERIAL PROBE TRANSFERT + POWER SUPPLY

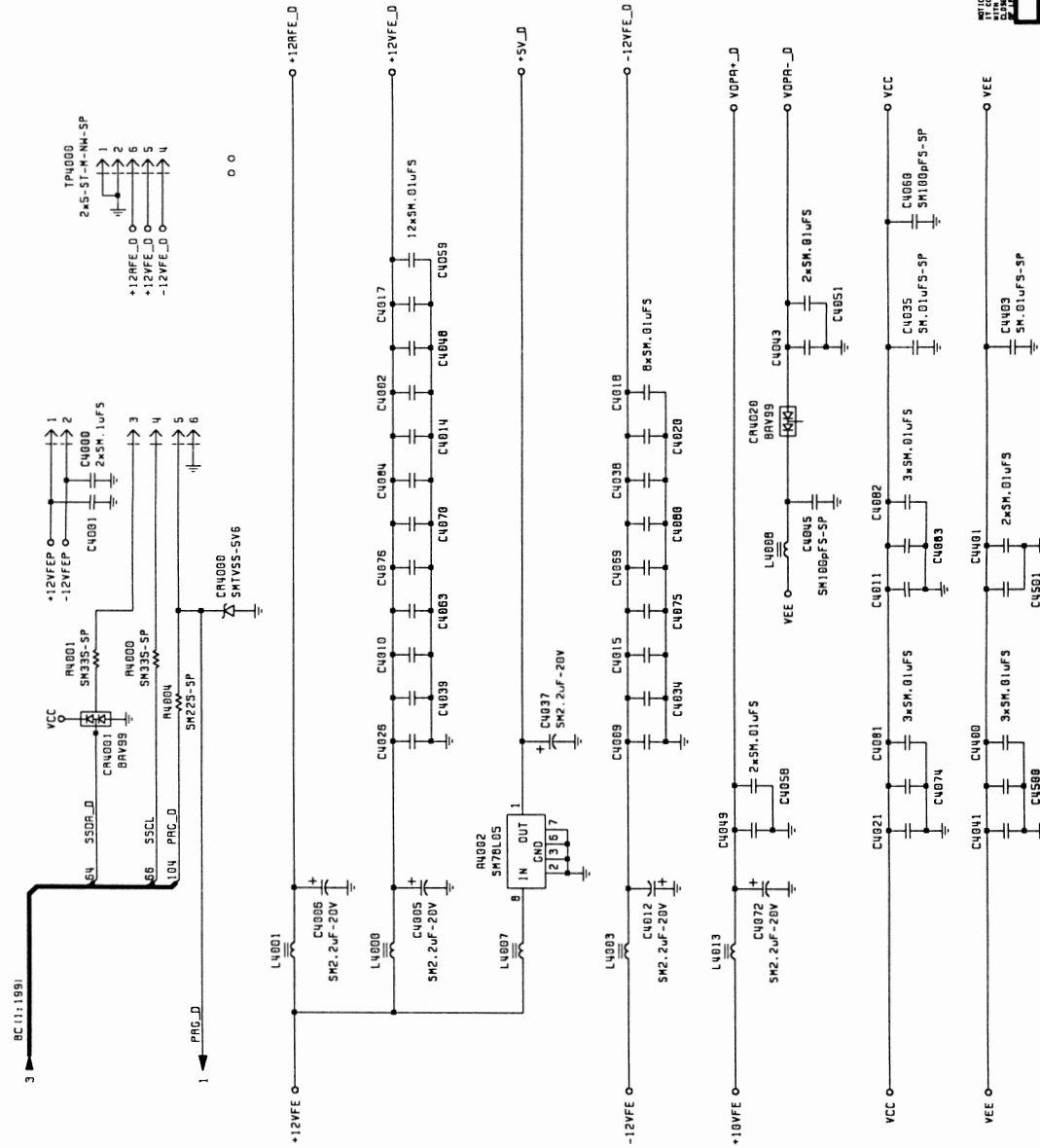

NOTICE: THIS DRAWING IS THE SOLE PROPERTY OF LOCKHEED CORP. IT IS TO BE USED FOR THE PROJECT AND FOR THE QUANTITY SPECIFIED HEREIN. IT IS TO BE RETURNED TO THE OFFICE OF ORIGINATOR UPON COMPLETION OF THE PROJECT. NO PARTS ARE TO BE ORDERED FROM THIS DRAWING WITHOUT THE APPROVAL OF THE OFFICE OF ORIGINATOR.

VERSION	LABORATORY CORPORATION
MODEL	9324-3
REV	FE - RDC CHANNEL 0
DATE	17-MAY-83
DRG NO.	9324-3-S1
ECO	1 1803

VIEW D

FRONT-END & ADC CHANNEL D

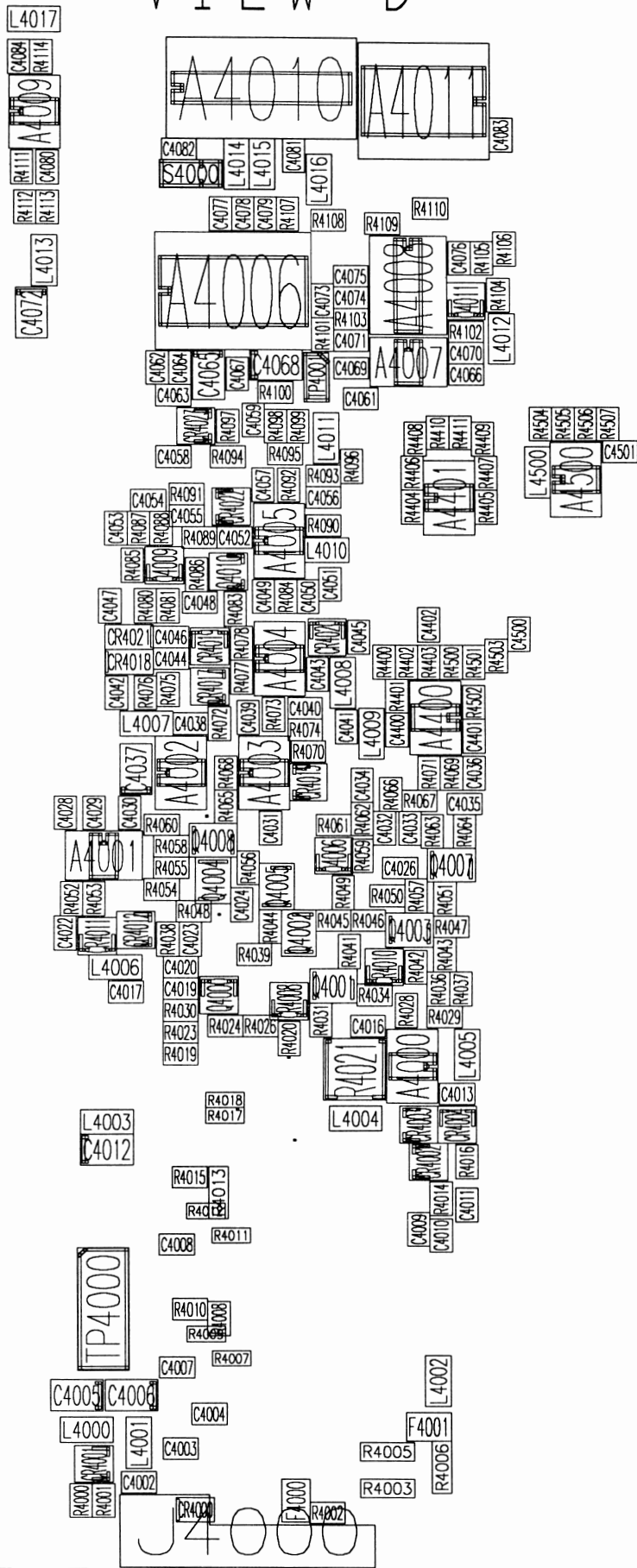

VIEW D

FRONT-END & ADC CHANNEL D

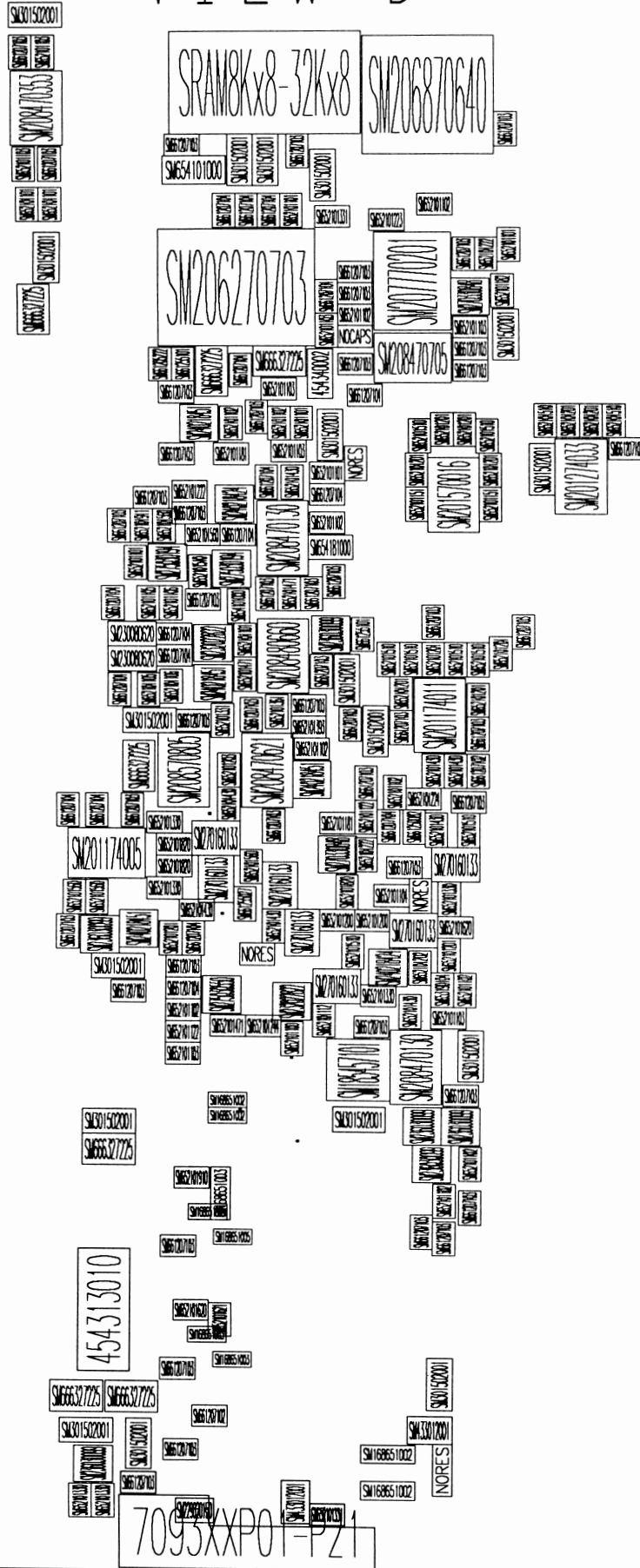

7093XXP01-P21

FRONT-END & ADC CHANNEL D

VIEW D

SOLDER
SIDE

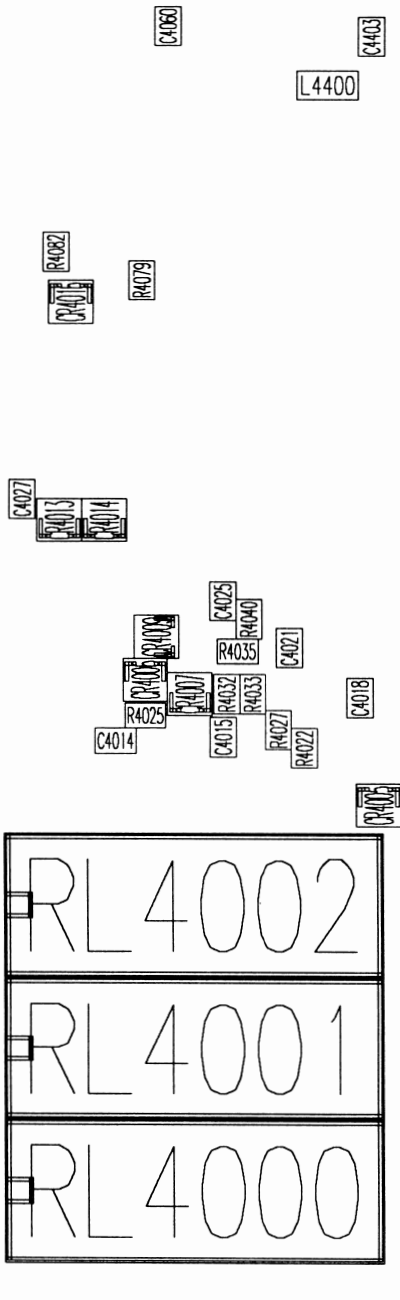

VIEW D

FRONT-END & ADC CHANNEL D

SOLDER
SIDE

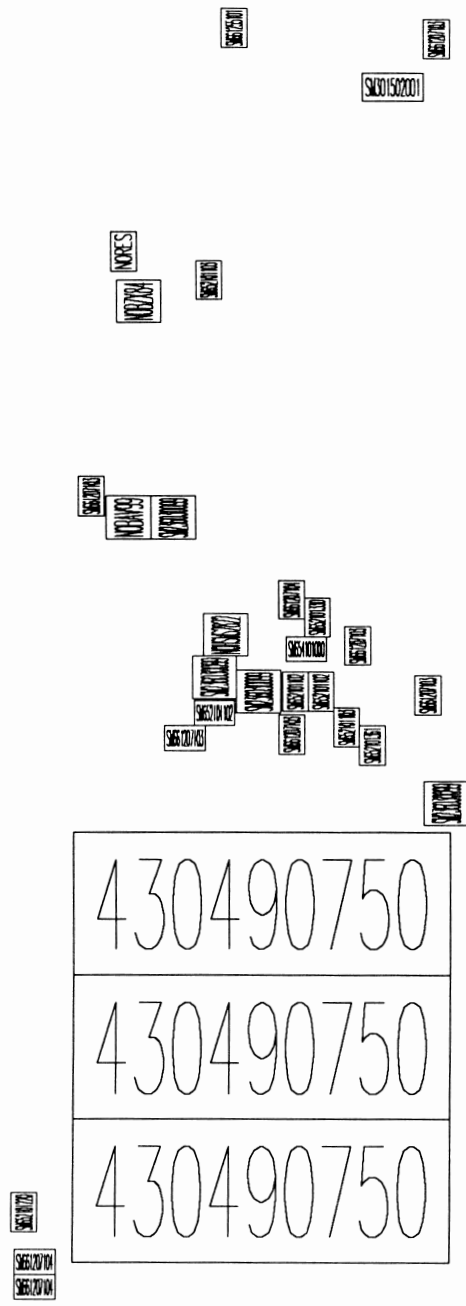

VIEW D

FRONT-END & ADC CHANNEL D

SOLDER
SIDE

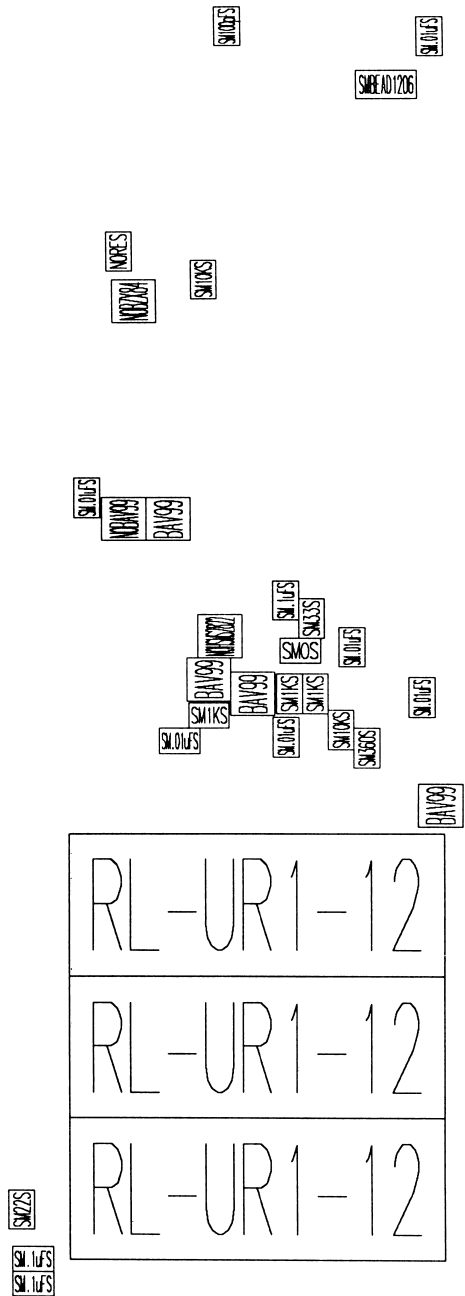

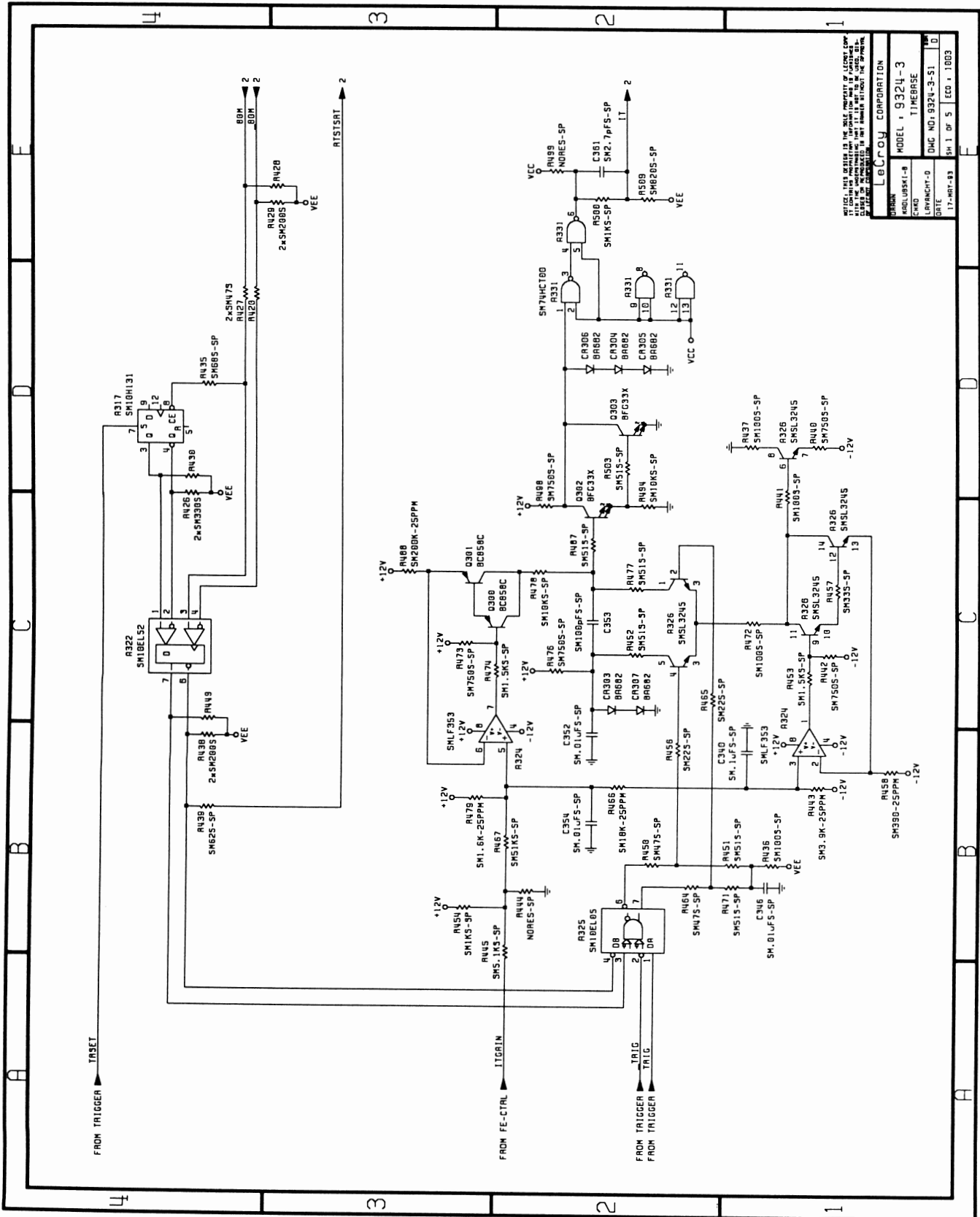

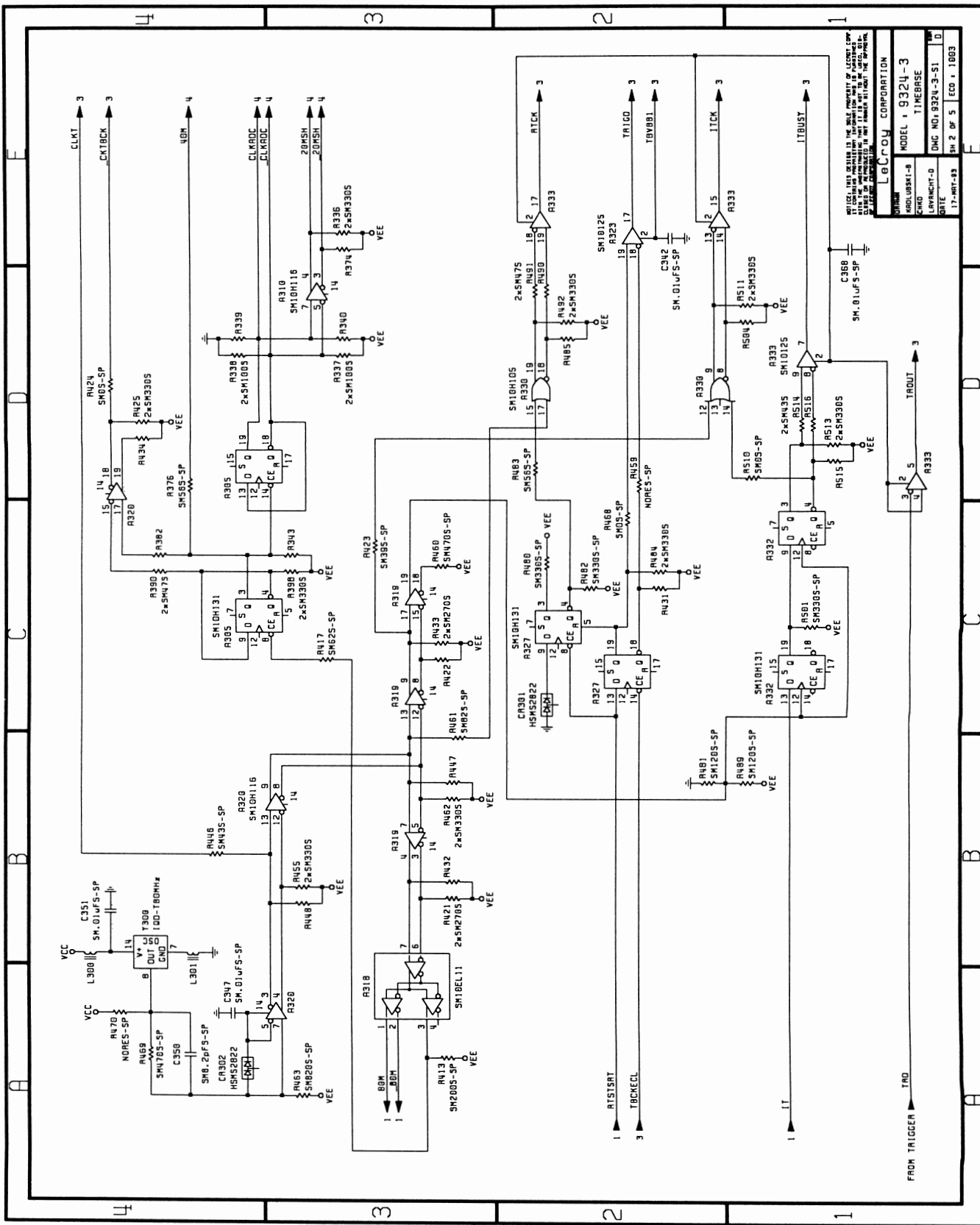

LECROY CORPORATION

MODEL :	9324-3
TITLE :	TIMEBASE
LAYOUT-D :	DMG NO. 9324-3-S1
DATE :	17-MAY-83

SN 2 OF 5 | ECO 1 1003

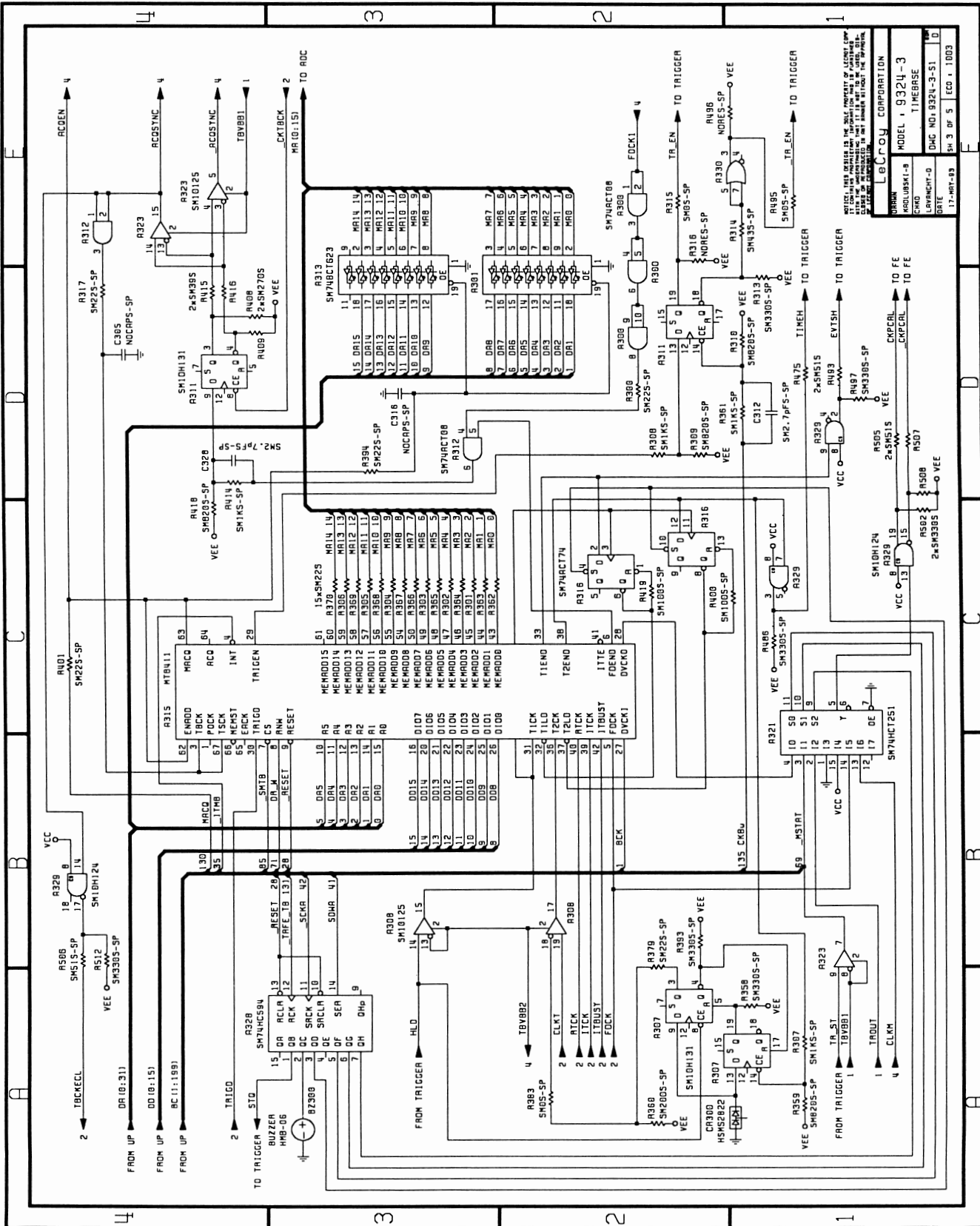

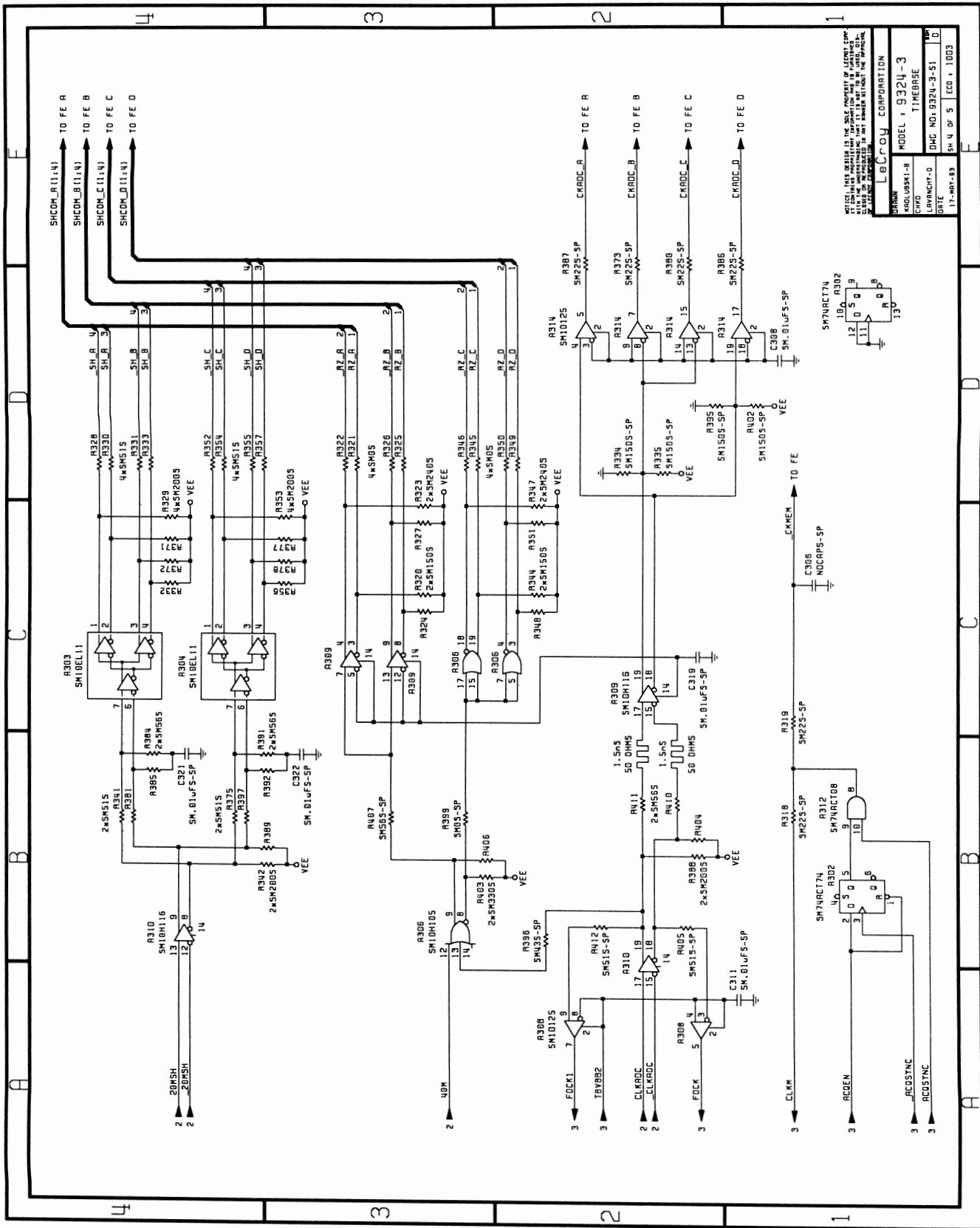

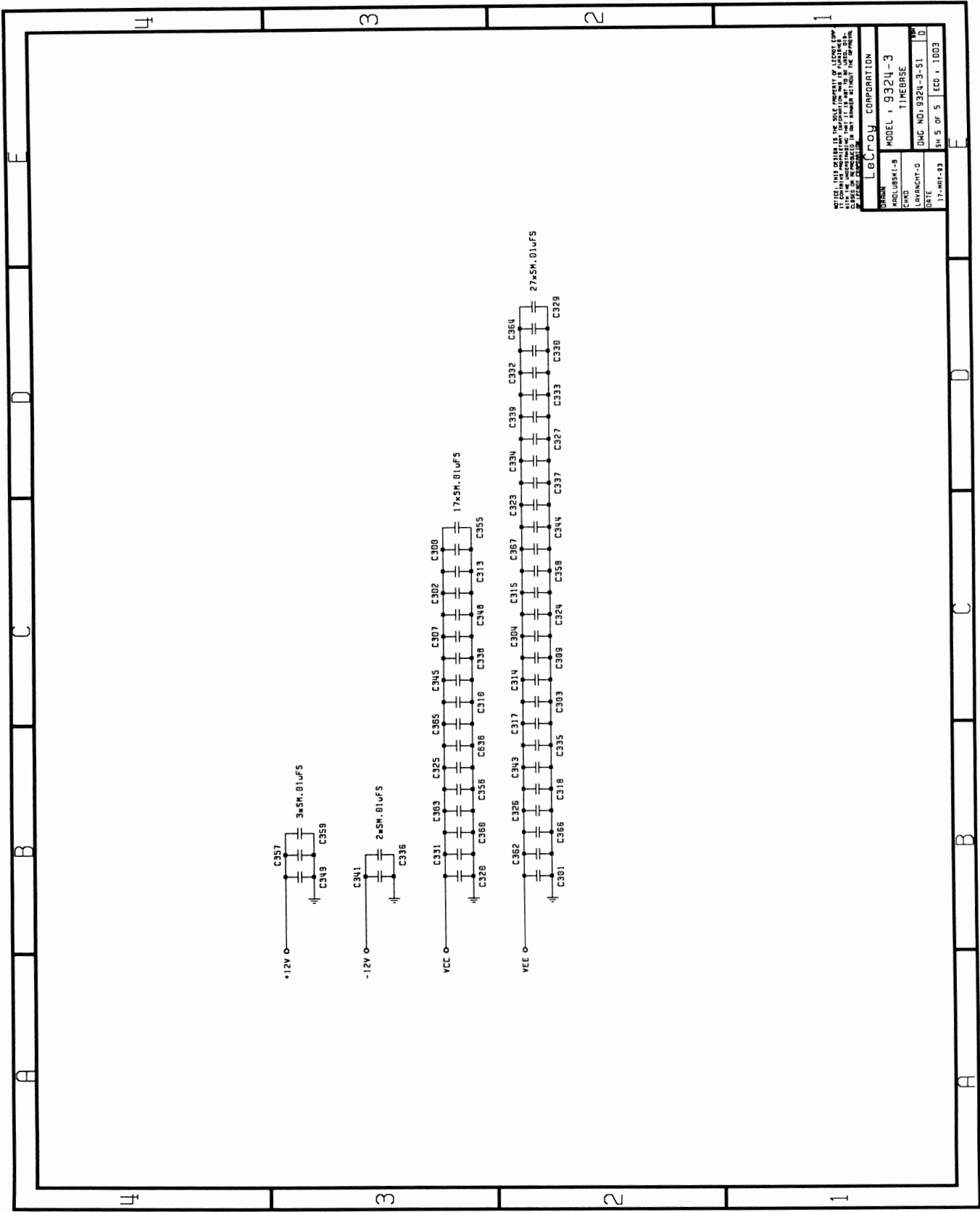

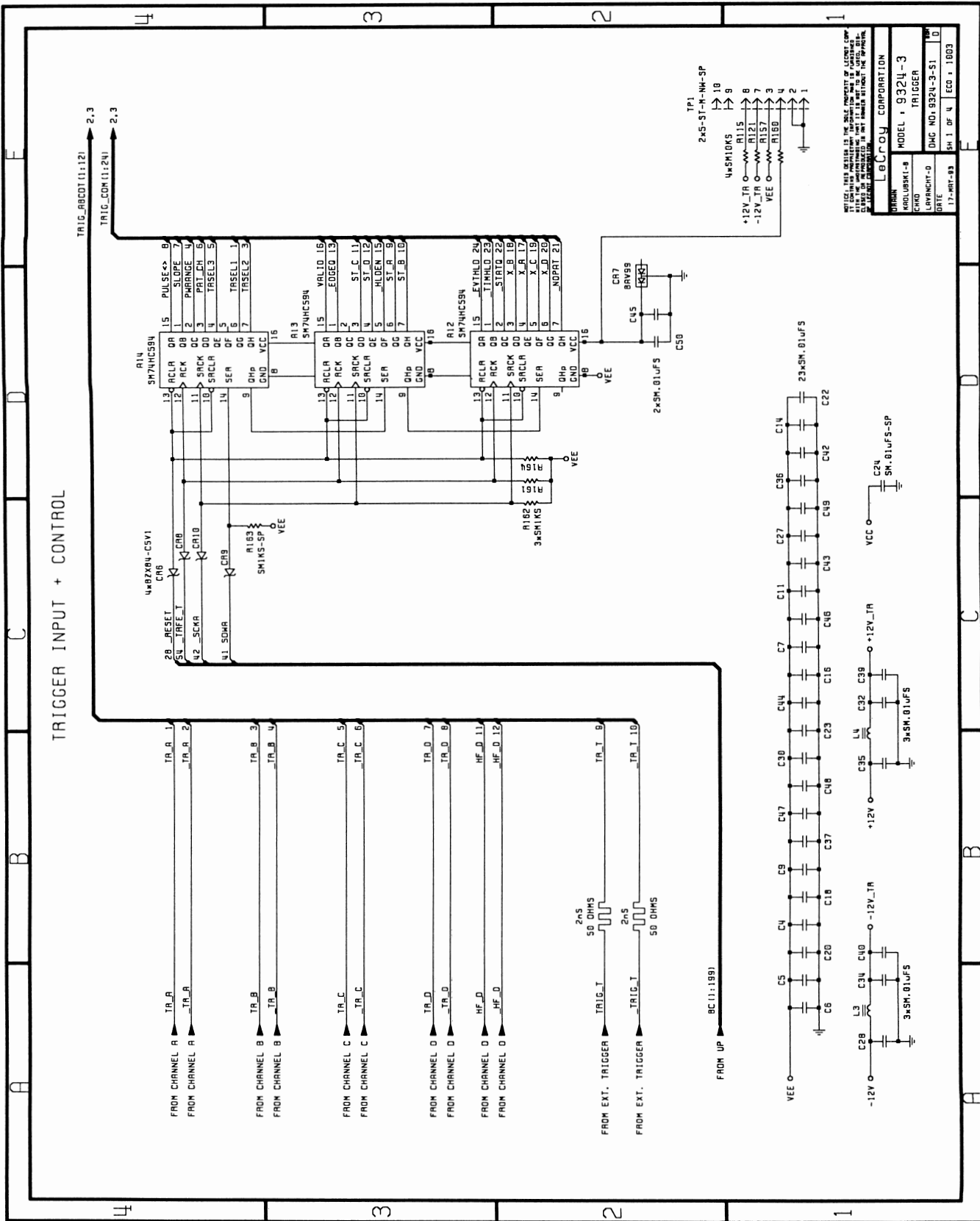

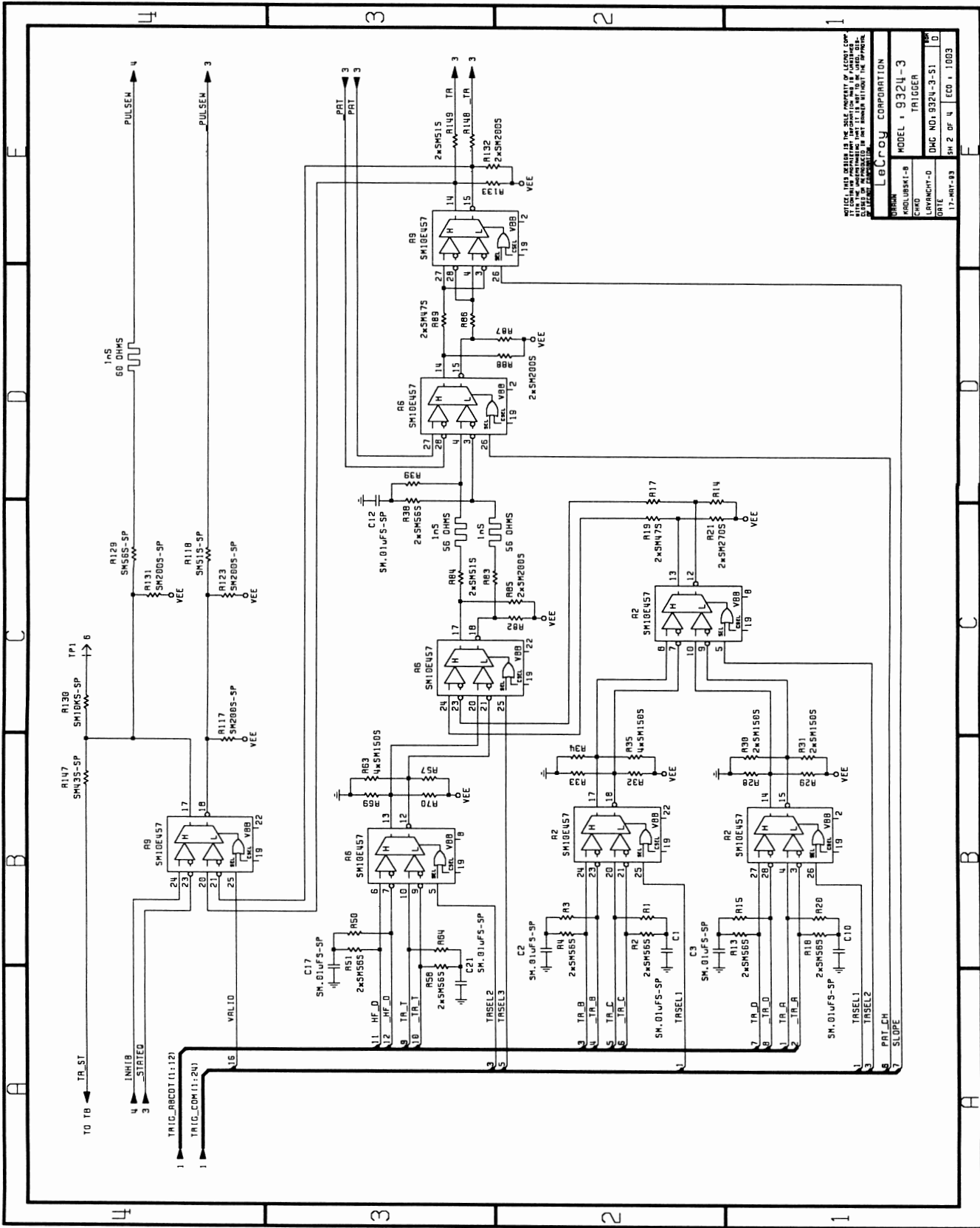

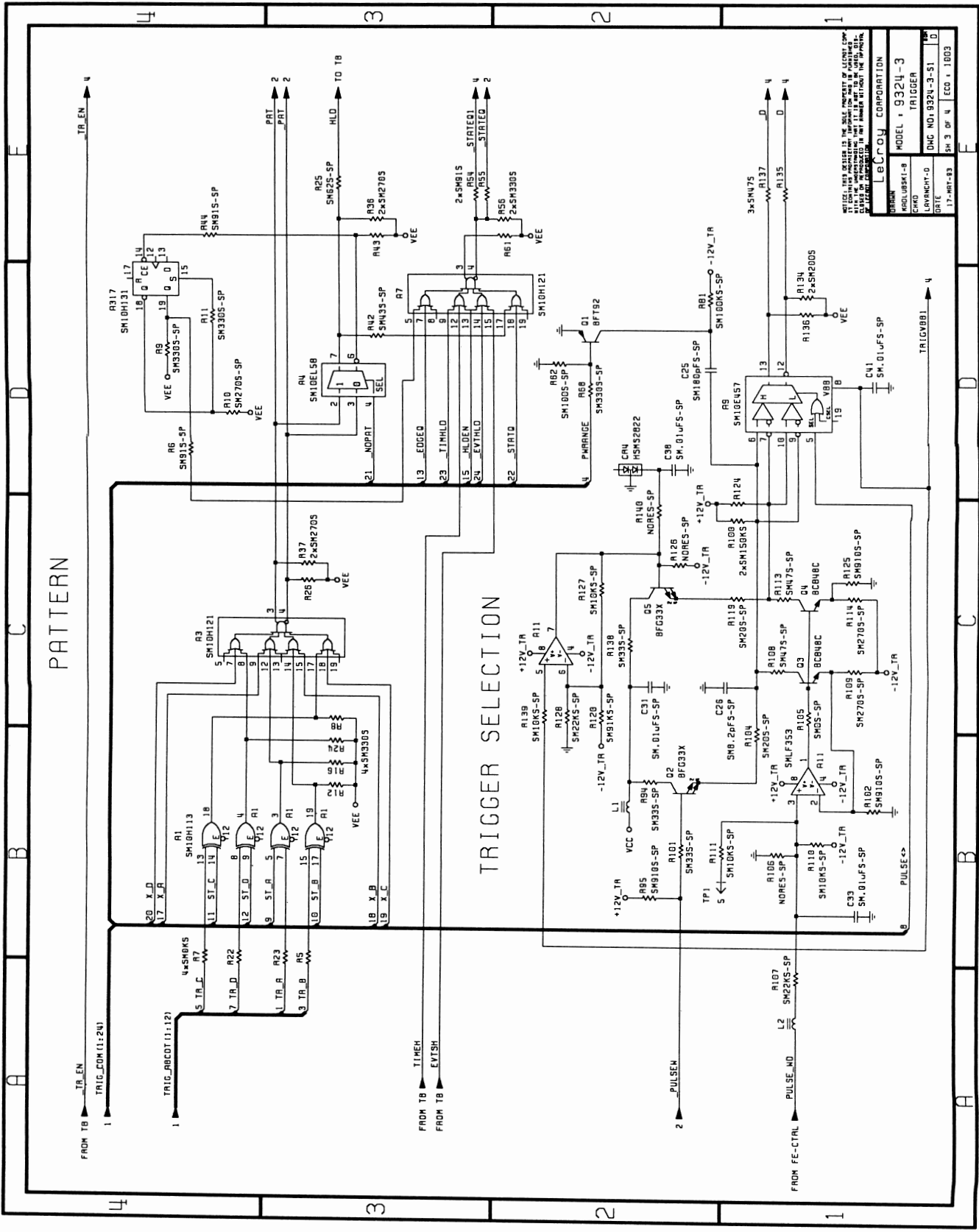

WHILE THIS DESIGN IS THE SOLE PROPERTY OF ALICORP, IT IS HEREBY OFFERED TO YOU ON THE UNDERSTANDING THAT YOU WILL NOT REPRODUCE OR TRANSMIT THIS DESIGN OR INFORMATION HEREIN WITHOUT THE WRITTEN PERMISSION OF ALICORP.

DESIGN	LECOIL CORPORATION
MODEL	9324-3
TRIGGER	
DATE	17-MAR-83
REV	1
ECO	1003

SYNCHRONISER

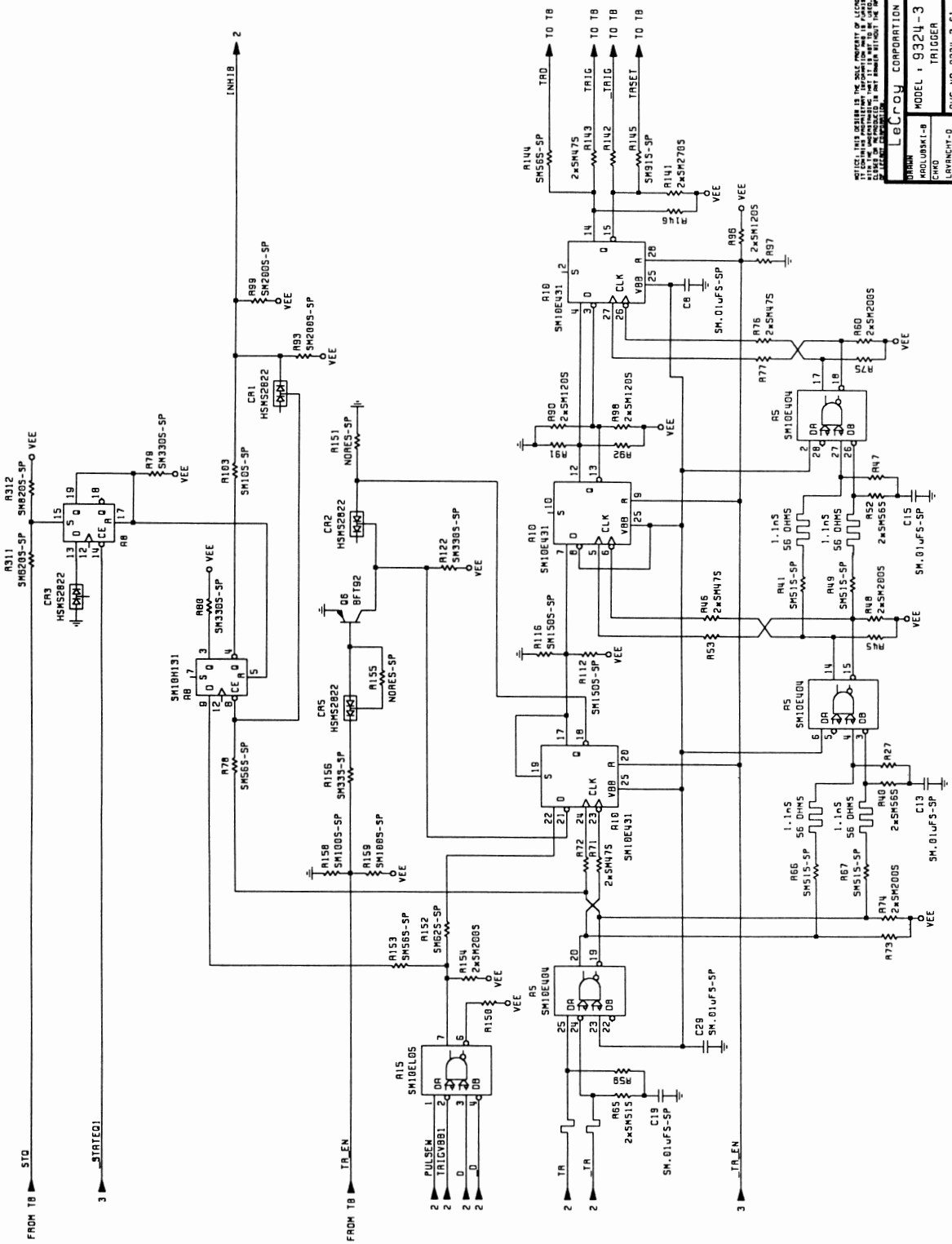

VEE CANNOT BE OPENED FOR THE SINGLE-PHASE OF ALTERNATE COMPANY. THE PARTS LIST IS THE PROPERTY OF LECROY CORPORATION. THIS SCHEMATIC IS NOT TO BE REPRODUCED OR TRANSMITTED IN ANY FORM OR BY ANY MEANS, ELECTRONIC OR MECHANICAL, INCLUDING PHOTOCOPYING, RECORDING, OR BY ANY INFORMATION STORAGE AND RETRIEVAL SYSTEM.

DATE	17-MAY-83
DR	LRYAN/CYD
CHKD	MLC/LRSK/L-R
WORK	MODEL 1 9324-3
TRIGGER	
DATE	
DR	
CHKD	
WORK	
DATE	
DR	
CHKD	
WORK	

9324-3 Rev:C

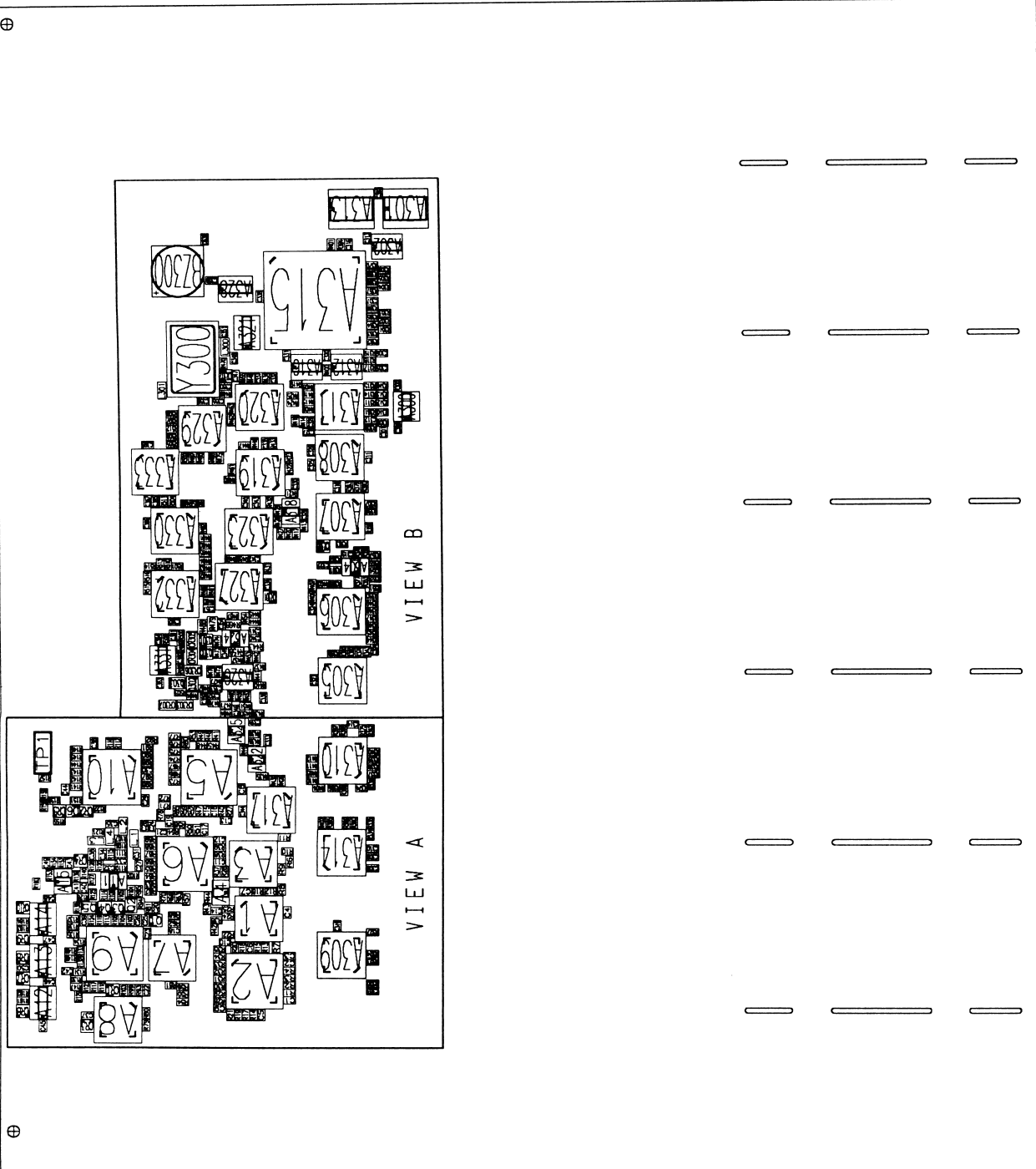

TRIGGER & TIME BASE

9324-3 Rev:C

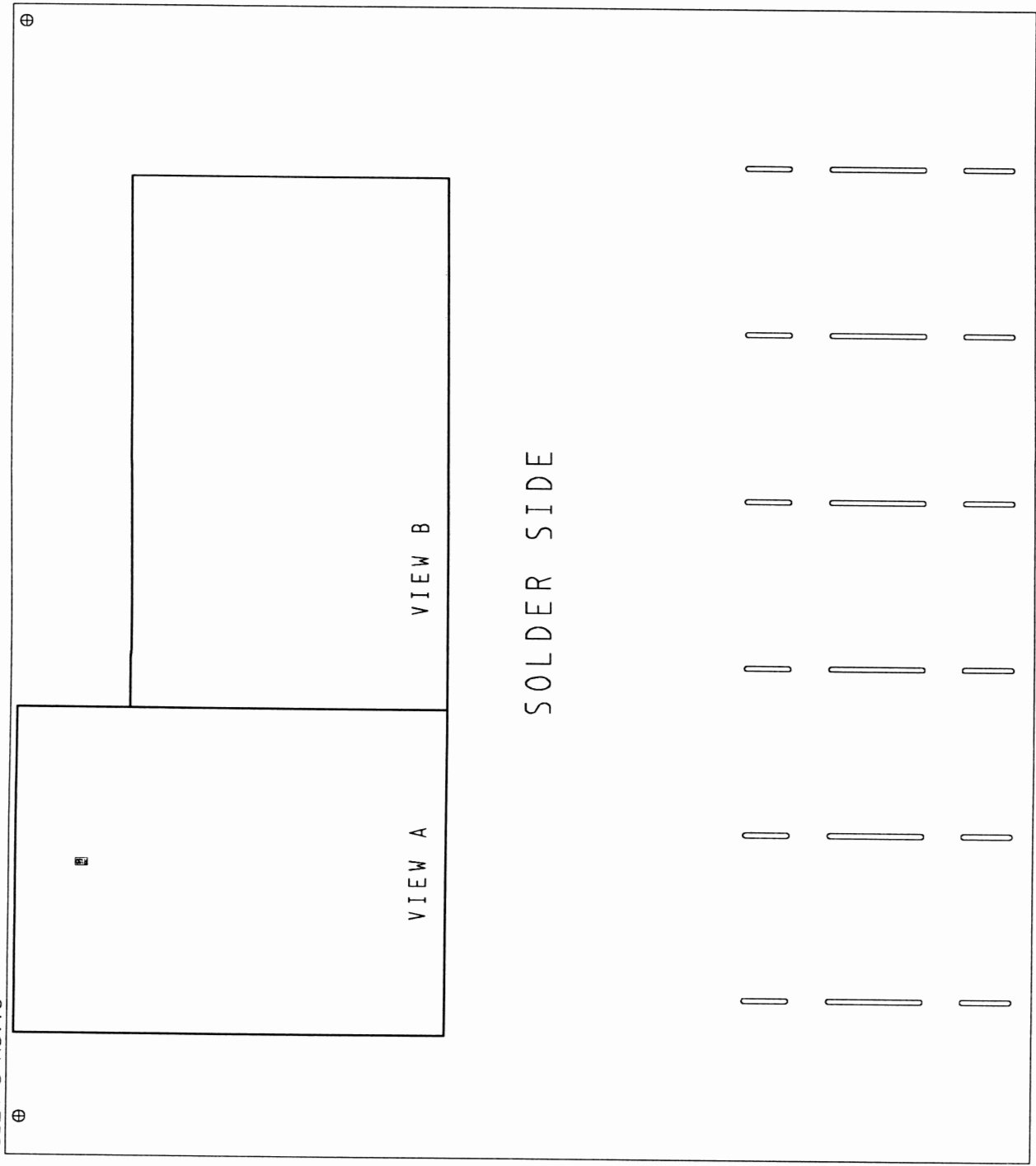

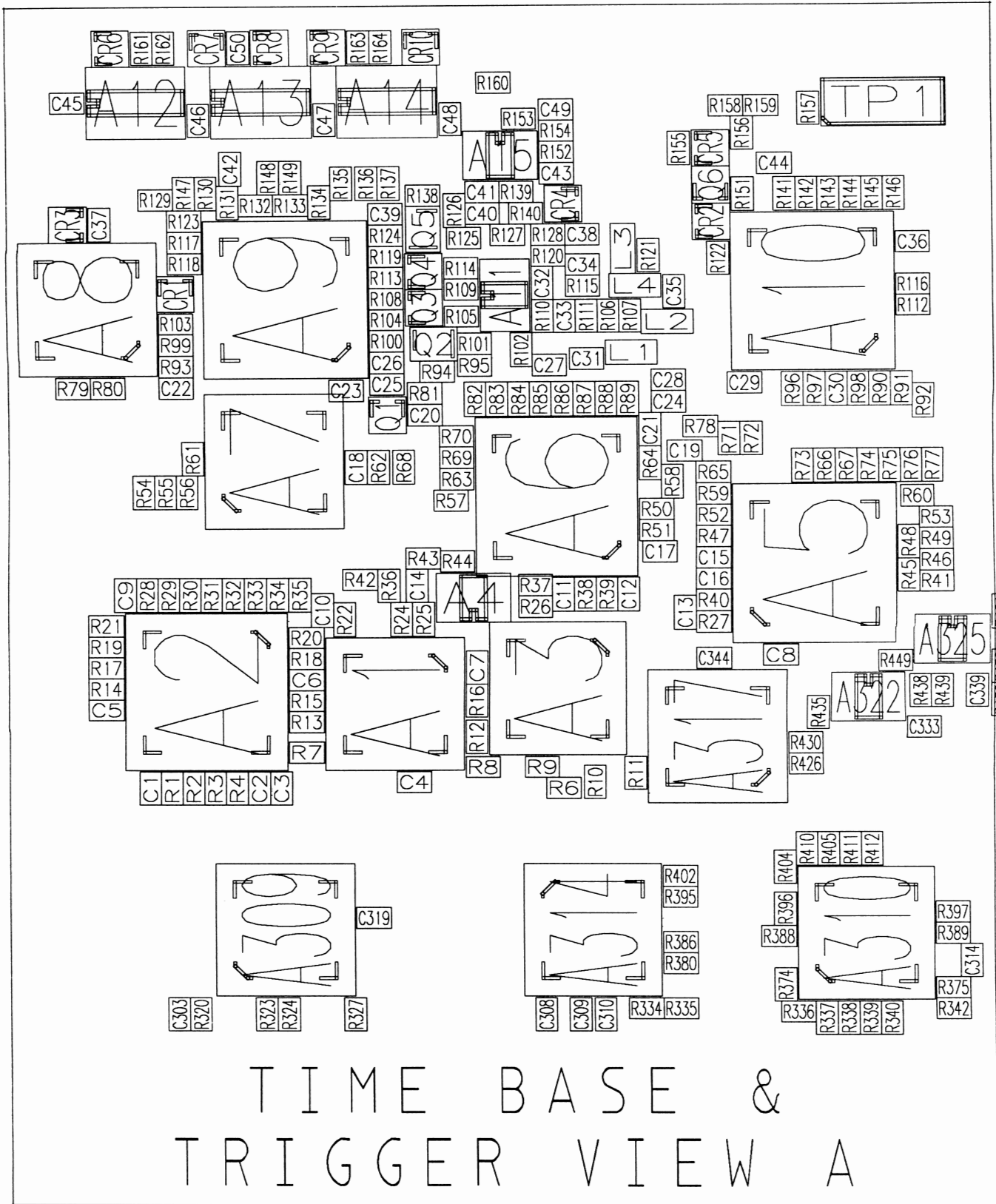

R150

SOLDER SIDE

TIME BASE &
TRIGGER VIEW A



SOLDER SIDE

TIME BASE &
TRIGGER VIEW A

8000

TIME BASE &
TRIGGER VIEW A

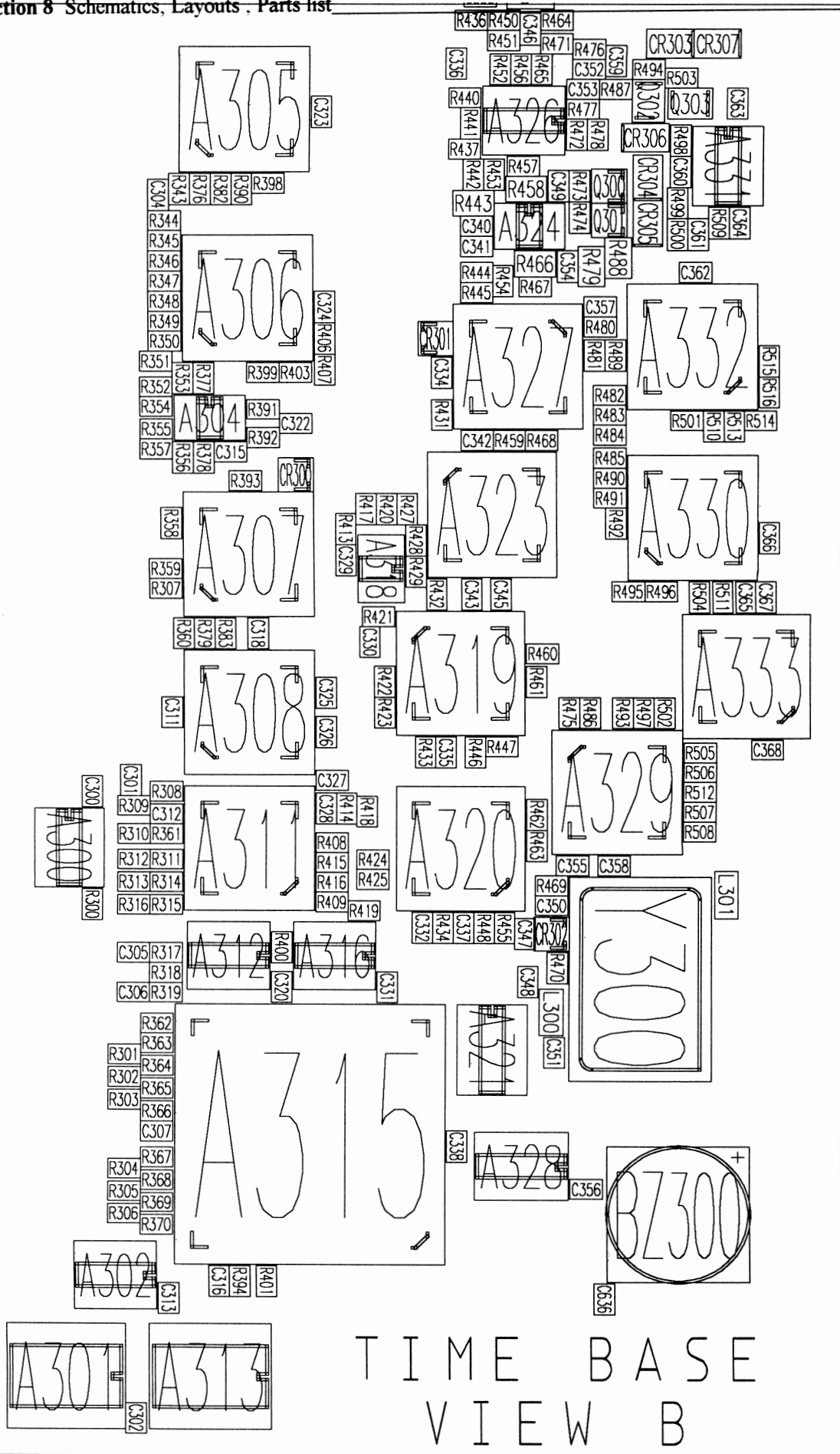

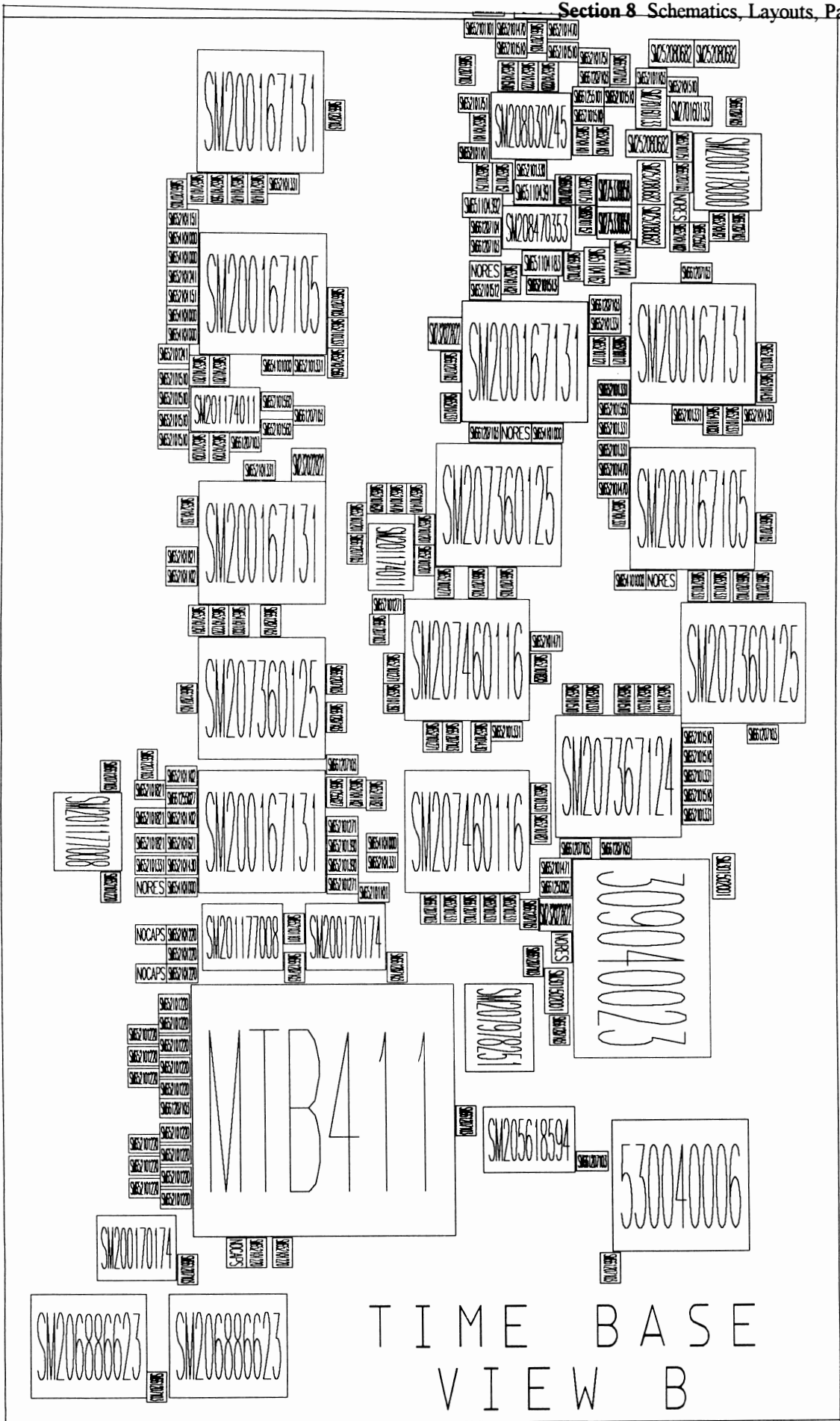

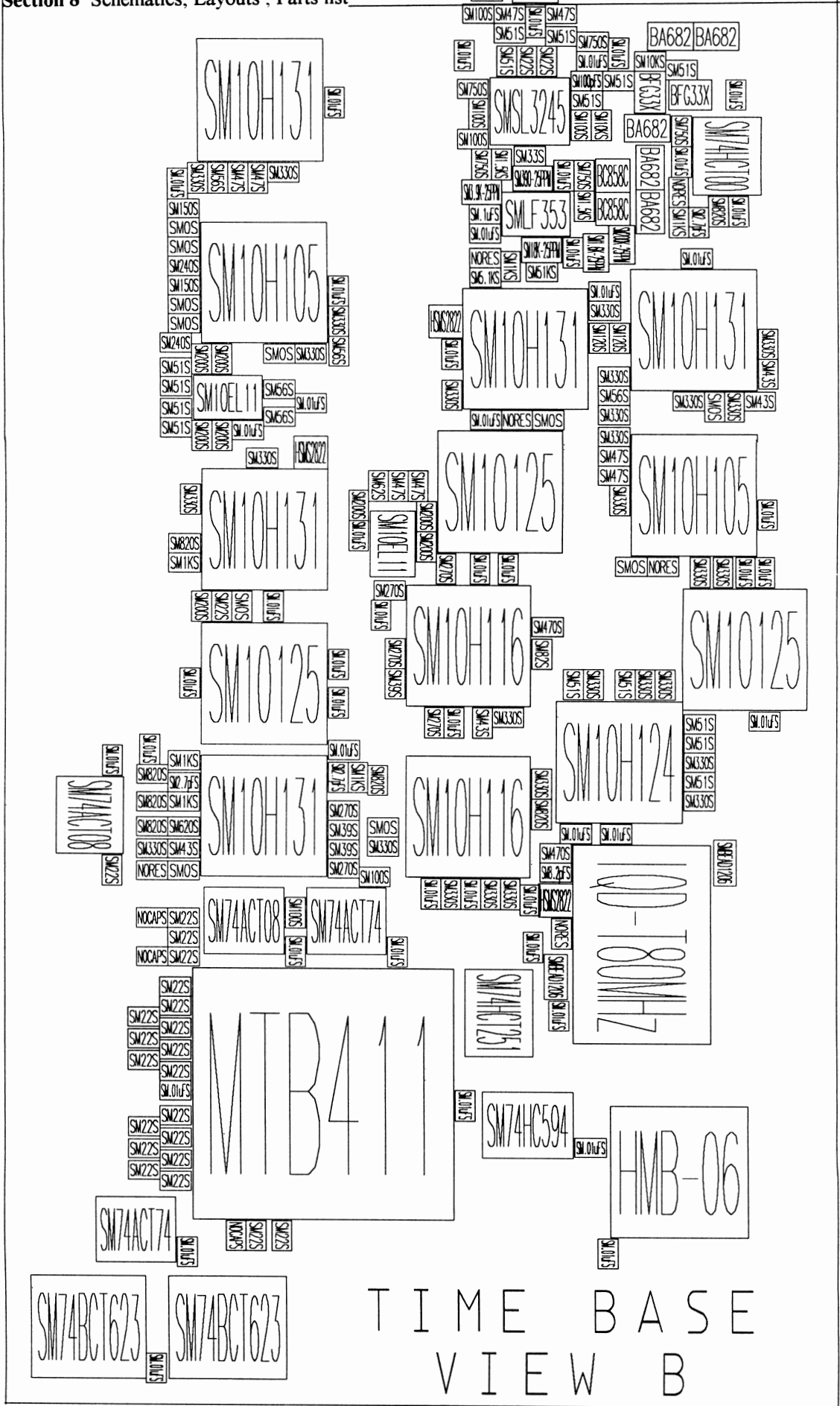

A1	SM200167113	SM10H113	PLCC_20
A2	SM206970457	SM10E457	PLCC_28
A3	SM200167121	SM10H121	PLCC_20
A4	SM201574058	SM10EL58	SOIC_8
A5	SM201166404	SM10E404	PLCC_28
A6	SM206970457	SM10E457	PLCC_28
A7	SM200167121	SM10H121	PLCC_20
A8	SM200167131	SM10H131	PLCC_20
A9	SM206970457	SM10E457	PLCC_28
A10	SM201474431	SM10E431	PLCC_28
A11	SM208470353	SMLF353	SOIC_8
A12	SM205618594	SM74HC594	SOIC_16
A13	SM205618594	SM74HC594	SOIC_16
A14	SM205618594	SM74HC594	SOIC_16
A15	SM201174005	SM10EL05	SOIC_8
A300	SM201177008	SM74ACT08	SOIC_14
A301	SM206886623	SM74BCT623	SOIC_20
A302	SM200170174	SM74ACT74	SOIC_14
A304	SM201174011	SM10EL11	SOIC_8
A305	SM200167131	SM10H131	PLCC_20
A306	SM200167105	SM10H105	PLCC_20
A307	SM200167131	SM10H131	PLCC_20
A308	SM207360125	SM10125	PLCC_20
A309	SM207460116	SM10H116	PLCC_20
A310	SM207460116	SM10H116	PLCC_20
A311	SM200167131	SM10H131	PLCC_20
A312	SM201177008	SM74ACT08	SOIC_14
A313	SM206886623	SM74BCT623	SOIC_20
A314	SM207360125	SM10125	PLCC_20
A315	MTB411	MTB411	PLCC_68
A316	SM200170174	SM74ACT74	SOIC_14
A317	SM200167131	SM10H131	PLCC_20
A318	SM201174011	SM10EL11	SOIC_8
A319	SM207460116	SM10H116	PLCC_20
A320	SM207460116	SM10H116	PLCC_20
A321	SM207978251	SM74HCT251	SOIC_16
A322	SM201174052	SM10EL52	SOIC_8
A323	SM207360125	SM10125	PLCC_20
A324	SM208470353	SMLF353	SOIC_8
A325	SM201174005	SM10EL05	SOIC_8
A326	SM208030245	SMSL3245	SOIC_14
A327	SM200167131	SM10H131	PLCC_20
A328	SM205618594	SM74HC594	SOIC_16
A329	SM207367124	SM10H124	PLCC_20
A330	SM200167105	SM10H105	PLCC_20
A331	SM200178000	SM74HCT00	SOIC_14
A332	SM200167131	SM10H131	PLCC_20
A333	SM207360125	SM10125	PLCC_20
A600	SM208870339	SMLM339	SOIC_14
A601	SM206260858	SMADC0858	PLCC_20
A602	SM200178138	SM74HCT138	SOIC_16
A603	SM207970351	SM74HC4351	SOIC_20
A604	SM200178138	SM74HCT138	SOIC_16
A605	SM201177008	SM74ACT08	SOIC_14
A606	SM207878245	SM74HCT245	SOIC_20
A607	SM205108002	SMPCF8582A	SOIC_8
A608	SM207878245	SM74HCT245	SOIC_20
A609	SM200178000	SM74HCT00	SOIC_14
A610	SM207178541	SM74HCT541	SOIC_20
A611	SM205618165	SM74HCT165	SOIC_16
A612	SM207178541	SM74HCT541	SOIC_20
A613	205750000	C16L8L	DIP20
A614	SM200178000	SM74HCT00	SOIC_14

A615	205750000	C16L8L	DIP20
A616	SM207178541	SM74HCT541	SOIC_20
A617	SM200178138	SM74HCT138	SOIC_16
A618	SM207978251	SM74HCT251	SOIC_16
A619	205750000	C16R4L	DIP20
A620	SM200178374	SM74HCT374	SOIC_20
A621	SM207178541	SM74HCT541	SOIC_20
A622	SM200278040	SM74HCT4040	SOIC_16
A623	SM200170174	SM74ACT74	SOIC_14
A624	SM201177008	SM74ACT08	SOIC_14
A625	208124003	LM320T-12	TO220_ST_WHSC
A626	208123002	LM340T-12	TO220_ST_WHSC
A627	208122002	7805	TO220_ST_WHSC
A628	208124003	LM320T-12	TO220_ST_WHSC
A629	208123002	LM340T-12	TO220_ST_WHSC
A630	SM206070584	SMPCD8584	SOIC_20
A631	MCL404	MCL404	PLCC_68
A632	SM207280703	SMDAC703	SOIC_24
A802	SM207288800	SMDAC8800	SOIC_20
A803	SM205618594	SM74HC594	SOIC_16
A804	SM208470347	SMLF347	SOIC_14
A805	SM207770201	SMDG201	SOIC_16
A807	SM208470347	SMLF347	SOIC_14
A809	SM205618594	SM74HC594	SOIC_16
A811	SM289772003	SMULN2003	SOIC_16
A812	SM208470347	SMLF347	SOIC_14
A813	SM207770201	SMDG201	SOIC_16
A814	SM208470705	SMAD705	SOIC_8
A815	SM208470347	SMLF347	SOIC_14
A816	SM207770201	SMDG201	SOIC_16
A3000	SM208470130	SMHFA1130	SOIC_8
A3001	SM201174005	SM10EL05	SOIC_8
A3002	SM208570805	SM78L05	SOIC_8
A3003	SM208470621	SMOPA621	SOIC_8
A3004	SM208480660	SMOPA660	SOIC_8
A3005	SM208470130	SMHFA1130	SOIC_8
A3006	SM206270703	SMTDA8703	SOIC_24
A3007	SM208470705	SMAD705	SOIC_8
A3008	SM207770201	SMDG201	SOIC_16
A3009	SM208470353	SMLF353	SOIC_8
A3010	SRAM8Kx8-32Kx8	SRAM8Kx8-32Kx8	SOJ_28
A3011	SM206870640	SM74HCT640	SOIC_20
A3400	SM201570016	SM10EL16	SOIC_8
A3401	SM201570016	SM10EL16	SOIC_8
A4000	SM208470130	SMHFA1130	SOIC_8
A4001	SM201174005	SM10EL05	SOIC_8
A4002	SM208570805	SM78L05	SOIC_8
A4003	SM208470621	SMOPA621	SOIC_8
A4004	SM208480660	SMOPA660	SOIC_8
A4005	SM208470130	SMHFA1130	SOIC_8
A4006	SM206270703	SMTDA8703	SOIC_24
A4007	SM208470705	SMAD705	SOIC_8
A4008	SM207770201	SMDG201	SOIC_16
A4009	SM208470353	SMLF353	SOIC_8
A4010	SRAM8Kx8-32Kx8	SRAM8Kx8-32Kx8	SOJ_28
A4011	SM206870640	SM74HCT640	SOIC_20
A4400	SM201174011	SM10EL11	SOIC_8
A4401	SM201570016	SM10EL16	SOIC_8
A4500	SM201274033	SM10EL33	SOIC_8
A5000	SM208473100	SMCA3100	SOIC_8
A5001	SM207770201	SMDG201	SOIC_16
A5002	SM208470705	SMAD705	SOIC_8
A5003	SM201570016	SM10EL16	SOIC_8

A5004	SM201570016	SM10EL16	SOIC_8
A6000	SM208470705	SMAD705	SOIC_8
A6001	SM207460116	SM10H116	PLCC_20
BZ300	530040006	HMB-06	HBM_06
C1	SM661207103	SM.01uFS	SM0805SP
C2	SM661207103	SM.01uFS	SM0805SP
C3	SM661207103	SM.01uFS	SM0805SP
C4	SM661207103	SM.01uFS	SM0805SP
C5	SM661207103	SM.01uFS	SM0805SP
C6	SM661207103	SM.01uFS	SM0805SP
C7	SM661207103	SM.01uFS	SM0805SP
C8	SM661207103	SM.01uFS	SM0805SP
C9	SM661207103	SM.01uFS	SM0805SP
C10	SM661207103	SM.01uFS	SM0805SP
C11	SM661207103	SM.01uFS	SM0805SP
C12	SM661207103	SM.01uFS	SM0805SP
C13	SM661207103	SM.01uFS	SM0805SP
C14	SM661207103	SM.01uFS	SM0805SP
C15	SM661207103	SM.01uFS	SM0805SP
C16	SM661207103	SM.01uFS	SM0805SP
C17	SM661207103	SM.01uFS	SM0805SP
C18	SM661207103	SM.01uFS	SM0805SP
C19	SM661207103	SM.01uFS	SM0805SP
C20	SM661207103	SM.01uFS	SM0805SP
C21	SM661207103	SM.01uFS	SM0805SP
C22	SM661207103	SM.01uFS	SM0805SP
C23	SM661207103	SM.01uFS	SM0805SP
C24	SM661207103	SM.01uFS	SM0805SP
C25	SM661255181	SM180pFS	SM0805SP
C26	SM661250082	SM8.2pFS	SM0805SP
C27	SM661207103	SM.01uFS	SM0805SP
C28	SM661207103	SM.01uFS	SM0805SP
C29	SM661207103	SM.01uFS	SM0805SP
C30	SM661207103	SM.01uFS	SM0805SP
C31	SM661207103	SM.01uFS	SM0805SP
C32	SM661207103	SM.01uFS	SM0805SP
C33	SM661207103	SM.01uFS	SM0805SP
C34	SM661207103	SM.01uFS	SM0805SP
C35	SM661207103	SM.01uFS	SM0805SP
C36	SM661207103	SM.01uFS	SM0805SP
C37	SM661207103	SM.01uFS	SM0805SP
C38	SM661207103	SM.01uFS	SM0805SP
C39	SM661207103	SM.01uFS	SM0805SP
C40	SM661207103	SM.01uFS	SM0805SP
C41	SM661207103	SM.01uFS	SM0805SP
C42	SM661207103	SM.01uFS	SM0805SP
C43	SM661207103	SM.01uFS	SM0805SP
C44	SM661207103	SM.01uFS	SM0805SP
C45	SM661207103	SM.01uFS	SM0805SP
C46	SM661207103	SM.01uFS	SM0805SP
C47	SM661207103	SM.01uFS	SM0805SP
C48	SM661207103	SM.01uFS	SM0805SP
C49	SM661207103	SM.01uFS	SM0805SP
C50	SM661207103	SM.01uFS	SM0805SP
C300	SM661207103	SM.01uFS	SM0805SP
C301	SM661207103	SM.01uFS	SM0805SP
C302	SM661207103	SM.01uFS	SM0805SP
C303	SM661207103	SM.01uFS	SM0805SP
C304	SM661207103	SM.01uFS	SM0805SP
C307	SM661207103	SM.01uFS	SM0805SP
C308	SM661207103	SM.01uFS	SM0805SP
C309	SM661207103	SM.01uFS	SM0805SP
C310	SM661207103	SM.01uFS	SM0805SP

C311	SM661207103	SM.01uFS	SM0805SP
C312	SM661255027	SM2.7pFS	SM0805SP
C313	SM661207103	SM.01uFS	SM0805SP
C314	SM661207103	SM.01uFS	SM0805SP
C315	SM661207103	SM.01uFS	SM0805SP
C318	SM661207103	SM.01uFS	SM0805SP
C319	SM661207103	SM.01uFS	SM0805SP
C320	SM661207103	SM.01uFS	SM0805SP
C322	SM661207103	SM.01uFS	SM0805SP
C323	SM661207103	SM.01uFS	SM0805SP
C324	SM661207103	SM.01uFS	SM0805SP
C325	SM661207103	SM.01uFS	SM0805SP
C326	SM661207103	SM.01uFS	SM0805SP
C327	SM661207103	SM.01uFS	SM0805SP
C328	SM661255027	SM2.7pFS	SM0805SP
C329	SM661207103	SM.01uFS	SM0805SP
C330	SM661207103	SM.01uFS	SM0805SP
C331	SM661207103	SM.01uFS	SM0805SP
C332	SM661207103	SM.01uFS	SM0805SP
C333	SM661207103	SM.01uFS	SM0805SP
C334	SM661207103	SM.01uFS	SM0805SP
C335	SM661207103	SM.01uFS	SM0805SP
C336	SM661207103	SM.01uFS	SM0805SP
C337	SM661207103	SM.01uFS	SM0805SP
C338	SM661207103	SM.01uFS	SM0805SP
C339	SM661207103	SM.01uFS	SM0805SP
C340	SM661207104	SM.luFS	SM0805SP
C341	SM661207103	SM.01uFS	SM0805SP
C342	SM661207103	SM.01uFS	SM0805SP
C343	SM661207103	SM.01uFS	SM0805SP
C344	SM661207103	SM.01uFS	SM0805SP
C345	SM661207103	SM.01uFS	SM0805SP
C346	SM661207103	SM.01uFS	SM0805SP
C347	SM661207103	SM.01uFS	SM0805SP
C348	SM661207103	SM.01uFS	SM0805SP
C349	SM661207103	SM.01uFS	SM0805SP
C350	SM661250082	SM8.2pFS	SM0805SP
C351	SM661207103	SM.01uFS	SM0805SP
C352	SM661207103	SM.01uFS	SM0805SP
C353	SM661255101	SM100pFS	SM0805SP
C354	SM661207103	SM.01uFS	SM0805SP
C355	SM661207103	SM.01uFS	SM0805SP
C356	SM661207103	SM.01uFS	SM0805SP
C357	SM661207103	SM.01uFS	SM0805SP
C358	SM661207103	SM.01uFS	SM0805SP
C359	SM661207103	SM.01uFS	SM0805SP
C360	SM661207103	SM.01uFS	SM0805SP
C361	SM661255027	SM2.7pFS	SM0805SP
C362	SM661207103	SM.01uFS	SM0805SP
C363	SM661207103	SM.01uFS	SM0805SP
C364	SM661207103	SM.01uFS	SM0805SP
C365	SM661207103	SM.01uFS	SM0805SP
C366	SM661207103	SM.01uFS	SM0805SP
C367	SM661207103	SM.01uFS	SM0805SP
C368	SM661207103	SM.01uFS	SM0805SP
C600	SM661207103	SM.01uFS	SM0805SP
C601	SM661207104	SM.luFS	SM0805SP
C602	SM661207103	SM.01uFS	SM0805SP
C603	SM661207103	SM.01uFS	SM0805SP
C604	SM661207103	SM.01uFS	SM0805SP
C605	SM661207104	SM.luFS	SM0805SP
C606	SM661207104	SM.luFS	SM0805SP
C607	SM666327225	SM2.2uF-20V	SMCAPETD2

C608	SM661255181	SM180pFS	SM0805SP
C609	SM661207104	SM.1uFS	SM0805SP
C610	SM661207104	SM.1uFS	SM0805SP
C611	SM661207104	SM.1uFS	SM0805SP
C612	SM661207104	SM.1uFS	SM0805SP
C613	SM661207103	SM.01uFS	SM0805SP
C614	SM661207103	SM.01uFS	SM0805SP
C615	SM661207104	SM.1uFS	SM0805SP
C616	SM661207104	SM.1uFS	SM0805SP
C617	SM661207103	SM.01uFS	SM0805SP
C618	SM661207104	SM.1uFS	SM0805SP
C619	SM661207104	SM.1uFS	SM0805SP
C620	SM661207103	SM.01uFS	SM0805SP
C621	SM661207103	SM.01uFS	SM0805SP
C623	SM661207103	SM.01uFS	SM0805SP
C624	SM661207103	SM.01uFS	SM0805SP
C625	SM661207103	SM.01uFS	SM0805SP
C626	SM661207103	SM.01uFS	SM0805SP
C627	SM661207103	SM.01uFS	SM0805SP
C628	SM661207103	SM.01uFS	SM0805SP
C629	SM661207103	SM.01uFS	SM0805SP
C630	SM661207103	SM.01uFS	SM0805SP
C631	SM661207103	SM.01uFS	SM0805SP
C632	SM661207103	SM.01uFS	SM0805SP
C633	SM661207103	SM.01uFS	SM0805SP
C634	SM661207103	SM.01uFS	SM0805SP
C636	SM661207103	SM.01uFS	SM0805SP
C639	SM661207103	SM.01uFS	SM0805SP
C640	SM661207103	SM.01uFS	SM0805SP
C641	SM661207104	SM.1uFS	SM0805SP
C645	SM666327225	SM2.2uF-20V	SMCAPETD2
C646	SM666327225	SM2.2uF-20V	SMCAPETD2
C647	SM666327225	SM2.2uF-20V	SMCAPETD2
C648	SM666327225	SM2.2uF-20V	SMCAPETD2
C649	SM666327225	SM2.2uF-20V	SMCAPETD2
C651	SM666327225	SM2.2uF-20V	SMCAPETD2
C652	SM661207104	SM.1uFS	SM0805SP
C653	SM666247106	SM10uF-25V	SMCAPD
C654	SM666327225	SM2.2uF-20V	SMCAPETD2
C655	SM666327225	SM2.2uF-20V	SMCAPETD2
C656	SM661207103	SM.01uFS	SM0805SP
C657	SM661207103	SM.01uFS	SM0805SP
C658	146544471	470uF-25V-AL-RA	R P200 D420POL
C659	SM661207103	SM.01uFS	SM0805SP
C660	SM661207103	SM.01uFS	SM0805SP
C662	SM666327225	SM2.2uF-20V	SMCAPETD2
C663	SM666327225	SM2.2uF-20V	SMCAPETD2
C664	SM666327225	SM2.2uF-20V	SMCAPETD2
C665	SM661207103	SM.01uFS	SM0805SP
C666	SM661207103	SM.01uFS	SM0805SP
C667	SM666247106	SM10uF-25V	SMCAPD
C668	SM666327225	SM2.2uF-20V	SMCAPETD2
C669	SM666327225	SM2.2uF-20V	SMCAPETD2
C670	SM666247106	SM10uF-25V	SMCAPD
C671	SM666247106	SM10uF-25V	SMCAPD
C806	SM661207103	SM.01uFS	SM0805SP
C809	SM661255102	SM1000pFS	SM0805SP
C810	SM661255102	SM1000pFS	SM0805SP
C811	SM661255102	SM1000pFS	SM0805SP
C812	SM661255102	SM1000pFS	SM0805SP
C813	SM661255102	SM1000pFS	SM0805SP
C814	SM661255102	SM1000pFS	SM0805SP
C815	SM661255102	SM1000pFS	SM0805SP

C816	SM661255102	SM1000pFS	SM0805SP
C817	SM661207104	SM.1uFS	SM0805SP
C818	SM661207104	SM.1uFS	SM0805SP
C819	SM661207103	SM.01uFS	SM0805SP
C820	SM661726103	SM.01uF-NPO	SM2220
C821	SM661726103	SM.01uF-NPO	SM2220
C822	SM661207103	SM.01uFS	SM0805SP
C823	SM661207103	SM.01uFS	SM0805SP
C824	SM661207103	SM.01uFS	SM0805SP
C825	SM661207103	SM.01uFS	SM0805SP
C826	SM661726103	SM.01uF-NPO	SM2220
C827	SM661726103	SM.01uF-NPO	SM2220
C829	SM661207103	SM.01uFS	SM0805SP
C831	SM661207103	SM.01uFS	SM0805SP
C833	SM661207103	SM.01uFS	SM0805SP
C834	SM661726103	SM.01uF-NPO	SM2220
C835	SM661726103	SM.01uF-NPO	SM2220
C837	SM661207103	SM.01uFS	SM0805SP
C838	SM661207103	SM.01uFS	SM0805SP
C839	SM661207103	SM.01uFS	SM0805SP
C840	SM661207103	SM.01uFS	SM0805SP
C841	SM661726103	SM.01uF-NPO	SM2220
C842	SM661726103	SM.01uF-NPO	SM2220
C843	SM661207103	SM.01uFS	SM0805SP
C844	SM661255102	SM1000pFS	SM0805SP
C845	SM661207103	SM.01uFS	SM0805SP
C846	SM661726103	SM.01uF-NPO	SM2220
C847	SM661726103	SM.01uF-NPO	SM2220
C848	SM661207103	SM.01uFS	SM0805SP
C849	SM661207103	SM.01uFS	SM0805SP
C850	SM661207103	SM.01uFS	SM0805SP
C851	SM661726103	SM.01uF-NPO	SM2220
C852	SM661726103	SM.01uF-NPO	SM2220
C853	SM661207103	SM.01uFS	SM0805SP
C854	SM661207103	SM.01uFS	SM0805SP
C3000	SM661207104	SM.1uFS	SM0805SP
C3001	SM661207104	SM.1uFS	SM0805SP
C3002	SM661207103	SM.01uFS	SM0805SP
C3003	SM661207103	SM.01uFS	SM0805SP
C3004	SM661207102	SM.001uFS	SM0805SP
C3005	SM666327225	SM2.2uF-20V	SMCAPETD2
C3006	SM666327225	SM2.2uF-20V	SMCAPETD2
C3007	SM661207103	SM.01uFS	SM0805SP
C3008	SM661207103	SM.01uFS	SM0805SP
C3009	SM661207103	SM.01uFS	SM0805SP
C3010	SM661207103	SM.01uFS	SM0805SP
C3011	SM661207103	SM.01uFS	SM0805SP
C3012	SM666327225	SM2.2uF-20V	SMCAPETD2
C3013	SM661207103	SM.01uFS	SM0805SP
C3014	SM661207103	SM.01uFS	SM0805SP
C3015	SM661207103	SM.01uFS	SM0805SP
C3016	SM661207103	SM.01uFS	SM0805SP
C3017	SM661207103	SM.01uFS	SM0805SP
C3018	SM661207103	SM.01uFS	SM0805SP
C3019	SM661207104	SM.1uFS	SM0805SP
C3020	SM661207103	SM.01uFS	SM0805SP
C3021	SM661207103	SM.01uFS	SM0805SP
C3022	SM661207103	SM.01uFS	SM0805SP
C3023	SM661207104	SM.1uFS	SM0805SP
C3024	SM661255027	SM2.7pFS	SM0805SP
C3025	SM661207104	SM.1uFS	SM0805SP
C3026	SM661207103	SM.01uFS	SM0805SP
C3027	SM661207103	SM.01uFS	SM0805SP

C3028	SM661207104	SM.1uFS	SM0805SP
C3029	SM661207104	SM.1uFS	SM0805SP
C3030	SM661207103	SM.01uFS	SM0805SP
C3031	SM661207103	SM.01uFS	SM0805SP
C3032	SM661207104	SM.1uFS	SM0805SP
C3033	SM661250082	SM8.2pFS	SM0805SP
C3034	SM661207103	SM.01uFS	SM0805SP
C3035	SM661207103	SM.01uFS	SM0805SP
C3036	SM661207102	SM.001uFS	SM0805SP
C3037	SM666327225	SM2.2uF-20V	SMCAPETD2
C3038	SM661207103	SM.01uFS	SM0805SP
C3039	SM661207103	SM.01uFS	SM0805SP
C3040	SM661207103	SM.01uFS	SM0805SP
C3041	SM661207103	SM.01uFS	SM0805SP
C3042	SM661207104	SM.1uFS	SM0805SP
C3043	SM661207103	SM.01uFS	SM0805SP
C3044	SM661207104	SM.1uFS	SM0805SP
C3045	SM661255101	SM100pFS	SM0805SP
C3046	SM661207104	SM.1uFS	SM0805SP
C3047	SM661207104	SM.1uFS	SM0805SP
C3048	SM661207103	SM.01uFS	SM0805SP
C3049	SM661207103	SM.01uFS	SM0805SP
C3050	SM661207103	SM.01uFS	SM0805SP
C3051	SM661207103	SM.01uFS	SM0805SP
C3052	SM661207104	SM.1uFS	SM0805SP
C3053	SM661207103	SM.01uFS	SM0805SP
C3054	SM661207103	SM.01uFS	SM0805SP
C3055	SM661207103	SM.01uFS	SM0805SP
C3056	SM661207104	SM.1uFS	SM0805SP
C3057	SM661207104	SM.1uFS	SM0805SP
C3058	SM661207103	SM.01uFS	SM0805SP
C3059	SM661207103	SM.01uFS	SM0805SP
C3060	SM661255101	SM100pFS	SM0805SP
C3061	SM661207104	SM.1uFS	SM0805SP
C3062	SM661205222	SM.0022uFS	SM0805SP
C3063	SM661207103	SM.01uFS	SM0805SP
C3064	SM661255101	SM100pFS	SM0805SP
C3065	SM666327225	SM2.2uF-20V	SMCAPETD2
C3066	SM661207103	SM.01uFS	SM0805SP
C3067	SM661207104	SM.1uFS	SM0805SP
C3068	SM666327225	SM2.2uF-20V	SMCAPETD2
C3069	SM661207103	SM.01uFS	SM0805SP
C3070	SM661207103	SM.01uFS	SM0805SP
C3072	SM666327225	SM2.2uF-20V	SMCAPETD2
C3073	SM661207104	SM.1uFS	SM0805SP
C3074	SM661207103	SM.01uFS	SM0805SP
C3075	SM661207103	SM.01uFS	SM0805SP
C3076	SM661207103	SM.01uFS	SM0805SP
C3077	SM661207104	SM.1uFS	SM0805SP
C3078	SM661207104	SM.1uFS	SM0805SP
C3079	SM661207104	SM.1uFS	SM0805SP
C3080	SM661207103	SM.01uFS	SM0805SP
C3081	SM661207103	SM.01uFS	SM0805SP
C3082	SM661207103	SM.01uFS	SM0805SP
C3083	SM661207103	SM.01uFS	SM0805SP
C3084	SM661207103	SM.01uFS	SM0805SP
C3400	SM661207103	SM.01uFS	SM0805SP
C3401	SM661207103	SM.01uFS	SM0805SP
C3402	SM661207103	SM.01uFS	SM0805SP
C4000	SM661207104	SM.1uFS	SM0805SP
C4001	SM661207104	SM.1uFS	SM0805SP
C4002	SM661207103	SM.01uFS	SM0805SP
C4003	SM661207103	SM.01uFS	SM0805SP

C4004	SM661207102	SM.001uFS	SM0805SP
C4005	SM666327225	SM2.2uF-20V	SMCAPETD2
C4006	SM666327225	SM2.2uF-20V	SMCAPETD2
C4007	SM661207103	SM.01uFS	SM0805SP
C4008	SM661207103	SM.01uFS	SM0805SP
C4009	SM661207103	SM.01uFS	SM0805SP
C4010	SM661207103	SM.01uFS	SM0805SP
C4011	SM661207103	SM.01uFS	SM0805SP
C4012	SM666327225	SM2.2uF-20V	SMCAPETD2
C4013	SM661207103	SM.01uFS	SM0805SP
C4014	SM661207103	SM.01uFS	SM0805SP
C4015	SM661207103	SM.01uFS	SM0805SP
C4016	SM661207103	SM.01uFS	SM0805SP
C4017	SM661207103	SM.01uFS	SM0805SP
C4018	SM661207103	SM.01uFS	SM0805SP
C4019	SM661207104	SM.1uFS	SM0805SP
C4020	SM661207103	SM.01uFS	SM0805SP
C4021	SM661207103	SM.01uFS	SM0805SP
C4022	SM661207103	SM.01uFS	SM0805SP
C4023	SM661207104	SM.1uFS	SM0805SP
C4024	SM661255027	SM2.7pFS	SM0805SP
C4025	SM661207104	SM.1uFS	SM0805SP
C4026	SM661207103	SM.01uFS	SM0805SP
C4027	SM661207103	SM.01uFS	SM0805SP
C4028	SM661207104	SM.1uFS	SM0805SP
C4029	SM661207104	SM.1uFS	SM0805SP
C4030	SM661207103	SM.01uFS	SM0805SP
C4031	SM661207103	SM.01uFS	SM0805SP
C4032	SM661207104	SM.1uFS	SM0805SP
C4033	SM661250082	SM8.2pFS	SM0805SP
C4034	SM661207103	SM.01uFS	SM0805SP
C4035	SM661207103	SM.01uFS	SM0805SP
C4036	SM661207102	SM.001uFS	SM0805SP
C4037	SM666327225	SM2.2uF-20V	SMCAPETD2
C4038	SM661207103	SM.01uFS	SM0805SP
C4039	SM661207103	SM.01uFS	SM0805SP
C4040	SM661207103	SM.01uFS	SM0805SP
C4041	SM661207103	SM.01uFS	SM0805SP
C4042	SM661207104	SM.1uFS	SM0805SP
C4043	SM661207103	SM.01uFS	SM0805SP
C4044	SM661207104	SM.1uFS	SM0805SP
C4045	SM661255101	SM100pFS	SM0805SP
C4046	SM661207104	SM.1uFS	SM0805SP
C4047	SM661207104	SM.1uFS	SM0805SP
C4048	SM661207103	SM.01uFS	SM0805SP
C4049	SM661207103	SM.01uFS	SM0805SP
C4050	SM661207103	SM.01uFS	SM0805SP
C4051	SM661207103	SM.01uFS	SM0805SP
C4052	SM661207104	SM.1uFS	SM0805SP
C4053	SM661207103	SM.01uFS	SM0805SP
C4054	SM661207103	SM.01uFS	SM0805SP
C4055	SM661207103	SM.01uFS	SM0805SP
C4056	SM661207104	SM.1uFS	SM0805SP
C4057	SM661207104	SM.1uFS	SM0805SP
C4058	SM661207103	SM.01uFS	SM0805SP
C4059	SM661207103	SM.01uFS	SM0805SP
C4060	SM661255101	SM100pFS	SM0805SP
C4061	SM661207104	SM.1uFS	SM0805SP
C4062	SM661205222	SM.0022uFS	SM0805SP
C4063	SM661207103	SM.01uFS	SM0805SP
C4064	SM661255101	SM100pFS	SM0805SP
C4065	SM666327225	SM2.2uF-20V	SMCAPETD2
C4066	SM661207103	SM.01uFS	SM0805SP

C4067	SM661207104	SM. 1uFS	SM0805SP
C4068	SM666327225	SM2. 2uF-20V	SMCAPETD2
C4069	SM661207103	SM. 01uFS	SM0805SP
C4070	SM661207103	SM. 01uFS	SM0805SP
C4072	SM666327225	SM2. 2uF-20V	SMCAPETD2
C4073	SM661207104	SM. 1uFS	SM0805SP
C4074	SM661207103	SM. 01uFS	SM0805SP
C4075	SM661207103	SM. 01uFS	SM0805SP
C4076	SM661207103	SM. 01uFS	SM0805SP
C4077	SM661207104	SM. 1uFS	SM0805SP
C4078	SM661207104	SM. 1uFS	SM0805SP
C4079	SM661207104	SM. 1uFS	SM0805SP
C4080	SM661207103	SM. 01uFS	SM0805SP
C4081	SM661207103	SM. 01uFS	SM0805SP
C4082	SM661207103	SM. 01uFS	SM0805SP
C4083	SM661207103	SM. 01uFS	SM0805SP
C4084	SM661207103	SM. 01uFS	SM0805SP
C4400	SM661207103	SM. 01uFS	SM0805SP
C4401	SM661207103	SM. 01uFS	SM0805SP
C4402	SM661207103	SM. 01uFS	SM0805SP
C4403	SM661207103	SM. 01uFS	SM0805SP
C4500	SM661207103	SM. 01uFS	SM0805SP
C4501	SM661207103	SM. 01uFS	SM0805SP
C5000	SM661207104	SM. 1uFS	SM0805SP
C5002	SM661207104	SM. 1uFS	SM0805SP
C5003	SM661207103	SM. 01uFS	SM0805SP
C5004	SM661207103	SM. 01uFS	SM0805SP
C5005	SM666327225	SM2. 2uF-20V	SMCAPETD2
C5006	SM661207103	SM. 01uFS	SM0805SP
C5007	SM661207103	SM. 01uFS	SM0805SP
C5008	SM661207103	SM. 01uFS	SM0805SP
C5009	SM661207104	SM. 1uFS	SM0805SP
C5010	SM666327225	SM2. 2uF-20V	SMCAPETD2
C5011	SM666327225	SM2. 2uF-20V	SMCAPETD2
C5012	SM661207102	SM. 001uFS	SM0805SP
C5014	SM661207103	SM. 01uFS	SM0805SP
C5015	SM661207103	SM. 01uFS	SM0805SP
C5016	SM661207103	SM. 01uFS	SM0805SP
C5017	SM661207103	SM. 01uFS	SM0805SP
C5018	SM661207103	SM. 01uFS	SM0805SP
C5019	SM661207103	SM. 01uFS	SM0805SP
C5020	SM661207103	SM. 01uFS	SM0805SP
C5022	SM661207104	SM. 1uFS	SM0805SP
C5024	SM661207103	SM. 01uFS	SM0805SP
C5025	SM661207103	SM. 01uFS	SM0805SP
C5026	SM661207103	SM. 01uFS	SM0805SP
C5027	SM661207103	SM. 01uFS	SM0805SP
C5028	SM661207103	SM. 01uFS	SM0805SP
C5029	SM661207103	SM. 01uFS	SM0805SP
C5030	SM661207103	SM. 01uFS	SM0805SP
C6000	SM661207104	SM. 1uFS	SM0805SP
C6001	SM661207103	SM. 01uFS	SM0805SP
C6002	SM661207104	SM. 1uFS	SM0805SP
C6003	SM661207103	SM. 01uFS	SM0805SP
C6004	SM661207103	SM. 01uFS	SM0805SP
C6005	SM666327225	SM2. 2uF-20V	SMCAPETD2
C6006	SM666327225	SM2. 2uF-20V	SMCAPETD2
C6007	SM661207103	SM. 01uFS	SM0805SP
C6008	SM661255150	SM15pFS	SM0805SP
C6009	SM661207103	SM. 01uFS	SM0805SP
C6010	SM661207103	SM. 01uFS	SM0805SP
C6011	SM661207103	SM. 01uFS	SM0805SP
C6012	SM661207103	SM. 01uFS	SM0805SP

C6013	SM661207103	SM.01uFS	SM0805SP
C6014	SM661207103	SM.01uFS	SM0805SP
CR1	SM232022822	HSMS2822	SOT23
CR2	SM232022822	HSMS2822	SOT23
CR3	SM232022822	HSMS2822	SOT23
CR4	SM232022822	HSMS2822	SOT23
CR5	SM232022822	HSMS2822	SOT23
CR6	SM240218451	BZX84-C5V1	SOT23
CR7	SM236030099	BAV99	SOT23
CR8	SM240218451	BZX84-C5V1	SOT23
CR9	SM240218451	BZX84-C5V1	SOT23
CR10	SM240218451	BZX84-C5V1	SOT23
CR300	SM232022822	HSMS2822	SOT23
CR301	SM232022822	HSMS2822	SOT23
CR302	SM232022822	HSMS2822	SOT23
CR303	SM252080682	BA682	SOD80
CR304	SM252080682	BA682	SOD80
CR305	SM252080682	BA682	SOD80
CR306	SM252080682	BA682	SOD80
CR307	SM252080682	BA682	SOD80
CR600	SM240218491	BZX84-C9V1	SOT23
CR601	SM240218443	BZX84-C4V3	SOT23
CR602	SM240218491	BZX84-C9V1	SOT23
CR603	SM236030099	BAV99	SOT23
CR800	SM208591336	SMLM336-5	SOIC 8
CR801	SM240218451	BZX84-C5V1	SOT23
CR3000	SM229020150	SMTVSS-5V6	SMDIO_0805
CR3001	SM236030099	BAV99	SOT23
CR3002	SM236030099	BAV99	SOT23
CR3003	SM236030099	BAV99	SOT23
CR3004	SM236030099	BAV99	SOT23
CR3005	SM236030099	BAV99	SOT23
CR3006	SM236030099	BAV99	SOT23
CR3007	SM236030099	BAV99	SOT23
CR3008	SM232022822	HSMS2822	SOT23
CR3010	SM240218424	BZX84-C2V4	SOT23
CR3011	SM236030099	BAV99	SOT23
CR3012	SM240218451	BZX84-C5V1	SOT23
CR3014	SM236030099	BAV99	SOT23
CR3015	SM240218451	BZX84-C5V1	SOT23
CR3017	SM240218451	BZX84-C5V1	SOT23
CR3018	SM230080620	BB620	MINIPLAST
CR3019	SM232022822	HSMS2822	SOT23
CR3020	SM236030099	BAV99	SOT23
CR3021	SM230080620	BB620	MINIPLAST
CR3022	SM240218424	BZX84-C2V4	SOT23
CR3023	SM240218451	BZX84-C5V1	SOT23
CR4000	SM229020150	SMTVSS-5V6	SMDIO_0805
CR4001	SM236030099	BAV99	SOT23
CR4002	SM236030099	BAV99	SOT23
CR4003	SM236030099	BAV99	SOT23
CR4004	SM236030099	BAV99	SOT23
CR4005	SM236030099	BAV99	SOT23
CR4006	SM236030099	BAV99	SOT23
CR4007	SM236030099	BAV99	SOT23
CR4008	SM232022822	HSMS2822	SOT23
CR4010	SM240218424	BZX84-C2V4	SOT23
CR4011	SM236030099	BAV99	SOT23
CR4012	SM240218451	BZX84-C5V1	SOT23
CR4014	SM236030099	BAV99	SOT23
CR4015	SM240218451	BZX84-C5V1	SOT23
CR4017	SM240218451	BZX84-C5V1	SOT23
CR4018	SM230080620	BB620	MINIPLAST

CR4019	SM232022822	HSMS2822	SOT23
CR4020	SM236030099	BAV99	SOT23
CR4021	SM230080620	BB620	MINIPLAST
CR4022	SM240218424	BZX84-C2V4	SOT23
CR4023	SM240218451	BZX84-C5V1	SOT23
CR5000	SM229020150	SMTVSS-5V6	SMDIO_0805
CR5001	SM236030099	BAV99	SOT23
CR5002	SM240218436	BZX84-C3V6	SOT23
CR5003	SM234101385	SMLM385-1.2	SOIC_8
CR6000	SM229020150	SMTVSS-5V6	SMDIO_0805
CR6001	SM208591336	SMLM336-5	SOIC_8
CR6002	SM236030099	BAV99	SOT23
CR6003	SM232022822	HSMS2822	SOT23
F3000	SM433012001	SM. 2A	SML206
F3001	SM433012001	SM. 2A	SML206
F4000	SM433012001	SM. 2A	SML206
F4001	SM433012001	SM. 2A	SML206
F5000	SM433012001	SM. 2A	SML206
J600	454320096	3x32-ST-F	CONN3X32_ST_F
J601	454110010	POWER1x10-M	POWER1X10_M
J602	454390002	1x2-ST-M-PL	CONN1X2_ST_M_PL
J3000	7093XXP01-P21	BNC-93XX-PROBE	BNC_93XX_PROBE
J4000	7093XXP01-P21	BNC-93XX-PROBE	BNC_93XX_PROBE
J5000	7093XXP01-P21	BNC-93XX-PROBE	BNC_93XX_PROBE
J6000	7093XXP01-P21	BNC-93XX-PROBE	BNC_93XX_PROBE
L1	SM301502001	SMBEAD1206	SMBEAD1206
L2	SM301502001	SMBEAD1206	SMBEAD1206
L3	SM301502001	SMBEAD1206	SMBEAD1206
L4	SM301502001	SMBEAD1206	SMBEAD1206
L300	SM301502001	SMBEAD1206	SMBEAD1206
L301	SM301502001	SMBEAD1206	SMBEAD1206
L600	SM301502001	SMBEAD1206	SMBEAD1206
L601	SM301502001	SMBEAD1206	SMBEAD1206
L602	SM301502001	SMBEAD1206	SMBEAD1206
L603	SM301502001	SMBEAD1206	SMBEAD1206
L604	SM301502001	SMBEAD1206	SMBEAD1206
L605	SM301502001	SMBEAD1206	SMBEAD1206
L606	SM301502001	SMBEAD1206	SMBEAD1206
L608	SM301502001	SMBEAD1206	SMBEAD1206
L801	SM301502001	SMBEAD1206	SMBEAD1206
L802	SM301502001	SMBEAD1206	SMBEAD1206
L3000	SM301502001	SMBEAD1206	SMBEAD1206
L3001	SM301502001	SMBEAD1206	SMBEAD1206
L3002	SM301502001	SMBEAD1206	SMBEAD1206
L3003	SM301502001	SMBEAD1206	SMBEAD1206
L3004	SM301502001	SMBEAD1206	SMBEAD1206
L3005	SM301502001	SMBEAD1206	SMBEAD1206
L3006	SM301502001	SMBEAD1206	SMBEAD1206
L3007	SM301502001	SMBEAD1206	SMBEAD1206
L3008	SM301502001	SMBEAD1206	SMBEAD1206
L3009	SM301502001	SMBEAD1206	SMBEAD1206
L3010	SM654181000	SM0	SML206SP
L3011	SM301502001	SMBEAD1206	SMBEAD1206
L3012	SM301502001	SMBEAD1206	SMBEAD1206
L3013	SM301502001	SMBEAD1206	SMBEAD1206
L3014	SM301502001	SMBEAD1206	SMBEAD1206
L3015	SM301502001	SMBEAD1206	SMBEAD1206
L3016	SM301502001	SMBEAD1206	SMBEAD1206
L3017	SM301502001	SMBEAD1206	SMBEAD1206
L3400	SM301502001	SMBEAD1206	SMBEAD1206
L3401	SM301502001	SMBEAD1206	SMBEAD1206
L4000	SM301502001	SMBEAD1206	SMBEAD1206
L4001	SM301502001	SMBEAD1206	SMBEAD1206

L4002	SM301502001	SMBEAD1206	SMBEAD1206
L4003	SM301502001	SMBEAD1206	SMBEAD1206
L4004	SM301502001	SMBEAD1206	SMBEAD1206
L4005	SM301502001	SMBEAD1206	SMBEAD1206
L4006	SM301502001	SMBEAD1206	SMBEAD1206
L4007	SM301502001	SMBEAD1206	SMBEAD1206
L4008	SM301502001	SMBEAD1206	SMBEAD1206
L4009	SM301502001	SMBEAD1206	SMBEAD1206
L4010	SM654181000	SMO	SML206SP
L4011	SM301502001	SMBEAD1206	SMBEAD1206
L4012	SM301502001	SMBEAD1206	SMBEAD1206
L4013	SM301502001	SMBEAD1206	SMBEAD1206
L4014	SM301502001	SMBEAD1206	SMBEAD1206
L4015	SM301502001	SMBEAD1206	SMBEAD1206
L4016	SM301502001	SMBEAD1206	SMBEAD1206
L4017	SM301502001	SMBEAD1206	SMBEAD1206
L4400	SM301502001	SMBEAD1206	SMBEAD1206
L4500	SM301502001	SMBEAD1206	SMBEAD1206
L5000	SM301502001	SMBEAD1206	SMBEAD1206
L5001	SM301502001	SMBEAD1206	SMBEAD1206
L5002	SM301502001	SMBEAD1206	SMBEAD1206
L5003	SM301502001	SMBEAD1206	SMBEAD1206
L6000	SM301502001	SMBEAD1206	SMBEAD1206
L6001	SM301502001	SMBEAD1206	SMBEAD1206
Q1	SM275030092	BFT92	SOT23
Q2	SM270160133	BFG33X	SOT143
Q3	SM270330848	BC848C	SOT23
Q4	SM270330848	BC848C	SOT23
Q5	SM270160133	BFG33X	SOT143
Q6	SM275030092	BFT92	SOT23
Q300	SM275330858	BC858C	SOT23
Q301	SM275330858	BC858C	SOT23
Q302	SM270160133	BFG33X	SOT143
Q303	SM270160133	BFG33X	SOT143
Q3000	SM275030550	BF550	SOT23
Q3001	SM270160133	BFG33X	SOT143
Q3002	SM270160133	BFG33X	SOT143
Q3003	SM270160133	BFG33X	SOT143
Q3004	SM270160133	BFG33X	SOT143
Q3005	SM270160133	BFG33X	SOT143
Q3006	SM270330848	BC848C	SOT23
Q3007	SM270160133	BFG33X	SOT143
Q3008	SM270160133	BFG33X	SOT143
Q3009	SM275030194	BFR194	SOT23
Q3010	SM275030194	BFR194	SOT23
Q3011	SM270330848	BC848C	SOT23
Q4000	SM275030550	BF550	SOT23
Q4001	SM270160133	BFG33X	SOT143
Q4002	SM270160133	BFG33X	SOT143
Q4003	SM270160133	BFG33X	SOT143
Q4004	SM270160133	BFG33X	SOT143
Q4005	SM270160133	BFG33X	SOT143
Q4006	SM270330848	BC848C	SOT23
Q4007	SM270160133	BFG33X	SOT143
Q4008	SM270160133	BFG33X	SOT143
Q4009	SM275030194	BFR194	SOT23
Q4010	SM275030194	BFR194	SOT23
Q4011	SM270330848	BC848C	SOT23
Q5000	SM275030550	BF550	SOT23
Q5001	SM270160133	BFG33X	SOT143
Q5002	SM270160133	BFG33X	SOT143
Q6000	SM275030550	BF550	SOT23
Q6001	SM275030550	BF550	SOT23

Q6002	SM270160133	BFG33X	SOT143
Q6003	SM270160133	BFG33X	SOT143
R1	SM652101560	SM56S	SM0805SP
R2	SM652101560	SM56S	SM0805SP
R3	SM652101560	SM56S	SM0805SP
R4	SM652101560	SM56S	SM0805SP
R6	SM652101910	SM91S	SM0805SP
R7	SM654101000	SM0S	SM0805SP
R8	SM652101331	SM330S	SM0805SP
R9	SM652101331	SM330S	SM0805SP
R10	SM652101271	SM270S	SM0805SP
R11	SM652101331	SM330S	SM0805SP
R12	SM652101331	SM330S	SM0805SP
R13	SM652101560	SM56S	SM0805SP
R14	SM652101271	SM270S	SM0805SP
R15	SM652101560	SM56S	SM0805SP
R16	SM652101331	SM330S	SM0805SP
R17	SM652101470	SM47S	SM0805SP
R18	SM652101560	SM56S	SM0805SP
R19	SM652101470	SM47S	SM0805SP
R20	SM652101560	SM56S	SM0805SP
R21	SM652101271	SM270S	SM0805SP
R22	SM654101000	SM0S	SM0805SP
R24	SM652101331	SM330S	SM0805SP
R25	SM652101620	SM62S	SM0805SP
R26	SM652101271	SM270S	SM0805SP
R27	SM652101560	SM56S	SM0805SP
R28	SM652101151	SM150S	SM0805SP
R29	SM652101151	SM150S	SM0805SP
R30	SM652101151	SM150S	SM0805SP
R31	SM652101151	SM150S	SM0805SP
R32	SM652101151	SM150S	SM0805SP
R33	SM652101151	SM150S	SM0805SP
R34	SM652101151	SM150S	SM0805SP
R35	SM652101151	SM150S	SM0805SP
R36	SM652101271	SM270S	SM0805SP
R37	SM652101271	SM270S	SM0805SP
R38	SM652101560	SM56S	SM0805SP
R39	SM652101560	SM56S	SM0805SP
R40	SM652101560	SM56S	SM0805SP
R41	SM652101510	SM51S	SM0805SP
R42	SM652101430	SM43S	SM0805SP
R43	SM652101271	SM270S	SM0805SP
R44	SM652101910	SM91S	SM0805SP
R45	SM652101201	SM200S	SM0805SP
R46	SM652101470	SM47S	SM0805SP
R47	SM652101560	SM56S	SM0805SP
R48	SM652101201	SM200S	SM0805SP
R49	SM652101510	SM51S	SM0805SP
R50	SM652101560	SM56S	SM0805SP
R51	SM652101560	SM56S	SM0805SP
R52	SM652101560	SM56S	SM0805SP
R53	SM652101470	SM47S	SM0805SP
R54	SM652101910	SM91S	SM0805SP
R55	SM652101910	SM91S	SM0805SP
R56	SM652101331	SM330S	SM0805SP
R57	SM652101151	SM150S	SM0805SP
R58	SM652101560	SM56S	SM0805SP
R59	SM652101510	SM51S	SM0805SP
R60	SM652101201	SM200S	SM0805SP
R61	SM652101331	SM330S	SM0805SP
R62	SM652101101	SM100S	SM0805SP
R63	SM652101151	SM150S	SM0805SP

R64	SM652101560	SM56S	SM0805SP
R65	SM652101510	SM51S	SM0805SP
R66	SM652101510	SM51S	SM0805SP
R67	SM652101510	SM51S	SM0805SP
R68	SM652101331	SM330S	SM0805SP
R69	SM652101151	SM150S	SM0805SP
R70	SM652101151	SM150S	SM0805SP
R71	SM652101470	SM47S	SM0805SP
R72	SM652101470	SM47S	SM0805SP
R73	SM652101201	SM200S	SM0805SP
R74	SM652101201	SM200S	SM0805SP
R75	SM652101201	SM200S	SM0805SP
R76	SM652101470	SM47S	SM0805SP
R77	SM652101470	SM47S	SM0805SP
R78	SM652101560	SM56S	SM0805SP
R79	SM652101331	SM330S	SM0805SP
R80	SM652101331	SM330S	SM0805SP
R81	SM652101104	SM100KS	SM0805SP
R82	SM652101201	SM200S	SM0805SP
R83	SM652101510	SM51S	SM0805SP
R84	SM652101510	SM51S	SM0805SP
R85	SM652101201	SM200S	SM0805SP
R86	SM652101470	SM47S	SM0805SP
R87	SM652101201	SM200S	SM0805SP
R88	SM652101201	SM200S	SM0805SP
R89	SM652101470	SM47S	SM0805SP
R90	SM652101121	SM120S	SM0805SP
R91	SM652101121	SM120S	SM0805SP
R92	SM652101121	SM120S	SM0805SP
R93	SM652101201	SM200S	SM0805SP
R94	SM652101330	SM33S	SM0805SP
R95	SM652101911	SM910S	SM0805SP
R96	SM652101121	SM120S	SM0805SP
R97	SM652101121	SM120S	SM0805SP
R98	SM652101121	SM120S	SM0805SP
R99	SM652101201	SM200S	SM0805SP
R100	SM652101154	SM150KS	SM0805SP
R101	SM652101330	SM33S	SM0805SP
R102	SM652101911	SM910S	SM0805SP
R103	SM652101100	SM10S	SM0805SP
R104	SM652101200	SM20S	SM0805SP
R105	SM654101000	SM0S	SM0805SP
R107	SM652101223	SM22KS	SM0805SP
R108	SM652101470	SM47S	SM0805SP
R109	SM652101271	SM270S	SM0805SP
R110	SM652101103	SM10KS	SM0805SP
R111	SM652101103	SM10KS	SM0805SP
R112	SM652101151	SM150S	SM0805SP
R113	SM652101470	SM47S	SM0805SP
R114	SM652101271	SM270S	SM0805SP
R115	SM652101103	SM10KS	SM0805SP
R116	SM652101151	SM150S	SM0805SP
R117	SM652101201	SM200S	SM0805SP
R118	SM652101510	SM51S	SM0805SP
R119	SM652101200	SM20S	SM0805SP
R120	SM652101913	SM91KS	SM0805SP
R121	SM652101103	SM10KS	SM0805SP
R122	SM652101331	SM330S	SM0805SP
R123	SM652101201	SM200S	SM0805SP
R124	SM652101154	SM150KS	SM0805SP
R125	SM652101911	SM910S	SM0805SP
R127	SM652101103	SM10KS	SM0805SP
R128	SM652101223	SM22KS	SM0805SP

R129	SM652101560	SM56S	SM0805SP
R130	SM652101103	SM10KS	SM0805SP
R131	SM652101201	SM200S	SM0805SP
R132	SM652101201	SM200S	SM0805SP
R133	SM652101201	SM200S	SM0805SP
R134	SM652101201	SM200S	SM0805SP
R135	SM652101470	SM47S	SM0805SP
R136	SM652101201	SM200S	SM0805SP
R137	SM652101470	SM47S	SM0805SP
R138	SM652101330	SM33S	SM0805SP
R139	SM652101103	SM10KS	SM0805SP
R141	SM652101271	SM270S	SM0805SP
R142	SM652101470	SM47S	SM0805SP
R143	SM652101470	SM47S	SM0805SP
R144	SM652101560	SM56S	SM0805SP
R145	SM652101910	SM91S	SM0805SP
R146	SM652101271	SM270S	SM0805SP
R147	SM652101430	SM43S	SM0805SP
R148	SM652101510	SM51S	SM0805SP
R149	SM652101510	SM51S	SM0805SP
R150	SM652101201	SM200S	SM0805SP
R152	SM652101620	SM62S	SM0805SP
R153	SM652101560	SM56S	SM0805SP
R154	SM652101201	SM200S	SM0805SP
R156	SM652101330	SM33S	SM0805SP
R157	SM652101103	SM10KS	SM0805SP
R158	SM652101101	SM100S	SM0805SP
R159	SM652101101	SM100S	SM0805SP
R160	SM652101103	SM10KS	SM0805SP
R161	SM652101102	SM1KS	SM0805SP
R162	SM652101102	SM1KS	SM0805SP
R163	SM652101102	SM1KS	SM0805SP
R164	SM652101102	SM1KS	SM0805SP
R300	SM652101220	SM22S	SM0805SP
R301	SM652101220	SM22S	SM0805SP
R302	SM652101220	SM22S	SM0805SP
R303	SM652101220	SM22S	SM0805SP
R304	SM652101220	SM22S	SM0805SP
R305	SM652101220	SM22S	SM0805SP
R306	SM652101220	SM22S	SM0805SP
R307	SM652101102	SM1KS	SM0805SP
R308	SM652101102	SM1KS	SM0805SP
R309	SM652101821	SM820S	SM0805SP
R310	SM652101821	SM820S	SM0805SP
R311	SM652101621	SM620S	SM0805SP
R312	SM652101821	SM820S	SM0805SP
R313	SM652101331	SM330S	SM0805SP
R314	SM652101430	SM43S	SM0805SP
R315	SM654101000	SM0S	SM0805SP
R317	SM652101220	SM22S	SM0805SP
R318	SM652101220	SM22S	SM0805SP
R319	SM652101220	SM22S	SM0805SP
R320	SM652101151	SM150S	SM0805SP
R323	SM652101241	SM240S	SM0805SP
R324	SM652101151	SM150S	SM0805SP
R327	SM652101241	SM240S	SM0805SP
R334	SM652101151	SM150S	SM0805SP
R335	SM652101151	SM150S	SM0805SP
R336	SM652101331	SM330S	SM0805SP
R337	SM652101101	SM100S	SM0805SP
R338	SM652101101	SM100S	SM0805SP
R339	SM652101101	SM100S	SM0805SP
R340	SM652101101	SM100S	SM0805SP

Section 8 Schematics, Layouts , Parts list

R342	SM652101201	SM200S	SM0805SP
R343	SM652101331	SM330S	SM0805SP
R344	SM652101151	SM150S	SM0805SP
R345	SM654101000	SM0S	SM0805SP
R346	SM654101000	SM0S	SM0805SP
R347	SM652101241	SM240S	SM0805SP
R348	SM652101151	SM150S	SM0805SP
R349	SM654101000	SM0S	SM0805SP
R350	SM654101000	SM0S	SM0805SP
R351	SM652101241	SM240S	SM0805SP
R352	SM652101510	SM51S	SM0805SP
R353	SM652101201	SM200S	SM0805SP
R354	SM652101510	SM51S	SM0805SP
R355	SM652101510	SM51S	SM0805SP
R356	SM652101201	SM200S	SM0805SP
R357	SM652101510	SM51S	SM0805SP
R358	SM652101331	SM330S	SM0805SP
R359	SM652101821	SM820S	SM0805SP
R360	SM652101201	SM200S	SM0805SP
R361	SM652101102	SM1KS	SM0805SP
R362	SM652101220	SM22S	SM0805SP
R363	SM652101220	SM22S	SM0805SP
R364	SM652101220	SM22S	SM0805SP
R365	SM652101220	SM22S	SM0805SP
R366	SM652101220	SM22S	SM0805SP
R367	SM652101220	SM22S	SM0805SP
R368	SM652101220	SM22S	SM0805SP
R369	SM652101220	SM22S	SM0805SP
R370	SM652101220	SM22S	SM0805SP
R374	SM652101331	SM330S	SM0805SP
R375	SM652101510	SM51S	SM0805SP
R376	SM652101560	SM56S	SM0805SP
R377	SM652101201	SM200S	SM0805SP
R378	SM652101201	SM200S	SM0805SP
R379	SM652101220	SM22S	SM0805SP
R380	SM652101220	SM22S	SM0805SP
R382	SM652101470	SM47S	SM0805SP
R383	SM654101000	SM0S	SM0805SP
R386	SM652101220	SM22S	SM0805SP
R388	SM652101201	SM200S	SM0805SP
R389	SM652101201	SM200S	SM0805SP
R390	SM652101470	SM47S	SM0805SP
R391	SM652101560	SM56S	SM0805SP
R392	SM652101560	SM56S	SM0805SP
R393	SM652101331	SM330S	SM0805SP
R394	SM652101220	SM22S	SM0805SP
R395	SM652101151	SM150S	SM0805SP
R396	SM652101430	SM43S	SM0805SP
R397	SM652101510	SM51S	SM0805SP
R398	SM652101331	SM330S	SM0805SP
R399	SM654101000	SM0S	SM0805SP
R400	SM652101101	SM100S	SM0805SP
R401	SM652101220	SM22S	SM0805SP
R402	SM652101151	SM150S	SM0805SP
R403	SM652101331	SM330S	SM0805SP
R404	SM652101201	SM200S	SM0805SP
R405	SM652101510	SM51S	SM0805SP
R406	SM652101331	SM330S	SM0805SP
R407	SM652101560	SM56S	SM0805SP
R408	SM652101271	SM270S	SM0805SP
R409	SM652101271	SM270S	SM0805SP
R410	SM652101560	SM56S	SM0805SP
R411	SM652101560	SM56S	SM0805SP

R412	SM652101510	SM51S	SM0805SP
R413	SM652101201	SM200S	SM0805SP
R414	SM652101102	SM1KS	SM0805SP
R415	SM652101390	SM39S	SM0805SP
R416	SM652101390	SM39S	SM0805SP
R417	SM652101620	SM62S	SM0805SP
R418	SM652101821	SM820S	SM0805SP
R419	SM652101101	SM100S	SM0805SP
R420	SM652101470	SM47S	SM0805SP
R421	SM652101271	SM270S	SM0805SP
R422	SM652101271	SM270S	SM0805SP
R423	SM652101390	SM39S	SM0805SP
R424	SM654101000	SM0S	SM0805SP
R425	SM652101331	SM330S	SM0805SP
R426	SM652101331	SM330S	SM0805SP
R427	SM652101470	SM47S	SM0805SP
R428	SM652101201	SM200S	SM0805SP
R429	SM652101201	SM200S	SM0805SP
R430	SM652101331	SM330S	SM0805SP
R431	SM652101331	SM330S	SM0805SP
R432	SM652101271	SM270S	SM0805SP
R433	SM652101271	SM270S	SM0805SP
R434	SM652101331	SM330S	SM0805SP
R435	SM652101680	SM68S	SM0805SP
R436	SM652101101	SM100S	SM0805SP
R437	SM652101101	SM100S	SM0805SP
R438	SM652101201	SM200S	SM0805SP
R439	SM652101620	SM62S	SM0805SP
R440	SM652101751	SM750S	SM0805SP
R441	SM652101101	SM100S	SM0805SP
R442	SM652101751	SM750S	SM0805SP
R443	SM651104392	SM3.9K-25PPM	SM1206
R445	SM652101512	SM5.1KS	SM0805SP
R446	SM652101430	SM43S	SM0805SP
R447	SM652101331	SM330S	SM0805SP
R448	SM652101331	SM330S	SM0805SP
R449	SM652101201	SM200S	SM0805SP
R450	SM652101470	SM47S	SM0805SP
R451	SM652101510	SM51S	SM0805SP
R452	SM652101510	SM51S	SM0805SP
R453	SM652101152	SM1.5KS	SM0805SP
R454	SM652101102	SM1KS	SM0805SP
R455	SM652101331	SM330S	SM0805SP
R456	SM652101220	SM22S	SM0805SP
R457	SM652101330	SM33S	SM0805SP
R458	SM651104391	SM390-25PPM	SM1206
R460	SM652101471	SM470S	SM0805SP
R461	SM652101820	SM82S	SM0805SP
R462	SM652101331	SM330S	SM0805SP
R463	SM652101821	SM820S	SM0805SP
R464	SM652101470	SM47S	SM0805SP
R465	SM652101220	SM22S	SM0805SP
R466	SM651104183	SM18K-25PPM	SM1206
R467	SM652101513	SM51KS	SM0805SP
R468	SM654101000	SM0S	SM0805SP
R469	SM652101471	SM470S	SM0805SP
R471	SM652101510	SM51S	SM0805SP
R472	SM652101101	SM100S	SM0805SP
R473	SM652101751	SM750S	SM0805SP
R474	SM652101152	SM1.5KS	SM0805SP
R475	SM652101510	SM51S	SM0805SP
R476	SM652101751	SM750S	SM0805SP
R477	SM652101510	SM51S	SM0805SP

R478	SM652101103	SM10KS	SM0805SP
R479	SM651104162	SM1.6K-25PPM	SM1206
R480	SM652101331	SM330S	SM0805SP
R481	SM652101121	SM120S	SM0805SP
R482	SM652101331	SM330S	SM0805SP
R483	SM652101560	SM56S	SM0805SP
R484	SM652101331	SM330S	SM0805SP
R485	SM652101331	SM330S	SM0805SP
R486	SM652101331	SM330S	SM0805SP
R487	SM652101510	SM51S	SM0805SP
R488	SM651104204	SM200K-25PPM	SM1206
R489	SM652101121	SM120S	SM0805SP
R490	SM652101470	SM47S	SM0805SP
R491	SM652101470	SM47S	SM0805SP
R492	SM652101331	SM330S	SM0805SP
R493	SM652101510	SM51S	SM0805SP
R494	SM652101103	SM10KS	SM0805SP
R495	SM654101000	SM0S	SM0805SP
R497	SM652101331	SM330S	SM0805SP
R498	SM652101751	SM750S	SM0805SP
R500	SM652101102	SM1KS	SM0805SP
R501	SM652101331	SM330S	SM0805SP
R502	SM652101331	SM330S	SM0805SP
R503	SM652101510	SM51S	SM0805SP
R504	SM652101331	SM330S	SM0805SP
R505	SM652101510	SM51S	SM0805SP
R506	SM652101510	SM51S	SM0805SP
R507	SM652101510	SM51S	SM0805SP
R508	SM652101331	SM330S	SM0805SP
R509	SM652101821	SM820S	SM0805SP
R510	SM654101000	SM0S	SM0805SP
R511	SM652101331	SM330S	SM0805SP
R512	SM652101331	SM330S	SM0805SP
R513	SM652101331	SM330S	SM0805SP
R514	SM652101430	SM43S	SM0805SP
R515	SM652101331	SM330S	SM0805SP
R516	SM652101430	SM43S	SM0805SP
R600	SM652101183	SM18KS	SM0805SP
R601	SM652101332	SM3.3KS	SM0805SP
R602	SM652101102	SM1KS	SM0805SP
R603	SM652101102	SM1KS	SM0805SP
R604	SM652101122	SM1.2KS	SM0805SP
R605	SM652101824	SM820KS	SM0805SP
R606	SM652101332	SM3.3KS	SM0805SP
R607	SM652101103	SM10KS	SM0805SP
R608	SM652101103	SM10KS	SM0805SP
R609	SM652101512	SM5.1KS	SM0805SP
R610	SM652101332	SM3.3KS	SM0805SP
R611	SM652101332	SM3.3KS	SM0805SP
R612	SM652101302	SM3KS	SM0805SP
R613	SM652101332	SM3.3KS	SM0805SP
R614	SM652101332	SM3.3KS	SM0805SP
R615	SM652101332	SM3.3KS	SM0805SP
R616	SM652101332	SM3.3KS	SM0805SP
R617	169416473	NTC-DISC-47K	NTC_DISC
R618	SM652101100	SM10S	SM0805SP
R619	SM652101223	SM22KS	SM0805SP
R620	SM652101122	SM1.2KS	SM0805SP
R621	SM652101220	SM22S	SM0805SP
R622	SM652101103	SM10KS	SM0805SP
R623	SM652101220	SM22S	SM0805SP
R624	SM652101220	SM22S	SM0805SP
R625	SM652101103	SM10KS	SM0805SP

R626	SM652101220	SM22S	SM0805SP
R627	SM652101220	SM22S	SM0805SP
R628	SM652101472	SM4.7KS	SM0805SP
R629	SM652101472	SM4.7KS	SM0805SP
R630	SM652101472	SM4.7KS	SM0805SP
R631	SM654101000	SM0S	SM0805SP
R632	SM652101103	SM10KS	SM0805SP
R633	SM652101103	SM10KS	SM0805SP
R634	SM652101220	SM22S	SM0805SP
R635	SM652101220	SM22S	SM0805SP
R636	SM652101220	SM22S	SM0805SP
R637	SM652101103	SM10KS	SM0805SP
R638	SM652101103	SM10KS	SM0805SP
R639	SM652101103	SM10KS	SM0805SP
R640	SM652101220	SM22S	SM0805SP
R641	SM652101220	SM22S	SM0805SP
R642	SM652101220	SM22S	SM0805SP
R643	SM652101220	SM22S	SM0805SP
R645	SM652101271	SM270S	SM0805SP
R646	SM652101331	SM330S	SM0805SP
R647	SM652101102	SM1KS	SM0805SP
R649	161445100	10-1/2W	RES20
R800	SM652101102	SM1KS	SM0805SP
R805	SM652101331	SM330S	SM0805SP
R808	SM652101103	SM10KS	SM0805SP
R809	SM652101103	SM10KS	SM0805SP
R810	SM652101103	SM10KS	SM0805SP
R811	SM652101103	SM10KS	SM0805SP
R812	SM652101103	SM10KS	SM0805SP
R813	SM652101103	SM10KS	SM0805SP
R815	SM652101103	SM10KS	SM0805SP
R817	SM652101103	SM10KS	SM0805SP
R818	SM652101103	SM10KS	SM0805SP
R819	SM652101103	SM10KS	SM0805SP
R820	SM652101103	SM10KS	SM0805SP
R821	SM652101103	SM10KS	SM0805SP
R822	SM652101103	SM10KS	SM0805SP
R823	SM652101112	SM1.1KS	SM0805SP
R824	SM652101203	SM20KS	SM0805SP
R825	SM652101103	SM10KS	SM0805SP
R826	SM652101103	SM10KS	SM0805SP
R827	SM652101103	SM10KS	SM0805SP
R828	SM652101223	SM22KS	SM0805SP
R829	SM652101103	SM10KS	SM0805SP
R830	SM652101101	SM100S	SM0805SP
R3000	SM652101330	SM33S	SM0805SP
R3001	SM652101330	SM33S	SM0805SP
R3002	SM652101331	TH330S	SM0805SP
R3003	SM168651002	SM120-1%MMHF	SMRES_MINIMELFSP
R3004	SM652101220	SM22S	SM0805SP
R3005	SM168651002	SM120-1%MMHF	SMRES_MINIMELFSP
R3007	SM168651003	TH130-1%MMHF	THRES_MINIMELFSP
R3008	SM652101621	SM620S	SM0805SP
R3009	SM168651003	TH130-1%MMHF	THRES_MINIMELFSP
R3010	SM652101620	SM62S	SM0805SP
R3011	SM168651005	TH180-1%MMHF	THRES_MINIMELFSP
R3012	SM168651005	TH180-1%MMHF	THRES_MINIMELFSP
R3013	SM168651003	SM130-1%MMHF	SMRES_MINIMELFSP
R3014	SM652101102	SM1KS	SM0805SP
R3015	SM652101910	SM91S	SM0805SP
R3016	SM652101102	SM1KS	SM0805SP
R3017	SM168651002	TH120-1%MMHF	THRES_MINIMELFSP
R3018	SM168651002	TH120-1%MMHF	THRES_MINIMELFSP

R3019	SM652101103	SM10KS	SM0805SP
R3020	SM652101100	SM10S	SM0805SP
R3021	SM185457101	SM100-1T	SMPOT_ST4
R3022	SM652101361	SM360S	SM0805SP
R3023	SM652101122	SM1.2KS	SM0805SP
R3024	SM652101471	SM470S	SM0805SP
R3025	SM652101102	SM1KS	SM0805SP
R3026	SM652101244	SM240KS	SM0805SP
R3027	SM652101103	SM10KS	SM0805SP
R3028	SM652101430	SM43S	SM0805SP
R3029	SM652101103	SM10KS	SM0805SP
R3030	SM652101102	SM1KS	SM0805SP
R3031	SM652101112	SM1.1KS	SM0805SP
R3032	SM652101102	SM1KS	SM0805SP
R3033	SM652101102	SM1KS	SM0805SP
R3034	SM652101330	SM33S	SM0805SP
R3035	SM654101000	SM0S	SM0805SP
R3036	SM653190104	SMNTC-100KS	SM0805SP
R3037	SM652101102	SM1KS	SM0805SP
R3038	SM652101201	SM200S	SM0805SP
R3040	SM652101330	SM33S	SM0805SP
R3041	SM652101510	SM51S	SM0805SP
R3042	SM652101202	SM2KS	SM0805SP
R3043	SM652101201	SM200S	SM0805SP
R3044	SM652101430	SM43S	SM0805SP
R3045	SM652101200	SM20S	SM0805SP
R3046	SM652101200	SM20S	SM0805SP
R3047	SM652101620	SM62S	SM0805SP
R3048	SM652101430	SM43S	SM0805SP
R3049	SM652101820	SM82S	SM0805SP
R3050	SM652101104	SM100KS	SM0805SP
R3051	SM652101330	SM33S	SM0805SP
R3052	SM652101560	SM56S	SM0805SP
R3053	SM652101560	SM56S	SM0805SP
R3054	SM652101330	SM33S	SM0805SP
R3055	SM652101820	SM82S	SM0805SP
R3056	SM652101560	SM56S	SM0805SP
R3058	SM652101820	SM82S	SM0805SP
R3059	SM652101222	SM2.2KS	SM0805SP
R3060	SM652101330	SM33S	SM0805SP
R3061	SM652101181	SM180S	SM0805SP
R3062	SM652101122	SM1.2KS	SM0805SP
R3063	SM652101430	SM43S	SM0805SP
R3064	SM652101510	SM51S	SM0805SP
R3065	SM652101430	SM43S	SM0805SP
R3066	SM652101102	SM1KS	SM0805SP
R3067	SM652101224	SM220KS	SM0805SP
R3068	SM652101203	SM20KS	SM0805SP
R3069	SM652101430	SM43S	SM0805SP
R3070	SM652101102	SM1KS	SM0805SP
R3071	SM652101430	SM43S	SM0805SP
R3072	SM652101331	SM330S	SM0805SP
R3073	SM652101361	SM360S	SM0805SP
R3074	SM652101393	SM39KS	SM0805SP
R3075	SM652101106	SM10MS	SM0805SP
R3076	SM652101105	SM1MS	SM0805SP
R3077	SM652101471	SM470S	SM0805SP
R3078	SM652101101	SM100S	SM0805SP
R3079	SM652101103	SM10KS	SM0805SP
R3080	SM652101105	SM1MS	SM0805SP
R3081	SM652101106	SM10MS	SM0805SP
R3083	SM654101000	SM0S	SM0805SP
R3084	SM652101471	SM470S	SM0805SP

R3085	SM652101101	SM100S	SM0805SP
R3086	SM652101510	SM51S	SM0805SP
R3087	SM652101911	SM910S	SM0805SP
R3088	SM652101560	SM56S	SM0805SP
R3089	SM652101560	SM56S	SM0805SP
R3090	SM652101102	SM1KS	SM0805SP
R3091	SM652101222	SM2.2KS	SM0805SP
R3092	SM652101430	SM43S	SM0805SP
R3093	SM652101101	SM100S	SM0805SP
R3094	SM652101181	SM180S	SM0805SP
R3095	SM652101103	SM10KS	SM0805SP
R3097	SM652101102	SM1KS	SM0805SP
R3098	SM652101102	SM1KS	SM0805SP
R3099	SM652101101	SM100S	SM0805SP
R3100	SM652101103	SM10KS	SM0805SP
R3101	SM652101103	SM10KS	SM0805SP
R3102	SM652101103	SM10KS	SM0805SP
R3103	SM652101102	SM1KS	SM0805SP
R3104	SM652101182	SM1.8KS	SM0805SP
R3105	SM652101222	SM2.2KS	SM0805SP
R3106	SM652101101	SM100S	SM0805SP
R3107	SM652101101	SM100S	SM0805SP
R3108	SM652101331	SM330S	SM0805SP
R3109	SM652101223	SM22KS	SM0805SP
R3110	SM652101102	SM1KS	SM0805SP
R3111	SM652101103	SM10KS	SM0805SP
R3112	SM652101101	SM100S	SM0805SP
R3113	SM652101101	SM100S	SM0805SP
R3114	SM652101103	SM10KS	SM0805SP
R3400	SM652101510	SM51S	SM0805SP
R3401	SM652101201	SM200S	SM0805SP
R3402	SM652101201	SM200S	SM0805SP
R3403	SM652101510	SM51S	SM0805SP
R3404	SM652101151	SM150S	SM0805SP
R3405	SM652101151	SM150S	SM0805SP
R3406	SM652101201	SM200S	SM0805SP
R3407	SM652101201	SM200S	SM0805SP
R3408	SM652101510	SM51S	SM0805SP
R3409	SM652101510	SM51S	SM0805SP
R3410	SM652101201	SM200S	SM0805SP
R3411	SM652101201	SM200S	SM0805SP
R4000	SM652101330	SM33S	SM0805SP
R4001	SM652101330	SM33S	SM0805SP
R4002	SM652101331	TH330S	SM0805SP
R4003	SM168651002	SM120-1%MMHF	SMRES_MINIMELFSP
R4004	SM652101220	SM22S	SM0805SP
R4005	SM168651002	SM120-1%MMHF	SMRES_MINIMELFSP
R4007	SM168651003	TH130-1%MMHF	THRES_MINIMELFSP
R4008	SM652101621	SM620S	SM0805SP
R4009	SM168651003	TH130-1%MMHF	THRES_MINIMELFSP
R4010	SM652101620	SM62S	SM0805SP
R4011	SM168651005	TH180-1%MMHF	THRES_MINIMELFSP
R4012	SM168651005	TH180-1%MMHF	THRES_MINIMELFSP
R4013	SM168651003	SM130-1%MMHF	SMRES_MINIMELFSP
R4014	SM652101102	SM1KS	SM0805SP
R4015	SM652101910	SM91S	SM0805SP
R4016	SM652101102	SM1KS	SM0805SP
R4017	SM168651002	TH120-1%MMHF	THRES_MINIMELFSP
R4018	SM168651002	TH120-1%MMHF	THRES_MINIMELFSP
R4019	SM652101103	SM10KS	SM0805SP
R4020	SM652101100	SM10S	SM0805SP
R4021	SM185457101	SM100-1T	SMPOT_ST4
R4022	SM652101361	SM360S	SM0805SP

R4023	SM652101122	SM1.2KS	SM0805SP
R4024	SM652101471	SM470S	SM0805SP
R4025	SM652101102	SM1KS	SM0805SP
R4026	SM652101244	SM240KS	SM0805SP
R4027	SM652101103	SM10KS	SM0805SP
R4028	SM652101430	SM43S	SM0805SP
R4029	SM652101103	SM10KS	SM0805SP
R4030	SM652101102	SM1KS	SM0805SP
R4031	SM652101112	SM1.1KS	SM0805SP
R4032	SM652101102	SM1KS	SM0805SP
R4033	SM652101102	SM1KS	SM0805SP
R4034	SM652101330	SM33S	SM0805SP
R4035	SM654101000	SM0S	SM0805SP
R4036	SM653190104	SMNTC-100KS	SM0805SP
R4037	SM652101102	SM1KS	SM0805SP
R4038	SM652101201	SM200S	SM0805SP
R4040	SM652101330	SM33S	SM0805SP
R4041	SM652101510	SM51S	SM0805SP
R4042	SM652101202	SM2KS	SM0805SP
R4043	SM652101201	SM200S	SM0805SP
R4044	SM652101430	SM43S	SM0805SP
R4045	SM652101200	SM20S	SM0805SP
R4046	SM652101200	SM20S	SM0805SP
R4047	SM652101620	SM62S	SM0805SP
R4048	SM652101430	SM43S	SM0805SP
R4049	SM652101820	SM82S	SM0805SP
R4050	SM652101104	SM100KS	SM0805SP
R4051	SM652101330	SM33S	SM0805SP
R4052	SM652101560	SM56S	SM0805SP
R4053	SM652101560	SM56S	SM0805SP
R4054	SM652101330	SM33S	SM0805SP
R4055	SM652101820	SM82S	SM0805SP
R4056	SM652101560	SM56S	SM0805SP
R4058	SM652101820	SM82S	SM0805SP
R4059	SM652101222	SM2.2KS	SM0805SP
R4060	SM652101330	SM33S	SM0805SP
R4061	SM652101181	SM180S	SM0805SP
R4062	SM652101122	SM1.2KS	SM0805SP
R4063	SM652101430	SM43S	SM0805SP
R4064	SM652101510	SM51S	SM0805SP
R4065	SM652101430	SM43S	SM0805SP
R4066	SM652101102	SM1KS	SM0805SP
R4067	SM652101224	SM220KS	SM0805SP
R4068	SM652101203	SM20KS	SM0805SP
R4069	SM652101430	SM43S	SM0805SP
R4070	SM652101102	SM1KS	SM0805SP
R4071	SM652101430	SM43S	SM0805SP
R4072	SM652101331	SM330S	SM0805SP
R4073	SM652101361	SM360S	SM0805SP
R4074	SM652101393	SM39KS	SM0805SP
R4075	SM652101106	SM10MS	SM0805SP
R4076	SM652101105	SM1MS	SM0805SP
R4077	SM652101471	SM470S	SM0805SP
R4078	SM652101101	SM100S	SM0805SP
R4079	SM652101103	SM10KS	SM0805SP
R4080	SM652101105	SM1MS	SM0805SP
R4081	SM652101106	SM10MS	SM0805SP
R4083	SM654101000	SM0S	SM0805SP
R4084	SM652101471	SM470S	SM0805SP
R4085	SM652101101	SM100S	SM0805SP
R4086	SM652101510	SM51S	SM0805SP
R4087	SM652101911	SM910S	SM0805SP
R4088	SM652101560	SM56S	SM0805SP

R4089	SM652101560	SM56S	SM0805SP
R4090	SM652101102	SM1KS	SM0805SP
R4091	SM652101222	SM2.2KS	SM0805SP
R4092	SM652101430	SM43S	SM0805SP
R4093	SM652101101	SM100S	SM0805SP
R4094	SM652101181	SM180S	SM0805SP
R4095	SM652101103	SM10KS	SM0805SP
R4097	SM652101102	SM1KS	SM0805SP
R4098	SM652101102	SM1KS	SM0805SP
R4099	SM652101101	SM100S	SM0805SP
R4100	SM652101103	SM10KS	SM0805SP
R4101	SM652101103	SM10KS	SM0805SP
R4102	SM652101103	SM10KS	SM0805SP
R4103	SM652101102	SM1KS	SM0805SP
R4104	SM652101182	SM1.8KS	SM0805SP
R4105	SM652101222	SM2.2KS	SM0805SP
R4106	SM652101101	SM100S	SM0805SP
R4107	SM652101101	SM100S	SM0805SP
R4108	SM652101331	SM330S	SM0805SP
R4109	SM652101223	SM22KS	SM0805SP
R4110	SM652101102	SM1KS	SM0805SP
R4111	SM652101103	SM10KS	SM0805SP
R4112	SM652101101	SM100S	SM0805SP
R4113	SM652101101	SM100S	SM0805SP
R4114	SM652101103	SM10KS	SM0805SP
R4400	SM652101510	SM51S	SM0805SP
R4401	SM652101201	SM200S	SM0805SP
R4402	SM652101510	SM51S	SM0805SP
R4403	SM652101201	SM200S	SM0805SP
R4404	SM652101151	SM150S	SM0805SP
R4405	SM652101151	SM150S	SM0805SP
R4406	SM652101201	SM200S	SM0805SP
R4407	SM652101201	SM200S	SM0805SP
R4408	SM652101510	SM51S	SM0805SP
R4409	SM652101510	SM51S	SM0805SP
R4410	SM652101201	SM200S	SM0805SP
R4411	SM652101201	SM200S	SM0805SP
R4500	SM652101510	SM51S	SM0805SP
R4501	SM652101510	SM51S	SM0805SP
R4502	SM652101201	SM200S	SM0805SP
R4503	SM652101201	SM200S	SM0805SP
R4504	SM652101510	SM51S	SM0805SP
R4505	SM652101201	SM200S	SM0805SP
R4506	SM652101201	SM200S	SM0805SP
R4507	SM652101510	SM51S	SM0805SP
R5000	SM652101330	SM33S	SM0805SP
R5001	SM652101330	SM33S	SM0805SP
R5002	SM168651004	SM300-1*MMHF	SMRES_MINIMELFSP
R5003	SM652101220	SM22S	SM0805SP
R5004	SM168651005	SM180-1*MMHF	SMRES_MINIMELFSP
R5005	SM168651003	SM130-1*MMHF	SMRES_MINIMELFSP
R5006	SM652101910	SM91S	SM0805SP
R5007	SM168651005	SM180-1*MMHF	SMRES_MINIMELFSP
R5008	SM168651001	SM30-1*MMHF	SMRES_MINIMELFSP
R5009	SM652101101	SM100S	SM0805SP
R5010	SM652101103	SM10KS	SM0805SP
R5011	SM652101103	SM10KS	SM0805SP
R5012	SM652101102	SM1KS	SM0805SP
R5013	SM652101224	SM220KS	SM0805SP
R5014	SM652101103	SM10KS	SM0805SP
R5015	SM168651001	SM30-1*MMHF	SMRES_MINIMELFSP
R5016	SM652101103	SM10KS	SM0805SP
R5017	SM652101510	SM51S	SM0805SP

R5018	SM652101151	SM150S	SM0805SP
R5019	SM652101104	SM100KS	SM0805SP
R5020	SM652101153	SM15KS	SM0805SP
R5021	SM652101510	SM51S	SM0805SP
R5022	SM652101331	SM330S	SM0805SP
R5023	SM651104104	SM100K-25PPM	SM1206SP
R5024	SM652101101	SM100S	SM0805SP
R5025	SM652101104	SM100KS	SM0805SP
R5026	SM652101103	SM10KS	SM0805SP
R5027	SM652101101	SM100S	SM0805SP
R5028	SM652101430	SM43S	SM0805SP
R5029	SM652101103	SM10KS	SM0805SP
R5030	SM652101102	SM1KS	SM0805SP
R5031	SM652101224	SM220KS	SM0805SP
R5032	SM652101621	SM620S	SM0805SP
R5033	SM652101224	SM220KS	SM0805SP
R5034	SM652101430	SM43S	SM0805SP
R5035	SM652101510	SM51S	SM0805SP
R5036	SM652101201	SM200S	SM0805SP
R5037	SM652101201	SM200S	SM0805SP
R5038	SM652101510	SM51S	SM0805SP
R5039	SM652101471	SM470S	SM0805SP
R5040	SM652101103	SM10KS	SM0805SP
R5041	SM652101151	SM150S	SM0805SP
R5042	SM652101151	SM150S	SM0805SP
R5043	SM652101201	SM200S	SM0805SP
R5044	SM652101201	SM200S	SM0805SP
R5045	SM652101510	SM51S	SM0805SP
R5046	SM652101201	SM200S	SM0805SP
R5047	SM652101201	SM200S	SM0805SP
R5048	SM652101510	SM51S	SM0805SP
R6000	SM652101330	SM33S	SM0805SP
R6001	SM652101220	SM22S	SM0805SP
R6002	SM652101330	SM33S	SM0805SP
R6003	SM168659297	SM100-1/∞	SMRES_MINIMELF
R6004	SM168659297	SM100-1/∞	SMRES_MINIMELF
R6006	SM168659001	SM1.0K-1/∞	SMRES_MINIMELF
R6007	SM654101000	SM0S	SM0805SP
R6008	SM168659001	SM1.0K-1/∞	SMRES_MINIMELF
R6009	SM654101000	SM0S	SM0805SP
R6010	SM652101821	SM820S	SM0805SP
R6011	SM652101510	SM51S	SM0805SP
R6012	SM652101102	SM1KS	SM0805SP
R6014	SM652101510	SM51S	SM0805SP
R6015	SM652101201	SM200S	SM0805SP
R6016	SM652101330	SM33S	SM0805SP
R6017	SM652101510	SM51S	SM0805SP
R6018	SM652101201	SM200S	SM0805SP
R6019	SM652101271	SM270S	SM0805SP
R6020	SM652101271	SM270S	SM0805SP
R6021	SM652101331	SM330S	SM0805SP
R6022	SM652101560	SM56S	SM0805SP
R6023	SM652101560	SM56S	SM0805SP
R6024	SM652101331	SM330S	SM0805SP
RL3000	430490750	RL-UR1-12	RELAYSG5Y_254P
RL3001	430490750	RL-UR1-12	RELAYSG5Y_254P
RL3002	430490750	RL-UR1-12	RELAYSG5Y_254P
RL4000	430490750	RL-UR1-12	RELAYSG5Y_254P
RL4001	430490750	RL-UR1-12	RELAYSG5Y_254P
RL4002	430490750	RL-UR1-12	RELAYSG5Y_254P
RL5000	430490750	RL-UR1-12	RELAYSG5Y_254P
RN600	190042102	1K-SIPC	SIP10RES
RN601	190042103	10K-SIPC	SIP10RES

RN602	190042103	10K-SIPC	SIP10RES
RN603	190042103	10K-SIPC	SIP10RES
RN604	190042103	10K-SIPC	SIP10RES
RN605	190042103	10K-SIPC	SIP10RES
S600	SM654101000	SM0S-2P	SM0805_2P
S601	SM654101000	SM0S-2P	SM0805_2P
S602	SM654101000	SM0S-2P	SM0805_2P
S3000	SM654101000	SM0S-2P	SM0805_2P
S4000	SM654101000	SM0S-2P	SM0805_2P
TP1	454313010	2x5-ST-M-NW-SP	CONN2X5_ST_M_NW
TP800	454313010	2x5-ST-M-NW-SP	CONN2X5_ST_M_NW
TP801	454313010	2x5-ST-M-NW-SP	CONN2X5_ST_M_NW
TP802	454313010	2x5-ST-M-NW-SP	CONN2X5_ST_M_NW
TP3000	454313010	2x5-ST-M-NW-SP	CONN2X5_ST_M_NW
TP3001	454340002	2x1-ST-M-NW	CONN2X1_ST_M_NW
TP4000	454313010	2x5-ST-M-NW-SP	CONN2X5_ST_M_NW
TP4001	454340002	2x1-ST-M-NW	CONN2X1_ST_M_NW
TP5000	454313010	2x5-ST-M-NW-SP	CONN2X5_ST_M_NW
Y300	309040023	IQD-T80MHz	\$1100_QUARTZ

PART: F9320-3 DESC: MAIN CARD DUAL 20Ms/s, 1GHz

COMPONENT	PART DESCRIPTION	QTY PER ASSEMBLY
-----	-----	-----
103327103	CAP CERA MONO 50V .01 UF	2
146544471	CAP MINI ALUM 20% 470UF	1
158899002	CAP VARIABLE .2 - .6 PF	2
161445100	RES COMP 1/2W 5% 10 OHMS	1
169416473	RESISTOR DISC NTC 47 K	1
190042102	RESISTOR NETWORK 1 K	1
190042103	RESISTOR NETWORK 10 K	5
205750000	IC AND-OR GATE ARRAY 16V8	3
208122002	IC VOLT REG POS UA7805	1
208123002	IC +12 VOLT REG LM340T-12	2
208124003	IC VOLT REG NEG LM320T-12	2
309040023	CRYSTAL OSCILLATOR TTL 80MHZ	1
430490750	RELAY HF DPDT 75 OHMS	7
454110010	HDR SOLD TAIL/MALE PIN 10	1
454313010	HDR DIP SOLD TO PCB 2X5	7
454320096	HDR DIP SOLD TO FEM 96	1
454340002	HDR MALE PIN TO WW 02	2
454390002	HDR FRICTION LOCK 2-PIN	1
505019968	HEAT SINK VERTICAL MTG	5
530040006	BUZZER 85DB 4 TO 7V	1
554425003	SCREW S/TAP PHIL M2.5X6 BLACK	4
585252236	RIVET HOLLOW 2.5X6MM	2
709324331	BASE SHIELD	1
709324341	SHIELD LOWER PARTITION	4
7093XX361	SHIELD LOWER PARTITION	2
7093XXP01	RIGHT ANGLE RECEPT. CONNECTOR	4
7093XXP21	BULKHEAD RECEPTACLE FEMALE BNC	4
7093XXP41	PROBE HOLDER	4
7093XXP91	PROBE RING CONTACT	4
719324303	PC BD PREASS'Y 9324-3	1
719324313	PC BD PREASS'Y T-COIL	2
FP9320-3	MAIN CARD PANEL 9320-3	1
MCL404	IC MEM GATE ARRAY MCL404	1
MTB411	IC TIME BASE GATE-ARRAY	1
SM168651001	RES METAL FILM 1% 30 OHMS	2
SM168651002	RES METAL FILM 1% 120 OHMS	8
SM168651003	RES METAL FILM 1% 130 OHMS	7
SM168651004	RES METAL FILM 1% 300 OHMS	1
SM168651005	RES METAL FILM 1% 180 OHMS	6
SM168659001	RES METAL FILM .1% 1.00K	1
SM168659297	RES METAL FILM .1% 100 OHMS	2
SM185457101	RES VARI CERMET 100 OHMS	2
SM200167105	IC 2-3-2 OR/NOR 10H105	2
SM200167113	IC 2-IN XOR 10H113	1

PART: F9320-3 DESC: MAIN CARD DUAL 20Ms/s, 1GHz

COMPONENT -----	PART DESCRIPTION -----	QTY PER ASSEMBLY -----
SM200167121	IC OR-AND/O-A-INV 10H121	2
SM200167131	IC M-S TYP D FLOP 10H131	7
SM200170174	IC D-TYPE FLOP 74ACT74	3
SM200178000	IC 2-INPUT NAND HCT00	3
SM200178138	IC 3-8 LINE DECOD HCT 138	3
SM200178374	IC D-TYP FLOP 74HCT374	1
SM200278040	IC COUNTER HCT4040	1
SM201166404	IC 4 DIFF AND/NAND 10E404	1
SM201174005	IC ECL 2-IN DIF AND/NAND	4
SM201174011	IC ECL 1:2 DIF CLOCK DRVR	3
SM201174052	IC ECL DIF CLK DATA F-F	1
SM201177008	IC 4X2 INPUT AND 74ACT08	4
SM201274033	IC ECL DIV:4 10EL33D	1
SM201474431	IC 3 DIF FLIP/FLOP MC10E431	1
SM201570016	IC ECL DIF RECEIVER 10EL16D	5
SM201574058	IC ECL 2:1 MUX 10EL58D	1
SM205108002	IC EEPROM 2K BIT IIC BUS	1
SM205228863	IC 8K X 8 STATIC RAM 25NS	2
SM205618165	IC 8-BIT SHIFT REG 74HCT165	1
SM205618594	IC 8-BIT SHIFT REG 74HC594T	6
SM206070584	IC BUS CONTROLLER	1
SM206260858	IC OCT 8-BIT ADC SYSTEM	1
SM206270703	IC 8-BIT ADC 8703	2
SM206870640	IC INV BUS TRANSCVR HCT640	2
SM206886623	IC OCTAL BUS TRANSCVR. BCT623	2
SM206970457	IC 3 DIF 2:1 MUX MC10E457	3
SM207178541	IC BUFFER/LINE DR HCT541	4
SM207280703	IC 16-BIT DAC 703	1
SM207288800	IC OCTAL 8-BIT CMOS D/A CONV	1
SM207360125	IC TRANSLATO MC10125	4
SM207367124	IC TRANSLATOR 10H124	1
SM207460116	IC LINE RECEIVER 10H116	5
SM207770201	IC ANALOG SWITCH DG201	6
SM207878245	IC BUS TRANSCVR HCT 245	2
SM207970351	IC OCTAL ANALOG MUX/DEMUX	1
SM207978251	IC 8-IN MUX 3-ST 74HCT251	2
SM208030245	IC TRANS ARRAY NPNX6 SL3245	1
SM208470130	IC FAST OP AMP HFA1130	4
SM208470347	IC J-FET OP AMP 347	4
SM208470353	IC DUAL OP AMP 353	4
SM208470621	IC HIGH SPEED OP AMP	2
SM208470705	IC OP AMP PICOAMP INPUT AD705	5
SM208473100	IC OP AMP CA3100	1
SM208480660	IC OP AMP OPA660	2

PART: F9320-3 DESC: MAIN CARD DUAL 20Ms/s, 1GHz

COMPONENT	PART DESCRIPTION	QTY PER ASSEMBLY
SM208570805	IC POS VOLT REG 78L05	2
SM208591336	IC VOLT REF DIODE LM336	2
SM208870339	IC VOLT COMPARATOR 339	1
SM229020150	MLC TRANS VOLT SUPPRESSOR	4
SM230080620	DIODE TUNING SMD BB620	4
SM232022822	DIODE ARRAY SCHTTKY 2822	13
SM234101385	DIODE VOLT REG 385-1.2	1
SM236030099	DIODE SO-PKG BAV99	24
SM240218424	DIODE ZENER BZX84C2V4	4
SM240218436	DIODE ZENER BZX84C3V6	1
SM240218443	DIODE ZENER BZX84C4V3	1
SM240218451	DIODE ZENER BZX84C5V1	13
SM240218491	DIODE ZENER BZX84C9V1	2
SM252080682	DIODE PIN BA682	5
SM270160133	TRANSISTOR NPN HF BFG33X	22
SM270330848	TRANSISTOR NPN BC848C	6
SM275030092	TRANSISTOR PNP BFT92	2
SM275030194	TRANSISTOR PNP BFR 194	4
SM275030550	TRANSISTOR PNP BF550	5
SM275330858	TRANSISTOR PNP BC858C	2
SM289772003	TRANSISTOR ARRAY 2003	1
SM301502001	BEAD (FERRITE CHIP)	60
SM433012001	FUSE THIN FILM 200 MA	5
SM651104104	RES CHIP 1% 25PPM 100K	1
SM651104162	RES CHIP 1% 25PPM 1.6K	1
SM651104183	RES CHIP 1% 25PPM 18 K	1
SM651104204	RES CHIP 1% 25PPM 200 K	1
SM651104391	RES CHIP 1% 25PPM 390 OHMS	1
SM651104392	RES CHIP 1% 25PPM 3.9K	1
SM652101100	RES CHIP (E24) 1% 10 OHMS	4
SM652101101	RES CHIP (E24) 1% 100 OHM	33
SM652101102	RES CHIP (E24) 1% 1 K	45
SM652101103	RES CHIP (E24) 1% 10 K	64
SM652101104	RES CHIP (E24) 1% 100 K	5
SM652101105	RES CHIP (E24) 1% 1 M	4
SM652101106	RES CHIP (E24) 1% 10 MEG	4
SM652101112	RES CHIP (E24) 1% 1.1 K	3
SM652101121	RES CHIP (E24) 1% 120 OHM	8
SM652101122	RES CHIP (E24) 1% 1.2 K	6
SM652101151	RES CHIP (E24) 1% 150 OHM	29
SM652101152	RES CHIP (E24) 1% 1.5 K	2
SM652101153	RES CHIP (E24) 1% 15 K	1
SM652101154	RES CHIP (E24) 1% 150 K	2
SM652101181	RES CHIP (E24) 1% 180 OHM	4

PART: F9320-3 DESC: MAIN CARD DUAL 20Ms/s, 1GHz

COMPONENT -----	PART DESCRIPTION -----	QTY PER ASSEMBLY -----
SM652101182	RES CHIP (E24) 1% 1.8 K	2
SM652101183	RES CHIP (E24) 1% 18 K	1
SM652101200	RES CHIP (E24) 1% 20 OHMS	6
SM652101201	RES CHIP (E24) 1% 200 OHM	63
SM652101202	RES CHIP (E24) 1% 2 K	2
SM652101203	RES CHIP (E24) 1% 20 K	3
SM652101220	RES CHIP (E24) 1% 22 OHMS	42
SM652101222	RES CHIP (E24) 1% 2.2 K	6
SM652101223	RES CHIP (E24) 1% 22 K	6
SM652101224	RES CHIP (E24) 1% 220 K	5
SM652101241	RES CHIP (E24) 1% 240 OHM	4
SM652101244	RES CHIP (E24) 1% 240K	2
SM652101271	RES CHIP (E24) 1% 270 OHM	20
SM652101302	RES CHIP (E24) 1% 3 K	1
SM652101330	RES CHIP (E24) 1% 33 OHMS	24
SM652101331	RES CHIP (E24) 1% 330 OHM	56
SM652101332	RES CHIP (E24) 1% 3.3 K	8
SM652101361	RES CHIP (E24) 1% 360 OHM	4
SM652101390	RES CHIP (E24) 1% 39 OHMS	3
SM652101393	RES CHIP (E24) 1% 39 K	2
SM652101430	RES CHIP (E24) 1% 43 OHMS	25
SM652101470	RES CHIP (E24) 47 OHMS	24
SM652101471	RES CHIP (E24) 1% 470 OHM	9
SM652101472	RES CHIP (E24) 1% 4.7 K	3
SM652101510	RES CHIP (E24) 1% 51 OHMS	57
SM652101512	RES CHIP (E24) 1% 5.1 K	2
SM652101513	RES CHIP (E24) 1% 51 K	1
SM652101560	RES CHIP (E24) 1% 56 OHM	41
SM652101620	RES CHIP (E24) 1% 62 OHMS	8
SM652101621	RES CHIP (E24) 1% 620 OHM	4
SM652101680	RES CHIP (E24) 1% 68 OHMS	1
SM652101751	RES CHIP (E24) 1% 750 OHM	5
SM652101820	RES CHIP (E24) 1% 82 OHMS	7
SM652101821	RES CHIP (E24) 1% 820 OHM	8
SM652101824	RES CHIP (E24) 1% 820 K	1
SM652101910	RES CHIP (E24) 1% 91 OHMS	8
SM652101911	RES CHIP (E24) 1% 910 OHM	5
SM652101913	RES CHIP (E24) 1% 91 K	1
SM653185621	RES THICK FILM 620 OHMS	1
SM653190104	RES PTAT 100K SMD0805	2
SM654101000	CHIP JUMPER ZERO OHMS	30
SM654181000	CHIP JUMPER ZERO OHMS	2
SM661205222	CAP CERA CHIP 5% 2200 PF	2
SM661207102	CAP CERA CHIP 10% .001UF	5

PART: F9320-3**DESC: MAIN CARD DUAL 20Ms/s, 1GHz**

COMPONENT -----	PART DESCRIPTION -----	QTY PER ASSEMBLY -----
SM661207103	CAP CERA CHIP 20% .01UF	290
SM661207104	CAP CERA CHIP 20% .1 UF	64
SM661250082	CAP CERA CHIP .1% 8.2 PF	4
SM661255027	CAP CERA CHIP 2.7 PF	5
SM661255039	CAP CERA CHIP 3.9 PF	4
SM661255101	CAP CERA CHIP 5% 100 PF	7
SM661255102	CAP CERA CHIP 5% 1000 PF	9
SM661255150	CAP CERA CHIP 5% 15 PF	1
SM661255181	CAP CERA CHIP 5% 180 PF	2
SM661726103	CAP CERA CHIP 10% .01 UF	12
SM666247106	CAP MOLD TANT CHIP 10 UF	4
SM666327225	CAP MOLD TANT CHIP 2.2 UF	33

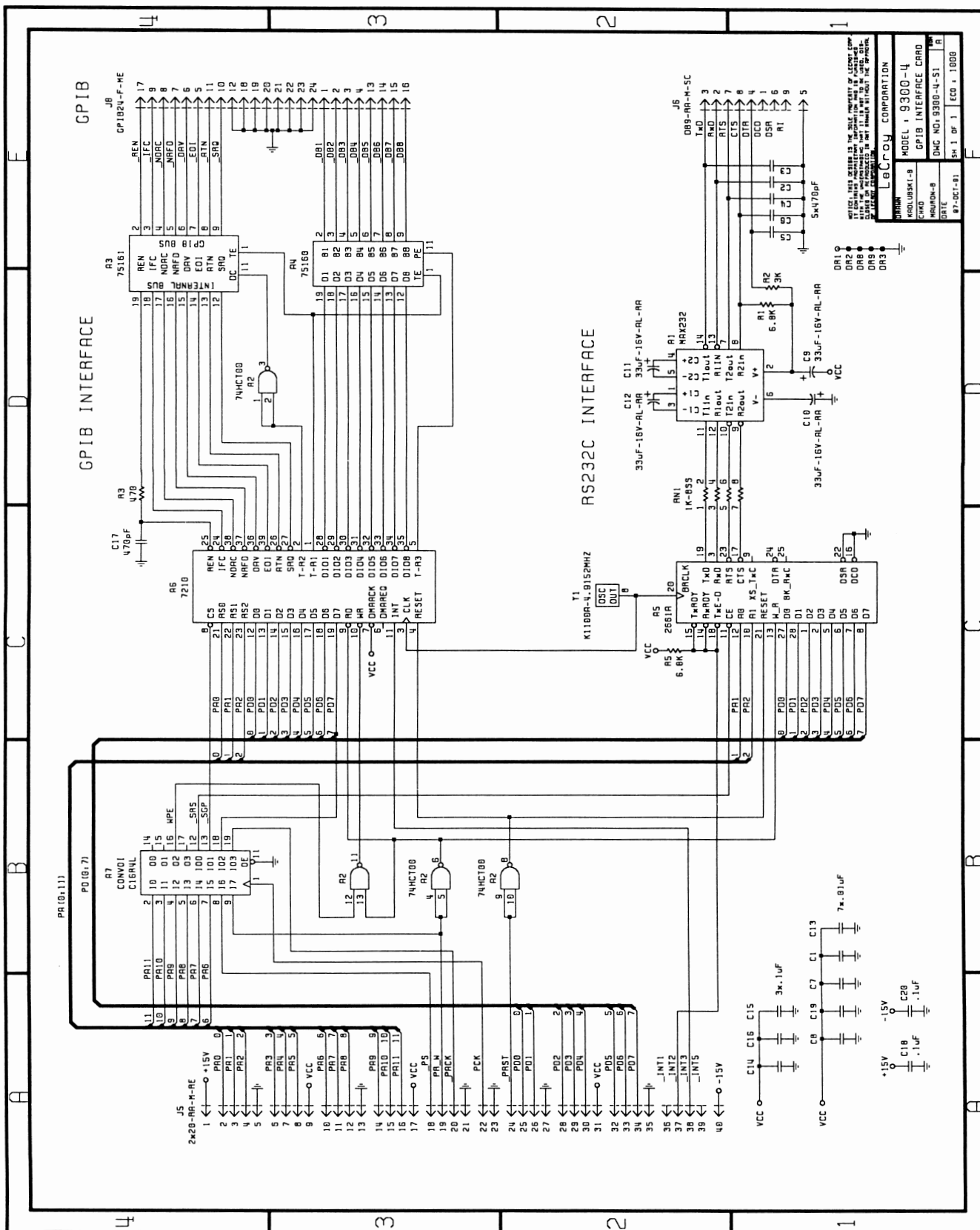

DATE	REV.	BY	APP.
07-01-81	1	ECG	J. BOOB

MODEL	9300-4
DESCRIPTION	GPIB INTERFACE CARD
DWG. NO.	9300-4-S1
REV.	1

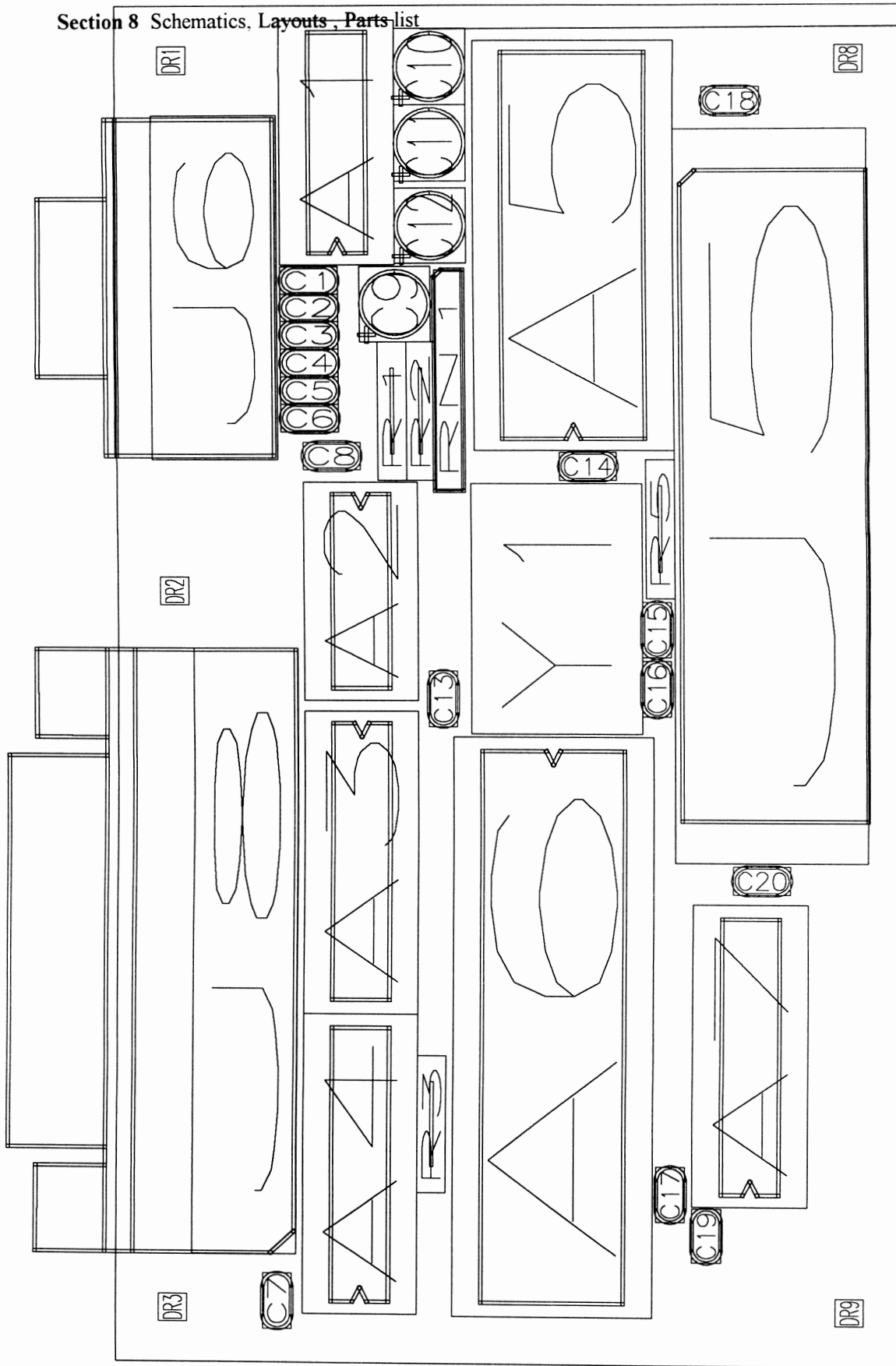

9300-4 REV:D

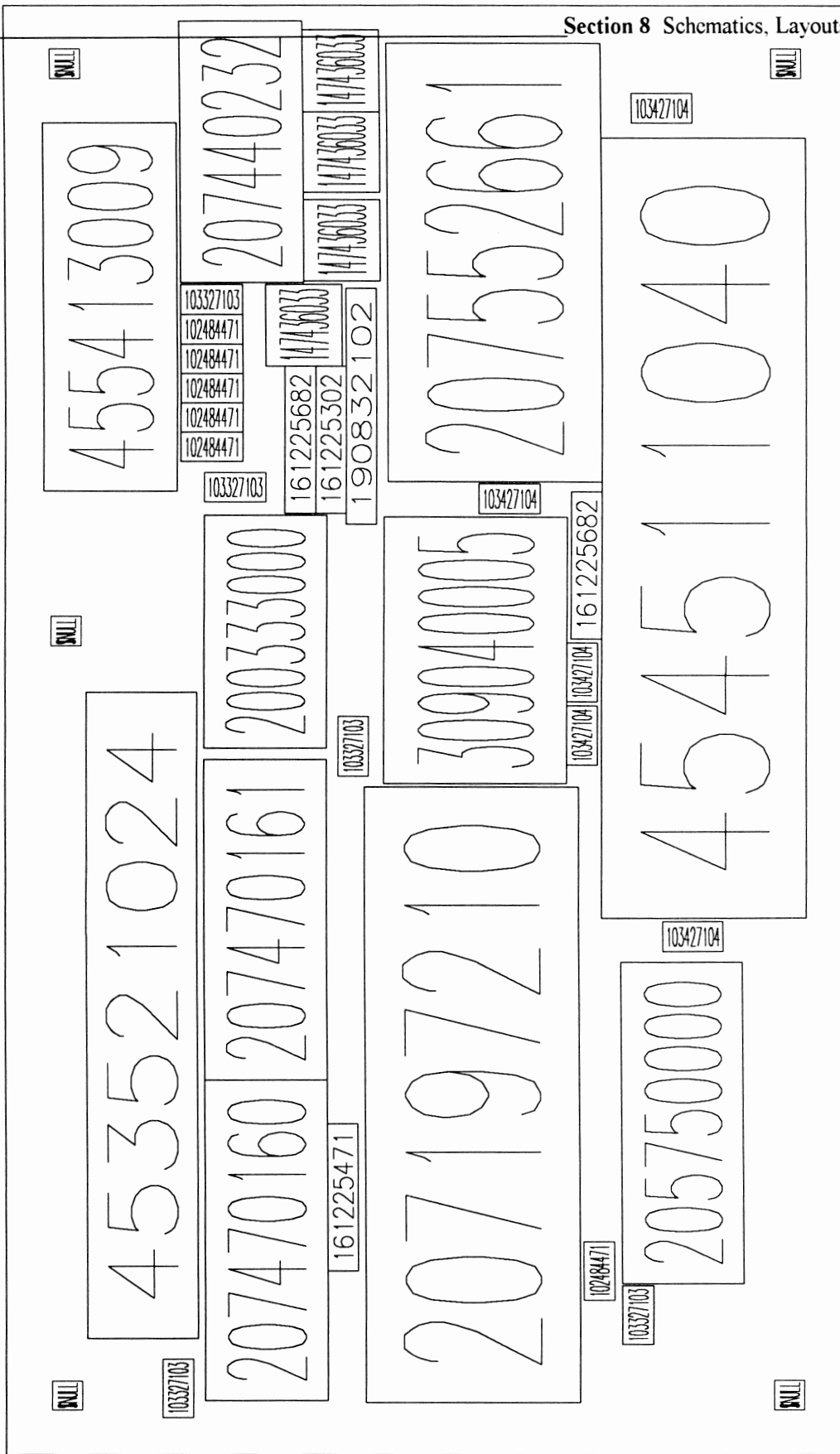

9300-4 REV:D

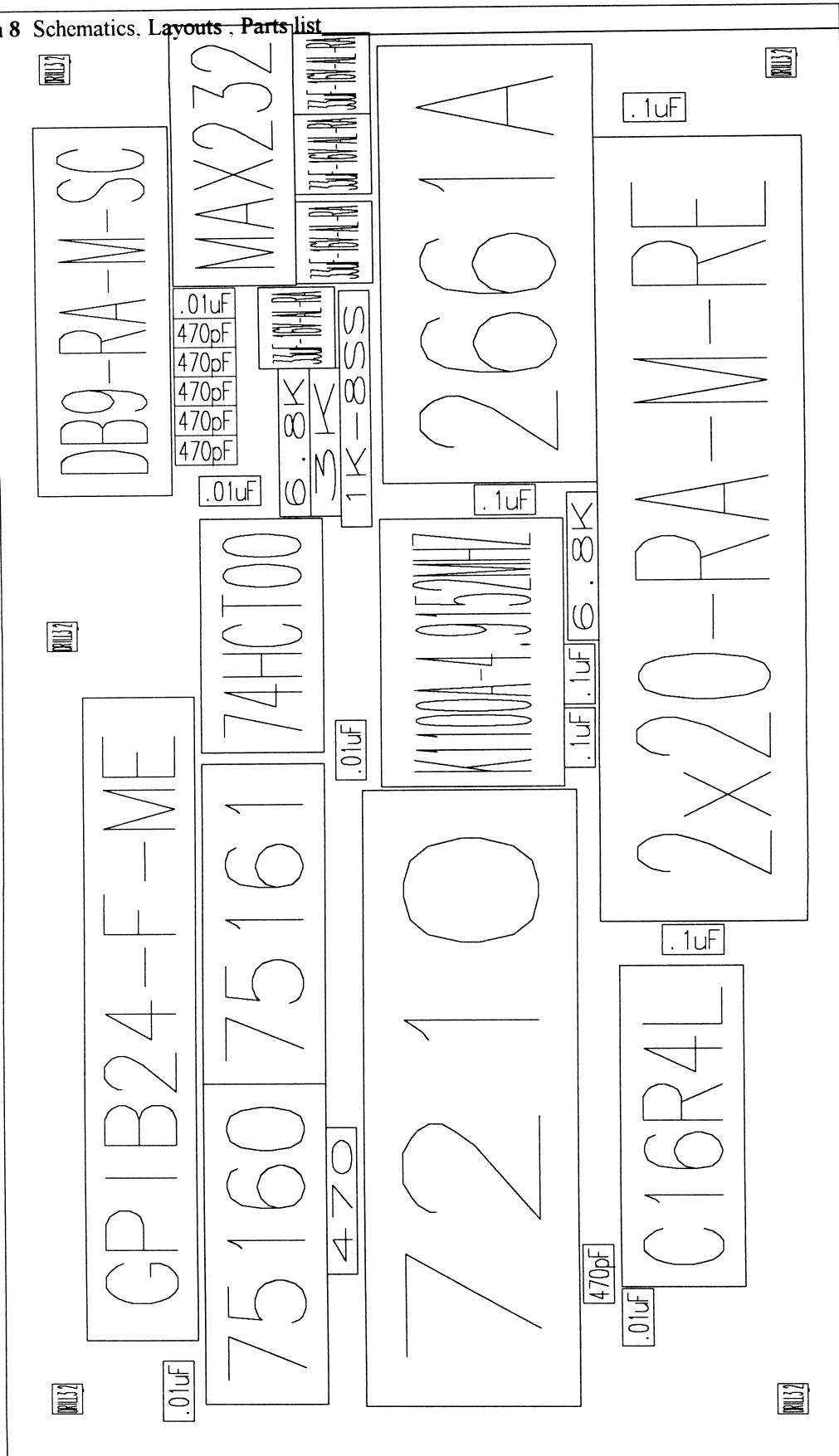

9300-4 REV:D

A1	207440232	MAX232	DIP16
A2	200333000	74HCT00	DIP14
A3	207470161	75161	DIP20
A4	207470160	75160	DIP20
A5	207552661	2661A	DIP28
A6	207197210	7210	DIP40
A7	205750000	C16R4L	DIP20
C1	103327103	.01uF	SMONOBP
C2	102484471	470pF	SMONO
C3	102484471	470pF	SMONO
C4	102484471	470pF	SMONO
C5	102484471	470pF	SMONO
C6	102484471	470pF	SMONO
C7	103327103	.01uF	SMONOBP
C8	103327103	.01uF	SMONOBP
C9	147436033	33uF-16V-AL-RA	TCAP
C10	147436033	33uF-16V-AL-RA	TCAP
C11	147436033	33uF-16V-AL-RA	TCAP
C12	147436033	33uF-16V-AL-RA	TCAP
C13	103327103	.01uF	SMONOBP
C14	103427104	.1uF	SMONOBP
C15	103427104	.1uF	SMONOBP
C16	103427104	.1uF	SMONOBP
C17	102484471	470pF	SMONO
C18	103427104	.1uF	SMONOBP
C19	103327103	.01uF	SMONOBP
C20	103427104	.1uF	SMONOBP
J5	454511040	2x20-RA-M-RE	CONN2X20_RA_M_RE
J6	455413009	DB9-RA-M-SC	DB9_RA_M_SC
J8	453521024	GPIB24-F-ME	GPIB24_F_ME
R1	161225682	6.8K	RES05
R2	161225302	3K	RES05
R3	161225471	470	RES05
R5	161225682	6.8K	RES05
RN1	190832102	1K-8SS	SIP8RES
Y1	309040005	K1100A-4.9152MHZ	\$1100_QUARTZ

PART: F9300-4

DESC: GPIB + RS232 INTERFACE CARD

COMPONENT	PART DESCRIPTION	QTY PER ASSEMBLY
-----	-----	-----
102484471	CAP CERA DISC 100V 470 PF	6
103327103	CAP CERA MONO 50V .01 UF	5
103427104	CAP CERA MONO 100V .1 UF	5
147436033	CAP ALUM METAL CAN 33 UF	4
161225302	RES COMP 1/8W 5% 3 K	1
161225471	RES COMP 1/8W 5% 470 OHMS	1
161225682	RES CARBON FILM 6.8 K	2
190832102	RES NETWORK 1 K	1
200333000	IC QUAD 2-IN NAND HCT00	1
205750000	IC AND-OR GATE ARRAY 16V8	1
207197210	IC BUS INTERF CONTR 7210	1
207440232	IC XMTR/RCVR MAX 232	1
207470160	IC OCTAL BUS XCVR 75160A	1
207470161	IC OCTL BUS XCEIR 75161A	1
207552661	IC INTERFACE 2661A	1
309040005	CRYSTAL OSCIL. 4.9152MHZ	1
453521024	CONN RT ANGLE IEEE FEM 24	1
454511040	HDR SOLD TAIL/MALE/40/RT	1
455413009	CONN RT ANGLE MALE 9 S-CLIP	1
455980002	MOUNTING HDW FOR CONN SHELL	2
550130108	SCREW CYL HD M3X8	2
550430106	SCREW CYL HD PHIL M3X6	1
551430400	WASHER SHAKEPROOF M3	1
709300411	GPIB-RS232 INTERFACE BRACKET D	1
709300421	LABEL RS232-IEEE488-2 A	1
719300403	PC BD PREASS'Y 9300-4 D	1

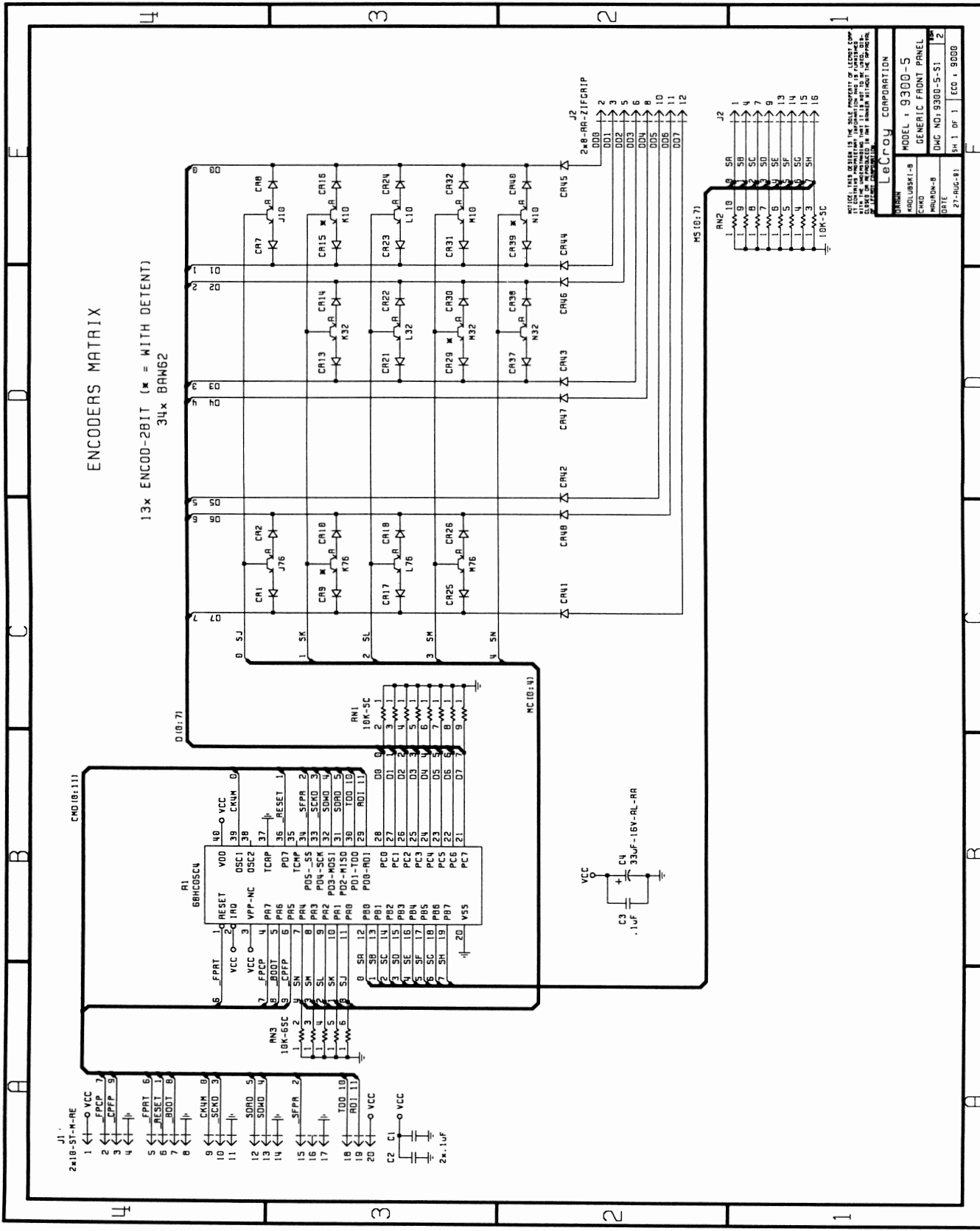

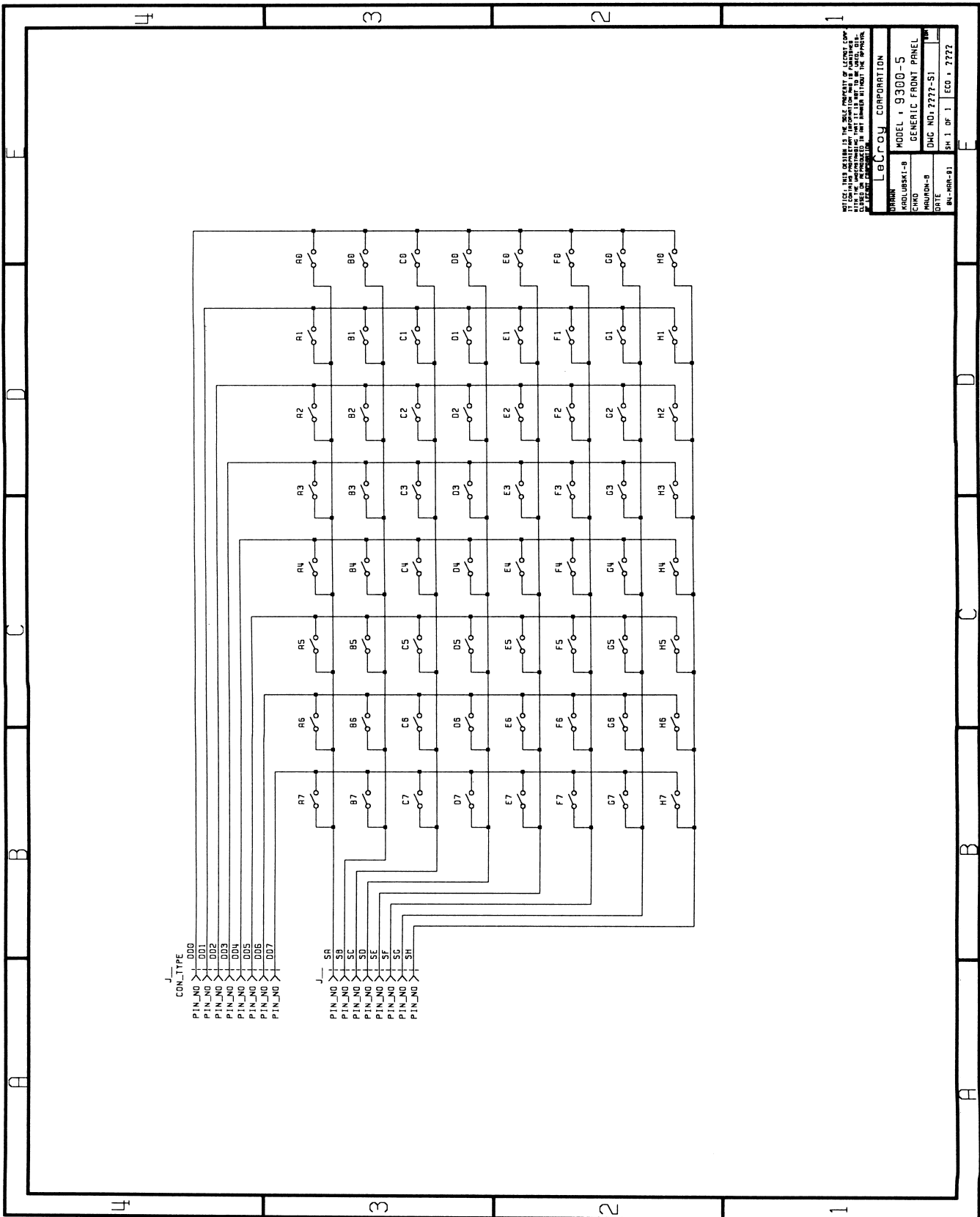

NOTICE: THIS DESIGN IS THE SOLE PROPERTY OF LEICROY COMPANY. ALL RIGHTS ARE RESERVED. THIS DESIGN IS TO BE USED ONLY FOR THE PURPOSES AND IN THE MANNER SPECIFIED IN THE ORIGINAL DRAWING. ANY REPRODUCTION OR TRANSMISSION OF THIS DESIGN IN ANY FORM OR BY ANY MEANS, WITHOUT THE WRITTEN PERMISSION OF LEICROY CORPORATION IS PROHIBITED.

LeCroy CORPORATION
 MODEL : 9300-S
 GENERIC FRONT PANEL
 DRAWING NO: 2272-51
 SH. 1 OF 1 ECO : 7272

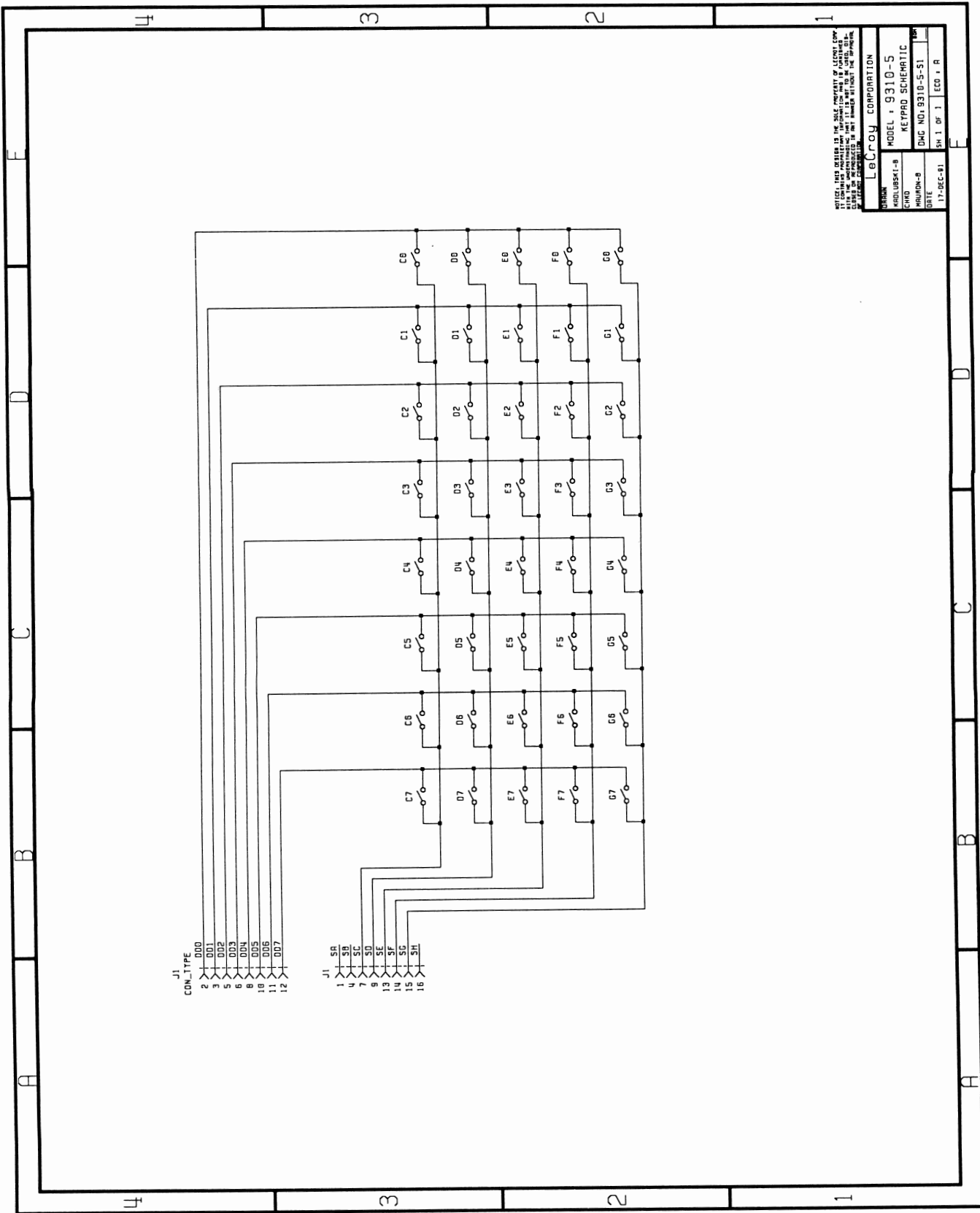

NOTICE: THIS DRAWING IS THE SOLE PROPERTY OF LEICROY CORPORATION. IT CONTAINS PROPRIETARY INFORMATION AND IS NOT TO BE REPRODUCED OR TRANSMITTED IN ANY FORM OR BY ANY MEANS, ELECTRONIC OR MECHANICAL, INCLUDING PHOTOCOPYING, RECORDING, OR BY ANY INFORMATION STORAGE AND RETRIEVAL SYSTEM. FOR FURTHER INFORMATION, CONTACT THE DRAWING ENGINEER.

LeCroy CORPORATION
 MODEL 9310-5
 KEYBOARD SCHEMATIC
 DMC NO. 9310-5-S1
 SH 1 OF 1 ECO R

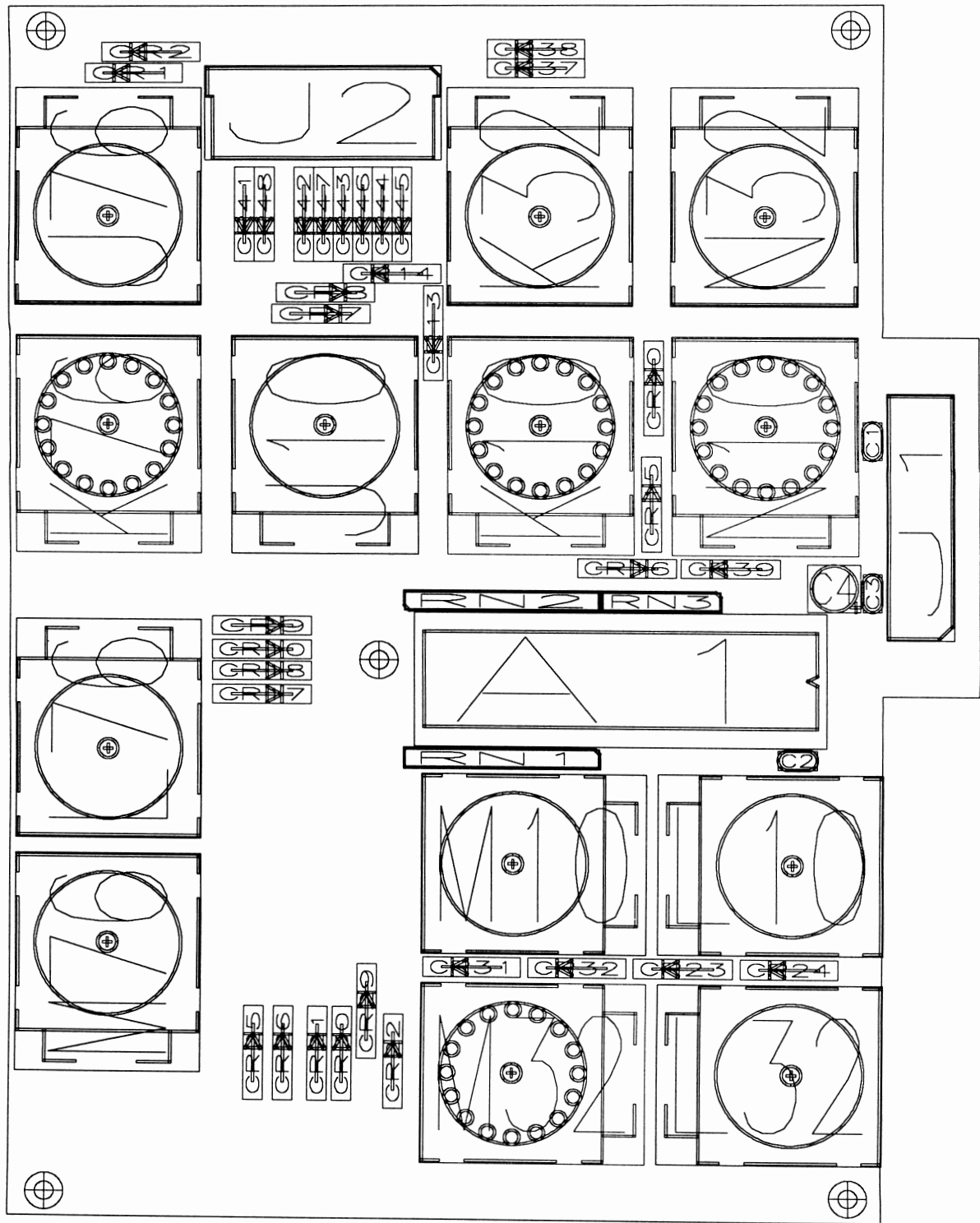

931x-5 REV. A

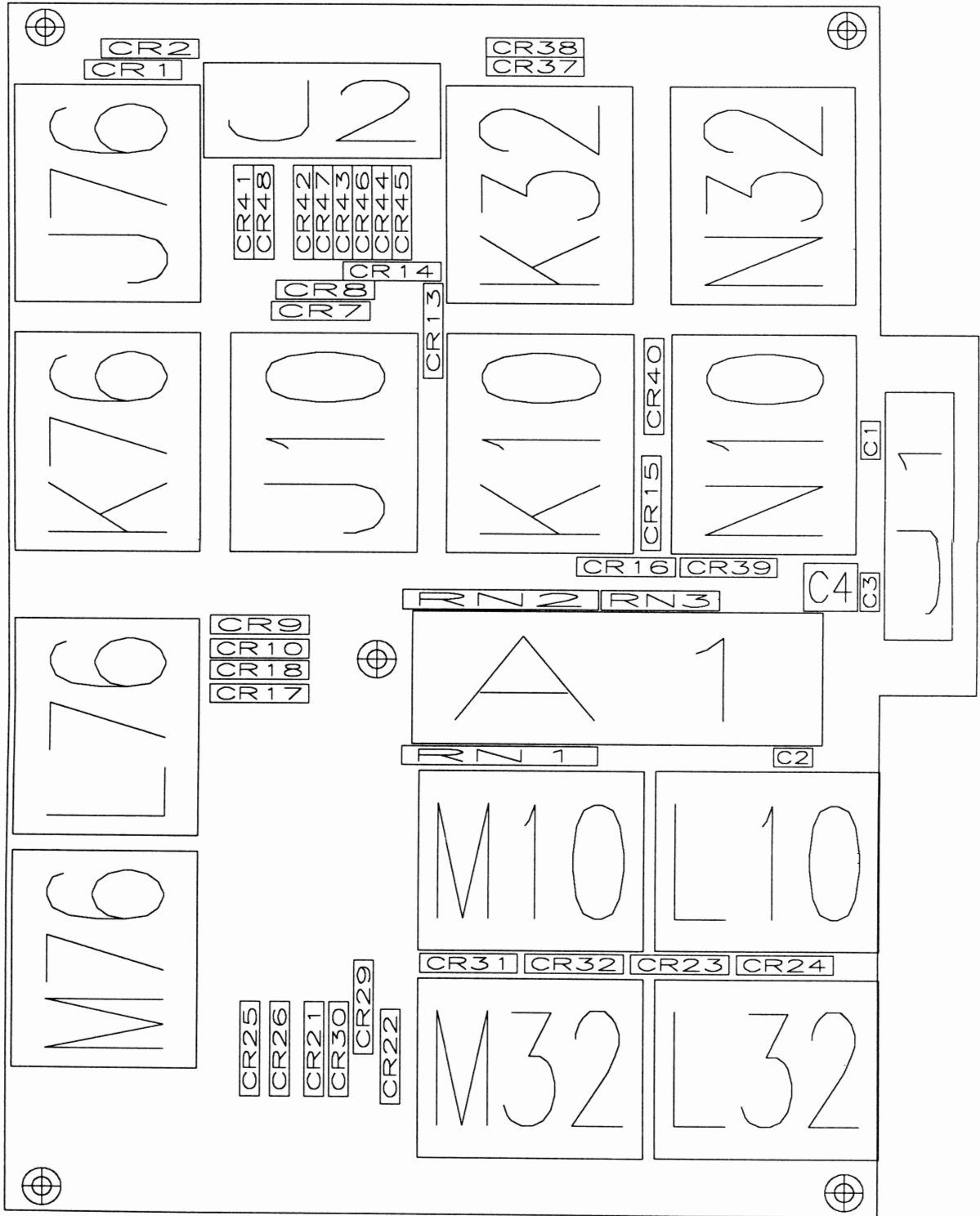

931x-5 REV.A

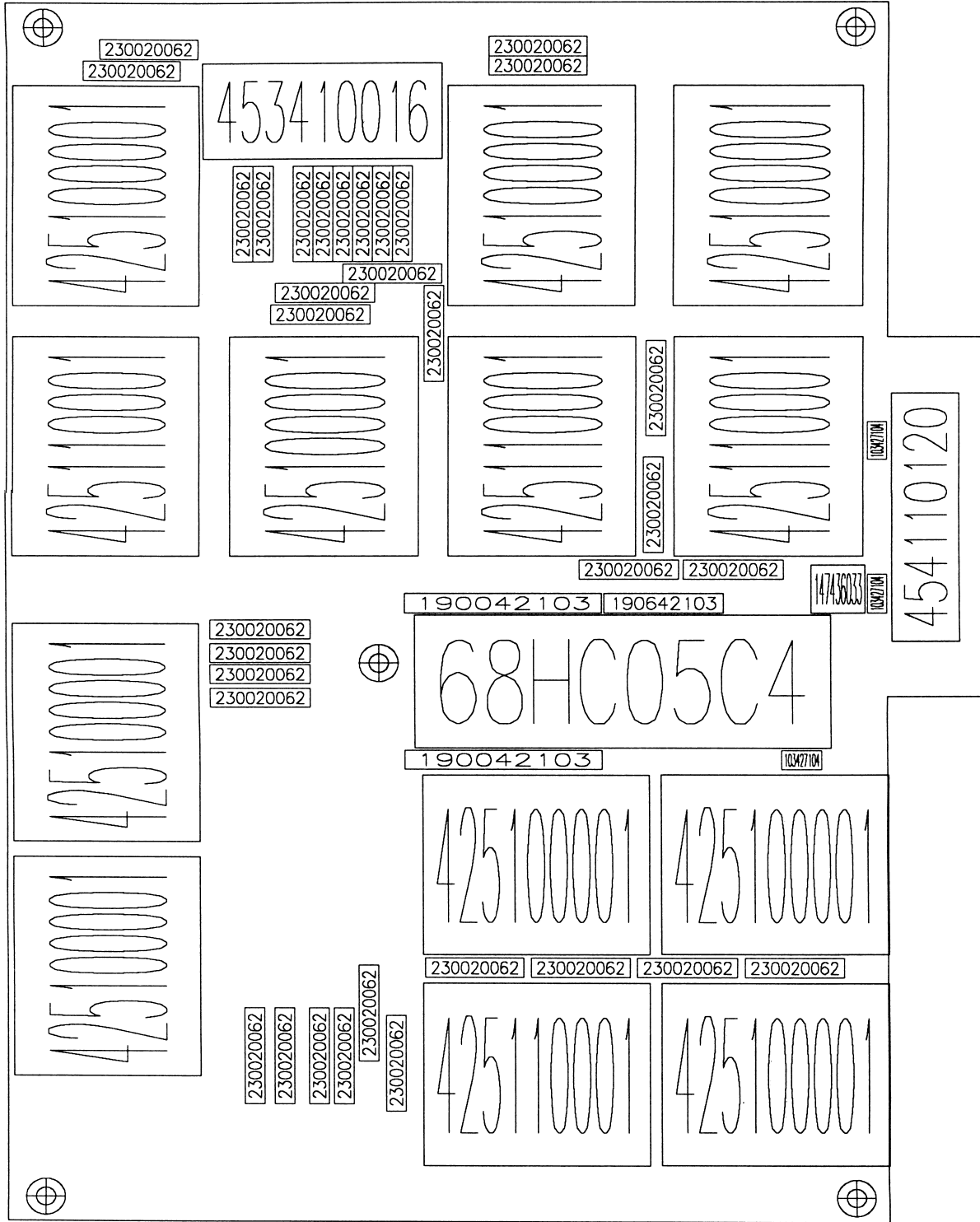

931x-5 REV.A

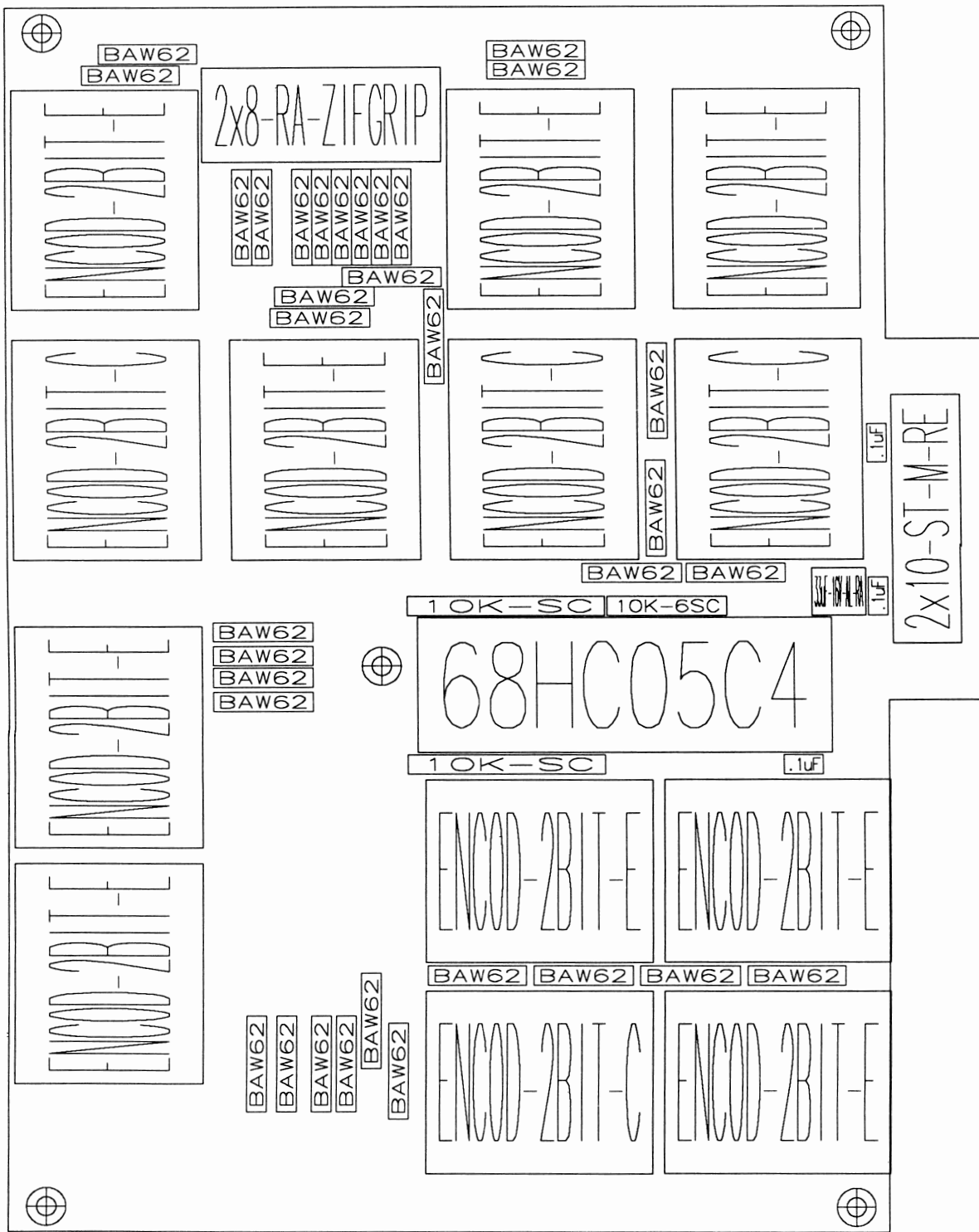

931x-5 REV. A

CR1	230020062	BAW62	DO35
CR2	230020062	BAW62	DO35
CR7	230020062	BAW62	DO35
CR8	230020062	BAW62	DO35
CR9	230020062	BAW62	DO35
CR10	230020062	BAW62	DO35
CR13	230020062	BAW62	DO35
CR14	230020062	BAW62	DO35
CR15	230020062	BAW62	DO35
CR16	230020062	BAW62	DO35
CR17	230020062	BAW62	DO35
CR18	230020062	BAW62	DO35
CR21	230020062	BAW62	DO35
CR22	230020062	BAW62	DO35
CR23	230020062	BAW62	DO35
CR24	230020062	BAW62	DO35
CR25	230020062	BAW62	DO35
CR26	230020062	BAW62	DO35
CR29	230020062	BAW62	DO35
CR30	230020062	BAW62	DO35
CR31	230020062	BAW62	DO35
CR32	230020062	BAW62	DO35
CR37	230020062	BAW62	DO35
CR38	230020062	BAW62	DO35
CR39	230020062	BAW62	DO35
CR40	230020062	BAW62	DO35
CR41	230020062	BAW62	DO35
CR42	230020062	BAW62	DO35
CR43	230020062	BAW62	DO35
CR44	230020062	BAW62	DO35
CR45	230020062	BAW62	DO35
CR46	230020062	BAW62	DO35
CR47	230020062	BAW62	DO35
CR48	230020062	BAW62	DO35
RN3	190642103	10K-6SC	SIP6RES
RN1	190042103	10K-SC	SIP10RES
RN2	190042103	10K-SC	SIP10RES
K10	425110001	ENCOD-2BIT-C	ENCOD_2BIT_C
K76	425110001	ENCOD-2BIT-C	ENCOD_2BIT_C
M32	425110001	ENCOD-2BIT-C	ENCOD_2BIT_C
N10	425110001	ENCOD-2BIT-C	ENCOD_2BIT_C
J10	425100001	ENCOD-2BIT-E	ENCOD_2BIT_E
J76	425100001	ENCOD-2BIT-E	ENCOD_2BIT_E
K32	425100001	ENCOD-2BIT-E	ENCOD_2BIT_E
L10	425100001	ENCOD-2BIT-E	ENCOD_2BIT_E
L32	425100001	ENCOD-2BIT-E	ENCOD_2BIT_E
L76	425100001	ENCOD-2BIT-E	ENCOD_2BIT_E
M10	425100001	ENCOD-2BIT-E	ENCOD_2BIT_E
M76	425100001	ENCOD-2BIT-E	ENCOD_2BIT_E
N32	425100001	ENCOD-2BIT-E	ENCOD_2BIT_E
C4	147436033	33uF-16V-AL-RA	TCAP
C1	103427104	.1uF	SMONOBP
C2	103427104	.1uF	SMONOBP
C3	103427104	.1uF	SMONOBP
A1	68HC05C4	68HC05C4	DIP40
J1	454110120	2x10-ST-M-RE	CONN2X10_ST M RE
J2	453410016	2x8-RA-ZIFGRIP	CONN2X8_RA_ZIFGRIP

PART: F9320-5**DESC: DUAL CHANNEL FRONT PANEL**

COMPONENT -----	PART DESCRIPTION -----	QTY PER ASSEMBLY -----
103427104	CAP CERA MONO 100V .1 UF	3
147436033	CAP ALUM METAL CAN 33 UF	1
190042103	RESISTOR NETWORK 10 K	2
190642103	RESISTOR NETWORK 10 K	1
230020062	DIODE SWITCHING BAW62	34
425100001	ENCODER DIGITAL 24 POS	9
425110001	ENCODER DIGITAL 24 POS	4
453410016	CONN FLEX CIRCUIT 16-POS	1
454110120	HDR SLD TAIL/MALE/20/STRAIGHT	1
554435004	SCREW PT PHIL KA35X10	1
7093XX511	KNOB 10MM DIAMETRE	8
7093XX521	KNOB 14MM DIAMETRE	5
719300503	PC BD PREASS'Y 9300-5	1
729320503	FP KEY BOARD ASS'Y 9320-5	1
MFP414	IC FRT PANEL PROCESSOR MFP414	1

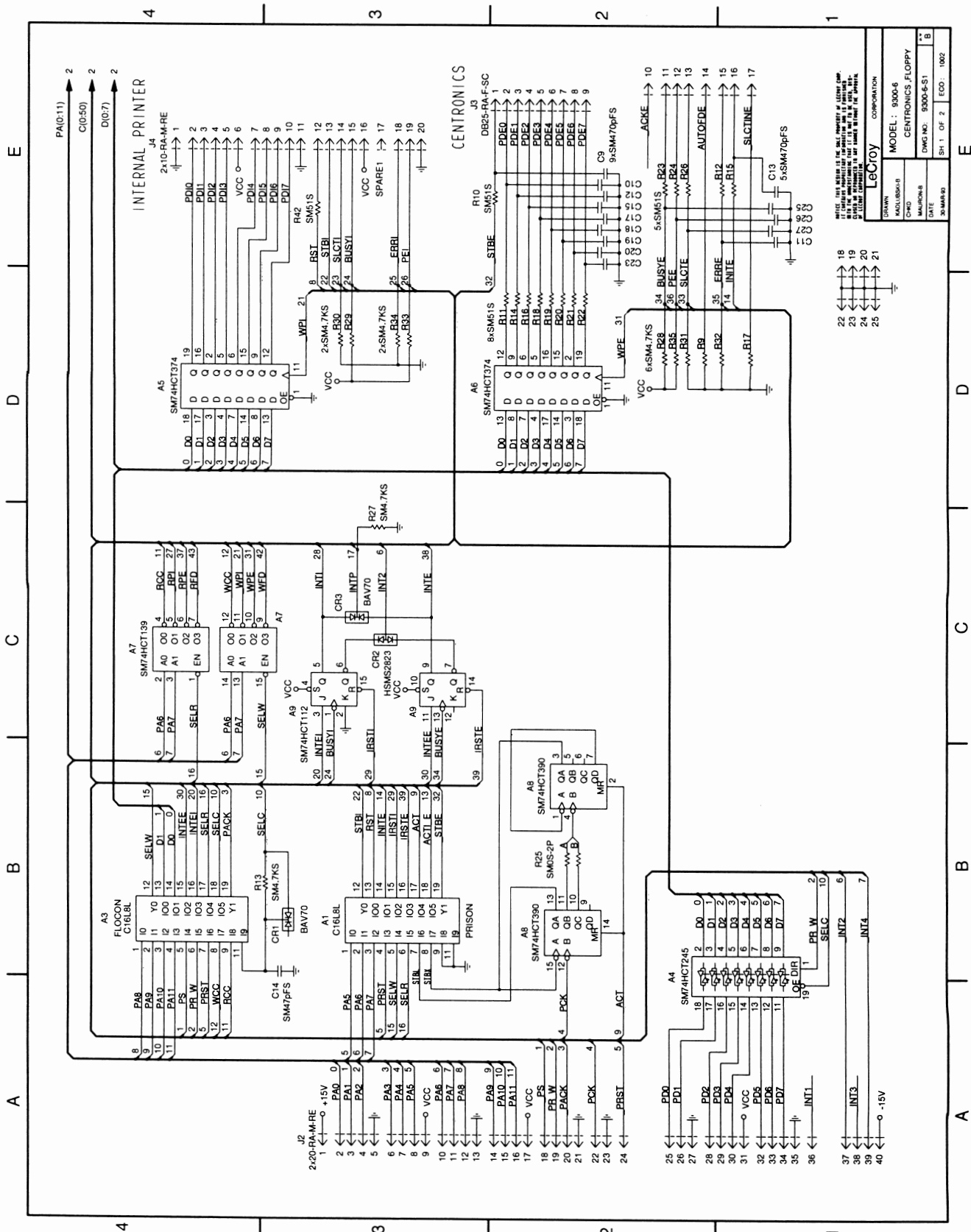

DATE	30-MAR-93
DRAWN	MAJUL/RSK/AR
CHECK	MAJUL/RSK/AR
DATE	30-MAR-93
DRWG NO.	9300-6-S1
MODEL :	9300-6
COMPANION	CENTRONICS_FLOPPY
SH 1	OF 2
ECO :	1002

22	←	18
23	←	19
24	←	20
25	←	21

NOTICE: THIS DRAWING IS THE SOLE PROPERTY OF LECTROY CORP. NO PART OF THIS DRAWING IS TO BE REPRODUCED OR TRANSMITTED IN ANY FORM OR BY ANY MEANS, ELECTRONIC OR MECHANICAL, INCLUDING PHOTOCOPYING, RECORDING, OR BY ANY INFORMATION STORAGE AND RETRIEVAL SYSTEM, WITHOUT THE WRITTEN PERMISSION OF LECTROY CORPORATION.

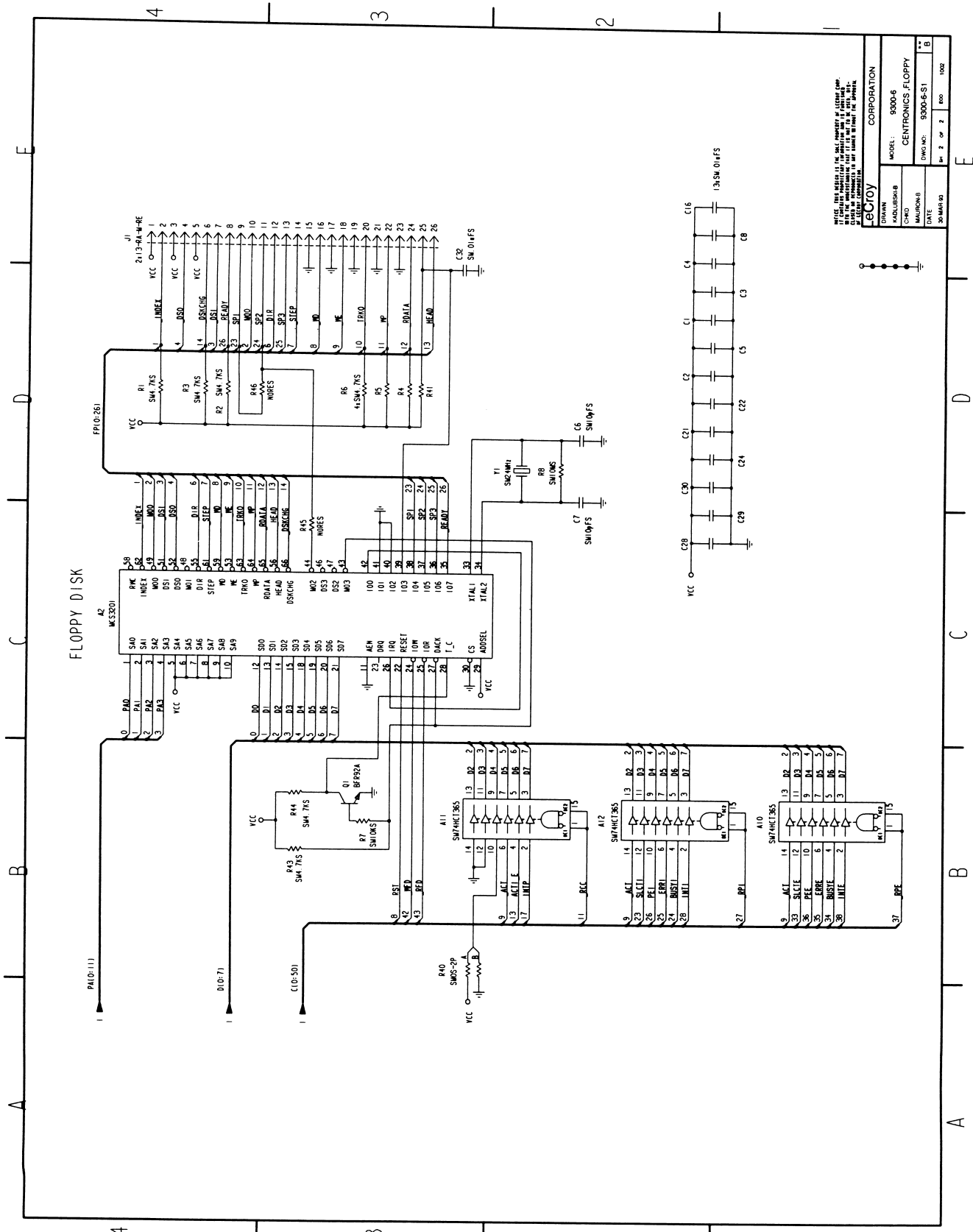

DRAWN		CORPORATION	
MODEL: 9300-6		CENTRONICS FLOPPY	
MODULE: 9300-6-S1		DWG NO: 9300-6-S1	
DATE: 10/22/80		REV: 1002	
BY: 2		OF: 2	

IF YOU ARE HAVING PROBLEMS WITH THIS PRODUCT, PLEASE CONTACT THE MANUFACTURER'S SERVICE DEPARTMENT FOR ASSISTANCE. THE MANUFACTURER'S SERVICE DEPARTMENT IS LOCATED AT 1000 W. 10TH ST., DENVER, CO 80202.

Section 8 Schematics, Layouts , Parts list

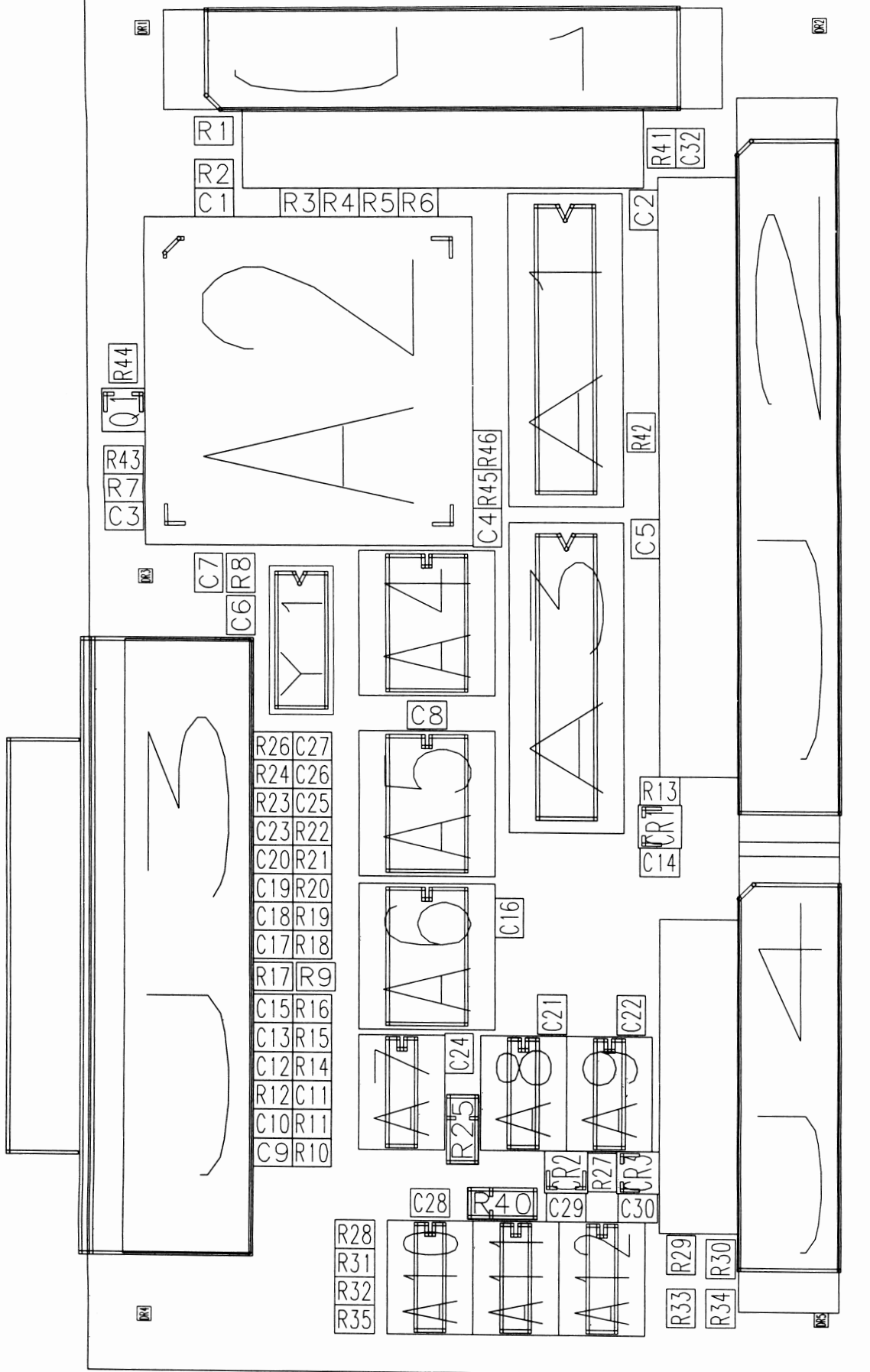

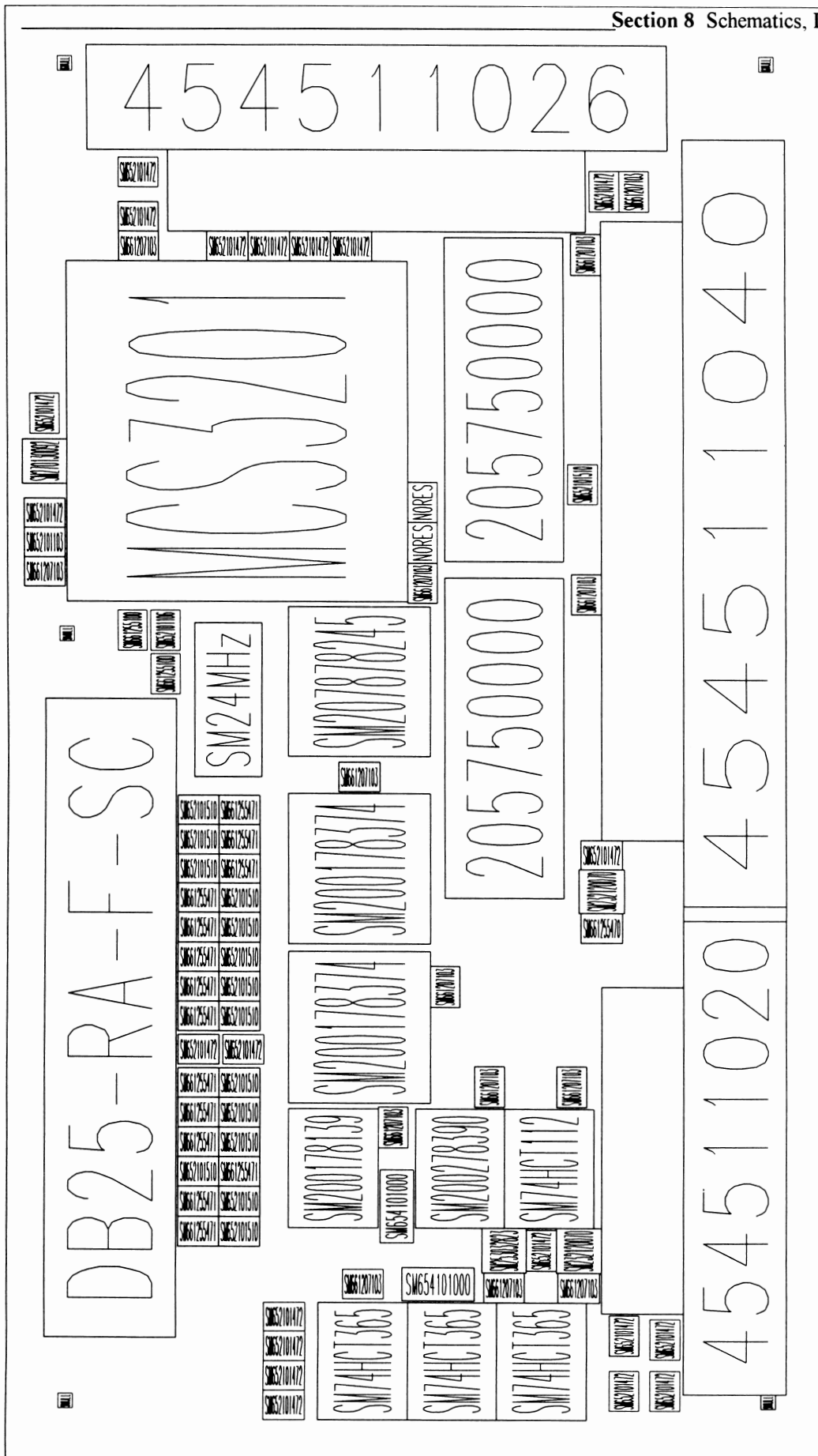

Section 8 Schematics, Layouts, Parts list

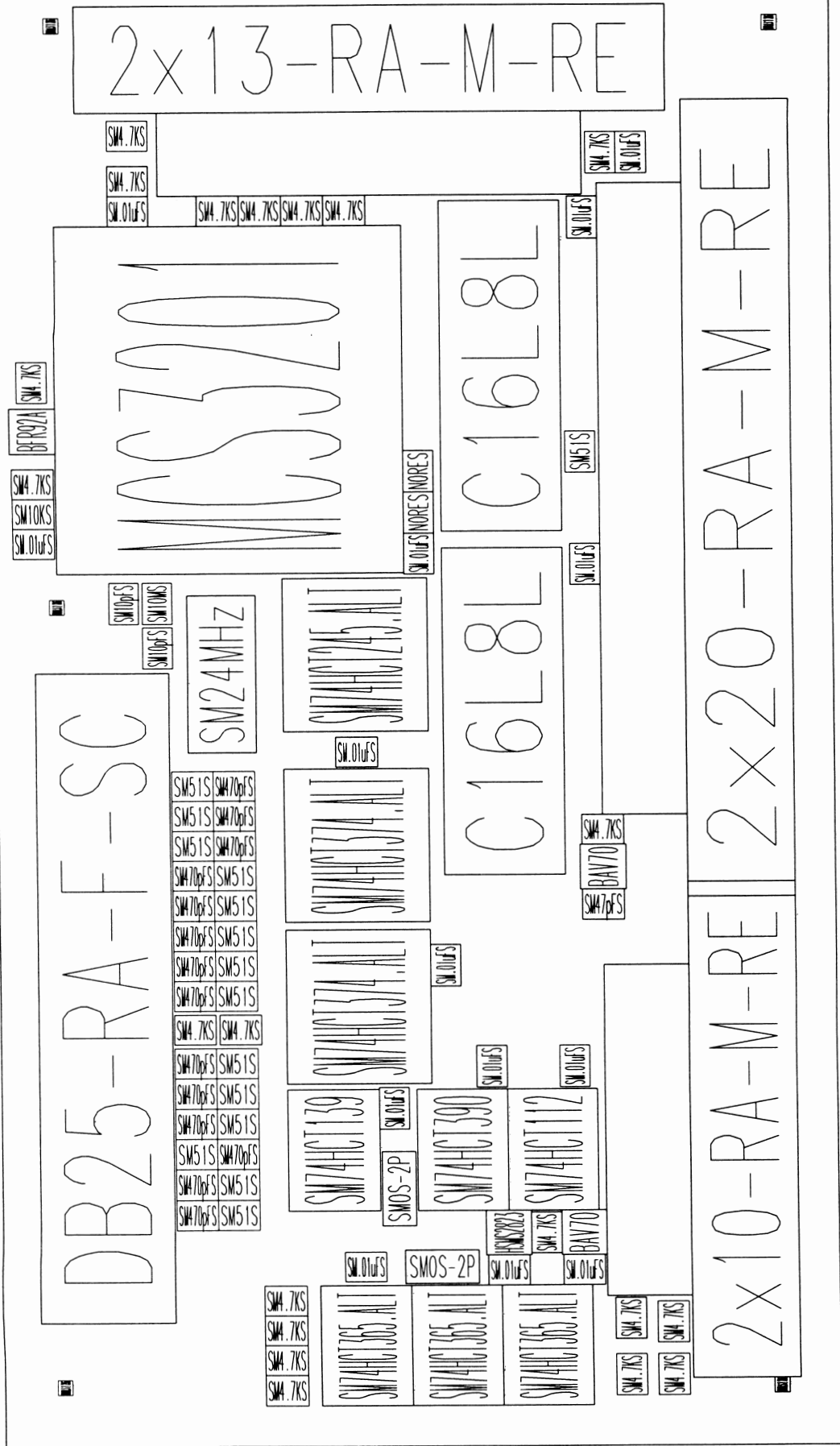

A1	205750000	C16L8L	DIP20
A2	SM227063201	MCS3201	PLCC_68
A3	205750000	C16L8L	DIP20
A4	SM207878245	SM74HCT245	SOIC_20
A5	SM200178374	SM74HCT374	SOIC_20
A6	SM200178374	SM74HCT374	SOIC_20
A7	SM200178139	SM74HCT139	SOIC_16
A8	SM200278390	SM74HCT390	SOIC_16
A9	SM201170112	SM74HCT112	SOIC_16
A10	SM207170036	SM74HCT365	SOIC_16
A11	SM207170036	SM74HCT365	SOIC_16
A12	SM207170036	SM74HCT365	SOIC_16
C1	SM661207103	SM.01uFS	SM0805
C2	SM661207103	SM.01uFS	SM0805
C3	SM661207103	SM.01uFS	SM0805
C4	SM661207103	SM.01uFS	SM0805
C5	SM661207103	SM.01uFS	SM0805
C6	SM661255100	SM10pFS	SM0805
C7	SM661255100	SM10pFS	SM0805
C8	SM661207103	SM.01uFS	SM0805
C9	SM661255471	SM470pFS	SM0805
C10	SM661255471	SM470pFS	SM0805
C11	SM661255471	SM470pFS	SM0805
C12	SM661255471	SM470pFS	SM0805
C13	SM661255471	SM470pFS	SM0805
C14	SM661255470	SM47pFS	SM0805
C15	SM661255471	SM470pFS	SM0805
C16	SM661207103	SM.01uFS	SM0805
C17	SM661255471	SM470pFS	SM0805
C18	SM661255471	SM470pFS	SM0805
C19	SM661255471	SM470pFS	SM0805
C20	SM661255471	SM470pFS	SM0805
C21	SM661207103	SM.01uFS	SM0805
C22	SM661207103	SM.01uFS	SM0805
C23	SM661255471	SM470pFS	SM0805
C24	SM661207103	SM.01uFS	SM0805
C25	SM661255471	SM470pFS	SM0805
C26	SM661255471	SM470pFS	SM0805
C27	SM661255471	SM470pFS	SM0805
C28	SM661207103	SM.01uFS	SM0805
C29	SM661207103	SM.01uFS	SM0805
C30	SM661207103	SM.01uFS	SM0805
C32	SM661207103	SM.01uFS	SM0805
CR1	SM232120070	BAV70	SOT23
CR2	SM253032823	HSMS2823	SOT23
CR3	SM232120070	BAV70	SOT23
J1	454511026	2x13-RA-M-RE	CONN2X13_RA_M_RE
J2	454511040	2x20-RA-M-RE	CONN2X20_RA_M_RE
J3	454520025	DB25-RA-F-SC	DB25_RA_F_SC
J4	454511020	2x10-RA-M-RE	CONN2X10_RA_M_RE
Q1	SM270130092	BFR92A	SOT23
R1	SM652101472	SM4.7KS	SM0805
R2	SM652101472	SM4.7KS	SM0805
R3	SM652101472	SM4.7KS	SM0805
R4	SM652101472	SM4.7KS	SM0805
R5	SM652101472	SM4.7KS	SM0805
R6	SM652101472	SM4.7KS	SM0805
R7	SM652101103	SM10KS	SM0805
R8	SM652101106	SM10MS	SM0805
R9	SM652101472	SM4.7KS	SM0805
R10	SM652101510	SM51S	SM0805
R11	SM652101510	SM51S	SM0805
R12	SM652101510	SM51S	SM0805
R13	SM652101472	SM4.7KS	SM0805

R14	SM652101510	SM51S	SM0805
R15	SM652101510	SM51S	SM0805
R16	SM652101510	SM51S	SM0805
R17	SM652101472	SM4.7KS	SM0805
R18	SM652101510	SM51S	SM0805
R19	SM652101510	SM51S	SM0805
R20	SM652101510	SM51S	SM0805
R21	SM652101510	SM51S	SM0805
R22	SM652101510	SM51S	SM0805
R23	SM652101510	SM51S	SM0805
R24	SM652101510	SM51S	SM0805
R25	SM654101000	SM0S-2P	SM0805_2P
R26	SM652101510	SM51S	SM0805
R27	SM652101472	SM4.7KS	SM0805
R28	SM652101472	SM4.7KS	SM0805
R29	SM652101472	SM4.7KS	SM0805
R30	SM652101472	SM4.7KS	SM0805
R31	SM652101472	SM4.7KS	SM0805
R32	SM652101472	SM4.7KS	SM0805
R33	SM652101472	SM4.7KS	SM0805
R34	SM652101472	SM4.7KS	SM0805
R35	SM652101472	SM4.7KS	SM0805
R40	SM654101000	SM0S-2P	SM0805_2P
R41	SM652101472	SM4.7KS	SM0805
R42	SM652101510	SM51S	SM0805
R43	SM652101472	SM4.7KS	SM0805
R44	SM652101472	SM4.7KS	SM0805
Y1	SM310900024	SM24MHZ	FPX_SM

PART: F9300-6

DESC: CENTRONICS/FLOPPY/PRINTER INTERFACE

COMPONENT -----	PART DESCRIPTION -----	QTY PER ASSEMBLY -----
205750000	IC AND-OR GATE ARRAY 16V8	2
454511020	HDR SOLD TAIL/MALE 20	1
454511026	HDR SOLD TAIL/MALE 26	1
454511040	HDR SOLD TAIL/MALE/40/RT	1
454520025	CONN RT ANGLE FEM 25 S-CLIP	1
455980002	MOUNTING HDW FOR CONN SHELL	2
550430106	SCREW CYL HD PHIL M3X6	4
551430400	WASHER SHAKEPROOF M3	4
709300611	CENTR. FLOPPY INTERF. BRACKET B	1
709300621	LABEL PARA-INTERF. CENTRONICS A	1
719300603	PC BD PREASS'Y 9300-6 C	1
SM200178139	IC 2-TO-4-LINE DEC HCT139	1
SM200178374	IC D-TYP FLOP 74HCT374	2
SM200278390	IC 4-BIT RIPPLE COUNTER	1
SM201170112	IC DUAL JK FF WITH SET-RESET	1
SM207170036	IC HEX BUFFER 3-STATE	3
SM207878245	IC BUS TRANSCVR HCT 245	1
SM227063201	IC IBM PC FLOPPY DISK CONTR.	1
SM232120070	DIODE ARRAY BAV70	1
SM253032823	DIODE SCHOTTKY 2823	1
SM270130092	TRANSISTOR NPN BFR92A	1
SM310900024	CRYSTAL 24 MHZ SMD	1
SM652101103	RES CHIP (E24) 1% 10 K	1
SM652101106	RES CHIP (E24) 1% 10 MEG	1
SM652101472	RES CHIP (E24) 1% 4.7 K	21
SM652101510	RES CHIP (E24) 1% 51 OHMS	15
SM654101000	CHIP JUMPER ZERO OHMS	2
SM661207103	CAP CERA CHIP 20% .01UF	14
SM661255100	CAP CERA CHIP 10PF	2
SM661255470	CAP CERA CHIP 47PF	1
SM661255471	CAP CERA CHIP 5% 470 PF	14

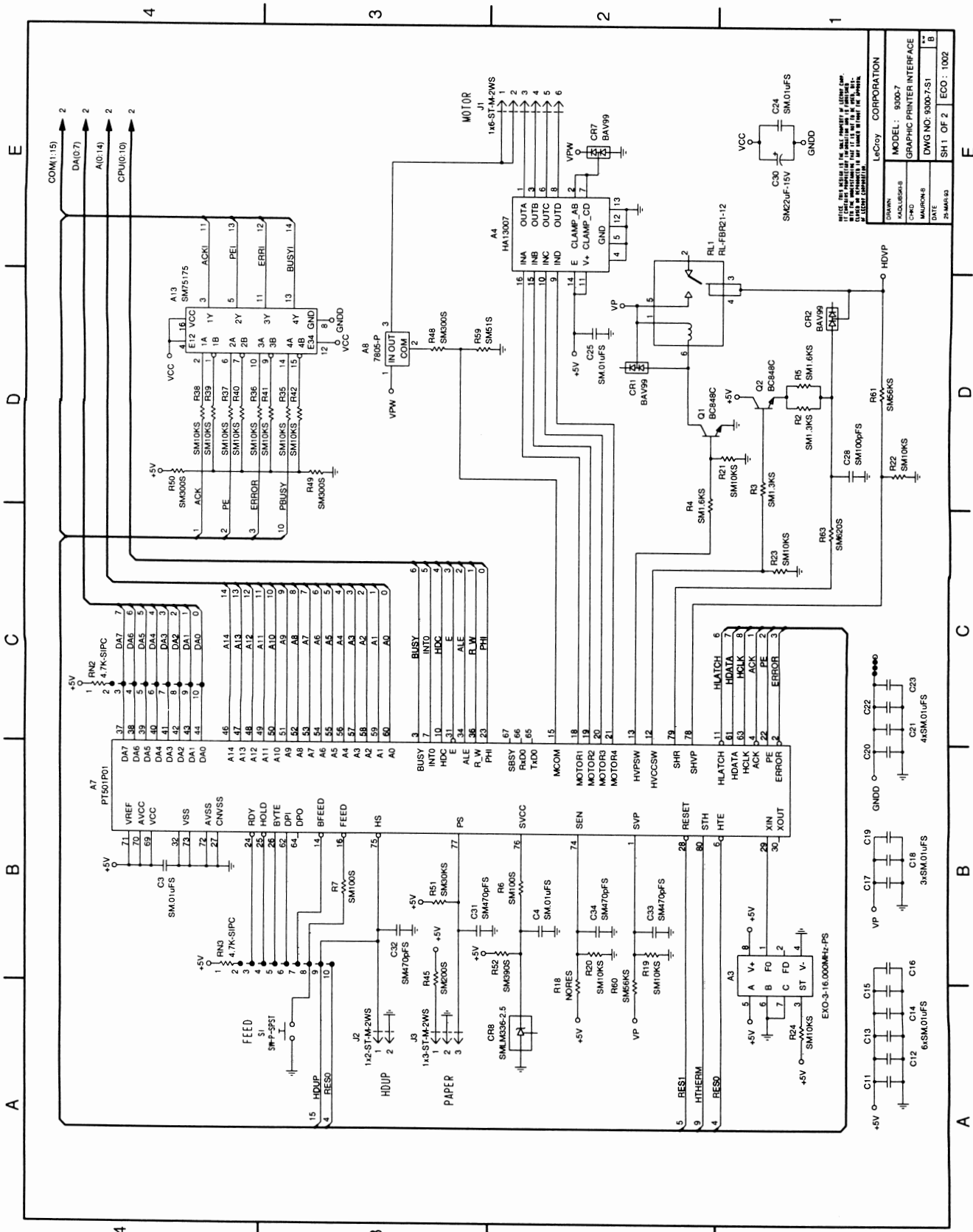

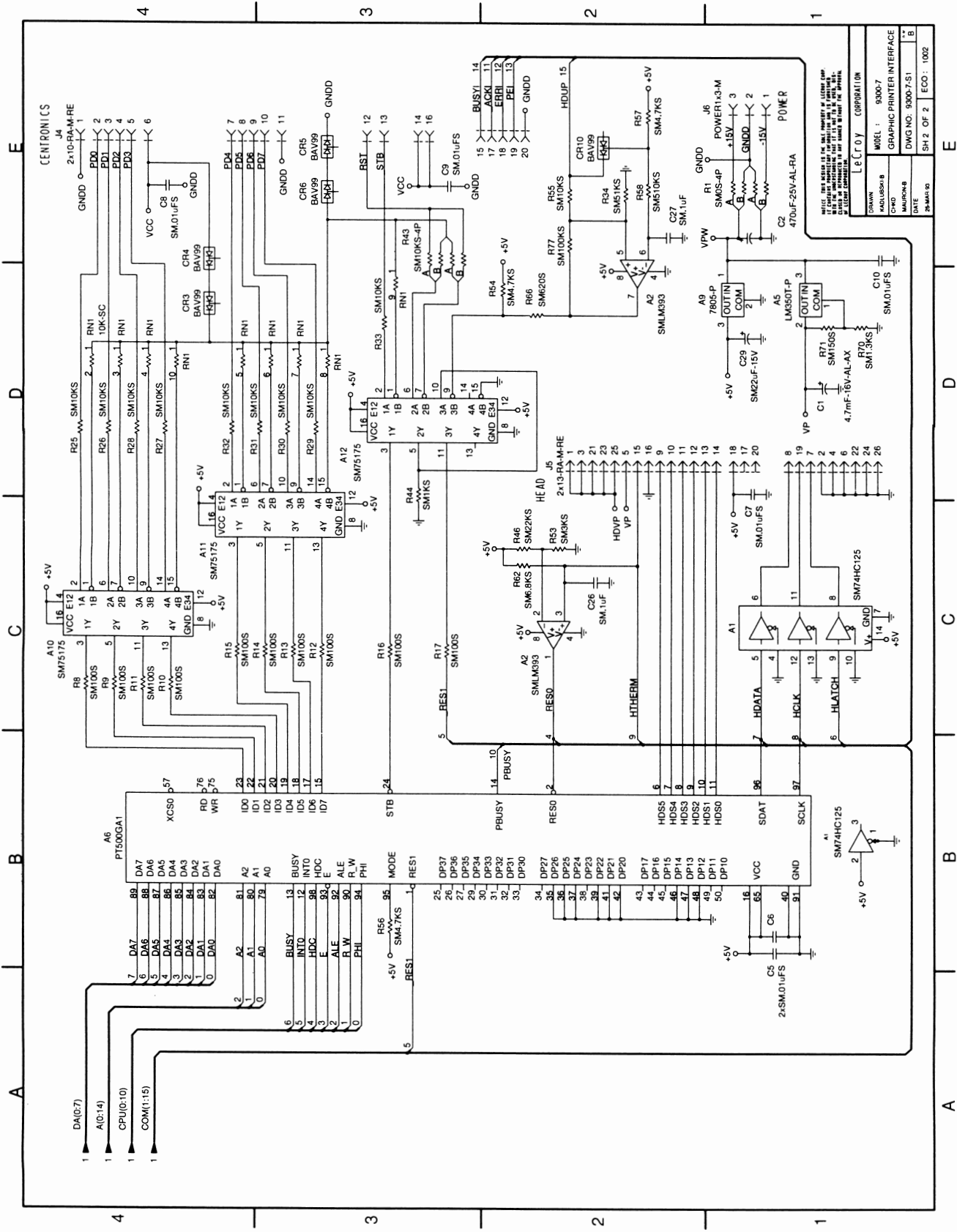

CENTRONICS
2x10-RA-MRE
PDD1, PDD2, PDD3, PDD4, PDD5, PDD6, PDD7, PDD8, PDD9, PDD10, PDD11, PDD12, PDD13, PDD14, PDD15, PDD16, PDD17, PDD18, PDD19, PDD20

POWER
R1 SM05-4P, R2 POWER13-M, R3 +15V, R4 GND, R5 -15V, R6 GND

LM350T-P
A9 OUTIN, A10 COM, A11 OUTIN, A12 COM, A13 COM, A14 COM, A15 COM

RESISTORS
R1-R10, R25-R43

CAPACITORS
C1-C5

DIODES
D1-D3

ICs
PT500CA1, SMLM933, SMLM932, SMT74HC125

Legend:
R1 R0007
R2 R0008
R3 R0009
R4 R0010
R5 R0011
R6 R0012
R7 R0013
R8 R0014
R9 R0015
R10 R0016
R11 R0017
R12 R0018
R13 R0019
R14 R0020
R15 R0021
R16 R0022
R17 R0023
R18 R0024
R19 R0025
R20 R0026
R21 R0027
R22 R0028
R23 R0029
R24 R0030
R25 R0031
R26 R0032
R27 R0033
R28 R0034
R29 R0035
R30 R0036
R31 R0037
R32 R0038
R33 R0039
R34 R0040
R35 R0041
R36 R0042
R37 R0043
R38 R0044
R39 R0045
R40 R0046
R41 R0047
R42 R0048
R43 R0049

Legend:
C1 C0001
C2 C0002
C3 C0003
C4 C0004
C5 C0005

Legend:
D1 D0001
D2 D0002
D3 D0003

Legend:
R1 R0007
R2 R0008
R3 R0009
R4 R0010
R5 R0011
R6 R0012
R7 R0013
R8 R0014
R9 R0015
R10 R0016
R11 R0017
R12 R0018
R13 R0019
R14 R0020
R15 R0021
R16 R0022
R17 R0023
R18 R0024
R19 R0025
R20 R0026
R21 R0027
R22 R0028
R23 R0029
R24 R0030
R25 R0031
R26 R0032
R27 R0033
R28 R0034
R29 R0035
R30 R0036
R31 R0037
R32 R0038
R33 R0039
R34 R0040
R35 R0041
R36 R0042
R37 R0043
R38 R0044
R39 R0045
R40 R0046
R41 R0047
R42 R0048
R43 R0049

Legend:
C1 C0001
C2 C0002
C3 C0003
C4 C0004
C5 C0005

Legend:
D1 D0001
D2 D0002
D3 D0003

Legend:
R1 R0007
R2 R0008
R3 R0009
R4 R0010
R5 R0011
R6 R0012
R7 R0013
R8 R0014
R9 R0015
R10 R0016
R11 R0017
R12 R0018
R13 R0019
R14 R0020
R15 R0021
R16 R0022
R17 R0023
R18 R0024
R19 R0025
R20 R0026
R21 R0027
R22 R0028
R23 R0029
R24 R0030
R25 R0031
R26 R0032
R27 R0033
R28 R0034
R29 R0035
R30 R0036
R31 R0037
R32 R0038
R33 R0039
R34 R0040
R35 R0041
R36 R0042
R37 R0043
R38 R0044
R39 R0045
R40 R0046
R41 R0047
R42 R0048
R43 R0049

Legend:
C1 C0001
C2 C0002
C3 C0003
C4 C0004
C5 C0005

Legend:
D1 D0001
D2 D0002
D3 D0003

Legend:
R1 R0007
R2 R0008
R3 R0009
R4 R0010
R5 R0011
R6 R0012
R7 R0013
R8 R0014
R9 R0015
R10 R0016
R11 R0017
R12 R0018
R13 R0019
R14 R0020
R15 R0021
R16 R0022
R17 R0023
R18 R0024
R19 R0025
R20 R0026
R21 R0027
R22 R0028
R23 R0029
R24 R0030
R25 R0031
R26 R0032
R27 R0033
R28 R0034
R29 R0035
R30 R0036
R31 R0037
R32 R0038
R33 R0039
R34 R0040
R35 R0041
R36 R0042
R37 R0043
R38 R0044
R39 R0045
R40 R0046
R41 R0047
R42 R0048
R43 R0049

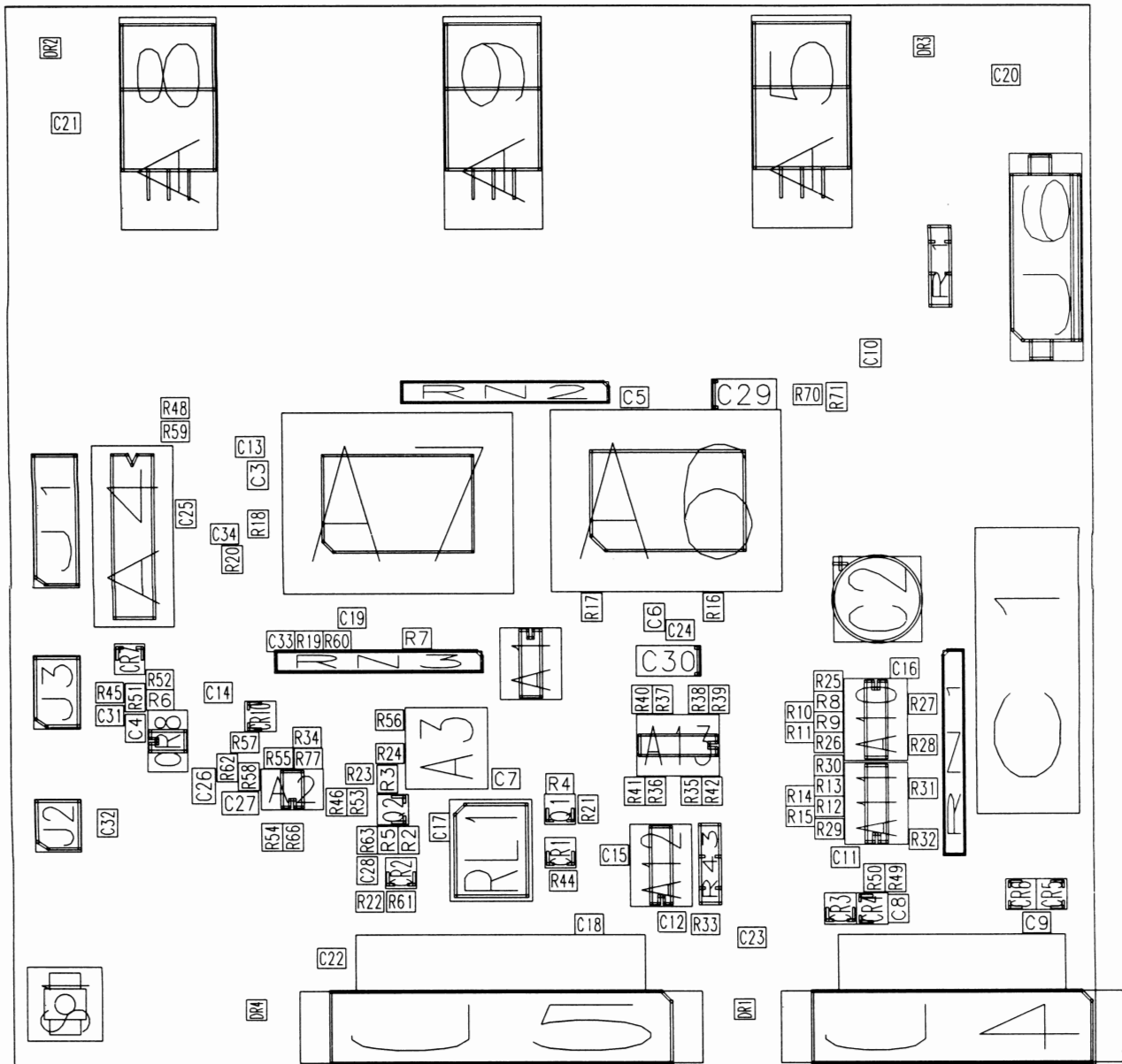

9300-7 Rev:C

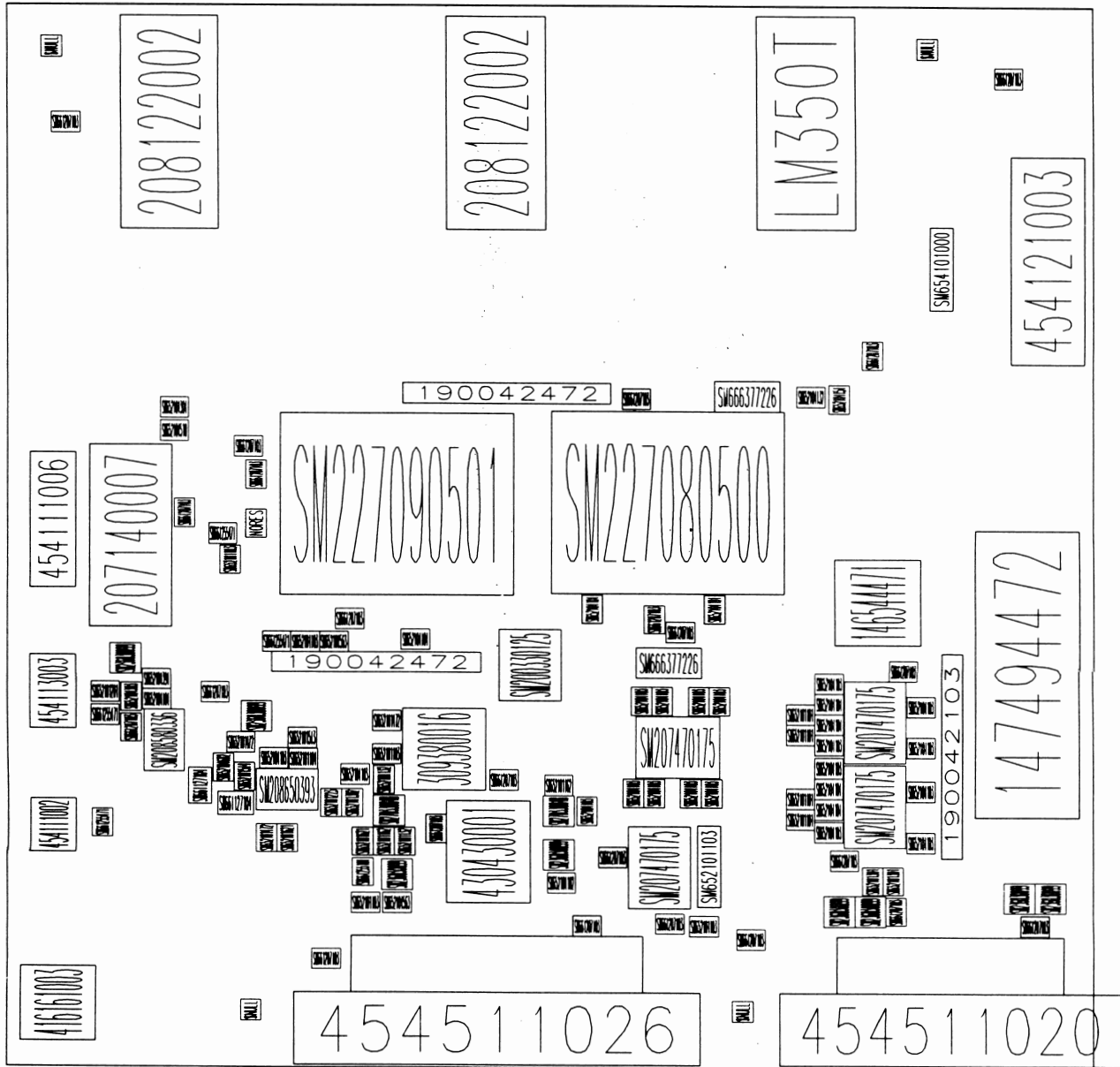

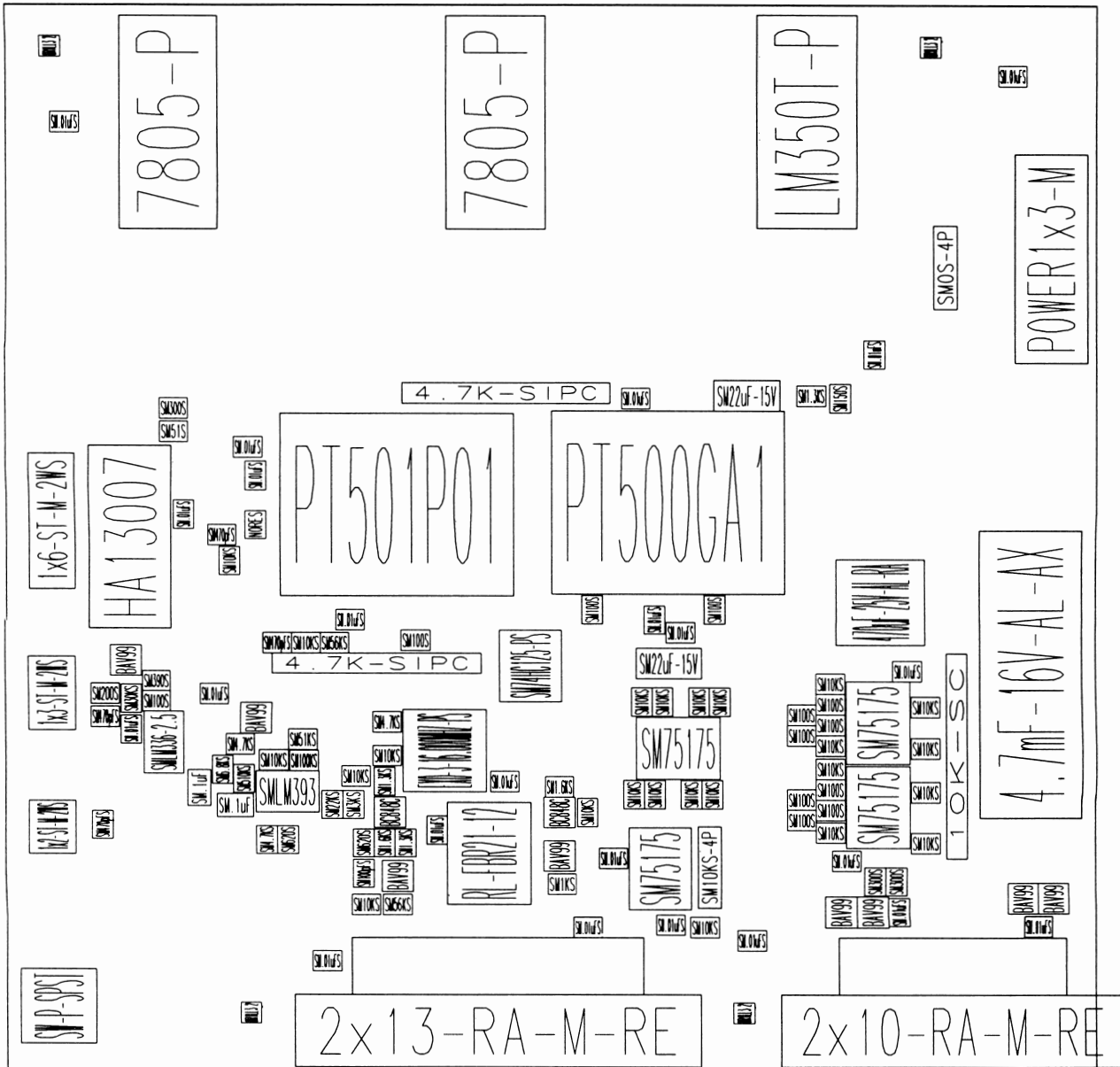

A1	SM200330125	SM74HC125-PS	SOIC_14
A2	SM208650393	SMLM393	SOIC_8
A3	309380016	EXO-3-16.000MHZ-PS	DIP8
A4	207140007	HA13007	DIP16
A5	208590350	LM350T-P	TO220_PLATED
A6	SM227080500	PT500GA1	PQFP_100
A7	SM227090501	PT501P01	PQFP_80
A8	208122002	7805-P	TO220_PLATED
A9	208122002	7805-P	TO220_PLATED
A10	SM207470175	SM75175	SOIC_16
A11	SM207470175	SM75175	SOIC_16
A12	SM207470175	SM75175	SOIC_16
A13	SM207470175	SM75175	SOIC_16
C1	147494472	4.7mF-16V-AL-AX	A_P1377_L1200X610
C2	146544471	470uF-25V-AL-RA	R_P200_D420POL
C3	SM661207103	SM.01uFS	SM0805
C4	SM661207103	SM.01uFS	SM0805
C5	SM661207103	SM.01uFS	SM0805
C6	SM661207103	SM.01uFS	SM0805
C7	SM661207103	SM.01uFS	SM0805
C8	SM661207103	SM.01uFS	SM0805
C9	SM661207103	SM.01uFS	SM0805
C10	SM661207103	SM.01uFS	SM0805
C11	SM661207103	SM.01uFS	SM0805
C12	SM661207103	SM.01uFS	SM0805
C13	SM661207103	SM.01uFS	SM0805
C14	SM661207103	SM.01uFS	SM0805
C15	SM661207103	SM.01uFS	SM0805
C16	SM661207103	SM.01uFS	SM0805
C17	SM661207103	SM.01uFS	SM0805
C18	SM661207103	SM.01uFS	SM0805
C19	SM661207103	SM.01uFS	SM0805
C20	SM661207103	SM.01uFS	SM0805
C21	SM661207103	SM.01uFS	SM0805
C22	SM661207103	SM.01uFS	SM0805
C23	SM661207103	SM.01uFS	SM0805
C24	SM661207103	SM.01uFS	SM0805
C25	SM661207103	SM.01uFS	SM0805
C26	SM661127104	SM.1uF	SM1206
C27	SM661127104	SM.1uF	SM1206
C28	SM661255101	SM100pFS	SM0805
C29	SM666377226	SM22uF-15V	SMCAPETD5
C30	SM666377226	SM22uF-15V	SMCAPETD5
C31	SM661255471	SM470pFS	SM0805
C32	SM661255471	SM470pFS	SM0805
C33	SM661255471	SM470pFS	SM0805
C34	SM661255471	SM470pFS	SM0805
CR1	SM236030099	BAV99	SOT23
CR2	SM236030099	BAV99	SOT23
CR3	SM236030099	BAV99	SOT23
CR4	SM236030099	BAV99	SOT23
CR5	SM236030099	BAV99	SOT23
CR6	SM236030099	BAV99	SOT23
CR7	SM236030099	BAV99	SOT23
CR8	SM208580336	SMLM336-2.5	SOIC_8
CR10	SM236030099	BAV99	SOT23
J1	454111006	1x6-ST-M-2WS	CONN1X6_ST_M_2WS
J2	454111002	1x2-ST-M-2WS	CONN1X2_ST_M_2WS
J3	454113003	1x3-ST-M-2WS	CONN1X3_ST_M_2WS
J4	454511020	2x10-RA-M-RE	CONN2X10_RA_M_RE
J5	454511026	2x13-RA-M-RE	CONN2X13_RA_M_RE
J6	454121003	POWER1x3-M	POWER1X3_M
Q1	SM270330848	BC848C	SOT23
Q2	SM270330848	BC848C	SOT23

R1	SM654101000	SM0S-4P	SM0805_4P
R2	SM652101132	SM1.3KS	SM0805
R3	SM652101132	SM1.3KS	SM0805
R4	SM652101162	SM1.6KS	SM0805
R5	SM652101162	SM1.6KS	SM0805
R6	SM652101101	SM100S	SM0805
R7	SM652101101	SM100S	SM0805
R8	SM652101101	SM100S	SM0805
R9	SM652101101	SM100S	SM0805
R10	SM652101101	SM100S	SM0805
R11	SM652101101	SM100S	SM0805
R12	SM652101101	SM100S	SM0805
R13	SM652101101	SM100S	SM0805
R14	SM652101101	SM100S	SM0805
R15	SM652101101	SM100S	SM0805
R16	SM652101101	SM100S	SM0805
R17	SM652101101	SM100S	SM0805
R19	SM652101103	SM10KS	SM0805
R20	SM652101103	SM10KS	SM0805
R21	SM652101103	SM10KS	SM0805
R22	SM652101103	SM10KS	SM0805
R23	SM652101103	SM10KS	SM0805
R24	SM652101103	SM10KS	SM0805
R25	SM652101103	SM10KS	SM0805
R26	SM652101103	SM10KS	SM0805
R27	SM652101103	SM10KS	SM0805
R28	SM652101103	SM10KS	SM0805
R29	SM652101103	SM10KS	SM0805
R30	SM652101103	SM10KS	SM0805
R31	SM652101103	SM10KS	SM0805
R32	SM652101103	SM10KS	SM0805
R33	SM652101103	SM10KS	SM0805
R34	SM652101513	SM51KS	SM0805
R35	SM652101103	SM10KS	SM0805
R36	SM652101103	SM10KS	SM0805
R37	SM652101103	SM10KS	SM0805
R38	SM652101103	SM10KS	SM0805
R39	SM652101103	SM10KS	SM0805
R40	SM652101103	SM10KS	SM0805
R41	SM652101103	SM10KS	SM0805
R42	SM652101103	SM10KS	SM0805
R43	SM652101103	SM10KS-4P	SM0805_4P
R44	SM652101102	SM1KS	SM0805
R45	SM652101201	SM200S	SM0805
R46	SM652101223	SM22KS	SM0805
R48	SM652101301	SM300S	SM0805
R49	SM652101301	SM300S	SM0805
R50	SM652101301	SM300S	SM0805
R51	SM652101303	SM30KS	SM0805
R52	SM652101391	SM390S	SM0805
R53	SM652101302	SM3KS	SM0805
R54	SM652101472	SM4.7KS	SM0805
R55	SM652101103	SM10KS	SM0805
R56	SM652101472	SM4.7KS	SM0805
R57	SM652101472	SM4.7KS	SM0805
R58	SM652101514	SM510KS	SM0805
R59	SM652101510	SM51S	SM0805
R60	SM652101563	SM56KS	SM0805
R61	SM652101563	SM56KS	SM0805
R62	SM652101682	SM6.8KS	SM0805
R63	SM652101621	SM620S	SM0805
R66	SM652101621	SM620S	SM0805
R70	SM652101132	SM1.3KS	SM0805
R71	SM652101151	SM150S	SM0805

R77	SM652101104	SM100KS	SM0805
RL1	430430001	RL-FBR21-12	RL_FBR20
RN1	190042103	10K-SC	SIP10RES
RN2	190042472	4.7K-SIPC	SIP10RES
RN3	190042472	4.7K-SIPC	SIP10RES
S1	416161003	SW-P-SPST	SW_P_SPST

PART: F9300-7

DESC: LTP 5446 PRINTER CONTROLLER

COMPONENT -----	PART DESCRIPTION -----	QTY PER ASSEMBLY -----
146544471	CAP MINI ALUM 20% 470UF	1
147494472	CAP ALU COMPACT AXIAL 4700 UF	1
190042103	RESISTOR NETWORK 10 K	1
190042472	RESISTOR NETWORK 4.7 K	2
207140007	IC QUAD STEP MOTOR DRIVER	1
208122002	IC VOLT REG POS UA7805	2
208590350	IC ADJ POWER REG 3A LM350	1
309380016	CRYSTAL OSC (PROGR) 16 MHZ	1
416161003	SWITCH PUSHBUTTON SPST	1
430430002	RELAY 1 FORM C SPDT	1
454111002	HEADER STRAIGHT 2-PINS	1
454111006	HEADER STRAIGHT 6-PINS	1
454113003	HEADER STRAIGHT 3-PINS	1
454121003	BLOC FOR SOCKETS 3-PIN	1
454511020	HDR SOLD TAIL/MALE 20	1
454511026	HDR SOLD TAIL/MALE 26	1
554435401	RIVET "RIVSCREW" M 3.5	3
719300703	PC BD PREASS'Y 9300-7	1
SM200330125	IC QUAD BUFFER 74HC125	1
SM207470175	IC QUAD DIFF LINE RECEIVER	4
SM208580336	IC REF DIODE LM336-2.5V	1
SM208650393	IC DUAL VOLT COMP LM393M	1
SM227080500	IC THERM PRINTER GATE ARRAY	1
SM227090501	IC THERM PRINTER CPU	1
SM236030099	DIODE SO-PKG BAV99	8
SM270330848	TRANSISTOR NPN BC848C	2
SM652101101	RES CHIP (E24) 1% 100 OHM	12
SM652101102	RES CHIP (E24) 1% 1 K	1
SM652101103	RES CHIP (E24) 1% 10 K	25
SM652101104	RES CHIP (E24) 1% 100 K	1
SM652101132	RES CHIP (E24) 1% 1.3 K	3
SM652101151	RES CHIP (E24) 1% 150 OHM	1
SM652101162	RES CHIP (E24) 1% 1.6 K	2
SM652101201	RES CHIP (E24) 1% 200 OHM	1
SM652101223	RES CHIP (E24) 1% 22 K	1
SM652101301	RES CHIP (E24) 1% 300 OHM	3
SM652101302	RES CHIP (E24) 1% 3 K	1
SM652101303	RES CHIP (E24) 1% 30 K	1
SM652101391	RES CHIP (E24) 1% 390 OHM	1
SM652101472	RES CHIP (E24) 1% 4.7 K	3
SM652101510	RES CHIP (E24) 1% 51 OHMS	1
SM652101513	RES CHIP (E24) 1% 51 K	1
SM652101514	RES CHIP (E24) 1% 510 K	1
SM652101563	RES CHIP (E24) 1% 56 K	2

PART: F9300-7 DESC: LTP 5446 PRINTER CONTROLLER

COMPONENT -----	PART DESCRIPTION -----	QTY PER ASSEMBLY -----
SM652101621	RES CHIP (E24) 1% 620 OHM	2
SM652101682	RES CHIP (E24) 1% 6.8 K	1
SM654101000	CHIP JUMPER ZERO OHMS	1
SM661127104	CAP CERA CHIP 20% .1 UF	2
SM661207103	CAP CERA CHIP 20% .01UF	23
SM661255101	CAP CERA CHIP 5% 100 PF	1
SM661255471	CAP CERA CHIP 5% 470 PF	4
SM666377226	CAP MOLD TANT CHIP 22 UF	2

PART: M932X DESC: MECHANICAL FOR 932X-SERIES

COMPONENT -----	PART DESCRIPTION -----	QTY PER ASSEMBLY -----
377051005	LABEL "DANGER-----ONLY"	1
377131001	LABEL (GROUND SYMBOL)	1
407036002	FUSE HOLDER 2 POLE BLK 6.3X32	1
433162500	FUSE 250V/5A	2
434690002	LINE INPUT MODULE 250V/6A	1
485023462	FOOT BUMPON GREY	4
530301009	BLK HANDLE W/2 BLACK END CAPS	1
530904000	FAN GRID FOR SERIE 4000	1
550430106	SCREW CYL HD PHIL M3X6	9
550430116	SCREW CYL HD PHIL M3X16	7
550430120	SCREW CYL HD PHIL M3X20	12
550430508	SCREW FLAT HD PHIL M3X8	2
550430706	SCREW ECO-FIX M3X6	6
550440516	SCREW FLAT HD PHIL M4X16	4
550440605	SCREW OVAL HD PHIL M4X5	8
550440608	SCREW OVAL PHIL M4X8	7
551430400	WASHER SHAKEPROOF M3	4
551450400	WASHER SHAKEPROOF M5	2
552440300	NUT OPEN-END ACORN M4	4
554030101	NUT BANC-LOK TYPE MV M3	9
554425003	SCREW S/TAP PHIL M2.5X6 BLACK	6
554425004	NAIL RIVET 2.5X6	12
554435003	SCREW PT PHIL KA35X20	4
554435004	SCREW PT PHIL KA35X10	4
554440001	SCREW PT PHIL KA 40 X 12	4
554440202	FLAT WASHER M4	4
560032008	SCREW PHILIPS 10-32X1/2	2
594120003	TIEWRAP	1
709324321	MAIN CARD 9324-3 SHIELDING	1
7093XX041	FOOT SUPPORT 93XX	2

PART: M932X		DESC: MECHANICAL FOR 932X-SERIES	
COMPONENT	PART DESCRIPTION	QTY PER ASSEMBLY	
-----	-----	-----	
7093XX051	FOOT 93XX	2	
7093XX091	FRONT FRAME BRACKET 93XX	4	
7093XX321	MAIN CARD STANDOFF 12MM	3	
7093XX351	SHIELD UPPER PARTITION	6	
7093XX371	SHIELD CONTACT	6	
7093XX902	FAN 93XX-9 ASSEMBLY	1	
7093XX931	INTERF. HOLE CLOSURE 93XX-9	1	
709424096	INSERTION GUIDE FOR MC	1	
780220030	BASE CARD POWER CABLE	1	
780661104	FLAT CABLE 2X7 (4 CM)	1	
780671107	FLAT CABLE 2X20 (7CM)	1	
780681611	PS1715 LINE INPUT CABLE	1	
780721105	FLAT CABLE 2X10 (5,5CM)	1	
780754515	GROUND CABLE YEL/GREEN 15CM	1	
93XX-DISPLAY	RASTER MONITOR KIT	1	
93XX-PS1715	DSO POWER SUPPLY W/SHIELDING	1	
FF93XX	FRONT FRAME DSO 93XX	1	
LC93XX	LOWER COVER DSO 93XX	1	
RP93XX-9	REAR PANEL 93XX-9	1	

PART: ACCESSORIES-9320 **DESC: ACCESSORIES FOR 9320**

COMPONENT	PART DESCRIPTION	QTY PER ASSEMBLY	
-----	-----	-----	
407099008	PLUG FOR AC LINE -ENGLAND	1	
433162500	FUSE 250V/5A	2	
589202100	AC CORD/PLUG FOR FRANCE	1	
589202200	AC CORD/PLUG FOR GERMANY	2	
589203100	AC CORD/"SEV-ASE" PLUG	1	
589203218	AC CORD/US-CANADA PLUG	5	
597930001	CARTON FOR 93XX	1	
597930002	ETHAFOAM FOR 93XX	2	
597940014	PLASTIC BAG FOR 94XX & 93XX	2	
597940015	MANUAL/ACCESSORY CTN 9400	2	
7093XX061	FRONT COVER 93XX	1	
931X-RCM-E	931X SERIES REMOTE CONTROL MAN A	1	
932X-OM-E	9320/24 OPERATOR'S MANUAL ENG. A	1	
PP062	PROBE OSCILLOSCOPE 500 OHM	2	

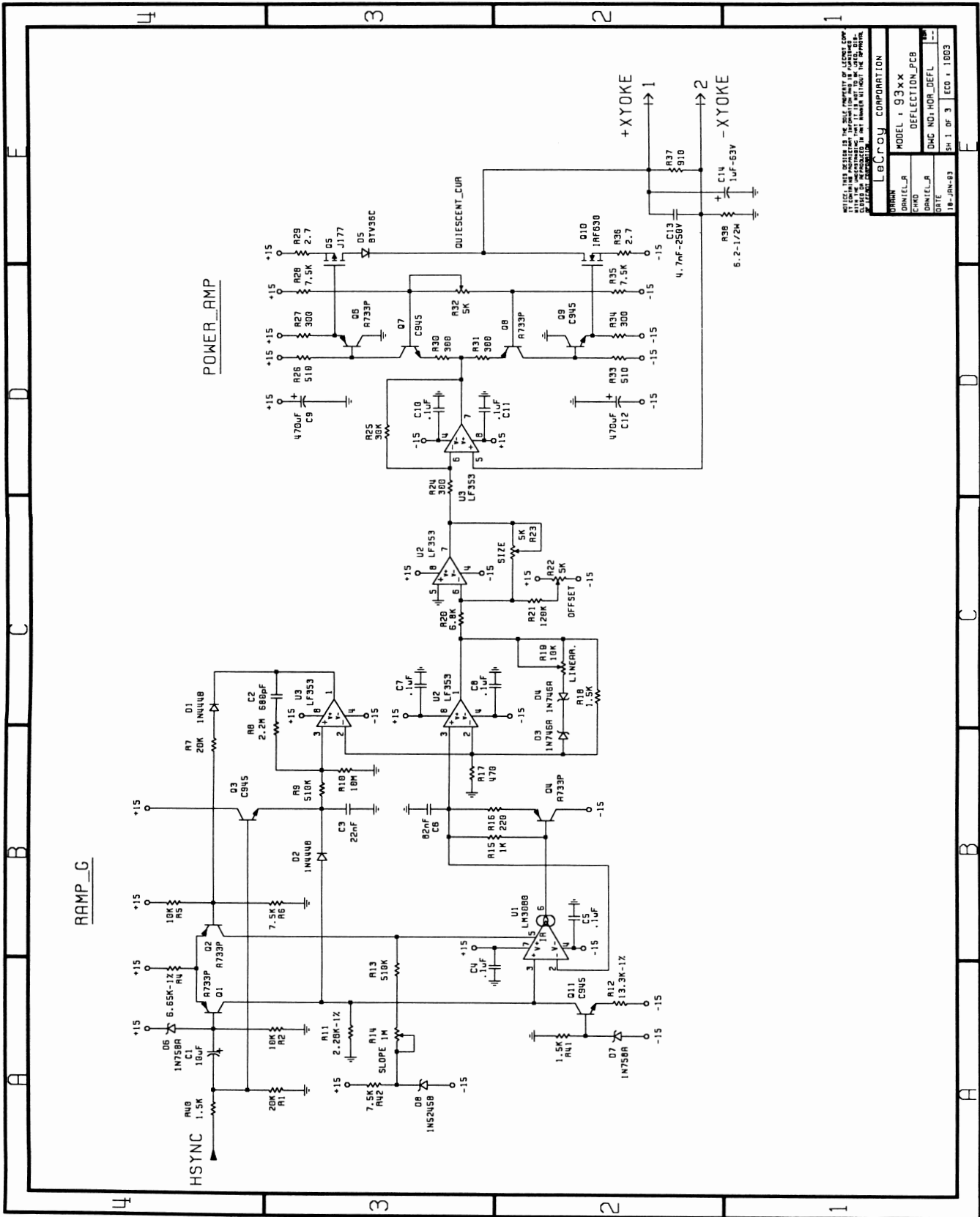

WHILE THIS SCHEMATIC IS THE SOLE PROPERTY OF ELECTRONIC INDUSTRIES, INC., IT IS LOANED TO YOU BY THE COMPANY. IT IS TO BE RETURNED TO THE COMPANY AT THE END OF THE LOAN PERIOD.

UNION	LeCroy CORPORATION
DANIEL, J.	MODEL: 93XX
CHOD	DEFLECTION PCB
DANIEL, J.	DMC NO. HOR. DEFL.
ORTE	REV. 1
18-JAN-83	SK. 1 OF 3 ECO. 1 1003

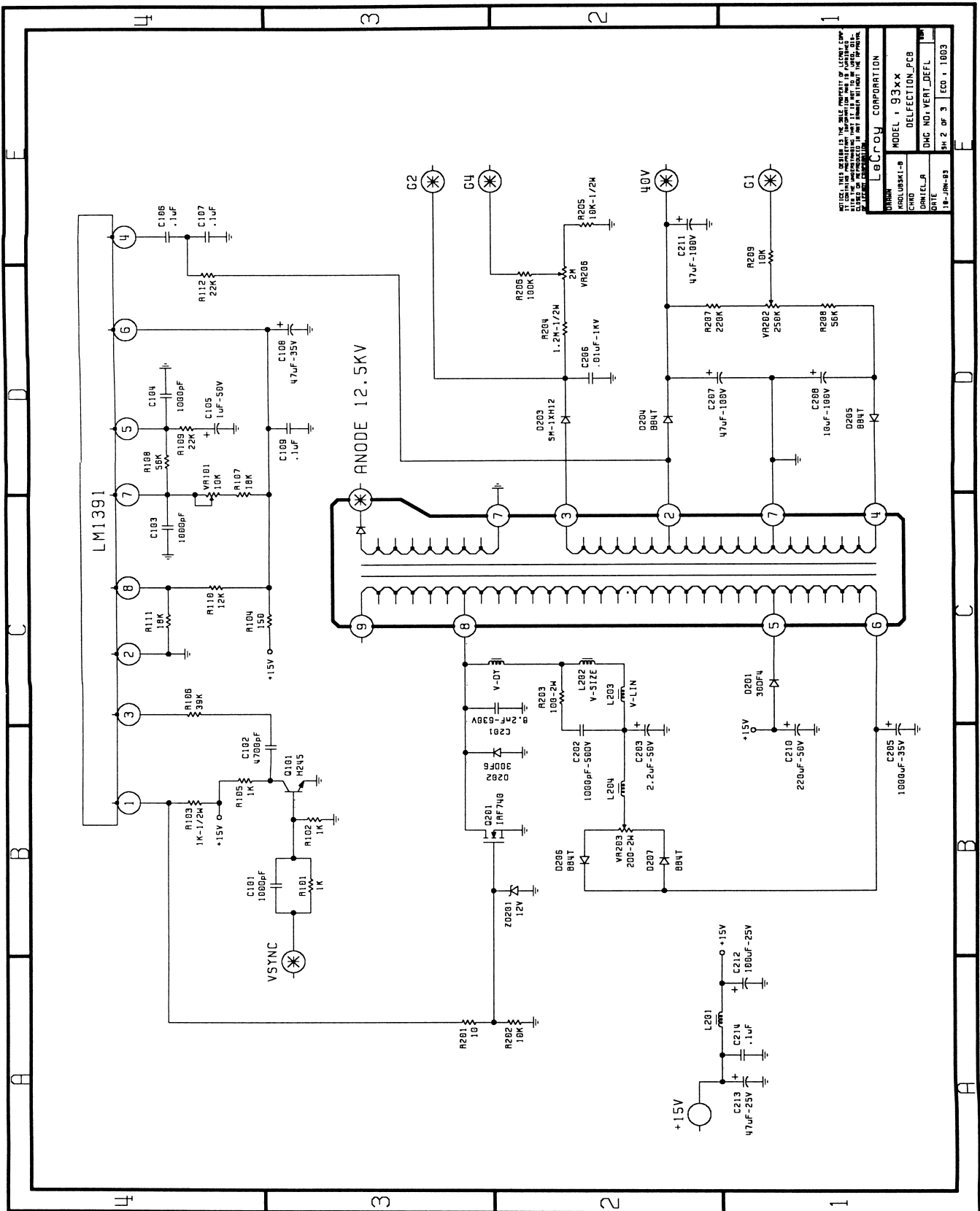

NOTICE: THIS DRAWING IS THE PROPERTY OF LECOROY CORPORATION. IT IS TO BE USED ONLY FOR THE PROJECT AND QUANTITY SPECIFIED. IT IS NOT TO BE REPRODUCED, COPIED, OR TRANSMITTED IN ANY FORM OR BY ANY MEANS, ELECTRONIC OR MECHANICAL, INCLUDING PHOTOCOPYING, RECORDING, OR BY ANY INFORMATION STORAGE AND RETRIEVAL SYSTEM.

DRIVER	LECOROY CORPORATION
MODEL	MODEL 1 93XX
REV	DELFECTION-PCB
DATE	DWG NO: VERT_DEFLL
REV	REV 2 OF 3
ECO	ECO 1 1983

C1	10uF	-	Q10	IRF630	-	R209	10K
C2	680pF	-	Q11	C945	-	T201	HT
C3	22nF	-	Q101	H245	-	U1	LM3080
C4	.1uF	-	Q201	IRF740	-	U2	LF353
C5	.1uF	-	R1	20K	-	U3	LF353
C6	82nF	-	R2	10K	-	VR101	10K
C7	.1uF	-	R4	6.65K-1%	-	VR202	250K
C8	.1uF	-	R5	10K	-	VR203	200-2W
C9	470uF	-	R6	7.5K	-	VR206	2M
C10	.1uF	-	R7	20K	-	ZD201	12V
C11	.1uF	-	R8	2.2M			
C12	470uF	-	R9	510K			
C13	4.7nF-250V	-	R10	10M			
C14	1uF-63V	-	R11	2.26K-1%			
C101	1000pF	-	R12	13.3K-1%			
C102	4700pF	-	R13	510K			
C103	1000pF	-	R14	1M			
C104	1000pF	-	R15	1K			
C105	1uF-50V	-	R16	220			
C106	.1uF	-	R17	470			
C107	.1uF	-	R18	1.5K			
C108	47uF-35V	-	R19	10K			
C109	.1uF	-	R20	6.8K			
C201	8.2nF-630V	-	R21	220K			
C202	1000pF-500V	-	R22	5K			
C203	2.2uF-50V	-	R23	5K			
C205	1000uF-35V	-	R24	300			
C206	.01uF-1KV	-	R25	30K			
C207	47uF-100V	-	R26	510			
C208	10uF-100V	-	R27	300			
C210	220uF-50V	-	R28	7.5K			
C211	47uF-100V	-	R29	2.7			
C212	100uF-25V	-	R30	300			
C213	47uF-25V	-	R31	300			
C214	.1uF	-	R32	5K			
D1	1N4448	-	R33	510			
D2	1N4448	-	R34	300			
D3	1N746A	-	R35	7.5K			
D4	1N746A	-	R36	2.7			
D5	BYV36C	-	R37	910			
D6	1N758D	-	R38	6.2-1/2W			
D7	1N758D	-	R40	1.5K			
D8	1N5245B	-	R41	1.5K			
D201	30DF4	-	R42	7.5K			
D202	30DF6	-	R101	1K			
D203	SM-LXH12	-	R102	1K			
D204	BB4T	-	R103	1K-1/2W			
D205	BB4T	-	R104	150			
D206	BB4T	-	R105	1K			
D207	BB4T	-	R106	39K			
L201	5nH	-	R107	18K			
V-DY	V-DY	-	R108	56K			
L202	V-SIZE	-	R109	22K			
L203	V-LIN	-	R110	12K			
L204	5nH	-	R111	18K			
Q1	A733P	-	R112	22K			
Q2	A733P	-	R201	10			
Q3	C945	-	R202	10K			
Q4	A733P	-	R203	100-2W			
Q5	J177	-	R204	1.2M-1/2W			
Q6	A733P	-	R205	10K-1/2W			
Q7	C945	-	R206	100K			
Q8	A733P	-	R207	220K			
Q9	C945	-	R208	56K			

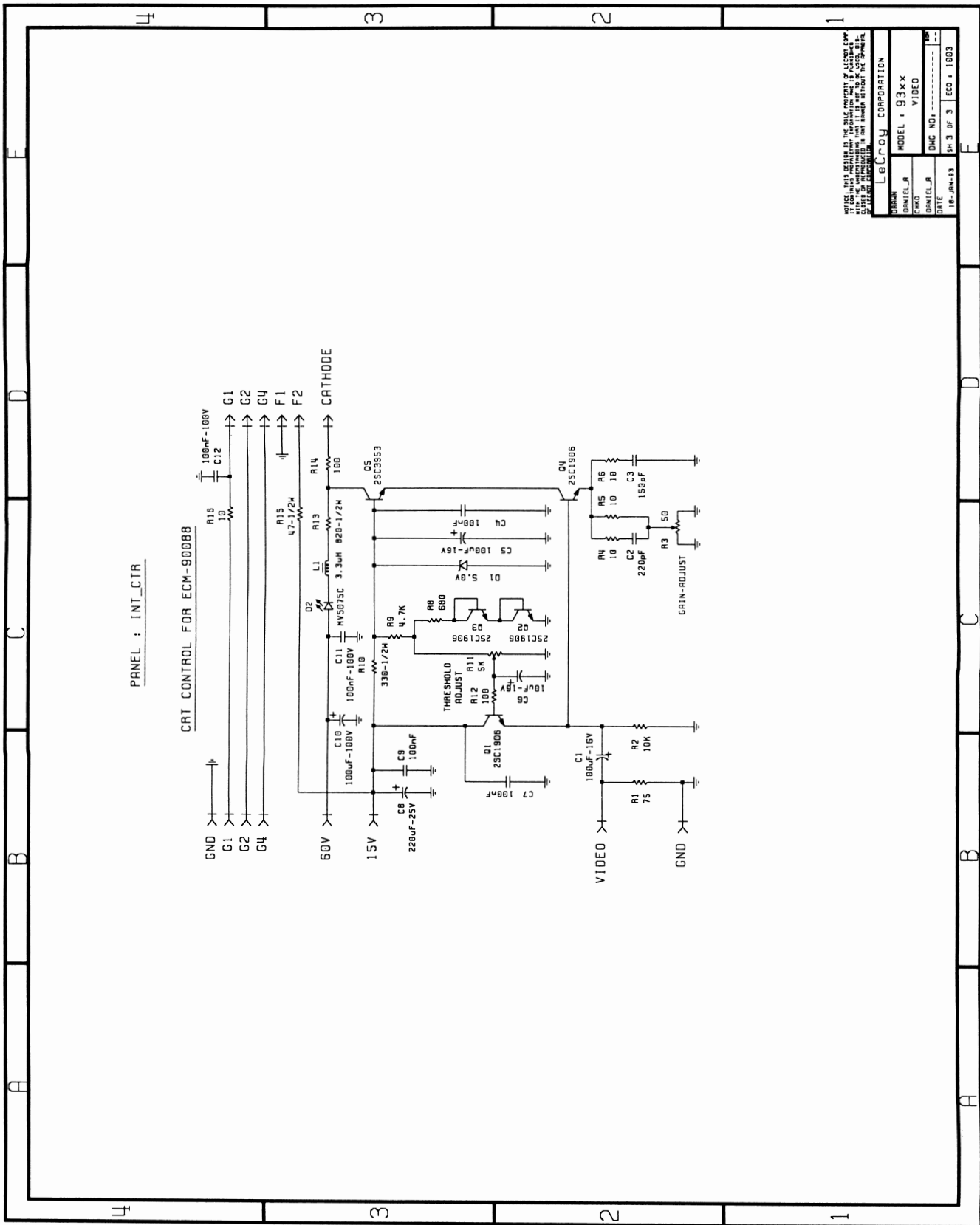

NOTE: THIS DESIGN IS THE SOLE PROPERTY OF LEONARDO CORPORATION. IT IS TO BE USED ONLY FOR THE PURPOSES SPECIFIED HEREIN. NO PARTS OR MATERIALS ARE TO BE REPRODUCED OR TRANSMITTED IN ANY FORM OR BY ANY MEANS WITHOUT THE WRITTEN PERMISSION OF LEONARDO CORPORATION.

LEONARDO CORPORATION
 MODEL : 93xx
 DMC NO :
 RM 3 OF 3 ECO : 1003

C1	100uF-16V
C2	220pF
C3	150pF
C4	100nF
C5	100uF-16V
C6	10uF-16V
C7	100nF
C8	220uF-25V
C9	100nF
C10	100uF-100V
C11	100nF-100V
C12	100nF-100V
D1	5.0V
D2	MV5075C
L1	3.3uH
Q1	2SC1906
Q2	2SC1906
Q3	2SC1906
Q4	2SC1906
Q5	2SC3953
R1	75
R2	10K
R3	50
R4	10
R5	10
R6	10
R8	680
R9	4.7K
R10	330-1/2W
R11	5K
R12	100
R13	820-1/2W
R14	100
R15	47-1/2W
R16	10

PART: 93XX-FDGP DESC: GRAPHIC PRINTER & FLOPPY DISK

COMPONENT	PART DESCRIPTION	QTY PER ASSEMBLY
334000402	THERMAL PAPER FOR SEIKO PRINT	1
334000832	THERMAL PRINTER UNIT	1
335023203	FLOPPY DISK DRIVE 31/2"	1
530040005	SLIDE LATCH TAB STYLE	2
550425104	SCREW CYL HD PHIL M2,5X4	4
550430106	SCREW CYL HD PHIL M3X6	10
551430100	FLAT WASHER M3	3
551430400	WASHER SHAKEPROOF M3	2
552430300	NUT OPEN-END ACORN M3	3
554030101	NUT BANC-LOK TYPE MV M3	2
554430002	SCREW S/TAP PHIL M3X5	8
709450523	PUSH SWITCH EXTENDER	1
70FD01021	FLOPPY DISK DRIVE SUPPORT	1
70FD01031	FLOPPY DISK DRIVE FRAME	1
70GP01031	GRAPHIC PRINTER FRAME	1
70GP01041	GRAPHIC PRINTER COVER AXLE	1
70GP01051	GRAPHIC PRINTER CUTTER	1
70GP01061	GRAPHIC PRINTER SWITCH BUTTON	1
780210030	DISPLAY POWER CABLE	1
780721022	FLAT CABLE 2X10 (22CM)	1
780791604	FLAT CABLE 2X13 (4CM)	1
780791630	FLAT CABLE 2X13 (30CM)	1
780801012	FLAT CABLE 2X20 (3 CONNECT.)	1
BOX-GP01	GP01 GRAPHIC PRINTER BOX	1
COVER-GP01	GP01 GRAPHIC PRINTER COVER	1
CUP-FD01	FD01 FLOPPY DISK DRIVE CUP	1
F9300-6	CENTRONICS/FLOPPY/PRINTER INT	1
F9300-7	LTP 5446 PRINTER CONTROLLER	1
UC93XX-FDGP	UPPER COVER FOR FD/GP OPTIONS	1

PART: 93XX-FD01 DESC: FLOPPY DISK

COMPONENT	PART DESCRIPTION	QTY PER ASSEMBLY
335023203	FLOPPY DISK DRIVE 31/2"	1
550425104	SCREW CYL HD PHIL M2,5X4	4
550430106	SCREW CYL HD PHIL M3X6	4
551430400	WASHER SHAKEPROOF M3	2
551430400	WASHER SHAKEPROOF M3	2
554030101	NUT BANC-LOK TYPE MV M3	2
554430002	SCREW S/TAP PHIL M3X5	4
70FD01021	FLOPPY DISK DRIVE SUPPORT	1
70FD01031	FLOPPY DISK DRIVE FRAME	1
780791630	FLAT CABLE 2X13 (30CM)	1
780801012	FLAT CABLE 2X20 (3 CONNECT.)	1
CUP-FD01	FD01 FLOPPY DISK DRIVE CUP	1
F9300-6	CENTRONICS/FLOPPY/PRINTER INT. B	1
UC93XX-FD01	UPPER COVER FOR FD01 OPTION	1

PART: 93XX-GP01 DESC: GRAPHICS PRINTER

COMPONENT -----	PART DESCRIPTION -----	QTY PER ASSEMBLY -----
34000402	THERMAL PAPER FOR SEIKO PRINT	1
334000832	THERMAL PRINTER UNIT	1
530040005	SLIDE LATCH TAB STYLE	2
550430106	SCREW CYL HD PHIL M3X6	8
551430100	FLAT WASHER M3	3
551430400	WASHER SHAKEPROOF M3	2
552430300	NUT OPEN-END ACORN M3	3
554430002	SCREW S/TAP PHIL M3X5	4
709450523	PUSH SWITCH EXTENDER	1
70GP01031	GRAPHIC PRINTER FRAME	1
70GP01041	GRAPHIC PRINTER COVER AXLE	1
70GP01051	GRAPHIC PRINTER CUTTER	1
70GP01061	GRAPHIC PRINTER SWITCH BUTTON	1
780210030	DISPLAY POWER CABLE	1
780721022	FLAT CABLE 2X10 (22CM)	1
780791604	FLAT CABLE 2X13 (4CM)	1
780801012	FLAT CABLE 2X20 (3 CONNECT.)	1
BOX-GP01	GP01 GRAPHIC PRINTER BOX	1
COVER-GP01	GP01 GRAPHIC PRINTER COVER	1
F9300-6	CENTRONICS/FLOPPY/PRINTER INT	1
F9300-7	LTP 5446 PRINTER CONTROLLER	1
UC93XX-GP01	UPPER COVER FOR GP01 OPTION	1

REV	DESCRIPTION	EC	IC	DATE	APP
1	SEE SHEET 1 FOR REVISIONS				

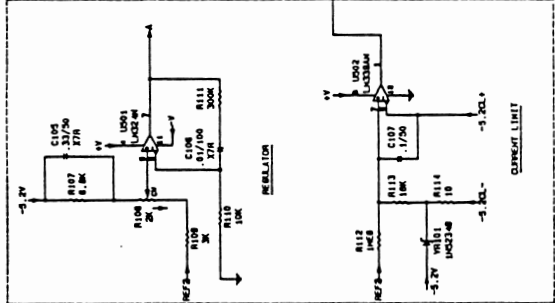
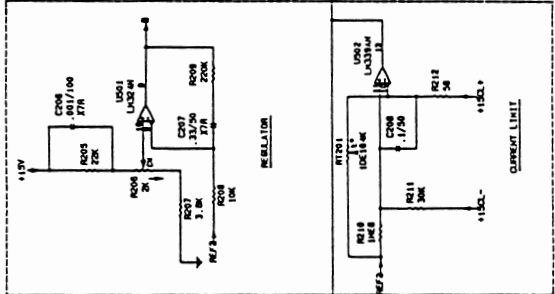
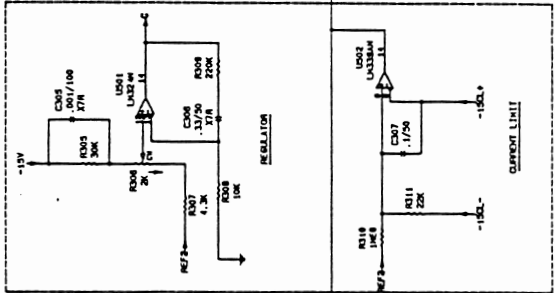
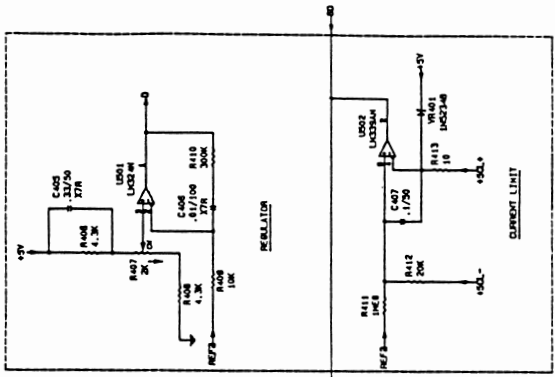

NOTICE: THIS DESIGN IS THE SOLE PROPERTY OF LECROY CORP. IT IS THE PROPERTY OF LECROY CORP. AND IS NOT TO BE REPRODUCED OR TRANSMITTED IN ANY FORM OR BY ANY MEANS, ELECTRONIC OR MECHANICAL, INCLUDING PHOTOCOPYING, RECORDING, OR BY ANY INFORMATION STORAGE AND RETRIEVAL SYSTEM, WITHOUT THE UNDERSTANDING THAT IT IS NOT TO BE USED, DISCLOSED OR REPRODUCED IN ANY MANNER WITHOUT THE APPROVAL OF LECROY CORPORATION.

LeCroy CORPORATION	
DRAWN	MODEL : 93xx-1715
J-P-VITTET	POWER SUPPLY
CHKD	
J-P-VITTET	DWG NO: -----
DATE	10-APR-92
	SH 2 OF 2
	ECO 1

SECTION 9 MECHANICAL PARTS

9320 Digital Oscilloscope

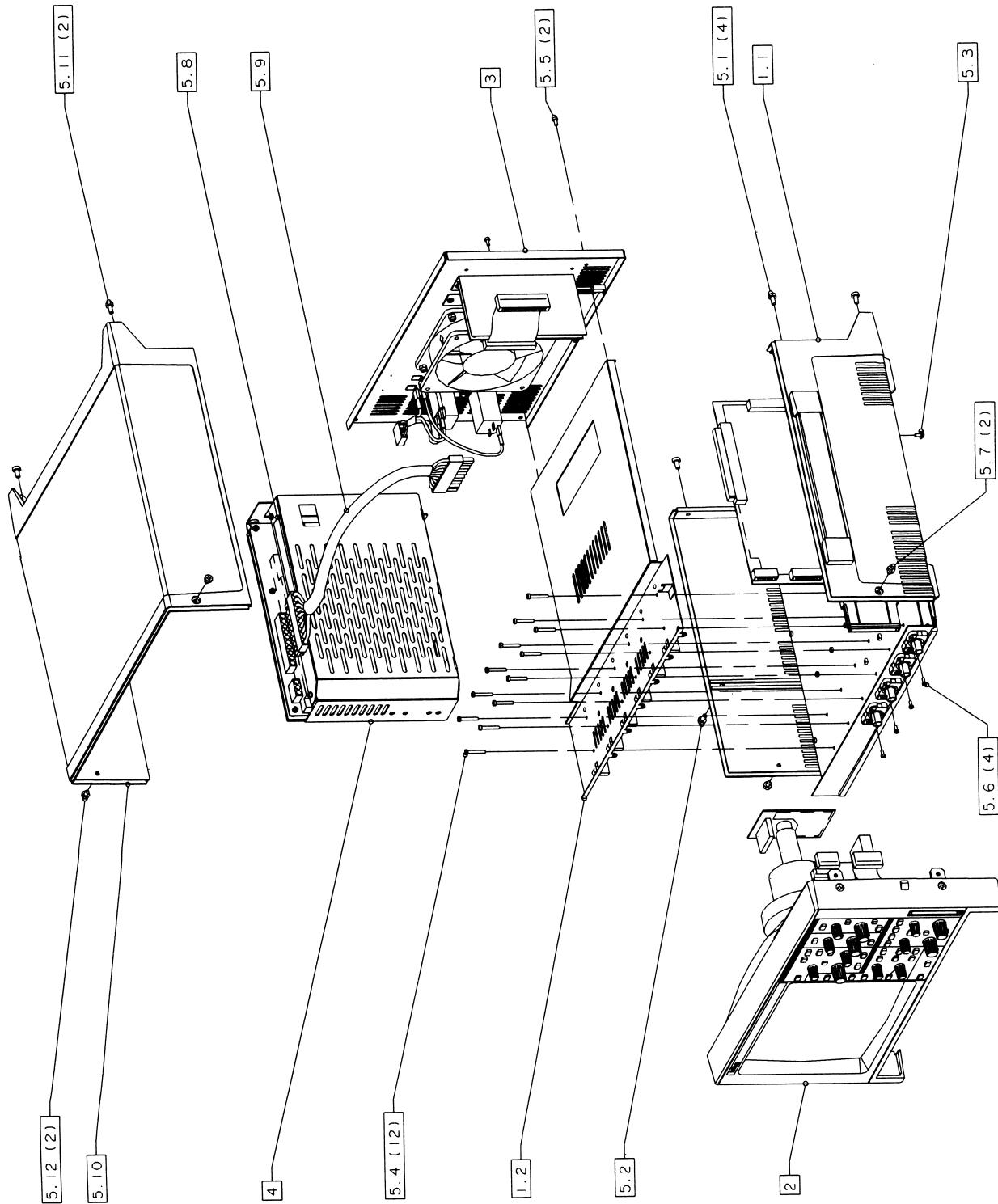

FIGURE 9.1: 9320 DSO EXPLODED VIEW

	9320 Assembly	Part Description	Quantity per Assembly
	-----	-----	-----
1.1	9320 lower cover assembly		1
1.2	9320 upper shield assembly		1
2.	9320 front frame assembly		1
3.	Rear panel assembly		1
4.	PS 1715 power supply	93XX-PS1715	1
5.1	Screw oval head M4x8	550 440 608	4
5.2	Screw oval head M4x8	550 440 608	1
5.3	Screw eco-fix M3x6	550 430 706	1
5.4	Screw cyl head M3x20	550 430 120	12
5.5	Screw eco-fix M3x6	550 430 706	2
5.6	Screw taptite M2,5x6	554 425 003	6
5.7	Screw oval head M4x5	550 440 605	2
5.8	Label "Danger ... only"	377 051 005	1
5.9	Main card power cable	780 220 030	1
5.10	Upper cover	UC 93XX	1
5.11	Screw oval head M4x8	550 440 608	2
5.12	Screw oval head M4x5	550 440 605	2

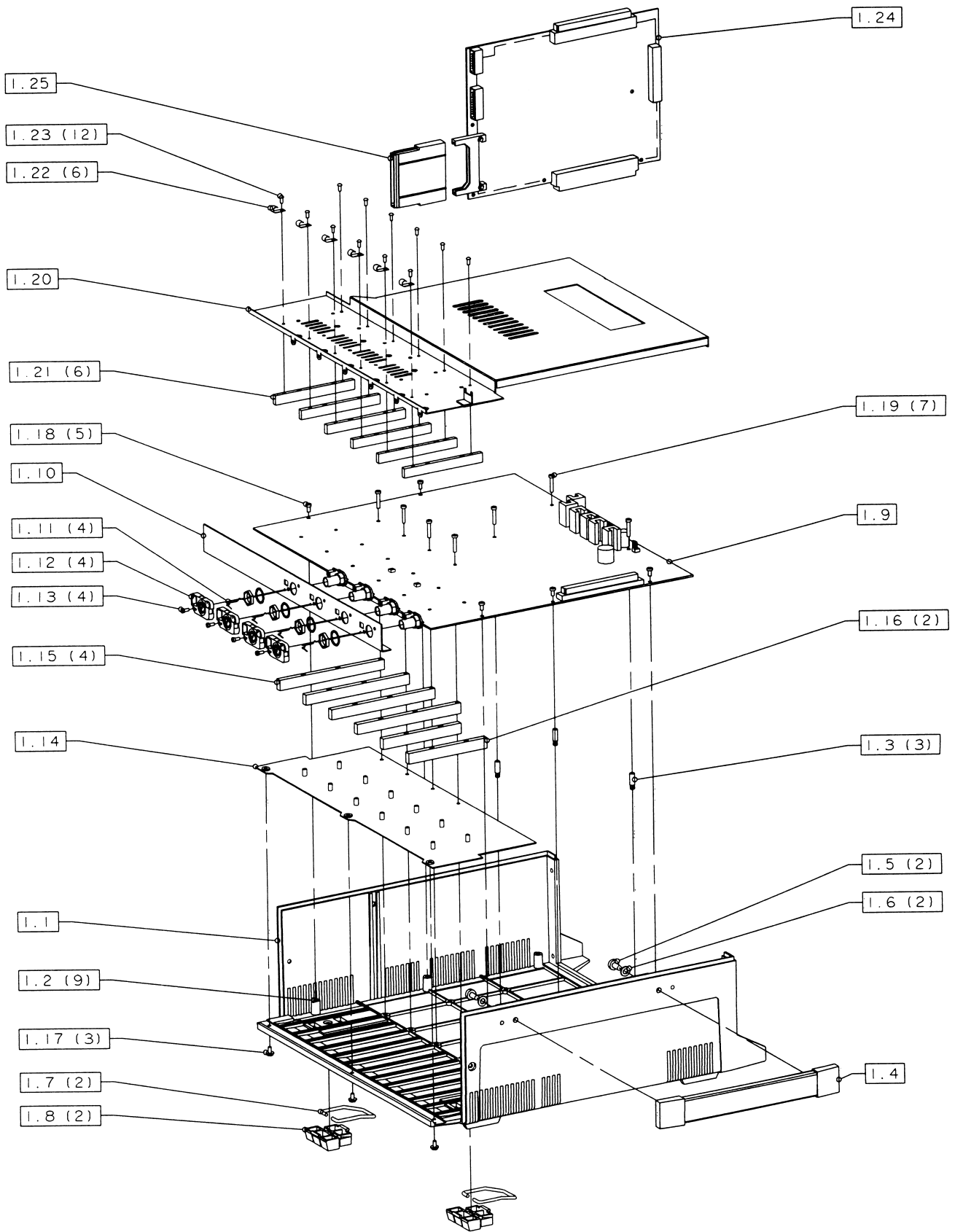

FIGURE 9.2: 9320 LOWER COVER EXPLODED VIEW

1.	9320 Lower Cover Assembly	Part Description	Quantity per Assembly
	-----	-----	-----
1.1	Lower cover	LC 93XX	1
1.2	Nut Banc-Lock M3	554 030 101	9
1.3	Main card standoff M3	709 3XX 321	3
1.4	Handle with caps	530 301 009	1
1.5	Screw cyl head 10-32 x 1/2	560 032 008	2
1.6	Lockwasher M5	551 450 400	2
1.7	Foot	709 3XX 051	2
1.8	Foot support	709 3XX 041	2
1.9	Main board 9320	F9320-3	1
1.10	Main board panel 9320	FP9320-3	1
1.11	Probe ring contact	709 3XX P91	6
1.12	Probe holder	709 3XX P41	6
1.13	Screw taptite M2,5x6	554 425 003	6
1.14	9320 base shield	709 324 331	1
1.15	9320 lower partition shield	709 324 341	4
1.16	Lower partition shield	709 3XX 361	2
1.17	Screw eco-fix M3x6	550 430 706	3
1.18	Screw cyl head M3x6	550 430 106	5
1.19	Screw cyl head M3x16	550 430 116	7
1.20	9320 upper shield	709 324 321	1
1.21	Upper partition shield	709 3XX 351	6
1.22	Shield contact	709 3XX 371	6
1.23	Nail rivet M2,5x6	554 425 004	12
1.24	Processor card	F9314M-1	1
1.25	Memory card insertion guide	709 424 096	1

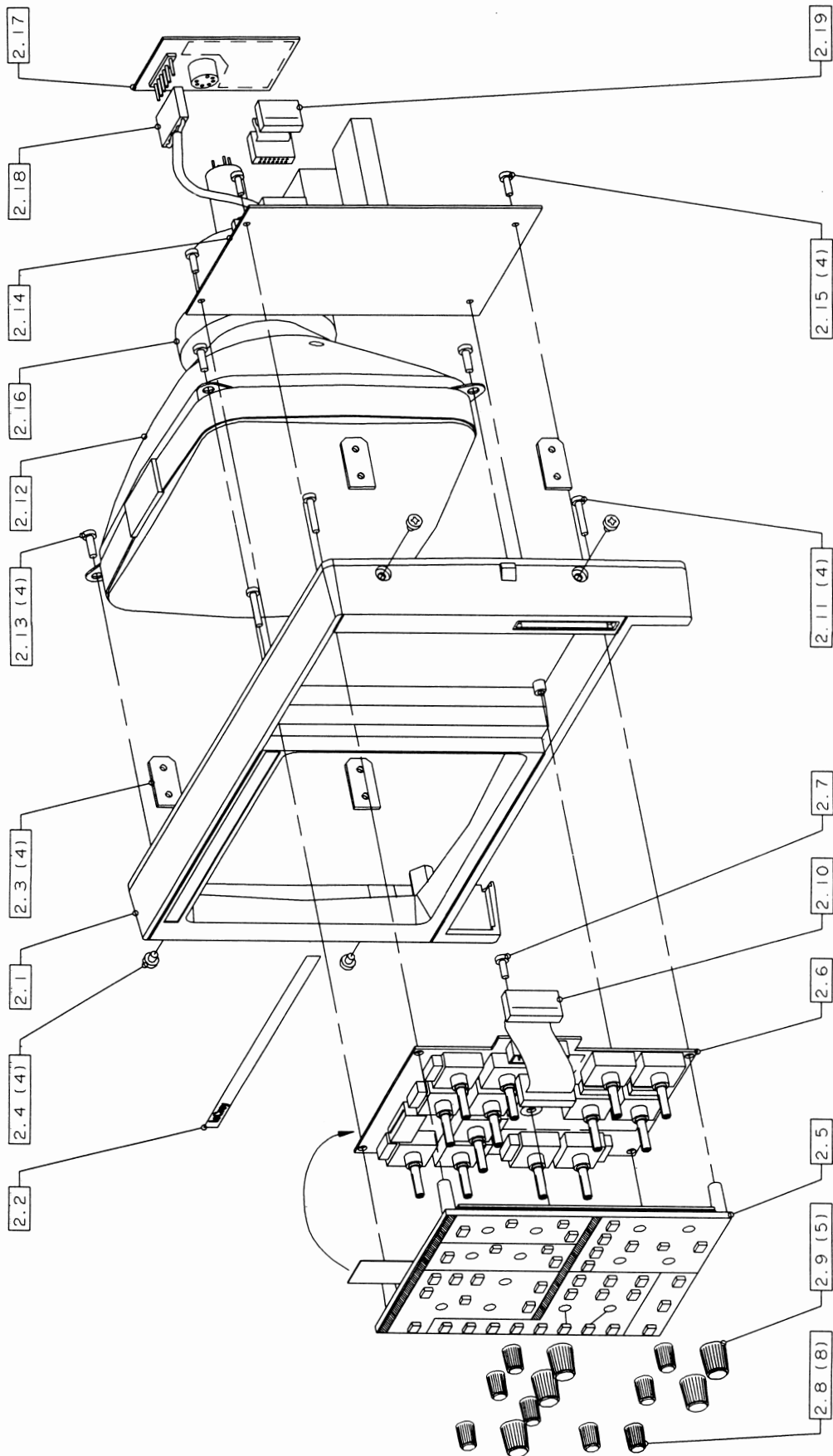

FIGURE 9.3: 9320 FRONT FRAME EXPLODED VIEW

2.	9320 Front Panel Assembly	Part Description	Quantity per Assembly
	-----	-----	-----
2.1	Front frame	FF 9320	1
2.2	Front label	709 320 013	1
2.3	Front frame bracket	709 3XX 091	4
2.4	Screw oval head M4x5	550 440 605	4
2.5	Front panel keyboard ass'y	729 320 503	1
2.6	Front panel pcb ass'y	F9320-5	1
2.7	Screw PT KA 35x10	554 435 004	1
2.8	Knob diameter 10mm	709 3XX 511	8
2.9	Knob diameter 14mm	709 3XX 521	5
2.10	20 lines flat cable	780 721 105	1
2.11	Screw PT KA 35x20	554 435 003	4
2.12	9 inch CRT	93XX-CRT	1
2.13	Screw PT KA 40x12	554 440 001	4
2.14	Deflection board	93XX-Deflection	1
2.15	Screw PT KA 35x10	554 435 004	4
2.16	Deflection yoke	93XX-Yoke	1
2.17	Video board	93XX-Video	1
2.18	Monitor cable		1
2.19	14 lines flat cable	780 661 104	1

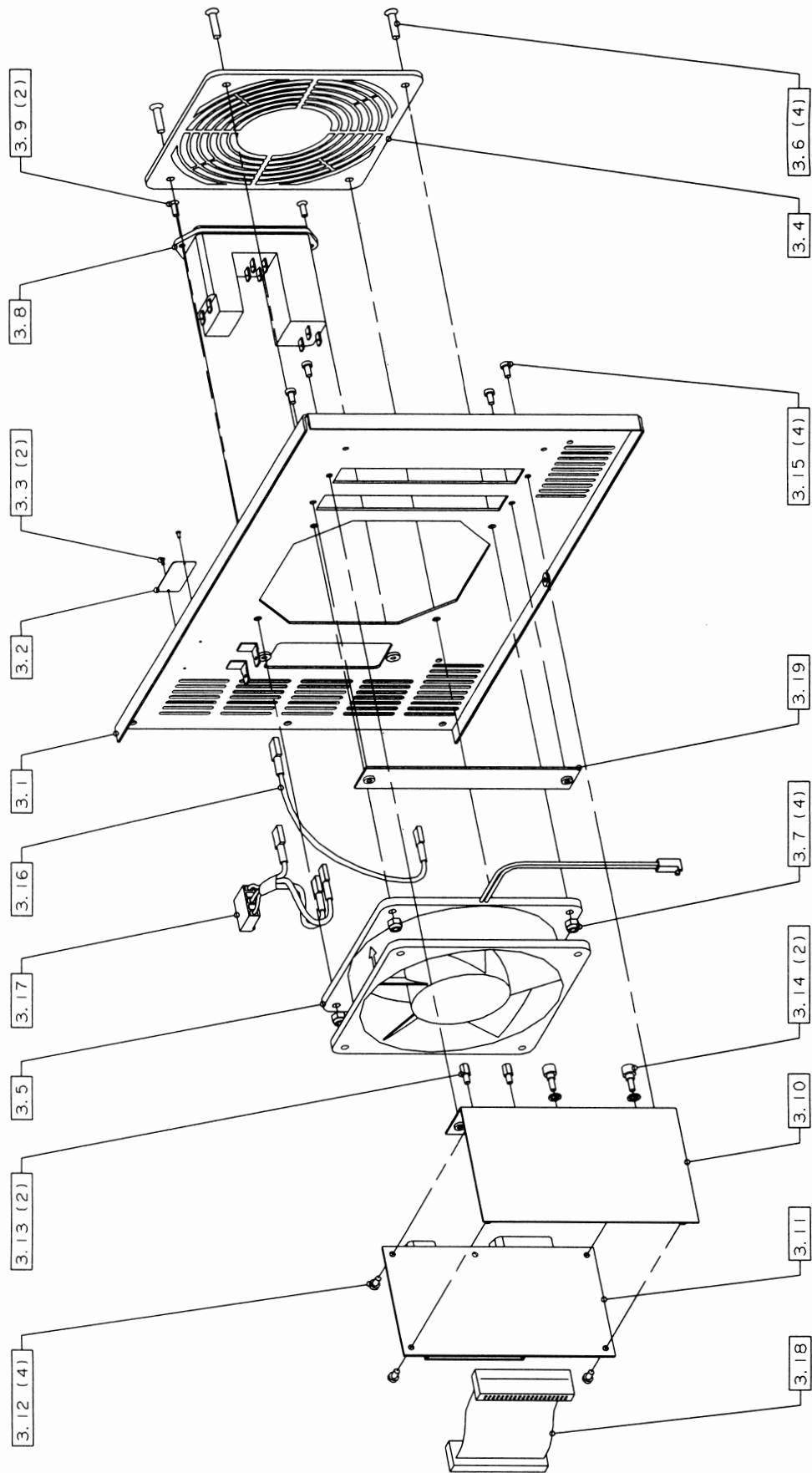

FIGURE 9.4: 9320 REAR PANEL EXPLODED VIEW

3	9320 Rear Panel Assembly	Part Description	Quantity per Assembly
	-----	-----	-----
3.1	Rear panel	RP 93XX-9	1
3.2	Serial number plate	709 324 913	1
3.3	Taping screw	554 500 001	2
3.4	Fan grid	530 904 000	1
3.5	Fan assembly	709 3XX 902	1
3.6	Screw flat head M4x16	550 440 516	4
3.7	Nut acom M4	552 440 300	4
3.8	Line input module	434 690 002	1
	Fuse holder	407 036 002	1
	Fuse 5A / 250 V	433 162 500	2
3.9	Screw flat head M3x8	550 430 508	2
3.10	Interface card bracket	709 300 411	1
3.11	Interface card	F9300-4	1
3.12	Screw cyl head M3x6	550 430 106	4
3.13	Screw lock	455 980 002	2
3.14	Screw lock and washer		2
3.15	Screw cyl head M3x6	550 430 106	4
3.16	Ground wire cable	780 754 515	1
3.17	Line input cable	780 681 611	1
3.18	40 lines flat cable	780 671 110	1
3.19	Interface hole closure	709 3XX 931	1

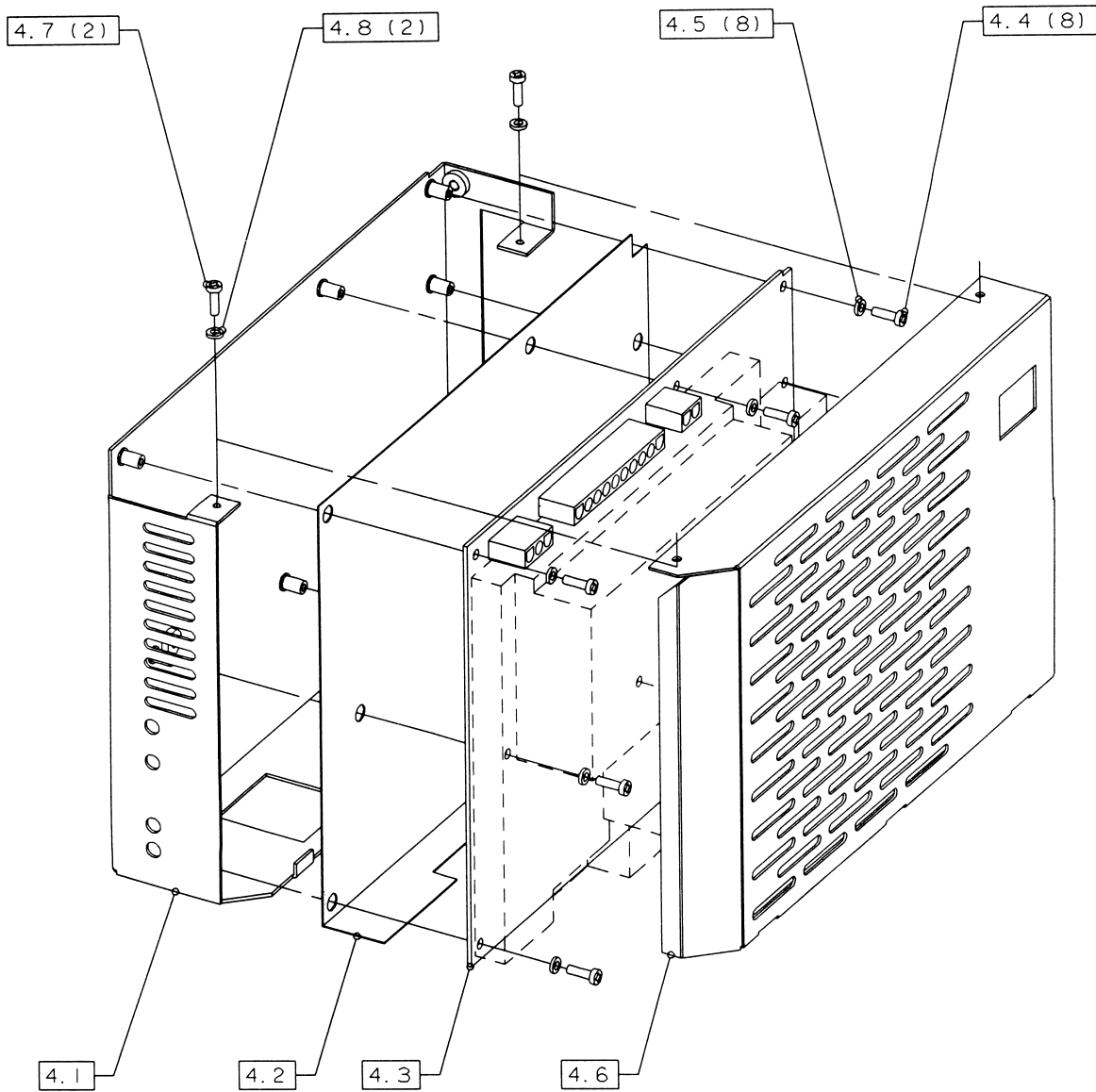

FIGURE 9.5: 93XX-PS1715 POWER SUPPLY EXPLODED VIEW

4.	Power supply 93XX-PS1715	Part Description	Quantity per Assembly
4.1	Chassis	709 3XX 071	1
4.2	Insulator		1
4.3	Power supply board	93XX-PS 1701	1
4.4	Screw cyl head M3x6	550 430 106	8
4.5	Lockwasher M3	551 430 400	8
4.6	shielding	709 3XX 081	1
4.7	Screw cyl head M3x6	550 430 106	2
4.8	Lockwasher M3	551 430 400	2

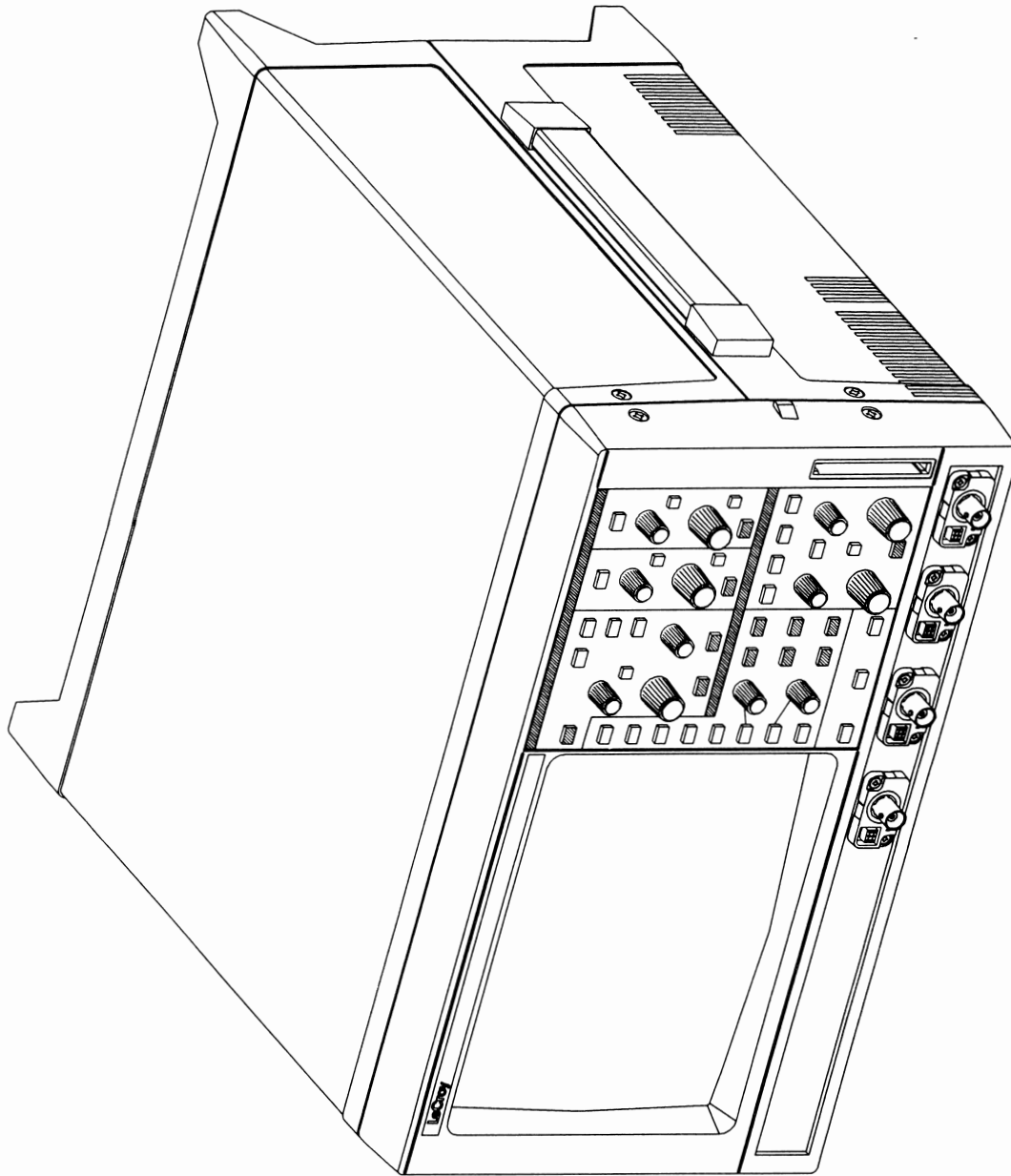

FIGURE 9.6: 9320 DSO FRONT VIEW

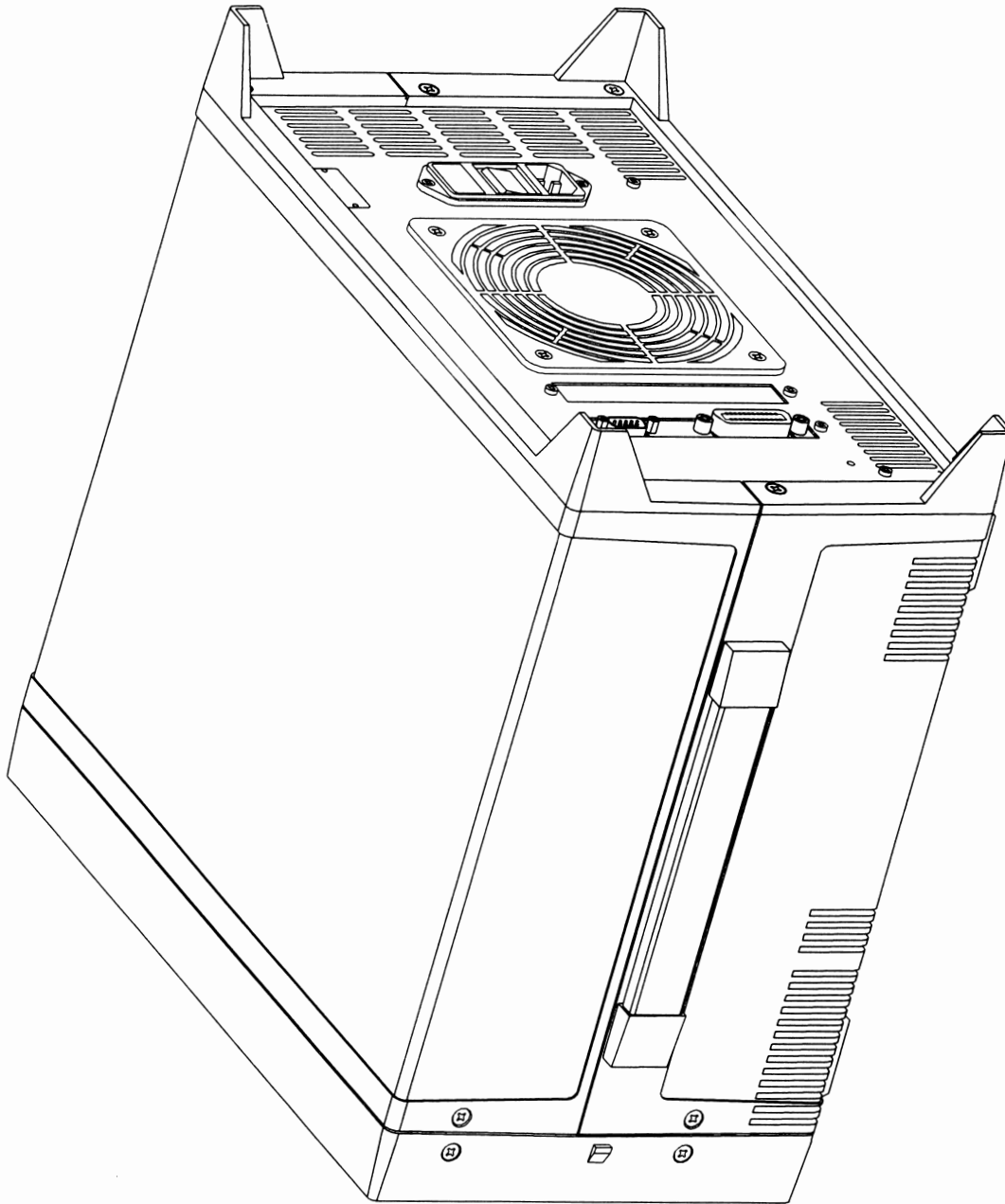

FIGURE 9.7: 9320 DSO REAR VIEW

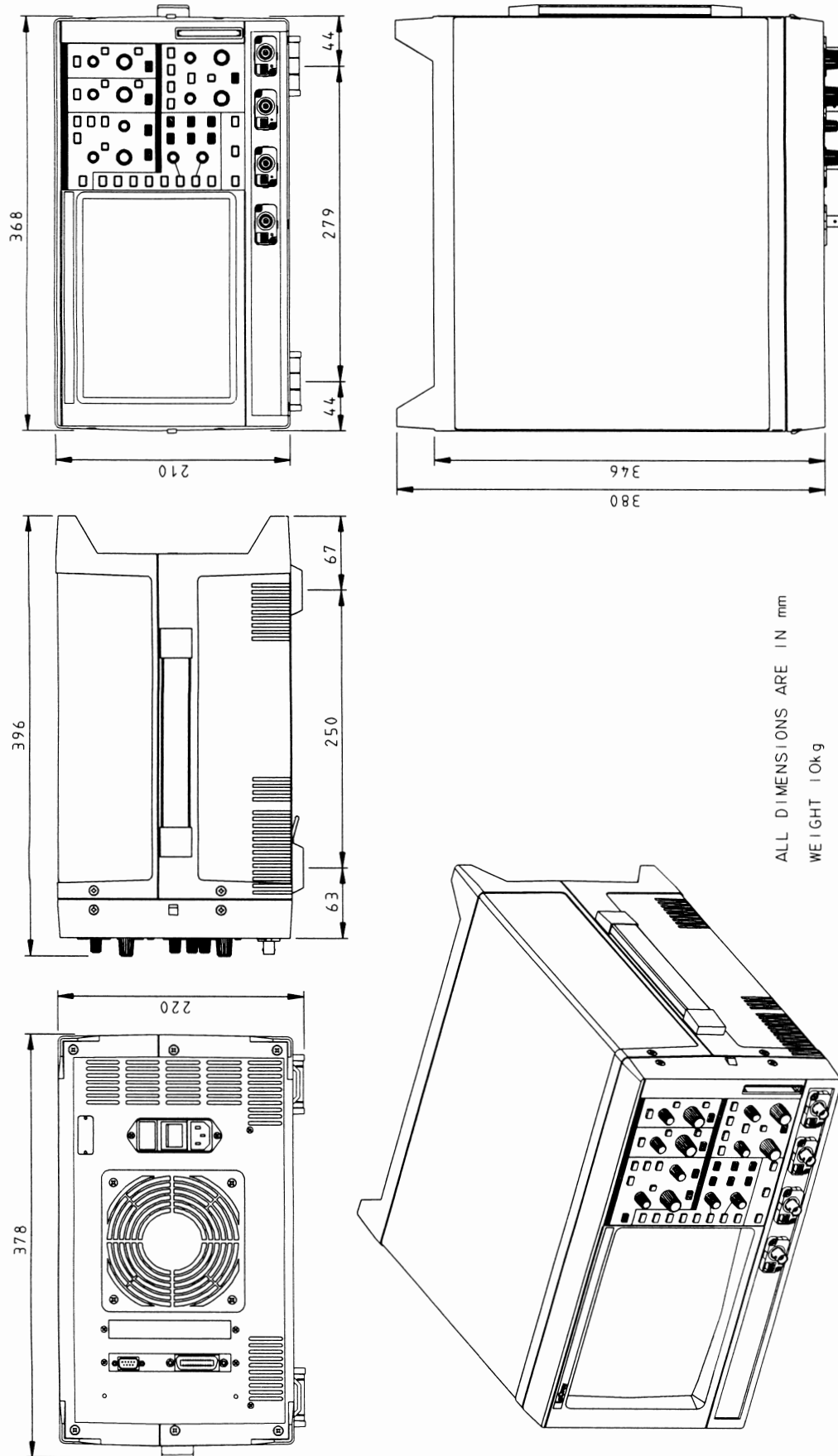

FIGURE 9.8: 9320 DSO DIMENSIONS

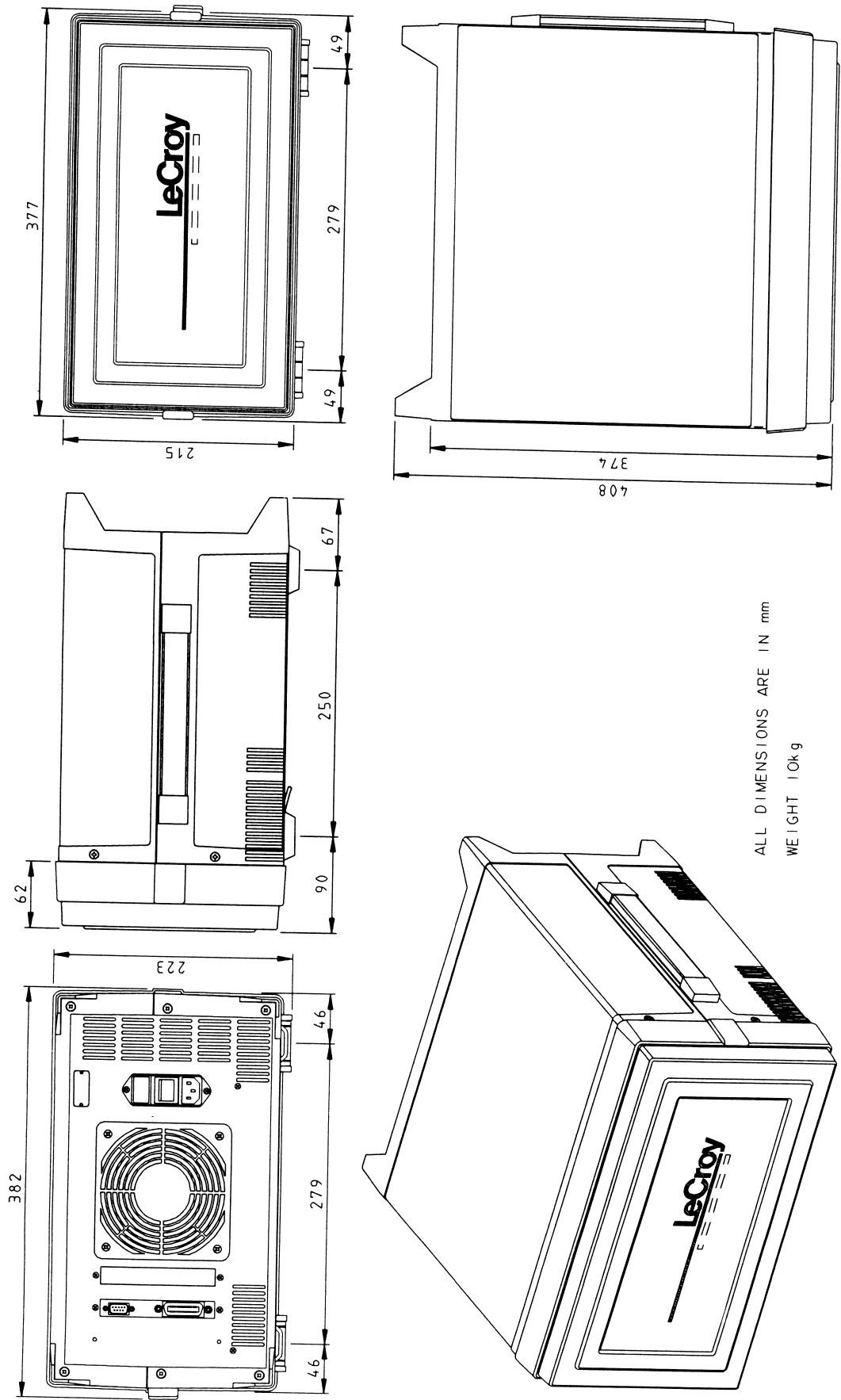

FIGURE 9.9: 9320 DSO DIMENSIONS WITH PROTECTIVE COVER

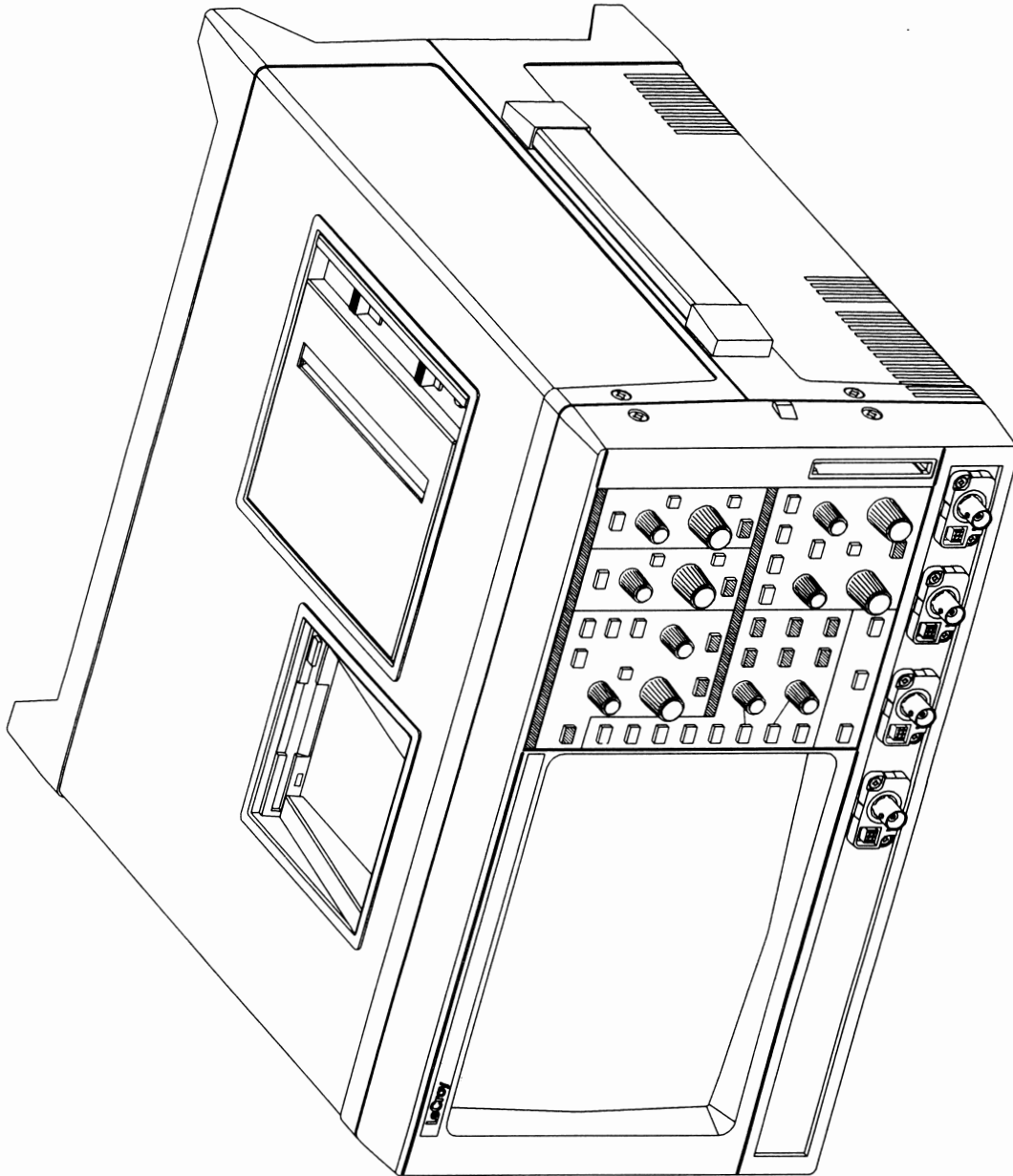

FIGURE 9.10: 9320 DSO WITH FLOPPY AND PRINTER OPTIONS

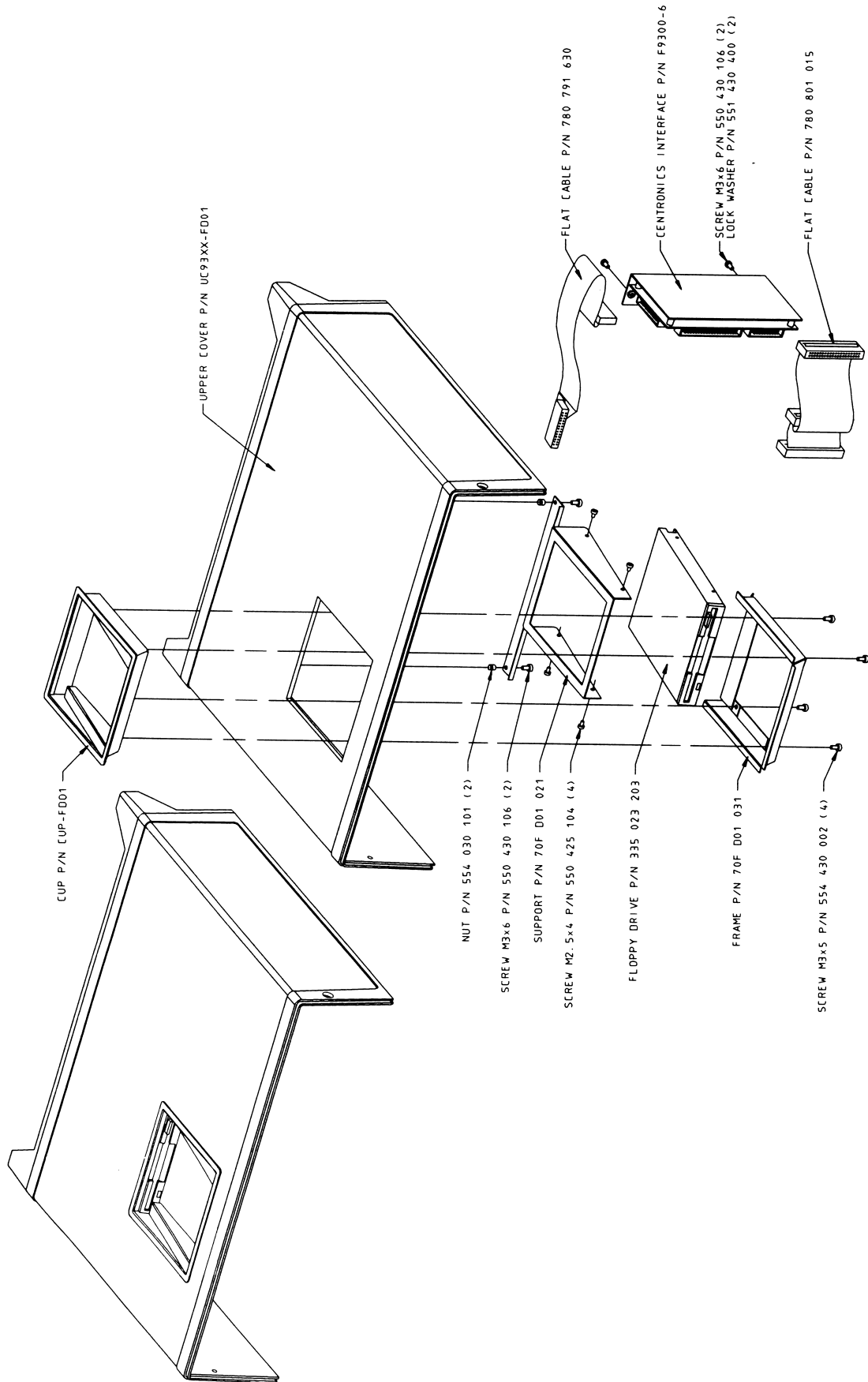

FIGURE 9.11: 9320-FD01 ASSEMBLY: FLOPPY OPTION

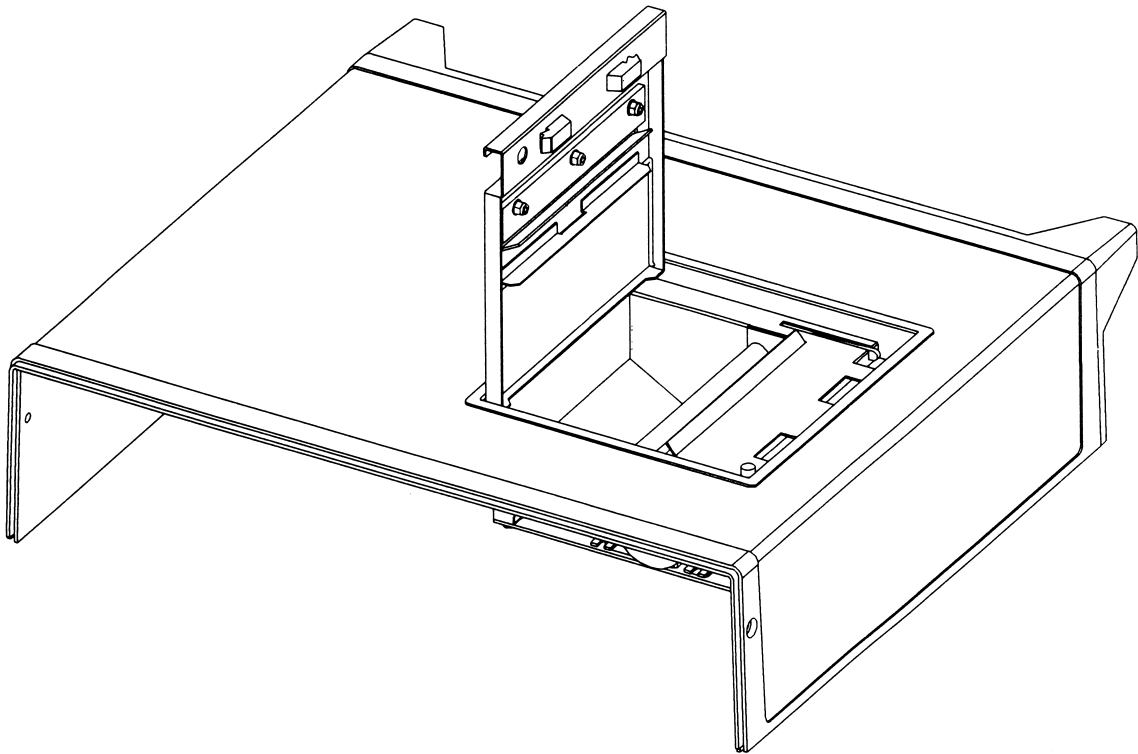
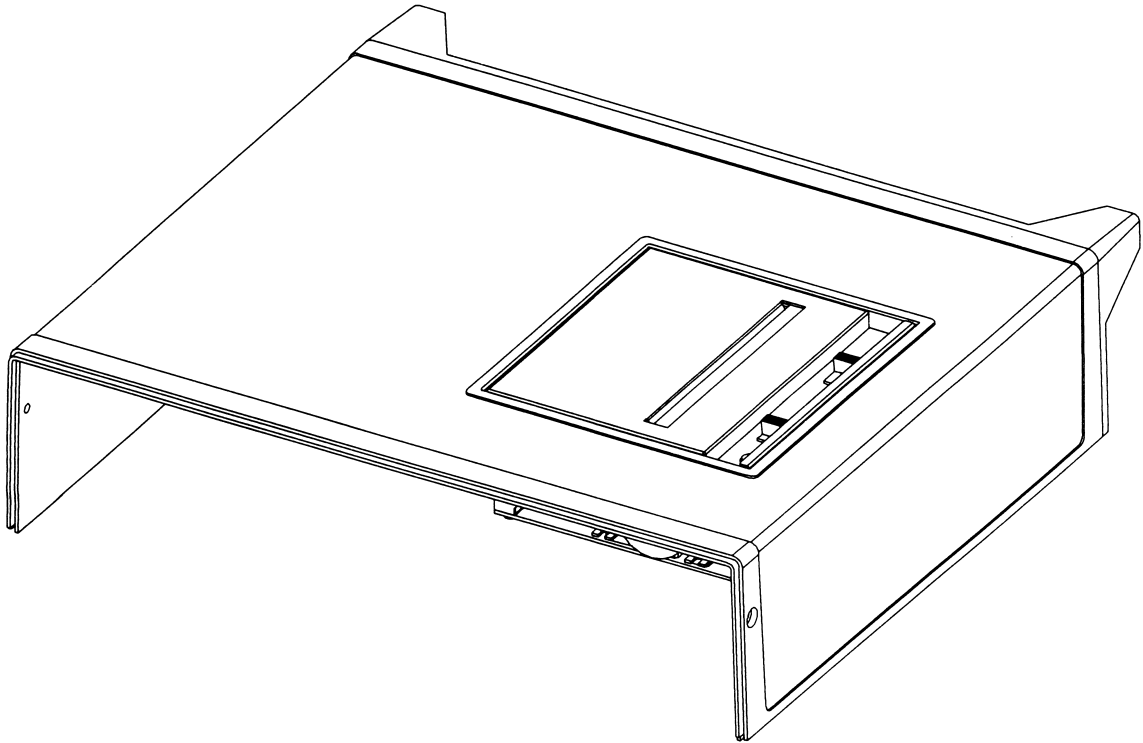

FIGURE 9.12: 9320-GP01 PRINTER OPTION

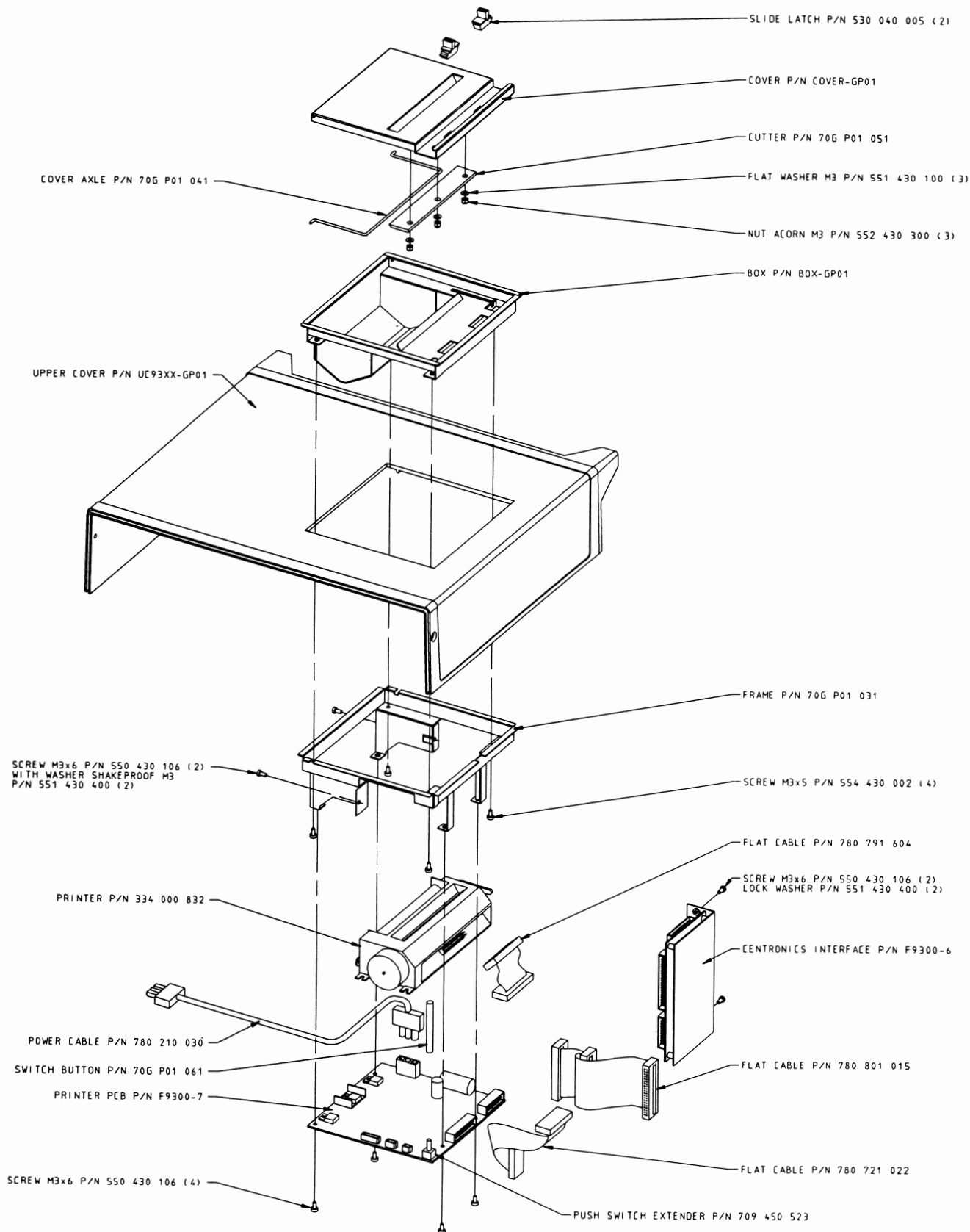

FIGURE 9.13: 9320-GP01 ASSEMBLY: PRINTER OPTION

SECTION 10 CONNECTING the 9320 to a PLOTTER or a PRINTER

10.1 Introduction

LeCroy oscilloscopes are supplied with a list of plotters and printers known to work with them.

This list is not final, so any suggestions are welcome.

HP plotter responses to some RS-232 configuration commands have been evolved. Consequently, the 9320 generation DSO support HP plotters of two types, 7470A and 7550A. The only difference lies in the RS-232 initialization codes. They may however, despite these changes, work with HPGL compatible plotters from other manufacturers. If the HPGL data is used as input for a CAD or word processing system, it might be necessary to remove the data preceding the in command. Before connecting a plotter to a 9320 do not forget to select the appropriate settings in the printer setup menu and the GPIB & RS-232 setup menu.

GPIB & RS232

Remote
Control From
GPIB **RS232**

RS232 Mode
7-bit
8-bit

Parity
none
odd even

Stop bits
1 2

Baud Rate
300 1200
2400 4800
9600 19200

GPIB Device
Talk Only

HARDCOPY

output to
Card
Floppy
GPIB
RS232
Centronics

page feed
Off On

printer
TIFF
HP 7470
HP 7550
DeskJet
TIFF compr.

RS-232 connection

The following settings are assumed for the scope.

Baud rate : 9600
 Character : 8 bits
 Parity : none
 Stop bits : 1

Any exceptions will be mentioned.

RS 232 interface

Pin 1 : DCD
 2 : RD
 3 : TD
 4 : DTR
 5 : GND
 6 : DSR
 7 : RTS
 8 : CTS
 9 : RI

A cable with the following pinout can be used in almost every case:

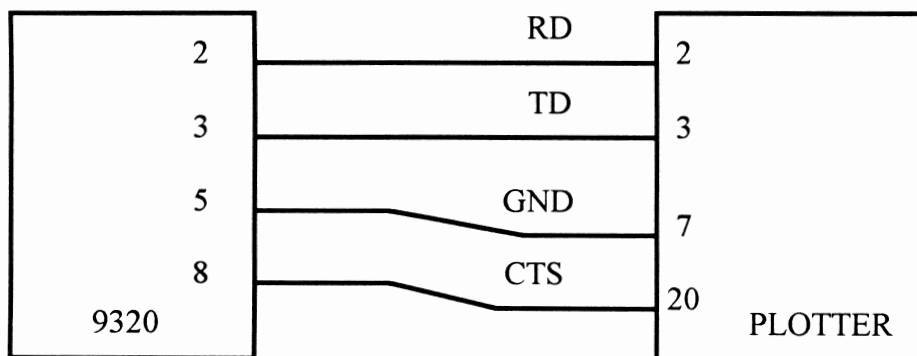

The cable has D25 connector with male pins on the plotter side, and a D9 connector with female pins on the 9320 oscilloscope side.

GPIB Connection

To have a plot done through GPIB initiated with the front panel screen dump push button, you must set the 9320 in talk only mode by selecting remote control from RS-232, and the plotter in listen only mode.

If a computer controls the GPIB Bus, both the scope and the plotter must be set in addressed mode (remote control from GPIB). Remark: the listen only mode does not work on some old HP plotters such as HP7585B or HP7475. The plotter must be set to listener before being able to receive any commands, which is a violation of the GPIB standard.

10.2 Plotters

10.2.1 HP 7470A Plotter

Switch settings:

- RS-232 Connection:
 S1 and S2 : 0 0
 Y/D : D
 A4/US : User selectable
 B4 to B1 : 1 0 1 0

- GPIB listen only:
 A4/US : User selectable
 16 to 1 : 1 1 1 1 1

- GPIB Addressed:
 A4/US : User selectable
 16 to 1 : 0 0 1 1 1

10.2.2 HP 7550A Plotter

Responses to some ESC characters commands are not the same in this plotter as in older HP models like the 7470A. In fact, ESC sequences of commands which give excellent results in the 7470A can prevent any handshake in RS-232.

Problems of this kind have been reported in the case of ESC.R and ESC.@ commands. When combined with ESC.I and ESC.N, ESC.@ breaks up all handshakes.

- RS-232 configuration:
- Enter into display 5 (HP-IB MONITOR...).
- Select STANDARD OF STANDARD/ENHANCED.
- Enter into SERIAL sub-menu (display 6)
- For DATA_FLOW, select REMOTE. Either STANDALONE or EAVESDROP may be chosen.
- Enter into display 7 (DUPLEX, PARITY, BAUD).
- Select FULL duplex.
- Configuration PARITY and BAUD rate to the same values as on the DSO.

A standard cable may be used.

Do not start a plot while a sheet of paper is being loaded!

- GPIB configuration:

If the scope is in TALK ONLY, the plotter must be in LISTEN ONLY. Selection will be done at display 5.

- Note : Its seems that the plotter must be powered off, then on again, to take any configuration change into account.

10.2.3 Hitachi 672 Graph Plotter (or NSA 672)

As this plotter is compatible with the 7470A, select this mode on the plotter menu page.

Switch settings

- RS-232 Connection:

Sw. A, 1 and 2 : 1 1 (ISO A3) or (ISO A4).
 Sw. A, 3 to 8 : 1 0 1 1 0 1
 Sw. B : 1 1 1 1

- Note: When switches are set to ISO A4, the pen must be manually repositioned at the top of the page (or plotter reset by powering it off and on) before loading a new sheet of paper.

10.3 Printers

Interfacing is possible through RS-232, GPIB directly, and in option through Centronics. The parallel interface F9300-6 (Centronics) is an option, see section 4.5.

10.3.1 Centronics Printers

Most printers use a Centronics parallel connection which makes direct connection possible if the 9320 is equipped with the optional Centronics interface F9300-6 board. If the printer has a Centronics connector then it's a parallel printer, and the F9300-6 board is required or a serial to parallel converter.

If a serial to parallel converter is used, in the printer setup menu select device type Epson, and remote control from RS-232.

RS-232 Remote control port settings:

Baud rate : 9600 or 19200
 Characters length (bits): 8
 Parity : none
 Number of stop bits : 1

The following printers and printer switch positions have been tested via serial to parallel adapter.

	Switch 1	Switch 2
1. Epson LQ-1000	1, 2, 3, 4 : ON	2, 6, 7 : ON
2. Diconix 150P	1: ON	2, 6, 7 : ON
3. HP-ThinkJet 2225C	2, 4, 5 : ON	
4. HP-DeskJet 550 C	all down	6 up for 19200 bauds

Note: all Epson and Epson Compatible printers are likely to work if the switches are set properly. (Some experimentation may be required).

Some available serial to parallel converters need power through the RS-232 lines. Do not use them, as we do not guarantee that the serial port is able to furnish enough power.

10.3.2 RS-232 Printers

10.3.2.1 Epson FX80

It is possible to use the standard RS-232 cable. Such a printer has the optional RS-232 interface "#8143" installed. The configuration that follows is valid for the default scope setting. The standard cable is usable.

In the particular case of an FX850:

- the main switches SW1 SW2 remain at the factory configuration

SW1	:	1	2	3	4	5	6	7	8
		OFF	OFF	ON	OFF	OFF	ON	ON	ON

SW2	:	1	2	3	4
		ON	OFF	OFF	OFF

- the 8143 switches are set to:

1	2	3	4	5	6	7	8
ON	OFF	OFF	OFF	n/a	OFF	OFF	ON

- the 8143 jumpers remain at the factory settings:

J1	J2	J3	J4	J5	JC	JNOR	JRVE	JF	JX
OFF	OFF	OFF	OFF	ON	OFF	ON	OFF	ON	OFF

Note: Epson printers only support XON/XOFF support handshake if they have a print buffer. Such printer are:

FX, FX+, JX-80, LQ-800/1000, EX-800 and LQ-25000.

Otherwise, use DTR/RTS handshake.

10.3.2.2 Citizen 120D

To use this printer with the default RS-232 setting and default printer setting of the 9320, select the following switch configuration:

DIP switch bank 1 : all OFF except 3 and 8, DIP switch bank 2 : all OFF.

10.3.2.3 HP LaserJet

Make sure that page feed is ON in the plotter menu to use the LaserJet. It is advisable to start out in single density with a size of A5. Then, depending upon the internal buffer size on the LaserJet, the image size and/or density can be increased. At one point, the internal buffer size of the DSO is also reached. The image is simply truncated, indicating that either density or size have to be reduced.

10.3.2.4 HP QuietJet

10.3.2.5 HP ThinkJet

To use printer with the default RS-232 setting and with the default cable select the following switch configuration:

- mode switch:

1	2	3	4	5	6	7	8		
0	0	0	0	:	11" page length	0	0	0	0
			1	:	12" page length				

- RS-232 switch:

1	2	3	4	5
1	0	0	0	0

(use DTR handshake) (8bits, parity none) (9600 bauds)

Note: it may be possible that old ThinkJet recognize only the Epson protocol. If it is the case use the Epson.

10.3.2.6 HP DeskJet 550C

The standard cable is usable. The printer has been tested at 19200 bauds with the following configuration :

Switch 1 or Bank A : all down

Switch 2 or Bank B : 6 up for 19200 bauds, all the other down

10.3.2.7 Brother Printers

The Brother M-1509 and M-1709 have been tested with a serial connection. On the oscilloscope select "Epson FX-80 or compatible printer".

The switch settings are identical for both the printers:

- SW1	:	1	2	3	4	5	6	7	8
		ON	ON	ON	OFF	ON	n/a	n/a	ON

- SW1	:	1	2	3	4	5	6	7	8
			←		ALL OFF			→	

- SW1	:	1	2	3	4	5	6	7	8
		OFF	OFF	OFF	OFF	11" : OFF	OFF	ON	OFF
						12" : ON			

10.3.3 GPIB Printers

10.3.3.1 HP QuietJet

Make sure the dip switches on the backplane of the printer are set to

- SRQ enable:	0
- GPIB listen only:	
Listen always:	1
A5 to A1:	0 0 1 1 1
- GPIB Addressed:	
Listen always:	0
A5 to A1:	0 0 1 1 1

10.3.3.2 HP ThinkJet (HP 2225A)

Make sure the dip switches on the backplane of the printer are set to

- SRQ Enable:	0
- GPIB listen only:	
Listen always	1
A5 to A1:	0 0 1 1 1
- GPIB Addressed:	
Listen always:	0
A5 to A1:	0 0 1 1 1

10.3.3.3 HP PaintJet (black/white only)

Make sure the dip switches near the GPIB connector are set to:

- GPIB Listen only:	
NORM/SCS:	NORM
A3 to A1:	1 1 1
PC8/ROM8:	N/A
ENG/MET:	has to match paper size ENG = 11" MET = 12"
- GPIB addressed:	
NORM/SCS:	NORM
A3 to A1:	any combination except 1 1 1 (correspond to add. 0-6)
PC8/ROM8:	N/A
ENG/MET:	has to match paper size ENG = 11" MET = 12"

10.4 Information on GPIB

10.4.1 Introduction

This section is a simple description of the GPIB interface as an aid to understanding the interface in the 9320 DSO: it is not intended as a complete specification of the system.

The GPIB system is designed for the interaction of a number of devices, which may transmit or receive information as required. The system includes data lines over which the actual data are sent, bus management lines for control, and handshake lines to ensure correct acceptance of data at the right destination. The main features of the bus are summarized below:

Maximum number of devices	15
Maximum bus length	20 meters or 2 meters per device, whichever is less
Connection	star or chain

Note that more than half of any connected devices must be powered up, even if they will not be used.

Data lines	8 DIO	1 to 8
Handshake lines	DAV	Data available
	NRFD	Not ready for data
	NDAC	not data accepted
Bus management lines	EOI	End or identity
	IFC	Interface clear
	SRQ	Service request
	ATN	Attention
	REN	Remote enable
Active level	+0.4 V	
Inactive level	+3,3 V	

Note that all signal lines are active low, and that they are wire ORed to allow participation by all devices.

In addition, there are 8 ground lines, making a total of 24 lines.

10.4.2 Functions in the GPIB

In order to allow satisfactory interconnection of several devices the following functions must be provided

- Enabling any device to transmit data
- Preventing any device from transmitting data
- Enabling any device to receive data
- Preventing any device to receive data
- Transmitting data to a specific device
- Ensuring that only one device is transmitting
- Ensuring that transmitting takes place only when reception is possible
- Enabling any device to request servicing
- Identify type of data to be sent

Any device can be activated into the "talk" or "listen" state, and can be deactivated by the commands "untalk" and "unlisten". Also a device can be a "controller".

Maximum number of current talkers	1
Maximum number of current listeners	14
Maximum number of current controllers	1

Function of bus lines:

- DAV Data available; talker says the data on the line are valid.
- NRFD Not ready for data; listener says it is not ready for more data. All listeners must release the NRFD line, i.e., let it go high, before talker can send.
- NDAC Not data accepted; listener says it has not yet accepted the data. Talker must hold all data lines steady until all listeners have released this line, i.e., it goes high.

Clearly, the NRFD and NDAC are easy to implement by a wired OR system, so that any one device asserting the signal prevents progress to the next step. Progress is made at the speed of the slowest listener. A simple timing diagram is given in figure 10.1, and another way of presenting the system is given in figure 10.2.

The bus management lines functions as follows:

- EOI End Or Identify; talker sends this with last byte of a block transfer to indicate last byte. Also used with ATN to parallel poll devices for their status bit.
- IFC InterFace Clear; places the GPIB system into a quiescent state.
- SRQ Service ReQuest; any device can send it to the controller to indicate need for attention, and to request interruption of current operations.
- ATN ATeNtion; controller sends this to specify whether DIO lines are to be used for interface messages, e.g., addressing, or for data.
- REN Remote ENable; selects a device as being under local or remote control.

Addressing of the devices on the GPIB bus consult a specialized GPIB-IEEE488 document.

The principles of GPIB are quite simple - the system must wait for all users, and lines are wire ORed so that all can pull the lines down. The handshake sequence is illustrated in two ways. In figure 10.1 the signal waveforms are sketched, while figure 10.2 is a flowchart.

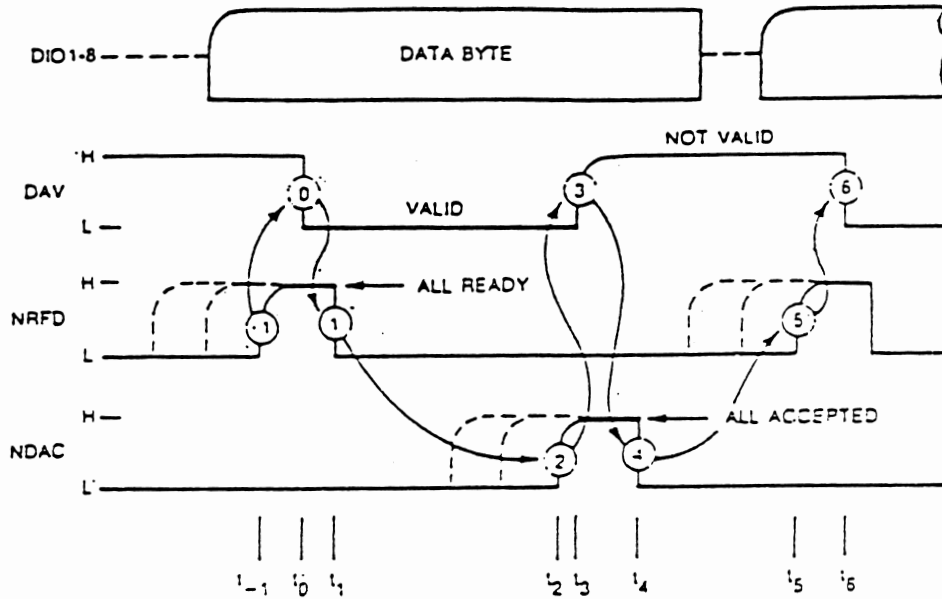

Figure 10.1
DATA BYTE TRANSFER IN GPIB IEEE-488

The handshake timing sequence proceeds as follows:

- Preliminary The source checks for presence of listeners and places the next data byte on the data lines DI01-8.
- t-1 Acceptors one by one become ready for byte. Last one allows NRFD to go high.
- t0 Sources pulls down DAV to validate data.
- t1 The first listener to accept the data pulls down NRFD to show it is no longer ready for a new byte.
- t2 The listeners one by one accept the data, and the last one lets NDAC go high.
- t3 The source sets DAV high to show this byte is no longer valid.
- t4 The listeners one by one accept this, the first one pulling NDAC low for the next cycle.
- t5 As for t-1.

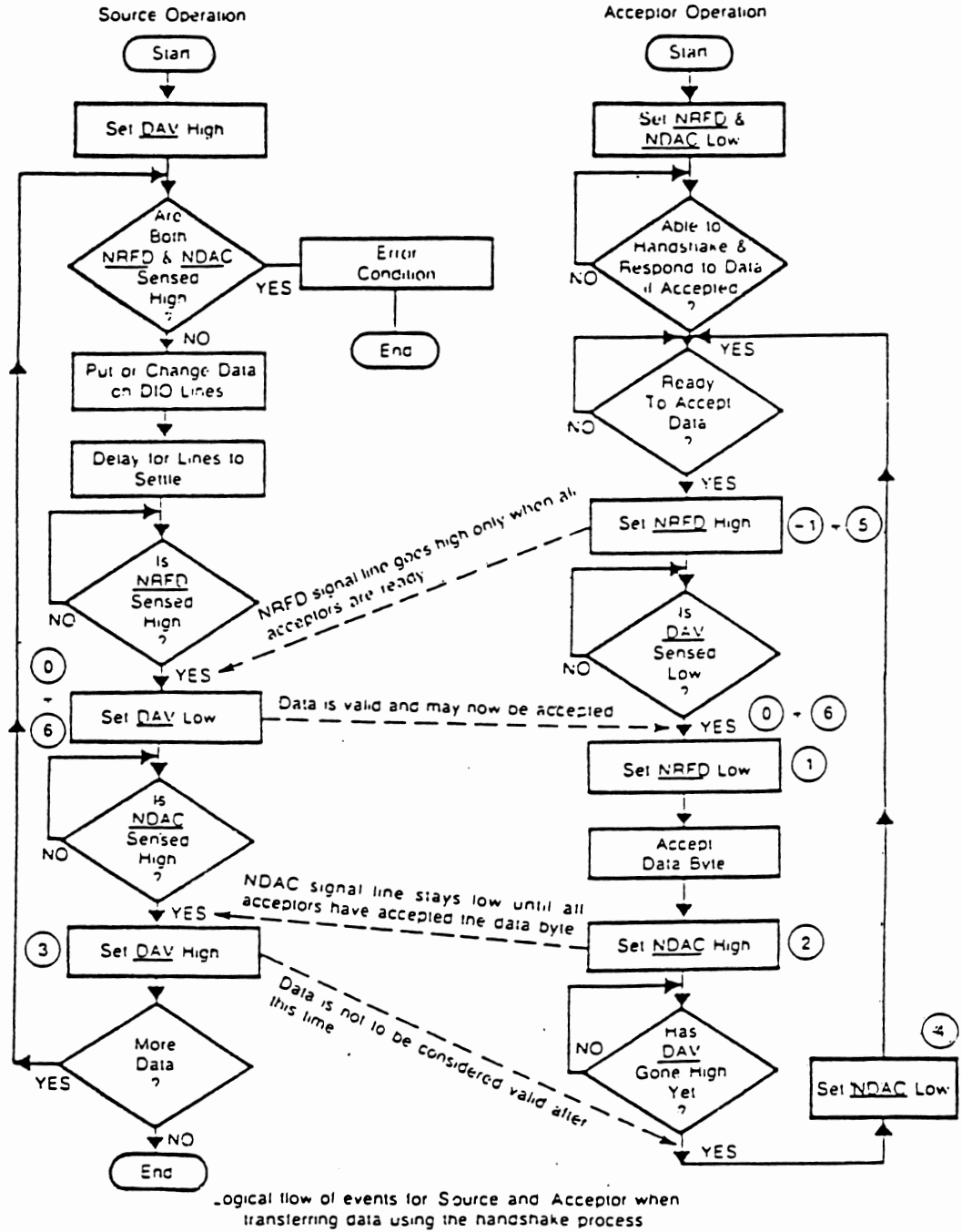

Figure 10.2

HANDSHAKE TIMING SEQUENCE IN GPIB IEEE-488

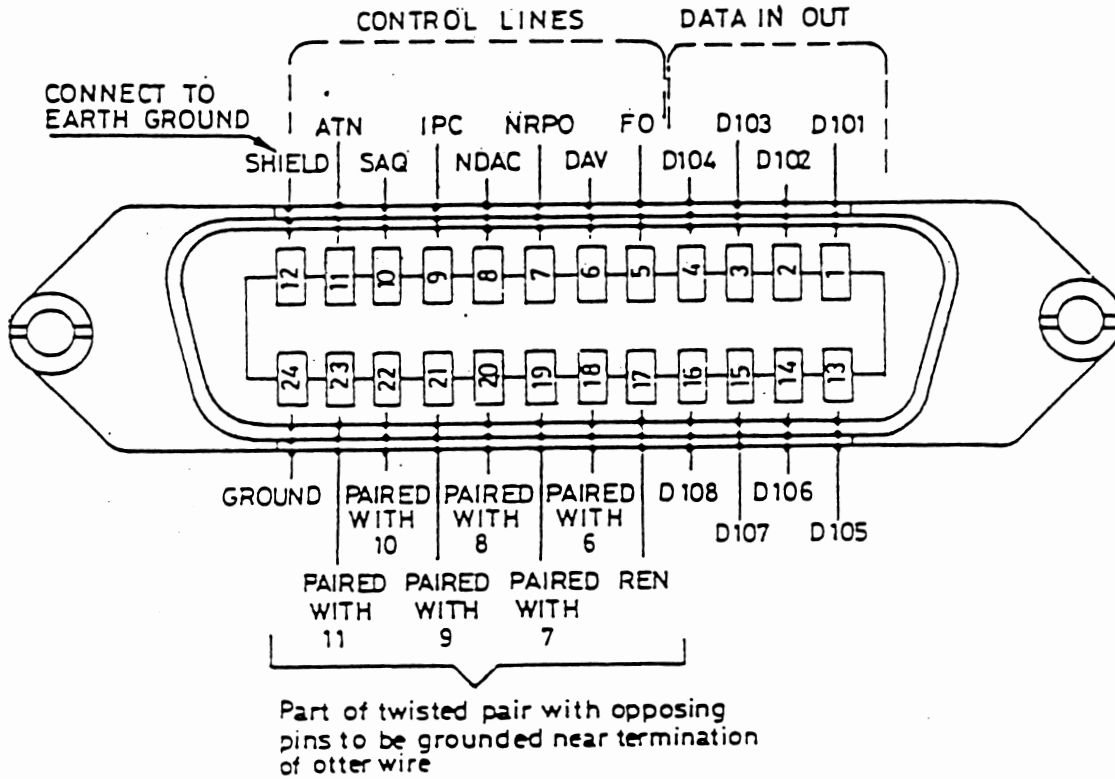

Figure 10.3
GPIB IEEE-488 INTERFACE