

**LeCroy 9384/M/TM/L/AL
Digital Storage Oscilloscope
Service Manual**

Version 1.0
June , 1997
First Printing

THIS MANUAL WAS SCANNED AT THE BEST USABLE RESOLUTION FROM A PHOTOCOPY SUPPLIED BY A GROUP MEMBER. IF YOU HAVE A BETTER SCAN OR COPY TO LEND FOR SCANNING PLEASE LET THE GROUP MODERATOR KNOW BY POSTING A MESSAGE TO:

LeCroy_Owners_Group

Attention: Moderator

ON YAHOO GROUPS

NOTE: THIS MANUAL TO BE DISTRIBUTED FREE OF CHARGE.

YOU MAY INCLUDE A COPY WITH AN ITEM FOR SALE BUT YOU MAY NOT PROVIDE IT INDIVIDUALLY FOR SALE ON ANYWHERE ON ANY MEDIUM.

LeCroy Corporate Headquarters

700 Chestnut Ridge Road
Chestnut Ridge, NY 10977-6499
USA

Tel : (914) 425-2000

Fax : (914) 425-8967

<http://www.lecroy.com>

LeCroy European Headquarters

LeCroy Europe GMBH
Mannheimer Strasse 175
D-69123 Heidelberg
Germany

Tel : 49.6221.82700

Fax : 49.6221.834655

LeCroy European Manufacturing

LeCroy SA
2, Chemin Pre-de-la Fontaine
CH-1217 Meyrin 1 Geneva
Switzerland

Tel : 41 (22) 719-21-11

Fax : 41 (22) 782-39-15

Information in this publication supersedes all earlier versions.
Specifications subject to change.

Section 1	General Information	Page
1.1	Initial Inspection	1-1
1.2	Warranty	1-1
1.3	Product Assistance	1-1
1.4	Address of Service Centers	1-2
1.5	Maintenance Agreements	1-5
1.6	Documentation Discrepancies	1-5
1.7	Service Procedure	1-5
1.8	Return Procedure	1-5
1.9	Safety Precautions	1-6
1.1	Antistatic Precautions	1-6
Section 2	Specifications	
2.1	9384 Specifications	2-2
2.2	Hard Disk, Floppy, RAM Card, Internal Printer Options	2-7
2.3	Active Fet Probes	2-10
2.4	Active Differential Probes	2-12
2.5	Current Probe	2-14
2.6	Trigger Pick-Off	2-16
2.7	WP01 Waveform Processing Firmware	2-18
2.8	WP02 Spectrum Analysis Firmware	2-21
2.9	WP03 Parameter Distribution Analysis Firmware	2-24
2.10	Disk Drive Measurement Packages	2-27
2.11	Optical Recording Measurement Package	2-31
2.12	Telecommunications Test Masks	2-35
2.13	64 Mega Bytes Extended Processing Memory	2-37
2.14	CKTRIG option	2-39
2.15	LeCalsoft Calibration Software	2-41
Section 3	Block Diagram and Sub-Assemblies	
3.1	9384 Sub-Assemblies	3-1
3.2	9384 Hardware Options	3-1
3.3	9384 Block Diagram	3-2
3.4	9384M Block Diagram	3-3
3.5	9384L Block Diagram	3-4
3.6	9384AL Block Diagram	3-5
Section 4	Theory of Operation	
4.1	Processor Board for 9384/M/TM/L/AL	4-1
4.1.1	Processor Block Diagram	4-1
4.1.2	Parallel Peripherals	4-2
4.1.3	Serial Peripherals	4-3
4.1.4	External Interfaces	4-3
4.1.5	Optional Interfaces	4-3
4.2	F9384-3 Main Card	4-4

Section 4	Theory of Operation	Page
4.2.1	Introduction	4-4
4.2.2	Microprocessor Control	4-4
4.2.2.3	Microprocessor Control Block Diagram	4-5
4.2.3	Front End	4-9
4.2.3.1	Channel Description	4-9
4.2.3.2	Digital Controls	4-11
4.2.3.3	Analog Controls	4-12
4.2.4	Trigger	4-12
4.2.4.1	Digital Controls	4-12
4.2.4.2	Analog Controls	4-13
4.2.4.3	TV Trigger	4-13
4.2.4.4	Trigger Block Diagram	4-14
4.2.5	ADC	4-15
4.2.5.1	ADC Block Diagram	4-16
4.2.6	Timebase	4-17
4.2.6.2	Timebase Block Diagram	4-18
4.2.6.3	Digital Controls	4-19
4.2.6.4	Trigger Selection	4-19
4.2.6.5	Smart Trigger	4-19
4.3	F9300-4 GPIB and RS232	4-20
4.3.1	RS232 Interface	4-20
4.3.2	GPIB Interface	4-20
4.4	F9350-5 Front Panel	4-20
4.5	F9300-6 Centronics Interface	4-20
4.5.1	Centronics Interface Option	4-20
4.5.2	Floppy Disk Drive Interface Option	4-20
4.5.3	Printer Interface Option	4-20
4.6	F9300-7 Printer Controller	4-21
4.7	F9300-8 Hard Disk Option	4-21
4.8	93XX-Display	4-21
4.8.1	General Description	4-21
4.8.2	Basic Characteristics	4-21
4.8.3	Horizontal Deflection	4-22
4.8.4	Horizontal Resolution	4-23
4.8.5	Vertical Synchronization	4-23
4.8.6	Vertical Resolution	4-23
4.9	9384 Power Supply	4-24
4.9.1	Power Supply Specifications	4-24
4.9.2	Power Supply Block Diagram	4-25
Section 5	Performance Verification	
5.1	Introduction	5-1
5.2	Test Equipment Needed	5-2
5.3	Turn On	5-2
5.4	Input Impedance	5-3
5.4.1	Procedure	5-3

Section 5	Performance Verification	Page
5.4.1.a	DC 1M Ohm	5-3
5.4.1.b	AC 1M Ohm	5-4
5.4.1.c	DC 50 Ohm	5-5
5.4.2	External Trigger Input Impedance	5-6
5.4.2.a	DC 1M Ohm	5-6
5.4.2.b	DC 50 Ohm	5-7
5.4.3	Internal Protective Resistor Verification	5-8
5.5	Leakage Current	5-9
5.6	Average Noise Level	5-9
5.6.1	Peak to Peak Noise	5-9
5.6.1.a	DC 1M Ohm	5-9
5.6.1.b	AC 1M Ohm	5-12
5.6.1.c	DC 50 Ohm	5-14
5.6.2	RMS Noise	5-16
5.6.2.a	DC 1M Ohm	5-16
5.6.2.b	AC 1M Ohm	5-18
5.6.2.c	DC 50 Ohm	5-18
5.6.3	Inputs Grounded	5-19
5.7	DC Linearity	5-23
5.7.1	Description	5-23
5.7.1.a	DC 50 Ohm	5-23
5.7.1.a.1	Positive DC Linearity	5-24
5.7.1.a.2	Negative DC Linearity	5-27
5.7.1.b	DC 1M Ohm	5-29
5.8	Offset	5-32
5.8.1	Description	5-32
5.8.1.a	Negative Offset Control Procedure	5-32
5.8.1.b	Positive Offset Control Procedure	5-35
5.9	Bandwidth	5-37
5.9.1	Description	5-37
5.9.1.a	DC 50 Ohm	5-38
5.9.1.a.1	Trigger Bandwidth	5-43
5.9.1.b	1 M Ohm	5-45
5.10	Trigger Level	5-47
5.10.1	Description	5-47
5.10.2	Channel (internal)	5-47
5.10.3	External Trigger	5-55
5.10.4	External/10 Trigger	5-63
5.11	Smart Trigger	5-71
5.11.1	Trigger on Pulse Width < 10 nsec	5-71
5.11.2	Trigger on Pulse Width > 10 nsec	5-71
5.11.3	Trigger on Pulse Width < 100 nsec	5-73
5.11.4	Trigger on Pulse Width > 100 nsec	5-74
5.12	Time Base Accuracy	5-75
5.12.1	Description	5-75
5.12.2	500 MHz Clock Manual Verification Procedure	5-75
5.13	Overshoot and Rise Time (10% - 90%)	5-79

Section 5	Performance Verification	Page
5.14	Probe Calibrator Verification	5-83
5.15	Overload	5-85
5.16	Combining Channels	5-87
Section 6	Maintenance	
6.1	Introduction	6-1
6.2	Disassembly and Assembly Procedure	6-1
6.2.1	Removal of the Upper Cover	6-1
6.2.2	Removal of the PS9384 Power Supply	6-1
6.2.3	Disassembly and Assembly Diagram	6-2
6.2.3.1	Figure 6.1 : 9384 Assembly	6-3
6.2.3.2	Figure 6.2 : Lower Cover Assembly	6-4
6.2.3.3	Figure 6.3 : Front Frame Assembly	6-5
6.2.3.4	Figure 6.4 : Rear Panel Assembly	6-6
6.2.4	Removal of the F9300-4 GPIB and RS232 Interface	6-7
6.2.5	Removal of the Fan	6-7
6.2.6	Removal of the Fuse Holder	6-7
6.2.7	Removal of the 93XX-Video	6-7
6.2.8	Removal of the 93XX-Yoke	6-8
6.2.9	Removal of the Front Frame Assembly	6-8
6.2.10	Removal of the 93XX-Deflection	6-8
6.2.11	Removal of the 93XX-CRT	6-9
6.2.12	Removal of the F9354-5 Front Panel	6-9
6.2.13	Removal of the Front Panel Keyboard	6-9
6.2.14	Removal of the Processor	6-10
6.2.15	Removal of the F9384-31 Main Board	6-10
6.2.16	Removal of the Handle	6-11
6.2.17	Removal of the Foot Support	6-11
6.2.18	Removal of the 93XX-FD01 Floppy Disk	6-11
6.2.19	Removal of the 93XX-GP01 Graphic Printer	6-11
6.2.20	Removal of the F9300-6 Centronics Interface	6-11
6.2.19	Removal of the F9300-7 Printer Controller	6-11
6.2.21	Figure 6.5 : Floppy Drive Assembly (p/n 335023203)	6-12
6.2.22	Figure 6.6 : Graphic Printer Assembly	6-13
6.3	Software Upgrade Procedure	6-14
6.3.1	Upgrading Firmware	6-14
6.3.1.1	Upgrading Firmware from Memory Card	6-14
6.3.1.2	Upgrading Firmware from Floppy	6-15
6.3.2	Changing Software Options	6-16
6.3.3	Software Option Selection GAL	6-16
6.3.4	Processor Board Exchange Procedure	6-19
6.4	Equipment and Spare Parts Recommended for Service	6-21
6.4.1	Equipment	6-21
6.4.2	Spare Parts	6-22
6.5	Troubleshooting and Flow Charts	6-22
6.5.1	Introduction	6-22

Section 6	Maintenance	Page
6.5.2	Line Voltage Autoranging	6-22
6.5.3	Initial Troubleshooting Chart	6-23
6.5.4	No Power Supply	6-24
6.5.4.1	Line Fuses Replacement	6-24
6.5.5	No Display	6-25
6.5.6	Abnormal Image on Screen	6-26
6.5.7	Front Panel Controls Do Not Operate	6-27
6.5.8	No Remote Control GPIB or RS232	6-28
6.5.9	Performance Verification Fails	6-29
6.5.10	Floppy Disk Drive Fails	6-30
6.5.11	Graphic Printer Fails	6-31
6.5.12	Centronics Fails	6-32
6.5.13	Hard Disk Option Fails	6-33
6.6	Calibration Procedures	6-34
6.6.1	PS9384 Power Supply Calibration	6-34
6.6.1.1	Figure 6.9 : Power Supply	6-35
6.6.2	93XX-Display Adjustment Procedure	6-36
6.6.2.1	Introduction	6-36
6.6.2.2	Coarse Adjustment	6-37
6.6.2.3	Fine Adjustment	6-38
Section 7	Schematics, Diagrams, Parts List	
7.1.1	9384 Bill of Material	7-2
7.1.2	9384M Bill of Material	7-2
7.1.3	9384TM Bill of Material	7-2
7.1.4	9384L Bill of Material	7-3
7.1.5	9384AL Bill of Material	7-3
7.2	S9302-1-X Processor Board Schematic	7-4
7.2.1	F9302-1-8 Processor Board Parts List	7-13
7.2.2	F9302-1-16 Processor Board Parts List	7-13
7.2.4	S9302-1-X Processor Board Layout	7-14
7.2.5	S9302-1-X Processor Board Parts List	7-15
7.3	F9384-3 Main Board Schematic	7-19
7.3.1	F9384-3 Microprocessor Control Schematic	7-20
7.3.2	F9384-3 Front End Control Schematic	7-25
7.3.2.1	F9384-3 Front End Power Supply Schematic	7-27
7.3.2.2	F9384-3 Front End Channel 1 Schematic	7-28
7.3.2.3	F9384-3 Front End Channel 2 Schematic	7-32
7.3.2.3	F9384-3 Front End Channel 3 Schematic	7-36
7.3.2.3	F9384-3 Front End Channel 4 Schematic	7-40
7.3.2.4	F9384-3 Front End Trigger Schematic	7-44
7.3.2.5	F9384-3 Front End Probe Calibrator Schematic	7-48
7.3.3	F9384-3 ADC Schematic	7-49
7.3.3.1	F9384-3 ADC Power Supply Schematic	7-50
7.3.3.2	F9384-3 ADC Control Channel 1 & 2	7-51
7.3.3.3	F9384-3 ADC Channel 1 Schematic	7-52

Section 7	Schematics, Diagrams, Parts List	
7.3.3.4	F9384-3 ADC Channel 2 Schematic	7-53
7.3.3.5	F9384-3 ADC Channel 1 & 2 Connector Schematic	7-54
7.3.3.6	F9384-3 ADC Channel 1 & 2 Demux Schematic	7-55
7.3.3.7	F9384-3 ADC Buffer Channel 1 Schematic	7-57
7.3.3.8	F9384-3 ADC Buffer Channel 2 Schematic	7-58
7.3.3.9	F9384-3 ADC Control Channel 3 & 4	7-59
7.3.3.10	F9384-3 ADC Channel 3 Schematic	7-60
7.3.3.11	F9384-3 ADC Channel 4 Schematic	7-61
7.3.3.12	F9384-3 ADC Channel 3 & 4 Connector Schematic	7-62
7.3.3.13	F9384-3 ADC Channel 3 & 4 Demux Schematic	7-63
7.3.3.14	F9384-3 ADC Buffer Channel 3 Schematic	7-65
7.3.3.15	F9384-3 ADC Buffer Channel 4 Schematic	7-66
7.3.4.1	F9384-3 Time Base Schematic	7-67
7.3.4.2	F9384-3 Main Board Layout	7-75
7.3.4.3	F9384-3 Parts List	7-95
7.3.5.1	F9384-7 T-Coil Schematic	7-136
7.3.5.2	F9384-7 Parts List	7-137
7.3.6.1	F9354-4 400-500 MHz Oscillator Schematic	7-138
7.3.6.2	F9354-4 400-500 MHz Oscillator Parts List	7-139
7.4.1	9384MEM-2 Acquisition Memory Schematic	7-140
7.4.2	9384MEM-2 Parts List	7-150
7.4.3	9384MEM-2 Layout	7-152
7.5.1	9384M-2 Acquisition Memory Schematic	7-154
7.5.2	9384M-2 Layout	7-164
7.5.3	9384M-2 Parts List	7-166
7.6.1	F9300-4 GPIB/RS232 Interface Layout	7-168
7.6.2	F9300-4 GPIB/RS232 Interface Parts List	7-169
7.7	F9354-5 Front Panel Schematic	7-171
7.7.1	F9354-5 Front Panel Layout	7-172
7.7.2	F9354-5 Front Panel Parts List	7-174
7.8	F9300-6 Centronics Interface Schematic	7-175
7.8.1	F9300-6 Centronics Interface Layout	7-177
7.8.2	F9300-6 Centronics Interface Parts List	7-178
7.9	F9300-7 Printer Controller Schematic	7-180
7.9.1	F9300-7 Printer Controller Layout	7-182
7.9.2	F9300-7 Printer Controller Parts List	7-183
7.10	F9300-8 PCMCIA III Hard Disk Controller Schematic	7-187
7.10.1	F9300-8 PCMCIA III Hard Disk Controller Layout	7-188
7.10.2	F9300-8 PCMCIA III Hard Disk Controller Parts List	7-189
7.11	Deflection and Video Schematic	7-191
7.11.1	93XX-Deflection Schematic	7-191
7.11.2	93XX-Video Schematic	7-193
7.11.3	93XX-Deflection Parts List	7-194
7.11.4	93XX-Video Parts List	7-195
7.12	Accessories for 9384	7-196
7.13	93XX-GP01, Graphic Printer Parts List	7-197
7.14	93XX-FDGP Graphic Printer & Floppy Disk Parts List	7-198

Section 7	Schematics, Diagrams, Parts List	Page
7.15	93XX-FD01 Floppy Disk Parts List	7-199
7.16	M9384 Mechanical for 9384	7-200
7.17	PS9384 Power Supply Parts List	7-202
7.17.1	PS9384 Power Supply Schematic	7-203
7.17.2	PS9384-2 Power Supply Schematic	7-205
7.17.3	PS9384-2 Power Supply Parts List	7-206
7.17.4	PS9384-3 Power Supply Schematic	7-207
7.17.5	PS9384-3 Power Supply Parts List	7-208
Section 8	Mechanical Parts	
8.1	Figure 8.1 : 9384 Exploded View	8-2
8.1.1	9384 Assembly Part Description	8-3
8.2	Figure 8.2 : Lower Cover Exploded View	8-4
8.2.1	Lower Cover Assembly Description	8-5
8.3	Figure 8.3 : Front Frame Assembly Exploded View	8-6
8.3.1	Front Panel Assembly Description	8-7
8.4	Figure 8.4 : Rear Panel Assembly Exploded View	8-8
8.4.1	Rear Panel Assembly Description	8-9
8.5	Figure 8.5 : Power Supply Exploded View	8-10
8.5.1	Power Supply Description	8-11
8.6	Figure 8.6 : FD01 Floppy Option Assembly	8-12
8.6.1	FD01 Floppy Option Assembly Description	8-13
8.7	Figure 8.8 : GP01 Printer Option Assembly	8-16
8.7.1	GP01 Printer Option Assembly Description	8-17
8.8	Figure 8.9 : 9384 Front View	8-18
8.9	Figure 8.10 : 9384 Rear View	8-19
8.1	Figure 8.11 : 9384 Dimensions	8-20
Section 9	Connecting the 9384 to a Plotter or a Printer	
9.1	Introduction	9-1
9.2	Plotters	9-3
9.2.1	HP 7470A Plotter	9-3
9.2.2	HP 7550A Plotter	9-3
9.2.3	Hitachi 672 Graph Plotter (or NSA 672)	9-4
9.3	Printers	9-4
9.3.1	Centronics Printers	9-4
9.3.2	RS 232 Printers	9-5
9.3.2.1	Epson FX80	9-5
9.3.2.2	Citizen 120D	9-5
9.3.2.3	HP LaserJet	9-5
9.3.2.4	HP ThinkJet	9-6
9.3.2.5	HP DeskJet	9-6
9.3.2.6	Brother Printers	9-6
9.3.3	GPIB Printers	9-7
9.3.3.1	HP QuietJet	9-7

Section 9	Connecting the 9384 to a Plotter or a Printer	Page
9.3.3.2	HP ThinkJet	9-7
9.3.3.3	HP PaintJet	9-7
9.4	Information on GPIB	9-8
9.4.1	Introduction	9-8
9.4.2	Functions in the GPIB	9-8

SECTION 1	GENERAL INFORMATION
------------------	----------------------------

1.1 Initial Inspection

It is recommended that the shipment be thoroughly inspected immediately upon delivery to the purchaser. All material in the container should be checked against the enclosed Packing List. LeCroy cannot accept responsibility for shortages in comparison with the Packing List unless notified promptly. If the shipment is damaged in any way, please contact the Customer Service Department or local field office immediately.

1.2 Warranty

LeCroy warrants its oscilloscope products to operate within specifications under normal use for a period of three years from date of shipment. Spares, replacement parts and repairs are warranted for 90 days. The instrument's firmware is thoroughly tested and thought to be functional, but is supplied "as is" with no warranty of any kind covering detailed performance. Products not manufactured by LeCroy are covered solely by the warranty of the original equipment manufacturer.

In exercising this warranty, LeCroy will repair or, at its option, replace any product returned to the Customer Service Department or an authorized service facility within the warranty period, provided that the warrantor's examination discloses that the product is defective due to workmanship or materials and that the defect has not been caused by misuse, neglect, accident or abnormal conditions of operation.

LeCroy will return all in-warranty products with transportation prepaid.

This warranty is in lieu of all other warranties, expressed or implied, including but not limited to any implied warranty of merchantability, fitness, or adequacy for any particular purpose or use. LeCroy shall not be liable for any special, incidental, or consequential damages, whether in contract or otherwise.

1.3 Product Assistance

Answers to questions concerning installation, calibration, and use of LeCroy equipment are available from the Customer Service Department, 700 Chestnut Ridge Road, Chestnut Ridge, New York 10977-6499, U.S.A., Tel: (914) 578-6020, and 2 rue du Pré-de-la-Fontaine, 1217 Meyrin 1, Geneva, Switzerland, Tel : (41) 22.719.21.11, or your local field engineering office.

1.4 Addresses**Corporate Headquarters**

LECROY CORPORATION
700 CHESTNUT RIDGE ROAD
CHESTNUT RIDGE, NY 10977-6499
USA
TEL: (914) 425-2000 578-6020
FAX: (914) 425-8967

European Headquarters

LECROY SA
2, CHEMIN PRE-DE-LA FONTAINE
CH-1217 MEYRIN 1 GENEVA
SWITZERLAND
TEL: 41 (22) 719-21-11
FAX: 41 (22) 782-39-15

Europe

LECROY GMBH
MANNHEIMER STRASSE 175
POSTFACH 103767
D-69123 HEIDELBERG GERMANY
TEL: 49.6221.827085
FAX: 49.6221.827026

LECROY LTD
27 BLACKLANDS WAY
ABINGDON, OXON OX14 1DY
GREAT BRITAIN
TEL: 44.23.553.31.14
FAX: 44.23.552.87.96

LECROY SARL
1, AVENUE DE L'ATLANTIQUE
LES ULIS 91976 COURTABOEUF
FRANCE
TEL: 33.1.69.18.83.20
FAX: 33.1.69.07.40.42

LECROY SA
BAHNHOFSTRASSE 18
5600 LENZBURG
SWITZERLAND
TEL: 4164.519.181
FAX: 4164.519.192

ESSA
EUIPOS Y SISTEMAS SA
APOLONIO MORALES 13-B
E-28036 MADRID
TEL: 34.1.359.0088
FAX: 34.1.359.0298

M.T. BRANDAO, LDA
RUA DO QUANZA, 150
4000 PORTO
PORTUGAL
TEL: 351.2.830.2709
FAX: 351.2.830.2710

DEWETRON ELEKTRONISCHE
MESSGERAETE Ges.M.B.H.
FOELLINGERSTRASSE 9E
8044 GRAZ AUSTRIA
TEL: 43.316.391.804
FAX: 43.316.391.052

LUTRONIC APS
NAVERLAND 2
2600 GLOSTRUP
DENMARK
TEL: 45.4342.9764
FAX: 45.4342.9765

ORBIS OY
VANHA KAARELANTIE 9
01610 VANTAA
FINLAND
TEL: 358.0.566.4066
FAX: 358.0.531.604

HELLENIC SCIENTIFIC REP., LTD
11 VRASSIDA STREET
115 28 ATHENS
GREECE
TEL: 30.1.721.1140 or 721.3154
FAX: 30.1.724.1374

AVANTEC
TVETENVEIEN 6
0661 OSLO NORWAY
TEL: 4722.630520
FAX: 4722.610759

ABB NERA A/S
KOKSTADVEGEN 23
KOKSTAD BERGEN NORWAY
TEL: 351.2.815.680
FAX: 351.2.815.630

MEASUREMENT SYSTEMS SCANDINAVIA AB
P.O. BOX 393 FORETAGSALLEN 12, HUS 5 BV
184 24 AKERSBERGA SWEDEN
TEL: 46.8.540.68100
FAX: 46.8.540.66536

Eastern Europe

ELSINCO GMBH
 ROTENMUEHLGASSE 11
 1120 VIENNA
 AUSTRIA
 TEL: 43.222.812.1751
 FAX: 43.222.812.2329

Asia

LECROY JAPAN CORPORATION
 ESAKA SANSHO BLDG - 3RD FLOOR
 16-3, 3-CHOME
 TARUMICHO, SUIITA CITY
 OSAKA 564 JAPAN
 TEL: 816.330.0961
 FAX: 816.330.8096

PHILIPS SCIENTIFIC
 34 WATERLOO ROAD
 NORTH RYDE NSW 2113
 AUSTRALIA
 TEL: 61.3579.3622
 FAX: 61.3579.0971

ELECTRO TECH CORPORATION
 1ST FLOOR, 16 KAZI CHAMBERS
 BAHADURSHAH ZAFAR ROAD
 KARACHI-74800 PAKISTAN
 TEL: 92.21.493-8087
 FAX: 92.21.493-7749

SINGAPORE ELECTRONICS
 AND ENGINEERING, LTD
 24 ANG MO KIO STREET, 65
 SINGAPORE 2056
 TEL: 65.480.7783
 FAX: 65.481.4272

LECOLN TECHNOLOGY CO.,LTD.
 5F, NO649 CHUNG JENG ROAD
 YUNG-HO city TAIPEI HSIEN
 TAIWAN R.O.C.
 TEL: 886.2.2326368
 FAX: 886.2.2326369

Mideast

AMMO
 9, HARUGEI MALKHUT
 RAMAT HACHAYAL. P.O BOX 13132,
 61131 TEL AVIV ISRAEL
 TEL: 972.3.6478740
 FAX: 972.3.6478771

LECROY JAPAN CORPORATION
 ZAIKEN BLDG 6TH FLOOR
 19-3, 2-CHOME
 SASAZUKA, SHIBUYA-KU
 TOKYO 151 JAPAN
 TEL: 813.3376-9400
 FAX: 813.3376.9587

TATA-HONEYWELL
 55-A/8 & 9 HADAPSPAR
 INDUSTRIAL ESTATE
 PUNE 411 013 INDIA
 TEL: 91.212.670445
 FAX: 91.212.672205

P.T. DWI TUNGGAL JAYA SAKTI
 WISMA RAJAWALI, 14TH FLOOR
 JL JENDRAL SUDIRMAN
 34 JAKARTA
 10220INDONESIA
 TEL: 62.21.570.4563
 FAX: 62.21.583.218

ABEX ENGINEERING PTE. LTD.
 37 KALLANG PUDDING ROAD 08-08
 TONG LEE BUILDING BLOCK B
 SINGAPORE 1334
 TEL: 8412818
 FAX: 8415988

MEASURETRONIX
 2102/31 RAMKAMHANG ROAD
 BANGKOK 10240
 THAILAND
 TEL: 66.2.375.2733-4
 FAX: 66.2.374.9965

Asia

SCHMIDT ELECTRONICS LTD
18 F, GREAT EAGLE CENTRE
23 HARBOUR ROAD WANCHAI
HONG KONG
TEL: 852.2507.0222
FAX: 852.2827.5656

WOOJOO HI-TECH CORP.
DONGHYUN BLDG.
102-4 MOONJUNG-DONG,
SONGPA-KU SEOUL 138-200 KOREA
TEL: 82.2.449.5472
FAX: 82.2.449.5475

North America

ALLAN CRAWFORD LTD
5835 COOPERS AV, MISSISSAUGA
ONTARIO L4Z 1Y2, CANADA
TEL: 416 890.2010
FAX: 416 890.1959

South America

SEARCH SA
ARAOZ 823
1414 BUENOS AIRES
ARGENTINA
TEL: 54.1.375.1435
FAX: 54.1.803.2505

ATP-HI-TEK
ALAMEDA AMAZONAS
422 ALPHAVILLE 06454-030
BARUEI, SP BRAZIL
TEL: 55.11.421.5477
FAX: 55.11.421.5032

Central America

NUCLEOELECTRONICA, SA
CALZ. LAS AGUILAS 101
DELEGACION ALVARO OBREGON
01710 MEXICO, 20, d.f.
MEXICO
TEL: 52.5593.604
FAX: 52.5593.6021

South Africa

WESTPLEX LTD
TUSCANY HOUSE
376 OAK AVENUE
RANDBURG 2194
REPUBLIC OF SOUTH AFRICA
TEL: 27.11.787.0473
FAX: 27.11.787.0237

1.5 Maintenance Agreements

LeCroy offers a selection of customer support services. Maintenance agreements provide extended warranty and allow the customer to budget maintenance costs after the initial three years warranty has expired. Other services such as installation, training, enhancements and on-site repair are available through specific Supplemental Support Agreements.

1.6 Documentation Discrepancies

LeCroy is committed to providing state-of-the-art instrumentation and is continually refining and improving the performance of its products. While physical modifications can be implemented quite rapidly, the corrected documentation frequently requires more time to produce. Consequently, this manual may not agree in every detail with the

accompanying product. There may be small discrepancies in the values of components for the purposes of pulse shape, timing, offset, etc., and, occasionally, minor logic changes. Where any such inconsistencies exist, please be assured that the unit is correct and incorporates the most up-to-date circuitry. In a similar way the firmware may undergo revision when the instrument is serviced. Should this be the case, manual updates will be made available as necessary.

1.7 Service Procedure

Products requiring maintenance should be returned to the Customer Service Department or authorized service facility. LeCroy will repair or replace any product under warranty at no charge. The purchaser is only responsible for one way transportation charges. For all LeCroy products in need of repair after the warranty period, the customer must provide a Purchase Order Number before repairs can be initiated. The customer will be billed for parts and labor for the repair, as well as for shipping.

1.8 Return Procedure

To determine your nearest authorized service facility, contact the Customer Service Department or your field office. All products returned for repair should be identified by the model and serial numbers and include a description of the defect or failure, name and phone number of the user, and, in the case of products returned to the factory, a Return Authorization Number (RAN). The RAN may be obtained by contacting the customer service department in New York, Tel: (914)578-6060, or 6061 ; in Geneva, Tel: (41)22/719.21.11, or your nearest sales office.

Return shipment should be made prepaid. LeCroy will not accept C.O.D. or Collect Return Shipments. Air-freight is generally recommended. The oscilloscope should be packed with the protective cover in place. Wherever possible, the original shipping carton should be used. If a substitute carton is used, it should be rigid and be packed such that the product is surrounded with a minimum of four inches of excelsior or similar shock-absorbing material. In addressing the shipment, it is important that the Return Authorization Number be displayed on the outside of the container to ensure its prompt routing to the proper department within LeCroy.

1.9 Safety Precautions

The following servicing instructions are for use by qualified personnel only. Do not perform any servicing other than contained in service instructions. Refer to procedures prior to performing any service.

Exercise extreme safety when testing high energy power circuits. Always turn the power OFF, disconnect the power cord, discharge the cathode ray tube and all capacitors before disassembling the instrument.

The **WARNING** symbol used in this manual indicates dangers that could result in personal injury.

The **CAUTION** symbol used in this manual identify conditions or practices that could damage the instrument.

1.10 Antistatic Precautions

CAUTION

Any static charge that builds on your person or clothing may be sufficient to destroy CMOS components, integrated circuits.

In order to avoid possible damage, the usual precautions against static electricity are required.

- Handle the boards in antistatic boxes or containers with foam specially designed to prevent static build-up.
- Ground yourself with a suitable wrist strap.
- Disassembly the instrument at a properly grounded work station equipped with antistatic mat.
- When handling the boards, do not touch the pins.
- Stock the boards in antistatic bags.

SECTION 2 SPECIFICATIONS

9384, 9384M, 9384TM, 9384L, 9384AL Digital Oscilloscope

LeCroy Digital Oscilloscopes

Get the Complete Picture

9384 Datasheet

LEADING SPECIFICATIONS

- 1 GHz Bandwidth
- Sample rates to 4 GS/s
- Memory lengths to 8M points
- 8-bit vertical resolution, 11 with ERES option
- Four full independent channels
- Vertical accuracy to 1% typical
- Triggering to 1 GHz
- Innovative Peak Detect
- Glitch, Pattern, Qualified, Interval, Dropout, TV, and Exclusion Triggers
- Histogram and FFT Signal Processing Options

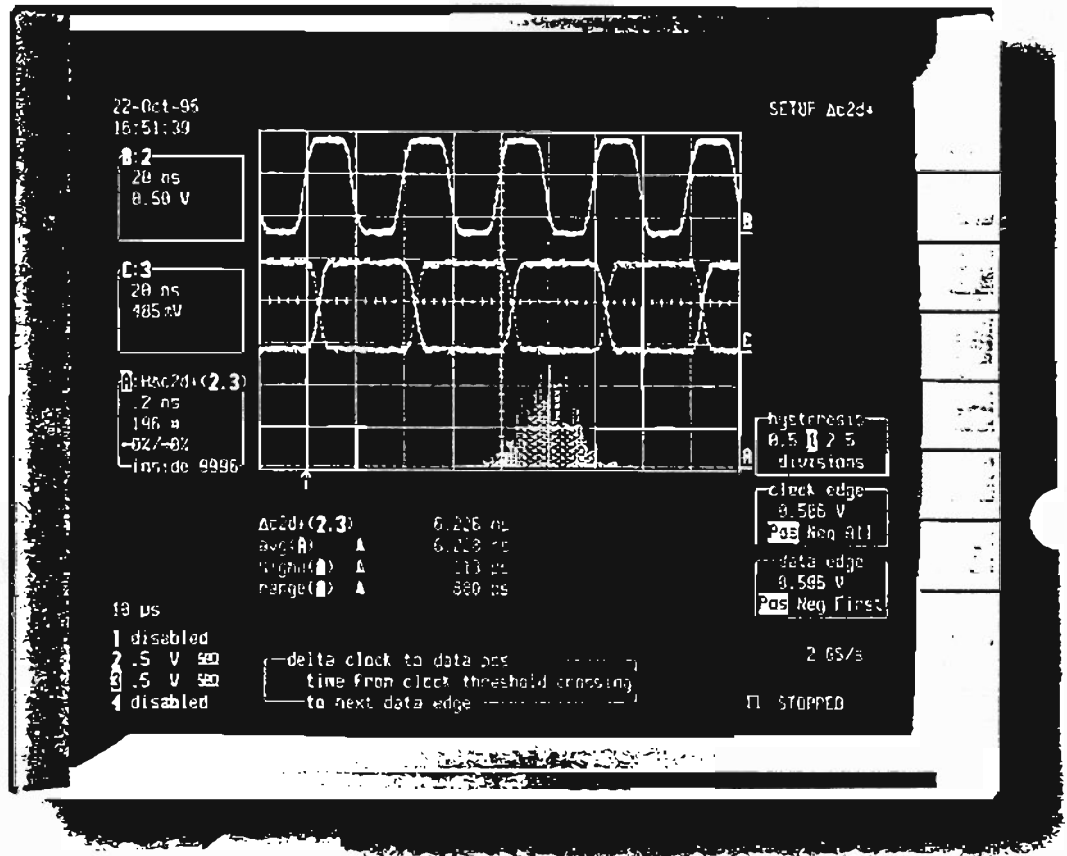

Digital oscilloscopes from LeCroy are designed to save engineers valuable time in troubleshooting and problem-solving.

Each oscilloscope is an integrated and powerful system providing the capability to:

- Capture the key events with high resolution for longer time intervals

- View data like never before, giving you more information more quickly, with a large CRT and advanced display techniques

- Analyze your signal to get answers quickly and more accurately with a powerful processing system and math packages.

LeCroy

1 GHz BANDWIDTH

The 9384 series digital storage oscilloscope opens up new horizons for engineers and scientists at the leading edge of technological developments. With 1 GHz bandwidth, long acquisition memories and 1 GHz edge triggering, it is now possible to reveal previously hidden waveform details. Narrow glitches are more accurately defined; risetime measurements below 1 nanosecond are more precise; and high-frequency content, filtered out in lower bandwidth systems, is retained, thereby preserving signal amplitudes and overall signal integrity.

4 GS/S SAMPLE RATE

The 9384 samples simultaneously on all channels at 1 GS/s. Thus, it is ideal for demanding high speed applications. In addition, two channels can be combined to provide a sample rate of 2 GS/s or 4 GS/s in single channel mode. Finer horizontal resolution and accuracy are assured by high sample rates. This is especially critical in digital design where unpredictable circuit behavior needs to be identified and analyzed in detail to be fully understood. Together with this excellent single-shot performance the 9384 series also provides a sample rate equivalent to 10 GS/s for repetitive signals. The innovative peak-detect mode enables glitch capture even at the slowest time settings without loss of precision.

8M POINTS ACQUISITION MEMORY

Channel record lengths of 100k, 500k, 1M and 2M are available on the 9384 series oscilloscopes. The memory power is revealed when the user seeks to sample at the highest speed over many timebase settings. DSOs with less memory may boast a high sample rate for short waveforms, but only LeCroy's long memory oscilloscope delivers high sample rates for long waveforms. To exploit this capability to its fullest, the LeCroy 9384AL combines its channel acquisition memories to give the user up to 8 million sample points, thereby providing the waveform detail required on long and complex signals.

The combined capabilities of the 9384 place it in the forefront of DSO capability.

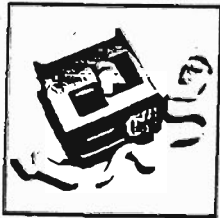

The unique 'Strip-Chart' format expands the horizontal axis up to 200 cm per division

ADVANCED PEAK DETECT SYSTEM

The 9384 series offers an innovative peak detect capture mode. This captures fast glitches by running the ADCs at a high sampling rate even at slow time base settings thereby capturing signal details that might have been missed due to under sampling.

SMART TRIGGER™ SYSTEM

SMART Trigger functions including Glitch, Pattern, Interval, Exclusion, TV, Dropout, and State-or-Edge Qualified triggers are available. Pre- and Post-trigger delay are fully variable, Time and Events Holdoff are also included.

AUTOMATIC PARAMETRIC MEASUREMENTS AND STATISTICS

The 9384 provides more than 40 parametric measurements and their Average, Highest, Lowest values and Standard Deviation. Pass/Fail testing allows up to 5 parameters to be tested against selectable thresholds. Waveform Limit Testing can also be performed using Masks which may be defined inside the instrument. Any failure will activate preprogrammed actions such as Hardcopy, Save, Stop, Beep, GPIB SRQ, or Pulse Out.

INTERNAL PRINTER

Most printers and plotters can be driven via GPIB, RS-232-C and an optional Centronics interface. The 9384 offers an optional internal printer which can produce a 126 X 90 mm full resolution screen dump in under 10 seconds at the push of a button.

The unique 'Strip-Chart' format expands the horizontal axis up to 200 cm per division for viewing fine waveform detail within long memory acquisitions.

REMOTE INTERFACING

GPIB and RS-232-C interfaces may be used for full remote control of the instrument. All front panel and internal processing functions can be controlled via either interface.

MAXIMUM SAMPLE RATE AND ACQUISITION MEMORIES:

Channel Use	Maximum Sample Rate	Memory per Channel					Active Channels
		9384	9384M	9384TM	9384L	9384AL	
All Peak Detect OFF	1 GS/s	100 k	500 k	900 k	1 M	2 M	All
Paralle Peak Detect OFF	2 GS/s	200 k	1 M	1 M	2 M	4 M	CH2 & CH3
Paralle +PP054 Peak Detect OFF	4 GS/s	400 k	2 M	2 M	4 M	8 M	(PP054 input)
All 2.5 ns Peak Detect ON	100 MS/s data + 400 MS/s peaks	50 k data+ 50 k peaks	250 k data+ 250 k peaks	250 k data+ 250 k peaks	500 k data+ 500 k peaks	1 M data+ 1 M peaks	All 2.5 ns Peak Detect

OPTIONAL ADVANCED MATH PACKAGE - WP01

Option WP01 provides Summed and Continuous Averaging, Waveform Math Functions, Extrema and Enhanced Resolution Modes.

Functions can be chained together, allowing complex computations. Waveform operations can be performed on live, stored, processed or expanded waveforms without altering the original capture data.

OPTIONAL SPECTRAL ANALYSIS PACKAGE - WP02

Option WP02 provides comprehensive Spectral Analysis capabilities permitting the system designer to identify characteristics which may not be apparent in the time domain. WP02 provides a wide selection of windowing functions as well as averaging in the frequency domain.

Spectral analysis can be performed on repetitive and single-shot waveforms, on any part or zoomed portions of a waveform up to 8M points, not just the first 10k points of the waveform.

OPTIONAL PARAMETER ANALYSIS PACKAGE - WP03

Option WP03 provides extensive parameter analysis capabilities. Using histograms of measured waveform phenomena such as amplitude changes or timing jitter, engineers can view the statistical distribution of how their signal is changing.

ACQUISITION SYSTEM

Bandwidth (-3 dB):

@ 50Ω: DC to 1 GHz 10 mV/div and above

@ 1MΩ DC: DC to 500 MHz typ. at probe tip, with PP005 supplied standard. 1 GHz FET probe optional.

No. of Channels: 4

No. of Digitizers: 4

Maximum Sample Rate: 4 GS/s

Memories: (See table)

Sensitivity: 2 mV/div to 1 V/div, 50Ω fully variable, 2 mV/div to 10 V/div, 1MΩ fully variable.

Scale Factors: A wide choice of probe attenuation factors are selectable.

Offset Range:

2.00 - 4.99 mV/div: ±400 mV

5.00 - 99 mV/div: ±1 V

0.1 - 1.0 V/div: ±10 V

1.0 - 10 V/div: ±100 V (1MΩ only)

± 20 V across the whole sensitivity range when using the AP 020 FET probe.

DC Accuracy: 10 mV and above, 1% typical

Vertical Resolution: 8 bits

Bandwidth Limiter: 25 MHz or 200 MHz user selectable

Input Coupling: AC, DC, GND.

Input Impedance: 1 MΩ // 11 pF typical system capacitance using PP005 probe or 50Ω ±1%

Max Input:

1 MΩ: 400 V (DC+peak AC ≤ 10 kHz)

50Ω: ± 5 V DC

TIME BASE SYSTEM

Timebases: Main and up to 4 Zoom Traces.

Time/Div Range: 1 ns/div to 1000 s/div.

Clock Accuracy: < 10 ppm

Interpolator Resolution: 10 ps

Roll Mode: ranges 500 ms to 1,000 s/div. For > 50k points: 10 s to 1,000 s/div.

TRIGGERING SYSTEM

Trigger Modes: Normal, Auto, Single.

Trigger Sources: CH1, CH2, CH3 and CH4, External and Line, Slope, Level and Coupling for each source can be set independently.

Slope: Positive, Negative.

Coupling: AC, DC, HF, LFREJ, HFREJ.

Pre-trigger Recording: 0 to 100% of full scale (adjustable in 1% increments).

Post-trigger Delay: 0 to 10,000 divisions (adjustable in 0.1 div. increments).

Holdoff by Time: 10 ns to 20 s.

Holdoff by Events: 0 to 99,999,999 events.

Width Trigger Sensitivity:

<10% of full scale > 1 ns;

<20% of full scale 500 ps to 1 ns

Internal Trigger Sensitivity Range:
± 5 div.

EXT Trigger Max Input:
1 M Ω // 11 pF using PP005 probe
400 V (DC+peak AC<10 kHz)

50 Ω ± 1%
± 5 V DC (500 mW) or 5V RMS
EXT Trigger Range: ± 0.5 V (± 5 V
with Ext/10)

Trigger Timing: Trigger Date and
Time are listed in the Waveform Status
Menu.

SMART TRIGGER TYPES

Pattern: Trigger on the logic AND of 5
inputs - CH1, CH2, CH3, CH4, and EXT
Trigger, where each source can be
defined as High, Low or Don't Care. The
Trigger can be defined as the beginning
or end of the specified pattern.

Signal or Pattern Width: Trigger on
glitches <2.5 ns (1 ns typical) or on
pulse widths between two limits
selectable from <2.5 ns to 20s exclusive.

Exclusion Trigger: Trigger on a signal or
period outside two limits selectable
from <2.5 ns to 20s.

Signal or Pattern Interval: Trigger on
an interval between two limits selectable
from 10 ns to 20 s.

Dropout: Trigger if the input signal
drops out for longer than a time-out
from 25 ns to 20 s.

State/Edge Qualified: Trigger on any
source only if a given state (or
transition) has occurred on another
source. The delay between these events
can be defined as a number of events
on the trigger channel or as a time
interval.

TV: Allows selection of both line (up to
1500) and field number (up to 8) for
PAL, SECAM, NTSC or non-standard
video.

ACQUISITION MODES

Random Interleaved Sampling (RIS):
for repetitive signals from 1 ns/div to
2 ms/div.

Random Interleaved Sampling Rate:
10 GS/s

Single Shot: for transient and repetitive
signals from 2 ns/div (all channels
active).

Peak Detect: captures and displays <2.5
ns glitches (1 ns typical) or other high-
speed events.

Sequence: Stores multiple events - each
of them time stamped - in segmented
acquisition memories.

Number of Segments Available:

9384	2-500
9384M	2-2,000
9384TM	2-2,000
9384L	2-2,000
9384AL	2-2,000

DISPLAY

Waveform Style: Vectors connect the
individual sample points, which are
highlighted as dots. Vectors may be
switched off.

CRT: 12.5 x 17.5 cm (9" diagonal) raster.
Resolution: 810 x 696 points.

Modes: Normal, X-Y, Variable or
Infinite Persistence.

Real-time Clock: Date, hours, minutes,
seconds.

Graticules: Internally generated;
separate intensity control for grids and
waveforms.

Grids: 1, 2 or 4 grids.

Formats: YT, XY, and both together.

Vertical Zoom: Up to 5x Vertical
Expansion (25x with averaging, up to
80 μ V sensitivity with Advanced Math
option WP01).

Horizontal Zoom Factors up to:

9384	20,000x
9384M	100,000x
9384TM	100,000x
9384L	200,000x
9384AL	400,000x

Waveforms can be expanded to give
0.4-0.5 points/division. Zoom factors up
to 2,000,000x for the 9384AL with all
channels combined.

INTERNAL MEMORY

Waveform Memory: Up to four 16-bit
Memories (M1,M2,M3,M4). The length
of each memory is equal to the data
acquisition memory.

Processing Memory: Up to four 16-bit
Waveform Processing Memories
(A,B,C,D).

Setup Memory: Four non-volatile
memories. Optional IC Memory Cards,
floppy disk or PCMCIA hard drives may
also be used for high-capacity waveform
and setup storage.

CURSOR MEASUREMENTS

Relative Time: Two cursors provide
time measurements with resolution of
±0.05% full-scale for unexpanded
traces; up to 10% of the sampling
interval for expanded traces. The
corresponding frequency value is
displayed.

Relative Voltage: Two horizontal bars
measure voltage differences up to
±0.2% of full-scale in single-grid mode.

Absolute Time: A cross-hair marker
measures time relative to the trigger and
voltage with respect to ground.

Absolute Voltage: A reference bar
measures voltage with respect to
ground.

AUTOMATIC MEASUREMENTS

The following Parametric measurements are available, together with their Average, Highest, Lowest values and Standard Deviation:

amplitude	Δt at level ($t=0, \%$)	minimum
area	duration	overshoot +
base	duty cycle	overshoot -
cmean	falltime	peak to peak
cmedian	first	period
crms	f 80-20%	risetime
csdev	f@level (abs)	r20-80%
cycles	f@level (%)	r@level (%)
delay	last	RMS
Δ delay	maximum	std dev
Δt at level (abs)	mean	top
Δt at level (%)	median	width
Δt at level ($t=0, abs$)		
$\Delta C2D+(hold)$		
$\Delta C2D-(setup)$		

Pass/Fail testing allows any 5 items (parameters and/or masks) to be tested against selectable thresholds. Waveform Limit Testing is performed using Masks which may be defined inside the instrument. Any failure can initiate preprogrammed actions such as Hardcopy, Save to internal memory, Save to mass storage device (card or disk), GPIB SRQ or Pulse Out. $\Delta C2D+$ and $\Delta C2D-$ measure setup and hold times.

WAVEFORM PROCESSING

Up to four processing functions may be performed simultaneously. Functions available are: Add, Subtract, Multiply, Divide, Negate, Identity and Summation Averaging.

Average: Summed averaging of up to 1,000 waveforms in the basic instrument. Up to a million sweeps are possible with Option WP01.

Envelope: Max, Min, or Max and Min values of up to one million sweeps.

ERES: Low-Pass digital filter provides up to 11 bits vertical resolution.

Sampled data is always available, even when a trace is turned off. Any of the above modes can be invoked without destroying the data.

FFT: Spectral Analysis with four windowing functions and FFT averaging.

*Envelope and ERES modes are provided in Advanced Math Package WP01. FFT is in Package WP02.

AUTOSETUP

Pressing Autoseup sets timebase, trigger and sensitivity to display a wide range of repetitive signals. (Amplitude 2 mV to 40 V; frequency above 50Hz; Duty cycle greater than 0.1%).

Autoseup Time: Approximately 2 seconds.

Vertical Find: Automatically sets sensitivity and offset.

PROBES

Model: One PP005 (X10, 10 M Ω) probe supplied per channel.

The 9384 family is fully compatible with LeCroy's range of FET Probes, which may be purchased separately.

Probe Calibration: Max 1 V into 1 M Ω , 500 mV into 50 Ω , frequency and amplitude programmable, pulse or square wave selectable, rise and fall time 1 ns typical.

Alternatively, the Calibrator output can provide a trigger output or a PASS/FAIL test output.

INTERFACING

Remote Control: All front-panel controls, as well as all internal functions are possible by GPIB and RS-232-C.

RS-232-C Port (Standard):

Asynchronous up to 19200 baud for computer/terminal control or printer/plotter connection.

GPIB Port (Standard): (IEEE-488.1)

Configurable as talker/listener for computer control and fast data transfer

Centronics Port: Hardcopy parallel interface is available as part of either floppy disk or internal printer options.

Hardcopy: Screen dumps are activated by a front panel button or via remote control. TIFF format is available for importing to Desktop Publishing programs. The following printers and plotters can be used to make hardcopies: HPThinkJet, QuietJet, LaserJet, PaintJet, and EPSON printers, HP7400 and 7500 series, or HPGL compatible plotters.

An optional internal high resolution graphics printer is also available.

GENERAL

Auto-calibration ensures specified DC and timing accuracy.

Temperature: 5° to 40° C rated accuracy. 0° to 50° C operating. Derate @ 1°C/1000 ft of altitude to 10,000 ft.

Humidity: <80%

Shock and Vibration: Meets MIL-STD-810C modified to LeCroy design specifications and MIL-T-28800C.

Power: 90-250 VAC, 45-66 Hz, 350 W.

Compliance: Complies with the EU-EMC Directive

Battery Backup: Front panel settings maintained for two years.

Dimensions: (HWD)

8.5" x 14.5" x 16.25",
(210mm x 370mm x 410mm).

Weight: 13 kg (28.6 lbs) net, 18.5 kg (40.7 lbs) shipping.

Warranty: Three years

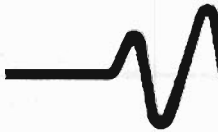

LeCroy

The Digital Scope Specialists

9300 Series PCMCIA Hard Disk Adapter, Internal Printer, 3.5" Floppy Disk Drive and Ram Card

Main Features

- PCMCIA Type III compatible Hard Disk Adapter, DOS Compatible
- High-resolution Printer, ideal for fast, on-the-spot documentation
- 3.5" Floppy disk drive, DOS format - affordable and convenient
- Ultra-fast RAM card, DOS format, ideal for PASS/FAIL testing
- Convenient Hardcopy storage to card/disk

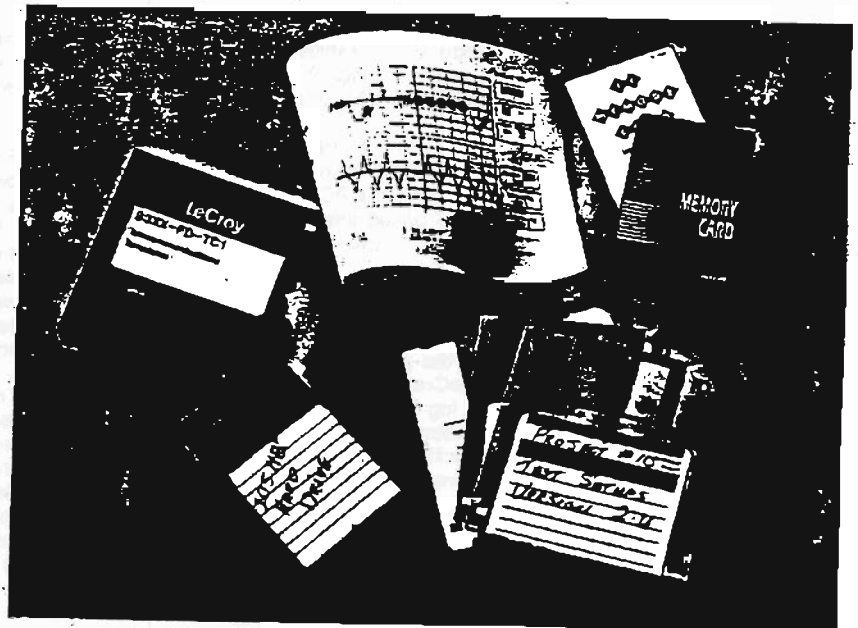

3.5" Floppy

The floppy drive is a convenient storage medium, not only for saving and retrieving waveforms or instrument settings, but also for storing hardcopies that can be printed from a PC when desired. The floppy supports both 720k and 1.44M DOS formats so that it can be read back on any PC with a 3.5" drive, avoiding the need to interface the oscilloscope to your PC. As with the RAM-card option, the floppy system capabilities include automatic storage of data under pre-programmed conditions.

PCMCIA Storage

PCMCIA Interfaces for RAM card and Hard Disk allow the use of fast, removable and compact storage media for saving and retrieving waveforms and instrument settings. They comply fully with the PC industry's PCMCIA and JEIDA standards. With the special Autostore feature, waveforms can be automatically stored after every acquisition and "played back" when desired. When used in combination with the PASS/FAIL feature, failure data can be saved automatically for later analysis.

Printer

The internal printer is an invaluable tool for instant, on-the-spot documentation. It generates a clear, crisp hardcopy of the screen in just a few seconds. The large size of the printout, combined with its high resolution, provide you with an excellent document that matches the screen's superior quality to its finest details. And because it frees you from the trouble of carrying and interfacing a bulky printer, it is the ideal solution for field measurements.

Mass Storage Features and Benefits

LeCroy's mass storage capabilities provide a range of benefits:

- Easy data transfers to PCs
- Waveform logging
- Waveform archiving for future use
- Faster troubleshooting
- Faster, more reproducible testing
- Shared oscilloscope resources

EASY DATA TRANSFER TO PC

Because the 9300 series oscilloscope uses DOS-formatted floppy disks, hard disks and memory cards, transferring waveform data to a PC is simple. The removable storage allows transfers without cables, programming, or any knowledge of GPIB, RS-232, or other interfaces.

In addition, LeCroy provides free of charge, a binary-to-ASCII format conversion program for the PC, accommodating those PC-based analysis packages (such as spreadsheets) that require ASCII format.

WAVEFORM LOGGING

By using Glitch or Dropout triggering in combination with the powerful AUTO-STORE mode, LeCroy oscilloscopes can monitor and log intermittent problems automatically. To store a waveform, the oscilloscope opens and names a DOS-compatible file and then stores the waveform data in the file. This logging feature requires no operator intervention and maintains data and the operational setup through power line failures. Logged waveforms can be selectively played back by trigger time/date or by sequence number, or can be scrolled through sequentially.

WAVEFORM ARCHIVING FOR FUTURE USE

- Recallable proof of performance
- Additional data analysis as needed
- Accurate trend or drift monitoring
- Calibration procedure verification

When storing waveforms, LeCroy DSOs also archive a header of setup information and the acquisition time/date. After recalling an archived waveform, the several hundred byte header ensures correct time and voltage scaling. When recalled into the oscilloscope, the waveform can be zoom expanded,

compared, or analyzed just like a live waveform. The time/date offers proof of measurement authenticity and trend sequence.

All LeCroy DSOs store raw waveform data using one byte per sample point. Signal averaged, Enhanced Resolution (ERES) filtered, and other processed data use two bytes per point, to take advantage of the added resolution.

HARDCOPY ARCHIVING

Hardcopies of the screen can also be stored for future use. For instance, a screen saved in a TIFF format can be imported into a Word Processor to illustrate a report. Additionally, field-measurement screens can be saved in LaserJet format on the memory card or floppy disk, and then printed from a PC back in the lab.

FASTER FIELD MEASUREMENTS

Recallable reference waveforms and oscilloscope setups for each test point on a Device Under Test (DUT) can make fault troubleshooting faster and more accurate. A dedicated memory card or floppy disk will hold all of the correct test point waveforms and associated DSO setups for a particular DUT.

The technician can recall stored setups quickly and consistently, thereby avoiding incorrect measurement conditions. He can then compare actual waveforms to recalled reference waveforms taken from a known working system. He will therefore spend less time probing a large number of test points and verifying that the correct waveforms exist.

If a problem is found, the aberrant waveform may be saved. It can later be shown to laboratory-based engineers, for example, for problem-solving guidance or for improvement of DUT design.

Memory cards - rugged and pocket-sized - are ideal for this application.

FASTER, MORE REPRODUCIBLE TESTING

LeCroy oscilloscopes will compare measured waveforms against upper and lower waveshape tolerances or against parameter limits, such as risetime, overshoot, or peak voltage, and make PASS/FAIL decisions. This PASS/FAIL

testing decreases test times in GPIB-based ATE systems by reducing data transfers. It increases reproducibility and accuracy in manual tests by eliminating human errors.

Once defined, these tests may be saved by storing instrument setups which include the specified tolerances and/or reference waveforms. Different test personnel can easily share a common test library via a PC network.

Waveshape test limits can be generated by capturing a "golden" waveform and by then selecting amplitude and timing limits (in-fractions of screen graticule divisions). Or a user can create standard waveform limit templates on a computer (e.g. ANSI/CCITT telecommunication templates).

With the LeCroy 9300 series DSOs, specific parameter tolerance test procedures are created by selecting limits for any five out of twenty pulse parameters with Boolean AND / OR conditions between them. During testing, FAIL responses can include an audible beep, GPIB SRQ, hardcopy output, or store to memory card.

SHARED OSCILLOSCOPE RESOURCES

By plugging-in your *personal* floppy disk, RAM card or PCMCIA Hard Disk you can restore your setup in seconds. Individual users can keep preferred setups on separate disks or cards or within separate directories.

COPY FILES	
Direction	Card -> Floppy
	Floppy -> Card
	Card -> HDD
	HDD -> Card
Which Files	
	Params
	Prints
	AUTO Wfms
	Norm Wfms
	SETUP FILES
DO COPY	
OVERWRITES FILES WITH SAME NAME	

A selection of files can be copied between the available mass storage devices.

Hardcopy Features and Benefits

The internal printer adds a whole range of benefits to the LeCroy 9300 series:

- Ultra-fast printouts
- High resolution printing
- Easy transportation
- Trouble-free interfacing
- Auto Print on Trigger

ULTRA-FAST PRINTOUTS

Measurement documentation is made easier and faster since the internal printer produces a hardcopy in less than 10 seconds. In addition the document is date- and time-stamped: a real bonus for archiving test results.

HIGH RESOLUTION PRINTING

With a resolution of 190 dots-per-inch, the internal printer matches the screen's superior quality. And for even higher resolution, the printout can be stretched to a full 70 meter length so you can see those traces down to their finest details.

EASY TRANSPORTATION

A printer that is totally integrated in the instrument makes life much easier for field-measurement applications. Imagine carrying a scope, a printer (and perhaps a floppy drive) in one hand!

TROUBLE-FREE INTERFACING

The internal printer frees your mind from the struggle with cable schematics, baud rates, gender-changers and dip switches, for more productive tasks. Select the internal printer in the scope's utilities menu, hit the SCREEN DUMP button, and you're in business!

AUTO PRINT ON TRIGGER

The Auto Print feature is used to print a screen image on each acquisition.

The 9300 series oscilloscope supports a whole range of popular printers and plotters. Hardcopies can be either sent directly to the peripheral device or to the floppy disk, Ram Card or Hard disk for future use.

HARDCOPY	
output to	Card Floppy GP/IB RS232 Centronics
Page Feed	OFF On
plotter	LaserJet ThinkJet TIFF HP 7472 no. 7550
plot size	A5 (8.5" / 5.5") A4 (11" / 8.5")
pen number	2

OTHER HARDCOPY SOLUTIONS

High quality project reports, presentation materials, technical manuals, and troubleshooting instructions often require integration of text and graphics on the same page.

Advanced PC desktop publishing and word processors such as Word-for-Windows, WordPerfect, or AMI Pro can directly import graphic files, size them, and position them anywhere on the page. Written text can then wrap around or be positioned within the graphics.

LeCroy 9300 oscilloscopes will save screens in TIFF (Tagged Image Format - File), or BMP. After transferring the file to a PC, the DTP software can import and manipulate the document like any other graphic object.

The LeCroy 9300 series also offers a wide range of interfacing capabilities with external hardcopy devices:

- Plotters. HPGL HP 7400 and 7500 compatible
- Printers. HP LaserJet, ThinkJet, Paintjet (including color), DeskJet (including color) and Epson
- Interfacing. RS-232, GPIB, or even Centronics (optional)

Specifications

MASS STORAGE

	Floppy Disk	Ram Card	Hard Disk
Compatibility	3.5" Floppy Drive	PCMCIA I II JEIDA 3.0, 4.0	PCMCIA III
Supported Formats	DOS Format	Read/Write: SRAM Read: OTP, ROM, Flash DOS Format	DOS Format
Size	720k byte, 1.44M byte	Up to 8M byte	Up to 512M byte * Note 1
Max Transfer Rate	18k byte/sec	500k byte/sec	150k byte/sec
Typical waveform Transfer Speed (Store/Recall)			
1000 point	1.1s / 0.4s	40ms / 30ms	140ms / 120ms
10000 point	1.8s / 1.0s	70ms / 60ms	240ms / 220ms
100000 point	7.5s / 6.5s	300ms / 300ms	1.0s / 0.9s
1M point	57s / 55s	2s / 2s	7.0s / 6.5s

Waveform File size: A channel-trace will use 1 byte per sample plus approximately 360 bytes of waveform descriptor. A processed trace will use 2 bytes per sample.
Template Size: Approximately 21k bytes.
Panel Setup Size: Approximately 3k bytes.

*Note 1: When available

PRINTER

Type: Raster printer, thermal.
Resolution: 190 DPI.
Printout Size: 126 mm x 90 mm
Paper: Thermal printer paper, 30 meter roll, 110 mm width, type Seiko or similar.
Printing speed: 6 seconds approx. for one screen.



LeCroy

The Digital Scope Specialists

AP003, AP020 and AP021 Active FET Probes

Main Features

- Bandwidths to 1 GHz
- LeCroy ProBus™ interface for the AP020 and the AP021
- 1 MΩ input Impedance
- Low capacitance at probe tip
- Rugged mechanical construction
- Automatic sensing and control on scopes equipped with ProBus™



FET Probes provide the oscilloscope user with a higher level of measurement capability. Compared with passive probes, they offer low circuit loading, low capacitance and high bandwidth. This combination makes them the ideal tools for working on sensitive or high-speed electronics.

This performance is achieved by the integration of a high-impedance Field Effect Transistor (FET) amplifier into the probe tip. The circuit under test sees only the amplifier's input impedance - it is effectively buffered from the scope's input impedance and the probe cable.

LeCroy's AP series of FET probes are mechanically rugged in design, while their miniature construction allows them to be used in hand-held PCB probing applications. Their detachable tips are designed for simple replacement, and they are supplied with a full set of accessories.

Models AP020 and AP021 offer 1 GHz and 800 MHz Bandwidth respectively. AP020 features X10 signal attenuation and is especially recommended for LeCroy's 9320 and 9324 1 GHz oscilloscopes. The AP021 offers X5 attenuation when used with the new 9360.

As an active device, the FET probe requires a stabilized power supply. LeCroy provides an elegant solution to this with the ProBus™ probe interface.

ProBus™ provides probe power and signal connection in one integrated package. It also allows the scope to control other probe functions, such as input coupling and DC offset. The ProBus™ interface is now available on a growing range of LeCroy oscilloscopes and probes. AP003 has an external power connector for use with scopes which are not ProBus™ compatible. All other models use the ProBus™ interface.

Features and Benefits

Connecting a probe to a circuit can significantly distort its signals by adding undesired loading - mostly capacitive and resistive. FET probes offer high resistance and low capacitance therefore they present minimal loading to the circuit under test, and protect from making erroneous measurements.

HIGH RESISTANCE

Low resistance probes have significant DC effects when used in high impedance circuits. They can greatly affect the behaviour of the device under test by changing the swing and the DC offset of the probed signal. A 1 MΩ impedance FET probe will not affect gain or offset in virtually all the cases.

LOW CAPACITANCE

Although not important in DC measurements, capacitive loading is very

disruptive at high signal frequencies. The capacitive loading effects can be drastic. When probed with a 10 MΩ, 15

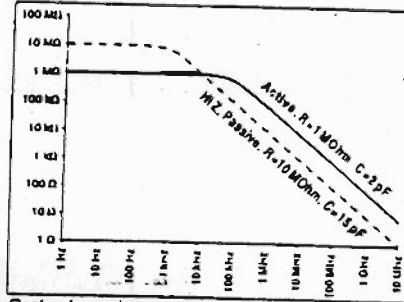

Probe Impedance versus Frequency

pF passive probe, a 100 MHz signal "sees" a 100 Ω load as illustrated on the picture below.

With only 2 pF of capacitance at the probe tip, LeCroy's FET probes reduce

circuit loading at high frequencies by a factor of 10. Minimizing tip capacitance can also push the probe's resonant frequency beyond the system bandwidth. Sensitivity to ground lead inductance is also minimized.

PROBUS

The ProBus™ system is a complete measurement solution from probe tip to oscilloscope display. It supplies power to active probes, while automatically sensing probe attenuation. ProBus™ enables direct control of the probe offset and input coupling from the scope's front panel, extending the instrument's accuracy up to the probe tip. In addition, ProBus™ automatically optimizes scope and probe offset adjustments, calibrates the gain at the probe tip and compensates for non-linearities, providing most accurate measurements.

Specifications

MODEL	AP003	AP020	AP021	MODEL	AP003	AP020	AP021
Bandwidth (MHz)	DC-1000	DC-1000	DC-800	Dynamic Range	±7 V	±5 V	±2.5 V
Risetime (ps)	< 350	< 350	< 437	DC Offset Range	N/A	±20 V	±10 V
Attenuation	10:1 ±2%	10:1 ±2%	5:1 ±2%	Input Coupling	DC	DC/AC	DC/AC
Input R (MΩ)	1 ±5%	1 ±2%	1 ±2%	Total length (m)	1.5	1.5	1.5
Input C (pF)	1.9 ±0.3	1.8 ±0.2	2.7 ±0.2	Power requirement	±12 V	±12 V	±12 V
Max Input Voltage	±100 V	±40 V	±20 V	Interface	N/A	ProBus™	ProBus™

Recommended Matching

LeCroy Model	AP-003	AP-020	AP-021
9304-10-14	XX		
9350-61			X
9320-24		X	
94XX	X		
7200	XX		
7200A	X		
ScopeStation	X		

X: External Power Supply not required
XX: External Power Supply required

Ordering Information

AP003	1 GHz active FET probe
AP020	1 GHz active FET probe
AP021	800 MHz active FET probe with ProBus™ interface. All probes are shipped with the following accessories: 1x Retractable hook 1x Ground Lead 1x BNC Adaptor 1x IC Tip 3x Ground Bayonets 1x Mini pincher with Lead Adaptor
AP501	Power Supply for the AP003

USA Direct Sales: 1 (800) 5LE-CROY

LeCroy Worldwide Sales Offices

ASIA/PACIFIC	LeCroy Pty Ltd	61.38.90.7358
BENELUX	LeCroy BV	04902.8.9285
CANADA	LeCroy Cnd	514.928.4707
FRANCE	LeCroy SARL	(1).69.18.83.20
GERMANY	LeCroy GmbH	06221 83.10.01
ITALY Milano	LeCroy SRL	02.204.70.82
ITALY Rome	LeCroy SRL	06.336.797.00
JAPAN Osaka	LeCroy Japan	0816.330.0961
JAPAN Tokyo	LeCroy Japan	0813.3376.9400
SWITZERLAND Geneva		022.719.21.11
SWITZERLAND Lenzburg		064.51.91.81
United Kingdom	LeCroy Ltd	0235-533114

Other sales and service representatives throughout the world.

Copyright © May, 1993. LeCroy is a registered trademark of LeCroy Corporation. All rights reserved. Information in this publication supersedes all earlier versions. Specifications subject to change without notice.



LeCroy

The Digital Scope Specialists

AP030, SI 9000 and SI 9000A Active Differential Probes

Main Features

- Bandwidths to 15 MHz
- Multiple:
 - Attenuations
 - Differential Voltage Ranges
 - Common Mode Voltages
- High Input Impedance
- Rugged and Lightweight Mechanical Construction

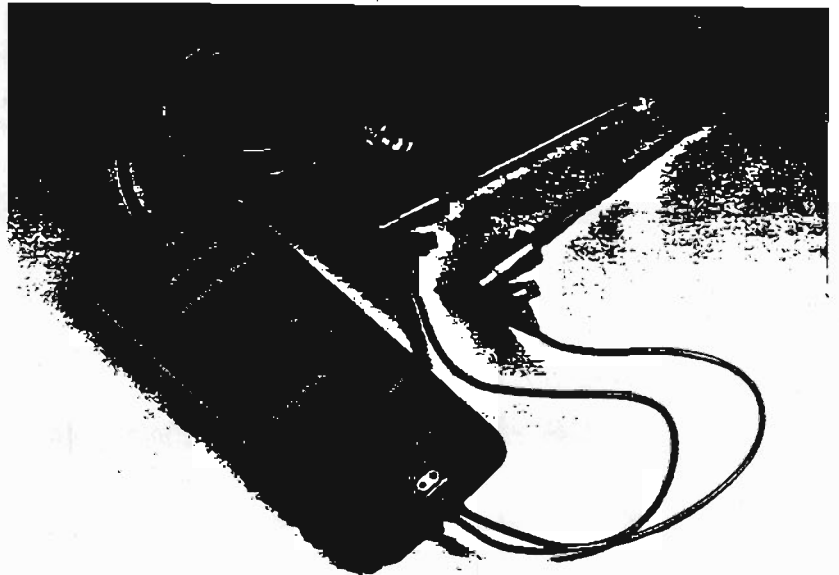

The Models AP030, SI 9000 and SI 9000A are fully differential active probes designed for applications where electric signals must be measured relative to a floating voltage, other than ground potential.

These probes are designed specifically for situations where:

- the reference voltage may be several hundreds volts above or below ground;

- measurements require the rejection of common-mode signals. (e.g. to evaluate small amplitude pulses riding on big common-mode signals);
- ground loops and currents produce so much interference that small signals cannot be detected.

With these differential probes the oscilloscope user avoids both the dangerous practice of floating the

scope, and the technique of using two scope channels in "Invert and Add" mode, which is limited both in common mode rejection and in dynamic range.

Models AP030, SI 9000 and SI 9000A are lightweight and easy to use. They have the rugged mechanical construction required for laboratory, manufacturing and field service environments, and are battery powered for greater safety and convenience.

Features and Benefits

FULLY DIFFERENTIAL INPUTS
The probes are fully differential active devices. The differential technique allows measurements to be made between two points in a circuit without reference to ground. The two input signals are processed inside the probe (as illustrated in figure) and the resulting single-ended signal may be measured by any grounded oscilloscope.

HIGH COMMON MODE VOLTAGE
The three probes offer a range of Common Mode Voltages from 40 V to 1000 V.

RUGGED CONSTRUCTION
The probes are designed to be compact and lightweight with power provided by four AA size 1.5 V batteries. A rubber casing enhances the probes' resistance to shocks.

SAFETY
Use of differential probes is safe within the specified voltages. Their

use avoids less reliable alternatives, or possible dangerous practices.

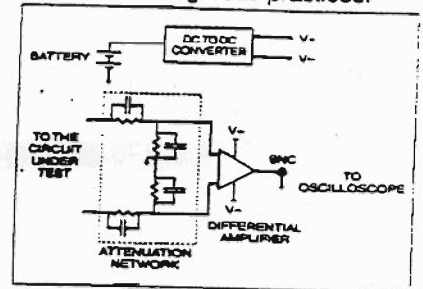

Specifications

MODEL	AP030	SI 9000	SI 9000A
Bandwidth (MHz)	15 MHz	15 MHz	15 MHz
Risetime	24 ns	24 ns	24 ns
Attenuation	1:10/1:100	1:20/1:200	1:50/1:500
Atten. Accuracy	2%	2%	2%
Input Resistance	2 MΩ	2 MΩ	2 MΩ
Input Capacitance	12 pF each side to ground		
Input Configuration	Differential		
Input Voltage			
Differential Max	±400 VDC or 280 Vrms for 1:100 ±40 VDC or 28 Vrms for 1:10	±700 VDC or 500 Vrms for 1:200 ±70 VDC or 50 Vrms for 1:20	±1000 VDC or 700 Vrms for 1:500 100 VDC or 70 Vrms for 1:50
Common Mode Max	±420 VDC or 300 Vrms	±700 VDC or 500 Vrms	±1000 VDC or 700 Vrms
Absolute Max		±1000 VDC or 700 Vrms	
CMRR			
50Hz	-90db	-80db	-80db
1KHz	-80db	-70db	-70db
1MHz	-53 db	-45db	-45db
Output Voltage			
Amplitude Max	±4 V	±3.5 V	±2 V
Offset	≤± 5 mV	≤±10 mV	≤±10 mV
Noise		typical -10° C to +40° C 1.5 to 2mV typical	
Source Impedance		1Ω at 1 KHz, 8Ω at 1 MHz typical	
Ambient Temperature			
Operating		-10° C to +40° C	
Storage		-30° C to +70° C	
Power requirement	Four internal 1.5 V AA size batteries or external AC to 6 Vdc adaptor Typical consumption 50 mA		
Dimensions	6.6" (168mm) x 2.4" (62mm) x 0.79" (20mm) excluding casing		
Weight	9.35 oz (265 gr) excluding batteries and casing		

Ordering Information

AP030	15 MHz differential probe 1:10 / 1:100
SI 9000	15 MHz differential probe 1:20 / 1:200
SI 9000A	15 MHz 1:50 / 1:500

All models are delivered with rubber casing. Batteries not included

USA Direct Sales: 1 (800) 5LE-CROY

LeCroy Worldwide Sales Offices

ASIAPACIFIC	LeCroy Pty Ltd	61.38.90.7358
BENELUX	LeCroy BV	04902.8.9285
FRANCE	LeCroy SARL	(1).69.18.83.20
GERMANY	LeCroy GmbH	06221.83.10.01
ITALY	LeCroy SRL	06.336.797.00
JAPAN Osaka	LeCroy Japan	0816.330.0961
JAPAN Tokyo	LeCroy Japan	0813.3376.9400
SWITZERLAND Geneva		022.719.21.11
SWITZERLAND Lanzburg		064.51.91.81
United Kingdom	LeCroy Ltd	(01235) 533114

Other sales and service representatives throughout the world.

Copyright December, 1994. LeCroy is a registered trademark of LeCroy Corporation. All rights reserved. Information in this publication supersedes all earlier versions.

Specifications subject to change without notice

AP011 Current Probe

Main Features

- DC, AC or impulse currents
- 150A maximum current
- DC - 120 kHz Bandwidth
- Probe Accuracy 1% \pm 2mA
- Measurement units in amperes
- ProBus™ compatible, sensed automatically by the 93XX family of oscilloscopes.
- Rugged mechanical design

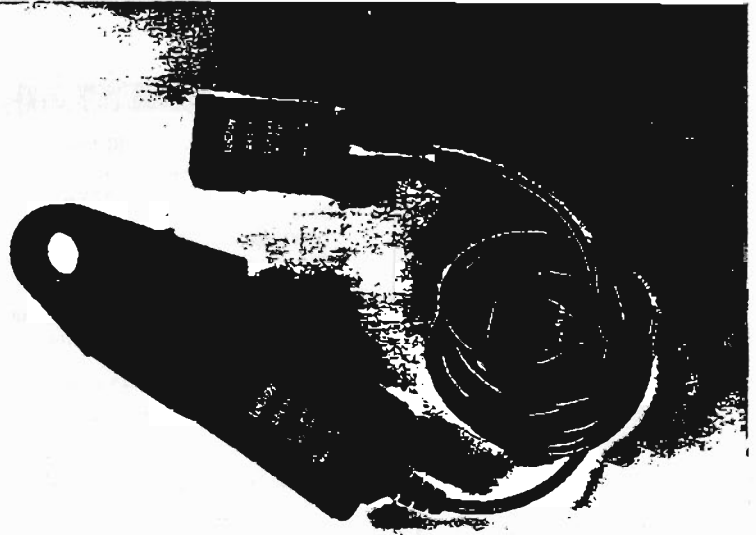

CURRENT MEASURING

The AP011 allows the oscilloscope to measure current flowing through a conductor. The AP011 is based on a combination of Hall effect and transformer technology which allows measurements to be made on DC, AC and impulse currents. It is rugged in design and uses a split-core transformer to allow the probe head to be clamped around a conductor that remains in circuit.

FULLY INTEGRATED

With the ProBus™ interface, the AP011 probe becomes an integral part of the oscilloscope. The probe is automatically detected with full calibration and control achieved from the on-screen menu system. No external power supplies or amplifiers are required.

Full Remote control is possible over GPIB or RS-232-C interfaces.

SCALED MEASUREMENTS

Waveform scaling factors and unit conversions are automatically applied.

The existing wide range of oscilloscope software analysis functions and parameter measurements are compatible and handle mixed unit conversion.

Features and Benefits

FULLY INTEGRATED SYSTEM

ProBus™ compatibility ensures full integration of the AP011 features into the oscilloscope. The probe is fully operational whenever it is attached to the instrument. There is no need for external amplifiers or power supplies. All controls are menu-driven from the oscilloscope screen, avoiding the need for access-probe mounted controls which can be particularly difficult and dangerous in some applications.

AUTO-ZERO ADJUSTMENT

Optimal calibration of the probe is achieved by using the Auto-Zero feature. This should be done whenever the probe is first connected, subjected to wide temperature variations, re-oriented with respect to the earth's magnetic field, or subjected to overload conditions. The auto-zero operation on the AP011 is performed automatically by pressing the 'AUTO ZERO' menu button in the associated channel menu (see Figure 1).

AUTOMATIC MEASUREMENT UNIT CONVERSION

Automatic unit conversion and calibration ensures correct interpretation of data and avoids the painstaking task of recording and applying conversion and scaling factors.

All waveforms acquired from the AP011 are automatically calibrated and adjusted to be scaled in ampere units. A wide range of functions can be applied to current waveforms. Advanced functions such as FFT's and statistical analysis are available as optional firmware packages.

All functions and measurements recognize ampere vertical scales and adjust the resulting waveform or calculation units, including mixed unit conversions (e.g. current multiplied by voltage as shown in Figure 1).

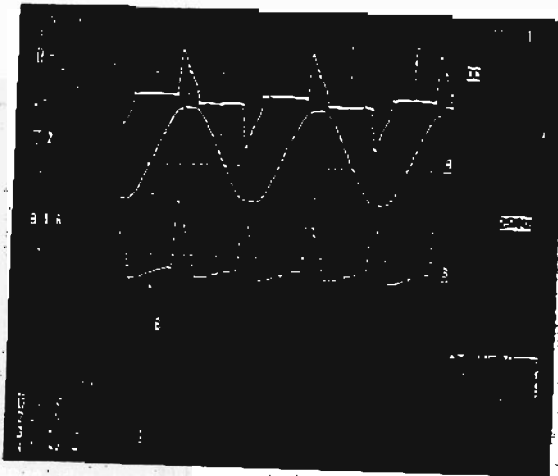

Figure 1: This example shows a power supply input current (top trace) vs. voltage (middle trace). These are multiplied to provide the input power waveform (lower trace). A parameter measurement is then made to calculate the mean input power.

Note that the input coupling menu is automatically configured to control the AP011 attached to that channel.

Specifications

ELECTRICAL CHARACTERISTICS

System Bandwidth: DC to 120kHz
 Measuring Range: 0 to ±150A
 Max. Overload Current: 1500A
 Offset Range: ±150A
 Output sensitivity: 50 mV/A
 DC Accuracy (@25°C): 1% of reading ±2mA*
 AC Accuracy (@25°C): 1% of reading DC to 2kHz decreasing to 5% @ 120kHz
 Delay Time: < 1µs
 di/dt Tracking: > 35A/µs
 Dielectric Strength: 2.3kV, 50Hz, 1min
 External field rejection: 500:1 @ DC
 100:1 @ 10 kHz

GENERAL CHARACTERISTICS

Operating Temperature: 0°C to 50°C
 Max Conductor Size: 19mm
 Cable Length: 2m
 Interface: ProBus™, 1 MΩ only
 Weight: 300g
 Usage Environment: indoor
 Max. Altitude: 2000m.
 Max. relative humidity: 80% (max. 31°C)

* Note: Accuracy is specified for probe operating in fixed orientation with respect to earth's magnetic field following an auto-zero operation

SAFETY

The probe has been designed to comply with IEC1010-2-032 Installation Category (Overvoltage Category) II, 300V, Pollution Degree 1.

PERFORMANCE DATA

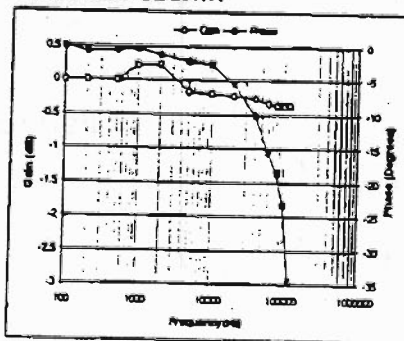

Typical probe amplitude and phase response

Ordering Information

AP011 Current Probe

Software Options:

- 93XX-WP01 Waveform Math Package
- 93XX-WP02 FFT Processing Waveform
- 93XX-WP03 Statistical Analysis Package

USA Direct Sales: 1 (800) SLE-CROY

LeCroy Worldwide Sales Offices

ASIA/PACIFIC	LeCroy Pty Ltd	61 38 90 7358
BENELUX	LeCroy BV	0490 208 9285
FRANCE	LeCroy SARL	(1) 69 18 83 20
GERMANY	LeCroy Europe GmbH	06221 87 200
ITALY	LeCroy SRL	06 336 797 00
JAPAN Osaka	LeCroy Japan	0816 330 0961
JAPAN Tokyo	LeCroy Japan	0813 3376 9400
SWITZERLAND	Geneve	022 719 21 11
SWITZERLAND	Niedererz	062 885 80 50
United Kingdom	LeCroy Ltd	012351 533114

Other sales and service representatives throughout the world.

Copyright January, 1996. LeCroy is a registered trademark of LeCroy Corporation. All rights reserved. Information in this publication supersedes all earlier versions. Specifications subject to change without notice.



LeCroy

Innovators in Instrumentation

AP082 / AP083 Trigger Pick-off for SDH: STM-1E and SONET: STS-3

Main Features

- AP082 for SDH, AP083 for SONET.
- Ideal for pulse mask-testing (G.703 fig 24 and 25).
- Works with scrambled or live data streams.
- Automatic impedance matching and scaling.
- ProBus™ design, automatically sensed by the 93XX oscilloscopes.
- Includes ready-to-load G.703 masks fig. 24 and 25.

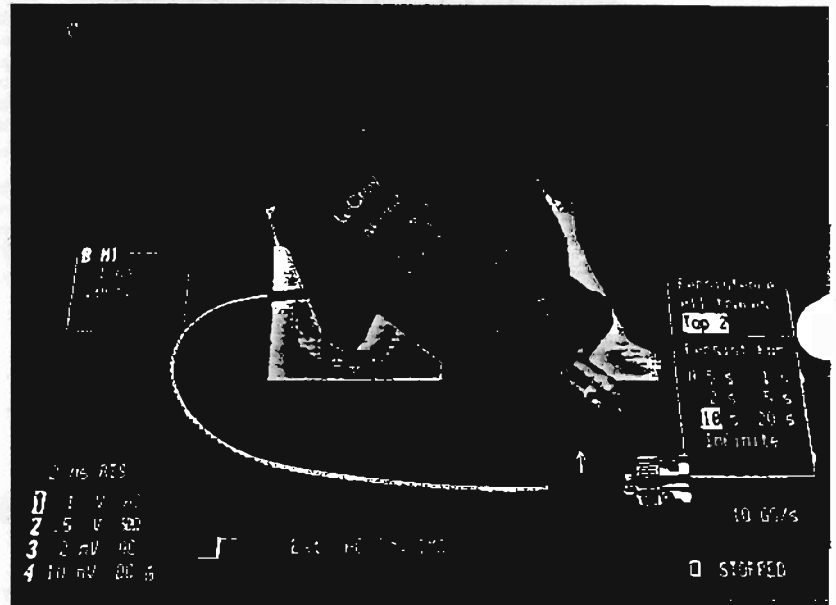

Choose to trigger on "0"s or on "1"s

155 Mbps electrical SDH and SONET signals use the CMI encoding. Using an oscilloscope to selectively trigger on the leading edge of a "1" pattern, and reject all the zeros (or vice versa) has been practically impossible until now. Thanks to its dedicated circuitry, the AP082/083 can easily isolate either

"0" or "1" patterns, allowing for further analysis such as jitter characterization or mask testing – G.703 Fig. 24 and 25 masks are supplied with the accessory.

Accurate readings

Both the AP082 and the AP083 have been designed to provide the correct impedance matching (50Ω for SONET and 75Ω for SDH) and because the accessory is automati-

cally sensed by the oscilloscope, the amplitude readings are correctly scaled on screen.

High Bandwidth

In addition, the accessory's high bandwidth make it suitable for testing with an oscilloscope of 1 GHz or greater, to minimize attenuation and distortion, and to comfortably analyze the signal well beyond its 5th harmonic.

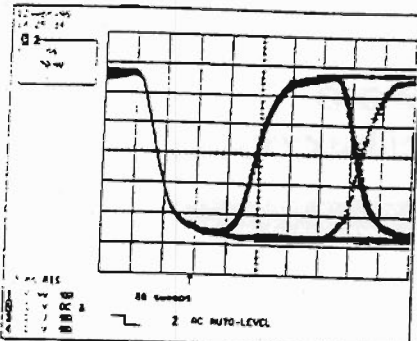

Without the adequate triggering provided by the AP082/083, both "0" and "1" patterns overlap.

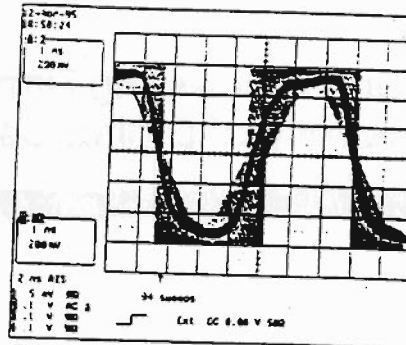

The same signal as in column 1, but with AP082/083 trigger set to trigger on a "0" pattern.

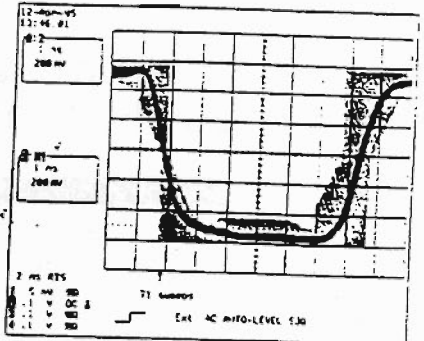

The same signal as in column 1, but with AP082/083 trigger set to trigger on a "1" pattern.

Specifications

AP082

Bandwidth (3 dB): 1 GHz

Input range: $\pm 2V$

Input coupling: DC

Input impedance: 75Ω

Trigger output impedance: 50Ω

Trigger output range: $\pm 300mV$

AP083

Bandwidth (3 dB): 1 GHz

Input range: $\pm 2V$

Input coupling: DC

Input impedance: 50Ω

Trigger output impedance: 50Ω

Trigger output range: $\pm 300mV$

Ordering Information

- AP082 SDH: STM-1E trigger pick-off with SDH masks on 3.5" Floppy disk.
- AP083 SONET: STS-3 trigger pick-off with SONET masks on 3.5" Floppy disk.

USA Direct Sales: 1 (800) 5LE-CROY

LeCroy Worldwide Sales Offices

ASIA/PACIFIC	LeCroy Pty Ltd	61.38.90.7358
BENELUX	LeCroy BV	04902 8.9285
FRANCE	LeCroy SARL	(1).69.18.83.20
GERMANY	LeCroy GmbH	06221 83.10.01
ITALY	LeCroy SRL	06.336.797 00
JAPAN Osaka	LeCroy Japan	0816.330.0961
JAPAN Tokyo	LeCroy Japan	0813.3376.9400
SWITZERLAND Geneva		022.719.21.11
SWITZERLAND Lenzburg		064 51 91 81
United Kingdom	LeCroy Ltd	(01235) 533114

Copyright May, 1995. LeCroy is a registered trademark of LeCroy Corporation. All rights reserved. Information in this publication supersedes all earlier versions.

Specifications subject to change without notice.

Other sales and service representatives throughout the world.

LeCroy

Innovators in Instrumentation

WP01 Waveform Processing Firmware for the 9300 Family of Digital Oscilloscopes

Main Features

- High-precision averaging up to 1 million sweeps
- Extended digital filtering capabilities
- Rescale function, with $(ax + b)$ correction factor
- Envelope mode
- Integration
- Differentiation
- $\text{Log}(e)$ and $\text{Log}(10)$
- $\text{Exp}(e)$ and $\text{Exp}(10)$
- Absolute, Reciprocal
- Square, Square root
- Powerful function chaining feature

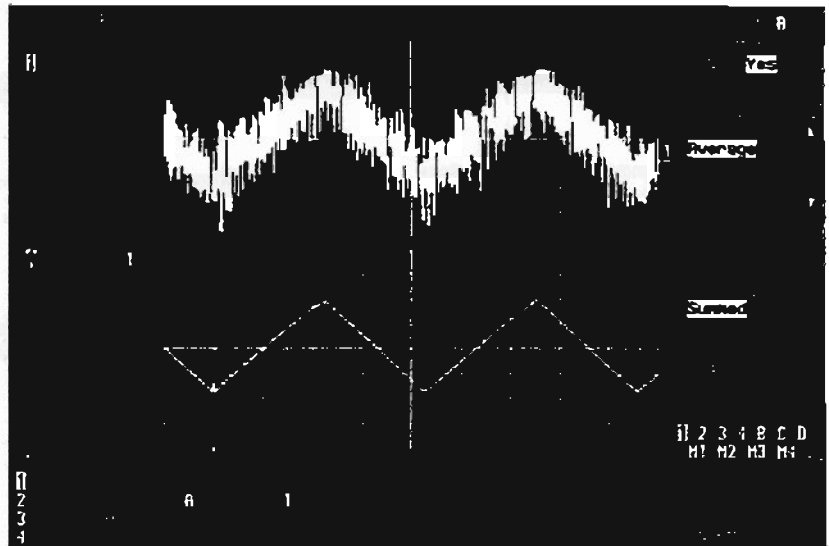

Summed Averaging is applied to the signal in Channel 1, to remove random noise. Trace A shows the result after 377 sweeps: the noise has practically disappeared.

The LeCroy WP01 Waveform Processing package features a powerful toolset that extends the processing power inside the 9300 oscilloscope, well beyond the capabilities of a traditional instrument.

In fact, all the processing is built-in to eliminate the need for external computers and controllers. High-speed microprocessors are used to ensure real-time updates of computed waveforms on the screen.

The package is fully programmable over GPIB or RS-232-C interfaces, and hard copies can be made directly on to a wide range of printers – including the optional internal printer – plotters or graphic formats.

Features and Benefits

EXTENSIVE SIGNAL AVERAGING

WP01 offers two powerful, high-speed averaging modes that can be used to reduce noise and improve the signal-to-noise ratio. Vertical resolution can be extended by several bits to improve dynamic range and increase the overall input sensitivity to as much as 50 $\mu\text{V}/\text{div}$.

Summed averaging, where up to 1,000,000 sweeps are repeatedly summed, with equal weight, in a 32-bit accumulation buffer for improved accuracy. The accumulated result is then divided by the number of sweeps.

Continuous/exponential averaging where a weighted addition of successive waveforms can be performed with weighting factors from 1:1 to 1:1023. The averaging goes on indefinitely with the contribution of "older" sweeps gradually decreasing. The method is particularly appropriate to reduce noise on signals drifting very slowly in time or amplitude.

ENHANCED RESOLUTION BY DIGITAL FILTERING

Allows low-pass F.I.R. filtering of the digitized signals, with 6 different cut-off frequencies per sampling rate setting. As a result, the vertical resolution of the captured signals – single-shot or repetitive – increases from 8 bits to 11 bits in 0.5-bit steps. This feature is a post-acquisition process which allows the user to capture, save and view the raw data as well as the processed data after applying one or more filters.

RESCALING

Allows an input signal to be rescaled using a $(ax + b)$ correction factor to compensate for gain and offset. This is very useful when dealing with various types of transducers, to read the correct temperature or pressure value directly from the scope's cursor.

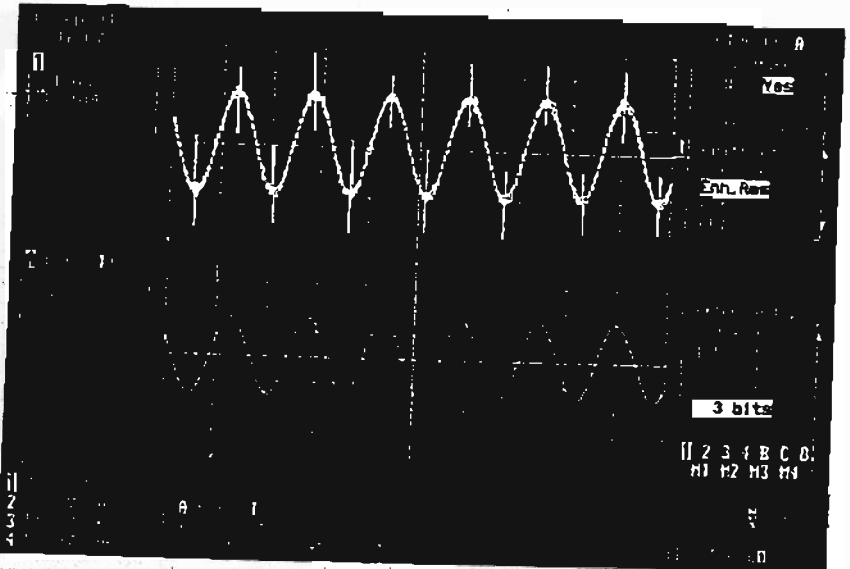

High-frequency glitches in Channel 1 have been dramatically reduced in Trace A by using the low-pass filtering properties of the Enhanced Resolution Function.

ENVELOPE MODE

Shows the signal envelope by retaining only the highest and lowest amplitudes for every sampling interval, over a user-definable number of sweeps. Ideal to visualize the time or amplitude jitter in a signal.

POWERFUL MATH TOOLSET

In addition to the basic arithmetic functions found in the standard models (+, -, \times , /), WP01 adds an impressive set of functions such as integration, differentiation, logarithms and exponential – in both bases 10 and e – square, square root, reciprocal and absolute value.

All these functions are updated automatically each time a new waveform is acquired, showing a "live" representation of a computed trace. This would be impossible to achieve on a separate computer.

FUNCTION CHAINING

When more than one math function is needed in the equation, WP01 supports function chaining, and allows the user to multiply, for instance, the "Voltage" and the "Current" channel and to integrate the result to get an instantaneous energy curve.

REMOTE CONTROL

All of the waveform processing can be controlled via GPIB or RS-232-C remote control. And the function traces do not even need to be called up on screen to be updated, an important feature that speeds up the computation.

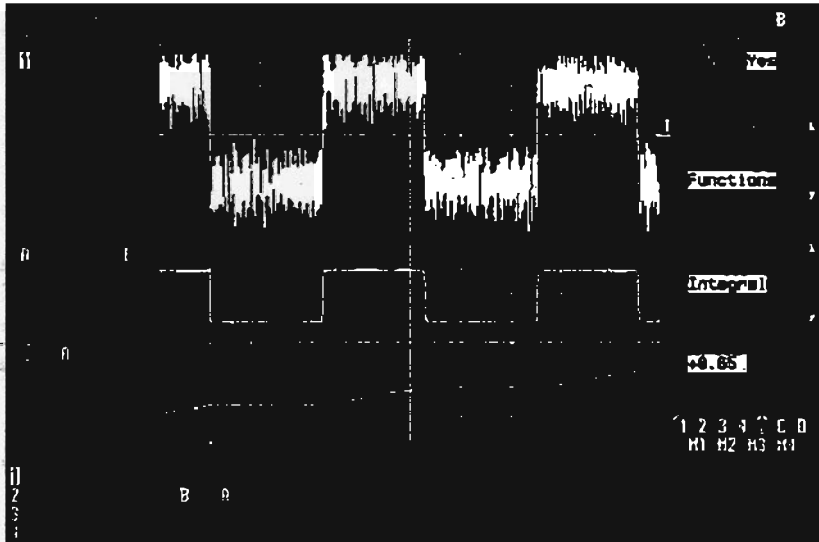

To illustrate WP01's function chaining ability, the noisy signal in Channel 1 has been averaged in Trace A to remove undesired noise, and the result integrated in trace B.

WP01 Specifications

GENERAL

Max. number data points: only limited by the available amount of system memory (indicated in the "memory used" status menu).

Min. number data points: Data points can be reduced down to 50 in the processing function to improve update rate.

Vertical Zoom: supported, 50x maximum.

Horizontal Zoom: supported, maximum zooming to a point where 20 samples of the source trace occupy the full screen.

Maximum Sensitivity: 50 μ V/div after vertical expansion.

SUMMATION AVERAGING

Number of Sweeps: 1 to 1,000,000.

Speed: up to 200,000 points/s.

CONTINUOUS AVERAGING

Possible Weighting Factors: 1:1, 1:3, 1:7, 1:15, 1:31, 1:63, 1:127, 1:255, 1:511 and 1:1023.

ENHANCED RESOLUTION

Choice of six low-pass filters to improve vertical resolution improvement from 8 to 11 bits in 0.5-bit steps.

Resulting bandwidth:

0.5 bit	0.5 \times Nyquist BW
1 bit	0.241 \times Nyquist BW
1.5 bit	0.058 \times Nyquist BW
2 bit	0.029 \times Nyquist BW
2.5 bit	0.016 \times Nyquist BW
Nyquist BW = 1/2 \times sample frequency.	

RESCALE

$ax + b$ rescaling with a and b ranging from $\pm 0.00001 E-15$ to $\pm 9.99999 E+15$

ARITHMETIC

Addition, subtraction, multiplication and ratio on any two waveforms.

FUNCTIONS

Identity, negation, integration (including additive constant), differentiation, square, square root, logarithm and exponential (base e and 10), reciprocal and absolute value of any waveform.

EXTREMA

Shows the signal envelope by retaining only the highest and lowest amplitudes for every sampling interval. Logs all extreme values of a waveform over a programmable number of sweeps. Maxima and minima can be displayed together, or separately by choosing roof or floor traces.

Number of Sweeps: 1 to 1,000,000.

FUNCTION CHAINING

Up to four functions can be automatically chained using traces A, B, C and D. Using memories M1 to M4 for intermediate results, any number of operations can be chained manually or via remote control.

REMOTE CONTROL

All controls and waveform processing functions are fully programmable using simple commands over the oscilloscope's GPIB or RS-232-C interfaces.

LeCroy

The Digital Scope Specialists

WP02 Spectrum Analysis Firmware for the 9300 Family of Digital Oscilloscopes

Main Features

- Frequency range from DC up to the instrument's full bandwidth
- Simultaneous FFTs on up to four channels
- Frequency resolution down to 100 μ Hz
- Frequency domain averaging
- Wide selection of scaling formats
- Five window functions
- Up to Five 1000-point FFTs per second
- Full support of cursors and automatic waveform parameters
- Full PASS/FAIL testing support

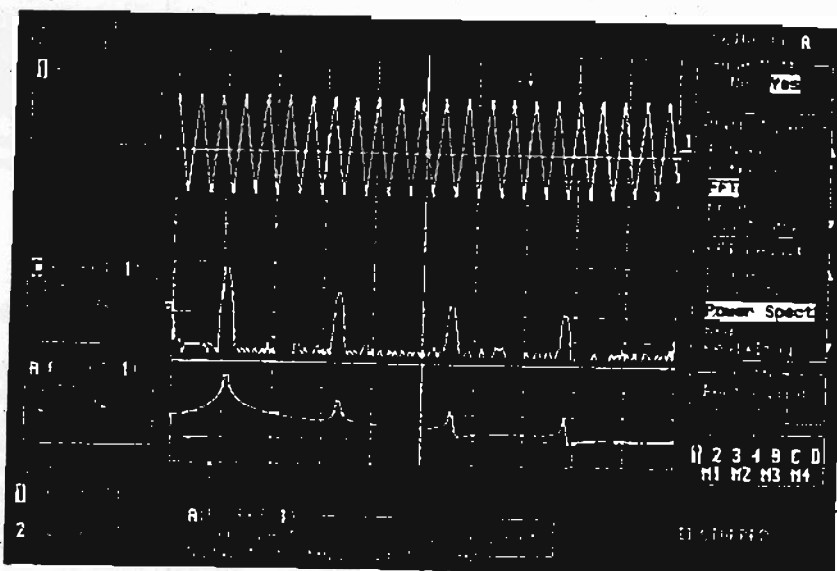

Adding the WP02 Spectrum Analysis Package to the 9300 family of digital oscilloscopes provides a fast and economical solution to frequency domain applications.

The WP02 Spectrum Analysis package provides the 9300 oscilloscope with a powerful frequency-domain toolset that extends its processing capabilities well beyond the realm of a standard instrument. In fact, all the processing is built-in to eliminate the need for external computers and controllers.

High-speed microprocessors are used to ensure real-time update of computed waveforms on the screen. Fast Fourier Transforms (FFTs) rapidly convert time domain waveforms into frequency domain records to reveal valuable spectral information such as phase, magnitude and power.

The package is fully programmable over GPIB and RS-232-C interfaces, and hardcopies can be made directly on to a wide range of printers – including the optional internal printer – plotters or graphic formats.

Features and Benefits

WHY FFT IN A SCOPE?

The FFT package on a LeCroy 9300 has at least four clear advantages over common swept spectrum analyzers:

- It can show the spectrum of a **transient signal**.
- Both **time and frequency** information can be monitored **simultaneously**.
- Phase information is **available**.
- The price is **attractive**.

It has two definite advantages over FFT analyzers:

- It can show higher-frequency components.
- Both **time and frequency** information can be monitored **simultaneously**.
- The price is **attractive**.

BROAD SPECTRUM COVERAGE

The frequency spectrum ranges from DC to the full bandwidth of the oscilloscope for repetitive signals, and to one half of the maximum sampling frequency for transients.

MULTI-CHANNEL ANALYSIS

All input channels can be analyzed simultaneously to look for common frequency-domain characteristics in independent signals.

VERSATILE SCALING FORMATS

Frequency-domain data may be presented as magnitude, phase, real, imaginary, complex, log-power and log-PSD (Power Spectral Density).

STANDARD WINDOW FUNCTIONS

Use rectangular for transient signals; von Hann (Hanning) and Hamming for continuous waveform data; Flattop for accurate amplitude measurements; Blackman-Harris for maximum frequency resolution.

FREQUENCY DOMAIN AVERAGING

Up to 50,000 FFT sweeps may be averaged to reduce base-line noise, enable analysis of phase-incoherent signals or signals which cannot be triggered on.

FREQUENCY CURSORS AND WAVEFORM PARAMETERS

Cursors can be set on the FFT trace to show up to 0.004% frequency resolution (up to 0.002% for 10,000 point memory) and measure power or voltage differences to 0.2% of full scale. Automatic waveform param-

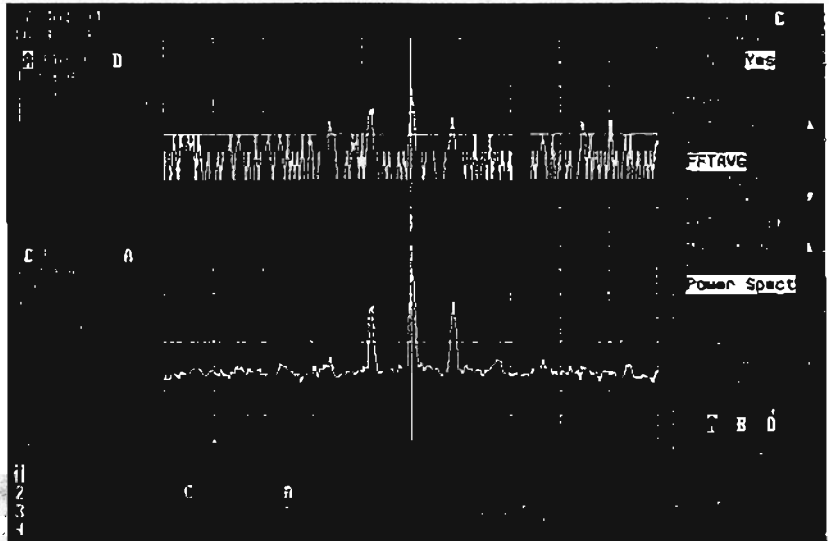

An FFT (top trace) with spectral components buried in noise. By applying the power averaging function (lower trace), all the baseline noise is removed, and the spectral components of an AM signal are clearly visible.

eters can also be applied to FFT traces.

PASS/FAIL TESTING ON FFT TRACES

PASS/FAIL testing is fully supported on FFT traces. The instrument can be setup to test incoming spectra against tolerance masks. In case the signal "fails", the instrument can be programmed to perform a choice of actions (screen dump, waveform storage, pulse out, etc.)

RESCALING

Allows an input signal to be rescaled using a $(ax + b)$ correction factor to compensate for gain and offset. This is very useful when dealing with various types of transducers, to read the correct temperature or pressure value directly from the scope's cursor.

FUNCTION CHAINING

When more than one math function is needed in the equation, WP02 supports function chaining, and allows the user to subtract a signal from a background reference stored in memory and then perform an FFT after the subtraction.

REMOTE CONTROL

All of the waveform processing can be controlled via GPIB or RS-232-C remote control. And the function traces do not even need to be called up on screen to be updated, an important feature that speeds up the computation.

FOURIER PROCESSING

Fourier processing is a mathematical technique which enables a time-domain waveform to be described in terms of frequency-domain magnitude and phase, or real and imaginary spectra. It is used, for example, in spectral analysis where a waveform is sampled and digitized, then transformed by a Discrete Fourier Transform (DFT). Fast Fourier Transforms (FFT) are a set of algorithms used to reduce the computation time (by better than a factor of 100 for a 1000 point FFT) needed to evaluate a DFT.

WP02 Specifications

GENERAL

Max. number data points: only limited by the available amount of system memory (indicated in the "memory used" status menu).

Min. number data points: Data points can be reduced down to 50 in the processing function to improve update rate.

Vertical Zoom: supported, 50x maximum.

Horizontal Zoom: supported, maximum zooming to a point where 20 samples of the source trace occupy the full screen.

Maximum Sensitivity: 50 μ V/div after vertical expansion.

Frequency Range:

Repetitive signals: DC to instrument bandwidth.

Transient signals: DC to 1/2 maximum single-shot sampling frequency

Frequency Scale Factors: 0.05 Hz/div to 0.2 GHz/div in a 1-2-5 sequence.

Frequency Accuracy: 0.01%.

AMPLITUDE AND PHASE

Amplitude Accuracy: Better than 2%.

Amplitude accuracy may be modified by the window function (see the window functions table).

Signal Overflow: A warning is provided at the top of the display when the input signal exceeds the ADC range.

Number of Traces: Time domain and frequency domain data can be displayed simultaneously (up to 4 waveforms).

Phase Range: -180° to +180°.

Phase Accuracy: $\pm 5^\circ$ (for amplitudes > 1.4 div).

Phase Scale Factor: 50° /division.

SPECTRUM SCALING FORMATS

Horizontal Scale: Linear, in Hz

Vertical Scales:

Power Spectrum in dBm (1 mW into 50 Ω).

Power Spectral Density (PSD) in dBm.

Magnitude, Real, Imaginary: Linear, in V/div

Phase Display: Linear, in degrees.

WINDOW FUNCTIONS

Rectangular, von Hann (Hanning), Hamming, Flattop and Blackman-Harris (see table below).

FFT EXECUTION TIMES*

100 points in less than 0.03 s.

1000 points in less than 0.3 s.

10000 points in less than 3 s.

* Only valid for 9370, 9350, 9360, and 9304/10 with MWP option. Other models, add 50%

FREQUENCY DOMAIN POWER AVERAGING

Summation averaging of power, PSD or magnitude for up to 50,000 sweeps.

FUNCTION CHAINING

Up to four functions can be automatically chained using traces A, B, C and D. Using memories M1 to M4 for intermediate results, any number of operations can be chained manually or via remote control.

REMOTE CONTROL

All controls and waveform processing functions are fully programmable using simple commands over the oscilloscope's GPIB or RS-232-C interfaces.

Window type	FILTER PASS BAND AND RESOLUTION			
	Filter bandwidth at -6 dB (freq. bins)	Highest side lobe (dB)	Scallop loss (dB)	Noise bandwidth (freq. bins)
Rectangular	1.21	-13	3.92	1.0
von Hann	2.00	-32	1.42	1.5
Hamming	1.81	-43	1.78	1.36
Flattop	1.78	-44	0.01	2.96
Blackman-Harris	1.81	-57	1.13	1.71

Filter Bandwidth at -6 dB characterizes the frequency resolution of the filter.

Highest Side Lobe indicates the reduction in leakage of signal components into neighboring frequency bins.

Scallop Loss is the loss associated with the picket fence effect.

LeCroy Digital Oscilloscopes

Get the Complete Picture

WP03 Parameter Analysis Datasheet

LEADING SPECIFICATIONS

- Histogram over 40 Different Waveform Parameters
- Up to 2000 Histogram Bins
- Population of up to 2,000,000,000
- 18 Histogram Measurement Parameters
- Autoscale on Histogram
- Histograms of all or Individual Segments in Sequence Waveforms
- Trend Analysis of Measurements

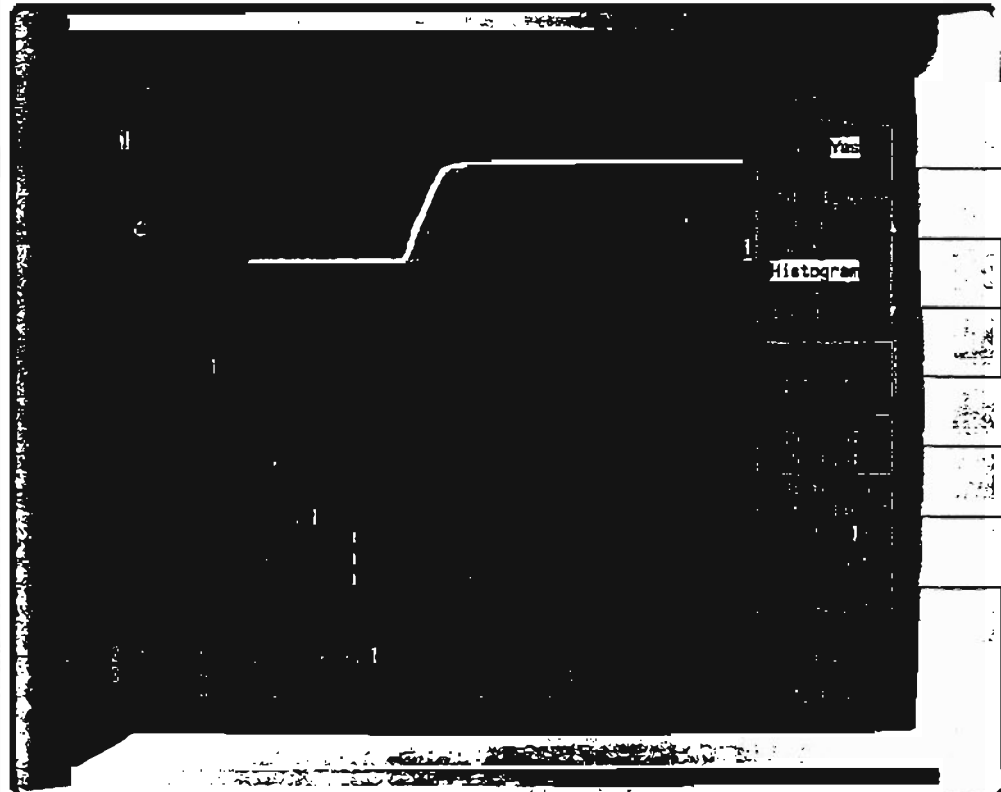

The LeCroy WP03 Parameter Analysis package extends the measurement capability of any LeCroy oscilloscope by providing two new processing functions – built into the oscilloscope – to perform in-depth statistical analysis of waveform parameters – a task that was formerly carried out either manually, with a notepad, or by means of an external computer, in a spreadsheet program.

The new functions provide **histogramming** and **trending** of any waveform parameter measurement. Both of these analysis techniques are

easy to use. For example, histograms can be conveniently **autoscaled** to display the center and width of the distribution. In addition, an already wide range of automated measurements are extended to provide a new category of statistical measurements specifically designed to analyze histogram distributions.

The package is fully programmable over GPIB and RS-232-C interfaces, and hardcopies can be made directly to a wide range of printers (including the optional internal printer), plotters or graphic formats.

Parameter Histogram Display shows the statistical distribution of timing jitter.

LeCroy

WAVEFORM PARAMETER ANALYSIS

WP03 adds a powerful dimension to waveform analysis by recording and analyzing the properties of a series of waveform parameter measurements. This is accomplished by a function that records the parameter values and presents the data in a statistical form - the Histogram - or shows the values in time order - the Trend.

The Histogram function produces a barchart where each bar represents a range of parameter measurement values consisting of one bin. The height of each bar is equal to the number of parameter values which fall into the corresponding bar. Analysis of histogram distributions is supported by a wide range of automated statistical parameters, which provide insight into and quantitative analysis for difficult-to-measure phenomena such as jitter and amplitude fluctuation. This function is also invaluable in establishing production test limits.

The Trend function displays the time sequenced values of selected parameters. Key performance parameters can be tracked during changes in temperature or variation of supply voltage, to plot amplitude modulation or other time-ordered dependencies.

A DATABASE IN THE OSCILLOSCOPE

The Parameter Analysis functions perform calculations on a stored history database of waveform parameter values. This allows the user to redefine the number of bins or histogram scale and see results on the histogram distribution without the need to reacquire the waveforms. Having the parameter database available also allows automatic scaling of histogram and trend displays.

Histogram of a pulse width parameter recorded on a single sequence acquisition with N occurrences of the parameter.

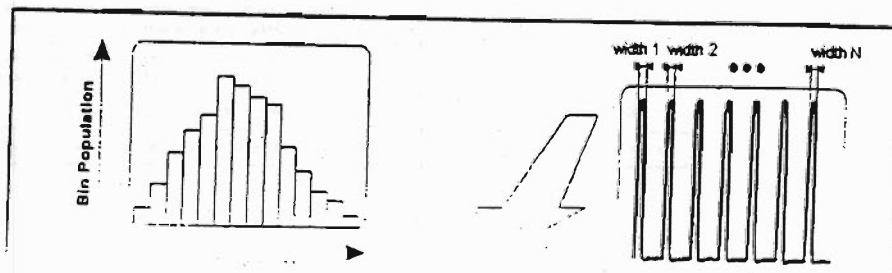

WAVEFORM PARAMETER MEASUREMENTS

LeCroy oscilloscopes have the capability to perform a wide range of automated waveform parameter measurements which make interpretation of waveform data easy, accurate and repeatable. The distribution of these parameter measurements can be analyzed by histogramming their values.

Some of the waveforms parameters available include:

amplitude	r@level (abs)	overshoot +
area	r@level (%)	overshoot -
base	duty cycle	peak to peak
cmean	duration	period
cmedian	falltime	phse
crms	ISO-20%	risetime
csdev	f@level (abs)	r20-80%
cycles	f@level (%)	r@level (abs)
delay	frequency	r@level (%)
Δdelay	maximum	RMS
Δr@level (abs)	mean	std dev
Δr@level (%)	median	top
Δr clock to data +	minimum	width
Δr clock to data -		

This screen shows trend of the pulse widths driving the gate current of a power FET. The amber cursors are measuring a difference of 1.93 μsec between the narrowest and widest widths while the trend line shows the linearity of the pulse width modulation.

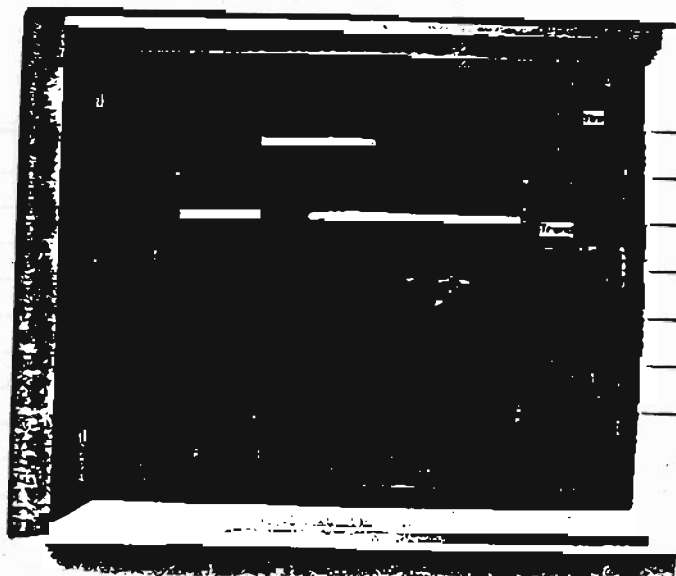

HISTOGRAM FEATURES

Provided below are just some of the histogramming capabilities.

Vertical: Autoscaling, choice of "Linear", "Log" or "Constant maximum" scales.

Horizontal: 20 to 2000 bins in a 1-2-5 sequence. User specified center and width or Autosetup of center and width.

Population: 20 to 2,000,000,000 selectable in a 1-2-5 sequence.

Data Source: Any waveform parameter.

Value Displayed: The bin event count/div, number of events contained within the histogram, and the percent of the captured events lower and greater than the histogram scale, are automatically displayed.

Measurements: 18 Statistical parameters operate directly on the histogram. Cursor measurements can also be made directly on histograms.

HISTOGRAM PARAMETERS

The standard 9300 and LC Series oscilloscope offer basic parameter statistics (maximum, minimum, average and standard deviation). WP03 adds 18 Parameters for use directly on the histogram displays. These additional measurements allow detailed analysis of waveform parameter distributions and can be monitored by the Pass/Fail system to provide go/no-go testing based on parameter statistics.

TREND FEATURES

Up to four graphs of successive values of any waveform parameters may be generated through the Trend function. Output of the function is a line graph whose vertical axis is the value of the parameter and whose horizontal axis is the order in which the values were acquired.

HISTOGRAM PARAMETERS

Parameter	Abbreviation	Explanation
Histogram Base	hbase	Horizontal position of left-most statistically significant bin.
Histogram Top	htop	Horizontal position of right-most statistically significant bin.
Histogram Amplitude	hamp	Horizontal difference between the htop and hbase values.
Histogram RMS Value	hrms	Root Mean Square value of histogram distribution.
Sigma	sigma	Standard Deviation of histogram distribution.
Low	low	Horizontal position of left-most non-zero bin.
High	high	Horizontal position of right-most non-zero bin.
Range	range	Horizontal difference between the high and low values.
Total Population	totp	Total population in the histogram.
Maximum Population	maxp	Maximum population in any histogram bin (i.e. vertical value of the mode).
Peaks	pks	Number of peaks in the distribution.
Mode	mode	Horizontal position of the bin with the maximum population.
Average	avg	Horizontal mean of the distribution.
Median	hmedian	Horizontal median of distribution. The value of the mid-point of the distribution.
Full width at half max.	fwfm	The width of the distribution around the maximum population bin, including bins which contain at least one half of the maximum population.
Full width at x% of max.	fwxx	The width of the distribution around the maximum population bin, including bins which contain at least x% of the maximum population.
x Position at Peak	xapk	Horizontal position of the n th largest peak by area.
Percentile	pct	Value in histograms for which % of population is smaller.

LeCroy

Innovators in Instrumentation

9300 Family Disk Drive Measurement Packages

Main Features

- **IDEMA Test Standards Measurements**
 - Pulse Width 50
 - Track Average Amplitude
 - Resolution
 - Overwrite
- **PRML Measurements**
 - Non Linear Transition Shift
 - Auto Correlation Signal-To-Noise
 - Auto Correlation
- **Peak/Trough Pair Measurements**
 - Time between peaks
 - Time between troughs
 - Time over threshold
 - And ten others...
- **Histograms for Statistical Analysis**
 - Histograms provide bar charts for easy analysis of measurement results over many events.

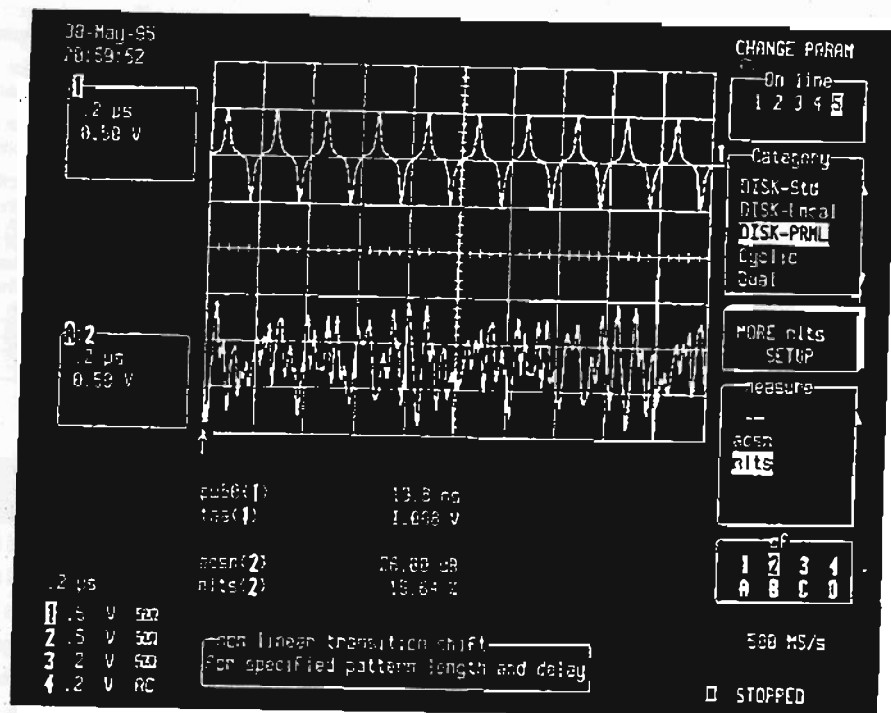

DISK DRIVE MEASUREMENT PACKAGES

LeCroy's Disk Drive Measurement Packages provide the ability to perform automated drive waveform measurements. The combination of automated measurements, long memory, and waveform display enables previously unavailable drive analysis capabilities.

The Disk Drive Measurement Packages include the DDM package and the PRML package. The DDM package provides IDEMA Test methods measurements and many other measurements for analysis of Lorentzian signals. The PRML package provides parameter measurements specifically for PRML

signals including PR4, EPR4 and E²PR4.

Also provided with the DDM package is a powerful histogram math function capability. The histogram math function allows any drive waveform parameter to be histogrammed and statistically analyzed.

DDM (Disk Drive Measurement) PACKAGE

IDEMA® TEST METHODS PARAMETERS

The DDM package includes processing functions specified in the international Disk Drive Equipment and Materials Association (IDEMA®) test standards document*.

Parameter	Description
PW50 ⁽¹⁾	Pulse Width 50: Provides an average pulse width, measured at 50% peak amplitude, of all peak/trough pairs in the specified waveform.
PW50(+)	Pulse Width 50 (+): Provides an average pulse width, measured at 50% peak amplitude, of all peaks in the specified waveform.
PW50 (-)	Pulse Width 50 (-): Provides an average pulse width, measured at 50% peak amplitude, of all troughs in the specified waveform.
TAA (+)	Track Average Amplitude: Provides an average peak-to-peak amplitude of all Peak/Trough pairs in the specified waveform.
TAA (+)	Track Average Amplitude (+): Provides an average peak amplitude of all peaks in the specified waveform.
TAA (-)	Track Average Amplitude (-): Provides an average peak amplitude of all troughs in the specified waveform.
RESOLUTION ⁽³⁾	Specified as $(TAA(F1)/TAA(F2)) * 100\%$ Where: F1 = Low Frequency F2 = High Frequency
OW ⁽⁴⁾	Overwrite: Specified as: $10 \log (V_r/V_o)$ Where: V_r is the residual V_{ms} of F1 (low frequency) after F2 (high frequency) write V_o is the V_{ms} of F1 (low frequency) after F1 write.

PEAK/TROUGH PAIR PARAMETERS

Parameters that measure amplitude and timing relationships between positive peaks and negative peaks (troughs) of a waveform are also included in the DDM package. Used in conjunction with the Histogram processing function a statistical description of the waveform can be calculated.

Parameter	Description
lbase	local baseline
lbasep	local baseline separation
lmax	peak maximum voltage
lmin	trough minimum voltage
lnum	number of local peak and trough pairs.
lpp	peak to trough amplitude (lmax - lmin)
ltbe	time between events (either peak to trough or trough to peak)
ltop	time between peaks
ltbt	time between troughs
ltmn	time at minimum trough voltage
ltmw	time at maximum peak voltage
ltot	width of peak over threshold
ltpt	time between peak and trough
lttp	time between trough and peak
ltut	width of trough under threshold

*As specified in IDEMA Standards, 1994 Revised Edition

- (1) Document No. T15-91
- (2) Document No. T3-91
- (3) Document No. T4-91
- (4) Document No. T14-91

FREQUENCY DOMAIN PARAMETERS

These parameters provide a rapid technique to extract amplitude and phase of single frequencies from complex waveforms. These parameters are more efficient than using an FFT for specific frequencies of interest.

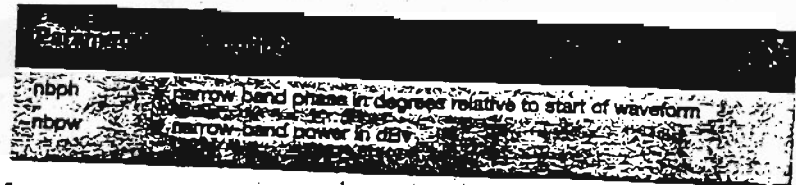

Histograms

Any waveform parameter may be histogrammed. The histogram function produces a waveform with the vertical axis in units of 'Events' and the horizontal axis in parameter units (volts, nanoseconds,etc.). The histogram shows the statistical variation of the selected parameter and is an extremely valuable analysis tool. Using scope measurement cursors the value and population of any bin can be exactly determined.

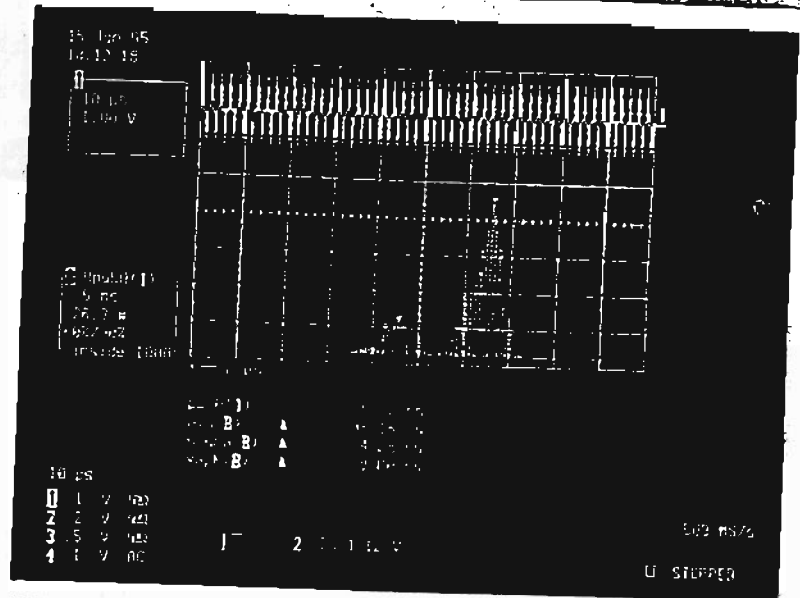

Histogram of PW50 for Trace 1 Signal

HISTOGRAM PARAMETERS

Histogram parameters provide the ability to obtain numeric values for statistics or other features of a histogram. When combined with the 9300 family parameter cursors the statistics or other characteristics of a selected section of interest in a histogram can be measured.

Low	Minimum value
High	Maximum value
Range	High - Low
FWHM	Width of largest peak at half amplitude
Maxp	Highest population (vertical value) in the histogram
Average	Mean value
Sigma	Standard deviation
Tpop	Total Population
XAPK	Horizontal position of the selected peak
Pks	Total number of peaks
Median	Horizontal position of the value which divides the histogram into two equal populations
Mode	Horizontal position of the most frequently occurring value
Percentile	Horizontal position separating histogram population to specified % on left such that the population on the left is a specified percentage of the total.

PRML Measurement Package

PRML PARAMETERS

PRML (Partial Response Maximum Likelihood) recording channels provide higher areal densities by allowing magnetic transitions to be written at closer spacing than peak detection channels. The following parameters provide a time domain technique to measure the time shift and S/N ratio created by this magnetic writing process.

NLTS Non-Linear Transition Shift:
 $NLTS = 200 \cdot r$
 Where r = auto correlation coefficient @ time delay

ACSN Auto Correlation Signal-to-Noise Ratio:
 $ACSN = 10 \log (R/1-R)$
 Where R = correlation coefficient

AutoCorrelation $R_c(u) = \int f_c(t)f_c(t-u)dt$

Ordering Information

93XX-DDM	Disk Drive Measurement Package
93XX-PRML	PRML Measurement Package
93XX-VP1	WP01, WP02 and DDM Package
93XX-VP2	WP01, WP02, DDM and PRML Package
93XX-VP3	DDM and PRML Package

Copyright © October LeCroy is a registered trademark of LeCroy Corporation. All rights reserved. Information in this publication supersedes all earlier versions.

Specifications subject to change without notice.

9510/8

LeCroy
 Innovators in Instrumentation



LeCroy

9300 Family Optical-Recording Measurement Package

Main Features

- **Optical Recording Applications**
 - CD-ROM, CD-R
 - Magnetic-Optical (MO)
 - PD, DVD
- **Optical Recording Parameters**
Fourteen optical-recording specific measurements including pit width, time from pit edge to clock, resolution...
- **List by nT Display Mode**
Display a list of optical-recording measurement values indexed by each (nT) pulse width.
- **Histograms of Measurements**
Generate histogram bar charts for analysis of parameter value distributions.
- **Trend Analysis of Measurements**
Generate trend lines of parameter measurement values to study sector variations, modulation and other time ordered dependencies.

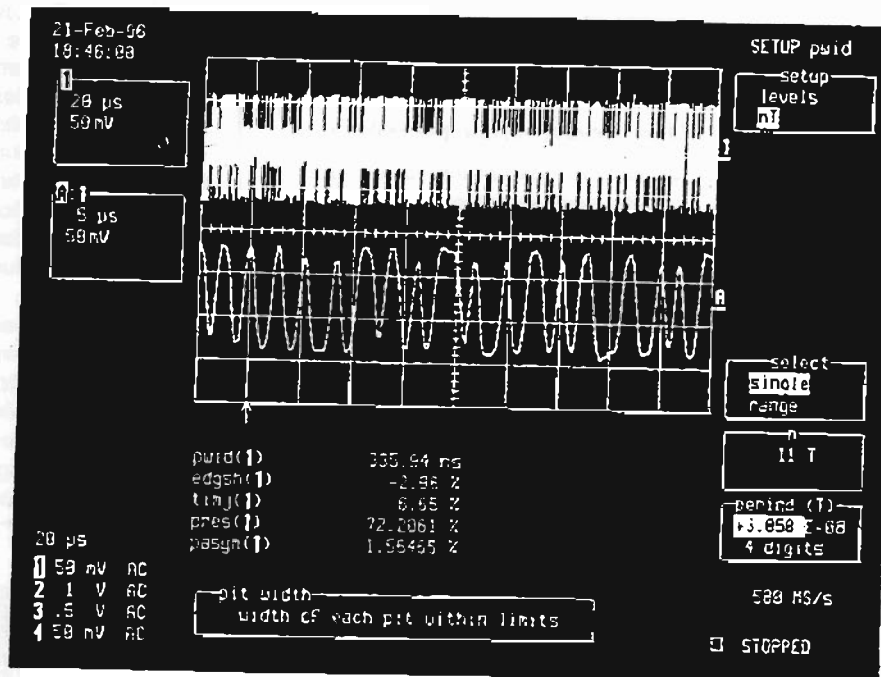

Trace 1 is a captured CD waveform. Trace A is a zoom expansion of Trace 1. Measurements performed on Trace 1 are Pit Width (pwid), Edge Shift (edgsh), Timing Jitter (timj), Resolution (pres) and Pit Asymmetry (pasyn).

Optical-Recording Measurement Package

LeCroy's Optical-Recording Measurement Package provides the ability to perform automated measurements of optically recorded data waveforms. The combination of automated optical-recording measurements, long DSO memory, advanced triggering features and a large screen waveform display provides previously unavailable optical recording analysis capabilities.

Fourteen optical-recording waveform specific parameter measurements are provided.

Up to five different parameter values can be displayed simultaneously with statistics such as average, maximum, minimum and sigma.

Also provided is a unique "List by nT" display mode, which simultaneously provides for each group of 'nT' width pits/spaces, the values of measurements such as edge shift, timing jitter, etc.

Histogram graphs of parameter measurements can be selected to observe statistical anomalies not normally identifiable by calculating, for example, a parameter's average or sigma.

Trend graphs of parameter measurements can also be selected to observe the variation of successive parameter measurements within a sector or even around a track.

OPTICAL-RECORDING PARAMETERS

Optical-Recording Measurement Package parameters directly support the pit/space width based data encoding mechanism used in optical recording, by pre-screening waveform pits and spaces into width ranges of $[T \pm .5T, 2T \pm .5T, \dots, nT \pm .5T]$ where T is the clock period.

User options include the ability to:

- calculate parameter values for pits, spaces or both
- calculate parameter values for pits and/or spaces of a specific 'nT' value or range of 'nT' values.
- set the voltage threshold level at which to measure pits/spaces widths.

and many more....

Parameter	Description
dp2clk	Delta Pit to Clock - time between the pit or space edges and the next clock edge. The measurement is normalized by the period of the clock signal.
edgsh	Edge Shift - the mean value of the difference between pits or space widths and their ideal widths.
paa	Pit Average Amplitude - average amplitude of pits in a waveform.
pasym	Pit Asymmetry - ratio of the difference between the amplitude of the largest 'nT' width pits and the smallest 'nT' width pits to the amplitude of the largest 'nT' width pits.
pbase	Pit Base - the value for the base level of a space.
pmidl	Pit Middle - the midpoint between the top and base of pits.
pmax	Pit Max - the maximum value of a pit.
pmin	Pit Min - the minimum value of a space.
pmoda	Pit Modulation Amplitude - ratio of the amplitude of pits of the smallest 'nT' width to the top of pits of the largest 'nT' width.
pnum	Pit Number - total number of pits and/or spaces in a waveform.
pres	Pit Resolution - ratio of the amplitude of pits of the smallest 'nT' width to pits of the largest 'nT' width.
ptop	Pit Top - the value for the top level of a pit space.
pwid	Pit Width - the width of pits and/or spaces measured at a user defined threshold.
timj	Timing Jitter - the standard deviation of the difference between pit and/or space widths and their ideal widths.

OPTICAL-RECORDING 'List by nT' DISPLAY MODE

Often it is desirable to view a measurement value for each 'n' value for all possible 'nT' width ranges simultaneously. The List by nT display is provided to accommodate this need. Up to 25 'nT' values can be displayed simultaneously in this mode. Measurements that can be displayed in the List by nT mode are:

- Time from Pit to Clock
- Pit Width
- Edge Shift
- Timing Jitter
- Pit Top
- Pit Base
- Pit Maximum
- Pit Minimum
- Pit Number
- Pit Average Amplitude

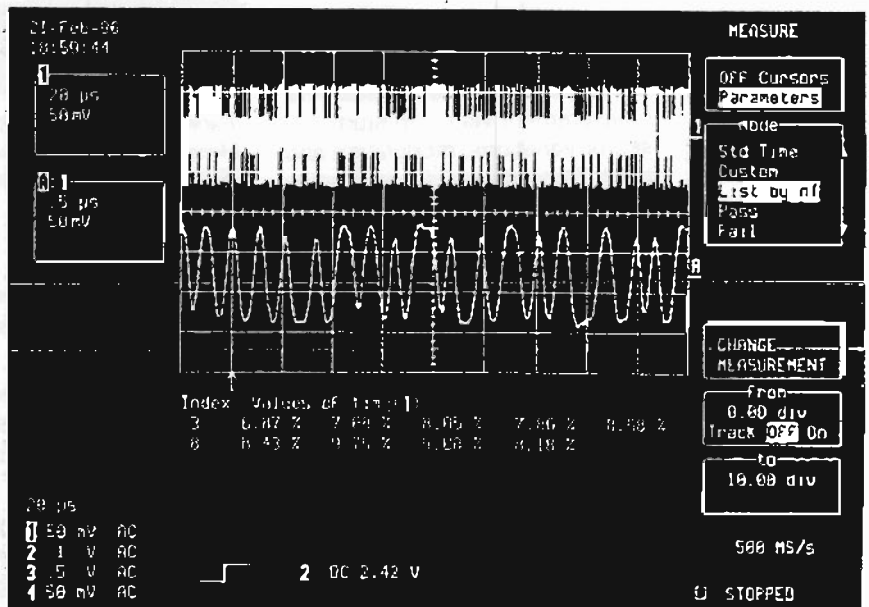

List by nT mode display of Timing Jitter (timj) measurement of CD-ROM Data Waveform with separate values displayed for each 'nT' mark/space width (3T-11T)

HISTOGRAM FUNCTION

A histogram of any waveform parameter measurement can be displayed. The histogram function produces a bar graph with the vertical axis in units of 'Events' and the horizontal axis in the unit of the parameter being histogrammed (i.e., volts, nanoseconds, etc.). Histograms graphically represent the distribution of parameter measurements providing insights often not available through standard statistical measurements such as the average and standard deviation.

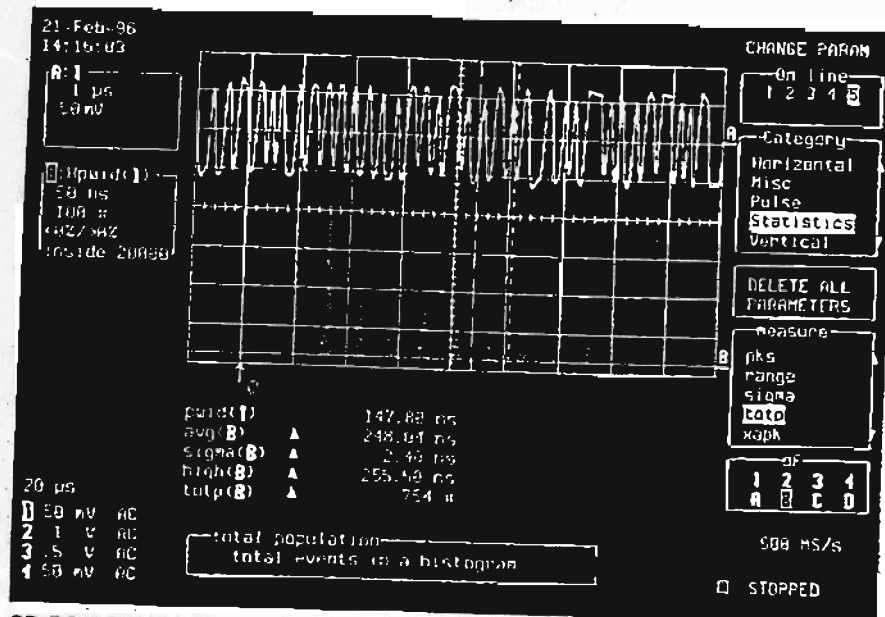

CD-ROM Data Waveform with Histogram of Pit Width (*pwid*) parameter. Notice the distinct peaks resulting from pits/spaces all being an integral number of clock periods in width. Statistical analysis of histograms is performed using histogram parameters. For the above figure the histogram peak representing 8T pits and spaces is selected and the average (*avg*) sigma, and the highest value and population of the peak (*ttop*) is displayed.

HISTOGRAM PARAMETERS

Histogram parameters provide the ability to obtain numeric values for the statistics or other features of a histogram distribution. When combined with the ability of LeCroy DSOs to place parameter cursors onto the histogram, the statistics or other characteristics of a selected section of interest in a histogram, such as a specific histogram peak, can be directly measured.

Parameter	Description
Low	Minimum horizontal axis value in a histogram.
High	Maximum horizontal axis value in a histogram.
Range	High - Low.
FWHM	The width of the largest peak in a histogram at half the peak's amplitude.
Maxp	Population of the highest bin in a histogram.
Average	The mean value of a histogram.
Sigma	The standard deviation of the values in a histogram.
Ttop	The total number of parameter measurement values displayed in a histogram.
XAPK	The horizontal axis value of the selected histogram peak.
Pks	The number of distinct peaks (modes) in a histogram.
Median	The horizontal axis value which divides the histogram population into two equal populations.
Mode	The horizontal axis value of the most populated histogram bin.
Percentile	Horizontal position separating a histogram population such that the population on the left is equal to the selected per-

TREND FUNCTION

A graph of successive values of any waveform parameter measurement may be generated through the Trend function. The Trend function produces a line graph with the vertical axis representing the values of parameter measurements and the horizontal axis representing the rank order number (i.e., first parameter measurement calculated, second parameter...) in which each parameter value displayed was calculated.

The trend function provides instant insight about the variation of a selected waveform attribute for successive parameter measurements calculations. This is particularly useful when trying to determine the modulation of a track or other time- or position-based variations of interest.

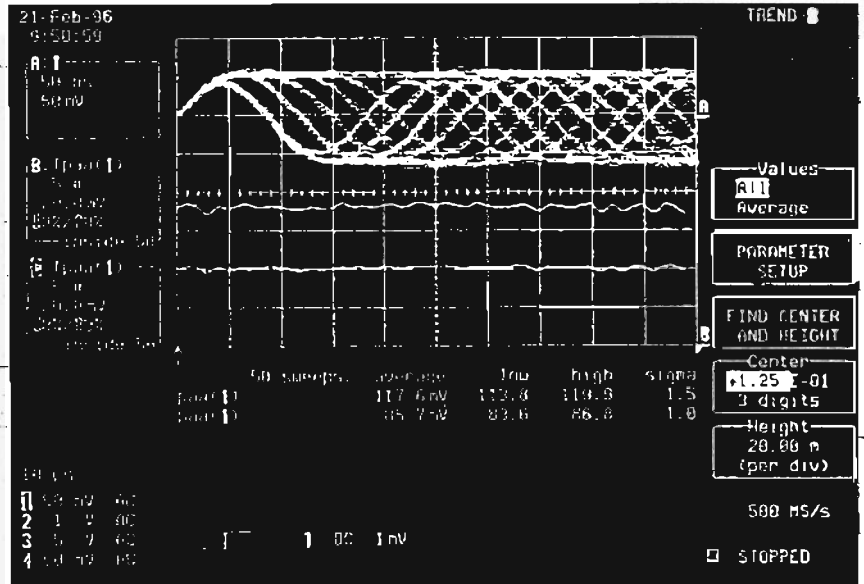

Trace A shows on one diagram of a CD signal. Trace B is a trend of the Pit Amplitude of 11T pits and Trace C is a trend of the Pit Amplitude of 3T pits. Notice the similarity of the variation in the two trend lines.

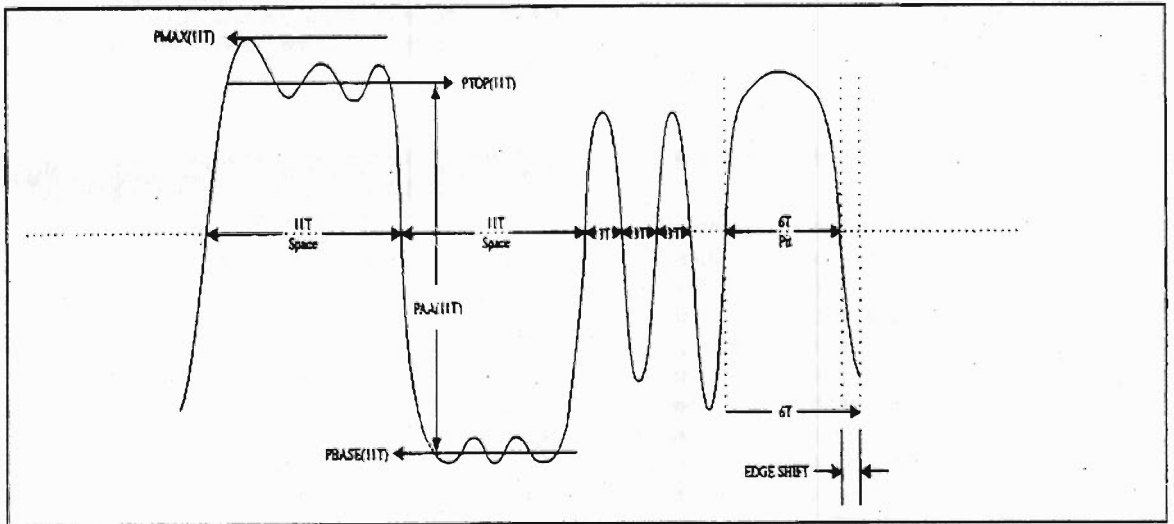

Ordering Information	
93XX-ORM	Optical-Recording Measurement Package
RK-93XXORM	Optical-Recording Measurement Package Retrofit Kit

Copyright August 1996. LeCroy is a registered trademark of LeCroy Corporation. All rights reserved. Information in this publication supersedes all earlier versions.

Specifications subject to change without notice.

USA Direct Sales: 1 (800) 5LE-CROY

LeCroy Worldwide Sales Offices	
ASIA/PACIFIC	LeCroy Corp. Hong Kong 852 2511 8772
ASIA/PACIFIC	LeCroy Pty Ltd 61 3 9890 7358
BENELUX	LeCroy GmbH 49 6221 82700
FRANCE	LeCroy SARL 33 (1) 69 18 83 20
GERMANY	LeCroy GmbH 49 6221 82700
ITALY	LeCroy SRL Venice 39 41 4589700
JAPAN Osaka	LeCroy Japan 81 6 330 0961
JAPAN Tokyo	LeCroy Japan 81 3 3376 9400
SWITZERLAND	LeCroy SA Geneva 41 22 719 2228
SWITZERLAND	LeCroy SA Niederenz 41 62 885 80 50
United Kingdom	LeCroy Ltd 44 89 1344 882

Other sales and service representatives throughout the world.



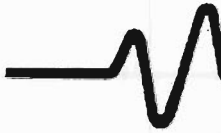

LeCroy

Innovators in Instrumentation

TC1 - CCITT, ANSI and ISDN Telecommunications Test Masks

Main Features

- 25 standard telecom signal masks including SDH and SONET
- Available on 3.5" DOS floppy or PCMCIA memory card
- Up to 4 different pulses can be tested simultaneously
- Allows combination of mask and pulse-parameter testing
- Actions such as Storage, Hardcopy, Beeping, or TTL pulse can be carried out when signal fails

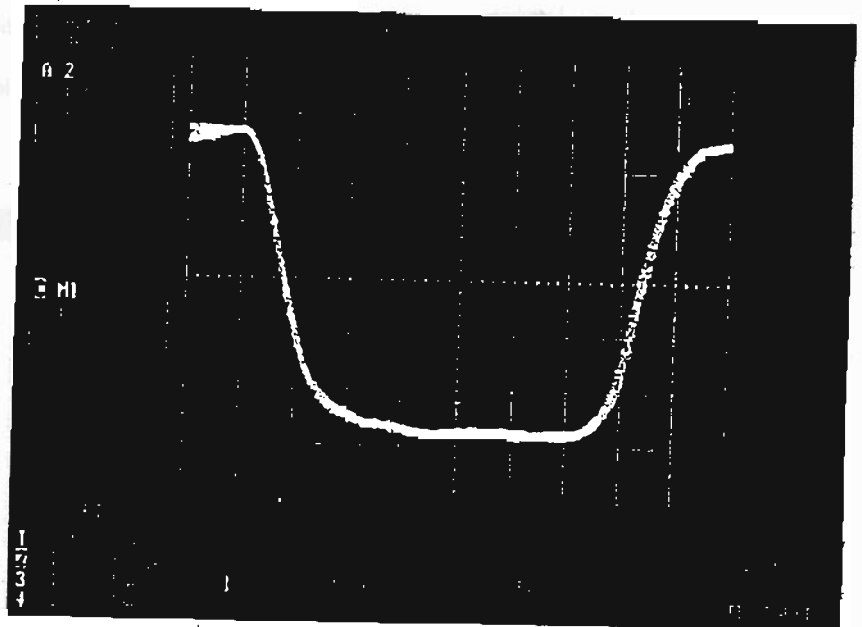

Now you can make telecom pulse-shape measurements to CCITT, ANSI and ISDN standards without using Mylar overlays. LeCroy TC1 automates the mask measurements that are so time-consuming with analog oscilloscopes. In addition the computed Pass/Fail test brings accuracy and repeatability to what used to be simple eyeballing. Human errors can therefore be significantly minimized. And when the test fails, actions such as a TTL pulse output

can drive another test device, eliminating the need for developing costly software for production test. The test masks are available on a PCMCIA memory card or a 3.5" DOS floppy disk. That means they can be used on any LeCroy 9300 or 9400 oscilloscope carrying either option, eliminating the need for costly factory retrofits. Just plug in the card or floppy and turn your LeCroy oscilloscope into a Telecom Physical-Layer Tester.

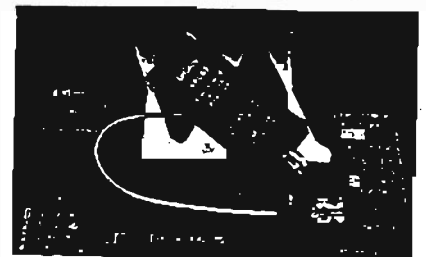

The AP082/83 trigger pick-offs can trigger on scrambled SDH/SONET data streams.

Features and Benefits

WIDE RANGE OF TELECOM MASKS

TC1 provides a total of 25 masks:

- 6 from ANSI T1.102-1987
- 19 from CCITT G.703
- 2 from the ISDN I.403

EASY INSTALLATION

Simply transfer the requested template from the TC1 card or disk to the scope's internal memory and you are ready for testing.

EASY TO USE

Use the built-in Pass/Fail utility to set the oscilloscope to Fail as soon as the acquired signal leaves the mask, then start the acquisition.

CUSTOM TOLERANCES

Masks can be customized by adding extra vertical or horizontal tolerances.

FLEXIBLE TEST ROUTINES

Up to 4 different mask tests can be carried out at the same time. They can also be combined with pulse parameter tests chosen from a list of 32 (rise-time, frequency, amplitude etc.).

FLEXIBLE ACTIONS

If the signal fails, the user can select any of the following procedures:

- Stop the acquisition and show the failed trace.
- Store the signal in internal memory.

- Store the signal on the PCMCIA memory card.
- Store the signal on the 3.5" DOS floppy disk.
- Make a screen dump to a printer or plotter, or to the card/disk for future use in your word processor.
- Generate a "beep".
- Send a TTL pulse from the "CAL OUT" BNC connector.
- Send an SRQ to the GPIB port.

Ordering Information

93XX-MC-TC1 Telecom Templates on a 512K PCMCIA card. Requires the 93XX-MC01/04 card-reader option.

93XX-FD-TC1 Telecom Templates on a 3.5" DOS floppy disk. Requires the 93XX-FD floppy-drive option.

PP 090 75 Ω to 50 Ω ProBus Adaptor

AP082 SDH: STM-1E trigger pick-off with SDH masks on 3.5" Floppy disk.

AP083 SONEt: STS-3 trigger pick-off with SONEt masks on 3.5" Floppy disk.

USA Direct Sales: 1 (800) 5LE-CROY

LeCroy Worldwide Sales Offices

ASIA/PACIFIC	LeCroy Pty Ltd	61.38.90.7358
BENELUX	LeCroy BV	04902.8.9285
FRANCE	LeCroy SARL	(1).66.18.83.20
GERMANY	LeCroy GmbH	06221.83.10.01
ITALY	LeCroy SRL	06.336.797.00
JAPAN Osaka	LeCroy Japan	0816.330.0961
JAPAN Tokyo	LeCroy Japan	0813.3376.9400
SWITZERLAND	Geneva	022.719.21.11
SWITZERLAND	Lanzburg	064.51.91.81
United Kingdom	LeCroy Ltd	(0235) 533114

Other sales and service representatives throughout the world.

Specifications

STANDARD	DATA RATE	FILE NAME	FILE SIZE
ANSI-DSX-1C	3.152 Mbit/s	DSX1CF5	4402
ANSI-DSX-1 NEW	1.544 Mbit/s	DSX1F1	3600
ANSI-DSX-1 OLD	1.544 Mbit/s	DSX1F2	3601
ANSI-DSX-2	6.312 Mbit/s	DSX2F7	4400
ANSI-DSX-3	44.736 Mbit/s	DSX3F8	4401
ANSI-T1.403	1.544 Mbit/s	DS1F2	3614
CCITT-G.703	1.544 Mbit/s	G703F10	4390
CCITT-G.703	6.312 Mbit/s	G703F11	4389
CCITT-G.703	6.312 Mbit/s	G703F12	4389
CCITT-G.703	32.064 Mbit/s	G703F13	4390
CCITT-G.703	44.736 Mbit/s	G703F14	4390
CCITT-G.703	2.048 Mbit/s	G703F15	4389
CCITT-G.703	8.448 Mbit/s	G703F16	3589
CCITT-G.703	34.368 Mbit/s	G703F17	4390
CCITT-G.703	139.264 Mbit/s	G703F19	3591
CCITT-G.703	139.264 Mbit/s	G703F20	3591
CCITT-G.703	2048 kHz	G703F21C	4421
CCITT-G.703	2048 kHz	G703F21S	4421
CCITT-G.703	97.728 Mbit/s	G703F22	4394
CCITT-G.703	155.520 Mbit/s	G703F24	4414
CCITT-G.703	155.520 Mbit/s	G703F25	4414
CCITT-G.703	64 kbit/s	G703F5A	4400
CCITT-G.703	64 kbit/s	G703F5B	3601
CCITT-G.703	64 kbit/s	G703F8	4397
CCITT-G.703	64 kbit/s	G703F9	3599
CCITT-I.430	192 kbit/s	I430F13	3588
CCITT-I.430	192 kbit/s	I430F14	3588

Copyright May, 1995. LeCroy is a registered trademark of LeCroy Corporation. All rights reserved. Information in this publication supersedes all earlier versions. Specifications subject to change without notice.

LeCroy

Innovators in Instrumentation

LeCroy

Innovators in Instrumentation

930x-64 64 Mega Bytes Extended Processing Memory

Main Features

- Extended memory capacity for processing long waveforms.
- High-speed signal processing.
- Fast Fourier Transforms on long waveforms.
- Improved trace update rate.

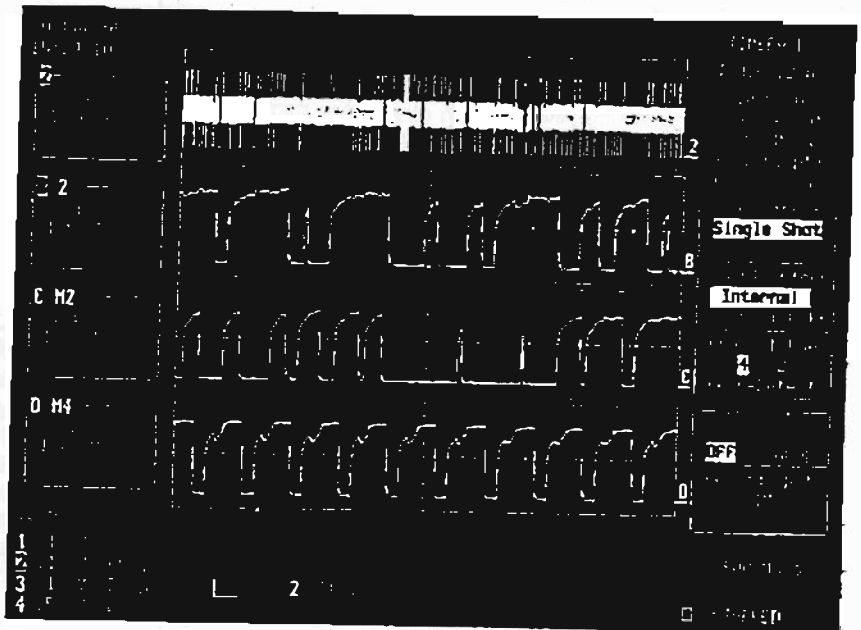

Power and Speed

This option offers 64 Mbytes of processing RAM for the 9300 series of DSOs that have a 68030 processor installed. One benefit of the 64 Mbyte option is its ability to handle longer FFTs, multiple zooms, math function chaining, and storage of very long waveforms. In addition to increased capability for memory intensive applications the extra memory results in higher processing speed for all operations.

Memory Usage

In a typical 9300 series oscilloscope about 1.5 MB of RAM is used by the operating system and the remainder (2.5 MB for standard models, 6.5 MB for 'M' models and 14.5 MB for 'L' models) is available for waveform processing. The amount of memory needed depends on the length of waveforms being processed. For example, performing a simple function on a 1 million point waveform requires 4 Mbytes, performing an FFT on a 1 million point signal requires 8 Mbytes.

Enough Memory?

Without sufficient processing memory users can run into application problems. Two 2 million point signals may be stored in the RAM of an 'L' model DSO but an additional oscilloscope operation may demand more than the remaining available RAM. The result is memory crunch, and the scope slows down. The 64 Mbyte option gives 'power users' the capability they need to ensure that processing of long waveforms does not cause a problem.

Memory for Analysis

LeCroy high performance DSOs (9350 and 9370 series) can acquire signals of 8 million points and process them with calculations including integration, differentiation, FFT, square-root, log, exponential and six selectable digital filters using the 64 Mbytes of RAM. The benefit to the user is more accurate measurements with better resolution.

An FFT is a complex calculation which requires up to 10 bytes of processing RAM for each point of signal data. One approach to this computational challenge is to reduce the number of points used in the FFT calculation, to use only the first 10 k for example. This compromise can lead to inaccurate analysis and wrong results. With extra RAM FFT calculations can be performed on waveforms of several million points without loss of accuracy.

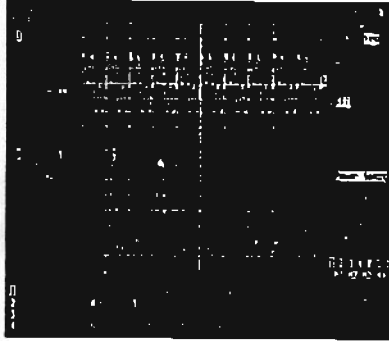

Displayed above is a waveform and an FFT performed on its first 10,000 points. Its resolution is 50 kHz.

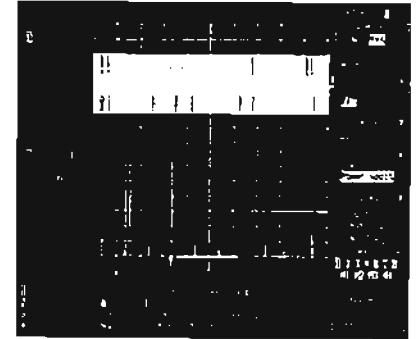

Extended processing-memory allows FFTs to be performed quickly on signals of several million points. Above is an FFT of the same signal with 1,000,000 points captured and analyzed. Note that the initial peak of the first screen (left) is resolved into two peaks (above) and that the frequency resolution is now 500 Hz. A DSO with long FFT capability shows more detail and allows more precise measurements in the frequency domain.

Memory Utilization Table

	Record Length			
	Millions of Points			
	1	2	4	8
Store to each of M1 to M4	2	5	10	20
Simple function (e.g. log)	4	10	20	40
Add/sub/mult/div 2 signals	6	15	30	60
Summed Average	8	20	40	80
FFT	8	20	40	80

Memory in Mbytes

This table outlines the memory utilization for computation intensive signal processing. For example, the total processing memory required to perform an FFT on a 4 million point waveform is 40 Mbytes.

Copyright January, 1998. LeCroy is a registered trademark of LeCroy Corporation. All rights reserved. Information in this publication supersedes all earlier versions. Specifications subject to change without notice.

Ordering Information

930x-64 Option for:
 935X
 937X

It is also possible to add the 64 Mbyte option to the 930X and 931X series of DSOs if they have already been upgraded with the MWP option but this would be an unlikely requirement due to the length of the acquisition memory of these oscilloscopes.

USA Direct Sales: 1 (800) 5LE-CROY

LeCroy Worldwide Sales Offices

ASIA/PACIFIC	LeCroy Pty Ltd	61 78 90 7258
BENELUX	LeCroy BV	+31 208 9285
FRANCE	LeCroy SARL	(1) 69 18 83 20
GERMANY	LeCroy Europe GmbH	06221 82700
ITALY	LeCroy SRL	06 336 797 00
JAPAN Osaka	LeCroy Japan	0816 330 0961
JAPAN Tokyo	LeCroy Japan	0813 3376 9400
SWITZERLAND	Geneva	022 719 21 11
SWITZERLAND	Niederentz	062 885 80 50
United Kingdom	LeCroy Ltd	(01235) 533114

Other sales and service representatives throughout the world.

LeCroy

Innovators in Instrumentation

LeCroy

Innovators in Instrumentation

CKTRIG hardware option for the 9350A, 9370, and 9384 series oscilloscopes

Main Features

- High speed 500 MHz external clock input.
- 10 MHz external clock reference input.
- Edge trigger comparator output.
- BNC, rear-panel mounted connectors.

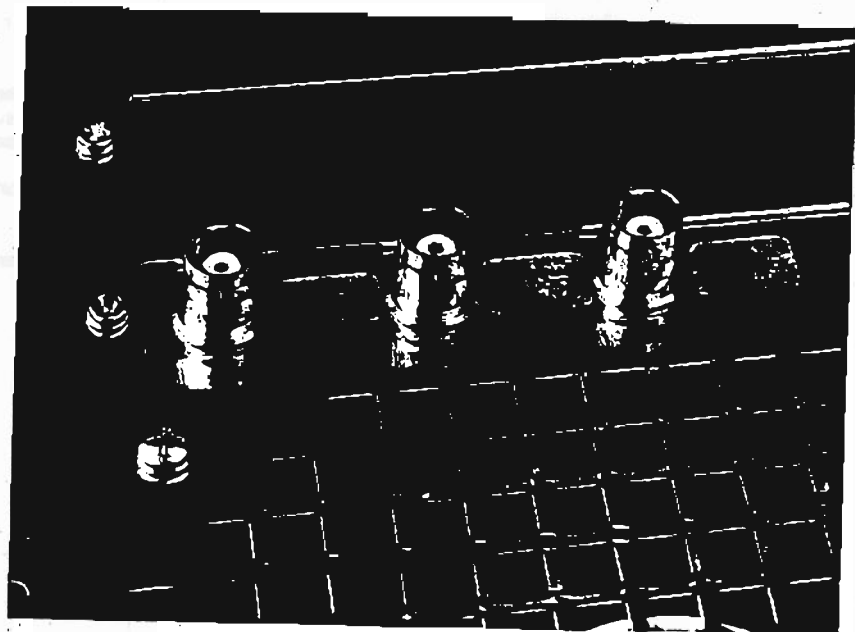

External clock

This feature allows the 9350A, 9370, and 9384 series DSOs to be externally clocked at a fixed rate from 50 MS/s to 500 MS/s, enabling full phase control over the acquired signal. The sample rate can be fine-tuned to the exact speed required by the application.

External reference

The external reference allows the scope to be phase-synchronized to an external 10 MHz reference, either to match the stability of the external source or to phase lock the acquired signal. Several DSOs can then be synchronized using a simple source as reference.

Trigger comparator

The trigger comparator signal outputs a pulse for each valid edge-trigger condition on the trigger signal. This is an invaluable feature for event-counting and throughput applications.

Specifications

EXTERNAL CLOCK INPUT

Input signal requirements:

Amplitude: 800 mV p-p typical; 1.25V p-p minimum for guaranteed switching.
 Frequency range: 50 MHz to 500 MHz.
 Offset: 0V; Any DC offset may require a larger input swing

Input impedance: 50Ω ±5%
 Maximum input voltage: ±2.5V

The negative pulse width must be less than 5ns. (2ns recommended)

Note: The 9384 does not have the limitation that the negative pulse width be less than 5 ns. A 50% duty cycle is sufficient.

Calibration must be initiated for each external clock change.

Swept Clock: Only a fixed frequency external clock is supported. Swept clocks may cause offset errors of up to 10% worst-case.

EXTERNAL CLOCK REFERENCE INPUT

Input signal requirements:

Amplitude: 800 mV p-p typical; 1.25V p-p minimum for guaranteed switching.
 Frequency range: 10 MHz ±5%
 Offset: 0V; Any DC offset may require a larger input swing.

Input impedance: 50Ω ±5%
 Maximum input voltage: ±2.5V

TRIGGER COMPARATOR OUTPUT

The comparator operates in a 'time-over-threshold' mode and generates a pulse edge of the same polarity as the polarity of the selected triggering edge each time a valid EDGE TRIGGER condition is met on the trigger signal. The duration of the pulse will be equal to the time the trigger signal is above/below the trigger level.

Note: This does not operate in SMART Trigger™ mode.

Output signal characteristics:
 Amplitude: ECL swing (800mV p-p typ.); 50Ω series terminated.

Note: Will not work into a 50Ω load to ground.

Maximum externally applied voltage: +0V, -2.5V

Ordering information

935XA-CKTRIG	CKTRIG option for the 9350A oscilloscope family.
935XA-RKCKTRIG	Retrofit kit for the 9350A oscilloscope family.
937X-CKTRIG	CKTRIG option for the 9370 oscilloscope family.
937X-RKCKTRIG	Retrofit kit for the the 9370 oscilloscope family.
938X-CKTRIG	CKTRIG option for the 9384 oscilloscope family.
938X-RKCKTRIG	Retrofit kit for the the 9384 oscilloscope family.

USA Direct Sales: 1 (800) 5LE-CROY

LeCroy Worldwide Sales Offices

ASIA/PACIFIC	LeCroy Pty Ltd	813.9890.7358
FRANCE	LeCroy SARL	(1).69.18.83.20
GERMANY	LeCroy Europe GmbH	06221 82 70-0
ITALY	LeCroy SRL	041.456.9700
JAPAN/Osaka	LeCroy Japan	0816.330.0961
JAPAN/Tokyo	LeCroy Japan	0813.3376.9400
SWITZERLAND	Geneve	022.719.21.11
SWITZERLAND	Niederenz	062.883.80.50
United Kingdom	LeCroy Ltd	(01235) 533114

See our expanded web site at <http://www.lecroy.com>

Copyright July, 1996. LeCroy is a registered trademark of LeCroy Corporation. All rights reserved. Information in this publication supersedes all earlier versions. Specifications subject to change without notice.

LeCroy

Innovators in Instrumentation

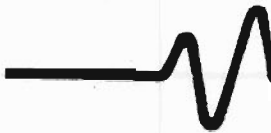

LeCroy

Innovators in Instrumentation

LeCalsoft—Calibration Software for LeCroy Digital Oscilloscopes

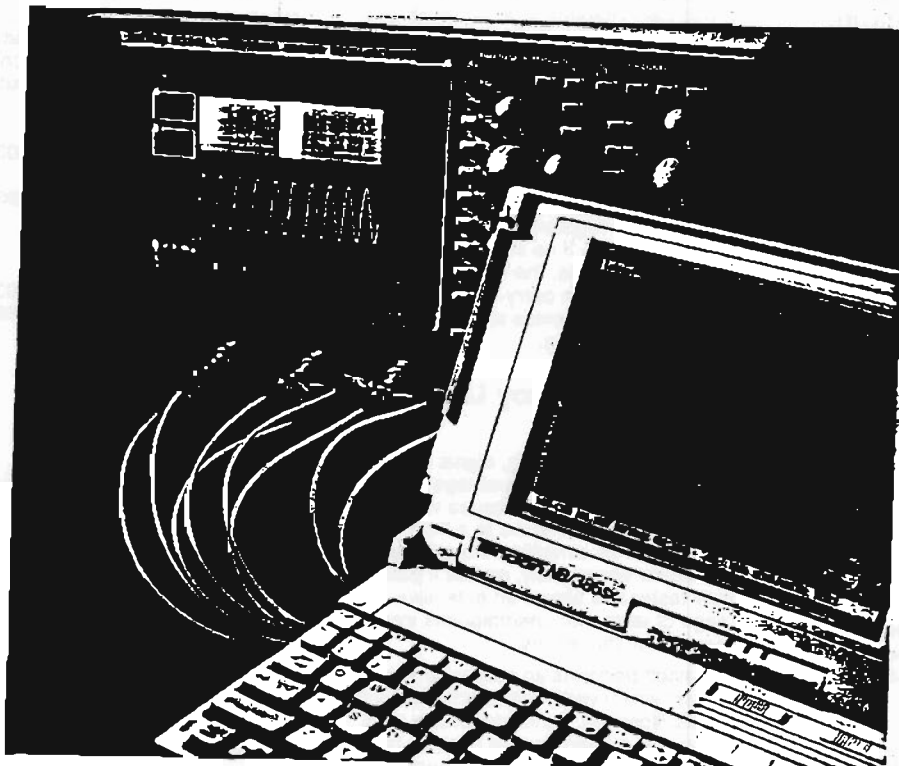

The LeCalsoft package enables a fast and thorough verification of all key specifications.

Main Features

- Traceability to reference standards
- Computer check of key specifications
- Computer-aided readjustment
- Fully automated configurations available
- Supports all 93XX and 94XX models
- IBM® PC-AT compatible.

General

The LeCroy LeCalsoft (94XXCS05) test and calibration package provides a convenient, unambiguous check of LeCroy oscilloscopes. Designed for users who require traceability to reference standards (NIST, etc.), this package is ideally suited for use in calibration laboratories where the oscilloscopes are checked at fixed intervals.

Results of the calibration check are fully documented on hard copy, or they can be archived on hard disk or diskette.

LeCalsoft works on any PC compatible with the IBM®-AT standard. It controls the oscilloscope and the calibration sources through a National Instruments® GPIB interface.

Features

Calibration Check

All the essential specifications of the Digital Oscilloscope, such as bandwidth, linearity, noise, trigger, timebase and effective-bit count are tested. Deviations from nominal values are calculated and displayed on the screen, printed, or archived on hard disk or diskette.

Comprehensive Documentation of the Test Results

At the end of each calibration check, two types of documentation are available: a long form printout which gives details of the results of all the tests executed, and states whether or not the results are within the specifications, and a short form printout which gives a summary of the test results.

Calibration Traceable to National Standards (NIST, etc.)

By using signal sources traceable to a standard, the calibration will be traceable to the same standard, provided the relevant documentation is maintained.

Manual and Automated Calibration Check

Both manual operation with computer assistance, and automated operation are possible. Automated operation requires programmable multiplexer and signal sources. See the list of supported devices below.

Assisted Adjustment of the Oscilloscope

A computer-aided adjustment procedure is also provided. By following instructions on the screen, the trained technician is guided through the adjustments required to correct the settings of the oscilloscope so that it is within the specifications.

Calibration Certificate

On request, LeCroy will perform calibration traceable to National Standard Organizations. Calibration certificates are provided as part of this service.

Functional Description

Calibration Practice

LeCroy oscilloscopes are auto-calibrating digital oscilloscopes and therefore do not require regular calibration like analog oscilloscopes. However, for users who require traceability to reference standards (such as those provided by the National Institutes of Standards and Technology), and for calibration laboratories which must inspect incoming instruments and perform recalibration at prescribed intervals, the LeCroy computer-aided test and calibration packages provide an easy solution.

Under guidance of the LeCroy program, some adjustments to the oscilloscope can be made by an electronics technician. However major deviations from specifications usually require repair by a trained service engineer. LeCroy regularly schedules training classes. If no in-house trained person is available, the nearest LeCroy service center can carry out repairs and calibration, and provide traceability to reference standards.

Using the LeCroy LeCalsoft Packages

For calibration checking, digital oscilloscopes have a great advantage over analog oscilloscopes because waveforms can be transferred to a host computer. This simplifies the calibration procedure enormously, makes it potentially faster and allows an extensive range of tests with unambiguous interpretation of the results.

LeCroy performs an extensive series of tests which verify the specifications of the oscilloscope. It includes many tests relevant to analog scopes such as Noise and Linearity tests. Although these tests are difficult and time consuming on an analog oscilloscope, they can be computer controlled and are quickly and easily performed on a digital oscilloscope. Tests which are specific to digital oscilloscopes, such as Sinefit tests are also included.

The various test options in LeCalsoft are presented to the operator in the form of a simple menu system. The user has the choice of performing an automated calibration check of the oscilloscope, or individually testing any of the specifications. Some of the tests require the use of high-quality external signal generators. The user receives instructions on

the screen when it is necessary to change the cable connections, but apart from this minor intervention, the tests are fully computer controlled when supported GPIB-programmable instruments are used.

Supported Instrumentation

LeCroy software works on any AT-compatible equipped with a math coprocessor and a National Instruments GPIB interface. Automated calibration checking is possible using a set of instruments from the following list. (For an automated calibration check, either the LeCroy or Keithley programmable multiplexer is required to feed the calibration signals to the oscilloscope input.)

RF sinewave generators:
 Marconi 2019A, 2022C, 2030, 2031
 Fluke 6060B, 6061A
 Hewlett-Packard 8642A, 8642B
 Rohde & Schwarz SMX

AF sinewave generators:
 Marconi 2019A, 2022C, 2030, 2031
 Hewlett-Packard 8642A, 8642B
 Rohde & Schwarz SMX
 Tektronix FG5010
 LeCroy AFG 9100

DC Precision Power Supply:
 Tektronix PS5004
 Datron 4708 Autocal Multifunction Standard

Fast Pulse Generator:
 Tektronix CG5001/CG551AP

Power Meters:
 Hewlett-Packard HP436A, HP437B

Multiplexers:
 Keithley 199 SYSTEM DMM/
 SCANNER with LeCroy interface board.
 LeCroy 4951, 4973-1, 4973-2
 Multiplexers.

Frequency standard:
 WWV or HBG1500

Recommended Accessories

A full kit of calibration connectors and interfaces is available from LeCroy. It includes all the necessary cables, adapters, splitters and filters, as well as the Programmable Multiplexer. Also available is a repair package including special tools, board extenders, etc., for computer-aided adjustment.

Use of Other Instruments

It is possible to perform the calibration check with some other unsupported signal sources. However, the user is then required to set up these instruments manually and to perform one measurement at a time. The LeCalsoft package

guides the user step by step, and controls the oscilloscope data acquisition and the computation of the results.

LeCalsoft compares the signal measured by the oscilloscope with the signal it would expect to receive from the generator. Warning messages are displayed

whenever tolerances are exceeded. Some of the adjustments may be carried out by the user when the test sequence is finished. In this case, the software will guide the user through the correct adjustment procedure. At the end of the calibration check, a printout can be generated to list the results.

Specifications

Computer Required: Any PC compatible with the IBM-AT standard, and equipped with a mathematical coprocessor and a National Instrument Inc. GPIB interface.

Operating System: DOS 3.0 upward

Medium: 3 1/2" 1.44 Mb
5 1/4" 1.2 Mb diskette

Major Tests Supported by LeCalsoft

Internal

To ensure proper calibration of the oscilloscope, internal auto-calibration tests are automatically executed during normal operation. This standard sequence of internal auto calibration tests is initiated by the software and the results are transferred to the PC for analysis.

The tests are:

- Calibration of the resolution of the time-to-digital converter with respect to the system clock
- Determination of the gain constants of the input amplifiers
- Offset compensation versus gain variation
- Global internal non-linearity
- General functionality check

Bandwidth

To calculate the bandwidth, the amplitudes of sine waves of increasing frequencies are measured. The sine wave generator is first set to 500 kHz with an amplitude 75% of full screen, i.e. ± 3 vertical divisions. The frequency is then swept up to the point where an amplitude drop of 3 dB is observed. This indicates the bandwidth.

This test is executed on all channels for 1 M Ω and 50 Ω input impedance and for all vertical sensitivities. It requires a sine wave generator with good flatness.

Generators supported under program

control are listed on page 2.

Linearity

15 different known voltages, varying from 5% to 95% of full screen, are applied by the external voltage reference source. For each voltage value, a full waveform is acquired, and the mean value is compared to the known input voltage. The linearity is determined through a linear regression fit to the 15 measurements. The slope, the offset and the chi-square of the fit are computed.

With the linearity test, many other related tests are performed: response time of the overload protection of the 50 Ω input, linearity of the variable gain calibration, range and linearity of the offset setting, and quality of the input coupling.

This procedure is executed on all channels for both 1 M Ω and 50 Ω input impedance. The test requires a DC source with a precision and time stability of 0.1%, a voltage range of 0 V to 20 V adjustable in steps of 5 mV, and an output current capability of 300 mA.

Power supplies supported under program control are listed on page 2.

Noise

The noise tests are executed on all channels for both 1 M Ω and 50 Ω input impedance, with AC and DC coupling, five different time-base settings, and open inputs. Full waveforms are acquired with different offset values. The peak-to-peak as well as the RMS values of each measurement are computed, and the maximum values are recorded. The program also indicates the occurrence of any "flyers", i.e. short noise peaks generated by the ADC's.

The noise tests also include:

- checking the linearity of the variable offsets of all channels between 2.5% and 97.5% of full screen.

- checking the stability of the ground line when switching the inputs between GROUND and DC coupling modes.

Rise time/Overshoot

Executed on all channels for both 1 M Ω and 50 Ω input impedance, these tests measure the rise time of the oscilloscope response to the input voltage step, as well as the amount of pre-shoot and overshoot. They require a voltage step generator with calibrated fast rise-time amplitude.

The Voltage Step Generator supported under program control is the Tektronix CG5001.

Sinefit

The performance of the analog-to-digital converter is evaluated in terms of the number of effective bits (a measure of the signal-to-noise ratio). It is measured on all channels, at a sensitivity of 50 mV/div., by applying a pure sine wave at varying frequencies and timebase settings.

This test is a measurement of dynamic linearity. It shows the effect of such errors as noise, non-linearities and aperture jitter.

Timebase

The timebase test compares the internal clock with a very precise and stable external timebase reference (clock generator) such as the WWV standard or HBG 1500.

Trigger

The trigger capabilities are tested for all possible configurations. These include:

- Internal and external trigger sources
- DC, AC, HF-reject, and LF-reject couplings
- Trigger level settings in all slope modes.

SECTION 3	Block Diagram and Sub-Assemblies
------------------	---

3.1 9384, 9384M, 9384L & 9384AL Sub-Assemblies

F9302-1-8	Processor, 8 Mbytes RAM for 9384, 9384M
F9302-1-16	Processor, 16 Mbytes RAM for 9384L, 9384AL
F9384-3	Main card, Dual Channel Front end, ADC, Time base, 5 GS/s
9384M-2	Acquisition Memory card for 9384, 9384M, 9384L
9384MEM-2	Acquisition Memory card for 9384AL
F9300-4	GPiB + RS232 interface
F9354-5	Dual channel front panel
PS9384	Power supply +/- 5V, +/- 15V.
93XX-Display	Video, deflection, CRT, yoke
M9384	Mechanical for 9384

3.2 9384 Hardware Options

93xx-FDGP	Graphic Printer & Floppy Disk F9300-6 : Centronics, Floppy, Printer interface F9300-7 : Printer controller
93xx-GP01	Graphic Printer F9300-6 : Centronics, Floppy, Printer interface F9300-7 : Printer controller
93xx-FD01	Floppy Disk F9300-6 : Centronics, Floppy, Printer interface
93xx-HDD	Hard Disk Drive, 130 MB F9300-8 : PCMCIA III, Hard Disk Controller

3.3 9384 Block Diagram

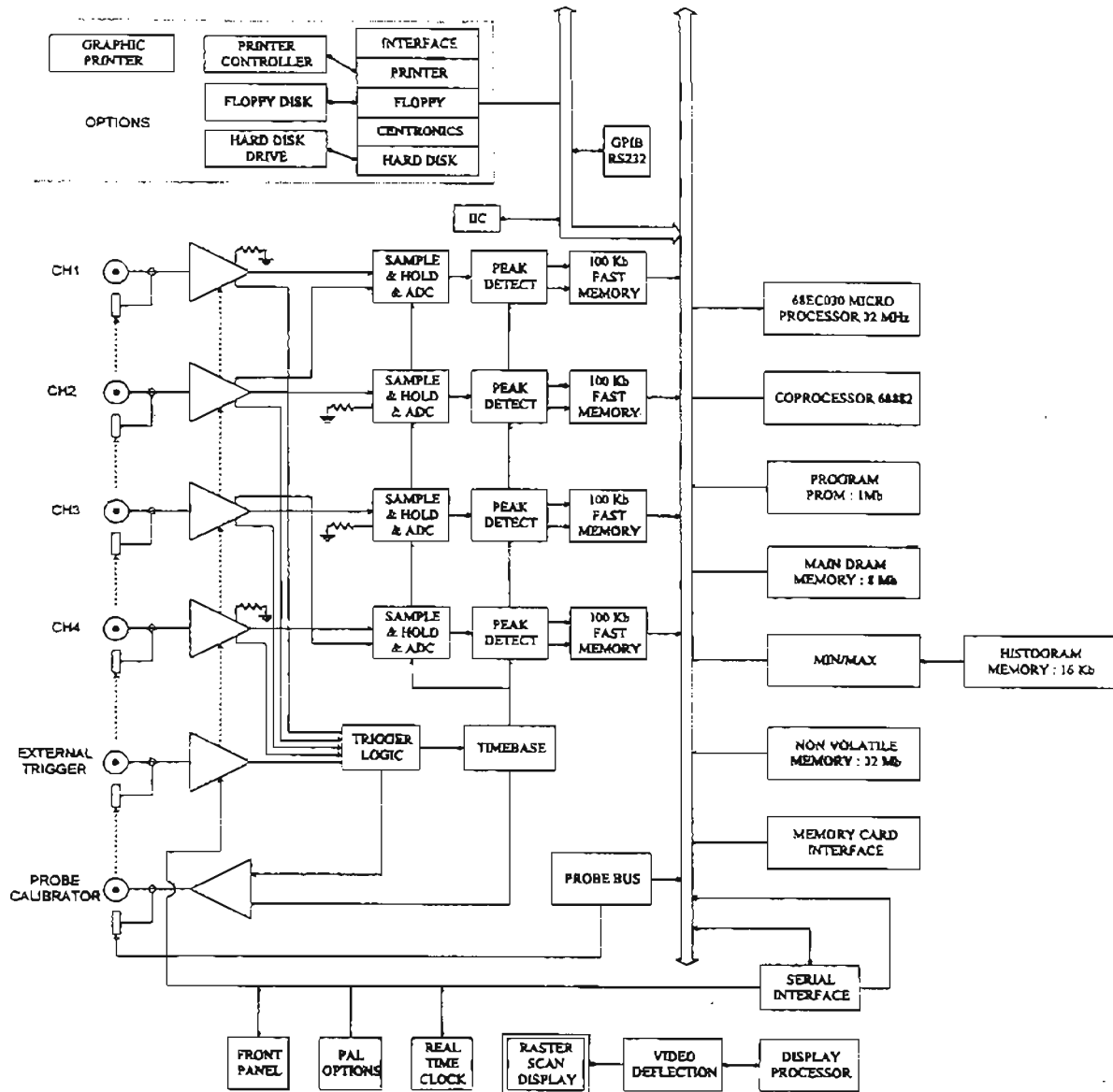

3.4 9384M Block Diagram

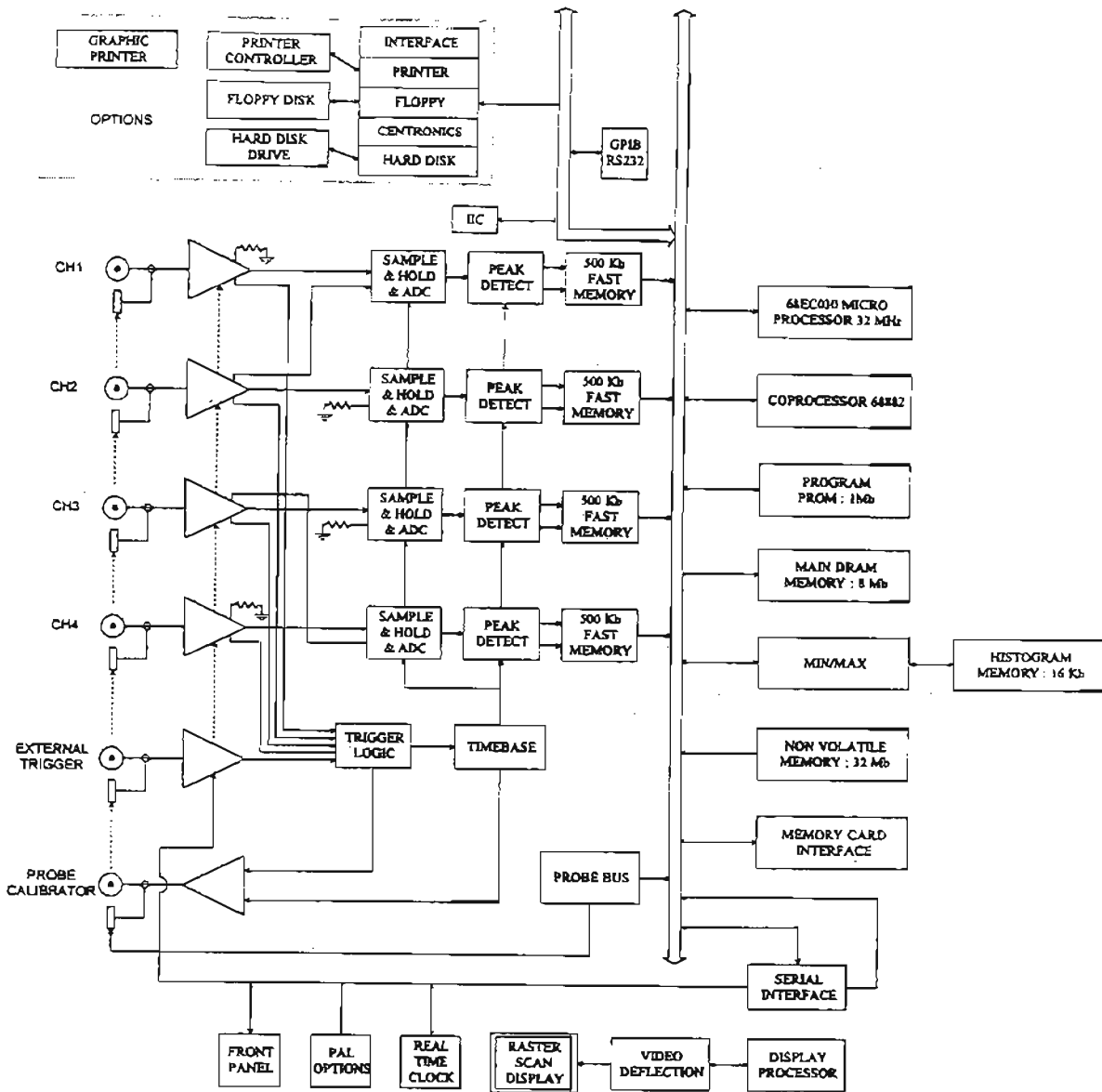

3.5 9384L Block Diagram

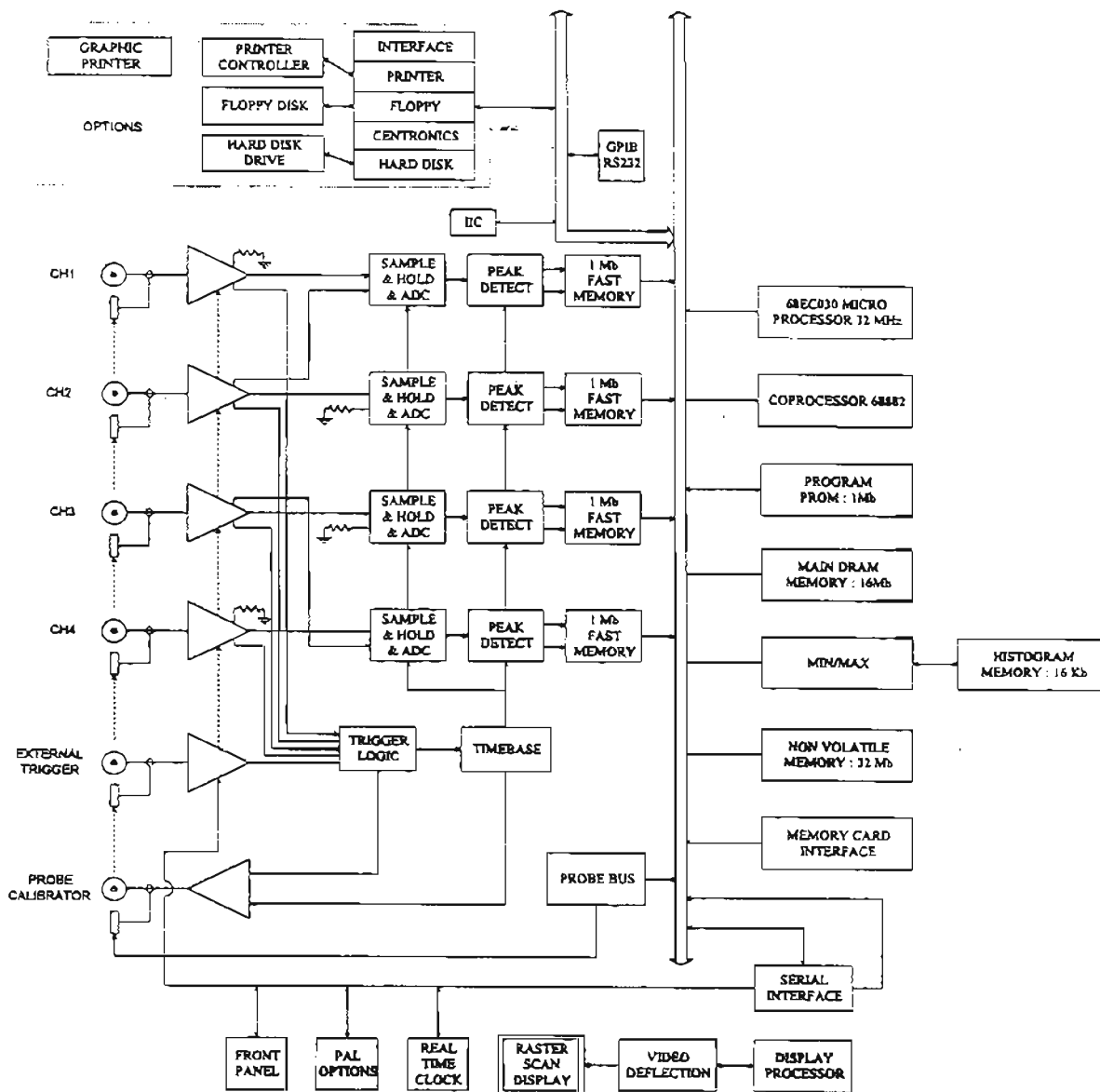

3.6 9384AL Block Diagram

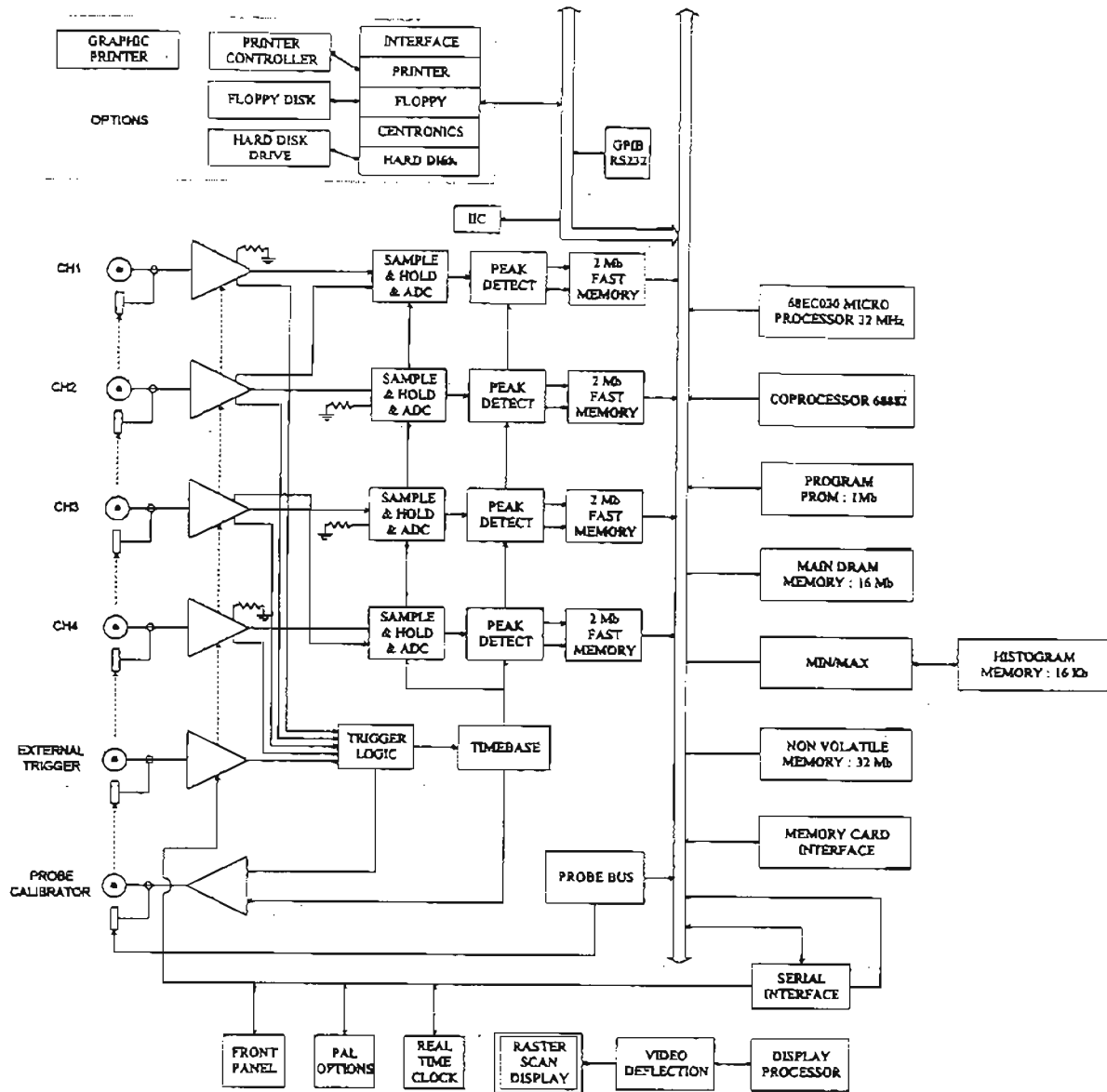

SECTION 4 THEORY of OPERATION

4.1 Processor Board : F9302-1-8 for 9384, 9384M & 9384TM, F9302-1-16 for 9384L & 9384AL

This processor board is based on the 68EC030 and 68882 coprocessor, with an internal clock frequency of 32 MHz, and 8 Mbytes or 16 Mbytes of memory. The internal Data Bus is 32 bits wide (DRAM, DSP), the peripheral Data Bus has 8 or 16 bits, and the Address Bus has 32 bits (A0-A30 and A31 for the Min/Max.).

4.1.1 Processor Block Diagram

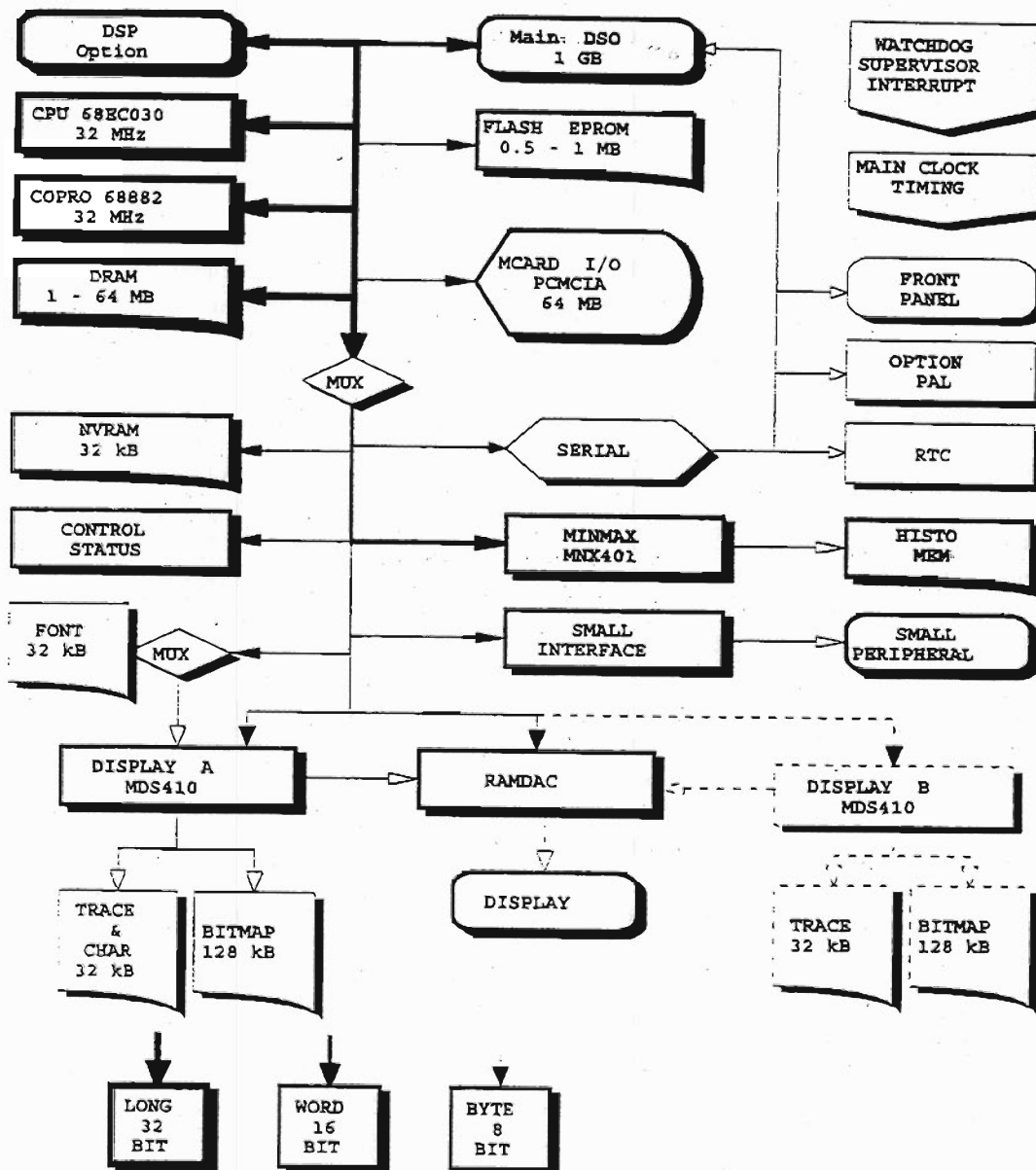

4.1.2 Parallel Peripherals

DRAM memory : Data bus 32 bits

The DRAM memory of 4 Mbytes (up to 64 Mbytes) is used as the program memory and working memory.

The compressed program of 1 Mbytes, stored in the Flash EPROM, is uncompressed then loaded and executed in the DRAM.

DSP interface : Data bus 32 bits.

An optional Digital Signal Processor is connected to the processor board via a 32 bit address bus.

F9384-3 main board interface : Data bus 16 bits.

The main board is connected to the processor via a 32 bit address bus.
See section 4.3.

Min/Max calculation : Data bus 16 bits.

A gate array, MNX401, makes a histogram of the waveform in its associated 16 Kbyte memory and at the same time stores the minimum and maximum data values of the waveform.

Flash memory : Data bus 8 bits.

The 1 Mbyte flash EEPROM contains a 16 Kbyte boot program, executable at power on, and the operating system of the oscilloscope. The boot program uncompresses the operating system and moves it to the DRAM for execution. This EEPROM can be updated from a floppy disk or memory card with a new operating system when available.

Memory card : Data bus 8 bits.

An interface is implemented to support an external memory card, PCMCIA / JEIDA 4, type 68 pins, whose size can range from 16 Kbytes to 64 Mbytes, with the extension to support flash memory and I/O cards.

Graphic processor : Data bus 8 bits.

The graphic processor of the raster scan display is a gate array designated MDS410.

Clock frequency:48 MHz.

Trace and characters memory:32 Kbytes (SRAM).

Bitmap memory:128 Kbytes (BMRAM).

Character font:32 Kbytes (SRAM).

Non volatile memory : Data bus 8 bits.

A static RAM of 32 Kbytes contains the parameters used at power on to initialize the scope and the stored panel parameters. This memory is battery backed up

Display intensity : Data bus 8 bits.

The control of the display intensity is done by a RAMDAC, up to 8 traces.

Status and command registers : Data bus 8 bits.

Status (read) and command (write) registers of 12 bit address, control the memory card and front panel interface during the boot process or after a RESET.

4.1.3 Serial Peripherals

The processor controls the digital and analog section with a dual serial controller.

DAC registers (read/write)
Front panel registers (68HC05C4)
RTC registers (68HC68T1)
Probe detection
Software options (GAL)
Front end control
Trigger control (MTR408)

Real time clock

Integrated circuit 68HC68T1 (Motorola or RCA).
Resolution: 1 sec to 99 years.
Clock frequency: 32.768 KHz.
Non volatile memory: 32 Kbytes.
Data & Address bus: 8 bits.
Interrupt level: 5.

4.1.4 External Interfaces

Serial RS232 interface and Parallel GPIB interface.
See F9300-4 description, section 4.4.

4.1.5 Optional Interfaces

Graphic Printer: F9300-6 interface and F9300-7 printer controller.
Internal graphic printer

Floppy Disk Drive: F9300-6 interface
1.44 Mbyte floppy

Section 4 Theory of Operation

Centronics Printer: F9300-6 interface

Hard Disk Drive: F9300-8 PCMCIA III controller,
130 Mbyte hard disk

4.2 F9384-3 Main Board

4.2.1 Introduction

The board is divided into five sections :

- Microprocessor control.
- Front-end
- Trigger
- Analog to Digital Converter and memory
- Time base

4.2.2 Microprocessor Control

The microprocessor interface provides the address, data, and control interface for the microprocessor card plugged into connector J1. This is the only interface to the data acquired by the acquisition card. This interface is essentially identical to the 9354 and 9374 interface. The main power supplies provided on connector J2 are +/-15 volts, +/-6 volts, +/-5 volts, and +3.3 volts.

4.2.2.1 Data Bus Buffer

The data bus BD(0:15) from the microprocessor is buffered by A12 and A14 to unload the microprocessor bus from the extended bus DD(0:15) on the acquisition card. There is a one to one mapping of the two busses. All data flows through this bi-directional bus buffer. An additional eight bit buffer (A27) provides zero fill for the least significant eight bits of the bus when the processor reads data from the acquisition or buffer memory.

Bus	Bus name	Description
BD(0:15)	Data bus	Microprocessor data bus, bi-directional
DD(0:15)	Internal data bus	Internal buffered microprocessor data bus, bi-directional

4.2.2.2 ADC Address Shifter

Four GAL16V8's, ROUTE1-A, ROUTE2-A, ROUTE2-B, and ROUTE3-C shift and buffer the address bus BA(0:31) from the microprocessor. The shifted address bus DA(0:31) is used to read the data from the acquisition memory and the buffer memory.

Data from the four acquisition channels are not written into the acquisition memory in a linear sequential fashion. For example, when interleaving channel 1 and channel 2 for a sample rate of 2 Gs/S, channel 1 acquisition memory has the first sample point and channel 2 has the second sample point, these must be read in the correct time sequence to the microprocessor. The address bus shifter is programmed to read the first sample point from channel 1 and the

second from channel 2, etc. Similarly, when 4 Gs/S is selected, one sample from each channel is read in the correct time sequence for the microprocessor

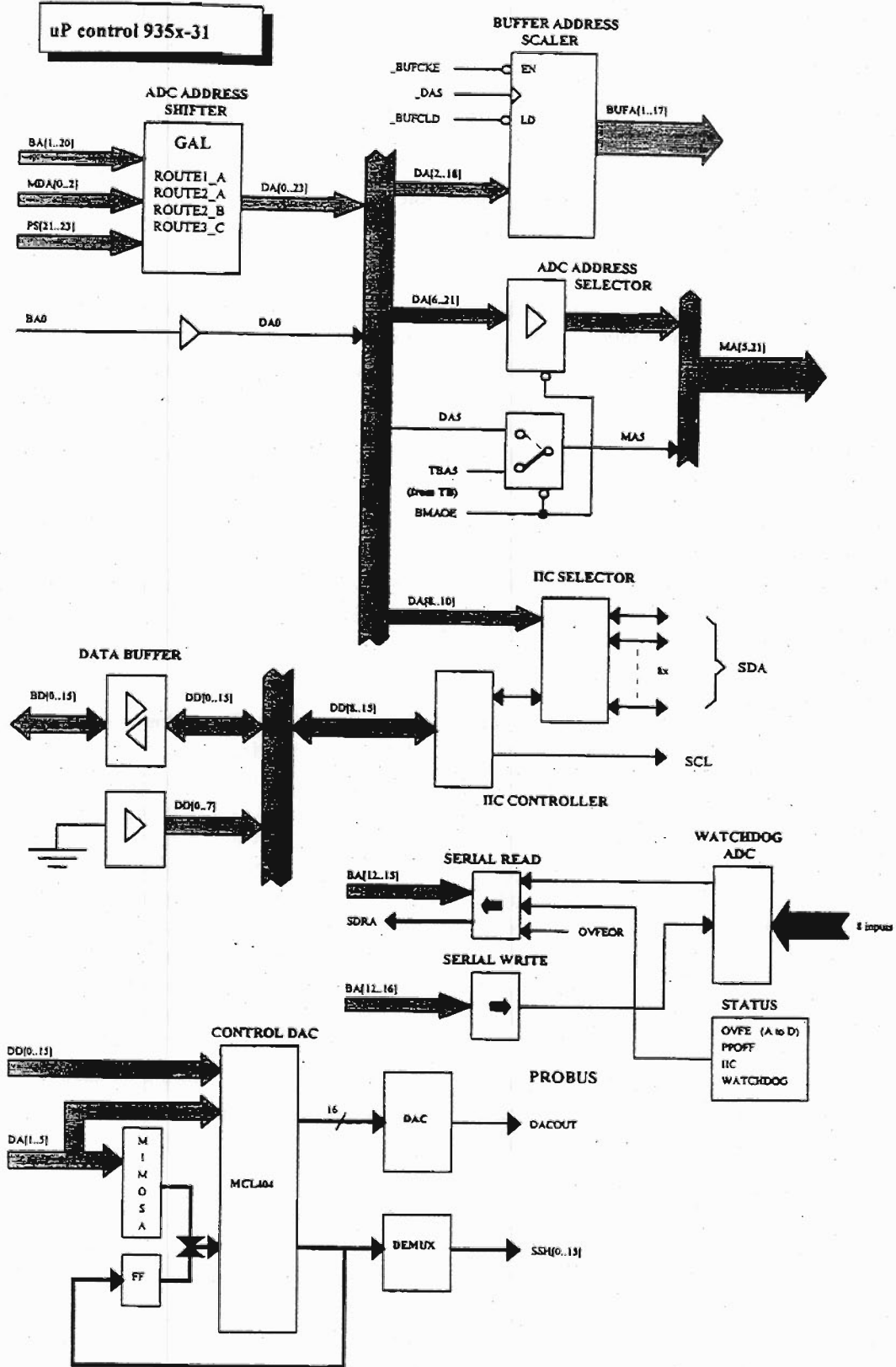

Section 4 Theory of Operation

Each channel also interleaves two ADC's to sample at 1 Gs/S. At this sample rate two demultiplexers write sample points to memory in a non time ordered sequence. The address shifter must shift the microprocessor address bus to read the sample points in the correct time sequence.

Bus	Bus name	Description
BA (0:31)	Address bus	Address bus from the microprocessor
DA (0:31)	Shifted address bus	Acquisition memory bus and when selected, the buffer memory address bus

4.2.2.3 Buffer Address Scalar

Acquisition memory is off-loaded to the buffer memory via the MDX622 demultiplexers for direct access by the microprocessor. The buffer memory is sequentially addressed via the address bus BUFA(1:17) by the buffer address scalar, a seventeen bit counter. The buffer address scalar can be loaded with an address pointing to the start of data, then sequential address strobes from the microprocessor increments the scalar, sequentially addressing the buffer memory and writing waveform data. Meanwhile the address shifter reads the waveform data from the acquisition memory in the correct time sequence.

Bus	Bus name	Description
BUFA (1:17)	Buffer address bus	Address bus for the buffer memory which stores a portion of the acquisition memory data.

4.2.2.4 ADC Address Selector

After the acquisition memory is filled by the waveform data, the buffer address scalar is loaded with the starting address for the buffer memory and the shifted address bus is connected to the acquisition memory address bus MA(5:22) with the ADC address selector. (NOTE: During acquisition, the monolithic timebase, MTB411, provides the memory addresses.) Sequential addresses from the microprocessor address the acquisition memory and increment the buffer address scalar, moving the waveform data from the acquisition memory to the microprocessor card. The buffer memory snoops the data and saves the waveform data from the acquisition memory in the local buffer memory. Subsequent accesses to the waveform data by the microprocessor can come from the buffer memory instead of the acquisition memory. The buffer memory stores only 128k samples, one eighth of the samples stored in the acquisition memory. At memory sizes above this value, double buffering in the buffer memory is of little use.

Notice that the buffered sample points are in the correct time sequence for single channel operation. However, when two or four channels are interleaved, the address shifter must be used to read the data from the buffer memory in the correct time sequence for the microprocessor.

Bus	Bus name	Description
MA (5:22)	Memory address	High speed acquisition memory address bus

4.2.2.5 Decode Logic

A programmable device, GAL16V8, called AVENUE-A decodes the upper address bits of the microprocessor address bus to generate the signals shown below.

AVENUE-A	
SPER0, SPER1	select peripheral group
PS21, PS22, PS23	pseudo address output for the address shifter
EBA	select card
SMDX	select MDX

Two more GAL16V8's (CHEMIN-A and ARTERE-A) use the output of AVENUE-A, part of the shifted address bus (DA(0:31)), and the microprocessor signals `_BAS` and `_BR_W` to write and read the acquisition memory and buffer memory.

The decoded signals of these two decoders are:

CHEMIN-A	
BOFCLO, BUFCKE	buffer scalar command output
WEBUFE, WEBUFL, BUWALL	buffer memory command output
EADR AB, EADR CD, DICE	ADC command
ARTERE-A	
EZERO, EADCW	driver command
SADCM, ADCOE1, ADCOE2	ADC memory command output
WE AB, WE CD	ADC write output
REBUF	buffer READ output

Another GAL16V8 (MIMOSA-A) is the state machine for the scanning DAC.

The following table is the memory map for the 9384-3 card.

ADC memories (0200 0000 - 0200 FFFF) 16MB			
0200 0000	021F FFFF	ADC memory ch. A 1MP	2MB
	023F FFFF	ADC memory ch. A 2MP	4MB
0220 0000	0227 FFFF	BUF memory ch. A 256kP	512kB
0240 0000	025F FFFF	ADC memory ch. B 1MP	2MB
	027F FFFF	ADC memory ch. B 2MP	4MB
0260 0000	0267 FFFF	BUF memory ch. B 256kP	512kB
0280 0000	029F FFFF	ADC memory ch. C 1MP	2MB
	02BF FFFF	ADC memory ch. C 2MP	4MB
02A0 0000	02A7 FFFF	BUF memory ch. C 256kP	512kB
02C0 0000	02DF FFFF	ADC memory ch. D 1MP	2MB
	02FF FFFF	ADC memory ch. D 2MP	4MB

02E0 0000	02E7 FFFF	BUF memory ch. D 256kP	512kB
Small peripherals (0300 0000 - 033F FFFF) 4MB			
0300 0000	0300 0062	MCL404 Multiplexed DAC	2*36B
0308 0000	0308 0N02	Smart probe IIC controller	x8
0310 0000	0310 000E	MDX416 Data demux ch. A	4B
0314 0000	0314 000E	MDX416 Data demux ch. B	4B
0318 0000	0318 000E	MDX416 Data demux ch. C	4B
031C 0000	031C 000E	MDX416 Data demux ch. D	4B
	031F FFFF	spare	
0320 0000	0320 0005	MST412 Smart trigger	6B
0320 0006	0320 0007	Mode control / status	2B
	032F FFFF	spare	
0330 0000	0330 003F	MTB411 Timebase	64B
Extended buffer memories (0300 0000 - 033F FFFF) 4MB			
0340 0000	0347 FFFF	BUF memory ch. A 2x128kB	512kB
0350 0000	0357 FFFF	BUF memory ch. B 2x128kB	512kB
0360 0000	0367 FFFF	BUF memory ch. C 2x128kB	512kB
0370 0000	0377 FFFF	BUF memory ch. D 2x128kB	512kB
Spare (0380 0000 - 03FF FFFF) 8MB			
0380 0000	03FF FFFF	spare	12MB

4.2.2.6 Serial, Watchdog ADC, Overload, and IIC Control

The microprocessor card provides the serial clock SCKA, write data SDWA, and strobe STRA for the serial data stream that programs most of the DAC's and registers. It reads back the serial data via SDRA. Two decoders (A4 and A10) provide 13 write strobes, generated by STRA. The data is shifted in from the microprocessor to all of the serial DAC's and registers but only the intended DAC's or registers are strobed by the write strobe.

The 9384 has controls for the gain of each flash and delay and offset of each S/H for each channel, a total of six DAC's per channel. These DACs are provided by three octal 8-bit DACs.

The watchdog ADC monitors probe attenuation, calibration voltage, and VCCADC and generates an interrupt when any monitored voltage is outside of the valid range. Attaching a probe to the input of the scope changes the monitored voltage and alerts the microprocessor that a new probe is connected. The probe is interrogated by the microprocessor to determine the type of probe.

An overload condition at any of the 50 ohm inputs generates an interrupt to the microprocessor. The microprocessor reads the status register to determine which of the 8 possible overload conditions caused the interrupt.

The probus connectors are controlled by the IIC controller and IIC selector. IIC is a two wire serial bus used to control the probus probes. The controller controls the four input channels, external trigger input, probe cal, an EEPROM, and another input.

4.2.2.7 Scanning DAC

The scanning DAC is an 18 channel 16 bit DAC for use where precision and resolution are needed in the analog circuits. The DAC output range is +/-10 volts. It has its own reference and is not trimmed for gain or offset.

The MCL404 is a controller chip for the scanning DAC subsystem. Eighteen sample and hold circuits can be updated periodically with the MCL404. The MCL404 sequentially enables each of the sample and hold circuits. A precision 16 bit DAC provides the input to the sample and hold circuits through an analog multiplexer also controlled by the MCL404. The MCL404 has eighteen internal 16 bit registers for the eighteen sample and hold circuits.

Each frontend channel has a gain, offset, and trigger level sample and hold. External trigger level is connected to one sample and hold. Probe calibrate also uses one of the sample and hold outputs.

The scanning DAC is not used to calibrate the S/H and flash gain, offset, and delay. These are independent DAC's near each acquisition hybrid.

4.2.2.8 Power Supply Connector

The power supply provides +/-15 volts, +/-6 volts, +/-5 volts, +3.3 volts, -2 volts and line. All voltages except for line appear at connector J2. Line appears on connector J4. Line is a TTL compatible square wave synchronized to the ac power supplying the instrument.

4.2.3 Front End

The front end system provides the signal conditioning for the ADC system. The main functions are :

- four channel operation, calibration with software control
- input protection and coupling : AC, DC, 1 M Ω , 50 Ω
- amplitude normalisation for the ADC system : 320 mV full scale
- fine gain control
- offset control
- bandwidth limit filter : BWL 25 MHz or 200 MHz user selctable
- triggering with standard coupling and TV trigger on four channels and External

Six power supplies are generated from +/-15 volts and +/-6 volts for use in the frontend. These are: +/-12VFEP, +/-12VFE, and +/-5VFE. A reference supply VREF at 5 volts is generated by an SMLM336-5 from +12VFE.

4.2.3.1 Channel Description

The four channels are identical, thus only one channel will be described for brevity.

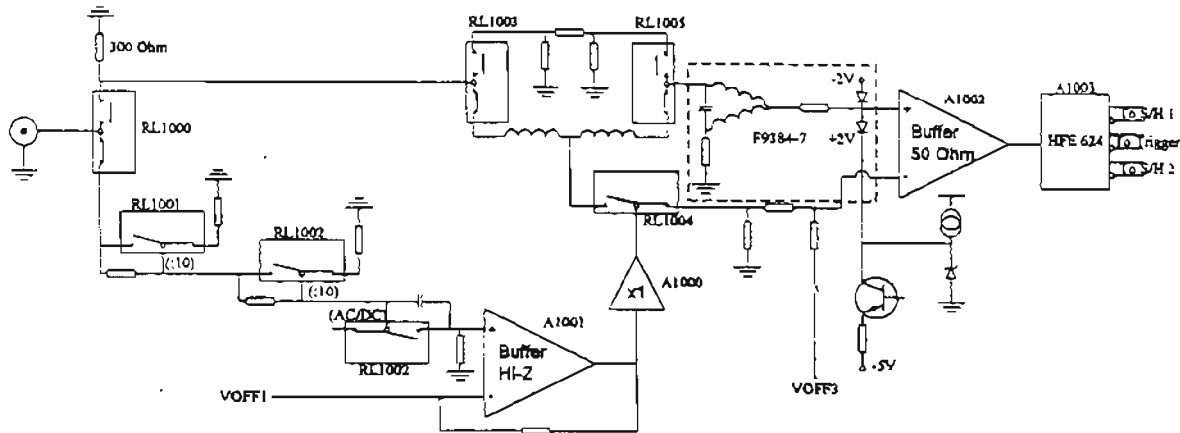

Attenuation/Coupling Stage

- Relay RL1000 selects the input between the HiZ (1 MΩ) and the 50 Ω path. A diode circuit senses the temperature of the 300 Ω termination and sets the `_OVL` bit low if overheating is detected. If overload is detected the 50 Ω path is then disconnected by the hardware and the 1 Mohm input is switched in.
- Relay RL1001 selects the input between divide-by-10 or direct for the signal in the HiZ path.
- Relay RL1002 selects another divide-by-10 or direct for the signal in the HiZ path
- Relay RL1003 selects the input between another divide-by-10 or direct for the signal in the 50 Ω path.
- Relay RL1004 enables the HiZ output (selection between 1MΩ output & offset for 50 Ω buffer).
- Relay RL1006 sets the AC/DC coupling in HiZ.
- Relay RL1007 selects the output between no attenuation in 50 Ω or HiZ (if RL5 is ON) to attenuate by 10 in 50 Ω.
- Switch SW1 (`_Voff3`) enable :This signal is only used for the calibration of the 50 Ω path when 1 MΩ coupling.

HFE624:

The HFE624 provides the following functions:

- Fine gain control to fill up the fixed vertical sensitivities with a 13:1 gain control range
- Bandwidth limit filter at 25 MHz and 200 MHz
- Three outputs, one for the trigger circuit and two for sample and hold input.
- Amplitude normalisation for the ADC system : at the BNC the dynamic range is 16 mV to 8V FS at 50 Ω and to 80V FS (full scale) at 1 MOhm in a 1-2-5 step sequence and the ADC system input is 500 mV differential,

4.2.3.2 Digital controls

The following controls are for the front end in the 9354. Note: Bits 16-23 are internal to the HFE624 and are written as a serial data stream.

0141 0z00 - 0141 0zff write channel A control register
 0141 1z00 - 0141 1zff write channel B control register
 0141 2z00 - 0141 2zff write channel C control register
 0141 3z00 - 0141 3zff write channel D control register

23	—	ENc	ENb	ENa	G1	G0	BWL1	BWL0	16
15	RELSHA	:1 50	:10 50	:100 1M	:10 1M	AC/DC	1M	50	8
7	—	—	—	—	—	—	OF_BUF50	—	0

ENc : Enable MFE output C
 ENb : Enable MFE output B
 ENa : Enable MFE output A
 G1,G0 : Gain range; 0 = range*1, 1 = range*2, 3 = range*5
 BWL1,BWL0 : Bandwidth limit; 0 = off, 1 = 200 MHz, 2 = 20 MHz
 RELSHA : 0 = direct, 1 = (A:BA, D:CD)
 :1 50 : RL7; 1 = x0.1 and 1M calibration, 2 = x1
 :10 50 : RL6; 1 = 50 Ohm calibration and 1mohm running
 :100 1M : RL3; 1
 :10 1M : RL2;
 AC/DC : RL4; 0 = AC, 1 = DC
 1M : RL5;
 50 : RL1
 OF_BUF50 : 0 = user mode, 1 = 1mohm calibration mode

0140 4z00 - 0140 4zff read channels overload (and option package availability)

7	_INTWD	_INTIIC	_OVL_T	_PPOFF	_OVL_D	_OVL_C	_OVL_B	_OVL_A	LSB-1 OPT
---	--------	---------	--------	--------	--------	--------	--------	--------	--------------

_INTWD watchdog ADC interrupt,
 _INTIIC I2C protocol interrupt,
 _PPOFF probe power overload interrupt,
 _OVL_noverload indicator (Ch A, B, C, D, EXT).
 OPT935XA-CKTRIG option package (9th bit of serial read).

A low state indicate that overload or interrupt is detected. Bit OPT is high when the options are available.

0140 5z00 - 0140 5zff read overload sum

OVLSUMbit 7, Sum of the eight above bits.
 0 = OK, 1 = problem occurred (read channels overload)

4.2.3.3 Analog controls

- One precision DAC, with its associated control system, drives and refreshes a multiple sample-and-hold system. Each channel has three analog controls VOFF1_x, VOFF3_x and IVGAIN_x, where x refers to channel A, B, C, or D corresponding to channels 1, 2, 3, and 4. VOFF1_x is the offset control in 50 Ohm coupling,, VOFF3_x is used to control the offset of the 50 Ohm path when in 1 MOhm coupling and IVGAIN_x is used to calibrate the gain of the front end and perform the variable gain control.
- The DAC dynamic range ($\pm 10V$) is scaled to the proper range by means of resistor dividers.

The addresses are :

- 0300 0000 write channel A gain control
- 0300 0002 write channel A offset control
- 0300 0004 write channel B gain control
- 0300 0006 write channel B offset control
- 0300 0008 write channel C gain control
- 0300 000a write channel C offset control
- 0300 000c write channel D gain control
- 0300 000e write channel D offset control

4.2.4 Trigger

The different trigger couplings are :

- DC
- AC : cut off frequency approximately 10 Hz.
- LF REJ: a single pole high pass filter with a cut off frequency at 50 kHz.
- HF REJ: a single pole low pass filter with a cut off frequency at 50 kHz.
- HF: divides the trigger frequency by two.

The amplitude at the input of the MTR408 is approximately 400 mV FS (identical to the ADC system),

4.2.4.1 Digital Controls

The 40 bit shift register, is allocated as follows :

0141 4z00 - 0141 4zff write trigger control register

39	—	TBWL_A	HFR_A	AC_A	DC_A	—	SNEG_A	SPOS_A	32
31	TEXT50	TBWL_B	HFR_B	AC_B	DC_B	—	SNEG_B	SPOS_B	24
23	---	TBWL_C	HFR_C	AC_C	DC_C	—	SNEG_C	SPOS_C	16
15	—	TBWL_D	HFR_D	AC_D	DC_D	—	SNEG_D	SPOS_D	8
7	_EXT/10	TBWL_EXT	HFR_EXT	AC_EXT	DC_EXT	—	SNEG_EXT	SPOS_EXT	0

TEXT50 0 = 1 M Ω external input coupling, 1 = 50 Ω external input coupling.
 _EXT/10 0 = attenuation is ON, 1 = OFF.

4.2.4.2 Analog Controls

A sample and hold fed by the precision DAC provides the threshold level.

The addresses are :

0300 0010 write EXT threshold control
 0300 0018 write channel A threshold control
 0300 001a write channel B threshold control
 0300 001c write channel C threshold control
 0300 001e write channel D threshold control

4.2.4.3 TV Trigger

Each channel has an analog pick-off for the tv trigger after the HFE624. The external trigger has a pickoff after the high impedance buffer. The TV trigger source is selected via the three bits of TVS and drives an amplifier with complementary outputs. These outputs are selected by _TVINV.

The TV trigger uses a commercial chip (LM1881) and provides two outputs, TV1 & TV2. This circuit is able to trigger on several different TV line number standards.

• Digital Controls

The 16 bit shift register, written using the serial protocol, is allocated as follows :

0141 5z00 - 0141 5zff write trigger TV and MST412 oscillator control register

15	8
_TVINV	MA
TVS2	TVS1
TVS0	HDTV
875	MB
7	0
_STI	_STW
_SVS	_STS
—	—
—	—

_TVINV 0 = inverting TV trigger (to compensate for inversion in MFE409).
 _SVS 0 = enable TV1 source.
 _STS 0 = enable TV2 source.
 _STI 0 = enable interval width mode for MST412 oscillator control.
 _STW 0 = enable pulse width mode for MST412 oscillator control.

TVS2	TVS1	TVS0	TV trigger source	HDTV	875	line setting
0	0	1	channel A	0	0	525-625 TVLO
0	1	0	channel B	0	1	875 (MED)
0	1	1	channel C	1	0	1225 (HIGH)
1	0	0	channel D	1	1	2500 (HDTV)
1	0	1	external trigger			

4.2.4.4 Block Diagram

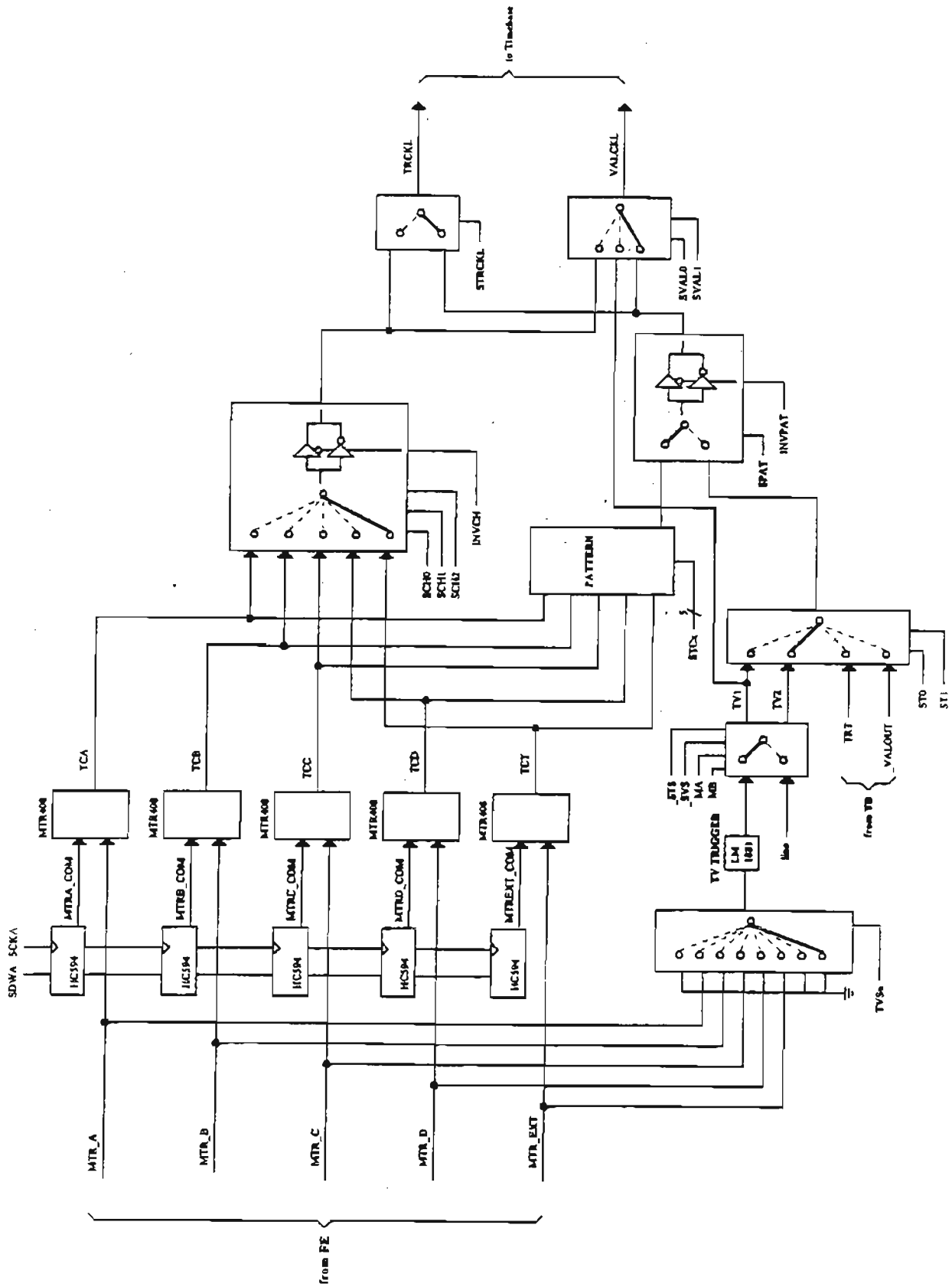

4.2.5 Analog to Digital Converter

4.2.5.1 Introduction

The analog to digital converter system does the signal conversion to 8 bits. Each channel has a custom hybrid, HAD621, that contains two identical channels A and B consisting of a sample and hold, MSH417, and an ADC, TDA8718. Each hybrid is followed by a data demultiplexer, MDX622 and memory.

- Sample and Hold : the MSH417 with an analog bandwidth of 1GHz, performs the track and hold before the ADC. It is clocked at three different frequencies : 500 MHz, 400 MHz, and 200 MHz. The offset difference between the two channels in the HAD621 is adjusted by an 8 bit DAC.
- Flash ADC : the TDA8718 is a folding ADC working at a maximum clock speed of 500 MS/s. The gain difference between channels in the HAD621 is calibrated by adjusting the internal resistor ladder using an 8 bit DAC. The ADC input level is nominally 2 volts peak to peak.
- Demultiplexer : the MDX622 monolithic is used to demultiplex the ADC output for the slower memories and to peak detect the data on the fly.
- Buffer Memory : 128K bytes
- ADC Memory : 100 K for the 9384, 500 K for the 9384M and 1 M for the 9384L. Memory length may be extended by combining the acquisition memories of multiple channels to a maximum of 8 Mpoints for one channel.

Any time two channels are interleaved to produce a higher sample rate, the timing between the S/H's must be precise. A square wave oscillator at a frequency of 15.5029 MHz provides the edge required to calibrate the timing. The square wave is injected into the 50 ohm signal path at the buffer driving the HFE624 and is used by the software to calibrate out this internal delay.

Section 4 Theory of Operation

4.2.5.2 ADC Block Diagram

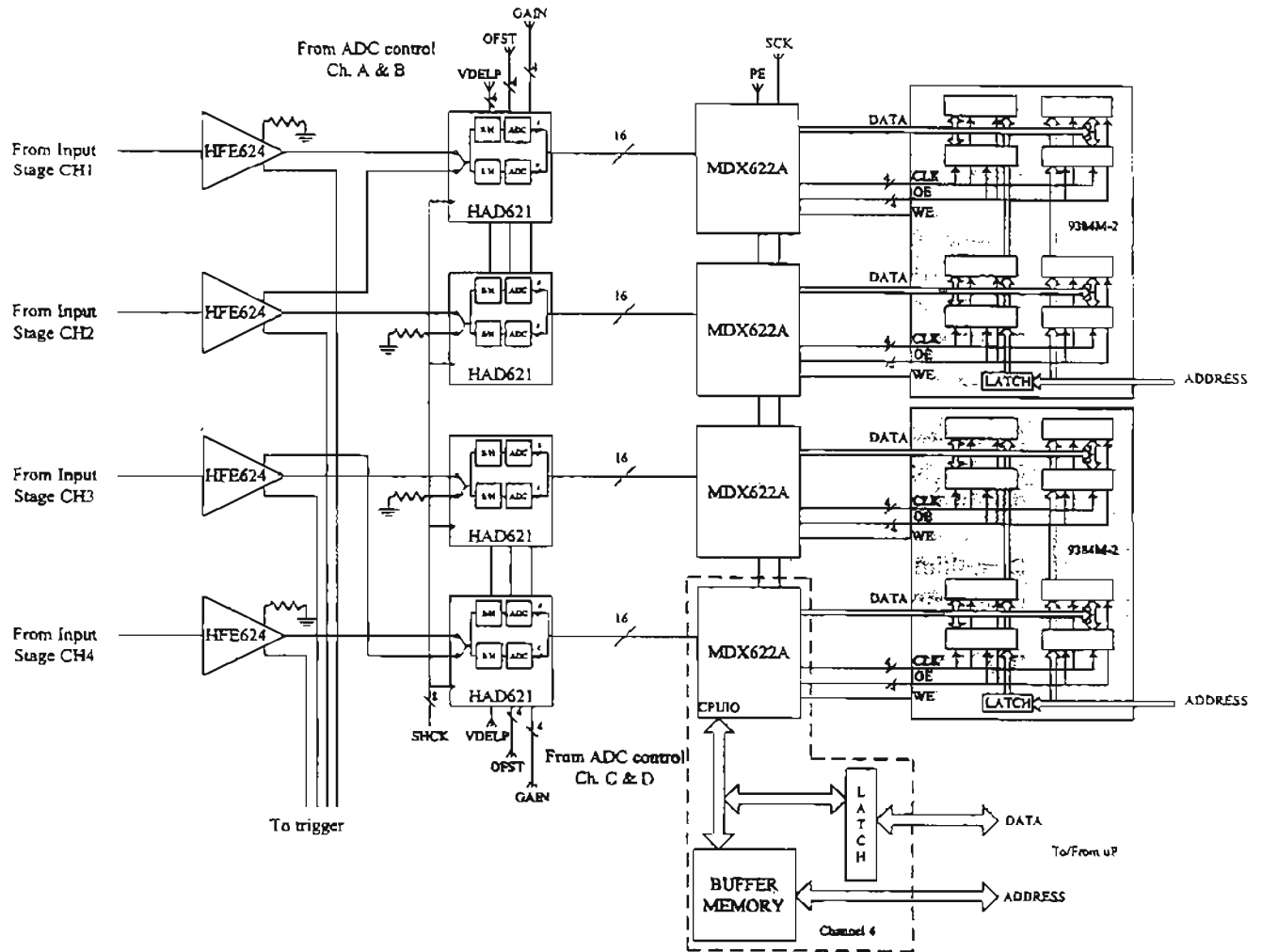

4.2.6 Time Base

4.2.6.1 Introduction

The main clock comes from a PLL oscillator that uses a precision 10 MHz reference. There is a control bit, SEXTREF, to select an optional external reference providing a 0 dbm signal level.

The PLL output frequency is controlled by three bits, SF500, SF400, and _SF200. One branch of the main clock, SHCK, is directly used by the sample-and-hold, the analog-to-digital converter and the time-to-digital converter for data acquisition. A differential ECL clock from each channel, called MCK, synchronizes the MDX622 data demultiplexer with the data from the adc.

Another branch of the main clock, MDXCK, is routed to the time where the basic timing of the oscilloscope is generated. A programmable divider using a fast ECL first stage and a slower TTL second stage generate a signal called SAMPLE CLOCK. A second programmable ECL divider uses SAMPLE CLOCK to generate the timing signals for the MDX622 data demultiplexers, the time to digital converter, the trigger recognizer, and the MTB411 timebase.

The main clock can also be driven from the external trigger BNC, this path is selected by a control bit (SEXTCK). The external clock threshold can be modified by two bits from the time base mode control (EXTCTH1 and EXTCTH2). This external clock frequency range is 0 to 100 MHz. An optional rear panel input can drive the external clock to 500 MS/s.

The PLL oscillator has in fact only two values, 500 and 400 MHz, the 200 MHz is a secondary path coming from a divide by two.

- 500 MHz is used for the fast timebase settings, 250 MS/s, 500 MS/s, 1 GS/s, 2 GS/s, 4 GS/s and RIS mode.
- 400 MHz is used for all other timebase settings including Roll mode.

The time to digital converter is a variation on the classic Wilkinson charge to time converter. The capacitor is charged by the time difference between the trigger and the main clock, while the discharge is controlled by a fixed current source approximately 0.001 times the charging current. The MTB411 counts a clock called ICK, which is 1/8 th. of the main clock, during the discharge part of the TDC. The value of the counter after the discharge cycle is proportional to the time difference.

Another clock called TRT, derived from the main clock is used by the processor to calibrate the smart trigger.

4.2.6.2 Time Base Block Diagram

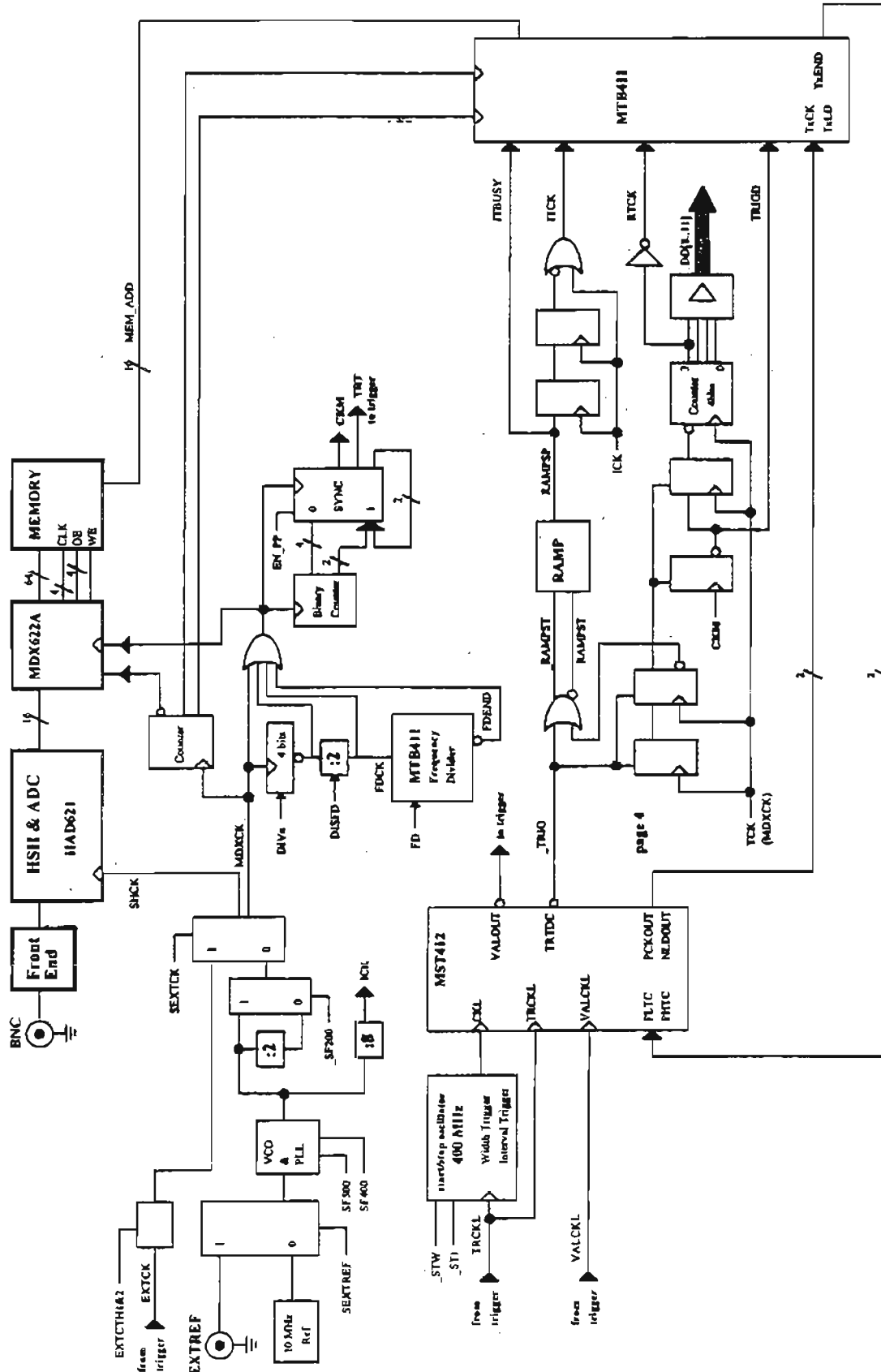

4.2.6.3 Digital Control

0141 8z00 - 0141 8zffwrite Time Base divider register

15							8
MDX_CNT7	MDX_CNT6	MDX_CNT5	MDX_CNT4	MDX_CNT3	MDX_CNT2	MDX_CNT1	SEXTREF
7							0
DISFD	_SF200	SF500	SF400	DIV3	DIV2	DIV1	DIV0

where :

- SEXTREF select optional external PLL clock reference (10 MHz \pm 5 %).
- DISFD disable FD clock to MTB411.
- _SF200 select oscillator frequency 200 MHz.
- SF500 select oscillator frequency 500 MHz.
- SF400 select oscillator frequency 400 MHz.
- DIVn frequency pre-divider (4 bits).
- MDX_CNT1:7 master MDX622 divider.

4.2.6.4 Trigger Selection

Each differential output of the five MTR408's from the Front-End (TCx) are selected (bit SCHn) and then inverted (bit INVCH) to drive the TRCKL signal and the VALCKL signal (bit SVAL1).

A logical function of the TCx signals can be selected (bit STCx) for the pattern generator. A few single ended signals can also be selected one at a time (bit STn). These signals are TV1 and TV2 for television trigger, TRT for test and calibration of MST412, _VALOUT for drop-out trigger.

Then there is a selection between the pattern and the single ended sources (bit SPAT). The signal obtained is inverted (bit INVPAT) and used to drive TRCKL (bit STRCKL). There is also a choice between this signal and TV1 to drive VALCKL (bit SVAL0). The pattern trigger logic function is any "AND" combination of TCx input signals, inverted or not. All the controls are done through a 16 bit serial register.

4.2.6.5 Smart Trigger

The VALCKL source drives the MST412. The TRCKL source goes through a buffer to drive the MST412, the fast trigger latch, and control the smart trigger 400 MHz start/stop oscillator. The DC trigger coupling mode uses the fast trigger latch path for triggering to approximately 700 MHz. Selecting HF trigger coupling extends the trigger sensitivity to beyond 1 GHz.

The MST412 oscillator is usually free running, but when using glitch trigger mode, the oscillator is enabled only during the pulse duration (bit _STW), and when using interval width trigger mode the oscillator is restarted at each edge (bit _STI).

There is also a time base mode control register with roll mode interrupt enable (RMIE), external clock control (SEXTCK, EXTCTH1 and EXTCTH2), buzzer (BUZZ) and calibration front panel output signal selection (PCSn).

4.3 F9300-4 GPIB and RS 232 Interface

This board is connected to the processor through a flat cable.
Data bus is 8 bits, address bus: 12 bits.
Address 0180 000 to 0180 00FF.

4.3.1 RS 232 Serial Interface

Based on the 2661A IC from Signetics or Philips.

- Clock frequency 4.9152 MHz.
- 4 internal registers of 8 bits.
- Interrupt level 2.
- Connector type DB9 with 9 male pins.

4.3.2 GPIB Interface

Based on the 7210 IC from NEC.

- Clock frequency 5 MHz.
- 8 internal registers of 8 bits.
- Tri-state external GPIB drivers. - Low level output.
- Interrupt level 3.

The GPIB address is set by software and stored in non-volatile memory.

4.4 F9354-5 Front Panel

The front panel is connected to the processor board with a flat cable. Power supply and control signals are supplied from the processor. The front panel is divided in two sections:

- One board with Motorola 68HC05C4 processor, coders, and serial data interface.
- One matrix Keyboard with push buttons.

4.5 F9300-6 Centronics, Floppy, Printer interface option

4.5.1 Centronics interface option

This Centronics interface makes direct connection possible to external parallel printer.

- Address 0130 0180 to 0130 01A0
- Interrupt level 2

4.5.2 Floppy Disk drive interface option

Based on the circuit MCS3201 from Motorola.

- Address 0130 01C0 to 0130 01C7
- Interrupt level 4

Address ReadWrite

0130 01C0 Input register-----
 0130 01C2 ----Digital output register
 0130 01C4 Main status register-----
 0130 01C5 Data registerData register
 0130 01C7 Data input registerDisk control register

4.5.3 Printer Interface option

Internal graphic printer : Seiko LPT5446

- Address 0130 0140 to 0130 0160
- Interrupt level 2

4.6 F9300-7 Printer Controller option

Based on the LPT5000 series control chip set from Seiko instrument Inc

- PT501P01 CPU
- PT500GA1 Gate array
- Technical reference 39019-2234-01
- Address 0130 0100

4.7 F9300-8 Hard Disk option, PCMCIA III Controller

- Address 0130 0800 to 0130 0bff
- Interrupt level 5

4.8 93XX-Display

4.8.1 General Description

The raster scan display module is divided into five sections:

- Graphic processor
- Deflection
- Video
- Yoke
- Cathode ray tube

4.8.2 Basic Characteristics

- Nine inch diagonal monochrome, yellowish, orange CRT.
- CRT anti-glare treated
- Non interlaced resolution of (X)810 x (Y)696 pixels at 60 Hz or 50 Hz frequency.

- Landscape vertical raster
- Electromagnetic deflection.
- Intensity control rise and fall time > 12 ns.
- Analog intensity input
- TTL synchronization input.
- Horizontal nominal size: 165 mm for X-on = 15.39 Ms.
- Horizontal size adjustment: > +/- 5 mm.
- Horizontal offset adjustment: +/- 5 mm.
- Vertical nominal size: 120 mm for Y-on = 14.5μs.
- Vertical size adjustment: > +/- 5 mm.
- Vertical offset adjustment: +/- 5 mm.
- X and Y differential non linearity: 10%.

The line deflection is vertical, from bottom to top. The field deflection is horizontal, from left to right and is resynchronized to the power line frequency.

4.8.3 Horizontal Deflection

The horizontal deflection is synchronized to the 50 or 60 Hertz power line frequency. The on time display is the same for both frequencies, therefore the deflection is calculated for 60 Hz. The horizontal deflection is controlled by the HSYNC signal.

The trailing edge of HSYNC resets the horizontal spot position to a hardware predefined position at the left side of the screen: MAX_left. When ever HSYNC is high, the spot stays at this position.

The falling edge of HSYNC starts the horizontal deflection ramp. The ramp has the same rate for either 50 or 60 Hertz frequency. When ever HSYNC is low, the horizontal deflection will rise left to right, until HSYNC becomes high, or the system has reached the maximum right position (MAX_RIGHT).

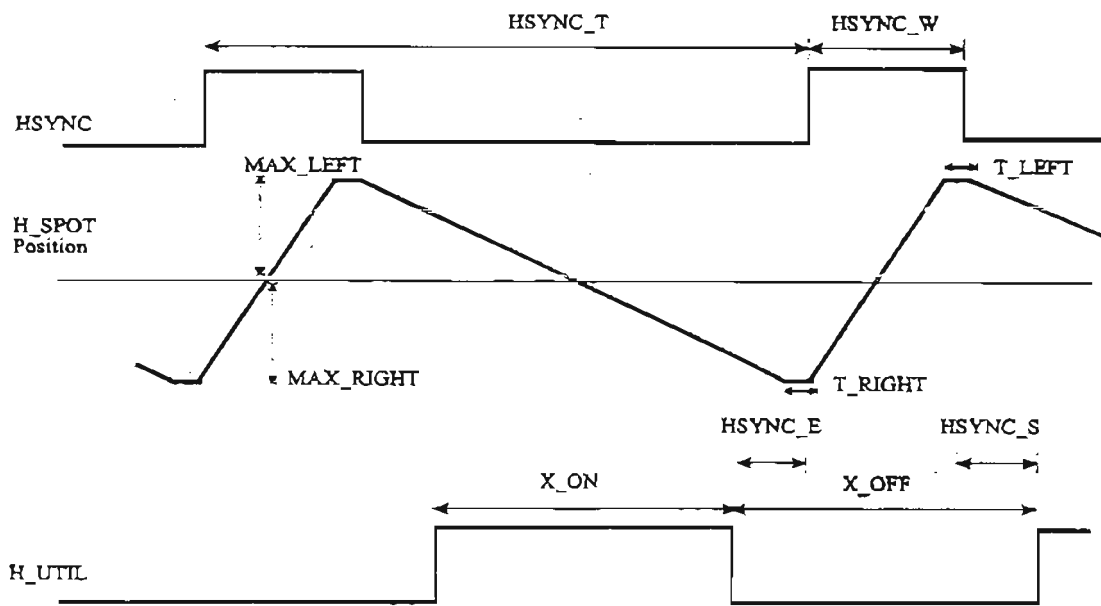

4.8.4 Vertical Synchronization

The timing of both VSYNC and HSYNC is synchronized to the pixel clock (PCLK).

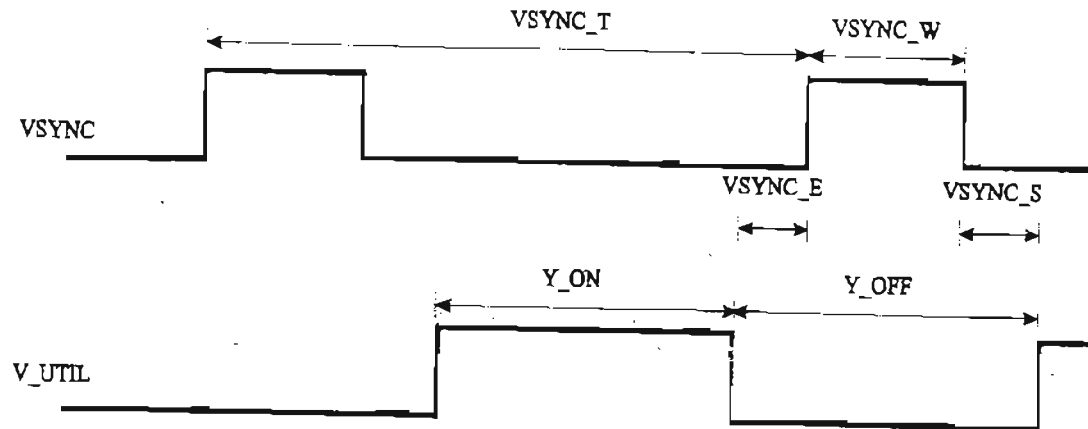

The pixel rate is 48 MHz.

4.8.5 Horizontal Resolution

	# of vertical line	Time in ms
HSYNC_T	842	15.998
HSYNC_W	22	0.418
HSYNC_E	4	0.076
HSYNC_S	6	0.114
X-ON	810	15.390
X-OFF	32	0.608

Values of the horizontal timing for the maximum field refresh frequency.

4.8.6 Vertical Resolution

	# of Pixels	Time in μ s
VSYNC_T	912	19.000
VSYNC_W	136	2.833
VSYNC_E	0	0.000
VSYNC_S	80	1.666
Y-ON	696	14.500
Y-OFF	216	4.500

4.9 PS9384 Power Supply

4.9.1 Power Supply Specifications

Input voltage	: 90 to 130 V or 180 to 260 V. Auto ranging line voltage.
Input frequency	: 47 Hz to 63 Hz.
Input rush current	: Max. 40 A peak at start up.
Environmental	: Operating temperature range 0 °C to + 50 °C
Storage temperature range	: -55 °C to + 80 °C
Relative humidity from	: 5% to 95%.
Output voltages:	- 5.2 VDC, 13 amp Max. + 5.2 VDC, 14 amp Max. - 15.1 VDC, 4.5 amp Max + 15.1 VDC, 4 amp Max.
Output adjustment	: +/- 5%.
Regulation	: +/- 1%.
Transient response	: recover to 1% of its final value within 500 µsec.
Ripple and noise	: Peak to peak value < 50 mv
Hold up time	: 16 msec at full load
Output short circuit protection	: Yes.
Output over voltage protection	: Yes.
Input protection	: 6 amp fuses.
Thermal protection	: Yes.
Safety	: VDE 0806, IEC 380, 435, 950 & UL1012, 478, CSAC22.2#1402C
EMI	: VDE 0871 class A, FCC 20780 class A.

4.9.2 Power Supply Block Diagram

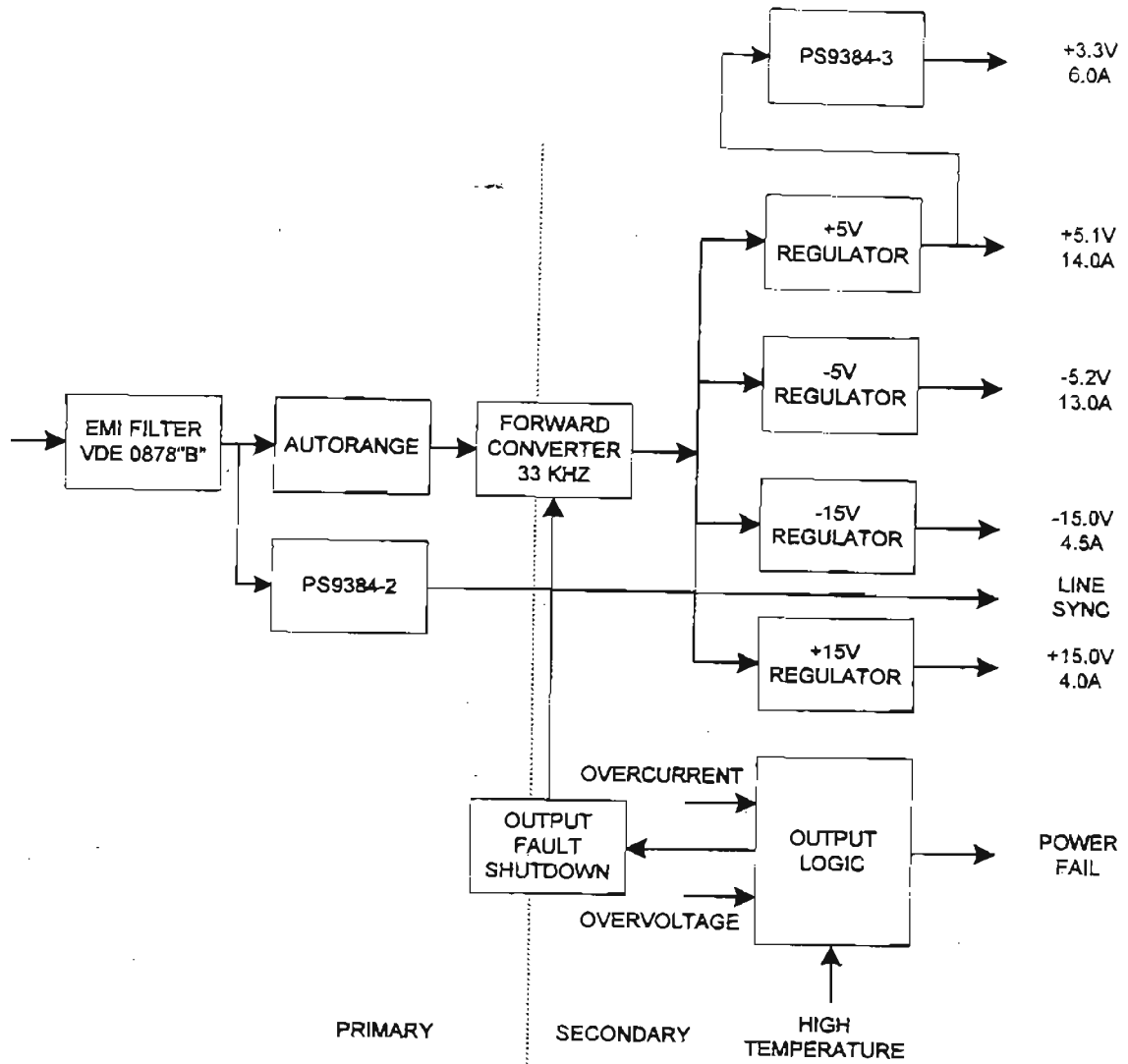

SECTION 5 Performance Verification**5.1 Introduction**

This chapter contains procedures suitable for determining if the 9384/M/L/TM/AL Digital Storage Oscilloscope performs as warranted.

They check all the characteristics that are designated as warranted specifications in subsection 5.1.1. A more complete list of specifications is given in section 2.1.

Because they require time and suitable test equipment, you may not need to perform all of these procedures, depending on what you want to accomplish.

In the absence of the computer automated calibration system based on LeCroy Calibration Software (LeCalsoft), this manual performance verification procedure can be followed to establish a traceable calibration.

It is the calibrating entities responsibility to ensure that all laboratory standards used to perform this procedure are operating within their specifications and traceable to required standards if a traceable calibration certificate is to be issued for the 9384/M/L/TM/AL Digital Storage Oscilloscope.

5.1.1 List of Warranted Specifications

The electrical warranted specifications are listed in this subsection.

Warranted specifications are described in terms of quantifiable performance limits which are warranted.

- Input Impedance
- Leakage Current
- Peak to Peak and RMS Average noise level
- Positive and Negative DC linearity
- Positive and Negative Offset
- Bandwidth
- Trigger Level
- Smart Trigger
- Time Base Accuracy
- Overshoot and Rise Time
- Probe Calibrator
- Overload

5.2 Test Equipment Required

These procedures use external, traceable signal generators, DC precision power supply and digital multimeter, to directly check warranted specifications.

Instrument	Specifications	Recommended	Where used
Signal Generator (sine wave)	Frequency : .5 MHz to 2 GHz Frequency Accuracy : 1 PPM Amplitude : 5 V peak to peak	HP8648B or equivalent	5.9.1 5.11 5.12
Fast pulse Generator	Rise time < 70 psec	Picosecond TD1107 B or equivalent	5.13
Sine Wave Generator	Frequency : 5 KHz Amplitude : 6 V peak to peak	LeCroy LW420 or equivalent	5.10
DC precision Power Supply	Amplitude : 10 V, DC Accuracy : < 0.1 %	Tektronix PS5004 or equivalent	5.7, 5.8 5.15
Digital Multimeter	4 digits	Keithley 199 or equivalent	5.4 5.5
10:1 Passive Probe	500 MHz , 10 M Ω	LeCroy PP005	5.9.1.b
Cable	BNC, 50 Ω , length 20 cm, 1ns (7.87 inches)	LeCroy 480232001	5.10.3 5.10.4
Cable	BNC, 50 Ω , length 100 cm, 5 ns (39.37 inches)	LeCroy 480020101	5.XX
Attenuator	50 Ω , 20 dB 1% accuracy	Suhner	5.7
Attenuator	1 M Ω , 20 dB 1% accuracy	Suhner	5.7
Attenuator	50 Ω , 3 dB 1% accuracy	Suhner	5.10
Terminator	50 Ω Feed through, 1% accuracy	Suhner	5.13
BNC T adapter	BNC, 50 Ω , T adapter	LeCroy 402222002	5.10.3 5.10.4

Table 5-1 : Test Equipment

5.3 Turn On

If you are not familiar with operating the 9384/M/L/TM/AL oscilloscope, read the operator's manual.

- Switch on the power using the power switch on the rear panel and verify :
- The display turns on after about 10 seconds and is stable
- The range of intensity and grid intensity is reasonable
- Wait for about 10 minutes for the scope to reach a stable operating temperature.

5.4 Input Impedance

Specifications

- DC 1.00 MΩ ± 1%
- AC 1.11 MΩ ± 2%
- DC 50 Ω ± 1%

5.4.1 Procedure

The impedance values for 50 Ω and 1 MΩ couplings are measured, with a high precision digital multimeter.

5.4.1.a DC 1MΩ

- Set DSO Channel 1 : On
- Input Coupling : DC 1 MΩ
- Input gain : 50 mV/div.
- Trigger on : Channel 1
- Trigger mode : Auto
- Time base : 50 μsec/div.

26-Feb-96
16:12:27

50 μs
50 mV

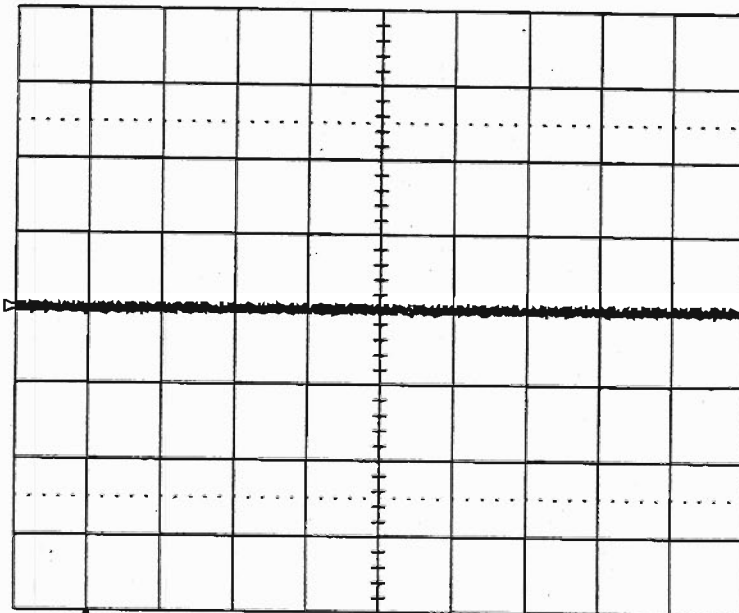

CHANNEL 1
Coupling
DC50Ω
Grounded
DC1MΩ
Grounded
AC1MΩ
V/div Offset
NORMAL
ECL TTL
Global BWL
OFF 25MHz
200MHz

Probe Atten
x1
x2
x5
x10
x20

50 μs
1 50 mV DC
2 50 mV DC
3 50 mV DC
4 50 mV DC

1 DC 0mV

100 MS/s

AUTO

- Measure the impedance using a DMM with sense : must be 1.00 MΩ ± 1%.
- Repeat the above test for input volt/div. of 200 mV.

5.4.1.b AC 1MΩ

- Set DSO Channel 1 : On
- Input Coupling : AC 1 MΩ
- Input gain : 50 mV/div.
- Trigger on : Channel 1
- Trigger mode : Auto
- Time base : 50 μsec/div.

26-Feb-96
16:28:34

50 μs
50 mV

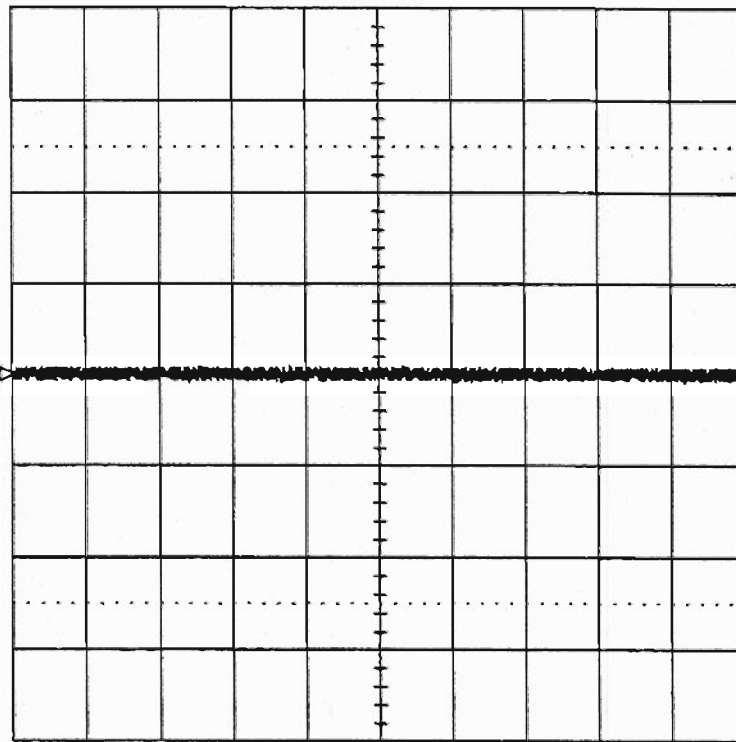

50 μs

- 1 50 mV AC
- 2 50 mV AC
- 3 50 mV AC
- 4 50 mV AC

1 DC 0 mV

CHANNEL 1

Coupling
DC50Ω
Grounded
DC1MΩ
Grounded
AC1MΩ

V/div Offset
NORMAL
ECL TTL

Global BWL
OFF 25MHz
200MHz

Probe Atten
x1
x2
x5
x10
x20

100 MS/s

AUTO

- Measure the impedance using a DMM with sense : must be 1.11 MΩ ± 2%.
- Repeat the test for input volt/div. of 200 mV, the impedance must be 1.00 MΩ ± 2%.

5.4.1.c DC 50Ω

- Set DSO Channel 1 : On
- Input Coupling : DC 50Ω
- Input gain : 50 mV/div.
- Trigger on : Channel 1
- Trigger mode : Auto
- Time base : 50 μsec/div.

26-Feb-96
16:38:58

50 μs
50 mV

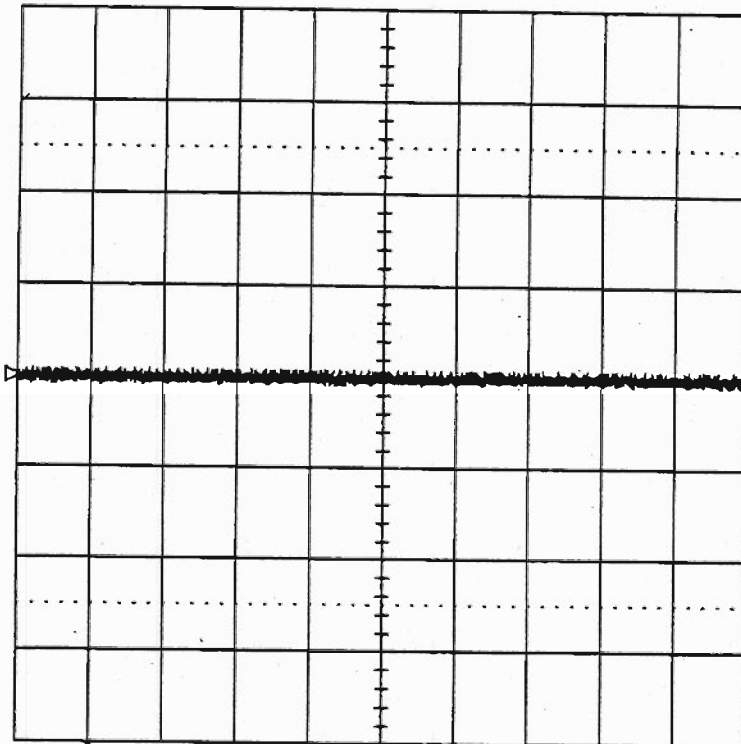

CHANNEL 1
Coupling
DC50Ω
Grounded
DC1MΩ
Grounded
AC1MΩ

V/div Offset
NORMAL
ECL TTL

Global BWL
OFF 25MHz
200MHz

Probe Atten
x1
x2
x5
x10
x20

50 μs

- 1 50 mV 50Ω
- 2 50 mV 50Ω
- 3 50 mV 50Ω
- 4 50 mV 50Ω

1 DC 0 mV

100 MS/s

AUTO

- Measure the impedance using a high precision DMM with sense : must be 50 Ω ± 1%
- Repeat the above test for input volt/div. of 200 mV.
- Repeat steps 5.4.1.a, 5.4.1.b and 5.4.1.c for Channel 2, Channel 3 and Channel 4.

Section 5 Performance Verification

5.4.2 External Trigger Input Impedance

5.4.2.a DC 1MΩ

- Set Trigger on : EXT
- Trigger mode : Auto
- Coupling Ext : DC
- External : DC 1MΩ
- Time base : 50 μsec/div.

26-Feb-96
16:33:29

TRIGGER SETUP

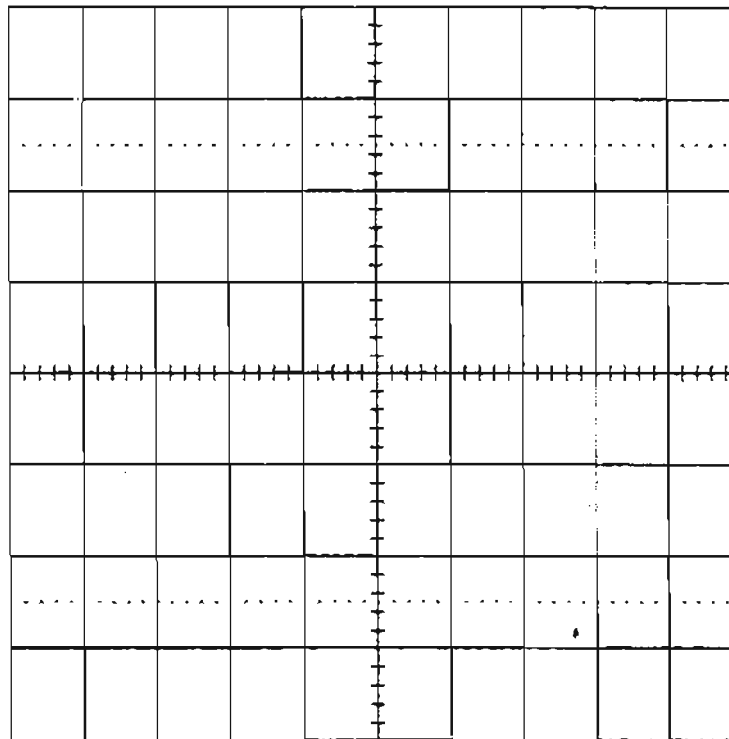

Edge SMART

trigger on
1 2 3 4 Ext
Ext10 Line

cp1g Ext
DC AC LFREJ
HFREJ HF

slope Ext
Pos Neg

External
DC50Ω DC1MΩ

holdoff
- - -
OFF Time Evts

50 μs

- 1 50 mV 50Ω
- 2 50 mV 50Ω
- 3 50 mV 50Ω
- 4 50 mV 50Ω

Ext DC 0mV 1MΩ

100 MS/s

□ AUTO

- Measure the impedance using a high precision DMM : must be 1.00 MΩ ±1%.

5.4.2.b DC 50Ω

- Set Trigger on : **EXT**
- Trigger mode : **Auto**
- Coupling Ext : **DC**
- External : **DC 50Ω**
- Time base : **50 μsec/div.**

26-Feb-96
16:34:33

TRIGGER SETUP

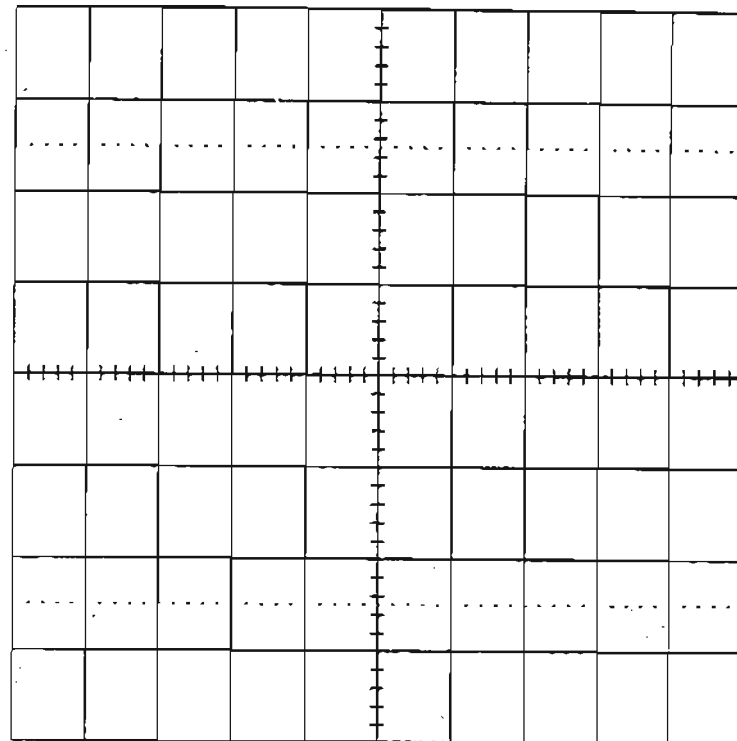

Edge SMART

trigger on
1 2 3 4 **EXT**
Ext10 Line

cp1g Ext
DC AC LFREJ
HFREJ HF

slope Ext
Pos Neg

External
DC50Ω DC1MΩ

holdoff
OFF Time Evts

50 μs

- 1 50 mV 50Ω
- 2 50 mV 50Ω
- 3 50 mV 50Ω
- 4 50 mV 50Ω

 Ext DC 0mV 50Ω

100 MS/s

AUTO

- Measure the impedance using a high precision DMM with sense : must be 50 Ω ± 1%.
- Repeat steps 5.4.2.a, for Ext/10, and check as above.

5.4.3 Internal Protective Resistor Verification

With any time base and gain, set DSO as follows :

- Input Coupling : Grounded
- Check with a high precision DMM : input impedance must be $1\text{ M}\Omega \pm 2\%$.

17-Jan-96
13:57:25

50 μs
100 mV

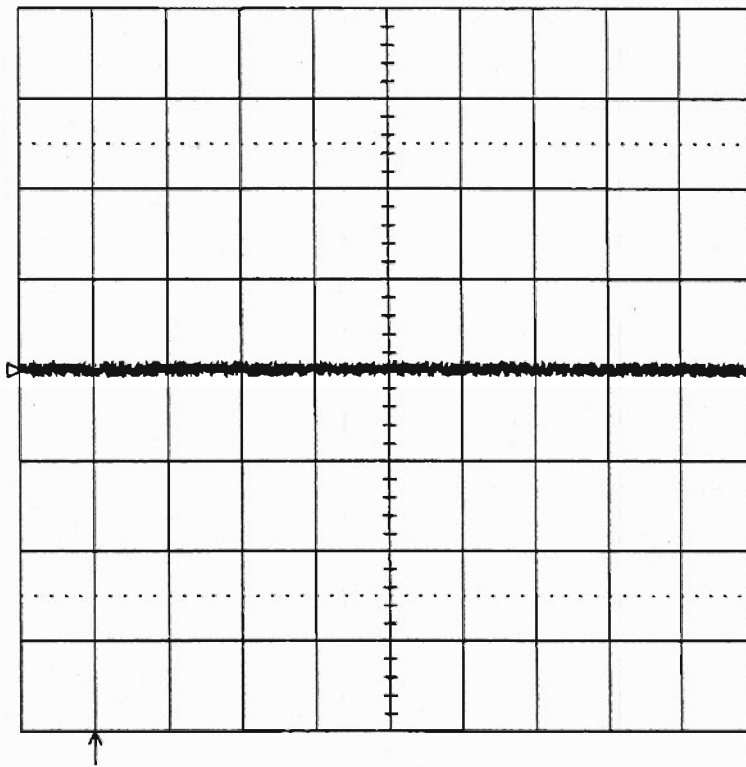

50 μs
1 .1 V $\frac{1}{2}$
2 .1 V $\frac{1}{2}$
3 .1 V $\frac{1}{2}$
4 .1 V $\frac{1}{2}$

1 DC 0 mV

CHANNEL 1

Coupling
DC50 Ω
Grounded
DC1M Ω
Grounded
AC1M Ω

V/div Offset
NORMAL
ECL TTL

Global BWL
OFF 25MHz
200MHz

Probe Atten
x1
x2
x5
x10
x20

100 MS/s

AUTO

- Repeat the above test for Channel 2, Channel 3 and Channel 4.

5.5 Leakage Current

Specifications

DC 1 M Ω , AC 1 M Ω , DC 50 Ω : ± 1 mV

5.5.1 Procedure

The leakage current is tested by measuring the voltage across the input of each channel.

- Set DSO Ch1 : On
- Input Coupling : DC 50 Ω
- Input gain : 50 mV/div.
- Trigger on : Channel 1
- Trigger mode : Auto
- Time base : 10 μ sec

- Connect a high precision DMM to Channel 1, and verify that the reading is not larger than ± 1 mV.
- Repeat the above test for input volt/div. of 200 mV.
- Repeat the procedure for 1M Ω DC and 1M Ω AC.
- Repeat step 5.5.1 for Channel 2, Channel 3, Channel 4 and External .

5.6 Average Noise Level

Description

The 9384/M/L/TM/AL inputs average noise level is tested at 10 mV/div., with 0 mV offset.

This is to verify the proper operation of the main board, front-end and ADC's.

The scope parameters functions are used to measure the RMS and Peak amplitude of the noise.

5.6.1 Peak to Peak Noise

Specifications

< ± 7.2 mV Peak to Peak at 10 mV/div.

5.6.1.a DC 1M Ω

Procedure

- With no signal connected to the inputs, set 9384/M/L/TM/AL DSO settings as follows
- Turn on traces : Ch1, Ch2, Ch3, Ch4

Section 5 Performance Verification

- Display setup : Standard, Dot Join on, Persistence off, Single grid
- Input Coupling : DC 1M Ω
- V/div. offset : Normal
- Probe atten : X1
- Global BWL : Off
- Input gain : 10 mV/div.
- Trigger setup : Edge
- Trigger on : 1
- Coupling 1 : DC
- Slope 1 : Pos
- Holdoff : Off
- Trigger Mode : Auto
- Timebase : 20 msec/div.
- Channel use : 4
- Record up : 50 K

26-Feb-96
16:46:09

1
20 ms
10.0 mV

2
20 ms
10.0 mV

3
20 ms
10.0 mV

4
20 ms
10.0 mV

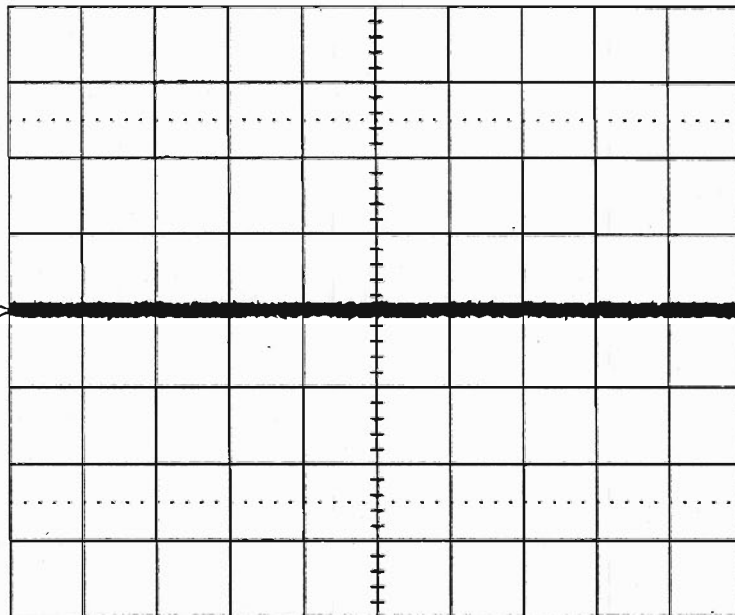

- 20 ms
- 1 10 mV DC
 - 2 10 mV DC
 - 3 10 mV DC
 - 4 10 mV DC

1 DC 0.8 mV

CHANNEL 1

Coupling
DC50 Ω
Grounded
DC1M Ω
Grounded
AC1M Ω

V/div Offset
NORMAL
ECL TTL

Global BWL
OFF 25MHz
200MHz

Probe Atten
x1
x2
x5
x10
x20

250 kS/s

AUTO

- Press : Cursors/Measure
- Measure : Parameters
- Mode : Custom
- Statistics : On
- Change parameters
- Category : All
- On line 1 : Measure pkpk of Ch1
- On line 2 : Measure pkpk of Ch2
- On line 3 : Measure pkpk of Ch3

On line 4 : Measure pkpk of Ch4

27-Feb-96
8:37:46

1
20 ms
10.0 mV

2
20 ms
10.0 mV

3
20 ms
10.0 mV

4
20 ms
10.0 mV

20 ms
1 10 mV DC
2 10 mV DC
3 10 mV DC
4 10 mV DC

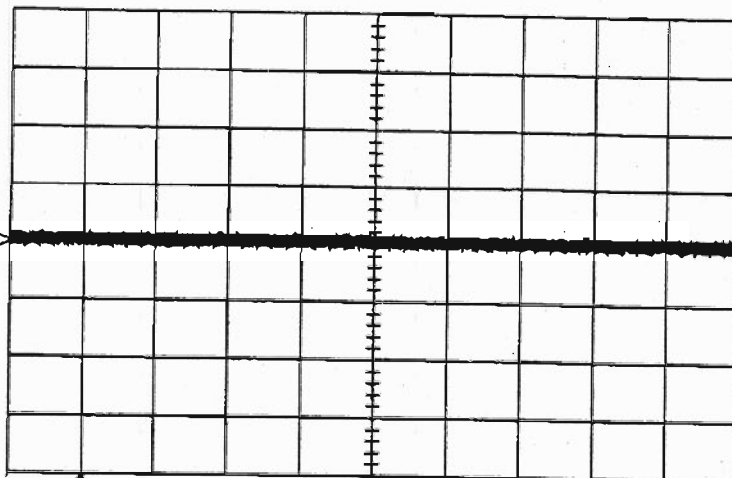

106 sweeps:

	average	low	high	sigma
pkpk (1)	2.2 mV	1.9	2.8	0.2
pkpk (2)	2.5 mV	2.2	2.8	0.1
pkpk (3)	2.3 mV	2.2	2.8	0.2
pkpk (4)	2.3 mV	1.9	2.5	0.1

1 DC 0.8 mV

MEASURE

OFF Cursors
Parameters

mode
Std Voltage
Std Time
Custom
Pass
Fail

statistics
OFF On

CHANGE
PARAMETERS

from
0.00 div
Track OFF On

to
10.00 div

250 kS/s

AUTO

Section 5 Performance Verification

27-Feb-96
8:39:41

1
20 ms
10.0 mV

2
20 ms
10.0 mV

3
20 ms
10.0 mV

4
20 ms
10.0 mV

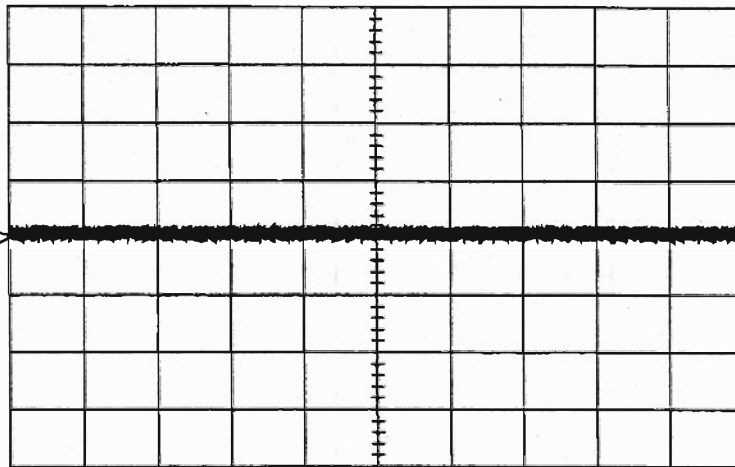

326 sweeps:

	average	low	high	sigma
pkpk (1)	2.3 mV	1.9	2.8	0.2
pkpk (2)	2.5 mV	2.2	3.1	0.2
pkpk (3)	2.4 mV	2.2	2.8	0.2
pkpk (4)	2.2 mV	1.9	2.5	0.1

20 ms

- 1 10 mV DC
- 2 10 mV DC
- 3 10 mV DC
- 4 10 mV DC

peak to peak
difference between maximum and
minimum data values

CHANGE PARAM

On line
1 2 3 4 5

Category
All
DISK-Std
DISK-Local
DISK-PRML
Cyclic

DELETE ALL
PARAMETERS

measure
pct1
period
pkpk
pks
points

of
0 2 3 4
A B C D

250 kS/s

AUTO

- Check after at least 50 sweeps that : high pkpk readout is less than ± 7.2 mV, corresponding to 9% of full scale.
- Repeat the test for Timebase : 1 msec/div, 50 μ sec/div, and 10 μ sec/div. and check as above.

5.6.1.b AC 1M Ω

- Select Ch1, Ch2, Ch3 & Ch4 : AC 1M Ω
- Input gain : 10 mV/div.
- Timebase : 10 μ sec/div.
- Check after at least 50 sweeps that the high pkpk readout is less than ± 7.2 mV, corresponding to 9% of full scale.

27-Feb-96
8:41:34

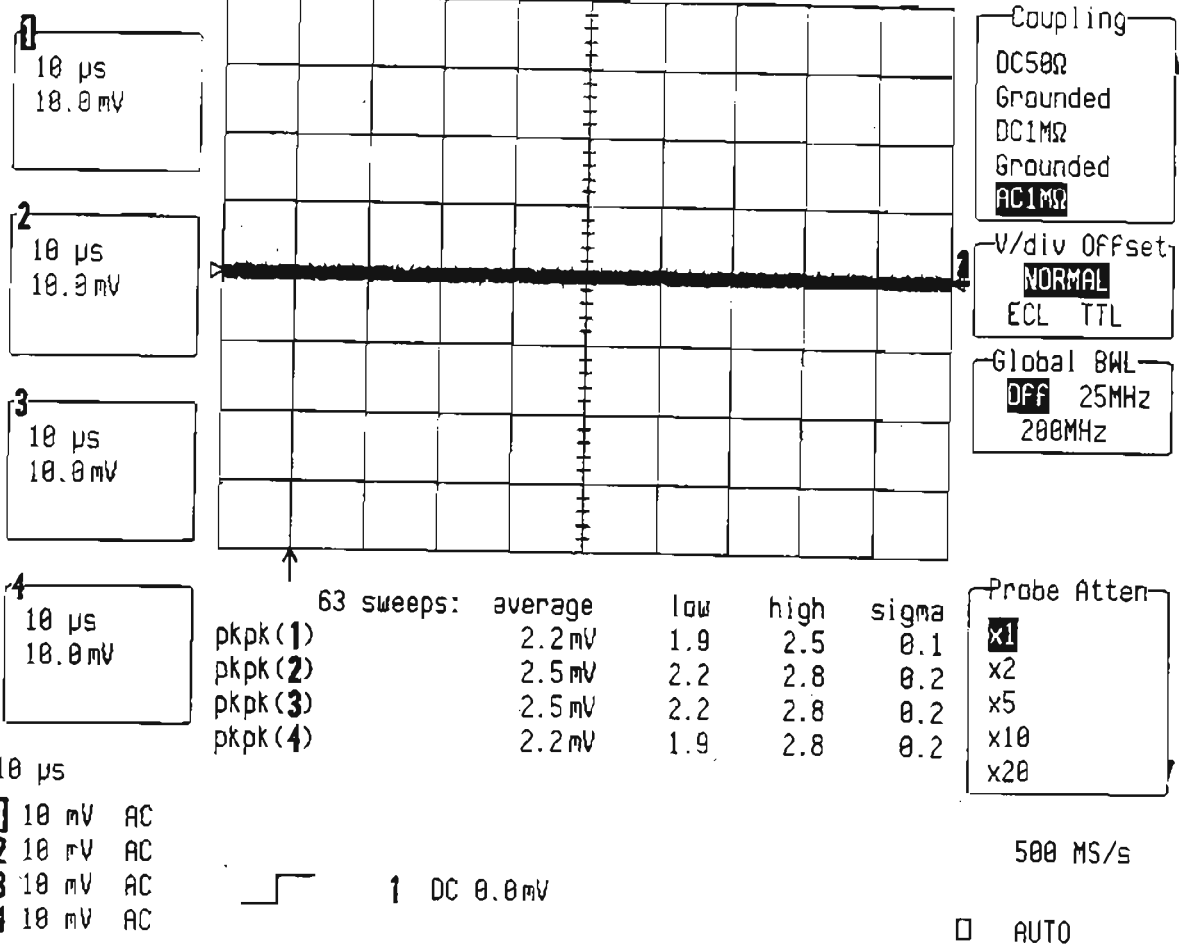

Section 5 Performance Verification

5.6.1.c DC 50Ω

- Select Ch1, Ch2, Ch3 & Ch4 : DC 50Ω
- Input gain : 10 mV/div.
- Set Timebase : 50 μsec/div.

- Check after at least 50 sweeps that the high pkpk readout is less than ± 7.2 mV, corresponding to 9% of full scale.

27-Feb-96
8:46:11

1
50 μs
10.0 mV

2
50 μs
10.0 mV

3
50 μs
10.0 mV

4
50 μs
10.0 mV

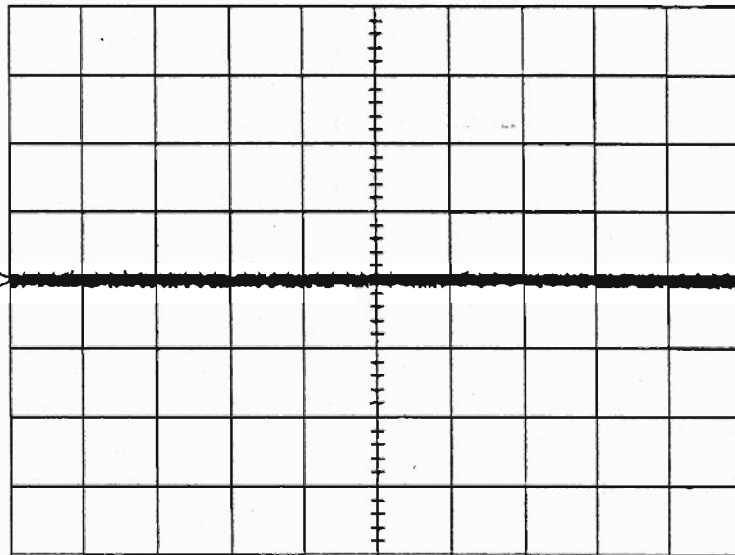

75 sweeps:

	average	low	high	sigma
pkpk (1)	1.9 mV	1.9	2.2	0.1
pkpk (2)	1.9 mV	1.9	2.2	0.1
pkpk (3)	2.1 mV	1.6	2.5	0.2
pkpk (4)	2.1 mV	1.9	2.5	0.2

- 50 μs
- 1 10 mV 50Ω
 - 2 10 mV 50Ω
 - 3 10 mV 50Ω
 - 4 10 mV 50Ω

1 DC 0.0 mV

CHANNEL 1

Coupling
DC50Ω
Grounded
DC1MΩ
Grounded
AC1MΩ

V/div Offset
NORMAL
ECL TTL

Global BWL
OFF 25MHz
200MHz

Probe Atten
x1
x2
x5
x10
x20

100 MS/s

AUTO

- Repeat the tests for Timebase : 10 μsec/div and check as above.

- Select : Timebase Setup
- Select Channel use : 2
- Set Timebase : 5 μsec/div.

27-Feb-96
8:49:05

1←2
5 μ s
10.0 mV

2
5 μ s
10.0 mV

3
5 μ s
10.0 mV

4←3
5 μ s
10.0 mV

5 μ s
1 disabled
2 10 mV 50 Ω
3 10 mV 50 Ω
4 disabled

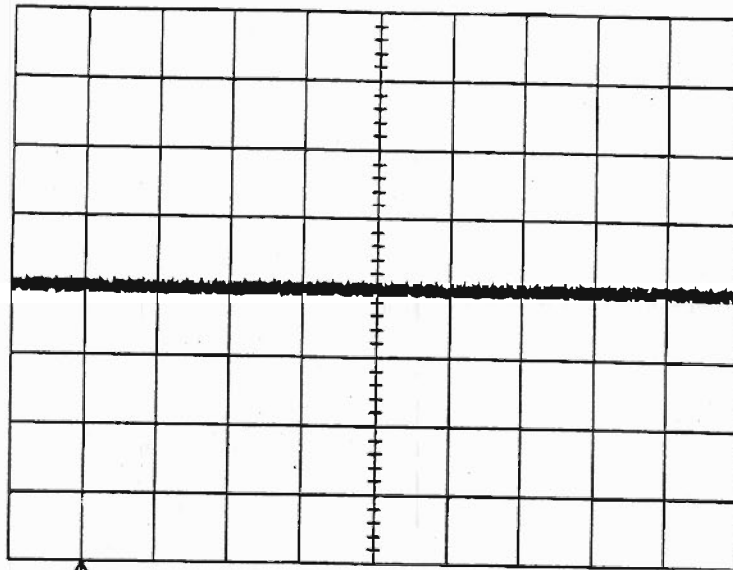

55 sweeps:

	average	low	high	sigma
pkpk (1)	2.0 mV	1.9	2.5	0.2
pkpk (2)	2.0 mV	1.9	2.5	0.2
pkpk (3)	2.2 mV	1.9	2.5	0.2
pkpk (4)	2.2 mV	1.9	2.5	0.2

TIMEBASE
T/div 5 μ s
50000
samples at
1 GS/s
(1 ns/pt)
for 50 μ s

Sampling
Single Shot

Channel Use
4 2
Peak-Detect

Sequence
OFF On Wrap

Record up to
50k

1 GS/s

AUTO

- Check after at least 50 sweeps that the high pkpk readout is less than ± 7.2 mV, corresponding to 9% of full scale.

5.6.2 Rms Noise

Specifications

< $\pm 720 \mu\text{V}$ at 10 mV/div.

5.6.2.a DC 1M Ω

Procedure

- With no signal connected to the inputs, set 9384/M/L/TM/AL DSO settings as follows

- Turn on traces : Ch1, Ch2, Ch3 & Ch4
- Display setup : Standard, Dot Join on, Persistence off, Single grid
- Input Coupling : DC 1M Ω
- V/div. offset : Normal
- Probe atten : X1
- Global BWL : Off
- Input gain : 10 mV/div.
- Trigger setup : Edge
- Trigger on : 1
- Coupling 1 : DC
- Slope 1 : Pos
- Holdoff : Off
- Trigger Mode : Auto
- Timebase : 20 msec/div.
- Channel use : 4
- Record up : 50 K

- Press : Cursors/Measure
- Measure : Parameters
- Mode : Custom
- Statistics : On

- Change parameters

- On line 1 : Measure sdev of Ch1
- On line 2 : Measure sdev of Ch2
- On line 3 : Measure sdev of Ch3
- On line 4 : Measure sdev of Ch4

- Check after at least 50 sweeps that : high sdev readout is less than $\pm 720 \mu\text{V}$, corresponding to 0.9% of full scale.
- Repeat the test for Timebase : 1 msec/div, 50 $\mu\text{sec/div}$, and 10 $\mu\text{sec/div}$. and check as above.

27-Feb-96
8:53:57

1
20 ms
10.0 mV

2
20 ms
10.0 mV

3
20 ms
10.0 mV

4
20 ms
10.0 mV

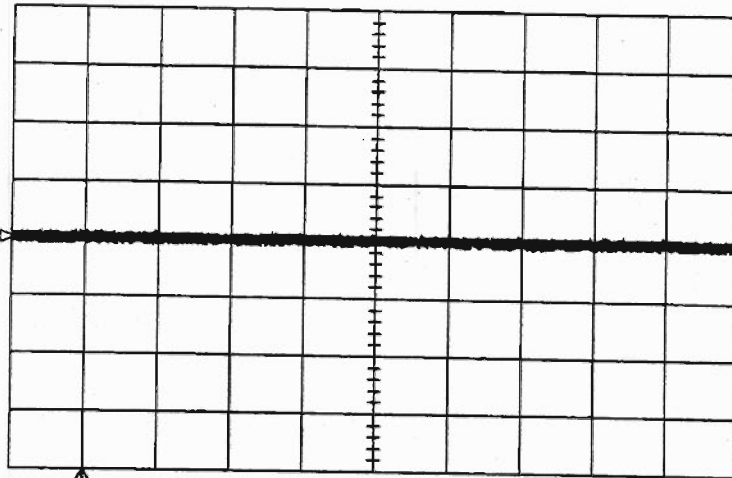

52 sweeps:

	average	low	high	sigma
sdev(1)	0.29 mV	0.27	0.29	0.01
sdev(2)	0.34 mV	0.34	0.34	0.00
sdev(3)	0.29 mV	0.29	0.29	0.00
sdev(4)	0.30 mV	0.30	0.30	0.00

- 20 ms
- 1 10 mV DC
 - 2 10 mV DC
 - 3 10 mV DC
 - 4 10 mV DC

standard deviation
of the data values
from the mean value

CHANGE PARAM

On line
1 2 3 4 5

Category
All
DISK-Std
DISK-Local
DISK-PRML
Cyclic

DELETE ALL
PARAMETERS

measure
r@level
rms
sdev
sigma
taa

of
1 2 3 4
A B C D

250 KS/s

AUTO

27-Feb-96
8:58:04

1
10 μs
10.0 mV

2
10 μs
10.0 mV

3
10 μs
10.0 mV

4
10 μs
10.0 mV

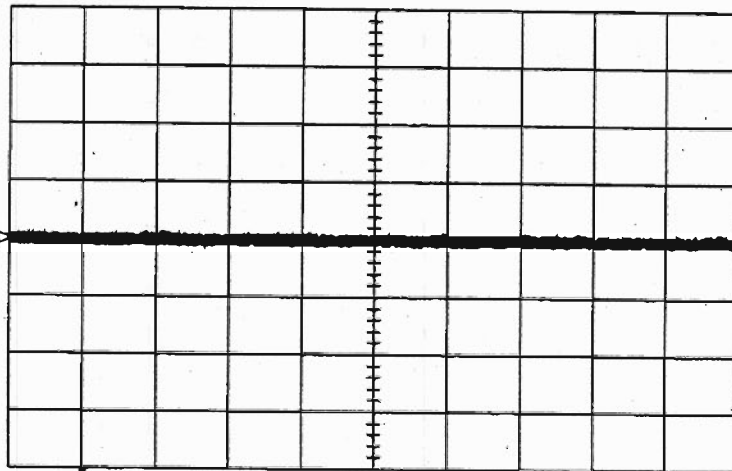

54 sweeps:

	average	low	high	sigma
sdev(1)	0.30 mV	0.29	0.32	0.01
sdev(2)	0.33 mV	0.30	0.35	0.01
sdev(3)	0.28 mV	0.26	0.30	0.01
sdev(4)	0.28 mV	0.25	0.32	0.01

- 10 μs
- 1 10 mV AC
 - 2 10 mV AC
 - 3 10 mV AC
 - 4 10 mV AC

1 DC 0.0 mV

CHANNEL 1

Coupling
DC50Ω
Grounded
DC1MΩ
Grounded
AC1MΩ

V/div Offset
NORMAL
ECL TTL

Global BWL
OFF 25MHz
200MHz

Probe Atten
x1
x2
x5
x10
x20

500 MS/s

AUTO

Section 5 Performance Verification

5.6.2.b AC 1MΩ

- Select Ch1, Ch2, Ch3 & Ch4 : AC 1MΩ
 - Input gain : 10 mV/div.
 - Timebase : 10 μsec/div.
- Check after at least 50 sweeps that the high Sdev readout is less than ± 720 μV, corresponding to 0.9% of full scale.

5.6.2.c DC 50Ω

- Select Ch1, Ch2, Ch3 & Ch4 : DC 50Ω
 - Input gain : 10 mV/div.
 - Set Timebase : 50 μsec/div.
- Check after at least 50 sweeps that the high Sdev readout is less than ± 720 μV, corresponding to 0.9% of full scale.

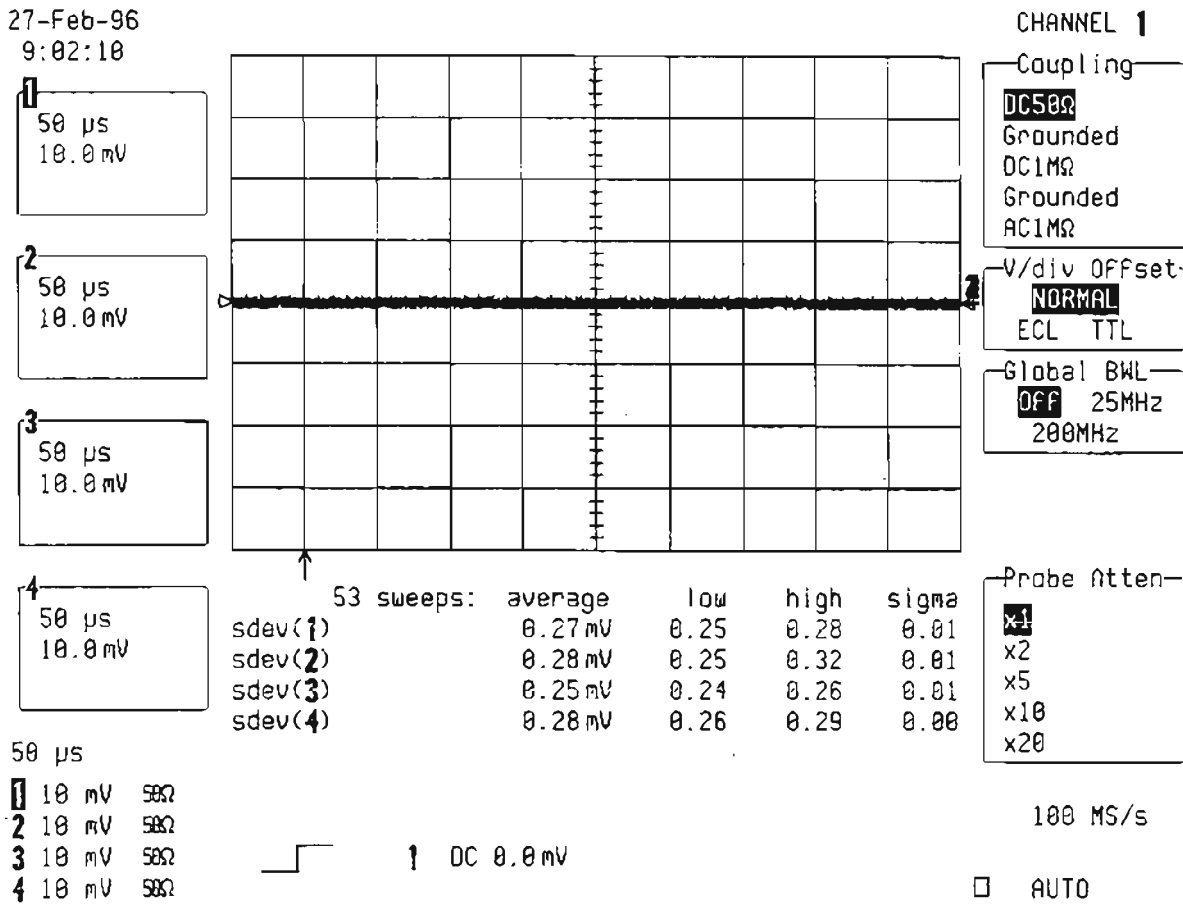

- Repeat the tests for Timebase : 10 μsec/div and check as above.

5.6.3 Inputs Grounded

With no cable plugged into scope, set the DSO as follows :

- Turn on trace : **Channel 1, Channel 2, Channel 3 & Channel 4**
- Input Coupling : **DC 50 Ω**
- Input gain : **10 mV/div.**
- Offset : **Zero**
- Trigger on : **Channel 1, DC**
- Trigger mode : **Auto**
- Timebase : **10 μ sec/div.**
- Channel use : **4**
- Record up : **50 K**
- Turn off trace : **Channel 1, Channel 2, Channel 3 & Channel 4**

- Turn on trace : **A, B, C, D**
- Select Math Setup
- For Math : **Use at most 5000 points**
- Redefine A, B, C, D : **Channel 1, Channel 2, Channel 3 & Channel 4**
- Use Math ? : **Yes**
- Math Type : **Average**
- Avg Type : **Summed**
- For : **1000 sweeps**

- Cursors/Measure : **Parameters**
- Mode : **Custom**
- Statistics : **off**
- Change parameters
- On line 1 : **Measure mean of A**
- On line 2 : **Measure mean of B**
- On line 3 : **Measure mean of C**
- On line 4 : **Measure mean of D**

- Check after at least 100 sweeps that the **mean** value of **A, B, C & D** is less than **± 1.6 mV**, corresponding to $\pm 2\%$ of full scale.
- Switch Channel 1, Channel 2, Channel 3 & Channel 4 between coupling **DC 50 Ω** and **Grounded**.
- Check after at least 100 sweeps that the **mean** value of **A, B, C & D** is less than **± 1.6 mV**, corresponding to $\pm 2\%$ of full scale.
- Set coupling all Channel : **DC 1M Ω**
- Check after at least 100 sweeps that the **mean** value of **A, B, C & D** is less than **± 1.6 mV**, corresponding to $\pm 2\%$ of full scale.
- Switch all Channel between coupling **DC 1M Ω** and **Grounded**.
- Check after at least 100 sweeps that the **mean** value of **A, B, C & D** is less than **± 1.6 mV**, corresponding to $\pm 2\%$ of full scale.

Section 5 Performance Verification

27-Feb-96
9:08:12

- A: Average(1)
10 μ s
10.0 mV
326 swps
- B: Average(2)
10 μ s
10.0 mV
325 swps
- C: Average(3)
10 μ s
10.0 mV
324 swps
- D: Average(4)
10 μ s
10.0 mV
323 swps

10 μ s

- 1 10 mV 50 Ω
- 2 10 mV 50 Ω
- 3 10 mV 50 Ω
- 4 10 mV 50 Ω

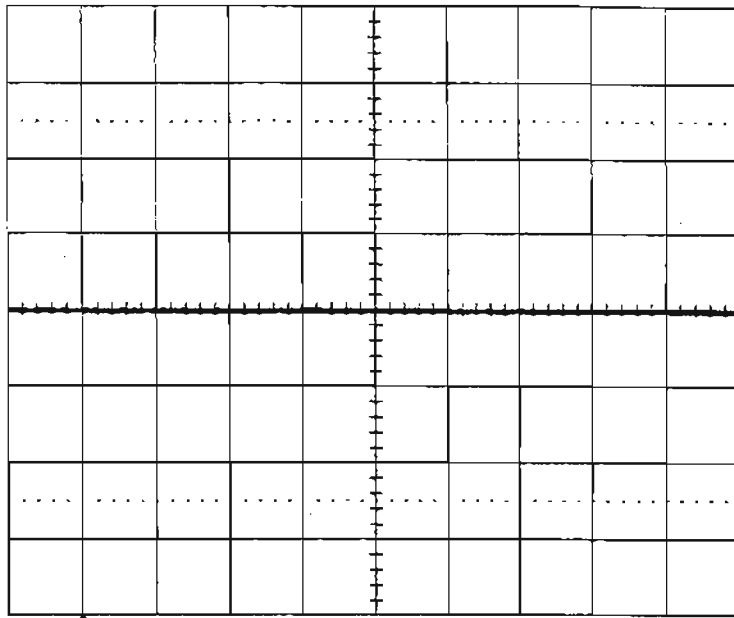

1 DC 0.0 mV

ZOOM + MATH

REDEFINE A
A=Average(1)

REDEFINE B
B=Average(2)

REDEFINE C
C=Average(3)

REDEFINE D
D=Average(4)

Multi-Zoom
OFF On

for Math use
max points
5000

500 MS/s

AUTO

27-Feb-96
9:08:37

- A: Average(1)
10 μ s
10.0 mV
448 swps
- B: Average(2)
10 μ s
10.0 mV
447 swps
- C: Average(3)
10 μ s
10.0 mV
446 swps
- D: Average(4)
10 μ s
10.0 mV
445 swps

10 μ s

- 1 10 mV 50 Ω
- 2 10 mV 50 Ω
- 3 10 mV 50 Ω
- 4 10 mV 50 Ω

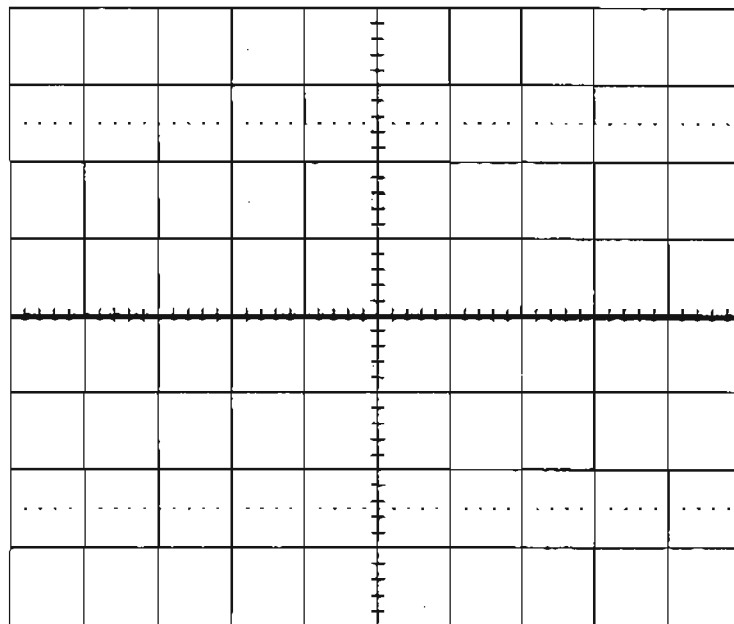

A: Average(1) 50000 -> 5000 pts

SETUP OF A

Use Math?
No Yes

Math Type
Arithmetic
Average
Correlate
Enh. Res
Extrema

Avg Type
Summed
Continuous

for
1000
(sweeps)

of
D 2 3 4 B C D
M1 M2 M3 M4

500 MS/s

AUTO

27-Feb-96
9:18:30

- A: Average(1)
10 μ s
10.0 mV
-671 swps
- B: Average(2)
10 μ s
10.0 mV
-670 swps
- C: Average(3)
10 μ s
10.0 mV
-669 swps
- D: Average(4)
10 μ s
10.3 mV
-668 swps

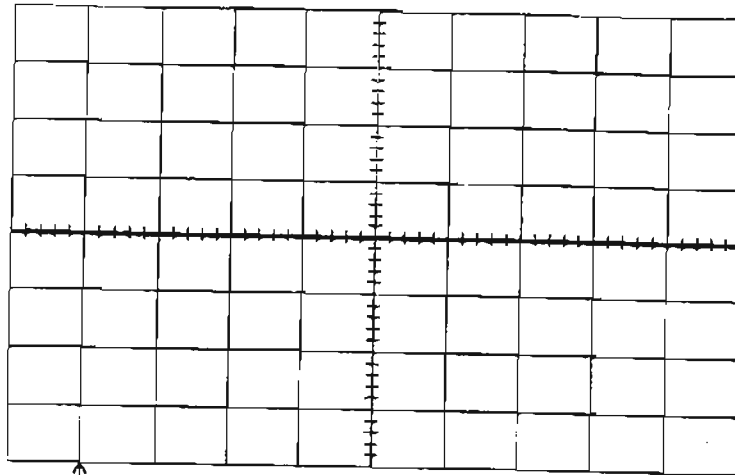

mean(A)	-0.09 mV
mean(B)	0.01 mV
mean(C)	-0.20 mV
mean(D)	-0.18 mV

MEASURE

OFF Cursors
Parameters

mode

Std Voltage
Std Time
Custom
Pass
Fail

statistics
OFF On

CHANGE PARAMETERS

from
0.00 div
Track OFF On

to
10.00 div

- 10 μ s
- 1 10 mV 500
 - 2 10 mV 500
 - 3 10 mV 500
 - 4 10 mV 500

1 DC 0.0 mV

500 MS/s

AUTO

27-Feb-96
9:10:51

- A: Average(1)
10 μ s
10.0 mV
-743 swps
- B: Average(2)
10 μ s
10.0 mV
-742 swps
- C: Average(3)
10 μ s
10.0 mV
-741 swps
- D: Average(4)
10 μ s
10.0 mV
-740 swps

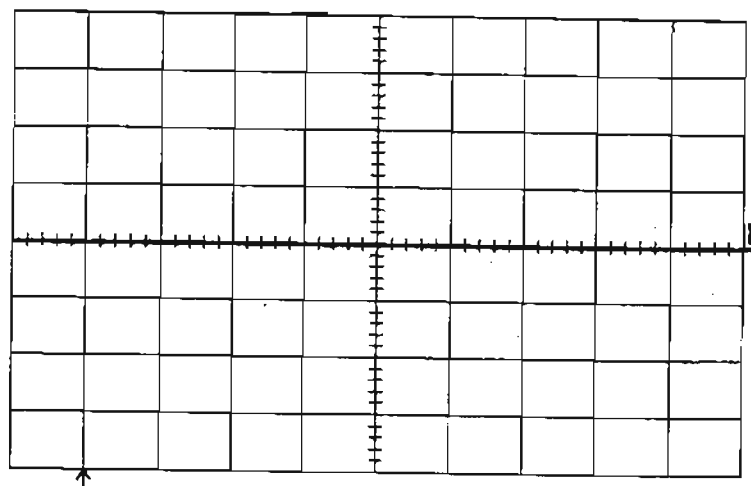

mean(A)	-0.10 mV
mean(B)	0.01 mV
mean(C)	-0.19 mV
mean(D)	-0.18 mV

CHANGE PARAM

On line
1 2 3 4 5

Category

All
DISK-Std
DISK-Local
DISK-PRML
Cyclic

DELETE ALL PARAMETERS

measure

maximum
maxp
mean
median
minimum

OF

1 2 3 4
A B C D

- 10 μ s
- 1 10 mV 500
 - 2 10 mV 500
 - 3 10 mV 500
 - 4 10 mV 500

mean
average of data values

500 MS/s

AUTO

Section 5 Performance Verification

27-Feb-96
9:11:26

A: Average(1)
10 μ s
10.0 mV
67 swps

B: Average(2)
10 μ s
10.0 mV
58 swps

C: Average(3)
10 μ s
10.0 mV
52 swps

D: Average(4)
10 μ s
10.0 mV
48 swps

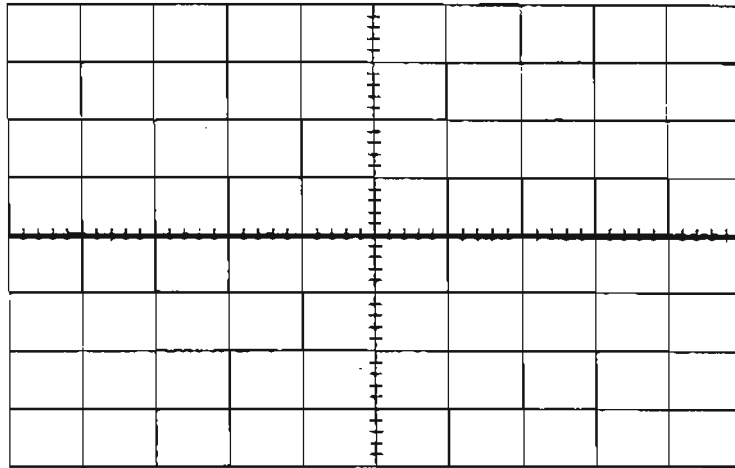

mean(A)	-0.14 mV
mean(B)	-0.19 mV
mean(C)	-0.18 mV
mean(D)	-0.27 mV

CHANNEL 1

Coupling
DC50 Ω
Grounded
DC1M Ω
Grounded
AC1M Ω

V/div Offset
NORMAL
ECL TTL

Global BWL
OFF 25MHz
200MHz

Probe Atten

x1
x2
x5
x10
x20

- 10 μ s
- 1 10 mV $\frac{1}{2}$
 - 2 10 mV $\frac{1}{2}$
 - 3 10 mV $\frac{1}{2}$
 - 4 10 mV $\frac{1}{2}$

1 DC 0.0 mV

500 MS/s

AUTO

27-Feb-96
9:11:55

A: Average(1)
10 μ s
10.0 mV
86 swps

B: Average(2)
10 μ s
10.0 mV
71 swps

C: Average(3)
10 μ s
10.0 mV
67 swps

D: Average(4)
10 μ s
10.0 mV
63 swps

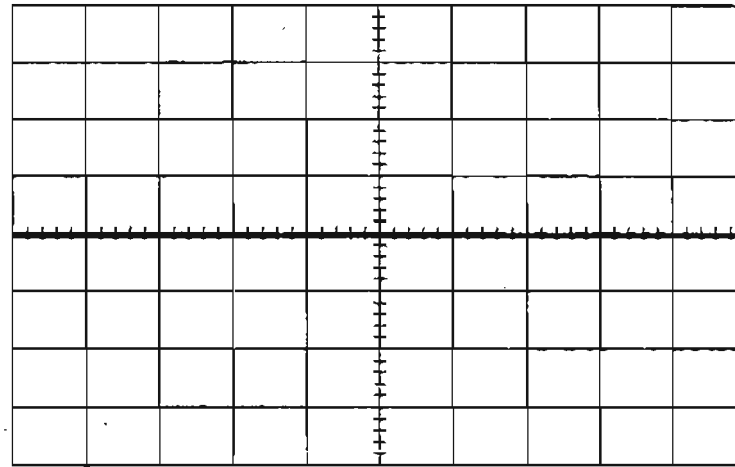

mean(A)	-0.15 mV
mean(B)	-0.18 mV
mean(C)	-0.10 mV
mean(D)	-0.28 mV

CHANNEL 1

Coupling
DC50 Ω
Grounded
DC1M Ω
Grounded
AC1M Ω

V/div Offset
NORMAL
ECL TTL

Global BWL
OFF 25MHz
200MHz

Probe Atten

x1
x2
x5
x10
x20

- 10 μ s
- 1 10 mV $\frac{1}{2}$
 - 2 10 mV $\frac{1}{2}$
 - 3 10 mV $\frac{1}{2}$
 - 4 10 mV $\frac{1}{2}$

1 DC 0.0 mV

500 MS/s

AUTO

5.7 DC Linearity

Specification

- ≤ ± 5 % of full scale at 2mV/div, with 0 mV offset.
- ≤ ± 3 % of full scale at 5mV/div, with 0 mV offset.
- ≤ ± 2 % of full scale at 10mV/div and above.

5.7.1 Description

This test measures the DC Accuracy within the gain range specified.
The parameters Std voltage are used to measure the amplitude of the DC input signal.

5.7.1.a DC 50Ω

Procedure

- Turn on trace : Ch1
- Display setup : Standard, Persistence off, Dot join on, Single grid
- Input Coupling : DC 50 Ω
- V/div. offset : Normal
- Global BWL : Off
- Probe atten : X1
- Input offset : 0.0 mV
- Input gain : from 2mV/div to 5 V/div. (see table 5-2 and 5-3)

- Trigger setup : Edge
- Trigger on : 1
- Coupling 1 : DC
- Slope 1 : Pos
- Mode : Auto
- Holdoff : Off

- Timebase : 2 msec/div.
- Channel use : 4
- Record up : 50 K

- Turn on trace : A
- Select Math Setup : Use at most 5000 points
- For Math : Use at most 5000 points
- Redefine A : Use at most 5000 points
- Use Math ? : Yes
- Math Type : Average
- Avg Type : Summed
- For : 1000 sweeps
- Of : Channel 1

- Turn off trace : Channel 1

Section 5 Performance Verification

- Cursors/Measure : Parameters
- Mode : Std Voltage
- Statistics : off
- on displayed trace : A

5.7.1.a.1 Positive DC Linearity

- For the ranges 2 mV/div. to 1 V/div., from the high precision voltage source, apply to Channel 1 : + 3 major screen divisions.
- For the low sensitivities : 2 mV, 5 mV, 10 mV, 20 mV and 50 mV/div., use a 50 Ohm 20 dB attenuator.

27-Feb-96
9:26:19

Average(1)
2 ms
2.00 mV
106 swps

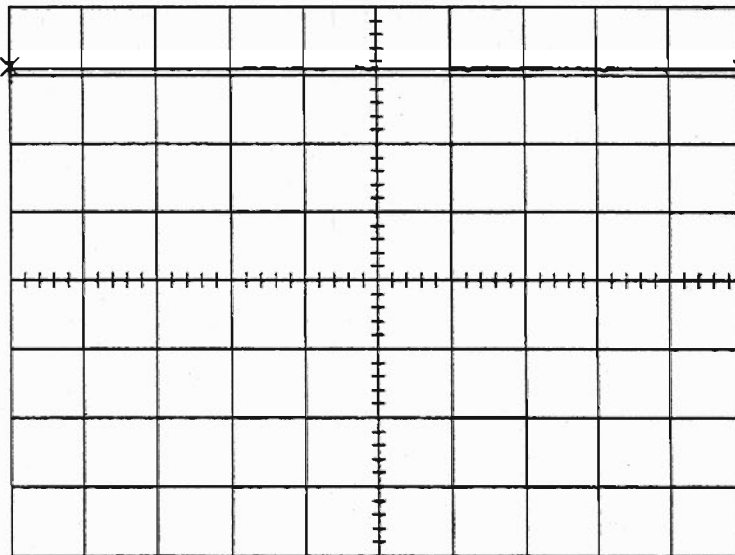

pkpk(A) 8.14 mV
mean(A) 6.222 mV
sdev(A) 20 µV
rms(A) 6.222 mV
ampl(A) 8.14 mV

- 1 2 mV 50Ω
- 2 2 mV 50Ω
- 3 2 mV 50Ω
- 4 2 mV 50Ω

Average(1) 50000 -> 5000 pts

SETUP OF A

use Math?
No Yes

Math Type
Arithmetic
Average
Correlate
Enh. Res
Extrema

Avg Type
Summed
Continuous

for
1000
(sweeps)

of
1 2 3 4 B C D
M1 M2 M3 M4

2.5 MS/s

AUTO

Range	Attenuator	Conditions of Test			Average Mean Parameter Reading		
		PS Output	9384/ML/TM/AL Input	9384/ML/TM/AL Full scale	Min Value -X % of FS	Max. Value +X% of FS	X%
2 mV	Yes	+ 60 mV	+ 6 mV	16 mV	+ 5.2 mV	+ 6.8 mV	5%
5 mV	Yes	+ 150 mV	+ 15 mV	40 mV	+ 13.8 mV	+ 16.2 mV	3%
10 mV	Yes	+ 300 mV	+ 30 mV	80 mV	+ 28.4 mV	+ 31.6 mV	2%
20 mV	Yes	+ 600 mV	+ 60 mV	160 mV	+ 56.8 mV	+ 63.2 mV	2%
50 mV	Yes	+ 1.5 V	+150 mV	400 mV	+ 142 mV	+ 158 mV	2%
.1 V	No	+ 300 mV	+ 300 mV	800 mV	+ 284 mV	+ 316 mV	2%
.2 V	No	+ 600 mV	+ 600 mV	1.6 v	+ 568 mV	+ 632 mV	2%
.5 V	No	+ 1.5 V	+ 1.5 V	4 V	+ 1.42 V	+ 1.58 V	2%
1 V	No	+ 3 V	+ 3 V	8 V	+ 2.84 V	+ 3.16 V	2%

Table 5-2 : Positive DC Linearity Readout Accuracy

- For each point, read off the **Mean** parameter voltage, and compare it to the digital readout of the voltage reference
- The **Mean** parameter reading should be within the limits shown in table 5-2.

Section 5 Performance Verification

27-Feb-96
9:31:59

1: Average(1)
2 ms
2.00 mV
152 swps

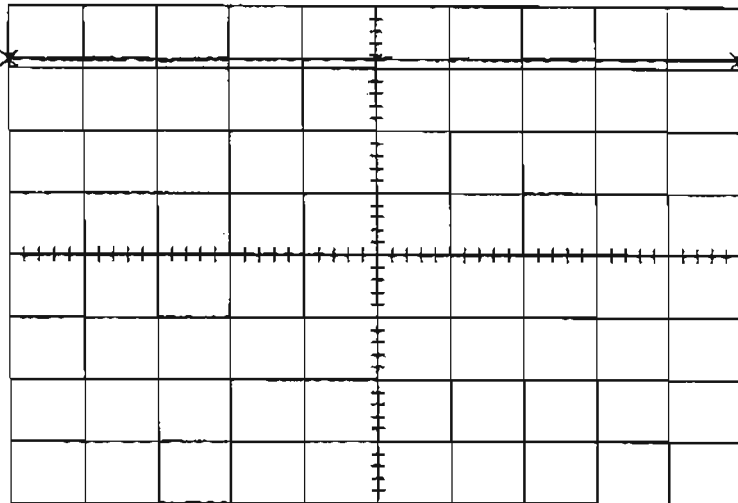

pkpk(A) 0.16 mV
mean(A) 6.323 mV
sdev(A) 20 μV
rms(A) 6.323 mV
ampl(A) 0.16 mV

2 ms

- 1 2 mV 500
- 2 2 mV 500
- 3 2 mV 500
- 4 2 mV 500



1 DC 0.00 mV

MEASURE

OFF Cursors
Parameters

mode
Std Voltage
Std Time
Custom
Pass
Fail

statistics
OFF On

on displayed
(trace)
A

from
8.00 div
Track OFF On

to
10.00 div
5000 pts

2.5 MS/s

AUTO

27-Feb-96
10:02:54

Average(1)
2 ms
1.00 V
1000 swps

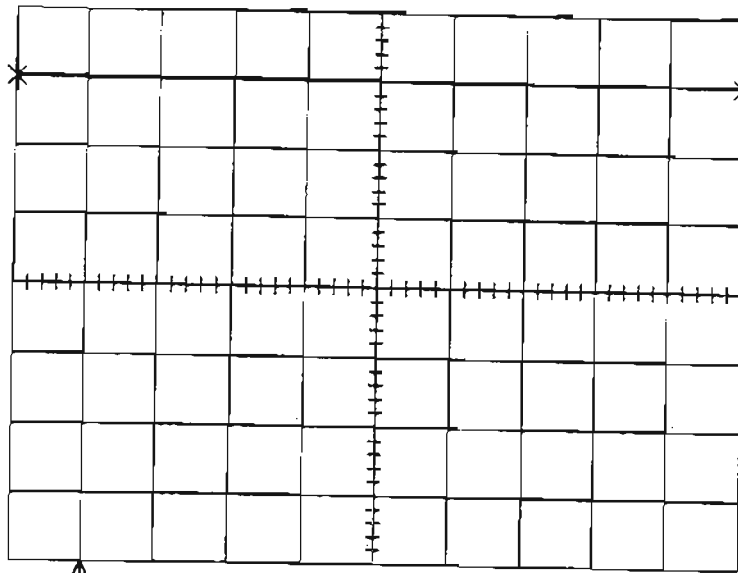

pkpk(A) 0.01 V
mean(A) 3.012 V
sdev(A) 1 mV
rms(A) 3.012 V
ampl(A) 0.01 V

2 ms
1 1 V 50Ω
2 1 V 50Ω
3 1 V 50Ω
4 1 V 50Ω

1 DC 0.00 V

MEASURE

OFF Cursors
Parameters

Mode
Std Voltage
Std Time
Custom
Pass
Fail

statistics
OFF On

on displayed
(trace)
A

From
0.00 div
Track OFF On

to
10.00 div
5000 pts

2.5 MS/s

AUTO

5.7.1.a.2 Negative DC Linearity

- For the ranges 2 mV/div. to 1 V/div., from the high precision voltage source, apply to Channel 1 : - 3 major screen divisions.
- For the low sensitivities : 2 mV, 5 mV, 10 mV, 20 mV and 50 mV/div., use a 50Ω 20 dB attenuator.
- For each point, read off the Mean parameter voltage, and compare it to the digital readout of the voltage reference.
- The mean parameter reading should be within the limits shown in table 5-3.

Section 5 Performance Verification

Range	Attenuator	Conditions of Test			Average Mean Parameter Reading		
		PS Output	9384/M/L/TM /AL Input	9384/M/L/TM/ AL Full scale	Min Value -X % of FS	Max. Value +X% of FS	X%
2 mV	Yes	- 60 mV	- 6 mV	16 mV	- 5.2 mV	- 6.8 mV	5%
5 mV	Yes	- 150 mV	- 15 mV	40 mV	- 13.8 mV	- 16.2 mV	3%
10 mV	Yes	- 300 mV	- 30 mV	80 mV	- 28.4 mV	- 31.6 mV	2%
20 mV	Yes	- 600 mV	- 60 mV	160 mV	- 56.8 mV	- 63.2 mV	2%
50 mV	Yes	- 1.5 V	-150 mV	400 mV	- 142 mV	- 158 mV	2%
.1 V	No	- 300 mV	- 300 mV	800 mV	- 284 mV	- 316 mV	2%
.2 V	No	- 600 mV	- 600 mV	1.6 v	- 568 mV	- 632 mV	2%
.5 V	No	- 1.5 V	- 1.5 V	4 V	- 1.42 V	- 1.58 V	2%
1 V	No	- 3 V	- 3 V	8 V	- 2.84 V	- 3.16 V	2%

Table 5-3 : Negative DC Linearity Readout Accuracy

27-Feb-96
10:22:53

Average(1)
2 ms
200 mV
109 sups

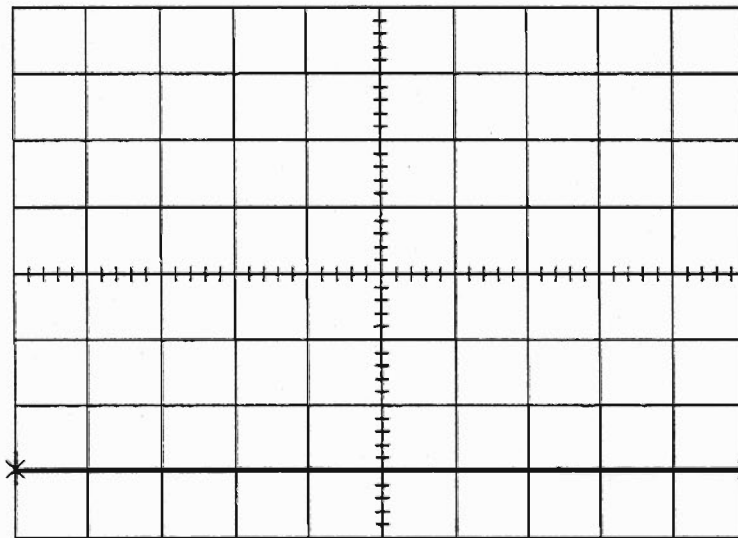

pkpk(A) 3 mV
mean(A) -591.4 mV
sdev(A) 0.4 mV
rms(A) 591.4 mV
ampl(A) * 3 mV

2 ms

- 1 .2 V 500
- 2 .2 V 500
- 3 .2 V 500
- 4 .2 V 500



1 DC 0.000 V

MEASURE

OFF Cursors
Parameters

mode
Std Voltage
Std Time
Custom
Pass
Fail

statistics
OFF On

on displayed
(trace)
A

from
0.00 div
Track OFF On

to
10.00 div
5000 pts

2.5 MS/s

AUTO

27-Feb-96

10:21:43

Average(1)
2 ms
1.00 V
-115 swps

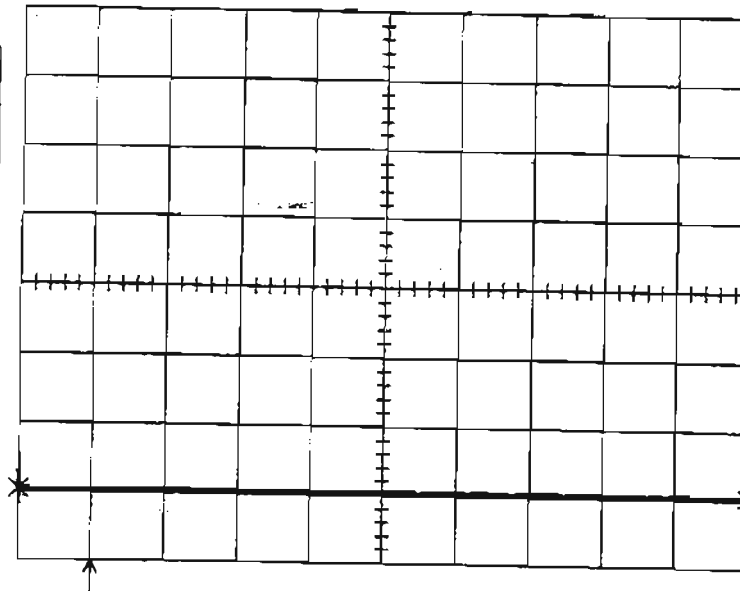

pkpk(A) 0.01 V
mean(A) -2.953 V
sdev(A) 2 mV
rms(A) 2.953 V
ampl(A) 0.01 V

2 ms
1 1 V 50Ω
2 1 V 50Ω
3 1 V 50Ω
4 1 V 50Ω

1 DC 0.00 V

MEASURE

OFF Cursors
Parameters

mode
Std Voltage
Std Time
Custom
Pass
Fail

statistics
OFF On

on displayed
(trace)

from
0.00 div
Track OFF On

to
10.00 div
5000 pts

2.5 MS/s

AUTO

5.7.1.b DC 1MΩ

Set the DSO as follows :

- Input Coupling : DC 1MΩ
- Input offset : 0.0 mV
- Input gain : from 2mV/div. to 5 V/div.

- For the ranges 2 mV/div. to 5 V/div., from the high precision voltage source, apply to Channel 1 the following 2 voltages values, one after another : + 3 major screen divisions, - 3 major screen divisions.

- For the low sensitivities : 2, 5, 10, 20 and 50 mV/div., use a 1MΩ 20 dB attenuator (1/10), see table 5-4.

Range	Attenuator	Conditions of Test			Average Mean Parameter Reading		
		PS Output	9384/M/L/TM /AL Input	9384/M/L/TM /AL Full scale	Min Value ±X% of FS	Max. Value ±X% of FS	± X%
2 mV	Yes	± 60 mV	± 6 mV	16 mV	± 5.2 mV	± 6.8 mV	5%
5 mV	Yes	± 150 mV	± 15 mV	40 mV	± 13.8 mV	± 16.2 mV	3%
10 mV	Yes	± 300 mV	± 30 mV	80 mV	± 28.4 mV	± 31.6 mV	2%
20 mV	Yes	± 600 mV	± 60 mV	160 mV	± 56.8 mV	± 63.2 mV	2%
50 mV	Yes	± 1.5 V	±150 mV	400 mV	± 142 mV	± 158 mV	2%
.1 V	No	± 300 mV	± 300 mV	800 mV	± 284 mV	± 316 mV	2%
.2 V	No	± 600 mV	± 600 mV	1.6 v	± 568 mV	± 632 mV	2%
.5 V	No	± 1.5 V	± 1.5 V	4 V	± 1.42 V	± 1.58 V	2%
1 V	No	± 3 V	± 3 V	8 V	± 2.84 V	± 3.16 V	2%
2 V	No	± 6 V	± 6 V	16 V	± 5.68 V	± 6.32 V	2%
5 V	No	± 15 V	± 15 V	40 V	± 14.2 V	± 15.8 V	2%

Table 5-4 : 1MΩ DC Linearity Readout Accuracy

- For each point, read off the **Mean** parameter voltage, and compare it to the digital readout of the voltage reference.
- The **mean** parameter reading should be within the limits shown in table 5-4.
- Repeat steps 5.7.1.a and 5.7.1.b for Channel 2, Channel 3 and Channel 4 substituting channel controls and input connector.

27-Feb-96
10:37:29

Average(1)
2 ms
1.00 V
1000 swps

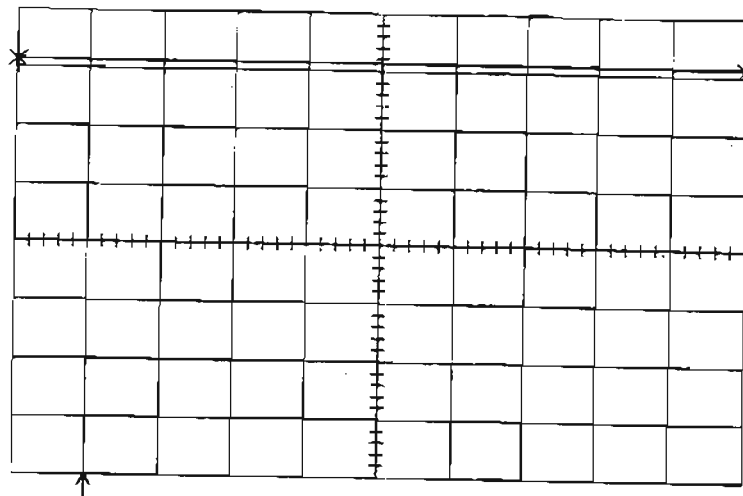

CHANNEL 1
Coupling
DC50Ω
Grounded
DC1MΩ
Grounded
AC1MΩ
V/div Offset
NORMAL
ECL TTL
Global BWL
OFF 25MHz
200MHz

pkpk(A) 0.01 V
mean(A) 3.141 V
sdev(A) 1 mV
rms(A) 3.141 V
ampl(A) ~~3.141~~ 0.01 V

Probe Atten
x1
x2
x5
x10
x20

2 ms
1 1 V DC
2 1 V DC
3 1 V DC
4 1 V DC

1 DC 0.00 V

2.5 MS/s

AUTO

27-Feb-96
10:38:49

Average(1)
2 ms
5.0 V
135 swps

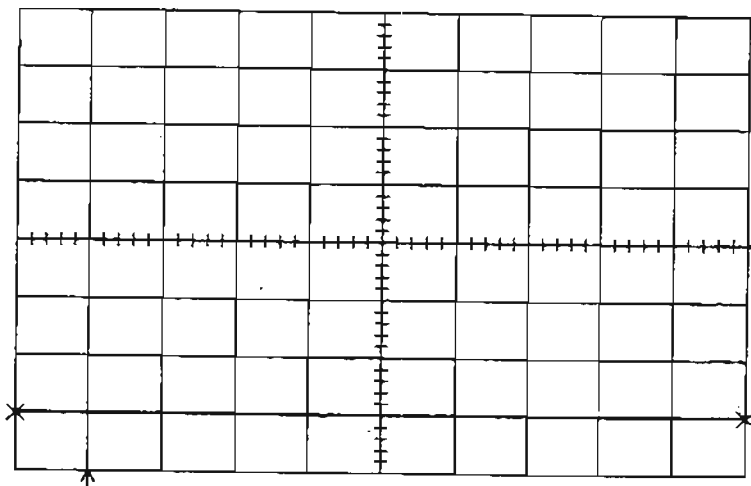

CHANNEL 1
Coupling
DC50Ω
Grounded
DC1MΩ
Grounded
AC1MΩ
V/div Offset
NORMAL
ECL TTL
Global BWL
OFF 25MHz
200MHz

pkpk(A) 0.08 V
mean(A) -14.965 V
sdev(A) 9 mV
rms(A) 14.965 V
ampl(A) ~~14.965~~ 0.08 V

Probe Atten
x1
x2
x5
x10
x20

2 ms
1 5 V DC
2 5 V DC
3 5 V DC
4 5 V DC

1 DC 0.0 V

2.5 MS/s

AUTO

5.8 Offset

5.8.1 Description

The maximum allowed offsets depend on the sensitivity as described in the specifications, and is tested at 2 mV and 5 mV range.

Specifications

- ± 400 mV : for the range 2mV/div.
- ± 1 V : for 5 mV/div., 10 mV/div., 20 mV/div., 50 mV/div.,
- ± 10 V : for 100 mV/div., 200 mV/div., 500 mV/div., 1 V/div (50 Ω)
- ± 100 V : for (1 MΩ), 1 V/div., 2 V/div., 5 V/div., 10 V/div.

5.8.1.a Negative Offset Control Procedure

Set the DSO as follows :

- Turn on trace : **Channel 1**
- Display setup : **Standard, Persistence off, Dot join on, Single grid**
- Input Coupling : **DC 1MΩ**
- V/div. offset : **Normal**
- Global BWL : **Off**
- Probe atten : **X1**
- Input gain : **5 mV**
- Trigger setup : **Edge**
- Trigger on : **1**
- Coupling 1 : **DC**
- Slope 1 : **Pos**
- Mode : **Auto**
- Holdoff : **Off**
- Timebase : **2 msec/div.**
- Channel use : **4**
- Record up : **50 K**
- Turn on trace : **A**
- Select Math Setup
- For Math : **Use at most 5000 points**
- Redefine A
- Use Math ? : **Yes**
- Math Type : **Average**
- Avg Type : **Summed**
- For : **1000 sweeps**
- Of : **Channel 1**

- Turn off trace : **Channel 1**
- Cursors/Measure : **Parameters**
- Mode : **Std Voltage**
- Statistics : **off**
- On displayed trace : **A**

- From the high precision voltage source PS5004, apply to Channel 1 +1 V.
- Using the offset control, move Channel 1 trace through the entire range until the maximum offset value is reached : - 1 V.
- Verify that the displayed trace A : Average (1) is in the screen, near to the center horizontal graticule line.
- Press clear sweeps.
- Check after at least 100 sweeps that the mean (A) parameter readout is : minimum + .985 V, maximum + 1.015 V. (see table 5-5).

Range	Conditions of Test		Offset Control	Mean Parameter Reading	
	PS Output	9384/M/L/TM /AL Input		Minimum Value,	Maximum Value,
5 mV	+1 V	+1 V	- 1 V	+ .985 V	+ 1.015 V
2 mV	+400 mV	+400 mV	- 400 mV	+ 392 mV	+ 408 mV

Table 5-5 : Negative offset control

27-Feb-96
11:01:11

Average(1)
2 ms
5.0 mV
1000 swps

Offset 1 = -1.00000 V

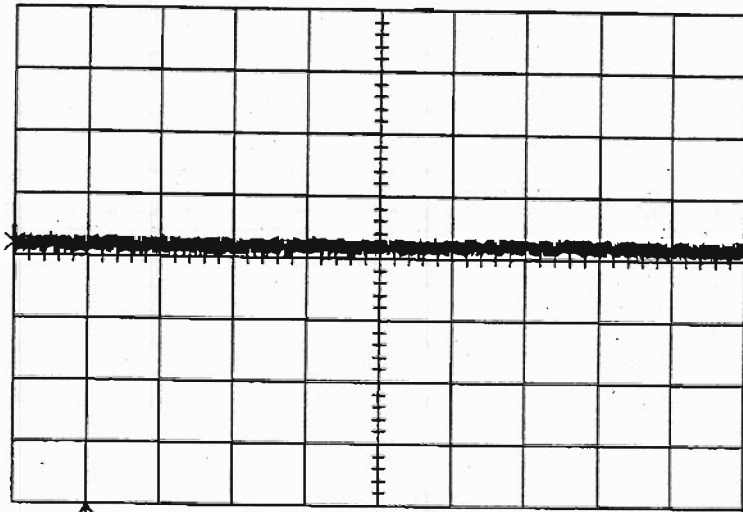

MEASURE

OFF Cursors
Parameters

mode
Std Voltage
Std Time
Custom
Pass
Fail

statistics
OFF On

on displayed (trace)
A

from
0.00 div
Track OFF On

to
10.00 div
5000 pts

pkpk(A) 1.65 mV
mean(A) 1.00109 V
sdev(A) 237 μV
rms(A) 1.00109 V
ampl(A) * 1.65 mV

2 ms
1 5 mV DC
2 5 mV DC
3 5 mV DC
4 5 mV DC

1 DC 975.0 mV

2.5 MS/s

AUTO

Section 5 Performance Verification

- Select Input Coupling: **DC 50Ω**
- Input gain : **5 mV**

- Press clear sweeps

- Check after at least 100 sweeps that the mean (A) parameter readout is :
minimum + .985 V , maximum + 1.015 V.

- Set input gain to **2 mV/div** from the high precision voltage source, apply to Channel 1 the following voltage value : **+ 400 mV**.

- Using the offset control, move the Ch1 trace through the entire range until the following offset value is reached : **- 400 mV**.

- Press clear sweeps

- Check after at least 100 sweeps that the mean (A) parameter readout is :
minimum + **392 mV**, maximum + **408 mV** (see table 5-5).

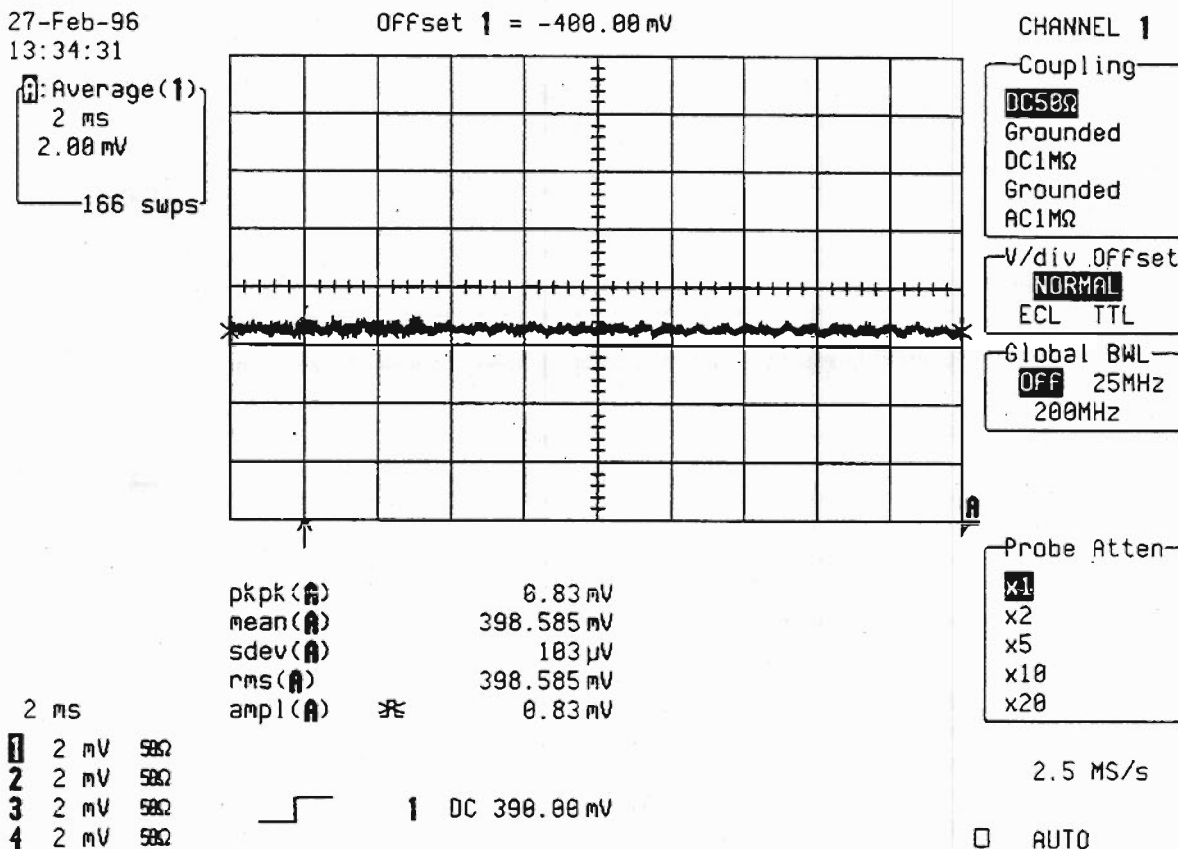

- Repeat step 5.8.1.a for Channel 2, Channel 3 and Channel 4 substituting channel controls and input connector.

5.8.1.b Positive Offset Control Procedure

Set the DSO as in 5.8.1.a:

- Input Coupling : DC 1M Ω
- Channel 1 input gain : 5 mV

- From the high precision voltage source PS5004, apply to Channel 1 - 1 V.
- Using the offset control, move Channel 1 trace through the entire range until the maximum offset value is reached : + 1 V.
- Verify that the displayed trace A : Average (1) is in the screen, near to the center horizontal graticule line.

- Check after at least 100 sweeps that the mean (A) parameter readout is : minimum - .985 V, maximum - 1.015 V. (see table 5-6).

Range	Conditions of Test		Offset Control	Mean Parameter Reading	
	PS Output	9384/M/L/TM /AL Input	9384/M/L/TM /AL Offset	Minimum Value,	Maximum Value,
5 mV	- 1 V	- 1 V	+ 1 V	- .985 V	- 1.015 V
2 mV	- 400 mV	- 400 mV	+ 400 mV	- 392 mV	- 408 mV

Table 5-6 : Positive offset control

Section 5 Performance Verification

27-Feb-96
13:28:02

Offset 1 = 1.00000 V

Average (1)
2 ms
5.0 mV
134 swps

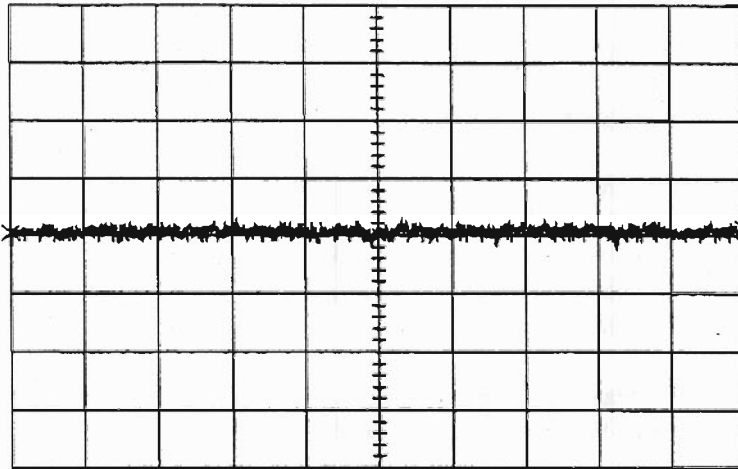

pkpk(A) 2.78 mV
mean(A) -999.687 mV
sdev(A) 271 μV
rms(A) 999.687 mV
ampl(A) 2.78 mV

2 ms

- 1 5 mV DC
- 2 5 mV DC
- 3 5 mV DC
- 4 5 mV DC

1 DC -975.0 mV

MEASURE

OFF Cursors
Parameters

mode
Std Voltage
Std Time
Custom
Pass
Fail

statistics
OFF On

on displayed
(trace)

from
8.00 div
Track OFF On

to
10.00 div
5000 pts

2.5 MS/s

AUTO

- Select Input Coupling : **DC 50Ω**
- Input gain : **5 mV**
- Press clear sweeps
- Check after at least 100 sweeps that the mean (A) parameter readout is :
minimum - .985 V , maximum - 1.015 V.
- Set input gain to **2 mV/div** from the high precision voltage source, apply to
Channel 1 the following voltage value : - **400 mV**.
- Using the offset control, move the Ch1 trace through the entire range until the
following offset value is reached : + **400 mV**.
- Press clear sweeps
- Check after at least 100 sweeps that the mean (A) parameter readout is :
minimum - **392 mV**, maximum - **408 mV** (see table 5-6).

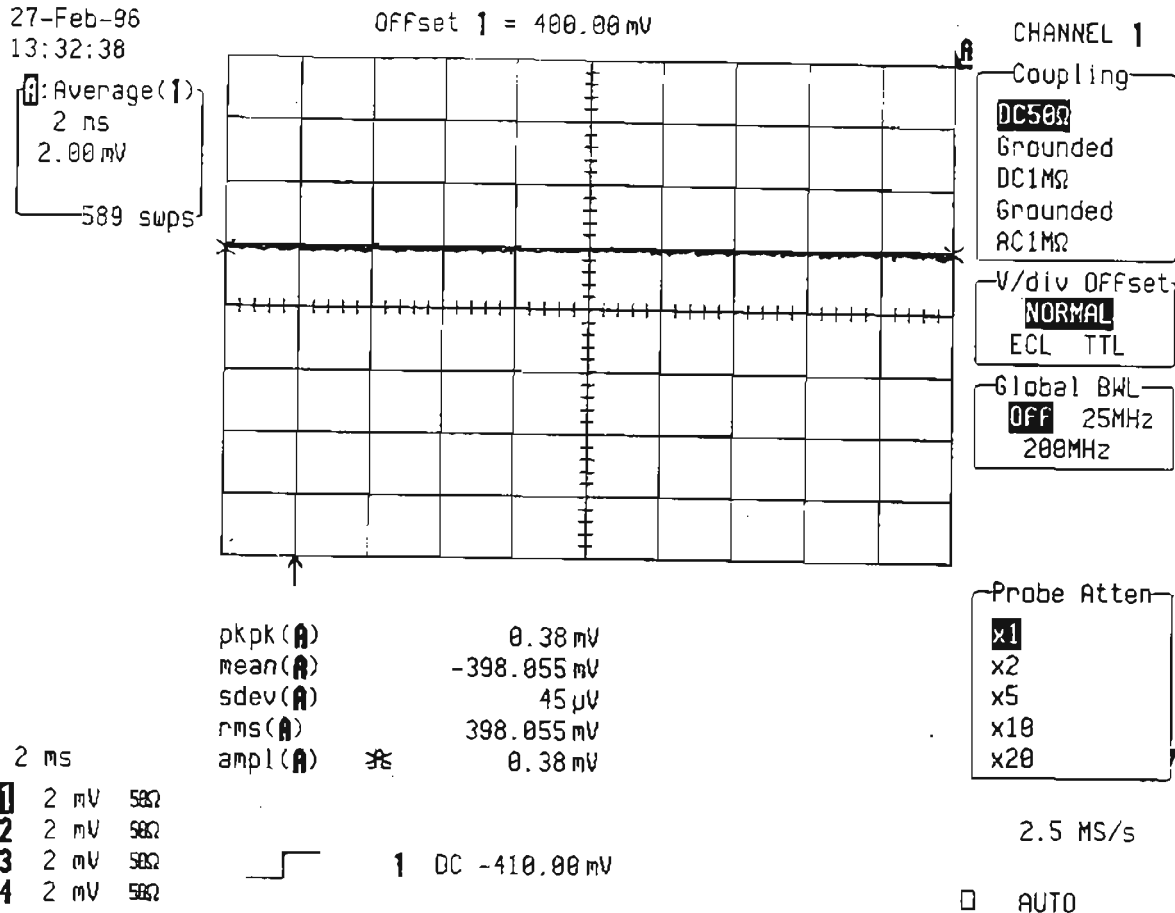

- Repeat step 5.8.1.b for Channel 2, Channel 3 and Channel 4 substituting channel controls and input connector.

5.9 Bandwidth

5.9.1 Description

The purpose of this test is to ensure that the entire system has a bandwidth of at least 1 GHz . An external source is used as the reference to provide a signal where amplitude and frequency are well controlled. A serious measurement of the bandwidth requires the use of a source whose amplitude does not change with frequency. The LeCroy calibration software corrects for the measured amplitude variation of the generator used. Generators can have errors of - 1 dB above 500 MHz. The non flatness of the generator should be taken into consideration.

Specifications

- DC to at least 1 GHz (- 3 dB) at 10 mV/div. and above.
- DC to at least 400 MHz at 5 mV/div.
- DC to at least 150 MHz at 2 mV/div.

5.9.1.a DC 50 Ω

Procedure

- Turn on trace : **Ch1**
 - Display setup : **Standard, Persistence off, Dot join on, Single grid**
 - Input Coupling : **DC 50 Ω**
 - V/div. offset : **Normal**
 - Global BWL : **Off**
 - Probe atten : **X1**
 - Input gain : **50 mV/div.**
 - Offset : **0 mV**
 - Trigger setup : **Edge**
 - Trigger on : **Line**
 - Slope Line : **Pos**
 - Mode : **Norm or Auto**
 - Timebase : **10 μ sec/div.**
 - Channel use : **4**
 - Record up : **50 K**
 - Press Cursors/Measure: **Parameters**
 - Mode : **Custom**
 - Statistics : **off**
 - Change parameters : **Measure**
 - On line 1 : **sdev of 1**
 - On line 2 : **freq of 1**
- Connect a HP8648B sine wave generator to Channel 1, set the frequency to **500 KHz**, adjust the generator output amplitude to get on DSO : **sdev(1) = 80 mV**.

27-Feb-96
14:05:29

10 μ s
50 mV

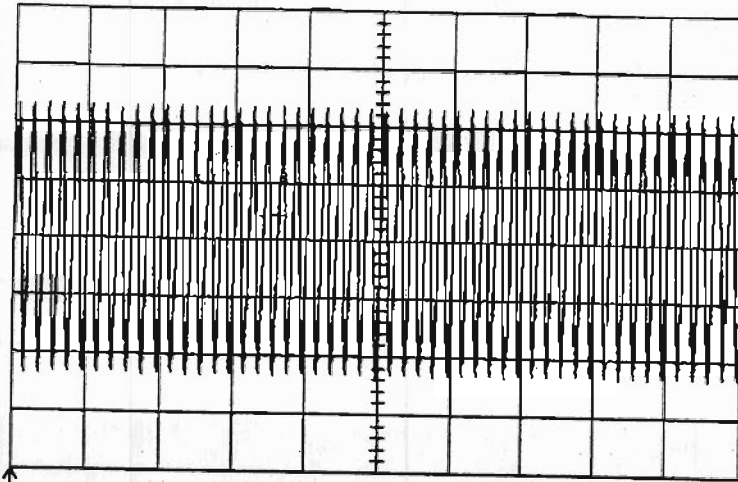

TRIGGER SETUP

Edge SMART

trigger on
1 2 3 4 Ext
Ext10 Line

slope Line
Positive
Negative

sdev(1) 80.66 mV
Freq(1) 499.849 kHz

10 μ s

- 1 50 mV 50 Ω
- 2 50 mV 50 Ω
- 3 50 mV 50 Ω
- 4 50 mV 50 Ω

Line

500 MS/s

AUTO

27-Feb-96
14:05:44

10 μ s
50 mV

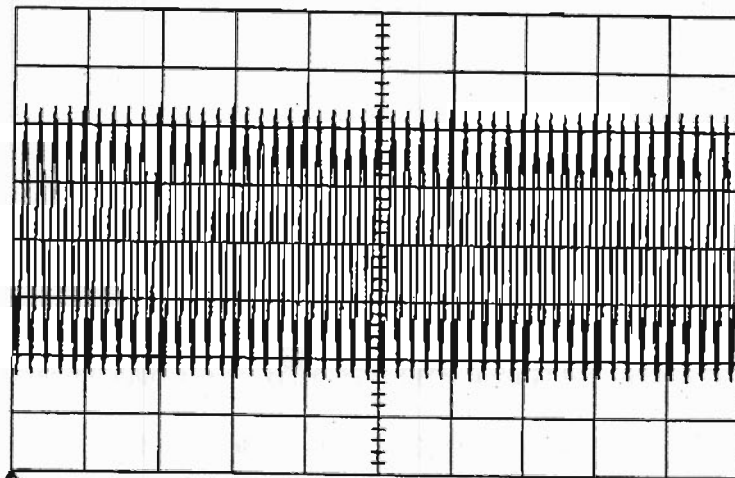

MEASURE

OFF Cursors
Parameters

mode
Std Voltage
Std Time
Custom
Pass
Fail

statistics
OFF On

CHANGE
PARAMETERS

from
8.00 div
Track OFF On

to
10.00 div

sdev(1) 80.73 mV
Freq(1) 499.838 kHz

10 μ s

- 1 50 mV 50 Ω
- 2 50 mV 50 Ω
- 3 50 mV 50 Ω
- 4 50 mV 50 Ω

Line

500 MS/s

AUTO

Section 5 Performance Verification

- Increase the generator frequency in multi 50 MHz steps until the sine wave amplitude is 70% of the initial amplitude at 500 KHz .
- At each 50 MHz step, check that $sdev(1) > 56 \text{ mV}$
- When $sdev(1) = 56 \text{ mV}$ (3 dB point) the frequency of the generator must be at least 1 GHz.

27-Feb-96
14:09:28

10 μs
50 mV

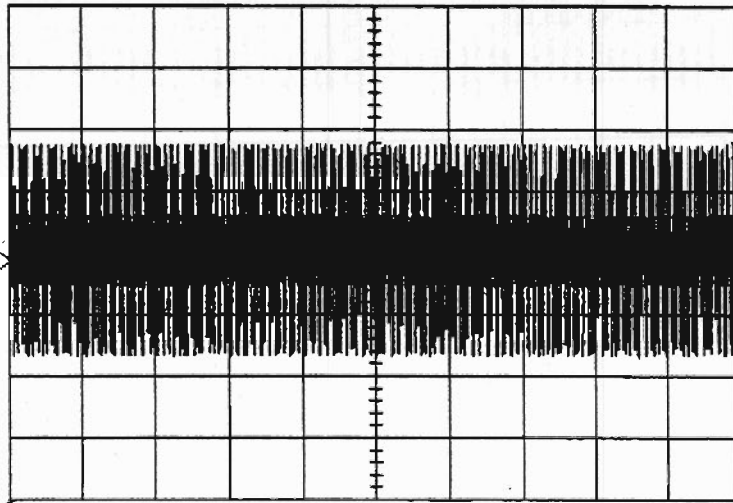

pkpk(1)	173.4 mV
mean(1)	1.08 mV
sdev(1)	58.57 mV
rms(1)	58.58 mV
ampl(1)	164.0 mV

10 μs
 50 mV 500
 2 50 mV 500
 3 50 mV 500
 4 50 mV 500

 Line

MEASURE

OFF Cursors
Parameters

mode
 Std Voltage
 Std Time
 Custom
 Pass
 Fail

statistics
 Off On

on displayed
(trace)

from
 0.00 div
 Track Off On

to
 10.00 div
 50000 pts

500 MS/s

NORMAL

- Select Coupling and Global BWL : 25 MHz (bandwidth limiter on)
- Check that the frequency at the 3 dB point ($sdev(1) = 56 \text{ mV}$) is typically 25 MHz . (between 10 MHz and 37 MHz).

27-Feb-96
14:12:53

10 μ s
50 mV

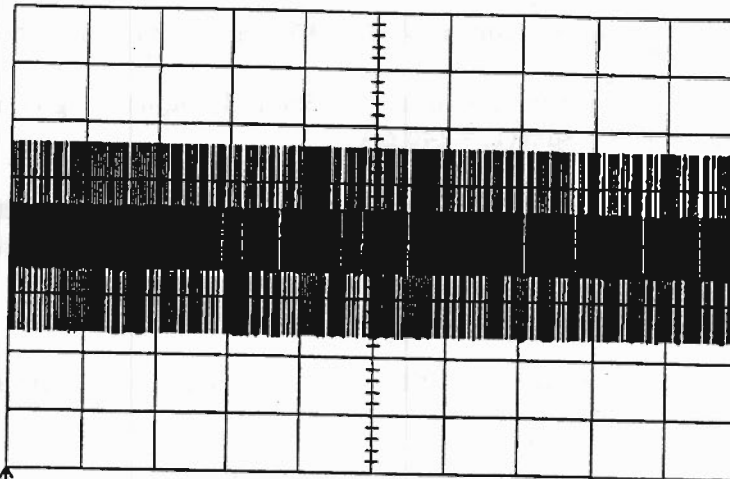

sdev(1) 57.23 mV
Freq(1) 24.8001 MHz

CHANNEL 1
Coupling
DC50 Ω
Grounded
DC1M Ω
Grounded
AC1M Ω
V/div Offset
NORMAL
ECL TTL
Global BWL
OFF 25MHz
200MHz

Probe Atten
x1
x2
x5
x10
x20

10 μ s BWL
50 mV 50 Ω

500 MS/c

- Select Coupling and Global BWL : 200 MHz (bandwidth limiter on)
- Check that the frequency at the 3 dB point (sdev(1) = 56 mV) is typically 200 MHz . (between 110 MHz and 290 MHz) .

27-Feb-96
14:14:39

10 μ s
50 mV

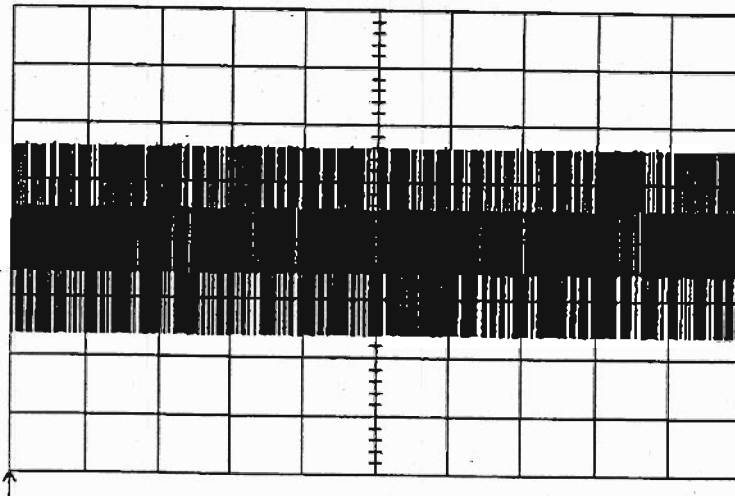

sdev(1) 56.27 mV
Freq(1) 175.188 MHz

CHANNEL 1
Coupling
DC50 Ω
Grounded
DC1M Ω
Grounded
AC1M Ω
V/div Offset
NORMAL
ECL TTL
Global BWL
OFF 25MHz
200MHz

Probe Atten
x1
x2
x5
x10
x20

10 μ s BWL
50 mV 50 Ω

500 MS/c

Section 5 Performance Verification

- Set DSO Input gain : 100 mV/div.
- Select Coupling and Global BWL : Off (bandwidth limiter off)
- Set sine wave generator frequency to 500 KHz, adjust the generator output amplitude to get on DSO : sdev(1) = 140 mV.
- Increase the generator frequency in multi 50 MHz steps until the sine wave amplitude is 70% of the initial amplitude at 500 KHz .
- At each 50 MHz step, check that sdev(1) > 98 mV
- When sdev(1) = 98 mV (3 dB point) the frequency of the generator must be at least 1 GHz.

27-Feb-96
14:29:46

10 μ s
100 mV

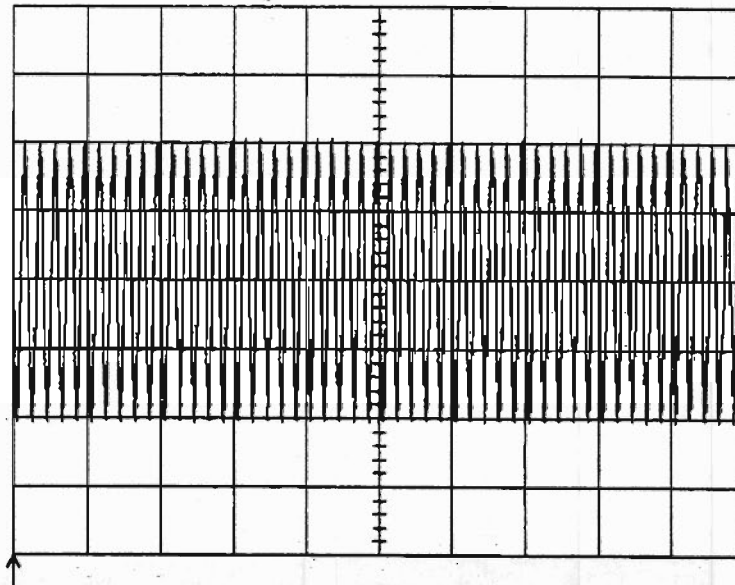

sdev(1) 140.3 mV
freq(1) 499.846 kHz

10 μ s
1 .1 V 50 Ω
2 .1 V 50 Ω
3 .1 V 50 Ω
4 .1 V 50 Ω

Line

MEASURE

OFF Cursors
Parameters

mode
Std Voltage
Std Time
CUSTOM
Pass
Fail

statistics
OFF On

CHANGE
PARAMETERS

from
0.00 div
Track OFF On

to
10.00 div

500 MS/s

NORMAL

27-Feb-96
14:23:33

10 μ s
100 mV

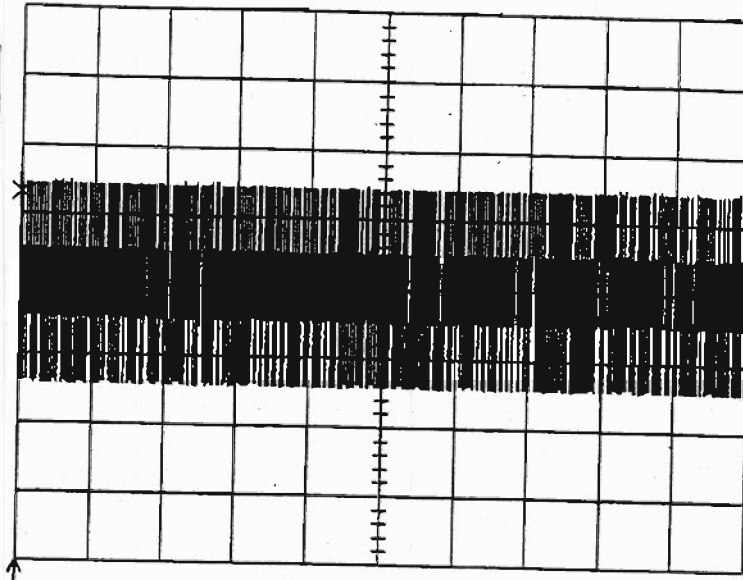

MEASURE

OFF Cursors
Parameters

mode
Std Voltage
Std Time
Custom
Pass
Fail

statistics
OFF On

on displayed
(trace)
1

from
8.00 div
Track OFF On

to
10.00 div
50000 pts

500 MS/s

NORMAL

pkpk(1) 294 mV
mean(1) 0.9 mV
sdev(1) 98.7 mV
rms(1) 98.7 mV
ampl(1) 273 mV

10 μ s
1 .1 V 50 Ω
2 .1 V 50 Ω
3 .1 V 50 Ω
4 .1 V 50 Ω

 Line

5.9.1.a.1 Trigger Bandwidth

- Set DSO Input gain : 100 mV/div.
- Set Trigger on : 1
- Coupling 1 : HF
- Mode : Norm
- Timebase : 1 nsec/div.
- Set sine wave generator frequency to 501 MHz
- Change Trigger level, until the scope triggers on Channel 1.

Section 5 Performance Verification

27-Feb-96
14:31:27

1 ns
100 mV

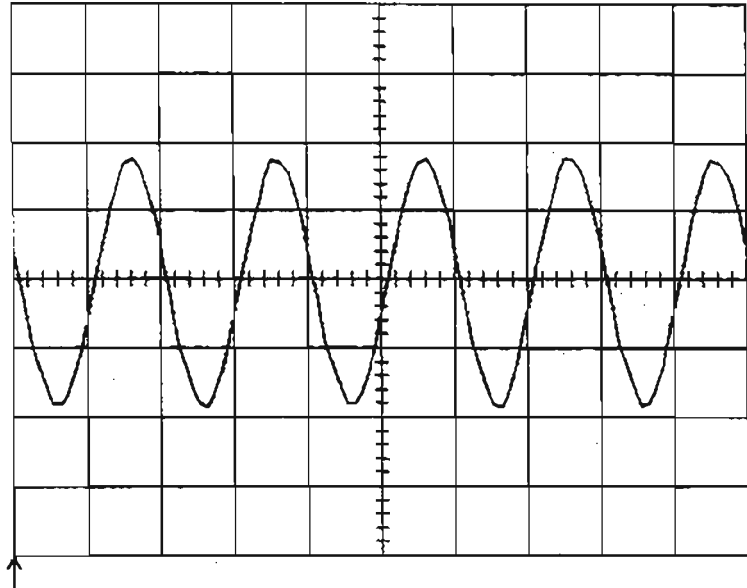

sdev(1) 126.4 mV
freq(1) 500.961 MHz

TRIGGER SETUP

Edge SMART

trigger on 1 2 3 4 Ext
Ext10 Line

coupling 1
DC AC LFREJ
HFREJ HF

holdoff
- - -
OFF Time Evts

1 ns RIS

1 .1 V 50Ω
2 .1 V 50Ω
3 .1 V 50Ω
4 .1 V 50Ω

1 HF 6 mV

10 GS/s

NORMAL

- Check : The scope must keep triggering in a stable way, a smooth 501 MHz sine wave must be visible on the screen.
- Repeat step 5.9.1.a and 5.9.1.a.1 for Channel 2, Channel 3 and Channel 4 substituting channel controls and input connector.

5.9.1.b 1 M Ω

The purpose of this test is to ensure that the entire 9384/M/L/TM/AL system has a bandwidth of at least **450 MHz at probe tip**.

Set up a HP8648B sine wave generator or equivalent.

- Terminate the output of the HP8648B via a **50 Ω feed through** and connect it to the channel 1 input through a LeCroy PP005 10X-probe using a probe tip BNC Jack adapter.

Make sure the probe compensation is perfectly adjusted at low frequency.

- Turn on trace : **Ch1**
 - Display setup : **Standard, Persistence off, Dot join on, Single grid**
 - Input Coupling : **AC 1M Ω**
 - V/div. offset : **Normal**
 - Global BWL : **Off**
 - Input gain : **1 V/div.**
 - Offset : **0 mV**
 - Trigger setup : **Edge**
 - Trigger on : **Line**
 - Slope Line : **Pos**
 - Mode : **Norm**
 - Timebase : **10 μ sec/div.**
 - Channel use : **4**
 - Record up : **50 K**
 - Press Cursors/Measure: **Parameters**
 - Mode : **Custom**
 - Statistics : **off**
 - Change parameters : **Measure**
 - On line 1 : **sdev of 1**
 - On line 2 : **freq of 1**
- Set sine wave generator frequency to **500 KHz**, adjust the generator output amplitude to get on DSO : **sdev(1) = 2.5 V**.
 - Increase the generator frequency in multi **50 MHz** steps until the sine wave amplitude is 70% of the initial amplitude at 500 KHz .
 - At each frequency step, check that **sdev(1) > 1.75 V**
 - When **sdev(1) = 1.75 V (3 dB point)** the frequency of the generator must be at least **450 MHz**.
 - Repeat step 5.9.1.b for Channel 2, Channel 3 and Channel 4 substituting channel control and input connector.

Section 5 Performance Verification

28-Feb-96
9:22:14

10 μ s
1.00 V

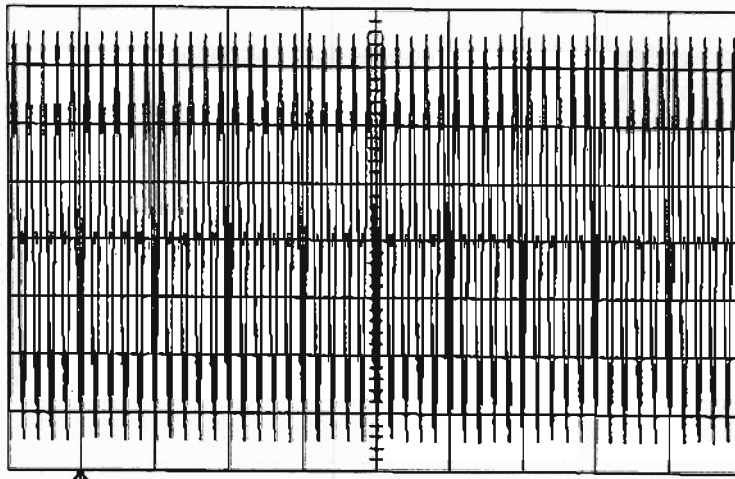

sdev(1) 2.587 V
Freq(1) 499.839 kHz

CHANNEL 1

Coupling
DC50 Ω
Grounded
DC1M Ω
Grounded
AC1M Ω
V/div Offset
NORMAL
ECL TTL
Global BWL
OFF 25MHz
200MHz

Probe sensed
(x10)

10 μ s

1 .1 V AC \times
2 .1 V AC
3 .1 V AC
4 .1 V AC

Line

500 MS/s

NORMAL

28-Feb-96
9:24:19

10 μ s
1.00 V

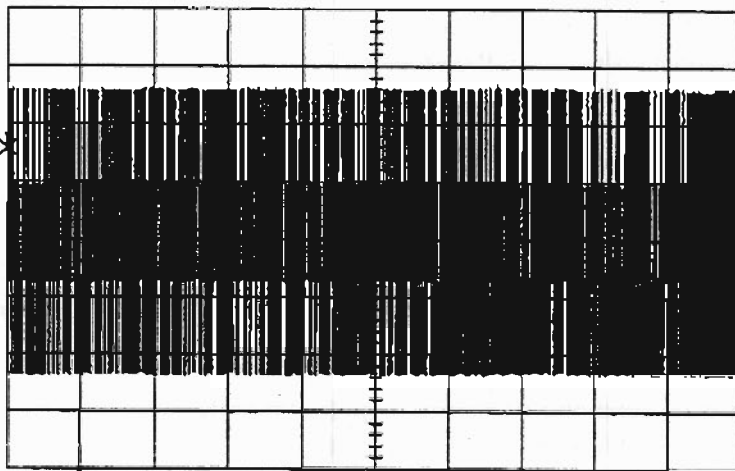

pkpk(1) 5.06 V
mean(1) 102 mV
sdev(1) 1.743 V
rms(1) 1.746 V
ampl(1) 4.78 V

MEASURE

OFF Cursors
Parameters
mode
Std Voltage
Std Time
Custom
Pass
Fail
statistics
OFF On
on displayed
(trace)
1
from
0.00 div
Track **OFF** On
to
10.00 div
50000 pts

500 MS/s

NORMAL

10 μ s

1 .1 V AC \times
2 .1 V AC
3 .1 V AC
4 .1 V AC

Line

5.10 Trigger Level

5.10.1 Description

The trigger capabilities are tested for several cases of the standard edge trigger :

- Channel (internal), and External Trigger sources
- Three DC levels : -3, 0, +3 major screen divisions
- DC coupling
- Positive and negative slopes

5.10.2 Channel (internal)

The horizontal and vertical errors for a trigger at 0 v threshold are determined by comparing the crossing point of the same sine wave at two different amplitudes.

- Setup any sine wave generator capable of generating sine waves of 1 KHz, 4V pkpk.
- Connect the generator output to Channel 1

- Turn on trace : **Ch1**
- Input Coupling Ch 1 : **DC 50 Ω**
- V/div. offset : **Normal**
- Input gain : **.5 V/div.**
- Input offset : **0 mV**
- Trigger setup : **Edge**
- Trigger on : **1**
- Coupling 1 : **DC**
- Slope 1 : **Pos**
- Set Trigger level : **DC 0.0 mV**
- Mode : **Single**
- Pre-Trigger Delay : **50 %**
- Timebase : **.1 msec/div.**
- Channel Use : **4**
- Record up to : **50 K samples**

- Adjust the sine wave generator's output amplitude to get **8 divisions peak to peak**, corresponding to a **4 V** amplitude.
- It is important that the offset of the input is set to **zero mV**, use show status and acquisition status to verify.

- Display setup : **Dot join Off**
- Set **Persistence On**, and acquire few sweeps in Single Trigger mode.
- Connect a **3 dB attenuator**, and acquire few more sweeps in Single mode.

- Select Cursors/Measure : **Cursors, Time, Absolute**
- Use the " cursor position " knob, to move the marker at the **horizontal crossing point** of the two sine waves.

- Check that the **time** difference obtained between the marker and the trigger is within **± 20 μ sec**. The time readout is below 0.50 V in the icon 1, at top left.

- Select Cursors mode : **Amplitude, Absolute**
- Use the " cursor position " knob, to move the marker at the **vertical crossing point** of the two sine waves.
- Check that the **voltage** difference obtained between the marker and the trigger level is within ± 200 mV. The level readout is below 0.50 V in the icon 1, at top left.

28-Feb-96
11:28:31

1
.1 ms
8.58 V
8 mV

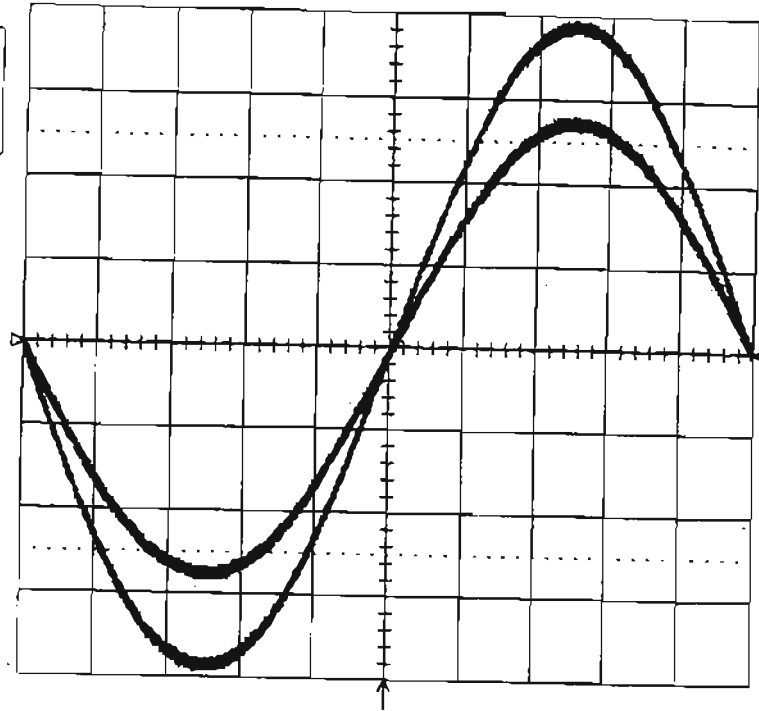

MEASURE

OFF **Cursors**
Parameters

mode
Time
Amplitude

type
Relative
Absolute

cursor
Position

.1 ms
 1 .5 V 50Ω
 2 .5 V 50Ω
 3 .5 V 50Ω
 4 .5 V 50Ω

21 sweeps

DC 0.00 V

58 MS/s

STOPPED

- Set Trigger Slope 1 : **Neg**
- Disconnect the **3 dB attenuator** from the BNC input
- Acquire few sweeps in Single Trigger mode.
- Connect the **3 dB attenuator**, and acquire few more sweeps in Single mode.
- Select Cursors/Measure : **Cursors, Time, Absolute**
- Use the " cursor position " knob, to move the marker at the **horizontal crossing point** of the two sine waves.
- Check that the **time** difference obtained between the marker and the trigger is within ± 20 μ sec. The time readout is below 0.50 V in the icon 1, at top left.
- Select Cursors mode : **Amplitude, Absolute**
- Use the " cursor position " knob, to move the marker at the **vertical crossing point** of the two sine waves.
- Check that the **voltage** difference obtained between the marker and the trigger level is within ± 200 mV. The level readout is below 0.50 V in the icon 1, at top left.

Section 5 Performance Verification

28-Feb-96
11:30:32

1
.1 ms
0.50 V
-2 μ s

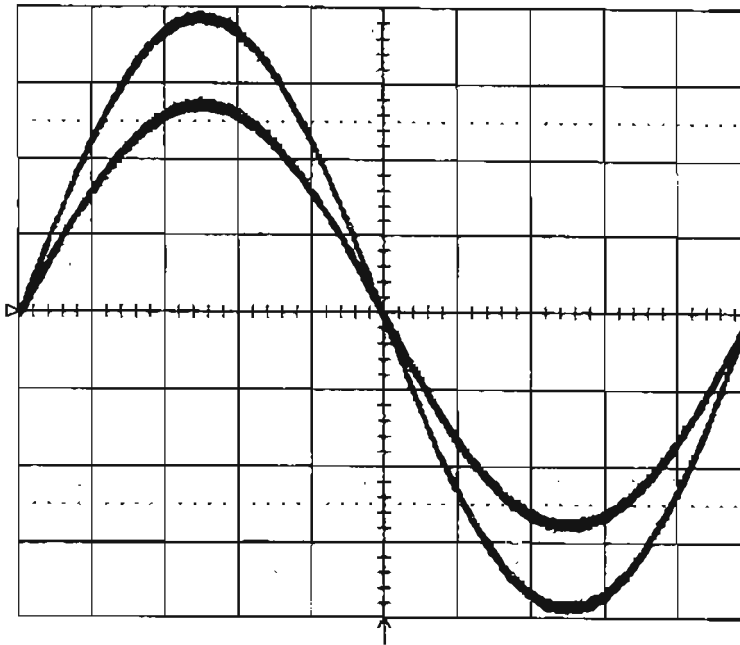

TRIGGER SETUP

Edge SMART
trigger on **1** 2 3 4 Ext Ext10 Line
coupling **1** DC AC LFREJ HFREJ HF
slope **1** Pos Neg
holdoff
OFF Time Evts

.1 ms
1 .5 V 50 Ω
2 .5 V 50 Ω
3 .5 V 50 Ω
4 .5 V 50 Ω

21 sweeps
1 DC 0.00 V

50 MS/s
 STOPPED

28-Feb-96
11:31:08

1
.1 ms
0.50 V
-16 mV

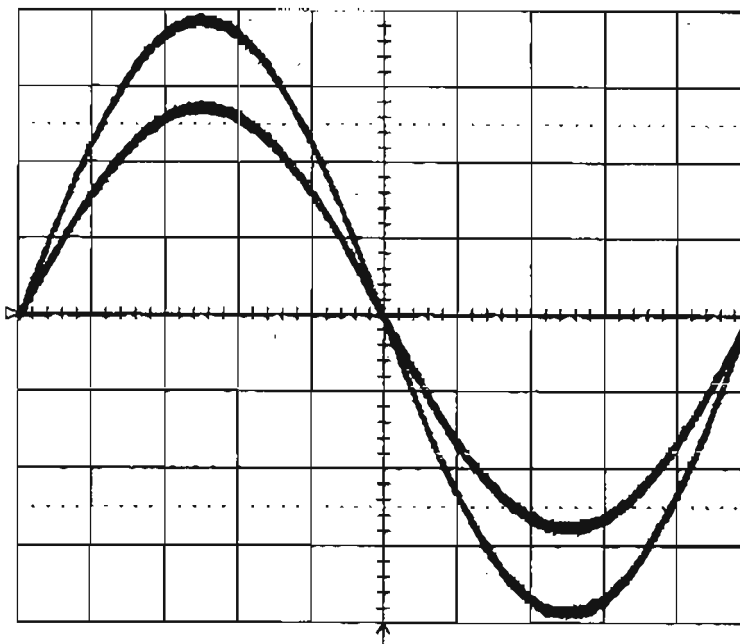

MEASURE

OFF Cursors Parameters
made
Time
Amplitude
type
Relative
Absolute
cursor
Position

.1 ms
1 .5 V 50 Ω
2 .5 V 50 Ω
3 .5 V 50 Ω
4 .5 V 50 Ω

21 sweeps
1 DC 0.00 V

50 MS/s
 STOPPED

- Set Trigger level : DC + 1.5 V
- Disconnect the 3 dB attenuator from the BNC input
- Set Trigger Slope 1 : Pos

- Acquire few sweeps in Single Trigger mode.

- The sine wave must pass through the **horizontal center** of the screen at the **vertical + 3 divisions**.

- Select Cursors/Measure : **Cursors, Amplitude, Absolute**

- Use the " cursor position " knob, to move the marker, at the **crossing point** of the **sine wave** and the **horizontal center of the screen** (50% pre-trigger line).

- Check that the **vertical crossing point level is + 1.5 V ± .2 V**. See icon 1 at top left.

28-Feb-96
11:33:57

1
.1 MS
0.50 V
1.547 V

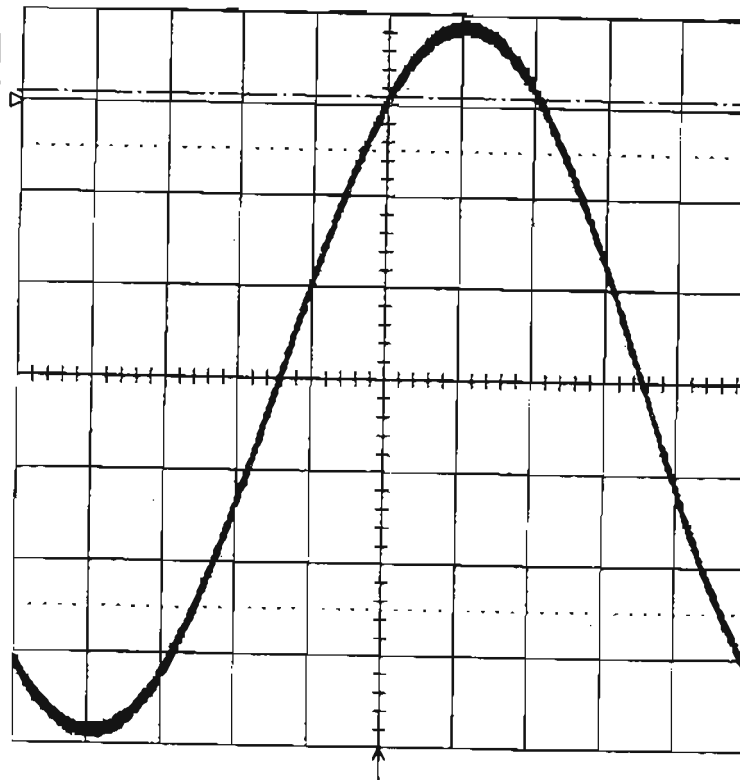

MEASURE

OFF **Cursors**
Parameters
mode
Time
Amplitude
type
Relative
Absolute

cursor
Position

.1 MS
1 .5 V 50Ω
2 .5 V 50Ω
3 .5 V 50Ω
4 .5 V 50Ω

11 sweeps

1 DC 1.50 V

50 MS/s

STOPPED

Section 5 Performance Verification

- Set Trigger Slope 1 : Neg
- Acquire few sweeps in Single Trigger mode.
- The sine wave must pass through the **horizontal center** of the screen at the **vertical + 3 divisions**.
- Select Cursors/Measure : **Cursors, Amplitude, Absolute**
- Use the " cursor position " knob, to move the marker, at the **crossing point** of the sine wave and the **horizontal center of the screen** (50% pre-trigger line).
- Check that the **vertical crossing point level is + 1.5 V ± .2 V**. See icon at top left.

28-Feb-96
11:34:47

1
.1 ms
0.50 V
1.484 V

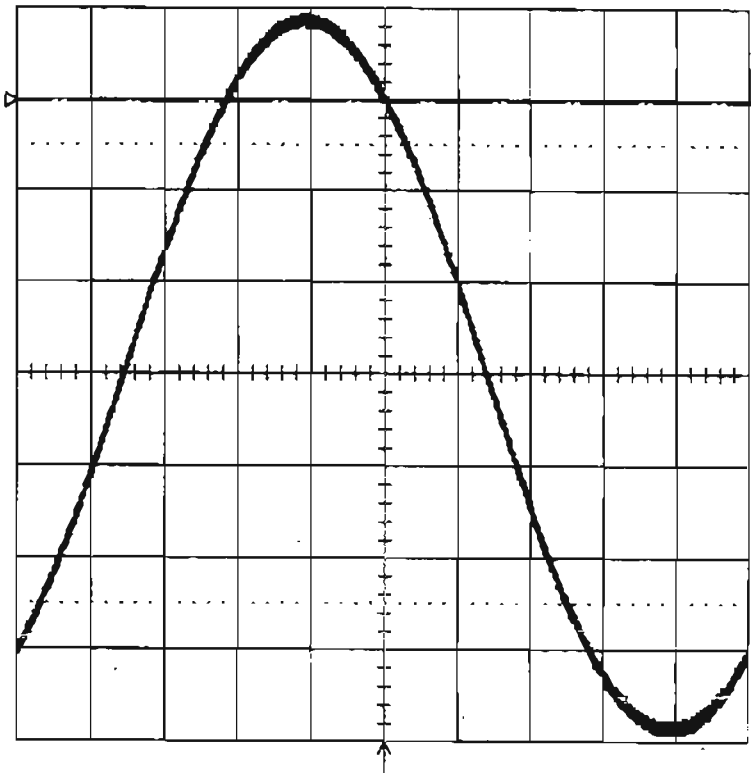

TRIGGER SETUP

edge SMART

trigger on
1 2 3 4 Ext
Ext10 Line

coupling **1**
DC AC LFREJ
HFREJ HF

slope **1**
Pos **Neg**

holdoff

OFF Time Evts

.1 ms
1 .5 V 50Ω
2 .5 V 50Ω
3 .5 V 50Ω
4 .5 V 50Ω

11 sweeps

1 DC 1.50 V

50 MS/s

STOPPED

- Set Trigger level : DC - 1.5 V
- Set Trigger Slope 1 : Pos
- Acquire few sweeps in Single Trigger mode.
- The sine wave must pass through the **horizontal center** of the screen at the **vertical - 3 divisions**.
- Select Cursors/Measure : **Cursors, Amplitude, Absolute**
- Use the " cursor position " knob, to move the marker, at the **crossing point** of the **sine wave** and the **horizontal center of the screen** (50% pre-trigger line).
- Check that the **vertical crossing point level is - 1.5 V ± .2 V**. See icon 1 at top left.

28-Feb-96
11:36:19

1
.1 ms
0.50 V
-1.477 V

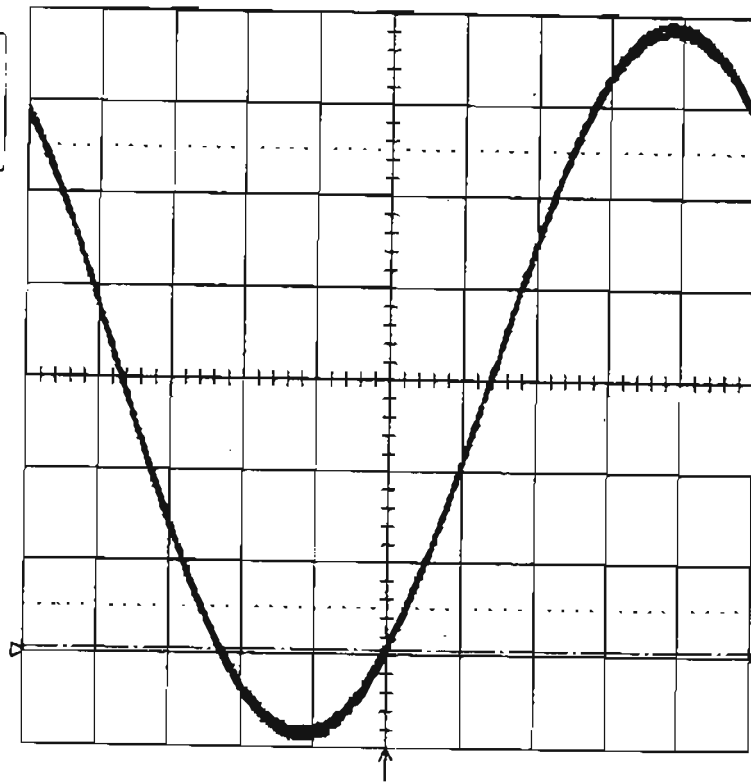

TRIGGER SETUP

Edge SMART

trigger on
1 2 3 4 Ext
Ext10 Line

coupling 1
DC AC LFREJ
HFREJ HF

slope 1
Pos Neg

holdoff

OFF Time Evts

.1 ms
1 .5 V 50Ω
2 .5 V 50Ω
3 .5 V 50Ω
4 .5 V 50Ω

11 sweeps

↑ DC -1.50 V

50 MS/s

□ STOPPED

Section 5 Performance Verification

- Set Trigger Slope 1 : **Neg**
- Acquire few sweeps in Single Trigger mode.
- The sine wave must pass through the **horizontal center** of the screen at the **vertical - 3 divisions**.
- Select Cursors/Measure : **Cursors, Amplitude, Absolute**
- Use the " cursor position " knob, to move the marker, at the **crossing point** of the **sine wave** and the **horizontal center of the screen** (50% pre-trigger line).
- Check that the **vertical crossing point level is - 1.5 V ± .2 V**. See icon 1 at top left.

28-Feb-96
11:37:25

1
.1 ms
0.50 V
-1.508 V

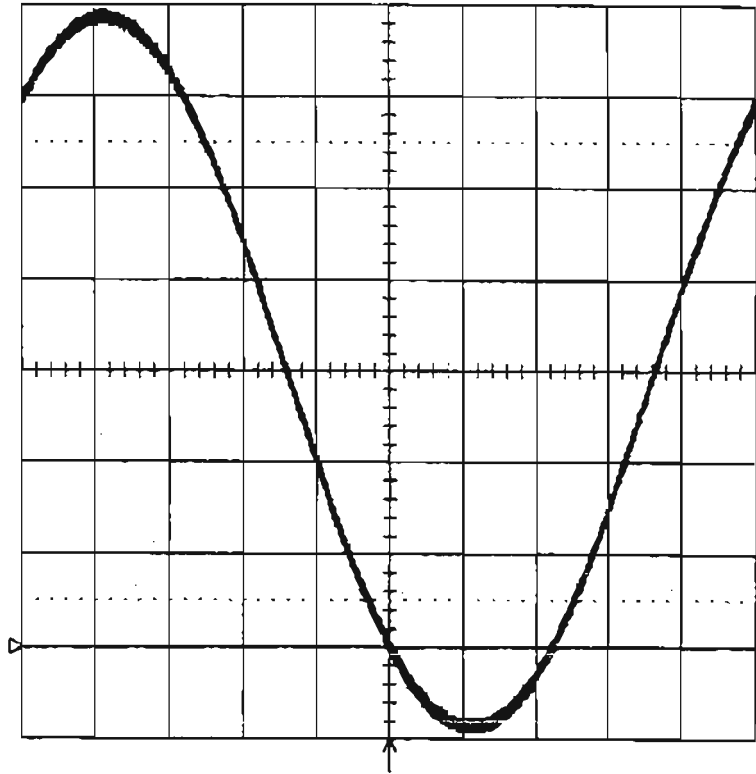

TRIGGER SETUP

Edge SMART

trigger on
1 2 3 4 Ext
Ext10 Line

coupling 1
DC AC LFREJ
HFREJ HF

slope 1
Pos **Neg**

holdoff
- - -
OFF Time Evts

.1 ms

1 .5 V 50Ω
2 .5 V 50Ω
3 .5 V 50Ω
4 .5 V 50Ω

12 sweeps

1 DC -1.50 V

50 MS/s

□ STOPPED

- Repeat step 5.10.2 for Channel 2, Channel 3 and Channel 4, substituting channel controls and input connector.

5.10.3 External Trigger

Specifications

External trigger range : DC \pm .5 V

Procedure

- Connect the output of the generator to External input and to Channel 2 via a coaxial T-connector. The cable length from External to Channel 2 must be short, at most 2 nsec.
- Set frequency : **1 KHz**
- Turn on trace : **Ch2**
- Input Coupling Ch 2 : **DC 50 Ω**
- V/div. offset : **Normal**
- Input gain : **100 mV/div.**
- Input offset : **0 mV**
- Trigger setup : **Edge**
- Trigger on : **Ext**
- Coupling Ext : **DC**
- Slope Ext : **Pos**
- External : **DC 1M Ω**
- Set Ext Trigger level : **DC 0.0 mV**
- Mode : **Single**
- Pre-Trigger Delay : **50 %**
- Timebase : **.1 msec/div.**
- Channel use : **4**
- Record up to : **50 K samples**
- Adjust the sine wave generator's output amplitude to get **8 divisions peak to peak**, corresponding to a **.8 V** amplitude.
- It is important that the offset of the input is set to **zero mV**, use show status and acquisition status to verify.
- Display setup : **Dot join Off**
- Set **Persistence On**, and acquire few sweeps in Single Trigger mode.
- Connect a **3 dB attenuator**, and acquire few more sweeps in Single mode.
- Select Cursors/Measure : **Cursors, Time, Absolute**
- Use the " cursor position " knob, to move the marker at the **horizontal crossing point** of the two sine waves.
- Check that the **time** difference obtained between the marker and the trigger is within \pm 20 μ sec. The time readout is below 100 mV in the icon 2, at top left.

Section 5 Performance Verification

28-Feb-96
11:44:42

2
.1 ms
100 mV

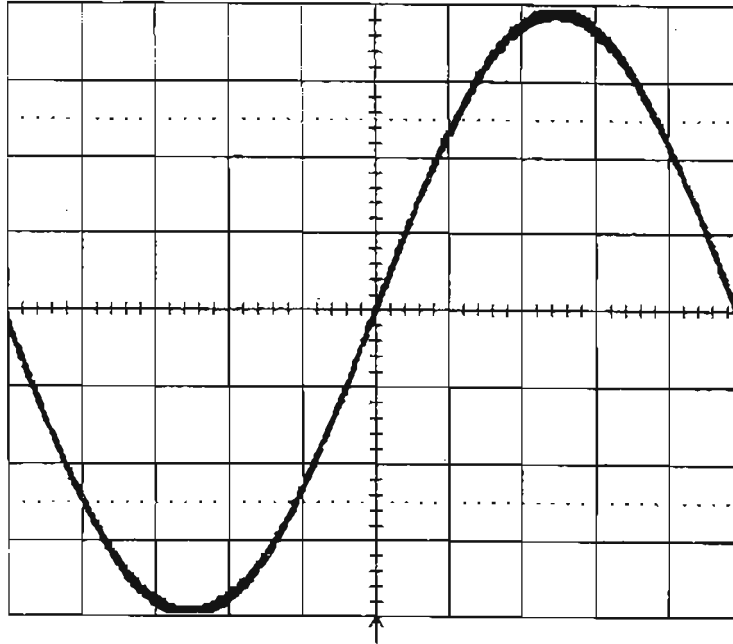

TRIGGER SETUP

Edge SMART

trigger on
1 2 3 4 Ext
Ext10 Line

cp1g Ext
DC AC LFREJ
HFREJ HF

slope Ext
Pos Neg

External
DC50Ω DC1MΩ

holdoff
OFF Time Evts

- .1 ms
- 1 .1 V 50Ω
 - 2 .1 V 50Ω
 - 3 .1 V 50Ω
 - 4 .1 V 50Ω

11 sweeps

Ext DC 0 mV 1MΩ

50 MS/s

STOPPED

28-Feb-96
11:45:21

2
.1 ms
100 mV
-2 μs

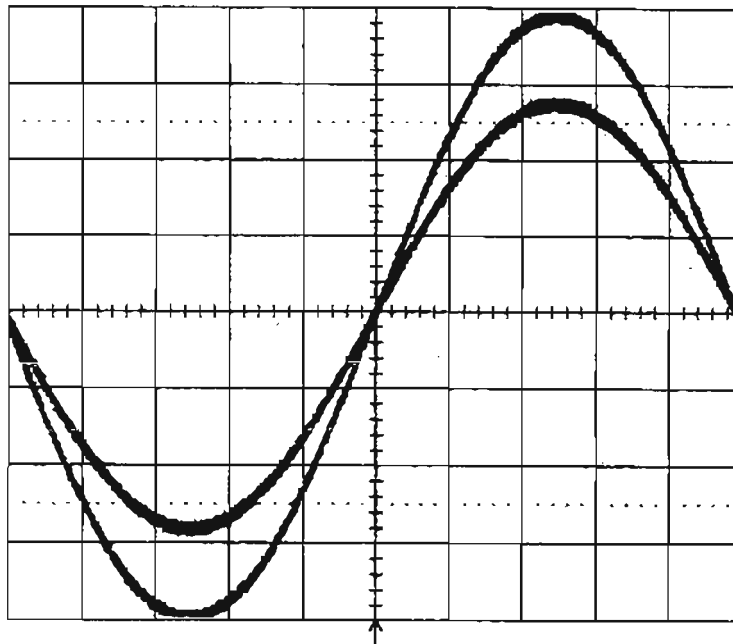

MEASURE

OFF Cursors
Parameters

mode
Time
Amplitude

type
Relative
Absolute

- .1 ms
- 1 .1 V 50Ω
 - 2 .1 V 50Ω
 - 3 .1 V 50Ω
 - 4 .1 V 50Ω

21 sweeps

Ext DC 0 mV 1MΩ

50 MS/s

STOPPED

cursor
Position

- Select Cursors mode : **Amplitude, Absolute**
- Use the " cursor position " knob, to move the marker at the vertical crossing point of the two sine waves.
- Check that the **vertical crossing point level is within ± 40 mV**. See icon 2 at top left.

28-Feb-96
11:45:40

2
.1 ms
100 mV
5 mV

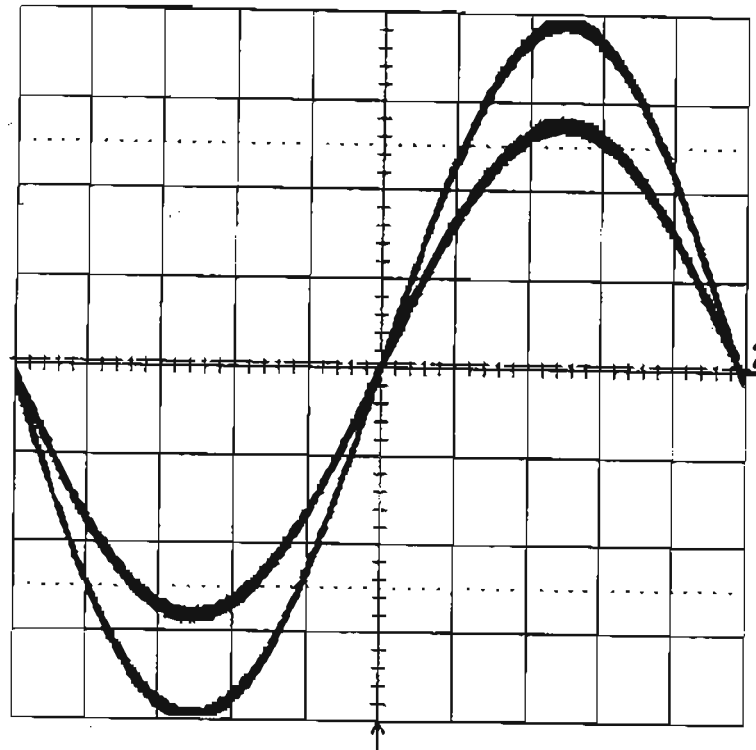

MEASURE

OFF **Cursors**
Parameters

mode
Time
Amplitude

type
Relative
Absolute

cursor
Position

.1 ms

1 .1 V 50Ω
2 .1 V 50Ω
3 .1 V 50Ω
4 .1 V 50Ω

21 sweeps



Ext DC 0 mV 1MΩ

50 MS/s

□ STOPPED

- Set Slope Ext : **Neg**
- Disconnect the **3 dB attenuator** from the BNC input
- Acquire few sweeps in Single Trigger mode.
- Connect the **3 dB attenuator**, and acquire few more sweeps in Single mode.
- Select Cursors/Measure : **Cursors, Time, Absolute**
- Use the " cursor position " knob, to move the marker at the **horizontal crossing point** of the two sine waves.
- Check that the **time difference** obtained between the marker and the trigger is within ± 20 μ sec. The time readout is below 100 mV in the icon 2, at top left.

Section 5 Performance Verification

28-Feb-96
11:48:00

2
.1 ms
100 mV

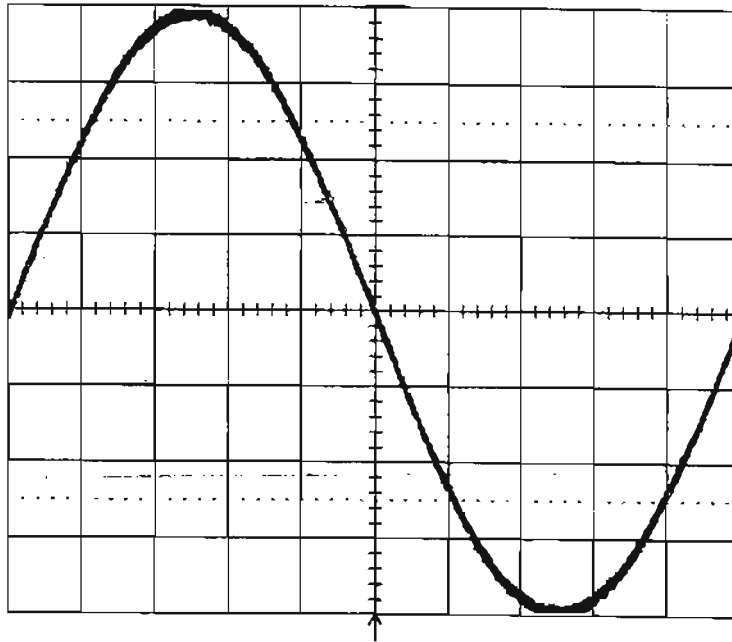

TRIGGER SETUP

Edge SMART

trigger on
1 2 3 4 Ext
Ext10 Line

cp1g Ext
DC AC LFREJ
HFREJ HF

slope Ext
Pos Neg

External
DC50Ω DC1MΩ

holdoff
OFF Time Evts

.1 ms

- 1 .1 V 50Ω
- 2 .1 V 50Ω
- 3 .1 V 50Ω
- 4 .1 V 50Ω

11 sweeps

Ext DC 0 mV 1MΩ

50 MS/s

STOPPED

28-Feb-96
11:48:51

2
.1 ms
100 mV
0 μs

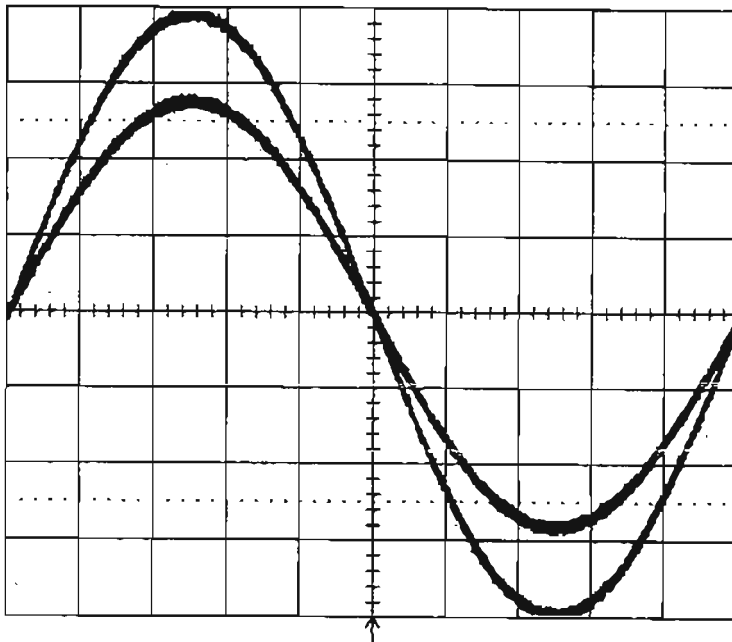

MEASURE

OFF Cursors
Parameters

mode
Time
Amplitude

type
Relative
Absolute

cursor
Position

.1 ms

- 1 .1 V 50Ω
- 2 .1 V 50Ω
- 3 .1 V 50Ω
- 4 .1 V 50Ω

21 sweeps

Ext DC 0 mV 1MΩ

50 MS/s

STOPPED

- Select Cursors mode : **Amplitude, Absolute**
- Use the " cursor position " knob, to move the marker at the **vertical crossing point** of the two sine waves.
- Check that the **voltage** difference obtained between the marker and the trigger level is within ± 40 mV. The level readout is below 100 mV in the icon 2, at top left.

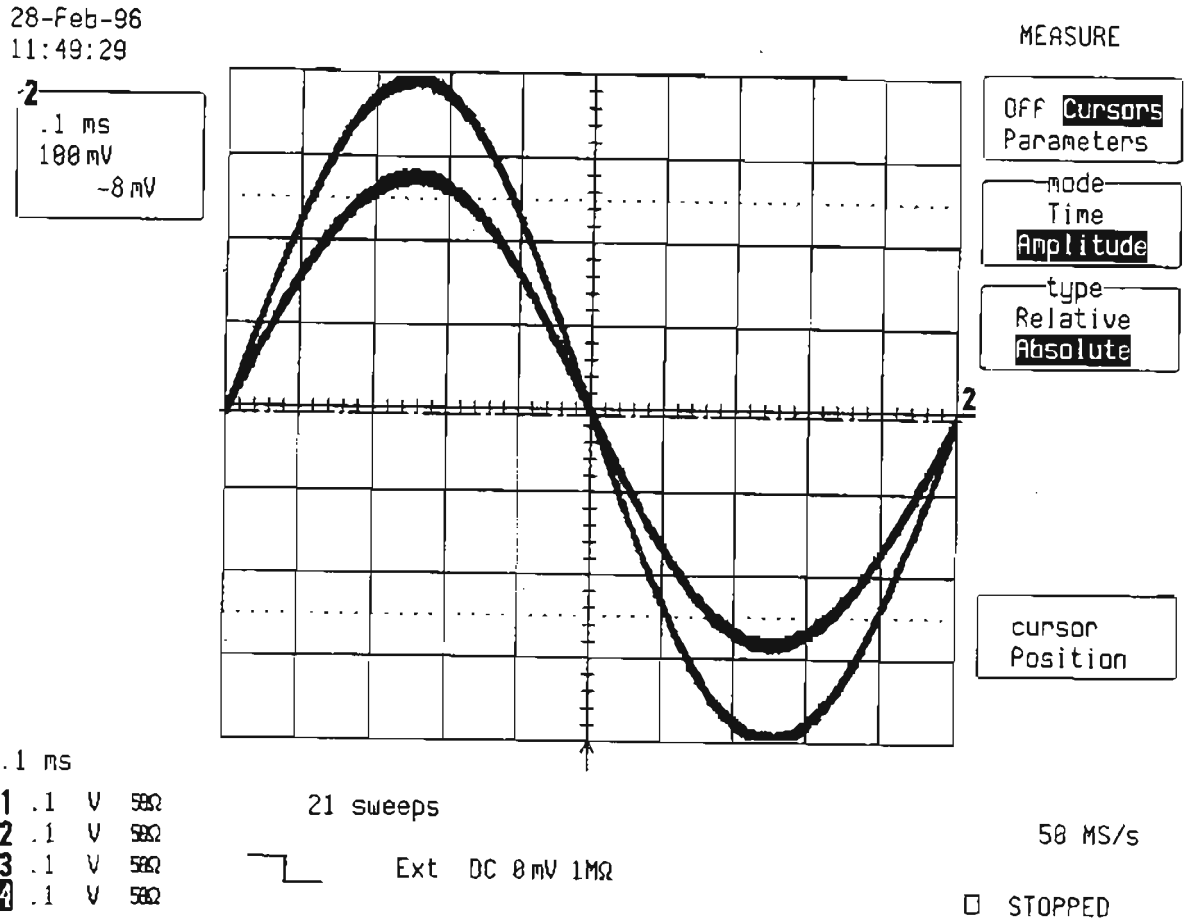

- Set Trigger level : **DC + 300 mV**
- Disconnect the **3 dB attenuator** from the BNC input
- Set Trigger Slope Ext : **Pos**
- Acquire few sweeps in Single Trigger mode.
- The sine wave must pass through the **horizontal center** of the screen at the **vertical + 3 divisions**.
- Select Cursors/Measure : **Cursors, Amplitude, Absolute**
- Use the " cursor position " knob, to move the marker, at the **crossing point** of the **sine wave** and the **horizontal center of the screen** (50% pre-trigger line).
- Check that the **vertical crossing point level** is **+ 300 mV \pm 40 mV**. See icon 2 at top.

Section 5 Performance Verification

28-Feb-96
11:53:02

2
.1 ms
100 mV
313 mV

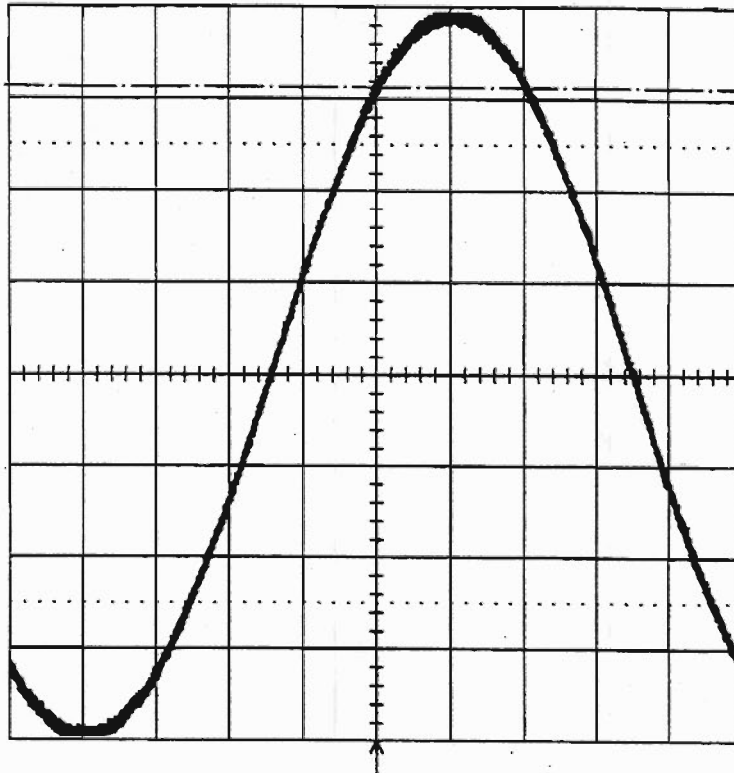

MEASURE

OFF **Cursors**
Parameters

mode
Time
Amplitude

type
Relative
Absolute

cursor
Position

.1 ms

1 .1 V 50Ω
2 .1 V 50Ω
3 .1 V 50Ω
4 .1 V 50Ω

11 sweeps



Ext DC 300 mV 1MΩ

50 MS/s

STOPPED

- Set Trigger Slope Ext : Neg
- Acquire few sweeps in Single Trigger mode.
- The sine wave must pass through the **horizontal center** of the screen at the **vertical + 3 divisions**.
- Select Cursors/Measure : **Cursors, Amplitude, Absolute**
- Use the " cursor position " knob, to move the marker, at the **crossing point** of the **sine wave** and the **horizontal center of the screen** (50% pre-trigger line).
- Check that the **vertical crossing point level is + 300 mV ± 40 mV**. See icon 2 at top .

28-Feb-96
11:53:44

2
.1 ms
100 mV
303 mV

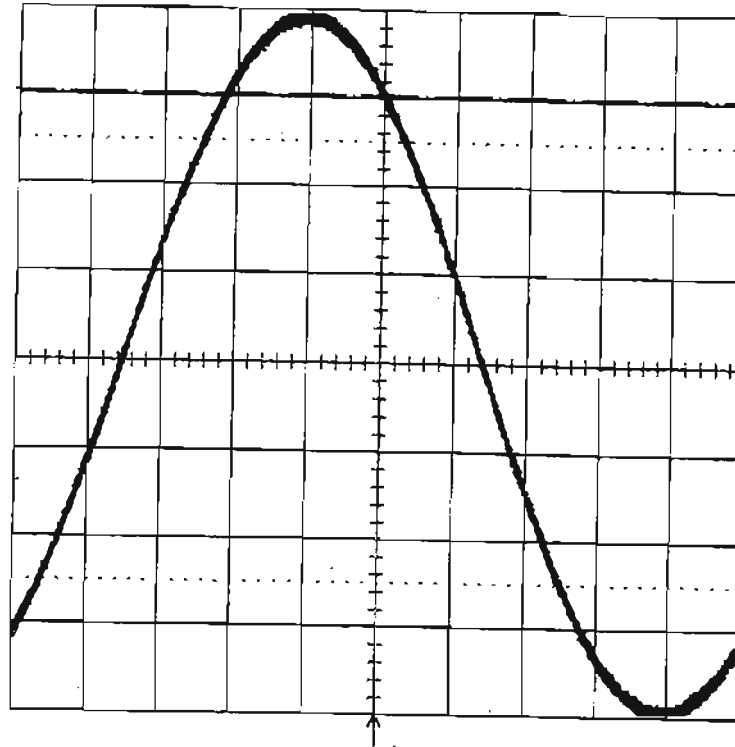

TRIGGER SETUP

Edge SMART

trigger on
1 2 3 4 Ext
Ext10 Line

cplg Ext
DC AC LFREJ
HFREJ HF

slope Ext
Pos Neg

External
DC50Ω DC1MΩ

holdoff
OFF Time Evts

.1 ms

- 1 .1 V 50Ω
- 2 .1 V 50Ω
- 3 .1 V 50Ω
- 4 .1 V 50Ω

11 sweeps

Ext: DC 300 mV 1MΩ

50 MS/s

□ STOPPED

- Set Trigger level : DC - 300 mV
- Set Trigger Slope Ext : Pos
- Acquire few sweeps in Single Trigger mode.
- The sine wave must pass through the **horizontal center** of the screen at the **vertical - 3 divisions**.
- Select Cursors/Measure : **Cursors, Amplitude, Absolute**
- Use the " cursor position " knob, to move the marker, at the **crossing point** of the **sine wave** and the **horizontal center of the screen** (50% pre-trigger line).
- Check that the **vertical crossing point level is - 300 mV ± 40 mV**. See icon 2 at top.
- Set Trigger Slope Ext : Neg
- Acquire few sweeps in Single Trigger mode.
- The sine wave must pass through the **horizontal center** of the screen at the **vertical - 3 divisions**.
- Select Cursors/Measure : **Cursors, Amplitude, Absolute**
- Use the " cursor position " knob, to move the marker, at the **crossing point** of the **sine wave** and the **horizontal center of the screen** (50% pre-trigger line).
- Check that the **vertical crossing point level is - 300 mV ± 40 mV**. See icon 2 at top.

Section 5 Performance Verification

28-Feb-96
11:55:25

2
.1 ms
100 mV
-306 mV

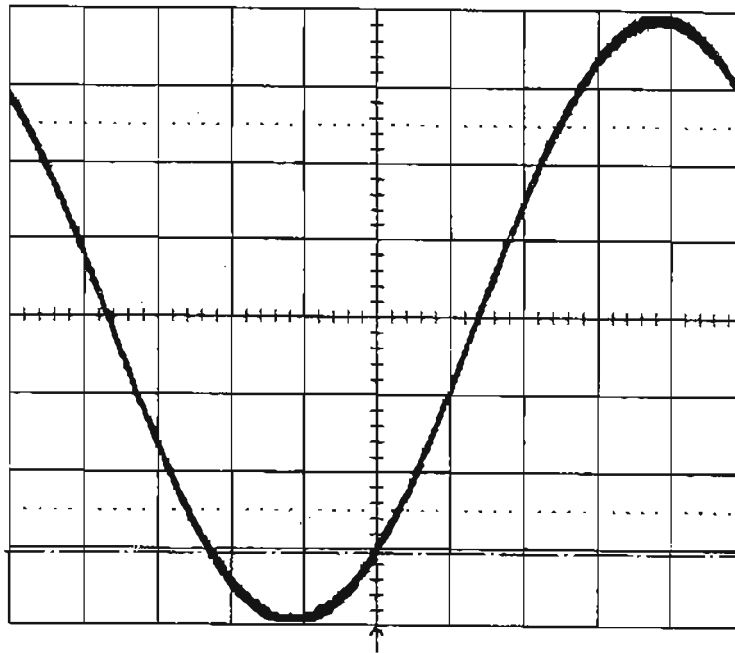

11 sweeps

Ext DC -300 mV 1M Ω

- .1 ms
- 1 .1 V 50 Ω
 - 2 .1 V 50 Ω
 - 3 .1 V 50 Ω
 - 4 .1 V 50 Ω

TRIGGER SETUP

Edge SMART

trigger on
1 2 3 4 Ext
Ext10 Line

cp1g Ext
DC AC LFREJ
HFREJ HF

slope Ext
Pos Neg

External
DC50 Ω DC1M Ω

holdoff
OFF Time Evts

50 MS/s

STOPPED

28-Feb-96
11:55:55

2
.1 ms
100 mV
-298 mV

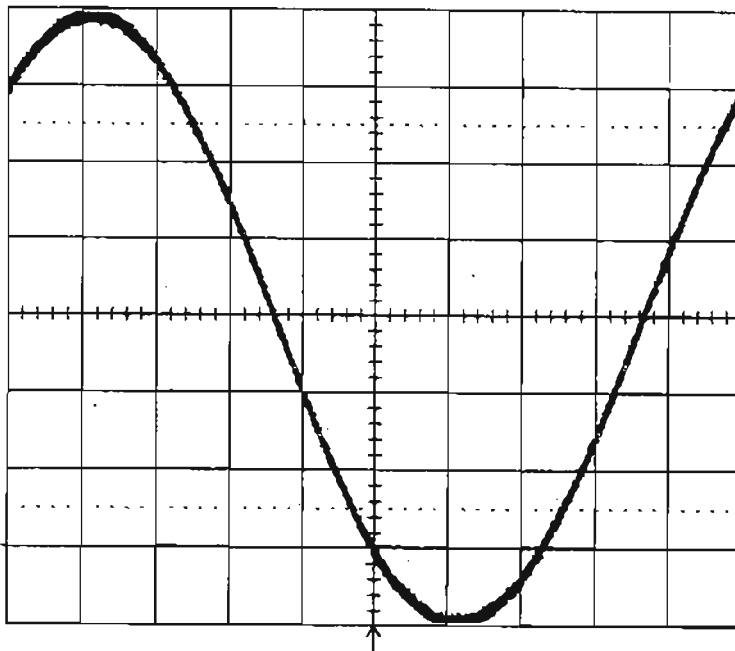

11 sweeps

Ext DC -300 mV 1M Ω

- .1 ms
- 1 .1 V 50 Ω
 - 2 .1 V 50 Ω
 - 3 .1 V 50 Ω
 - 4 .1 V 50 Ω

TRIGGER SETUP

Edge SMART

trigger on
1 2 3 4 Ext
Ext10 Line

cp1g Ext
DC AC LFREJ
HFREJ HF

slope Ext
Pos Neg

External
DC50 Ω DC1M Ω

holdoff
OFF Time Evts

50 MS/s

STOPPED

5.10.4 External /10 Trigger

Specifications

External trigger range : DC \pm 5 V

Procedure

- Connect the output of the generator to External input and to Channel 2 via a coaxial T-connector. The cable length from External to Channel 2 must be short, at most 2 nsec.
- Set frequency : 1 KHz
- Turn on trace : Ch2
- Input Coupling Ch 2 : DC 50 Ω
- V/div. offset : Normal
- Input gain : 1 V/div.
- Input offset : 0 mV
- Trigger setup : Edge
- Trigger on : Ext10
- Coupling Ext10 : DC
- Slope Ext10 : Pos
- External : DC 1M Ω
- Set Ext Trigger level : DC 0.0 mV
- Mode : Single
- Pre-Trigger Delay : 50 %
- Timebase : .1 msec/div.
- Channel use : 4
- Record up to : 50 K samples
- Adjust the sine wave generator's output amplitude to get 8 divisions peak to peak, corresponding to a 8 V amplitude.
- It is important that the offset of the input is set to zero mV, use show status and acquisition status to verify.
- Display setup : Dot join Off
- Set Persistence On, and acquire few sweeps in Single Trigger mode.
- Connect a 3 dB attenuator, and acquire few more sweeps in Single mode.
- Select Cursors/Measure : Cursors, Time, Absolute
- Use the " cursor position " knob, to move the marker at the horizontal crossing point of the two sine waves.
- Check that the time difference obtained between the marker and the trigger is within \pm 20 μ sec. The time readout is below 1 V in the icon 2, at top left.

Section 5 Performance Verification

28-Feb-96
12:01:22

2
.1 ms
1.00 V
0 μ s

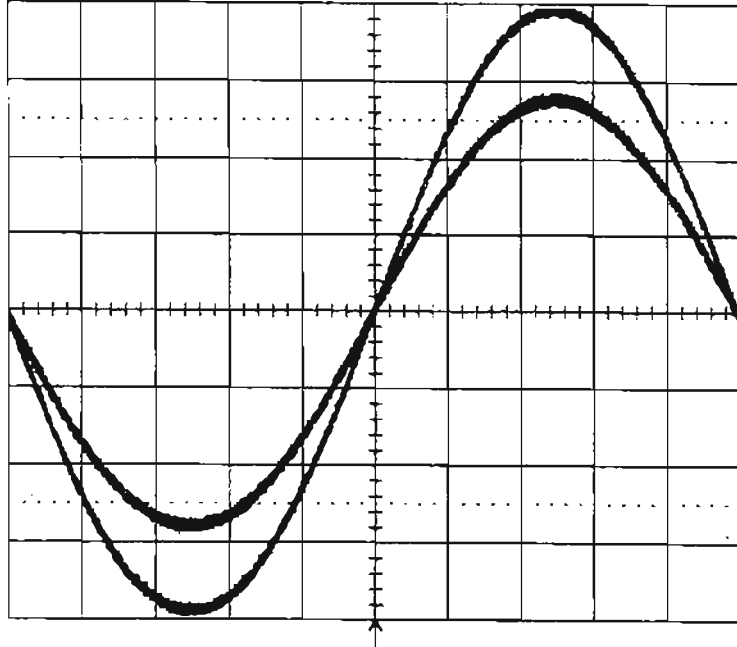

TRIGGER SETUP

Edge SMART

trigger on
1 2 3 4 Ext
Ext10 Line

cp1g Ext10
DC AC LFREJ
HFREJ HF

slope Ext10
Pos Neg

External
DC50 Ω DC1M Ω

holdoff
OFF Time Evts

.1 ms
1 1 V 50 Ω
2 1 V 50 Ω
3 1 V 50 Ω
4 1 V 50 Ω

22 sweeps

Ext10 DC 0.00 V 1M Ω

50 MS/s

STOPPED

28-Feb-96
12:01:44

2
.1 ms
1.00 V
0.02 V

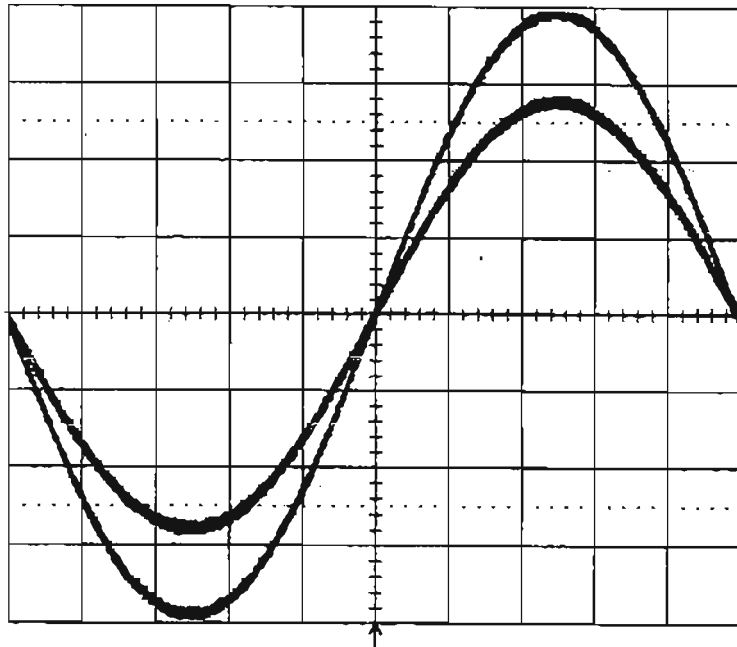

MEASURE

OFF Cursors
Parameters

made
Time
Amplitude

type
Relative
Absolute

cursor
Position

.1 ms
1 1 V 50 Ω
2 1 V 50 Ω
3 1 V 50 Ω
4 1 V 50 Ω

22 sweeps

Ext10 DC 0.00 V 1M Ω

50 MS/s

STOPPED

- Select Cursors mode : **Amplitude, Absolute**
- Use the " cursor position " knob, to move the marker at the **vertical crossing point** of the two sine waves.
- Check that the **voltage** difference obtained between the marker and the trigger level is within ± 400 mV. The level readout is below 1 V in the icon 2, at top left.

- Set Trigger Slope Ext10 : **Neg**
- Disconnect the **3 dB attenuator** from the BNC input
- Acquire few sweeps in Single Trigger mode.
- Connect the **3 dB attenuator**, and acquire few more sweeps in Single mode.
- Select Cursors/Measure : **Cursors, Time, Absolute**
- Use the " cursor position " knob, to move the marker at the **horizontal crossing point** of the two sine waves.
- Check that the **time** difference obtained between the marker and the trigger is within ± 20 μ sec. The time readout is below 1 V in the icon 2, at top left.

- Select Cursors mode : **Amplitude, Absolute**
- Use the " cursor position " knob, to move the marker at the **vertical crossing point** of the two sine waves.

- Check that the **vertical crossing point level** is within ± 400 mV. See icon 2 at left.

Section 5 Performance Verification

28-Feb-96
12:04:54

2
.1 ms
1.00 V
-2 μ s

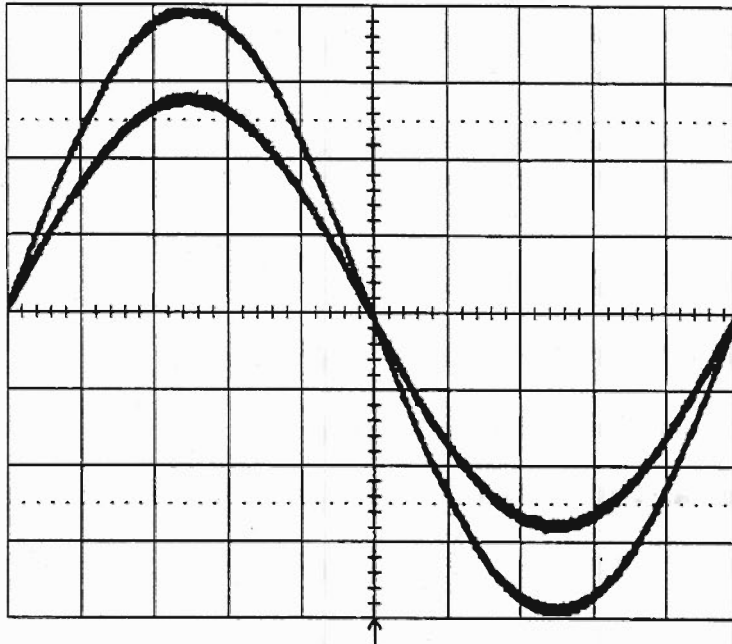

TRIGGER SETUP

Edge SMART

trigger on
1 2 3 4 Ext
Ext10 Line

cplg Ext10
DC AC LFREJ
HFREJ HF

slope Ext10
Pos Neg

External
DC50 Ω DC1M Ω

holdoff
Off Time Evts

50 MS/s

STOPPED

.1 ms

1 1 V 50 Ω
2 1 V 50 Ω
3 1 V 50 Ω
4 1 V 50 Ω

21 sweeps

Ext10 DC 0.00 V 1M Ω

MEASURE

OFF Cursors
Parameters

mode
Time
Amplitude

type
Relative
Absolute

cursor
Position

50 MS/s

STOPPED

28-Feb-96
12:05:11

2
.1 ms
1.00 V
-0.08 V

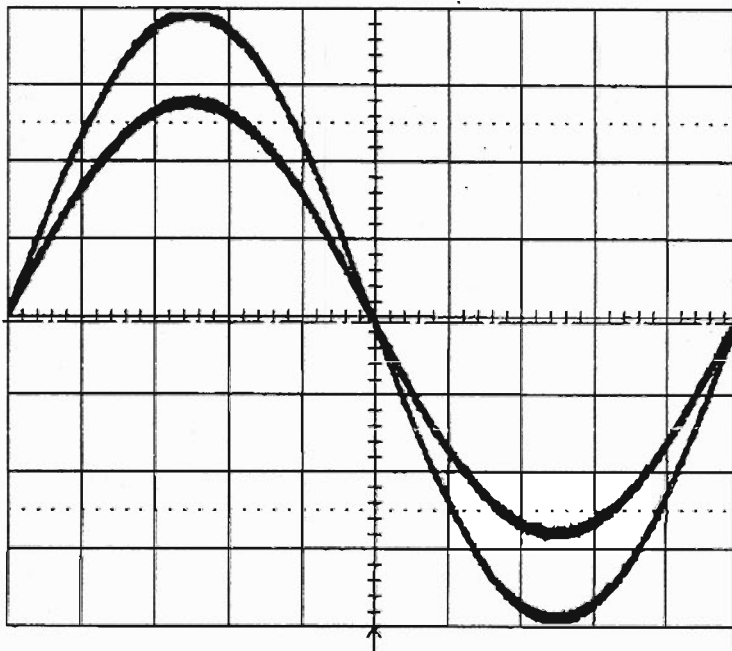

.1 ms

1 1 V 50 Ω
2 1 V 50 Ω
3 1 V 50 Ω
4 1 V 50 Ω

21 sweeps

Ext10 DC 0.00 V 1M Ω

- Set Trigger level : DC + 3 V
- Set Trigger Slope Ext10 : Pos
- Disconnect the 3 dB attenuator from the BNC input
- Acquire few sweeps in Single Trigger mode.
- The sine wave must pass through the horizontal center of the screen at the vertical + 3 divisions.
- Select Cursors/Measure : Cursors, Amplitude, Absolute
- Use the " cursor position " knob, to move the marker, at the crossing point of the sine wave and the horizontal center of the screen (50% pre-trigger line).
- Check that the vertical crossing point level is + 3 V ± 400 mV. See icon 2 at top.

28-Feb-96
12:07:42

2
.1 ms
1.00 V
3.12 V

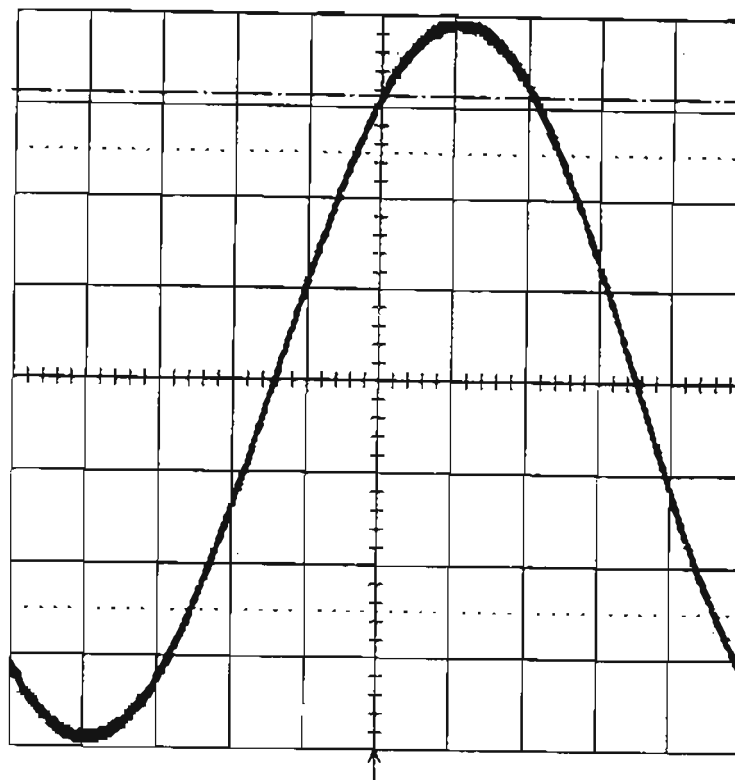

MEASURE

OFF **Cursors**
Parameters

mode
Time
Amplitude

type
Relative
Absolute

cursor
Position

.1 ms
1 1 V 50Ω
2 1 V 50Ω
3 1 V 50Ω
4 1 V 50Ω

10 sweeps

Ext10 DC 3.00 V 1MΩ

50 MS/s

STOPPED

Section 5 Performance Verification

- Set Trigger Slope Ext10 : **Neg**
- Acquire few sweeps in Single Trigger mode.
- The sine wave must pass through the **horizontal center** of the screen at the **vertical + 3 divisions**.
- Select Cursors/Measure : **Cursors, Amplitude, Absolute**
- Use the " cursor position " knob, to move the marker, at the **crossing point** of the **sine wave** and the **horizontal center** of the screen (50% pre-trigger line).
- Check that the **vertical crossing point level is + 3 V ± 400 mV**. See icon 2 at top .

28-Feb-96
12:08:22

2
.1 ms
1.00 V
3.05 V

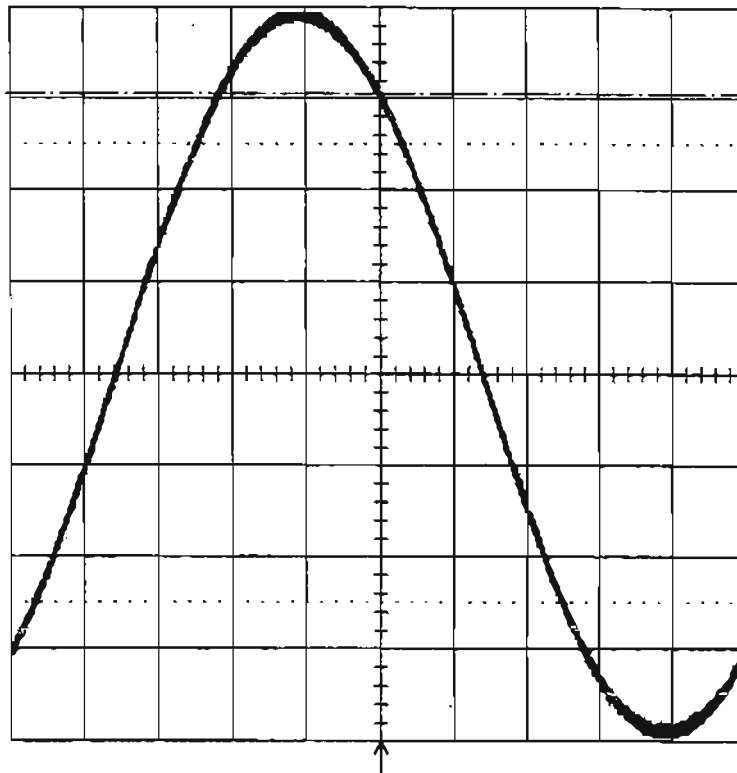

TRIGGER SETUP

Edge SMART

trigger on
1 2 3 4 Ext
Ext10 Line

cp1g Ext10
DC AC LFREJ
HFREJ HF

slope Ext10
Pos **Neg**

External
DC50Ω **DC1MΩ**

holdoff
- - -
OFF Time Evts

.1 ms

- 1 1 V 50Ω
- 2 1 V 50Ω
- 3 1 V 50Ω
- 4 1 V 50Ω

11 sweeps

Ext10 DC 3.00 V 1MΩ

50 MS/s

□ STOPPED

Section 5 Performance Verification

28-Feb-96
11:25:17

1
.1 ms
0.50 V

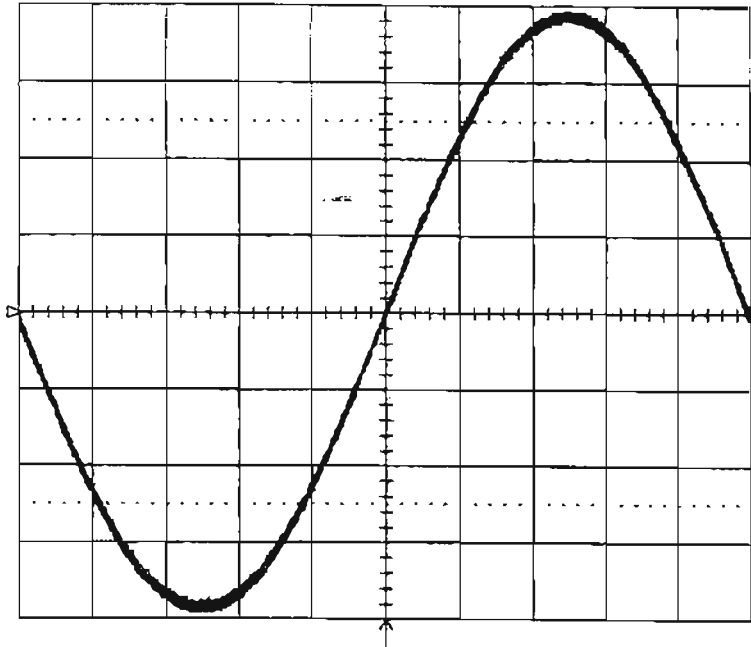

11 sweeps

1 DC 0.00 V

DISPLAY SETUP

Standard
XY

Persistence
OFF **On**
(Infinite)

Dot Join
OFF On

Persistence
Setup

Grids
Single Dual
Quad

Waveform+Text
Intensity
90 %

Grid
intensity
60 %

50 MS/s

STOPPED

.1 ms

- 1** .5 V 50Ω
- 2** .5 V 50Ω
- 3** .5 V 50Ω
- 4** .5 V 50Ω

28-Feb-96
11:27:09

1
.1 ms
0.50 V
4 μs

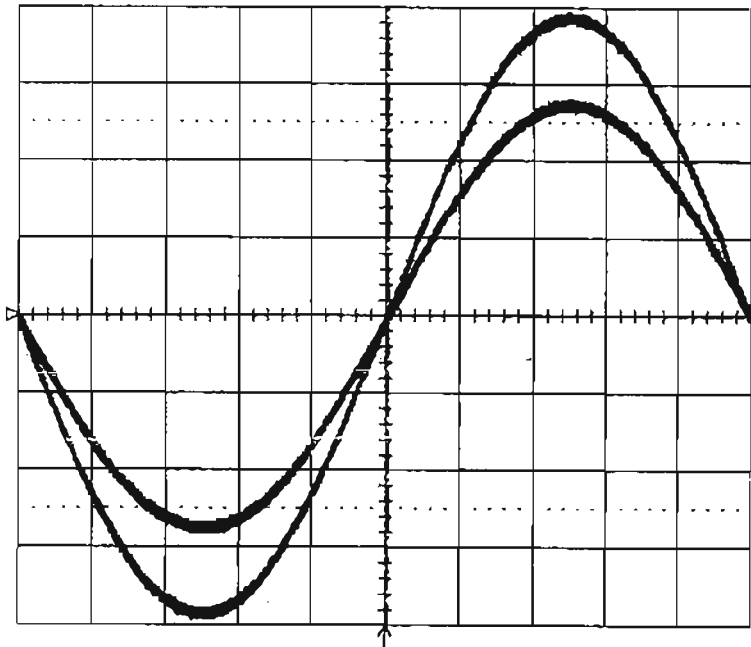

21 sweeps

1 DC 0.00 V

MEASURE

OFF **Cursors**
Parameters

mode
Time
Amplitude

type
Relative
Absolute

cursor
Position

50 MS/s

STOPPED

.1 ms

- 1** .5 V 50Ω
- 2** .5 V 50Ω
- 3** .5 V 50Ω
- 4** .5 V 50Ω

- Set Trigger level : DC -3 V
- Trigger Slope Ext10 : Pos
- Acquire few sweeps in Single Trigger mode.
- The sine wave must pass through the **horizontal center** of the screen at the **vertical - 3 divisions**.
- Select Cursors/Measure : **Cursors, Amplitude, Absolute**
- Use the " cursor position " knob, to move the marker, at the **crossing point** of the **sine wave** and the **horizontal center of the screen** (50% pre-trigger line).
- Check that the **vertical crossing point level is -3 V ± 400 mV**. See icon 2 at top.

28-Feb-96
12:09:42

2
.1 ms
1.00 V
-2.95 V

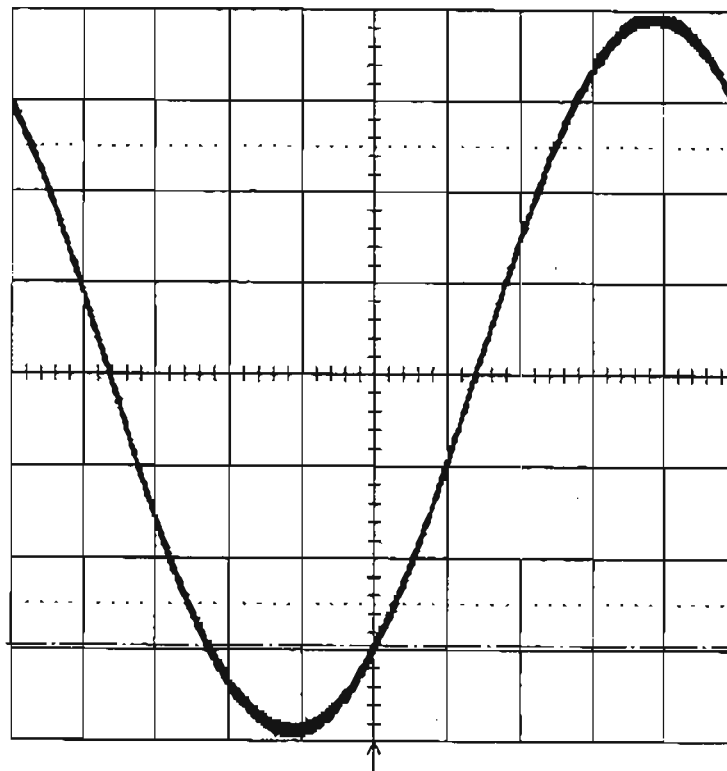

TRIGGER SETUP

Edge SMART

trigger on
1 2 3 4 Ext
Ext10 Line

cplg Ext10
DC AC LFREJ
HFREJ HF

slope Ext10
Pos Neg

External
DC50Ω DC1MΩ

holdoff

OFF Time Evts

.1 ms

- 1 1 V 50Ω
- 2 1 V 50Ω
- 3 1 V 50Ω
- 4 1 V 50Ω

11 sweeps

Ext10 DC -3.00 V 1MΩ

50 MS/s

STOPPED

Section 5 Performance Verification

- Trigger Slope Ext10 : Neg
- Acquire few sweeps in Single Trigger mode.
- The sine wave must pass through the **horizontal center** of the screen at the **vertical - 3 divisions**.
- Select Cursors/Measure : **Cursors, Amplitude, Absolute**
- Use the " cursor position " knob, to move the marker, at the **crossing point** of the **sine wave** and the **horizontal center of the screen** (50% pre-trigger line).
- Check that the **vertical crossing point level is - 3 V ± 400 mV**. See icon 2 at top.

28-Feb-96
12:10:14

2
.1 ms
1.00 V
-3.11 V

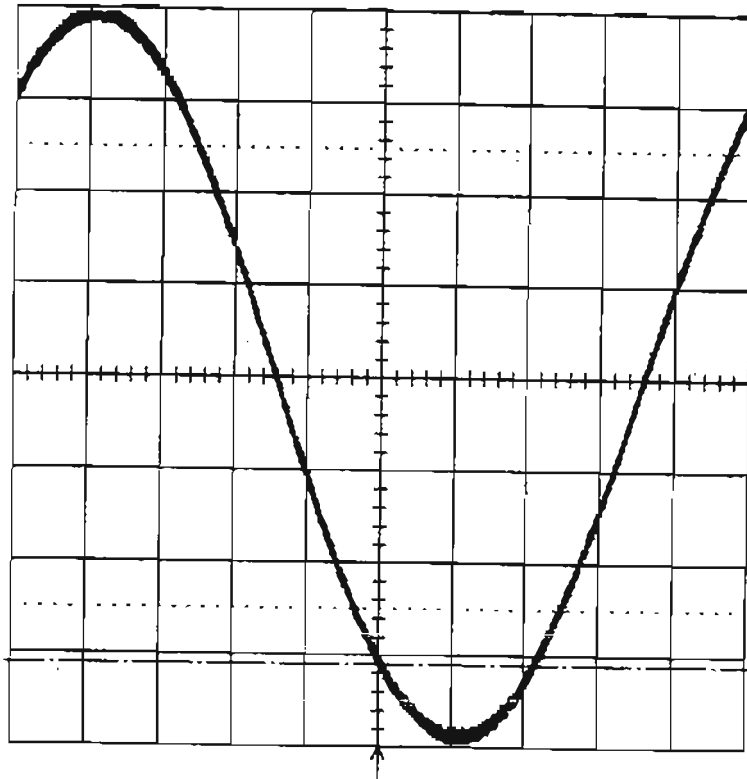

TRIGGER SETUP

Edge SMART

trigger on
1 2 3 4 Ext
Ext10 Line

cplg Ext10
DC AC LFREJ
HFREJ HF

slope Ext10
Pos Neg

External
DC50Ω DC1MΩ

holdoff

OFF Time Evts

.1 ms
1 1 V 50Ω
2 1 V 50Ω
3 1 V 50Ω
4 1 V 50Ω

11 sweeps

Ext10 DC -3.00 V 1MΩ

50 MS/s

STOPPED

5.11 Smart Trigger

Specifications

Pulse width < or > 2.5 nsec to 20 sec.

5.11.1 Trigger on Pulse Width < 10 nsec

Procedure

- Connect a sine wave generator to Channel 1
- Frequency : 100 MHz
- Turn on trace : Ch1
- Display setup : Standard, Persistence off, Dot join on, Single grid
- Input Coupling : DC 50 Ω
- V/div. offset : Normal
- Global BWL : Off
- Probe atten : X1
- Input gain : .5 V/div.
- Trigger setup : Smart
- Setup Smart Trigger : Glitch
- Trigger on : 1
- Coupling 1 : DC
- At end of : Neg
- Width : < 10 nsec
- Mode : Norm
- Timebase : 5 nsec/div.
- Adjust the generator output amplitude to get a five division amplitude sine wave.
- Check that the scope triggers
- Switch to Width : > 10 nsec
- Check that the scope **doesn't trigger** : slow trigger and no flashes in box next to normal.

5.11.2 Trigger on Pulse Width > 10 nsec

- Adjust the generator frequency to 40 MHz
- Check that the scope triggers
- Switch to Width : < 10 nsec
- Check that the scope **doesn't trigger** : slow trigger and no flashes in box next to normal.

Section 5 Performance Verification

28-Feb-96
9:41:43

5 ns
0.50 V
-20 mV

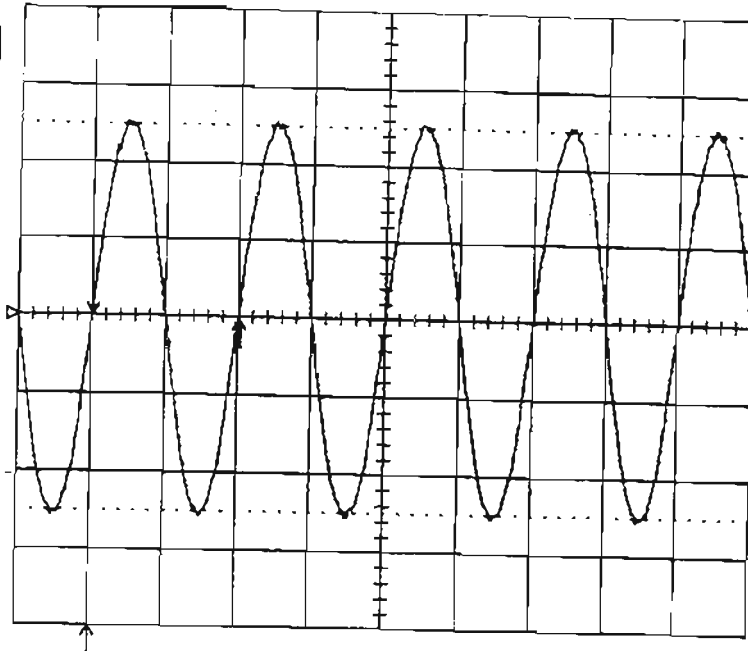

TRIGGER SETUP

Edge **SMART** (GLITCH)

SETUP SMART TRIGGER

trigger on **1** 2 3 4 Ext Ext10 Pattern

coupling **1** DC AC LFREJ HFREJ

at end of **Neg** Pos pulse

width < 10.0 ns OFF **On**

width > OFF **On**

5 ns RIS

- 1** .5 V 50Ω
- 2** .5 V 50Ω
- 3** .5 V 50Ω
- 4** .5 V 50Ω

Δt 10.000 ns $\frac{1}{\Delta t}$ 100.00 MHz



1 DC 0.00 V pulse < 10.0 ns

10 GS/s

NORMAL

28-Feb-96
9:43:20

5 ns
0.50 V
35 mV

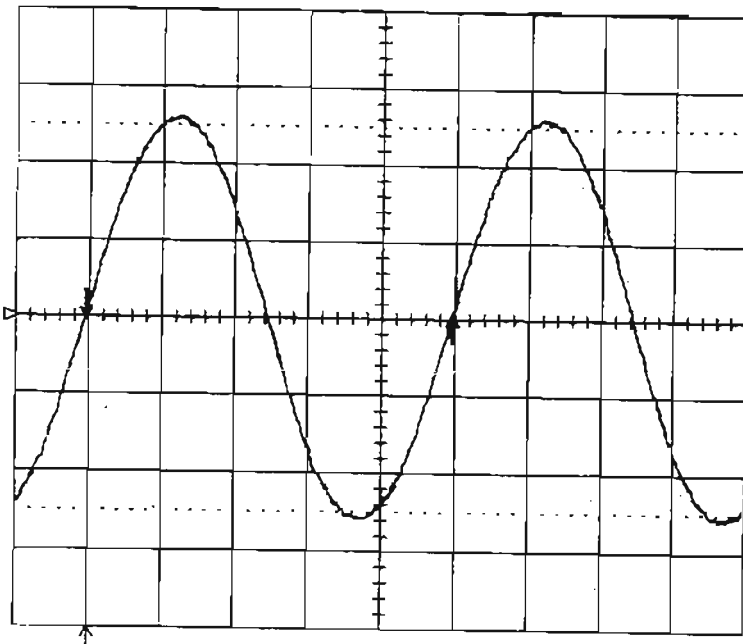

TRIGGER SETUP

Edge **SMART** (GLITCH)

SETUP SMART TRIGGER

trigger on **1** 2 3 4 Ext Ext10 Pattern

coupling **1** DC AC LFREJ HFREJ

at end of **Neg** Pos pulse

width < OFF **On**

width > 10.0 ns OFF **On**

5 ns RIS

- 1** .5 V 50Ω
- 2** .5 V 50Ω
- 3** .5 V 50Ω
- 4** .5 V 50Ω

Δt 25.000 ns $\frac{1}{\Delta t}$ 40.000 MHz

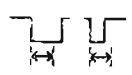

1 DC 0.00 V 10.0 ns < pulse

10 GS/s

NORMAL

5.11.3 Trigger on Pulse Width < 100 nsec

- Set the generator frequency to 10 MHz
- Pulse width : < 100 nsec
- Timebase : 20 nsec/div.
- Check that the scope triggers.

28-Feb-96
9:47:47

20 ns
0.50 V
-1 mV

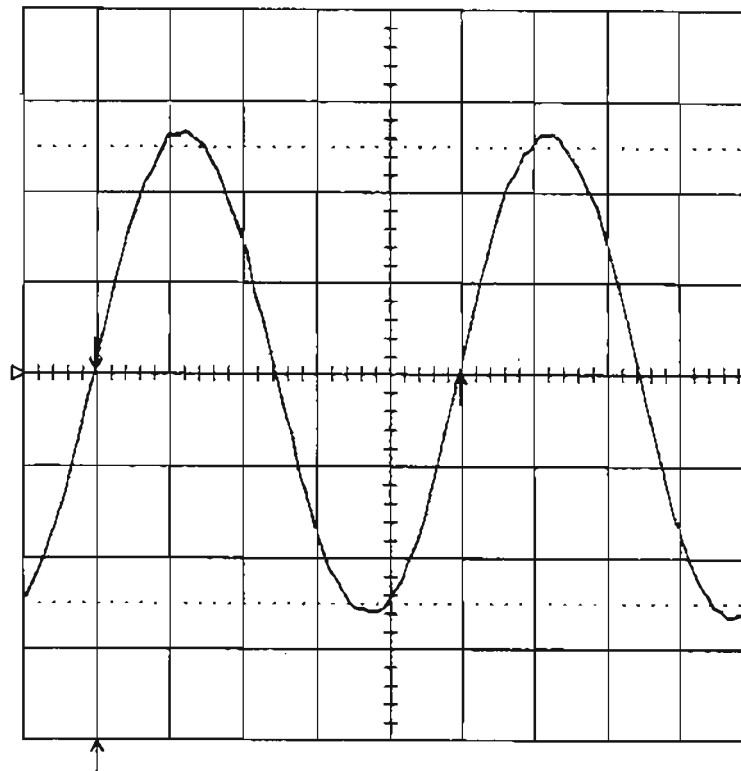

TRIGGER SETUP

Edge SMART
(GLITCH)

SETUP SMART TRIGGER

trigger on 1 2 3 4 Ext
Ext10 Pattern

coupling DC AC
LFREJ HFREJ

at end of Neg Pos
pulse

width < 100.0 ns
OFF On

width > OFF On

20 ns

- .5 V 50Ω
- .5 V 50Ω
- .5 V 50Ω
- .5 V 50Ω

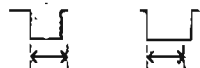

Δt 100.0 ns 1/Δt 10.00 MHz

500 MS/s

DC 0.00 V
pulse < 100.0 ns

NORMAL

- Switch to Width : > 100 nsec
- Check that the scope **doesn't trigger** : slow trigger and no flashes in box next to normal.

Section 5 Performance Verification

5.11.4 Trigger on Pulse Width > 100 nsec

- Adjust the generator frequency to 4 MHz
- Pulse width : > 100 nsec
- Set Timebase : 50 nsec/div.
- Check that the scope triggers.

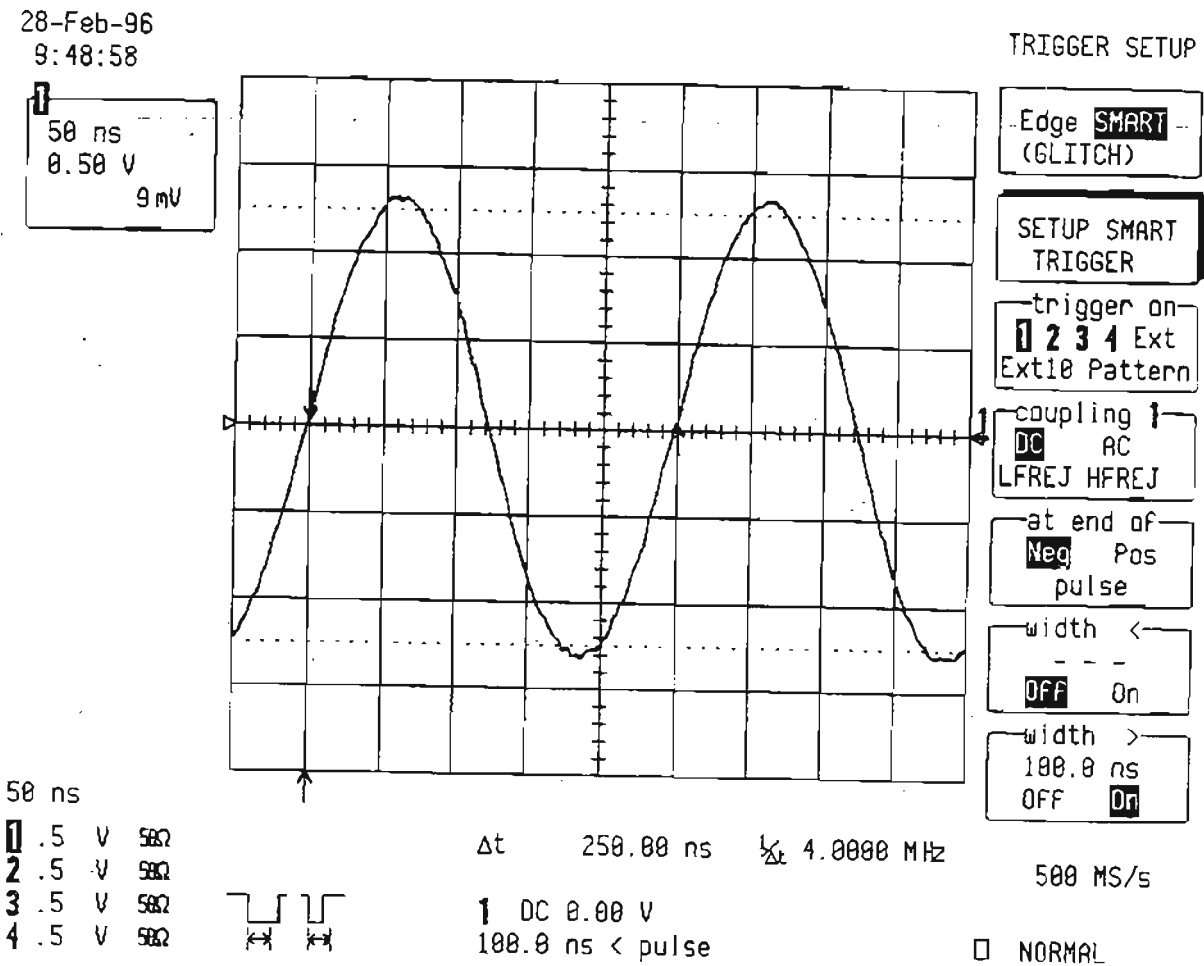

- Switch to Width : < 100 nsec
- Check that the scope **doesn't trigger** : slow trigger and no flashes in box next to normal.
- Repeat all the above tests for Channel 2, Channel 3 and Channel 4 substituting channel controls and input connector, and check as above.

5.12 Time Base Accuracy

5.12.1 Description

An external sine wave generator of 1 MHz with a frequency accuracy better than 1 PPM is used.

Specifications

500 MHz clock : accuracy : $\leq \pm 0.001\%$ or $\leq \pm 10$ PPM

5.12.2 500 MHz Clock Manual Verification Procedure

Setup a sine wave generator.

- Frequency : 1 MHz
- Connect the generator output to Channel 1
- Turn on trace : Ch1
- Display setup : Standard, Persistence off, Dot join on, Single grid
- Input Coupling : DC 50 Ω
- V/div. offset : Normal
- Probe atten : X1
- Input gain : .5 V/div.
- Trigger setup : Edge
- Trigger on : 1
- Coupling 1 : DC
- Slope 1 : Pos
- Level 1 : 0.5 V
- Mode : Norm
- Holdoff : Off
- Delay : 0 %
- Timebase : .5 μ sec/div.
- Channel use : 4
- Record up to : 50 K
- Adjust the generator output amplitude and Ch1 offset to get a five divisions peak to peak amplitude sine wave.
- Store Channel 1 in Memory 1
- Set Post-trigger delay to 5.00 msec

This allows the accuracy of the time base clock to be checked 5000 periods after the trigger point.

Section 5 Performance Verification

28-Feb-96
9:53:23

1 stored to M1

STORE W'FORMS

0.5 μ s
0.50 V
-16 mV

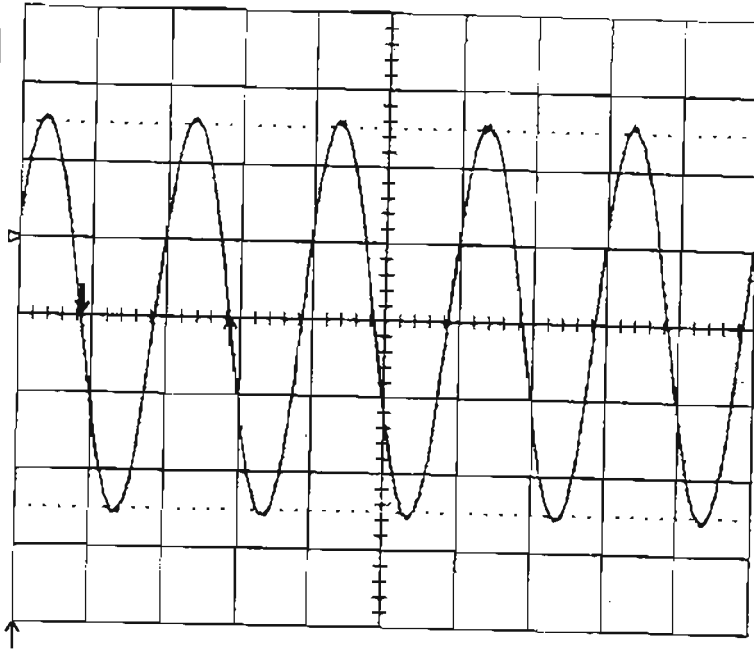

DO STORE
(1-M1)

store

0	2
3	4
A	B
C	D

All displayed

to

M2 M3 M4
Card

- 0.5 μ s
- 1 .5 V 50 Ω
- 2 .5 V 50 Ω
- 3 .5 V 50 Ω
- 4 .5 V 50 Ω

Δt 1.0000 μ s $\frac{1}{\Delta t}$ 1.0000 MHz

500 MS/s

1 DC 0.50 V

NORMAL

28-Feb-96
9:54:18

ACQUISITION STATUS

	1	2	3	4
Vertical				
V/div	.5 V	.5 V	.5 V	.5 V
Probe	x1	x1	x1	x1
Offset	0 mV	0 mV	0 mV	0 mV
Coupling	DC50 Ω	DC50 Ω	DC50 Ω	DC50 Ω

Acquisition System

Text & Times

WaveForm

Memory Used

Bandwidth Limit OFF

Time base

Time/div .5 μ s Time/pnt 2 ns (500 MS/s)

RIS OFF

Sequence OFF Pts/div 250

Trigger Edge Mode NORMAL

External Attenuation x1

1 DC 0.50 V

Post-trigger Delay 5.00000 ms

500 MS/s

The currently preselected Smart Trigger type is
GLITCH

NORMAL

- Recall Memory 1 to A
- Turn on trace A
- Check that the displayed Channel 1 trace is **aligned** with the sine wave from memory 1.
- Press : **Cursors/Measure**
- Measure : **Parameters**
- Mode : **Custom**
- Statistics : **Off**
- Change parameters
- On line 1 : **Delay of 1**
- On line 2 : **Delay of A**
- Check that $(\text{delay}(A) - \text{delay}(1) + 5 \text{ msec}) \leq \pm 0.00005 \text{ msec}$ corresponding to **10 PPM**.

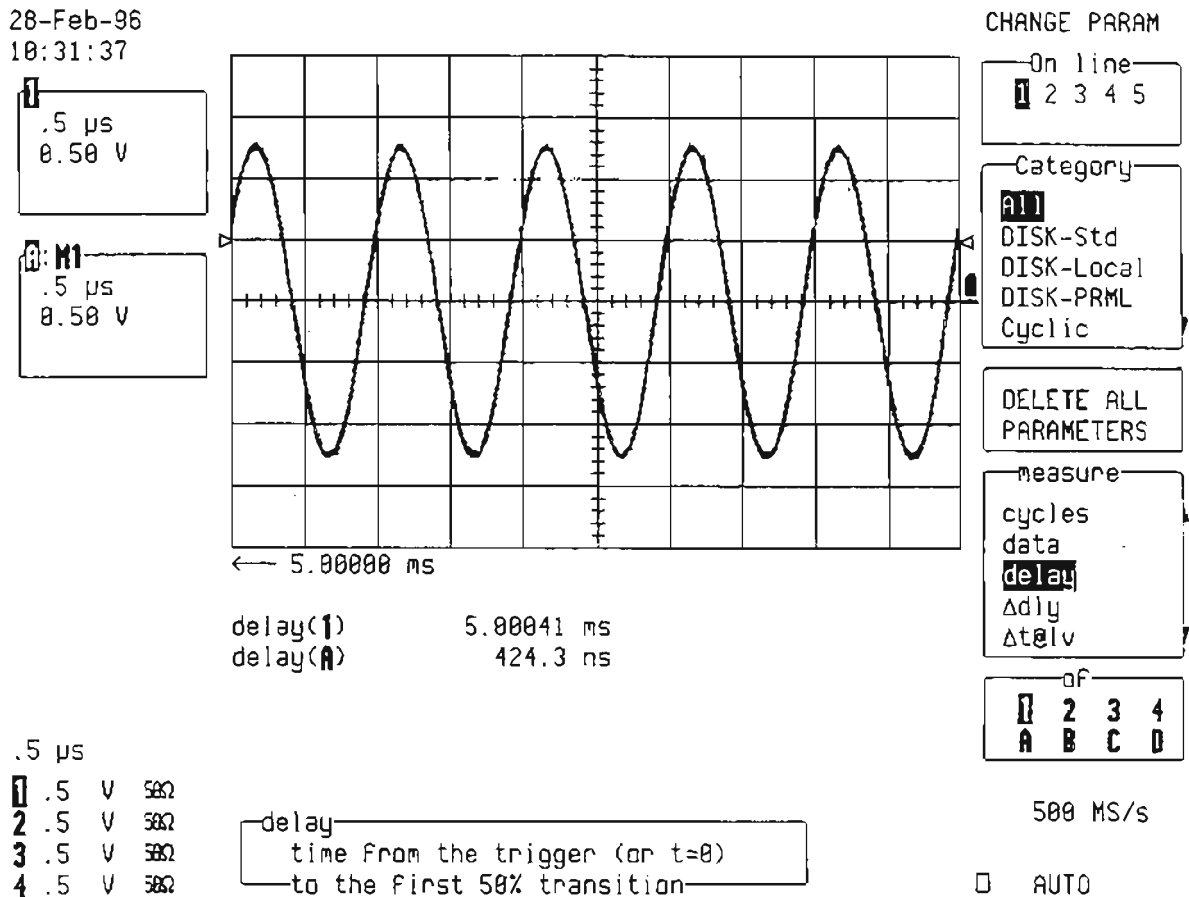

Section 5 Performance Verification

A difference of $\pm 0.05 \mu\text{sec}$ corresponds to $\pm 10 \text{ PPM}$.

See screen dump below :

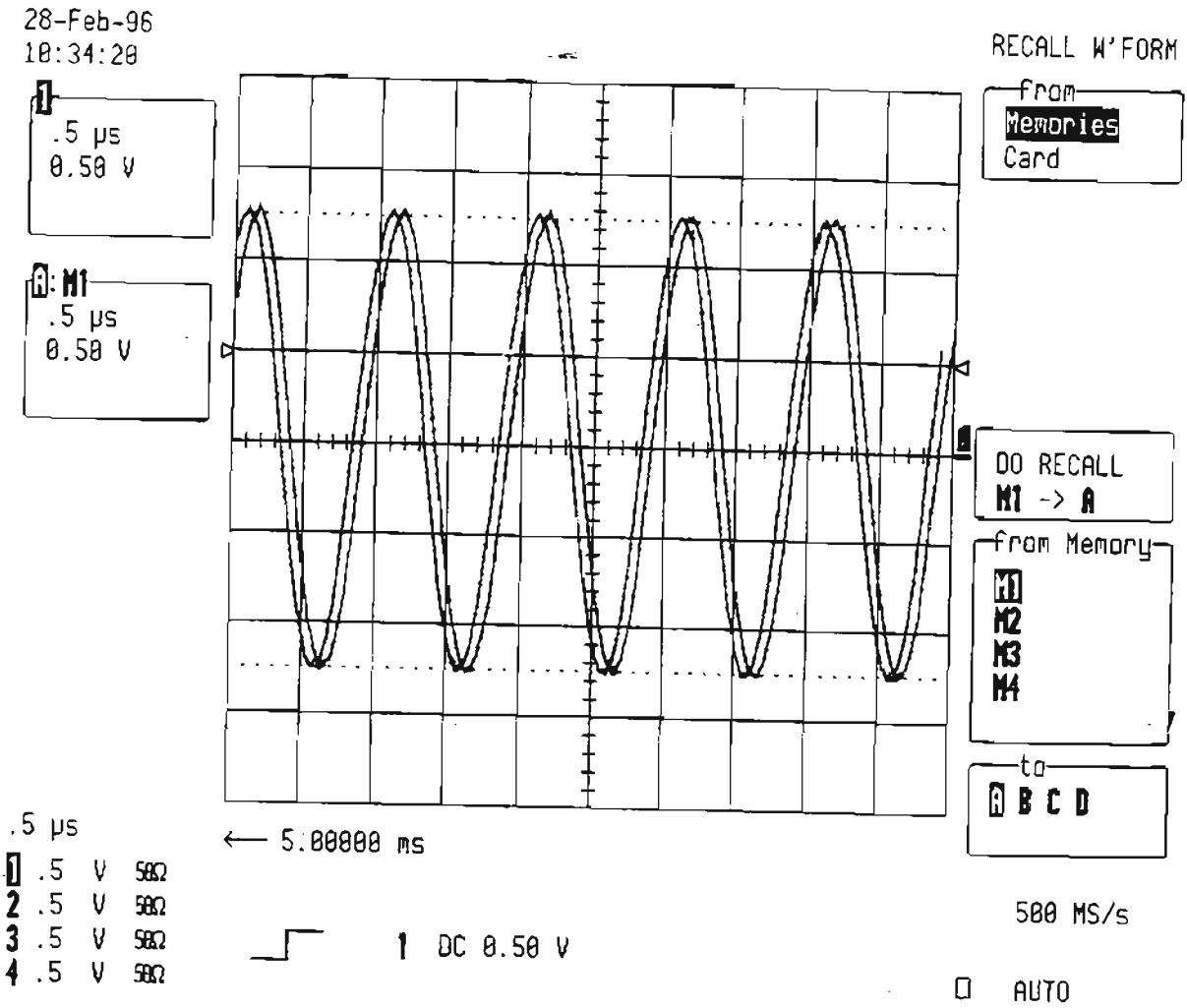

5.13 Overshoot and Rise time (10%-90%)

SpecificationsDC 50 Ω , 50 mV/div., : overshoot < 20 %, rise time < 0.5 nsDC 1 M Ω , 100 mV/div., : rise time < 1.5 ns**Procedure**

- Apply the fast pulse generator TD-1107B (< 70 psec) or equivalent, to Channel 1
- Set the DSO as follows :
 - Turn on trace : Ch1
 - Display setup : Standard, Persistence off, Dot join on, Single grid
 - Coupling Channel 1 : DC 50 Ω
 - V/div. offset : Normal
 - Global BWL : Off
 - Probe atten : X1
 - Input offset : - 250 mV
 - Input gain : 50 mV/div
 - Trigger setup : Edge
 - Trigger on : 1
 - Trigger level : DC 250 mV
 - Coupling 1 : DC
 - Slope 1 : Pos
 - Mode : Normal
 - Holdoff : Off
 - Timebase : 1 nsec/div
 - Record up to : 50K samples
 - Delay : 30 % Pre-Trigger
 - Turn on trace : A
 - Select Math Setup
 - For Math : Use at most 1000 points
 - Use Math ? : Yes
 - Math Type : Average
 - Avg Type : Summed
 - Of : Channel 1
 - Turn off trace : Channel 1
 - Cursors/Measure : Parameters
 - Mode : Custom
 - Statistics : On
 - Change Parameters
 - on displayed trace : A
 - On line 1 :
 - Measure : Over + of A
 - On line 2 :
 - Measure : Rise of A

Section 5 Performance Verification

28-Feb-96

11:06:35

Average(1)
1 ns
50 mV
1000 sups

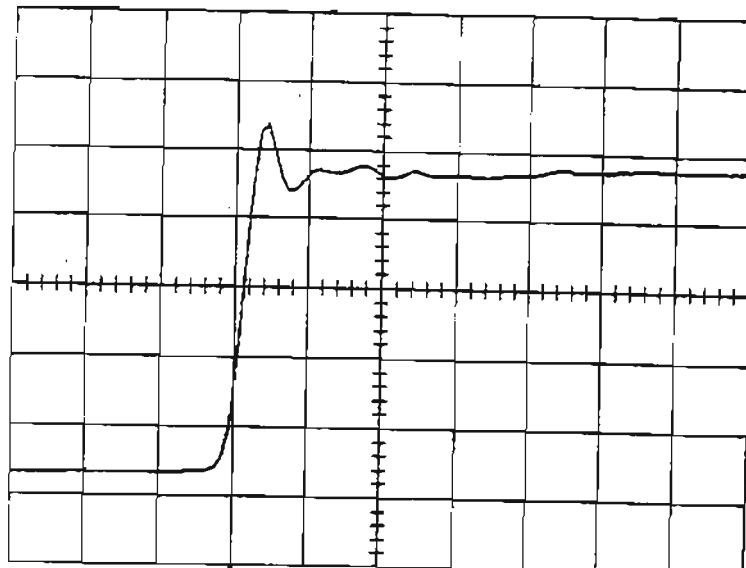

16 sweeps:

	average	low	high	sigma
over+(A)	15.13 %	14.25	16.20	0.45
rise(A)	0.34 ns	0.34	0.35	0.00

CHANGE PARAM

On line
1 2 3 4 5

Category
All
DISK-Std
DISK-Local
DISK-PRML
Cyclic

DELETE ALL
PARAMETERS

measure
range
res
rise
r20-80%
relevel

of
1 2 3 4
A B C D

1 ns RIS

- 1 50 mV 50Ω
- 2 50 mV 50Ω
- 3 50 mV 50Ω
- 4 50 mV 50Ω



1 DC 250 mV

10 GS/s

NORMAL

- Check that the average overshoot is < 20 % and rise time is < 0.5 ns (measured in scope and not corrected for the effect of the step generator).
- Set Input Coupling : DC 1 MΩ
- Timebase : 2 nsec/div
- Terminate the output of the TD-1107B pulser with a 50Ω feed through and connect it to Ch1
- Check that the Average rise time is < 1.5 ns (measured in scope and not corrected for the effect of the step generator).

28-Feb-96
11:08:34

Average(1)
2 ns
50 mV
552 swps

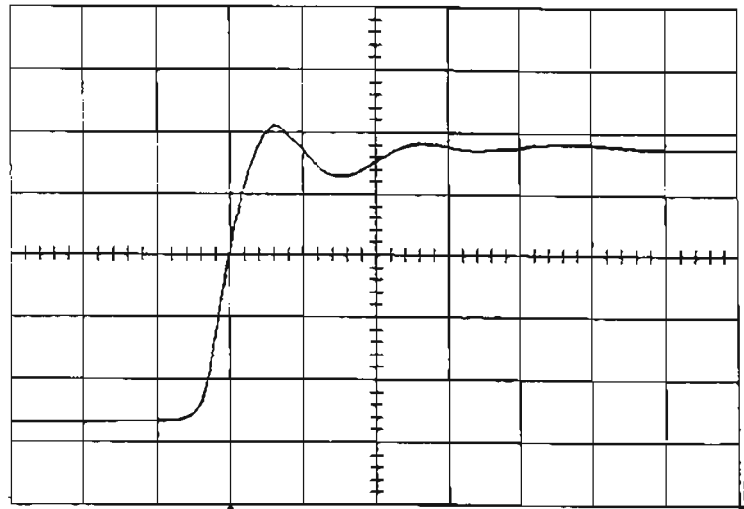

9 sweeps: average low high sigma
rise(A) 1.20 ns 1.19 1.24 0.02

CHANNEL 1
Coupling
DC50Ω
Grounded
DC1MΩ
Grounded
AC1MΩ
V/div Offset
NORMAL
ECL TTL
Global BWL
OFF 25MHz
200MHz

Probe Atten
x1
x2
x5
x10
x20

2 ns RIS
1 50 mV DC
2 50 mV DC
3 50 mV DC
4 50 mV DC

1 DC 250 mV

10 GS/s
 NORMAL

- Repeat the above tests for Channel 2, Channel 3 and Channel 4 substituting channel controls and input connector, and check as above.

5.14 Probe Calibrator Verification

Specifications

Amplitude : 50 mV to 500 mV ± 2 % into 50Ω
: 50 mV to 1 V ± 2 % into 1 MΩ

Frequency : 500 Hz to 2 MHz ± 1 %

Probe Calibrator Verification Procedure

- Connect the Probe Calibrator output to Channel 1, using a 5 nsec BNC cable
- Select : Utilities
- Press : Cal BNC Setup
- Mode : Cal signal
- Set Frequency : 500 Hz
- Amplitude : 1 V (500 mV into 50 Ω)
- Turn on trace : Ch1

Section 5 Performance Verification

- Display setup : **Standard, Persistence off, Dot join on, Single grid**
- Input Coupling : **DC 50 Ω**
- V/div. offset : **Normal**
- Probe atten : **X1**
- Input offset : **- 250 mV**
- Input gain : **100 mV/div.**

- Trigger setup : **Edge**
- Trigger on : **1**
- Trigger level : **DC 250 mV**
- Coupling 1 : **DC**
- Slope 1 : **Pos**
- Mode : **Normal**
- Holdoff : **Off**

- Timebase : **.5 msec/div.**
- Delay : **10 % Pre-Trigger**

- Cursors/Measure : **Parameters**
- Mode : **Custom**
- Change parameters :
- On line 1 : **Measure ampl of 1**
- On line 2 : **Measure freq of 1**

- Check parameters readout : freq (1) = **500 Hz \pm 1 %** , and ampl (1) = **500 mV \pm 6 %**
(\pm 2 % plus \pm 4 % due to the non linearity of the scope)

- Set Cal frequency : **2 MHz**
- Timebase : **.2 μ s**
- Check that freq (1) is **2 MHz \pm 1 %**

- Repeat test for amplitude of **0.05 V (25 mV into 50 Ω)**

- Set Cal amplitude : **50 mV (25 mV into 50 Ω)**
- DSO Input gain : **5 mV/div.**

- Check parameters readout ampl (1) = **25 mV \pm 6 %**

28-Feb-96
11:14:15

1
.5 ms
100 mV

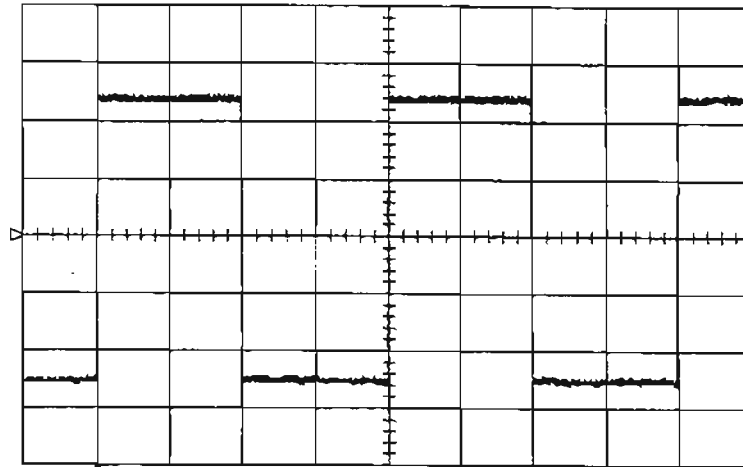

109 sweeps: average low high sigma
 ampl(1) 492 mV 491 492 1
 freq(1) 500.01 Hz 500.00 500.03 0.01

CAL BNC OUT
 mode
CAL signal
 OFF
 Pass/Fail
 Trigger Out
 Trigger Rdy

SET TO 1 KHz
 1 V SQUARE

Shape
Square
 Pulse(25 ns)

Amplitude
 1.00 V
 into 1 MΩ

Frequency
 500 Hz

.5 ms

- 1 .1 V 50Ω
- 2 .1 V 50Ω
- 3 .1 V 50Ω
- 4 .1 V 50Ω

1 DC 250 mV

10 MS/s

NORMAL

28-Feb-96
11:15:26

1
.2 μs
100 mV

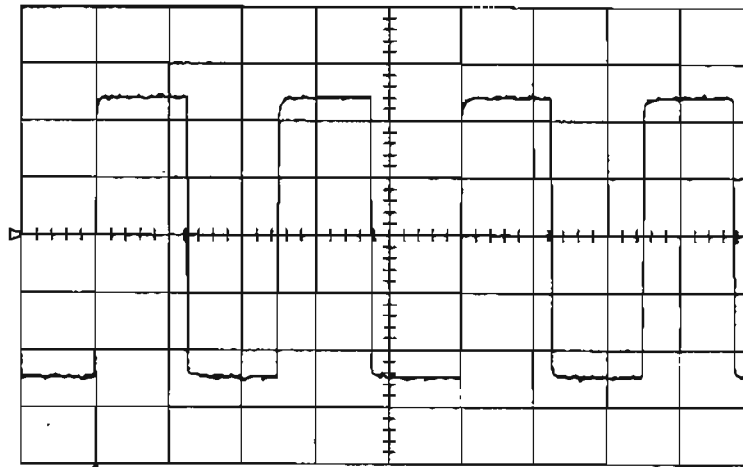

1285 sweeps: average low high sigma
 ampl(1) 487 mV 484 491 1
 freq(1) 1.99998 MHz 1.99557 2.00388 0.00065

CAL BNC OUT
 mode
CAL signal
 OFF
 Pass/Fail
 Trigger Out
 Trigger Rdy

SET TO 1 KHz
 1 V SQUARE

Shape
Square
 Pulse(25 ns)

Amplitude
 1.00 V
 into 1 MΩ

Frequency
 2 MHz

.2 μs

- 1 .1 V 50Ω
- 2 .1 V 50Ω
- 3 .1 V 50Ω
- 4 .1 V 50Ω

1 DC 250 mV

500 MS/s

NORMAL

Section 5 Performance Verification

- Repeat the tests for the amplitude of 0.05 V and 1 V into 1 MΩ
- Cal amplitude : 50 mV
- Set Input Coupling : DC 1M Ω
- DSO Input gain : 10 mV/div.
- Check parameters readout $ampl(1) = 50 \text{ mV} \pm 6 \%$

28-Feb-96
11:18:52

1
.2 μs
10.0 mV

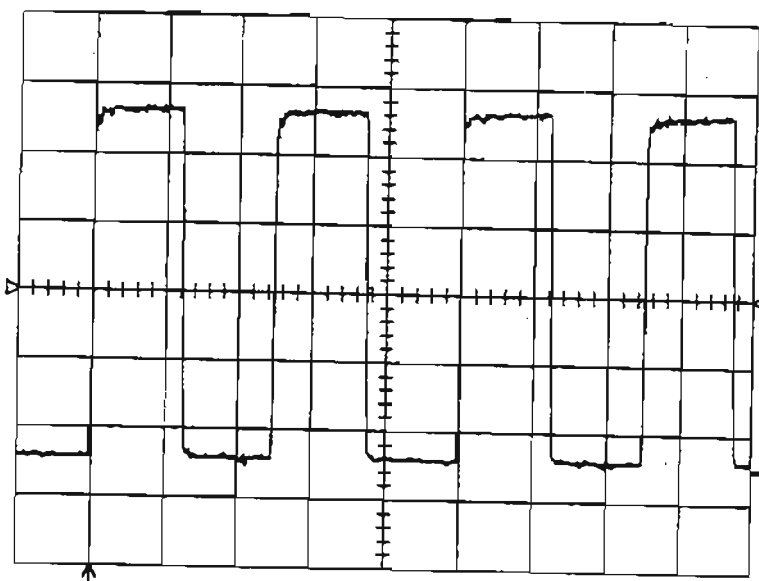

312 sweeps: average				
	low	high	sigma	
ampl(1)	49.9	50.8	0.1	50.5 mV
Freq(1)	1.99828	2.00241	0.00044	1.99998 MHz

CAL BNC OUT
mode
CAL signal
OFF
Pass/Fail
Trigger Out
Trigger Rdy

SET TO 1 kHz
1 V SQUARE

Shape
Square
Pulse(25 ns)

Amplitude
0.05 V
into 1 MΩ

Frequency
2 MHz

- .2 μs
- 1 10 mV DC
 - 2 10 mV DC
 - 3 10 mV DC
 - 4 10 mV DC

1 DC 25.0 mV

500 MS/s

AUTO

- Set Cal amplitude : 1 V
- DSO Input gain : 200 mV/div.
- Check parameters readout $ampl(1) = 1 \text{ V} \pm 6 \%$

5.15 Overload

Specifications

1 Watt into 50 Ω : Overload < 17 seconds

Procedure

- Set the DSO as follows :
 - Display setup : **Standard, Persistence off, Dot join on, Single grid**
 - Input Coupling : **DC 50 Ω**
 - V/div. offset : **Normal**
 - Global BWL : **Off**
 - Probe atten : **X1**
 - Input offset : **- 3.5 V**
 - Input gain : **1 V/div.**
 - Trigger setup : **Edge**
 - Trigger on : **1**
 - Trigger level : **DC - 0.04 V**
 - Delay : **zero**
 - Coupling 1 : **DC**
 - Slope 1 : **Pos**
 - Mode : **Norm**
 - Holdoff : **Off**
 - Timebase : **2 sec/div.**
 - Channel Use : **4**
 - Record up to : **1000 samples**
- From Tektronix power supply PS5004, apply 7.07 V (1 Watt) to Channel 1.
- Check that the overload trips, within 17 seconds.
- Set Timebase : **5 sec/div.**
- From Tektronix power supply PS5004, apply 5 V (.5 Watt) to Channel 1
- Check that the overload doesn't trip for at least 30 seconds.
- Repeat the above tests for Channel 2, Channel 3 and Channel 4 substituting channel controls and input connector, and check as above.

Section 5 Performance Verification

27-Feb-96
13:48:29

Acquisition slowly starting

2 s
1.00 V

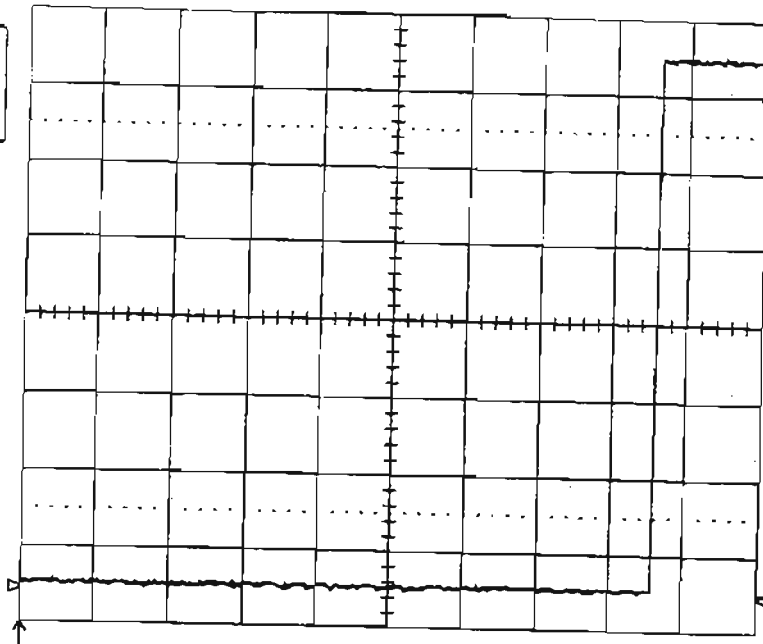

CHANNEL 1
Coupling
DC50Ω
OVERLOAD
DC1MΩ
Grounded
AC1MΩ
V/div Offset
NORMAL
ECL TTL
Global BWL
OFF 25MHz
200MHz

Probe Atten
x1
x2
x5
x10
x20

2 s
1 1 V $\frac{1}{2}$
2 1 V 50Ω
3 1 V 50Ω
4 1 V 50Ω

1 DC -0.04 V

50 S/s

NORMAL

27-Feb-96
13:46:49

5 s
1.00 V

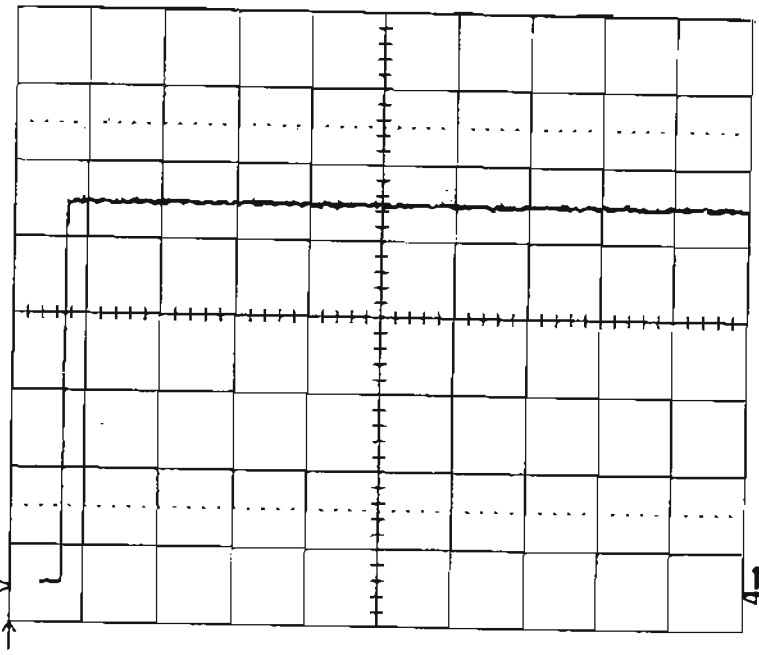

CHANNEL 1
Coupling
DC50Ω
Grounded
DC1MΩ
Grounded
AC1MΩ
V/div Offset
NORMAL
ECL TTL
Global BWL
OFF 25MHz
200MHz

Probe Atten
x1
x2
x5
x10
x20

5 s
1 1 V 50Ω
2 1 V 50Ω
3 1 V 50Ω
4 1 V 50Ω

1 DC -0.04 V

20 S/s

NORMAL

5.16 Combining Channels

Channels can be combined to achieve more memory and more sampling rate by interleaving the ADC's in time. It is possible to achieve 4 GS/s and up to 8M record length (9384AL) by means of a special adaptor call PP094.

- Set DSO Timebase : $.2 \mu\text{sec/div.}$
- Connect the **PP094** adaptor to Channel 2 and Channel 3 and check that :
 - The PP094 is identified on **Channel 2**
 - Channel 1, Channel 3 and Channel 4 are **disabled**
 - Channel 2 is set to **DC 50 Ω , X2**
 - Sampling rate is **4 GS/s**
- Connect the **Probe calibrator** output to **PP094** input using a 5 nsec BNC cable.
- Set Cal frequency to **2 MHz** and Amplitude to **1 V** into **1 M Ω**
- Turn on **trace 2** and check that :
 - A Square wave of 500 mV is displayed on Channel 2

28-Feb-96
14:22:21

2
.2 μs
100 mV

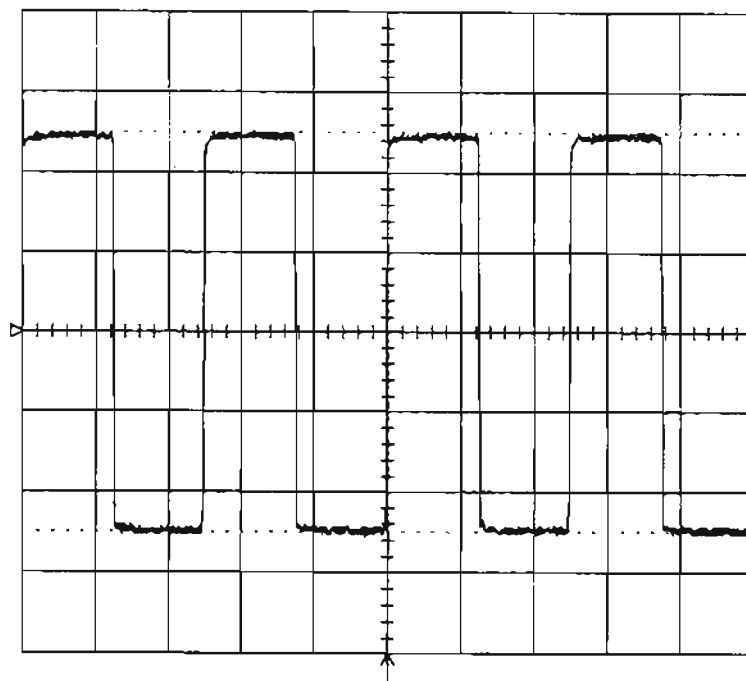

TIMEBASE
T/div .2 μs
4000
samples at
2 GS/s
(.5 ns/pt)
for 2.0 μs

Sampling
 Single Shot
RIS

All Channels
combined for
2 GS/s (2)

Sequence
 Off On Wrap
Record up to
50k

.2 μs
1 disabled
 2 50 mV 50 Ω X2
3 disabled
4 disabled

2 DC 250 mV

2 GS/s
 NORMAL

- Turn on trace 1, 3, 4 and check that :
- A Square wave of 500 mV is displayed on Channel 1, Channel 3, and Channel 4.

SECTION 6 MAINTENANCE**6.1 Introduction**

This section contains information necessary to disassemble, assemble, maintain, calibrate and troubleshoot the LeCroy 9384 digital storage oscilloscope.

6.2 Disassembly and Assembly Procedure

The disassembly and assembly procedures detailed below refer to the assembly and disassembly diagram 6.2.3, and the view of figures 6.1, 6.2, 6.3, 6.4, 6.5, 6.6 and 6.7. Please study the diagram and figures before attempting disassembly.

WARNING

Before removing any parts from the LeCroy 9384, be sure to read carefully the instructions referring to those parts, noting any precautions needed to avoid problems caused by mechanical behavior, high voltage supplies, etc.

CAUTION

The usual precautions against static electricity are required, (see 1.10)

6.2.1 Removal of the Upper Cover (5.10)

The top cover (5.9) is secured by two M4x5 screws (5.11) on both sides of the front panel assembly (2), and by two M4x8 screws (5.10) on the rear panel (3). Remove the screws and carefully slide the cover off the unit to the rear. Removal of the top cover gives access to the boards and parts listed in section 6.2.3.

6.2.2 Removal of the PS9384 Power Supply (4)**WARNING**

Ensure the line cord is disconnected. Remove the following:

- Top cover (6.2.1).
- One M4X8 screw (5.2) from left side of the bottom cover (1.1).
- Two M4X8 screws (5.1) from left side of the rear panel (3).

Disconnect the following:

- Base card power cable (5.9) from 9384-3 main board connector J31.
- PS9384 line input cable (3.20) from connector J6.

The power supply can now be removed vertically from the oscilloscope.

6.2.3 Disassembly and Assembly Diagram

Disassembly : If it becomes necessary to replace a board or a part, use the disassembly diagram to disassemble the unit. Any board can be removed if items higher in the diagram and connected by a line are already out.

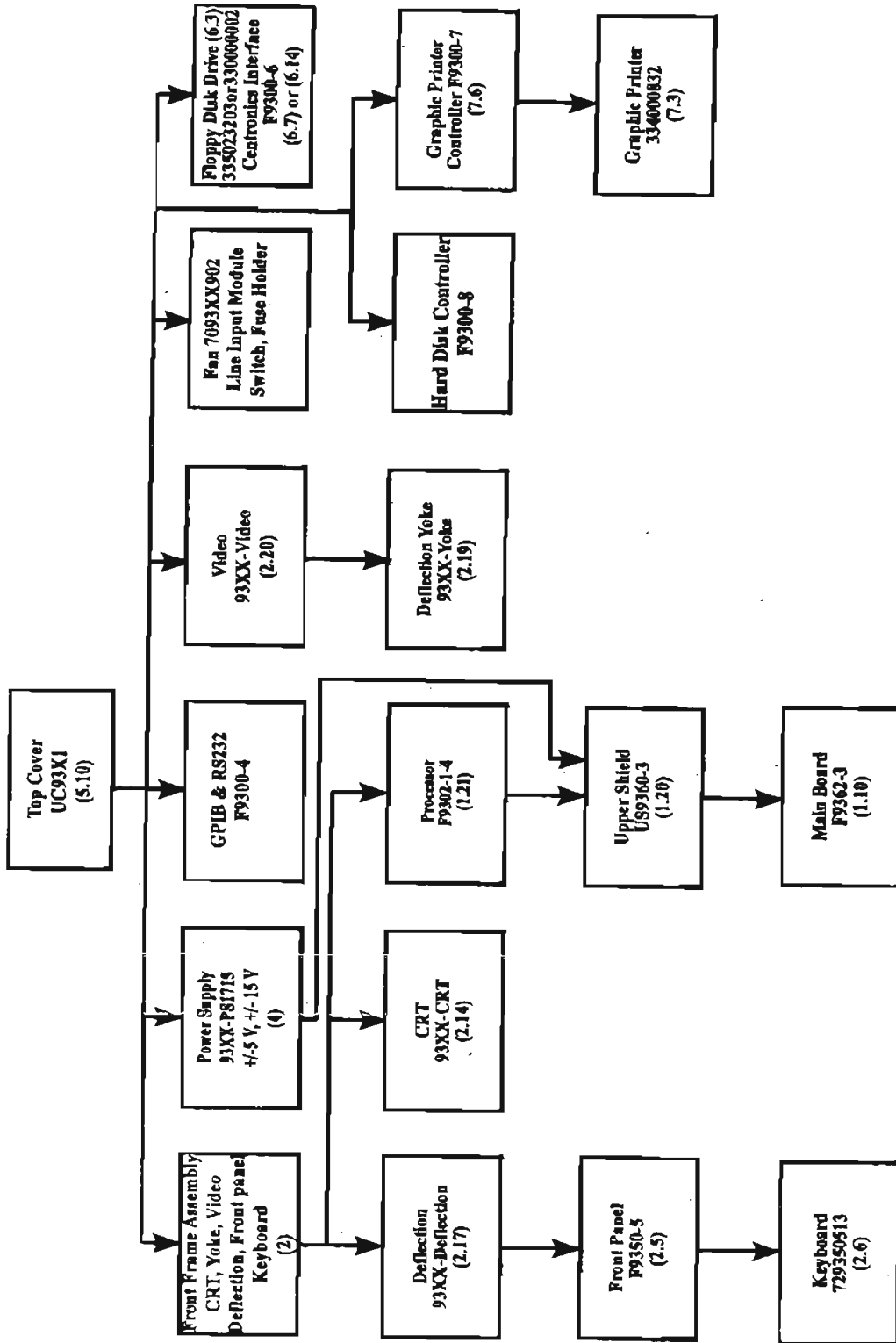

Assembly : Reassemble the unit in the reverse order.

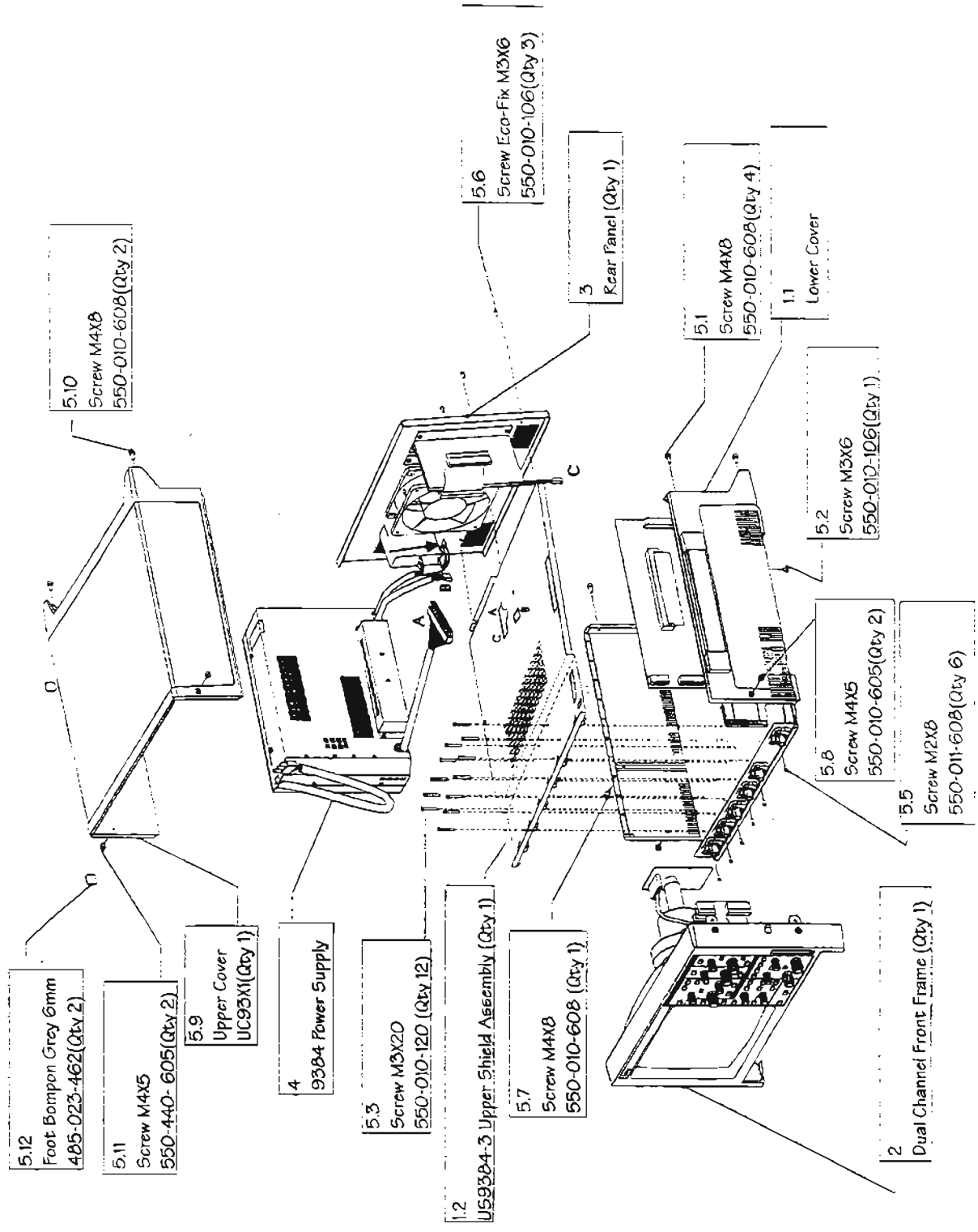

Figure 6.1 : 9384 Assembly

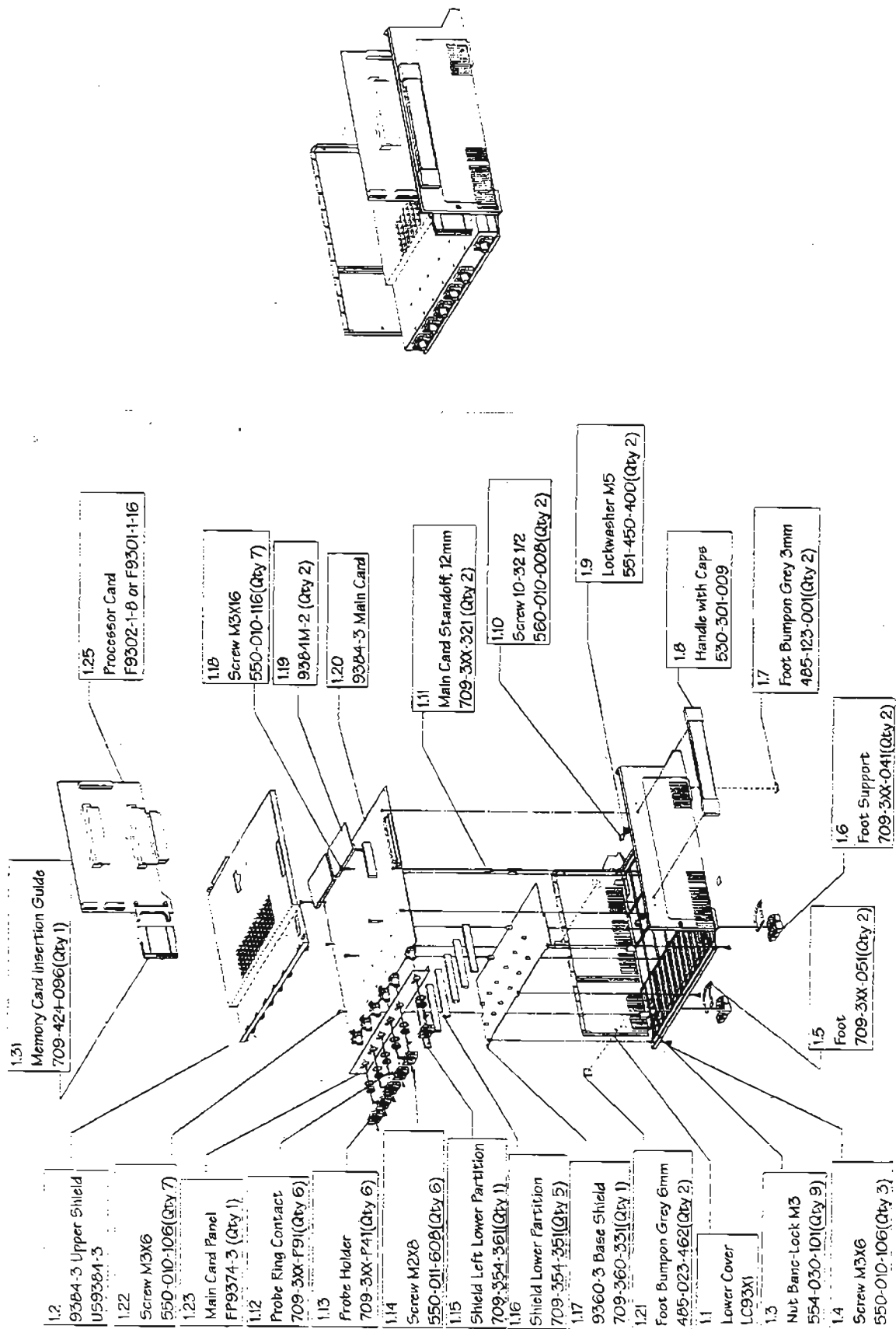

Figure 6.2 : Lower Cover Assembly

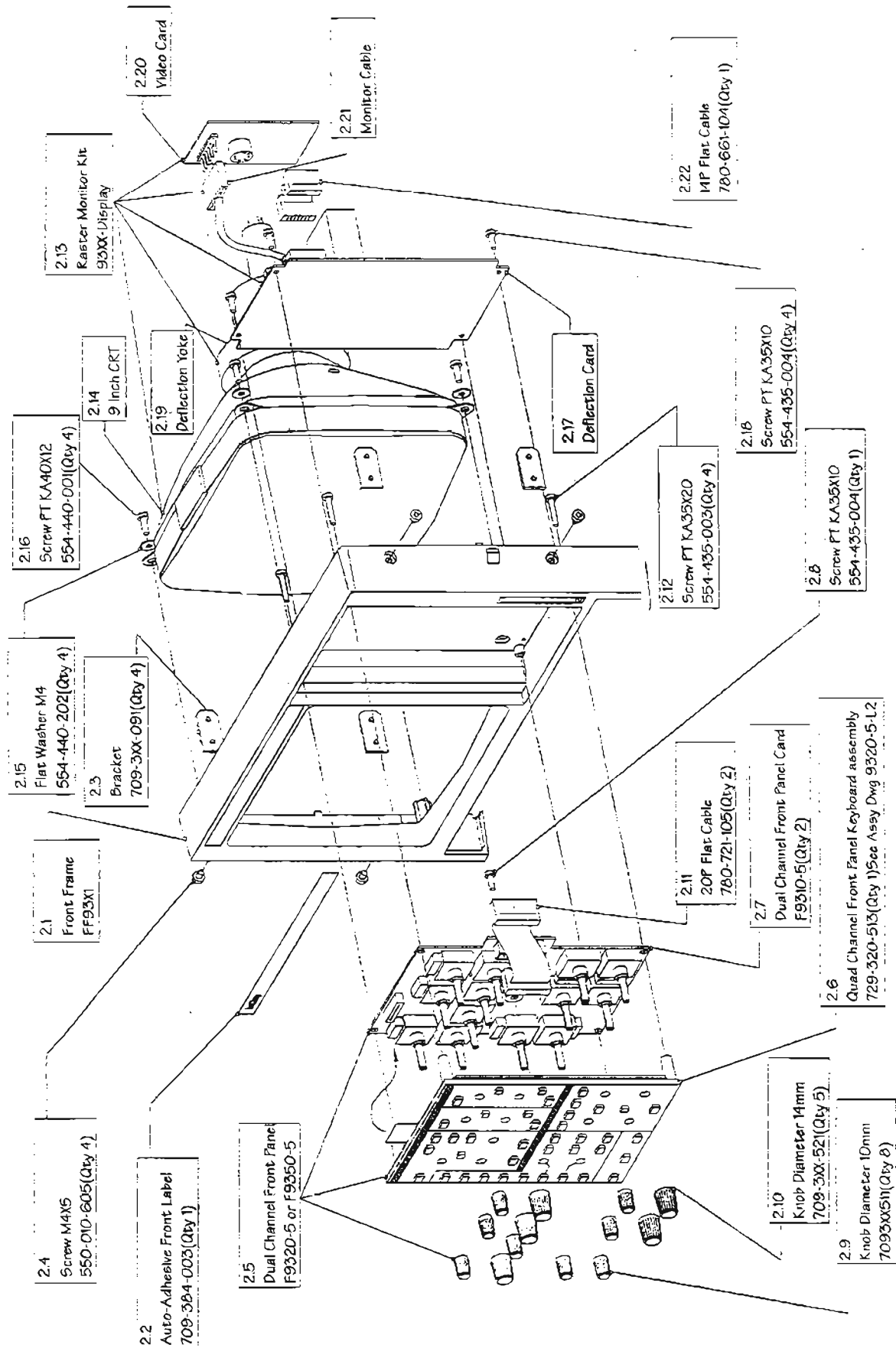

Figure 6.3 : Front Frame Assembly

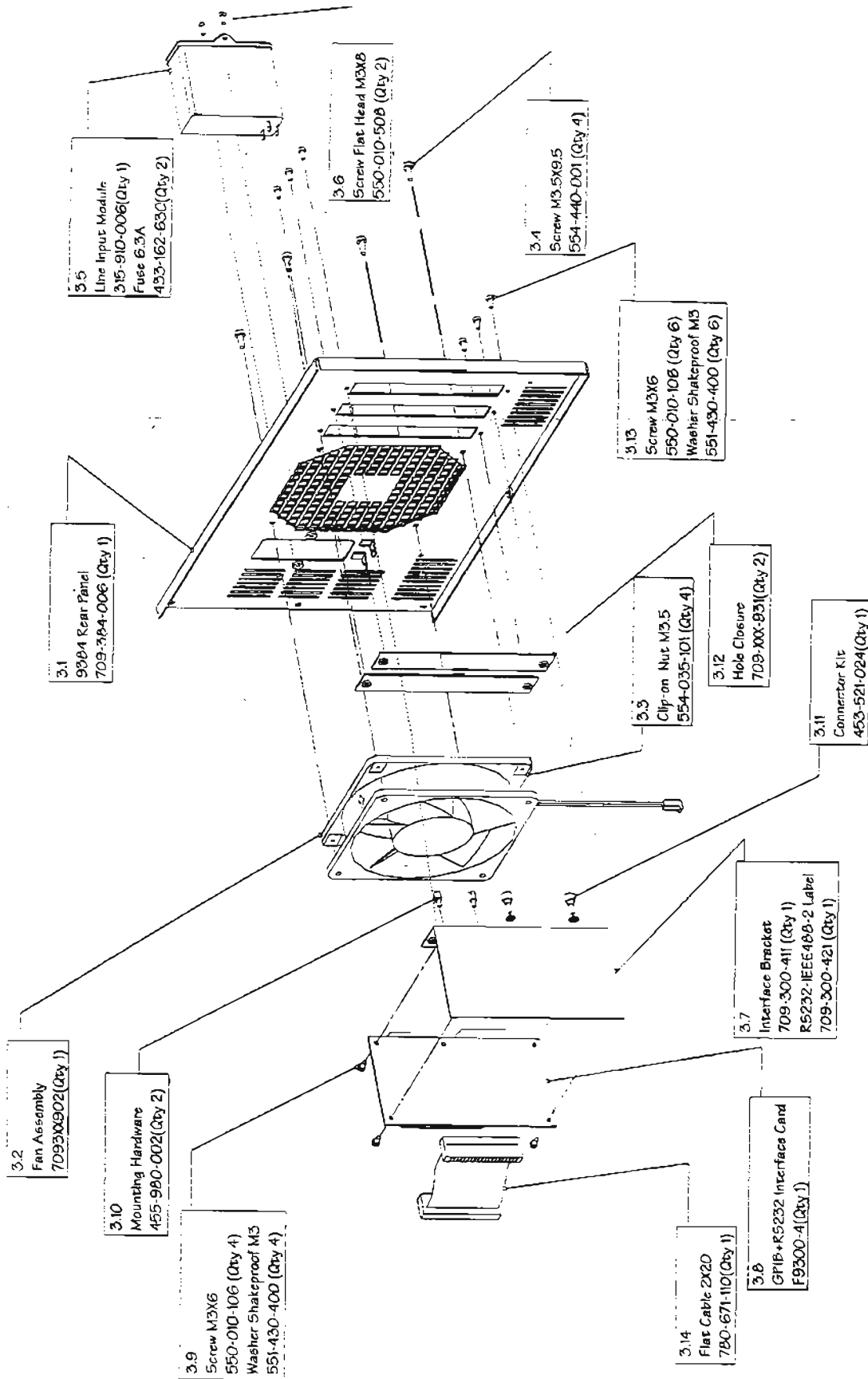

Figure 6.4 : Rear Panel Assembly

6.2.4 Removal of the F9300-4 GPIB/RS232 Interface (3.10)

The GPIB/RS232 interface (3.7) is vertically mounted on the rear panel (3.1).

Remove the following:

- Top cover (6.2.1).
- Two M3x6 screws (3.17) and washers from the rear panel (3.1).
- Disconnect the flat cable (3.14) from the processor board (1.25) connector J5.

The GPIB/RS232 board can be removed forwards from the rear panel.

6.2.5 Removal of the Fan (3.3)

Remove the following:

- Top cover of 9384 (6.2.1)
- Four screws (3.4) from the rear panel (3.1).
- Disconnect the fan power cable from the main card F9384-3 connector J33.

The fan (3.3) part number : 7093XX902 can be removed from the unit.

CAUTION

Note the air flow, the fan extracts air from the unit and expels it.

6.2.6 Removal of the Fuse Holder (3.6)

WARNING

Disconnect the power cord.

Remove the following:

- Top cover (6.2.1).
- Two screws (3.6) from the rear panel.
- Disconnect the power cable from the power supply.
- Disconnect the earth cable.

The fuse holder assembly (3.5) can be removed from the rear panel (3.1).

6.2.7 Removal of the 93XX-Video (2.20)

- Remove the top cover (6.2.1).
- Disconnect the ground cable from CRT (black wire)
- Disconnect the monitor cable (2.21) from the deflection board, connector W301 & W302.

Ease the video board (2.20) carefully toward the back of the DSO, until it is free.

6.2.8 Removal of the 93XX-Yoke (2.19)

- Remove the top cover (6.2.1).
- Remove the 93XX-video board (6.2.7)
- Disconnect the cable from the deflection board connector W201.
- Loose the screw on the yoke ring holder.

The deflection yoke (2.19) can be removed from the cathode ray tube (2.14).

6.2.9 Removal of the front frame Assembly (2)

Remove the following:

- Top cover (6.2.1)
- Two screws (5.8) that secure the front frame assembly (2) to the lower cover (1.1).
- Disconnect the front panel flat cable (2.11) from the processor (1.25) connector J4.
- Disconnect the deflection flat cable (2.22) from the processor board connector J6.

The front frame assembly (2) with the CRT (2.14), yoke (2.19), video (2.20), deflection (2.17), front panel (2.7) and keyboard (2.6) can with care be removed forward from the unit.

CAUTION

Hold the CRT very carefully, or place soft padding under it.

6.2.10 Removal of the 93XX-Deflection (2.17)

The deflection board (2.17) is situated to the back of the front panel (2.5).

Remove the following

- Top cover (6.2.1).
- Front frame assembly (6.2.9).
- Disconnect the monitor cable (2.21) which leads to the video board (2.20), connector W301 and W302.
- Disconnect the cable from the deflection yoke, connector W201.
- Disconnect the red high voltage cable from the receptacle at the right side of the CRT (2.14).

WARNING

Touch the free end of the high voltage cable to the ground, this ensures that no significant charge remains. The CRT must be discharged similarly, using a tool or a long screw driver which is first placed to the ground and on the CRT receptacle.

Remove the four M35x10 screws (2.18) that secure the deflection board to the plastic front frame.

The board (2.17) can now be removed from the unit.

6.2.11 Removal of the 93XX-CRT (2.14)

It is necessary to remove the front frame assembly (6.2.9). The CRT is secured to the plastic front frame by four screws (2.16).

- Remove the 93XX-video (6.2.7).
- Remove the 93XX-yoke (6.2.8).
- Disconnect the red high voltage cable from the deflection board.
- Remove the four screws.

The CRT can now be removed from the front frame.

WARNING

Use care when handling the CRT. Avoid striking it on any object which may cause the tube to implode. Store the cathode ray tube face down on a soft surface. To avoid electrical shock the CRT should be discharged after the 9384 oscilloscope is powered OFF. After disconnecting the red high voltage cable, ground the cable to the metallic display support, repeat the operation to fully dissipate the charge.

6.2.12 Removal of the F9354-5 Front Panel (2.5)

Remove the following:

- Upper cover (6.2.1).
- Front frame assembly (6.2.9).
- 93XX-deflection board (6.2.10).
- Four screws (2.12) that secure the front panel.

The front panel (2.5) with the keyboard (2.6) can be removed forward from the unit.

6.2.13 Removal of the Front Panel Keyboard (2.6)

Remove the following:

- Upper cover (6.2.1).
- Front frame assembly (6.2.9).
- 93XX-deflection board (6.2.10).
- F9350-5 front panel (6.2.12).
- The 13 rotary knobs (2.9 and 2.10). Take great care of the soft plastic
- One screw (2.8) that secures the keyboard to the front panel.
- Disconnect the flat ribbon cable from the front panel connector J2, and remove the keyboard P/N : 729350513.

CAUTION

When removing or installing the keyboard or the front panel, be careful of the fragile flat ribbon cable and connector.

6.2.14 Removal of the Processor (1.21)

The processor board F9302-1-8 is located along the right side of the instrument.

Remove the following:

- Top cover (6.2.1).
- Front frame assembly (6.2.9).
- Disconnect the flat cable (3.14) from the F9300-4 GPIB interface connector J5

The processor can be removed vertically from the main card (1.20) connector J34

CAUTION

Static electricity can damage components (RAM, EPROM's, microprocessor...). Antistatic precautions are required.

6.2.15 Removal of the F9384-3 Main Card (1.20)

Remove the following:

- Top cover (6.2.1).
- Front frame assembly (6.2.9).
- Power supply (6.2.2).
- Processor (6.2.14).

The main board with the upper shield (1.2) is horizontally mounted to the lower case cover (1.1).

- Remove the twelve M3x20 screws (5.3) and four M2.5x6 (5.6) that secure the upper shield (1.2) to the main board and front panel.
- Remove the two M4x8 (5.1) and one M3x6 (5.2) that secure the rear panel assembly (3) to the lower cover (1.1)
- Disconnect the fan cable from connector J33

The upper shield (1.2) attached to the rear panel (3) can be removed forward from the board.

- Remove the five M3x6 screws (1.22), four M3x16 (1.18) and three M3x6 flat head screws (1.4) that secure the board to the lower cover (1.1).

The main board F9384-3 (1.10) with base shield (1.15) and card panel (1.11) can be removed from the scope.

CAUTION

Antistatic precautions are required.

6.2.16 Removal of the Handle (1.4)

The handle with two black end caps is secured to the right side of the lower cover (1.1) by two screws (1.10) and washers (1.9).

- Remove the upper cover (6.2.1), and processor board (6.2.14).

The handle can be removed from the lower case.

6.2.17 Removal of the Foot Support (1.8)

The two foot supports are clipped on the lower cover (1.1).

- Remove the foot (1.5) or the support (1.6) by inserting a small flat screwdriver under the support

6.2.18 Removal of the 93XX-FD01 Floppy Disk Drive Option

- Remove the upper cover (6.2.1).
- Disconnect the flat ribbon cable from the F9300-6 interface (see figure 6.6).
- Remove the two M3x6 screws that secure the floppy drive support to the upper cover.
- Remove the support 70FD01021 and frame 70FD01031 from the cover.
- Remove the four M2.5x4 screws (6.14) that secure the floppy to the support

The floppy disk (6.4) drive can be removed from the frame

6.2.19 Removal of the 93XX-GP01 Graphic Printer and F9300-7 Controller Option

- Remove the upper cover (6.2.1).
- Disconnect the power cable from the auxiliary power supply (315070025) (see figure 6.3 & 6.7).
- Disconnect the flat ribbon cable (780791604) from the F9300-7 controller (see figure 6.7).
- Disconnect the flat ribbon cable (780721022) between the F9300-6 interface and F9300-7 controller.
- Remove the four M3x6 screws (6.21) that secure the F9300-7 controller to frame (70GP01031).
- Remove the F9300-7 controller (6.9).
- Remove the two M3x6 screws (6.18) that secure the printer to the frame

The graphic printer (6.3) can now be removed from the upper cover.

6.2.20 Removal of the F9300-6 Centronics Interface Option

- Remove the upper cover (6.2.1).
- Remove the two M3x6 screws from the rear panel
- Disconnect the flat cable from the F9300-4 GPIB/RS232 board (see figure 6.6).

The Centronics interface board can be removed forward from the rear panel.

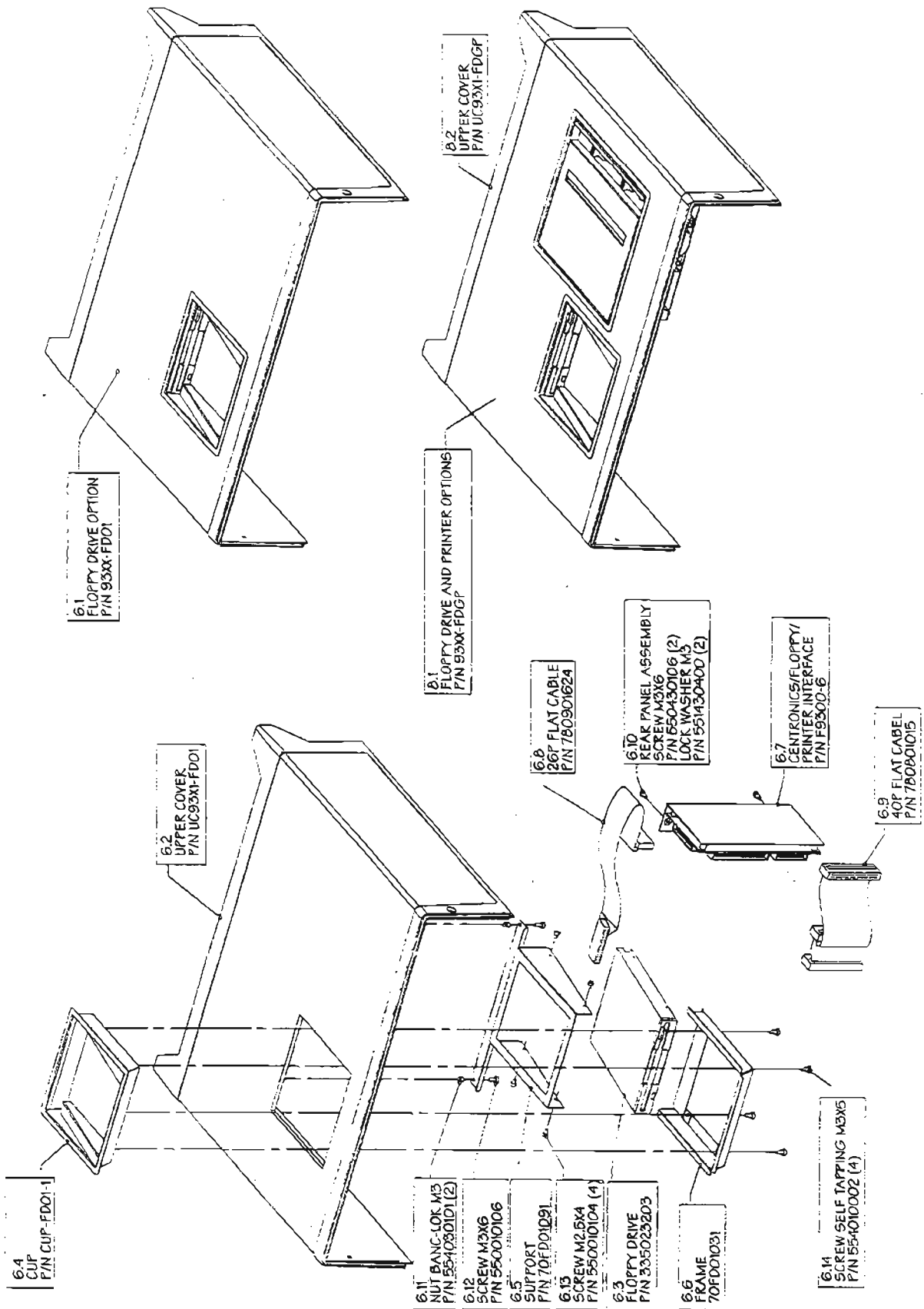

Figure 6.5 : Floppy Drive Assembly P/N: 335023203

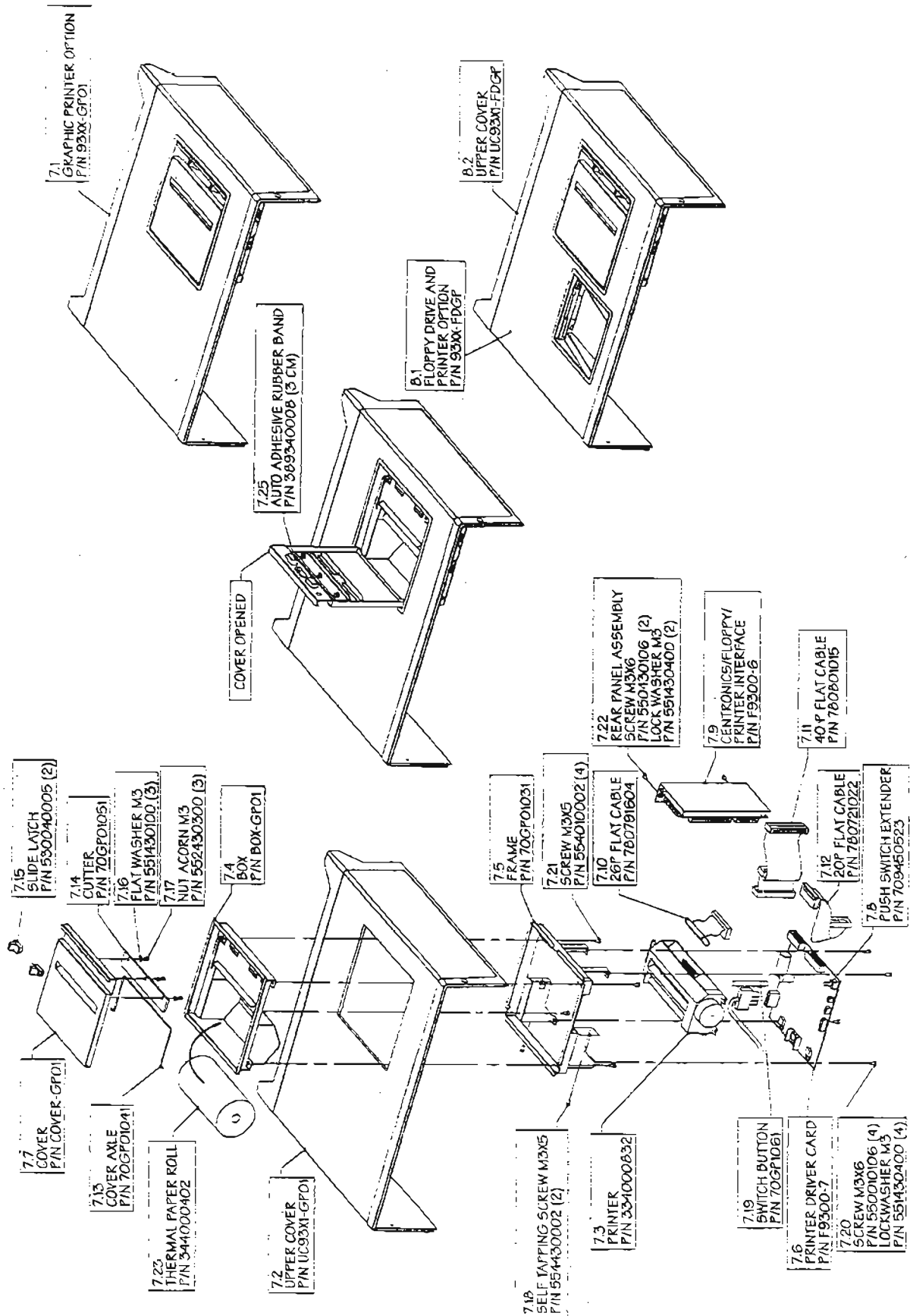

Figure 6.6 : Graphic Printer Assembly

6.3 Software Upgrade Procedure

F9302-1-8 processor board has one 8 MB Flash Prom which contains the program memory and the character font used by the graphic processor of the raster scan display.

After any software change, a general instrument reset is mandatory. Simultaneously press the autoseup button, the top menu button and the return button.

6.3.1 Upgrading Firmware

LeCroy Corporation has a policy of continually improving and upgrading its products.

The 9384 instrument is equipped with Flash Prom on processor board, the Software is upgraded to the latest version using either the Memory Card interface or the Floppy disk drive.

6.3.1.1 Upgrading Firmware from Memory Card

A single memory card containing the 93XX36XX.bin file in the Lecroy_P directory is required.

- Insert the card and cycle power to the scope. Once re-booted enter the **Utilities, Special Modes, Firmware Update** menu.

2-Oct-95
14:40:08

SPECIAL MODES

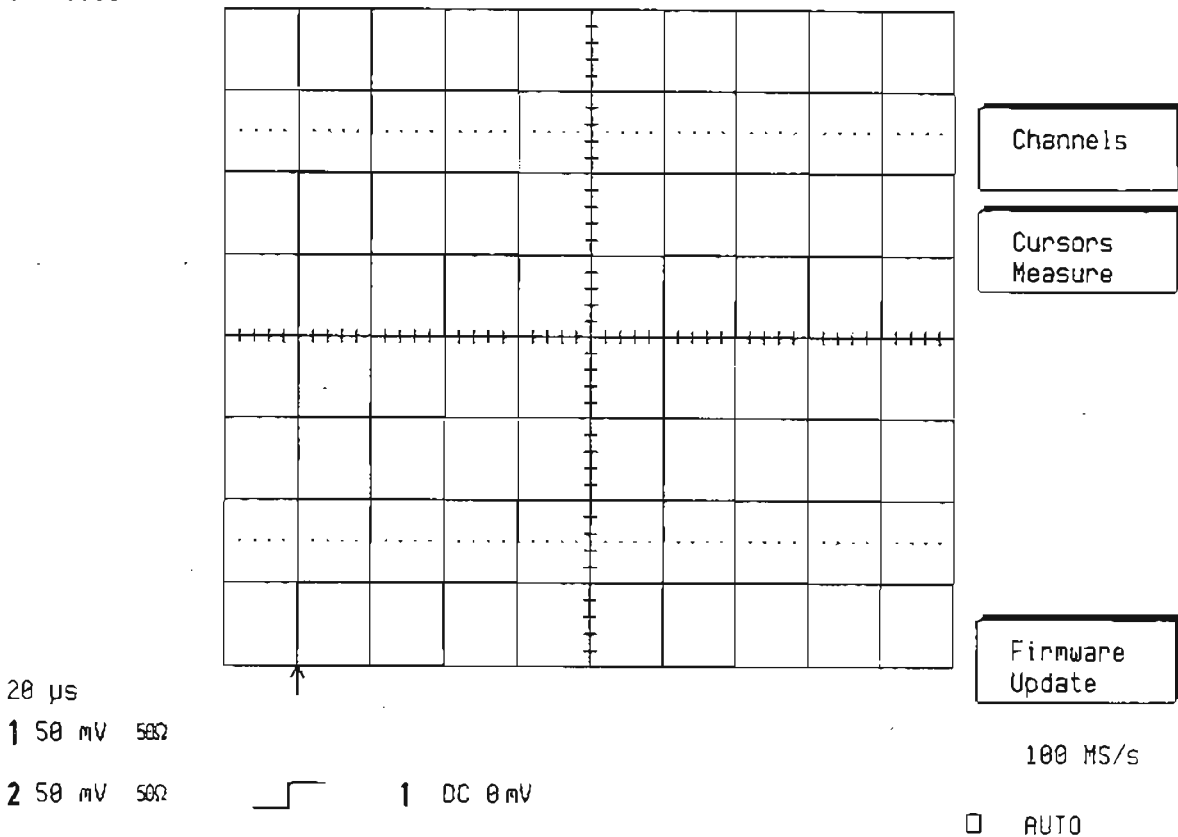

- Change the **Update From** control to **Card**
- Press **Update Program**.

The Software is then downloaded to the Flash Prom on the processor board.

2-Oct-95
14:35:52

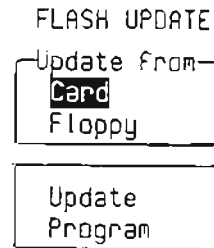

Warning:

Reprogramming the flash memory is a procedure to be performed with care.

Any loss of power during the update process could cause the scope to require factory service.

The update process requires a LeCroy supplied software update memory card or floppy disk. This contains the necessary information to update your scope software.

Note that once software has been updated it is not possible to revert to the previous software version.

6.3.1.2 Upgrading Firmware from Floppy

In order to update the scope firmware from floppy, two disks are required.

The first contains a **93XX36XX.bin** file in the Lecroy_P directory.

The second contains a **93XX36XX fla** file in the Lecroy_P directory

- Insert the first disk and cycle power to the scope. Once re-booted enter the **Utilities, Special Modes, Firmware Update** menu.
- Change the **Update From** control to **Floppy**
- Insert the second floppy disk and press **Update Program**.

The Software is then downloaded to the Flash Prom.

2-Oct-95
14:38:44

FLASH UPDATE

Update From
Card
Floppy

Update
Program

Warning:

Reprogramming the Flash memory is a procedure to be performed with care.

Any loss of power during the update process could cause the scope to require factory service.

The update process requires a LeCroy supplied software update memory card or Floppy disk. This contains the necessary information to update your scope software.

Note that once software has been updated it is not possible to revert to the previous software version.

6.3.2 Changing Software Options

The software option selection GAL is located on the processor board at location A49.

Insert or replace the GAL to select new options.

Make sure that the orientation notch is correctly aligned with the PCB.

6.3.3 Software Option Selection GAL

The following software options are available : (see section 2)

WP01	Advanced Math Firmware
WP02	Basic FFT Firmware
WP03	Parameter Distribution Analysis Firmware
DDM	Disk Drive Measurements
PRML	Partial Response Maximum Likelihood
ORM	Optical Recording Measurement Package
MC01	Memory Card Reader

PAL	MC01	ORM	PRML	DDM	WP03	WP02	WP01
KEY001-A							WP01
KEY002-A						WP02	
KEY003-A						WP02	WP01
KEY004-A					WP03		
KEY005-A					WP03		WP01
KEY006-A					WP03	WP02	
KEY007-A					WP03	WP02	WP01
KEY008-A				DDM			
KEY009-A				DDM			WP01
KEY00A-A				DDM		WP02	
KEY00B-A				DDM		WP02	WP01
KEY00C-A				DDM	WP03		
KEY00D-A				DDM	WP03		WP01
KEY00E-A				DDM	WP03	WP02	
KEY00F-A				DDM	WP03	WP02	WP01
KEY020-A			PRML				
KEY021-A			PRML				WP01
KEY022-A			PRML			WP02	
KEY023-A			PRML			WP02	WP01
KEY024-A			PRML		WP03		
KEY025-A			PRML		WP03		WP01
KEY026-A			PRML		WP03	WP02	
KEY027-A			PRML		WP03	WP02	WP01
KEY028-A			PRML	DDM			
KEY029-A			PRML	DDM			WP01
KEY02A-A			PRML	DDM		WP02	
KEY02B-A			PRML	DDM		WP02	WP01
KEY02C-A			PRML	DDM	WP03		
KEY02D-A			PRML	DDM	WP03		WP01
KEY02E-A			PRML	DDM	WP03	WP02	
KEY02F-A			PRML	DDM	WP03	WP02	WP01
KEY040-A		ORM					
KEY041-A		ORM					WP01
KEY042-A		ORM				WP02	
KEY043-A		ORM				WP02	WP01
KEY044-A		ORM			WP03		
KEY045-A		ORM			WP03		WP01
KEY046-A		ORM			WP03	WP02	
KEY047-A		ORM			WP03	WP02	WP01
KEY048-A		ORM		DDM			
KEY049-A		ORM		DDM			WP01
KEY04A-A		ORM		DDM		WP02	
KEY04B-A		ORM		DDM		WP02	WP01
KEY04C-A		ORM		DDM	WP03		
KEY04D-A		ORM		DDM	WP03		WP01
KEY04E-A		ORM		DDM	WP03	WP02	
KEY04F-A		ORM		DDM	WP03	WP02	WP01
KEY060-A		ORM	PRML				

Section 6 Maintenance

PAL	MC01	ORM	PRML	DDM	WP03	WP02	WP01
KEY061-A		ORM	PRML				WP01
KEY062-A		ORM	PRML			WP02	
KEY063-A		ORM	PRML			WP02	WP01
KEY064-A		ORM	PRML		WP03		
KEY065-A		ORM	PRML		WP03		WP01
KEY066-A		ORM	PRML		WP03	WP02	
KEY067-A		ORM	PRML		WP03	WP02	WP01
KEY068-A		ORM	PRML	DDM			
KEY069-A		ORM	PRML	DDM			WP01
KEY06A-A		ORM	PRML	DDM		WP02	
KEY06B-A		ORM	PRML	DDM		WP02	WP01
KEY06C-A		ORM	PRML	DDM	WP03		
KEY06D-A		ORM	PRML	DDM	WP03		WP01
KEY06E-A		ORM	PRML	DDM	WP03	WP02	
KEY06F-A		ORM	PRML	DDM	WP03	WP02	WP01
KEY200-A	MC01						
KEY201-A	MC01						WP01
KEY202-A	MC01					WP02	
KEY203-A	MC01					WP02	WP01
KEY204-A	MC01				WP03		
KEY205-A	MC01				WP03		WP01
KEY206-A	MC01				WP03	WP02	
KEY207-A	MC01				WP03	WP02	WP01
KEY208-A	MC01			DDM			
KEY209-A	MC01			DDM			WP01
KEY20A-A	MC01			DDM		WP02	
KEY20B-A	MC01			DDM		WP02	WP01
KEY20C-A	MC01			DDM	WP03		
KEY20D-A	MC01			DDM	WP03		WP01
KEY20E-A	MC01			DDM	WP03	WP02	
KEY20F-A	MC01			DDM	WP03	WP02	WP01
KEY220-A	MC01		PRML				
KEY221-A	MC01		PRML				WP01
KEY222-A	MC01		PRML			WP02	
KEY223-A	MC01		PRML			WP02	WP01
KEY224-A	MC01		PRML		WP03		
KEY225-A	MC01		PRML		WP03		WP01
KEY226-A	MC01		PRML		WP03	WP02	
KEY227-A	MC01		PRML		WP03	WP02	WP01
KEY228-A	MC01		PRML	DDM			
KEY229-A	MC01		PRML	DDM			WP01
KEY22A-A	MC01		PRML	DDM		WP02	
KEY22B-A	MC01		PRML	DDM		WP02	WP01
KEY22C-A	MC01		PRML	DDM	WP03		
KEY22D-A	MC01		PRML	DDM	WP03		WP01
KEY22E-A	MC01		PRML	DDM	WP03	WP02	
KEY22F-A	MC01		PRML	DDM	WP03	WP02	WP01
KEY240-A	MC01	ORM					
KEY241-A	MC01	ORM					WP01
KEY242-A	MC01	ORM				WP02	

PAL	MC01	ORM	PRML	DDM	WP03	WP02	WP01
KEY243-A	MC01	ORM				WP02	WP01
KEY244-A	MC01	ORM			WP03		
KEY245-A	MC01	ORM			WP03		WP01
KEY246-A	MC01	ORM			WP03	WP02	
KEY247-A	MC01	ORM			WP03	WP02	WP01
KEY248-A	MC01	ORM		DDM			
KEY249-A	MC01	ORM		DDM			WP01
KEY24A-A	MC01	ORM		DDM		WP02	
KEY24B-A	MC01	ORM		DDM		WP02	WP01
KEY24C-A	MC01	ORM		DDM	WP03		
KEY24D-A	MC01	ORM		DDM	WP03		WP01
KEY24E-A	MC01	ORM		DDM	WP03	WP02	
KEY24F-A	MC01	ORM		DDM	WP03	WP02	WP01
KEY260-A	MC01	ORM	PRML				
KEY261-A	MC01	ORM	PRML				WP01
KEY262-A	MC01	ORM	PRML			WP02	
KEY263-A	MC01	ORM	PRML			WP02	WP01
KEY264-A	MC01	ORM	PRML		WP03		
KEY265-A	MC01	ORM	PRML		WP03		WP01
KEY266-A	MC01	ORM	PRML		WP03	WP02	
KEY267-A	MC01	ORM	PRML		WP03	WP02	WP01
KEY268-A	MC01	ORM	PRML	DDM			
KEY269-A	MC01	ORM	PRML	DDM			WP01
KEY26A-A	MC01	ORM	PRML	DDM		WP02	
KEY26B-A	MC01	ORM	PRML	DDM		WP02	WP01
KEY26C-A	MC01	ORM	PRML	DDM	WP03		
KEY26D-A	MC01	ORM	PRML	DDM	WP03		WP01
KEY26E-A	MC01	ORM	PRML	DDM	WP03	WP02	
KEY26F-A	MC01	ORM	PRML	DDM	WP03	WP02	WP01

6.3.4 Processor Board Exchange Procedure

The replacement board is supplied without any options. Therefore the existing GAL at Loc. A49, must be transferred from the faulty board to the new board.

After upgrading firmware or changing the software option, check that the scope boots correctly.

Then check in the system summary, by using the show status button on the front panel, the software version, software options and serial number.

Section 6 Maintenance

2-Oct-95
14:31:35

STATUS

Serial Number 936201732

Soft Version 9362- 06.4.2
Wednesday, 20. September 1995 18:00
(build 72)

Acquisition
System
Text & Times
Waveform
Memory Used

Soft Options

WP01 WP02 WP03 DDM CKIO PRML MC01

Hard Options

GPIB R232 CLBZ FD01 CENT CPU3 I2C

MORE VERSION
INFORMATION

Main RAM size 4 Mbytes

The serial number of the 9384 oscilloscope is loaded in the real time clock memory which is battery backed up. If it becomes necessary to replace the processor board, the serial number must be loaded in the memory of the new board by using LeCroy program " LeCalsoft " under GPIB remote control.

To run " LeCalsoft " type SKP.exe, in the main menu type S, and follow the instructions, use five digits to enter the serial number (i.e. 01732).

6.4 Equipment and Spare Parts Recommended for Service

6.4.1 Equipment

The following equipment is needed to provide the technician access to the 9384 subassemblies during repair and calibration
See also Performance Verification section 5.

Instrument	Qty	Specifications	Recommended
Signal Generator (sine wave)	1	Frequency : .5 MHz to 2 GHz Accuracy : 1ppm Amplitude : 5 V peak to peak	HP8648B or equivalent
Digital Multimeter	1	5 digits	Keithley 2000
Fast pulser	1	Rise time < 500 psec	LeCroy 4969
Cable	1	BNC, 50 Ω , length 20 cm & 100 cm (6.87 & 39.37 inches)	Suhner

6.4.2 Spare Parts

In order to make the repair of 9384 oscilloscope at board level, a minimum stock of boards is at least one each:

- F9302-1-8 : Processor board
- 9384-3 : Main board
- 9384M-2 : 1 M Memory board
- 9384MEM-2 : 2 M Memory board
- F9300-4 : GPIB/RS232 interface
- F9354-5 : Front panel with keyboard
- 93XX-Display : Raster monitor kit (deflection, video, yoke & CRT)
- PS9384 : Power supply

If the unit is equipped with the 93XX-FD01 option :

- F9300-6 : Floppy, Graphic printer, Centronics Interface
- 335023203 : Floppy disk drive

If the unit is equipped with the **93XX-GP01** option :

- F9300-6 : Graphic printer, Floppy, Centronics Interface
- F9300-7 : Graphic printer controller
- 334000832 : LPT5446 Seiko Graphic printer

If the unit is equipped with the **93XX-HD01** option :

- F9300-8 : Hard disk Interface
- HDD02: Hard disk drive

6.5 Troubleshooting and Flow Charts

Most procedures in this section will allow troubleshooting down to the **BOARD LEVEL**. Defective circuit boards will be repaired or exchanged by the regional LeCroy service office or the local representative (see section 1.4).

6.5.1 Introduction

The troubleshooting information contained in this section is intended for use by qualified personnel having a basic understanding of electronics (analog and digital). In order to simplify servicing and minimize downtime, the following list of possible symptoms, likely causes, and troubleshooting steps have been prepared.

The first step in troubleshooting is to check for obvious items like blown fuses.

The power supply is the next item to check before proceeding to more detailed troubleshooting, since noise or low power supply voltages can cause a variety of digital and analog problems.

6.5.2 Line Voltage Autoranging

The 9384 oscilloscope operates from a 115 V (90 to 130 V) or 220 V (180 to 260 V) normal power source at 47 Hz to 63Hz.

No voltage selection is required since the instrument automatically adapts to the line voltage which is present.

The instrument operates at line frequencies up to 440 Hz.

6.5.3 Initial Troubleshooting Chart

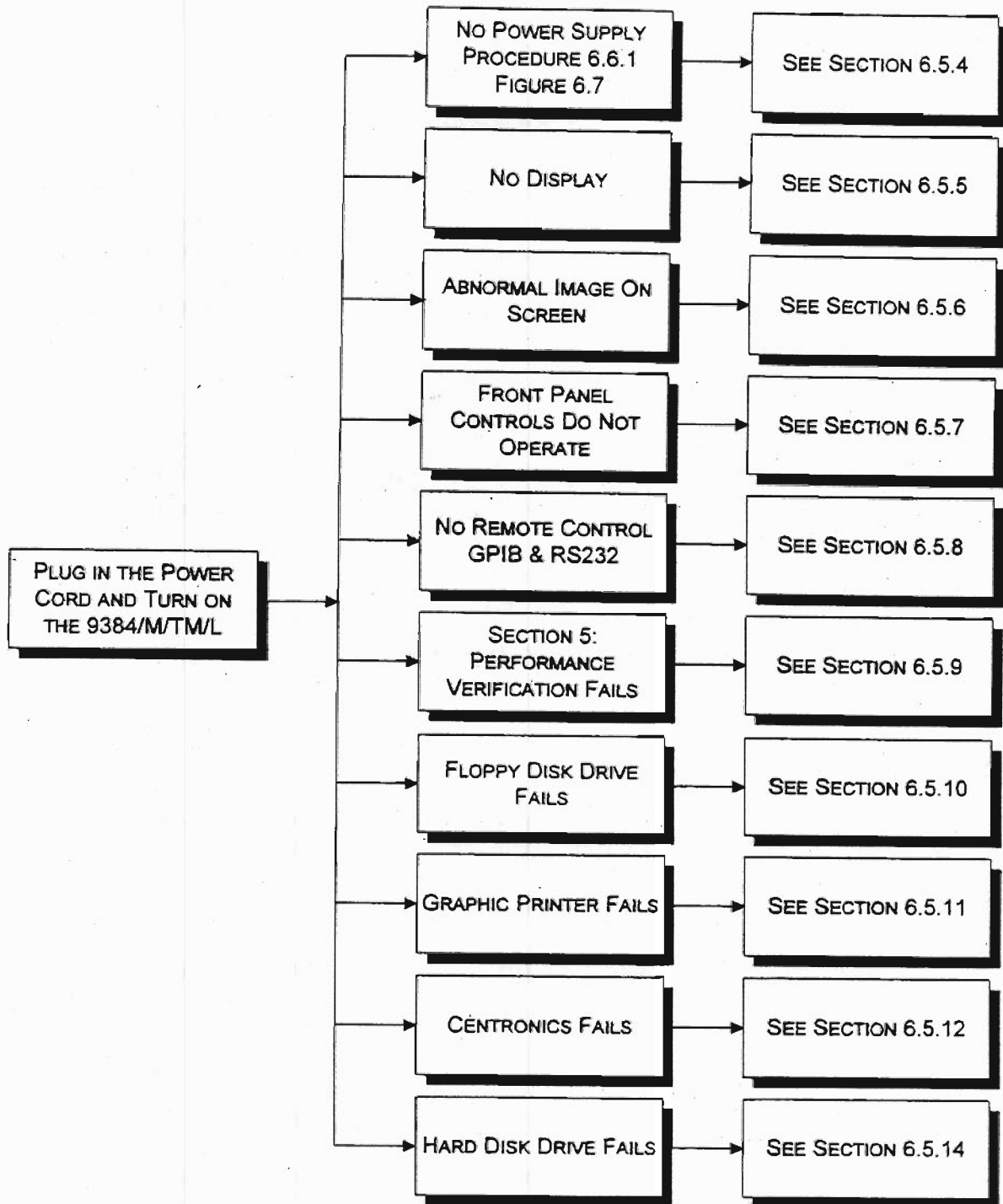

6.5.4 No Power Supply

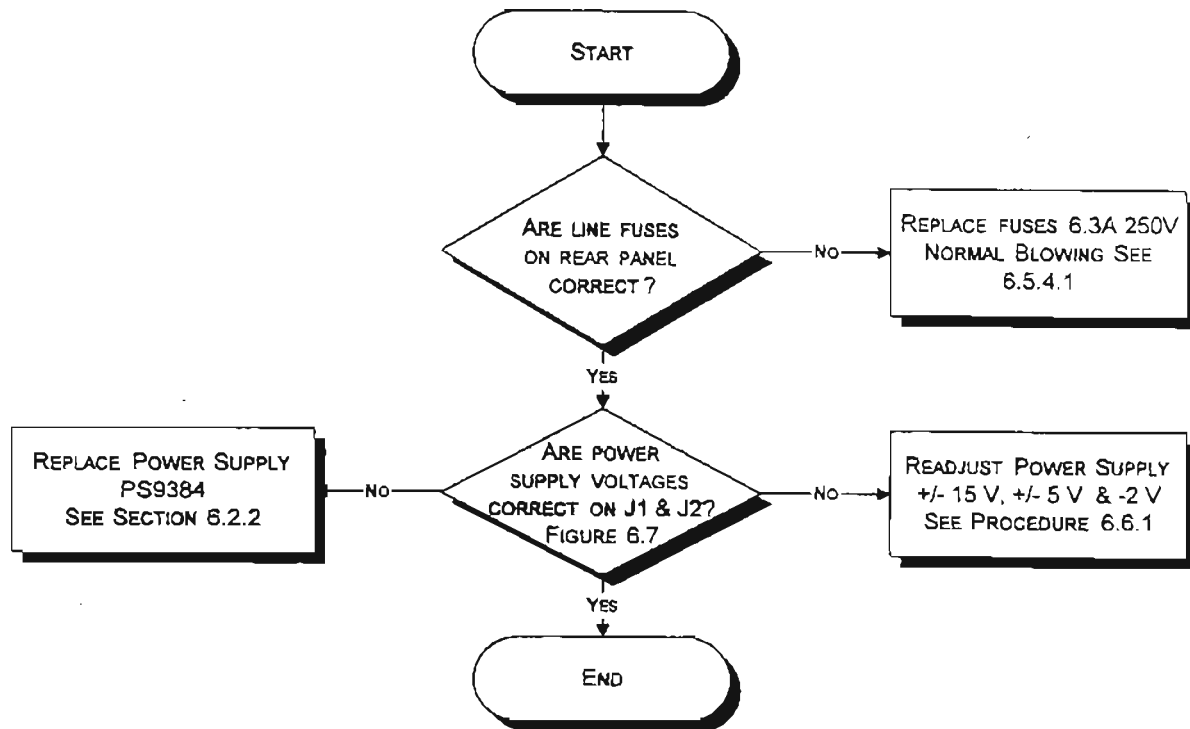

6.5.4.1 Line Fuses Replacement

The power supply of the oscilloscope is protected against short circuits and overload by means of two 6.3 A / 250 V fuses located above the main plugs.

WARNING

Disconnect the instrument from the power line and from other equipment before replacing fuses.

To replace line fuses, proceed as follow :

- Turn off the power and disconnect the line cord from the instrument
- Open the fuse box by inserting a small flat screwdriver under the plastic cover and remove the fuse carrier from the holder
- Remove the 6.3 amp fuse and replace it with the proper type:

6.3 amp/250 V, normal blowing.
LeCroy part number: 433 162 630

6.5.5 No Display

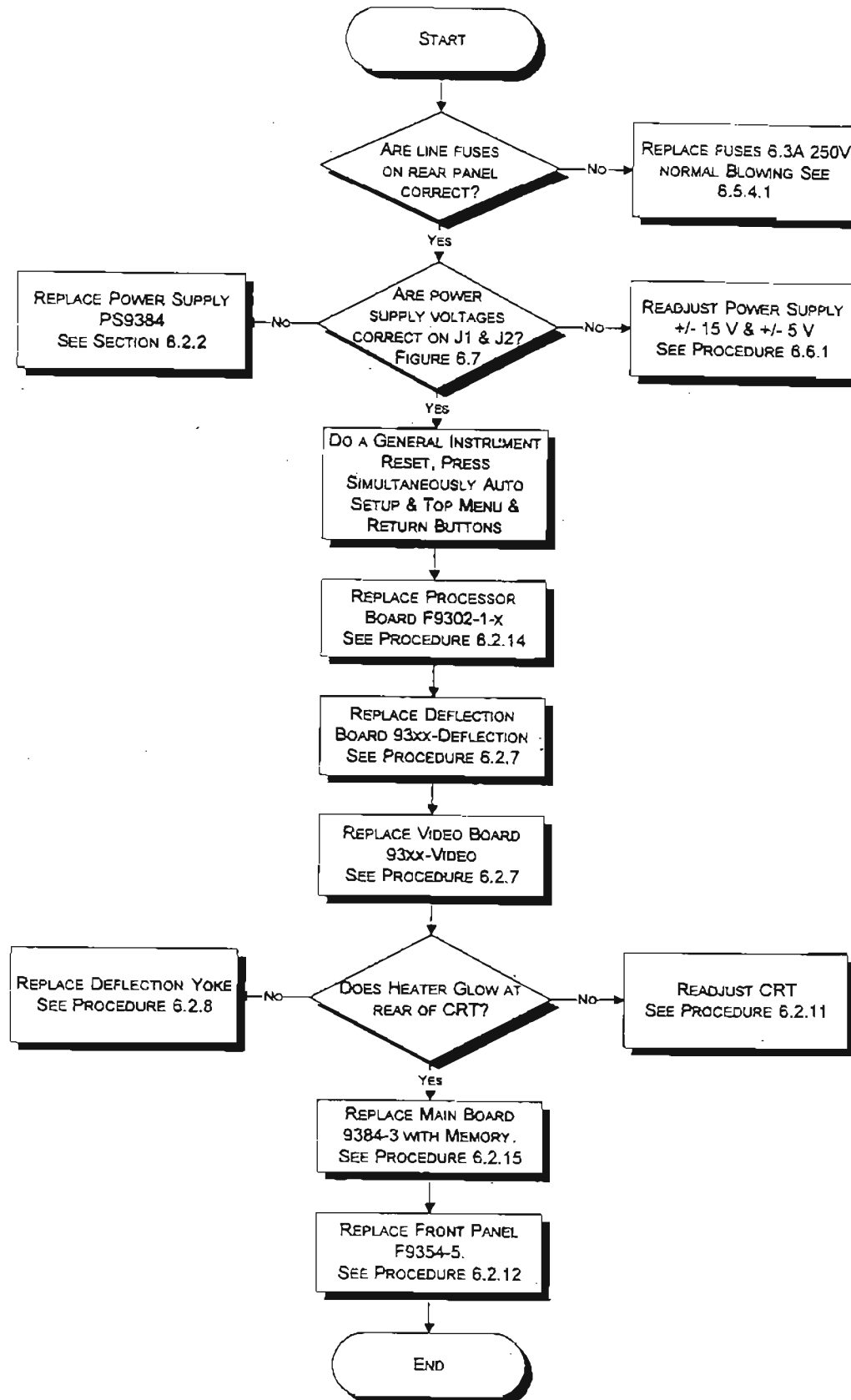

6.5.6 Abnormal Image On Screen

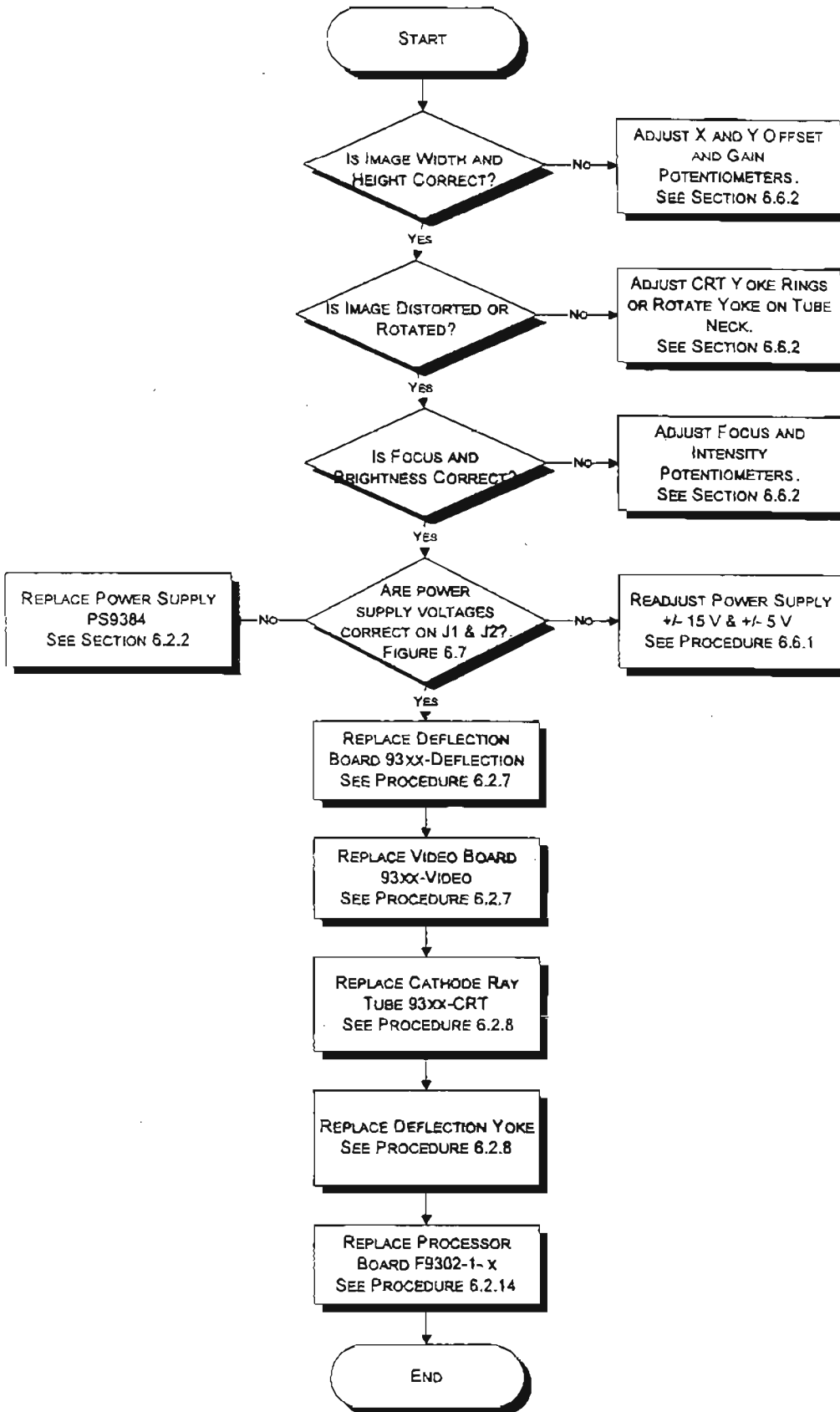

6.5.7 Front Panel Controls Do Not Operate

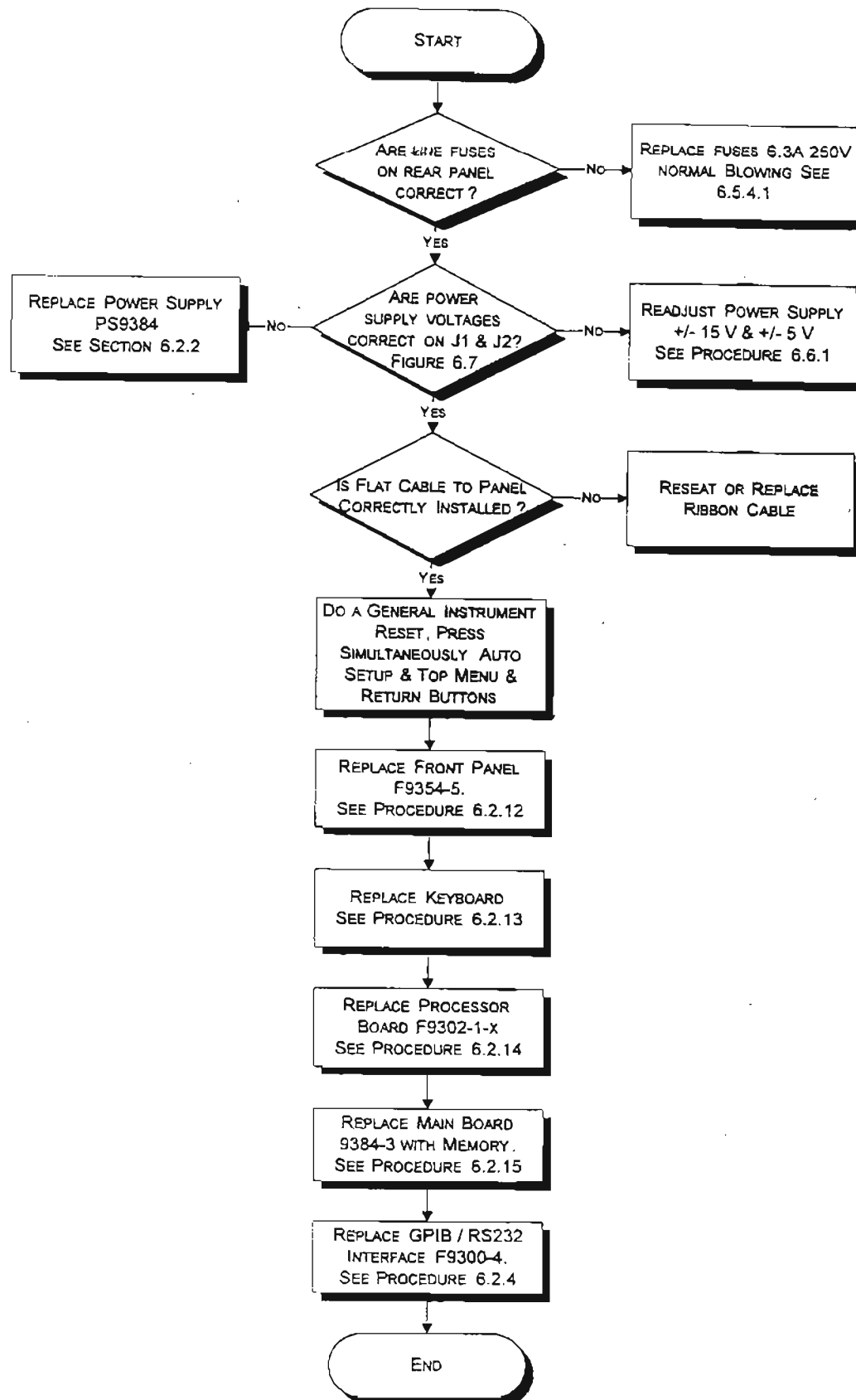

6.5.8 No Remote Control GPIB and RS232

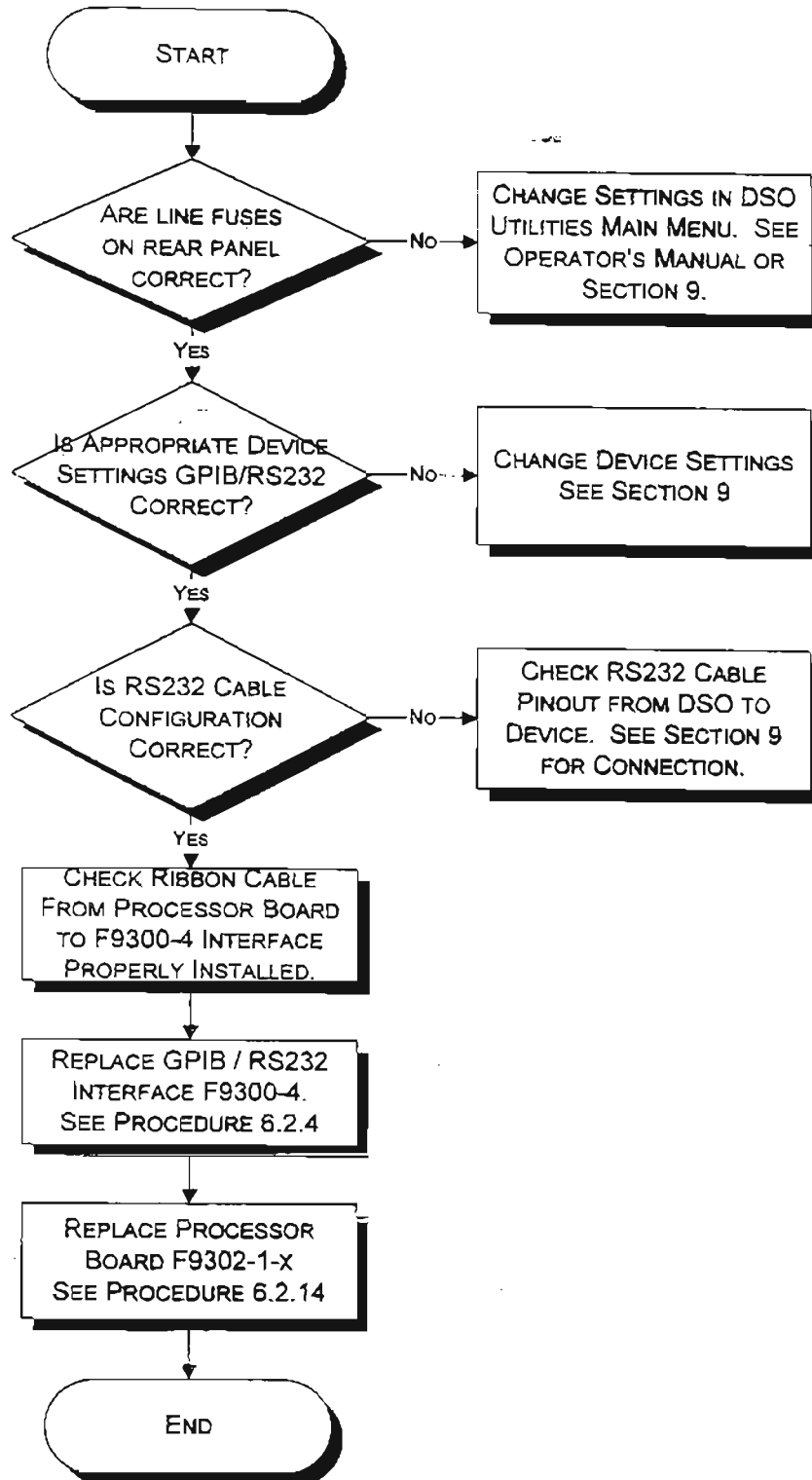

6.5.9 Performance Verification Fails

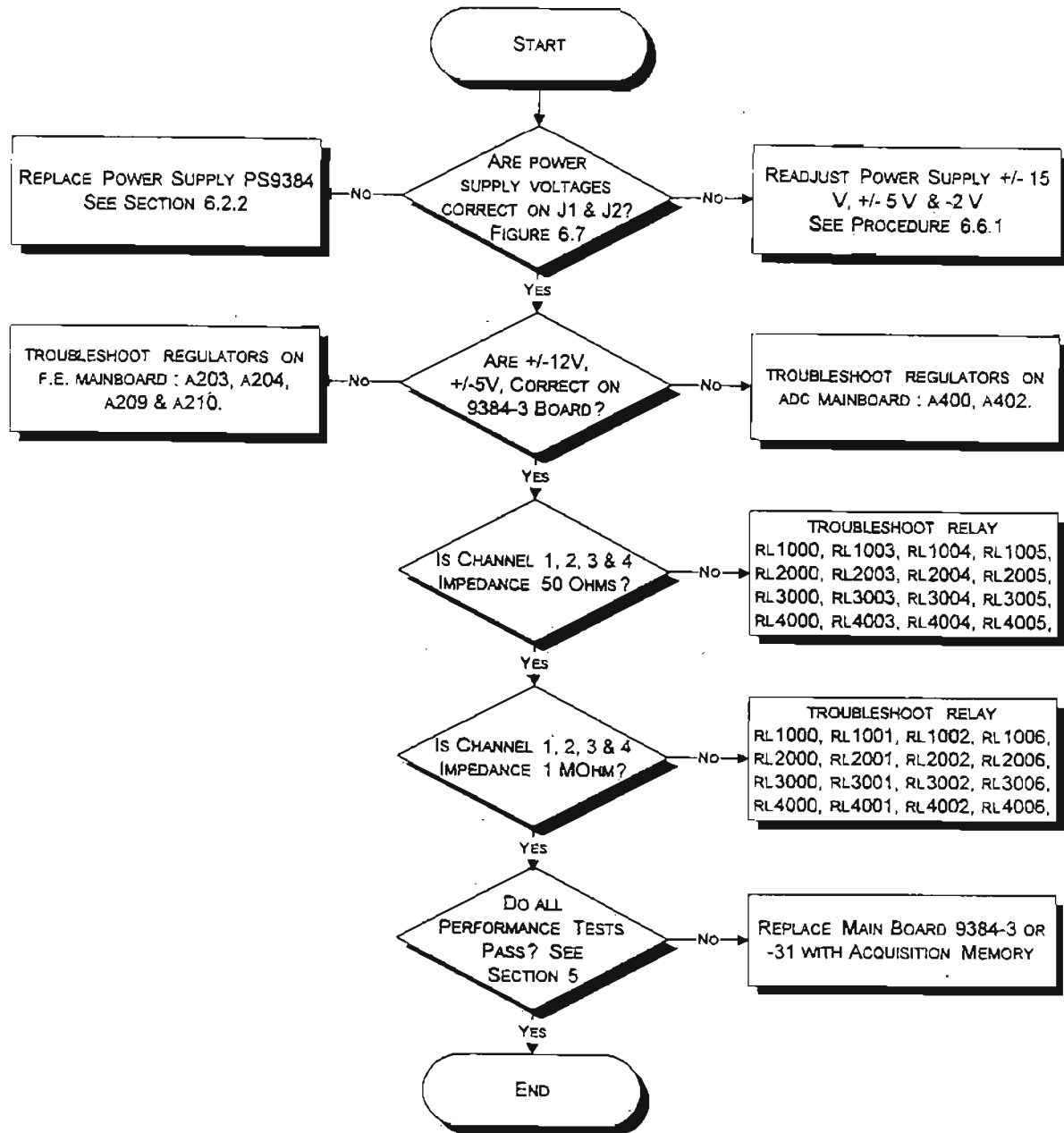

6.5.10 Floppy Disk Drive Fails

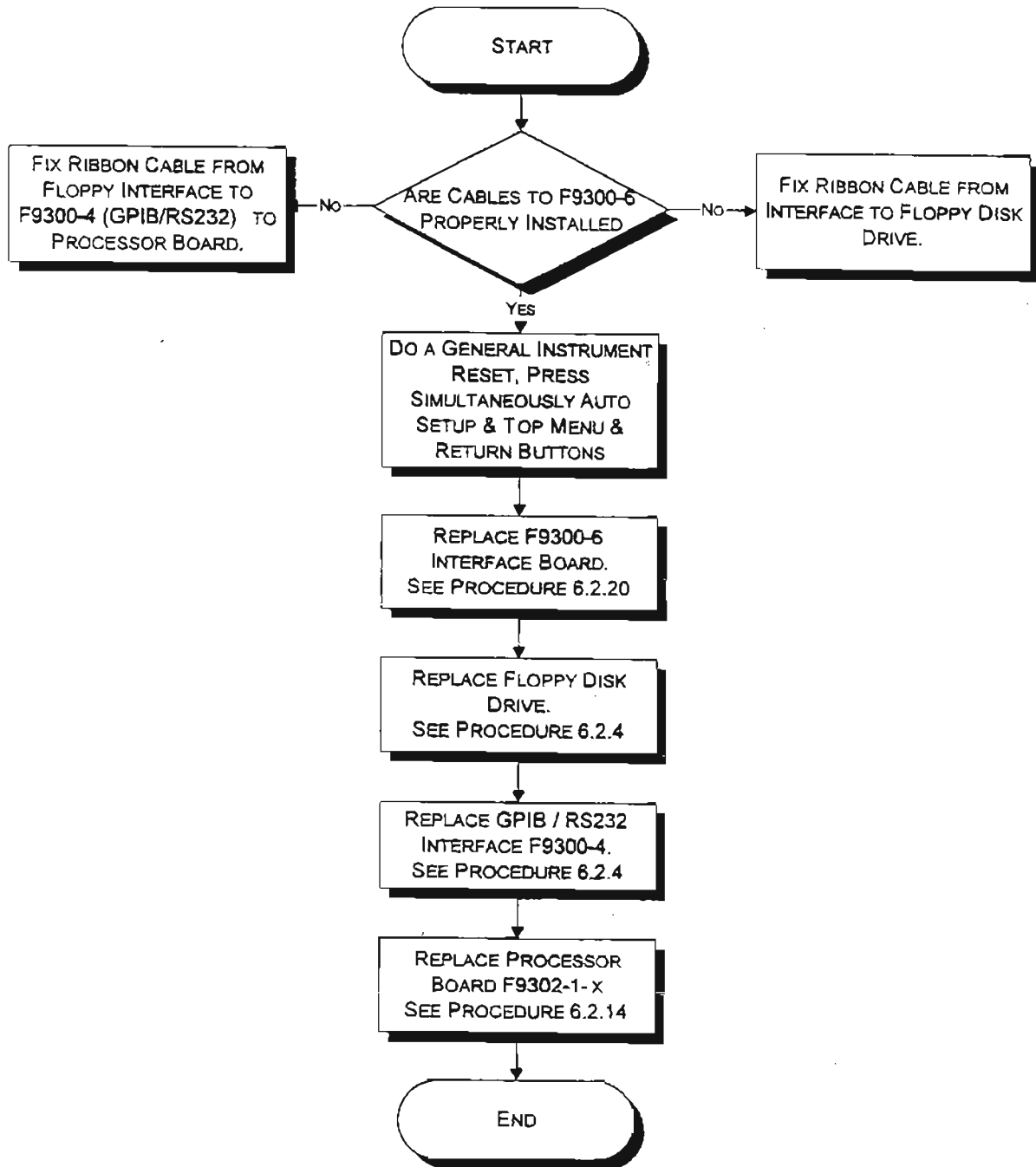

6.5.11 Graphic Printer Fails

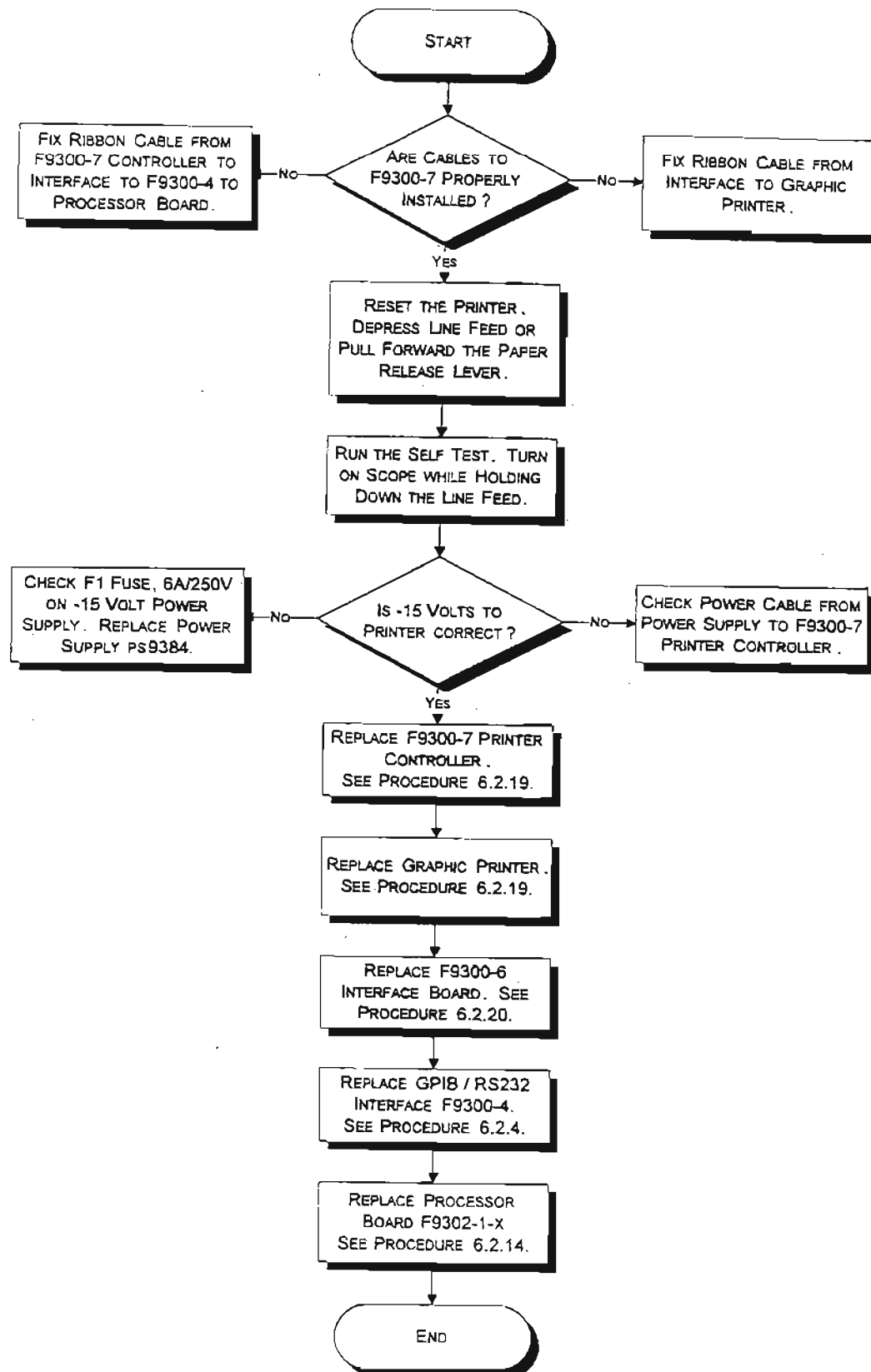

6.5.13 Centronics Fails

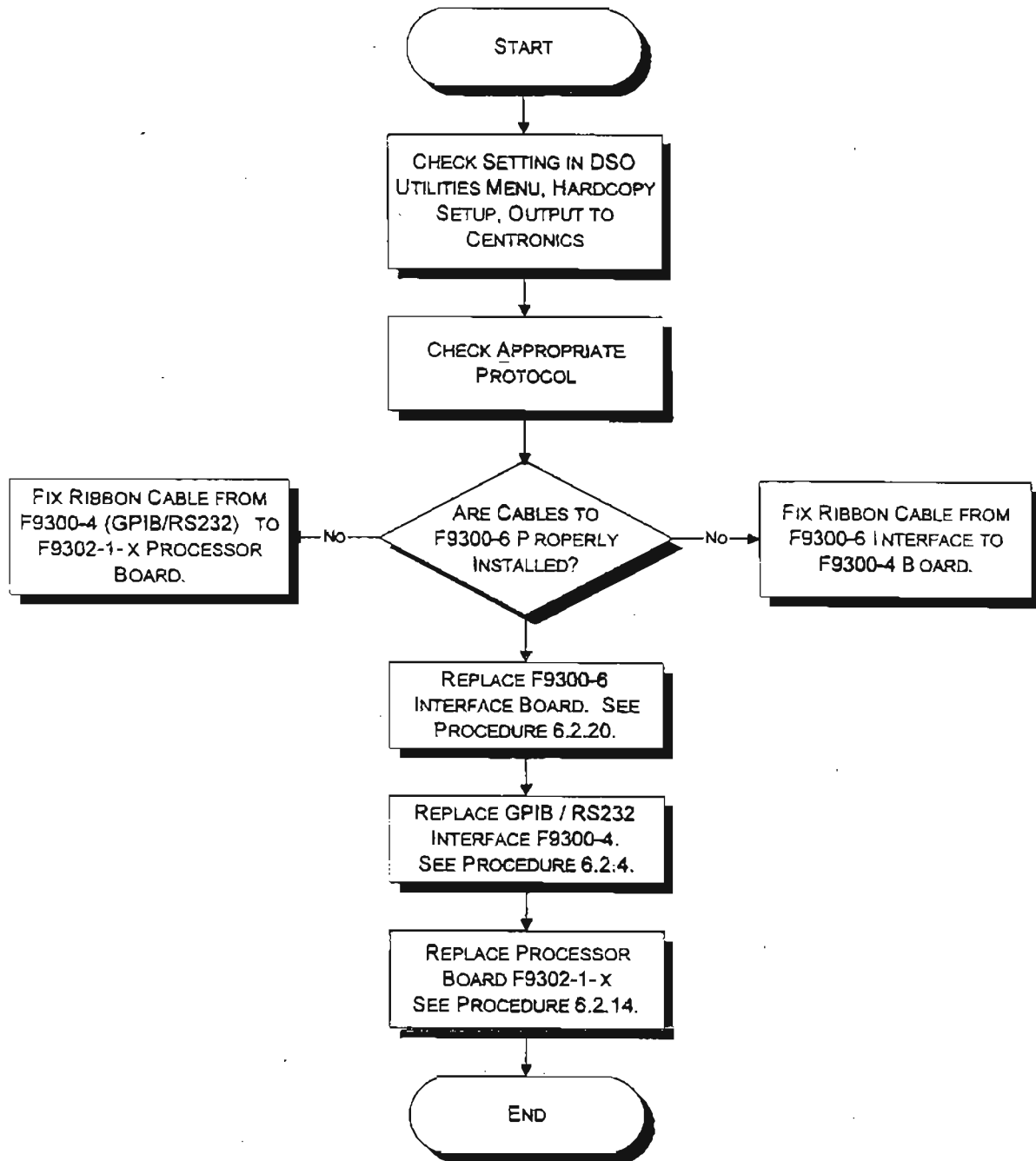

6.5.14 Hard Disk Fails

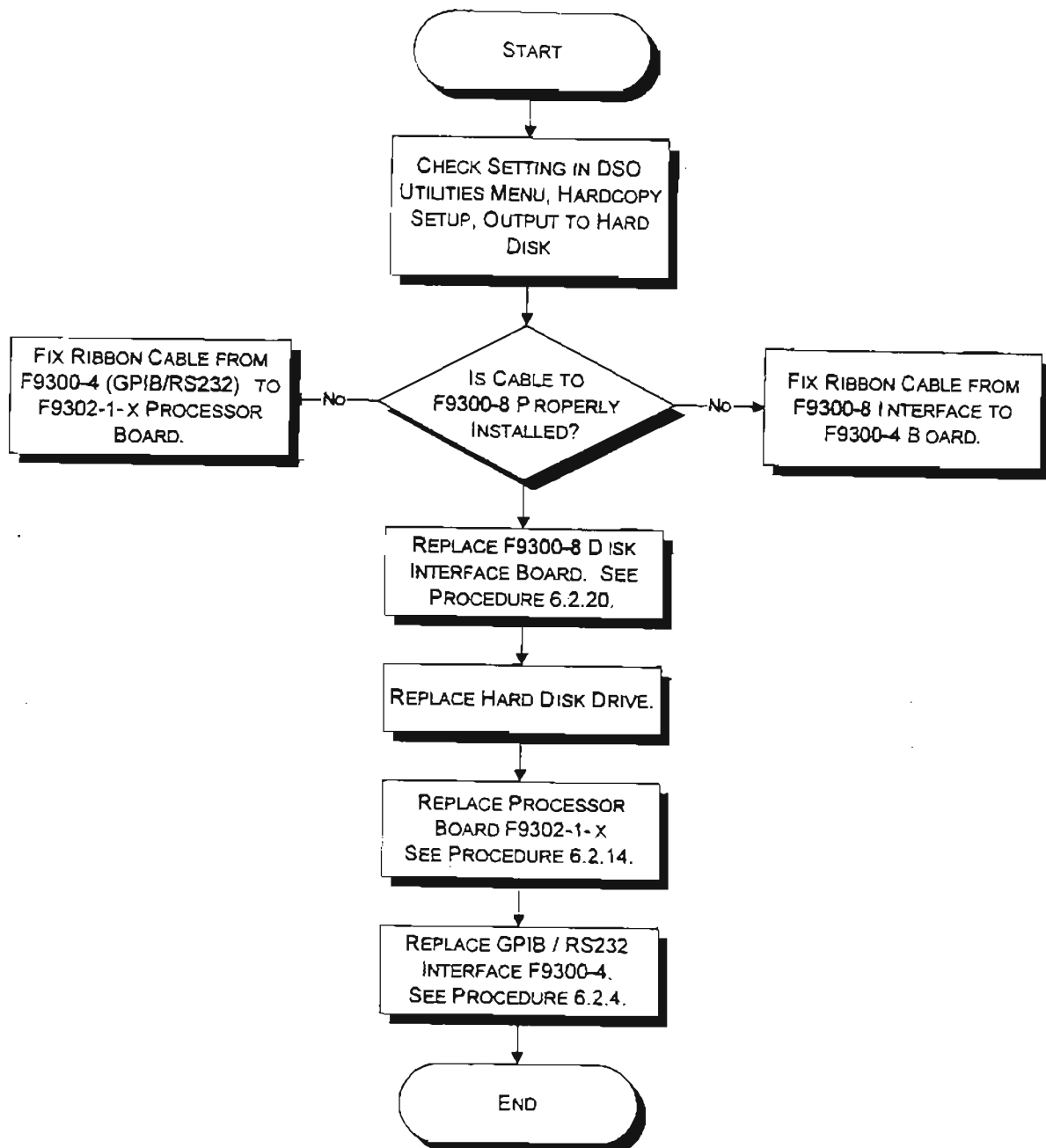

6.6 Calibration Procedures

The following section includes the adjustments required for the power supply and display. It is recommended that they be verified at one year intervals.

6.6.1 PS9384 Power Supply Calibration

The five voltages are adjustable by $\pm 5\%$ of the nominal value.

The reference for the measurements are the pins on top of connector J31 located on the main board F9384-3.

For the power supply calibration proceed as follow:

- Turn off the power
- Remove the top cover (6.2.1)
- Remove the front frame assembly (6.2.9) and put it to the right of the unit.

- By using two extension cables, reconnect the processor board to the front panel (J4) and to the deflection board (J6).

- Once the top cover is removed and the front panel is disassembled from the scope, extra cooling of the main board is required. It's mandatory to disconnect the existing Fan from connector J33, located on F9384-3 card, and to use a Fan with the air flow oriented to the front end section of the board.

- The front frame assembly is now reconnected to the processor through the extension cables.

- Turn on the power, set the scope to Auto Trigger, and perform the adjustments to get on J31 :

12	24		
11	23	Pin 15	: +15.0 V (Min = + 15.4 V, Max. = + 15.6 V)
10	22	Pin 14	: -15.0 V (Min = - 15.6 V, Max. = - 15.4 V)
9	21	Pin 13	: -6.0 V (Min = - 7.10 V, Max. = - 6.0 V)
8	20	Pin 10,11,12	: +3.3 V (Min = + 3.22 V, Max. = + 3.38 V)
7	19	Pin 9, 20, 21	: +5.18 V (Min = + 5.13 V, Max. = + 5.23 V)
6	18	Pin 6,7,8,19,23,24	: Ground
5	17	Pin 4,5,17,18	: -5.2 V (Min = - 5.15 V, Max. = + 5.15 V)
4	16	Pin 2,3,16	: -2.1 V (Min = - 2.15 V, Max. = -2.05 V)
3	15	Pin 1	: +6.0 V (Min = + 6.0 V, Max. = + 7.1 V)
2	14		
1	13		

Front

The four potentiometers R108, R206, R306, and R407 are accessible from the front through holes in the PS9384 power supply chassis. In order to adjust the -2v supply, the PS9384 must be removed from the unit. The adjustment hole is located on the rear side of the power supply.

- Turn the potentiometer clockwise to increase the tension or counterclockwise to decrease the voltage. When the adjustment is done, stop the acquisition by depressing the stop trigger push button, and verify that there is no large difference on the + 5.10 V, typically less than 30 mv.

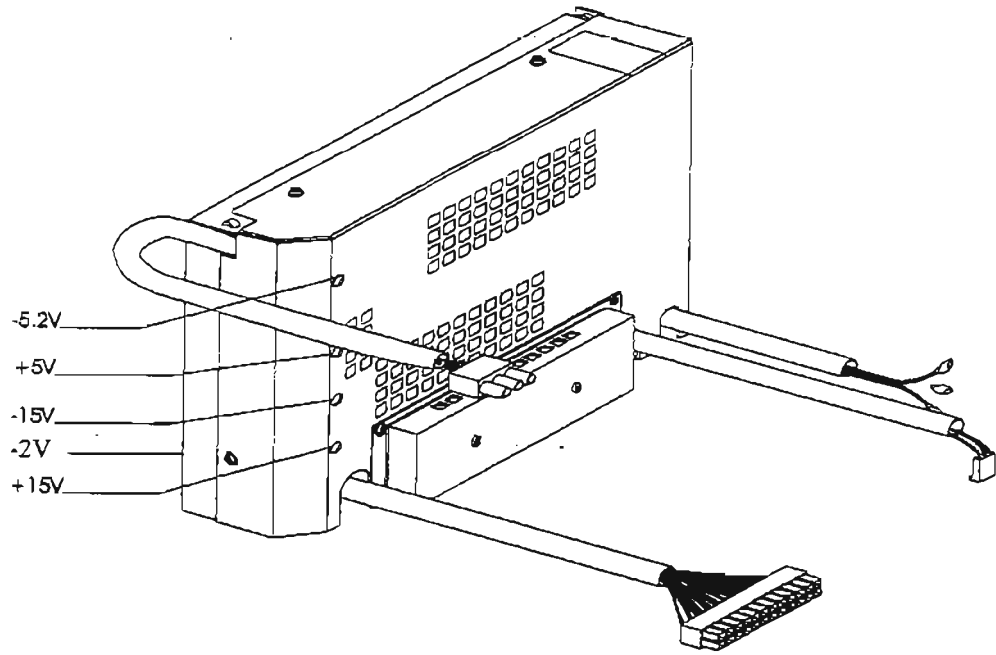

Figure 6.9 : Power Supply

6.6.2 93XX-Display Adjustment Procedure

6.6.2.1 Introduction

There is a total of 12 potentiometers or variable coils to adjust the deflection and video board.

Video: (2 adjustments)

- **Threshold** : **Level of the video board.**
- **Gain** : **Intensity of the screen.**

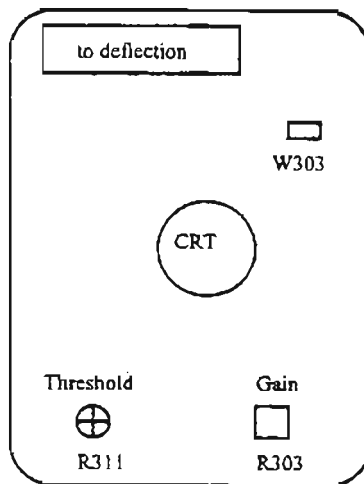

Video board component side

Deflection : (10 adjustments)

- **Vosc** : **Frequency of the vertical oscillator.**
- **Slope** : **Speed of the horizontal ramp.**
- **Focus** : **Focus of the screen.**
- **Cut off** : **Cathode ray tube cut off.**
- **Quiescent** : **Standby current of the horizontal deflection amplifier.**
- **H Linearity** : **Horizontal linearity.**
- **H Size** : **Horizontal size (Max. 165mm).**
- **H Offset** : **Horizontal position.**
- **V Size** : **Vertical size (Max. 120mm).**
- **V Offset** : **Vertical position.**

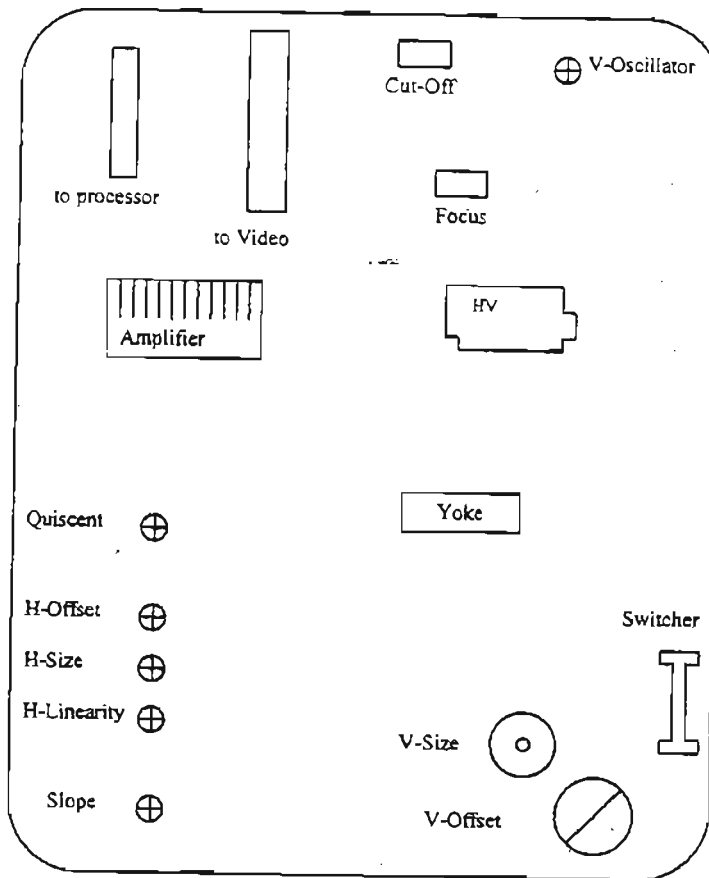

Deflection board component side

6.6.2.2 Coarse Adjustment

- Depress display button.
- Set W'form + text intensity to 0%.
- Set grid intensity to 0%
- Turn fully clockwise the intensity potentiometer on the video board.
- On the video board connect a digital multimeter on test point : W303
- Adjust threshold potentiometer to get $2\text{ V} \pm 0.1\text{ V}$ on W303.

SECTION 7 SCHEMATICS, LAYOUTS, PARTS LIST

9384, 9384M, 9384TM, 9384L & 9384AL

Digital Storage Oscilloscope

PART: 9384 **DESC: 1 GHz, QUAD CHANNEL 1 GS/s DSO 50KS/Ch**

COMPONENT	PART DESCRIPTION	QTY PER ASSEMBLY
205750000	IC GAL16V8A-15LP	1
709384001	FRONT PANEL LABEL 9384 USA	1
709384002	SERIAL NUMBER PLATE 9384 USA	1
9384-31	MAIN BOARD 9384	1
9384M-2	ACQUISITION MEMORY 9384M	2
ACCESSORIES-9384	9384 ACCESSORIES	1
F9300-4	GPIB & RS232 INTERFACE CARD	1
F9302-1-8	8 MEG PROC BD	1
F9354-5	FRONT PANEL	1
M9384	MECHANICAL FOR 9384	1

PART: 9384M **DESC: 1 GHz, QUAD CHANNEL 1 GS/s DSO 250KS/Ch**

COMPONENT	PART DESCRIPTION	QTY PER ASSEMBLY
205750000	IC GAL16V8A-15LP	1
709384002	SERIAL NUMBER PLATE 9384M USA	1
709384003	FRONT PANEL LABEL 9384 USA	1
9384-31	MAIN BOARD 9384	1
9384M-2	ACQUISITION MEMORY 9384M	2
ACCESSORIES-9384	9384 ACCESSORIES	1
F9300-4	GPIB & RS232 INTERFACE CARD	1
F9302-1-8	8 MEG PROC BD	1
F9354-5	FRONT PANEL	1
M9384	MECHANICAL FOR 9384	1

PART: 9384TM **DESC: 1 GHz, QUAD CHANNEL 1 GS/s DSO 500KS/Ch**

COMPONENT	PART DESCRIPTION	QTY PER ASSEMBLY
205750000	IC GAL16V8A-15LP	1
709384001	FRONT PANEL LABEL 9384 USA	1
709384007	SERIAL NUMBER PLATE 9384TM USA	1
9384-31	MAIN BOARD 9384	1
9384M-2	ACQUISITION MEMORY 9384M	2
93XX-FDGP	GRAPHIC PRINTER/FLOPPY DRIVE	1
ACCESSORIES-9384	9384 ACCESSORIES	1
F9300-4	GPIB & RS232 INTERFACE CARD	1
F9302-1-8	8 MEG PROC BD	1
F9354-5	FRONT PANEL	1
M9384	MECHANICAL FOR 9384	1

PART: 9384L

DESC: 1 GHz, QUAD CHANNEL 1 GS/s DSO 1MS/Ch

<u>COMPONENT</u>	<u>PART DESCRIPTION</u>	<u>QTY PER ASSEMBLY</u>
205750000	IC GAL16V8A-15LP	1
709384002	SERIAL NUMBER PLATE 9384 USA	1
709384004	FRONT PANEL LABEL 9384L USA	1
9384-31	MAIN BOARD 9384	1
9384M-2	ACQUISITION MEMORY 9384M	2
ACCESSORIES-9384	9384 ACCESSORIES	1
F9300-4	GPIB & RS232 INTERFACE CARD	1
F9302-1-16	16 MEG PROC BD	1
F9354-5	FRONT PANEL	1
M9384	MECHANICAL FOR 9384	1

PART: 9384AL

DESC: 1 GHz, QUAD CHANNEL 1 GS/s DSO 2MS/Ch

<u>COMPONENT</u>	<u>PART DESCRIPTION</u>	<u>QTY PER ASSEMBLY</u>
205750000	IC GAL16V8A-15LP	1
709384002	SERIAL NUMBER PLATE 9384 USA	1
709384004	FRONT PANEL LABEL 9384L USA	1
9384-31	MAIN BOARD 9384	1
9384MEM-2	ACQUISITION MEMORY 9384AL	2
ACCESSORIES-9384	9384 ACCESSORIES	1
F9300-4	GPIB & RS232 INTERFACE CARD	1
F9302-1-16	16 MEG PROC BD	1
F9354-5	FRONT PANEL	1
M9384	MECHANICAL FOR 9384	1

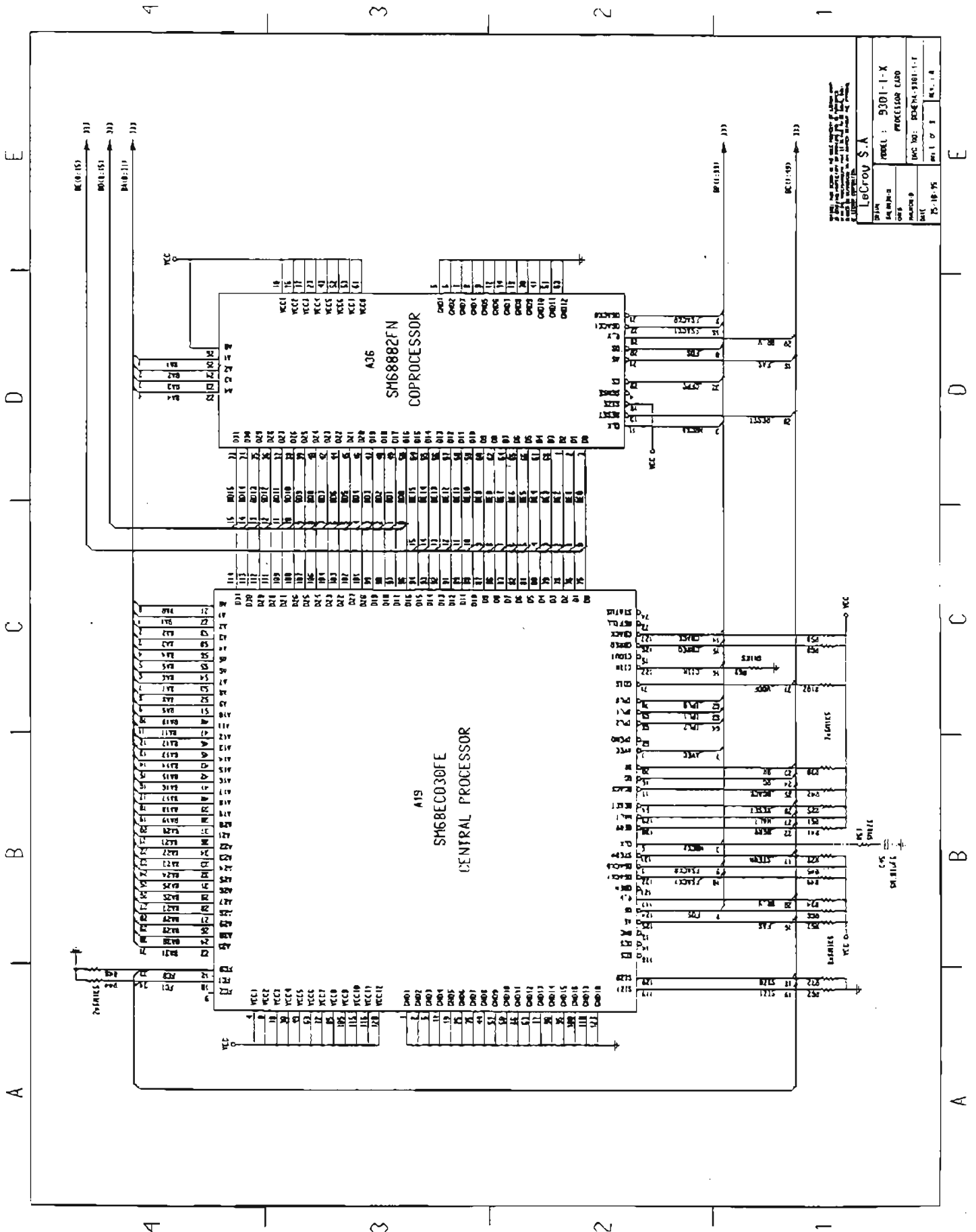

LOGICV S.A	
DESIGN	MODEL : 9301-1-X
REVISION	PROCESSOR LOAD
DATE	DATE: 04-1981-1-F
DESIGNER	DATE: 05-1981-1-F
DATE	DATE: 05-1981-1-F

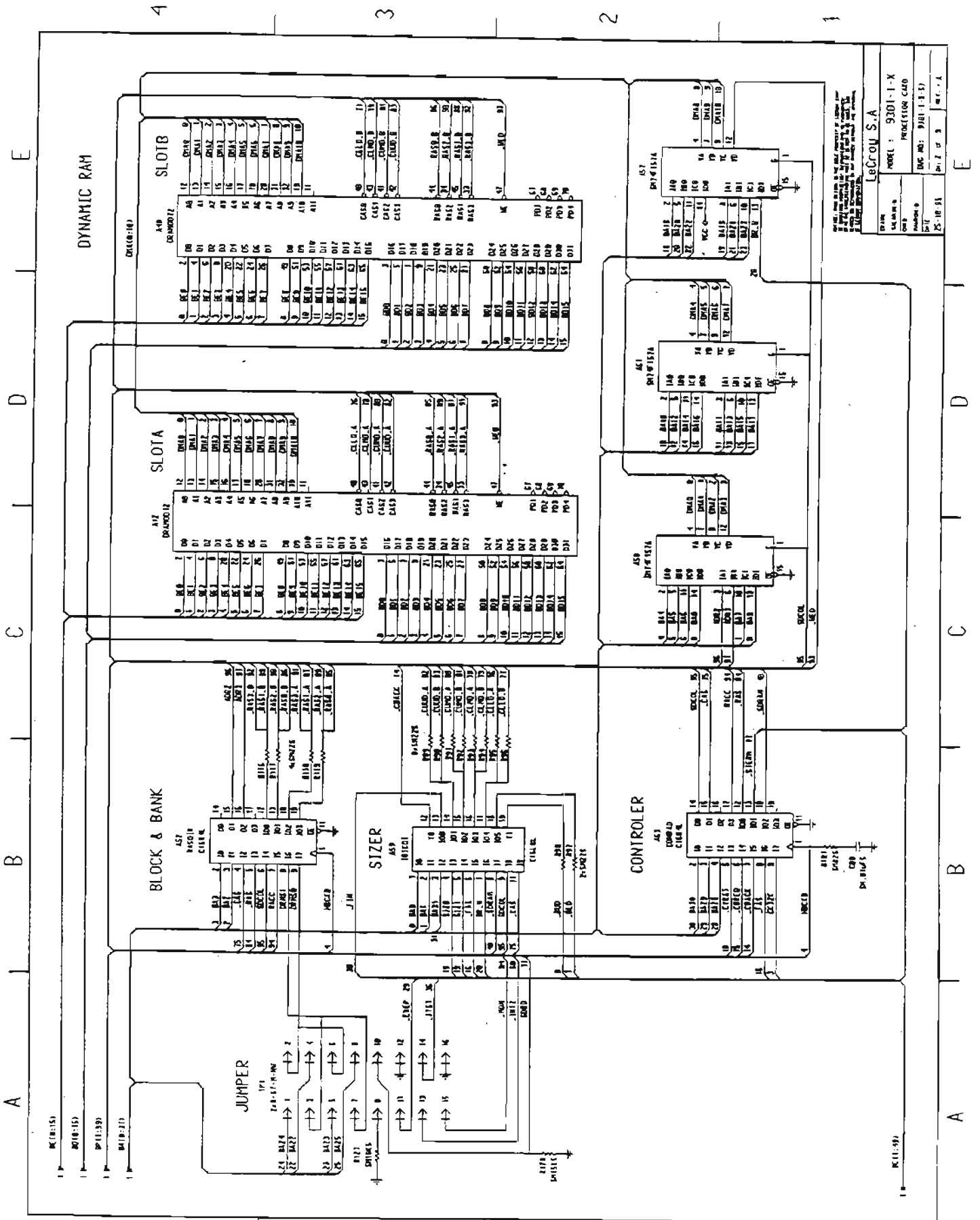

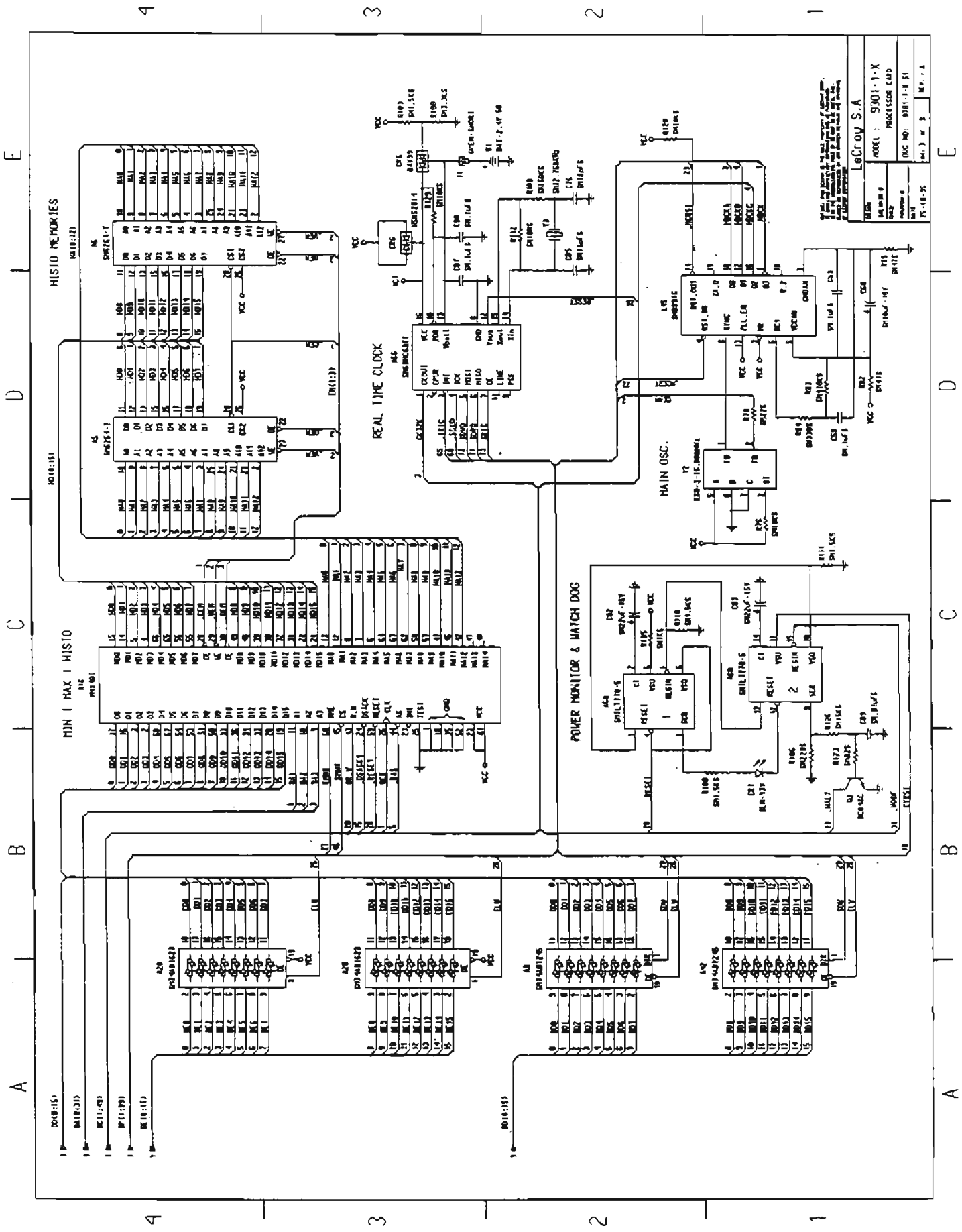

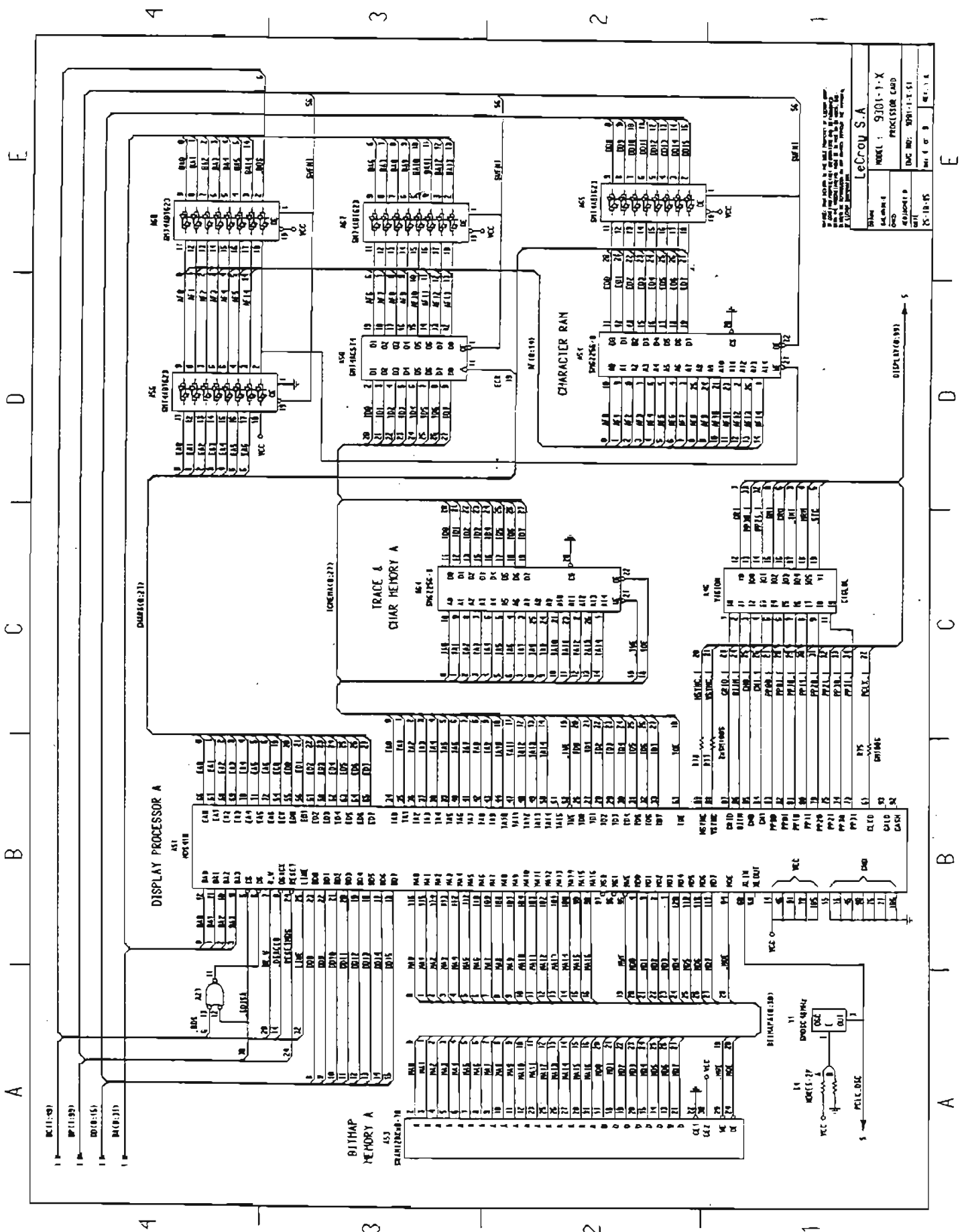

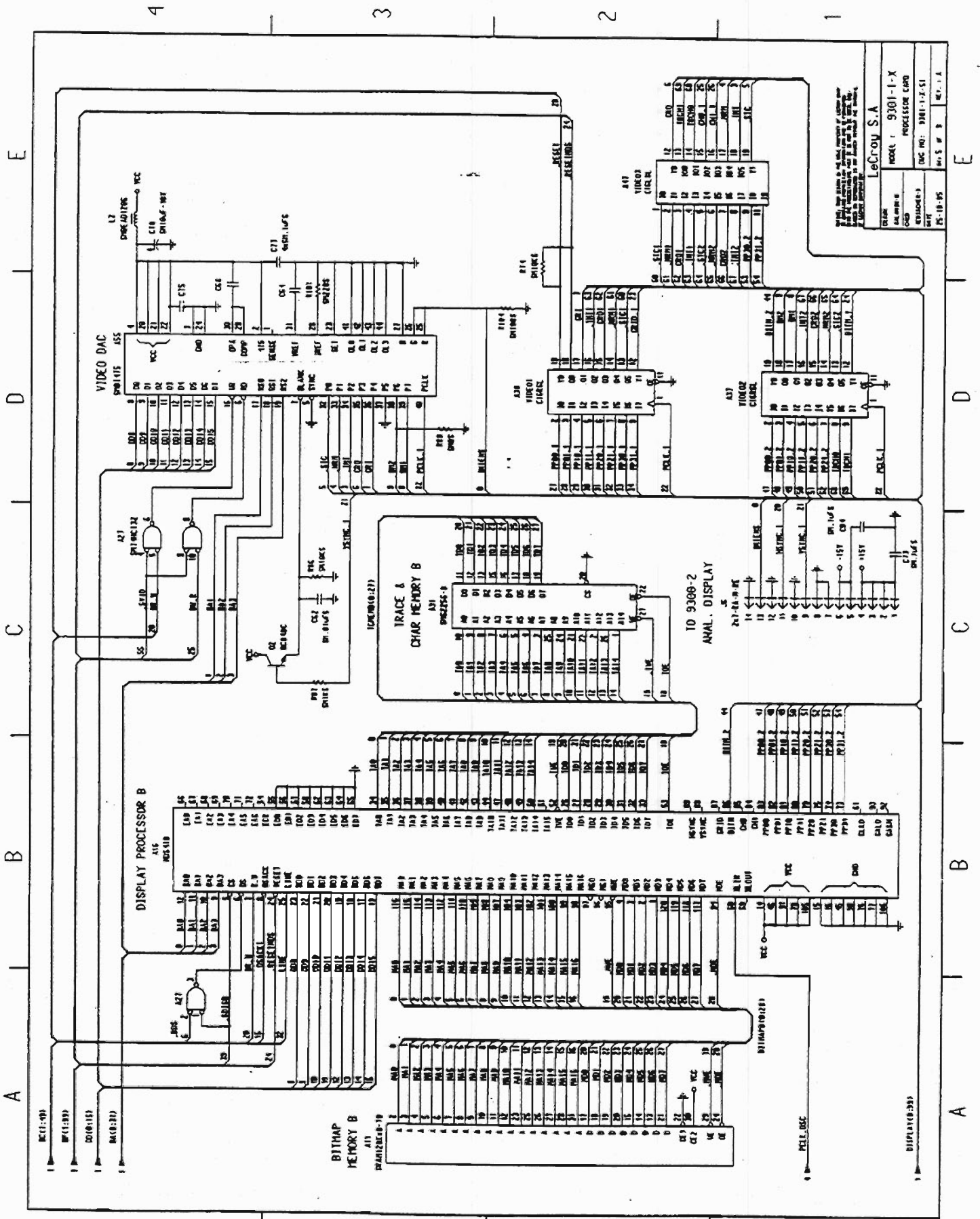

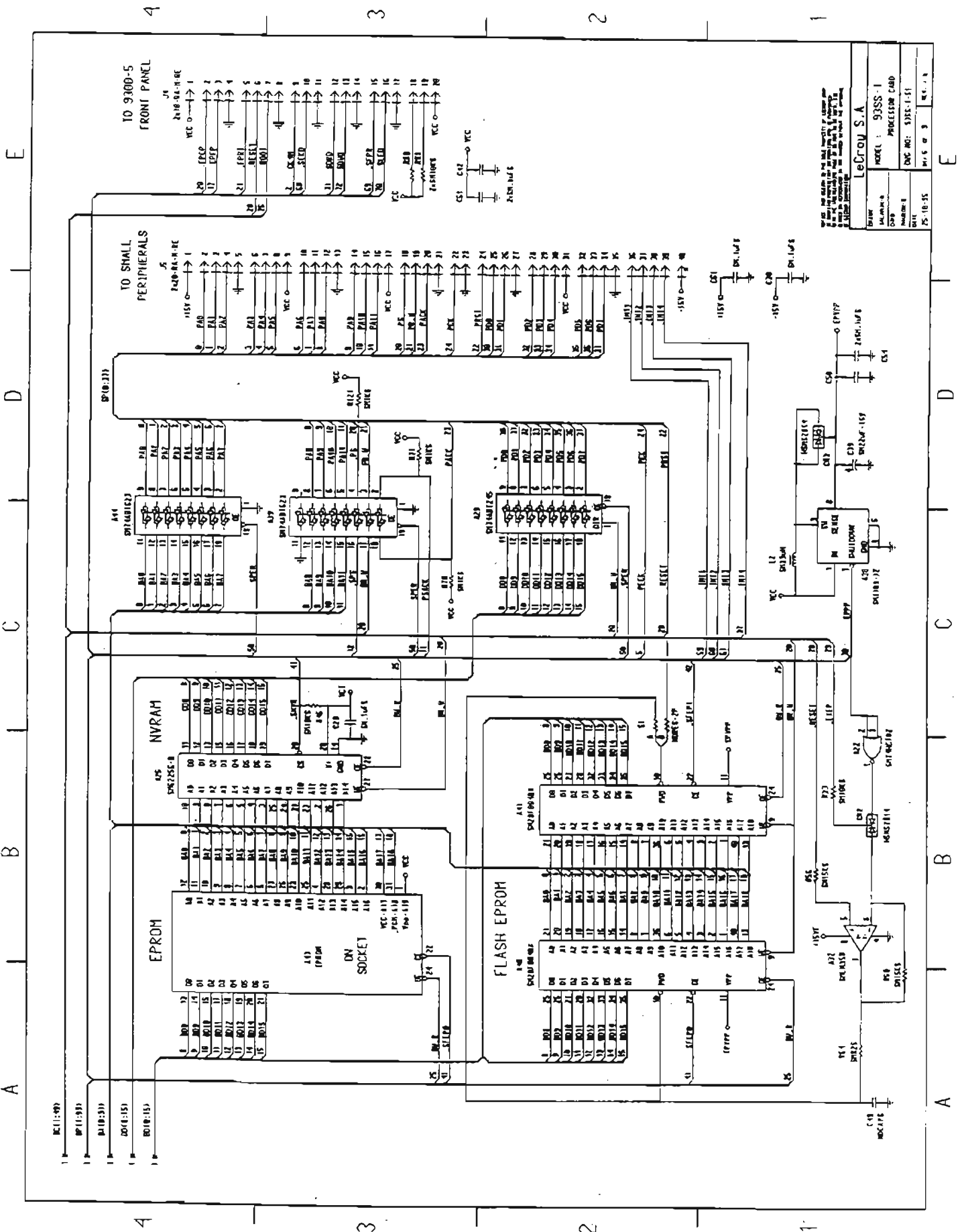

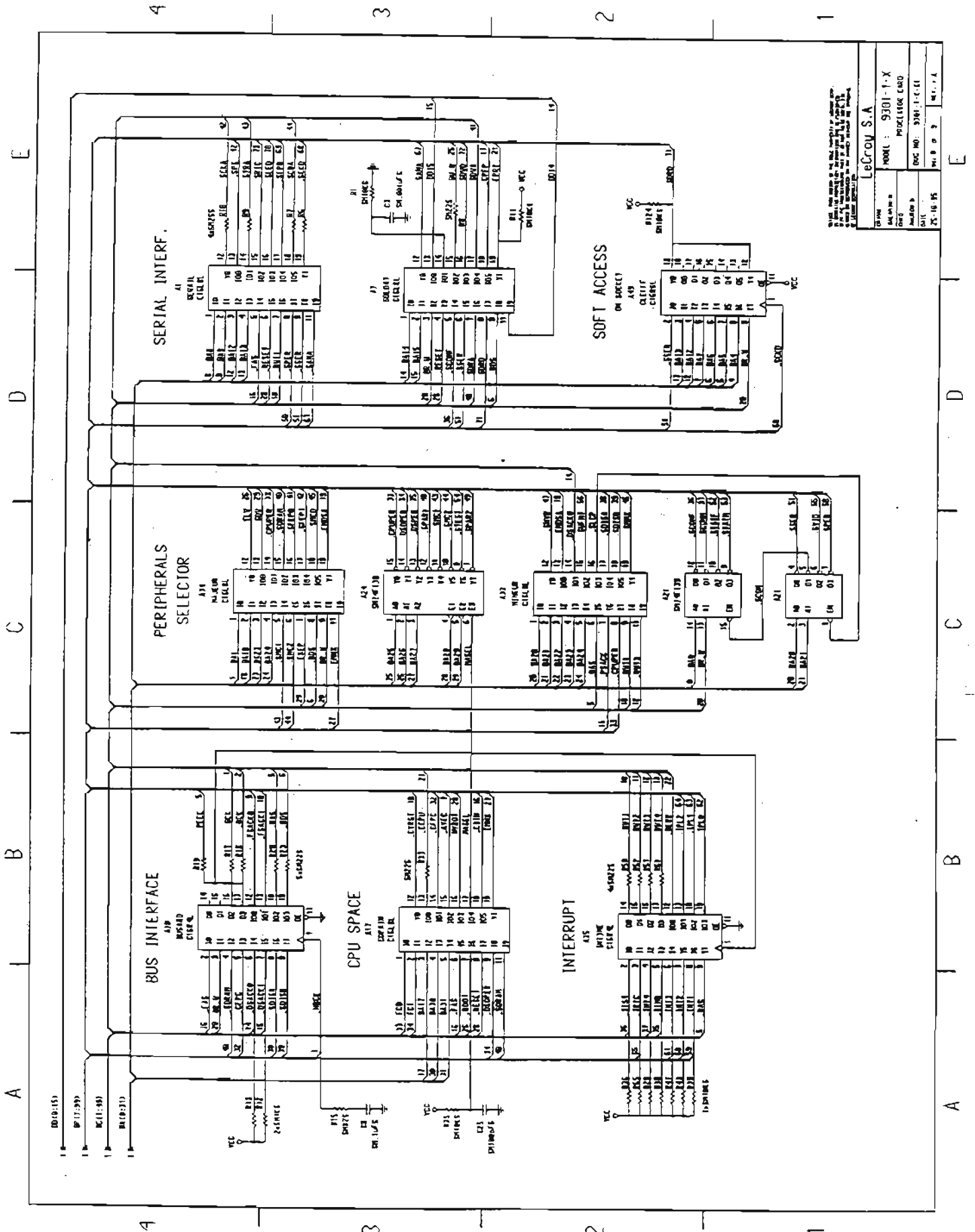

LeCroy S.A.

MODEL: 9301-1-X
 PRODUCT CODE
 DOC NO: 9301-1-1-11
 REV: 1.1

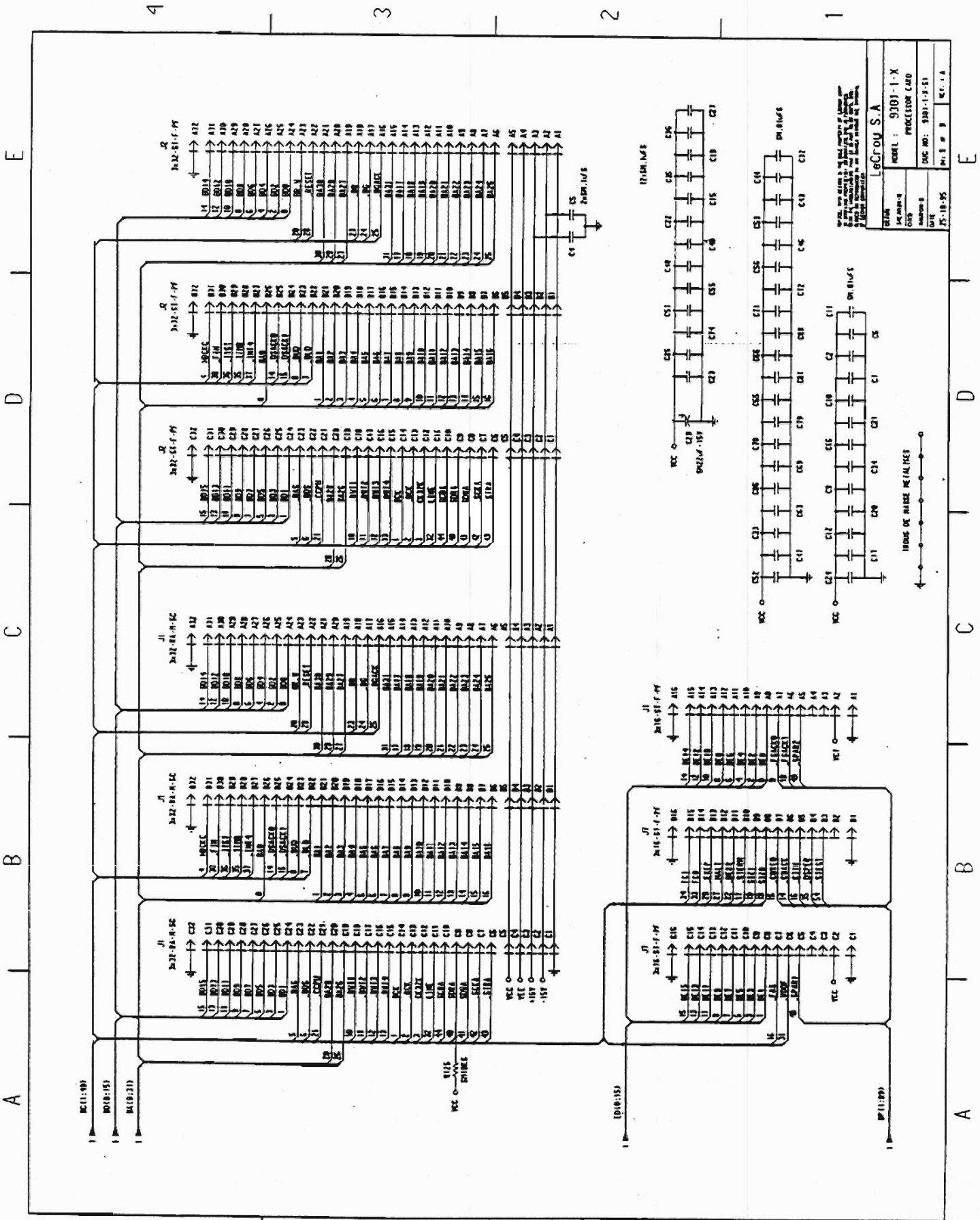

LeCroy S.A.	
MODEL : 9301-1-X	PROCESSION CMO
DWG NO: 9301-1-F-51	REV. 1 A
75-10-25	

SECTION 7 SCHEMATICS, LAYOUTS, PARTS LIST

9384, 9384M, 9384TM, 9384L & 9384AL

Digital Storage Oscilloscope

PART: 9384 **DESC: 1 GHz, QUAD CHANNEL 1 GS/s DSO 50KS/Ch**

COMPONENT	PART DESCRIPTION	QTY PER ASSEMBLY
205750000	IC GAL16V8A-15LP	1
709384001	FRONT PANEL LABEL 9384 USA	1
709384002	SERIAL NUMBER PLATE 9384 USA	1
9384-31	MAIN BOARD 9384	1
9384M-2	ACQUISITION MEMORY 9384M	2
ACCESSORIES-9384	9384 ACCESSORIES	1
F9300-4	GPIB & RS232 INTERFACE CARD	1
F9302-1-8	8 MEG PROC BD	1
F9354-5	FRONT PANEL	1
M9384	MECHANICAL FOR 9384	1

PART: 9384M **DESC: 1 GHz, QUAD CHANNEL 1 GS/s DSO 250KS/Ch**

COMPONENT	PART DESCRIPTION	QTY PER ASSEMBLY
205750000	IC GAL16V8A-15LP	1
709384002	SERIAL NUMBER PLATE 9384M USA	1
709384003	FRONT PANEL LABEL 9384 USA	1
9384-31	MAIN BOARD 9384	1
9384M-2	ACQUISITION MEMORY 9384M	2
ACCESSORIES-9384	9384 ACCESSORIES	1
F9300-4	GPIB & RS232 INTERFACE CARD	1
F9302-1-8	8 MEG PROC BD	1
F9354-5	FRONT PANEL	1
M9384	MECHANICAL FOR 9384	1

PART: 9384TM **DESC: 1 GHz, QUAD CHANNEL 1 GS/s DSO 500KS/Ch**

COMPONENT	PART DESCRIPTION	QTY PER ASSEMBLY
205750000	IC GAL16V8A-15LP	1
709384001	FRONT PANEL LABEL 9384 USA	1
709384007	SERIAL NUMBER PLATE 9384TM USA	1
9384-31	MAIN BOARD 9384	1
9384M-2	ACQUISITION MEMORY 9384M	2
93XX-FDGP	GRAPHIC PRINTER/FLOPPY DRIVE	1
ACCESSORIES-9384	9384 ACCESSORIES	1
F9300-4	GPIB & RS232 INTERFACE CARD	1
F9302-1-8	8 MEG PROC BD	1
F9354-5	FRONT PANEL	1
M9384	MECHANICAL FOR 9384	1

PART: 9384L **DESC: 1 GHz, QUAD CHANNEL 1 GS/s DSO 1MS/Ch**

<u>COMPONENT</u>	<u>PART DESCRIPTION</u>	<u>QTY PER ASSEMBLY</u>
205750000	IC GAL16V8A-15LP	1
709384002	SERIAL NUMBER PLATE 9384 USA	1
709384004	FRONT PANEL LABEL 9384L USA	1
9384-31	MAIN BOARD 9384	1
9384M-2	ACQUISITION MEMORY 9384M	2
ACCESSORIES-9384	9384 ACCESSORIES	1
F9300-4	GPIB & RS232 INTERFACE CARD	1
F9302-1-16	16 MEG PROC BD	1
F9354-5	FRONT PANEL	1
M9384	MECHANICAL FOR 9384	1

PART: 9384AL **DESC: 1 GHz, QUAD CHANNEL 1 GS/s DSO 2MS/Ch**

<u>COMPONENT</u>	<u>PART DESCRIPTION</u>	<u>QTY PER ASSEMBLY</u>
205750000	IC GAL16V8A-15LP	1
709384002	SERIAL NUMBER PLATE 9384 USA	1
709384004	FRONT PANEL LABEL 9384L USA	1
9384-31	MAIN BOARD 9384	1
9384MEM-2	ACQUISITION MEMORY 9384AL	2
ACCESSORIES-9384	9384 ACCESSORIES	1
F9300-4	GPIB & RS232 INTERFACE CARD	1
F9302-1-16	16 MEG PROC BD	1
F9354-5	FRONT PANEL	1
M9384	MECHANICAL FOR 9384	1

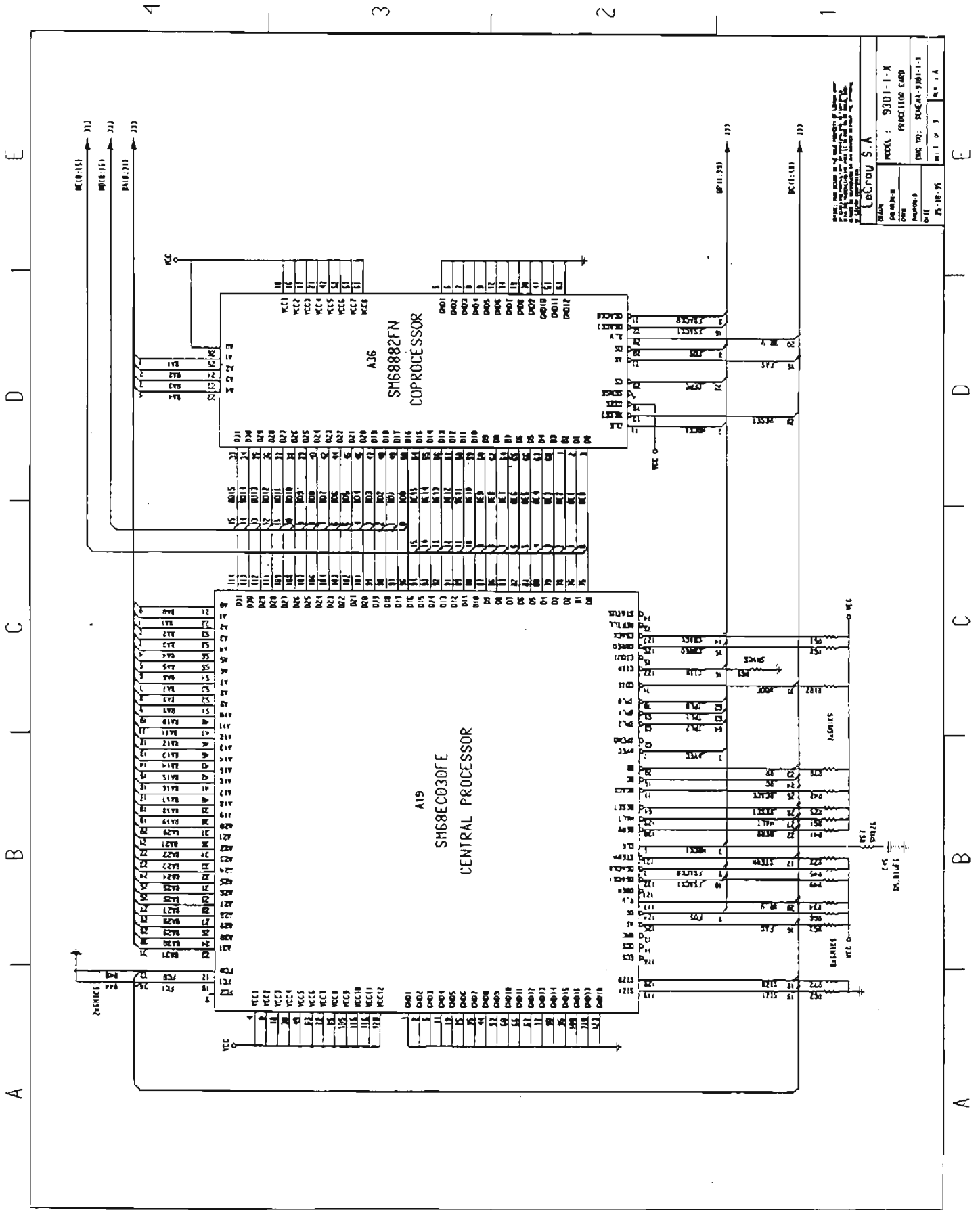

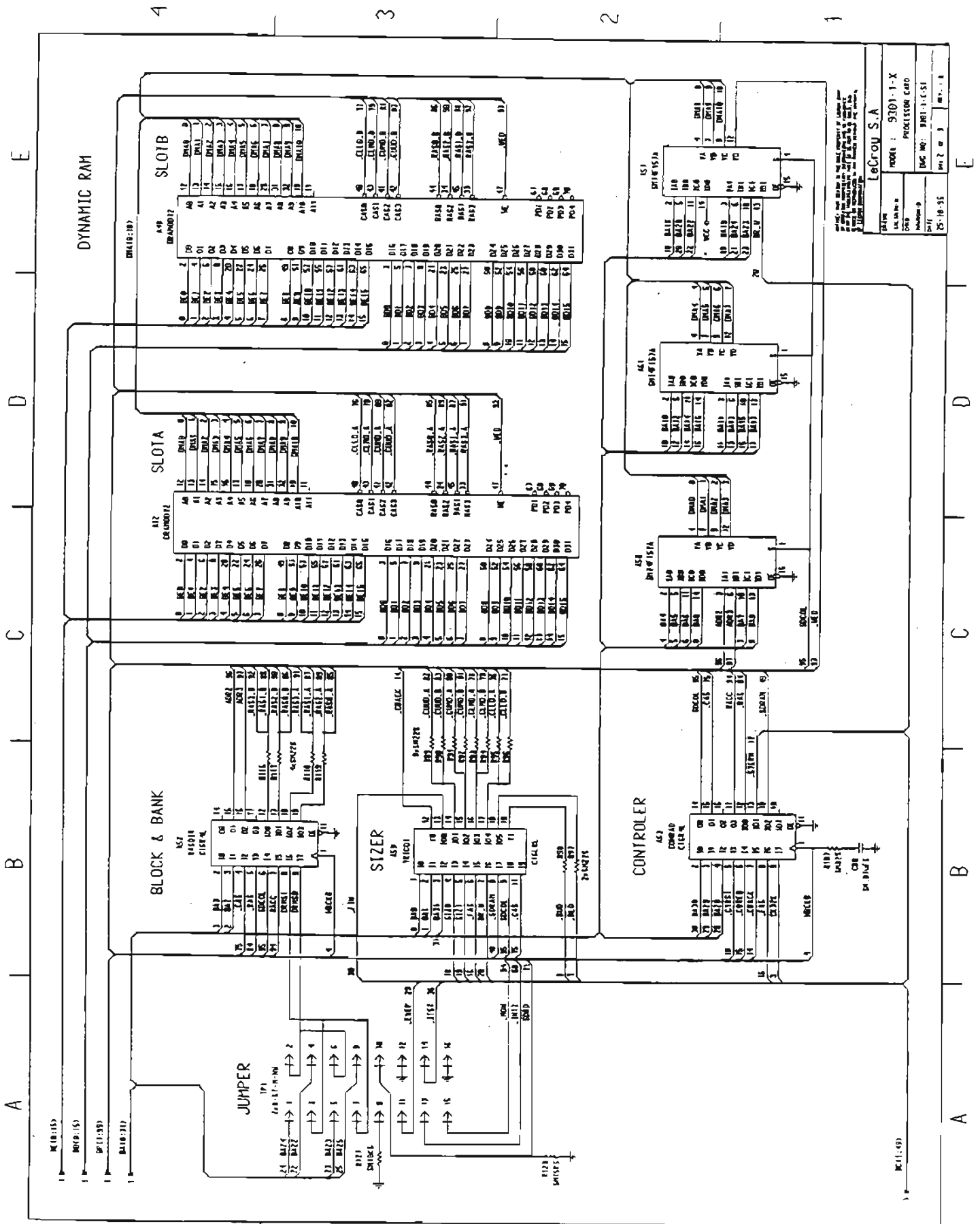

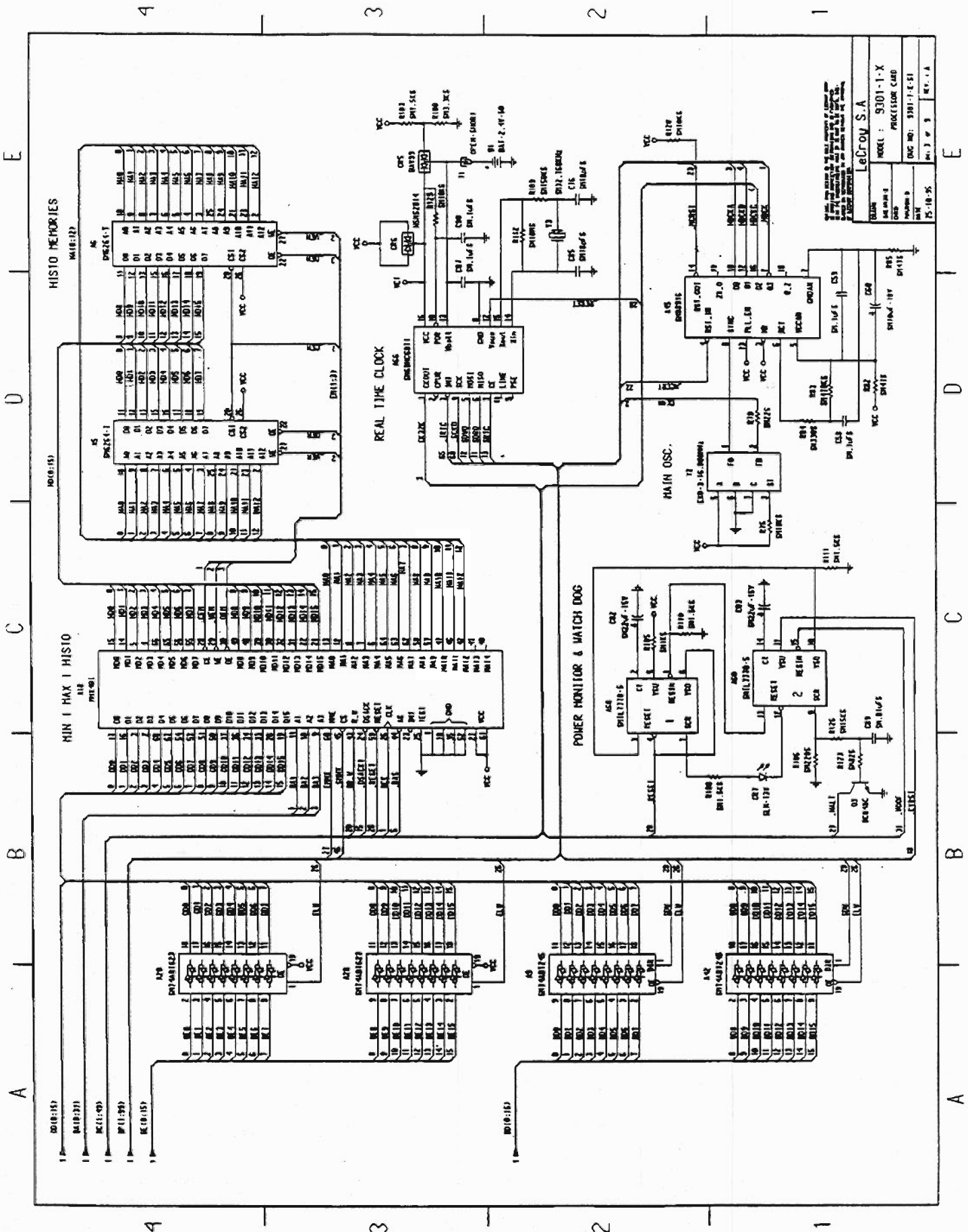

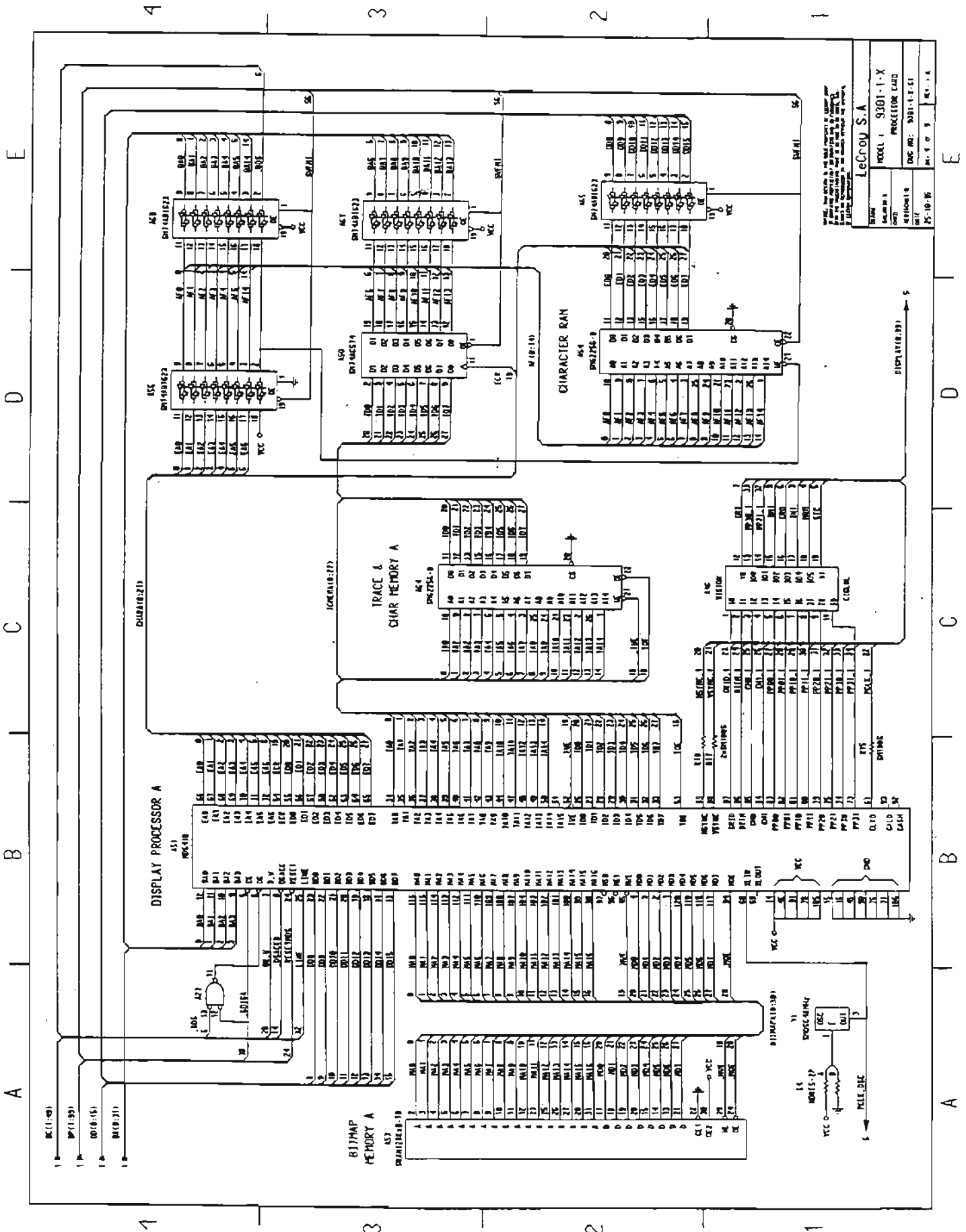

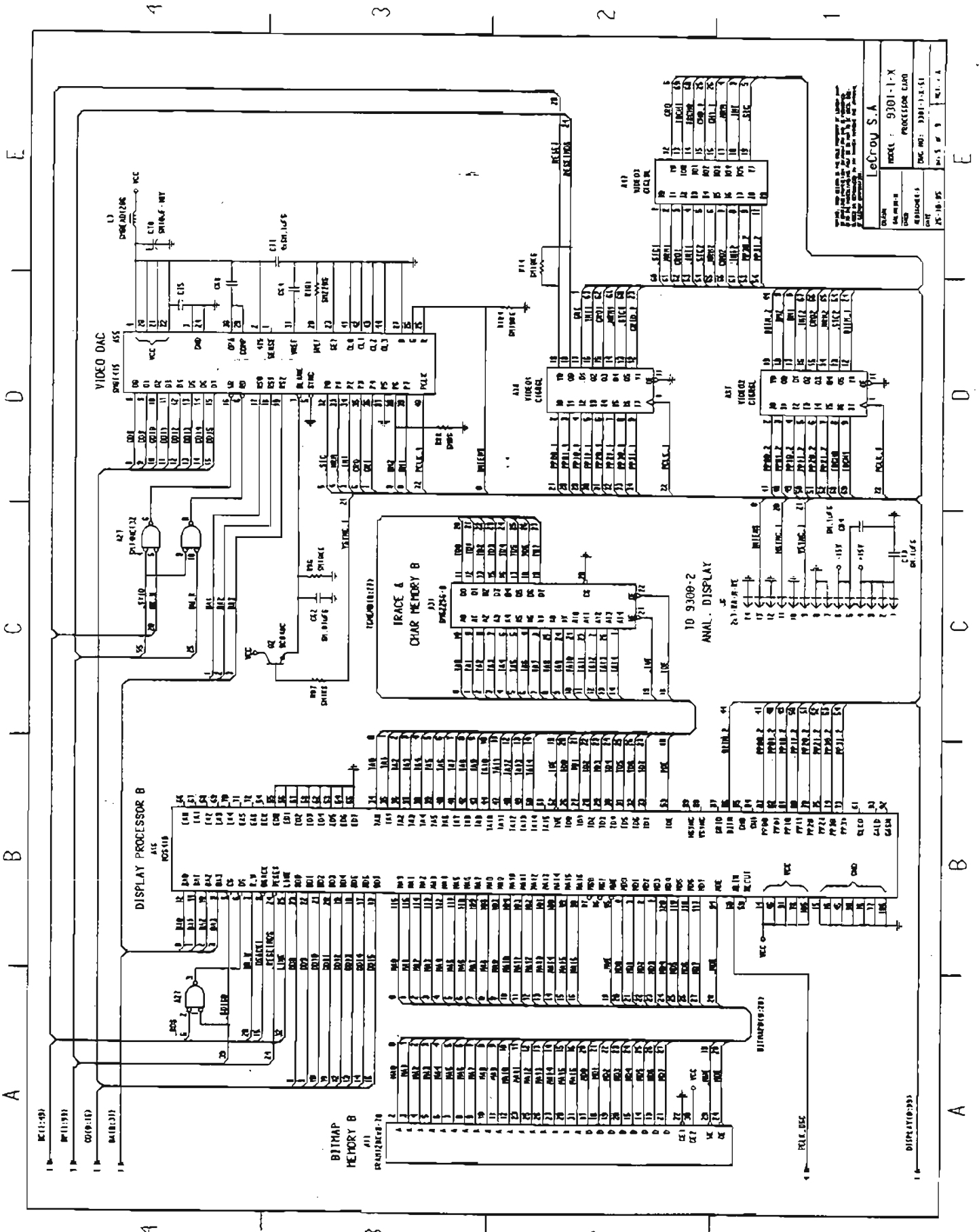

DATE	MODEL	9101-1-X
REVISION	PROCESSOR CARD	
DWG. NO.	9101-1-X-51	
DATE	25-10-95	
REV. 1		

LeCroy S.A.

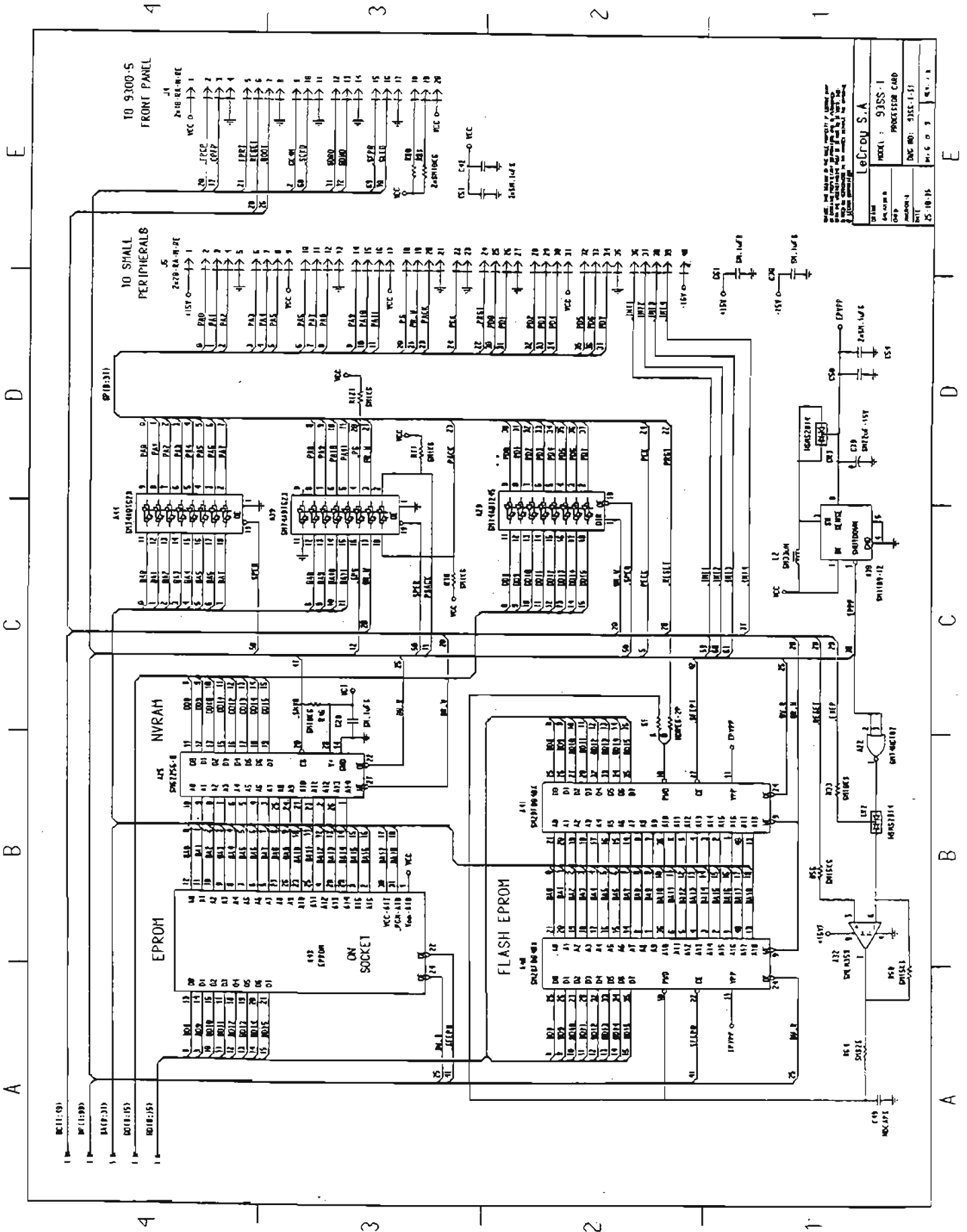

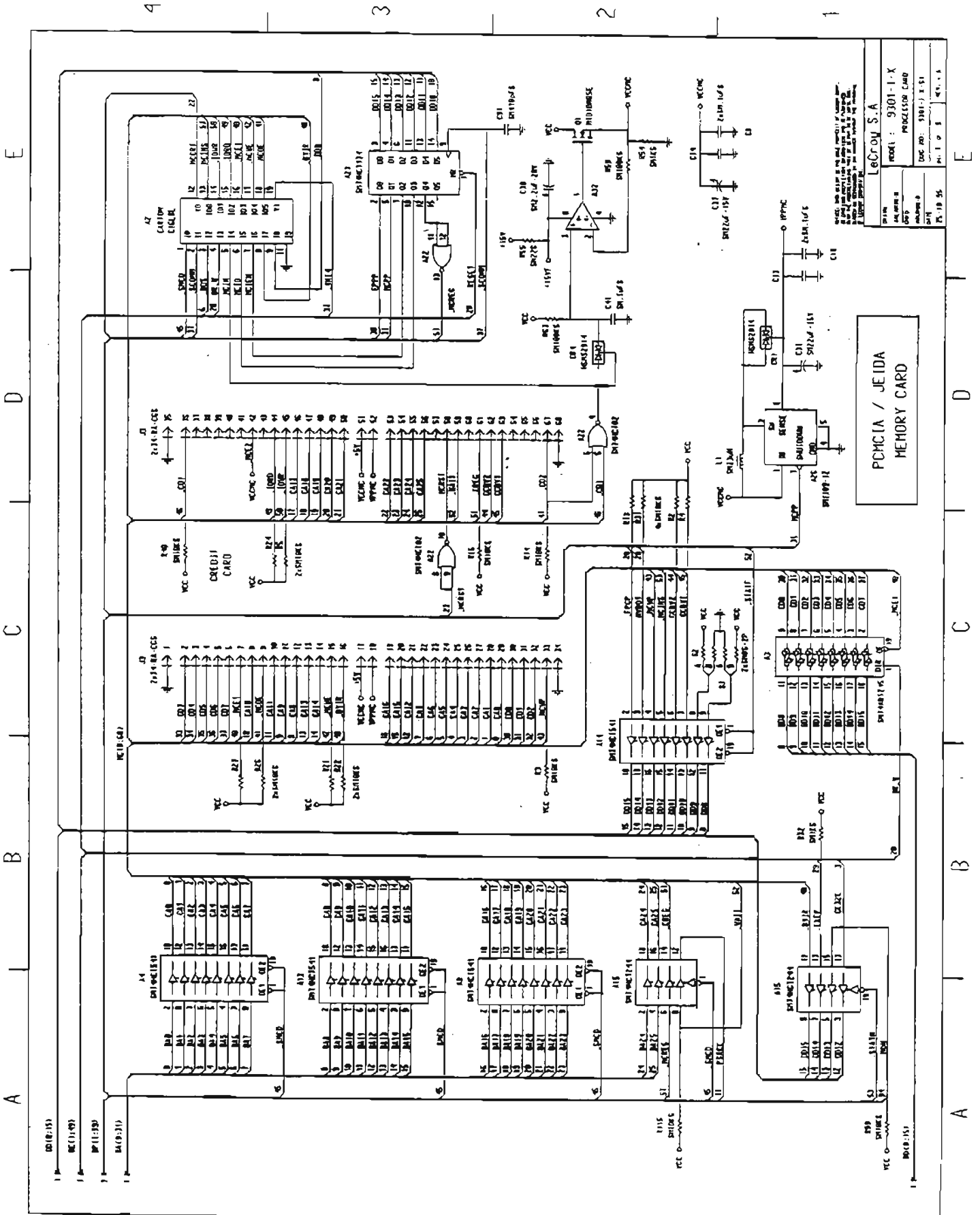

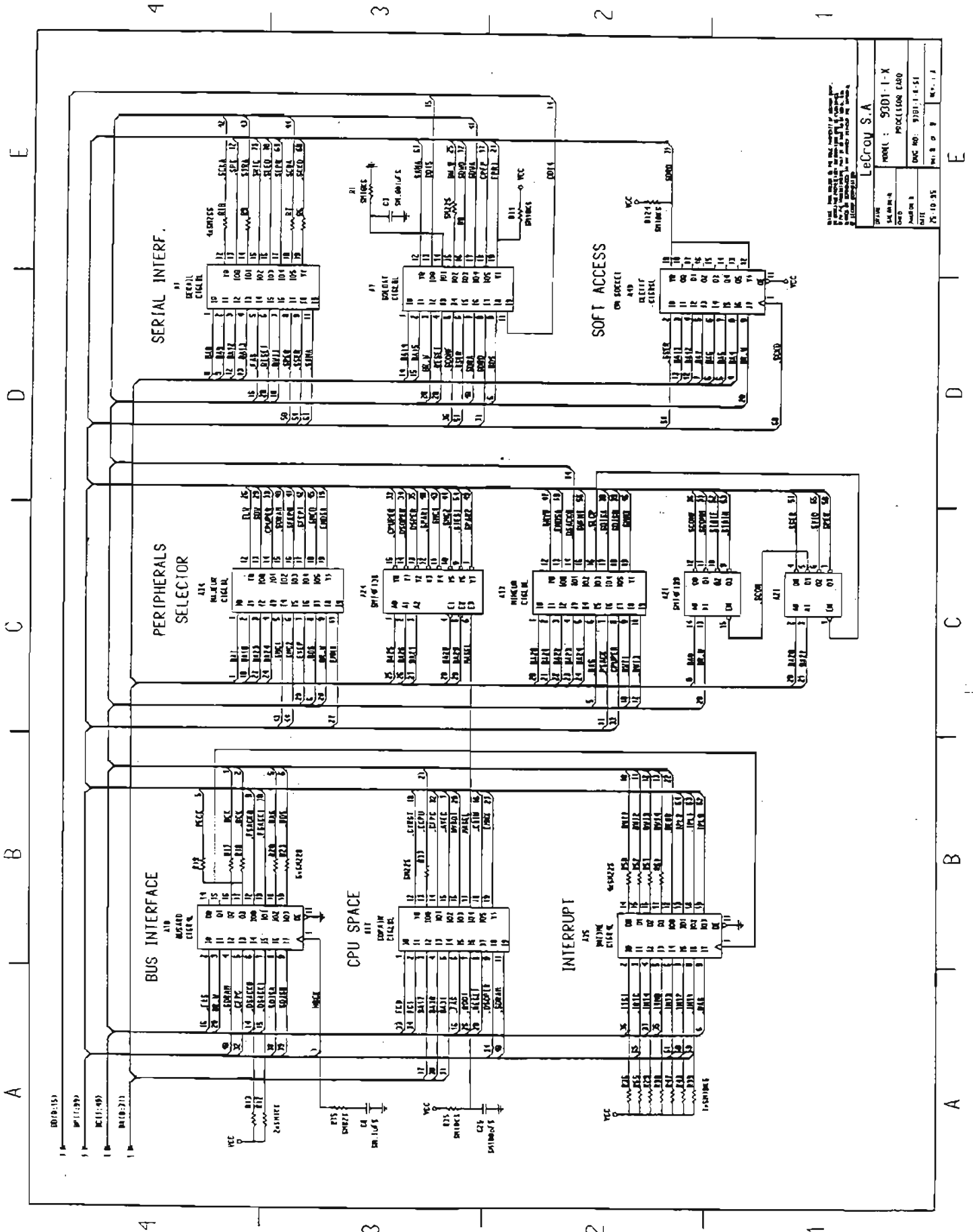

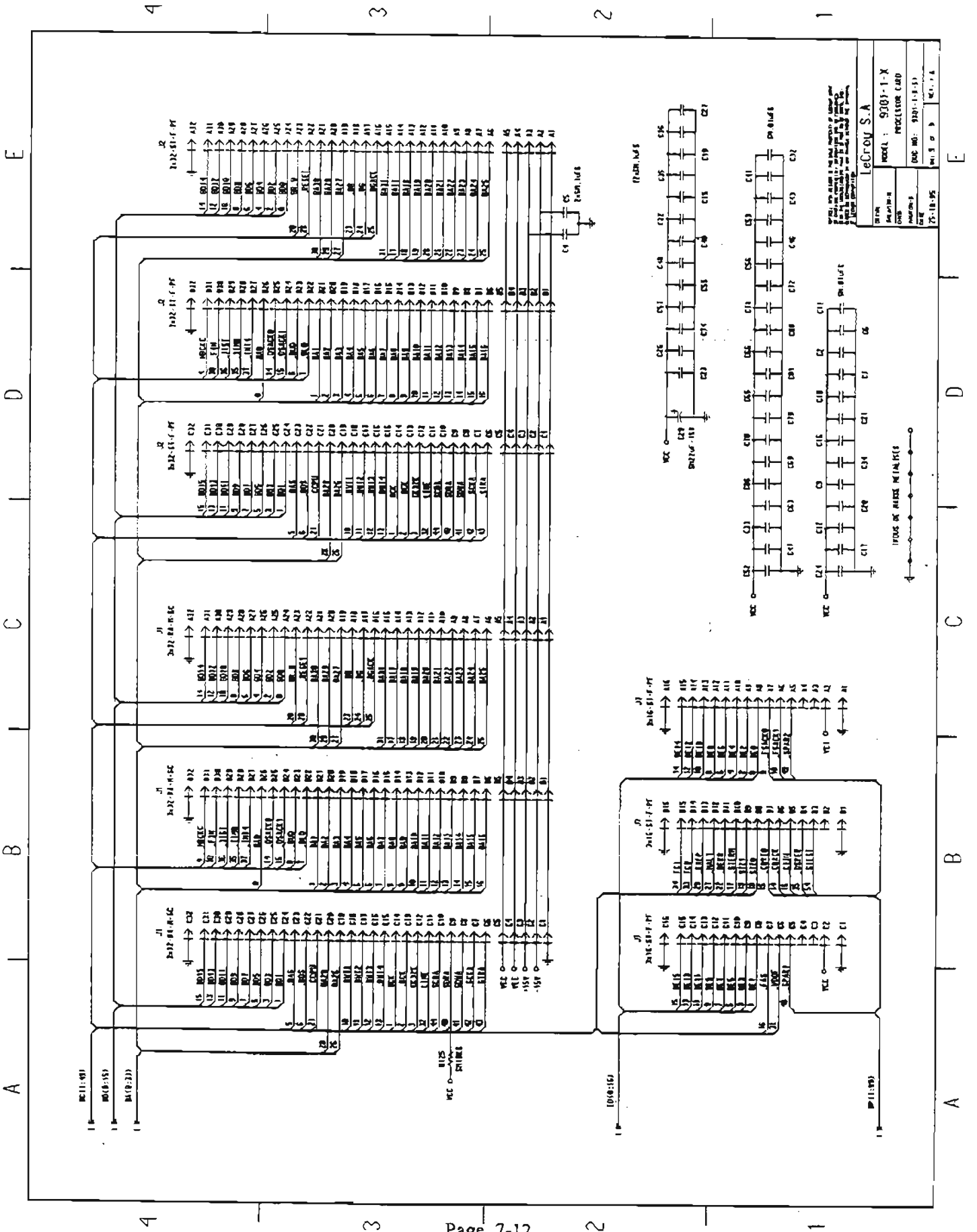

PART: F9302-1-8 DESC: PROCESSOR CARD with 8MB DRAM

<u>COMPONENT</u>	<u>PART DESCRIPTION</u>	<u>QTY PER ASSEMBLY</u>
205800230	MODULE DRAM 1MX32 BIT	1
454370002	SHUNT 2 POS	2
S9302-1	PROCESSOR CARD WHOUT DRAM	1

PART: F9302-1-16 DESC: PROCESSOR CARD with 16MB DRAM

<u>COMPONENT</u>	<u>PART DESCRIPTION</u>	<u>QTY PER ASSEMBLY</u>
205800230	MODULE DRAM 2MX32 BIT	2
454370002	SHUNT 2 POS	2
S9302-1	PROCESSOR CARD WHOUT DRAM	1

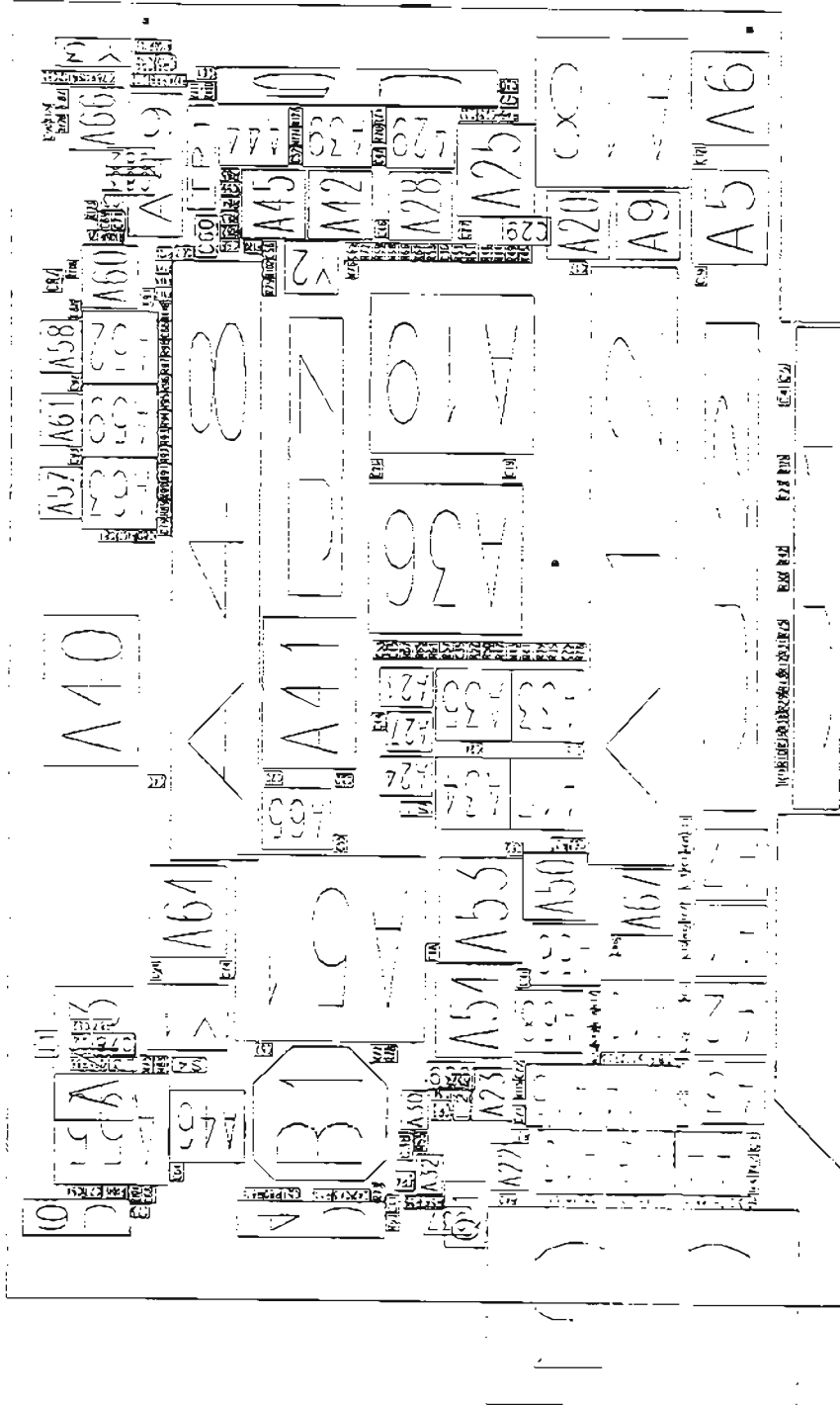

9-502-1 Rev. B

PART: S9302-1

DESC: PROCESSOR CARD without DRAM

<u>COMPONENT</u>	<u>PART DESCRIPTION</u>	<u>QTY PER ASSEMBLY</u>
309380016	CRYSTAL OSC (PROGR) 16 MHZ	1
312590070	BATTERY LITHIUM 3V 70MAH	1
400331020	SOCKET IC ST DIP-20	1
404500068	CONN BD TO BD 68 POS	1
453250072	CONN PC EDGE/SOLD TAIL 72	2
454314016	HDR DIP SOLD TO MALE 16	1
454511014	HDR SOLD TAIL/MALE/14/RT	1
454511020	HDR SOLD TAIL/MALE 20	1
454511040	HDR SOLD TAIL/MALE/40/RT	1
455410096	CONN RT ANGLE MALE 96 S-CLIP	1
550130108	SCREW CYL HD M3X8	2
552130101	NUT HEX M3	2
719302103	PC BD PREASS'Y 9302-1	1
MDS410	IC RSDP GATE ARRAY MDS410	1
MNX401	ICMIN MAX GATEARR. MNX401	1
SM200172138	IC 3-8 DECODER 74F138	1
SM200178002	IC 2-INPUT NOR HCT02	1
SM200178032	IC 2-IN OR HCT32	1
SM200276068	IC RTC SERIAL 68HC68T1	1
SM200344174	IC HEX D-FLOP HCT174	1
SM201186574	IC OCTAL D-TYP FLOP 74AC574	1
SM205010101	PROGRAMMED GAL CONRAD-A	1
SM205010102	PROGRAMMED GAL INTIME-B	1
SM205010103	PROGRAMMED GAL RASOIR-A	1
SM205010150	PROGRAMMED GAL CARTON-B	1
SM205010151	PROGRAMMED GAL COPAIN-A	1
SM205010153	PROGRAMMED GAL SERAIL-C	1
SM205010154	PROGRAMMED GAL SOLDAT-A	1
SM205010155	PROGRAMMED GAL TRICOT-A	1
SM205010156	PROGRAMMED GAL VISION-C	1
SM205010200	PROGRAMMED GAL BUTANE-A	1
SM205010252	PROGRAMMED GAL MAXIME-A	1
SM205010257	PROGRAMMED GAL MINIME-A	1
SM205144001	8-MBIT FLASH MEM 28F008SA	1
SM205219256	IC 32K X 8 SRAM MS62256	3
SM205219264	IC 8K X 8 SRAM 70 NSEC 6264	2
SM205701070	IC 128KX8 STAT RAM 70 NS	1
SM206884623	IC OCTAL BUS TRANSCVR ABT623	8
SM206885245	IC BUS TRANSCVR ABT245	4
SM207178541	IC BUFFER/LINE DR HCT541	4
SM207179244	IC BUF/LINE DRIV HCT244	1
SM207260475	IC RAMDAC 256W 50MHZ BT475	1
SM207668882	IC CO PROCESSOR 68882	1
SM207970139	IC DECODER/DEMUX 74F139	1
SM207972157	IC DATA SEL/MUX 74F157A	3
SM208277770	IC DUAL PWR SUPPLY SUP 7770-5	1
SM208470358	IC DUAL OP AMP 358D	1

PART: S9302-1

DESC: PROCESSOR CARD without DRAM

<u>COMPONENT</u>	<u>PART DESCRIPTION</u>	<u>QTY PER ASSEMBLY</u>
SM208680916	IC LOW SKEW CLOCK DRIVER 88916	1
SM208780109	IC MICROPOWER DC-DC CONV.	2
SM227132830	IC 32-BIT U PROC 68EC030	1
SM232032814	DIODE 2814	4
SM236030099	DIODE SO-PKG BAV99	1
SM256232013	DIODE LIGHT EMITTING RED	1
SM270330848	TRANS NPN BC848C	2
SM280171005	TRANS POWER MOSFET MTD10N05E	1
SM300056332	INDUCTOR WOUND 33 UH	2
SM301502001	BEAD (FERRITE CHIP)	1
SM310300406	CRYSTAL 32768HZ	1
SM311248000	CRYSTAL OSCILLATOR 48MHZ	1
SM652101101	RES CHIP (E24) 1% 100 OHM	4
SM652101102	RES CHIP (E24) 1% 1 K	28
SM652101103	RES CHIP (E24) 1% 10 K	34
SM652101104	RES CHIP (E24) 1% 100 K	2
SM652101106	RES CHIP (E24) 1% 10 MEG	1
SM652101152	RES CHIP (E24) 1% 1.5 K	4
SM652101153	RES CHIP (E24) 1% 15 K	2
SM652101154	RES CHIP (E24) 1% 150 K	1
SM652101220	RES CHIP (E24) 1% 22 OHMS	31
SM652101221	RES CHIP (E24) 1% 220 OHM	2
SM652101331	RES CHIP (E24) 1% 330 OHM	1
SM652101332	RES CHIP (E24) 1% 3.3 K	1
SM652101470	RES CHIP (E24) 47 OHMS	2
SM652101474	RES CHIP (E24) 1% 470 K	1
SM652101511	RES CHIP (E24) 1% 510 OHM	1
SM652101820	RES CHIP (E24) 1% 82 OHMS	4
SM654101000	CHIP JUMPER ZERO OHMS	4
SM661207102	CAP CERA CHIP 10% .001UF	1
SM661207103	CAP CERA CHIP 20% .01UF (0805)	41
SM661207104	CAP CERA CHIP 20% .1 UF	36
SM661255101	CAP CERA CHIP 5% 100 PF	2
SM661255180	CAP CERA CHIP 5% 18PF	2
SM666217106	CAP MOLD TANT CHIP 10 UF	2
SM666327225	CAP MOLD TANT CHIP 2.2 UF	1
SM666377226	CAP MOLD TANT CHIP 22 UF	6

PART: S9302-1

DESC: PROCESSOR CARD without DRAM

<u>Location</u>	<u>Part Number</u>	<u>Description</u>
MP1	309380016	CRYSTAL OSCILLATOR (PROG) 16 MHZ
MP2	312590070	BATTERY LITHIUM 3V 70MAH
MP3	400331020	SOCKET IC SOLD TAIL DIP-20
MP4	404500068	CONN BD TO BD 68 POS
MP5	453250072	CONN PC EDGE/SOLD TAIL 72
MP6	454314016	HDR SOLD TAIL/MALE 16
MP7	454511014	HDR SOLD TAIL/MALE 14/RT
MP8	454511020	HEADER RT ANGLE MALE 20
MP9	454511040	HDR SOLD TAIL/MALE 40/RT
MP10	455410096	CONN RT ANGL MALE 96 S-CLIP
MP11	550130108	SCREW CYL HD M3X8
MP12	552130101	NUT HEX M3
MP13	719302103	PC BD PREASS'Y 9302-1
MP14	MDS410	IC RSDP GATE ARRAY MDS410
MP15	MNX401	IC MIN-MAX GATE ARRAY MNX401
MP16	SM200172138	IC 3 TO 8 DECODER 74F138
MP17	SM200178002	IC 2-INPUT NOR HCT02
MP18	SM200178032	IC 2-IN OR HCT32
MP19	SM200276068	IC RTC SERIAL 68HC68T1
MP20	SM200344174	IC HEX D-FLOP HCT 174
MP21	SM201186574	IC OCTAL D-TYP FLOP 74AC574
MP22	SM205010101	PROGRAMMED GAL CONRAD-A
MP23	SM205010102	PROGRAMMED GAL INTIME-B
MP24	SM205010103	PROGRAMMED GAL RASOIR-A
MP25	SM205010150	PROGRAMMED GAL CARTON-B
MP26	SM205010151	PROGRAMMED GAL COPAIN-A
MP27	SM205010153	PROGRAMMED GAL SERAIL-C
MP28	SM205010154	PROGRAMMED GAL SOLDAT-A
MP29	SM205010155	PROGRAMMED GAL TRICOT-A
MP30	SM205010156	PROGRAMMED GAL VISION-C
MP31	SM205010200	PROGRAMMED GAL BUTANE-A
MP32	SM205010252	PROGRAMMED GAL MAXIME-A
MP33	SM205010257	PROGRAMMED GAL MINIME-A
MP34	SM205144001	IC 8-MBIT FLASH MEM 28F008SA
MP35	SM205219256	IC 32K X 8 SRAM MS62256
MP36	SM205219264	IC 8K X 8 SRAM 70 NSEC 6264
MP37	SM205701070	IC 128KX8 STAT RAM 70 NS
MP38	SM206884623	IC OCTAL BUS TRANSCVR ABT623
MP39	SM206885245	IC BUS TRANSCVR ABT245
MP40	SM207178541	IC BUFFER/LINE DR HCT541
MP41	SM207179244	IC BUFFER/LINE DRIV HCT244
MP42	SM207260475	IC RAMDAC 256W 50MHZ BT475
MP43	SM207668882	IC CO PROCESSOR 68882
MP44	SM207970139	IC DECODER/DEMUX 74F139
MP45	SM207972157	IC DATA SEL/MUX 74F157A
MP46	SM208277770	IC DUAL PWR SUPPLY SUPR 7770-5
MP47	SM208470358	IC DUAL OP AMP 358D

PART: S9302-1

DESC: PROCESSOR CARD without DRAM

<u>Location</u>	<u>Part Number</u>	<u>Description</u>
MP48	SM208680916	IC LOW SKEW CLOCK DRIVER 88916
MP49	SM208780109	IC MICROPOWER DC-DC CONV 1109CS8
MP50	SM227132830	IC 32-BIT U PROC 68EC030
MP51	SM232032814	DIODE ARRAY 2814
MP52	SM236030099	DIODE SO-PKG BAV99
MP53	SM256232013	DIODE LIGHT EMITTING RED
MP54	SM270330848	TRANSISTOR NPN BC848C
MP55	SM280171005	TRANSISTOR POWER MOSFET MTD10N05E
MP56	SM300056332	INDUCTOR WOUND 33 UH
MP57	SM301502001	BEAD (FERRITE CHIP)
MP58	SM310300406	CRYSTAL 32768 HZ
MP59	SM311248000	CRYSTAL OSCILLATOR 48MHZ
MP60	SM652101101	RES CHIP 1% 100 OHMS
MP61	SM652101102	RES CHIP 1% 1.00 K
MP62	SM652101103	RES CHIP 1% 10.0 K
MP63	SM652101104	RES CHIP 1% 100 K
MP64	SM652101106	RES CHIP 1% 10.0 M
MP65	SM652101152	RES CHIP 1% 1.50 K
MP66	SM652101153	RES CHIP 1% 15.0 K
MP67	SM652101154	RES CHIP 1% 150 K
MP68	SM652101220	RES CHIP 1% 22.1 OHMS
MP69	SM652101221	RES CHIP 1% 221 OHMS
MP70	SM652101331	RES CHIP 1% 332 OHMS
MP71	SM652101332	RES CHIP 1% 3.32 K
MP72	SM652101470	RES CHIP 1% 47.5 OHMS
MP73	SM652101474	RES CHIP 1% 475 K
MP74	SM652101511	RES CHIP 1% 511 OHMS
MP75	SM652101820	RES CHIP 1% 82.5 OHMS
MP76	SM654101000	CHIP JUMPER ZERO OHMS
MP77	SM661207102	CAP CERA CHIP 20% .001 UF
MP78	SM661207103	CAP CERA CHIP 20% .01 UF
MP79	SM661207104	CAP CERA CHIP 20% .1 UF
MP80	SM661255101	CAP CERA CHIP 5% 100 PF
MP81	SM661255180	CAP CERA CHIP 5% 18 PF
MP82	SM666217106	CAP MOLD TANT CHIP 10 UF
MP83	SM666327225	CAP MOLD TANT CHIP 2.2 UF
MP84	SM666377226	CAP MOLD TANT CHIP 22 UF

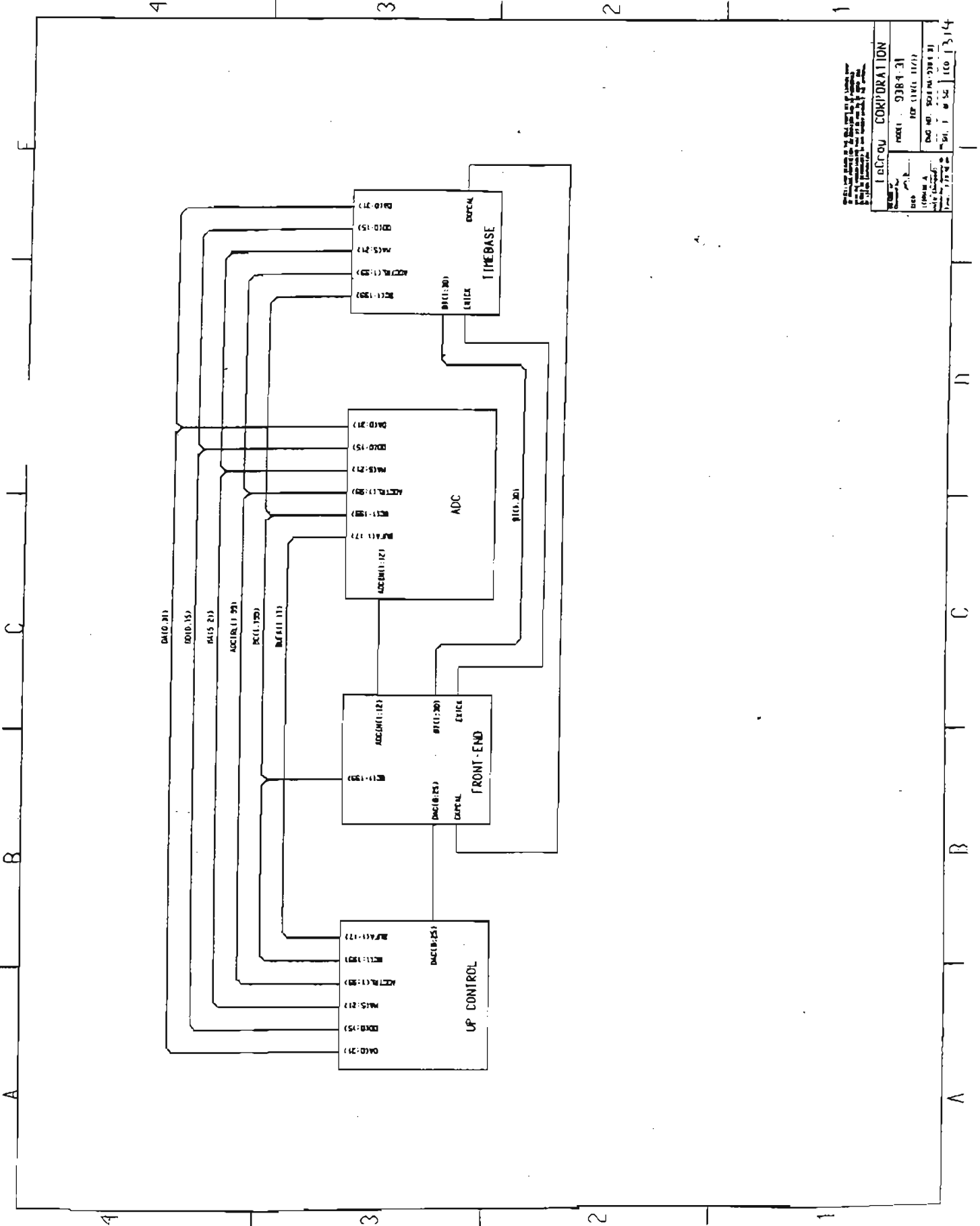

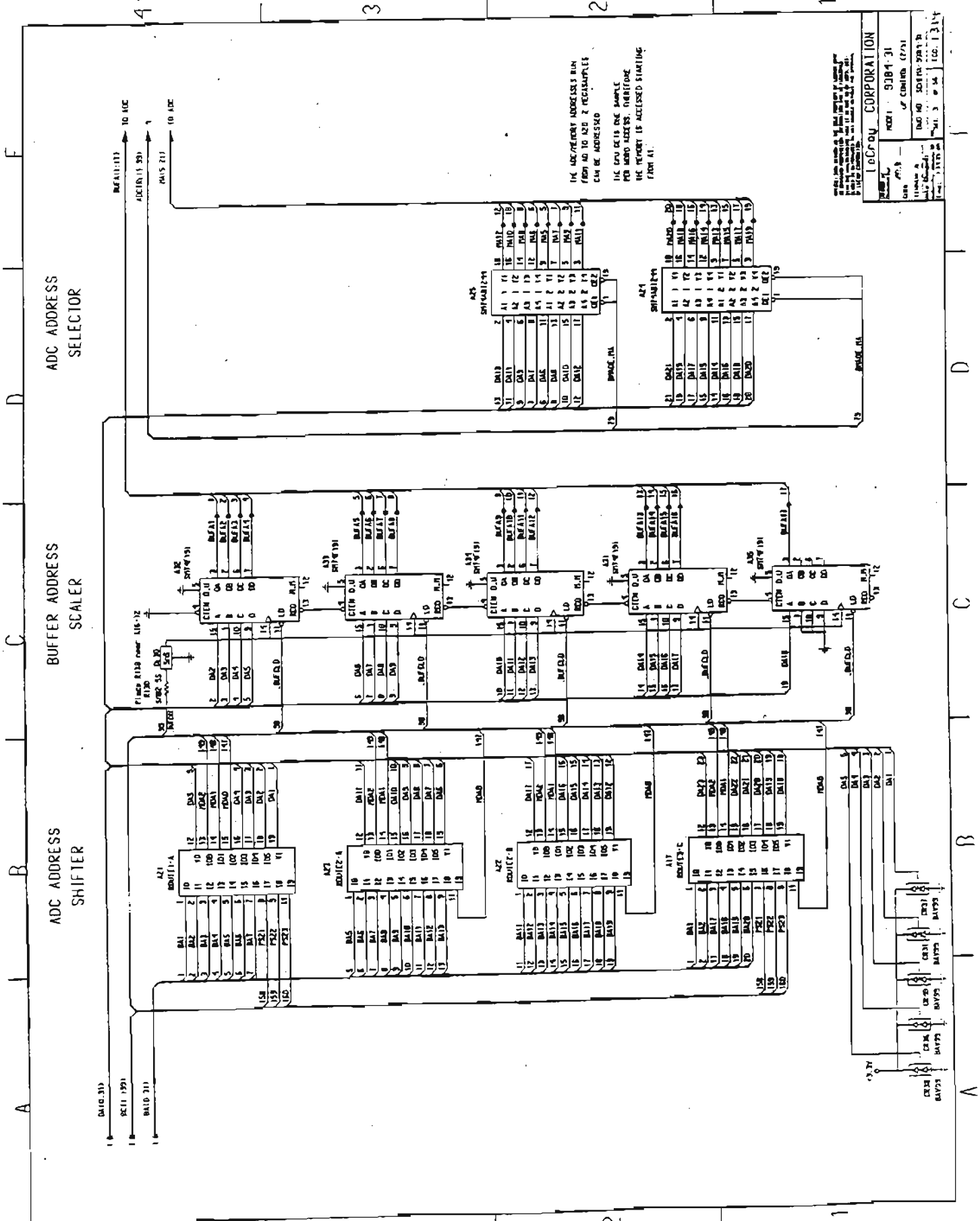

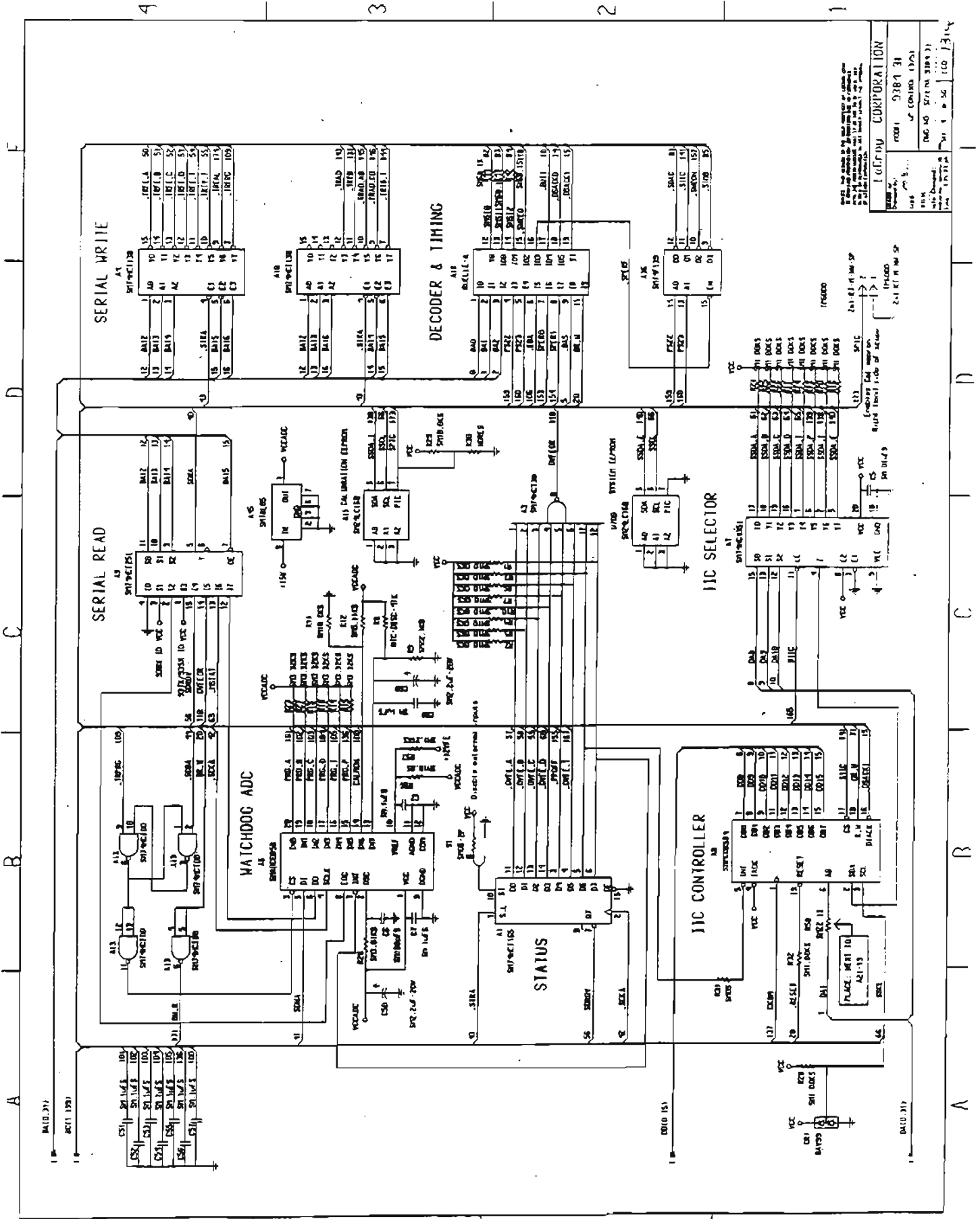

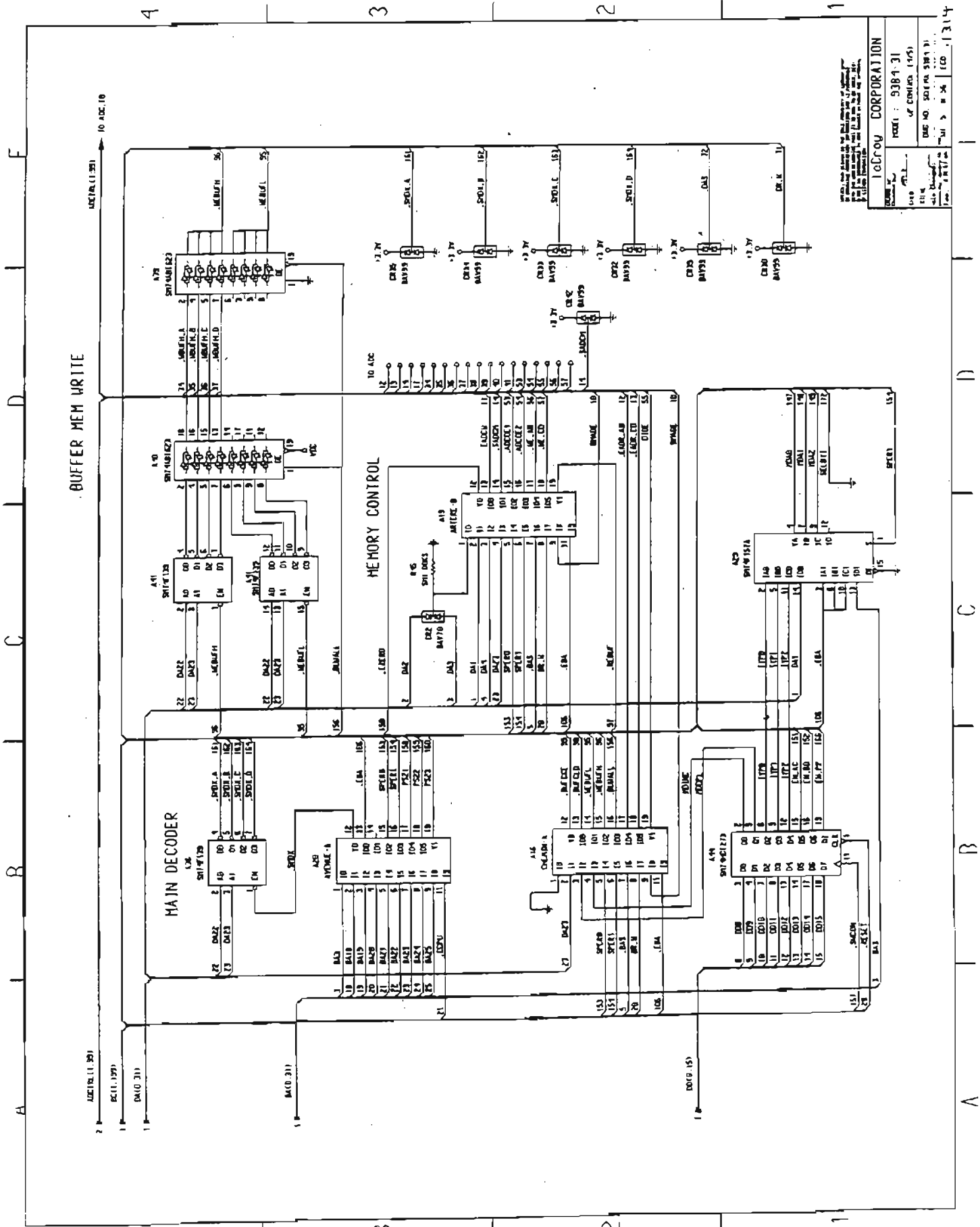

100CROW CORPORATION
 MODEL : 5384-31
 DATE NO. 5015A 5384-31
 DATE 11/1971

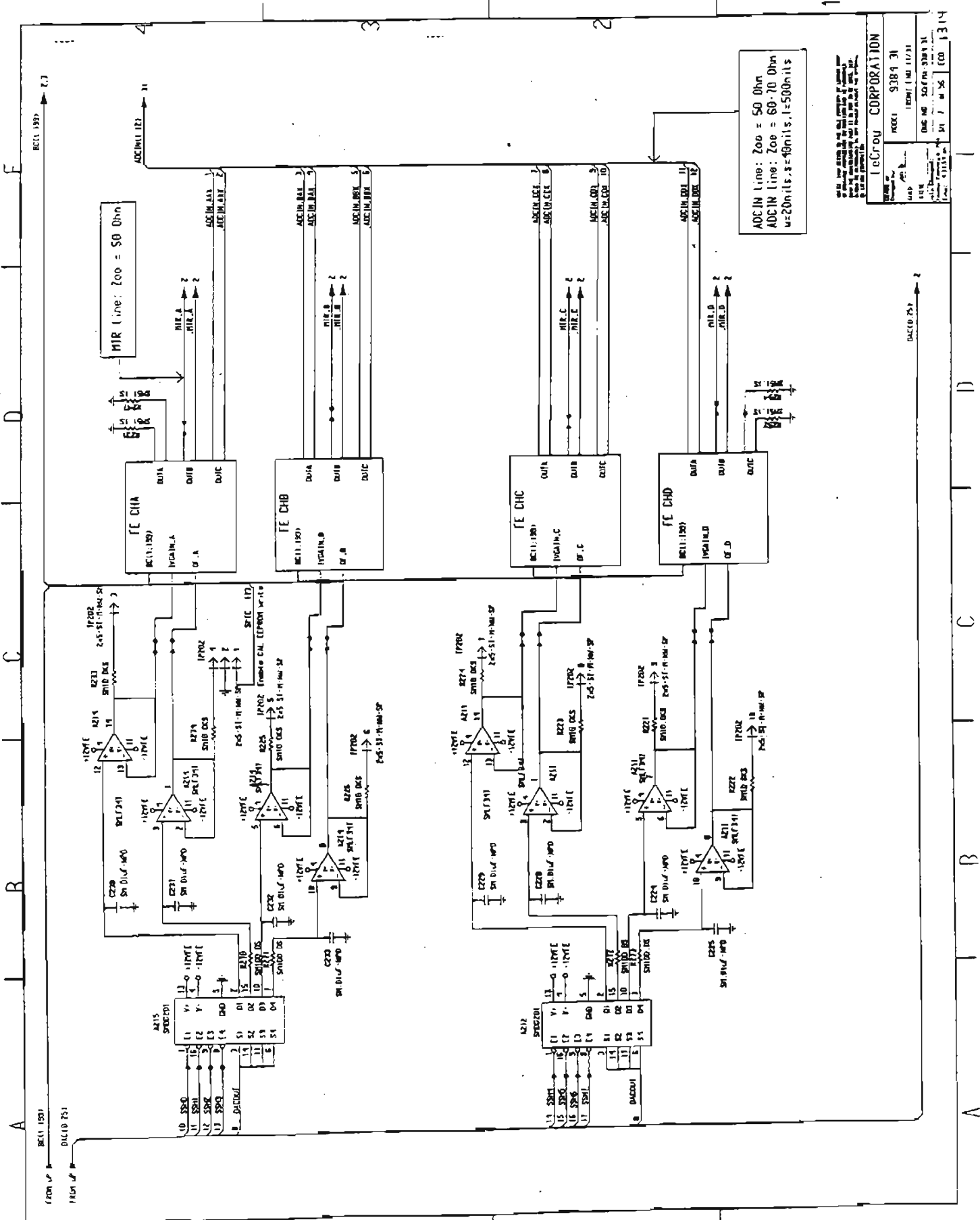

ADC IN line: $Z_{00} = 50 \text{ Ohm}$
 ADC IN line: $Z_{00} = 60-70 \text{ Ohm}$
 $w=20\text{mils}, s=40\text{mils}, l=500\text{mils}$

ALL DIMENSIONS ARE IN MILLIMETERS UNLESS OTHERWISE SPECIFIED.
 DIMENSIONS IN PARENTHESES ARE FOR INFORMATION ONLY.

TeCroy CORPORATION	
PROJECT	9384 J1
DATE	11/11/81
DESIGNER	W. J. ...
CHECKED	...
APPROVED	...

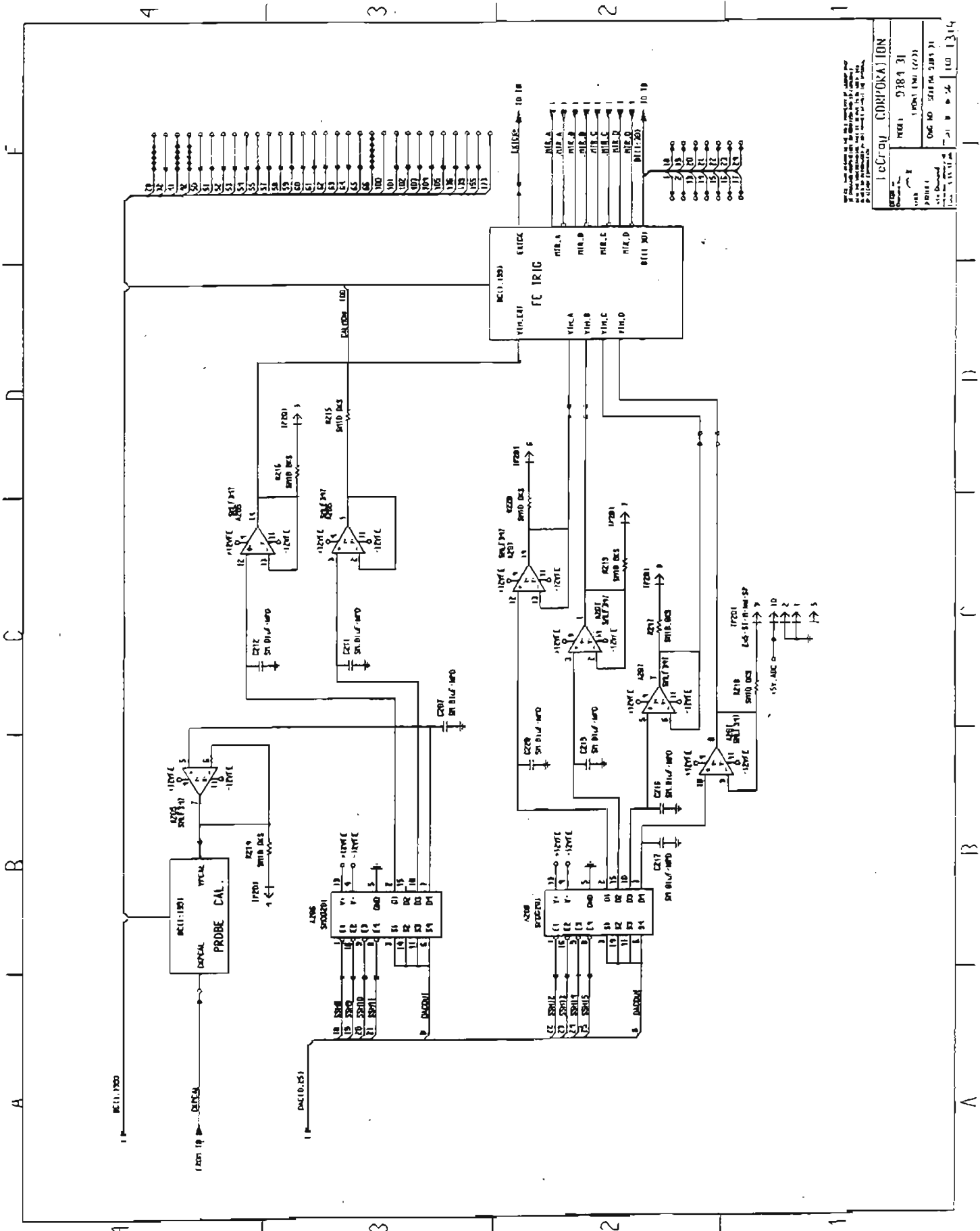

THIS DRAWING IS THE PROPERTY OF THE COMPANY AND IS NOT TO BE REPRODUCED OR TRANSMITTED IN ANY FORM OR BY ANY MEANS, ELECTRONIC OR MECHANICAL, INCLUDING PHOTOCOPYING, RECORDING, OR BY ANY INFORMATION STORAGE AND RETRIEVAL SYSTEM.

TeCray CORPORATION	
REV. 1	9784 31
DATE	1984 JUN 22
PROJ. NO.	55184 2183 31
DESIGNED BY	11/11/84
DRAWN BY	11/11/84
CHECKED BY	11/11/84
APPROVED BY	11/11/84
SCALE	1:1
SHEET NO.	1314

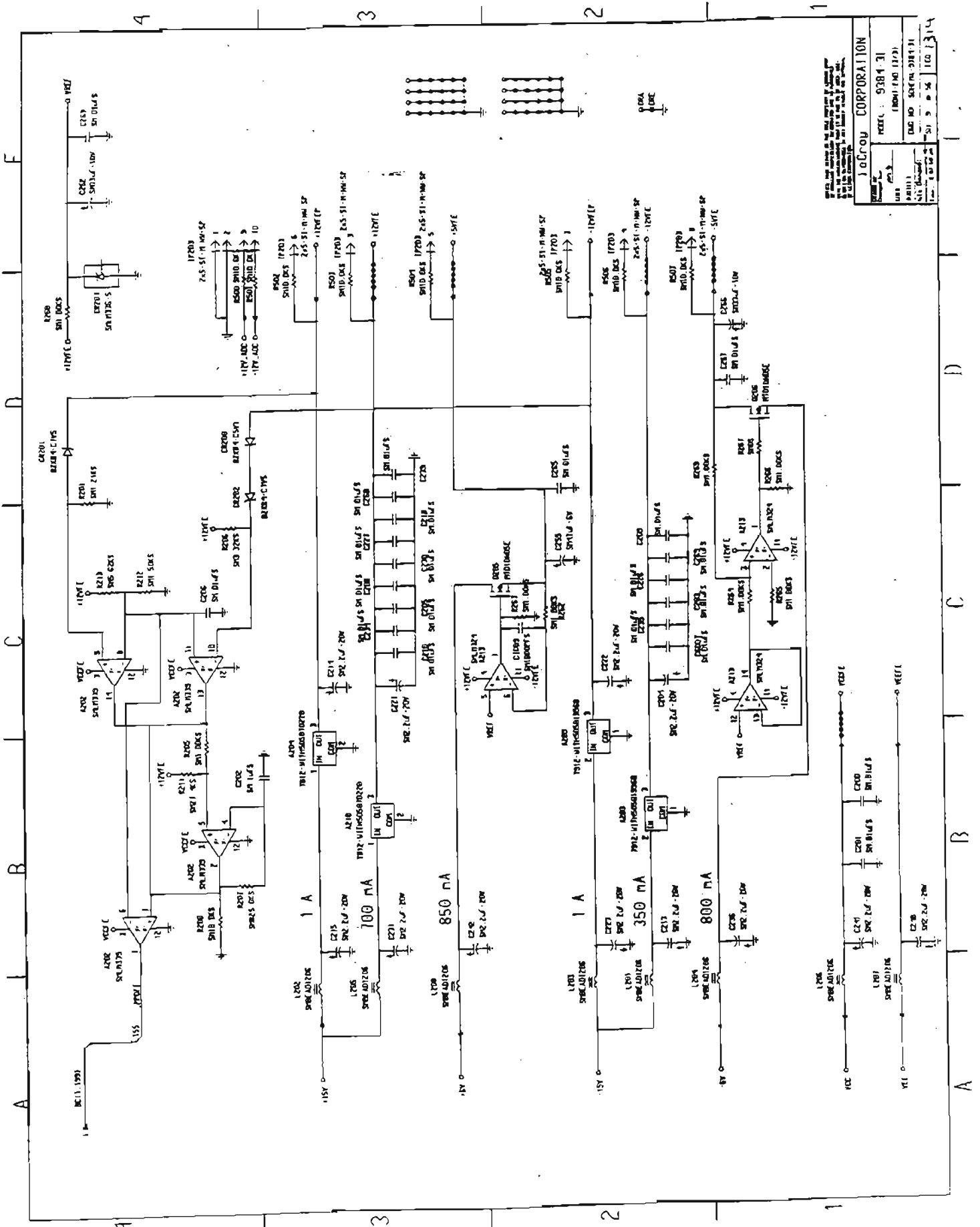

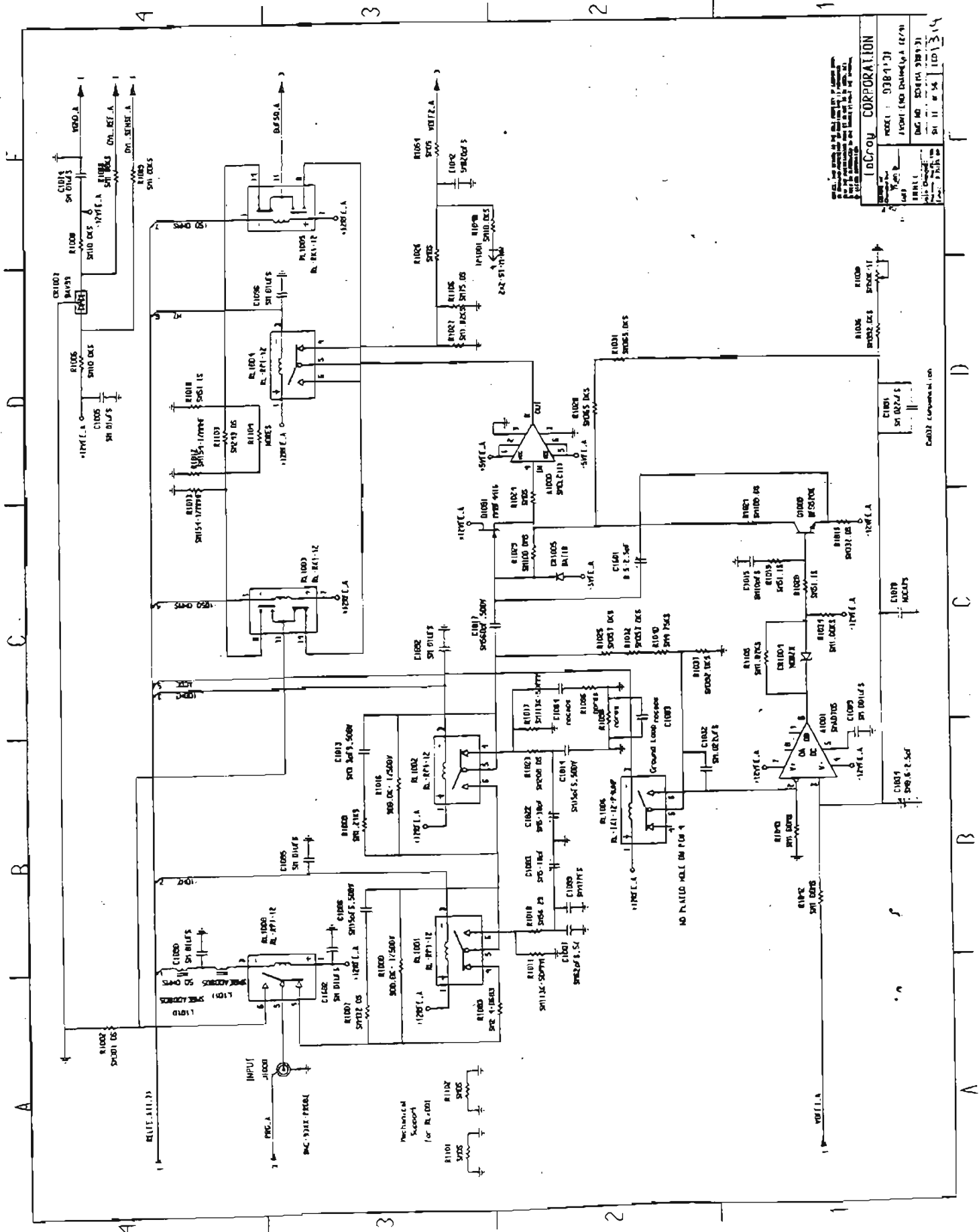

IDC Group CORPORATION	
MODEL: 038-1-31	REV: 10/24/54
DATE: 10/24/54	BY: 11/54
DRG NO: 328-1-31	10/24/54
10/24/54	10/24/54

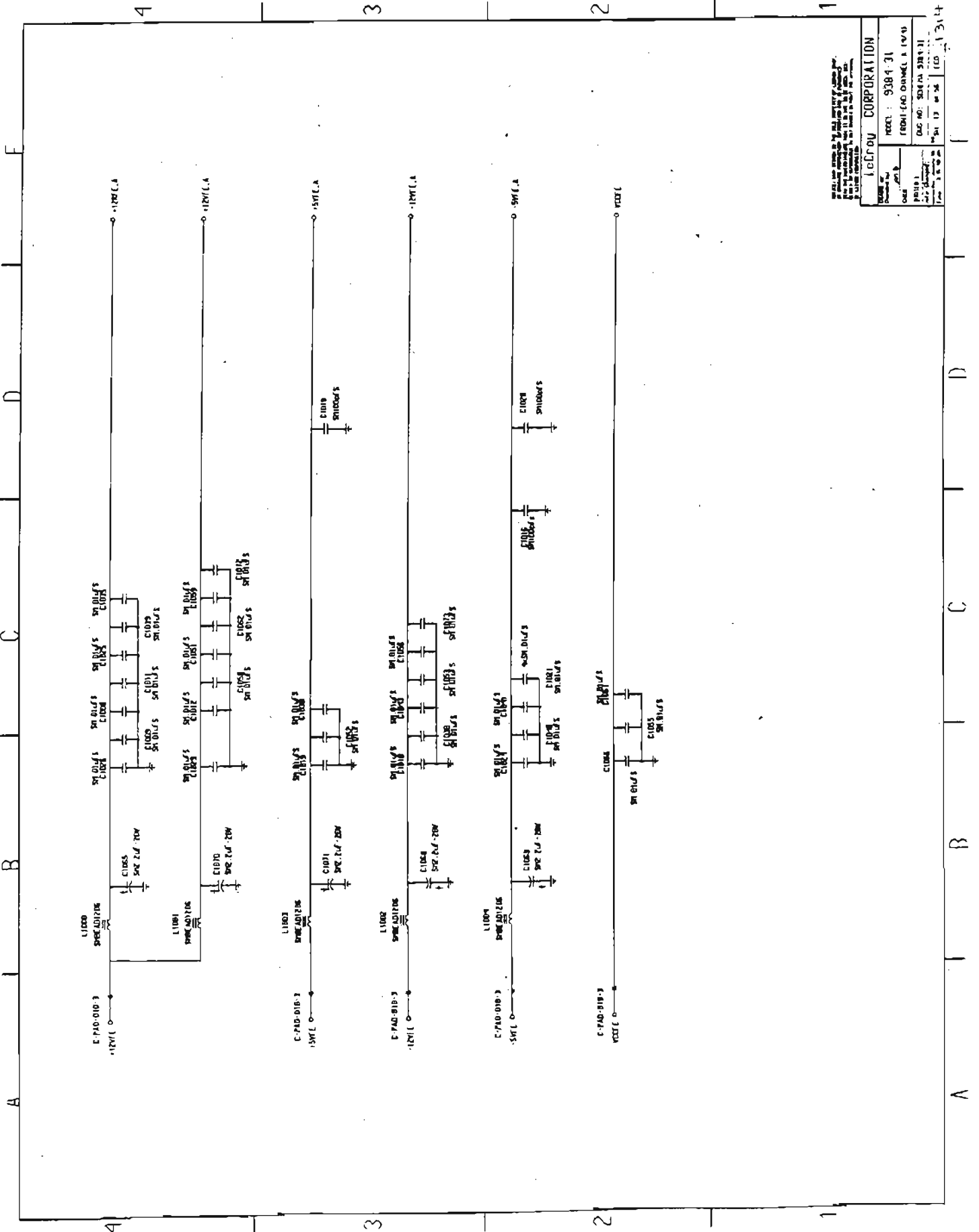

Telray CORPORATION	
REVISION	9384-31
DATE	1961-10-01
BY	W. J. DANKEL, JR.
CHECKED	W. J. DANKEL, JR.
APPROVED	W. J. DANKEL, JR.
SCALE	1:1
FIG. NO.	308 (A)
REV.	1
DATE	1961-10-01

Section 7 Schematics, Layouts, Parts list

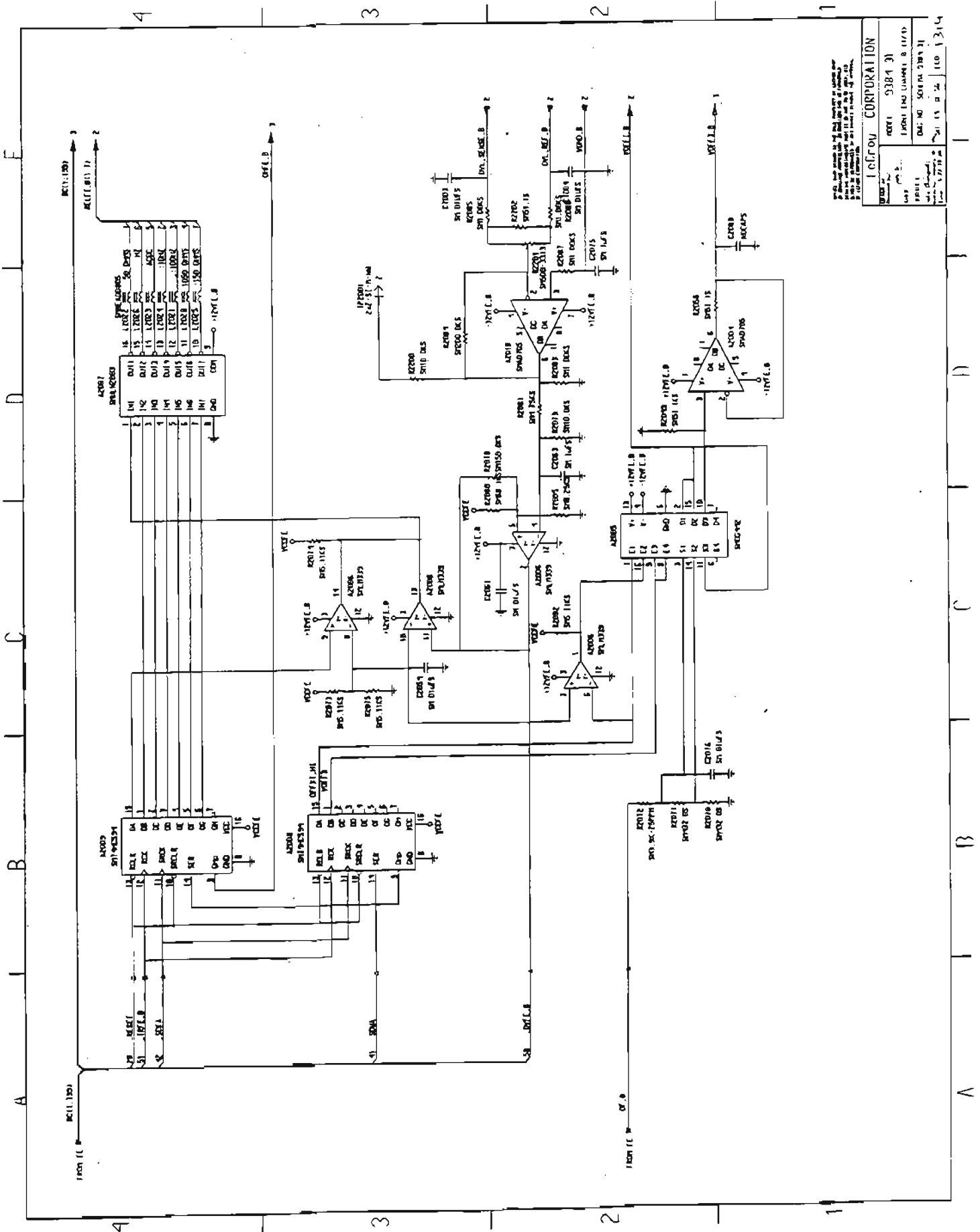

1. This schematic is for the...
 2. All dimensions are in millimeters...
 3. All dimensions are in inches...
 4. All dimensions are in centimeters...

Infogrou CORPORATION

REV. 1 9384 31
 (MONTREAL, QUEBEC, CANADA)

DATE: 01/01/84
 BY: J. B. B.

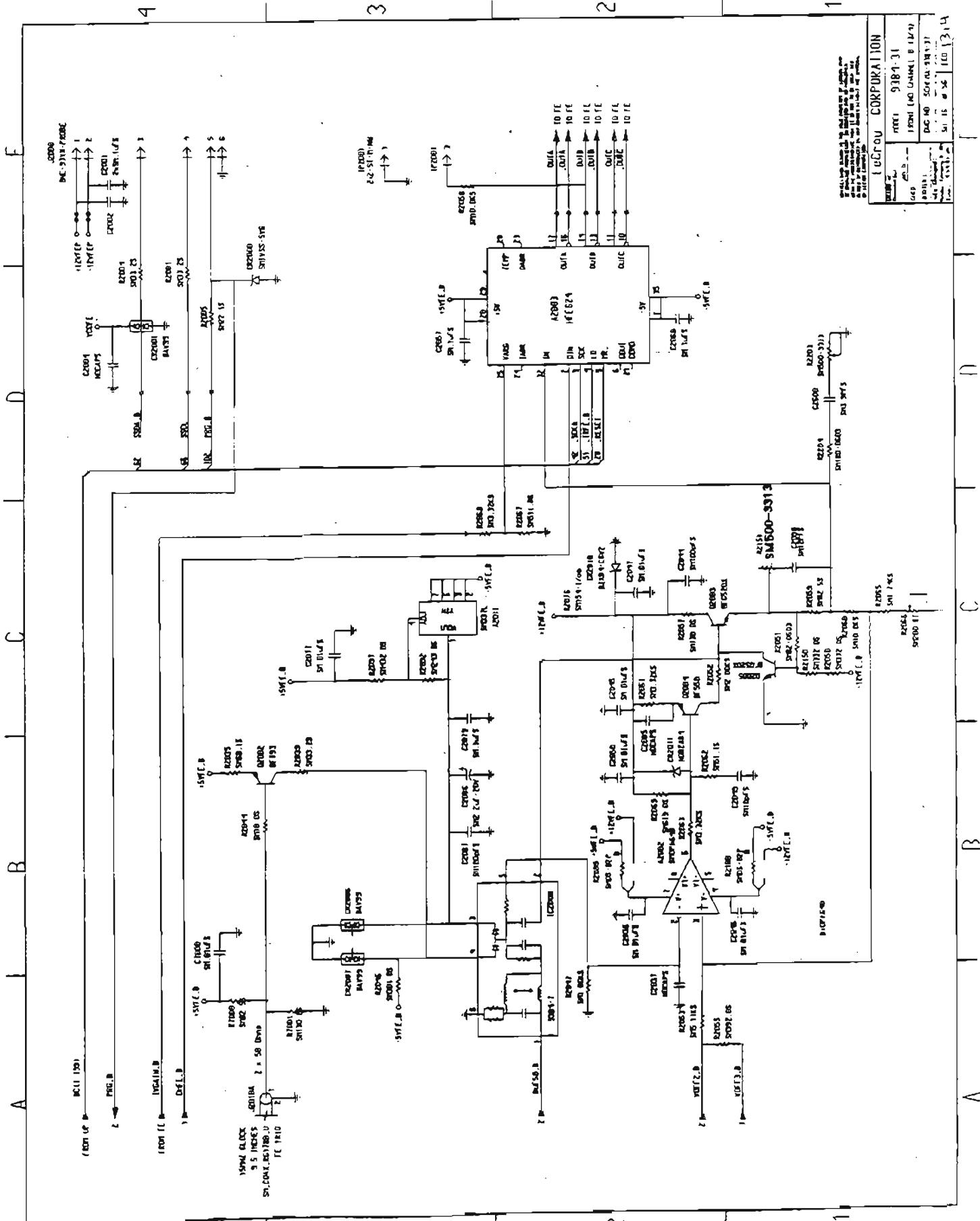

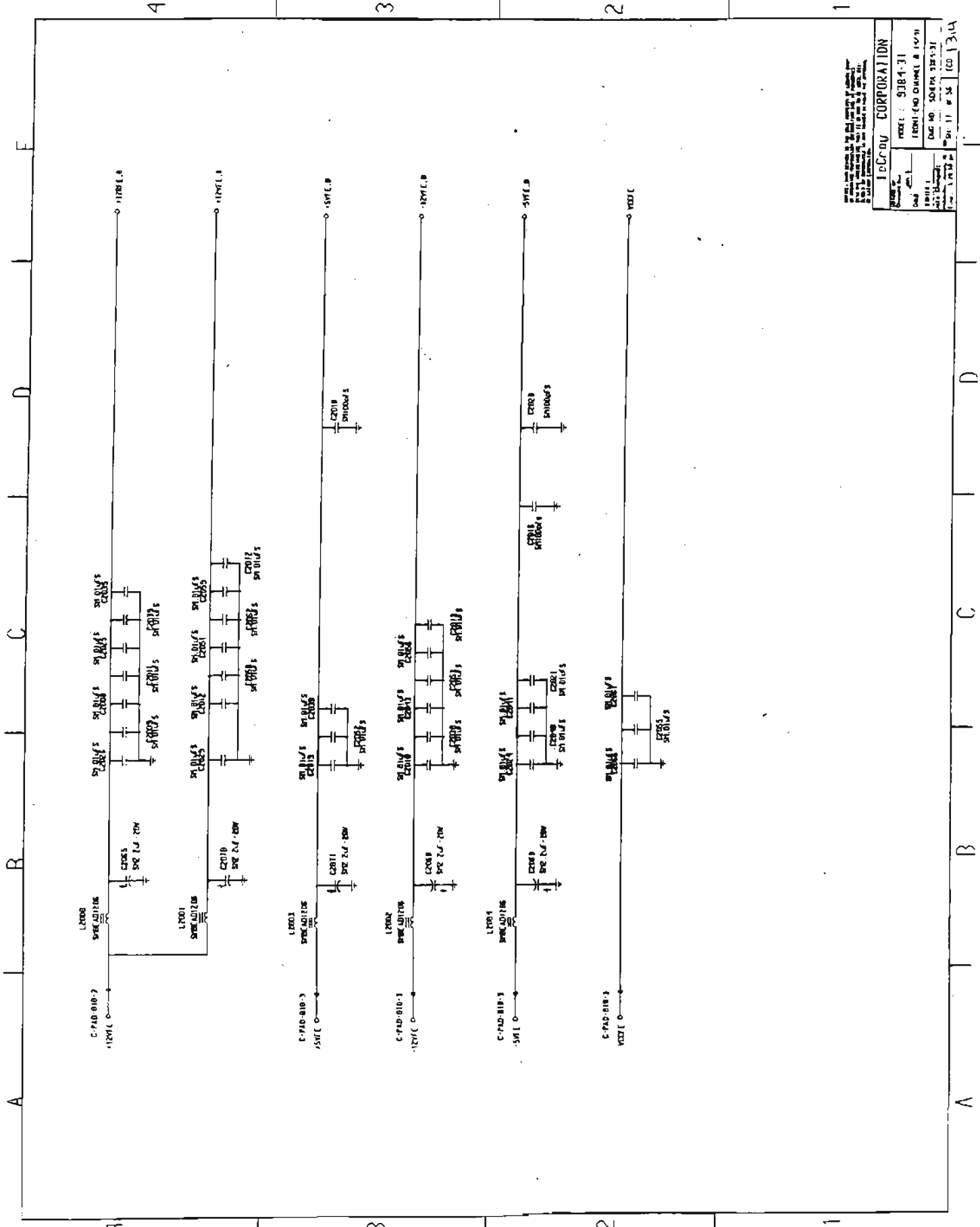

ITCORP CORPORATION 10000 ITCORP BLVD FORT WORTH, TEXAS 76116	
MODEL: 9384-31 FRONT-END CHANNEL B (V/F)	DATE: 04/01/80 DRAWN: J. B. BROWN CHECKED: J. B. BROWN
SHEET: 11 of 35 (REV. 1/1/78)	(REV. 1/1/78)

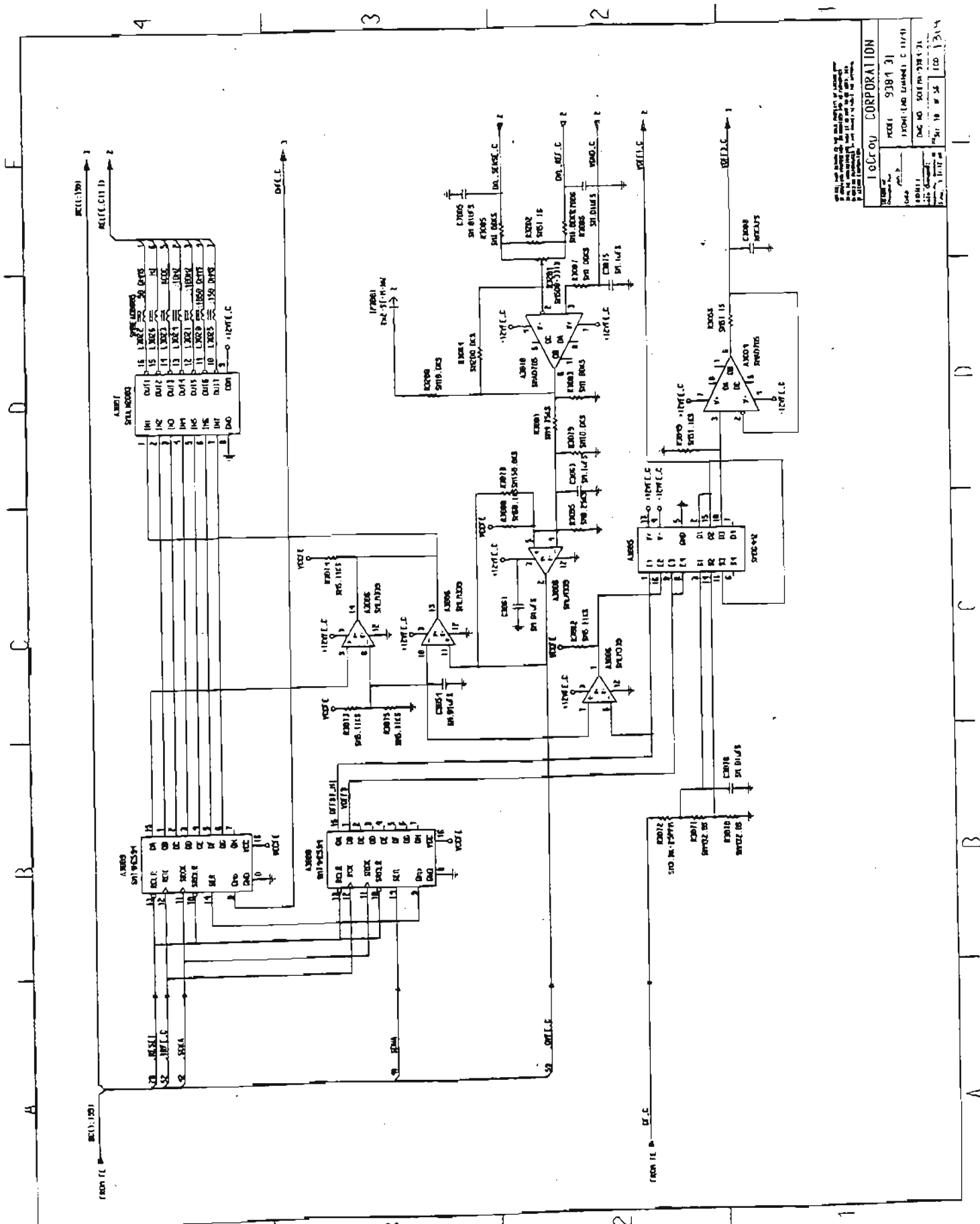

IECROU CORPORATION
 MODEL 9381-31
 IYOMI-LEAD LUMINA C 11/41
 DATE 10/20/81
 DRAWN BY: [Name]
 CHECKED BY: [Name]
 APPROVED BY: [Name]
 100 1 31/4

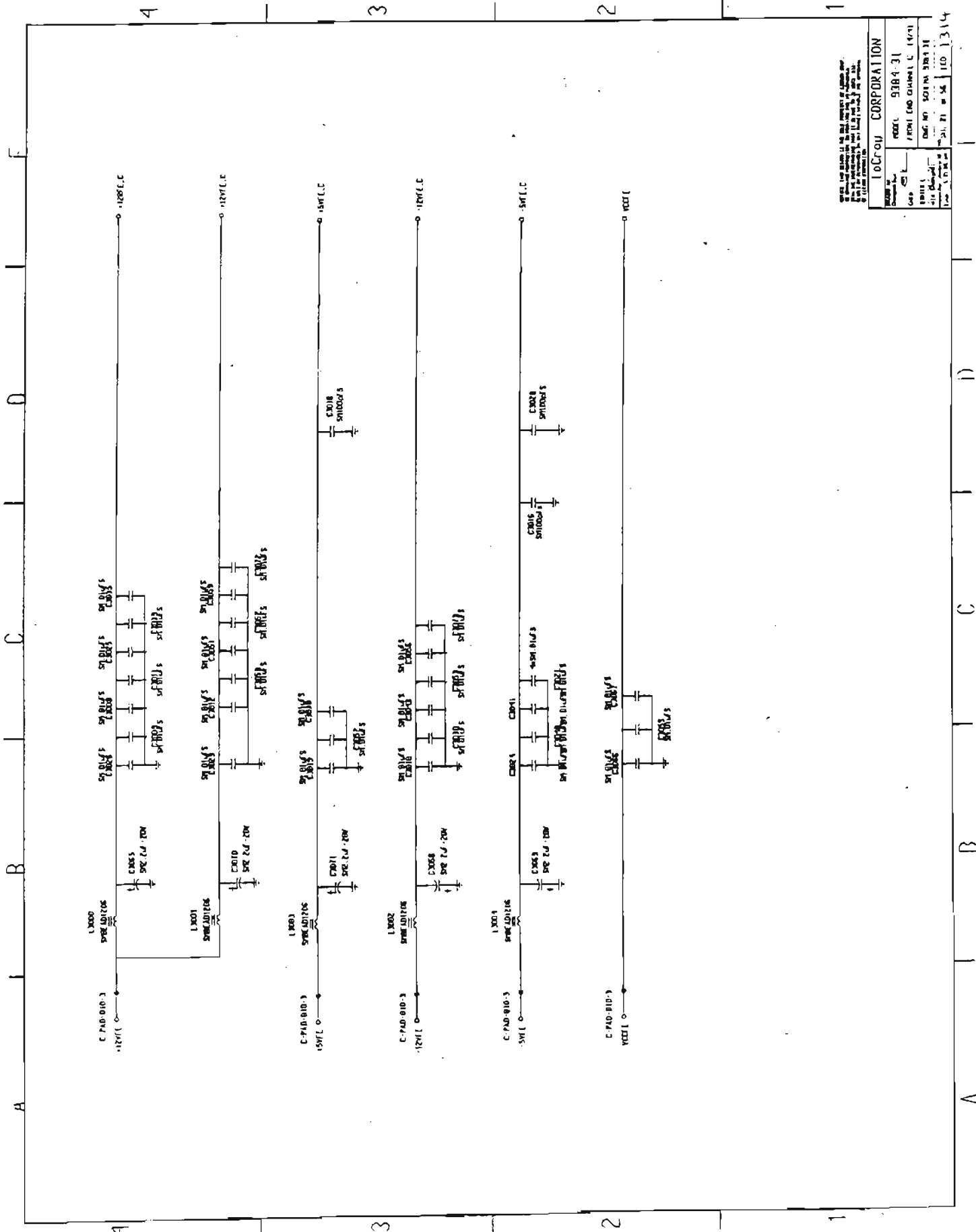

MODEL 9384-31 PART NO 9384-31	
Iocroy CORPORATION 10000 W. 10th Street, Denver, CO 80202	
DATE: 11/10/81	DRAWN BY: J. J. ...
CHECKED BY: ...	APPROVED BY: ...

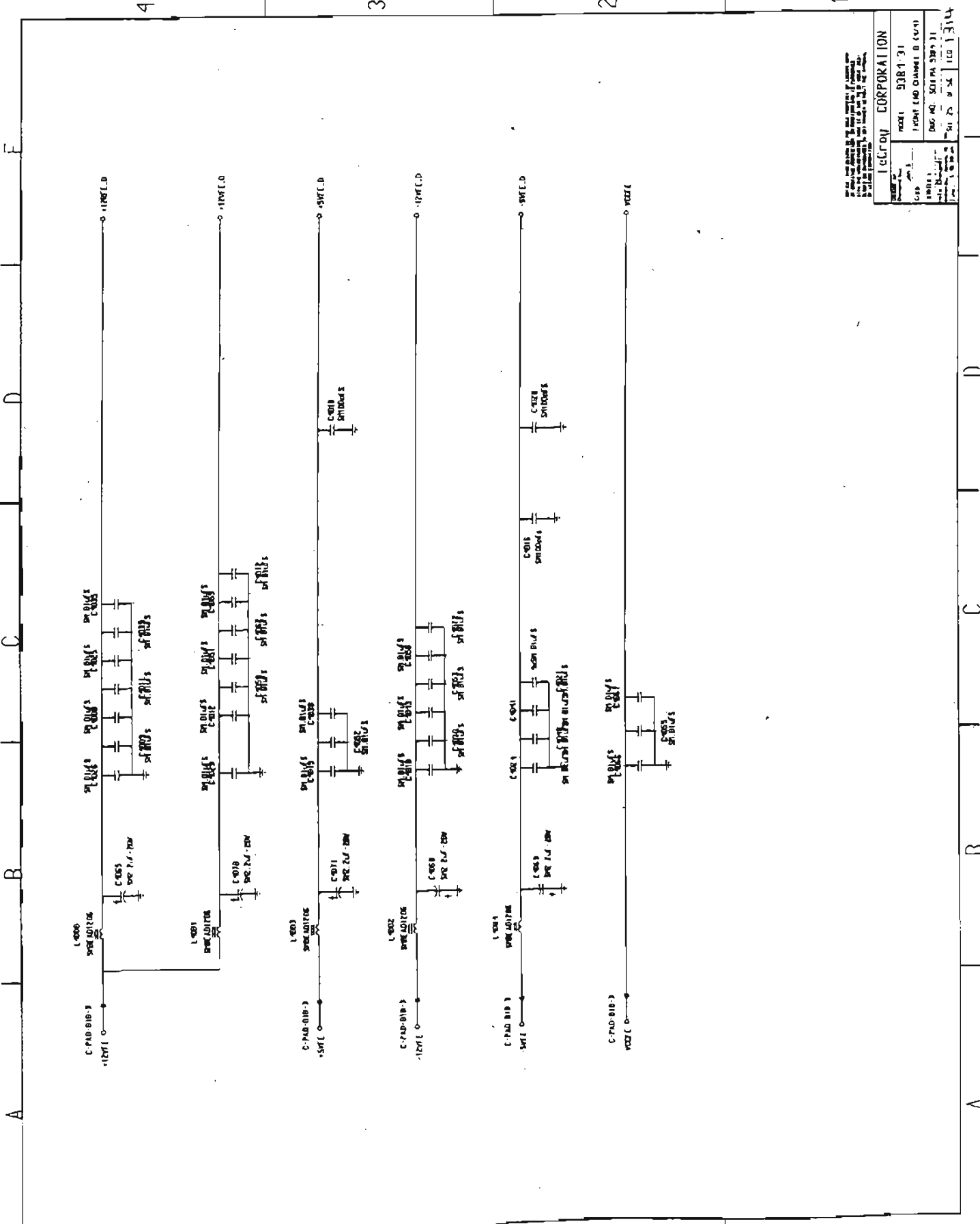

TELECOR CORPORATION	
MODEL	5381-31
ISSUE	10001 (NO CHANGE) 0 (REV)
DATE	NOV 20 1974
BY	...
CHECKED	...
APPROVED	...
DESIGNED	...
DRW. NO.	5381 PA 3100 31
REV. NO.	100 1314

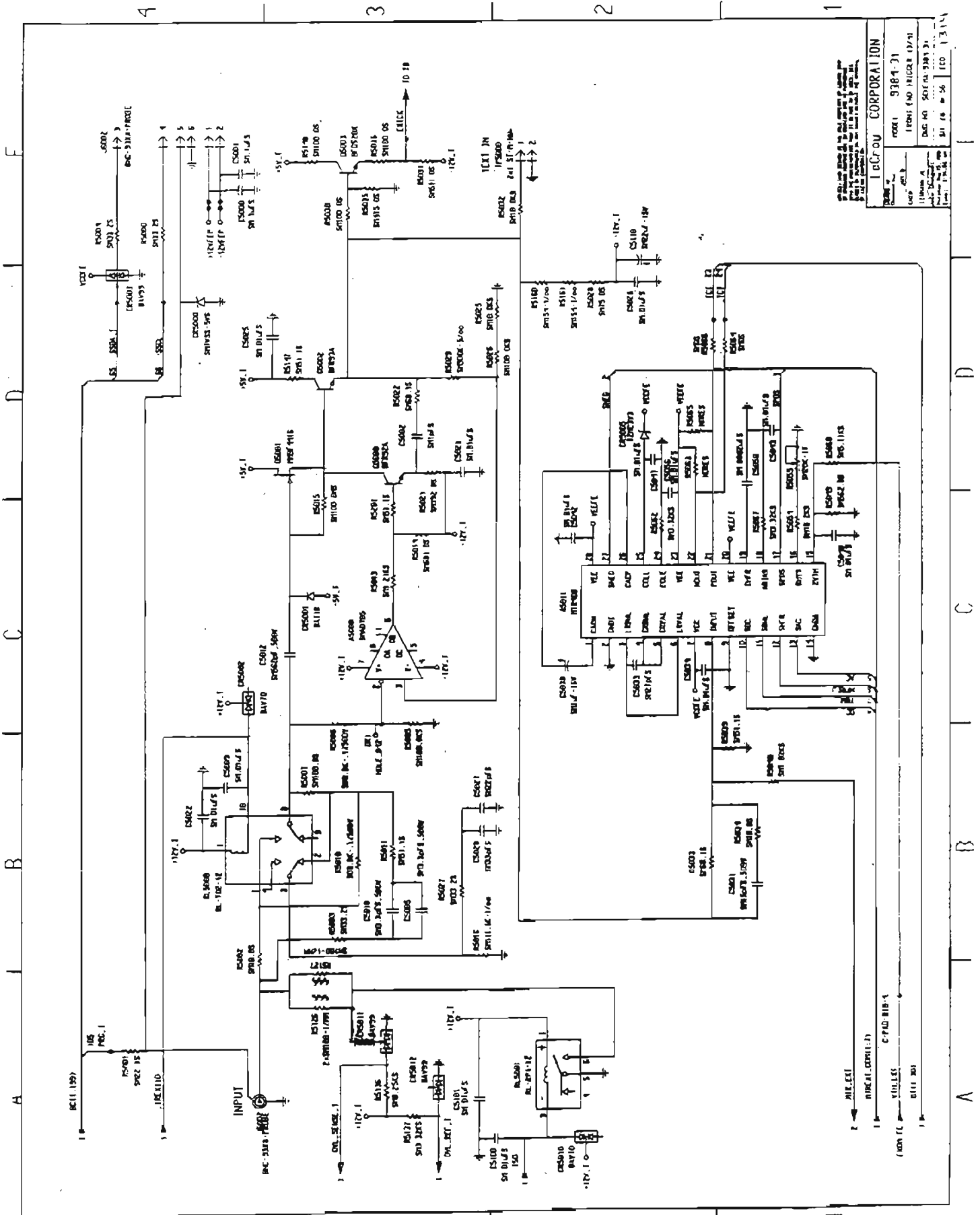

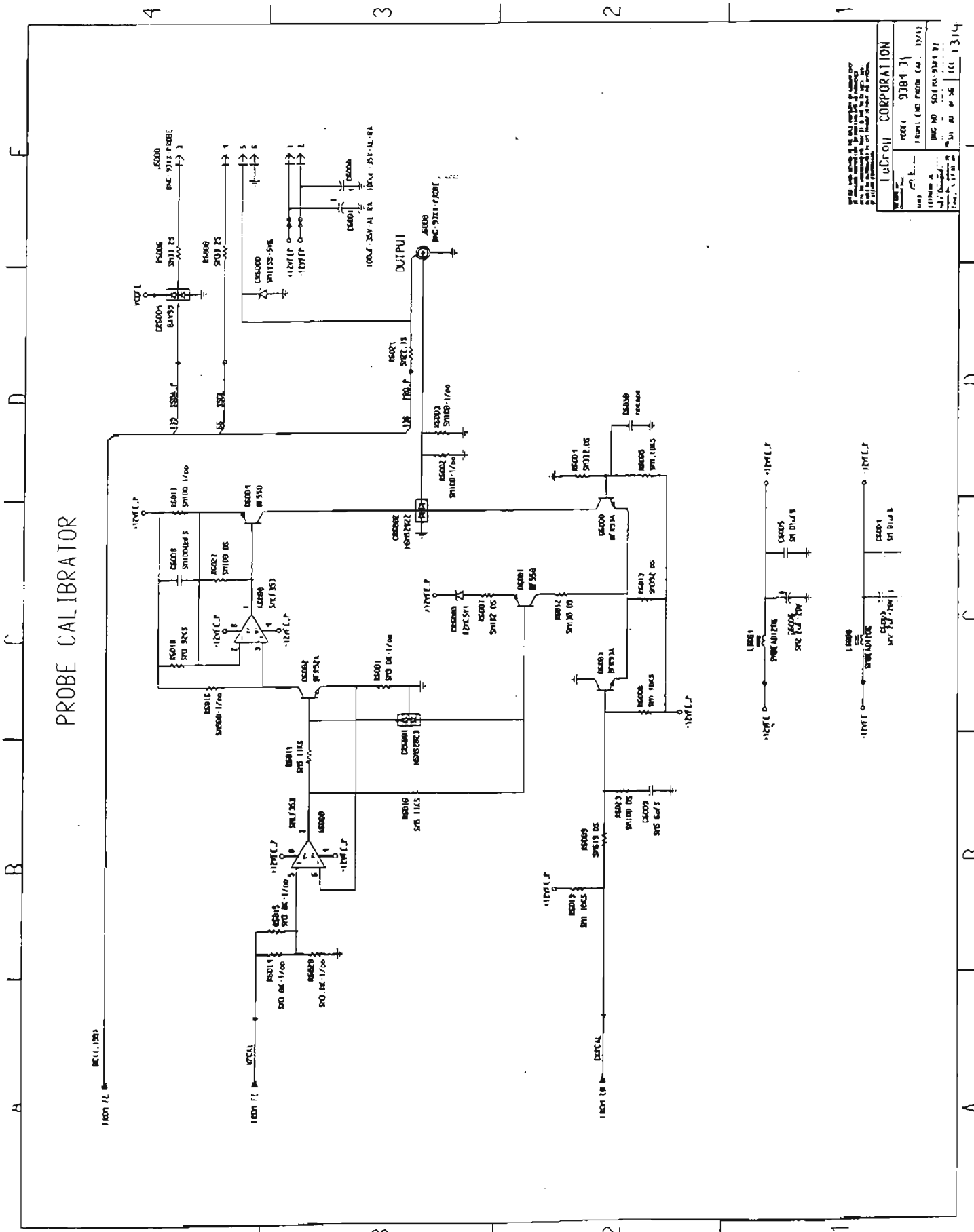

PROBE CALIBRATOR

LUCROJ CORPORATION	
REV. 308-31	
DATE: 10/10/71	
BY: J. M. ...	
CHECKED: ...	
APPROVED: ...	
DESIGNED BY: ...	
DRWING NO: ...	
SCALE: ...	
SHEET NO: ...	
TOTAL SHEETS: ...	

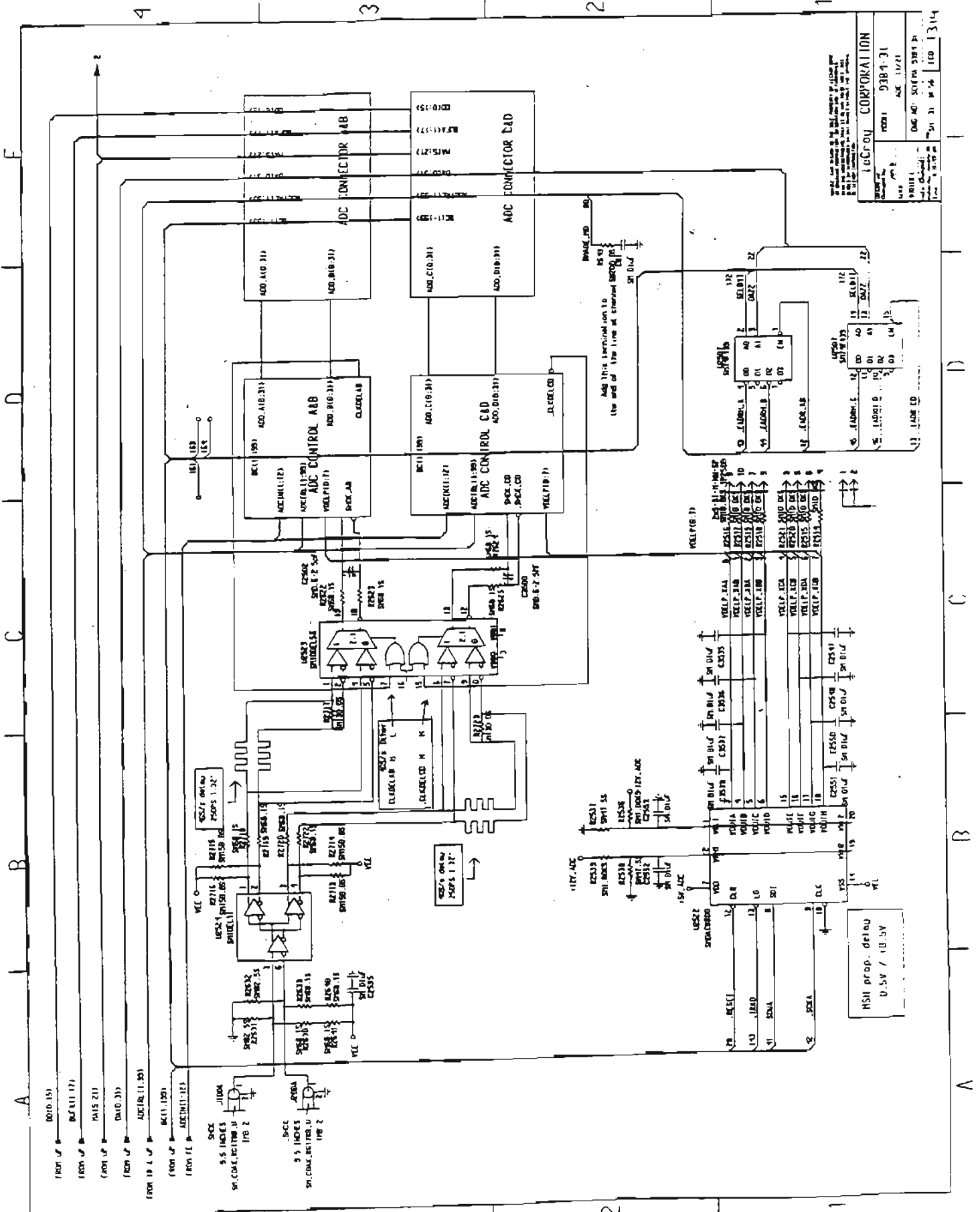

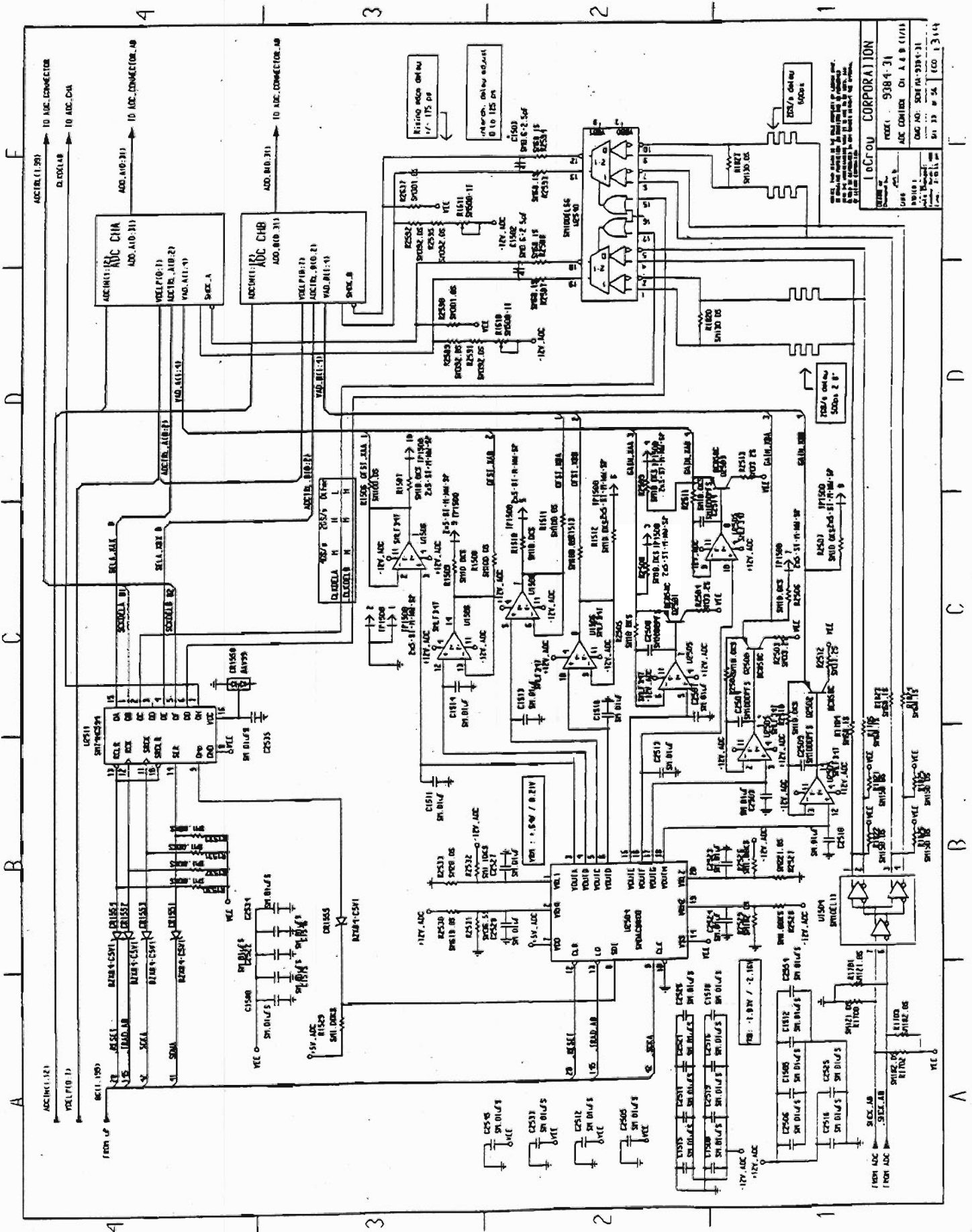

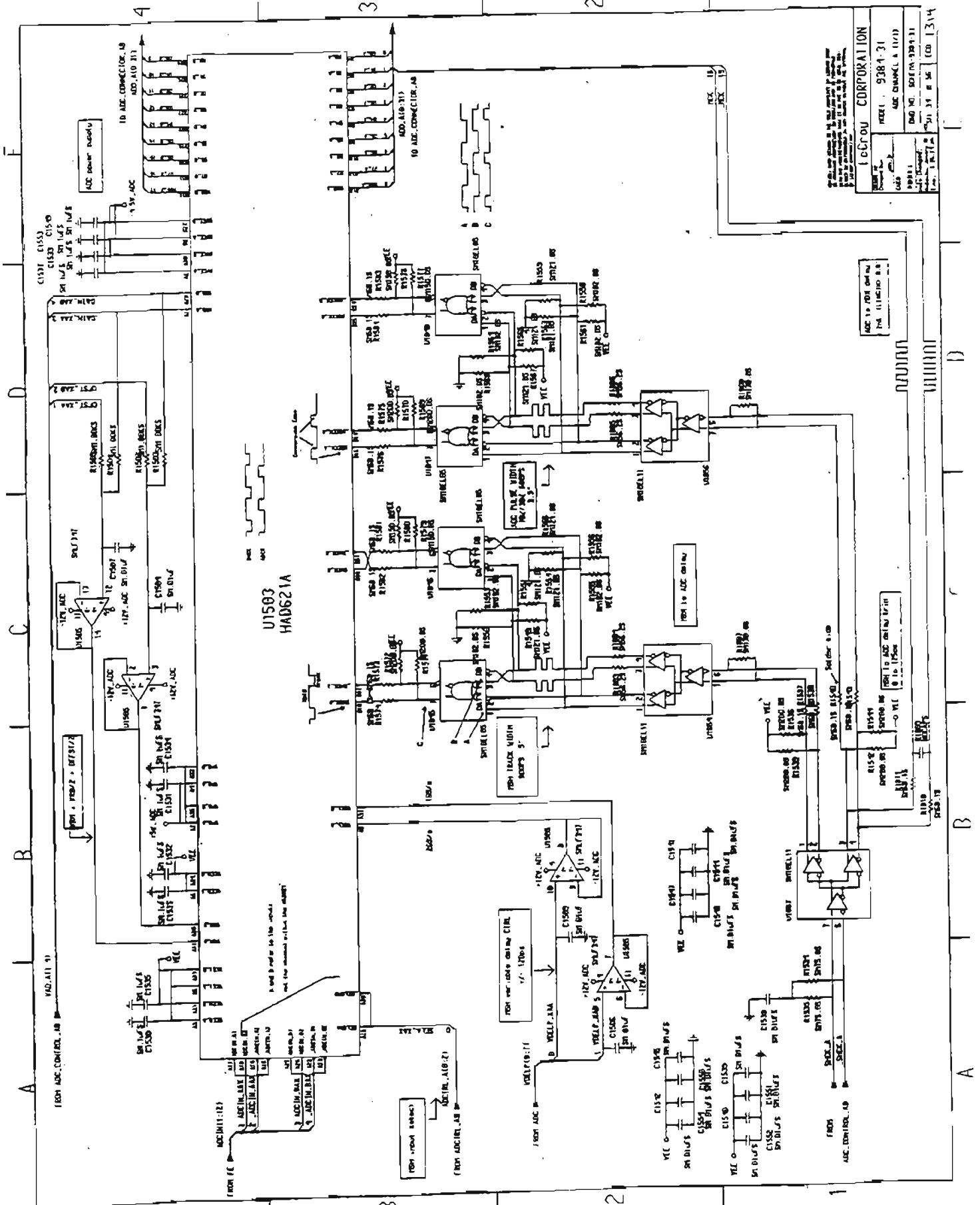

Section 7 Schematics, Layouts, Parts list

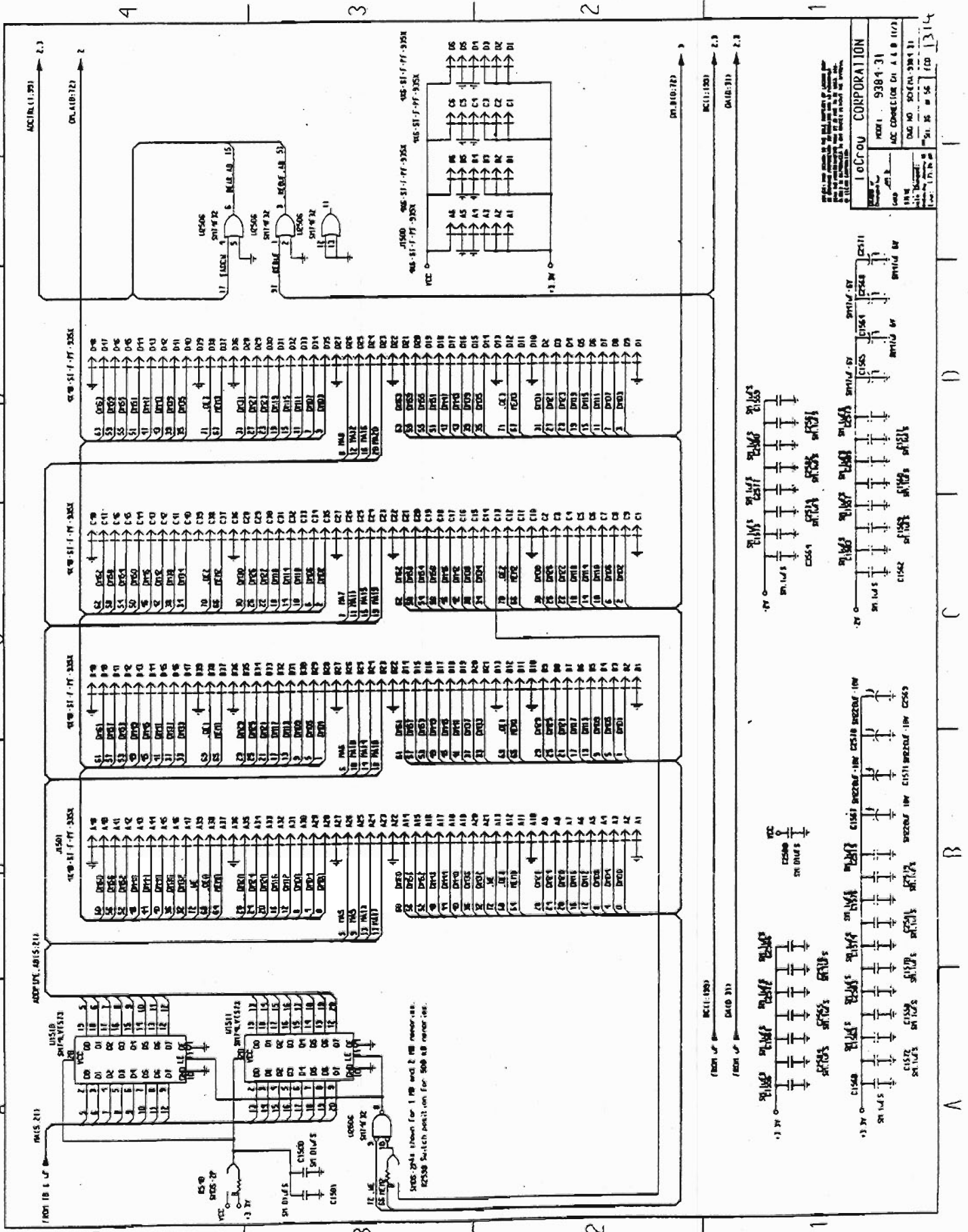

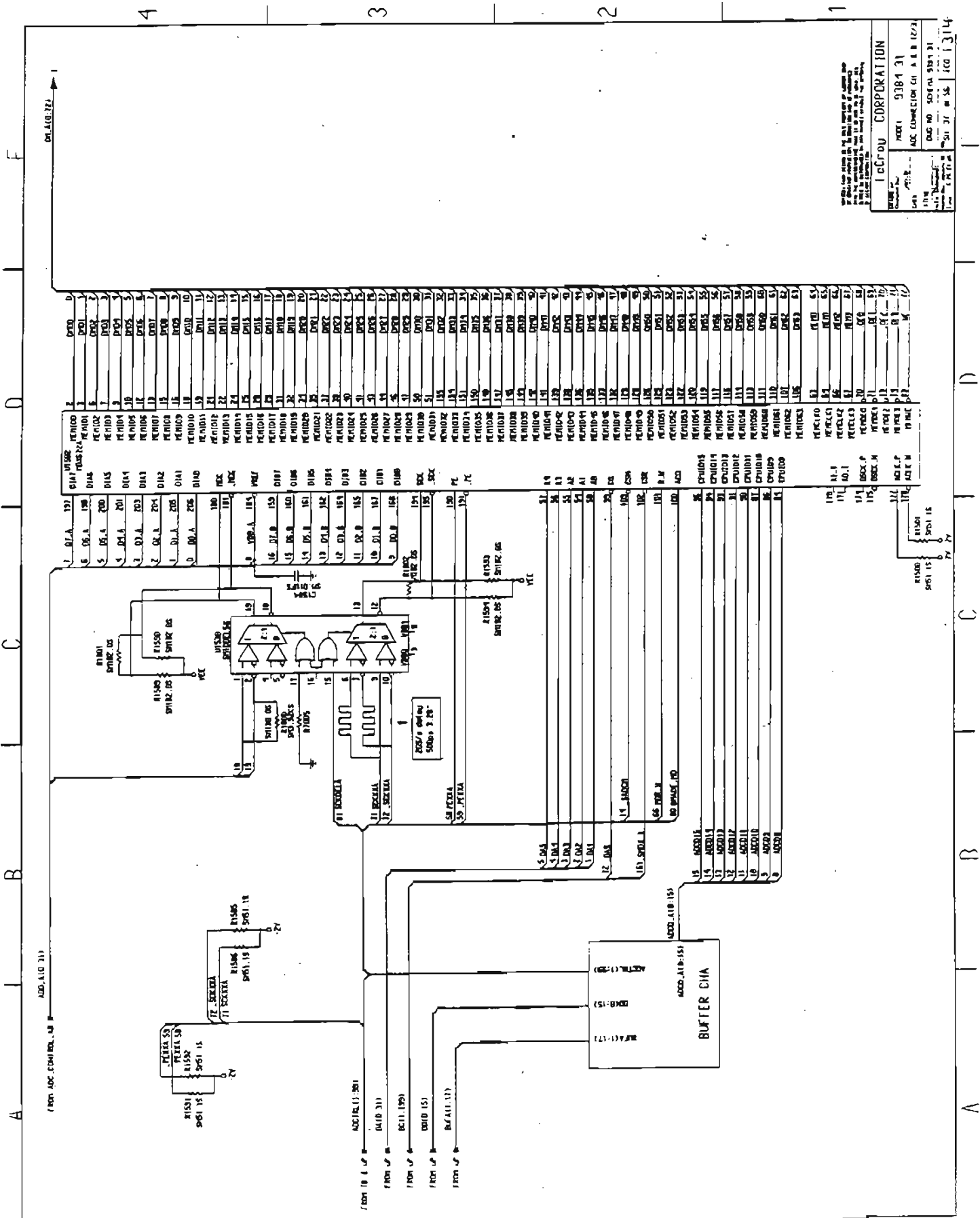

IECROU CORPORATION
 PROJECT: 9384 31
 DATE: 05/04/64
 DRAWING NO: 50764 9384 31
 SHEET NO: 31 OF 35
 SECTION: 7

Section 7 Schematics, Layouts, Parts list

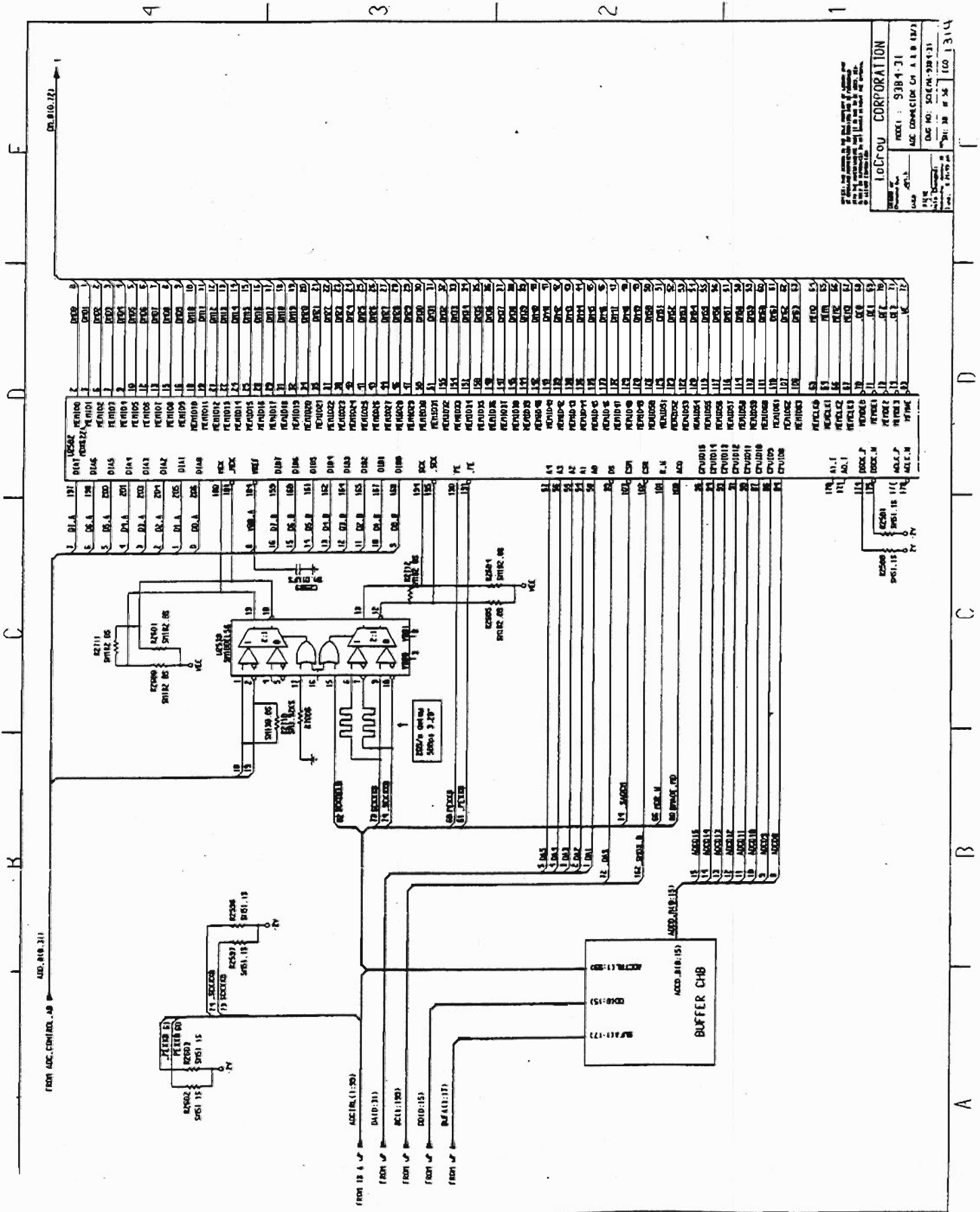

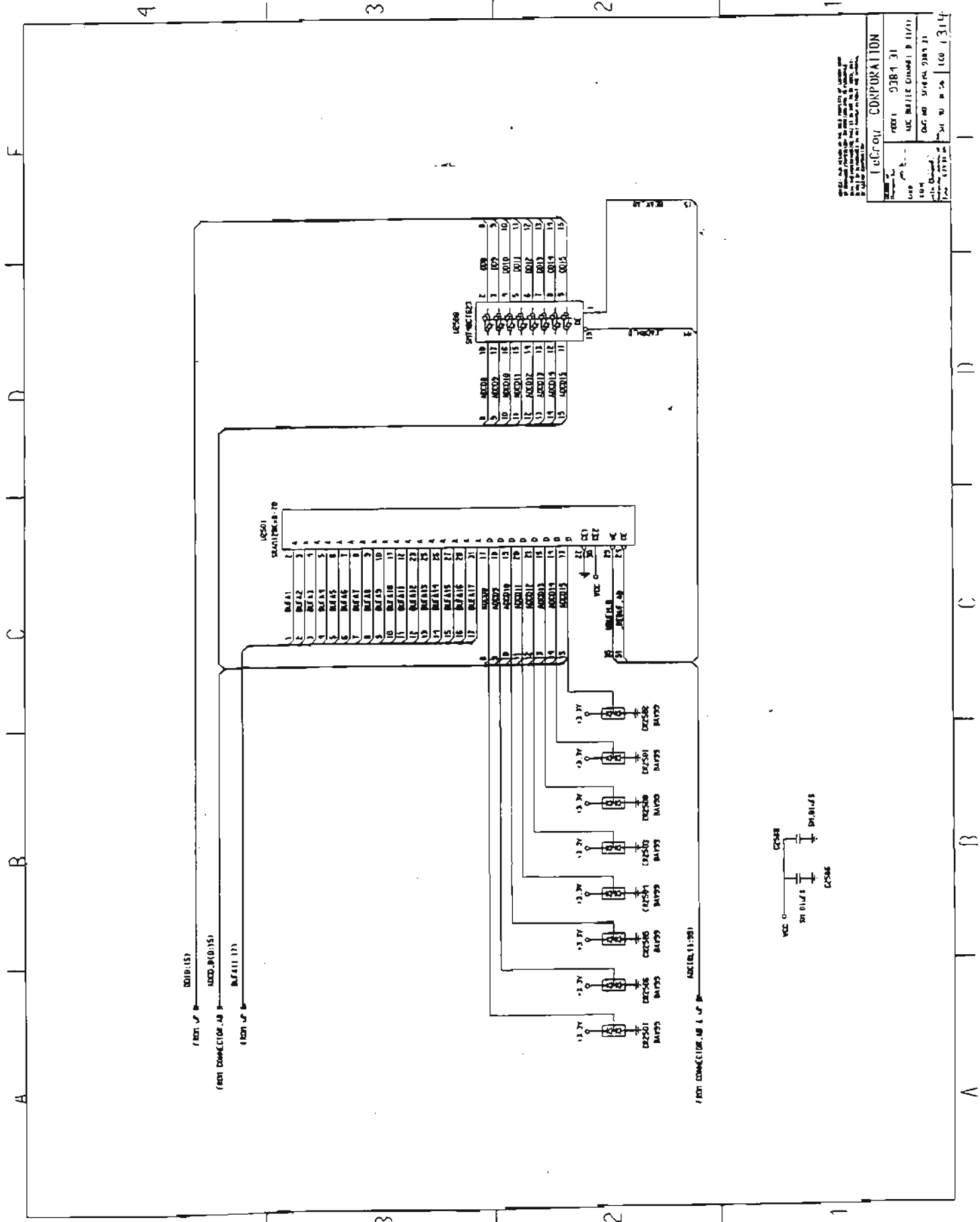

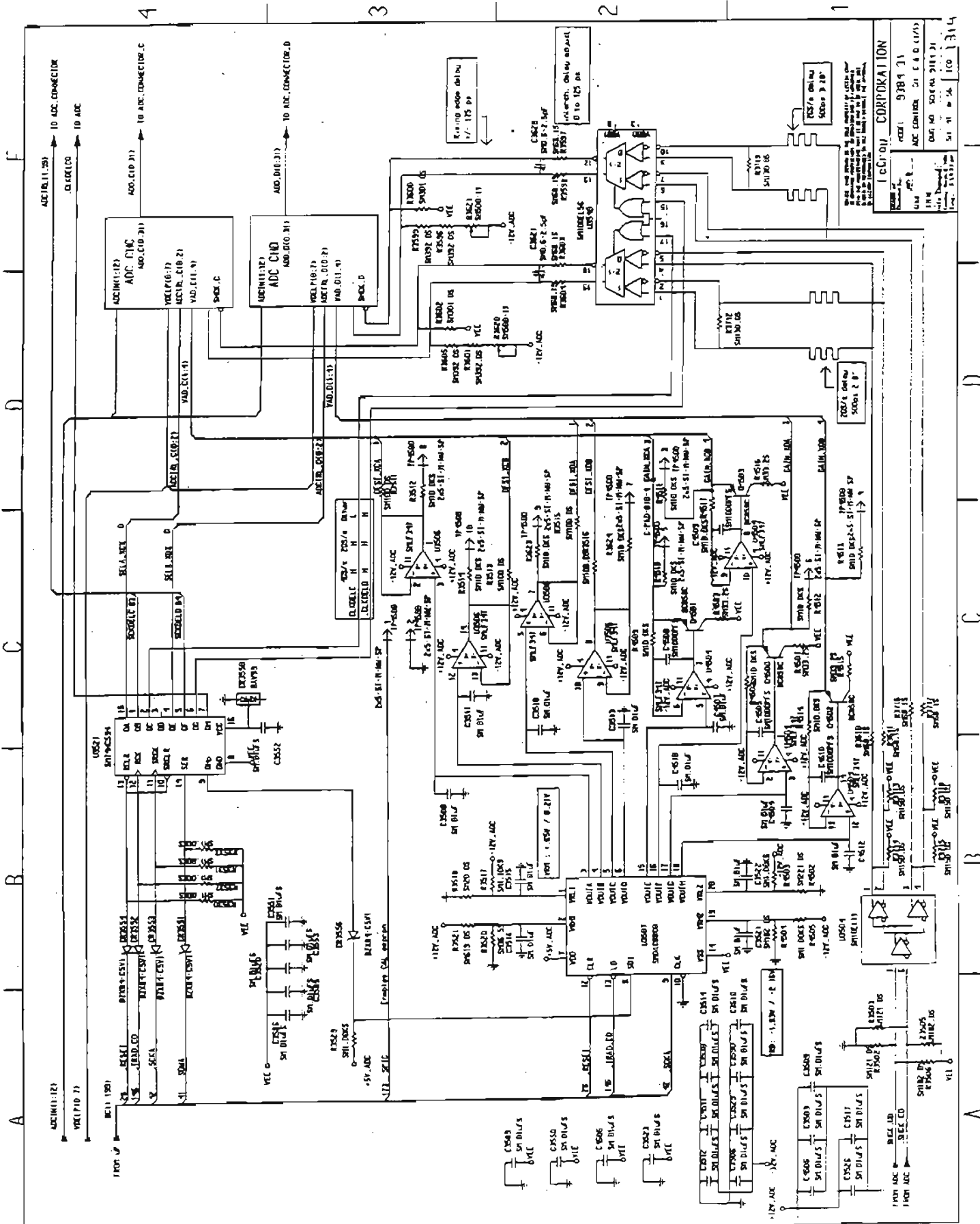

CORROSION

DO NOT USE SOLDER ON THIS BOARD. THE BOARD IS PREPARED FOR SURFACE MOUNT TECHNOLOGY (SMT) COMPONENTS. THE BOARD IS NOT TO BE SOLDERED.

DATE: 01/15/91
 DRAWN BY: J. J. J. J.
 CHECKED BY: J. J. J. J.
 APPROVED BY: J. J. J. J.

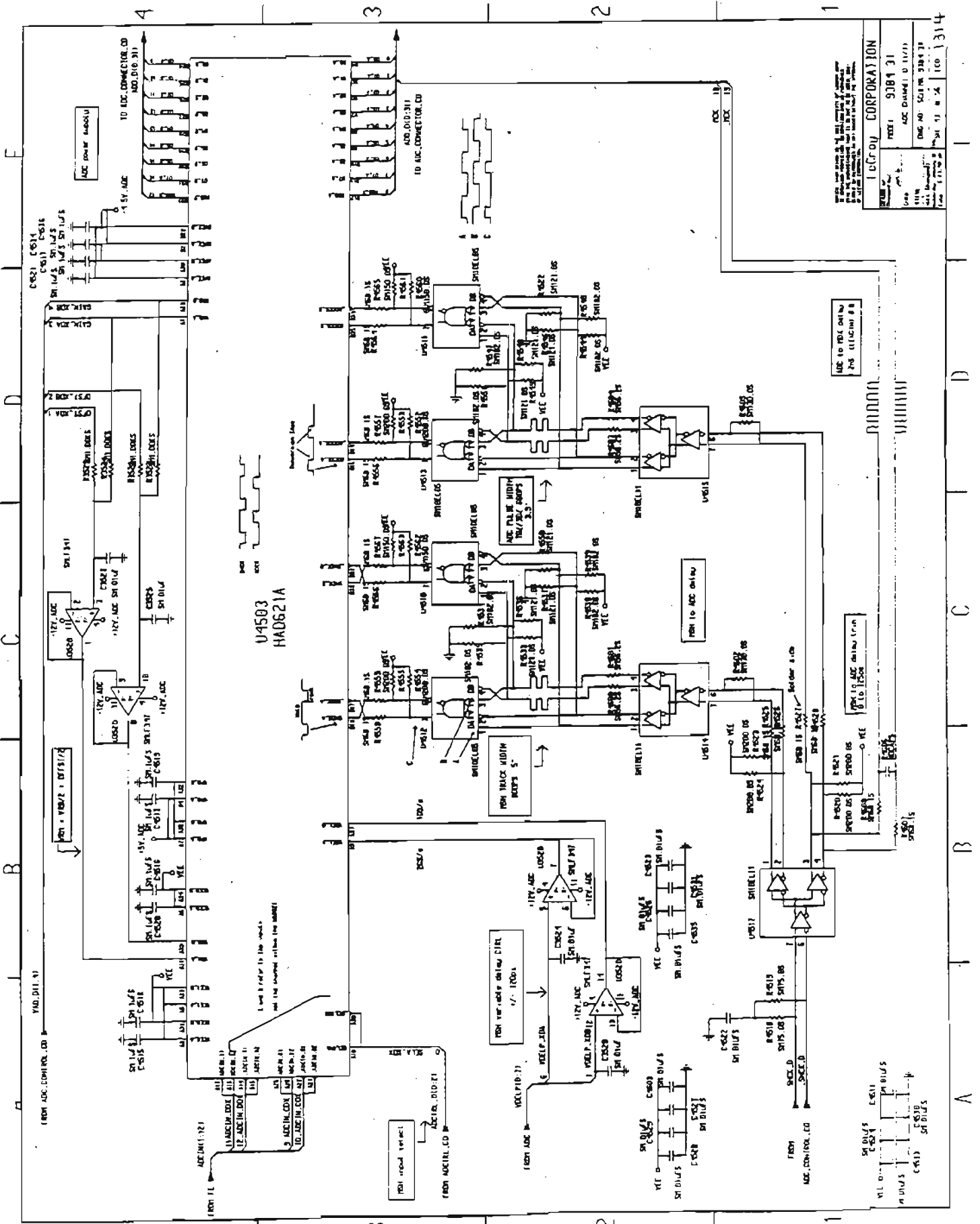

ICGroy CORPORATION	
REV. 1	DATE 11/7/71
REV. 2	DATE 11/7/71
REV. 3	DATE 11/7/71
REV. 4	DATE 11/7/71
REV. 5	DATE 11/7/71
REV. 6	DATE 11/7/71
REV. 7	DATE 11/7/71
REV. 8	DATE 11/7/71
REV. 9	DATE 11/7/71
REV. 10	DATE 11/7/71
REV. 11	DATE 11/7/71
REV. 12	DATE 11/7/71
REV. 13	DATE 11/7/71
REV. 14	DATE 11/7/71
REV. 15	DATE 11/7/71
REV. 16	DATE 11/7/71
REV. 17	DATE 11/7/71
REV. 18	DATE 11/7/71
REV. 19	DATE 11/7/71
REV. 20	DATE 11/7/71
REV. 21	DATE 11/7/71
REV. 22	DATE 11/7/71
REV. 23	DATE 11/7/71
REV. 24	DATE 11/7/71
REV. 25	DATE 11/7/71
REV. 26	DATE 11/7/71
REV. 27	DATE 11/7/71
REV. 28	DATE 11/7/71
REV. 29	DATE 11/7/71
REV. 30	DATE 11/7/71
REV. 31	DATE 11/7/71
REV. 32	DATE 11/7/71
REV. 33	DATE 11/7/71
REV. 34	DATE 11/7/71
REV. 35	DATE 11/7/71
REV. 36	DATE 11/7/71
REV. 37	DATE 11/7/71
REV. 38	DATE 11/7/71
REV. 39	DATE 11/7/71
REV. 40	DATE 11/7/71
REV. 41	DATE 11/7/71
REV. 42	DATE 11/7/71
REV. 43	DATE 11/7/71
REV. 44	DATE 11/7/71
REV. 45	DATE 11/7/71
REV. 46	DATE 11/7/71
REV. 47	DATE 11/7/71
REV. 48	DATE 11/7/71
REV. 49	DATE 11/7/71
REV. 50	DATE 11/7/71

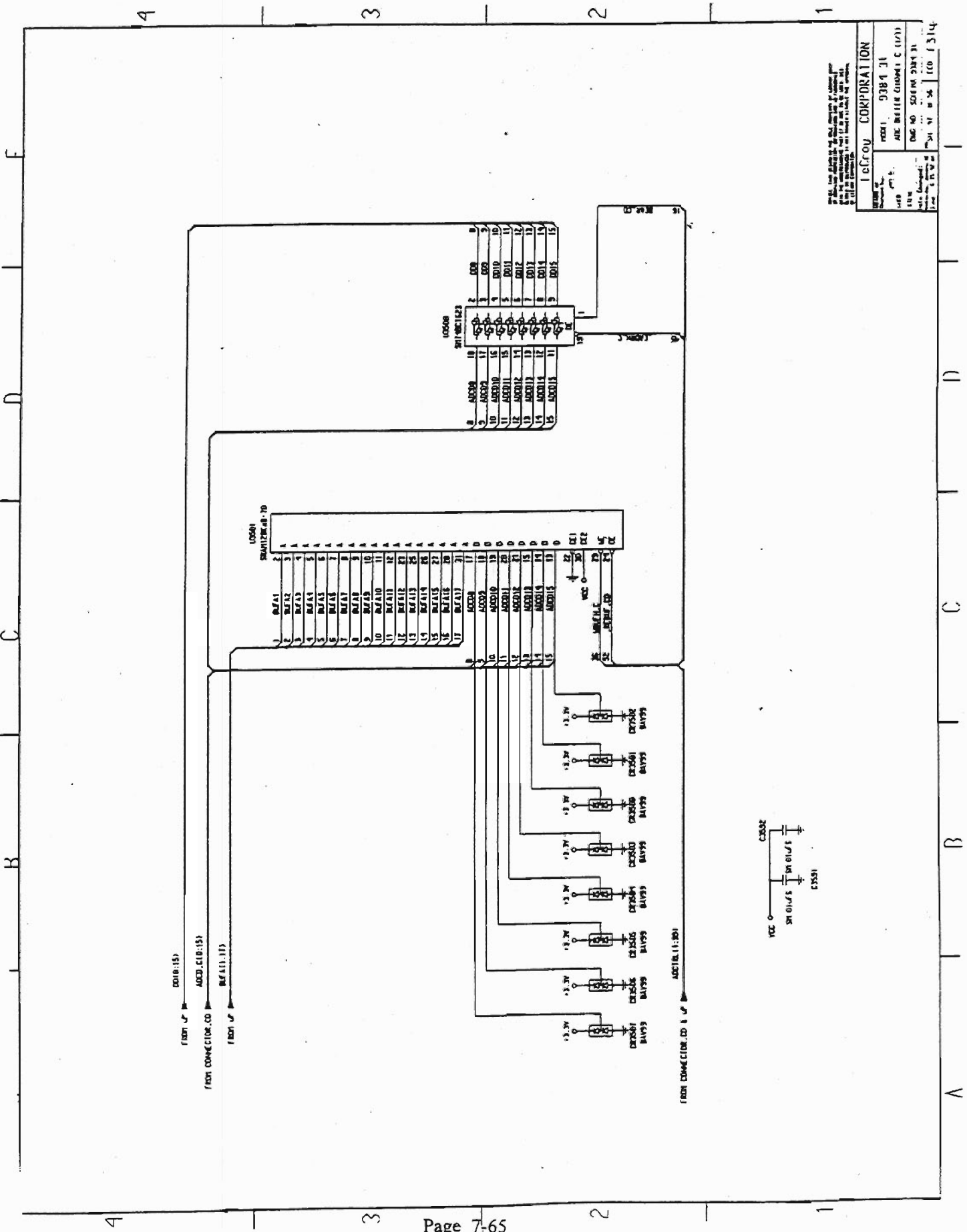

IECROU CORPORATION
 9384 JI
 ARE BULK (1000) C (1/71)
 ENG NO 50748 2184 31
 DATE 11/10/54
 Dwg No 100 1314

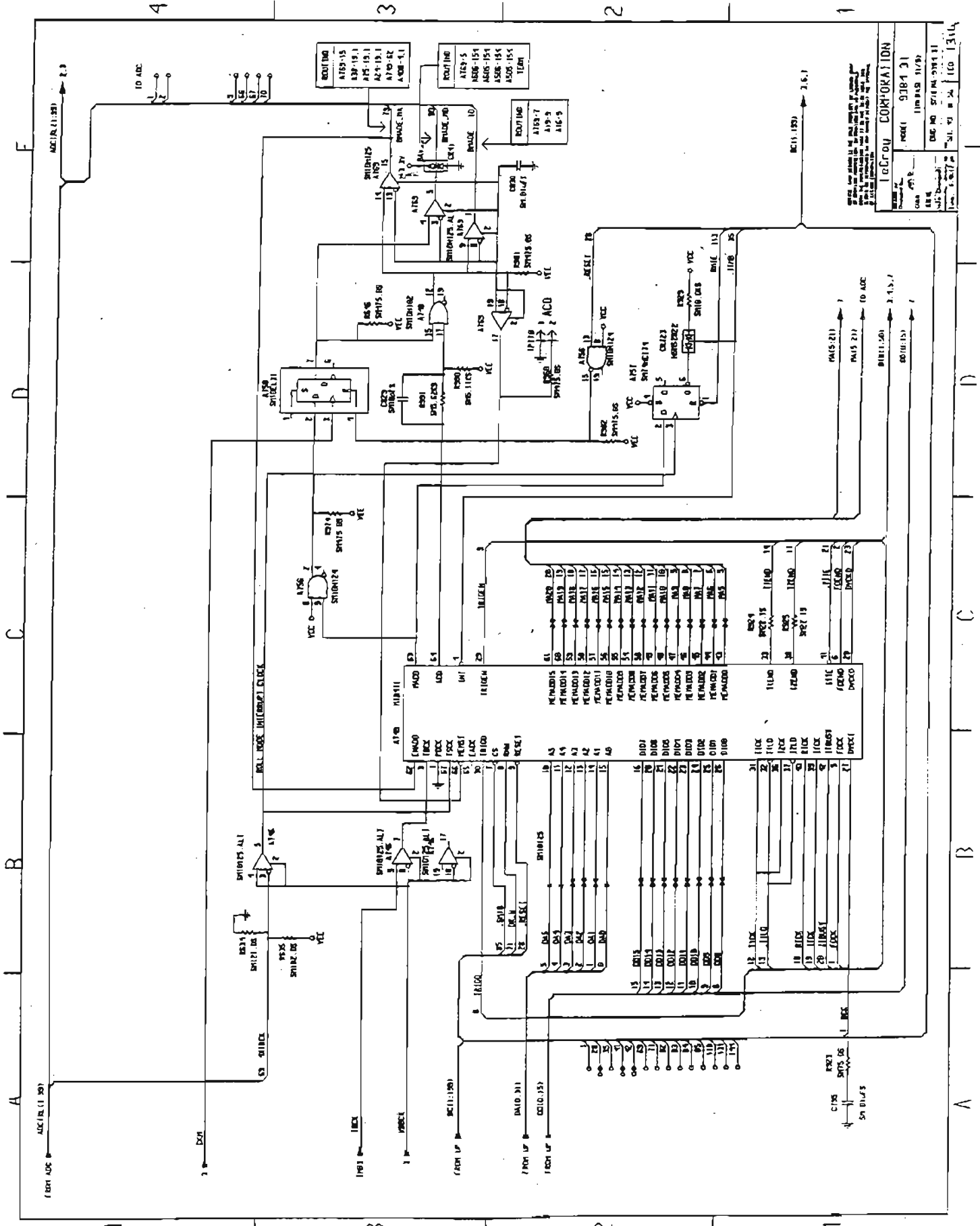

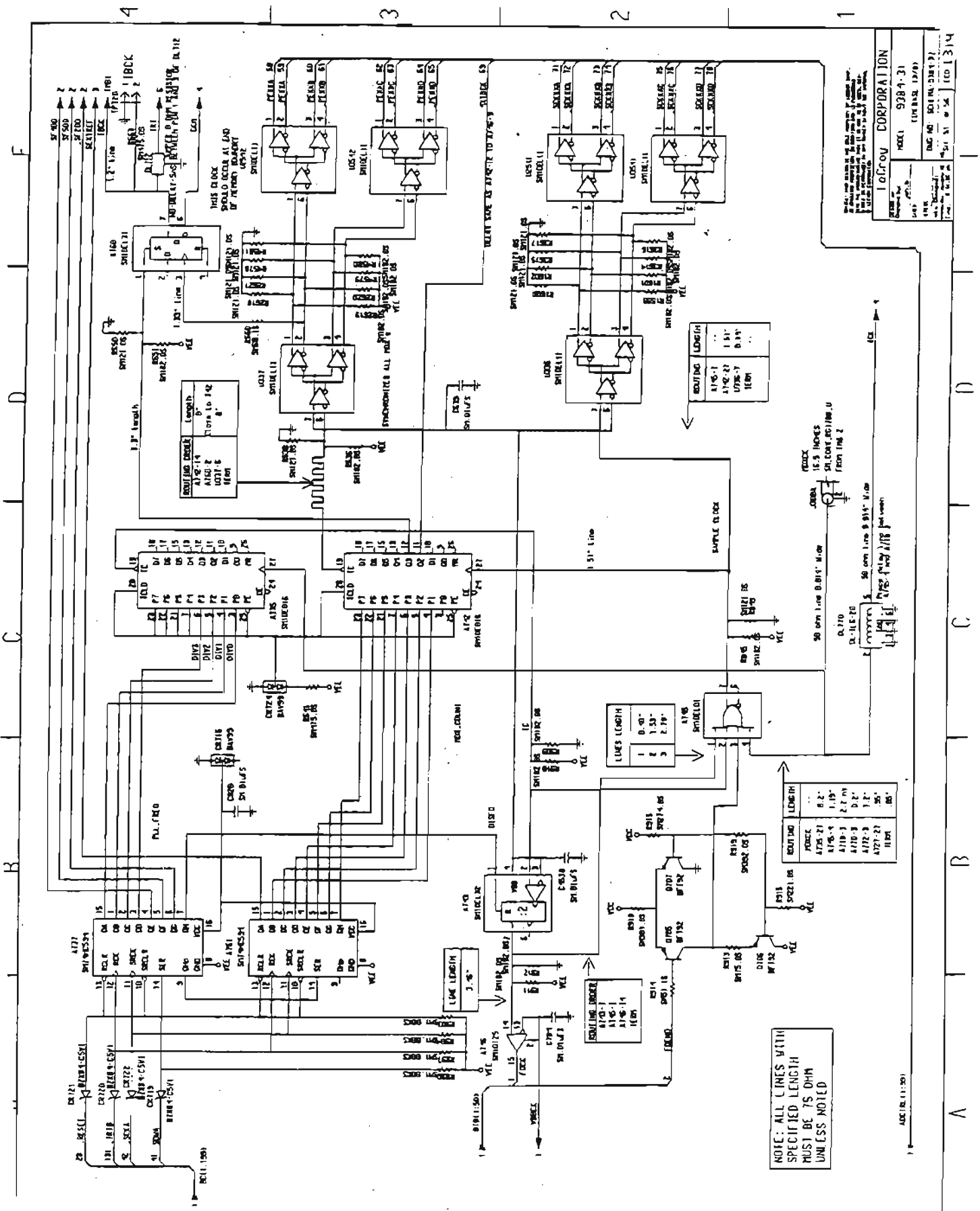

100-CROWN CORPORATION
 MODEL 938-A-31
 (100-BAS 13740)
 DIM. NO. 5014M (2181-2)
 100-31 100-34 100-35 100-36 100-37 100-38 100-39 100-40 100-41 100-42 100-43 100-44 100-45 100-46 100-47 100-48 100-49 100-50 100-51 100-52 100-53 100-54 100-55 100-56 100-57 100-58 100-59 100-60 100-61 100-62 100-63 100-64 100-65 100-66 100-67 100-68 100-69 100-70 100-71 100-72 100-73 100-74 100-75 100-76 100-77 100-78 100-79 100-80 100-81 100-82 100-83 100-84 100-85 100-86 100-87 100-88 100-89 100-90 100-91 100-92 100-93 100-94 100-95 100-96 100-97 100-98 100-99 100-100

NOTE: ALL LINES WITH SPECIFIED LENGTH MUST BE 75 OHM UNLESS NOTED

ROUTING	LENGTH
A16-1	1.51
A16-2	1.51
UPR-1	0.14
TERM	

LINE LENGTH	ROUTING	LENGTH
0.40	A16-1	1.51
1.53	A16-2	1.51
2.79	UPR-1	0.14
3	TERM	

ROUTING	LENGTH
A16-1	0.2
A16-2	1.19
A17-1	2.2
A17-2	0.2
A17-3	1.7
A17-4	1.56
A17-5	0.1

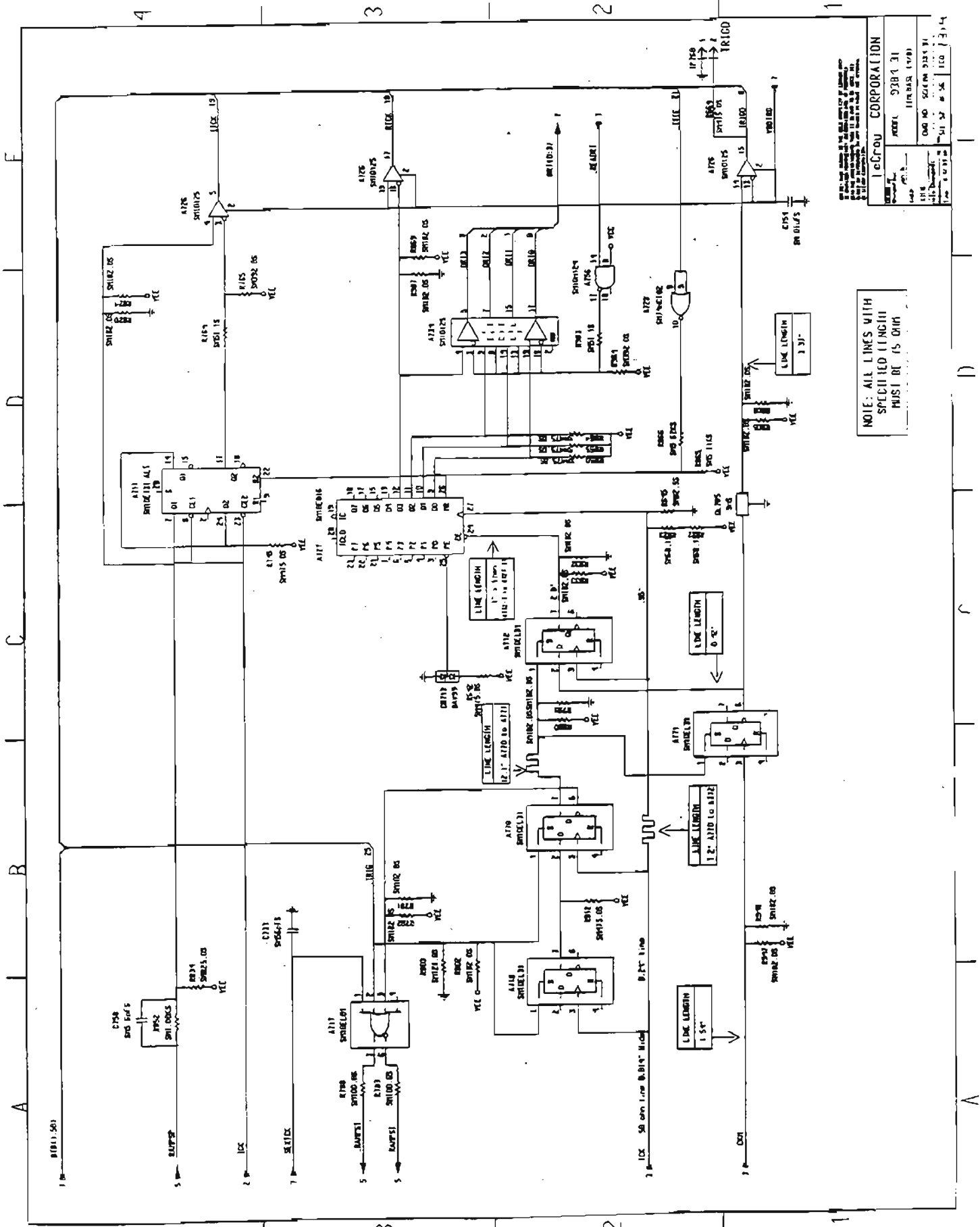

DATE	BY	CHKD BY	APPROVED BY
11/10/70	J. B.
IECROU CORPORATION 1100			

NOTE: ALL LINES WITH SPECIFIED LENGTH MUST BE 15 OHM

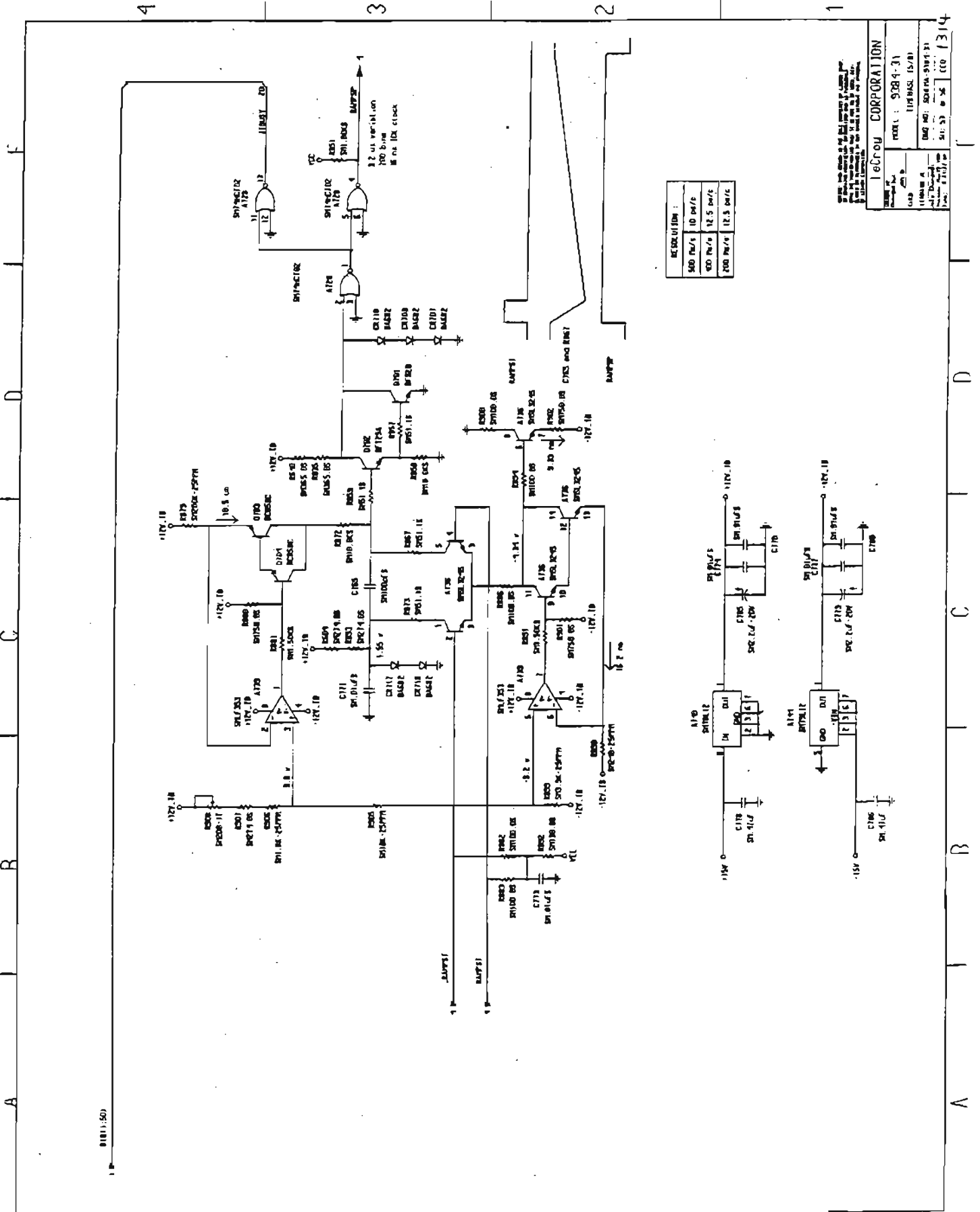

RECORDING TIME :	
500 Pw/s	10 Div/c
400 Pw/s	12.5 Div/c
200 Pw/s	12.5 Div/c

IECROU CORPORATION
 MODEL : 9089-31
 118785L (5/78)
 DATE : 2024-11-13
 118785L (5/78)
 118785L (5/78)
 118785L (5/78)
 118785L (5/78)

Section 7 Schematics, Layouts, Parts list

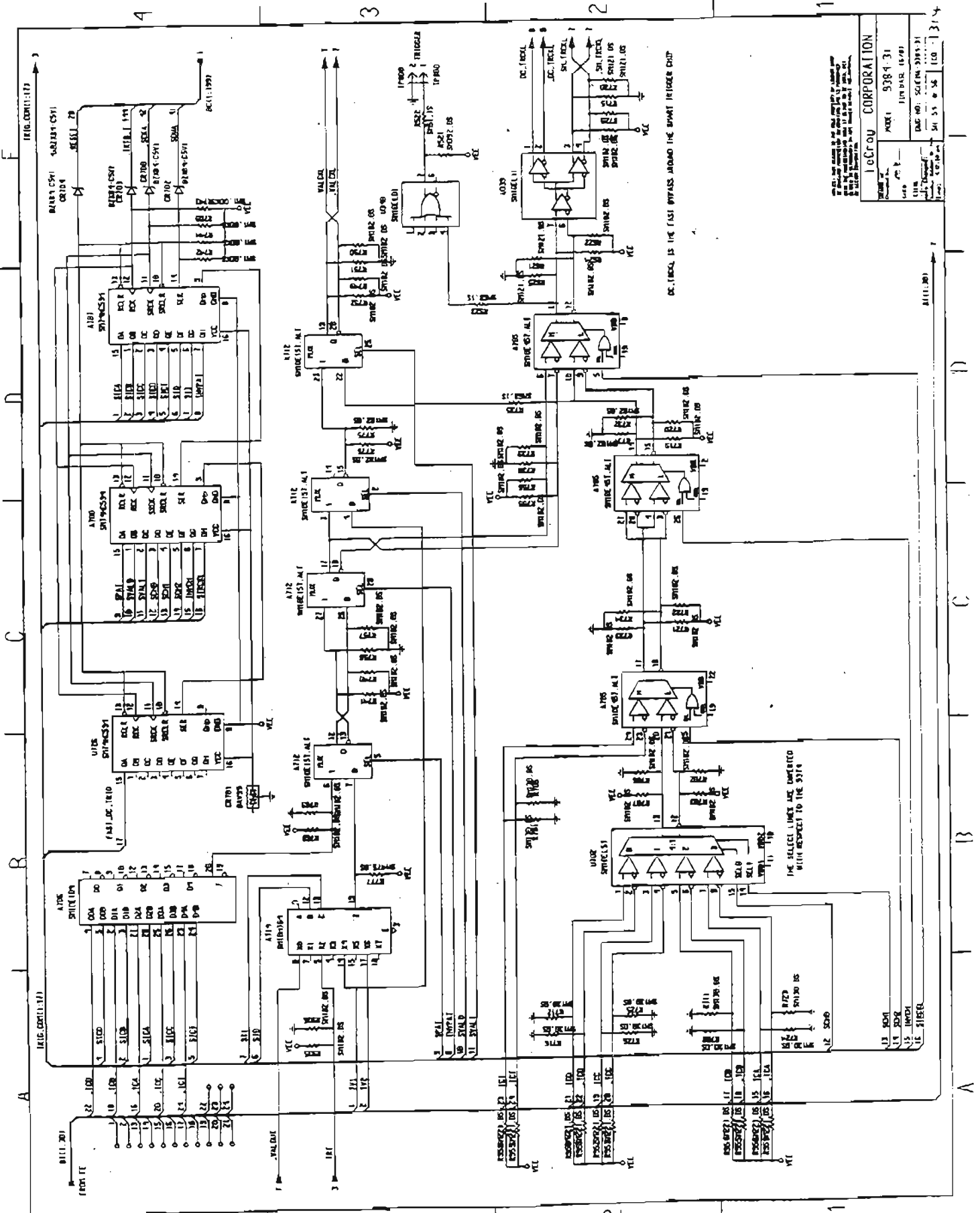

icCrou CORPORATION
 MODEL 9384-31
 DATE 10/28/68
 DRAWN BY SCHEMATIC
 CHECKED BY
 PARTS LIST NO. 100-1314

PAGES 7-75 THROUGH AND INCLUDING PAGES 7-93 WERE UNREADABLE SO THEY WERE NOT SCANNED. IF YOU HAVE ACCESS TO THEM AND CAN PROVIDE A SCAN PLEASE LET THE MODERATOR KNOW BY POSTING A MESSAGE TO:

LeCroy_Owners_Group

ON YAHOO GROUPS

PART: F9384-31 DESC: MAIN CARD (FRONT END, ADC, TDC) for 9384

Location	Part Number	Description	Location	Part Number	Description
A1	SM205618165	SM74HCT165	A203	208124003	7912
A2	SM200178138	SM74HCT138	A204	208123002	7812
A3	SM200178030	SM74HCT30	A205	SM208470347	SMLF347
A4	SM200178138	SM74HCT138	A206	SM207770201	SMDG201-PS
A5	SM200178138	SM74HCT138	A207	SM208470347	SMLF347
A6	SM206260858	SMADC0858	A208	SM207770201	SMDG201-PS
A7	SM207970351	SM74HC4351	A209	208124003	7912
A8	SM206070584	SMPCD8584	A210	208123002	7812
A9	SM207978251	SM74HCT251	A211	SM208470347	SMLF347
A10	SM200178138	SM74HCT138	A212	SM207770201	SMDG201-PS
A11	SM205108016	SM24LC16B	A213	SM208470324	SMLM324
A12	SM206885245	SM74ABT245	A214	SM208470347	SMLF347
A13	SM200178000	SM74HCT00	A215	SM207770201	SMDG201-PS
A14	SM206885245	SM74ABT245	A400	208124003	7912-SP
A15	SM207171244	SM74ABT244	A402	208123002	7812-SP
A16	SM205045357	CHEMIN-A	A700	SM205618594	SM74HC594-PS
A17	SM205045358	ROUTE3-C	A701	SM200178002	SM74HCT02
A18	SM205045355	RUELLE-A	A702	SM207978251	SM74HCT251
A19	SM205045359	ARTERE-B	A703	SM201274033	SM10EL33
A20	SM205045354	AVENUE-A	A705	SM206970457	SM10E457
A21	SM205045350	ROUTE1-A	A706	SM201164104	SM10E104
A22	SM205045352	ROUTE2-B	A707	SM205618594	SM74HC594-PS
A23	SM205045351	ROUTE2-A	A708	SM200178273	SM74HCT273
A24	SM207171244	SM74ABT244	A709	SM200167102	SM10H102
A25	SM207171244	SM74ABT244	A710	SM201174011	SM10EL11
A26	MCL404	MCL404	A711	SM201164131	SM10E131
A27	SM207171244	SM74ABT244	A712	SM207960157	SM10E157
A28	SM205045300	MIMOSA-A	A713	SM201570016	SM10EL16
A29	SM207972157	SM74F157A	A714	SM200167164	SM10H164
A30	SM207280703	SMDAC703	A717	SM201174001	SM10EL01
A31	SM200169191	SM74F191	A718	SM201174031	SM10EL31
A32	SM200169191	SM74F191	A723	SM201274032	SM10EL32
A33	SM200169191	SM74F191	A724	MST412	MST412
A34	SM200169191	SM74F191	A726	SM207360125	SM10125
A35	SM200169191	SM74F191	A727	SM200169016	SM10E016
A36	SM207970139	SM74F139	A728	SM200178002	SM74HCT02
A37	SM200278040	SM74HCT4040	A734	SM207360125	SM10125
A39	SM206884623	SM74ABT623	A735	SM200169016	SM10E016
A40	SM206884623	SM74ABT623	A736	SM208030245	SMSL3245
A41	SM207970139	SM74F139	A737	SM205618594	SM74HC594-PS
A42	SM200178374	SM74HCT374	A739	SM208470353	SMLF353
A43	SM200178074	SM74HCT74	A740	SM208570078	SM78L12
A44	SM200178273	SM74HCT273	A741	SM201274032	SM10EL32
A45	SM208570805	SM78L05	A742	SM200169016	SM10E016
A202	SM208870339	SMLM339	A743	SM201274032	SM10EL32

Section 7 Schematics, Layouts, Parts list

PART: F9384-31 DESC: MAIN CARD (FRONT END, ADC, TDC) for 9384

Location	Part Number	Description	Location	Part Number	Description
A744	SM208880079	SM79L12	A3004	SM208470705	SMAD705
A745	SM201174001	SM10EL01	A3005	SM207770442	SMDG442-PS
A746	SM207360125	SM10125	A3006	SM208870339	SMLM339
A748	SM200167102	SM10H102	A3007	SM289772003	SMULN2003
A749	MTB411	MTB411	A3008	SM205618594	SM74HC594-PS
A756	SM207367124	SM10H124	A3009	SM205618594	SM74HC594-PS
A757	SM200178074	SM74HCT74	A3010	SM208470705	SMAD705
A758	SM201174031	SM10EL31	A3011	SM208880337	SM337L
A759	SM207170367	SM74HC367	A4000	SM208470111	SMCLC111
A760	SM201174031	SM10EL31	A4001	SM208470705	SMAD705
A761	SM205618594	SM74HC594-PS	A4002	SM208480640	SMOPA640
A765	SM201174031	SM10EL31	A4003	HFE624	HFE624
A769	SM207367125	SM10H125	A4004	SM208470705	SMAD705
A770	SM201174031	SM10EL31	A4005	SM207770442	SMDG442-PS
A771	SM201174031	SM10EL31	A4006	SM208870339	SMLM339
A772	SM201174031	SM10EL31	A4007	SM289772003	SMULN2003
A773	SM208570805	SM78L05	A4008	SM205618594	SM74HC594-PS
A1000	SM208470111	SMCLC111	A4009	SM205618594	SM74HC594-PS
A1001	SM208470705	SMAD705	A4010	SM208470705	SMAD705
A1002	SM208480640	SMOPA640	A4011	SM208880337	SM337L
A1003	HFE624	HFE624	A5000	SM208470705	SMAD705
A1004	SM208470705	SMAD705	A5001	SM208971881	SMLM1881
A1005	SM207770442	SMDG442-PS	A5002	SM208470037	SMOP37
A1006	SM208870339	SMLM339	A5003	SM208470351	SMLF351
A1007	SM289772003	SMULN2003	A5004	SM207770403	SMDG403-PS
A1008	SM205618594	SM74HC594-PS	A5005	SM207970508	SMDG508-PS
A1009	SM205618594	SM74HC594-PS	A5006	SM205618594	SM74HC594-PS
A1010	SM208470705	SMAD705	A5007	SM207770442	SMDG442-PS
A1011	SM208880337	SM337L	A5008	SM205618594	SM74HC594-PS
A2000	SM208470111	SMCLC111	A5009	SM205618594	SM74HC594-PS
A2001	SM208470705	SMAD705	A5010	MTR408	MTR408
A2002	SM208480640	SMOPA640	A5011	MTR408	MTR408
A2003	HFE624	HFE624	A5012	SM205618594	SM74HC594-PS
A2004	SM208470705	SMAD705	A5013	SM205618594	SM74HC594-PS
A2005	SM207770442	SMDG442-PS	A5014	MTR408	MTR408
A2006	SM208870339	SMLM339	A5015	MTR408	MTR408
A2007	SM289772003	SMULN2003	A5016	SM205618594	SM74HC594-PS
A2008	SM205618594	SM74HC594-PS	A5017	MTR408	MTR408
A2009	SM205618594	SM74HC594-PS	A5018	SM201570016	SM10EL16-PS
A2010	SM208470705	SMAD705	A5019	SM205618594	SM74HC594-PS
A2011	SM208880337	SM337L	A5020	SM205618594	SM74HC594-PS
A3000	SM208470111	SMCLC111	A5021	SM207978153	SM74HCT153-PS
A3001	SM208470705	SMAD705	A5022	SM208870339	SMLM339
A3002	SM208480640	SMOPA640	A6000	SM208470353	SMLF353
A3003	HFE624	HFE624	BR1	BRIDGE	BRIDGE-026

PART: F9384-31 DESC: MAIN CARD (FRONT END, ADC, TDC) for 9384

Location	Part Number	Description	Location	Part Number	Description
BZ700	530040007	TMB-05	C45	SM661207104	SM.1uFS
C1	SM661207103	SM.01uFS	C46	146544471	470uF-25VALRA
C2	SM661207104	SM.1uFS	C47	SM666247106	SM10uF-25V
C3	SM661207103	SM.01uFS	C48	SM666247106	SM10uF-25V
C4	SM661207103	SM.01uFS	C49	SM661207103	SM.01uFS
C5	SM661207103	SM.01uFS	C50	SM666327225	SM2.2uF-20V
C6	SM661255181	SM180pFS	C51	SM661207104	SM.1uFS
C7	SM661207104	SM.1uFS	C52	SM661207104	SM.1uFS
C8	SM661207103	SM.01uFS	C53	SM661207104	SM.1uFS
C9	SM661207103	SM.01uFS	C54	SM661207104	SM.1uFS
C10	SM661207103	SM.01uFS	C55	SM661207104	SM.1uFS
C11	SM661207103	SM.01uFS	C56	SM661207104	SM.1uFS
C12	SM661207103	SM.01uFS	C57	SM661207104	SM.1uFS
C13	SM666247106	SM10uF-25V	C58	SM661207104	SM.1uFS
C14	SM661207103	SM.01uFS	C60	SM666327225	SM2.2uF-20V
C15	SM661207103	SM.01uFS	C62	SM666377226	SM22uF-15V
C16	SM661207103	SM.01uFS	C63	SM666377226	SM22uF-15V
C17	SM666247106	SM10uF-25V	C64	SM661207104	SM.1uFS
C18	SM661207103	SM.01uFS	C81	SM661286103	SM.01uF
C19	SM661207103	SM.01uFS	C82	SM666377226	SM22uF-15V
C20	SM661207103	SM.01uFS	C90	SM666377226	SM22uF-15V
C21	SM661207103	SM.01uFS	C200	SM661207103	SM.01uFS
C22	SM661207103	SM.01uFS	C201	SM661207103	SM.01uFS
C23	SM666377226	SM22uF-15V	C202	SM661207104	SM.1uFS
C24	SM666377226	SM22uF-15V	C203	SM661207103	SM.01uFS
C25	SM661207103	SM.01uFS	C204	SM666327225	SM2.2uF-20V
C26	SM661207103	SM.01uFS	C205	SM661207103	SM.01uFS
C27	SM661207103	SM.01uFS	C206	SM661207103	SM.01uFS
C28	SM661207103	SM.01uFS	C207	SM661726103	SM.01uF-NPO
C29	SM661207103	SM.01uFS	C208	SM661207103	SM.01uFS
C30	SM661207103	SM.01uFS	C209	SM661207103	SM.01uFS
C31	SM661207103	SM.01uFS	C210	SM661207103	SM.01uFS
C32	SM661207103	SM.01uFS	C211	SM661726103	SM.01uF-NPO
C33	SM661207103	SM.01uFS	C212	SM661726103	SM.01uF-NPO
C34	SM661207103	SM.01uFS	C213	SM666327225	SM2.2uF-20V
C35	SM661207103	SM.01uFS	C214	SM666327225	SM2.2uF-20V
C36	SM661207103	SM.01uFS	C215	SM666327225	SM2.2uF-20V
C37	SM661207103	SM.01uFS	C216	SM661726103	SM.01uF-NPO
C38	SM661207103	SM.01uFS	C217	SM661726103	SM.01uF-NPO
C39	SM661207103	SM.01uFS	C218	SM661207103	SM.01uFS
C40	SM661207103	SM.01uFS	C219	SM661726103	SM.01uF-NPO
C41	SM661207104	SM.1uFS	C220	SM661726103	SM.01uF-NPO
C42	SM661207103	SM.01uFS	C221	SM666327225	SM2.2uF-20V
C43	SM661207103	SM.01uFS	C222	SM666327225	SM2.2uF-20V
C44	SM661207103	SM.01uFS	C223	SM666327225	SM2.2uF-20V

Section 7 Schematics, Layouts, Parts list

PART: F9384-31 DESC: MAIN CARD (FRONT END, ADC, TDC) for 9384

Location	Part Number	Description	Location	Part Number	Description
C224	SM661726103	SM.01uF-NPO	C711	SM661207103	SM.01uFS
C225	SM661726103	SM.01uF-NPO	C713	SM661207103	SM.01uFS
C226	SM661207103	SM.01uFS	C714	SM661207103	SM.01uFS
C227	SM661207103	SM.01uFS	C716	SM661207103	SM.01uFS
C228	SM661726103	SM.01uF-NPO	C718	SM661207103	SM.01uFS
C229	SM661726103	SM.01uF-NPO	C719	SM661207103	SM.01uFS
C230	SM661207103	SM.01uFS	C720	SM661207103	SM.01uFS
C231	SM666327225	SM2.2uF-20V	C721	SM661207103	SM.01uFS
C232	SM661726103	SM.01uF-NPO	C722	SM661207103	SM.01uFS
C233	SM661726103	SM.01uF-NPO	C723	SM661207103	SM.01uFS
C234	SM661207103	SM.01uFS	C724	SM661207103	SM.01uFS
C235	SM661207103	SM.01uFS	C725	SM661207103	SM.01uFS
C236	SM666327225	SM2.2uF-20V	C728	SM661207103	SM.01uFS
C237	SM661726103	SM.01uF-NPO	C730	SM661207103	SM.01uFS
C238	SM661726103	SM.01uF-NPO	C732	SM661207103	SM.01uFS
C239	SM661207103	SM.01uFS	C733	SM661255560	SM56pFS
C240	SM666327225	SM2.2uF-20V	C734	SM661207103	SM.01uFS
C241	SM666327225	SM2.2uF-20V	C735	SM661207103	SM.01uFS
C242	SM666327225	SM2.2uF-20V	C737	SM661207103	SM.01uFS
C255	SM666237476	SM47uF-6V	C738	SM661207103	SM.01uFS
C262	SM666387336	SM33uF-10V	C739	SM661207103	SM.01uFS
C263	SM661207103	SM.01uFS	C744	SM661207103	SM.01uFS
C265	SM661207103	SM.01uFS	C745	SM661207103	SM.01uFS
C266	SM666387336	SM33uF-10V	C752	SM661207103	SM.01uFS
C267	SM661207103	SM.01uFS	C753	SM661207103	SM.01uFS
C268	SM661207103	SM.01uFS	C754	SM661207103	SM.01uFS
C269	SM661207103	SM.01uFS	C756	SM661207103	SM.01uFS
C270	SM666327225	SM2.2uF-20V	C758	SM661255056	SM5.6pFS
C271	SM661255102	SM1000pFS	C760	SM661207103	SM.01uFS
C272	SM661207103	SM.01uFS	C761	SM661207103	SM.01uFS
C400	146574227	220uF-25VALRA	C765	SM661255101	SM100pFS
C403	146554476	47uF-25VALRA	C768	SM661207103	SM.01uFS
C600	SM661207103	SM.01uFS	C769	SM661207103	SM.01uFS
C601	SM661207103	SM.01uFS	C770	SM661207103	SM.01uFS
C602	SM661207103	SM.01uFS	C771	SM661207103	SM.01uFS
C604	SM661207103	SM.01uFS	C773	SM661207103	SM.01uFS
C613	SM661207103	SM.01uFS	C774	SM661207103	SM.01uFS
C639	SM661207103	SM.01uFS	C776	SM661207103	SM.01uFS
C700	SM661207103	SM.01uFS	C777	SM661207103	SM.01uFS
C702	SM661207103	SM.01uFS	C778	SM661446474	SM.47uF
C703	SM661207103	SM.01uFS	C779	SM666327225	SM2.2uF-20V
C704	SM661207103	SM.01uFS	C780	SM661207103	SM.01uFS
C706	SM158240201	SM1-5pF	C781	SM661207103	SM.01uFS
C708	SM661255560	SM56pFS	C783	SM661207103	SM.01uFS
C710	SM661207103	SM.01uFS	C784	SM661207103	SM.01uFS

PART: F9384-31 DESC: MAIN CARD (FRONT END, ADC, TDC) for 9384

Location	Part Number	Description	Location	Part Number	Description
C785	SM666327225	SM2.2uF-20V	C1017	SM661526561	SM560pF_500V
C786	SM661446474	SM.47uF	C1018	SM661255101	SM100pFS
C787	SM661207103	SM.01uFS	C1019	SM661207103	SM.01uFS
C788	SM661207103	SM.01uFS	C1021	SM661207103	SM.01uFS
C789	SM661207103	SM.01uFS	C1022	SM158240203	SM5-18pF
C793	SM661207103	SM.01uFS	C1024	SM661207103	SM.01uFS
C795	SM661207103	SM.01uFS	C1025	SM661207103	SM.01uFS
C797	SM661207103	SM.01uFS	C1026	SM661207103	SM.01uFS
C798	SM661207103	SM.01uFS	C1028	SM661255101	SM100pFS
C799	SM661207103	SM.01uFS	C1029	SM661207103	SM.01uFS
C800	SM661207103	SM.01uFS	C1030	SM661207103	SM.01uFS
C801	SM661207103	SM.01uFS	C1031	SM661207223	SM.022uFS
C802	SM661207103	SM.01uFS	C1032	SM661207223	SM.022uFS
C803	SM661207103	SM.01uFS	C1034	SM158240200	SM0.6-2.5pF
C805	SM661207103	SM.01uFS	C1035	SM661207103	SM.01uFS
C807	SM661207103	SM.01uFS	C1036	SM661207103	SM.01uFS
C809	SM661207103	SM.01uFS	C1038	SM661207103	SM.01uFS
C813	SM661207103	SM.01uFS	C1039	SM661207103	SM.01uFS
C820	SM661207103	SM.01uFS	C1041	SM661207103	SM.01uFS
C823	SM661207103	SM.01uFS	C1042	SM661255821	SM820pFS
C824	SM661207103	SM.01uFS	C1043	SM661207103	SM.01uFS
C825	SM661207103	SM.01uFS	C1044	SM661255101	SM100pFS
C826	SM661207103	SM.01uFS	C1045	SM661207103	SM.01uFS
C827	SM661207103	SM.01uFS	C1046	SM661207103	SM.01uFS
C828	SM661207103	SM.01uFS	C1047	SM661207103	SM.01uFS
C829	SM661255180	SM18pFS	C1048	SM661207103	SM.01uFS
C830	SM661207103	SM.01uFS	C1049	SM661255100	SM10pFS
C831	SM661207103	SM.01uFS	C1050	SM661207103	SM.01uFS
C832	SM666327225	SM2.2uF-20V	C1051	SM661207103	SM.01uFS
C833	SM661207103	SM.01uFS	C1052	SM661207103	SM.01uFS
C1001	SM661207104	SM.1uFS	C1053	SM661207103	SM.01uFS
C1002	SM661207104	SM.1uFS	C1054	SM661207103	SM.01uFS
C1003	SM158240203	SM5-18pF	C1055	SM661207103	SM.01uFS
C1005	SM661207103	SM.01uFS	C1056	SM661207103	SM.01uFS
C1006	SM661545150	SM15pFS_500V	C1057	SM661207104	SM.1uFS
C1007	SM661535620	SM62pFS_5%	C1058	SM661207103	SM.01uFS
C1008	SM661207103	SM.01uFS	C1059	SM661207103	SM.01uFS
C1009	SM661207103	SM.01uFS	C1060	SM661207104	SM.1uFS
C1010	SM661207103	SM.01uFS	C1061	SM661207103	SM.01uFS
C1011	SM661207103	SM.01uFS	C1062	SM661207103	SM.01uFS
C1012	SM661207103	SM.01uFS	C1063	SM661207104	SM.1uFS
C1013	SM661540033	SM3.3pFS_500V	C1065	SM666327225	SM2.2uF-20V
C1014	SM661545150	SM15pFS_500V	C1066	SM661207103	SM.01uFS
C1015	SM661255100	SM10pFS	C1067	SM661207103	SM.01uFS
C1016	SM661255101	SM100pFS	C1068	SM666327225	SM2.2uF-20V

PART: F9384-31 DESC: MAIN CARD (FRONT END, ADC, TDC) for 9384

Location	Part Number	Description	Location	Part Number	Description
C1069	SM666327225	SM2.2uF-20V	C1533	SM661207104	SM.1uFS
C1070	SM666327225	SM2.2uF-20V	C1534	SM661207104	SM.1uFS
C1071	SM666327225	SM2.2uF-20V	C1535	SM661207104	SM.1uFS
C1072	SM661207103	SM.01uFS	C1536	SM661207104	SM.1uFS
C1073	SM661207103	SM.01uFS	C1537	SM661207104	SM.1uFS
C1074	SM661207103	SM.01uFS	C1538	SM661207103	SM.01uFS
C1075	SM661207104	SM.1uFS	C1539	SM661207103	SM.01uFS
C1076	SM661207103	SM.01uFS	C1540	SM661207103	SM.01uFS
C1077	SM661207103	SM.01uFS	C1541	SM661207103	SM.01uFS
C1079	SM661207104	SM.1uFS	C1542	SM661207103	SM.01uFS
C1086	SM666327225	SM2.2uF-20V	C1544	SM661207103	SM.01uFS
C1087	SM661255101	SM100pFS	C1545	SM661207103	SM.01uFS
C1089	SM661207102	SM.001uFS	C1546	SM661207103	SM.01uFS
C1090	SM661207103	SM.01uFS	C1547	SM661207103	SM.01uFS
C1092	SM661207103	SM.01uFS	C1548	SM661207103	SM.01uFS
C1095	SM661207103	SM.01uFS	C1549	SM661207104	SM.1uFS
C1096	SM661207103	SM.01uFS	C1550	SM661207103	SM.01uFS
C1098	SM661256120	SM12pFS	C1551	SM661207103	SM.01uFS
C1099	SM661255470	SM47pFS	C1552	SM661207103	SM.01uFS
C1500	SM661207103	SM.01uFS	C1553	SM661207104	SM.1uFS
C1501	SM661207103	SM.01uFS	C1554	SM661207103	SM.01uFS
C1502	SM158240200	SM0.6-2.5pF	C1556	SM661207104	SM.1uFS
C1503	SM158240200	SM0.6-2.5pF	C1557	SM661207104	SM.1uFS
C1504	SM661286103	SM.01uF	C1558	SM661207104	SM.1uFS
C1505	SM661207103	SM.01uFS	C1559	SM661207104	SM.1uFS
C1506	SM661286103	SM.01uF	C1560	SM661207104	SM.1uFS
C1507	SM661286103	SM.01uF	C1561	SM661207104	SM.1uFS
C1508	SM661207103	SM.01uFS	C1562	SM661207104	SM.1uFS
C1509	SM661286103	SM.01uF	C1563	SM661207104	SM.1uFS
C1510	SM666257336	SM33uF-16V	C1564	SM666237476	SM47uF-6V
C1511	SM661286103	SM.01uF	C1565	SM666237476	SM47uF-6V
C1512	SM661207103	SM.01uFS	C1566	SM666267227	SM220uF-10V
C1513	SM661286103	SM.01uF	C1567	SM666267227	SM220uF-10V
C1514	SM661286103	SM.01uF	C1568	SM661207104	SM.1uFS
C1515	SM661207103	SM.01uFS	C1569	SM661207104	SM.1uFS
C1516	SM661286103	SM.01uF	C1570	SM661207104	SM.1uFS
C1517	SM661207103	SM.01uFS	C1571	SM666267227	SM220uF-10V
C1518	SM661207103	SM.01uFS	C1572	SM661207104	SM.1uFS
C1520	SM661207103	SM.01uFS	C1573	SM661207104	SM.1uFS
C1521	SM666257336	SM33uF-16V	C1574	SM661207104	SM.1uFS
C1522	SM666327225	SM2.2uF-20V	C1575	SM661207103	SM.01uFS
C1523	146574227	220uF-25VALRA	C1576	SM661207104	SM.1uFS
C1530	SM661207104	SM.1uFS	C1577	SM661207104	SM.1uFS
C1531	SM661207104	SM.1uFS	C1578	SM661207103	SM.01uFS
C1532	SM661207104	SM.1uFS	C1580	SM661207103	SM.01uFS

PART: F9384-31 DESC: MAIN CARD (FRONT END, ADC, TDC) for 9384

Location	Part Number	Description	Location	Part Number	Description
C1581	SM661207103	SM.01uFS	C2046	SM661207103	SM.01uFS
C1582	SM661207103	SM.01uFS	C2047	SM661207103	SM.01uFS
C1583	SM661207104	SM.1uFS	C2048	SM661207103	SM.01uFS
C1584	SM661207103	SM.01uFS	C2049	SM661255100	SM10pFS
C1600	SM661255039	SM3.9pFS	C2050	SM661207103	SM.01uFS
C1601	158849009	0.5-2.5pF	C2051	SM661207103	SM.01uFS
C1602	SM661207103	SM.01uFS	C2052	SM661207103	SM.01uFS
C2001	SM661207104	SM.1uFS	C2053	SM661207103	SM.01uFS
C2002	SM661207104	SM.1uFS	C2054	SM661207103	SM.01uFS
C2003	SM158240203	SM5-18pF	C2055	SM661207103	SM.01uFS
C2005	SM661207103	SM.01uFS	C2056	SM661207103	SM.01uFS
C2006	SM661545150	SM15pFS_500V	C2057	SM661207104	SM.1uFS
C2007	SM661535620	SM62pFS_5%	C2058	SM661207103	SM.01uFS
C2008	SM661207103	SM.01uFS	C2059	SM661207103	SM.01uFS
C2009	SM661207103	SM.01uFS	C2060	SM661207104	SM.1uFS
C2010	SM661207103	SM.01uFS	C2061	SM661207103	SM.01uFS
C2011	SM661207103	SM.01uFS	C2062	SM661207103	SM.01uFS
C2012	SM661207103	SM.01uFS	C2063	SM661207104	SM.1uFS
C2013	SM661540033	SM3.3pFS_500V	C2065	SM666327225	SM2.2uF-20V
C2014	SM661545150	SM15pFS_500V	C2066	SM661207103	SM.01uFS
C2015	SM661255100	SM10pFS	C2067	SM661207103	SM.01uFS
C2016	SM661255101	SM100pFS	C2068	SM666327225	SM2.2uF-20V
C2017	SM661526561	SM560pF_500V	C2069	SM666327225	SM2.2uF-20V
C2018	SM661255101	SM100pFS	C2070	SM666327225	SM2.2uF-20V
C2019	SM661207103	SM.01uFS	C2071	SM666327225	SM2.2uF-20V
C2021	SM661207103	SM.01uFS	C2072	SM661207103	SM.01uFS
C2022	SM158240203	SM5-18pF	C2073	SM661207103	SM.01uFS
C2024	SM661207103	SM.01uFS	C2074	SM661207103	SM.01uFS
C2025	SM661207103	SM.01uFS	C2075	SM661207104	SM.1uFS
C2026	SM661207103	SM.01uFS	C2076	SM661207103	SM.01uFS
C2028	SM661255101	SM100pFS	C2077	SM661207103	SM.01uFS
C2029	SM661207103	SM.01uFS	C2079	SM661207104	SM.1uFS
C2030	SM661207103	SM.01uFS	C2086	SM666327225	SM2.2uF-20V
C2031	SM661207223	SM.022uFS	C2087	SM661255101	SM100pFS
C2032	SM661207223	SM.022uFS	C2089	SM661207102	SM.001uFS
C2034	SM158240200	SM0.6-2.5pF	C2090	SM661207103	SM.01uFS
C2035	SM661207103	SM.01uFS	C2092	SM661207103	SM.01uFS
C2036	SM661207103	SM.01uFS	C2095	SM661207103	SM.01uFS
C2038	SM661207103	SM.01uFS	C2096	SM661207103	SM.01uFS
C2039	SM661207103	SM.01uFS	C2098	SM661256120	SM12pFS
C2041	SM661207103	SM.01uFS	C2099	SM661255470	SM47pFS
C2042	SM661255821	SM820pFS	C2500	SM661207103	SM.01uFS
C2043	SM661207103	SM.01uFS	C2501	SM661207103	SM.01uFS
C2044	SM661255101	SM100pFS	C2502	SM158240200	SM0.6-2.5pF
C2045	SM661207103	SM.01uFS	C2503	SM661286103	SM.01uF

Section 7 Schematics, Layouts, Parts list

PART: F9384-31 DESC: MAIN CARD (FRONT END, ADC, TDC) for 9384

Location	Part Number	Description	Location	Part Number	Description
C2504	SM661255102	SM1000pFS	C2551	SM661286103	SM.01uF
C2505	SM661207103	SM.01uFS	C2552	SM661286103	SM.01uF
C2506	SM661207103	SM.01uFS	C2553	SM661286103	SM.01uF
C2507	SM661286103	SM.01uF	C2554	SM661207103	SM.01uFS
C2508	SM661255102	SM1000pFS	C2555	SM661207103	SM.01uFS
C2509	SM661255102	SM1000pFS	C2556	SM661207104	SM.1uFS
C2510	SM661286103	SM.01uF	C2557	SM661207103	SM.01uFS
C2511	SM661207103	SM.01uFS	C2558	SM661207103	SM.01uFS
C2512	SM661207103	SM.01uFS	C2559	SM661207103	SM.01uFS
C2513	SM661286103	SM.01uF	C2560	SM661207104	SM.1uFS
C2514	SM661255102	SM1000pFS	C2561	SM661207103	SM.01uFS
C2515	SM661286103	SM.01uF	C2562	SM661207103	SM.01uFS
C2516	SM661207103	SM.01uFS	C2563	SM661207103	SM.01uFS
C2517	SM661286103	SM.01uF	C2564	SM661207104	SM.1uFS
C2518	SM661286103	SM.01uF	C2565	SM661207104	SM.1uFS
C2519	SM661207103	SM.01uFS	C2566	SM661207104	SM.1uFS
C2520	SM661286103	SM.01uF	C2567	SM661207104	SM.1uFS
C2521	SM661207103	SM.01uFS	C2568	SM666237476	SM47uF-6V
C2522	SM661207103	SM.01uFS	C2569	SM666267227	SM220uF-10V
C2523	SM661286103	SM.01uF	C2570	SM666267227	SM220uF-10V
C2524	SM661286103	SM.01uF	C2571	SM666237476	SM47uF-6V
C2525	SM661207103	SM.01uFS	C2572	SM661207104	SM.1uFS
C2526	SM661207103	SM.01uFS	C2573	SM661207104	SM.1uFS
C2527	SM661286103	SM.01uF	C2574	SM661207104	SM.1uFS
C2528	SM661286103	SM.01uF	C2575	SM661207104	SM.1uFS
C2529	SM661207104	SM.1uFS	C2576	SM661207103	SM.01uFS
C2530	SM661207104	SM.1uFS	C2577	SM661207104	SM.1uFS
C2531	SM661207104	SM.1uFS	C2578	SM661207104	SM.1uFS
C2532	SM661207104	SM.1uFS	C2579	SM661207104	SM.1uFS
C2533	SM661207103	SM.01uFS	C2580	SM661207104	SM.1uFS
C2534	SM661207103	SM.01uFS	C2581	SM661207104	SM.1uFS
C2535	SM661207103	SM.01uFS	C2582	SM661207104	SM.1uFS
C2536	SM661207103	SM.01uFS	C2583	SM661207104	SM.1uFS
C2537	SM661207103	SM.01uFS	C2584	SM661207104	SM.1uFS
C2538	SM661207103	SM.01uFS	C2585	SM661207104	SM.1uFS
C2540	SM661207103	SM.01uFS	C2586	SM661207103	SM.01uFS
C2541	SM661207104	SM.1uFS	C2588	SM661207103	SM.01uFS
C2542	SM661207104	SM.1uFS	C2589	SM661207103	SM.01uFS
C2543	SM661207104	SM.1uFS	C2590	SM661207103	SM.01uFS
C2544	SM661207104	SM.1uFS	C2595	SM661286103	SM.01uF
C2545	SM661207103	SM.01uFS	C2600	SM661255039	SM3.9pFS
C2546	SM661207103	SM.01uFS	C2601	158849009	0.5-2.5pF
C2547	SM661286103	SM.01uF	C2602	SM661207103	SM.01uFS
C2548	SM661286103	SM.01uF	C3001	SM661207104	SM.1uFS
C2550	SM661286103	SM.01uF	C3002	SM661207104	SM.1uFS

PART: F9384-31 DESC: MAIN CARD (FRONT END, ADC, TDC) for 9384

Location	Part Number	Description	Location	Part Number	Description
C3003	SM158240203	SM5-18pF	C3055	SM661207103	SM.01uFS
C3005	SM661207103	SM.01uFS	C3056	SM661207103	SM.01uFS
C3006	SM661545150	SM15pFS_500V	C3057	SM661207104	SM.1uFS
C3007	SM661535620	SM62pFS_5%	C3058	SM661207103	SM.01uFS
C3008	SM661207103	SM.01uFS	C3059	SM661207103	SM.01uFS
C3009	SM661207103	SM.01uFS	C3060	SM661207104	SM.1uFS
C3010	SM661207103	SM.01uFS	C3061	SM661207103	SM.01uFS
C3011	SM661207103	SM.01uFS	C3062	SM661207103	SM.01uFS
C3012	SM661207103	SM.01uFS	C3063	SM661207104	SM.1uFS
C3013	SM661540033	SM3.3pFS_500V	C3065	SM666327225	SM2.2uF-20V
C3014	SM661545150	SM15pFS_500V	C3066	SM661207103	SM.01uFS
C3015	SM661255100	SM10pFS	C3067	SM661207103	SM.01uFS
C3016	SM661255101	SM100pFS	C3068	SM666327225	SM2.2uF-20V
C3017	SM661526561	SM560pF_500V	C3069	SM666327225	SM2.2uF-20V
C3018	SM661255101	SM100pFS	C3070	SM666327225	SM2.2uF-20V
C3019	SM661207103	SM.01uFS	C3071	SM666327225	SM2.2uF-20V
C3021	SM661207103	SM.01uFS	C3072	SM661207103	SM.01uFS
C3022	SM158240203	SM5-18pF	C3073	SM661207103	SM.01uFS
C3024	SM661207103	SM.01uFS	C3074	SM661207103	SM.01uFS
C3025	SM661207103	SM.01uFS	C3075	SM661207104	SM.1uFS
C3026	SM661207103	SM.01uFS	C3076	SM661207103	SM.01uFS
C3028	SM661255101	SM100pFS	C3077	SM661207103	SM.01uFS
C3029	SM661207103	SM.01uFS	C3079	SM661207104	SM.1uFS
C3030	SM661207103	SM.01uFS	C3086	SM666327225	SM2.2uF-20V
C3031	SM661207223	SM.022uFS	C3087	SM661255101	SM100pFS
C3032	SM661207223	SM.022uFS	C3089	SM661207102	SM.001uFS
C3034	SM158240200	SM0.6-2.5pF	C3090	SM661207103	SM.01uFS
C3035	SM661207103	SM.01uFS	C3092	SM661207103	SM.01uFS
C3036	SM661207103	SM.01uFS	C3095	SM661207103	SM.01uFS
C3038	SM661207103	SM.01uFS	C3096	SM661207103	SM.01uFS
C3039	SM661207103	SM.01uFS	C3098	SM661256120	SM12pFS
C3041	SM661207103	SM.01uFS	C3099	SM661255470	SM47pFS
C3042	SM661255821	SM820pFS	C3500	SM158240200	SM0.6-2.5pF
C3043	SM661207103	SM.01uFS	C3502	SM661286103	SM.01uF
C3044	SM661255101	SM100pFS	C3503	SM661207103	SM.01uFS
C3045	SM661207103	SM.01uFS	C3504	SM661286103	SM.01uF
C3046	SM661207103	SM.01uFS	C3505	SM661286103	SM.01uF
C3047	SM661207103	SM.01uFS	C3506	SM661207103	SM.01uFS
C3048	SM661207103	SM.01uFS	C3507	SM661286103	SM.01uF
C3049	SM661255100	SM10pFS	C3508	SM661286103	SM.01uF
C3050	SM661207103	SM.01uFS	C3509	SM661207103	SM.01uFS
C3051	SM661207103	SM.01uFS	C3510	SM661286103	SM.01uF
C3052	SM661207103	SM.01uFS	C3511	SM661286103	SM.01uF
C3053	SM661207103	SM.01uFS	C3512	SM661207103	SM.01uFS
C3054	SM661207103	SM.01uFS	C3513	SM661286103	SM.01uF

PART: F9384-31 DESC: MAIN CARD (FRONT END, ADC, TDC) for 9384

Location	Part Number	Description	Location	Part Number	Description
C3514	SM661207103	SM.01uFS	C3560	SM661207103	SM.01uFS
C3515	SM661286103	SM.01uF	C3561	SM661207103	SM.01uFS
C3516	SM661286103	SM.01uF	C3562	SM661207104	SM.1uFS
C3517	SM661207103	SM.01uFS	C3563	SM661207104	SM.1uFS
C3518	146554476	47uF-25VALRA	C3564	SM661207104	SM.1uFS
C3519	146574227	220uF-25VALRA	C3565	SM661207104	SM.1uFS
C3520	SM661207103	SM.01uFS	C3566	SM661207104	SM.1uFS
C3521	SM661286103	SM.01uF	C3567	SM666237476	SM47uF-6V
C3522	SM661286103	SM.01uF	C3568	SM661207104	SM.1uFS
C3523	SM661207103	SM.01uFS	C3569	SM661207104	SM.1uFS
C3524	SM661286103	SM.01uF	C3570	SM661207104	SM.1uFS
C3525	SM661286103	SM.01uF	C3571	SM661207104	SM.1uFS
C3526	SM661207103	SM.01uFS	C3572	SM666237476	SM47uF-6V
C3527	SM661286103	SM.01uF	C3573	SM666267227	SM220uF-10V
C3528	SM661286103	SM.01uF	C3574	SM661207104	SM.1uFS
C3529	SM661207103	SM.01uFS	C3575	SM661207104	SM.1uFS
C3530	SM661207103	SM.01uFS	C3576	SM661207104	SM.1uFS
C3531	SM661207104	SM.1uFS	C3579	SM661207104	SM.1uFS
C3532	SM661207104	SM.1uFS	C3580	SM661207104	SM.1uFS
C3533	SM661207104	SM.1uFS	C3581	SM661207104	SM.1uFS
C3534	SM661207104	SM.1uFS	C3582	SM666267227	SM220uF-10V
C3535	SM661286103	SM.01uF	C3584	SM661207104	SM.1uFS
C3536	SM661286103	SM.01uF	C3585	SM661207103	SM.01uFS
C3537	SM661286103	SM.01uF	C3586	SM661207103	SM.01uFS
C3538	SM661286103	SM.01uF	C3587	SM661207104	SM.1uFS
C3539	SM661207103	SM.01uFS	C3588	SM661207104	SM.1uFS
C3540	SM661207103	SM.01uFS	C3589	SM661207103	SM.01uFS
C3541	SM661207103	SM.01uFS	C3590	SM661207103	SM.01uFS
C3543	SM661207103	SM.01uFS	C3591	SM661207103	SM.01uFS
C3544	SM661207103	SM.01uFS	C3592	SM661207103	SM.01uFS
C3545	SM661207103	SM.01uFS	C3593	SM661207103	SM.01uFS
C3546	SM661207104	SM.1uFS	C3600	SM661255039	SM3.9pFS
C3547	SM661207104	SM.1uFS	C3601	158849009	0.5-2.5pF
C3548	SM661207104	SM.1uFS	C3602	SM661207103	SM.01uFS
C3549	SM661207104	SM.1uFS	C3610	SM661207103	SM.01uFS
C3550	SM661207103	SM.01uFS	C3620	SM158240200	SM0.6-2.5pF
C3551	SM661207103	SM.01uFS	C3621	SM158240200	SM0.6-2.5pF
C3552	SM661207103	SM.01uFS	C4001	SM661207104	SM.1uFS
C3553	SM661207103	SM.01uFS	C4002	SM661207104	SM.1uFS
C3554	SM661207103	SM.01uFS	C4003	SM158240203	SM5-18pF
C3555	SM661207103	SM.01uFS	C4005	SM661207103	SM.01uFS
C3556	SM661207103	SM.01uFS	C4006	SM661545150	SM15pFS_500V
C3557	SM661207103	SM.01uFS	C4007	SM661535620	SM62pFS_5%
C3558	SM661207104	SM.1uFS	C4008	SM661207103	SM.01uFS
C3559	SM661207103	SM.01uFS	C4009	SM661207103	SM.01uFS

PART: F9384-31 DESC: MAIN CARD (FRONT END, ADC, TDC) for 9384

Location	Part Number	Description	Location	Part Number	Description
C4010	SM661207103	SM.01uFS	C4061	SM661207103	SM.01uFS
C4011	SM661207103	SM.01uFS	C4062	SM661207103	SM.01uFS
C4012	SM661207103	SM.01uFS	C4063	SM661207104	SM.1uFS
C4013	SM661540033	SM3.3pFS_500V	C4065	SM666327225	SM2.2uF-20V
C4014	SM661545150	SM15pFS_500V	C4066	SM661207103	SM.01uFS
C4015	SM661255100	SM10pFS	C4067	SM661207103	SM.01uFS
C4016	SM661255101	SM100pFS	C4068	SM666327225	SM2.2uF-20V
C4017	SM661526561	SM560pF_500V	C4069	SM666327225	SM2.2uF-20V
C4018	SM661255101	SM100pFS	C4070	SM666327225	SM2.2uF-20V
C4019	SM661207103	SM.01uFS	C4071	SM666327225	SM2.2uF-20V
C4021	SM661207103	SM.01uFS	C4072	SM661207103	SM.01uFS
C4022	SM158240203	SM5-18pF	C4073	SM661207103	SM.01uFS
C4024	SM661207103	SM.01uFS	C4074	SM661207103	SM.01uFS
C4025	SM661207103	SM.01uFS	C4075	SM661207104	SM.1uFS
C4026	SM661207103	SM.01uFS	C4076	SM661207103	SM.01uFS
C4028	SM661255101	SM100pFS	C4077	SM661207103	SM.01uFS
C4029	SM661207103	SM.01uFS	C4079	SM661207104	SM.1uFS
C4030	SM661207103	SM.01uFS	C4086	SM666327225	SM2.2uF-20V
C4031	SM661207223	SM.022uFS	C4087	SM661255101	SM100pFS
C4032	SM661207223	SM.022uFS	C4089	SM661207102	SM.001uFS
C4034	SM158240200	SM0.6-2.5pF	C4090	SM661207103	SM.01uFS
C4035	SM661207103	SM.01uFS	C4092	SM661207103	SM.01uFS
C4036	SM661207103	SM.01uFS	C4095	SM661207103	SM.01uFS
C4038	SM661207103	SM.01uFS	C4096	SM661207103	SM.01uFS
C4039	SM661207103	SM.01uFS	C4098	SM661256120	SM12pFS
C4041	SM661207103	SM.01uFS	C4099	SM661255470	SM47pFS
C4042	SM661255821	SM820pFS	C4500	SM661207103	SM.01uFS
C4043	SM661207103	SM.01uFS	C4501	SM661207103	SM.01uFS
C4044	SM661255101	SM100pFS	C4502	SM661207103	SM.01uFS
C4045	SM661207103	SM.01uFS	C4504	SM661286103	SM.01uF
C4046	SM661207103	SM.01uFS	C4505	SM661255102	SM1000pFS
C4047	SM661207103	SM.01uFS	C4506	SM661207103	SM.01uFS
C4048	SM661207103	SM.01uFS	C4507	SM661286103	SM.01uF
C4049	SM661255100	SM10pFS	C4508	SM661255102	SM1000pFS
C4050	SM661207103	SM.01uFS	C4509	SM661255102	SM1000pFS
C4051	SM661207103	SM.01uFS	C4510	SM661286103	SM.01uF
C4052	SM661207103	SM.01uFS	C4511	SM661207103	SM.01uFS
C4053	SM661207103	SM.01uFS	C4512	SM661286103	SM.01uF
C4054	SM661207103	SM.01uFS	C4513	SM661207104	SM.1uFS
C4055	SM661207103	SM.01uFS	C4515	SM661207104	SM.1uFS
C4056	SM661207103	SM.01uFS	C4516	SM661207104	SM.1uFS
C4057	SM661207104	SM.1uFS	C4517	SM661207104	SM.1uFS
C4058	SM661207103	SM.01uFS	C4518	SM661207104	SM.1uFS
C4059	SM661207103	SM.01uFS	C4519	SM661207104	SM.1uFS
C4060	SM661207104	SM.1uFS	C4520	SM661207104	SM.1uFS

Section 7 Schematics, Layouts, Parts list

PART: F9384-31 DESC: MAIN CARD (FRONT END, ADC, TDC) for 9384

Location	Part Number	Description	Location	Part Number	Description
C4521	SM661207104	SM.1uFS	C5000	SM661207104	SM.1uFS
C4522	SM661207103	SM.01uFS	C5001	SM661207104	SM.1uFS
C4523	SM661207103	SM.01uFS	C5002	SM661255010	SM1pFS
C4524	SM661207103	SM.01uFS	C5003	SM661207103	SM.01uFS
C4526	SM661207103	SM.01uFS	C5004	SM661207103	SM.01uFS
C4527	SM661207103	SM.01uFS	C5005	SM661540033	SM3.3pFS_500V
C4528	SM661207103	SM.01uFS	C5006	SM661207103	SM.01uFS
C4529	SM661207103	SM.01uFS	C5007	SM661207103	SM.01uFS
C4530	SM661207103	SM.01uFS	C5008	SM661207103	SM.01uFS
C4531	SM661207103	SM.01uFS	C5009	SM661207103	SM.01uFS
C4533	SM661207103	SM.01uFS	C5010	SM661540033	SM3.3pFS_500V
C4534	SM661207104	SM.1uFS	C5011	SM661207103	SM.01uFS
C4535	SM661207103	SM.01uFS	C5012	SM661526561	SM560pF_500V
C4536	SM661207104	SM.1uFS	C5013	SM661207103	SM.01uFS
C4537	SM661207104	SM.1uFS	C5014	SM661207104	SM.1uFS
C4538	SM661207103	SM.01uFS	C5015	SM661207103	SM.01uFS
C4539	SM661207104	SM.1uFS	C5016	SM661207103	SM.01uFS
C4540	SM661207104	SM.1uFS	C5017	SM661207103	SM.01uFS
C4541	SM661207104	SM.1uFS	C5018	SM661255821	SM820pFS
C4542	SM661207104	SM.1uFS	C5019	SM666327225	SM2.2uF-20V
C4543	SM661207104	SM.1uFS	C5020	SM661207104	SM.1uFS
C4544	SM666237476	SM47uF-6V	C5021	SM661207103	SM.01uFS
C4545	SM666267227	SM220uF-10V	C5022	SM661207103	SM.01uFS
C4546	SM666237476	SM47uF-6V	C5023	SM661207103	SM.01uFS
C4547	SM661207104	SM.1uFS	C5024	SM661207103	SM.01uFS
C4548	SM661207104	SM.1uFS	C5025	SM661207103	SM.01uFS
C4549	SM661207104	SM.1uFS	C5026	SM661207103	SM.01uFS
C4550	SM661207104	SM.1uFS	C5027	SM661255220	SM22pFS
C4551	SM661207104	SM.1uFS	C5028	SM661255330	SM33pFS
C4552	SM661207104	SM.1uFS	C5029	SM661207103	SM.01uFS
C4553	SM661207104	SM.1uFS	C5030	SM661207103	SM.01uFS
C4554	SM661207104	SM.1uFS	C5031	SM661545150	SM15pFS_500V
C4555	SM661207104	SM.1uFS	C5032	SM661255270	SM27pFS
C4556	SM661207104	SM.1uFS	C5033	SM661255270	SM27pFS
C4557	SM661207104	SM.1uFS	C5034	SM661207103	SM.01uFS
C4558	SM661207103	SM.01uFS	C5035	SM666427105	SM1uF-16V
C4559	SM661207103	SM.01uFS	C5038	SM666427105	SM1uF-16V
C4600	SM661255039	SM3.9pFS	C5039	SM661207103	SM.01uFS
C4601	158849009	0.5-2.5pF	C5040	SM661207103	SM.01uFS
C4602	SM661207103	SM.01uFS	C5041	SM661207103	SM.01uFS
C4603	SM661207103	SM.01uFS	C5042	SM661207103	SM.01uFS
C4604	SM661207103	SM.01uFS	C5043	SM661207103	SM.01uFS
C4606	SM661207103	SM.01uFS	C5044	SM661207103	SM.01uFS
C4610	SM661255102	SM1000pFS	C5045	SM661207103	SM.01uFS
C4611	SM661207103	SM.01uFS	C5046	SM661207103	SM.01uFS

PART: F9384-31 DESC: MAIN CARD (FRONT END, ADC, TDC) for 9384

Location	Part Number	Description	Location	Part Number	Description
C5047	SM661207103	SM.01uFS	C5095	SM666327225	SM2.2uF-20V
C5048	SM661207103	SM.01uFS	C5096	SM661207103	SM.01uFS
C5049	SM661205822	SM.0082uFS	C5097	SM661207103	SM.01uFS
C5050	SM661205822	SM.0082uFS	C5098	SM661207103	SM.01uFS
C5051	SM661255270	SM27pFS	C5100	SM661207103	SM.01uFS
C5052	SM661207103	SM.01uFS	C5101	SM661207103	SM.01uFS
C5053	SM661207103	SM.01uFS	C5103	SM661207104	SM.1uFS
C5054	SM661255270	SM27pFS	C5104	SM661207104	SM.1uFS
C5055	SM661207103	SM.01uFS	C5106	SM661207103	SM.01uFS
C5056	SM661207103	SM.01uFS	C5107	SM661255100	SM10pFS
C5057	SM666427105	SM1uF-16V	C5108	SM661207103	SM.01uFS
C5058	SM666427105	SM1uF-16V	C5110	SM666377226	SM22uF-15V
C5059	SM661207103	SM.01uFS	C5111	SM666377226	SM22uF-15V
C5060	SM661207103	SM.01uFS	C5112	SM661207103	SM.01uFS
C5061	SM661207103	SM.01uFS	C5113	SM661207103	SM.01uFS
C5062	SM661207103	SM.01uFS	C5114	SM661207103	SM.01uFS
C5063	SM661207103	SM.01uFS	C5115	SM661207103	SM.01uFS
C5064	SM661207103	SM.01uFS	C5120	SM661255470	SM47pFS
C5065	SM661207103	SM.01uFS	C5121	SM661255470	SM47pFS
C5066	SM661207103	SM.01uFS	C6000	146654107	100uF-35VALRA
C5067	SM661207103	SM.01uFS	C6001	146654107	100uF-35VALRA
C5068	SM661205822	SM.0082uFS	C6003	SM666327225	SM2.2uF-20V
C5069	SM661207103	SM.01uFS	C6004	SM661207103	SM.01uFS
C5070	SM661205822	SM.0082uFS	C6005	SM661207103	SM.01uFS
C5071	SM661207103	SM.01uFS	C6006	SM666327225	SM2.2uF-20V
C5072	SM661207103	SM.01uFS	C6007	SM661207103	SM.01uFS
C5073	SM661207103	SM.01uFS	C6008	SM661255102	SM1000pFS
C5074	SM666327225	SM2.2uF-20V	C6009	SM661255056	SM5.6pFS
C5075	SM666327225	SM2.2uF-20V	C7000	SM661207103	SM.01uFS
C5076	SM661255270	SM27pFS	C7001	SM661207103	SM.01uFS
C5077	SM661207103	SM.01uFS	C7002	SM661207103	SM.01uFS
C5078	SM661255101	SM100pFS	C7003	SM661207103	SM.01uFS
C5079	SM666427105	SM1uF-16V	C7004	SM661207103	SM.01uFS
C5083	SM661207104	SM.1uFS	C7005	SM661207103	SM.01uFS
C5084	SM661207103	SM.01uFS	C7006	SM661207103	SM.01uFS
C5085	SM661207103	SM.01uFS	C7007	SM661207103	SM.01uFS
C5086	SM661207103	SM.01uFS	C7008	SM661207103	SM.01uFS
C5087	SM661207103	SM.01uFS	C7009	SM661255102	SM1000pFS
C5088	SM661207103	SM.01uFS	C7013	SM661207103	SM.01uFS
C5089	SM661207103	SM.01uFS	CR1	SM236030099	BAV99
C5090	SM661207103	SM.01uFS	CR2	SM232120070	BAV70
C5091	SM661207103	SM.01uFS	CR30	SM236030099	BAV99
C5092	SM666327225	SM2.2uF-20V	CR31	SM236030099	BAV99
C5093	SM661205822	SM.0082uFS	CR32	SM236030099	BAV99
C5094	SM661207103	SM.01uFS	CR33	SM236030099	BAV99

PART: F9384-31 DESC: MAIN CARD (FRONT END, ADC, TDC) for 9384

Location	Part Number	Description	Location	Part Number	Description
CR34	SM236030099	BAV99	CR1007	SM236030099	BAV99
CR35	SM236030099	BAV99	CR1010	SM240218462	BZX84-C6V2
CR36	SM236030099	BAV99	CR1011	NOBZX84	NOBZX84
CR37	SM236030099	BAV99	CR1500	SM236030099	BAV99
CR38	SM236030099	BAV99	CR1501	SM236030099	BAV99
CR39	SM236030099	BAV99	CR1502	SM236030099	BAV99
CR40	SM236030099	BAV99	CR1503	SM236030099	BAV99
CR41	SM236030099	BAV99	CR1504	SM236030099	BAV99
CR42	SM236030099	BAV99	CR1505	SM236030099	BAV99
CR100	SM253032823	HSMS2823	CR1506	SM236030099	BAV99
CR200	SM240218451	BZX84-C5V1	CR1507	SM236030099	BAV99
CR201	SM240218475	BZX84-C7V5	CR1550	SM236030099	BAV99
CR202	SM240218475	BZX84-C7V5	CR1551	SM240218451	BZX84-C5V1
CR207	SM208591336	SMLM336-5	CR1552	SM240218451	BZX84-C5V1
CR400	SM236654004	SM4004	CR1553	SM240218451	BZX84-C5V1
CR401	SM236654004	SM4004	CR1554	SM240218451	BZX84-C5V1
CR700	SM240218451	BZX84-C5V1	CR1555	SM240218451	BZX84-C5V1
CR701	SM236030099	BAV99	CR2000	SM229020150	SMTVSS-5V6
CR702	SM240218451	BZX84-C5V1	CR2001	SM236030099	BAV99
CR703	SM240218451	BZX84-C5V1	CR2003	SM236030099	BAV99
CR704	SM240218451	BZX84-C5V1	CR2004	NOBZX	NOBZX
CR705	235010005	1N4005	CR2005	SM252023018	BAT18
CR707	SM252080682	BA682	CR2006	SM236030099	BAV99
CR708	SM252080682	BA682	CR2007	SM236030099	BAV99
CR710	SM252080682	BA682	CR2010	SM240218462	BZX84-C6V2
CR713	SM236030099	BAV99	CR2011	NOBZX84	NOBZX84
CR716	SM236030099	BAV99	CR2500	SM236030099	BAV99
CR717	SM252080682	BA682	CR2501	SM236030099	BAV99
CR718	SM252080682	BA682	CR2502	SM236030099	BAV99
CR719	SM240218451	BZX84-C5V1	CR2503	SM236030099	BAV99
CR720	SM240218451	BZX84-C5V1	CR2504	SM236030099	BAV99
CR721	SM240218451	BZX84-C5V1	CR2505	SM236030099	BAV99
CR722	SM240218451	BZX84-C5V1	CR2506	SM236030099	BAV99
CR723	SM232022822	HSMS2822	CR2507	SM236030099	BAV99
CR724	SM236030099	BAV99	CR2550	SM253032823	HSMS2823
CR730	SM236030099	BAV99	CR2551	SM253032823	HSMS2823
CR731	SM236030099	BAV99	CR2552	SM253032823	HSMS2823
CR732	SM236030099	BAV99	CR2553	SM253032823	HSMS2823
CR733	SM236030099	BAV99	CR2554	SM253032823	HSMS2823
CR1000	SM229020150	SMTVSS-5V6	CR2555	SM253032823	HSMS2823
CR1001	SM236030099	BAV99	CR2556	SM253032823	HSMS2823
CR1003	SM236030099	BAV99	CR2557	SM253032823	HSMS2823
CR1004	NOBZX	NOBZX	CR2558	SM253032823	HSMS2823
CR1005	SM252023018	BAT18	CR3000	SM229020150	SMTVSS-5V6
CR1006	SM236030099	BAV99	CR3001	SM236030099	BAV99

PART: F9384-31 DESC: MAIN CARD (FRONT END, ADC, TDC) for 9384

Location	Part Number	Description	Location	Part Number	Description
CR3003	SM236030099	BAV99	CR5007	SM240050033	TZMC3V3
CR3004	NOBZX	NOBZX	CR5008	NODIODE	NODIODE
CR3005	SM252023018	BAT18	CR5009	SM240050033	TZMC3V3
CR3006	SM236030099	BAV99	CR5010	SM232120070	BAV70
CR3007	SM236030099	BAV99	CR5011	SM236030099	BAV99
CR3010	SM240218462	BZX84-C6V2	CR5012	SM236030099	BAV99
CR3011	NOBZX84	NOBZX84	CR6000	SM229020150	SMTVSS-5V6
CR3500	SM236030099	BAV99	CR6001	SM253032823	HSMS2823
CR3501	SM236030099	BAV99	CR6002	SM232022822	HSMS2822
CR3502	SM236030099	BAV99	CR6003	SM240050051	TZMC5V1
CR3503	SM236030099	BAV99	CR6004	SM236030099	BAV99
CR3504	SM236030099	BAV99	DL30	290120005	5nS
CR3505	SM236030099	BAV99	DL700	290199015	DL-1L6-15
CR3506	SM236030099	BAV99	DL701	290199015	DL-1L6-15
CR3507	SM236030099	BAV99	DL705	290120009	9nS
CR3550	SM236030099	BAV99	DL712	NO-DELAY	NO-DELAY-5nS
CR3551	SM240218451	BZX84-C5V1	DL770	290199020	DL-1L6-20
CR3552	SM240218451	BZX84-C5V1	J1	454220096	3x32-ST-F-PF
CR3553	SM240218451	BZX84-C5V1	J2	454112024	2x12-ST
CR3554	SM240218451	BZX84-C5V1	J3	454390002	1x2-ST-M-PL
CR3556	SM240218451	BZX84-C5V1	J4	454117003	1x3-ST-M-PL
CR4000	SM229020150	SMTVSS-5V6	J710	SM454120025	SM1x12-13-ST-
CR4001	SM236030099	BAV99	J1000	7093XXP01	BNC-93XX-
CR4003	SM236030099	BAV99	J1500	454111024	4x6-ST-F-PF-
CR4004	NOBZX	NOBZX	J1501	454111024	4x48-ST-F-PF-
CR4005	SM252023018	BAT18	J2000	7093XXP01	BNC-93XX
CR4006	SM236030099	BAV99	J3000	7093XXP01	BNC-93XX-
CR4007	SM236030099	BAV99	J3500	454111024	4x6-ST-F-PF-
CR4010	SM240218462	BZX84-C6V2	J3501	454111024	4x48-ST-F-PF-
CR4011	NOBZX84	NOBZX84	J4000	7093XXP01	BNC-93XX-
CR4500	SM236030099	BAV99	J6000	7093XXP01	BNC-93XX-
CR4501	SM236030099	BAV99	J6002	7093XXP01	BNC-93XX-
CR4502	SM236030099	BAV99	J100A	593910001	RG178B_U
CR4503	SM236030099	BAV99	J100B	593910001	RG178B_U
CR4504	SM236030099	BAV99	J10A	593910001	RG178B_U
CR4505	SM236030099	BAV99	J10B	593910001	RG178B_U
CR4506	SM236030099	BAV99	J200A	593910001	RG178B_U
CR4507	SM236030099	BAV99	J200B	593910001	RG178B_U
CR5000	SM229020150	SMTVSS-5V6	J2010A	593910001	RG178B_U
CR5001	SM252023018	BAT18	J2010B	593910001	RG178B_U
CR5002	SM232120070	BAV70	J20A	593910001	RG178B_U
CR5003	SM236030099	BAV99	J20B	593910001	RG178B_U
CR5004	SM240050033	TZMC3V3	J300A	593910001	RG178B_U
CR5005	SM240050033	TZMC3V3	J300B	593910001	RG178B_U
CR5006	SM240050033	TZMC3V3	J3010A	593910001	RG178B_U

PART: F9384-31 DESC: MAIN CARD (FRONT END, ADC, TDC) for 9384

Location	Part Number	Description	Location	Part Number	Description
J3010B	593910001	RG178B_U	L3001	SM301502001	SMBEAD1206
J40A	593910001	RG178B_U	L3002	SM301502001	SMBEAD1206
J40B	593910001	RG178B_U	L3003	SM301502001	SMBEAD1206
J50A	593910001	RG178B_U	L3004	SM301502001	SMBEAD1206
J50B	593910001	RG178B_U	L3010	SM669080181	SMBEAD0805
L201	SM301502001	SMBEAD1206	L3011	SM669080181	SMBEAD0805
L202	SM301502001	SMBEAD1206	L3020	SM669080181	SMBEAD0805
L203	SM301502001	SMBEAD1206	L3021	SM669080181	SMBEAD0805
L204	SM301502001	SMBEAD1206	L3022	SM669080181	SMBEAD0805
L205	SM301502001	SMBEAD1206	L3023	SM669080181	SMBEAD0805
L206	SM301502001	SMBEAD1206	L3024	SM669080181	SMBEAD0805
L207	SM301502001	SMBEAD1206	L3025	SM669080181	SMBEAD0805
L208	SM301502001	SMBEAD1206	L3026	SM669080181	SMBEAD0805
L209	SM301502001	SMBEAD1206	L4000	SM301502001	SMBEAD1206
L700	SM300446150	SM.015uH	L4001	SM301502001	SMBEAD1206
L1000	SM301502001	SMBEAD1206	L4002	SM301502001	SMBEAD1206
L1001	SM301502001	SMBEAD1206	L4003	SM301502001	SMBEAD1206
L1002	SM301502001	SMBEAD1206	L4004	SM301502001	SMBEAD1206
L1003	SM301502001	SMBEAD1206	L4010	SM669080181	SMBEAD0805
L1004	SM301502001	SMBEAD1206	L4011	SM669080181	SMBEAD0805
L1010	SM669080181	SMBEAD0805	L4020	SM669080181	SMBEAD0805
L1011	SM669080181	SMBEAD0805	L4021	SM669080181	SMBEAD0805
L1020	SM669080181	SMBEAD0805	L4022	SM669080181	SMBEAD0805
L1021	SM669080181	SMBEAD0805	L4023	SM669080181	SMBEAD0805
L1022	SM669080181	SMBEAD0805	L4024	SM669080181	SMBEAD0805
L1023	SM669080181	SMBEAD0805	L4025	SM669080181	SMBEAD0805
L1024	SM669080181	SMBEAD0805	L4026	SM669080181	SMBEAD0805
L1025	SM669080181	SMBEAD0805	L5000	SM301502001	SMBEAD1206
L1026	SM669080181	SMBEAD0805	L5001	SM301502001	SMBEAD1206
L1500	SM301502001	SMBEAD1206	L5002	SM301502001	SMBEAD1206
L2000	SM301502001	SMBEAD1206	L5003	SM301502001	SMBEAD1206
L2001	SM301502001	SMBEAD1206	L6000	SM301502001	SMBEAD1206
L2002	SM301502001	SMBEAD1206	L6001	SM301502001	SMBEAD1206
L2003	SM301502001	SMBEAD1206	Q205	SM280171005	MTD10N05E
L2004	SM301502001	SMBEAD1206	Q206	SM280171005	MTD10N05E
L2010	SM669080181	SMBEAD0805	Q207	SM280171005	MTD10N05E
L2011	SM669080181	SMBEAD0805	Q700	SM275030092	BFT92
L2020	SM669080181	SMBEAD0805	Q701	SM270030020	BFS20
L2021	SM669080181	SMBEAD0805	Q702	SM207130025	BFT25A
L2022	SM669080181	SMBEAD0805	Q703	SM275330858	BC858C
L2023	SM669080181	SMBEAD0805	Q704	SM275330858	BC858C
L2024	SM669080181	SMBEAD0805	Q705	SM275030092	BFT92
L2025	SM669080181	SMBEAD0805	Q706	SM275030092	BFT92
L2026	SM669080181	SMBEAD0805	Q707	SM275030092	BFT92
L3000	SM301502001	SMBEAD1206	Q710	SM270130092	BFR92A

PART: F9384-31 DESC: MAIN CARD (FRONT END, ADC, TDC) for 9384

Location	Part Number	Description	Location	Part Number	Description
Q711	SM270130092	BFR92A	R3	SM653101489	SM10.0KS
Q1000	SM270160520	BFG520X	R4	SM653101489	SM10.0KS
Q1001	SM280120416	MMBF4416	R5	SM653101489	SM10.0KS
Q1002	NOBFT93	NOBFT93	R6	SM653101489	SM10.0KS
Q1003	SM270160520	BFG520X	R7	SM653101489	SM10.0KS
Q1004	SM275030550	BF550	R8	169416473	NTC-DISC-47K
Q1005	SM270160520	BFG520X	R9	SM653101522	SM22.1KS
Q1500	SM280171005	MTD10N05E	R10	SM653101489	SM10.0KS
Q2000	SM270160520	BFG520X	R11	SM653101489	SM10.0KS
Q2001	SM280120416	MMBF4416	R12	SM653101461	SM5.11KS
Q2002	SM275030093	BFT93	R13	SM653101393	SM1.00KS
Q2003	SM270160520	BFG520X	R14	SM653101443	SM3.32KS
Q2004	SM275030550	BF550	R15	SM653101443	SM3.32KS
Q2005	SM270160520	BFG520X	R16	SM653101393	SM1.00KS
Q2500	SM275330858	BC858C	R17	SM653101393	SM1.00KS
Q2501	SM275330858	BC858C	R18	SM653101443	SM3.32KS
Q2502	SM275330858	BC858C	R19	SM653101443	SM3.32KS
Q2503	SM275330858	BC858C	R20	SM653101393	SM1.00KS
Q3000	SM270160520	BFG520X	R21	SM653101393	SM1.00KS
Q3001	SM280120416	MMBF4416	R22	SM653101393	SM1.00KS
Q3002	SM275030093	BFT93	R23	SM653101443	SM3.32KS
Q3003	SM270160520	BFG520X	R24	SM653101393	SM1.00KS
Q3004	SM275030550	BF550	R25	SM653101393	SM1.00KS
Q3005	SM270160520	BFG520X	R26	SM653101439	SM3.01KS
Q4000	SM270160520	BFG520X	R27	SM653101443	SM3.32KS
Q4001	SM280120416	MMBF4416	R28	SM653101393	SM1.00KS
Q4002	NOBFT93	NOBFT93	R29	SM653101489	SM10.0KS
Q4003	SM270160520	BFG520X	R31	SM654101000	SM0S
Q4004	SM275030550	BF550	R32	SM653101393	SM1.00KS
Q4005	SM270160520	BFG520X	R33	SM653101393	SM1.00KS
Q4500	SM275330858	BC858C	R34	SM653101489	SM10.0KS
Q4501	SM275330858	BC858C	R35	SM653101393	SM1.00KS
Q4502	SM275330858	BC858C	R36	SM653101393	SM1.00KS
Q4503	SM275330858	BC858C	R37	SM653101234	SM22.1S
Q5000	SM270130092	BFR92A	R38	SM653101489	SM10.0KS
Q5001	SM280120416	MMBF4416	R39	SM653101234	SM22.1S
Q5002	SM270130093	BFR93A	R40	SM653101234	SM22.1S
Q5003	SM270160520	BFG520X	R41	SM653101234	SM22.1S
Q6000	SM270130093	BFR93A	R42	SM653101281	SM68.1S
Q6001	SM275030550	BF550	R43	SM653101281	SM68.1S
Q6002	SM270130092	BFR92A	R44	SM653101281	SM68.1S
Q6003	SM270130093	BFR93A	R45	SM653101393	SM1.00KS
Q6004	SM275030550	BF550	R46	SM653101489	SM10.0KS
R1	SM653101489	SM10.0KS	R47	SM653101489	SM10.0KS
R2	SM653101489	SM10.0KS	R48	SM653101489	SM10.0KS

PART: F9384-31 DESC: MAIN CARD (FRONT END, ADC, TDC) for 9384

Location	Part Number	Description	Location	Part Number	Description
R49	SM653101489	SM10.0KS	R270	SM653101297	SM100.0S
R52	SM652115062	SM6.2-1W	R271	SM653101297	SM100.0S
R54	SM653101489	SM10.0KS	R272	SM653101297	SM100.0S
R56	SM653101201	SM10.0S	R273	SM653101297	SM100.0S
R57	SM653101401	SM1.21KS	R280	SM653101393	SM1.00KS
R58	SM653101234	SM22.1S	R281	SM653101393	SM1.00KS
R59	SM654101000	SM0S-B2P	R500	SM653101489	SM10.0KS
R60	SM654101000	SM0S-B2P	R501	SM653101489	SM10.0KS
R61	SM654101000	SM0S-B2P	R502	SM653101489	SM10.0KS
R130	SM653101289	SM82.5S	R503	SM653101489	SM10.0KS
R200	SM653101489	SM10.0KS	R504	SM653101489	SM10.0KS
R201	SM653101401	SML21KS	R505	SM653101489	SM10.0KS
R205	SM653101393	SM1.00KS	R506	SM653101489	SM10.0KS
R206	SM653101443	SM3.32KS	R507	SM653101489	SM10.0KS
R207	SM653101673	SM825.0KS	R510	SM653101489	SM10.0KS
R211	SM653101531	SM27.4KS	R511	SM653101489	SM10.0KS
R212	SM653101410	SM1.50KS	R512	SM653101489	SM10.0KS
R213	SM653101465	SM5.62KS	R513	SM653101489	SM10.0KS
R214	SM653101489	SM10.0KS	R521	SM653101354	SM392.0S
R215	SM653101489	SM10.0KS	R522	SM653101269	SM51.1S
R216	SM653101489	SM10.0KS	R523	SM653101281	SM68.1S
R217	SM653101489	SM10.0KS	R530	SM653101489	SM10.0KS
R218	SM653101489	SM10.0KS	R531	SM653101489	SM10.0KS
R219	SM653101489	SM10.0KS	R532	SM653101489	SM10.0KS
R220	SM653101489	SM10.0KS	R533	SM653101489	SM10.0KS
R221	SM653101489	SM10.0KS	R534	SM653101489	SM10.0KS
R222	SM653101489	SM10.0KS	R535	SM653101489	SM10.0KS
R223	SM653101489	SM10.0KS	R536	SM653101489	SM10.0KS
R224	SM653101489	SM10.0KS	R537	SM653101489	SM10.0KS
R225	SM653101489	SM10.0KS	R540	SM654101000	SM0S-2P
R226	SM653101489	SM10.0KS	R541	SM654101000	SM0S-2P
R231	SM653101269	SM51.1S	R600	SM653101305	SM121.0S
R233	SM653101489	SM10.0KS	R601	SM653101322	SM182.0S
R234	SM653101489	SM10.0KS	R602	SM653101322	SM182.0S
R247	SM653101269	SM51.1S	R603	SM653101305	SM121.0S
R252	SM653101269	SM51.1S	R604	SM653101339	SM274.0S
R254	SM653101269	SM51.1S	R605	SM653101305	SM121.0S
R260	SM653101393	SM1.00KS	R606	SM653101322	SM182.0S
R262	SM653101393	SM1.00KS	R607	SM653101397	SM1.10KS
R263	SM653101393	SM1.00KS	R608	SM653101393	SM1.00KS
R264	SM653101393	SM1.00KS	R609	SM653101397	SM1.10KS
R265	SM653101393	SM1.00KS	R610	SM653101393	SM1.00KS
R266	SM653101393	SM1.00KS	R611	SM653101289	SM82.5S
R267	SM654101000	SM0S	R612	SM653101281	SM68.1S
R269	SM653101393	SM1.00KS	R614	SM653101322	SM182.0S

PART: F9384-31 DESC: MAIN CARD (FRONT END, ADC, TDC) for 9384

Location	Part Number	Description	Location	Part Number	Description
R615	SM653101322	SM182.0S	R675	SM653101362	SM475.0S
R616	SM653101305	SM121.0S	R676	SM653101351	SM365.0S
R617	SM653101305	SM121.0S	R701	SM653101308	SM130.0S
R618	SM653101322	SM182.0S	R702	SM653101322	SM182.0S
R619	SM653101305	SM121.0S	R703	SM653101322	SM182.0S
R620	SM653101281	SM68.1S	R704	SM653101354	SM392.0S
R621	SM653101305	SM121.0S	R705	SM653101308	SM130.0S
R622	SM653101322	SM182.0S	R706	SM653101322	SM182.0S
R624	SM653101322	SM182.0S	R707	SM653101322	SM182.0S
R625	SM653101305	SM121.0S	R708	SM653101308	SM130.0S
R626	SM653101305	SM121.0S	R709	SM653101393	SM1.00KS
R627	SM653101322	SM182.0S	R710	SM653101234	SM22.1S
R628	SM653101322	SM182.0S	R711	SM653101308	SM130.0S
R629	SM653101305	SM121.0S	R712	SM653101308	SM130.0S
R630	SM653101305	SM121.0S	R713	SM653101393	SM1.00KS
R631	SM653101322	SM182.0S	R714	SM653101322	SM182.0S
R632	SM653101305	SM121.0S	R715	SM653101305	SM121.0S
R633	SM653101322	SM182.0S	R716	SM653101308	SM130.0S
R634	SM653101305	SM121.0S	R717	SM653101354	SM392.0S
R635	SM653101322	SM182.0S	R718	SM653101289	SM82.5S
R636	SM653101322	SM182.0S	R719	SM653101322	SM182.0S
R638	SM653101305	SM121.0S	R720	SM653101322	SM182.0S
R640	SM653101351	SM365.0S	R721	SM653101322	SM182.0S
R641	SM653101362	SM475.0S	R722	SM653101322	SM182.0S
R642	SM653101362	SM475.0S	R723	SM653101308	SM130.0S
R643	SM653101326	SM200.0S	R724	SM653101308	SM130.0S
R645	SM653101289	SM82.5S	R725	SM653101308	SM130.0S
R646	SM653101362	SM475.0S	R726	SM653101308	SM130.0S
R650	SM653101305	SM121.0S	R727	SM653101362	SM475.0S
R651	SM653101322	SM182.0S	R728	SM653101354	SM392.0S
R660	SM653101281	SM68.1S	R729	SM653101322	SM182.0S
R661	SM653101362	SM475.0S	R730	SM653101305	SM121.0S
R662	SM653101322	SM182.0S	R731	SM653101322	SM182.0S
R663	SM653101362	SM475.0S	R732	SM653101322	SM182.0S
R664	SM653101362	SM475.0S	R733	SM653101322	SM182.0S
R665	SM653101269	SM51.1S	R734	SM653101322	SM182.0S
R666	SM653101269	SM51.1S	R735	SM653101281	SM68.1S
R667	SM653101269	SM51.1S	R736	SM653101339	SM274.0S
R668	SM653101269	SM51.1S	R737	SM653101339	SM274.0S
R669	SM653101269	SM51.1S	R738	SM653101322	SM182.0S
R670	SM653101269	SM51.1S	R739	SM653101322	SM182.0S
R671	SM653101269	SM51.1S	R740	SM653101322	SM182.0S
R672	SM653101269	SM51.1S	R741	SM653101322	SM182.0S
R673	SM653101397	SM1.10KS	R742	SM653101393	SM1.00KS
R674	SM653101397	SM1.10KS	R743	SM653101393	SM1.00KS

PART: F9384-31 DESC: MAIN CARD (FRONT END, ADC, TDC) for 9384

Location	Part Number	Description	Location	Part Number	Description
R744	SM653101393	SM1.00KS	R791	SM653101305	SM121.0S
R745	SM653101362	SM475.0S	R792	SM653101322	SM182.0S
R746	SM653101362	SM475.0S	R793	SM653101322	SM182.0S
R747	SM653101362	SM475.0S	R794	SM653101305	SM121.0S
R748	SM653101362	SM475.0S	R795	SM653101234	SM22.1S
R749	SM653101322	SM182.0S	R797	SM653101305	SM121.0S
R750	SM653101322	SM182.0S	R799	SM653101322	SM182.0S
R751	SM653101322	SM182.0S	R800	SM653101322	SM182.0S
R752	SM653101322	SM182.0S	R801	SM653101322	SM182.0S
R753	SM653101305	SM121.0S	R802	SM653101322	SM182.0S
R754	SM653101305	SM121.0S	R803	SM653101305	SM121.0S
R755	SM653101322	SM182.0S	R804	SM653101322	SM182.0S
R756	SM653101322	SM182.0S	R805	SM653101322	SM182.0S
R757	SM653101322	SM182.0S	R806	SM653101305	SM121.0S
R758	SM653101322	SM182.0S	R807	SM653101322	SM182.0S
R759	SM653101297	SM100.0S	R808	SM653101308	SM130.0S
R760	SM653101393	SM1.00KS	R809	SM653101322	SM182.0S
R761	SM653101393	SM1.00KS	R812	SM653101362	SM475.0S
R762	SM653101326	SM200.0S	R820	SM653101322	SM182.0S
R763	SM653101326	SM200.0S	R821	SM653101422	SM2.00KS
R764	SM653101269	SM51.1S	R822	SM653101281	SM68.1S
R765	SM653101354	SM392.0S	R823	SM653101281	SM68.1S
R766	SM653101362	SM475.0S	R824	SM653101322	SM182.0S
R767	SM653101281	SM68.1S	R832	SM653101322	SM182.0S
R768	SM653101322	SM182.0S	R833	SM653101322	SM182.0S
R769	SM653101322	SM182.0S	R834	SM653101385	SM825.0S
R770	SM653101322	SM182.0S	R835	SM653101351	SM365.0S
R771	SM653101322	SM182.0S	R845	SM653101322	SM182.0S
R772	SM653101305	SM121.0S	R847	SM653101393	SM1.00KS
R773	SM653101461	SM5.11KS	R848	SM653101393	SM1.00KS
R775	SM653101322	SM182.0S	R849	SM653101305	SM121.0S
R776	SM653101322	SM182.0S	R850	SM653101362	SM475.0S
R777	SM653101362	SM475.0S	R851	SM653101393	SM1.00KS
R778	SM653101322	SM182.0S	R852	SM653101393	SM1.00KS
R779	SM653101305	SM121.0S	R855	SM653101362	SM475.0S
R781	SM653101322	SM182.0S	R857	SM653101269	SM51.1S
R782	SM653101322	SM182.0S	R858	SM653101489	SM10.0KS
R783	SM653101297	SM100.0S	R859	SM653101269	SM51.1S
R784	SM653101234	SM22.1S	R864	SM653101362	SM475.0S
R785	SM653101234	SM22.1S	R865	SM653101461	SM5.11KS
R786	SM653101305	SM121.0S	R866	SM653101465	SM5.62KS
R787	SM653101305	SM121.0S	R867	SM653101269	SM51.1S
R788	SM653101297	SM100.0S	R869	SM653101322	SM182.0S
R789	SM653101234	SM22.1S	R872	SM653101489	SM10.0KS
R790	SM653101322	SM182.0S	R873	SM653101269	SM51.1S

PART: F9384-31 DESC: MAIN CARD (FRONT END, ADC, TDC) for 9384

Location	Part Number	Description	Location	Part Number	Description
R879	SM651104204	SM200K-25PPM	R952	SM653101330	SM221.0S
R880	SM653101381	SM750.0S	R953	SM653101330	SM221.0S
R881	SM653101410	SM1.50KS	R954	SM653101330	SM221.0S
R882	SM653101297	SM100.0S	R955	SM653101330	SM221.0S
R883	SM653101297	SM100.0S	R956	SM653101330	SM221.0S
R886	SM653101297	SM100.0S	R957	SM653101330	SM221.0S
R890	SM653101393	SM1.00KS	R958	SM653101330	SM221.0S
R891	SM653101410	SM1.50KS	R959	SM653101330	SM221.0S
R892	SM653101308	SM130.0S	R960	SM653101362	SM475.0S
R893	SM653101339	SM274.0S	R974	SM653101362	SM475.0S
R894	SM653101297	SM100.0S	R981	SM653101362	SM475.0S
R897	SM653101393	SM1.00KS	R982	SM653101362	SM475.0S
R898	SM651104241	SM240-25PPM	R983	SM653101269	SM51.1S
R899	SM651104392	SM3.9K-25PPM	R984	SM653101354	SM392.0S
R900	SM653101297	SM100.0S	R987	SM653101322	SM182.0S
R901	SM653101381	SM750.0S	R990	SM653101461	SM5.11KS
R902	SM653101381	SM750.0S	R991	SM653101465	SM5.62KS
R903	SM653101393	SM1.00KS	R1000	168909001	900.0K-.1%500V
R904	SM653101393	SM1.00KS	R1001	SM653101251	SM33.2S
R905	SM651104183	SM18K-25PPM	R1002	SM653101343	SM301.0S
R906	SM651104182	SM1.8K-25PPM	R1003	SM652061024	SM2.4-0603
R907	SM653101339	SM274.0S	R1004	SM653101251	SM33.2S
R908	SM185457201	SM200-1T	R1005	SM653101234	SM22.1S
R909	SM653101322	SM182.0S	R1006	SM653101489	SM10.0KS
R910	SM653101322	SM182.0S	R1007	SM653101358	SM432.0S
R911	SM653101322	SM182.0S	R1008	SM653101489	SM10.0KS
R912	SM653101322	SM182.0S	R1009	SM653101401	SM1.21KS
R913	SM653101285	SM75.0S	R1010	SM653101273	SM56.2S
R914	SM653101269	SM51.1S	R1011	SM652181590	SM113K-50PPM
R915	SM653101339	SM274.0S	R1012	SM168651315	SM154-1%
R916	SM653101330	SM221.0S	R1013	SM168651315	SM154-1%
R918	SM653101343	SM301.0S	R1015	SM653101347	SM332.0S
R919	SM653101354	SM392.0S	R1016	168909001	900.0K-.1%500V
R923	SM653101285	SM75.0S	R1017	SM652181590	SM113K-50PPM
R924	SM653101234	SM22.1S	R1018	SM653101269	SM51.1S
R925	SM653101234	SM22.1S	R1019	SM653101269	SM51.1S
R929	SM653101489	SM10.0KS	R1020	SM653101269	SM51.1S
R935	SM653101322	SM182.0S	R1021	SM653101297	SM100.0S
R936	SM653101322	SM182.0S	R1023	SM653101326	SM200.0S
R945	SM653101461	SM5.11KS	R1024	SM654101000	SM0S
R946	SM653101465	SM5.62KS	R1025	SM653101638	SM357.0KS
R947	SM653101322	SM182.0S	R1026	SM654101000	SM0S
R948	SM653101322	SM182.0S	R1027	SM653101418	SM1.82KS
R950	SM653101330	SM221.0S	R1028	SM653101639	SM365.0KS
R951	SM653101330	SM221.0S	R1029	SM653185107	SM100.0MS

PART: F9384-31 DESC: MAIN CARD (FRONT END, ADC, TDC) for 9384

Location	Part Number	Description	Location	Part Number	Description
R1031	SM653101639	SM365.0KS	R1084	SM653101614	SM200.0KS
R1032	SM653101638	SM357.0KS	R1085	SM653101393	SM1.00KS
R1034	SM653101393	SM1.00KS	R1086	SM653101393	SM1.00KS
R1036	SM653101642	SM392.0KS	R1087	SM653101393	SM1.00KS
R1037	SM653101642	SM392.0KS	R1088	SM653101393	SM1.00KS
R1038	SM185457503	SM50K-1T	R1089	SM653101393	SM1.00KS
R1040	SM653101458	SM4.75KS	R1092	SM653101334	SM243.0S
R1042	SM653101681	SM1.00MS	R1095	SM653101481	SM8.25KS
R1043	SM653101681	SM1.00MS	R1097	SM653101358	SM432.0S
R1046	SM653101343	SM301.0S	R1099	SM654101000	SM0S-B2P
R1047	SM653101393	SM1.00KS	R1100	SM654101000	SM0S-B2P
R1048	SM653101489	SM10.0KS	R1101	SM654101000	SM0S
R1049	SM653101557	SM51.1KS	R1102	SM654101000	SM0S
R1050	SM653101347	SM332.0S	R1103	SM653101334	SM243.0S
R1051	SM652061820	SM82-0603	R1105	SM653101418	SM1.82KS
R1052	SM653101422	SM2.00KS	R1106	SM653101285	SM75.0S
R1053	SM653101461	SM5.11KS	R1150	SM653101347	SM332.0S
R1054	SM654101000	SM0S	R1151	SM185657201	SM200-3313
R1055	SM653101354	SM392.0S	R1200	SM653101489	SM10.0KS
R1056	SM653101269	SM51.1S	R1201	SM185657500	SM500-3313
R1057	SM653101308	SM130.0S	R1202	SM653101269	SM51.1S
R1058	SM653101489	SM10.0KS	R1203	SM185657500	SM500-3313
R1059	SM653101289	SM82.5S	R1204	SM652061181	SM180-0603
R1060	SM653101489	SM10.0KS	R1500	SM653101269	SM51.1S
R1061	SM653101443	SM3.32KS	R1501	SM653101269	SM51.1S
R1062	SM653101269	SM51.1S	R1502	SM653101393	SM1.00KS
R1063	SM653101443	SM3.32KS	R1503	SM653101393	SM1.00KS
R1065	SM653101416	SM1.74KS	R1504	SM653101393	SM1.00KS
R1066	SM185457201	SM200-1T	R1505	SM653101393	SM1.00KS
R1067	SM653101365	SM511.0S	R1506	SM653101297	SM100.0S
R1068	SM653101443	SM3.32KS	R1507	SM653101489	SM10.0KS
R1069	SM653101373	SM619.0S	R1508	SM653101297	SM100.0S
R1070	SM653101358	SM432.0S	R1509	SM653101489	SM10.0KS
R1071	SM653101358	SM432.0S	R1510	SM653101489	SM10.0KS
R1072	SM651104392	SM3.9K-25PPM	R1511	SM653101297	SM100.0S
R1073	SM653101461	SM5.11KS	R1512	SM653101489	SM10.0KS
R1074	SM653101461	SM5.11KS	R1513	SM653101297	SM100.0S
R1075	SM653101461	SM5.11KS	R1514	SM654101000	SM0S
R1076	SM168651315	SM154-1/∞	R1515	SM653101393	SM1.00KS
R1078	SM653101602	SM150.0KS	R1516	SM653101393	SM1.00KS
R1079	SM653101489	SM10.0KS	R1517	SM653101393	SM1.00KS
R1080	SM653101569	SM68.1KS	R1518	SM653101393	SM1.00KS
R1081	SM653101458	SM4.75KS	R1519	SM653101489	SM10.0KS
R1082	SM653101461	SM5.11KS	R1520	SM653101393	SM1.00KS
R1083	SM653101393	SM1.00KS	R1529	SM653101393	SM1.00KS

PART: F9384-31 DESC: MAIN CARD (FRONT END, ADC, TDC) for 9384

Location	Part Number	Description	Location	Part Number	Description
R1530	SM653101393	SM1.00KS	R1584	SM653101281	SM68.1S
R1531	SM653101393	SM1.00KS	R1585	SM653101269	SM51.1S
R1532	SM653101393	SM1.00KS	R1586	SM653101269	SM51.1S
R1533	SM653101393	SM1.00KS	R1589	SM653101322	SM182.0S
R1534	SM653101285	SM75.0S	R1590	SM653101322	SM182.0S
R1535	SM653101285	SM75.0S	R1591	SM653101269	SM51.1S
R1536	SM653101326	SM200.0S	R1592	SM653101269	SM51.1S
R1537	SM653101281	SM68.1S	R1593	SM653101322	SM182.0S
R1538	SM653101281	SM68.1S	R1594	SM653101322	SM182.0S
R1539	SM653101326	SM200.0S	R1599	SM653101322	SM182.0S
R1540	SM653101281	SM68.1S	R1600	SM653101305	SM121.0S
R1542	SM653101326	SM200.0S	R1601	SM653101322	SM182.0S
R1543	SM653101281	SM68.1S	R1602	SM653101305	SM121.0S
R1544	SM653101326	SM200.0S	R1610	SM185457501	SM500-1T
R1549	SM653101305	SM121.0S	R1611	SM185457501	SM500-1T
R1550	SM653101322	SM182.0S	R1700	SM653101305	SM121.0S
R1551	SM653101305	SM121.0S	R1701	SM653101305	SM121.0S
R1553	SM653101322	SM182.0S	R1702	SM653101322	SM182.0S
R1554	SM653101305	SM121.0S	R1703	SM653101322	SM182.0S
R1555	SM653101322	SM182.0S	R1704	SM653101281	SM68.1S
R1556	SM653101322	SM182.0S	R1705	SM653101281	SM68.1S
R1558	SM653101322	SM182.0S	R1800	SM653101308	SM130.0S
R1559	SM653101305	SM121.0S	R1801	SM653101322	SM182.0S
R1561	SM653101322	SM182.0S	R1802	SM653101322	SM182.0S
R1563	SM653101305	SM121.0S	R1803	SM653101273	SM56.2S
R1564	SM653101322	SM182.0S	R1804	SM653101273	SM56.2S
R1565	SM653101305	SM121.0S	R1805	SM653101273	SM56.2S
R1566	SM653101305	SM121.0S	R1806	SM653101273	SM56.2S
R1567	SM653101305	SM121.0S	R1807	SM653101308	SM130.0S
R1568	SM653101322	SM182.0S	R1808	SM653101308	SM130.0S
R1569	SM653101326	SM200.0S	R1810	SM653101281	SM68.1S
R1570	SM653101326	SM200.0S	R1811	SM653101281	SM68.1S
R1571	SM653101326	SM200.0S	R1820	SM653101308	SM130.0S
R1572	SM653101326	SM200.0S	R1821	SM653101314	SM150.0S
R1573	SM653101281	SM68.1S	R1822	SM653101314	SM150.0S
R1574	SM653101281	SM68.1S	R1823	SM653101281	SM68.1S
R1575	SM653101281	SM68.1S	R1824	SM653101281	SM68.1S
R1576	SM653101281	SM68.1S	R1825	SM653101314	SM150.0S
R1577	SM653101314	SM150.0S	R1826	SM653101314	SM150.0S
R1578	SM653101314	SM150.0S	R1827	SM653101308	SM130.0S
R1579	SM653101314	SM150.0S	R2000	168909001	900.0K-.1%500V
R1580	SM653101314	SM150.0S	R2001	SM653101251	SM33.2S
R1581	SM653101281	SM68.1S	R2002	SM653101343	SM301.0S
R1582	SM653101281	SM68.1S	R2003	SM652061024	SM2.4-0603
R1583	SM653101281	SM68.1S	R2004	SM653101251	SM33.2S

Section 7 Schematics, Layouts, Parts list

PART: F9384-31 DESC: MAIN CARD (FRONT END, ADC, TDC) for 9384

Location	Part Number	Description	Location	Part Number	Description
R2005	SM653101234	SM22.1S	R2056	SM653101269	SM51.1S
R2006	SM653101489	SM10.0KS	R2057	SM653101308	SM130.0S
R2007	SM653101358	SM432.0S	R2058	SM653101489	SM10.0KS
R2008	SM653101489	SM10.0KS	R2059	SM653101289	SM82.5S
R2009	SM653101401	SM1.21KS	R2060	SM653101489	SM10.0KS
R2010	SM653101273	SM56.2S	R2061	SM653101443	SM3.32KS
R2011	SM652181590	SM113K-50PPM	R2062	SM653101269	SM51.1S
R2012	SM168651315	SM154-1%	R2063	SM653101443	SM3.32KS
R2013	SM168651315	SM154-1%	R2065	SM653101416	SM1.74KS
R2015	SM653101347	SM332.0S	R2066	SM185457201	SM200-1T
R2016	168909001	900.0K-.1%500V	R2067	SM653101365	SM511.0S
R2017	SM652181590	SM113K-50PPM	R2068	SM653101443	SM3.32KS
R2018	SM653101269	SM51.1S	R2069	SM653101373	SM619.0S
R2019	SM653101269	SM51.1S	R2070	SM653101358	SM432.0S
R2020	SM653101269	SM51.1S	R2071	SM653101358	SM432.0S
R2021	SM653101297	SM100.0S	R2072	SM651104392	SM3.9K-25PPM
R2023	SM653101326	SM200.0S	R2073	SM653101461	SM5.11KS
R2024	SM654101000	SM0S	R2074	SM653101461	SM5.11KS
R2025	SM653101638	SM357.0KS	R2075	SM653101461	SM5.11KS
R2026	SM654101000	SM0S	R2076	SM168651315	SM154-1/oo
R2027	SM653101418	SM1.82KS	R2078	SM653101602	SM150.0KS
R2028	SM653101639	SM365.0KS	R2079	SM653101489	SM10.0KS
R2029	SM653185107	SM100.0MS	R2080	SM653101569	SM68.1KS
R2031	SM653101639	SM365.0KS	R2081	SM653101458	SM4.75KS
R2032	SM653101638	SM357.0KS	R2082	SM653101461	SM5.11KS
R2034	SM653101393	SM1.00KS	R2083	SM653101393	SM1.00KS
R2035	SM653101281	SM68.1S	R2084	SM653101614	SM200.0KS
R2036	SM653101642	SM392.0KS	R2085	SM653101393	SM1.00KS
R2037	SM653101642	SM392.0KS	R2086	SM653101393	SM1.00KS
R2038	SM185457503	SM50K-1T	R2087	SM653101393	SM1.00KS
R2039	SM653101251	SM33.2S	R2088	SM653101393	SM1.00KS
R2040	SM653101458	SM4.75KS	R2089	SM653101393	SM1.00KS
R2042	SM653101681	SM1.00MS	R2092	SM653101334	SM243.0S
R2043	SM653101681	SM1.00MS	R2095	SM653101481	SM8.25KS
R2044	SM653101201	SM10.0S	R2097	SM653101358	SM432.0S
R2046	SM653101343	SM301.0S	R2099	SM654101000	SM0S-B2P
R2047	SM653101393	SM1.00KS	R2100	SM654101000	SM0S-B2P
R2048	SM653101489	SM10.0KS	R2101	SM654101000	SM0S
R2049	SM653101557	SM51.1KS	R2102	SM654101000	SM0S
R2050	SM653101347	SM332.0S	R2103	SM653101334	SM243.0S
R2051	SM652061820	SM82-0603	R2105	SM653101418	SM1.82KS
R2052	SM653101422	SM2.00KS	R2106	SM653101285	SM75.0S
R2053	SM653101461	SM5.11KS	R2150	SM653101347	SM332.0S
R2054	SM654101000	SM0S	R2151	SM185657201	SM200-3313
R2055	SM653101354	SM392.0S	R2200	SM653101489	SM10.0KS

PART: F9384-31 DESC: MAIN CARD (FRONT END, ADC, TDC) for 9384

Location	Part Number	Description	Location	Part Number	Description
R2201	SM185657500	SM500-3313	R2541	SM653101285	SM75.0S
R2202	SM653101269	SM51.1S	R2542	SM653101326	SM200.0S
R2203	SM185657500	SM500-3313	R2544	SM653101281	SM68.1S
R2204	SM652061181	SM180-0603	R2545	SM653101281	SM68.1S
R2500	SM653101269	SM51.1S	R2546	SM653101281	SM68.1S
R2501	SM653101269	SM51.1S	R2547	SM653101326	SM200.0S
R2502	SM653101489	SM10.0KS	R2548	SM653101281	SM68.1S
R2503	SM653101251	SM33.2S	R2549	SM653101326	SM200.0S
R2504	SM653101251	SM33.2S	R2550	SM653101326	SM200.0S
R2505	SM653101489	SM10.0KS	R2554	SM653101305	SM121.0S
R2506	SM653101489	SM10.0KS	R2555	SM653101322	SM182.0S
R2507	SM653101489	SM10.0KS	R2556	SM653101322	SM182.0S
R2508	SM653101489	SM10.0KS	R2557	SM653101305	SM121.0S
R2509	SM653101489	SM10.0KS	R2558	SM653101305	SM121.0S
R2510	SM653101489	SM10.0KS	R2559	SM653101322	SM182.0S
R2511	SM653101489	SM10.0KS	R2560	SM653101322	SM182.0S
R2512	SM653101251	SM33.2S	R2562	SM653101305	SM121.0S
R2513	SM653101251	SM33.2S	R2563	SM653101305	SM121.0S
R2514	SM653101489	SM10.0KS	R2564	SM653101322	SM182.0S
R2515	SM653101489	SM10.0KS	R2565	SM653101305	SM121.0S
R2516	SM653101489	SM10.0KS	R2566	SM653101322	SM182.0S
R2517	SM653101489	SM10.0KS	R2567	SM653101322	SM182.0S
R2518	SM653101489	SM10.0KS	R2568	SM653101305	SM121.0S
R2519	SM653101489	SM10.0KS	R2569	SM653101322	SM182.0S
R2520	SM653101489	SM10.0KS	R2570	SM653101305	SM121.0S
R2521	SM653101489	SM10.0KS	R2571	SM653101326	SM200.0S
R2522	SM653101393	SM1.00KS	R2572	SM653101326	SM200.0S
R2523	SM653101393	SM1.00KS	R2573	SM653101326	SM200.0S
R2524	SM653101393	SM1.00KS	R2574	SM653101326	SM200.0S
R2525	SM653101393	SM1.00KS	R2575	SM653101281	SM68.1S
R2526	SM653101393	SM1.00KS	R2576	SM653101281	SM68.1S
R2527	SM653101330	SM221.0S	R2577	SM653101281	SM68.1S
R2528	SM653101393	SM1.00KS	R2578	SM653101281	SM68.1S
R2529	SM653101322	SM182.0S	R2579	SM653101314	SM150.0S
R2530	SM653101373	SM619.0S	R2580	SM653101314	SM150.0S
R2531	SM653101255	SM36.5S	R2581	SM653101314	SM150.0S
R2532	SM653101397	SM1.10KS	R2582	SM653101314	SM150.0S
R2533	SM653101230	SM20.0S	R2583	SM653101281	SM68.1S
R2534	SM653101269	SM51.1S	R2584	SM653101281	SM68.1S
R2535	SM653101269	SM51.1S	R2585	SM653101281	SM68.1S
R2536	SM653101393	SM1.00KS	R2586	SM653101281	SM68.1S
R2537	SM653101266	SM47.5S	R2587	SM653101281	SM68.1S
R2538	SM653101266	SM47.5S	R2588	SM653101281	SM68.1S
R2539	SM653101393	SM1.00KS	R2589	SM653101354	SM392.0S
R2540	SM653101285	SM75.0S	R2590	SM653101343	SM301.0S

PART: F9384-31 DESC: MAIN CARD (FRONT END, ADC, TDC) for 9384

Location	Part Number	Description	Location	Part Number	Description
R2591	SM653101354	SM392.0S	R2718	SM653101281	SM68.1S
R2592	SM653101354	SM392.0S	R2719	SM653101281	SM68.1S
R2593	SM653101281	SM68.1S	R2720	SM653101281	SM68.1S
R2594	SM653101281	SM68.1S	R2722	SM653101281	SM68.1S
R2595	SM653101354	SM392.0S	R2723	SM653101308	SM130.0S
R2596	SM653101269	SM51.1S	R3000	168909001	900.0K-.1%500V
R2597	SM653101269	SM51.1S	R3001	SM653101251	SM33.2S
R2598	SM654101000	SM0S-2P	R3002	SM653101343	SM301.0S
R2600	SM653101322	SM182.0S	R3003	SM652061024	SM2.4-0603
R2601	SM653101322	SM182.0S	R3004	SM653101251	SM33.2S
R2602	SM653101269	SM51.1S	R3005	SM653101234	SM22.1S
R2603	SM653101269	SM51.1S	R3006	SM653101489	SM10.0KS
R2604	SM653101322	SM182.0S	R3007	SM653101358	SM432.0S
R2605	SM653101322	SM182.0S	R3008	SM653101489	SM10.0KS
R2618	SM653101305	SM121.0S	R3009	SM653101401	SM1.21KS
R2619	SM653101322	SM182.0S	R3010	SM653101273	SM56.2S
R2620	SM653101322	SM182.0S	R3011	SM652181590	SM113K-50PPM
R2621	SM653101305	SM121.0S	R3012	SM168651315	SM154-1%
R2622	SM653101281	SM68.1S	R3013	SM168651315	SM154-1%
R2623	SM653101281	SM68.1S	R3015	SM653101347	SM332.0S
R2624	SM653101281	SM68.1S	R3016	168909001	900.0K-.1%500V
R2625	SM653101281	SM68.1S	R3017	SM652181590	SM113K-50PPM
R2630	SM653101281	SM68.1S	R3018	SM653101269	SM51.1S
R2631	SM653101289	SM82.5S	R3019	SM653101269	SM51.1S
R2632	SM653101289	SM82.5S	R3020	SM653101269	SM51.1S
R2633	SM653101281	SM68.1S	R3021	SM653101297	SM100.0S
R2637	SM653101343	SM301.0S	R3023	SM653101326	SM200.0S
R2640	SM653101281	SM68.1S	R3024	SM654101000	SM0S
R2641	SM653101281	SM68.1S	R3025	SM653101638	SM357.0KS
R2700	SM653101273	SM56.2S	R3026	SM654101000	SM0S
R2701	SM653101273	SM56.2S	R3027	SM653101418	SM1.82KS
R2702	SM653101308	SM130.0S	R3028	SM653101639	SM365.0KS
R2703	SM653101273	SM56.2S	R3029	SM653185107	SM100.0MS
R2704	SM653101273	SM56.2S	R3031	SM653101639	SM365.0KS
R2705	SM653101308	SM130.0S	R3032	SM653101638	SM357.0KS
R2707	SM653101281	SM68.1S	R3034	SM653101393	SM1.00KS
R2708	SM653101281	SM68.1S	R3035	SM653101281	SM68.1S
R2710	SM653101308	SM130.0S	R3036	SM653101642	SM392.0KS
R2711	SM653101322	SM182.0S	R3037	SM653101642	SM392.0KS
R2712	SM653101322	SM182.0S	R3038	SM185457503	SM50K-1T
R2713	SM653101314	SM150.0S	R3039	SM653101251	SM33.2S
R2714	SM653101314	SM150.0S	R3040	SM653101458	SM4.75KS
R2715	SM653101314	SM150.0S	R3042	SM653101681	SM1.00MS
R2716	SM653101314	SM150.0S	R3043	SM653101681	SM1.00MS
R2717	SM653101308	SM130.0S	R3044	SM653101201	SM10.0S

PART: F9384-31 DESC: MAIN CARD (FRONT END, ADC, TDC) for 9384

Location	Part Number	Description	Location	Part Number	Description
R3046	SM653101343	SM301.0S	R3099	SM654101000	SM0S-B2P
R3047	SM653101393	SM1.00KS	R3100	SM654101000	SM0S-B2P
R3048	SM653101489	SM10.0KS	R3101	SM654101000	SM0S
R3049	SM653101557	SM51.1KS	R3102	SM654101000	SM0S
R3050	SM653101347	SM332.0S	R3103	SM653101334	SM243.0S
R3051	SM652061820	SM82-0603	R3105	SM653101418	SM1.82KS
R3052	SM653101422	SM2.00KS	R3106	SM653101285	SM75.0S
R3053	SM653101461	SM5.11KS	R3150	SM653101347	SM332.0S
R3054	SM654101000	SM0S	R3151	SM185657201	SM200-3313
R3055	SM653101354	SM392.0S	R3200	SM653101489	SM10.0KS
R3056	SM653101269	SM51.1S	R3201	SM185657500	SM500-3313
R3057	SM653101308	SM130.0S	R3202	SM653101269	SM51.1S
R3058	SM653101489	SM10.0KS	R3203	SM185657500	SM500-3313
R3059	SM653101289	SM82.5S	R3204	SM652061181	SM180-0603
R3060	SM653101489	SM10.0KS	R3500	SM653101269	SM51.1S
R3061	SM653101443	SM3.32KS	R3501	SM653101269	SM51.1S
R3062	SM653101269	SM51.1S	R3502	SM653101305	SM121.0S
R3063	SM653101443	SM3.32KS	R3503	SM653101305	SM121.0S
R3065	SM653101416	SM1.74KS	R3505	SM653101322	SM182.0S
R3066	SM185457201	SM200-1T	R3506	SM653101322	SM182.0S
R3067	SM653101365	SM511.0S	R3507	SM653101393	SM1.00KS
R3068	SM653101443	SM3.32KS	R3508	SM653101393	SM1.00KS
R3069	SM653101373	SM619.0S	R3509	SM653101393	SM1.00KS
R3070	SM653101358	SM432.0S	R3510	SM653101393	SM1.00KS
R3071	SM653101358	SM432.0S	R3511	SM653101297	SM100.0S
R3072	SM651104392	SM3.9K-25PPM	R3512	SM653101489	SM10.0KS
R3073	SM653101461	SM5.11KS	R3513	SM653101297	SM100.0S
R3074	SM653101461	SM5.11KS	R3514	SM653101489	SM10.0KS
R3075	SM653101461	SM5.11KS	R3515	SM653101297	SM100.0S
R3076	SM168651315	SM154-1/oo	R3516	SM653101297	SM100.0S
R3078	SM653101602	SM150.0KS	R3517	SM653101397	SM1.10KS
R3079	SM653101489	SM10.0KS	R3518	SM653101230	SM20.0S
R3080	SM653101569	SM68.1KS	R3520	SM653101255	SM36.5S
R3081	SM653101458	SM4.75KS	R3521	SM653101373	SM619.0S
R3082	SM653101461	SM5.11KS	R3522	SM653101393	SM1.00KS
R3083	SM653101393	SM1.00KS	R3523	SM653101393	SM1.00KS
R3084	SM653101614	SM200.0KS	R3524	SM653101393	SM1.00KS
R3085	SM653101393	SM1.00KS	R3525	SM653101393	SM1.00KS
R3086	SM653101393	SM1.00KS	R3526	SM653101269	SM51.1S
R3087	SM653101393	SM1.00KS	R3527	SM653101269	SM51.1S
R3088	SM653101393	SM1.00KS	R3529	SM653101393	SM1.00KS
R3089	SM653101393	SM1.00KS	R3530	SM653101393	SM1.00KS
R3092	SM653101334	SM243.0S	R3531	SM653101393	SM1.00KS
R3095	SM653101481	SM8.25KS	R3532	SM653101393	SM1.00KS
R3097	SM653101358	SM432.0S	R3533	SM653101393	SM1.00KS

PART: F9384-31 DESC: MAIN CARD (FRONT END, ADC, TDC) for 9384

Location	Part Number	Description	Location	Part Number	Description
R3534	SM653101285	SM75.0S	R3586	SM653101322	SM182.0S
R3535	SM653101285	SM75.0S	R3587	SM653101269	SM51.1S
R3536	SM653101326	SM200.0S	R3588	SM653101269	SM51.1S
R3537	SM653101326	SM200.0S	R3589	SM653101322	SM182.0S
R3538	SM653101281	SM68.1S	R3590	SM653101322	SM182.0S
R3539	SM653101281	SM68.1S	R3596	SM653101354	SM392.0S
R3540	SM653101281	SM68.1S	R3597	SM653101281	SM68.1S
R3541	SM653101326	SM200.0S	R3598	SM653101281	SM68.1S
R3542	SM653101281	SM68.1S	R3599	SM653101354	SM392.0S
R3543	SM653101326	SM200.0S	R3600	SM653101343	SM301.0S
R3548	SM653101305	SM121.0S	R3601	SM653101354	SM392.0S
R3549	SM653101305	SM121.0S	R3602	SM653101343	SM301.0S
R3550	SM653101322	SM182.0S	R3603	SM653101281	SM68.1S
R3551	SM653101305	SM121.0S	R3604	SM653101281	SM68.1S
R3553	SM653101322	SM182.0S	R3605	SM653101354	SM392.0S
R3554	SM653101322	SM182.0S	R3610	SM653101281	SM68.1S
R3555	SM653101305	SM121.0S	R3611	SM653101281	SM68.1S
R3556	SM653101322	SM182.0S	R3614	SM653101322	SM182.0S
R3557	SM653101322	SM182.0S	R3615	SM653101305	SM121.0S
R3558	SM653101305	SM121.0S	R3616	SM653101322	SM182.0S
R3559	SM653101322	SM182.0S	R3617	SM653101305	SM121.0S
R3560	SM653101305	SM121.0S	R3620	SM185457501	SM500-1T
R3561	SM653101305	SM121.0S	R3621	SM185457501	SM500-1T
R3562	SM653101305	SM121.0S	R3623	SM653101489	SM10.0KS
R3563	SM653101322	SM182.0S	R3624	SM653101489	SM10.0KS
R3564	SM653101322	SM182.0S	R3700	SM653101308	SM130.0S
R3565	SM653101314	SM150.0S	R3701	SM653101322	SM182.0S
R3566	SM653101314	SM150.0S	R3702	SM653101322	SM182.0S
R3567	SM653101314	SM150.0S	R3703	SM653101273	SM56.2S
R3568	SM653101314	SM150.0S	R3704	SM653101273	SM56.2S
R3569	SM653101281	SM68.1S	R3705	SM653101308	SM130.0S
R3570	SM653101281	SM68.1S	R3706	SM653101273	SM56.2S
R3571	SM653101281	SM68.1S	R3707	SM653101273	SM56.2S
R3572	SM653101281	SM68.1S	R3708	SM653101308	SM130.0S
R3573	SM653101326	SM200.0S	R3710	SM653101281	SM68.1S
R3574	SM653101326	SM200.0S	R3711	SM653101281	SM68.1S
R3575	SM653101326	SM200.0S	R3712	SM653101308	SM130.0S
R3576	SM653101326	SM200.0S	R3713	SM653101314	SM150.0S
R3577	SM653101281	SM68.1S	R3714	SM653101314	SM150.0S
R3578	SM653101281	SM68.1S	R3715	SM653101314	SM150.0S
R3579	SM653101281	SM68.1S	R3716	SM653101281	SM68.1S
R3580	SM653101281	SM68.1S	R3717	SM653101281	SM68.1S
R3581	SM653101269	SM51.1S	R3718	SM653101314	SM150.0S
R3582	SM653101269	SM51.1S	R3719	SM653101308	SM130.0S
R3585	SM653101322	SM182.0S	R4000	168909001	900.0K-.1%500V

PART: F9384-31 DESC: MAIN CARD (FRONT END, ADC, TDC) for 9384

Location	Part Number	Description	Location	Part Number	Description
R4001	SM653101251	SM33.2S	R4055	SM653101354	SM392.0S
R4002	SM653101343	SM301.0S	R4056	SM653101269	SM51.1S
R4003	SM652061024	SM2.4-0603	R4057	SM653101308	SM130.0S
R4004	SM653101251	SM33.2S	R4058	SM653101489	SM10.0KS
R4005	SM653101234	SM22.1S	R4059	SM653101289	SM82.5S
R4006	SM653101489	SM10.0KS	R4060	SM653101489	SM10.0KS
R4007	SM653101358	SM432.0S	R4061	SM653101443	SM3.32KS
R4008	SM653101489	SM10.0KS	R4062	SM653101269	SM51.1S
R4009	SM653101401	SM1.21KS	R4063	SM653101443	SM3.32KS
R4010	SM653101273	SM56.2S	R4065	SM653101416	SM1.74KS
R4011	SM652181590	SM113K-50PPM	R4066	SM185457201	SM200-1T
R4012	SM168651315	SM154-1%	R4067	SM653101365	SM511.0S
R4013	SM168651315	SM154-1%	R4068	SM653101443	SM3.32KS
R4015	SM653101347	SM332.0S	R4069	SM653101373	SM619.0S
R4016	168909001	900.0K-.1%500V	R4070	SM653101358	SM432.0S
R4017	SM652181590	SM113K-50PPM	R4071	SM653101358	SM432.0S
R4018	SM653101269	SM51.1S	R4072	SM651104392	SM3.9K-25PPM
R4019	SM653101269	SM51.1S	R4073	SM653101461	SM5.11KS
R4020	SM653101269	SM51.1S	R4074	SM653101461	SM5.11KS
R4021	SM653101297	SM100.0S	R4075	SM653101461	SM5.11KS
R4023	SM653101326	SM200.0S	R4076	SM168651315	SM154-1/oo
R4024	SM654101000	SM0S	R4078	SM653101602	SM150.0KS
R4025	SM653101638	SM357.0KS	R4079	SM653101489	SM10.0KS
R4026	SM654101000	SM0S	R4080	SM653101569	SM68.1KS
R4027	SM653101418	SM1.82KS	R4081	SM653101458	SM4.75KS
R4028	SM653101639	SM365.0KS	R4082	SM653101461	SM5.11KS
R4029	SM653185107	SM100.0MS	R4083	SM653101393	SM1.00KS
R4031	SM653101639	SM365.0KS	R4084	SM653101614	SM200.0KS
R4032	SM653101638	SM357.0KS	R4085	SM653101393	SM1.00KS
R4034	SM653101393	SM1.00KS	R4086	SM653101393	SM1.00KS
R4036	SM653101642	SM392.0KS	R4087	SM653101393	SM1.00KS
R4037	SM653101642	SM392.0KS	R4088	SM653101393	SM1.00KS
R4038	SM185457503	SM50K-1T	R4089	SM653101393	SM1.00KS
R4040	SM653101458	SM4.75KS	R4092	SM653101334	SM243.0S
R4042	SM653101681	SM1.00MS	R4095	SM653101481	SM8.25KS
R4043	SM653101681	SM1.00MS	R4097	SM653101358	SM432.0S
R4046	SM653101343	SM301.0S	R4099	SM654101000	SM0S-B2P
R4047	SM653101393	SM1.00KS	R4100	SM654101000	SM0S-B2P
R4048	SM653101489	SM10.0KS	R4101	SM654101000	SM0S
R4049	SM653101557	SM51.1KS	R4102	SM654101000	SM0S
R4050	SM653101347	SM332.0S	R4103	SM653101334	SM243.0S
R4051	SM652061820	SM82-0603	R4105	SM653101418	SM1.82KS
R4052	SM653101422	SM2.00KS	R4106	SM653101285	SM75.0S
R4053	SM653101461	SM5.11KS	R4150	SM653101347	SM332.0S
R4054	SM654101000	SM0S	R4151	SM185657201	SM200-3313

PART: F9384-31 DESC: MAIN CARD (FRONT END, ADC, TDC) for 9384

Location	Part Number	Description	Location	Part Number	Description
R4200	SM653101489	SM10.0KS	R4551	SM653101322	SM182.0S
R4201	SM185657500	SM500-3313	R4552	SM653101326	SM200.0S
R4202	SM653101269	SM51.1S	R4553	SM653101326	SM200.0S
R4203	SM185657500	SM500-3313	R4554	SM653101326	SM200.0S
R4204	SM652061181	SM180-0603	R4555	SM653101326	SM200.0S
R4502	SM653101330	SM221.0S	R4556	SM653101281	SM68.1S
R4503	SM653101393	SM1.00KS	R4557	SM653101281	SM68.1S
R4504	SM653101322	SM182.0S	R4558	SM653101281	SM68.1S
R4505	SM653101393	SM1.00KS	R4559	SM653101281	SM68.1S
R4507	SM653101251	SM33.2S	R4560	SM653101314	SM150.0S
R4508	SM653101489	SM10.0KS	R4561	SM653101314	SM150.0S
R4509	SM653101489	SM10.0KS	R4562	SM653101314	SM150.0S
R4510	SM653101489	SM10.0KS	R4563	SM653101314	SM150.0S
R4511	SM653101489	SM10.0KS	R4564	SM653101281	SM68.1S
R4512	SM653101489	SM10.0KS	R4565	SM653101281	SM68.1S
R4513	SM653101489	SM10.0KS	R4566	SM653101281	SM68.1S
R4514	SM653101489	SM10.0KS	R4567	SM653101281	SM68.1S
R4515	SM653101251	SM33.2S	R4568	SM653101322	SM182.0S
R4516	SM653101251	SM33.2S	R4569	SM653101322	SM182.0S
R4517	SM653101489	SM10.0KS	R4570	SM653101269	SM51.1S
R4518	SM653101285	SM75.0S	R4571	SM653101269	SM51.1S
R4519	SM653101285	SM75.0S	R4572	SM653101322	SM182.0S
R4520	SM653101326	SM200.0S	R4573	SM653101322	SM182.0S
R4521	SM653101326	SM200.0S	R4576	SM653101269	SM51.1S
R4522	SM653101305	SM121.0S	R4577	SM653101269	SM51.1S
R4523	SM653101326	SM200.0S	R4578	SM653101305	SM121.0S
R4524	SM653101326	SM200.0S	R4579	SM653101322	SM182.0S
R4525	SM653101281	SM68.1S	R4580	SM653101322	SM182.0S
R4526	SM653101281	SM68.1S	R4581	SM653101305	SM121.0S
R4527	SM653101281	SM68.1S	R4583	SM653101251	SM33.2S
R4528	SM653101281	SM68.1S	R4584	SM654101000	SM0S-2P
R4533	SM653101305	SM121.0S	R4600	SM653101273	SM56.2S
R4534	SM653101322	SM182.0S	R4601	SM653101273	SM56.2S
R4535	SM653101322	SM182.0S	R4602	SM653101308	SM130.0S
R4536	SM653101305	SM121.0S	R4603	SM653101273	SM56.2S
R4537	SM653101305	SM121.0S	R4604	SM653101273	SM56.2S
R4538	SM653101322	SM182.0S	R4605	SM653101308	SM130.0S
R4539	SM653101322	SM182.0S	R4607	SM653101281	SM68.1S
R4540	SM653101322	SM182.0S	R4608	SM653101281	SM68.1S
R4544	SM653101322	SM182.0S	R4610	SM653101322	SM182.0S
R4546	SM653101305	SM121.0S	R4611	SM653101322	SM182.0S
R4547	SM653101322	SM182.0S	R4620	SM653101308	SM130.0S
R4548	SM653101305	SM121.0S	R5000	SM653101251	SM33.2S
R4549	SM653101305	SM121.0S	R5001	SM653101234	SM22.1S
R4550	SM653101305	SM121.0S	R5002	SM653101201	SM10.0S

PART: F9384-31 DESC: MAIN CARD (FRONT END, ADC, TDC) for 9384

Location	Part Number	Description	Location	Part Number	Description
R5003	SM653101251	SM33.2S	R5057	SM654101000	SM0S
R5004	SM653101251	SM33.2S	R5060	SM654101000	SM0S
R5005	SM653101585	SM100.0KS	R5061	SM653101443	SM3.32KS
R5006	168909001	900.0K-.1%500V	R5062	SM653101443	SM3.32KS
R5007	SM653101297	SM100.0S	R5064	SM654101000	SM0S
R5008	SM653101418	SM1.82KS	R5066	SM654101000	SM0S
R5010	168909001	900.0K-.1%500V	R5067	SM653101443	SM3.32KS
R5011	SM653101269	SM51.1S	R5068	SM653101461	SM5.11KS
R5012	SM653101418	SM1.82KS	R5071	SM653101269	SM51.1S
R5013	SM653101401	SM1.21KS	R5072	SM653101269	SM51.1S
R5014	SM653101377	SM681.0S	R5073	SM653101418	SM1.82KS
R5015	SM653185107	SM100.0MS	R5074	SM653101418	SM1.82KS
R5016	SM168659006	SM111.1K-1/oo	R5075	SM653101369	SM562.0S
R5017	SM653101506	SM15.0KS	R5076	SM653101369	SM562.0S
R5018	SM653101514	SM18.2KS	R5077	SM653101509	SM16.2KS
R5020	SM653101297	SM100.0S	R5078	SM185457203	SM20K-1T
R5021	SM653101354	SM392.0S	R5079	SM653101509	SM16.2KS
R5022	SM653101281	SM68.1S	R5080	SM185457203	SM20K-1T
R5023	SM653101650	SM475.0KS	R5081	SM653101443	SM3.32KS
R5024	SM653101665	SM681.0KS	R5082	SM654101000	SM0S
R5025	SM653101489	SM10.0KS	R5084	SM654101000	SM0S
R5026	SM653101585	SM100.0KS	R5086	SM653101443	SM3.32KS
R5027	SM653101251	SM33.2S	R5087	SM653101461	SM5.11KS
R5028	SM653101285	SM75.0S	R5088	SM653101443	SM3.32KS
R5029	SM652110904	SM900K-5/oo	R5089	SM654101000	SM0S
R5030	SM653101297	SM100.0S	R5091	SM654101000	SM0S
R5031	SM653101365	SM511.0S	R5093	SM653101443	SM3.32KS
R5032	SM653101489	SM10.0KS	R5094	SM653101461	SM5.11KS
R5033	SM653101281	SM68.1S	R5095	SM653101269	SM51.1S
R5034	SM653101201	SM10.0S	R5096	SM653101269	SM51.1S
R5035	SM653101362	SM475.0S	R5097	SM653101418	SM1.82KS
R5036	SM653101297	SM100.0S	R5099	SM653101369	SM562.0S
R5038	SM653101673	SM825.0KS	R5100	SM653101326	SM200.0S
R5039	SM653101269	SM51.1S	R5101	SM653101269	SM51.1S
R5040	SM653101418	SM1.82KS	R5103	SM653101509	SM16.2KS
R5041	SM653101269	SM51.1S	R5104	SM653101326	SM200.0S
R5042	SM653101418	SM1.82KS	R5106	SM653101322	SM182.0S
R5045	SM653101369	SM562.0S	R5107	SM653101461	SM5.11KS
R5049	SM653101369	SM562.0S	R5108	SM185457203	SM20K-1T
R5051	SM653101461	SM5.11KS	R5109	SM653101322	SM182.0S
R5052	SM653101509	SM16.2KS	R5110	SM653101461	SM5.11KS
R5053	SM185457203	SM20K-1T	R5111	SM653101461	SM5.11KS
R5054	SM653101509	SM16.2KS	R5112	SM653101443	SM3.32KS
R5055	SM185457203	SM20K-1T	R5113	SM654101000	SM0S
R5056	SM653101443	SM3.32KS	R5115	SM654101000	SM0S

PART: F9384-31 DESC: MAIN CARD (FRONT END, ADC, TDC) for 9384

Location	Part Number	Description	Location	Part Number	Description
R5117	SM653101443	SM3.32KS	R6012	SM653101308	SM130.0S
R5118	SM653101461	SM5.11KS	R6013	SM653101354	SM392.0S
R5119	SM653101465	SM5.62KS	R6014	SM168659007	SM3.0K-1/oo
R5120	SM653101465	SM5.62KS	R6015	SM168659007	SM3.0K-1/oo
R5121	SM653101461	SM5.11KS	R6016	SM168659004	SM900-1/oo
R5122	SM653101465	SM5.62KS	R6017	SM168659297	SM100-1/oo
R5123	SM653101465	SM5.62KS	R6018	SM653101450	SM3.92KS
R5125	SM653101305	SM121.0S	R6019	SM653101397	SM1.10KS
R5126	SM168651297	SM100-1%MM	R6020	SM168659007	SM3.0K-1/oo
R5127	SM168651297	SM100-1%MM	R6021	SM653101234	SM22.1S
R5129	SM185457502	SM5K-1T	R6022	SM653101297	SM100.0S
R5130	SM653101569	SM68.1KS	R6023	SM653101297	SM100.0S
R5131	SM653101450	SM3.92KS	R7000	SM653101289	SM82.5S
R5132	SM653101681	SM1.00MS	R7001	SM653101308	SM130.0S
R5133	SM653101461	SM5.11KS	R7002	SM653101308	SM130.0S
R5134	SM653101461	SM5.11KS	R7003	SM653101269	SM51.1S
R5135	SM653101461	SM5.11KS	R7004	SM653101289	SM82.5S
R5136	SM653101481	SM8.25KS	R7005	SM653101450	SM3.92KS
R5137	SM653101443	SM3.32KS	R7006	SM653101450	SM3.92KS
R5139	SM653101397	SM1.10KS	R7007	SM653101450	SM3.92KS
R5140	SM653101393	SM1.00KS	R7008	SM653101450	SM3.92KS
R5141	SM653101461	SM5.11KS	RL1000	430430004	RL-RP1-12
R5142	SM653101461	SM5.11KS	RL1001	430430004	RL-RP1-12
R5143	SM653101269	SM51.1S	RL1002	430430004	RL-RP1-12
R5144	SM653101269	SM51.1S	RL1003	430490005	RL-RK1-12
R5145	SM653101269	SM51.1S	RL1004	430430004	RL-RP1-12
R5146	SM653101269	SM51.1S	RL1005	430490005	RL-RK1-12
R5147	SM653101269	SM51.1S	RL1006	430430004	RL-TK1-12
R5148	SM653101297	SM100.0S	RL2000	430430004	RL-RP1-12
R5150	SM653101297	SM100.0S	RL2001	430430004	RL-RP1-12
R5160	SM168651315	SM154-1/oo	RL2002	430430004	RL-RP1-12
R5161	SM168651315	SM154-1/oo	RL2003	430490005	RL-RK1-12
R5201	SM653101269	SM51.1S	RL2004	430430004	RL-RP1-12
R6000	SM653101251	SM33.2S	RL2005	430490005	RL-RK1-12
R6001	SM168659007	SM3.0K-1/oo	RL2006	430430004	RL-TK1-12
R6002	SM168659297	SM100-1/oo	RL3000	430430004	RL-RP1-12
R6003	SM168659297	SM100-1/oo	RL3001	430430004	RL-RP1-12
R6004	SM653101347	SM332.0S	RL3002	430430004	RL-RP1-12
R6005	SM653101397	SM1.10KS	RL3003	430490005	RL-RK1-12
R6006	SM653101251	SM33.2S	RL3004	430430004	RL-RP1-12
R6007	SM653101322	SM182.0S	RL3005	430490005	RL-RK1-12
R6008	SM653101397	SM1.10KS	RL3006	430430004	RL-TK1-12
R6009	SM653101373	SM619.0S	RL4000	430430004	RL-RP1-12
R6010	SM653101461	SM5.11KS	RL4001	430430004	RL-RP1-12
R6011	SM653101461	SM5.11KS	RL4002	430430004	RL-RP1-12

PART: F9384-31 DESC: MAIN CARD (FRONT END, ADC, TDC) for 9384

Location	Part Number	Description	Location	Part Number	Description
RL4003	430490005	RL-RK1-12	U702	SM207970057	SM10EL57
RL4004	430430004	RL-RP1-12	U703	SM200178002	SM74HCT02
RL4005	430490005	RL-RK1-12	U704	SM201574058	SM10EL58
RL4006	430430004	RL-TK1-12	U726	SM205618594	SM74HC594-PS
RL5000	430490003	RL-TQ2-12	U1041	SM201174011	SM10EL11
RL5001	430430004	RL-RP1-12	U1045	SM201174005	SM10EL05
S1	SM654101000	SM0S-2P	U1046	SM201174005	SM10EL05
TC1000	F9384-7	9384-7	U1047	SM201174005	SM10EL05
TC2000	F9384-7	9384-7	U1048	SM201174005	SM10EL05
TC3000	F9384-7	9384-7	U1054	SM201174011	SM10EL11
TC4000	F9384-7	9384-7	U1056	SM201174011	SM10EL11
TP201	454313010	2x5-ST-M-NW	U1057	SM201174011	SM10EL11
TP202	454313010	2x5-ST-M-NW-	U1500	SM206884623	SM74ABT623
TP203	454313010	2x5-ST-M-NW-	U1501	SM205701070	SRAM128Kx8-70
TP700	454340002	2x1-ST-M-NW	U1502	MDX622	MDX622A
TP710	454340002	2x1-ST-M-NW	U1503	HAD621	HAD621A
TP720	454340002	2x1-ST-M-NW	U1504	SM201174011	SM10EL11
TP730	454340002	2x1-ST-M-NW	U1505	SM208470347	SMLF347
TP740	454340002	2x1-ST-M-NW	U1506	SM208470347	SMLF347
TP750	454340002	2x1-ST-M-NW	U1508	SM208591336	SMLM336-5
TP760	454340002	2x1-ST-M-NW	U1509	SM208470353	SMLF353
TP770	454340002	2x1-ST-M-NW	U1510	SM200470573	SM74LVT573
TP800	454340002	2x1-ST-M-NW	U1511	SM200470573	SM74LVT573
TP1001	454312004	2x2-ST-M-NW	U1530	SM206980056	SM100EL56
TP1500	454313010	2x5-ST-M-NW	U2500	SM206884623	SM74ABT623
TP2001	454312004	2x2-ST-M-NW	U2501	SM205701070	SRAM128Kx8-70
TP2500	454313010	2x5-ST-M-NW	U2502	MDX622	MDX622A
TP2501	454312010	2x5-ST-M-NW	U2503	HAD621	HAD621A
TP3001	454312004	2x2-ST-M-NW	U2504	SM207288800	SMDAC8800
TP4001	454312004	2x2-ST-M-NW	U2505	SM208470347	SMLF347
TP4500	454313010	2x5-ST-M-NW	U2506	SM200170032	SM74F32
TP5000	454340002	2x1-ST-M-NW	U2507	SM207970139	SM74F139
TP5500	454313010	2x5-ST-M-NW	U2511	SM205618594	SM74HC594-PS
TP6000	454710002	2x1-RT-M-NW	U2513	SM201174005	SM10EL05
U114	C-PAD-010-4	C-PAD-010-4	U2514	SM201174005	SM10EL05
U336	SM201174011	SM10EL11	U2515	SM201174005	SM10EL05
U337	SM201174011	SM10EL11	U2516	SM201174005	SM10EL05
U338	SM201174011	SM10EL11	U2517	SM201174011	SM10EL11
U339	SM201174011	SM10EL11	U2518	SM201174011	SM10EL11
U340	SM201174001	SM10EL01	U2520	SM201174011	SM10EL11
U360	SM201174031	SM10EL31	U2521	SM208470347	SMLF347
U361	SM201174031	SM10EL31	U2522	SM207288800	SMDAC8800
U364	SM207970057	SM10EL57	U2523	SM206980056	SM100EL56
U700	SM205108016	SM24LC16B	U2524	SM201174011	SM10EL11
U701	SM207970057	SM10EL57	U2530	SM206980056	SM100EL56

Section 7 Schematics, Layouts, Parts list

PART: F9384-31 DESC: MAIN CARD (FRONT END, ADC, TDC) for 9384

Location	Part Number	Description	Location	Part Number	Description
U2540	SM206980056	SM100EL56			
U2541	SM201174011	SM10EL11			
U2542	SM201174011	SM10EL11			
U3453	SM206980056	SM100EL56			
U3500	SM206884623	SM74ABT623			
U3501	SM205701070	SRAM128Kx8-70			
U3502	MDX622	MDX622A			
U3503	HAD621	HAD621A			
U3504	SM201174011	SM10EL11			
U3505	SM208470347	SMLF347			
U3506	SM208470347	SMLF347			
U3507	SM207288800	SMDAC8800			
U3512	SM201174005	SM10EL05			
U3513	SM201174005	SM10EL05			
U3514	SM201174005	SM10EL05			
U3515	SM201174005	SM10EL05			
U3516	SM201174011	SM10EL11			
U3517	SM201174011	SM10EL11			
U3519	SM201174011	SM10EL11			
U3520	SM208470347	SMLF347			
U3521	SM205618594	SM74HC594-PS			
U3530	SM206980056	SM100EL56			
U3540	SM206980056	SM100EL56			
U3541	SM201174011	SM10EL11			
U3542	SM201174011	SM10EL11			
U4500	SM206884623	SM74ABT623			
U4501	SM205701070	SRAM128Kx8-70			
U4502	MDX622	MDX622A			
U4503	HAD621	HAD621A			
U4504	SM208470347	SMLF347			
U4510	SM201174005	SM10EL05			
U4511	SM201174005	SM10EL05			
U4512	SM201174005	SM10EL05			
U4513	SM201174005	SM10EL05			
U4514	SM201174011	SM10EL11			
U4515	SM201174011	SM10EL11			
U4517	SM201174011	SM10EL11			
U4520	SM200470573	SM74LVT573			
U4521	SM200470573	SM74LVT573			
U4522	SM200170032	SM74F32			
Y700	311210000	OSC-18D10MHz			
Y5001	SM311414318	SM14.31818MHz			

PART: F9384-31 DESC: MAIN CARD (FRONT END, ADC, TDC) for 9384

COMPONENT	PART DESCRIPTION	QTY PER ASSEMBLY
146544471	CAP MINI ALUM 20% 470 UF	1
146554476	CAP MINI ALUM 20% 47 UF	2
146574227	CAP MINI ALUM 20% 220 UF	3
146654107	CAP MINI ALUM 20% 100 UF	2
158899003	CAP VARIABLE .5 - 2.5 PF	4
161030000	RES COMP ZERO OHMS	1
168909001	RES ULTRA PREC 900K 0.25% 500V	10
169416473	RESISTOR DISC NTC 47 K	1
208123002	IC +12 VOLT REG LM340T-12	3
208124003	IC VOLT REG -12V LM320T-12	3
235010005	DIODE RECTIFIER 1N4005	1
290120005	DELAY LINE 5 N-SEC	1
290120009	DELAY LINE 9 N-SEC	1
290199015	DELAY LINE 1.5 NS	2
290199020	DELAY LINE 2.0 NS	1
311210000	CRYSTAL OSCILLATOR 3PPM 10MHZ	1
430430004	RELAY HF 12V MINIATURE	21
430490003	RELAY 2 FORM C DPDT	1
430490005	RELAY 1 FORM C SPDT	8
454111024	HDR 2MM PRESSFIT TO FEMALE 4X6	18
454112024	HDR SOLD TAIL/MAIL 24	1
454117003	FRICTION HEADER STRAIGHT .1 CENTERS	1
454220096	HDR PRESSFIT TO FEM 96	1
454312004	HDR SOLD TAIL/WW 4	4
454312010	HDR SOLD TAIL/MALE 10	1
454313010	HDR DIP SOLD TO PCB 2X5	7
454340002	HDR SOLD TAIL/WW 2	10
454390002	HDR FRICTION LOCK 2-PIN	1
454710002	HDR SOLD TAIL/MALE 2	1
505019968	HEAT SINK VERTICAL MTG	2
505070220	HEATSINK WITH TAG FOR TO-220	2
505112016	HEAT SINK FOR DIP-16	5
505121002	HEATSINK 1.5"X.65", .8" HIGH	4
505121003	HEATSINK, 1.1"X1.0", .8" HIGH	4
505121004	HEATSINK, .9"X1.0", .8" HIGH	1
530040007	BUZZER 85DB 5V SMALL	1
593910001	CABLE CO-AXIAL RG178B/U	5
594220026	MICRO WIRE CLIP, SIDE ENTRY	7
709354411	9354-4 OSCILLATOR SHIELD	1
709370311	HFE419 HEATSINK	4
709370321	HFE419 HEATSINK CLIP	4
7093XXP01	RIGHT ANGLE RECEPT. CONNECTOR	6
7093XXP21	BULKHEAD RECEPTACLE FEMALE BNC	6
719384301	PC BD PREASSEMBLY 9384-31	1
CH599041022	HEAT SINK COMPOUND 251	0

PART: F9384-31 DESC: MAIN CARD (FRONT END, ADC, TDC) for 9384

COMPONENT	PART DESCRIPTION	QTY PER ASSEMBLY
CH599045013	THERMALLY CONDUCTIVE ADHESIVE	0
F9354-4	400-500MHZ PLL OSCILLATOR	1
F9384-7	T-COIL 9384	4
FP9384-3	MAIN CARD FRONT PANEL 9384-3	1
HAD621	HYBRID 1GS/S DUAL DIFF INPUT ADC	4
HFE624	HYBRID FRONT END HFE624	4
MCL404	IC MEM GATE ARRAY MCL404	1
MDX622IC 2:8 ECL TO TTL	DEMULTIPLEXER	4
MST412	IC SMART TRIGGER GATE ARRAY MST412	1
MTB411	IC TIME BASE GATE ARRAY MTB411	1
MTR408	INTEGRATED TRIGGER	5
SM158240200	CAP VARIABLE .6 - 2.5 PF	10
SM158240201	CAP VARIABLE 1 - 5 PF	1
SM158240203	CAP VARIABLE 5 - 18 PF	8
SM168651297	RES METAL FILM 1% 100 OHM	2
SM168651315	RES METAL FILM 1% 154 OHMS	14
SM168659004	RES METAL FILM .1% 900 OHMS	1
SM168659006	RES METAL FILM .1% 111.1 K	1
SM168659007	RES METAL FILM .1% 3.00K	4
SM168659297	RES METAL FILM .1% 100 OHMS	3
SM185457201	RES VARI CERMET 200 OHMS	5
SM185457203	RES VARI CERMET 20 K	5
SM185457501	RES VARI CERMET 500 OHMS	4
SM185457502	RES VARI CERMET 5 K	1
SM185457503	RES VARI CERMET 50 K	4
SM185657201	RES VARI CERMET 200 OHMS 3MM	4
SM185657500	RES VARI CERMET 500 OHMS 3MM	8
SM200167102	IC NOR GATE 10H102	2
SM200167164	IC 8 TO 1 MPLX 10H164	1
SM200169016	IC BINARY UP COUNTER 10E016	3
SM200169191	IC UP-DOWN BIN COUNTER N74F191D	5
SM200170032	IC 2-IN OR GATE 74F32	2
SM200178000	IC 2-INPUT NAND HCT00	1
SM200178002	IC 2-INPUT NOR HCT02	3
SM200178030	IC 8-IN NAND HCT30	1
SM200178074	IC D-TYP FLOP 74HCT74	2
SM200178138	IC 3-TO-8-LINE DECODER HCT138	4
SM200178273	IC D-TYP FLOP 74HCT273	2
SM200178374	IC D-TYP FLOP 74HCT374	1
SM200278040	IC COUNTER HCT4040	1
SM200470573	IC 3.3V D-TYPE LATCH	4
SM201164104	IC QUINT 2-IN AND/NAND 10E104	1
SM201164131	IC M/S D-TYP FLOP 10E131	1
SM201174001	IC ECL 4 IN OR/NOR 10EL01D	3
SM201174005	IC ECL 2-IN DIFF AND/NAND 10EL05D	16

PART: F9384-31 DESC: MAIN CARD (FRONT END, ADC, TDC) for 9384

COMPONENT	PART DESCRIPTION	QTY PER ASSEMBLY
SM201174011	IC ECL 1:2 DIFF CLOCK DRVR 10EL11D	25
SM201174031	IC ECL FLIP FLOP SET/RESET 10EL31D	9
SM201274032	IC ECL DIVIDE BY 2 10EL32D	3
SM201274033	IC ECL DIVIDE BY 4 MC10EL33	1
SM201570016	IC ECL DIFF RECEIVER 10EL16D	2
SM201574058	IC ECL 2:1 MUX 10EL58D	1
SM205045300	PROGRAMMED GAL MIMOSA-A	1
SM205045350	PROGRAMMED GAL ROUTE1-A	1
SM205045351	PROGRAMMED GAL ROUTE2-A	1
SM205045352	PROGRAMMED GAL ROUTE2-B	1
SM205045354	PROGRAMMED GAL AVENUE-A	1
SM205045355	PROGRAMMED GAL RUELLE-A	1
SM205045357	PROGRAMMED GAL CHEMIN-A	1
SM205045358	PROGRAMMED GAL ROUTE 3-C	1
SM205045359	PROGRAMMED GAL ARTERE-B	1
SM205108016	IC EEPROM 16K BIT IIC BUS	2
SM205618165	IC 8-BIT SHIFT REG 74HCT165	1
SM205618594	IC 8-BIT SHIFT REG 74HC594	23
SM205701070	IC 128KX8 STAT RAM 70 NS	4
SM206070584	IC BUS CONTROLLER 8584	1
SM206260858	IC OCT 8-BIT ADC SYSTEM 858	1
SM206884623	IC OCTAL BUS TRANSCVR ABT623	6
SM206885245	IC BUS TRANSCVR ABT245	2
SM206970457	IC 3 DIFF 2:1 MUX MC10E457	1
SM206980056	IC ECL DUAL DIFF 2:1 MUX MC100EL56	7
SM207130025	TRANSISTOR NPN BFT25A	1
SM207170367	IC HEX BUFFER 74HC367	1
SM207171244	IC OCTAL BUFFER ABT244	4
SM207280703	IC 16-BIT DAC 703	1
SM207288800	IC OCTL 8-BIT CMOS D/A CONV DAC8800	3
SM207360125	IC TRANSLATOR MC10125	3
SM207367124	IC TRANSLATOR 10H124	1
SM207367125	IC TRANSLATOR 10H125	1
SM207770201	IC ANALOG SWITCH DG201	4
SM207770403	IC ANALOG SWITCH DG403	1
SM207770442	IC ANALOG SWITCH DG442	5
SM207960157	IC QUAD 2:1 MULTIPLEXER 10E157	1
SM207970057	IC 4:1 DIFF MUX 10EL57	3
SM207970139	IC DECODER/DEMUX 74F139	3
SM207970351	IC OCTAL ANALOG MUX/DEMUX 74HC4351	1
SM207970508	IC ANALOG MULT PLX 8 TO 1 DG508	1
SM207972157	IC DATA SEL/MUX 74F157A	1
SM207978153	IC 4-INPUT MUX HCT153	1
SM207978251	IC 8-IN MUX 3-ST 74HCT251	2
SM208030245	IC TRANS ARRAY NPNX6 SL3245	1

PART: F9384-31 DESC: MAIN CARD (FRONT END, ADC, TDC) for 9384

COMPONENT	PART DESCRIPTION	QTY PER ASSEMBLY
SM208470037	IC OP AMP 37GS	1
SM208470111	IC HF BUFFER CLC111	4
SM208470324	IC OP AMP LM324M	1
SM208470347	IC J-FET OP AMP 347	12
SM208470351	IC J-FET OP AMP 351	1
SM208470353	IC DUAL OP AMP LF353	3
SM208470705	IC OP AMP PICOAMP INPUT AD705	13
SM208480640	IC WIDEBAND OP AMP OPA640	4
SM208570078	IC LOW POWER REG +12V 78L12	1
SM208570805	IC POS VOLT REG 78L05	2
SM208591336	IC VOLT REF DIODE LM336	2
SM208870339	IC VOLT COMPARATOR 339	6
SM208880079	IC LOW POW REG -12V 79L12	1
SM208880337	IC ADJ VOLT REG LM337	4
SM208971881	IC VIDEO SYNC SEPARATOR LM1881	1
SM229020150	MLC TRANS VOLT SUPPRESSOR	6
SM232022822	DIODE ARRAY SCHOTTKY 2822	2
SM232120070	DIODE ARRAY BAV70	3
SM236030099	DIODE SO-PKG BAV99	76
SM236654004	DIODE RECTIFIER 4004	2
SM240050033	DIODE ZENER TZM-C-3V3	5
SM240050051	DIODE ZENER TZM-C-5V1	1
SM240218451	DIODE ZENER BZX84C5V1	19
SM240218462	DIODE ZENER BZX84C6V2	4
SM240218475	DIODE ZENER BZX84C7V5	2
SM252023018	DIODE PIN BAT18	5
SM252080682	DIODE PIN BA682	5
SM253032823	DIODE SCHOTTKY 2823	11
SM270030020	TRANSISTOR NPN BFS20	1
SM270130092	TRANSISTOR NPN BFR92A	4
SM270130093	TRANSISTOR NPN BFR93A	3
SM270160520	TRANSISTOR NPN HF BFG520/X	13
SM275030092	TRANSISTOR PNP BFT92	4
SM275030093	TRANSISTOR PNP BFT93	2
SM275030550	TRANSISTOR PNP BF550	6
SM275330858	TRANSISTOR PNP BC858C	10
SM280120416	TRANSISTOR JFET N MMBF4416	5
SM280171005	TRANSISTOR POWER MOSFET MTD10N05E	4
SM289772003	TRANSISTOR ARRAY 2003	4
SM300446150	INDUCTOR 10% .015 UH	1
SM301502001	BEAD (FERRITE CHIP)	36
SM311414318	CRYSTAL OSCILLATOR 14.31818MHZ	1
SM454120025	CONN 1MM FEMALE 25	1
SM651104182	RES CHIP 1% 25PPM 1.8K	1
SM651104183	RES CHIP 1% 25PPM 18 K	1

PART: F9384-31 DESC: MAIN CARD (FRONT END, ADC, TDC) for 9384

COMPONENT	PART DESCRIPTION	QTY PER ASSEMBLY
SM651104204	RES CHIP 1% 25PPM 200 K	1
SM651104241	RES CHIP 1% 25PPM 240 OHM	1
SM651104392	RES CHIP 1% 25PPM 3.9K	5
SM652061024	RES CHIP 1% PRECISION 2.4 OHM	4
SM652061181	RES CHIP PRECISION 1% 182 OHM	4
SM652061820	RES CHIP 1% PRECISION 82 OHM	4
SM652110904	RES CHIP (E24) 0.5% 900K	1
SM652115062	RES CHIP (E24) 5% 6.2 OHMS	1
SM652181590	RES CHIP 1% PRECISION 113K	8
SM653101201	RES CHIP 1% 10.0 OHMS	5
SM653101230	RES CHIP 1% 20.0 OHMS	2
SM653101234	RES CHIP 1% 22.1 OHMS	18
SM653101251	RES CHIP 1% 33.2 OHMS	24
SM653101255	RES CHIP 1% 36.5 OHMS	2
SM653101266	RES CHIP 1% 47.5 OHMS	2
SM653101269	RES CHIP 1% 51.1 OHMS	85
SM653101273	RES CHIP 1% 56.2 OHMS	20
SM653101281	RES CHIP 1% 68.1 OHMS	99
SM653101285	RES CHIP 1% 75.0 OHMS	15
SM653101289	RES CHIP 1% 82.5 OHMS	13
SM653101297	RES CHIP 1% 100 OHMS	32
SM653101305	RES CHIP 1% 121 OHMS	74
SM653101308	RES CHIP 1% 130 OHMS	37
SM653101314	RES CHIP 1% 150 OHMS	28
SM653101322	RES CHIP 1% 182 OHMS	150
SM653101326	RES CHIP 1% 200 OHMS	41
SM653101330	RES CHIP 1% 221 OHMS	13
SM653101334	RES CHIP 1% 243 OHMS	8
SM653101339	RES CHIP 1% 274 OHMS	6
SM653101343	RES CHIP 1% 301 OHMS	13
SM653101347	RES CHIP 1% 332 OHMS	13
SM653101351	RES CHIP 1% 365 OHMS	3
SM653101354	RES CHIP 1% 392 OHMS	21
SM653101358	RES CHIP 1% 432 OHMS	16
SM653101362	RES CHIP 1% 475 OHMS	23
SM653101365	RES CHIP 1% 511 OHMS	5
SM653101369	RES CHIP 1% 562 OHMS	5
SM653101373	RES CHIP 1% 619 OHMS	7
SM653101377	RES CHIP 1% 681 OHMS	1
SM653101381	RES CHIP 1% 750 OHMS	3
SM653101385	RES CHIP 1% 825 OHMS	1
SM653101393	RES CHIP 1% 1.00 K	111
SM653101397	RES CHIP 1% 1.10 K	10
SM653101401	RES CHIP 1% 1.21 K	7
SM653101410	RES CHIP 1% 1.50 K	3

PART: F9384-31 DESC: MAIN CARD (FRONT END, ADC, TDC) for 9384

COMPONENT	PART DESCRIPTION	QTY PER ASSEMBLY
SM653101416	RES CHIP 1% 1.74K	4
SM653101418	RES CHIP 1% 1.82 K	15
SM653101422	RES CHIP 1% 2.00 K	6
SM653101439	RES CHIP 1% 3.01 K	1
SM653101443	RES CHIP 1% 3.32 K	30
SM653101450	RES CHIP 1% 3.92 K	5
SM653101458	RES CHIP 1% 4.75 K	8
SM653101461	RES CHIP 1% 5.11 K	40
SM653101465	RES CHIP 1% 5.62 K	8
SM653101481	RES CHIP 1% 8.25 K	6
SM653101489	RES CHIP 1% 10.0 K	119
SM653101506	RES CHIP 1% 15.0 K	1
SM653101509	RES CHIP 1% 16.2 K	5
SM653101514	RES CHIP 1% 18.2 K	1
SM653101522	RES CHIP 1% 22.1 K	1
SM653101531	RES CHIP 1% 27.4 K	1
SM653101557	RES CHIP 1% 51.1 K	4
SM653101569	RES CHIP 1% 68.1 K	5
SM653101585	RES CHIP 1% 100 K	2
SM653101602	RES CHIP 1% 150 K	4
SM653101614	RES CHIP 1% 200 K	4
SM653101638	RES CHIP 1% 357K	8
SM653101639	RES CHIP 1% 365 K	8
SM653101642	RES CHIP 1% 392 K	8
SM653101650	RES CHIP 1% 475 K	1
SM653101665	RES CHIP 1% 681 K	1
SM653101673	RES CHIP 1% 825 K	2
SM653101681	RES CHIP 1% 1.00 M	9
SM653181999	THERMAL SHUNT	1
SM653185107	RES CHIP 5% 100PPM 100M	5
SM654101000	CHIP JUMPER ZERO OHMS	50
SM661205822	CAP CERA CHIP 8200 PF	5
SM661207102	CAP CERA CHIP 20% .001 UF	4
SM661207103	CAP CERA CHIP 20% .01 UF	522
SM661207104	CAP CERA CHIP 20% .1 UF	157
SM661207223	CAP CERA CHIP 20% .022 UF	8
SM661255010	CAP CERA CHIP 1.0 PF	1
SM661255039	CAP CERA CHIP +/-0.25PF 3.9 PF	4
SM661255056	CAP CERA CHIP 5.6 PF	2
SM661255100	CAP CERA CHIP 5% 10 PF	9
SM661255101	CAP CERA CHIP 5% 100 PF	22
SM661255102	CAP CERA CHIP 5% 1000 PF	11
SM661255180	CAP CERA CHIP 5% 18 PF	1
SM661255181	CAP CERA CHIP 5% 180 PF	1
SM661255220	CAP CERA CHIP 5% 22 PF	1

PART: F9384-31 DESC: MAIN CARD (FRONT END, ADC, TDC) for 9384

COMPONENT	PART DESCRIPTION	QTY PER ASSEMBLY
SM661255270	CAP CERA CHIP 5% 27 PF	5
SM661255330	CAP CERA CHIP 5% 33 PF	1
SM661255470	CAP CERA CHIP 5% 47 PF	6
SM661255560	CAP CERA CHIP 5% 56 PF	2
SM661255821	CAP CERA CHIP 5% 820 PF	5
SM661256120	CAP CERA CHIP 10% 12 PF	4
SM661286103	CAP CERA CHIP 10% .01 UF	52
SM661446474	CAP CERA CHIP 10% .47 UF	2
SM661526561	CAP CERA CHIP 560PF 500V	5
SM661535620	CAP CERA CHIP 62PF 200V	4
SM661540033	CAP CERA CHIP 3.3PF 500V	6
SM661545150	CAP CERA CHIP 15PF 500V	9
SM661726103	CAP CERA CHIP 10% .01 UF	15
SM666237476	CAP MOLD TANT CHIP 47 UF	9
SM666247106	CAP MOLD TANT CHIP 10 UF	4
SM666257336	CAP MOLD TANT CHIP 33 UF	2
SM666267227	CAP TANT 220UF 10V 20%	8
SM666327225	CAP MOLD TANT CHIP 2.2 UF	50
SM666377226	CAP MOLD TANT CHIP 22 UF	8
SM666387336	CAP MOLD TANT CHIP 33 UF	2
SM666427105	CAP MOLD TANT CHIP 1 UF	5
SM669080181	CHIP FERRITE BEAD	36

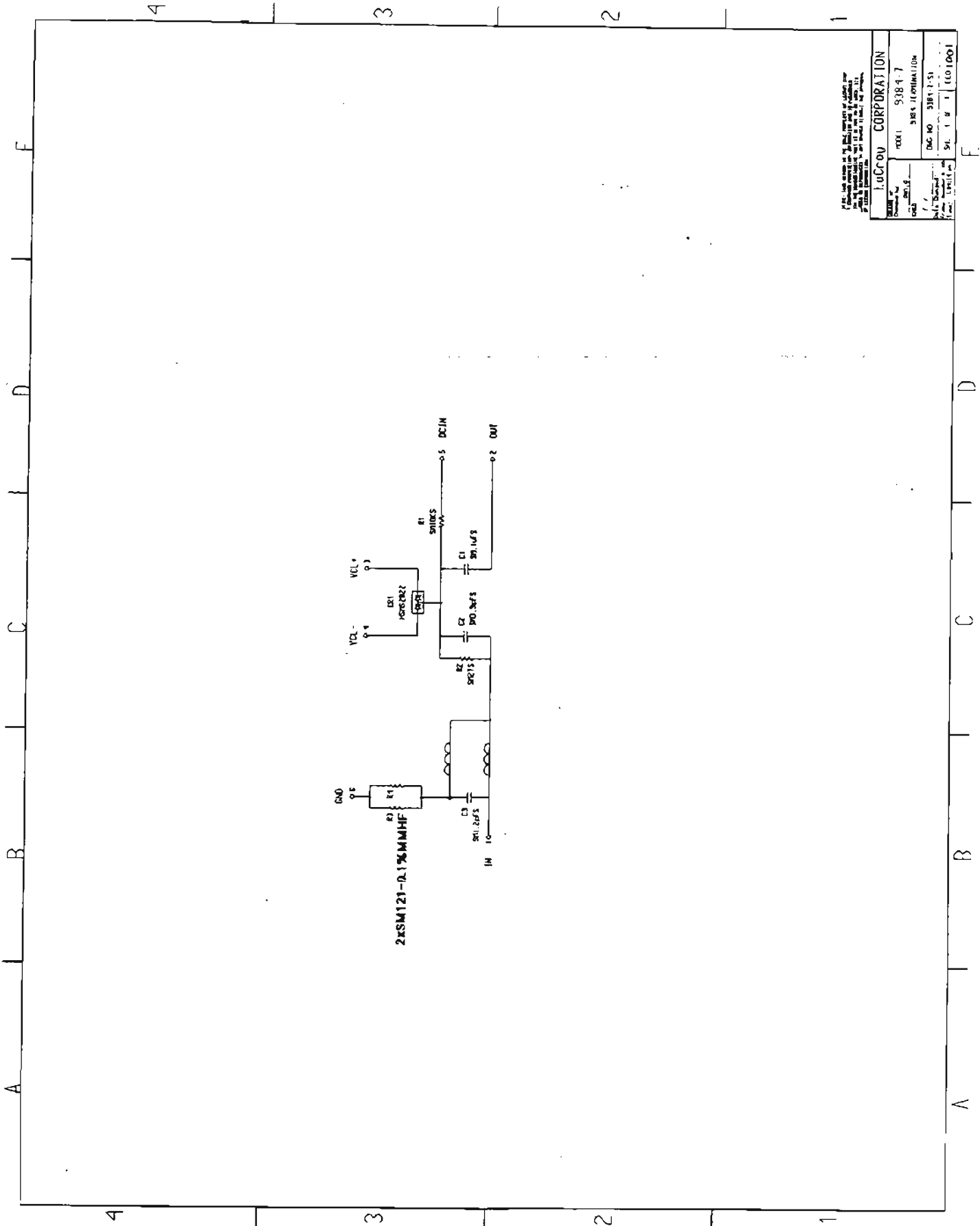

LUCROU CORPORATION	
Doc No	9384-7
Doc No	9384-1001A1104
Doc No	9384-1-53
Doc No	9384-1-1001

PART: F9384-7 DESC: T-COIL for 9384-31

<u>Location</u>	<u>Part Number</u>	<u>Description</u>
C1	SM661207104	CAP CERA CHIP 20% .1 UF
C2	SM661255039	CAP CERA CHIP +/-0.25PF 3.9 PF
C3	SM661255012	CAP CERA CHIP +/- .1PF 1.2PF
CR1	SM232022822	DIODE ARRAY SCHOTTKY 2822
R1	SM652101489	RES CHIP 1% 10.0 K
R2	SM652101243	RES CHIP 1% 27.4 OHMS
R3	SM168651002	RES METAL FILM 1% 120 OHM
R4	SM168651002	RES METAL FILM 1% 120 OHM

PART: F9354-4 DESC: 400-500MHZ PLL OSCILLATOR

COMPONENT	PART DESCRIPTION	QTY PER ASSEMBLY
719354403	PC BD PREASS'Y 9354-4	1
SM200169016	IC BINARY UP COUNTER 10E016	1
SM201274032	IC ECL DIVIDE BY 2 10EL32D	1
SM201549040	IC PHASE-FREQ DET MC12040	1
SM201570016	IC ECL DIFF RECEIVER 10EL16D	1
SM208272148	IC LOW POWER VCO MC12148	1
SM208470027	IC SINGLE OP AMP OP-27	1
SM208570078	IC LOW POWER REG +12V 78L12	1
SM208570805	IC POS VOLT REG 78L05	1
SM208880079	IC LOW POW REG -12V 79L12	1
SM230080619	DIODE TUNING SMD BB619	1
SM236030099	DIODE SO-PKG BAV99	4
SM240218475	DIODE ZENER BZX84C7V5	2
SM281120610	LOW POWER PMOSFET TRANSISTOR	1
SM301502001	BEAD (FERRITE CHIP)	1
SM303062068	INDUCTOR CHIP COIL 2% 6.8NH	1
SM454110025	CONN 1MM MALE 25	1
SM653101314	RES CHIP 1% 150 OHMS	1
SM653101322	RES CHIP 1% 182 OHMS	5
SM653101365	RES CHIP 1% 511 OHMS	2
SM653101389	RES CHIP 1% 909 OHMS	2
SM653101393	RES CHIP 1% 1.00 K	3
SM653101426	RES CHIP 1% 2.21K	1
SM653101447	RES CHIP 1% 3.65 K	4
SM653101557	RES CHIP 1% 51.1 K	1
SM661207103	CAP CERA CHIP 20% .01 UF	13
SM661207104	CAP CERA CHIP 20% .1 UF	2
SM661207223	CAP CERA CHIP 20% .022 UF	2
SM661255010	CAP CERA CHIP 1.0 PF	1
SM661255152	CAP CERA CHIP 5% 1500 PF	2
SM661255270	CAP CERA CHIP 5% 27 PF	1
SM666247106	CAP MOLD TANT CHIP 10 UF	7

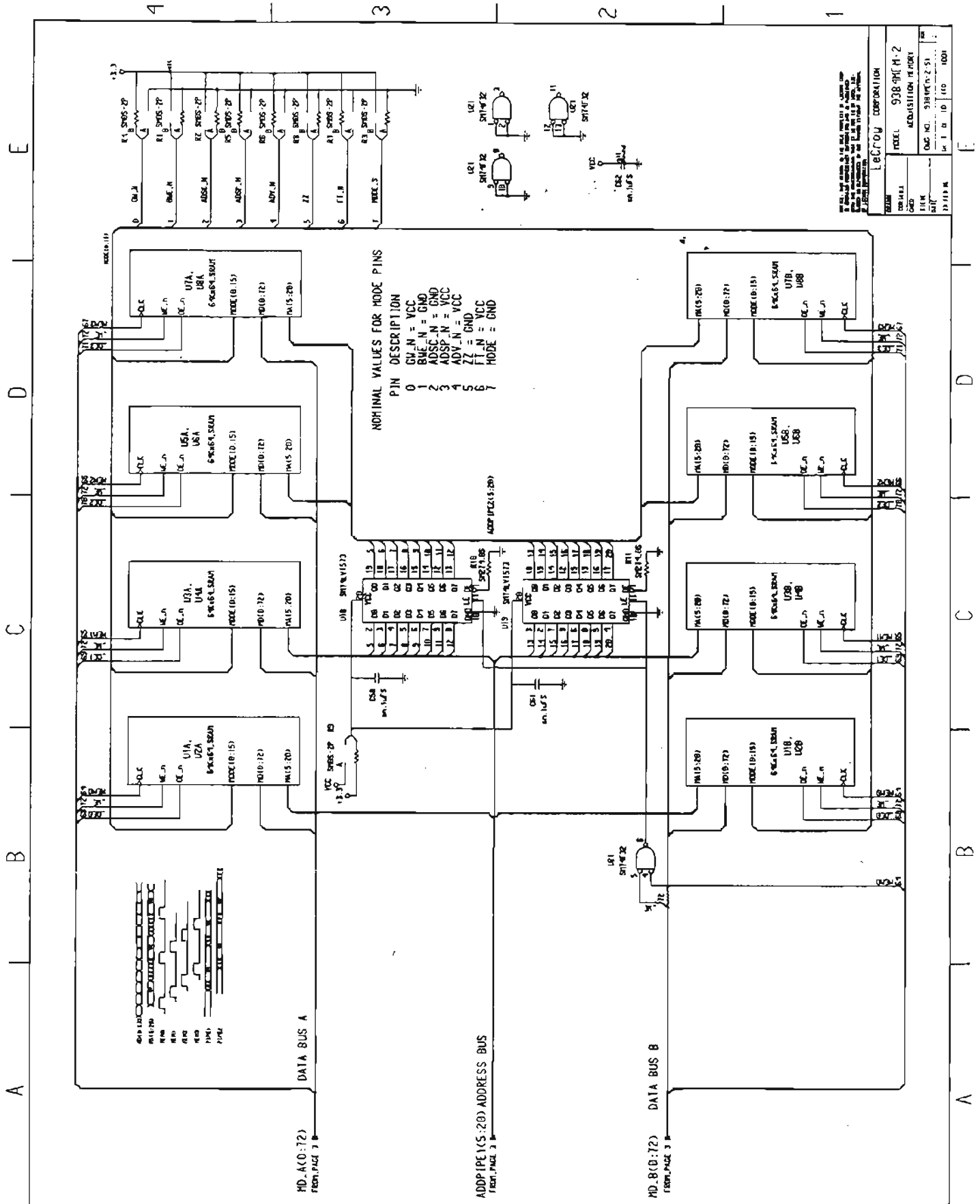

Section 7 Schematics, Layouts, Parts list

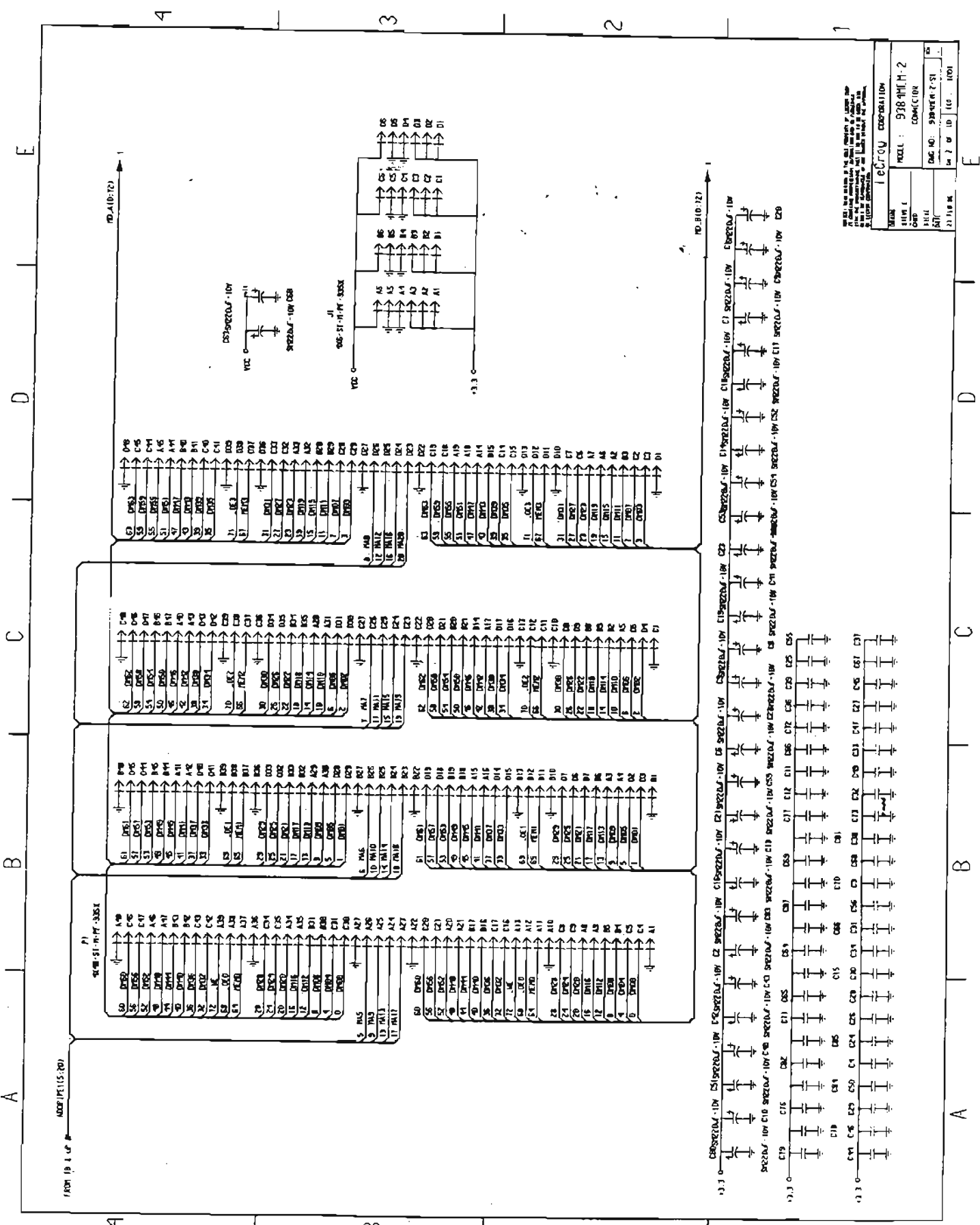

MODEL : 9384M-2
 DRAWING : 9384M-2-1
 DATE : 11/18/84
 BY : J. H. H.

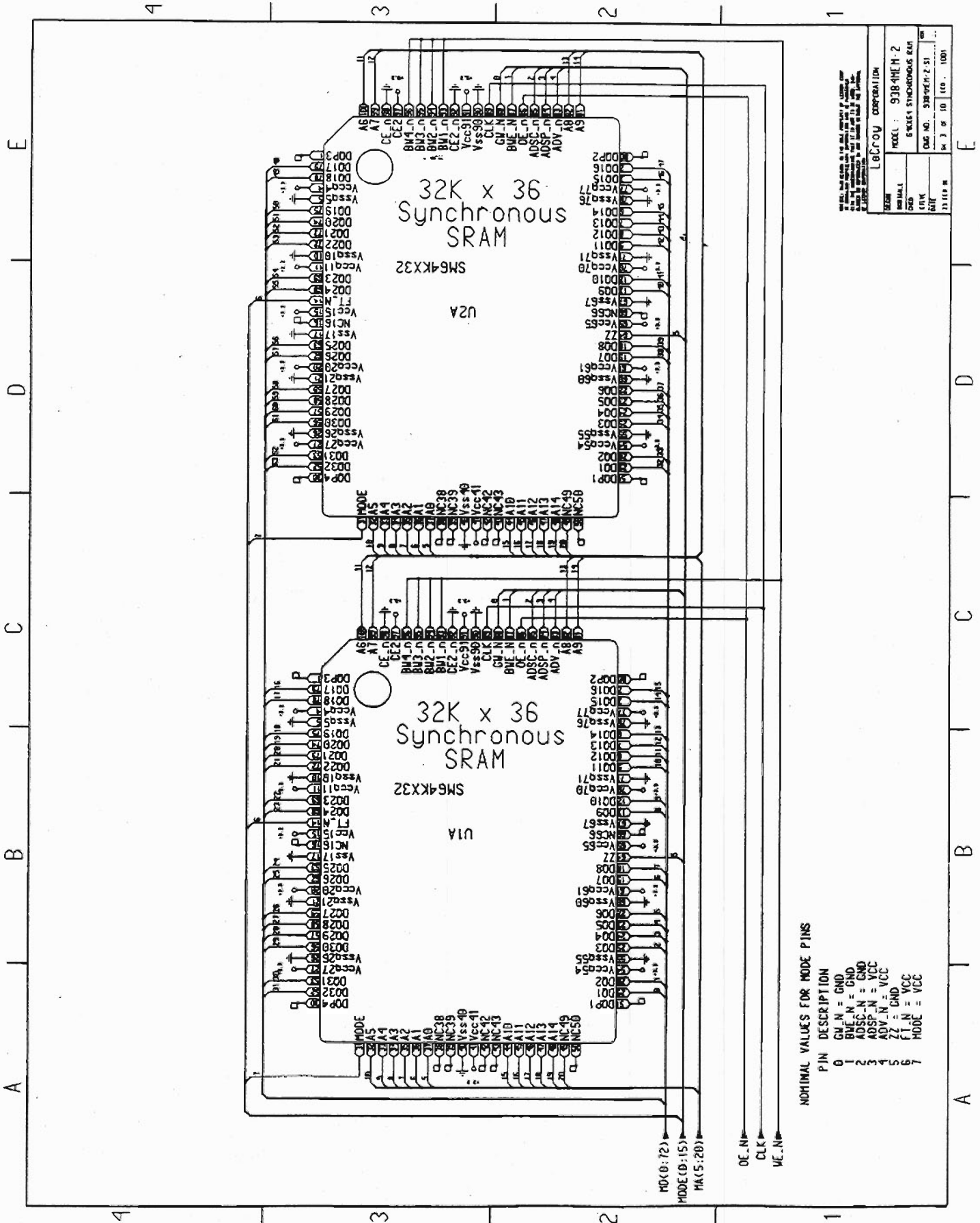

LeCroy CORPORATION

MODEL: 9184H-2

DATE: 1984

REV: 1

DATE: 1984-12-2

REV: 100

DATE: 1984-12-2

REV: 100

DATE: 1984-12-2

REV: 100

DATE: 1984-12-2

REV: 100

NOMINAL VALUES FOR MODE PINS

PIN	DESCRIPTION
0	GM_N = GND
1	BVE_N = GND
2	ADSC_N = GND
3	ADSP_N = VCC
4	ADV_N = VCC
5	ZZ = GND
6	FT_N = VCC
7	MODE = VCC

Section 7 Schematics, Layouts, Parts list

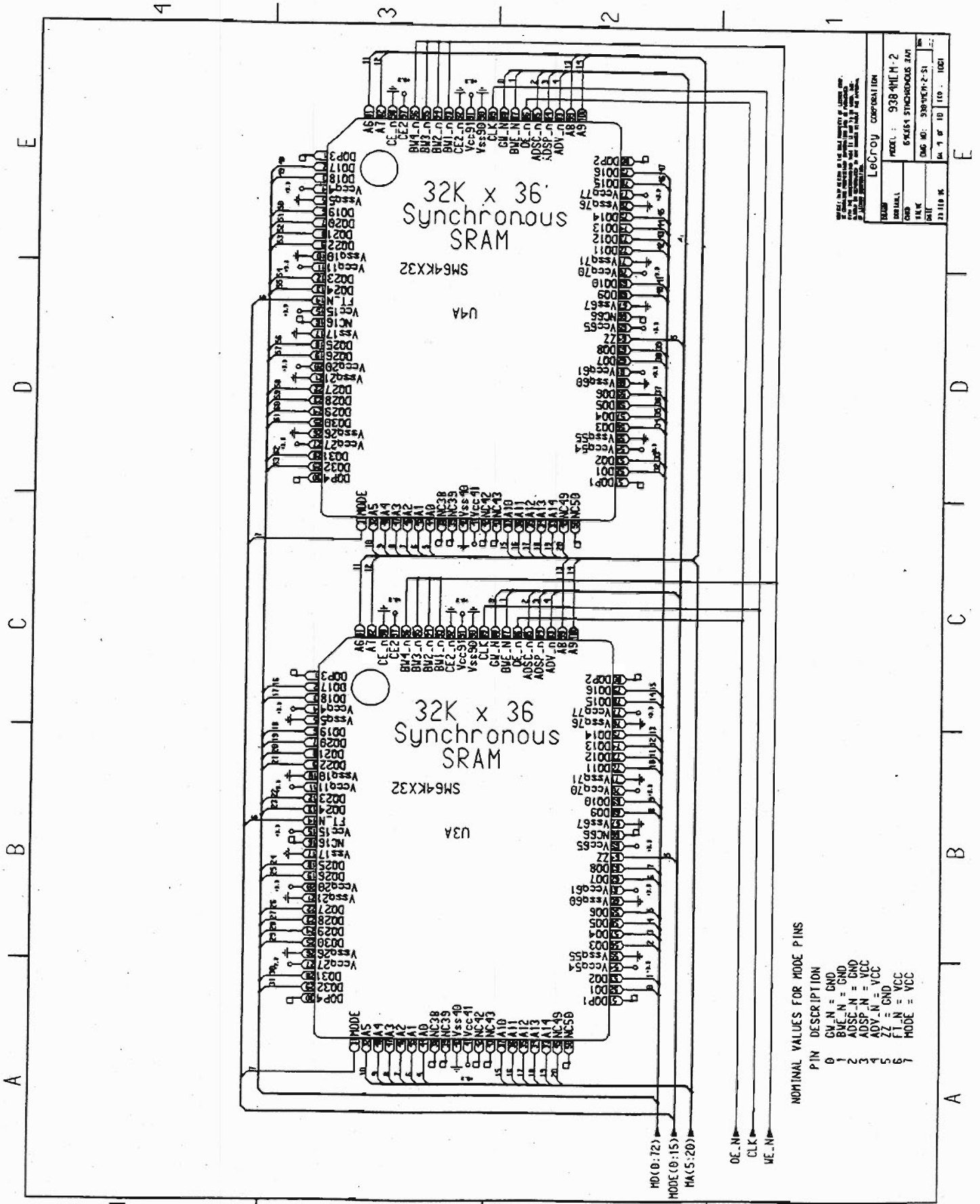

LeCroy Corporation

MODEL:	9384H M-2
DESCRIPTION:	64KX36 SYNCHRONOUS SRAM
DATE:	3/8/84
REV:	1
BY:	10
CHK:	100
APP:	1001

NOMINAL VALUES FOR MODE PINS

PIN	DESCRIPTION
0	GV_N = GND
1	BVE_N = GND
2	ADSP_N = GND
3	ADV_N = VCC
4	ADV_N = VCC
5	Z7 = GND
6	FT_N = VCC
7	MODE = VCC

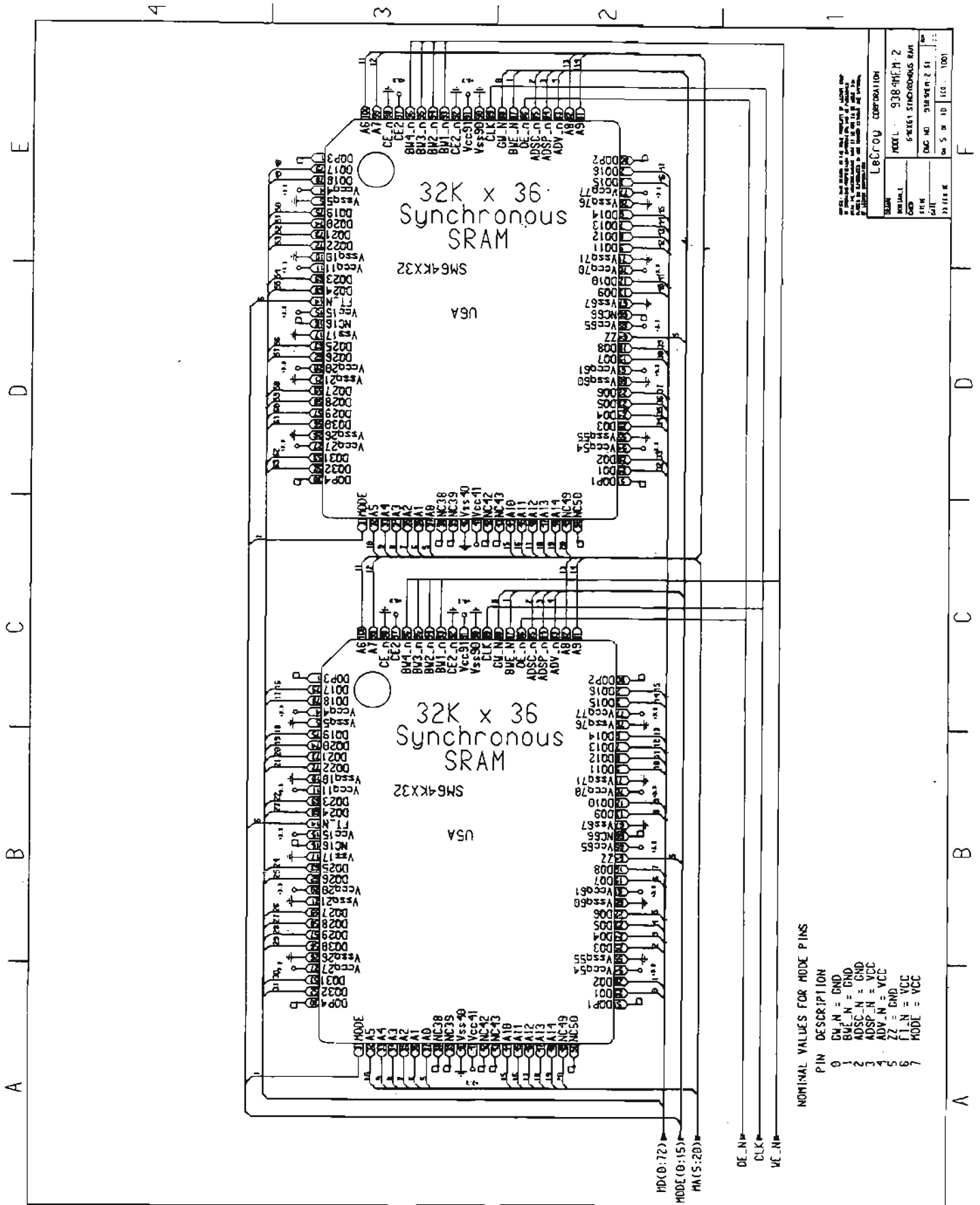

THE INFORMATION ON THIS DRAWING IS THE PROPERTY OF LUCAS. ANY REPRODUCTION OR TRANSMISSION OF THIS INFORMATION IN ANY FORM OR BY ANY MEANS, WITHOUT THE WRITTEN PERMISSION OF LUCAS, IS STRICTLY PROHIBITED.

LBCroy fabrication	
MODEL	938-9HEM 2
DESCRIPTION	32K X 36 SYNCHRONOUS SRAM
DATE	9/18/94 PM 2:51
DESIGNER	
DR	S W ID
DATE	1000

NOMINAL VALUES FOR MODE PINS

PIN	DESCRIPTION
0	DN_N = GND
1	BUE_N = GND
2	ADSC_N = GND
3	ADSP_N = VCC
4	ADV_N = VCC
5	FT_N = GND
6	FT_N = VCC
7	MODE = VCC

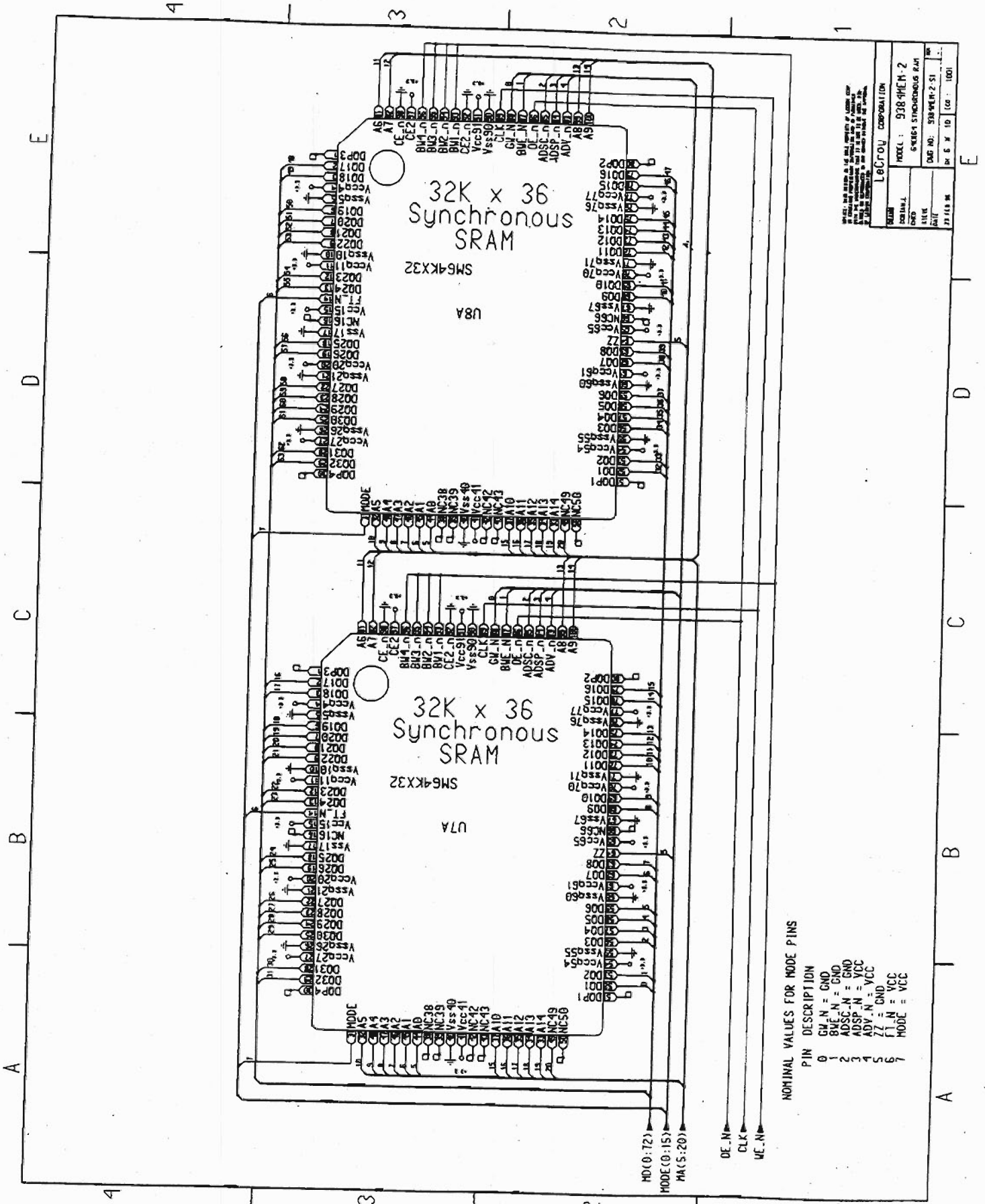

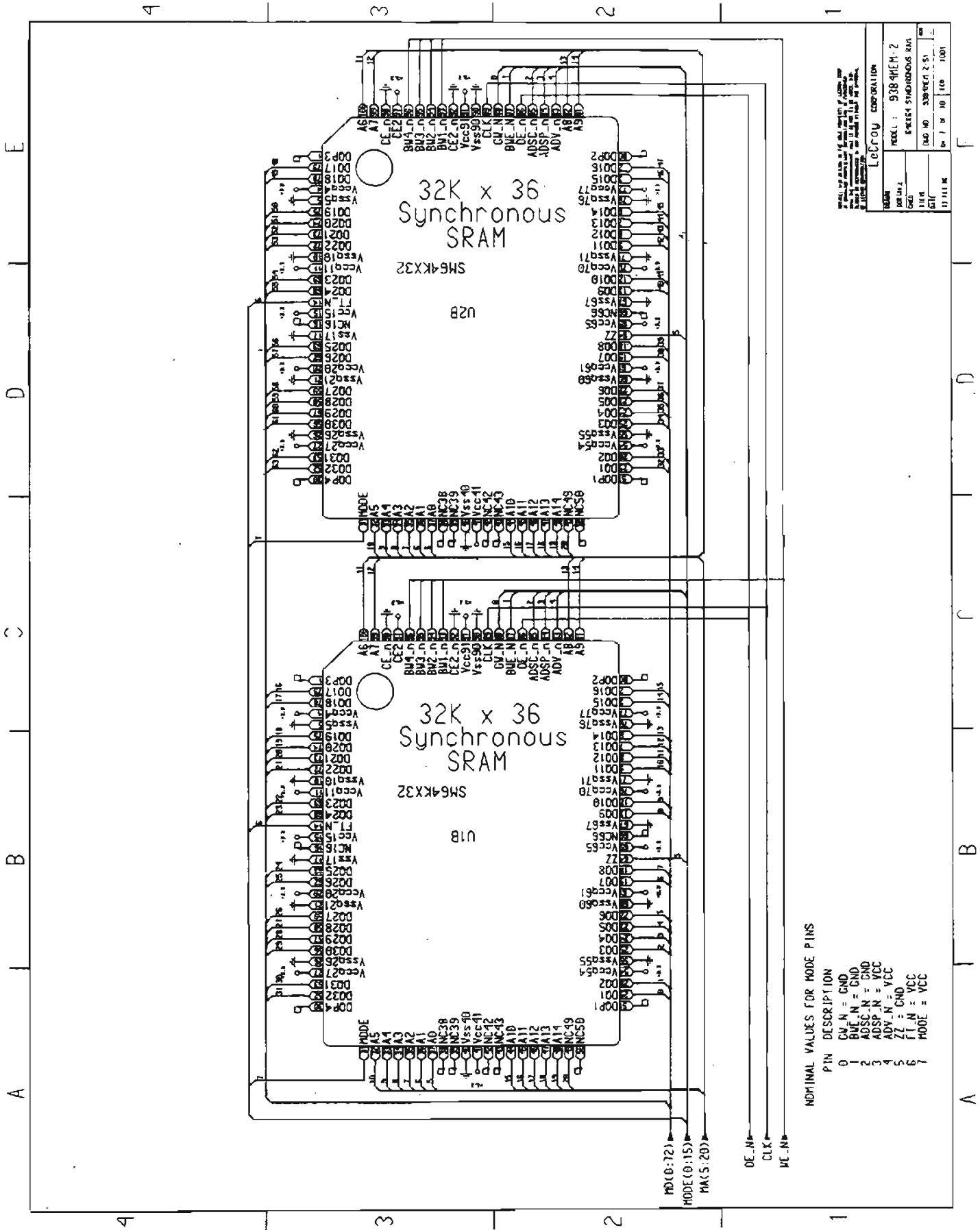

MINIMAL VALUES FOR MODE PINS

PIN	DESCRIPTION
0	GM_N = GND
1	BUF_N = GND
2	ADSC_N = GND
3	ADSP_N = VCC
4	ADV_N = VCC
5	7 = GND
6	7.1_N = VCC
7	MODE = VCC

LeCroy CORPORATION

MODEL: 9384EM-2

DATE: 8/1/81

REV: 1

QTY: 1

DATE: 8/1/81

BY: J. B. 10

FILE: 7101

DATE: 8/1/81

BY: J. B. 10

FILE: 7101

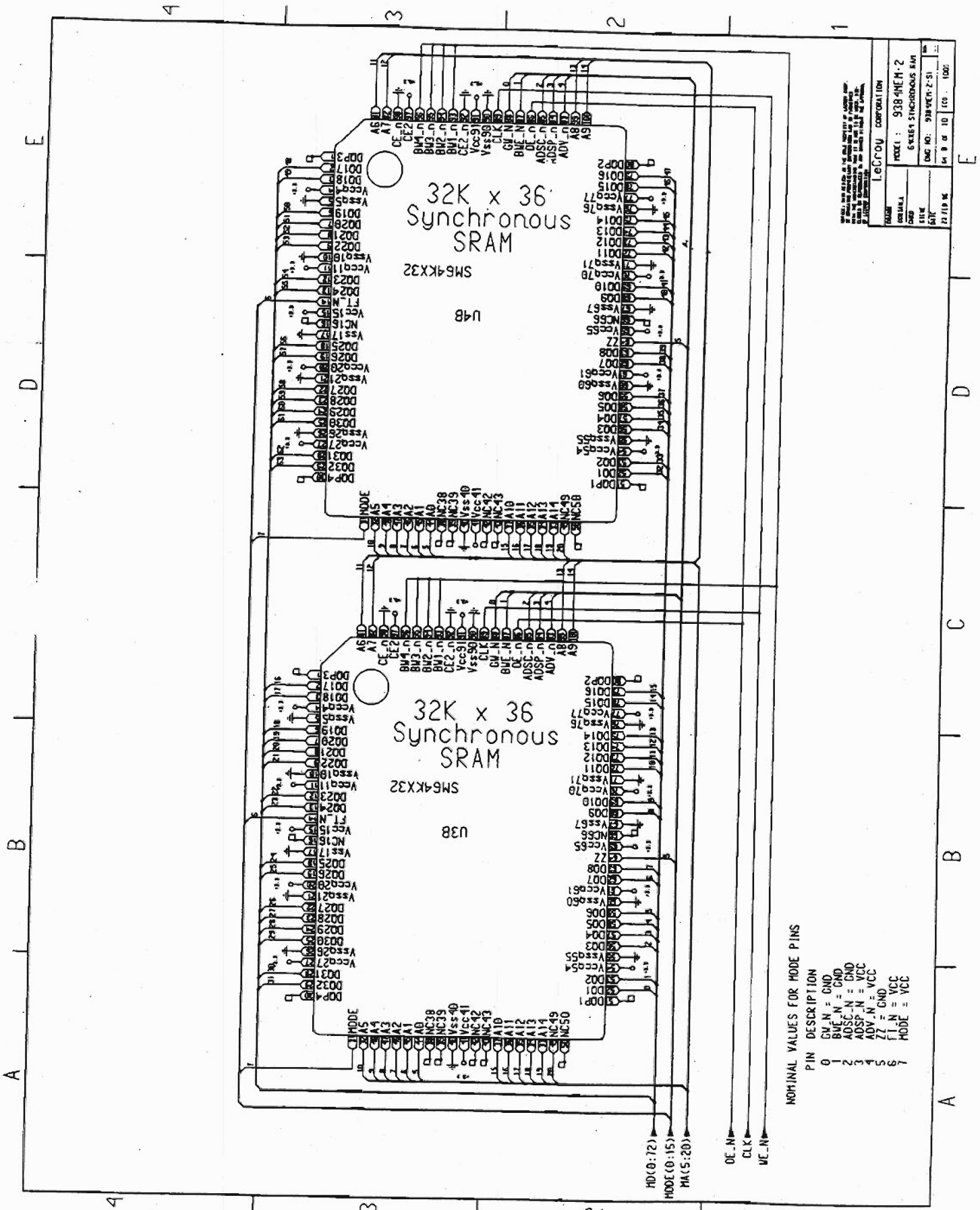

MODEL	9384ME-M-2
MANUFACT	6384E1 SYNCHRONOUS RAM
DATE	04C NO: 9384ME-2-51
REV	7210P M
REV	100
REV	1000

LEGRON CORPORATION

NOMINAL VALUES FOR MODE PINS

PIN	DESCRIPTION
0	GM_N = GND
1	BM_N = GND
2	ADSC_N = GND
3	ADSP_N = VCC
4	ADV_N = VCC
5	ZZ = GND
6	FT_N = VCC
7	MODE = VCC

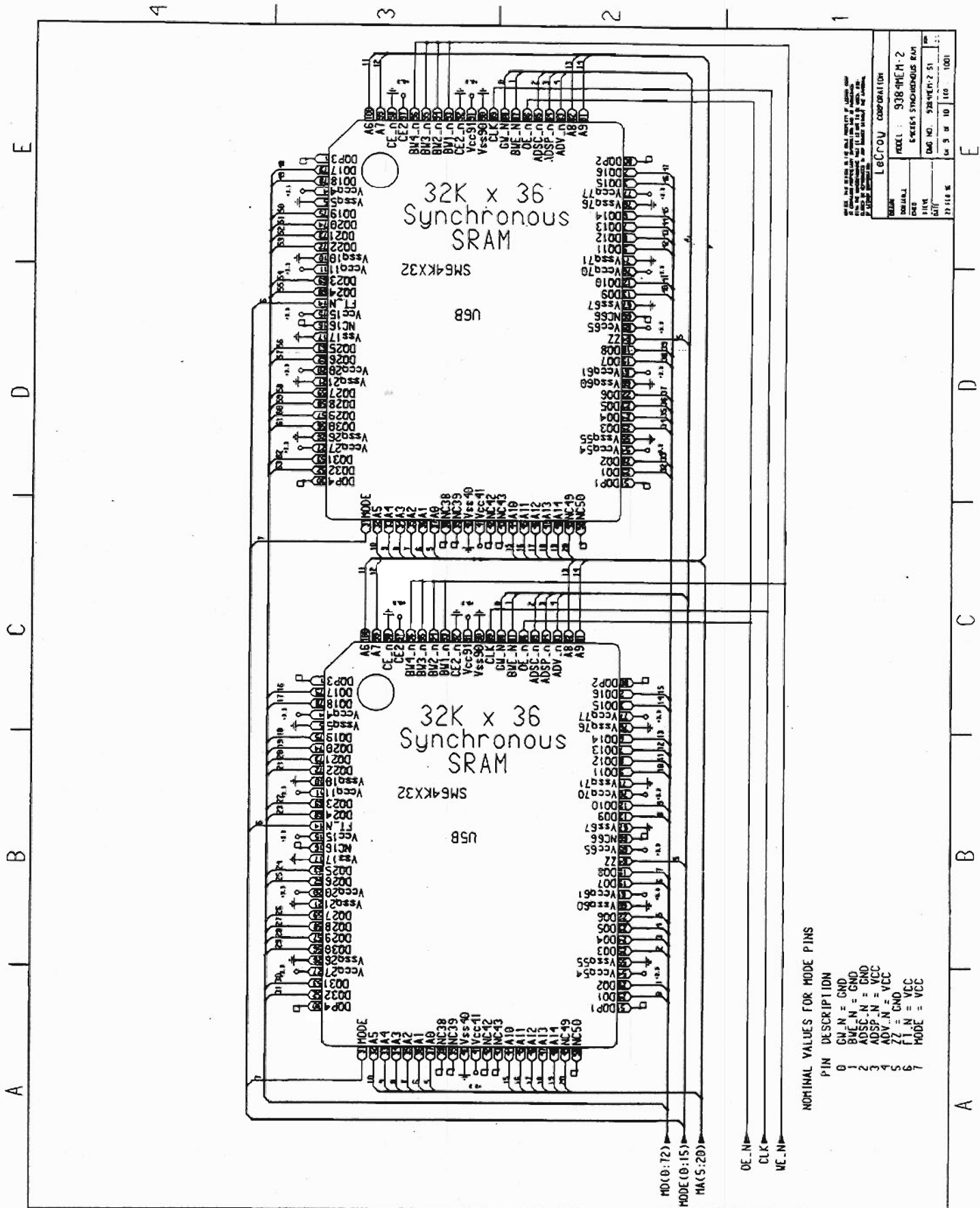

ALL DIMENSIONS ARE IN MILLIMETERS UNLESS OTHERWISE SPECIFIED.
 DIMENSIONS IN PARENTHESES ARE FOR REFERENCE ONLY.
 DIMENSIONS IN SQUARE BRACKETS ARE FOR REFERENCE ONLY.
 DIMENSIONS IN BRACKETS ARE FOR REFERENCE ONLY.

TECROY Corporation	
MODEL	9384MEM-2
DESCRIPTION	32K X 36 SYNCHRONOUS SRAM
DATE	93-04-27
REV	1
DRW NO.	9384MEM-2 51
DATE	93-04-27
BY	W 5 W 10 100
CHK	100

NOMINAL VALUES FOR MODE PINS

PIN	DESCRIPTION
0	GM.N = GND
1	BM.N = GND
2	ADSC.N = GND
3	ADSP.N = VCC
4	ADV.N = VCC
5	ZZ = GND
6	FT.N = VCC
7	MODE = VCC

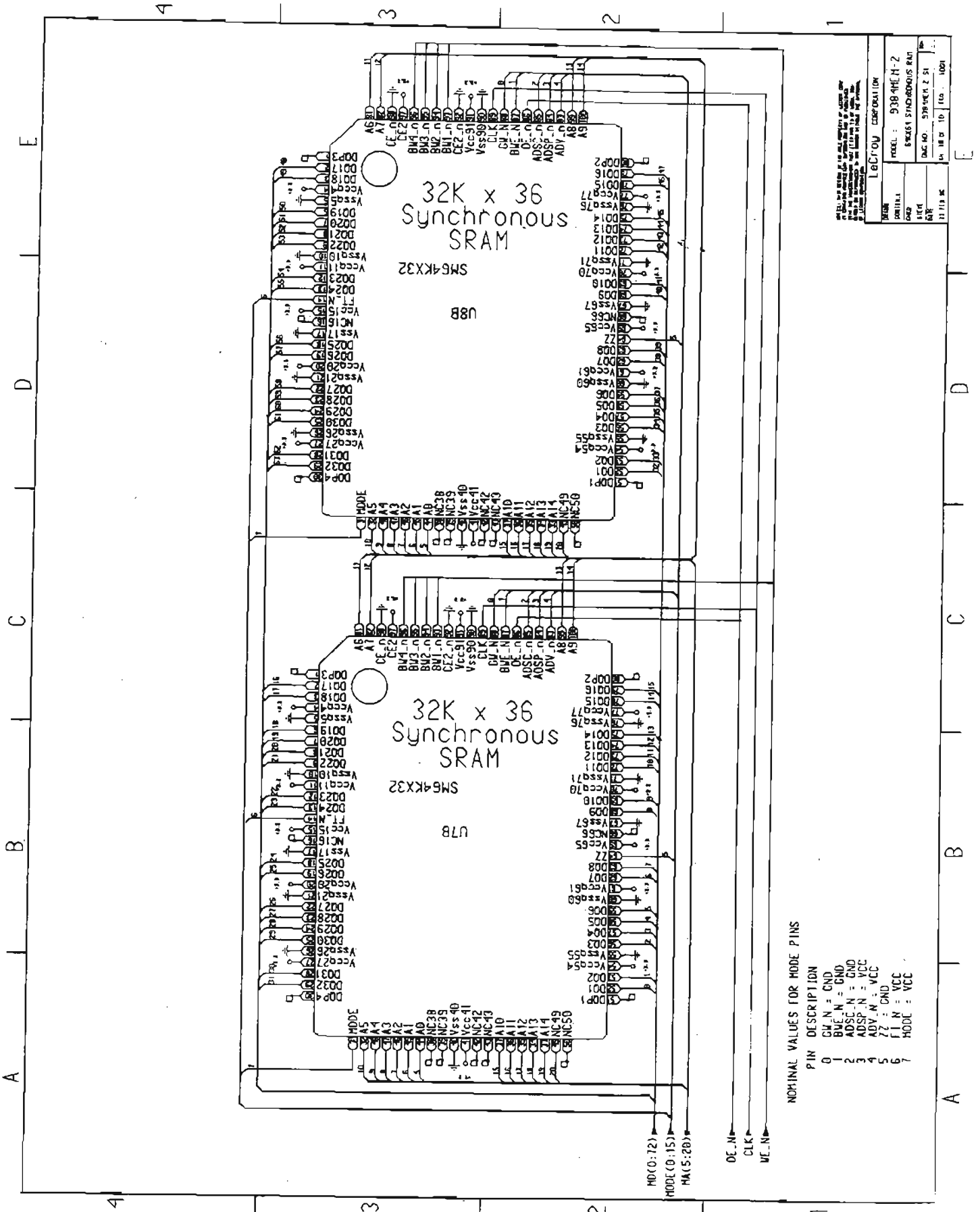

LEADERSHIP CORPORATION

MODEL :	9384H-N-2
QTY :	13973
DATE :	5/18/80
BY :	1001

NOMINAL VALUES FOR MODE PINS

PIN	DESCRIPTION
0	GM_N = GND
1	BUE_N = GND
2	ADSC_N = GND
3	ADSP_N = VCC
4	ADV_N = VCC
5	72 = GND
6	FL_N = VCC
7	MODE = VCC

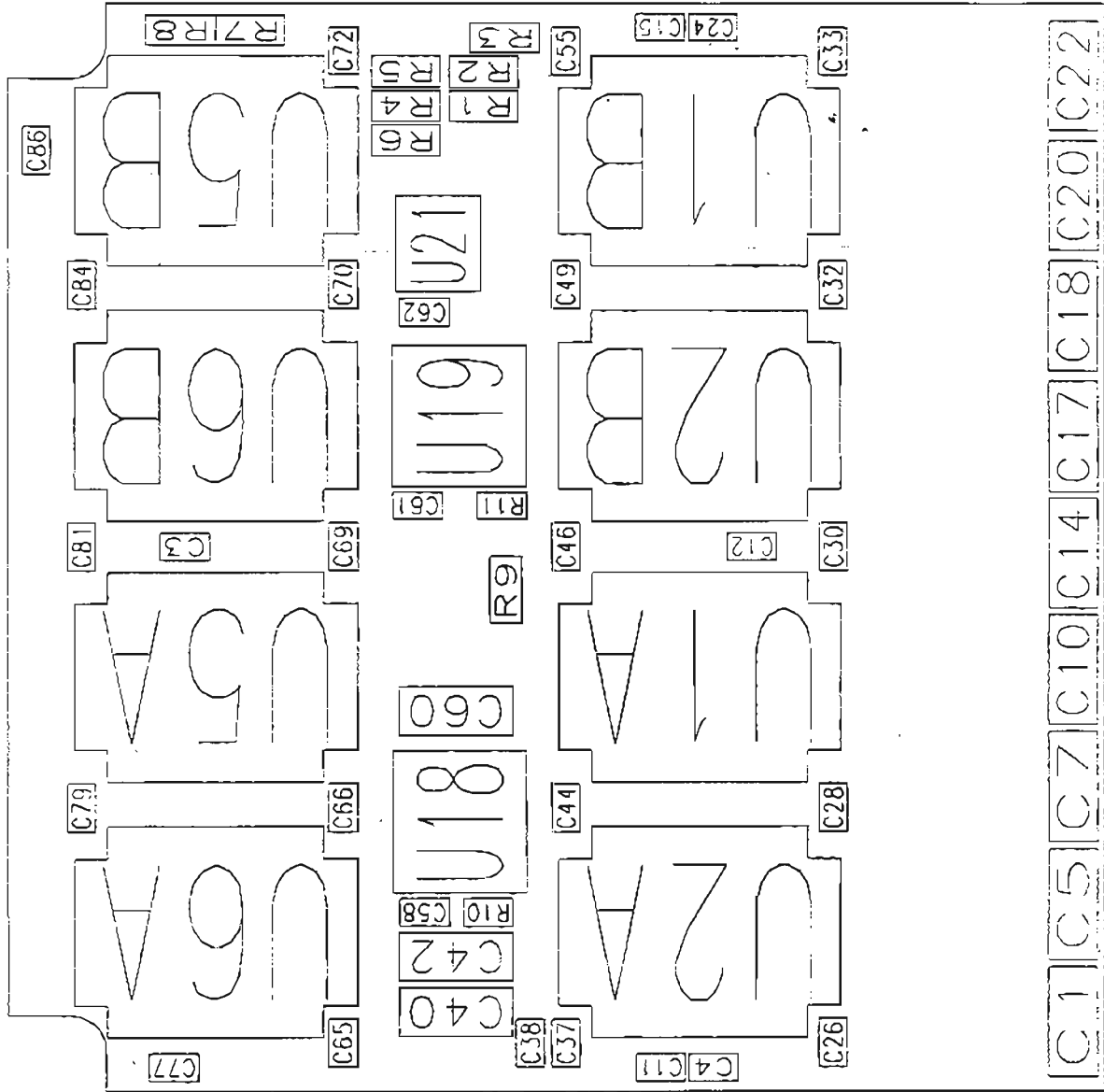

9384MEM-2 Component Side

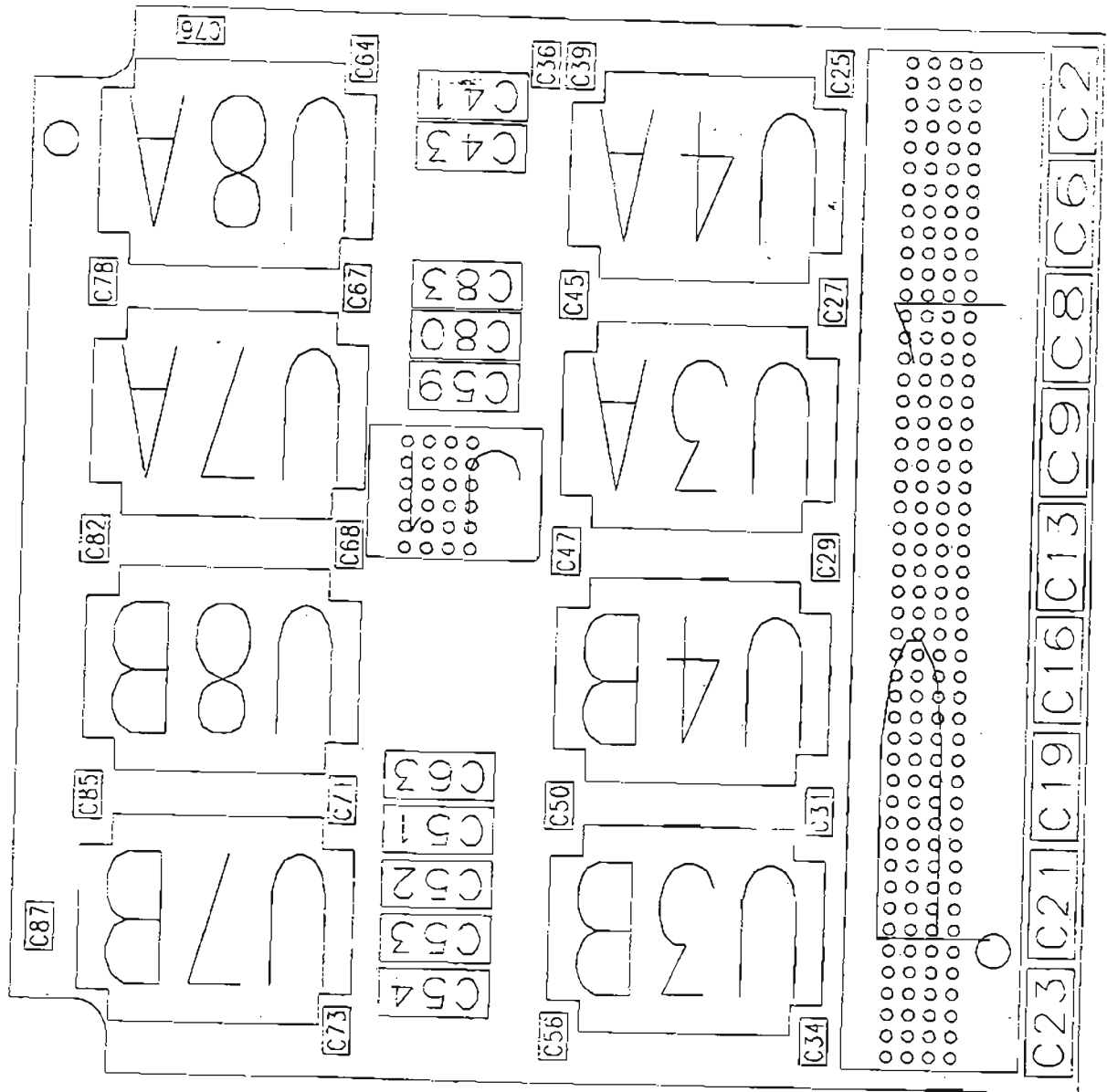

9384MEM-2 Solder Side

PART: 9384MEM-2 DESC: 2Mb ACQUISITION MEMORY CARD FOR 9384AL

Location	Part Number	Description	Location	Part Number	Description
C1	SM666267227	SM220UF	C47	SM661207104	SM.1UF
C2	SM666267227	SM220UF	C48	SM666267227	SM220UF
C3	SM661207104	SM.1UF	C49	SM661207104	SM.1UF
C4	SM661207104	SM.1UF	C50	SM661207104	SM.1UF
C5	SM666267227	SM220UF	C51	SM666267227	SM220UF
C6	SM666267227	SM220UF	C52	SM666267227	SM220UF
C7	SM666267227	SM220UF	C53	SM666267227	SM220UF
C8	SM666267227	SM220UF	C54	SM666267227	SM220UF
C9	SM666267227	SM220UF	C55	SM661207104	SM.1UF
C10	SM666267227	SM220UF	C56	SM661207104	SM.1UF
C11	SM661207104	SM.1UF	C57	SM666267227	SM220UF
C12	SM661207104	SM.1UF	C58	SM661207104	SM.1UF
C13	SM666267227	SM220UF	C59	SM666267227	SM220UF
C14	SM666267227	SM220UF	C60	SM666267227	SM220UF
C15	SM661207104	SM.1UF	C61	SM661207104	SM.1UF
C16	SM666267227	SM220UF	C62	SM661207104	SM.1UF
C17	SM666267227	SM220UF	C63	SM666267227	SM220UF
C18	SM666267227	SM220UF	C64	SM661207104	SM.1UF
C19	SM666267227	SM220UF	C65	SM661207104	SM.1UF
C20	SM666267227	SM220UF	C66	SM661207104	SM.1UF
C21	SM666267227	SM220UF	C67	SM661207104	SM.1UF
C22	SM666267227	SM220UF	C68	SM661207104	SM.1UF
C23	SM666267227	SM220UF	C69	SM661207104	SM.1UF
C24	SM661207104	SM.1UF	C70	SM661207104	SM.1UF
C25	SM661207104	SM.1UF	C71	SM661207104	SM.1UF
C26	SM661207104	SM.1UF	C72	SM661207104	SM.1UF
C27	SM661207104	SM.1UF	C73	SM661207104	SM.1UF
C28	SM661207104	SM.1UF	C74	SM661207104	SM.1UF
C29	SM661207104	SM.1UF	C75	SM661207104	SM.1UF
C30	SM661207104	SM.1UF	C76	SM661207104	SM.1UF
C31	SM661207104	SM.1UF	C77	SM661207104	SM.1UF
C32	SM661207104	SM.1UF	C78	SM661207104	SM.1UF
C33	SM661207104	SM.1UF	C79	SM661207104	SM.1UF
C34	SM661207104	SM.1UF	C80	SM666267227	SM220UF
C35	SM666267227	SM220UF	C81	SM661207104	SM.1UF
C36	SM661207104	SM.1UF	C82	SM661207104	SM.1UF
C37	SM661207104	SM.1UF	C83	SM666267227	SM220UF
C38	SM661207104	SM.1UF	C84	SM661207104	SM.1UF
C39	SM661207104	SM.1UF	C85	SM661207104	SM.1UF
C40	SM666267227	SM220UF	C86	SM661207104	SM.1UF
C41	SM666267227	SM220UF	C87	SM661207104	SM.1UF
C42	SM666267227	SM220UF	J1	454110024	2MM HDR
C43	SM666267227	SM220UF	P1	454110024	2MM HDR
C44	SM661207104	SM.1UF	R1	SM654101000	SMZEROOHM
C45	SM661207104	SM.1UF	R2	SM654101000	SMZEROOHM
C46	SM661207104	SM.1UF	R3	SM654101000	SMZEROOHM

PART: 9384MEM-2 DESC: 2Mb ACQUISITION MEMORY CARD FOR 9384AL

Location	Part Number	Description	Location	Part Number	Description
R4	SM654101000	SMZEROOHM			
R5	SM654101000	SMZEROOHM			
R6	SM654101000	SMZEROOHM			
R7	SM654101000	SMZEROOHM			
R8	SM654101000	SMZEROOHM			
R9	SM652101750	SM75.0OHM			
R10	SM652101750	SM75.0OHM			
U1	SM191160750	SM75OHMRC			
U1A	SM205211001	SM32K SRAM			
U1B	SM205211001	SM32K SRAM			
U2	SM191160750	SM75OHMRC			
U2A	SM205211001	SM32K SRAM			
U2B	SM205211001	SM32K SRAM			
U3	SM191160750	SM75OHMRC			
U3A	SM205211001	SM32K SRAM			
U3B	SM205211001	SM32K SRAM			
U4	SM191160750	SM75OHMRC			
U4A	SM205211001	SM32K SRAM			
U4B	SM205211001	SM32K SRAM			
U5	SM191160750	SM75OHMRC			
U5A	SM205211001	SM32K SRAM			
U5B	SM205211001	SM32K SRAM			
U6	SM191160750	SM75OHMRC			
U6A	SM205211001	SM32K SRAM			
U6B	SM205211001	SM32K SRAM			
U7	SM191160750	SM75OHMRC			
U7A	SM205211001	SM32K SRAM			
U7B	SM205211001	SM32K SRAM			
U8	SM191160750	SM75OHMRC			
U8A	SM205211001	SM32K SRAM			
U8B	SM205211001	SM32K SRAM			
U9	SM191160750	SM75OHMRC			
U10	SM191160750	SM75OHMRC			
U11	SM191160750	SM75OHMRC			
U12	SM191160750	SM75OHMRC			
U13	SM191160750	SM75OHMRC			
U14	SM191160750	SM75OHMRC			
U15	SM191160750	SM75OHMRC			
U16	SM191160750	SM75OHMRC			
U17	SM191160750	SM75OHMRC			
U18	SM200479573	SM74ABT573			
U19	SM200479573	SM74ABT573			
U20	SM191160750	SM75OHMRC			
U21	SM200170032	SM74F32			

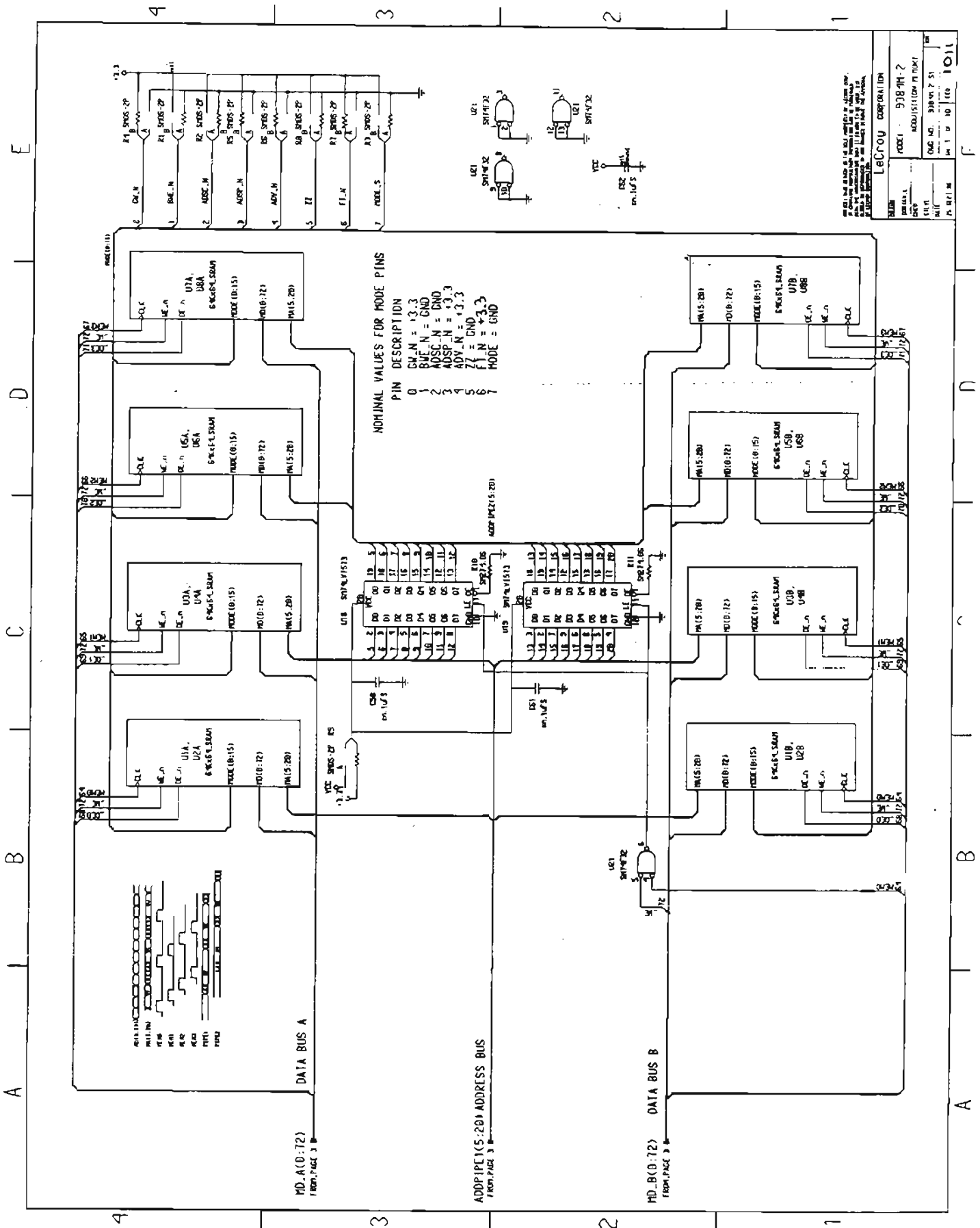

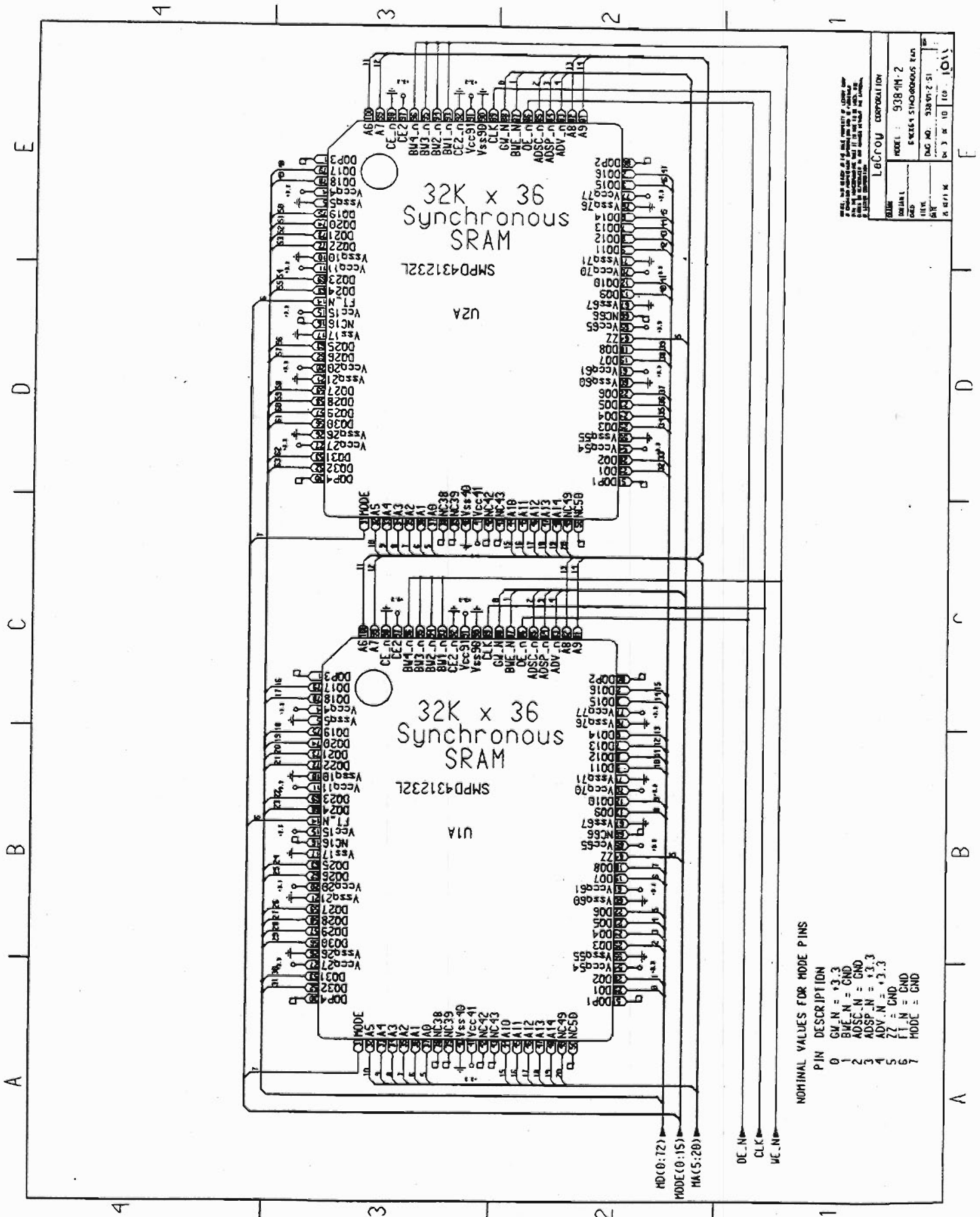

Section 7 Schematics, Layouts, Parts list

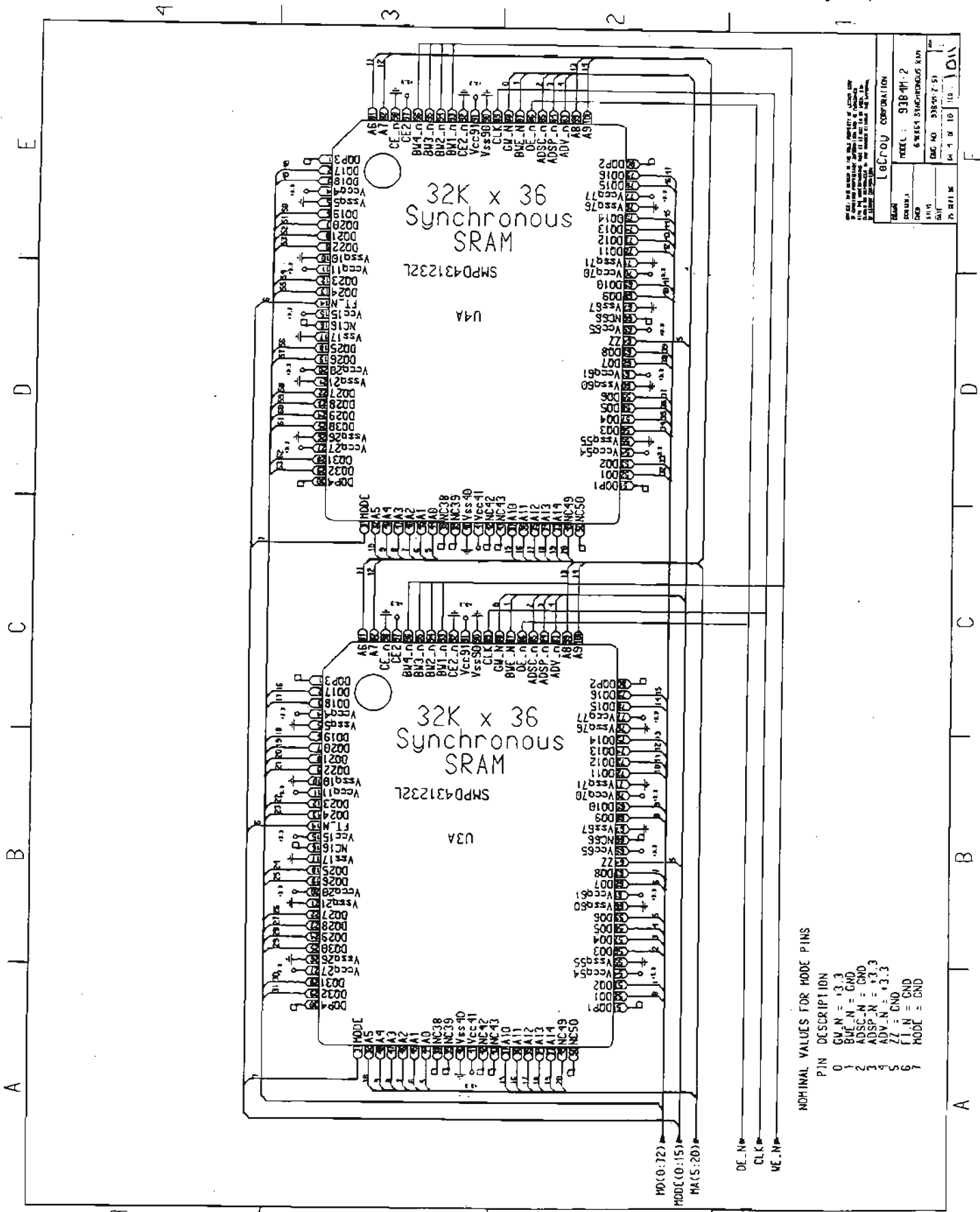

NOMINAL VALUES FOR MODE PINS

PIN	DESCRIPTION
0	GM-N = 1.3
1	BUEN = GND
2	ADSC-N = GND
3	ADSP-N = +3.3
4	ADV-N = +3.3
5	ZZ = GND
6	FT-N = GND
7	MODE = GND

LECTROY CORPORATION

MODEL:	93B-4M-2
REV:	6-1984 Synchronous k up
DWG NO:	93B-4M-2-51
DATE:	10-1-84
BY:	1011
CHKD BY:	

NOTES: 1. SEE DRAWING FOR THE FULL RANGE OF VALUES FOR ALL DIMENSIONS AND TOLERANCES. 2. ALL DIMENSIONS ARE IN MILLIMETERS UNLESS OTHERWISE SPECIFIED. 3. THE MODEL NO. IS 93B-4M-2-51.

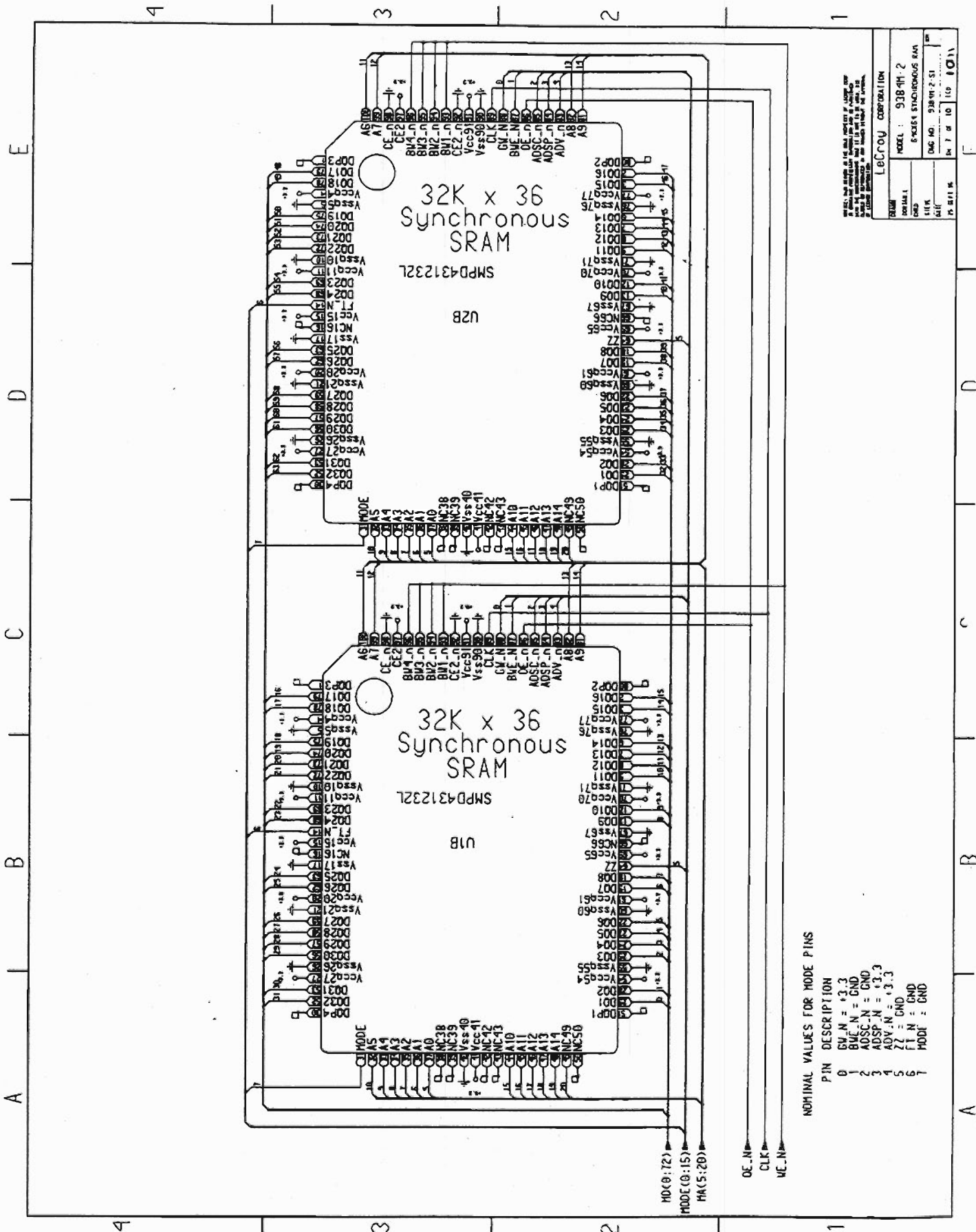

NOMINAL VALUES FOR MODE PINS

PIN	DESCRIPTION
0	GV.N = +3.3
1	BVE.N = GND
2	ADSC.N = GND
3	ADSP.N = +3.3
4	ADV.N = +3.3
5	FT.N = GND
6	FT.N = GND
7	MODE = GND

THIS IS THE BOARD AS SHOWN IN THE PHOTOGRAPH OF THIS BOARD. THE BOARD IS NOT THE BOARD AS SHOWN IN THE PHOTOGRAPH OF THIS BOARD. THE BOARD IS NOT THE BOARD AS SHOWN IN THE PHOTOGRAPH OF THIS BOARD.

REV	1
DATE	03/01/2011
DESIGNER	...
DATE	...
REV	...
DATE	...

LeCroy Corporation
 MODEL : 9384H-2
 8-PORT SYNCHRONOUS SRAM
 DATE : 03/01/2011
 REV : 1

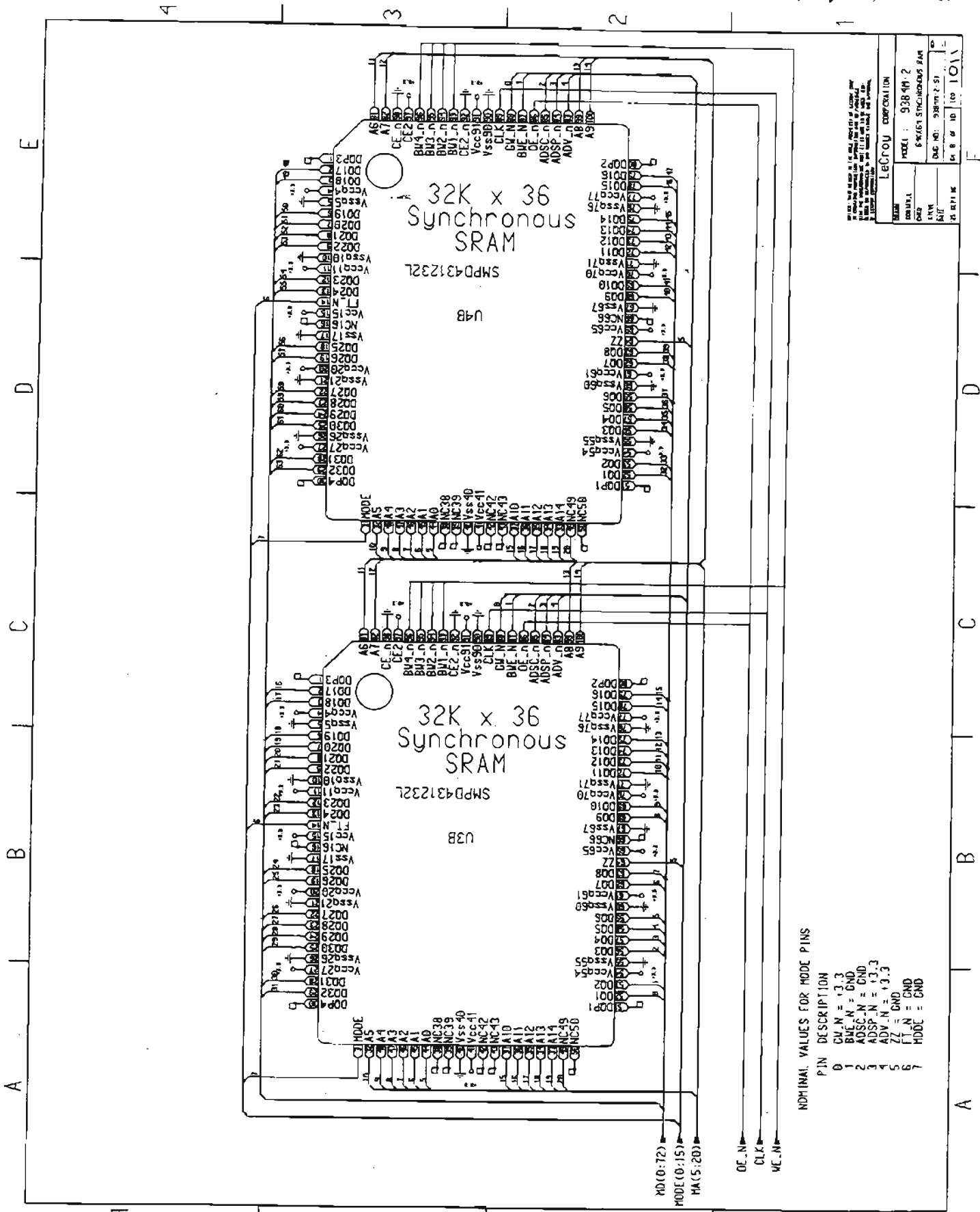

LECROY CORPORATION	
MODEL: 9384M-2	REV: 10/11
DATE: 6/26/11	DESIGN: 9384M-2-S1
BY: [Signature]	IN: 8 W: 10

MINIMAL VALUES FOR MODE PINS

PIN	DESCRIPTION
0	CLK = 1.7
1	BUSCIN = GND
2	ADSCIN = GND
3	ADSPIN = 1.3
4	ADV = 1.3
5	ZL = GND
6	FTIN = GND
7	MODE = GND

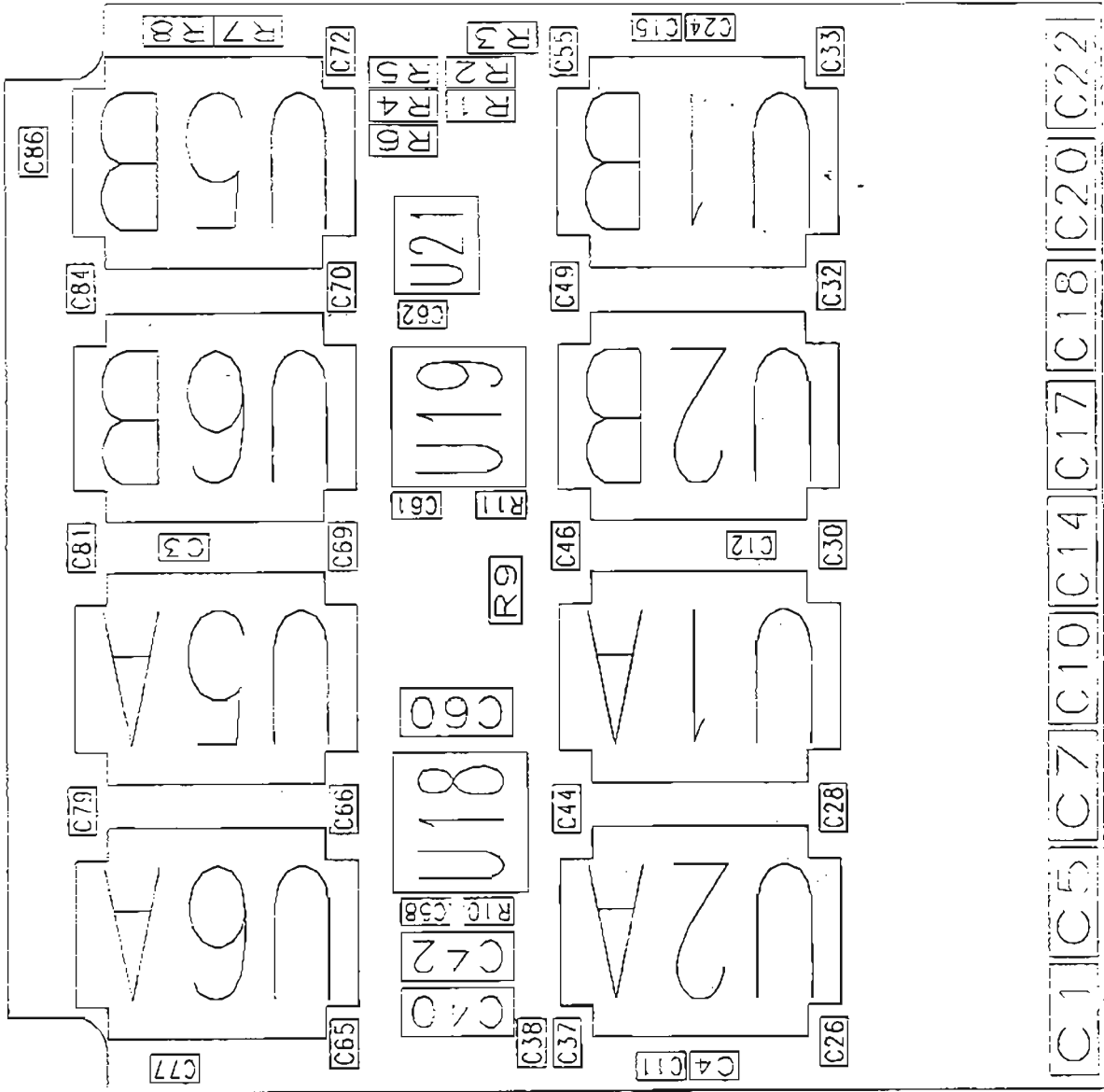

9384M-2 Component Side

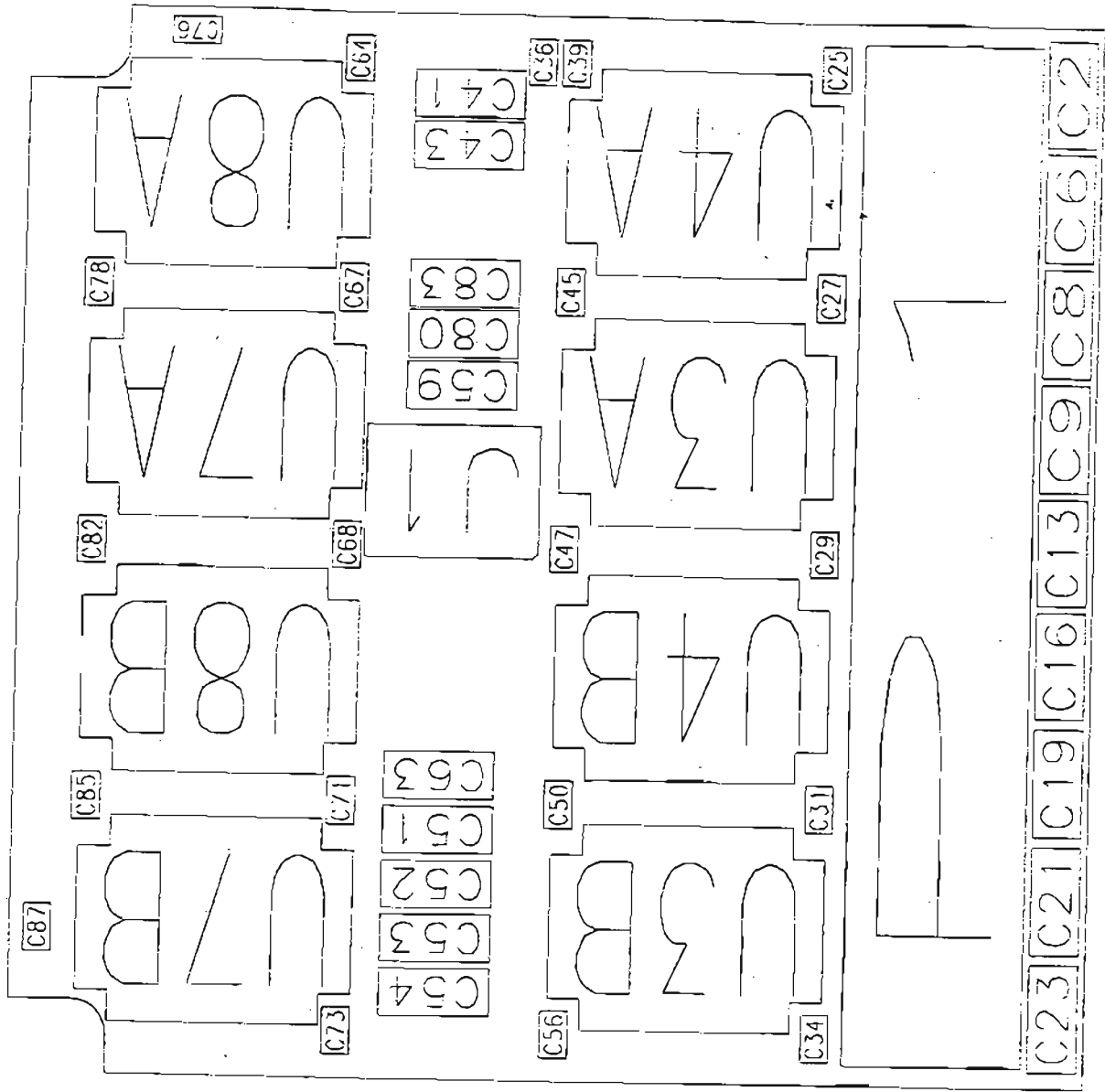

9384M-2 Solder Side

PART: 9384M-2 DESC: 2Mb ACQUISITION MEMORY CARD FOR 9384

Location	Part Number	Description	Location	Part Number	Description
C1	SM666267227	SM220uF-10V	C49	SM661207104	SM.1uFS
C2	SM666267227	SM220uF-10V	C50	SM661207104	SM.1uFS
C3	SM661207104	SM.1uFS	C51	SM666267227	SM220uF-10V
C4	SM661207104	SM.1uFS	C52	SM666267227	SM220uF-10V
C5	SM666267227	SM220uF-10V	C53	SM666267227	SM220uF-10V
C6	SM666267227	SM220uF-10V	C54	SM666267227	SM220uF-10V
C7	SM666267227	SM220uF-10V	C55	SM661207104	SM.1uFS
C8	SM666267227	SM220uF-10V	C56	SM661207104	SM.1uFS
C9	SM666267227	SM220uF-10V	C58	SM661207104	SM.1uFS
C10	SM666267227	SM220uF-10V	C59	SM666267227	SM220uF-10V
C11	SM661207104	SM.1uFS	C60	SM666267227	SM220uF-10V
C12	SM661207104	SM.1uFS	C61	SM661207104	SM.1uFS
C13	SM666267227	SM220uF-10V	C62	SM661207104	SM.1uFS
C14	SM666267227	SM220uF-10V	C63	SM666267227	SM220uF-10V
C15	SM661207104	SM.1uFS	C64	SM661207104	SM.1uFS
C16	SM666267227	SM220uF-10V	C65	SM661207104	SM.1uFS
C17	SM666267227	SM220uF-10V	C66	SM661207104	SM.1uFS
C18	SM666267227	SM220uF-10V	C67	SM661207104	SM.1uFS
C19	SM666267227	SM220uF-10V	C68	SM661207104	SM.1uFS
C20	SM666267227	SM220uF-10V	C69	SM661207104	SM.1uFS
C21	SM666267227	SM220uF-10V	C70	SM661207104	SM.1uFS
C22	SM666267227	SM220uF-10V	C71	SM661207104	SM.1uFS
C23	SM666267227	SM220uF-10V	C72	SM661207104	SM.1uFS
C24	SM661207104	SM.1uFS	C73	SM661207104	SM.1uFS
C25	SM661207104	SM.1uFS	C76	SM661207104	SM.1uFS
C26	SM661207104	SM.1uFS	C77	SM661207104	SM.1uFS
C27	SM661207104	SM.1uFS	C78	SM661207104	SM.1uFS
C28	SM661207104	SM.1uFS	C79	SM661207104	SM.1uFS
C29	SM661207104	SM.1uFS	C80	SM666267227	SM220uF-10V
C30	SM661207104	SM.1uFS	C81	SM661207104	SM.1uFS
C31	SM661207104	SM.1uFS	C82	SM661207104	SM.1uFS
C32	SM661207104	SM.1uFS	C83	SM666267227	SM220uF-10V
C33	SM661207104	SM.1uFS	C84	SM661207104	SM.1uFS
C34	SM661207104	SM.1uFS	C85	SM661207104	SM.1uFS
C36	SM661207104	SM.1uFS	C86	SM661207104	SM.1uFS
C37	SM661207104	SM.1uFS	C87	SM661207104	SM.1uFS
C38	SM661207104	SM.1uFS	P1	454110024	4x48-ST-M-PF
C39	SM661207104	SM.1uFS	R1	SM654101000	SM0S-2P
C40	SM666267227	SM220uF-10V	R2	SM654101000	SM0S-2P
C41	SM666267227	SM220uF-10V	R3	SM654101000	SM0S-2P
C42	SM666267227	SM220uF-10V	R4	SM654101000	SM0S-2P
C43	SM666267227	SM220uF-10V	R5	SM654101000	SM0S-2P
C44	SM661207104	SM.1uFS	R6	SM654101000	SM0S-2P
C45	SM661207104	SM.1uFS	R7	SM654101000	SM0S-2P
C46	SM661207104	SM.1uFS	R8	SM654101000	SM0S-2P
C47	SM661207104	SM.1uFS	R9	SM654101000	SM0S-2P

PART: 9384M-2 DESC: ACQUISITION MEMORY CARD FOR 9384

Location	Part Number	Description	Location	Part Number	Description
R10	SM653101339	SM274.0S			
R11	SM653101339	SM274.0S			
U18	SM200470573	SM74LVT573			
U19	SM200470573	SM74LVT573			
U1A	SM205211002	SM64KX32			
U1B	SM205211002	SM64KX32			
U21	SM200170032	SM74F32			
U2A	SM205211002	SM64KX32			
U2B	SM205211002	SM64KX32			
U3A	SM205211002	SM64KX32			
U3B	SM205211002	SM64KX32			
U4A	SM205211002	SM64KX32			
U4B	SM205211002	SM64KX32			
U5A	SM205211002	SM64KX32			
U5B	SM205211002	SM64KX32			
U6A	SM205211002	SM64KX32			
U6B	SM205211002	SM64KX32			
U7A	SM205211002	SM64KX32			
U7B	SM205211002	SM64KX32			
U8A	SM205211002	SM64KX32			
U8B	SM205211002	SM64KX32			

PART: F9300-4

DESC: GPIB + RS232 INTERFACE CARD

Location	Part Number	Description
A1	207440232	MAX232
A2	200333000	74HCT00
A3	207470161	75161
A4	207470160	75160
A5	207552661	2661A
A6	207197210	7210
A7	205750000	C16R4L
C1	103327103	.01uF
C2	102484471	470pF
C3	102484471	470pF
C4	102484471	470pF
C5	102484471	470pF
C6	102484471	470pF
C7	103327103	.01uF
C8	103327103	.01uF
C9	147436033	33uF-16V-AL-RA
C10	147436033	33uF-16V-AL-RA
C11	147436033	33uF-16V-AL-RA
C12	147436033	33uF-16V-AL-RA
C13	103327103	.01uF
C14	103427104	.1uF
C15	103427104	.1uF
C16	103427104	.1uF
C17	102484471	470pF
C18	103427104	.1uF
C19	103327103	.01uF
C20	103427104	.1uF
J5	454511040	2x20-RA-M-RE
J6	455413009	DB9-RA-M-SC
J8	453521024	GPIB24-F-ME
R1	161225682	6.8K
R2	161225302	3K
R3	161225471	470
R5	161225682	6.8K
RN1	190832102	1K-8SS
Y1	309040005	K1100A-4.9152MHz

PART: F9300-4

DESC: GPIB +RS232 INTERFACE CARD

COMPONENT	PART DESCRIPTION	QTY PER ASSEMBLY
102484471	CAP CERA DISC 100V 470 PF	6
103327103	CAP CERA MONO 50V .01 UF	5
103427104	CAP CERA MONO 100V .1 UF	5
147436033	CAP ALUM METAL CAN 33 UF	4
161225302	RES COMP 1/8W 5% 3 K	1
161225471	RES COMP 1/8W 5% 470 OHMS	1
161225682	RES CARBON FILM 6.8 K	2
190832102	RES NETWORK 1 K	1
200333000	IC QUAD 2-IN NAND HCT00	1
205750000	IC AND-OR GATE ARRAY 16V8	1
207197210	IC BUS INTERF CONTR 7210	1
207440232	IC XMTR/RCVR MAX 232	1
207470160	IC OCTAL BUS XCVR 75160A	1
207470161	IC OCTL BUS XCEIR 75161A	1
207552661	IC INTERFACE 2661A	1
309040005	CRYSTAL OSCIL. 4.9152MHZ	1
453521024	CONN RT ANGLE IEEE FEM 24	1
454511040	HDR SOLD TAIL/MALE/40/RT	1
455413009	CONN RT ANGLE MALE 9 S-CLIP	1
455980002	MOUNTING HDW FOR CONN SHELL	2
550130108	SCREW CYL HD M3X8	2
550430106	SCREW CYL HD PHIL M3X6	1
551430400	WASHER SHAKEPROOF M3	1
709300411	GPIB-RS232 INTERFACE BRACKET D	1
709300421	LABEL RS232-IEEE488-2 A	1
719300403	PC BD PREASS'Y 9300-4 D	1

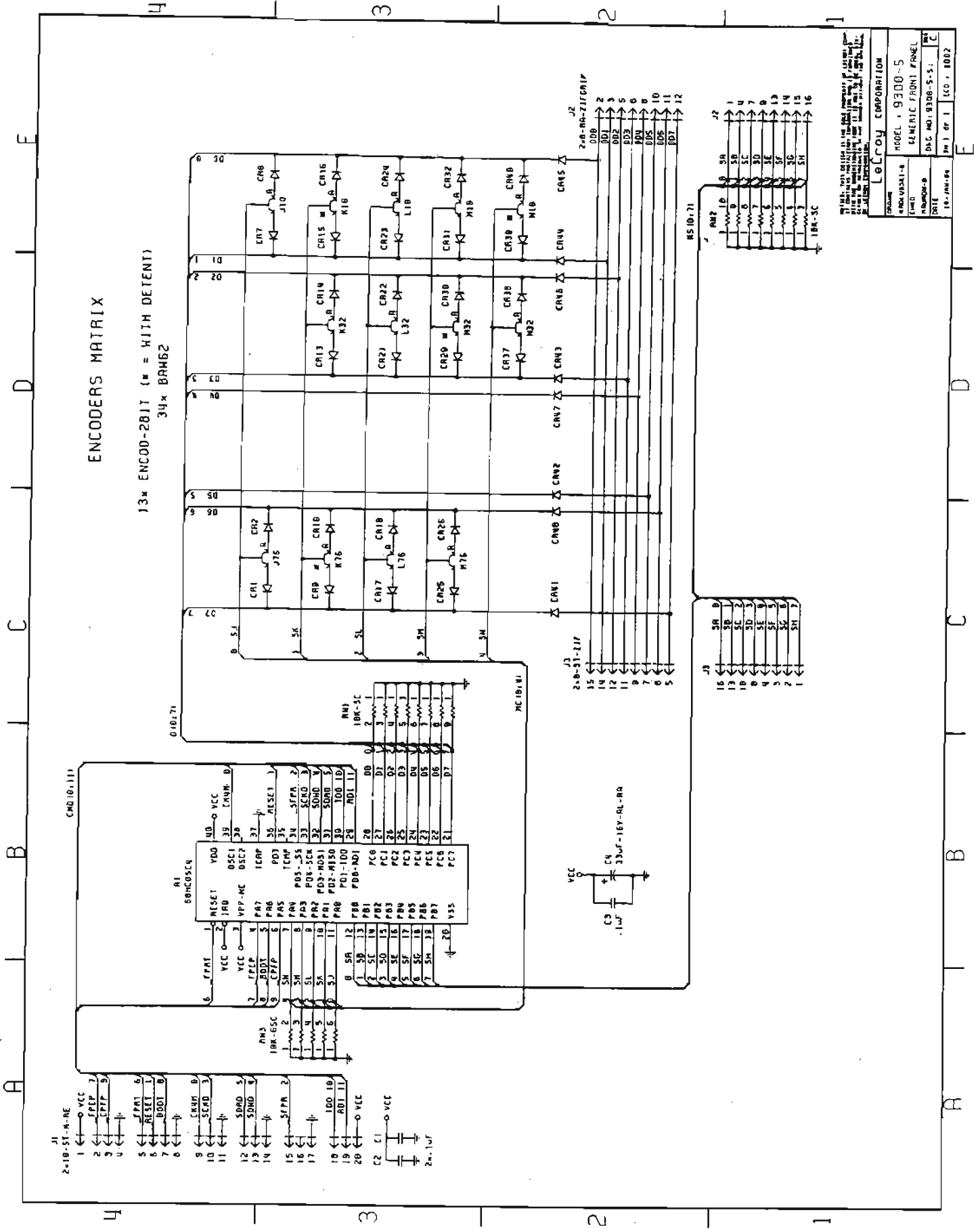

LELCOY CORPORATION
 MODEL: 9300-S
 GENERIC FRONT PANEL
 DDC NO. 9308-S-S
 DATE: 10-JUN-84
 PH: 011 ECD 1002

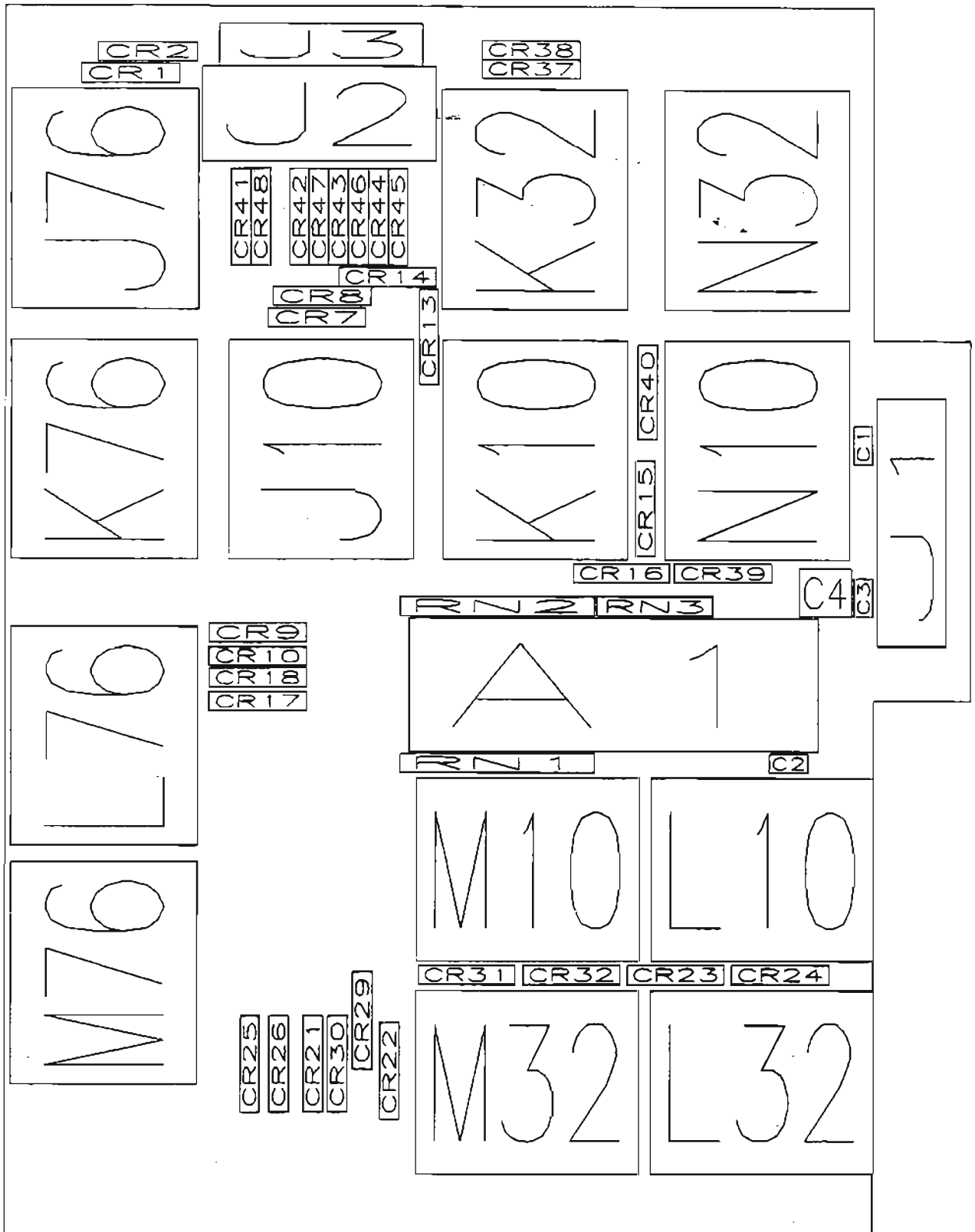

PART: F9354-5

DESC : Quad Channel Front Panel

Location	Part Number	Description	Location	Part Number	Description
A1	68HC05C4	68HC05C4	CR15	230020062	BAW62
C1,2,3	103427104	.1uF	CR16	230020062	BAW62
C4	147436033	33uF-16V	CR17	230020062	BAW62
J1	454110120	2x10-ST-M-RE	CR18	230020062	BAW62
J2	453410016	2x8-RA-ZIFGRIP	CR21	230020062	BAW62
J3	453411016	2x8-ST-ZIF	CR22	230020062	BAW62
J10	425100001	ENCOD-2BIT-E	CR23	230020062	BAW62
J76	425100001	ENCOD-2BIT-E	CR24	230020062	BAW62
K10	425110001	ENCOD-2BIT-C	CR25	230020062	BAW62
K32	425100001	ENCOD-2BIT-E	CR26	230020062	BAW62
K76	425110001	ENCOD-2BIT-C	CR29	230020062	BAW62
L10	425100001	ENCOD-2BIT-E	CR30	230020062	BAW62
L32	425100001	ENCOD-2BIT-E	CR31	230020062	BAW62
L76	425100001	ENCOD-2BIT-E	CR32	230020062	BAW62
M10	425100001	ENCOD-2BIT-E	CR37	230020062	BAW62
M32	425110001	ENCOD-2BIT-C	CR38	230020062	BAW62
M76	425100001	ENCOD-2BIT-E	CR39	230020062	BAW62
N10	425110001	ENCOD-2BIT-C	CR40	230020062	BAW62
N32	425100001	ENCOD-2BIT-E	CR41	230020062	BAW62
CR1	230020062	BAW62	CR42	230020062	BAW62
CR2	230020062	BAW62	CR43	230020062	BAW62
CR7	230020062	BAW62	CR44	230020062	BAW62
CR8	230020062	BAW62	CR45	230020062	BAW62
CR9	230020062	BAW62	CR46	230020062	BAW62
CR10	230020062	BAW62	CR47	230020062	BAW62
CR13	230020062	BAW62	CR48	230020062	BAW62
CR14	230020062	BAW62	RN1,2,3	190042103	10K-SC

COMPONENT

PART DESCRIPTION

QTY PER ASSEMBLY

103427104	CAP CERA MONO 100V .1 UF	3
147436033	CAP ALUM METAL CAN 33 UF	1
190042103	RESISTOR NETWORK 10 K	2
190642103	RESISTOR NETWORK 10 K	1
230020062	DIODE SWITCHING BAW62	34
425100001	ENCODER DIGITAL 24 POS	9
425110001	ENCODER DIGITAL 24 POS	4
453410016	CONN FLEX CIRCUIT 16-POS	1
454110120	HDR SLD TAIL/MALE/20/STRAIGHT	1
554435004	SCREW PT PHIL KA35X10	1
7093XX511	KNOB 10MM DIAMETRE	8
7093XX521	KNOB 14MM DIAMETRE	5
719300503	PC BD PREASS'Y 9300-5	1
729350513	FP KEYBOARD ASS'Y 9350-5	1
MFP414	IC FRT PANEL PROCESSOR MFP414	1

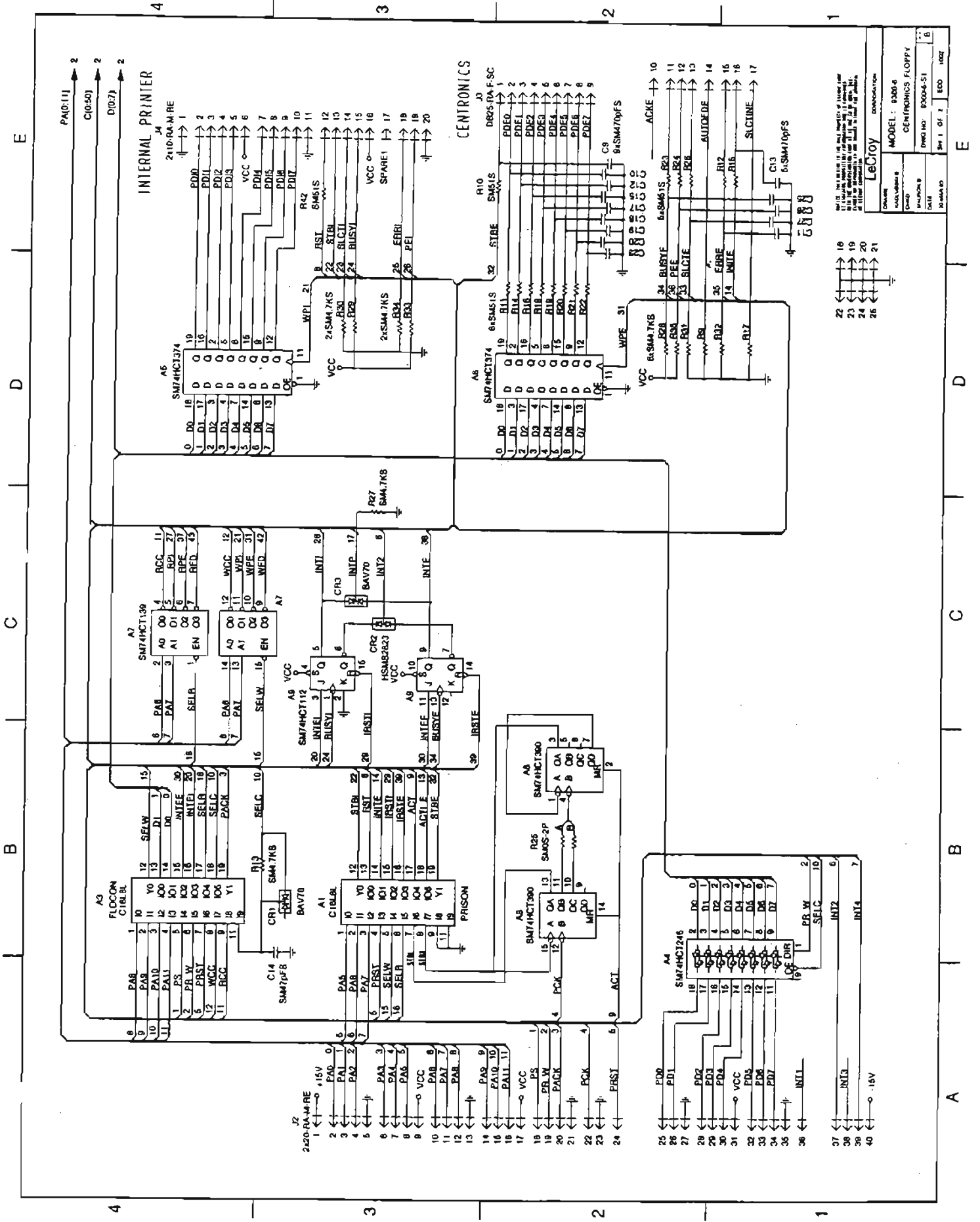

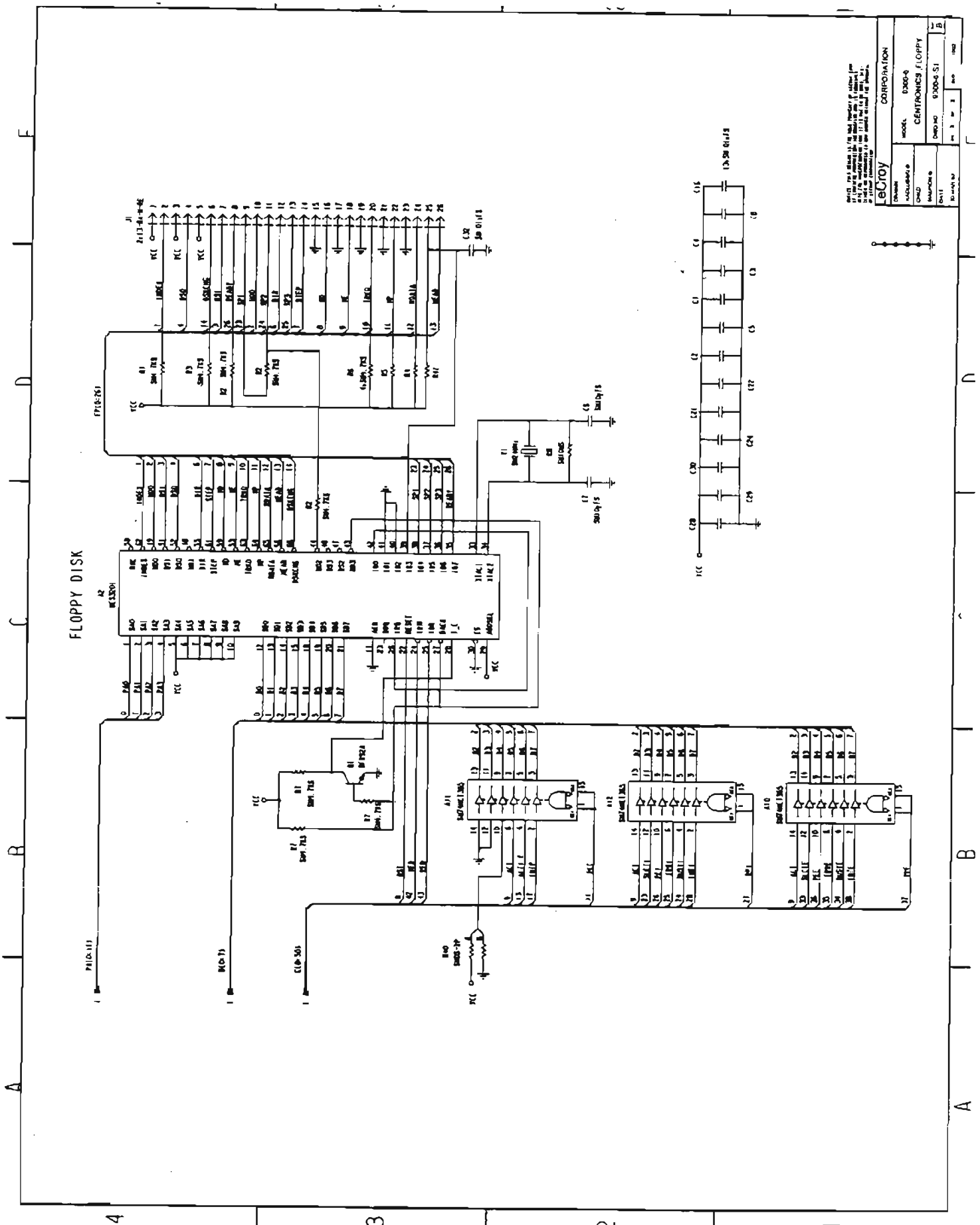

© 1975, All Rights Reserved. This document is the property of Centronics Corporation. It is to be used only for the equipment for which it was prepared. No part of this document may be reproduced without the prior written permission of Centronics Corporation.

Centronics Corporation
 MODEL: 8300-A
 CENTRONICS FLOPPY
 9300-A S1
 9300-A S1

9300-6 Rev:C

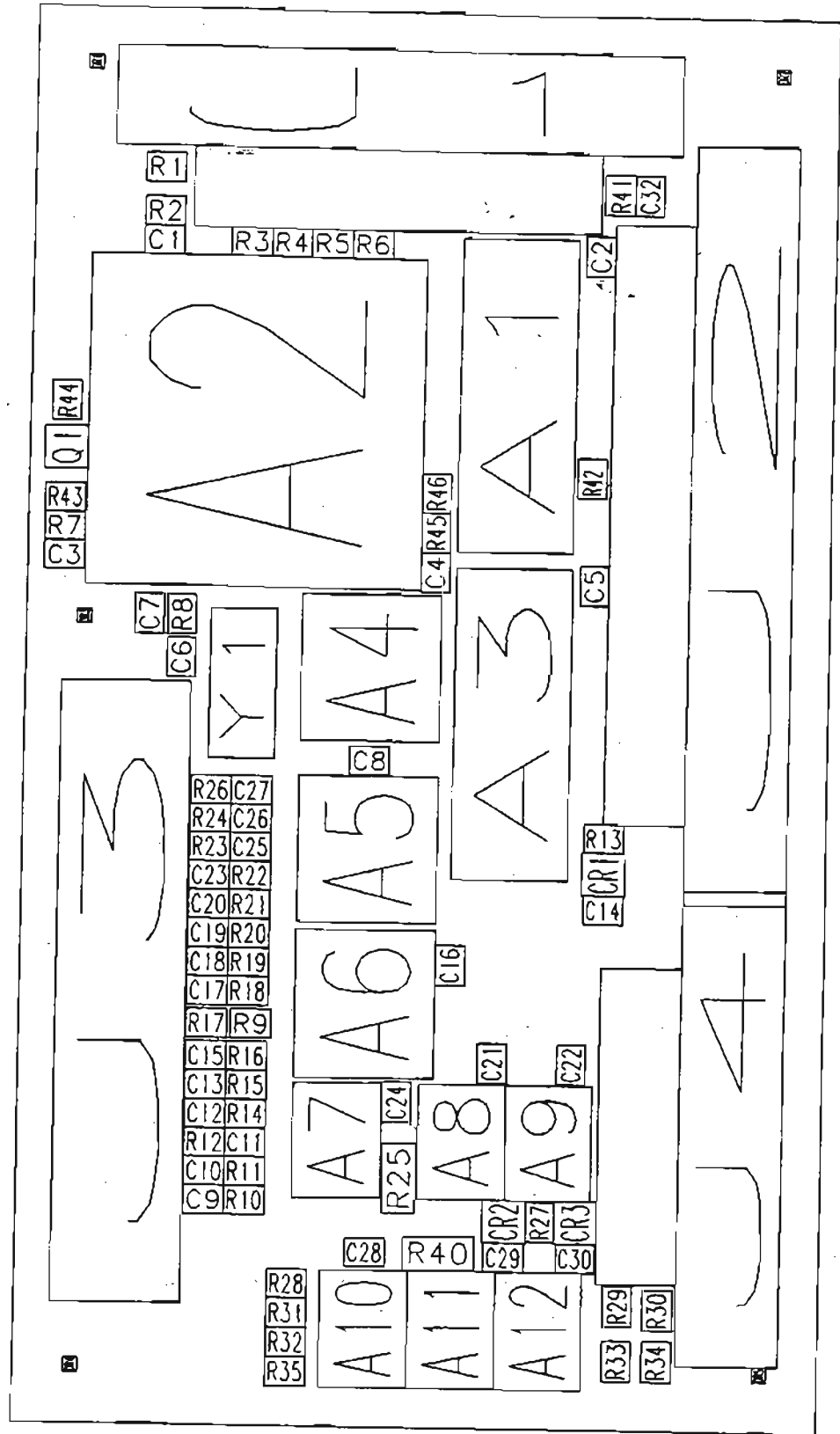

PART: F9300-6

DESC: CENTRONICS, FLOPPY AND PRINTER INTERFACE

Location	Part Number	Description	Location	Part Number	Description
A1	205750000	C16L8L	CR2	SM253032823	HSMS2823
A2	SM227063201	MCS3201	CR3	SM232120070	BAV70
A3	205750000	C16L8L	J1	454511026	2x13-RA-M-RE
A4	SM207878245	SM74HCT245	J2	454511040	2x20-RA-M-RE
A5	SM200178374	SM74HCT374	J3	454520025	DB25-RA-F-SC
A6	SM200178374	SM74HCT374	J4	454511020	2x10-RA-M-RE
A7	SM200178139	SM74HCT139	Q1	SM270130092	BFR92A
A8	SM200278390	SM74HCT390	R1	SM652101472	SM4.7KS
A9	SM201170112	SM74HCT112	R2	SM652101472	SM4.7KS
A10	SM207170036	SM74HCT365	R3	SM652101472	SM4.7KS
A11	SM207170036	SM74HCT365	R4	SM652101472	SM4.7KS
A12	SM207170036	SM74HCT365	R5	SM652101472	SM4.7KS
C1	SM661207103	SM.01uF	R6	SM652101472	SM4.7KS
C2	SM661207103	SM.01uF	R7	SM652101103	SM10KS
C3	SM661207103	SM.01uF	R8	SM652101106	SM10MS
C4	SM661207103	SM.01uF	R9	SM652101472	SM4.7KS
C5	SM661207103	SM.01uF	R10	SM652101510	SM51S
C6	SM661255100	SM10pF	R11	SM652101510	SM51S
C7	SM661255100	SM10pF	R12	SM652101510	SM51S
C8	SM661207103	SM.01uF	R13	SM652101472	SM4.7KS
C9	SM661255471	SM470pF	R14	SM652101510	SM51S
C10	SM661255471	SM470pF	R15	SM652101510	SM51S
C11	SM661255471	SM470pF	R16	SM652101510	SM51S
C12	SM661255471	SM470pF	R17	SM652101472	SM4.7KS
C13	SM661255471	SM470pF	R18	SM652101510	SM51S
C14	SM661255470	SM47pF	R19	SM652101510	SM51S
C15	SM661255471	SM470pF	R20	SM652101510	SM51S
C16	SM661207103	SM.01uF	R21	SM652101510	SM51S
C17	SM661255471	SM470pF	R22	SM652101510	SM51S
C18	SM661255471	SM470pF	R23	SM652101510	SM51S
C19	SM661255471	SM470pF	R24	SM652101510	SM51S
C20	SM661255471	SM470pF	R25	SM654101000	SM0S-2P
C21	SM661207103	SM.01uF	R26	SM652101510	SM51S
C22	SM661207103	SM.01uF	R27	SM652101472	SM4.7KS
C23	SM661255471	SM470pF	R28	SM652101472	SM4.7KS
C24	SM661207103	SM.01uF	R29	SM652101472	SM4.7KS
C25	SM661255471	SM470pF	R30	SM652101472	SM4.7KS
C26	SM661255471	SM470pF	R31	SM652101472	SM4.7KS
C27	SM661255471	SM470pF	R32	SM652101472	SM4.7KS
C28	SM661207103	SM.01uF	R33	SM652101472	SM4.7KS
C29	SM661207103	SM.01uF	R34	SM652101472	SM4.7KS
C30	SM661207103	SM.01uF	R35	SM652101472	SM4.7KS
C32	SM661207103	SM.01uF	R40	SM654101000	SM0S-2P
CR1	SM232120070	BAV70	R41	SM652101472	SM4.7KS

PART: F9300-6 DESC: CENTRONICS/FLOPPY/PRINTER INTERFACE

Location	Part Number	Description
R42	SM652101510	SM51S
R43	SM652101472	SM4.7KS
R44	SM652101472	SM4.7KS
Y1	SM310900024	SM24MHz

PART: F9300-6 DESC: CENTRONICS/FLOPPY/PRINTER INTERFACE

COMPONENT	PART DESCRIPTION	QTY PER ASSEMBLY
205750000	IC AND-OR GATE ARRAY 16V8	2
454511020	HDR SOLD TAIL/MALE 20	1
454511026	HDR SOLD TAIL/MALE 26	1
454511040	HDR SOLD TAIL/MALE/40/RT	1
454520025	CONN RT ANGLE FEM 25 S-CLIP	1
455980002	MOUNTING HDW FOR CONN SHELL	2
550430106	SCREW CYL HD PHIL M3X6	4
551430400	WASHER SHAKEPROOF M3	4
709300611	CENTR. FLOPPY INTERF. BRACKET	1
709300621	LABEL PARA-INTERF. CENTRONICS	1
719300603	PC BD PREASS'Y 9300-6 C	1
SM200178139	IC 2-TO-4-LINE DEC HCT139	1
SM200178374	IC D-TYP FLOP 74HCT374	2
SM200278390	IC 4-BIT RIPPLE COUNTER	1
SM201170112	IC DUAL JK FF WITH SET-RESET	1
SM207170036	IC HEX BUFFER 3-STATE	3
SM207878245	IC BUS TRANSCVR HCT 245	1
SM227063201	IC IBM PC FLOPPY DISK CONTR.	1
SM232120070	DIODE ARRAY BAV70	1
SM253032823	DIODE SCHOTTKY 2823	1
SM270130092	TRANS NPN BFR92A	1
SM310900024	CRYSTAL 24 MHZ SMD	1
SM652101103	RES CHIP (E24) 1% 10 K	1
SM652101106	RES CHIP (E24) 1% 10 MEG	1
SM652101472	RES CHIP (E24) 1% 4.7 K	21
SM652101510	RES CHIP (E24) 1% 51 OHMS	15
SM654101000	CHIP JUMPER ZERO OHMS	2
SM661207103	CAP CERA CHIP 20% .01UF	14
SM661255100	CAP CERA CHIP 10PF	2
SM661255470	CAP CERA CHIP 47PF	1
SM661255471	CAP CERA CHIP 5% 470 PF	14

Section 7 Schematics, Layouts, Parts list

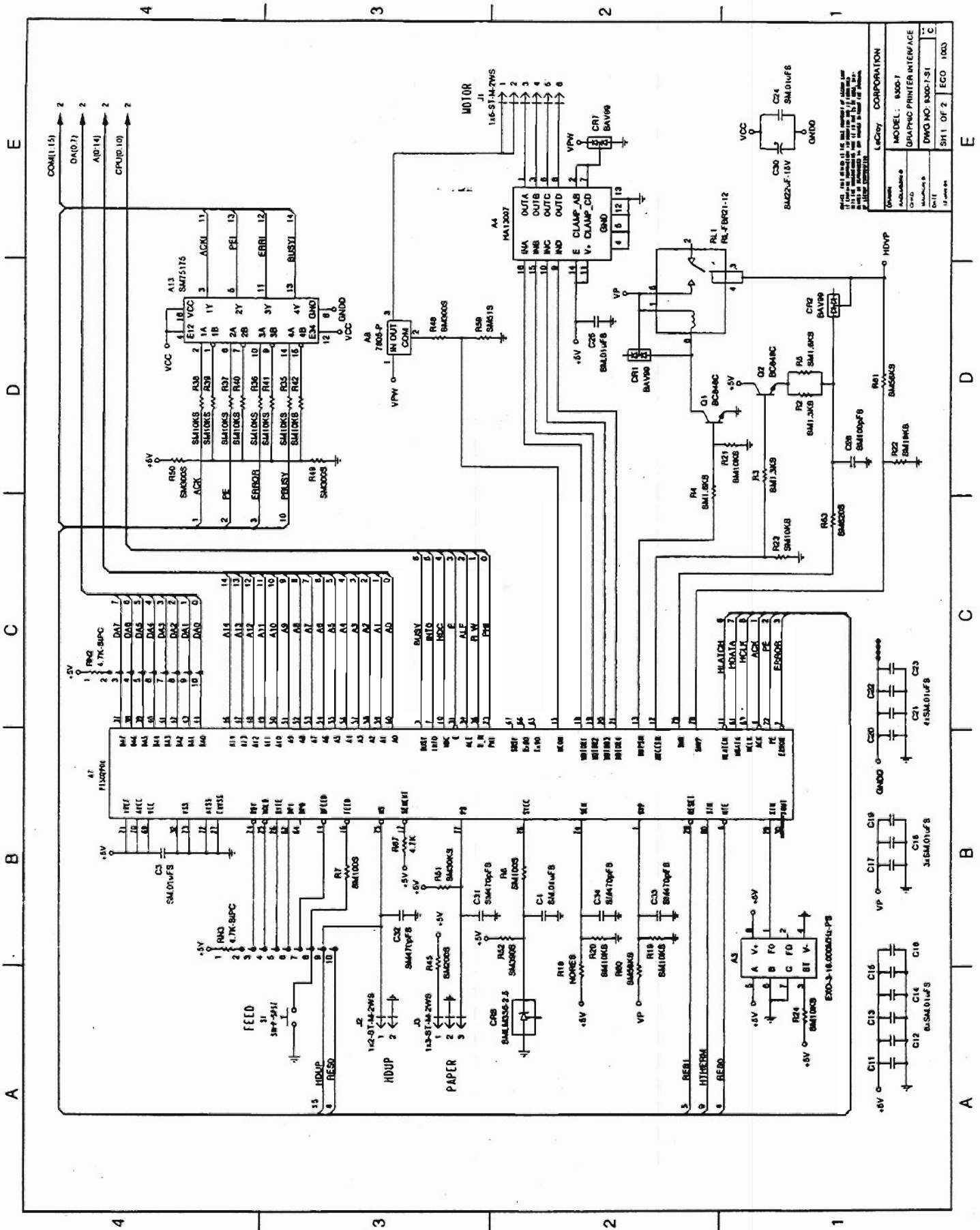

LeCroy CORPORATION	
MODEL: 8300-1	GRAPHIC PRINTER INTERFACE
MANUFACTURED BY: LeCroy Corporation	DATE: 12-1984
DWG NO: 8300-1-S1	ECO 1003
SH1 OF 2	

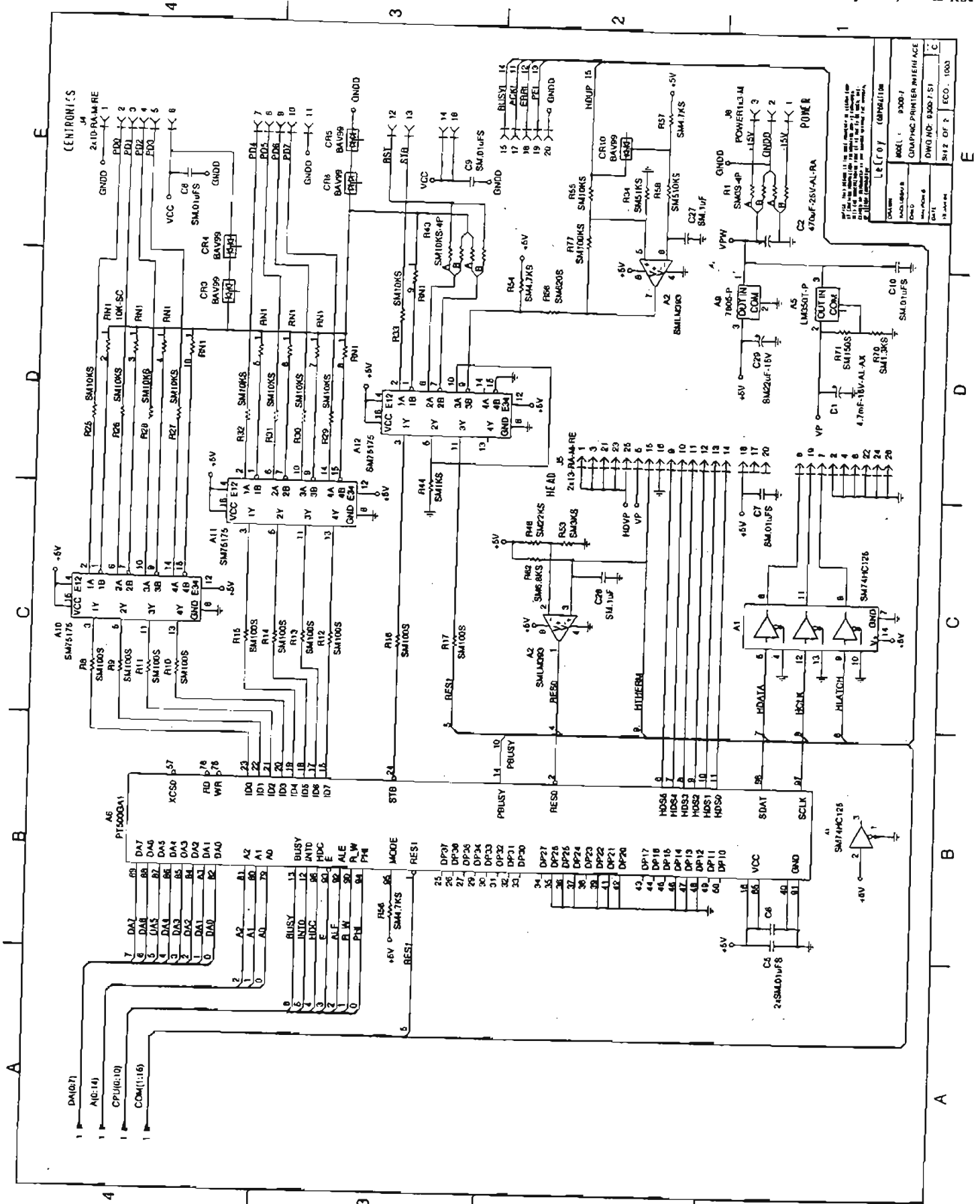

PART: F9300-7

DESC: LTP 5446 PRINTER CONTROLLER

Location	Part Number	Description	Location	Part Number	Description
A1	SM200330125	SM74HC125	C32	SM661255471	SM470pF
A2	SM208650393	SMLM393	C33	SM661255471	SM470pF
A3	309380016	16.000MHZ	C34	SM661255471	SM470pF
A4	207140007	HA13007	CR1	SM236030099	BAV99
A5	208590350	LM350T-P	CR2	SM236030099	BAV99
A6	SM227080500	PT500GA1	CR3	SM236030099	BAV99
A7	SM227090501	PT501P01	CR4	SM236030099	BAV99
A8	208122002	7805-P	CR5	SM236030099	BAV99
A9	208122002	7805-P	CR6	SM236030099	BAV99
A10	SM207470175	SM75175	CR7	SM236030099	BAV99
A11	SM207470175	SM75175	CR8	SM208580336	SMLM336-2.5
A12	SM207470175	SM75175	CR10	SM236030099	BAV99
A13	SM207470175	SM75175	J1	454111006	1x6-ST-M-2WS
C1	147494472	4.7mF-16V	J2	454111002	1x2-ST-M-2WS
C2	146544471	470uF-25V	J3	454113003	1x3-ST-M-2WS
C3	SM661207103	SM.01uF	J4	454511020	2x10-RA-M-RE
C4	SM661207103	SM.01uF	J5	454511026	2x13-RA-M-RE
C5	SM661207103	SM.01uF	J6	454121003	POWER1x3-M
C6	SM661207103	SM.01uF	Q1	SM270330848	BC848C
C7	SM661207103	SM.01uF	Q2	SM270330848	BC848C
C8	SM661207103	SM.01uF	R1	SM654101000	SM0S-4P
C9	SM661207103	SM.01uF	R2	SM652101132	SM1.3KS
C10	SM661207103	SM.01uF	R3	SM652101132	SM1.3KS
C11	SM661207103	SM.01uF	R4	SM652101162	SM1.6KS
C12	SM661207103	SM.01uF	R5	SM652101162	SM1.6KS
C13	SM661207103	SM.01uF	R6	SM652101101	SM100S
C14	SM661207103	SM.01uF	R7	SM652101101	SM100S
C15	SM661207103	SM.01uF	R8	SM652101101	SM100S
C16	SM661207103	SM.01uF	R9	SM652101101	SM100S
C17	SM661207103	SM.01uF	R10	SM652101101	SM100S
C18	SM661207103	SM.01uF	R11	SM652101101	SM100S
C19	SM661207103	SM.01uF	R12	SM652101101	SM100S
C20	SM661207103	SM.01uF	R13	SM652101101	SM100S
C21	SM661207103	SM.01uF	R14	SM652101101	SM100S
C22	SM661207103	SM.01uF	R15	SM652101101	SM100S
C23	SM661207103	SM.01uF	R16	SM652101101	SM100S
C24	SM661207103	SM.01uF	R17	SM652101101	SM100S
C25	SM661207103	SM.01uF	R19	SM652101103	SM10KS
C26	SM661127104	SM.1uF	R20	SM652101103	SM10KS
C27	SM661127104	SM.1uF	R21	SM652101103	SM10KS
C28	SM661255101	SM100pF	R22	SM652101103	SM10KS
C29	SM666377226	SM22uF-15V	R23	SM652101103	SM10KS
C30	SM666377226	SM22uF-15V	R24	SM652101103	SM10KS
C31	SM661255471	SM470pF	R25	SM652101103	SM10KS

PART: F9300-7

DESC: LTP 5446 PRINTER CONTROLLER

Location	Part Number	Description	Location	Part Number	Description
R26	SM652101103	SM10KS	R50	SM652101301	SM300S
R27	SM652101103	SM10KS	R51	SM652101303	SM30KS
R28	SM652101103	SM10KS	R52	SM652101391	SM390S
R29	SM652101103	SM10KS	R53	SM652101302	SM3KS
R30	SM652101103	SM10KS	R54	SM652101472	SM4.7KS
R31	SM652101103	SM10KS	R55	SM652101103	SM10KS
R32	SM652101103	SM10KS	R56	SM652101472	SM4.7KS
R33	SM652101103	SM10KS	R57	SM652101472	SM4.7KS
R34	SM652101513	SM51KS	R58	SM652101514	SM510KS
R35	SM652101103	SM10KS	R59	SM652101510	SM51S
R36	SM652101103	SM10KS	R60	SM652101563	SM56KS
R37	SM652101103	SM10KS	R61	SM652101563	SM56KS
R38	SM652101103	SM10KS	R62	SM652101682	SM6.8KS
R39	SM652101103	SM10KS	R63	SM652101621	SM620S
R40	SM652101103	SM10KS	R66	SM652101621	SM620S
R41	SM652101103	SM10KS	R70	SM652101132	SM1.3KS
R42	SM652101103	SM10KS	R71	SM652101151	SM150S
R43	SM652101103	SM10KS-4P	R77	SM652101104	SM100KS
R44	SM652101102	SM1KS	RL1	430430001	RL-FBR21-12
R45	SM652101201	SM200S	RN1	190042103	10K-SC
R46	SM652101223	SM22KS	RN2	190042472	4.7K-SIPC
R48	SM652101301	SM300S	RN3	190042472	4.7K-SIPC
R49	SM652101301	SM300S	S1	416161003	SW-P-SPST

PART: F9300-7

DESC: LTP 5446 PRINTER CONTROLLER

COMPONENT	PART DESCRIPTION	QTY PER ASSEMBLY
146544471	CAP MINI ALUM 20% 470UF	1
147494472	CAP ALU COMPACT AXIAL 4700 UF	1
190042103	RESISTOR NETWORK 10 K	1
190042472	RESISTOR NETWORK 4.7 K	2
207140007	IC QUAD STEP MOTOR DRIVER	1
208122002	IC VOLT REG POS UA7805	2
208590350	IC ADJ POWER REG 3A LM350	1
309380016	CRYSTAL OSC (PROGR) 16 MHZ	1
416161003	SWITCH PUSHBUTTON SPST	1
430430002	RELAY 1 FORM C SPDT	1
454111002	HEADER STRAIGHT 2-PINS	1
454111006	HEADER STRAIGHT 6-PINS	1
454113003	HEADER STRAIGHT 3-PINS	1
454121003	BLOC FOR SOCKETS 3-PIN	1
454511020	HDR SOLD TAIL/MALE 20	1
454511026	HDR SOLD TAIL/MALE 26	1
554435401	RIVET "RIVSCREW" M 3.5	3
719300703	PC BD PREASS'Y 9300-7	1
SM200330125	IC QUAD BUFFER 74HC125	1
SM207470175	IC QUAD DIFF LINE RECEIVER	4
SM208580336	IC REF DIODE LM336-2.5V	1
SM208650393	IC DUAL VOLT COMP LM393M	1
SM227080500	IC THERM PRINTER GATE ARRAY	1
SM227090501	IC THERM PRINTER CPU	1
SM236030099	DIODE SO-PKG BAV99	8
SM270330848	TRANS NPN BC848C	2
SM652101101	RES CHIP (E24) 1% 100 OHM	12
SM652101102	RES CHIP (E24) 1% 1 K	1
SM652101103	RES CHIP (E24) 1% 10 K	25
SM652101104	RES CHIP (E24) 1% 100 K	1
SM652101132	RES CHIP (E24) 1% 1.3 K	3
SM652101151	RES CHIP (E24) 1% 150 OHM	1
SM652101162	RES CHIP (E24) 1% 1.6 K	2
SM652101201	RES CHIP (E24) 1% 200 OHM	1
SM652101223	RES CHIP (E24) 1% 22 K	1
SM652101301	RES CHIP (E24) 1% 300 OHM	3
SM652101302	RES CHIP (E24) 1% 3 K	1
SM652101303	RES CHIP (E24) 1% 30 K	1
SM652101391	RES CHIP (E24) 1% 390 OHM	1
SM652101472	RES CHIP (E24) 1% 4.7 K	3
SM652101510	RES CHIP (E24) 1% 51 OHMS	1
SM652101513	RES CHIP (E24) 1% 51 K	1
SM652101514	RES CHIP (E24) 1% 510 K	1
SM652101563	RES CHIP (E24) 1% 56 K	2

COMPONENT	PART DESCRIPTION	QTY PER ASSEMBLY
SM652101621	RES CHIP (E24) 1% 620 OHM	2
SM652101682	RES CHIP (E24) 1% 6.8 K	1
SM654101000	CHIP JUMPER ZERO OHMS	1
SM661127104	CAP CERA CHIP 20% .1 UF	2
SM661207103	CAP CERA CHIP 20% .01UF	23
SM661255101	CAP CERA CHIP 5% 100 PF	1
SM661255471	CAP CERA CHIP 5% 470 PF	4
SM666377226	CAP MOLD TANT CHIP 22 UF	2

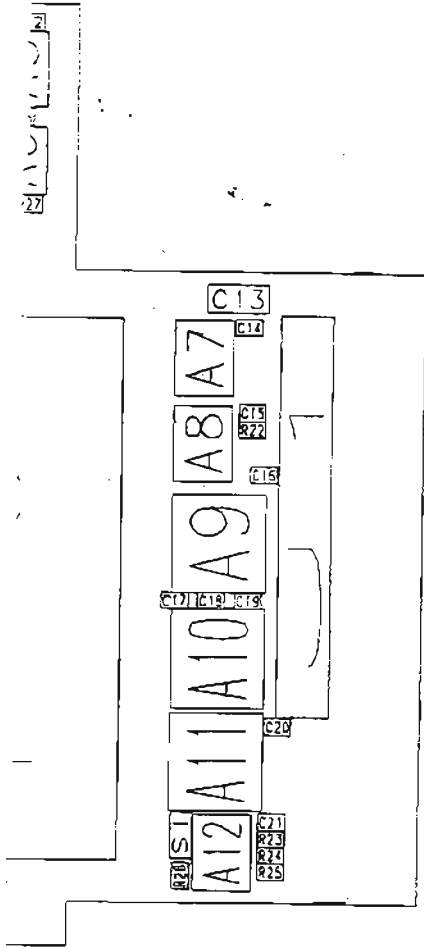

PART: F9300-8

DESC: PCMCIA 3 HARD DISK CONTROLLER

Location	Part Number	Description	Location	Part Number	Description
A1	205750000	C16R4L	L1	SM300056332	SM33uH
A2	205750000	C16L8L	Q1	SM280171005	MTD10N05E
A3	SM201178175	SM74HCT175	Q2	SM275330858	BC858C
A4	SM208470358	SMLM358	R1	SM652101334	SM330KS
A5	SM208780109	SM1109-12	R2	SM652101103	SM10KS
A6	SM200178002	SM74HCT02	R3	SM652101104	SM100KS
A7	SM207170036	SM74HCT365	R4	SM652101102	SM1KS
A8	SM207170036	SM74HCT365	R5	SM652101103	SM10KS
A9	SM206885245	SM74ABT245	R6	SM652101103	SM10KS
A10	SM200178374	SM74HCT374	R7	SM652101103	SM10KS
A11	SM200178374	SM74HCT374	R8	SM652101103	SM10KS
A12	SM207170036	SM74HCT365	R9	SM652101103	SM10KS
C1	SM661207103	SM.01uFS	R10	SM652101103	SM10KS
C2	SM661207103	SM.01uFS	R11	SM652101220	SM22S
C3	SM661207104	SM.1uFS	R12	SM652101103	SM10KS
C4	SM661207104	SM.1uFS	R13	SM652101334	SM330KS
C5	SM666377226	SM22uF-15V	R14	SM652101102	SM1KS
C6	SM666327225	SM2.2uF-20V	R15	SM652101104	SM100KS
C7	SM661207104	SM.1uFS	R16	SM652101334	SM330KS
C8	SM661207103	SM.01uFS	R17	SM652101103	SM10KS
C9	SM661255101	SM100pFS	R18	SM652101103	SM10KS
C10	SM661207104	SM.1uFS	R19	SM652101103	SM10KS
C11	SM661207103	SM.01uFS	R20	SM652101103	SM10KS
C12	SM666377226	SM22uF-15V	R21	SM652101102	SM1KS
C13	SM666377226	SM22uF-15V	R22	SM652101103	SM10KS
C14	SM661207103	SM.01uFS	R23	SM652101103	SM10KS
C15	SM661207103	SM.01uFS	R24	SM652101103	SM10KS
C16	SM661207103	SM.01uFS	R25	SM652101103	SM10KS
C17	SM661207104	SM.1uFS	R26	SM652101103	SM10KS
C18	SM661207104	SM.1uFS	R27	SM652101103	SM10KS
C19	SM661207103	SM.01uFS	S1	SM654101000	SM0S-2P
C20	SM661207103	SM.01uFS	CR1	SM232032814	HSMS2814
C21	SM661207103	SM.01uFS	CR2	SM232032814	HSMS2814
J1	454511040	2x20-RA-M-RE	CR3	SM232032814	HSMS2814
J2	330100100	2x34-RA-CGE	CR4	SM232032814	HSMS2814

PART: F9300-8

DESC: PCMCIA III HARD DISK CONTROLLER

COMPONENT	PART DESCRIPTION	QTY PER ASSEMBLY
205750000	IC AND-OR GATE ARRAY 16V8	2
330100100	PCMCIA HEADER ASS'Y TOP/LEFT	1
389340009	AUTO-ADHES. RUBBER BAND	1
454511040	HDR SOLDER TAIL/MALE/40/RT	1
550120606	SCREW OVAL HD PHIL M2X6	4
550430106	SCREW CYL HD PHIL M3X6	4
551430400	WASHER SHAKEPROOF M3	4
552120100	NUT HEX M2X0.5D	4
594230002	CABLE CLIP ADHESIVE BACK	1
709300811	9300-8 PCMCIA III CONT. BRACKET	1
709300821	9300-8 PCMCIA III CONT. COVER	1
709300831	9300-8 PCMCIA III CONTR. LABEL	1
719300803	PC BD PREASS'Y 9300-8	1
SM200178002	IC 2-INPUT NOR HCT02	1
SM200178374	IC D-TYP FLOP 74HCT374	2
SM201178175	IC QUAD D FLIP/FLOP 74HCT175	1
SM206885245	IC BUS TRANSCVR ABT245	1
SM207170036	IC HEX BUFFER 3-ST. PC74HCT365	3
SM208470358	IC DUAL OP AMP 358D	1
SM208780109	IC MICROPOWER DC-DC CONV.	1
SM232032814	DIODE 2814	4
SM275330858	TRANS PNP BC858C	1
SM280171005	TRANS POWER MOSFET MTD10N05E	1
SM300056332	INDUCTOR WOUND 33 UH	1
SM652101102	RES CHIP (E24) 1% 1 K	3
SM652101103	RES CHIP (E24) 1% 10 K	18
SM652101104	RES CHIP (E24) 1% 100 K	2
SM652101220	RES CHIP (E24) 1% 22 OHMS	1
SM652101334	RES CHIP (E24) 1% 330 K	3
SM654101000	CHIP JUMPER ZERO OHMS	1
SM661207103	CAP CERA CHIP 20% .01UF (0805)	10
SM661207104	CAP CERA CHIP 20% .1 UF	6
SM661255101	CAP CERA CHIP 5% 100 PF	1
SM666327225	CAP MOLD TANT CHIP 2.2 UF	1
SM666377226	CAP MOLD TANT CHIP 22 UF	3

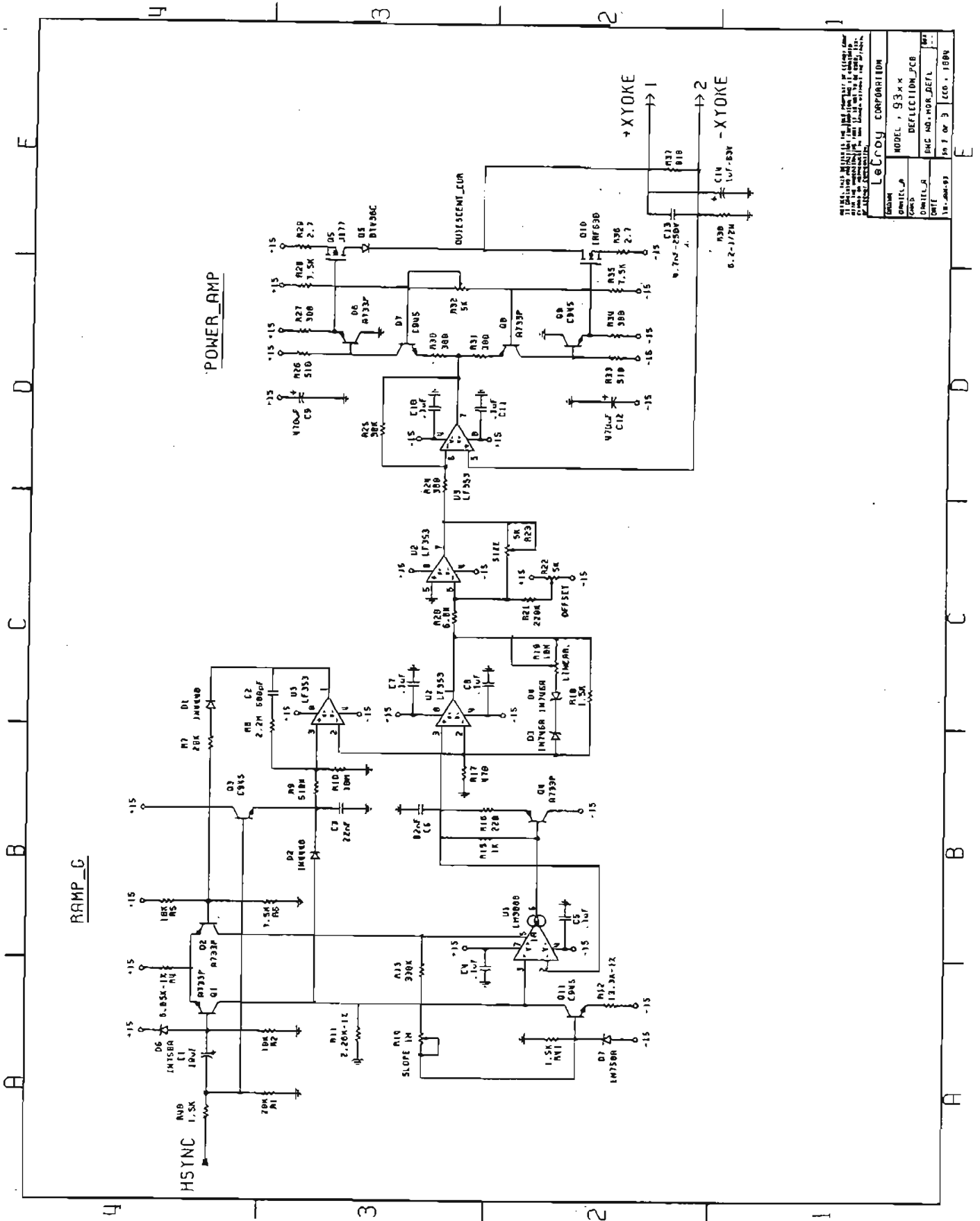

LeCroy CORPORATION	
MODEL	93 X X
DEFLECTION PCB	DEFLECTION PCB
DATE	18-04-93
REV	1 of 3
REV	CCO - 188N

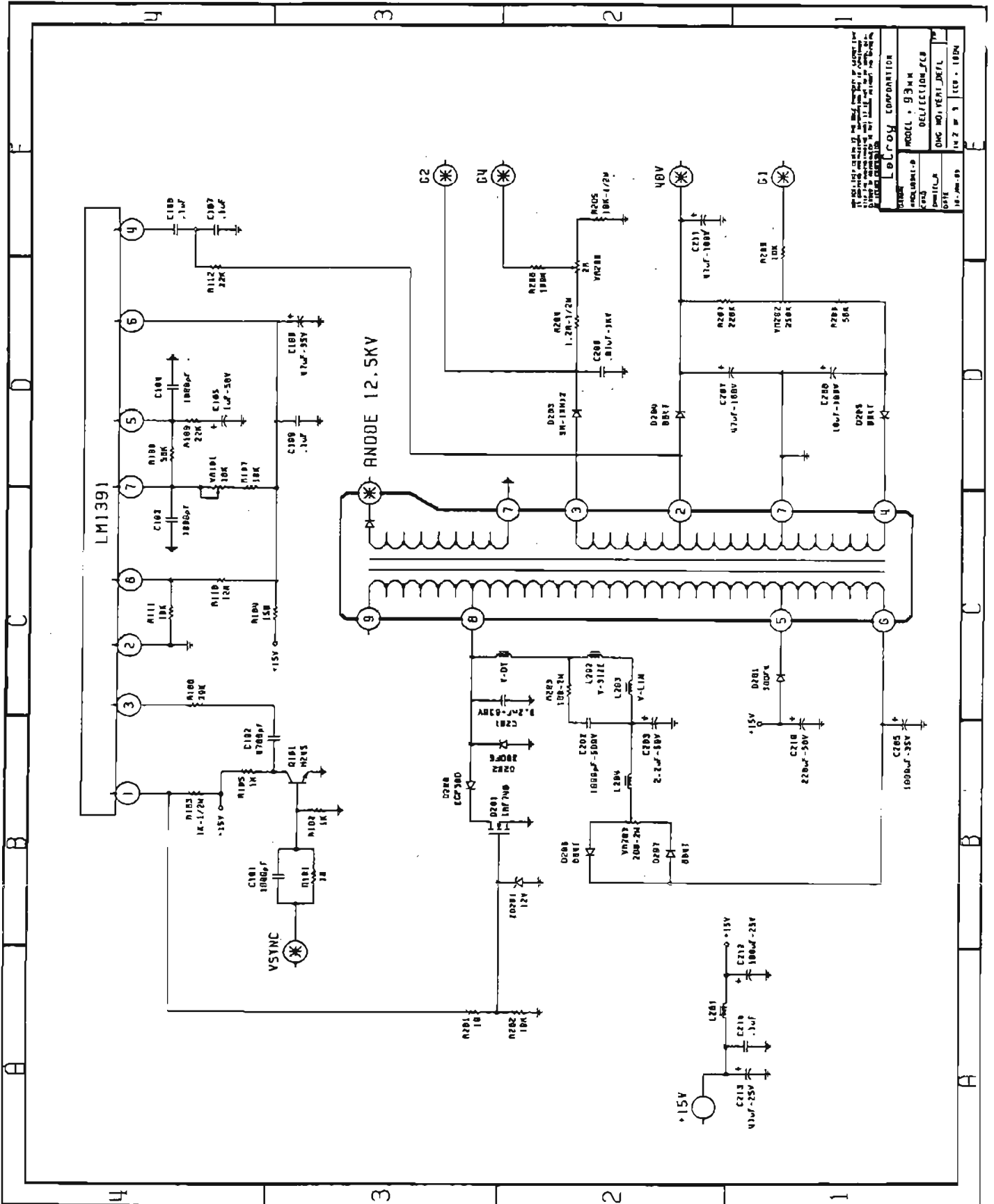

LORCOR CORPORATION	
DESIGNER	W. E. B. M. H.
DATE	10-2-68
PROJECT	DELTA 1000
REVISION	001
DRW	W. E. B. M. H.
CHECKED	W. E. B. M. H.
APPROVED	W. E. B. M. H.
SCALE	1:1
SHEET NO.	1
TOTAL SHEETS	1

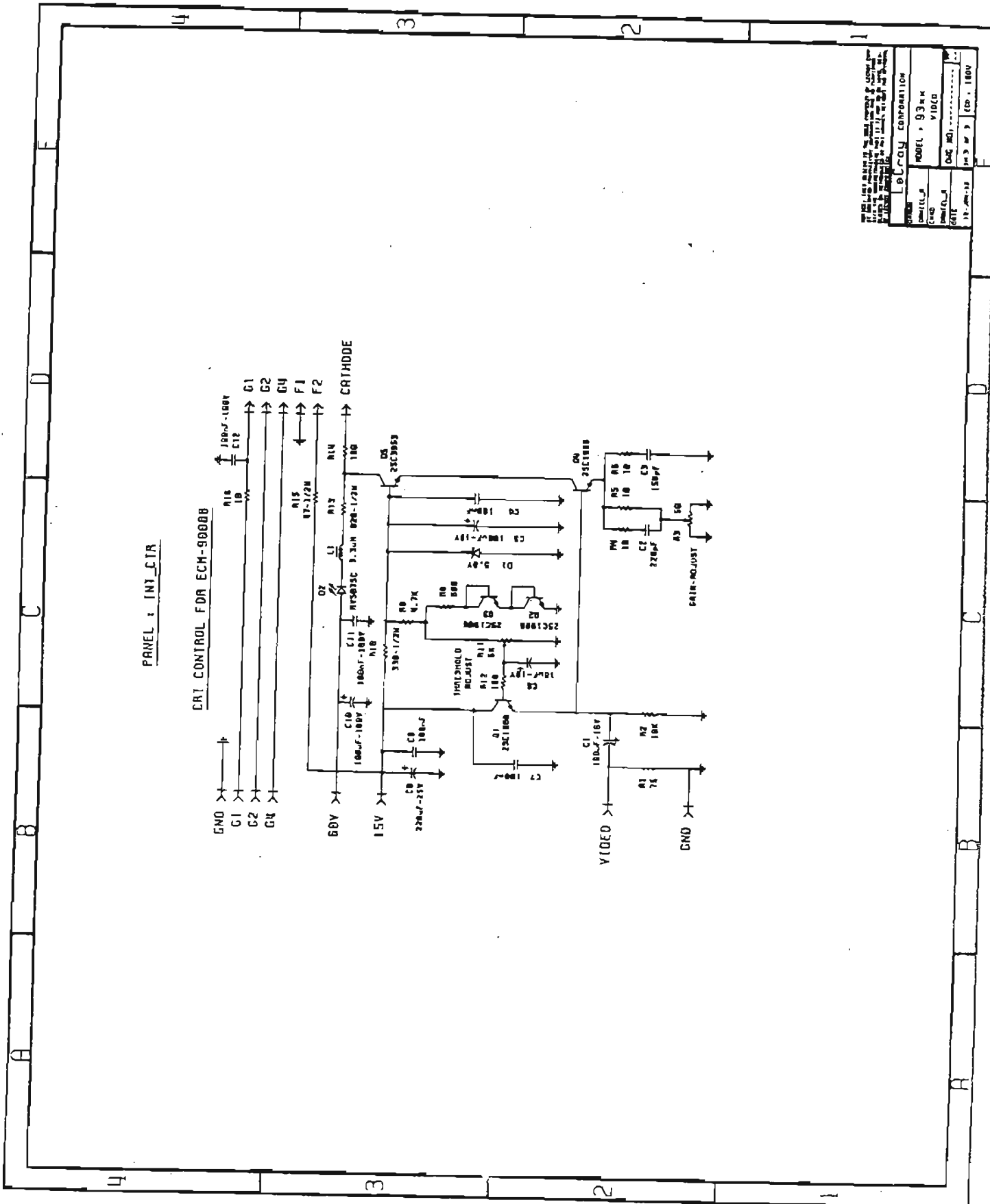

ELECTRONIC CORPORATION	
MODEL	9300
DATE	VIDCO
REV.	1
BY	10-1-1960

Section 7 Schematics, Layouts, Parts list

PART : F93XX-DEFLECTION

<u>Location</u>	<u>Description</u>	<u>Location</u>	<u>Description</u>
		D202	30DF6
C1	10uF	D203	SM-1XH12
C2	680pF	D204	BB4T
C3	22nF	D205	BB4T
C4	.1uF	D206	BB4T
C5	.1uF	D207	BB4T
C6	82nF	L201	5nH
C7	.1uF	V-DY	V-DY
C8	.1uF	L202	V-SIZE
C9	470uF	L203	V-LIN
C10	.1uF	L204	5nH
C11	.1uF	Q1	A733P
C12	470uF	Q2	A733P
C13	4.7nF250V	Q3	C945
C14	1uF-63V	Q4	A733P
C101	1000pF	Q5	J177
C102	4700pF	Q6	A733P
C103	1000pF	Q7	C945
C104	1000pF	Q8	A733P
C105	1uF-50V	Q9	C945
C106	.1uF	Q10	IRF630
C107	.1uF	Q11	C945
C108	47uF-35V	Q101	H245
C109	.1uF	Q201	IRF740
C201	8.2nF-630V	R1	20K
C202	1000pF-500V	R2	10K
C203	2.2uF-50V	R4	6.65K-1%
C205	1000uF-35V	R5	10K
C206	.01uF-1KV	R6	7.5K
C207	47uF-100V	R7	20K
C208	10uF-100V	R8	2.2M
C210	220uF-50V	R9	510K
C211	47uF-100V	R10	10M
C212	100uF-25V	R11	2.26K-1%
C213	47uF-25V	R12	13.3K-1%
C214	.1uF	R13	510K
D1	1N4448	R14	1M
D2	1N4448	R15	1K
D3	1N746A	R16	220
D4	1N746A	R17	470
D5	BYV36C	R18	1.5K
D6	1N758D	R19	10K
D7	1N758D	R20	6.8K
D8	1N5245B	R21	220K
D201	30DF4		

PART : F93XX-DEFLECTION

<u>Location</u>	<u>Description</u>	<u>Location</u>	<u>Description</u>
R22	5K	U3	LF353
R23	5K	VR101	10K
R24	300	VR202	250K
R25	30K	VR203	200-2W
R26	510	VR206	2M
R27	300	ZD201	12V
R28	7.5K		
R29	2.7	PART :	F93XX-VIDEO
R30	300		
R31	300	<u>Location</u>	<u>Description</u>
R32	5K	C1	100uF-16V
R33	510	C2	220pF
R34	300	C3	150pF
R35	7.5K	C4	100nF
R36	2.7	C5	100uF-16V
R37	910	C6	10uF-16V
R38	6.2-1/2W	C7	100nF
R40	1.5K	C8	220uF-25V
R41	1.5K	C9	100nF
R42	7.5K	C10	100uF-100V
R101	1K	C11	100nF-100V
R102	1K	C12	100nF-100V
R103	1K-1/2W	D1	5.0V
R104	150	D2	MV5075C
R105	1K	L1	3.3uH
R106	39K	Q1	2SC1906
R107	18K	Q2	2SC1906
R108	56K	Q3	2SC1906
R109	22K	Q4	2SC1906
R110	12K	Q5	2SC3953
R111	18K	R1	75
R112	22K	R2	10K
R201	10	R3	50
R202	10K	R4	10
R203	100-2W	R5	10
R204	1.2M-1/2W	R6	10
R205	10K-1/2W	R8	680
R206	100K	R9	4.7K
R207	220K	R10	330-1/2W
R208	56K	R11	5K
R209	10K	R12	100
T201	HT	R13	820-1/2W
U1	LM3080	R14	100
U2	LF353	R15	47-1/2W
		R16	10

PART: ACCESSORIES-9384 DESC: ACCESSORIES FOR 9384

<u>COMPONENT</u>	<u>PART DESCRIPTION</u>	<u>QTY PER ASSEMBLY</u>
407099008	PLUG FOR AC LINE -ENGLAND	0
433162630	FUSE SLO-BLO 250V 6.30AMP	2
589202200	AC CORD/PLUG FOR GERMANY	0
589203100	AC CORD/"SEV-ASE" PLUG	0
589203218	AC CORD/US-CANADA PLUG	1
597930001	CARTON FOR 93XX	1
597930002	ETHAFOAM FOR 93XX	2
597940014	PLASTIC BAG FOR 94XX & 93XX	2
597940015	MANUAL/ACCESSORY CTN 9400	2
700009001	USER REGISTRATION CARD	1
7093XX061	93XX PROTECTIVE COVER	1
931X-RCM-E	931X SERIES REMOTE CONTROL MAN	1
9384-OM	OPERATOR'S MANUAL	1
PP005	PROBE 10 MOHM 10:1 500V 500MHZ	4
PP094	4GS/S ADAPTER FOR 9384	1

PART: 93XX-GP01

DESC: GRAPHIC PRINTER

PART NUMBER	DESCRIPTION	QTY
334000402	THERMAL PAPER FOR SEIKO PRINTER	1
334000832	THERMAL PRINTER UNIT	1
389340008	AUTO-ADHESIVE RUBBER BAND 12X2MM	3
530040005	SLIDE LATCH TAB STYLE	2
550010106	SCREW CYL HD PHIL M3X6 WITH NYLOCK	4
551430100	FLAT WASHER M3	3
551430400	WASHER SHAKEPROOF M3	4
552430300	NUT OPEN-END ACORN M3	3
554010002	SCREW S/TAP PHIL M3X5 WITH NYLOCK	6
594120003	TIEWRAP	2
709300621	LABEL PARA-INTERF. CENTRONICS	1
709450523	PUSH SWITCH EXTENDER	1
70GP01031	GRAPHIC PRINTER FRAME	1
70GP01041	GRAPHIC PRINTER COVER AXLE	1
70GP01051	GRAPHIC PRINTER CUTTER	1
70GP01061	GRAPHIC PRINTER SWITCH BUTTON	1
780721022	FLAT CABLE 2X10 (22CM)	1
780791604	FLAT CABLE 2X13 (4CM)	1
780801015	FLAT CABLE 2X20 (3 CONNECTOR)	1
BOX-GP01	GP01 GRAPHIC PRINTER BOX	1
COVER-GP01	GP01 GRAPHIC PRINTER COVER	1
F9300-6	CENTRO/FLOP/PRINT/INT	1
F9300-7	PRINTER CONTROLLER	1
UC93X1-RK-GP01	UPPER COVER FOR GP01 OPTION	1

PART: 93XX-FDGP DESC: GRAPHIC PRINTER & FLOPPY DISK

<u>COMPONENT</u>	<u>PART DESCRIPTION</u>	<u>QTY PER ASSEMBLY</u>
330000002	FLOPPY DISK DRIVE 3.5"	1
334000402	THERMAL PAPER FOR SEIKO PRINTER	1
334000832	THERMAL PRINTER UNIT	1
389340008	AUTO-ADHESIVE RUBBER BAND 12X2MM	3
530040005	SLIDE LATCH TAB STYLE	2
550010104	SCREW PAN HEAD PHIL M2.5X4 W/NYLOCK	4
550010106	SCREW PAN HEAD PHIL M3X6 W/NYLOCK	6
551430100	FLAT WASHER M3	3
551430400	WASHER SHAKEPROOF M3	4
552430300	NUT OPEN-END ACORN M3	3
554010002	SCREW S/TAP PHIL M3X5 W/NYLOCK	10
554030101	NUT BANC-LOC TYPE MV M3	2
594120001	TIEWRAP	2
709300621	LABEL PARA-INTERF. CENTRONICS	1
709450523	PUSH SWITCH EXTENDER	1
70FD01031	FLOPPY DISK DRIVE FRAME	1
70FD01091	FLOPPY DISK DRIVE SUPPORT	1
70GP01031	GRAPHIC PRINTER FRAME	1
70GP01041	GRAPHIC PRINTER COVER AXLE	1
70GP01051	GRAPHIC PRINTER CUTTER	1
70GP01061	GRAPHIC PRINTER SWITCH BUTTON	1
780721022	FLAT CABLE 2X10 (22CM)	1
780791604	FLAT CABLE 2X13 (4CM)	1
780801015	FLAT CABLE 2X20 (3 CONNECTOR)	1
780901624	FLAT CABLE 26 P. /24CM LENGTH	1
780919905	FLAT FLEX CABLE 26 P. 5CM	1
BOX-GP01	GP01 GRAPHIC PRINTER BOX	1
COVER-GP01	GP01 GRAPHIC PRINTER COVER	1
CUP-FD01-1	FD01 FLOPPY DISK DRIVE CUP	1
F9300-6	CENTRO/FLOP/PRINT/INT	1
F9300-7	PRINTER CONTROLLER	1
F9301-6	FLOPPY ADAPTOR	1
UC93X1-RK-FDGP	UPPER COVER FOR FD/GP OPTIONS	1

PART: 93XX-FD01

DESC: FLOPPY DISK

<u>COMPONENT</u>	<u>PART DESCRIPTION</u>	<u>QTY PER ASSEMBLY</u>
330000002	FLOPPY DISK DRIVE 3.5"	1
550010104	SCREW PAN HEAD PHIL M2.5X4 W/NYLOCK	4
550010106	SCREW PAN HEAD PHIL M3X6 W/NYLOCK	4
551430400	WASHER SHAKEPROOF M3	2
554010002	SCREW S/TAP PHIL M3X5 W/NYLOCK	4
554030101	NUT BANC-LOC TYPE MV M3	2
709300621	LABEL PARA-INTERF. CENTRONICS	1
70FD01031	FLOPPY DISK DRIVE FRAME	1
70FD01091	FLOPPY DISK DRIVE SUPPORT	1
780801015	FLAT CABLE 2X20 (3 CONNECTOR)	1
780901624	FLAT CABLE 26 P. /24CM LENGTH	1
780919905	FLAT FLEX CABLE 26 P. 5CM	1
CUP-FD01-1	FD01 FLOPPY DISK DRIVE CUP	1
F9300-6	CENTRO/FLOP/PRINT/INT	1
F9301-6	FLOPPY ADAPTOR	1
UC93X1-RK-FD01	UPPER COVER FOR FD01 OPTION	1

PART: M9384

DESC: MECHANICAL FOR 9384

<u>COMPONENT</u>	<u>PART DESCRIPTION</u>	<u>QTY PER ASSEMBLY</u>
315910006	COMBI FILTER WITH FUSES - 6 A	1
377000104	LABEL, CE & UL, TEST EQUIP.	1
377051005	LABEL "DANGER -----ONLY"	1
377131001	LABEL (GROUND SYMBOL)	1
433162630	FUSE SLO-BLO 250V 6.30AMP	2
485023462	FOOT BUMPS GREY	4
485123001	BUMPER (FOOT) SQUARE GREY RUBBER	2
530301009	BLK HANDLE W/2 BLK END CAPS	1
550010106	SCREW PAN HEAD PHIL M3X6 W/NYLOCK	24
550010116	SCREW PAN HEAD PHIL M3X16 W/NYLOCK	7
550010120	SCREW PAN HEAD PHIL M3X20 W/NYLOCK	12
550010508	SCREW FLAT HEAD PHIL M3X8 W/NYLOCK	2
550010605	SCREW PAN HEAD PHIL M4X5 W/NYLOCK	8
550010608	SCREW PAN HEAD PHIL M4X8 W/NYLOCK	7
550011608	SCREW PHIL M2X8 BLK W/NYLOCK	12
551430400	WASHER SHAKEPROOF M3	43
551440300	WASHER SHAKEPROOF M4	12
551450400	WASHER SHAKEPROOF M5	2
551620100	#2 FLAT WASHER S.STEEL/BLACK OXIDE	12
554010005	SCREW PAN HEAD PHIL M3.5X9.5 W/NYLO	4
554030101	NUT BANC-LOC TYPE MV M3	9
554035101	CLIP-ON NUT DIAM. 3.5	4
554416000	NAIL RIVET 1.6X6	2
554435003	SCREW S/TAP PAN PHIL KA35X20	4
554435004	SCREW S/TAP PAN PHIL KA35X10	4
554440001	SCREW S/TAP PAN PHIL KA40X12	4
554440202	WASHER FLAT M4	4
560010008	SCREW PHIL 10-32X1/2 W/NYLOCK	2
594120001	TIEWRAP	1
705740017	SERIAL NUMBER PLATE FOR DSO	1
709354331	BASE SHIELD	1
709354351	SHIELD LOWER PARTITION	5
709354361	SHIELD LEFT LOWER PARTITION	1
709354371	FRONT LEFT SHIELDING GRID	1
709354372	REAR LEFT SHIELDING GRID	1
709354373	REAR RIGHT SHIELDING GRID	1
709354374	FRONT RIGHT SHIELDING GRID	1
7093XX041	FOOT SUPPORT	2
7093XX051	FOOT	2
7093XX091	BRACKET	4
7093XX321	MAIN CARD STANDOFF	5
7093XX902	FAN 93XX-9 ASSEMBLY	1
7093XX931	INTERF. HOLE CLOSURE 93XX-9	2
7093XXP41	PROBE HOLDER	6
7093XXP91	PROBE RING CONTACT	6
709424096	MEMORY CARD INSERT	1
780661104	CABLE FLAT 2X7 (4CM)	1

PART: M9384

DESC: MECHANICAL FOR 9384

<u>COMPONENT</u>	<u>PART DESCRIPTION</u>	<u>QTY PER ASSEMBLY</u>
780671110	FLAT CABLE 2X20 (10 CM)	1
780721105	20 LINE FLAT CABLE	1
780834509	GROUND CABLE YELLOW/GREEN 9CM	1
93XX-DISPLAY	RASTER MONITOR KIT	1
FF93X1	FRONT FRAME DSO 93XX	1
LC93X1	LOWER COVER DSO 93XX	1
PS9384	POWER SUPPLY 9384	1
RP9374-9	REAR PANEL 9374-9	1
UC93X1	UPPER COVER DSO 93XX	1
US9384-31	UPPER SHIELD ASSEMBLY-9384	1

PART: PS9384

DESC: POWER SUPPLY FOR 9384

<u>COMPONENT</u>	<u>PART DESCRIPTION</u>	<u>QTY PER ASSEMBLY</u>
315116045	45W POWER SUPPLY -2V +/-6V	1
377051005	LABEL "DANGER -----ONLY"	1
520001006	LOCKIN NYLON P.C.BOARD SUPPORT	6
550010106	SCREW PAN HEAD PHIL M3X6 W/NYLOCK	9
551430400	WASHER SHAKEPROOF M3	9
560010003	SCREW PAN PHIL 6-32X3/16 W/NYLOCK	10
577600001	WASHER SHAKEPROOF SIZE 6	10
594120001	TIEWRAP	5
594120030	CABLE TIE NYLON HI-TEMP	3
709384005	9384 LINE TRIGGER CABLE	1
709384031	MAIN POWER SUPPLY INSULATOR	1
709384032	SECONDARY SUPPLY INSULATOR	1
709384041	POWER SUPPLY BRACKET	1
780811622	PS9351 INPUT CABLE	1
789384002	-2V SUPPLY LINE CABLE	1
935X-PS1225	POWER SUPPLY PS1724	1
PS9384-2	PS9384 LINE TRIGGER CARD	1
PS9384-3	PS9384 3.3V DC-DC CONV.	1
PSC9384	PS9384 POWER SUPPLY COVER	1

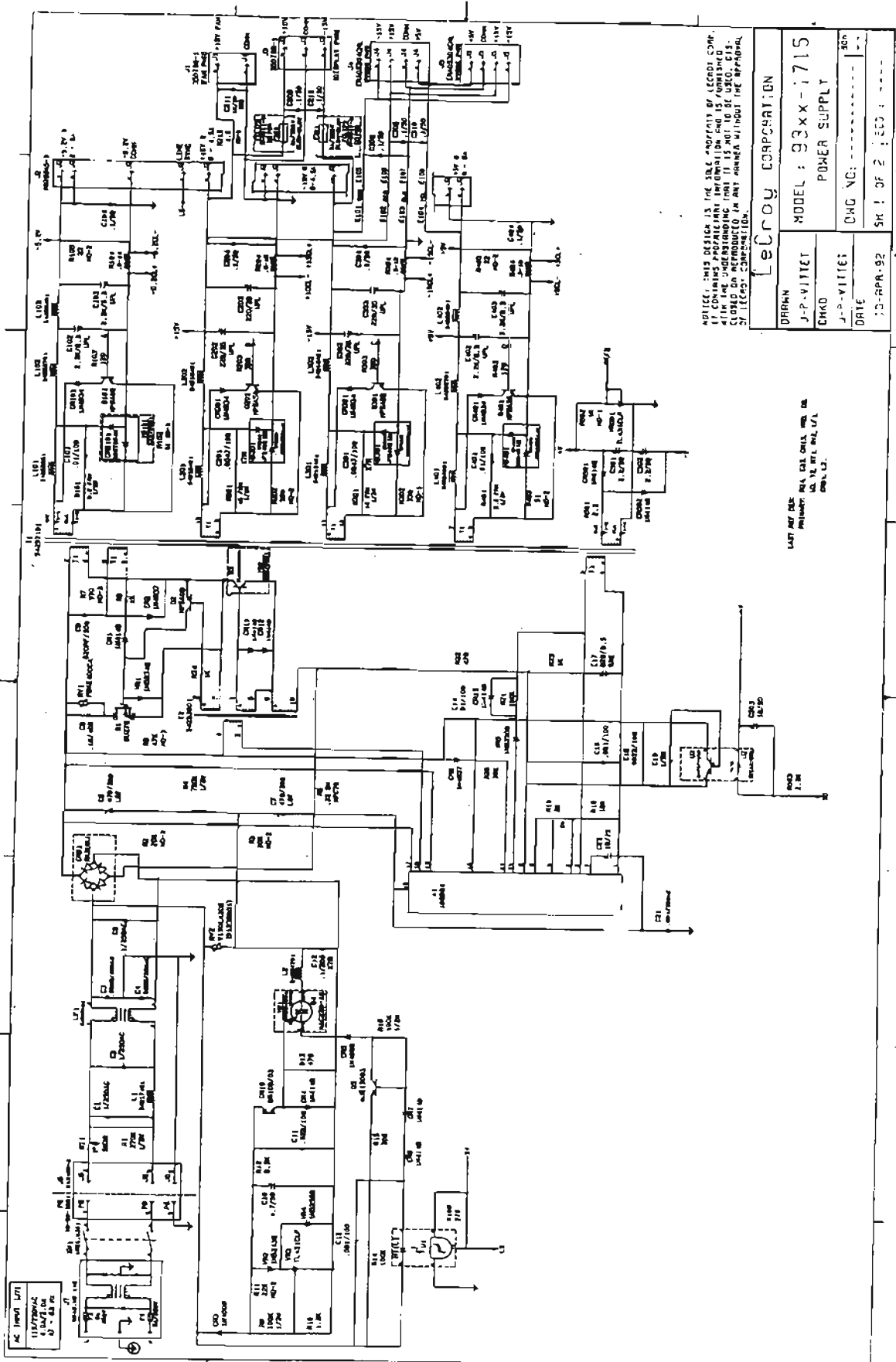

NOTICE: THIS DESIGN IS THE SOLE PROPERTY OF LECROY CORP.
 IT CONTAINS PROPRIETARY INFORMATION AND IS NOT TO BE REPRODUCED,
 COPIED, OR TRANSMITTED IN ANY MANNER WITHOUT THE APPROVAL
 OF LECROY CORPORATION.

LECROY CORPORATION	
DRAWN	J-P-VITTEC
MODEL:	93xx-1715
CHKD	J-P-VITTEC
DATE	10-APR-92
DWG NO:	30
SK 1 OF 2	ECO

LAST REV DATE
 PARTIAL REV. DATE
 NO. OF REV. U.S.A.
 CRY, U.S.

Section 7 Schematics, Layouts, Parts list

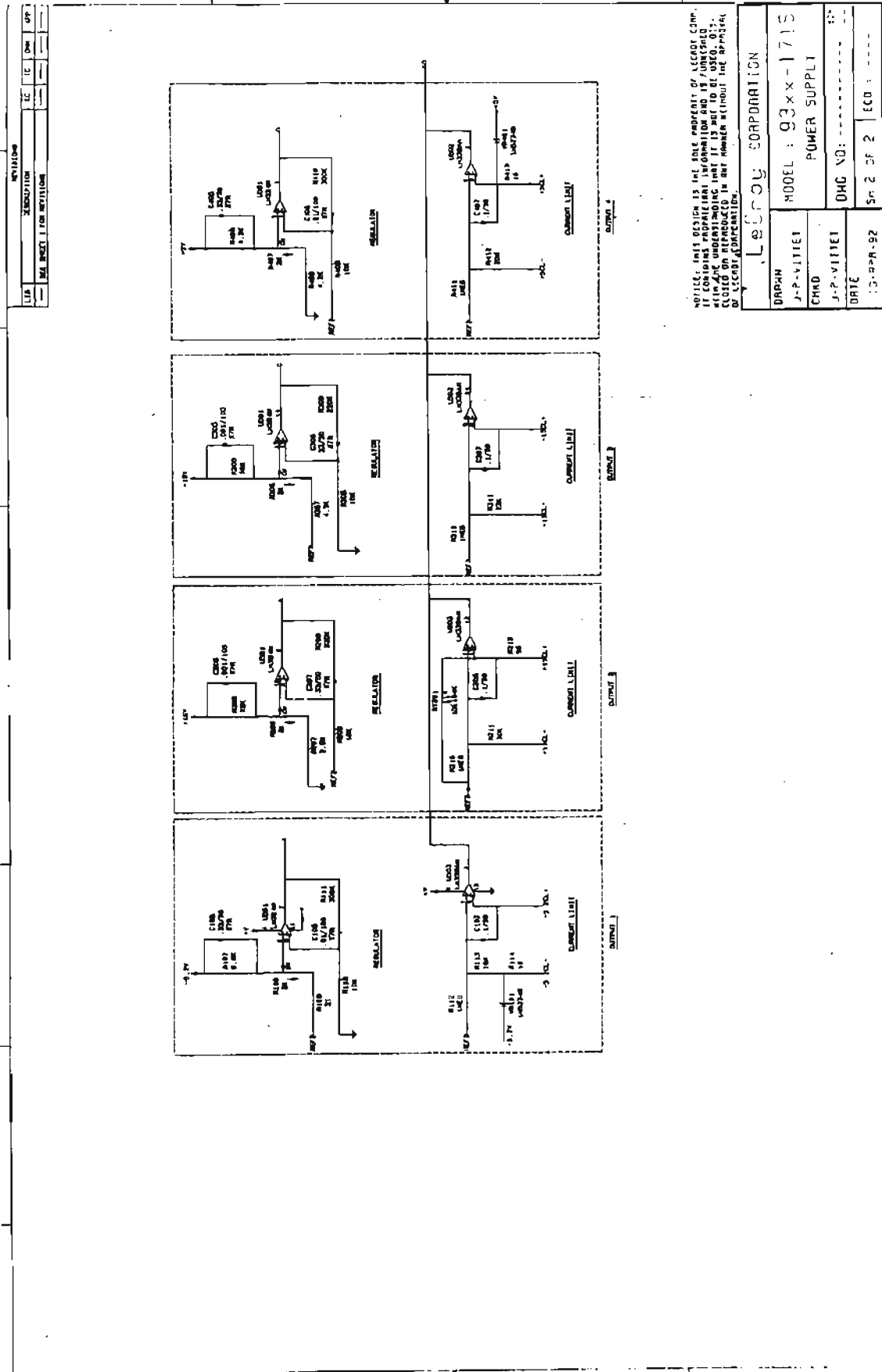

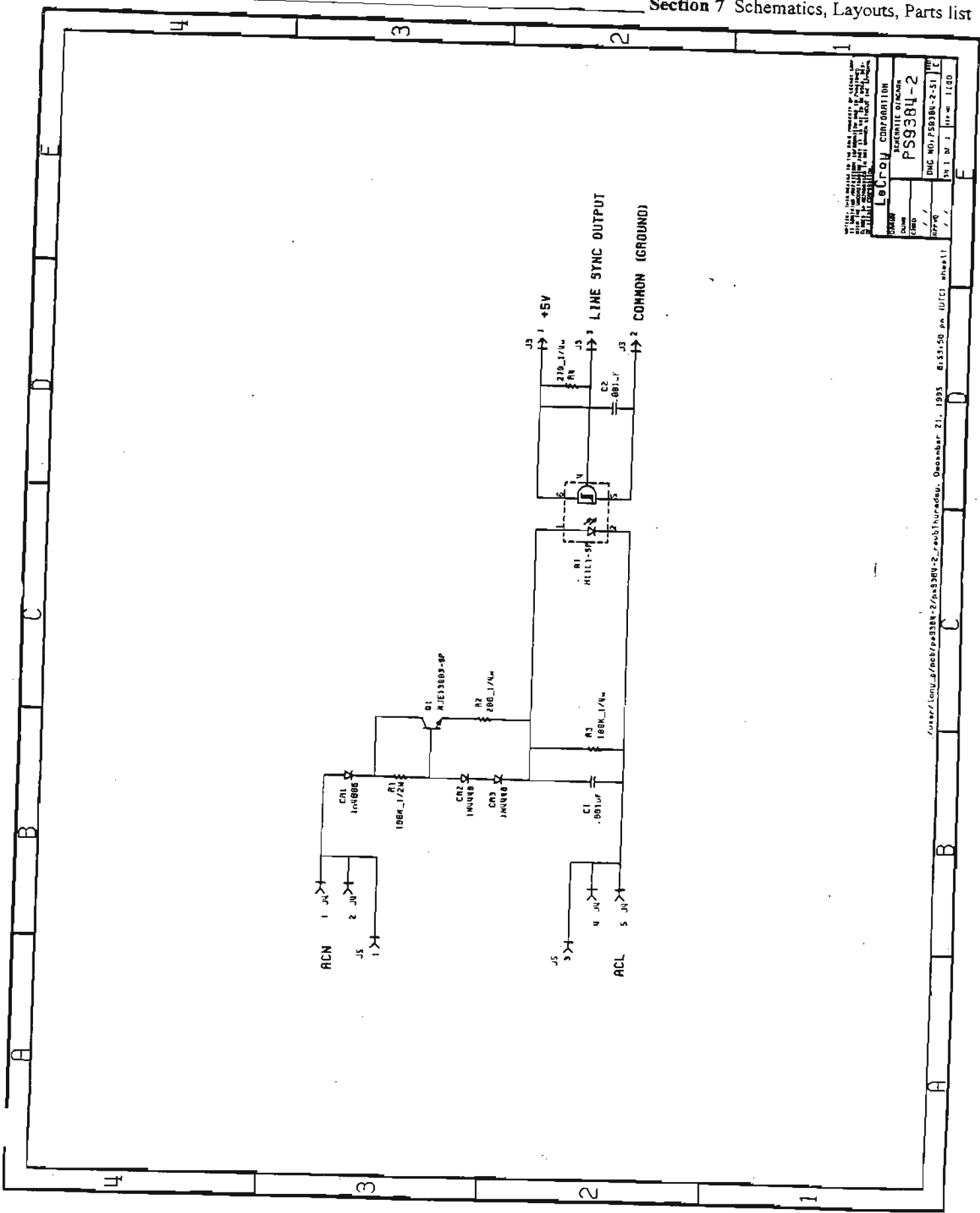

ALL RIGHTS RESERVED FOR THE TRADE INFORMATION OF ASSOCIATED COMPANIES. THIS DOCUMENT IS UNCLASSIFIED. DATE 11/19/01 BY 60322 UCBAW/STW

FORM	LeCroy CORPORATION
QUANTITY	REVENUE CENTER
CIRCUIT	PS9384-2
REV	1
DATE	11/19/01
BY	STW
CHKD	11/19/01
APP'D	11/19/01

655158 Rev. (UTC) sheet 1
 /user/leny_b/act/ps384-2/ps384-2_reobthruadv. December 21, 1993

PART: PS9384-2**DESC: LINE TRIGGER CARD**

<u>COMPONENT</u>	<u>PART DESCRIPTION</u>	<u>QTY PER ASSEMBLY</u>
106435102	CAP CERA MONO .001UF	2
161335104	RES CARBON FILM 100 K	1
161335201	RES CARBON FILM 200 OHMS	1
161335271	RES CARBON FILM 270 OHMS	1
161445104	RES COMP 1/2W 5% 100 K	1
230110005	DIODE SWITCHING 1N4448	2
235010006	DIODE RECTIFIER 1N4006	1
260000111	OPTOISOLATOR H11L1	1
270121003	TRANSISTOR PWR NPN MJE13003	1
454115003	HDR FRICTION LOCK 3	1
454115004	HDR FRICTION LOCK 4	1
454117003	FRICTION HEADER STRAIGHT .1 CENTERS	1
71PS93842	PC BOARD PREASS'Y PS9384-2	1

PART: PS9384-3

DESC: 3.3V DC-DC CONV. FOR 9384 POWER SUPPLY

<u>COMPONENT</u>	<u>PART DESCRIPTION</u>	<u>QTY PER ASSEMBLY</u>
142824685	CAP TANT DIP CASE 6.8 UF	1
146564227	CAP MINI ALUM 20% 220 UF	3
161225201	RES CARBON FILM 200 OHMS	1
161225511	RES CARBON FILM 510 OHMS	1
270110003	TRANSISTOR NPN PN2222A	1
315826501	PWR CONVERTER DC-DC 3.3VDC OUTPUT	1
408070001	SLOTTED SOLDER TERMINAL	8
591101018	WIRE BUS TIN-COPP AWG 18	0
71PS93843	PC BOARD PREASS'Y PS9384-3	1
789384001	PS9384 OUTPUT CABLE	1
CH599064012	SILICONE SEALANT RTV162	0

SECTION 8 MECHANICAL PARTS

**9384, 9384M, 9384TM, 9384L & 9384AL
Digital Oscilloscope**

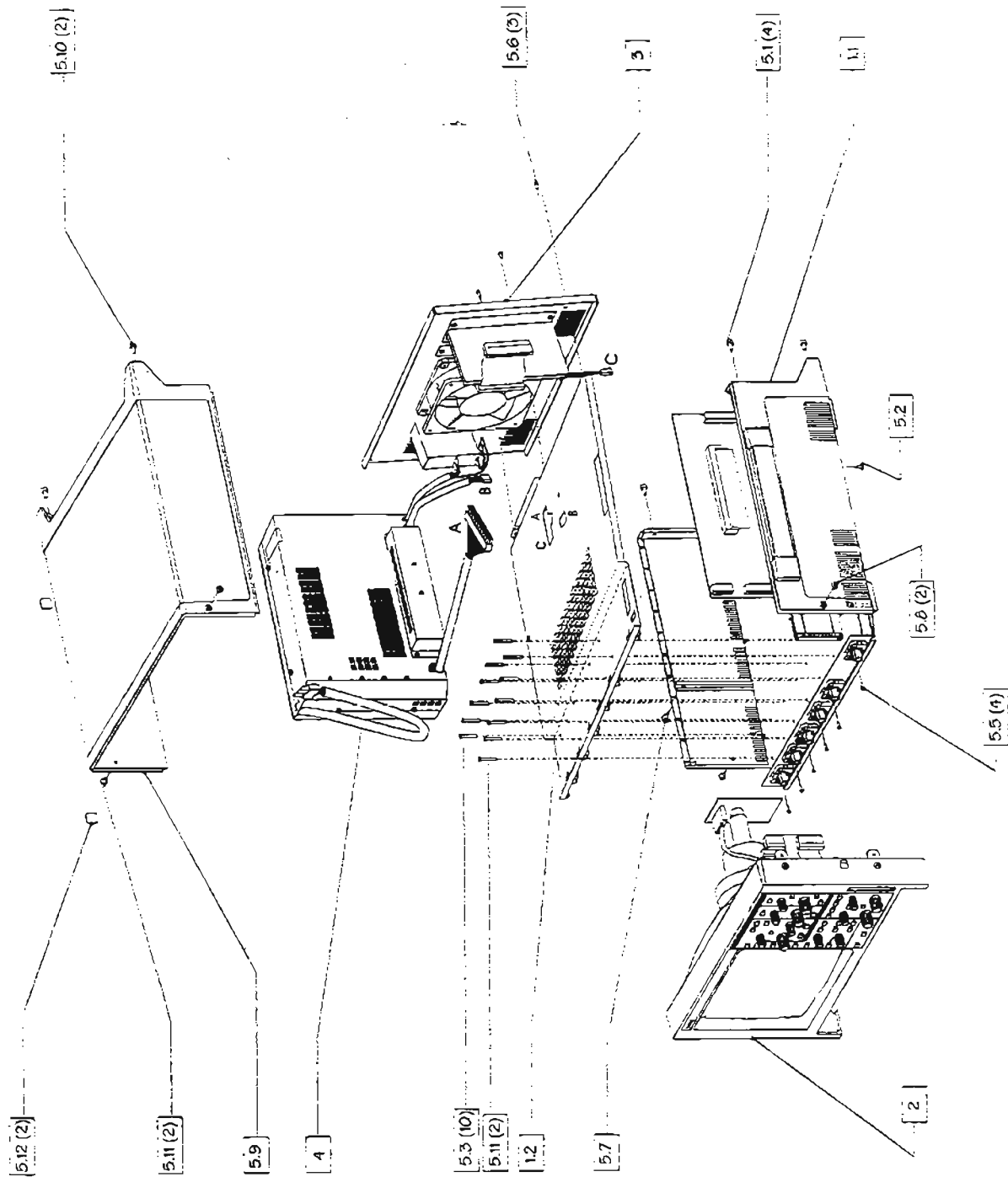

Figure 8.1 : 9384 DSO Exploded View

8.1.1	9384 Assembly	Part Description	Quantity per Assembly
1.1	Lower Cover DSO 93xx	LC93X1	1
1.2	Upper Shield Assembly-9384	US9384-3	1
2	Front Frame DSO 93xx	FF93X1	1
3	Rear Panel 9384-9	RP9384-9	1
4	Power Supply 9384	PS9384	1
5.1	Screw Pan Head Phil M4x8 with Nylock	550010608	4
5.2	Screw Pan Head Phil M3x6 with Nylock	550010706	2
5.3	Screw Pan Head Phil M3x20 with Nylock	550010120	10
5.5	Screw Phil M2x8 Black	550011608	6
5.6	Screw Pan Head Phil M3x6 with Nylock	550010706	3
5.7	Screw Pan Head Phil M4x8 with Nylock	550010608	1
5.8	Screw M3x6 with Nylock	550010106	2
5.9	Upper Cover DSO 93xx	UC93X1	1
5.10	Screw Pan Head Phil M4x8 with Nylock	550010608	2
5.11	Screw Pan Head Phil M4x5 with Nylock	550010605	2
5.12	Foot Bumpons Grey	485023462	2

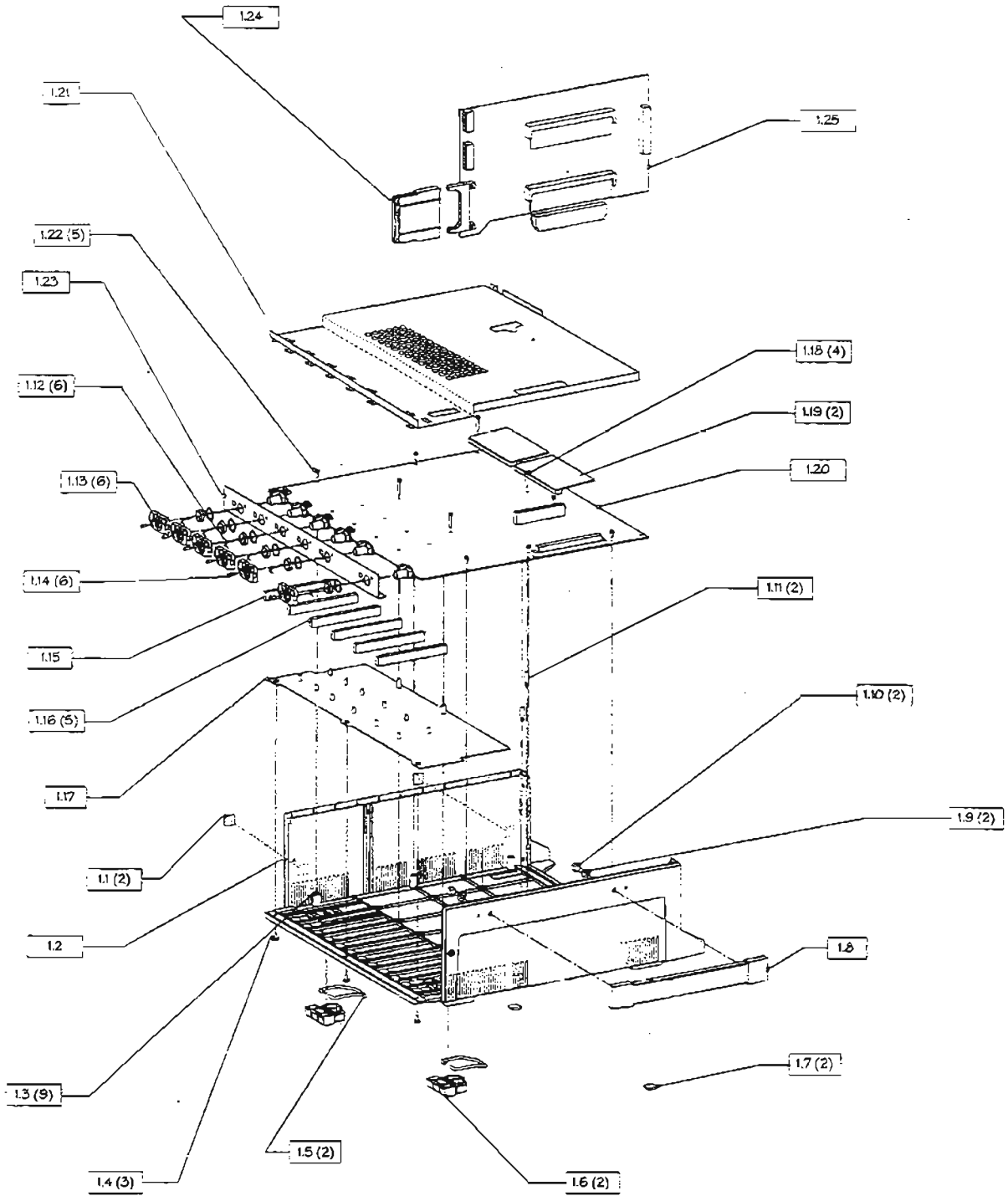

Figure 8.2 : Lower Cover Exploded View

8.2.1	Lower Cover Assembly	Part Description	Quantity per Assembly
1.1	Foot Bumpons Grey	485023462	4
1.2	Lower Cover Dso 93xx	LC93X1	1
1.3	Nut Banc-Loc Type Mv M3	554030101	7
1.4	Screw Pan Head Phil M3x6 with Nylock	550010106	3
1.5	Foot	7093XX051	2
1.6	Foot Support	7093XX041	2
1.7	Bumper (Foot) Square Grey Rubber	485123001	2
1.8	Blk Handle W/2 Blk End Caps	530301009	1
1.9	Washer Shakeproof M5	551450400	2
1.10	Screw Philips 10-32x1/2	560010008	2
1.11	Main Card Standoff	7093XX321	2
1.12	Probe Ring Contact	7093XXP91	6
1.13	Probe Holder	7093XXP41	6
1.14	Screw Phil M2x8 Black with Nylock	550011608	6
1.15	Shield Left Lower Partition	709354361	1
1.16	Shield Lower Partition	709354351	5
1.17	Base Shield	709354331	1
1.18	Screw Cyl Hd Phil M3x16 with Nylock	550010116	4
1.19	Acquisition Memory Card (9384,M,TM,L)	9384M-2	2
	Acquisition Memory Card (9384AL)	9384MEM-2	2
1.20	Main Card	9384-3	1
1.21	Upper Shield Assembly-9384	US9384-3	1
1.22	Screw Cyl Hd Phil M3x6 with Nylock	550010106	5
1.23	Main Card Panel	FP9384-3	1
1.24	Memory Card Insert	709424096	1
1.25	9384,9384M,9384TM Processor Card	F9302-1-8	1
	9384L, 9384AL Processor Card	F9302-1-16	1

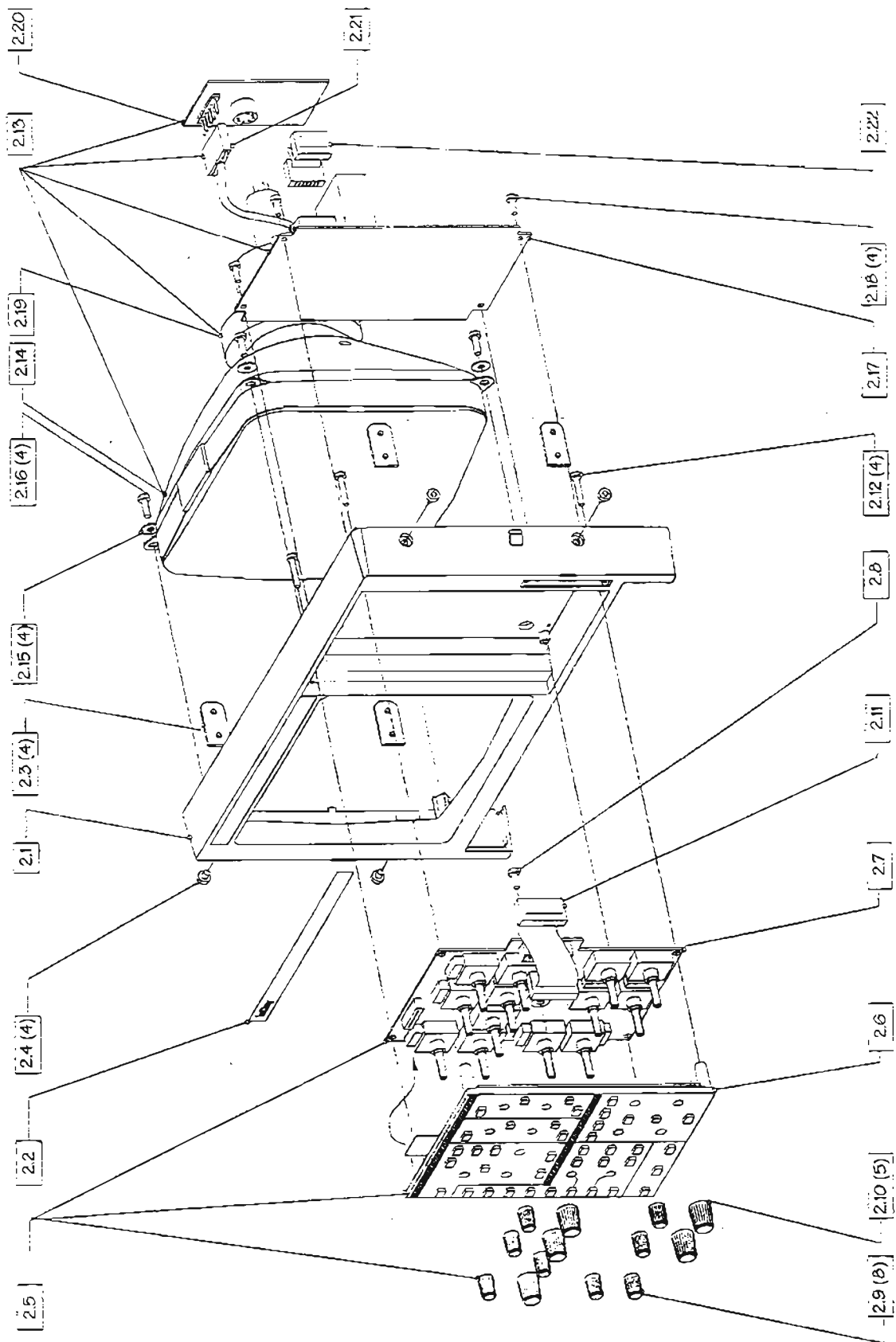

Figure 8.3 : Front Frame Exploded View

8.3.1	Front Panel Assembly	Part Description	Quantity per Assembly
2.1	Front frame	FF 93X1	1
2.2	Front label 9384	709 384 001	1
	Front label 9384M	709 384 003	
	Front label 9384L	709 384 004	
	Front label 9384TM	709 384 007	
	Front label 9384AL	709 384 012	
2.3	Front frame bracket	709 3XX 091	4
2.4	Screw oval head M4x5 with Nylock	550 010 605	4
2.5	Front panel assembly	F9354-5	1
2.6	Front panel keyboard ass'y	729 354 513	1
2.7	Front panel pcb ass'y	9354-5	1
2.8	Screw PT KA 35x10	554 435 004	1
2.9	Knob diameter 10mm	709 3XX 511	8
2.10	Knob diameter 14mm	709 3XX 521	5
2.11	20 lines flat cable	780 721 105	1
2.12	Screw PT KA 35x20	554 435 003	4
2.13	Raster monitor kit	93XX-Display	1
2.14	9 inch CRT	93XX-CRT	1
2.15	Flat washer M4	554 440 202	4
2.16	Screw PT KA 40x12	554 440 001	4
2.17	Deflection board	93XX-Deflection	1
2.18	Screw PT KA 35x10	554 435 004	4
2.19	Deflection yoke	93XX-Yoke	1
2.20	Video board	93XX-Video	1
2.21	Monitor cable		1
2.22	14 lines flat cable	780 661 104	1

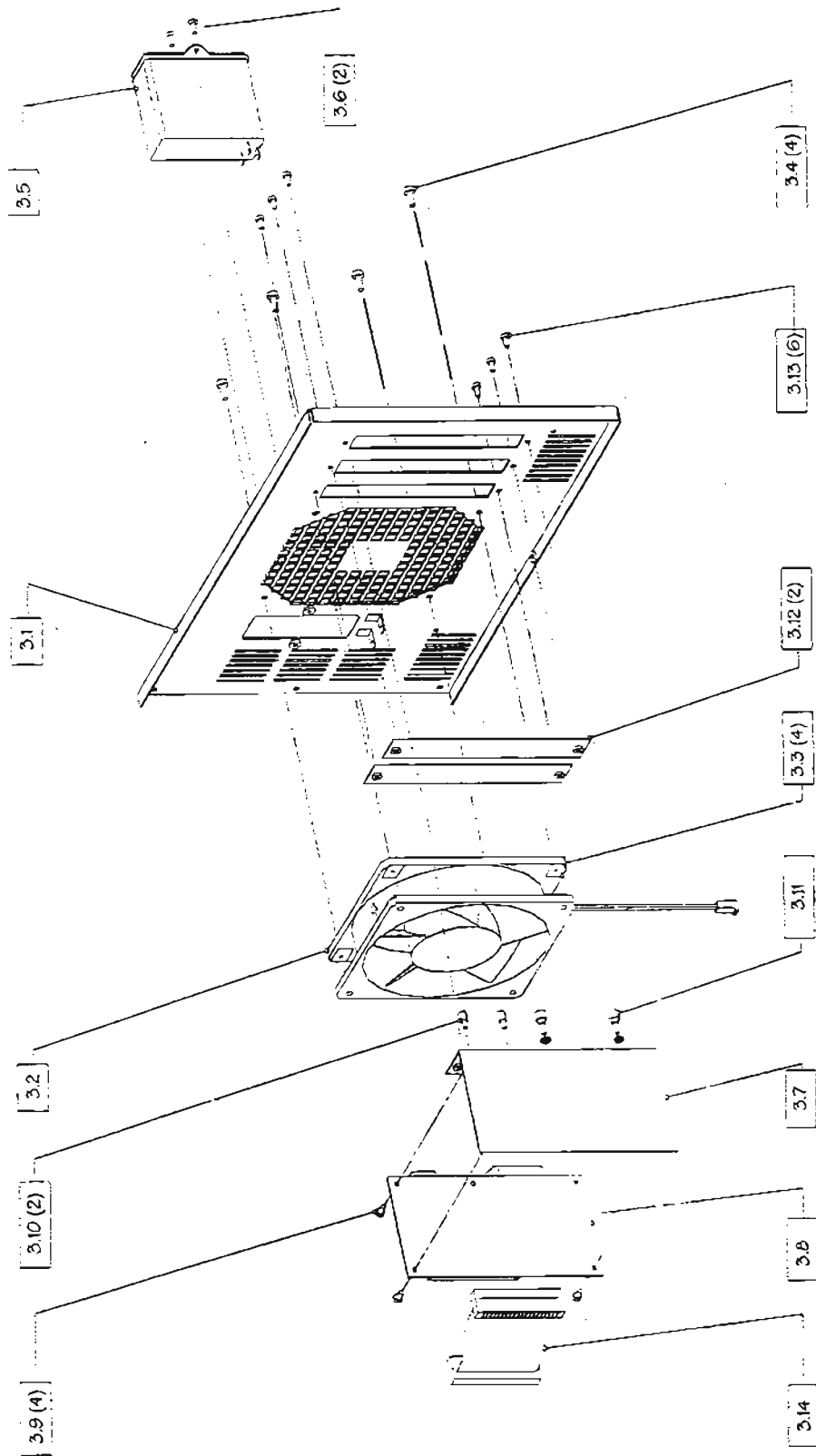

Figure 8.4 : Rear Panel Exploded View

8.4.1	<u>Rear Panel Assembly</u>	<u>Part Description</u>	<u>Quantity per Assembly</u>
3.1	Rear panel	RP 9374-9	1
3.2	Fan assembly	709 3XX 902	1
3.3	Clip on nut M3.5	554 035 101	4
3.4	Screw 3.5 X 9	554 440 001	4
3.5	Line input module	434 690 002	1
	Fuse holder	407 036 002	1
	Fuse 6.3A / 250 V	433 162 630	2
3.6	Screw flat head M3x8 with Nylock	550 010 508	2
3.7	Interface card bracket	709 300 411	1
	RS232-IEEE488-2 Label	709 300 421	1
3.8	RS232/GPIB interface card	F9300-4	1
3.9	Screw cyl head M3x6 with Nylock	550 010 106	6
	Washer Shakeproof M3	551 430 400	6
3.10	Mounting hardware	455 980 002	2
3.11	Connector kit	435 521 024	2
3.12	Interface hole closure	709 3XX 931	2
3.13	Screw cyl head M3x6 with Nylock	550 010 106	6
	Washer shakeproof M3	551 430 400	6
3.14	Flat cable	780 671 110	1

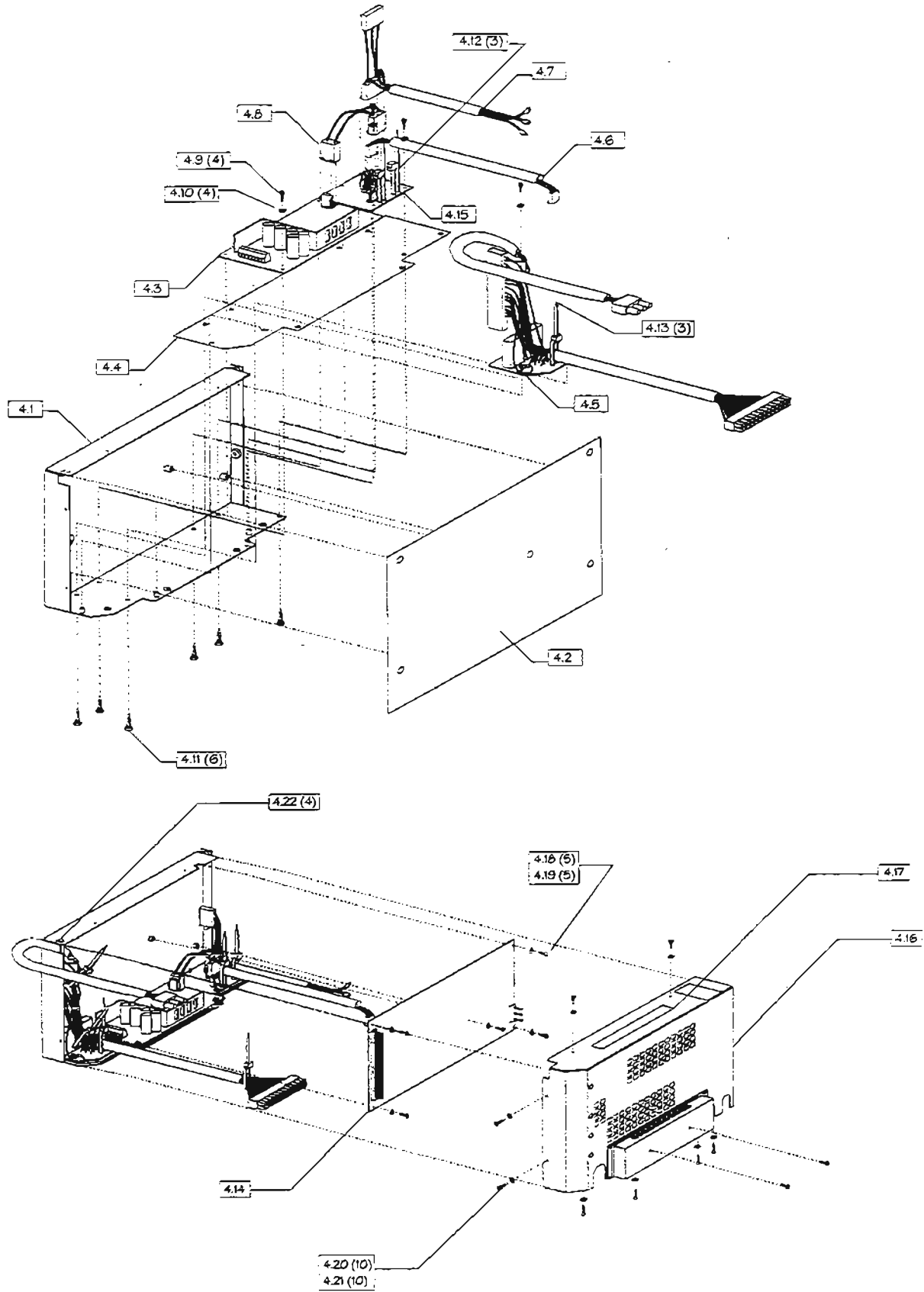

Figure 8.5 : PS9384 Power Supply Exploded View

8.5.1 Power supply PS9384		per Assembly	Part Description	Quantity
4.1	Power Supply Bracket	709384041		1
4.2	Main Power Supply Insulator	709384031		1
4.3	45w Power Supply -2v +/-6v	315116045		1
4.4	Secondary Supply Insulator	709384032		1
4.5	PS9384 3.3v Dc-Dc Conv.	PS9384-3		1
4.6	9384 Line Trigger Cable	709384005		1
4.7	PS9351 Input Cable	780811622		1
4.8	-2v Supply Line Cable	789384002		1
4.9	Screw Cyl Hd Phil M3x6 w/ Nylock	550010106		4
4.10	Washer Shakeproof M3	551430400		4
4.11	Lockin Nylon P.C.Board Support	520001006		6
4.12	Tiewrap	594120001		2
4.13	Cable Tie Nylon Hi-Temp	594120030		3
4.14	Power Supply PS1724	935X-PS1225		1
4.15	PS9384 Line Trigger Card	PS9384-2		1
4.16	PS9384 Power Supply Cover	PSC9384		1
4.17	Label "Danger -----Only"	377051005		1
4.18	Screw Cyl Hd Phil M3x6 w/ Nylock	550010106		5
4.19	Washer Shakeproof M3	551430400		5
4.20	Screw Philips 6-32x3/16 with Nylock	560010003		10
4.21	Washer Shakeproof Size 6	577600001		10
4.22	Tiewrap	594120001		3

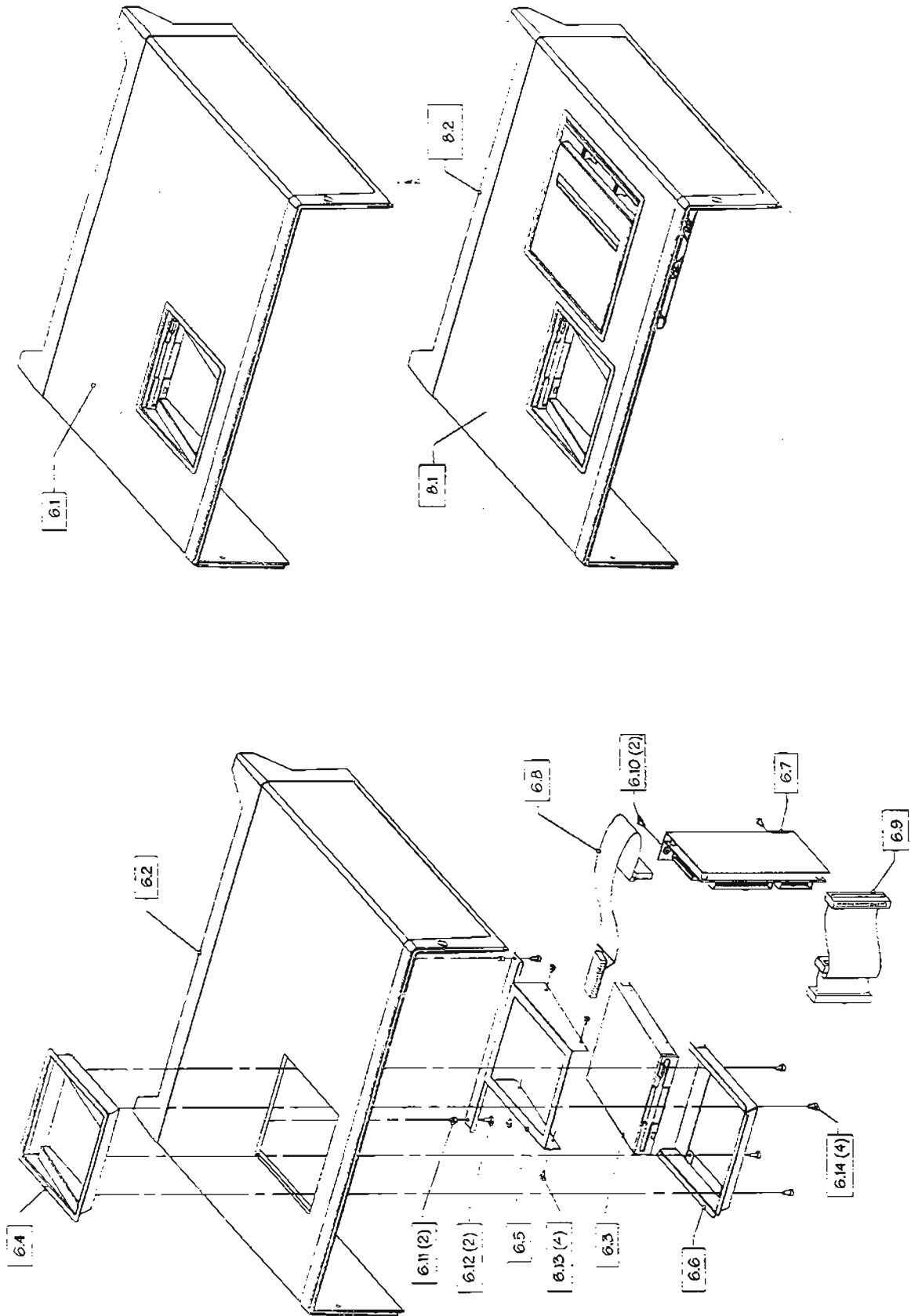

Figure 8.6 : Floppy Drive Assembly

8.6.2	FD01 Floppy Option	Part Description	Quantity per Assembly
6.1	Floppy drive option	93XX-FD01	1
6.2	Upper cover	UC93X1-FD01	1
6.3	Floppy drive	335 023 203	1
6.4	Cup	CUP-FD01-1	1
6.5	Support	70FD01091	1
6.6	Frame	70FD01031	1
6.7	Floppy/Printer/Centronics interface	F9300-6	1
6.8	Flat cable 26 P	780 791 630	1
6.9	Flat cable 40 P	780 801 015	1
6.10	Screw M3x6 with Nylock Washer M3	550 010 106 551 430 400	2 2
6.11	Nut banc lock M3	554 030 101	2
6.12	Screw M3x6 with Nylock	550 010 106	1
6.13	Screw M2.5X4 with Nylock	550 010 104	4
6.14	Screw self taping M3x5 with Nylock	554 010 002	4
8.1	Floppy and Printer options	93XX-FDGP	1
8.2	Floppy&Printer Upper cover	UC93X1-FDGP	1

8.7.1	9384-GP01 Printer Option	Part Description	Quantity per Assembly
7.1	Graphic printer option	93XX-GP01	1
7.2	Upper cover	UC93X1-GP01	1
7.3	Graphic printer	334 000 832	1
7.4	Box	BOX-GP01	1
7.5	Frame	70GP01031	1
7.6	Printer interface card	F9300-7	1
7.7	Cover	COVER-GP01	1
7.8	Switch push button	709 450 523	1
7.9	Floppy/Printer/Cent interface	F9300-6	1
7.10	Flat cable 26 P	780 791 604	1
7.11	Flat cable 40 P	780 801 015	1
7.12	Flat cable 20 P	780 721 022	1
7.13	Power supply cable	780 210 030	1
7.14	Cover Axle	70GP01041	1
7.15	Cutter	70GP01051	1
7.16	Slide latch	530 040 005	2
7.17	Flat washer M3	551 430 100	3
7.18	Nut acorn M3	552 430 300	3
7.19	Screw self tapping M3x5 with Nylock	554 010 002	2
7.20	Push switch extender	70GP01061	1
7.21	Screw M3x6 with Nylock	550 010 106	4
	Washer M3	551 430 400	4
7.22	Screw M3x5 with Nylock	554 010 002	4
7.23	Screw M3x6 with Nylock	550 010 106	2
	Washer M3	551 430 400	2
7.24	Thermal paper roll	344 000 042	1
7.25	Auto adhesive rubber band		1
8.1	Floppy and Printer options	93XX-FDGP	1
8.2	Floppy&Printer Upper cover	UC93X1-FDGP	1

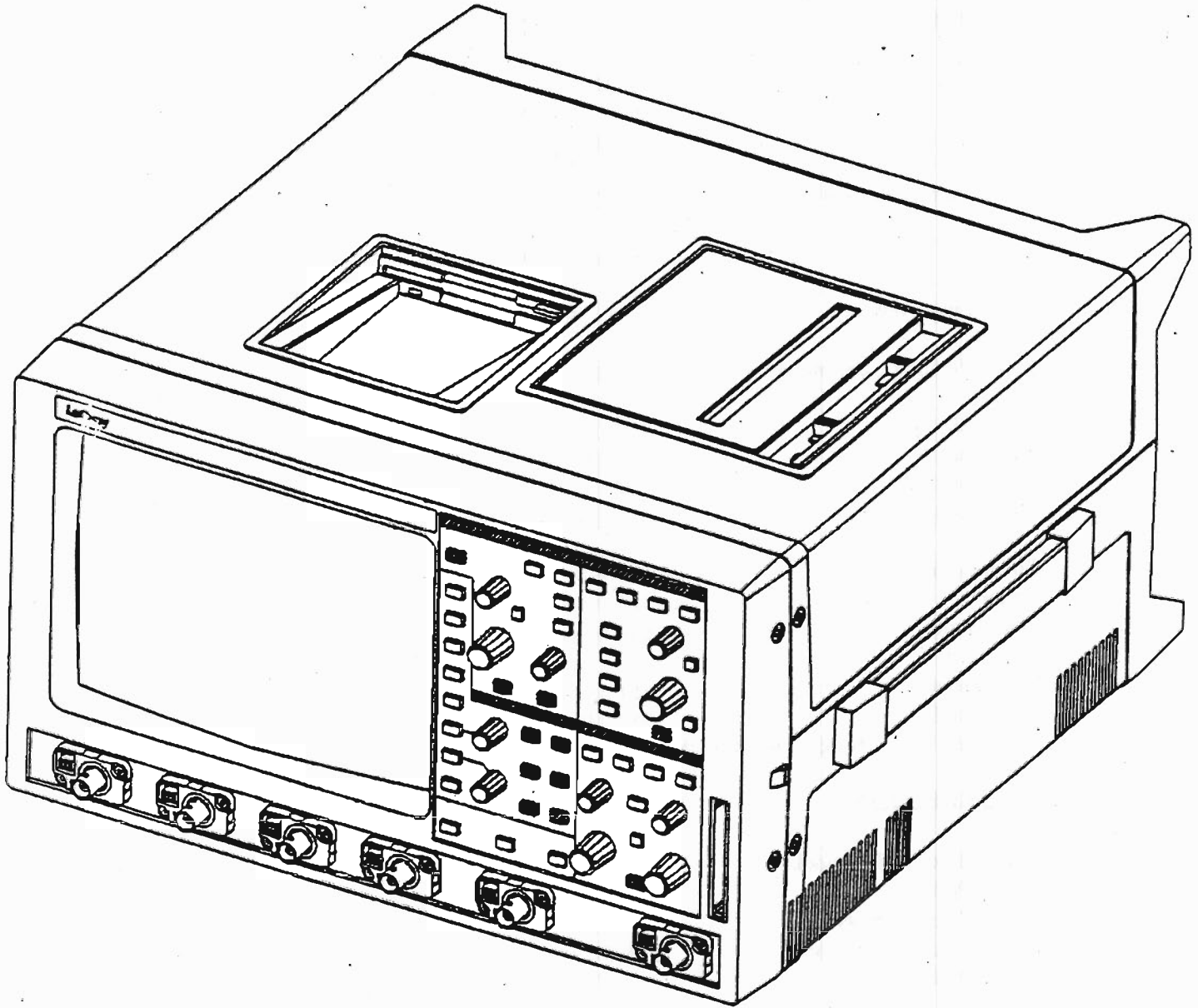

Figure 8.9 : 9384 DSO Front View

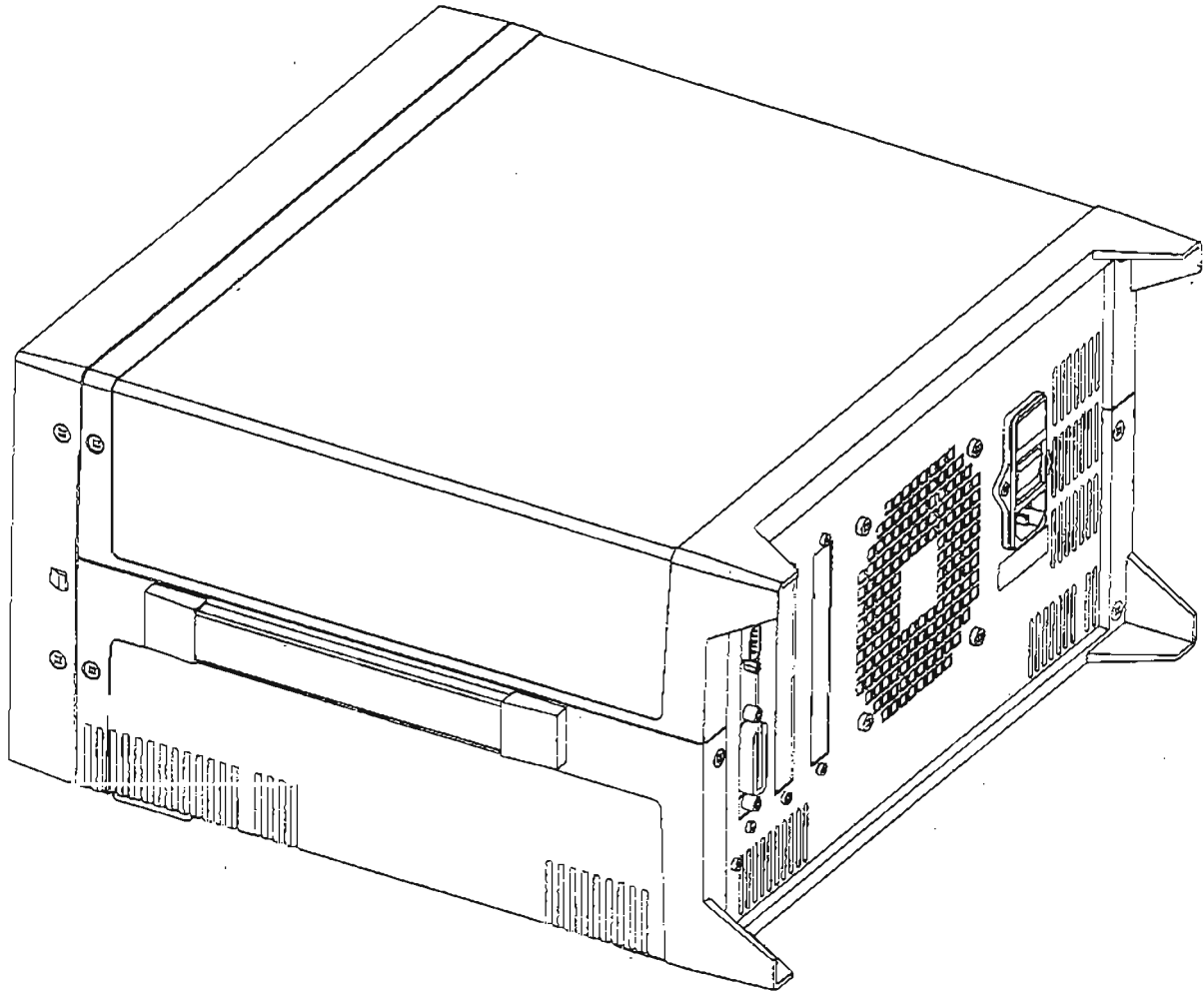
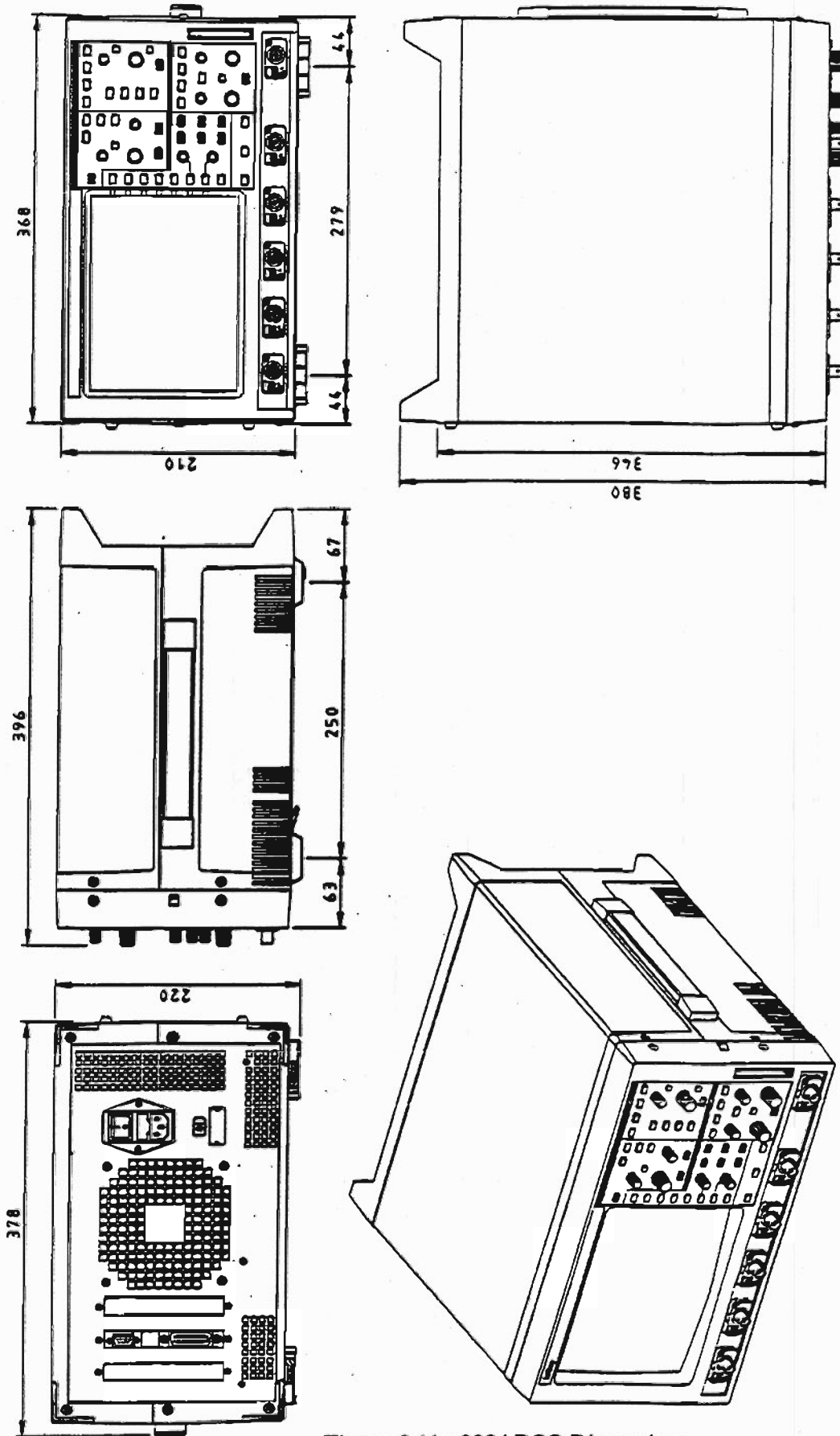

Figure 8.10 : 9384 DSO Rear View



ALL DIMENSIONS ARE IN mm
WEIGHT 11.5 kg

Figure 8.11 : 9384 DSO Dimensions

SECTION 9 CONNECTING the 9384 to a PLOTTER or a PRINTER

9.1 Introduction

LeCroy oscilloscopes are supplied with a list of plotters and printers known to work with them.

This list is not final, so any suggestions are welcome.

HP plotter responses to some RS-232 configuration commands have been evolved. Consequently, the 9384 generation DSO supports HP plotters of two types, 7470A and 7550A. The only difference lies in the RS-232 initialization codes. They may however, despite these changes, work with HPGL compatible plotters from other manufacturers. If the HPGL data is used as input for a CAD or word processing system, it might be necessary to remove the data preceding the in command. Before connecting a plotter to a 9384, do not forget to select the appropriate settings in the printer setup menu and the GPIB & RS-232 setup menu.

<p>GPIB & RS232</p> <div style="border: 1px solid black; padding: 2px; margin-bottom: 5px;">Remote Control From GPIB RS232</div> <div style="border: 1px solid black; padding: 2px; margin-bottom: 5px;">RS232 Mode 7-bit 8-bit</div> <div style="border: 1px solid black; padding: 2px; margin-bottom: 5px;">Parity none add even</div> <div style="border: 1px solid black; padding: 2px; margin-bottom: 5px;">Stop bits 1 2</div> <div style="border: 1px solid black; padding: 2px; margin-bottom: 5px;">Baud Rate 300 1200 2400 4800 9600 19200</div> <p>GPIB Device Talk Only</p>	<p>HARDCOPY</p> <div style="border: 1px solid black; padding: 2px; margin-bottom: 5px;">output to Card Disk GPIB RS232 Centronics</div> <div style="border: 1px solid black; padding: 2px; margin-bottom: 5px;">page feed OFF On</div> <div style="border: 1px solid black; padding: 2px; margin-bottom: 5px;">protocol HP 7470 HP 7550 TIFF TIFF compr. BMP</div>
--	---

RS-232 connection

The following settings are assumed for the scope.

- Baud rate : 9600
 - Character : 8 bits
 - Parity : none
 - Stop bits : 1
- Any exceptions will be mentioned.

RS 232 interface

- Pin 1 : DCD
- 2 : RD
- 3 : TD
- 4 : DTR
- 5 : GND
- 6 : DSR
- 7 : RTS
- 8 : CTS
- 9 : RI

A cable with the following pinout can be used in almost every case:

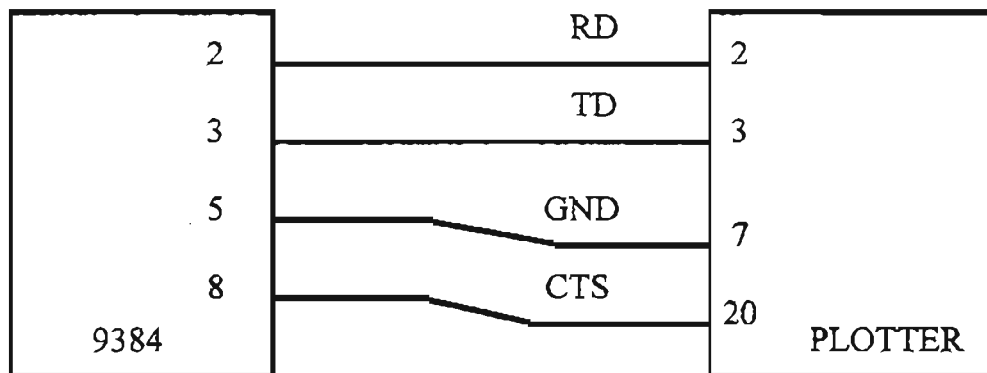

The cable has D25 connector with male pins on the plotter side, and a D9 connector with female pins on the 9384 oscilloscope side.

GPIB Connection

To have a plot done through GPIB initiated with the front panel screen dump push button, you must set the 9384 in talk only mode by selecting remote control from RS-232, and the plotter in listen only mode.

If a computer controls the GPIB Bus, both the scope and the plotter must be set in addressed mode (remote control from GPIB).

Remark: the listen only mode does not work on some old HP plotters such as HP7585B or HP7475. The plotter must be set to listener before being able to receive any commands, which is a violation of the GPIB standard.

9.2 Plotters

9.2.1 HP 7470A Plotter

Switch settings:

- RS-232 Connection:
 - S1 and S2 : 0 0
 - Y/D : D
 - A4/US : User selectable
 - B4 to B1 : 1 0 1 0
- GPIB listen only:
 - A4/US : User selectable
 - 16 to 1 : 1 1 1 1 1
- GPIB Addressed:
 - A4/US : User selectable
 - 16 to 1 : 0 0 1 1 1

9.2.2 HP 7550A Plotter

Responses to some ESC characters commands are not the same in this plotter as in older HP models like the 7470A. In fact, ESC sequences of commands which give excellent results in the 7470A can prevent any handshake in RS-232. Problems of this kind have been reported in the case of ESC.R and ESC.@ commands. When combined with ESC.I and ESC.N, ESC.@ breaks up all handshakes.

RS-232 configuration:

- Enter into display 5 (HP-IB MONITOR...).
- Select STANDARD OF STANDARD/ENHANCED.
- Enter into SERIAL sub-menu (display 6)
- For DATA_FLOW, select REMOTE. Either STANDALONE or EAVESDROP may be chosen.
- Enter into display 7 (DUPLEX, PARITY, BAUD).
- Select FULL duplex.
- Configuration PARITY and BAUD rate to the same values as on the DSO.

A standard cable may be used.

Do not start a plot while a sheet of paper is being loaded!

GPIB configuration:

If the scope is in TALK ONLY, the plotter must be in LISTEN ONLY. Selection will be done at display 5.

Note : Its seems that the plotter must be powered off, then on again, to take any configuration change into account.

9.2.3 Hitachi 672 Graph Plotter (or NSA 672)

As this plotter is compatible with the 7470A, select this mode on the plotter menu page.
Switch settings

- RS-232 Connection:

Sw. A, 1 and 2 : 1 1 (ISO A3) or (ISO A4).
Sw. A, 3 to 8 : 1 0 1 1 0 1
Sw. B : 1 1 1 1

Note : When switches are set to ISO A4, the pen must be manually repositioned at the top of the page (or plotter reset by powering it off and on) before loading a new sheet of paper.

9.3 Printers

Interfacing is possible through RS-232, GPIB directly, and in option through Centronics. The parallel interface F9300-6 (Centronics) is an option, see section 4.5.

9.3.1 Centronics Printers

Most printers use a Centronics parallel connection which makes direct connection possible if the 9384 is equipped with the optional Centronics interface F9300-6 board. If the printer has a Centronics connector then it's a parallel printer, and the F9300-6 board is required or a serial to parallel converter.

If a serial to parallel converter is used, in the printer setup menu select device type Epson, and remote control from RS-232.

RS-232 Remote control port settings:

Baud rate : 9600 or 19200
Characters length (bits) : 8
Parity : none
Number of stop bits : 1

The following printers and printer switch positions have been tested via serial to parallel adapter.

	Switch 1	Switch 2
1. Epson LQ-1000	1, 2, 3, 4 : ON	2, 6, 7 : ON
2. Diconix 150P	1: ON	2, 6, 7 : ON
3. HP-ThinkJet 2225C	2, 4, 5 : ON	
4. HP-DeskJet 550 C	all down	6 up for 19200 baud

Note: all Epson and Epson Compatible printers are likely to work if the switches are set properly, (Some experimentation may be required).

Some available serial to parallel converters need power through the RS-232 lines. Do not use them, as we do not guarantee that the serial port is able to furnish enough power.

9.3.2 RS-232 Printers

9.3.2.1 Epson FX80

It is possible to use the standard RS-232 cable. Such a printer has the optional RS-232 interface " #8143 " installed. The configuration that follows is valid for the default scope setting. The standard cable is usable.

In the particular case of an FX850:

- the main switches SW1 SW2 remain at the factory configuration

SW1	:	1	2	3	4	5	6	7	8
		OFF	OFF	ON	OFF	OFF	ON	ON	ON

SW2	:	1	2	3	4
		ON	OFF	OFF	OFF

- the 8143 switches are set to:

1	2	3	4	5	6	7	8
ON	OFF	OFF	OFF	N/A	OFF	OFF	ON

- the 8143 jumpers remain at the factory settings:

J1	J2	J3	J4	J5	JC	JNOR	JRVE	JF	JX
OFF	OFF	OFF	OFF	ON	OFF	ON	OFF	ON	OFF

Note: Epson printers only support XON/XOFF support handshake if they have a print buffer. Such printer are : FX, FX+, JX-80, LQ-800/1000, EX-800 and LQ-25000. Otherwise, use DTR/RTS handshake.

9.3.2.2 Citizen 120D

To use this printer with the default RS-232 setting and default printer setting of the 9384, select the following switch configuration:

DIP switch bank 1 : all OFF except 3 and 8, DIP switch bank 2 : all OFF.

9.3.2.3 HP Laserjet

Make sure that page feed is ON in the plotter menu to use the Laserjet. It is advisable to start out in single density with a size of A5. Then, depending upon the internal buffer size on the Laserjet, the image size and/or density can be increased. At one point, the internal buffer size of the DSO is also reached. The image is simply truncated, indicating that either density or size have to be reduced.

9.3.3 GPIB Printers

9.3.3.1 HP QuietJet

Make sure the dip switches on the backplane of the printer are set to

- SRQ enable:	0
- GPIB listen only:	
Listen always:	1
A5 to A1:	0 0 1 1 1
- GPIB Addressed:	
Listen always:	0
A5 to A1:	0 0 1 1 1

9.3.3.2 HP ThinkJet (HP 2225A)

Make sure the dip switches on the backplane of the printer are set to

- SRQ Enable:	0
- GPIB listen only:	
Listen always	1
A5 to A1:	0 0 1 1 1
- GPIB Addressed:	
Listen always:	0
A5 to A1:	0 0 1 1 1

9.3.3.3 HP PaintJet (black/white only)

Make sure the dip switches near the GPIB connector are set to:

- GPIB Listen only:	
NORM/SCS:	NORM
A3 to A1:	1 1 1
PC8/ROM8:	N/A
ENG/MET:	has to match paper size ENG = 11" MET = 12"
- GPIB addressed:	
NORM/SCS:	NORM
A3 to A1:	any combination except 1 1 1 (correspond to add. 0-6)
PC8/ROM8:	N/A
ENG/MET:	has to match paper size ENG = 11" MET = 12"

9.4 Information on GPIB

9.4.1 Introduction

This section is a simple description of the GPIB interface as an aid to understanding the interface in the 9384 DSO: it is not intended as a complete specification of the system.

The GPIB system is designed for the interaction of a number of devices, which may transmit or receive information as required. The system includes data lines over which the actual data are sent, bus management lines for control, and handshake lines to ensure correct acceptance of data at the right destination. The main features of the bus are summarized below:

Maximum number of devices	15
Maximum bus length	20 meters or 2 meters per device, whichever is less.
Connection	star or chain

Note that more than half of any connected devices must be powered up, even if they will not be used.

Data lines	8 DIO	1 to 8
Handshake lines	DAV	Data available
	NRFD	Not ready for data
	NDAC	not data accepted
Bus management lines	EOI	End or identity
	IFC	Interface clear
	SRQ	Service request
	ATN	Attention
	REN	Remote enable
Active level	+0.4 V	
Inactive level	+3,3 V	

Note that all signal lines are active low, and that they are wire ORed to allow participation by all devices.

In addition, there are 8 ground lines, making a total of 24 lines.

9.4.2 Functions in the GPIB

In order to allow satisfactory interconnection of several devices the following functions must be provided

- Enabling any device to transmit data
- Preventing any device from transmitting data
- Enabling any device to receive data
- Preventing any device to receive data

- Transmitting data to a specific device
- Ensuring that only one device is transmitting
- Ensuring that transmitting takes place only when reception is possible
- Enabling any device to request servicing
- Identify type of data to be sent

Any device can be activated into the "talk" or "listen" state, and can be deactivated by the commands "untalk" and "unlisten". Also a device can be a "controller".

Maximum number of current talkers	1
Maximum number of current listeners	14
Maximum number of current controllers	1

Function of bus lines:

- DAV Data available; talker says the data on the line are valid.
- NRFD Not ready for data; listener says it is not ready for more data. All listeners must release the NRFD line, i.e., let it go high, before talker can send.
- NDAC Not data accepted; listener says it has not yet accepted the data. Talker must hold all data lines steady until all listeners have released this line, i.e., it goes high.

Clearly, the NRFD and NDAC are easy to implement by a wired OR system, so that any one device asserting the signal prevents progress to the next step. Progress is made at the speed of the slowest listener. A simple timing diagram is given in figure 9.1, and another way of presenting the system is given in figure 9.2.

The bus management lines functions as follows:

- EOI End Or Identify; talker sends this with last byte of a block transfer to indicate last byte. Also used with ATN to parallel poll devices for their status bit.
- IFC interface Clear; places the GPIB system into a quiescent state.
- SRQ Service ReQuest; any device can send it to the controller to indicate need for attention, and to request interruption of current operations.
- ATN ATeNtion; controller sends this to specify whether DIO lines are to be used for interface messages, e.g., addressing, or for data.
- REN Remote ENable; selects a device as being under local or remote control.

Addressing of the devices on the GPIB bus consult a specialized GPIB-IEEE488 document.

The principles of GPIB are quite simple - the system must wait for all users, and lines are wire ORed so that all can pull the lines down. The handshake sequence is illustrated in two ways. In figure 9.1 the signal waveforms are sketched.

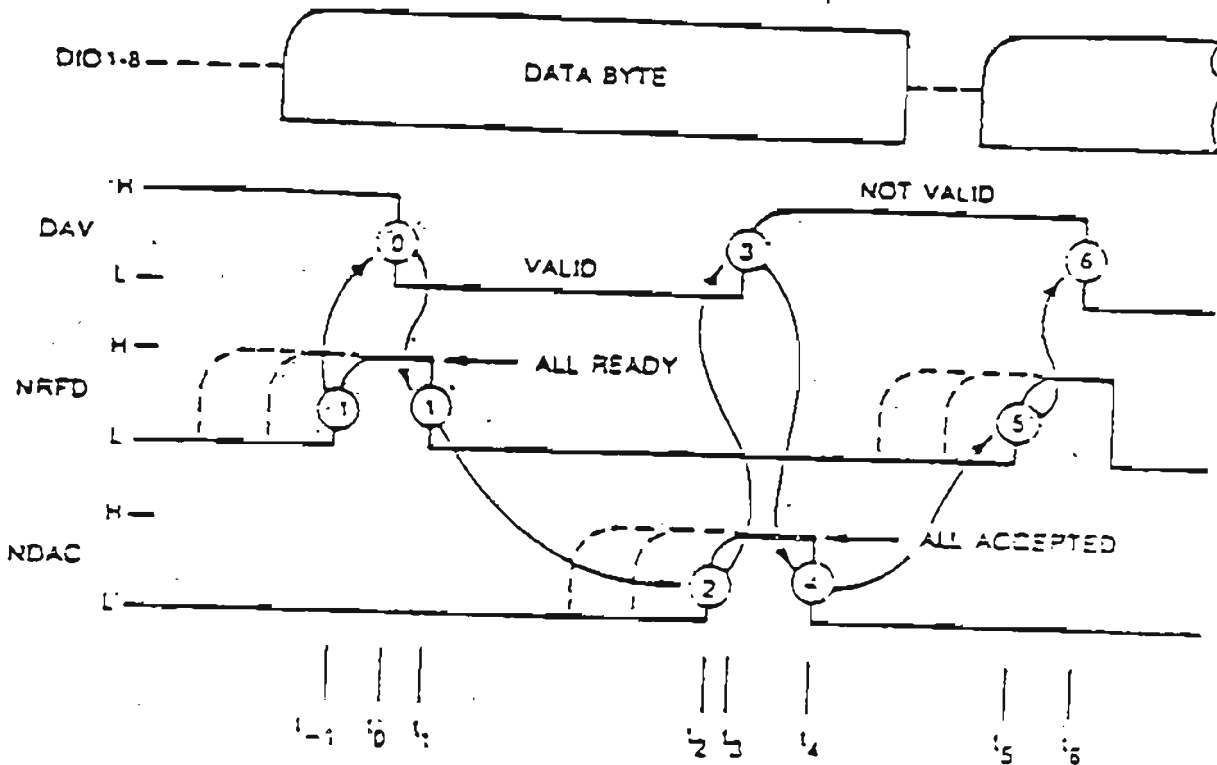

Figure 9.1 : DATA BYTE TRANSFER IN GPIB IEEE-488

The handshake timing sequence proceeds as follows:

- | | |
|-------------|---|
| Preliminary | The source checks for presence of listeners and places the next data byte on the data lines DI01-8. |
| t-1 | Acceptors one by one become ready for byte. Last one allows NRFD to go high. |
| t0 | Sources pulls down DAV to validate data. |
| t1 | The first listener to accept the data pulls down NRFD to show it is no longer ready for a new byte. |
| t2 | The listeners one by one accept the data, and the last one lets NDAC go high. |
| t3 | The source sets DAV high to show this byte is no longer valid. |
| t4 | The listeners one by one accept this, the first one pulling NDAC low for the next cycle. |
| t5 | As for t-1. |