

**EVERYTHING 4 LESS**

**ENJOY YOUR BOOKS**

**PLEASE VISIT OUR STORE FOR EVEN MORE GREAT STUFF!**

**[WWW.EVERYTHING4LESSSTORE.COM](http://WWW.EVERYTHING4LESSSTORE.COM)**

**COPYRIGHT NOTICE**

**ALL MATERIALS INCLUDING CD/DVD AND PDF FILES ARE COPYRIGHTED**

**[WWW.EVERYTHING4LESSSTORE.COM](http://WWW.EVERYTHING4LESSSTORE.COM) VON WALTHOUR PRODUCTIONS AND MAY NOT BE REPRODUCED, COPIED OR RESOLD UNDER ANY CIRCUMSTANCES. YOU MAY HOWEVER MAKE A COPY FOR YOUR OWN PERSONAL BACKUP. MATERIALS ARE FOR PERSONAL USE ONLY.**

**IF YOU PURCHASED THIS FROM ANYWHERE BUT FROM US PLEASE NOTIFY US IMMEDIATELY SO THAT WE MAY CHECK IF YOU PURCHASED FROM AN AUTHORIZED RESELLER SO WE CAN LET YOU KNOW IF YOU NEED TO RETURN FOR FULL REFUND FROM AN UNAUTHORIZED SELLER.**

**THANKS AGAIN AND PLEASE TAKE THE TIME TO VISIT OUR STORE.**

**ATTENTION! EVERYTHING ON SALE NOW!!**



**HOT SALE!**

MODEL LBO-508

# DUAL TRACE / DUAL CHANNEL 5" OSCILLOSCOPE

OPERATING INSTRUCTIONS

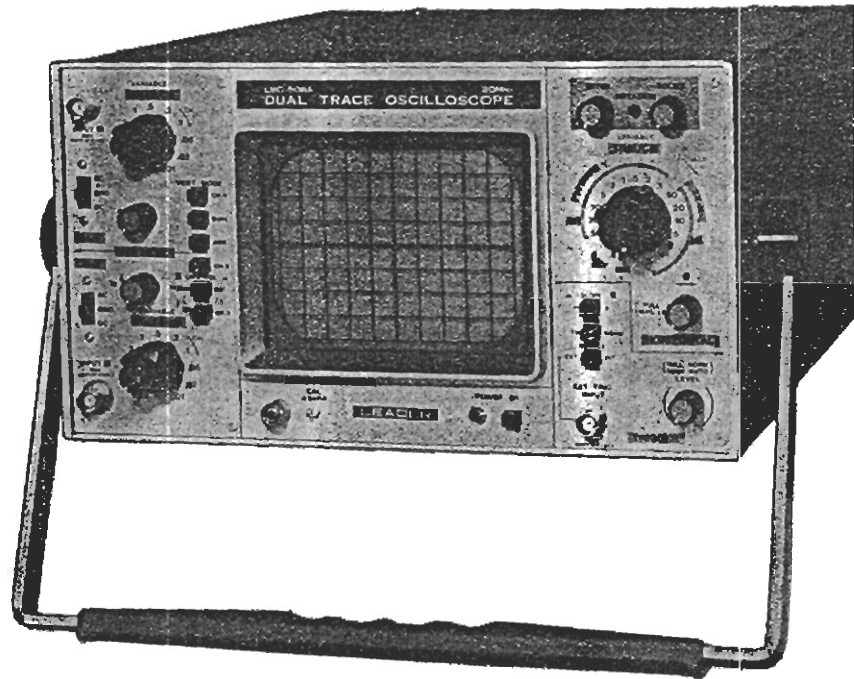

LEADER ELECTRONICS CORP.

## TABLE OF CONTENTS

	PAGE		PAGE
1. INTRODUCTION .....	2	6.6 Frequency Measurement .....	20
2. SPECIFICATIONS .....	2	6.7 Rise Time of Pulse .....	20
3. DESCRIPTION OF PANEL		6.8 Time Difference between Two	
FUNCTIONS .....	4	Signals .....	21
3.1 Front panel .....	4	6.9 Phase Difference between Two	
3.2 Rear panel .....	8	Signals .....	22
4. PRECAUTIONS .....	9	6.10 Measurement of Phase Difference	
4.1 Power Source Voltage .....	9	by X-Y Operation .....	23
4.2 Signal Input .....	9	6.11 Measurements of Error between	
4.3 Horizontal trace line tilt .....	9	Two Signals and Push-Pull Signal ...	24
4.4 Operation in a Powerful		6.12 AM, SSB Transmission Modulated	
Magnetic Field .....	9	Wave Measurement .....	24
4.5 Operation in a Hot and		6.13 Description of Applications by	
Humid Place .....	10	Transducers of Various Kinds .....	25
4.6 Intensity .....	10	6.14 Intensity Modulation Terminal	
5. FUNDAMENTAL OPERATION		(Z axis) .....	25
INSTRUCTIONS .....	10	7. MAINTENANCE AND CALIBRATION	
5.1 Preparation .....	10	BY THE USER .....	26
5.2 Check of Gain by Calibrated Waves ..	11	7.1 ROTATION (Trace Slope) .....	26
5.3 How to Use a Low-Capacitance/		7.2 Preparations and checking before	
Direct Probe .....	11	Calibration .....	26
5.3.1 Specifications .....	11	7.3 Vertical Variable Balance .....	26
5.3.2 Operation of Low Capacitance		7.4 Balance Adjustments	
Probe .....	11	of ATT STEP .....	26
5.3.3 Adjustment of Probe .....	12	7.5 Vertical Gains .....	27
5.4 Dual Trace Measurement .....	12	7.6 Width .....	27
5.4.1 ALT. (Alternation) .....	12	7.7 Length adjustment .....	27
5.4.2 CHOP .....	13	7.8 Stability Adjustments .....	27
5.5 Precautions on Direct Connection		8. PARTS LIST .....	28
and Using a Probe .....	13	9. P.C.B. LAYOUT .....	36
5.6 Ground Connection .....	14	10. SCHEMATIC DIAGRAM .....	40
5.7 Synchronization to Waveforms .....	14		
5.7.1 Mode of Synchronizing Sweep ...	14		
5.7.2 Selection of Synchronizing			
Signal Source .....	14		
5.7.3 Coupling of Synchronizing			
Signals .....	15		
5.7.4 Selection of synchronization			
position .....	16		
6. MEASUREMENTS .....	17		
6.1 AC Peak Voltage .....	17		
6.2 DC Voltage .....	18		
6.3 DC + AC Peak Voltage .....	18		
6.4 Current Measurement .....	19		
6.5 Time Interval Measurement .....	19		

## 1. INTRODUCTION

LBO-508A is a dual trace oscilloscope with bandwidth of DC-20MHz and sensitivity of 10mV/cm. With the adoption of 130mm highly bright C.R.T., large display in highly spot brilliancy and clearness is to be obtained. Engineered for service in the field of television, V.T.R., computer with wide bandwidth LBO-508A is portable, easy and convenient of operation for use in school.

- **Wide bandwidth and high Sensitivity**  
In addition to wide bandwidth, DC-20 MHz, (-3dB, 4cm) this instrument provide high sensitivity of 10mV/cm. 30MHz frequency is to be obtained with the improved triggered synchronization.
- **New highly bright C.R.T.**  
With the adoption of New, highly bright C.R.T. Stable accelerated high voltage to C.R.T. and Calibration Accuracy of Voltage and Time Base are to be obtained.

- **TV Synchronization**  
Circuit for extracting the synchronizing signal is equipped to synchronize easily with composite video signal. Synchronizing pulse of TV-Vert and TV-hcriz, is automatically selected by Time Base Switch.
- **Two functions of Addition and Subtraction by two signals.**  
Not only phase comparison or level comparison but also addition and subtraction can be observed by two signals functions. This function enable push pull signal to be displayed precisely.
- **Improvement in portability and operation**  
Equipped with a high carrying handle and designed for lightness, this unit is excellent both in portability and operation with various functions installed on the front panel.
- **X-Y functions**  
Set the switch at X-Y position and X-Y oscilloscope is displayed with CH-1 as X axis and CH-2 as Y axis.

## 2. SPECIFICATION

### CRT Display

Type 130BXB31  
Acceleration Voltage 2000V  
Effective display area 8 X 10 cm

### INTENSITY MODULATION:

Blanked by TTL Level signal

### Vertical amplifier

(Identical for both channels)

Sensitivity: 10mV/cm - 20V/cm calibrated in 11 steps (1-2-5 Sequence up to 50V/cm with variable control)

Accuracy ±3%

Bandwidth (DC) DC-20MHz (-3dB, 4 cm deflection)  
(AC) 2Hz-20MHz (-3dB, 4 cm deflection)

Rise time 17.5 nSec.

Input impedance 1MΩ shunted by 35pF ± 5pF

Input coupling AC, DC, GND

Max. input voltage 600V (DC + ACp-p)

Channel 2 pol Inverts CH-2 polarity

Input connector BNC

### Time base

Sweep speed 0.5 μS/cm - 200mS/cm  
18 steps, 1-2-5 sequence

Accuracy ±5%

Magnification X5 ±5% (max speed)  
100nS/cm

### Dual trace display

Mode CH-1, CH-2, X-Y, Dual, Add.  
Chop (automatic select in dual mode) 200mS/cm - 0.5mS/cm  
ALT (Automatic select in dual mode) 200 μS/cm - 0.5 μS/cm  
ADD Sum or difference (with channel 2 invert)

### X-Y display

(X = CH-1 Y = CH-2)

Sensitivity Y axis: 10mV/cm-20V/cm

X axis: 10mV/cm-20V/cm

Bandwidth X axis: DC or 2Hz - 800 kHz (-3dB, 10cm deflection)

X-Y phase Less than 3% at 100kHz

### Synchronization

Mode

Normal trigger and AUTOmatic trigger

On automatic synchronization, in some cases, no signal is provided. Trace can be seen with synchronization level off very little to do with time base range.

Signal source

Internal (CH-1 or CH-2) or external, + or - slope

TV Synchronization	Extracts the synchronizing signal from composite video signal and provides stable synchronization. Slope switch is selected according to polarity of video signals.	Automatic (INT) 50Hz – 20MHz at 1 cm (EXT) 50Hz – 20MHz at 150 mVp-p
Trigger sensitivity	Triggered (INT) 2Hz – 20MHz at 1 cm on the screen. (EXT) 2Hz – 20MHz at 150 mVp-p	Calibrator Waveform Square wave (line freq.) Voltage 0.5 Vp-p ±3%
		Power supply 100/117/220/240V 50/60Hz 33W
		Size and weight 160(H) × 290(W) × 375(D) mm, 7kg

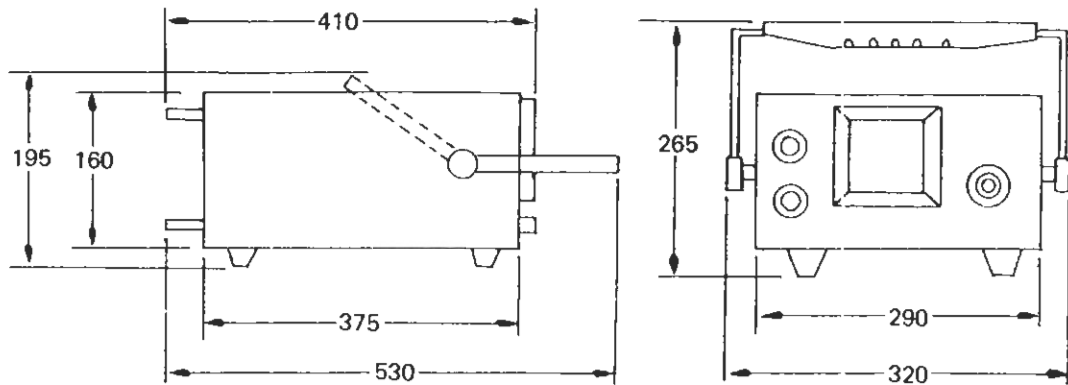

Accessories furnished

- Direct/Low capacitance probe LP-16AX . . . . .2
- BNC terminal adapter . . . . .2
- Slow blow fuse . . . . .1

### 3. DESCRIPTION OF PANEL FUNCTIONS

The numbers enclosed with circles in this instruction manual refers to the control knobs and func-

tion switches of the LBO-508A.

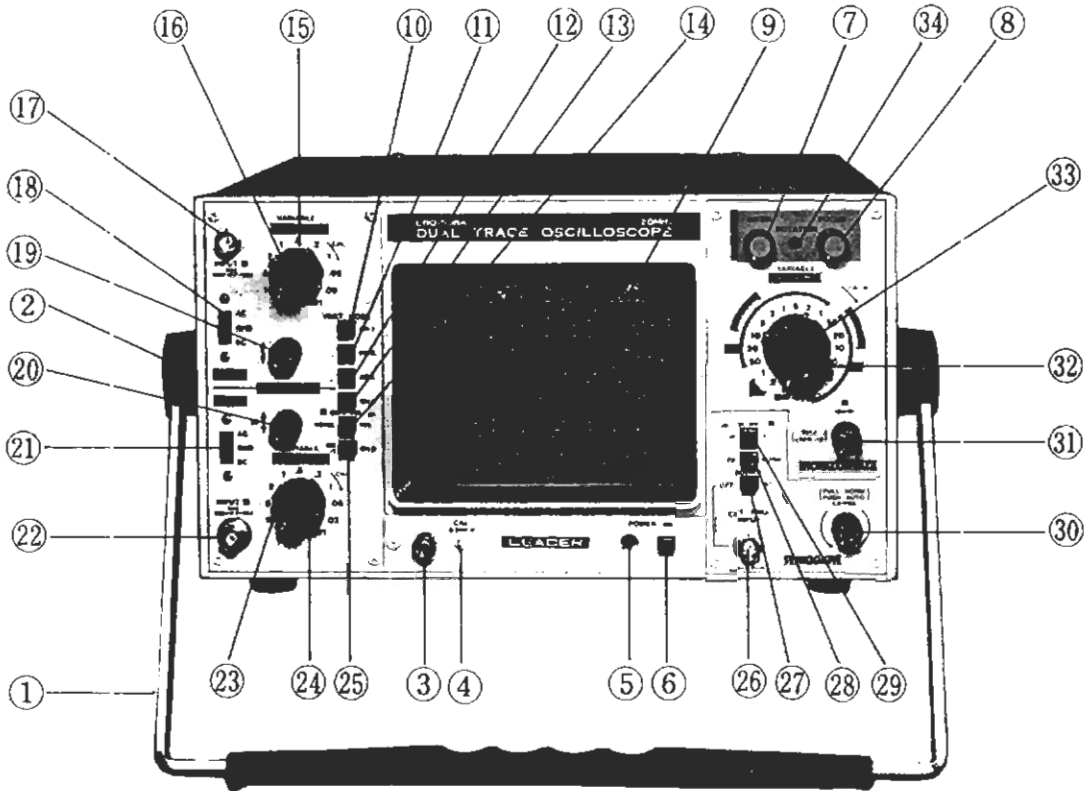

#### 3-1 Front Panel

- ① Hand carrier  
The hand carrier can also be used as a stand.
- ② Hand carrier stopper  
Locks the hand carrier at 22.5°. Firmly press in each stopper with both hands, the hand carrier will be unlocked and rotate freely. Upon release the hand carrier will revert to locked position.
- ③ Ground terminal
- ④ CAL 0.5V<sub>p-p</sub> (Calibration wave)  
Signal output terminal for amplitude and probe calibration.

- ⑤ Pilot lamp  
The lamp lights when the power is on.
- ⑥ POWER ON  
Turns the power on or off.
- ⑦ INTEN.  
Adjusts pattern luminance or brightness on the screen. With the knob turned clockwise, the pattern luminance or brightness increases, with the knob turned counterclockwise, the luminance or brightness decreases.
- ⑧ FOCUS  
Adjusts focus for clarity of the display.



⑨ Graticule  
A size of graticule is 8 by 10cm, Sub-scales of intervals of 2mm are imprinted on the graticule in the form of Cross for easy reading. Vertical Voltage sensitivity (Volt/cm) and Sweep time (Time/cm) are calibrated and can be read with reference to this sub-scales.

⑩ CH-1  
Only the input signal applied to CH-1 is displayed.

⑪ DUAL Trace  
Dual trace display can be obtained by CHOP. or ALT. (Refer to "Dual Trace Measurement" of 5-4 about further details)  
Time Switch of ⑩ does automatic-change-over to CHOP. at 0.5mS/cm – 0.2S/cm, and to ALT. at 0.2mS/cm – 0.5μS/cm.

⑫ ADD. (Addition)  
The input signals of CH-1 and CH-2 are algebraically added and displayed. When the CH-2 polarity inversion switch ⑭ is at INV., subtraction is accomplished.

⑬ CH-2  
Only the signal applied to CH-2 is displayed.

⑭  CH-2 POL.  INV. (CH-2 Polarity inversion switch)  
Set at  (push-out) for normal operation. At INV. (inversion)  (push-in), the polarity of the signal applied to CH-2 will be inverted. That is, the upper part will become negative and the lower part, positive.

⑮ VOLTS/cm (CH-1 or  sensitivity switch), black knob  
This is a knob for switching the sensitivity of the input signal fed to CH-1 ⑰. Switching action is accomplished in 11 steps from 10mV/cm to 20V/cm. On X-Y operation, the knob functions to change the sensitivity of the X-axis.  
To measure by the use of the indicated voltage sensitivity, be sure to set the VARIABLE ⑯ (red knob) to CAL'D by turning it fully clockwise until it clicks. If the signal is applied to the input terminal ⑰ by the use of a 1/10 low capacitance probe, the values are ten times the indicated voltage.

⑯ VARIABLE (CH-1 or  sensitivity fine adjuster), red knob  
This is a vertical axis sensitivity fine adjuster which is capable of attenuating to less than 1/2.5 by indication of each range of VOLTS/cm.

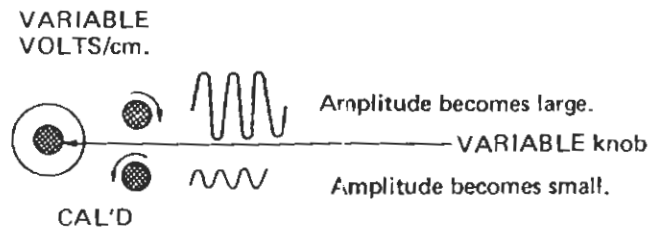

When measuring a voltage by the use of voltage sensitivity indicated by VOLTS/cm, turn the VARIABLE clockwise to the full position, that is, to  CAL'D until it clicks.

⑰ CH-1 or  IN  
This is an input plug for use with the CH-1 vertical amplifier and X-axis (horizontal axis) amplifier during X-Y operation. Caution not to exceed maximum permissible input voltage, 600V (ACp-p + DC).

⑱ AC-GND-DC (Alternating Current-Ground-Direct Current Switch)  
Switches the coupling of the signal fed to the vertical axis input ⑰. DC coupling is obtained on the DC position, on AC position the direct current component is blocked by a capacitor. The GND position grounds the input of the amplifiers and opens the input terminal ⑰. The following table illustrates a display at each switching position (AC-GND-DC).

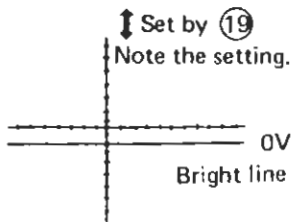
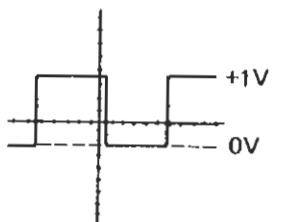
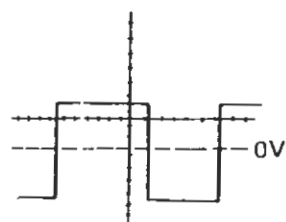
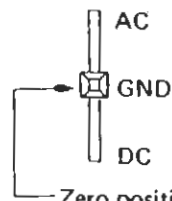
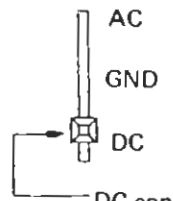
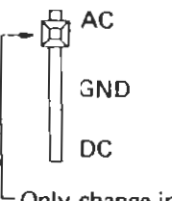
Input signal	 <p style="text-align: right;">Symmetrical square wave</p>		
Wave form and its position on the screen	 <p style="text-align: center;">↑ Set by ①⑨ Note the setting.</p> <p style="text-align: center;">0V Bright line</p>	 <p style="text-align: center;">+1V 0V</p>	 <p style="text-align: center;">0V</p>
Position of switch ①⑧	 <p style="text-align: center;">AC GND DC</p> <p style="text-align: center;">Zero position (0V)</p>	 <p style="text-align: center;">AC GND DC</p> <p style="text-align: center;">DC content can be measured</p>	 <p style="text-align: center;">AC GND DC</p> <p style="text-align: center;">Only change in AC content can be measured.</p>

①⑨ ↑ (Vertical position adjustment)  
With the knob turned clockwise, the waveforms of CH-1 move upward. When the knob is turned counterclockwise, the waveforms move downward.

②⑩ ↕ (Vertical position adjustment)  
Clockwise rotation will move pattern up, and counterclockwise rotation will move pattern down.

②⑪ AC-GND-DC: (Alternating Current-Ground-Direct Current Switch)  
Switches the coupling of the signal fed to the vertical axis input ②②. DC coupling is obtained on the DC position, on AC position the direct current component is blocked by a capacitor. The GND position grounds the input of the amplifiers and opens the input terminal ②②. An example of display at each switching position (AC-GND-DC) is shown by the table at switch ①⑧

②⑫ CH-2 or [Y] IN  
This is an input plug for use with the CH-2 vertical amplifier and Y-axis (vertical axis) amplifier during X-Y operation. Caution not to exceed maximum permissible input voltage, 60V (ACp-p + DC).

②⑬ VOLTS/cm (CH-2 or [Y] sensitivity switch), black knob  
This is a knob for switching the sensitivity

of the input signal fed to CH-2 ②⑫. Switching action is accomplished in 11 steps from 10mV/cm to 20V/cm. On X-Y operation, the knob functions to change the sensitivity of the Y-axis.

To measure by the use of the indicated voltage sensitivity, be sure to set the VARIABLE ②⑭ (red knob) to CAL'D by turning it fully clockwise until it clicks. If the signal is applied to the input terminal ②② by the use of a 1/10 low capacitance probe, the values are ten times the indicated voltage.

②⑭ VARIABLE (CH-2 or [Y] sensitivity fine adjuster), red knob  
This is a vertical axis sensitivity fine adjuster which is capable of attenuating to less than 1/2.5 the indication of each range of VOLTS/cm.

To measure a voltage by the use of voltage sensitivity indicated by VOLTS/cm, turn the VARIABLE clockwise to the full, to CAL'D until it clicks.

②⑮ ■ TRIG. ■ CH-1/CH-2  
This is a switch for selecting the internal synchronizing signal for CH-1 or CH-2. On single trace display; switched at CH-1, this unit synchronizes with CH-1, same with CH-2 as to CH-2.

②⑯ EXT. TRIG. INPUT  
For connection to the external triggering signal source.



- 27) **TRIG SOURCE**  $\blacksquare$  INT./EXT.  
 Selects synchronizing signal source. At INT., part of the signal taken from the vertical amplifier selected by the TRIG CH-1 or CH-2 trigger selector switch 25 is utilized for synchronization. Normal operation is performed with this switch at the INT. position. EXT. position is used when synchronization is desired when another signal synchronized with the signal fed into the vertical input is applied to the EXT. TRIG. INPUT terminal 26

- 28) **TV (Video signal)**  
 Extracts the synchronizing signal from composite TV or VTR signals (video signals) and provides synchronization with the TV vertical synchronizing signal (TV-VERT) when the sweep time 32 is in the range of 0.1ms/cm or less and with the horizontal synchronizing signal (TV-HORIZ) in the range of 50 $\mu$ s/cm or more. At this point, it is necessary to select the SLOPE 29 as illustrated below in accordance with the polarity of the video signals.  
 Synchronizing pulse polarity of video signal and selection of SLOPE.

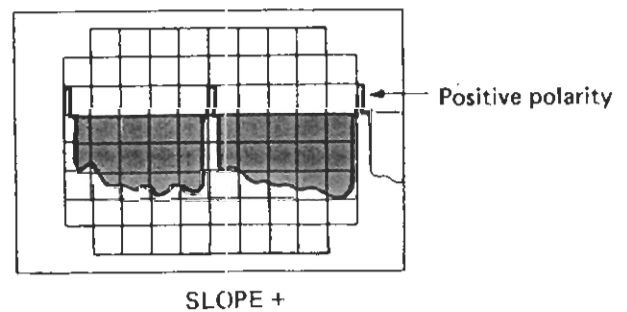
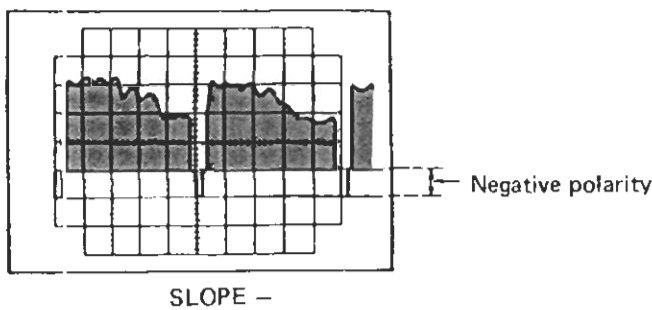

- 29) **SLOPE**  $\blacksquare$  +/-  
 If triggered sweep is desired against the positive slope of waveforms displayed on the

screen, set this switch to (+) position, and against negative slope, set it to (-) position, whichever is applicable.

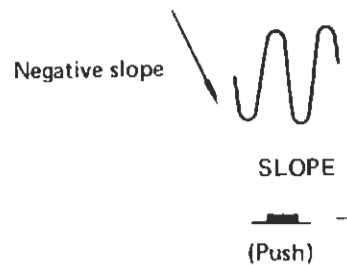
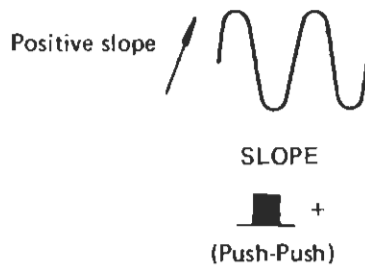

- 30) **LEVEL**  
 (PULL NORM)  
 (PUSH AUTO)  
 The control knob is used to adjust the triggering level of the sweep. At the "out" (PULL) setting, the sweep will be in the normal condition, i.e., triggered with the input waveform. At the "in" (PUSH) setting, the sweep will be automatically synchronized with the input waveform provided the frequency is above 50Hz. However, at no input, or at low

triggering levels when there is no control, only the horizontal trace will be displayed. In operation, the knob is generally at the in. or AUTO, setting.

- 31) **(PULL MAG X5)**  $\boxtimes$   $\longleftrightarrow$   
 The knob is used to position the trace in the horizontal direction. When the knob is pulled out, the sweep is magnified by a factor of 5.

③② TIME/cm  
Sweep Time is changeable within  $0.5\mu\text{S}/\text{cm}$  –  $0.2\text{S}/\text{cm}$ . With the switch at X-Y Position, CH-1 operates as X axis and CH-2 operates as Y axis.

③③ VARIABLE (Time adjuster of Sweep Time)  
Red knob  
This is fine adjuster covering time uncovered

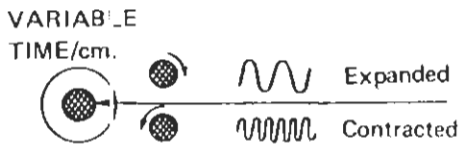

Fine Adjustment of sweep time. (Red knob)

by Time change-steps.

When measuring with an indication of Time, turn VARIABLE clockwise to the full, that is, to CAL'D where it clicks

③④ ROTATION

The effect of the earth's magnetic field may cause slight tilting of the horizontal traces due to placement of the instrument. Move the traces to the center of the scales on the screen, adjust the ROTATION knob with a screw driver in the direction that cause the traces to become parallel with the horizontal scales.

### 3-2 Rear Panel

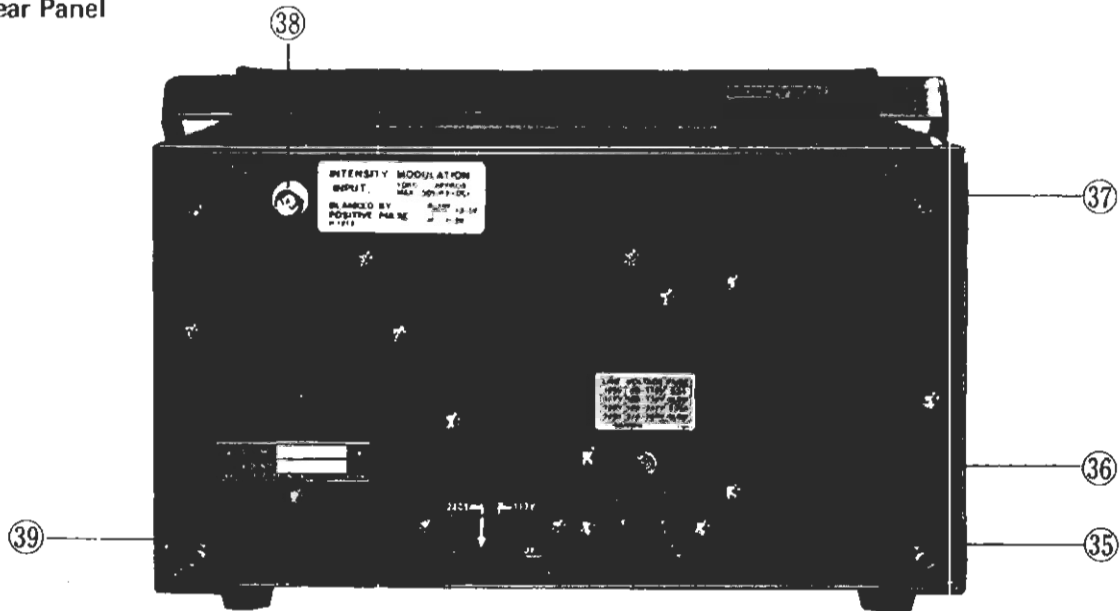

③⑤ AC inlet  
Make sure at rated voltage  
(Refer to Section 4-1).

③⑥ Fuse  
The fuse is released when the cap is rotated counterclockwise. Note the type and rating of the fuse used. (Refer to Section 4-1).

③⑦ Legs for vertical viewing and AC cord winding  
These are legs for vertical viewing and AC cord winding convenience.  
To store or shorten AC cord wind around legs.

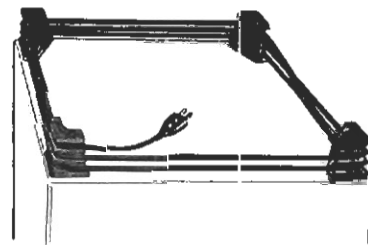

③⑧ INTENSITY MODULATION Terminal  
Intensity modulation can be obtained when the voltage of  $0 \sim +5\text{V}$  is applied. The bright line will be blanked by a positive pulse about  $+2 \sim +5\text{V}$ .

Cautions should be taken not exceed maximum allowed input voltage,  $50\text{V}$  (p-p + DC) and input impedance,  $10\text{k}\Omega$ .

③⑨ Voltage selector.

## 4. PRECAUTIONS

### 4.1 Power Source Voltage

In use, a power source voltage must be applied within  $\pm 10\%$  of the rated value. Operation with a voltage less than 10% of rated value may result in improper performance, and a voltage more than +10% of rated value may damage power supply circuitry. Before use, check a voltage range and a fuse rating, both being indicated on the rear panel.

### Way on setting indicated power source voltages

For setting an indicated power source voltage, insert a voltage switch plug into a socket so that an arrowhead marked on the plug may be directed to one of power source voltages marked on the socket along with a guide plate, as shown in the following drawings.

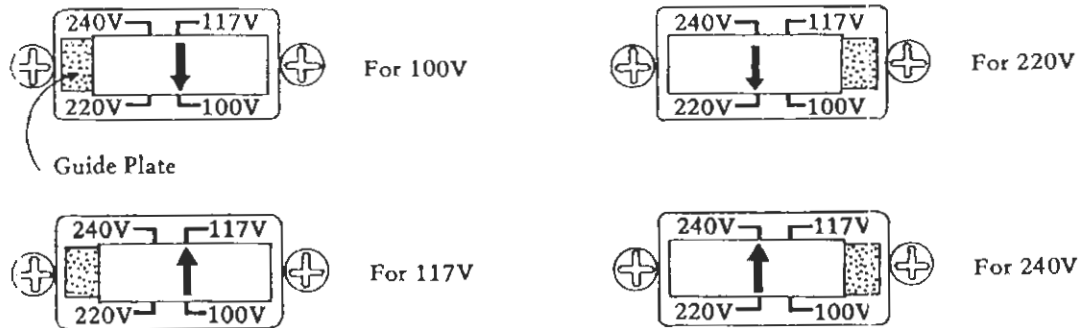

NOTE: For sets delivered for specific countries, the AC cord is fixed with a single voltage preset.

### 4-2 Signal Input

A voltage higher than 600V (ACp-p + DC) applied to the VERT. Input, or Trig. Input or the low capacitance probe may damage circuit components.

Vertical input terminal

INPUT (17), (22) MAX 600V (ACp-p + DC)

External synchronizing signal  
input terminal

TRIG. IN (26) MAX 600V (ACp-p + DC)  
Probe input (LP-16A)

MAX 600V (ACp-p + DC)

The value of 600V (ACp-p + DC) is shown in the following figure.

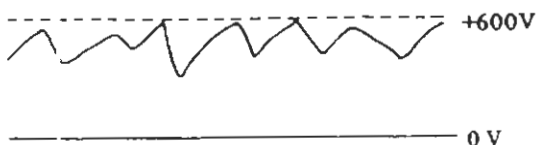

### 4-3 Horizontal Trace Tilt

The effect of the earth's magnetic field may cause slight tilting of the horizontal traces due to placement of the instrument. Move the traces to the center of the scales on the screen, adjust the ROTATION knob with a screw driver in the direction that cause the traces to become parallel with the horizontal scales.

### 4-4 Operation in a Powerful Magnetic Field

Operation in a powerful magnetic field will cause distortion of waveforms or make traces tilt excessively. Special care should be exercised when operating the instrument close to machinery or equipment using a large transformer.

#### 4-5 Operation in a Hot and Humid Place

This instrument is designed to operate in a temperature range of 0°C to +40°C and humidity range of 10 to 90%. Operation in severe environment may shorten the life of the instrument.

#### 4-6 Intensity

A burn-resisting fluorescent material is used in the cathodes ray tube. But, If the cathode ray tube is left with a bright dot or bright line, or with unnecessarily raised intensity its fluorescent screen may be damaged. When observing waveforms, therefore, the intensity should be maintained at the minimum necessary level. If the instrument is left on for extended periods, lower the intensity and obscure the focus.

### 5. FUNDAMENTAL OPERATION INSTRUCTIONS

The fundamental operation for observing waveforms with the Oscilloscope LBO-508A are described as follows.

#### 5-1 Preparation

Before using the LBO-508A, set the controls and switches as follows.

In addition, use these settings when checking proper operation of the instrument.

1. INTEN. (7) – Midposition
2. FOCUS (8) – Midposition
3.  $\updownarrow$  (19), (21) – Midposition
4. VOLTS/cm. (15), (23) – 0.1
5. VARIABLE (16), (24) – Turn clockwise to the full, CAL'D
6. AC-GND-DC (18), (21) – DC
7. VERT MODE – (11) DUAL
8. CH-2 POL (14) –  $\blacksquare$  (Push-out), NORM
9.  $\leftrightarrow$  (31) (PULL MAG. X5) – Midposition (PUSH IN X1)

10. VARIABLE (33) – Turn clockwise to the full, CAL'D
11. TIME/cm (32) – 5mS/cm
12. TRIG. CH-1/CH-2 (25) – CH-1 ( $\blacksquare$ : push-out)
13. SLOPE +/- (29) – + (arbitrary)
14. MODE TV/NORM. (28) – NORM (Push-out)
15. SOURCE EXT./INT. (27) – INT. (Push-out)
16. LEVEL (30) (PULL NORM./PUSH AUTO) – Midposition, Push-in AUTO

After all settings are made, set the POWER switch (6) at ON. After about 30 seconds, two traces will appear on the screen. Adjust the INTENSITY (7) and FOCUS (8) controls for a clear display of the traces.

17. Connect the attached probe to CH-1 (17) and CAL (4) terminals. At this time, the probe should be at X1. For use of the probe, refer to Section 5-3; "How to Use a Low-capacity/ Direct Probe."

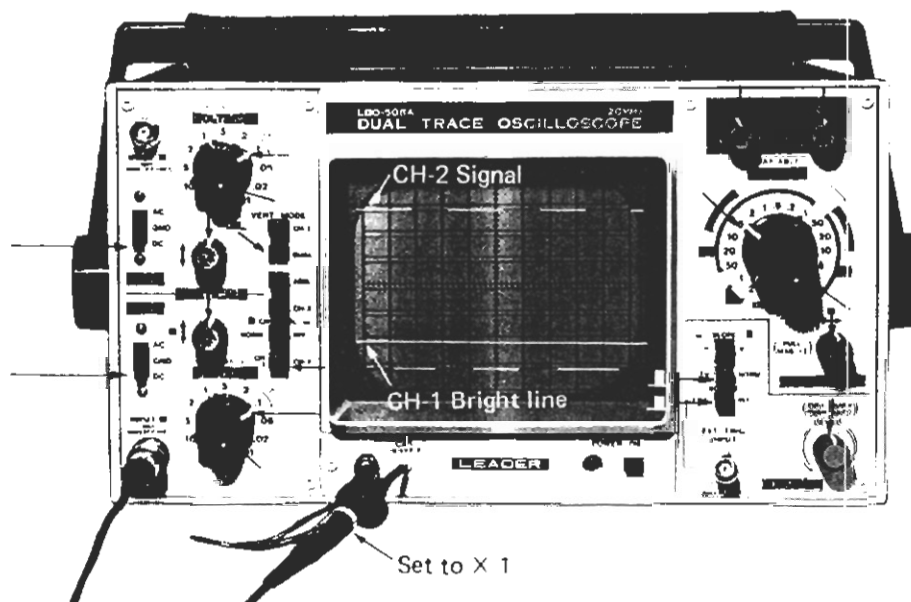

## 5-2 Check of Gain by Calibrated Waves

After all settings are made as shown in Section 5-1, (Refer to "Front Panel Diagram.") ascertain that a square wave with an amplitude of 5 cm is displayed on the screen.

This indicates that the instrument is operating properly

## 5-3 How To Use a Low-capacitance/Direct Probe

The LP-16AX Probe is an extremely well designed, high-performance probe equipped with X1 and X10 switching functions.

### 5-3-1 Specifications

Maximum input voltage  
250Vrms or 600V DC

- |     |        |                     |   |
|-----|--------|---------------------|---|
| 1-1 | At X10 | Input resistance:   | 10M $\Omega$ (connected to oscilloscope of 1M $\Omega$ in input resistance) |
|     |        | Input capacitance:  | 25pF or less  |
|     |        | Correction range:   | Oscilloscope with input capacitance 20 – 40pF                               |
|     |        | Attenuation factor: | 1/10 $\pm$ 2%   |
|     |        | Frequency range:    | DC – 40MHz  |
| 1-2 | At X1  | Input resistance:   | 1M $\Omega$ (connected to oscilloscope of 1M $\Omega$ in input resistance). |
|     |        | Input capacitance:  | 250pF or less (connected to oscilloscope of 50pF or less)                   |
|     |        | Frequency range:    | DC – 5MHz   |

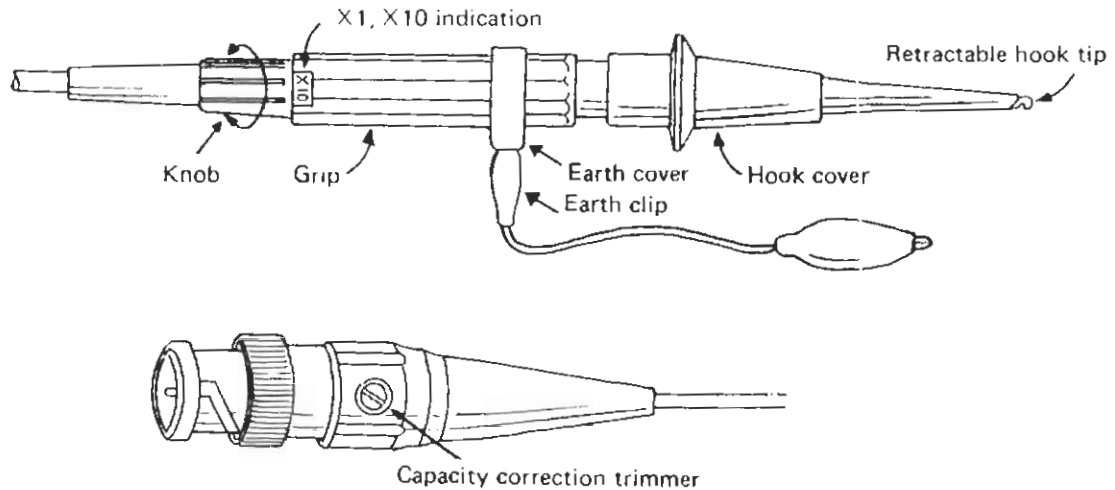

### 5-3-2 Operation of low capacitance probe.

Turn the knob and grip to the required position to set the arrow to X1 or X10. The knob and grip may be turned in any direction.

#### 2-1 Measurement at X10

The probe exhibits high resistance and low capacity at X10. However, the input voltage is attenuated to 1/10 and, therefore, this must be accounted for in voltage measurement.

Measured voltage = Sensitivity of oscilloscope V/DIV  $\times$  screen amplitude DIV  $\times$  10  
At X10, it is necessary to correct the pulse

characteristic by adjusting the capacitor in the probe for flat top of the square wave calibration voltage.

#### 2-2 Measurement at X1

This probe maintains high sensitivity in the X1 position so that it may be used directly with the oscilloscope. However, the input capacity is large approx. 250pF, and it is necessary to take this into account when making measurements.

#### 2-3 How to use the straight tip

For the use of straight-tip, please detach the retractive hook tip as shown in illustration.

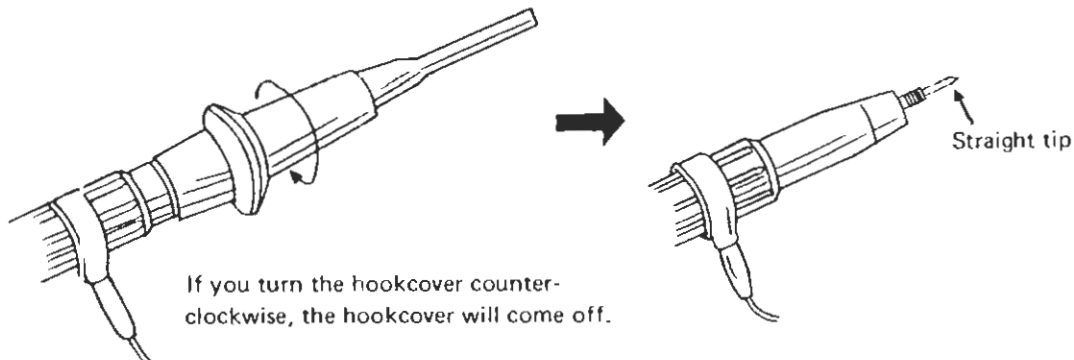

The straight tip is extremely convenient when testing points on printed circuit boards.

### 5-3-3 Adjustment of Probe

When observing the signal waveforms of high impedance circuit, the operation of the signal source and waveforms on the screen are liable to change due to the input impedance of the oscilloscope, parallel capacity of a coupling line, induction noise and other effects, leading to measurement error. The use of a low-capacity probe avoids these effects. A low-capacity probe of 10:1 attenuation type such as the LP-16AX should be used for high impedance circuitry measurements. Its input impedance is  $10M\Omega$  at 25pF. The basic construction of this probe is as shown below. Proper compensation may be obtained if the circuit constant is adjusted in such a way that the following equation will hold:

$$R_1 \times C_1 = R_2 \times C_2, (C_2 = C_3 + C_4)$$

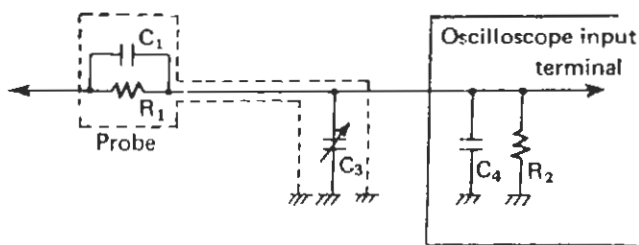

To adjust the probe, connect as shown below and turn the variable capacitor ( $C_3$ ) in the probe connector using a small screw driver, to provide proper square wave compensation.

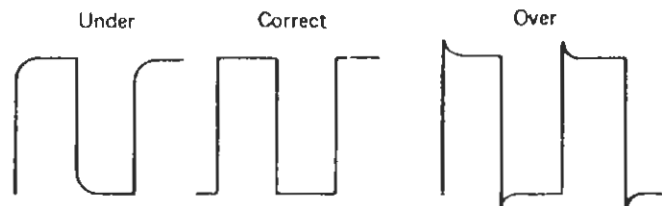

### 5-4 Dual Trace Measurement

Two vertical axis input circuits are provided in this instrument, and the waveforms of the two input signals are alternately shown on the screen by means of an electronic switch. However, since there is only one horizontal sweep circuit, it is not possible to have two synchronized or locked-in waveforms of two unrelated, independent input signals simultaneously on the screen. Two different methods are available for alternately switching of two signals making use of the electronic switch.

ALT, and CHOP are selected automatically by Time-base switch.

#### 5-4-1 ALT. (Alternation)

ALT. (Alternation) serves to show two signals, CH-1 and CH-2, alternately sweep by sweep.

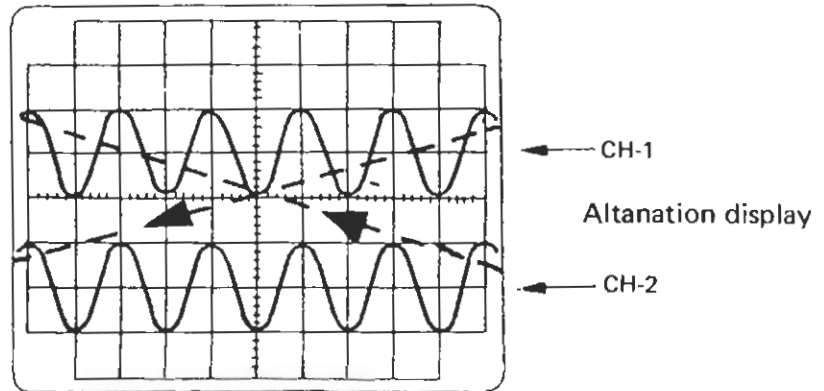

Two signals are alternately displayed on the screen as shown.

- Notes:
1. The dotted lines shown in the above figure do not appear on the screen.
  2. The comparison and observation of two independent phenomena from one source are not possible.
  3. If no signal is fed to CH-2 while the TRIG. switch (25)

is set for CH-2, synchronization will not take place even though a signal is fed to CH-1.

#### 5-4-2 CHOP

CHOP performs switching between two signals, CH-1 and CH-2, in high speed (about 250kHz) and displays the two waveforms on the screen so that both waveforms look continuous.

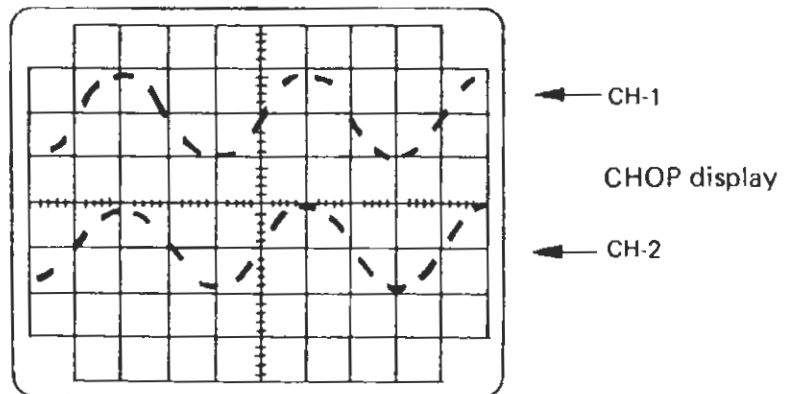

#### 5-5 Precautions on Direct Connection and Using a Probe

Two different methods are available for applying signals. One is to connect a lead wire or the like to the input terminal of the oscilloscope directly, and another is to use a probe.

When viewing a small signal in a circuit having high signal source impedance, error is liable to occur in measurement due to the effect of parallel capacity or induced noise in the input cable. The following precautions should be observed to avoid false readings. Generally, with the exception of a low-

impedance circuit, the use of a lead wire should be avoided as far as possible. That is, use X1 of the attached probe or a shielded wire such as coaxial cable. If a lead wire other than the probe or shielded wire is used, make the lead as short as possible. When using a shielded wire in a circuit having high impedance, attention should be paid to the loading effects of the sum of the input capacity of the oscilloscope and the distributed capacitance of the probe or shielded wire on the signal source. The input terminal of the oscilloscope has a capacity of about 35pF in parallel with 1MΩ. In addition, the direct probe has a distributed capacity of

about 250pF, and the coaxial shielded wire 60 to 70pF per meter. If the effect of this parallel capacity on the high impedance signal source can not be ignored. The use of the low capacity X10 probe is recommended.

### Low-capacitance probe

To avoid many ill effects by direct connection, use a low-capacitance probe (X10) as much as possible. When this probe is used, input impedance is 10MΩ, 25pF, thus making it possible to reduce the loading effects upon the signal source to a great extent. However, when the probe is used at X10, the input signal is attenuated to 1/10, this must be taken into account in all measurements.

### 5-6 Ground Connection



















For ground connection, use the shortest possible wire as described in Section 5-5.





When using a probe, connect to a ground point close to the signal source, and use the probe ground wire.

### 5-7 Synchronization to Waveforms

The most important factor in operating the oscilloscope is to lock and display waveforms properly before measuring them.

To make the most use of the synchronizing capacity of this instrument, a proper method of operation is described below, taking waveforms as an example. In addition, the following procedures describe how to obtain proper synchronization. For details, refer to 5-7-1 through 5-7-4.

1. Synchronizing Sweep	AUTO NORM	 Push in the knob  Push out the knob
2. Selection of trigger Source	Internal Synchronization { CH-1 CH-2 External Synchronization (Ext)	         
3. Coupling of Trigger Source	NORM TV Signal	   
4. Selection of Synchronization Position	Variable starting point Slope of Waveforms	 Variable adjuster  Selection of plus and minus

For simple waveform observation push in knob of  at AUTO, push out source of  at INT, push in Mode of  at NORM and set level knob of  at the white dotted midpoint.

#### 5-7-1 Mode of synchronizing sweep

The synchronizing sweep circuit of this instrument stops functioning if a trigger pulse is not produced as a sweep starting pulse. It is, therefore, necessary to select this sweep according to purpose desired.

Generally, for waveforms which have a frequency of 50Hz or more and are not complex, use AUTO synchronization. At AUTO synchronization, the sweep circuit is automatically placed in the free-run state when the aforementioned trigger pulse is not produced and a horizontal trace is displayed irrespective of sweep time set by the knob .

To remove waveforms on the screen when no input signal is applied or the trigger level is not correct, PULL a knob  to NORM.

#### 5-7-2 Selection of synchronizing signal source

The operation called "synchronization" takes place to lock waveforms being observed. It is necessary to supply a synchronizing signal for this purpose to the oscilloscope. This instrument is capable of selecting either internal (INT) or external (EXT) sources of synchronization.

The SOURCE switch  is capable of supplying this synchronizing signal (source) from inside at INT and from outside at EXT.



## INT Position

In normal observation of waveforms, the synchronizing signal is mostly supplied from inside by setting the switch at INT. In the internal (INT) position a part of the vertical input signal which is amplified is extracted and supplied to the synchronizing sweep circuit as a synchronizing signal. However, since this instrument is a dual trace oscilloscope which is provided with 2 input circuits (terminals), two synchronizing signals are produced from the waveforms. It is, therefore, necessary to select

from the 2 synchronizing signals by setting the TRIG switch ②⑤ at CH-1 or CH-2. When the switch is set at CH-1, the waveforms being observed at CH-1 are synchronized. At CH-2, synchronization takes place of the waveforms being observed at CH-2. When the waveforms being observed at CH-1 and CH-2 are in synchronous relationship, stable synchronization can be obtained in both channels if the frequency is the same, no matter which channel is selected. If the frequency is different, selection of the low-frequency one as a synchronizing signal source permits stable synchronization in both channels.

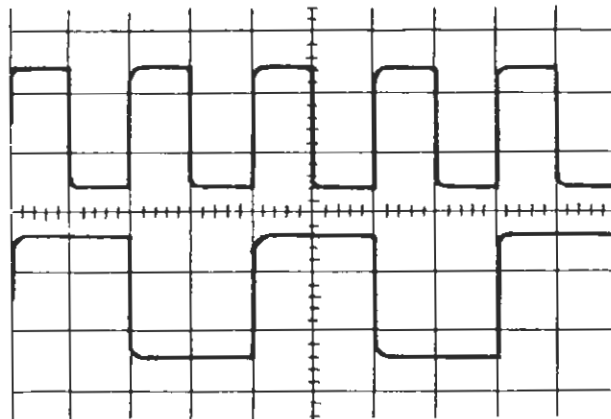

Set the TRIG. switch ②⑤ to the low-frequency one, to select a synchronizing signal source.

## EXT Position

When observing composite signals or the like in which different types of signals in synchronous relationship are combined, the INT position permits stable synchronization, if each independent signal of the composite signal can be separated and used as a synchronizing signal. If not, this external (EXT) position permits supplying the required synchronizing signal to the synchronizing sweep circuit directly from outside. Set the SOURCE switch ②⑦ at EXT, apply a synchronizing signal to the TRIG. IN terminal ②⑥. Since the level of the synchronizing signal is constant, stable synchronization can be obtained even if the level of the waveforms being observed varies.

It is also possible to have the synchronizing sweep circuit fail to operate even if the synchronizing signal is supplied. This occurs because insufficient synchronizing component to synchronize the waveforms being observed is contained in the signal. In either case, select the COUPLING switches as follows so that proper synchronization is obtained.

### Normal waveform observation

Set switch ②③ at NORM. At this point, the synchronizing signal is connected to the synchronizing sweep circuit through a capacitor, thus eliminating the DC component and provides stable synchronization over the whole bandwidth of 2Hz or higher. AC coupling takes place with synchronization that is not affected by a change in the DC component of the waveforms being observed. Signals of 2Hz or below, however, are difficult to synchronize. Set switch ②⑦ at EXT, and connect an external synchronizing signal from TRIG. IN terminal ②⑥ to obtain stable synchronization for this condition.

### 5-7-3 Coupling of synchronizing signals

Even when the synchronizing signal is actuating the synchronizing sweep circuit it is possible to have unstable synchronization of the waveforms being observed. This is due to an unwanted signal contained in the synchronizing signal.

## T.V. (Video) composite waveforms

In T.V. video waveforms, horizontal and vertical synchronizing components are combined. It is, therefore, very difficult to apply synchronization to the horizontal component or vertical component. In this case, set switch ⑳ at TV, and this will automatically select a horizontal synchronizing signal and vertical synchronizing signal and obtain stable synchronization. However, if the sweep time set by the switch ㉑ is 0.5ms/cm or less, the vertical synchronizing signal is selected. If it is 0.2mS/cm or more, the horizontal synchronizing signal is selected.

Position SLOPE switch ㉒ according to

the polarity of the composite Video signals, as shown in the explanation of switch ㉓ Section 3-6.

### 5-7-4 Selection of synchronization position

In a triggered sweep type oscilloscope, it is possible to adjust the position or timing of starting of the waveform so that stable trigger (starting) pulses may be obtained.

#### Adjustment of starting (trigger) position

To move the synchronization position to the section where changing waveforms are stable, adjust LEVEL knob ㉔ as shown below.

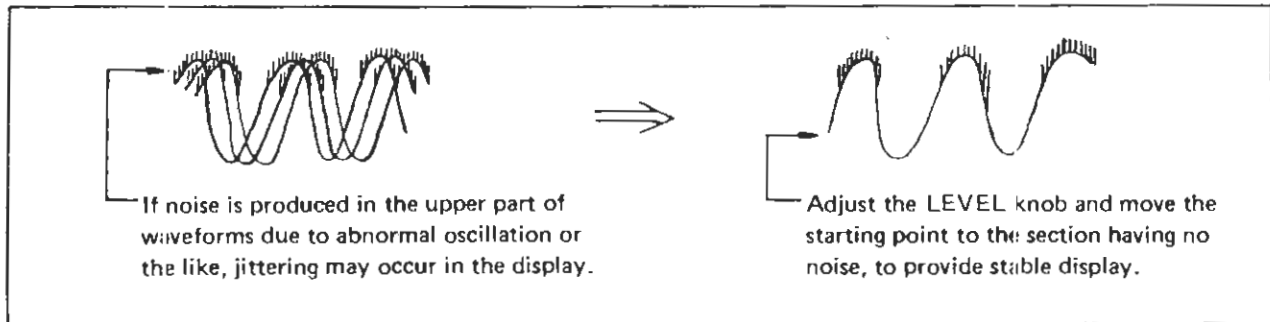
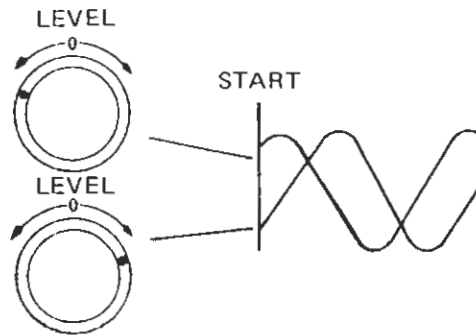

### Selection of waveform slope (SLOPE +/-)

When the rise portion of the waveform is smooth and the fall section is steep, like a sawtooth wave, stable synchronization can be obtained if starting (trigger) is performed in the fall portion. Also, in case of a square wave, especially when jittering

is taking place in the fall portion, stable synchronization can be obtained if starting is performed in the rise portion. SLOPE switch ㉒ functions to select the slope (rise or fall section) of the starting (trigger) point of this synchronizing signal waveform.

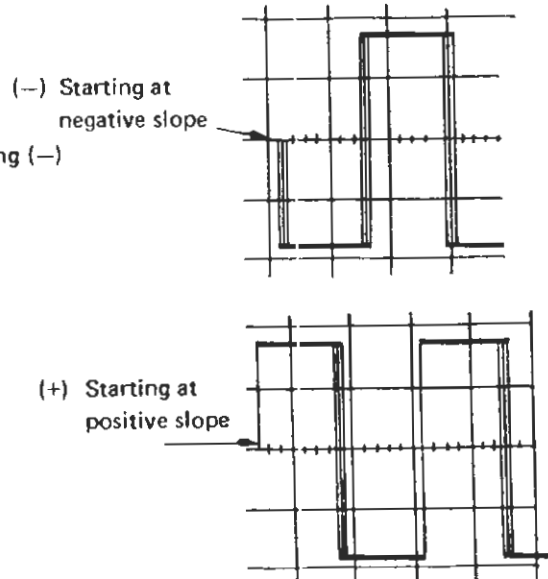
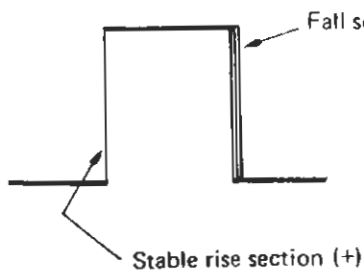
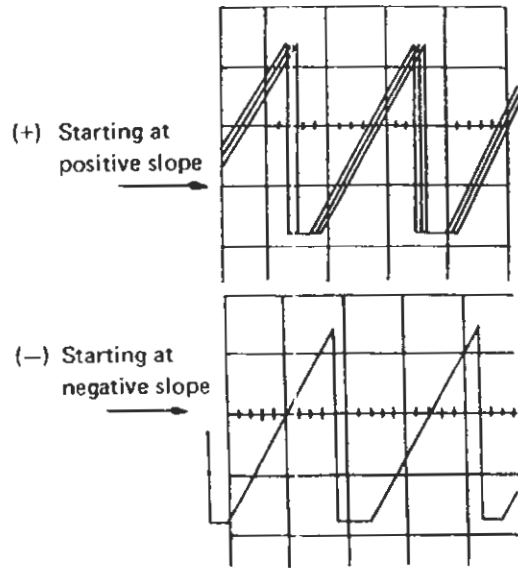
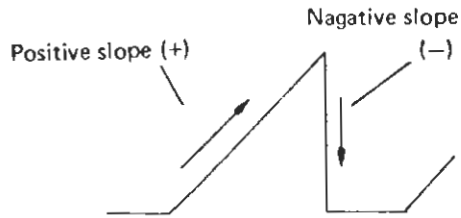

## 6. MEASUREMENTS

### 6-1 AC Peak Voltage

When it is desired to determine only the AC voltage component of the signal being measured, set AC-GND-DC switch (18) or (21) at AC and, from the amplitude on the screen at this time, calculate the peak voltage as follows:

Measurement using a X1 probe or lead wire  
 Peak voltage (Vp-p) = Value indicated at VOLTS/cm X amplitude (cm)

Measurement using a X10 probe  
 Peak voltage (Vp-p) = Value indicated at VOLTS/cm X amplitude (cm) X 10

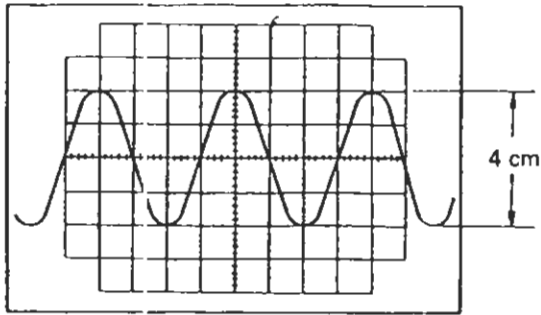

As shown above, the voltage of the signal being measured is calculated as follows:

If, VOLTS/cm = 0.05V/cm

Peak voltage when a X1 probe or lead wire is connected directly = 0.05V/cm × 4 cm = 0.2Vp-p

Peak voltage when using a X 10 probe = 0.05V/cm × 4 cm × 10 = 2Vp-p

If the input waveform is a sine wave, the measured voltage (p-p) can be converted to effective voltage (rms). The following relationship exists between the peak voltage (Vp-p) and the effective voltage (Vrms).

$$\text{Effective voltage (Vrms)} = \frac{\text{Peak voltage (Vp-p)}}{2\sqrt{2}}$$

2Vp-p, for instance, is converted to rms value as follows:

$$\frac{2\text{Vp-p}}{2\sqrt{2}} = \frac{2}{2 \times 1.414} = 0.707 \text{ Vrms}$$

Notes: 1. When switch (18) or (21) is set at "AC," the low frequency characteristic is attenuated to -3dB at 2Hz. Also, note that no AUTO synchronization is ac-

complished at 50Hz or less.

- When measuring a voltage, be sure to turn the VARIABLE knobs (16) and (24) fully clockwise to CAL'D.

## 6-2 DC Voltage

Use AUTO sweep, set AC-GND-DC switch (18) or (21) at GND. The trace (bright line) should show 0V. Set the trace to a position for easy measurement on the screen. Next, set the AC-GND-DC switch at DC and read the shift of the trace on the screen. Adjust the VOLTS/cm switch so that the trace will be displayed on the screen. An upward shift of the trace (bright line) represents (+) and a downward shift (-).

From the shift of the trace on the screen, the voltage of the signal being measured is calculated as follows:

Voltage when a X1 probe or lead wire is connected directly

Voltage (V) = Value (V/cm) indicated at VOLTS/cm × shift (cm)

Voltage when using a X10 probe

Voltage (V) = Value (V/cm) indicated at VOLTS/cm × shift (cm) × 10

### Example

If the range indicated at the VOLTS/cm is 2V/cm, the voltage of the signal being measured is calculated as follows:

When a X1 probe or lead wire is connected directly  
2V/cm × 3 cm = +6V

When using a X10 probe  
2V/cm × 3 cm × 10 = +60V

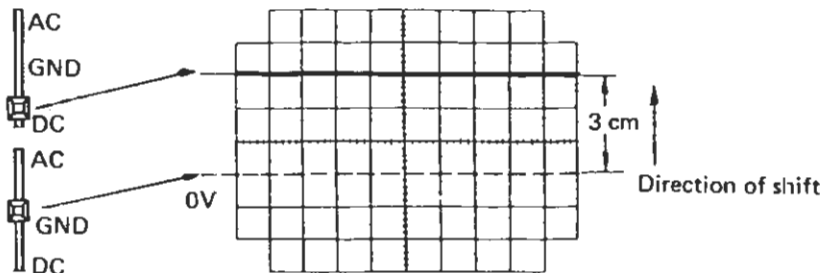

## 6-3 DC + AC Peak Voltage

Make measurement using the "DC" and the "GND" as in the case of the measurement of DC

voltage. If the range indicated at the VOLTS/cm is 0.2V/cm, the voltage of the signal being measured is obtained as shown below.

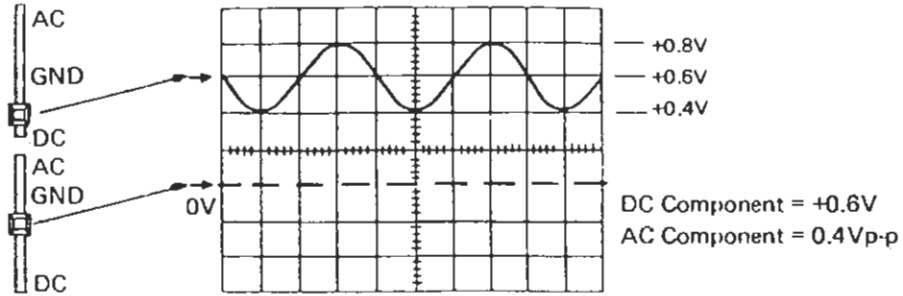

Note: When the DC component is much greater than the AC component, the waveform may be pushed off the screen making observation impossible. In this case, make measurements of the AC component and the DC component separately.

for voltage, mechanical oscillation and all other phenomena must be converted into voltage and then applied to the input terminal.

When measuring current, insert known resistance into the circuit to be measured, observe a change in voltage across that resistance with an oscilloscope and convert it into current according to Ohm's law, that is  $E = IR$ . However, the resistance to be inserted must be within the range that causes no change in the operating condition of the circuit being measured.

#### 6-4 Current Measurement

The voltage signal is the only phenomenon that can be observed by applying it to the oscilloscope directly. Accordingly, electric phenomena except

Low frequency current measurement

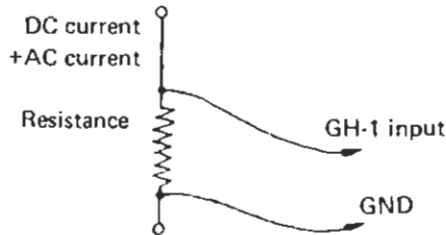

High frequency current measurement

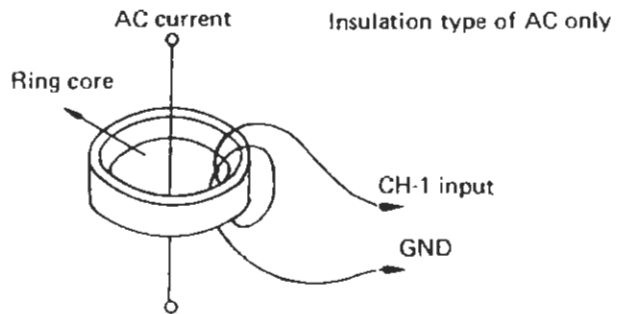

#### 6-5 Time Interval Measurement

The time interval  $T$  is calculated as follows:

Time  $T$  (sec) = Value indicated at TIME/cm  $\times$  Interval on the screen  $\times$  Reciprocal of magnification of the magnifier

The reciprocal of magnification of the magnifier is 1 when not magnified and 0.2 when magnified.

The time interval  $T$  in the left-hand figure is calculated as follows:

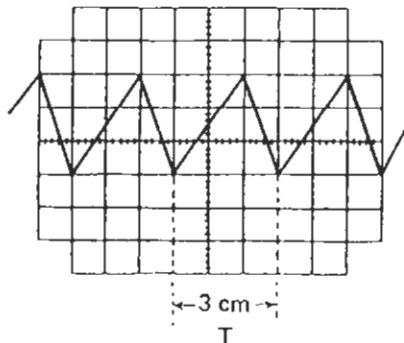

$$\text{TIME/cm} = 0.5 \text{ (0.5mS/cm)}$$

When the magnifier is X1,

$$T = 0.5 \text{ mS/cm} \times 3 \text{ cm} \times 1 = 1.5 \text{ msec}$$

When the magnifier is X5

$$T = 0.5 \text{ mS/cm} \times 3 \text{ cm} \times 0.2 = 0.3 \text{ msec}$$

### 6-6 Frequency Measurement

There are two methods using waveforms to measure frequency. One is to calculate the frequency from the time of 1 period, and the second method is to count the number of complete waveforms, or pulses, over the 10 cm horizontal width.

As regards to first method, the time of 1 period, T, is measured as given in the Section 6-5 above, and its reciprocal is the frequency F.

$$\text{Frequency } F(\text{Hz}) = \frac{1}{T \text{ (seconds)}}$$

$$= \frac{1}{\text{Value indicated at TIME/cm} \times \text{interval of 1 period on the screen} \times \text{reciprocal of magnification of the magnifier}}$$

For example, in the figure as shown bellow.  
 TIME/cm : 0.5mS/cm  
 Magnifier (MAG) : X1

Then, T = 0.5mS/cm X 4 cm X 1 = 2msec.

$$\text{Frequency } F(\text{Hz}) = \frac{1}{T \text{ (sec.)}} = \frac{1}{2 \times 10^{-3}}$$

$$= 500\text{Hz}$$

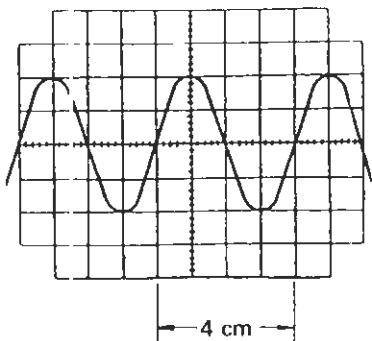

As regards the second method, that is, counting the number of complete waveforms, or pulses, over the 10 cm horizontal width, the frequency is calculated as follows.

$$\text{Frequency } F(\text{Hz}) = \frac{\text{Number of pulses } N}{\text{Value indicated at TIME/cm} \times \text{Reciprocal of magnification} \times 10 \text{ cm}}$$

Where, the reciprocal of magnification of the magnifier is 0.2 when magnified and 1 when not magnified.

For example, in the figure as follow.

TIME/cm : 1μs/cm

Magnifier : X1

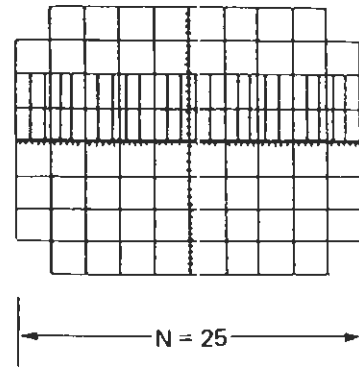

Then,

$$\text{Frequency } F(\text{Hz}) = \frac{25}{1 \mu \text{ sec/cm} \times 10 \text{ cm} \times 1} = 2.5\text{MHz}$$

### 6-7 Rise Time of Pulse

When measuring the rise time of a pulse, the X5 horizontal magnifier (30) is used. Before measuring the rise time of a pulse, proper use of the magnifier will be described.

- (1) Place the portion being observed on the center of the scale by means of the ←→ knob.

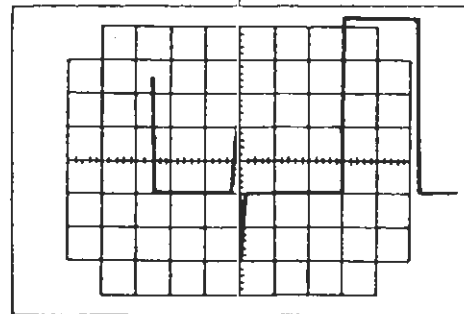

- (2) 5 times magnification to both sides.

PULL the ←→ knob

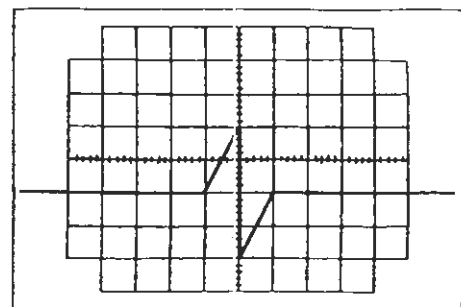

As mentioned above, the magnifier is used for detailed observation of a portion of a waveform. This is especially convenient when the enlargement of a portion of a waveform, away from its sync. sweep starting point, is desired.

#### Rise Time of Pulse

(Procedure 1)

SLOPE (29) : -(Push)  
MAG. (31) : X1(Push)

Set TIME/cm (32) so that the leading edge of the pulse is caught on the screen. Position the VARIABLE (33) (red knob) to the end of its clockwise rotation.

(Procedure 2)

Position the pulse so that the flat portion is placed on the screen at a height with no fractional values, e.g. just 5 cm. (This is for easy calculation of 10% upper and lower deduction, when required.)

(Procedure 3)

Place the leading edge of the pulse on the center line of the scale by means of the horizontal positioning knob.

(Procedure 4)

Make certain the MAGNIFIER is set at X5 (PULL) calculation of rise time:

$$Tr = (\text{TIME/cm range}) \times (\text{Horizontal interval on the screen, cm}) \times (\text{Magnification rate, 1/5})$$

Example

$$Tr = 2\mu\text{s/cm} \times 2.9 \text{ cm} \times 1/5 = 1.16\mu\text{s}$$

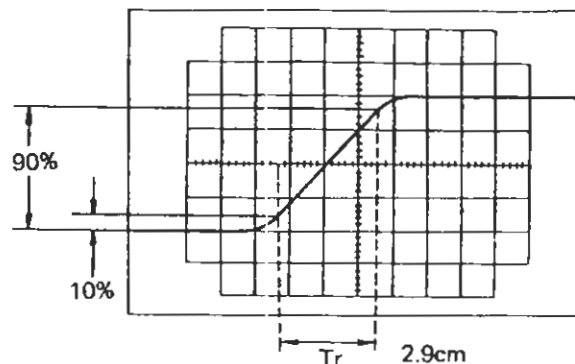

On the basis of this rise time,  $Tr$ , the upper limit frequency of the amplifier,  $fc$  (-3dB), can be determined. For instance, on the assumption that the above measurement was performed with input pulses which were fast enough and that the value calculated represents the output waveform of the amplifier being tested, then the upper limit frequency,  $fc$ , of the amplifier can be found.

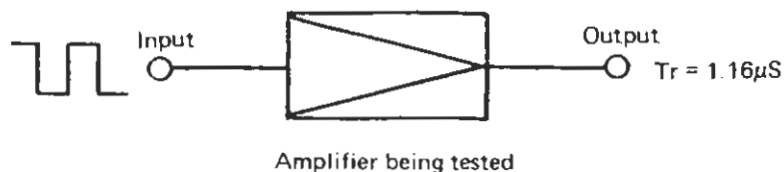

$$Tr \leq \frac{\text{Tr of Output}}{10}$$

$$fc = \frac{0.35}{Tr} = \frac{0.35}{1.16 \times 10^{-6}} = 0.3 \times 10^6 = 300\text{kHz, } (-3\text{dB})$$

Units of time are enumerated below for reference:

Millisecond; mS =  $10^{-3}$  Sec.

Microsecond;  $\mu\text{S}$  =  $10^{-6}$  Sec.

Nanosecond; nS =  $10^{-9}$  Sec.

Picosecond; pS =  $10^{-12}$  Sec.

This relationship is to determine  $fc$  (-3dB) from the rise time of the square wave input pulse. In the measurement of a comparatively fast pulse, the rise time of the LBO-508A must also be taken into consideration.

Rise time of The LBO-508A;  $Ta = 0.0175\mu\text{s}$

Rise time of the output of the amplifier being tested;  $Ti$

Rise time observed on the screen;  $Tr$

With this data, the true rise time  $Ti$  is calculated:

$$Tr = \sqrt{Tr^2 - Ta^2}$$

#### 6-8 Time Difference between Two Signals

By making use of the dual trace advantage, it is possible to measure a time difference between two signals. The adoption of a fixed trigger system in CH-1 or CH-2 permits measurement of the time difference without error even at ALT or CHOP.

When TRIG. (25) is set at  $\blacksquare$  CH-1, it is possible to measure a delay time difference of CH-2 on the basis of the signal of CH-1.

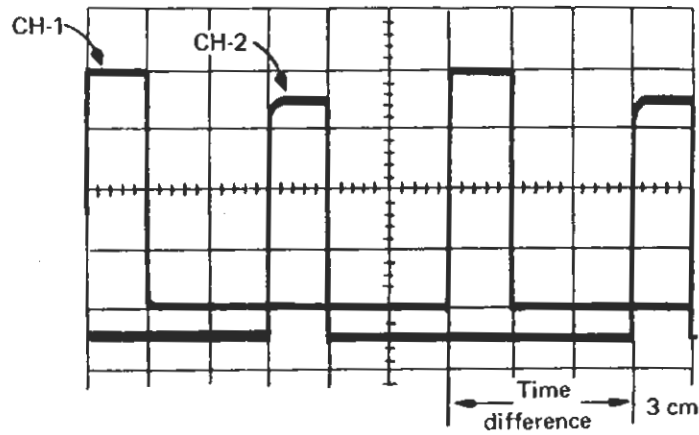

When this time difference is extremely small, use the **MAGNIFIER** at the X5 position. If it is troublesome to superimpose two signals, as in the case illustrated above, set the polarity inversion switch of CH-2 (14) at **INV.** then use **ADD** (addition). This will facilitate the measurement as

shown in the following figure.

In case of a pulse train of computer word pulse or the like, set the polarity inversion switch of CH-2 at **INV.** to identify the signal of CH-1 or CH-2.

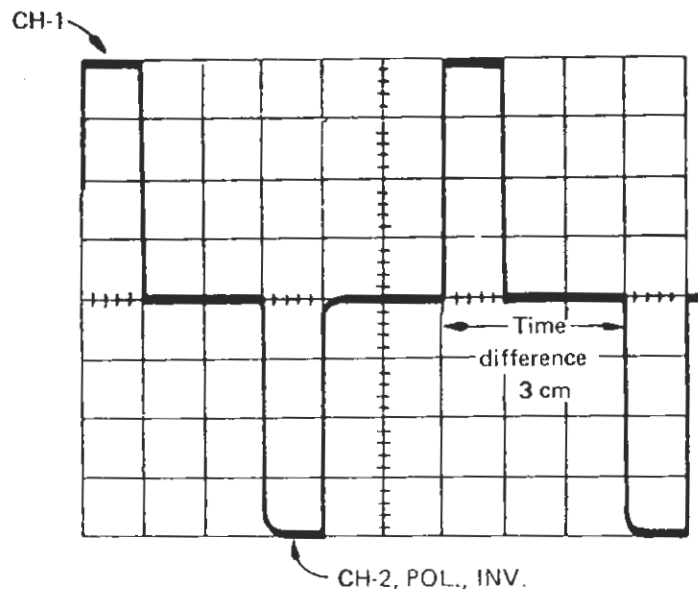

### 6-9 Phase Difference between Two Signals

To measure a phase difference between two signals of the same frequency, the dual trace display system can be utilized up to the upper limit frequency of the amplifier.

First, position both signals on the center line of the scale, e.g. just 4 cm, as shown in the following figure by means of the **VARIABLE** and horizontal positioning knobs.

Next, set the distance where the center of the

waveform of the base channel intersects with the center of the scale to 8cm horizontally.

If difficulty is encountered in properly displaying the phase difference as shown in the following figure because it (phase difference) is too large, use the polarity inversion switch of CH-2 (14) and move the phase by 180° beforehand, and then display the phase difference. After that, this 180° should be taken into account.



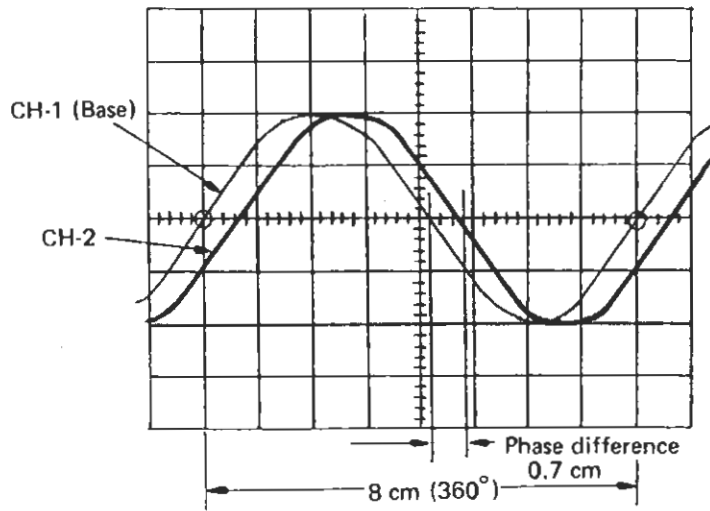

As shown in the above figure, set 1 cycle,  $360^\circ$  to 8cm. Then,

$$\frac{360^\circ}{8\text{cm}} = 45^\circ/\text{cm}$$

Accordingly, the phase difference in the above example can be calculated as follows:

Horizontal distance on the screen: 0.7cm  
 Phase difference =  $45^\circ/\text{cm} \times 0.7\text{cm} = 31.5^\circ$

The portion of the phase difference is much smaller, use the MAGNIFIER at the X5 position in the above setting. At this time,  $360^\circ$  is displayed in  $8\text{cm} \times 5$ .

Then,

$$\frac{360^\circ}{8\text{cm} \times 5} = 9^\circ/\text{cm} \quad (0.2\text{cm} = 1.8^\circ)$$

### 6-10 Measurement of Phase Difference by X-Y Operation

The phase difference between two signals of the same frequency can also be measured using a Lissajous' figure by X-Y operation.

In this case, however, the frequency band of the X-axis is 800kHz ( $-3\text{dB}$ ) thus causing a phase difference of  $3^\circ$  or less at 100kHz between X and Y.

$$\sin \theta = \frac{B}{A} = \frac{2B}{2A}$$

$$\theta = \sin^{-1} \frac{B}{A}$$

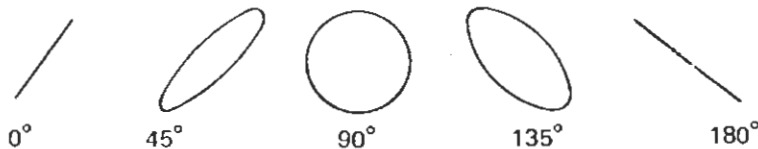
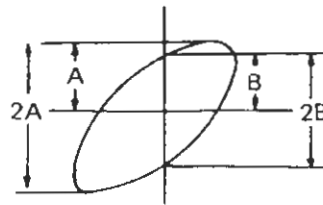

Place the Lissajous' figure on the center line of the scale both horizontally and vertically.

This X-Y operation can effectively be used to display the input and output characteristics of all kinds of electric circuits.

Also, to measure TV color hue, there is a method of displaying 10 colors of the gated rainbow pattern by X-Y operation (making use of a color bar

pattern generator such as LEADER Model LCG-395A).

### Phase relationships of the gated rainbow signal

The ten gated rainbow signals have the phase relationships as shown in the following figure. The color tint pattern (VECTOR) is obtained by apply-

ing the S-Y SIGNAL to the X-axis and the R-Y SIGNAL to the Y-axis.

Feed the gated rainbow signals obtained from the color bar pattern generator to the color TV set.

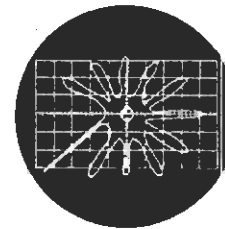
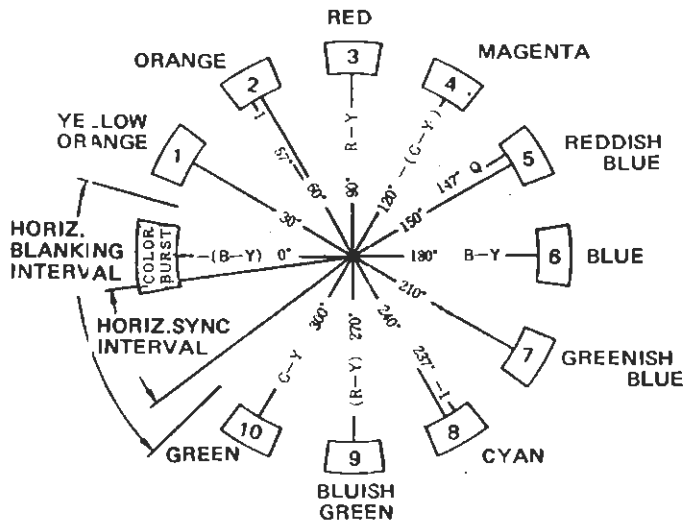

Vector pattern

The floral pattern rotates as the TINT or HUE knob of the TV set is turned. If the pattern spreads long instead of getting round, color saturation is responsible.

### 6-11 Measurements of Error between Two Signals and Push-Pull Signal

If the addition and subtraction functions of two signals are utilized, error and push-pull waveforms can properly be displayed.

Apply an input signal to CH-1 and an output signal to CH-2 and set CH-2 POL. (polarity) so that the waveforms of the same amplitude may be displayed on the whole screen as far as possible; these signals may be out of phase with each other. Depress the ADD. button and estimate the size of the remaining waveform and the condition of waveform distortion when subtracted. Also, as regards the signal waveform of the push-pull circuit, the condition of the original push-pull operation can

not be determined even if the waveform of one is observed separately. Set the polarity inversion switch of CH-2 at INV and depress the ADD. switch. Then, noise, hum and other in-phase components will compensate each other and push-pull signals will be added and displayed properly.

### 6-12 AM, SSB Transmission Modulated Wave Measurement

When observing modulation distortion or the like by providing synchronization to the envelope of amplitude modulated waves (SSB/DSB), apply voice waves to external synchronization.

In the use of the trapezoid display, it is possible to confirm the linearity of modulation irrespective of modulated voice waves.

For trapezoid display, perform the aforementioned X-Y operation and apply voice waves to the X-axis of CH-1 and high-frequency waves to the Y-axis of CH-2.

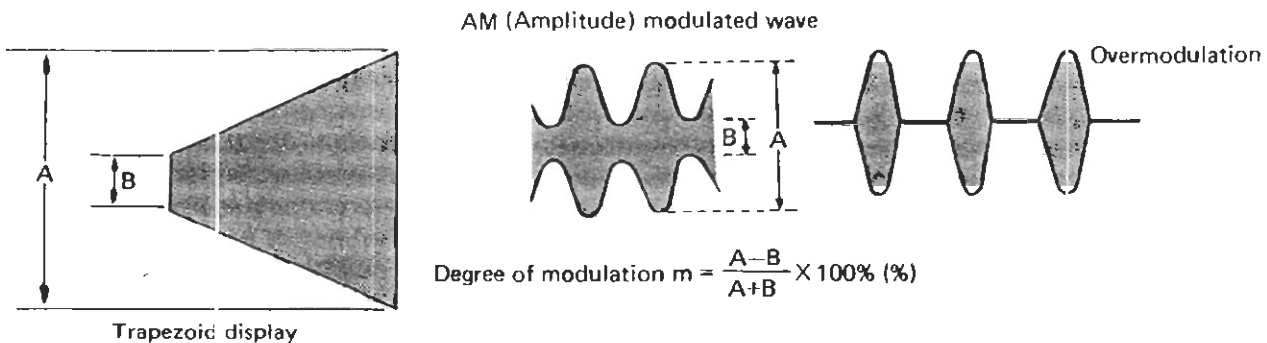

The oscilloscope is intended to observe electric oscillation, and it is also possible to observe all sorts of phenomena if they can be converted into electric signals by the use of transducers.

- 1) A change in tension is converted into an electric signal using a resistance wire or the like.
- 2) A change in pressure is observed by the use of a piezo-electric device.
- 3) Displacement is converted into a capacity change, and then it is further applied to an oscillator or the like and observed as a change in frequency.
- 4) A magnetic variation is observed using a magnetostriction device.
- 5) An optical displacement is observed using a photo transducer.
- 6) A temperature change is observed using a thermistor or thermocouple.

Besides all these mentioned above, many studies have been made on sensors recently, and it is suggested that reference be made to technical books.

Intensity modulation can be obtained when a voltage of  $0V \sim +5V$  is applied to this terminal in DC coupling under ordinary intensity condition.

When a voltage of  $+2V \sim +5V$  (by a intensity control position) is applied, the trace line on the CRT will be erased. When a voltage of  $0V \sim +1V$  (by a intensity control position) is applied, the trace line will be intensified. That is, the instrument is used to erase a certain part of the trace line on the CRT or to intensify a certain part of the trace line in particular.

#### Application examples

1. Making character display by computer output  
 Since the intensity modulation terminal is in DC coupling, intensity modulation can be driven by a TTL level signal.  
 Generally, there are two methods in making character display: random scanning method and raster scanning method. In either case, a needed portion can be made bright by giving a voltage of  $0 \sim +0.4V$  to it. On the other hand, an unnecessary portion can be erased at a level of  $+2 \sim +5V$ .

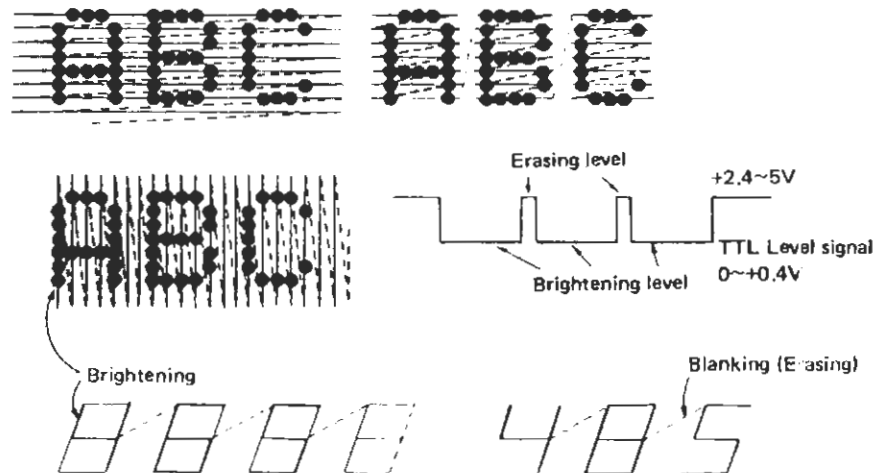

2. Making marker display when measuring frequency response by means of a sweep generator

When the frequency response of a measuring circuit are drawn on the CRT by means of a sweep generator, the instrument is capable of displaying the marker frequency point more precisely. When a precise display of the marker point is desired, apply a level signal

of  $0V \sim +0.4V$  to the brightness modulation terminal. When other level exceeds  $+2V$  at this time, the response trace may disappear. Care, therefore, should be used not to exceed  $+2V$  in amplitude of the signal to be applied.

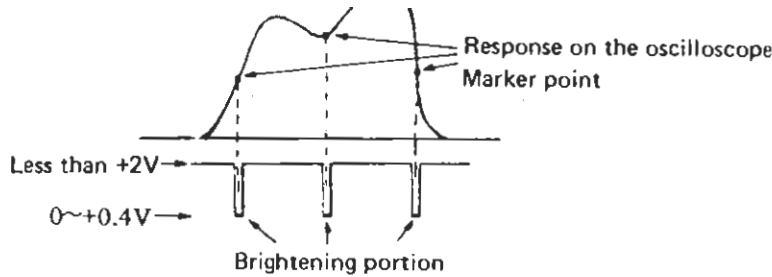

## 7. MAINTENANCE AND CALIBRATION BY THE USER

The following performance checks and internal adjustments should be made by means of an insulated screw driver (about 2mm) by opening the cabinet.

Adjusting Trimmers are shown in letters and symbols on the PC board.

### 7-1 Ⓞ ROTATION (Trace Slope)

Adjust the Ⓞ ROTATION (beam rotation) trimmer on the front panel when slight tilting of the traces is caused by the effect of the external magnetic fields. Make certain that tilting of the traces is not caused by the effect of unusually strong external magnetic fields due to the position of the oscilloscope.

### 7-2 Preparations and checkings before Calibration

Set the power supply to the stipulated value. Please start calibration after calibration switch has been on for over 20 minutes.

Check each voltage at each test point before calibration. Each voltage allowances are as follows: (All the below test points are installed on the power supply H AMP PC board.)

TP-1	-13.5 ~ 16.5V
TP-2	+13.5 ~ 16.5V
TP-3	+180 ~ 220V
TP-4	+280 ~ 350V

### 7-3 Vertical Variable Balance

Adjust Ⓞ DC BAL, if the vertical position moves when the VARIABLE knobs are turned.

With the switch at AUTO, let a horizontal trace appear on the screen and turn the VARIABLE knob fully counterclockwise. Then, set the vertical position at this time to the center of the screen. (VOLTS/cm → 20 mV/cm or other constant range)

Next, turn the knob fully clockwise. If the position moves a large amount at this time, see it to the center of the scale by means of Ⓞ DC BAL. CH-1 Ⓞ DC BAL (VR1202) CH-2 Ⓞ DC BAL (VR2202) are installed on Vertical pre-amp board T-1315.

CH-1 Ⓞ STEP ATT. BAL (VR1201) and CH-2 Ⓞ STEP ATT. BAL (VR2201) are installed on Vertical pre-amp P.C. board T-1315.

### 7-4 Balance Adjustments of ATT. STEP

This is to adjust trace line at the time of attenuator range change.

- Set the AC-GND-DC switch at GND.
- Set the VOLTS/cm switch at .02 Position the trace on the center horizontal line.
- Set the VOLTS/cm at .01.

If there is any shift in position, adjust VR-1201 (CH-1) or VR2201 (CH-2) to return the trace to the .02 position

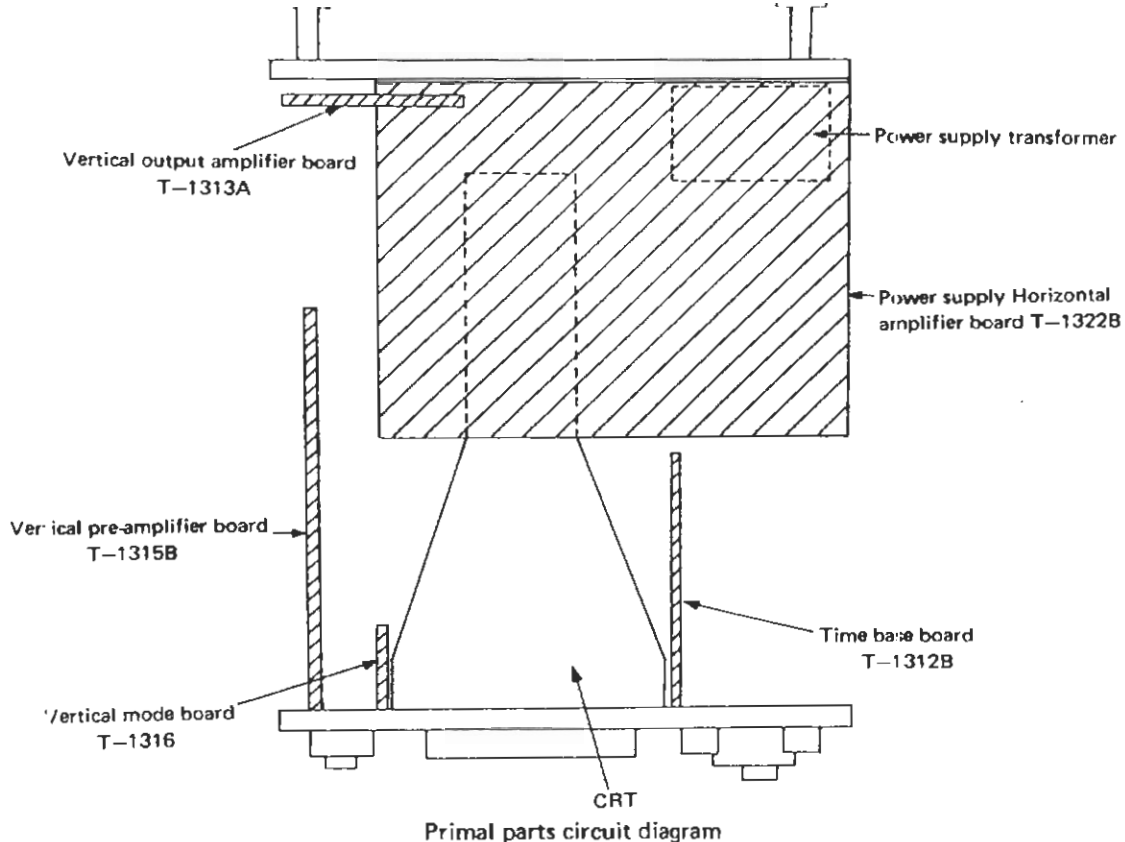

## 7-5 Vertical Gains

⊗ CH-1 GAIN, ⊗ CH-2 GAIN must be calibrated in same range. On dual trace, adjust that there is little sensitivity difference between CH-1 and CH-2.

CH-1, CH-2 should be .1V/cm DC. Turn VARIABLE to the full CAL'D 0.5Vp-p short waveform is to be fed to 2 input terminals to display dual trace lines.

Adjust ⊗ CH-1 GAIN and ⊗ CH-2 GAIN to make dual trace lines lie on each other in 5cm length.

CH-1 ⊗ GAIN (VR 1204) and CH-2 ⊗ GAIN (VR2204) are installed on vertical pre-amp PC board T-1315.

## 7-6 Width

Control ⊗ WIDTH; (VR304) so that the calibrated 1.00kHz square wave and pulse connected with vertical input terminal be displayed as long as 10cm on the graticule. (time base PC board, T-1312)

## 7-7. Length adjustment

Control ⊗ LENGTH (VR-305) to adjust horizontal trace line be 11cm (time base PC board T-1312).

## 7-8 STABILITY Adjustments

- Feed a sine wave 1kHz signal to the INPUT so that the amplitude on the display be 4–5cm.
- Set the level knob at auto. The sweep should synchronize when the white dot on the knob is around the midposition. If not, adjust stability (VR302).
- Rotate VR302 in counterclockwise direction to the free-run condition and then in clockwise direction to the position where the sweep is stopped.

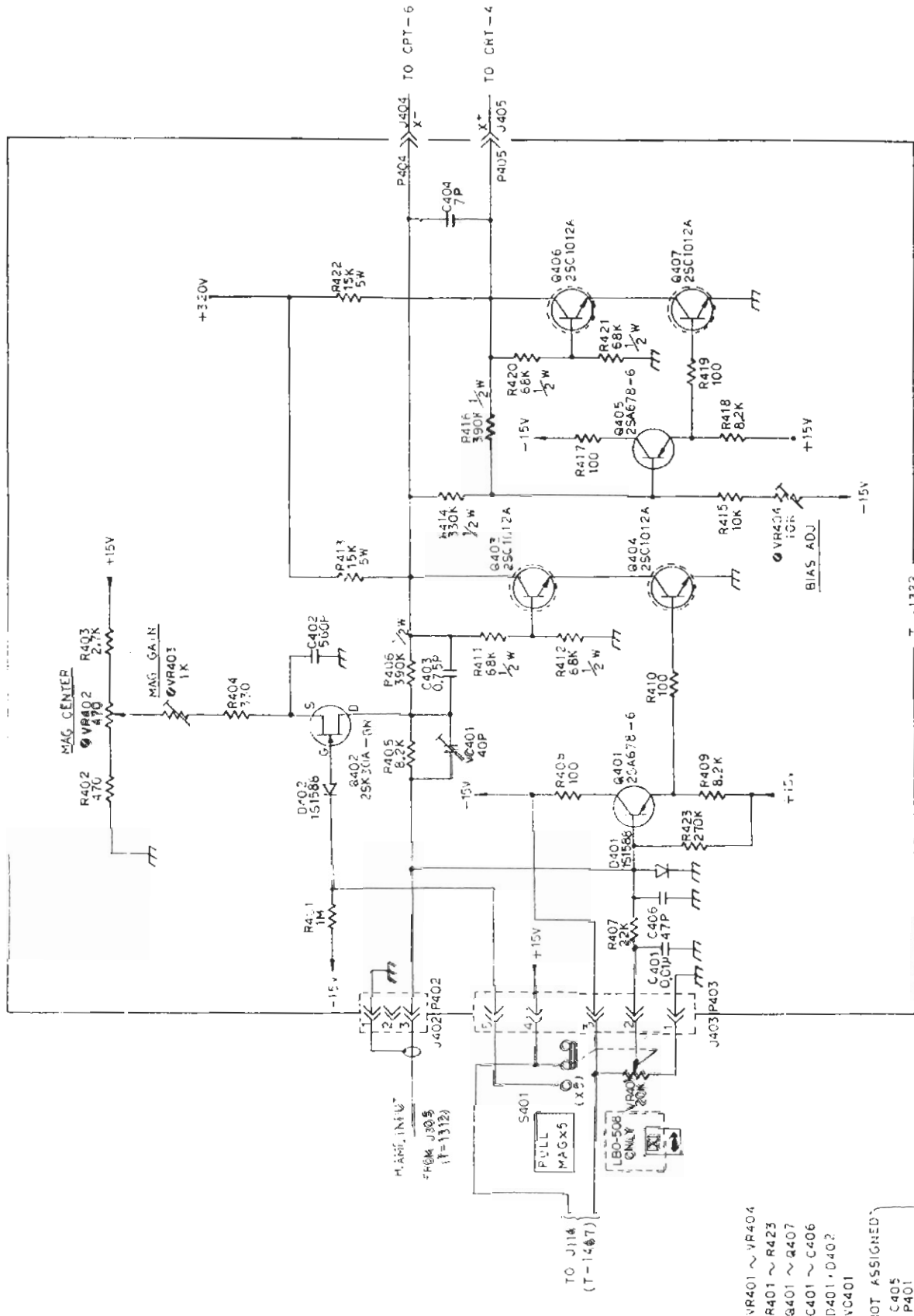

T - 1322

- VR401 ~ VR404
  - R401 ~ R423
  - Q401 ~ Q407
  - C401 ~ C406
  - D401 ~ D402
  - VC401
- (NOT ASSIGNED)
- C405
  - P401
  - J401

SCHEMATIC	MODEL LBO-507A/508A	0-995A (7/7)
OSCILLOSCOPE	HORIZONTAL AMP.	LEADER ELECTRONICS CORP.

**EVERYTHING 4 LESS**



**ENJOY YOUR BOOKS**



**PLEASE VISIT OUR STORE FOR EVEN MORE GREAT STUFF!**

**[WWW.EVERYTHING4LESSSTORE.COM](http://WWW.EVERYTHING4LESSSTORE.COM)**

**COPYRIGHT NOTICE**

**ALL MATERIALS INCLUDING CD/DVD AND PDF FILES ARE COPYRIGHTED**

**[WWW.EVERYTHING4LESSSTORE.COM](http://WWW.EVERYTHING4LESSSTORE.COM) VON WALTHOUR PRODUCTIONS AND MAY NOT BE REPRODUCED, COPIED OR RESOLD UNDER ANY CIRCUMSTANCES. YOU MAY HOWEVER MAKE A COPY FOR YOUR OWN PERSONAL BACKUP. MATERIALS ARE FOR PERSONAL USE ONLY.**

**IF YOU PURCHASED THIS FROM ANYWHERE BUT FROM US PLEASE NOTIFY US IMMEDIATELY SO THAT WE MAY CHECK IF YOU PURCHASED FROM AN AUTHORIZED RESELLER SO WE CAN LET YOU KNOW IF YOU NEED TO RETURN FOR FULL REFUND FROM AN UNAUTHORIZED SELLER.**

**THANKS AGAIN AND PLEASE TAKE THE TIME TO VISIT OUR STORE.**

**ATTENTION! EVERYTHING ON SALE NOW!!**



**HOT SALE!**

**THIS PAGE COPYRIGHT VON WALTHOUR PRODUCTIONS  
[WWW.EVERYTHING4LESSSTORE.COM](http://WWW.EVERYTHING4LESSSTORE.COM)**