

Low Noise Varactor Biasing with Switching Regulators

Vanquishing Villainous Vitiators Vis-à-Vis Vital Varactors

Jim Williams and David Beebe

INTRODUCTION

Telecommunication, satellite links and set-top boxes all require tuning a high frequency oscillator. The actual tuning element is a varactor diode, a 2-terminal device that changes capacitance as a function of reverse bias voltage.¹ The oscillator is part of a frequency synthesizing loop, as detailed in Figure 1. A phase locked loop (PLL) compares a divided down representation of the oscillator with a frequency reference. The PLL's output is level shifted to provide the high voltage necessary to bias the varactor, which closes a feedback loop by voltage tuning the oscillator. This loop forces the voltage controlled oscillator (VCO) to operate at a frequency determined by the frequency reference and the divider's division ratio.

Varactor Biasing Considerations

The high voltage bias is required to achieve wide-range varactor operation. Figure 2 shows varactor capacitance vs reverse voltage curves for a family of devices. A 10:1 capacitance shift is available, although a 0.1V to 30V swing is required. The curves shown are characteristic of typical

“hyperabrupt” devices. Response modification is possible, with compromises in performance, particularly with regard to linearity and sensitivity.²

Note 1. Theoretical considerations of varactor diodes are treated in Appendix A, “Zetex Variable Capacitance Diodes,” guest written by Neil Chadderton of Zetex.

Note 2. The reader is again referred to Appendix A for in-depth discussion of varactor diodes.

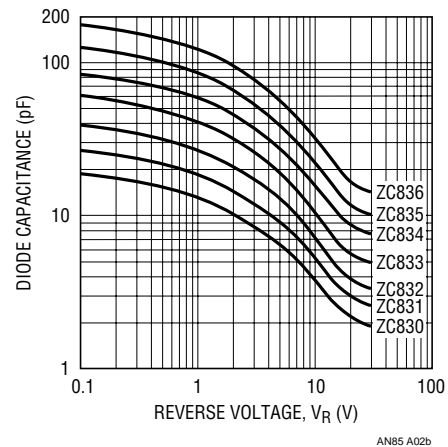

Figure 2. Typical Capacitance Voltage Characteristics for the Zetex ZC830-6 Range. 0.1V to 30V Swing Results in ≈10× Capacitance Shift

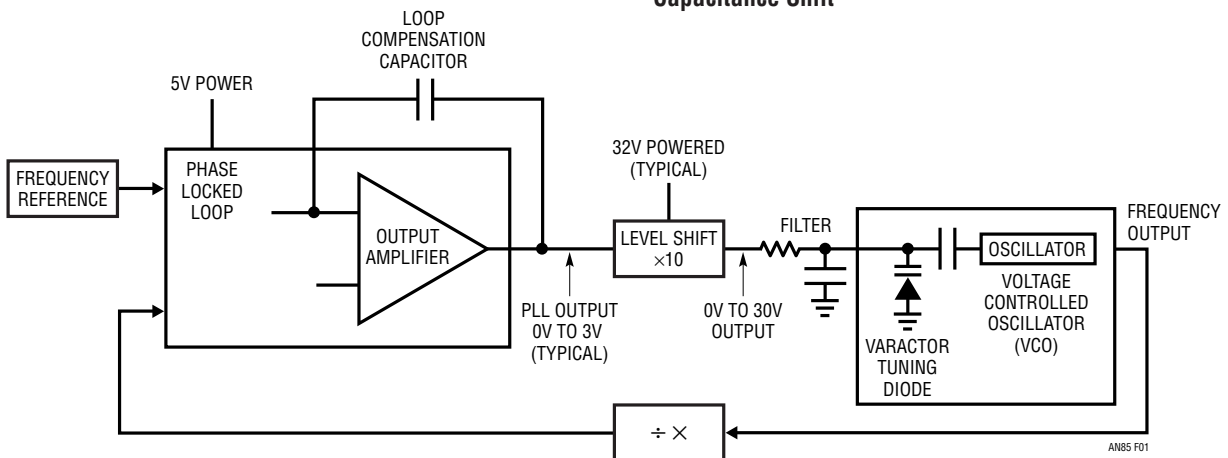

Figure 1. Typical Phase Lock Loop-Based Frequency Synthesizer. Level Shift Furnishes 0V to 30V Bias to VCO Varactor Diode, Although a 32V Supply is Required

Application Note 85

The bias voltage requirement has traditionally been met by utilizing existing high voltage rails. The current trend towards low voltage powered systems means the high voltage bias must be locally generated. This implies some form of voltage step-up switching regulator. This is certainly possible, but varactor noise sensitivity complicates design. In particular, the varactor responds to any form of amplitude variation of its bias, resulting in an undesired capacitance shift. Such a shift causes VCO frequency movement, resulting in spurious oscillator outputs. DC and low frequency shifts are removed by PLL loop action, but activity outside the loop's passband causes undesired outputs. Most applications require spurious oscillator output content to be 80dB or more below the nominal output frequency³. This implies a low noise, high voltage supply, mandating caution in the switching regulator design. Switching regulators are often associated with noisy operation, making a varactor bias application seem hazardous. Careful preparation can eliminate this concern, allowing a practical switching regulator-based approach to varactor biasing.

Low Noise Switching Regulator Design

In theory, a simple flyback regulator will work, but component choice and attention to layout are critical to achieving low noise. Additionally, component count, size and cost are usually considerations in varactor bias applications. Figure 3 shows a step-up switching regulator that, properly incarnated, permits low noise varactor biasing. The circuit is a simple boost regulator. L1, in

conjunction with the SW pin's ground-referred switching, provides voltage step-up. D1 and C2 filter the output to DC, D2 clips possible L1 negative excursions and the feedback resistor ratio sets the loop servo point, and hence, the output voltage. C3 tailors loop frequency response, minimizing switching-frequency ripple components at the output. C1 and C2 are specified for low loss dynamic characteristics and the LT[®]1613's 1.7MHz switching frequency allows miniature, small value components. This relatively high switching frequency also means that ancillary "downstream" filtering is possible with similarly miniature, small value components.

Layout Issues

Layout is the most crucial design aspect for obtaining low noise. Figure 4 shows a suggested layout. Ground, V_{IN} and V_{OUT} are distributed in planes, minimizing impedance. The LT1613 GND pin (Pin 2) carries high speed, switched current; its path to the circuit's power exit should be direct and highly conductive at all frequencies. R2's return current, to the extent possible, should not mix with Pin 2's large dynamic currents. C1 and C2 should be located close to Pin 5 and D1 respectively. Their grounded ends

Note 3. Spurious oscillator outputs are referred to as "spurs" in RF parlance.

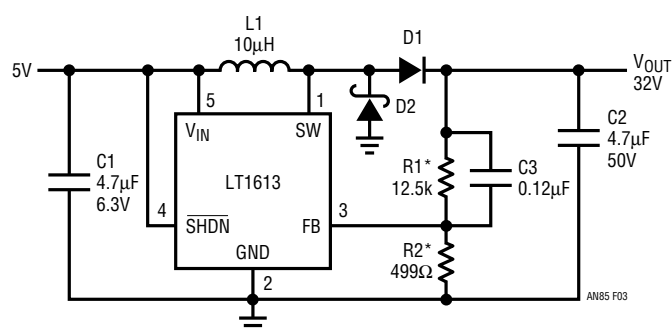

*1% METAL FILM RESISTORS
C1: TAIYO YUDEN JMK212BJ475MG
C2: MURATA GRM235V5V475Z50
D1: 1N4148
D2: ON SEMICONDUCTOR MBR0540 OR LITE ON/DIODES INC. B0540W
L1: MURATA LQH3C100

Figure 3. LT1613-Based Boost Regulator with Appropriate Component Selection and Layout Has Low Noise Characteristics Needed for Varactor Biasing

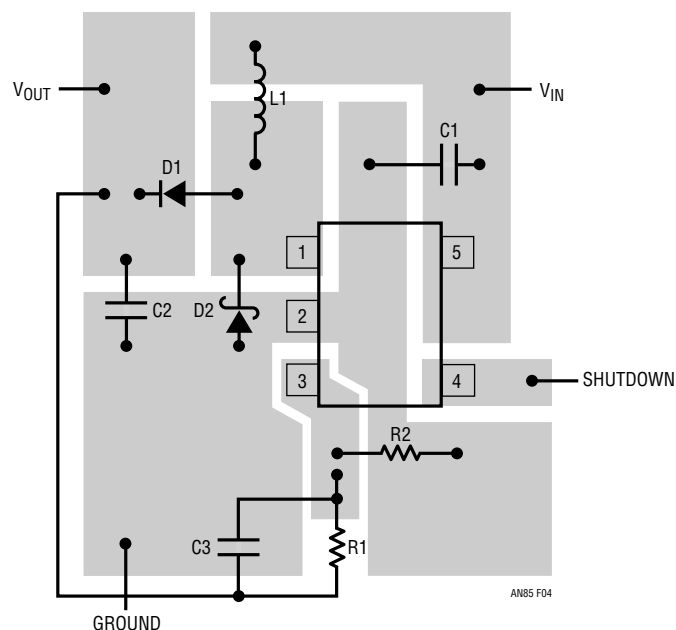

Figure 4. Layout Requires Attention to Component Placement and Ground Current Flow Management. Compact Layout Reduces Parasitic Inductance, Radiation and Crosstalk. Grounding Scheme Minimizes Return Current Mixing

should tie directly to the ground plane. L1 has a low impedance path to V_{IN} ; its driven end returns directly to LT1613 Pin 1. D1 and D2 should have short, low inductance runs to C2 and Pin 2, respectively; their common connection mating tightly with Pin 1 and L1. Pin 1 has a small area, minimizing radiation. Note that this point is enclosed by planes operating at AC ground, forming a shield. The feedback node (Pin 3) is further shielded from switching radiation, preventing unwanted interaction. Finally, L1 should be oriented so its radiation causes minimal circuit disruption.

Level Shifts

The low voltage PLL output (see Figure 1) requires an analog level shift to bias the varactor. Figure 5 shows some alternatives. Figure 5a is an amplifier powered from the LT1613's 32V output. The feedback ratio sets a gain of 10, resulting in a 0V to 30V output for a 0V to 3V input. Figure 5b is a noninverting common base stage. Gain is less well controlled than in Figure 5a, but overall frequency synthesizer loop action obviates this concern. Figure 5c's common emitter circuit is similar except that it inverts.

Test Circuit

Figure 6 combines the above considerations into a realistic test circuit. The 5V powered design is composed of the

LT1613 regulator, an amplifier-based level shift and a GHz range VCO. The amplifier is biased by a filtered LT1004 reference to a 12V output, simulating a typical varactor bias point. The LT1613 configuration's low noise output receives additional filtering via the 100Ω - $0.1\mu\text{F}$ network at the amplifier power pin and by the amplifier's power supply rejection ratio (PSRR). The RC combination provides a theoretical (unloaded) break below 20kHz; the amplifier's PSRR benefit is derived from Figure 7. This graph shows PSRR vs frequency for a typical amplifier. There is a steep roll-off beyond 100Hz, although almost 20dB attenuation is available in the MHz region. This implies that the amplifier provides some beneficial filtering of the LT1613's residual 1.7MHz switching components.

A final RC filter section is placed directly at the VCO varactor bias input. Ideally this filter's break frequency is far removed from the 1.7MHz switching rate for maximum ripple attenuation. In practice, the filter is within the PLL loop, placing restrictions on how much delay it can introduce. A PLL loop bandwidth of 5kHz is usually desirable, dictating a filter point of about 50kHz to ensure closed-loop stability. As such, the final RC filter ($1.6\text{k}\Omega$ - $0.002\mu\text{F}$) is set at this frequency. It is worth noting that the varactor's input resistance is quite high—essentially that of a reverse-biased diode—and no filter buffering is required to drive it.

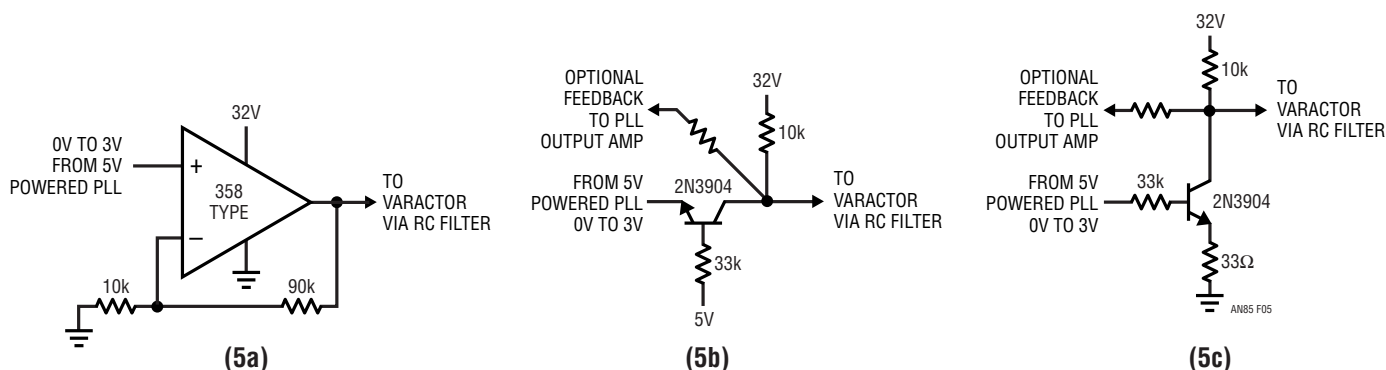

Figure 5. Level Shift Options Include Op Amp (5a), Noninverting Common Base (5b) and Inverting Common Emitter (5c). Op Amp's Operating Point is Inherently Stable; 5b and 5c Rely on PLL Closed-Loop Action Unless Optional Feedback is Used

Application Note 85

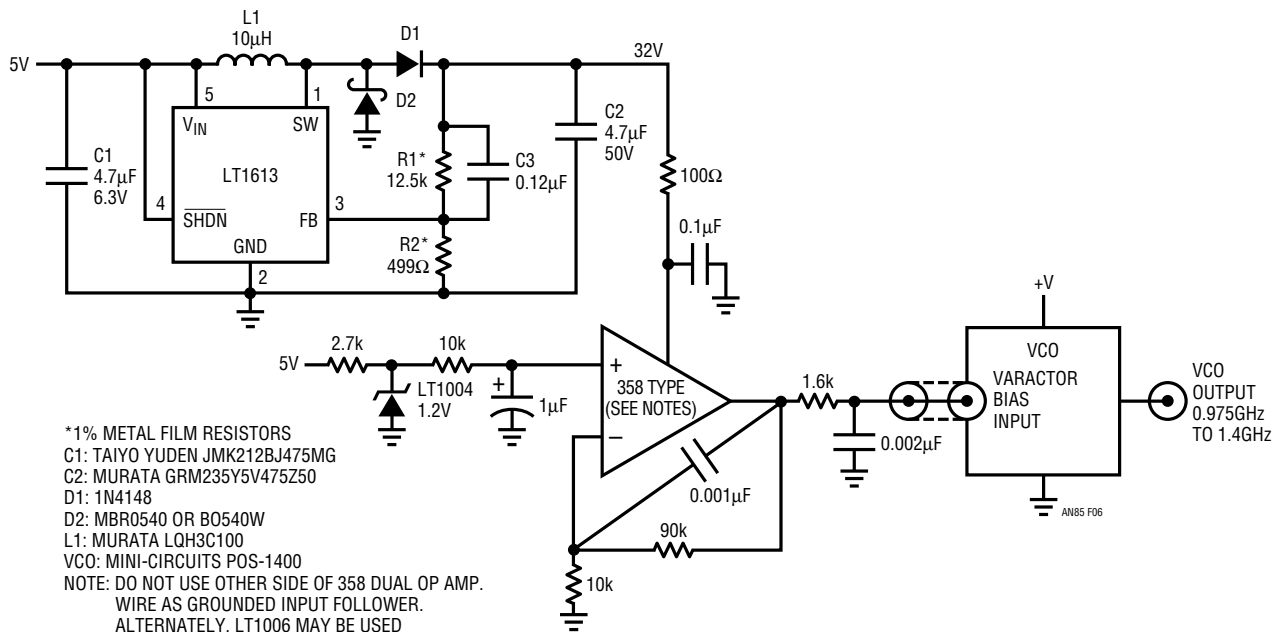

Figure 6. Noise Test Circuit Includes Step-Up Switching Regulator, Biased Op Amp Level Shift, Filtering Elements and GHz Range VCO. Switching Regulator-Associated L1 is the Only Inductor Required

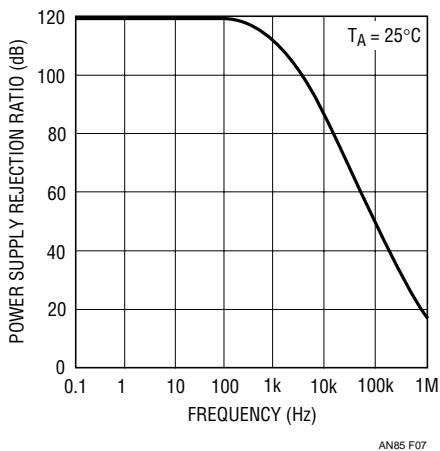

Figure 7. Typical Op Amp Power Supply Rejection Ratio Degrades with Frequency, Although Nearly 20dB is Available in LT1613's MHz Switching Range

Noise Performance

Careful measurements permit verification of circuit noise performance.⁴ Figure 8 shows about 2mV ripple at the LT1613's 32V output. Figure 9, taken at the amplifier power pin, shows the effect of the 100Ω-0.1μF filter. Ripple and noise are reduced to about 500μV. Figure 10, recorded at the amplifier output, shows the influence of amplifier PSRR. Ripple and noise are further reduced to

about 300μV. The actual ripple component is about 100μV. The final RC filter, located directly at the VCO varactor input, gives about 20dB further attenuation. Figure 11 shows ripple and noise inside 20μV with a ripple component of about 10μV.

Effects of Poor Measurement Technique

The above results require good measurement technique. The measurements were taken utilizing a purely coaxial probing environment. Deviations from this regime will produce misleading and unduly pessimistic indications.⁵ For example, Figure 12 shows a 50% amplitude error over Figure 8, even though it nominally monitors the same point. The difference is that Figure 12 utilizes a 3" probe ground lead instead of Figure 8's coaxial ground tip adapter. Similarly, Figure 9's amplifier power pin 500μV measurement degrades to Figure 13's indicated 2mV representation using the 3" probe ground strap. The same

Note 4. See Appendix B, "Preamplifier and Oscilloscope Selection," for equipment recommendations to make the high sensitivity oscilloscope measurements described in this section. See also Appendix C, "Probing and Connection Techniques for Low Level, Wideband Signal Integrity."

Note 5. Additional discourse along these lines is presented in Appendix C, "Probing and Connection Techniques for Low Level, Wideband Signal Integrity." See also Reference 2-5.

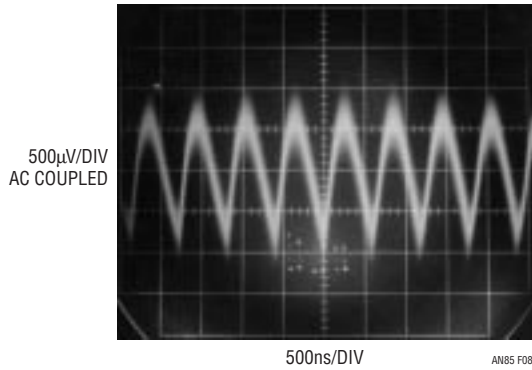

Figure 8. LT1613-Based Output Shows 2mV_{p-p} Ripple and Noise

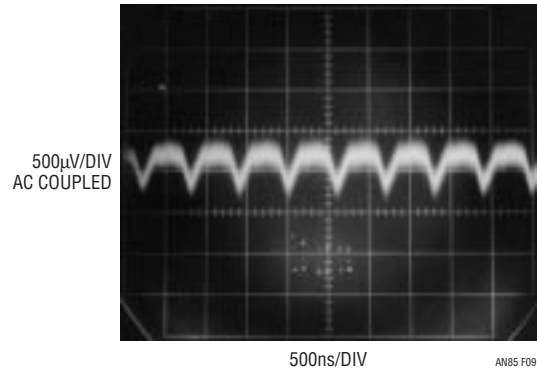

Figure 9. RC Filter at Amplifier's Power Input Pin Reduces Ripple and Noise to 500µV_{p-p}

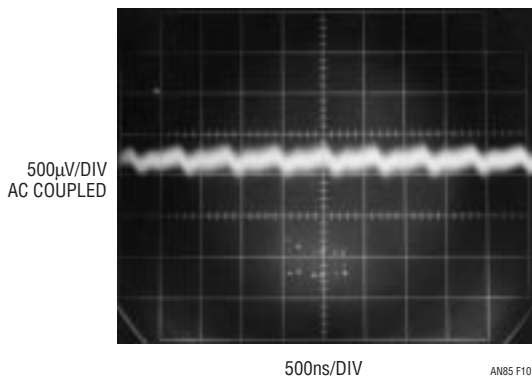

Figure 10. Amplifier Output Shows Additional Filtering Due to Amplifier PSRR. Aberrations Are Inside 300µV

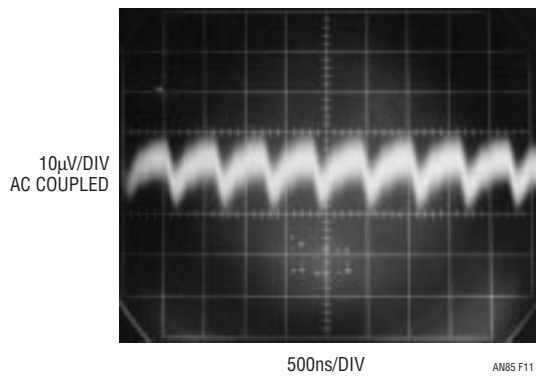

Figure 11. VCO Varactor Bias Input, After 50kHz RC Filter, Displays Less Than 20µV Ripple and Noise. Content Coherent with LT1613's 1.7MHz Switching is Inside 10µV

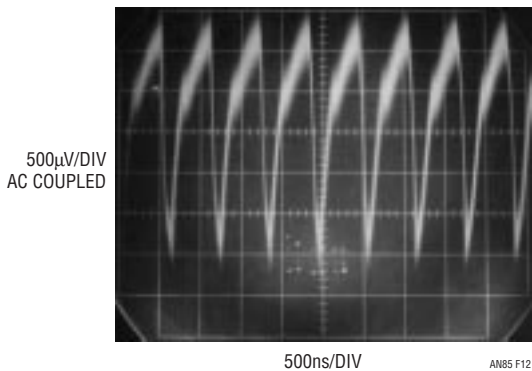

Figure 12. Improper Probing Technique. 3" Ground Lead Causes 50% Display Error vs Figure 8's Purely Coaxial Measurement

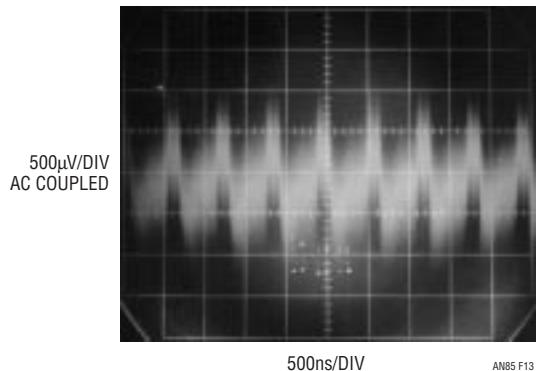

Figure 13. 3" Ground Lead Degrades Figure 9's 500µV Reading to 2mV

Application Note 85

ground strap causes pronounced error in Figure 14's apparent 2mV amplifier output vs Figure 10's correct 300 μ V excursion. Figure 15 shows a 70 μ V indication at the VCO varactor input using the 3" ground strap. That's a long way from Figure 11's 20 μ V data taken with the coaxial ground tip adapter!⁶

In Figure 16 the coaxial ground tip adapter is used but the VCO varactor input shows a blizzard of noise compared to Figure 11's orderly trace. The reason is that a 12" voltmeter lead was connected to the point. Pickup and stray RF act against the node's finite output impedance, corrupting the measurement. Figure 17, also taken at the VCO input, is better but still shows greater than 50% error. The culprit

here is a second probe, located at the LT1613 V_{SW} pin, used to trigger the oscilloscope. Even with coaxial techniques in use at both probe points, the trigger probe dumps transient currents into the ground plane. This introduces small common mode voltages, resulting in the apparent noise increase. The cure is to trigger the oscilloscope with a noninvasive probe.⁷

Note 6. If you don't think 70 μ V is a "long way" from 20 μ V, consider your reaction to a 3.5 \times income tax reduction.

Note 7. The reader is not being requested to indulge wishful thinking. Such a probe is more easily realized than might be supposed. See Appendix C, "Probing and Connection Techniques for Low Level, Wideband Signal Integrity."

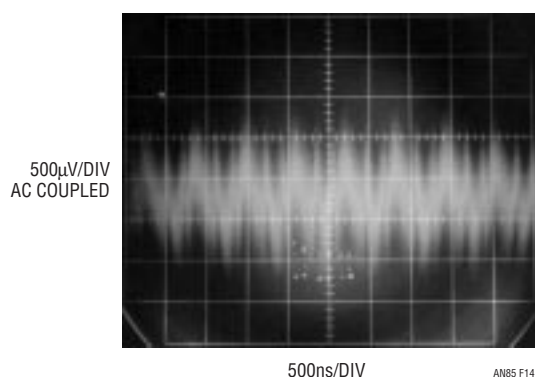

Figure 14. Probe Ground Strap Causes Erroneous 2mV Indication. Actual Value is Figure 10's 300 μ V Reading

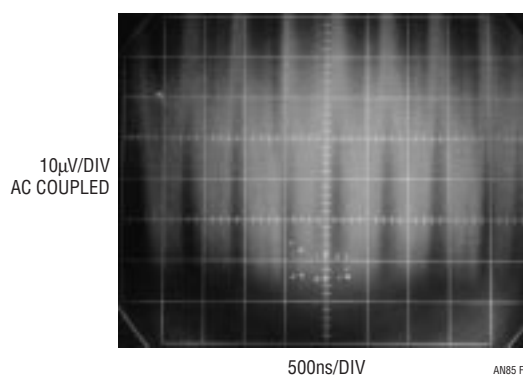

Figure 15. Probe Ground Strap Causes 3.5 \times Readout Error vs Figure 11's Correctly Measured 20 μ V

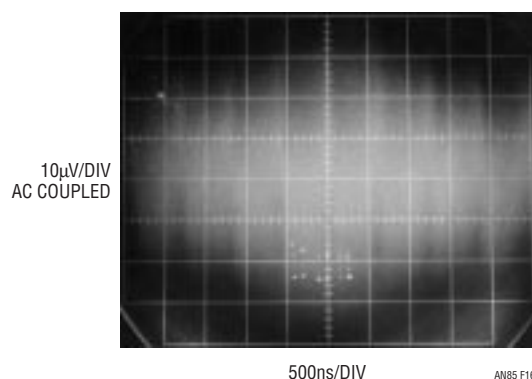

Figure 16. Effect of 12" Voltmeter Probe on VCO Varactor Input. Coaxially Connected 'Scope Probe is in Use. 2.5 \times Measurement Error Referred to Figure 11 Results

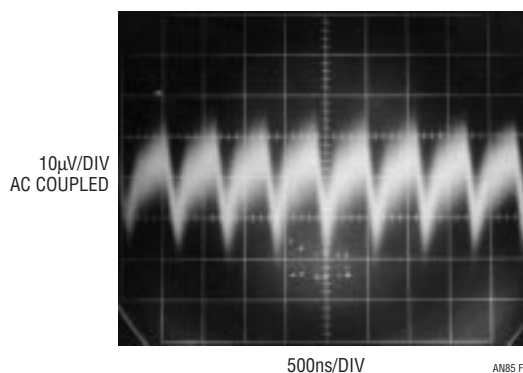
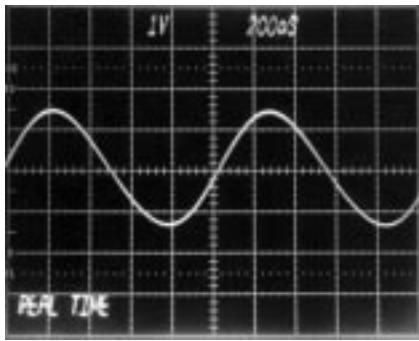

Figure 17. Oscilloscope Trigger Channel Probe at LT1613 SW Pin Causes 50% Measurement Error vs Figure 11

Frequency-Domain Performance

Although the varactor bias noise amplitude measurements are critical, it is difficult to correlate them with frequency-domain performance. Varactor bias noise amplitude translates into spurious VCO outputs and that is the measurement of ultimate concern. Although it is possible to view the GHz range VCO on an oscilloscope (Figure 18), this time domain measurement lacks adequate sensitivity to detect spurious activity. A spectrum analyzer is required. Figure 19, a spectral plot of VCO output, shows a center frequency of 1.14GHz, with no

apparent spurious activity within the ≈ 90 dB measurement noise floor. A marker has been placed at 1.7MHz (3.5 divisions from center), corresponding to the LT1613's switching frequency. No readily distinguishable activity is apparent at about -90 dBc. Succeeding figures "sanity check" this performance by systematically degrading the circuit and noting results. In Figure 20, the VCO varactor input's RC filter has been replaced with a direct connection. Now the 1.7MHz spurious outputs are easily seen, about -62 dBc. In Figure 21, a 12" voltmeter lead as been connected to the measurement point, resulting in a 4dB



AN85 F18

Figure 18. GHz Range VCO Output is Viewable on Oscilloscope, But Spurious Activity is Undetectable. Spectral Measurements Are Required

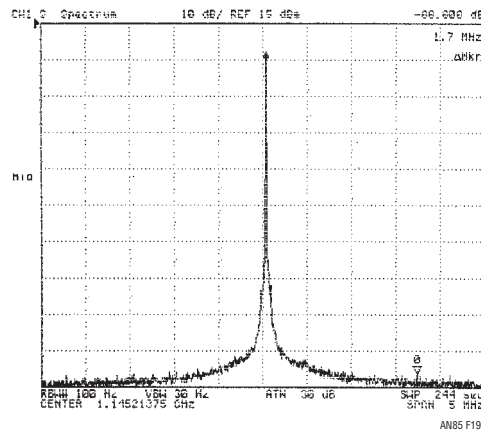

AN85 F19

Figure 19. HP-4396B Spectrum Analyzer Indicates Spurious Outputs at Least -90 dBc Referred to 1.14GHz VCO Center Frequency

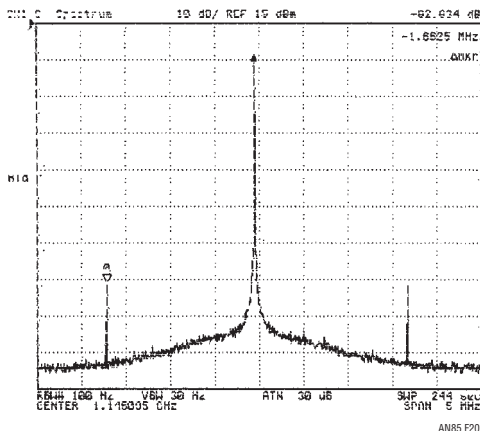

AN85 F20

Figure 20. "Sanity Checking" Figure 19's Results by Replacing RC Filter at VCO Varactor Input with Direct Connection. LT1613 1.7MHz Switching Frequency Related Activity Appears at -62 dBc

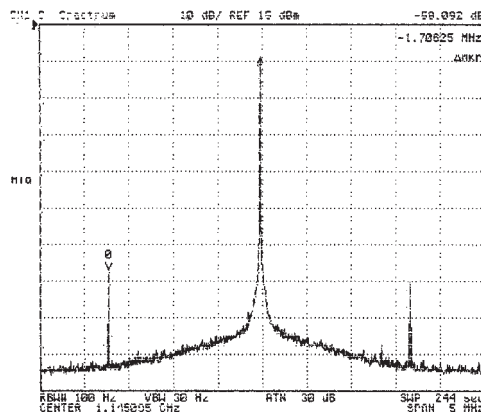

AN85 F21

Figure 21. Similar Measurement Conditions to Previous Figure with 12" Voltmeter Probe Added. "Spurs" Increase by 4dB to -58 dBc

Application Note 85

degradation, to about -58dBc . Figure 22 shows pronounced effects due to poor LT1613 layout (power ground pin routed circuitously, rather than directly, back to input common) and component choice (lossy capacitor substituted for C2). Spurious activity jumps to -48dBc . In Figure 23 proper layout and components are used, but the varactor bias line has been placed in close proximity to switching inductor L1. Additionally, the bias line and RC filter components have been distanced from the ground plane. The resultant electromagnetic pickup and increase in bias line effective inductance cause

1.7MHz “spurs” at -54dBc . Additional harmonically related activity, although less severe, is also apparent. Figure 24 indicates favorable results when the bias line and RC filter are restored to their proper orientation. The plot is essentially identical to Figure 19. The lesson here is clear. Layout and measurement practice are at least as important as circuit design. As always, the “hidden schematic” dominates performance.⁸

Note 8: Charly Gullett of Intel Corporation originated the quoted descriptive, an author favorite.

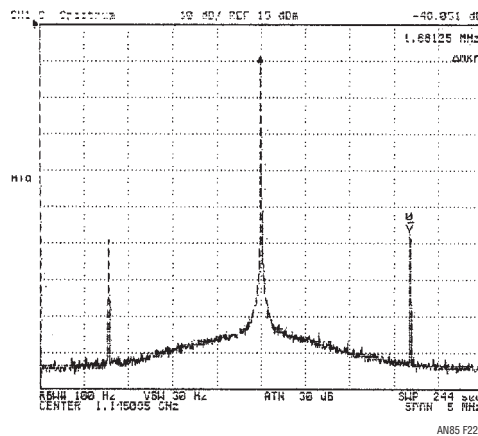

Figure 22. Deliberate Degradation of LT1613’s Grounding Scheme and Output Capacitor Raise Spurious Outputs to -48dBc

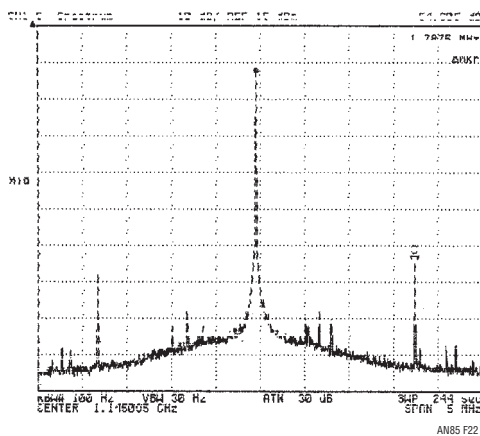

Figure 23. Results with Varactor Bias Line Deliberately Routed Near LT1613’s Switching Inductor, and RC Filter Components Lifted from Ground Plane. 1.7MHz “Spurs” at -54dBc ; Other Harmonically Related Components Also Appear

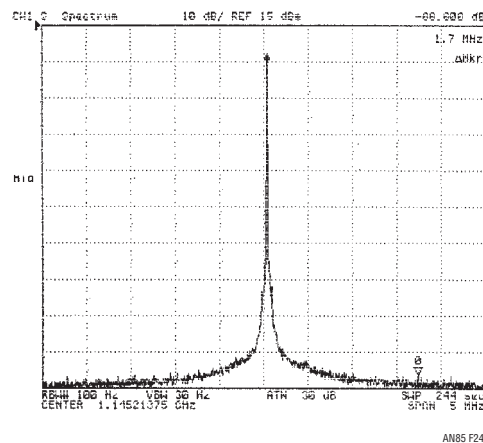

Figure 24. Varactor Bias Line and RC Filter Replaced in Proper Orientation. Figure 19’s Silence is Restored

REFERENCES

1. Chadderton, Neil, "Zetex Variable Capacitance Diodes," Application Note 9, Issue 2, January 1996. Zetex Applications Handbook, 1998. Zetex plc. UK.
2. Williams, Jim, "A Monolithic Switching Regulator with 100µV Output Noise," Linear Technology Corporation, Application Note 70, October 1997.
3. Williams, Jim, "High Speed Amplifier Techniques," Linear Technology Corporation, Application Note 47, August 1991.
4. Hurlock, Les, "ABCs of Probes," Tektronix, Inc., 1990
5. McAbel, W. E., "Probe Measurements," Tektronix, Inc., 1971.

APPENDIX A

The following section, excerpted with permission from Zetex Application Note 9 (see Reference 1), reviews theoretical considerations of varactor diodes.

ZETEX VARIABLE CAPACITANCE DIODES

Neil Chadderton, Zetex plc

Background

The varactor diode is a device that is processed so to capitalise on the properties of the depletion layer of a P-N diode. Under reverse bias, the carriers in each region (holes in the P type and electrons in the N type) move away from the junction, leaving an area that is depleted of carriers. Thus a region that is essentially an insulator has been created, and can be compared to the classic parallel plate capacitor model. The effective width of this depletion region increases with reverse bias, and so the capacitance decreases. Thus the depletion layer effectively creates a voltage dependent junction capacitance, that can be varied between the forward conduction region and the reverse breakdown voltage (typically +0.7V to -35V respectively for the ZC830 and ZC740 series diodes).

Different junction profiles can be produced that exhibit different Capacitance-Voltage (C-V) characteristics. The Abrupt junction type of example, shows a small range of capacitance due to its diffusion profile, and as a consequence of this is capable of high Q and low distortion, while the Hyperabrupt variety allows a larger change in capacitance for the same range of reverse bias. So called Hyper-hyperabrupt, or octave tuning variable capacitance diodes show a large change in capacitance for a relatively

small change in bias voltage. This is particularly useful in battery powered systems where the available bias voltage is limited.

The varactor can be modelled as a variable capacitance (C_{jv}), in series with a resistance (R_s). (Please refer to Figure A1.)

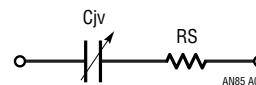

Figure A1. Common Model for the Varactor Diode

The capacitance, C_{jv} , is dependent upon the reverse bias voltage, the junction area, and the doping densities of the semiconductor material, and can be described by:

$$C_{jv} = \frac{C_{j0}}{(1 + V_r/\phi)^N}$$

where:

- C_{j0} = Junction capacitance at 0V
- C_{jv} = Junction capacitance at applied bias voltage V_r
- V_r = Applied bias voltage
- ϕ = Contact potential
- N = Power law of the junction or slope factor

The series resistance exists as a consequence of the remaining undepleted semiconductor resistance, a contribution due to the die substrate, and a small lead and package component, and is foremost in determining the performance of the device under RF conditions.

Application Note 85

This follows, as the quality factor, Q, is given by:

$$Q = \frac{1}{2\pi f C_{jv} R_S}$$

where:

C_{jv} = Junction capacitance at applied bias voltage V_r

R_S = Series Resistance

f = Frequency

So, to maximise Q, R_S must be minimised. This is achieved by the use of an epitaxial structure so minimising the amount of high resistivity material in series with the junction.

Note: Zetex has produced a set of SPICE models to enable designers to simulate their circuits in SPICE, PSPICE and similar simulation packages. The models use a version of the above capacitance equation and so the model parameters may also be of interest for other software packages. Information is also provided to allow inclusion of parasitic elements to the model. These models are available on request, from any Zetex sales office.

Important Parameters

This section reviews the important characteristics of varactor diodes with particular reference to the Zetex range of variable capacitance diodes.

The characteristic of prime concern to the designer is the Capacitance-Voltage relationship, illustrated by a C-V curve, and expressed at a particular voltage by C_x , where x is the bias voltage. The C-V curve summarises the range of useful capacitance, and also shows the shape of the relationship, which may be relevant when a specific response is required. Figures A2a, A2b and A2c show families of C-V curves for the ZC740-54 (Abrupt), ZC830-6 (Hyperabrupt), and ZC930 (Hyper-hyperabrupt) ranges respectively. Obviously, the choice of device type depends upon the application, but aspects to consider include: the range of frequencies the circuit must operate with, and hence an appropriate capacitance range; the available bias voltage; and the required response.

The capacitance ratio, commonly expressed as C_x/C_y (where x and y are bias voltages), is a useful parameter that shows how quickly the capacitance changes with applied bias voltage. So, for an Abrupt junction device, a

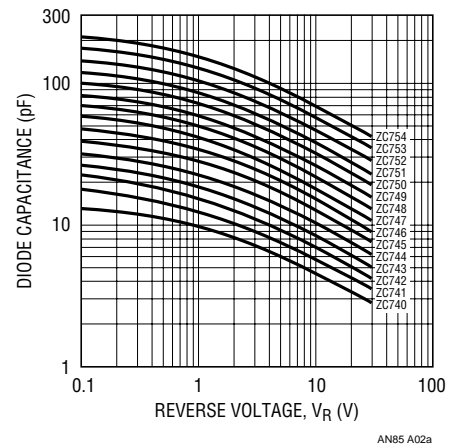

Figure A2a. Typical Capacitance-Voltage Characteristics for the ZC740-54 Range

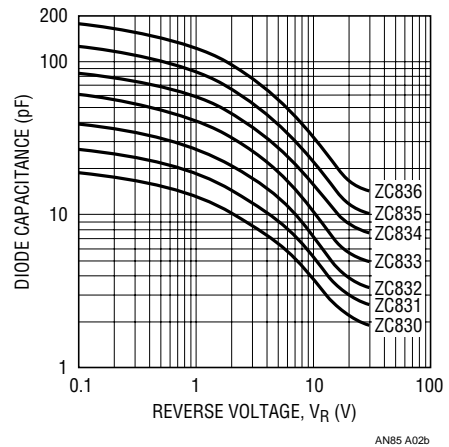

Figure A2b. Typical Capacitance-Voltage Characteristics for the ZC830-6 Range

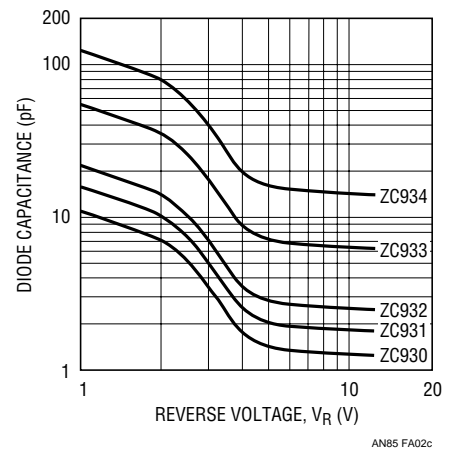

Figure A2c. Typical Capacitance-Voltage Characteristics for the ZC930-4 Range

C2/C20 figure of 2.8 may be typical, whereas a C2/C20 ratio of 6 may be expected for a Hyperabrupt device. This feature of the Hyperabrupt variety can be particularly important when assessing devices for battery-powered applications, where the bias voltage range may be limited. In this instance, the ZC930 series that feature a better than 2:1 tuning range for a 0 to 6V bias may be of particular interest.

The quality factor, Q , at a particular condition is a useful parameter in assessing the performance of a device with respect to tuned circuits, and the resulting loaded Q .

Zetex guarantees a minimum Q at test conditions of 50MHz, and a relatively low V_R of 3 or 4V, and ranges 100 to 450 depending on device type.

The specified V_R is very important in assessing this parameter, because as well as the C-V dependence as detailed previously, a significant part of the series resistance (R_S), is due to the remaining undepleted epitaxial layer, which is also dependant upon V_R . This R_S - V_R relationship is shown in Figure A3 for the ZC830, ZC833 and ZC836 Hyperabrupt devices, measured at frequencies of 470MHz, 300MHz and 150MHz respectively, and also serves to illustrate the excellent performance of Zetex Variable Capacitance Diodes at VHF and UHF.

Also of interest, with respect to stability, is the temperature coefficient of capacitance, as capacitance changes with V_R , and is shown for the three ranges in Figures A4a, A4b and A4c respectively.

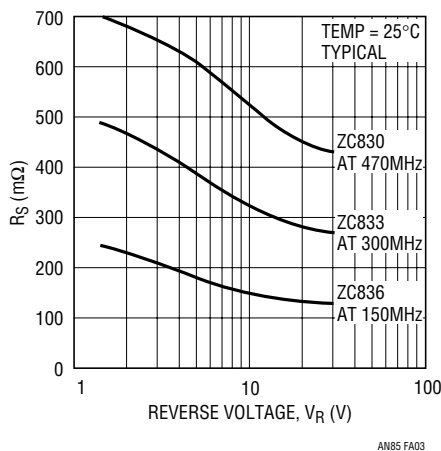

Figure A3. Typical R_S vs V_R Relationship for ZC830 Series Diodes

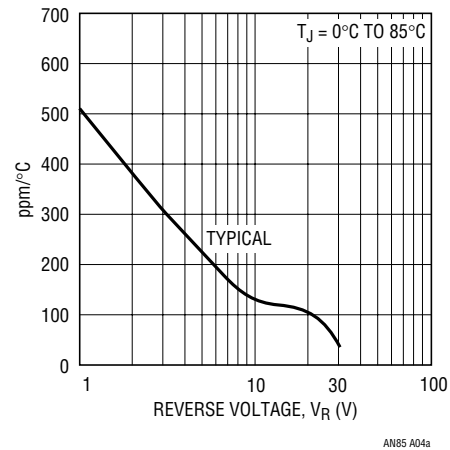

Figure A4a. Temperature Coefficient of Capacitance vs V_R for the ZC740 Series

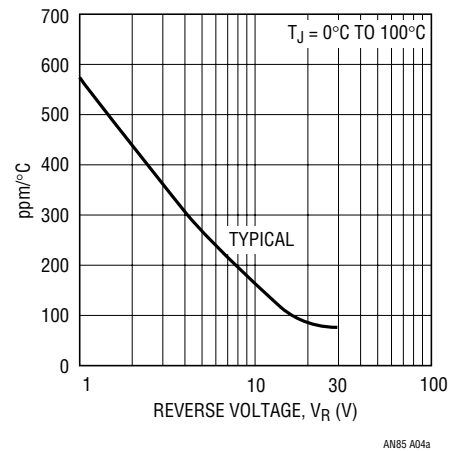

Figure A4b. Temperature Coefficient of Capacitance vs V_R for the ZC830 Series

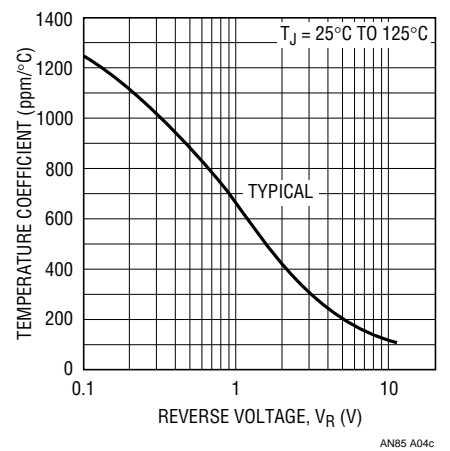

Figure A4c. Temperature Coefficient of Capacitance vs V_R for the ZC930 Series

Application Note 85

The reverse breakdown voltage, $V(BR)$ also has a bearing on device selection, as this parameter limits the maximum V_R that may be used when biasing for minimum capacitance. Zetex variable capacitance diodes typically possess a $V(BR)$ of 35V.

The maximum frequency of operation will depend on the required capacitance and the series resistance (and hence useful Q), that is possessed by a particular device type, but also of consequence are the parasitic components

exhibited by the device package. These depend on the size, material and construction of the package. For example, the Zetex SOT-23 package has a typical stray capacitance of 0.08pF, and a total lead inductance of 2.8nH, while the E-line package shows less than 0.2pF and 5nH respectively. These low values allow a wide frequency application, for example, the ZC830 and ZC930 series, configured as series pairs are ideal for low cost microwave designs extending to 2.5GHz and above.

APPENDIX B

PREAMPLIFIER AND OSCILLOSCOPE SELECTION

The low level measurements described require some form of preamplification for the oscilloscope. Current generation oscilloscopes rarely have greater than 2mV/DIV sensitivity, although older instruments offer more capability. Figure B1 lists representative preamplifiers and oscilloscope plug-ins suitable for noise measurement. These units feature wideband, low noise performance. It is particularly significant that many of these instruments are no longer produced. This is in keeping with current instrumentation trends, which emphasize digital signal acquisition as opposed to analog measurement capability.

The monitoring oscilloscope should have adequate bandwidth and exceptional trace clarity. In the latter regard high quality analog oscilloscopes are unmatched. The exceptionally small spot size of these instruments is well-suited to low level noise measurement.¹ The digitizing uncertainties and raster scan limitations of DSOs impose display resolution penalties. Many DSO displays will not even register the small levels of switching-based noise.

Note 1: In our work we have found Tektronix types 454, 454A, 547 and 556 excellent choices. Their pristine trace presentation is ideal for discerning small signals of interest against a noise floor limited background.

INSTRUMENT TYPE	MANUFACTURER	MODEL NUMBER	BANDWIDTH	MAXIMUM SENSITIVITY/GAIN	AVAILABILITY	COMMENTS
Amplifier	Hewlett-Packard	461A	150MHz	Gain = 100	Secondary Market	50Ω Input, Stand-Alone
Differential Amplifier	Preamble	1855	100MHz	Gain = 10	Current Production	Stand-Alone, Settable Bandstops
Differential Amplifier	Tektronix	1A7/1A7A	1MHz	10μV/DIV	Secondary Market	Requires 500 Series Mainframe, Settable Bandstops
Differential Amplifier	Tektronix	7A22	1MHz	10μV/DIV	Secondary Market	Requires 7000 Series Mainframe, Settable Bandstops
Differential Amplifier	Tektronix	5A22	1MHz	10μV/DIV	Secondary Market	Requires 5000 Series Mainframe, Settable Bandstops
Differential Amplifier	Tektronix	ADA-400A	1MHz	10μV/DIV	Current Production	Stand-Alone with Optional Power Supply, Settable Bandstops
Differential Amplifier	Preamble	1822	10MHz	Gain = 1000	Current Production	Stand-Alone, Settable Bandstops
Differential Amplifier	Stanford Research Systems	SR-560	1MHz	Gain = 50000	Current Production	Stand-Alone, Settable Bandstops, Battery or Line Operation

Figure B1. Some Applicable High Sensitivity, Low Noise Amplifiers. Trade-Offs Include Bandwidth, Sensitivity and Availability

APPENDIX C

PROBING AND CONNECTION TECHNIQUES FOR LOW LEVEL, WIDEBAND SIGNAL INTEGRITY¹

The most carefully prepared breadboard cannot fulfill its mission if signal connections introduce distortion. Connections to the circuit are crucial for accurate information extraction. The low level, wideband measurements demand care in routing signals to test instrumentation.

Ground Loops

Figure C1 shows the effects of a ground loop between pieces of line-powered test equipment. Small current flow between test equipment's nominally grounded chassis creates 60Hz modulation in the measured circuit output. *This problem can be avoided by grounding all line powered test equipment at the same outlet strip or otherwise ensuring that all chassis are at the same ground potential. Similarly, any test arrangement that permits circuit current flow in chassis interconnects must be avoided.*

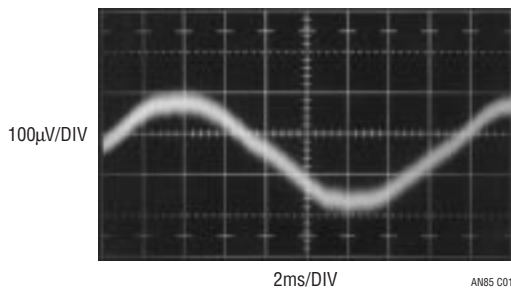

Figure C1. Ground Loop Between Pieces of Test Equipment Induces 60Hz Display Modulation

Pickup

Figure C2 also shows 60Hz modulation of the noise measurement. In this case, a 4-inch voltmeter probe at the feedback input is the culprit. *Minimize the number of test connections to the circuit and keep leads short.*

Poor Probing Technique

Figure C3's photograph shows a short ground strap affixed to a scope probe. The probe connects to a point which provides a trigger signal for the oscilloscope. Circuit output noise is monitored on the oscilloscope via the coaxial cable shown in the photo.

Note 1: Veterans of LTC Application Notes, a hardened crew, will recognize this Appendix from AN70 (see Reference 2). Although that publication concerned considerably more wideband noise measurement, the material is directly applicable to this effort. As such, it is reproduced here for reader convenience.

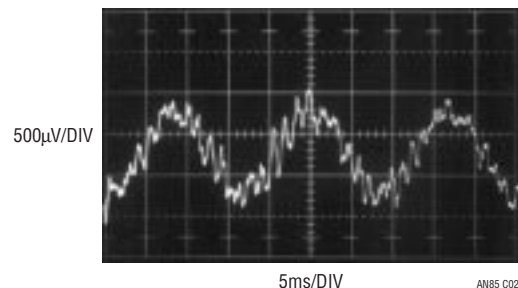

Figure C2. 60Hz Pickup Due to Excessive Probe Length at Feedback Node

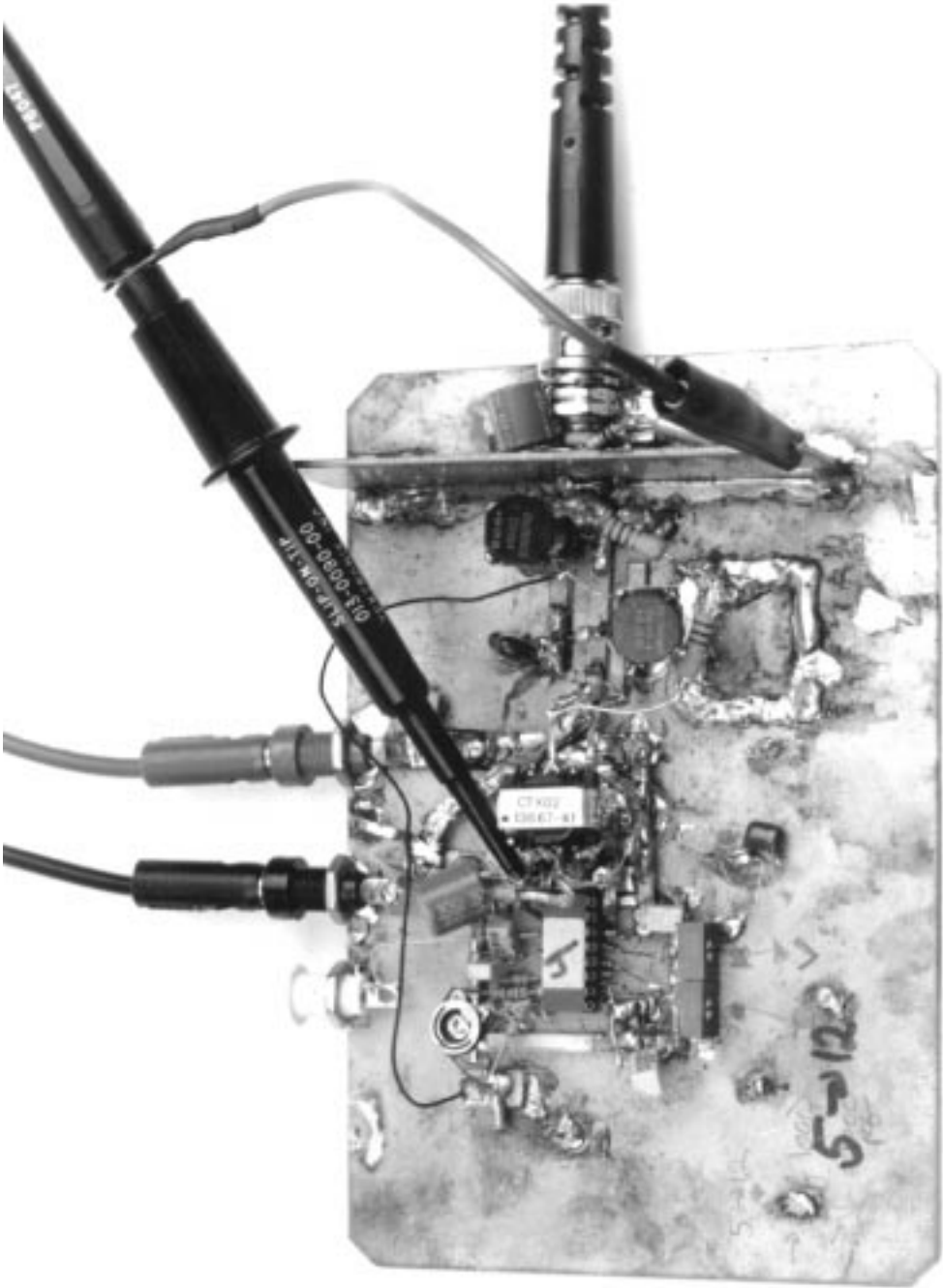

Figure C3. Poor Probing Technique. Trigger Probe Ground Lead Can Cause Ground Loop-Induced Artifacts to Appear in Display

Figure C4 shows results. A ground loop on the board between the probe ground strap and the ground referred cable shield causes apparent excessive ripple in the display. *Minimize the number of test connections to the circuit and avoid ground loops.*

Violating Coaxial Signal Transmission—Felony Case

In Figure C5, the coaxial cable used to transmit the circuit output noise to the amplifier-oscilloscope has been replaced with a probe. A short ground strap is employed as the probe's return. The error inducing trigger channel probe in the previous case has been eliminated; the 'scope is triggered by a noninvasive, isolated probe.² Figure C6 shows excessive display noise due to breakup of the coaxial signal environment. The probe's ground strap violates coaxial transmission and the signal is corrupted by RF. *Maintain coaxial connections in the noise signal monitoring path.*

Violating Coaxial Signal Transmission—Misdemeanor Case

Figure C7's probe connection also violates coaxial signal flow, but to a less offensive extent. The probe's ground strap is eliminated, replaced by a tip grounding attachment. Figure C8 shows better results over the preceding case, although signal corruption is still evident. *Maintain coaxial connections in the noise signal monitoring path.*

Proper Coaxial Connection Path

In Figure C9, a coaxial cable transmits the noise signal to the amplifier-oscilloscope combination. In theory, this affords the highest integrity cable signal transmission.

Figure C10's trace shows this to be true. The former example's aberrations and excessive noise have disappeared. The switching residuals are now faintly outlined in the amplifier noise floor. *Maintain coaxial connections in the noise signal monitoring path.*

Direct Connection Path

A good way to verify there are no cable-based errors is to eliminate the cable. Figure C11's approach eliminates all cable between breadboard, amplifier and oscilloscope. Figure C12's presentation is indistinguishable from Figure C10, indicating no cable-introduced infidelity. *When results seem optimal, design an experiment to test them. When results seem poor, design an experiment to test them. When results are as expected, design an experiment to test them. When results are unexpected, design an experiment to test them.*

Test Lead Connections

In theory, attaching a voltmeter lead to the regulator's output should not introduce noise. Figure C13's increased noise reading contradicts the theory. The regulator's output impedance, albeit low, is not zero, especially as frequency scales up. The RF noise injected by the test lead works against the finite output impedance, producing the 200 μ V of noise indicated in the figure. If a voltmeter lead must be connected to the output during testing, it should be done through a 10k Ω -10 μ F filter. Such a network eliminates Figure C13's problem while introducing minimal error in the monitoring DVM. *Minimize the number of test lead connections to the circuit while checking noise. Prevent test leads from injecting RF into the test circuit.*

Note 2: To be discussed. Read on.

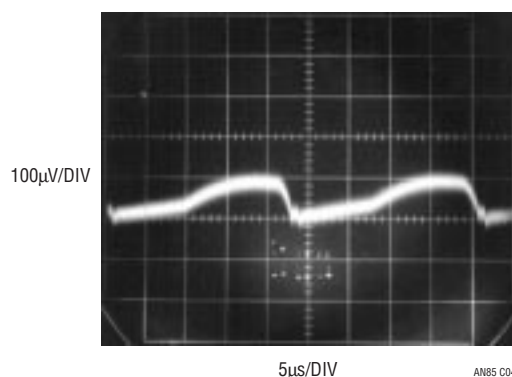

Figure C4. Apparent Excessive Ripple Results from Figure C3's Probe Misuse. Ground Loop on Board Introduces Serious Measurement Error

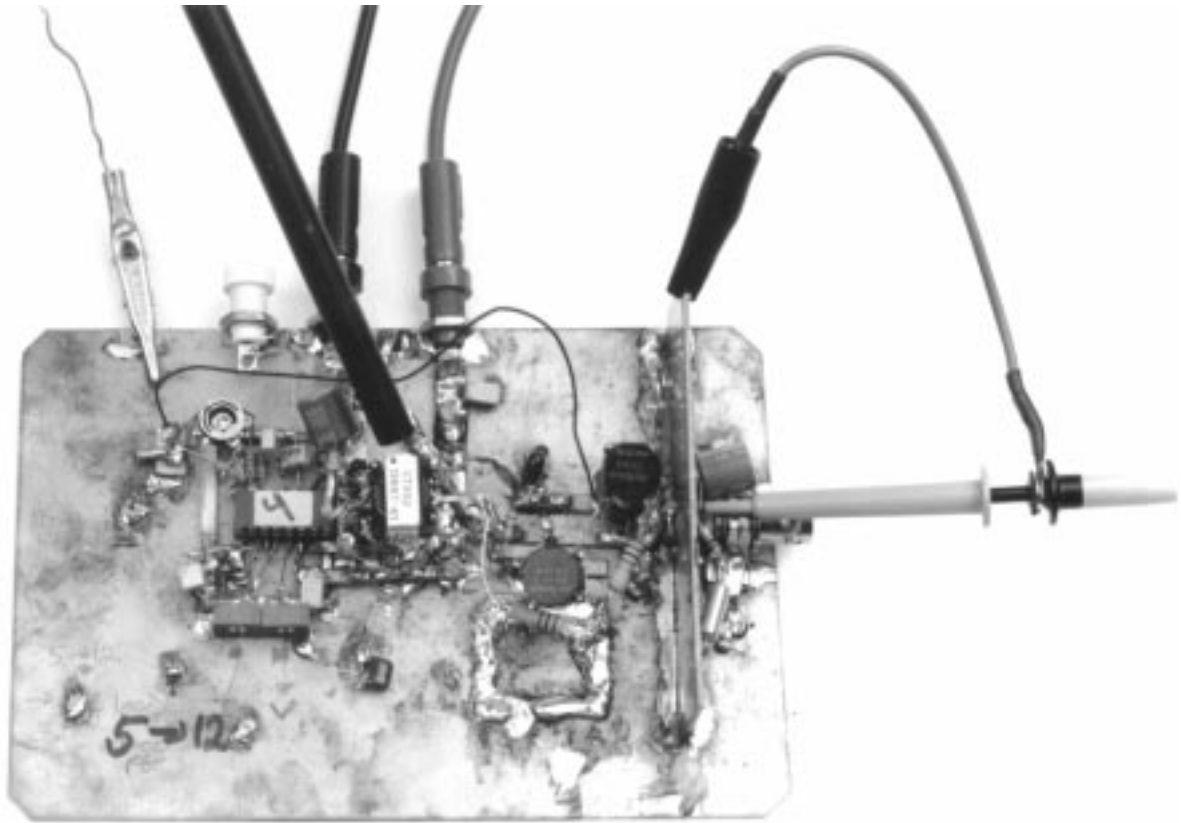

Figure C5. Floating Trigger Probe Eliminates Ground Loop, But Output Probe Ground Lead (Photo Upper Right) Violates Coaxial Signal Transmission

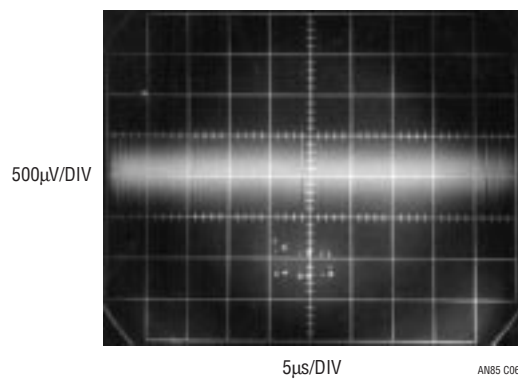

Figure C6. Signal Corruption Due to Figure C5's Noncoaxial Probe Connection

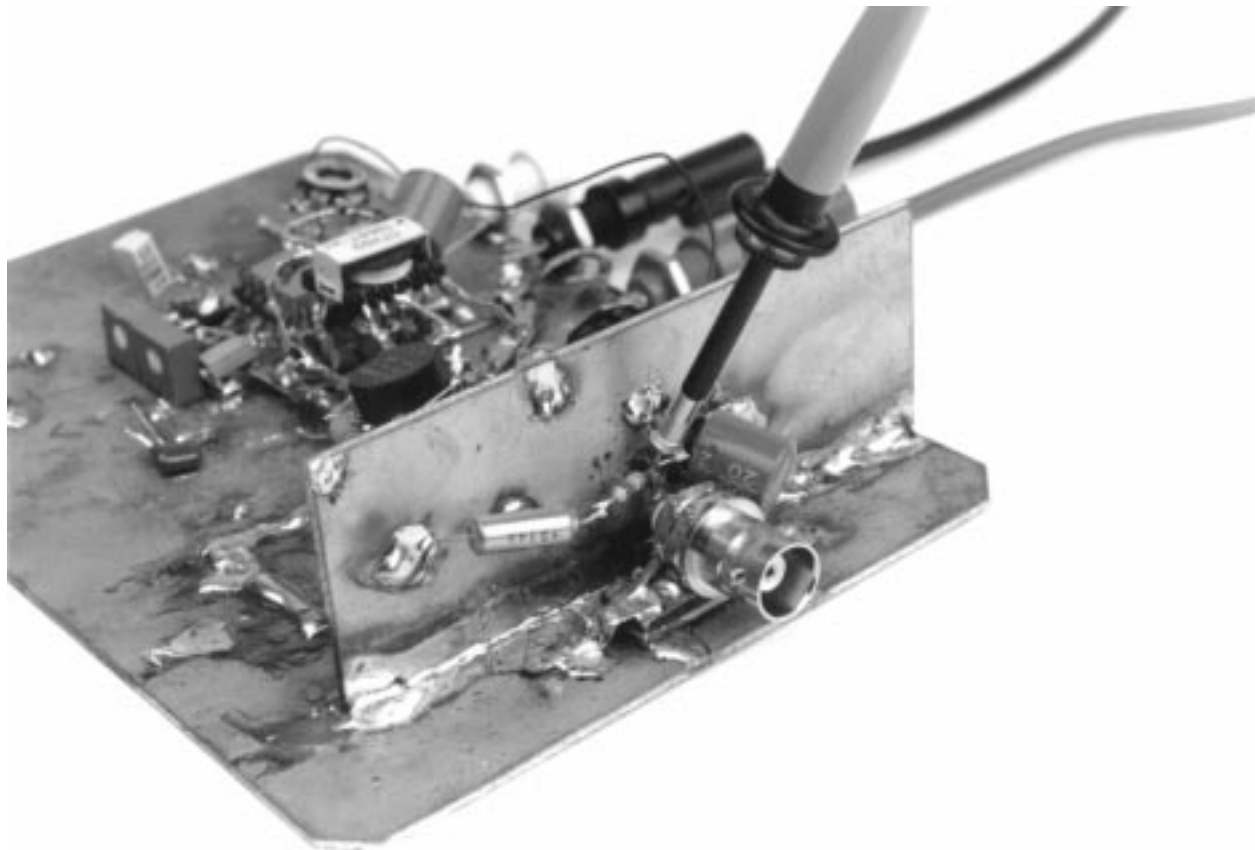

Figure C7. Probe with Tip Grounding Attachment Approximates Coaxial Connection

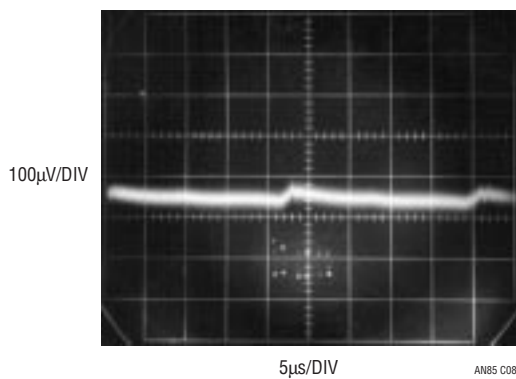

Figure C8. Probe with Tip Grounding Attachment Improves Results. Some Corruption is Still Evident

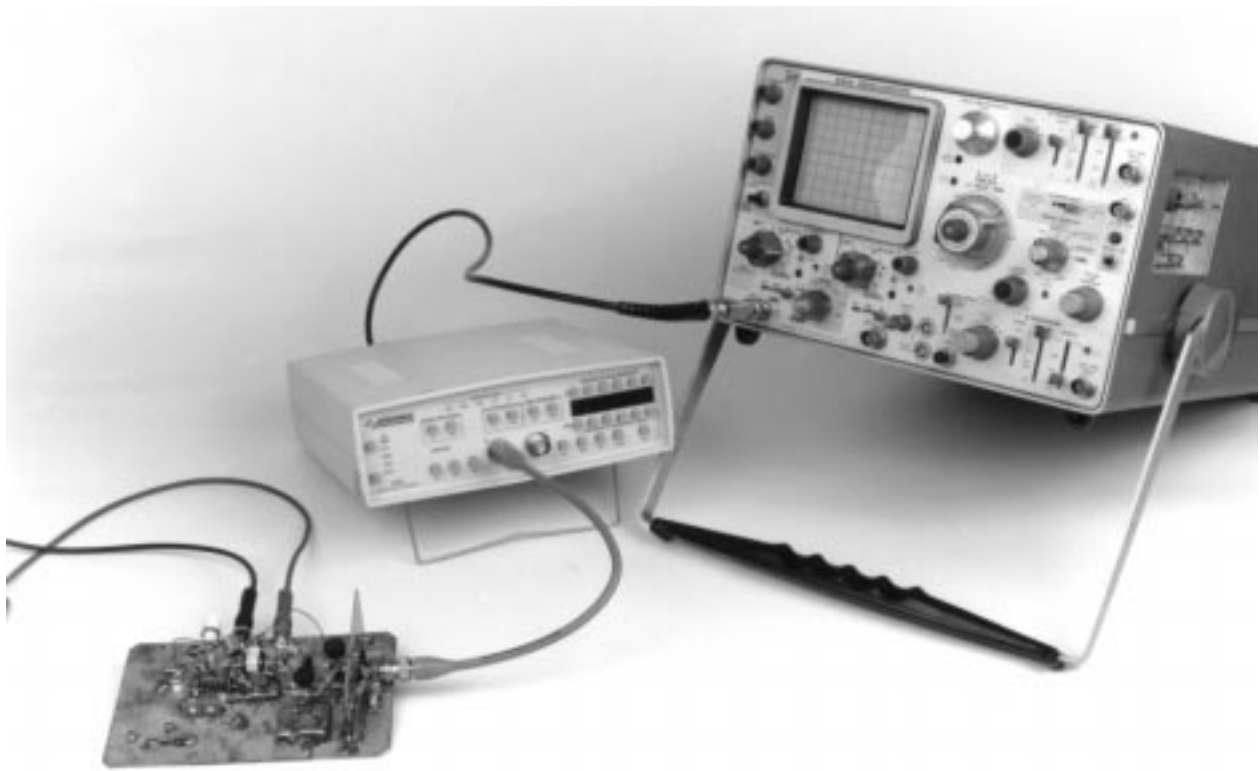

Figure C9. Coaxial Connection Theoretically Affords Highest Fidelity Signal Transmission

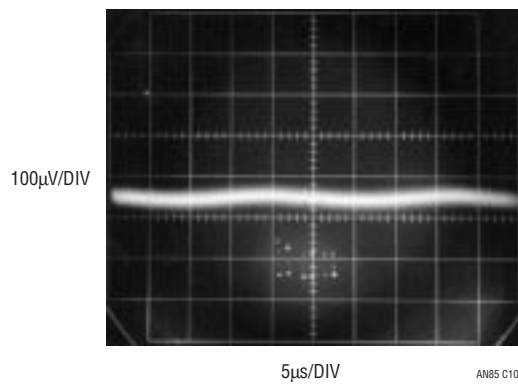

Figure C10. Life Agrees with Theory. Coaxial Signal Transmission Maintains Signal Integrity. Switching Residuals Are Faintly Outlined in Amplifier Noise

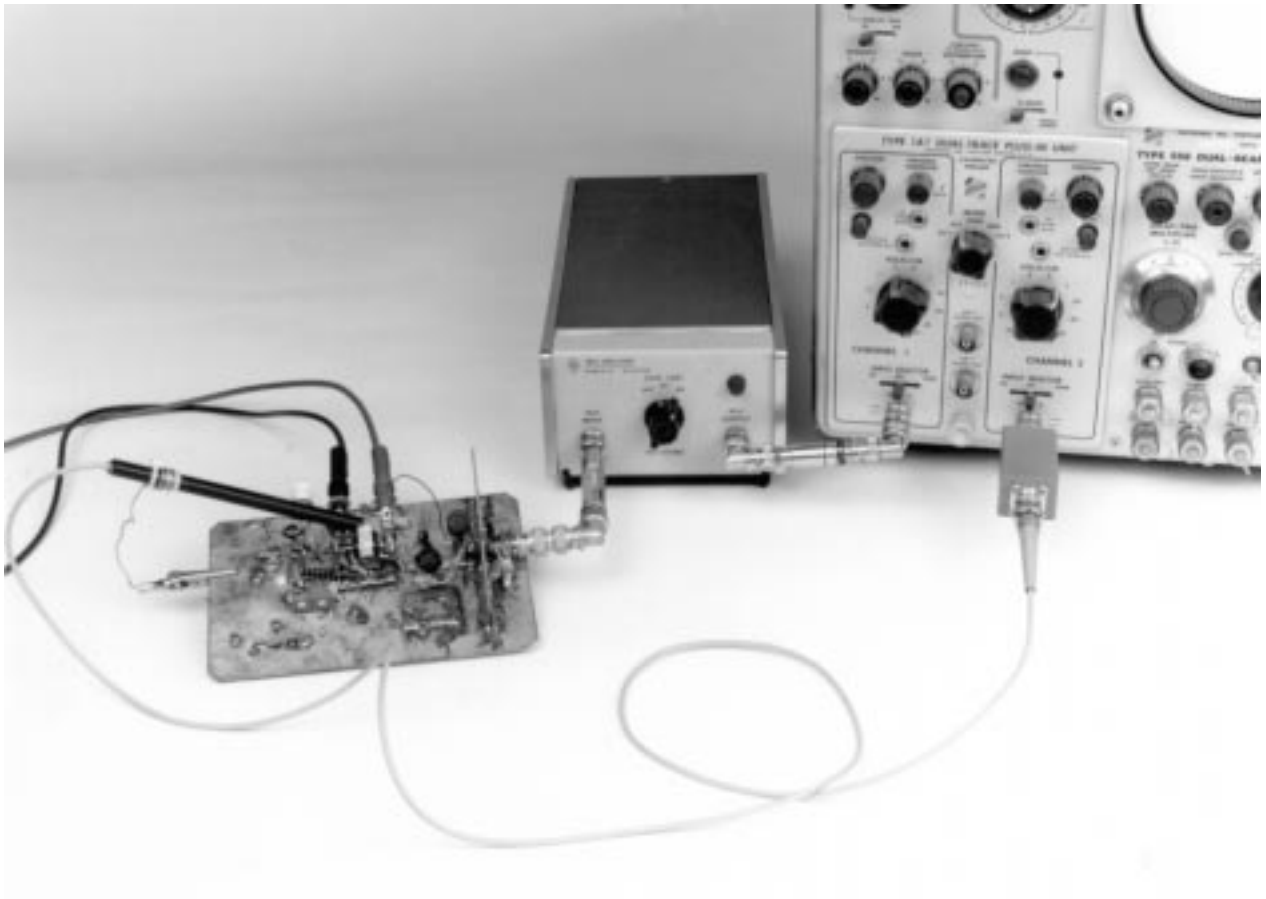

Figure C11. Direct Connection to Equipment Eliminates Possible Cable-Termination Parasitics, Providing Best Possible Signal Transmission

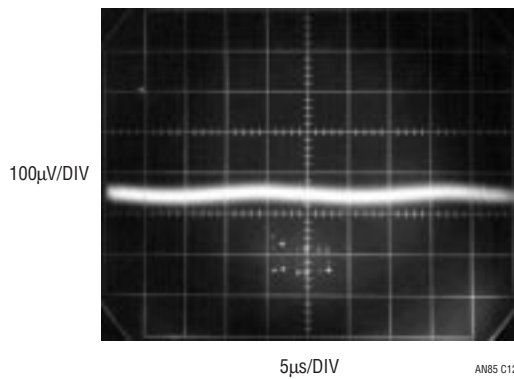

Figure C12. Direct Connection to Equipment Provides Identical Results to Cable-Termination Approach. Cable and Termination Are Therefore Acceptable

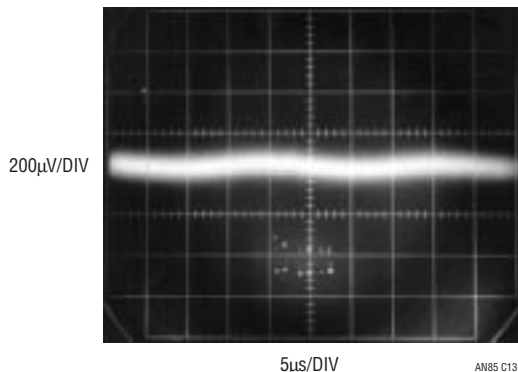

Figure C13. Voltmeter Lead Attached to Regulator Output Introduces RF Pickup, Multiplying apparent Noise Floor

Isolated Trigger Probe

The text associated with Figure C5 somewhat cryptically alluded to an “isolated trigger probe.” Figure C14 reveals this to be simply an RF choke terminated against ringing. The choke picks up residual radiated field, generating an isolated trigger signal. This arrangement furnishes a scope trigger signal with essentially no measurement corruption. The probe’s physical form appears in Figure C15. For good results, the termination should be adjusted for minimum ringing while preserving the highest possible amplitude output. Light compensatory damping produces Figure C16’s output, which will cause poor scope triggering. Proper adjustment results in a more favorable output (Figure C17), characterized by minimal ringing and well-defined edges.

Trigger Probe Amplifier

The field around the switching magnetics is small and may not be adequate to reliably trigger some oscilloscopes. In such cases, Figure C18’s trigger probe amplifier is useful. It uses an adaptive triggering scheme to compensate for variations in probe output amplitude. A stable 5V trigger output is maintained over a 50:1 probe output range. A1, operating at a gain of 100, provides wideband AC gain. The output of this stage biases a 2-way peak detector (Q1 through Q4). The maximum peak is stored in Q2’s emitter capacitor, while the minimum excursion is retained in Q4’s emitter capacitor. The DC value of the midpoint of A1’s

output signal appears at the junction of the 500pF capacitor and the 3MΩ units. This point always sits midway between the signal’s excursions, regardless of absolute amplitude. This signal-adaptive voltage is buffered by A2 to set the trigger voltage at the LT1394’s positive input. The LT1394’s negative input is biased directly from A1’s output. The LT1394’s output, the circuit’s trigger output, is unaffected by >50:1 signal amplitude variations. An X100 analog output is available at A1.

Figure C19 shows the circuit’s digital output (Trace B) responding to the amplified probe signal at A1 (Trace A).

Figure C20 is a typical noise testing setup. It includes the breadboard, trigger probe, amplifier, oscilloscope and coaxial components.

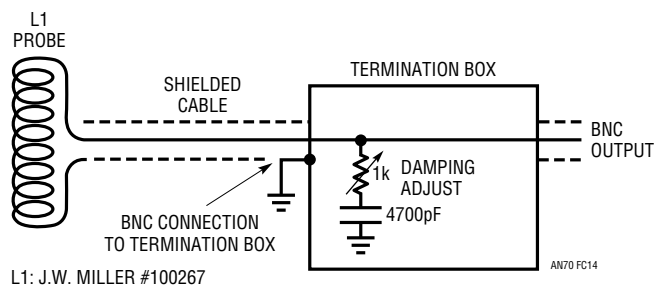

Figure C14. Simple Trigger Probe Eliminates Board Level Ground Loops. Termination Box Components Damp L1’s Ringing Response



Figure C15. The Trigger Probe and Termination Box. Clip Lead Facilitates Mounting Probe, Is Electrically Neutral

Application Note 85

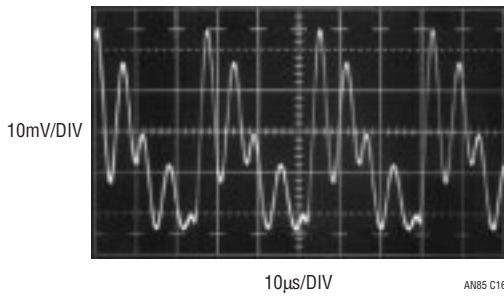

Figure C16. Misadjusted Termination Causes Inadequate Damping. Unstable Oscilloscope Triggering May Result

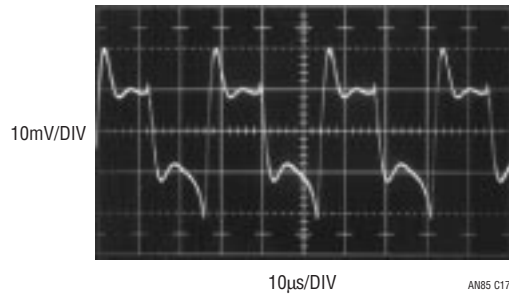

Figure C17. Properly Adjusted Termination Minimizes Ringing with Small Amplitude Penalty

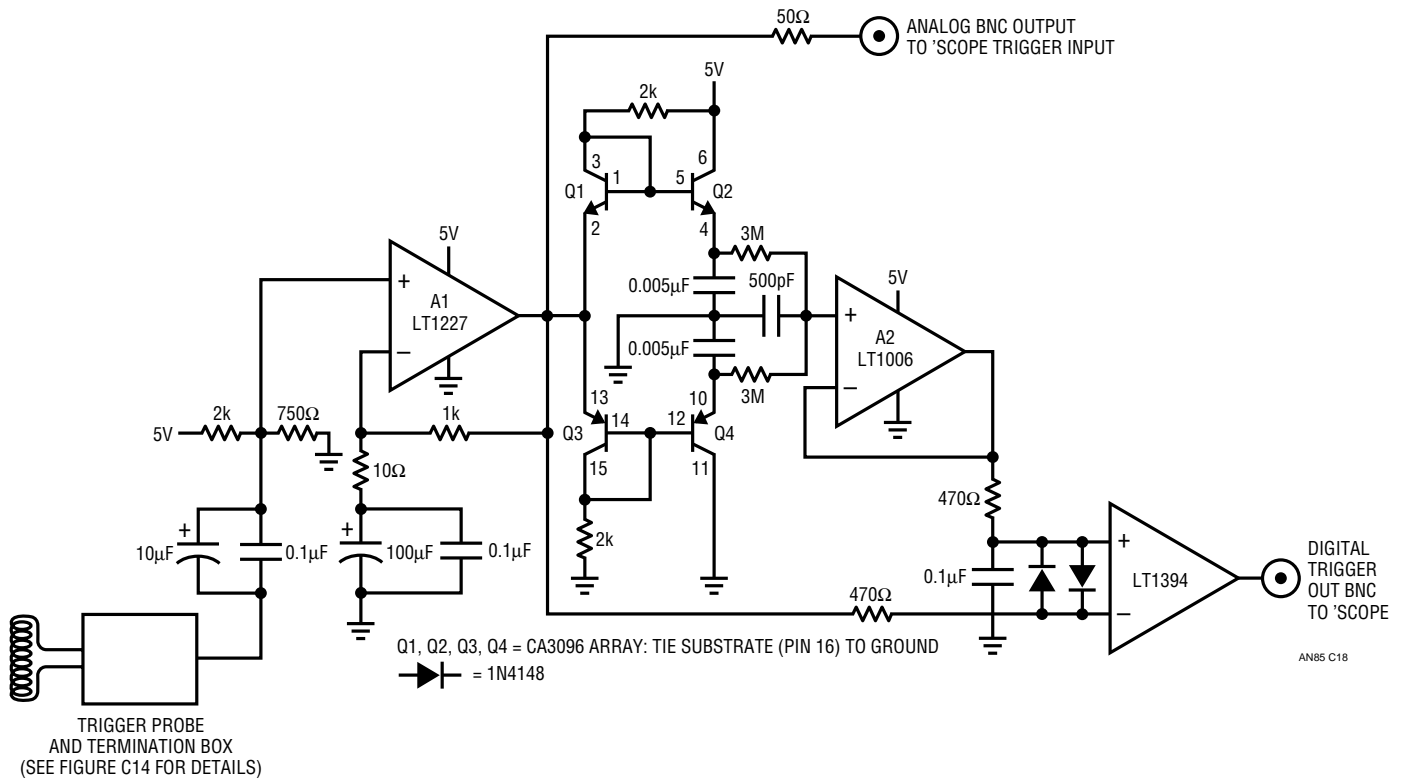

Figure C18. Trigger Probe Amplifier Has Analog and Digital Outputs. Adaptive Threshold Maintains Digital Output Over 50:1 Probe Signal Variations

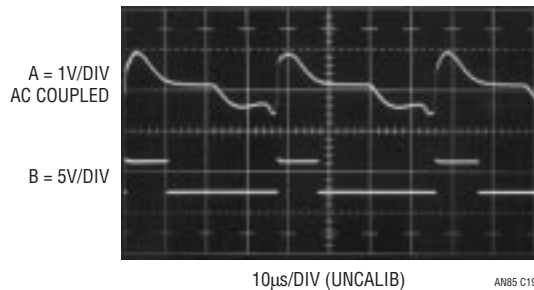

Figure C19. Trigger Probe Amplifier Analog (Trace A) and Digital (Trace B) Outputs

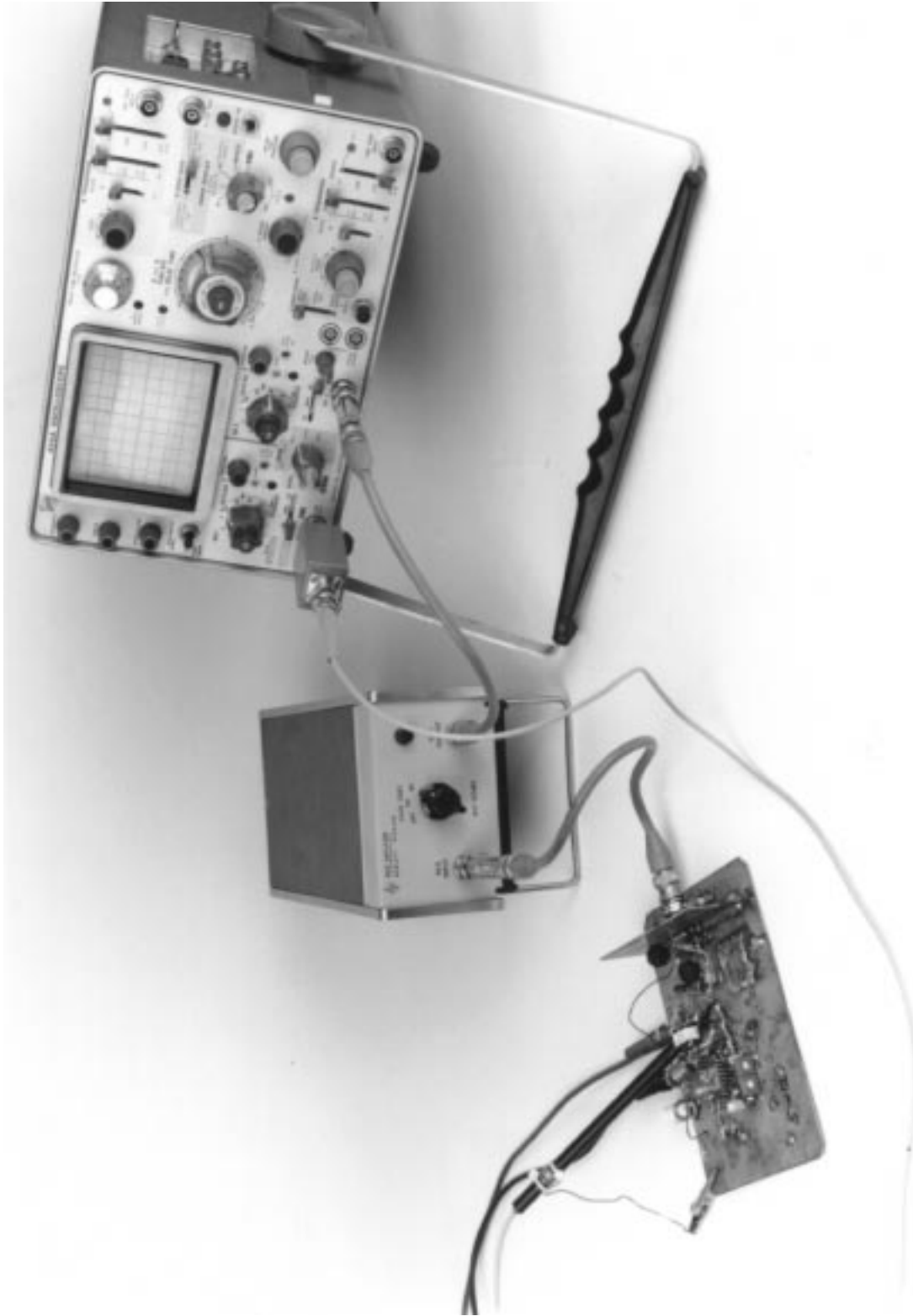
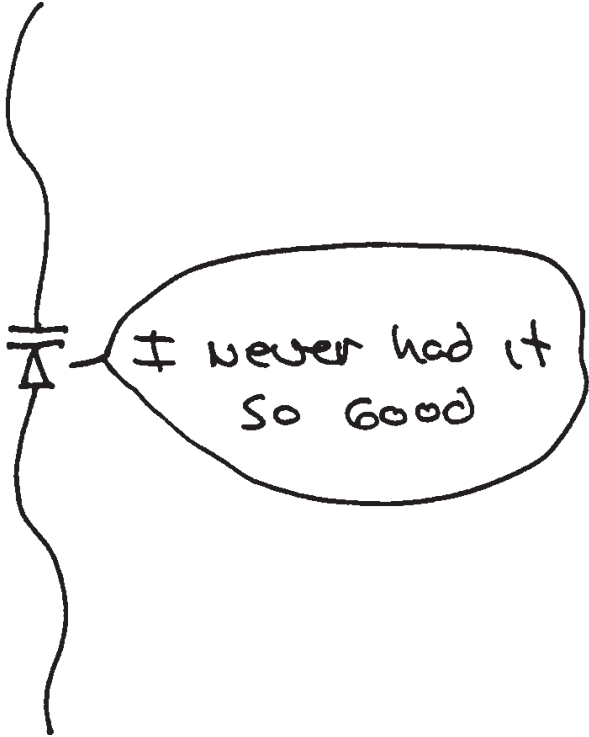

Figure C20. Typical Noise Test Setup Includes Trigger Probe, Amplifier, Oscilloscope and Coaxial Components



Will do