



Radio Test Set IFR 2975

Operation Manual

1002-4202-2P0
Version 1.9.1

OPERATION MANUAL

RADIO TEST SET

IFR 2975

PUBLISHED BY
Aeroflex

COPYRIGHT © Aeroflex 2005

All rights reserved. No part of this publication may be reproduced, stored in a retrieval system, or transmitted in any form or by any means, electronic, mechanical, photocopying, recording or otherwise without the prior permission of the publisher.

Original Printing Jan 2005

10200 West York Street/ Wichita, Kansas 67215 U.S.A. / (316) 522-4981 / FAX (316) 524-2623

CABLE STATEMENT

Double shielded and properly terminated external interface cables must be used with this equipment when interfacing with the RS-232 and IEEE-488.

For continued EMC compliance, all external cables must be 3 meters or less in length.

NOMENCLATURE STATEMENT

The IFR 2975 Radio Test Set is the official nomenclature for the IFR 2975 Radio Test Set. In this manual, 2975, unit or test set, refers to the IFR 2975 Radio Test Set.

THIS PAGE INTENTIONALLY LEFT BLANK.

SAFETY FIRST: TO ALL OPERATIONS PERSONNEL

REFER ALL SERVICING OF UNIT TO QUALIFIED TECHNICAL PERSONNEL. THIS UNIT CONTAINS NO OPERATOR SERVICEABLE PARTS.

CASE, COVER OR PANEL REMOVAL

Removing protective covers, casings or panels from this unit exposes the operator to electrical hazards that can result in electrical shock or equipment damage. Do not operate this unit with the case, cover or panels removed.

SAFETY IDENTIFICATION IN TECHNICAL MANUAL

This manual uses the following terms to draw attention to possible safety hazards, that may exist when operating or servicing this equipment.

CAUTION: THIS TERM IDENTIFIES CONDITIONS OR ACTIVITIES THAT, IF IGNORED, CAN RESULT IN EQUIPMENT OR PROPERTY DAMAGE (e.g., FIRE).

WARNING: THIS TERM IDENTIFIES CONDITIONS OR ACTIVITIES THAT, IF IGNORED, CAN RESULT IN PERSONAL INJURY OR DEATH.

SAFETY SYMBOLS IN MANUALS AND ON UNITS



CAUTION: Refer to accompanying documents.



AC TERMINAL: Terminal that may supply or be supplied with ac or alternating voltage.



SWITCH OFF: AC line power to the device is OFF.



SWITCH ON: AC line power to the device is ON.



DANGEROUS VOLTAGE: Indicates electrical shock hazard due to high voltage levels.

EQUIPMENT GROUNDING PRECAUTION

Improper grounding of equipment can result in electrical shock.

USE OF PROBES

Check the specifications for the maximum voltage, current and power ratings of any connector on the unit before connecting it with a probe from a terminal device. Be sure the terminal device performs within these specifications before using it for measurement, to prevent electrical shock or damage to the equipment.

USE RECOMMENDED FUSES ONLY

Use only fuses specifically recommended for the equipment at the specified current and voltage ratings.

CAUTION: SIGNAL GENERATORS CAN BE A SOURCE OF ELECTRO-MAGNETIC INTERFERENCE (EMI) TO COMMUNICATION RECEIVERS. SOME TRANSMITTED SIGNALS CAN CAUSE DISRUPTION AND INTERFERENCE TO COMMUNICATION SERVICES OUT TO A DISTANCE OF SEVERAL MILES. USERS OF THIS EQUIPMENT SHOULD SCRUTINIZE ANY OPERATION THAT RESULTS IN RADIATION OF A SIGNAL (DIRECTLY OR INDIRECTLY) AND SHOULD TAKE NECESSARY PRECAUTIONS TO AVOID POTENTIAL COMMUNICATION INTERFERENCE PROBLEMS.

THIS PAGE INTENTIONALLY LEFT BLANK.

ESD WARNING!

PROTECTING THE 2975 AGAINST ELECTROSTATIC DISCHARGE

Electrostatic Discharge (ESD) can cause damage or even destroy circuitry within the 2975. This damage is often unseen and can occur whenever the 2975 is incorrectly touched or connected to other equipment.

To help reduce the chances of ESD damage, observe the following:

- Make sure the 2975 and all associated equipment are properly earth-grounded to prevent build up of static charge.
- All persons using the 2975 should be grounded with a 1 M Ω resistor-isolated wrist strap before touching any conductor on the 2975, or any equipment connected to the 2975.
- Before connecting an open coaxial cable to the 2975, short the center conductor of the coaxial cable to the outer conductor of the coaxial cable to discharge any potential static that may exist.
- If a "rubber-ducky," telescopic, or similar antenna is directly connected to the 2975, do not touch the antenna unless properly grounded.
- All external antennas must use approved outdoor ESD and/or lightning suppression. **Use extreme caution whenever an external antenna is connected to any device!**
- Use the 2975 and associated equipment at static-safe workstations that includes conductive mats, ionizing blowers, wrist straps and any other necessary items as appropriate.
- Keep all static-generating materials at least one meter from the 2975 and connected equipment.
- Store and transport the 2975 in an approved container.
- Touch and handle all printed circuit assemblies by the edges to reduce the chances of ESD damage.

For more information about ESD and how to prevent damage, check the Electrostatic Discharge Association web site at:

<http://www.esda.org> .

THIS PAGE INTENTIONALLY LEFT BLANK.

PREFACE

SCOPE

This manual contains operating information for the 2975, including features and functions up to Software Version 1.9.1.

ORGANIZATION

The 2975 Operation Manual is composed of the following sections:

SECTION 1 - DESCRIPTION

Contains the 2975 Functions, Capabilities (Product Specifications) and Connector Descriptions.

SECTION 2 - OPERATION

Contains a functional description of the Generator, Receiver, Duplex, Function Generator, Oscilloscope, Spectrum Analyzer and Meters.

SECTION 3 - OPTIONAL FEATURES

Contains information describes optional features available for the 2975.

SECTION 4 - APPLICATIONS

Contains step-by-step procedures for operating the 2975.

SECTION 5 - REMOTE COMMANDS

Tool Command Language (TCL) allows creation of automated sequences and remote operation.

SECTION 6 - SYSTEM SETTINGS

Contains descriptions for network, remote and system features settings.

THIS PAGE INTENTIONALLY LEFT BLANK.

TABLE OF CONTENTS

Paragraph	Title	Page
SECTION 1 - DESCRIPTION		
1-1	Functions and Capabilities	1-1
1-2	Specifications.....	1-5
1-3	Connectors.....	1-22
	2975 Front Panel.....	1-22
	2975 Rear Panel	1-24
SECTION 2 - OPERATION		
2-1	Operational Concepts.....	2-1
2-2	Monitor and Control Functions	2-2
2-3	Operation.....	2-3
2-4	Operation Modes	2-22
	Generator Mode	2-22
	Receiver Mode	2-31
	Duplex Mode	2-34
	Function Generator.....	2-35
	Oscilloscope	2-39
	Spectrum Analyzer	2-43
	SINAD Meter	2-52
	Distortion Meter	2-54
	Power Meter.....	2-56
	RSSI Meter	2-57
	Deviation Meter.....	2-58
	AM Modulation Meter	2-59
	Digital (AC/DC) Voltmeter	2-60
	Modulation Fidelity Meter.....	2-61
	AF Counter	2-63
	RF Error Meter	2-64
	BER Meter	2-65
	Meter Panel	2-67

TABLE OF CONTENTS (cont)

Paragraph	Title	Page
SECTION 3 - OPTIONAL FEATURES		
3-1	Optional Features and Functions.....	3-1
3-2	Description of Options.....	3-3
	P25 Trunking Opt 3.....	3-3
	SmartNet™ / SmartZone™ Testing Opt 4	3-3
	Control Channel Logger Opt 6	3-4
	Smartnet/Smartzone® 900 MHz Opt 8.....	3-5
	AutoTest Opt 9.....	3-6
	AES Opt 10.....	3-8
	LSM / P25 Phase II Opt 11	3-8
	KVL Loader Opt 12	3-9
	KVL ASN Opt 20.....	3-9
	LSM Advanced / P25 Advanced Opt 13	3-12
	P25 Trunking VHF/UHF/700 MHz Opt 14.....	3-13
	Audio Analyzer Opt 15	3-14
	Audio Simulcast Align Opt 16	3-16
	Rx BER Opt 17.....	3-17
	LTR Trunking Opt 18.....	3-17
	PassPort® Opt 19.....	3-18
	Secondary Control Channel Broadcast (SCCB) Opt 21	3-19
	Explicit Mode of Operation Opt 22.....	3-20
	P25 Explicit Unit to Unit and PSTN Emulation Opt 23.....	3-21
	P25 Explicit Adjacent Status Broadcast Channel Message Opt 24	3-22
SECTION 4 - APPLICATIONS		
4-1	Digital Transmitter Testing	4-1
	Digital Receiver Testing	4-6
	Analog Transmitter Testing.....	4-8
	Analog Receiver Testing.....	4-11
	Measuring Cable Fault	4-13
	Measuring Return Loss.....	4-15
	Measuring Filters.....	4-17
	Filter Pass Band Adjustments	4-19
	Notch Filter Adjustment	4-20
	P25 Self Check.....	4-21

TABLE OF CONTENTS (cont)

Paragraph	Title	Page
SECTION 5 - REMOTE COMMANDS		
5-1	Introduction	5-1
5-2	TCL Basics	5-4
5-3	Controlling the 2975	5-6
5-4	Controlling the 2975 Display	5-7
5-5	Recalling Saved Instrument States	5-8
5-6	Using the 2975 TCL Command Verbs	5-10
5-7	Quick Reference List	5-12
5-8	2975 Commands	5-22
SECTION 6 - SYSTEM SETTINGS		
6-1	General	6-1
	Configuration	6-1
	IP Parameter Setup	6-2
	IEEE-488 (GPIB) Setup	6-2
	System Parameter Setup	6-2
	RS-232 (Serial) Setup	6-3
	Factory Default (F2).....	6-3
	Time / Date	6-3
	Version.....	6-4
	Reload	6-4
	Calibrations	6-5
	Save / Recall	6-5

TABLE OF CONTENTS (cont)

Paragraph	Title	Page
APPENDIX A - I/O CONNECTOR PIN-OUT TABLES		
	Table of I/O Connectors (Front Panel)	A-1
	Table of I/O Connectors (Rear Panel)	A-1
	Pin-Out Table for MIC Connector.....	A-2
	Pin-Out Table for AUDIO I/O Connector	A-2
	Pin-Out Table for GPIB Connector.....	A-3
	Pin-Out Table for RS-232 Connector.....	A-4
	Pin-Out Table for PRINTER Connector.....	A-5
	Pin-Out Table for TEST PORT Connector	A-6
	Pin-Out Table for VGA Connector.....	A-6
	Pin-Out Table for MOUSE Connector	A-7
	Pin-Out Table for KEYBOARD Connector	A-7
	Pin-Out Table for USB Connector.....	A-8
	Pin-Out Table for ETHERNET Connector.....	A-8
APPENDIX B - REPACKING FOR SHIPMENT		
	Shipping Information	B-1
	Authorization.....	B-1
	Tagging Test Sets.....	B-1
	Shipping Containers.....	B-1
	Freight Costs.....	B-1
	Repacking Procedure	B-1
	Repacking Diagram.....	B-2
APPENDIX C - P25 TERMINOLOGY		

SERVICE UPON RECEIPT

Unpacking

Special-design packing material inside this shipping carton provides maximum protection for the 2975. Avoid damaging the carton and packing material during equipment unpacking. Use the following steps for unpacking the 2975.

- Cut and remove the sealing tape on the carton top and open the carton.
- Grasp the 2975 firmly, while restraining the shipping carton, and lift the equipment and packing material vertically.
- Place the 2975 and end cap packing on a suitable flat, clean and dry surface.
- Remove the protective plastic bag from the 2975. Place the desiccant bags back inside the protective plastic bag.
- Place protective plastic bag and end cap packing material inside shipping carton.
- Store the shipping carton for future use should the 2975 need to be returned.

Checking Unpacked Equipment

- Inspect the equipment for damage incurred during shipment. If the equipment has been damaged, report the damage to Aeroflex.
- Check the equipment against the packing slip to see if the shipment is complete. Report all discrepancies to Aeroflex.

DESCRIPTION	PART NUMBER	QTY
2975	7003-4248-500	1
COVER	1414-4452-900	1
ANTENNA	1201-0909-900	1
CONN,ADAPT,M2F BNC,RT.ANGLE	2113-0000-013	1
CONN,ADAPT BNC JACK - TNC PLUG	2200-0410-700	2
CONN,ADAPT BNC JACK/N PLUG	2113-0000-004	1
FUSE,3 AMP,FAST,5MMX20MM,250 V	5106-0000-055	2
CORD,AC,NEMA5-15,IEC320-C13,RA	6041-0001-200	1
OPERATION MANUAL (CD-ROM)	1002-4202-2C0	1
OPERATION MANUAL (PAPER)	(OPTIONAL)	



THIS PAGE INTENTIONALLY LEFT BLANK.

SECTION 1 - DESCRIPTION

1-1 FUNCTIONS AND CAPABILITIES

The 2975 Radio Test Set is a multi-purpose test solution with all the tools necessary for advanced testing of conventional two-way and Project 25 Compliant Radios. These tools have been integrated into a single platform offering over 20 discrete instruments which are presented in a comprehensive, user-friendly style.

A closer look at the 2975 reveals these exciting capabilities:

- Operation from front panel, keyboard, mouse or remote connection
- Protected RF Inputs
- RF Receive/Generate with full Duplex Operation to 2.7 GHz
- AM, FM and C4FM Modulation
- RF Power/Frequency/Frequency Error/Distortion/SINAD/AF Level/Voltage Meters
- Full Function Spectrum Analyzer/Oscilloscope/DVM
- IP Addressable
- Supports Network Connectivity
- Portable at 33 lbs.; ideal for the field technician

Standard functions and features of the 2975 include:

- Spectrum Analyzer functions:
 - Eight (8) Markers with frequency / level readout, with marker-to-marker readouts, plus horizontal or vertical placement
 - Sweep speeds and zero span operation
 - Cable Fault measurement calculator
 - "Quick Span" using mouse for simultaneous frequency and span settings
- Digital Coded Squelch (DCS), Dual-Tone, Multiple Frequency (DTMF) and Continuous Tone Coded Squelch System (CTCSS) decoding
- Volume and Squelch controls are accessible using the mouse
- RF Generator ON / OFF control is accessible on the Receiver screen
- An internal hard drive and 3.5 inch floppy drive for simplified program installation.
- User definable screen permits customized screen construction
- Screen capture function allows to capture spectrum displays and oscilloscope displays
- SETUP RECALL accessible from any screen providing easier access to stored information
- Receiver "Find Frequency" function which automatically tunes to the frequency of a transmitter
- Internal Web Server. The 2975 features an internal web server that:
 - Permits upload and download of files to and from the 2975
 - Permits viewing the 2975 settings and meters on the PC browser
 - Permits browsing the internal 2975 HELP files
 - Provides access to the 2975 Operation Manuals and Technical Application Notes
 - Permits downloading the 2975 LabWindows® CVI driver zip file for the user to develop user specific LabWindows® applications

- The 2975 supports DHCP, permitting easy connection onto a computer network. For easy remote display connection, the 2975 display can be redirected to a PC's X Windowing System client from the 2975 Internal Web Server.
- P25 functionality which includes:
 - Wider frequency error capture range for P25 radios (more forgiving for radios that are off-frequency)
 - C4FM Modulation Fidelity Meter displays frequency error and deviation at symbol time in addition to the modulation fidelity reading
 - Rx BER function permits stimulus / response of P25 radios with support for four standard test patterns
 - LCO #7 (telephone number dialing) support
 - Op-codes "03" and "06" have continuous delivery
- Function Generator has Arbitrary and SINC waveform capability
- RF Generator microphone press-to-talk (PTT) control
- Audio Route controls for the MODULATOR loopback
- Demod Audio filter selection for APCO-25
- Deviation Meter and AM% Meter have added functionality for Peak, Average, Positive Peak and Negative Peak
- Scope markers for the integral dual channel oscilloscope

Optional functions and features available on the 2975 include:

P25 Options

- **Control Channel Logger (2975OPT6)** for capturing P25 trunking protocol messages;
- **LSM / P25 Phase II (2975OPT11)** for Transmit and Receive of CQPSK waveforms; the option also features the ability to generate P25 LSM waveform (12.5 kHz BW) in addition to the P25 Phase II waveform (6.25 kHz BW)
- **LSM Advanced / P25-2 Advanced (2975OPT13)** adds powerful measurement capabilities for P25 waveforms, including error vector magnitude (EVM) and I-Q constellation display;
- **P25 Trunking VHF/UHF/700 MHz (2975OPT14)** for testing P25 systems in various frequency bands of operation.
- **Rx BER Option (2975OPT17)** extends the BER function within the 2975 by adding external data input through the front panel Test Connector (data from radio under test).

2975 SmartNet™/SmartZone™ Option

- **SmartNet™/SmartZone™ 900 MHz (2975OPT8)** for testing radios in the 900 MHz band using this trunking protocol.

Encryption Options

- **AES (2975OPT10)** Advanced Encryption System to permit testing radios using this powerful encryption scheme;
- **KVL Keyloader (2975OPT12)** to permit loading and management of encryption keys within the 2975.
- **KVL ASN Option (2975OPT20)** is a proprietary key transfer protocol used by Motorola KVL-3000 and older keyloaders. This protocol is proprietary to Motorola and Aeroflex is under license by Motorola to distribute this technology.

AutoTest Option

- **Autotest 1 (2975OPT9)** provides user defined tests and limits for transmit, receive and audio systems.

Audio Analyzer Option

- **Audio Analyzer Option (2975OPT15)** provides a frequency domain spectrum display of the audio band.
- **Analog Simulcast Align Option (2975OPT16)** extends the test capability of the Audio Analyzer Option for test and alignment of Motorola base stations.

LTR Trunking Option

- **LTR Trunking Option (2975OPT18)** for testing radios utilizing the LTR trunking protocol.

Passport Trunking

- **Passport® Option (2975OPT19)** is a proprietary analog trunking protocol developed by Trident Microsystems, Inc., Two Trident Drive - Arden, NC 28704. Aeroflex is under license by Trident Microsystems, Inc. to distribute this technology.

P25 Secondary Control Channel Broadcast Message

- **P25 Secondary Control Channel Broadcast Message (2975OPT21)** for verifying how P25 radios switch over to secondary control channels.

P25 Explicit Mode Operation

- **P25 Explicit Mode Operation (2975OPT22)** for testing trunked VHF/UHF radios systems that use explicit message format for the latest P25 trunking systems
- **P25 Explicit Unit to Unit and PSTN Emulation (2975OPT23)** for verifying that a radio can generate and receive Unit to Unit and PSTN calls.
- **P25 Explicit Adjacent Status Broadcast Channel Message (2975OPT24)** for verifying how P25 radios switch over to adjacent control channels when roaming.

AVAILABLE 2975 OPTIONS

Option Number	Option Name	Screen Name	Requires Option	Export?
2975OPT3	SmartNet™/SmartZone™ Testing	SzSnet	-	OK
2975OPT4	P25 Trunking Radio Test	P25_trunk	-	OK
2975OPT6	Control Channel Logger	P25_CTRL_LOG	2975OPT4 OR 2975OPT14	OK
2975OPT8	SmartNet™/SmartZone™ 900 MHz	SzSnet_900	2975OPT3	OK
2975OPT9	Autotest 2	Auto_Test	-	OK
2975OPT10	AES	AES	-	OK
2975OPT11	LSM / P25 Phase II	P25_LSM	-	OK
2975OPT12	KVL Keyloader	KEY_MGT	-	OK
2975OPT13	LSM Advanced / P25-2 Advanced	EVM	2975OPT11	OK
2975OPT14	P25 Trunking VHF/UHF/700MHz	P25_OBT	-	OK
2975OPT15	Audio Analyzer	Audio_Analyzer	-	OK
2975OPT16	Analog Simulcast Align	Analog_Simulcast	2975OPT15	OK
2975OPT17	RX BER	RX_BER	-	OK
2975OPT18	LTR Trunking	LTR	-	OK
2975OPT19	Passport	PASSPORT	-	OK
2975OPT20	KVL ASN Mode	MOTOROLA_ASN	2975OPT12	OK
2975OPT21	P25 Secondary Control Channel Broadcast Message	P25_trunk		OK
2975OPT22	P25 Explicit Mode Operation	P25_trunk		OK
2975OPT23	P25 Explicit Unit to Unit and PSTN Emulation	P25_trunk	2975OPT22	OK
2975OPT24	P25 Explicit Adjacent Status Broadcast Channel Message	P25_trunk	2975OPT22	OK

1-2 SPECIFICATIONS

A warm-up time of 5 minutes is required for the following performance requirements.

RF measurements are referenced to 50 Ω .

Accuracy and Resolution stated in percent are referenced to measured or selected value unless otherwise stated.

Receive IF Bandwidth set to the narrowest setting that does not limit input signal bandwidth.

Where resolution exceeds accuracy, resolution takes precedence.

Specifications and features are subject to change without notice.

GENERATE FUNCTIONS

GEN PORT

Protection

10 W for 30 sec.

Threshold 100 mW input (nominal)

GEN PORT VSWR

2.05:1 max

FREQUENCY

Range

1 MHz to 2.7 GHz

Resolution

1 Hz

Accuracy

Same as Time Base

AMPLITUDE - GEN PORT

Range

+10 to -110 dBm

Resolution

0.1 dB

Accuracy

± 1.5 dB (≤ 1.3 GHz)

± 2.5 dB (> 1.3 GHz)

AMPLITUDE - T/R PORT

Range

-30 to -137 dBm

Resolution

0.1 dB

Accuracy

± 1 dB (≤ 1.3 GHz, > -120 dBm)

± 1.5 dB (> 1.3 GHz, > -110 dBm)

SPECTRAL PURITY

Harmonic Spurious

-20 dBc max ≤ 50 MHz

-25 dBc max > 50 MHz

Non-Harmonic Spurious

-40 dBc max ≤ 1.5 GHz

-30 dBc max > 1.5 GHz and < 2.7 GHz

Residual Spurious

-95 dBm max < -50 dBm

Residual FM

< 15 Hz rms (Post Detection BW = 300 Hz to 3 kHz)

SSB Phase Noise (20 kHz offset)

-100 dBc/Hz typical

-92 dBc/Hz max (≤ 1 GHz)

-90 dBc/Hz max (> 1 GHz)

Residual AM

0.1% (Post Detection BW = 300 Hz to 3 kHz)

FREQUENCY AGILITY

10 mS < 100 MHz step to < 1 kHz frequency error

MODULATION - FM

Deviation Accuracy

3%, + residual, \pm LSD (1 kHz through 20 kHz deviation, 1 through 10 kHz rate)

5%, + residual, \pm LSD (> 20 kHz deviation, 1 through 20 kHz rate)

Deviation Range

Off, 10 Hz to 40 kHz deviation

Deviation Resolution

10 Hz

MODULATION – FM (cont)

Modulation Rate Bandwidth

50 to 20 kHz (MOD 1, MOD 2, and Audio In [SINAD] unbalanced)

50 Hz to 20 kHz (Audio In [SINAD] balanced and Mic In)

Modulation Distortion (THD)

1% (1 kHz rate, 6 kHz deviation, 50 Hz to 15 kHz bandwidth)

External Modulation Sensitivity (Audio 1 Input)

1 Vpp = 4 kHz deviation $\pm 15\%$ (50 Hz to 10 kHz unbalanced)

1 Vpp = 4 kHz deviation $\pm 15\%$ (1 kHz balanced)

External Modulation Sensitivity (MIC Input)

1 Vpp = 40 kHz deviation $\pm 15\%$ (300 Hz to 3 kHz)

MODULATION - AM

Depth Range

30% to 90% (Usable 0% to 100%)

Depth Accuracy

$\pm 2\%$ of full scale at 1 kHz rate Typical (Generate level $< \text{dBm}$ T/R Port and $< \text{dBm}$ Gen Port)

Depth Resolution

1%

Modulation Rate Bandwidth

100 Hz to 3 kHz

Modulation Distortion (THD)

4% typical

External AM Sensitivity (Audio 1 Input)

1 Vpp = 8% modulation (balanced and unbalanced)

External AM Sensitivity (MIC 1)

0.1 Vpp = 8% modulation

DIGITAL MODULATION FORMAT

C4FM

9600 bits/sec, 4800 symbols/sec

FSK Error

$< 1\%$ typical, $< 2\%$ max

P25 User Defined Signals

1011 Hz Tone

5% BER Calibration tone

Speech (repeated test phrases)

Silence

Voice from audio inputs

P25 Standard Signals

STD 1011	STD IDLE	STD SYMRATE
STD CAL	STD LDU1TRG	STD LOWDEV
STD SILENCE	STD NOTRIG	STD FIDPAT
STD INTFRNC	STD LDU2TRG	STD FIDSPECT
STD BUSY	STD 511	

RECEIVE FUNCTIONS

ANT PORT

Protection

10 W for 30 sec.

Threshold 100 mW input (nominal)

ANT PORT VSWR

2.15:1 max

LO EMISSIONS

T/R Port: ≤ -110 dBm

ANT Port: ≤ -70 dBm

10.7 MHZ IF OUTPUT

-10 dBm (50 Ω nominal) typical

FILTERS

IF Filters

12.5 kHz, 25 kHz, 60 kHz, 200 kHz

POWER METER

VSWR - T/R Port

<1.2:1 to 1 GHz, <1.25:1 (typical) >1 GHz to 2.7 GHz, 1.3:1 max

Frequency Range

1 MHz to 2.7 GHz

Accuracy

10% \pm LSD

Meter Range

100 mW to 200 W in a 1,2,5 sequence

Dynamic Range

100 mW to 125 W

Resolution

3 digits

POWER METER (cont)

Alarm

Alert sounds at 100°C Pad Temp or 135 W

Maximum Power

50 W continuous, 125 W 1 min ON / 4 min OFF

FREQUENCY COUNTER/FREQUENCY ERROR METER

RF Frequency Range

1 MHz to 2.7 GHz

Accuracy

Same as timebase ± 1 Hz

In-Band Frequency Range

$\frac{1}{2}$ selected receive bandwidth, nominal

Resolution

1 Hz

Frequency Error Ranges

AUTO, ± 100 Hz, ± 200 Hz, ± 500 Hz, ± 1 kHz, ± 5 kHz, ± 10 kHz, ± 20 kHz, ± 50 kHz, ± 100 kHz

Input Level Sensitivity

T/R Port: Input Level > -10 dBm, 0 dB attenuation

ANT Port: Input Level > -40 dBm, 0 dB attenuation

Input Level Range (T/R Port)

T/R Port: Input Level > -10 dBm, 0 dB attenuation, not to exceed +50 dBm

ANT Port: Input Level > -60 dBm, 0 dB attenuation

FM DEVIATION METER

Frequency Range

1 MHz to 2.7 GHz

Resolution

10 Hz

Accuracy

$\pm 5\%$, ± 2 LSD + residual (12.5 kHz IF, 1 kHz rate, deviation > 1 kHz and ≤ 5 kHz)

$\pm 5\%$, ± 2 LSD + residual (25 kHz IF, 1 kHz rate, deviation > 1 kHz and ≤ 10 kHz)

$\pm 5\%$, ± 2 LSD + residual (60 kHz IF, 1 kHz rate, deviation > 1 kHz and ≤ 25 kHz)

$\pm 7\%$, ± 2 LSD + residual (200 kHz IF, 50 to 20 kHz rate, deviation > 5 kHz and ≤ 40 kHz)

Meter Ranges

AUTO, 5 kHz, 10 kHz, 20 kHz, 50 kHz, 100 kHz

FM DEVIATION METER (cont)

Input Level Sensitivity

T/R Port: Input Level >-10 dBm, 0 dB attenuation

ANT Port: Input Level -40 to -20 dBm, 0 dB attenuation

Input Level Range

T/R Port: Input Level -20 to +30 dBm, 0 dB attenuation, not to exceed +50 dBm

ANT Port: Input Level -60 to -10 dBm, 0 dB attenuation, not to exceed +10 dBm

AF Bandwidth

DC to 20 kHz

Demod Output Sensitivity

1 Vpp = 5 kHz deviation typical

AM MODULATION METER

Frequency Range

1 MHz to 2.7 GHz

Accuracy

(antenna input -40 dBm to -30 dBm)

$\pm 5\%$ of Full Scale + residual (6 kHz IF, 1 kHz rate, 10% to 90% depth)

Resolution

1%

Meter Ranges

5%, 10%, 20%, 50%, 100%, AUTO

Input Level Sensitivity

T/R Port: Input Level >-10 dBm, 0 dB attenuation

ANT Port: Input Level -40 to -20 dBm, 0 dB attenuation

Input Level Range

T/R Port: Input Level -20 to +30 dBm, 0 dB attenuation, not to exceed +50 dBm

ANT Port: Input Level -60 to -10 dBm, 0 dB attenuation, not to exceed +10 dBm

AF Bandwidth

100 Hz to 3 kHz

Demod Output Sensitivity

1 Vpp = 8% modulation depth typical

AUDIO FREQUENCY COUNTER

Frequency Range

1 MHz to 2.7 GHz

Accuracy

Same as timebase ± 1 Hz

Resolution

0.1 or 1 Hz

Frequency Range (FM)

50 Hz to 10 kHz

10 kHz to 20 kHz (Modulation level >1 kHz deviation)

Input Level Sensitivity

T/R Port: Input Level >-10 dBm, 0 dB attenuation

ANT Port: Input Level -40 to -20 dBm, 0 dB attenuation

Input Level Range (T/R Port)

T/R Port: Input Level -20 to +30 dBm, 0 dB attenuation, not to exceed \pm dBm

ANT Port: Input Level -60 to -10 dBm, 0 dB attenuation, not to exceed +10 dBm

Audio Filters

None, 300 Hz LP, 4 kHz LP, 4 kHz LP (Butterworth), 4 kHz HP, 15 kHz LP, 20 kHz LP, 300 Hz HP, 300 Hz to 4 kHz BP

RECEIVE SIGNAL STRENGTH INDICATION (RSSI) METER

Frequency Range

1 MHz to 2.7 GHz

Accuracy

± 1.5 dB (typical)

Resolution

0.1 dB

Input Level Sensitivity

T/R Port: Input Level -30 to +20 dBm, 0 dB attenuation

ANT Port: Input Level -70 to -20 dBm, 0 dB attenuation

Input Level Range (T/R Port)

T/R Port: Input Level -40 to +30 dBm, 0 dB attenuation

ANT Port: Input Level -80 to -10 dBm, 0 dB attenuation

SINAD METER

Frequency Range

1 MHz to 2.7 GHz

Accuracy

± 1 dB ± 1 LSD at 1 kHz rate and 12 dB SINAD

Resolution

0.1 dB

Modulation Level Range (FM)

500 Hz to 60 kHz deviation

Test Frequency

1 kHz nominal

Meter Range

20 and 40 dB full scale

Input Level Sensitivity

T/R Port: Input Level > -10 dBm, 0 dB attenuation

ANT Port: Input Level -40 to -20 dBm, 0 dB attenuation

Input Level Range

T/R Port: Input Level -20 to $+30$ dBm, 0 dB attenuation, not to exceed $+50$ dBm

ANT Port: Input Level -60 to -10 dBm, 0 dB attenuation, not to exceed $+10$ dBm

Audio Filters

None, C-Weighted

DISTORTION METER

Frequency Range

1 MHz to 2.7 GHz

Accuracy

$\pm 1.5\%$ ± 1 LSD at 1 kHz rate at 5% distortion

Resolution

0.1%

Modulation Level Range (FM)

500 Hz to 40 kHz deviation

Test Frequency

1 kHz

Meter Ranges

5%, 10%, 20%, 50%, 100% Full Scale

Input Level Sensitivity

T/R Port: Input Level > -10 dBm, 0 dB attenuation

ANT Port: Input Level -40 to -20 dBm, 0 dB attenuation

DISTORTION METER (cont)

Input Level Range

T/R Port: Input Level -20 to +30 dBm, 0 dB attenuation

ANT Port: Input Level -60 to -10 dBm, 0 dB attenuation

Audio Filters

None, C-Weighted

DIGITAL DEMODULATION METERS (C4FM)

Input Level Range

T/R Port: Input Level -20 to +30 dBm, 0 dB attenuation

ANT Port: Input Level -60 to -10 dBm, 0 dB attenuation

FSK Error

(Antenna input -40 dBm to -30 dBm)

<2% + residual, 3% to 10% reading, 400 symbols

Meter Ranges

5%, 10%, 20%, 50%, 100% Full Scale

SPECTRUM ANALYZER FUNCTIONS

SWEEP (HORIZONTAL) ACCURACY

Frequency Range

1 MHz to 2.7 GHz

Frequency Resolution

1 Hz

Frequency Span Width Range

Analyzer Screen: Zero Span, 1 kHz to 2 GHz in a 1/2/5 sequence, 3 GHz

Gen / Rec Screens: Zero Span, 1 kHz to 5 MHz in a 1/2/5 sequence

Span Accuracy

±1% of (total) Span Width

Frequency Display

Span Accuracy + Frequency Standard Accuracy + 50% of RBW

Sweep Rate Range

200 ms, 500 ms, 750 ms, 1 sec, 2 sec, 3 sec, 4 sec, 5 sec, 6 sec, 7 sec

Sweep Rate Accuracy

1%

1 dB COMPRESSION

>-10 dBm (Antenna Port, 10 dB attenuation)

>-20 dBm (Antenna Port, no attenuation)

3RD ORDER INTERMOD

-60 dBc (1 MHz to 2.7 GHz),(-30 dBm input), (Antenna Port, No input attenuation)

HARMONIC SPURIOUS

-55 dBc at -40 dBm (Antenna Port, no attenuation)

NON-HARMONIC SPURIOUS

-60 dBc at -40 dBm (10 MHz to 2.7 GHz) (Antenna Port, no attenuation)

RESIDUAL SPURIOUS

≤-80 dBm (Input terminated, Antenna Port, no input attenuation)

AMPLITUDE (VERTICAL)

Level Accuracy

±2 dB (-30 dBm input, Antenna Port, 0 dB attenuation, -20 dB reference level, normalized)

Scales

2 dB/div, 5 dB/div, 10 dB/div

LOG Linearity

±2 dB

Reference Level Resolution

0.1 dB

Attenuator Range

0 to 40 dB, 10 dB steps (Auto coupled to reference level)

0 to 10 dB (ANT Port) (Auto coupled to reference level)

Attenuator Accuracy

±0.5 dB/step, ±1 dB maximum at 100 MHz

Dynamic Range

ANT Port: -100 to -20 dBm, no attenuation
≤-10 dBm, 10 dB attenuation

T/R Port: -30 to +30 dBm, no attenuation

Typical Noise Floor Performance

-110 dBm, 10 MHz to 2.7 GHz

(300 Hz Resolution Bandwidth selected)

Residual Phase Noise

-92 dBc/Hz at 20 kHz offset

RESOLUTION BANDWIDTH

Analyzer Screen

300 Hz, 3 kHz, 30 kHz, 60 kHz, 300 kHz, 6 MHz

Generate and Receive Screens

300 Hz, 3 kHz, 60 kHz

Selectivity

60 dB/3 dB ratio <15:1

Bandwidth Switching Error

±1 dB typical

VIDEO BANDWIDTHS

None, 10 Hz to 3 MHz in 1-3-10 steps

SPECIAL FUNCTIONS

Display Modes

Live, Average, Peak, Compare, Tracking Generator
Manual / Auto coupling for Span, Sweep, VBW, RBW

SPECTRUM ANALYZER VIDEO OUTPUT

Reference Level

= -5 V

Bottom-of-Screen

= +5 V

TRACKING GENERATOR

Frequency Range

10 MHz to 2.7 GHz

Output Level Range

GEN Port, +10 to -110 dBm

Output Level Resolution

0.1 dBm

Output Flatness

±2 dB, ≤500 MHz Span, up to 1.25 GHz Center Frequency

Harmonic Spurious

-20 dBc max ≤50 MHz

-25 dBc max >50 MHz

Non-Harmonic Spurious

-40 dBc max ≤1.5 GHz

-30 dBc max >1.5 GHz

Input Ports

Reference appropriate Receive function for Antenna and T/R Port specifications.

TIME BASE

ACCURACY

I/O Frequency

10 MHz nominal

Temperature Stability

±0.01 ppm

Time Base Aging

±0.1 ppm per year

OUTPUT LEVEL

1 to 5 Vpp into 10 kΩ

WARM-UP

<5 min.

INPUT LEVEL

1 to 5 Vpp input (sine or square wave)

OSCILLOSCOPE FUNCTIONS

Vertical Inputs

2 input channels (CH1 and CH2), MIC Input, Audio I/O Input, Internal Demod

Input Impedance

1 MΩ, 80 pF nominal

External Coupling

AC, DC, GND

Range

20 mV to 50 V/div in a 1, 2, 5 sequence

Accuracy

10% of full scale (DC to 50 kHz, Vertical position set on CENTER graticule))

Bandwidth

500 kHz usable

HORIZONTAL SWEEP

Range

10 μs to 1 sec per division (selectable to 1 μs/div)

Accuracy

1% of Full Scale sweep

TRIGGER SOURCE

Channel 1, Channel 2, Internal or External Trigger

External Trigger: TTL input level (nominal 2 V - trigger level)

SPECIAL FUNCTIONS

Modes

Live, Triggered Mode (Auto, Normal, Single)

AF Filters on Demod Input

None, 300 Hz LP, 4 kHz LP (Butterworth), 4 kHz LP (Bessel), 4 kHz LP, 15 kHz LP, 20 kHz LP, 300 Hz HP. 300 Hz to 4 kHz BP

AUDIO FREQUENCY GENERATOR

WAVE SHAPE FORMATS

Wave Shapes

Sine, Square, Triangle, Ramp

AMPLITUDE

Level

The combination of FGEN 1 and FGEN 2 cannot exceed the following:

Unbalanced: 0 to 20 Vpp into 10 k Ω (Audio Out 1 [FGEN] and Audio Out 2 [DEMODO])

Balanced - High Range: 0 to 6 Vrms into 10 k Ω (Audio Out 1 [FGEN] only)

Balanced - Low Range: 0 to 600 mVrms into 10 k Ω (Audio Out 1 [FGEN] only)

RESOLUTION

High Range

1 mV (Audio Out 1 [FGEN] and Audio Out 2 [DEMODO])

Low Range

0.1 mV (Audio Out 1 [FGEN] only)

ACCURACY (SINE WAVE)

Unbalanced (Audio 1 or 2, Level >0.5 Vpp)

3% (20 Hz through 3 kHz)

5% (3 through 5 kHz)

15% (5 through 10 kHz)

Balanced

High Range: 10% (frequency at 1 kHz, level >0.5 Vpp)

Low Range: 10% (frequency at 1 kHz, level >0.05 Vpp)

Distortion (THD, sinewave)

<0.5% (1 kHz, 3 Vpp)

<2% (20 Hz to 20 kHz, 1 through 15 Vpp)

FREQUENCY

Range

Unbalanced: DC to 20 kHz (Audio Out 1 [FGEN] and Audio Out 2 [DEMOD])

Balanced: 50 Hz to 20 kHz (Audio Out 1 [FGEN] only)

Resolution

0.1 Hz

Accuracy

±1 Hz

SIGNALING ENCODER

DTMF ENCODE

(Generation DTMF Tones)

Modes: Continuous, One-Shot, Key

Digits: (0-9, *, A, B, C, D)

CTCSS Encode

Generation of Standard Tone frequencies selected from a menu.

Decoding of received frequency displayed.

DCS Encode

Generation of digitally coded squelch.

Tones Remote Encoding Functions

Standard tone remote signaling and user defined tone signaling.

Fully programmable from the Remote Command Interface.

Tone Signaling Encoding Functions

Fully programmable from the Remote Command Interface.

BASE-BAND AUDIO FUNCTIONS

Input Level Range

Audio In: 200 mVpp to 20 Vpp

MIC: 10 mVpp to 1 Vpp

Frequency Range

Audio In (SINAD): 50 Hz to 20 kHz (unbalanced)

Audio In (SINAD) 50 Hz to 20 kHz (balanced)

Mic In (MIC) 50 Hz to 20 kHz (unbalanced)

INPUT IMPEDANCE

Audio In (SINAD)

Low Impedance Input: 600 Ω (balanced) nominal

High Impedance Input: 10 k Ω (unbalanced) nominal

MIC In (MIC)

High Impedance Input: 10 k Ω nominal

Phantom Power (Electret): +5 V through 5 k Ω nominal

AUDIO FREQUENCY COUNTER

Input Sources

Demodulated Audio, MIC Input, Audio I/O Input

Ranges

200, 500, 1 k, 2 k, 5 k, 10 k, 20 k

Accuracy

± 1 Hz

Resolution

0.1 Hz

Audio Filters (Demod only)

None, 300 Hz LP, 4 kHz LP, 4 kHz LP (Butterworth), 4 kHz HP, 15 kHz LP, 20 kHz LP, 300 Hz HP, 300 Hz to 4 kHz BP

MICROPHONE AUDIO INPUT

Modes

Electret: +5 V through 5 k Ω nominal

Dynamic

DVM FUNCTIONS

AC

Input Impedance

1 M Ω : $\pm 15\%$ (Range >0.4 V)

600 Ω : $\pm 10\%$

150 Ω : $\pm 10\%$

Range

400 mV to 100 V in a 1,2,4 sequence

Resolution

0.1 mV: 0.4 V scale

1 mV: 1 V, 2 V and 4 V scales

10 mV: 10 V, 20 V and 40 V scales

100 mV: 100 V scale

Accuracy

6% of Full Scale (50 Hz to 10 kHz) ± 1 LSD

6% of Full Scale (10 kHz to 20 kHz) ± 1 LSD input <60 Vac

9% of Full Scale (10 kHz to 20 kHz) ± 1 LSD input >60 Vac

DC

Range

400 mV to 100 V in a 1,2,4 sequence

Resolution

0.1 mV: 0.4 V scale

1 mV: 1 V, 2 V and 4 V scales

10 mV: 10 V, 20 V and 40 V scales

100 mV: 100 V scale

Accuracy

2% of full scale ± 1 LSD

Input Impedance

10 M Ω nominal

DIGITAL I/O

GPIB (IEEE-488-2)

Parallel Printer Port

Serial Port (RS-232)

Video Monitor Port (VGA)

Mouse Port (PS2 compatible)

Keyboard Port

Ethernet Port (10T/100T)

Front Panel Test Port

3.5 inch Floppy Drive

USB Port

AC POWER

Input Range

100 to 120 VAC, 60 Hz

220 to 240 VAC, 50 Hz

Fuse Requirements

3 A, 250 V, Type F

Maximum Power Consumption

200 W

Main Supply Fluctuations

$\leq 10\%$ of nominal voltage

Transient Over-Voltage Installation

Installation Category II

ENVIRONMENTAL/MECHANICAL

Weight

33 lbs. (15 kg)

Volume

7.75 in. (H) x 14 in. (W) x 19in. (D)

19.7 cm (H) x 35.6 cm (W) x 48.3 cm (D)

Operating Temp Range

32° to 104°F (0° to 40°C)

Storage Temp Range

-13° to 158°C (-25° to 70°C)

Humidity

80% up to 31°C, decreasing linearly to 50% at 40°C

Pollution

Pollution Degree 2

Shock

MIL-PRF-28800F Class 3 (30g)

Vibration

MIL-PRF-28800F Class 3

Altitude

9,843 feet (3000 meters)

Bench Handling

MIL-PRF-28800F Class 3

WARRANTY

2 years

Extended warranty available upon request

COMPLIANCE

The 2975 shall be modified in the future to be compliant with the following standards:

Electromagnetic Compliance

EMC Directive 89/336/EEC

EN 61326: 1997+A1 1998

Safety

EN 61010-1

UL 3111-1

CSA C22.2 No. 1010-1

1-3 CONNECTORS

CONNECTORS (Front Panel)



1 TEST PORT

This port is used for the purpose of programming radios through a data connection. The port consists of 4 digital input and 4 digital output (open collector) lines. The port also provides a 0 to 12 V, 50 mA programmable source. Software to support specific radios is planned for future software releases.

Refer to Appendix A for Connector Pin-Out Table.

2 SCOPE CH1 and CH2

The 2975 includes a dual channel oscilloscope suitable for trouble shooting audio paths.

⚠ 100 V maximum input!

⚡ Use caution when probing live circuits! DO NOT connect to AC line!

3 DVM (Input)

AC/DC Voltmeter

⚠ 100 V maximum input!

⚡ Use caution when probing live circuits! DO NOT connect to AC line!

- 4** **MIC (Input)**
Electret (+5 V through 5 kΩ) or Dynamic Microphone Connection

PIN	SIGNAL
1	GND
2	GND
3	MIC+
4	PTT
5	DEMODO+
6	GND

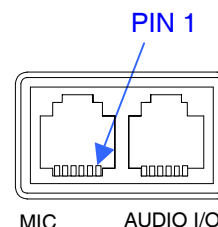

- 5** **AUDIO I/O**
SINAD Meter Input
600Ω Balanced / Unbalanced Audio Output
600Ω Balanced / Unbalanced Audio Input

PIN	SIGNAL
1	SINAD+ (Audio Input)
2	SINAD- (Audio Input)
3	FGEN+ (Audio Output 1)
4	FGEN- (Audio Output 1)
5	DEMODO+ (Audio Output 2)
6	GND (Audio Output 2)

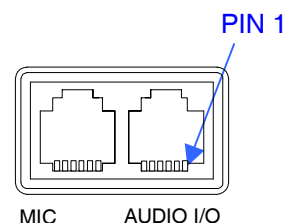

- 6** **GEN**
RF Generator output
Protected to 10 W in case of accidental connection to transmit power
Used for Signal Generator high output level and Tracking Generator output
LED indicates port selected for generator output

 DO NOT transmit RF into this connector!

- 7** **T/R**
Transmit / Receive
Used for direct connection to transmitter output
LED indicates port selected for generator output

 DO NOT exceed 50 W continuous RF power!

 Use caution when connecting high power transmitters!

- 8** **ANT**
Protected to 10 W in case of accidental connection to transmit power
Used for off-the-air monitoring

 DO NOT transmit RF into this connector!

- 9** **FLOPPY DISK DRIVE**
3½" floppy disk drive for copying data and program files to/from the 2975 system

- 10** **LCD**
Liquid Crystal Display

CONNECTORS (Rear Panel)

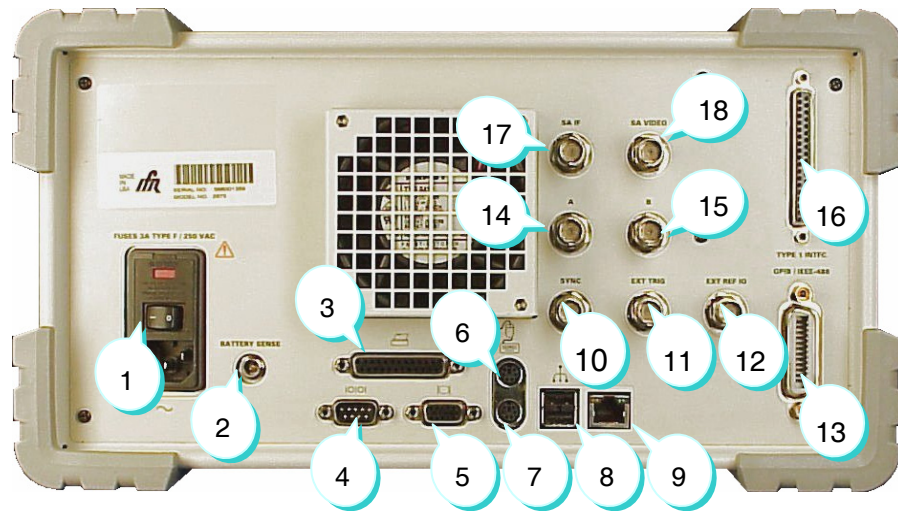

1

MAIN POWER SWITCH

System AC Input

2

BATTERY SENSE

Future Use

3

PARALLEL PORT

Future Use

Refer to Appendix A for Connector Pin-Out Table.

4

RS-232

Serial I/O Connection with the 2975

Refer to Appendix A for Connector Pin-Out Table.

5

VIDEO PORT

External VGA Monitor Port

Refer to Appendix A for Connector Pin-Out Table.

6

MOUSE

Control connection designed for PS-2 compatible mouse. Mouse controls cursor for point and click control of screen items in addition to front panel keyboard operation.

Refer to Appendix A for Connector Pin-Out Table.

7

KEYBOARD

Control connection designed for PS-2 compatible keyboard. Keyboard controls function of unit in addition to front panel keyboard operation.

Refer to Appendix A for Connector Pin-Out Table.

8

USB

Future use: Universal Serial Bus connection with the 2975

Refer to Appendix A for Connector Pin-Out Table.

- 9** **ETHERNET**
The Ethernet connection allows the 2975 to be configured as a computer on the network. The display and front panel keyboard can be routed to any other computer on that network allowing for complete remote control.
Refer to Appendix A for Connector Pin-Out Table.
- 10** **SYNC**
Future Use
- 11** **EXT TRIG**
External Oscilloscope Trigger
- 12** **EXTERNAL RF I/O**
10 MHz Timebase In and Out
- 13** **GPIB**
IEEE-488 Remote Control Interface
Refer to Appendix A for Connector Pin-Out Table.
- 14** **A**
Future Use
- 15** **B**
Future Use
- 16** **TYPE I INTERFACE**
Not Used
Refer to Appendix A for Connector Pin-Out Table.
- 17** **SPECTRUM ANALYZER IF**
Intermediate Frequency Output (10.7 MHz)
- 18** **SPECTRUM ANALYZER VIDEO**
Video Output (LOG Detector)

THIS PAGE INTENTIONALLY LEFT BLANK.

SECTION 2 - OPERATION

2-1 OPERATIONAL CONCEPTS

The 2975 is equipped with all of the tools required for the maintenance and calibration of FM, AM and Project 25 Radio Systems. These tools work together in harmony to easily accomplish routine tasks.

The 2975 is equipped with an IQ modulator and demodulator to handle the demands of digital communications systems. Digital IF and audio processing allow the 2975 to be configured as required through software changes for future upgrades. Hard drives and floppy drives provide vast storage capabilities for test setups and configurations.

Primary modes of operation for transceiver testing include:

- Generate (Receiver Test)
- Receive (Transmitter Test)
- Duplex (Transmitter / Receiver Test)
- Scope
- Spectrum Analyzer
- Function Generator

NOTE: Examples may reference optional modes of operation. Examples may also include screens containing tiles for optional modes of operation.

The 2975 operates continuously in Duplex mode with both the Generator and Receiver active. The Duplex, Generate and Receive modes offer a control panel for the Generator, the Receiver or both, along with empty screen space where additional monitor or control functions can be enabled.

Empty screen segments can be filled with any monitor or control function that is available for the actively displayed screen mode. Both Generate and Receive modes offer up to 6 free screen segments and Duplex mode offers 4. All monitor and control features require at least 1 segment each. The Scope and Spectrum Analyzer functions each require 2 screen segments. The Audio Analyzer option and some Trunking options functions also require 2 screen segments.

Monitor and control functions may be expanded into larger windows that allow access to all features of that function. The Scope and Spectrum Analyzer occupy the full screen when expanded.

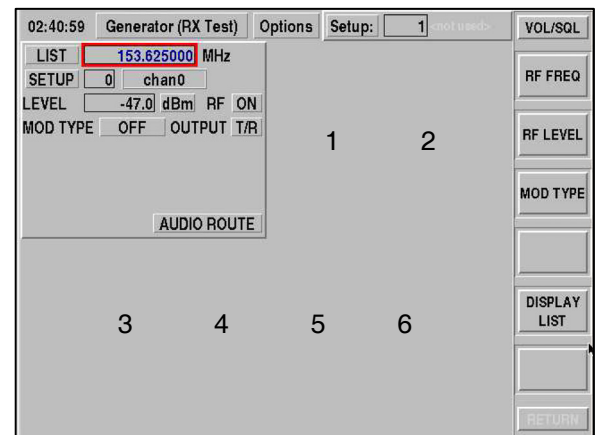
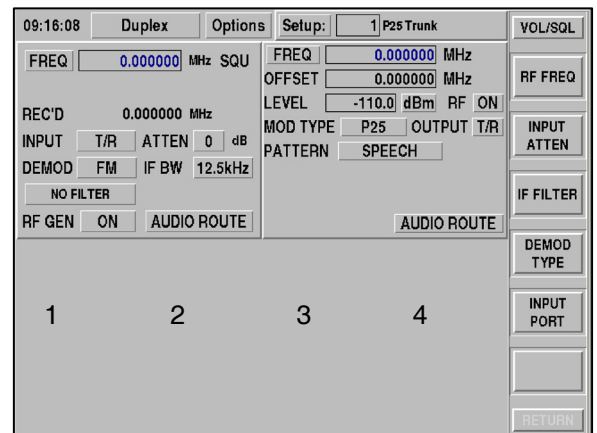

2-2 MONITOR AND CONTROL FUNCTIONS

The following monitor and control functions are available in various screen displays and can be placed in the numbered locations on the previous page.

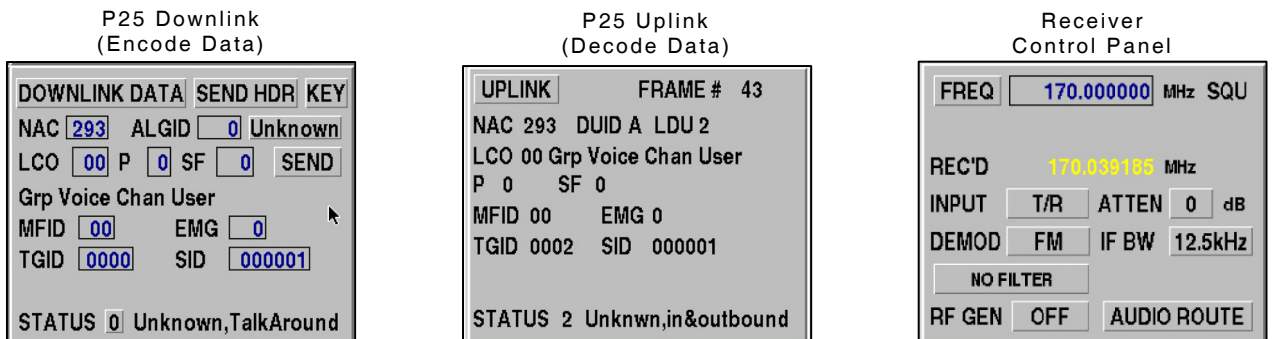
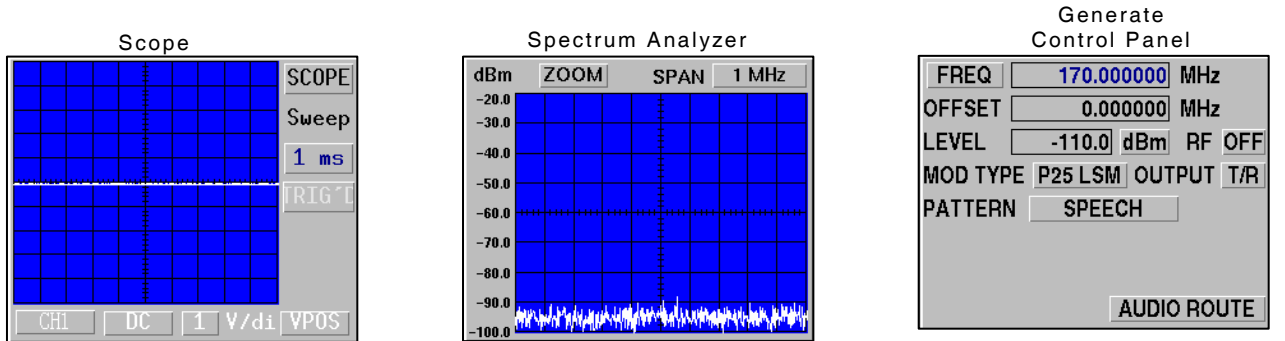
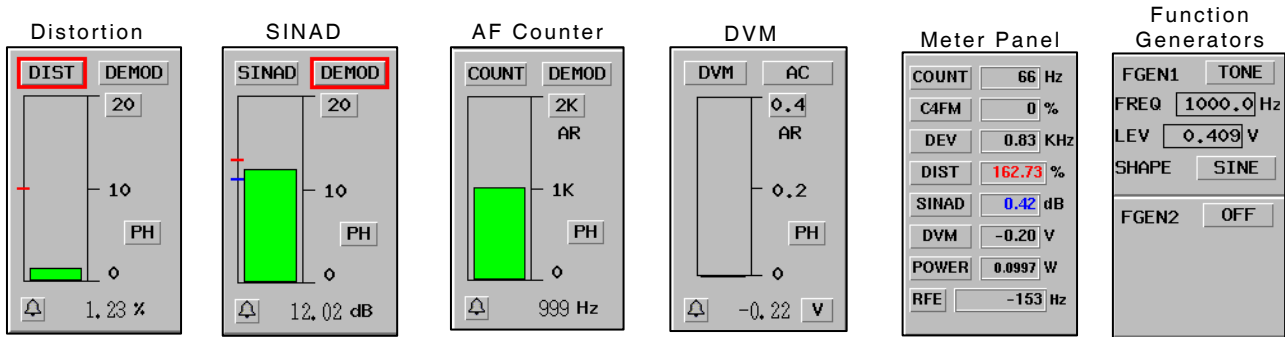
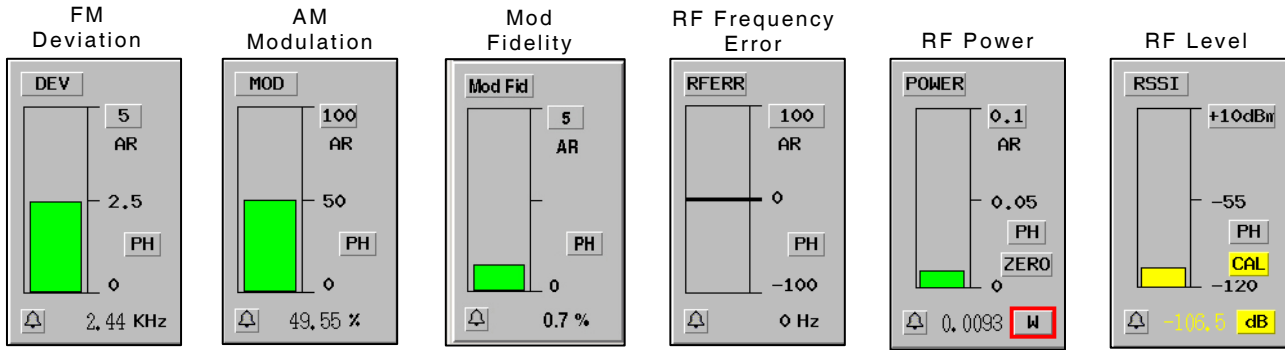

2-3 2975 OPERATION

USER SCREEN

The 2975 has a user configurable screen, allowing for the creation of customized test scenarios. Unlike other screens, such as Generator or Receiver, the User screen has **NO** preset tiles. The User screen can be set up to resemble other screens, or it may simply be set up for a single measurement.

The screen (to the right) shows the USER screen selections available on the 2975.

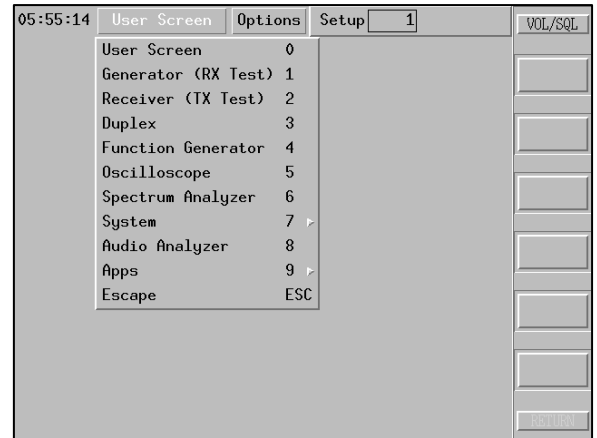

The screen (to the right) shows one example of how the User screen may be configured. This screen shows nine (9) meters, the Spectrum Analyzer with markers, the Oscilloscope, the I-Q constellation plot and the EVM function, all running simultaneously. The RF Generator and Receiver systems are operating, but not visible, permitting all the instruments to be displayed together.

NOTE: The I-Q Constellation plot and EVM function are optional features.

All instrument selections are available for use on the User screen using the **Options** selector located at the top of the screen.

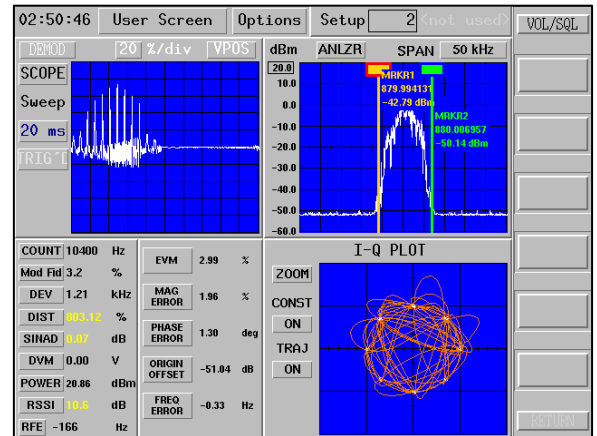

SELECTING OPERATION MODE

Pressing the [MODE] Key activates a pull down menu to allow access to available operating modes. Screen or mode selection can be made by pressing the associated menu selection number.

The 2975 offers the modes of operation displayed below:

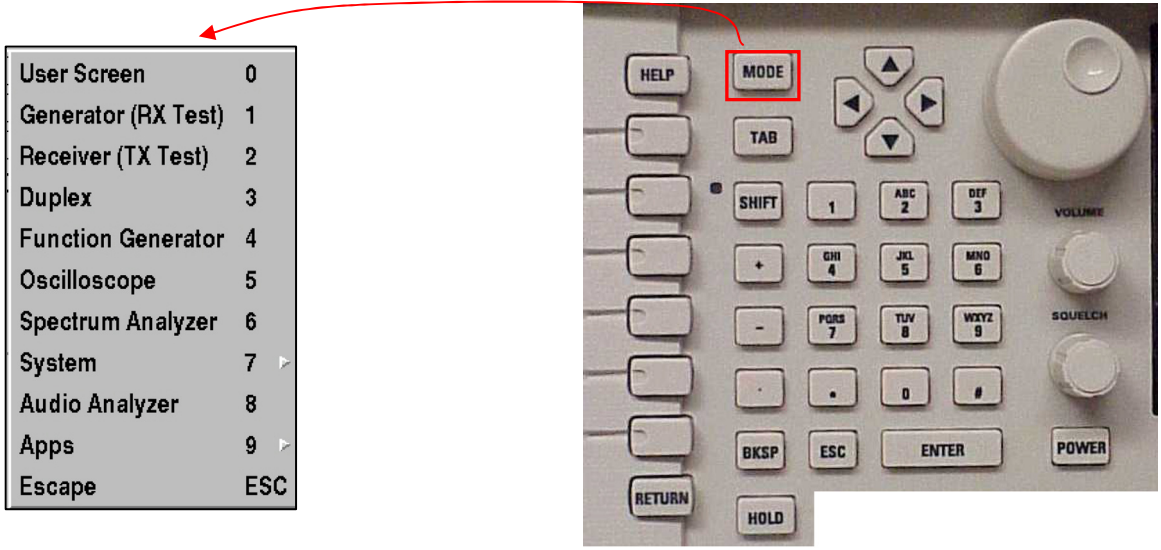

NOTE: Audio Analyzer is an optional mode.

The following key sequence could be used to select the **GENERATE** mode of operation:

[MODE]

[1]

If a mouse is connected to the 2975, click on the screen identifier label to access the pull down menu. Selection can be made by clicking on the desired mode of operation.

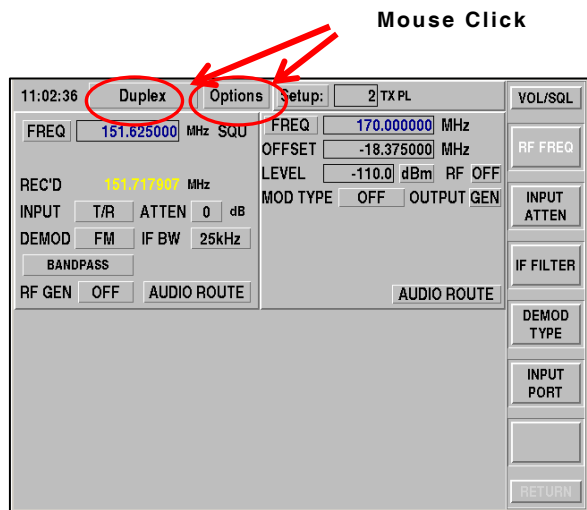

SELECTING OPTIONS

After an operational mode has been selected, the operator interface allows for screen reconfiguration. There are 6 definable segments available in the Generate mode. A bar graph meter takes up 1 segment. The Scope or Spectrum Analyzer requires 2 segments. There are more functions available than segments, so the operator has the ability to choose the functions that are to be displayed.

The Options menu is accessed by pressing **[SHIFT]** **[MODE]** or by clicking on the screen "options" tab. Pressing **[0]** **[1]** **[2]** **[3]** enables the first four items on the list. Pressing the **[RETURN]** key or selecting Accept Options configures the selected items onto the screen.

All other options should be turned OFF. An item is selected when the adjacent square is checked with a red square.

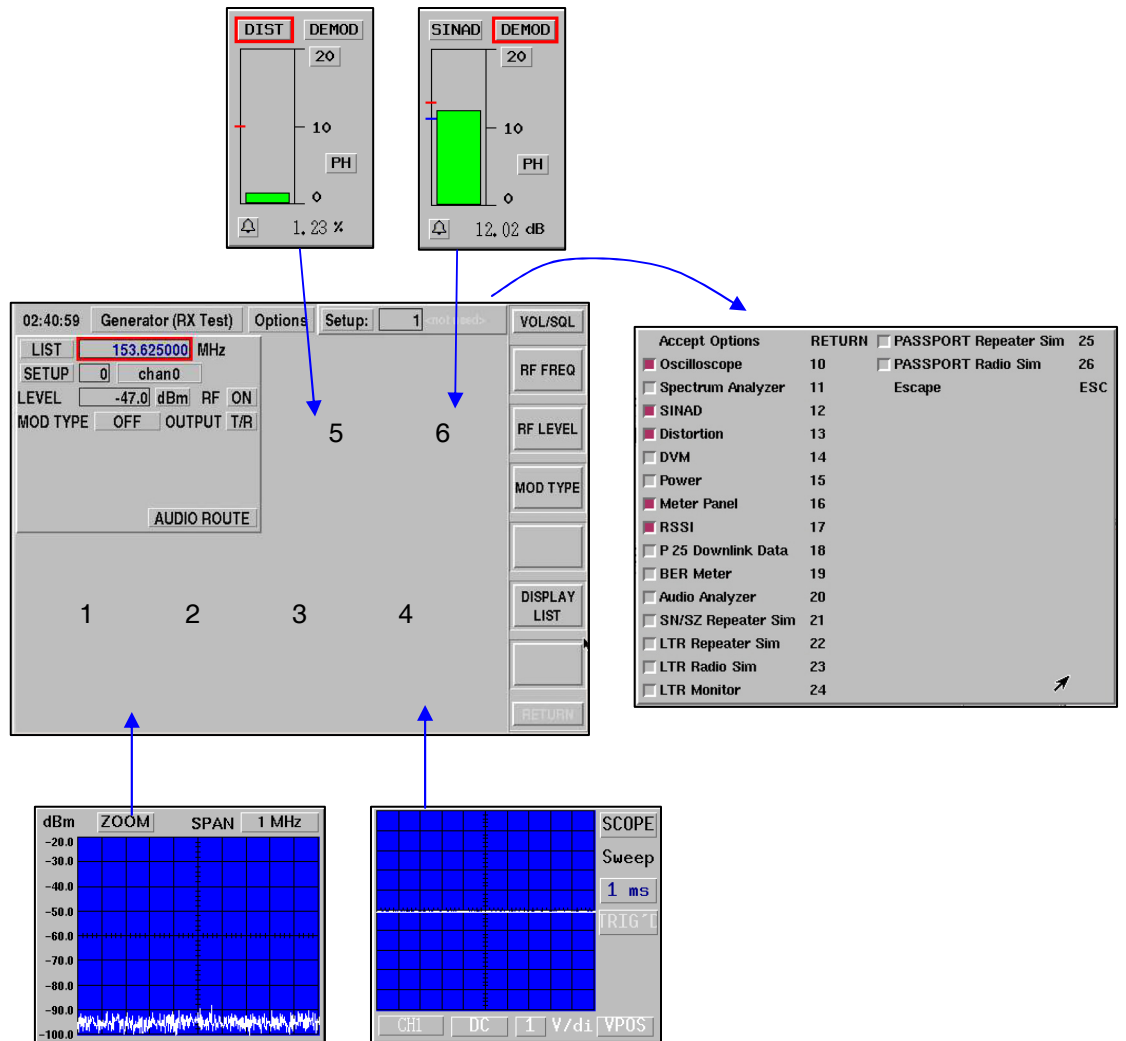

ZOOMING

The 2975 interface allows function tiles to be expanded to a larger scale, which also provides more controls for that function. A function can be expanded by positioning the cursor to a function label and pressing the **[ENTER]** Key. Some examples of this are shown in the Duplex mode below. The expanded function can be exited by pressing the **[RETURN]** Key.

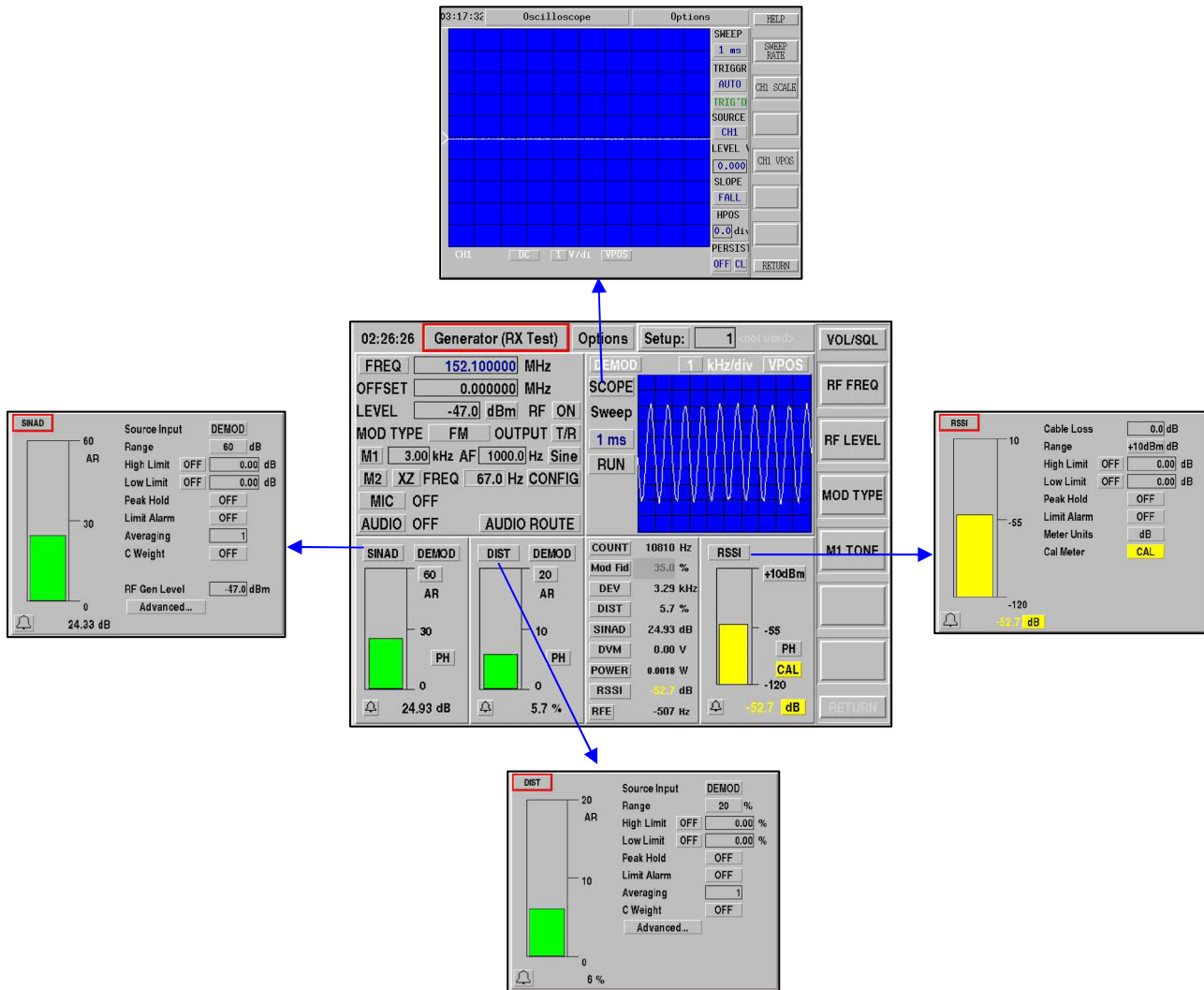

TONE SIGNALING DECODE

The 2975 has the ability to decode and display **DCS**, **DTMF** and **CTCSS** from a radio (off-air or direct RF connection).

The **Tone Signal Decode** is accessible from the Receiver or Duplex screen Options menu.

Tone Signal Decode 24 (number may vary)

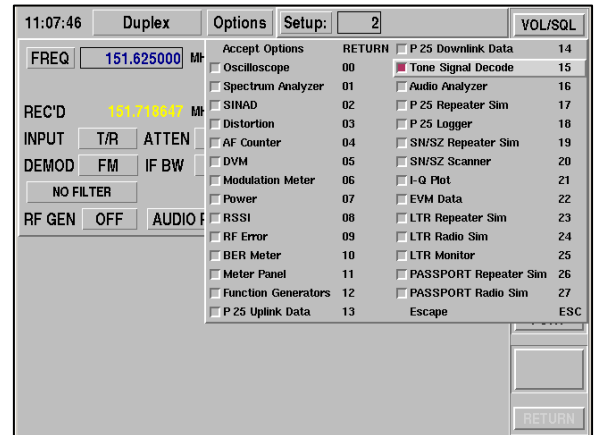

DCS (Digital Coded Squelch)

The **DCS Decode** is selected in the **Tone Signaling Decode** tile using the button in the upper right corner.

The **RECEIVED** code field indicates the 3-digit octal code decoded. This code may be an alternate (ALT) image to a valid DCS CODE.

The **DCS CODE** field is the 3-digit octal squelch code. This code is the value to reference as the DCS value.

The **INVERTED** field is the logical inversion of the **DCS CODE** value. This is provided as a convenience as some systems deviation is reversed in polarity, yielding the inverted code.

The **STATUS** field indicates the most recently received code is:

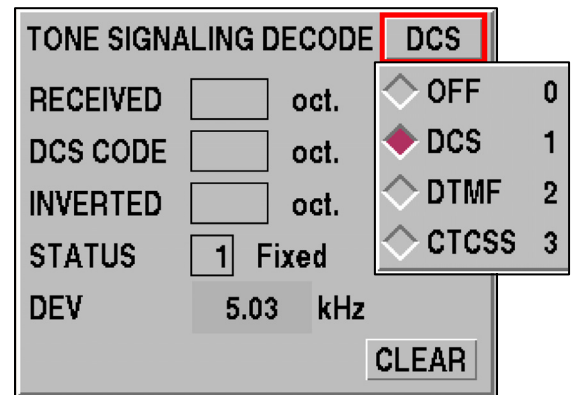

OK means the DCS code was received with no errors.

FIXED means the DCS code had an error, but the error was correctable. This occurs if the receive signal level is close to the noise floor or at higher receive signal levels if the UUT has a faulty encoder.

COULD NOT FIX means the DCS code had too many errors for correction (noise, no code or bad code).

The **CLEAR** button resets the DCS decoder and display fields to start a new set of readings.

The **DEV** Field indicates the deviation of the DCS signal.

DTMF (Dual-Tone, Multiple Frequency)

The **DTMF Decode** is selected from the **Tone Signaling Decode** tile using the button in the upper right corner.

The **DIGITS** field indicates the particular **DTMF** digit decoded. Digits range from 0 through 9, A, B, C, D, E, F, # or *.

The **STATUS** field indicates whether the most recently received DTMF digits are:

VALID means the DTMF digits are correct.

INVALID means the DTMF could not be detected (noise, wrong frequencies, etc.).

The **CLEAR** button resets the DTMF decoder and display fields to start a new set of readings.

The **DEV** field indicates the deviation of the DTMF signal.

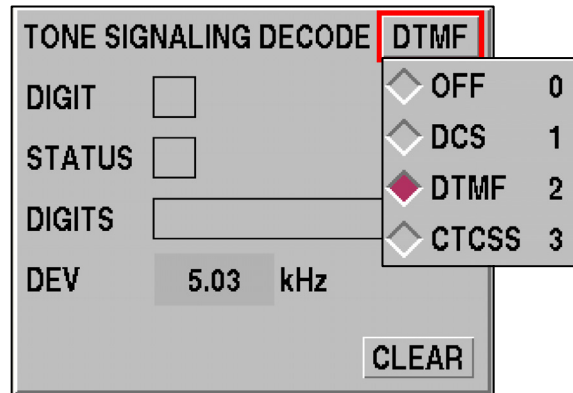

CTCSS (Continuous Tone Coded Squelch System)

The **CTCSS Decode** is selected from the **Tone Signaling Decode** tile using the button in the upper right corner.

The **FREQUENCY** field indicates the frequency of the received CTCSS code..

The **REED CODE** is the code designator assigned to the frequency of the CTCSS code.

The **TARGET FREQ** field indicates the targeted frequency.

The **ERROR** field indicates the difference between the **TARGET FREQUENCY** and the **FREQUENCY**.

The **DEV** field indicates the deviation of the CTCSS signal.

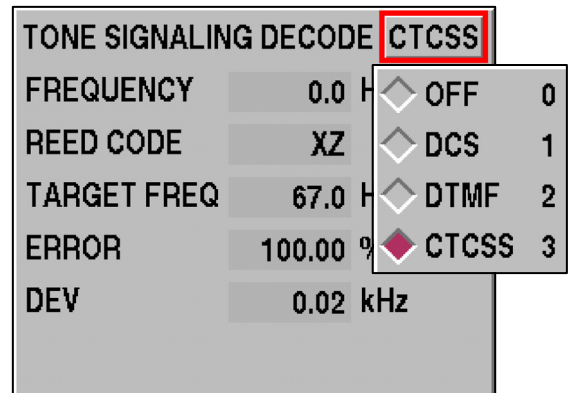

VOLUME AND SQUELCH CONTROLS

The 2975 has the ability to control the Volume and Squelch functions using the mouse, with the added benefit of observing the relative position of the knob settings.

When the **VOL/SQL** button (upper right corner of the screen) is pressed, using the mouse, or if either the **VOLUME** or **SQUELCH** control is turned, the Volume / Squelch sliders are displayed.

The 2975 also provides the user with the ability to turn the Volume Display Box ON/OFF. The **ON/OFF** button is accessed via the System Setup Screen [Mode],[7].

The Volume / Squelch sliders show a relative position number and sliding scale slider buttons. The left side is minimum volume and minimum squelch setting. The right side is maximum volume and maximum squelch setting.

The numbers indicate the relative value for the current position.

Volume range of values is 0 to 100 (left to right).

Squelch range of values is 821 to -140 (left to right).

As the corresponding knob is rotated, the value and slider moves to indicate the setting. Also, the mouse cursor may be placed on a slider, push and hold with mouse while moving the slider. Release at the desired setting.

After the knob motion or mouse movement stops for 5 seconds, the Volume / Squelch display pop-up disappears (hides).

RF GENERATOR ON/OFF CONTROL

The 2975 allows the user to control the RF Generator output (ON, OFF or PTT) from the Receiver tile.

This control allows users to turn the 2975 Generator ON and OFF while testing simplex radio systems, alleviating the need to switch between the Generator and Receiver screens.

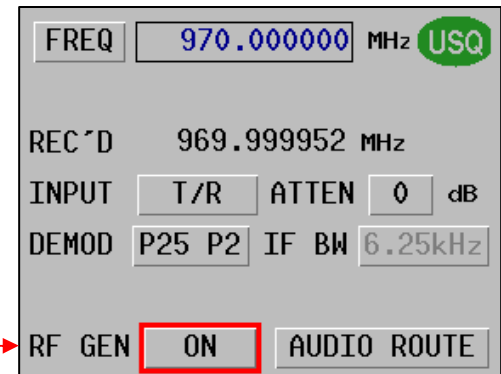
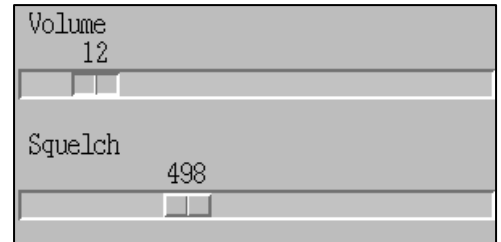
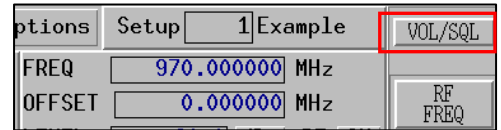

SETUP / RECALL

Fast Setup / Recall

The 2975 has a Fast Setup Recall function which allows users to quickly select and restore setups from any screen.

The Setup field is located on the top line of all screens. The number field shows the recall item number: the name assigned to the recall item is shown next to the number ("Example").

The Save/Recall screen example (to the right) (**MODE, 7, 6**) includes a FILE name, descriptive LABEL, DATE and DIRECTORY. The Save/Recall screen combines a directory listing of the setups and permits RECALL, SAVE, BACKUP and DELETE for stored items. The SAVE / RECALL may also be selected by pressing the SETUP button for quick access.

To recall a Setup, the mouse or keyboard may be used.

- Mouse recall requires clicking on the recall number field to select the field for numeric edit, and then pressing ENTER to recall. If the desired number is displayed, double-clicking the number recalls the setup.
- Keyboard recall is similar to Mouse recall. Move the cursor (RED BOX) to the Setup number field, enter the desired setup number and press ENTER.

When the RECALL SETUP softkey is pressed, the highlighted directory list item is restored and activated. If mouse operation is being used, simply double-click the desired directory list item to restore.

The SAVE SETUP softkey invokes a screen (to the right) to allow selection, naming and storage of Setups. A dropdown menu offers the user the option to save the Setups on an INTERNAL disk or FLOPPY or to store them in a subdirectory. The feature also allows Setups to be labeled with a descriptive title.

The BACKUP function allows users to save existing Setups to a floppy or restore backup Setups from a floppy.

NOTE: Standard Setups are embedded in the 2975 and may not be modified by the user.

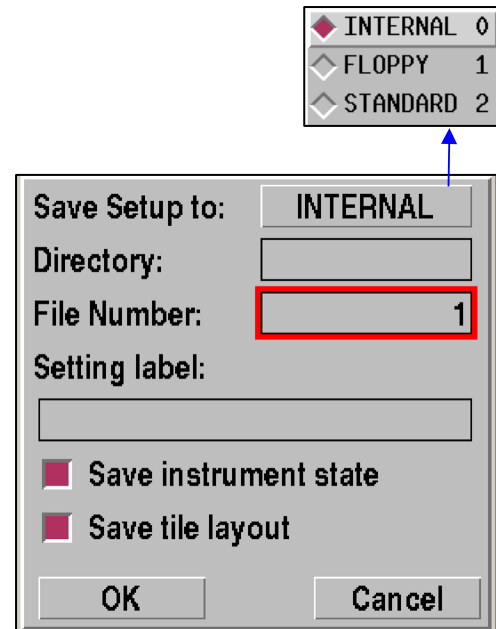
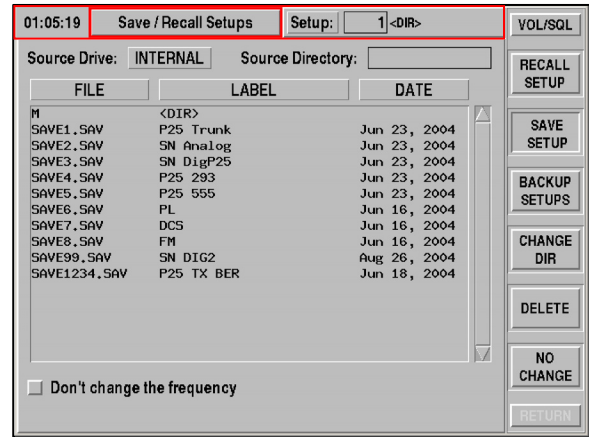

AUDIO ROUTE

The AUDIO ROUTE function is common to Function Generator Mode, Receiver Mode, and Generator Mode. This function provides the ability to route the DEMOD audio or a SQUELCH demod audio to the 2975 modulator.

The Modulator routing may be set to either of these sources. Selecting DEMOD or SQUELCH permits the demodulated audio to be looped back to the generate modulator in a repeater-type action. AUDIO ROUTE status is displayed in the Rx field of the M1 and M2 screens.

This function, available on the Audio Output ports, also allows for special tone conditioning.

DEMOD AUDIO, FGEN 1, FGEN 2, MIC In, and AUDIO IN functions allow for various signal routing configurations. The Output Filter and Output Level functions allow special signal conditioning to be performed. DEMOD AUDIO also allows the 2975's Receiver demod audio to be routed to AUDIO OUT 1, AUDIO OUT 2 or to the internal speaker.

FREQ	0.000000	MHz
OFFSET	170.000000	MHz
LEVEL	-110.0	dBm RF OFF
MOD TYPE	FM	OUTPUT GEN
M1	1050	SEND CONFIG
M2	OFF	
MIC	OFF	RX: OFF
AUDIO	OFF	AUDIO ROUTE

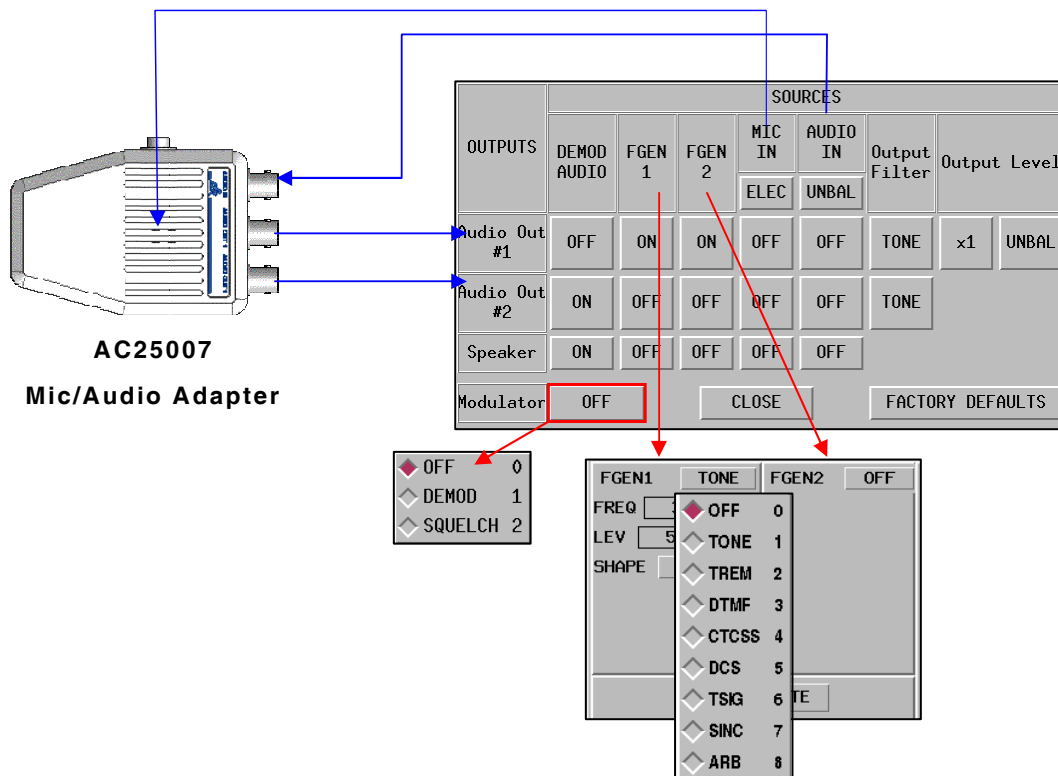

MIC Connector

PIN	SIGNAL
1	GND
2	GND
3	MIC+
4	PTT
5	DEMOD+
6	GND

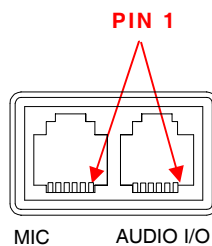

AUDIO I/O Connector

PIN	SIGNAL
1	SINAD+ (Audio Input)
2	SINAD- (Audio Input)
3	FGEN+ (Audio Output 1)
4	FGEN- (Audio Output 1)
5	DEMOD+ (Audio Output 2)
6	GND (Audio Output 2)

NETWORK CONNECTIVITY

Network connectivity features of the 2975 extend use and functionality. Network Connectivity options can be accessed through the CONFIGURATION screen (MODE, 7, 1). The CONFIGURATION screen allows the network items to be viewed and changed.

IP PARAMETER SETUP

The IP Address (ADDRESS field) is selectable between FIXED and DHCP (Dynamic Host Configuration Protocol) easing network installation. Whenever DHCP is selected, the 2975 negotiates an IP address with the network resource server and receives a valid address.

WEB SERVER SETUP

The 2975 has the ability to be accessed as a web server whenever installed onto a network. The WEB SERVER SETUP ENABLE/DISABLE set to ENABLE provides server functions; DISABLE halts the server functions.

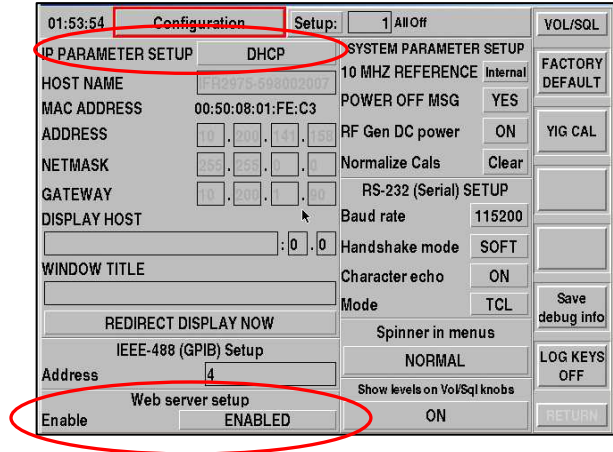

VOL/SQL WINDOW CONTROL

Selecting ON/OFF allows the user to display the VOLUME/SQUELCH Slider.

WEB SERVER USAGE

The screen below shows the 2975 web server page using a PC web browser. The URL (web address) shown is the IP address for the 2975, or the DNS name of the unit if your network administrator has assigned one. When the 2975 web server is accessed, this page is returned and updated at approximately 5 sec intervals, refreshing the 2975 settings and meters.

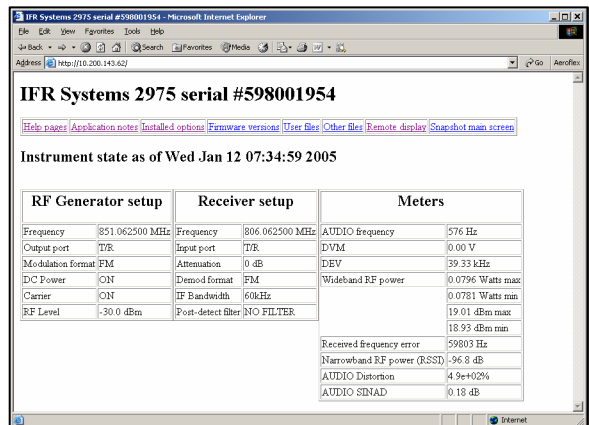

The various links provide access to the following information:

- **Help Pages.** This link accesses the HELP system within the 2975 for online descriptions for each screen and for various functions.

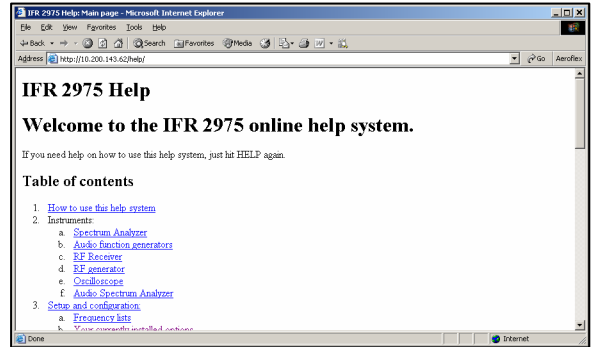

- **Application Notes.** This link provides access to the Application Notes and technical information stored within the 2975 for explaining how to use the 2975.

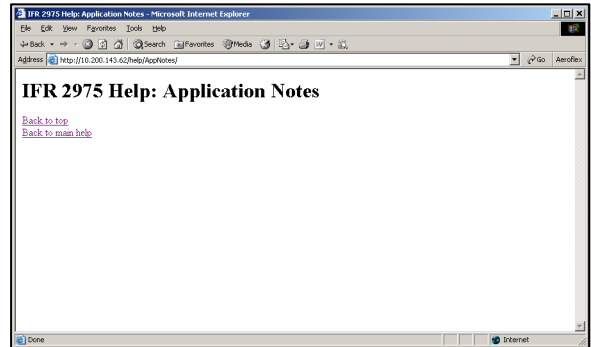

- **Installed Options.** This link displays the Option Status page within the 2975.

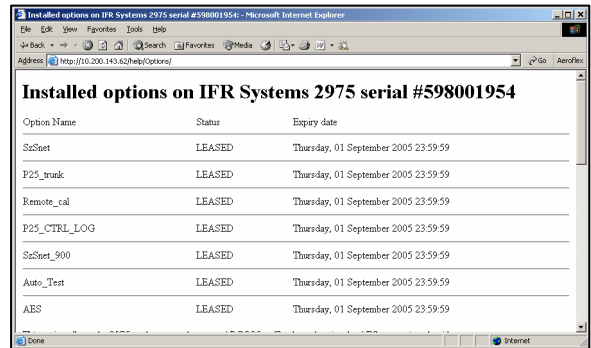

- **Firmware Versions.** This link displays the Firmware Status page within the 2975.

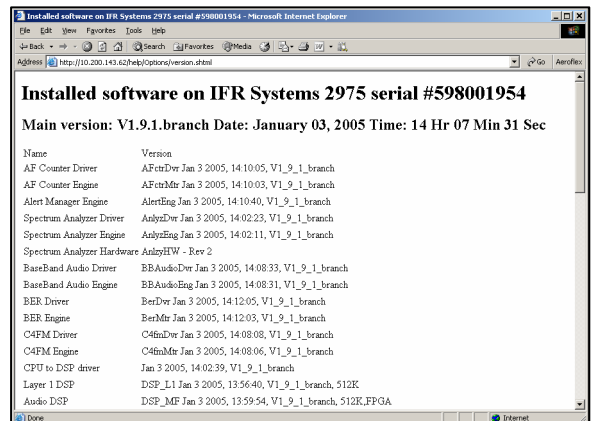

- **User Files.** This link provides access to User file storage areas within the 2975. The directories listed may be used to store information or provide access to system files, such as frequency lists and setups.

The two error log files (errorLog and errorLog.old) contain useful debug information in the event of error conditions. Files may be uploaded and downloaded from and to a computer.

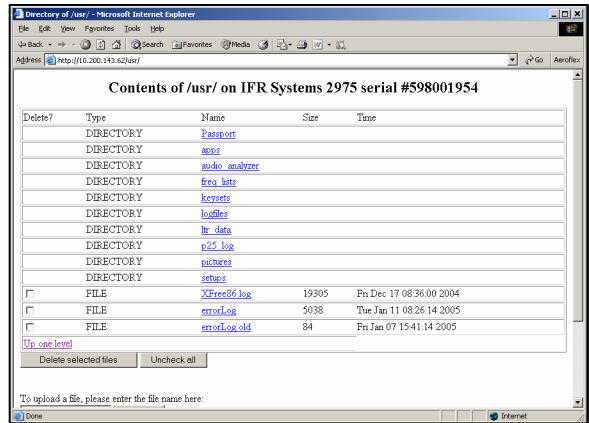

- **Other Files.** This link provides access to the 2975 Operation Manual and to the 2975 LabWindows® CVI driver. The Operation Manual is in Adobe® Acrobat format and the driver is in ZIP format.

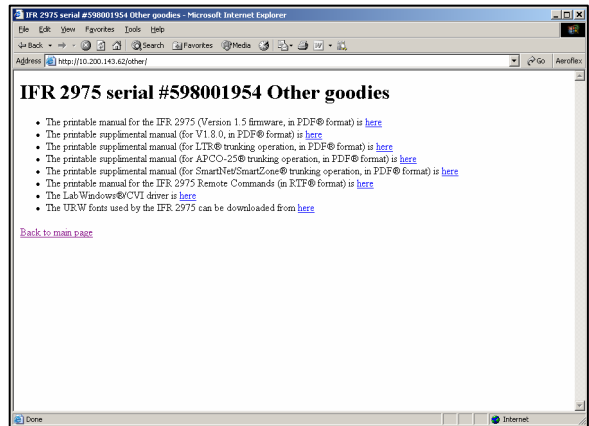

- **Remote Display.** This link provides a convenient means to run a remote 2975 display on a PC. The remote PC must run an X Windowing System and must grant the 2975 permission to use the X server. If the PC does not support X Windowing System, links to several X Windowing programs are included for reference and consideration.

When the Remote Display link is selected from the web browser screen the 2975 displays a small window indicating the remote display is being generated. When the remote display is acquired this window opens into the 2975 remote display screen.

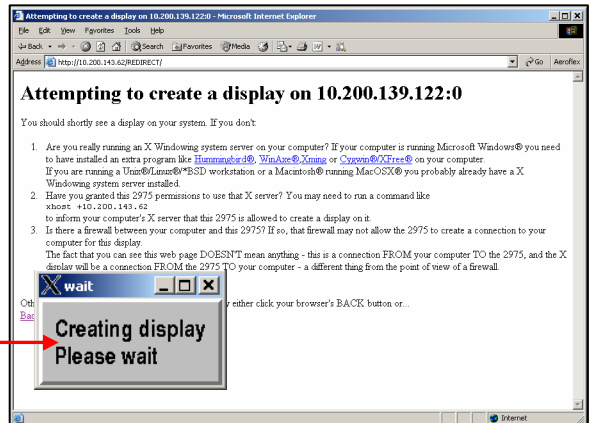

RECEIVER FIND FREQUENCY

The **FIND** command searches for an RF signal by starting at 0 MHz and progressively looks at the selected RF input for signals. If no signals are found, the original starting frequency is restored. If a signal is found, the 2975 stops at the new frequency.

The **FIND NEXT** command searches for an RF signal beginning at the currently selected frequency and looks for the signals higher in frequency from this point. This is useful for finding harmonics of a transmitter.

The **FINE TUNE** command searches for an RF signal "near" the currently selected frequency (within the selected IF bandwidth) and adjusts the receiver frequency for the lowest measured RF error. This is useful after finding a signal and the FIND result is slightly off-frequency.

◆	FREQ	0
◇	INCR	1
◇	SCAN	2
◇	LIST	3
	Find	4
	Find Next	5
	Fine Tune	6

Important considerations for FIND functions:

- If the RF signal is too low for an accurate frequency count, the receiver frequency is not changed.
- If the RF signal is being modulated, there is some residual frequency error after the fine tune operation; a modulated signal is a moving target.
- The transmitter should be directly connected to the 2975; off-the-air reception may be confused by other RF signals being received.
- The signal to be found should be at least 30 dB above the noise floor of the 2975. Depending upon input selection (ANT or T/R) and attenuation settings, this can range from about -50 dBm (Antenna, 0 dB attenuation) to +10 dBm (T/R, 40 dB attenuation). In general, the signal should be 30 dB above the noise floor of the spectrum analyzer in 5 MHz span mode.

DEMOD FILTER

The **DEMOD FILTER** within the 2975 Receiver tile has been enhanced to add **APCO-25** filter as a selection.

This filter is the same as used by APCO-25 radios utilizing C4FM modulation. The plot display (to the right) shows the APCO-25 filter response while using the Audio Analyzer Option.

◇	NO FILTER	00	◇	300 Hz - 4 kHz BP	07
◇	300 Hz HP	01	◇	4 kHz BUTTERWORTH LP	08
◇	300 Hz LP	02	◇	80 Hz NARROW BP	09
◇	4 kHz BESSEL LP	03	◇	3 kHz NARROW BP	10
◇	15 kHz LP	04	◆	APCO-25	11
◇	20 kHz LP	05			
◇	4 kHz HP	06			

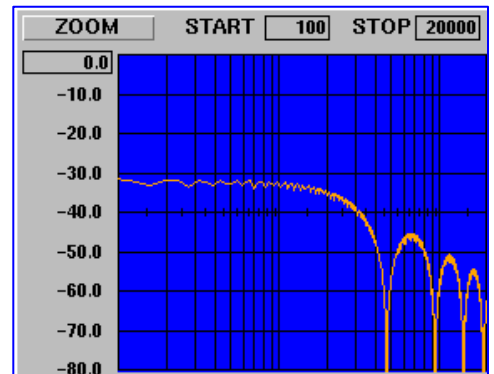

P25 UPLINK DATA TILE

The 2975 P25 Uplink Data feature allows users to monitor P25 Uplink Data. The fields displayed on the Uplink Data tile are display only fields and can not be edited by user.

The P25 Uplink Data tile can be enabled when the 2975 is operating in Duplex Mode (as shown in the following examples), Receiver (Tx Test) Mode or when the user Screen is selected.

The P25 Uplink Data Tile updates automatically to display the proper data sent by the radio. When individual messages are sent this tile periodically switches to display individual messages, before reverting back to the radio's continuous mode of operation. For example, LCO's 00, 03 and 06 are continuously sent LCO's which designate call types so these messages continuously send messages to transfer voice data.

Occasionally control messages are sent interspersed within the voice data messages. The control messages are only visible for a moment before the LCO decode reverts back to the voice data messages.

The following field definitions are for a Group voice channel user. Refer to TIA/EIA-102.BAAA, "Link Control Word Formats and Messages" for more information about LCO configurations.

FIELD DEFINITIONS

UPLINK

The **UPLINK** button expands the Uplink Data tile to provide more detail of the received P25 data.

FRAME

This field displays the frame number of the P25 Uplink Data stream.

NAC

This field displays the Network Access Code of the P25 Uplink Data stream.

DUID

This field displays the Data Unit ID in the P25 Uplink Data stream.

LDU

This field displays the Logic Link Data Unit in the P25 Uplink data stream.

LCO

This field displays the Link Control Opcode in the P25 Uplink Data stream.

P

This field displays the Protected flag value in the P25 Uplink Data stream.

SF

This field displays the State Flag value in the P25 Uplink Data stream.

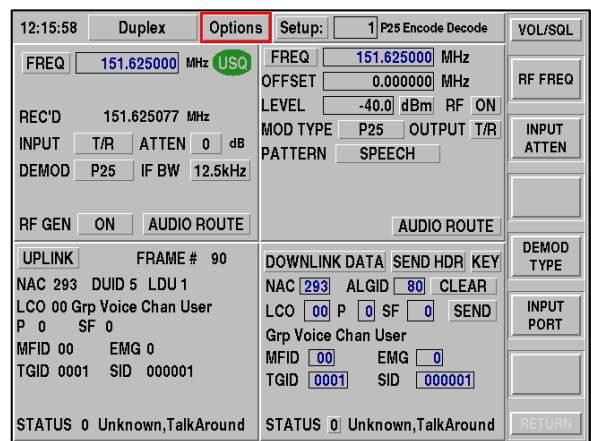
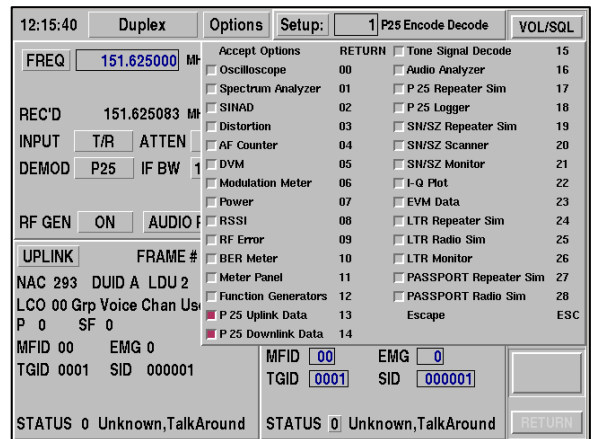

MFID

This field displays the Manufacturer Identifier in the header of the P25 Uplink data stream.

EMG

This field displays the Emergency value in the P25 Uplink data stream.

TGID

This field displays the Talk Group Identifier value in the header of the P25 Uplink data stream.

SID

This field displays the Source Address Identifier in the P25 Uplink data stream.

STATUS

This field displays the current P25 Uplink status message. A text description of the status value is displayed to the right of this field.

EXPANDED UPLINK DATA TILE

MFID

This field displays the Manufacturer Identifier in the header of the P25 Uplink data stream.

ALGID

This field displays the Algorithm Identifier in the header of the P25 Uplink data stream.

TGID

This field displays the Talk Group Identifier in the header of the P25 Uplink data stream.

KEY ID

This field displays the Key Identifier in the header of the P25 Uplink data stream.

MI

This displays the Message Identifier in the header of the P25 Uplink data stream.

VOICE FRAMES

NAC

This field displays the Network Access Code in the P25 Uplink data stream.

DATA UNIT ID

This field displays the Data Unit Identifier in the P25 Uplink data stream.

LDU

This field indicates the Logical Link Data Unit value in the P25 Uplink data stream.

12:16:28	Duplex	Options	Setup: 1	P25 Encode Decode	VOL/SQL						
FREQ	151.625000	MHz	USQ	FREQ	151.625000	MHz					
REC'D	151.625065	MHz	OFFSET	0.000000	MHz	RF FREQ					
INPUT	T/R	ATTEN	0	dB	LEVEL	-40.0	dBm	RF	ON	INPUT	ATTEN
DEMOD	P25	IF BW	12.5kHz	MOD TYPE	P25	OUTPUT	T/R	PATTERN	SPEECH	DEMOD	TYPE
RF GEN	ON	AUDIO ROUTE	AUDIO ROUTE	UPLINK	FRAME #	174	DOWNLINK DATA	SEND HDR	KEY	INPUT	PORT
NAC	293	DUID	5	LDU	1	NAC	293	ALGID	80	CLEAR	SEND
LCO	00	Grp	Voice Chan	User	P	0	SF	0	STATUS	0	Unknown, TalkAround
MFID	00	EMG	0	TGID	0001	SID	000001	STATUS	0	Unknown, TalkAround	RETURN

HEADER WORD	FRAME #	134							
MFID	00	ALGID	00	TGID	0000				
KEY ID	0000	MI	000000000000000000						
VOICE FRAMES	NAC	293	DATA UNIT ID	5	LDU	1			
LINK CONTROL	RAW	00	00	00	00	01	00	00	01
LCO	00	Group	Voice Channel	User	P	0	SF	0	
MFID	00	EMG	0	TGID	0001	SID	000001		
ESDATA:	KID	0000	ALGID	80	MI	000000000000000000			
LSD	00000000	STATUS SYM	0	Unknown, for talk-around					

LINK CONTROL

RAW

This field displays the raw hexadecimal values in the P25 Uplink data stream.

LCO

This field displays the Link Control Opcode in the P25 Uplink data stream.

P

This field displays the Protected flag value in the P25 Uplink data stream.

SF

This field displays the SF value in the P25 Uplink data stream.

MFID

This field displays the Manufacturer Identifier in the P25 Uplink data stream.

TGID

This field displays the Talk Group Identifier in the P25 Uplink data stream.

SID

This field displays the System Identifier in the P25 Uplink data stream.

ES DATA (Encryption Synchronization)

KID

This field displays the Key Identifier in the Encryption Synchronization Data of the P25 Uplink data stream.

ALGID

This field displays the Algorithm Identifier in the Encryption Synchronization Data of the P25 Uplink data stream.

MI

This field displays the Message Identifier in the Encryption Synchronization Data of the P25 Uplink data stream.

LSD

This field displays the Low Speed Data value in the P25 Uplink data stream.

STATUS SYM

This value displays the P25 Uplink status message. A text description of the status value is displayed to the right of this field.

HEADER WORD	FRAME # 134	
MFID 00	ALGID 00	TGID 0000
KEY ID 0000	MI 00000000000000000000	
VOICE FRAMES		
NAC 293	DATA UNIT ID 5	LDU 1
LINK CONTROL		
RAW	00 00 00 00 00 01 00 00 01	
LCO	00	Group Voice Channel User
P	0	SF 0
MFID	00	EMG 0
TGID	0001	SID 000001
ES DATA: KID 0000 ALGID 80		
MI 00000000000000000000		
LSD 00000000		
STATUS SYM 0 Unknown, for talk-around		

P25 DOWNLINK DATA

The P25 Downlink Data tile provided users with the ability to configure P25 Downlink Data.

The P25 Downlink Data tile can be enabled when the 2975 is operating in Duplex Mode (as shown in the following examples) or in Generate (Rx Test) Mode, or when User Screen is selected.

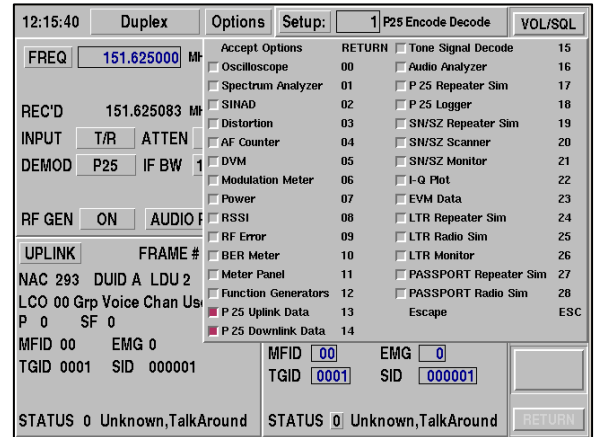

FIELD DEFINITIONS

DOWNLINK DATA

The **DOWNLINK** button expands the Downlink Data tile to provide more detail of the received P25 data.

SEND HEADER

Selecting this toggle button stops the current P25 downlink data stream and sends a new data stream with a header containing displayed information.

KEY / LOAD KEYS

Selecting this button displays the Key Management Dialogue screen. This button is only enabled when P25 KEYLOADER (2975OPT12) is installed.

NAC

This field displays the Network Access Code in the P25 Downlink Data stream.

ALGID

This field displays the Algorithmic Identifier in the header of the P25 Downlink data stream. User may edit field to define this ALGID value.

AES / DES / CLEAR

Advanced Encryption is available only when AES (2975OPT10) is installed in the 2975. User may select AES, however, data encryption does not occur if the AES option is not installed. Data is transmitted as CLEAR (not encrypted).

LCO

This field displays the Link Control Opcode present in the P25 Downlink Data stream. User may edit field to define this value. A text description of the LCO message is displayed below this field.

P

This field displays the Protected Flag value present in the P25 Downlink data stream. User may edit field to define this value.

SF

This field displays the State Flag value present in the P25 Downlink data stream. User may edit field to define this value.

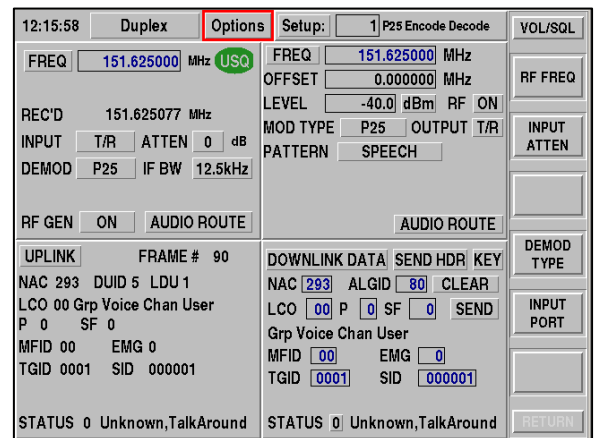

SEND

Selecting this button sends the currently displayed LCO message. After this message is sent the data stream defaults to sending either Group (LCO 00), Unit to Unit (LCO 03) or Telephone Voice (LCO 06) messages according to how the call was configured prior to being sent. LCO's 00, 03 and 06 are sent continuously unless the SEND button sends a particular message or changes the call type.

MFID

This field displays the Manufacturer Identifier in the header of the P25 Downlink data stream. User may edit field to define this value.

EMG

This field displays the Emergency value present in the P25 Downlink data stream. User may edit field to define this value.

TGID

This field displays the Targeted Group Identifier in the P25 Downlink data stream. User may edit field to define this value.

SID

This field displays the Source Address Identifier present in the P25 Downlink data stream. User may edit field to define this value.

STATUS

This field displays the current P25 Downlink status message. User may select this field to set the status. A text description of the status value is displayed to the right of this field.

EXPANDED DOWNLINK DATA TILE

MFID

This field displays the Manufacturer Identifier in the header of the P25 Downlink data stream. User may edit field to define this value.

ALGID

This field displays the Algorithmic Identifier in the header of the P25 Downlink data stream. User may edit field to define this value.

AES / DES / CLEAR

Advanced Encryption is available only when AES (2975OPT10) is installed in the 2975. User may select AES, however, data encryption does not occur unless the AES option is not installed. Data is transmitted as CLEAR (not encrypted). Reference 2975 Operation Manual for description regarding use of this option.

TGID

This field displays the Targeted Group Identifier in the header of the P25 Downlink data stream. User may edit field to define this value.

KEY ID

This field displays the Key Identifier in the header of the P25 Downlink data stream. User may edit field to define this value.

12:17:03 Duplex Options Setup: 1 P25 Encode Decode VOL/SQL

FREQ 151.625000 MHz USQ

REC'D 151.625065 MHz

INPUT T/R ATTN 0 dB

DEMOD P25 IF BW 12.5kHz

RF GEN ON AUDIO ROUTE

UPLINK FRAME # 271

NAC 293 DUID A LDU 2

LCO 00 Grp Voice Chan User

P 0 SF 0

Grp Voice Chan User

MFID 00 EMG 0

TGID 0001 SID 000001

STATUS 0 Unknown,TalkAround

FREQ 151.625000 MHz

OFFSET 0.000000 MHz

LEVEL -40.0 dBm RF ON

MOD TYPE P25 OUTPUT T/R

PATTERN SPEECH

RF FREQ

INPUT ATTN

AUDIO ROUTE

DEMOD TYPE

INPUT PORT

RETURN

DOWNLINK DATA SEND HDR KEY

NAC 293 ALGID 80 CLEAR

LCO 00 P 0 SF 0 SEND

Grp Voice Chan User

MFID 00 EMG 0

TGID 0001 SID 000001

HEADER WORD SEND HEADER LOAD KEYS

MFID 00 ALGID 80 CLEAR

TGID 0001 KEY ID 0000

VOICE FRAMES

NAC 293

LINK CONTROL

RAW 00 00 00 00 00 01 00 00 01

LCO 00 P 0 SF 0 SEND

Grp Voice Chan User

MFID 00 EMG 0

TGID 0001 SID 000001

LSD 0000 0000

STATUS SYM 0 Unknown, for talk-around

MODE MANUAL LOAD

KEYID 0000hex ALGID DES FORMAT TEK

SIZE 64bits SLN / CKR 10

NAME (opt.)

KEY ***** hex

ADD KEY DELETE KEY

KEYID(hex)	ALGID(hex)	FORMT	NAME	SLN
0000	81 (DES)	TEK	DES_Testkey	1
0000	84 (DES)	TEK	DES_Testkey	2
50BC	81 (DES)	KEK	TIR/EIR KEK	65261

ZEROIZE SAVE RECALL DEFAULTS

USE KEYS CANCEL

NAC

This field displays the Network Access Code in the P25 Downlink Data stream.

LINK CONTROL

RAW

This field displays the raw hexadecimal values present in the P25 Downlink data stream.

LCO

This field displays the Link Control Opcode present in the header of the P25 Downlink Data stream. User may edit field to define this value. A text description of the LCO message is displayed below this field.

P

This field displays the Protected Flag value present in the P25 Downlink data stream. User may edit field to define this value.

SF

This field displays the State Flag value present in the P25 Downlink data stream. User may edit field to define this value.

SEND

Selecting this button sends the currently displayed LCO message. After this message is sent the data stream defaults to sending "LCO 00" messages.

MFID

This field displays the Manufacturer Identifier in the P25 Downlink data stream. User may edit field to define this value.

EMG

This field displays the Emergency value present in the P25 Downlink data stream. User may edit field to define this value.

TGID

This field displays the Targeted Group Identifier in the P25 Downlink data stream. User may edit field to define this value.

SID

This field displays the Source Address Identifier present in the P25 Downlink data stream. User may edit field to define this value.

LSD

The LSD field on the left displays the upper 16 bits of Low Speed Data. The LSD field on the right displays the lower 16 bits of Lows Speed Data. User may edit both of these fields to define these values.

STATUS SYM

This field displays the current P25 Downlink status message. User may select this field to set the status. A text description of the status value is displayed to the right of this field.

HEADER WORD	SEND HEADER	LOAD KEYS
MFID	00	ALGID 80 CLEAR
TGID	0001	KEY ID 0000
VOICE FRAMES		
NAC 293		
LINK CONTROL		
RAW 00 00 00 00 00 01 00 00 01		
LCO	00	P 0 SF 0 SEND
Grp Voice Chan User		
MFID	00	EMG 0
TGID	0001	SID 000001
LSD 0000 0000		
STATUS SYM	0	Unknown, for talk-around

2-4 OPERATION MODES

GENERATOR MODE

The Generate mode allows testing of Analog FM, AM or Digital P25 Receivers. To access the Generate mode, use the following key sequence:

[MODE] Key

[1] Key

FIELD DEFINITIONS

FREQUENCY ENTRY

Allows entry of the receiver channel frequency in MHz. Using the rotary knob, position the cursor on the frequency field. A new frequency can be entered directly through the numeric keypad and terminated by pressing the [ENTER] Key. To edit an existing frequency, press the [ENTER] Key to highlight the existing frequency, then use the left or right arrow keys to position a cursor to the digit to edit. Using the up or down arrow keys or the rotary knob increments/ decrements the current value. Frequency values ranging from 0 to 2800 MHz can be made with 1 Hz resolution.

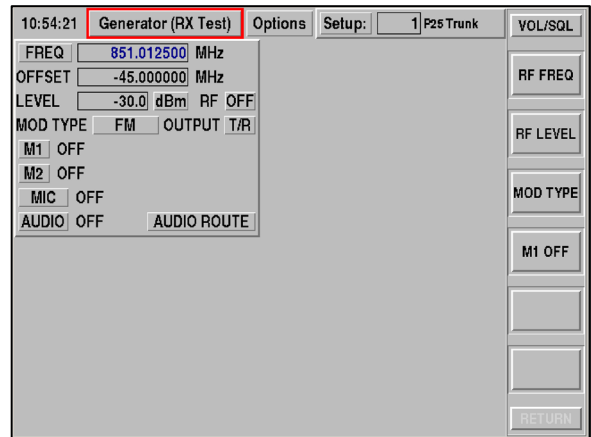

FREQUENCY LABEL

INCR

Allows entry of a frequency increment value. When in Generator mode of operation, the frequency can be set with the frequency field and then adjusted by the defined increment value through the use of the side function keys.

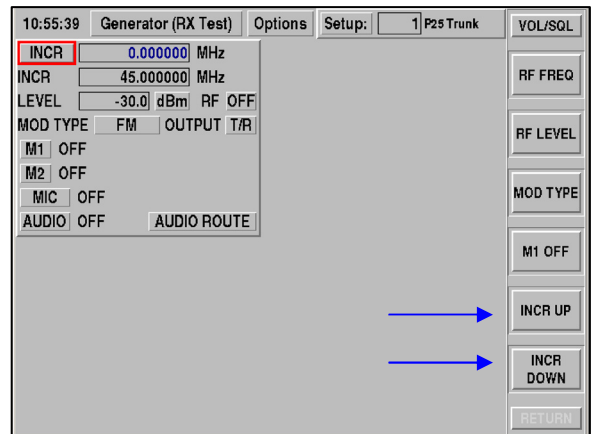

SWEEP

Allows entry of a start and stop frequency with increment for swept RF measurements. Select **SETUP** to configure the sweep parameters. To begin the sweep, press function key labeled **START SWEEP**.

The frequency sweep begins with the **START** frequency and increments by the value defined in the **INCR** field value, after delaying the number of seconds that have been specified in the **RATE** field. The sweep continues until the **STOP** frequency is reached and the sweep starts over. Once the sweep has started, function keys allow for **STOP SWEEP** or **PAUSE SWEEP**.

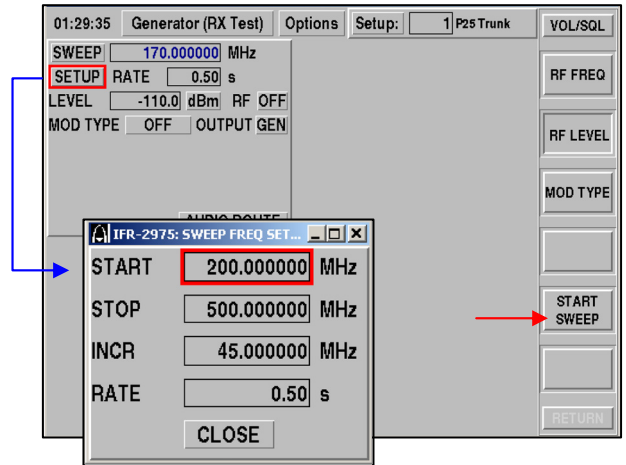

LIST

Allows frequencies to be selected from a pre-programmed list. The frequency list box allows entry of up to 300 generate and receive frequencies. Frequencies are selected by entry of the list index value associated with the frequencies in the list. The list can be auto-filled by entering a base frequency in the **REC FREQ** field and an increment value. The list is filled automatically by activating the **FILL LIST** function which is accessed from the **SETUP** key. Each frequency pair has a default label that may be changed to better identify the frequency pair.

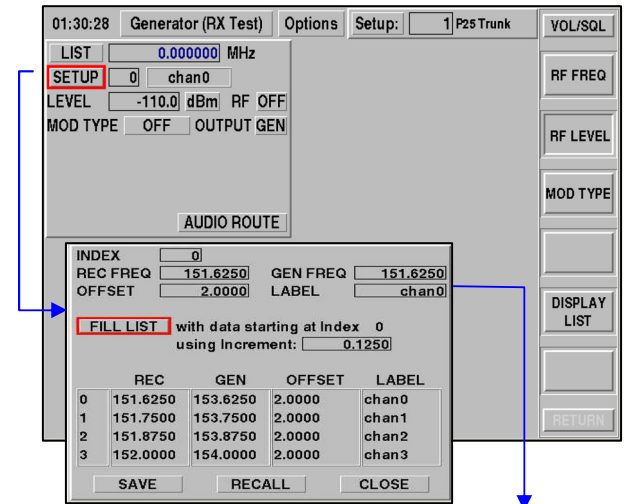

LEVEL

This field changes the RF Output level that appears at either the T/R or GEN Port. Units can be selected to be dBm, mV or μ V. Output level range varies with output port selection.

GEN Port: +10 to -110 dBm

TR Port: -30 to -137 dBm

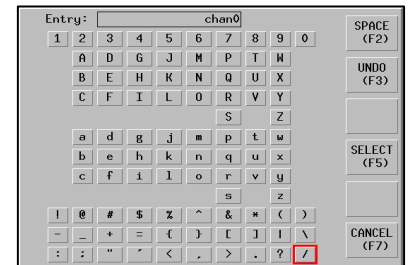

RF GENERATOR ON/OFF CONTROL

The 2975 has the capability to control the RF Generator output (**ON**, **OFF** or **PTT**) from the Receiver tile and from the PTT.

This control allows users to turn the 2975 Generator **ON** and **OFF** while testing simplex radio systems, alleviating the need to switch between the Generator and Receiver screens.

NOTE: This may need to be turned **OFF** if working with simplex systems prior to entering the Receive mode of operation. The 2975 can monitor its own output signal if both input and output ports are selected to be the TR Port.

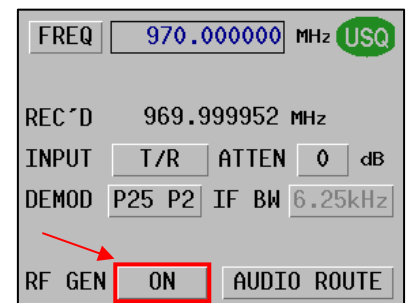

MOD TYPE

Select FM or AM mode for testing radios in the Analog mode. Select P25 or P25 Encrypted for testing Project 25 radios in the Digital mode.

NOTE: To test P25 Digital radio's the TGID, SID and NAC settings must be configured in the Project 25 Downlink window available from the Options Menu.

OFF

Allows CW signal generator operation when no modulation source is desired.

P 25

Configures Project 25 modulation type without encryption. With P25 selected, a **PATTERN** field becomes available to allow selection of the P25 waveform.

1011 - A defined bit pattern, which when decoded, sounds like the traditional 1 kHz (1011 Hz) tone. This pattern is normally used to perform BER tests on a receiver. This pattern may have the **NAC**, **TGID** and **SID** modified to accommodate the system under test.

CALIBRATION - A defined bit pattern representing the 1011 tone as above, but with a 5% BER added. A P25 receiver should be able to decode this pattern successfully with a strong receive RF level. This pattern may have the **NAC**, **TGID** and **SID** modified to accommodate the system under test.

SILENCE - A defined bit pattern, which when decoded, produces no sound (silence) on the receiver audio. This pattern may have the **NAC**, **TGID** and **SID** modified to accommodate the system under test.

SPEECH - Embedded Speech patterns that repeat the following phrases:

“These shoes were black and brown”

“They took the cross town bus”

“Don't throw trash on the street”

The **SPEECH** pattern is used for testing repeater sensitivity without the use of other external equipment. This pattern may be encrypted. This pattern may have the **NAC**, **TGID** and **SID** modified to accommodate the system under test.

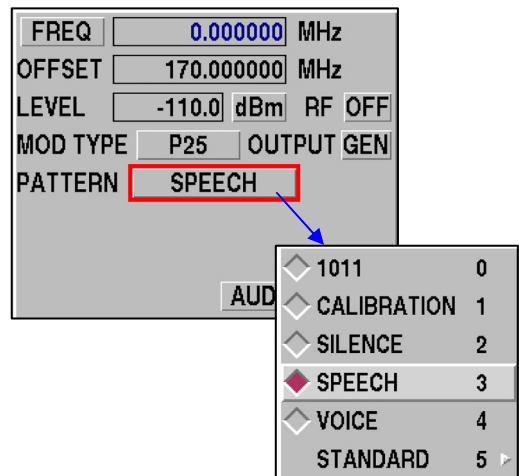
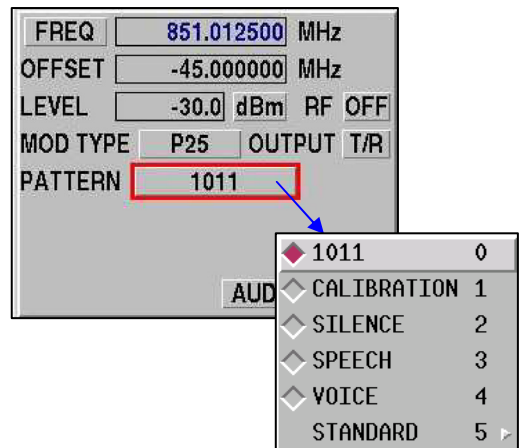
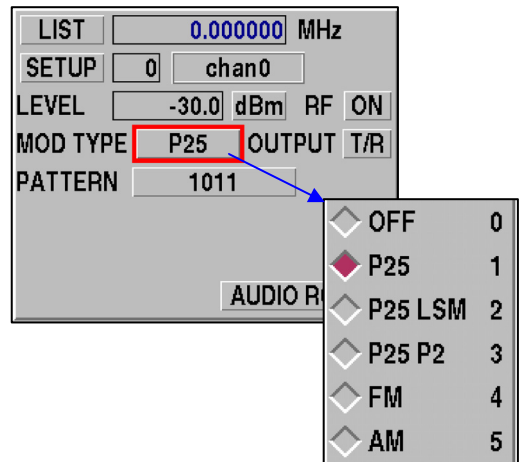

VOICE - Internal or external audio source for modulating P25. Includes the following audio sources:

- M1 Function Generator (internal)
- M2 Function Generator (internal)
- MIC Input (external)
- Audio In (external)
- Demod

This pattern may be encrypted. This pattern may have the **NAC**, **TGID** and **SID** modified to accommodate the system under test.

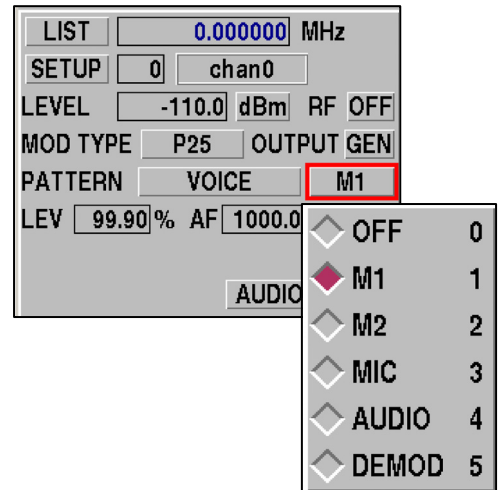

STANDARD - Pre-defined patterns waveforms, as per the TIA/EIA 102.CAAA P25 standard. The screen (to the right) shows the STANDARD available patterns.

Refer to the TIA/EIA 102.CAAA for details for each of these standard patterns. These patterns may be used to stimulate a P25 receiver under test for test and analysis purposes. These patterns are fixed format, and cannot have the **NAC**, **TGID** and **SID** modified to accommodate the system under test. **TGID = 1**, **SID = 1** and **NAC = 293** (per the Standard). These patterns cannot be encrypted.

<previous menu>	ESC	◇ STD NOTRIG	07
◇ STD 1011	00	◇ STD LDU2TRG	08
◇ STD CAL	01	◇ STD 511	09
◇ STD SILENCE	02	◇ STD SYMRATE	10
◇ STD INTFRNC	03	◇ STD LOWDEV	11
◇ STD BUSY	04	◇ STD FIDPAT	12
◇ STD IDLE	05	◇ STD FIDSPECT	13
◇ STD LDU1TRG	06		

FM

Configures FM modulation type. Enables tones menu to select various FM modulation modes.

LIST	0.000000 MHz	
SETUP	0	chan0
LEVEL	-110.0 dBm	RF OFF
MOD TYPE	FM	OUTPUT GEN
M1	5.00 kHz AF	1000.0 Hz Sine
M2	5.00 kHz AF	1000.0 Hz Sine
MIC	OFF	RX: OFF
AUDIO	OFF	AUDIO ROUTE

M1 AND M2

Selecting a MOD TYPE of **FM** or **AM** allows control of internal modulation sources 1 and 2. Selecting **M1** or **M2** allows access to a tone signaling selection list.

OFF

Disable internal modulation source.

TONE

Configures M1 or M2 for Function Generator operation and allows entry of FM Deviation or AM modulation level, audio frequency rate and wave shape. Sinewave, Squarewave, Triangle or Ramp wave shapes may be selected.

FREQ	851.012500 MHz	
OFFSET	-45.000000 MHz	
LEVEL	-30.0 dBm	RF OFF
MOD TYPE	FM	OUTPUT T/R
M1	5.00 kHz AF	1000.0 Hz Sine
M2	OFF	
MIC	OFF	
AUDIO	OFF	AUDIO ROUTE

<input type="radio"/> OFF	0
<input checked="" type="radio"/> TONE	1
<input type="radio"/> TREM	2
<input type="radio"/> DTMF	3
<input type="radio"/> CTCSS	4
<input type="radio"/> DCS	5
<input type="radio"/> TSIG	6
<input type="radio"/> SINC	7
<input type="radio"/> ARB	8

<input checked="" type="radio"/> Sine	0
<input type="radio"/> Sqr	1
<input type="radio"/> Tri	2
<input type="radio"/> Rmp	3

TREM

Select Tone Remote operation. The Tone Remote function provides default settings for frequency, level and duration. These values may be altered for specific requirements by selecting the CONFIG function. Selecting the tone format and pressing the SEND button activates the selected tone sequence.

FREQ	0.000000 MHz	
OFFSET	170.000000 MHz	
LEVEL	-110.0 dBm	RF OFF
MOD TYPE	FM	OUTPUT GEN
M1	1050	SEND CONFIG
M2	OFF	
MIC	OFF	RX: OFF
AUDIO	OFF	AUDIO ROUTE

CODE	1050 Hz	MAX LEVEL	20 dB
DEV	5.00 kHz	MAX FREQ	2175 Hz
SEND		MAX DURATION	120 mS
		FUNCTION LEVEL	0 dB
		FUNCTION FREQ	1050 Hz
		FUNCTION DUR	40 mS
		GUARD LEVEL	-10 dB
		GUARD FREQ	2175 Hz
		GUARD DUR	CONT 120 mS
CLOSE			
RESTORE DEFAULTS			

DTMF

Select DTMF operation. Values are entered and sent after pressing the ENTER key. Mode selections for Continuous, Burst or Keypad are available. The CONFIG button allows changes to the Mark, Space and End timing in ms.

08:02:30 Generator (RX Test) Options Setup: 1 P25 Trunk VOL/SQL

FREQ 0.000000 MHz
 OFFSET 170.000000 MHz
 LEVEL -110.0 dBm RF OFF

MOD TYPE FM OUTPUT GEN
 M1 BURST CONFIG

M2 OFF CONT 0
 MIC OFF BURST 1
 AUDIO OFF KEY PAD 2

CODE MARK TIME 100 mS
 DEV 5.00 kHz SPACE TIME 100 mS
 MODE BURST END TIME 1000 mS

SEND

CLOSE RESTORE DEFAULTS

CTCSS

Select CTCSS operation. In this mode, CTCSS entries may be made by code value. If the code value is unknown, use the TONE selection. The CONFIG button allows configuration of the deviation level to be used.

08:04:00 Generator (RX Test) Options Setup: 1 P25 Trunk VOL/SQL

FREQ 0.000000 MHz
 OFFSET 170.000000 MHz
 LEVEL -110.0 dBm RF OFF

MOD TYPE FM OUTPUT GEN
 M1 XZ FREQ 67.0 Hz CONFIG

M2 OFF RX: OFF
 MIC OFF AUDIO ROUTE

◆ XZ - 67.0	00	◆ -- - 290.3	16	◆ -- - 74.4	33
◆ XB - 77.0	01	◆ XA - 71.9	17	◆ -- - 79.7	34
◆ YB - 88.5	02	◆ YZ - 82.5	18	◆ YA - 85.4	35
◆ 1Z - 100.0	03	◆ ZA - 94.8	19	◆ ZZ - 91.5	36
◆ 1B - 107.2	04	◆ 1A - 103.5	20	◆ ZB - 97.4	37
◆ 2A - 114.8	05	◆ 2X - 110.9	21	◆ -- - 259.1	38
◆ 3Z - 123.0	06	◆ 2B - 118.8	22	◆ -- - 69.3	39
◆ 3B - 131.8	07	◆ 3A - 127.3	23	◆ -- - 36.6	40
◆ 4A - 141.3	08	◆ 4Z - 136.5	24	◆ -- - 196.6	41
◆ 5Z - 151.4	09	◆ 4B - 146.2	25		
◆ 5B - 162.2	10	◆ 5A - 156.7	26		
◆ 6A - 173.8	11	◆ 6Z - 167.9	27		
◆ 7Z - 186.2	12	◆ 6B - 179.9	28		
◆ M1 - 203.5	13	◆ 7A - 192.8	29		
◆ M3 - 218.1	14	◆ M2 - 210.7	30		
◆ -- - 233.6	15	◆ M4 - 225.7	31		
		◆ -- - 241.8	32		

CLOSE

DCS

Select DCS operation. In this mode, DCS entries may be made by code value. The CONFIG button allows configuration of the deviation level to be used as well as the code type of Normal or Inverted.

CODE 023
 DEV 0.50 kHz
 NORMAL
 OFF

CLOSE

TSIG

Tone Signaling operation provides several pre-configured setups for paging formats. The User_TS selection allows configuration of a unique tone sequence. Frequency, Mark and Space timing can be configured. 13 separate tones can be configured.

The screenshot shows the TSIG configuration interface. The top part is a table for configuring digits and their timing:

FORMAT	USER	DIGITS/FREQ	MARK TIME	SPACE TIME
CODE		0 1000.0 Hz	100 mS	100 mS
DEV	5.00 kHz	1 1010.0 Hz	100 mS	100 mS
MODE	BURST	2 1020.0 Hz	100 mS	100 mS
		3 1030.0 Hz	100 mS	100 mS
		4 1040.0 Hz	100 mS	100 mS
		5 1050.0 Hz	100 mS	100 mS
		6 1060.0 Hz	100 mS	100 mS
		7 1070.0 Hz	100 mS	100 mS
		8 1080.0 Hz	100 mS	100 mS
		9 1090.0 Hz	100 mS	100 mS
		R 1100.0 Hz	100 mS	100 mS
		G 1110.0 Hz	100 mS	100 mS
		A 1120.0 Hz	100 mS	100 mS

Below the table is a list of signaling formats:

- 56TONE 00 EIA 07
- CCIR 01 EUROSIG 08
- CCIRH 02 MODAT 09
- CCIRH4 03 NATEL 10
- DDZVEI 04 User_TS 11
- DZVEI 05 ZVEI 12
- EEA 06

SINC CONFIG

The SINC waveform is used for audio spectrum analysis, somewhat similar to a tracking generator for RF spectrum analysis. However, since the audio analyzer uses digital signal processing techniques rather than a swept-mixer approach, a different method of generating the stimulus signal is needed.

The SINC waveform defined as:

$$\text{SINC}(t) = \frac{\sin(\omega t)}{(\omega t)}$$

Like all signals in the 2975, this signal is generated digitally at a specified number of samples per second.

RATE

This is the equivalent sample rate of the signal, in samples per second. The faster this number, the more frequently the pattern repeats, the higher the maximum frequency of the signal, and the greater the resolution bandwidth of the signal.

OMEGA

This sets how wide the signal is in frequency. Higher omegas give a signal with a narrower frequency band, lower omegas give a signal with a wider frequency band (for a given sample rate). However, as the signal gets wider, it also "droops," so that wider signals are not as flat as narrower signals.

The screenshot shows the SINC CONFIG interface. The top part displays signal parameters:

- LIST: 0.000000 MHz
- SETUP: 0 chan0
- LEVEL: -110.0 dBm RF OFF
- MOD TYPE: FM OUTPUT GEN
- M1 DEV: 5.00 kHz SINC CONFIG
- M2 5.00 kHz AF 1000.0 Hz Sine
- MIC: OFF RX: OFF
- AUDIO: OFF AUDIO ROUTE

Below the parameters is a list of options:

- DEV: 5.00 kHz
- RATE: 10000 S/sec
- OMEGA: 1.00

Buttons include RESTORE DEFAULTS and CLOSE.

ARB

The ARB function is a simple arbitrary waveform generator that provides up to 16384 samples per waveform. The samples repeat.

RATE

This is the sample rate at which to play back the waveform. For example, a waveform derived from a CD must be played back at 44100 Hz to sound correct.

SHAPE

This selects the shape file from the hard disk. User generated files may be uploaded (via the web server interface) to /usr/waveforms and are automatically added to the waveform menu. (It may be necessary to create the /usr/waveforms directory first).

SHAPE FILE LAYOUT

A waveform file is a text file, that resembles the following:

```
NAME noise
DESCRIPTION "Band limited AGN to (0.3 * Fs/2)"
data {
-0.178018803083987
-0.314125720479411
-0.385662785219341
...
0.005406993939079
}
```

NAME

This field indicates the name of the waveform that appears in the menu

DESCRIPTION

This field provides a more detailed description of the waveform as it appears when selected. This value **MUST BE IN QUOTATION MARKS (or CURVED BRACKETS {})**.data: This is the waveform data, as 16384 floating-point values from -1.0 to 1.0. This data **MUST BE IN CURVED BRACKETS**. The data can be one value per line, or multiple values per line.

MIC

The MIC routes the Microphone input jack to the modulator to allow voice modulation. When the function is enabled, the microphone bias type may be selected (Dynamic or Electret). The MIC/Audio Adapter (AC25007) combination is of the Electret type.

OUTPUT

Allows selection of the 2975's RF Output Port. Use the T/R Port for single connection transmit and receive operations or GEN for output only operation.

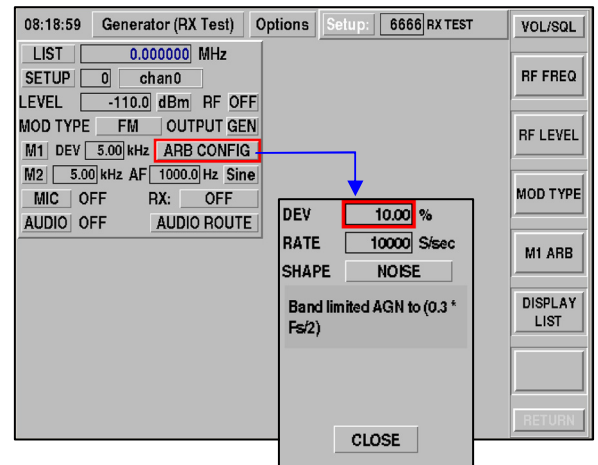

AUDIO

Routes external audio input to the modulator to allow for external modulation.

NOTE: If the MIC/Audio Adapter (AC25007) is used, ensure that AUD is turned OFF when making SINAD measurements.

AUDIO ROUTE

Refer to para 2-11 for information on AUDIO ROUTE capabilities.

RECEIVER MODE

The Receiver (TX Test) mode is used to test an analog or digital P25 transmitter. To access the Receiver mode, use the following key sequence:

[MODE] Key

[2] Key

FIELD DEFINITIONS

FREQ

This field allows entry of the transmitter channel frequency in MHz. Using the rotary knob, position the cursor on the frequency field. A new frequency can be entered directly through the numeric keypad and terminated by pressing the [ENTER] Key. To edit an existing frequency, press the [ENTER] Key to highlight the existing frequency, then use the left or right arrow keys to position a cursor to the digit to edit. Using the up or down arrow keys or the rotary knob increments or decrements the current value. Frequency values ranging from 0 to 2700 MHz can be made with 1 Hz resolution.

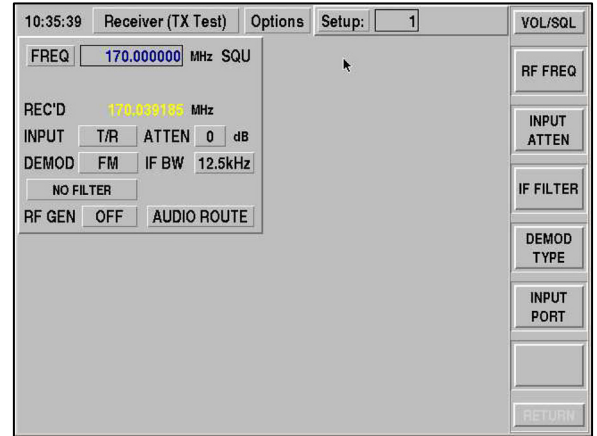

FREQ Label

INCR

Allows entry of a frequency increment value. When in this mode of operation, the frequency can be set with the frequency field and then adjusted by the defined increment value through use of the side function keys.

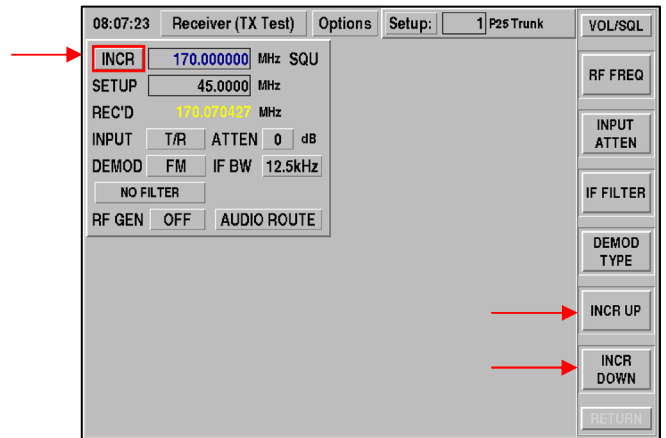

SCAN

Allows entry of a start and stop frequency with increment for swept RF measurements. Select SETUP to configure the sweep parameters. To begin the sweep, press function key labeled START SWEEP.

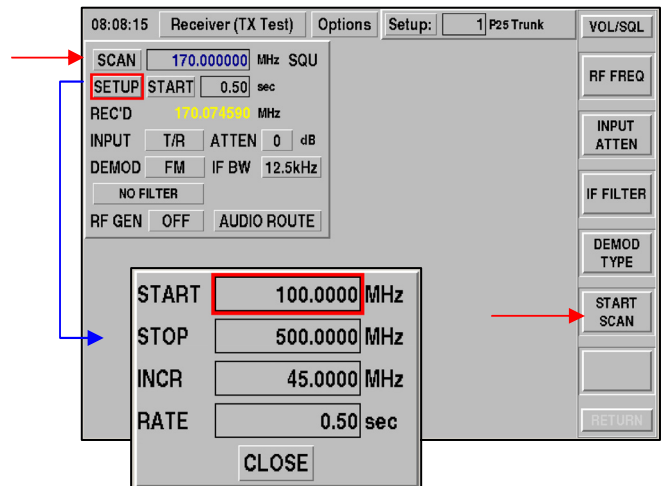

LIST

Allows frequencies to be selected from a pre-programmed list. The frequency list box allows entry of up to 300 generate and receive frequencies. Frequencies are selected by entry of the list index value associated with the frequencies in the list. The list can be auto-filled by entering a base frequency in the REC FREQ field and an increment value. The list is filled automatically by activating the FILL LIST function. Each frequency pair has a default label that may be changed to better identify the frequency pair.

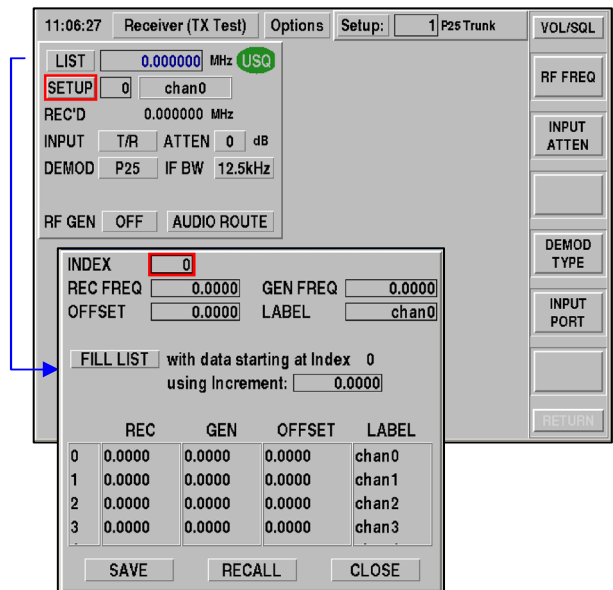

REC'D

This field indicates the measured transmitter frequency. It is for viewing only as it is an actual measurement of frequency in MHz. The frequency indicated is a calculation based on the entered frequency - the indicated frequency error. The received frequency must be within the IF Bandwidth that has been selected.

INPUT

This field allows selection of the input port where the signal is injected into the 2975. Use the ANT Port for low level off-the-air measurements where signal strengths are <-10 dBm. Use the T/R Port for direct connection to a transmitter where power levels may reach 50 W continuous or up to 125 W for 1 minute ON, 4 minutes OFF.

ATTEN

- 0 (ANT) (T/R)
- 10 (ANT) (T/R)
- 20 (T/R)
- 30 (T/R)

Select an appropriate amount of attenuation to achieve the maximum signal strength as viewed on the Spectrum Analyzer. The signal level should not exceed the top reference line on the Spectrum Analyzer, as this would cause compression in the 2975 Receiver.

DEMOM

Select the demodulator type:

- P25 (Project 25 FDMA Digital Modulation)
- FM (Analog Frequency Modulation)
- AM (Analog Amplitude Modulation)
- P25 LSM (P25 CQPSK Data as used in Motorola Simulcast) (Optional feature)
- P25 P2 (P25 Phase II CQPSK per APCO 25 Standards) (Optional feature)

IF

Select the IF Bandwidth:

- 6 kHz (AM)
- 12.5 kHz (FM, P25)
- 25 kHz (FM, P25)
- 60 kHz (FM)
- 200 kHz (FM)

NOTE: When DEMOD has been set to AM, the IF is automatically set to 6 kHz and cannot be changed.

FILTER

Audio Filters are available during Receiver (TX Test) when DEMOD is set to AM or FM. Selecting a Filter setting filters the Audio Bandwidth to the Oscilloscope, Deviation Meter, Frequency Counter and Speaker.

NOTE: The Audio Filters are not available with P25 selected.

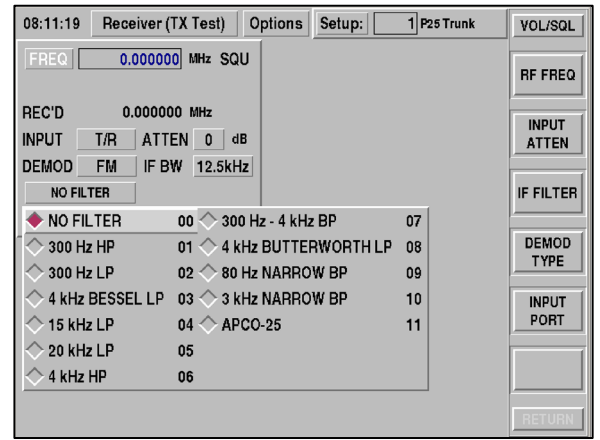

AUDIO ROUTE

Refer to para 2-11 for information on AUDIO ROUTE capabilities.

DUPLEX MODE

The Duplex Mode allows simultaneous control of the RF signal generator and the RF Receiver. To access the Duplex Mode, use the following key sequence:

[MODE] Key

[3] Key

The two RF systems are completely independent of each other allowing any frequency offset or modulation type. This feature is required to test VHF to UHF Cross-Band Duplex Systems.

The upper left quadrant allows configuration and control of the RF Receiver while the upper right quadrant allows configuration and control of the RF Generator. The features in the upper quadrants are fixed and cannot be changed by the Options Menu.

The Options Menu may be used to configure the lower left and right quadrants.

All functions for the Generator and Receiver in the Duplex Screen are the same as the stand-alone Generate and Receive Screens.

The screenshot displays the Duplex Mode interface with the following settings:

08:11:59	Duplex	Options	Setup: 1 P25 Trunk	VOL/SQL
FREQ	0.000000 MHz	SQU	FREQ	0.000000 MHz
REC'D	0.000000 MHz		OFFSET	0.000000 MHz
INPUT	T/R	ATTEN 0 dB	LEVEL	-110.0 dBm RF OFF
DEMOD	FM	IF BW 12.5kHz	MOD TYPE	FM OUTPUT GEN
NO FILTER			M1	BURST CONFIG
RF GEN	OFF	AUDIO ROUTE	M2	OFF
			MIC	OFF
			RX:	OFF
			AUDIO	OFF
			AUDIO ROUTE	

Vertical buttons on the right side of the screen include: RF FREQ, INPUT ATTEN, IF FILTER, DEMOD TYPE, INPUT PORT, and RETURN.

FUNCTION GENERATOR

The **FUNCTION GENERATOR** within the 2975 has **SINC** [$\sin(x)/x$] and **ARB** (arbitrary) waveform capabilities.

In the example to the right, FGEN1 is set to **SINC** mode, and the oscilloscope is set up to monitor the resulting waveform. The $\sin(x)/x$ sample rate, omega (width) and level may be varied as desired.

The **ARB** function is shown on FGEN2 (to the right). The oscilloscope shows a $\sin(x)/x$ pulse, followed later by the arbitrary burst.

The level and rate may be set as desired; the **SHAPE** is bandwidth limited **NOISE (AGN)**.

The Field Definitions are the same for Function Generator #1 and Function Generator #2.

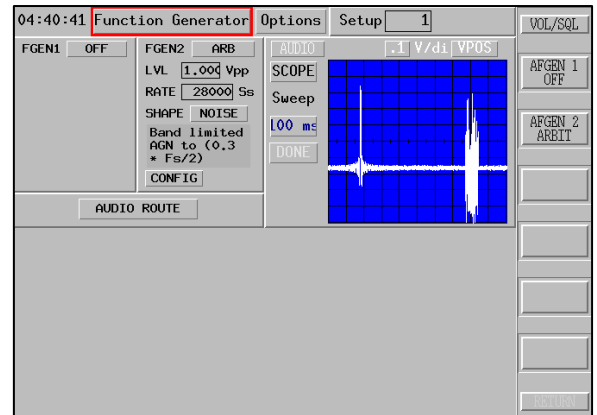
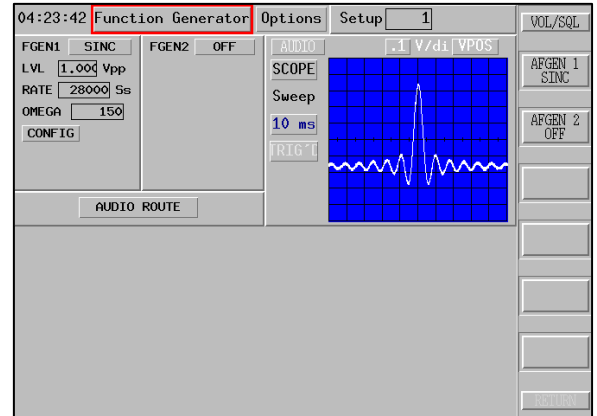

To access the Function Generator, use the following key sequence:

[MODE] Key

[4] Key

These Function Generators are configurable as Audio Sources routed to the Front Panel.

NOTE: The Oscilloscope is always available when displayed on the Function Generator screen.

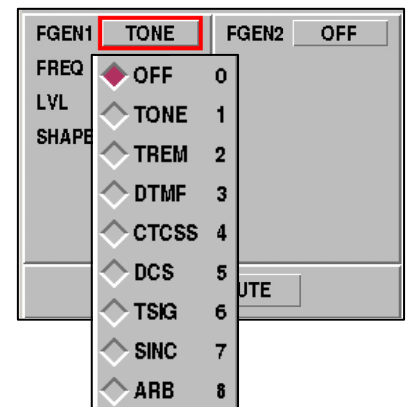

FIELD DEFINITIONS

OFF

Disables internal modulation source.

TONE

Allows entry of audio frequency, level and wave shape. Sinewave, Squarewave, Triangle or Ramp wave shapes are the available selections.

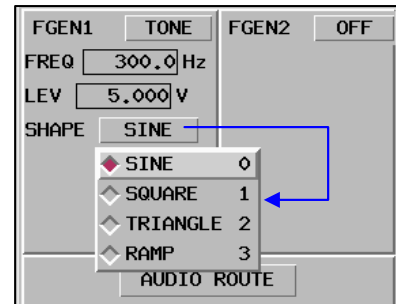

TREM

Select Tone Remote operation. The Tone Remote function provides default settings for frequency, level and duration. These values may be altered for specific requirements by selecting the CONFIG function. Selecting the tone format and pressing the SEND button activates the selected tone sequence.

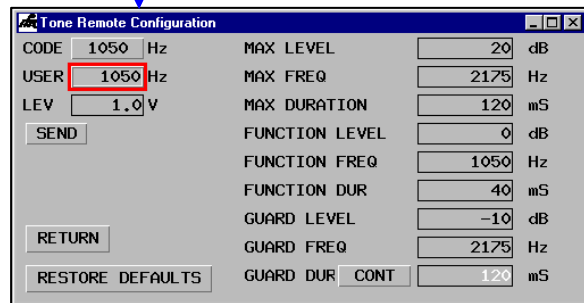
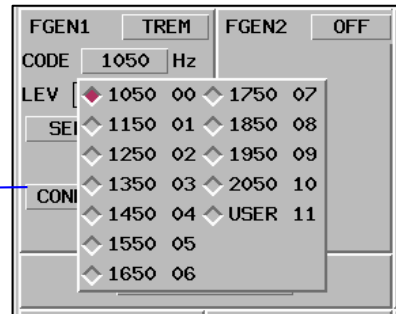

DTMF

Select DTMF operation. Values are entered and sent after pressing the ENTER key. Mode selections for Continuous, Burst or Keypad are available. The CONFIG button allows changes to the Mark, Space and End timing in ms.

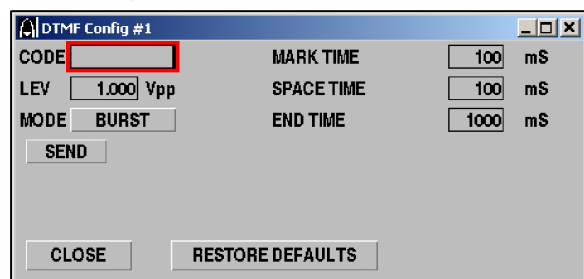
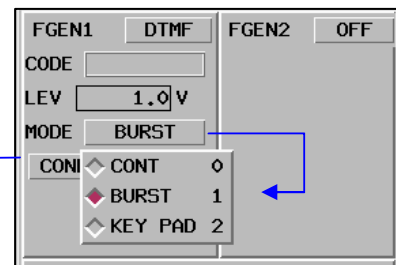

CTCSS

Select CTCSS operation. In this mode, CTCSS entries may be made by code value. If the code value is unknown, use the TONE selection.

FGEN1	CTCSS	FGEN2	OFF
CODE	XZ		
FREQ	◆ XZ - 67.0	00 ◆ ... - 250.3	16 ◆ ... - 74.4 33
LVL	◆ XB - 77.0	01 ◆ XA - 71.9	17 ◆ ... - 79.7 34
	◆ YB - 88.5	02 ◆ YZ - 82.5	18 ◆ YA - 85.4 35
	◆ 1Z - 100.0	03 ◆ ZA - 94.8	19 ◆ ZZ - 91.5 36
	◆ 1B - 107.2	04 ◆ 1A - 103.5	20 ◆ ZB - 97.4 37
	◆ 2A - 114.8	05 ◆ 2X - 110.9	21 ◆ ... - 259.1 38
	◆ 3Z - 123.0	06 ◆ 2B - 118.8	22 ◆ ... - 69.3 39
	◆ 3B - 131.8	07 ◆ 3A - 127.3	23 ◆ ... - 36.6 40
	◆ 4A - 141.3	08 ◆ 4Z - 136.5	24 ◆ ... - 196.6 41
	◆ 5Z - 151.4	09 ◆ 4B - 145.2	25
	◆ 5B - 162.2	10 ◆ 5A - 155.7	26
	◆ 6A - 173.8	11 ◆ 6Z - 167.9	27
	◆ 7Z - 186.2	12 ◆ 6B - 179.9	28
	◆ M1 - 203.5	13 ◆ 7A - 192.8	29
	◆ M3 - 218.1	14 ◆ M2 - 210.7	30
	◆ ... - 233.6	15 ◆ M4 - 225.7	31
		◆ ... - 241.8	32

DCS

Select DCS operation. In this mode, DCS entries may be made by code value. The CONFIG button allows configuration of the level and one code type of Normal or Inverted.

FGEN1	DCS	FGEN2	OFF	DEMOD	1
CODE	023			SCOPE	
◆ 023	00 ◆ 116	16 ◆ 244	33 ◆ 411	50 ◆ 612	67
◆ 025	01 ◆ 125	17 ◆ 245	34 ◆ 412	51 ◆ 624	68
◆ 026	02 ◆ 131	18 ◆ 251	35 ◆ 413	52 ◆ 627	69
◆ 031	03 ◆ 132	19 ◆ 261	36 ◆ 423	53 ◆ 631	70
◆ 032	04 ◆ 134	20 ◆ 263	37 ◆ 431	54 ◆ 632	71
◆ 043	05 ◆ 143	21 ◆ 265	38 ◆ 432	55 ◆ 654	72
◆ 047	06 ◆ 152	22 ◆ 271	39 ◆ 445	56 ◆ 662	73
◆ 051	07 ◆ 155	23 ◆ 306	40 ◆ 464	57 ◆ 664	74
◆ 054	08 ◆ 156	24 ◆ 311	41 ◆ 465	58 ◆ 703	75
◆ 065	09 ◆ 162	25 ◆ 315	42 ◆ 466	59 ◆ 712	76
◆ 071	10 ◆ 165	26 ◆ 331	43 ◆ 503	60 ◆ 723	77
◆ 072	11 ◆ 172	27 ◆ 343	44 ◆ 506	61 ◆ 731	78
◆ 073	12 ◆ 174	28 ◆ 346	45 ◆ 516	62 ◆ 732	79
◆ 074	13 ◆ 205	29 ◆ 351	46 ◆ 532	63 ◆ 734	80
◆ 114	14 ◆ 223	30 ◆ 364	47 ◆ 546	64 ◆ 743	81
◆ 115	15 ◆ 226	31 ◆ 365	48 ◆ 565	65 ◆ 754	82
	◆ 243	32 ◆ 371	49 ◆ 606	66	

TSIG

Tone Signaling operation provides several pre-configured setups for paging formats. The User_TS selection allows configuration of a unique tone sequence for 13 separate tones. Frequency, Mark and Space timing can also be configured.

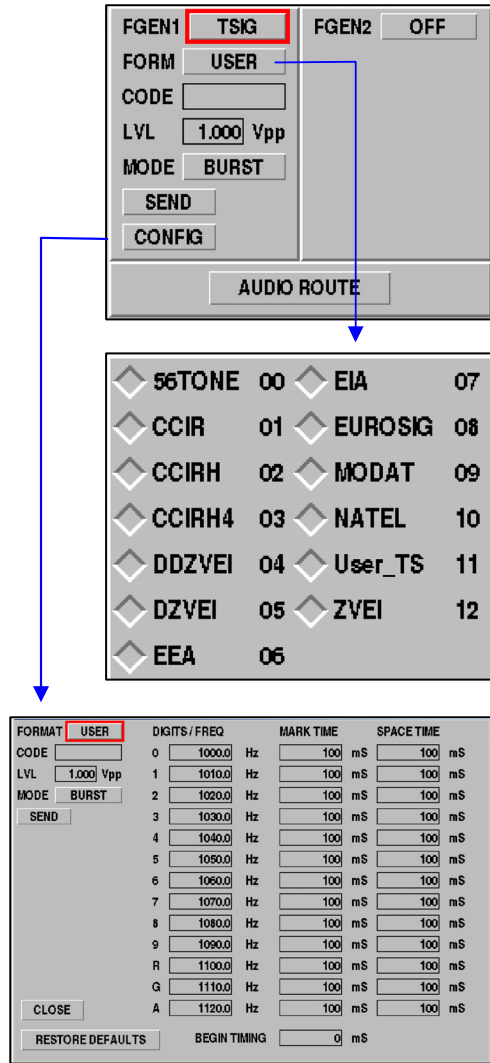

AUDIO ROUTE

Refer to para 2-11 for information on AUDIO ROUTE capabilities.

OSCILLOSCOPE

Available Signal Input

Accept Options	RETURN
CH1	1
CH2	2
MIC (Dynamic)	3
MIC (Electret)	4
AUDIO	5
Audio Balance	6
DEMOD	7
SQLCH	8

Sweep Rates

1 us	00	1 ms	09
2 us	01	2 ms	10
5 us	02	5 ms	11
10 us	03	10 ms	12
20 us	04	20 ms	13
50 us	05	50 ms	14
100 us	06	100 ms	15
200 us	07	200 ms	16
500 us	08	500 ms	17
		1 s	18

Markers Setup

Marker 1	OFF	VERT	0.00	Sec	0.002 V
Marker 2	OFF	VERT	0.00	Sec	0.0 V
Marker 3	OFF	VERT	0.00	Sec	0.0 V
Marker 4	OFF	VERT	0.00	Sec	0.0 V
Marker 1 - Marker 1			0.000	V	0.00 uSec
Marker 1 - Marker 1			0.000	V	0.00 uSec

Trigger Mode Control

AUTO	0
NORM	1
ONE	2

Vertical Position

Persistence Control

Horizontal Trigger Offset

Vertical Scale

.02	00	1	05
.05	01	2	06
.1	02	5	07
.2	03	10	08
.5	04	20	09
		50	10

The Oscilloscope (Scope) provides users with the ability to perform time dependent measurement analysis. The Scope Screen can be expanded from any function screen that lists Scope in the Options Menu. The Scope Options Menu permits selection of various Scope Inputs.

The screen to the right shows an example of the Scope Screen with two active markers. User can configure Markers by selecting the **MARKERS** soft key.

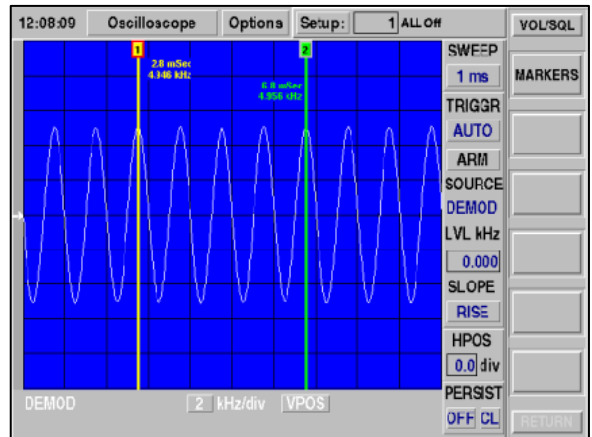

SCOPE INPUT OPTIONS

CH1 and CH2 route the front panel Scope input connectors to the Scope trace functions.

Selecting CH1 and CH2 Scope inputs activates additional soft keys on the Scope Screen which are not available with other Scope input selections.

NOTE: CH1 or CH2 cannot be used with any other input sources.

MIC (Dynamic)

Routes the MIC input to the Scope Input (switches to Dynamic MIC Type).

MIC (Electret)

Routes the MIC input to the Scope Input (switches to Electret MIC Type).

AUDIO

Routes the AUDIO Input (Mic/Audio Adapter) (AC25007) to the Scope Input through the MIC and AUDIO I/O Connectors on the Front Panel (switches to unbalanced input).

AUDIO BAL

Routes the AUDIO Input (Mic/Audio Adapter) (AC25007) to the Scope Input through the MIC and AUDIO I/O Connectors on the Front Panel (switches to unbalanced input).

DEMOD

Routes the 2975's Receiver Demod to the Scope Input.

SQUELCH

Routes the 2975's Receive Demod to the Scope Input, stopping the Scope SQUELCH is closed.

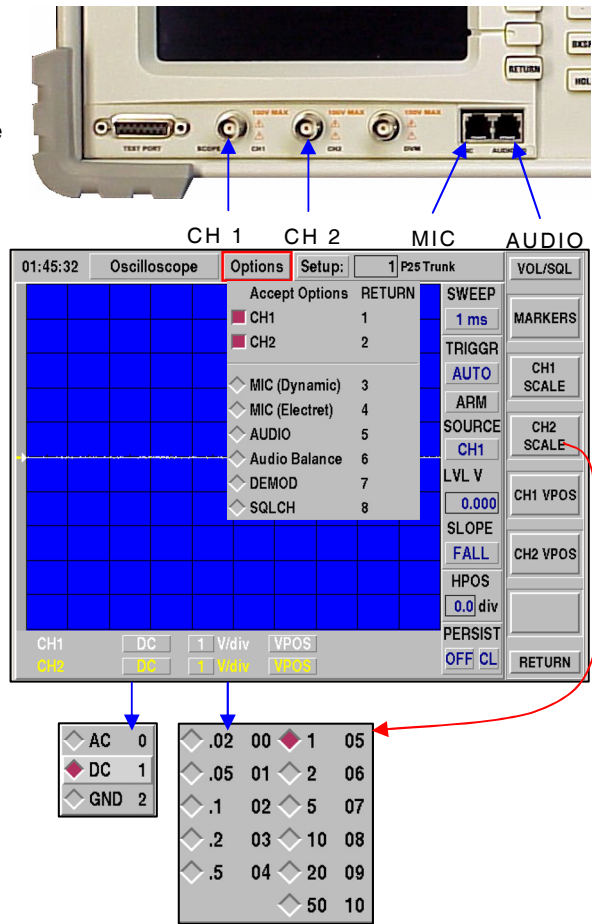

FIELD DEFINITIONS

SWEEP

The SWEEP field sets the sweep rate of the Scope. The sweep rate is the sample time per horizontal division on the Scope. The range of Sweep times vary according to the selected input.

TRIGGER (TRIGGER)

TRIGGR sets the triggering mode control of the Scope. TRIGGER mode selections are:

- | | |
|------|---|
| AUTO | Scope is free-running and is always triggered |
| NORM | Scope is triggered each time signal crosses the defined trigger level |
| ONE | Scope is triggered the first time the signal crosses the defined trigger level. |

ARM

This button re-arms the Scope when it is set to ONE shot mode.

SOURCE

The SOURCE button selects the triggering source of the Scope. Available selections are:

CH1	Trigger from the Scope Channel 1 input.
CH2	Trigger from the Scope Channel 2 input.
EXT	Trigger from the external trigger input on the rear panel.
AUDIO	When an input other than CH1 or CH2 is selected, the AUDIO source is the only available triggering source.

LVL V / LVL kHz

This field sets the triggering level of the Scope. The trigger level is indicated in volts below the LVL field and by an arrow on the left side of the user screen.

CH1, CH2, MIC, AUDIO	Units are in Volts
DEMOD FM	Units are in kHz Deviation
DEMOD AM	Units are in % AM
DEMOD P25	Units are in % Maximum Audio Level

SLOPE

This field indicates the direction the signal must cross the TRIGGER level in order to trigger the Scope. User may select from:

RISE triggers as the signal crosses the trigger level going down (negative).

FALL triggers as the signal crosses the trigger level going up (positive).

HPOS

This field set the horizontal position of the trigger on user screen. An **HPOS** of 0 indicates the trigger will appear at the left edge of the screen. An **HPOS** of +1 division positions the trigger 1 division to the right from the left edge of the screen. An **HPOS** of -1 positions the trigger off of the screen to the left. User may edit field to define this value.

PERSIST

Persistence Control permits successive traces to remain on the screen until the screen is turned OFF or cleared.

ON prevents scope trace from being erased on each sweep.

OFF causes sweep trace to be erased on each sweep.

CL clears the sweep trace.

AC / DC / GND (Coupling)

Scope channels 1 and 2 may be set to DC Coupling or AC Coupling. AC Coupling removes any DC offset from the signal, allowing small AC signals on top of large DC offsets to be seen. Coupling for any of the other signals is always DC. User may select from drop-down menu to define field.

V/div

This button selects the vertical scale for the channel. User can select from drop-down menu to define this value.

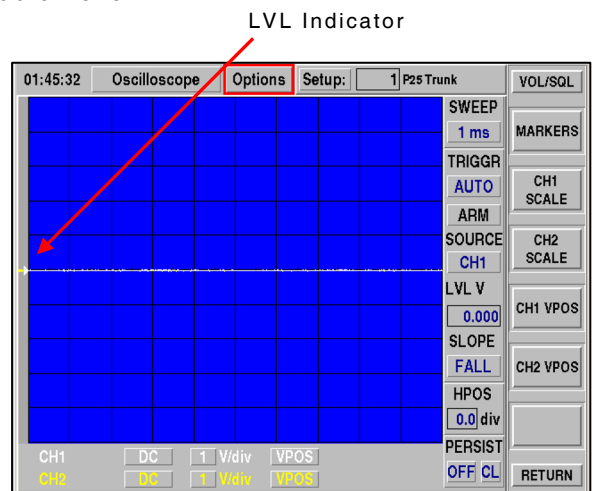

VPOS

This field allows the vertical trace to be moved up or down on the display.

Selecting VPOS to change button text to BLACK on a WHITE background engages use of spinner knob to move Scope trace up and down on user screen.

Selecting VPOS to change button text to WHITE on a GRAY background disables use of spinner knob to move vertical position of Scope trace.

SPECTRUM ANALYZER

The Spectrum Analyzer permits viewing off-air or directly connected RF signals in an RF-level versus frequency display format.

The 2975 Spectrum Analyzer has two basic modes of operation: Channel Mode or Stand-Alone Mode.

CHANNEL MODE

The Channel Mode is available when zoomed in from any of the other functional test screens (i.e., Receive, Generate, Duplex, etc.). When in Channel Mode, spans of up to 5 MHz can be selected to view the channel under test. The Tracking Generator is not available in Channel Mode.

STAND-ALONE MODE

To access window spans of up to 3 GHz, the Stand-Alone Spectrum Analyzer must be selected from the Mode Selection Menu [MODE] [6].

OPTIONS

The Spectrum Analyzer option selections control the display mode of operation and the Tracking Generator. These options are accessible by pressing the [SHIFT] [MODE] keys.

LIVE

The LIVE mode displays the signals on-screen immediately upon being received. This mode is the "standard" operating mode for general use.

Live may be used simultaneously with Compare and/or Tracking Generator operation as desired, but is mutually exclusive to Average and Peak operation.

Live selection sets (F5) Soft Key to SAVE TRACE function to permit storing trace to reference memory.

While in Live operation, the trace line is displayed in WHITE.

The message "Displaying Live Trace" is shown at the top left of the Spectrum Analyzer when LIVE is activated.

AVERAGE

The Average mode displays the signals on-screen as the average of the specified number of traces in the AVG edit field. The AVG field appears in the area below the lower-right corner of the Spectrum window. This mode is useful for displaying repetitive signals in the presence of noise.

Average may be used simultaneously with Compare and/or Tracking Generator operation as desired, but is mutually exclusive to Live and Peak operation.

Average selection sets (F5) Soft Key to SAVE TRACE function to permit storing trace to reference memory.

Average selection sets (F6) Soft Key to CLEAR TRACE function to permit restarting of the average function by purging previous trace data with new traces received.

While in Average operation, the trace line is displayed in LIGHT GREEN.

The message "Displaying Avg Trace" is shown at the top left of the Spectrum Analyzer when AVERAGE is activated.

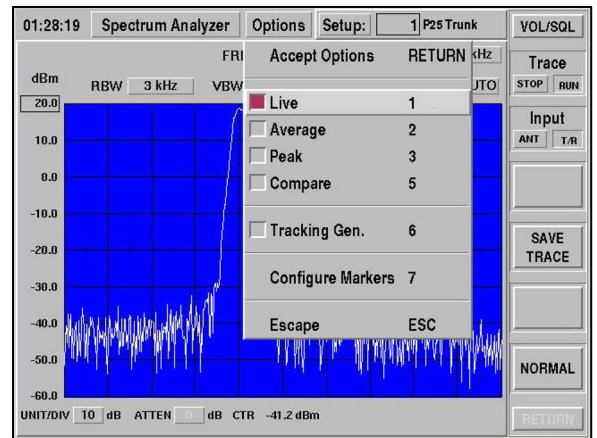

PEAK

The Peak mode displays the signals on-screen as two traces; one as in Live operation as most recently received and a second as the peak value for each frequency point on the trace display. This mode is useful for catching spurious, one-time events or monitoring a portion of the spectrum over a long period of time.

Peak may be used simultaneously with Compare and/or Tracking Generator operation as desired, but is mutually exclusive to Live and Average operation.

Peak selection sets (F5) Soft Key to SAVE TRACE function to permit storing trace to reference memory.

Peak selection sets (F6) Soft Key to CLEAR TRACE function to permit restarting of the peak function by purging previous trace data with new traces received.

While in Peak operation, the Live trace line is displayed in WHITE and the Peak line is displayed in LIGHT BLUE.

The message "Displaying Peak Trace" is shown at the top left of the Spectrum Analyzer when PEAK is activated.

COMPARE

The Compare mode displays the last SAVE TRACE display line on the Spectrum Analyzer. This mode is useful for visual comparison of a reference trace (the SAVE TRACE) to the Live, Average or Peak trace that is displayed simultaneously.

Compare may be used simultaneously with Live, Average, Peak and/or Tracking Generator operation as desired.

Compare mode selection sets (F5) Soft Key to RECALL TRACE function to permit retrieving the trace from reference memory.

While in Compare operation, the RECALL TRACE is displayed in YELLOW, and other simultaneously displayed trace line is displayed in its respective color.

TRACKING GENERATOR

The Tracking Gen mode provides a great tool for RF analysis by activating a RF source signal (generator) that is swept in synchronism with the Spectrum Analyzer RF receiver. This swept RF generator may be applied to components or systems and the output monitored to display the frequency response of these items.

The Tracking Generator mode activates additional controls when selected.

The TG LVL edit field appears in the area below the center-right of the Spectrum window. This field displays and permits changes to the RF level of the Tracking Generator.

The (F4) Soft Key becomes the TG OUTPUT selection control, permitting the Tracking Generator to be routed to the GEN or T/R Port on the 2975 Front Panel.

The Tracking Generator may be used simultaneously with Live, Average, Peak and/or Compare operation as desired, with the trace lines displayed in their respective colors.

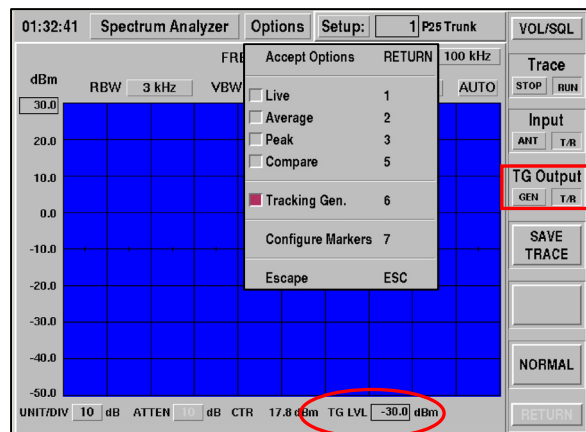

MARKERS

The Spectrum Analyzer is accessed on the 2975 by pressing ([MODE] and [6]) or by using the mouse and selecting the Spectrum Analyzer screen.

The Spectrum Analyzer Control **Options** selection screen shows the **Configure Markers** addition for:

Configure Markers 7

The **Configure Markers** menu allows for:

- entry of Marker frequencies for eight Markers with corresponding level readout;
- difference calculations for level or frequency between any two Markers;
- a cable fault calculator based on two Marker positions. This calculation determines the distance to a fault (a short or open) within a transmission line from the 2975.
- the ability to orient a Marker either horizontally or vertically.

Marker 1	ON	HORIZ	0.000000 MHz	-50.00 dB		
Marker 2	ON	VERT	815.512194 MHz	-88.6 dB		
Marker 3	OFF	VERT	0.000000 MHz	0.00 dB		
Marker 4	OFF	VERT	0.000000 MHz	0.00 dB		
Marker 5	OFF	VERT	0.000000 MHz	0.00 dB		
Marker 6	OFF	VERT	0.000000 MHz	0.00 dB		
Marker 7	OFF	VERT	0.000000 MHz	0.00 dB		
Marker 8	OFF	VERT	0.000000 MHz	0.00 dB		
DIFF: Marker		1	-	Marker	2	5.512194 MHz
DIFF: Marker		1	-	Marker	1	0.00 dB
Cable FauLMkr		1	to	2	VF	0.00 0.00 m
CLOSE						

The Spectrum Analyzer screen (to the right) shows three active Markers. The Marker level and frequency values are displayed next to the respective Marker line. The Markers may be re-positioned on the screen in one of two ways:

- If using a mouse, left-click and hold on the Marker box at the top of a Marker line and move the Marker to a desired location, then release the mouse button.
- If using the keyboard / spinner, highlight the desired Marker box using the spinner or left/right keys and then press ENTER. Move the Marker to the desired location, then press ENTER to set.

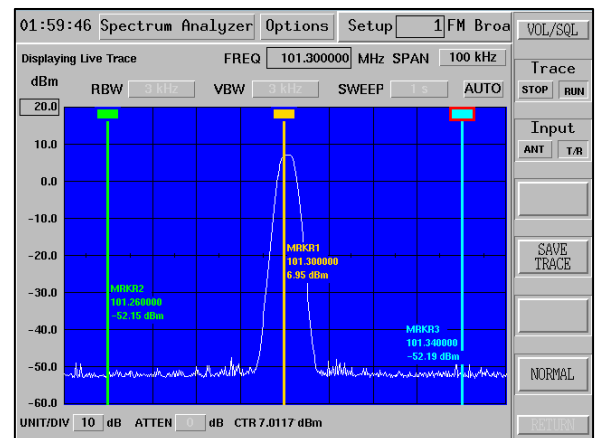

CABLE FAULT MEASUREMENT CALCULATOR

The Spectrum Analyzer Markers have a cable fault feature, providing a convenient way to find the location of a problem in a coaxial transmission line.

The technique for measuring a transmission line is described in Section 3 of this manual. Select the velocity factor (VF) of the particular coaxial cable and position two markers at two adjacent null points. The 2975 displays the distance to the fault on the **Configuration Markers** screen.

The example screens show the Markers set at the null points and the accompanying cable fault calculation for an open-ended 15 ft, RG-58 coaxial cable. Note the use of the 5 dB/div scale to make positioning of the markers easier.

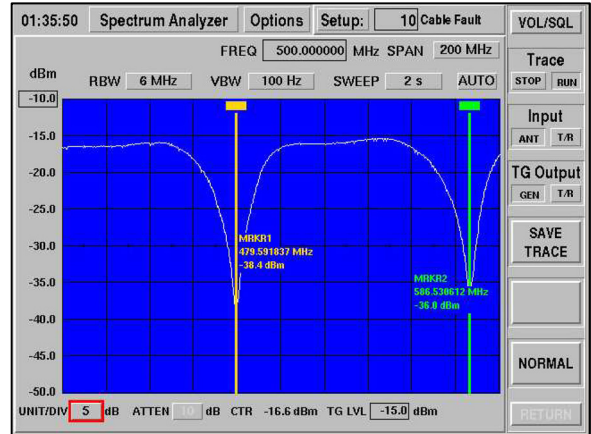

Marker 1	ON	VERT	479.591837	MHz	-38.3	dB		
Marker 2	ON	VERT	586.530612	MHz	-36.0	dB		
Marker 3	OFF	VERT	0.000000	MHz	0.00	dB		
Marker 4	OFF	VERT	0.000000	MHz	0.00	dB		
Marker 5	OFF	VERT	0.000000	MHz	0.00	dB		
Marker 6	OFF	VERT	0.000000	MHz	0.00	dB		
Marker 7	OFF	VERT	0.000000	MHz	0.00	dB		
Marker 8	OFF	VERT	0.000000	MHz	0.00	dB		
DIFF:	Marker	1	-	Marker	1	0.00	dB	
DIFF:	Marker	1	-	Marker	1	0.00	dB	
Cable Fault:	Mkr	1	to	2	VF	65.9%	3.03	ft

CLOSE

QUICK SPAN

The Spectrum Analyzer has additional features available whenever a mouse is used. The "Quick Span" feature permits rapid center frequency and span selection using a drag-and-drop type of mouse action.

The screen (to the right) shows how to perform Quick Span.

Position the mouse cursor at a position just to the left of Marker 1 (white arrow), then push and hold the right mouse button. Drag the mouse to the position just to the right of Marker 2 and release the mouse button.

After release of the mouse button, the SPAN is changed to the closest fit for the selected range and the FREQ is adjusted to the mid-point of the mouse-selected span. The result of the above action is shown.

Remember, the Quick Tune feature remains available, permitting left button double-click on a Spectrum Analyzer screen position to tune to center frequency.

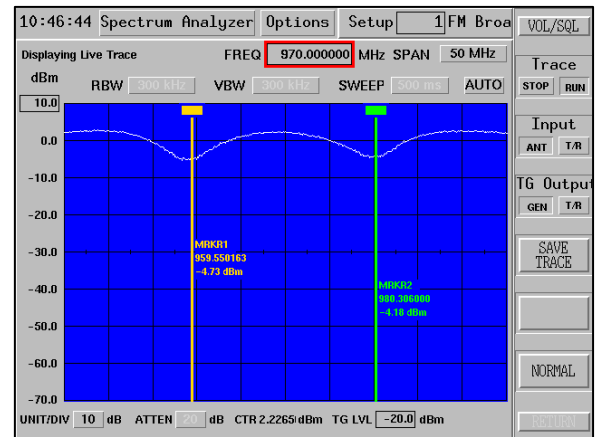
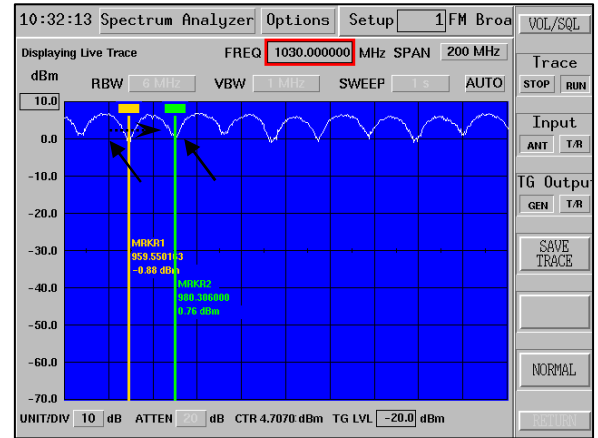

SWEEP SPEED AND ZERO SPAN

The example screens (to the right) show the Spectrum Analyzer 2-5-10 sweep progressions from 5 ms to 10 sec. Zero span (0 SPAN) has 5 and 10 ms minimum sweep time, while the minimum sweep time for 1 kHz through 3 GHz is 20 ms. The selected SPAN dictates allowable sweep speeds appropriate for correct operation.

The Spectrum Analyzer screen has triggering and display controls for capturing dynamic signals. The example screen (to the right) shows a captured AM signal that triggered the trace when the signal level exceeded -75 dBm with a rising slope, with a shift of 5 divisions. This shift positions the trigger point at mid-screen for easy viewing and analysis.

The TRIGGER field option selections are:

- AUTO for free-running operation.
- NORMAL for repetitive trigger upon trigger condition occurrence.
- ONE SHOT for a capture and hold display. The ONE SHOT may be repeated by pressing the TRACE-RUN soft-key.

Zero Span Sweep Speeds

1 kHz Span and above

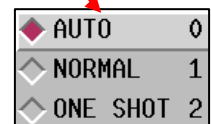
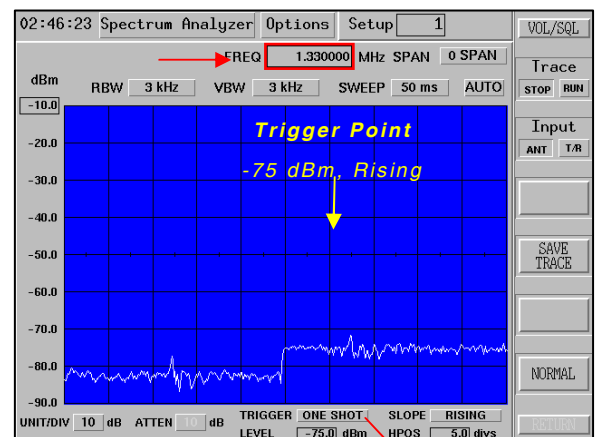
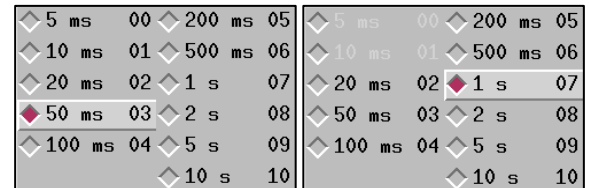

FIELD DEFINITIONS

The various control fields permit changes to the Spectrum Analyzer RF and display systems within the 2975.

FREQ

The FREQ field is the frequency at the center graticule of the trace display. This frequency is set to the Receiver frequency when the Spectrum Analyzer initially entered and can be edited as desired thereafter. Frequency changes for the Spectrum Analyzer are simultaneously made to the Receiver frequency.

The range of Frequency entry is 0 to 2800 MHz. When displaying trace areas that would be outside this range of frequencies, the trace line drops to the bottom of the trace window to indicate the frequency area is invalid.

Resolution of Frequency is 1 Hz (0.000001 MHz).

SPAN

The SPAN field defines the size of the window over which the Spectrum Analyzer sweeps. This SPAN is the entire window size left to right, therefore each vertical graticule line represents 1/10th of this frequency.

The range of Span values is 0 to 3 GHz SPAN in Stand-Alone Mode and 0 to 5 MHz SPAN in Channel Mode.

Changing SPAN while in AUTO mode causes the RBW, VBW and SWEEP fields to update automatically to the optimum settings for frequency and level accuracy at the selected SPAN.

Changing SPAN while in MAN mode may cause the RBW, VBW and/or SWEEP fields to change background color, and an UNCAL annunciator to appear on the screen. This indicates that one or more fields may need to be changed to achieve frequency and level accuracy.

◇ 0 SPAN	00	◇ 5 MHz	12
◇ 1 kHz	01	◇ 10 MHz	13
◇ 2 kHz	02	◇ 20 MHz	14
◇ 5 kHz	03	◇ 50 MHz	15
◇ 10 kHz	04	◇ 100 MHz	16
◇ 20 kHz	05	◇ 200 MHz	17
◇ 50 kHz	06	◇ 500 MHz	18
◇ 100 kHz	07	◆ 1 GHz	19
◇ 200 kHz	08	◇ 2 GHz	20
◇ 500 kHz	09	◇ 3 GHz	21
◇ 1 MHz	10		
◇ 2 MHz	11		

RBW

The RBW field defines the Resolution Bandwidth (RBW) that is used by the Spectrum Analyzer. The RBW is the width of the filter that is used within the receiver as it is swept over the specified SPAN (the filter located before the log detector).

RBW selections are:

Stand-Alone Mode: 300 Hz, 3 kHz, 30 kHz, 60 kHz, 300 kHz and 6 MHz

Channel Mode: 300 Hz, 3 kHz and 60 kHz

RBW is NOT selectable while in AUTO mode, as RBW is set automatically according to SPAN.

◇ 300 Hz	0
◇ 3 kHz	1
◇ 30 kHz	2
◇ 60 kHz	3
◇ 300 kHz	4
◆ 6 MHz	5

Changing RBW while in MAN mode may cause the RBW, VBW and/or SWEEP fields to change background color, and an UNCAL annunciator to appear on screen. This indicates that one or more fields may need to be changed to achieve frequency and level accuracy.

VBW

The VBW field defines the Video Bandwidth (RBW) that is used by the Spectrum Analyzer. The VBW is the width of the filter that is applied to the signal after it has been processed by the detector, commonly called Log Video.

VBW selections are: 10 Hz, 30 Hz, 100 Hz, 300 Hz, 1 kHz, 3 kHz, 10 kHz, 30 kHz, 100 kHz, 300 kHz, 1 MHz, 3 MHz and NONE (no filter).

VBW is NOT selectable while in AUTO mode, as VBW is set automatically according to SPAN.

Changing VBW while in MAN mode may cause the RBW, VBW and/or SWEEP fields to change background color, and an UNCAL annunciator to appear on screen. This indicates that one or more fields may need to be changed to achieve frequency and level accuracy.

◇ 10 Hz	00	◇ 30 kHz	07
◇ 30 Hz	01	◇ 100 kHz	08
◇ 100 Hz	02	◇ 300 kHz	09
◇ 300 Hz	03	◆ 1 MHz	10
◇ 1 kHz	04	◇ 3 MHz	11
◇ 3 kHz	05	◇ NONE	12
◇ 10 kHz	06		

SWEEP

The SWEEP field defines the rate at which the Spectrum Analyzer takes to traverse the display area from left to right.

SWEEP selections are: 100 ms, 200 ms, 500 ms, 1 s, 2 s, 5 s and 10 s.

SWEEP is NOT selectable while in AUTO mode, as SWEEP is set automatically according to SPAN.

Changing SWEEP while in MAN mode may cause the RBW, VBW and/or SWEEP fields to change background color, and an UNCAL annunciator to appear on screen. This indicates that one or more fields may need to be changed to achieve frequency and level accuracy.

◇ 5 ms	00	◇ 200 ms	05
◇ 10 ms	01	◇ 500 ms	06
◇ 20 ms	02	◇ 1 s	07
◇ 50 ms	03	◇ 2 s	08
◆ 100 ms	04	◇ 5 s	09
		◇ 10 s	10

AUTO/MAN

The AUTO/MAN field permits selection of automatic (AUTO) SWEEP, RBW and VBW settings according to SPAN or manual (MAN) selections for SWEEP, RBW and VBW.

During AUTO operation, the 2975 Spectrum Analyzer selects optimum SWEEP, RBW and VBW settings.

It may be necessary to view spectrum conditions at other settings, so MANUAL selection may be used. It is possible to set conditions using MANUAL settings that place the Spectrum Analyzer into an uncalibrated mode of operation, which is indicated by the appearance of the UNCAL annunciator on the screen. This indicates that one or more fields may need to be changed to achieve frequency and level accuracy.

TRACE (F2)

Soft Key (F2) controls the TRACE STOP / RUN condition.

The Spectrum Analyzer begins in RUN condition, where repetitive spectral traces occur at current settings, each new trace eliminating the previous trace.

If a particular condition displayed on-screen needs to be observed in detail, press STOP to halt the repetitive trace action until RUN is pressed.

INPUT (F3)

Soft Key (F3) controls the RF input that is currently displayed on the Spectrum Analyzer.

Selections are: T/R or ANT (Antenna) Port

The TOP OF SCALE reference level and ATTEN (attenuation) settings change according to the selected input.

TG OUTPUT (F4)

Soft Key (F4) is only active if the Tracking Generator is ON.

Soft Key (F4) controls the RF output that is currently active for the Tracking Generator.

Selections are: T/R or ANT (Antenna) Port

SAVE TRACE (F5)

Soft Key (F5) is used to SAVE TRACE displays when COMPARE mode is NOT active.

Pressing this key saves the current trace display to reference memory for later recall when COMPARE mode is activated.

RECALL TRACE (F5)

Soft Key (F5) is used to RECALL TRACE when COMPARE is active.

Pressing this key recalls and displays the reference trace memory when in COMPARE mode.

NORMAL (F6)

Soft Key (F6) is used to normalize (NORMAL) the Spectrum Analyzer system.

Normalization adjusts internal settings to compensate for differences between the various filters within the 2975 to give accurate spectrum displays.

When (F6) is pressed, a pop up window displays progress of the internal calibration process.

Perform normalization initially on first use of the Spectrum Analyzer and as desired thereafter.

TOP OF SCALE

The far-left of the display area has eight (8) numbers vertically indicating the level at each major division. The TOP OF SCALE, or the top-most value is commonly referred to as the Reference Level.

This TOP OF SCALE value may be edited to set the desired reference level depending upon which INPUT is selected (T/R or ANT) and for the signal level of the desired carrier.

UNITS/DIV

The UNITS/DIV field selects the resolution of the vertical axis.

Each major division vertically may be selected to be in the step size of 10, 5 or 2 dB/div.

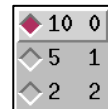

ATTEN

The ATTEN field is used to indicate the amount of attenuation that is applied to the selected input to achieve the desired TOP OF SCREEN value.

AVG

The AVG field is only displayed when the AVERAGE mode is activated.

The AVG field is the number of display sweeps that are averaged for the currently displayed spectrum trace.

CTR

The CTR field displays the RF level of the signal at the center position of the analyzer display.

TG LVL

The TG LVL field is only displayed when the Tracking Generator mode is activated.

The TG LVL field is the RF level for the Tracking Generator output. The range of TG LVL varies according to the selected TG OUTPUT, either the T/R or GEN Port.

T/R Port level range is: -30 to -137 dBm

GEN Port level range is: +10 to -110 dBm

RETURN

The RETURN key is active in the Channel Analyzer Mode only. When pressed, the Analyzer "un-zooms" and return to the previous Generator, Receiver or Duplex mode in minimized format.

QUICK TUNE (Mouse Required)

If a mouse is attached to the 2975, a quick and convenient method called Quick Tune is provided for tuning the Spectrum Analyzer.

The Spectrum Analyzer display window may be "double-clicked" on a signal of interest, and the 2975 tunes the center frequency to the selected signal. This permits easy and quick centering of the desired signal.

As shown in the top screen, the mouse pointer (white arrow) is positioned over the signal of interest at 102.1 MHz. When the left mouse button is double-clicked, the Spectrum Analyzer re-tunes to this position of 102.1 MHz, as shown in the lower screen.

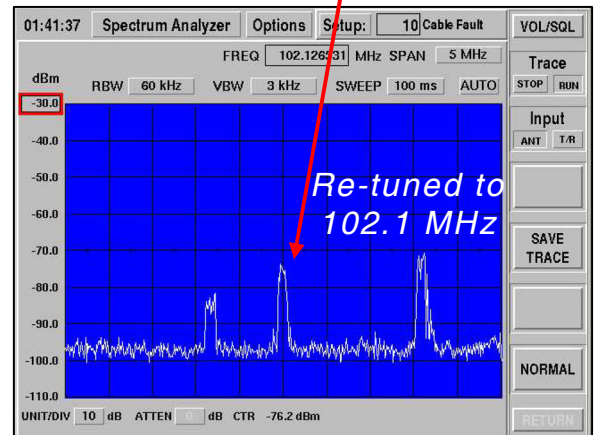
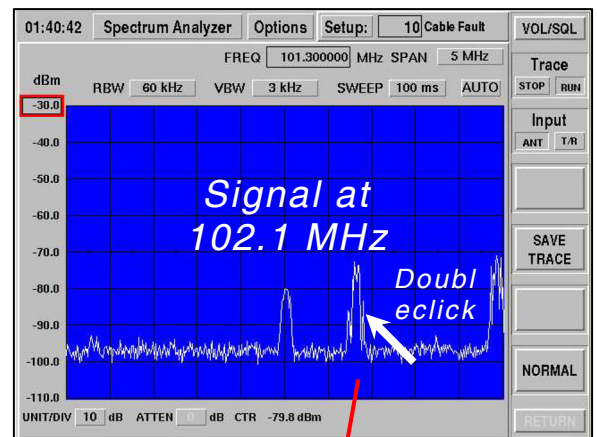

SINAD METER

The **SINAD** Meter is used for making audio quality measurements on analog receivers and allows measurement of a receiver's sensitivity. The audio quality is measured as a ratio of (Signal + Noise) / Noise.

The SINAD Meter function allows selection of the input signal source. The Scope and Distortion Meter inputs are automatically updated to match any change to the input field that is made.

FIELD DEFINITIONS

SOURCE INPUT

DEMODO

Allows the demodulated audio from the 2975's Receiver to be routed to the SINAD Meter input.

MIC (Dynamic or Electret)

Allows the MIC input to be routed to the SINAD Meter input. This input selection has greater sensitivity than other inputs and is better suited for very low audio levels.

AUD BAL

Allows the input to the SINAD Meter to be 600 Ω balanced input.

AUDIO

Allows the input to the SINAD Meter to be an unbalanced input.

RANGE

Selects the SINAD Meter range (20, 60 or AR [Auto-Range]) for the bar graph display. When in Auto-Range, the SINAD Meter automatically selects the appropriate range for the bar graph display.

NOTE: The range selection is for display purposes only and has no effect on the reading accuracy.

HIGH LIMIT

Allows setting of a High limit. When the measured level exceeds the High Limit setting, the Bar Graph changes from GREEN to RED.

LOW LIMIT

Allows setting of a Low limit. When the measured level drops below the Low Limit setting, the Bar Graph changes from GREEN to BLUE.

PEAK HOLD

With Peak Hold enabled, the highest reading remains on the display.

LIMIT ALARM

When enabled, an audible alarm sounds if the High or Low limit is exceeded.

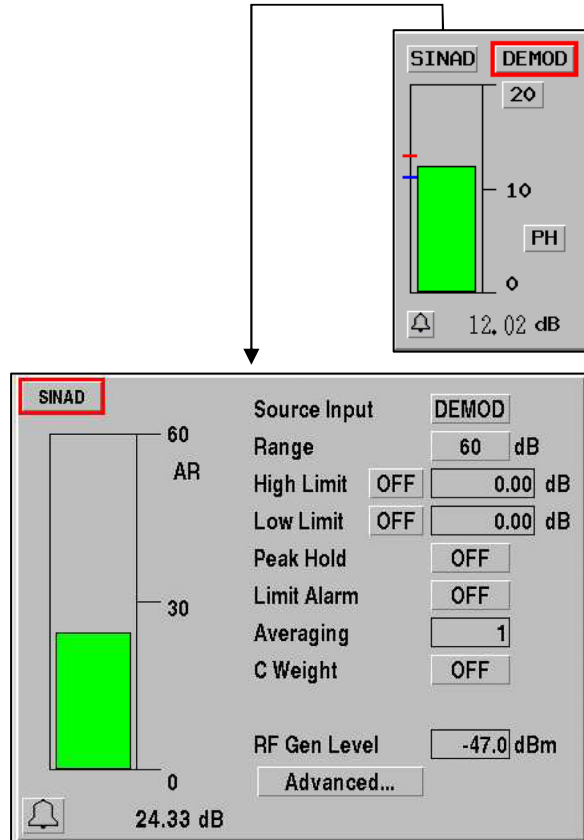

AVERAGE

Allows the indicated SINAD Meter reading to be the average of a specified number of readings. Setting this value to one (1) turns averaging OFF.

C WEIGHT

The C-Weight field turns the C-Weight Bandpass Filter ON or OFF as required. The C-Weight Filter is specified by many Radio Manufacturers for SINAD measurement.

RF GEN LEVEL

Allows the Generator RF Level to be adjusted within the “zoomed” SINAD Meter. The Generator Level range is the same as the Generator screen for the particular port (T/R or GEN) selected.

ADVANCED

This window allows customization of how the SINAD is measured. The default values are correct for most conditions.

WINDOWING

Selects the type of window applied to the data before computing the FFT. KAISER is the default and is recommended; however, NONE may be selected for special conditions.

NOISE LOW FREQ

This is the lowest frequency that is considered when computing the SINAD. Any signals below this frequency are ignored. This can be used to eliminate CTCSS and DCS signals from being considered.

NOISE HIGH FREQ

This is the highest frequency that is considered when computing the SINAD.

SIGNAL LOW FREQUENCY

This is the lowest frequency that is considered signal, rather than noise.

SIGNAL HIGH FREQUENCY

This is the highest frequency that is considered signal, rather than noise.

EXAMPLE:

User would like to measure the SINAD of a channel using a 2 kHz tone, in the presence of a 107 Hz PL tone and a 6 kHz supervisor audio tone.

- To eliminate the 107 Hz PL, set the Noise low frequency above the PL frequency ≤ 150 Hz.
- To eliminate the 6 kHz SAT, set the Noise high frequency below the SAT frequency ≤ 5 kHz.
- Set the Signal low and Signal high to 1900 and 2100 Hz, respectively, to select the 2 kHz signal.

RESTORE DEFAULTS

Restores the SINAD meter to the proper value to measure a 1 kHz tone.

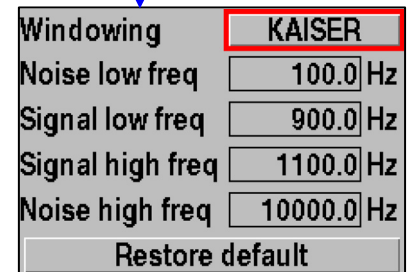
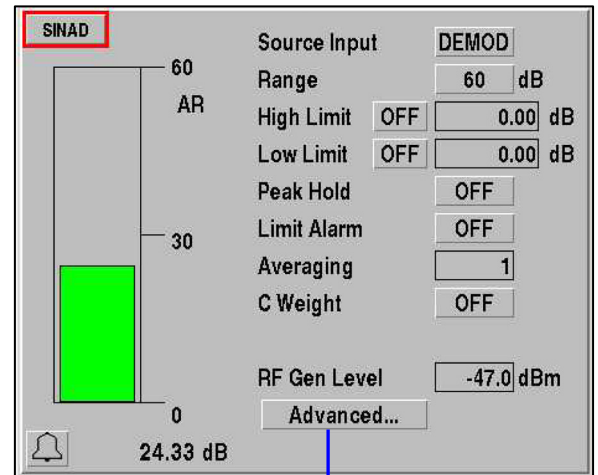

DISTORTION METER

The Distortion Meter is used for making audio quality measurements on analog receivers and allows measurement of a receiver's sensitivity. The audio quality is measured as a percentage where the RMS level of the 1 kHz test tone is measured and compared to the same signal with the 1 kHz tone removed.

The 2975 Distortion Meter function allows selection of the input signal source. The SINAD and Distortion Meter inputs are automatically updated to match any change made to the input field.

FIELD DEFINITIONS

SOURCE INPUT

DEMOD

Allows the demodulated audio from the 2975's Receiver to be routed to the Distortion Meter input.

MIC (Dynamic or Electret)

Allows the MIC input to be routed to the Distortion Meter input. This input selection has greater sensitivity than other inputs and is better suited for very low audio levels.

AUD BAL

Allows the input to the Distortion Meter to be 600 Ω balanced input.

AUDIO

Allows the input to the Distortion Meter to be an unbalanced input.

RANGE

Selects the Distortion Meter range (5, 10, 20, 50, 100 or AR [Auto-Range]) for the bar graph display. When in Auto-Range, the Distortion Meter automatically selects the appropriate range for the bar graph display.

NOTE: The range selection is for display purposes only and has no effect on the reading accuracy.

HIGH LIMIT

Allows setting of a High limit. When the measured level exceeds the High Limit setting, the Bar Graph changes from GREEN to RED.

LOW LIMIT

Allows setting of a Low limit. When the measured level drops below the Low Limit setting, the Bar Graph changes from GREEN to BLUE.

PEAK HOLD

With Peak Hold enabled, the highest reading remains on the display.

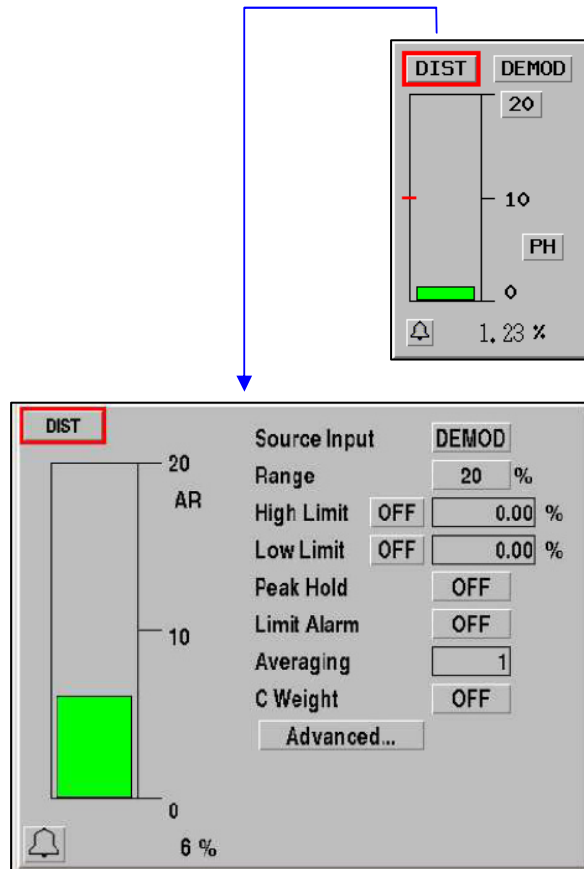

LIMIT ALARM

When enabled, an audible alarm sounds if the High or Low limit is exceeded.

AVERAGE

Allows the indicated Distortion Meter reading to be the average of a specified number of readings. Setting this value to one (1) turns averaging OFF.

C WEIGHT

The C-Weight field turns the C-Weight Bandpass Filter ON or OFF as required. The C-Weight Filter is specified by many Radio Manufacturers for Distortion measurement.

ADVANCED

This window allows customization of how the SINAD is measured. The default values are correct for most conditions.

WINDOWING

Selects the type of window applied to the data before computing the FFT. KAISER is the default and is recommended; however, NONE may be selected for special conditions.

NOISE LOW FREQ

This is the lowest frequency that will be considered when computing the SINAD. Any signals below this frequency are ignored. This can be used to eliminate CTCSS and DCS signals from being considered.

NOISE HIGH FREQ

This is the highest frequency that is considered when computing the SINAD.

SIGNAL LOW FREQUENCY

This is the lowest frequency that is considered signal, rather than noise.

SIGNAL HIGH FREQUENCY

This is the highest frequency that is considered signal, rather than noise.

EXAMPLE:

User would like to measure the SINAD of a channel using a 2 kHz tone, in the presence of a 107 Hz PL tone and a 6 kHz supervisor audio tone.

- To eliminate the 107 Hz PL, set the Noise low frequency above the PL frequency ≤ 150 Hz.
- To eliminate the 6 kHz SAT, set the Noise high frequency below the SAT frequency ≤ 5 kHz.
- Set the Signal low and Signal high to 1900 and 2100 Hz, respectively, to select the 2 kHz signal.

RESTORE DEFAULTS

Restores the SINAD meter to the proper value to measure a 1 kHz tone.

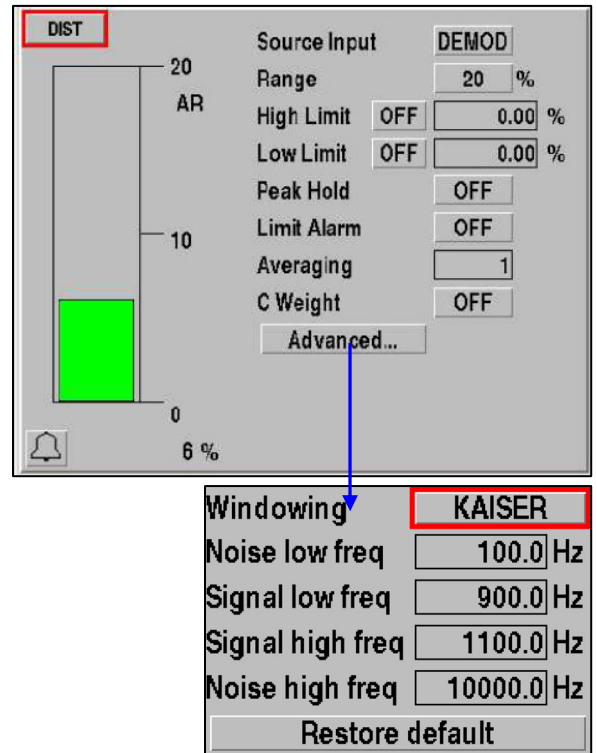

POWER METER

The Power Meter is used to measure RF power at the T/R Port. The 2975 has a 50 Ω power termination pad within the unit that sustains RF transmitter power of 50 W continuously.

FIELD DEFINITIONS

CABLE LOSS

Entering a positive value compensates for external cable loss, allowing the Power Meter to reflect the amount of power (in dB) that is at the source output as opposed to the end of the cable.

RANGE

Selects the Power Meter range for the bar graph display:

Watts Mode: 0.1, 0.2, 0.5, 1, 2, 5, 10, 20, 50, 100, 200 or AR (Auto-Range)

dBm Mode: 20, 30, 40 or 50

When in Auto-Range, the Power Meter automatically selects the appropriate range for the bar graph display.

HIGH LIMIT

Allows setting of a High limit. When the measured level exceeds the High Limit setting, the Bar Graph changes from GREEN to RED.

LOW LIMIT

Allows setting of a Low limit. When the measured level drops below the Low Limit setting, the Bar Graph changes from GREEN to BLUE.

PEAK HOLD

With Peak Hold enabled, the highest reading remains on the display.

LIMIT ALARM

When enabled, an audible alarm sounds if the High or Low limit is exceeded.

METER UNITS

Power can be displayed in Watts or dB.

ZERO METER

For accurate measurements, the Power meter must be zeroed with no power applied.

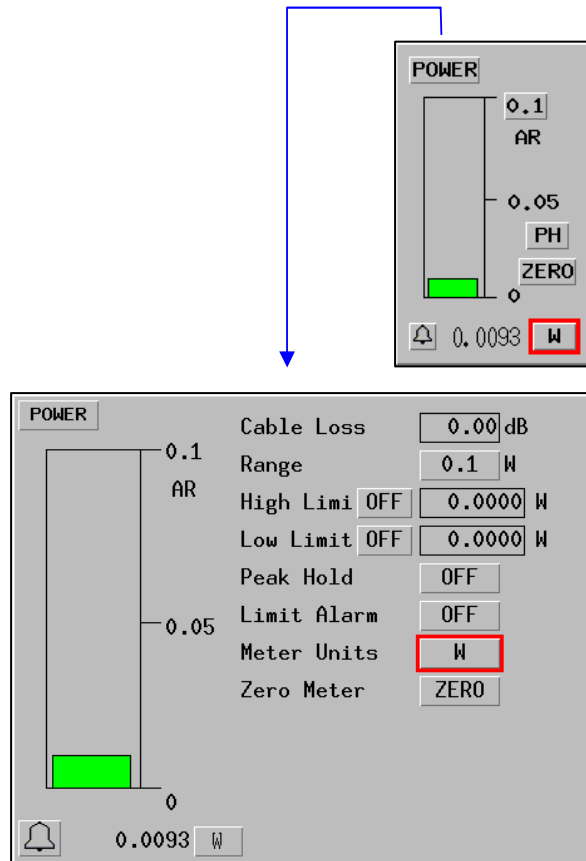

RSSI METER

The RSSI (Received Signal Strength Indication) Meter is useful for measuring RF signals at the IF detector. The RSSI Meter is also useful for monitoring off-air signals using an antenna, or for measuring amplitude modulated (AM) transmitter power.

FIELD DEFINITIONS

CABLE LOSS

Entering a positive value compensates for external cable loss, allowing the RSSI Meter to reflect the amount of power (in dB) that is at the source output as opposed to the end of the cable.

RANGE

Selects the RSSI Meter range (+53, +10, -30 or AR [Auto-Range]) for the bar graph display. When in Auto-Range, the RSSI Meter automatically selects the appropriate range for the bar graph display.

HIGH LIMIT

Allows setting of a High limit. When the measured level exceeds the High Limit setting, the Bar Graph changes to RED.

LOW LIMIT

Allows setting of a Low limit. When the measured level drops below the Low Limit setting, the Bar Graph changes from GREEN to BLUE.

PEAK HOLD

With Peak Hold enabled, the highest reading remains on the display.

LIMIT ALARM

When enabled, an audible alarm sounds if the High or Low limit is exceeded.

METER UNITS

Power is displayed in dBm. When the RF Level is too low to verify accuracy the Units change to dB (relative) and the RSSI Meter and Bar changes from GREEN to YELLOW.

CAL METER

Calibrates the RSSI Meter so accurate measurements can be obtained. CAL is required when the CAL background changes to YELLOW.

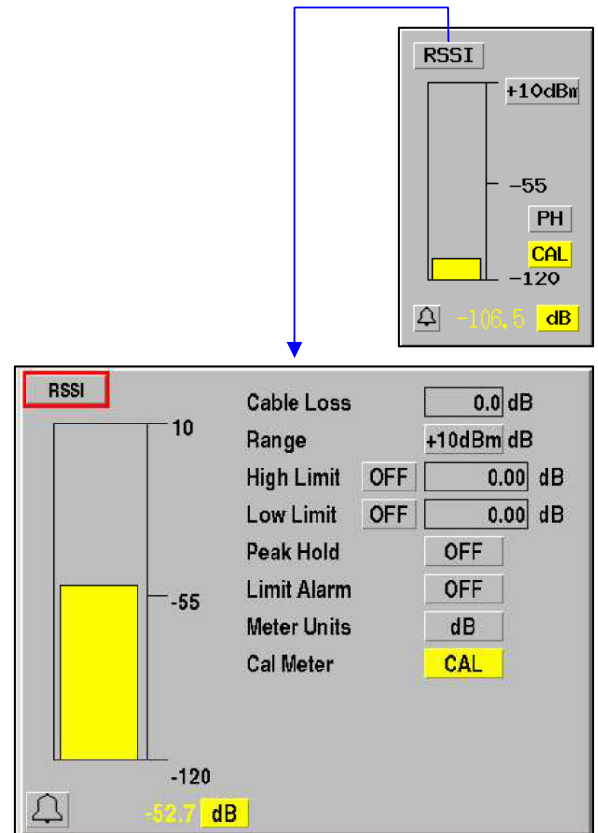

DEVIATION METER

The Deviation Meter is used to measure the modulation level of frequency modulated (FM) systems. The Deviation Meter may also be used for directly connected transmitters (T/R Port) or off-air signals (ANT Port).

FIELD DEFINITIONS

RANGE

Selects the Deviation Meter range (5, 10, 20, 50, 100 or AR [Auto-Range]) for the bar graph display. When in Auto-Range, the Deviation Meter automatically selects the appropriate range for the bar graph display.

HIGH LIMIT

Allows setting of a High limit. When the measured level exceeds the High Limit setting, the Bar Graph changes from GREEN to RED.

LOW LIMIT

Allows setting of a Low limit. When the measured level drops below the Low Limit setting, the Bar Graph changes from GREEN to BLUE.

PEAK HOLD

With Peak Hold enabled, the highest reading remains on the display.

LIMIT ALARM

When enabled, an audible alarm sounds if the High or Low limit is exceeded.

AVERAGE

Allows the indicated Deviation Meter reading to be the average of a specified number of readings. Setting this value to one (1) turns averaging OFF.

MONITOR SQUELCH

The Monitor squelch button allows the receiver squelch to be turned **ON** and **OFF**. When the Monitor is **ON**, the meter shows a gray background to indicate the receiver is squelched. When the Monitor is **OFF**, the meter continues to indicate readings as normal, even if no signal is received.

MODE

The Mode selection permits **PEAK** readings to be displayed, **AVERAGE** readings (RMS), **POS PEAK** (positive peaks) and **NEG PEAK** (negative peaks).

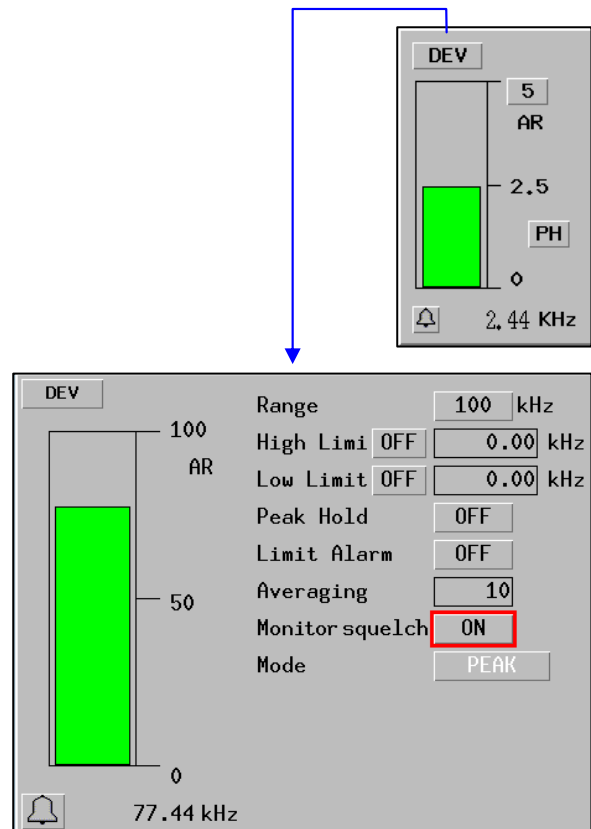

AM MODULATION METER

The AM Modulation Meter is used to measure the modulation level of amplitude modulated (AM) systems. The AM Modulation Meter may also be used for directly connected transmitters (T/R Port) or off-air signals (ANT Port).

FIELD DEFINITIONS

RANGE

Selects the AM Modulation Meter range (5, 10, 20, 50, 100 or AR [Auto-Range]) for the bar graph display. When in Auto-Range, the Deviation Meter automatically selects the appropriate range for the bar graph display.

HIGH LIMIT

Allows setting of a High limit. When the measured level exceeds the High Limit setting, the Bar Graph changes from GREEN to RED.

LOW LIMIT

Allows setting of a Low limit. When the measured level drops below the Low Limit setting, the Bar Graph changes from GREEN to BLUE.

PEAK HOLD

With Peak Hold enabled, the highest reading remains on the display.

LIMIT ALARM

When enabled, an audible alarm sounds if the High or Low limit is exceeded.

AVERAGE

Allows the indicated Deviation Meter reading to be the average of a specified number of readings. Setting this value to one (1) turns averaging OFF.

MONITOR SQUELCH

The Monitor squelch button allows the receiver squelch to be turned **ON** and **OFF**. When the Monitor is **ON**, the meter shows a gray background to indicate the receiver is squelched. When the Monitor is **OFF**, the meter continues to indicate readings as normal, even if no signal is received.

MODE

The Mode selection permits **PEAK** readings to be displayed, **AVERAGE** readings (RMS), **POS PEAK** (positive peaks) and **NEG PEAK** (negative peaks).

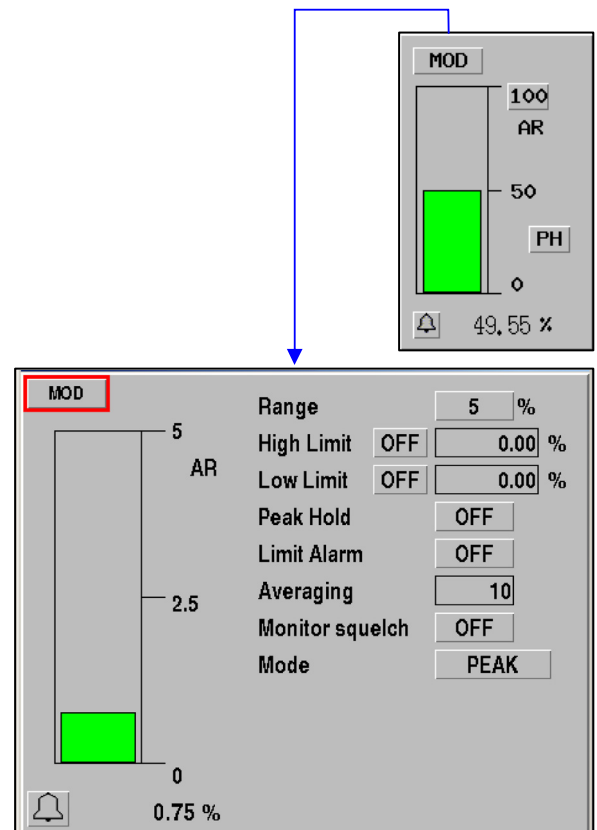

DIGITAL (AC/DC) VOLTMETER

The Digital Voltmeter is used to measure AC and DC voltages with selectable loads. For audio system measurements, the AC Voltmeter provides dBm units.

The Digital Voltmeter is accessed at the DVM (Input) Port on the 2975 Front Panel.

FIELD DEFINITIONS

MEASURE TYPE

Select AC or DC (Volts).

RANGE

Selects the Digital Voltmeter range for the bar graph display:

Volts Mode: 0.4, 1, 2, 4, 10, 20, 40, 100
or AR (Auto-Range)

dBm Mode: -8, 12, 32, 40 or
AR (Auto-Range)

When in Auto-Range, the Digital Voltmeter automatically selects the appropriate range for the bar graph display.

HIGH LIMIT

Allows setting of a High limit. When the measured level exceeds the High Limit setting, the Bar Graph changes from GREEN to RED.

LOW LIMIT

Allows setting of a Low limit. When the measured level drops below the Low Limit setting, the Bar Graph changes from GREEN to BLUE.

PEAK HOLD

With Peak Hold enabled, the highest reading remains on the display.

LIMIT ALARM

When enabled, an audible alarm sounds if the High or Low limit is exceeded.

METER UNITS

Signal levels can be displayed in Volts or dB when the Digital Voltmeter is set to AC Mode.

Signal levels can be displayed in Volts only when the Digital Voltmeter is set to DC Mode.

AVERAGING

Allows the indicated Digital Voltmeter reading to be the average of a specified number of readings. Setting this value to one (1) turns averaging OFF.

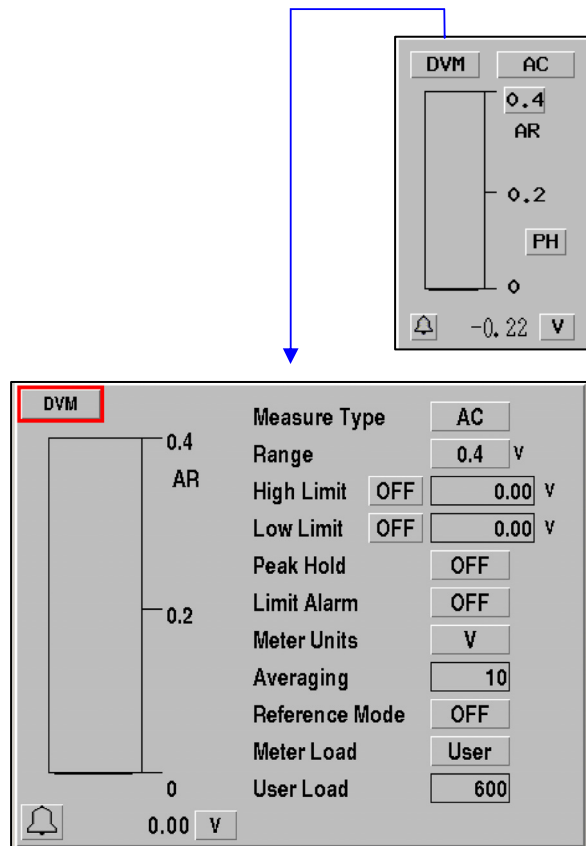

REFERENCE MODE

When reference mode is selected, the current value of the DVM reading is recorded for comparing all subsequent readings.

Example:

User would like to record how many volts a battery drops when the transmitter is keyed.

- With the transmitter un-keyed, select REFERENCE mode.
- Key transmitter. The DVM directly reads the drop in volts.
- Return the DVM to normal mode.

METER LOAD

Select 150 (Ω), 600 (Ω), 1 M (Ω) or User. Selecting "User" indicates the Meter Load is within the Unit Under Test (i.e., 600 Ω).

USER LOAD

Set from 1 to 999. (Available only when Load Type is set to User.) The entered value is used to calculate dBm into the specified Load value. The USER LOAD setting does not use the load within the 2975, but uses the impedance of the UUT.

MOD FIDELITY METER

The Mod Fidelity Meter is used to measure the modulation accuracy of APCO-25 Compliant (P25) Radios. The C4FM measurement is a complex process involving demodulation of the C4FM waveform over a specified number of symbols, and analyzing the results by comparing the results to the "ideal" waveform. The units for the C4FM Meter is percentage error as compared to the ideal waveform.

The Mod Fidelity Meter may also be used for directly connected transmitters (T/R Port) or off-air signals (ANT Port).

FIELD DEFINITIONS

RANGE

Selects the Mod Fidelity Meter range (2, 5, 10, 20, 50 or AR [Auto-Range]) for the bar graph display. When in Auto-Range, the Mod Fidelity Meter automatically selects the appropriate range for the bar graph display.

HIGH LIMIT

Allows setting of a High limit. When the measured level exceeds the High Limit setting, the Bar Graph changes from GREEN to RED.

LOW LIMIT

Allows setting of a Low limit. When the measured level drops below the Low Limit setting, the Bar Graph changes from GREEN to BLUE.

PEAK HOLD

With Peak Hold enabled, the highest reading remains on the display.

LIMIT ALARM

When enabled, an audible alarm sounds if the High or Low limit is exceeded.

AVERAGE

Allows the indicated Mod Fidelity Meter reading to be the average of a specified number of symbols. 200 is the minimum.

SYMBOL FREQ ERROR

Since a C4FM signal is constantly modulated, and almost never at the nominal carrier frequency, it is necessary to take that modulation into account when trying to measure the frequency error of a signal. This field shows the frequency error of the carrier taking into account the modulation of the signal.

SYMBOL DEVIATION

Since the deviation of a C4FM signal depends upon the data modulating the signal, it is necessary to take that data into account to obtain an accurate reading of the modulation of the signal. This field shows the deviation of the C4FM signal at symbol time, taking into account the data modulating the signal. The nominal value for a C4FM signal is 1800 Hz.

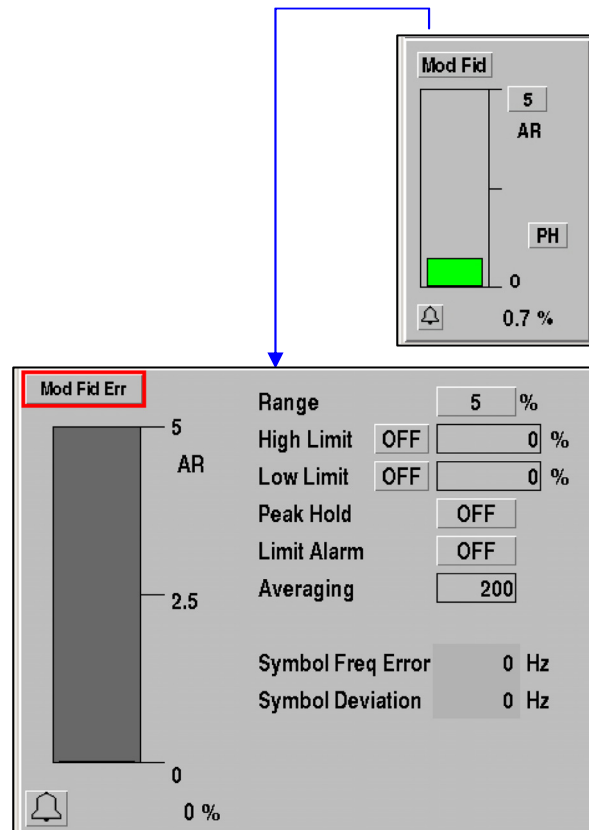

AF COUNTER

The AF Counter is used to measure demodulated audio frequencies, or audio frequencies input to the 2975 through one of the audio input paths (MIC or AUDIO I/O).

FIELD DEFINITIONS

SOURCE INPUT

DEMOD

Allows the demodulated audio from the 2975's Receiver to be routed to the AF Counter input.

MIC (Dynamic or Electret)

Allows the MIC input to be routed to the AF Counter input. This input selection has greater sensitivity than other inputs and is better suited for very low audio levels.

AUD BAL

Allows the input to the AF Counter to be 600 Ω balanced input.

AUDIO

Allows the input to the AF Counter to be an unbalanced input.

RANGE

Selects the AF Counter range (200, 500, 1K, 2K, 5K, 10K, 20K or AR [Auto-Range]) for the bar graph display. When in Auto-Range, the AF Counter automatically selects the appropriate range for the bar display.

HIGH LIMIT

Allows setting of a High limit. When the measured level exceeds the High Limit setting, the Bar Graph changes from GREEN to RED.

LOW LIMIT

Allows setting of a Low limit. When the measured level drops below the Low Limit setting, the Bar Graph changes from GREEN to BLUE.

PEAK HOLD

With Peak Hold enabled, the highest reading remains on the display.

LIMIT ALARM

When enabled, an audible alarm sounds if the High or Low limit is exceeded.

RESOLUTION

Allows the AF Counter to be set to 1.0 or 0.1 (Hz).

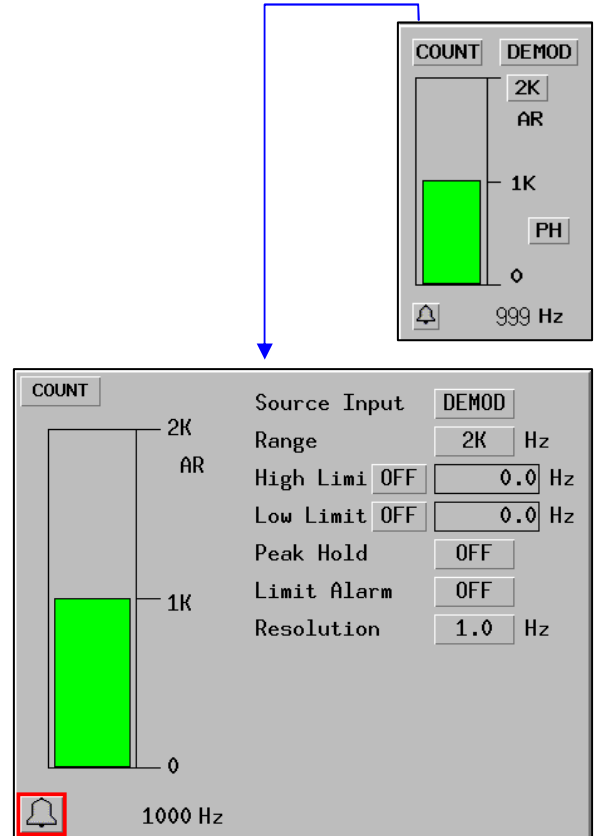

RF ERROR METER

The RF Error Meter is used to measure the difference between the RF Receiver frequency value and the actual frequency as received on the T/R or ANT Port.

The range of the RF Error Meter is directly related to the IF bandwidth selected. The range is approximately $\pm 1/2$ the selected IF bandwidth (i.e., the 200 kHz IF bandwidth can measure approximately ± 100 kHz RF error). When the received signal is too low or is out of range, the Bar Graph appears YELLOW.

FIELD DEFINITIONS

RANGE

Selects the RF Error Meter range (100, 200, 500, 1000, 5000, 10k, 20k, 50K, 100K or AR [Auto-Range]) for the bar graph display. When in Auto-Range, the RF Error Meter automatically selects the appropriate range for the bar graph display.

HIGH LIMIT

Allows setting of a High limit. When the measured level exceeds the High Limit setting, the Bar Graph changes from GREEN to RED.

LOW LIMIT

Allows setting of a Low limit. When the measured level drops below the Low Limit setting, the Bar Graph changes from GREEN to BLUE.

PEAK HOLD

With Peak Hold enabled, the highest reading remains on the display.

LIMIT ALARM

When enabled, an audible alarm sounds if the High or Low limit is exceeded.

RESOLUTION

Allows the RF Error Meter to be set to 1.0 or 0.1 (Hz).

RF RCV FREQ

Allows the RF Receiver to be set to the desired frequency.

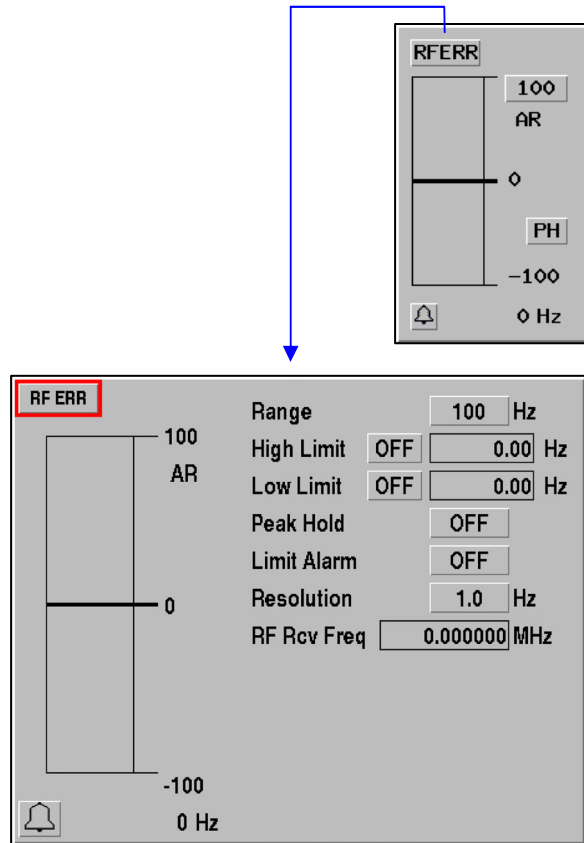

BER METER

The BER Meter measures Bit Error Rate of P25 systems by transmitting a pattern to a radio under test, and monitoring a source for the echoed pattern. Any variances detected on a bit-by-bit comparison are logged as errors and reported, either by percent or ppm (parts per million).

FIELD DEFINITIONS

RANGE

Selects the BER Meter range for the bar graph display. When in Auto-Range, the BER Meter automatically selects the appropriate range for the bar graph display.

HIGH LIMIT

Allows setting of a High limit. When the measured level exceeds the High Limit setting, the Bar Graph changes from GREEN to RED.

LOW LIMIT

Allows setting of a Low limit. When the measured level drops below the Low Limit setting, the Bar Graph changes from GREEN to BLUE.

PEAK HOLD

With Peak Hold enabled, the highest reading remains on the display.

LIMIT ALARM

When enabled, an audible alarm sounds if the High or Low limit is exceeded.

FRAME SAMPLES

This sets the number of frames to measure before updating the meter. Larger numbers slow down the meter updates.

SAMPLE TIME

This displays the length of time that data is sampled - it is a function of the frame samples, and the length of a frame.

TEST PATTERN

This selects the pattern against which the incoming data is tested. This is automatically set to match the Generator bit pattern, and turns YELLOW if the currently selected test pattern does not match the Generator pattern.

RESET TOTALS

Resets the accumulated error values to 0.

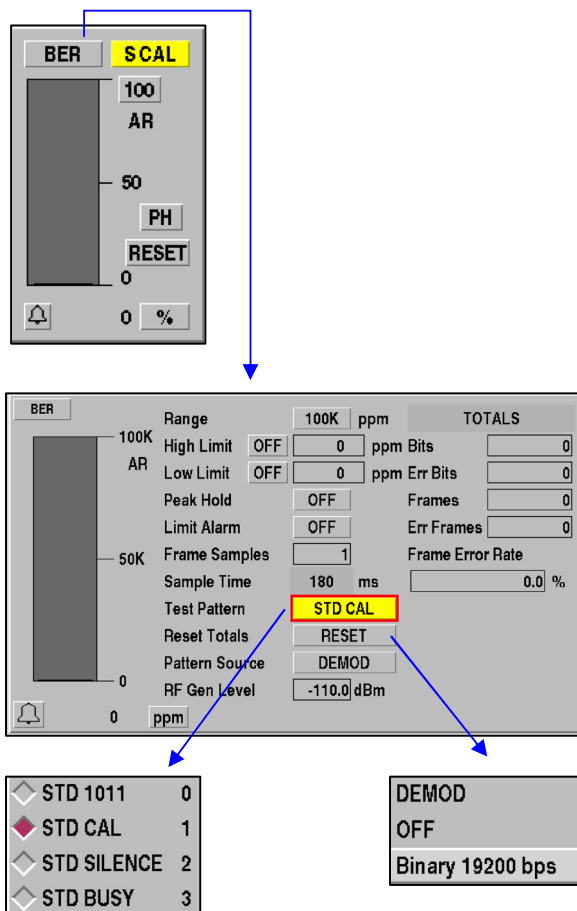

PATTERN SOURCE

Selects the source of the data to be tested. Source options are the demodulated RF, or (optionally) the front panel UUT connector.

RF GEN LEVEL

This field functions the same as the level field in the Generator tile. It allows the generator level to be reduced from the BER meter when conducting RX BER testing.

BITS

This field displays the number of bits over which the accumulated BER is calculated. The field may be reset using the Reset Totals button.

ERR BITS

This field displays the number of bits which were received in error. The field may be reset using the Reset Totals button.

FRAMES

This field displays the number of received frames over which the accumulated FER is calculated. The field may be reset using the Reset Totals button.

ERR FRAMES

This field displays the number of frames received that contained at least 1 bit error. The field may be reset using the Reset Totals button.

FRAME ERROR RATE

This field displays the percentage of frames which contained errors. The field may be reset using the Reset Totals button.

METER PANEL

The Meter Panel is available in the Generator, Receiver and Duplex screens. This feature allows a group of meter values to be displayed in a single panel.

Any of the meters can be expanded to allow adjustment to the individual meter parameters. To expand a meter, position the cursor to the meter label and press the **[ENTER]** Key. To close the window, press the **[RETURN]** Key. This feature is useful to maximize the information content of a single screen.

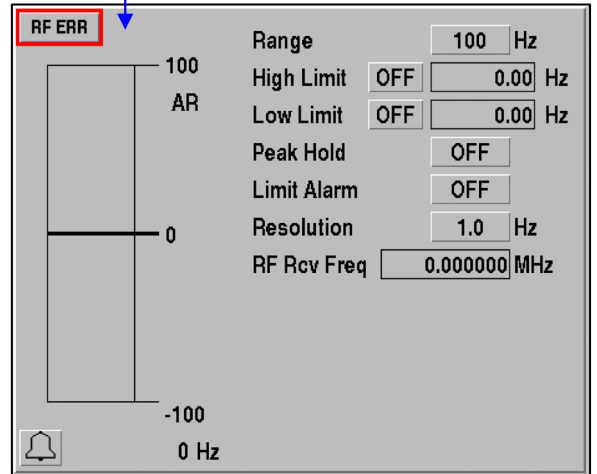
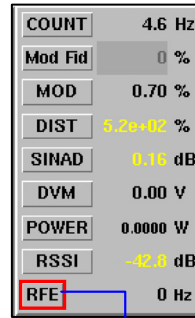

In the Receive screen, the Scope, Spectrum Analyzer, Meter Panel and a Bar Graph Meter can all be displayed simultaneously.

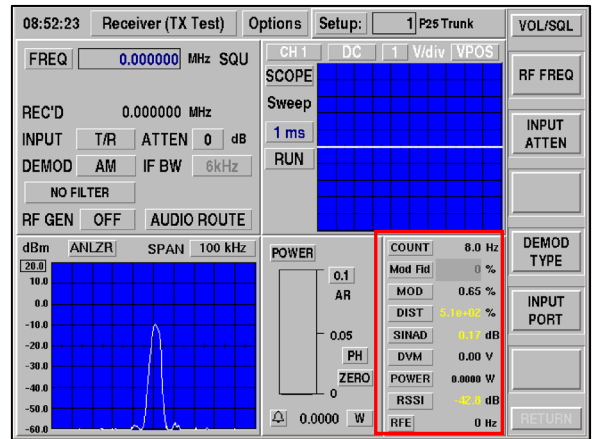

Receive Screen with Meter Panel Enabled

THIS PAGE INTENTIONALLY LEFT BLANK.

SECTION 3 - OPTIONAL FEATURES

3-1 OPTIONAL FUNCTIONS AND FEATURES

CHECKING FOR INSTALLED OPTIONS

The 2975 option control system permits the addition of new software options and for checking the status of the installed options.

An option may be installed at the factory or by the customer.

To check which options are installed in the 2975, select the **VERSION** screen [MODE], [7], [3]) and then press the **Installed Options** Soft Key to access to the **Installed Options** screen.

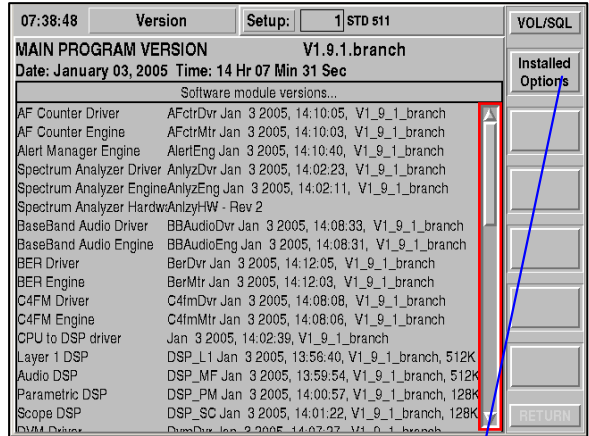

The **Installed Options** screen shows the 2975 serial number and the options that are installed.

If an option Status is shown as **ENABLED** or **LEASED**, the options are correctly set up and ready to use.

If an option is **NOT** listed, or is shown as **DISABLED**, or has **EXPIRED**, then the option needs to be installed in order to function.

To install an option that has been delivered from Aeroflex, proceed to the next section, "INSTALLING 2975 OPTIONS."

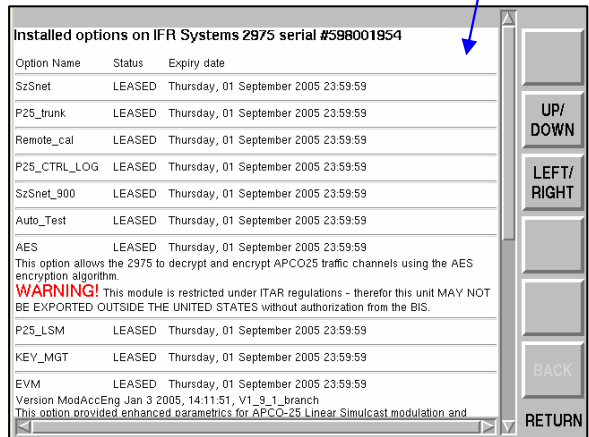

If an option status shows **BAD_CLOCK**, this indicates the internal clock / calendar has been modified by more than ± 24 hours. If **BAD_CLOCK** status is reported, the 2975 may only use **ENABLED** (purchased) options and cannot use **LEASED** options. The 2975 must be returned to Aeroflex Customer Service to be reset.

The "Try Before You Buy" offer for the 2975 uses **LEASED** options, so take care not to change the date in the 2975 by more than 24 hours, either *before* or *after* the option is installed.

To purchase an option for the 2975, contact information is shown in **APPENDIX B**.

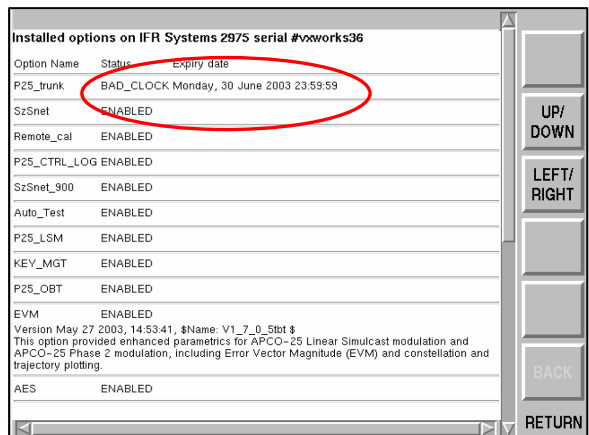

INSTALLING 2975 OPTIONS

If you have received an option from Aeroflex, the option needs to be installed in the 2975 before the option is accessible.

If the option is already installed, you may skip this section.

The 2975 Option File (“**options.new**”) is distributed by Aeroflex via email, floppy disk or CD-ROM.

The Option File (“**options.new**”) must be placed onto a blank, formatted floppy disk (if received by email or CD-ROM) for installation into the 2975. Use a PC to copy the file onto a blank floppy disk.

The Option File (“**options.new**”) is 2975 serial number specific, so label the disk (if not already labeled) for the particular 9-digit serial number for which the disk is made and ***KEEP THE DISK IN A SAFE PLACE.***

OPTION INSTALLATION:

Power ON the 2975.

After the 2975 has booted, press [MODE], [7] and [4] to display the RELOAD screen.

Insert the Option floppy disk for this 2975 (serial number specific) into the floppy drive.

Press the CHECK FLOPPY Soft Key.

The floppy disk is accessed and the INSTALL OPTION FILE Soft Key appears. Press the INSTALL OPTION FILE Soft Key.

When the red warning screen appears, press the START INSTALL Soft Key.

When installation is completed and the 2975 has been rebooted, go to the VERSION screen ([MODE], [7] and [3]) to verify the Option is installed. Press the INSTALLED OPTIONS Soft Key to verify the Option is ENABLED.

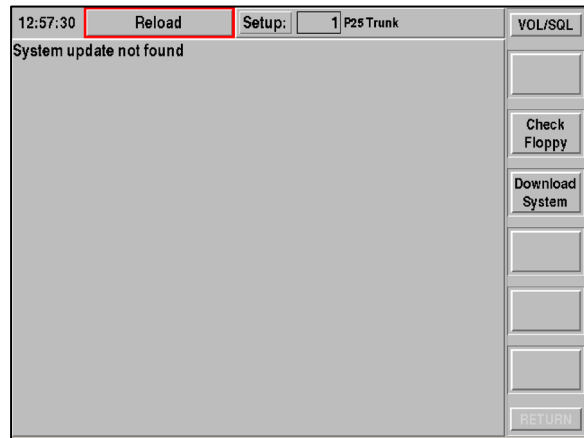

Installation of an Option is only required once - it is not required to be reinstalled each time the system is upgraded with new software.

3-2 DESCRIPTION OF OPTIONS

SMARTNET™/ SMARTZONE™ TESTING (2975OPT3)

The 2975 SmartNet™/SmartZone™ option provides test features for SmartNet™/SmartZone™ radios and systems.

Included within the SmartNet™/SmartZone™ option is:

- the ability to emulate a repeater station operation (not locked to a specific "test sequence" for the radio);
- the ability to "find" and monitor a SmartNet™/SmartZone™ control channel and then "follow" the channel, the group or the individual unit;
- the ability to perform full analog (FM) parametric tests and digital P25 mode tests;
- 800 MHz, 800 MHz Splinter and VHF /UHF frequency band selection;
- Channel designation and frequency settings for each band.

The screenshot shows the 'Options' menu for the 2975 SmartNet/SmartZone testing interface. The 'FOLLOW CONTROL CHANNEL' section is expanded, showing a 'LIST' field with the value '2' highlighted by a red box. Other visible settings include 'BAND' set to 800, 'SYS ID' set to 2, and 'START' set to 300. The interface also displays various other parameters like 'FREQ', 'OFFSET', 'LEVEL', and 'MOD TYPE'.

P25 TRUNKING (2975OPT4)

The 2975 P25 Trunking Option provides powerful test features for these radios and systems.

Included within the P25 Trunking Option is:

- the ability to emulate a P25 repeater station;
- the ability to perform mobile-initiated call function;
- the ability to perform RF and modulation parametric tests on the unit under test (UUT).

The 2975 P25 Trunking Option does not test all of the control channel messages; however it does verify a number of major interactions between the RFSS and the SU. These are protocol messages in which the mobile (the SU) is verified to correctly respond to commands from the 2975 (the RFSS).

The screenshot shows the 'Options' menu for the 2975 P25 Trunking testing interface. The 'Duplex' button is highlighted with a red box. The interface displays various settings for a P25 trunking test, including 'FREQ' set to 170.000000 MHz, 'MOD TYPE' set to FM, and 'P 25 TRUNKING' set to 800. A list of test options is visible on the right side of the screen, including 'Accept Options', 'Oscilloscope', 'Spectrum Analyzer', and 'P 25 Downlink Data'.

The 2975 P25 Trunking Option emulates some of the protocol (OSPs) of the RFSS. The 2975 responds to ISPs the mobile sends in order to get the mobile onto a traffic channel for parametric testing.

While operating on the traffic channel, the 2975 maintains communication with the mobile through P25 specified Logical Link Data Units (LDUs). These data units carry both voice and data information during the traffic channel session.

In addition to maintaining the traffic channel session, the 2975 simultaneously provides the capability to verify the parametric performance of the mobile, including frequency, power and modulation.

Refer to the P25 Trunking Manual (1002-4202-3P0) for details about using the P25 Trunking Option.

CONTROL CHANNEL LOGGER (2975OPT6)

The 2975 Control Channel Logger Option provides the capability to monitor and log P25 control channel Outbound Signaling Packets (OSPs), Inbound Signaling Packets (ISPs) and Link Control Octets (LCOs).

The logging function is initiated by selecting the **START** button on the P25 Logger tile. The P25 Logger permits capture of control channel information to the designated file. The captured data may be inspected using the **VIEW LOG** button on the P25 Logger Tile.

Refer to “Using the 2975 to Perform Control Channel Logging” (Aeroflex Application Note, 46891/917) for details on using the Control Channel Logger.

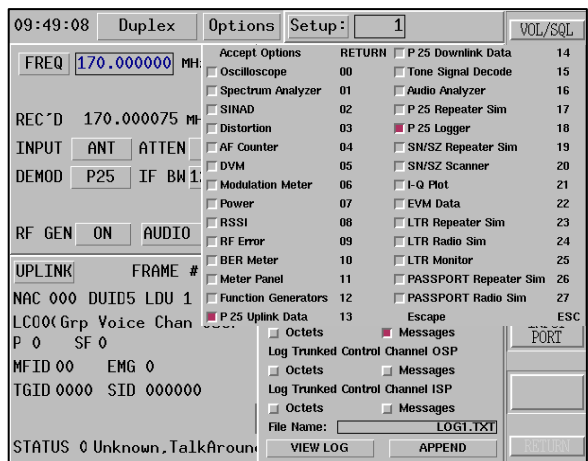

FIELD DEFINITIONS

START / STOP

This toggle button **STARTS / STOPS** logging of P25 data.

RAW SYMBOLS

This toggle button **ENABLES / DISABLES** logging raw symbols. **Raw Symbols** may be simultaneously enabled with any of the control channels.

OCTETS / MESSAGES

Enabling either of these toggle buttons allows P25 data to be captured and logged. User may simultaneously enable **Octets** and **Messages** for one type of control channel, however this feature does not allow users to simultaneously enable octets and/or message logging for various control channel groups. For example, a user can not simultaneously enable Log Trunked Control Channel OSP **Octets/Message** and Log Conventional P25 LCO **Octets/Message** in any combination.

FILE NAME

This field displays the file name used to save the P25 data. User may edit this field to specify file name.

VIEW LOG

Selecting **VIEW LOG** opens a screen which opens the P25 Logging View dialog box. The P25 Logging View dialog box displays the current logged P25 data.

APPEND / OVERWRITE

This toggle button displays the mode used to save P25 data to the file.

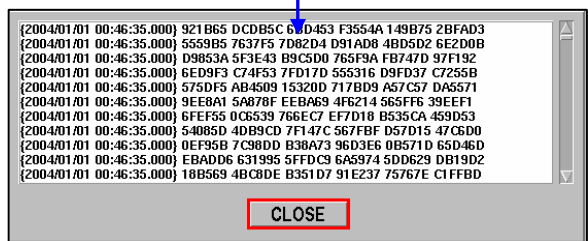
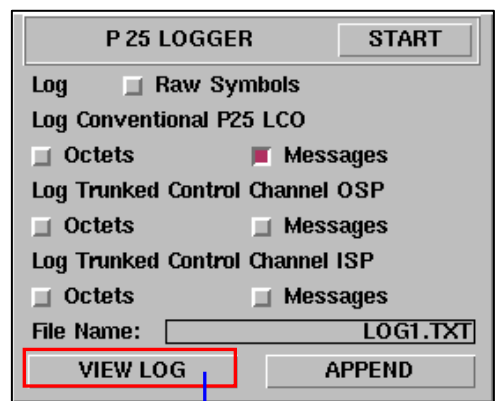

SMARTNET™/SMARTZONE™ 900 MHZ (2975OPT8)

The SmartNet™/SmartZone™ Option builds upon the SmartNet™/SmartZone™ Testing option (2975OPT3) by extending the frequency band coverage to the new 900 MHz frequency band.

The SmartNet™/SmartZone™ Testing option must be installed for the SmartNet™/SmartZone™ 900 MHz option to operate.

This option provides channel designation and frequency settings for the 900 band. The SN/SZ Control Channel tile (to the right) shows the selections added for **900**.

The operation for the SN/SZ Trunking is the same as 800 MHz band operation with the exception of channel to frequency.

Refer to the SmartNet™/SmartNet™ Option Manual (1002-4201-3P0) for details about using the SmartNet™/SmartZone™ Trunking Option.

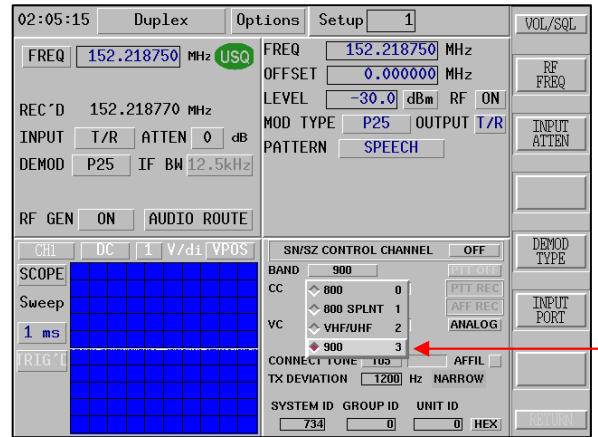

AUTO TEST (2975OPT9)

The **Auto Test** Option adds the ability to define, recall and run tests for conventional two-way radios and P25 Phase I non-trunked radios. This capability makes repeatability of the radio test process easy, insuring the same tests are performed the same way all of the time, plus the test results can be printed, reducing documentation time.

The Auto Test is an Application accessible under the Apps selection on the Main Function Select Menu.

The first example screen is the **TEST INFORMATION** screen. This allows entry for various general information fields, such as date, time, name and radio information plus comments.

New selection types may be added using the soft keys (**ADD / DELETE RADIO**, **ADD / DELETE TEST**) or a **CONNECT DIAGRAM** may be selected for display to show how to interconnect the 2975, the UUT and any other accessory equipment.

Once this screen is complete, press the **CONTINUE** Soft Key for the next screen.

The **TEST SELECTION** screen allows selection and configuration for various types of test types, such as Receiver or Transmitter tests for Analog (FM / AM) and Digital systems. The box at the left of each line item shows if the item is selected (red) or not selected (gray). The MDC-1200 test is a Power / Frequency test.

In the example screen, the **Analog Receiver Test** is selected and all other items are not selected.

Pressing the **CONFIG** button to the right of a line item selects the setup screen for that particular test.

The example **Analog Receiver Test** configuration screen (to the right) shows the several fields that may be set for performing Receiver tests, including frequency and channel, modulation and measurement pass / fail limits.

Once this screen is set as desired, press the **RETURN** Soft Key to return to the **TEST SELECTION** screen.

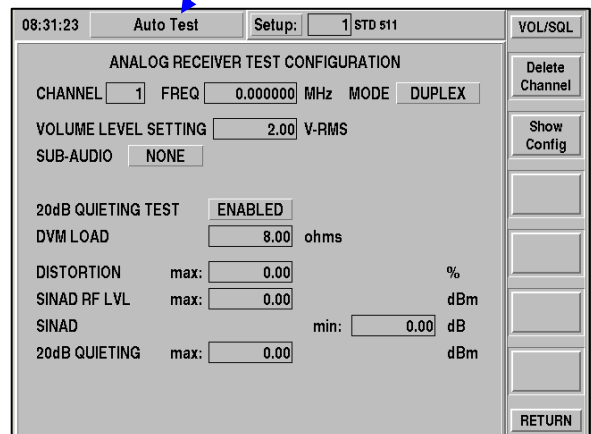
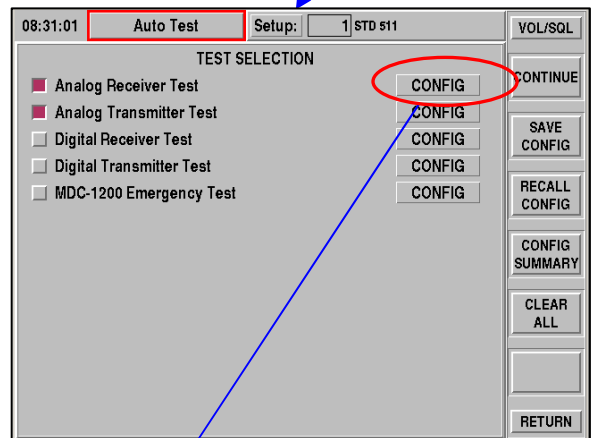
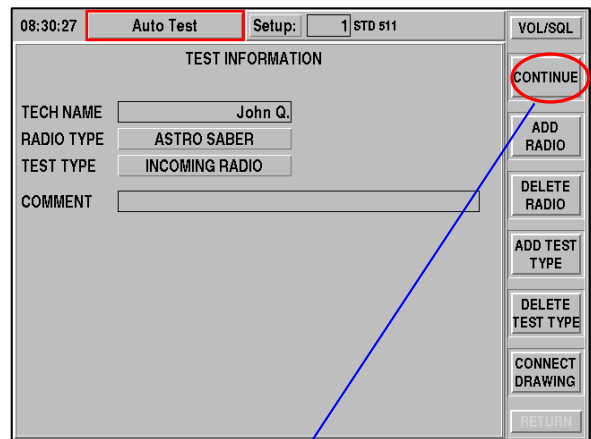
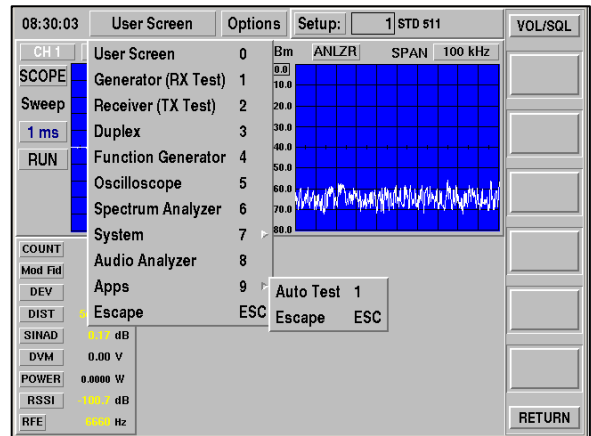

Press the **CONTINUE** Soft Key on the **TEST SELECTION** screen to display the **TEST RESULTS** screen. This screen allows the tests to be started / stopped (using the Soft Key), results viewed on-screen or printed and settings to be saved and recalled to and from internal storage.

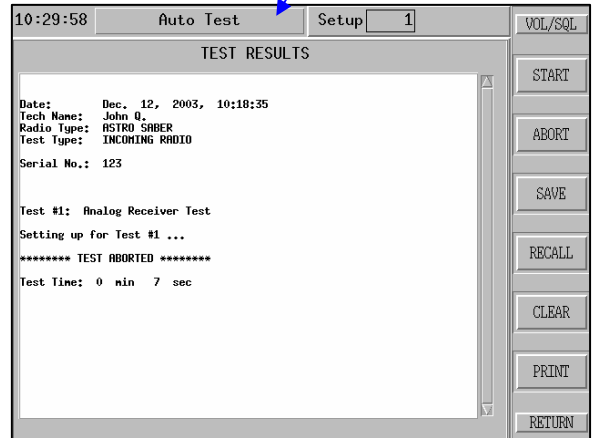
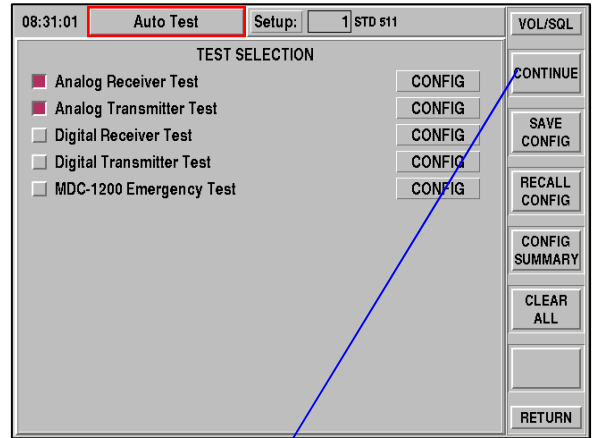

AES (2975OPT10)

The AES Option adds the Advanced Encryption System algorithm to the 2975. This encryption system provides additional capability to customers needing to verify operation of radios while in secure mode.

The AES encryption mode is selected on the **DOWNLINK** tile under the encryption button. Selections for **CLEAR**, **DES** and **AES** are available. The corresponding algorithm ID (ALGID) is displayed as well (**CLEAR** is 80, **DES** is 81 and **AES** is 84).

The decryption mode is also displayed within the **UPLINK** data window. This decrypted information is shown in two places: the **HEADER** section and in the **ES DATA** (Encryption Sync) section, since the **HEADER** data may be sent either encrypted or non-encrypted.

The algorithm ID (**ALGID**) is displayed to indicate the particular decryption mode (**CLEAR** is 80, **DES** is 81 and **AES** is 84).

The **AES ALGID** may be selected, but no encryption of data occurs unless the AES option is installed. The data is transmitted as **CLEAR** (not encrypted).

Refer to “Using the 2975 for Advanced Project 25 Keyloading Capabilities and AES/DES Encryption” (Aeroflex Application Note, 46891/926) for details on using the Advanced Encryption System.

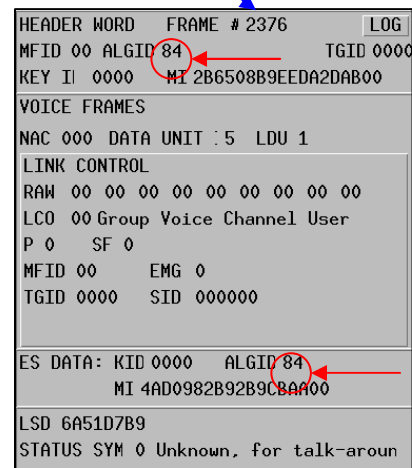
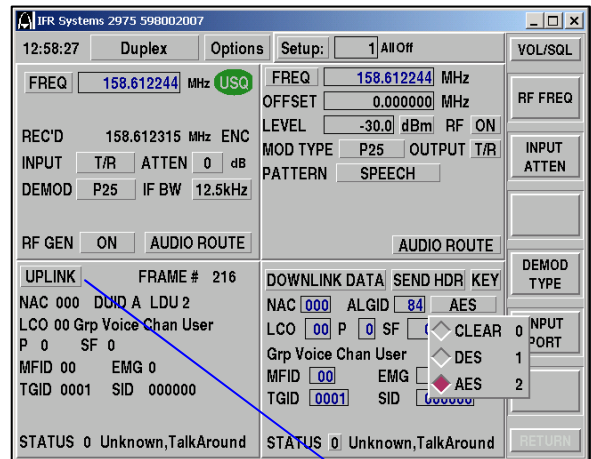

LSM / P25 PHASE II (2975OPT11)

The LSM / P25 Phase II Option adds CQPSK (compatible quadrature phase-shift keying) modulation and demodulation capability to the 2975.

As shown in the screen (to the right), the Receiver **DEMOD** type adds the **P25 P2** and **P25LSM** selections.

P25 P2 uses a 6.25 kHz IF bandwidth and the **P25LSM** uses a 12.5 kHz IF bandwidth. Both **P25 P2** and **P25LSM** demodulate the P25 CQPSK waveforms in the respective IF bandwidths.

The Generator **MOD TYPE** also adds **P25 P2** and **P25 LSM** selections.

The **P25 P2** modulation type generates a P25 CQPSK waveform, with the data as specified in the **PATTERN** selection field. This **MOD TYPE** selection is also used for P25 LSM applications.

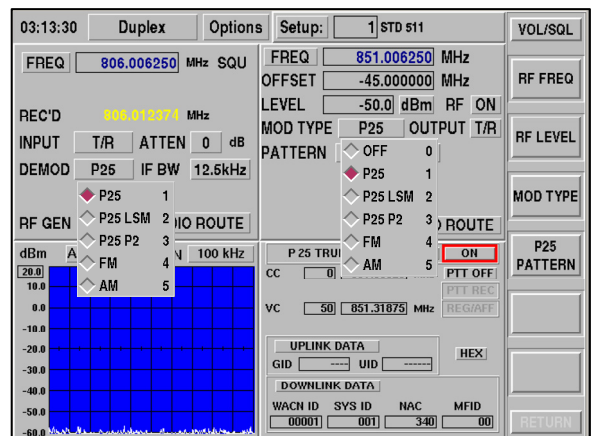

**KVL KEYLOADER (2975OPT12) AND
KVL ASN (2975OPT20)**

The KVL Keyloader Option adds the ability to enter encryption keys into the 2975 for DES and AES.

Encryption keys may be loaded manually using either the front panel or external keypad, or the Project 25 Key Fill Device (KFD) interface protocol (for 2975OPT12). Optionally, the 2975OPT20 KVL ASN Mode provides the ability to load keys using the ASN mode of operation found in KVL-3000 and older model key loaders from Motorola.

Automatic Loading

The picture shows the connection to the KVL-3000 Plus™ device. The KVL Keyloader option includes a cable for interconnecting the 2975 Test Connector to the KVL-3000 Plus™.

The KVL-3000 Plus™ may be set to load keys as is done for a radio, but instead the 2975 receives the key for checking the radio in secure mode. Refer to the KVL-3000 Plus™ User's Guide (68P81131E16-A) for more information about KVL device, and for details about how key loading is performed.

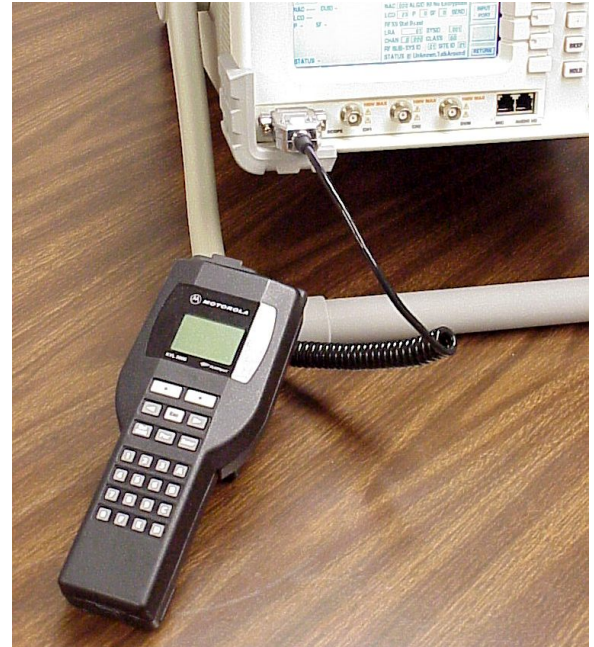

Use the "ASTRO 25" mode of operation on the KVL device with the 2975. KVL ASN Mode is only supported with Option 20.

The screens (to the right) show the selection for AUTO LOAD from the KVL device.

From the DOWNLINK DATA button, select LOAD KEYS, then select AUTO LOAD.

The prompt appears instructing the Key Fill device be connected to the 2975. Once this connection is made and the KVL-3000 Plus™ is activated, the key(s) are loaded into the 2975.

Refer to "Using the 2975 for Advanced Project 25 Keyloading Capabilities and AES/DES Encryption" (Aeroflex Application Note, 46891/926) for details on using the Advanced Encryption System.

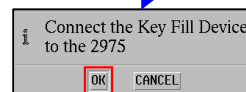
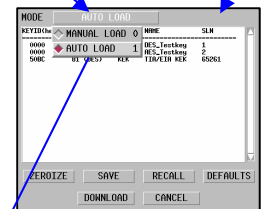
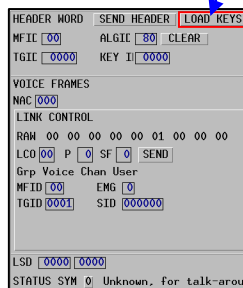
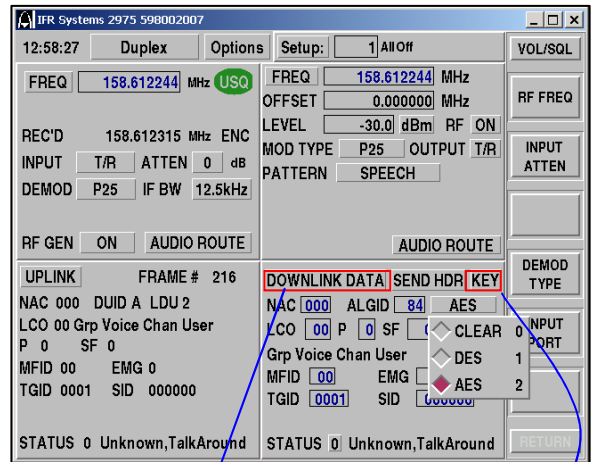

Manual Loading

If a KVL device is not used, the key data may be entered and maintained using the 2975 in **MANUAL LOAD** mode.

The screens (to the right) show the selection for **MANUAL LOAD**, located under the **DOWNLINK DATA** button, then **LOAD KEYS**.

The P25 Logger permits capture of control channel information to the designated file. The captured data may be inspected using the **VIEW LOG** button.

The **MANUAL LOAD** function provides the ability to enter all of the required and optional fields for setting key information, as well as store, recall and deletion of key information stored within the 2975.

KEYID is the hexadecimal number for the key identifier.

ALGID is the encryption method used, either DES or AES.

FORMAT is the type of encryption key, either **KEK** (Key Encryption Key) or **TEK** (Traffic Encryption Key).

SIZE is the key length (in bits) for the selected **ALGID**.

SLN / CKR is the Storage Location Number / Common Key Reference field (refer to Motorola KVL Manual for more information). An entry may be made into this field to set the SLN/CKR of the next key to be added to the key set.

NAME is an optional field for alphanumeric entry for the key name.

KEY is the hexadecimal entry field for the key. The **DES** key length is 64 bits (8 bytes) and the **AES** key length is 256 bits (32 bytes).

ADD KEY uses the entered information and attempts to add it to the unit as a new key. During this process the 2975 performs a validation procedure which generates the following prompts if a conflict is detected:

Duplicate KeyID and AlgID

The 2975 allows the user to select a key to encrypt P25 traffic using only a KeyID and AlgID. To ensure that the KeyID and AlgID select a unique key, the 2975 does not allow the user to enter a new key when another slot uses the same KeyID/AlgID combinations. If a user enters a new key with KeyID/AlgID's identical to those being used by another slot, a prompt appears which requests the user to either cancel the ADD request, or to replace key in the old slot with a key in the new slot.

Duplicate AlgID and SLN

The 2975 only allows one key assignment per SLN/CKR slot for a specific encryption algorithm. If a user attempts to duplicate a key assignment for a SLN/CKR for a specific encryption algorithm, a prompt appears requesting user verify that the existing key in that slot is to be overwritten.

DELETE KEY attempts to delete the key by searching for the specified KeyID and AlgID. If a matching key is found, a prompt appears which requests user to verify the delete request.

01:58:31 Duplex Options Setup: 1 APO# VOL/SOL

FREQ 306.012500 MHz SQU OFFSET 851.012500 MHz RF FREQ

REC'D 300.012500 MHz OFFSET -45.000000 MHz RF FREQ

INPUT T/R ATTN 0 dB LEVEL -30.0 dBm RF OFF

DEMOD P25 IF BW 12.5kHz MOD TYPE P25 OUTPUT T/R INPUT

PATTERN 1011

RF GEN OFF AUDIO ROUTE AUDIO ROUTE

UPLINK FRAME# 43 DOWNLINK DATA SEND HDR KEY DEMOD TYPE

NAC 293 DUID A LDU 2 NAC 293 ALGID 0 Unknown

LCO 00 Grp Voice Chan User LCO 00 P 0 SF 0 SEND INPUT

P 0 SF 0 Grp Voice Chan User

MFID 00 EMG 0 MFID 00 EMG 0

TGID 0002 SID 000001 TGID 0000 SID 000001

STATUS 2 Unknown,in&outbound STATUS 0 Unknown,TalkAround

HEADER WORD SEND HEADER LOAD KEYS

MFID 00 ALGID 0 Unknown

TGID 0000 KEY ID 0000

VOICE FRAMES

NAC 000

LINK CONTROL

RAW 00 00 00 00 00 01 00 00 00

LCO 00 P 0 SF 0 SEND

Grp Voice Chan User

MFID 00 EMG 0

TGID 0001 SID 000000

LSD 0000 0000

STATUS SYM 0 Unknown, for talk-around

MODE MANUAL LOAD

KEYID 0000 hex ALGID DES FORMAT TEK

SIZE 64 bits SLN / CKR 10

NAME (opt.)

KEY hex

ADD KEY DELETE KEY

KEYID(hex)	ALGID(hex)	FORMAT	NAME	SLN
0000	81 (DES)	TEK	DES_Testkey	1
0000	84 (RES)	TEK	RES_Testkey	2
500C	81 (DES)	KEK	TIR/EIR KEK	65261

ZEROIZE SAVE RECALL DEFAULTS

USE KEYS CANCEL

ZEROIZE button is pressed to wipe all keys from the 2975. Keys are deleted and overwritten to eliminate the key data from all internal storage. This purges the keys from the 2975 for security purposes (no key information is present within the 2975 after **ZEROIZE**).

SAVE button accesses the 2975 file system to permit saving the key information to internal storage.

RECALL button accesses the 2975 file system to permit restoring the key information from internal storage.

DEFAULTS button permits restoring the factory default key information.

DOWNLOAD button transfers the key information from the internal storage system to the internal DSP system for use.

MODE: **MANUAL LOAD**

KEYID: 0000 hex ALGID: DES FORMAT: TEK

SIZE: 64 bits SLN / CKR: 10

NAME: (opt.)

KEY: ***** hex

ADD KEY DELETE KEY

KEYID(hex)	ALGID(hex)	FORMAT	NAME	SLN
0000	81 (DES)	TEK	DES_Testkey	1
0000	84 (DES)	TEK	DES_Testkey	2
50BC	81 (DES)	KEK	TIR/EIR KEK	65261

ZEROIZE SAVE RECALL DEFAULTS

USE KEYS CANCEL

LSM ADVANCED / P25-2 ADVANCED (2975OPT13)

The LSM Advanced / P25-2 Advanced Option builds upon the basic LSM / P25 Phase II option by adding powerful measurement capabilities for I-Q (In-phase / Quadrature) constellation plot and EVM (error vector magnitude) measurement. The LSM Advanced / P25-2 Advanced option requires the LSM / P25 Phase II option (2975OPT11).

Both the I-Q Plot and the EVM data may be displayed, permitting detailed evaluation and testing for P25 waveforms.

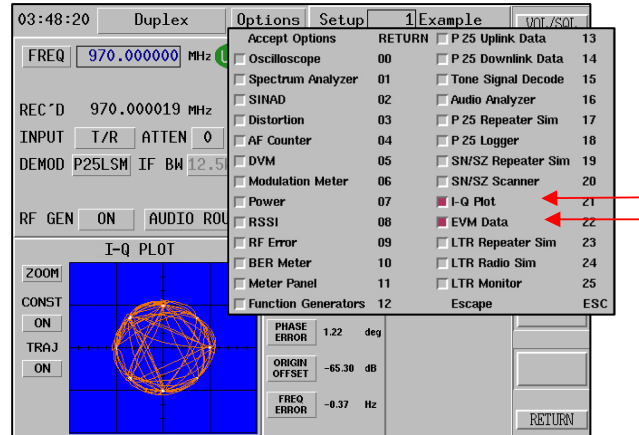

If unfamiliar with I-Q modulation, or to review some of the details regarding I-Q modulation, refer to "Advancing Wireless Test - RF Datamate" (Aeroflex Booklet, 46891/883). This booklet contains useful information about digital modulation, RF measurements and general communications. Pages 14 to 22 (RF Datamate) provide information specific to I-Q modulation and EVM measurements.

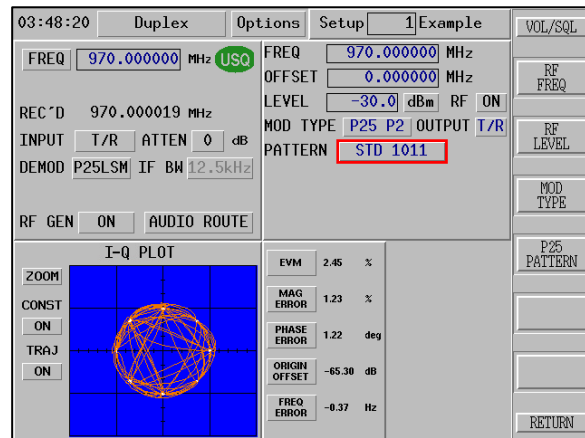

CONST (constellation) button turns the decision point display **ON** and **OFF** (the white dots).

TRAJ (trajectory) button turns the plot of the path, the I-Q signal takes, **ON** and **OFF** (the red trace).

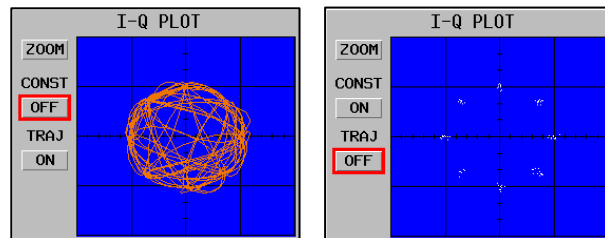

ZOOM button enlarges the I-Q PLOT to full screen and displays the associated EVM and the various components comprising the EVM measurement.

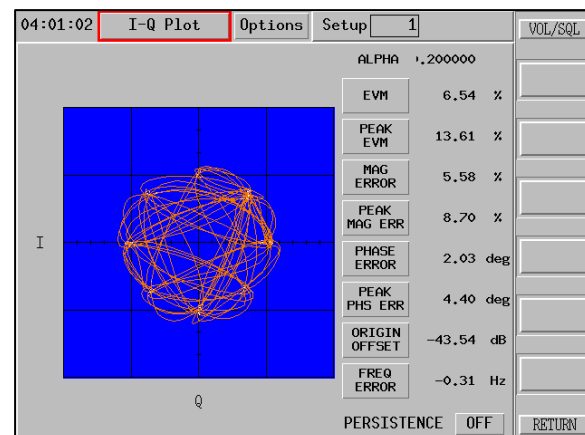

PERSISTENCE accumulates constellation points until the feature is turned **OFF**, permitting an accumulation of decision points over time.

Refer to “Using the 2975 for Advanced Project 25 Phase II and LSM Analysis” (Aeroflex Application Note, 46891/919) for details on using the LSM and P25 Phase II Advanced option.

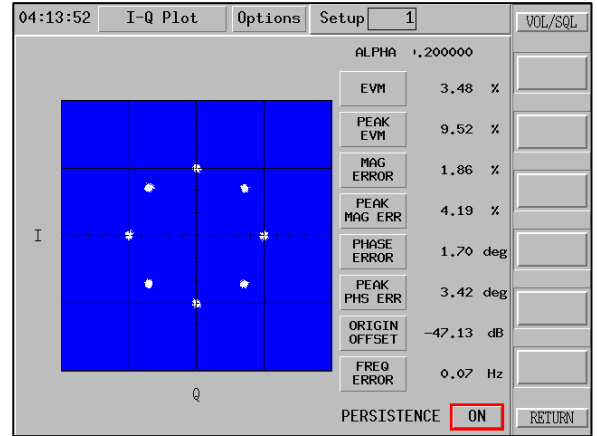

P25 TRUNKING VHF/UHF/700 MHZ (2975OPT14)

The P25 Trunking VHF/UHF/700MHz Option builds upon the P25 Trunking Radio Test option (2975OPT4) by extending the frequency band coverage to the new VHF, UHF and 700 MHz frequency bands.

This options provides channel designation and frequency settings for each band. The screen (to the right) shows the selections added for **700** and **UHF/VHF** for the P25 Trunking tile.

The operation for the P25 Trunking is same as 800 MHz band operation with the exception of channel to frequency allocations for each particular band.

Refer to the P25 Trunking Option Manual (1002-4202-3P0) for details about using the P25 Trunking Option.

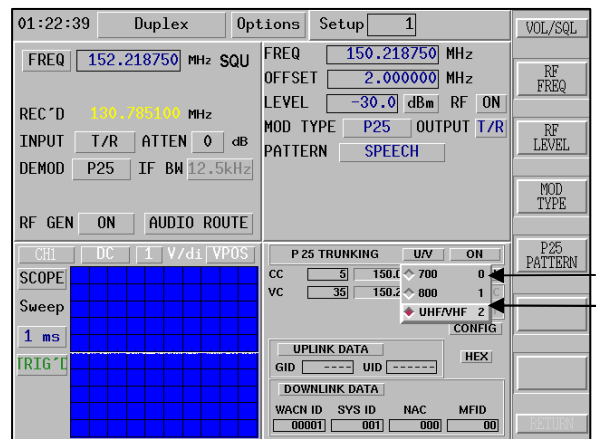

AUDIO ANALYZER OPTION (2975OPT15)

The Audio Analyzer Option is a display of the audio frequency band of a selected input. This display is presented in much the same manner as the RF Spectrum Analyzer. Two major differences exist between the Audio Analyzer and the Spectrum Analyzer:

- The frequency of operation.
- The audio analyzer is a time sampled system and uses signal processing techniques to display the selected input in the frequency domain.

The Audio Analyzer is accessible as a stand-alone instrument from the MODE select, or as a component within a particular screen, such as Function Generator.

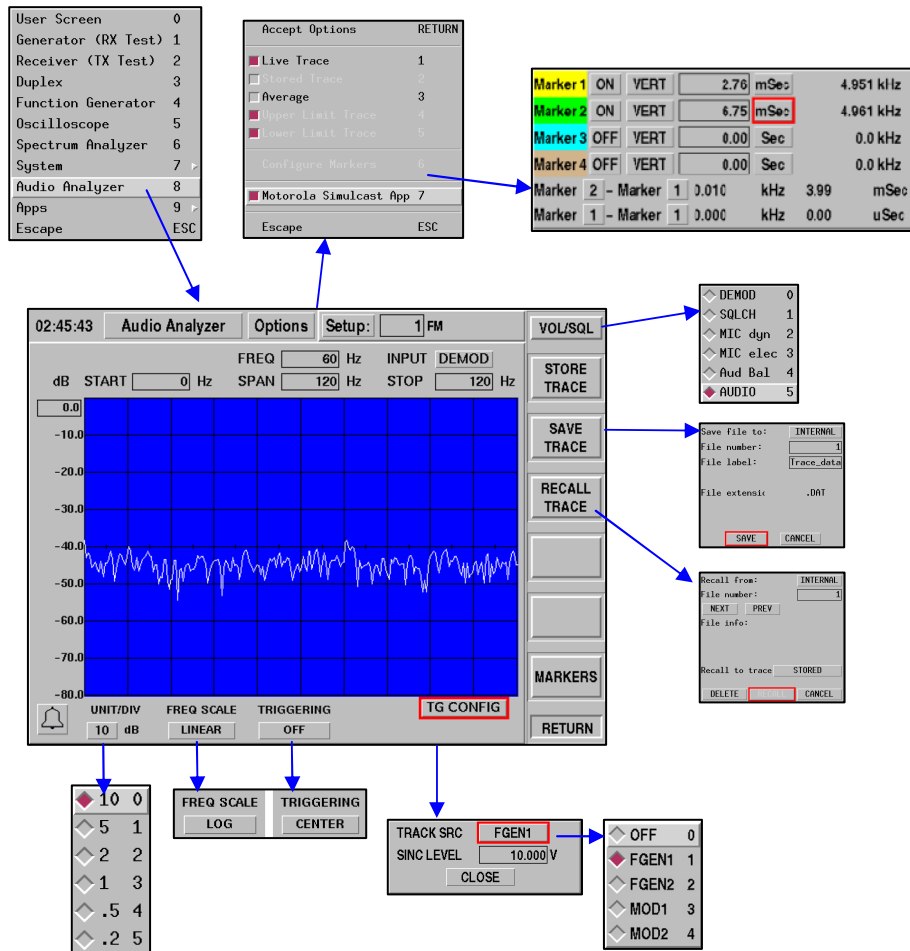

The Audio Analyzer permits several Options to be selected. Current selections are:

Live Trace activates the Audio Analyzer on the selected Audio Input.

Stored Trace displays the last stored trace, activated whenever the STORE TRACE soft key is pressed.

Average activates the Average entry field below the graticule area to permit entry of averaging number. Average of 0.0 is same as LIVE, 0.1 is 1 of 10, 1.0 is HOLD trace mode (no update).

Upper Limit / Lower Limit Traces are used with the Analog Simulcast Align Option (2975OPT16) that are set for upper and lower bounds for acceptable trace. Refer to Analog Simulcast Align Option (2975OPT16) in this manual for details of the limit traces.

Configure Markers. The Audio Analyzer has 6 markers that may be placed on-screen to permit monitoring a single point level or frequency. Each marker may be set to ON or OFF and aligned horizontally or vertically.

Motorola Simulcast is an option described in para 2-30.

FREQ / START / SPAN / STOP. The center FREQUENCY, SPAN, START and STOP frequencies may be entered as desired. After the entry of any one of these fields, the remaining three fields are updated to correspond to the entered value.

EXAMPLE: If the START is at 10 Hz and STOP is at 1000 Hz, then SPAN is 990 Hz and FREQ is 550 Hz. If FREQ is changed to 600 Hz, then START becomes 105 Hz, SPAN remains at 990 Hz and STOP becomes 1095 Hz. The START and STOP FREQ soft keys permit access to these fields respectively.

INPUT. The audio INPUT may be selected as DEMOD, SQLCH (squelch-controlled demod audio), MIC (dynamic or electret), AUDIO BALANCED input or AUDIO unbalanced input. The INPUT soft key permits access to the selection input.

REFERENCE LEVEL. The top display line reference may be entered in the range of 0.0 to -80.0 dB. The displayed trace is referenced to the peak level of the input signal.

STORE / SAVE / RECALL TRACE. The TRACE soft keys permit capture, storage and retrieval of Audio Analyzer waveforms. The STORE key captures the current trace to memory. This trace may be viewed if the Stored Trace (Item #2) is ON.

TRIGGERING of the display waveform may be selected to be OFF, or CENTERed. The CENTER is selected whenever a pulsed signal, such as SINC is being observed, or if looking at tone bursts.

FREQ SCALE. The horizontal frequency axis (FREQ SCALE) may be changed between LINEAR, with 10 divisions equally spread between Start and Stop frequencies, or LOG, where each decade in frequency is spaced in a logarithmic fashion.

UNIT/DIV. The vertical level axis may be changed so that each division is 10, 5, 2, 1, 0.5 or 0.2 dB per division.

TG CONFIG The Audio Analyzer supports the use of four function generators (FGEN1, FGEN2, MOD1 or MOD2) as sources for testing a system's frequency response. The **TG CONFIG** function is similar to the Tracking Generator of the RF Spectrum Analyzer. When a function generator has been selected on the Audio Analyzer the **TG CONFIG** key turns white, indicating a function generator is active.

When activating function generators some settings must be manually configured:





FGEN1 or FGEN2. The FGEN1 or FGEN2 function generators must be manually routed to the appropriate output port (Audio 1 or Audio 2). The generator level and the connection from the correct audio port to the unit under test must also be manually configured. Refer to para 2-10 for information on Audio Routing.

MOD1 or MOD2. RF Generator modulation mode (AM or FM), RF Generator RF level and port, and the modulation level of the Modulator must be manually configured when selecting **MOD1** or **MOD2** function generators.

When enabled the function generators initially default to SINC mode and automatically set the correct sample rate and omega to provide a signal which appears as a flat line on the Audio Analyzer screen. When using the Audio Analyzer function generators no other signal should be routed to the UUT port.

Enabling the Audio Analyzer's Tracking Generator activates the CENTER triggering mode. CENTER triggering mode is required for Tracking Generator Mode to function properly.

NOTE: The transformer used in BALANCED Mode alters the frequency response of frequencies below 300 Hz. To obtain an accurate reading use UNBALANCED Mode when using the AUDIO 1 port.

	OFF	0
	FGEN1	1
	FGEN2	2
	MOD1	3
	MOD2	4

AUDIO SIMULCAST ALIGN OPTION (2975OPT16)

The Audio Simulcast Align Option is an addition to the Audio Analyzer Option specifically designed for setup and checkout of a Simulcast repeater sub-audible path.

The Audio Simulcast Align Option uses Function Generator #1 (FGEN1) as the stimulus source for the audio system, and the Audio Analyzer is used to display the response of the unit under test (UUT).

The applied audio signal is a SINC signal that is preset for observing the response of the sub-audible band of a repeater system. The SINC waveform provides a pulsed output that is ideal for checking frequency response over a band.

When the SINC output is connected to the audio input of a transmitter, and the audio spectrum of the corresponding system is received and plotted, the audio response of the system is displayed.

The screen (to the right) shows the Simulcast Option screen. The trace shown is the 2975 RF Generator FM modulated with the SINC waveform, then connected to the 2975 RF Receiver, with FM demodulation and a 300 Hz low-pass filter. This trace is the response of the receiver and the receiver's audio path.

Pressing the TG CONFIG button shows the settings for the UPPER and LOWER LIMITS, TRACK SRC and the SINC LEVEL and permits editing for each field.

The GRAB TRACE button captures the most recent trace data and applies the UPPER and LOWER limit values to the trace, producing a screen where the UPPER limit is shown with the GREEN trace, the most recent trace shown in WHITE and the LOWER limit is shown in BLUE. This is useful for capturing a reference trace AND using the trace as a mask to view the audio response. The UNIT/DIV field was changed to 5 dB to make the waveform comparison easier to see.

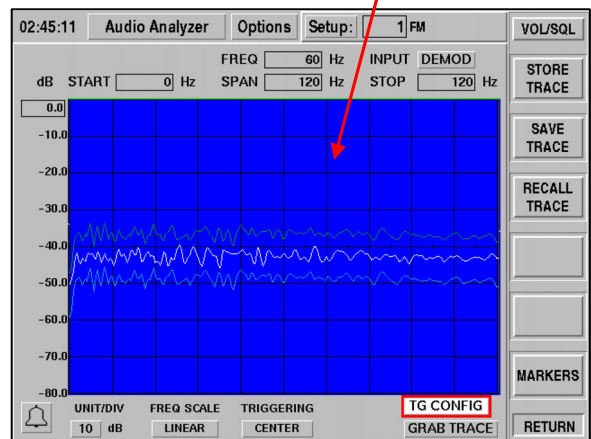
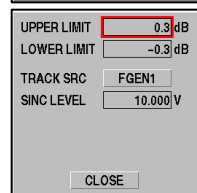
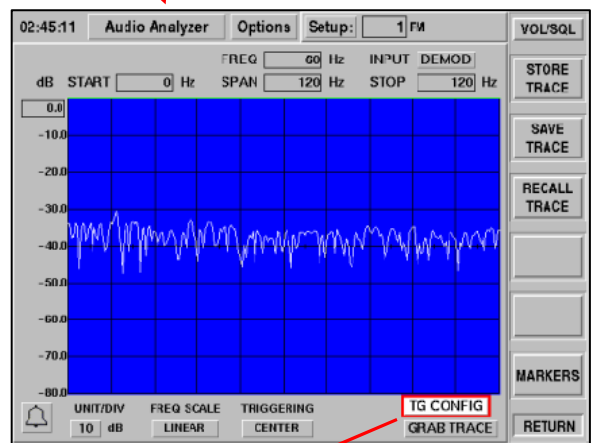
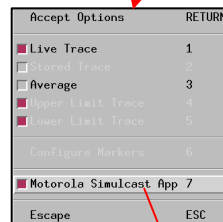
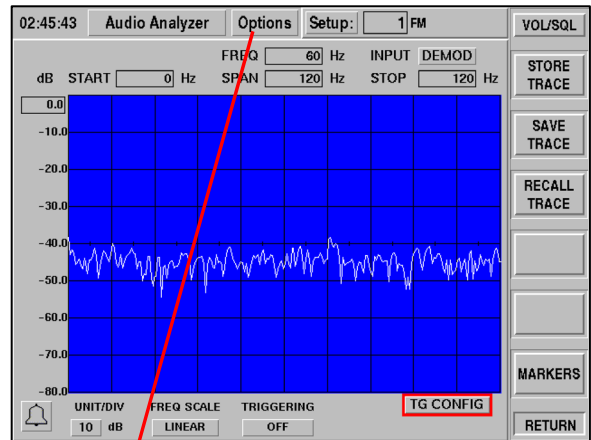

RX BER OPTION (2975OPT17)

The Rx BER Option builds upon 2975 BER meter capabilities. This option adds a Pattern Source for external digital input, referred to as **Binary 19200 bps**.

This external input has the following attributes:

- Input is the 2975 Front Panel 15 Pin D-Sub Test Port:
 - Pin 5 - Serial Input
 - Pin 7 - Ground (Earth, logic reference)
- Input logic level is TTL (>2.4 V is logic "1" and <0.8 V is logic "0").
- Input data is RS-232 style serial format:
 - 1 Start bit, 8 Data bits, 1 Stop bit, No Parity and 19,200 bits per second rate.
 - 8 Data bits are arranged as 4 (four) P25 symbols; most significant symbol sent first.

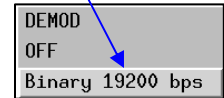
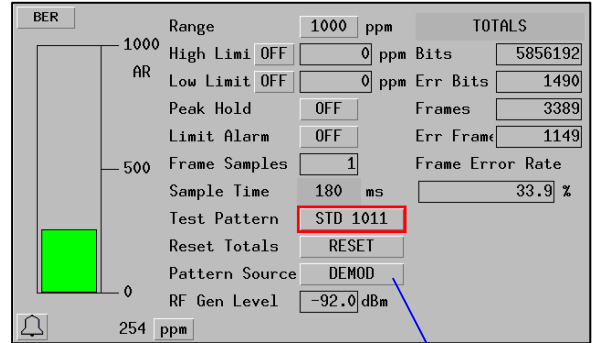

LTR® TRUNKING OPTION (2975OPT18)

The 2975 LTR® Option provides powerful test features for LTR® radios and systems. This option provides users with the following capabilities:

- ability to emulate repeater station operation;
- ability to emulate mobile radio operation;
- ability to monitor a LTR® repeater or radio channel;
- ability to perform parametric tests and measurements.

Refer to the LTR Trunking Option Manual (1002-4203-3P0) for details about using the LTR Trunking Option.

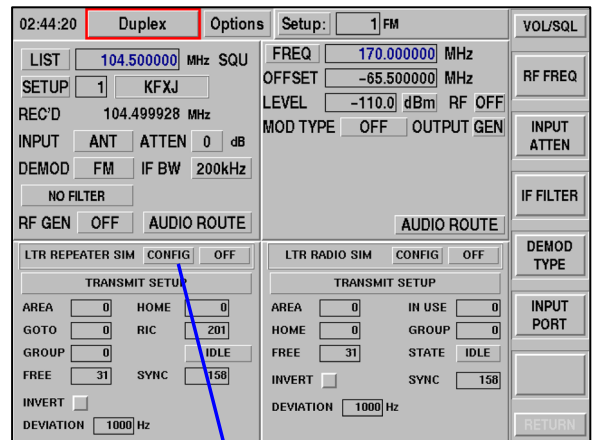

CHAN	BAND	MOBILE Rx FREQ (MHz)	MOBILE Tx FREQ (MHz)	FCC CH#	BORDER BIT
1	800	851.012500	806.012500	1	0
2	800	851.0375	806.0375	2	0
3	800	851.0625	806.0625	3	0
4	800	851.0875	806.0875	4	0
5	800	851.1125	806.1125	5	0
6	800	851.1375	806.1375	6	0
7	800	851.1625	806.1625	7	0
8	800	851.1875	806.1875	8	0

PASSPORT® OPTION (2975OPT19)

The 2975 PassPort® Option provides powerful test features for Passport® radios and systems. This option provides users with the following capabilities:

- ability to emulate repeater station operation;
- ability to emulate mobile radio operation;
- ability to monitor a PassPort® repeater or radio channel;
- ability to perform parametric tests and measurements.

Refer to PassPort® Option Manual (1002-4204-3P0) and “Using the 2975 to Test PassPort® Radios” (Aeroflex Application Note 46891/940) for details about using the PassPort® Option.

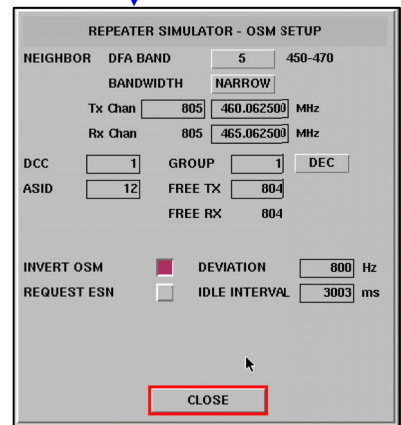
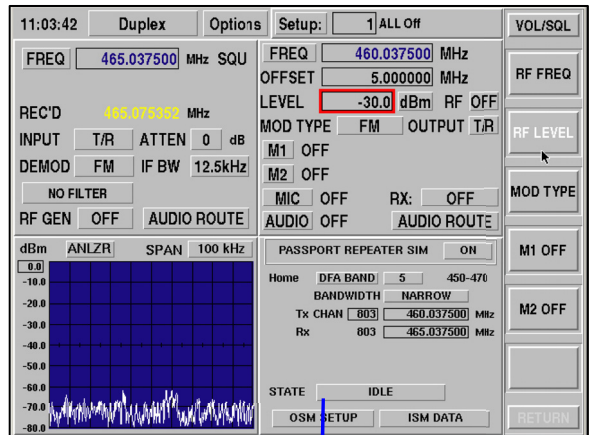

SECONDARY CONTROL CHANNEL BROADCAST (SCCB) (OPTION 21)

The SCCB feature allows users to configure repeater messages (SCCB and SCCB_EXP) to define the parameters of two secondary control channels. System Service Class fields for each channel can be used to control message transmission.

Implicit message format transmits all data to the repeater simulator as single block messages. This format is designed for simple networks operating on 700 Hz and 800 Hz bands where the repeater can provide a minimum amount of information. The radio uses the provided information to imply what the remaining data should be.

For example, since the 800 MHz band uses a standard -45 MHz transmit offset, the repeaters only need to inform the radio of the receive frequency when it assigns a voice channel. Because the receive channel has been identified, the radio can “imply” the transmit channel. Implicit Mode Operation is available with 2975 Opt 21. If the SCCB Option (OPT21) is enabled with Explicit Mode (OPT22), the IFR 2975 will also support the SCCB Explicit mode of operation.

The SCCB fields are visible only when P25 Secondary Control Channel Broadcast Message Option (OPT21) is installed in the 2975.

FIELD DEFINITIONS

SCCB TX

SCCB Transmit Channel ID

This field displays the Channel ID field of the Tx Channel in SCCB packets. The value selects the channel configuration associated with the channel number to determine the Tx frequency. Field values range from 0 to 15.

SCCB Transmit Channel Number

This field displays the Channel Number field of the Tx Channel in SCCB packets. The value sets the number of channel slots to offset the Channel ID from the selected base frequency to calculate the Tx Frequency. Field values range from 0 to 4095.

SCCB Tx Frequency

This field displays the Tx Channel frequency for information purposes only: this frequency is not transmitted. Users set the SCCB Tx frequency by entering a value in this field. The closest corresponding channel number is displayed in the Channel Number field. Changing this field does not affect the Channel ID setting.

SVC CLASS

This field displays the System Service Class of an SCCB channel. Zero indicates that a Channel is invalid, therefore a user can enter “0” in this field to block the transmission of SCCB message(s). Field values range from 0 to 255.

The screenshot shows a configuration window for the Secondary Control Channel Broadcast (SCCB). The window contains several fields and buttons. Three red arrows point to specific fields: 'Tx Channel ID' points to the 'SITE ID' field (value 01), 'Tx Channel Number' points to the 'RV' field (value 0), and 'Tx Frequency' points to the 'SVC CLASS' field (value 851.00625 MHz). The 'SVC CLASS' field is highlighted with a red box. Below the SCCB section, there are checkboxes for 'Registration', 'Affiliation', and 'Voice Request', and buttons for 'CLOSE', 'DEFAULTS', 'HEX', and 'IMPLICIT'.

RFSS ID	SITE ID	WGID	WUID	LRA	P	A
01	01	0001	000001	01	0	1
LG	GAV	RV	SVC CLASS	SVC OPT	ANN GRP	ADDR
0	0	0	60	00		0000

Secondary Control Channel Broadcast (SCCB)

SCCB1 Tx	0	0	851.00625	MHz	SVC CLASS	00
SCCB2 Tx	0	0	851.00625	MHz	SVC CLASS	00

Auto Copy

Registration Affiliation Voice Request

CLOSE DEFAULTS HEX **IMPLICIT**

IMPLICIT / EXPLICIT

The **IMPLICIT / EXPLICIT** button allows users to access Implicit and Explicit message format data fields according to the options installed in the 2975.

In **IMPLICIT** mode the SCCB message is sent as long as at least one of the service class variables are values other than zero. No messages are sent when both channels are zero.

In **EXPLICIT** mode the SCCB_EXP message is only sent for channels with a System Service Class field other than zero (zero indicates the channel is disabled). If both channels are values other than zero SCCB_EXP messages are sent periodically, alternating between channels. If the SCCB Option (OPT21) is enabled with Explicit Mode (OPT22), the IFR 2975 will also support the SCCB Explicit mode of operation.

Both **IMPLICIT** and **EXPLICIT** modes use main repeater simulation variables for the MFID, RFSS ID and SITE ID. Modifying SCCB variables does **NOT** affect similarly named fields on this or other 2975 screens.

IMPLICIT MODE OPERATION

To enable Implicit Mode, select **DOWNLINK DATA** which opens the Downlink Data configuration screen. Select the **IMPLICIT** button, and then click **CLOSE** to return to the P25 Trunking screen.

Implicit Mode is only available when P25 Secondary Control Channel Broadcast Message Option (2975OPT21) is installed in the 2975.

02:48:27 Duplex Options Setup: 1 not used VOL/SQL

FREQ 806.006250 MHz SQU FREQ 851.006250 MHz

REC'D 806.006250 MHz

INPUT T/R ATTN 0 dB

DEMOM P25 IF BW 12.5kHz

RF GEN OFF AUDIO ROUTE AUDIO ROUTE

P 25 TRUNKING U/V OFF

CC 0 150.00000 MHz PTT OFF

VC 50 150.31250 MHz

UPLINK DATA

GID UID HEX

DOWNLINK DATA

WACH ID SYS ID NAC MFID

00001 001 000 00

P 25 LOGGER START

Log Raw Symbols

Log Conventional P25 LCO

Log Trunked Control Channel OSP

Log Trunked Control Channel ISP

File Name: LOG1.TXT

VIEW LOG APPEND RETURN

EXPLICIT MODE OF OPERATION (2975OPT22)

Explicit message format uses multiple block messages to convey information. When the repeater assigns a voice channel it provides both receive and transmit channel information, allowing the offset of these channels to be arbitrary. P25 Explicit Mode Operation (2975OPT22) is required for this feature.

To enable Explicit Mode, open **DOWNLINK DATA** screen. Select **IMPLICIT** button at bottom of screen to open the Explicit message format screen. Select **EXPLICIT** button to enable Explicit message mode, then select **CLOSE** button to return to P25 Trunking screen. Explicit Mode is now enabled.

NOTE: Explicit message format should be used for VHF / UHF band for radios which conform to the latest P25 standards.

TYPE1 / TYPE2

The feature is only used for Explicit message formats.

TYPE1 causes single data block packets to be expanded by nulls (0). This is the default value.

TYPE2 causes single data block packets to be expanded by a standard "P25 Simple Terminator Data Unit" packets (TIA/EIA-102.BAAA, 8.2.3), which is simply an FS + NID.

RFSS ID 01 SITE ID 01 WGID 0001 WUID 000001 LRA 01 P 0 A 1

LG 0 GAV 0 RV 0 SVC CLASS 60 SVC OPT 00 ANN GRP ADDR 0000

Secondary Control Channel Broadcast (SCCB)

SCCB1 Tx 0 0 851.00625 MHz SVC CLASS 00

SCCB2 Tx 0 0 851.00625 MHz SVC CLASS 00

Auto Copy

Registration Affiliation Voice Request

CLOSE DEFAULTS HEX IMPLICIT

RFSS ID 01 SITE ID 01 WGID 0001 WUID 000001 LRA 01 P 0 A 1

LG 0 GAV 0 RV 0 SVC CLASS 60 SVC OPT 00 ANN GRP ADDR 0000

SRC ID 000000 SRC ADDR 000000 TGT ADDR 000000 TIMER 0000 PHONE NUM 0000000000

Secondary Control Channel Broadcast (SCCB)

SCCB1 Tx 0 0 851.00625 MHz SVC CLASS 00

Rx 0 0 806.00625 MHz

SCCB2 Tx 0 0 851.00625 MHz SVC CLASS 00

Rx 0 0 806.00625 MHz

Adjacent Repeater Site Configuration

MFID 00 RFSS ID 00 SYS ID 000 SITE ID 00

LRA 00 SVC CLASS 00 C 0 F 0 V 0 A 0

ChanTx 0 0 851.00625 MHz

ChanRx 0 0 851.00625 MHz

Auto Copy

Registration Affiliation Voice Req UU Req Dial Req

CLOSE DEFAULTS HEX EXPLICIT TYPE 1

P25 EXPLICIT UNIT TO UNIT AND PSTN EMULATION (OPTION 23)

The IFR 2975 now optionally supports Unit to Unit and PSTN interconnect calls in the explicit mode of operation. This optional feature enables user to establish Unit to Unit and PSTN interconnect calls within the Explicit Mode of operation (2975OPT22). This feature allows users to verify that a radio can generate and receive Unit to Unit and PSTN calls.

NOTE: This option requires Option 22, Explicit Mode Operation.

Field definitions

The following fields are only visible when P25 Explicit Unit to Unit and PSTN Emulation (2975OPT23) is installed with Explicit Mode Operation (2975OPT22)

SRC ID

This field displays the Source ID used for Unit to Unit Explicit messages. The radio may compare this value to its transmitted value for some calls, therefore, Auto Copy can automatically copy the radio data into this field during call set up.

SRC ADDR

This field displays the Source Address used by the 2975 for specific explicit messages (Group, Unit and Dialing). The radio may compare this value to its transmitted value for some calls, therefore, Auto Copy can automatically copy radio data into this field during call set up. If expert control is desired disable Auto Copy.

TGT ADDR

This field displays the Target Address used for Unit to Unit Explicit Messages. The radio may compare this value to its transmitted value for some calls, therefore, Auto Copy can automatically copy radio data into this field during call set up. If expert control is desired disable **Auto Copy**.

TIMER

This field displays the Call Timer used for telephone Explicit messages. TIMER specifies the time (in 100 ms intervals) allocated for the call. A value of zero indicates that the information is not being provided.

PHONE NUM

This field indicates the phone number used for telephone Explicit messages. This field allows users to set a phone number to transmit to the radio when a simulated DIALing message request is initiated.

The screenshot shows a configuration window for the IFR 2975. The 'EXPLICIT' tab is selected and highlighted with a red box. The interface includes several sections:

- RFSS ID, SITE ID, WUID, LRA, P, A:** Fields for identifying the radio and site.
- LG, GAV, RV, SVC CLASS, SVC OPT, ANN GRP ADDR:** Fields for call parameters.
- SRC ID, SRC ADDR, TGT ADDR, TIMER, PHONE NUM:** Fields for source and target information.
- Secondary Control Channel Broadcast (SCCB):** Configuration for SCCB1 and SCCB2, including Tx/Rx frequencies and SVC CLASS.
- Adjacent Repeater Site Configuration:** Fields for MFID, RFSS ID, SYS ID, SITE ID, LRA, SVC CLASS, C, F, V, A, ChanTx, and ChanRx.
- Auto Copy:** Checkboxes for Registration, Affiliation, Voice Req, UU Req, and Dial Req.

At the bottom, there are buttons for 'CLOSE', 'DEFAULTS', 'HEX', 'EXPLICIT', and 'TYPE 1'.

P25 EXPLICIT ADJACENT STATUS BROADCAST CHANNEL MESSAGE (OPTION 24)

This optional feature provides users with the ability to configure repeater control channel messages. These variables are used to define the parameters of an adjacent repeater site. Modification of the Adjacent Site variables does **NOT** affect similarly named variables on this or other user screens. These variables are used to define the parameters of an adjacent repeater site. The adjacent site transmissions are **NOT** simulated.

NOTE: This option requires Option 22, Explicit Mode Operation.

Field definitions

Adjacent Repeater Site Configuration fields are only visible when P25 Explicit Adjacent Status Broadcast Channel Message (2975OPT24) is installed with Explicit Mode Operation (2975OPT22).

MFID

This field displays the Manufacturer Identifier sent out on adjacent site packets.

RFSS ID

This field displays the RF Sub-system ID sent out on adjacent site packets.

SYS ID

This field displays the System ID sent out on the adjacent site packets.

SITE ID

This field displays the Site ID sent out on the adjacent site packets.

LRA

This field displays the Local Registration Area sent out on the adjacent site packets.

SVC CLASS

This field displays the Service Class sent out on the adjacent site packets.

C

This field displays the “C” bit sent out on the adjacent site packets. Set this field to 1 if the adjacent site is advertising a conventional channel.

F

This field displays the “F” bit sent out on the adjacent site packets. Set this field to 1 to stimulate a site failure on the adjacent site.

V

This field displays the “V” bit sent out on the adjacent site packets. Set this field to 1 if all adjacent site message data is valid.

A

This field displays the “A” bit sent out on the adjacent site packets. Set this field to 1 if the adjacent site has a valid, active RFSS network connection.

RFSS ID	SITE ID	WGID	WUID	LRA	P	A
01	01	0001	000001	01	0	1
LG	GAV	RV	SVC CLASS	SVC OPT	ANN GRP ADDR	
0	0	0	60	00	0000	
SRC ID	SRC ADDR	TGT ADDR	TIMER	PHONE NUM		
000000	000000	000000	0000	0000000000		
Secondary Control Channel Broadcast (SCCB)						
SCCB1 Tx	0	0	851.00625	MHz	SVC CLASS	00
Rx	0	0	806.00625	MHz		
SCCB2 Tx	0	0	851.00625	MHz	SVC CLASS	00
Rx	0	0	806.00625	MHz		
Adjacent Repeater Site Configuration						
MFID	RFSS ID	SYS ID	SITE ID	Auto Copy		
00	00	000	00	<input checked="" type="checkbox"/> Registration <input checked="" type="checkbox"/> Affiliation <input checked="" type="checkbox"/> Voice Req <input checked="" type="checkbox"/> UU Req <input checked="" type="checkbox"/> Dial Req		
LRA	SVC CLASS	C	F	V	A	
00	00	0	0	0	0	
ChanTx	0	0	851.00625	MHz		
ChanRx	0	0	851.00625	MHz		
<input type="button" value="CLOSE"/> <input type="button" value="DEFAULTS"/> <input type="button" value="HEX"/> <input checked="" type="button" value="EXPLICIT"/> <input type="button" value="TYPE 1"/>						

ChanTx

Adjacent Site Tx Channel ID

This field displays value used for the Channel ID field of the Tx Channel in adjacent site packets. The value selects the channel configuration associated with the channel number to determine the Tx frequency. Values range from 0 to 15.

Adjacent Site Tx Channel Number

This field displays the Channel Number field of the Tx Channel in adjacent site packets. The value sets the number of channel slots to offset the Channel ID from the selected base frequency to calculate the Tx Frequency. Field values range from 0 to 4095.

Adjacent Site Tx Frequency

This field displays the Tx Channel frequency of the adjacent site for information purposes only: this frequency is not transmitted. If the channel configuration settings of the adjacent channel is identical to those of the repeater simulator the user can enter a value in this field to set the adjacent site transmit frequency. The closest corresponding control channel number is displayed in the channel number field. Changing this field does not affect the Channel ID setting. If the channel configuration settings for the adjacent site and the repeater simulator are not identical setting the frequency will not select a correct channel number because the channel computation is based upon the repeater simulator's configuration.

RFSS ID	SITE ID	WGID	WUID	LRA	P	A				
01	01	0001	000001	01	0	1				
LG	GAV	RV	SVC CLASS	SVC OPT	ANN GRP ADDR					
0	0	0	60	00	0000					
SRC ID	SRC ADDR	TGT ADDR	TIMER	PHONE NUM						
000000	000000	000000	0000	0000000000						
Secondary Control Channel Broadcast (SCCB)										
SCCB1 Tx	0	0	851.00625	MHz	SVC CLASS 00					
Rx	0	0	806.00625	MHz						
SCCB2 Tx	0	0	851.00625	MHz	SVC CLASS 00					
Rx	0	0	806.00625	MHz						
Adjacent Repeater Site Configuration				Auto Copy						
MFID	RFSS ID	SYS ID	SITE ID	<input type="checkbox"/>	Registration					
00	00	000	00	<input type="checkbox"/>	Affiliation					
LRA	SVC CLASS	C	F	V	A	<input type="checkbox"/>	Voice Req			
00	00	0	0	0	0	<input type="checkbox"/>	UU Req			
ChanTx	0	0	851.00625	MHz	<input type="checkbox"/>		Dial Req			
ChanRx	0	0	851.00625	MHz						
CLOSE							DEFAULTS	HEX	EXPLICIT	TYPE 1

Tx Frequency
Tx Channel Number
Tx Channel ID

ChanRx

Adjacent Site Rx Channel ID

This field displays value used for the Channel ID field of the Rx Channel in adjacent site packets. The value selects the channel configuration associated with the channel number to determine the Tx frequency. Field values range from 0 to 15.

Adjacent Site Rx Channel Number

This field displays the Channel Number field of the Rx Channel in adjacent site packets. The value sets the number of channel slots to offset from the base frequency selected by the Channel ID. The determined frequency is only valid if the adjacent site uses the same configuration settings as the Repeater Simulator. If adjacent site settings differ from Repeater Simulator settings disregard the computed frequency because it is not part of the information transmitted in the adjacent site packet. Field values range from 0 to 4095.

Adjacent Site Rx Frequency

This field displays the Rx Channel frequency of the adjacent site for information purposes only: this frequency is not transmitted. If the channel configuration settings of the adjacent channel is identical to those of the repeater simulator the user can enter a value in this field to set the adjacent site receive frequency. The closest corresponding control channel number is displayed in the channel number field. Changing this field does not affect the Channel ID setting. If the channel configuration settings for the adjacent site and the repeater simulator are not identical setting the frequency will not select a correct channel number because the channel computation is based upon the repeater simulator's configuration.

THIS PAGE INTENTIONALLY LEFT BLANK.

SECTION 4 - APPLICATIONS

DIGITAL TRANSMITTER TESTING



Equipment Needed

2975

Interconnect

Establish the cable interconnect shown above.

Configure the Radio

1. Set the Radio to the desired test channel frequency.
2. Configure the Radio for P25 mode of operation.

Configure the 2975

1. Select the Receiver (Tx Test) screen [MODE] [2].
2. Enter the 2975 Receive frequency to match that of the Radio channel selected.
3. Select **INPUT PORT** to T/R.
4. Set **ATTEN** to 20 dB.
5. Set **DEMOD** to "P25."
6. Set **IF BANDWIDTH** to 12.5 kHz.
7. Turn 2975 Signal Generator Output **OFF**.
8. Enable the Modulation Meter, Power Meter, RF Error Meter and P25 Uplink Data from the option tile.

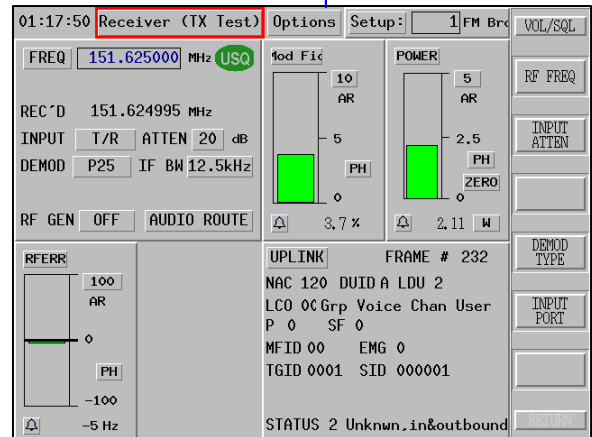

Accept Options	RETURN	P 25 Uplink Data	
<input type="checkbox"/> Oscilloscope	00	<input type="checkbox"/> Tone Signal Decode	14
<input type="checkbox"/> Spectrum Analyzer	01	<input type="checkbox"/> Audio Analyzer	15
<input type="checkbox"/> SINAD	02	<input type="checkbox"/> SN/SZ Repeater Sim	16
<input type="checkbox"/> Distortion	03	<input type="checkbox"/> SN/SZ Scanner	17
<input type="checkbox"/> AF Counter	04	<input type="checkbox"/> I-Q Plot	18
<input type="checkbox"/> DVM	05	<input type="checkbox"/> EVM Data	19
<input checked="" type="checkbox"/> Modulation Meter	06	<input type="checkbox"/> LTR Repeater Sim	20
<input checked="" type="checkbox"/> Power	07	<input type="checkbox"/> LTR Radio Sim	21
<input type="checkbox"/> RSSI	08	<input type="checkbox"/> LTR Monitor	22
<input checked="" type="checkbox"/> RF Error	09	<input type="checkbox"/> PASSPORT Repeater Sim	23
<input type="checkbox"/> BER Meter	10	<input type="checkbox"/> PASSPORT Radio Sim	24
<input type="checkbox"/> Meter Panel	11	Escape	ESC
<input type="checkbox"/> Function Generators	12		

DIGITAL TRANSMITTER TESTING (cont)

9. Expand Power Meter and set to **AR** (Autorange). "ZERO" Power Meter if necessary. Press RETURN. Verify that Cable Loss is 0. If cable loss is anticipated, expand Power Meter and enter cable loss factor.
10. Set RF Error Meter to **AR** (Autorange).
11. Set the Modulation Meter to **AR** (Autorange).
12. Key the transmitter.
Review Power reading.
Review Frequency Error reading.
Verify Modulation Fidelity is <5%.
13. Record **NAC**, **TGID** and **SID** readings from 2975 Uplink Data tile for use in Digital Receiver Testing.
14. Unkey the transmitter.

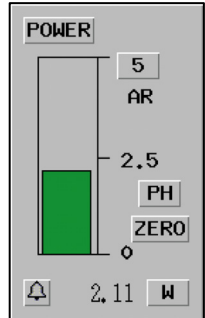

```
UPLINK FRAME # 232
NAC 120 DUID A LDU 2
LC0 0C Grp Voice Chan User
P 0 SF 0
MFID 00 EMG 0
TGID 0001 SID 000001

STATUS 2 Unknwn.in&outbound
```

DIGITAL TRANSMITTER TESTING (cont)

Proper P25 transmitter operation can also be observed by the **UPLINK DATA** screen. Position the cursor to the **UPLINK DATA** field and press the [ENTER] key to expand the window. This window decodes the signaling information elements of the P25 signal. Most of the decoded values remain unchanged with only a few exceptions. The **DATA UNIT ID** field toggles values at a constant rate. A high bit error rate is indicated if the value transition times are unequal or the updates hesitate. The **STATUS SYM** field is another indication that there may be transmit bit errors. It should remain constant at all times during a transmission.

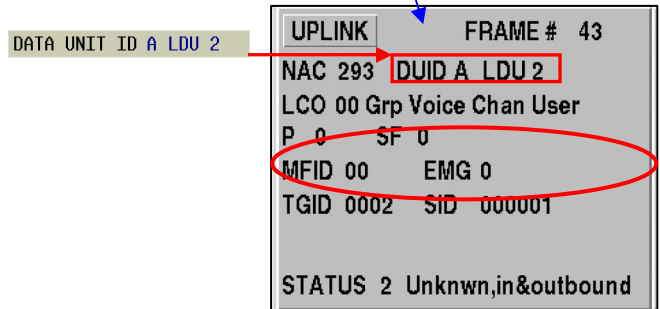
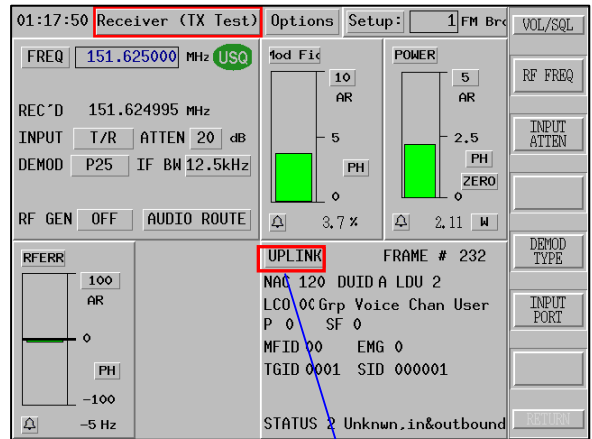

DIGITAL TRANSMITTER TESTING (cont)

For more detailed parametric diagnostics, the 2975 can be configured to display the Spectrum Analyzer and Scope.

To Enable the Spectrum Analyzer and Scope displays, press the **[SHIFT]** **[MODE]** Keys to select the options menu, turn OFF the P25 Uplink and P25 Downlink options and turn ON the Scope and Spectrum Analyzer options. Press **[RETURN]** Key to accept options.

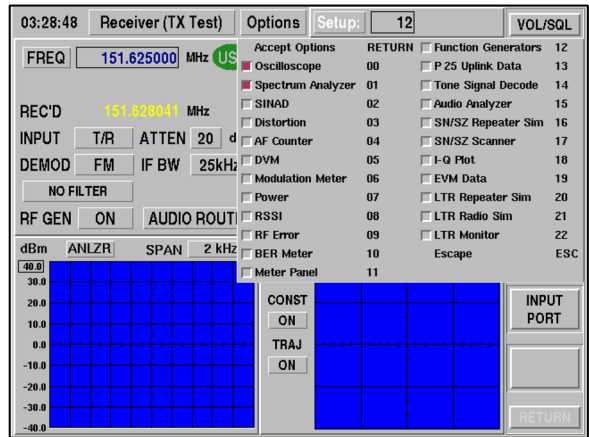

The Spectrum analyzer can be used to condition the input signal to ensure that the level being received is not too high or low. To do this, position the cursor to the **ANLZ** field and press the **[ENTER]** key to expand the Analyzer screen. Position the cursor to the **REF LEVEL** field and adjust the level until the peak of the transmitter signal is at the top of the analyzer display.

With the signal positioned to the top, the Frequency and SPAN may be adjusted to view harmonic content, spectral purity and spurious emissions.

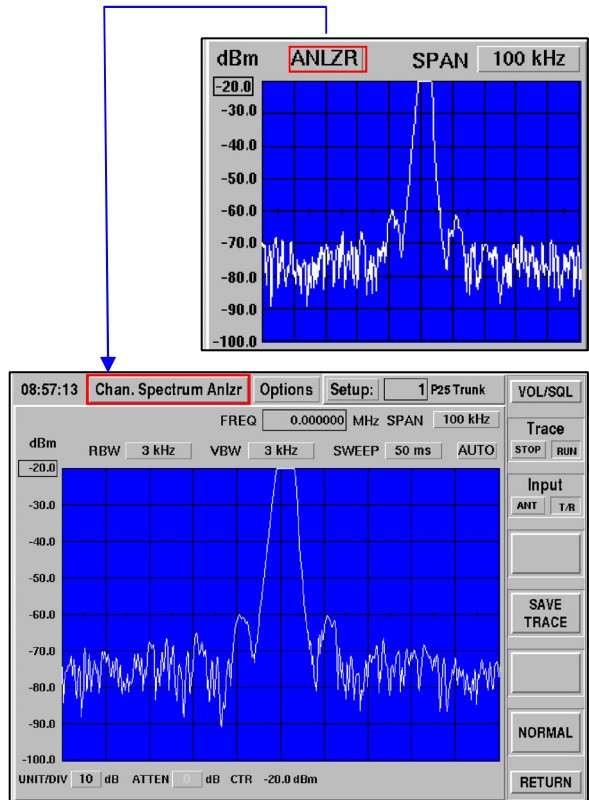

DIGITAL TRANSMITTER TESTING (cont)

The Scope can be configured to view the demodulated audio from the **IMBE VOCODER** in the 2975. To configure the scope input, position the cursor to the **SCOPE** label and press the **[ENTER]** key to expand the full scope screen. Press the **[SHIFT] [MODE]** keys to open the Scope Options menu and select **DEMOD** as the desired selection by pressing the **[6]** key. The demodulated audio is displayed on the scope. If the radio is configured to encode a 1011 tone, a sine wave would be viewed on the scope display.

NOTE: The **Scope**, **MOD FIDELITY** meter and **UPLINK DATA** screen are only operational when a valid P25 signal can be synchronized and decoded. If these functions cannot decode the P25 signal, the P25 receiver is not able to decode the signal either and it is an indication that the transmitter is malfunctioning in the digital P25 mode.

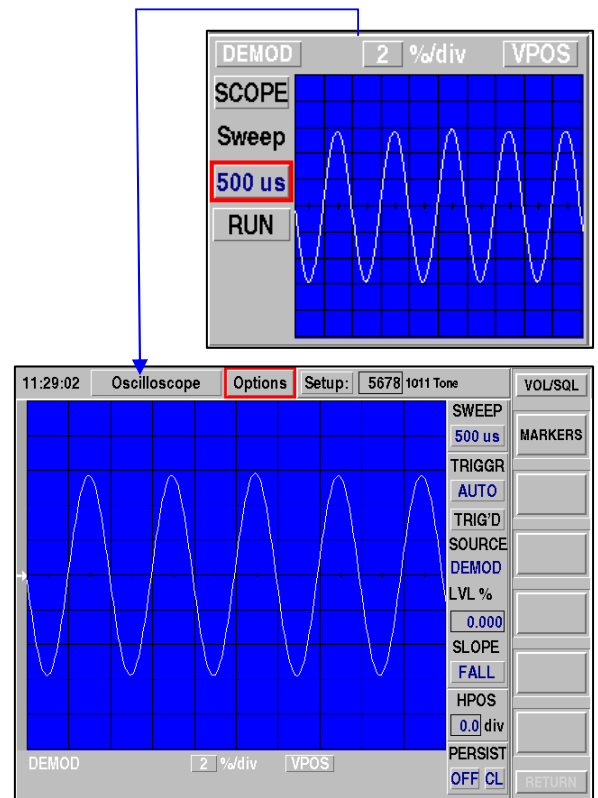

DIGITAL RECEIVER TESTING



Equipment Needed

2975

Interconnect

Establish the cable interconnect shown above.

Configure the Radio

1. Set the Radio to the desired test channel frequency.
2. Configure the Radio for P25 mode of operation without encryption.

Configure the 2975

1. Select the Generate screen [MODE] [1].
2. Set the 2975 Generator Frequency to match that of the radio channel.
3. Set the RF Output level to -47.0 dBm (1000 μV).
4. Set the RF Output to ON.
5. Select **MOD TYPE** "P25."
6. Select **OUTPUT PORT** to T/R.
7. Set **PATTERN** to 1011.
8. Open the Generator (Rx Test) Options menu and enable **P25 Downlink Data**. Turn all other options off.

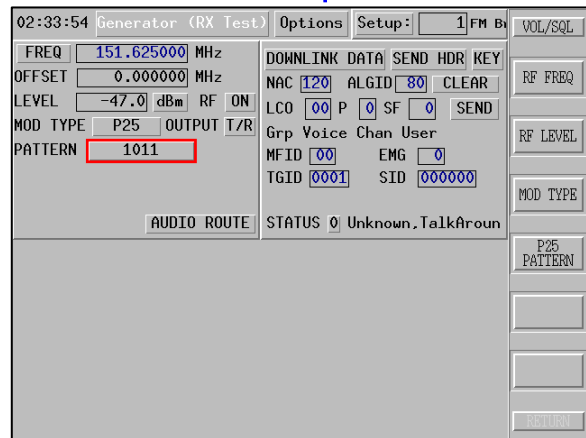

Accept Options	RETURN	BER Meter	09
<input type="checkbox"/> Oscilloscope	00	<input type="checkbox"/> Audio Analyzer	10
<input type="checkbox"/> Spectrum Analyzer	01	<input type="checkbox"/> SN/SZ Repeater Sim	11
<input type="checkbox"/> SINAD	02	<input type="checkbox"/> LTR Repeater Sim	12
<input type="checkbox"/> Distortion	03	<input type="checkbox"/> LTR Radio Sim	13
<input type="checkbox"/> DVM	04	<input type="checkbox"/> LTR Monitor	14
<input type="checkbox"/> Power	05	<input type="checkbox"/> PASSPORT Repeater Sim	15
<input type="checkbox"/> Meter Panel	06	<input type="checkbox"/> PASSPORT Radio Sim	16
<input type="checkbox"/> RSSI	07	Escape	ESC
<input checked="" type="checkbox"/> P 25 Downlink Data	08		

DIGITAL RECEIVER TESTING (cont)

9. Configure the **DOWNLINK DATA** fields for **TGID**, **NAC** and **SID** with information obtained during Digital Transmitter Test.

10. Set remaining **DOWNLINK DATA** fields as follows:

ALGID: 80 (Clear)
LCO: 00 (Group Voice Chan User)
P: 0
SF: 0
MFID: 0
EMG: 0
STATUS: 0 (Unknown, Talk Around)

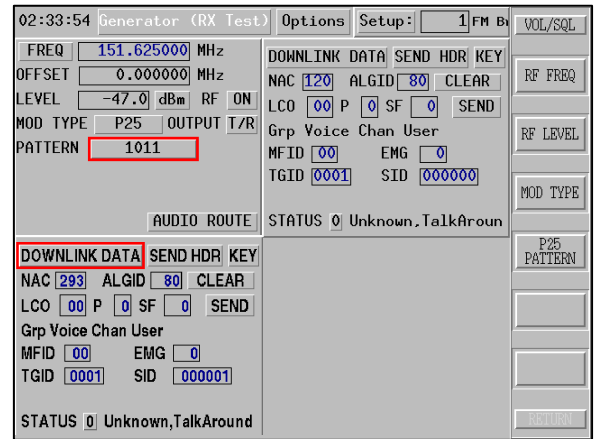

11. The radio should now be receiving the 1011 tone from the 2975. The radio should produce a clear tone. Adjust the radio's volume control to monitor the tone.

12. Change the 2975 Pattern Control to **CALIBRATION**. The radio should now be producing an unstable tone.

13. Change the 2975 Pattern Control to **SILENCE**. The radio should not be producing a tone.

14. Change the 2975 Pattern Control to **SPEECH**. The radio should be producing 3 phrases which are preprogrammed into the 2975.

15. Decrease the 2975 RF Level control until the phrases are no longer completely intelligible. The usable sensitivity of the radio is the minimum RF Level at which all the phrases can be understood.

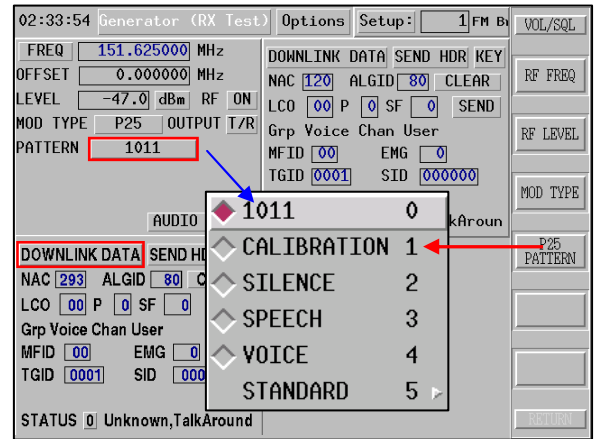

NOTE: This test method can be used with the radio operating in its current configuration. The radio does not need to be configured for a special test mode. The STANDARD patterns have a forced configuration of TGID = 1, SID = 1 and NAC = 293. To use this pattern, the radio must be configured to accept these fixed parameters.

ANALOG TRANSMITTER TESTING

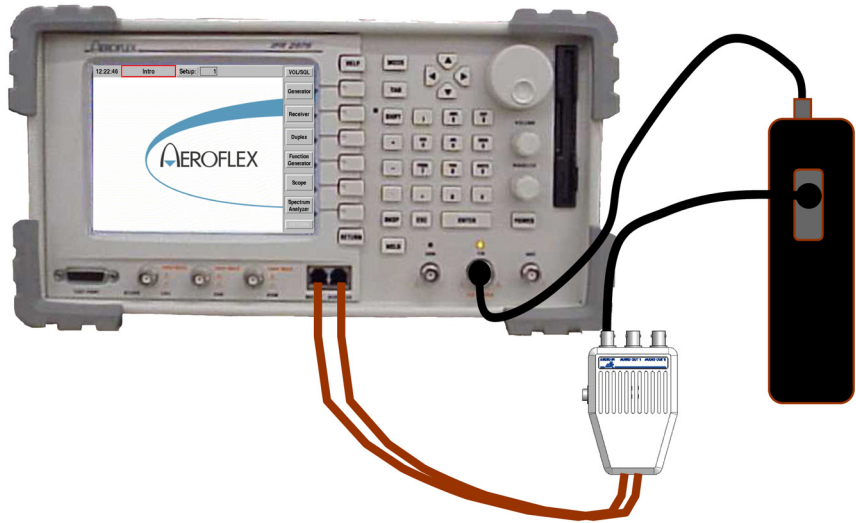

Equipment Needed

- 2975
- MIC/Audio Adapter (AC25007)

Interconnect

Establish the cable interconnect shown above.

Configure the Radio

1. Set the Radio to the desired test channel frequency.
2. Configure the Radio for analog CW mode of operation (No CTCSS or DCS).

Configure the 2975

1. Select Receiver (TX Test) [**MODE**] [2].
2. Enable the following option tiles:
 - Oscilloscope
 - Spectrum Analyzer
 - RF Error Meter
 - Power Meter
3. Set the 2975 Receive **FREQ**uency to match the Radio transmit frequency.
4. Select INPUT PORT **T/R**.
5. Set **ATTEN** to **20 dB**.
6. Set the 2975 Receive Frequency to match the Radio frequency.
8. Select IF **12.5 kHz**.
9. Set **ATTEN** to **20 dB**.
10. Select RF GEN **OFF**.

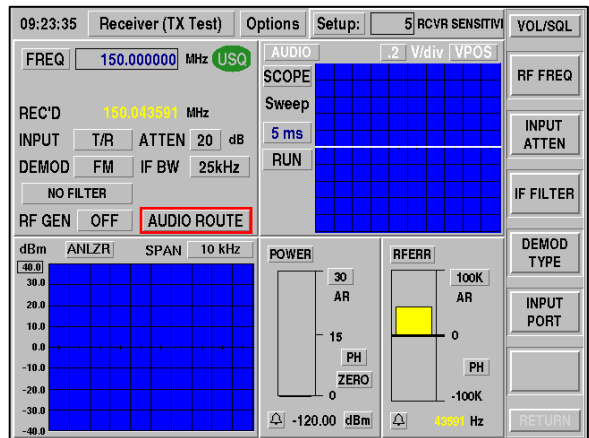

ANALOG TRANSMITTER TESTING (cont)

11. Configure Oscilloscope as follows:
Set **DEMOD** to **1kHz/div**.
Set Sweep to **500us**.
12. Adjust the squelch and volume control.

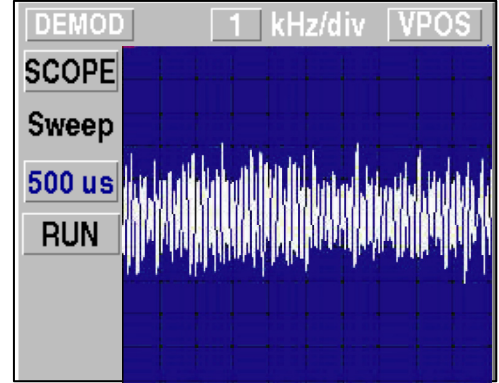

13. Zero the Power Meter by clicking the ZERO button on the POWER METER tile (see example).

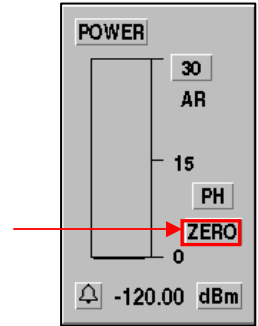

14. Key the Radio and hold.
Review Power Reading.
Review Transmit Frequency Error reading.
15. Select User Screen **[MODE] [0]**. Selecting the User Screen allows additional meters to be configured and displayed.
16. Configure 2975 to enable the following option tiles:

Receiver (Tx Test)
AF Counter
Modulation Meter
Power Meter
RF Error Meter
Function Generators

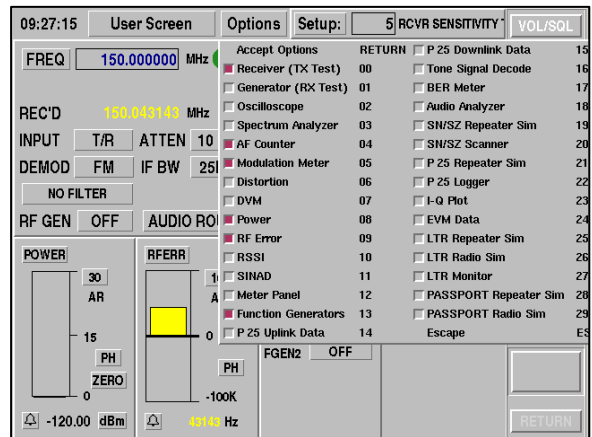

ANALOG TRANSMITTER TESTING (cont)

17. Configure **AF COUNTER** to monitor **DEMOM**.

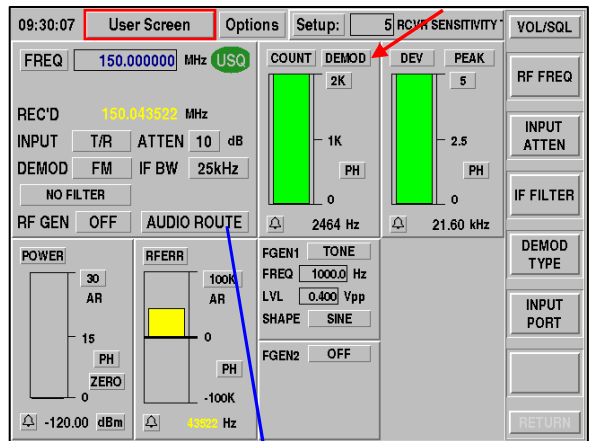

18. Select **AUDIO ROUTE** and set as follows:
 Turn Audio Out #1/**FGEN1 ON**.
 Set Output Level **BALAN x0.1**
 Set **DEMOM/Speaker ON**
 Turn all others Audio Route functions **OFF**.
19. Close menu to return to Receiver (Tx Test) screen.

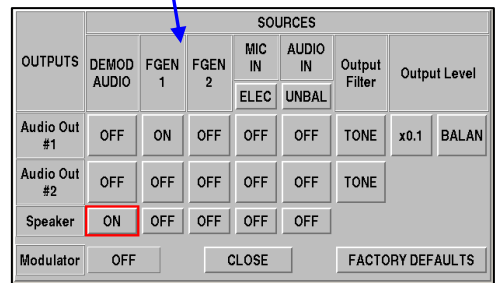

20. Configure **FGEN1** as follows:

Select **FGEN1 Tone**
 Set **FREQ to 1000 Hz**
 Set **LVL to .400 VPP**

21. Key the Radio and hold.

Speak or whistle into Radio microphone and verify voice deviation on oscilloscope and deviation meter does not exceed limits (5 kHz for narrow band systems). Deviation meter does not exceed limits (5 kHz for narrow band systems).

22. Adjust audio level for 3.0 kHz deviation on the Deviation Meter.

Measured distortion should be <10%.

23. Unkey the Radio.

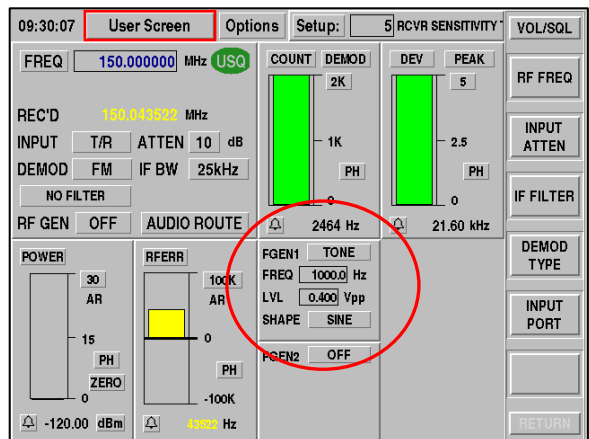

NOTE: Test setup may be saved for future use via 2975 SAVE/RECALL function (**MODE, 7, 6**).

ANALOG RECEIVER TESTING

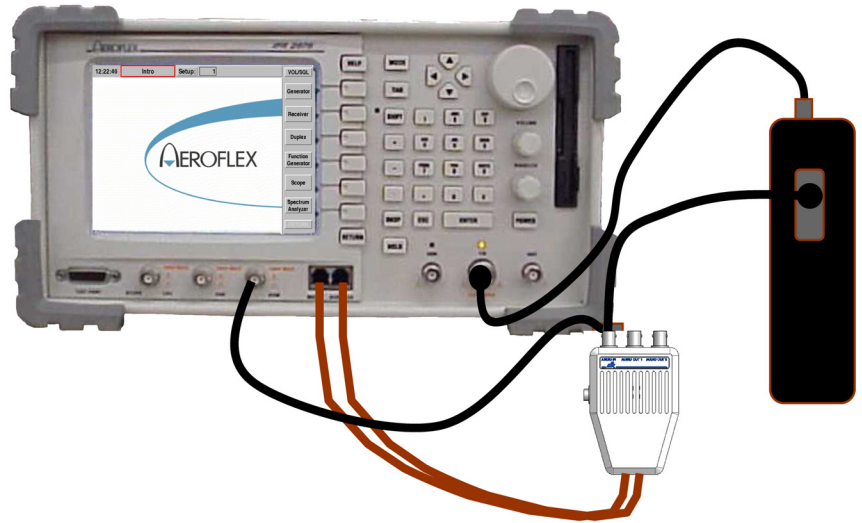

Equipment Needed

2975

MIC/Audio Adapter (AC25007)

Interconnect

Establish the cable interconnect shown.

Configure the Radio

1. Set the Radio to the desired test channel frequency.
2. Enable Analog and carrier squelch mode of operation.

Configure the 2975

1. Select Generator (RX Test) [MODE] [1].
2. Enable the following **Options**:
Oscilloscope
SINAD Meter
Distortion Meter
DVM Meter
3. Match the 2975 Generator Frequency to the Radio.
4. Set the RF Output **Level** to -47.0 dBm (1000 μ V).
5. Select RF OUTPUT ON.
5. Select MOD TYPE **FM**.
6. Select OUTPUT PORT T/R.
7. Set **M1** to **Tone 3.0 kHz** deviation at **1000 Hz** rate.
8. Set the SINAD Meter to **AUDIO BAL** input.
9. Set the Oscilloscope for **AUDIO BAL** input. **Sweep** 500 usec
10. Set DVM to **AC**

Accept Options	RETURN	P 25 Downlink Data	08
<input checked="" type="checkbox"/> Oscilloscope	00	<input type="checkbox"/> BER Meter	09
<input type="checkbox"/> Spectrum Analyzer	01	<input type="checkbox"/> Audio Analyzer	10
<input checked="" type="checkbox"/> SINAD	02	<input type="checkbox"/> SN/SZ Repeater Sim	11
<input checked="" type="checkbox"/> Distortion	03	<input type="checkbox"/> LTR Repeater Sim	12
<input checked="" type="checkbox"/> DVM	04	<input type="checkbox"/> LTR Radio Sim	13
<input type="checkbox"/> Power	05	<input type="checkbox"/> LTR Monitor	14
<input type="checkbox"/> Meter Panel	06	Escape	ESC
<input type="checkbox"/> RSSI	07		

02:27:46 Generator (RX Test) Options Setup: 8 FM VOL/SQ

FREQ 851.012500 MHz AUDIO 1 Vdiv VPOS

OFFSET -45.000000 MHz SCOPE

LEVEL -118.4 dBm RF ON Sweep

MOD TYPE FM OUTPUT T/R 500 us

M1 3.00 kHz AF 1000.0 Hz SINE RUN

M2 OFF RX: OFF

MIC OFF AUDIO OFF **AUDIO ROUTE**

SINAD 20 DIST 20 DVM 4 AC

PH 10 PH 2

PH 0 PH 0 PH 0

21.50 dB 8.5 % 2.02 V

OUTPUTS	SOURCES					Output Filter	Output Level
	DEMOD AUDIO	FGEN 1	FGEN 2	MIC IN ELEC	AUDIO IN UNBAL		
Audio Out #1	OFF	ON	ON	OFF	OFF	TONE	x1 UNBAL
Audio Out #2	ON	OFF	OFF	OFF	OFF	TONE	
Speaker	ON	OFF	OFF	OFF	OFF		
Modulator	OFF						

CLOSE **FACTORY DEFAULTS**

ANALOG RECEIVER TESTING (cont)

11. Adjust the Radio receiver volume level to a level equivalent to 60% of the rated audio output.
12. Verify Audio **DIST**ortion is <10%.
13. Lower RF Output **LEVEL** until **SINAD** Meter indicates 12 dB. To steady SINAD reading increase the average sample rate as needed (reference example to the right).
The resulting RF Output Level reading is the sensitivity level of the Radio receiver.

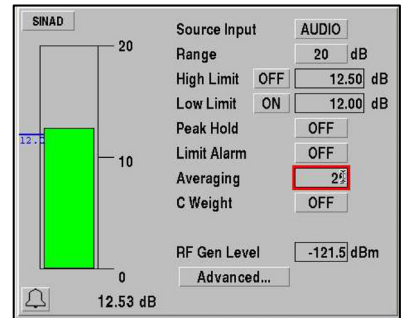

MEASURING CABLE FAULT

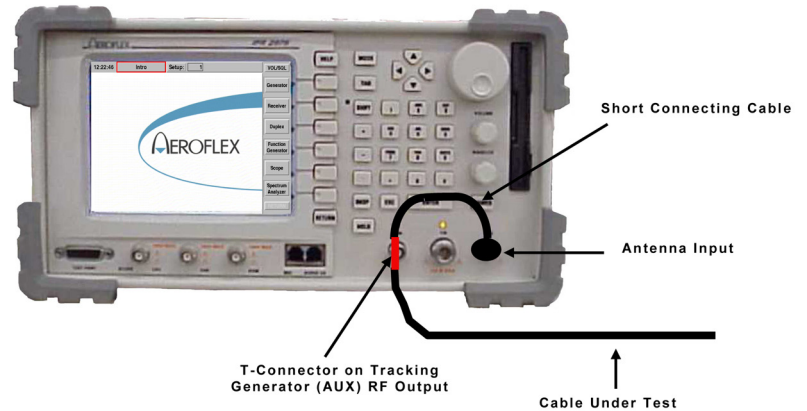

Equipment Needed

2975

Interconnect

Establish the cable interconnect shown above.

Configure the 2975

1. Select the Spectrum Analyzer screen [MODE] [6].
2. Turn the Tracking Generator *ON* [SHIFT] [MODE] [6] ENTER.
3. Establish Spectrum Analyzer option configuration as shown.
4. Select **FREQ 500 MHz**.
5. Select **SPAN 200 MHz**.
6. Select **COUPLING AUTO**.
7. Select Spectrum Analyzer Reference Level **-10.0 dBm**.
8. Select **TG LVL -15.0 dBm**.
9. Select **TG OUTPUT GEN**.
10. Select **INPUT ANT**.
11. Adjust the Tracking Generator Level to position the 'dips' (nulls) close to the center horizontal grid lines.
12. Adjust the Center Frequency to position a 'dip' (null) close to a vertical grid line.

Accept Options	RETURN
<input checked="" type="checkbox"/> Live	1
<input type="checkbox"/> Average	2
<input type="checkbox"/> Peak	3
<input type="checkbox"/> Compare	5
<input checked="" type="checkbox"/> Tracking Gen.	6
Configure Markers	7
Escape	ESC

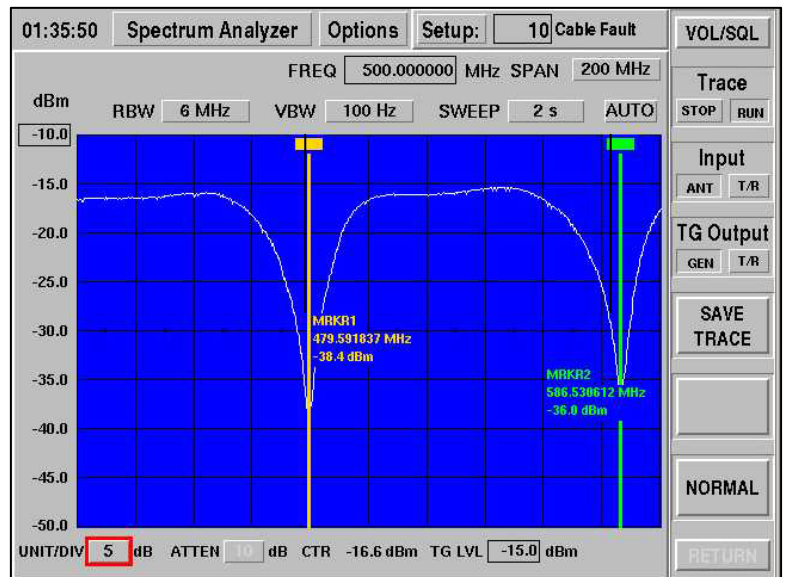

MEASURING CABLE FAULT (cont)

Display Interpretation

13. Enable the Marker function [SHIFT] [MODE] [6] and turn on Markers 1 and 2. Set the Markers to the dips (nulls) of the displayed waveform.

14. Set the Cable Fault Meter Marker to display from 1 to 2.

NOTE: The 2975 allows the user to select a predetermined velocity factor or enter a known velocity factor for the cable under test. Select or enter the appropriate velocity factor by selecting VF or entering the value in the box immediately to the right of VF.

15. Use the following formula to determine the cable fault:

$$\frac{492 * \text{Velocity Factor}}{\text{Delta Freq. in MHz}} = \text{Cable Fault Distance}$$

16. Toggle the ft/m button next to the distance readout field to display the cable fault in feet (ft) or meters (m).

NOTE: The velocity factor for RG-58 is 65.9% or 0.659.

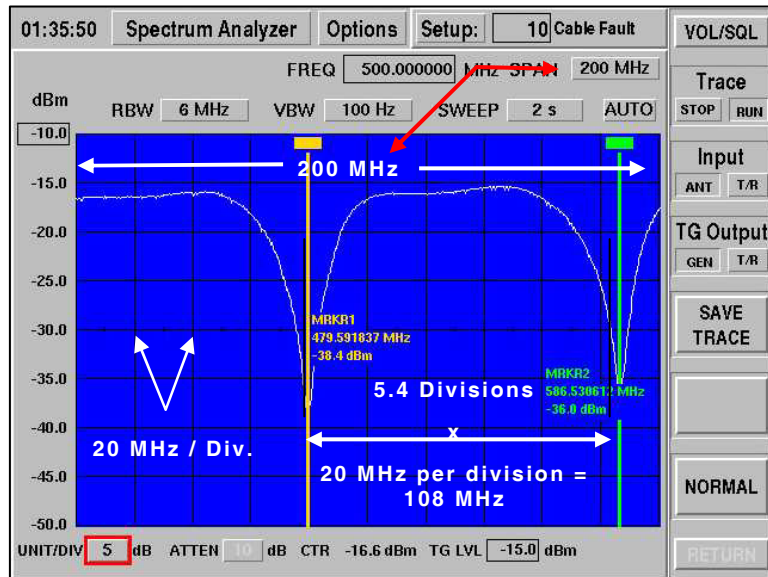

MEASURING RETURN LOSS

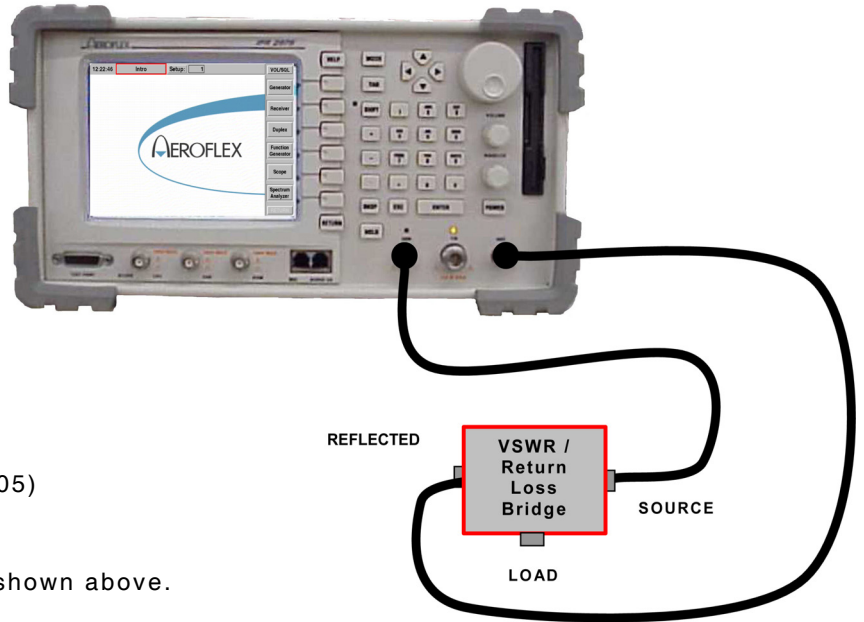

Equipment Needed

2975

VSWR/Return Loss Bridge (AC4105)

Interconnect

Establish the cable interconnect shown above.

Configure the 2975

1. Select the Spectrum Analyzer screen [**MODE**] [**6**].
2. Turn the Tracking Generator *ON* [**SHIFT**] [**MODE**] [**5**] **ENTER**.
3. Select **FREQ 160 MHz**.
4. Select **SPAN 10 MHz**.
5. Select **COUPLING AUTO**.
6. Select Spectrum Analyzer Reference Level **-10.0 dBm**.
7. Adjust the Tracking Generator level control for a top line reference on the Spectrum Analyzer display.

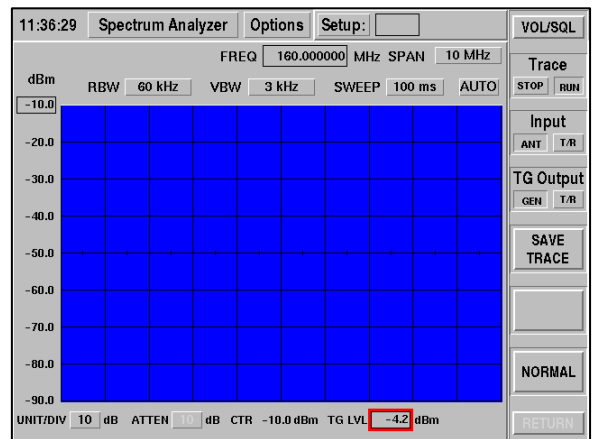

MEASURING RETURN LOSS (cont)

Setup

1. Connect the Load connector of the Return Loss Bridge to the 160 MHz connector of the Duplexer Filter.
2. Connect 50 Ω terminations to the remaining connectors on the Duplexer Filter.
3. The resulting return loss for the 160 MHz connector of the Duplexer Filter is displayed in dB. In this case, the indicated Return Loss is approximately 40 dB down from the top line reference.

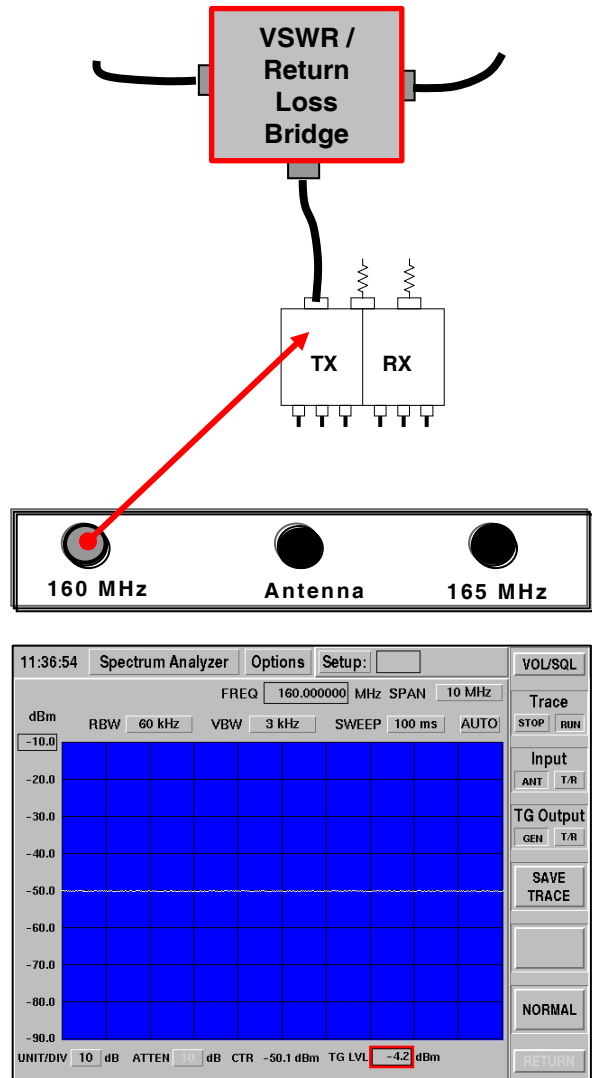

MEASURING FILTERS

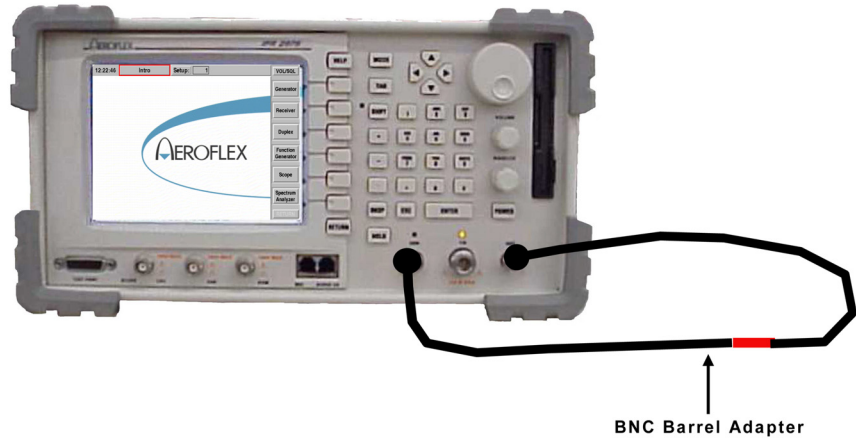

Equipment Needed

2975

BNC Barrel Adapter

Interconnect

1. Connect an RF Cable to the 2975 GEN Connector.
2. Connect an RF Cable to the 2975 ANT Connector.
3. Using a BNC Barrel Adapter, connect the two RF Cables together to form a loop. This configures the 2975 to zero out the test cables prior to making insertion loss measurements.

Configure the 2975

1. Select the Spectrum Analyzer screen [MODE] [6].
2. Turn the Tracking Generator *ON* [SHIFT] [MODE] [6], **ENTER**.
3. Select **FREQ 160 MHz**.
4. Select **SPAN 10 MHz**.
5. Select **COUPLING AUTO**.
6. Select Spectrum Analyzer Reference Level **-10.0 dBm**.
7. Adjust the Tracking Generator level control for a top line reference on the Spectrum Analyzer display.

Accept Options	RETURN
<input checked="" type="checkbox"/> Live	1
<input type="checkbox"/> Average	2
<input type="checkbox"/> Peak	3
<input type="checkbox"/> Compare	5
<input checked="" type="checkbox"/> Tracking Gen.	6
Configure Markers	7
Escape	ESC

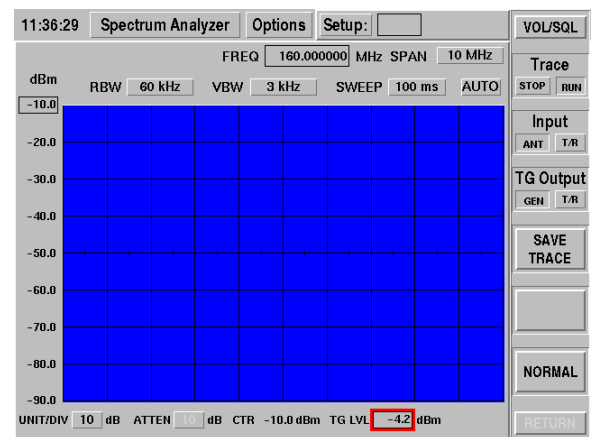

MEASURING FILTERS (cont)

The Tracking Generator function allows analysis of:

- Filter Insertion Loss
- Filter Notch Depth
- Filter Pass Band
- Filter Bandwidth

The current hookup and 2975 configuration is as follows:

The tracking generator (RF GEN OUT) is connected to the ANT Connector, therefore the output is looped back around to the input. This is done to allow the tracking generator output level to be adjusted for a zero reference on the spectrum analyzer display. This must be done to accurately measure insertion loss.

To do this, position the cursor to the **TG Level** control to allow access to generator functions. Press the **ENTER** key and then use the knob to adjust the Tracking Generator level for a top line reference on the spectrum analyzer.

NOTE: The Tracking generator level may not indicate 0 dBm and it is not necessary for it to be 0 dBm.

After the reference level has been established, connect the Duplexer Filter and evaluate the insertion loss through the pass band.

FILTER PASS BAND ADJUSTMENTS



1. Connect the Duplexer Filter Antenna port to the 2975's AUX RF Output.
2. Connect the Duplexer Filter 160 MHz port to the 2975's Antenna port.
3. Connect a 50Ω Termination to the remaining port.

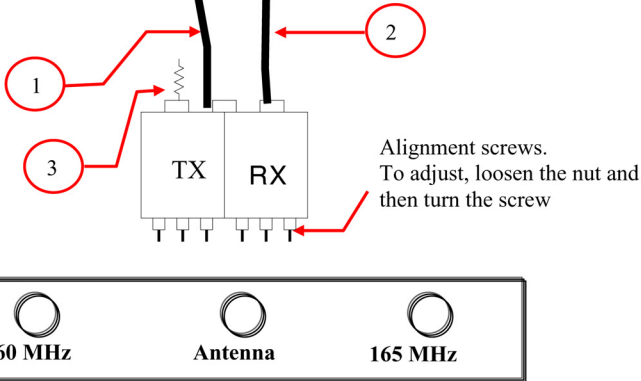

If the filter is properly aligned, the screen to the right is displayed. The center of the analyzer is set to the pass band frequency and the RX alignment screws should be adjusted for a minimum insertion loss at this frequency. The marker value indicates the amount of insertion loss at this frequency.

NOTE: The reference level started at -10 dBm, so the insertion loss in this example is -1.29 dB.

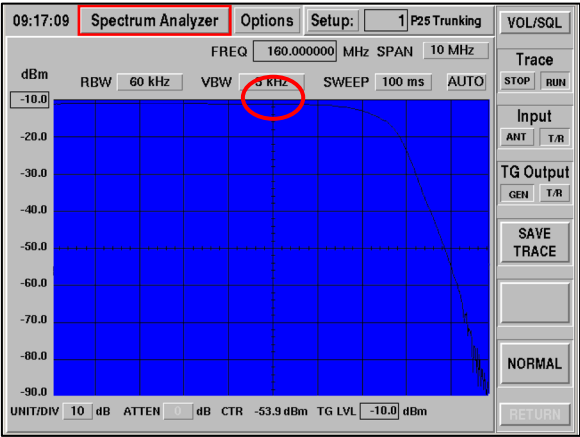

NOTCH FILTER ADJUSTMENTS

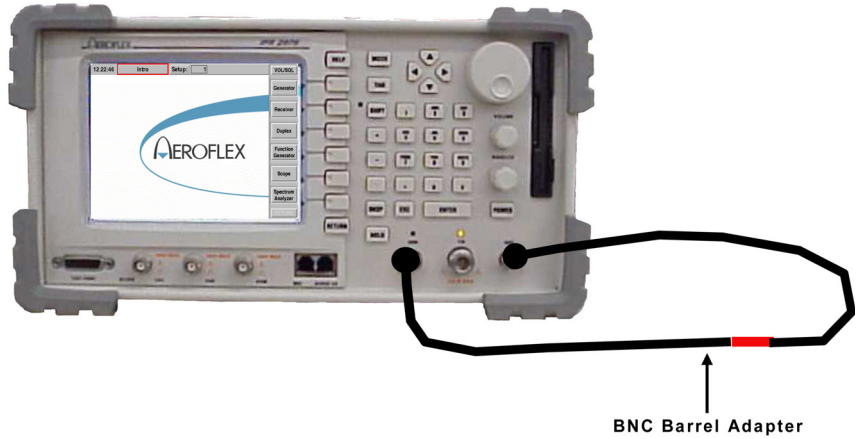

To Measure the Notch Depth:

Set the center frequency to 165 MHz to measure the notch depth. The Reference level must be adjusted to -30 dBm or lower to see the bottom of the displayed trace.

The filter may now be evaluated for the reject band. This image indicates that the filter has a notch depth of 71.97 dB because an initial reference trace set was set with a -10 dB indication.

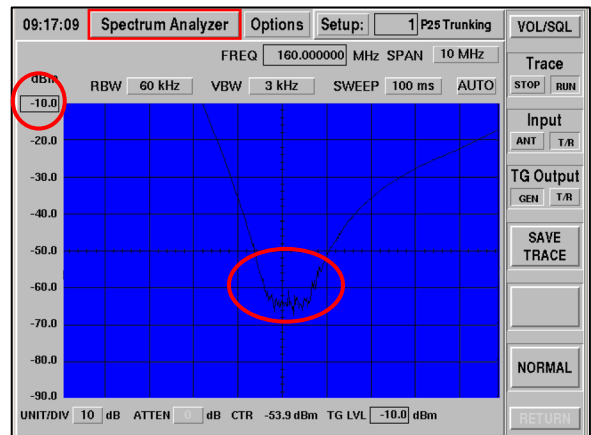

P25 SELF CHECK

The advanced features of the 2975 can be demonstrated with no external devices. To perform the Self-Check, establish the following setup:

Configure the 2975

1. Select the Duplex screen [MODE] [3].
2. Configure the Duplex screen as shown with only the P25 Uplink Data and P25 Downlink Data options selected.

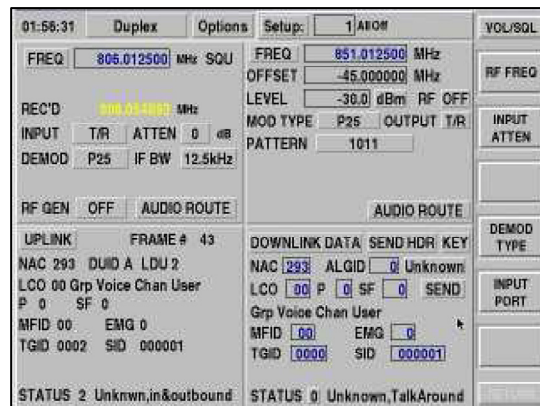

IMBE Vocoder

The instrument should now be configured to generate a P25 signal encoded with SPEECH Voice patterns. Turn the volume up to hear the following three voice patterns:

“These shoes were black and brown”

“They took the cross town bus”

“Don’t throw trash on the street”

These messages are repeated continuously. The messages when encoded and decoded verify specific aspects of the vocoder. The fact that the messages can be clearly heard serves as a test.

The IMBE vocoder found in a P25 receiver was designed to pass voice information. The vocoder attempts to eliminate constant sounds making it impossible to perform receiver quality measurements with a 1 kHz tone as done in traditional analog systems. When testing a receiver for sensitivity, the SPEECH pattern should be used.

MOD FIDELITY FSK Error Meter

The 2975 offers a *unique* advantage for verifying the 4 level FSK modulation scheme. The Modulation Fidelity Meter measures deviation offsets of a P25 signal at specific time intervals synchronously with the decoded symbol clock.

While the speech is being encoded and decoded, the MOD FIDELITY meter is also measuring the deviation accuracy of the signal. A standard deviation meter cannot measure the deviation accurately. The data must be decoded and measured synchronously with the symbol clock. In the event of a high Bit Error Rate, the data cannot be synchronized and no indication is displayed on the MOD FIDELITY Meter. The 4 deviation levels associated with C4FM are ± 1.8 kHz and ± 0.6 kHz. These 4 deviation levels are used to represent the bit patterns as shown in the illustration above (right). Transmitters should indicate $\leq 10\%$. Most systems would use primarily one radio manufacturer. A "Typical" performance standard should be determined by sampling the characteristic percentage error indication of a group of similar radios to obtain a percentage error by which similar radios could be judged.

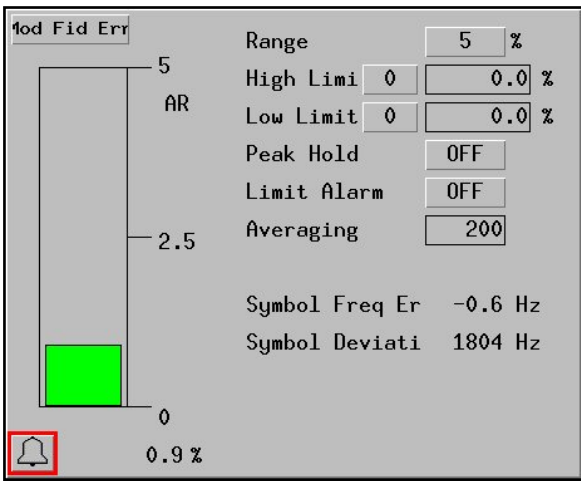

Actual 2975 Screen

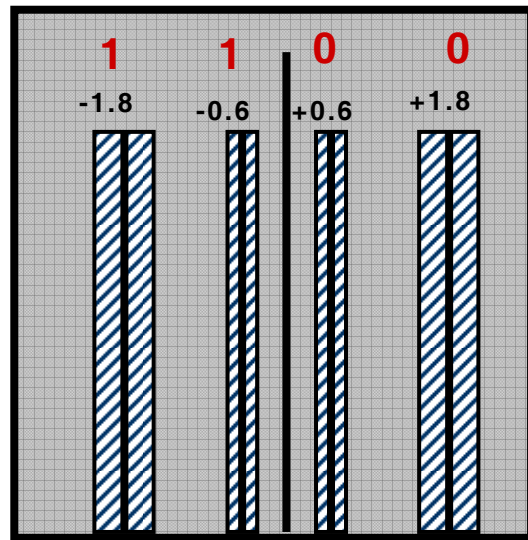

Deviation Levels Measured

Uplink Data Window

Notice the Uplink Data window. This window is decoding the P25 data stream. The information displayed in this window is decoded from the P25 transmitter and allows the operator to see certain aspects of the transmitters programming. The emergency call feature of a radio can be evaluated by monitoring the **EMG** bit field without alarming the system with an actual emergency call. In this particular instance, the window is decoding the data from the 2975 signal generator as programmed by the **DOWNLINK DATA** window. The **UPLINK DATA** window can be expanded to show additional information by placing the cursor on the **UPLINK DATA** label and pressing the **ENTER** key.

NOTE: When testing a P25 transceiver, first key the radio and note the decoded values for **TGID**, **NAC** and **SID** fields in the **UPLINK DATA** window. Transfer decoded information into like fields in the **DOWNLINK DATA** window to generate into the receiver under test. These entries can be made in all **PATTERN** selections except **STANDARD**, as this pattern has the following fixed parameters: **TGID** = 1, **SID** = 1 and **NAC** = 293.

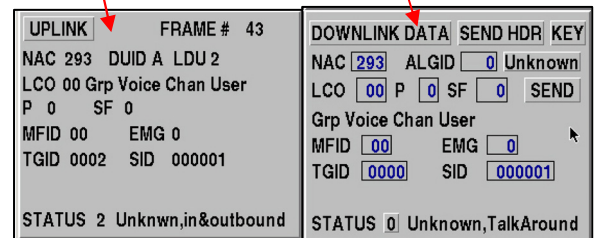
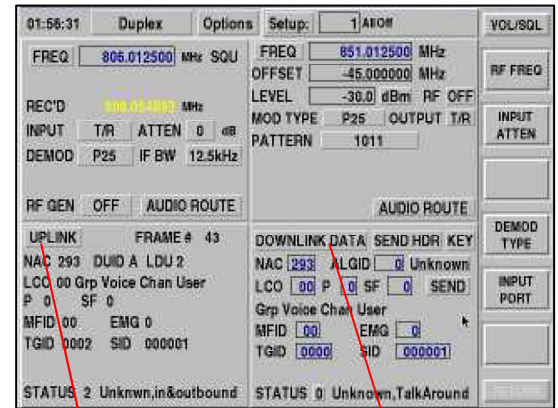

Downlink Data Window

This window allows repeater simulation to evaluate a receiver. Information entered into this window is encoded and transmitted to the receiver under test.

MOD Type

Either Encrypted or Non-Encrypted P25 modulation can be selected as the modulation type. The Encrypted version uses a standard test key that has been defined in the Standards for P25.

Pattern Formats

1011 - A defined bit pattern, which when decoded, sounds like the traditional 1 kHz (1011 Hz) tone. This pattern is normally used to perform BER tests on a receiver. This pattern cannot be encrypted. This pattern may have the **NAC**, **TGID** and **SID** modified to accommodate the system under test.

CALIBRATION - A defined bit pattern representing the 1011 tone as above, but with a 5% BER added. A P25 receiver should be able to decode this pattern successfully with a strong receive RF level. This pattern cannot be encrypted. This pattern may have the **NAC**, **TGID** and **SID** modified to accommodate the system under test.

SILENCE - A defined bit pattern, which when decoded, produces no sound (silence) on the receiver audio. This pattern cannot be encrypted. This pattern may have the **NAC**, **TGID** and **SID** modified to accommodate the system under test.

SPEECH - Embedded Speech patterns that repeat the following phrases:

“These shoes were black and brown”

“They took the cross town bus”

“Don’t throw trash on the street”

The **SPEECH** is used for testing repeater sensitivity without the use of other external equipment. This pattern may be encrypted. This pattern may have the **NAC**, **TGID** and **SID** modified to accommodate the system under test.

VOICE - Internal or external audio source for modulating P25. Includes the following audio sources:

- M1 Function Generator (internal)
- M2 Function Generator (internal)
- MIC Input (external)
- Audio In (external)

This pattern may be encrypted. This pattern may have the **NAC**, **TGID** and **SID** modified to accommodate the system under test.

FREQ	0.000000	MHz
OFFSET	170.000000	MHz
LEVEL	-110.0	dBm RF OFF
MOD TYPE	P25	OUTPUT GEN
PATTERN	SPEECH	
AUDIO ROUTE		

<input type="checkbox"/>	1011	0
<input type="checkbox"/>	CALIBRATION	1
<input type="checkbox"/>	SILENCE	2
<input checked="" type="checkbox"/>	SPEECH	3
<input type="checkbox"/>	VOICE	4
<input type="checkbox"/>	STANDARD	5

<input checked="" type="checkbox"/>	STD 1011	00	<input type="checkbox"/>	STD LDU2TRG	08
<input type="checkbox"/>	STD CAL	01	<input type="checkbox"/>	STD 511	09
<input type="checkbox"/>	STD SILENCE	02	<input type="checkbox"/>	STD SYMRATE	10
<input type="checkbox"/>	STD INTFRNC	03	<input type="checkbox"/>	STD LOWDEV	11
<input type="checkbox"/>	STD BUSY	04	<input type="checkbox"/>	STD FIDPAT	12
<input type="checkbox"/>	STD IDLE	05	<input type="checkbox"/>	STD FIDSPECT	13
<input type="checkbox"/>	STD LDU1TRG	06			
<input type="checkbox"/>	STD NOTRIG	07			

STANDARD - Pre-defined patterns waveforms, as per the TIA/EIA 102.CAAA-A P25 standard. The following STANDARD patterns may be selected:

STD 1011	STD NOTRG	STD CAL
STD LDU2TRG	STD SILENCE	STD 511
STD INTRNC	STD SYMRATE	STD BUSY
STD LOWDEV	STD IDL	STD FIDPAT
STD LDU1TRG	STD FIDSPECT	

Refer to the TIA/EIA 102.CAA for details for each of these standard patterns. These patterns may be used to stimulate a P25 receiver under test for test and analysis purposes. These patterns are fixed format, and cannot have the **NAC**, **TGID** and **SID** modified to accommodate the system under test. **TGID** = 1, **SID** = 1 and **NAC** = 293 (per the Standard).

STD 1011

Reference - TIA/EIA 102.CAAA, Section 1.3.3.6, a)

Standard Tone Test Pattern

This test pattern produces a 1011 Hz tone at the reference level at the receiver vocoder. This pattern has no bit errors.

STD CAL

Reference - TIA/EIA 102.CAAA, Section 1.3.3.6, f)

Calibration Test Pattern

This test pattern is a modified version of the 1011 Hz tone as described in STD 1011. The STD 1011 pattern is modified by inverting every 20th bit, yielding 172 errors out of 3456 bits (4.977% BER).

STD SILENCE

Reference - TIA/EIA 102.CAAA, Section 1.3.3.6, b)

Standard Silence Test Pattern

This test pattern produces audio silence (no sound) at the receiver vocoder output.

STD INTRNC

Reference - TIA/EIA 102.CAAA, Section 1.3.3.6, c)

Standard Interference Test Pattern

This test pattern produces audio silence (no sound) at the receiver vocoder output and is balanced to have approximately equal positive and negative signal deviations.

STD BUSY

Reference - TIA/EIA 102.CAAA, Section 1.3.3.6, d)

Standard Busy Test Pattern

This test pattern provides channel busy information.

STD IDLE

Reference - TIA/EIA 102.CAAA, Section 1.3.3.6, e)

Standard Idle Test Pattern

This test pattern provides channel idle information.

STD LDU1TRG

Reference - TIA/EIA 102.CAAA, Section 1.3.3.7, a)

Trigger On Start Of Link Data Unit 1 (LDU1)

This test pattern provides a trigger at the start of Link Data Unit 1 (LDU1).

STD NOTRIG

Reference - TIA/EIA 102.CAAA, Section 1.3.3.7, b)

No Trigger

This test pattern provides no trigger.

STD LDU2TRG

Reference - TIA/EIA 102.CAAA, Section 1.3.3.7, c)

Trigger On Start Of Link Data Unit 2 (LDU2)

This test pattern provides a trigger at the start of Link Data Unit 2 (LDU2).

STD 511 (V.52)

Reference - TIA/EIA 102.CAAA, Section 1.3.4.3

Standard Transmitter Test Pattern

The standard transmitter test pattern is a continuously repeating 511-bit binary pseudo-random bit sequence based upon ITU-T O-153, formerly CCITT V.52.

STD SYMRATE

Reference - TIA/EIA 102.CAAA, Section 1.3.4.4

Standard Transmitter Symbol Rate Pattern

The standard transmitter symbol rate pattern is a continuously repeating bit stream defined as the following pattern:

01 01 11 11 01 01 11 11 ...

STD LOWDEV

Reference - TIA/EIA 102.CAAA, Section 1.3.4.5

Standard Transmitter Low Deviation Pattern

The standard transmitter low deviation pattern is a continuously repeating bit stream defined as the following pattern:

10 10 00 00 10 10 00 00 ...

STD FIDPAT

Reference - TIA/EIA 102.CAAA, Section 1.3.4.6

Standard Transmitter C4FM Modulation Fidelity Pattern

The standard transmitter C4FM modulation fidelity pattern is a continuously repeating bit stream defined as the following 24-bit pattern:

01 01 11 00 00 01 10 01 11 10 11 11 ...

STD FIDSPECT

Reference - TIA/EIA 102.CAAA, Section 1.3.4.7

Standard Transmitter C4FM Modulation Fidelity Spectrum

The standard transmitter C4FM modulation fidelity spectrum is the ideal spectrum of the baseband modulating signal that is generated when the bit stream is the standard transmitter C4FM modulation fidelity pattern (STD FIDPAT).

The spectrum is described by the magnitude and phase of the spectral components at each specified frequency defined within TIA/EIA 102.CAAA, Section 1.3.4.7.

Scope and Spectrum Analyzer

A Scope and Spectrum Analyzer can replace the Uplink and Downlink data screens for diagnostic purposes. To configure the screen in this manner open the Option Screen by pressing **[SHIFT] [MODE]**. Deselect the Uplink and Downlink screens **[1]** and **[2]** and select the Scope and Analyzer **[3]** and **[4]**. Press the **[RETURN]** key or select "Accept Options" from the drop down menu.

The spectrum analyzer should display the received signal. If testing an actual transmitter, it is possible to verify that the correct channel is being used and that sufficient signal strength is available to decode the signal (>-70 dBm). The Scope can display the recovered audio from the Vocoder. To select demodulated audio for the scope display, zoom in on the scope and select the **DEMOD AUDIO** selection from the Option Screen by pressing **[SHIFT] [MODE] [7]** and **[RETURN]**.

Demodulated audio for FM systems can be viewed in a similar fashion from the Receive or Duplex screens once the scope has been selected and expanded.

To expand the scope to full screen, position the cursor to the SCOPE label and press the **[ENTER]** key on the keypad. This expands the scope to full screen mode as shown above. From the Options menu (**[SHIFT] [MODE]**) select **DEMOD [7]**. Similarly, the scope in the Generate mode of operation can select the audio input from the SINAD meter to be displayed.

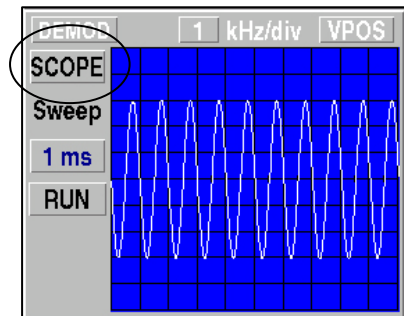
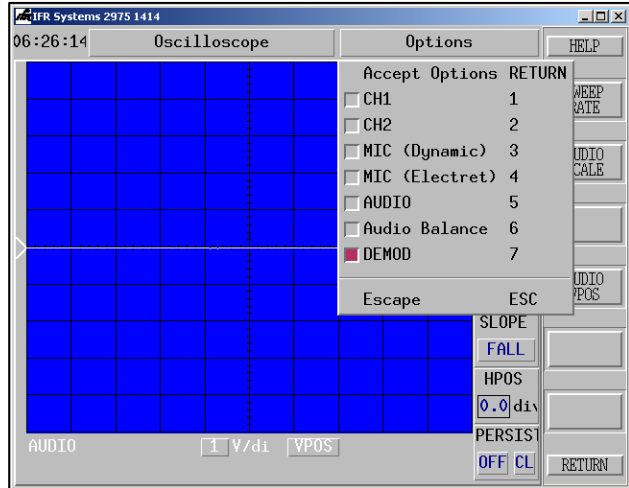

Project 25 Uplink Data Decoding

MFID – **Manufacturers ID** 8 Bits

00 indicates that the following data is P25 compliant.

Any other value means that the following data stream is specific to a particular radio for data transmissions.

```

UPLINK          FRAME # 43
NAC 293  DUID A LDU 2
LCO 00 Grp Voice Chan User
P 0      SF 0
MFID 00   EMG 0
TGID 0002  SID 000001

STATUS 2 Unknwn,in&outbound
    
```

ALGID – **Algorithm ID** 8 Bits

ALGID Code Definitions

80 - Unencrypted message.	81 - P25 DES-OFB encryption is being used.
---------------------------	--

TGID – **Talk Group ID** 16 Bits

Identifies the Talk group Identification.

NOTE: Enter this value into the TGID Downlink screen to talk back to the radio.

Key ID – **Encryption Key ID** 16 Bits

The KID has only one standardized value, which is used for either unencrypted messages, or as a default value for encrypted messages. This value is the null (0000) value.

MI – **Message Identifier** 72 Bits

If Encryption is used, this value indicates the encryption synchronization word.

The MI has only one standardized value, which is used for unencrypted messages. This is the null (000000...0) value. The null value is never used for encrypted messages.

NAC – **Network Access Code** 12 Bits

NAC has 4096 values. The values are expressed in HEX format.

```

HEADER WORD  FRAME # 525
MFID 00 ALGID 00          TGID 0000
KEY ID 0000  MI 000000000000000000
VOICE FRAMES
NAC 734  DATA UNIT ID 7  Trunk Sig Data
LINK CONTROL
RAW 00 00 04 00 00 01 00 00 01
LCO 00 Group Voice Channel User
P 0   SF 0
MFID 00   EMG 0
TGID 0001  SID 000001
ES DATA: KID 0000  ALGID 80
          MI 000000000000000000
LSD 00000000
STATUS SYM 2 Unknwn,Inbound&Outbound

```

- 0 - Header Data Unit
- 1 - Reserved
- 2 - Reserved
- 3 - Terminator without subsequent Link Control
- 4 - Reserved
- 5 - Logical Link Data Unit 1
- 6 - Reserved
- 7 - Trunking Signaling Data Unit
- 8 - Reserved
- 9 - Reserved
- A - Logical Link Data Unit 2
- B - Reserved
- C - Packet Data Unit
- D - Reserved
- E - Reserved
- F - Terminator with subsequent Link Control

DATA UNIT ID - Data Unit Identifier

The Data Unit Identifier identifies the type of data that is being transmitted.

NOTE: This field changes quickly when decode operations are operating as they should. Erratic or sluggish decoding operation indicates a high bit error rate from the transmitter, low signal strength at the input of the 2975 or excessive frequency error.

Link Control

LCO – Link Control Op Code / LCF Link Control Format

The LCF has four standard values with remaining values reserved for future standard definitions. Future trunking standards are expected to define various LCF values. These are tabulated below.

Standard LCF Values

- 00 - Defines the format for Group Calls. The LC contains an Emergency bit, TGID and a Source ID.
- 03 - Defines the format for Individual Calls. The LC contains a Source ID and a Destination ID.
- 80 - Encrypted LC information, with same contents as 00.
- 83 - Encrypted LC information, with same contents as 03.

P – Protected Flag

Indicates whether the information is protected or not.

A "1" shall indicate the message is protected and Octets 1 through 8 are encrypted.

A "0" shall indicate the LC is not encrypted.

SF – Implicit / Explicit MFID Format

Indicates whether the format employs an implicit standard MFID or not. A 1 indicates Implicit MFID where the standard Manufacturers ID is implied.

MFID – Manufacturer's ID

The MFID has one standard value to represent operation in conformance to the standard. Other values are defined for manufacturer's and are used to signify that the information content of the message does not necessarily conform to the Common Air Interface.

Standard MFID Values

00	Standard Value -- denotes conformance to standard
10	BK Radio
20	Cycomm
28	Efratom Time and Frequency Products, Inc.
30	Ericsson
40	E.F. Johnson
48	Garmin
50	GTE
55	IFR
60	GEC-Marconi
70	Glenayre Electronics
74	Japan Radio Co.
78	Kokusai
79	Maxon
80	Midland
90	Motorola
A0	Racal
B0	Raytheon
C0	SEA
C8	Securicor
D0	Stanilite
E0	Teletec
F0	Transcrypt International

EMG - **Emergency Indicator**

0 indicates a non-emergency condition.

1 indicates an emergency condition.

MFID - **Manufacturer's ID**

TGID - **Talk Group Identifier**

Identifies the Talk group Identification number of the transmitter.

DID - **Destination ID**

When placing a unit to unit call, DID field appears in place of TGID field.

This field identifies the calling radio's ID number.

SID - **System Identifier**

LSD - **Low Speed Data**

Decoded values for Low Speed Data

Status Symbol -

- 0 Unknown Talkaround
- 1 Inbound Channel Busy
- 2 Unknown, In and Output Bound
- 3 Inbound Channel Idle

THIS PAGE INTENTIONALLY LEFT BLANK.

SECTION 5 - REMOTE COMMANDS

5-1 INTRODUCTION

TCL (Tool Command Language) was developed by John Ousterhout at the University of California to automate a variety of computer environment tasks. Aeroflex elected to use TCL in the 2975 for remote operation and to create automated test sequences. Combining TCL programming with the test functions in the 2975 provides the user with considerable flexibility in creating automated tests.

The 2975 scripting language has three main parts:

- The basic TCL syntax
- The 2975 specific commands
- The user interface system

The first part of the system is the basic TCL language. Books on TCL are available in most bookstores with a computer books section. Aeroflex suggests the purchase of a TCL book if the plan is serious programming development. TCL allows macros to be defined (known as procedures or simply “procs”) that contain a repeated command, a decision, loops, mathematical operation and any other operations needed to make a test.

The second part of the system is the set of commands specific to the 2975. These commands allow control of the unit (i.e., setting the frequency, turning on modulation sources) and otherwise controlling the hardware.

The third part of the system is the user interface. The 2975 user interface is implemented using a standard extension to TCL called Tk (consult a good TCL book for further Tk description). The user can write programs to extend the user interface, add functions to the screens or create windows to display prompts, results and other information.

Connecting to the 2975

The three basic ways to connect to the 2975 and establish remote control of the unit are: RS-232, IEEE-488 or TCP/IP over Ethernet. The commands and reactions are the same regardless of the connection.

Verify the settings on the 2975. Press **[MODE]**, **[7]** and **[1]** to display the main setup screen.

The screenshot shows the 'Configuration' screen of the 2975. The title bar includes the time '07:37:32', the title 'Configuration', and 'Setup: 1 STD 511'. The screen is divided into several sections:

- IP PARAMETER SETUP:** Includes fields for HOST NAME (xworks), MAC ADDRESS (00:50:08:01:F9:4A), ADDRESS (10.200.183.52), NETMASK (255.255.255.0), and GATEWAY (10.200.0.30).
- SYSTEM PARAMETER SETUP:** Includes 10 MHZ REFERENCE (Internal), POWER OFF MSG (YES), RF Gen DC power (ON), and Normalize Cals (Clear).
- RS-232 (Serial) SETUP:** Includes Baud rate (115200), Handshake mode (SOFT), Character echo (ON), and Mode (TCL).
- IEEE-488 (GPIB) Setup:** Includes Address (4) and Web server setup (ENABLED).
- Other controls:** Includes a 'REDIRECT DISPLAY NOW' button, 'Spinner in menus' (NORMAL), 'Show levels on Vol/SqI knobs' (ON), and buttons for 'Save debug info', 'LOG KEYS IS OFF', and 'RETURN'.

RS-232

The RS-232 Port on the 2975 rear panel is a standard, nine-pin serial port wired as a DTE (Data Terminal Equipment).

The 2975 supports the following settings on the RS-232:

- Data Rate: 110, 130, 300, 600, 1200, 2400, 4800, 9600, 19200, 38400, 57600, 115200 bits per second
- 8 Data Bits
- 1 Stop Bit
- 1 Start Bit
- No Parity
- No Handshaking or XON/XOFF Handshaking (“software” handshaking)

Follow these simple steps to configure the 2975 for remote operation using RS-232.

- Use a null-modem cable to connect the RS-232 Port on the 2975 rear panel to the RS-232 Port on the computer.
- On the computer, start the terminal emulator program and set the terminal program to the same baud rate and handshaking mode as the 2975.
- Serial MODE to TCL
- Press RETURN on the computer in the terminal emulator program a couple times. The “%” symbol is the main TCL prompt which indicates the 2975 is ready to receive commands. *If no prompt appears, make sure the Serial character echo is turned on at the 2975.*

GPIB

The 2975 is a talk/listen instrument.

The IEEE-488 has only one setting, the address the 2975 is to use. This value may be from 1 to 30.

Once this value is set, communication with the 2975 is possible via IEEE-488.

Telnet Over Ethernet

The 2975 can be controlled via TCP/IP through the Ethernet Port on the rear panel. The port is a standard 100base-T port capable of operating on either a 10 or 100 MBit network. To use this option, manually configure the 2975 for network operation.

The screenshot shows the 'Configuration' menu of the 2975 device. The 'IP PARAMETER SETUP' section is highlighted with a red box. Callouts point to the following fields:

- ADDRESS:** The NUMERICAL address assigned to the 2975 by a network administrator.
- NETMASK:** Value provided by a network administrator.
- GATEWAY:** Value provided by a network administrator.
- DISPLAY HOST:** DO NOT change the DISPLAY HOST address unless an external X Windowing System display server is used to display the 2975 screen.

The configuration screen also shows other settings like DHCP, SYSTEM PARAMETER SETUP, and RS-232 (Serial) SETUP.

At a minimum, correctly set the following fields and execute the steps:

- Verify the 2975 is connected to the network and is accessible from the computer by “pinging” the unit.

Example: Assume the unit was given the address of:

333.333.333.333 (this is NOT a valid address)

The command to verify connection would be:

```
ping 333.333.333.333
```

The command to access the unit would be:

```
telnet 333.333.333.333 71
```

- To control the unit from a computer program, open a TCP socket on port 71 at the 2975 address.
- Write commands to that port.

5-2 TCL BASICS

The remote control language of the 2975 is based on the standard TCL scripting language. This is a standard language in Unix systems, and versions are available for IBM and Macintosh computers.

The 2975 has TCL built-in making it unnecessary to install TCL on the host computer.

Issuing Commands

TCL commands are one-word commands with parameters given after the command and separated by spaces.

Example: To turn the character echo on, the command is:

```
echo on
```

Multiple commands are separated by semicolons.

Example: To turn the character echo off, then back on, the command is:

```
echo off; echo on
```

Variables

TCL supports variables. Variables are useful for stored procedures. The 2975 also places values of meter readings into variables. Variables may contain numbers or words.

Example: To set a variable, use the following command:

```
set foo 1
```

Sets the value of the variable "foo" to 1.

Variables can be used without being declared.

Example: To access the value of a variable, prepend a \$ onto the variable:

```
set foo $bar
```

Sets the variable "foo" to the value of the variable "bar," while:

```
set foo bar
```

Sets the variable "foo" to "bar," not the value of the variable "bar."

To see what the value of a variable is, use the following command:

```
return $foo
```

This returns the value of the variable "foo."

Delaying

When conducting tests, sometimes a delay is needed for a period of time after issuing a command to allow the unit under test to stabilize.

Example: To delay for a period of time after issuing a command:

```
after 10000
```

This command delays for 10 seconds (10000 ms) before returning. Consult any TCL book for more information on the standard "after" command.

Finding Out What Went Wrong (errorInfo)

If an error occurs in the processing of a command, the 2975 records more information about the error in the "errorInfo" variable. This information contains the exact error message text and in what procedure the error occurred.

Example: To access the errorInfo variable:

```
return $errorInfo
```

Defining Procedures

The whole purpose of having a scripting language in the 2975 is to allow a test station to offload some work onto the unit. Procedures can be defined and then called to perform tasks.

For example, suppose there is a consistent need to set the 2975 to receive and generate at a given frequency, then report a SINAD measurement after a five second stabilization period. Manually it would look like this:

```
Screens::Show . Duplex_Screen dup
Receiver freq 100 MHz
Generator freq 100 MHz
Sinad enable
after 5000
return $::Sinad::State(sinad)
```

This requires the test station send these commands every time.

A stored procedure would look like this:

```
proc      Get_sinad {rec_freq gen_freq}{
  Screens::Show . Duplex_Screen dup
  Receiver freq $rec_freq MHz
  Generator freq $gen_freq MHz
  Sinad enable
  after 5000
  return $::Sinad::State(sinad)
}
```

Example: This command is issued by saying:

```
Get_sinad 100 100
```

5-3 CONTROLLING THE 2975

Issuing Commands

Most of the commands that control the 2975 are of the form:

```
SYSTEM SUBSYSTEM {args}
```

The SYSTEM is the major function of the instrument, such as:

```
Receiver  
Generator  
FGen (Function Generator)  
Sinad
```

and so forth. The command must be capitalized as shown. "RECEIVER" or "receiver" fails. Only "Receiver" works.

The SUBSYSTEM part of a command refers to what part of that instrument you are accessing.

```
Receiver frequency - set receiver frequency  
Receiver rinput - set the input port
```

and so on. The SUBSYSTEM can be abbreviated to an extent. For example, "Receiver freq" is valid.

The "args" part specifies what value to set. In most cases, if the value is not specified, the current value is returned. For example, "Receiver freq" returns the current receiver frequency.

-onchange commands-using events

Situation: monitor the RX Sinad of the unit under test, and get new readings as when available. Use an "-onchange" modifier to ask the 2975 to execute a procedure when a subsystem is changed. For example, try this:

```
Sinad -onchange reading {puts "Current Sinad is %V";}
```

The -onchange parameter tells the command to save the TCL command which is in the brackets {}, and execute this command every time there is a new value for the "reading" subsystem. The "%V" parameter is replaced by the actual values returned by the engine from the "reading" subsystem, which allows access to the information.

The -onchange option is designed for continuous monitoring of information, and is not a good choice when only a single reading is desired. Most instrument information is available through a query process, such as:

```
Sinad value
```

which provides an immediate return of the last meter reading.

5-4 CONTROLLING THE 2975 DISPLAY

DISPLAY CONTROL IS OPTIONAL. The 2975 can be controlled as an instrument without displaying a special screen or meter. A user only needs to control the display to monitor data during a test or while debugging the automated test procedure.

The 2975 utilizes a number of defined screens. Each screen usually contains one or more permanently displayed tiles as well as a number of User selectable optional tiles. An RCI command is provided to change the screen, however, it does not allow the user to select which optional tiles are available. Therefore, the following steps are recommended when establishing test procedures:

- Configure each of the screens on the 2975 to display the information to be monitored during the test. The User Screen is useful when there is a need to simultaneously display a wide range of information, or when combinations of tiles not available on other screens need to be displayed.
- Save the screen configuration as a "Setup" so the screen can be recalled when the test needs to be run. This is helpful when different screen configurations are needed for various tests.

A specific page can be displayed on the 2975 using the command below.

NOTE: The "period" in the command is required, and there must be at least one space before and after the period. "screen_name" should be replaced with the desired screen to be activate, with the options provided below.

- Screens::Show . screen_name
- Standard available values for "screen_name":
 - User_Screen This is the "User Screen" on the menu
 - Gen_Screen This is the "Generator (Rx Test)" screen on the menu
 - Rec_Screen This is the "Receiver (Tx Test)" screen on the menu
 - Duplex_Screen This is the "Duplex" screen on the menu
 - AFGen_Screen This is the "Function Generator" screen on the menu
 - Scope_Screen This is the "Oscilloscope" (full screen scope) on the menu
 - Analyzer_Screen This is the "Spectrum Analyzer" screen on the menu
- Values for "screen_name" which are only available if the option is installed in the unit:
 - Audio_Analyzer_Screen This is the "Audio Analyzer" screen on the menu
 - Auto_Test_2 The is the "Auto Test" Application screen

NOTE: Screen changes may take a few seconds. While the meters are continuously updating their values during this time, TCL may delay updating some information while it is busy redrawing the screen. Do NOT plan to capture data during a screen change. Typically wait a few seconds after requesting a screen change before setting up new automated test conditions.

The display can be locked to prevent the user from interfering with an automated test. The display will still update normally and the screens can be changed during the lockout. The lockout also prevents any new TELNET sessions from being created.

- To initiate keyboard lockout, type: LOCKOUT 1
- To restore keyboard control to the user: LOCKOUT 0

5-5 RECALLING SAVED INSTRUMENT STATES

The 2975 provides a method for capturing the current state of the instrument and display modes, and writing this information to a file. This file is encoded as simple ASCII text, and can be viewed with any text editor. The file is a list of RCI commands which are used to restore the instrument to the same condition as when the file was written. This file has several uses:

- Several standard test configurations can be set up on the instrument and saved to unique files, allowing the user to quickly switch between the configurations.
- The saved test configurations can be downloaded to a PC, either for archival purposes or for generating common test setups on one unit and transferring them to other units.
- The file can be viewed to see practical examples of the RCI command syntax
- When writing an automated test, and specific test conditions are required, set up the condition using the instrument controls, save the instrument state, and then review the file to see the specific commands used to set up the condition.

When the 2975 is connected to a network, any network PC can access various files and the current instrument state using a WEB browser. To remote access the 2975:

- Determine the IP address of the 2975. This information is located on the **Configuration** screen of the unit. To access this screen use the following key sequence (**MODE, 7, 1**).
- The IP address of the 2975 is located in the ADDRESS fields.
- In the Address (URL) field of the WEB browser, enter the IP address of the 2975, including the periods. For example: 10.200.126.75
- A page should be displayed indicating that a connection has been made to a 2975 with a specific serial number. The page displays basic information from the unit and also displays a row of links to obtain additional information.
- If using a mouse, click on the “User Files” link. A page is displayed showing available files and directories.
- If using a mouse, click on the “Setups” directory. A list of saved instrument setup files is displayed (file names are similar in format to SAVExx.SAV). The WEB page allows these files to be downloaded to a PC from the test set or uploaded from a PC to a 2975.

The screenshot shows the 'Configuration' screen of the 2975 instrument. The 'ADDRESS' field is highlighted with a red box. The screen displays various network and system parameters.

07:37:32	Configuration	Setup:	1 STD 511	VOL/SQL
IP PARAMETER SETUP		DHCP	SYSTEM PARAMETER SETUP	
HOST NAME	works		10 MHZ REFERENCE	Internal
MAC ADDRESS	00:50:08:01:F9:4A		POWER OFF MSG	YES
ADDRESS	[] . [] . [] . []		RF Gen DC power	ON
NETMASK	[] . [] . [] . []		Normalize Cals	Clear
GATEWAY	[] . [] . [] . []		RS-232 (Serial) SETUP	
DISPLAY HOST	[] . [] . [] . []		Baud rate	115200
WINDOW TITLE	[]		Handshake mode	SOFT
REDIRECT DISPLAY NOW		Mode		TCL
IEEE-488 (GPIB) Setup		Spinner in menus		Save debug info
Address	4		NORMAL	
Web server setup		Show levels on Vol/Sql knobs		LOG KEYS IS OFF
Enable	ENABLED		ON	
RETURN				

NOTE: If a setup file is downloaded using Microsoft Internet Explorer, the file must be saved as a .txt file. If the setup file is saved as a WEB page (.htm or .html), Microsoft inserts information into the file which causes an error when attempting to restore the instrument state.

NOTE: Also be aware that Microsoft changes the file name when it saves it on the PC. Rename the file after the file has been saved on the PC.

After the current state of the test set has been saved to a file, this file can be recalled in order to restore the test set to the saved file state. The file can be recalled using the instrument menus **Save /Recall Setups (MODE, 6, 1)**, or by using the remote command **“Recall.”**

- The **“Recall”** command assumes that the setups are stored in the /usr/setups directory, or a subdirectory of this directory. Files stored in other locations cannot be recalled.
- The **“Recall”** command can be given a file number instead of a file name. The command assumes that the number given replaces the “xx” in the standard name of “SAVExx.SAV.”
- The **“Recall”** command is CASE SENSITIVE. If the file name is SAVE5.SAV, the command does not recall the file if the file name is entered as save5.sav.

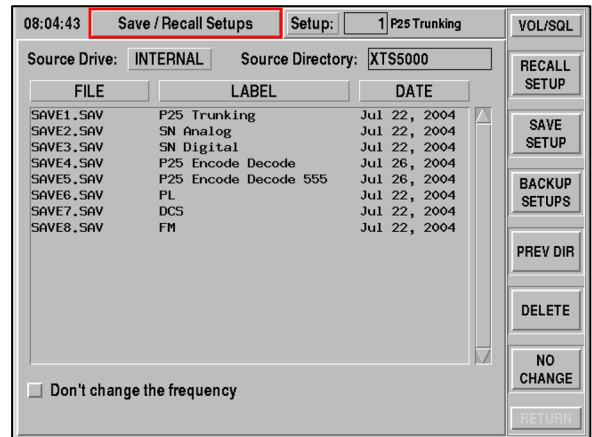

Examples of using the **Recall** command:

- | | |
|----------------------------|--|
| ● Recall 3 | Recalls file /usr/setups/SAVE3.SAV |
| ● Recall SAVE25.SAV | Recalls file /usr/setups/SAVE25.SAV |
| ● Recall ./mydir/SAVE4.SAV | Recalls file /usr/setups/mydir/SAVE4.SAV |

5-6 USING THE 2975 TCL COMMAND VERBS

A number of TCL commands have been defined to allow control of the 2975 hardware, and to access acquired data.

Command Name

The TCL commands have a basic name which reflects the 2975 subsystem being controlled. Currently, all TCL command names are CASE SENSITIVE. The names were created as extensions to the TCL language and TCL verbs are case sensitive.

Subcommand Name

For each TCL command a series of subcommands are defined and are unique to the command. Each subcommand name has a short and long form (which may be identical for short commands).

The short form of the subcommand is listed in capital letters, and the long form in lower case. If a subcommand is shown as FREQuency, the short form is:

FREQ or freq.

The long form is:

FREQuency or frequency (or any combination)

The short or long form of the name must match exactly to be accepted. Subcommand names are NOT case sensitive.

For engines with more than one LUN (Logical Unit Number), the subcommand can have an attached numeric value at the end to indicate the LUN.

Example: AFCOUNTER avg Requests AVERAGE for LUN=1 (assumed)
 AFCOUNTER avg2 Requests AVERAGE for LUN=2

Data Retrieval or Modification

The use of a command and subcommand with no supplied data is interpreted as a *request for information* unless that subcommand does not require any data.

The use of a command and subcommand with supplied data is interpreted as a *request to modify* the data

Some commands allow the setting of the value by using either a numeric value or a text string (example 1 = ON, 0 = OFF). The text string is NOT case sensitive.

Data Returned By The Command

If a request is made to modify the instrument settings, the actual setting applied to the instrument is returned. This returned value might be different from the commanded value if the desired value is outside the valid range for the setting and the “-forgive” modifier option is used. See the “Command Modifier” section for more details.

There are times when a command has only a small, specific group of valid values (example: 0 = Off, 1 = On). These commands can often be set either by sending the correct numeric value for the setting, or by a specific text string to select the value. The reply to the command is always the NUMERIC setting.

Command Modifiers

-forgive

The 2975 normally expects that all requests to change parameters have data within a valid range, and ignores the request and returns an error for illegal data. This default behavior can be changed for many subcommands to request the 2975 to replace an illegal setting value with a valid one. The replaced setting is normally an instrument limit or a safe default. This is a *temporary* change effective for the single request to change data.

Example: Fgen freq 30000 -forgive
Returns 20000, which is the maximum setting

-range

The use of this modifier causes any supplied data to be ignored, and the engine is requested to provide the valid data range for the indicated subcommand.

-onchange

This modifier allows specification of a TCL script to be executed when the engine provides notification that the specified subsystem has new data. If the string %V is put in the TCL script, a TCL LIST variable is generated from the 2975 data and a textual substitution made of the data before the script is executed. The command returns a numeric value which is used by the -unbind command to cancel the monitor process.

Example: AFCCounter
-onchange reading {set count "%V";}

The TCL command should be enclosed in brackets, each TCL command should be closed with a ";" and there should be a space before the closing bracket.

-unbind

This modifier allows the removal of a TCL script execution set up by the onchange modifier.

-queue

This modifier is similar to the **-onchange** modifier with the exception of the returned values. If the value changes multiple times before the TCL processes the command **-onchange** will return **ONLY** the last value, while **-queue** will sequentially process **ALL** of the values.

-help

This will return a list of available subsystems for the specified system.

Example: Receiver -help
Returns a list of all subsystems on the receiver command.

5-7 QUICK REFERENCE LIST

The Quick Reference List is a brief listing of the Specific and most General TCL commands used with the 2975. The Quick Reference List is meant to be an aid to the experienced TCL user.

COMMAND	RANGE	PAGE	DESCRIPTION
ANALYZER			
Analyzer			
auto_couple	0 or 1	5-22	Sets the analyzer coupling.
CALibration		5-22	Sends calibration data to analyzer.
IFGAIN	-14.0 to 82.0	5-22	Sets the IF Gain.
messageENABLE	message bits	5-22	Sets which messages are enabled.
NORMALize	0 or non	5-22	Starts/Stops analyzer normalization.
rbw	300...3000000	5-23	Sets the Resolution Bandwidth.
RUNalyzer	1, 2, 3	5-23	Sets the analyzer run state.
SPAN		5-23	Returns the Start/Stop frequency.
SWEEPspeed	1 or 2	5-23	Returns the current sweep speed.
topofscreen/tos	-99.9 to 80.0	5-23	Sets the Top of Screen.
VERsion	1 or 2	5-23	Query only command.
verticalSCALE	0.1 to 30.0	5-24	Sets the Vertical scale.
vbw	0...3000000	5-24	Sets the Video bandwidth.
AUDIO FREQUENCY COUNTER			
AFCounter			
ALerts	0, 1, 2, 3	5-25	Returns the current Alert Enable Status.
AVG/AVERAGE	0 to 200	5-25	Sets the samples to average.
ENable	1 or 3	5-25	Sets the Enabled data mode(s).
GATE	0 or 1	5-25	Sets the gate time.
LLIMit	0 to 40	5-25	Sets the lower alert limit.
PEAKhold	0 or 1	5-26	Sets the Peak Hold mode.
PHRESET/PHRST		5-26	Resets the Peak Hold readings.
READING		5-26	Only available with -onchange option. Returned list variable: Count, Precision, Status, Accuracy.
READPEAKhold		5-26	Only available with -onchange option. Returned list variable: PeakHi, Hi Precision, PeakLo, Lo Precision, Status.
RESources		5-26	Lists the USER resources.
RUN	0 or 1	5-26	Turns data collection on or off.
TRIGger	1 or 2	5-26	Sets the trigger mode.
ULIMit	0 to 40	5-27	Sets the upper alert limit.
VALue		5-27	Query only command.
VERsion	1 or 2	5-27	Query only command.
BIT ERROR RATE - BER			
Ber			
ALerts	0, 1, 2, 3	5-28	Returns the current Alert Enable Status.
ENable	1 or 3	5-28	Sets the Enabled data mode(s).
FRAMES	0 to 5	5-28	Sets the frame pattern.
LLIMit	0 to 1.0	5-28	Sets the lower alert limit.
PEAKhold	0 or 1	5-29	Sets the Peak Hold mode.

COMMAND	RANGE	PAGE	DESCRIPTION
BIT ERROR RATE - BER (cont)			
Ber (cont)			
PHRESET/PHRST		5-29	Resets the Peak Hold readings.
READING		5-29	Only available with -onchange option. Returned list variable: Bit Error Rate, Frame Error Rate, Total Bits, Total Errors, Total Frames, Total Error Frames
RESETErrors		5-29	Resets the BER error counters.
RESources		5-29	Lists the USER resources.
RUN	0 or 1	5-29	Turns data collection on or off.
ULIMit	0 to 1.0	5-29	Sets the upper alert limit.
VERsion	1 or 2	5-30	Query only command.
BBAUDIO			
BBAudio			
audioROUTE	-1 to 18	5-31	Routes internal/external signals.
clearmixer/clrmix		5-31	Clears baseband audio connections.
DEMODFILter	0 or 1	5-31	Sets the Demod audio filter type.
digitalinauto	0-1000	5-32	Sets the UUT connector digital inputs.
enscalar	0 or 1	5-32	Enable/disable the Scalar Module.
FGENBALance	0 or 1	5-32	Sets the Fgen output balance.
FGENFILTer	0 or 1	5-32	Sets the Fgen audio filter type.
FGENLEVEl	0 or 1	5-32	Sets the Fgen output level.
micbias	0 or 1	5-33	Sets the microphone bias.
MIXer	0 or 1	5-33	Selects the routing of signals.
SINADBALance	0 or 1	5-33	Sets the Sinad output balance.
utdigitalinput		5-34	Query only command.
utdigitalout	0 to 31	5-34	Sets the UUT digital output.
uutvoutadj	-99 to 99	5-34	Sets the analog voltage output.
uutvoutput	0 to 99	5-34	Sets the analog voltage output of the UUT port.
CONTINUOUS 5-LEVEL FREQUENCY MODULATION			
C4fm			
ALerts	0, 1, 2, 3	5-35	Returns the current Alert Enable Status.
AVG/AVERAGE	200 to 65535	5-35	Sets the samples to average.
ENable	1 or 3	5-35	Sets the Enabled data mode(s).
LLIMit	0 to 50.0	5-35	Sets the lower alert limit.
PEAKhold	0 or 1	5-35	Sets the Peak Hold mode.
PHRESET/PHRST		5-36	Resets the Peak Hold readings.
READING		5-36	Only available with -onchange option. Returned list variable: Reading, Precision, Status, Accuracy.
READPEAKhold		5-36	Only available with -onchange option. Returned list variable: PeakHi, Hi Precision, PeakLo, Lo Precision, Status.
RESources		5-36	Lists the USER resources.
RUN	0 or 1	5-36	Turns data collection on or off.
TRIGger	1 or 2	5-36	Sets the trigger mode.

COMMAND	RANGE	PAGE	DESCRIPTION
CONTINUOUS 5-LEVEL FREQUENCY MODULATION (cont)			
C4fm (cont)			
ULIMit	0 to 50.0	5-36	Sets the upper alert limit.
VALue		5-36	This is a query only command.
VERsion	1 or 2	5-37	This is a query only command.
DIGITAL CODED SQUELCH - Dcs			
Dcs			
Enable	1 or 3	5-38	Sets the Enabled data mode(s).
READING		5-38	Only available with -onchange option. Returned list variable: Raw value, Corrected value, Status.
RESources		5-38	Lists the USER resources.
RUN	0 or 1	5-38	Turns data collection on or off.
VERsion	1 or 2	5-38	Query only command.
DIGITAL VOLTMETER			
Dvm			
ALerts	0, 1, 2, 3	5-39	Sets the Alert Enable Status.
AVG/AVERAGE	2 to 255	5-39	Sets the samples to average.
ENable	1 or 3	5-39	Sets the enabled data mode(s).
HOLD	0 or 1	5-39	Sets the Hold status.
HWRANge	-400 or 0	5-39	Sets the Hardware range.
IMPedance	0, 150, 600	5-40	Sets the impedance.
LINEFILter	50 or 60	5-40	Sets the Line Filter setting.
LLIMit	-200 to 200	5-40	Sets the lower alter limit.
MODE	1 or 2	5-40	Sets the AC/DC mode.
PEAKhold	0 or 1	5-40	Sets the Peak Hold mode.
PHRESET/PHRST		5-40	Resets the Peak Hold readings.
READING		5-41	Only available with -onchange option. Returned list variable: DVM value, Precision, Status, Accuracy.
READPEAKhold		5-41	Only available with -onchange option. Returned list variable: PeakHi, Hi Precision, PeakLo, Lo Precision, Status.
RESources		5-41	Lists the USER resources.
RUN	0 or 1	5-41	Turns data collection on or off.
SOURce	0, 1, 2	5-41	Sets the Hardware input source.
ULIMit	-200 to 200	5-41	Sets the upper alert limit.
VALue		5-41	Query only command.
VERsion	1 or 2	5-42	Query only command.
ZERO	0 or 1	5-42	Forces the DVM chip to zero its DC offset.
DISTORTION			
Dist			
ALerts	0, 1, 2, 3	5-43	Sets the Alert Enable Status.
ALpha		5-43	Returns the current FFT alpha value.
AVG/AVERAGE	1 to 2000	5-43	Sets the number of symbols in a sample.
ENable	1 or 3	5-43	Sets the enabled data mode(s).
Enablecwt/encwt	0 or 1	5-44	Enable/disable the C-Weight Filter.

COMMAND	RANGE	PAGE	DESCRIPTION
DISTORTION (cont)			
Dist (cont)			
FILTer	1 to 100	5-44	Sets the samples to average.
HNOISE		5-44	Modifies the High Noise Frequency.
HNOTch		5-44	Modifies the High Notch Frequency.
LLIMit	0 to 40.0	5-44	Sets the lower alert limit.
LNOISE		5-44	Modifies the Low Noise Frequency.
LNOTch		5-45	Modifies the Low Notch Frequency
MATH	0 or 1	5-45	Enables or disables filtering.
PEAKhold	0 or 1	5-45	Sets the Peak Hold mode.
PHRESET/PHRST		5-45	Resets the Peak Hold readings.
READING		5-45	Only available with -onchange option. Returned list variable: Sinad, Precision, Status.
READPEAKhold		5-45	Only available with the -onchange option. Return list variable: PeakHi, Hi Precision, PeakLo, Lo Precision, Status.
RESources		5-45	Lists the USER resources.
RUN	0 or 1	5-46	Turns data collection on or off.
SENDCWT		5-46	Sends an array of data PAIRS to represent the frequency response of the C-Weight Filter.
SIZE		5-46	Modifies the FFT size value.
TRIGger	1 or 2	5-46	Sets the Trigger mode.
ULIMit	0 to 40.0	5-46	Sets the upper alert limit.
VALue		5-46	Query only command.
VERsion	1 or 2	5-47	Query only command.
WINdow		5-47	Modifies the FFT window.
FM DEVIATION METER			
FMDeviation/FMDev			
ALerts	0, 1, 2, 3	5-48	Sets the Alert Enable status.
AVG/AVERAGE	50 to 10000	5-48	Sets the samples to average.
ENable	1 or 3	5-48	Sets the enabled data mode(s).
LLIMit	0% to 100%	5-48	Sets the lower alert limit.
MATH	0 or 1	5-48	Sets the way FM Deviation readings are taken.
PEAKhold	0 or 1	5-49	Sets the Peak Hold mode.
PHRESET/PHRST		5-49	Resets the Peak Hold readings.
READING		5-49	Only available with -onchange option. Returned list variable: +Deviation, -Deviation, Average Deviation, Precision.
READPEAKhold		5-49	Only available with -onchange option. Returned list variable: PeakHi, Hi Precision, PeakLo, Lo Precision, Status.
RESources		5-49	Lists the USER resources.
RUN	0 or 1	5-49	Turns data collection on or off.
TRIGger	1 or 2	5-49	Sets the trigger mode.

COMMAND	RANGE	PAGE	DESCRIPTION
FM DEVIATION METER (cont)			
FMDeviation/FMDev (cont)			
ULIMit	0% to 100%	5-50	Sets the upper alert limit.
VALue		5-50	Query only command.
VERsion	1 or 2	5-50	Query only command.
FUNCTION GENERATORS			
Fgen/FGen			
DEVIation	0 to 40.0	5-51	Sets the Function Generator voltage level using a conversion of 1 V = 5 kHz.
DURation	1 to 100	5-51	Sets the Function Generator tone duration.
FREQuency	0 to 20000	5-51	Sets the Function Generator frequency.
LEVeL	0 to 20.0	5-51	Sets the Function Generator voltage level.
MODE	0, 1, 2	5-52	Sets the Function Generator mode.
-onchange STATus		5-52	Only available through the -onchange option. Provides the status of execution of a sequence of tones for use in continuous tone signaling.
PERcent	0% to 100%	5-52	Sets the FGen AM percentage modulation.
RESources		5-52	Lists the USER resources.
SEQuence		5-52	Sends a single tone (pair) or a tone sequence to a Function Generator.
SHape	0, 1, 2, 3, 6	5-53	Sets the Function Generator wave shape.
SYNChronize		5-53	Synchronizes Function Generators.
VERsion	0 or 1	5-53	Query only command.
GENERATOR			
Generator			
DCPOWER	0 or 1	5-54	Turns the DC power on or off.
FREQuency	0 to 2.8	5-54	Sets the Generator frequency.
hwALC	0, 1, 2	5-54	Sets the hardware ALC tracking.
hwBW	0 or 1	5-54	Sets the generator bandwidth.
messageENABLE	0x02, 0x08, 0x10	5-54	Sets the bits to enable the desired data reporting.
MODulation	0 to 11	5-55	Sets the Generator modulation.
P25Mode	0 to 20	5-55	Sets the P25 modulation type.
pushtotalk/ptt	0,1,2	5-55	Sets the Push-To-Talk state.
RFLEVeL	-137.0 to +10.0	5-55	Sets the RF level.
RFOUtput	0 or 1	5-55	Sets the Generator output port.
VERsion	0 or 1	5-55	Query only command.
YIGSPEED	0 or 1	5-55	Sets the YIG speed.

COMMAND	RANGE	PAGE	DESCRIPTION
HW_control (Control of Miscellaneous Hardware Functions)			
HW_control			
ENable	0x02, 0x04, 0x08	5-57	Returns current enabled messages.
fp_leds/leds -onchange	0x01, 0x02, 0x04	5-57	Enables/disables front panel LEDs.
TEMPerature		5-57	Provides IF temperature.
Ref_10mhz/ref	0 or 1	5-57	Returns 10 MHz reference status.
TCXO	0 to 4095	5-57	Sets Temperature Control Oscillator.
VERsion		5-57	Query only command.
yig_lock/yig	0 or 1	5-58	Returns yig lock control status.
LOGIC TRUNKED RADIO - LTR			
LTR			
AREA	0 or 1	5-59	Sets the Area Bit.
BAND	0, 1, 2	5-59	Sets the Frequency Band.
BORDERoffset	0 or 1	5-59	Sets the Border Offset Flag.
Enable	0x02 or 0x04	5-59	Sets the Enabled Data Mode(s).
FCCRX	0 to 6000	5-59	Query only command.
FCCTX	0 to 6000	5-60	Query only command.
FREE	0 to 31	5-60	Sets the Free Channel.
Goto	0 to 31	5-60	Sets the Channel Number.
GROUP/GRP	0 to 255	5-60	Sets the Group Number.
HOME	0 to 31	5-60	Sets the Home Number.
INUSE	0 to 31	5-61	Sets the "In Use" Channel.
MOBILESTATE	0, 1, 2	5-61	Sets the desired Mobile Simulation State.
MOBILETRIES	0 to 100	5-61	Sets the desired number of "tries."
MODE	0 to 5	5-61	Sets the LTR mode.
MONitor	0 or 1	5-61	Sets the Monitor status.
PARAMS		5-62	Returns the current settings.
PORCH	0x01 or 0x02	5-62	Controls the porch enable bits.
PTT	0 or 1	5-62	Sets the Simulated PTT State.
READING		5-62	Only available with the -onchange option. See command description for returned list variables.
REPEATERSTATE	0 to 4	5-63	Sets the current state of the repeater.
RICode	0 to 255	5-63	Sets the current RIC code.
RXCHANnel	1 to 31	5-63	Sets the current Receive Channel.
RXFREQuency	0.0 to 2800.0	5-63	Sets the Receive Frequency.
TXCHANnel	0.0 to 2800.0	5-63	Sets the Transmit Channel.
TXFREQuency	0.0 to 2800.0	5-64	Sets the Transmit Frequency.
VERsion	1 or 2	5-64	Query only command.
P25			
decode			
ENable	0 or 1	5-65	Data Decode is always enabled.
ENCRYPTion -onchange		5-65	Requests encryption status.
encryptstate/encrstate		5-65	Provides a TCL list of the current encryption state.
sampleRATE	1, 2, 4, 8...128	5-65	Sets the sample rate.

COMMAND	RANGE	PAGE	DESCRIPTION
P25 (cont)			
encode			
C4FMpercent	0.0 to 100.0	5-65	Sets C4FM modulation percentage.
DIGITS		5-66	Sets the DTMF digit string.
ENCRYPTenable	0 to 255	5-66	Sets the encryption status.
FIELD		5-66	Sets up data fields.
Icomessage	0 to 37	5-69	Sets required parameters for LCO packet.
Namespace Variables		5-69	Decoded status information from received P25 data.
POWER			
Power			
detector/dect	0 or 1	5-70	Sets the Detector speed.
ENable	OFF or ON	5-70	Sets the Enabled data mode(s).
overload/ovld		5-70	Sets the Enabled data mode(s) option. Returned list variable: AntennaOverload, GeneratorOverload.
powerrange/prange	0, 1, 2	5-70	Sets the Power range.
READING		5-70	Only available with -onchange option. Returned list variable: Power, PowerRange, Accuracy, OverRange.
TEMPerature		5-70	Only available with -onchange option. Returned list variable: Temperature_1, Temperature_2, FanSpeed.
tempoverload/overtemp		5-70	Only available with -onchange option. Returned list variable: Temperature, Accuracy.
VALue		5-71	Query only command.
ZERO		5-71	Forces power meter to read zero.
RECEIVER			
Receiver			
AGCMODE	0 or 1	5-72	Sets the Receiver Software AGC mode.
ATTENUation	-50 to +50	5-72	Sets the Receiver attenuation.
CaptureRANGE	0 or 1	5-72	Sets the Receiver Range.
DEMODulation	0-5, 10-14	5-72	Sets the Receiver demodulation.
Enable	0x01, 0x02, 0x08	5-73	Sets the Enabled Receiver Broadcast Message.
FREQuency	0 to 2.8	5-73	Sets the RF frequency.
HWAGC	0 or 1	5-73	Sets the Receiver Hardware AGC speed.
ifbandwidth/ifbw	30, 300, 3	5-73	Sets the Receiver IF bandwidth in Hz, kHz, MHz, GHz.
IFGAIN	-14.0 to 82.0	5-73	Sets the Receiver IF Gain.
RFINput	0 or 1	5-74	Sets the Receiver input port.
sweepLOCK	0 or 1	5-74	Sets the Receiver frequency lock.
VERsion	0 or 1	5-74	Query only command.

COMMAND	RANGE	PAGE	DESCRIPTION
RF ERROR			
RFError			
ALerts	0, 1, 2, 3	5-75	Sets the Alert Enable Status.
AVG/AVERAGE	1 to 100	5-75	Sets the samples to average.
ENable	1 or 3	5-75	Sets the enabled data mode(s).
GATE	0 or 1	5-75	Sets the gate time.
LLIMit	-3.0 to 3.0	5-75	Sets the Lower Alert Limit.
PEAKhold	0 or 1	5-76	Sets the Peak Hold mode.
PHRESET/PHRST		5-76	Resets the Peak Hold readings.
READING		5-76	Only available with -onchange option. Returned list variable: Frequency, Frequency Precision, Frequency Error, Frequency Error Precision, Status, Frequency Error Accuracy.
READPEAKhold		5-76	Only available with -onchange option. Returned list variable: PeakHi, Hi Precision, PeakLo, Lo Precision, Status.
RESources		5-76	Lists the USER resources.
RUN	0 or 1	5-76	Turns data collection on or off.
ULIMit	-3.0 to 3.0	5-76	Sets the Upper Alert Limit.
VALue		5-77	Query only command.
VERsion	1 or 2	5-77	Query only command.
RLmeter (Narrowband)			
Rlmeter			
ALerts	0, 1, 2, 3	5-78	Sets the Alert Enable Status.
CABLEloss	-60.0 to 60.0	5-78	Sets the Cable loss.
CALibration		5-78	No query available.
ENable	off or on	5-78	Sets the Enabled data mode(s).
LLIMit	-110 to 53.0	5-78	Sets the Lower Alert Limit.
PEAKhold	0 or 1	5-79	Sets the Peak Hold mode.
PHRESET		5-79	Resets the Peak Hold Readings.
RATE	OFF or ON	5-79	Sets the update rate.
READING		5-76	Only available with -onchange option. Returned list variable Power, Accuracy, Status.
READPEAKhold		5-79	Only available with -onchange option. Returned list variable: PeakHi, Hi Precision, PeakLo, Lo Precision, Status.
STATus		5-79	Only available with -onchange option. Returned list variable: StateMachineHistory.
ULIMit	-3.0 to 3.0	5-79	Sets the Upper Alert Limit.
VALue		5-80	Query only command.
VERsion	0 or 1	5-80	Query only command.

COMMAND	RANGE	PAGE	DESCRIPTION
SCOPE			
Scope			
average/avg	2 to 255	5-81	Sets the samples to average.
caloffset		5-81	See SCOPEMESSAGECAL.
calibrategain/calgain		5-81	Sets the gain.
horizontalPOSITION	-100 to 100	5-81	Sets the horizontal offset.
horizontalSWEEP	1 to 10000000	5-81	Sets the Sweep rate.
inputCOUPLING	0 or 1	5-81	Sets the input coupling.
messageENABLE	0 to 31	5-82	Sets which messages are enabled.
peakreset	1 to 31	5-82	Sets the peak hold reset flags.
RUN	0 or 1	5-82	Turns Scope on or off.
traceMATH	0, 1, 2, 3	5-82	Sets the trace math mode.
triggerarm/trigarm		5-82	Arms a one-shot trigger mode.
triggerlevel/triglev	-500 to 500	5-82	Sets the trigger level.
triggerpolarity/pol	0 or 1	5-83	Sets trigger polarity.
triggersource	0, 1, 2	5-83	Sets the trigger source.
triggertype/trigtype	0, 1, 2	5-83	Sets the scope trigger type.
VERsion	1 to 4	5-83	Selects version number access.
verticalSCALE	0-12	5-83	Sets the Vertical scale.
SINAD			
Sinad			
ALerts	0, 1, 2, 3	5-84	Sets the Alert Enable Status.
ALPHA		5-84	Modifies the FFT Alpha value.
AVG/AVERAGE	1 to 2000	5-84	Sets the number of symbols in a sample.
ENable	1 or 3	5-84	Sets the enabled data mode(s).
ENABLECWT	0 or 1	5-84	Enable/disable the C-Weight Filter.
fft_MAXX	0.0 to 40000.0	5-85	Sets the maximum FFT frequency.
fft_MAXY	-80.0 to 0.0	5-85	Sets the maximum FFT dbc level.
fft_MINX	0.0 to 40000.0	5-85	Sets the minimum FFT frequency.
fft_MINY	.80.0 to 0.0	5-85	Sets the minimum FFT dbc level.
fft_RATE	1 to 10	5-85	Controls the rate of FFT traces.
FILTer	1 to 100	5-85	Sets the samples to average.
HNOISE		5-86	Modifies the High Noise Frequency.
HNOTch		5-86	Modifies the High Notch Frequency.
LLIMit	0 to 40.0	5-86	Sets the Lower Alert Limit.
LNOISE		5-86	Modifies the Low Noise Frequency.
LNOTch		5-86	Modifies the Low Notch Frequency.
MARKer	0 to 9	5-86	Identifies which marker is being selected.
MATH	0 or 1	5-87	Enables or disables filtering.
PEAKhold	0 or 1	5-87	Sets the Peak Hold mode.
PHRESET/PHRST		5-87	Resets the Peak Hold readings.
READING		5-87	Only available with -onchange option. Returned list variable: Sinad, Precision, Status.
READPEAKhold		5-87	Only available with -onchange option. Returned list variable: PeakHi, Hi Precision, PeakLo, Lo Precision, Status.
RESources		5-87	Lists the USER resources.

COMMAND	RANGE	PAGE	DESCRIPTION
SINAD			
Sinad			
RUN	0 or 1	5-87	Turns data collection on or off.
SENDCWT		5-88	
SIZE		5-88	Modifies the FFT Size Value.
TRACE			
TAVG		5-88	Returns the latest average FFT trace data.
TLIVE		5-88	Initializes/Returns live trace data.
TLLIM		5-88	Sets up FFT trace for Lower Limit Reference.
TREF		5-88	Sets up a reference FFT trace.
TULIM		5-88	Sets up FFT trace for Upper Limit Reference.
TAVG_FACTOR	0.0 to 1.0	5-88	Turns data collection on or off.
TCFG		5-88	Not usable as a remote command.
TLIVE		5-86	Not usable as a remote command.
TLLIM		5-89	Not usable as a remote command.
TREF		5-89	Not usable as a remote command.
TULIM		5-89	Not usable as a remote command.
TRIGger	1 or 2	5-89	Sets the Trigger mode.
ULIMit	0 to 40.0	5-89	Sets the Upper Limit Alert.
VALue		5-90	Query only command.
VERsion	1 or 2	5-90	Query only command.
WINdow		5-90	Modifies the FFT window.

5-8 2975 COMMANDS

Analyzer

Analyzer auto couple

If no parameter setting is provided, this command returns the current coupling setting for sweep speed, resolution bandwidth, video bandwidth and span. Use the value parameter to set coupling parameters.

SYNTAX: [value] [-forgive]

RANGES: 0 Off
1 On

Analyzer CALibration

This command is used to send calibration data to the analyzer.

SYNTAX: [state]

Analyzer IFGAIN

If no parameter setting is provided, this command returns the current IF Gain. Use the value parameter to set the IF Gain.

SYNTAX: [value] [-forgive]

RANGES: -14.0 to 82.0

Analyzer messageENABLE

If no parameter setting is provided, this command returns the current enabled messages. Use the value parameter to set which messages are enabled.

SYNTAX: [value]

RANGES: Bit 0x01 Control (always active)
Bit 0x02 Trace
Bit 0x04 Not used
Bit 0x08 Peak
Bit 0x10 Average
Bit 0x20 SGL Point
Bit 0x40 Top of Screen
Bit 0x80 Reference

Analyzer NORMalize

If no parameter setting is provided, this command returns the current normalize state. Use the value parameter to start or stop the analyzer normalization.

SYNTAX: [state] [-forgive]

RANGES: 0 Stop
Non zero Start

Analyzer (cont)

Analyzer resolutionbandwidth or rbw

If no parameter value is provided, this command returns the current resolution bandwidth. Use the value parameter to set the resolution bandwidth.

SYNTAX: [value] [-forgive] [units]

RANGES: values 300, 3000, 30000, 60000, 300000, 3000000
units Hz, kHz, MHz (not case sensitive)

Analyzer RUNalyzer

If no parameter setting is provided, this command returns the current run state of the analyzer. Use the value parameter to set the analyzer run state.

SYNTAX: [state] [-forgive]

RANGES: 1 Channel active
2 Main active
3 Off

Analyzer SPAN

If no START and STOP parameters are provided, this command returns the current Start and Stop frequencies the analyzer display is spanning. If both the START and STOP frequencies are provided, the values determine the range of frequencies the analyzer displays. This causes a modification of the center frequency. If the STOP frequency is -1.0, the START frequency specifies the width of the analyzer span, which is centered on the current center frequency. There is no range check.

SYNTAX: [Start Stop]

Analyzer SWEEPspeed

If no SPEED and TYPE parameters are provided, this command returns the current sweep speed (ms) and the type = 2. The speed (ms) is specified per point (type = 1) or for the full screen (type = 2).

SYNTAX: [speed type] [-forgive]

Analyzer topofscreen

If no parameter value is provided, this command returns the current top of screen value. Use the value parameter to set the top-of-screen.

SYNTAX: [value] [-forgive]

RANGES: -99.9 to 80.0

Analyzer VERsion

This is a query only command. "System" is a required parameter.

SYNTAX: [system] [-forgive]

RANGES: 1 Driver ID
2 Engine ID

Analyzer (cont)

Analyzer verticalSCALE

If no parameter setting is provided, this command returns the current vertical scale. Use the value parameter to set the vertical scale.

SYNTAX: [setting] [-forgive] [-range]

RANGES: 0.1 to 30.0

Analyzer videobandwidth *or* vbw

If no parameter value is provided, this command returns the current video bandwidth. Use the value parameter to set the video bandwidth.

SYNTAX: [value] [-forgive] [units]

RANGES: values 0, 10, 30, 100, 300, 1000, 3000, 10000, 30000, 100000, 300000, 1000000, 3000000

units Hz, kHz, MHz (not case sensitive)

Audio Frequency Counter

The Audio Frequency Counter meter is used to count the audio present on the received RF carrier or inputs from the front panel connectors. The units are in Hz or tenths of Hz.

AFCounter ALerts

If no parameter value is provided, this command returns the current alert enable status. Use the value parameter to set the alert enable status as:

SYNTAX: [value] [-forgive] [-range]

RANGES:

0	Off
1	EnableLo
2	EnableHi
3	EnableBoth

AFCounter AVERAGE or AVG

If no parameter setting is provided, this command returns the current number of samples used to average the AF Counter. Use the setting parameter to set the samples to average.

SYNTAX: [setting] [-forgive] [-range]

RANGES: 0 to 200

AFCounter ENable

If no parameter setting is provided, this command returns the current enabled mode(s). Use the setting parameter to set the enabled mode(s).

SYNTAX: [setting]

RANGES:

1	Disable
3	Enable

AFCounter GATE

If no parameter setting is provided, this command returns the current gate status. Use the setting parameter to set the gate time to 0.1 or 1.0 seconds.

SYNTAX: [setting] [-forgive] [-range]

RANGES:

0	Tenth
1	Second

AFCounter LLIMit

If no parameter value is provided, this command returns the current lower alert limit. Use the value parameter to set the lower alert limit.

SYNTAX: [value] [-forgive] [-range] [Hz] [kHz]

RANGES: 0 to 40 kHz

Audio Frequency Counter (cont)

AFCounter PEAKhold

If no parameter setting is provided, this command returns the current peak hold mode. Use the setting parameter to set the peak hold mode.

SYNTAX: [setting] [-forgive] [-range]
RANGES: 0 Off
1 On (enables peak recording)

NOTE: The ENable subcommand must also have readings enabled for data to be provided.

AFCounter PHRESET or PHRST

This command resets the peak hold readings. No data is required.

AFCounter READING

This command is only available with the -onchange option. Returned list variable: Count, Precision, Status, Accuracy.

AFCounter READPEAKhold

This command is only available with the -onchange option. Returned list variable: PeakHi, Hi Precision, PeakLo, Lo Precision, Status.

AFCounter RESources

This command returns a list of the USER resources. No data is required.

AFCounter RUN

If no parameter setting is provided, this command returns whether the AF Counter is actively trying to obtain readings. Use the setting parameter to turn the data collection on or off.

SYNTAX: [setting] [-forgive] [-range]
RANGES: 0 Off
1 On (enables AF Counter readings)

AFCounter TRIGger

If no parameter setting is provided, this command returns the current trigger mode. Use the setting parameter to set the trigger mode.

SYNTAX: [setting] [-forgive] [-range]
RANGES: 1 Continuous
2 OneShot

Audio Frequency Counter (cont)

AFCounter ULIMit

If no parameter value is provided, this command returns the current upper alert limit. Use the value parameter to set the upper alert limit.

SYNTAX: [value] [-forgive] [-range] [Hz] [kHz]

RANGES: 0 to 40 kHz

AFCounter VALue

This is a query only command that provides the last frequency reading. Similar to the “reading” command, this command provides only the frequency and no indication if the data is stale. When the counter is running, the data is not stale longer than a gate time.

AFCounter VERsion

This is a query only command. “System” is a required parameter.

SYNTAX: [system] [-range]

RANGES:

1	AF Counter Driver ID
2	AF Counter Engine ID

Bit Error Rate - Ber

This a test of the radio Bit Error Rate when in the P25 mode. Any one of several standard P25 patterns can be used to determine the error rate.

Ber ALerts

If no parameter value is provided, this command returns the current alert enable status. Use the value parameter to set the alert enable status.

SYNTAX: [value] [-forgive] [-range]

RANGES:

0	Off
1	EnableLo
2	EnableHi
3	EnableBoth

Ber ENable

If no parameter setting is provided, this command returns the current enabled mode(s). Use the setting parameter to set the enabled data mode(s).

SYNTAX: [setting]

RANGES:

1	Disable
3	Enable

Ber FRAMEDEPTH or FRAMES

If no parameters are provided, this command returns the current frame_cnt and pattern. The "frame_cnt" is the number of P25 frames over which to accumulate the errors: {1 to 200}. The "pattern" is the standard P25 pattern used to compare the received data.

SYNTAX: [frame_cnt] [pattern] [-forgive] [-range]

RANGES:

0	Std 1011 tone
1	Std Calibration
2	Std Silence
3	Std Interference
4	Std Busy
5	Std Idle

Ber LLIMit

If no parameter value is provided, this command returns the current lower alert limit. Use the value parameter to set the lower alert limit.

SYNTAX: [value] [-forgive] [-range]

RANGES: 0 to 1.0

Bit Error Rate - Ber (cont)

Ber PEAKhold [setting] [-forgive] [-range]

If no parameter setting is provided, this command returns the current peak hold mode. Use the setting parameter to set the peak hold mode.

SYNTAX: [setting] [-forgive] [-range]

RANGES: 0 Off
1 On

NOTE: The ENable subcommand must also have readings enabled for data to be provided.

Ber PHRESET or PHRST

This command resets the peak hold readings. No data is required.

Ber READING

This command is ONLY available with the -onchange option. Returned list variable: Bit Error Rate, Frame Error Rate, Total Bits, Total Errors, Total Frames or Total Error Frames.

Ber RESETERRors

This command resets the BER error counters. No data is required.

Ber RESources

This command returns a list of the USER resources. No data is required.

Ber RUN

If no parameter setting is provided, this command returns whether the BER engine is actively trying to obtain readings. Use the setting parameter to turn the data collection on or off.

SYNTAX: [setting] [-forgive] [-range]

RANGES: 0 Off
1 On (enables BER readings)

Ber ULIMit

If no parameter value is provided, this command returns the upper alert limit. Use the value parameter to set the upper alert limit.

SYNTAX: [value] [-forgive] [-range]

RANGES: 0 to 1.0

Bit Error Rate - Ber (cont)

Ber VERsion

This is a query only command. "System" is a required parameter.

SYNTAX: [system] [-forgive] [-range]

RANGES:

1	Ber Driver ID
2	Ber Engine ID

BBAudio

These commands control the routing, selection and special functions for the internal and external audio signals.

BBAudio audioROUTE

This command provides a way of connecting a data output source to a data consumer that is only able to handle a SINGLE input connection. No query mode and returns no useful information. The "source" data output can be connected to a number of consumer "destinations." To break all connections to a given destination, set the connection value to NONE.

SYNTAX: [source] [destination] [-forgive]

RANGES:

<u>source</u>	<u>source</u>	<u>destination</u>
-1=None	9=Speaker	User0
0=L1	10=Demod	User1
1=Mic	11=Fgen	User2
2=Sinad	12=MixL1	User3
3=File	13=User0	User4
4=Fgen0	14=User1	User5
5=Fgen1	15=afcounter	AFCOUNTER
6=Fgen2	16=SinadMtr	Sinad
7=Fgen3	17=Scope	Scope
8=Fgen4	18=Scalar	Scalar

NOTE: The numeric equivalent for the source is provided for information only.

BBAudio clearmixer or clrmix

This command removes ALL input data connections to ALL the mixers. No query mode and no data is required.

BBAudio DEMODFILTER

If no parameter setting is provided, this command returns the current Demodulation filter setting. This command sets the audio filter type the demod audio uses to output to the front panel connectors. Use the value parameter to set the Demodulation filter.

SYNTAX: [value] [-forgive]

RANGES:

0	Square
1	Sine

BBAudio (cont)

BBAudio digitalinauto

If no parameter value is provided, this command returns the current digital in auto setting. Use the value parameter to set the digital in auto.

SYNTAX: [value] [-forgive]

RANGES: 0 to 1000 milliseconds

BBAudio enablescalar | enscalar

If no parameter value is provided, this command returns the status of the scalar enable. Use the value parameter to enable or disable the scalar module.

SYNTAX: [value] [-forgive]

RANGES: 0 Off
1 On

BBAudio FGENBALance

If no parameter setting is provided, this command returns the current FGEN balance setting. This command selects the FGEN audio output to use a transformer or direct connection to the front panel connector. Use the value parameter to set the FGEN output balance.

SYNTAX: [value] [-forgive]

RANGES: 0 Unbalanced
1 Balanced

BBAudio FGENFILTER

If no parameter setting is provided, this command returns the current FGEN filter setting. This command sets the audio filter type the FGEN audio output uses for connecting to the front panel connectors. Use the value parameter to set the FGEN output filter.

SYNTAX: [value] [-forgive]

RANGES: 0 Square
1 Sine

BBAudio FGENLEVel

If no parameter setting is provided, this command returns the current FGEN output level. This command controls an FGEN audio output attenuator, either direct or divide by ten. Use the value parameter to set the FGEN output level.

SYNTAX: [value] [-forgive]

RANGES: 0 Normal
1 Tenth

BBAudio (cont)

BBAudio microphonebias or micbias

If no parameter setting is provided, this command returns the current microphone bias. This command turns on or off the voltage required to operate an external Electret microphone. Use the value parameter to set the microphone bias.

SYNTAX: [value] [-forgive]
RANGES: 0 Normal
1 Powered

BBAudio MIXer

This command selects the routing of signals in the unit to the front panel connections. No query mode is available. Mixers are software components that combine one or more signals and provide an output. This command provides a way to connect or disconnect signal inputs to a mixer.

SYNTAX: [source] [mixer] [state] [-forgive]
RANGES:

<u>source</u>	<u>source</u>	<u>mixer</u>	<u>state</u>
1=L1	256=Fgen4	1=Speaker	0=Off
2=Mic	512=User0	2=Demod	1=On
4=Sinad	1024=User1	4=Fgen	
8=File	2048=User2	8=L1	
16=Fgen0	4096=User3	16=User0	
32=Fgen1	8192=User4	32=User1	

NOTE: The numeric equivalent for the source and mixer are provided for information only.

NOTE: "On" is a connected data path.

BBAudio SCALar

The scalar is a software module used to adjust signal amplitude by means of a simple multiplier. The multiplier is sent by the BBAudio Scalar command. If no parameter value is provided, the command returns the last scalar value issued. Use the value parameter to set the scalar value.

SYNTAX: [value] [-forgive]
RANGES: 0 to 8388606

BBAudio SINADBALance

If no parameter setting is provided, this command returns the current Sinad balance setting. This command selects the SINAD input to be direct or transformer coupled. Use the value parameter to set the Sinad output balance.

SYNTAX: [value] [-forgive]
RANGES: 0 Balanced
1 Unbalanced

BBAudio (cont)

BBAudio uutdigitalinput

This command reads the state of the UUT connector's 5 digital inputs. No data is required.

BBAudio uutdigitalout

If no parameter setting is provided, this command returns the current UUT Digital Output setting. Use the value parameter to set the state of UUT connector's 5 digital outputs.

SYNTAX: [value] [-forgive]

RANGES: 0 to 31

BBAudio uutvoutadj

If no parameter setting is provided, this command returns the current analog output setting. Use the value parameter to set the analog output voltage by N (-99 to 99) steps relative to its current setting.

SYNTAX: [value] [-forgive]

RANGES: -99 to 99

BBAudio uutvoutput

If no parameter setting is provided, this command returns the current analog output setting of the UUT port. The reading depends upon the current drawn by the equipment connected to the port.

SYNTAX: [value] [-forgive]

RANGES: 0 to 99

C4FM (Continuous 4-Level Frequency Modulation)

The C4FM meter is a special meter for the measurement of the quality of a P25 C4FM modulated signal. The meter reading is in % and represents the difference from an ideal signal.

C4fm ALerts

If no parameter value is provided, this command returns the current alert enable status. Use the value parameter to set the alert enable status.

SYNTAX: [value] [-forgive] [-range]

RANGES:

0	Off
1	EnableLo
2	EnableHi
3	EnableBoth

C4fm AVERAGE or AVG

If no parameter setting is provided, this command returns the current number of symbols used to average. Use the setting parameter to set the samples to average.

SYNTAX: [setting] [-forgive] [-range]

RANGES: 200 to 65535

C4fm ENable

If no parameter setting is provided, this command returns the current enabled mode(s). Use the setting parameter to set the enabled data mode(s).

SYNTAX: [setting]] [-forgive] [-range]

RANGES:

1	Disable
3	Enable

C4fm LLIMit

If no parameter value is provided, this command returns the current lower alert limit. Use the value parameter to set the lower alert limit.

SYNTAX: [value] [-forgive] [-range][Hz kHz]

RANGES: 0 to 50.0

C4fm PEAKhold

If no parameter setting is provided, this command returns the current peak hold mode. Use the setting parameter to set the peak hold mode.

SYNTAX: [setting] [-forgive] [-range]

RANGES:

0	Off
1	On

NOTE: The ENable subcommand must also have readings enabled for data to be provided.

C4FM (Continuous 4-Level Frequency Modulation) (cont)

C4fm PHRESET or PHRST

This command resets the peak hold readings. No data is required.

C4fm READING

This command is only available with the -onchange option. Returned list variable: Reading, Precision, Status or Accuracy.

C4fm READPEAKhold

This command is only available with the -onchange option. Returned list variable: PeakHi, Hi Precision, PeakLo, Lo Precision or Status.

C4fm RESources

This command returns a list of the USER resources. No data is required.

C4fm RUN

If no parameter setting is provided, this command returns whether the C4FM is actively trying to obtain readings. Use the setting parameter to turn the data collection on or off.

SYNTAX: [setting] [-forgive] [-range]
RANGES: 0 Off
1 On (enables C4FM readings)

C4fm TRIGger

If no parameter setting is provided, this command returns the current trigger mode. Use the setting parameter to set the trigger mode.

SYNTAX: [setting] [-forgive] [-range]
RANGES: 1 Continuous
2 OneShot

C4fm ULIMit

If no parameter value is provided, this command returns the current upper alert limit. Use the value parameter to set the upper alert limit.

SYNTAX: [value] [-forgive] [-range][Hz | kHz]
RANGES: 0 to 50.0

C4fm VALue

This is a query only command that provides the last C4fm reading. Similar to the “reading” command, this command provides only the reading with no indication that the data is stale.

C4FM (Continuous 4-Level Frequency Modulation) (cont)

C4fm VERsion

This is a query only command. "System" is a required parameter.

SYNTAX: [system] [-forgive] [-range]

RANGES: 1 C4fm Driver ID
2 C4fm Engine ID

Digital Coded Squelch - Dcs

The Digital Coded Squelch controls the detection of a received digital coded squelch signal.

Dcs ENable

If no parameter setting is provided, this command returns the current Enabled mode(s). Use the setting parameter to set the Enabled data mode(s).

SYNTAX: [setting] [-forgive] [-range]

RANGES: 1 Disable
3 Enable

Dcs READING

This command is only available with the -onchange option. Returned list variable: Raw value, Corrected value or Status.

Dcs RESources

This command returns a list of the USER resources. No data is required.

Dcs RUN

If no parameter setting is provided, this command returns whether the AF Counter is actively trying to obtain readings. Use the setting parameter to turn the data collection on or off.

SYNTAX: [setting] [-forgive] [-range]

RANGES: 0 Off
1 On (enables AF Counter Readings)

Dcs VERsion

This is a query only command.

SYNTAX: [system] [-range]

RANGES: 1 Dcs Driver ID
2 Dcs Engine ID

Digital Voltmeter (DVM)

The Digital Voltmeter reads AC/DC volts input from the front panel connector. The voltmeter contains internal loads for measuring audio power.

Dvm ALerts

If no parameter value is provided, this command returns the current alert enable status. Use the value parameter to set the alert enable status.

SYNTAX: [value] [-forgive] [-range]

RANGES:

0	Off
1	EnableLo
2	EnableHi
3	EnableBoth

Dvm AVERAGE or AVG

If no parameter setting is provided, this command returns the current number of samples used to average the DVM. Use the setting parameter to set the samples to average.

SYNTAX: [setting] [-forgive] [-range]

RANGES: 2 to 255

Dvm ENable

If no parameter setting is provided, this command returns the current enabled mode(s). Use the setting parameter to set the enabled mode(s).

SYNTAX: [setting]

RANGES:

1	Disable
3	Enable

Dvm HOLD

If no parameter setting is provided, this command returns the current hold status. Use the setting parameter to set the hold status.

SYNTAX: [setting] [-forgive] [-range]

RANGES:

0	Off
1	On (holds the current reading)

Dvm HWRANge

If no parameter setting is provided, this command returns the current hardware range. Use the setting parameter to set the hardware range.

SYNTAX: [setting] [-forgive] [-range]

RANGES:

-400 to 0.400 mV
0 Autorange, 4 V, 40 V, 400 V

Digital Voltmeter (DVM) (cont)

Dvm IMPedance

If no parameter setting is provided, this command returns the current impedance. Use the setting parameter to set the impedance.

SYNTAX: [setting] [-forgive] [-range]

RANGES: 0, 150, 600

Dvm LINEFILter

If no parameter setting is provided, this command returns the current line filter setting. Use the setting parameter to set the line filter setting.

SYNTAX: [setting] [-forgive] [-range]

RANGES: 50 or 60 Hz

Dvm LLIMit

If no parameter value is provided, this command returns the current lower alert limit. Use the value parameter to set the lower alert limit.

SYNTAX: [value] [-forgive] [-range]

RANGES: -200 to 200

Dvm MODe

If no parameter setting is provided, this command returns the current AC/DC mode. Use the setting parameter to set the impedance.

SYNTAX: [setting] [-forgive] [-range]

RANGES: 1 AC
2 DC

Dvm PEAKhold

If no parameter setting is provided, this command returns the current peak hold mode. Use the setting parameter to set the peak hold mode.

SYNTAX: [setting] [-forgive] [-range]

RANGES: 0 Off
1 On (enables peak recording)

NOTE: The ENable subcommand must also have readings enabled for data to be provided.

Dvm PHRESET or PHRST

This command resets the peak hold readings. No data is required.

Digital Voltmeter (DVM) (cont)

Dvm READING

This command is only available with the -onchange option. Returned list variable: DVM value, Precision, Status or Accuracy.

Dvm READPEAKhold

This command is only available with the -onchange option. Returned list variable: PeakHi, Hi Precision, PeakLo, Lo Precision or Status.

Dvm RESources

This command returns a list of the USER resources. No data is required.

Dvm RUN

If no parameter setting is provided, this command returns whether the DVM is actively trying to obtain readings. Use the setting parameter to turn the data collection on or off.

SYNTAX: [setting] [-forgive] [-range]
RANGES: 0 Off
1 On (enables DVM readings)

Dvm SOURce

If no parameter setting is provided, this command returns the current hardware input source. Use the setting parameter to set the hardware input source.

SYNTAX: [setting] [-forgive] [-range]
RANGES: 0 DVM
1 Scope1
2 Scope2

Dvm ULIMit

If no parameter value is provided, this command returns the current upper alert limit. Use the value parameter to set the upper alert limit.

SYNTAX: [value] [-forgive] [-range]
RANGES: -200 to 200 volts

Dvm VALue

This is a query only command that provides the last frequency reading. Similar to the “reading” command, this command provides only the voltage and no indication that the data is stale.

Digital Voltmeter (DVM) (cont)

Dvm VERsion

This is a query only command. "System" is a required parameter.

SYNTAX: [system] [-forgive] [-range]

RANGES: 1 DVM Driver ID
2 DVM Engine ID

Dvm ZERO

Use the setting parameter to force the DVM chip to zero its DC offset.

SYNTAX: [setting] [-forgive] [-range]

RANGES: 0 Normal Operation
1 Zero DC offset

Distortion

The Distortion Meter uses the same equation as the SINAD Meter (signal + noise/distortion) except the unit solves for the distortion component.

SINAD and Distortion readings are derived from a common set of data. Consequently, using either the "SINAD" or "Dist" commands which turn the meter on/off, the set filtering and trigger affects both meters. Peak readings and alerts are maintained individually for each reading type and those commands only affect the specific meter.

Dist Alerts

If no parameter value is provided, this command returns the current alert enable status. Use the value parameter to set the alert enable status.

SYNTAX: [value] [-forgive] [-range]

RANGES:

0	Off
1	EnableLo
2	EnableHi
3	EnableBoth

Dist ALPHA

If no parameter setting is provided, this command returns the current FFT alpha value. Use the setting parameter to modify the FFT alpha value.

SYNTAX: [value] [-forgive]

Dist AVERAGE or AVG

If no parameter setting is provided, this command returns the current number of symbols used to by the DSP to average the SINAD/Distortion. Use the setting parameter to set the number of symbols in a sample.

SYNTAX: [setting] [-forgive] [-range]

RANGES: 1 to 2000 (normally set to 1)

Dist ENable

If no parameter setting is provided, this command returns the current enabled mode(s). Use the setting parameter to set the enabled mode(s).

SYNTAX: [setting] [-forgive] [-range]

RANGES:

1	Disable
3	Enable

Distortion (cont)

Dist enablecwt or encwt

If no parameter setting is provided, this command returns whether the center weight filter is enabled. Use the setting parameter to enable or disable the center weight filter.

SYNTAX: [setting] [-forgive] [-range]

RANGES: 0 Disable
1 Enable

Dist FILTER

If no parameter setting is provided, this command returns the number of samples used to average the SINAD/Distortion. Use the setting parameter to set the samples to average.

SYNTAX: [setting] [-forgive] [-range]

RANGES: 1 to 100

Dist HNOISE

If no parameter setting is provided, this command returns the current high noise frequency setting for the FFT. Use the setting parameter to modify the high noise frequency.

SYNTAX: [setting] [-forgive]

Dist HNOTch

If no parameter setting is provided, this command returns the current high notch frequency setting for the FFT. Use the setting parameter to modify the high notch frequency.

SYNTAX: [setting] [-forgive]

Dist LLIMit

If no parameter value is provided, this command returns the current lower alert limit. Use the value parameter to set the lower alert limit.

SYNTAX: [value] [-forgive] [-range]

RANGES: 0 to 40.0

Dist LNOISE

If no parameter setting is provided, this command returns the current low noise frequency setting for the FFT. Use the setting parameter to modify the low noise frequency.

SYNTAX: [setting] [-forgive]

Distortion (cont)

Dist LNOTch

If no parameter setting is provided, this command returns the current low notch frequency setting for the FFT. Use the setting parameter to modify the low notch frequency.

SYNTAX: [setting] [-forgive]

Dist MATH

If no parameter setting is provided, this command returns the current math mode. Use the setting parameter to set the math mode.

SYNTAX: [setting] [-forgive] [-range]

RANGES: 0 Off
1 On (on enables filtering)

Dist PEAKhold

If no parameter setting is provided, this command returns the current peak hold mode. Use the setting parameter to set the peak hold mode.

SYNTAX: [setting] [-forgive] [-range]

RANGES: 0 Off
1 On (enables peak recording)

NOTE: The ENable subcommand must also have readings enabled for data to be provided.

Dist PHRESET or PHRST

This command resets the peak hold readings. No data is required.

Dist READING

This command is only available with the -onchange option. It is not a value which can be modified or queried. Returned list variable: Distortion, Precision or Status.

Dist READPEAKhold

This command is only available with the -onchange option. Returned list variable: PeakHi, Hi Precision, PeakLo, Lo Precision or Status.

Dist RESources

This command returns a list of the USER resources. No data is required.

Distortion (cont)

Dist RUN

If no parameter setting is provided, this command returns whether the SINAD/Distortion is actively trying to obtain readings. Use the setting parameter to turn the data collection on or off.

SYNTAX: [setting] [-forgive] [-range]

RANGES: 0 Off
1 On (enables SINAD/Distortion readings)

Dist SENDCWT

This command is sent an array of data PAIRS [freq db] which represent the desired frequency response of the C-Weight Filter. These data pairs are splined to obtain values at regular frequency intervals, and then the pairs are sent to the DSP for use as a filter.

SYNTAX: [filter array]

Dist SIZE

If no parameter setting is provided, this command returns the current FFT size value. Use the parameter setting to modify the FFT size value.

SYNTAX: [setting] [-forgive]

Dist TRIGger

If no parameter setting is provided, this command returns the current trigger mode. Use the setting parameter to set the trigger mode.

SYNTAX: [setting] [-forgive] [-range]

RANGES: 1 Continuous
2 OneShot

Dist ULIMit

If no parameter value is provided, this command returns the current upper alert limit. Use the value parameter to set the upper alert limit.

SYNTAX: [value] [-forgive] [-range]

RANGES: 0 to 40.0

Dist VALue

This is a query only command that provides the last distortion reading. Similar to the “reading” command, this command provides only the distortion and no indication that the data is stale.

Distortion (cont)

Dist VERsion

This is a query only command. "System" is a required parameter.

SYNTAX: [system] [-forgive] [-range]

RANGES: 1 SINAD/Distortion Driver ID
2 SINAD/Distortion Engine ID

Dist WINdow

If no parameter setting is provided, this command returns the current FFT window value. Use the setting parameter to modify the FFT window.

SYNTAX: [system] [-forgive]

FM Deviation

The Deviation Meter reads the amount the RF carrier is shifted from the non-modulated state in average or peak modes. The units are in kHz.

FMDev ALERTS

If no parameter value is provided, this command returns the current alert enable status. Use the value parameter to set the alert enable status.

SYNTAX: [value] [-forgive] [-range]

RANGES:

0	Off
1	EnableLo
2	EnableHi
3	EnableBoth

FMDev AVERAGE or AVG

If no parameter setting is provided, this command returns the current number of samples used to average the FM Deviation. Use the setting parameter to set the number of samples to average.

SYNTAX: [setting] [-forgive] [-range]

RANGES: 50 to 10000 (typical is 100 to 10000) (default is 1000)

FMDev ENable

If no parameter setting is provided, this command returns the current enabled mode(s). Use the setting parameter to set the enabled mode(s).

SYNTAX: [setting] [-forgive] [-range]

RANGES:

1	Disable
3	Enable

FMDEV LLIMit

If no parameter value is provided, this command returns the current lower alert limit. Use the value parameter to set the lower alert limit.

SYNTAX: [value] [-forgive] [-range]

RANGES: 0% to 100%

FMDev MATH

If no parameter setting is provided, this command returns the current math mode. Use the setting parameter to set the math mode.

SYNTAX: [setting] [-forgive] [-range]

RANGES:

0	Peak
1	Average

FM Deviation (cont)

FMDev PEAKhold

If no parameter setting is provided, this command returns the current peak hold mode. Use the setting parameter to set the peak hold mode.

SYNTAX: [setting] [-forgive] [-range]

RANGES: 0 Off
1 On (enables peak recording)

NOTE: The ENable subcommand must also have readings enabled for data to be provided.

FMDev PHRESET or PHRST

This command resets the peak hold readings. No data is required.

FMDev READING

This command is only available with the -onchange option. Returned list variable: +Deviation, -Deviation, Average Deviation or Precision.

FMDev READPEAKhold

This command is only available with the -onchange option. Returned list variable: PeakHi, Hi Precision, PeakLo, Lo Precision or Status.

FMDev RESources

This command returns a list of the USER resources. No data is required.

FMDev RUN

If no parameter setting is provided, this command returns whether the FM Deviation is actively trying to obtain readings. Use the setting parameter to turn the data collection on or off.

SYNTAX: [setting] [-forgive] [-range]

RANGES: 0 Off
1 On (enables FM deviation readings)

FMDev TRIGger

If no parameter setting is provided, this command returns the current trigger mode. Use the setting parameter to set the trigger mode.

SYNTAX: [setting] [-forgive] [-range]

RANGES: 1 Continuous
2 OneShot

FM Deviation (cont)

FMDev ULIMit

If no parameter value is provided, this command returns the current upper alert limit. Use the value parameter to set the upper alert limit.

SYNTAX: [value] [-forgive] [-range]

RANGES: 0% to 100%

FMDev VALue

This is a query only command that provides the last average deviation reading. Similar to the “reading” command, this command provides only a single, average deviation and no indication that the data is stale.

FMDev VERsion

This is a query only command. “System” is a required parameter.

SYNTAX: [system] [-forgive] [-range]

RANGES:

1	FM Deviation Driver ID
2	FM Deviation Engine ID

Function Generators

The Function Generators are audio sources used to modulate the RF generator. The audio is available at the front panel connectors. The upper range is 20 kHz with the capability of one-tenth Hz resolution.

Subcommands can be followed by an attached number (i.e., Freq2) that indicates the LUN. LUN=0 SHOULD NOT BE USED. LUN1 and LUN2 are used for audio output and LUN3 and LUN4 are used to modulate the RF. Identifiable as M1 and M2 respectively.

FGen DEVIation

If no parameter value is provided, this command returns the current voltage level. Use the value parameter to set the function generator voltage level using a conversion of 1 V = 5 kHz.

SYNTAX: [value] [-forgive] [-range]

RANGES: 0 to 40.0 kHz

NOTE: The return from setting the value is similar to the results received from a query for information. The third value should match the requested setting, the first value is the equivalent voltage level and the second value is the equivalent AM percentage.

FGen DURation

If no parameter value is provided, this command returns the current tone duration. Use the value parameter to set the function generator tone duration.

SYNTAX: [value] [-forgive] [-range]

RANGES: 1 ms to 100 seconds (in ms)

FGen FREQuency

If no parameter value is provided, this command returns the current audio frequency. Use the value parameter to set the function generator audio frequency.

SYNTAX: [value] [-forgive] [-range]

RANGES: 0 to 20000 Hz

FGen LEVel

If no parameter value is provided, this command returns the current voltage level. Use the value parameter to set the function generator voltage level.

SYNTAX: [value] [-forgive] [-range]

RANGES: 0 to 20.0 V

NOTE: The return from setting the value is similar to the results received from a query for information. The first value should match the requested setting, the second value is the equivalent percentage and the third value is the equivalent deviation.

Function Generators (cont)

FGen MODe

If no parameter value is provided, this command returns the current fgen mode. Use the value parameter to set the function generator mode.

SYNTAX: [value] [-forgive] [-range]

RANGES:

0	Off
1	Tone
2	Burst

FGen -onchange STATus

This command is only available with the -onchange option. Provides the status of the execution of a sequence of tones for use in continuous tone signaling. Data provided: Status code or Reference code.

SYNTAX: [value][-forgive][-range]

Fgen PERcent

If no parameter value is provided, this command returns the function generator voltage settings. Use the value parameter to set the function generator AM percentage modulation.

SYNTAX: [value] [-forgive] [-range]

RANGES: 0% to 100%

NOTE: The information returned when setting the value is similar to the information generated from the query. The second value should match the requested setting, the first value is the equivalent voltage level and the third value is the equivalent FM deviation.

FGen RESources

This command returns a list of the USER resources. No data is required.

FGen SEQuence

This command is used to send a single tone (pair) of a tone sequence to a function generator. Allows control of the standard parameters for a two tone signal, along with a reference number used in a sequence of commands. There is no query available for this command.

SYNTAX: [freq1 freq2 shape duration level ref] [-forgive] [-range]

RANGES: (See the individual tone commands for valid range settings.)

Function Generators (cont)

FGen SHape

If no parameter value is provided, this command returns the current audio wave shape. Use the value parameter to set the function generator wave shape.

SYNTAX: [value] [-forgive] [-range]

RANGES:

0	Sine
1	Triangle
2	Square
3	Ramp
6	DTMF

FGen SYNChronize

This command sends down a command to synchronize the phase of the function generators. No data is required or returned.

FGen VERsion

This is a query only command. "System" is a required parameter.

SYNTAX: [system] [-forgive] [-range]

RANGES:

0	Driver
1	Engine

Generator

Generator DCPOWER

This command turns the power to the RF Generator on or off.

If no parameter value is provided, this command returns the current DC power setting. Use the value parameter to turn the DC power on or off.

SYNTAX: [value] [-forgive] [-range]

RANGES: 0 Off
1 On

Generator FREQUENCY

This command sets the RF frequency of the generator.

If no parameter value is provided, this command returns the generator frequency. Use the value parameter to set the desired generator frequency.

SYNTAX: [value] [-forgive] [-range] [-units]

RANGES: value 0 to 2.8 GHz
units Hz, kHz, MHz, GHz (not case sensitive)

Generator hwALC

If no parameter value is provided, this command returns the hardware ALC tracking. Use the value parameter to set the hardware ALC tracking.

SYNTAX: [value] [-forgive] [-range]

RANGES: 0 Slow
1 Fast
2 Digital

Generator hwBW

If no parameter value is provided, this command returns the generator bandwidth. Use the value parameter to set the generator bandwidth.

SYNTAX: [value] [-forgive] [-range]

RANGES: 0 Narrow
1 Wide

Generator ENable

If no parameter setting is provided, this command returns the enabled mode(s). Use the setting parameter to set the bits to enable the desired data reporting.

SYNTAX: [setting] [-forgive] [-range]

RANGES: 0x02 Lock status
0x08 Yig status
0x10 ALC status

Generator (cont)

Generator MODulation

This command sets the modulation type used by the RF Generator.

If no parameter value is provided, this command returns the current modulation. Use the value parameter to set the generator modulation.

SYNTAX: [value] [-forgive] [-range]

RANGES:

0	Off
1	FMN
2	FMW
3	PM
4	AM
5	PSK
6	USB
7	LSB
8	P25MIS
9	P25MCC
10	AMV
11	P25LSM

NOTE: Modes PM, PSK, USB and LSB are not currently available. Mode P25LSM is only available when the appropriate software has been installed.

Generator P25Mode

This command sets the modulation pattern for P25.

If no parameter value is provided, this command returns the current P25 mode. Use the value parameter to set the P25 modulation type.

SYNTAX: [value] [-forgive] [-range]

RANGES:

0	Off
1	Speech
2	Silence
3	Err5percent
4	Hz1011
5	File
6	StdTone
7	StdSilence
8	Interference
9	Busy
10	Idle
11	Calibration
12	Lud1Trig
13	NoTrig
14	Lud2Trig
15	Std511
16	SymRate
17	LowDeviation
18	FidPattern
19	FidSpectrum
20	Trunking

Generator (cont)

Generator pushtotalk or ptt

This command turns the IF signal off that goes to the RF Generator, turning off the RF output to the front panel connectors.

If no parameter value is provided, this command returns the Push-To-Talk state. Use the value parameter to set the Push-To-Talk state.

SYNTAX: [value] [-forgive] [-range]

RANGES:

0	Off
1	On
2	PTT mode

Generator RFLEVel

This command sets the RF Generator output level in dBm.

If no parameter value is provided, this command returns the RF level setting. Use the value parameter to set the RF level.

SYNTAX: [value] [-forgive] [-range]

RANGES:

GEN connector	-137.0 to -30.0
T/R connector	-110.0 to +10.0

Generator RFOUtput

This command sets the RF Generator front panel output port.

If no parameter value is provided, this command returns the current RF output port. Use the value parameter to set the RF output port.

SYNTAX: [value] [-forgive] [-range]

RANGES:

0	T/R
1	GEN

Generator VERsion

This is a query only command.

SYNTAX: [system]

RANGES:

0	Generator Engine ID
1	Generator Driver ID

Generator YIGSPEED

If no parameter setting is provided, this command returns the current YIG speed. Use the setting parameter to set the YIG speed.

SYNTAX: [setting] [-forgive] [-range]

RANGES:

0	Fast
1	Slow

HW_control (Control of Miscellaneous Hardware Functions)

HW_control ENable

If no parameter setting is provided, this command returns the enabled messages.

SYNTAX: [setting]
RANGES: 0x02 Temperature
0x04 DMA status
0x08 YIG Calibration

HW_control FP LEDS or LEDS

If no parameter value is provided, this command returns the status of the front panel LEDs. The “mask” word specifies which LEDs are affected. The “state” variable enables/disables the LEDs controlled by the mask.

SYNTAX: [state mask] [-forgive]
RANGES: 0x01 SHIFT Key active
0x02 T/R Port
0x04 GEN Port

HW_control -onchange TEMPerature

This command is only available with the -onchange option. No query or set value allowed. Data provided: IF temperature.

HW_control REF 10MHZ or REF

If no parameter value is provided, this command returns the current state of the 10 MHz reference. Use the value parameter to control the use of an internal 10 MHz reference.

SYNTAX: [value] [-forgive]
RANGES: 0 External
1 Internal

HW_control TCXO

If no parameter value is provided, this command returns the current TCXO setting. Use the value parameter to set the Temperature Controlled Oscillator adjustment.

SYNTAX: [value] [-forgive]
RANGES: 0 to 4095

HW_control VERsion

This is a query only command.

SYNTAX: [value] [-forgive]

HW_control (Control of Miscellaneous Hardware Functions) (cont)

HW_control yig lock *or* yig

If no parameter value is provided, this command returns the status of the yig lock control. Use the value parameter to control the transmission of the yig lock message.

SYNTAX: [value] [-forgive]

RANGES: 0 Disable
 1 Enable

Logic Trunked Radio - Ltr

The Logic Trunked Radio command is used to set up the 2975 to communicate with a radio using the LTR protocol.

Ltr AREA

If no parameter value is provided, this command returns the current status of the area bit. Use the value parameter to set the area bit for repeater and mobile simulation.

SYNTAX: [value] [-forgive] [-range]

RANGES: 0
1

Ltr BAND

If no parameter value is provided, this command returns the currently selected frequency band. Use the value parameter to set the frequency band.

SYNTAX: [value] [-forgive] [-range]

RANGES: 0 800 MHz
1 900 MHz
2 User

Defined

Ltr BORDERoffset

If no parameter value is provided, this command returns the current selected border offset. Use the value parameter to set the border offset flag which is used when associating FCC frequency channels to the LTR channel numbers.

SYNTAX: [value] [-forgive] [-range]

RANGES: 0
1

Ltr ENable

If no parameter setting is provided, this command returns the current enabled mode(s). Use the value parameter to set the enabled data mode(s) (BIT FIELD).

SYNTAX: [setting]

RANGES: 0x02 Enable Input
0x04 Enable Output

Ltr FCCRX

This is a query only command. The channel parameter is required to use this command to obtain the receive frequency (with respect to the 2975) for the specified channel number. The border offset and selected frequency band affect this value.

SYNTAX: [channel] [-forgive] [-range]

RANGES: 0 to 6000

Logic Trunked Radio - Ltr (cont)

Ltr FCCTX

This is a query only command. The channel parameter is required to use this command to obtain the transmit frequency (with respect to the 2975), for the specified channel number. The border offset and selected frequency band affect this value.

SYNTAX: [channel] [-forgive] [-range]

RANGES: 0 to 6000

Ltr FREE

If no parameter value is provided, this command returns the free channel for repeater and mobile simulation. Use the value parameter to set the free channel.

SYNTAX: [value] [-forgive] [-range]

RANGES: 1 to 20 (Valid range for setting)
0 to 31 (Data entry range limits)

Ltr Goto

If no parameter value is provided, this command returns the selected channel for repeater and mobile simulation. Use the value parameter to set the channel number.

SYNTAX: [value] [-forgive] [-range]

RANGES: 1 to 20 (Valid range for setting)
0 to 31 (Data entry range limits)

Ltr GROUP or GRP

If no parameter value is provided, this command returns the selected group for repeater and mobile simulation. Use the value parameter to set the group number.

SYNTAX: [value] [-forgive] [-range]

RANGES: 0 to 255

Ltr HOME

If no parameter value is provided, this command returns the home channel for repeater and mobile simulation. Use the value parameter to set the home channel.

SYNTAX: [value] [-forgive] [-range]

RANGES: 1 to 20 (Valid range for setting)
0 to 31 (Data entry range limits)

Logic Trunked Radio - Ltr (cont)

Ltr INUSE

If no parameter value is provided, this command returns the “in use” channel for repeater and mobile simulation. Use the value parameter to set the “in use” channel.

SYNTAX: [value] [-forgive] [-range]

RANGES: 1 to 20 (Valid range for setting)
0 to 31 (Data entry range limits)

Ltr MOBILESTATE or MSTATE

If no parameter value is provided, this command returns the current mobile simulation state. Use the value parameter to set the desired mobile simulation state.

SYNTAX: [value] [-forgive] [-range]

RANGES: 0 Idle
1 Initialize
2 Listening

Ltr MOBILETRIES or MTRIES

If no parameter value is provided, this command returns the number of tries that the mobile simulator uses when attempting to acquire repeater service. Use the value parameter to set the desired number of “tries.”

SYNTAX: [value] [-forgive] [-range]

RANGES: 0 to 100

Ltr MODE

If no parameter value is provided, this command returns the current LTR mode. Use the value parameter to set the LTR mode.

SYNTAX: [value] [-forgive] [-range]

RANGES: 0 No Mode
1 Monitor a Repeater
2 Monitor a Radio
3 Reserved
4 Repeater Simulation
5 Mobile Simulation

Ltr MONitor

If no parameter value is provided, this command returns the current monitor status. Use the value parameter to set the monitor status, which switches between the receive and transmit frequency settings.

SYNTAX: [value] [-forgive] [-range]

RANGES: 0 Monitor OFF (transmit)
1 Monitor ON (receive)

Logic Trunked Radio - Ltr (cont)

Ltr PARAMS

If no parameters are provided, this command returns the current settings.

SYNTAX: [deviation] [inverted] [sync] [-forgive] [-range]

RANGES (Deviation): 0 to 40000 Hz (Default is 1000)

NOTE: Use the deviation parameter to set the output frequency deviation (in Hz).

RANGES (Inverted): 0 Normal (Default)
1 Inverted

NOTE: Use the inverted parameter to invert every bit in the transmitted word.

RANGES (Sync): 0 to 0x1FF (Default is 0x158)

NOTE: Use the sync parameter to change the specified transmit sync code word.

Ltr PORCH

If no parameter value is provided, this command returns the current porch enable status. Use the value parameter to control the porch enable bits. The “front” and “back” porch are 3 and 2 bits respectively, which can be added to a packet to assist propagation through data filters.

SYNTAX: [value] [-forgive] [-range]

RANGES: 0x01 Front (“1” enables the respective porch)
0x02 Back

Ltr PTT

If no parameter value is provided, this command returns the Push-To-Talk (PTT) status. Use the value parameter to set the simulated PTT state during mobile simulation.

SYNTAX: [value] [-forgive] [-range]

RANGES: 0 Off
1 On

Ltr READING

This command is ONLY available with the -onchange option. Returned list variable: 9-bit LTR sync code, 28-bit LTR word, 7-bit LTR checksum, relative time stamp, state of the inversion detection flag (1/0), “area” bit, 5 bit goto channel field, 5 bit home channel field, 8 bit group field or 5 bit free channel field.

Logic Trunked Radio - Ltr (cont)

Ltr REPEATERSTATE or RSTATE

If no parameter value is provided, this command returns the current state of the repeater. Use the value parameter to set the current state of the repeater.

SYNTAX: [value] [-forgive] [-range]

RANGES:

0	Idle
1	Repeater Busy (forces the Mobile to switch to the free channel)
2	Continuous (forces the Mobile of set group to listen)
3	Radio Initiated Call
4	Radio Initiated Call in RIC Mode

Ltr RICcode

If no parameter value is provided, this command returns the current Radio-InterConnect (RIC) group parameter for repeater and mobile simulation. Use the value parameter to set the current RIC code.

SYNTAX: [value] [-forgive] [-range]

RANGES: 0 to 255

Ltr RXCHANnel

If no parameter channel is provided, this command returns the current receive channel. Use the channel parameter to set the current receive channel.

SYNTAX: [channel] [-forgive] [-range]

RANGES: 1 to 20 (valid range for channel)
1 to 31 (valid range for setting)

Ltr RXFREQuency

The parameter channel is **REQUIRED** for a query. If no frequency field is provided, this command returns the current receive frequency assigned to the specified channel. Use the channel parameter to set the receive frequency for a specific channel.

SYNTAX: [channel] [freq] [-forgive] [-range]

RANGES: 0.0 to 2800.0 MHz (valid range for frequency)
1 to 20 (valid range for channel)

Ltr TXCHANnel

If no parameter channel is provided, this command returns the current transmit channel. Use the channel parameter to set the current transmit channel.

SYNTAX: [channel] [-forgive] [-range]

RANGES: 1 to 20 (valid range for channel)
1 to 31 (valid range for setting)

Logic Trunked Radio - Ltr (cont)

Ltr TXFREQUENCY

The parameter channel is REQUIRED for a query. If no frequency field is provided, this command returns the current transmit frequency assigned to the specified channel. Use the channel parameter to set the transmit frequency for a specific channel.

SYNTAX: [channel] [freq] [-forgive] [-range]

RANGES: 0.0 to 2800.0 MHz (valid range for frequency)
1 to 20 (valid range for channel)

Ltr VERSION

This is a QUERY only command.

SYNTAX: [system] [-range]

RANGES: 1 LTR Driver ID
2 LTR Engine ID

P25

The P25 commands control the receiver and generator functions and encode/decode the P25 waveform. The commands simultaneously set the data the generator transmits and shows the data being received.

P25 commands are divided into two groups: commands which affect data received by the 2975 (decode) and commands which affect data transmitted by the 2975 (encode).

P25 decode ENable

If no parameter value is provided, this command returns whether P25 data is decoded or ignored. Use the value parameter to enable/disable P25 data collection.

SYNTAX: [value] [-forgive] [-range]

RANGES: 0 Off
1 On (enables data collection)

P25 decode ENCRYPTION

This command requests transmission of an encryption status. No data is needed or returned.

P25 decode -onchange encryptstate or encrstate

This command provides a TCL list of the LSD: LSD, Status_1, Status_2 or Status_3.

This command is only available with the -onchange subcommand. No data is needed.

P25 decode sampleRATE

If no parameter value is provided, this command returns the current sample rate. Use the value parameter to set the desired sample rate.

SYNTAX: [value] [-forgive] [-range]

RANGES: 1, 2, 4, 8, 16, 32, 64, 128

P25 encode C4FMpercent

If no parameter value is provided, this command returns the C4FM modulation percentage. Use the value parameter to set the C4FM modulation percentage.

SYNTAX: [value] [-forgive] [-range]

RANGES: 0 to 100

P25 (cont)

P25 encode DIGITS

If no parameter setting is provided, this command returns the current DTMF string which is transmitted on LCO = 7. Use the setting parameter to set the DTMF digit string.

LCO 7 has the ability to transmit a maximum of 10 DTMF 4-bit “nibbles.” Standard digits (0-9) and a few special characters require one nibble; letters (A-D) require two nibbles. This command can manage outgoing strings which contain more legal symbols than fit in 10 nibbles; however, if input strings are too large, the input strings are converted until 10 nibbles are stored, and the remainder of the string is ignored. Any unused nibble fields are filled with the DTMF escape nibble (0x0f).

SYNTAX: [settings] [-forgive]

RANGES: 0 to 9, A, B, C, D, H, P, *, # (H sends “Hook Flash” symbol) (P sends “Pause” symbol)

NOTE: The setting is treated as a String and not a number because it can contain non-digit characters and a 10 digit string exceeds the data limitations of a 32 bit integer value.

P25 encode ENCRYPTenable

Valid settings are required when running this command. Use the command to set the transmitted encryption type and the Algorithm ID. These variables typically match; however, this command transmits an Algorithm ID which differs from the one currently being used in the encryption process.

SYNTAX: [encrypt_type] [algid] [-forgive] [-range]

RANGES:

<u>encrypt_type</u>	<u>algid</u>
0 or 0x80 = clear text	0 to 255
0x81 = DES	
0x83 = AES	

NOTE: “Clear text” encryption is used if: the specified encrypt_type is unknown; it specifies an encryption process which requires an unavailable option; if a key has not been loaded into the slot specified by the KEYID field.

P25 encode FIELD

This is a required parameter. If a field value parameter is not provided, the command returns the value of the specified field. Use field name parameter to individually set up the various data fields used in standard P25 and P25 trunking. To set the data for a specific LCO, use remote command “lcomsg.”

NOTE: P25 specifications define messages which share common data or have common data names. The 2975 internally defines a set of data fields, then uses these fields to generate the various message blocks. Knowing which data fields to set up requires a knowledge of the P25 specifications and, for certain messages, may require information from Aeroflex.

SYNTAX: [field_name] [field_value] [-forgive]

P25 (cont)

P25 encode FIELD (cont)

RANGES ("field_name" - header):	algid	(Header) Algorithm ID	8 bits
	keyid	Key Identifier	16 bit
	lsd1	LSD Info (MSW)	16 bits
	lsd2	LSD Info (LSW)	16 bits
	mfid	(Header) Manufacturers ID	8 bits
	nac	Network Access Code	12 bits
	s	Status Symbol	2 bit
	tgid	Talk Group ID	16 bits
RANGES ("field_name" - LCO):	bfreq	Base Frequency Octet 0-1	16 bits
	bw	Bandwidth	9 bits
	chanid	Generic Channel identifier	4 bits
	channum	Generic Channel number	12 bits
	chanid_a	Channel A identifier	4 bits
	channum_a	Channel A number	12 bits
	chanid_b	Channel B identifier	4 bits
	channum_b	Channel B number	12 bits
	chanid_r	Channel R identifier	4 bits
	channum_r	Channel R number	12 bits
	chanid_t	Channel T identifier	4 bits
	channum_t	Channel T number	12 bits
	cspace	Channel Spacing	10 bits
	ctime	Call Timer	16 bits
	efun_a	Ext. Function Octet 0-2	24 bits
	efun_b	Ext. Function Octet 4-4	16 bits
	emg	Emergency bit	1 bit
	grpaddr	Generic Group Address	16 bits
	grpaddr_a	Group Address - A	16 bits
	grpaddr_b	Group Address - B	16 bits
	lco	Link Control Opcode	6 bits
	lco_algid	(LCO) Algorithm ID	8 bits
	lco_mfid	(LCO) Manufacturers ID	8 bits
	lra	Location Registration Area	8 bits
	msg	Data message	16 bits
	netid	Network Identification	20 bits
	p	Priority bit	1 bit
	priorreq	Requested Priority	4 bits
	res_4	Reserved	4 bits
	res_8	Reserved	8 bits
	res_16	Reserved	16 bits
	res_24	Reserved	24 bits
	rfsbid	RF Sub-System Id	8 bits
	sclass	Service Class	8 bits
	sclass_a	Service Class - A	8 bits
	sclass_b	Service Class - B	8 bits
	servop	Service Options	8 bits
	sf	Standard Format bit	1 bit
	siteid	Site Id	8 bits
	srcaddr	Source Address	24 bits
	srcid	Source Identification	24 bits
	ssavail	Available System Services	24 bits
	sssup	Supported System Services	24 bits
	stsupdate	Status	16 bits
sysid	System Identification	12 bits	
tgtaddr	Target Address	24 bits	
xmitoff	Transmit Offset	9 bits	

P25 (cont)

P25 encode FIELD (cont)

RANGES ("field_name" - Trunking):	anngrpadr	Announcement Group Add	16 bits
	chanid_c	Control Channel identifier	4 bits
	channum_c	Control Channel number	12 bits
	chanid_v	Voice Channel identifier	4 bits
	channum_v	Voice Channel number	12 bits
	chanidrx_c	Control Channel Rcv ID	4 bits
	channumrx_c	Control Channel Rcv number	12 bits
	chanidtx_c	Control Channel Xmit ID	4 bits
	channumtx_c	Control Channel Xmit number	12 bits
	chanidrx_v	Voice Channel Rcv ID	4 bits
	hannumrx_v	Voice Channel Rcv number	12 bits
	chanidtx_v	Voice Channel Xmit ID	4 bits
	channumtx_v	Voice Channel Xmit number	12 bits
	targetid	Target Address	24 bit
	t_anet	Active Network Flag	1 bit
	t_gav	Group Affiliation Value	2 bit
	t_lg	Local/Global Flag	1 bit
	t_prot	Protected Trunking Flag	1 bit
	t_rv	Registration Value	2 bit
	wacnid	Wide Area Communication Net	20 bits
	wgid	Working Group ID	16 bits
	wuid	Working Unit ID	24 bits

P25 (cont)

P25 encode lcomessage | lcomsg

This command does not have a query. Use this command to set up the required parameters for a specific LCO message packet. When standard P25 transmission is active, it causes the data to be transmitted at least once. Note that for LCO = 7, the string of DTMF digits must be set using the “P25 encode digits” command.

The number and source of the information in the parameter list is specific to the LCO specified. See TIA/EIA Specification 102.AABF for more information.

NOTE: Commas are included to clarify field separation only. Commas are NOT needed in the command.

RANGES:

0	p, sf, lco_mfid, emg, servop, 0, grpaddr, srcaddr
2	p, sf, chanid_a, channum_a, grpaddr_a, chanid_b, channum_b, grpaddr_b
3	p, sf, lco_mfid, emg, servop, tgtaddr, srcaddr
4	p, sf, 0, emg, servop, grpaddr, chanid_t, channum_t, chanid_r, channum_r
5	p, sf, emg, servop, 0, tgtaddr, srcaddr
6	p, sf, 0, emg, servop, 0, ctime, tgtaddr
7	p, sf, tgtaddr
15	p, sf, 0, 0, tgtaddr
16	p, sf, 0, tgtaddr, srcaddr
17	p, sf, netid, sysid, srcid, 0
18	p, sf, netid, sysid, srcid, 0
19	p, sf, 0, tgtaddr, srcaddr
20	p, sf, stsupdate, tgtaddr, srcaddr
21	p, sf, msg, tgtaddr, srcaddr
22	p, sf, 0, tgtaddr, srcaddr
23	p, sf, efun_a, efun_b, tgtaddr
24	p, sf, chanid, bw, xmitoff, cspace, bfreq
32	p, sf, 0, 0, priorreq, ssavail, sssup
33	p, sf, rfsupid, siteid, chanid_a, channum_a, sclass_a, chanid_b, channum_b, sclass_b
34	p, sf, lra, 0, sysid, rfsupid, siteid, chanid, channum, sclass
35	p, sf, lra, 0, sysid, rfsupid, siteid, chanid, channum, sclass
36	p, sf, 0, netid, sysid, chanid, channum, sclass
37	p, sf, 0, lco_algid, lco_kid, tgtaddr

P25 Namespace Variables

The current status of the P25 uploaded data is stored in TCL namespace array variables (::P25::DecodeState). The DecodeState variable provides both raw and decoded status information obtained from received P25 data.

Power

The Power commands set up and measure the RF power present at the T/R Port. The bandwidth is 2.7 GHz.

Power detector or dect

If no parameter setting is provided, this command returns the detector setting. Use the setting parameter to set the detector setting.

SYNTAX: [setting]
RANGES: 0 Fast
 1 Slow

Power ENable

If no parameter setting is provided, this command returns the current enabled mode(s). Use the setting parameter to set the enabled data mode(s).

SYNTAX: [setting]
RANGES: Off
 On

Power overload or ovid

This command is only available with the -onchange option. Returned list variable: AntennaOverload or GeneratorOverload.

Power powerrange or prange

If no parameter setting is provided, this command returns the current power range. Use the setting parameter to set the power range.

SYNTAX: [setting]
RANGES: 0 Auto
 1 Low
 2 High

Power READing

This command is only available with the -onchange option. Returned list variable: Power, PowerRange, Accuracy or OverRange.

Power TEMPerature

This command is only available with the -onchange option. Returned list variable: Temperature_1, Temperature_2 or FanSpeed.

Power tempoverload or overtemp

This command is only available with the -onchange option. Returned list variable: Temperature or Accuracy.

Power (cont)

Power VALue

This is a query only command that provides the last power reading. Similar to the “reading” command, this command provides only the power and no indication that the data is stale.

Power ZERO

This command forces the power meter to read zero. When using this command, all RF power must be removed from the T/R Front Panel connector. No data is required or returned.

Receiver

The Receiver commands set up the RF Receiver for FM measurements or P25 measurements.

Receiver AGCMODE

If no parameter value is provided, this command returns the software AGC mode. Use the value parameter to set the receiver software AGC mode.

SYNTAX: [value] [-forgive] [-range]

RANGES: 0 Off
1 On

Receiver AGCsystem

SYNTAX: [value] [-forgive] [-range]

Receiver ATTENUation

This command selects the amount of attenuation in the Receiver path in 0, 10, 20, 30, 40 and 50 dB steps. If no parameter value is provided, this command returns the selected receiver attenuation. Use the value parameter to set the receiver attenuation.

SYNTAX: [value] [-forgive] [-range]

RANGES: -50 to 50 dB

Receiver captureRANGE

If no parameter is provided, this command returns the selected receiver range. Use the value parameter to set the receiver range.

SYNTAX: [value] [-forgive] [-range]

RANGES: 0 Wide
1 Narrow

Receiver DEMODulation

This command selects the digital domain IF filter parameters. If no parameter value is provided, this command returns the selected receiver demodulation. Use the value parameter to set the receiver demodulation.

SYNTAX: [value] [-forgive] [-range]

RANGES: 0 FMWide
1 FMNarrow
2 FMWideband
3 FMTV
4 AM
5 P25
10 MMedium
11 Off
12 P25qpsk
13 P25_P2
14 P25_wide

Receiver (cont)

Receiver Enable

If no parameter value is provided, this command returns the currently enabled messages. Use the value parameter to enable or disable selected receiver broadcast messages. This field is a logical OR of bits which enable specific data messages to be provided.

SYNTAX: [value] [-forgive] [-range]
RANGES: 0x01 Control (always set)
0x02 Status
0x08 YIG Status

Receiver FREQuency

This command sets the RF frequency. If no parameter value is provided, this command returns the selected receiver frequency. Use the value parameter to set the frequency.

SYNTAX: [value] [-forgive] [-range] [units]
RANGES: value 0 to 2.8 GHz
units Hz, kHz, MHz, GHz (not case sensitive)

Receiver HWAGC

If no parameter value is provided, this command returns the current hardware AGC speed. Use the value parameter to set the receiver hardware AGC speed.

SYNTAX: [value] [-forgive] [-range]
RANGES: 0 Fast
1 Slow

Receiver IFBANDWIDTH or IFBW

This command sets the IF filters. If no parameter value is provided, this command returns the selected receiver IF bandwidth. Use the value parameter to set the receiver IF bandwidth.

SYNTAX: [value] [-forgive] [-range] [units]
RANGES: value 30 kHz, 300 kHz, 3 MHz
units Hz, kHz, MHz, GHz (not case sensitive)

Receiver IFGAIN

If no parameter value is provided, this command returns the current receiver IF gain. Use the value parameter to set the receiver IF gain.

SYNTAX: [value] [-forgive] [-range]
RANGES: -14.0 to 82.0

Receiver (cont)

Receiver RFIInput

This command sets the RF input port to the receiver. If no parameter value is provided, this command returns the selected receiver frequency. Use the value parameter to set the receiver frequency.

SYNTAX: [value] [-forgive] [-range]

RANGES: 0 T/R
1 ANT

Receiver sweepLOCK

If no parameter value is provided, this command returns the receiver frequency lock setting. Use the value parameter to set the receiver frequency lock.

SYNTAX: [value] [-forgive] [-range]

RANGES: 0 Sweep
1 Lock

Receiver VERsion

This is a query only command.

SYNTAX: [system]

RANGES: 0 Receiver Engine ID
1 Receiver Driver ID

RF Error

The RF Meter measures the internal 10.7 MHz IF and performs a frequency error from received signal translation.

RFError ALerts

If no parameter value is provided, this command returns the current alert enable status. Use the value parameter to set the alert enable status.

SYNTAX: [value] [-forgive] [-range]

RANGES:

0	Off
1	EnableLo
2	EnableHi
3	EnableBoth

RFError AVERAGE or AVG

If no parameter setting is provided, this command returns the current number of samples used to average the frequency error. Use the setting parameter to set the samples to average.

SYNTAX: [setting] [-forgive] [-range]

RANGES: 1 to 100

RFError ENable

If no parameter setting is provided, this command returns the current enabled mode(s). Use the setting parameter to set the enabled data mode(s).

SYNTAX: [setting]

RANGES:

1	Disable
3	Enable

RFError GATE

If no parameter setting is provided, this command returns the current gate status. Use the setting parameter to set the gate time.

SYNTAX: [setting] [-forgive] [-range]

RANGES:

0	Second
1	Tenth

RFError LLIMit

If no parameter value is provided, this command returns the current lower alert limit. Use the value parameter to set the lower alert limit.

SYNTAX: [value] [-forgive] [-range]

RANGES: -3.0 to 3.0 {Hz / kHz / MHz / GHz (not case sensitive)}

RF Error (cont)

RFError PEAKhold

If no parameter setting is provided, this command returns the current peak hold mode. Use the setting parameter to set the peak hold mode.

SYNTAX: [setting] [-forgive] [-range]
RANGES: 0 Off
1 On (enables peak recording)

NOTE: The ENable subcommand must also have peak readings enabled to receive data.

RFError PHRESET or PHRST

This command resets the peak hold readings. No data is required.

RFError READING

This command is only available with the -onchange option. Returned list variable: Frequency, Frequency Precision, Frequency Error, Frequency Error Precision, Status or Frequency Error Accuracy.

RFError READPEAKhold

This command is only available with the -onchange option. Returned list variable: PeakHi, Hi Precision, PeakLo, Lo Precision or Status.

RFError RESources

This command returns a list of the USER resources. No data is required.

RFError RUN

If no parameter setting is provided, this command returns whether the frequency error meter is actively trying to obtain readings. Use the setting parameter to turn the data collection on or off.

SYNTAX: [setting][-forgive] [-range]
RANGES: 0 Off
1 On (enables frequency error readings)

RFError ULIMit

If no parameter value is provided, this command returns the current upper alert limit. Use the value parameter to set the upper alert limit.

SYNTAX: [value][-forgive] [-range][units]
RANGES: -3.0 to 3.0 GHz (valid range for value)
Hz / KHz / MHz / GHz (valid range for units)

RF Error (cont)

RFError VALue

This is a query only command that provides the last frequency error reading. Similar to the “reading” command, this command provides only the reading and no indication that the data is stale.

RFError VERsion

This is a query only command. “System” is a required parameter.

SYNTAX: [system] [-forgive] [-range]

RANGES: 1 RF Error Driver ID
2 RF Error Engine ID

RLmeter (Narrowband)

RLmeter ALerts

If no parameter value is provided, this command returns the current alert enable status. Use the value parameter to set the alert enable status.

SYNTAX: [value] [-forgive] [-range]

RANGES:

0	Off
1	EnableLo
2	EnableHi
3	EnableBoth

RLmeter CABLEloss

If no parameter setting is provided, this command returns the current cable loss. Use the setting parameter to set the desired cable loss (dB).

SYNTAX: [setting] [-forgive]

RANGES: -60.0 to 60.0

RLmeter CALibration

This is a series of commands which are specified by data type. These command allow the setup and execution of the Receive Level Meter calibration. No query is available.

RLmeter ENable

If no parameter setting is provided, this command returns the current enabled mode(s). Use the setting parameter to set the enabled data mode(s).

SYNTAX: [setting]

RANGES: Off
On

RLmeter LLIMit

If no parameter value is provided, this command returns the current lower alert limit. Use the value parameter to set the lower alert limit.

SYNTAX: [value] [-forgive] [-range] [-units]

RANGES: -110 dBm to 53.0 dBm

RLmeter (Narrowband) (cont)

RLmeter PEAKhold

IF no parameter setting is provided, this command returns the current peak hold mode. Use the setting parameter to set the peak hold mode.

SYNTAX: [setting] [-forgive] [-range]

RANGES: 0 Off
1 On (enables peak recording)

NOTE: The ENable subcommand must also have peak readings enabled to receive data.

RLmeter PHRESET or PHRST

This command resets the peak hold readings. No data is required.

RLmeter RATE

If no parameter setting is provided, this command returns the current update rate. Use the setting parameter to set the desired update rate.

SYNTAX: [setting]

RANGES: Off
On

RLmeter READING

This command is only available with the -onchange option. Returned list variable: Power, Accuracy or Status.

RLmeter READPEAKhold

This command is only available with the -onchange option. Returned list variable: PeakHi, Hi Precision, PeakLo, Lo Precision or Status.

RLmeter STATus

This command returns a history of the cable loss analysis state machine. This command is only available with the -onchange option. Returned list variable: StateMachineHistory.

RLmeter ULIMit

If no parameter value is provided, this command returns the current upper alert limit. Use the value parameter to set the upper alert limit.

SYNTAX: [value] [-forgive] [-range][units]

RANGES: -3.0 to 3.0 GHz (valid range for value)
Hz / KHz / MHz / GHz (valid range for units)

RLmeter (Narrowband) (cont)

RLmeter VALue

This is a query only command that provides the last RL power reading. Similar to the “reading” command, this command provides only the reading and no indication that the data is stale.

RLmeter VERsion

This is a query only command.

SYNTAX: [system] [-range]

RANGES: 0 RLmeter Engine ID
1 RLmeter Driver ID

Scope

Scope average or avg

If no parameter value is provided, this command returns the current average setting. Use the value parameter to set the samples to average.

SYNTAX: [value] [-forgive] [-range]

RANGES: 2 to 255 (Default is 10)

Scope calibrationgainoffset or caloffset

This command requires a list of values to set the calibration gain offset.

SYNTAX: [structure] [-forgive] [-range]

RANGES: (See structure SCOPEMESSAGECAL.)

Scope calibrategain or calgain

This function requires two integer parameters to set the gain.

Scope horizontalPOSITION

If no parameter value is provided, this command returns the current horizontal position offset. Use the value parameter to set the horizontal position offset.

SYNTAX: [value] [-forgive] [-range]

RANGES: -100 to 100 (Default is 0)

Scope horizontalSWEEP

If no parameter value is provided, this command returns the current sweep rate. Use the value parameter to set the sweep rate.

SYNTAX: [value] [-forgive] [-range]

RANGES: 1 to 10,000,000 Channel 1 and 2
100 to 1,000,000 Channel 3

Scope inputCOUPLING

If no parameter value is provided, this command returns the current input coupling. Use the value parameter to set the input coupling.

SYNTAX: [value] [-forgive] [-range]

RANGES: 0 AC
1 DC (default)

Scope (cont)

Scope messageENABLE

If no parameter value is provided, this command returns the peak hold flags. Use the value parameter to set the peak hold reset flags.

SYNTAX: [value] [-forgive] [-range]

RANGES: 0 to 31 (Default is 1)

Scope peakholdreset or peakreset

If no parameter value is provided, this command returns the current enabled messages. Use the value parameter to set which messages are enabled.

SYNTAX: [value] [-forgive] [-range]

RANGES: 0 to 31 (Default is 1)

Scope RUN

If no parameter value is provided, this command returns the current execution state. Use the value parameter to turn a given oscilloscope on or off.

SYNTAX: [value] [-forgive] [-range]

RANGES: 0 Off (Default)
1 On

Scope traceMATH

If no parameter value is provided, this command returns the current math type. Use the value parameter to set the trace math mode.

SYNTAX: [value] [-forgive] [-range]

RANGES: 0 None (Default)
1 Live-Ref
2 Ref-Live
3 Live + Ref

Scope triggerarm or trigarm

This command arms a one-shot trigger mode. No data is required.

Scope triggerlevel or triglev

If no parameter value is provided, this command returns the current trigger level. Use the value parameter to set the trigger level.

SYNTAX: [value] [-forgive] [-range]

RANGES: -500 to +500 dBm

Scope (cont)

Scope triggerpolarity or trigpol

If no parameter value is provided, this command returns the current trigger polarity. Use the value parameter to set the trigger polarity.

SYNTAX: [value] [-forgive] [-range]

RANGES: 0 (Default)
1

Scope triggersource or trigsources

If no parameter value is provided, this command returns the current trigger source. Use the value parameter to set the trigger source.

SYNTAX: [value] [-forgive] [-range]

RANGES: 0 External (Default)
1 Channel #1
2 Channel #2

Scope triggertype or trigtype

If no parameter value is provided, this command returns the current trigger type. Use the value parameter to set the scope trigger type.

SYNTAX: [value] [-forgive] [-range]

RANGES: 0 Auto (Default)
1 Normal
2 One Shot

Scope VERSION

Use the "value" parameter to select which version number to access.

SYNTAX: [value] [-forgive] [-range]

RANGES: 1 to 4

Scope verticalSCALE

If no parameter value is provided, this command returns the current vertical scale. Use the value parameter to set the vertical scale.

SYNTAX: [value] [-forgive] [-range]

RANGES: 0 to 12

Sinad

The SINAD (signal + noise/distortion) Meter is used to check the sensitivity of FM receivers. Units are in dB.

SINAD and Distortion readings are derived from a common set of data. Consequently, using either the "SINAD" or "Dist" commands, which turn the Sinad or Distortion Meter on/off, the set filtering and trigger affects both meters. Peak readings and alerts are maintained individually for each reading type. Those commands only affect the specific meter.

Sinad Alerts

If no parameter value is provided, this command returns the current alert enable status. Use the value parameter to set the alert enable status.

SYNTAX: [value] [-forgive] [-range]

RANGES:

0	Off
1	EnableLo
2	EnableHi
3	EnableBoth

Sinad Alpha

If no parameter setting is provided, this command returns the current FFT alpha value. Use the setting parameter to set the FFT alpha value.

SYNTAX: [setting] [-forgive]

Sinad AVERAGE or AVG

If no parameter setting is provided, this command returns the current number of symbols used to by the DSP to average the SINAD/Distortion. Use the setting parameter to set the number of symbols in a sample.

SYNTAX: [setting] [-forgive] [-range]

RANGES: 1 to 2000 (normally set to 1)

Sinad ENable

If no parameter setting is provided, this command returns the current enabled mode(s). Use the setting parameter to set the enabled mode(s).

SYNTAX: [setting]

RANGES:

1	Disable
3	Enable

Sinad ENABLECWT or ENCWT

If on parameter setting is provided, this command returns disabled/enabled for the center weight filter. Use the setting parameter to enable or disable the center weight frequency.

SYNTAX: [setting]

RANGES:

0	Disable
1	Enable

Sinad (cont)

Sinad fft MAXX

If no parameter setting is provided, this command returns the maximum FFT frequency. Use the setting parameter to set the maximum FFT frequency.

SYNTAX: [setting] [-forgive] [-range]

RANGES: 0.0 to 40000.0

Sinad fft MAXY

If no parameter setting is provided, this command returns the maximum FFT dbc level. Use the setting parameter to set the maximum FFT dbc level.

SYNTAX: [setting] [-forgive] [-range]

RANGES: -80.0 to 0.0 dbc (decibels below carrier)

Sinad fft MINX

If no parameter setting is provided, this command returns the minimum FFT frequency. Use the setting parameter to set the minimum FFT frequency.

SYNTAX: [setting] [-forgive] [-range]

RANGES: 0.0 to 40000.0

Sinad fft MINY

If no parameter setting is provided, this command returns the minimum FFT dbc level. Use the setting parameter to set the minimum FFT dbc level.

SYNTAX: [setting] [-forgive] [-range]

RANGES: -80.0 to 0.0 dbc (decibels below carrier)

Sinad fft RATE

If no parameter setting is provided, this command returns the current setting for the FFT rate. Use the setting parameter to control the rate at which new FFT traces are sent from the DSP. A setting of "1" results in every trace being sent while other settings result in a trace being sent every "X" number of traces, essentially skipping some.

SYNTAX: [setting] [-forgive] [-range]

RANGES: 1 to 10 (fast update to slow update) (4 is frequently used)

Sinad FILTER

If no parameter setting is provided, this command returns the current number of samples used to average the SINAD/Distortion. Use the setting parameter to set the samples to average.

SYNTAX: [setting] [-forgive] [-range]

RANGES: 1 to 100

Sinad (cont)

Sinad HNOISE

If no parameter setting is provided, this command returns the current high noise frequency setting for the FFT. Use the setting parameter to modify the high noise frequency.

SYNTAX: [setting] [-forgive]

Sinad HNOTch

If no parameter setting is provided, this command returns the current high notch frequency setting for the FFT. Use the setting parameter to modify the high notch frequency.

SYNTAX: [setting] [-forgive]

Sinad LLIMit

If no parameter value is provided, this command returns the current lower alert limit. Use the value parameter to set the lower alert limit.

SYNTAX: [value] [-forgive] [-range]

RANGES: 0 to 40.0

Sinad LNOISE

If no parameter setting is provided, this command returns the current low noise frequency setting for the FFT. Use the setting parameter to modify the low noise frequency.

SYNTAX: [setting] [-forgive]

Sinad LNOTch

If no parameter setting is provided, this command returns the current low notch frequency setting for the FFT. Use the setting parameter to modify the low notch frequency.

SYNTAX: [setting] [-forgive]

Sinad MARKer

When the parameter frequency is provided, the specified marker is updated to use the new frequency to select which data from the FFT traces is retrieved. When the frequency is changed or a marker is queried, a list of data items is returned from the stored FFT traces. The data items represent the value of the FFTs at the specified frequency. This is a required field. Returned list variable: Marker_ID, Marker_Freq, Live_FFT value, Avg_FFT value, Ref_FFT value, UpperLimit_FFT value or LowerLimit_FFT value.

SYNTAX: [marker_ID] [frequency] [-forgive] [-range]

Sinad (cont)

Sinad MATH

If no parameter setting is provided, this command returns whether filtering is enabled. Use the setting parameter to enable/disable filtering.

SYNTAX: [setting] [-forgive] [-range]

RANGES: 0 Off
1 On (enables filtering)

Sinad PEAKhold

If no parameter setting is provided, this command returns the current peak hold mode. Use the setting parameter to set the peak hold mode.

SYNTAX: [setting] [-forgive] [-range]

RANGES: 0 Off
1 On (enables peak recording)

NOTE: The ENable subcommand must also have readings enabled for data to be provided.

Sinad PHRESET or PHRST

This command resets the peak hold readings. No data is required.

Sinad READING

This command is only available with the -onchange option. Returned list variable: Sinad, Precision or Status.

Sinad READPEAKhold

This command is only available with the -onchange option. Returned list variable: PeakHi, Hi Precision, PeakLo, Lo Precision or Status.

Sinad RESources

This command returns a list of the USER resources. No data is required.

Sinad RUN

If no parameter setting is provided, this command returns whether the SINAD/Distortion is actively trying to obtain readings. Use the setting parameter to turn the data collection on or off.

SYNTAX: [setting] [-forgive] [-range]

RANGES: 0 Off
1 On (enables SINAD/Distortion readings)

Sinad (cont)

Sinad SENDCWT

This command receives an array of data pairs {freq db} representing the desired frequency response of the C-Weight Filter. After the data pairs are splined to obtain values at regular frequency intervals, the data pairs are sent to the DSP to be used as a filter.

SYNTAX: [filter array]

Sinad Size

If no parameter setting is provided, this command returns the current FFT size value. Use the setting parameter to modify the FFT size value.

SYNTAX: [setting] [-forgive]

Sinad TRACE

Sinad TRACE is used for setting or retrieving sets of FFT trace data. Each of the TRACE commands utilizes a TCL variable as a parameter. This variable must be in current scope and it must be a TCL list.

Sinad TRACE AVG or TAVG

This command returns the latest average FFT trace data in the form of a TCL list.

If no TCL variable is provided, this command uses the data to initialize the average trace data. Use the Sinad Trace_Avg command as an alternative way to initialize the average. The TCL variable is expected to be a valid TCL list of FFT trace data.

SYNTAX: [TCL variable name]

Sinad TRACE AVG FACTOR or TAVG FACTOR

If no parameter setting is provided, this command returns whether the SINAD/Distortion is actively trying to obtain readings. Use the setting parameter to turn the data collection on or off.

SYNTAX: [setting] [-forgive] [-range]

RANGES: 0.0 to 1.0

Sinad TRACE CFG or TCFG

The 2975 trace widget utilizes this command to obtain the numeric value of the subsystem. It is not a usable remote command.

Sinad (cont)

Sinad TRACE LIVE or TLIVE

This command returns the most recent set of FFT trace data in the form of a TCL list.

The TCL variable name is optional. If no TCL variable is provided, this command uses the FFT trace data to initialize and return live trace data. This does not affect the average trace or the Sinad reading which means the results are of questionable value. When a signal is available for Sinad readings, trace data is overwritten with valid data, which is then available for queries. The TCL variable is expected to be a valid TCL list of FFT trace data.

SYNTAX: [TCL variable name]

Sinad TRACE LOWERLIMIT or TLLIM

This command returns the current lower limit FFT trace in the form of a TCL list. This command also sets up the FFT trace to be used as a lower limit reference. The TCL variable is expected to be a valid TCL list of FFT trace data.

SYNTAX: [TCL variable name]

Sinad TRACE REFERENCE or TREF

This command returns the current reference FFT trace in the form of a TCL list. Use the command to set the reference FFT trace. The TCL variable is expected to be a list of FFT trace data.

SYNTAX: [TCL variable name]

Sinad TRACE UPPERLIMIT or TULIM

This command returns the current upper limit FFT trace in the form of a TCL list. The command sets up an FFT trace for use as an upper limit reference. The TCL variable is expected to be a list of FFT trace data.

SYNTAX: [TCL variable name]

Sinad TRIGger

If no parameter setting is provided, this command returns the current trigger mode. Use the setting parameter to set the trigger mode.

SYNTAX: [setting] [-forgive] [-range]

RANGES: 1 Continuous
2 OneShot

Sinad ULIMit

If no parameter value is provided, this command returns the current trigger mode. Use the value parameter to set the trigger mode.

SYNTAX: [value] [-forgive] [-range]

RANGES: 0 to 40.0

Sinad (cont)

Sinad VALue

This is a query only command that provides the last Sinad reading. Similar to the “reading” command, this command provides only the Sinad and no indication that the data is stale.

Sinad VERsion

This is a query only command. “System” is a required parameter.

SYNTAX: [system] [-forgive] [-range]

RANGES: 1 SINAD/Distortion Driver ID
2 SINAD/Distortion Engine ID

Sinad WINDow

If no parameter setting is provided, this command returns the current FFT window value. Use the setting parameter to modify the FFT window.

SYNTAX: [setting] [-forgive]

SECTION 6 - SYSTEM SETTINGS

6-1 GENERAL

The following key sequence is used to select the **SYSTEM** settings:

[MODE]

[7]

followed by the desired System item and the [ENTER] Key.

Configuration	1
Time / Date	2
Version	3
Reload	4
Calibrations	5 ▶
Save / Recall Setups	6
Escape	ESC

CONFIGURATION

This screen provides access to the 2975 remote control settings and general system parameters.

07:37:32	Configuration	Setup: 1	STD 511	VOL/SQL
IP PARAMETER SETUP		DHCP		SYSTEM PARAMETER SETUP
HOST NAME	vxworks		10 MHZ REFERENCE	Internal
MAC ADDRESS	00:50:08:01:F9:4A		POWER OFF MSG	YES
ADDRESS	10	200	143	62
NETMASK	255	255	255	0
GATEWAY	10	200		00
DISPLAY HOST			RF Gen DC power	ON
WINDOW TITLE			Normalize Cals	Clear
REDIRECT DISPLAY NOW		RS-232 (Serial) SETUP		
IEEE-488 (GPIB) Setup		Baud rate	115200	
Address	4	Handshake mode	SOFT	
Web server setup		Character echo	ON	
Enable	ENABLED	Mode	TCL	Save debug info
		Spinner in menus	NORMAL	LOG KEYS IS OFF
		Show levels on Vol/Sql knobs	ON	RETURN

IP PARAMETER SETUP

When the 2975 is configured to operate within your network, various parameters and names are needed. Your Network Administrator can provide you with the proper values (listed below) to insure the 2975 is correct for your particular network. Use care when changing these parameters, as incorrect address settings can affect other devices within your network.

HOST NAME

This is an ASCII string used to identify the 2975.

ADDRESS

The IP address for the 2975. (Assigned by your Network Administrator.)

NETMASK

Additional IP address information. (Assigned by your Network Administrator.)

GATEWAY

Additional IP address information. (Assigned by your Network Administrator.)

DISPLAY HOST

When the 2975 is hosted by remote X Windows, this is the host computer.

WINDOW TITLE

This is an ASCII string used within the host computer Window.

REDIRECT DISPLAY NOW

This button activates redirected display when pressed.

IEEE-488 (GPIB) SETUP

IEEE-488 is an industry standard connection for ATE applications. The 2975 is a talker/ listener device, and requires the GPIB address be set for your system.

ADDRESS

Set the address (0 to 30) for your particular application.

SYSTEM PARAMETER SETUP

The System Parameters affect the 2975 hardware across various modes of operation.

10 MHz REFERENCE

Select INTERNAL or EXTERNAL frequency reference. If EXTERNAL is selected, insure that a 10 MHz reference is connected to the rear panel input.

RF GEN DC POWER

Controls power to the RF Generator system (ON or OFF). ON is normal operation, and OFF is selected if reduced power consumption mode is required. When OFF, the RF ON/OFF selection within the Generator (Rx Test) screen indicates "XXX."

NORMALIZE CALS

This button CLEARS the current Spectrum Analyzer calibrations to default state. Re-normalizing establishes new normalize cals.

RS-232 (Serial) SETUP

The RS-232 Port on the 2975 is a 9-pin, DTE (data terminal equipment) interface.

BAUD RATE

Data rates are selectable as 110, 150, 300, 600, 1200, 2400, 4800, 9600, 19200, 38400, 57600 or 115200 bits per second.

HANDSHAKE MODE

Data transfer handshake method is selectable as NONE or SOFT. SOFT (software) is Xon / Xoff protocol.

CHARACTER ECHO

Each received character may be sent back to the sender (echo) when ON. OFF is no echo characters.

MODE

Serial information may be selected to be TCL mode or NONE for no protocol.

FACTORY DEFAULT (F2)

The FACTORY DEFAULT Soft Key restores settings and internal variables back to the original factory settings.

TIME / DATE

The Time / Date allows the internal clock and calendar settings to be changed.

07:38:16 Time / Date Setup: 1 STD 511 VOL/SQL

Time and date setup

Time Date

07 38 16 AM Wednesday Jan 12 2005

Clock Format 12 hour

Enable corner clock ON

RETURN

VERSION

The version screen shows the main software and module versions. The Installed Options (F2) Soft Key displays software options.

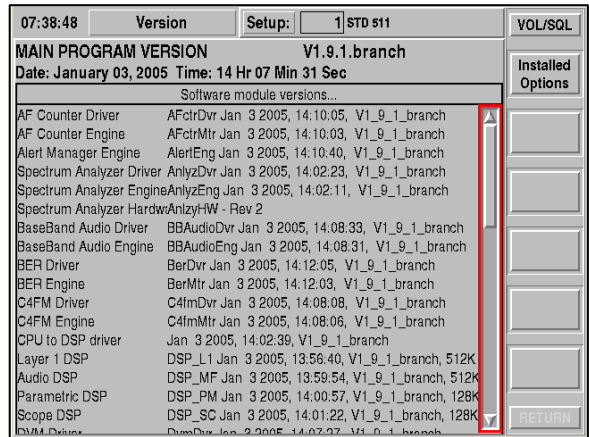

RELOAD

The Reload screen allows the user to load new versions of software into the 2975. The Check Floppy (F3) Soft Key is used to load new software from the 2975 floppy drive. The Download System (F4) Soft Key is used to download the new software when the 2975 is configured to operate within your computer network.

In either floppy or network Reload, follow the instructions as they appear on screen, as updates may require different loading or installation procedures.

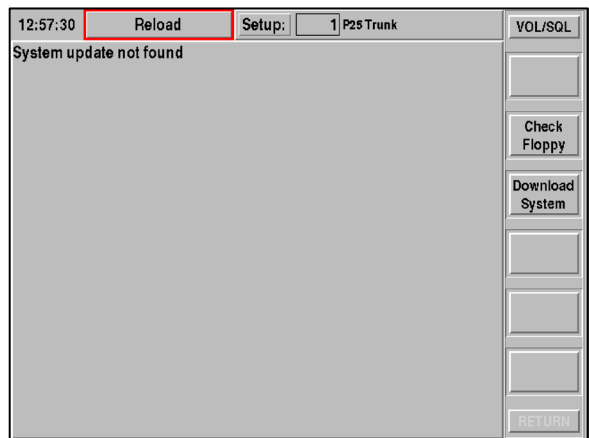

CALIBRATIONS

The 2975 calibration system is not accessible to the user without a password. The calibration process requires extensive software and hardware equipment, therefore customers are prevented from entering without authorization. Contact Aeroflex Customer Service if problems are encountered.

To access the calibration system select [MODE], [7], [5] and select the desired system to be calibrated.

After the desired system is selected a prompt screen is displayed for entering password. A password is required to proceed.

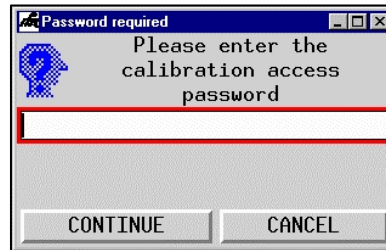
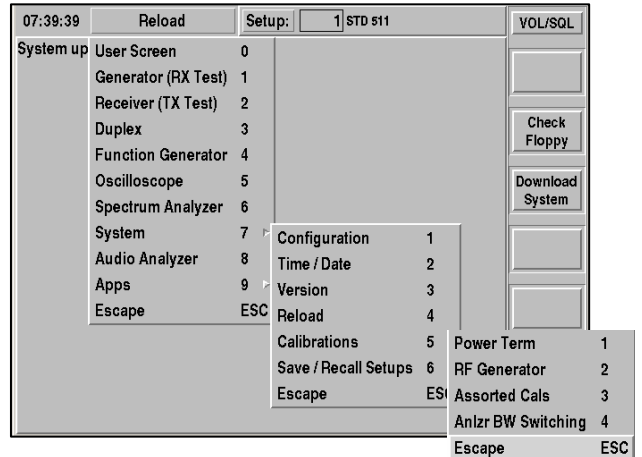

SAVE/RECALL

The Save/Recall function allows users to save, delete, and recall stored items.

The SAVE SETUP function allows the 2975 instrument settings to be saved to either the **INTERNAL** Hard Disk or the External **FLOPPY** Disk. Settings are saved by number, and may also have a Setting Label for identifying items easier during Recall.

The RECALL function allows the 2975 instrument settings to be restored from either the **INTERNAL** Hard Disk or the External **FLOPPY** Disk. Settings are identified by number and Setting Label. Optionally, the current Generate and Receive frequencies may be left at current settings, with all other instrument settings restored.

The BACKUP SETUPS function allows existing setups to be saved to or restored from a floppy.

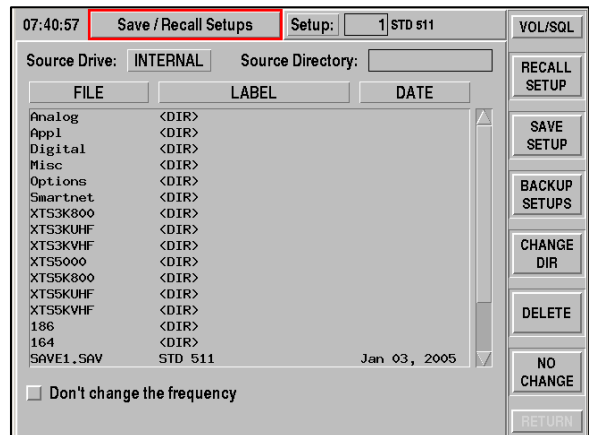

THIS PAGE INTENTIONALLY LEFT BLANK.

APPENDIX A - CONNECTOR PIN-OUT TABLES

**TABLE OF I/O CONNECTORS
2975 FRONT PANEL**

CONNECTOR NAME	CONNECTOR TYPE	SIGNAL IN/OUT	SIGNAL TYPE
SCOPE CH1	BNC	IN	AC or DC to 100 Vp
SCOPE CH2	BNC	IN	AC or DC to 100 Vp
DVM	BNC	IN	AC or DC to 100 Vp
GEN	TNC	OUT	RF SIGNAL GENERATOR
T/R	N-Type	IN/OUT	HIGH PWR RF IN, DPLX OUT
ANTENNA	TNC	IN	LOW LVL RF INPUT

**TABLE OF I/O CONNECTORS
2975 REAR PANEL**

CONNECTOR NAME	CONNECTOR TYPE	SIGNAL IN/OUT	SIGNAL TYPE
SA IF	BNC	OUT	SPECTRUM ANALYZER IF
SA VIDEO	BNC	OUT	SPECTRUM ANALYZER DETECTOR OUT
Q OUT	BNC	OUT	NOT USED
I OUT	BNC	OUT	NOT USED
SYNC	BNC	IN	
EXT TRIG	BNC	IN	AUX OSCILLOSCOPE TRIGGER IN
EXT REF IO	BNC	IN/OUT	FREQ STD IN/OUT

PIN-OUT TABLE FOR MIC CONNECTOR

PIN NUMBER	SIGNAL NAME	SIGNAL TYPE	I/O
1	GND	GND	GND
2	GND	GND	GND
3	MIC IN	IN	DYNAMIC/ELECTRET
4	PTT	IN	GND=PUSH
5	AUDIO 2(+)	OUT	AUDIO FREQ OUT #2
6	AUDIO 2 GND	GND	AUDIO FREQ OUT #2 GND

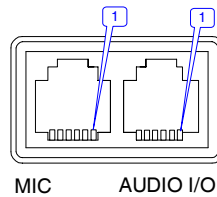

PIN-OUT TABLE FOR AUDIO I/O CONNECTOR

PIN NUMBER	SIGNAL NAME	SIGNAL TYPE	I/O
1	AUDIO IN (+)	IN	AUDIO FREQ IN, BAL/UNBAL, (+)
2	AUDIO IN (-)	IN/GND	AUDIO FREQ IN, BAL/UNBAL, (-)/GND
3	AUDIO 1 (+)	OUT	AUDIO FREQ OUT #1, BAL/UNBAL, (+)
4	AUDIO 1 (-)	OUT/GND	AUDIO FREQ OUT #1, BAL/UNBAL, (-)/GND
5	AUDIO 2 (+)	OUT	AUDIO FREQ OUT #2
6	AUDIO 2 GND	GND	AUDIO FREQ OUT #2 GND

PIN-OUT TABLE FOR GPIB CONNECTOR

PIN NUMBER	ASSIGNMENT	PIN NUMBER	ASSIGNMENT
1	DIO 1	13	DIO 5
2	DIO 2	14	DIO 6
3	DIO 3	15	DIO 7
4	DIO 4	16	DIO 8
5	EOI	17	REN
6	DAV	18	DIGITAL GND
7	NFRD	19	DIGITAL GND
8	NDAC	20	DIGITAL GND
9	IFC	21	DIGITAL GND
10	SRO	22	DIGITAL GND
11	ATN	23	DIGITAL GND
12	DIGITAL GND	24	DIGITAL GND

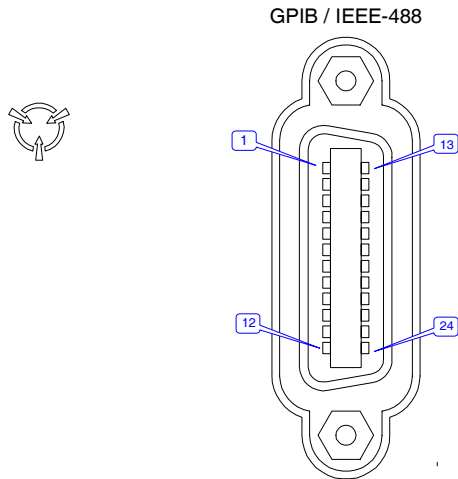

PIN-OUT TABLE FOR RS-232 CONNECTOR

PIN NUMBER	ASSIGNMENT	SIGNAL NAME
1	INPUT	DATA CARRIER DETECT (DCD)
2	INPUT	RECEIVE DATA (RX)
3	OUTPUT	TRANSMIT DATA (TX)
4	OUTPUT	DATA TERMINAL READY (DTR)
5	POWER	DIGITAL GND
6	INPUT	DATA SET READY (DSR)
7	OUTPUT	REQUEST TO SEND (RTS)
8	INPUT	CLEAR TO SEND (CTS)
9	INPUT	RING INDICATOR (RI0)

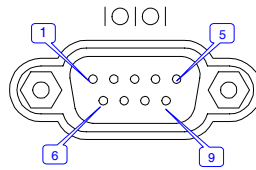

PIN-OUT TABLE FOR PRINTER CONNECTOR

PIN NUMBER	ASSIGNMENT	SIGNAL NAME
1	BI-DIRECTIONAL	/STROBE
2	BI-DIRECTIONAL	PD0
3	BI-DIRECTIONAL	PD1
4	BI-DIRECTIONAL	PD2
5	BI-DIRECTIONAL	PD3
6	BI-DIRECTIONAL	PD4
7	BI-DIRECTIONAL	PD5
8	BI-DIRECTIONAL	PD6
9	BI-DIRECTIONAL	PD7
10	INPUT	/ACK
11	INPUT	BUSY
12	INPUT	PE
13	INPUT	SLCT
14	BI-DIRECTIONAL	/AFD
15	INPUT	/ERR
16	BI-DIRECTIONAL	/INIT
17	BI-DIRECTIONAL	/SLIN
18	POWER	GND
19	POWER	GND
20	POWER	GND
21	POWER	GND
22	POWER	GND
23	POWER	GND
24	POWER	GND

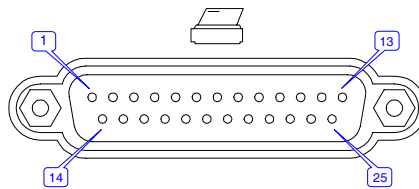

PIN-OUT TABLE FOR TEST PORT CONNECTOR

PIN NUMBER	ASSIGNMENT	PIN NUMBER	ASSIGNMENT
1	DIGITAL IN 1	9	DIGITAL OUT 1
2	DIGITAL IN 2	10	DIGITAL OUT 2
3	DIGITAL IN 3	11	DIGITAL OUT 3
4	DIGITAL IN 4	12	DIGITAL OUT 4
5	DIGITAL IN 5	13	SERIAL OUT
6	N/C	14	N/C
7	GND	15	GND
8	PGM V+ OUT		

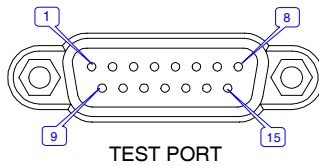

PIN-OUT TABLE FOR VGA CONNECTOR

PIN NUMBER	ASSIGNMENT	PIN NUMBER	ASSIGNMENT
1	RED VIDEO	9	N/C
2	GREEN VIDEO	10	SYNC RETURN
3	BLUE VIDEO	11	MONITOR ID 0
4	MONITOR ID 2	12	MONITOR ID 1
5	GND	13	HORIZONTAL SYNC
6	RED RETURN	14	VERTICAL SYNC
7	GREEN RETURN	15	MONITOR ID 3
8	BLUE RETURN		

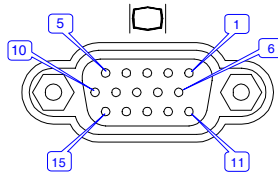

PIN-OUT TABLE FOR MOUSE CONNECTOR

PIN NUMBER	SIGNAL TYPE	SIGNAL NAME	DESCRIPTION
1	Bi-directional	MDATA	Mouse Data
2	N/C		
3	Power	GND	GND
4	Power	+5 V	Supply Voltage
5	Bi-directional	MCLK	Mouse Clock
6	N/C		
Shell	Earth ground		Chassis ground

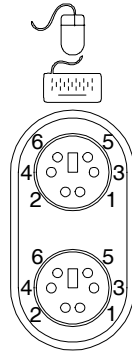

PIN-OUT TABLE FOR KEYBOARD CONNECTOR

PIN NUMBER	SIGNAL TYPE	SIGNAL NAME	DESCRIPTION
1	Bi-directional	KBDATA	Keyboard Data
2	N/C		
3	Power	GND	GND
4	Power	+5 V	Supply Voltage
5	Bi-directional	KBCLK	Keyboard Clock
6	N/C		
Shell	Earth ground		Chassis ground

PIN-OUT TABLE FOR USB CONNECTOR

PIN NUMBER	SIGNAL NAME	SIGNAL TYPE	I/O
1	VCC	PWR	
2	(-) DATA	DATA	I/O
3	(+) DATA	DATA	I/O
4	GND	PWR	
5	VCC	PWR	
6	(-) DATA	DATA	I/O
7	(+) DATA	DATA	I/O
8	GND	PWR	

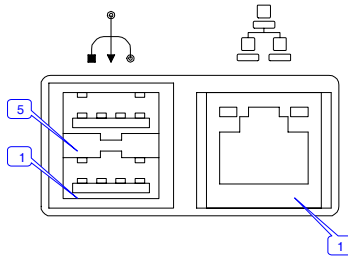

PIN-OUT TABLE FOR ETHERNET CONNECTOR

PIN NUMBER	SIGNAL NAME	SIGNAL TYPE	I/O
1	TX (+)	DATA	OUT
2	TX (-)	DATA	OUT
3	RX (+)	DATA	IN
4	RX (-)	DATA	IN
5	GND	GND	GND
6	GND	GND	GND
7	GND	GND	GND
8	GND	GND	GND

APPENDIX B - REPACKING/SHIPPING

REPACKING FOR SHIPPING

Aeroflex Test Sets returned to factory for calibration, service or repair must be repackaged and shipped subject to the following conditions:

AUTHORIZATION

Do not return any products to factory without authorization from Aeroflex Customer Service Department.

CONTACT: Aeroflex
Customer Service Dept.
10200 West York Street
Wichita, Kansas 67215

Telephone: 800-835-2350
FAX: 316-524-2623
email: service@aeroflex.com

TAGGING TEST SETS

All test sets must be tagged with:

- Owner's identification and address.
- Nature of service or repair required.
- Model No. and Serial No.

SHIPPING CONTAINERS

Test Sets must be repackaged in original shipping containers using Aeroflex packing materials. If original shipping containers and materials are not available, contact Aeroflex Customer Service Department for shipping instructions.

FREIGHT COSTS

All freight costs on non-warranty shipments are assumed by the customer. (See "Warranty Packet" for freight charge policy on warranty claims.)

REPACKING PROCEDURE

- Make sure bottom packing mold is seated on floor of shipping container.
- Adjust handle to lay unlocked against Test Set as shown.
- Place Elastic Retainer around Test Set to secure handle.
- Carefully wrap Test Set with polyethylene sheeting.
- Place Test Set into shipping container, making sure Test Set is securely seated in bottom packing mold.
- Place top packing mold over top of Test Set and press down until mold rests solidly on bottom packing mold.
- Close shipping container lids and seal with shipping tape or an industrial stapler. Tie all sides of container with break resistant rope, twine or equivalent.

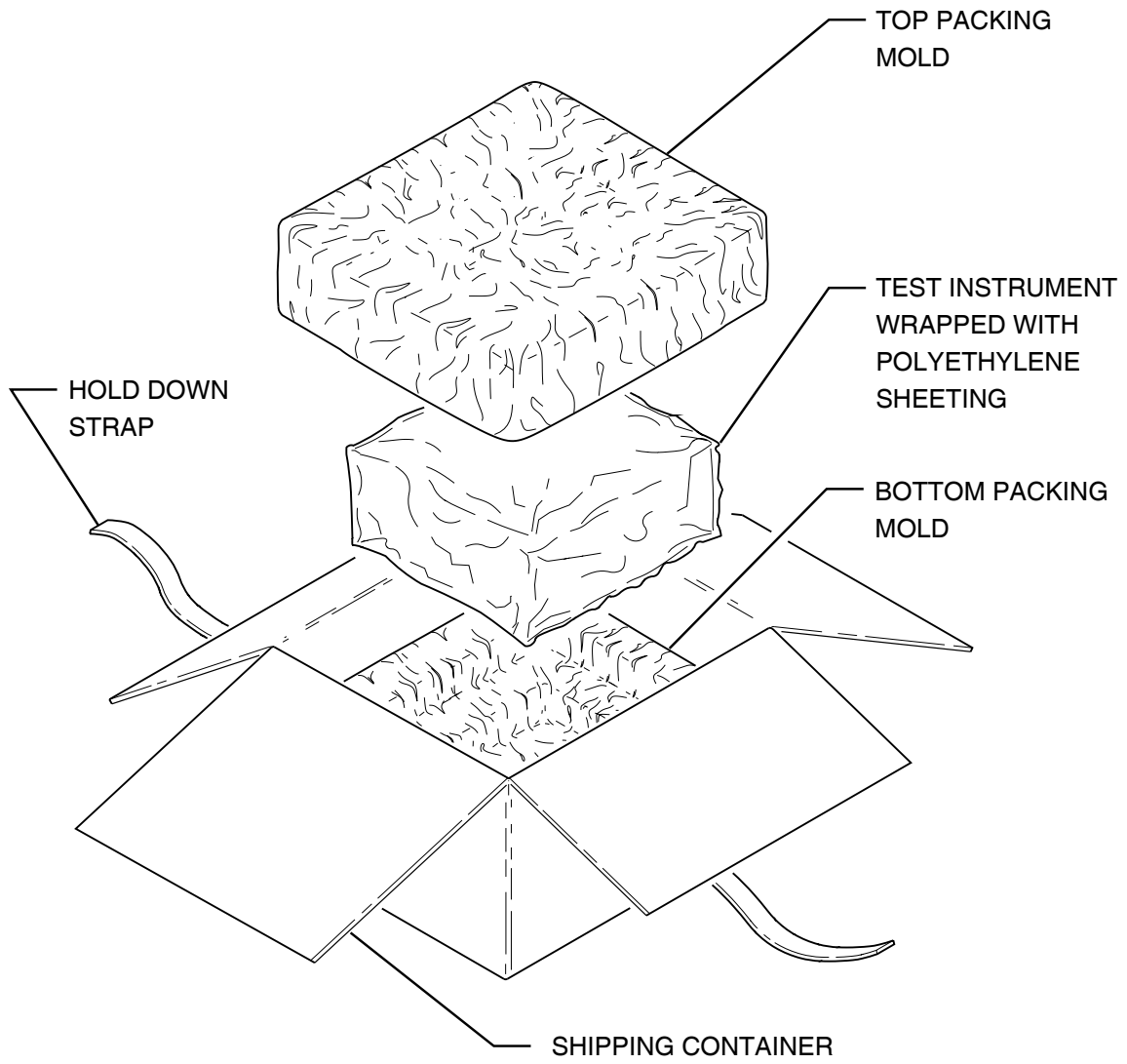

Repacking Procedure
Figure 1

APPENDIX C - P-25 TERMINOLOGY

A	Acknowledgement request bit in a data packet. A = 1 to request an ACK
ACK	Acknowledgement
ALGID	Algorithm Identifier describes the type of encryption being used on the link.
C4FM	Compatible 4-level FM version of QPSK-c modulation
CQPSK	Compatible QPSK version of QPSK-c modulation
CRC	Cyclic Redundancy Check; data packets have several CRCs
Dibit	Two bits grouped together to represent a 4-level symbol
DID	Destination Identifier call destination, default value and reference as for SID.
DUID	Data Unit Identifier
ES	Encryption Synchronization information
FMF	Full Message Flag in data packet. FMF = 1 for a full message
FS	Frame Synchronization to mark the first information bit
FSNF	Fragment Sequence Number Field in a data packet
Golay	Name of a standard error correction code
IMBE	Improved Multi-Band Excitation coder for voice
IO	Inbound/Outbound bit in a data packet. IO = 0 for inbound
KID	Key Identifier identifies which key is in use for encryption.
LC	Link Control information
LCF	Link Control Format describes the contents of the Link Control Word and has four predefined values.
LDU	Link Data Unit, there is an LDU 1 and LDU 2 for voice
LLID	Logical Link Identifier, can be either a source or destination ID
LSD	Low Speed Data embedded in voice. Reserved for message services.
MFID	Manufacturer's Identifier is a set of reserved values to identify equipment.
MI	Message Indicator
NAC	Network Access Code has 4096 values and are mapped into the CTSS (Continuous Tone Coded Squelch System) and also CDCSS (Continuous Digital Coded Squelch System).
NID	Network Identifier, contains the NAC and DUID
N(S)	Sending Number for a data packet, to distinguish duplicate packets
Octet	Eight bits grouped together, also called a byte
QPSK-c	Compatible Quadrature Phase Shift Keying family of modulations
RS	Reed-Solomon error correction code
SAP	Service Access Point, where a network provides a service.
SID	Source Identifier is for individual radio units default value \$000000 indicating no one.

SS Status Symbol to represent whether a channel is busy or idle

Status Symbols Describes the availability of the inbound channel and therefore represents part of the message from a repeater (which the RTS is for Terminal testing).

01	Inbound Channel is Busy
00	Unknown, use for Talk-Around
10	Unknown, use for Inbound or Outbound
11	Inbound Channel is Idle

TGID Talk Group Identifier identifies the talk group selected. Default values for no one = \$0000, default talk group = \$0001 and everyone = \$FFFF.

VC Voice Code word, encodes 20 ms of speech with IMBE

INDEX

A		F	
AC Power	1-19	Filter Pass Band Adjustments	4-19
Fuse Requirements	1-20	Front Panel Connectors	1-22
Specifications	1-20	Function Generator Mode	2-35
AF Counter, Function	2-63	Functions and Capabilities	1-1
Alphabetical Quick Reference TCL		Fuse Requirements, AC	1-20
Commands	5-12		
AM Modulation Meter, Function	2-59	G	
Analog Receiver Testing	4-11	Generate Functions, Specifications	
Analog Transmitter Testing	4-8	Amplitude (Gen Port)	1-5
Applications	4-1	Amplitude (T/R Port)	1-6
Audio Frequency Generator, Specifications	1-17	Digital Modulation	1-7
Accuracy (Sine Wave)	1-17	Frequency	1-5
Amplitude	1-17	Frequency Agility	1-6
Frequency	1-18	GEN Port	1-5
Resolution	1-17	GEN Port VSWR	1-5
Wave Shape Formats	1-17	Modulation – AM	1-7
Audio Route, Function	2-11	Modulation - FM	1-6
		P25 Standard Symbols	1-8
		Spectral Purity	1-6
		Generator Mode	2-22
B		M	
Base Band Audio Functions, Specifications	1-18	Measuring Cable Fault	4-13
Audio Frequency Counter	1-19	Measuring Filters	4-17
Input Impedance	1-19	Measuring Return Loss	4-15
Microphone Audio Input	1-19	Meter Panel, Function	2-67
BER Meter, Function	2-65	Meters, Operation	
		AF Counter	2-63
C		AM Modulation Meter	2-59
Compliance Specification	1-21	BER Meter	2-65
Connector Pin Out Tables		Deviation Meter	2-58
Front Panel	App A, p 1	Digital (AC/DC) Voltmeter	2-60
Rear Panel	App A, p 1	Distortion Meter	2-54
MIC Connector	App A, p 2	Meter Panel	2-67
Audio I/O Connector	App A, p 2	Mod Fidelity Meter	2-62
GPIN Connector	App A, p 3	Power Meter	2-56
RS-232 Connector	App A, p 4	RF Error Meter	2-64
Printer Connector	App A, p 5	RSSI Meter	2-57
Test Port Connector	App A, p 6	Sinad Meter	2-52
VGA Connector	App A, p 6	Mod Fidelity Meter, Function	2-62
Mouse Connector	App A, p 7	Modes, Operation	
Keyboard Connector	App A, p 7	AF Counter	2-63
USB Connector	App A, p 8	AM Modulation Meter	2-59
Ethernet Connector	App A, p 8	BER Meter	2-65
Controls, Connectors and Indicators	1-22	Deviation Meter	2-58
2975 Front Panel	1-22	Digital (AC/DC) Voltmeter	2-60
2975 Rear Panel	1-24	Distortion Meter	2-54
		Duplex Mode	2-34
		Function Generator	2-35
		Generator Mode	2-22
		Meter Panel	2-67
		Mod Fidelity Meter	2-62
		Power Meter	2-56
		Receiver Mode	2-31
		RF Error Meter	2-64
		RSSI Meter	2-57
		Scope (Oscilloscope)	2-39
		Sinad Meter	2-52
		Spectrum Analyzer	2-43
D		N	
Description	1-1	Network Connectivity	2-12
DEMOD Filter	2-15	Notch Filter Adjustments	4-20
Deviation Meter, Function	2-58		
Digital (AC/DC) Voltmeter, Function	2-60		
Digital I/O, Specifications	1-20		
Digital Receiver Testing	4-6		
Digital Transmitter Testing	4-1		
Distortion Meter, Function	2-54		
Duplex Mode	2-34		
DVM Functions Specifications	1-19		
AC	1-19		
DC	1-20		
E			
EMC and Safety Compliance	1-21		
Environmental Specifications	1-21		

O		P	
Oscilloscope (Scope) Mode	2-39	P25 Downlink Data Tile	2-19
Specifications	1-16	P25 Self Check	4-21
Horizontal Sweep	1-16	P25 Terminology	App C, p 1
Special Functions	1-17	P25 Uplink Data Tile	2-16
Trigger Source	1-16	Power Specifications, AC	1-20
Operation	2-1	Power Meter, Function	2-56
2975 Operation	2-3		
Monitor and Control Functions	2-2	R	
Operation Modes	2-22	Rear Panel Connectors	1-24
AF Counter	2-63	Receive Functions, Specifications	1-8
AM Modulation Meter	2-59	10.7 MHz I/F Output	1-8
BER Meter	2-65	AM Modulation Meter	1-10
Deviation Meter	2-58	ANT Port	1-8
Digital (AC/DC) Voltmeter	2-60	ANT Port VSWR	1-8
Distortion Meter	2-54	Audio Frequency Counter	1-11
Duplex Mode	2-34	Digital Demodulation Meter (C4FM)	1-13
Function Generator	2-35	Distortion Meter	1-12
Generator Mode	2-22	Filters	1-8
Meter Panel	2-67	FM Deviation Meter	1-9
Mod Fidelity Meter	2-62	Frequency Counter/Error Meter	1-9
Power Meter	2-56	LO Emissions	1-8
Receiver Mode	2-31	Power Meter	1-8
RF Error Meter	2-64	RSSI Meter	
RSSI Meter	2-57	(Receive Signal Strength Indicator)	1-11
Scope (Oscilloscope)	2-39	SINAD Meter	1-12
Sinad Meter	2-52	Receiver Mode	2-31
Spectrum Analyzer	2-43	Receiver Find Frequency	2-15
Selecting Modes	2-4	Remote Commands	5-1
Optional Functions and Features	1-2, 3-1	Alphabetical Quick Reference	5-12
Description	3-3	Controlling the 2975	5-6
AES	3-8	Controlling the 2975 Display	5-7
Audio Analyzer	3-14	Introduction	5-1
Audio Simulcast	3-16	Recalling Saved Instrument States	5-8
Auto Test	3-6	TCL Basics	5-4
Control Channel Logger	3-4	Repacking	
KVL ASN	3-9	Diagram	App B, p 2
KVL Keyloader	3-9	Procedure	App B, p 1
LSM Advanced	3-12	RF Error Meter, Function	2-64
LSM/P25 Phase II	3-8	RF Generator Control	2-9
LTR® Trunking	3-17	RSSI Meter, Function	
PassPort®	3-18	(Receive Signal Strength Indicator)	2-57
P25 Explicit Adjacent Status		S	
Broadcast Control Channel Message	3-22	Safety Compliance, EMC and	1-21
P25 Explicit Mode of Operation	3-20	Service Upon Receipt	App D, p 1
P25 Explicit Unit to Unit		Shipping	App B, p 1
and PSTN Emulation	3-21	Setup / Recall Feature	2-10
P25 Trunking	3-3	Scope (Oscilloscope) Mode	2-39
P25 Trunking VHF / UHF / 700 MHz	3-13	Signaling Encoder, Specifications	1-18
RX BER	3-17	CTCSS Encode	1-18
Secondary Control Channel		DCS Encode	1-18
(SCCB) Broadcast	3-19	DTMF Encode	1-18
SmartNet™ / SmartZone™	3-3	Sinad Meter, Function	2-52
SmartNet™ / SmartZone™ 900 MHz	3-5		
Installation of Options	3-2		
Selecting Options	2-5		
Oscilloscope, Specification			
Horizontal Sweep	1-16		
Special Functions	1-16		
Trigger Source	1-16		

	S (cont)			
Specifications		1-5		
AC Power		1-20		
Audio Frequency Generator		1-17		
Base-Band Audio Functions		1-18		
Compliance		1-21		
Digital I/O		1-20		
DVM Functions		1-19		
Environmental/Mechanical		1-21		
Generate Functions		1-5		
Receive Functions		1-8		
Signaling Encoder		1-18		
Scope (Oscilloscope)		1-16		
Spectrum Analyzer		1-13		
Time Base		1-16		
Warranty		1-21		
Spectrum Analyzer				
Function		2-43		
Specifications		1-13		
1 dB Compression		1-13		
3 rd Order Intermod		1-14		
Amplitude (Vertical)		1-14		
Harmonic Spurious		1-14		
Non-Harmonic Spurious		1-14		
Resolution Bandwidth		1-15		
Special Functions		1-15		
Spectrum Analyzer Video Output		1-15		
Sweep Accuracy (Horizontal)		1-13		
Tracking Generator		1-15		
Video Bandwidths		1-15		
System Settings		6-1		
	T			
TCL (Remote) Commands		5-1		
Command Verbs		5-10		
Commands		5-22		
Connections		5-1		
Controlling the 2975		5-6		
Controlling the 2975 Display		5-7		
Introduction		5-1		
Quick Reference List		5-12		
Saved Instrument States		5-8		
TCL Basics		5-4		
Testing				
Analog Receiver		4-11		
Analog Transmitter		4-8		
Cable Fault Measurement		4-13		
Digital Receiver		4-6		
Digital Transmitter		4-1		
Filter Measurements		4-17		
Filter Pass Band Adjustments		4-19		
P25 Self Check		4-21		
Return Loss Measurement		4-15		
Time Base, Specification		1-16		
Accuracy		1-16		
Input Level		1-16		
Output Level		1-16		
Warmup		1-16		
Tone Signaling Decode		2-7		
	U			
User Screen		2-3		
			V	
			Volume and Squelch Control	2-9
			W	
			Warranty, Specifications	1-21
			Z	
			Zoom Feature	2-6

THIS PAGE INTENTIONALLY LEFT BLANK.

As we are always seeking to improve our products, the information in this document gives only a general indication of the product capacity, performance and suitability, none of which shall form part of any contract. We reserve the right to make design changes without notice.

CHINA	Tel: [+86] (10) 6467 2716	Fax: [+86] (10) 6467 2821
FRANCE	Tel: [+33] 1 60 79 96 00	Fax: [+33] 1 60 0177 69 22
HONG KONG	Tel: [+852] 2832 7988	Fax: [+852] 2834 5364
SCANDINAVIA	Tel: [+45] 9614 0045	Fax: [+45] 9614 0047
SPAIN	Tel: [+34] (91) 640 11 34	Fax: [+34] (91) 640 06 40
UNITED KINGDOM	Tel: [+44] (0) 1438 742200 Toll Free: 0800 282388 (UK only)	Fax: [+44] (0) 1438 7276
USA	Tel: [+1] (316) 522 4981 Toll Free: 800 835 2352 (US only)	Fax: [+1] (316) 522 1360

The logo for AEROFLEX features a stylized 'A' icon on the left, composed of a blue triangle pointing down and a grey triangle pointing up, followed by the word 'AEROFLEX' in a bold, black, sans-serif font.

Our passion for performance is defined by three attributes represented by these three icons: solution-minded, performance-driven, customer-focused.