

SIGNAL GENERATORS

2040 series

2040 10 kHz to 1.35 GHz
2041 10 kHz to 2.7 GHz
2042 10 kHz to 5.4 GHz

Includes information on:

Option 001 - Second modulation oscillator
Option 002 - Pulse modulation
Option 003 - High output power
Option 006 - Avionics
Option 008 - RF profiles and complex sweep
Option 100 - Single fuse version
Option 105 - Modified pulse modulation

This manual applies to instruments with software issues of 5.003 and higher.

© Marconi Instruments Ltd. 1993

No part of this book may be reproduced or transmitted in any form or by any means, electronic or mechanical, including photocopying, or recorded by any information storage or retrieval system, without permission in writing by Marconi Instruments Ltd.

Printed in the UK

Manual part no. 46882-074C

Issue 13

29 June 1993

CONTENTS

	Page
Preface	iii
Operating precautions	iv
Chapter 1 GENERAL INFORMATION	1-1
Chapter 2 INSTALLATION	2-1
Chapter 3-1 OPERATION	3-1-1
Chapter 3-2 GPIB OPERATION	3-2-2
Chapter 4-1 BRIEF TECHNICAL DESCRIPTION	4-1-1
Chapter 5-1 ACCEPTANCE TESTING	5-1-1
App. 5-1-A ACCEPTANCE TESTING SECOND MODULATION OSCILLATOR OPTION	5-1-A-1
App. 5-1-B ACCEPTANCE TESTING PULSE MODULATION OPTION	5-1-B-1
App. 5-1-C ACCEPTANCE TESTING HIGH OUTPUT POWER OPTION	5-1-C-1
Annex A OPTION 006 AVIONICS	Annex A-1
Annex B OPTION 008 RF PROFILE AND COMPLEX SWEEP	Annex B-1
Index	Index 1

PREFACE

WARNINGS, CAUTIONS and NOTES

These terms have specific meanings in this manual:-





WARNINGS contain information to prevent personal injury.

CAUTIONS contain information to prevent damage to the equipment.

Notes contain important general information.

HAZARD SYMBOLS

The meaning of hazard symbols appearing on the equipment is as follows:

Symbol	Nature of hazard	Reference in manual
	Dangerous voltage	Page iv
	Beryllium	Page v
	Fire hazard	Page iv
	Lithium batteries are used in this equipment. Appropriate caution should be exercised when handling these items.	Page v

SAFETY

This product has been designed and tested in accordance with BS4743 'Specification for safety requirements for electronic measuring apparatus' and IEC Publication 348 'Safety requirements for electronic measuring apparatus'.

OPERATING PRECAUTIONS

WARNING - ELECTRICAL HAZARDS

AC supply voltage. This equipment conforms with IEC Safety Class 1, meaning that it is provided with a protective grounding lead. To maintain this protection the supply lead must always be connected to the source of supply via a socket with a grounded contact.

Be aware that the supply filter contains capacitors that may remain charged after the equipment is disconnected from the supply. Although the stored energy is within the approved safety requirements, a slight shock may be felt if the plug pins are touched immediately after removal.

Removal of covers. Disconnect the supply before removing the covers so as to avoid the risk of exposing high voltage parts. If any internal adjustment or servicing has to be carried out with the supply on, it must only be performed by a skilled person who is aware of the hazard involved.

Fuses. Note that there are supply fuses in both the live and neutral wires of the supply lead. If only one of these fuses should rupture, certain parts of the equipment could remain at supply potential.

For Option 100, single fuse version only:

Fuses. Note that the internal supply fuse is in series with the live (brown) conductor of the supply lead. If connection is made to a 2-pin unpolarized supply socket, it is possible for the fuse to become transposed to the neutral conductor, in which case, parts of the equipment could remain at supply potential even after the fuse has ruptured.

WARNING - FIRE HAZARD

Make sure that only fuses of the correct rating and type are used for replacement.

If an integrally fused plug is used on the supply lead, ensure that the fuse rating is commensurate with the with current requirements of this equipment. See under 'Performance Data' in Chapter 1 for power requirements.

CAUTION - PULSE INPUT

Before switching the instrument on, ensure that no signal voltage is present on the PULSE INPUT socket.

WARNING - OTHER HAZARDS

Some of the components used in this equipment may include resins and other materials which give off toxic fumes if incinerated. Take appropriate precautions, therefore, in the disposal of these items.

Beryllia (beryllium oxide) is used in the construction of some of the components in this equipment.

This material, if incorrectly handled, could cause a danger to health - refer to the Maintenance part of the Service Manual for safe handling precautions.

A **Lithium** battery is used in this equipment.

Lithium is a toxic substance. Therefore these items should in no circumstances be crushed, incinerated or disposed of in normal waste.

CAUTION - STATIC SENSITIVE COMPONENTS

This equipment contains static sensitive components which may be damaged by handling - refer to the service manual for handling precautions.

CAUTION - TILT FACILITY

When the instrument is in the tilt position, it is inadvisable for stability reasons, to stack other instruments on top of it.

Blank Page

Chapter 1

GENERAL INFORMATION

CONTENTS

	PAGE
INTRODUCTION	1-2
MAIN FEATURES	1-2
Operation	1-2
Display	1-2
Frequency selection	1-2
Output	1-2
Modulation	1-3
Incrementing	1-3
Sweep	1-3
Non-volatile memory	1-3
Programming	1-4
Protection	1-4
Spectral purity	1-4
Calibration	1-4
Options	1-4
PERFORMANCE DATA	1-5

LIST OF FIGURES

Fig. 1-1 Typical phase noise performance of 2040 series	1-5
---	-----

INTRODUCTION

The 2040 series of Signal Generators cover the frequency range 10 kHz to 5.4 GHz with three models: 2040 (10 kHz to 1.35 GHz), 2041 (10 kHz to 2.7 GHz) and 2042 (10 kHz to 5.4 GHz). A dot matrix display with soft key selected screen options allow flexibility of operation and ease of use. The output may be amplitude, phase, or frequency modulated with pulse modulation available as an option. Modulation is available using a combination of up to two external signal inputs and a built-in LF source (a second internal source is optional).

Microprocessor control ensures that the instruments are flexible and easy to use and allows programming by the General Purpose Interface Bus (GPIB). The GPIB is designed to IEEE Standard 488.2 and is a means of sending commands to an instrument, via a data bus, from a remote controller or personal computer. The instruments can therefore be used manually or as part of a fully automated test system.

MAIN FEATURES

Operation

Selection of parameters on the screen may involve one or more of the numeric, hard or soft keys or the rotary knob. Hard keys have single or dual functions which remain constant throughout, whereas soft keys have functions dependent on the present mode of operation. Parameters may be set to specific values by numeric key entry, while values may be varied in steps of any size using the \uparrow/\downarrow keys or altered by moving the knob, set to a particular sensitivity.

The SIG GEN, LF, SWEEP, MEM (memory), Δ (delta) and UTIL (utility) menus are selectable, at any point of operation, via the keys below the display panel. Within the display, the soft key functions are indicated by labels which appear alongside the keys situated at either side of the display panel.

Display

The display is a dot matrix liquid crystal panel, with backlighting. Carrier frequency, modulation and RF level are shown in horizontal regions on the principal screen. The display features 11-digit resolution for carrier frequency, 4-digit for RF level and 3-digit for modulation, with unit annunciators.

Contrast may be varied, using the control knob, to optimize the viewing angle. Differing lighting conditions may be accommodated using the backlight intensity function, variable from no backlight to full intensity. A full graphical display test is available, refer to the Service Manual.

Frequency selection

Carrier frequency is selected via the soft key option on the SIG GEN display and direct entry via the keyboard. Alternatively, selection may be made via the General Purpose Interface Bus (GPIB). Frequency resolution is 0.1 Hz across the band. Carrier frequencies can be stored in a non-volatile memory with complete recall when required. An ON-OFF key is provided to completely disable the output.

Output

RF output up to +13 dBm can be set by direct keyboard entry with a resolution of 0.1 dB or better over the entire range. A high output option is available to extend the maximum calibrated level to +19 dBm on the 2040 instrument.

An extended hysteresis facility allows for extended electronic control of RF output level without introducing mechanical attenuator transients when testing squelch systems.

A low intermodulation mode can be selected which disables the RF levelling system and improves the intermodulation performance when combining the outputs of two signal generators.

A choice of calibration units is available to the operator and provision is made for the simple conversion of units (for example, dBm to μV). Calibration data for the output level is held in memory and may be altered from the front panel or over the interface bus.

The output level can be offset by up to ± 2 dB by keyboard entry. Offsets from the calibrated value may be used to compensate for cable or switching losses external to the generator. This facility can be used as a means of deliberately offsetting the output level to ensure that all generators in an area give identical measurements. While using the offsetting facility, the principal calibration of the generator is not lost and may be returned to at any time.

An electronic trip protects the generator output against reverse power of up to 50 W, preventing damage to output circuits when RF or DC power is accidentally applied.

Modulation

Comprehensive amplitude, frequency (plus wide bandwidth FM), phase and optional pulse modulation are provided for testing a wide range of receivers. An internal modulation oscillator is provided, having a frequency range of 0.1 Hz to 500 kHz, with a resolution of 0.1 Hz. A second modulation oscillator can be included as an option. Two independent BNC inputs on the front panel allow external modulation signals to be mixed with the internal signal(s). Therefore, a maximum of four modulation sources may be available at one time. These sources may be combined to give the single, dual, composite and dual composite modes, see 'MODULATION MODES', Chap. 3-1.

The signalling facility allows testing of radio equipment with sequential and sub-audible tone capability. The sequential calling tone system is accessible from the utility menu for all four modulation modes. Sub-audible calling tones are specified within the modulation source select display.

Incrementing

All major parameters can be incremented or decremented in step sizes entered via keyboard entry or the GPIB. If no step size is entered for a parameter, the steps are preset to 1 kHz for carrier frequency, 1 kHz for modulation oscillator and LF frequency, 1 kHz for FM deviation, 1% for AM depth and 1 dB for output level.

In addition the rotary control can be used to vary the parameter with the sensitivity of the knob being changed by means of the $\times 10$ and $\div 10$ keys.

Sweep

The sweep capability of the 2040 series allows comprehensive testing of systems. Four parameters are used to specify sweep; start, stop, number of steps and time per step. These are specified by the user, with upper and lower limits for the parameter values being dependent on the function. The sweep markers menu is available by soft key selection on the sweep display, allowing the placement of up to five user defined markers.

Non-volatile memory

The non-volatile memory allows 50 complete instrument settings, 50 partial settings, 100 carrier frequency settings, 20 sweep settings and 20 signalling tone sequences to be stored for later use at any time.

Programming

A GPIB interface is fitted so that all functions are controllable via the interface bus which is designed to the IEEE Standard 488.2. The instrument can function both as a talker and a listener.

Protection

To prevent accidental interference with the contents of internal memories, internal data is protected by a secure key sequence.

Two levels of protection are offered, appropriate to the function being accessed. The most secure is reserved for features which alter the calibration data of the instrument. The first level of protection is less severe, enabling the user to access functions which are relevant to normal operation, such as selecting the RF level calibration units, RF level offsets and external standard frequency.

Spectral purity

With an SSB phase noise performance of better than -140 dBc/Hz at 1 GHz (20 kHz offset), the 2040 series can be used for both in-channel and adjacent channel receiver measurements. Harmonically related signals and non-harmonics are better than -30 dBc and -90 dBc respectively.

Calibration

The 2040 series has a two year calibration interval and is calibrated entirely by electronically controlled adjustment. There are no internal mechanically adjustable components to affect the calibration. The calibration display is available via soft key selection at the utilities menu.

Options

The following factory-fitted options are available:

Option 001 - Second modulation oscillator

An additional modulation oscillator is available to enable greater flexibility. This second oscillator has the same specification as the first and allows full use of complex modulation modes.

Option 002 - Pulse modulation

The pulse modulation facility allows radar RF and IF stages to be tested and features rise and fall times of less than 15 ns with an on/off ration of better than 70 dB.

Option 003 - High output power

This option extends the output level to +19 dBm on the 2040 model.

Option 006 - Avionics

Provides internally generated modulation waveforms suitable for the testing of Instrument Landing systems (ILS) and VHF Omni Range (VOR) beacons.

Option 008 - RF profiles and complex sweep

The RF profile facility provides compensation for frequency dependent level errors introduced by cables, amplifiers and signal combiners. The complex sweep facility generates sweeps whose step size, step time and RF level change while the sweep is in progress. These features are particularly useful for EMC, Tempest and ATE applications.

Option 100 - Single fuse

A single fuse is used in place of the standard double fuse.

Option 105 - Modified pulse modulation

Modifies the pulse modulator (Option 002) to provide a slower rise and fall time for testing time domain duplex and time domain multiple access receivers.

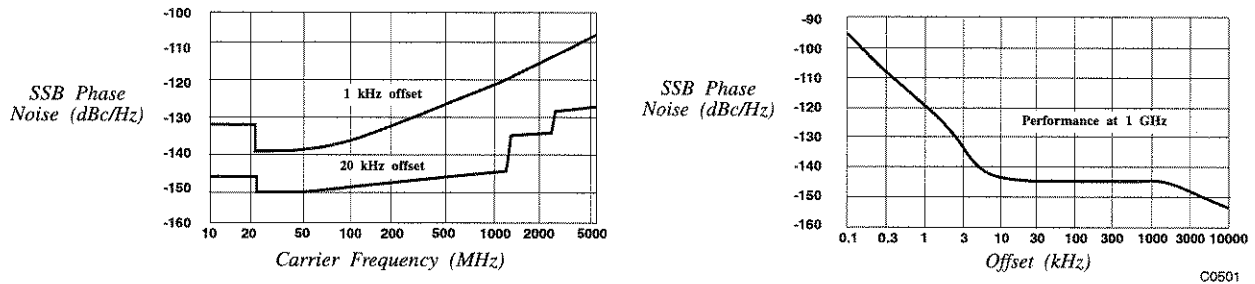

Fig. 1-1 Typical phase noise performance of 2040 series

PERFORMANCE DATA

Carrier frequency

Range	10 kHz to 1.35 GHz (2040); 10 kHz to 2.7 GHz (2041); 10 kHz to 5.4 GHz (2042).
Selection	By keyboard entry of data. Variation by \uparrow/\downarrow keys and by rotary control.
Indication	11 digits with annunciators.
Resolution	0.1 Hz.
Accuracy	As frequency standard.
Phase incrementing	The carrier phase can be advanced or retarded in steps of $\pi/128$ radians (approximately 1.4°) using the rotary control.

RF OUTPUT

Range -144 dBm to +13 dBm (2040, 2041);
 -144 dBm to +19 dBm (2040 with Option 003);
 -144 dBm to +13 dBm (2042), derated over 4 GHz by 0.1 dB/°C above 40°C.

When AM is selected the maximum output level reduces linearly with AM depth to +7 dBm (+13 dBm for 2040 with Option 003) at maximum AM depth.

Selectable overrange mode allows uncalibrated output levels to +19 dBm to be generated.

Selectable extended hysteresis provides for uncalibrated level control over an 24 dB range without the mechanical attenuator operating.

Selection By keyboard entry of data. Variation by ↑/↓ keys and by rotary control. Units may be μV , mV, V EMF or PD; dB relative to 1 μV , 1 mV EMF or PD; dBm. Conversion between dB and voltage units may be achieved by pressing the appropriate units key (dB, or V, mV, μV).

Indication 4 digits with unit annunciators.

Resolution 0.1 dB.

Overtime* Adjustable up to typically +19 dBm (typically +25 dBm for 2040 with Option 003).

Extended electronic level setting range* Non-interrupting level control range of 18 dB.

* When mode is enabled.

Accuracy At 23 ± 5 °C ambient:

Output level	Carrier frequency range		
	10 kHz to 1.35 GHz	1.35 GHz to 2.7 GHz	2.7 GHz to 5.4 GHz
> -127 dBm	± 0.85 dB	± 1.0 dB	-
> -100 dBm	± 0.85 dB	± 1.0 dB	± 1.5 dB
> -50 dBm	± 0.85 dB	± 1.0 dB	± 1.5 dB
> =0 dBm	± 0.50 dB	± 0.7 dB	± 1.0 dB
Temperature coefficient (dB/°C)	± 0.005	± 0.01	± 0.02

2040 with Option 003: ± 1.2 dB for output levels greater than -127 dBm.

VSWR	For output levels less than 0 dBm: Less than 1.25:1 to 2.2 GHz (return loss greater than 19.1 dB); Less than 1.4:1 to 2.7 GHz. (return loss greater than 15.6 dB); Less than 1.5:1 to 5.4 GHz (return loss greater than 14 dB).
Output protection	An electronic trip protects the generator output against reverse power of up to 50 W from a source VSWR of up to 5:1.
Output connector	50 Ω normal, N-type female socket.

SPECTRAL PURITY

At RF levels up to +7 dBm :-

Harmonics	2040, 2041: Better than -30 dBc for carrier frequencies to 1 GHz; Better than -27 dBc for carrier frequencies to 2.7 GHz. Better than -27 dBc for carrier frequencies to 1.35 GHz; (2040 with Option 003). 2042: Better than -25 dBc for carrier frequencies to 5.4 GHz.
Sub-harmonics	Better than -90 dBc to 1.35 GHz, Better than -40 dBc to 2.3 GHz, Better than -30 dBc to 5.4 GHz.
Non-harmonics (offsets greater than 3 kHz)	In low noise mode 1: Better than -70 dBc up to 21.09375 MHz; better than -90 dBc from 21.09375 MHz to 2.7 GHz; and better than -84 dBc from 2.7 to 5.4 GHz. In normal mode: Better than -70 dBc to 5.4 GHz.
Residual FM (FM off)	Low noise mode: Less than 0.3 Hz RMS deviation in a 300 Hz to 3.4 kHz unweighted bandwidth at 1 GHz. Normal mode: Less than 7 Hz RMS deviation in a 300 Hz to 3.4 kHz unweighted bandwidth at 470 MHz.
SSB phase noise	Low noise mode 1: Less than -115 dBc/Hz at an offset of 1 kHz from a carrier frequency of 1 GHz; Less than -140 dBc/Hz at an offset of 20 kHz from a carrier frequency of 1 GHz. Normal mode: Less than -116 dBc/Hz (typically -122 dBc/Hz) at an offset of 20 kHz from a carrier frequency of 470 MHz.
RF leakage	Less than 0.5 μ V PD generated at the carrier frequency across a 50 Ω load by a two turn 25 mm loop, 25 mm or more from the case of the generator with the output terminated in a 50 Ω sealed load.
FM on AM	Typically less than 100 Hz for 30% AM depth at a modulation frequency of 1 kHz and a carrier frequency of 500 MHz.
Φ M on AM	Typically less than 0.1 radians at a carrier frequency of 500 MHz for 30% AM depth for modulation rates up to 10 kHz.

MODULATION MODES

Four modulation modes are available:

- Single FM, Wideband FM, Φ M, AM or pulse (optional).
- Dual Two independent channels of differing modulation type (e.g. AM with FM).
- Composite Two independent channels of the same modulation type. (e.g. FM1 with FM2).
- Dual composite A combination of Dual and Composite modes providing four independent channels (e.g. AM1 with AM2 and FM1 with FM2).
- Phase modulation can be used instead of FM (but not simultaneously).

FREQUENCY MODULATION

- Deviation Peak deviation from 0 to 1 MHz for carrier frequencies up to 21.09375 MHz;
Peak deviation from 0 to 1% of carrier frequency above 21.09375 MHz.

Deviation for 2040 series in low noise mode is limited to:

Carrier frequency range	Deviation limit
2.7 GHz - 5.4 GHz	200.0 kHz
1.35 GHz - 2.7 GHz	100.0 kHz
675 MHz - 1.35 MHz	50.0 kHz
337.5 MHz - 675 MHz	25.0 kHz
168.75 MHz - 337.5 MHz	12.5 kHz
84.375 MHz - 168.75 MHz	6.25 kHz
42.1875 MHz - 84.375 MHz	3.125 kHz
21.09375 MHz - 42.1875 MHz	1.0625 kHz
below 21.09375 MHz	6.25 kHz

- Selection By keyboard entry of data. Variation by \uparrow/\downarrow keys and by rotary control.
- Indication 3 digits with annunciators.
- Displayed resolution 1 Hz or 1 least significant digit, whichever is greater.
- Accuracy at 1 kHz internal modulation In low noise modes: $\pm 6\%$ of indication ± 1 Hz excluding residual FM.
In normal noise modes: $\pm 5\%$ of indication ± 10 Hz excluding residual FM.

Accuracy at 1 kHz external modulation	In normal mode: $\pm 5\%$ of indication ± 10 Hz excluding residual FM. With ALC off, the modulation is calibrated for an input level of 1.0 V PD RMS sine wave. In low noise mode: $\pm 6\%$ of indication ± 1 Hz excluding residual FM.
1 dB bandwidth	DC to 300 kHz (DC coupled). 10 Hz to 300 kHz (AC coupled). Typically 500 kHz.
3 dB bandwidth	Bandwidth is limited to 100 kHz in low noise mode. Typically greater than 1 MHz. Capable of accepting external sources of FSK signals.
Carrier frequency offset	In DC FM mode less than $\pm(1 \text{ Hz} + 0.1\%$ of set deviation) after using DC FM nulling facility.
Distortion	Using external modulation without ALC: Less than 3% at maximum deviation for modulation frequencies up to 20 kHz. Less than 0.3% at 10% of maximum deviation for modulation frequencies up to 20 kHz.
Modulation source	Internal LF generator or external via front panel sockets.
Group delay	Less than 1 μs , 3 kHz to 500 kHz. In low noise mode less than 3 μs , 3 kHz to 250 kHz.

WIDEBAND FM

Deviation	A rear panel input on a BNC connector allows an external modulation signal to produce up to the maximum deviation. The deviation is controlled in 3 dB steps only and the generator will display the deviation equivalent to 1 V RMS sine wave input.
Indication	3 digits with annunciators.
Selection	By keyboard entry of data. The sensitivity is controlled in 3 dB steps and the display will indicate the value of deviation nearest to the requested value.
Input level	1 V RMS sine wave to achieve indicated deviation.
Accuracy	As FM.
3 dB bandwidth	In normal noise mode typically 10 MHz (DC or AC coupled). In low noise modes typically 250 kHz (DC or AC coupled).
Modulation source	External via rear panel socket (50 Ω impedance).
Group Delay	Less than 0.5 μs , 3 kHz to 10 MHz.

PHASE MODULATION

(Normal mode only)

Deviation	0 to 10 radians in 0.01 radian steps.
Selection	By keyboard entry of data. Variation by \uparrow/\downarrow keys and by rotary control.
Indication	3 digits with annunciators.
Resolution	0.01 radians.
Accuracy at 1 kHz	Better than $\pm 5\%$ of indicated deviation excluding residual phase modulation.
3 dB bandwidth	100 Hz to 10 kHz.
Distortion	Less than 3% at maximum deviation at 1 kHz modulation rate.
Modulation source	Internal LF generator or external via front panel sockets.

AMPLITUDE MODULATION

For carrier frequencies up to 1 GHz (and for output levels less than +13 dBm with Option 003):

Range	0 to 99.9% in 0.1% steps.
Selection	By keyboard entry of data. Variation by \uparrow/\downarrow keys and by rotary control.
Indication	3 digits with annunciator.
Depth accuracy at 1 kHz	$\pm 4\%$ of setting $\pm 1\%$. Usable to 5.4 GHz.
Envelope distortion	For a modulation rate of 1 kHz: Less than 1% total harmonic distortion for depths up to 30%. Less than 3% total harmonic distortion for depths up to 80%.
Modulation source	Internal LF generator or external via front panel sockets.
External AM accuracy	With ALC off the modulation is calibrated for an input level of 1.0 V PD RMS sine wave.
External AM 1 dB bandwidth	With modulation ALC off; DC to 30 kHz in DC coupled mode and 10 Hz to 30 kHz in AC coupled mode. Typical modulation bandwidth exceeds 50 kHz. Modulation bandwidth is limited to 1.5 kHz in low noise mode 1.

MODULATION OSCILLATOR

Frequency range	0.1 Hz to 500 kHz (sine wave).
Selection	By keyboard entry of data. Variation by \uparrow/\downarrow keys and by rotary control.

Indication	7 digits with annunciators.
Resolution	0.1 Hz.
Frequency accuracy	As frequency standard.
Distortion	Less than 0.1% THD in sine wave mode at frequencies up to 20 kHz.
Alternative waveforms	A triangular wave is available for frequencies up to 100 kHz. A square wave is available for frequencies up to 2 kHz (requires Option 006 - Avionics or Option 008 - RF Profiles and Complex Sweep to be fitted).
Signalling tones	The modulation oscillator can be used to generate sequential (up to 16 tones) or sub-audible tones in accordance with EIA, ZVEI1, ZVEI2, DZVEI, CCIR, EURO 1, EEA, NATEL and DTMF* standards. Facilities are also available for creating and storing user defined tone systems. *Requires second modulation oscillator (Option 001) to be fitted.

EXTERNAL MODULATION

Two independent inputs on the front panel with BNC connectors, EXT MOD 1 and EXT MOD 2. The modulation is calibrated with 1 V RMS sine wave applied. Input impedance 100 k Ω nominal.

MODULATION ALC

The EXT MOD 1 and EXT MOD 2 INPUTS can each be levelled by an ALC system.

Level range	0.7 V RMS to 1.4 V RMS sine wave.
Distortion	Less than 0.1% additional distortion for frequencies up to 20 kHz at 1 V RMS sine wave (typically less than 0.1% up to 50 kHz).
1 dB bandwidth	Typically 10 Hz to 500 kHz.

LF OUTPUT

Front panel BNC connector. The output may be configured in either LF Generator Mode to give an output from the internal modulation oscillator or in LF Monitor Mode to give an output from the internal modulation signal paths.

Selection	By keyboard entry of data. Variation by \uparrow/\downarrow keys and by rotary control.
Indication	7 digits with unit annunciators for frequency and 4 digits with unit annunciators for level.
Level	100 μ V to 5 V RMS with a load impedance of greater than 600 Ω . 100 μ V to 1.4 V RMS with a load impedance of greater than 50 Ω .
Common mode voltage	\pm 0.5 V maximum.
Source impedance	5.6 Ω nominal.

Level accuracy at 1 kHz	With a load impedance of greater than 10 k Ω :- $\pm 5\%$ for levels above 50 mV and $\pm 10\%$ for levels from 500 μ V to 50 mV.
Frequency response	Typically better than ± 1 dB from 0.1 Hz to 300 kHz.

SWEEP

Control modes	Start/stop values of selected parameter; Number of steps; Time per step.
Step time	1 ms to 20 s per step.
Sweep ramp	Synchronized analogue ramp with an amplitude of nominally 0 V to 10 V peak on rear panel BNC connector.
Markers	5 user selectable markers for frequency or level provide an indication when specified parameter values have been reached. Output 0 V to +5 V from 600 Ω on rear panel BNC socket.
Trigger	Rear panel BNC connector. Applying 0 V or a switch closure starts the sweep or steps the sweep from point to point. Socket is internally connected via 10 k Ω pull-up resistor to +5 V.

FREQUENCY STANDARD

Frequency	10 MHz.
Temperature stability	Better than ± 5 in 10^8 over the operating range of 0 to 50°C.
Warm up time	Within 2 in 10^7 of final frequency within 10 minutes from switch on at 20°C ambient.
Aging rate	Better than 2 in 10^7 per year; better than 5 in 10^{10} per day after 1 month continuous use.
Output	Rear panel BNC socket provides an output at frequencies of 1, 5 or 10 MHz with a nominal 2 V pk-pk level into 50 Ω .
External input	Rear panel BNC socket accepts an input at 1, 5 or 10 MHz with a minimum level of 2 V pk-pk. Maximum input level 5 V pk-pk.

GPIB INTERFACE

	A GPIB interface is fitted. All functions except the supply switch are remotely programmable.
Capabilities	Complies with the following subsets as defined in IEEE Std. 488.1: SH1, AH1, T6, TE0, L4, LE0, SR1, RL1, PP0, DC1, DT1, C0, E2.

RADIO FREQUENCY INTERFERENCE

Confirms to EEC directive 76/889 and VDE 0871 as to limits of RF interference.

SAFETY

Complies with IEC 348.
UL 1244 approved.

RATED RANGE OF USE

(Over which full specification is met).

Temperature	0 to 55°C.
Humidity	Up to 93% at 40°C.

CONDITIONS OF STORAGE AND TRANSPORT

Temperature	-40°C to +71°C.
Humidity	Up to 93% relative humidity at 40°C.
Altitude	Up to 4600 m (15,000 ft).

POWER REQUIREMENTS

AC supply	Four settings covering 90-115 V, 105-132 V, 188-242 V and 216-265 V. 45 Hz to 400 Hz. 120 to 180 VA maximum dependant on version and options fitted.
-----------	--

CALIBRATION INTERVAL

2 years.

DIMENSIONS AND WEIGHT

(Over projections but excluding front panel handles).

Height	Width	Depth	Weight
152 mm 6.0 in	425 mm 16.6 in	525 mm 20.5 in	21.0 kg 46 lb

SECOND MODULATION OSCILLATOR OPTION

Specification as Modulation Oscillator.

PULSE MODULATION OPTION

Modulation modes	Pulse modulation may be used alone or in conjunction with FM, Φ M or Wideband FM.
Rise time	For carrier frequencies above 21.09375 MHz less than 15 ns (typically 5 ns) from 10% to 90%. For carrier frequencies below 21.09375 MHz less than 25 ns from 10% to 90%.
Control	0 to + 1 V for carrier off, +3.5 to + 5 V for carrier on.
Maximum input level	+5.0 V.
ON/OFF ratio	Better than 70 dB at the carrier frequency, typically exceeds 80 dB.

Additional level error	Less than ± 0.5 dB.
Propagation delay	Typically 80 ns from PULSE INPUT to RF OUTPUT. Typically 5 μ s with Option 105 (DECT).
Input impedance	50 Ω nominal.
Switching speed	Rise and fall times less than 25 ns from 10% to 90%. Typically 2 μ s with Option 105 (DECT).

**+19 dBm RF OUTPUT
LEVEL OPTION**

For 2040 model only.

RF OUTPUT

Range	-138 dBm to +19 dBm. When AM is selected the maximum output level reduces linearly with AM depth to +13 dBm at maximum AM depth.
-------	---

SPECTRAL PURITY

At RF levels up to +7 dBm:

Harmonics	Better than -27 dBc.
-----------	----------------------

AVIONICS OPTION

See Annex A.

**RF PROFILES AND
COMPLEX SWEEP
OPTION**

See Annex B.

VERSIONS, OPTIONS AND ACCESSORIES

When ordering please quote the full ordering number information.

Ordering numbers

2040
2041
2042

Versions

10 kHz to 1.35 GHz Signal Generator.
10 kHz to 2.7 GHz Signal Generator.
10 kHz to 5.4 GHz Signal Generator.

Options

Option 001 Second internal modulation oscillator.
Option 002 External pulse modulation.
Option 003 High output power (available for 2040 only).
Option 006 Avionics.
Option 008 RF profiles and complex sweep.
Option 100 Single supply fuse.
Option 105 Modified pulse modulation.

Supplied Accessories

43129-003W AC supply lead.
46882-074C Operating manual for 2040 series.

Optional Accessories

46882-075R Service manual (for 2040 series).
43126-012S RF connector cable, TM 4969/3, 50 Ω , 1.5 m, BNC.
54311-092P Coaxial adapter N male to BNC female.
59999-163K Precision co-axial adapter, N male to SMA female.
54411-051X Impedance adapter, 50 to 75 Ω , BNC connectors.
54311-095C RF connector cable, 1 m, type N connectors.
43129-189U GPIB lead assembly.
46883-408K IEEE/IEC adapter block for GPIB socket.
46884-291A Rack mounting kit (with slides) for rack cabinets with depths from 480 mm to 680 mm.
46884-292Z Rack mounting kit (with slides) for rack cabinets with depths from 680 mm to 840 mm.
46884-541Y Rack mounting kit (without slides).
46884-444G Maintenance kit for 2030/2040 series.
59000-178G National Instruments LabWindows instrument drivers.
46662-525Y Transit case (aluminium).
54499-044F DECT filter.

GERMAN RFI DECLARATION FOR CLASS B SELF-CERTIFICATION

Hiermit wird bescheinigt, dass der 10 kHz - 2.7 GHz Low Noise AM/FM Signal Generator 2041 in Übereinstimmung mit den Bestimmungen der Vfg 1046/1984 funk-entstört ist.

Der Deutschen Bundespost wurde das Inverkehrbringen dieses Gerätes angezeigt und die Berechtigung zur Überprüfung der Serie auf Einhaltung der Bestimmungen eingeräumt.

**Marconi Instruments Ltd., Longacres, St. Albans
Hertfordshire, AL4 0JN, UK**

English translation:

We hereby certify that the 10 kHz - 2.7 GHz Low Noise AM/FM Signal Generator 2041 complies with the RFI suppression requirements of Vfg 1046/1984. The German Postal Service was notified that this equipment is being marketed. The German Postal Service has the right to re-test the equipment and verify compliance.

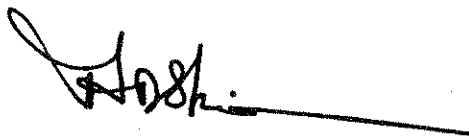

Signed

A D SKINNER

Head of Measurement Standards

Chapter 2 INSTALLATION

CONTENTS

	PAGE
MOUNTING ARRANGEMENTS.....	2-2
CONNECTING TO SUPPLY.....	2-2
Voltage selector.....	2-2
Fuses.....	2-2
Supply cable.....	2-3
GENERAL PURPOSE INTERFACE BUS (GPIB).....	2-3
GPIB cable connection.....	2-3
GPIB connector contact assignments.....	2-3
IEEE to IEC conversion.....	2-3
Interface bus connection.....	2-4
RACK MOUNTING.....	2-4
BATTERY REPLACEMENT.....	2-4

LIST OF FIGURES

Fig. 2-1 AC connector showing voltage selector and fuse holders.....	2-2
Fig. 2-2 GPIB connector contact assignments.....	2-3
Fig. 2-3 IEEE to IEC conversion.....	2-4

MOUNTING ARRANGEMENTS

Excessive temperatures may affect the performance of the instrument. Completely remove the plastic cover, if one is supplied over the case, and avoid standing the instrument on or close to other equipment which is hot.

CONNECTING TO SUPPLY

Before connecting the instrument to the AC supply, check the setting of the voltage selector switch which is an integral part of the supply connector at the rear of the instrument.

Voltage selector

The selected voltage is displayed in a window at the top of the connector. The instrument is normally despatched with the selector set to 240 V. To select another voltage, insert a screwdriver into the slot at the top of the moulding and twist slightly so that the cover is free to hinge downwards. Rotate the barrel so that the correct setting is displayed, see Fig. 2-1.

Setting	Voltage range
100 V	90 - 115 V
120 V	105 - 132 V
220 V	188 - 242 V
240 V	216 - 265 V

Fuses

The correct fuse rating for each voltage setting is as follows:

100 V to 120 V, 1.6 A-TT (1.6 amp double time lag)

220 V to 240 V, 1 A-TT (1 amp double time lag)

Fuses are cartridge type measuring 20 mm x 5 mm.

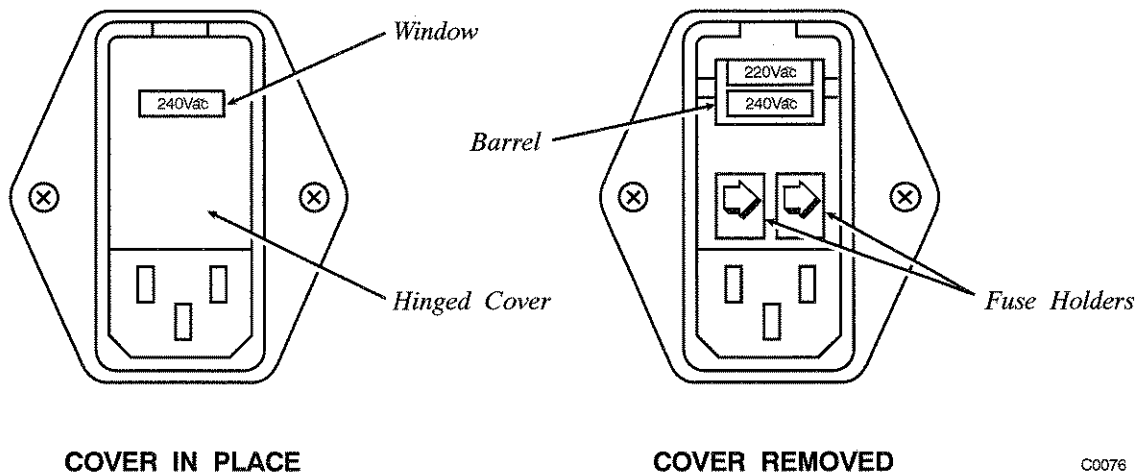

Fig. 2-1 AC connector showing voltage selector and fuse holders

Supply cable

The AC supply cable is fitted at one end with a socket which mates with the AC connector on the rear panel. When fitting a supply plug, ensure that connections are made as follows:

Earth - Green/Yellow
 Neutral - Blue
 Live - Brown

When attaching the supply lead to a non-soldered plug, it is recommended that the tinned ends of the lead are cut off to avoid intermittent connections resulting from cold flow.

GENERAL PURPOSE INTERFACE BUS (GPIB)

The GPIB interface built into the 2040 Series enables the signal generators to be remotely controlled to form part of an automatic measuring system.

GPIB cable connection

Connection to other equipment which has a 24-way connector to IEEE Standard 488 is made using the rear panel GPIB socket. For this purpose, the GPIB cable assembly, available as an optional accessory, (see Chap. 1 'Accessories') may be used.

GPIB connector contact assignments

The contact assignments of the GPIB cable connector and the device connector are as shown in Fig. 2-2.

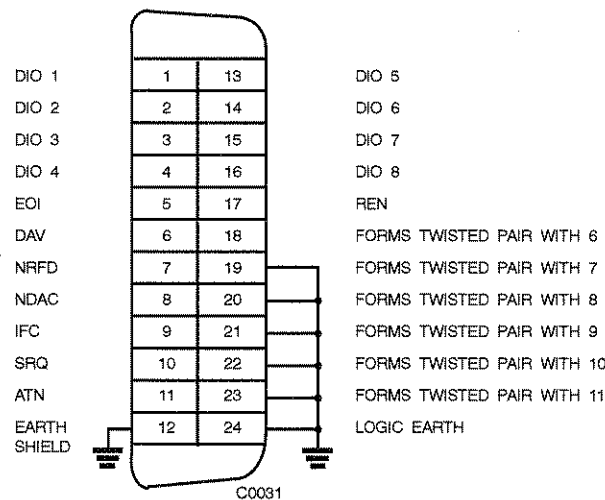

Fig. 2-2 GPIB connector contact assignments

IEEE to IEC conversion

An optional IEEE to IEC adapter is also available (see Chap. 1 'Accessories') for interfacing with systems using a 25-way bus connector to IEC Recommendation 625. The method of use is shown in Fig. 2-3.

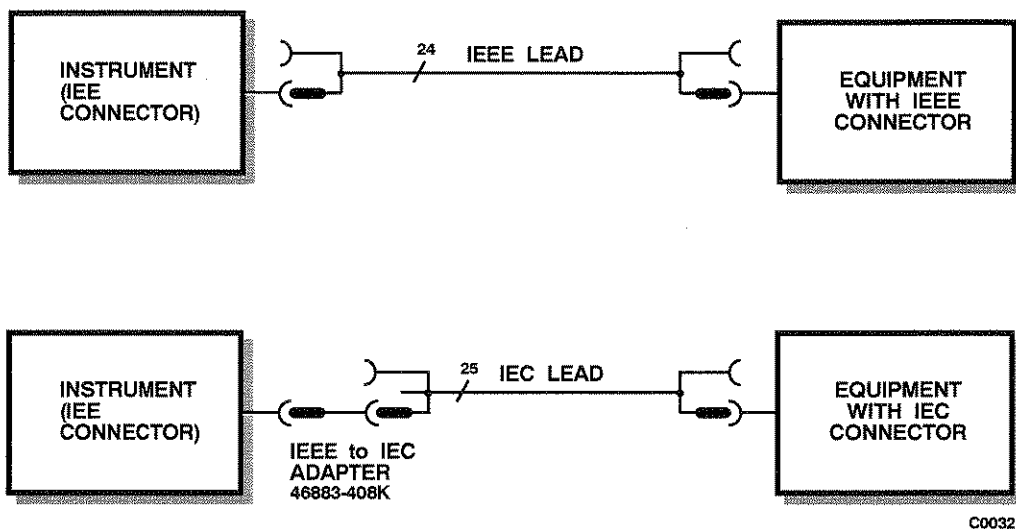

Fig. 2-3 IEEE to IEC conversion

Interface bus connection

The cables for the interface bus use special male-female connectors at both ends. This allows several connectors to be stacked one on top of another permitting several cables to be connected to the same source and secured by a lock screw mechanism. Too large a stack, however, may form a cantilevered structure which might cause damage and should be avoided. The piggyback arrangement permits star or linear interconnection between the devices with the restriction that the total cable length for the system must be:-

- (1) No greater than 20 m (65 ft).
- (2) No greater than 2 m (6 ft) times the total number of devices (including the controller) connected to the bus.

RACK MOUNTING

The instrument, which is normally supplied for bench mounting, may be mounted in a standard 19 inch rack (see 'Optional accessories'). There are two slide rack mounting kits to accommodate different depths of cabinet. These kits include full fitting instructions. A rack mounting kit without slides is also available which contains front panel mounting brackets only.

BATTERY REPLACEMENT

The lithium battery has an estimated life of 5 years, but it is recommended that it should be replaced every two years. The clock will continue to run for approximately 30 seconds while the replacement is made.

If a lithium battery is unobtainable an alkaline battery can be used, but will have a shorter life.

Chapter 3-1 OPERATION

CONTENTS

	PAGE
INTRODUCTION	3-1-4
CONVENTIONS	3-1-4
FRONT PANEL	3-1-4
REAR PANEL	3-1-6
THE MENUS	3-1-7
FIRST TIME USE	3-1-9
Switching on	3-1-9
Changing the value of the selected parameter	3-1-9
Enabling or disabling the modulation	3-1-10
Using the [$\uparrow \times 10$] and [$\downarrow \div 10$] keys	3-1-10
Using the control knob	3-1-10
DETAILED OPERATION	3-1-12
CARRIER FREQUENCY	3-1-12
Carrier ON/OFF	3-1-12
OUTPUT LEVEL	3-1-12
Choice of units	3-1-12
Reverse power protection	3-1-12
MODULATION	3-1-13
Selecting the modulation	3-1-13
Modulation ON/OFF	3-1-13
Selecting amplitude modulation	3-1-14
Selecting frequency modulation	3-1-14
Selecting phase modulation	3-1-14
Selecting wideband frequency modulation	3-1-14
Modulation source frequency	3-1-15
Source selection - internal	3-1-15
LF phase	3-1-16
Source selection - external	3-1-17
Low intermodulation mode	3-1-17
Selecting pulse modulation (applies if Option 002 is fitted)	3-1-18
MODULATION ALC	3-1-18
MODULATION MODES	3-1-19
Single	3-1-19
Dual	3-1-19
Composite	3-1-19
Dual composite	3-1-19
Modulation mode selection	3-1-19
Setting the modulation	3-1-20
CONTINUOUS TONE SIGNALLING (CTCSS)	3-1-20
Tone selection	3-1-21
Selecting alternative tone standards	3-1-21
Editing a tone standard	3-1-21
SIGNALLING (sequential calling tones)	3-1-22
Tone selection	3-1-22
Selecting alternative tone standards	3-1-25
Editing a tone standard	3-1-25
INCREMENTING (using Δ)	3-1-27
Displaying shifts	3-1-27
Setting increment values	3-1-27
SWEEP	3-1-28
Sweep type	3-1-28

Sweep mode.....	3-1-30
Start value.....	3-1-30
Stop value.....	3-1-30
Number of steps.....	3-1-31
Step time.....	3-1-31
Markers.....	3-1-31
Starting the sweep.....	3-1-32
Stopping the sweep.....	3-1-32
UTILITIES.....	3-1-34
Adjusting the display.....	3-1-34
Hardware information.....	3-1-35
Software information.....	3-1-35
External trigger.....	3-1-35
Setting the modulation mode.....	3-1-36
Setting the GPIB address.....	3-1-36
Sequential calling tones.....	3-1-36
Carrier phase adjustment.....	3-1-36
Selection of frequency standard.....	3-1-36
Noise mode selection.....	3-1-37
Selection menu 2.....	3-1-38
Calibration.....	3-1-38
Latch data.....	3-1-39
Elapsed time.....	3-1-39
Setting time and date.....	3-1-39
Locking and unlocking.....	3-1-39
Display blanking.....	3-1-40
Power up options.....	3-1-40
RF level units.....	3-1-40
LF level units.....	3-1-41
RF level utility.....	3-1-42
LOW FREQUENCY OPERATION.....	3-1-45
LF monitor.....	3-1-45
Modulation source monitoring.....	3-1-45
Modulation drive monitoring.....	3-1-45
Use as an independent LF generator.....	3-1-46
MEMORY.....	3-1-47
Memory recall.....	3-1-47
Full recall.....	3-1-47
Partial recall.....	3-1-47
Carrier recall.....	3-1-48
Sweep recall.....	3-1-48
Recalling data.....	3-1-48
Inhibit ON/OFF.....	3-1-48
Memory stepping facility.....	3-1-48
Memory store.....	3-1-49
Full store.....	3-1-50
Partial store.....	3-1-50
Carrier store.....	3-1-51
Sweep store.....	3-1-51
Storing data.....	3-1-51
Store erase.....	3-1-51
Frequency hopping.....	3-1-51
ERROR HANDLING.....	3-1-55
Foreground errors.....	3-1-55
Background errors.....	3-1-55
ERROR MESSAGES.....	3-1-56

LIST OF TABLES

Table 3-1-1	List of available softkeys for different modulation modes	3-1-45
Table 3-1-2	Background errors	3-1-56
Table 3-1-3	Foreground errors.....	3-1-56
Table 3-1-4	GPIB errors.....	3-1-57
Table 3-1-5	Fatal errors	3-1-58

LIST OF FIGURES

Fig. 3-1-1	2041 front panel	3-1-4
Fig. 3-1-2	2041 rear panel.....	3-1-6
Fig. 3-1-3	Sig gen menu - default display for 2040	3-1-7
Fig. 3-1-4	Sig gen menu - default display for 2041	3-1-7
Fig. 3-1-5	Sig gen menu - default display for 2042	3-1-8
Fig. 3-1-6	Amplitude modulation - menu configuration	3-1-10
Fig. 3-1-7	RPP tripped	3-1-13
Fig. 3-1-8	Internal source selection menu.....	3-1-16
Fig. 3-1-9	LF phase control.....	3-1-16
Fig. 3-1-10	External source selection menu	3-1-17
Fig. 3-1-11	Sig gen menu with two modulation channels	3-1-20
Fig. 3-1-12	Continuous tone selection menu	3-1-21
Fig. 3-1-13	Sequential calling tones utility menu	3-1-22
Fig. 3-1-14	Sequential calling tones utility menu (DTMF mode)	3-1-23
Fig. 3-1-15	Calling tones mode control menu (with [FM] selected)	3-1-24
Fig. 3-1-16	Tone standard selection menu.....	3-1-25
Fig. 3-1-17	Edit sequential tones standard menu	3-1-26
Fig. 3-1-18	Total shift menu	3-1-27
Fig. 3-1-19	Sweep parameters display.....	3-1-28
Fig. 3-1-20	Sweep type menu	3-1-29
Fig. 3-1-21	Sweep trigger mode menu	3-1-30
Fig. 3-1-22	Markers menu	3-1-31
Fig. 3-1-23	Sweep in progress	3-1-32
Fig. 3-1-24	Sweep stopped.....	3-1-33
Fig. 3-1-25	RF level transferred.....	3-1-33
Fig. 3-1-26	Utilities selection menu 1	3-1-34
Fig. 3-1-27	Display adjust menu	3-1-35
Fig. 3-1-28	Noise mode selection menu	3-1-37
Fig. 3-1-29	Utilities selection menu 2	3-1-38
Fig. 3-1-30	Calibration utilities menu	3-1-39
Fig. 3-1-31	RF level units selection menu (shown unlocked to level 1).....	3-1-41
Fig. 3-1-32	LF level units selection menu (shown unlocked to level 1).....	3-1-41
Fig. 3-1-33	RF level utility menu.....	3-1-42
Fig. 3-1-34	Normal signal generator level control operation	3-1-43
Fig. 3-1-35	Extended hysteresis operation with an RF level of -9 dBm as the starting level.....	3-1-43
Fig. 3-1-36	RF offset adjustment menu.....	3-1-44
Fig. 3-1-37	LF generator menu	3-1-46
Fig. 3-1-38	Memory recall menu	3-1-47
Fig. 3-1-39	Memory stepping menu	3-1-49
Fig. 3-1-40	Memory store menu	3-1-50
Fig. 3-1-41	Frequency hopping menu	3-1-53

INTRODUCTION

This chapter explains how to:

- Set up the signal generator to produce a typical basic signal.
- Select the main operating parameters; carrier frequency, output level and type of modulation.
- Use the full range of supporting facilities.

CONVENTIONS

The following conventions are used in this chapter:

- RF OUTPUT Capitals refer to titles marked on the panel.
- [MEM] Capitals in square brackets indicate hard key titles.
- Int. F4* Italics refer to data or messages on the display.
- [*Pulse*] Italics in square brackets indicate soft key titles, e.g. [*Pulse*] means the soft key adjacent to the *Pulse* title box at the side of the menu.

FRONT PANEL

Parameters are selected by means of hard keys, which have their function printed on them, soft keys, which do not have any notation, a numerical key pad and a rotary control knob, see Fig. 3-1-1. The hard keys have functions which do not change, whereas the soft key functions are determined by the menu which is displayed. The numerical keys are used to set parameters to specific values which can also be varied in steps of any size by using the \uparrow/\downarrow keys or the rotary control knob.

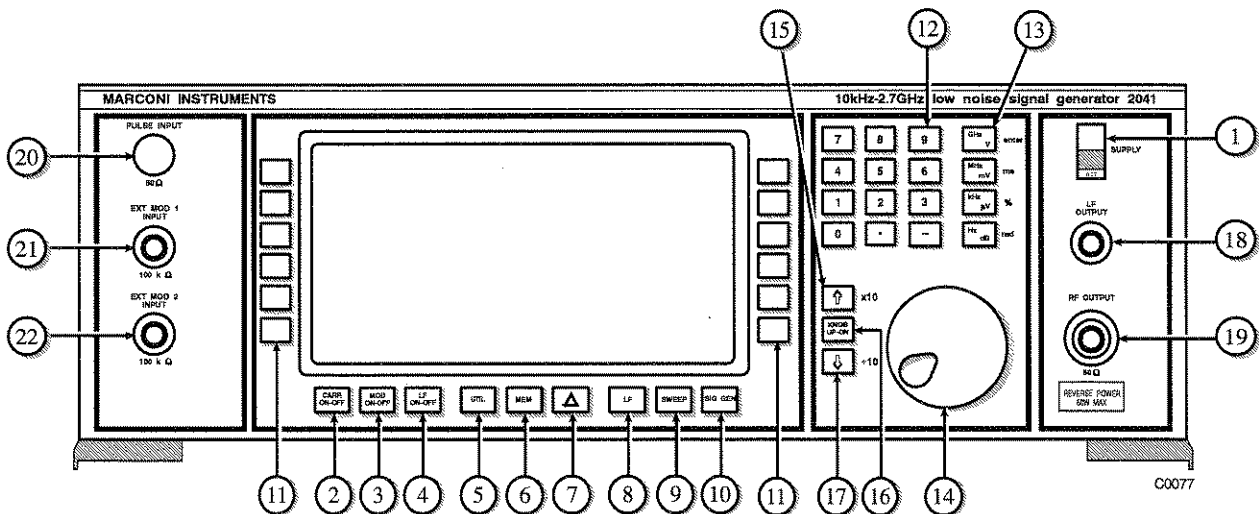

Fig. 3-1-1 2041 front panel

- | | | |
|------|----------------------|---|
| (1) | SUPPLY | Switches the AC supply voltage on and off. |
| (2) | CARR ON-OFF | Enables or disables the carrier frequency. |
| (3) | MOD ON-OFF | Enables or disables the modulation. |
| (4) | LF ON-OFF | Switches the low frequency output on and off. |
| (5) | UTIL | Displays the utilities menu. |
| (6) | MEM | Displays the memory store/recall menu. |
| (7) | Δ | Displays the total shift menu. |
| (8) | LF | Displays the LF and monitor menus. |
| (9) | SWEEP | Displays the sweep status menu. |
| (10) | SIG GEN | Displays the main menu. |
| (11) | SOFT KEYS | Twelve function keys change notation as the menu changes. |
| (12) | NUMERICAL
KEY PAD | For changing the value of a selected parameter. Minus sign and decimal point are included. |
| (13) | UNITS KEYS | Determine the units of set parameters and terminate the numerical entry. |
| (14) | CONTROL KNOB | When enabled, adjusts the value of the selected parameter. |
| (15) | $\uparrow \times 10$ | When knob disabled, increments a selected parameter. When knob enabled, increases knob sensitivity by value of ten. |
| (16) | KNOB UP-DN | Switches between control knob and $\uparrow \downarrow$ keys. |
| (17) | $\downarrow \div 10$ | When knob disabled, decrements a selected parameter. When knob enabled, decreases knob sensitivity by value of ten. |
| (18) | LF OUTPUT | BNC socket provides a low impedance output at the frequency selected at the <i>LF GENERATOR MENU</i> or monitors the modulating signal. |
| (19) | RF OUTPUT | 50 Ω N type socket with reverse power protection. |
| (20) | PULSE
INPUT | 50 Ω BNC socket (if fitted) accepts a pulsed signal. |
| (21) | EXT MOD 1
INPUT | 100 k Ω BNC socket. An independent input which allows an external modulation signal to be applied. |
| (22) | EXT MOD 2
INPUT | 100 k Ω BNC socket, similar to (21). |

REAR PANEL

The following facilities are available on the rear panel, see Fig. 3-1-2.

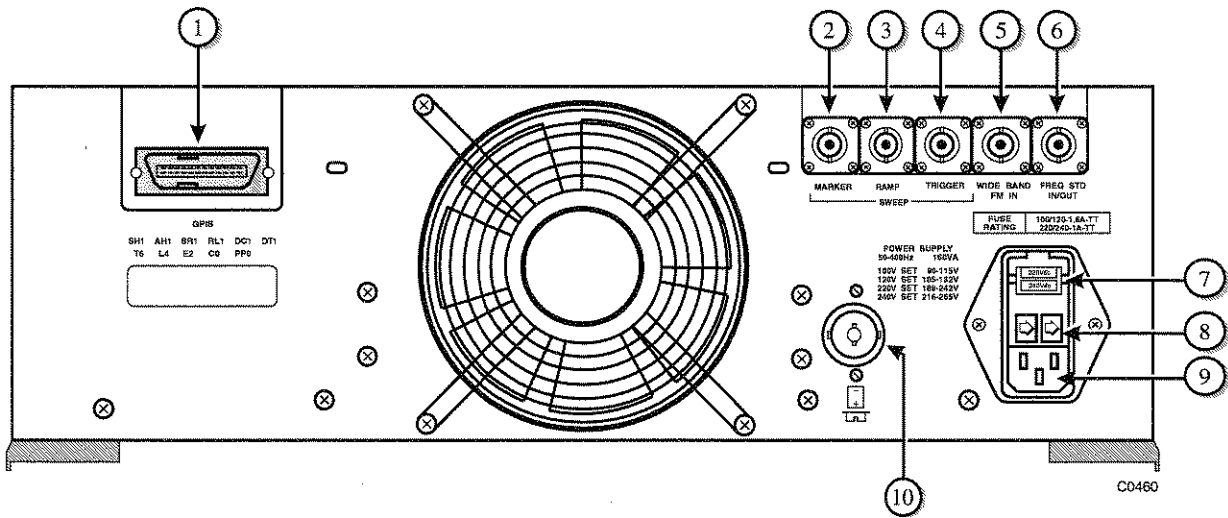
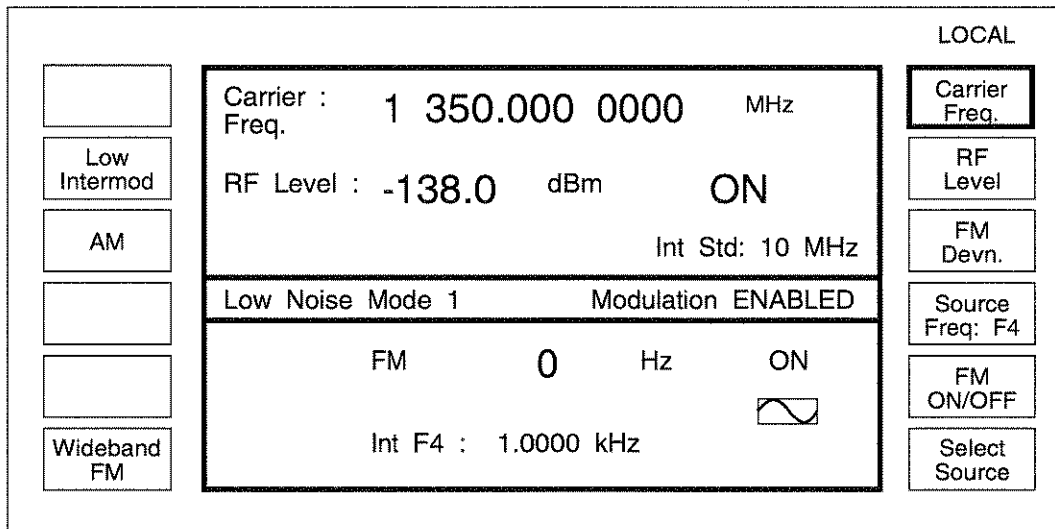

Fig. 3-1-2 2041 rear panel

- | | | |
|------|------------------|--|
| (1) | GPIB | 24 pin socket accepts standard IEEE connector to allow remote control of the instrument. |
| (2) | SWEEP MARKER | BNC socket supplies sweep marker. |
| (3) | SWEEP RAMP | BNC socket provides a ramp output at 0 to 10 V peak to peak. |
| (4) | SWEEP TRIGGER | BNC socket provides access for a trigger input. |
| (5) | WIDE BAND FM IN | BNC socket accepts a wide bandwidth FM signal into 50 Ω with a typical bandwidth of 10 MHz. |
| (6) | FREQ STD IN/OUT | BNC socket for standard frequencies at 1, 5, or 10 MHz at TTL levels. |
| (7) | VOLTAGE SELECTOR | Removable cover reveals barrel which can be rotated to select the required voltage range. |
| (8) | FUSES | AC fuses rated at 1.6 A (double time lag) for the 100 to 120 V range and 1 A (double time lag) for the 220 to 240 V range. |
| (9) | AC SUPPLY INPUT | 3 pin plug integral with voltage selector and fuse holders. Mates with supply lead socket. |
| (10) | BATTERY HOLDER | Houses battery for real time clock. |

THE MENUS

The 2040 series instruments are operated by calling up various displays or menus on the screen. Menus are accessed via both hard and soft keys. Pressing a hard key normally causes the appropriate primary menu to appear on the screen regardless of the current working position within the menu hierarchy. As the display changes from one menu to another, so the 12 soft keys assume those functions necessary to drive the instrument from that menu. Secondary menus are displayed by pressing a soft key while in a primary menu. Some sub-menus are nested e.g. UTILITIES. Clearance from these is obtained by pressing the [EXIT] key.



C0467

Fig. 3-1-3 Sig gen menu - default display for 2040

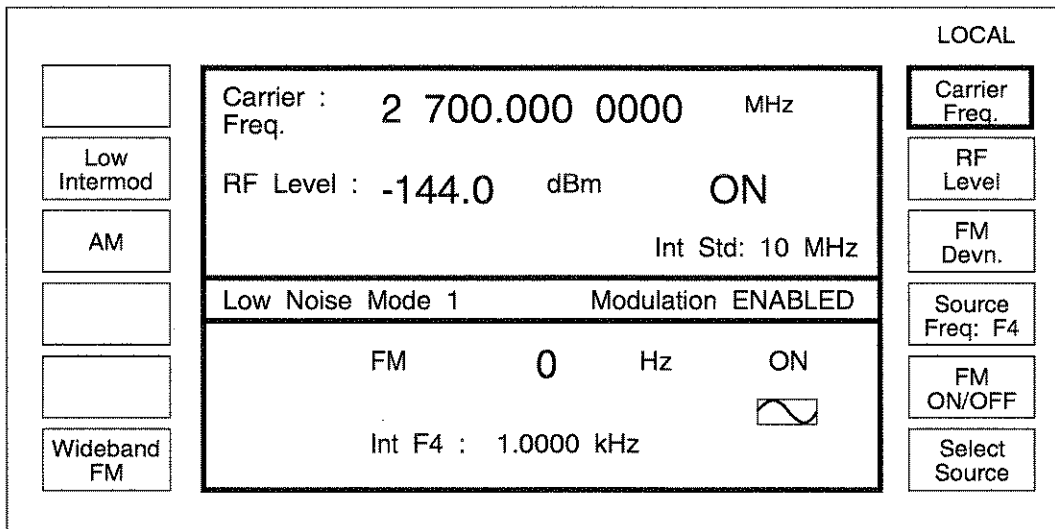

C0468

Fig. 3-1-4 Sig gen menu - default display for 2041

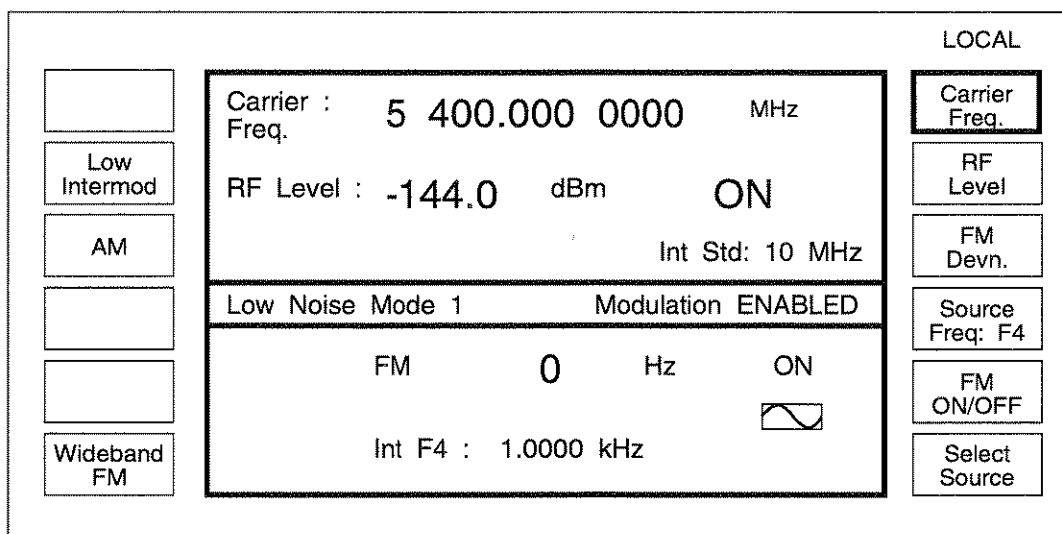

C0469

Fig. 3-1-5 Sig gen menu - default display for 2042

FIRST TIME USE

First time users can quickly become familiar with the principles of control and display by carrying out the following exercise, which demonstrates how to set up a typical basic signal having the following parameters:

Carrier frequency: 100 MHz.
Output level: 10 dBm.
Amplitude modulation: 30% depth at 1 kHz.

Switching on

- (1) Before switching the instrument on, check that the voltage selector has been set to the value of the power supply as described in Chap. 2, and that no signal voltage is present on the PULSE INPUT socket.
- (2) If the default display shown in Fig. 3-1-3, Fig. 3-1-4 or Fig. 3-1-5 is not obtained, a previous user may have set the instrument to switch on with one of the user memories recalled rather than using the default factory settings. Before proceeding any further you should reset this selection, see 'Power up options'. Switch off and on again. Alternatively use the MEM key followed by entering 50 and terminating by pressing the [enter] key. This will reset the instrument to the factory default setting.

If the RF level units and the internal/external standard are not as shown, they can be changed as described on Page 3-1-42, 'RF level units' and Page 3-1-36 'Selection of frequency standard'.

- (3) Observe that the main menu appears on the display showing default parameters for FM. The soft key label marked [*Carrier Freq.*] is highlighted (i.e. the line bordering the label is increased in thickness to about 1 mm), which means that anything entered at this stage will change the carrier frequency.
- (4) If necessary, adjust the display for brightness and contrast, see 'UTILITIES' Page 3-1-34.

Changing the value of the selected parameter

If an error is made when keying in, press the soft key again and key in the correct value. If an error message is displayed, it can be cancelled by entering a value which is within limits.

- (1) Using the numerical key pad, enter 100 MHz by pressing keys [1], [0], [0] and the key marked [MHz/mV/ms]. Observe that the Carrier Freq. display changes to 100.000 0000 MHz.
- (2) Press [*RF level*]. The *RF level* soft key label is now highlighted.
- (3) Using the numerical key pad, enter 10 dBm by pressing keys [1], [0] and the key marked [Hz/dB/rad]. Observe that the RF Level display changes to 10.0 dBm.
- (4) Press [*AM*] on the left-hand side of the display. The menu will now change to display AM modulation parameters in the lower panel. The [*FM Devn.*] soft key on the right-hand side of the menu changes to [*AM depth*] and this label is now highlighted. *AM* disappears from the left-hand side.

- (5) Using the numerical key pad, enter 30% AM depth by pressing [3], [0] and [kHz/μV/%]. Observe that the AM depth display changes to 30%. The display will now be as in Fig. 3-1-6 and the selected signal will now be present at the RF OUTPUT socket.

Enabling or disabling the modulation

The modulation is ON by default, but the AM can be turned ON and OFF by pressing [AM ON/OFF] at the right-hand side of the display and the modulation can be enabled or disabled by pressing [MOD ON-OFF]. These are both toggle actions, i.e. press ON, press OFF. The soft key acts only on the selected modulation whereas the [MOD ON-OFF] acts on all modulations.

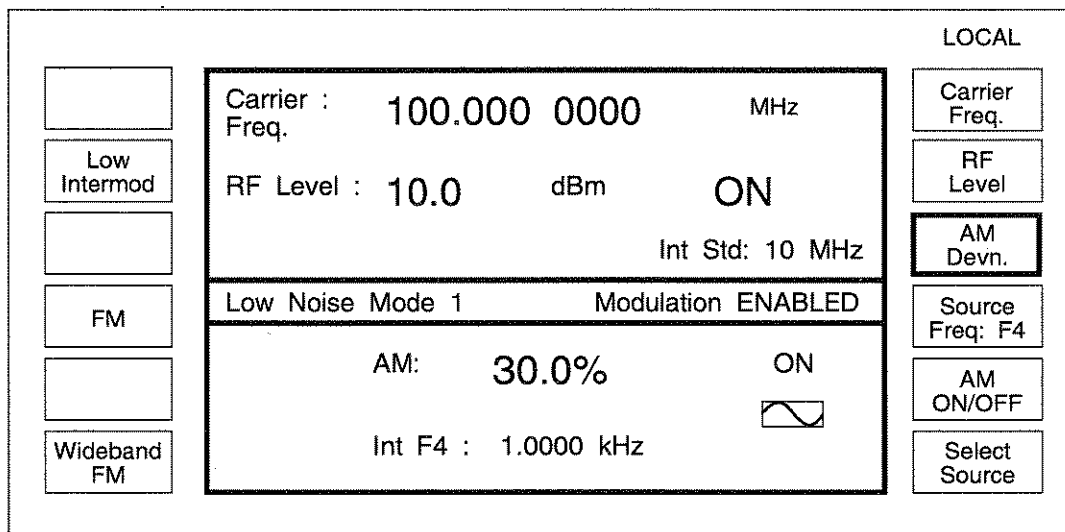

C0470

Fig. 3-1-6 Amplitude modulation - menu configuration

Using the [$\uparrow \times 10$] and [$\downarrow \div 10$] keys

When a parameter has been selected via the numerical key pad, its value can be incremented or decremented either in steps using the [\uparrow] key and the [\downarrow] key, or continuously with the control knob. Select [Carrier Freq.] and observe that the effect of pressing the [\uparrow] and [\downarrow] keys is to change the carrier frequency in steps of 1 kHz. Default step sizes are assigned to all parameters but these can be changed, see Page 3-1-27, 'INCREMENTING (using the delta function)'.

Using the control knob

- (1) Press [KNOB UP-DN] to enable the control knob.
- (2) On the display, brackets will appear above and below the selected parameter. These brackets embrace the part of the value which the control knob can change. Pressing the [$\times 10$] key shortens the bracket length by one decimal place. Pressing the [$\div 10$] key increases the bracket length by one decimal place. In this way the sensitivity of the control knob can be increased or decreased by a factor of ten.

- (3) Rotate the control knob and observe the change in the selected parameter. Press [KNOB UP-DN] to disable the knob.
- (4) For other parameters, press the relevant soft key and use the [↑] and [↓] keys or the control knob.

Note...

For *RF Level* the knob resolution is fixed at 0.1 dB.

DETAILED OPERATION

CARRIER FREQUENCY

The carrier frequency is selected from the main menu by pressing [*Carrier Freq.*], unless it is already highlighted as in the default display.

Enter the required value via the numerical key pad. The value can then be incremented or decremented using the control knob and its associated keys, [KNOB UP-DN], [$\times 10$] and [$\div 10$].

If a value outside the specified range is requested, the message:

ERROR 51: Carrier Outside Limits

is displayed on the screen when the terminator key is pressed, and the instrument is automatically set to the end of the range.

Carrier ON/OFF

The carrier may be switched *ON* or *OFF* at any time via the [CARR ON-OFF] key. This effectively switches the output ON and OFF, retaining the 50 Ω output impedance.

OUTPUT LEVEL

The output level is selected at the Sig Gen menu by pressing [*RF Level*] and entering the required value on the numerical key pad. If a value outside the specified range is requested the message:

ERROR 52: RF Level Outside Limits

or

ERROR 17: RF Level limited by AM

is displayed and the instrument is automatically set to the end of the range.

Choice of units

Units may be μV , mV, V or dB. Conversion between dB and the voltage units is carried out by pressing the appropriate units key, i.e. to change dBm to a voltage unit, press any voltage key for the correct conversion. The choice of Volts EMF, Volts PD, and the dB reference is made by using the [*RF Level Units*] utility, see Page 3-1-40, 'RF level units'.

Reverse power protection

Accidental application of power to the RF OUTPUT socket trips the reverse power protection circuit (RPP) and a flashing message appears on the display, see Fig. 3-1-7.

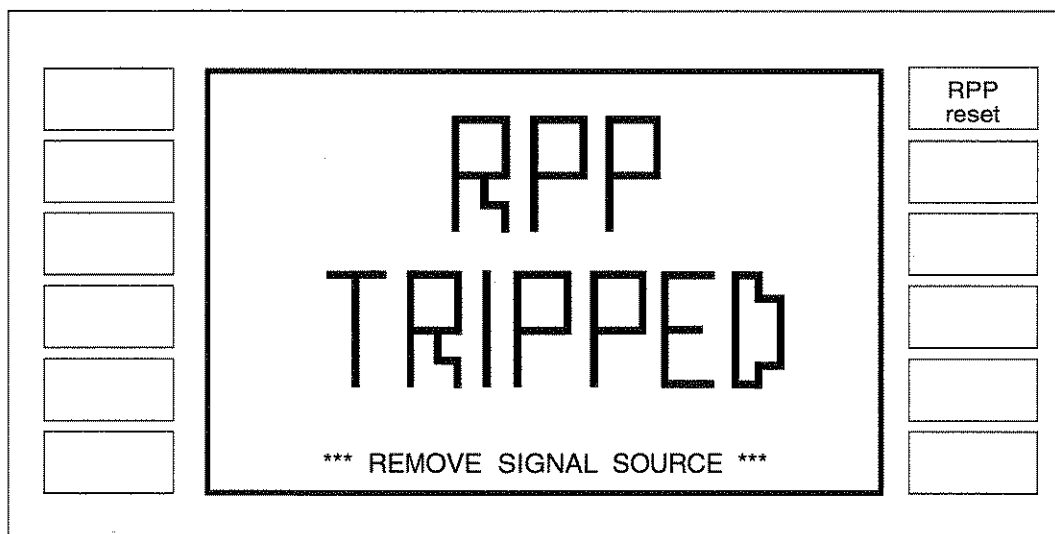

C0039

Fig. 3-1-7 RPP tripped

Pressing *[RPP reset]* resets the RPP and returns the display to the menu in use when the reverse power protection was tripped. If *[RPP reset]* is pressed with the signal still applied, the RPP will trip again.

MODULATION

The carrier can be frequency, amplitude, or phase modulated, with pulse modulation as an option. The internal modulation oscillator has a frequency range of 0.1 Hz to 500 kHz, with a resolution of 0.1 Hz. The modulation bandwidth available depends on the noise mode selected see the PERFORMANCE DATA section in Chapter 1.

Selecting the modulation

The type of modulation required, AM, FM, Φ M, wideband and optional pulse modulation can be selected by soft keys at the main menu. Four modulation modes are available, see Page 3-1-19, 'Modulation mode selection'.

Modulation ON/OFF

[MOD ON-OFF] switches all modulation *ON* or *OFF* and the condition is indicated in the centre of the main display, e.g:

Modulation DISABLED

Modulation is also controlled by a soft key which turns the selected modulation on and off. For modulation to appear on the carrier, modulation must be both enabled with the *[MOD ON-OFF]* hard key and turned on via the soft key. In single modulation modes the *[MOD ON-OFF]* key and the *[FM ON/OFF]*, *[AM ON/OFF]*, *[Φ M ON/OFF]* keys appear to carry out the same function, but the action is different, particularly in the FM mode. The *[FM ON/OFF]* etc. soft keys only reduce the modulation to zero whereas the *[MOD ON-OFF]* key completely disables the modulation system such that the instrument reverts to a carrier frequency generator.

Selecting amplitude modulation

- (1) At the Sig Gen menu, press *[AM]*, the *[AM Depth]* box is now highlighted.
- (2) Enter the required modulation depth via the numerical key pad and terminate with the [%] key. If the modulation depth requested exceeds 99.9%, the depth is reset to the maximum value available and the message:

ERROR 56: AM Outside Limits

is displayed at the top of the screen.

- (3) Switch the AM ON or OFF by pressing *[AM ON/OFF]*. The AM information is displayed in the lower half of the screen.

Selecting frequency modulation

- (1) At the Sig Gen menu, press *[FM]*, the *[FM Devn.]* box will be highlighted.
- (2) Enter the FM deviation value via the numerical key pad and terminate it with [Hz], [kHz] or [MHz].
- (3) Switch the FM ON or OFF via *[FM ON/OFF]*. The FM information is displayed in the lower half of the screen.

Selecting phase modulation

Note that phase modulation is not available in the low noise modes of the 2040 series. To use phase modulation the instrument must be in the normal noise mode (see Page 3-1-37).

- (1) At the Sig Gen menu, press *[ΦM]*. The *[ΦM Devn.]* box will be highlighted.
- (2) Enter the phase modulation deviation value via the numeric key pad and terminate it with the [RAD] key.
- (3) Switch the ΦM ON or OFF via the *[ΦM ON/OFF]* key. The ΦM information is displayed in the lower half of the screen.

Selecting wideband frequency modulation

- (1) At the Sig Gen menu, press *[Wideband FM]*. The *[Wideband FM]* box will be highlighted.
- (2) The value can be changed via the key pad and frequency terminator key. To preserve the widest bandwidth, the control of the wideband FM is carried out in a series of fixed steps and the signal generator automatically displays the calculated fixed step which is closest to the keyed in value. Applying a 1 V RMS signal to the rear panel WIDE BAND FM IN socket will produce the indicated deviation.

- (3) Pressing *[AC/DC Coupling]* changes the coupling from AC to DC and vice versa. When the input is DC coupled, small frequency offsets can be reduced by using the nulling facility. Nulling can be effected by pressing *[DCFM Nulling]*. The legend:

*** DCFM NULLING ***

appears briefly on the display.

Note...

The [↑] and [↓] keys and the control knob do not operate for wideband FM.

CAUTION

The WBFM socket input impedance is 50 Ω. The DC component of of any applied voltage must not exceed 5 V.

Modulation source frequency

- (1) At the Sig Gen menu press *[Source Freq.]*.
- (2) Enter the required source frequency and terminate the entry with [Hz], [kHz] or [MHz].

Note...

When the modulation source is operating as a continuous signalling tone the *[Source Freq.]* legend is replaced with the *[Tone Number]*. Pressing the key allows a new tone number to be entered.

Source selection - internal

The modulation source may be selected by pressing *[Select Source]*. Sources may be internal or external. If the currently selected source is internal, the *Internal Source Selection Menu* is displayed, giving a choice of six frequencies, F1-F6, see Fig. 3-1-8. The frequency assigned to the highlighted F number may be changed by the numerical key pad and terminated with [Hz], [kHz], [MHz] or [GHz]. Soft keys allow the selection of either a sine or triangular waveform. The selection of sub-audible continuous tones can be achieved by pressing *[CTCSS]*, see 'SIGNALLING'. Pressing *[Mod. Src Phase]* displays the *LF Source Phase Control* menu, see Fig. 3-1-9. The LF source phase angle can be varied from -180° to +180°. The pictograms at the end of each line show a symbolic sine wave when a source is selected. This changes to a triangular wave if *[Triangle Wave]* is selected. These symbols also appear on the main menu. A horizontal bar is shown when a source is not selected or is not available.

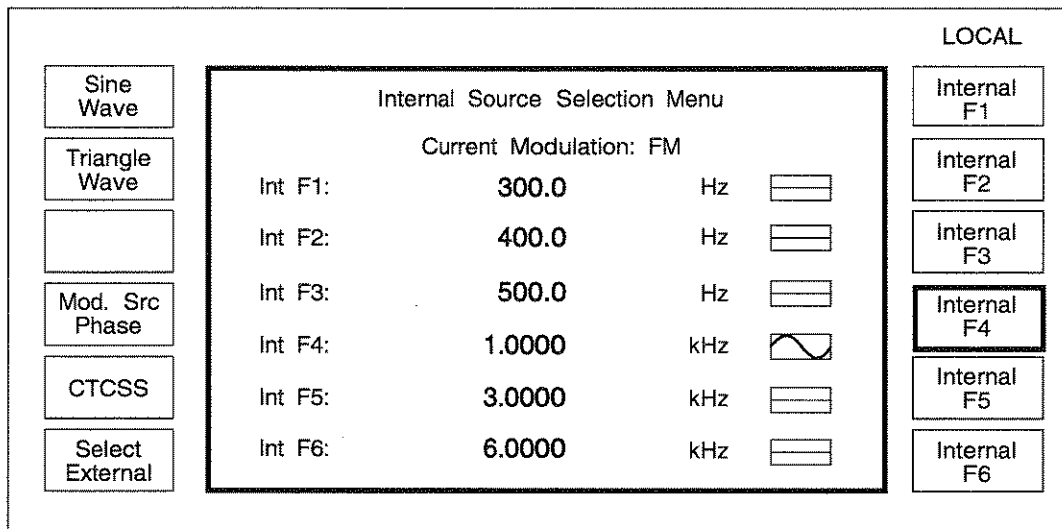

C0040

Fig. 3-1-8 Internal source selection menu

LF phase

When an internal source has been selected, its phase relative to the second modulation oscillator (if fitted) can be changed by pressing *[Mod. Src Phase]* and entering the required value. Where two internal modulation frequencies are active, the starting phase difference between the two signals can be set up and the phase angle is referred to the currently selected oscillator.

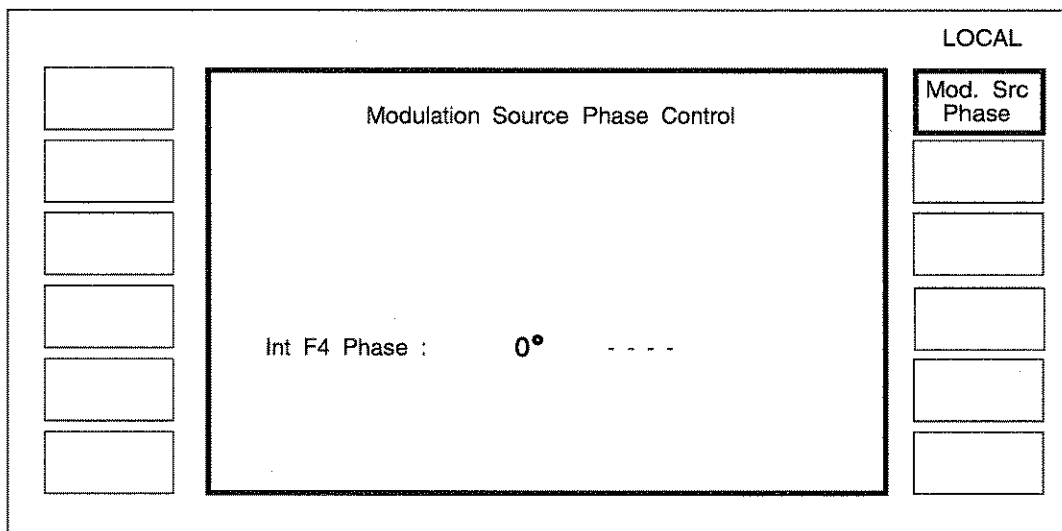

C0041

Fig. 3-1-9 LF phase control

Source selection - external

An external source may be selected by pressing [*Select External*]. The *External Source Selection Menu* is then displayed on the screen. (This menu is displayed immediately when pressing [*Select Source*] if the currently selected source is external.) This menu allows the choice of two input sockets EXT MOD 1 INPUT and EXT MOD 2 INPUT and AC, ALC, or DC coupling by pressing the appropriate soft key. The pictograms at the end of each line show a symbolic arbitrary waveform when an external source is selected. This symbol also appears on the main menu. A horizontal bar is shown when a source is not selected or is not available. When the input is DC coupled, small frequency offsets can be reduced by using the nulling facility. Nulling can be effected by pressing [*DCFM Nulling*].

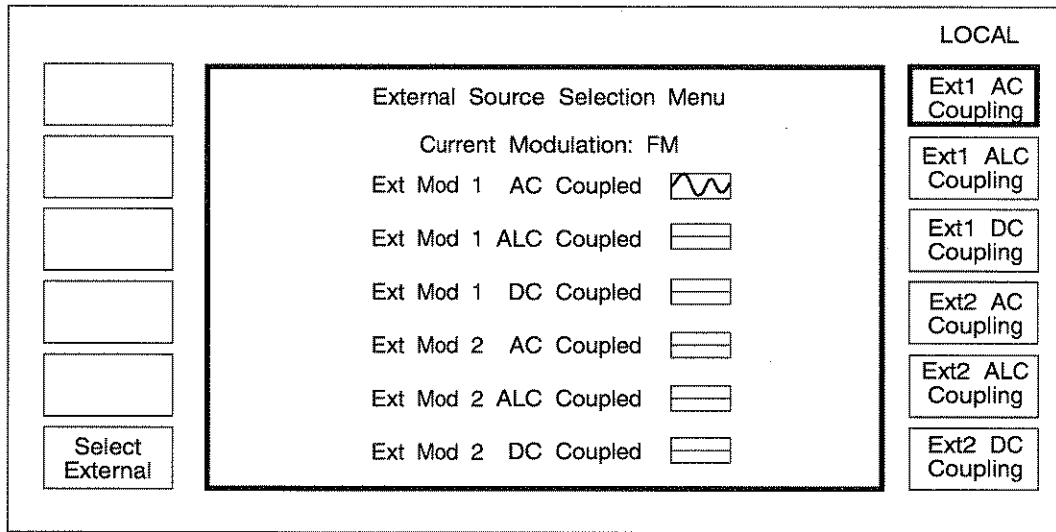

Fig. 3-1-10 External source selection menu

Low intermodulation mode

When carrying out intermodulation tests the output signal from two signal generators is combined using a resistive or hybrid combiner. If the carrier frequencies are relatively close together (less than 2 MHz in normal noise mode) each generator will receive an interfering signal from the other source. The RF ALC system will detect a beat frequency equal to the difference in carrier frequencies and attempt to apply AM in order to cancel the signal. In so doing the RF ALC system will generate AM sidebands which are indistinguishable from intermodulation products. By using the low intermodulation mode the RF ALC system can be disabled to prevent the injection of AM sidebands.

If pulse modulation is not fitted proceed as follows:

- (1) At the Sig Gen menu press [*Low Intermod*].
- (2) This causes either *Low Intermodulation Disabled* or *Low Intermodulation Enabled* to be displayed in the lower panel.
- (3) Press the [MOD ON-OFF] key to toggle between the enabled and disabled states.
- (4) If an attempt is made to [*Set Steps*] from the Δ menu, the message *Low Intermod: No Steps Allowed* will be displayed.

If pulse modulation (Option 002) is fitted proceed as follows:

- (1) Press the [*Pulse Mod*] key.
- (2) This causes the message *PULSE ON* to be displayed.
- (3) Press the [*Pulse ON/OFF*] key.
- (4) This causes *PULSE OFF* to be displayed together with *Low Intermodulation Disabled* or *Low Intermodulation Enabled* shown in the lower panel.
- (5) Press the [MOD ON-OFF] key to toggle between the enabled and disabled states.
- (6) If an attempt is made to [*Set Steps*] from the Δ menu, the message *PULSE : No Steps Allowed* will be displayed.

Note...

AM is not available in the Pulse Modulation or Low Intermodulation modes of operation.

Selecting pulse modulation (applies if Option 002 is fitted)

- (1) At the Sig Gen menu, press [*Pulse Mod*], when the Pulse Mod box on the display will be highlighted.
- (2) Selecting and enabling pulse mod changes the RF level control loop to the Direct Level Control mode, which can take up to 100 ms to action. For best accuracy, this process should be repeated before measurements are taken if neither the carrier frequency or RF level have been changed recently. When pulse mod is disabled the RF level is controlled in the normal way.
- (3) Switch pulse mod on or off with the [*Pulse On/Off*] key. When 'On', the carrier is controlled by the logic level applied to the PULSE INPUT socket mounted on the front panel. A logical '1' (a voltage between 3.5 and 5 V) allows carrier output, a logical '0' (a voltage between 0 and 1.0 V) suppresses it. Turning pulse mod off effectively applies a logical '1' allowing carrier output.

MODULATION ALC

The automatic levelling control (ALC) is used in conjunction with an external source and can be disabled when not required. To enable the ALC, proceed as follows:

- (1) At the Sig Gen menu, press [*Select Source*]. The display will show the *Internal or External Source Selection Menu* (Fig. 3-1-8 or Fig. 3-1-10).
- (2) If necessary press [*Select External*] to obtain the *External Source Selection Menu* (Fig. 3-1-10).
- (3) Select the required external source from the options shown, e.g. [*Ext 1 ALC Coupling*] or [*Ext 2 ALC Coupling*]. The pictogram at the end of each line will change from a horizontal line to an arbitrary waveform symbol when the source is selected.
- (4) Return to the Sig Gen menu by pressing [SIG GEN]. The legend *Ext Mod 1 (or 2) ALC coupled* appears at the bottom of the display.

- OPERATION
- (5) Apply a signal to the EXT MOD 1 or EXT MOD 2 input socket and vary the level. If the input applied to the external modulation socket is outside the ALC range (at least 0.7 to 1.4 V RMS) *HI* or *LO* will be indicated and an error message will be displayed at the top of the screen. If the level is within the required range, the arbitrary waveform symbol will appear alongside the modulation value.

MODULATION MODES

Two independent inputs on the front panel allow external modulation signals to be summed with signals from the internal oscillator and a second optional internal oscillator (if fitted). Thus up to four modulations may be available at one time. These can be combined to give single, dual, composite and dual composite modes.

Single

In the single mode, only one modulation can be active at any one time, and selecting another modulation cancels the first.

Dual

In the dual mode, a common carrier wave is modulated by two different types of modulation, e.g. one AM and one FM. Each type of modulation carries separate information.

Composite

This mode consists of two modulating channels with similar types of modulation, the effective modulation being the sum of the two waveforms e.g. FM1 + FM2. This mode cannot be used for pulse or wideband modulation.

Dual composite

This mode is similar to single composite with each of the two modulating channels being the sum of two sources, e.g. FM1 + FM2 and AM1 + AM2.

Modulation mode selection

In order to select a different modulation mode;

- (1) Press [UTIL]. *Utilities Selection Menu 1* will appear on the display.
- (2) Press [*Mod'n Mode*]. The display changes to show the four options. Press the required soft key.
- (3) Press [SIG GEN] to return to the Sig Gen menu where the modulation and individual source parameters will be shown.

Note...

Full information on the range of utilities can be found under 'UTILITIES'.

Setting the modulation

- (1) Select the required modulation channel by pressing the relevant soft key, e.g. *[FM1]* or *[FM2]*. The box containing the parameters for the selected channel is now highlighted, see Fig. 3-1-11.
- (2) At this point, the modulation frequency, deviation or depth can be altered. The source frequency can also be changed by pressing *[Source Freq:Fn]* and entering the value in the usual way.
- (3) The source can be changed from internal to external or vice versa by pressing *[Select Source]* for the relevant source selection menu.
- (4) When an internal source has been selected, its phase can be changed by pressing *[Mod. Src Phase]* and entering the required value. Where two internal modulation frequencies are active, the starting phase difference between the two signals can be set up and the phase angle is referred to the currently selected oscillator.

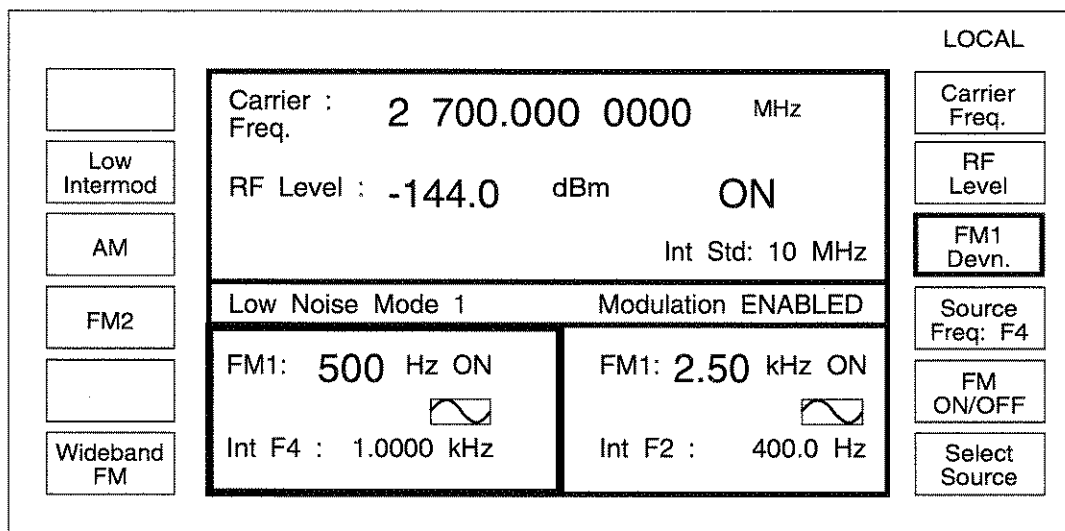

C0471

Fig. 3-1-11 . Sig gen menu with two modulation channels

CONTINUOUS TONE SIGNALLING (CTCSS)

A CTCSS tone is any one of 32 standard sub-audible tones ranging from 67 Hz to 250.3 Hz and would generally be used in conjunction with an audible modulation signal in a composite modulation mode. The procedure for initiating these tones is as follows:

Tone selection

- (1) At the Sig Gen menu, press [*Select Source*].
- (2) At the *Internal Source Selection Menu*, press [*CTCSS*]. The *Continuous Tone Selection Menu* is now displayed, see Fig 3-1-12.
- (3) Key in the required tone number (0 to 15) and press [enter].

The screenshot shows a terminal-style interface for the 'Continuous Tone Selection Menu'. The title is 'Continuous Tone Selection Menu' and the current standard is 'CTCSS 1'. The 'Tone Number' is set to '01 --'. The 'Int F4:' is set to '71.9 Hz' with a small 'ctc1' icon to its right. On the left side, there are five buttons: 'Select Standard', 'Edit Standard', and three empty boxes. On the right side, there are five buttons: 'Tone Number', three empty boxes, and 'Select Source'. The word 'LOCAL' is printed in the top right corner. The ID 'C0044' is at the bottom right.

Fig. 3-1-12 Continuous tone selection menu

Selecting alternative tone standards

A list of the 16 tones of the current standard is available by pressing [*Select Standard*]. This action displays the *Tone Standard Selection Menu* with the current standard highlighted. To select from further lists of 16 tones, press [*CTCSS2*] or [*USER*]. The *Tone Standard Selection Menu* changes to show the new list.

Editing a tone standard

Pressing [*TEMP*] displays a further list of 16 tones set to the default value of 10 Hz. The standard can be edited by selecting [*Edit Standard*] from the menu in Fig. 3-1-12. This gives the *Continuous Tone Edit Utility* menu.

CTCSS 1, CTCSS 2 or USER can be loaded to TEMP, which is a volatile store of 16 tones set at a default value of 10 Hz at switch on. Tones can then be changed by using [*Tone No*], [*Tone Freq*], [*Next Tone*] or [*Previous Tone*]. When the required changes have been made, the new standard can be saved by pressing [*Store to User*]. USER then becomes a user defined standard.

Note...

Selecting [*CTCSS1*], [*CTCSS2*], [*USER*] or [*TEMP*] from the *Tone Standard Selection Menu* causes the pictogram in the *Continuous Tone Selection Menu* and the *Internal Source Selection Menu* to change e.g. *ctc1*. The pictogram is repeated in the modulation section of the Sig Gen menu.

SIGNALLING (sequential calling tones)

There are eight sequential calling tone standards available, each having 16 set tones, see Tone Standard Selection Menu, Fig. 3-1-16. They are, CCIR, EURO, DZVEI, ZVEI1, ZVEI2, EEA, EIA and NATEL. There is also provision for the user to define sets of user tones in USER1 and USER2. DTMF signalling tones can also be generated if the second modulation oscillator (Option 001) is fitted.

Sequential calling tones are set up from a utility menu, Fig. 3-1-26, and are activated by pressing *[Send Tones]* which appears on the main menu after the tones have been set up. *[Send Tones]* also appears on the calling tones menu.

Tone selection

Pressing the *[Calling Tones]* soft key at *Utilities Selection Menu 1* calls up the *Sequential Calling Tones Utility* menu, see Fig. 3-1-13.

Sequential Calling Tones Utility
Current Standard: CCIR
Mode: NO MODULATION SELECTED

Tone Seq.: FFFFFFFFFFFFFFFFFF
Dur. Seq.: - - - - -

Frequency Offset : 0 %
Extended Duration: 500 ms
Repeat Tone : E -
Start Delay : 200 ms

Default Duration : 100 ms Gap : 6 ms

LOCAL

Mode Control
Select Standard
Edit Standard
Store Tones
Recall Tones

Tone Sequence
Duration Sequence
Freq. Offset
Extended Duration
Define Repeat
Start Delay

C0472

Fig. 3-1-13 Sequential calling tones utility menu

[Tone Sequence] Pressing this key causes hexadecimal data entry keys to appear at the left-hand side of the menu. To change the sequence, enter the tone numbers via the digits 0-9 on the numerical keypad and the soft keys *[A]* to *[F]* and press *[enter]*.

[Duration Sequence] Pressing this key causes *[Default Duration]* and *[Extended Duration]* to appear at the left-hand side of the menu. Press either key in turn to set the duration of tones in the sequence. A dash (-) indicates the default duration and Ξ indicates an extended duration. These two keys disappear when *[enter]* is pressed.

[Define Repeat] allows a repeat tone to be defined, by using the *[A]* to *[F]* keys and the keypad and pressing enter. For example, if the repeat tone is defined as tone C, the sequence 11111 will be sent as 1C1C1 so that the receiver decoders will sense a change in frequency at the start of each digit sent.

[Freq. Offset] This facility alters the nominal tone frequency by a set percentage (up to $\pm 10\%$) for use in tolerance testing. To change the frequency offset value, select *[Freq. Offset]* and enter the new value on the keypad. Terminate with the *[%]* key.

[Store Tones] Up to 20 sequence set-ups can be stored. Use the keypad to enter the store location, number and press [enter].

[Recall Tones] To recall a tone sequence, use the key pad to select the required store location and press [enter].

[Start Delay] The delay before the tone sequence starts and the gap between sequences can be adjusted by pressing this soft key, entering the required delay time on the keypad and pressing [ms].

[Mode Control] Pressing this enables the user to assign the calling tones to a selected type of modulation, see Fig. 3-1-15. Modulation, on the selected channel, is turned off when the tones are triggered and restored after the tones have been sent. Modulation on other channels is not affected by the calling tones and this allows sequential signalling tones to be combined with sub-audible tones. [NO mod] This option effectively inhibits sequential tones. The tone sequence can be sent between 1 and 9 times, set by [No. of Repeats], every time the [Send Tones] key is pressed. Setting the number of repeats to 10 allows the tones to be sent continually under control of the [Send Tones]/[Stop Tones] key at the main menu.

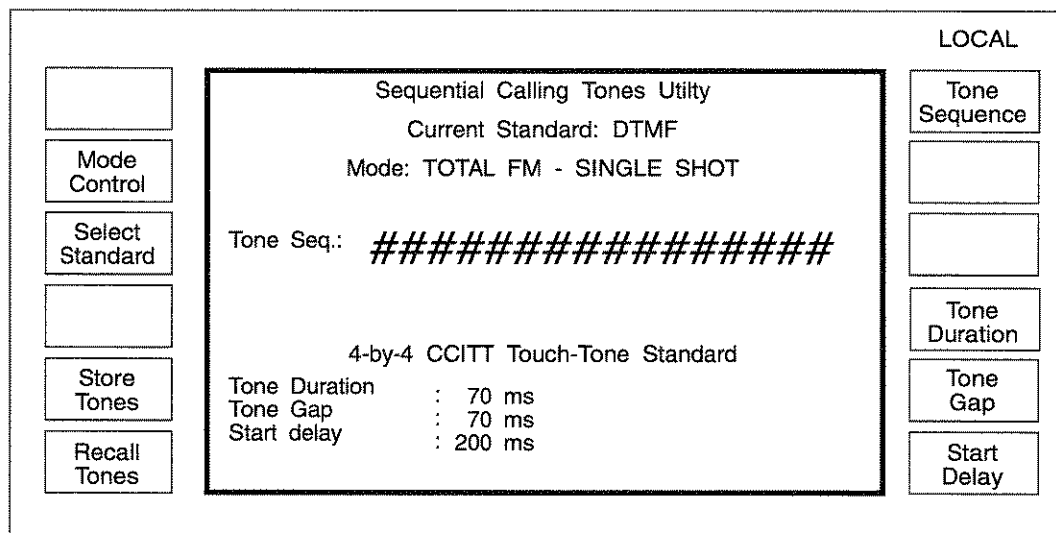

Fig. 3-1-14 Sequential calling tones utility menu (DTMF mode)

On 2040 series fitted with the second modulation oscillator (Option 001) the DTMF signalling capability is also provided. If this standard is selected the main menu accessed after pressing the [Calling Tones] soft key at *Utilities Selection Menu 1* will be as shown in Fig. 3-1-14. The functions of the soft keys are as follows:

[Tone Sequence] Pressing this key allows a tone sequence to be set up using the digits 0-9 on the numerical keypad and the soft keys [A], [B], [C], [D], [*] and [#]. The sequence entry is terminated by pressing [enter].

[Tone Duration] The default duration of 70 ms for each tone in the sequence can be changed by pressing this key, entering the required duration value and pressing [ms].

[Tone Gap] The default gap duration of 70 ms between each tone in the sequence can be changed by pressing this key, entering the required gap length and pressing [ms].

[Start Delay] The delay before the tone sequence starts and the gap between sequences can be adjusted by pressing this soft key, entering the required delay time on the keypad and pressing [ms].

[Mode Control] Pressing this enables the user to assign the calling tones to a selected type of modulation, see Fig. 3-1-15. Modulation, on the selected channel, is turned off when the tones are triggered and restored after the tones have been sent. Modulation on other channels is not affected by the calling tones and this allows sequential signalling tones to be combined with sub-audible tones. [NO mod] This option effectively inhibits sequential tones. The tone sequence can be sent between 1 and 9 times, set by [No. of Repeats], every time the [Send Tones] key is pressed. Setting the number of repeats to 10 allows the tones to be sent continually under control of the [Send Tones]/[Stop Tones] key at the main menu.

[Select Standard] Selection of alternative signalling standards is achieved by pressing this key to access the *Select Standard Menu*.

[Store Tones] Up to 20 sequence set-ups can be stored. Use the keypad to enter the store location number and press [enter].

[Recall Tones] To recall a tone sequence, use the key pad to select the required store location and press [enter].

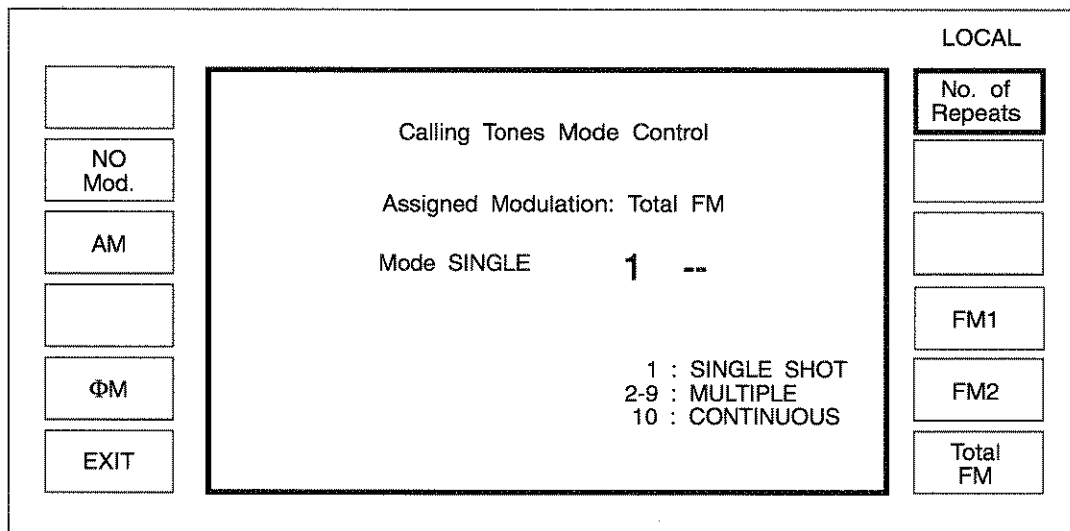

C0047

Fig. 3-1-15 Calling tones mode control menu (with [FM] selected)

Selecting alternative tone standards

The *[Select Standard]* key causes the *Tone Standard Selection Menu* to be displayed, see Fig. 3-1-16.

Tone Standard Selection Menu	
Current Standard: CCIR	
Tone 0: 1.9810 kHz	Tone 8: 1.7470 kHz
Tone 1: 1.1240 kHz	Tone 9: 1.8600 kHz
Tone 2: 1.1970 kHz	Tone A: 2.0000 kHz
Tone 3: 1.2750 kHz	Tone B: 930.0 Hz
Tone 4: 1.3580 kHz	Tone C: 2.2570 kHz
Tone 5: 1.4460 kHz	Tone D: 991.0 Hz
Tone 6: 1.5400 kHz	Tone E: 2.1100 kHz
Tone 7: 1.6400 kHz	Tone F: 0 Hz
Default Duration : 100ms	
Tone Gap : 6ms	

C0048

Fig. 3-1-16 Tone standard selection menu

The tone sequential standard to be used is selected by pressing the appropriate soft key. This menu also shows the frequency and timing characteristics for each tone in the standard. User 1 and User 2 are user defined tone standards stored in non-volatile memory. The *[DTMF]* softkey only appears on the display if the instrument is fitted with a second modulation oscillator (Option 001 fitted). If only a single oscillator is fitted the *[DTMF]* key is left blank

Editing a tone standard

Pressing the *[Edit Standard]* key when in the *Sequential Calling Tones Utility* menu (Fig. 3-1-13) will produce the *Edit Sequential Tones Utility*, see Fig. 3-1-17, which allows a user defined tone system to be set up.

All editing is carried out in a tone standard called TEMP which is not stored beyond switch off. To ensure that the alterations are available for future use the newly defined tone standard must be saved to non-volatile storage in either USER1 or USER2.

The editing facility allows the user to define the frequency of each of the 16 tones in the system and to set the default duration of each tone in the sequence and the gap between tones (if any). All other settings are handled in the normal *Sequential Tones Utility* menu.

The currently selected tone standard may be copied into the TEMP working space using the top left soft key (shown *[CCIR to TEMP]* in Fig. 3-1-17) and often this is a convenient way to start, particularly when the user defined system is similar to one of the standard systems.

To edit the system in TEMP use [Tone Number] to select the number of the tone to be edited (0 to 15) and after pressing [Tone Freq.] enter the new frequency to be assigned to this tone number. Select other tones in the system by means to the [Tone Number] key or use the [Next Tone] and [Previous Tone] keys to step through the list. Enter the frequencies of the tones and then use [Default Duration] and [Tone Gap] to set the times in milliseconds for the default duration of each tone and the gap between each tone.

Finally store the user defined tone system parameters in USER1 or USER2 by pressing [Store to USER1] or [Store to User2].

Note that when using the DTMF tone signalling capability no editing facility is provided. Changes to the default settings are made directly on the *Calling Tones Utility Menu*.

		LOCAL
CCIR to TEMP	Edit Sequential Tones Standard Tone Number: 0 - - Tone Frequency : 10.0 Hz Default Duration : 100 ms Tone Gap : 0 ms	Tone Number
		Tone Freq.
Store to USER1		Default Duration
Store to USER2		Tone Gap
		Next Tone
EXIT		Previous Tone

C0049

Fig. 3-1-17 Edit sequential tones standard menu

INCREMENTING (using Δ)

Displaying shifts

Press the [Δ] hard key. The total shift menu is displayed as shown in Fig. 3-1-18. This menu displays the difference between the current value and the keyed-in value. Parameters can be incremented or decremented by using the [↑] or [↓] key or the control knob, see 'Using the control knob' on Page 3-1-10. To cancel any changes made by the rotary control or the [↑/↓] keys, press [Return Value]. This will restore the setting of the selected parameter to the keyed-in value, i.e. the indicated shift will return to zero. Pressing [Transfer Value] transfers the current value to the Sig Gen menu as the keyed in value.

Transfer Value	Carrier + Freq. 0 Hz	LOCAL Carrier Freq.
Return Value	RF Level + 0.0 dB ON	RF Level
AM	Int Std: 10 MHz	FM Shift
	Low Noise Mode 1 Modulation ENABLED	Int F4 Shift
	FM+ 0 Hz ON	FM ON/OFF
Set Steps	Int F4+ 0 Hz	

C00050

Fig. 3-1-18 Total shift menu

Setting increment values

- (1) From the total shift menu select [Set Steps]. The screen shows the currently set step sizes.
- (2) Select [Carrier Step], enter the value on the key pad and press a terminator key. The step value will appear on the screen.
- (3) Return to the main menu by pressing [SIG GEN].
- (4) Using the [↑/↓] keys respectively will now increment or decrement the carrier frequency by the set value.
- (5) [RF Level Step], [AM Step] and [Source Step] values can be entered in the same way.

Note...

Wideband FM and pulse modulation parameters cannot be incremented in this manner.

SWEEP

The sweep capability allows the comprehensive testing of systems, as measurements at single points will not necessarily give an overall indication of the performance. The sweep function is specified by the following parameters:

- Start value
- Stop value
- Number of steps
- Time per step

Up to five individually adjustable markers may be set. Each marker can be turned on and off separately. Sweep functions available are:

- Carrier frequency with or without modulation (available in normal noise mode only)
- RF level
- Internal modulation rate
- LF frequency (if in LF generator mode)
- LF level (if in LF generator mode).

The sweep can be operated in single shot or continuous modes with the start command triggered by a key press, an external pulse or GPIB control. Once started, the sweep can be stopped at any time when the display will indicate the current parameter value. The sweep can be used with oscilloscopes, X-Y display units and X-Y plotters by connecting the display unit X input to the SWEEP RAMP output on the rear panel.

A sweep routine is set up as described in the following paragraphs:

Sweep type

- (1) Press the [SWEEP] hard key. The sweep parameters display, with soft key options, appears on the screen, see Fig. 3-1-19.

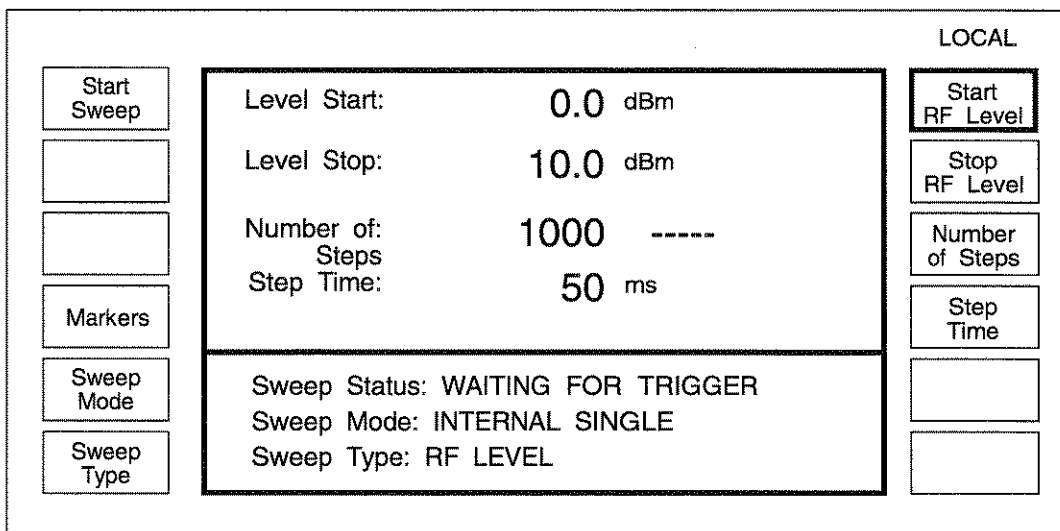

C0051

Fig. 3-1-19 Sweep parameters display

- (2) Press [*Sweep Type*]. The *Sweep Type Menu* is displayed, see Fig. 3-1-20.

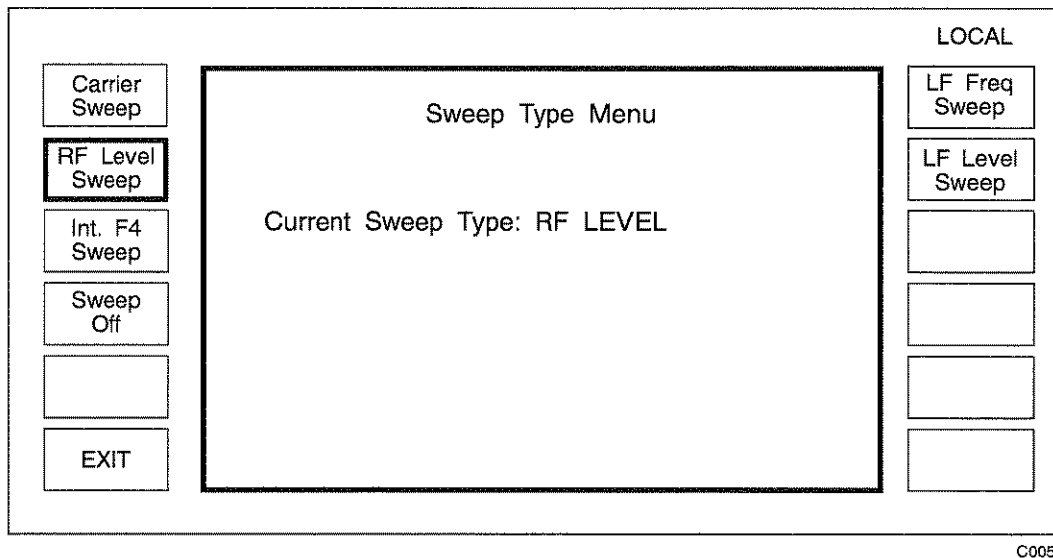

Fig. 3-1-20 Sweep type menu

The instrument must be in the LF generator mode before an LF frequency sweep and LF level sweep can be initiated.

The [*Carrier Sweep*] soft key only appears in the normal noise mode. In the two low noise modes this key is not present.

Modulation required during sweep should be entered before putting the instrument in the sweep mode.

- (3) Select the required sweep type by pressing the appropriate soft key, e.g. [*Carrier Sweep*]. The Sweep Type screen changes to confirm the selection.
- (4) Press [*EXIT*] or [*SWEEP*] to return to the sweep parameters display.

Sweep mode

- (1) At the sweep parameters menu, press [*Sweep Mode*]. The *Sweep Trigger Mode Menu* is displayed, see Fig. 3-1-21.

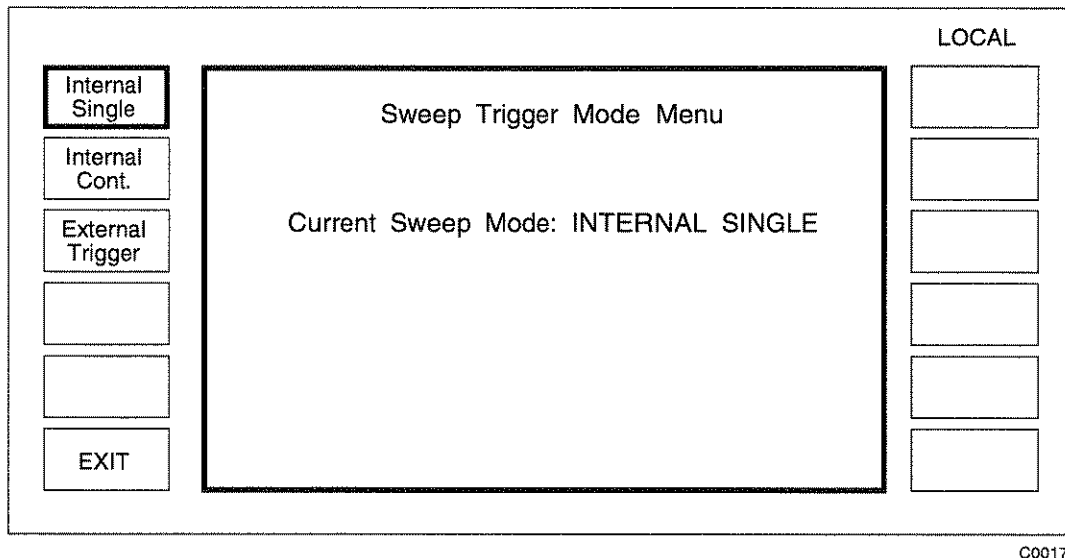

Fig. 3-1-21 Sweep trigger mode menu

- (2) Select the sweep mode, [*Internal Single*], [*Internal Cont.*], or [*External Trigger*].
- (3) Press [*EXIT*] to return to the sweep parameters display menu.
- (4) If [*External trigger*] is selected, press [UTIL], select [*Utils. Menu 1*] and from this menu press [*External Trigger*]. The *External Trigger Selection Menu* will be displayed. Then press [SWEEP] to return to the Sweep Parameters display.

Start value

- (1) Select the appropriate soft key to enter the start value, e.g. [*Start Freq*].
- (2) Enter the required start value via the numerical key pad and the appropriate terminator key.

Stop value

- (1) Select the appropriate soft key to enter the stop value, e.g. [*Stop Freq*].
- (2) Enter the required stop value via the numerical key pad and the appropriate terminator key.

When carrier frequency parameters are entered, the instrument calculates all the individual step values together with any level and modulation correction factors. While this process is taking place, the sweep status line changes to indicate 'CALCULATING SWEEP'.

Number of steps

- (1) Select *[Number of Steps]*.
- (2) Enter the number of steps via the numerical key pad and the [GHz/V/enter] terminator key.

Note...

If an inappropriate number of steps is selected, the instrument will automatically choose a more reasonable value. The number of steps available depends on the operating mode and the maximum values are:

- 250 for carrier frequency with FM, Φ M or Wideband FM enabled.
- 1,000 for carrier frequency without FM, Φ M or Wideband FM enabled.
- 10,000 for RF level, RF modulation frequency, LF frequency and LF level.

Step time

- (1) Select *[Step Time]*.
- (2) Enter the step time via the numerical key pad and the [MHz/mV/ms] terminator key.

Markers

A facility exists for producing markers, controlled by the *Sweep Markers Menu*, see Fig. 3-1-22.

The screenshot shows the 'Sweep Markers menu' with the following data:

Marker	Value	Unit	Status
Marker 1	2.0	dBm	OFF
Marker 2	4.0	dBm	OFF
Marker 3	6.0	dBm	OFF
Marker 4	8.0	dBm	OFF
Marker 5	10.0	dBm	OFF

Additional menu elements include: 'Enable/Disable', 'Marker ON/OFF', 'EXIT', and a 'LOCAL' section with buttons for 'Marker 1' through 'Marker 5'. The status 'Markers : DISABLED' is displayed at the top of the menu.

C0461

Fig. 3-1-22 Markers menu

To set a marker, press one of the marker soft keys e.g. [Marker 3], enter the required value on the key pad and terminate with the appropriate units hard key. Turn the marker ON using the [Marker ON/OFF] key. When all markers have been entered use the [Enable/Disable] key to activate the marker output on the rear panel. The marker output produces a positive going pulse with a duration of one sweep step when the sweep passes a marker value.

Starting the sweep

From the sweep parameters menu, press [Start Sweep]. The single sweep status line display changes from *WAITING FOR TRIGGER* to *SWEEPING* and a solid bar increments to show the sweep progression, see Fig. 3-1-23.

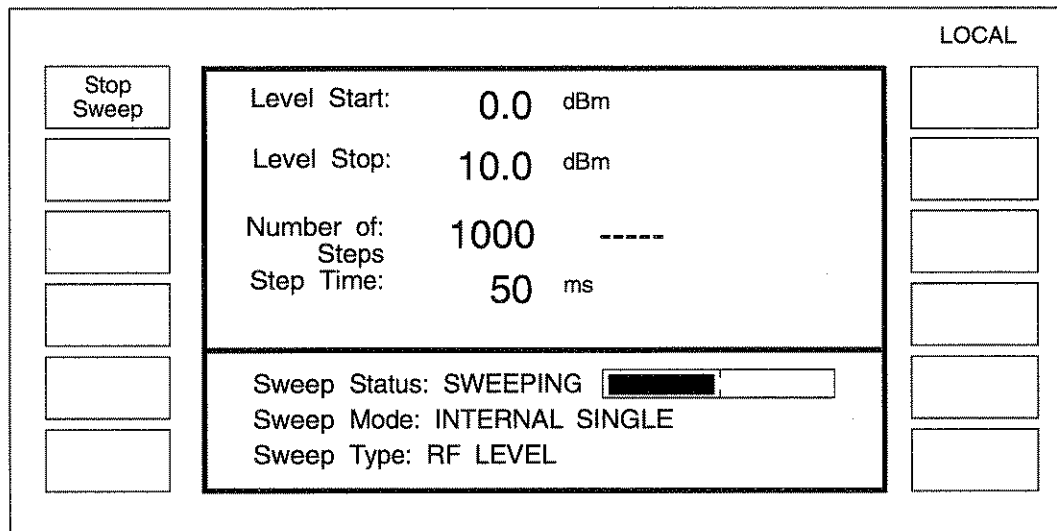

C0055

Fig. 3-1-23 Sweep in progress

Note ...

When the sweep is in progress, all the hard keys are disabled and [Stop Sweep] is the only active soft key.

Stopping the sweep

Press [Stop Sweep]. The sweep stops and the menu presents the opportunity to press:-
 [Reset Sweep] to change the sweep parameters, or
 [Continue Sweep] to continue the sweep, or
 [Transfer] to transfer the current value of the swept parameter as the last keyed in value in the [SIG GEN] or [LF]([LF Gen]) mode, see Figs. 3-1-24 and 3-1-25. When the sweep is in the paused state, the ↑ and ↓ keys can be used to step the parameter up or down. The sweep can then be continued by pressing [Continue Sweep].

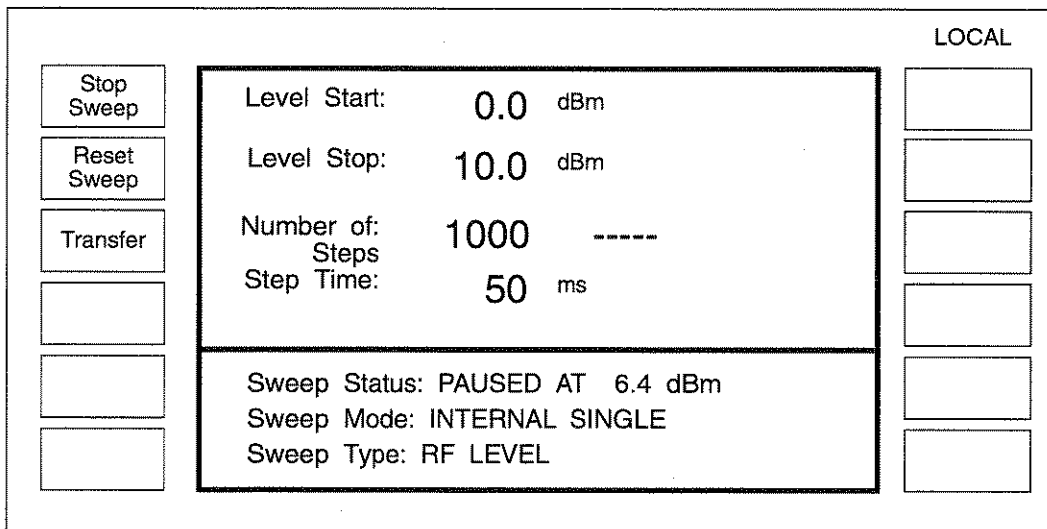

C0056

Fig. 3-1-24 Sweep stopped

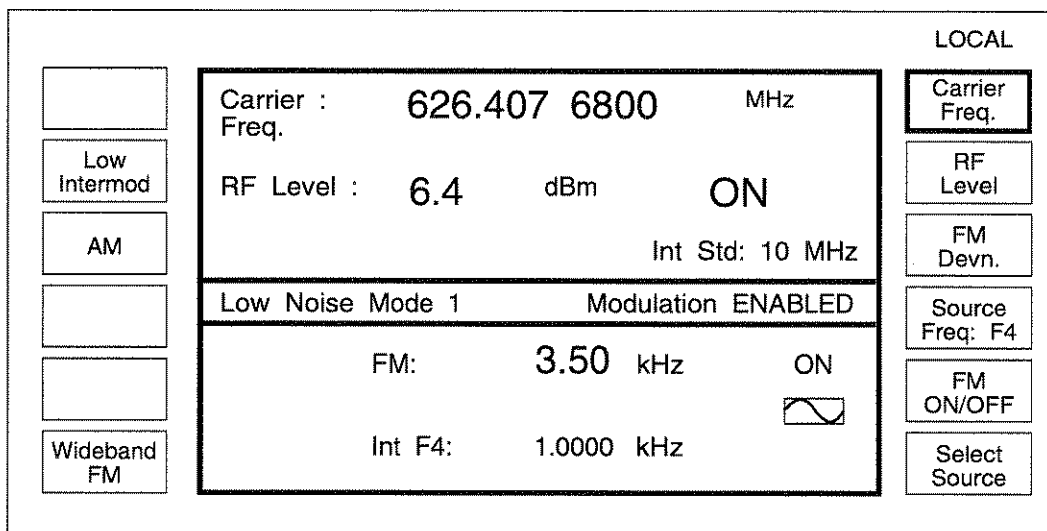

C0473

Fig. 3-1-25 RF level transferred

UTILITIES

The utilities options are accessible from two primary menus, *Utilities Selection Menu 1* and *Utilities Selection Menu 2*. When a selection is made from either of these menus and [UTIL] is subsequently pressed, the primary menu is re-displayed. However, if instead a selection is made and then one of the other hard keys e.g. [SWEEP] is pressed, pressing [UTIL] subsequently once returns to the sub-menu, pressing it again returns to the primary menu. This provides an operating short-cut in that it allows a sub-menu to be re-accessed without first having to go again through the primary menu. This scheme does not apply to the [TIME & DATE] soft key or to the [Sig Gen] hard key. The display for *Utilities Selection Menu 1* is shown in Fig. 3-1-26. To obtain *Utilities Selection Menu 2* from the menu, press [Utils. Menu 2].

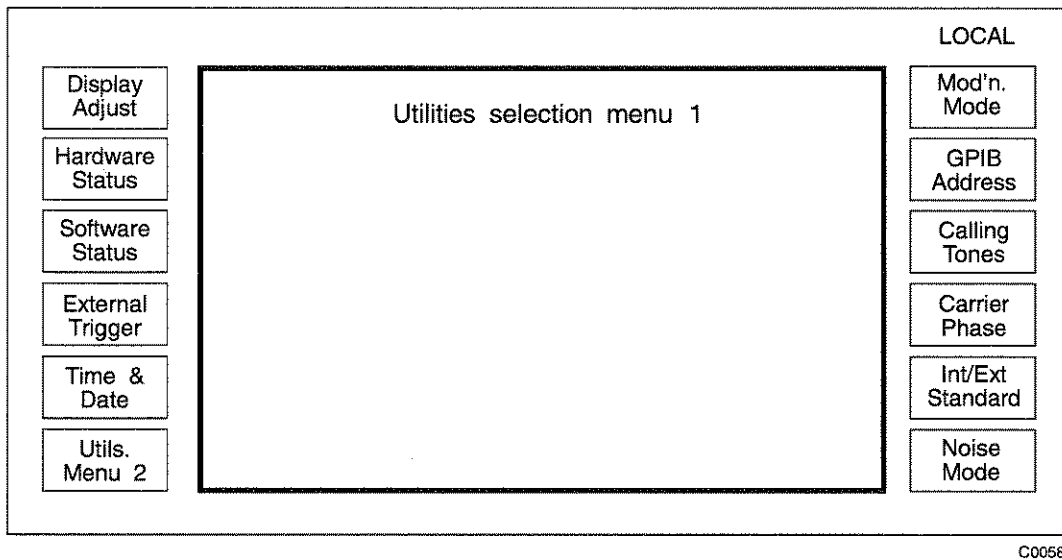

Fig. 3-1-26 Utilities selection menu 1

Adjusting the display

To adjust the display, press [Display Adjust]. The *Display Adjust* menu is displayed on the screen, see Fig. 3-1-27. The backlight, which is on when the instrument is switched ON, can be toggled ON or OFF using the [Display On/Off] key, and when ON can be varied in brightness by [Dim], [Medium 1], [Medium 2] and [Bright]. Contrast is adjusted with the control knob. Once adjusted, the LCD setting can be stored in the the non-volatile memory by pressing [Save LCD Setting]. The instrument always activates the backlighting whenever it is switched on.

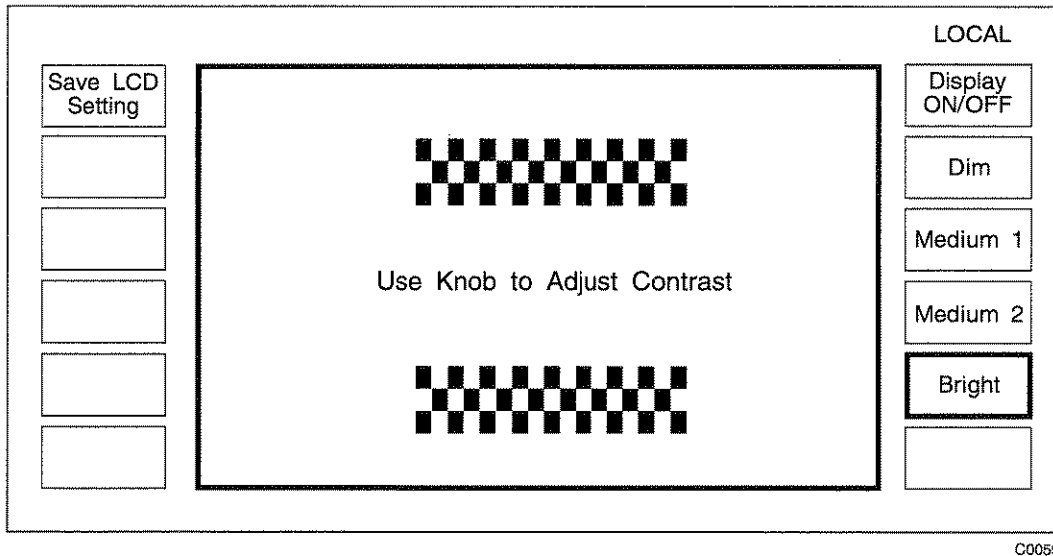

Fig. 3-1-27 Display adjust menu

Hardware information

To obtain a description of the instrument hardware, press [*Hardware Status*] and the following information is displayed:

Instrument type (e.g. 2041)
 Serial no. (e.g. 1543256/045)
 Options fitted (e.g. *SECOND LF OSC.*)
 Attenuator type and serial number.

For attenuator calibration information, refer to the Service Manual.

Software information

To obtain a description of the instrument software, press [*Software Status*] and the following information is displayed:

Software version number e.g. 2.008
 Part number e.g. 44533-366
 GPIB address e.g. 07

External trigger

The external trigger facility allows the rear panel TRIGGER input to be set up so as to initiate a defined change in the generator setting. To define the function press [*External Trigger*]. The display changes to show the *External Trigger Selection Menu* which has the following options:

[<i>Sweep Start</i>]	Starts the external sweep.
[<i>Sweep Step</i>]	Goes to next step of external sweep.
[<i>Send Seq Tones</i>]	Equivalent to [<i>Send Tones</i>] on main menu.
[<i>Recall Up</i>]	Recall next store.
[<i>Recall Down</i>]	Recall previous store.
[<i>No Ext. Trigger</i>]	Trigger ignored (default).

A switch closure or voltage transition from +5 V to 0 V applied to the rear panel socket initiates the trigger action.

Setting the modulation mode

Modulation mode selection allows the generator to be configured to provide carriers modulated by one, two or four (2 internal and 2 external) modulation sources.

Press [*Mod'n Mode*] to display the *Modulation Mode Selection Menu*, choose the type of modulation required by pressing [*Single*], [*Dual*], [*Comp*] or [*Dual Comp*] see Page 3-1-19, 'Modulation mode selection'.

Setting the GPIB address

Press [*GPIB Address*] to display the *GPIB Address Change Menu*. To change the address, enter the address, in the range 0-30, via the numerical key pad and press [enter]. The data is then saved automatically in the non-volatile memory. For information on operating the instrument via the GPIB, refer to Chapter 3-2.

Sequential calling tones

Sequential calling tones are set up from a utility menu, Fig. 3-1-26, and are activated by pressing [*Send Tones*] which appears on the main menu after the tones have been set up. [*Send Tones*] also appears on the calling tones menu. Pressing the [*Calling Tones*] soft key at *Utilities Selection Menu 1* calls up the *Sequential Calling Tones Utility* menu, see 'SIGNALLING'.

Carrier phase adjustment

Pressing [*Carrier Phase*] displays the *Carrier Phase Control Menu*. To advance or retard the carrier phase (with respect to its current phase) in steps of $\pi/128$ radians, approximately 1.4° , rotate the control knob clockwise to advance the phase and counter-clockwise to retard the phase.

Selection of frequency standard

Pressing [*Int/Ext Standard*] changes the menu to display the *Frequency Standard Selection Menu* which has the following options:

- 1 MHz Int. Std.
- 5 MHz Int. Std.
- 10 MHz Int. Std.
- 1 MHz Ext. Std.
- 5 MHz Ext. Std.
- 10 MHz Ext. Std.

If the internal standard is selected, it is available as an output at the selected frequency on the rear panel. Selecting an external option enables the instrument to accept a standard from an external source at that frequency. These settings are saved in the non-volatile memory.

Noise mode selection

The 2040 series of signal generators have three noise modes. The two low noise modes (low noise mode 1 and low noise mode 2) provide the lowest levels of SSB phase noise and residual FM whilst the normal noise mode allows the instrument to operate with the widest range of modulation capabilities. The capabilities of the different modes are as follows:

Low noise mode 1

In this mode the 2040 series offer the lowest level of noise with a restricted FM deviation capability and a reduced AM bandwidth. Phase modulation is not available and the carrier sweep capability is not provided. This mode is suitable for a wide range of applications where relatively low modulating frequencies are used.

Low noise mode 2

Compared with low noise mode 1, noise mode 2 provides a wider AM bandwidth with a slightly higher level of noise. This mode should be used when full AM performance is required with good noise performance.

Normal noise mode

In the normal mode the 2040 series offer a level of performance equivalent to the 2030 series. Full FM, Φ M and AM capabilities are available and the full range of sweep facilities are implemented.

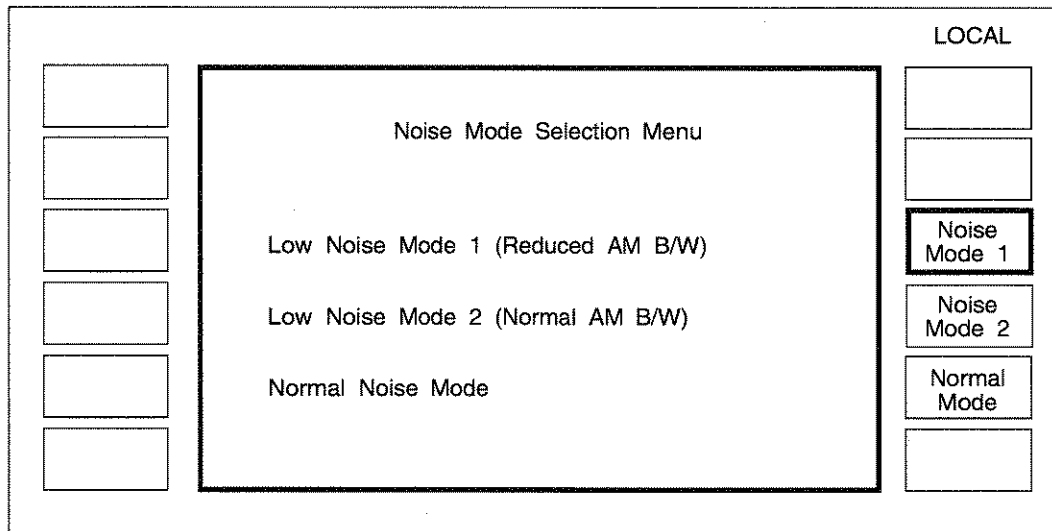

C0060

Fig. 3-1-28 Noise mode selection menu

Press the *[Noise Mode]* soft key on the *Utilities Selection Menu 1* and in the *Noise Mode Selection Menu* press the relevant soft key to select the desired operating mode.

Selection menu 2

Press [Utils Menu 2] from *Utilities Selection Menu 1*. The display now changes to show *Utilities Selection Menu 2*, see Fig. 3-1-29. This menu allows access to the protected data. Utilities on this menu have either 1st or 2nd level protection.

If the instrument is locked, the appropriate level must be unlocked otherwise the utility will only be usable in a read only mode. To change parameters, the function must be unlocked. The procedure is:

[UTIL] ⇒ [Utils. Menu 2] ⇒ [Lock & Unlock] ⇒ *Function Unlocking Utility menu* ⇒ [Unlock Level 1] or, for servicing, [Unlock Level 2].

The correct password must be entered. Many of these activities are intended for use in servicing and are described in the Service Manual.

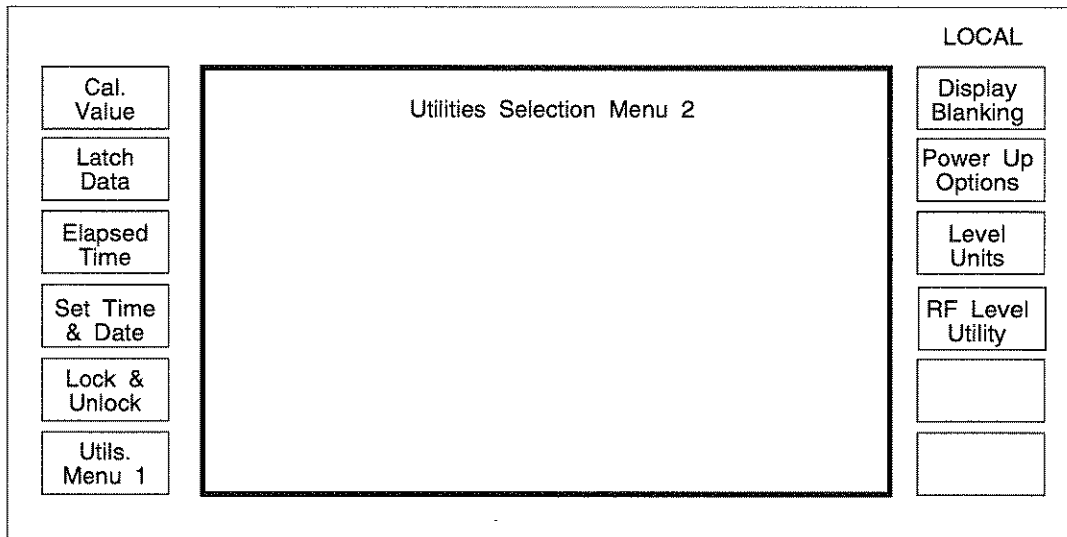

Fig. 3-1-29 Utilities selection menu 2

Calibration

Pressing [Cal. Value] brings the *Calibration Utilities Menu* to the display, see Fig. 3-1-30. This menu shows when the last complete check was made and when the next calibration check is due. It also shows the date on which the individual items were adjusted. It is possible to inspect the calibration value of these items but calibration cannot be carried out unless the protection facility is unlocked at Level 2. Full details regarding calibration can be found in the Service Manual.

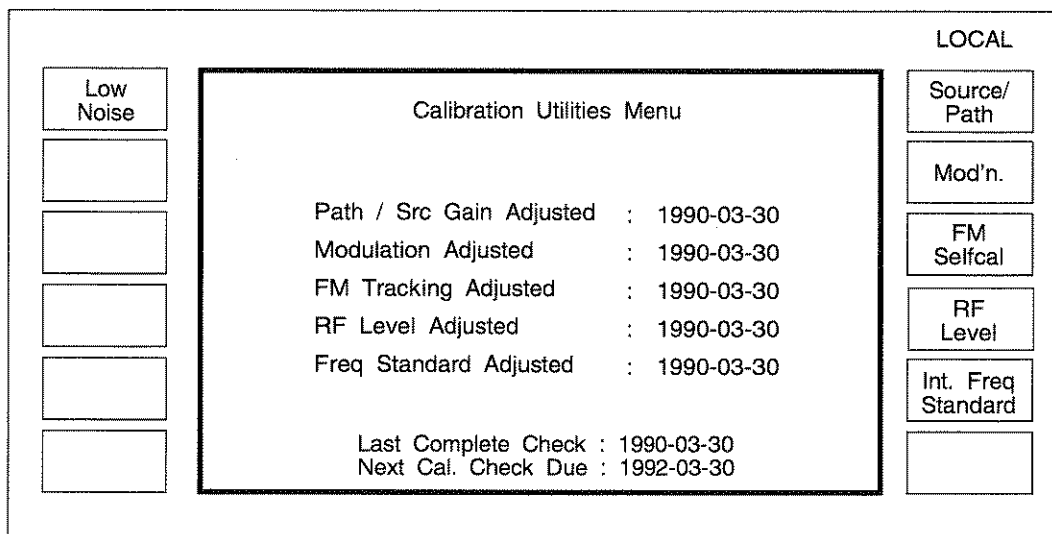

Fig. 3-1-30 Calibration utilities menu

Latch data

The latch data menu is intended for use as a diagnostic aid by allowing data to be sent to latches within the instrument. For further information consult the Service Manual.

Elapsed time

The elapsed time facility displays the number of operating hours since the function was last reset. Pressing [*Elapsed Time*] displays the number of operating hours and the date on which the function was last set to zero. This facility can be used to assess the instrument's operational reliability and utilisation.

Setting time and date

Unlock to Level 1 (see 'Selection menu 2' and 'Locking and unlocking'). Set the time and date by pressing [*Set Time & Date*] at *Utilities Selection Menu 2*. The screen shows the current time, date and day of the week. The time shown does not change during display. The clock is powered by a rear panel battery, see Chap. 2, 'BATTERY REPLACEMENT'.

[*Set Time*] Press this key to set the time. Using the keypad enter the hour and minutes (24 hour clock). Separate the hour and minutes fields by a hyphen, e.g. 21-30. Terminate the entry by [enter] which starts the clock.

[*Set Date*] Press this key to set the date (in ISO format). Using the keypad enter the year, month and day. Separate the year, month and day fields by a hyphen e.g. 1992-04-23. Terminate the entry by [enter]. The day of the week is automatically determined when the date is set.

Locking and unlocking

Press [*Lock & Unlock*]. When Level 1 and Level 2 are both locked, the menu displays three soft keys:

Unlock Level 1
Unlock Level 2
Serial No. Set

Press [*Unlock Level 1*] and the message *Enter 4 Digit Password:* will appear on the display. Level 1 is unlocked by entering the 4 digits on the key pad and pressing [enter]. The menu will change and two soft keys, [*Lock Level 1*] and [*Lock Keyboard*], will appear on the left-hand side. The default password is 1234. If this password is not recognised by the instrument, the password has been changed by your calibration/repair department personnel who should be consulted for further information. [*Unlock Level 2*] is only used during servicing. Refer to the Service Manual for details.

Keyboard locking

Unlock to Level 1, see 'Selection Menu 2' and 'Locking and Unlocking' above. Keyboard operation is disabled by pressing [*Lock Keyboard*]. The instrument automatically returns to the main menu which indicates the locked status by displaying a key-shaped icon in the top left-hand corner of the display. The keyboard can be re-enabled by entering the 4 digit password for Level 1 using the keypad and pressing [enter]. The keyboard status is saved in the non-volatile memory.

Display blanking

To prevent sensitive data from being displayed, the 2040 series Signal Generators include a display blanking facility. This allows various parts of the display to be replaced by a series of dashes so that values entered by the user or recalled from the memory will not be visible. The instrument must be unlocked to Level 2 to enable or disable this facility. Consult the Service Manual for further information.

Power up options

Unlock to Level 1, see 'Selection Menu 2' and 'Locking and unlocking' above. Two options are available by pressing [*Power Up Options*] at *Utilities Selection Menu 2*. These options are [*Factory*] and [*Memory*]. When [*Factory*] is pressed, the factory set power up state is recalled. Pressing [*Memory*] causes [*Memory Number*] to appear at the right-hand side of the menu. To change the power up state of the instrument to a particular setting, enter the memory number of the full store on the key pad and press [enter].

RF level units

RF output level units can be altered using the [*Level Units*] key. The level units may be entered as an EMF or PD, and the logarithmic units can be referred to volts (dBV), millivolts (dBmV), microvolts (dB μ V) or to 1 milliwatt into 50 Ω (dBm). Select the units by pressing [*Level Units*] which displays the *RF Level Units Selection Menu* shown in Fig. 3-1-31.

To change the default RF level units shown at switch on, first unlock the instrument to Level 1. This causes an additional soft key to be displayed in the top left box (see Fig. 3-1-31). Select the required RF level units and press the additional [*Save RF Units*] key to save these as the default units.

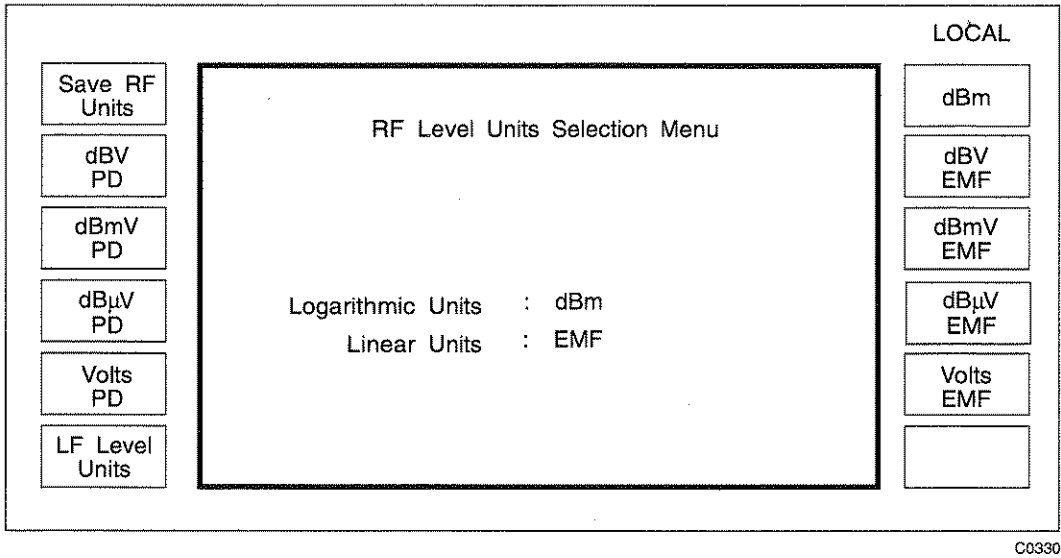

Fig. 3-1-31 RF level units selection menu (shown unlocked to level 1)

LF level units

LF level logarithmic units may be referenced to 1 volt EMF (dBV EMF), 1 millivolt EMF (dBmV EMF) or 1 milliwatt into 600 Ω (dBm). Linear units are always set EMF values.

Select the units by pressing the [LF Level Units] soft key on the RF Level Units Selection Menu which calls up the LF Level Units Selection Menu shown in Fig. 3-1-32.

To change the default LF level units shown at switch on, first unlock the instrument to Level 1. This causes an additional soft key to be displayed in the top left box (see Fig. 3-1-32). Select the required LF level units and press the additional [Save LF Units] key to save these as the default units.

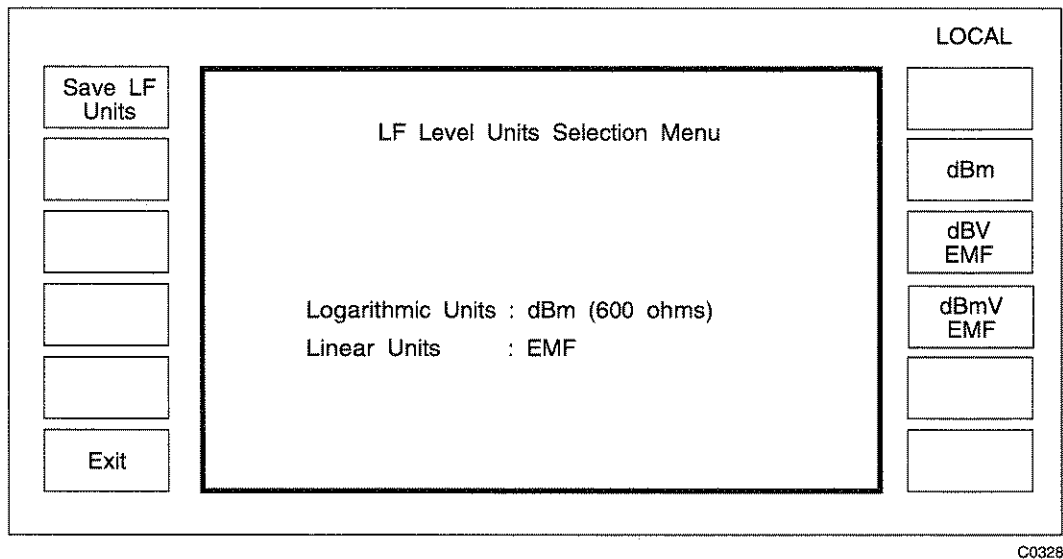

Fig. 3-1-32 LF level units selection menu (shown unlocked to level 1)

RF level utility

Selecting *[RF Level Utility]* from the *Utilities Selection Menu 2* displays the *RF Level Utility Menu* shown in Fig. 3-1-33.

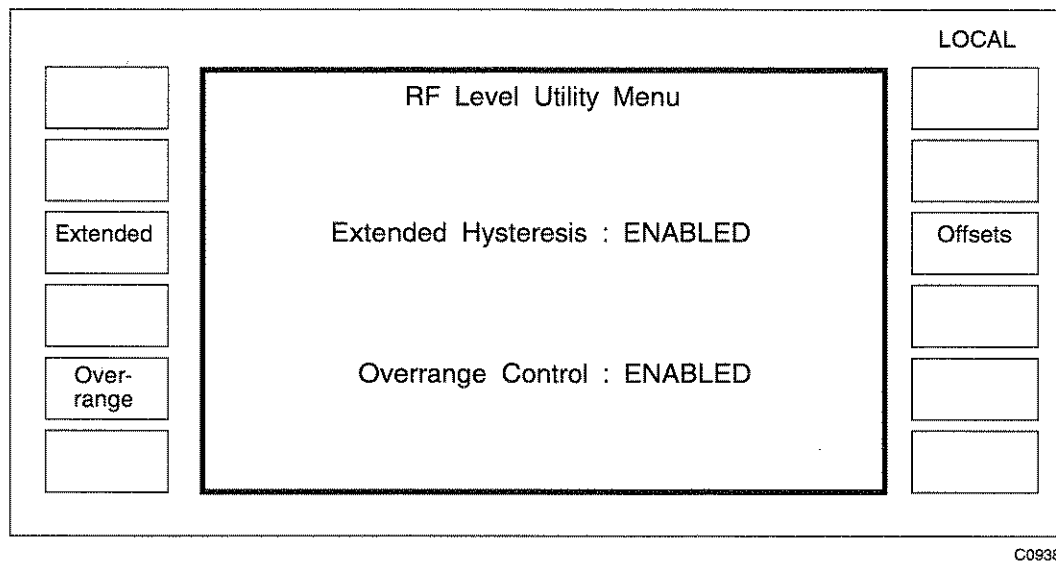

Fig. 3-1-33 RF level utility menu

Extended hysteresis

Pressing the *[Extended]* soft key toggles the status (Enable/Disable) of extended hysteresis. When enabled, this provides an electronic level function which uses the internal D/A converter, rather than the attenuators, to provide an uninterrupted (glitch-free) level control. This increases the electronic level control from ± 7 dB to +12 to -18 dB. A *+HYST* or *-HYST* message is displayed on the *Sig Gen* menu to indicate when in hysteresis and in which direction.

During normal operation the RF output is controlled as shown in Fig. 3-1-34 by electronically controlling the output level over a limited range (normally approximately 0 to +6 dBm) and switching in 6 dB attenuator pads to provide lower RF levels.

When the hysteresis function is enabled and a keyboard entry of the RF level is made, the signal generator sets the level in the normal way. However, when the rotary control is enabled and used to adjust the RF level, the normal attenuator changes are suppressed. When the level is increased, the attenuator change is suppressed for 6 dB above the normal range and *+HYST* is displayed. Similarly, when the level is reduced attenuator changes are suppressed for 12 dB below the normal range and *-HYST* is displayed. When the extended hysteresis range is exceeded the attenuator and the electronic control are reset to values corresponding to the normal operation of the generator. An example of extended hysteresis operation is shown in Fig. 3-1-35.

With the rotary control in use in the hysteresis range of operation, the generator can be instructed to set the RF level to the same value, but set using the *[V]*, *[mV]*, *[μ V]* or *[dB]* keys. This is a useful facility if the user is investigating squelch systems and wants to ensure that varying the level around the current value will not result in an attenuator change.

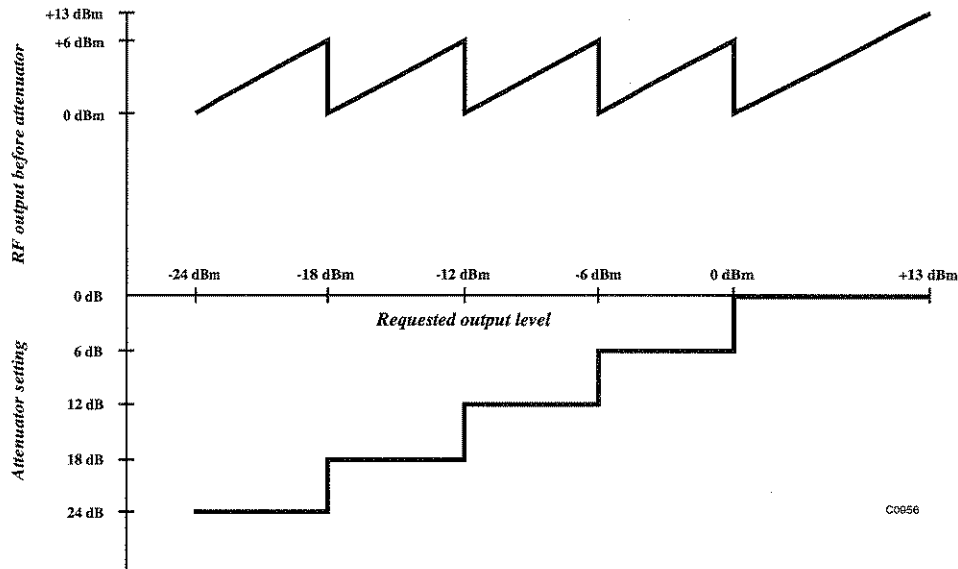

Fig. 3-1-34 Normal signal generator level control operation

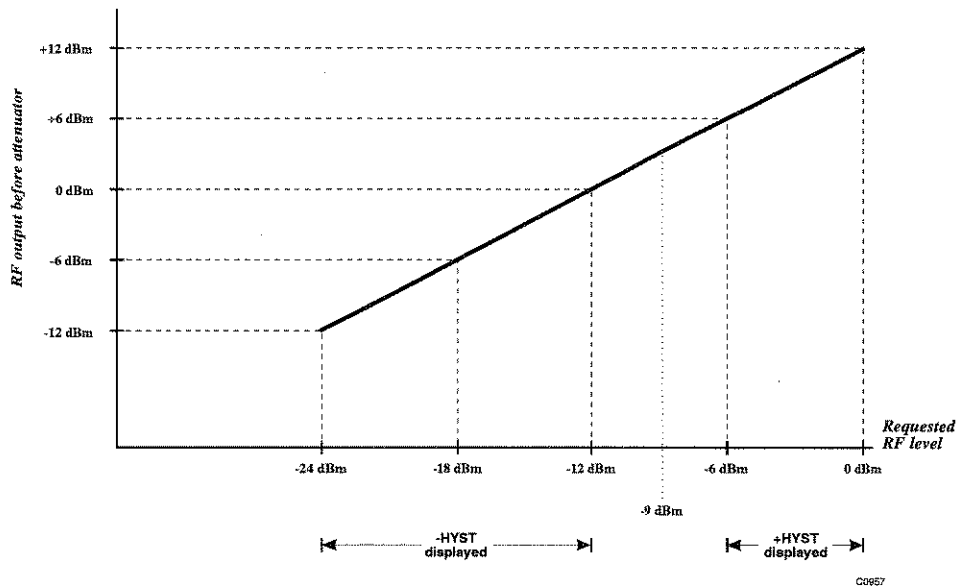

Fig. 3-1-35 Extended hysteresis operation with an RF level of -9 dBm as the starting level

Note...

In the hysteresis range the RF level is set in a different way to the normal operation and this will affect some performance aspects. AM distortion and accuracy will be affected. With no AM selected, the effect on RF accuracy in the +HYST region will be relatively minor. But the effect in the -HYST region on RF level accuracy will be more significant.

Overrange

Pressing the *[Over-range]* soft key toggles the status (Enable/Disable) of the overrange control. When enabled, the maximum RF output power is extended by an additional 6 dB (subject to instrument capability). This increases the maximum output power from +13 to +19 dBm for the standard instrument and from +19 to +25 dBm for an instrument fitted with Option 003. If the requested output level is in the overrange region the *UNCAL* message is displayed on the *Sig Gen* menu.

Note...

If the overrange facility is enabled the signal generator is capable of generating much higher signal levels. If the generator is set to a frequency below 21.09375 MHz and the RF output is not terminated in 50 Ω then the RPP may be tripped by the internal RF signal. If this happens the RPP can only be reset if a 50 Ω termination is connected to the RF OUTPUT socket.

RF offset

With the instrument unlocked to Level 1, see 'Locking and unlocking' above, pressing *[Offsets]* produces the layout for the soft keys shown in Fig. 3-1-36.

Save Offset	Carrier : 1 050.000 000 MHz	LOCAL
Enable/Disable	Carrier Freq.	Carrier Freq.
Offset ON/OFF	RF Level : -102.0 dBm ON	Offset Value
	Offsets: DISABLED	
	Offset (675MHz - 1.35GHz) : 0.0 dB OFF	

C1029

Fig. 3-1-36 RF offset adjustment menu

To compensate for cable or switching losses or to standardize a group of instruments so that they give identical measurements, the RF output level can be offset by up to ± 2 dB. This is done by selecting *[Offset Value]* and either keying in the value or making the adjustment with the control knob. A separate offset can be set for the carrier frequency range 10 kHz to 337.5 MHz and each octave above this. Offsets can be turned on or off individually using the *[Offset ON/OFF]* key or all offsets can be turned on or off via the *[Enable/Disable]* key.

Note...

This facility is replaced by a more versatile system on generators supplied with Option 008, RF profiles and complex sweep. The facility is described in Chap. 1 under 'Options'.

LOW FREQUENCY OPERATION

The instrument has two modes of LF operation. The LF output can be used either as a modulation signal monitor or as an independent low frequency generator. Pressing [LF] displays either the *LF Monitor Menu* or the *LF Generator Menu*, depending on which mode was last selected.

LF monitor

The left-hand side of the *LF Monitor Menu*, varies according to the modulation mode; single, composite, dual or dual composite. In each case the right-hand side is occupied by a single soft key, [*LF Gen.*].

TABLE 3-1-1
LIST OF AVAILABLE SOFTKEYS FOR DIFFERENT MODULATION MODES

Single	Composite	Dual	Dual Composite
Mod. Drive Mod. Source	Mod. Drive Mod. 1 Source Mod. 2 Source	AM Drive AM Source - FM/ΦM Drive FM/ΦM Source -	AM Drive AM 1 Source AM 2 Source FM/ΦM Drive FM/ΦM 1 Source FM/ΦM 2 Source

Modulation source monitoring

Internal sources only may be monitored. To monitor a modulating signal source, press the appropriate key. The source monitor level and the source information appear on the display. The modulating signal output is fed to the LF OUTPUT socket at a fixed level of 1 V.

Modulation drive monitoring

Modulation drive monitoring is intended for the user to monitor complex modulating signals from both internal and external sources. To monitor a modulation drive, press the appropriate key. The LF monitor level and the selected drive are displayed.

When the summed AM drive signal is selected, a signal which is the sum of both AM channels is fed to the LF OUTPUT socket, if in a composite or dual composite mode. The LF level function controls the output level at 100% depth, therefore the actual output voltage depends on the modulation depth. If AM is turned off, the associated LF output is removed.

The summed FM/ΦM drive signal is also fed to the LF OUTPUT socket. The signal is the sum of both FM/ΦM channels. The FM drive signal at the monitored point is nominally 1 V but varies over a range of approximately 3 dB (except at deviation values below about 1 kHz) depending on the set modulation and the carrier frequency selected. If FM/ΦM is turned off, the LF signal is removed. If one component of a composite modulation setting is turned off, the component which is left on remains at its original level.

Note...

Wideband FM and pulse modulating signals are not accessible via the monitor mode.

Use as an independent LF generator

To use the instrument as an independent LF generator, select [LF Gen.] at the LF Monitor Menu. The LF Generator Menu appears on the display as shown in Fig. 3-1-37.

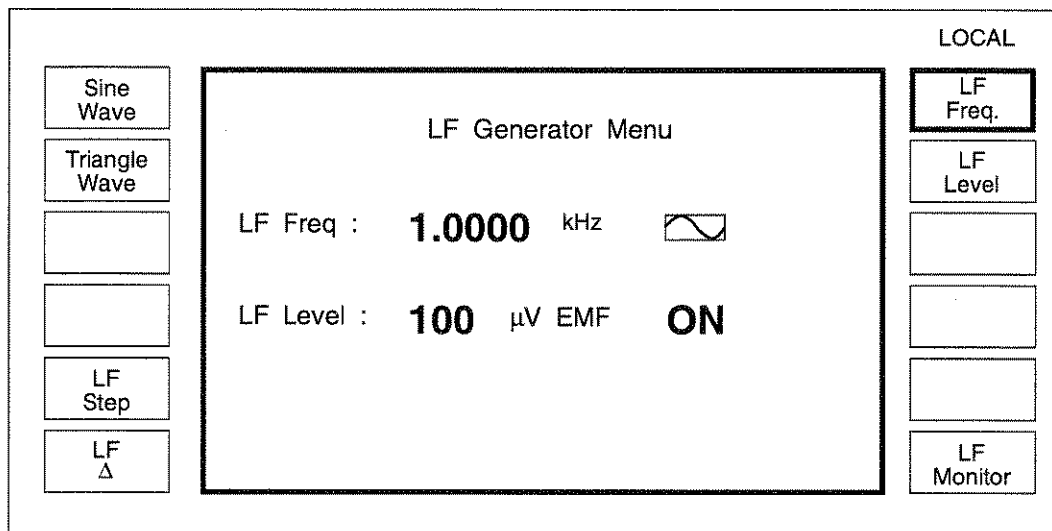

C0462

Fig. 3-1-37 LF generator menu

In this mode, one internal oscillator must be used exclusively for this task. Consequently if only one oscillator is fitted, no internal modulation is available to the signal generator while the LF generator is in use. If a second oscillator is fitted, only one is available to the signal generator.

LF frequency and LF level are adjusted by pressing the appropriate key and entering the value via the numerical keypad and pressing [enter]. To set step values, press [LF Step] for the LF Step Menu. [Freq. Step] or [Level Step] can be selected and the values entered as before. To display the LF Total Shift Menu, press [LF Δ].

To regain the oscillator as a modulation source, select the monitor mode.

Note...

The LF output is entered as V/mV/μV or dBm/dBV/dBmV representing the open circuit voltage fed to a high impedance, but the steps are entered in dB and the control knob has a fixed resolution of 0.1 dB.

MEMORY

Memory recall

Pressing the [MEM] hard key after switch on, causes the *Memory Recall Menu*, Fig. 3-1-38, to be displayed. There are four types of recall, full, partial, carrier frequency and sweep. Provision is made for an option not to recall the carrier frequency for full and partial stores. This allows one carrier frequency to be used with a series of stored settings. Pressing [*Inhibit ON/OFF*] turns the option ON and OFF. The state of the option is indicated on the display.

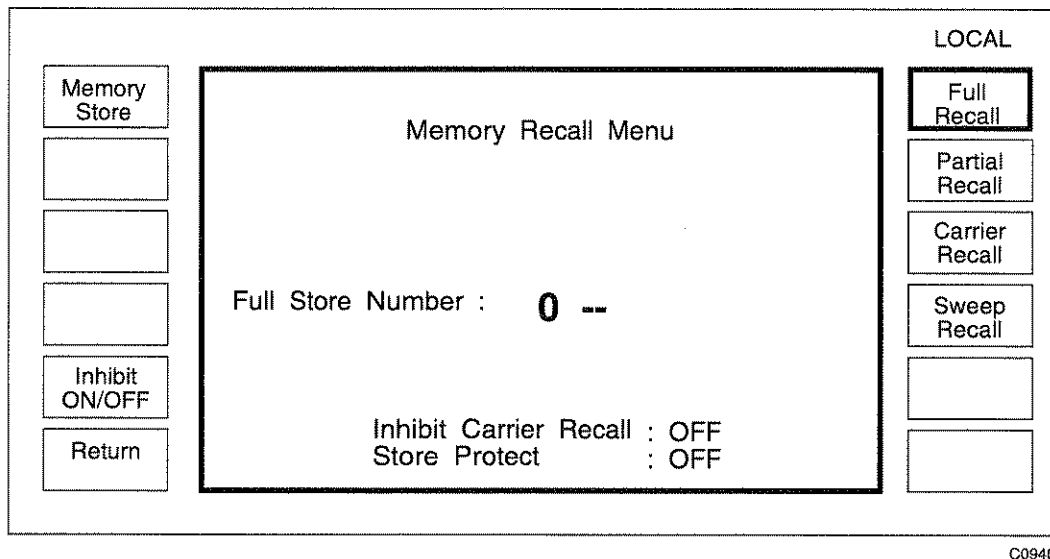

Fig. 3-1-38 Memory recall menu

Full recall

Selecting [*Full Recall*] enables the recall of a complete instrument setting, i.e. carrier frequency, RF level, modulations and their increments, ON/OFF and source information. Also recalled are all 6 modulation oscillator frequencies, plus one increment, and the LF Generator/Monitor setting. [*Inhibit ON/OFF*] provides the option not to recall the carrier frequency setting. The state of the option is indicated on the display. There are 50 locations (numbered 0 to 49) for full recall. A further location (50) allows the factory default settings to be recalled. The factory default settings are listed in Table 3-2-1.

Partial recall

This is a less comprehensive recall of only those parameters which currently affect the RF output; carrier frequency, RF level, modulations in use (without increments), ON/OFF and source information and the two modulation oscillator frequencies in use. As with full store, the option not to recall the carrier frequency is provided. There are 50 locations (numbered 0 to 49) for partial storage.

Carrier recall

The carrier frequency store has 100 locations (numbered 0 to 99) which may be recalled when required.

Sweep recall

The sweep store has 20 locations (numbered 0 to 19) containing complete sets of sweep parameters which may be recalled when required.

Note...

Sweep parameters can be recalled whether the instrument is in sweep mode or not. They are only used when sweep is selected.

Recalling data

To recall data, press the soft key for the type of recall required, e.g. [*Carrier Recall*] and select the location by means of the key pad. The ↑ and ↓ keys can be used to recall the next locations. Pressing [*Return*] recalls the location last specified on the numerical key pad.

Stores can be incremented or decremented externally by means of the SWEEP TRIGGER socket (see 'External trigger' above).

Note...

The settings for the sequential calling tones are recalled via the calling tones menu in UTILITIES, see Fig. 3-1-26. These stores can be erased from the *Store Erase Menu*.

Inhibit ON/OFF

When recalling full or partial stores it is sometimes useful for the existing carrier frequency setting to remain and not be replaced by the stored setting. The Inhibit Carrier Recall facility offers this capability. To prevent the current carrier frequency from being replaced use the [*Inhibit ON/OFF*] key to set the *Inhibit Carrier Recall* annunciator to *ON*.

To allow the carrier frequency setting to be overwritten use the [*Inhibit ON/OFF*] key to set the *Inhibit Carrier Recall* annunciator to *OFF*.

Memory stepping facility

The [*Sig Gen*] key has a toggle action in that pressing the key a second time displays the *Memory Stepping* menu shown in Fig. 3-1-39. This facility enables the memory to be stepped up and down from a start location (selected using the *Memory Recall Menu*), whilst displaying the settings for each location.

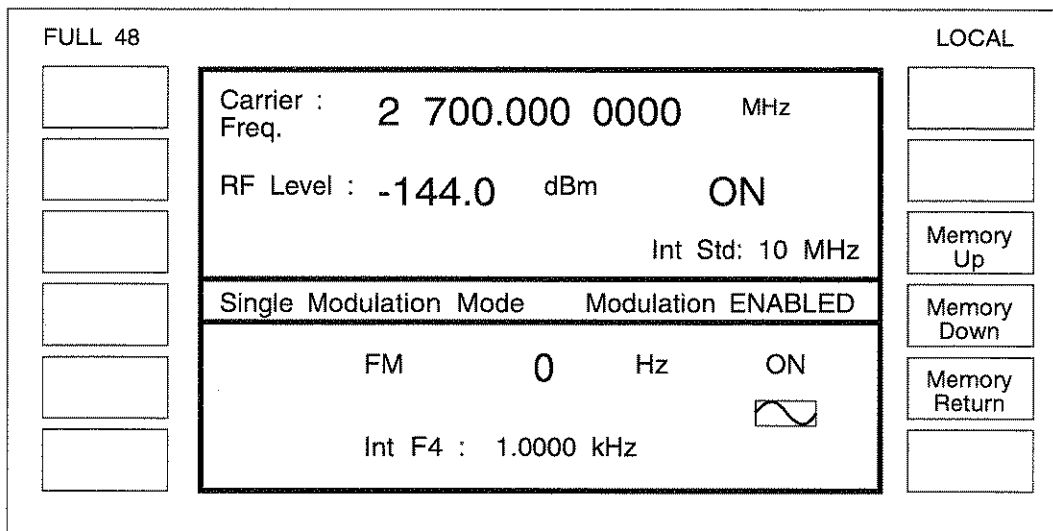

C1030

Fig. 3-1-39 Memory stepping menu

Pressing [*Memory Up*] or [*Memory Down*] respectively increments or decrements the memory location. With each step the settings stored in the location are displayed together with, at the top left of screen, the memory type and location e.g. *Full 48*. Incrementing and decrementing can also be done externally by means of the SWEEP TRIGGER socket (see 'External trigger' above). Pressing [*Memory Return*] at any time returns to the start location.

When a limit is reached, e.g. for Full Recall locations 0 and 49, a further step will reset to the start location. But note that if the start location coincides with a limit, trying to step past that limit will cause the limit and start locations (in this case the same numbered locations) to be alternately displayed. To make the user aware of this situation, the message *At Top Limit* or *At Bottom Limit* is displayed at the top centre of screen.

Memory store

Pressing the [*Memory Store*] soft key causes the *Memory Store Menu*, Fig. 3-1-40, to be displayed. There are four types of store, full, partial, carrier frequency and sweep.

To prevent the accidental overwriting of memory contents, a store protection facility is provided. If this feature is enabled, the screen legend will indicate *Store Protect: ON* and the store key legends at the right of the screen will not appear.

Note...

Sequential calling tone sequences can be stored from the *Sequential Calling Tones Utility* menu. There is provision for storing up to 20 tone sequences.

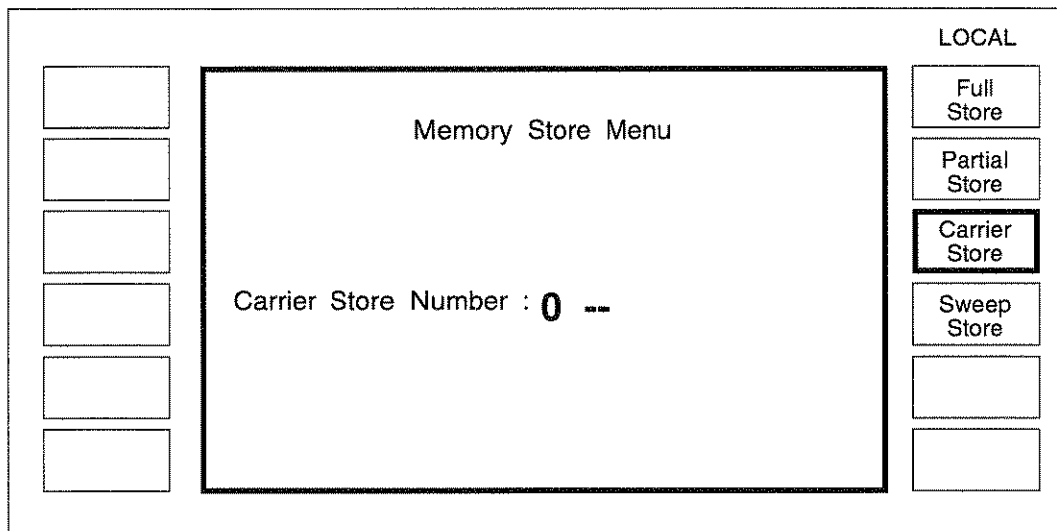

C0941

Fig. 3-1-40 Memory store menu

Full store

Selecting [*Full Store*] enables the storage of a complete instrument setting, i.e. carrier frequency, RF level, modulations and their increments, ON/OFF and source information. Also stored are all 6 modulation oscillator frequencies, plus one increment, and the LF Generator Monitor setting. There are 50 locations (numbered 0 to 49) for full storage. A further location (50) holds the factory default settings. This memory cannot be written to by the user. The factory default settings are listed in Table 3-2-1.

A Full Store contains the following information:

- Carrier frequency setting
- Carrier frequency step size
- RF level setting
- RF level step size
- All modulation settings
- All modulation step sizes
- Modulation mode and status
- All six internal oscillator frequency settings
- The modulation frequency step size
- LF generator frequency setting
- LF generator frequency step size
- LF generator level setting
- LF generator level step size
- LF monitor settings
- Display blanking settings

Partial store

This is a less comprehensive store of only those parameters which currently affect the RF output; carrier frequency, RF level, modulations in use (without increments), ON/OFF and source information and the two modulation oscillator frequencies in use. There are 50 locations (numbered 0 to 49) for partial storage.

A Partial Store contains the following information:

- Carrier frequency setting
- RF level setting
- The active modulation settings
- Modulation mode and status
- The frequency of the active modulation frequencies
- Either the LF generator frequency and level setting or the LF monitor setting (depending on which mode is selected)

Carrier store

The carrier frequency store has 100 locations (numbered 0 to 99) for the storage of carrier frequency only. This store can be used in conjunction with the full and partial stores to apply a set of test conditions to a range of frequencies.

Sweep store

The sweep store has 20 locations (numbered 0 to 19) for the storage of complete sets of sweep parameters.

Note...

Sweep parameters can be stored whether the instrument is in sweep mode or not. They are only used when sweep is selected.

Storing data

To store data, press the soft key for the type of store required, e.g. [*Partial Store*] and define a store location via the numerical key pad, then press [**enter**].

Note...

The settings for the sequential calling tones are stored via the calling tones menu in UTILITIES, see Fig. 3-1-26. These stores can be erased from the *Store Erase Menu*.

Store erase

Unlock to Level 1. Pressing [*Store Erase*] causes the *Store Erase Menu* to appear on the screen. The opportunity to erase all the stores of a given type is available by pressing the relevant key and then pressing [*Erase*].

Frequency hopping

Carrier frequency hopping is a GPIB operation only available in the normal noise mode. The instrument can be instructed to hop between any of the frequencies contained in the carrier frequency stores and a sequence of up to 1024 hops may be entered. The time interval between hops can also be entered.

Before executing a carrier hopping sequence, the frequencies must be loaded into the carrier frequency stores (0 - 99). This can be achieved via the GPIB using the following commands -

CFRQ < frequency value >
STO:CFRQ < store number >

To enter the frequency hopping mode, enter the following GPIB commands -

IMODE SWEEPER
SWEEP:TYPE HOP

This will cause the screen as shown in Fig. 3-1-41 to appear on the signal generator -

The screenshot shows a central display area with a black border. At the top, it reads "GPIB OPERATION ONLY !!!". Below this, the "Step Time" is set to "50 ms". A horizontal line separates the top section from the "Sweep Status" section, which displays "Sweep Status: WAITING FOR TRIGGER", "Sweep Mode: INTERNAL SINGLE", and "Sweep Type: CARRIER HOPPING". To the left of the display are six empty rectangular boxes. To the right, under the heading "REMOTE", there is a "Go To Local" button and four more empty rectangular boxes. The label "C0067" is located at the bottom right of the display area.

Fig. 3-1-41 Frequency hopping menu

To load in a sequence, the following command is used -

HOPSEQ <n0>,<n1>,<n2>,<n3>,<n4>.....

where <n0> - <n4> are numeric values in the range 0 - 99 corresponding to the carrier frequency store at which the necessary frequency is stored. The hopping sequence length is determined by the amount of numbers entered.

The other parameter that can be set to control the hopping sequence is the time between steps. This is done using the command -

SWEEP:HOP:TIME < t >

where t represents the number of milliseconds.

The 100 frequencies are precalculated and loaded into a software sweep table using the GPIB command -

SWEEP:CALC

Note...

If any of the carrier frequency stores have become corrupt and so result in a checksum error, the following message will appear in the centre of the screen -

*CARRIER STORE < x > CORRUPTED.
RE - ENTER FREQUENCY.*

where x is the corrupted store number.

With the frequencies, sequence and step time loaded, the hopping operation is controlled in the same manner as the ordinary sweeps by using the following commands -

SWEEP:GO	starts the hopping sequence (and will do any precalculation if required).
SWEEP:HALT	pause the hopping sequence.
SWEEP:UP	go up to the next step while paused.
SWEEP:DN	go down to previous step while paused.
SWEEP:CONT	continue hopping sequence.
SWEEP:RESET	reset sequence to start value.

When paused the carrier store number is displayed on the screen.

Note...

There are no markers available and the operation of transferring the paused value to the main parameter is not permitted.

To enter a new sequence use the HOPSEQ command but the number 255 is inserted at the beginning of the string.

e.g. existing sequence - 0, 6, 53, 72, 43, 96

sequence required - 22, 16, 7, 41, 59, 66

send GPIB command -

HOPSEQ 255,22,16,7,41,59,66

To add to an existing sequence use the HOPSEQ command without 255 at the beginning of the string.

e.g. existing sequence - 12, 24, 36, 48

sequence required - 12, 24, 36, 48, 60, 72, 84

send GPIB command -

HOPSEQ 60,72,84

To determine the length of the hopping sequence the following GPIB command is used -

HOPSEQ?

This returns a value 1 - 1024.

Like other sweep settings the frequency hopping mode can be set to -

single sweep (internal trigger),
continuous sweep (internal trigger) or
external sweep (external trigger)

by using the following commands -

SWEEP:MODE SNGL
SWEEP:MODE CONT
SWEEP:MODE EXT

For externally triggered operation the trigger facility can be used in the same manner as another sweep function.

ERROR HANDLING

Errors may be divided into three groups - foreground errors generally caused by a user, background errors which represent a condition of the instrument and GPIB errors which occur only when the unit is being controlled by a GPIB controller.

Foreground errors

Attempts to set the instrument to a parameter value outside its known range result in the generation of an error message.

For example, trying to select a carrier frequency above or below the specified range results in the message *Carrier Outside Limits* being displayed at the top of the screen.

Foreground errors are cleared automatically when a correct entry is made by the user.

Background errors

An incorrect operating condition within the instrument automatically generates an error message to warn the operator. For example, if the internal frequency standard should fail the message *Int. Standard Failure* will be displayed at the top of the screen.

GPIB errors

Errors caused by incorrect programming are displayed at the top of the screen and may also generate a Service Request if the relevant status registers are set.

Error display - Front panel

Errors are displayed as a single line of text at the top of the screen. If more than one error is present an internal priority ordering algorithm determines which error is displayed.

Error display - GPIB

When an error occurs, its number is entered into the Error Queue. Errors are not removed from the queue when they are cleared, but only by the ERROR? query, which returns the error at the head of the queue, or by the *CLS command which clears the whole queue. When the queue contains an error entry, a bit (<erb>) on the status byte is set.

The error queue has a capacity of 100 error numbers. If an error occurs while the queue is full the last error number is replaced with 255 so that the ERROR? query returns a value of 255 to indicate a full queue. An empty queue returns a value of 0 following an ERROR? query.

In addition to the error queue entry, the appropriate bit in the Standard Event Register will also be set (one of <cmd>, <exe>, <dde> or <qye>). Many background errors are also reported in the Hardware and Coupling Status Registers. For the above registers see Chap. 3-2.

ERROR MESSAGES

TABLE 3-1-2 BACKGROUND ERRORS

Error		Descriptive text	Error		Descriptive text
No.	Type		No.	Type	
1	dde	RPP Tripped	6	dde	VCXO Out of Lock
2	dde	Fractional N Out of Lock	7	dde	Ext1 Too Low
3	dde	Int. Standard Failure	8	dde	Ext1 Too High
4	dde	Ext. Standard Failure	9	dde	Ext2 Too Low
5	dde	Incorrect Ext. Standard	10	dde	Ext2 Too High
11	dde	Harmonic Loop Volts Low	16	dde	Output Loop Unlocked
12	dde	Harmonic Loop Volts High	17	exe	RF Level limited by AM
13	dde	Harmonic Loop Unlocked	18	exe	FM limited by Carrier
14	dde	Output Loop Volts Low	19	exe	WBFM limited by Carrier
15	dde	Output Loop Volts High	20	exe	AM2 limited by AM1
21	exe	FM2 limited by FM1	26	dde	Real Time Clock Problem
22	exe	PM2 limited by PM1	27	dde	Calibration Date Expired
23	exe	Steps limited by Span	28	dde	Pad Calibration Checksum
24	exe	FM Selfcal Error	29	dde	RF Calibration Checksum
25	dde	Internal Osc.1 Missing	30	dde	FM Calibration Checksum
31	dde	Path/Source Calibration	36	dde	O/P Loop Tune Calibration
32	dde	Absolute Mod. Calibration	37	dde	Band Break Calibration
33	dde	Freq. Std. Calibration	38	dde	Tracking Calibration
34	dde	Harm. Select Calibration	39	-	-
35	dde	Harm. Tune Calibration	40	-	-

TABLE 3-1-3 FOREGROUND ERRORS

Error		Descriptive text	Error		Descriptive text
No.	Type		No.	Type	
46	exe	Recall Checksum	51	exe	Carrier Outside Limits
47	exe	Incorrect Setup	52	exe	RF Level Outside Limits
48	exe	Invalid Memory Number	53	exe	Mod Rate Outside Limits
49	exe	MODULATION NOT ENABLED	54	exe	LF Freq. Outside Limits
50	exe	Out of Range	55	exe	LF Level Outside Limits
56	exe	AM Outside Limits	61	exe	RF Level Step Too Big
57	exe	FM Outside Limits	62	exe	Mod Rate Step Too Big
58	exe	PM Outside Limits	63	exe	LF Freq. Step Too Big
59	exe	WBFM Outside Limits	64	exe	LF Level Step Too Big
60	exe	Carrier Step Too Big	65	exe	AM Step Too Big
66	exe	FM Step Too Big	71	exe	Sweep Stop Out of Range
67	exe	PM Step Too Big	72	exe	Sweep Steps Out of Range
68	exe	Invalid Latch Number	73	exe	Sweep Time Out of Range
69	exe	Invalid Latch Data	74	exe	Sweep Marker Out of Range
70	exe	Sweep Start Out of Range	75	exe	Attenuator EAROM Read

TABLE 3-1-3 FOREGROUND ERRORS (continued)

76	exe	Attenuator EAROM Write	81	exe	EAROM Wrap Around Error
77	exe	Low Noise Box EAROM Read	82	exe	Continuous Tone Checksum
78	exe	Low Noise Box EAROM Write	83	exe	Sequential Tone Checksum
79	exe	EAROM Write Error	84	exe	Tone data Out of Range
80	exe	EAROM Read Error	85	exe	Tone Offset Out of Range
86	exe	Clock Data Entry Error	91	exe	RF levelling fault
87	exe	At Top Limit	92	exe	REPEAT THIS CALIBRATION
88	exe	At Bottom Limit	93	-	-
89	exe	Ext. Trigger Disabled	94	-	-
90	dde	Int. Std. Not Selected	95	-	-

TABLE 3-1-4 GPIB ERRORS

Error		Descriptive text	Error		Descriptive text
No.	Type		No.	Type	
101	-	-	106	cmd	Data Expected
102	cmd	Mnemonic Fault	107	cmd	Illegal Data
103	cmd	Block Definition	108	cmd	Terminator Expected
104	cmd	Block Size	109	cmd	GET Error
105	cmd	Numeric Syntax	110	cmd	EOM Error
111	exe	Illegal Modulation Mode	116	qye	Unterminated
112	exe	No Such Monitor Mode	117	qye	Interrupted
113	exe	Cannot Monitor	118	qye	Deadlock
114	exe	Instrument Mode Wrong	119	cmd	Missing Quote
115	cmd	Lost Data After Comma	120	cmd	Terminator Expected
121	exe	String Length	126	exe	Illegal SeqTones Mode
122	exe	Illegal Tone Character	127	exe	Overflow
123	exe	Illegal Duration Char	128	cmd	Data Too Long
124	exe	Illegal Standard	129	exe	Voltage Type Error
125	exe	Illegal Save Destination	130	exe	Sweep Not Possible
131	exe	Unknown Cal Point	136	exe	Unknown Freq. Standard.
132	exe	Unknown RF Band	137	exe	User Data Locked
133	exe	Unknown Instrument Mode	138	exe	Trigger Unknown
134	exe	User Data Checksum	139	exe	Illegal Tones Operation
135	qye	Query Lost after arb. char	140	cmd	Error in Char Data
141	exe	Wrong RF units	146	exe	Wrong Family For Command
142	cmd	Data Unknown	147	exe	Not Suitable For Hopping
143	exe	Negative Value Illegal	148	exe	Hopping Sequence Full
144	exe	Illegal Modulation Mode	149	-	-
145	exe	Unavailable Mod Source	150	-	-

TABLE 3-1-5 FATAL ERRORS

Error		Descriptive text	Error		Descriptive text
No.	Type		No.	Type	
171	exe	Main RAM Faulty	176	-	-
172	exe	Main PROM Faulty	177	-	-
173	exe	Microwave Board Error	178	-	-
174	exe	Attenuator Type Unknown	179	-	-
175	exe	Wrong Attenuator fitted	180	-	-

Chapter 3-2

GPIB OPERATION

CONTENTS

	PAGE
INTRODUCTION	3-2-2
GPIB FUNCTIONS	3-2-2
DEVICE LISTENING ELEMENTS	3-2-3
DEVICE TALKING ELEMENTS	3-2-3
PROGRAMMING	3-2-4
Program messages	3-2-4
Compound headers	3-2-4
Program data	3-2-5
Message exchange protocol	3-2-5
Remote/local operation	3-2-5
Common commands and queries (IEEE 488.2)	3-2-6
DEVICE DEPENDENT COMMANDS	3-2-8
DEFAULT SETTINGS	3-2-8
INSTRUMENT MODE	3-2-10
CARRIER FREQUENCY	3-2-10
RF LEVEL	3-2-11
MODULATION MODE	3-2-14
MODULATION CONTROL	3-2-15
FREQUENCY MODULATION	3-2-16
PHASE MODULATION	3-2-17
AMPLITUDE MODULATION	3-2-18
WIDEBAND FM	3-2-19
PULSE MODULATION	3-2-20
MODULATION FREQUENCY	3-2-21
CTCSS TONES EDIT	3-2-23
SEQUENTIAL TONES	3-2-24
LF CONTROL	3-2-28
LF GENERATOR FREQUENCY	3-2-29
LF GENERATOR LEVEL	3-2-30
MEMORY - STORE	3-2-31
MEMORY - RECALL	3-2-31
MEMORY - ERASE	3-2-31
SWEEP OPERATION	3-2-32
SWEEP MODE/TYPE	3-2-35
SWEEP CONTROL	3-2-36
FREQUENCY HOPPING	3-2-36
MISCELLANEOUS COMMANDS	3-2-37
THE STATUS BYTE	3-2-40
STATUS DATA STRUCTURE - REGISTER MODEL	3-2-41
STANDARD EVENT REGISTERS	3-2-43
HARDWARE EVENT REGISTERS	3-2-44
COUPLING EVENT REGISTERS	3-2-45
INSTRUMENT EVENT REGISTERS	3-2-46
QUEUE FLAG DETAILS	3-2-47
STATUS BYTE WHEN READ BY *STB?	3-2-48
STATUS BYTE WHEN READ BY SERIAL POLL	3-2-49
SUMMARY OF STATUS REPORTING COMMANDS AND QUERIES	3-2-50

LIST OF TABLES

Table 3-2-1 Instrument default settings	3-2-8
---	-------

INTRODUCTION

The 2040 series Signal Generators can be operated remotely from a personal computer fitted with a GPIB interface card or a dedicated GPIB controller. All functions can be controlled by coded messages sent over the interface bus via the 24 way socket on the rear panel of the instrument. IEEE Standard 488.2 (1987) is implemented, which defines the protocols and syntax of commands.

The instrument can function either as a talker or a listener. In the listen mode, it will respond to IEEE 488.2 common commands and queries and device-specific commands and queries. These allow various device functions to be controlled and operating parameters to be set. In the talk mode, device status information and parameter settings can be read from the instrument.

For full information on the IEEE protocols and syntax the IEEE 488.2 Standard should be consulted.

GPIB FUNCTIONS

The IEEE 488.1 interface functions offered by 2040 series are as follows:

Source handshake (SH1)	complete capability.
Acceptor handshake (AH1)	complete capability.
Talker (T6)	basic talker, serial poll, unaddress if MLA.
Listener (L4)	basic listener, unaddress if MTA.
Service request (SR1)	complete capability.
Remote/Local (RL1)	complete capability.
Device clear (DC1)	complete capability.
Device trigger (DT1)	complete capability.
Parallel poll (PP0)	no capability.
Controller (C0)	no capability.
Tri-state drivers (E2)	as opposed to open collector drivers.

DEVICE LISTENING ELEMENTS

The following is a list of the device listening elements (as defined in the IEEE 488.2 standard) which are used in the 2040 series of signal generators:

- <PROGRAM MESSAGE>
- <PROGRAM MESSAGE TERMINATOR>
- <PROGRAM MESSAGE UNIT>
- <PROGRAM MESSAGE UNIT SEPARATOR>
- <COMMAND MESSAGE UNIT>
- <QUERY MESSAGE UNIT>
- <COMPOUND COMMAND PROGRAM HEADER>
- <COMPOUND QUERY PROGRAM HEADER>
- <PROGRAM HEADER SEPARATOR>
- <PROGRAM DATA>
- <PROGRAM DATA SEPARATOR>
- <DECIMAL NUMERIC PROGRAM DATA>
- <CHARACTER PROGRAM DATA>
- <SUFFIX PROGRAM DATA>
- <STRING PROGRAM DATA>
- <ARBITRARY BLOCK PROGRAM DATA>

DEVICE TALKING ELEMENTS

The following is a list of the device talking elements (as defined in the IEEE 488.2 standard) which are used in the 2040 series of signal generators:

- <RESPONSE MESSAGE>
- <RESPONSE MESSAGE TERMINATOR>
- <RESPONSE MESSAGE UNIT>
- <RESPONSE MESSAGE UNIT SEPARATOR>
- <COMPOUND RESPONSE HEADER>
- <RESPONSE HEADER SEPARATOR>
- <RESPONSE DATA>
- <RESPONSE DATA SEPARATOR>
- <NR1 NUMERIC RESPONSE DATA>
- <NR2 NUMERIC RESPONSE DATA>
- <ARBITRARY ASCII RESPONSE DATA>
- <CHARACTER RESPONSE DATA>
- <STRING RESPONSE DATA>
- <DEFINITE LENGTH ARBITRARY BLOCK RESPONSE DATA>

PROGRAMMING

Program messages

A message consists of one or more message units. Message units are separated by a semi-colon (;). The whole message is ended by the Program Message Terminator (or End Of Message) defined as one of the following:

- (1) <newline> (ASCII 10 - often known as 'line feed') or
- (2) <newline> + END (the EOI line is asserted as well) or
- (3) + END (EOI is asserted on the last data byte of the message)

Note ...

A response message is always terminated by <EOM> consisting of <newline> + END.

A message unit consists of a mnemonic header which may be followed by data. If data follows, then it must be separated from its header by at least one space:

<header><SPACE><data>
e.g. RFLV:INC 6.0 dB

Spaces may be freely inserted in a message to improve readability, except within a header or within data.

A header may be a command or a query. A query has a '?' as its final character and causes the generation of a response message which will be read by the controller. Common commands and queries (defined in IEEE 488.2) begin with a '*'.

Upper and lower case characters are considered equivalent (i.e. FM fm Fm fM are all interpreted by the 2040 series in the same way).

Compound headers

The 2040 series implements compound headers which allow a complex set of commands to be built up from a small set of basic elements in a 'tree and branch' structure. The elements of a compound header are separated by a colon (:). Spaces are not allowed within a header.

Special rules apply when more than one compound header is used in one message. When the separator ';' is encountered, all headers except the trailing element of the previous header in the message are assumed to precede the following header, for example:

AM:DEPTH 30PCT;ON

is equivalent to the two commands:

AM:DEPTH 30PCT
and AM:ON

This does not apply to common commands (*RST etc.). The rule may be overridden by preceding a header with a colon, for example:

AM:ON;:FM:ON

Most main functions have a short form of header which may be used for clarity and brevity in simple messages, for example:

CRFQ 1.25GHZ is the same as CRFQ:VALUE 1.25GHZ

Program data

Data can take many forms, as follows:

Decimal Numeric Data is a flexible numeric format which encompasses integer, fixed point and floating point (mantissa and exponent) representations. Data is rounded to a resolution appropriate to the function. Decimal data can, in most cases, be followed by the appropriate units. If no units are present, the specified default units are assumed.

Character Data is an alphanumeric word.

String Data consists of a number of 7-bit ASCII characters enclosed in quotes, either a pair of single ('ASCII 39') or double ("ASCII 34") quotes may be used.

Block Data is used by *PUD and allows a number of 8-bit bytes to be transferred. For further information see the Service Manual.

Some commands can accept Multiple Data items which are separated by commas, for example MODE FM,AM.

Message exchange protocol

The controller should not attempt to read a response until it has sent the entire query message (terminated by EOM). Also, it should not start to send a new message until it has read the entire response (terminated by EOM). The query message may contain more than one query message unit, but only one response message (containing several response message units) is generated.

Failure to follow the protocol will generate a query error:

UNTERMINATED (error 116) occurs when the controller attempts to read a response without having sent a query.

INTERRUPTED (error 117) occurs when the controller starts to send a new message before having read the response to a preceding query.

DEADLOCK (error 118) can only occur if the input and output buffers are both filled by the controller having sent an extra long Message containing several query message units.

The 2040 series have input buffer stores of 256 characters and an output buffer of two response message units.

Remote/local operation

When the 2040 series Signal Generator is addressed by the controller it will enter its remote mode and the screen will have only one key legend, [LOCAL]. Pressing this key returns the unit to normal manual operation, unless Local Lockout has been asserted by the controller.

Common commands and queries (IEEE 488.2)

The IEEE 488.2 standard defines a set of common commands and queries which implement common system functions.

Common command and query mnemonics are preceded by an asterisk (*) to distinguish them from device dependent data such as instrument programming strings. The following common commands and queries are implemented in the 2040 series:

Mnemonic	Name and Description
*IDN?	Identification Query. Returns an arbitrary ASCII response comprising four data fields in the format: <Manufacturer>,<type number>,<serial number>,<firmware version number><EOM> Example: MARCONI INSTRUMENTS,2041,123456789,2.008<EOM>
*OPT?	Option Identification Query. Returns an arbitrary ASCII response containing a data field for each fitted option in the format: <option a>,<option d>, ... ,<option n><EOM> Example: SECOND OSCILLATOR,PULSE MODULATION, +19 dBm OUTPUT <EOM> If no options are fitted, ASCII '0' is returned.
Note...	Because an Arbitrary ASCII Response ends with the Response Message Terminator (<EOM>) either *IDN? or *OPT? must be the last Query Message Unit in a Program Message.
*RST	Reset Command. Sets the instrument functions to the factory default power up state. The default settings appear in Table 3-2-1.
*TST?	Self Test Query. Returns a '0' when the GPIB interface and processor are operating.
*OPC	Operation Complete Command. Sets the Operation Complete bit in the Standard Event Status Register when execution of the preceding operation is complete.
*OPC?	Operation Complete Query. Returns a '1' when the preceding operation has been completed.
*WAI	Wait to Continue Command. Inhibits execution of an overlapped command until the execution of the preceding operation has been completed.
*TRG	Trigger Command. Equivalent to Group Execute Trigger.
*PUD <block>	Protected User Data Command. Sets the Protected User Data, accepts Definite Block Data when enabled. This command is covered in further detail in the Service Manual.

*PUD? Protected User Data Query. Returns the User Data as a Definite Block Response.

Example: #221Inventory Number 1234

*STB? Read Status Byte Query. Returns the value of the Status Byte as an nr1 number (0-255).

*SRE <nr1> Service Request Enable Command. Sets the Service Request Enable Register.

*SRE? Service Request Enable Query. Returns the value of the Service Request Enable Register as nr1.

*ESR? Standard Event Status Register Query. Returns the value of the Status Event Status Register as nr1.

*ESE <nr1> Standard Event Status Enable Command. Sets the Standard Event Enable Register.

*ESE? Standard Event Status Enable Query. Returns the value of the Standard Event Status Enable Register as nr1.

*CLS Clear Status Command. Clears all the Status Event registers and clears the Error Queue. Does not affect the Enable Registers.

Note...

The IEEE 488.2 Device Clear function only affects the GPIB functions. The input and output buffers are cleared and the instrument put into a state of accept new Messages. It no longer puts the instrument functions into a defined state, this is now performed by the *RST common command.

DEVICE DEPENDENT COMMANDS

The following list describes the features of the device dependent mnemonics for the 2040 series signal generators together with simple examples of their use within each major section (Carrier frequency, RF Level, etc.). The root mnemonic is listed first followed by the lower level mnemonics. Each group is followed by a list of requirements for data type and suffix.

In addition to the normal listen commands the 2040 series accept query commands which cause the instrument to prepare a message which will be sent to the controller when the instrument is next addressed to talk. For each query an example of a response is given. Where responses are similar for a group of queries not all are listed. Some queries can produce more than one type of response - an example of each is usually given.

In the list which follows, the abbreviations <char>, <nrf> and <str> have the following meanings:

<char> = Character Program Data
<nrf> = Decimal Numeric Program Data
<str> = String Program Data

Where the data format is Decimal Numeric Program Data, the value may be expressed as a signed or unsigned number in any of the following formats:

nr1: Decimal integer, e.g. 1234 or -567
nr2: Floating point number, e.g. 1.234 or -56.789
nr3: Floating point number with exponent, e.g. 1.2345E5 or -12.47E-8

DEFAULT SETTINGS

These are the settings assigned to instrument functions in the following cases:

- (i) Power-up to factory default settings.
- (ii) Execution of *RST command.
- (iii) Recall Full Store 50.

The instrument functions set to the factory default power-up state by the reset command (*RST) are as shown in Table 3-2-1

TABLE 3-2-1 INSTRUMENT DEFAULT SETTINGS

Instrument Mode	:	Normal
Noise Mode	:	Low Noise 1
Carrier Frequency	:	(Maximum available) 1.35 GHz/2.7 GHz/5.4 GHz
Step	:	1 kHz
RF Level	:	(Minimum available) -144 dBm
Step	:	1 dB Status: ON
Modulation Mode	:	Single FM , Modulation enabled

TABLE 3-2-1 INSTRUMENT DEFAULT SETTINGS (continued)

Modulations	:	FM1	:	0 Hz, Int F4, ON
		FM2	:	0 Hz, Ext 1 ALC, ON
		Φ M1	:	0 rad, Int F4, ON
		Φ M2	:	0 rad, Ext 1 ALC, ON
		AM1	:	0%, Int F4, ON
		AM2	:	0%, Ext 2 ALC, ON
		WBFM	:	(Minimum setting), AC coupled, ON
Steps	:	Δ FM	:	1 kHz, Δ Φ M 0.1 rad, Δ AM 1%
Modulation source	:	IntF1	:	300 Hz sine
		IntF2	:	400 Hz sine
		IntF3	:	500 Hz sine
		IntF4	:	1 kHz sine
		IntF5	:	3 kHz sine
		IntF6	:	6 kHz sine
Step	:		:	1 kHz
LF	:	Mode	:	Monitor, Mod Source
LF Generator	:	Frequency	:	1 kHz sine, step 1 kHz
		Level	:	100 μ V
		Step	:	1 dB
		Status	:	ON
Sweep:				
Type	:		:	RF Level
Mode	:		:	Single Internal
RF Level Sweep	:		:	
Start	:	0 dBm	Stop:	10 dBm Steps: 100 Time: 50 ms
Markers	:	2, 4, 6, 8, 10 dBm, disabled		
Carrier Freq. Sweep	:		:	
Start	:	100 MHz	Stop:	(Maximum available) Steps: 250 Time 50 ms
Markers	:	200, 400, 600, 800, 1000 MHz, disabled		
Mod. source Freq.	:		:	
Start	:	0.1 Hz	Stop:	500 kHz Steps: 10,000 Time: 500 ms
Markers	:	100, 20, 30, 400, 500 kHz		
Sequential Tones :				
Mode	:	No modulation selected.		
Standard	:	CCIR		
Sequence	:	16 Tone Fs		
Duration	:	All normal.		
Frequency Offset	:	0		
Extended Duration	:	500 ms		
Repeat Tone	:	E		
Start Delay	:	200 ms		

INSTRUMENT MODE

IMODE Select instrument mode

Data type : Character Program Data (either NORMAL, NOISE1 OR NOISE2 for signal generator operation or SWEEPER for swept operation)
Allowed suffices : None
Default suffix : None

Examples: IMODE NORMAL
IMODE NOISE1

CARRIER FREQUENCY

CFRQ Set Carrier Frequency (short form)
:VALUE Set Carrier Frequency
:INC Set Carrier Frequency step

Data type : Decimal Numeric Program Data
Allowed suffices : Any one of: GHZ, MHZ, KHZ or HZ
Default suffix : HZ

:UP Go UP one step
:DN Go DOWN one step
:RET Return to original setting
:XFER Transfer current value to be the new setting

Data type : None
Allowed suffices : None
Default suffix : None

:PHASE Adjust Phase of Carrier in steps of $\pi/128$ radians (approximately 1.4°) over a range of ± 255 steps

Data type : Decimal Numeric Program Data
Allowed suffices : None
Default suffix : None

Examples: CFRQ:VALUE 1.23MHZ;INC 10KHZ
CFRQ:UP;XFER

CFRQ? Prepares message containing information on Carrier Frequency setting in the following format:

:CFRQ:VALUE <nr2>; INC <nr2>

Example: :CFRQ:VALUE 1000000000.0;INC 25000.0

RF LEVEL

RFLV Set RF output level (short form)
:VALUE Set RF output level

Data type : Decimal Numeric Program Data
Allowed suffices : Any one of: DBM, DBV, DBMV, DBUV, V, MV or UV
Default suffix : dBm unless changed by UNITS command

:INC Set RF level step (dB)

Data type : Decimal Numeric Program Data
Allowed suffices : DB only
Default suffix : DB

:UP Go UP one step
:DN Go DOWN one step
:RETN Return to original setting
:XFER Transfer current value to be the new setting
:ON Turn RF output ON
:OFF Turn RF output OFF

Data type : None
Allowed suffices : None
Default suffix : None

:TYPE Selects EMF or PD for voltage related units

Data type : Character Program Data (EMF or PD)
Allowed suffices : None
Default suffix : None

:UNITS Select default RF level units.

Data type : Character Program Data (DBM, DBV, DBMV, DBUV, V, MV or UV)
Allowed suffices : None
Default suffix : None

Examples: RFLV:VALUE -27.3DBM;ON
RFLV:TYPE PD;VALUE 1.23UV

RFLV (continued)

:OFFS [not used alone]
:VALUE Set Offset of current band

Data type : Decimal Numeric Program Data
Allowed suffices : DB only
Default suffix : DB

:ON Turn ON offset of current band
:OFF Turn OFF offset of current band
:ENABLE Enable Offsets
:DISABLE Disable Offsets
:SAVE Store Offsets in memory

Data type : None
Allowed suffices : None
Default suffix : None

Example: RFLV:OFFS:VALUE -0.2DB;ON;ENABLE

RFLV?

Prepares message containing information on RF Level setting in the following format:

RFLV:UNITS <unit>;TYPE <type>;VALUE <nr2>;INC <nr2>;<status>

where: <unit> is character program data defining the default RF level units (DBM, DBV, DBMV, DBUV, V, MV or UV), <type> is character program data indicating EMF or PD and <status> is a program mnemonic indicating whether the RF output is ON or OFF.

Examples: :RFLV:UNITS DBM;VALUE -103.5;INC 2.0;ON
:RFLV:UNITS DBV;TYPE EMF;VALUE -83.2;INC 0.5;ON

RFLV:OFFS?

Prepares message containing information on RF Level offsets in the following format:

:CFRQ:VALUE <nr2>;:RFLV:OFFS:VALUE <nr2>;<status>;<activity>

where: <status> is a program mnemonic indicating whether the RF offset is ON or OFF and <activity> is a program mnemonic indicating whether the offset mode is enabled or disabled.

Example: :CFRQ:VALUE 500000000.0;;:RFLV:OFFS:VALUE -0.4;ON;ENABLE

RFLV (continued)

RFLV

:HYST [not used alone]
:ENABLE Enable Extended Hysteresis mode
:DISABLE Disable Extended Hysteresis mode

Data type : None
Allowed suffices : None
Default suffix : None

:RFLV:HYST? Responds with status as follows:

:RFLV:HYST:ENABLE
or **:RFLV:HYST:DISABLE**

RFLV

:OVER [not used alone]
:ENABLE Enable Overrange mode
:DISABLE Disable Overrange mode

Data type : None
Allowed suffices : None
Default suffix : None

:RFLV:OVER? Responds with status as follows:

:RFLV:OVER:ENABLE
or **:RFLV:OVER:DISABLE**

MODULATION MODE

MODE Set modulation mode

Data type : Character Program Data (valid combinations of AM, AM1, AM2, FM, FM1, FM2, PM, PM1, PM2, WBFM or PULSE, see Table below)
Allowed suffices : None
Default suffix : None

Examples: `MODE AM,FM`
`MODE FM1,FM2`

VALID MODE COMBINATIONS TABLE

Single	Composite	Dual	Dual Composite
AM1	AM1,AM2	AM1,FM1	AM1,AM2,FM1,FM2
FM1	FM1,FM2	AM1,PM1	AM1,AM2,PM1,PM2
PM1	PM1,PM2	AM1,WBFM	AM1,AM2,WBFM
WBFM		PULSE,FM1	PULSE,FM1,FM2
PULSE		PULSE,PM1	PULSE,PM1,PM2
		PULSE,WBFM	

Note...

At any time the '1' may be omitted, for example FM is equivalent to FM1. Order is not important, for example AM,FM is equivalent to FM,AM.

For instruments without pulse modulation (Option 002) fitted select Low Intermodulation mode by using character data type PULSE.

MODE? Prepares message containing information on Modulation Mode in the following format:

`:MODE <mode>`

where: <mode> is character program data indicating the modulation mode settings.

Example: `:MODE FM1,FM2`

MODULATION CONTROL

MOD

:ON
:OFF

[not used alone]
Turn modulation globally ON
Turn modulation globally OFF

Examples: MOD:ON
MOD:OFF

MOD?

Prepares message containing information on Modulation Control in the following format:

:MOD:<status>

where: <status> is a program mnemonic indicating whether the Modulation is globally ON or OFF.

Example: :MOD:ON

FREQUENCY MODULATION

FM or FM1 or FM2 Set FM deviation (short form)
 :DEVN Set FM deviation
 :INC Set FM step size

 Data type : Decimal Numeric Program Data
 Allowed suffices : Any one of: GHZ, MHZ, KHZ or HZ
 Default suffix : HZ

:<src> Select modulation source where <src> is any one of: INTF1, INTF2, INTF3, INTF4, INTF5, INTF6, EXT1DC, EXT1AC, EXT1ALC, EXT2DC, EXT2AC or EXT2ALC

:ON Turn FM ON (locally)
 :OFF Turn FM OFF (locally)
 :UP Go UP one step
 :DN Go DOWN one step
 :RETN Return to original setting
 :XFER Transfer current value to be the new setting

DCFMNL Perform DC FM/WBFM null operation

 Data type : None
 Allowed suffices : None
 Default suffix : None

 Examples: FM:DEVN 25KHZ;INTF4;ON
 FM1:DEVN 15KHZ;INC 1KHZ;EXT1DC
 DCFMNL

FM? or FM1? or FM2? Prepares message containing information on FM setting in one of the following formats:

 :FM:DEVN <nr2>;<src>;<status>;INC <nr2>
 :FM1:DEVN <nr2>;<src>;<status>;INC <nr2>
 :FM2:DEVN <nr2>;<src>;<status>;INC <nr2>

 where: <src> is a program mnemonic representing the source of the modulation signal and <status> is a program mnemonic indicating whether the modulation is locally ON or OFF

 Example: :FM1:DEVN 25000.0;INTF1;ON;INC 1000.0

PHASE MODULATION

PM or PM1 or PM2 Set Phase deviation (short form)
:DEVN Set Phase deviation
:INC Set Phase Modulation step size

 Data type : Decimal Numeric Program Data
 Allowed suffices : RAD or RADS
 Default suffix : RAD

:<src> Select modulation source where <src> is any one of: INTF1, INTF2, INTF3, INTF4, INTF5, INTF6, EXT1DC, EXT1AC, EXT1ALC, EXT2DC, EXT2AC or EXT2ALC,

:ON Turn PM ON (local)
:OFF Turn PM OFF (local)
:UP Go UP one step
:DN Go DOWN one step
:RETN Return to original setting
:XFER Transfer current value to be the new setting

 Data type : None
 Allowed suffices : None
 Default suffix : None

Examples: PM:DEVN 2.5RAD;INTF4;ON
 PM1:DEVN 1.5RAD;INC 0.1RAD;EXT1AC

PM? or PM1? or PM2? Prepares message containing information on Phase Modulation setting in one of the following formats:

:PM:DEVN <nr2>;<source>;<status>;INC <nr2>
 :PM1:DEVN <nr2>;<source>;<status>;INC <nr2>
 :PM2:DEVN <nr2>;<source>;<status>;INC <nr2>

where: <src> is a program mnemonic representing the source of the modulation signal and <status> is a program mnemonic indicating whether the modulation is locally ON or OFF

Example: :PM2:DEVN 2.30;INT4;OFF;INC 0.05

AMPLITUDE MODULATION

AM or AM1 or AM2 Set AM Depth (short form)
:DEPTH Set AM Depth
:INC Set AM step size

Data type : Decimal Numeric Program Data
Allowed suffices : PCT
Default suffix : PCT

:<src> Select modulation source where <src> is any one of: INTF1, INTF2, INTF3, INTF4, INTF5, INTF6, EXT1DC, EXT1AC, EXT1ALC, EXT2DC, EXT2AC or EXT2ALC

:ON Turn AM ON (local)
:OFF Turn AM OFF (local)
:UP Go UP one step
:DN Go DOWN one step
:RETN Return to original setting
:XFER Transfer current value to be the new setting

Data type : None
Allowed suffices : None
Default suffix : None

Examples: AM:DEPTH 30PCT;INTF4;ON
AM1:DEPTH 40PCT;EXT1DC;ON

AM? or AM1? or AM2?

Prepares message containing information on Amplitude Modulation setting in one of the following formats:

:AM:DEPTH <nr2>;<src>;<status>;INC <nr2>
:AM1:DEPTH <nr2>;<src>;<status>;INC <nr2>
:AM2:DEPTH <nr2>;<src>;<status>;INC <nr2>

where: <src> is a program mnemonic representing the source of the modulation signal and <status> is a program mnemonic indicating whether the modulation is locally ON or OFF

Example: :AM1:DEPTH 56.6;INTF3;ON;INC 5.0

WIDEBAND FM

WBFM Set WBFM deviation (short form)
:DEVN Set WBFM deviation

Data type : Decimal Numeric Program Data
Allowed suffices : Any one of: GHZ, MHZ, KHZ or HZ
Default suffix : HZ

:ON Turn WBFM ON (local)
:OFF Turn WBFM OFF (local)
:AC Select AC coupling
:DC Select DC coupling

Data type : None
Allowed suffices : None
Default suffix : None

DCFMNL Perform DC FM/WBFM null operation

Examples: WBFM:DEVN 10MHZ;ON;AC
WBFM:DEVN 13MHZ;ON;DC;:DCFMNL

WBFM? Prepares message containing information on Wideband Frequency Modulation setting in the following format:

:WBFM:DEVN <nr2>;<coupling>;<status>

where: <coupling> is a program mnemonic indicating AC or DC coupling of the modulation signal and <status> is a program mnemonic indicating whether the modulation is locally ON or OFF

Example: :WBFM:DEVN 500000.0;AC;ON

PULSE MODULATION

PULSE [not used alone]
:ON Turn Pulse modulation ON
:OFF Turn Pulse modulation OFF and select Low Intermodulation

Data type : None
Allowed suffices : None
Default suffix : None

Examples: PULSE:ON
PULSE:OFF

PULSE? Prepares message containing information on Pulse Modulation setting in the following format:

:PULSE:<status>

where: <status> is a program mnemonic indicating whether the modulation is ON or OFF

Example: :PULSE:ON
:PULSE:OFF

MODULATION FREQUENCY

INTF1 or INTF2 or INTF3 or INTF4 or INTF5 or INTF6 Set modulation oscillator frequency (short form)

:FREQ Set modulation oscillator frequency
:INC Set modulation oscillator frequency step size

Data type : Decimal Numeric Program Data
 Allowed suffices : Any one of: GHZ, MHZ, KHZ or HZ
 Default suffix : HZ

:SIN Select sinusoidal waveform
:TRI Select triangle wave
:UP Go UP one step
:DN Go DOWN one step
:RETN Return to original setting
:XFER Transfer current value to be the new setting

Data type : None
 Allowed suffices : None
 Default suffix : None

:PHASE Adjust Phase of Modulation Oscillator

Data type : Decimal Numeric Program Data
 Allowed suffices : DEG
 Default suffix : DEG

:CTC1 Select tone number (0 to 15) from Continuous Tone Group 1
:CTC2 Select tone number (0 to 15) from Continuous Tone Group 2
:USER Select tone number (0 to 15) from Continuous Tone USER group
:TEMP Select tone number (0 to 15) from Continuous Tone TEMP group

Data type : Decimal Numeric Program Data
 Allowed suffices : None
 Default suffix : None

Examples: INTF1:FREQ 1.5KHZ;SIN
 INTF1;CTC1 3

INTF1, etc. (continued)

INTF1? or INTF2? or INTF3?
or INTF4? or INTF5? or
INTF6? Prepares message containing information on
modulation oscillator setting in one of the following
formats:

```
:INTF1:FREQ <nr2>;INC <nr2>;<waveform>  
:INTF6:<standard> <nr1>
```

where: <waveform> is a program mnemonic (SIN or
TRI) indicating the waveform shape and
<standard> is a program mnemonic (CTC1,
CTC2, USER or TEMP) indicating the
continuous tone signalling standard selected.

Example: :INTF2:FREQ 440.0;INC 100.0;SIN
:INTF3:CTC1 5

CTCSS TONES EDIT

CTONES [not used alone]
:EDIT [not used alone]
:TNUM Select tone number 0-15

Data type : Decimal Numeric Program Data
 Allowed suffices : None
 Default suffix : None

:TFREQ Set tone frequency

Data type : Decimal Numeric Program Data
 Allowed suffices : Any one of: GHZ, MHZ, KHZ or HZ
 Default suffix : HZ

:LOAD Copy Standard to TEMP for editing

Data type : Character Program Data (any one of: CTC1, CTC2 or USER)
 Allowed suffices : None
 Default suffix : None

:SAVE Save TEMP to USER after editing for non-volatile storage (if required)

Data type : None
 Allowed suffices : None
 Default suffix : None

CTONES? [not used alone]

CTONES:EDIT? Prepares message containing information on the current tone number being edited and its frequency in the following format:

:CTONES:EDIT:TNUM <nr1>;TFREQ <nr2>

Example: :CTONES:EDIT:TNUM 5;TFREQ 202.8

SEQUENTIAL TONES

SEQT [not used alone]
:SEQ Set Tone sequence

Data type : String Program Data consisting of up to 16 characters from 0 to 9 and A to F between string delimiters (eg. "123C5" or '123C5'). For DTMF E and F are not allowed and are replaced by * and #.

Allowed suffices : None
Default suffix : None

:DUR Set Duration Mask

Data type : String Program Data consisting of up to 16 characters "-" or "E" between string delimiters (eg. "---E-" or '---E-')

Allowed suffices : None
Default suffix : None

:SEND Send Sequence *n* times where *n* has the value 1 to 9 indicating the number of tone sequences to be sent.

Data type : Decimal Numeric Program Data
Allowed suffices : None
Default suffix : None

:STOP Stop sending sequence.

Data type : None
Allowed suffices : None
Default suffix : None

:MODE [not used alone]
:STD Select Tones standard

Data type : Character Program Data (any one of: CCIR, EURO, DZVEI, ZVEI1, ZVEI2, EEA, EIA, NATEL, TEMP, USER1, USER2 or DTMF)

Allowed suffices : None
Default suffix : None

:MOD Select Modulation Channel

Data type : Character Program Data (any one of: AM1, AM2, FM1, FM2, PM1, PM2, TOTAL_AM, TOTAL_FM, TOTAL_PM or NO_TONES)

Allowed suffices : None
Default suffix : None

SEQT (continued)

- :PARAM** [not used alone]
- :EXTD** Set the duration of the Extended tone.
- :SDLY** Set Starting Delay

- Data type : Decimal Numeric Program Data
- Allowed suffices : MS
- Default suffix : MS

- :SHFT** Set Frequency Shift (up to $\pm 10.0\%$)

- Data type : Decimal Numeric Program Data
- Allowed suffices : PCT
- Default suffix : PCT

- :RPTT** Select Repeat Tone

- Data type : String Program Data (any one of 0 to 9 or A to F between strings delimiters (eg. "E" or 'E')).
- Allowed suffices : None
- Default suffix : None

- :TDUR** Set DTMF Tone duration
- :TGAP** Set DTMF inter-element gap.

- Data type : Decimal Numeric Program Data
- Allowed suffices : MS
- Default suffix : MS

- :EDIT** [not used alone]
- :TNUM** Select Number of Tone to Edit

- Data type : Decimal Numeric Program Data
- Allowed suffices : None
- Default suffix : None

- :TFRQ** Set Tone Frequency of tone selected by TNUM

- Data type : Decimal Numeric Program Data
- Allowed suffices : Any one of: GHZ, MHZ, KHZ or HZ
- Default suffix : HZ

- :TDUR** Set Normal Tone Duration
- :TGAP** Set Inter-element Gap

- Data type : Decimal Numeric Program Data
- Allowed suffices : MS
- Default suffix : MS

- :LOAD** Load a Standard to TEMP for editing

- Data type : Character Program Data (any one of: CCIR, EURO, DZVEI, ZVEI1, ZVEI2, EEA, EIA, NATEL, USER1 or USER2)
- Allowed suffices : None
- Default suffix : None

SEQT:EDIT (continued)

:SAVE Copy TEMP to USER1 or USER2

Data type : Character Program Data (either USER1 or USER2)
Allowed suffices : None
Default suffix : None

Examples: SEQT:SEQ "12245B7";DUR "----E--"
SEQT:MODE STD CCIR;MOD TOTAL_FM
SEQT:PARAM:EXTD 200MS;SHFT 0.5PCT
SEQT:EDIT:TNUM 3;TRFQ 1342.7HZ;SAVE USER1

SEQT?

Prepares message containing information on the signalling sequence and duration settings in the following format:

:SEQT:SEQ <toneseq>;DUR <durseq>

where: <toneseq> is string program data defining the tone sequence and <durseq> is string program data defining the duration sequence.

Examples: :SEQT:SEQ "12245B7";DUR "----E--"
:SEQT:SEQ "1234*#9" (DTMF ONLY)

SEQT:MODE?

Prepares message containing information on the signalling standard and the modulation channel selected in the following format:

:SEQT:MODE:STD <standard>;MOD <modchannel>

where: <standard> is a program mnemonic defining the tone standard and <modchannel> is character program data defining the modulation channel allocated to tone signalling.

Example: :SEQT:MODE:STD ZVEI;MOD TOTAL_FM

SEQT:PARAM?

Prepares message containing information on signalling parameter settings in the following format:

:SEQT:PARAM:EXTD <nr1>;SHFT <nr2>;RPTT <rpt>;SDLY <nr1>

where: <rpt> is string program data defining the tone number used to represent the repeat tone.

Examples: :SEQT:PARAM:EXTD 200;SHFT -1.6;RPPT "E"; SDLY 300
:SEQT:PARAM:SDLY 30;TDUR 100;TGAP 75 (DTMF ONLY).

SEQT:EDIT?

Prepares message containing information on signalling editing
in the following format:

:SEQT:EDIT:TNUM <nr1>;TFREQ <nr2>;TDUR <nr1>;TGAP <nr1>

Example: :SEQT:EDIT:TNUM 3;TFREQ 1342.7;TDUR 40;TGAP 0

LF CONTROL

LF [not used alone]
:ON Turn LF output ON
:OFF Turn LF output OFF
:GEN Select LF Generator

Data type : None
Allowed suffices : None
Default suffix : None

:MON Select source monitor mode

Data type : Character Program Data (any one of: AM1S, AM2S, AMD, ANG1S, ANG2S, ANGD or OFF, where AM represents Amplitude Modulation, ANG represents Angular Modulation, the suffix 'S' indicates Source and 'D' indicates Drive)
Allowed suffices : None
Default suffix : None

Examples: LF:MON FM;ON
LF:MON ANGD
LF:GEN

LF? Prepares message containing information on the LF operation in one of the following formats depending on which LF mode is currently in use:

:LF:GEN;<status>
:LF:MON <source>;<status>

where: <source > is character program data representing the source being monitored and <status> is a program mnemonic indicating whether the output is ON or OFF.

Example: LF:GEN;ON
LF:MON AM1S;OFF

LF GENERATOR FREQUENCY

LFGF Set LF Generator frequency (short form)
:VALUE Set LF Generator frequency
:INC Set LF Generator frequency step

Data type : Decimal Numeric Program Data
Allowed suffices : Any one of: GHZ, MHZ, KHZ or HZ
Default suffix : HZ

:UP Go UP one step
:DN Go DOWN one step
:RETN Return to original setting
:XFER Transfer current value to be the new setting
:SIN Select sinusoidal waveform
:TRI Select triangle wave

Data type : None
Allowed suffices : None
Default suffix : None

Examples: LFGF:VALUE 25KHZ;INC 500HZ

LFGF? Prepares message containing information on LF Generator Frequency setting in the following format:

:LFGF:VALUE <nr2>;INC <nr2>

Example: :LFGF:VALUE 25067.8;INC 500.0

LF GENERATOR LEVEL

LFGL Set LF Generator level (short form)
:VALUE Set LF Generator level

Data type : Decimal Numeric Program Data
Allowed suffices : V, MV, UV, DBMV
Default suffix : V

:INC Set LF Generator level step

Data type : Decimal Numeric Program Data
Allowed suffices : DB
Default suffix : DB

:UP Go UP one step
:DN Go DOWN one step
:RETN Return to original setting
:XFER Transfer current value to be the new setting

Data type : None
Allowed suffices : None
Default suffix : None

:UNITS Select default LF level units

Data type : Character Program Data (DBM, DBV, DBMV, V, MV, or UV)
Allowed suffices : None
Default suffix : None

Examples: LFGL:VALUE 75.6MV;INC 20DB
LFGL:UP

LFGL? Prepares the message containing information on LF Generator Level setting in the following format:

:LFGL:UNITS<unit>;VALUE<nr2>;INC<nr2>

where: <unit> is character programmed data defining the default LF level units (DBM, DBV, DBMV, V, MV or UV).

Example: :LFGL:UNITS MV;VALUE 125.8;INC 1.0

MEMORY - STORE

STO [not used alone]
:FULL Full Store 0-49
:PART Partial Store 0-49
:CFRQ Carrier Freq Store 0-99
:SEQT Sequential Tones Store 0-19
:SWEEP Sweep Store 0-19

Data type : Decimal Numeric Program Data
Allowed suffices : None
Default suffix : None

Examples: :STO:FULL 17
:STO:CFRQ 83

MEMORY - RECALL

RCL [not used alone]
:FULL Recall Full 0-49
:FXCF Recall Full 0-49 (without carrier frequency)
:PART Recall Partial 0-49
:RXCF Recall Partial 0-49 (without carrier frequency)
:CFRQ Recall Carrier Freq 0-99
:SEQT Recall Sequential Tones Sequence 0-19
:SWEEP Recall Sweep 0-19

Data type : Decimal Numeric Program Data
Allowed suffices : None
Default suffix : None

Examples: :RCL:FULL 15
:RCL:CFRQ 75

MEMORY - ERASE

ERASE [not used alone]
:FULL Erase all Full Stores
:PART Erase all Partial Stores
:CFRQ Erase all Carrier Freq Stores
:SEQT Erase all Sequential Tones Stores
:SWEEP Erase all Sweep Stores
:ALL Erase all Stores

Data type : None
Allowed suffices : None
Default suffix : None

Examples: :ERASE:FULL 12
:ERASE:ALL

SWEEP OPERATION

IMODE Select Instrument Mode

Data type : Character Program Data (either NORMAL, NOISE1 OR NOISE2 for signal generator operation or SWEEPER for swept operation)

Allowed suffices : None

Default suffix : None

Example: IMODE SWEEPER

SWEEP [not used alone]

:MKRON Enable Sweep Markers

:MKROFF Disable sweep Markers

Data type : None

Allowed suffices : None

Default suffix : None

Examples: SWEEP:CFRQ:START 75MHZ;STOP 150MHZ;STEP 100;TIME 10MS
SWEEP:RFLV:START -56DBM;STOP -12DBM;STEP 440;TIME 25MS
SWEEP:CFRQ:MKRNUM 1;VALUE 83MHZ;MKRON

:CFRQ [not used alone]
:<cmd> Select Carrier Frequency sweep parameter entry where <cmd> is replaced by one of the commands (START, STOP, STEP, TIME, MKRNUM, MKRON, MKROFF or VALUE)

:RFLV [not used alone]
:<cmd> Select RF Level sweep parameter entry where <cmd> is replaced by one of the commands (START, STOP, STEP, TIME, MKRNUM, MKRON, MKROFF or VALUE)

:LFGF [not used alone]
:<cmd> Select LF Generator Frequency sweep parameter entry where <cmd> is replaced by one of the commands (START, STOP, STEP, TIME, MKRNUM, MKRON, MKROFF or VALUE)

:LFGL [not used alone]
:<cmd> Select LF Generator Level sweep parameter entry where <cmd> is replaced by one of the commands (START, STOP, STEP, TIME, MKRNUM, MKRON, MKROFF or VALUE)

:INTF [not used alone]
:<cmd> Select Internal Modulation Oscillator Frequency sweep parameter entry where <cmd> is replaced by one of the commands (START, STOP, STEP, TIME, MKRNUM, MKRON, MKROFF or VALUE)

SWEEP (continued)

:HOP [not used alone]
:<cmd> Select Frequency Hopping sweep parameter entry where <cmd> is replaced by TIME.

:START Select start value of the parameter to be swept.
:STOP Select stop value of the parameter to be swept.

Data type : As used for the parameter
Allowed suffices : As used for the parameter
Default suffix : As used for the parameter

:STEP Select number of steps in the sweep.

Data type : Decimal Numeric Program Data
Allowed suffices : None
Default suffix : None

:TIME Select time per sweep step

Data type : Decimal Numeric Program Data
Allowed suffices : MS
Default suffix : MS

:MKRNUM Select marker

Data type : Decimal Numeric Program Data
Allowed suffices : None
Default suffix : None

:MKROFF Turn Current Marker OFF
:MKRON Turn Current Marker ON

Data type : None
Allowed suffices : None
Default suffix : None

:VALUE Set Value of Current Marker

Data type : Decimal Numeric Program Data
Allowed suffices : As used for the parameter
Default suffix : As used for the parameter

SWEEP? Prepares message containing information on Sweep Mode, Type and Marker status in the following format:

:SWEEP:MODE <mode>;TYPE <type>;<status>

where: <mode> is a program mnemonic representing the sweep mode selected, <type> is a program mnemonic representing the sweep type selected and <status> is a program mnemonic indicating whether the Marker output is ON or OFF.

Sample responses: **:SWEEP:MODE CONT;TYPE CFRQ;MKROFF**
:SWEEP:TYPE HOP:MODE SNGL

SWEEP? (continued)

:CFRQ?

Prepares message containing information on Carrier Frequency Sweep settings in the following format:

```
:SWEEP:START <nr2>;STOP <nr2>;STEP <nr1>;TIME <nr1>;  
MKRNUM <nr1>;<status>;VALUE <nr2>
```

where: <status> is a program mnemonic indicating whether the selected Marker is ON or OFF.

Sample response: :SWEEP:START 1230000.0;STOP 1330000.0;STEP 100;
TIME 20;MKRNUM 2;MKRON;VALUE 1240000.0

:RFLV?

Prepares message containing information on RF Level Sweep settings in the following format:

```
:SWEEP:START <nr2>;STOP <nr2>;STEP <nr1>;TIME <nr1>;  
MKRNUM <nr1>;<status>;VALUE <nr2>
```

where: <status> is a program mnemonic indicating whether the selected Marker is ON or OFF.

Sample response: :SWEEP:START -107.0;STOP -27.0;STEP 80;TIME 50;
MKRNUM 2;MKRON;VALUE -97.0

:LFGF?

Prepares message containing information on LF Generator Frequency Sweep settings in the following format:

```
:SWEEP:START <nr2>;STOP <nr2>;STEP <nr1>;TIME <nr1>;  
MKRNUM <nr1>;<status>;VALUE <nr2>
```

where: <status> is a program mnemonic indicating whether the selected Marker is ON or OFF.

Sample response: :SWEEP:START 300.0;STOP 3000.0;STEP 2700;TIME 1;
MKRNUM 1;MKRON;VALUE 400.0

SWEEP? (continued)

:LFGL? Prepares message containing information on LF Generator Level Sweep settings in the following format:

```
:SWEEP:LFGL:START <nr2>;STOP <nr2>;STEP <nr1>;TIME <nr1>;  
MKRNUM <nr1>;<status>;VALUE <nr2>
```

where: <status> is a program mnemonic indicating whether the selected Marker is ON or OFF.

Sample response: :SWEEP:LFGL:START 1.0;STOP 120.0;STEP 120;TIME 10;
MKRNUM 2;MKRON;VALUE 5.0

:INTF? Prepares message containing information on Modulation Oscillator Frequency Sweep settings in the following format:

```
:SWEEP:INTF:START <nr2>;STOP <nr2>;STEP <nr1>;TIME <nr1>;  
MKRNUM <nr1>;<status>;VALUE <nr2>
```

where: <status> is a program mnemonic indicating whether the selected Marker is ON or OFF.

Sample response: :SWEEP:INTF:START 270.0;STOP 3300.0;STEP 500;TIME 1;
MKRNUM 4;MKRON;VALUE 2900.0

:HOP? Prepares message containing information on Frequency Hopping Sweep in the following format:

```
;SWEEP:HOP:TIME <nr1>
```

SWEEP MODE/TYPE

SWEEP [not used alone]
:MODE Select Mode of operation for Sweep generator (single shot, continuous or externally triggered)

Data type : Character Program Data (any one of SNGL, CONT or EXT)
Allowed suffices : None
Default suffix : None

:TYPE Select Type of Sweep (Carrier Frequency, RF Level, LF Generator Frequency, LF Generator Level, Internal Modulation Oscillator Frequency or Off)

Data type : Character Program Data (any one of: OFF, CFRQ, RFLV, LFGF, LFGL, INTF1, INTF2, INTF3, INTF4, INTF5, INTF6, HOP or OFF)
Allowed suffices : None
Default suffix : None

Examples: :SWEEP:MODE SNGL;TYPE CFRQ
:SWEEP:MODE CONT;TYPE INTF4

SWEEP?

Prepares message containing information on Sweep Mode, Type and Marker status in the following format:

```
:SWEEP:MODE <mode>;TYPE <type>;<status>
```

where: <mode> is a program mnemonic representing the sweep mode selected, <type> is a program mnemonic representing the sweep type selected and <status> is a program mnemonic indicating whether the Marker output is ON or OFF.

Examples: `:SWEEP:TYPE CFRQ:MODE CONT;MKROFF`
`:SWEEP:TYPE HOP:MODE SNGL`

SWEEP CONTROL

SWEEP

	[not used alone]
:GO	Commence Sweep
:CALC	Initiate Pre-calculation
:HALT	Pause Sweep
:CONT	Continue Sweep
:RESET	Reset sweep to Start Value
:XFER	Transfer Paused Value to Main Parameter
:UP	Go up one sweep step while paused
:DN	Go down one sweep step while paused

Data type : None
Allowed suffices : None
Default suffix : None

Examples: `SWEEP:GO`
`SWEEP:RESET`

FREQUENCY HOPPING

HOPSEQ

Enter frequency hopping sequence

Data type : Decimal Numeric Program data (can be multiple)
Allowed suffices : None
Default suffix : None

Examples: `HOPSEQ 56, 72, 0, 4, 99, 72`
`HOPSEQ 255, 0, 4, 17, 23, 64, 72`

HOPSEQ?

Returns a value 0-1024 indicating the number of steps in the Frequency Hopping Sequence.

MISCELLANEOUS COMMANDS

- IMODE** Select Instrument Mode
- Data type : Character Program Data (either NORMAL, NOISE1 OR NOISE2 for signal generator operation or SWEEPER for swept operation)
- Allowed suffices : None
- Default suffix : None
- RPPR** Reset reverse power protection trip
- Data type : None
- Allowed suffices : None
- Default suffix : None
- FSTD** Select internal or external frequency standard
- Data type : Character program data (any one of INT1, INT5, INT10, EXT1, EXT5 or EXT10)
- Allowed suffices : None
- Default suffix : None
- Examples: INT10
EXT5
- FSTD?** Prepares message containing information on frequency standard selection in the format:
- :FSTD <char>
- Example: :FSTD EXT10
- BLANK** Blank or unblank various parts of the display. The number sent after the command determines the action to be taken as follows:
- 0 blank or unblank the Carrier Frequency display
 - 1 blank or unblank the RF Level display
 - 2 blank or unblank the Modulation Frequency display
 - 3 blank or unblank the Modulation display
 - 4 blank all displays
- Data type : Decimal Numeric Program Data (any one of 0, 1, 2, 3 or 4)
- Allowed suffices : None
- Default suffix : None
- Examples: BLANK 0
BLANK 4

BACKL [not used alone]
:ON Backlighting On
:OFF Backlighting Off

Data type : None
Allowed suffices : None
Default suffix : None

Examples: BACKL:ON
BACKL:OFF

TIME? Prepares message containing information on current real time clock time setting in the format:

<HH:MM>

where: <HH:MM> is string program data representing the time in hours and minutes using the 24 hour clock notation.

Example: "17:55"

DATE? Prepares message containing information on current real time clock date setting in the format:

<YYYY-MM-DD>

where: <YYYY-MM-DD> is string program data representing the date in ISO notation (year number, month number, day number).

Example: "1990-04-01"

OPER? Prepares message containing information on total operating hours in the following format:

<nr2>

Example: 1453.0

ELAPSED? Prepares message containing information on elapsed operating hours since last reset in the following format:

<nr2>

Example: 454.5

ERROR?

Prepares message containing the number of the next error in the error queue in the following format:

<nr1>

The numeric value returned is either that of the next error number or 0 if the queue is empty or 255 if the queue was full

Example: 37

DEFTRG

Set Device Trigger Function (action on receipt of *TRG)

Data type : Character Program Data (any one of: SEQT, FLSWP, SSSWP or VOID)

Allowed suffices : None

Default suffix : None

EXTTRG

Set External Trigger Function (action on Low signal being applied to External Trigger Socket).

Data type : Character Program Data (any one of: SEQT, FLSWP, SSSWP, MEMUP, MEMDN or VOID)

Allowed suffices : None

Default suffix : None

Examples: DEFTRG SEQT
EXTTRG MEMUP

KLOCK

Disables keyboard entry except RPP Reset and Go to Local

Data type : None

Allowed suffices : None

Default suffix : None

KUNLOCK

Enables keyboard entry

Data type : None

Allowed suffices : None

Default suffix : None

THE STATUS BYTE

The Status Byte provides information about events and conditions within the instrument. It may be read by a conventional Serial Poll or its value obtained as a response to the *STB? query. Bits 0 to 5 and bit 7 are each single bit Summary Messages which may be of two types (or not used at all).

- (i) Query Status - a '1' indicates that an associated Queue is non-empty and has data available to be read.
- (ii) Status Register Summary - reports the occurrence of an enabled event monitored by a Status Register Structure.

The Service Request Enable Register determines which of the bits can generate an SRQ, this register may be set by *SRE or read by *SRE?. If the bitwise -AND of the Status Byte and the Enable Register is non-zero the Flag Master Summary Status (<mss>) is True. Bit 6 of the Status byte value read by *STB? holds <mss>. However bit 6 of the Status Byte when Serial Polled is the Request For Service bit used to determine which device on the Bus has asserted SRQ, and is cleared by a Serial Poll.

The IEEE 488.2 Standard defines bit 4 as Message Available (<mav>), the Queue Summary for the Output Buffer, indicating whether any part of a Response Messages is available to be read. Bit 5 is the Event Summary Bit (<esb>), the Summary Message from the Standard Event Status Register.

In 2040 series, bit 7 is a Queue Summary for the Error Queue. Bits 1, 2, and 3 are Status summaries for the Instrument Status, Coupling Status and Hardware Status Registers. Bit 0 is unused.

STATUS DATA STRUCTURE - REGISTER MODEL

Below is a generalised model of the Register Set which funnels the monitored data into a single summary bit to set the appropriate bit in the Status Byte.

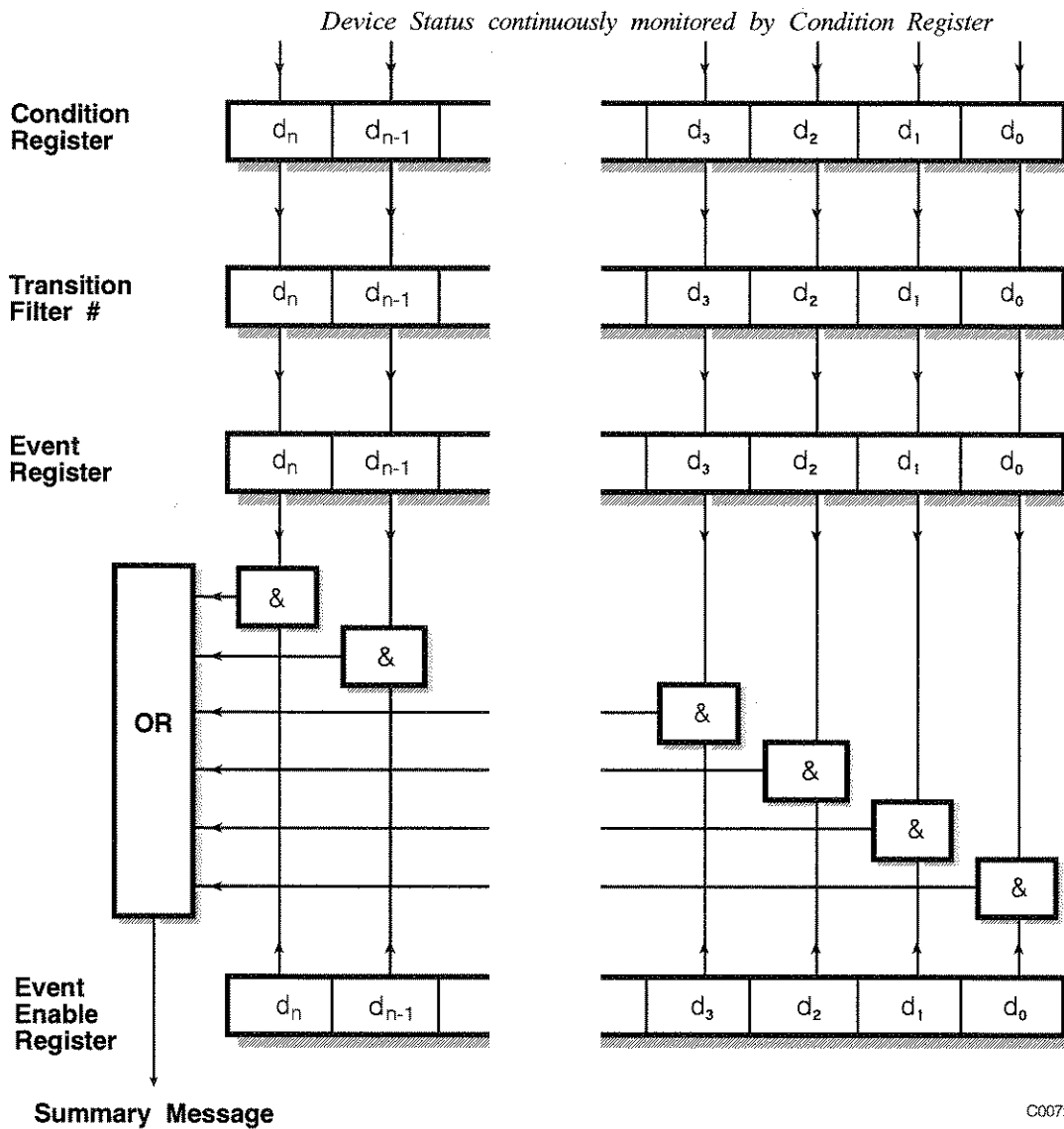

Notes...

The Device Status is continuously monitored by the Condition Register. If a Query to read a Condition Register is provided, the Response represents the Status of the instrument at the moment the Response is generated. A Condition Register cannot be written to.

The Transition Filter determines which transition of the Condition Register data bits will set the corresponding bit in the Event Register. Either positive-going, negative-going or both transitions can set bits in an Event Register. But in the 2040 series the Transition Filters are pre-set as either Positive or Negative, as described in the following pages.

The bits in an Event Register are "latched". Once set they remain set, regardless of subsequent changes in the associated condition bit until the Event Register is cleared by

being read or by the *CLS common command. Once cleared, an Event Register bit will only be set again if the appropriate change in the Condition bit occurs.

The Event Enable Register may be both written to and read from. It is bitwise AND-ed with the Event Register and if the result is non-zero the Summary Message is true, otherwise the Summary Message is false. Enable Registers are not affected by *CLS but are however clear at power-on.

STANDARD EVENT REGISTERS

This Register is defined by IEEE 488.2 and each bit has the meaning shown below:-

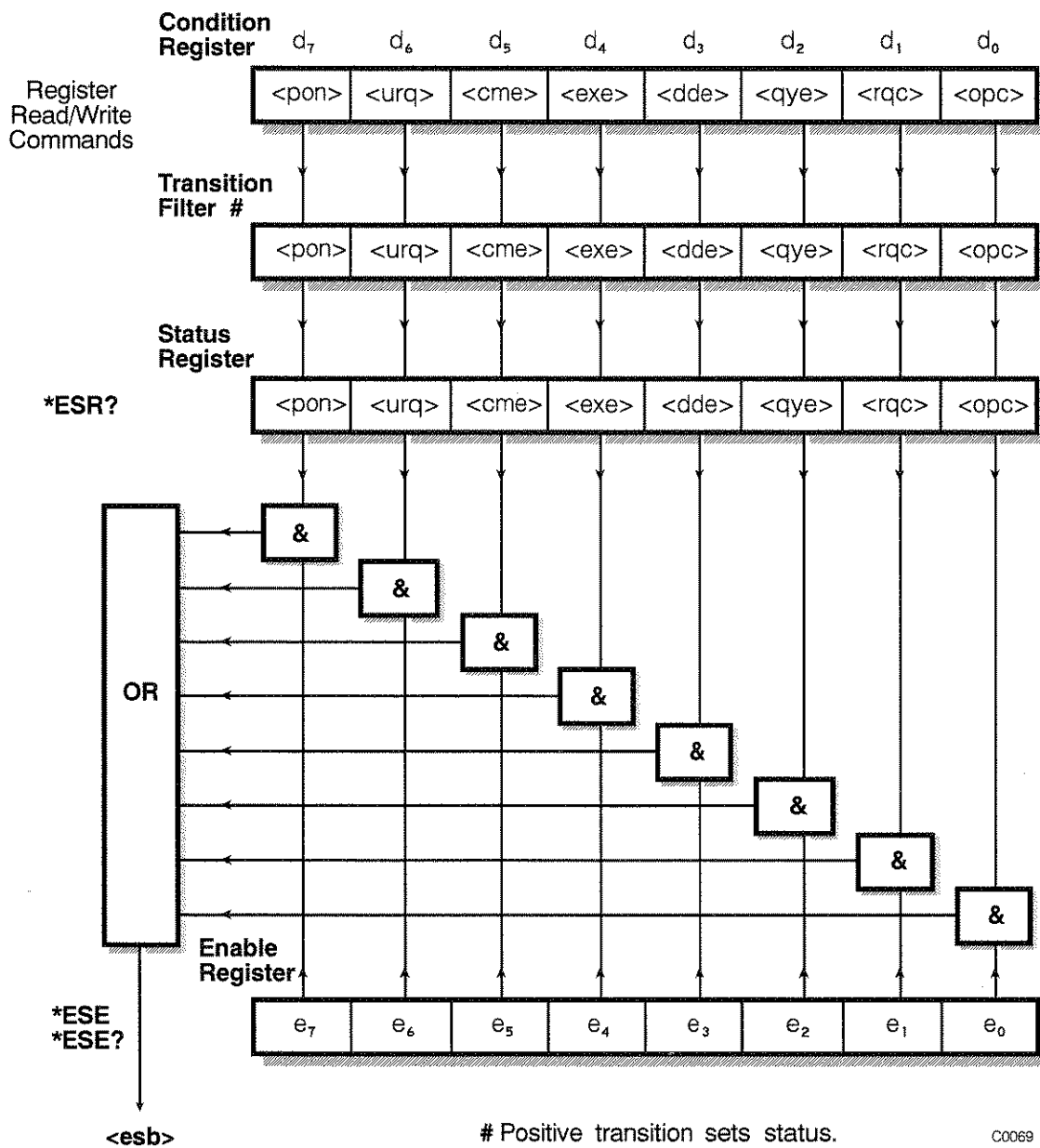

C0069

- <pon> power on
- <urq> user request - not implemented in this product
- <cme> command error
- <exe> execution error
- <dde> device dependent error
- <qye> query error
- <rqc> request control - not implemented in this product
- <opc> operation complete - set in response to the *OPC command for synchronisation.

<esb> standard event register summary bit

HARDWARE EVENT REGISTERS

This is a device dependant Register and the bits have meanings as shown in the list at the bottom of the page.

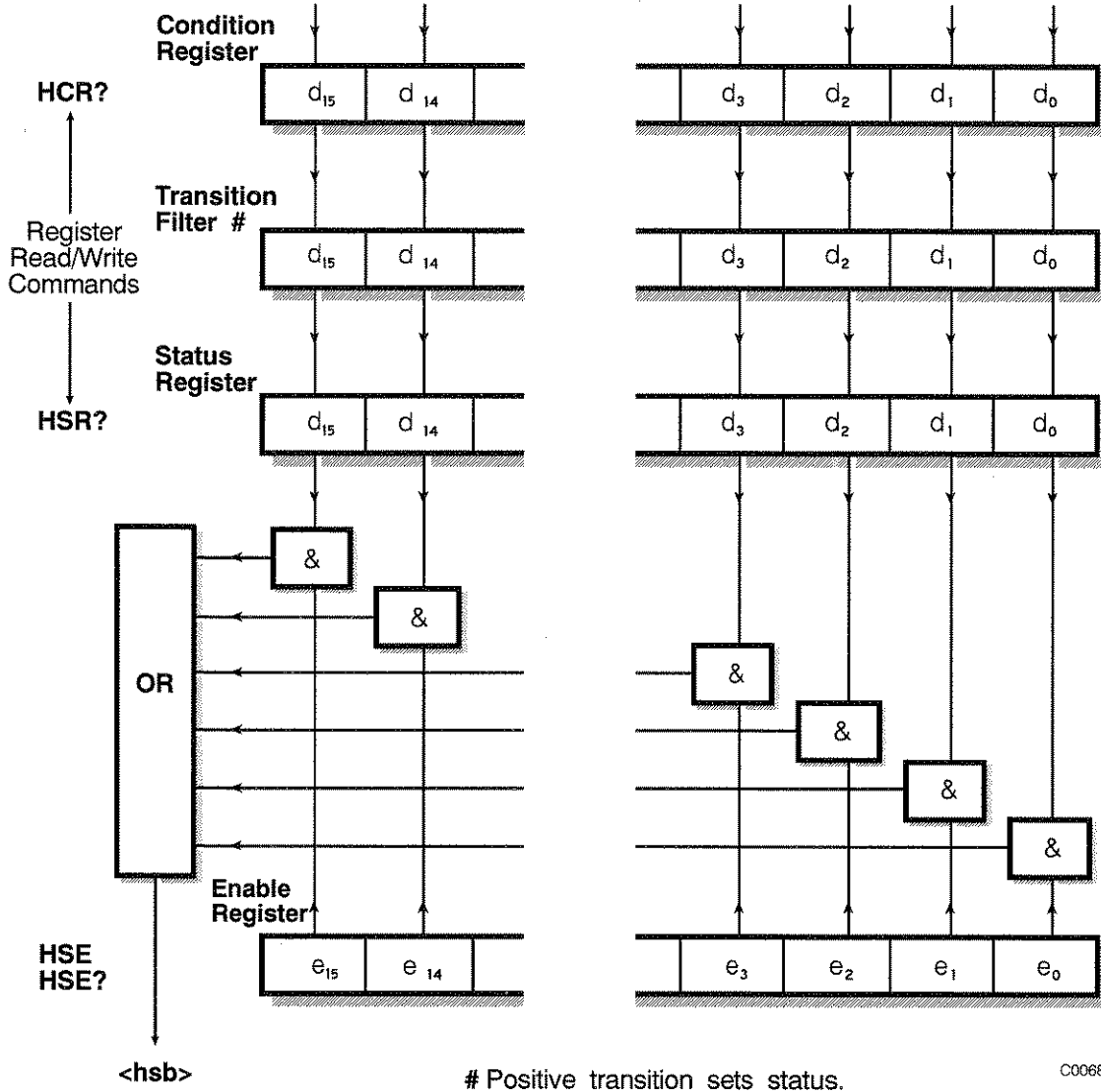

- d₀ reverse power protection tripped
- d₁ fractional-n system out-of-lock
- d₂ vcxo out-of-lock
- d₃ frequency standard missing
- d₄ external mod 1 aic loop signal too low
- d₅ external mod 1 aic loop signal too high
- d₆ external mod 2 aic loop signal too low
- d₇ external mod 2 aic loop signal too high

- d₈ harmonic loop signal to low
- d₉ harmonic loop signal too high
- d₁₀ harmonic loop out-of-lock
- d₁₁ output loop signal too low
- d₁₂ output loop signal too high
- d₁₃ output loop out-of-lock
- d₁₄ not used
- d₁₅ not used

<hsb> hardware event register summary bit

COUPLING EVENT REGISTERS

This is a device dependant Register and the bits have meanings as shown in the list at the bottom of the page.

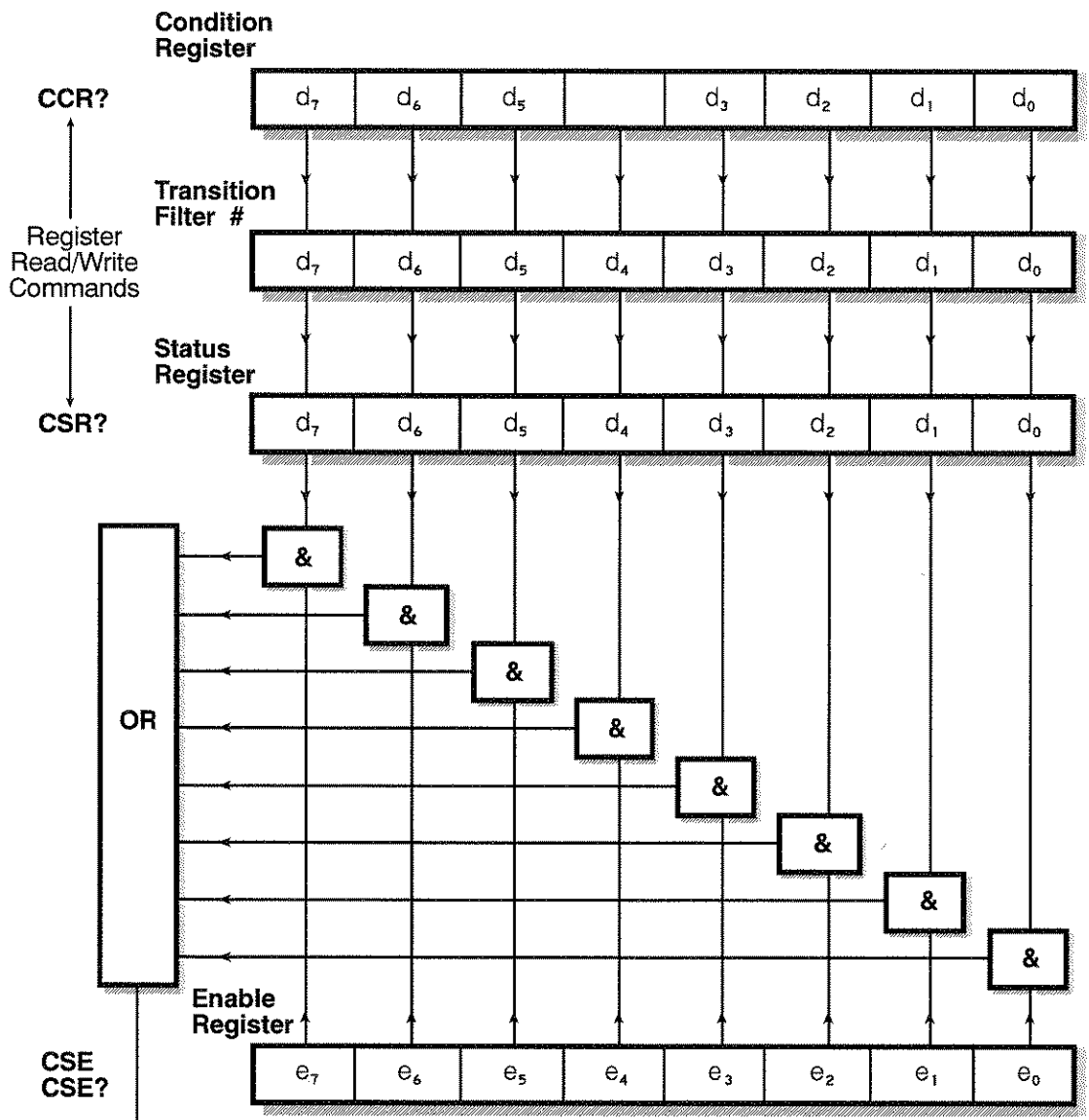

<csb>

Positive transition sets status.

C0070

- d_0 rf level restricted by requested am
- d_1 fm restricted by requested carrier frequency
- d_2 widebandfm restricted by requested carrier frequency
- d_3 am2 depth restricted by requested am1 depth
- d_4 fm2 deviation restricted by requested fm1 deviation
- d_5 pm2 deviation restricted by requested pm1 deviation
- d_6 number of sweep steps restricted by other parameters
- d_7 not used

<csb> coupling event register summary bit

INSTRUMENT EVENT REGISTERS

This is a device dependant Register and the bits have meanings as shown in the list at the bottom of the page.

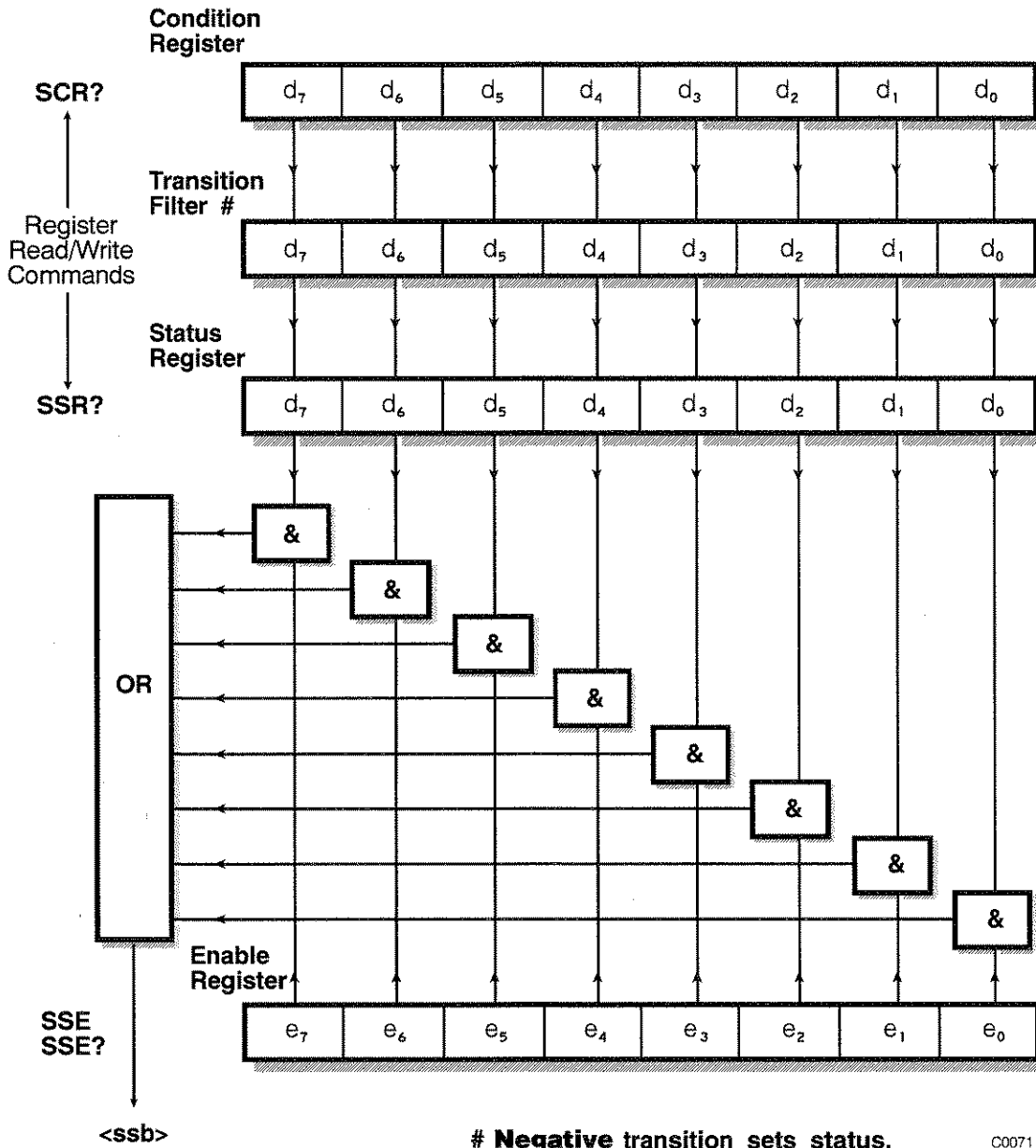

Negative transition sets status.

C0071

	<u>Condition (*SCR?)</u>	<u>Event Status (*SSR?)</u>
d ₀	sweep in progress	end of sweep
d ₁	sending tones	tones sent
d ₂	selfcal in progress	selfcal completed
d ₃	dc fm null in progress	dc fm null completed
d ₄	not used	not used
d ₅	not used	not used
d ₆	not used	not used
d ₇	not used	not used

<ssb> instrument event register summary bit

QUEUE FLAG DETAILS

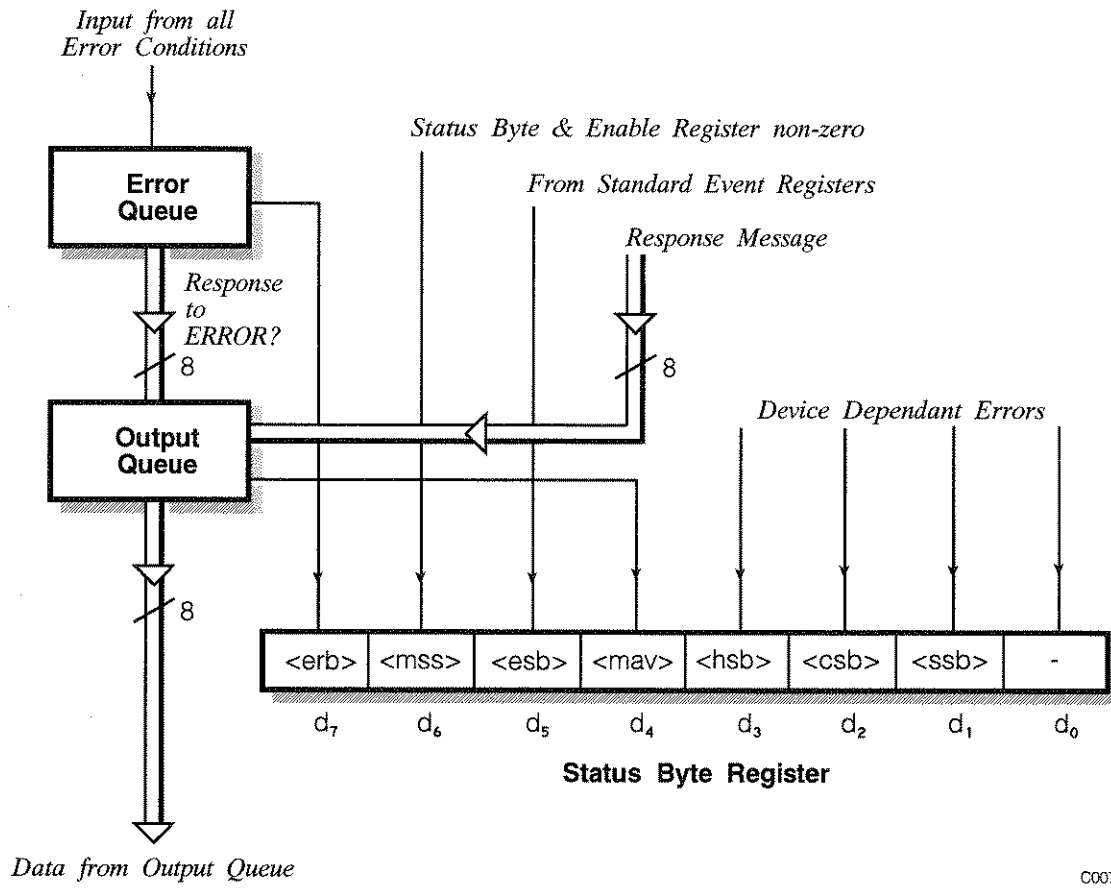

C0075

The <mav> status bit is set when one or more bytes are available to be read from the Output Queue.

The <erb> status bit is set when one or more errors are present in the Error Queue. The ERROR? query will place a nr1 response message in the Output Queue representing the Error at the head of the queue; if the queue is empty then this message will be 0.

STATUS BYTE WHEN READ BY *STB?

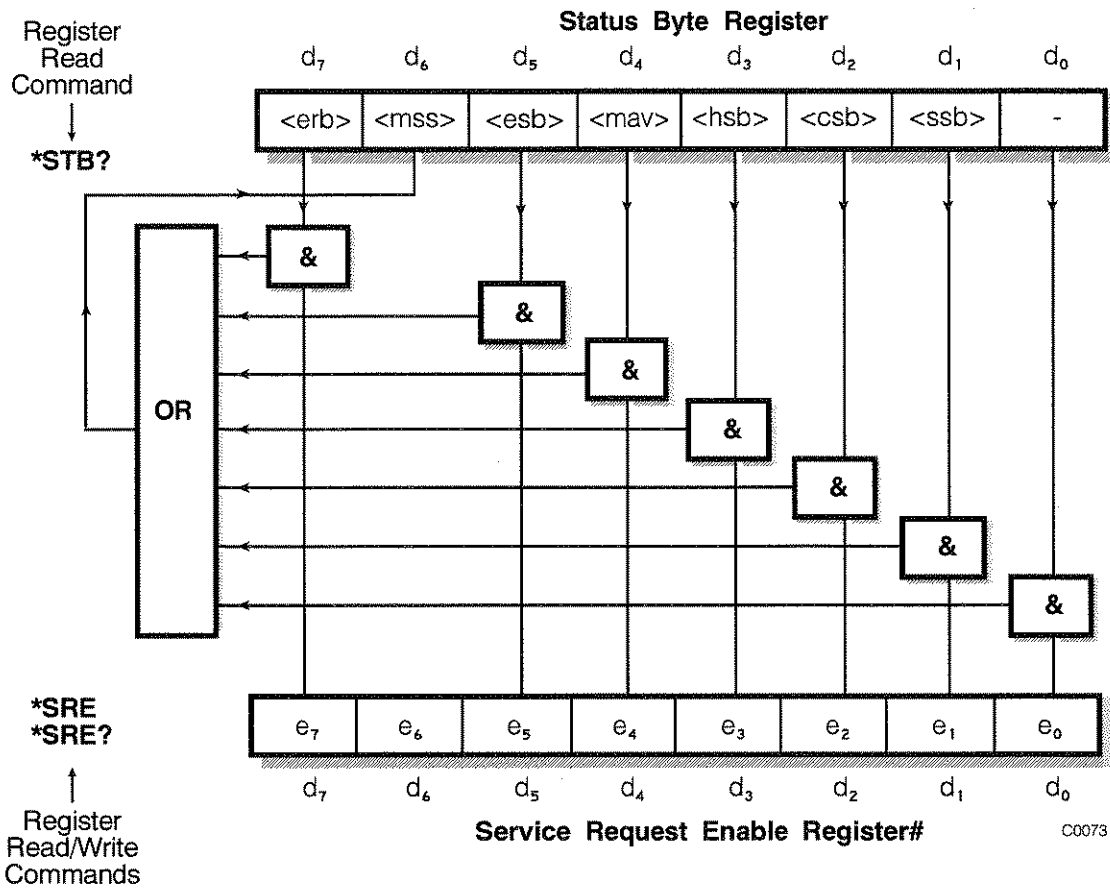

Bit 6 in this register ignores data sent by *SRE and always returns 0 in response to *SRE?

<rq>, <esb> and <mav> are defined in IEEE 488.2

- <erb> is a device defined queue summary bit indicating that the error queue is non-empty.
- <mss> is true when (Status Byte) AND (Enable register) > 0.
- <esb> is the standard event register summary bit.
- <mav> is 'message available' indicating that the output queue is non-empty.
- <hsb> is 'hardware status' summary bit
- <csb> is 'coupling status' summary bit
- <ssb> is 'instrument status' summary bit

Note...

The Status Byte Register is Not cleared by the *STB? query.

STATUS BYTE WHEN READ BY SERIAL POLL

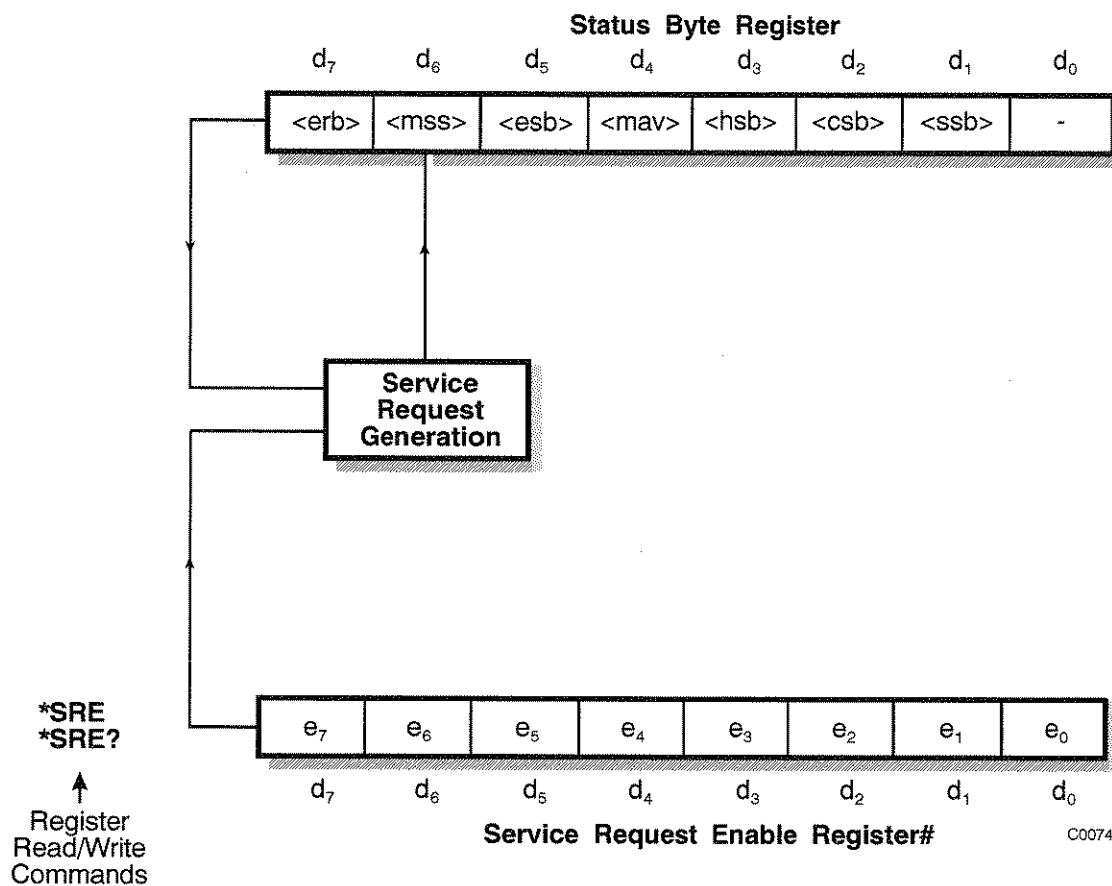

C0074

Bit 6 in this register ignores data sent by *SRE and always returns 0 in response to *SRE?

- <erb> is a device defined queue summary bit indicating that the error queue is non-empty.
- <rqs> is set by a request for service and is cleared by the poll.
- <esb> is the standard event register summary bit.
- <mav> is 'message available' indicating that the output queue is non-empty.
- <hsb> is 'hardware status' summary bit
- <csb> is 'coupling status' summary bit
- <ssb> is 'instrument status' summary bit

<rqs>, <esb> and <mav> are defined in IEEE 488.2

<rqs> (request for service) will produce an SRQ at the controller. It is set by a change to either the Status Byte or the Service Enable Register that results in a New Reason for Service. It is cleared when <mss> goes FALSE (i.e. no reason for service) or by Serial Poll.

SUMMARY OF STATUS REPORTING COMMANDS AND QUERIES

*CLS	Clears Status Registers and the Error Queue
*ESE<nrf>	Writes to Standard Event Enable Register
*ESE?	Reads from Standard Event Enable Register
*ESR?	Reads from Standard Event Status Register
*SRE<nrf>	Writes to Service Request Enable Register
*SRE?	Reads from Service Request Enable Register
*STB?	Reads from Status Byte Register
CCR?	Reads from Coupling Condition Register
CSE<nrf>	Writes to Coupling Status Enable Register
CSE?	Reads from Coupling Status Enable Register
CSR?	Reads from Coupling Status Register
HCR?	Reads from Hardware Condition Register
HSE<nrf>	Writes to Hardware Status Enable Register
HSE?	Reads from Hardware Status Enable Register
HSR?	Reads from Hardware Status Register
SCR?	Reads from Instrument Condition Register
SSE<nrf>	Writes to Instrument State Enable Register
SSE?	Reads from Instrument State Enable Register
SSR?	Reads from Instrument State Status Register
<nrf>	Decimal Numeric Program Data

All of the above queries respond with a nr1 numeric format.

Chapter 4-1

BRIEF TECHNICAL DESCRIPTION

INTRODUCTION

The 2040 series low noise signal generators cover a wide range of frequencies from 10 kHz to 1.35 GHz (2040), 10 kHz to 2.7 GHz (2041) and 10 kHz to 5.4 GHz (2042). Output levels from -144 or -138 dBm to +13 dBm (+19 dBm on 2040 with option 003 fitted) are available. The simplified block schematic diagram for the instrument is shown in Fig. 4-1.

MODULATION

The carrier frequency can be frequency, phase or amplitude modulated from internal or external modulation sources. A maximum of four modulation channels can be made available by the use of the internal oscillator and a second optional internal oscillator together with two external modulation signals applied to the EXT MOD 1 INPUT and EXT MOD 2 INPUT connectors on the front panel.

FREQUENCY GENERATION

Four voltage controlled oscillators (VCOs) covering the frequency range 675 to 1350 MHz are phase locked to a 10 MHz oven controlled crystal oscillator using a fractional-N synthesizer system. In low noise modes the noise performance is improved using a synthesizer system located in the low noise tray. Additional frequency coverage is achieved by means of frequency division or multiplication. Low frequencies are generated by a beat frequency oscillator (BFO) system.

DISPLAY

The display is a high definition dot matrix liquid crystal panel with backlighting to cater for variations in ambient light conditions. The display can be adjusted for both contrast and brightness.

CONTROL

The 2040 series are menu driven instruments. Main menus are displayed by the use of hard keys, and parameters are changed by means of soft keys which change as the menu changes. Internal control of the instruments is achieved by a microprocessor which receives data from the various controls and sends instructions via an internal 8-bit data bus to the signal processing circuits.

The instruments can also be controlled by the built in general purpose interface bus (GPIB). This facility enables the instruments to be used both as manually operated bench mounted instruments or as part of a fully automated test system.

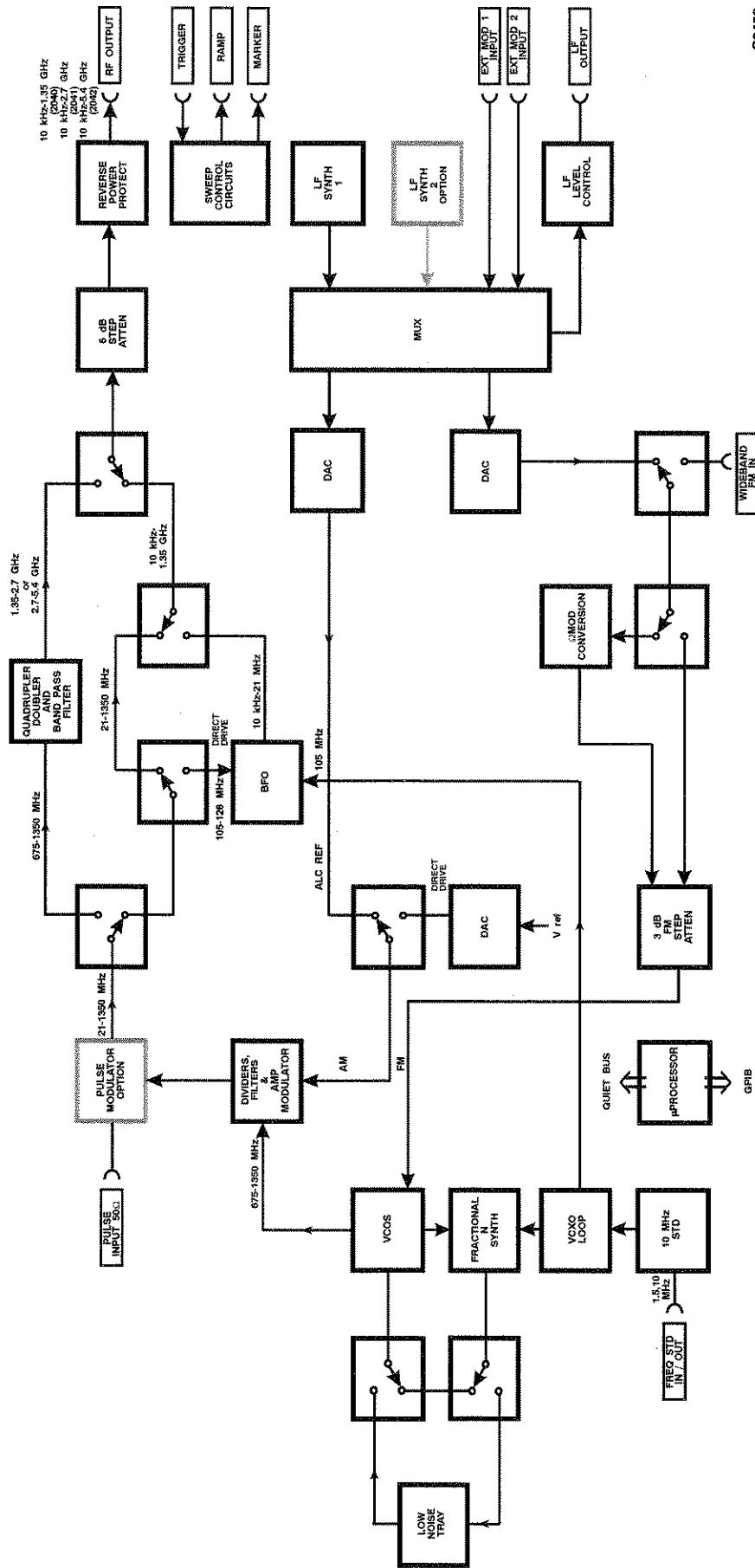

C0459

Fig. 4-1-1 Block schematic diagram