

# 3001

## Operator's Manual

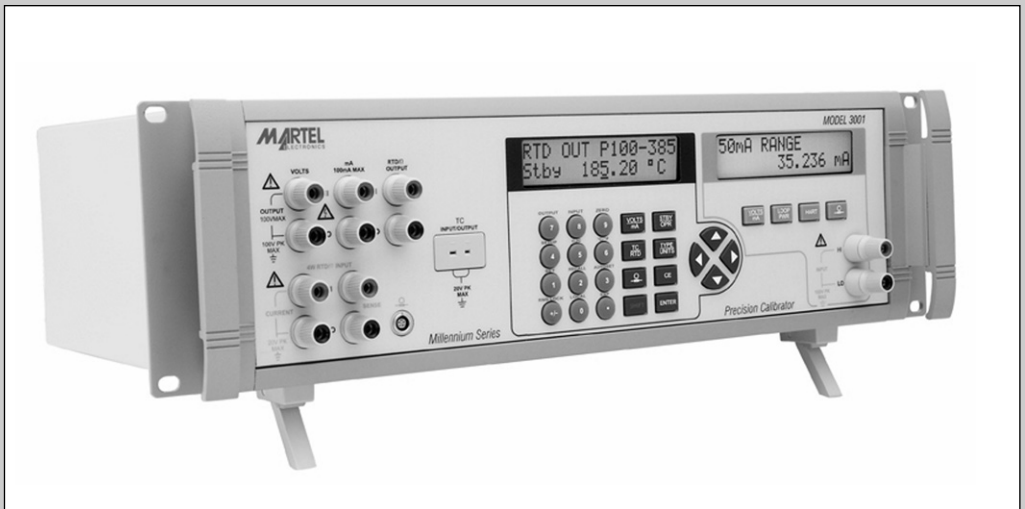

# 3001 Operator's Manual

<b>1. Introduction</b>	<b>1</b>
1.1 Customer Service	1
1.2 Standard Equipment	1
1.3 Options and Accessories	1
1.4 Unpacking	1
1.5 Safety Information	2
<b>2. Calibrator Description</b>	<b>4</b>
2.1 Front Panel Overview	4
2.2 Primary Input/Output Terminals	5
2.3 Primary Input/Output Display and Controls	6
2.4 Isolated Input Display, Controls, and Terminals	8
2.5 Rear Panel	10
2.6 Display Layouts	11
2.7 Error Messages	13
<b>3. Getting Started</b>	<b>14</b>
<b>4. Primary Inputs and Outputs</b>	<b>14</b>
4.1 DC Voltage Output	14
4.2 DC Current Output	15
4.3 Resistance Temperature Detector (RTD) and Ohms Measure	16
4.4 Resistance Temperature Detector (RTD) and Ohms Source	18
4.5 Resistance Temperature Detector (RTD) with Custom Coefficients	19
4.6 Standard Platinum Resistance Thermometer (SPRT) Coefficients	20
4.7 Thermocouple (T/C) Measure	21
4.8 Thermocouple (TC) Source	23
4.9 Pressure Measure	24
<b>5. Isolated Inputs</b>	<b>25</b>
5.1 Voltage Input	25
5.2 Current Input	25
5.3 Pressure Input	26
<b>6. Output Setpoints</b>	<b>27</b>
<b>7. Application Notes</b>	<b>28</b>
7.1 P/I Transmitter	28
7.2 I/P Transmitter	29
7.3 V/I Transmitter	30
7.4 RTD Test	30
7.5 RTD Transmitter	31
7.6 Thermocouple Test	32
7.7 Thermocouple Transmitter	32
7.8 RTD Indicator	33
7.9 Precision Current Trip	34
7.10 I/I Isolator/Transmitter	35
7.12 Precision Temperature Measurement with IBP-2 Probe	36
<b>8. LCD and Remote Interface Setup Procedures</b>	<b>37</b>

<b>9. Remote Interface</b>	<b>37</b>
9.1 Introduction	37
9.2 Setting up the RS-232 Port for Remote Control	38
9.3 Setting up the IEEE-488 Port for Remote Control	38
9.4 Changing Between Local and Remote Operation	39
9.5 IEEE-488 Interface Overview	40
9.6 Using Commands	41
9.7 Checking 3001 Status	45
<b>10. Remote Commands</b>	<b>50</b>
10.1 Introduction	50
10.2 Command Summary by Function	50
10.3 Error Code Listing	52
10.4 Remote Command Listing	54
<b>11. Maintenance</b>	<b>77</b>
11.1 Cleaning the Calibrator	77
11.2 Replacing a Line Fuse	77
11.3 Changing the Line Voltage	78
<b>12. Specifications</b>	<b>79</b>
12.1 General Specifications	79
12.2 DC Voltage Specifications, Output	80
12.3 DC Voltage Specifications, Isolated Input	80
12.4 DC Current Specifications, Output	80
12.5 DC Current Specifications, Isolated Input	81
12.6 Resistance Specifications, Output	81
12.7 Resistance Specifications, Input	81
12.8 Thermocouple Specification, Output and Input	82
12.9 RTD and Thermistor Specification, Output	84
12.10 RTD and Thermistor Specification, Input	86
12.11 Pressure Measurement Specifications	87
<b>13. Warranty</b>	<b>88</b>



# 1. Introduction

The Martel series 3001 calibrator is an accurate full-featured temperature, pressure and DC calibrator intended for R & D, manufacturing and calibration lab applications. The unit's simple design and ease of operation allow users to quickly familiarize themselves with its operations and features. Time saving functions like the ability to save, recall and automatically cycle through setpoints for each output range, the ability to enter user definable RTD curves, and a complete remote interface are several key features offered by the 3001.

## 1.1 Customer Service

### **Corporate Office:**

[www.martelcorp.com](http://www.martelcorp.com)

e-mail: [sales@martelcorp.com](mailto:sales@martelcorp.com)

Tel: (603) 434-8179 800-821-0023 Fax: (603) 434-1653

### **Martel Electronics**

PO Box 770

1F Commons Drive

Londonderry, NH 03053

## 1.2 Standard Equipment

- Power cord
- Thermocouple shorting jumper

## 1.3 Options and Accessories

- IBP-2 PT100 High Accuracy Probe
- 80029 JKTE Thermocouple Kit
- 80036 RSNB Thermocouple Kit
- PTL-1 Low EMF Beryllium Copper Test Leads

The 3001 and above options are available in a complete kit form.

## 1.4 Unpacking

Upon receipt of the shipment, inspect the container and equipment for any signs of damage. Take particular note of any evidence of rough handling in transit. Immediately report any damage to the shipping agent.

**NOTE:** The carrier will not honor any claims unless all shipping material is saved for their examination.

After examining and removing the contents, save the packing material and carton in the event that re-shipment is necessary.

Remove the Packing List and verify that all of the listed equipment has been received. If there are any questions about the shipment, please call Martel Electronics at 1-800-821-0023.

Check to see if your basic calibrator package is complete. It should include:















- 3001 Calibrator
- Instruction Manual

- AC Line Cord
- Thermocouple Shorting Jumper
- NIST Certificate

## 1.5 Safety Information

### ***Symbols Used***

The following table lists the International Electrical Symbols. Some or all of these symbols may be used on the instrument or in this manual.

Symbol	Description
	AC (Alternating Current)
	AC-DC
	Battery
	CE Complies with European Union Directives
	DC
	Double Insulated
	Electric Shock
	Fuse
	PE Ground
	Hot Surface (Burn Hazard)
	Read the User's Manual (Important Information)
	Off
	On
	Canadian Standards Association

The following definitions apply to the terms "Warning" and "Caution".

- " Warning" identifies conditions and actions that may pose hazards to the user.
- " Caution" identifies conditions and actions that may damage the instrument being used.

Use the calibrator only as specified in this manual, otherwise personal injury and/or damage to the calibrator may occur.



**To avoid possible electric shock or personal injury:**

- Do not apply more than the rated voltage between the terminals, or between any terminal and chassis ground. See specifications for supported ranges.
- Follow all equipment safety procedures.
- Always use the power cord and connector suitable for the voltage and outlet of the location in which you are working.
- Do not use the calibrator if it is damaged. Before you use the calibrator, inspect the case. Look for cracks or missing plastic. Pay particular attention to the insulation surrounding the connectors.
- Inspect the test leads for damaged insulation or exposed metal. Check test lead continuity. Replace damaged test leads before you use the calibrator.
- Never operate the calibrator with the cover removed or the case open, and never remove the cover or open the case without first disconnecting the power source and all test leads.
- Select the proper function and range for your measurement.
- Never touch the probe to a voltage source when the test leads are plugged into the current terminals.
- When using the probes, keep your fingers away from the probe contacts. Keep your fingers behind the finger guards on the probes.
- Connect the common test lead before you connect the live test lead. When you disconnect test leads, disconnect the live test lead first.
- Do not use the calibrator if it operates abnormally. Protection may be impaired. When in doubt, have the calibrator serviced.
- Do not operate the calibrator around explosive gas, vapor, or dust.
- When using a pressure module, make sure the process pressure line is shut off and depressurized before you connect it, or disconnect, it from the pressure module.
- Disconnect test leads before changing to another measure or source function.
- Have the calibrator serviced only by qualified personnel, and use only specified replacement parts.
- Use only the replacement fuse(s) specified in this manual.
- To avoid a violent release of pressure in a pressurized system, shut off the valve and slowly bleed off the pressure before you attach the pressure module to the pressure line.

## ⚠ **Caution**

**To avoid possible damage to the calibrator or to the equipment under test:**

- Use the proper terminals, function, and range for your measurement or sourcing application.
- To avoid mechanically damaging the pressure module, never apply more than 10 ft-lb of torque between the pressure module fittings, or between the fittings and the body of the module.
- To avoid damaging the pressure module from overpressure, never apply pressure above the rated maximum printed on the module.
- To avoid damaging the pressure module from corrosion, use it only with specified materials. Refer to the pressure module documentation for material compatibility.

## 2. Calibrator Description

### 2.1 Front Panel Overview

Figure 1 shows the overall layout of the front panel. Each of the three major divisions is described in detail in the following sections.

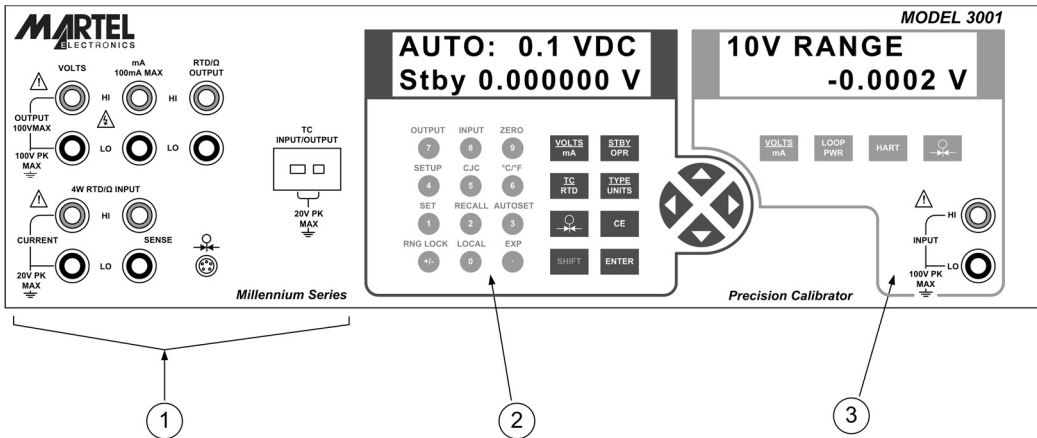

**Figure 1 - Front Panel**

Item	Name	Description
1	Primary input/output terminals	See section 2.2 for details
2	Primary input/output display and controls	See section 2.3 for details
3	Isolated input display, controls, and terminals	See section 2.4 for details



## 2.2 Primary Input/Output Terminals

Figure 2 describes the primary input/output terminals in detail. The display and controls for these terminals are described in the next section.

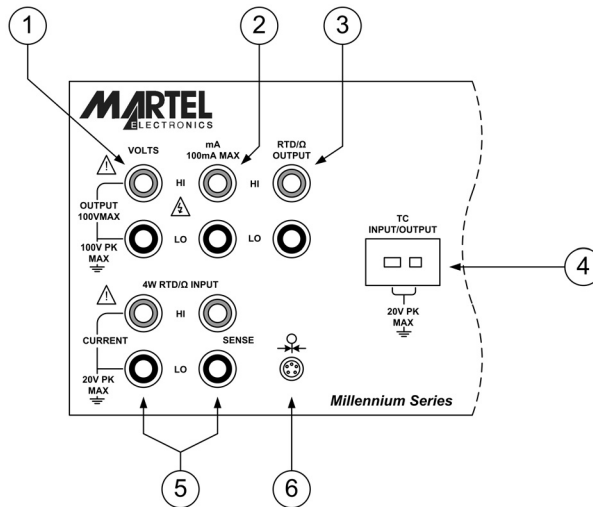

**Figure 2 - Primary Input/Output Terminals**

Item	Name	Description
1	VOLTS	DC voltage output terminals. See notes 1 and 2 below.
2	mA	DC current output terminals. See notes 1 and 2 below.
3	RTD/O OUTPUT	Two wire RTD and Ohms output terminals. See notes 1 and 2 below.
4	TC INPUT/OUTPUT	Thermocouple input and output terminals. These terminals accept a miniature polarized thermocouple plug with flat in-line blades spaced 7.9 mm (0.312 in.) center to center.
5	4W RTD/O INPUT	Four wire RTD and Ohms input terminals. See notes 1 and 3 below.
6		Pressure module input connector.

**Note 1:** These terminal binding posts are made of a special copper alloy to reduce thermal EMF's. They support the use of either discreet wires or standard banana plugs, and the HI/LO pairs are spaced for standard dual banana plugs.

**Note 2:** **Caution.** Do not exceed a maximum of 100 volts to chassis ground.

**Note 3:** **Caution.** Do not exceed a maximum of 20 volts to chassis ground.





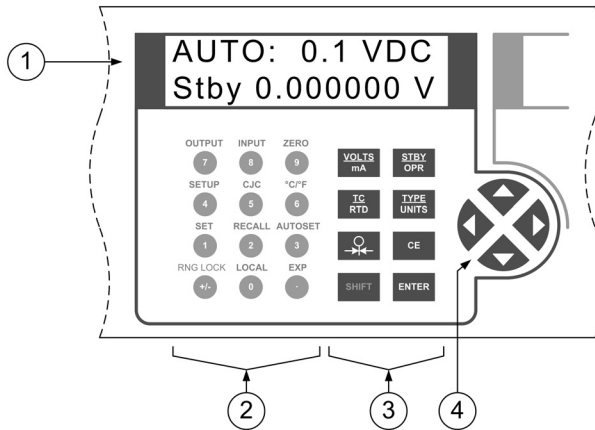













## 2.3 Primary Input/Output Display and Controls







Figure 3 describes the primary input/output display and controls in detail.



**Figure 3 - Primary Input/Output Display and Controls**

Item	Name	Description
1	Display	A 2 line, 16 character, display providing all visual user feedback for the primary output and input operations. See section 2.6 for layout details, and section 2.7 for possible error messages.
2	Numeric and secondary function keys	Output value data entry keys. Secondary function selection per the text printed above the numeric key. Press the <b>SHIFT</b> key followed by the numeric key to select the function.
	OUTPUT <b>SHIFT</b> 7	Change RTD/Ohms or Thermocouple to output mode.
	INPUT <b>SHIFT</b> 8	Change RTD/Ohms or Thermocouple to input mode.
	ZERO <b>SHIFT</b> 9	Zero the input for Pressure, Thermocouple millivolts, or RTD ohms
	SETUP <b>SHIFT</b> 4	Adjust the LCD Contrast, LCD Backlight, and Remote Interface Configuration as described in section 8.
	CJC <b>SHIFT</b> 5	Select internal or external cold junction compensation for Thermocouple temperature measurements. When external compensation is selected, XCJC is displayed at the start of the second line.
	°C/°F <b>SHIFT</b> 6	Select Centigrade or Fahrenheit units for RTD and Thermocouple temperature measurements.

	SET  	Set a new value for a preset output setpoint as described in section 6.
	RECALL  	Recall a preset output setpoint as described in section 6.
	AUTOSET  	Initiate automatic stepping of preset output setpoints as described in section 6.
	RNG LOCK  	Select Auto-range or Range Lock for voltage output.
	LOCAL  	Press to regain local control of the 3001 after the remote command REMOTE has been received; in this case all keys except this one are ignored. When the remote command LOCKOUT has been received, all keys are ignored including this one and the remote command LOCAL must be received to regain local control.
	EXP  	Press during entry of a RTD custom curve coefficient to begin entering the exponent.
3	Function keys	
		Select DC voltage or current output mode, and toggle between them.
		Select Thermocouple or RTD/Ohms input/output mode, and toggle between them.
		Select Pressure input mode.
		In Thermocouple mode, cycle through the thermocouple types, including millivolts. In RTD/Ohms mode, cycle through the RTD types, including ohms. In Pressure mode, cycle through the pressure units.
		For all output modes, except Thermocouple, toggle between Standby and Operate modes. In Standby mode, any change to the output value in the display is not driven to the terminals until the Operate mode is selected. In Operate mode, each change to the output value in the display is driven to the terminals immediately, except for DC voltages greater than 30V when the mode reverts to Standby automatically for safety reasons.
		Changes the calibrator output or parameter to the numeric value typed into the keypad.



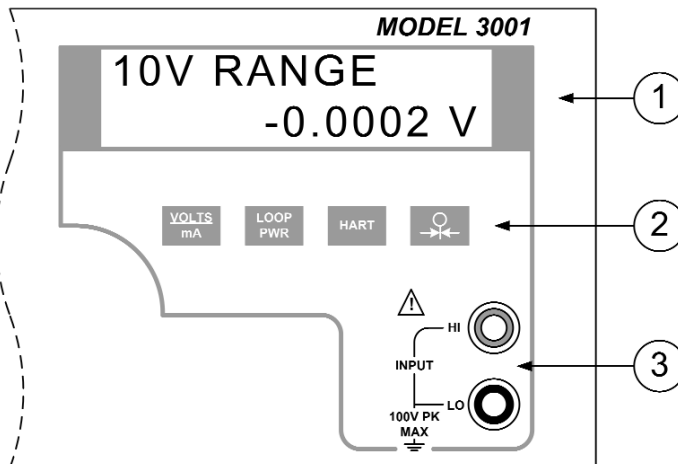

	<b>CE</b>	Clears a partial keypad entry and reverts the calibrator output or parameter to its last known value.
	<b>SHIFT</b>	Prepares for selection of a secondary function via the numeric keypad according to the text above each key. The display changes to SHIFT ENABLED until a numeric key is pressed. To cancel the selection press <b>SHIFT</b> again.
4	Cursor controls	<p>Press  or  to position the cursor under the digit in an output value that is to be incremented or decremented. Press  to increment the digit in the output value where the cursor is positioned.</p> <p>Press  to decrement the digit in the output value where the cursor is positioned.</p> <p>The  and  keys are also used to adjust LCD Contrast level, LCD Backlight level, and Remote Interface Configuration selections as described in section 8.</p>

## 2.4 Isolated Input Display, Controls, and Terminals

Figure 4 describes the isolated input display, controls, and terminals in detail.



**Figure 4 - Isolated Input Display, Controls, and Terminals**

Item	Name	Description
1	Display	A 2 line, 16 character, display providing all visual user feedback for the isolated input operations. See section 2.6 for layout details, and section 2.7 for possible error messages.
2	Function keys	
		Select DC voltage and current input mode. Subsequent presses of this key cycle through the ranges: 10V, 100V, and 50mA.
		When using 50mA mode to test a 2 wire loop powered transmitter that is disconnected from its wiring, press this key to activate an internal 24V power supply in series with the current measuring circuit. Press the key again to deactivate the 24V supply.
		When using 50mA mode to test a HART configuration device, press this key to activate an internal 250 ohm resistor in series. Press the key again to deactivate the resistor. Note that activating this resistor drops the maximum load driving capability from 1000 ohms at 20mA to 750 ohms at 20mA.
		Select Pressure input mode. Subsequent presses of this key cycle through the pressure units. Pressure input mode uses the pressure module connector on the primary input/output side. Both sides may be selected to pressure mode simultaneously and can be set to display the same pressure measurement in different units if desired.
3	Input Terminals	Common input terminals for DC voltage and current. See notes 1 and 2 below.

**Note 1:** These terminal binding posts are made of a special copper alloy to reduce thermal EMF's. They support the use of either discreet wires or standard banana plugs, and the HI/LO pairs are spaced for standard dual banana plugs.



**Note 2: Caution.** Do not exceed a maximum of 100 volts to chassis ground.

## 2.5 Rear Panel

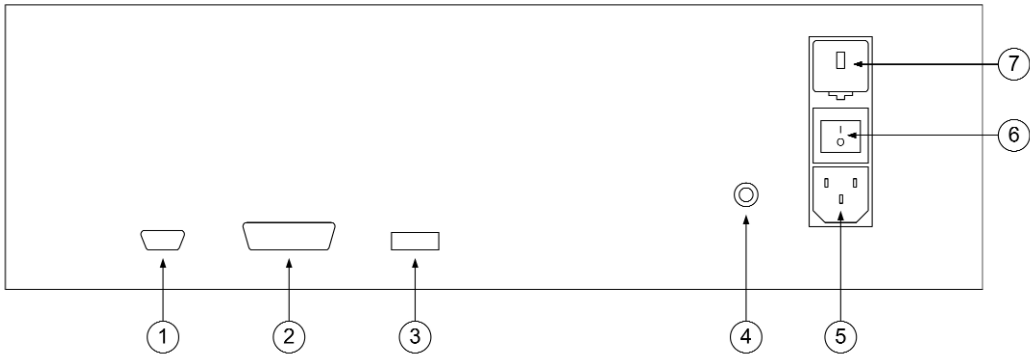
Figure 5 describes the rear panel layout.

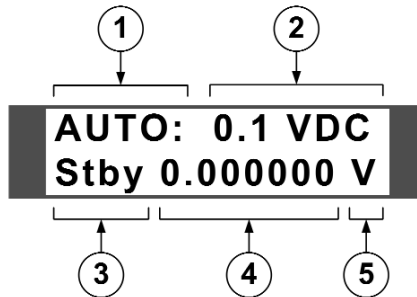

**Figure 5 - Rear Panel**

Item	Description
1	RS-232 9 pin connector for remote control of the 3001 via any computer's serial interface.
2	GPIB IEEE 488.2 connector for remote control of the 3001 via a GPIB bus.
3	Service port for updating the 3001 firmware.
4	Chassis ground terminal internally connected to the ground prong of the AC power inlet.  <b>Warning</b> To avoid shock hazard, connect the factory supplied 3 conductor power cord to a properly grounded power outlet. Do not use a 2 conductor adapter or extension cord as this will break the protective ground. Use the chassis ground terminal for a protective ground wire if there is any question about the grounding through the 3 conductor power cord.
5	Standard IEC AC power inlet for 120/240 VAC.
6	Main power on/off switch.
7	Power line voltage selector and fuse compartment. See section 11 for instructions on changing the line voltage selector and changing fuses.  <b>Warning</b> To prevent electrical shock, only remove the line voltage selector and fuse holder when the power cord is removed.

## 2.6 Display Layouts

### a) Primary Voltage and Current Display



**Figure 6 - Primary Voltage and Current Display Layout**

Item	Description
1	Operating mode: AUTO: Auto-range LOCK: Range lock rem remote operation SP# Automatic stepping of preset setpoints
2	Present range and output mode
3	Output state: Stby Standby, terminals inactive Opr Operating, terminals are active with output per the displayed value
4	Output value
5	Units

### b) Primary Thermocouple and RTD Display

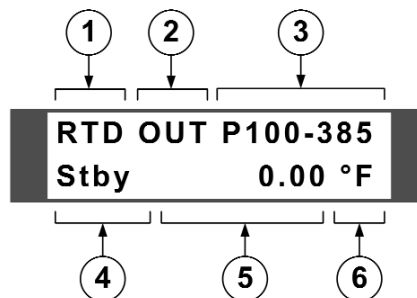
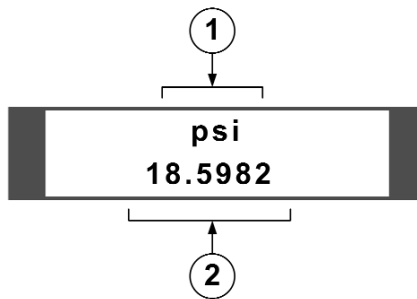

**Figure 7 - Primary Thermocouple and RTD Display Layout**

Item	Description
1	Output mode selection: RTD, TC, or rem for remote operation
2	Input or output selection
3	RTD or thermocouple type selection

4	Output state for RTD outputs: Stby     Standby, terminals inactive Opr     Operating, terminals are active with output per the displayed value Blank for RTD inputs Cold junction selection for thermocouple inputs and outputs: XCJC     External cold junction compensation; the 3001 automatic cold junction compensation is turned off, i.e. 0 mV is always 0°C Blank     Internal cold junction compensation; the 3001 automatically measures the ambient temperature at the thermocouple terminals and compensates the measurement, i.e. 0 mV is ambient temperature
5	Input or output value
6	Units

**c) Primary and Isolated Pressure Display**



**Figure 8 - Primary and Isolated Pressure Display Layout**

Item	Description
1	Units On the primary display, rem appears to the left during remote operation
2	Input value

**d) Isolated Voltage and Current Display**

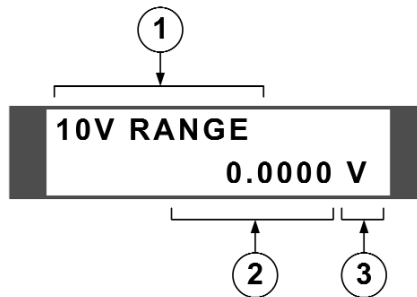

**Figure 9 - Isolated Voltage and Current Display Layout**



<b>Item</b>	<b>Description</b>
1	Selected range and input mode:· <ul style="list-style-type: none"> <li>• 10V RANGE or 100V RANGE for DC voltage·</li> <li>• 50mA RANGE for basic DC current·</li> <li>• 24mA LPWR for loop powered 2 wire transmitter·</li> <li>• 24mA LPWR HART for loop powered 2 wire transmitter with 250 ohm resistor in circuit</li> </ul>
2	Input value
3	Units

## 2.7 Error Messages

The following error messages may appear on either display.

**Table 1 - Error Messages**

<b>Message</b>	<b>Description</b>
OVER RANGE	The value entered on the numeric keypad exceeds the range of the output mode selected.
OVER LOAD	For DC voltage output mode, the current required to generate the output exceeds the 3001 specifications. For DC current mode, the resistance of the circuit exceeds the 3001 specifications.
OL	For input modes, the measured value exceeds the upper limit of the selected input mode range. For output modes, when the range is locked, the present automatically recalled preset setpoint exceeds the upper limit of the locked range. The output is set to zero for the duration of this setpoint.
-OL	For input modes, the measured value exceeds the lower limit of the selected input mode range.

### 3. Getting Started

After unpacking the 3001 and becoming familiar with the layout and general operation of the unit as described in the previous section, it is ready to set up for operation.

The following steps should be followed to set up the 3001 for operation:

- a) **Before** attaching the power cord to the rear connector, check that the line voltage selector is set appropriately for your location. The 3001 is shipped from the factory with the line voltage set for the country of purchase. To verify the line voltage setting, check the indicator on the power line voltage selector and fuse compartment cover; see figure 5 in section 2.5 for the location.

Confirm that the setting is correct according to the following guidelines:

Line Voltage (50/60Hz)	Selector Position
90 to 135 VAC	120 VAC position
220 to 250 VAC	240 VAC position

If the setting is not correct, follow the instructions in section 11.3 to change it.

- b) Once the voltage selection has been made, making sure that the power switch is off, connect the AC power cord to the 3001; see figure 5 in section 2.5 for the location.
- c) Turn on the 3001 using the rear panel mounted rocker switch. The 3001 should power up within a few seconds, briefly displaying the model number and firmware version in the primary display before reverting to the normal input/output display.

**NOTE:** If a proper power up display does not occur within 30 seconds, turn the power off, wait a few seconds, and repower the unit. If the problem persists, report the problem to Martel immediately.

Warm up time is twice the time since last warmed up, to a maximum of 30 minutes. For good stability it is best to leave the 3001 on all the time.

### 4. Primary Inputs and Outputs

#### 4.1 DC Voltage Output

The 3001 can source DC voltages from 0 V to 100 V, using the following four ranges for maximum accuracy: .1 V, 1 V, 10 V, and 100 V.

- a) Disconnect any test leads from external devices.
- b) Press the  key to select DC voltage and current mode, if not already selected. If DC current mode is displayed, press the key again to cycle to DC voltage mode.
- c) Connect the unit under test to the voltage output terminals of the 3001 as shown in figure 10.

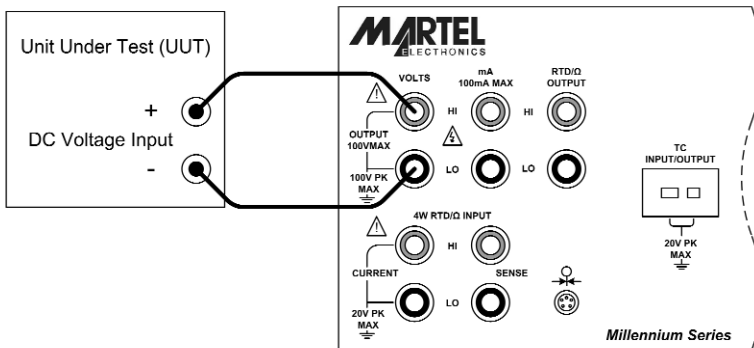

**Figure 10 - DC Voltage Output Connection**

d) Use the numeric keypad to enter the desired output value and press the **ENTER** key.

Alternatively, use the or cursor key to select a digit to modify, followed by the or cursor key to ramp the digit up or down. This method offers a simple solution when small changes to an output value are required, or if specific decades need to be incremented or decremented.

e) When DC voltage mode is first selected, the 3001 is placed in the standby (Stby) mode which puts the positive (+) output jack into a high impedance state

(>100k ohm) for safety. To place the output into the active state, press the **STBY OPR** key

The standby mode is also activated in the following situations:

- If a fault occurs during operation, such as an overload or short circuit condition.
- As a safety feature for all new outputs over 30 VDC. Refer to the product specification section of this manual for maximum drive currents.
- **Warning.** Scrolling the output when the output value is already over 30V will not place the 3001 in standby mode for each new value.
- **Warning.** Automatic setpoints over 30V will not place the 3001 in standby mode for each new value.

f) The 3001 can be locked to a specific voltage range by entering a value in that range and then selecting the secondary RNG LOCK function by pressing the **SHIFT** and keys.

## 4.2 DC Current Output

The 3001 can source DC current from 0 mA to 100 mA.

a) Disconnect any test leads from external devices.



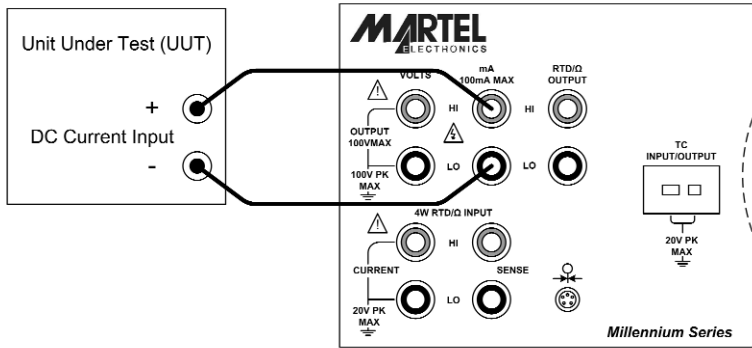

b) Press the **VOLTS mA** key to select DC voltage and current mode, if not already selected. If DC voltage mode is displayed, press the key again to cycle to DC current mode.

- c) Connect the unit under test to the current output terminals of the 3001 as shown in figure 11.



**Figure 11 - DC Current Output Connection**

- d) Use the numeric keypad to enter the desired output value and press the **ENTER** key.

Alternatively, use the  or  cursor key to select a digit to modify, followed by the  or  cursor key to ramp the digit up or down. This method offers a simple solution when small changes to an output value are required, or if specific decades need to be incremented or decremented.

- e) When DC current mode is first selected, the 3001 is placed in the standby (Stby) mode which puts the positive (+) output jack into a high impedance state

(>100k ohm) for safety. To place the output into the active state, press the **STBY OPR** key which toggles between the standby and operate modes.

The standby mode is also activated in the following situations:

- No connection made to the output terminals.
- The voltage compliance for a given output current is exceeded. The 3001 has a typical voltage compliance of 10V so that 4-20mA application loads of up to 500 ohms can be driven. At maximum current of 100mA, the maximum load is 100 ohms.

### 4.3 Resistance Temperature Detector (RTD) and Ohms Measure

The 3001 can measure all common RTD types, 5 custom RTD curves, and a custom SPRT in °F or °C, plus basic resistance from 0 to 4000 ohms.

The following common RTD types are supported:

Pt 385	100Ω, 200Ω, 500Ω, 1000Ω
Pt 3926	100Ω
Pt 3916 (JIS)	100Ω
Ni120	120Ω
Cu 427 (Minco)	10Ω
YSI 400	

- a) Disconnect any test leads from external devices.
- b) Press the **TC RTD** key to select thermocouple and RTD/ $\Omega$  mode, if not already selected. If thermocouple mode is displayed, press the key again to cycle to RTD/ $\Omega$  mode.
- c) If output mode is displayed, select input mode by pressing the **SHIFT** and **8** keys.
- d) Press the **TYPE UNITS** key to select the desired RTD type, the custom curve, the SPRT, or the desired ohms range. The set up and use of custom RTD coefficients is described in section 4.5. The set up and use of SPRT coefficients is described in section 4.6.
- e) Connect the unit under test to the 4 wire RTD/ $\Omega$  input terminals of the 3001 as shown in figure 12.

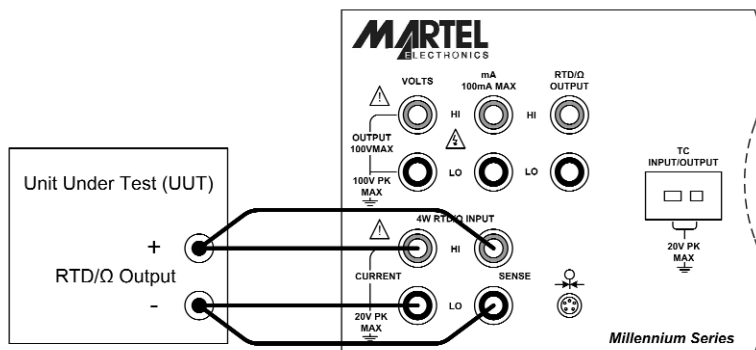

**Figure 12 - RTD/ $\Omega$  Input Connection**

- f) Press the **SHIFT** and **6** keys to toggle the RTD display between  $^{\circ}\text{F}$  and  $^{\circ}\text{C}$ .
- g) For best accuracy, it is advisable to zero the RTD resistance circuit(s) daily, or if the 3001 is being used outside of the ambient temperature range of 18 to 28  $^{\circ}\text{C}$ . The maximum offset from unit calibration that can be zeroed out is  $\pm 0.1$  ohm for the high range and  $\pm 0.01$  ohm for the low range.

To zero a RTD resistance circuit:

- Select the RTD measure function as described above, and press the **TYPE UNITS** key until the low or high ohms range is selected.
- Short the RTD/ $\Omega$  terminals with the test leads normally used for RTD/ $\Omega$  measurements.
- Allow at least 3 minutes for the test leads and terminals to stabilize to the same temperature.
- Press the **SHIFT** and **9** keys to zero the ohms range.

## 4.4 Resistance Temperature Detector (RTD) and Ohms Source

The 3001 can source all common RTD types and 5 custom RTD curves in °F or °C, plus basic resistance from 5 to 4000 ohms.

The following common RTD types are supported:

Pt 385	100Ω, 200Ω, 500Ω, 1000Ω
Pt 3926	100Ω
Pt 3916 (JIS)	100Ω
Ni120	120Ω
Cu 427 (Minco)	10Ω
YSI 400	

- Disconnect any test leads from external devices.
- Press the **TC RTD** key to select thermocouple and RTD/Ω mode, if not already selected. If thermocouple mode is displayed, press the key again to cycle to RTD/Ω mode.
- If input mode is displayed, select output mode by pressing the **SHIFT** and **7** keys.
- Press the **TYPE UNITS** key to select the desired RTD curve or ohms range. The set up and use of custom RTD coefficients is described in section 4.5.
- Connect the unit under test to the RTD/Ω output terminals of the 3001 as shown in figure 13.

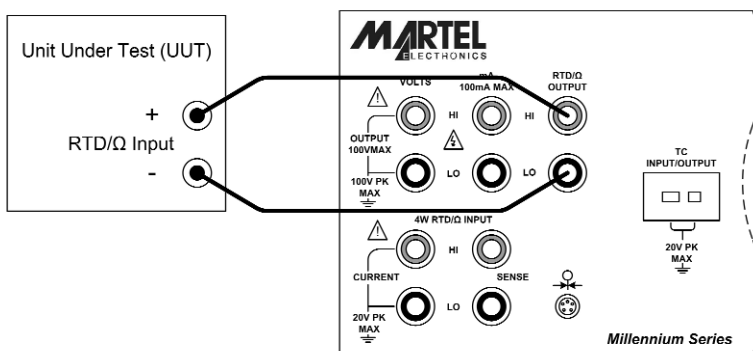

**Figure 13 - RTD/Ω Output Connection**

- Press the **SHIFT** and **6** keys to toggle the RTD display between °F and °C.
- Use the numeric keypad to enter the desired output value and press the **ENTER** key.

Alternatively, use the **◀** or **▶** cursor key to select a digit to modify, followed by the **▲** or **▼** cursor key to ramp the digit up or down. This method offers a simple solution when small changes to an output value are required, or if specific decades need to be incremented or decremented.

- h) When RTD/ $\Omega$  mode is first selected, the 3001 is placed in the standby (Stby) mode which puts the positive (+) output jack into a high impedance state (>100k ohm) for safety. To place the output into the active state, press the **STBY OPR** key which toggles between the standby and operate modes.

#### 4.5 Resistance Temperature Detector (RTD) with Custom Coefficients



The 3001 has the capability to store coefficients for up to 5 custom RTD curves.

To enter the coefficients for a custom RTD curve:

- a) Select RTD measure or source mode as described in the preceding sections.
- b) Press the **TYPE UNITS** key until the USR\_DEF type is selected.
- c) Press the **ENTER** key to display the curve selection prompt "RTD CUSTOM (1-5)".
- d) Press the numeric key corresponding to the custom RTD curve to be entered.
- e) At the "SET(1)/RECALL(2)" prompt, press **1** to select custom RTD curve data entry.
- f) At the "ENTER MIN TEMP" prompt, enter the minimum temperature limit for the custom RTD curve, and press the **ENTER** key.
- g) At the "ENTER MAX TEMP" prompt, enter the maximum temperature limit for the custom RTD curve, and press the **ENTER** key.
- h) At the "ENTER R0" prompt, enter the nominal resistance value (R0) for the custom RTD curve, and press the **ENTER** key.
- i) At the "ENTER COEFF A" prompt, enter the first (A) coefficient for the custom RTD curve, and press the **ENTER** key. To enter a coefficient that includes an exponent, enter the mantissa, press the **SHIFT** and **.** keys to select the EXP function, enter the exponent, and press the **ENTER** key.
- j) When prompted, enter the second (B) and third (C) coefficients in the same manner.
- k) To abort the curve entry without saving any changes, press the **TC RTD** key.

To use a custom RTD curve:

- a) Select RTD measure or source mode as described in the preceding sections.
- b) Press the **TYPE UNITS** key until the USR\_DEF type is selected.
- c) Press the **ENTER** key to display the curve selection prompt "RTD CUSTOM (1-5)".

- d) Press the numeric key corresponding to the custom RTD curve to be used.
- e) At the "SET(1)/RECALL(2)" prompt, press  to recall the custom RTD curve coefficients.
- f) To use a different custom RTD curve, press the  key twice to display the USR\_DEF selection prompt.

The USR\_DEF function of the 3001 uses the Calendar-Van Dusen equation for sourcing and measuring custom RTD's. The C coefficient is only used for the subrange -260 to 0 degrees Celsius. Only the A and B coefficients are needed for the subrange 0 to 630 degrees. The R0 value is the resistance of the probe at 0 degrees Celsius.

All 5 of the custom RTD curves are set to PT385 at the factory, as shown in Table 2.

**Table 2 - Default Custom RTD Coefficients**

Curve	Subrange	R0	Coefficient A	Coefficient B	Coefficient C
1	0 to 630	100	3.9083e10-3	-5.775e10-7	0
2	-260 to 0	100	3.9083e10-3	-5.775e10-7	-4.183e10-12
3	0 to 630	100	3.9083e10-3	-5.775e10-7	0
4	-260 to 0	100	3.9083e10-3	-5.775e10-7	-4.183e10-12
5	0 to 630	100	3.9083e10-3	-5.775e10-7	0

Table 3 shows the coefficients for RTD types PT391 and PT392. The C coefficient is only used for temperatures below 0 degrees Celsius.

**Table 3 - Other Common RTD Coefficients**

RTD Type	R0	Coefficient A	Coefficient B	Coefficient C
PT392	100	3.9848e10-3	-5.87e10-7	-4.0e10-12
PT391	100	3.9692e10-3	-5.8495e10-7	-4.2325e10-12

#### 4.6 Standard Platinum Resistance Thermometer (SPRT) Coefficients

The SPRT function of the 3001 uses ITS-90 standard coefficients as a basis for measuring a SPRT. The five custom coefficients are entered as deviations from the standard coefficients, and as such, all of them are set to zero at the factory.

The coefficients A- and B- represent the  $A_4$  and  $B_4$  coefficient, obtained when the SPRT is calibrated at the triple points of argon, mercury and water. This covers the 83.8058K to 273.16K subrange. Coefficients A, B and C can represent different coefficients based on which subranges of the SPRT has been calibrated. For example, if the 273.15K to 933.473K subrange was used, A, B and C would represent  $A_7$ ,  $B_7$  and  $C_7$  whereas if the 273.15K to 692.67K subrange was used, A and B would represent  $A_8$  and  $B_8$  and  $C=0$ .

To enter the deviation coefficients for a custom SPRT:

- a) Select RTD measure mode as described in the preceding section.



- b) Press the **TYPE UNITS** key until the SPRT type is selected.
- c) Press the **ENTER** key to display the action prompt "SET(1)/RECALL(2)".
- d) Press **1** to select custom SPRT data entry.
- e) At the "ENTER MIN TEMP" prompt, enter the minimum temperature limit for the custom SPRT, and press the **ENTER** key.
- f) At the "ENTER MAX TEMP" prompt, enter the maximum temperature limit for the custom SPRT, and press the **ENTER** key.
- g) At the "ENTER RTPW" prompt, enter the nominal resistance value (RTPW) for the custom SPRT, and press the **ENTER** key.
- h) At the "ENTER COEFF A" prompt, enter the first (A) deviation coefficient for the custom SPRT, and press the **ENTER** key. To enter a coefficient that includes an exponent, enter the mantissa, press the **SHIFT** and **.** keys to select the EXP function, enter the exponent, and press the **ENTER** key.
- i) When prompted, enter the second (B), third (C), fourth (A-), and fifth (B-) deviation coefficients in the same manner.
- j) To abort the SPRT entry without saving any changes, press the **TC RTD** key.

To use a custom SPRT:

- a) Select RTD measure mode as described in the preceding section.
- b) Press the **TYPE UNITS** key until the SPRT type is selected.
- c) Press the **ENTER** key to display the action prompt "SET(1)/RECALL(2)".
- d) Press **2** to recall the custom SPRT curve coefficients.
- e) To use a different custom SPRT, press the **TC RTD** key twice to display the SPRT selection prompt.

## 4.7 Thermocouple (T/C) Measure

The 3001 can measure all common thermocouple types in °F or °C, plus basic millivolts from -10.0 to 75.0 mV.

The following common thermocouple types are supported:

B, C, E, J, K, L, N, R, S, T, U, XK, BP

- a) Disconnect any test leads from external devices.
- b) Press the **TC RTD** key to select thermocouple and RTD/O mode, if not already

selected. If RTD/O mode is displayed, press the key again to cycle to thermocouple mode.

- c) If output mode is displayed, select input mode by pressing the **SHIFT** and **8** keys.
- d) Press the **TYPE UNITS** key to select the desired thermocouple type or the millivolt range.
- e) Connect the unit under test to the thermocouple terminals of the 3001 using a standard T/C miniplug as shown in figure 14. One pin is wider than the other; do not attempt to force the plug in the wrong polarization. The T/C wire used for the connection must match the thermocouple type selected for proper cold junction compensation. If the 3001 and the T/C miniplug are at different temperatures, wait at least 3 minutes for the miniplug and terminals to stabilize to the same temperature.

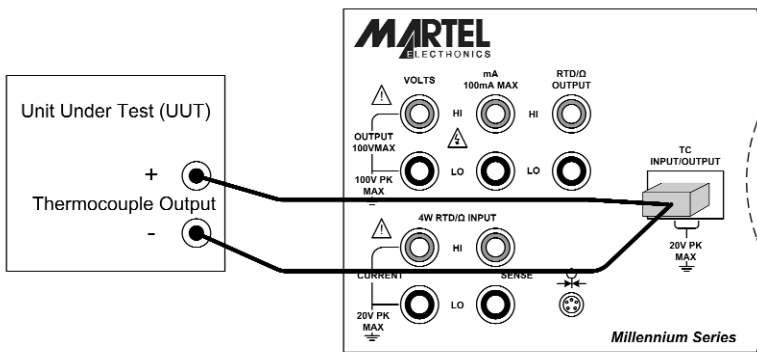

**Figure 14 - Thermocouple Input Connection**

- f) Press the **SHIFT** and **6** keys to toggle the thermocouple display between °F and °C.
- g) Press the **SHIFT** and **5** keys to toggle the cold junction compensation between the internal temperature sensor and an external reference.
- h) For best accuracy, it is advisable to zero the T/C millivolt circuit daily, or if the 3001 is being used outside of the ambient temperature range of 18 to 28 °C. The maximum offset from unit calibration that can be zeroed out is  $\pm 1$  mV.

To zero the T/C millivolt circuit:

- Select the thermocouple measure function as described above, and press the **TYPE UNITS** key until the millivolt range is selected.
- Insert the supplied thermocouple shorting jumper into the thermocouple terminals.
- Allow at least 3 minutes for the jumper and terminals to stabilize to the same temperature.
- Press the **SHIFT** and **9** keys to zero the T/C millivolt circuit.

## 4.8 Thermocouple (TC) Source

The 3001 can source all common thermocouple types in °F or °C, plus basic millivolts from -10.0 to 75.0 mV.

The following common thermocouple types are supported:

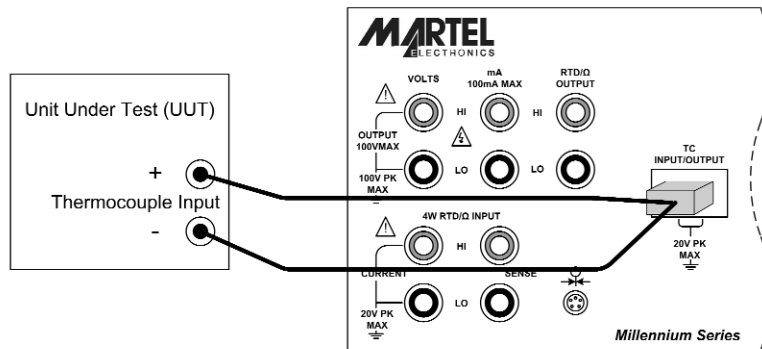

B, C, E, J, K, L, N, R, S, T, U, XK, BP

- a) Disconnect any test leads from external devices.
- b) Press the **TC**/**RTD** key to select thermocouple and RTD/Ω mode, if not already selected. If RTD/Ω mode is displayed, press the key again to cycle to thermocouple mode.
- c) If input mode is displayed, select output mode by pressing the **SHIFT** and **7** keys.
- d) Press the **TYPE**/**UNITS** key to select the desired thermocouple type or the millivolt range.
- e) Connect the unit under test to the thermocouple terminals of the 3001 using a standard T/C miniplug as shown in figure 15. One pin is wider than the other; do not attempt to force the plug in the wrong polarization. The T/C wire used for the connection must match the thermocouple type selected for proper cold junction compensation. If the 3001 and the T/C miniplug are at different temperatures, wait at least 3 minutes for the miniplug and terminals to stabilize to the same temperature.



**Figure 15 - Thermocouple Output Connection**

- f) Press the **SHIFT** and **6** keys to toggle the thermocouple display between °F and °C.
- g) Press the **SHIFT** and **5** keys to toggle the cold junction compensation between the internal temperature sensor and an external reference.
- h) Use the numeric keypad to enter the desired output value and press the **ENTER** key.

Alternatively, use the  or  cursor key to select a digit to modify, followed by the

◀ or ▶ cursor key to ramp the digit up or down. This method offers a simple solution when small changes to an output value are required, or if specific decades need to be incremented or decremented.

- i) For best accuracy, it is advisable to zero the T/C millivolt circuit daily, or if the 3001 is being used outside of the ambient temperature range of 18 to 28 °C. This procedure is described in section 4.7 on thermocouple measurements.

## 4.9 Pressure Measure

The 3001 can support the following types of pressure modules:



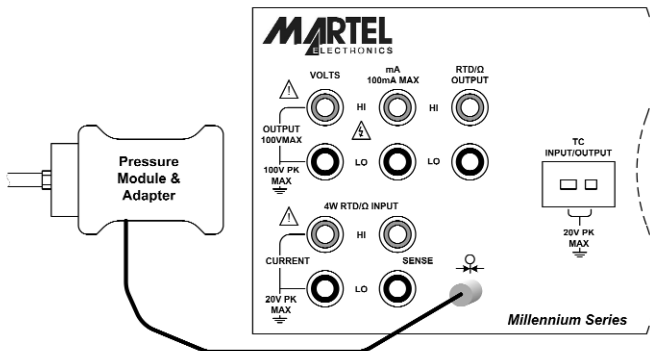

- BETA Calibrators Corporation BETA Port-P Modules
- Fluke Corporation Model 700 Series Modules
- Mensor Corporation Model 6100 Modules

The BETA modules require the use of the BETA BPPA-100 Adapter and offer the best performance vs. cost. The adapter allows the user to "Hot Swap" a pressure module for quick range changes. For applications that require very high accuracy the Mensor 6100 Series, while expensive, will yield the best accuracy. Pressure modules from Fluke will plug directly into the 3001. It may be helpful to discuss your pressure needs with Martel Technical Support before you purchase modules.

- a) Connect the pressure module to the 3001 as shown in figure 16.



**Figure 16 - Pressure Module Connection**

- b) Press the  key. The 3001 automatically senses which pressure module is attached and sets its range accordingly.
- c) Press the  key to select the desired pressure units for display.
- d) Before attaching the module to the pressure source, zero the module as described in the instruction sheet that came with the module. Procedures vary, but all end with pressing the  and  keys.
- e) Attach the module to the pressure source according to the instruction sheet that came with the module, taking care to follow all safety precautions when dealing with high pressures.

## 5. Isolated Inputs

### 5.1 Voltage Input

The 3001 can measure DC voltages from 0 V to 100 V, using the following two ranges for maximum accuracy: 10 V, and 100 V.

- Disconnect any test leads from external devices.
- Press the **VOLTS** **mA** key to select isolated DC voltage and current input mode, if not already selected. If the desired DC voltage mode is not displayed, press the key again to cycle to the desired DC voltage mode.
- Connect the unit under test to the isolated voltage/current input terminals of the 3001 as shown in figure 17.

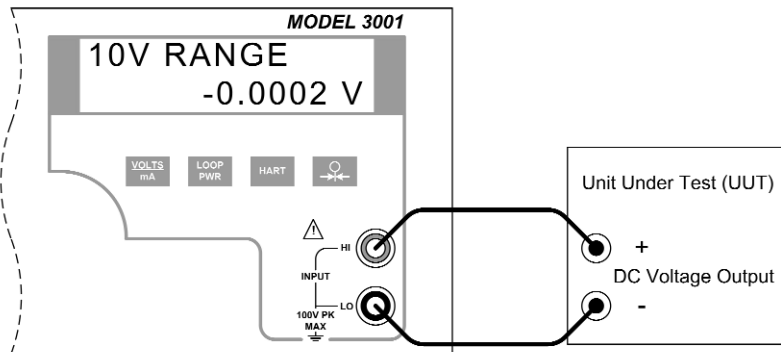
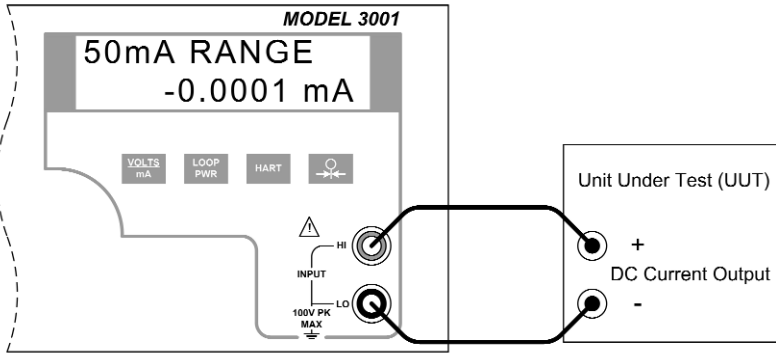

**Figure 17 - Isolated DC Voltage Input Connection**

### 5.2 Current Input

The 3001 can measure DC current from 0 mA to 50 mA.

- Disconnect any test leads from external devices.
- Press the **VOLTS** **mA** key to select isolated DC voltage and current input mode, if not already selected. If the DC current mode is not displayed, press the key again to cycle to it.
- Connect the unit under test to the isolated voltage/current input terminals of the 3001 as shown in figure 18.



**Figure 18 - Isolated DC Current Input Connection**

- d) If the UUT is a 2 wire loop powered transmitter that is disconnected from the wiring, press the **LOOP PWR** key to activate the 3001 internal 24V supply in series with the current measuring circuit. The top line changes to 24mA LPWR to indicate that the supply is activated. Press the key again to deactivate the supply, and the top line reverts to 50mA RANGE.
- e) If a 250 ohm resistor is required during a HART calibration procedure, press the **HART** key to switch in the 3001 internal 250 ohm resistor. The word HART is appended to the top line of the display to indicate that the resistor is switched in. Press the key again to switch out the resistor, and the display reverts to its previous state. This resistor lowers the maximum load driving capability from 1000 ohms at 20 mA to 750 ohms at 20 mA.



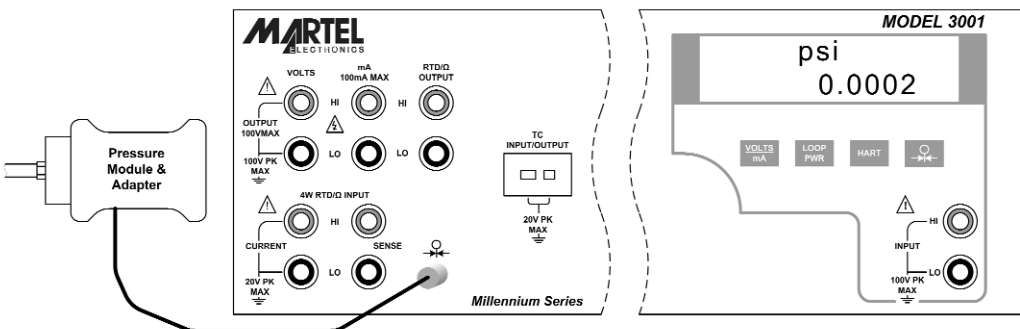

### 5.3 Pressure Input

The isolated pressure display uses the same physical pressure connector as the primary display. It is possible to have both displays selected to pressure simultaneously, showing the same source in different pressure units. See section 4.9 for a general discussion on pressure module selection.

- a) Connect the pressure module to the 3001 as shown in figure 19.



**Figure 19 - Isolated Pressure Module Connection**

- b) Press the  key. The 3001 automatically senses which pressure module is attached and sets its range accordingly.
- c) If necessary, press the  key again to cycle through the pressure units until the desired one is displayed.
- d) Before attaching the module to the pressure source, zero the module as described in the instruction sheet that came with the module. Procedures vary, but all end with pressing the  and  keys.
- e) Attach the module to the pressure source according to the instruction sheet that came with the module, taking care to follow all safety precautions when dealing with high pressures.



## 6. Output Setpoints

Nine preset output setpoints may be stored and recalled for each of the following output modes:

- Voltage
- Current
- each thermocouple type, including millivolts
- each RTD type, including each of the five custom curves.

They may be recalled on an individual basis, or as an automatic up and down cycle with a configurable dwell time between each setpoint. The automatic cycle feature always starts at setpoint number 1, stepping up to a user specified ending setpoint number, then back down in reverse order, and then repeats.

To set a setpoint:

- a) Select the output mode.
- b) Enter the output value for the setpoint.
- c) Press the  and  keys to select the SET function.
- d) At the setpoint number selection prompt "SET POINT#", press the numeric key, 1 to 9, corresponding to the setpoint to be set.
- e) If the automatic cycle feature is to be used, care should be taken to order the setpoint values in an appropriate manner. It always cycles between setpoint number 1 and a user specified ending setpoint number. The values in the cycled group of setpoints should be entered with this in mind. Any random setpoints used for individual checks can then be located after the usual ending setpoint number.

To recall a single setpoint:

- a) Select the output mode.
- b) Press the  and  keys to select the RECALL function.

- c) At the setpoint number selection prompt "RECALL SPT#", press the numeric key, 1 to 9, corresponding to the setpoint to be recalled.

To start an automatic setpoint cycle:

- a) Select the output mode.
- b) Press the **SHIFT** and **3** keys to select the AUTOSSET function.
- c) At the ending setpoint number selection prompt "AUTO SET POINT", press the numeric key, 1 to 9, corresponding to the ending setpoint number for the cycle.
- d) At the dwell time prompt "DWELL TIME", "5-500?", enter the number of seconds, 5 to 500, to dwell at each setpoint value, followed by the **ENTER** key.
- e) The **STBY OPR** key can be used at any time during the cycle without stopping it.
- f) Press any other key to terminate the cycle.

## 7. Application Notes

### 7.1 P/I Transmitter

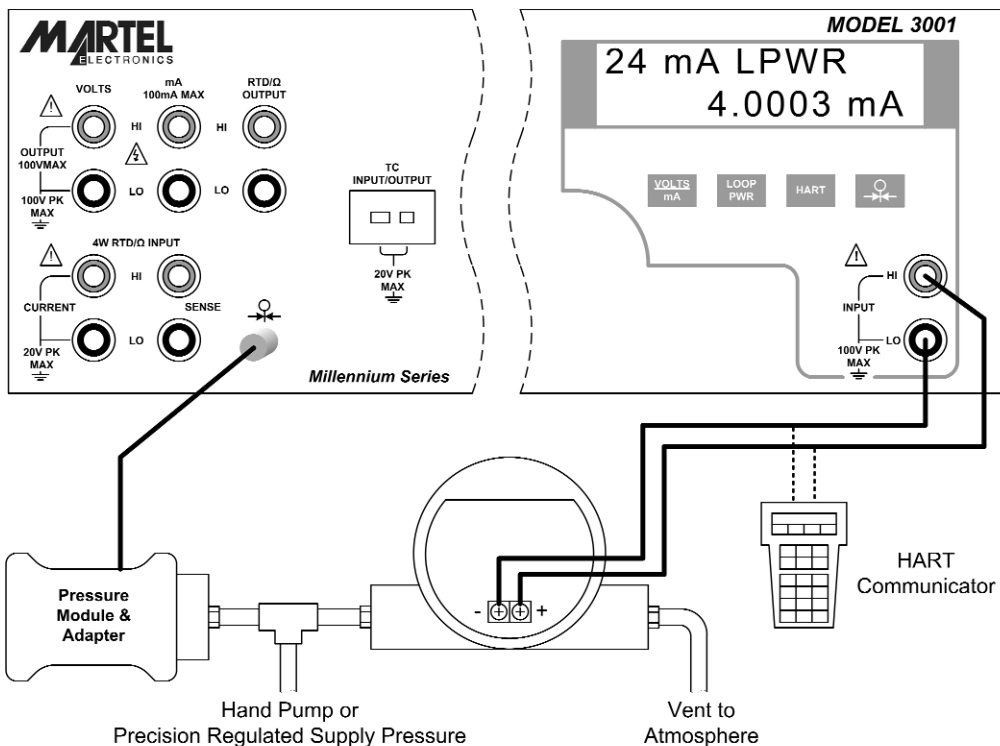
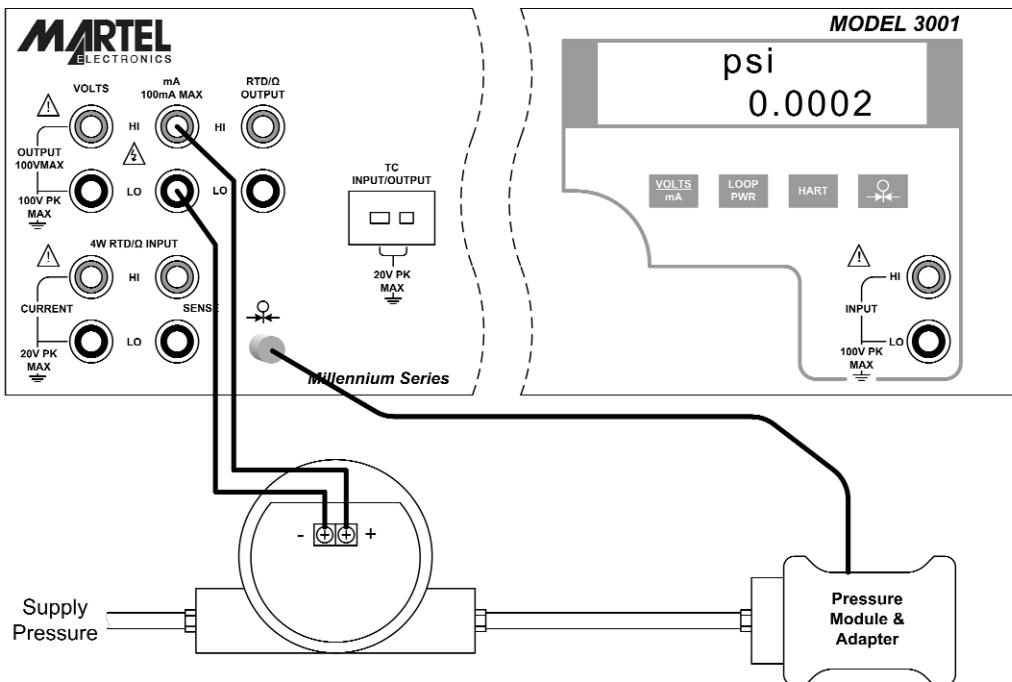

**Figure 20 - P/I Transmitter Application**



1. Disconnect any test leads from external devices.
2. Select pressure input on the primary display as described in section 4.9.
3. Select current input on the isolated display as described in section 5.2. Select the isolated loop power option. If a HART communicator is to be used for set up of the transmitter, select the HART option.
4. Connect the transmitter as shown in figure 20.
5. Test and calibrate the transmitter per the manufacturer's instructions.

## 7.2 I/P Transmitter



**Figure 21 - I/P Transmitter Application**

1. Disconnect any test leads from external devices.
2. Select current output on the primary display as described in section 4.2.
3. Select pressure input on the isolated display as described in section 5.3
4. Connect the transmitter as shown in figure 21.
5. Test and calibrate the transmitter per the manufacturer's instructions.

## 7.3 V/I Transmitter

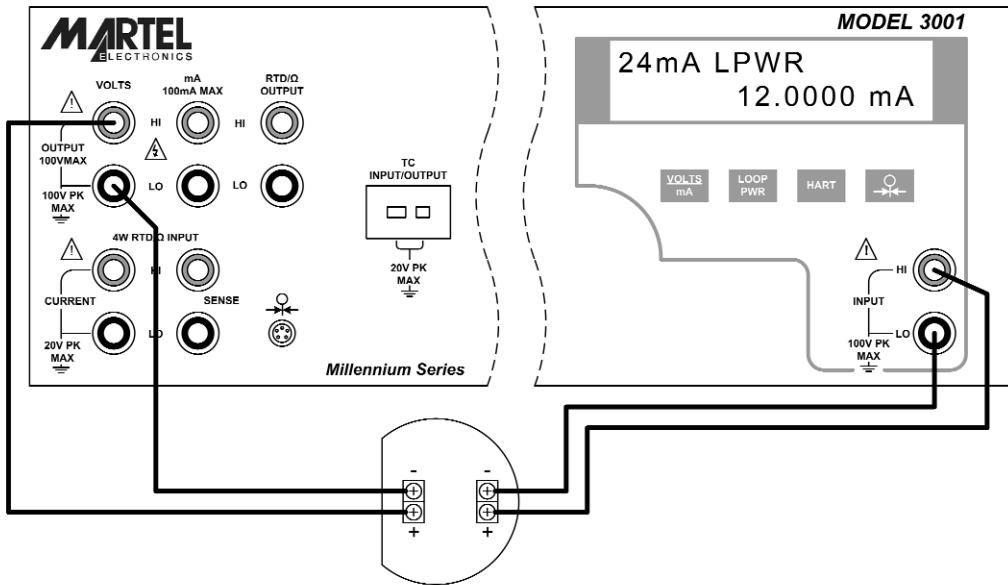

**Figure 22 - V/I Transmitter Application**

1. Disconnect any test leads from external devices.
2. Select voltage output on the primary display as described in section 4.1
3. Select current input on the isolated display as described in section 5.2. Select the isolated loop power option.
4. Connect the transmitter as shown in figure 22.
5. Test and calibrate the transmitter per the manufacturer's instructions.

## 7.4 RTD Test

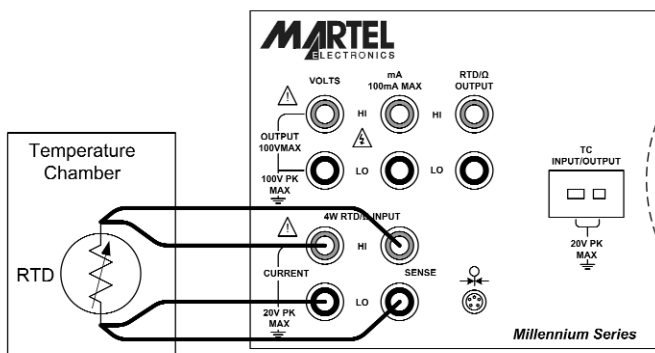

**Figure 23 - RTD Test Application**

1. Disconnect any test leads from external devices.
2. Select RTD input on the primary display as described in section 4.3. Select the RTD type which corresponds to the RTD being tested.
3. Connect the RTD as shown in figure 23.
4. Test the RTD per the manufacturer's instructions.

## 7.5 RTD Transmitter

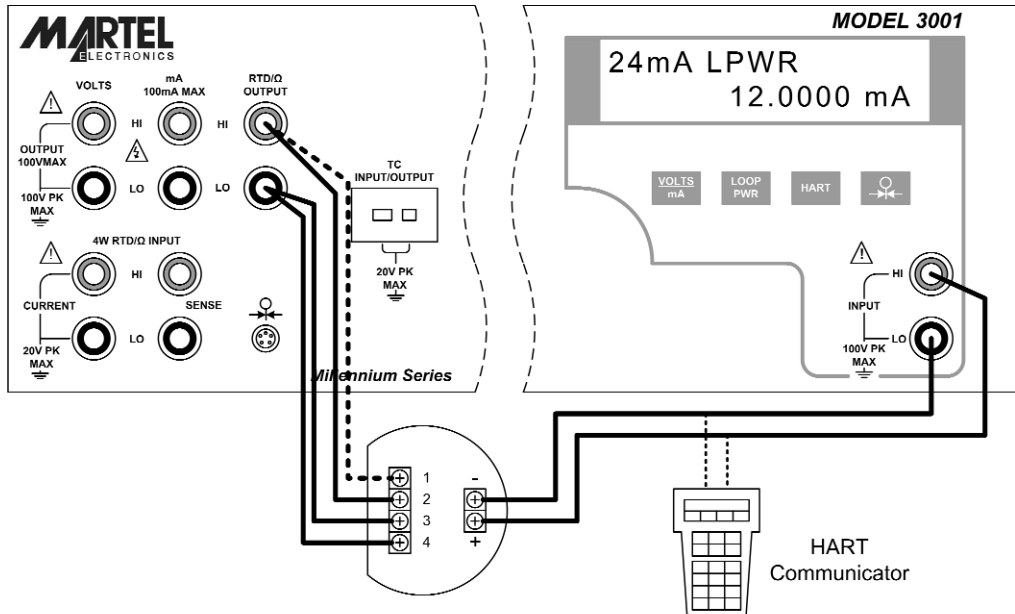

**Figure 24 - RTD Transmitter Application**

1. Disconnect any test leads from external devices.
2. Select RTD output on the primary display as described in section 4.4. Select the RTD type which corresponds to the transmitter being tested.
3. Select current input on the isolated display as described in section 5.2. Select the isolated loop power option. If a HART communicator is to be used for set up of the transmitter, select the HART option.
4. Connect the transmitter as shown in figure 24.
5. Test and calibrate the transmitter per the manufacturer's instructions.

## 7.6 Thermocouple Test

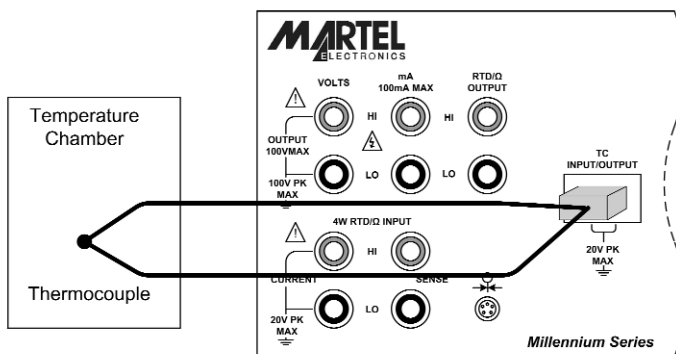

**Figure 25 - Thermocouple Test Application**

1. Disconnect any test leads from external devices.
2. Select thermocouple input on the primary display as described in section 4.7. Select the thermocouple type which corresponds to the thermocouple being tested.
3. Connect the thermocouple as shown in figure 25.
4. Test the thermocouple per the manufacturer's instructions.

## 7.7 Thermocouple Transmitter

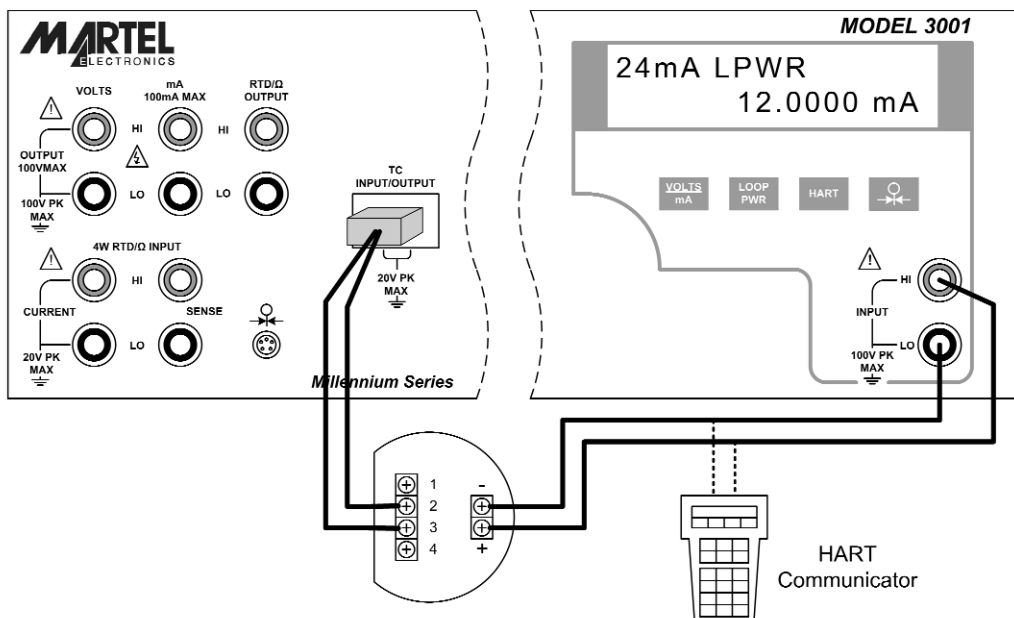

**Figure 26 - Thermocouple Transmitter Application**

1. Disconnect any test leads from external devices.
2. Select thermocouple output on the primary display as described in section 4.8. Select the thermocouple type which corresponds to the transmitter being tested.
3. Select current input on the isolated display as described in section 5.2. Select the isolated loop power option. If a HART communicator is to be used for set up of the transmitter, select the HART option.
4. Connect the transmitter as shown in figure 26.
5. Test and calibrate the transmitter per the manufacturer's instructions.

## 7.8 RTD Indicator

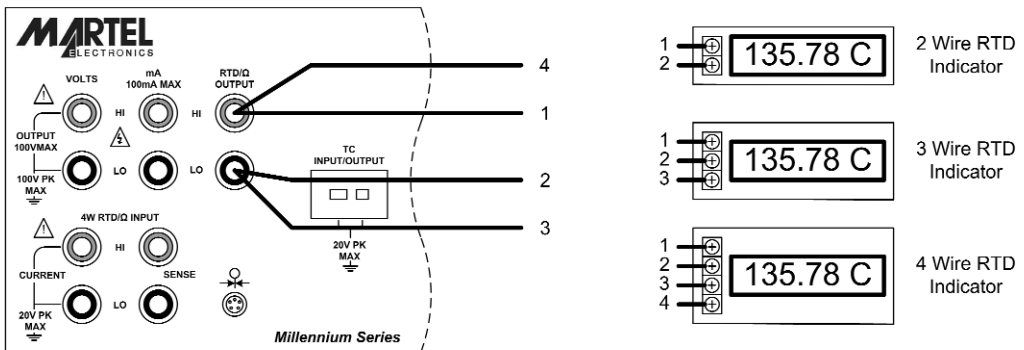

**Figure 27 - RTD Indicator Application**

1. Disconnect any test leads from external devices.
2. Select RTD output on the primary display as described in section 4.4. Select the RTD type which corresponds to the indicator being tested.
3. Connect the indicator as shown in figure 27.
4. Test and calibrate the indicator per the manufacturer's instructions.

## 7.9 Precision Current Trip

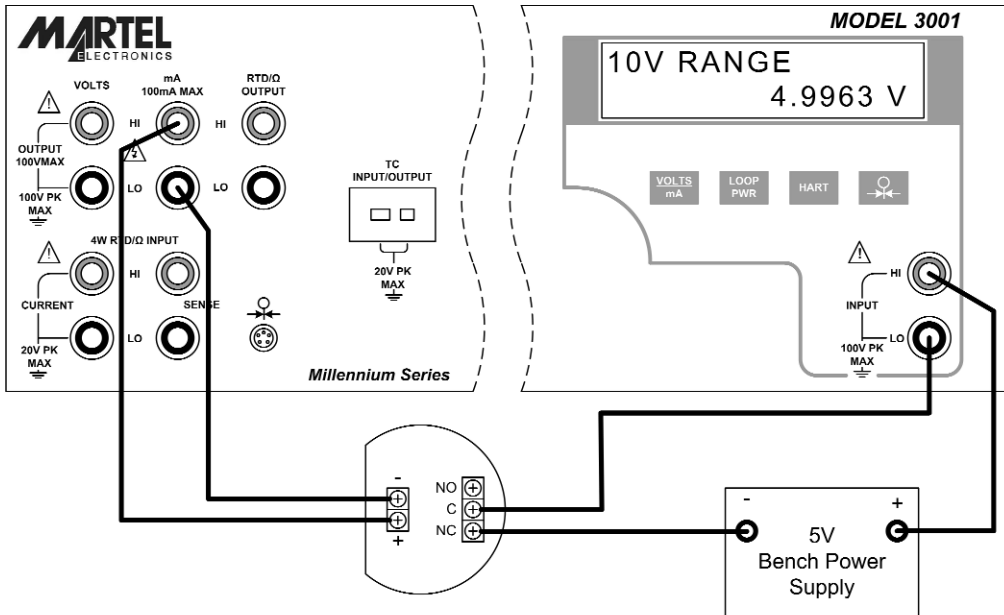

**Figure 28 - Precision Current Trip Application**

1. Disconnect any test leads from external devices.
2. Select current output on the primary display as described in section 4.2.
3. Select voltage input on the isolated display as described in section 5.1.
4. Connect the trip as shown in figure 28.
5. Test and calibrate the trip per the manufacturer's instructions.

## 7.10 I/I Isolator/Transmitter

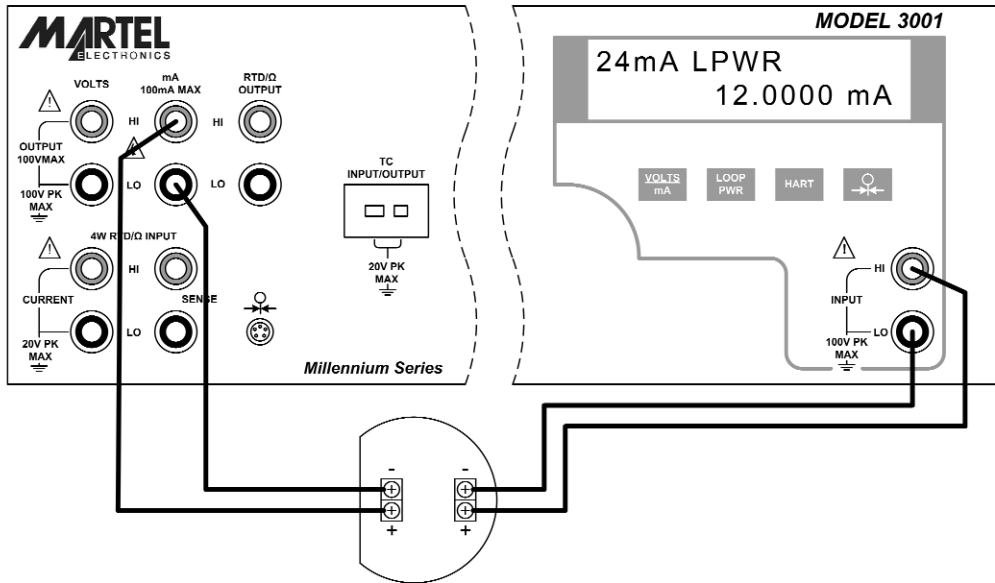

**Figure 29 - I/I Isolator/Transmitter Application**

1. Disconnect any test leads from external devices.
2. Select current output on the primary display as described in section 4.2.
3. Select current input on the isolated display as described in section 5.2. Select the isolated loop power option.
4. Connect the transmitter as shown in figure 29.
5. Test and calibrate the transmitter per the manufacturer's instructions.

## 7.12 Precision Temperature Measurement with IBP-2 Probe

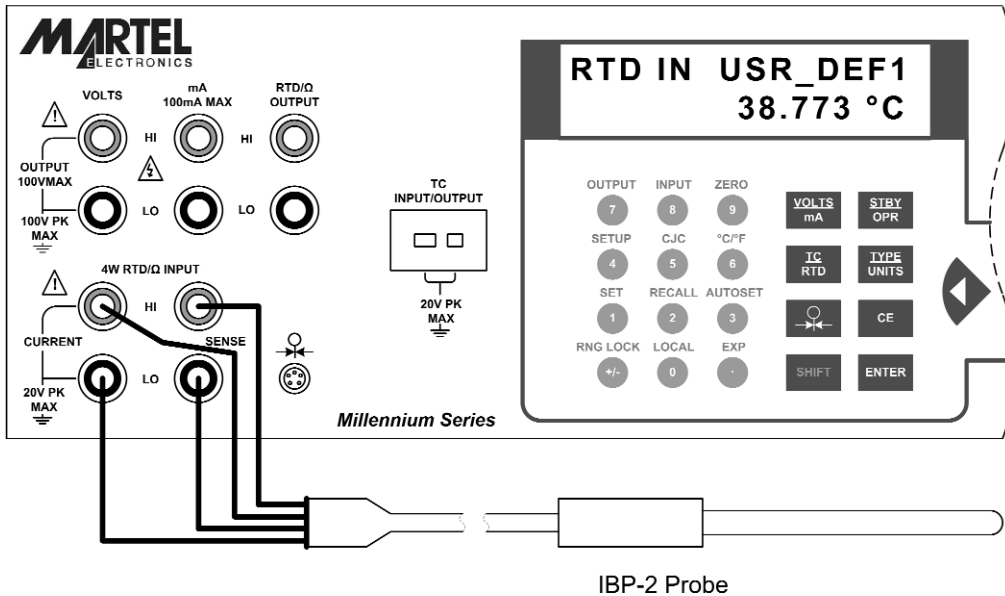















**Figure 30 - Precision Temperature Measurement with IBP-2 Probe**

1. With the IBP-2 probe and the corresponding custom coefficients, the total system error is 0.03°C.
2. Disconnect any test leads from external devices.
3. Select RTD input on the primary display as described in section 4.3. Select the user defined curve containing the custom coefficients for the IBP-2. If custom coefficients have not yet been entered for the IBP-2, follow the instructions in section 4.5 to do so.
4. Connect the probe as shown in figure 30.



## 8. LCD and Remote Interface Setup Procedures

These procedures are accessed in sequence as follows:

- a) Press the  and  keys to select the SETUP function.
- b) At the "LCD CONTRAST" prompt, press the  or  key to adjust the LCD contrast level. When complete, press the  key.
- c) At the "LCD BACKLIGHT" prompt, press the  or  key to adjust the LCD backlight level. When complete, press the  key.
- d) At the "Remote Interface" prompt, press the  or  key to select the RS-232 interface or the GPIB interface. When the desired interface is selected, press the  key.
- e) If the GPIB interface was selected, the "GPIB Address" prompt appears. Press the  or  key to ramp through the possible addresses, 0 to 30. When the desired address is displayed, press the  key.

## 9. Remote Interface

### 9.1 Introduction

The 3001 can be controlled remotely from a personal computer (PC) using either a RS-232 serial connection or an IEEE-488 parallel connection (also called a General Purpose Interface Bus, or GPIB, connection). In either case, individual commands can be typed into a terminal emulator program suitable for the connection type, or the calibrator can be controlled by an automated PC program using the 3001 command set. You can write your own automated PC program, or it may be possible to purchase a suitable third party program and configure it for the 3001. Compatible software for IEEE-488 operation, MET/CAL, may be purchased from Fluke.

The RS-232 connection allows one 3001 to be connected to one PC. The communications speed is slower than IEEE-488, but no extra equipment is required other than a low cost null modem cable.

The IEEE-488 connection allows up to 15 different calibrators, PC's, and items of test equipment to be connected together in a bus arrangement. The communications speed is much faster than RS-232, but it requires the purchase and installation of special PC interface card(s) and connecting cable(s).

This section describes the set up of the two types of connections, and the general operation of the command set. Section 10 describes the individual commands in detail.

## 9.2 Setting up the RS-232 Port for Remote Control

The 3001 is fully programmable over a standard RS-232 link with a PC. The RS-232 cable length for the port should not exceed 15 meters (50 feet), although longer cable lengths are permitted if the load capacitance measured at a connection point (including signal terminator) does not exceed 2500 pF.

The serial communications parameters in the 3001 are fixed at the following values:

- 9600 baud
- 8 data bits
- 1 stop bit
- no parity
- Xon/Xoff
- EOL (end-of-line) character CR (Carriage Return)

A typical RS-232 connection is shown in Figure 31. Note the use of a null modem cable for the connection. See section 2.5 for the location of the RS-232 port on the rear panel of the 3001.

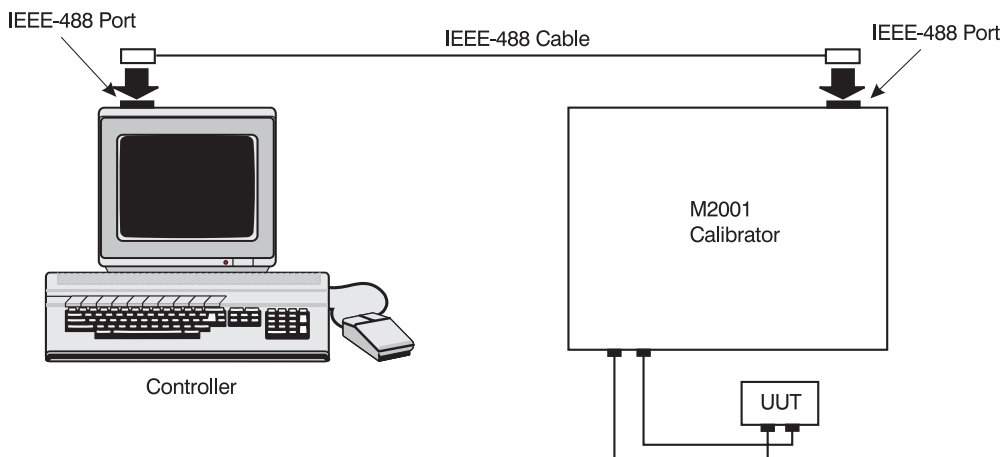

**Figure 31 - RS-232 Remote Connection**

## 9.3 Setting up the IEEE-488 Port for Remote Control

The 3001 is fully programmable for use on a standard IEEE-488 interface bus. The IEEE-488 interface is also designed in compliance with supplemental standard IEEE-488.2, which describes additional IEEE-488 features. Devices connected to the IEEE-488 bus are designated as talkers, listeners, talker/listeners, or controllers. Under remote control of an instrument, the 3001 operates as a talker/listener.

A PC equipped with an IEEE-488 interface controls the 3001. Compatible software for IEEE-488 operation, MET/CAL, may be purchased from Fluke.

When using the IEEE-488 remote control interface, there are two restrictions:

- A maximum of 15 devices can be connected in a single IEEE-488 bus system.

- The total length of IEEE-488 cables used in one IEEE-488 bus system is 2 meters times the number of devices in the system, or 20 meters, whichever is less.

See section 8 for instructions on configuring the 3001 for IEEE-488 (GPIB) operation, including selecting the interface and the bus address.

A typical IEEE-488 (GPIB) connection is shown in Figure 32. See section 2.5 for the location of the IEEE-488 (GPIB) port on the rear panel of the 3001.

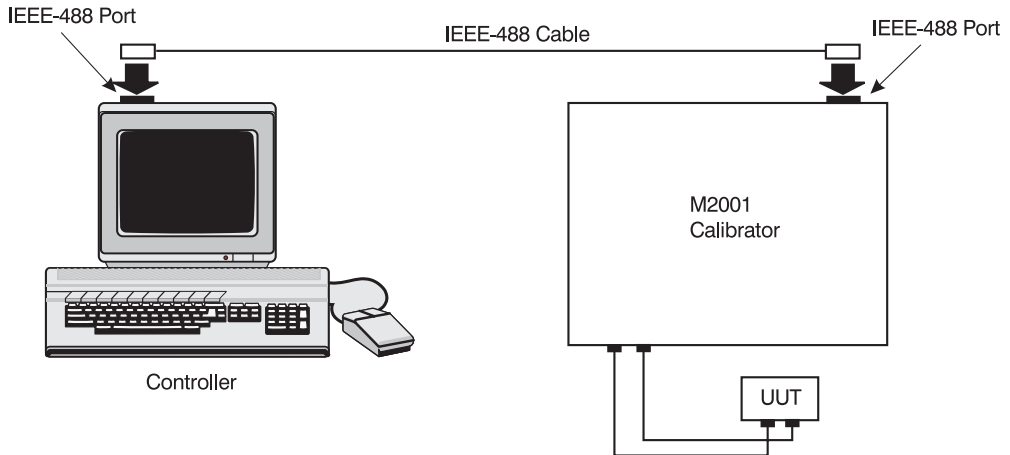

**Figure 32 - IEEE-488 (GPIB) Remote Connection**

## 9.4 Changing Between Local and Remote Operation

In addition to local mode (front panel operation) and remote, the 3001 can be placed into a local lockout condition at any time by command of the controller. Combined, the local, remote, and lockout conditions yield four possible operating states as follows.

- Local State**  
The 3001 responds to local and remote commands. This is normal front panel operation. All remote commands received by the 3001 are processed.
- Local with Lockout State**  
Local with lockout is identical to local, except that the 3001 will go into the remote with lockout state instead of the remote state when it receives a remote command. This state can only be entered by sending the IEEE-488 command GTL (Go To Local) when in the remote with lockout state.
- Remote State**  
When the 3001 is placed in remote, either via a RS-232 REMOTE command, or via the IEEE-488 asserting the REN line, it enters the remote state. The left end of the top line of the display changes to: rem.  
Front panel operation is disabled except for the LOCAL (0) key. Pressing the LOCAL key, using RS-232 to send the LOCAL command, or IEEE-488 to send the GTL (Go To Local) message, returns the 3001 to the local state.

d) Remote with Lockout State

When the 3001 is placed in lockout, either via a RS-232 LOCKOUT command, or via the IEEE-488 message LLO (Local Lockout), the 3001 front panel controls are totally locked out. The left end of the top line of the display changes to: rem.

To return the 3001 to the local with lockout state, send the RS-232 LOCAL command or the IEEE-488 GTL (Go To Local) message.

Table 4 summarizes the possible operating state transitions. For more information on IEEE-488 GPIB messages, see section 9.5.

**Table 4 - Operating State Transitions**

From	To	Front Panel	GPIB Message	Serial Command
Local	Remote Local with Lockout		MLA (REN True) LLO	REMOTE LOCKOUT
Remote	Local Remote with Lockout	Local 0 key	GTL or REN False LLO	LOCAL LOCKOUT
Local with Lockout	Local Remote with Lockout		REN False MLA (REN True)	LOCAL REMOTE
Remote with Lockout	Local Local with Lockout		REN False GTL	LOCAL

## 9.5 IEEE-488 Interface Overview

The IEEE-488 parallel interface sends commands as data and receives measurements and messages as data. The maximum data exchange rate is 1 Mbyte per second, with a maximum distance of 20 meters for the total length of the connecting cables. A single cable should not exceed 4 meters in length.

Several commands are used only for RS-232 serial operation because these functions must be implemented as IEEE uniline (single control line) bus management messages per the IEEE Standards. For example, the command REMOTE could be sent as data over the IEEE-488 interface to place the 3001 into remote operating mode, but it is not because the IEEE Standards call for the remote function to be sent to the device as the uniline message REN. This is also true for several other commands and functions, as shown in table 5 below with their RS-232 equivalents.

**Table 5 - RS-232 Emulation of IEEE-488 Messages**

IEEE-488 Message	RS-232 Equivalent
GTL	LOCAL command
GTR	REMOTE command
LLO	LOCKOUT command
SDC, DCL	(not emulated on RS-232)
GET	(not emulated on RS-232)
SPE, SPD	(not emulated on RS-232)
UNL, UNT	(not emulated on RS-232)

The IEEE-488 interface is based on the IEEE Standards 488.1 and 488.2. For detailed information, refer to the IEEE-488.1 and IEEE-488.2 standards.

## 9.6 Using Commands

Communications between the controller and the 3001 consist of commands, queries, and interface messages. Although the commands are based on the 488.2 standard, they can be used on either the IEEE-488 or RS-232 interface, except for a few specific RS-232 only commands as described in the subsection Commands for RS-232 Only below.

For more detailed information on IEEE command structures, see the IEEE 488.2 standard.

Refer to section 10 for more detailed information about the commands referenced in this section.

All commands, units, and text data may be entered in UPPER or lower case letters. The 3001 converts all lower case letters to upper case before processing.

### 9.6.1 Types of Commands

The commands for the 3001 can be grouped into the following categories based on how they function.

a) Device-Dependent Commands

Device-dependent commands are unique to the 3001. An example of a device-dependent command is:

OUT 1 V

This command instructs the 3001 to source 1 volt DC.

b) Common Commands

Common commands are defined by the IEEE 488.2 standard and are common to most bus devices. Common commands always begin with an asterisk (\*) character. Common commands are available whether you are using the IEEE-488 or RS-232 interface for remote control. An example of a common command is:

\*IDN?

This command instructs the 3001 to return the instrument identification string.

c) Query Commands

Query commands request information, which may be returned as the command executes, or may be placed in a buffer until requested later. Query commands always end with a question mark. An example of a query command is:

RANGE?

This command instructs the 3001 to return the present DC voltage output range.

d) Interface Messages (IEEE-488)

Interface messages manage traffic on the IEEE-488 interface bus. Device addressing and clearing, data handshaking, and commands to place status bytes on the bus are all directed by interface messages. Some of the interface

messages occur as state transitions of dedicated control lines. The rest of the interface messages are sent over the data lines with the ATN signal true. All device-dependent and common commands are sent over the data lines with the ATN signal false.

An important thing to note about interface messages is that, unlike device-dependent and common commands, interface messages are not sent literally (in a direct way). They are converted to parallel signal levels on the bus data and control lines.

IEEE-488 standards define interface messages which are handled automatically in most cases.

e) Compound Commands

A compound command is two or more commands placed on a single command line separated from each other with semicolons. For example, consider the following two individual commands:

```
OUT 1 V
OPER
```

These could be combined into the compound command:

```
OUT 1 V; OPER
```

These commands instruct the 3001 to source 1 V DC, and then go into operate mode.

f) Overlapped Commands

Commands that begin execution but require slightly more time than the normal communication command/response interval to complete are called overlapped commands. This is because they can be overlapped by receipt the next command before they have been completed.

The detailed command descriptions in section 10 show a check mark T beside Overlapped for overlapped commands.

Use the command \*WAI to wait until the overlapped command has completed execution before executing the next command. For example:

```
OUT 1 V; *WAI
```

You can also use the status commands \*OPC and \*OPC? to detect the completion of overlapped commands.

g) Sequential Commands

Commands that execute immediately are called sequential commands.

The detailed command descriptions in section 10 show a check mark T beside Sequential for sequential commands.

The majority of commands are sequential.

h) Commands for RS-232 Only

Several commands are used only for RS-232 serial operation because these functions must be implemented as IEEE uniline (single control line) bus management messages per the IEEE Standards. For example, the command REMOTE could be sent as data over the IEEE-488 interface to place the 3001 into remote operating mode, but it is not because the IEEE Standards call for

the remote function to be sent to the device as the uniline message REN. This is also true for several other commands and functions, as shown in table 6 below with their RS-232 equivalents.

For these commands, the detailed command descriptions in section 10 show a check mark  beside RS-232, but no check mark  beside IEEE-488.

**Table 6 - Commands for RS-232 Only**

IEEE-488 Message	RS-232 Equivalent
GTL	LOCAL command
GTR	REMOTE command
LLO	LOCKOUT command

i) Commands for IEEE-488

These are all of the commands except for those used for RS-232 only, as described above. All commands are transferred over the IEEE-488 as data, except for the commands LOCAL, REMOTE, and LOCKOUT, which are implemented per the IEEE Standards as uniline messages.

The detailed command descriptions in section 10 show a check mark T beside IEEE-488 for these commands.

**9.6.2 Command Syntax**

The following syntax rules apply to all of the remote commands. Information about the syntax of response messages is also given.

a) Parameter Syntax Rules

Table 7 lists the units accepted in command parameters and used in responses. All commands and units may be entered in upper or lower case.

**Table 7 - Units Accepted in Parameters and Used in Responses**

Units	Meaning
uV	Volts in units of microvolts <sup>1</sup>
mV	Volts in units of millivolts <sup>1</sup>
V	Volts in units of volts
kV	Volts in units of kilovolts <sup>1</sup>
uA	Current in units of microamperes <sup>1</sup>
mA	Current in units of milliamps <sup>1</sup>
A	Current in units of amps
Ohm	Resistance in units of ohms
kOhm	Resistance in units of kilohms <sup>1</sup>
MOhm	Resistance in units of megohms <sup>1</sup>
cel	Temperature in degrees Celsius
far	Temperature in degrees Fahrenheit
psi	Pressure in pounds per square inch

mmHg	Pressure in millimeters of mercury at 0 °C
inHg	Pressure in inches of mercury at 0 °C
inH2O4C	Pressure in inches of water at 4 °C
inH2O20C	Pressure in inches of water at 20 °C
inH2O60F	Pressure in inches of water at 60 °F
cmH2O4C	Pressure in centimeters of water at 4 °C
cmH2O20C	Pressure in centimeters of water at 20 °C
mmH2O4C	Pressure in millimeters of water at 4 °C
mmH2O20C	Pressure in millimeters of water at 20 °C
bar	Pressure in bar
mbar	Pressure in millibar
kPa	Pressure in kilopascals
MPa	Pressure in megapascals
kg/cm2	Pressure in kilograms per square centimeter

1 Parameter only

b) General Rules

The general rules for parameter usage are as follows:

- Numeric parameters may have up to 15 significant digits and their value can be in the range +/-1.0E+/-20.
- Including too many or too few parameters causes a command error.
- Null parameters cause an error, e.g., the adjacent commas in OUT 1V, ,;OPER.
- Expressions, for example 4+2\*13, are not allowed as parameters.

c) Extra Space or Tab Characters

In the command descriptions, parameters are shown separated by spaces. One space after a command is required (unless no parameters are required). All other spaces are optional. Spaces are inserted for clarity in the manual and may be left in or omitted as desired. You can insert extra spaces or tabs between parameters as desired. Extra spaces within a parameter are generally not allowed, except between a number and its associated multiplier or unit.

d) Terminators

Table 8 summarizes the terminator characters for both the IEEE-488 and the RS-232 remote interfaces.



**Table 8 - Terminator Characters**

Terminator Function	ASCII Character		Control Command Terminator	Language Command Terminator
	Number	Program		
Carriage Return (CR)	13	Chr(13)	<Cntl> M	\n
Line Feed (LF)	10	Chr(10)	<Cntl> J	\r
Backspace (BS)	8	Chr(8)	<Cntl> H	\b
Form Feed (FF)	12	Chr(12)	<Cntl> L	\f
Examples: RS-232 Mode, terminal:           OUT 1 V <Enter> RS-232 Mode, program:       Comm1.Output = "OUT 1 V" + Chr(10) IEEE-488 Mode:                OUT 1 V				

**IEEE-488 interface:**

The 3001 sends the ASCII character Carriage Return with the EOI control line held high as the terminator for response messages. The 3001 recognizes the following as terminators when encountered in incoming data:

- ASCII CR character
- Any ASCII character sent with the EOI control line asserted

**RS-232 interface:**

The 3001 sends a Carriage Return (CR) character as the terminator for response messages. The 3001 recognizes the following as terminators when encountered in incoming data:

- ASCII CR character
- ASCII LF character

## e) Incoming Character Processing

The 3001 processes all incoming data as follows:

- The most significant data bit (DIO8) is ignored
- All data is taken as 7-bit ASCII
- Lower case or upper case characters are accepted, with lower case converted to upper case before processing

## f) Response Message Syntax

In the detailed command descriptions in section 10, the responses from the 3001 are described wherever appropriate. In order to know what type of data to read in, refer to the beginning of the response description for the command.

**9.7 Checking 3001 Status**

Figure 33 shows the status registers, enable registers, and queues in the 3001 which indicate various conditions in the instrument. Some registers and queues are defined by the IEEE-488.2 standard, while the rest are specific to the 3001. In addition to the status registers, the Service Request (SRQ) control line and a 16-element buffer called the Error Queue provide also status information.

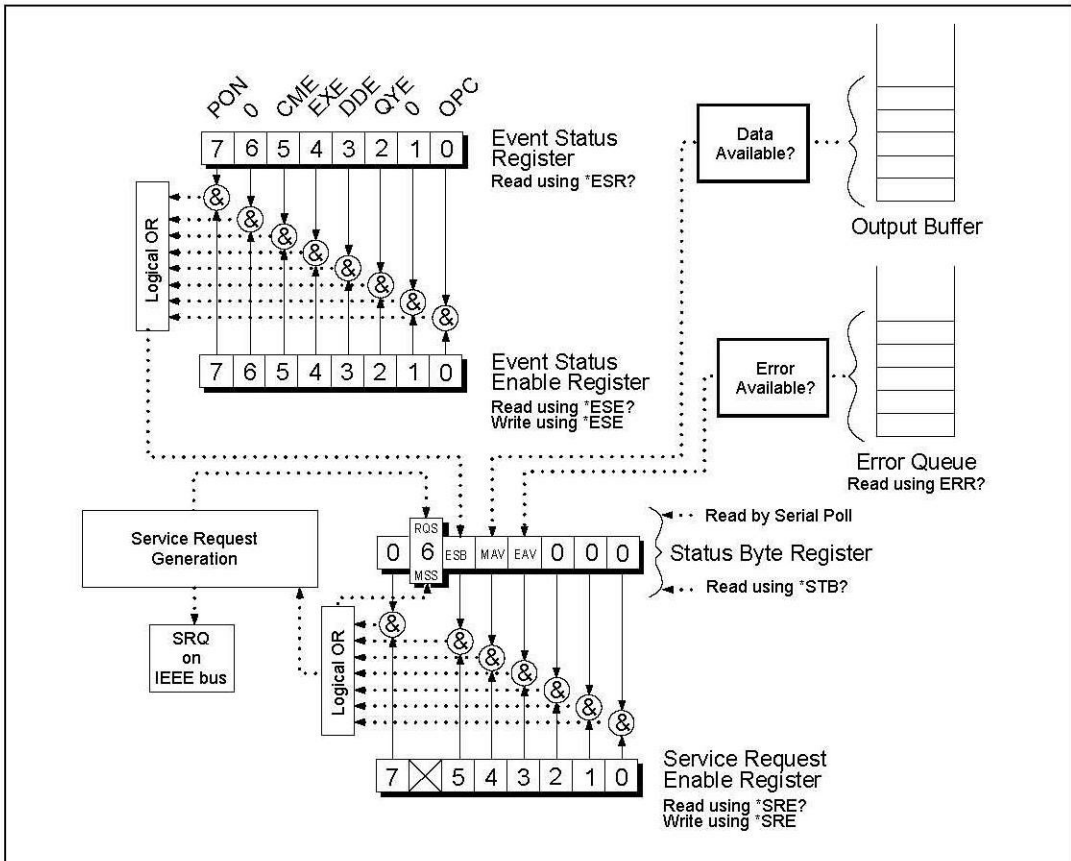

**Figure 33 - Status Register Overview**

Table 9 lists the status registers and gives the read/write commands and associated mask registers used to access them.

**Table 9 - Status Register Summary**

Status Register	Read Command	Write Command
Serial Poll Status Byte (STB)	*STB?	—
Service Request Enable Register (SRE)	*SRE?	*SRE
Event Status Register (ESR)	*ESR?	—
Event Status Enable Register (ESE)	*ESE?	*ESE

Each status register and queue has a summary bit in the Serial Poll Status Byte. Enable registers are used to mask various bits in the status registers and to generate summary bits in the Serial Poll Status Byte. For IEEE-488 interface operation, the Service Request Enable Register is used to assert the SRQ control line on detection of any status condition or conditions that the programmer chooses. For RS-232 interface operation, the SRQSTR string is sent over the serial interface when the SRQ line is set.

- 1) Serial Poll Status Byte (STB)

The Calibrator sends the serial poll status byte (STB) when it responds to a serial poll. This byte is cleared (set to 0) when the power is turned on. The STB byte structure is shown in Figure 34. Refer to the \*STB? command in section 10 for more information on reading this register.

7	6	5	4	3	2	1	0
0	RQS MSS	ESB	MAV	EAV	0	0	0
RQS	Requesting service. The RQS bit is set to 1 whenever bits ESB, MAV, EAV, or ISCB change from 0 to 1 and are enabled (1) in the SRE. When RQS is 1, the 3001 asserts the SRQ control line on the IEEE-488 interface. You can do a serial poll to read this bit to see if the 3001 is the source of an SRQ.						
MSS	Master summary status. Set to 1 whenever bits ESB, MAV, EAV, or ISCB are 1 and enabled (1) in the SRE. This bit can be read using the *STB? Remote command in place of doing a serial poll.						
ESB	Set to 1 when one or more ESR bits are 1.						
MAV	Message available. The MAV bit is set to 1 whenever data is available in the 3001's IEEE-488 interface output buffer.						
EAV	Error available. An error has occurred and an error is available to be read from the error queue by using the FAULT? query.						

**Figure 34 - Serial Poll Status Byte (STB) and Service Request Enable (SRE) Registers**

2) Service Request (SRQ) Line

IEEE-488 Service Request (SRQ) is an IEEE-488.1 bus control line that the 3001 asserts to notify the controller that it requires some type of service. Many instruments can be on the bus, but they all share a single SRQ line. To determine which instrument set SRQ, the Controller normally does a serial poll of each instrument. The calibrator asserts SRQ whenever the RQS bit in its Serial Poll Status Byte is 1. This bit informs the controller that the 3001 was the source of the SRQ.

The 3001 clears SRQ and RQS whenever the controller/host performs a serial poll, sends \*CLS, or whenever the MSS bit is cleared. The MSS bit is cleared only when ESB and MAV are 0, or they are disabled by their associated enable bits in the SRE register being set to 0.

3) Service Request Enable Register (SRE)

The Service Request Enable Register (SRE) enables or masks the bits of the Serial Poll Status Byte. The SRE is cleared at power up. Refer to Figure 34 for the bit functions.

4) Programming the STB and SRE

By resetting (to 0) the bits in the SRE, you can mask (disable) associated bits in the serial poll status byte. Bits set to 1 enable the associated bit in the serial poll status byte.

5) Event Status Register (ESR)

The Event Status Register is a two-byte register in which the higher eight bits are always 0, and the lower eight bits represent various conditions of the 3001. The ESR is cleared (set to 0) when the power is turned on, and every time it is read.

Many of the remote commands require parameters. Improper use of parameters causes command errors to occur. When a command error occurs, bit CME (5) in the Event Status Register (ESR) goes to 1 (if enabled in ESE register), and the error is logged in the error queue.

#### 6) Event Status Enable (ESE) Register

A mask register called the Event Status Enable register (ESE) allows the controller to enable or mask (disable) each bit in the ESR. When a bit in the ESE is 1, the corresponding bit in the ESR is enabled. When any enabled bit in the ESR is 1, the ESB bit in the Serial Poll Status Byte also goes to 1. The ESR bit stays 1 until the controller reads the ESR, does a device clear, a selected device clear, or sends the reset or \*CLS command to the 3001. The ESE is cleared (set to 0) when the power is turned on.

#### 7) Bit Assignments for the ESR and ESE

The bits in the Event Status Register (ESR) and Event Status Enable register (ESE) are assigned as shown in Figure 35.

15	14	13	12	11	10	9	8
0	0	0	0	0	0	0	0
7	6	5	4	3	2	1	0
PON	0	CME	EXE	DDE	QYE	0	OPC
PON	Power on. This bit is set to 1 if line power has been turned off and on since the last time the ESR was read.						
CME	Command error. The IEEE-488 interface of the 3001 encountered an incorrectly formed command and placed an error code in the error queue. The command FAULT? can be used to fetch error codes from the error queue, which is described in more detail below.						
EXE	Execution error. An error occurred when the 3001 tried to execute the last command and an error code was placed into the error queue. This could be caused, for example, by a parameter being out of range. The command FAULT? can be used to fetch error codes from the error queue, which is described in more detail below.						
DDE	Device-dependent error. An error related to a device-dependent command has occurred.						
QYE	Query error. The 3001 was addressed to talk when no response data was available or appropriate, or when the controller failed to retrieve data from the output queue.						
OPC	Operation complete. All commands previous to reception of a *OPC command have been executed, and the interface is ready to accept another message.						

**Figure 35 - Event Status Register (ESR) and Event Status Enable (ESE) Registers**

#### 8) Programming the ESR and ESE

To read the contents of the ESR, send the remote command, \*ESR?. The ESR is cleared (set to 0) every time it is read. To read the contents of the ESE, send the remote command, \*ESE?. The ESE is not cleared when it is read. When you read either register, the 3001 responds by sending a decimal number that when converted

to binary represents bits 0 through 15.

#### 9) Output Queue

The output queue is loaded whenever a query is processed, and holds up to 250 characters. The controller reads it with a statement such as a BASIC INPUT statement, removing what it reads from the queue. If the queue is empty, the 3001 does not respond to the INPUT statement from the controller. The Message Available (MAV) bit in the Serial Poll Status Byte is 1 if there is something in the output queue, and 0 if the output queue is empty.

#### 10) Error Queue

When a command error, execution error, or device-dependent error occurs, its error code is placed in the error queue where it can be read by the FAULT? command. Reading the first error with the FAULT? command removes that error from the queue. A response of 0 means the error queue is empty. The error queue is cleared when you turn off the power, and when you use the \*CLS (Clear Status) common command. The error queue contains up to 15 entries. If more than 15 errors occur, only the first 15 errors are kept in the queue. A 16th entry in the queue is always an "error queue overflow" error, and all later errors are discarded until the queue is at least partially read. The first errors are kept, because if many errors occur before the user can acknowledge and read them, the earliest errors are the most likely to point to the problem. The later errors are usually repetitions or consequences of the original problem.

#### 11) Input Buffer Operation

As the 3001 receives each data byte from the controller, it places the byte in a portion of memory called the input buffer. The input buffer holds up to 250 data bytes and operates in a first in, first out fashion.

#### **IEEE-488 interface:**

The 3001 treats the IEEE-488 EOI control line as a separate data byte and inserts it into the input buffer if it is encountered as part of a message terminator. Input buffer operation is transparent to the program running on the controller. If the controller sends commands faster than the 3001 can process them, the input buffer fills to capacity. When the input buffer is full, the 3001 holds off the IEEE-488 bus with the NRFD (Not Ready For Data) handshake line. When the 3001 has processed a data byte from the full input buffer, it then completes the handshake, allowing the controller to send another data byte. The calibrator clears the input buffer on power-up and on receiving the DCL (Device Clear) or SDC (Selected Device Clear) message from the controller.

#### **RS-232 interface:**

The 3001 uses the RS-232-C Xon/Xoff protocol to control buffer overflow. The 3001 sends a Xoff (Ctrl S) character when the input buffer becomes 80% full, and sends a Xon (Ctrl Q) character when it has processed enough of the input buffer so that it is less than 40% full.

## 10. Remote Commands

### 10.1 Introduction

Remote commands duplicate actions that can be initiated from the front panel in local operating mode. Following the summary table is a complete alphabetical listing of all commands complete with protocol details. Separate headings in the alphabetical listing provide the parameters and responses, plus an example for each command. For information on using the commands, see section 9.

### 10.2 Command Summary by Function

#### *Common Commands*

<b>Command</b>	<b>Description</b>
*CLS	Clear status. Clears the ESR, the error queue, and the RQS bit in the status byte. This command terminates any pending operation complete commands, *OPC or *OPC?.
*ESE	Loads a byte into the Event Status Enable register.
*ESE?	Returns the contents of the Event Status Enable register.
*ESR?	Returns the contents of the Event Status register and clears the register.
*IDN?	Identification query. Returns the manufacturer, model number, serial number, and firmware revision level of the Calibrator.
*OPC	Sets bit 0 (OPC for Operation Complete) in the Event Status Register to 1 when all pending device operations are complete.
*OPC?	Returns a 1 after all pending operations are complete. This command causes program execution to pause until all operations are complete. See also the *WAI command.
*OPT?	Returns a list of the installed hardware and software options.
*RST	Resets the state of the instrument to the power-up state. This command holds off execution of subsequent commands until it is complete.
*SRE	Loads a byte into the Service Request Enable register (SRE).
*SRE?	Returns the byte from the Service Request Enable register.
*STB?	Returns the status byte.
*TST?	Runs a series of self-tests and returns a "0" for pass or a "1" for fail. If any faults are detected, they are logged into the fault queue where they can be read by the FAULT? query.
*WAI	Prevents further remote commands from being executed until all previous remote commands have been completed.

### **External Connection Commands**

<b>Command</b>	<b>Description</b>
FUNC?	Returns the present output, measurement, or calibration function selected on the isolated and primary displays, in that order.
HART?	Returns the HART resistor setting for the isolated milliamp range, ON or OFF.
HART_OFF	Turns off the HART resistor on the isolated milliamp range.
HART_ON	Turns on the HART resistor on the isolated milliamp range.
ISO_PRES_UNIT	Sets the isolated display pressure units.
ISO_PRES_UNIT?	Returns the isolated display pressure units.
LOOP_POWER?	Returns the 24V loop power setting for the isolated milliamp range, ON or OFF.
LOOP_POWER_OFF	Turns off the 24V loop power on the isolated milliamp range.
LOOP_POWER_ON	Turns on the 24V loop power on the isolated milliamp range.
PRES_UNIT	Sets the primary display pressure units.
PRES_UNIT?	Returns the primary display pressure units.
RTD_TYPE	Sets the Resistance Temperature Detector (RTD) type.
RTD_TYPE?	Returns the Resistance Temperature Detector (RTD) type.
TC_REF	Selects the internal temperature sensor or an external reference value for cold junction compensation of thermocouple (TC) source and measurement.
TC_REF?	Returns the source of the temperature being used for cold junction compensation of thermocouple (TC) source and measurement.
TC_TYPE	Sets the thermocouple (TC) type.
TC_TYPE?	Returns the thermocouple (TC) type.
TSENS_TYPE	Sets temperature mode, RTD or TC.
TSENS_TYPE?	Returns the temperature mode.

### **Output Commands**

<b>Command</b>	<b>Description</b>
OPER	Activates the 3001 output if it is in standby mode.
OPER?	Returns the operate/standby mode setting.
OUT	Sets the output of the 3001.
OUT?	Returns the present output value of the 3001.
RANGE?	Returns the present output range, for voltage and current only.
RANGELCK	Locks the present output range, for voltage only.
RANGELCK?	Returns the RANGELOCK state, for voltage only.
STBY	Deactivates the 3001 output if it is in operate mode.

### **Measurement Commands**

<b>Command</b>	<b>Description</b>
ISO_MEAS	Sets the isolated input measurement type.
PRES?	Queries the attached pressure module for its manufacturer and serial number.
PRES_MEAS	Changes the operating mode of the primary display to pressure measurement.
RTD_MEAS	Changes the operating mode to RTD measurement.
TC_MEAS	Changes the operating mode to thermocouple measurement.
VAL?	Returns the last values for the isolated and primary measurements, in that order.
ZERO_MEAS	Zeros the pressure module, TC mV, or RTD ohms.
ZERO_MEAS?	Returns the zero offset for the pressure module, TC mV, or RTD ohms.

### **RS-232 Operating Mode Commands**

<b>Command</b>	<b>Description</b>
LOCAL	Puts the 3001 into the local state and disables lockout.
LOCKOUT	Puts the 3001 into the lockout state. This command duplicates the IEEE-488 LLO (Local Lockout) message.
REMOTE	Puts the 3001 into the remote state. This command duplicates the IEEE-488 REN (Remote Enable) message.

### **Status Commands**

<b>Command</b>	<b>Description</b>
FAULT?	Returns the most recent error code in the 3001 error queue, and then removes that error code from the queue.

## **10.3 Error Code Listing**

<b>Error Number</b>	<b>Message Class</b>	<b>Description</b>
1	DDE	Error queue overflow.
100	EXE	OPER or STBY was received when the 3001 is in measure mode or thermocouple source mode.
101	CME	A non-numeric entry was received in a field that should contain a numeric entry.
102	EXE	The numeric field exceeds 10 characters.
103	CME	Invalid units name or prefix.
104	EXE	An attempt to enter RTD source mode was made when SPRT is selected, or to select SPRT when RTD source mode is selected.
105	EXE	Entry is above upper limit for the selected output range.
106	EXE	Entry is below lower limit for the selected output range.



108	CME	A required command parameter was missing.
109	CME	An invalid TC_MEAS or RTD_MEAS unit parameter (not CEL or FAR) was received, or an invalid PRES_UNIT or ISO_PRES_UNIT parameter was received.
110	CME	An invalid RANGELCK parameter was received.
111	EXE	RANGELCK ON was received when the 3001 is not in Volts mode.
112	CME	An invalid RTD_TYPE parameter was received.
113	CME	An invalid TC_REF parameter was received.
114	CME	An invalid TSENS_TYPE parameter was received.
116	EXE	No pressure module was present when a pressure function was requested, or the total zero offset from calibration is more than 6%. This error can also occur if the total zero offset from calibration is out of limits when zeroing the thermocouple millivolts type (maximum offset $\pm 1$ mV), or the RTD ohms type (maximum $\pm 0.1$ ohm on high range, or $\pm 0.01$ ohm on the low range).
117	CME	An unrecognizable command was received.
118	CME	An invalid parameter was received.
120	EXE	The serial input buffer overflowed
121	EXE	The command string buffer overflowed.
122	QYE	The serial output buffer overflowed.
123	DDE	The output overloaded. See display error message OVER LOAD in section 2.7.
124	DDE	The 3001 is out of tolerance. This error is set after a failed initialization or a failed *TST? command.
125	DDE	The 3001 ADC has failed. This error is set after a failed initialization or a failed *TST? command.

## 10.4 Remote Command Listing

The following is an alphabetical list of all 3001 remote commands and queries, including the common commands and the device-dependent commands. Each command title includes a checkbox that indicates the remote interface applicability, IEEE-488 and/or RS-232, and the command group, Sequential or Overlapped; see section 9.6.1 for a description of these terms.

---

**\*CLS**  IEEE-488  RS-232  Sequential  Overlapped

Clear Status command. This command clears the ESR, the error queue, and the RQS bit in the status byte. This command terminates any pending operation complete commands, \*OPC or \*OPC?.

Parameter: <None>

Response: <None>

Example: \*CLS

This example clears the ESR, the error queue, and the RQS bit in the status byte.

---

**\*ESE**  IEEE-488  RS-232  Sequential  Overlapped

Event Status Enable command. This command loads a byte into the Event Status Enable (ESE) register. See the Event Status Enable Register (ESE) description in section 9.7.

Parameter: <value>  
where <value> is the decimal equivalent of the ESE byte, 0 to 255

Response: <None>

Example: \*ESE 140

This example loads decimal 140 (binary 10001100) to enable bits 7 (PON), 3 (DDE) and 2 (QYE).

---

**\*ESE?**  IEEE-488  RS-232  Sequential  Overlapped

Event Status Enable query. This command returns the contents of the Event Status Enable (ESE) register. See the Event Status Enable Register (ESE) description in section 9.7.

Parameter: <None>

Response: <value>  
where <value> is the decimal equivalent of the ESE byte, 0 to 255

Example: \*ESE?

133

This example returns decimal 133 (binary 10000101) which indicates that bits 7 (PON), 2 (QYE), 1 (OPC) are enabled.

---

**\*ESR?** IEEE-488  RS-232  Sequential  Overlapped

Event Status Register query. This command returns the contents of the Event Status Register (ESR) and clears the register. See the Event Status Register (ESR) description in section 9.7.

Parameter: <None>

Response: <value>  
where <value> is the decimal equivalent of the ESR byte, 0 to 255

Example: \*ESR?

61

This example returns decimal 61 (binary 00111101) which indicates that bits 5 (CME), 4 (EXE), 3 (DDE), 2 (QYE) and 0 (OPC) are enabled.

---

**FAULT?** IEEE-488  RS-232  Sequential  Overlapped

This command returns the most recent error code from the error queue. If the queue is empty (no errors have occurred) it returns 0. The command is normally used to verify that the previous command did what it was intended to do.

Parameter: <None>

Response: <value>  
where <value> is one of the error codes documented in section 10.3.

Example: FAULT?

105

This example shows the error code which would occur if the previous command attempted to set a value above 100 mA for current output. The error code 105 indicates that the value was above the upper limit for the selected output range.

---

---

**FUNC?** IEEE-488  RS-232  Sequential  Overlapped

This command returns the present output, measurement, or calibration function for the primary and isolated displays.

Parameter: <None>

Response: <isolated>,<primary>

where <isolated> is one of the following:

DC10V	measure DC voltage, 10V range
DC100V	measure DC voltage, 100V range
DCI	measure DC current
PRESSURE	measure pressure

and where <primary> is one of the following:

DCV	source DC voltage
DCI	source DC current
RTD_OUT	source RTD/Ohms
RTD_IN	measure RTD/Ohms
TC_OUT	source thermocouple
TC_IN	measure thermocouple
PRESSURE	measure pressure

Example: FUNC?

DC10V,PRESSURE

This example indicates that the isolated display is selected to the 10V range and the primary display is selected to pressure.

---

**HART?** IEEE-488  RS-232  Sequential  Overlapped

This command returns the isolated DC current input HART resistor status.

Parameter: <None>

Response: <value>

where <value> is ON or OFF

Example: HART?

OFF

This example indicates that the isolated DC current input HART resistor is turned off.

---

---

**HART\_OFF**                     IEEE-488    RS-232    Sequential    Overlapped

This command disables the isolated DC current input HART resistor.

Parameter:            <None>

Response:            <None>

Example:             HART\_OFF

This example disables the isolated DC current input HART resistor.

---

**HART\_ON**                     IEEE-488    RS-232    Sequential    Overlapped

This command enables the isolated DC current input HART resistor.

Parameter:            <None>

Response:            <None>

Example:             HART\_ON

This example enables the isolated DC current input HART resistor.

---

**\*IDN?**                     IEEE-488    RS-232    Sequential    Overlapped

This command returns the unit identification: instrument manufacturer, model number, serial number, and firmware revision level.

Parameter:            <None>

Response:            <text string>

where <text string> contains the following four fields separated by commas:

1. Manufacturer
2. Model number
3. Serial number (always 0)
4. Firmware revision level

Example:             \*IDN?

MARTEL, 3001,0,1.2

This example indicates the manufacturer is Martel, the model is 3001, the serial number is 0, and the firmware version is 1.2.

---

---

**ISO\_MEAS** IEEE-488  RS-232  Sequential  Overlapped

This command sets the isolated measurement type.

Parameter: <value>

where <value> is one of the following:

DC10V	measure DC voltage, 10V range
DC100V	measure DC voltage, 100V range
DCI	measure DC current
PRESSURE	measure pressure

Response: <None>

Example: ISO\_MEAS DCI

This example sets the isolated measurement to DC current.

---

**ISO\_PRES\_UNIT** IEEE-488  RS-232  Sequential  Overlapped

This command sets the isolated pressure unit.

Parameter: <value>

where <value> is one of the following:

PSI	pounds per square inch
INH2O4C	inches of water at 4 °C
INH2O20C	inches of water at 20 °C
INH2O60F	inches of water at 60 °F
CMH2O4C	centimeters of water at 4 °C
CMH2O20C	centimeters of water at 20 °C
MMH2O4C	millimeters of water at 4 °C
MMH2O20C	millimeters of water at 20 °C
BAR	bars
MBAR	millibars
KPA	kilopascals
MPA	megapascals
INHG	inches of mercury at 0 °C
MMHG	millimeters of mercury at 0 °C
KG/CM2	kilograms per square centimeter

Response: <None>

Example: ISO\_PRES\_UNIT BAR

This example sets the isolated pressure unit to bars.

---

---

**ISO\_PRES\_UNIT?**     IEEE-488     RS-232     Sequential     Overlapped

This command returns the isolated pressure unit.

Parameter:        <None>

Response:        <value>

where <value> is one of the following:

PSI	pounds per square inch
INH2O4C	inches of water at 4 °C
INH2O20C	inches of water at 20 °C
INH2O60F	inches of water at 60 °F
CMH2O4C	centimeters of water at 4 °C
CMH2O20C	centimeters of water at 20 °C
MMH2O4C	millimeters of water at 4 °C
MMH2O20C	millimeters of water at 20 °C
BAR	bars
MBAR	millibars
KPA	kilopascals
MPA	megapascals
INHG	inches of mercury at 0 °C
MMHG	millimeters of mercury at 0 °C
KG/CM2	kilograms per square centimeter

Example:        ISO\_PRES\_UNIT?

BAR

This example indicates that the isolated pressure unit is bars.

---

**LOCAL**         IEEE-488     RS-232     Sequential     Overlapped

This command puts the 3001 into the local state, clearing the remote state (see the REMOTE command) and the front panel lockout state (see the LOCKOUT command). It duplicates setting the IEEE-488 REN line to false.

Parameter:        <None>

Response:        <None>

Example:        LOCAL

This example puts the instrument into the local state, clearing the remote state and front panel lockout state, if enabled.

---

---

**LOCKOUT**       IEEE-488    RS-232    Sequential    Overlapped

This command puts the 3001 into the lockout state when in remote control (see the REMOTE command). In this state, no local operation is allowed at the front panel, including the LOCAL key. To clear the lockout condition, use the LOCAL command. This command duplicates the IEEE-488 LLO (Local Lockout) message.

Parameter:      <None>

Response:      <None>

Example:        LOCKOUT

This example puts the instrument into the lockout state. No front panel controls can be used.

---

**LOOP\_POWER?**       IEEE-488    RS-232    Sequential    Overlapped

This command returns the isolated DC current input 24V loop power status.

Parameter:      <None>

Response:      <value>  
where <value> is ON or OFF

Example:        LOOP\_POWER?  
OFF

This example indicates that the isolated DC current input 24V loop power is turned off.

---

**LOOP\_POWER\_OFF**       IEEE-488    RS-232    Sequential    Overlapped

This command disables the isolated DC current input 24V loop power.

Parameter:      <None>

Response:      <None>

Example:        LOOP\_POWER\_OFF

This example disables the isolated DC current input 24V loop power.

---

**LOOP\_POWER\_ON**       IEEE-488    RS-232    Sequential    Overlapped

This command enables the isolated DC current input 24V loop power.

Parameter:      <None>

Response:      <None>

Example:        LOOP\_POWER\_ON

This example enables the isolated DC current input 24V loop power.

---



---

**\*OPC**    IEEE-488    RS-232    Sequential    Overlapped

Operations Complete command. This command sets bit 0 (OPC) of the Event Status Register to 1 when all pending device operations are complete. Also see the \*ESR? command.

Parameter:        <None>

Response:        <None>

Example:         \*OPC

This example sets bit 0 of the Event Status Register to 1 when all pending device operations are done.

---

**\*OPC?**    IEEE-488    RS-232    Sequential    Overlapped

Operations Complete query. This command returns a 1 after all pending 3001 operations are complete. This command does not respond until all pending 3001 operations are complete, causing the control program execution to pause until operations are complete. Also see the \*WAI command.

Parameter:        <None>

Response:        1

Example:         \*OPC?

1

This example does not respond until all pending 3001 operations are complete, and then returns 1.

---

**OPER**    IEEE-488    RS-232    Sequential    Overlapped

This command places the 3001 in operate mode, activating the output at front panel terminals. This command acts the same as pressing the front panel key when in standby mode.

Parameter:        <None>

Response:        <None>

Example:         OPER

This example connects the selected output to the 3001 front panel terminals. It also indicates Opr on the display.

---

---

**OPER?**  IEEE-488  RS-232  Sequential  Overlapped

This command returns the present operate/standby mode setting.

Parameter: <None>

Response: <value>  
where <value> is "1" for operate mode and "0" for standby mode

Example: OPER?  
1

This example indicates that the 3001 is in operate mode.

---

**\*OPT?**  IEEE-488  RS-232  Sequential  Overlapped

This command returns a list of the installed hardware and software options. This command is reserved for future use.

Parameter: <None>

Response: <text string>  
where <text string> is "0" if no options are installed, or a list of installed options separated by commas

Example: \*OPT?  
0

The example indicates that no options are installed.

---

**OUT**  IEEE-488  RS-232  Sequential  Overlapped

This command sets the output mode and value of the 3001. To source a temperature, select the desired mode and sensor parameters first with the TSENS\_TYPE, RTD\_TYPE, and TC\_TYPE commands. Use the multiplier prefixes k for kilo, m for milli, and u for micro with the OUT command units, as desired. The unit may be omitted if the output mode is not to be changed.

Parameter: <value> <units>

where <value> is the output value to be generated

and where <units> is one of the following, with a possible prefix multiplier (k, m, or u) as described above:

V	DC volts
A	DC current
OHM	Resistance
CEL	Temperature in Celsius
FAR	Temperature in fahrenheit

Response: <None>

Examples:	Explanation
OUT 15.2 V	Change to DC volts, output 15.2 V
OUT 1.2 mA	Change to DC current, output 1.2 mA, note units prefix multiplier m
OUT 5 Ohm	Change to Resistance, output 5 O
OUT 100 CEL	Change to temperature in °C, output 100 °C
OUT 3	No change to output mode, output a value of 3 in the present units

---

**OUT?**                                     IEEE-488    RS-232    Sequential    Overlapped

This command returns the present output value and units of the 3001.

Parameter:            <None>

Response:            <value>,<units>  
 where <value> is the present output value  
 and where <units> is one of the following:

V	DC volts
A	DC current
OHM	Resistance
CEL	Temperature in Celsius
FAR	Temperature in fahrenheit

Examples:	Explanation
OUT? 1.88300E-02,A	Present output is 18.83 mA
OUT? 1.23000E+00,V	Present output is 1.23 V
OUT? 4.00000E+03,OHM	Present output is 4.0 KO
OUT? 1.0430E+02,CEL	Present output is 104.3 °C

---

---

**PRES?** IEEE-488  RS-232  Sequential  Overlapped

This command queries the attached pressure module for its manufacturer, serial number, and firmware version.

Parameter: <None>

Response: <text string>

where <text string> contains the following three fields separated by commas:

1. Manufacturer
2. Serial number
3. Firmware revision level (always 0)

Example: PRES?

MARTEL,610070,0

This example indicates that the manufacturer is Martel, the serial number is 610070, and the firmware version is 0.

---

**PRES\_MEAS** IEEE-488  RS-232  Sequential  Overlapped

This command changes the primary display operating mode to pressure measurement.

Parameter: <None>

Response: <None>

Example: PRES\_MEAS

This example changes the primary display operating mode to pressure measurement.

---

---

**PRES\_UNIT** IEEE-488    RS-232    Sequential    Overlapped

This command sets the primary display pressure units.

Parameter:      <value>

where <value> is one of the following:

PSI	pounds per square inch
INH2O4C	inches of water at 4 °C
INH2O20C	inches of water at 20 °C
INH2O60F	inches of water at 60 °F
CMH2O4C	centimeters of water at 4 °C
CMH2O20C	centimeters of water at 20 °C
MMH2O4C	millimeters of water at 4 °C
MMH2O20C	millimeters of water at 20 °C
BAR	bars
MBAR	millibars
KPA	kilopascals
MPA	megapascals
INHG	inches of mercury at 0 °C
MMHG	millimeters of mercury at 0 °C
KG/CM2	kilograms per square centimeter

Response:      <None>

Example:      PRES\_UNIT BAR

This example sets the primary display pressure units to bars.

---

**PRES\_UNIT?** IEEE-488    RS-232    Sequential    Overlapped

This command returns the primary display pressure units.

Parameter:      <None>

Response:      <value>

where <value> is one of the following:

PSI	pounds per square inch
INH2O4C	inches of water at 4 °C
INH2O20C	inches of water at 20 °C
INH2O60F	inches of water at 60 °F
CMH2O4C	centimeters of water at 4 °C
CMH2O20C	centimeters of water at 20 °C
MMH2O4C	millimeters of water at 4 °C
MMH2O20C	millimeters of water at 20 °C
BAR	bars
MBAR	millibars
KPA	kilopascals
MPA	megapascals
INHG	inches of mercury at 0 °C
MMHG	millimeters of mercury at 0 °C
KG/CM2	kilograms per square centimeter

Example:      PRES\_UNIT?

## BAR

This example indicates that the primary pressure display units are bars

---

### **RANGE?**

IEEE-488  RS-232  Sequential  Overlapped

This command returns the present DC voltage or current output range.

Parameter: <None>

Response: <value>

where <value> is one of the following:

V_0.1V	DC volts, 100 mV range
V_1V	DC volts, 1V range
V_10V	DC volts, 10 V range
V_100V	DC volts, 100 V range
A_0.1A	DC current
NONE	neither volts nor current is selected

Example: RANGE?

V\_10V

This example indicates that the present output range is 10 V.

---

### **RANGELCK**

IEEE-488  RS-232  Sequential  Overlapped

This command locks or unlocks the DC voltage output range per the present output value.

Parameter: <value>

where <value> is one of the following:

ON	to lock the present voltage range
OFF	to unlock the present voltage range

Response: <None>

Example: RANGELCK ON

If the present DC voltage output is 5 V, this example locks the range at 10 VDC.

---

---

**RANGELCK?**             IEEE-488    RS-232    Sequential    Overlapped

This command returns the DC voltage range lock status.

Parameter:            <None>

Response:            <value>  
                      where <value> is one of the following:

                      ON     DC voltage range lock is on  
                      OFF    DC voltage range lock is off

Example:             RANGELCK?  
                      OFF

This example indicates that the range lock is off.

---

**REMOTE**                 IEEE-488    RS-232    Sequential    Overlapped

This command places the 3001 into the remote state. It duplicates the IEEE-488 REN (Remote Enable) message. When the 3001 is in the remote state, but not locked out, only the LOCAL key is active. If the front panel is also locked out, no front panel keys are active; see the LOCKOUT command. To unlock the front panel, use the LOCAL command, or cycle the 3001 power switch.

Parameter:            <None>

Response:            <None>

Example:             REMOTE

This example places the 3001 into the remote state.

---

**\*RST**                     IEEE-488    RS-232    Sequential    Overlapped

This command resets the 3001 to the power-up state and holds off execution of subsequent commands until the reset operation is complete.

A reset action invokes the following commands and values for the primary display:

<b><u>Command</u></b>	<b><u>Value</u></b>
OUT	0 V
PRES_UNIT	Last selected
RANGE	0.1 V
RTD_TYPE	Last selected
STBY	(No output)
TC_REF	INT
TC_TYPE	Last selected
TSENS_TYPE	Last selected

The isolated display and selections remain as they were last selected.

Parameter:            <None>

Response:            <None>

Example:             \*RST

This example resets the 3001, invoking the commands and values shown above.

---

**RTD\_MEAS** IEEE-488    RS-232    Sequential    Overlapped

This command places the primary display in RTD measure mode.

Parameter:        <value>

where <value> is one of the following:

**CEL**        display in degrees celsius

**FAR**        display in degrees fahrenheit

    <None>        display in the last selected temperature unit

Response:        <None>

Example:         RTD\_MEAS CEL

This example sets the 3001 to RTD measure mode, displaying in degrees celsius.

---

**RTD\_TYPE** IEEE-488    RS-232    Sequential    Overlapped

This command sets the Resistance Temperature Detector (RTD) sensor type for RTD source and measure. Normally, before using the RTD\_TYPE command to select the RTD type, use the TSENS\_TYPE command to select RTD mode, and afterwards set the output temperature using the OUT command, if applicable. A change in temperature sensors sets the output to 0 °C. Note that the SPRT can only be used to measure signals, not source them.

Parameters:        <value>

where <value> is one of the following:

PT385\_100        100-ohm RTD, curve a=0.00385 ohms/ohm/°C

PT385\_200        200-ohm RTD, curve a=0.00385 ohms/ohm/°C

PT385\_500        500-ohm RTD, curve a=0.00385 ohms/ohm/°C

PT385\_1000       1000-ohm RTD, curve a=0.00385 ohms/ohm/°C

PT392\_100        100-ohm RTD, curve a=0.003926 ohms/ohm/°C

PTJIS\_100        100-ohm RTD, curve a=0.003916 ohms/ohm/°C

CU10             10-ohm RTD, empirical curve

NI120            120-ohm RTD, empirical curve

YSI\_400          YSI thermistor curve

OHMS\_HIGH       4000 ohms range

OHMS\_LOW        400 ohms range

SPRT             standard PRT with user defined error coefficients, only available for measurement

USR\_DEF<x>      RTD with user defined custom coefficients, where x is the curve number and ranges from 1 to 5, i.e. USR\_DEF2 for curve 2

Response:        <None>

Example:         RTD\_TYPE PTJIS\_100

This example sets the RTD sensor to a 100-ohm type, using the PT3916 curve (a=0.003916 ohms/ohm/°C). The resistance of 100 ohms refers to the ice point characteristic, the resistance of the RTD at 0 °C (32 °F).



---

**RTD\_TYPE?** IEEE-488    RS-232    Sequential    Overlapped

This command returns the Resistance Temperature Detector (RTD) sensor type being used for RTD temperature source and measurement.

Parameter:        <None>

Response:        <value>

where <value> is one of the following:

PT385_100	100-ohm RTD, curve a=0.00385 ohms/ohm/°C
PT385_200	200-ohm RTD, curve a=0.00385 ohms/ohm/°C
PT385_500	500-ohm RTD, curve a=0.00385 ohms/ohm/°C
PT385_1000	1000-ohm RTD, curve a=0.00385 ohms/ohm/°C
PT392_100	100-ohm RTD, curve a=0.003926 ohms/ohm/°C
PTJIS_100	100-ohm RTD, curve a=0.003916 ohms/ohm/°C
CU10	10-ohm RTD, empirical curve
NI120	120-ohm RTD, empirical curve
YSI_400	YSI thermistor curve
OHMS_HIGH	4000 ohms range
OHMS_LOW	400 ohms range
SPRT	standard PRT with user defined error coefficients, only available for measurement
USR_DEF<x>	RTD with user defined custom coefficients, where x is the curve number and ranges from 1 to 5, i.e. USR_DEF2 for curve 2

Example:        RTD\_TYPE?

PTJIS\_100

This example indicates that the RTD sensor type is a 100-ohm RTD with curve a=0.3916 ohm/°C.

---

---

**\*SRE**  IEEE-488  RS-232  Sequential  Overlapped

Service Request Enable command. This command loads a byte into the Service Request Enable (SRE) register. See the Service Request Enable Register (SRE) description in section 9.7. Since bit 6 is not used (decimal value 64), the maximum entry is  $255 - 64 = 191$ .

Parameter: <value>  
where <value> is the decimal equivalent of the SRE byte, 0 to 191

Response: <None>

Example: \*SRE 48  
This example enables bits 4 (MAV) and 5 (ESB).

---

**\*SRE?**  IEEE-488  RS-232  Sequential  Overlapped

Service Request Enable query. This command returns the byte in the Service Request Enable Register (SRE). See the Service Request Enable Register (SRE) description in section 9.7.

Parameter: <None>

Response: <value>  
where <value> is the decimal equivalent of the SRE byte, 0 to 191

Example: \*SRE?  
48  
This example indicates that bits 4 (MAV), and 5 (ESB) are enabled.

---

**\*STB?**  IEEE-488  RS-232  Sequential  Overlapped

Status Byte Register query. This command returns the byte in the Status Byte Register. See the Status Byte Register (STB) description in section 9.7.

Parameter: <None>

Response: <value>  
where <value> is the decimal equivalent of the STB byte, 0 to 255

Example: \* STB?  
96  
This example indicates that bits 5 (ESB) and 6 (MSS) are set.

---

---

**STBY** IEEE-488  RS-232  Sequential  Overlapped

This command places the 3001 in standby mode, deactivating the output at front panel terminals. This command acts the same as pressing the front panel key when in operate mode.

Parameter: <None>

Response: <None>

Example: STBY

This example disconnects the selected output from the 3001 front panel terminals. It also indicates Stby on the display.

---

**TC\_MEAS** IEEE-488  RS-232  Sequential  Overlapped

This command places the primary display in thermocouple measure mode.

Parameter: <value>

where <value> is one of the following:

CEL display in degrees celsius

FAR display in degrees fahrenheit

<None> display in the last selected temperature unit

Response: <None>

Example: TC\_MEAS FAR

This example sets the 3001 to thermocouple measure mode, displaying in degrees fahrenheit.

---

**TC\_REF** IEEE-488  RS-232  Sequential  Overlapped

This command selects the internal temperature sensor or an external reference value for cold junction compensation of thermocouple source and measurement.

Parameter: <value>

where <value> is one of the following:

INT use internal temperature sensor

EXT use external reference value

Response: <None>

Example: TC\_REF EXT

This example sets the thermocouple reference to external.

---

---

**TC\_REF?**                     IEEE-488    RS-232    Sequential    Overlapped

This command returns the source of the temperature being used for cold junction compensation of thermocouple source and measurement.

Parameter:            <None>

Response:            <value>

where <value> is one of the following:

INT	internal temperature sensor in use
EXT	external reference value in use

Example:            TC\_REF?

INT

This example indicates that the internal sensor is in use.

---

**TC\_TYPE**                     IEEE-488    RS-232    Sequential    Overlapped

This command sets the Thermocouple (TC) sensor type being used for TC temperature source and measurement. Normally, before using the TC\_TYPE command to select the TC type, use the TSENS\_TYPE command to select TC mode, and afterwards set the output temperature using the OUT command, if applicable. A change in temperature sensors sets the output to 0 °C.

Parameters:            <value>

where <value> is one of the following:

B	B-type thermocouple
C	C-type thermocouple
E	E-type thermocouple
J	J-type thermocouple
K	K-type thermocouple
L	L-type thermocouple
N	N-type thermocouple
R	R-type thermocouple
S	S-type thermocouple
T	T-type thermocouple
U	U-type thermocouple
XK	XK-type thermocouple
BP	BP-type thermocouple
Z	1 mV/°C

Response:            <None>

Example:            TC\_TYPE J

This example sets the thermocouple type to J-type.

---

---

**TC\_TYPE?**                     IEEE-488    RS-232    Sequential    Overlapped

This command returns the Thermocouple (TC) sensor type being used for TC temperature source and measurement.

Parameter:            <None>

Response:            <value>

where <value> is one of the following:

B	B-type thermocouple
C	C-type thermocouple
E	E-type thermocouple
J	J-type thermocouple
K	K-type thermocouple
L	L-type thermocouple
N	N-type thermocouple
R	R-type thermocouple
S	S-type thermocouple
T	T-type thermocouple
U	U-type thermocouple
XK	XK-type thermocouple
BP	BP-type thermocouple
Z	1 mV/°C

Example:            TC\_TYPE?

K

This example indicates that the thermocouple sensor type is K-type.

---

**TSENS\_TYPE**                     IEEE-488    RS-232    Sequential    Overlapped

This command sets the temperature mode to thermocouple (TC) or Resistance Temperature Detector (RTD) for temperature source and measurement.

Parameters:            <value>

where <value> is one of the following:

TC	Thermocouple
RTD	Resistance Temperature Detector

Response:            <None>

Example:            TSENS\_TYPE RTD

This example sets the temperature mode to RTD.

---

---

**TSENS\_TYPE?**       IEEE-488    RS-232    Sequential    Overlapped

This command returns the present temperature mode, thermocouple (TC) or Resistance Temperature Detector (RTD).

Parameter:      <None>

Response:      <value>

where <value> is one of the following:

TC	Thermocouple
RTD	Resistance Temperature Detector

Example:      TSENS\_TYPE?

TC

This example indicates that the present temperature mode is thermocouple.

---

**\*TST?**       IEEE-488    RS-232    Sequential    Overlapped

This command runs a series of self-tests and returns a "0" for pass or a "1" for fail. If any faults are detected, they are logged into the fault queue where they can be read by the FAULT? query.

Parameter:      <None>

Response:      <value>

where <value> is one of the following:

0	failed self test
1	passed self test

Example:      \*TST?

1

This example runs the self test and indicates that it passed.

---

**VAL?**       IEEE-488    RS-232    Sequential    Overlapped

This command returns the last values for the isolated and primary measurements, in that order.

Parameter:      <None>

Response:      <iso-value>, <iso-units>, <primary-value>, <primary-units>

where <iso-value> is the present isolated measurement expressed in scientific notation.

and where <iso-units> is one of the following:

V	DC volts
A	DC current
OVER	measurement is over or under range
or	one of the pressure units listed with the ISO_PRES_UNIT? command

and where <primary-value> is the present primary measurement

expressed in scientific notation.

and where <primary-units> is one of the following:

FAR	°F
CEL	°C
OHM	Ohms
V	DC volts (thermocouple millivolts)
OVER	measurement is over or under range
NONE	primary display is presently set to a source mode

or one of the pressure units listed with the PRES\_UNIT? command

Example: VAL?

2.137000E+00,V,5.763300E+01,CEL

This example indicates that the isolated measurement is 2.137 volts and that the primary measurement is 57.633 °C.

---

**\*WAI**  IEEE-488  RS-232  Sequential  Overlapped

This command prevents further remote commands from being executed until all previous remote commands have been completed. For example, if you send an OUT command, you can cause the 3001 to wait until the output has settled before continuing on to the next command if you follow OUT with a \*WAI command. The \*WAI command is useful with any overlapped command, preventing the 3001 from processing other commands until the overlapped command is completed.

Parameter: <None>

Response: <None>

Example: OUT 1.1 V

\*WAI  
OPER  
FAULT?

This example demonstrates setting the 3001 output to 1.1 volts, waiting for the output to settle before activating the output and checking if the sequence of commands completed successfully.

---

**ZERO\_MEAS**  IEEE-488  RS-232  Sequential  Overlapped

This command zeros a pressure module, the thermocouple mV offset, or the RTD ohms offset. For detailed zeroing instructions see section 4.3 for RTD ohms, section 4.7 for thermocouple millivolts, or section 4.9 for pressure.

Parameter: <None> for RTD ohms, thermocouple millivolts, or a pressure module that does not measure absolute pressure  
<value> is barometric pressure for absolute pressure modules, expressed in the currently selected pressure units

Response: <None>

Example: ZERO\_MEAS

If thermocouple millivolts are currently selected, this example zeros the offset.

---

**ZERO\_MEAS?** IEEE-488    RS-232    Sequential    Overlapped

This command returns the zero offset for pressure modules, thermocouple millivolts, or RTD ohms.

Parameter:            <None>

Response:            <zero offset>,<units>

where < zero offset > is the current offset.

and where <units> is one of the following:

        OHM    Ohms

        V      DC volts (thermocouple millivolts)

        or     one of the pressure units listed with the PRES\_UNIT?  
                  command

Example:            ZERO\_MEAS?

1.060000E-01,PSI

This example indicates that the pressure zero for the attached module is 0.106 psi.

---



# 11. Maintenance

## 11.1 Cleaning the Calibrator



### **Warning**

To avoid personal injury and/or damage to the Calibrator, use only the specified replacement parts and do not allow water into the case.



### **Caution**

To avoid damaging the case, do not use solvents or abrasive cleaners.

Clean the calibrator and pressure modules with a soft cloth dampened with water, or mild soap and water.

## 11.2 Replacing a Line Fuse



### **Warning**

To avoid electrical shock hazard disconnect line power before opening the case or fuse compartment.

The line power fuses and line voltage selector are located in the compartment above the power switch on the right rear of the Calibrator. See the rear panel layout in section 2.5.

Table 10 shows the correct replacement fuse for each line voltage setting.

**Table 10 - Replacement Fuses**

Fuse Description	Line Voltage Setting
0.25 A/250 V fast	120 V (90 V to 132 V)
0.125 A/250 V fast	240 V (198 V to 264 V)

To check or replace a fuse:

1. Disconnect the line power.
2. Using the blade of a suitable flat screwdriver, pry up the tab at the base of the line fuse compartment by inserting the blade in the center slot under the tab. The compartment cover will pop part way out.
3. Remove the compartment cover. The fuses come out with the compartment cover and can easily be checked or replaced.
4. To reinstall the fuse holder, push the compartment cover back into the compartment until the tab locks in place.

### 11.3 Changing the Line Voltage

The calibrator arrives from the factory configured for the line voltage appropriate for the country of purchase, or as specified when it is ordered. To verify the line voltage setting, check the line voltage indicator on the power line fuse compartment cover.

Confirm that the line voltage selection is set for 120 V for line voltages between 90 V and 132 V, or that the selector is set to 240 V for line voltages between 198 V and 264 V.



#### **Warning**

To avoid electrical shock hazard disconnect line power before opening the case or fuse compartment.

To change the line voltage:

1. Disconnect line power.
2. Using the blade of a suitable flat screwdriver, pry up the tab at the base of the line fuse compartment by inserting the blade in the center slot under the tab. The compartment cover will pop part way out.
3. Remove the compartment cover.
4. Remove the line voltage selector assembly by gripping the line voltage indicator tab with pliers and pulling it straight out of the compartment.
5. Rotate the line voltage selector assembly to the desired voltage and reinsert.
6. Verify you are using the appropriate fuse for the selected line voltage (see table 10 above), and reinstall the fuse compartment by pushing it in until the tab locks in place.

## 12. Specifications

### 12.1 General Specifications

Warm up time	Twice the time since last warmed up, to a maximum of 30 minutes.
Settling time	Less than 5 seconds for all functions and ranges except as noted.
Standard interfaces	RS-232 IEEE-488 (GPIB)
Temperature performance	Operating           0 °C to 50 °C Calibration (tcal)   18 °C to 28 °C Storage             -20 °C to 70 °C
Electromagnetic compatibility	CE: Conforms to EN61326
Temperature coefficient	Temperature coefficient for temperatures outside tcal $\pm 5$ °C is 10% of the 90 day specification (or 1 year if applicable) per °C
Relative humidity	Operating           <80% to 30 °C <70% to 40 °C <40% to 50 °C Storage             <95 % noncondensing
Altitude	Operating 3,050 m (10,000 ft) maximum Nonoperating 12,200 m (40,000 ft) maximum
Safety	EN 61010 Second, ANSI/ISA-S82.01-1994, CAN/CSA-C22.2 No. 1010.1-92, NRTL
Analog low isolation	20 V
Line power	Line Voltage (selectable)   100V/120V or 220V/240V Line Frequency             47 to 63 Hz Line Voltage Variation $\pm 10$ % about setting
Power consumption	15 VA maximum
Dimensions	Height   13.3 cm (5.25 in) plus 2.9 cm (1.15 in) for extended feet Width    standard rack width (19 inch) Depth    30.0 cm (11.81 in) overall
Weight (without options)	4 kg (9 lb)

## 12.2 DC Voltage Specifications, Output

Ranges <sup>1</sup>	Absolute Uncertainty, tcal $\pm 5^{\circ}\text{C}$ $\pm$ (ppm of output $+\mu\text{V}$ )				Stability	Resolution	Maximum Burden <sup>2</sup>
	90 days		1 year		24 hours, $\pm 1^{\circ}\text{C}$ $\pm$ (ppm of output $+\mu\text{V}$ )		
0 to 100.000 mV	25	3	30	3	5 ppm + 2	1 $\mu\text{V}$	10 mA
0 to 1.00000 V	25	10	30	10	4 ppm + 10	10 $\mu\text{V}$	10 mA
0 to 10.0000 V	25	100	30	100	4 ppm + 100	100 $\mu\text{V}$	10 mA
0 to 100.000 V	25	1 mV	30	1 mV	5 ppm + 1 mV	1 mV	1 mA
<b>TC Output and Input</b>							
-10 to 75.000 mV	25	3 mV	30	3 $\mu\text{V}$	5 ppm + 2 $\mu\text{V}$	1 $\mu\text{V}$	10 $\Omega$
1. All outputs are positive only.							
2. Remote sensing is not provided. Output resistance is $< 1\Omega$							

Ranges	Noise	
	Bandwidth 0.1 to 10 Hz p-p $\pm$ (ppm of output $+\mu\text{V}$ )	Bandwidth 10 Hz to 10 kHz rms $\mu\text{V}$
0 to 100.000 mV	1 $\mu\text{V}$	6 $\mu\text{V}$
0 to 1.00000 V	10 $\mu\text{V}$	60 $\mu\text{V}$
0 to 10.0000 V	100 $\mu\text{V}$	600 $\mu\text{V}$
0 to 100.000 V	10 ppm+1 mV	20 mV

## 12.3 DC Voltage Specifications, Isolated Input

Ranges	Absolute Uncertainty, tcal $\pm 5^{\circ}\text{C}$ , $\pm$ (ppm of reading + mV)		Resolution
0 to 10.0000 V	50	0.2	100 $\mu\text{V}$
0 to 100.000 V	50	2.0	1 mV

## 12.4 DC Current Specifications, Output

Ranges <sup>1</sup>	Absolute Uncertainty, tcal $\pm 5^{\circ}\text{C}$ $\pm$ (ppm of output $+\mu\text{A}$ )				Resolution	Maximum Compliance Voltage	Maximum Inductive Load
	90 days		1 year				
0 to 100.000 mA	40	1	50	1	1 $\mu\text{A}$	12 V	100 mH
1. All outputs are positive only.							

Ranges	Noise	
	Bandwidth 0.1 to 10 Hz p-p	Bandwidth 10 Hz to 10 kHz rms $\mu\text{V}$
0 to 100.000 mA	2000 nA	20 $\mu\text{A}$

## 12.5 DC Current Specifications, Isolated Input

Ranges	Absolute Uncertainty, tcal $\pm 5\text{ }^\circ\text{C}$ , $\pm$ (ppm of reading + mV)	Resolution
0 to 50.0000 mA	100                      1	0.1 $\mu\text{A}$
1. Loop power: 24V $\pm 10\%$ 2. HART resistor: 250 $\Omega$ $\pm 3\%$ 3. Maximum rated loop current: 24mA		

## 12.6 Resistance Specifications, Output

Ranges <sup>1</sup>	Absolute Uncertainty, tcal $\pm 5\text{ }^\circ\text{C}$ , $\pm$ ohms		Resolution	Nominal Current <sup>1</sup>
	90 days	1 year		
5 to 400.000 $\Omega$	0.012	0.015	0.001 $\Omega$	1 to 3 mA
5 to 4.00000 k $\Omega$	0.25	0.3	0.01 $\Omega$	100 $\mu\text{A}$ to 1 mA
1. Continuously variable from 0 to 4 k $\Omega$ . 2. For currents lower than shown, the specification becomes: New Spec. = Stated Spec. x Imin / Iactual. For example, a 500 $\mu\text{A}$ stimulus measuring 100 $\Omega$ has a specification of: 0.015 $\Omega$ x 1 mA / 500 $\mu\text{A}$ = 0.03 $\Omega$ .				

## 12.7 Resistance Specifications, Input

Ranges	Absolute Uncertainty, tcal $\pm 5\text{ }^\circ\text{C}$ $\pm$ (ppm of output + $\Omega$ )		Resolution	Stimulus Current
	90 days	1 year		
5 to 400.000 $\Omega$	20 + 0.0035	20 + 0.004	0.001 $\Omega$	1 mA
5 to 4.00000 k $\Omega$	20 + 0.0035	20 + 0.004	0.01 $\Omega$	0.1 mA

## 12.8 Thermocouple Specification, Output and Input

TC Type	Range (° C)		Absolute Uncertainty, tcal ±5 °C, ±(°C) <sup>1</sup>	
			Output/Input	
	Minimum	Maximum	90 days	1 year
B	600 °C	800 °C	0.42 °C	0.46 °C
	800 °C	1000 °C	0.39 °C	0.39 °C
	1000 °C	1550 °C	0.40 °C	0.40 °C
	1550 °C	1820 °C	0.44 °C	0.45 °C
C	0 °C	150 °C	0.25 °C	0.30 °C
	150 °C	650 °C	0.21 °C	0.26 °C
	650 °C	1000 °C	0.23 °C	0.31 °C
	1000 °C	1800 °C	0.38 °C	0.50 °C
	1800 °C	2316 °C	0.63 °C	0.84 °C
E	-250 °C	-100 °C	0.38 °C	0.50 °C
	-100 °C	-25 °C	0.16 °C	0.18 °C
	-25 °C	350 °C	0.14 °C	0.15 °C
	350 °C	650 °C	0.14 °C	0.16 °C
	650 °C	1000 °C	0.16 °C	0.21 °C
J	-210 °C	-100 °C	0.20 °C	0.27 °C
	-100 °C	-30 °C	0.18 °C	0.20 °C
	-30 °C	150 °C	0.14 °C	0.16 °C
	150 °C	760 °C	0.14 °C	0.17 °C
	760 °C	1200 °C	0.18 °C	0.23 °C
K	-200 °C	-100 °C	0.25 °C	0.33 °C
	-100 °C	-25 °C	0.19 °C	0.22 °C
	-25 °C	120 °C	0.14 °C	0.16 °C
	120 °C	1000 °C	0.19 °C	0.26 °C
	1000 °C	1372 °C	0.30 °C	0.40 °C
L	-200 °C	-100 °C	0.37 °C	0.37 °C
	-100 °C	800 °C	0.26 °C	0.26 °C
	800 °C	900 °C	0.17 °C	0.17 °C
N	-200 °C	-100 °C	0.33 °C	0.40 °C
	-100 °C	-25 °C	0.20 °C	0.24 °C
	-25 °C	120 °C	0.16 °C	0.19 °C
	120 °C	410 °C	0.14 °C	0.18 °C
	410 °C	1300 °C	0.21 °C	0.27 °C

1. Does not include thermocouple wire error.

### Thermocouple Specification, Output and Input (continued)

TC Type	Range (° C)		Absolute Uncertainty, tcal ±5 °C, ±(°C) <sup>1</sup>	
			Output/Input	
	Minimum	Maximum	90 days	1 year
R	0 °C	250 °C	0.58 °C	0.58 °C
	250 °C	400 °C	0.34 °C	0.35 °C
	400 °C	1000 °C	0.31 °C	0.33 °C
	1000 °C	1750 °C	0.30 °C	0.40 °C
S	0 °C	250 °C	0.56 °C	0.56 °C
	250 °C	1000 °C	0.36 °C	0.36 °C
	1000 °C	1400 °C	0.30 °C	0.37 °C
	1400 °C	1750 °C	0.35 °C	0.46 °C
T	-250 °C	-150 °C	0.51 °C	0.63 °C
	-150 °C	0 °C	0.18 °C	0.24 °C
	0 °C	120 °C	0.13 °C	0.16 °C
	120 °C	400 °C	0.12 °C	0.14 °C
U	-200 °C	0 °C	0.56 °C	0.56 °C
	0 °C	600 °C	0.27 °C	0.27 °C
XK	-200 °C	-100 °C	0.22 °C	0.22 °C
	-100 °C	300 °C	0.12 °C	0.13 °C
	300 °C	800 °C	0.19 °C	0.20 °C
BP	0 °C	200 °C	0.42 °C	0.42 °C
	200 °C	600 °C	0.32 °C	0.32 °C
	600 °C	800 °C	0.39 °C	0.40 °C
	800 °C	1600 °C	0.45 °C	0.46 °C
	1600 °C	2000 °C	0.57 °C	0.58 °C
	2000 °C	2500 °C	0.67 °C	0.80 °C

1. Does not include thermocouple wire error.

## 12.9 RTD and Thermistor Specification, Output

RTD Type	Range (° C)		Absolute Uncertainty, tcal ±5 °C, ±(°C) <sup>1</sup>	
			Output/Input	
	Minimum	Maximum	90 days	1 year
Pt 385, 100 Ω	-200 °C	-80 °C	0.03 °C	0.04 °C
	-80 °C	0 °C	0.04 °C	0.05 °C
	0 °C	100 °C	0.04 °C	0.05 °C
	100 °C	300 °C	0.03 °C	0.04 °C
	300 °C	400 °C	0.04 °C	0.04 °C
	400 °C	630 °C	0.04 °C	0.05 °C
	630 °C	800 °C	0.04 °C	0.05 °C
Pt 3926, 100 Ω	-200 °C	-80 °C	0.03 °C	0.04 °C
	-80 °C	0 °C	0.03 °C	0.04 °C
	0 °C	100 °C	0.03 °C	0.04 °C
	100 °C	300 °C	0.03 °C	0.04 °C
	300 °C	400 °C	0.03 °C	0.04 °C
	400 °C	630 °C	0.04 °C	0.05 °C
Pt 3916, 100 Ω	-200 °C	-190 °C	0.03 °C	0.03 °C
	-190 °C	-80 °C	0.03 °C	0.04 °C
	-80 °C	0 °C	0.03 °C	0.04 °C
	0 °C	100 °C	0.03 °C	0.04 °C
	100 °C	260 °C	0.03 °C	0.04 °C
	260 °C	300 °C	0.03 °C	0.04 °C
	300 °C	400 °C	0.03 °C	0.04 °C
	400 °C	600 °C	0.04 °C	0.05 °C
	600 °C	630 °C	0.04 °C	0.05 °C
Pt 385, 200 Ω	-200 °C	-80 °C	0.31 °C	0.38 °C
	-80 °C	0 °C	0.32 °C	0.38 °C
	0 °C	100 °C	0.33 °C	0.39 °C
	100 °C	260 °C	0.33 °C	0.39 °C
	260 °C	300 °C	0.36 °C	0.43 °C
	300 °C	400 °C	0.36 °C	0.43 °C
	400 °C	600 °C	0.42 °C	0.50 °C
	600 °C	630 °C	0.42 °C	0.50 °C
Pt 385, 500 Ω	-200 °C	-80 °C	0.13 °C	0.15 °C
	-80 °C	0 °C	0.13 °C	0.15 °C
	0 °C	100 °C	0.13 °C	0.16 °C
	100 °C	260 °C	0.14 °C	0.17 °C
	260 °C	300 °C	0.14 °C	0.17 °C
	300 °C	400 °C	0.15 °C	0.18 °C
	400 °C	600 °C	0.16 °C	0.19 °C
	600 °C	630 °C	0.16 °C	0.19 °C

1. 2-wire output



## RTD and Thermistor Specification, Output (continued)

RTD Type	Range (° C)		Absolute Uncertainty, tcal ±5 °C, ±(°C) <sup>1</sup>	
			Output/Input	
	Minimum	Maximum	90 days	1 year
Pt 385, 1000 Ω	-200 °C	-80 °C	0.06 °C	0.07 °C
	-80 °C	0 °C	0.06 °C	0.08 °C
	0 °C	100 °C	0.07 °C	0.08 °C
	100 °C	260 °C	0.07 °C	0.08 °C
	260 °C	300 °C	0.07 °C	0.09 °C
	300 °C	400 °C	0.07 °C	0.09 °C
	400 °C	600 °C	0.08 °C	0.09 °C
Ni 120, 120 Ω	-80 °C	0 °C	0.02 °C	0.02 °C
	0 °C	100 °C	0.02 °C	0.02 °C
	100 °C	260 °C	0.01 °C	0.02 °C
Cu 427, 10 Ω <sup>2</sup>	-100 °C	260 °C	0.30 °C	0.38 °C
YSI 400	15 °C	50 °C	0.005 °C	0.007 °C
1. 2-wire output 2. Based on MINCO Application Aid No. 18.				

## 12.10 RTD and Thermistor Specification, Input

RTD Type	Range (° C)		Absolute Uncertainty, tcal ±5 °C, ±(°C) <sup>1</sup>	
			Output/Input	
	Minimum	Maximum	90 days	1 year
Pt 385, 100 Ω	-200 °C	-80 °C	0.011 °C	0.012 °C
	-80 °C	0 °C	0.018 °C	0.020 °C
	0 °C	100 °C	0.018 °C	0.020 °C
	100 °C	300 °C	0.027 °C	0.030 °C
	300 °C	400 °C	0.031 °C	0.035 °C
	400 °C	630 °C	0.042 °C	0.047 °C
	630 °C	800 °C	0.050 °C	0.057 °C
Pt 3926, 100 Ω	-200 °C	-80 °C	0.011 °C	0.011 °C
	-80 °C	0 °C	0.014 °C	0.015 °C
	0 °C	100 °C	0.018 °C	0.019 °C
	100 °C	300 °C	0.026 °C	0.029 °C
	300 °C	400 °C	0.031 °C	0.034 °C
	400 °C	630 °C	0.041 °C	0.046 °C
Pt 3916, 100 Ω	-200 °C	-190 °C	0.006 °C	0.006 °C
	-190 °C	-80 °C	0.011 °C	0.012 °C
	-80 °C	0 °C	0.014 °C	0.015 °C
	0 °C	100 °C	0.018 °C	0.019 °C
	100 °C	260 °C	0.025 °C	0.028 °C
	260 °C	300 °C	0.026 °C	0.029 °C
	300 °C	400 °C	0.031 °C	0.034 °C
	400 °C	600 °C	0.040 °C	0.045 °C
	600 °C	630 °C	0.042 °C	0.047 °C
Pt 385, 200 Ω	-200 °C	-80 °C	0.008 °C	0.009 °C
	-80 °C	0 °C	0.012 °C	0.013 °C
	0 °C	100 °C	0.015 °C	0.017 °C
	100 °C	260 °C	0.020 °C	0.022 °C
	260 °C	300 °C	0.050 °C	0.053 °C
	300 °C	400 °C	0.053 °C	0.057 °C
	400 °C	600 °C	0.070 °C	0.075 °C
600 °C	630 °C	0.071 °C	0.076 °C	
Pt 385, 500 Ω	-200 °C	-80 °C	0.007 °C	0.008 °C
	-80 °C	0 °C	0.019 °C	0.020 °C
	0 °C	100 °C	0.023 °C	0.025 °C
	100 °C	260 °C	0.030 °C	0.033 °C
	260 °C	300 °C	0.032 °C	0.035 °C
	300 °C	400 °C	0.037 °C	0.041 °C
	400 °C	600 °C	0.047 °C	0.052 °C
	600 °C	630 °C	0.048 °C	0.053 °C

1. 4-wire mode. Uncertainties listed do not include probe uncertainties.

## RTD and Thermistor Specification, Input (continued)

RTD Type	Range (° C)		Absolute Uncertainty, tcal ±5 °C, ±(°C) <sup>1</sup>	
			Output/Input	
	Minimum	Maximum	90 days	1 year
Pt 385, 1000 Ω	-200 °C	-80 °C	0.011 °C	0.012 °C
	-80 °C	0 °C	0.014 °C	0.015 °C
	0 °C	100 °C	0.019 °C	0.020 °C
	100 °C	260 °C	0.025 °C	0.028 °C
	260 °C	300 °C	0.027 °C	0.030 °C
	300 °C	400 °C	0.030 °C	0.034 °C
	400 °C	600 °C	0.041 °C	0.045 °C
Ni 120, 120 Ω	-80 °C	0 °C	0.009 °C	0.010 °C
	0 °C	100 °C	0.010 °C	0.011 °C
	100 °C	260 °C	0.011 °C	0.012 °C
Cu 427, 10 Ω <sup>2</sup>	-100 °C	260 °C	0.067 °C	0.069 °C
YSI 400	15 °C	50 °C	0.005 °C	0.007 °C
SPRT	-200 °C	660 °C	0.05 °C	0.06 °C

1. 4-wire mode. Uncertainties listed do not include probe uncertainties  
2. Based on MINCO Application Aid No. 18.

### 12.11 Pressure Measurement Specifications

The 3001 can accept either the Fluke Corporation 700 series pressure modules, Mensor Corporation 6100 series pressure modules, or BETA Calibrators Corporation BETA Port-P pressure modules. Pressure modules plug directly into the front panel Lemo connector with the 3001 firmware autodetecting the type and value of the module you are attaching.

<b>Range</b>	<b>Accuracy and Resolution</b>	<b>Units</b>
Determined by the pressure module	Determined by the pressure module	PSI(pounds per square inch)
		in H <sub>2</sub> O 4°C (inches of water at 4 degrees Celsius)
		in H <sub>2</sub> O 20°C (inches of water at 20 degrees Celsius)
		in H <sub>2</sub> O 60°F (inches of water at 60 degrees Fahrenheit)
		cm H <sub>2</sub> O 4°C (centimeters of water at 4 degrees Celsius)
		cm H <sub>2</sub> O 20°C (centimeters of water at 20 degrees Celsius)
		mm H <sub>2</sub> O 4°C (millimeters of water at 4 degrees Celsius)
		mm H <sub>2</sub> O 20°C (millimeters of water at 20 degrees Celsius)
		BAR (bars)
		mBAR (millibars)
		kPa (kilopascals)
		MPa (megapascals)
		in HG 0°C (inches of mercury at 0 degrees Celsius)
		mm HG 0°C (millimeters of mercury at 0 degrees Celsius)
		Kg/cm <sup>2</sup> (kilograms per square centimeter)

### **13. Warranty**

Martel Electronics Corporation warrants all products against material defects and workmanship for a period of twelve (12) months after the date of shipment. Problems or defects that arise from misuse or abuse of the instrument are not covered. If any product is to be returned, a "Return Material Authorization" number must be obtained from our Customer Service Department. This number must be indicated on the return package as notice to our Receiving Department to accept the shipment. Any package not so marked will not be accepted and will be returned to the shipper. Martel will not be responsible for damage as a result of poor return packaging. Out of warranty repairs and recalibration will be subject to specific charges. Under no circumstances will Martel Electronics be liable for any device or circumstance beyond the value of the product.



# **MARTEL** ELECTRONICS

[www.martelcorp.com](http://www.martelcorp.com)  
e-mail: [sales@martelcorp.com](mailto:sales@martelcorp.com)  
Fax: (603) 434-1653 Tel: (603) 434-1433  
800-821-0023

Martel Electronics  
PO Box 770  
Londonderry, NH 03053