

Nikon

FE10

Instruction Manual (P.2–P.31)
Bedienungsanleitung (S.32–S.61)
Manuel d'utilisation (P.62–P.91)
Manual de instrucciones (P.92–P.121)
使用説明書 (P122～151)
使用说明书 (P152～181)



English

Thank you for purchasing the Nikon FE10 camera. The FE10 is a compact, light weight manual focus SLR camera incorporating a TTL full-aperture exposure metering system. This feature enables automatic and manual exposure control operations for a wide range of shooting situations. Be sure to read this instruction manual thoroughly before use, and keep it close at hand until you have fully mastered the camera's operation.

Take some trial shots.

Before taking important pictures, be sure to take a few trial shots first to familiarize yourself with the camera and all its features.

—Nikon cannot be held responsible for malfunctions caused by using the FE10 in ways not specified in this manual.

Attaching the neckstrap

Attach the neckstrap (provided) as shown in the figure below.

- 1** Thread the triangle ring through the neckstrap eyelet and attach the strap.
—Make sure the tip of the strap comes through on the inside of the strap.
- 2** Adjust the length as shown.
—Adjust the length by pulling one end of the strap with the help of the black plastic ring provided.

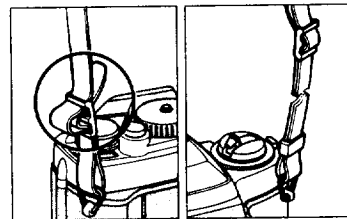

Contents

Attaching the neckstrap	2	Rewinding the film	19
Contents	3	B (bulb) setting	20
Nomenclature	4-5	Film plane indicator	21
Installing the batteries	6	Self-timer operation	21
Checking battery power	7	Flash photography	22
Loading the film	8-9	Holding the camera properly	23
Setting ISO film speed	10	Multiple exposure photography	24
Focusing	11	Infrared photography	25
Determining correct exposure (Aperture-priority automatic exposure mode)	12-13	Mounting and removing the lens	26
Using the AE-L (lock) button	14	Compatible lenses	26
Exposure compensation with ISO/film speed set ring	15	Optional accessories	27
Determining correct exposure (Manual exposure mode)	16-18	WARNING	28
Depth-of-field preview	18	Camera care tips	28-29
		Notes on batteries	30
		Specifications	31

Nomenclature

- 1 Shutter speed index
- 2 Shutter speed dial
- 3 Shutter speed dial lock button
- 4 Film advance lever
- 5 Shutter release button
- 6 Multiple exposure lever
- 7 Frame counter
- 8 Self-timer button
- 9 Neckstrap eyelet
- 10 Depth-of-field preview lever
- 11 Hand grip
- 12 Aperture ring
- 13 Zoom ring
- 14 Focusing ring
- 15 Hot shoe contact/ accessory shoe
- 16 Film plane indicator
- 17 Film rewind crank
- 18 Film speed lock lever
- 19 ISO/film speed indicator/
exposure compensation indicator
- 20 ISO/film speed set ring
- 21 AE-L (lock) button
- 22 Lens release button
- 23 Distance scale

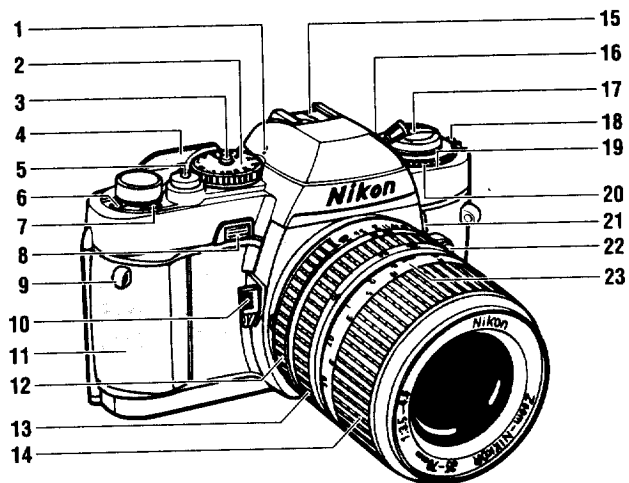

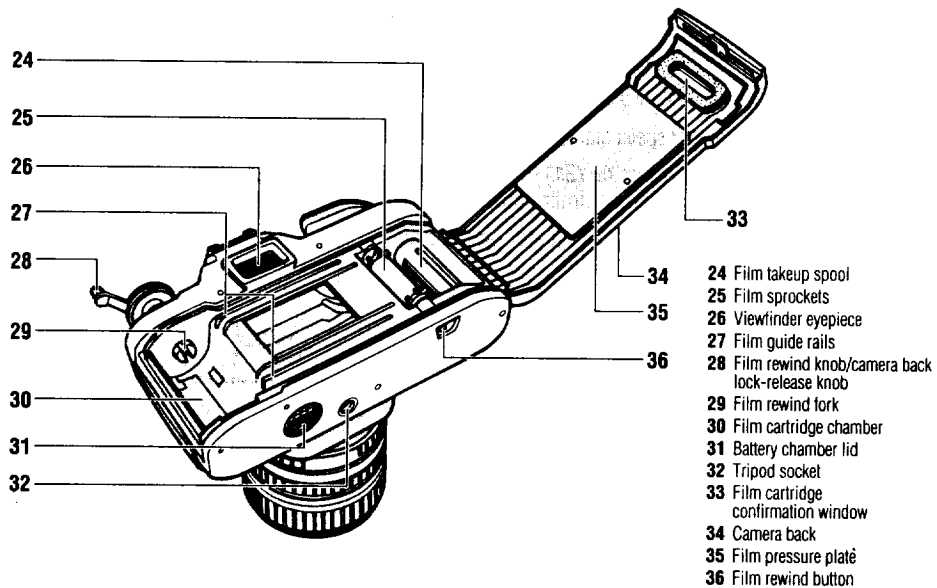

5

Installing the batteries

Caution: Keep batteries out of children's reach. If someone accidentally swallows a battery, call a doctor immediately.

Use two alkaline batteries (LR44), two silver batteries (SR44) or one lithium battery (CR-1/3N).

Note: Be sure to set the shutter speed dial to L (lock) when replacing batteries.

- 1** Unscrew the battery chamber lid (31) counter-clockwise using a small coin or similar object.
- 2** Place the batteries into the battery holder on the back of the battery chamber lid.
—Make sure that the "+" signs are lined up according to the indications on the side of the battery chamber lid.
- 3** Put the battery chamber lid back in its place and screw it in clockwise.

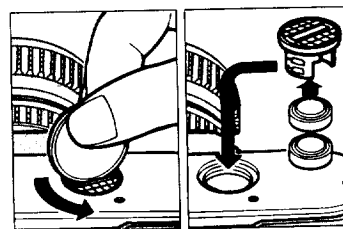

6

Checking battery power

- 1 Wind the film advance lever (4).
- 2 Set the shutter speed dial to any position other than L (lock).
- 3 While lightly pressing the shutter release button (5), look through the viewfinder eyepiece (26).
 - If any one of the three red LED indicators lights up, the camera is functioning normally. If none of the indicator lamps light up, either the battery is improperly installed or battery power is exhausted.
 - If battery power is exhausted, replace both batteries with fresh ones.

Note: Set the shutter speed dial to L when the camera is not in use to preserve battery power and prevent accidental shutter release.

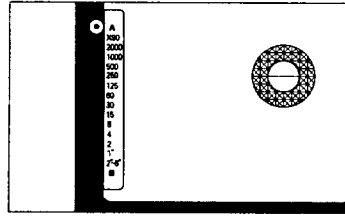

7

Loading the film

- Avoid loading or unloading the film in direct sunlight.
- Do not touch the shutter curtains with your finger or with the film leader when loading or unloading the film.

- 1 Pull out the film rewind knob (28) to open the camera back.
 - The frame counter (7) is reset to "S" when the camera back is opened.
- 2 Install the film cartridge.
 - Place the film cartridge in the film cartridge chamber (30) with the protruding part pointing downward.
- 3 Push the film rewind knob back down.
- 4 Pull the film leader across and insert it into one of the slots in the film takeup spool (24). Rotate the film takeup spool inward, making sure the latch in the slot engages the first or second perforation along the side of the film leader.

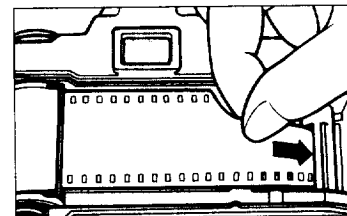
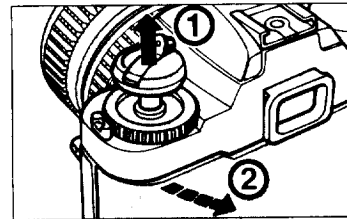

8

- 5** Wind the film advance lever to advance the film.
—Check to ensure the film is properly positioned between the film guide rails (27) and make sure that the film sprockets (25) engage the perforations on the edge of the film.
- 6** Gently close the camera back until it clicks shut.
- 7** Slowly rotate the film rewind crank in the direction of the arrow to take up film slack.
—Rotate the crank until there is no more slack and rotation becomes difficult.
- 8** Press the shutter release button and wind the film advance lever (blank exposures) until the frame counter reaches frame "1".
—Confirm that the film rewind knob rotates counter-clockwise as you wind the lever, indicating that the film has been loaded and advanced correctly.
—Slowly and securely wind the film advance lever.

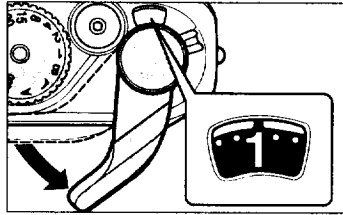
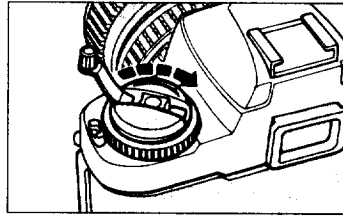

9

Setting ISO film speed

Check the film cartridge box or enclosed notice for ISO film speed numbers.

- 1** While sliding the film speed lock lever in the direction of the arrow, rotate the ISO/film speed ring (20).
- 2** Align the ISO/film speed indicator with the ISO value of the film in use.
—To perform the above operation correctly, the ring must click into position. Correct exposure cannot be obtained unless the film speed is set properly.
- 3** Remove your finger from the film speed lock lever to lock the ISO/film speed set ring.

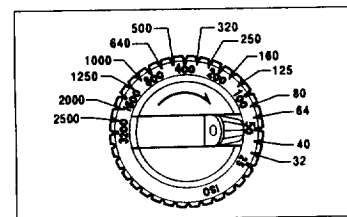
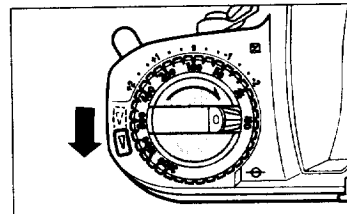

10

Focusing

The FE10 comes with a "K" focusing screen suitable for general photography, allowing three focusing aids: (A) Split image focusing, (B) Microprism focusing, and (C) Matte field focusing.

—Choose the most effective focusing aid depending on the shooting situation, lens used, subject, etc.

1 Look through the viewfinder and rotate the focusing ring.

- When focusing with the split image spot, turn the focusing ring until the image in the two halves becomes whole. When the upper and lower-half images are not in alignment, the subject is out of focus.
- When focusing with the microprism collar outside the center spot, turn the focusing ring until the shimmering image appears sharp.
- When focusing with the entire matte field, turn the focusing ring until the image looks sharp.

Note: As the FE10 viewfinder covers approx. 93% of the image area, the final picture area will be somewhat larger than the image in the viewfinder.

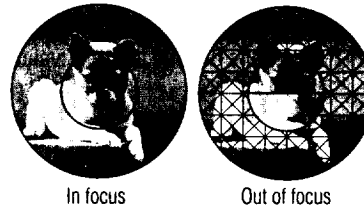
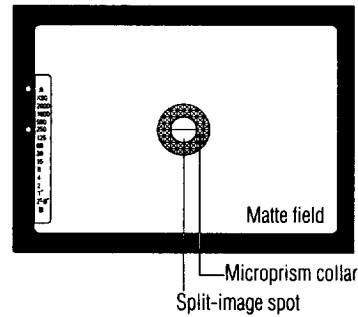

11

Determining correct exposure

Aperture-priority automatic exposure mode (suitable for portrait or landscape photography)

In this mode, the camera automatically sets the proper shutter speed corresponding to the brightness of the main subject by presetting the aperture.

Choose a suitable aperture value based on the brightness of the main subject, the desired depth-of-field and the speed of the film in use. Suggested aperture settings with ISO 100 film are shown in the table.

Main subject	Aperture (f/value)
In subdued light	f/1.4 to f/2
To narrow depth-of-field	f/1.4 to f/2
To deepen depth-of-field	f/11 to f/16
Indoors in normal conditions	f/2 to f/4
Outdoors on a cloudy day	f/4 to f/8
Outdoors on a fine day	f/8 to f/11
Seaside in midsummer	f/11 to f/16

- 1 While pressing the shutter speed dial lock button, rotate the shutter speed dial and align "A" with the shutter speed index.
- 2 Rotate the lens aperture ring in either direction to align the desired aperture value with the aperture index.

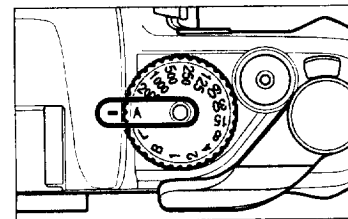

12

3 Look through the viewfinder and lightly press the shutter release button.

- The red LED indicator lamps inside the viewfinder light up next to the “A” mark and the suggested shutter speed.
- The red LED indicator next to the shutter speed scale moves up and down depending on the subject brightness and the aperture selected.
- If the red LED indicator lamp lights up next to 2”–8”, shutter speed is set to approx. 2 to 8 sec.
- If the red LED indicator lamp blinks at the “2000” mark, the main subject is too bright and overexposure will result. Choose a smaller aperture (higher f/value).
- The red LED indicator lamps remain lit inside the viewfinder for approx. 20 seconds after you remove your finger from the shutter release button.
- LED indicator lamp does not appear if the film has not been advanced.

Note: Use a tripod and/or cable release to minimize camera shake if the LED indicator lamp indicates a shutter speed value smaller than that of the focal length of the lens in use; for example if the LED indicator lamp shows 125 (1/125 sec.) or slower with a 135mm lens mounted. This applies even if the lens is set at its maximum aperture.

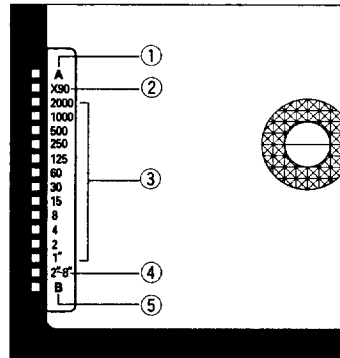

- ① A (Auto)
- ② Sync shutter speed
- ③ Shutter speed scale
- ④ 2”–8”
- ⑤ B (Bulb)

13

Using the AE-L (lock) button

In aperture-priority automatic exposure mode, when there is substantial difference in contrast between the main subject and the background, or the overall scene is unusually light or dark in tone, the photograph may be overexposed or underexposed. To ensure proper exposure, determine the correct exposure for the main subject and use the AE-L (lock) button.

- 1 Move the camera to center the main subject inside the viewfinder or move in closer until most of the viewfinder is covered by the subject.
- 2 Focus on the main subject.
- 3 Lightly press the shutter release button, and confirm that the red LED indicator lamp inside the viewfinder is lit. After lightly pressing the shutter release button, press the AE-L (lock) button.

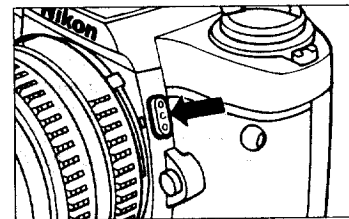

- When the AE-L (lock) button is pressed, exposure is locked, and it remains locked as long as the LED indicator lamp blinks next to “A”.
 - Approx. 20 seconds after removing your finger from the AE-L (lock) button, the red LED indicator lamp next to “A” stops blinking, and AE-L (lock) is canceled.
 - Exposure cannot be locked if you press the AE-L (lock) button without also pressing the shutter release button halfway.
- 4 Recompose, focus on the subject and shoot.
 - When the shutter is released, the AE-L (lock) is automatically canceled.
 - Press the AE-L (lock) button again to cancel the AE-L (lock) before shooting.

14

Exposure compensation with ISO/film speed set ring

In cases such as those described in "Using the AE-L (lock) button" above, you can perform exposure compensation within a range of ± 2 steps (in $1/3$ increments) by turning the ISO/film speed set ring.

Film speed	Exposure compensation possible				
	ISO 25	ISO 50	ISO 100-800	ISO 1600	ISO 3200
+ direction	0	+1 step	+2 steps	+2 steps	+2 steps
- direction	-2 steps	-2 steps	-2 steps	-1 step	0

- 1 While sliding the film speed lock lever in the direction of the arrow, rotate the ISO/film speed ring (20).
- 2 Align the exposure compensation indicator with the appropriate compensation value.
—To perform the above operation correctly, the ring must click into position. Correct exposure cannot be obtained unless exposure compensation is set properly.
- 3 Remove your finger from the film speed lock lever to lock the ISO/film speed set ring.

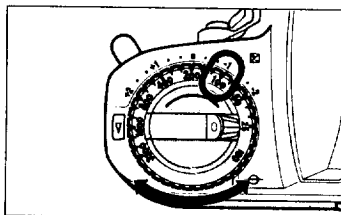
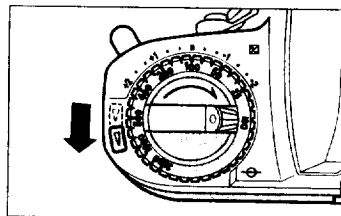

15

Determining correct exposure

Manual exposure mode

Suggested shutter speed settings with ISO 100 film are shown in the table.

- With bright subjects, fast moving subjects or high ISO film speeds, select a higher shutter speed.
- Select a higher shutter speed to minimize camera shake when using a telephoto lens.

- 1 Rotate the shutter speed dial (2) to align the desired shutter speed number with the shutter speed index (1).
—To rotate the dial from the "A" setting, depress the shutter speed dial lock button.
—Note that intermediate shutter speeds between the printed numbers cannot be used. Be sure to rotate the shutter speed dial until it click-stops otherwise a correct shutter speed cannot be obtained.
—When using the B (bulb) setting, the exposure display does not work.
—When set to L (lock) position, the shutter is locked.

Main subject	Shutter speed (sec.)
Stationary subjects in subdued light	1 to 1/15
Indoors in normal conditions	1/30 to 1/60
Outdoors on a fine day	1/125 to 1/250
Seaside in midsummer	1/500 to 1/2000
Mountain area with snow	1/500 to 1/2000
Fast moving subjects	1/500 to 1/2000

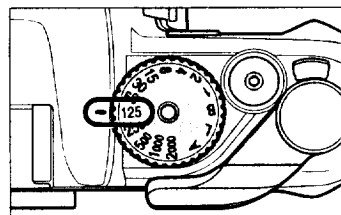

—On the shutter speed dial: "2000" means $1/2000$ sec., "1" means $1/1$ sec., and "B" means bulb.

16

2 Look through the viewfinder and lightly press the shutter release button.

—The red LED indicator lamp inside the viewfinder blinks next to the recommended shutter speed.

—The red LED indicator lamps remain lit inside the viewfinder for approx. 20 seconds after you remove your finger from the shutter release button. Should you press the AE-L (lock) button after lightly pressing the shutter release button, the red LED indicator lamps will stay lit for another 20 seconds.

3 Rotate the aperture or shutter speed dial and align the red LED indicator lamp with the blinking lamp inside the viewfinder.

—Once the two LED indicator lamps merge, the blinking stops and you can obtain a correct exposure.

—In manual exposure mode, the shutter speed changes by one-stop. If the LED indicator lamps inside the viewfinder light up and blink at an aperture less than one f/stop, select a half f/stop on the lens aperture ring.

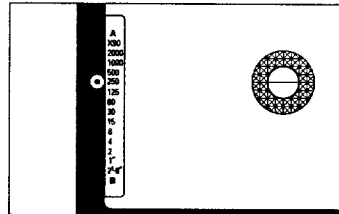
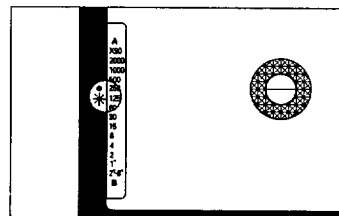

Note: When shooting extremely light or dark subjects, the correct exposure display cannot appear because the subject exceeds the camera's metering range of EV1–EV18.

17

What is EV value?

Exposure value (EV) is a number representing a variable combination of shutter speed and aperture producing the same exposure effect when the scene brightness and ISO remain the same.

At ISO 100, a shutter speed of 1 second at f/1.4 is defined as EV1. If the aperture is stopped down by one full f/stop (or the shutter speed is one step faster), the EV increases by one; if the aperture is opened up by one full f/stop (or the shutter speed is one step slower), the EV decreases by 1. For example, using ISO 100, 1 sec. at f/2 is EV2, 1 sec. at f/5.6 is EV5, while 1/125 sec. at f/8 is EV13. As the exposure is the same, 1/125 sec. at f/8 and 1/250 sec. at f/5.6 are also EV13.

Depth-of-field preview

Depth-of-field is the in-focus area behind and in front of a subject. Depth-of-field preview enables you to check the depth-of-field at any given aperture by looking through the viewfinder for creative effect.

1 Set the aperture to the desired f/stop, and depress the depth-of-field preview lever (10).

2 Look through the viewfinder and check the depth-of-field.

Note

- Fully depress the depth-of-field preview lever.
- Do not release the shutter or advance film while depressing the preview lever; as it may cause improper exposure or camera malfunction.

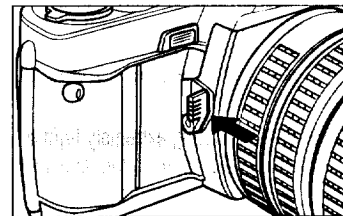

18

Rewinding the film

Avoid rewinding or unloading film in direct sunlight.

- 1** Toward the end of a roll of film, check the frame counter (7) as you rewind the film.
—If the frame counter shows that all frames have been exposed, rewind the film.
- 2** Press the film rewind button (36) on the camera base.
—You don't have to keep pressing, once is enough.
- 3** Lift the film rewind crank (17) and turn it in the direction of the arrow.
—When the crank feels lighter and there is no more resistance, the film is fully rewound.
- 4** Pull the film rewind knob to open the camera back. Remove the film cartridge.
—Do not open the camera back until the film is fully rewound, otherwise light comes into the camera, exposing the film.

Note: If the film reaches the end of the roll while you are advancing the film, the film advance lever will lock. Stop trying to advance the film. Rewind the entire roll, then complete the movement of the film advance lever and set it back into position.

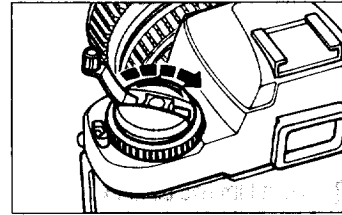
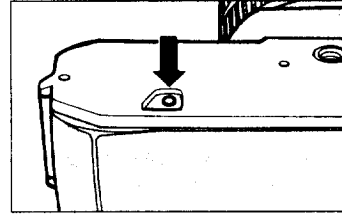

19

B (bulb) setting

This setting is useful when an exposure longer than one second is required, such as in landscape photography at night.

- Use of a tripod and/or cable release is recommended.
- Be sure to attach the optional eyepiece cover DK-5 when you shoot with your eye away from the viewfinder to prevent stray light from entering the viewfinder and affecting exposure.
- The self-timer does not work in B setting.

- 1** Set the shutter speed dial to B.
- 2** Depress the shutter release button.
—The red LED indicator lamp lights up next to "B" inside the viewfinder.
—The shutter remains open as long as the shutter release button is depressed.
- 3** When film has been exposed for a predetermined period of time, remove your finger from the shutter release button to stop B (bulb) operation.

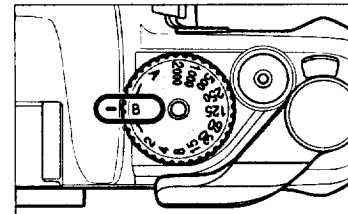

20

Film plane indicator

The film plane indicator shows the exact position of the film plane inside the camera and is used to measure the distance between subject and film plane, such as in macrography.

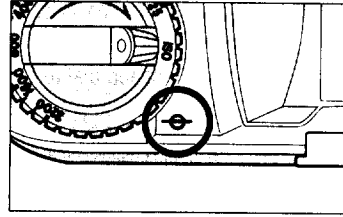

Self-timer operation

- 1 First compose the picture and check the focus, then press the self-timer button (8).

—The self-timer indicator lamp blinks for 8 sec., then stays lit for 2 sec. before the shutter is released.

Note

- To cancel self-timer operation after it has been selected, press the shutter release button or set the shutter speed dial to "L".
- The self-timer can be used with any shutter speed except for B (bulb).
- You can use the self-timer instead of a cable release to prevent camera shake during shutter release.

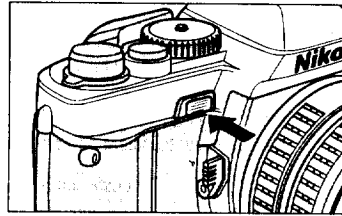

21

Flash photography

Mount the Nikon speedlight on the camera's hot shoe contact/accessory shoe (15).

—For more details, refer to the instruction manual provided with each speedlight.

- 1 Set the shutter speed dial to "A", or 1/60 sec. or slower.

—Lightly press the shutter release button, the red LED indicator lamp (next to X90 or shutter speed set) inside the viewfinder light up.

—When the shutter speed dial is set to "A" or set manually between 1/2000 and 1/125 sec., sync shutter speed is automatically switched to X90 by turning ON the speedlight power. With the shutter speed dial set manually between 1/60 and 1 sec., flash output is controlled at the shutter speed set.

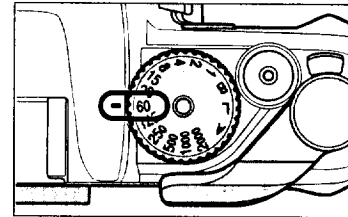

- 2 Set the aperture.

—When using a speedlight in auto flash mode, set the aperture value specified in the instruction manual of the speedlight.

—When using a speedlight in manual flash mode, select an aperture value by using the following equation.

$$\text{Aperture (f/stop)} = \frac{\text{guide number (GN)}}{\text{flash-to-subject distance (m)}} \times \sqrt{\frac{\text{ISO}}{100}}$$

Note: Do not use flash units made by other manufacturers since the camera may not work correctly.

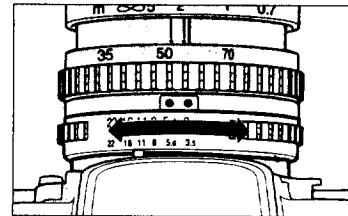

22

Holding the camera properly

- Use your left hand to cradle the bottom of the camera, with your thumb and index fingers wrapped around the focusing ring of the lens so that you can rotate it.
- Hold the hand grip lightly with your right hand, use your index finger of your right hand to depress the shutter release button.
- Keep your elbows in against the body, and steady the camera against your forehead as you look through the viewfinder eyepiece.

Note: Use of a tripod and/or cable release is recommended to minimize camera shake when using a telephoto lens or selecting slow shutter speeds.

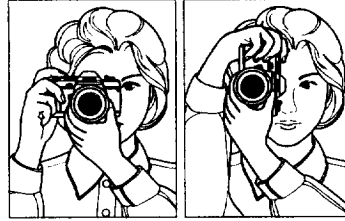

23

Multiple exposure photography

Overlapping several images on the same frame can produce special creative effects.

- 1** Press the shutter release button to take the first shot.
- 2** While pulling the multiple exposure lever (6) as far as it will go, wind the film advance lever fully.
—Make sure that the frame counter does not advance.
- 3** Press the shutter release button to take the second shot.

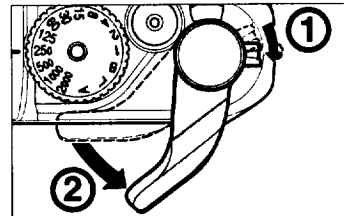

- 4** Repeat steps “2” and “3” above to take any number of multiple exposures.

—In multiple exposure photography, since several exposures are taken on the same frame, correct exposure is an aggregate of each successive exposure. We recommend using exposure compensation when the main subject overlaps over the background. Refer to the following values as a guide.

2 exposures: -1.0 3 exposures: -1.5 4 exposures: -2.0

Take a few test shots. If the background of the first shot is totally dark, and the subject of the next shot does not overlap another subject within the frame, as a rule exposure compensation is not necessary.

Note

- Do not touch the multiple exposure lever when advancing film unless taking multiple exposures.
- In multiple exposure photography, the FE10 is designed to reduce film dislocation to the minimum. But it may occur due to film curling, film slack or inappropriate film winding.
- Before having your pictures developed, we recommend informing the photo lab that some multiple exposures are included in the film.

24

Infrared photography

When using infrared film and filters, note that the plane of sharpest focus is slightly farther away than in visible-light photography. You can compensate for this shift in focus by referring to the infrared compensation index (green or yellow index with red line) on the lens barrel.

Note: For further details on infrared photography, refer to the instruction manual provided with the infrared film.

- 1 Look through the viewfinder with no filter attached, and focus on the subject.
- 2 Read the focus distance and rotate the focusing ring to align it with the infrared compensation index.
 - Align the distance with the green index for a 35mm (wide) side.
 - Align the distance with the yellow index for a 70mm (telephoto) side.
- 3 Be sure to attach the appropriate filter, such as an R60, etc. and take the shot.

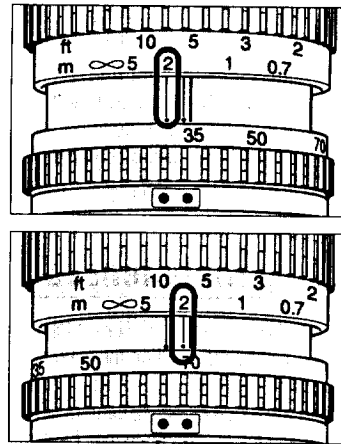

25

Mounting and removing the lens

- Avoid mounting or removing the lens in direct sunlight.
- Do not press the lens release button when mounting the lens.

- 1 Align the lens mounting index (white) on the camera body with the focusing index on the lens, and twist the lens counter-clockwise.
 - Rotate the lens until it clicks into place.
- 2 To remove the lens, push the lens release button (22) and rotate the lens clockwise until the lens comes off.

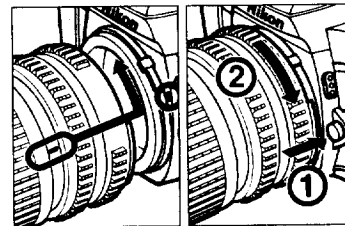

Compatible lenses

AI-type Nikkor lenses, AF Nikkor lenses, Nikon Series E lenses, Reflex Nikkor lenses, and Medical-Nikkor lenses can be mounted on the Nikon FE10 camera. Other Nikkor lenses are not compatible because these lenses do not make contact with the FE10's meter coupling lever on the camera body, and some lenses simply cannot be mounted on the camera. (Do not try to mount these lenses on the camera, as the lens may become stuck and the camera body may be damaged).

The following non-AI-type Nikkor lenses can be used:

- Reflex Nikkor 500mm f/8 lens
- PC-Nikkor 28mm f/3.5 lens
- Medical Nikkor 120mm f/4 lens

26

Optional accessories

Speedlights

Nikon Speedlights SB-27, SB-26, SB-22, and SB-16B can be used with the FE10. Speedlights are convenient for shooting in dim light or taking backlit portraits.

- The above Nikon Speedlights can be mounted directly onto the FE10's built-in hot shoe with no sync cord connected.
- With these Speedlights, flash photographs can be taken in non-TTL auto flash or manual flash modes. (For further details, read the instruction manual provided with each speedlight.)

Close-up equipment

Attach close-up lenses No. 0, No. 1 and No. 2 to the front of the lens. The Auto Extension Rings PK-11A, PK-12, PK-13, and Bellows Focusing Attachment PB-6 are attached between the lens and the camera body.

Viewfinder accessories

Rubber eyecup (square), eyepiece correction lenses (9 types), eyepiece adapter, eyepiece magnifier DG-2, eyepiece cover DK-5, and cable release AR-3 fit onto the viewfinder eyepiece or the camera body.

27

WARNING

- Do not disassemble or modify the camera, as this can result in malfunction or injury.
- Do not look at the sun or a strong light source directly through the viewfinder, as this may cause damage to the retina. Looking at the sun directly through the lens may result in permanent eye damage.
- Do not carry the camera when mounted on a tripod, to avoid injury resulting from a fall.
- If you detect smoke around the camera, immediately cease operation and turn OFF the camera. Remove the batteries and take it to your local Nikon dealer.
- Do not throw used batteries into the fire. Do not short circuit, disassemble or heat batteries: this may cause them to explode, resulting in injury.
- Follow the WARNING and CAUTION notices printed on the batteries.
- Keep batteries out of the reach of children. If someone accidentally swallows a battery, call a doctor immediately.
- Do not fire the flash close to people's eyes, as this may cause visual injury.

Camera care tips

- Never use thinner, benzene, or other active agents to clean the camera body and lens, as this may start a fire or result in damage to your health or your camera.
- Do not drop or hit the camera against a hard surface as it may cause damage to the precision mechanism and malfunction. Do not touch the shutter curtains as these are easily deformed resulting in damage to your camera.

28

- Prevent foreign matter from entering inside the camera through the lens mount or the camera back as this can cause damage or malfunction.
- As this camera is not waterproof, take care not to splash water on to it. If water is present, parts may corrode, increasing repair costs; in extreme cases, repair may be impossible.
- Use a blower to remove dust from the lens, mirror, or focusing screens. If necessary use a soft, dry cloth to clean stains such as fingerprints on the lens.
- Extreme changes in temperature (carrying the camera from the cold outside to a warm indoors or vice versa) may cause dew condensation to form on both the inside and the outside of the camera. This may cause the camera to malfunction. Put the camera into a vinyl bag to allow it to adjust gradually to temperature changes before use.
- Use a blower to remove dust from the camera and then wipe the camera clean with a soft, dry cloth. Wipe off salt using a cloth moistened with fresh water before cleaning the camera.
- Use a desiccating agent to store the camera in a polyethylene bag for safer keeping. Avoid storing a soft case in a vinyl bag as it may degrade. We recommend replacing the desiccating agent occasionally as it becomes ineffective due to absorption of humidity.
- Store the camera in a cool, dry place. Do not expose to chemicals such as camphor and naphthalene. Do not leave the camera near electronic appliances subject to electromagnetic wave (e.g. TVs and radios). Avoid leaving the camera in excessively hot places such as a car, a trunk or near a heater.
- Never disassemble the camera if the camera malfunctions or does not work.
- If the camera and lens are not used for a long time, they may get moldy and malfunction. Take the camera out once a month, turn the power ON and release the shutter several times.

29

Notes on batteries

- If the camera is not in use for a long time, remove the batteries from the camera body to protect the camera from leakage of battery corrosion and keep them in a cool, dry place below 20°C (68°F).
- When using exhausted batteries in cold temperature, the exposure display may not work. Use fresh batteries or carry spare batteries, keeping them warm alternately, when taking pictures in cold temperature. Weakened battery power due to a drop in temperature usually recovers when the temperature comes back to normal.
- Turn the camera power OFF when replacing the batteries. Make sure the battery terminals (+), (–) are correctly oriented.
- Do not disassemble, short-circuit, heat or throw used batteries into a fire, as an explosion may result.
- When replacing batteries, be sure to replace all the batteries at the same time. Always use fresh batteries of the same brand, otherwise battery life may be shortened or poor contact may result.

Specifications

Type of camera:	Electronically-controlled 35 mm single-lens reflex (SLR) focal plane shutter camera	Film advance:	By single lever-action. Double film advance and double exposure prevent mechanism provided.
Exposure mode:	Aperture-priority auto / manual exposure modes	Multiple exposure:	Provided via lever
Exposure metering:	Through-the-lens (TTL), center-weighted, full-aperture, stop-down exposure measurement	Film rewind:	By crank provided after film rewind button is pressed. (Film rewind button is automatically reset when film advance lever is wound.)
Metering range:	EV1 to EV18 (1 sec. at f/1.4 to 1/2000 sec. at f/11 using 50mm f/1.4 lens)	Frame counter:	Additive type; automatically resets to "S" when camera back is opened.
Usable film:	Any cartridge-type 35 mm film	Film speed range:	ISO 25 to 3200, in 1/3 steps with lock (ISO 100, 400 (red) in manual mode)
Picture format:	24 mm x 36 mm	Exposure compensation:	By ISO/film speed set ring within a range of ± 2 steps (in 1/3 increments) for film speeds ranging from ISO 100 to 800.
Lens mount:	Nikon F bayonet mount	AE-L (lock):	Via AE-L (lock) button in A mode
Shutter:	Electronically controlled vertical-travel metal focal plane shutter	Self-timer:	Electronic self-timer with 10 sec. shutter release delay, cancelable by pressing shutter release button again
Shutter speeds:	8 to 1/2000 sec. in A (auto) mode; 1 to 1/2000 sec. and B (bulb) in manual mode	Hot shoe contact/ accessory shoe:	Hot shoe only (with ready-light contact provided)
Sync shutter speed:	Automatically set to 1/90 sec. in auto mode (LED indicator lamp lights up next to X90 in the viewfinder.) 1/60 sec. or slower set manually (automatically switches to X90 when the shutter speed is set to between 1/2000 and 1/125 sec.)	Depth-of-field preview:	Provided: via lever on front of camera
Viewfinder:	Eye-level pentaprism type; approx. 0.84x magnification with 50mm lens set at infinity, approx. 93% frame coverage.	Tripod socket:	1/4 inch
Viewfinder display:	16 red LED indicator lamps (lighting up or blinking). Shooting mode: A, X90, or B. AUTO: LED lights up next to shutter speeds of 1/2000 to 1 sec., and 2"-8" (in 13 steps). Manual: LED lights up at 1/2000 to 1 sec. (12 steps) and B. Overexposure warning: LED blinks next to 1/2000	Power source:	Two 1.5V alkaline batteries (LR44), two silver batteries (SR44) or one 3V lithium battery (CR-1/3N)
Focusing screen:	Split-image micropism type (Type K)	Power switch:	Power is turned OFF by setting the shutter speed dial to L. Turned ON by pressing shutter release button halfway.
Mirror:	Quick-return type	Battery power check:	Press shutter lightly: red LED lamps light up indicating normal function.
		Dimensions (WxHxD):	Approx. 139 x 86 x 53 mm (5.5 x 3.4 x 2.1 inch)
		Weight (without batteries):	Approx. 400g (14.1 oz)

Specifications apply with fresh batteries used at normal temperature of 20°C (68°F).
Specifications are subject to change without notice.

31

No reproduction in any form of this manual, in whole or in part (except for brief quotation in critical articles or reviews), may be made without written authorization from NIKON CORPORATION.

Alle Rechte, auch die des auszugsweisen Nachdrucks (mit Ausnahme kurzer Zitate in technischen Besprechungen) ohne schriftliche Genehmigung durch NIKON CORPORATION, bleiben ausdrücklich vorbehalten.

Toute reproduction, en tout ou partie, de ce manuel est, sauf pour de brèves citations dans des bancs d'essai ou des articles de presse, interdite sans l'autorisation écrite de NIKON CORPORATION.

Queda prohibida la reproducción total o parcial de esta folleto (salvo en lo que se refiere a citas breves en artículos o revistas especializadas), sin la autorización escrita de NIKON CORPORATION.

沒有獲得日本株式會社尼康書面許可，不可擅自影印此說明書的型式，部分或全部內容（但摘要引用作評論文章除外）。

沒有獲得日本株式會社尼康書面許可，不可擅自影印此說明書的型式，部分或全部內容（但摘要引用作評論文章除外）。

Nikon

NIKON CORPORATION

FUJI BLDG., 2-3, MARUNOUCHI 3-CHOME, CHIYODA-KU, TOKYO 100, JAPAN
PHONE: 81-3-3214-5311 TELEX: NIKON J22601 FAX: 81-3-3201-5856

株式會社尼康

日本國東京都千代田區丸之內3-2-3富士大樓
電話：81-3-3214-5311 用戶電報：NIKON J22601
傳真：81-3-3201-5856

株式会社尼康

日本國東京都千代田區丸之內3-2-3富士大樓
電話：81-3-3214-5311 用戶電報：NIKON J22601
傳真：81-3-3201-5856