

Nikon

FM10

INSTRUCTION MANUAL
MANUEL D'UTILISATION
MANUAL DE INSTRUCCIONES
使用說明書 使用说明书

E
F
S
C

Congratulations on your selecting of Nikon Single Lens Reflex camera. This is a compact and lightweight SLR camera with full open aperture TTL exposure metering. Enjoying good photography becomes far easier with this camera. It just requires releasing the shutter on your focused subject at the setting which the LED displays green. With carefully reading this booklet, you can enjoy easy-to-take highest quality photography for the years ahead.

English
P1-P23

Nous tenons avant tout à vous remercier pour avoir porté votre choix sur un de nos produits: le FM10. Compact et léger, caractérisé par une mesure d'exposition TTL à pleine ouverture, cet appareil renferme aussi quelques caractéristiques nouvelles qui rendront son utilisation plus facile que jamais. Il suffira, par exemple, d'appuyer sur le déclencheur au moment précis où la mise au point du sujet provoque l'allumage de la LED de couleur verte. La lecture attentive de ce mode d'emploi vous permettra d'obtenir des prises de vues de qualité pendant une période prolongée.

Français
P24-46

Felicitaciones por haber elegido Nikon FM-10, nuestra compacta y ligera cámara fotográfica SLR, con la capacidad de medir la exposición TTL de abertura total, que le permitirá obtener fácilmente buenas fotografías. Para accionar, simplemente dispáre el obturador al encenderse la luz verde del diodo emisor que se prende al enfocar al sujeto. Antes de usar nuestra cámara y disfrutar de buenas fotografías, le recomendamos leer detenidamente este manual de instrucciones.

Español
P47-69

序文

感謝您選購尼康單鏡反光相機。本單鏡反光相機，結構精密，輕巧，帶全開光圈TTL測光。使用本相機，將極容易拍攝高質素照片，只要對準攝影對象，在LED指示亮綠燈時按下快門鈕即可。仔細閱讀本說明書，在今後悠長的歲月裏，您可享受拍攝高質素照片的樂趣。

中國語
P70-P92

序文

感谢您选购尼康单镜反光相机。本单镜反光相机，结构精密，轻巧，带全开光圈TTL测光。使用本相机，将极容易拍摄高质素照片，只要对准摄影对象，在LED指示亮绿灯时按下快门按钮即可。仔细阅读本说明书，在今后悠长的岁月里，您可享受拍摄高质素照片的乐趣。

中国語
P93-P115

Description of Parts

1. Shutter Speed ISO/
Film speed Set Ring
2. Shutter Release
Button
3. Film Advance Lever
4. Frame Counter
5. Neck Strap Eyelet
6. Hand Grip
7. Self-timer Lever
8. Lens Release Button
9. Hot Shoe Contact/
Accessory Shoe
10. Film Rewind Crank
11. Film Rewind Knob
12. Filmspeed Window
13. Aperture Ring
14. Distance Scale
15. Focusing Ring
16. Depth-of-field
Preview Lever
17. Multiple Exposure
Lever
18. Exposure Measure-
ment Button

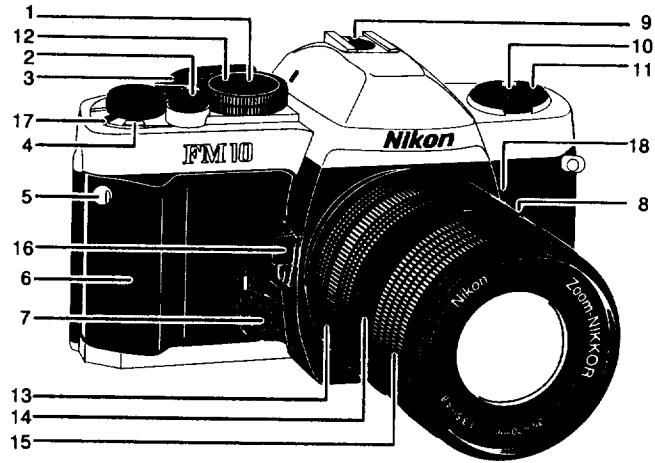

1

- 1 -

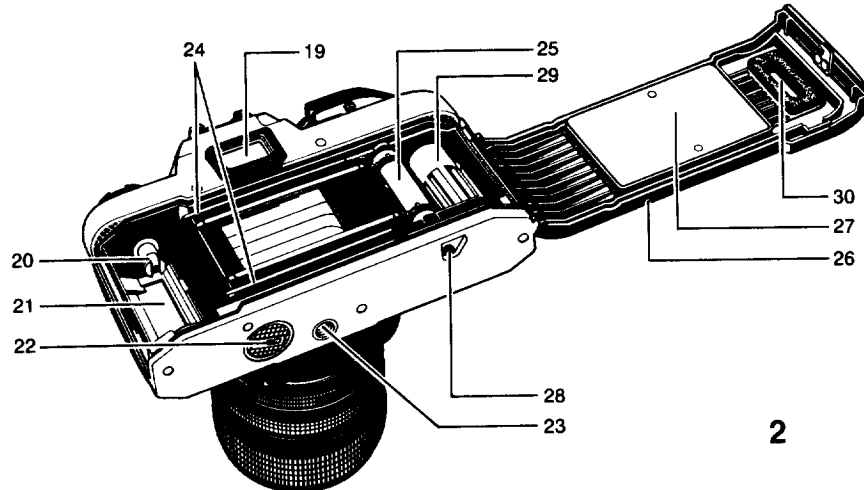

2

19. Viewfinder Eyepiece
20. Rewind Fork
21. Film Cartridge Chamber
22. Battery Chamber Lid
23. Tripod Socket
24. Film Guide Rails

25. Film Sprockets
26. Camera Back
27. Film Pressure Plate
28. Film Rewind Button
29. Film Takeup Spool
30. Film Cartridge Confirmation Window

- 2 -

Inserting Batteries

1. Turn the battery chamber lid (22) counterclockwise using a coin or something similar.
2. Two LR44 type alkaline batteries or two SR44 type silver batteries are used with this camera.
3. Place the batteries so that both positive (+) sides are at the bottom of the compartment.
4. Turn the battery compartment cover clockwise until it closes firmly.

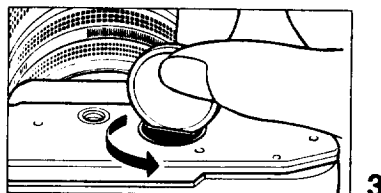

Battery Check

1. Move the film advance lever (3) to the ready position.
2. Lightly press the shutter release button (2). Now the exposure metering system is switched on. Next, look through the viewfinder. When one of three LED lamps (○, ⊕, or =) lights, then battery condition is satisfactory. If no lamp lights, the batteries need replacing or have been loaded incorrectly.
3. Renew both batteries as necessary.
4. When not using of the camera, always return the film advance lever to the original position to prevent accidentally releasing the shutter.

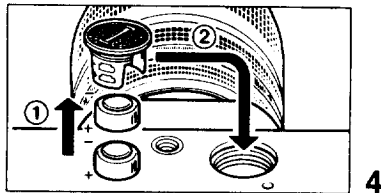

Caution: Keep batteries away from infants and small children. In case a battery is accidentally swallowed, call a doctor immediately as the material inside the batteries can cause serious problems.

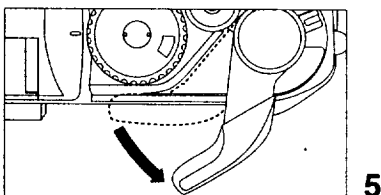

- 3 -

Loading Film

1. To open the camera back (26), pull knob (11) out. When the back cover opens, the frame counter (4) automatically resets to "S".
2. Insert the film cartridge into the film chamber so that the projecting end of the film cartridge is downward. Do this in a place away from direct sunlight.
3. Fold out and lift up the film rewind crank (10). Then rotate the crank carefully while push in it down lightly until the film locks on the film rewind fork (20).
4. Return the film rewind knob to its original position.
5. Insert the film leader into the groove of the film takeup spool (29) and place it so that the film perforations engage with the spool teeth.
6. Check that the film perforations engage properly with the teeth of sprocket (25) and the film slides smoothly along the film guide rails (24) by operating lightly the film advance lever (3) to advance the film.

Caution: Do not touch the shutter curtains.

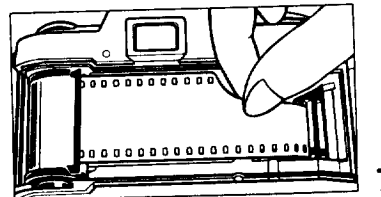
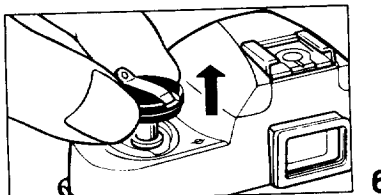

- 4 -

7. Turn the film rewind crank gently in the direction of the arrow to properly tension the loaded film. Stop turning the crank when it becomes stiff, and return the crank to its original position.
 8. Gently close the back cover and push it until it clicks.
 9. Advance the film a couple of frames, pressing the shutter release button each time, until the frame counter indicates "1" between 0 and 2.
(In this case, the film advance lever should be at the ready position, because the shutter release is interlocked when the lever is in the stored position).
The film rewind knob rotates each time the film is advanced showing that the film is advancing properly.
- ※ When advancing the film, wind the film advance lever slowly and securely until the film is fully transported to the next frame.

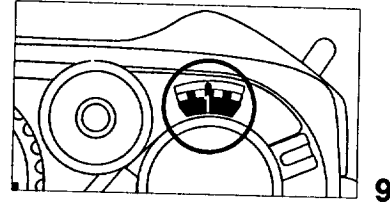
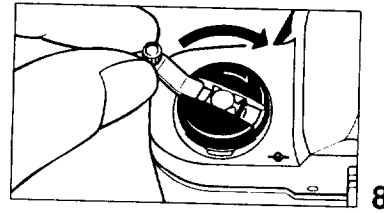

- 5 -

Filmspeed Setting

1. Filmspeed is indicated on the outside of the film package or in the film instructions.
2. To set the filmspeed: while raising the filmspeed setting ring turn it until the arrow indicator on the inner ring points the corresponding filmspeed (ISO) value which is seen through the filmspeed window.

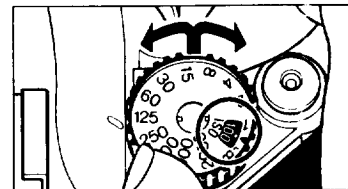

10

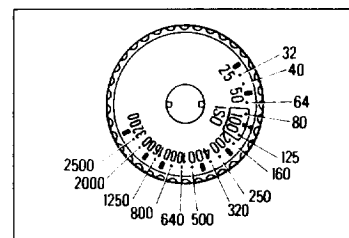

11

- 6 -

**Exposure Setting
(shutter speed priority)**

1. Place the film advance lever (3) in the ready position and turn the shutter speed dial so that the indicator white line aligns with the desired shutter speed value. Then if the dial is set at the intermediate positions of the index, shutter speed will be incorrect. Be sure that the dial clicks at the position where the white line aligns with the desired value.

With setting at "B" (bulb) position, exposure monitoring is impossible.

2. With brighter subjects, fast moving subjects or with the higher value film speed of the film used, it is recommended to use higher shutter speeds.
3. In photography using, telephoto lenses, use the highest shutter speed possible to avoid camera shake affecting your pictures. Generally selecting a higher shutter speed value than the focal length of the lens is recommended, i.e. 1/250s shutter speed is recommended for a telephoto lens with 135 mm focal length, and 1/500s for 300 mm focal length.

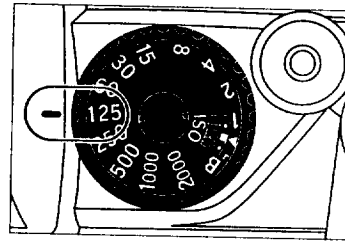

12

- 7 -

4. Recommended shutter speed with ISO 100/21* film and standard 35-70 mm focal length lens under typical situation is as follows:

Subject	Shutter speed
Stationary subjects In subdued light	1 to 1/15
Indoors in normal conditions	1/30 to 1/60
Outdoors on a fine day	1/125 to 1/250
Seaside in midsummer	1/500 to 1/2000
Mountain area with snow	
Fast moving subjects	

5. To monitor exposure, lightly press the shutter release button (2) and turn the aperture ring (13) until the green \circ mark lights in the viewfinder. When the red \oplus mark lights, it means over exposure. So turn the aperture ring in the direction of greater f/value. If the red \ominus mark lights, it means under exposure, so turn the aperture ring (13) to a smaller f/value.

Note: Outside the exposure metering range of your camera (EV2 to EV19), the exposure meter will not function properly and the green LED indicator may come on indicating incorrect exposure.

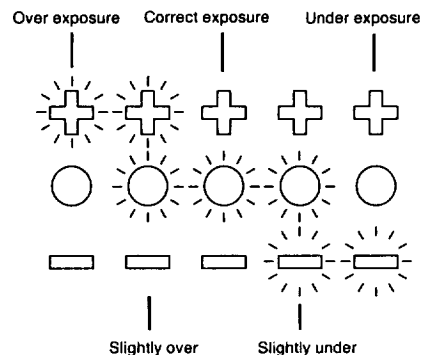

- 8 -

Exposure Setting (aperture priority)

- Place the film advance lever (3) in the ready position and turn the aperture ring (13) until the index on the lens barrel indicates the desired f/ value.
- The suitable aperture value changes according to the brightness of the subject, the depth-of-field desired or filmspeed of the film in use, and typical settings of the aperture with ISO 100/21* film are as follows:

Subject	F/value
In subdued light	F/1.4 to F/2
To narrow depth-of-field	
Indoors in normal conditions	F/2 to F/4
Outdoors on a cloudy day	F/4 to F/8
Outdoors on a fine day	F/8 to F/11
Seaside in midsummer	F/11 to F/16
Mountain areas with snow	

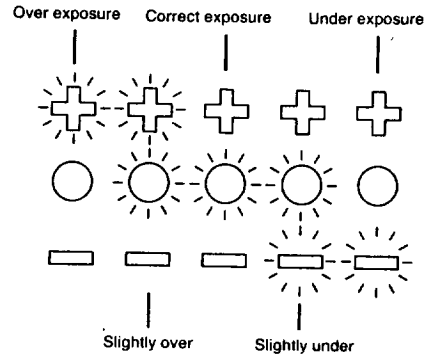

- To monitor the exposure, press the Exposure measurement button (18) and turn the shutter speed dial until the green ○ mark lights in the viewfinder. If the red ⊕ mark lights, turn the shutter speed dial to the higher shutter speed setting and if the red ⇐ mark lights, then turn the shutter speed dial to the lower shutter speed setting. When the green ○ mark lights at intermediate positions between click, first set the dial at a click on either side and make fine control by operating the aperture ring afterwards.

Note: Outside the exposure metering range of your camera (EV2 to EV19), the exposure meter will not function properly and the green LED indicator may come on indicating incorrect exposure.

Multiple Exposure Photography

The Multiple Exposure capability is a creative option used to take several different images on the same film frame.

1. Press the Shutter Release Button to make the first shot.
 2. Turn the film advance lever, while turning the Multiple Exposure Lever toward you. Frame Counter will not advance during multiple exposure photography.
 3. Press the Shutter Release Button to make the second shot. Repeat the process of No. 2-3 for as many times as you want.
- ※ If you touch the multiple exposure lever while winding the film by turning the film advance lever, the multiple exposure mechanism may be activated.

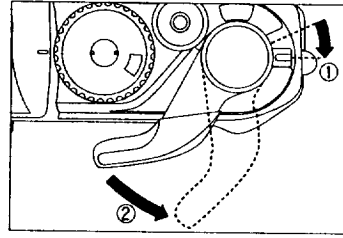

13

- 11 -

Holding Camera

1. Hold the camera in the palm of the left hand so as to turn the lens focusing ring (15) easily with fingers.
2. Hold the camera body lightly by hand grip (6) and place your right fore finger lightly on the shutter release button.
3. Press your left elbow lightly against your body and look through the viewfinder eyepiece (19) to steady the camera against your face. Then relax your right arm holding the grip.
4. With telephoto lenses or lower shutter speeds, it is recommended to use a tripod and/or cable release.

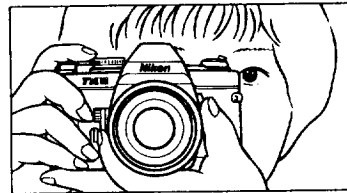

14

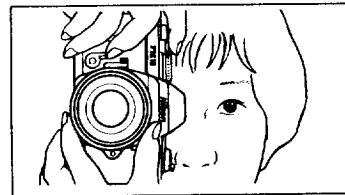

15

- 12 -

Focusing

1. Focusing is done by observing through the circled area in the center of the viewfinder screen. Within the circle is the split image spot prism and around the circle there is the microprism collar.
2. In focusing through the split image spot, when the image divided horizontally is brought into alignment by focusing, focus is correct. When the upper-and lower-half images do not align, it is out-of-focus.
3. To focus through the microprism collar outside center spot, a broken shimmering image is seen when it is out-of-focus and correct focus is at the setting in which the image becomes clear and sharp.
4. Focusing through the entire matte field of the viewfinder is also possible. In this case, at the setting where the sharpest image is obtained, precise focusing is secured.
5. Choose the most effective focusing method from the above that you are most comfortable with or according to the shooting situation, such as the lens used, the subject, etc.

Note: The FM10 viewfinder covers approx 92% of the image area of the actual photograph so the actual picture comes out larger than the image in the viewfinder.

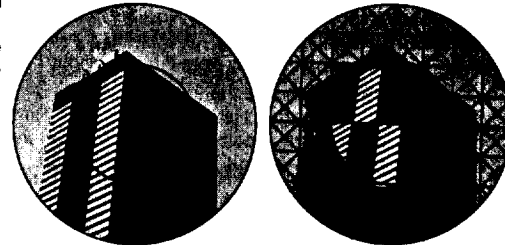
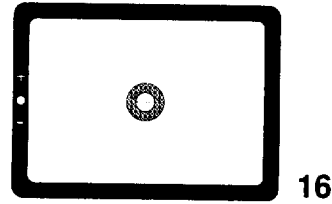

In focus 17

Not in focus 18

- 13 -

Rewinding the Film

1. When the film is at its end, the advance lever no longer operates smoothly, check the frame counter (4) display. If the frame counter shows that the all frames of the loaded film have been exposed, the film then needs to be rewind.
2. Press the film rewind button (28) on the camera base.
3. Fold out the film rewind crank (10) and turn it in the direction of the arrow.
4. Once the pressure eases, the film is completely wound into the cartridge.
5. Lift up the film rewind knob (11) and pull it out to open the camera back (26). Now the film cartridge can be taken out.
6. Do this in a place away from direct sunlight.

Note: If the film reaches the end of the roll during film advance, the film advance lever will lock. Rewind the entire roll, then complete the movement of the film advance lever and put it back into place.

"B" (bulb) Setting

1. With the shutter speed dial (1) set at "B" position, the shutter will remain open for as long as the shutter release button (2) is pressed.

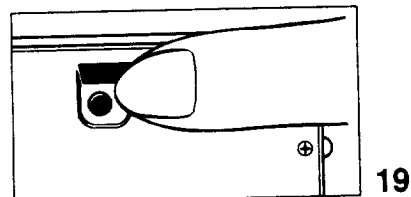

19

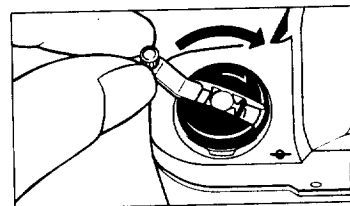

20

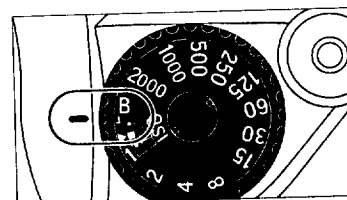

21

- 14 -

2. This setting is useful when an exposure longer than one second is required, such as in landscape photography at night. Or it can be used for the special effect photography by employing the flash test button together with very low light conditions.
3. Be sure to use a tripod and/or cable release when using this long time shutter speed setting.

Note: We recommend that you remove the Batteries from the camera at this setting to avoid wasting the batteries.

Self-Timer

1. Wind the film advance lever (3) and fully turn down the self-timer lever (7) counterclockwise. Now the self-timer is ready to use.
2. Press the shutter release button (2) and the self-timer operates to release the shutter in approximately 10 seconds later.
3. Once the self-timer becomes ready it is impossible to cancel it manually. So operate it only when needed.
4. The self-timer is very useful when you wish to include yourself in a picture, or, you can use it in order to prevent camera shake in shutter releasing instead of using the cable release.

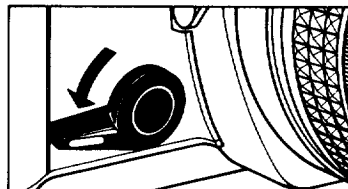

22

- 15 -

Flash Photography

1. Connect the flash unit in the Accessory-shoe (9).
2. Set the shutter speed dial (1) at 1/125 second or lower.
3. When using the automatic flash unit, set the aperture to the f-stop specified in the instruction manual of the flash unit.
4. When using the manual flash unit, use the f-stop value obtained by the formula shown below:

$$F - stop = \frac{G. NO. (m)}{Distance (m)} = \frac{G. NO. (Ft.)}{Distance (Ft.)}$$

Note: The flash units not designed for use with Nikon cameras may provide incorrect exposure and/or equipment damage.

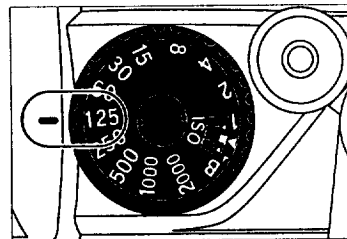

23

★ When using any other flash than a Nikon product and inserting it into the Accessory-shoe, please do not touch the contact. If you touch the contact, you may be subject to a shock.

When using a bracket type flash and connecting it to the contact, please use it without removing the black plastic plate covering the Accessory-shoe.

If you touch the Accessory-shoe without the plate, you may subject to a shock.

- 16 -

Depth-of-Field Preview

In the Viewfinder you can visually observe the depth-of-field provided by the selected F-stop.

1. Adjust the Lens Aperture to the desired F-stop. Press the Preview Button.
 2. Observe the results of increased sharpness on the (darkened) image in the Viewfinder.
- ※ As it will cause the camera to malfunction, please refrain from pushing the shutter release button or winding the film while holding down the preview lever.
 - ※ If you press the shutter release button while holding down the depth-of-field preview lever, the reflector mirror stays locked in the halfway position. Release the depth-of-field preview lever and the mirror returns to the normal position.

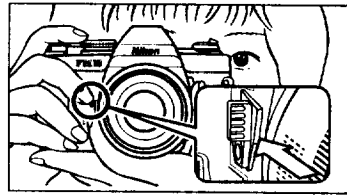

24

- 17 -

Eyepiece Correction Lenses

The viewfinder eyepiece has a built-in -1 correction (suitable for most normal vision).

If your vision requires correction and an eyepiece correction lens is fitted, you do not have to wear eye-glasses when taking pictures. Slip the lens in the groove in the finder eyepiece.

Eyepiece correction lenses are available in 9 types:

-5, -4, -3, -2, 0, +0.5, +1, +2, +3 (Diopters)

Note: Some forms of astigmatism etc. may make dioptric eyepiece correction impossible.

Please check with your vision specialist for a recommendation based on your prescription.

- 18 -

Infrared Photography

1. The dot marks printed in yellow and green are the infrared distance indicators. The green mark with a red line is for 35 mm (wide) and the yellow mark with a red line for 70 mm (telephoto). They are used for reading the distance scale in infrared photography using infrared film and filters.
2. First, secure focus in the normal manner. Then, read off the subject distance on the normal distance scale (14), then align it with the infrared distance indicator, according to the focal length.
3. For instance, when you focus on a subject at 2 m in the normal manner, read off the value "2" on the focusing scale and move the focusing ring until the infrared distance indicator points to "2".
4. Always use the red filter, such as the R60, when attempting infrared photography. For other details concerning infrared photography, follow the instructions of the infrared film used.

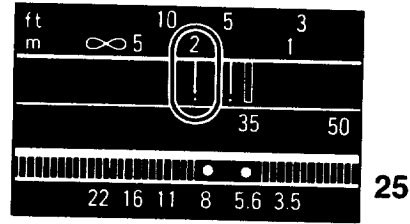

35mm

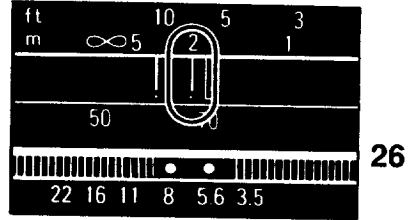

70mm

- 19 -

Mount the Lens onto the Camera

Position the lens in the camera's bayonet mount so that the mounting indexes on lens and camera body are aligned. Taking care not to press the lens release button, twist lens counterclockwise until it locks into place.

To remove: Push the lens release button (8) and turn the lens mounting ring clockwise until the lens comes off.

Note: When changing lenses with film loaded in the camera, be careful not to expose the mirror box to direct sunlight.

If the tripod has a large head, contact between the lens barrel and the head may make it impossible to turn the lens aperture ring. In this case, use the special tripod adapter supplied with the camera between the tripod head and the camera body.

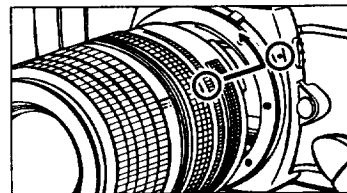

27

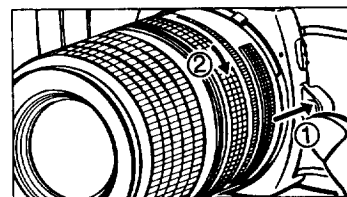

28

- 20 -

Specifications

Type: 35 mm SLR with focal plane shutter and TTL metering system

Film Format: 35 mm film, 24 × 36 mm

Lens Mount: Nikon F Mount

Shutter: Vertically moving metal focal plane shutter B, 1-1/2000 sec.

Self-Timer: Mechanical self-timer with 10 sec shutter release delay

Viewfinder: Field of view covers 92% horizontally and vertically

Magnification 0.84× (with 50 mm F1.4 standard lens)

Viewfinder Display

Red ⊕ mark LED Over exposure warning

Green ○ mark LED Correct exposure indication

Red = mark LED Under exposure warning

Focusing: Split-image micropism type surrounded by matte field

Exposure Metering: TTL center-weighted full aperture exposure measuring system

By pressing Exposure Measurement Button or Shutter Release Button

Metering Range: EV2-19 (ISO 100, F2, 1 sec. -F16, 1/2000 sec.)

Flash Synchronization: Standard ISO type hot-shoe contact on the Accessory-shoe.

Synchronization speed 1/125 or lower.

Film Advance: By single lever-action with 135° winding angle and 30° stand-off angle

Shutter Release Button is interlocked with the advance lever stored

Film Rewind: By film rewind button and film rewind crank

Frame Counter: Additive type with autoreset by opening the back cover

Other Functions: Multiple Exposure, Preview Lever

Film Speed Range: ISO 25 - 3200 by 1/3 steps

Power Source: Two 1.5V Alkaline batteries (LR44) or Silver batteries (SR44)

Dimensions: 139 (5.5 in.) (W) × 86 (3.4 in.) (H) × 53 (2.0 in.) (D) mm

Weight: 420 g

** These specifications and external appearance are subjected to change for improvement without prior notice.*

- 21 -

Tips on Camera Care

Although the FM10 is a tough and durable camera, bear in mind that is a precision optical instrument, and that careless or rough handling may damage it. Observe the following tips, and the FM10 will always work as perfectly as the day you bought it.

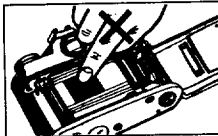

- Do not touch the shutter curtains.

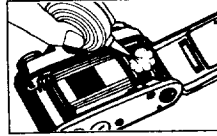

- Clean metallic parts with a blower-type brush or with a dry, soft cloth.

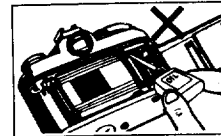

- Generally, the camera does not need lubrication.

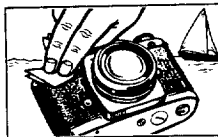

- If the camera body is exposed to rain or mist, wipe moisture gently with a soft cloth and dry the camera. After using the camera near salt water, take care that you wipe it with a cloth moistened with pure water to remove possible traces of salt.

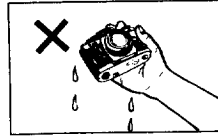

- If the inside of the camera body accidentally gets wet, its internal precision parts may get rusty. Take the camera right away to the nearest authorized Nikon dealer for a checkup which may require repair payment.

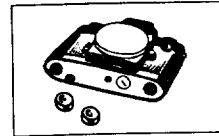

- When not using the camera for a long time, take out the batteries and store the camera away from high temperature, high humidity, naphthalene, or camphor.

- 22 -

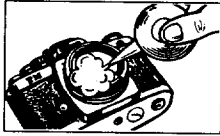

- Clean glass surfaces such as the lens or the finder eyepiece with a blower-type brush; avoid using lens tissue as much as possible. Gently wipe dirt, smudges or fingerprints with soft cotton moistened with a small amount of absolute alcohol, using a spiral motion from center to periphery. Make sure you leave no wiping traces.

Caution: Please note that the use of a spray-gun type blower to clean the lens may cause possible damage to the glass (especially when ED glass is used for the front lens element), by suddenly lowering the temperature on the lens surface. To avoid damage, hold the blower upright, keep its nozzle more than 30 cm away from the lens surface and move the nozzle around so that the stream of air is not concentrated in one spot.



- Before using the camera, it is a good practice to check it thoroughly first.



- In a humid environment, it is best to store the camera in a vinyl bag with a desiccant to keep away dust, moisture and salt.

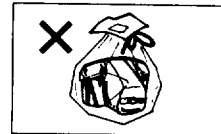

- Note that storing leatherette cases in a vinyl bag may cause the leather to deteriorate, so exercise due care.

- 23 -

No reproduction in any form of this manual, in whole or in part (except for brief quotation in critical articles or reviews), may be made without written authorization from NIKON CORPORATION.

Aucune reproduction sous quelque forme que ce soit de ce manuel, en totalité ou en partie (à l'exception de brèves mentions dans des articles de critique ou des comptes-rendus) ne pourra être faite sans l'autorisation de NIKON CORPORATION.

No se permite hacer la reproducción de este manual bajo ninguna forma, en su totalidad o en parte (excepto en breves citaciones para finalidad de crítica en artículos o revistas) sin la autorización por escrito de NIKON CORPORATION.

沒有獲得日本株式會社尼康書面許可，不可擅自影印此說明書的型式、部份或全部內容(但摘要引用作評論文章除外)。

沒有獲得日本株式會社尼康書面許可，不可擅自影印此說明書的型式、部份或全部內容(但摘要引用作評論文章除外)。

Nikon

NIKON CORPORATION

FUJII BLDG., 2-3, MARUNOUCHI 3-CHOME, CHIYODA-KU, TOKYO 100, JAPAN
PHONE: 81-3-3214-5311 TELEX: NIKON J22601 FAX: 81-3-3201-5856

株式會社尼康

日本國東京都千代田區丸之內3-2-3富士大樓
電話: 81-3-3214-5311 用戶電報: NIKON J22601
傳真: 81-3-3201-5856

株式會社尼康

日本國東京都千代田區丸之內3-2-3富士大樓
電話: 81-3-3214-5311 用戶電報: NIKON J22601
傳真: 81-3-3201-5856

N5 Printed in Japan