

作成承認印

配布許可印



Nikon

FM3A

FAA38001 (SILVER)

FAA38051 (BLACK)

REPAIR MANUAL

Nikon | NIKON CORPORATION
Tokyo, Japan

Copyright © 2001 by Nikon Corporation.
All Rights Reserved.

無断転載を禁ず !!

Recycled paper

SPECIFICATION

Type of camera	: Electronically controlled, mechanically controlled 35mm single-lens reflex focal plane shutter camera
Picture format	: 24mm x 36mm
Focusing screen	: Type K3, clear matte screen II
Possibility of finder replacement	: Impossible
Possibility of screen replacement	: Possible (B3 type, E3 type)
Viewfinder frame coverage	: Approximately 93% in vertical and horizontal
Finder magnification	: 0.83 times
Finder diopter	: -1m ⁻¹
Eye-point	: 14mm
Eyepiece frame	: Round eyepiece frame with screw \varnothing 19mm, pitch 0.75mm
Reflex mirror	: Automatic instant-return mirror
Shutter speed	: Aperture-Priority Auto (A) 8S-1/4000 Electronically controlled Manual B, 1S-1/4000 Mechanically controlled
Exposure metering	: TTL Metering Center-Weighted Metering (\varnothing 12mm : 60%)
Metering range	: EV1-20 (with ISO100, 50/1.4 lens)
Film speed	: Manual: ISO12-6400 (in 1/3 step) DX: ISO25-5000
Exposure compensation	: \pm 2 steps (in 1/3 step)
AE lock	: Available at Aperture-Priority Auto (A)only
Speedlight synchronization	: Synchronize at the speed slower than 1/250
Multiple exposure	: Available by the multiple exposure lever
Power source	: 1pc. of CR-1/3N lithium battery, 2pcs. of SR-44 silver-oxide batteries or 2pcs. of LR-44 alkaline batteries
Dimensions	: Approx. 142.5 (W) x 90 (H) x 58 (D)
Weight	: Approx. 570g (Only body with battery)

DISASSEMBLING/ASSEMBLING/ADJUSTMENT

The basic structure of FM3A is the same as that of FM2 and FE2 etc.

Please disassemble, assemble and adjust this camera with referring to the exploded drawing and Repair Manual of FM2 and FE2, etc.

Adjustment tools, the tools used for FM2 are usable.

Therefore, only the part where the adjustment value is different is mentioned in this manual.

Accuracy adjustment

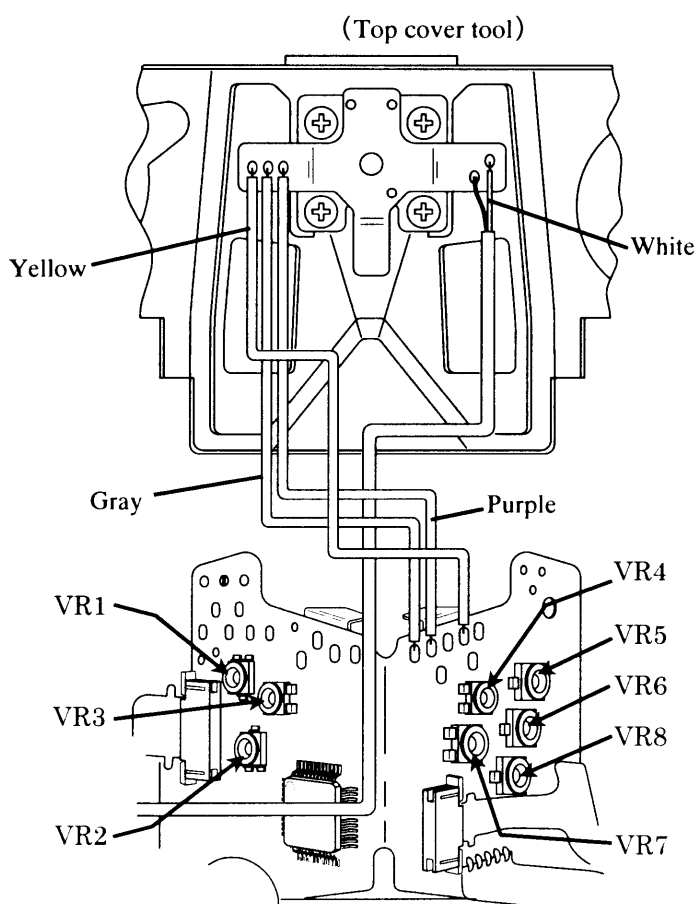

- Arrange the lead wires of the main FPC and the top cover tool as shown Figure on the left. Then, mount the top cover tool, film advance lever and ISO dial to the camera temporarily.

1. BC level (VR1)

Set the power voltage to 2.35V and rotate the exposure compensation dial to effect the exposure compensation.

At this time, adjust the VR1 to the position where the exposure compensation LED in the viewfinder turns off.

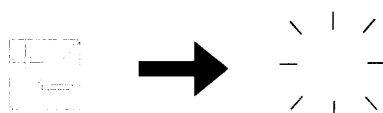

2 . Auto γ (V R 2)

Set the ISO dial of the camera to 100 and the lens aperture to F1.4.

Measure the shutter speeds at LV6 (1/30) and LV12 (1/2000) and adjust VR2 so that its difference may be 6EV.

If the difference is big, rotate the VR left and if it is small, rotate the VR right.

3 . ISO γ (V R 3)

Set the shutter tester to LV9 and the lens aperture to F5.6.

Measure the shutter speeds at ISO dial 25 and 800, and adjust VR3 so that its difference may be 5EV.

If the difference is big, rotate the VR right and if it is small, rotate the VR left.

4 . F-F0 γ (V R 4)

Set the shutter tester to LV9 and the ISO dial of the camera to 100.

Measure the shutter speeds of the lens aperture F2 (1/125) and F16 (1/2) and adjust VR4 so that its difference may be 6EV.

If the difference is big, rotate the VR right and if it is small, rotate the VR left.

5 . Auto level (V R 5)

Adjust VR5 so that the shutter speed may be 7.81mS (1/125) when setting the shutter tester to LV12, the ISO dial of the camera to 100 and the lens aperture to F5.6

If the shutter speed is fast, rotate the VR right, if it is slow, rotate the VR left.

6 . Meter γ (V R 7)

Set the ISO dial of the camera to 100 and the lens aperture to F5.6.

Adjust VR7 so that the difference between the meter at LV9 (1/15) and LV15 (1/1000) may be 6EV.

If the hand of the meter's moving width is wide, turn the VR right, if it is narrow, turn the VR left.

7 . Meter level (V R 6)

Adjust VR6 so that the hand of the meter may point 1/125 when setting the shutter tester to LV12, the ISO dial of the camera to 100 and the lens aperture to F5.6.

If the position of the hand is low, rotate the VR right, if it is high, rotate the VR left.

8. AE inspection

Check the shutter speed and the position of meter's hand with the following settings.

LV 1 5	ISO100	F2.8	1/4000
LV 1 2	ISO6400	F16	1/1000
LV 6	ISO100	F2.8	1/8

9. TTL level (VR 8)

Set the shutter tester to LV12, the ISO dial of the camera to 100 and the lens aperture to F1.4, and mount the standard reflector to the camera.

Set the TTL stop time to the standard time (0.250mS).

If the time is short, rotate the VR right, if the time is long, rotate the VR left.

TOOL

Make a hand-made tool

Make the top cover tool used for adjusting the TTL of the camera by using the repair part.

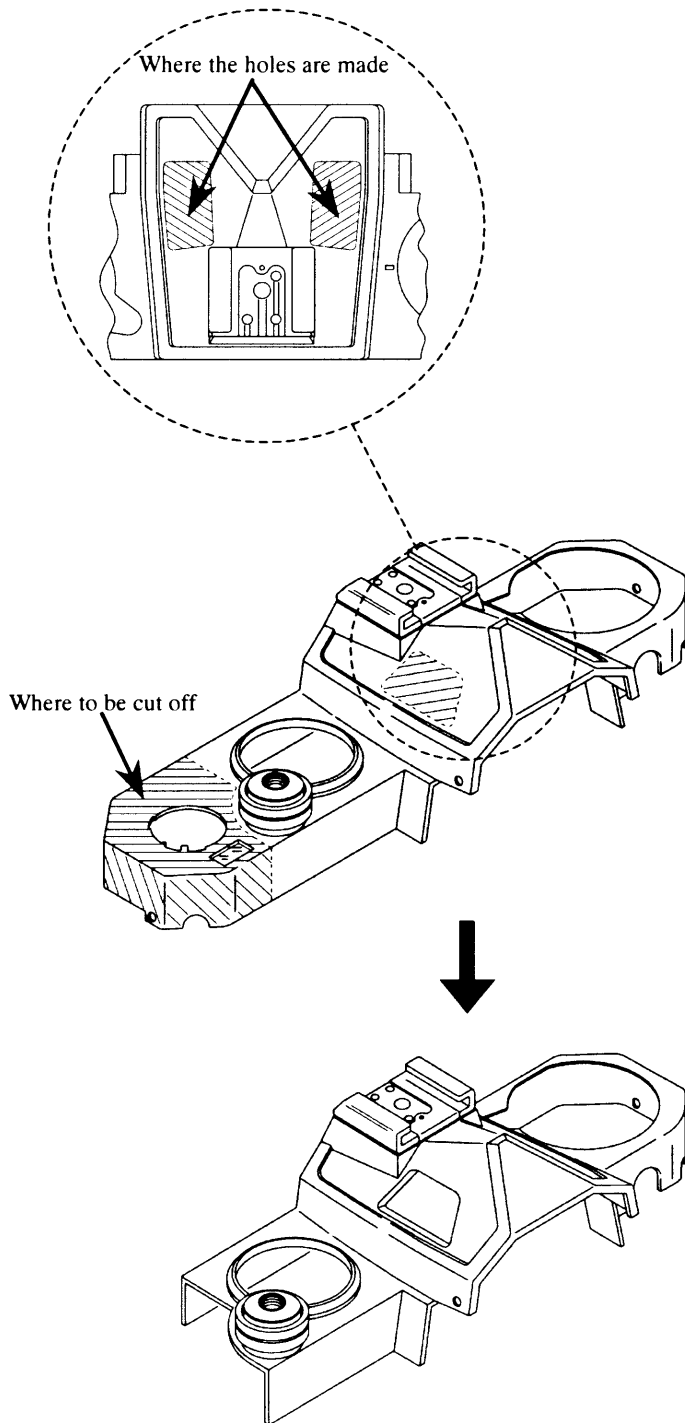

- Make the holes or cut the oblique lined part of the top cover shown in Figure on the left.

• Completed [Top cover tool]

- The procedure mentioned above is reference. The size of the hole and cutting amount can be decided at will.

実体配線図
WIRING

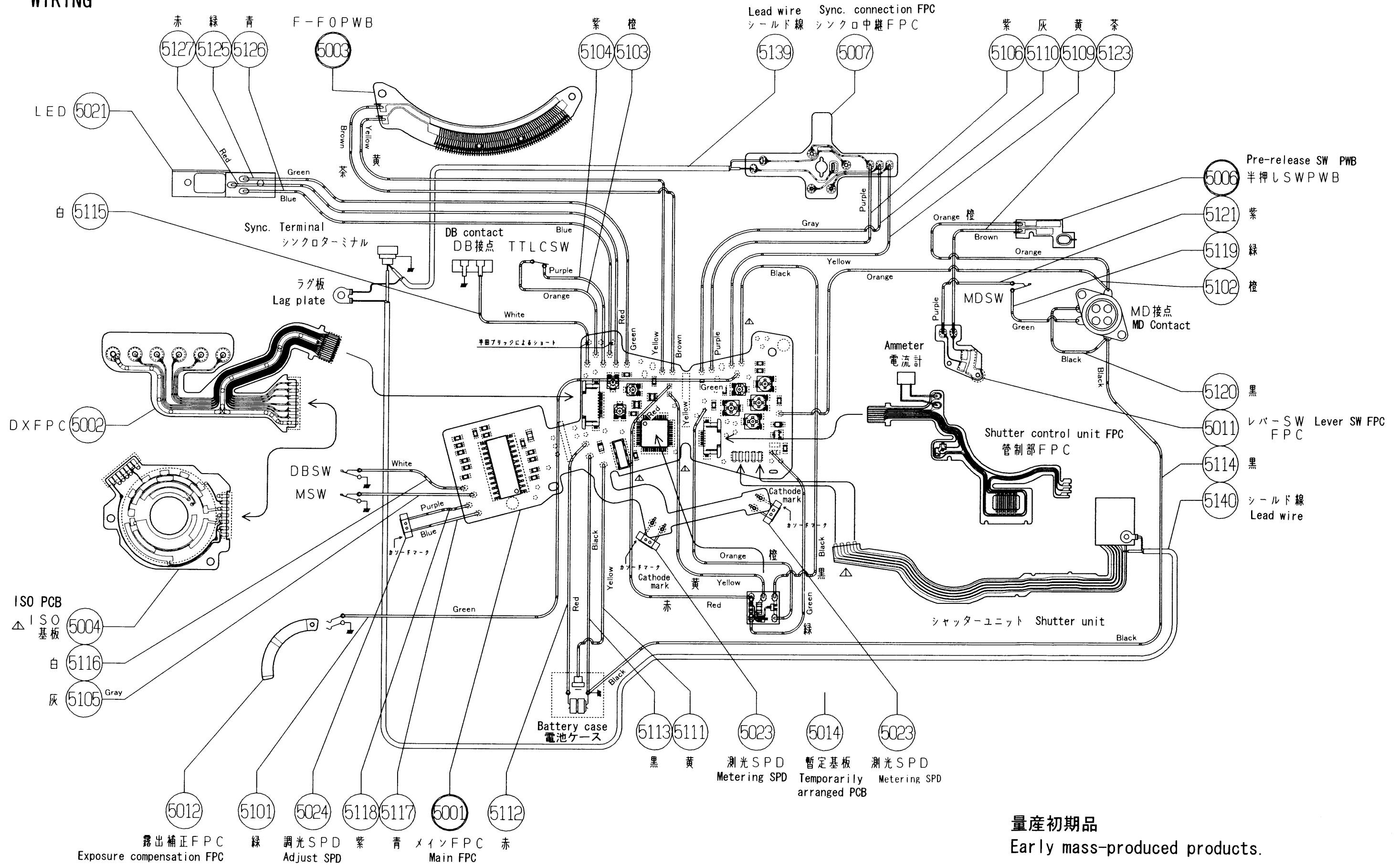

量産初期品
Early mass-produced products.

実体配線図 WIRING

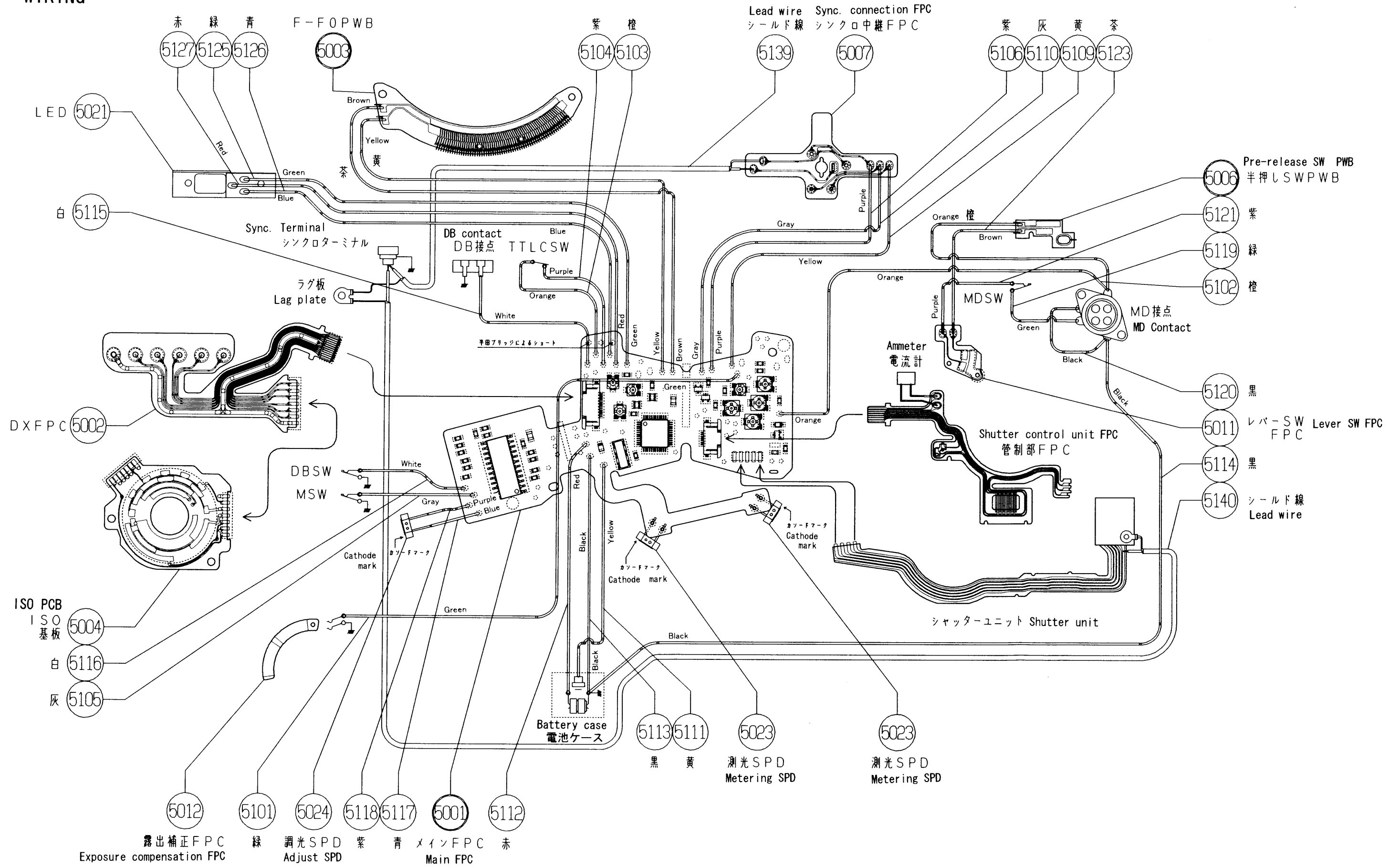

回路図 CIRCUIT DIAGRAM

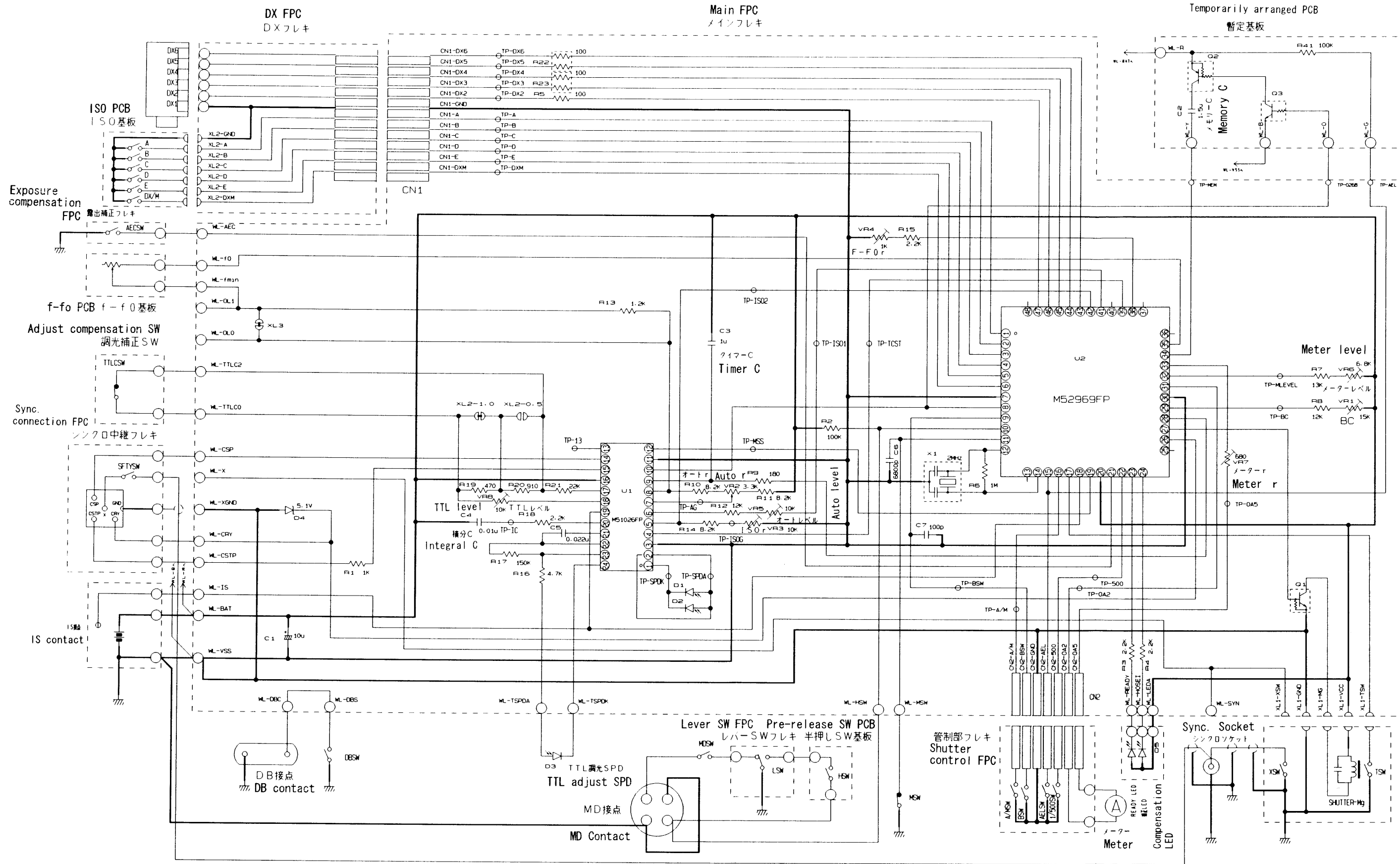

メイン基板
MAIN PCB

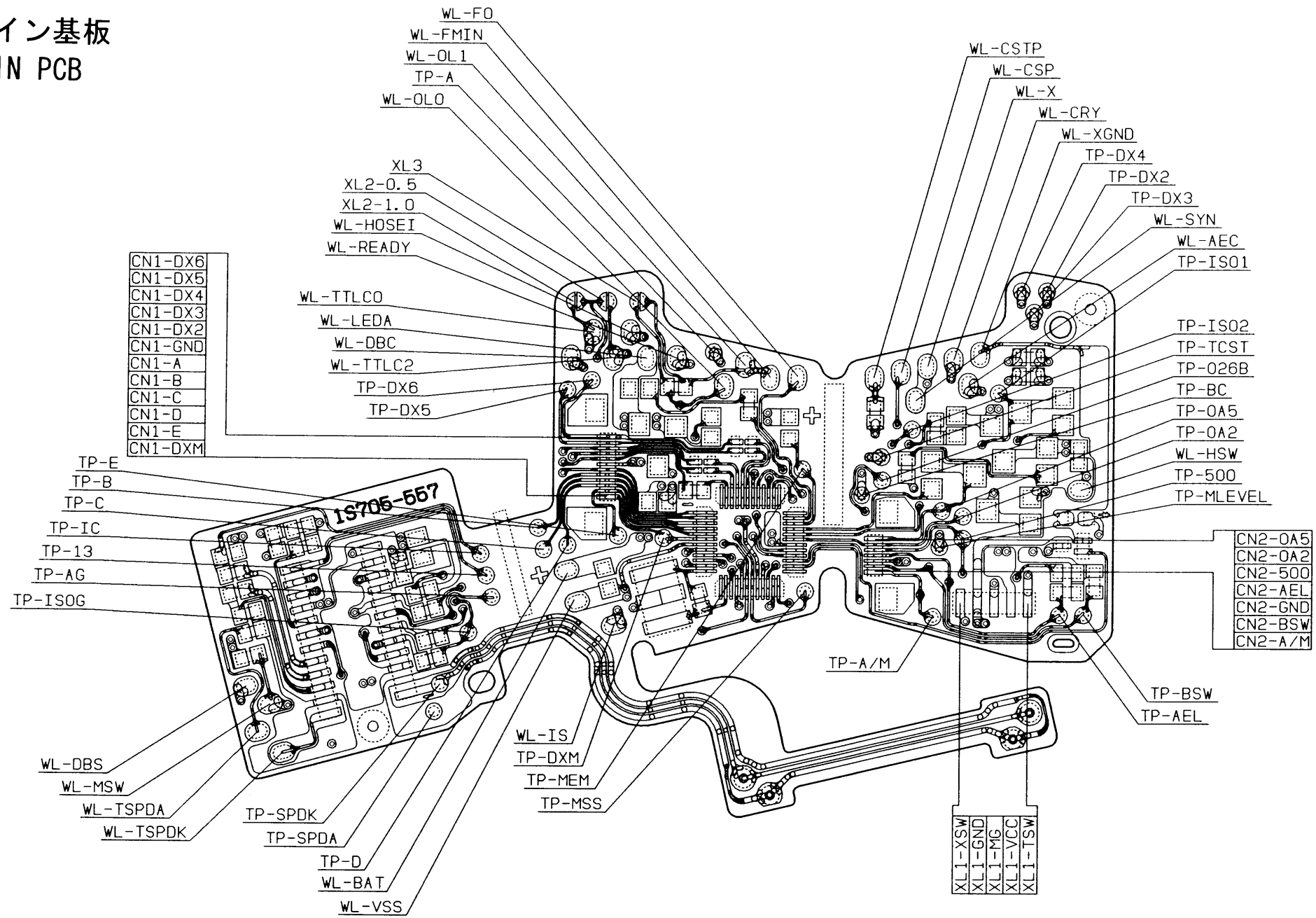

表面ランド名称入りパターン図
Surface pattern figure and lands name

メイン基板
MAIN PCB

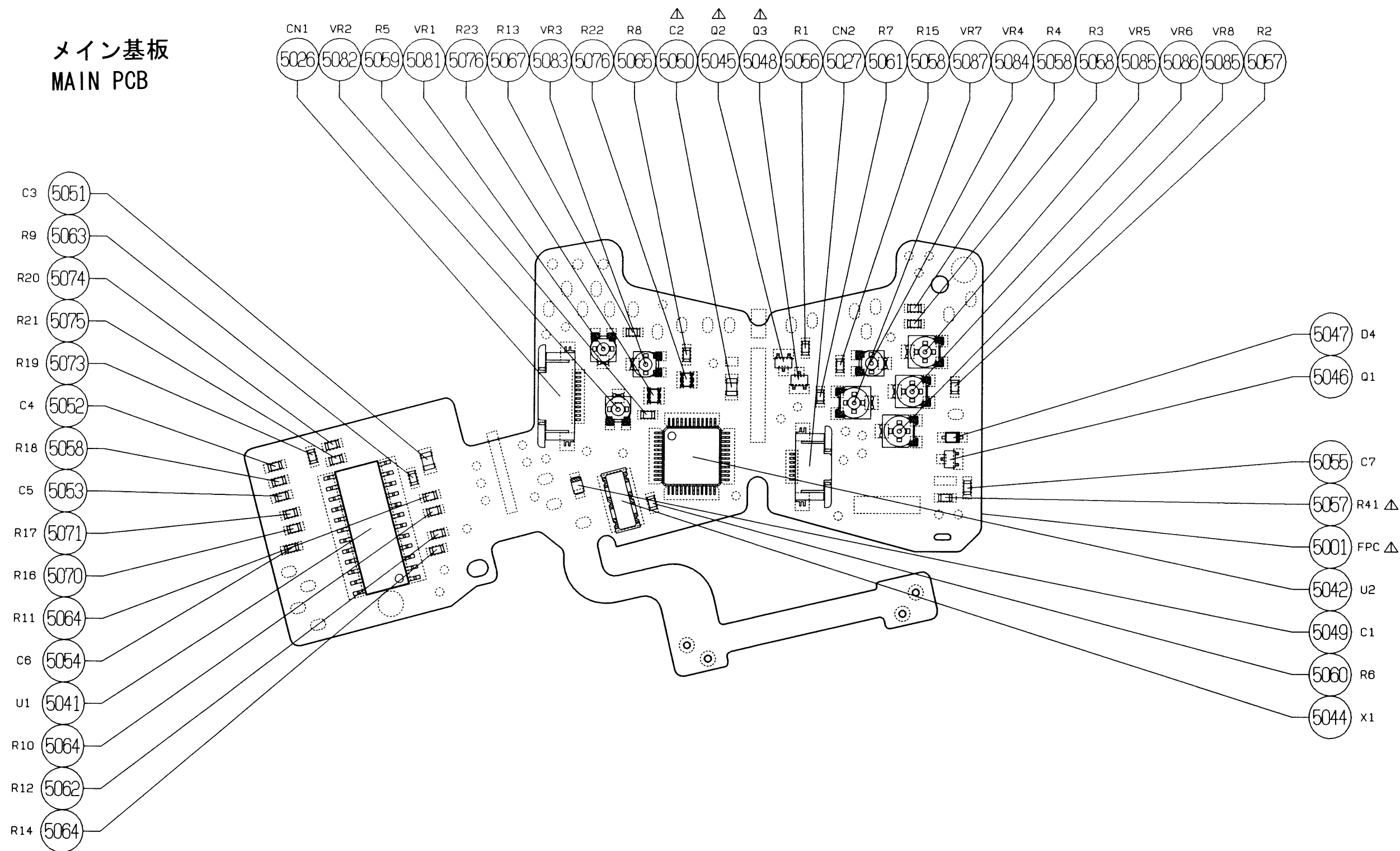

表面部品実装図
Surface Part mount figure

メイン基板
MAIN PCB

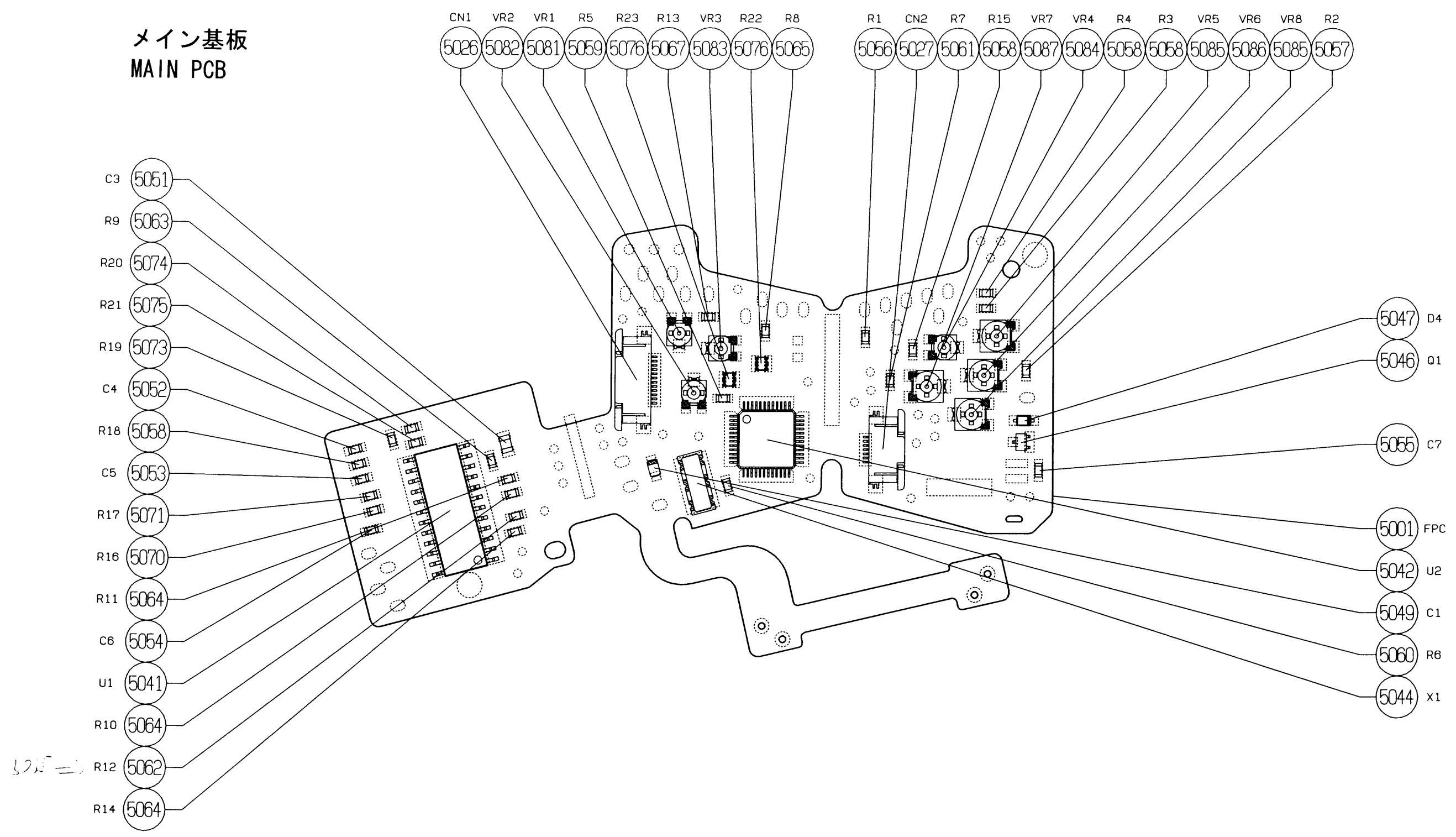

表面部品実装図
Surface Part mount figure